



HAL
open science

Generalized character varieties and quantization via factorization homology

Corina Keller

► **To cite this version:**

Corina Keller. Generalized character varieties and quantization via factorization homology. Algebraic Topology [math.AT]. Université de Montpellier, 2023. English. NNT : 2023UMONS021 . tel-04397332

HAL Id: tel-04397332

<https://theses.hal.science/tel-04397332>

Submitted on 16 Jan 2024

HAL is a multi-disciplinary open access archive for the deposit and dissemination of scientific research documents, whether they are published or not. The documents may come from teaching and research institutions in France or abroad, or from public or private research centers.

L'archive ouverte pluridisciplinaire **HAL**, est destinée au dépôt et à la diffusion de documents scientifiques de niveau recherche, publiés ou non, émanant des établissements d'enseignement et de recherche français ou étrangers, des laboratoires publics ou privés.

THÈSE POUR OBTENIR LE GRADE DE DOCTEUR DE L'UNIVERSITÉ DE MONTPELLIER

En Mathématiques et Modélisation

École doctorale : Information, Structures, Systèmes

Unité de recherche : Institut Montpellierain Alexander Grothendieck

Generalized Character Varieties and Quantization via Factorization Homology

Présentée par Corina KELLER
Le 3 Février 2023

Sous la direction de Damien CALAQUE

Devant le jury composé de

Philippe ROCHE, Directeur de Recherche, CNRS

Damien CALAQUE, Professeur, Université de Montpellier

David JORDAN, Reader, University of Edinburgh

Catherine MEUSBURGER, Professor, Friedrich-Alexander-Universität Erlangen-Nürnberg

Anton ALEKSEEV, Professeur Ordinaire, Université de Genève

Adrien BROCHIER, Maître de Conférences, Université Paris Cité

Claudia SCHEIMBAUER, Assistant Professor, Technische Universität München

Président du Jury

Directeur

Rapporteur

Rapporteuse

Examineur

Examineur

Examinatrice



UNIVERSITÉ
DE MONTPELLIER

Acknowledgements

First and foremost I would like to express my gratitude to Damien Calaque. Thank you for giving me the opportunity to do my PhD under your supervision, for patiently answering all of my questions and introducing me to such interesting mathematics. Your constant support, encouragement and enthusiasm for the project have carried me through all the stages of writing this thesis and are deeply appreciated.

I would like to thank David Jordan and Catherine Meusburger for refereeing this thesis. Likewise, I am grateful to Anton Alekseev, Adrien Brochier, Philippe Roche and Claudia Scheimbauer for agreeing to be part of my thesis committee.

I would like to offer my special thanks to David Jordan and Adrien Brochier for answering all of my questions and offering invaluable insights about their work on categorical factorization homology and quantization on which this thesis is building. Many thanks to Philippe Roche for sharing his knowledge and expertise on topics related to dynamical quantum groups. I would also like to say a special thank to Claudia Scheimbauer for inviting me to visit her and her research group at TU Munich. Thank you for making me feel welcome and for many interesting discussions about mathematics as well as non-math topics.

I am very grateful for the mathematical community that I got to be part of during my thesis. Many thanks to Nezhla Aghaei, Anna Cepek and Elba Garcia-Failde (the WOMAP group) for our online discussions about double categories and TFTs. It was a pleasure to be part of a group of such inspiring women. I also want to thank Albin Grataloup for our conversations about log de Rham theory. I had a lot of fun drawing blow-ups and discussing math with you. I would also like to express my gratitude to Eilind Karlsson, Lukas Müller and Jan Pulmann for our ongoing collaboration and many interesting discussions about skein theory and categorical quantization. To Eilind Karlsson, thank you for initiating our small reading group which turned into a fruitful collaboration. I very much enjoyed your visit to Montpellier, our conversations about math and life, and your positive and encouraging energy. To Lukas Müller, I am extremely grateful that our paths have crossed at the GRT Summer School in Edinburgh, which initiated our collaboration on factorization homology, symmetries and quantization that is part of this thesis. Working together has taught me a lot and brought me a lot of joy. Your mathematical knowledge and creativity are truly inspiring. Thank you for your hospitality during my stay in Bonn and for your visit to Montpellier, of which I have many fond memories. I am very thankful for your friendship over these years.

My time as a PhD student would not have been the same without the friends I found here in Montpellier. I am grateful to Ricardo, Joost, Albin and Pelle for many unforgettable moments and I hope that our paths will cross again in the future.

To Ricardo, thanks for bringing a little bit of magic into our lives. Und für die vile luschtige Moment(li) womer zeme hend döfe erlebe.

To Joost, I very much enjoyed strolling around Montpellier with you, visiting museums and discussing books over coffee and beer. It has been a real pleasure spending time

Acknowledgements

with you.

To Albin, I truly appreciate many moments we have shared together: our trips to the beach, going to classical concerts or even watching a mediocre movie with too many mushrooms for my taste. Thank you for all the great conversations and for sharing many interesting thoughts with me.

To Pelle, one of the two best roommates ever, I will never forget your support during difficult times, our kitchen dance parties, late-night political discussion, and so much more. You have made my life here in Montpellier feel like home and I will forever miss the time we spent together.

I would also like to thank my friends from Switzerland who came to visit me (and the beautiful South of France) over the years. To Dési & Andy, Sara & Andi, Myri & Carmen, Cristina, Nico & Giulia, Morgane & Valérie - thank you for many great memories.

Finally, and most importantly, I would like to thank my family for always being there for me and for their never ending encouragement. Mama, Papa, Liliane & Darja: Your love and support means the world to me.

Contents

| | |
|---|-----------|
| Acknowledgements | i |
| Introduction | vi |
| 1. Introduction in English | vi |
| 1.1. Factorization homology and topological field theory | vi |
| 1.2. Combinatorial quantization | viii |
| 1.3. Outline | x |
| 2. Introduction en français | xi |
| 2.1. Homologie à factorisation et théorie des champs topologiques | xi |
| 2.2. Quantification combinatoire | xiii |
| 2.3. Résumé | xvi |
| 1. Background | 1 |
| 1.1. Character varieties and lattice gauge theory | 1 |
| 1.1.1. Lie bialgebras and Poisson–Lie groups | 2 |
| 1.1.2. Fock–Rosly Poisson structure on character varieties | 6 |
| 1.1.3. Character stacks | 10 |
| 1.2. Hopf algebras and their representations | 11 |
| 1.2.1. Quantum groups with a formal parameter | 12 |
| 1.2.2. Quantum groups with a generic parameter | 15 |
| 1.3. Categorical factorization homology | 16 |
| 1.3.1. Factorization homology on oriented manifolds | 16 |
| 1.3.2. The categorical case | 20 |
| 1.3.3. Quantization and factorization homology | 23 |
| 1.3.4. Monadic reconstruction for abelian module categories | 27 |
| 2. Twisted character varieties | 31 |
| 2.1. Classical moduli space | 33 |
| 2.1.1. The twisted Fock–Rosly Poisson structure | 34 |
| 2.2. Factorization homology on surfaces with principal bundles | 36 |
| 2.2.1. Local categorical data | 37 |
| 2.2.2. \boxtimes -Excision | 41 |
| 2.2.3. Reconstruction for rigid balanced braided tensor categories with D -action | 44 |
| 2.3. Computations on punctured surfaces with principal bundles | 46 |
| 2.3.1. The case of the D -decorated annulus | 50 |
| 2.4. Quantization of the twisted Fock–Rosly Poisson structure | 53 |
| 2.4.1. Twisted character stack | 53 |
| 2.4.2. Deformation quantization | 53 |
| 2.5. Closed and marked surfaces with D -bundles | 56 |
| 2.5.1. Closed surfaces | 56 |
| 2.5.2. Point defects | 61 |

Contents

| | |
|---|------------|
| 3. Dynamical character varieties | 65 |
| 3.1. Dynamical Poisson spaces | 68 |
| 3.1.1. Dynamical r-matrices over Poisson base spaces | 69 |
| 3.1.2. Poisson structures from dynamical r-matrices | 70 |
| 3.1.3. Fusion | 73 |
| 3.1.4. Dynamical Fock–Rosly Poisson structure | 76 |
| 3.2. Point defects and dynamical quantum groups | 80 |
| 3.2.1. Base algebras | 80 |
| 3.2.2. Dynamical twists | 83 |
| 3.2.3. Digression - Dynamical twist from factorization homology on stratified annulus | 87 |
| 3.2.4. Braided modules and quasi-reflection data | 94 |
| 3.3. Factorization homology on surfaces with dynamical point defects | 100 |
| 3.3.1. Combinatorial algebras | 100 |
| 3.3.2. Computations on surfaces with point defects | 104 |
| 3.3.3. Dynamical algebras | 107 |
| 3.3.4. Module algebras over twisted bialgebroids | 109 |
| 3.4. Quantization of dynamical Poisson spaces | 110 |
| 3.4.1. Deformation quantization | 111 |
| 3.4.2. Classical and quantum dynamical character stacks | 115 |
| 3.4.3. Chern–Simons theory with sources | 117 |
| | |
| A. Background material on enriched presentable categories | 124 |
| A.1. The 2-category $\mathcal{V}\text{-Cat}$ | 124 |
| A.1.1. Example of enriching category: complete $\mathbb{C}[[\hbar]]$ -modules | 125 |
| A.2. Locally presentable enriched categories | 126 |
| A.2.1. Basic definitions | 126 |
| A.2.2. Free cocompletion | 129 |
| A.2.3. Enriched monadicity theorem | 131 |
| | |
| B. Bialgebroids | 133 |
| B.1. Definitions and examples | 133 |
| B.1.1. Dynamical FRT-algebra | 136 |
| B.2. Twists of bialgebroids | 138 |
| B.2.1. Bialgebroid twists from dynamical twists | 139 |

Introduction

1. Introduction in English

1.1. Factorization homology and topological field theory

Factorization homology as developed by Lurie and Ayala–Francis [Lur, AF15] is a local-to-global invariant for topological manifolds. The invariants are constructed by taking as local input data an E_n -algebra \mathcal{A} in a (nice) higher symmetric monoidal category \mathcal{V} , together with a geometric input given by an n -dimensional manifold M , and producing an object

$$\int_M \mathcal{A} \in \mathcal{V}$$

by ‘integrating’ \mathcal{A} over the n -manifold M in such a way that the construction is functorial in the geometric input variable. It is a homology theory for topological manifolds satisfying a generalization of the Eilenberg–Steenrod axioms for homology theories of spaces [AF15]. The notion of factorization homology dates back to the work of Beilinson–Drinfeld [BD04] in the setting of conformal field theory. Since then, it has appeared in many different areas of mathematics and physics. For instance, in dimension $n = 1$ factorization homology on S^1 computes Hochschild homology for E_1 -algebras in symmetric monoidal higher categories [Lur, AF15]. For coefficients in commutative differential graded algebras, derived higher Hochschild chains were obtained by computing factorization homology on higher dimensional spheres [GTZ14]. Factorization homology is intimately linked to factorization algebras: evaluating factorization homology on open subsets $U \subset M$ gives a locally constant factorization algebra on M , whose global sections compute the factorization homology of M . Factorization algebras play a key role in the work of Costello–Gwilliam [CG21] on perturbative quantum field theories, namely they capture the structure present on quantum observables. In this thesis we will explore applications of factorization homology in an area of quantum physics known as topological field theory.

An axiomatic approach to topological field theory (TFT) has been developed in the late 80’s by Atiyah and Segal [Ati88, Seg04], defining a functorial TFT as a symmetric monoidal functor from a d -dimensional topological bordism category, the category of ‘spacetimes’, to a category of algebraic nature. Depending on the target, a TFT may describe the ‘time evolution’ of either the space of states of a physical system or of the algebra of classical or quantum observables. However, in order to capture the locality of physics it might not be enough to define the theory only on $(d - 1)$ -dimensional ‘spatial slices’ and d -dimensional ‘spacetimes’, but a TFT should also assign algebraic data to lower dimensional manifolds, possibly with corners, so that one can not only propagate in the time direction but also in spatial directions. Categorically, this leads to the notion of a fully extended topological field theory defined as a symmetric monoidal functor from an (∞, d) -category of d -dimensional bordisms to a higher categorical target. It is in this context that Baez and Dolan [BD95] formulated the cobordism hypothesis stating that fully extended (framed) TFTs are classified by the space of fully dualizable objects in the

Introduction

target category. An elaborate outline for a proof of the cobordism hypothesis is given by Lurie [Lur09]. In the same work, Lurie indicates how factorization homology would determine a fully extended TFT. Thereafter, Scheimbauer explicitly constructed this fully extended TFT with target given by the Morita category $\mathbf{Alg}_n(\mathcal{S}^\otimes)$ of E_n -algebras in a symmetric monoidal higher category \mathcal{S}^\otimes [Sch14].

This thesis will focus on $(n = 2)$ -dimensional aspects of topological field theories. As a prominent example, we will consider Chern–Simons gauge theory. For an oriented surface Σ , the phase space of classical fields in Chern–Simons theory with symmetry group G on the product manifold $\Sigma \times \mathbb{R}$ is the space of principal G -bundles with flat connections on Σ modulo gauge equivalences. The corresponding moduli space of G -local systems can be described by the G -character stack of Σ :

$$\mathbf{Char}_G(\Sigma) = [\mathrm{Hom}(\pi_1(\Sigma), G)/G] \quad .$$

Algebraically, this quotient stack may be studied via its category $\mathrm{QCoh}(\mathbf{Char}_G(\Sigma))$ of quasi-coherent sheaves. From a field theoretical perspective, this means that the functorial TFTs we want to consider should take values in a target category of categories. One such target is provided by the Morita 4-category of E_2 -algebras in a suitable symmetric monoidal bicategory $\mathrm{LinCat}^\boxtimes$ of linear categories¹. It was shown by Ben-Zvi–Brochier–Jordan that factorization homology with coefficients in $\mathcal{A} = \mathrm{Rep}(G)$ computes the category of quasi-coherent sheaves on the moduli space of G -local systems [BZBJ18a]:

$$\int_{\Sigma} \mathrm{Rep}(G) \cong \mathrm{QCoh}(\mathbf{Char}_G(\Sigma)) \in \mathrm{LinCat} \quad .$$

More generally, any (locally presentable) rigid balanced braided tensor category \mathcal{A} determines a local 2-dimensional oriented TFT [Sch14, BZBJ18a]:

$$\int_{(-)} \mathcal{A}: \mathrm{Bord}_2^{\mathrm{or}, \sqcup} \longrightarrow \mathrm{Alg}_2(\mathrm{LinCat}^\boxtimes), \quad M^k \longmapsto \int_{M^k \times \mathbb{R}^{2-k}} \mathcal{A} \quad .$$

It is expected that the construction extends to define a 3-dimensional fully extended oriented TFT with values in $\mathrm{Alg}_2(\mathrm{LinCat}^\boxtimes)$, and even to a 4-dimensional TFT for suitable coefficients, e.g. for \mathcal{A} a fusion category [BJS21].

In topological field theory, bordism categories can be defined for manifolds with tangential structure, which amounts to a lift of the classifying map $M \rightarrow BGL(n)$ of the tangent bundle along a prescribed map $B\mathcal{X} \rightarrow BGL(n)$ of topological spaces. The same is true for factorization homology: for an n -manifold with tangential structure $M \rightarrow B\mathcal{X}$, its factorization homology is computed by ‘integrating’ a $B\mathcal{X}$ -framed E_n -algebra over M [AF15]. One part of this thesis will consist in computing factorization homology on surfaces with a $\mathcal{X} = D \times \mathrm{SO}(2)$ -tangential structure for finite groups D , i.e. on oriented 2-manifolds equipped with principal D -bundles. From a field theoretical perspective, adding a decoration by D -bundles leads to so-called D -equivariant field theories [Tur10]. The work in this thesis on factorization homology for surfaces with D -bundles can be understood as exploring the 2-dimensional aspects of field theories defined on D -decorated manifolds.

¹We will be more precise later on about the exact nature of the linear categories we want to consider. For explicit constructions of higher Morita categories of E_n -algebras in an (∞, k) -categories see [Sch14, Hau17, JFS17].

Field theories may also be defined on bordism categories of manifolds with stratifications and colorings, or in a more physical language: field theories with defects. The framework for computing factorization homology on stratified manifolds was constructed in [AFT17]. A concrete example is categorical factorization homology on surfaces with codimension 2 defects, or point defects, which are governed by braided module categories over the braided tensor category describing the bulk theory [BZBJ18b]. In this thesis we will compute factorization homology on marked surfaces for which the point defects come from the theory of dynamical quantum groups. In particular, this will allow us to access Poisson algebras arising in Chern–Simons theory with pointlike sources [BR05] and their quantization via categorical factorization homology.

1.2. Combinatorial quantization

Let $\Sigma = \Sigma_{g,r}$ be an oriented surface of genus g with r boundary components, $r > 0$. For a linear algebraic group G , the moduli space of flat G -connections on Σ can be described by the character variety:

$$\text{Char}_G(\Sigma) = \text{Hom}(\pi_1(\Sigma), G)/G \ .$$

This is the affine quotient of the representation variety $\text{Hom}(\pi_1(\Sigma), G) \cong G^{2g+r-1}$ under the conjugation action by the lattice gauge group G . The algebra of functions on the character variety is the subalgebra $(\mathcal{O}_{g,r})^G$ of G -invariant functions, where $\mathcal{O}_{g,r} = \mathcal{O}(G)^{\otimes 2g+r-1}$. Fock and Rosly [FR99] constructed a Poisson bracket on the algebra $(\mathcal{O}_{g,r})^G$ using a combinatorial model for Σ by means of a ciliated ribbon graph $\Gamma = (E, \bullet)$, as sketched below for the case $\Sigma = \Sigma_{1,r}$:

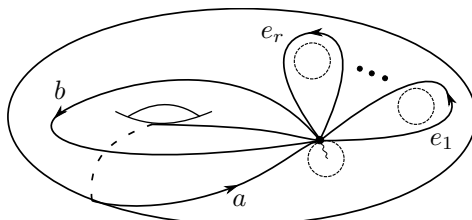

To each edge in Γ one assigns the Poisson $(G \times G)$ -space (G, Π_r) with Poisson bivector Π_r defined via a classical r-matrix $r \in \mathfrak{g} \otimes \mathfrak{g}$. Subsequently, one uses fusion for Poisson spaces [LM17] to obtain the Fock–Rosly Poisson bivector Π_{FR} on the product space G^{2g+r-1} compatible with the diagonal G -action. The fusion procedure parallels how the surface Σ may be obtained by successive fusion of disks $\mathbb{D}_{\bullet, \bullet}$ with two marked intervals in the boundary. The Fock–Rosly Poisson structure agrees with the Atiyah–Bott/Goldman Poisson structure on the moduli space of flat G -connections [AB83, Gol84].

A deformation quantization of the Fock–Rosly Poisson structure was defined by Alekseev–Grosse–Schomerus [AGS95, AGS96] and Buffenoir–Roche [BR95, BR96] who replaced the group G by the corresponding quantum group $U_q(\mathfrak{g})$ and classical r-matrices by quantum R-matrices for $U_q(\mathfrak{g})$. The resulting quantized algebra of functions on the representation variety is the tensor product $(\mathcal{O}_q)_{g,r} = \mathcal{O}_q(G)^{\otimes 2g+r-1}$, where \otimes is the tensor product in $\text{Rep}_q(G)$ and each $\mathcal{O}_q(G)$ is a copy of the braided dual of $U_q(\mathfrak{g})$, which is also known as the reflection equation algebra, quantizing the Semenov-Tian-Shansky bracket [STS94] on G . The commutation relations between the various tensor factors of $(\mathcal{O}_q)_{g,r}$ are given in terms of quantum R-matrices.

Introduction

In [BZBJ18a], Ben-Zvi–Brochier–Jordan use factorization homology with coefficients in the balanced braided tensor category $\text{Rep}_q(G)$ to obtain a functorial quantization of the moduli stack $\mathbf{Char}_G(\Sigma)$ of G -local systems on Σ . Intuitively, the local-to-global property of factorization homology allows to quantize the theory locally, which amounts to replacing the symmetric monoidal category $\text{Rep}(G)$ with the braided monoidal category $\text{Rep}_q(G)$, and subsequently gluing these local quantizations via factorization homology on Σ . Upon picking a combinatorial model for the surface, the internal endomorphism algebra of the distinguished object $\mathcal{O} \in \int_{\Sigma} \text{Rep}_q(G)$ is shown to agree with the quantized algebra of functions on the representation variety; $\underline{\text{End}}_{\text{Rep}_q(G)}(\mathcal{O}) \cong (\mathcal{O}_q)_{g,r}$ as algebras in $\text{Rep}_q(G)$, recovering the algebras previously obtained by Alekseev–Grosse–Schomerus and Buffenoir–Roche. The subalgebra of invariants of $\underline{\text{End}}_{\text{Rep}_q(G)}(\mathcal{O})$ gives an explicit quantization of the Fock–Rosly Poisson algebra of functions on the G -character variety, equivariant for the action of the mapping class group of Σ , which follows naturally from the topological framework of factorization homology.

In this thesis we will extend the factorization homology method for constructing functorial quantizations to the following generalized character varieties/stacks:

- Twisted character variety/stack:

Let $\varphi: \pi_1(\Sigma) \rightarrow \text{Out}(G)$ be a fixed $\text{Out}(G)$ -bundle on Σ , where $\text{Out}(G)$ is the group of outer automorphisms of G . A flat φ -twisted G -bundle is a flat $G \rtimes \text{Out}(G)$ -bundle $P \rightarrow \Sigma$ together with an equivalence $\pi_* P \cong \varphi$, where $\pi: G \rtimes \text{Out}(G) \rightarrow \text{Out}(G)$ is the natural projection. Moduli spaces of twisted bundles have previously appeared in relation with twisted group-valued moment maps in [Mei17, Zer21], or in the context of finite symmetries for 2-dimensional Yang–Mills theory in [MSS22]. We may describe the moduli space of flat φ -twisted G -bundles by either the φ -twisted G -character variety

$$\mathbf{Char}_{G,\varphi}(\Sigma) = G^{2g+r-1}/\varphi G \quad ,$$

which is the affine quotient with respect to the φ -twisted conjugation action, or the corresponding φ -twisted character stack:

$$\mathbf{Char}_{G,\varphi}(\Sigma) = [G^{2g+r-1}/\varphi G] \quad .$$

We will show that the twisted character variety admits a Fock–Rosly type Poisson bivector Π_{FR}^φ defined in terms of an $\text{Out}(G)$ -invariant classical r -matrix. We will then define a φ -twisted quantum character stack via factorization homology on $\text{Out}(G)$ -decorated surfaces, and in particular obtain a deformation quantization of the Poisson variety $(\mathbf{Char}_{G,\varphi}(\Sigma), \Pi_{FR}^\varphi)$.

- Dynamical character variety/stack:

Let $\Gamma = (E, V)$ be a ciliated ribbon graph with a collection of marked vertices $\{v_1, \dots, v_k\} \subseteq V$. For each marked vertex v_i , let $\mathfrak{h}_i \subset \mathfrak{g}$ be a Lie sub-bialgebra and (L_i, Π_{L_i}) a smooth Poisson variety for which Π_{L_i} is induced from an action of the double $\mathfrak{D}(\mathfrak{h}_i)$. We define the dynamical representation variety:

$$\text{Rep}_{\text{dyn}}(\Gamma, \{(\mathfrak{h}_i, L_i)\}_{i=1, \dots, k}) = \prod_{i=1}^k L_i \times G^E \quad .$$

A geometric example is the framed character variety of flat G -connections on the marked surface $\{v_1, \dots, v_k\} \subset \Sigma$ together with a reduction of the structure group

Introduction

from G to a maximal torus $H \subset G$ over a small loop γ_i wrapping around the marked point v_i . In this case we have that for all $i = 1, \dots, k$, $\mathfrak{h}_i = \mathfrak{h}$ is a Cartan subalgebra and $L_i = H$.

Let H_i be a group with Lie algebra \mathfrak{h}_i . The ribbon graph Γ determines an action ρ^Γ of the group $\prod_{i=1}^k H_i \times G^{V \setminus \{v_1, \dots, v_k\}}$ on the dynamical representation variety. We will show that given the data of classical dynamical r-matrices $r(\lambda_i): L_i \rightarrow \mathfrak{g} \otimes \mathfrak{g}$, as defined in [DM05], the dynamical representation variety admits a combinatorial Poisson structure Π_{dyn} which is compatible with the action ρ^Γ . This Poisson structure is a dynamical generalization of the Fock–Rosly Poisson structure on G -character varieties. In the special case where the base spaces $L_i = \mathfrak{h}$ are Cartan subalgebras, the Poisson structure Π_{dyn} has previously appeared in [BR05] in the context of Chern–Simons theory with dynamical sources.

For classical dynamical r-matrices $r(\lambda_i)$ admitting quantizations by dynamical twists $\mathcal{J}(\lambda_i)$, we will define braided module categories \mathcal{M}_i encoding the data of the corresponding dynamical quantum R-matrices $\mathcal{R}(\lambda_i)$. We obtain a deformation quantization of the dynamical Fock–Rosly Poisson structure on dynamical character varieties via factorization homology on a surface with point defects described by the \mathcal{M}_i .

We also define a dynamical character stack:

$$\mathbf{Char}_{\text{dyn}}(\Gamma, \{(\mathfrak{h}_i, L_i)\}_{i=1, \dots, k}) = \left[\prod_{i=1}^k L_i \times G^E / \prod_{i=1}^k H_i \times G^{V \setminus \{v_1, \dots, v_k\}} \right].$$

For $L_i = H \subset G$ a maximal torus, and $H_i = H$ for all $i = 1, \dots, k$, we describe the category of quasi-coherent sheaves on the dynamical character stack via factorization homology and define the corresponding dynamical quantum character stack.

1.3. Outline

- Chapter 1 establishes the context underlying the research in this thesis and covers the necessary background material. In § 1.1 we recall basics about Lie bialgebras, Poisson–Lie groups and lattice gauge theory. We review the construction of the Fock–Rosly Poisson structure on G -character varieties via fusion of Poisson spaces defined in terms of classical r-matrices. In § 1.2 we settle notation and conventions for quantum groups and their representations. In § 1.3 we recollect background material on factorization homology for oriented manifolds and establish the categorical setup in which we will operate. To that end, we introduce the bicategory of locally presentable enriched categories, which allows to compute factorization homology with coefficients coming from the representation theory of quantum groups with formal or generic parameter. The section also contains a discussion on the factorization homology approach to categorical quantization.
- Chapter 2 is based on joint work with Lukas Müller [KM23] on the quantization of twisted character stacks. In § 2.1 we define the classical moduli space of flat twisted bundles and present a novel combinatorial formula for the Poisson structure on the moduli space. § 2.2 contains background material on factorization homology on surfaces with principal D -bundles. Moreover, we show that the braided tensor category $\text{Rep}_q(G)$ is a coefficient system for factorization homology

Introduction

in the case that $D = \text{Out}(G)$. In § 2.3 we compute factorization homology over punctured surfaces with D -bundles decoration and use monadic reconstruction to identify factorization homology with categories of modules over algebras defined in purely combinatorial terms. In § 2.4 we prove that the algebras obtained via factorization homology give a deformation quantization of the moduli space of flat twisted bundles. In § 2.5 we discuss factorization homology for surfaces with D -bundles that are closed and/or have point defects. In this context, we give examples for point defects in the D -decorated setting coming from quantum symmetric pairs.

- In Chapter 3 we discuss dynamical character varieties/stacks and their quantization via factorization homology. In § 3.1 we introduce fusion for dynamical Poisson spaces defined in terms of dynamical r -matrices. As an application we show that dynamical character varieties admit dynamical Fock–Rosly type Poisson brackets. In § 3.2 we establish the categorical setup for studying dynamical quantum groups. We introduce the notion of a quasi-reflection datum giving rise to point defects encoding dynamical twist quantizations (dynamical point defects). In § 3.3 we compute factorization homology on surfaces with dynamical point defects. Using monadic techniques we obtain algebras in dynamical extensions of monoidal categories, which in particular give examples of dynamical algebras, such as the dynamical FRT-algebra. In § 3.4 we show that the algebras obtained via factorization homology give a deformation quantization of the dynamical character varieties. We also explain how, for certain coefficients, factorization homology with dynamical point defects defines a dynamical quantum character stack. As an application, we discuss how our results recover a quantization of dynamical Poisson algebras arising in Chern–Simons theory with pointlike sources.

2. Introduction en français

2.1. Homologie à factorisation et théorie des champs topologiques

L’homologie à factorisation comme développée selon Lurie et Ayala–Francis [Lur, AF15] est un invariant local-global pour les variétés topologiques. Les invariants sont construits en prenant comme donnée locale une algèbre E_n dans une catégorie monoïdale symétrique supérieure \mathcal{V} , comme donnée géométrique une variété M à dimension n , et produisant un objet

$$\int_M \mathcal{A} \in \mathcal{V}$$

en ‘intégrant’ \mathcal{A} sur la n -variété M telle que la construction soit fonctorielle dans la variable géométrique. C’est une théorie d’homologie pour les variétés topologiques satisfaisant une généralisation des axiomes d’Eilenberg–Steenrod pour les théories d’homologie des espaces topologiques [AF15]. L’homologie à factorisation trouve son origine dans les travaux de Beilinson–Drinfeld [BD04] dans le cadre de la théorie conforme des champs. Depuis lors, elle est apparu dans de nombreux domaines des mathématiques et de la physique. Par exemple, en dimension $n = 1$ l’homologie à factorisation sur S^1 calcule l’homologie de Hochschild des algèbres E_1 dans les catégories monoïdales symétriques supérieures [Lur, AF15]. Pour les algèbres différentielles graduées commutatives, les complexes de Hochschild supérieure ont été obtenus en calculant l’homologie à factorisation sur des sphères de dimension supérieure [GTZ14]. L’homologie à factorisation est

Introduction

intimement liée aux algèbres à factorisation: évaluer l’homologie à factorisation sur des ouverts $U \subset M$ donne une algèbre à factorisation localement constante sur M , dont les sections globales calculent l’homologie à factorisation de M . Les algèbres à factorisation jouent un rôle important dans les travaux de Costello–Gwilliam [CG21] sur la théorie quantique perturbative des champs; elles capturent la structure présente sur les observables quantiques. Dans cette thèse, nous explorerons les applications de l’homologie à factorisation dans un domaine de la physique quantique connu sous le nom de théorie des champs topologiques.

Une approche axiomatique de la théorie des champs topologiques (TFT) a été développée à la fin des années 80 par Atiyah et Segal [Ati88, Seg04], définissant une TFT fonctorielle comme un foncteur monoïdal symétrique d’une catégorie des bordismes topologiques de dimension d , la catégorie des ‘espaces-temps’, vers une catégorie algébrique. Selon la catégorie algébrique, une TFT peut décrire l’évolution temporelle soit de l’espace des états d’un système physique, soit de l’algèbre des observables classiques ou quantiques. Cependant, afin d’incorporer la localité de la physique, il pourrait ne pas suffire de définir la théorie uniquement sur des ‘tranches spatiales’ de dimension $(d - 1)$ et sur des ‘espaces-temps’ de dimension d , mais une TFT devrait également attribuer des données algébriques à des variétés de dimension inférieure, éventuellement à coins, de sorte que l’on puisse non seulement se propager dans la direction du temps mais aussi dans les directions spatiales. C’est dans ce contexte que Baez et Dolan [BD95] ont formulé l’hypothèse du cobordisme indiquant que les TFT pleinement étendues à valeurs dans \mathcal{C} sont classifiées par l’espace des objets complètement dualisables dans la catégorie \mathcal{C} . Une esquisse de preuve détaillée de l’hypothèse du cobordisme est donnée par Lurie [Lur09]. Dans le même travail, Lurie indique comment l’homologie à factorisation déterminerait une TFT pleinement étendue. Par la suite, Scheimbauer a construit cette TFT de manière explicite à valeurs dans la catégorie de Morita $\text{Alg}_n(\mathcal{S}^\otimes)$ des algèbres E_n dans une catégorie monoïdale symétrique supérieure \mathcal{S}^\otimes [Sch14].

Cette thèse se concentre sur les aspects des théories des champs topologiques de dimension $n = 2$. Entre autre, nous considérons la théorie de jauge de Chern–Simons avec le groupe de symétrie G . Etant donné une surface orientée Σ , l’espace des phases pour les champs classiques dans la théorie de Chern–Simons sur la variété $\Sigma \times \mathbb{R}$ est donné par l’espace de modules de connexions plates de G -fibrés principaux sur Σ . Cet espace de modules peut être décrit par le champ de caractères donné par le champ quotient:

$$\mathbf{Char}_G(\Sigma) = [\text{Hom}(\pi_1(\Sigma), G)/G] \quad .$$

Ce champ quotient peut être étudié par la catégorie $\text{QCoh}(\mathbf{Char}_G(\Sigma))$ de faisceaux quasi-cohérents. D’un point de vue de la théorie des champs, cela signifie que nous voulons considérer les TFT fonctorielles à valeurs dans une catégorie de catégories. Une telle catégorie est la 4-catégorie de Morita des algèbres E_2 dans une bicatégorie monoïdale symétrique LinCat^\boxtimes de catégories linéaires². Il a été démontré par Ben-Zvi–Brochier–Jordan que l’homologie à factorisation à coefficients dans $\mathcal{A} = \text{Rep}(G)$ calcule la catégorie de faisceaux quasi-cohérents sur l’espace de modules de connexions plates de G -fibrés

²Nous serons plus précis par la suite sur la nature exacte des catégories linéaires que nous voulons considérer. Pour des constructions explicites de catégories de Morita supérieures des algèbres E_n dans une (∞, k) -catégories, voir [Sch14, Hau17, JFS17].

principaux [BZBJ18a]:

$$\int_{\Sigma} \text{Rep}(G) \cong \text{QCoh}(\mathbf{Char}_G(\Sigma)) \in \text{LinCat} \ .$$

Plus généralement, étant donné une catégorie \mathcal{A} (localement présentable) monoïdale tressée balancée, \mathcal{A} définit une TFT locale orientée de dimension 2 [Sch14, BZBJ18a]:

$$\int_{(-)} \mathcal{A}: \text{Bord}_2^{\text{or}, \sqcup} \longrightarrow \text{Alg}_2(\text{LinCat}^{\boxtimes}), \quad M^k \longmapsto \int_{M^k \times \mathbb{R}^{2-k}} \mathcal{A} \ .$$

Il est attendu que cette construction s'étende pour définir une 3-TFT locale à valeurs dans $\text{Alg}_2(\text{LinCat}^{\boxtimes})$, et même à une 4-TFT pleinement étendue pour des coefficients appropriés, par exemple pour \mathcal{A} une catégorie de fusion [BJS21].

Dans la théorie des champs topologiques, les bordismes peuvent être munies d'une structure tangentielle, c'est-à-dire un relèvement de l'application classifiante $M \rightarrow BGL(n)$ du fibré tangent le long d'une application $B\mathcal{X} \rightarrow BGL(n)$ d'espaces topologiques. On peut également définir l'homologie à factorisation pour les variétés munies de structures tangentielles: étant donnée une n -variété munie d'une structure tangentielle $M \rightarrow B\mathcal{X}$, l'homologie à factorisation est calculée en 'intégrant' une algèbre $E_n B\mathcal{X}$ -structurée sur M [AF15]. Une partie de cette thèse consistera à calculer l'homologie à factorisation pour des surfaces munies d'une structure tangentielle $\mathcal{X} = D \times SO(2)$, pour D un groupe fini, c'est-à-dire sur les 2-variétés orientées munies des D -fibrés principaux. Du point de vue de la théorie des champs, la décoration par des D -fibrés principaux donne lieu à des théories des champs D -équivariantes [Tur10]. Le travail de cette thèse sur l'homologie à factorisation pour les surfaces munies des D -fibrés principaux est donc une exploration des théories des champs D -equivariantes de dimension 2.

Les théories des champs peuvent également être définies pour des catégories de bordismes stratifiés et colorés, ou dans un langage plus physique: pour les théories des champs avec défauts. Le cadre de calcul de l'homologie à factorisation sur les variétés stratifiées a été construit dans [AFT17]. Un exemple est donné par l'homologie à factorisation catégorique sur des surfaces avec des défauts de codimension 2 (défauts ponctuels) qui sont classifiés par des catégories modules tressées sur la catégorie monoïdale tressée décrivant la théorie du bulk [BZBJ18b]. Dans cette thèse nous calculons l'homologie à factorisation sur des surfaces marquées pour lesquelles les défauts ponctuels proviennent de la théorie des groupes quantiques dynamiques. En particulier, cela nous permettra d'accéder aux algèbres de Poisson et leur quantification issues de la théorie de Chern–Simons avec des sources ponctuelles [BR05].

2.2. Quantification combinatoire

Soit $\Sigma = \Sigma_{g,r}$ une surface orientée de genre g et r composantes de bord, $r > 0$. Pour un groupe algébrique linéaire G , l'espace de modules des G -connexions plates sur Σ peut être décrit par la variété de caractères:

$$\text{Char}_G(\Sigma) = \text{Hom}(\pi_1(\Sigma), G)/G \ .$$

C'est le quotient affine de la variété de représentations $\text{Hom}(\pi_1(\Sigma), G) \cong G^{2g+r-1}$ sous l'action de conjugaison par le groupe G . L'algèbre des fonctions sur la variété de caractères est la sous-algèbre $(\mathcal{O}_{g,r})^G$ des fonctions G -invariantes, avec $\mathcal{O}_{g,r} = \mathcal{O}(G)^{\otimes 2g+r-1}$.

Introduction

Fock et Rosly [FR99] ont construit un crochet de Poisson sur l'algèbre $(\mathcal{O}_{g,r})^G$ avec un modèle combinatoire pour Σ en utilisant un graphe orienté $\Gamma = (E, \bullet)$ plongé sur Σ muni d'un ordre linéaire sur l'ensemble des demi-arêtes, comme illustré ci-dessous pour le cas $\Sigma = \Sigma_{1,r}$:

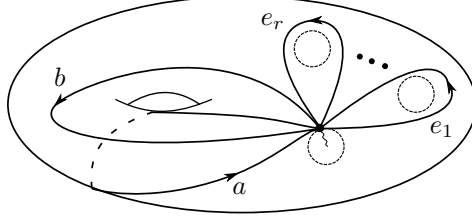

A chaque arête de Γ on attache la $(G \times G)$ -variété (G, Π_r) munie d'un tenseur de Poisson Π_r défini par une r -matrice classique $r \in \mathfrak{g} \otimes \mathfrak{g}$. Par la suite, on utilise la fusion des espaces de Poisson [LM17] pour obtenir le crochet de Poisson de Fock–Rosly Π_{FR} sur l'espace produit G^{2g+r-1} compatible avec l'action diagonale de G . La procédure de fusion est parallèle à la façon dont la surface Σ peut être obtenue par fusion successive de disques $\mathbb{D}_{\bullet, \bullet}$ avec deux intervalles marqués dans leur bord. La structure de Poisson de Fock–Rosly correspond à la structure de Atiyah–Bott/Goldman sur l'espace de modules de G -connexions plates [AB83, Gol84].

Une quantification par déformation de la structure de Poisson de Fock–Rosly a été définie par Alekseev–Grosse–Schomerus [AGS95, AGS96] et Buffenoir–Roche [BR95, BR96] en remplaçant le groupe G par le groupe quantique $U_q(\mathfrak{g})$ et les r -matrices classiques par des R -matrices quantiques pour $U_q(\mathfrak{g})$. Le résultat est une algèbre de fonctions quantifiées sur la variété de représentations donnée par le produit tensoriel $(\mathcal{O}_q)_{g,r} = \mathcal{O}_q(G)^{\otimes 2g+r-1}$ dans $\text{Rep}_q(G)$, où $\mathcal{O}_q(G)$ est l'algèbre quantifiant le crochet de Semenov-Tian-Shansky [STS94] sur G . Les relations de commutation entre les facteurs tensoriels de $(\mathcal{O}_q)_{g,r}$ sont données en termes de R -matrices quantiques.

Dans [BZBJ18a], Ben-Zvi–Brochier–Jordan utilisent l'homologie à factorisation avec des coefficients dans la catégorie $\text{Rep}_q(G)$ pour obtenir une quantification fonctorielle du champ $\mathbf{Char}_G(\Sigma)$ des G -fibrés plats sur Σ . Intuitivement, la propriété de localité de l'homologie à factorisation permet de quantifier la théorie localement, ce qui revient à remplacer la catégorie monoïdale symétrique $\text{Rep}(G)$ par la catégorie monoïdale tressée $\text{Rep}_q(G)$, et à recoller ensuite ces quantifications locales via l'homologie à factorisation sur Σ . En choisissant un modèle combinatoire pour la surface, l'algèbre des endomorphismes de l'objet distingué $\mathcal{O} \in \int_{\Sigma} \text{Rep}_q(G)$ est équivalent à l'algèbre des fonctions quantifiées sur la variété de représentations; $\underline{\text{End}}_{\text{Rep}_q(G)}(\mathcal{O}) \cong (\mathcal{O}_q)_{g,r}$ comme algèbres dans $\text{Rep}_q(G)$, retrouvant les algèbres précédemment obtenues par Alekseev–Grosse–Schomerus et Buffenoir–Roche. La sous-algèbre des invariants de $\underline{\text{End}}_{\text{Rep}_q(G)}(\mathcal{O})$ donne une quantification explicite de l'algèbre de Poisson de Fock–Rosly sur la variété de caractères, équivariante pour l'action du groupe des difféotopies de Σ , ce qui découle naturellement du cadre topologique de l'homologie à factorisation.

Dans cette thèse, nous étendons la méthode d'homologie à factorisation pour construire des quantifications fonctorielles aux variétés/champs de caractères généralisé(e)s qui suivent:

- Variété/Champ de caractères tordu(e):
Soit $\varphi: \pi_1(\Sigma) \rightarrow \text{Out}(G)$ un $\text{Out}(G)$ -fibré sur Σ , où $\text{Out}(G)$ est le groupe des automorphismes extérieurs de G . Un G -fibré plat φ -tordu est un $G \rtimes \text{Out}(G)$ -fibré

Introduction

plat $P \rightarrow \Sigma$ avec une équivalence $\pi_* P \cong \varphi$, où $\pi: G \rtimes \text{Out}(G) \rightarrow \text{Out}(G)$ est la projection naturelle. Les espaces de modules de fibrés tordus sont déjà apparus en relation avec des applications moments tordues dans [Mei17, Zer21], ou dans le contexte des symétries finies pour la théorie de Yang–Mills en dimension 2 dans [MSS22]. Nous pouvons décrire l’espace de modules de G -fibrés plats φ -tordus soit par la variété de caractères φ -tordue

$$\text{Char}_{G,\varphi}(\Sigma) = G^{2g+r-1}/\varphi G \quad ,$$

définie comme le quotient affine par rapport à l’action de conjugaison φ -tordue, soit par le champ de caractères φ -tordu:

$$\mathbf{Char}_{G,\varphi}(\Sigma) = [G^{2g+r-1}/\varphi G] \quad .$$

Nous montrerons que la variété de caractères tordue admet un tenseur de Poisson Π_{FR}^φ de type Fock–Rosly défini à l’aide d’une r -matrice classique $\text{Out}(G)$ -invariante. Nous définirons ensuite un champ de caractères quantique φ -tordu par l’homologie à factorisation sur des surfaces décorées avec des $\text{Out}(G)$ -fibrés, et en particulier nous obtiendrons une quantification par déformation de la variété de Poisson $(\text{Char}_{G,\varphi}(\Sigma), \Pi_{FR}^\varphi)$.

- Variété/Champ de caractères dynamique:

Soit $\Gamma = (E, V)$ un graphe orienté, muni d’un ordre linéaire sur l’ensemble des demi-arêtes incident à chaque sommet, avec une collection de sommets marqués $\{v_1, \dots, v_k\} \subseteq V$. Pour chaque sommet marqué v_i , on se donne $\mathfrak{h}_i \subset \mathfrak{g}$ une sous-bigèbre de Lie et (L_i, Π_{L_i}) une variété de Poisson lisse pour laquelle Π_{L_i} est induit par une action du double $\mathfrak{D}(\mathfrak{h}_i)$. On définit la variété de représentations dynamique:

$$\text{Rep}_{\text{dyn}}(\Gamma, \{(\mathfrak{h}_i, L_i)\}_{i=1, \dots, k}) = \prod_{i=1}^k L_i \times G^E \quad .$$

Un exemple géométrique est l’espace des G -connexions plates sur la surface marquée $\{v_1, \dots, v_k\} \subset \Sigma$ avec une réduction du groupe structural G à un tore maximal $H \subset G$ sur une petite boucle γ_i entourant le point marqué v_i et avec une trivialisation du fibré au voisinage de v_i . Dans ce cas on a que pour tout $i = 1, \dots, k$, $\mathfrak{h}_i = \mathfrak{h}$ est une sous-algèbre de Cartan et $L_i = H$.

Soit H_i un groupe d’algèbre de Lie \mathfrak{h}_i . Le graphe Γ détermine une action ρ^Γ du groupe $\prod_{i=1}^k H_i \times G^{V \setminus \{v_1, \dots, v_k\}}$ sur la variété de représentations dynamique. Nous montrerons que, étant donné des r -matrices dynamiques classiques $r(\lambda_i): L_i \rightarrow \mathfrak{g} \otimes \mathfrak{g}$, telles que définies dans [DM05], la variété de représentations dynamique admet une structure de Poisson combinatoire Π_{dyn} compatible avec l’action ρ^Γ . Cette structure de Poisson est une généralisation dynamique de la structure de Poisson de Fock–Rosly sur les variétés de caractères. Dans le cas particulier où les espaces de base $L_i = \mathfrak{h}$ sont des sous-algèbres de Cartan, la structure de Poisson Π_{dyn} est déjà apparue dans le contexte de la théorie de Chern–Simons avec des sources dynamiques [BR05].

Pour les r -matrices dynamiques classiques $r(\lambda_i)$ avec des quantifications par twists dynamiques $\mathcal{J}(\lambda_i)$, nous définirons des catégories modules tressés \mathcal{M}_i encodant les données des R -matrices quantiques dynamiques $\mathcal{R}(\lambda_i)$. On obtient une quantification par déformation de la structure de Poisson dynamique de type Fock–Rosly

Introduction

sur les variétés de caractères dynamiques via l'homologie à factorisation sur une surface avec des défauts ponctuels décrits par les \mathcal{M}_i .

Nous définissons le champ de caractères dynamique:

$$\mathbf{Char}_{\text{dyn}}(\Gamma, \{(\mathfrak{h}_i, L_i)\}_{i=1, \dots, k}) = \left[\prod_{i=1}^k L_i \times G^E / \prod_{i=1}^k H_i \times G^{V \setminus \{v_1, \dots, v_k\}} \right].$$

Pour $L_i = H \subset G$ un tore maximal, et $H_i = H$ pour tout $i = 1, \dots, k$, on décrit la catégorie des faisceaux quasi-cohérents sur le champ de caractères dynamique via l'homologie à factorisation et on définit le champ de caractère quantiques dynamiques correspondant.

2.3. Résumé

- Le Chapitre 1 établit le contexte sous-jacent à la recherche dans cette thèse et donne le matériel de base nécessaire. Dans le § 1.1 nous rapellons les bases sur les bigèbres de Lie, les groupes de Poisson–Lie et la théorie de jauge sur réseau. Nous rappelons la construction de la structure de Poisson de Fock–Rosly sur les variétés de caractères via la fusion d'espaces de Poisson définis en termes de matrices classiques. Dans le § 1.2 nous établissons la notation et les conventions pour les groupes quantiques et leurs représentations. Dans le § 1.3, nous donnons les bases sur l'homologie à factorisation pour les variétés orientées et établissons le cadre catégoriel dans lequel nous allons opérer. Pour cela, nous introduisons la bicatégorie des catégories localement présentables enrichies, qui permet de calculer l'homologie à factorisation avec des coefficients issus de la théorie des représentations des groupes quantiques. La section contient également une discussion sur l'approche d'homologie à factorisation pour la quantification catégorique.
- Le Chapitre 2 est basé sur une collaboration avec Lukas Müller [KM23] sur la quantification des champs de caractères tordus. Dans le § 2.1 nous définissons l'espace de modules classique de fibrés plats tordus et présentons une nouvelle formule combinatoire pour la structure de Poisson sur cet espace de modules. Le § 2.2 contient le matériel de base sur l'homologie à factorisation sur des surfaces munies des D -fibrés principaux. De plus, nous montrons que la catégorie monoïdale tressée $\text{Rep}_q(G)$ est un système de coefficients pour l'homologie à factorisation dans le cas où $D = \text{Out}(G)$. Dans le § 2.3 nous calculons l'homologie à factorisation sur des surfaces à bord munies de D -fibrés et utilisons la reconstruction monadique pour identifier l'homologie à factorisation avec des catégories de modules sur des algèbres définies en termes purement combinatoires. Dans le § 2.4 nous prouvons que les algèbres obtenues via l'homologie à factorisation donnent une quantification par déformation de l'espace de modules de fibrés plats tordus. Le § 2.5 concerne l'homologie à factorisation pour les surfaces munies de D -fibrés qui sont fermées et/ou qui ont des défauts ponctuels. Dans ce contexte, nous donnons des exemples de défauts ponctuels dans le cadre D -décoré provenant de paires symétriques quantiques.
- Dans le Chapitre 3, nous parlons des variétés/champs de caractères dynamiques et de leur quantification via l'homologie à factorisation. Dans le § 3.1 nous introduisons la fusion pour les espaces de Poisson dynamiques définis en termes de

Introduction

r-matrices dynamiques. Comme application, nous montrons que les variétés de caractères dynamiques admettent des crochets de Poisson dynamiques de type Fock–Rosly. Dans le § 3.2 nous établissons le cadre catégoriel pour étudier les groupes quantiques dynamiques. Nous introduisons la notion de donnée de quasi-reflection donnant lieu à des défauts ponctuels incorporant des quantifications par twist dynamique (défauts ponctuels dynamiques). Dans le § 3.3 nous calculons l’homologie à factorisation sur les surfaces avec des défauts ponctuels dynamiques. En utilisant des techniques monadiques, nous obtenons des algèbres dans des extensions dynamiques de catégories monoïdales, qui donnent notamment des exemples d’algèbres dynamiques, comme l’algèbre FRT dynamique. Dans le § 3.4 nous montrons que les algèbres obtenues via l’homologie à factorisation donnent une quantification par déformation des variétés de caractères dynamiques et nous expliquons comment l’homologie à factorisation avec des défauts ponctuels dynamiques définit un champ de caractères quantique dynamique. Comme application, nous discutons la façon dont nos résultats produisent une quantification des algèbres de Poisson dynamiques issues de la théorie de Chern–Simons avec des sources ponctuelles.

1. Background

1.1. Character varieties and lattice gauge theory

Let G be a semi-simple linear algebraic group over \mathbb{C} . The G -character variety $\text{Char}_G(\Sigma)$ of a surface Σ is defined as the set of equivalence classes

$$\text{Char}_G(\Sigma) = \text{Hom}(\pi_1(\Sigma), G)/G$$

of group homomorphisms from the fundamental group of Σ to G . It is well-known that character varieties describe the moduli space of flat G -bundles on Σ and as such are extensively studied in the context of gauge theories, for example in Chern–Simons on 3-manifolds of the form $\Sigma \times [0, 1]$. For closed surfaces, the moduli space of flat G -bundles is symplectic [AB83, Gol84]. The symplectic structure was constructed in the differential geometric setting by Atiyah–Bott [AB83] from the infinite-dimensional symplectic manifold of all connections via symplectic reduction with respect to the gauge group and moment map given by the curvature. The same symplectic structure appeared in the work of Goldman [Gol84], where the construction is in terms of group cohomology.

In this thesis we will focus on a later construction due to Fock–Rosly [FR93, FR99] for surfaces with boundary. Taking advantage of the fact that the moduli space is finite-dimensional, Fock–Rosly’s idea was to replace the gauge theory on Σ by a lattice gauge theory, meaning that the surface is considered as a combinatorial object for which a flat bundle is described by means of a discrete connection. In more details, for a finite collection of marked points $V \subset \partial\Sigma$ and a graph $\Gamma = (E, V)$ presenting the marked surface, Fock–Rosly constructed a Poisson structure Π_{FR} on the finite-dimensional space G^E of discrete flat connections, or equivalently on the moduli space of flat G -bundles with a fixed trivialization over each marked point. The lattice gauge group G^V naturally acts by changing the trivialization. Taking the quotient, the Fock–Rosly (FR) Poisson structure descends to the full moduli space of flat G -bundles. The latter agrees with the Poisson structure obtained via infinite-dimensional reduction from the space of all connections à la Atiyah–Bott [FR99, Proposition 5].

In § 1.1.1 we provide background on Poisson–Lie groups and their infinitesimal analogs, Lie bialgebras, which are part of the data entering the FR-construction. We recall how classical r-matrices give rise to multiplicative Poisson structures and more general Poisson varieties with compatible group actions. In § 1.1.2 we give a detailed overview on Fock–Rosly’s approach to defining Poisson structures on character varieties. We will see that the FR-construction is an example of a Poisson structure defined via Lie bialgebra actions and classical r-matrices. Finally, in § 1.1.3 we discuss how the same data used in the FR-construction also defines a (0-shifted) Poisson structure on the G -character stack.

1. Background

1.1.1. Lie bialgebras and Poisson–Lie groups

Unless otherwise stated, all groups will be semi-simple linear algebraic groups over \mathbb{C} . The main reference for the background material presented in this section are [KS04] and the lecture notes [ES02a].

Lie bialgebras The tensor product $\mathfrak{g} \otimes \mathfrak{g}$ is a \mathfrak{g} -module via the adjoint action

$$\mathrm{ad}_y^{(2)}(x_1 \otimes x_2) = \mathrm{ad}_y(x_1) \otimes x_2 + x_1 \otimes \mathrm{ad}_y(x_2) \quad ,$$

for any pure tensor $x_1 \otimes x_2 \in \mathfrak{g} \otimes \mathfrak{g}$.

Definition 1.1.1. A Lie bialgebra is a Lie algebra $(\mathfrak{g}, [-, -])$ together with an anti-symmetric linear map $\delta: \mathfrak{g} \rightarrow \mathfrak{g} \otimes \mathfrak{g}$, called the co-bracket, satisfying

- co-Jacobi identity:

$$\mathrm{Cyc}(\delta \otimes 1)\delta(x) = 0$$

where $\mathrm{Cyc}: \mathfrak{g}^{\otimes 3} \rightarrow \mathfrak{g}^{\otimes 3}$ is the linear map defined as

$$x_1 \otimes x_2 \otimes x_3 \longmapsto x_1 \otimes x_2 \otimes x_3 + x_2 \otimes x_3 \otimes x_1 + x_3 \otimes x_1 \otimes x_2$$

for any pure tensor $x_1 \otimes x_2 \otimes x_3 \in \mathfrak{g}^{\otimes 3}$.

- δ is a 1-cocycle:

$$\begin{aligned} \delta([x, y]) &= \mathrm{ad}_x^{(2)}\delta(y) - \mathrm{ad}_y^{(2)}\delta(x) \\ &= [1 \otimes x + x \otimes 1, \delta(y)] + [\delta(x), 1 \otimes y + y \otimes 1] \quad , \end{aligned}$$

for all $x, y \in \mathfrak{g}$.

The co-Jacobi identity for δ guarantees that the dual map $\delta^*: \mathfrak{g}^* \otimes \mathfrak{g}^* \rightarrow \mathfrak{g}^*$ endows \mathfrak{g}^* with the structure of a Lie algebra. Fixing a basis $(e_i)_{i \in I}$ for \mathfrak{g} with dual basis $(\theta^i)_{i \in I}$ for \mathfrak{g}^* , we introduce structure constants for the bracket and co-bracket

$$[e_i, e_j] = f_{ij}^k e_k, \quad \delta(e_k) = c_k^{ij} e_i \otimes e_j \tag{1.1}$$

and then we also have $\delta^*(\theta^i \otimes \theta^j) = c_k^{ij} \theta^k$.

Classical r-matrices We will now focus on the case where the co-bracket δ of a Lie bialgebra \mathfrak{g} is not just a 1-cocycle as in Definition 1.1.1, but also a 1-coboundary. More precisely, we are asking that $\delta: \mathfrak{g} \rightarrow \mathfrak{g} \otimes \mathfrak{g}$ is a linear map of the form

$$\begin{aligned} \delta(x) &= \mathrm{ad}_x^{(2)}(r) \\ &= [x \otimes 1 + 1 \otimes x, r] \end{aligned}$$

for a fixed element $r \in \mathfrak{g} \otimes \mathfrak{g}$. In this situation we write $\delta = \delta_r$. As every coboundary is a cocycle, the cocycle condition of Definition 1.1.1 is automatically satisfied.

Definition 1.1.2. An element $r \in \mathfrak{g} \otimes \mathfrak{g}$ is called a classical r-matrix if

- the symmetric part $r_{12} + r_{21}$ is \mathfrak{g} -invariant

1. Background

- r satisfies the classical Yang–Baxter equation (CYBE)

$$\text{CYB}(r) = 0$$

where $\text{CYB}(r) = [r_{12}, r_{13}] + [r_{12}, r_{23}] + [r_{13}, r_{23}]$ is the Yang–Baxter operator.

We will usually denote by $\omega = \frac{1}{2}(r_{12} - r_{21})$ the anti-symmetric part of r and by $t = \frac{1}{2}(r_{12} + r_{21})$ its symmetric part.

In a basis $(e_i)_{i \in I}$ for \mathfrak{g} the CYBE reads

$$r^{ij}r^{ab} \left([e_i, e_a] \otimes e_j \otimes e_b + e_i \otimes [e_j, e_a] \otimes e_b + e_i \otimes e_a \otimes [e_j, e_b] \right) = 0 \quad .$$

Note that \mathfrak{g} -invariance of the symmetric part guarantees that the bracket δ^* on \mathfrak{g}^* is anti-symmetric and the CYBE is a sufficient condition for the Jacobi identity to hold for $(\mathfrak{g}^*, \delta^*)$. This last point is nicely explained in [KS04, Section 2.2].

Definition 1.1.3. A Lie bialgebra $(\mathfrak{g}, [-, -], \delta)$ is called quasi-triangular if its cobracket is of the form

$$\delta_r : \mathfrak{g} \longrightarrow \mathfrak{g} \otimes \mathfrak{g}, \quad x \longmapsto [x \otimes 1 + 1 \otimes x, r]$$

where $r \in \mathfrak{g} \otimes \mathfrak{g}$ is a classical r -matrix.

Note that the co-bracket only depends on the anti-symmetric part ω since by assumption t is ad -invariant. The following two propositions will be useful when defining Poisson structures via Lie algebra actions and classical r -matrices.

Proposition 1.1.4. [KS04, Section 2.2] For $r = \omega + t \in \mathfrak{g} \otimes \mathfrak{g}$ we have that $\text{CYB}(r) \in \wedge^3 \mathfrak{g}$ and

$$\text{CYB}(r) = \text{CYB}(\omega) + \text{CYB}(t) \quad .$$

Proposition 1.1.5. $\text{CYB}(t) = [t_{13}, t_{23}] = [t_{23}, t_{12}] = [t_{12}, t_{13}]$

Proof. We have

$$\begin{aligned} \text{CYB}(t) &= t^{ij}t^{ab} \left([e_i, e_a] \otimes e_j \otimes e_b + e_i \otimes [e_j, e_a] \otimes e_b + e_i \otimes e_a \otimes [e_j, e_b] \right) \\ &= -t^{ij}t^{ab} \text{ad}_{e_a}^{(2)}(e_i \otimes e_j) \otimes e_b + t^{ij}t^{ab} e_i \otimes e_a \otimes [e_j, e_b] \\ &= t^{ij}t^{ab} e_i \otimes e_a \otimes [e_j, e_b] \\ &= [t_{13}, t_{23}] \end{aligned}$$

by ad -invariance of t , and similarly one can verify the remaining equalities. \square

Poisson–Lie groups Similarly to how Lie algebras are considered infinitesimal counterparts to groups, Lie bialgebras are infinitesimal structures associated to certain multiplicative Poisson structures called Poisson–Lie groups¹. The study of Poisson–Lie groups and their relation to Lie bialgebras was initiated by Drinfeld [Dri00].

Definition 1.1.6. A Poisson–Lie structure on a group G is a Poisson bivector $\Pi_G \in \wedge^2 TG$ which is such that the multiplication $m : G \times G \rightarrow G$ is a Poisson map. We call the pair (G, Π_G) a Poisson–Lie group.

¹In the algebraic setting such groups are sometimes called Poisson algebraic groups. We will however adapt the more common terminology and refer to G as a Poisson–Lie group.

1. Background

Let \mathfrak{g} be the Lie algebra of G . If (G, Π_G) is a Poisson–Lie group, \mathfrak{g} is naturally a Lie bialgebra: we may regard the Poisson bivector as a map $\Pi_G: G \rightarrow \wedge^2 \mathfrak{g}$ by identifying $T_g G \cong \mathfrak{g}$. Then, (\mathfrak{g}, δ) with $\delta = d\Pi_G: \mathfrak{g} \rightarrow \wedge^2 \mathfrak{g}$ is a Lie bialgebra, see for example [ES02a, Section 2.2]. The additional structure of a Poisson bivector on G thus corresponds to the additional structure of the co-bracket turning \mathfrak{g} into a Lie bialgebra. As for Lie algebras, the uniqueness in passing from Lie bialgebras to Poisson–Lie groups requires connectedness and simply-connectedness [Dri00], see also [ES02a, Theorem 2.2].

The main example for us of a multiplicative Poisson structure will be the following.

Example 1.1.7. Given a classical r-matrix $r \in \mathfrak{g} \otimes \mathfrak{g}$ one can define a 2-tensor by

$$\Pi = r^{R,R} - r^{L,L} \quad ,$$

where the superscripts indicate that both tensor factors of r act via right-, respectively left-invariant vector fields as defined in Equation (1.2) below. Since the symmetric part of r is ad-invariant this is a multiplicative bivector on G . One can show that the CYBE for r guarantees that Π is a Poisson bivector. The pair (G, Π) is called a quasi-triangular Poisson–Lie group since its tangent Lie bialgebra \mathfrak{g} is quasi-triangular with co-bracket δ_r . The corresponding Poisson bracket on $\mathcal{O}(G)$ is called the Sklyanin bracket. \triangle

Group actions and Poisson varieties Let M be a smooth algebraic variety with a left G -action $\rho: G \times M \rightarrow M$, $(g, m) \mapsto g \triangleright m$. We often refer to M simply as a G -space. For $x \in \mathfrak{g}$, the vector field x^ρ encoding the infinitesimal action of G on M is

$$x^\rho \triangleright f(m) = \left. \frac{d}{dt} \right|_{t=0} f(e^{-tx} \triangleright m) \quad ,$$

where we use the symbol \triangleright to denote both the action of the group G on M and the action of the corresponding vector field on the algebra of functions $\mathcal{O}(M)$. By the above we get a Lie algebra homomorphism $\rho_*: \mathfrak{g} \rightarrow \Gamma(M, TM)$, $x \mapsto x^\rho$, where the Lie bracket on the algebra of vector fields $\Gamma(M, TM)$ is the commutator. The map ρ_* extends to a morphism of associative algebras from $\wedge^\bullet \mathfrak{g}$ to the algebra of multi-vector fields $\Gamma(M, \wedge^\bullet TM)$ by setting

$$(x_1 \wedge \cdots \wedge x_p)^\rho(m) = x_1^\rho(m) \wedge \cdots \wedge x_p^\rho(m) \quad .$$

The group G acts on itself via right and left multiplication. The respective infinitesimal actions are encoded in left invariant and right invariant vector fields on G . These vector fields act on functions via²:

$$(f \triangleleft x^L)(g) = \left. \frac{d}{dt} \right|_{t=0} f(g e^{-tx}), \quad (x^R \triangleright f)(g) = \left. \frac{d}{dt} \right|_{t=0} f(e^{-tx} g) \quad , \quad (1.2)$$

So that for the left G -action given by conjugation $\text{Ad}: G \times G \rightarrow G$, $(g, h) \mapsto ghg^{-1}$, we get $x^{\text{ad}} = x^R - x^L$ for the infinitesimal action. Note that the left invariant vector fields act on the right, but the minus sign turns it into a left action.

Remark 1.1.8. *The formulas in (1.2) make sense in the algebraic setting since for all $x \in \mathfrak{g}$ we have that e^{tx} is a well-defined $\mathbb{C}[t]/t^n$ -point of G for every $n \in \mathbb{N}$.*

²Notice that here the superscripts L and R refer to left-, respectively right-, invariant vector fields and not to the action by right, respectively left, multiplication.

1. Background

Assume now that G is a Poisson–Lie group and M a G -space equipped with a Poisson structure $\{-, -\}_M$. The following is a compatibility condition between the action and the Poisson structures on G and M that will allow to define a Poisson structure on quotient spaces.

Definition 1.1.9. [LW90] *Let $(G, \{-, -\}_G)$ be a Poisson–Lie group and $(M, \{-, -\}_M)$ a Poisson space with a left G -action. The action $\rho: G \times M \rightarrow M$, $\rho(g, m) = g \triangleright m$, of G on M is called a Poisson action if ρ is a Poisson map. If ρ is a Poisson action, we call M a Poisson G -space.*

Explicitly, for $g, h \in G$, $m \in M$, the action ρ is Poisson if

$$\{\varphi, \psi\}_M(g \triangleright m) = \{\varphi(- \triangleright m), \psi(- \triangleright m)\}_G(g) + \{\varphi(g \triangleright -), \psi(g \triangleright -)\}_M(m) \quad .$$

Since for any G -invariant function $\vartheta \in \mathcal{O}(M)^G$ we have

$$\vartheta(g \triangleright -) = \vartheta, \quad \vartheta(- \triangleright m) = \vartheta(m) = \text{const} \quad ,$$

for all $m \in M$ and $g \in G$, the Poisson bracket on M descends to the algebra $\mathcal{O}(M)^G$ of G -invariant functions if the G -action is Poisson.

The following proposition gives an infinitesimal characterization of Poisson actions. We denote by δ the co-bracket on \mathfrak{g} coming from the Poisson–Lie structure on G .

Proposition 1.1.10. [LW90, Theorem 2.6] *Let Π_M be the Poisson bivector on M . The action $\rho: G \times M \rightarrow M$ is Poisson if and only if*

$$\mathcal{L}_{x\rho}(\Pi_M) = \rho_*\delta(x)$$

for all $x \in \mathfrak{g}$.

We end this section by giving an example of a Poisson G -space that will play a prominent role when defining Poisson structures on character varieties in the next section. We will use the implicit summation notation $r = r^1 \otimes r^2$ for the classical r-matrix.

Example 1.1.11. Consider G as a left $G \times G$ -space via $\rho: ((g_1, g_2), h) \mapsto g_1 h g_2^{-1}$. Assume that $r = \omega + t$ is a classical r-matrix for the Lie algebra \mathfrak{g} of G . Then, the bivector field

$$\Pi_G = r^{R,R} - r_{2,1}^{L,L} = \omega^{R,R} + \omega^{L,L} \tag{1.3}$$

on G is Poisson, due to \mathfrak{g} -invariance of t and the CYBE. Moreover, the left $G \times G$ -action on (G, Π_G) is Poisson. Indeed, the following is a classical r-matrix for $\mathfrak{g} \oplus \mathfrak{g}$:

$$\tilde{r} = (r^1, 0) \otimes (r^2, 0) - (0, r^2) \otimes (0, r^1) \quad .$$

It induces the above Poisson bivector via the $G \times G$ -action; $\Pi_G = \rho_*\tilde{r}$. Now, for any $(x, y) \in \mathfrak{g} \oplus \mathfrak{g}$ we can compute the Schouten bracket

$$\begin{aligned} \llbracket (x, y)^\rho, \Pi_G \rrbracket &= \llbracket x^R - y^L, \omega^{R,R} + \omega^{L,L} \rrbracket \\ &= \text{ad}_x^{(2)}(\omega)^{R,R} + \text{ad}_y^{(2)}(\omega)^{L,L} \\ &= \rho_*\text{ad}_{(x,y)}^{(2)}(\tilde{r}) \end{aligned}$$

and by Proposition 1.1.10 we conclude that the action ρ is Poisson. △

1. Background

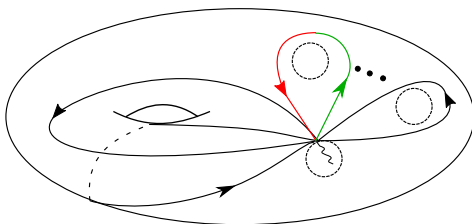

Figure 1.1.: An example of a ciliated ribbon graph embedded into a punctured surface. Every edge is divided into an outgoing half-edge (green) and an incoming half-edge (red). The linear order of the half-edges is represented by placing a cilium at the vertex separating the minimal and the maximal half-edge incident to that vertex.

1.1.2. Fock–Rosly Poisson structure on character varieties

The original reference for the material in this section is [FR93, FR99]. For a more detailed presentation of the subject we refer to the lecture notes [Aud97].

Let $\Sigma = \Sigma_{g,r}$ be a compact oriented surface of genus g with $r > 0$ boundary components and a collection V of marked points on the boundary $\partial\Sigma$. By a skeleton for Σ we mean an embedded graph $\Gamma \subset \Sigma$ such that the set of vertices is V and Γ is a deformation retract of Σ . Equivalently, the surface Σ may be combinatorially described by means of a *ciliated ribbon graph*, that is, a directed graph $\Gamma = (E, V)$, with E the set of oriented edges and V the set of vertices, together with a linear order on the set of ends of edges $\widehat{E}(v)$ at each vertex $v \in V$. Given a ciliated ribbon graph Γ , one can fatten each edge into a ribbon and each vertex into a disk such that Γ is a skeleton for the resulting surface. An example of a ciliated ribbon graph with one vertex is pictured in Figure 1.1.

Given the choice of a skeleton for Σ , let $\Pi_1(\Sigma, V)$ be the fundamental groupoid of Σ based at V . The *representation variety* is defined by

$$\text{Rep}_G(\Sigma, V) = \text{Hom}(\Pi_1(\Sigma, V), G) \quad ,$$

where G is regarded as a groupoid with one object and elements of G as morphisms. Since the edges of Γ constitute a system of free generators, there is a natural identification

$$\text{Rep}_G(\Sigma, V) \cong G^E \quad .$$

Note that G^E is a finite-dimensional smooth algebraic variety and independent of the concrete form of the ciliated ribbon graph Γ or topology of Σ . However, we will see that the FR-Poisson structure on $\text{Rep}_G(\Sigma, V)$ is sensitive to the topology.

An element in $\text{Rep}_G(\Sigma, V)$ is called a discrete connection. This terminology is motivated by the following remark.

Remark 1.1.12. *Geometrically, the representation variety is the moduli space of flat principal G -bundles $\mathcal{A}_G(\Sigma, V)$ that are trivialized over each point $v \in V$. The identification with the representation variety is via the holonomy map*

$$\mathcal{A}_G(\Sigma, V) \xrightarrow{\cong} G^E, \quad A \longmapsto \prod_{\gamma \in E} \text{hol}_\gamma(A)$$

where hol_γ is the holonomy along the path γ .

1. Background

There is a natural action of the lattice gauge group G^V on $\text{Rep}_G(\Sigma, V)$

$$\begin{aligned} G^V \times G^E &\longrightarrow G^E \\ ((h_v)_{v \in V}, (g_\gamma)_{\gamma \in E}) &\longmapsto (h_{t(\gamma)} g h_{s(\gamma)}^{-1})_{\gamma \in E} \quad , \end{aligned}$$

where $s(\gamma)$ is the starting and $t(\gamma)$ the target vertex of γ . Taking the affine quotient of the lattice gauge group action yields the character variety:

$$\text{Char}_G(\Sigma) = \text{Rep}_G(\Sigma, V) / G^V \quad .$$

Remark 1.1.13. *The moduli space $\mathcal{A}_G(\Sigma, V)$ from Remark 1.1.12 is the space of flat G -bundles modulo gauge transformations which are trivial at the set of vertices V of the graph Γ . Further reduction by the group G^V , which acts by changing the trivialization, then gives the space $\mathcal{M}_G(\Sigma)$ of flat G -bundles modulo all gauge transformations.*

Let $(e_i)_{i \in I}$ be a basis for \mathfrak{g} . We denote by $e_i^R(\alpha)$ and $e_i^L(\alpha)$ the right-, and left-invariant vector fields on G^E whose left action on a function $f \in \mathcal{O}(G^E)$ is:

$$e_i^R(\alpha) \triangleright f(g_1, \dots, g_E) = \frac{d}{dt} \Big|_{t=0} f(g_1, \dots, e^{-te_i} g_\alpha, \dots, g_E) \quad , \quad (1.4)$$

$$(-e_i^L(\alpha)) \triangleright f(g_1, \dots, g_E) = \frac{d}{dt} \Big|_{t=0} f(g_1, \dots, g_\alpha e^{te_i}, \dots, g_E) \quad . \quad (1.5)$$

The FR-Poisson structure on $\text{Char}_G(\Sigma)$ is constructed as follows: to each vertex $v \in V$ one assigns a classical r-matrix $r(v)$, such that the symmetric components of the chosen r-matrices agree and are non-degenerate. Denote the set of half-edges incident to a vertex v by $\widehat{E}(v)$ and fix a linear ordering \prec on $\widehat{E}(v)$. The Fock–Rosly Poisson bivector is defined as follows [FR99, Proposition 3]:

$$\Pi_{FR} = \sum_{v \in V} \sum_{\substack{\alpha \prec \beta \\ \alpha, \beta \in \widehat{E}(v)}} r(v)^{ij} x_i(\alpha, v) \wedge x_j(\beta, v) + \sum_{\alpha \in \widehat{E}(v)} r(v)^{ij} x_i(\alpha, v) \wedge x_j(\alpha, v) \quad , \quad (1.6)$$

where

$$x_i(\alpha, v) = \begin{cases} -e_i^L(\alpha), & \alpha \text{ is source half-edge at } v \\ e_i^R(\alpha), & \alpha \text{ is end half-edge at } v \quad . \end{cases}$$

In [FR99], the proof that Π_{FR} is indeed a Poisson bivector on the character variety $\text{Char}_G(\Sigma)$ is left as a computation to the reader. A more conceptual proof that $(\text{Rep}_G(\Sigma, V), \Pi_{FR})$ is a Poisson variety compatible with the action of the lattice gauge group was given by Mouquin in [Mou17, Theorem 4.2]. In the next paragraph we will outline Mouquin’s approach to defining the FR-Poisson structure via r-matrices and Lie bialgebra actions. We will adopt the same strategy when defining Poisson structures on twisted character varieties in § 2.1.1 of Chapter 2. Also, we will give a generalization of [Mou17, Theorem 4.2] to Poisson structures defined in terms of dynamical r-matrices in § 3.1.2 of Chapter 3.

Lastly, we should note that the FR-Poisson algebra on the character variety is independent of the choices of the r-matrices and the linear ordering at each vertex [FR99, Proposition 5], see also [Aud97, Section 2.3]. The Poisson structure only depends on the symmetric part $t \in \text{Sym}^2(\mathfrak{g})^{\mathfrak{g}}$ of the r-matrices, i.e. on a non-degenerate invariant symmetric pairing.

1. Background

FR-construction via fusion For simplicity we consider the case where Γ has only one vertex, for the general case see [Mou17, Section 4] or the proof of Proposition 3.1.4. As before, \widehat{E} is the set of half-edges of Γ with a linear order \prec . For an edge $\delta \in E$ we write $s(\delta) \in \widehat{E}$ for the source half-edge and $t(\delta) \in \widehat{E}$ for the end half-edge. The following is a classical r-matrix for the direct product Lie algebra $\mathfrak{g}^{\widehat{E}}$:

$$r^{\widehat{E}} = \sum_{\delta \in E} (r^1)_{t(\delta)} \otimes (r^2)_{t(\delta)} - (r^2)_{s(\delta)} \otimes (r^1)_{s(\delta)} \quad , \quad (1.7)$$

where $(x)_\alpha$ is the image of $x \in \mathfrak{g}$ under the embedding of \mathfrak{g} into $\mathfrak{g}^{\widehat{E}}$ as the α -component. One can modify the direct product r-matrix $r^{\widehat{E}}$ via

$$r^\Gamma = r^{\widehat{E}} - \text{Mix}^{\widehat{E}, \prec}(r), \quad \text{where } \text{Mix}^{\widehat{E}, \prec}(r) = \sum_{\substack{\alpha \prec \beta \\ \alpha, \beta \in \widehat{E}}} (r^2)_\alpha \wedge (r^1)_\beta \quad . \quad (1.8)$$

The resulting 2-tensor r^Γ is again a classical r-matrix for $\mathfrak{g}^{\widehat{E}}$ [LM17, Theorem 6.2]. It is important to note that while the diagonal map

$$(\mathfrak{g}, \delta_r) \xrightarrow{\text{diag}} (\mathfrak{g}^{\widehat{E}}, \delta_{r^\Gamma})$$

is an embedding of Lie bialgebras, the same is not true for the direct product Lie bialgebra $(\mathfrak{g}^{\widehat{E}}, \delta_{r^{\widehat{E}}})$, see also Remark 1.1.15 below.

There is a natural action of $G^{\widehat{E}}$ on G^E :

$$\begin{aligned} \rho^\Gamma : G^{\widehat{E}} \times G^E &\longrightarrow G^E \\ ((h_\alpha)_{\alpha \in \widehat{E}}, (g_\gamma)_{\gamma \in E}) &\longmapsto (h_{t(\gamma)} g_\gamma h_{s(\gamma)}^{-1})_{\gamma \in E} \quad . \end{aligned}$$

The induced 2-tensor field $\rho_*^\Gamma(r^\Gamma)$ on G^E is a bivector field since $\rho_*^\Gamma(r_{12}^\Gamma + r_{21}^\Gamma) = 0$ due to ad-invariance of the symmetric part of the r-matrix. It turns out that $\rho_*^\Gamma(r^\Gamma)$ is actually a Poisson bivector field, as can be deduced from the following proposition:

Proposition 1.1.14. [LM17, Proposition 2.18] *Let $\rho : G \times M \rightarrow M$ be a G -space and $r \in \mathfrak{g} \otimes \mathfrak{g}$ a classical r-matrix. If $\rho_* r$ is a bivector field then it is a Poisson bivector field and $(M, \rho_* r)$ is a Poisson G -space.*

Proof. One has to show that the Schouten bracket $[[\rho_* r, \rho_* r]]$ vanishes. By assumption $\rho_* t = 0$ and thus

$$\begin{aligned} [[\rho_* r, \rho_* r]] &= 2\rho_* \text{CYB}(\omega) \\ &= -2\rho_* \text{CYB}(t) \quad . \end{aligned}$$

We denote by $\underline{t} : \mathfrak{g}^* \rightarrow \mathfrak{g}$ the map defined by $\underline{t}(\eta) = \langle t^1, \eta \rangle t^2$. By Proposition 1.1.5 we have $\rho_* \text{CYB}(t) = \rho_* [t_{12}, t_{13}]$. Hence, for every $m \in M$ and $\alpha, \beta, \gamma \in T_m^* M$ we find

$$\rho_* \text{CYB}(t)(m)(\alpha, \beta, \gamma) = \langle \rho_m^* \alpha, [\underline{t}(\rho_m^* \beta), \underline{t}(\rho_m^* \gamma)] \rangle \quad , \quad (1.9)$$

where $\rho_m : \mathfrak{g} \rightarrow T_m M$, $\rho_m(x) = \rho_*(x)(m)$ and $\rho_m^* : T_m^* M \rightarrow \mathfrak{g}$ is the dual map. The stabilizer subalgebra $\ker(\rho_m) \subset \mathfrak{g}$ at m is coisotropic with respect to t , meaning that $\underline{t}(\text{im}(\rho_m^*)) \subset \ker(\rho_m)$. It follows that (1.9) = 0. Finally, the claim that (M, ρ_*) is a Poisson G -space then follows from

$$[[\rho_* x, \rho_* \omega]] = \rho_* \text{ad}_x^{(2)}(\omega) = \rho_* \delta(x)$$

for all $x \in \mathfrak{g}$ and Proposition 1.1.10. □

1. Background

The above proposition thus implies that $\text{Rep}_G(\Sigma)$ is a Poisson $G^{\widehat{E}}$ -space. Finally, since the diagonal map $\mathfrak{g} \xrightarrow{\text{diag}} \mathfrak{g}^{\widehat{E}}$ is an embedding of Lie bialgebras, one concludes that

$$(\text{Rep}_G(\Sigma), \rho_*^\Gamma(r^\Gamma)) \quad (1.10)$$

is a Poisson G -space, namely the one discovered by Fock–Rosly.

Remark 1.1.15. *The Poisson G -space defined in this way can be understood as the result of fusion of the Poisson $G^{\widehat{E}}$ -space $\text{Rep}_G(\Sigma) = G^E$ equipped with the direct product Poisson structure $\rho_*^\Gamma r^{\widehat{E}}$. The necessity of fusion is due to the following observation. For two Poisson G -spaces (Y_1, Π_{Y_1}) and (Y_2, Π_{Y_2}) , their direct product $Y_1 \times Y_2$ has a natural Poisson structure $\Pi_{Y_1} + \Pi_{Y_2}$ and a natural G -action coming from the diagonal map. However, the resulting Poisson space*

$$(Y_1 \times Y_2, \Pi_{Y_1} + \Pi_{Y_2})$$

is in general not a Poisson G -space under the diagonal action. One way to resolve this problem is to take their fusion product instead. A fusion product for Poisson spaces was defined by Lu–Mouquin in [LM17, Definition 6.9] by means of classical r -matrices. It agrees, up to a twist, with the fusion product of quasi-Poisson spaces introduced by Alekseev–Kosmann-Schwarzbach–Meinrenken in [AKSM00]. Coming back to the case of the representation variety: given several copies of the Poisson space (G, Π_G) , where Π_G is the Poisson structure from Example 1.1.11, the direct product Poisson space is

$$(G \times \cdots \times G, \Pi_G + \cdots + \Pi_G) = (G^E, \rho_*^\Gamma r^{\widehat{E}})$$

This is a Poisson $G^{\widehat{E}}$ -space under the action ρ^Γ . Whereas the fusion product due to [LM17] is

$$(G \times \cdots \times G, \Pi_G + \cdots + \Pi_G - \rho_*^\Gamma \text{Mix}^{\widehat{E}, \prec}(r))$$

equipped with the G -action $\rho^\Gamma \circ \text{diag}$. In summary, the Poisson structure (1.10) on the representation variety is a fusion product of several copies of the group G with its $G \times G$ -Poisson structure Π_G .

We are now going to describe $\Pi^\Gamma = \rho_*^\Gamma(r^\Gamma)$ in some more details, so that it will be easy to see that Π^Γ agrees with the Fock–Rosly Poisson bivector from Equation (1.6). To that end, decompose the bivector field as

$$\Pi^\Gamma = \sum_{\gamma \in E} \Pi_{\gamma, \gamma}^\Gamma + \sum_{\substack{\gamma < \delta \\ \delta, \gamma \in \{1, \dots, |E|\}}} (\Pi_{\gamma, \delta}^\Gamma - \tau(\Pi_{\gamma, \delta}^\Gamma)) \quad ,$$

where $\Pi_{\gamma, \delta}^\Gamma$ acts on the γ -component of the first tensor factor and on the δ -component of the second tensor factor of $G^E \times G^E$, and τ swaps the tensor factors of the 2-tensor field $\Pi_{\gamma, \delta}^\Gamma$.

The components of the r -matrix contributing to the first term $\Pi_{\gamma, \gamma}^\Gamma$ are

$$r_\gamma^\Gamma = (r^1)_{t(\gamma)} \otimes (r^2)_{t(\gamma)} - (r^2)_{s(\gamma)} \otimes (r^1)_{s(\gamma)} + (r^2)_{t(\gamma)} \wedge (r^1)_{s(\gamma)}$$

Under the pushforward ρ_*^Γ we then get

$$\Pi_{\gamma, \gamma} = \omega^{\text{ad}, \text{ad}} + t^{R, L} - t^{L, R} \quad , \quad (1.11)$$

1. Background

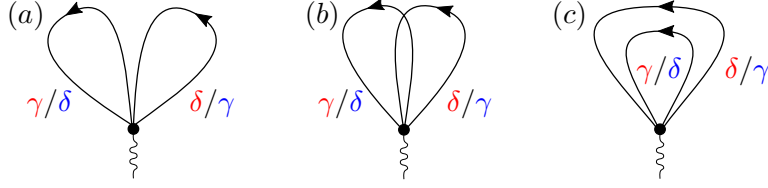

Figure 1.2.: Ciliated graphs with one vertex and two edges labeled by two ordered elements $\gamma < \delta$ of the set $\{1, \dots, |E|\}$. We will refer to the graphs with the red labels as *positively* (a) unlinked, (b) linked, (c) nested, and we say that the graphs with the blue labels are *negatively* (a) unlinked, (b) linked, (c) nested.

where we used *ad*-invariance of t . The above Poisson structure was first introduced by Semenov-Tian-Shansky (STS) [STS94] and we will accordingly denote this Poisson bivector field by Π_{STS} .

For $\Pi_{\gamma,\delta}$, $\gamma \neq \delta$, we have to distinguish the following cases, see also Figure 1.2:

- γ, δ are positively unlinked: $t(\gamma) \prec s(\gamma) \prec t(\delta) \prec s(\delta)$

$$r_{\text{unlinked}}^\Gamma \stackrel{(1.8)}{=} -((r^2)_{t(\gamma)} \otimes (r^1)_{t(\delta)} + (r^2)_{t(\gamma)} \otimes (r^1)_{s(\delta)} + (r^2)_{s(\gamma)} \otimes (r^1)_{t(\delta)} + (r^2)_{s(\gamma)} \otimes (r^1)_{s(\delta)})$$

$$\Pi_{\gamma,\delta}^\Gamma = \rho_*^\Gamma (r_{\text{unlinked}}^\Gamma) = -r_{2,1}^{\text{ad,ad}}$$

- γ, δ positively linked: $t(\gamma) \prec t(\delta) \prec s(\gamma) \prec s(\delta)$

$$r_{\text{linked}}^\Gamma \stackrel{(1.8)}{=} -((r^2)_{t(\gamma)} \otimes (r^1)_{t(\delta)} + (r^2)_{t(\gamma)} \otimes (r^1)_{s(\delta)} - (r^1)_{s(\gamma)} \otimes (r^2)_{t(\delta)} + (r^2)_{s(\gamma)} \otimes (r^1)_{s(\delta)})$$

$$\Pi_{\gamma,\delta}^\Gamma = \rho_*^\Gamma (r_{\text{linked}}^\Gamma) = -r_{2,1}^{\text{ad,ad}} - 2t^{L,R}$$

- γ, δ positively nested: $t(\gamma) \prec t(\delta) \prec s(\delta) \prec s(\gamma)$

$$r_{\text{nested}}^\Gamma \stackrel{(1.8)}{=} -((r^2)_{t(\gamma)} \otimes (r^1)_{t(\delta)} + (r^2)_{t(\gamma)} \otimes (r^1)_{s(\delta)} - (r^1)_{s(\gamma)} \otimes (r^2)_{t(\delta)} - (r^1)_{s(\gamma)} \otimes (r^2)_{s(\delta)})$$

$$\Pi_{\gamma,\delta}^\Gamma = \rho_*^\Gamma (r_{\text{nested}}^\Gamma) = -r_{2,1}^{\text{ad,ad}} - 2t^{L,R} + 2t^{L,L}$$

The remaining three cases depicted in Figure 1.2 can be worked out analogously.

1.1.3. Character stacks

In [Saf21b], Safronov relates multiplicative Poisson structures, such as Poisson–Lie groups, as well as Poisson G -spaces to the notion of shifted Poisson structures for (derived) Artin stacks introduced in [CPT⁺17]. The intuition behind the definition of a shifted Poisson structure on a stack is the following. First recall that for a smooth algebraic variety M , a Poisson structure is a bivector $\Pi \in \Gamma(M, \wedge^2 TM)$ such that $[[\Pi, \Pi]] = 0$. Now, let X be an Artin stack. For example; $X = [M/G]$ for M a smooth algebraic variety. Infinitesimally, an Artin stack may be studied via its tangent complex \mathbb{T}_X . Accordingly, the algebra of n -shifted polyvector fields is

$$\text{Pol}(X, n) = \Gamma(X, \text{Sym}(\mathbb{T}_X[-n-1])) \quad .$$

1. Background

Then, a n -shifted Poisson structure on X is a formal power series $\Pi = \Pi_2 + \Pi_3 + \dots$, where each $\Pi_k \in \text{Pol}(X, n)$ is of weight k and internal degree $n+2$, satisfying the Maurer–Cartan equation $d\Pi + \frac{1}{2}[[\Pi, \Pi]]$, that is, the Schouten bracket of the shifted bivector Π_2 is not zero on the nose but homotopic to zero in a coherent way. A precise definition of a shifted Poisson structure on an algebraic stack can be found in [CPT⁺17].

Recall that the G -character stack of Σ is defined by the quotient stack:

$$\mathbf{Char}_G(\Sigma) = [\text{Rep}_G(\Sigma)/G] \quad .$$

In the previous section we have seen that the representation variety $(\text{Rep}_G(\Sigma), \Pi_{FR})$ is a Poisson G -space in the case that G is equipped with the quasi-triangular Poisson–Lie group structure $\Pi_G = r^{R,R} - r^{L,L}$. We may view (Π_{FR}, Π_G) as an object in the groupoid $\text{QPois}(\text{Rep}_G(\Sigma), G)$ whose objects are (quasi-)Poisson structures on G and compatible (quasi-)Poisson structures on $\text{Rep}_G(\Sigma)$. Morphisms in this category are induced by twists $\lambda \in \wedge^2 \mathfrak{g}$ modifying both Π_G and $\Pi_{\text{Rep}_G(\Sigma)}$.

It was shown in [Saf21b, Proposition 2.14] that for any G -space M , there is an equivalence of groupoids

$$\text{Cois}(p, 1) \cong \text{QPois}(M, G), \quad p: [M/G] \longrightarrow BG \quad ,$$

where on the left we have the groupoid of 1-shifted coisotropic structures on p . In particular, $\text{Cois}(p, 1)$ contains the information of an 0-shifted Poisson structure on $[M/G]$ (see for example [Saf21b, Section 1.3] for more details on the relation between shifted coisotropic and Poisson structures).

Applying the above to the situation at hand, we find that the data (Π_{FR}, Π_G) gives rise to a 0-shifted Poisson structure on the character stack $\mathbf{Char}_G(\Sigma)$. It is expected that factorization homology $\int_{\Sigma} \text{Rep}_q(G)$ computes a quantization of this shifted Poisson structure. However, to our knowledge, there is so far no known formula for the shifted Poisson structure on $\mathbf{Char}_G(\Sigma)$.

1.2. Hopf algebras and their representations

Throughout, k is either a field \mathbb{K} of characteristic zero or the ring $\mathbb{K}[[\hbar]]$ of formal power series. We will write \otimes for the (completed) tensor product in the category of (complete) k -modules.

In this section we recall basic definitions of quasi-triangular Hopf algebra theory with a focus on the theory of quantum groups and their representations. For a detailed exposition on Hopf algebras we refer to Majid’s text [Maj95]. For basics on quantum groups and their representations we mainly follow the books by Chari–Pressley [CP95] and Kassel [Kas95].

Basic definitions and notation A Hopf algebra H is a unital k -algebra with coproduct $\Delta: H \rightarrow H \otimes H$, counit $\epsilon: H \rightarrow k$ and antipode $S: H \rightarrow H$. The maps Δ and ϵ are algebra homomorphisms and S is an anti-homomorphism. Usually we will adopt implicit summation notation for tensors, for example we will write $h = h^1 \otimes \dots \otimes h^k$ for an element $h \in H^{\otimes k}$. We will use Sweedler’s notation for the coproduct, i.e. $\Delta(h) = h_{(1)} \otimes h_{(2)}$, for $h \in H$.

The Hopf algebra H is called *quasi-triangular* if there exists a universal R-matrix, which is an invertible element $\mathcal{R} \in H \otimes H$ satisfying

$$(\Delta \otimes \text{id})\mathcal{R} = \mathcal{R}_{1,3}\mathcal{R}_{2,3}, \quad (\text{id} \otimes \Delta)\mathcal{R} = \mathcal{R}_{1,3}\mathcal{R}_{1,2} \quad ,$$

1. Background

where the notation means for example $\mathcal{R}_{1,3} = \mathcal{R}^1 \otimes 1 \otimes \mathcal{R}^2$ with implicit summation notation $\mathcal{R} = \mathcal{R}^1 \otimes \mathcal{R}^2$, and

$$\Delta^{\text{op}}(h) = \mathcal{R}\Delta(h)\mathcal{R}^{-1} \quad , \quad (1.12)$$

for all $h \in H$. The opposite coproduct Δ^{op} is the composition of Δ and the operator τ switching the two tensor factors. The above implies that the universal R-matrix satisfies the quantum Yang–Baxter equation (YBE):

$$\mathcal{R}_{1,2}\mathcal{R}_{1,3}\mathcal{R}_{2,3} = \mathcal{R}_{2,3}\mathcal{R}_{1,3}\mathcal{R}_{1,2} \quad .$$

Moreover, the following normalization condition holds

$$(\epsilon \otimes \text{id})\mathcal{R} = 1 \otimes 1 = (\text{id} \otimes \epsilon)\mathcal{R} \quad ,$$

and one also has

$$(S \otimes \text{id})\mathcal{R} = \mathcal{R}^{-1}, \quad (\text{id} \otimes S)\mathcal{R}^{-1} = \mathcal{R} \quad .$$

A quasi-triangular Hopf algebra is called *ribbon*, if it has an invertible, central element $\nu \in H$ such that

$$\nu^2 = uS(u) \quad ,$$

for $u = S(\mathcal{R}^2)\mathcal{R}^1$ and

$$S(\nu) = \nu, \quad \epsilon(\nu) = 1, \quad \Delta(\nu) = (\mathcal{R}_{2,1}\mathcal{R})^{-1}(\nu \otimes \nu) \quad .$$

On a categorical level, quasi-triangular Hopf algebras give rise to rigid braided tensor categories. Indeed, for a quasi-triangular Hopf algebra (H, \mathcal{R}) over \mathbb{K} , we will write $H\text{-Mod}$ for the category of locally-finite³ H -modules. One then defines a braiding for $H\text{-Mod}$ by acting with the universal R-matrix:

$$\beta_{V,W}(v \otimes w) = \mathcal{R}^2 \triangleright w \otimes \mathcal{R}^1 \triangleright v, \quad V, W \in H\text{-Mod} \quad .$$

This is an H -module map because of (1.12). The braid equation for β is a consequence of the quantum YBE. Also, note that the category $H\text{-Mod}$ is generated under filtered colimits by finite-dimensional H -modules and is therefore rigid⁴. For a finite-dimensional left H -module V , the dual \mathbb{K} -vector space V^* is again a left H -module using the antipode

$$(h \blacktriangleright \varphi)(v) = \varphi(S(h) \triangleright v), \quad v \in V, \varphi \in V^* \quad .$$

The pair $(V^*, \blacktriangleright)$ is the left dual to (V, \triangleright) . The right dual to V is defined similarly using the inverse of the antipode. If H is ribbon, there is a canonical identification of the left and right dual.

1.2.1. Quantum groups with a formal parameter

Throughout, let \mathfrak{g} be a finite-dimensional complex semi-simple Lie algebra and \hbar a formal parameter. A *quantized universal enveloping algebra* (QUEA) $U_{\hbar}(\mathfrak{g})$ is a formal deformation of the classical universal enveloping algebra $U(\mathfrak{g})$, according to the definition below.

Definition 1.2.1. A formal deformation of a Hopf algebra A with multiplication m and coproduct Δ is a topological Hopf algebra A_{\hbar} , which is isomorphic to $A[[\hbar]]$ as a $\mathbb{C}[[\hbar]]$ -module, with multiplication m_{\hbar} and coproduct Δ_{\hbar} such that

$$m = m_{\hbar} \bmod \hbar, \quad \Delta = \Delta_{\hbar} \bmod \hbar \quad .$$

³A module V is called locally-finite if for all $v \in V$ the submodule $H.v$ generated by v is finite-dimensional.

⁴We call a category rigid if the compact objects are dualizable.

1. Background

Drinfeld–Jimbo quantum groups In the following all tensor products are assumed to be completed in the \hbar -adic topology. Let \mathfrak{g} be of rank n with Cartan matrix $A = (a_{ij})_{1 \leq i, j \leq n}$. We write $\Pi = \{\alpha_1, \dots, \alpha_n\}$ for the set of simple roots. We rescale the pairing $(-, -)$ coming from the Killing form such that the entries of the symmetrized Cartan matrix $DA = (d_i a_{ij})_{i, j}$ are $(DA)_{ij} = (\alpha_i, \alpha_j)$.

Definition 1.2.2. Let $U_\hbar(\mathfrak{g})$ be the algebra topologically generated by the $3n$ symbols $(H_i, X_i^+, X_i^-)_{i=1, \dots, n}$ subjected to the following relations:

$$\begin{aligned} [H_i, H_j] &= 0, & [H_i, X_j^\pm] &= \pm a_{ij} X_j^\pm \\ [X_i^+, X_i^-] &= \delta_{ij} \frac{e^{d_i \hbar H_i} - e^{-d_i \hbar H_i}}{e^{d_i \hbar} - e^{-d_i \hbar}} \end{aligned} \quad (1.13)$$

and for $i \neq j$:

$$\sum_{k=0}^{1-a_{ij}} (-1)^k \begin{bmatrix} 1 - a_{ij} \\ k \end{bmatrix}_{e^{d_i \hbar}} (X_i^\pm)^k X_j^\pm (X_i^\pm)^{1-a_{ij}-k} = 0 \quad . \quad (1.14)$$

The deformation $U_\hbar(\mathfrak{g})$ of the universal enveloping algebra is again a Hopf algebra with coproduct

$$\begin{aligned} \Delta_\hbar(H_i) &= H_i \otimes 1 + 1 \otimes H_i \\ \Delta_\hbar(X_i^+) &= X_i^+ \otimes e^{d_i \hbar H_i} + 1 \otimes X_i^+, & \Delta_\hbar(X_i^-) &= X_i^- \otimes 1 + e^{-d_i \hbar H_i} \otimes X_i^- \quad . \end{aligned}$$

The rest of the Hopf algebra structure can be found in [CP95]. The Hopf algebra $U_\hbar(\mathfrak{g})$ is a QUEA [CP95, Proposition 6.5.1].

Let δ_r be the standard Lie bialgebra structure on \mathfrak{g} with classical r-matrix $r = \frac{1}{2} \sum_i H_i \otimes H_i + \sum_{\alpha \in \Delta^+} X_\alpha^+ \otimes X_\alpha^-$, where the second sum runs over the set of positive roots. The cobracket uniquely extends to the universal enveloping algebra $U(\mathfrak{g})$ [CP95, Proposition 6.2.3]. Then, one has

$$\delta_r(a) = \frac{\Delta_\hbar(a_\hbar) - \Delta_\hbar^{\text{op}}(a_\hbar)}{\hbar} \pmod{(\hbar)} \quad , \quad (1.15)$$

for $a = a_\hbar \pmod{(\hbar)}$, meaning that $U_\hbar(\mathfrak{g})$ is a quantization of the standard Lie bialgebra structure on \mathfrak{g} .

There is a PBW-type basis for $U_\hbar(\mathfrak{g})$ consisting of the generators $(H_i)_{i=1, \dots, n}$ and ‘root vectors’ associated to the set of positive roots Δ_+ . In order to define the root vectors in the quantum case one uses the action of the braid group $\mathfrak{B}_\mathfrak{g}$ on $U_\hbar(\mathfrak{g})$, in analogy to the classical situation where one uses the Weyl group action to define the root vectors. For Dynkin diagrams of ADE-type the braid group has generators $T_i, i = 1, \dots, n$, subjected to the following relations

$$\begin{aligned} T_i T_j T_i &= T_j T_i T_j & \text{if the vertices } i \text{ and } j \text{ are connected} \\ T_j T_i &= T_i T_j & \text{if the vertices } i \text{ and } j \text{ are not connected} \quad . \end{aligned}$$

Formulas for the action of $\mathfrak{B}_\mathfrak{g}$ on the generators of $U_\hbar(\mathfrak{g})$ can be found in [CP95, Theorem 8.1.2]. Positive and negative root vectors for the QUEA are now defined using the braid group action:

1. Background

Definition 1.2.3. Fix a reduced decomposition $\omega_0 = s_{i_1} s_{i_2} \dots s_{i_N}$ of the longest element ω_0 of the Weyl group W of \mathfrak{g} . The positive/negative root vectors $(X_{\beta_k}^{+/-})_{1 \leq k \leq N}$ are defined by

$$X_{\beta_k}^{+/-} = T_{i_1} T_{i_2} \dots T_{i_{k-1}} (X_{i_k}^{+/-}) \quad .$$

Remark 1.2.4. There is a bijective correspondence between reduced decompositions of the longest element of the Weyl group and normal orderings⁵ on the set of positive roots Δ_+ . Given a reduced composition $\omega_0 = s_{i_1} s_{i_2} \dots s_{i_N}$ the set

$$\beta_1 = \alpha_{i_1} \prec \beta_2 = s_{i_1}(\alpha_{i_2}) \prec \dots \prec \beta_N = s_{i_1} s_{i_2} \dots s_{i_{N-1}}(\alpha_{i_N})$$

is a normal ordering in Δ_+ [Zhe87].

The universal R-matrix The QUEA $U_{\hbar}(\mathfrak{g})$ is quasi-triangular [CP95, Theorem 8.3.9]. In order to give an explicit formula for the universal R-matrix, we fix a decomposition of the longest element ω_0 in the Weyl group and denote by $(X_{\beta_k}^{\pm})_{1 \leq k \leq N}$ the set of positive and negative root vectors. The R-matrix admits the following multiplicative formula

$$\begin{aligned} \mathcal{R}_{\hbar} &= \exp \left(\hbar \sum_{i,j} (B^{-1})_{ij} H_i \otimes H_j \right) \prod_{\beta_1 \prec \dots \prec \beta_k \prec \dots \prec \beta_N} \exp_{q_{\beta_k}} \left((1 - q_{\beta_k}^{-2}) X_{\beta_k}^+ \otimes X_{\beta_k}^- \right) \quad (1.16) \\ &= \Omega \widehat{\mathcal{R}} \quad , \end{aligned}$$

where $B = (d_j^{-1} a_{ij})_{i,j}$ and the product is ordered according to the chosen normal ordering on the positive roots as in Remark 1.2.4.

Representation theory For any complex vector space V , the left $\mathbb{C}[[\hbar]]$ -module $V[[\hbar]]$ is the set of all formal series

$$\sum_{n \in \mathbb{N}} v_n \hbar^n, \quad v_n \in V \quad .$$

We call $V[[\hbar]]$ a topologically free module. If V is finite-dimensional, we say that $V[[\hbar]]$ has finite rank. The topological tensor product $\widehat{\otimes}$ of two topologically free modules is again topologically free:

$$V[[\hbar]] \widehat{\otimes} W[[\hbar]] \cong (V \otimes W)[[\hbar]] \quad .$$

For a topological Hopf algebra A_{\hbar} we will write $A_{\hbar}\text{-Mod}^{\text{fd}}$ for the category of topologically free A_{\hbar} -modules of finite rank.

Since there are no non-trivial deformations of $U(\mathfrak{g})$ as an algebra, the representation theory $U_{\hbar}(\mathfrak{g})\text{-Mod}$ is analogous to that of the Lie algebra \mathfrak{g} : for a dominant integral weight $\lambda \in \mathbf{P}^+$ and highest weight module V_{λ} , there exists a unique topologically free $U_{\hbar}(\mathfrak{g})$ -module \widetilde{V}_{λ} , such that $\widetilde{V}_{\lambda}/\hbar \widetilde{V}_{\lambda} \cong V_{\lambda}$, and every module in $U_{\hbar}(\mathfrak{g})\text{-Mod}$ is a direct sum of modules of this form, see [Kas95, Section XVII.2].

The category $U_{\hbar}(\mathfrak{g})\text{-Mod}^{\text{fd}}$ is braided monoidal with braiding induced by the action of the universal R-matrix \mathcal{R}_{\hbar} . Moreover, every object $V[[\hbar]]$ has a dual $V^*[[\hbar]]$ with $U_{\hbar}(\mathfrak{g})$ -action defined via the antipode. The topological Hopf algebra $U_{\hbar}(\mathfrak{g})$ has a ribbon element [Kas95, Proposition XVII.3.1]

$$\theta_{\hbar} = e^{-\hbar \rho} u_{\hbar} \quad ,$$

where $\rho \in \mathfrak{h}$ corresponds to the half-sum of positive roots under the isomorphism $\mathfrak{h}^* \cong \mathfrak{h}$ and $u_{\hbar} = S(\mathcal{R}_{\hbar}^2) \mathcal{R}_{\hbar}^1$, turning $U_{\hbar}(\mathfrak{g})\text{-Mod}^{\text{fd}}$ into a ribbon tensor category.

⁵An ordering \prec of a set of positive roots Δ_+ is called normal if for any three roots α, β, γ such that $\gamma = \alpha + \beta$ we have either $\alpha \prec \gamma \prec \beta$ or $\beta \prec \gamma \prec \alpha$.

1. Background

1.2.2. Quantum groups with a generic parameter

Let G be a semi-simple linear algebraic group over \mathbb{C} and $H \subset G$ a maximal torus with corresponding Cartan subalgebra $\mathfrak{h} \subset \mathfrak{g}$. We denote by $\Lambda = \text{Hom}(H, \mathbb{C}^\times)$ the weight lattice of H . As before, $DA = (d_i a_{ij})_{1 \leq i, j \leq n}$ is the symmetrized Cartan matrix and from the Killing form we get a pairing $(-, -)$ on Λ which is such that $(\alpha_i, \alpha_j) = (DA)_{i,j}$ for all simple roots α_i . Let $q \in \mathbb{C}^\times$ be a complex number which is not a root of unity. Exponentiation gives the following pairing on the weight lattice:

$$\Lambda \times \Lambda \longrightarrow \mathbb{C}^\times, \quad (\lambda, \mu) \longmapsto q^{-(\lambda, \mu)} .$$

Set $q_i = q^{d_i}$. The algebra $U_q(\mathfrak{g})$ over \mathbb{C} has generators K_λ for $\lambda \in \Lambda$ and X_i^\pm for $i = 1, \dots, n$ subjected to the relations

$$\begin{aligned} K_0 &= 1, & K_\lambda K_\mu &= K_{\lambda+\mu} \\ K_\lambda X_i^+ K_\lambda^{-1} &= q^{(\lambda, \alpha_i)} X_i^+, & K_\lambda X_i^- K_\lambda^{-1} &= q^{-(\lambda, \alpha_i)} X_i^- \\ [X_i^+, X_j^-] &= \delta_{ij} \frac{K_{\alpha_i} - K_{\alpha_i}^{-1}}{q_i - q_i^{-1}} \end{aligned}$$

for all $\lambda, \mu \in \Lambda$ and $1 \leq i, j \leq n$, together with the quantum Serre relations, which are q -versions of the Equations (1.14). The quantum group $U_q(\mathfrak{g})$ is a Hopf algebra over \mathbb{C} with coproduct

$$\begin{aligned} \Delta(K_\lambda) &= K_\lambda \otimes K_\lambda \\ \Delta(X_i^+) &= X_i^+ \otimes K_i + 1 \otimes X_i^+, & \Delta(X_i^-) &= X_i^- \otimes 1 + K_i^{-1} \otimes X_i^- , \end{aligned}$$

and the rest of the Hopf algebra structure may be found in [CP95, Section 9.1]. The Cartan part $U_q(\mathfrak{h}) = \mathbb{C}[\Lambda]$ is generated by the K_λ for $\lambda \in \Lambda$ and we denote by $U_q(\mathfrak{b}), U_q(\mathfrak{b}^-) \subset U_q(\mathfrak{g})$ the quantum Borel subalgebras generated by the K_λ 's and the X_i^\pm 's, respectively by the K_λ 's and the X_i^- 's.

Representation theory We will denote by $\text{Rep}_q(H)$ the full subcategory of the category of $U_q(\mathfrak{h})$ -modules that are spanned by weight vectors v_λ , $\lambda \in \Lambda$, on which the generators K_μ act by multiplication with $q^{(\lambda, \mu)}$. The category $\text{Rep}_q(H)$ is a braided tensor category with braiding:

$$\beta(v_\lambda \otimes w_\mu) = q^{-(\lambda, \mu)} w_\mu \otimes v_\lambda .$$

The representation category $\text{Rep}_q(G)$ of the quantum group is defined as the category of locally-finite integrable $U_q(\mathfrak{g})$ -modules. These are modules with locally-finite $U_q(\mathfrak{g})$ -action, whose restriction to $U_q(\mathfrak{h})$ lies in $\text{Rep}_q(H)$. The action of the quantum nilpotent subalgebras $U_q(\mathfrak{n})$ and $U_q(\mathfrak{n}^-)$ is locally nilpotent.

The category $\text{Rep}_q(G)$ is semi-simple: every object may be presented as a (possibly infinite) direct sum of finite-dimensional irreducible highest weight modules $V(\lambda)$ for λ lying in the lattice \mathbf{P}^+ of dominant integral weights. Moreover, $\text{Rep}_q(G)$ is a braided tensor category [CP95, Section 10.1.D]. For a representation $V \otimes W \in \text{Rep}_q(G)$, the braiding is defined by the so-called quasi R-matrix

$$\Theta_{V,W} = \tau \circ E_{V,W} \widehat{\mathcal{R}}_{V,W} ,$$

where $\widehat{\mathcal{R}}_{V,W}$ is the q -version of $\widehat{\mathcal{R}}$ defined in (1.16) in the representation $V \otimes W$. This is well-defined since the action of the quantum nilpotent algebras is locally nilpotent. The operator $E_{V,W}$ is defined by $E_{V,W}(v_\lambda \otimes w_\mu) = q^{(\lambda, \mu)} v_\lambda \otimes w_\mu$, for all $\lambda, \mu \in \Lambda$, and τ flips the two tensor factors.

1.3. Categorical factorization homology

In § 1.3.1 we give a short introduction to factorization homology for oriented manifolds. We will also discuss factorization homology on surfaces with certain stratifications, namely with boundary conditions and with point defects. In § 1.3.2 we present the categorical set-up in which we will carry out our computations. To that end, we introduce the bicategory of locally presentable enriched categories and show that it satisfies the necessary technical conditions to serve as a target for computing factorization homology. In § 1.3.3 we lay out the main ideas behind the categorical approach to quantization. In § 1.3.4 we recall the basics about monadic reconstruction for abelian module categories which will be used throughout the thesis to obtain an explicit algebraic presentation for factorization homology on (decorated) surfaces.

1.3.1. Factorization homology on oriented manifolds

The algebraic input data for factorization homology on oriented n -manifolds are framed E_n -algebras in symmetric monoidal $(\infty, 1)$ -categories. Factorization homology then computes functorial invariants of oriented n -manifolds by ‘averaging’ the local input data over a given manifold. In the scope of this thesis we will only be concerned with the case of surfaces ($n = 2$) and categorical framed E_2 -algebras. We will nevertheless give first the basic definitions for manifolds of any dimension before restricting to the 2-dimensional, categorical case. References for a more in depth introduction to factorization homology are [AF19] as well as the lecture notes [Gin15].

Basic definitions The geometric input for factorization homology will be an object in the following category:

Definition 1.3.1. Man_n^{or} is the $(\infty, 1)$ -category whose

- objects are oriented n -dimensional manifolds
- the space of morphisms $\text{Emb}^{\text{or}}(X, Y)$ is the space of oriented smooth embeddings of X into Y equipped with the compact-open topology

The disjoint union of manifolds endows Man_n^{or} with the structure of a symmetric monoidal $(\infty, 1)$ -category.

We denote by $\text{Disk}_n^{\text{or}} \subset \text{Man}_n^{\text{or}}$ the full symmetric monoidal subcategory whose objects are Euclidean spaces and disjoint unions thereof.

We now fix a symmetric monoidal $(\infty, 1)$ -category (\mathcal{C}, \otimes) . We will assume that \mathcal{C} is cocomplete and the tensor functor \otimes distributes over colimits in each variable. These technical assumptions will ensure that factorization homology with coefficients in (\mathcal{C}, \otimes) as introduced in Definition 1.3.4 below is well-defined.

Definition 1.3.2. A framed E_n -algebra in \mathcal{C} is a symmetric monoidal functor

$$\mathcal{A}: \text{Disk}_n^{\text{or}, \sqcup} \longrightarrow \mathcal{C}^{\otimes} .$$

Since $\text{Disk}_n^{\text{or}}$ is generated as a symmetric monoidal category by \mathbb{R}^n , we also denote by \mathcal{A} the image of the generator \mathbb{R}^n under the above functor.

Example 1.3.3. In Figure 1.3 we give a sketch for $n = 2$ of the disk operations in $\text{Disk}_2^{\text{or}}$ and the corresponding algebraic structures on the framed E_2 -algebra $\mathcal{A}: \text{Disk}_2^{\text{or}, \sqcup} \rightarrow \mathcal{C}^{\otimes}$. △

1. Background

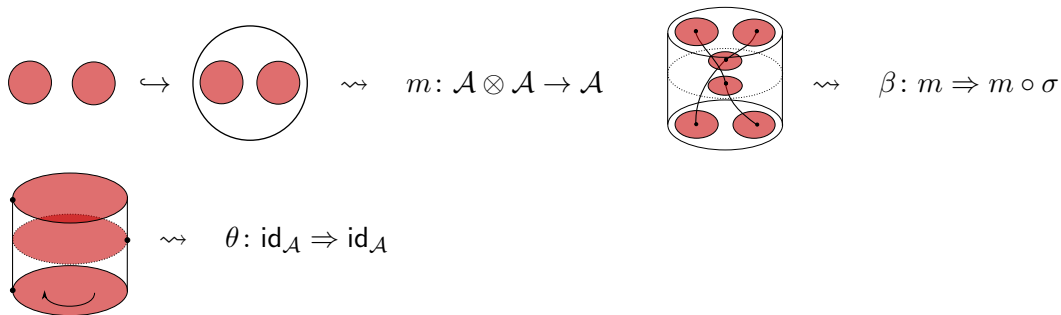

Figure 1.3.: *First row*: Disk embeddings (or isotopies thereof) in $\mathbb{D}\text{isk}_2^{\text{or}}$ that give rise to the multiplication m and the braiding β in $\mathcal{A} = \mathcal{A}(\mathbb{R}^2)$. Here σ denotes the braiding in \mathcal{C} . *Second row*: Loop in the space of disk embeddings $\mathbb{D}\text{isk}_2^{\text{or}}$ coming from rotating the disk by 2π .

Definition 1.3.4. [AF15] Factorization homology $\int_{(-)} \mathcal{A}$ with coefficients in the framed E_n -algebra \mathcal{A} is defined as the left Kan extension of the diagram

$$\begin{array}{ccc} \mathbb{D}\text{isk}_n^{\text{or}, \sqcup} & \xrightarrow{\mathcal{A}} & \mathcal{C}^{\otimes} \\ \downarrow & \dashrightarrow & \uparrow \\ \text{Man}_n^{\text{or}} & & \int_{(-)} \mathcal{A} \end{array}$$

The left Kan extension admits a point-wise formula: the value of factorization homology on a manifold M is computed by the colimit

$$\int_M \mathcal{A} = \text{colim}(\mathbb{D}\text{isk}_n^{\text{or}}/M \rightarrow \mathbb{D}\text{isk}_n^{\text{or}} \xrightarrow{\mathcal{A}} \mathcal{C})$$

over all possible disk embeddings into M . The assumptions on \mathcal{C} guarantee that the above colimit exists and makes factorization homology into a symmetric monoidal functor [AF15, Proposition 3.7]. The value of factorization homology on any manifold M is naturally pointed by the inclusion $\emptyset \hookrightarrow M$ of the empty manifold:

$$\int_{\emptyset} \mathcal{A} \cong 1_{\mathcal{C}} \longrightarrow \int_M \mathcal{A} .$$

Remark 1.3.5. Factorization homology can be defined on manifolds with more general tangential structures than the choice of an orientation. Recall that for a topological group G and a homomorphism $\rho: G \rightarrow \text{GL}(n)$, a G -structure on a manifold M is a homotopy lift of the classifying map of the frame bundle through $B\rho$:

$$\begin{array}{ccc} & & BG \\ & \dashrightarrow & \downarrow B\rho \\ M & \longrightarrow & B\text{GL}(n) \end{array}$$

An example that will play a key role later in Chapter 2 is the following. For D a finite group, let $G = D \times \text{SO}(n)$ and $\rho: D \times \text{SO}(n) \xrightarrow{\text{pr}_{\text{SO}(n)}} \text{SO}(n) \hookrightarrow \text{GL}(n)$. The resulting tangential structure amounts to the choice of an orientation together with a map $M \rightarrow BD$, i.e. a principal D -bundle.

1. Background

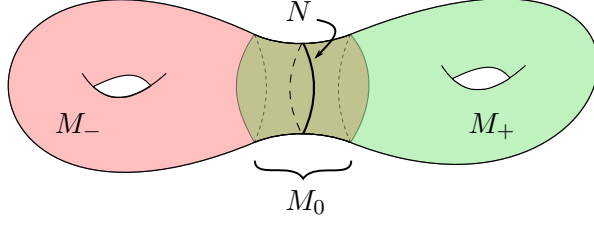

Figure 1.4.: Example of a collar-gluing.

\otimes -Excision Factorization homology, being a homology theory for manifolds, satisfies a certain gluing property called \otimes -excision. Excision will be the main tool for computing factorization homology since it allows to reconstruct the value of factorization homology from a certain decomposition of M , namely from a *collar-gluing* [AF15, Section 3.3]. A collar-gluing is a decomposition $M = M_- \cup_{M_0} M_+$, where M_+ and M_- are open subsets of M , together with a direct product structure on $M_0 = M_- \cap M_+$, i.e. a diffeomorphism $\theta: M_0 \xrightarrow{\cong} N \times (-1, 1)$ of oriented manifolds. See Figure 1.4 for an example.

Factorization homology $\int_{N \times (-1, 1)} \mathcal{A}$ for the product manifold $N \times (-1, 1)$ has a natural E_1 -algebra structure coming from embeddings of open intervals, which gives rise to an E_1 -algebra structure on $\int_{M_0} \mathcal{A}$ under the equivalence $M_0 \xrightarrow{\theta} N \times (-1, 1)$. Let us fix oriented embeddings

$$\mu_-: [-1, 1] \sqcup (-1, 1) \hookrightarrow [-1, 1] \quad \text{and} \quad \mu_+: (-1, 1] \sqcup (-1, 1) \hookrightarrow (-1, 1]$$

such that $\mu_-(-1) = -1$ and $\mu_+(1) = 1$. Under the diffeomorphism θ these maps lift to embeddings

$$\text{act}_-: M_- \sqcup M_0 \longrightarrow M_- \quad \text{and} \quad \text{act}_+: M_0 \sqcup M_+ \longrightarrow M_+$$

see Figure 1.5 for a sketch. The maps act_- and act_+ induce right-, respectively left-module $\int_{M_0} \mathcal{A}$ -module structures on the corresponding factorization homologies.

Lemma 1.3.6. [AF15, Lemma 3.18] *Let $M = M_- \cup_{M_0} M_+$ be a collar-gluing of oriented n -manifolds and let \mathcal{A} be a framed E_n -algebra in \mathcal{C} . There is an equivalence of categories*

$$\int_M \mathcal{A} \cong \int_{M_-} \mathcal{A} \otimes_{\int_{M_0} \mathcal{A}} \int_{M_+} \mathcal{A} ,$$

where on the right hand side the relative tensor product is computed by the colimit of the 2-sided bar construction:

$$\dots \rightrightarrows \mathcal{M}_- \otimes \mathcal{N} \otimes \mathcal{N} \otimes \mathcal{M}_+ \rightrightarrows \mathcal{M}_- \otimes \mathcal{N} \otimes \mathcal{M}_+ \rightrightarrows \mathcal{M}_- \otimes \mathcal{M}_+ \quad (1.17)$$

for $\mathcal{M}_- = \int_{M_-} \mathcal{A}$, $\mathcal{M}_+ = \int_{M_+} \mathcal{A}$ and $\mathcal{N} = \int_{M_0} \mathcal{A}$.

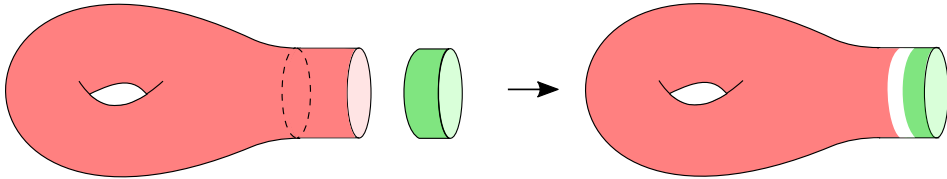

Figure 1.5.: The map which induces the right $\int_{M_0} \mathcal{A}$ -module structure on $\int_{M_-} \mathcal{A}$. Here, the green collar depicts the product manifold $N \times (-1, 1)$.

1. Background

Boundary conditions and point defects We will be interested in studying field theories and their quantization defined on surfaces with certain defects. For example, the Fock–Rosly Poisson algebra from § 1.1.2 arises from the G -character variety for a surface Σ with non-empty boundary $\partial\Sigma$. The algebraic data used to define a field theory on a manifold with boundary via factorization homology is called a *boundary condition*. The other type of defect we want to consider are codimension 2 defects, that is, surfaces with marked points. Algebraically, these defects are incorporated by so-called *point defects*. The latter will play an important role in Chapter 3, where we use factorization homology to describe moduli spaces arising in Chern–Simons theory with point-like sources. We can understand both manifolds with boundary and marked points as particular examples of stratified manifolds. The extension of factorization homology to stratified manifolds is due to [AFT17] and we will spell out the details for the two cases of interest to us.

For the case of boundary conditions, we introduce the $(\infty, 1)$ -category $\text{Man}_{2,\partial}^{\text{or}}$ of oriented 2-dimensional manifolds Σ with boundary $\partial\Sigma$. We denote by $\text{Disk}_{2,\partial}^{\text{or},\sqcup}$ the full subcategory with objects disjoint unions of disks \mathbb{R}^2 and half disks $\mathbb{R} \times \mathbb{R}_{\geq 0}$. We will adopt the following terminology:

Definition 1.3.7. A boundary condition is a symmetric monoidal functor $\mathcal{F}: \text{Disk}_{2,\partial}^{\text{or},\sqcup} \rightarrow \mathcal{C}^{\otimes}$.

Similarly to the case of smooth manifolds, given a boundary condition \mathcal{F} , factorization homology with coefficients in \mathcal{F} is defined by the left Kan extension [AFT17]:

$$\begin{array}{ccc} \text{Disk}_{2,\partial}^{\text{or},\sqcup} & \xrightarrow{\mathcal{F}} & \mathcal{C}^{\otimes} \\ \downarrow & \nearrow \int_{(-)} \mathcal{F} & \\ \text{Man}_{2,\partial}^{\text{or}} & & \end{array}$$

Remark 1.3.8. Unless otherwise stated, we will always work with trivial boundary conditions, meaning that we use the same disk algebra for a disk with empty boundary, as for a disk with non-empty boundary.

For the case of point defects, we define the category $\text{Man}_{2,*}^{\text{or}}$ whose objects are oriented 2-dimensional manifolds Σ together with a collection of marked points $x_1, \dots, x_n \in \Sigma$. Morphisms are embeddings of manifolds, mapping marked points bijectively onto marked points. We denote by $\text{Disk}_{2,*}^{\text{or}}$ the full subcategory generated under disjoint unions by disks \mathbb{R}^2 and disks \mathbb{R}_*^2 with precisely one marked point.

Definition 1.3.9. A point defect is a symmetric monoidal functor $\mathcal{F}: \text{Disk}_{2,*}^{\text{or},\sqcup} \rightarrow \mathcal{C}^{\otimes}$.

Given a point defect \mathcal{F} , factorization homology with coefficients in \mathcal{F} is defined by the left Kan extension [AFT17]:

$$\begin{array}{ccc} \text{Disk}_{2,*}^{\text{or},\sqcup} & \xrightarrow{\mathcal{F}} & \mathcal{C}^{\otimes} \\ \downarrow & \nearrow \int_{(-)} \mathcal{F} & \\ \text{Man}_{2,*}^{\text{or}} & & \end{array}$$

1. Background

1.3.2. The categorical case

From now on we specialize to factorization homology on 2-dimensional manifolds with values in a suitable category of (enriched) categories. Note that in this case factorization homology, being an $(\infty, 1)$ -functor from $\mathbf{Man}_2^{\text{or}}$ to the ambient category of categories, will factor through the homotopy 2-category of oriented manifolds since the target is only 2-categorical. More precisely, from now on $\mathbf{Man}_2^{\text{or}}$ denotes the $(2, 1)$ -category whose objects are oriented surfaces, 1-morphisms are oriented embeddings and 2-morphisms are equivalence classes of isotopies between embeddings.

Categorical framed E_2 -algebras By a result of Salvatore–Wahl [SW03] we have that categorical framed E_2 -algebras $\mathcal{F}: \mathbf{Disk}_2^{\text{or}} \rightarrow \mathbf{Cat}$ are classified by *balanced braided tensor categories*. Recall that for a braided tensor category \mathcal{A} a balancing (or twist) is an automorphism of the identity functor $\theta: \text{id} \Rightarrow \text{id}$ so that it is compatible with the braiding β of \mathcal{A} :

$$\theta_{X \otimes Y} = \beta_{Y, X} \circ \theta_Y \otimes \theta_X \circ \beta_{X, Y}: X \otimes Y \rightarrow X \otimes Y \ .$$

The balancing comes from the loop in the space of embeddings given by rotating a disk about 2π , see Figure 1.3. We also recall that a ribbon category is a rigid balanced braided tensor category so that the components of the balancing satisfy $\theta_{V^\vee} = (\theta_V)^\vee$.

Example 1.3.10. Important examples of balanced braided monoidal categories come from the representation theory of ribbon Hopf algebras (H, ν) . The balancing $\theta_V: V \rightarrow V$ for any $V \in H\text{-Mod}$ is induced by the action of the ribbon element ν . In particular, in § 1.2.1 we have seen that the quantum group $U_\hbar(\mathfrak{g})$ provides an example of a topological ribbon Hopf algebra. A closely related example is the category $\text{Rep}_q(G)$, which is also ribbon with balancing [CP95, Proposition 8.3.15]

$$\theta_{V(\lambda)}: V(\lambda) \rightarrow V(\lambda), \quad \theta_{V(\lambda)}(v) = q^{-(\lambda, \lambda) - \lambda(\rho)} v \ ,$$

for any highest weight vector $v \in V(\lambda)$. △

We will now further specify the categorical setting in which we want to compute factorization homology.

Locally presentable enriched categories The notion of locally presentable categories was first introduced by Gabriel–Ulmer in [GU71]. Their extension to the enriched setting is due to Kelly [Kel82] and was further developed in [BQR98]. One of the main advantages in working with locally presentable categories is that cocontinuous functors between them admit right adjoints. This will be of great importance if we want to obtain an explicit algebraic description of the categories computing factorization homology. The necessary background material on enriched locally presentable categories can be found in § A.2 of the appendix.

The target for factorization homology in this thesis will be the $(2, 1)$ -category $\mathcal{V}\text{-Pres}$ of \mathcal{V} -enriched locally presentable categories, introduced in Definition 1.3.11 below. We will show in Theorem 1.3.14 that for suitable \mathcal{V} , the ambient category $\mathcal{V}\text{-Pres}$ satisfies the conditions of [AF15] to compute factorization homology. When working with representation categories of quantum groups, we will be mostly interested in categories enriched over $\mathcal{V} = \mathbf{Vect}_{\mathbb{C}}$, i.e. the case of \mathbb{C} -linear categories, and $\mathcal{V} = \widehat{\mathbb{C}[[\hbar]]}\text{-Mod}$. Namely, the

1. Background

category of complete modules over the formal power series ring $\mathbb{C}[[\hbar]]$ introduced in § A.1.1 of the appendix.

Let \mathcal{V} be a complete and cocomplete symmetric monoidal closed category. We fix a regular cardinal α_0 and assume that \mathcal{V} is locally α_0 -presentable and that the subcategory of α_0 -compacts is closed under the tensor product and contains the monoidal unit. When in this situation we say that \mathcal{V} is a *locally α_0 -presentable base*.

Definition 1.3.11. *Let \mathcal{V} be locally α_0 -presentable base. Fix a regular cardinal $\alpha \geq \alpha_0$. We define $\mathcal{V}\text{-Pres}$ to be the $(2, 1)$ -category whose*

- *objects are locally α -presentable \mathcal{V} -enriched categories*
- *1-morphisms are \mathcal{V} -enriched cocontinuous functors preserving α -compact objects*
- *2-morphisms are \mathcal{V} -enriched natural isomorphisms*

For $\alpha = \aleph_0$ we call $\mathcal{V}\text{-Pres}$ the category of locally *finitely* presentable enriched categories.

Tensor product and cocompleteness It will be convenient to introduce the $(2, 1)$ -category $\mathcal{V}\text{-Rex}$ whose objects are small \mathcal{V} -enriched categories having all α -small colimits, 1-morphisms are \mathcal{V} -functors preserving α -small colimits, and 2-morphisms are natural isomorphisms. Given a category $\mathcal{C} \in \mathcal{V}\text{-Rex}$, one can take its ind-completion $\text{ind}(\mathcal{C})$, also known as free completion under α -filtered colimits, which lands in $\mathcal{V}\text{-Pres}$. Conversely, the subcategory of compact objects $\text{cmp}(\mathcal{A})$ of a locally α -presentable \mathcal{V} -category \mathcal{A} is small and has all α -small colimits. These operations extend to a 2-categorical equivalence [Kel82, Section 9]:

$$\text{ind} : \mathcal{V}\text{-Rex} \rightleftarrows \mathcal{V}\text{-Pres} : \text{cmp} \quad . \quad (1.18)$$

In [Kel05, Section 6.5], Kelly introduced a tensor product \boxtimes of small \mathcal{V} -enriched categories with α -small colimits, which is uniquely characterized by the following universal property: for \mathcal{C} and \mathcal{D} two categories in $\mathcal{V}\text{-Rex}$, their Kelly tensor product is an object $\mathcal{C} \boxtimes \mathcal{D} \in \mathcal{V}\text{-Rex}$ such that for any $\mathcal{E} \in \mathcal{V}\text{-Rex}$ there is a natural equivalence

$$\mathcal{V}\text{-Rex}[\mathcal{C} \boxtimes \mathcal{D}, \mathcal{E}] \cong \mathcal{V}\text{-Rex}[\mathcal{C}, \mathcal{D}; \mathcal{E}]$$

between the category of functors $\mathcal{C} \boxtimes \mathcal{D} \rightarrow \mathcal{E}$ in $\mathcal{V}\text{-Rex}$ and the category of functors $\mathcal{C} \times \mathcal{D} \rightarrow \mathcal{E}$ that preserve α -small colimits in each variable, where \times is the naive tensor product of \mathcal{V} -enriched categories from Appendix A.1. Furthermore, it is shown in [Kel05] that the Kelly tensor product endows $\mathcal{V}\text{-Rex}$ with the structure of a symmetric monoidal closed $(2, 1)$ -category.

Remark 1.3.12. *In the \mathbb{K} -linear setting, it was shown in [Fra13] that the Kelly tensor product of two abelian categories is again abelian and coincides in this case with the Deligne tensor product.*

We can now transport the Kelly tensor product along the equivalence (1.18). The resulting tensor product \boxtimes in $\mathcal{V}\text{-Pres}$ admits the following description. Let \mathcal{C} and \mathcal{D} be two \mathcal{V} -enriched locally presentable categories. Their tensor product $\mathcal{C} \boxtimes \mathcal{D} \in \mathcal{V}\text{-Pres}$ is defined by

$$\mathcal{C} \boxtimes \mathcal{D} = \mathcal{V}\text{-Lex}(\text{cmp}(\mathcal{C})^{\text{op}}, \text{cmp}(\mathcal{D})^{\text{op}}; \mathcal{V}) \quad ,$$

that is, by functors $\text{cmp}(\mathcal{C})^{\text{op}} \times \text{cmp}(\mathcal{D})^{\text{op}} \rightarrow \mathcal{V}$ preserving α -small limits in each variable separately. The equivalence (1.18) extends to an equivalence of symmetric monoidal $(2, 1)$ -categories.

1. Background

Example 1.3.13. Given $\mathcal{V} = \mathbf{Vect}_{\mathbb{K}}$, we write $\mathbf{Pres}_{\mathbb{K}}$ for the corresponding category of \mathbb{K} -linear locally finitely presentable categories. Let A, B be \mathbb{K} -algebras. Their categories of modules $A\text{-Mod}$ and $B\text{-Mod}$ are locally finitely presentable \mathbb{K} -linear categories. Their tensor product in $\mathbf{Pres}_{\mathbb{K}}$ is identified with $A\text{-Mod} \boxtimes B\text{-Mod} \cong (A \otimes B)\text{-Mod}$. \triangle

In Theorem 1.3.14 below we will show that bicolimits exist in $\mathcal{V}\text{-Pres}$ and that the tensor product \boxtimes preserves them. In the $\mathcal{V} = \mathbf{Set}$ case, a sketch of proof for 2-cocompleteness of \mathbf{Pres} can be found in [CJF13, Proposition 2.1.11]. The idea is to take the diagram whose bicolimit one wants to compute, and consider the corresponding diagram in the category $\mathbf{Pres}^{\text{op}}$, whose objects are locally presentable categories, 1-morphisms are right adjoints and 2-morphisms are natural isomorphisms. The claim is that the bilimit of this diagram exists and can be computed in \mathbf{Cat} . In the enriched case, we have the following:

Theorem 1.3.14. $\mathcal{V}\text{-Pres}$ has all bicolimits and the tensor product \boxtimes of locally presentable \mathcal{V} -categories preserves them.

Proof. Before turning to the case of $\mathcal{V}\text{-Pres}$, we first need to recall some basics about computing bilimits in bi- and 2-categories. To that end, let \mathcal{K} and \mathcal{B} be bicategories and $W: \mathcal{K} \rightarrow \mathbf{Cat}$ and $D: \mathcal{K} \rightarrow \mathcal{B}$ pseudo-functors. The W -weighted bilimit of D is an object $\{W, D\} \in \mathcal{B}$ together with an equivalence

$$\mathbf{Hom}_{\mathcal{B}}(X, \{W, D\}) \cong \mathbf{Hom}_{[\mathcal{K}, \mathbf{Cat}]_{\text{bicat}}}(W, \mathbf{Hom}_{\mathcal{B}}(X, D(-))) \quad ,$$

pseudo-natural in X , where $[\mathcal{K}, \mathbf{Cat}]_{\text{bicat}}$ is the 2-category of pseudo-functors, pseudo-natural transformations between them and modifications. If one considers diagrams in a 2-category \mathcal{C} , one can use the following strictification results. The inclusion of the category $\mathbf{2Cat}$ of 2-categories and 2-functors into the the category \mathbf{BiCat} of bicategories and pseudo-functors has a left adjoint known as *strictification*

$$\mathbf{st} : \mathbf{BiCat} \rightleftarrows \mathbf{2Cat} : \iota \quad .$$

Moreover, the components of the unit map $\mathcal{A} \rightarrow \mathbf{st}(\mathcal{A})$ are equivalences of bicategories [GPS95, Section 4.10]. Higher categorical aspects of the strictification adjunction were studied in [Cam19], where in particular the following universal property of strictification is proven: for every bicategory \mathcal{K} and 2-category \mathcal{C} there is an isomorphism of 2-categories

$$[\mathbf{st}(\mathcal{K}), \mathcal{C}]_{\text{pseudo}} \cong [\mathcal{K}, \mathcal{C}]_{\text{bicat}} \quad ,$$

where $[\mathbf{st}(\mathcal{K}), \mathcal{C}]_{\text{pseudo}}$ is the 2-category of 2-functors, pseudo-natural transformations and modifications. So if D is a diagram in \mathcal{C} , for any $X \in \mathcal{C}$ we have

$$\mathbf{Hom}_{[\mathcal{K}, \mathbf{Cat}]_{\text{bicat}}}(W, \mathbf{Hom}_{\mathcal{C}}(X, D(-))) \cong \mathbf{Hom}_{[\mathbf{st}(\mathcal{K}), \mathbf{Cat}]_{\text{pseudo}}}(W', \mathbf{Hom}_{\mathcal{C}}(X, D'(-))) \quad , \quad (1.19)$$

where W' and D' are the 2-functors corresponding to W and D under strictification. In the above we used that in the following diagram both the left triangle and the outer diagram commute by definition of the strictification of a pseudo-functor

$$\begin{array}{ccccc} \mathbf{st}(\mathcal{K}) & \xrightarrow{\quad \quad \quad} & \mathbf{Hom}_{\mathcal{V}\text{-Cat}}(X, D(-))' & & \\ \cong \uparrow & \searrow^{D'} & \searrow & & \\ \mathcal{K} & \xrightarrow{D} & \mathcal{V}\text{-Cat} & \xrightarrow{\mathbf{Hom}_{\mathcal{V}\text{-Cat}}(X, (-))} & \mathbf{Cat} \end{array}$$

1. Background

But then also the right triangle commutes since the unit of the strictification adjunction is an equivalence. From (1.19) we then find that a 2-category with all pseudo-limits also has all bilimits.

Now, consider the 2-category $\mathcal{V}\text{-Pres}^{\text{op}}$ of locally α -presentable \mathcal{V} -enriched categories, whose 1-morphisms are continuous functors with rank α and 2-morphisms are natural isomorphisms. In [Bir84, Theorem 6.10] it was shown that $\mathcal{V}\text{-Pres}^{\text{op}}$ has all products, inserters and equifiers and that they are computed in $\mathcal{V}\text{-Cat}$. It then follows by [Kel89, Proposition 5.2] that $\mathcal{V}\text{-Pres}^{\text{op}}$ has all pseudo-limits. We conclude by the previous discussion that $\mathcal{V}\text{-Pres}$ has all bicolimits.

For the second assertion, note that the tensor product preserves bicolimits since $\mathcal{V}\text{-Pres}$ is a symmetric monoidal closed $(2, 1)$ -category, which we may deduce from equivalence (1.18). \square

1.3.3. Quantization and factorization homology

In this section we will discuss the role of factorization homology in the quantization of G -character varieties.

Deformation quantization of braided categories Let $(A, \cdot, \{-, -\})$ be a Poisson algebra. A formal deformation quantization of A is an associative algebra $(A_{\hbar}, *)$ over the ring of formal power series $\mathbb{C}[[\hbar]]$, where $A_{\hbar} = A[[\hbar]]$ as a $\mathbb{C}[[\hbar]]$ -module. The product $*$ is such that $A_{\hbar}/(\hbar) = A$ as commutative algebras and in the semi-classical limit one recovers the Poisson bracket

$$\{a, b\} = \frac{\tilde{a} * \tilde{b} - \tilde{b} * \tilde{a}}{\hbar} \pmod{(\hbar)} ,$$

where $a = \tilde{a} \pmod{(\hbar)}$ and $b = \tilde{b} \pmod{(\hbar)}$. The categorical analog to a Poisson structure on a commutative algebra is an *infinitesimal braiding* on a symmetric monoidal \mathbb{K} -linear category. For a \mathbb{K} -linear monoidal category (\mathcal{C}, \otimes) with symmetry σ , an infinitesimal braiding on \mathcal{C} is a natural transformation

$$t_{X,Y} : X \otimes Y \rightarrow X \otimes Y, \quad X, Y \in \mathcal{C}$$

satisfying the symmetry condition $t_{Y,X} = \sigma_{X,Y} \circ t_{X,Y} \circ \sigma_{Y,X}$, such that $\beta = \sigma \circ (1 + \epsilon t)$ is a braiding in the $\mathbb{K}[\epsilon]/(\epsilon^2)$ -linear category $\mathcal{C}[\epsilon]$, which has the same objects as \mathcal{C} and whose morphisms spaces are defined by extension of scalars:

$$\text{Map}_{\mathcal{C}[\epsilon]}(X, Y) = \text{Map}_{\mathcal{C}}(X, Y) \otimes_{\mathbb{K}} \mathbb{K}[\epsilon]/(\epsilon^2) .$$

For us, the underlying symmetric monoidal category will be $U(\mathfrak{g})\text{-Mod}$ and $t \in (\text{Sym}^2 \mathfrak{g})^{\mathfrak{g}}$ is a symmetric \mathfrak{g} -invariant tensor. Then, $U(\mathfrak{g})\text{-Mod}$ is infinitesimally braided via

$$t_{X,Y}(x \otimes y) = t^{ij} e_i \triangleright x \otimes e_j \triangleright y, \quad x \in X, y \in Y ,$$

in a basis $(e_i)_{i \in I}$ of \mathfrak{g} .

Naturally, the question arises if one can deformation-quantize any infinitesimally braided category into a braided $\mathbb{K}[[\hbar]]$ -linear category. The answer is affirmative [Car93]. Namely, using Drinfeld's associator [Dri90], it has been shown in *loc. cit.* that any infinitesimally braided category (\mathcal{C}, t) is the semi-classical limit of a braided monoidal

1. Background

$\mathbb{K}[[\hbar]]$ -linear category $\mathcal{C}[[\hbar]]$ with the same tensor product, associativity constraint coming from the Drinfeld associator Φ and braiding $\beta = \sigma \circ e^{\hbar t/2}$.

For the example at hand, a quantization of $(U(\mathfrak{g})\text{-Mod}, t)$ is given by the Drinfeld category $U(\mathfrak{g})^\Phi\text{-Mod}[[\hbar]]$. In this thesis, instead of working with the Drinfeld category we shall work with categories coming from the representation theory of Drinfeld–Jimbo algebras. Equivalence of these two categories is due to Drinfeld:

Theorem 1.3.15. *[Dri89b, Dri89a] There exists a balanced braided tensor equivalence between the Drinfeld category $U(\mathfrak{g})^\Phi\text{-Mod}[[\hbar]]$ and the category $\text{Rep}_\hbar(G)$ of topologically free $U_\hbar(\mathfrak{g})$ -modules of finite rank.*

The category $\text{Rep}_\hbar(G)$ is a formal deformation of $\text{Rep}(G)$ as a braided monoidal category. Its semi-classical limit

$$\text{Rep}_\epsilon(G) \cong \text{Rep}_\hbar(G) \otimes_{\mathbb{K}[[\hbar]]} \mathbb{K}[\epsilon]/(\epsilon)^2$$

is a $\mathbb{K}_\epsilon = \mathbb{K}[\epsilon]/(\epsilon^2)$ -linear braided category of modules over $U_\epsilon(\mathfrak{g})$, where $U_\epsilon(\mathfrak{g}) \cong U(\mathfrak{g}) \otimes \mathbb{K}_\epsilon$ as \mathbb{K}_ϵ -modules. The braiding in $\text{Rep}_\epsilon(G)$ comes from the classical r-matrix r :

$$\beta_{X,Y}(x \otimes y) = \tau \circ (x \otimes y + \epsilon r^{ij} e_i \triangleright x \otimes e_j \triangleright y) \quad .$$

This is a natural isomorphism in $\text{Rep}_\epsilon(G)$ due to:

$$\Delta_\epsilon^{\text{op}}(-) = (1 - \epsilon r) \Delta_\epsilon(-) (1 + \epsilon r) \quad ,$$

where Δ_ϵ denotes the infinitesimally deformed coproduct. The category $\text{Rep}_\epsilon(G)$ should be understood as the categorical analog of a first order deformation of a commutative algebra.

“Factorization homology commutes with quantization” Assume we are given local (categorical) quantum observables $\text{Obs}_\hbar^{\text{loc}}$, by which we mean a $\mathbb{C}[[\hbar]]$ -linear braided category such that its classical limit $\text{Obs}_\hbar^{\text{loc}}/(\hbar) \cong \text{Obs}_{\text{cl}}^{\text{loc}}$ is symmetric monoidal. Following the ideas of Ben-Zvi–Brochier–Jordan [BZBJ18a], we may glue the local quantizations $\text{Obs}_\hbar^{\text{loc}}$ via factorization homology to obtain global quantum observables living on a surface Σ :

$$\text{Obs}_\hbar(\Sigma) = \int_\Sigma \text{Obs}_\hbar^{\text{loc}} \in (\mathbb{C}[[\hbar]]\text{-Mod})\text{-Cat} \quad .$$

Example 1.3.16. An example of a local quantum observable is the category $\text{Rep}_\hbar(G)$. We call its factorization homology $\int_\Sigma \text{Rep}_\hbar(G)$ the *quantum character stack* of Σ . This category was extensively studied by Ben-Zvi–Brochier–Jordan in the presentable, \mathbb{K} -linear setting [BZBJ18a]. △

Let $\text{Obs}_{\text{cl},\epsilon}^{\text{loc}}$ be the semi-classical limit of $\text{Obs}_\hbar^{\text{loc}}$. This is a braided \mathbb{C}_ϵ -linear category such that $\text{Obs}_{\text{cl},\epsilon}^{\text{loc}}/(\epsilon) \cong \text{Obs}_{\text{cl}}^{\text{loc}}$ is symmetric monoidal. As before, we may define the corresponding global observables $\text{Obs}_{\text{cl},\epsilon}(\Sigma)$ via factorization homology.

In an ongoing collaboration with Eilind Karlsson, Lukas Müller and Jan Pulmann [KKMP] we will show that given a local quantization $\text{Obs}_\hbar^{\text{loc}} \rightsquigarrow \text{Obs}_{\text{cl},\epsilon}^{\text{loc}}$, the factorization homology $\text{Obs}_\hbar(\Sigma)$ quantizes $\text{Obs}_{\text{cl},\epsilon}(\Sigma)$. To that end, we introduce bicategories $BD_0\text{-Cat}$ and $P_0\text{-Cat}$ of categorical quantum- and (semi-)classical observables, respectively. Roughly, objects in these bicategories are pointed $\mathbb{C}[[\hbar]]$ -, respectively \mathbb{C}_ϵ -enriched categories, together with the structure of a symmetric monoidal category on their classical limit $\hbar \rightarrow 0$, respectively $\epsilon \rightarrow 0$. Similarly, the *local* quantum and (semi-)classical observables live in bicategories $\mathbf{E}_2(BD_0\text{-Cat}) \cong BD_2\text{-Cat}$ and $\mathbf{E}_2(P_0\text{-Cat}) \cong P_2\text{-Cat}$, respectively. We will then show the following.

1. Background

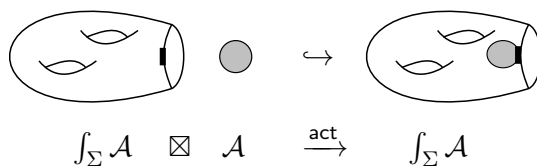

Figure 1.6.: Disk embedding inducing \mathcal{A} -module structure on $\int_{\Sigma} \mathcal{A}$.

Claim 1.3.17. [KKMP] *There exists a ‘classical limit functor’ $BD_i\text{-Cat} \rightarrow P_i\text{-Cat}$, given by $- \otimes_{\mathbb{C}[[\hbar]]} \mathbb{C}_{\epsilon}$, which is such that*

$$\text{Obs}_{\text{cl},\epsilon}(\Sigma) \cong \text{Obs}_{\hbar}(\Sigma) \otimes_{\mathbb{C}[[\hbar]]} \mathbb{C}_{\epsilon} .$$

That is, the classical limit functor commutes with factorization homology.

In this thesis we will follow a slightly different strategy, namely we will characterize the categories $\text{Obs}_{\hbar}(\Sigma)$ computed by factorization homology in terms of explicit algebraic data, as is explained in the next section. This allows for instance to compare $\text{Obs}_{\hbar}(\Sigma)$ to previously constructed quantizations, or to show by means of a direct computation that $\text{Obs}_{\hbar}(\Sigma)$ provides a quantization of a given classical Poisson algebra of observables.

Internal endomorphism algebras In order to extract explicit algebraic data from factorization homology, we will use the following observation due to Ben-Zvi–Brochier–Jordan: given local coefficients \mathcal{A} , the categories we are interested in are the factorization homologies $\int_{\Sigma} \mathcal{A}$ for surfaces Σ with boundary. As illustrated in Figure 1.6, embedding a disk along a marked interval in the boundary $\partial\Sigma$ turns $\int_{\Sigma} \mathcal{A}$ into a module category over $\int_{\mathbb{D}} \mathcal{A} \cong \mathcal{A}$. The \mathcal{A} -module structure then allows to describe the categories $\int_{\Sigma} \mathcal{A}$ internal to \mathcal{A} , as we will explain in the following.

We have seen that factorization homology is pointed via the canonical embedding $\emptyset \hookrightarrow \Sigma$. We denote the corresponding distinguished object by $\mathcal{O}_{\Sigma} \in \int_{\Sigma} \mathcal{A}$. Acting on the distinguished object gives a colimit preserving functor

$$\text{act}_{\mathcal{O}_{\Sigma}} : \mathcal{A} \longrightarrow \int_{\Sigma} \mathcal{A} .$$

In the presentable setting it is guaranteed that this functor has a right adjoint $\text{act}_{\mathcal{O}_{\Sigma}}^R$. If we assume that \mathcal{A} is rigid, the adjunction data defines a canonical algebra in \mathcal{A} ; the internal endomorphism algebra

$$\underline{\text{End}}_{\mathcal{A}}(\mathcal{O}_{\Sigma}) = \text{act}_{\mathcal{O}_{\Sigma}}^R(\text{act}_{\mathcal{O}_{\Sigma}}(1_{\mathcal{A}})) .$$

As an instructive example, we will now compute the internal endomorphism algebra for the case of the annulus $\Sigma = \mathbb{A}\text{nn}$ and we will see that we recover a quantization of the FR-Poisson algebra from § 1.1.2. Examples for more general surfaces will be presented in Chapters 2 and 3 of the thesis. The case of punctured surfaces in the \mathbb{K} -linear setting is content of [BZBJ18a, Section 5].

Let $\widehat{\mathcal{C}} \in \mathcal{V}\text{-Pres}$ be the free cocompletion of a small \mathcal{V} -enriched balanced braided category \mathcal{C} (we refer to A.2.2 for background on free cocompletions). To compute factorization homology on the annulus we make use of excision:

$$\int_{\text{Ann}} \widehat{\mathcal{C}} \cong \widehat{\mathcal{C}} \boxtimes_{\widehat{\mathcal{C}} \boxtimes \widehat{\mathcal{C}}} \widehat{\mathcal{C}} .$$

The relative tensor product is computed as the colimit of the truncated 2-sided bar construction (1.17) in $\mathcal{V}\text{-Pres}$.

1. Background

Proposition 1.3.18. *We have*

$$\underline{\text{End}}_{\widehat{\mathcal{C}}}(\mathcal{O}_{\text{Ann}}) \cong TT^R(1_{\widehat{\mathcal{C}}}) \cong \int^{c \in \mathcal{C}} c^\vee \otimes c \ ,$$

as algebras in $\widehat{\mathcal{C}}$.⁶

Proof. In Propositions A.2.14 and A.2.15 of the appendix we show that the right adjoint to the tensor product functor $T: \widehat{\mathcal{C}} \boxtimes \widehat{\mathcal{C}} \rightarrow \widehat{\mathcal{C}}$ is monadic and $\widehat{\mathcal{C}} \boxtimes \widehat{\mathcal{C}}$ -linear. Thus, there is an equivalence

$$\widehat{\mathcal{C}} \cong T^R(1_{\widehat{\mathcal{C}}})\text{-Mod}_{\widehat{\mathcal{C}} \boxtimes \widehat{\mathcal{C}}}$$

as right $(\widehat{\mathcal{C}} \boxtimes \widehat{\mathcal{C}})$ -module categories. Together with the fact that the excision property is compatible with the pointing, that is, $\mathcal{O}_{\text{Ann}} \cong \mathcal{O}_{\mathbb{D}} \boxtimes_{\widehat{\mathcal{C}} \boxtimes \widehat{\mathcal{C}}} \mathcal{O}_{\mathbb{D}}$, we find that the action functor induced by embedding a disk along a marked interval in ∂Ann may be identified with

$$\text{act}_{\mathcal{O}_{\text{Ann}}}(a) \cong a \boxtimes T^R(1_{\widehat{\mathcal{C}}})$$

Its right adjoint is

$$\text{act}_{\mathcal{O}_{\text{Ann}}}^R(a \boxtimes (b_1 \boxtimes b_2)) \cong a \triangleleft (b_1 \boxtimes b_2) = a \otimes T(b_1 \boxtimes b_2) \ .$$

□

Let's now consider the case of the G -character variety for the annulus. To that end, let $\widehat{\text{Rep}}_h(G)$ be the free cocompletion of the category of topologically free $U_h(\mathfrak{g})$ -modules of finite rank. By Proposition A.2.11, $\widehat{\text{Rep}}_h(G)$ is a locally presentable category enriched in complete $\mathbb{C}[[\hbar]]$ -modules. By the preceding discussion and the representation theory of the topological quantum group (§ 1.2.1) we find that the internal endomorphism algebra of the pointing $\mathcal{O}_{\text{Ann}} \in \int_{\text{Ann}} \widehat{\text{Rep}}_h(G)$ is

$$\begin{aligned} \underline{\text{End}}_{\widehat{\text{Rep}}_h(G)}(\mathcal{O}_{\text{Ann}}) &\cong \bigoplus_{\lambda \in \mathbf{P}^+} \widetilde{V}_\lambda^\vee \otimes \widetilde{V}_\lambda \\ &\cong \mathcal{O}_h(G) \ . \end{aligned}$$

In the above, $\mathcal{O}_h(G)$ is understood as its image under the restricted Yoneda embedding of the category of topologically free and locally-finite $U_h(\mathfrak{g})$ -modules⁷ into $\widehat{\text{Rep}}_h(G)$. We have that $\mathcal{O}_h(G) \cong \mathcal{O}(G)[[\hbar]]$ as $\mathbb{C}[[\hbar]]$ -modules. The algebra $\mathcal{O}_h(G)$ is well-known, it appeared for example in [DM03] under the name of *reflection equation dual* to the quantum group $U_h(\mathfrak{g})$.

Taking the semi-classical limit locally, i.e. $\widehat{\text{Rep}}_h(G) \rightsquigarrow \text{Rep}_\epsilon(G)$, we get a first-order deformation of the commutative algebra $\mathcal{O}(G)$:

$$\underline{\text{End}}_{\widehat{\text{Rep}}_\epsilon(G)}(\mathcal{O}_{\text{Ann}}) \cong \mathcal{O}_\epsilon(G)$$

where $\mathcal{O}_\epsilon(G) \cong \mathcal{O}(G)[\epsilon]/(\epsilon^2)$ as \mathbb{K}_ϵ -modules with multiplication m_ϵ satisfying

$$m_\epsilon - m_\epsilon^{\text{op}} = \{-, -\}_{\text{STS}} \ .$$

The bracket on the right is the STS-Poisson bracket on the representation variety $\text{Rep}_G(\text{Ann})$. But $(\mathcal{O}_\epsilon(G), m_\epsilon)$ is precisely the semi-classical limit of the internal endomorphism algebra of $\int_{\text{Ann}} \widehat{\text{Rep}}_h(G)$. This observation captures the idea that “factorization homology commutes with quantization” on the level of algebras.

⁶See Remark A.2.13 of the appendix for more details on the coend algebra $TT^R(1)$.

⁷We say that a topologically free module $W[[\hbar]]$ is locally-finite if W is so.

1. Background

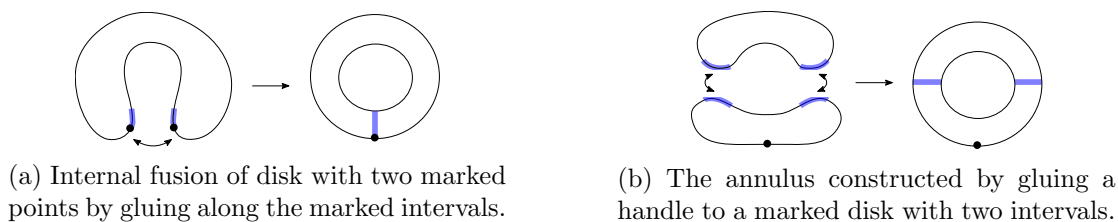

Figure 1.7.

Combinatorial Poisson structures and their categorical quantization Recall from Remark 1.1.15 that the Poisson G -space (G, Π_{STS}) was obtained by (internal) fusion from the Poisson $G \times G$ -space (G, Π_G) . Geometrically, for a disk with two marked points $\mathbb{D}_{\bullet, \bullet}$ in its boundary, internal fusion can be understood as the result of a self-gluing of the disk along two segments containing the marked points as illustrated in Figure 1.7a. In factorization homology, this gluing procedure is paralleled by excision: as pictured in Figure 1.7b, the marked annulus Ann_{\bullet} is obtained from a disk with two marked boundary intervals and a distinguished marked point by gluing a handle along the marked intervals. In this section we have seen that using excision in this way we indeed quantize the Poisson variety (G, Π_{STS}) . A similar observation can be made for more general surfaces with boundary. Namely, upon picking a combinatorial presentation of the surface Σ , excision allows to extract an explicit deformation quantization from $\int_{\Sigma} \text{Rep}_{\hbar}(G)$ of the Poisson structure on $\text{Char}_G(\Sigma)$ defined according to the fusion rules dictated by the combinatorial presentation.

1.3.4. Monadic reconstruction for abelian module categories

In this section we give some more details on monadic reconstruction for the special case of abelian module categories.

Applying monadic reconstruction techniques to module categories was first done for fusion categories in the work of Ostrik [Ost03], and later in the setting of finite abelian categories in [DSPS13]. Here, we will recall its further generalization to abelian categories in $\text{Pres}_{\mathbb{K}}$, as developed in [BZBJ18a, Section 4].

Given a tensor category $\mathcal{A} \in \text{Pres}_{\mathbb{K}}$ and a right \mathcal{A} -module category $\mathcal{M} \in \text{Pres}_{\mathbb{K}}$ with cocontinuous action functor

$$\text{act}: \mathcal{M} \boxtimes \mathcal{A} \longrightarrow \mathcal{M}, \quad \text{act}(m \boxtimes a) = m \triangleleft a,$$

define for every object $m \in \mathcal{M}$ a functor $\text{act}_m: \mathcal{A} \rightarrow \mathcal{M}$ by acting on the distinguished object; $\text{act}_m(a) = m \triangleleft a$. Since everything takes place in $\text{Pres}_{\mathbb{K}}$, the functor act_m has a right adjoint act_m^R . For objects $m, n \in \mathcal{M}$, define the internal homomorphisms

$$\underline{\text{Hom}}_{\mathcal{A}}(m, n) = \text{act}_m^R(n) \in \mathcal{A}$$

from m to n in \mathcal{A} . As in the previous section, the internal endomorphism algebra of m is then defined to be the algebra

$$\underline{\text{End}}_{\mathcal{A}}(m) = \underline{\text{Hom}}_{\mathcal{A}}(m, m) = \text{act}_m^R(\text{act}_m(1_{\mathcal{A}}))$$

internal to \mathcal{A} .

For each $m \in \mathcal{M}$, there is a functor

$$\widetilde{\text{act}}_m^R: \mathcal{M} \longrightarrow (\text{act}_m^R \circ \text{act}_m)\text{-Mod}_{\mathcal{A}} \quad (1.20)$$

1. Background

sending an object $n \in \mathcal{M}$ to the internal homomorphisms $\underline{\mathrm{Hom}}_{\mathcal{A}}(m, n)$ with canonical action $\mathrm{act}_m^R \circ \mathrm{act}_m \circ \mathrm{act}_m^R(n) \rightarrow \mathrm{act}_m^R(n)$ induced by the counit of the adjunction $\mathrm{act}_m \dashv \mathrm{act}_m^R$. The monadicity theorem, stated for the presentable \mathbb{K} -linear setting in Theorem 1.3.20 below, then tells us when the functor (1.20) is an equivalence. We will use the following terminology.

Definition 1.3.19. *An object $m \in \mathcal{M}$ is called*

- *an \mathcal{A} -generator if act_m^R is conservative,*
- *\mathcal{A} -projective if act_m^R is colimit-preserving,*
- *an \mathcal{A} -progenerator if it is both \mathcal{A} -projective and an \mathcal{A} -generator.*

The following is an application of Beck's monadicity theorem for module categories in $\mathrm{Pres}_{\mathbb{K}}$.

Theorem 1.3.20 ([BZBJ18a, Theorem 4.6]). *Let $\mathcal{A} \in \mathrm{Pres}_{\mathbb{K}}$ be a tensor category and $\mathcal{M} \in \mathrm{Pres}_{\mathbb{K}}$ an \mathcal{A} -module category. Assume that \mathcal{A} is rigid. Let $m \in \mathcal{M}$ be an \mathcal{A} -progenerator. Then, the functor*

$$\widetilde{\mathrm{act}}_m^R: \mathcal{M} \xrightarrow{\cong} \underline{\mathrm{End}}_{\mathcal{A}}(m)\text{-Mod}_{\mathcal{A}} \ , \quad (1.21)$$

is an equivalence of \mathcal{A} -module categories, where \mathcal{A} acts on the right by the tensor product.

Remark 1.3.21. *The rigidity assumption in the above theorem guarantees that the composition $\mathrm{act}_m^R \circ \mathrm{act}_m$ is again an \mathcal{A} -module functor, and as a consequence*

$$\mathrm{act}_m^R \circ \mathrm{act}_m \cong \mathrm{act}_m^R(\mathrm{act}_m(1_{\mathcal{A}})) \otimes (-) = \underline{\mathrm{End}}_{\mathcal{A}}(m) \otimes (-) \ ,$$

leading to the result as stated in (1.21).

When computing categorical factorization homology for a surface, we will make extensive use of \boxtimes -excision. In particular, this means that we wish to apply monadic reconstruction to relative tensor products $\mathcal{M} \boxtimes_{\mathcal{A}} \mathcal{N}$ of module categories. The following special case will be of particular interest for us. Assume that the \mathcal{A} -module structure on \mathcal{N} comes from a tensor functor $F: \mathcal{A} \rightarrow \mathcal{N}$ and assume $1_{\mathcal{N}}$ is a progenerator for the \mathcal{A} -module structure on \mathcal{N} induced by F . When in this setting, one has the following base-change formula for abelian categories in $\mathrm{Pres}_{\mathbb{K}}$:

Theorem 1.3.22 ([BZBJ18a, Theorem 4.12]). *Let $\mathcal{A}, \mathcal{M}, \mathcal{N} \in \mathrm{Pres}_{\mathbb{K}}$ be abelian categories. Assume that \mathcal{A} is rigid, \mathcal{M} is a right \mathcal{A} -module category with progenerator m and that $F: \mathcal{A} \rightarrow \mathcal{N}$ is a tensor functor such that $1_{\mathcal{N}}$ is a progenerator for the induced left \mathcal{A} -module structure. Then, there is an equivalence of \mathcal{N} -module categories:*

$$\mathcal{M} \boxtimes_{\mathcal{A}} \mathcal{N} \cong F(\underline{\mathrm{End}}_{\mathcal{A}}(m))\text{-mod}_{\mathcal{N}} \ .$$

The following is a slight modification of the above theorem. Again, all categories are assumed to be abelian.

Theorem 1.3.23. *Let $\mathcal{A} \in \mathrm{Pres}_{\mathbb{K}}$ be a rigid tensor category and let $\mathcal{M}, \mathcal{N} \in \mathrm{Pres}_{\mathbb{K}}$ be right and left \mathcal{A} -module categories. Assume that \mathcal{M} is dualizable as an object in $\mathrm{Pres}_{\mathbb{K}}$, and that $m \in \mathcal{M}$ is an \mathcal{A} -progenerator. Then, we have*

$$\mathcal{M} \boxtimes_{\mathcal{A}} \mathcal{N} \cong \underline{\mathrm{End}}_{\mathcal{A}}(m)\text{-Mod}_{\mathcal{N}} \ ,$$

where one uses the \mathcal{A} -action on \mathcal{N} to define the category of $\underline{\mathrm{End}}_{\mathcal{A}}(m)$ -modules in \mathcal{N} .

1. Background

Proof. Since $m \in \mathcal{M}$ is an \mathcal{A} -progenerator, we have that \mathcal{M} is \mathcal{A} -dualizable with dual $\mathcal{M}^\vee = \text{Mod}_{\mathcal{A}\text{-}\underline{\text{End}}(m)}$ [BJS21, Proposition 5.8], and we have

$$\mathcal{M} \cong \text{Hom}_{\mathcal{A}}(\mathcal{M}^\vee, \mathcal{A}), \quad m' \mapsto (-) \otimes_{\underline{\text{End}}(m)} \underline{\text{Hom}}(m, m')$$

as right \mathcal{A} -module categories. By rigidity we have that \mathcal{A} is dualizable over its enveloping algebra $\mathcal{A}^{\text{op}} \boxtimes \mathcal{A}$ and since \mathcal{M} is dualizable as an object in $\text{Pres}_{\mathbb{K}}$ we can apply [BJS21, Proposition 5.3] to get an equivalence

$$\text{Hom}_{\mathcal{A}}(\mathcal{M}^\vee, \mathcal{A}) \boxtimes_{\mathcal{A}} \mathcal{N} \cong \text{Hom}_{\mathcal{A}}(\mathcal{M}^\vee, \mathcal{N}), \quad F(-) \boxtimes n \mapsto F(-) \triangleright n .$$

Composition with evaluation at $\underline{\text{End}}(m) \in \mathcal{M}^\vee$, we get a functor $\mathcal{M} \boxtimes_{\mathcal{A}} \mathcal{N} \rightarrow \mathcal{N}$ admitting a left adjoint. In more details we have:

$$\begin{array}{ccc} \mathcal{M} \boxtimes_{\mathcal{A}} \mathcal{N} & \xrightarrow{G^R} & \mathcal{N} \\ m' \boxtimes n \mapsto \underline{\text{Hom}}(m, m') \triangleright n & & n \mapsto m \boxtimes n \end{array} \quad \mathcal{N} \xrightarrow{G^L} \mathcal{M} \boxtimes_{\mathcal{A}} \mathcal{N}$$

where we used that G^R fits into the following commutative diagram

$$\begin{array}{ccc} \mathcal{M} \boxtimes_{\mathcal{A}} \mathcal{N} & \xrightarrow{G^R} & \mathcal{N} \\ \cong \downarrow & & \uparrow \text{ev}_{\underline{\text{End}}(m)} \\ \text{Hom}_{\mathcal{A}}(\mathcal{M}^\vee, \mathcal{A}) \boxtimes_{\mathcal{A}} \mathcal{N} & \xrightarrow{\cong} & \text{Hom}_{\mathcal{A}}(\mathcal{M}^\vee, \mathcal{N}) \end{array}$$

The right adjoint G^R is colimit preserving and conservative. The latter assertion follows exactly as in the proof of [BZBJ18a, Theorem 4.12], namely from the fact that if an \mathcal{A} -module functor F evaluates to zero at $\underline{\text{End}}(m)$ implies that F is zero. But for abelian categories this implies that the evaluation functor is conservative. Thus, by Beck's monadicity theorem, we find $\mathcal{M} \boxtimes_{\mathcal{A}} \mathcal{N} \cong G^R \circ G^L\text{-Mod}_{\mathcal{N}} \cong \underline{\text{End}}_{\mathcal{A}}(m)\text{-Mod}_{\mathcal{N}}$. \square

Remark 1.3.24. *In Theorem 1.3.23, the \mathcal{A} -module category \mathcal{M} is assumed to be dualizable in $\text{Pres}_{\mathbb{K}}$. Typical examples of dualizable locally presentable categories are the presheaf categories $\hat{\mathcal{C}} = [\mathcal{C}^{\text{op}}, \text{Vect}_{\mathbb{K}}]$, that is, the free cocompletion of a small \mathbb{K} -linear category \mathcal{C} [BCJF15, Lemma 3.5]. It is shown in [Kel05, Theorem 5.26], that if a cocomplete category \mathcal{D} has a small set \mathcal{D}^{cp} of compact projective objects⁸ constituting a strong generator, then $\mathcal{D} \cong \widehat{\mathcal{D}^{\text{cp}}}$, and \mathcal{D} is dualizable.*

Another example is the following. Assume that $\mathcal{D} \in \text{Pres}_{\mathbb{K}}$ has a compact projective strong generator \mathcal{D}^{cp} . Let $T: \mathcal{D} \rightarrow \mathcal{D}$ be a monad and assume that T preserves colimits. Then, the forgetful functor $U: T\text{-Mod}_{\mathcal{D}} \rightarrow \mathcal{D}$ is cocontinuous and thus $\text{free}_T(x)$ for $x \in \mathcal{D}^{\text{cp}}$ is compact projective. It is also a strong generator since U is conservative and thus $T\text{-Mod}_{\mathcal{D}}$ is dualizable in $\text{Pres}_{\mathbb{K}}$.

⁸An object $c \in \mathcal{C}$ is compact projective if $\text{Map}_{\mathcal{C}}(c, -): \mathcal{C} \rightarrow \text{Vect}_{\mathbb{K}}$ preserves all colimits.

2. Twisted character varieties

This chapter is based on joint work with Lukas Müller [KM23].

In this chapter we extend the work on categorical factorization homology by Ben-Zvi–Brochier–Jordan [BZBJ18a, BZBJ18b] to oriented surfaces decorated with principal bundles with finite structure group D . In the oriented D -decorated setting, the coefficients \mathcal{A} for computing factorization homology are balanced braided tensor categories with a D -action via balanced braided automorphisms. For every oriented 2-dimensional manifold Σ with D -bundle decoration $\varphi: \Sigma \rightarrow BD$, factorization homology assigns a linear category

$$\int_{(\Sigma, \varphi)} \mathcal{A}$$

in a functorial way. For applications in mathematical physics, we will examine the example of $\mathcal{A} = \text{Rep}_q(G)$, where $\text{Rep}_q(G)$ is the category of integrable representations of the quantum group $U_q(\mathfrak{g})$ associated to a semi-simple group G , which admits a natural action of the group of outer automorphisms $\text{Out}(G)$. We will use these coefficients to construct a functorial quantization of the moduli space of flat $\text{Out}(G)$ -twisted bundles. These moduli spaces arise naturally when studying finite symmetries in gauge theory.

Symmetries for field theories can be understood as transformations of the space of fields preserving the classical action functional. We are interested in symmetries for gauge theories where the space of fields is described by means of connections on principal G -bundles. Explicitly, for an outer automorphism $\kappa: G \rightarrow G$ of the structure group, the symmetry lifts to the gauge fields by forming the associated G -bundle along the group homomorphism κ . In [MSS22], these symmetries were studied in the context of 2-dimensional Yang–Mills theory. Here, we will study $\text{Out}(G)$ -symmetries for the moduli space of flat G -bundles via factorization homology. On the level of the local coefficients, the symmetry is incorporated through the $\text{Out}(G)$ -action on the representation category of G via pullbacks. We will show that this action extends to the representation category of the quantum group. Hence, factorization homology with coefficients in $\text{Rep}_q(G)$ will allow us to study $\text{Out}(G)$ -symmetries for the corresponding quantum field theory.

Coupling of a gauge theory to background gauge fields may be realized by incorporating the symmetries as defects into the field theory. In [MSS22] it is shown that the partition function for Yang–Mills theory in the presence of an $\text{Out}(G)$ -defect network on a closed oriented surface Σ can be computed as a path integral over the space of so-called $\text{Out}(G)$ -twisted bundles with connections. The latter may be locally described by transition functions taking values in $G \rtimes \text{Out}(G)$, where the $\text{Out}(G)$ -bundle is fixed. In the topological setting, the moduli space of flat $\text{Out}(G)$ -twisted bundles was studied in [Mei17, Zer21] and in particular it has been shown there that it carries a canonical Atiyah–Bott like symplectic structure. Here, we realize the moduli space of flat twisted bundles as a lattice gauge theory. We will construct a Poisson structure on the moduli space in a combinatorial fashion à la Fock–Rosly. The value of factorization homology on a surface decorated with $\text{Out}(G)$ -bundles describes the coupling of the (quantum)

2. Twisted character varieties

field theory to non-trivial $\text{Out}(G)$ -background fields and yields a functorial quantization of the moduli space of flat twisted bundles.

Lastly, we note that factorization homology on surfaces with principal bundles examined in this chapter is a special case of equivariant factorization homology for global quotient orbifolds as introduced in [Wee18a], namely the case of free actions. Moreover, when we consider surfaces with marked points, the local coefficients realizing the point defects in the $D = \mathbb{Z}_2$ -decorated setting are closely related to so-called \mathbb{Z}_2 -braided pairs [Wee18b], which are local coefficients for \mathbb{Z}_2 -orbifold surfaces with isolated singularities. Prominent examples of \mathbb{Z}_2 -braided pairs come from the representation theory of quantum symmetric pairs. The methods developed in this chapter thus provide a step in the direction of computing the quantum character varieties of orbifold surfaces with isolated singularities via factorization homology on surfaces with principal bundles and point defects.

Outline Throughout, \mathbb{K} denotes a field of characteristic zero, usually $\mathbb{K} = \mathbb{C}$. Unless otherwise stated, G is a semi-simple algebraic group over \mathbb{C} .

Let Σ be a surface with a fixed $\text{Out}(G)$ -bundle $\varphi: \Sigma \rightarrow B\text{Out}(G)$. In § 2.1 we define the classical moduli space $\text{Char}_\varphi(\Sigma, G)$ of equivalence classes of φ -twisted G -representations of the fundamental group of Σ . We show that the twisted representation variety admits a Poisson structure, defined in terms of an $\text{Out}(G)$ -invariant classical r-matrix and a combinatorial presentation of the surface, which moreover descends to the quotient by the twisted conjugation action. The aim of this chapter is to work towards a functorial quantization of this Poisson variety.

In § 2.2 we review categorical factorization homology on 2-manifolds equipped with an $\text{SO}(2) \times D$ tangential structure, following [AF15]. We will see that the local categorical data for factorization homology on D -decorated surfaces is classified by balanced braided tensor categories with a D -action ϑ . As our main example, we will describe an action of Dynkin diagram automorphisms on the representation category $\text{Rep}_q(G)$ of a quantum group. We will also explain how D -twisted module categories arise from \boxtimes -excision on decorated surfaces. We conclude the section with reconstruction results for balanced braided tensor categories with D -action: for each group element $d \in D$ we obtain an algebra $\mathcal{F}_\mathcal{A}^d = \int^{V \in \text{cmp}(\mathcal{A})} V^\vee \otimes \vartheta(d^{-1}).V$ which is a twisted version of Lyubashenko's coend algebra [Lyu95b].

In § 2.3 we compute factorization homology of a punctured oriented surface Σ with a fixed D -bundle $\varphi: \Sigma \rightarrow BD$. We will use a combinatorial presentation of the surface (Σ, φ) by means of a ciliated ribbon graph Γ with one vertex, whose edges are decorated by group elements $d_1, \dots, d_n \in D$, $n = 2g + r - 1$, describing the bundle φ up to equivalence. This combinatorial description allows one to define an algebra $a_\Gamma^{d_1, \dots, d_n} = \bigotimes_{i=1}^n \mathcal{F}_\mathcal{A}^{d_i, \dots, d_n}$ internal to \mathcal{A} , where each $\mathcal{F}_\mathcal{A}^{d_i}$ is a twisted coend algebra. For a rigid balanced braided abelian category $\mathcal{A} \in \text{Pres}_\mathbb{K}$, we show in Theorem 2.3.2 that there is an equivalence of categories

$$\int_{(\Sigma, \varphi)} \mathcal{A} \cong a_\Gamma^{d_1, \dots, d_n} \text{-Mod}_\mathcal{A}$$

identifying factorization homology with the category of modules over an algebra which can be described in purely combinatorial terms. This result is an extension of [BZBJ18a,

2. Twisted character varieties

Theorem 5.14] to surfaces with D -bundles. We then consider the case of the D -decorated annulus. We will see that the factorization homologies $\int_{(\mathbb{S}^1 \times \mathbb{R}, \varphi)} \mathcal{A}$ for varying decoration φ assemble into a categorical algebra over the little bundles operad defined by Müller–Woiike in [MW20]. Moreover, for each $d \in D$ we identify $\int_{(\mathbb{S}^1 \times \mathbb{R}, \gamma_d)} \mathcal{A}$ with a twisted version of the Drinfeld center of \mathcal{A} .

§ 2.4 contains the main application of this chapter: the quantization of the twisted character variety $\text{Char}_\varphi(\Sigma, G)$ via factorization homology on the surface Σ with $\text{Out}(G)$ -bundle decoration φ and coefficients in $\text{Rep}_q(G)$. We will first show that the category of quasi-coherent sheaves on the classical moduli space can be computed via factorization homology

$$\int_{(\Sigma, \varphi)} \text{Rep}(G) \cong \bigotimes_{i=1}^n \mathcal{O}(G)_{\kappa_i}\text{-Mod}_{\text{Rep}(G)} \cong \text{QCoh}(\mathbf{Char}_\varphi(\Sigma, G)) \quad ,$$

where $\bigotimes_{i=1}^n \mathcal{O}(G)_{\kappa_i}$ is the algebra of functions on the φ -twisted representation variety $\text{Rep}_\varphi(\Sigma, G)$ with the induced φ -twisted action by G . We then proceed to quantize these moduli spaces by locally choosing coefficients in the representation category of the corresponding quantum group $\text{Rep}_q(G)$ and subsequently gluing this local data together via factorization homology over the decorated surface (Σ, φ) :

$$\int_{(\Sigma, \varphi)} \text{Rep}_q(G) \cong a_{\Gamma}^{\kappa_1, \dots, \kappa_n}\text{-Mod}_{\text{Rep}_q(G)} \quad .$$

We then show in Theorem 2.4.3 by means of a direct computation that the above provides indeed a quantization of the twisted character variety.

In § 2.5 we discuss the case of closed surfaces with D -bundles, as well as the case of D -decorated surfaces with point defects. For the latter, the categorical data classifying point defects are so-called equivariant braided module categories [KM23, Proposition 3.18]. Representation theoretic examples of point defects in the equivariant setting come from ribbon Hopf algebras equipped with an involution and their coideal subalgebras. Such data is for example provided by quantum symmetric pairs.

2.1. Classical moduli space

Given a fixed $\text{Out}(G)$ -bundle φ on a surface Σ , the *moduli space of flat φ -twisted bundles* on Σ is the space of flat $G \rtimes \text{Out}(G)$ -bundles together with a gauge transformation from the induced $\text{Out}(G)$ -bundle to φ [Mei17, MSS22]. This moduli space may be described by means of twisted character varieties, which we will introduce in what follows.

Throughout $\Sigma = \Sigma_{g,r}$ is a connected oriented surface with at least one boundary component. Let $\Gamma = (E, V)$ be a ciliated ribbon graph model for Σ with one vertex $V = \{v\}$ whose edges are the generators of the fundamental group $\pi_1(\Sigma) = \pi_1(\Sigma, v)$. Moreover, we decorate the surface with a principal $\text{Out}(G)$ -bundle, which we describe by a group homomorphism

$$\begin{aligned} \varphi: \pi_1(\Sigma) &\longrightarrow \text{Out}(G) \\ [\gamma_i] &\longmapsto \varphi([\gamma_i]) = \kappa_i \end{aligned}$$

Definition 2.1.1. *Let $p: G \rtimes \text{Out}(G) \rightarrow \text{Out}(G)$ be the natural projection. The φ -twisted representation variety $\text{Rep}_\varphi(\Sigma, G)$ is the preimage of φ under the map*

$$\text{Rep}(\Sigma, G \rtimes \text{Out}(G)) \xrightarrow{p^*} \text{Rep}(\Sigma, \text{Out}(G)) \quad .$$

2. Twisted character varieties

More explicitly, elements in $\text{Rep}_\varphi(\Sigma, G)$ are maps $\psi: \pi_1(\Sigma) \rightarrow G$, which are such that

$$\psi([\gamma_i] \circ [\gamma_j]) = \psi([\gamma_i])\kappa_i(\psi([\gamma_j])) \quad ,$$

for any pair γ_i, γ_j of loops in $\pi_1(\Sigma)$. There is a natural G -action on the φ -twisted representation variety via twisted conjugation, i.e. the action of an element $g \in G$ is

$$(g \cdot \psi)([\gamma_i]) = g\psi([\gamma_i])\kappa_i(g)^{-1} \quad .$$

Since $\pi_1(\Sigma)$ is a free group on $E = 2g + r - 1$ generators, we get an identification $\text{Rep}_\varphi(\Sigma, G) \cong G^E$. The φ -twisted character variety is then defined to be the quotient

$$\begin{aligned} \text{Char}_\varphi(\Sigma, G) &= \text{Rep}_\varphi(\Sigma, G) / {}^\varphi G \\ &\cong G^E / {}^\varphi G \quad , \end{aligned}$$

where the notation $/ {}^\varphi$ indicates that G acts via twisted conjugation.

Remark 2.1.2.

- *There is a bijective correspondence between elements in the twisted representation variety $\text{Rep}_\varphi(\Sigma, G)$ and elements in the moduli space $\mathcal{M}_\varphi(\Sigma, G)$ of isomorphism classes of flat twisted G -bundles which are trivial over v , which is established via the holonomy map. As in the untwisted case, the group G acts on $\mathcal{M}_\varphi(\Sigma, G)$ by changing the trivialization. The moduli space of flat twisted bundles is the quotient*

$$\mathcal{A}_\varphi(\Sigma, G) = \mathcal{M}_\varphi(\Sigma, G) / {}^\varphi G \quad .$$

- *Let $\kappa \in \text{Out}(G)$ and consider $\kappa' = \text{Ad}_g \circ \kappa$ for some $g \in G$. Right multiplication $G \xrightarrow{R_g} G$ is a map of G -spaces intertwining the κ - and the κ' -twisted conjugation action. Thus, in order to study twisted character varieties it suffices to work with outer automorphisms. The inner automorphisms correspond to gauge transformations.*

We denote the algebra of functions on the twisted character variety by $\mathcal{O}(G^E)_\varphi^G$. This is the algebra of functions on G^E which are invariant under the twisted conjugation action, i.e. functions on the the affine quotient by the G -action. If we consider the stacky quotient instead, we use boldface letters to denote the φ -twisted character stack:

$$\mathbf{Char}_\varphi(\Sigma, G) = [G^E / {}^\varphi G] \quad .$$

We may study character stacks via their categories of quasi-coherent sheaves. In our case, $\text{QCoh}(\mathbf{Char}_\varphi(\Sigma, G))$ is the category of modules over $\mathcal{O}(G^E)_\varphi^G$ in $\text{Rep}(G)$. Later on in § 2.4.1 we will see that one can recover the category of quasi-coherent sheaves on the twisted character stack via factorization homology on the φ -decorated surface Σ .

2.1.1. The twisted Fock–Rosly Poisson structure

In § 1.1.2 we recalled a construction due to Mouquin [Mou17] and Lu–Mouquin [LM17], which reformulates the Poisson structure on the character variety discovered by Fock and Rosly in the framework of Poisson structures defined via Lie bialgebra actions and classical r -matrices. We will pursue the same strategy here to show that twisted character varieties are Poisson.

2. Twisted character varieties

We fix a ribbon graph model Γ for the surface Σ together with a linear ordering \prec on the set \widehat{E} of ends of edges of Γ . We also fix an $\text{Out}(G)$ -invariant classical r -matrix $r \in \mathfrak{g} \otimes \mathfrak{g}$. For example, the r -matrix for the standard Lie bialgebra structure on \mathfrak{g} , i.e. the one quantized by the Drinfeld–Jimbo quantum group, is $\text{Out}(G)$ -invariant (see Proposition 2.2.4).

Recall from § 1.1.2 (Equations (1.7) and (1.8)) the definition of the r -matrix r^Γ for the Lie algebra $r^{\widehat{E}}$. Given the $\text{Out}(G)$ -bundle decoration $\varphi: \pi_1(\Sigma) \rightarrow \text{Out}(G)$, we define an action

$$\begin{aligned} \rho_\varphi^\Gamma: G^{\widehat{E}} \times G^E &\longrightarrow G^E \\ ((h_\alpha)_{\alpha \in \widehat{E}}, (g_\gamma)_{\gamma \in E}) &\longmapsto (h_{t(\gamma)} g_\gamma \kappa_\gamma (h_{s(\gamma)})^{-1})_{\gamma \in E} \end{aligned}$$

where $s(\gamma)$ is the source half-edge of γ and $t(\gamma)$ is the end half-edge. The action induces a Lie algebra homomorphism $(\rho_\varphi^\Gamma)_*: \mathfrak{g}^{\widehat{E}} \rightarrow \mathfrak{X}(G^E)$. The φ -twisted Fock–Rosly 2-tensor in Equation (2.1) below is the image of the r -matrix r^Γ under this pushforward map.

Proposition 2.1.3. *Let $\Gamma \subset \Sigma$ be a skeleton with one vertex v . For a given choice $r = r^{ij} e_i \otimes e_j \in \mathfrak{g} \otimes \mathfrak{g}$ of $\text{Out}(G)$ -invariant classical r -matrix, define the following 2-tensor on $\text{Rep}_\varphi(\Sigma, G)$*

$$\Pi_{FR}^\varphi = \sum_{\alpha \prec \beta} r^{ij} x_i(\alpha) \wedge x_j(\beta) + \frac{1}{2} \sum_{\alpha} r^{ij} x_i(\alpha) \wedge x_j(\alpha) \quad , \quad (2.1)$$

where α and β run over the set of ordered half-edges, and

$$x_i(\alpha) = \begin{cases} e_i^R(\alpha), & \alpha \text{ is end half-edge} \\ -(\kappa_\alpha)_* e_i^L(\alpha), & \alpha \text{ is source half-edge} \end{cases}$$

where $e_i^R(\alpha)$ and $e_i^L(\alpha)$ are right-, respectively left-invariant vector fields on G^E whose action on a function $f \in \mathcal{O}(G^E)$ was described in (1.4), and κ_α is the automorphism corresponding to the edge whose source half-edge is α . Then we have the following:

1. Π_{FR}^φ is a Poisson bivector on $\text{Rep}_\varphi(\Sigma, G)$.
2. $(\text{Rep}_\varphi(\Sigma, G), \Pi_{FR}^\varphi)$ is a Poisson G -space under the φ -twisted conjugation action.
3. The Poisson bracket between G -invariant functions is independent of the chosen ciliated ribbon graph $\Gamma \subset \Sigma$ and only depends on the symmetric part of the r -matrix.

Proof. The 2-tensor field Π_{FR}^φ in (2.1) is the image of the r -matrix r^Γ under the pushforward $(\rho_\varphi^\Gamma)_*$. The symmetric part of r^Γ is $t^\Gamma = \sum_{\alpha \in E} (t^1)_{t(\alpha)} \otimes (t^2)_{t(\alpha)} - (t^1)_{s(\alpha)} \otimes (t^2)_{s(\alpha)}$. Its image under $(\rho_\varphi^\Gamma)_*$ is thus:

$$\sum_{\alpha \in E} t^{R,R} - (\kappa_\alpha)_*(t^{L,L})$$

But by assumption the r -matrix $r = \omega + t$ is invariant under the action of the outer automorphism group. Together with the \mathfrak{g} -invariance of the symmetric part t of the classical r -matrix we thus find that $(\rho_\varphi^\Gamma)_*(r^\Gamma)$ is a bivector. We can now apply Proposition 1.1.14 to conclude that Π_{FR}^φ is a Poisson bivector for which the action of the quasi-triangular Poisson–Lie group G given by $\rho_\varphi^\Gamma \circ \text{diag}$ is Poisson. \square

2. Twisted character varieties

It will be convenient to rewrite the twisted FR-Poisson bivector Π_{FR}^φ in the following form: for an automorphism $\kappa \in \text{Out}(G)$, define the bivector field

$$\Pi_{STS}^\kappa = \omega^{\text{ad}(\kappa), \text{ad}(\kappa)} + t^{R, L(\kappa)} - t^{L(\kappa), R} \quad , \quad (2.2)$$

where the superscripts indicate that the action by left-invariant vector fields is twisted by the automorphism κ , and we used the notation $x^{\text{ad}(\kappa)} = x^R - \kappa_* x^L$ for the vector field generated by the element $x \in \mathfrak{g}$ via the twisted adjoint action $h \mapsto gh\kappa(g^{-1})$ of G on itself. At the identity $\kappa = e$, the bivector field Π_{STS}^e agrees with the STS-Poisson structure on G [STS94]. We then write the twisted FR-Poisson structure as follows

$$\Pi_{FR}^\varphi = \sum_{\alpha \in E} \Pi_{STS}^{\kappa_\alpha} + \sum_{\substack{\alpha < \beta \\ \alpha, \beta \in \{1, \dots, |E|\}}} (\Pi_{\alpha, \beta} - \tau(\Pi_{\alpha, \beta})) \quad ,$$

where $\Pi_{\alpha, \beta}$ is a 2-tensor, acting on the α -component of the first factor and on the β -component of the second factor of $G^E \times G^E$, and is defined by

$$\Pi_{\alpha, \beta} = \begin{cases} -r_{2,1}^{\text{ad}(\kappa_\alpha), \text{ad}(\kappa_\beta)} & , \text{ if } \alpha \text{ and } \beta \text{ are positively unlinked} \\ -r_{2,1}^{\text{ad}(\kappa_\alpha), \text{ad}(\kappa_\beta)} - 2t^{L(\kappa_\alpha), R} & , \text{ if } \alpha \text{ and } \beta \text{ are positively linked} \\ -r_{2,1}^{\text{ad}(\kappa_\alpha), \text{ad}(\kappa_\beta)} - 2t^{L(\kappa_\alpha), R} + 2t^{L(\kappa_\alpha), L(\kappa_\beta)} & , \text{ if } \alpha \text{ and } \beta \text{ are positively nested} \end{cases} \quad (2.3)$$

And for the remaining three cases we have

$$\Pi_{\alpha, \beta} = \begin{cases} r_{1,2}^{\text{ad}(\kappa_\alpha), \text{ad}(\kappa_\beta)} & , \text{ if } \alpha \text{ and } \beta \text{ are negatively unlinked} \\ r_{1,2}^{\text{ad}(\kappa_\alpha), \text{ad}(\kappa_\beta)} + 2t^{R, L(\kappa_\beta)} & , \text{ if } \alpha \text{ and } \beta \text{ are negatively linked} \\ r_{1,2}^{\text{ad}(\kappa_\alpha), \text{ad}(\kappa_\beta)} + 2t^{R, L(\kappa_\beta)} - 2t^{L(\kappa_\alpha), L(\kappa_\beta)} & , \text{ if } \alpha \text{ and } \beta \text{ are negatively nested} \end{cases} \quad (2.4)$$

2.2. Factorization homology on surfaces with principal bundles

Throughout we fix a finite group D . In this section we will explain how one computes categorical factorization homology of a surface Σ decorated with a principal D -bundle $\varphi: \Sigma \rightarrow BD$. We will see that the local categorical input data for factorization homology on a D -decorated surface are braided tensor categories with D -action. In applications to (quantum) physics, one is mostly interested in factorization homology with coefficients coming from the representation theory of (quantum) groups. Our main example for local coefficients will come from an action of the outer automorphism group on the representation category of the quantum group.

Setup We want to compute factorization homology of surfaces with $D \times \text{SO}(2)$ -tangential structure and values in the $(2, 1)$ -category $\text{Pres}_{\mathbb{K}}$ of locally finitely presentable \mathbb{K} -linear categories. Since the target is only 2-categorical, factorization homology with values in $\text{Pres}_{\mathbb{K}}$ will factor through the following $(2, 1)$ -category of D -decorated manifolds:

Definition 2.2.1. Man_2^D is the $(2, 1)$ -category whose

- objects are pairs (Σ, φ) , where Σ is a smooth oriented surface and $\varphi: \Sigma \rightarrow BD$ is a continuous map, i.e. the data of a principal D -bundle on Σ .

2. Twisted character varieties

- 1-morphisms $(\Sigma, \varphi) \xrightarrow{(f, h)} (\Sigma', \varphi')$ are embeddings $f: \Sigma \rightarrow \Sigma'$ together with a homotopy $h: \varphi \Rightarrow f^* \varphi'$.
- 2-morphisms $(f, h) \xrightarrow{(\chi, \gamma)} (f', h')$ are isotopies $\chi: f \rightarrow f'$, together with maps $\gamma: \Sigma \times \Delta^2 \rightarrow BD$ filling

$$\begin{array}{ccc}
 & f'^* \varphi' & \\
 h \nearrow & & \nwarrow \chi^* \varphi' \\
 \varphi & \xrightarrow{h'} & f^* \varphi'
 \end{array}$$

Two such pairs (χ, γ) and (χ', γ') are equivalent if there exists an isotopy of isotopies $\chi \rightarrow \chi'$, i.e. a map $\Omega: \Sigma \times \Delta^2 \rightarrow \Sigma'$ filling the bottom in Diagram (2.5), and a compatible homotopy $\Gamma: \Sigma \times \Delta^3 \rightarrow BD$ filling

$$\begin{array}{ccccc}
 & & \varphi & & \\
 & & \searrow h' & & \\
 & & & & f'^* \varphi' \\
 & h \nearrow & & \nearrow & \\
 & & \varphi & & \\
 & & \searrow h' & & \\
 & & & & f'^* \varphi' \\
 & \chi'^* \varphi' \nearrow & & \nearrow & \\
 f^* \varphi' & & & & \\
 & \searrow \chi^* \varphi' & & \nearrow & \\
 & & f'^* \varphi' & &
 \end{array} \tag{2.5}$$

where the faces are labeled with the various maps which are part of the 1-morphisms.

The category Man_2^D is symmetric monoidal under the disjoint union of manifolds. We denote by $\text{Disk}_2^D \subset \text{Man}_2^D$ the full symmetric monoidal subcategory generated by disks \mathbb{R}^2 with constant maps to the base point $* \in BD$. Note that even though the D -bundles on disks are trivial, there are non-trivial 1-morphisms given by gauge transformations.

We can now define categorical Disk_2^D -algebras analogously to the undecorated case, namely as symmetric monoidal functors $\mathcal{A}: \text{Disk}_2^D \rightarrow \text{Pres}_{\mathbb{K}}$. Factorization homology $\int_{(-)} \mathcal{A}$ with coefficients in the categorical Disk_2^D -algebra \mathcal{A} is then defined as the left Kan extension of the diagram [AF15]:

$$\begin{array}{ccc}
 \text{Disk}_2^D & \xrightarrow{\mathcal{A}} & \text{Pres}_{\mathbb{K}} \\
 \downarrow & \nearrow \int_{(-)} \mathcal{A} & \\
 \text{Man}_2^D & &
 \end{array}$$

2.2.1. Local categorical data

We have seen in § 1.3.2 that the data of a categorical $\text{Disk}_2^{\text{or}}$ -algebra is equivalent to that of a balanced braided tensor category. For the D -decorated case, we intuitively have the following: since D -bundles on a disk can be assumed to be trivial, Disk_2^D -algebras are again balanced braided tensor categories, however the D -bundle decoration adds non-trivial automorphisms on the level of 1-morphisms as sketched in Figure 2.1, inducing a D -action on the balanced braided tensor category. Group actions on categorical $\text{Disk}_2^{\text{or}}$ -algebras are defined as follows:

2. Twisted character varieties

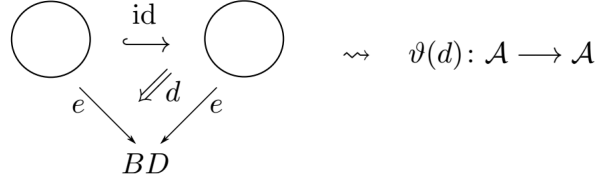

Figure 2.1.: Identity disk embedding in Disk_2^D with homotopy $d: \text{id}^*(*) \rightarrow *$ inducing an automorphism of \mathcal{A} for each $d \in D$, i.e. a D -action on \mathcal{A} .

Definition 2.2.2. Let \mathcal{A} be a balanced braided tensor category. A D -action on \mathcal{A} is a 2-functor

$$\vartheta: * // D \longrightarrow * // \text{Aut}_{bBr}(\mathcal{A})$$

from the category with one object and D as automorphisms to the 2-category with one object, balanced braided automorphisms of \mathcal{A} as 1-morphisms and natural transformations as 2-morphisms. In more details, the action consists of a monoidal equivalences

$$\vartheta(d): \mathcal{A} \longrightarrow \mathcal{A}, \quad \text{for each } d \in D$$

respecting the balancing and the braiding, such that for each composable pair $d_i, d_j \in D$ we have a natural isomorphism $c_{ij}: \vartheta(d_i d_j) \xrightarrow{\cong} \vartheta(d_i) \vartheta(d_j)$ satisfying the usual associativity axiom.

In summary, we have the following concise description of categorical Disk_2^D -algebras:

Proposition 2.2.3. [Wee18a, Proposition 4.6] A categorical Disk_2^D -algebra is a balanced braided tensor category equipped with a D -action.

The main example for us will be the following.

Actions of Dynkin diagram automorphisms and their quantization We assume that G is simply-connected. In this case, the outer automorphism group $\text{Out}(G)$ of G can be identified with the group of Dynkin diagram automorphisms. Concretely, the non-trivial outer automorphism groups are listed in the table below and the corresponding Dynkin diagram automorphisms are displayed in Figure 2.2.

| Type | $A_n, n \geq 2$ | $D_n, n > 4$ | D_4 | E_6 |
|-----------------|-----------------|----------------|-------|----------------|
| $\text{Out}(G)$ | \mathbb{Z}_2 | \mathbb{Z}_2 | S_3 | \mathbb{Z}_2 |

The category $\text{Rep}(G)$ of G -representations is a symmetric monoidal category. Moreover it is rigid and the trivial balancing turns $\text{Rep}(G)$ into a ribbon category. The finite group $\text{Out}(G)$ acts naturally on the category $\text{Rep}(G)$ by pulling back representations:

$$\vartheta(\kappa): \text{Rep}(G) \longrightarrow \text{Rep}(G), \quad V \longmapsto (\kappa^{-1})^*(V) .$$

The goal here is to show that this symmetry extends to the representation category of the corresponding quantum group, see Proposition 2.2.4 below.

We will use the following notation and conventions. Let \mathfrak{g} be a finite-dimensional semi-simple complex Lie algebra \mathfrak{g} with Cartan matrix $(a_{ij})_{1 \leq i, j \leq n}$. We fix a Cartan

2. Twisted character varieties

subalgebra $\mathfrak{h} \subset \mathfrak{g}$ and select a set of simple roots $\Pi = \{\alpha_1, \dots, \alpha_n\}$. We write Λ for the weight lattice and we choose a symmetric bilinear form $(-, -)$ on Λ such that $(\alpha_i, \alpha_j) = a_{ij}$. For the rest of this paragraph we will restrict our attention to Lie algebras with Dynkin diagrams of type A_n ($n \geq 2$), D_n ($n \geq 4$), or E_6 , since these are the only cases for which we have non-trivial Dynkin diagram automorphisms.

The QUEA $U_{\hbar}(\mathfrak{g})$ is the topological Hopf algebra over $\mathbb{C}[[\hbar]]$ with generators $\{H_{\alpha_i}, X_{\alpha_i}^{\pm}\}_{\alpha_i \in \Pi}$, subjected to certain relations, see § 1.2.1 for more details. In order to define positive and negative root vectors, we fix a reduced decomposition $\omega_0 = s_{i_1} s_{i_2} \dots s_{i_N}$ of the longest element ω_0 in the Weyl group of \mathfrak{g} . The positive and negative root vectors are then defined by

$$X_{\beta_r}^{\pm} = T_{i_1} T_{i_2} \dots T_{i_{r-1}} X_{\alpha_{i_r}}^{\pm} ,$$

that is by acting on the generators with elements $T_i \in \mathfrak{B}_{\mathfrak{g}}$ of the braid group associated to \mathfrak{g} . The QUEA $U_{\hbar}(\mathfrak{g})$ is quasi-triangular with universal R-matrix defined by the multiplicative formula

$$\mathcal{R} = \Omega \widehat{\mathcal{R}}, \quad \Omega = \prod_{\alpha_i \in \Pi} e^{\hbar(a_{ij}^{-1} H_{\alpha_i} \otimes H_{\alpha_j})}, \quad \widehat{\mathcal{R}} = \prod_{\beta_r}^{\prec} \widehat{\mathcal{R}}_{\beta_r} ,$$

where the second product is ordered according to the normal ordering \prec defined by the reduced decomposition of ω_0 , and $\widehat{\mathcal{R}}_{\beta_r} = \exp_q((1 - q^{-2})X_{\beta_r}^+ \otimes X_{\beta_r}^-)$ for $q = \exp(\hbar)$. It is shown in [CP95, Corollary 8.3.12] that \mathcal{R} is independent of the chosen reduced decomposition of ω_0 .

We denote by $\text{Rep}_{\hbar}(G)$ the category of topologically free left modules over $U_{\hbar}(\mathfrak{g})$ of finite rank. This tensor category comes with a braiding defined via the universal R-matrix \mathcal{R} of $U_{\hbar}(\mathfrak{g})$.

Proposition 2.2.4. *The braided tensor category $\text{Rep}_{\hbar}(G)$ admits a left action of $\text{Out}(G)$.*

Proof. The outer automorphisms $\text{Out}(G)$ can be identified with the automorphism group $\text{Aut}(\Pi)$ of the Dynkin diagram of \mathfrak{g} . An element $\kappa \in \text{Aut}(\Pi)$ acts on the generators of $U_{\hbar}(\mathfrak{g})$ via

$$H_{\alpha_i} \longmapsto H_{\alpha_{\kappa(i)}}, \quad X_{\alpha_i}^{\pm} \longmapsto X_{\alpha_{\kappa(i)}}^{\pm} .$$

The action respects the relations in Definition 1.2.2 since a Dynkin diagram automorphism preserves the Cartan matrix. We thus get an action ρ of $\text{Out}(G)$ on the tensor category $\text{Rep}_{\hbar}(G)$ defined by pulling back a representation along the inverse automorphism, i.e. $\rho(\kappa)(X) = (\kappa^{-1})^* X$, for any $X \in \text{Rep}_{\hbar}(G)$. It is left to show that the action preserves the braiding. The action of κ on a positive, respectively negative, root vector is

$$\kappa.X_{\beta_r}^{\pm} = T_{\kappa(i_r)} \dots T_{\kappa(i_{r-1})} X_{\alpha_{\kappa(i_r)}}^{\pm} .$$

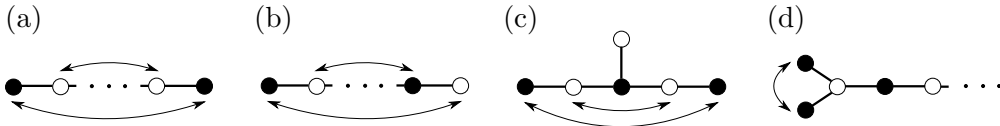

Figure 2.2.: Dynkin diagrams and their automorphisms a) A_n , n even b) A_n , n odd, c) E_6 , d) D_n , $n > 4$. The white nodes represent a commuting set of simple reflections, and similarly for the black nodes.

2. Twisted character varieties

We now make use of the following explicit expressions for ω_0 , details can be found for example in [Hum90, Section 3.19]. First, divide the nodes of the Dynkin diagram into two nonempty disjoint subsets S and S' so that each consists of nodes representing a commuting set of simple reflections. In Figure 2.2, the subsets S and S' are distinguished by their coloring. Let a and b be the products of the simple reflections in S and S' , respectively. For A_n (n odd), D_n ($n \geq 4$) and E_6 we can set $\omega_0 = (ab)^h$, where h is the respective Coxeter number. A Dynkin diagram automorphisms preserve the subsets S and S' , see Figure 2.2, and thus sends a reduced decomposition of the longest Weyl group element ω_0 to another reduced decomposition of ω_0 . For A_n (n even), ω_0 can be represented either as $\omega_0 = (ab)^{\frac{n}{2}}a$ or as $\omega_0 = b(ab)^{\frac{n}{2}}$. For a Dynkin diagram of this type the automorphism exchanges S and S' , see again Figure 2.2, thus sending a reduced decomposition of ω_0 to another one. But since the R-matrix is independent of the chosen reduced decomposition the result follows. \square

Example 2.2.5. Let $\mathfrak{g} = \mathfrak{sl}_3$ with simple roots $\Pi = \{\alpha_1, \alpha_2\}$. There are two choices of normal orderings on the set of positive roots Δ_+ corresponding to the two reduced decompositions $\omega_0 = s_1 s_2 s_1$ and $\omega_0 = s_2 s_1 s_2$. The positive/negative root vectors for the two choices are

- $\omega_0 = s_1 s_2 s_1$: $X_{\beta_1}^\pm = X_1^\pm$, $X_{\beta_2}^\pm = -X_1^\pm X_2^\pm + e^{-\hbar} X_2^\pm X_1^\pm$, $X_{\beta_3}^\pm = X_2^\pm$
- $\omega_0 = s_2 s_1 s_2$: $X_{\beta_1}^\pm = X_2^\pm$, $X_{\beta_2}^\pm = -X_2^\pm X_1^\pm + e^{-\hbar} X_1^\pm X_2^\pm$, $X_{\beta_3}^\pm = X_1^\pm$

and the Dynkin diagram automorphism $\kappa(\{1, 2\}) = \{2, 1\}$ relates the two sets of root vectors. \triangle

Proposition 2.2.6. *The action of $\text{Out}(G)$ on $\text{Rep}_\hbar(G)$ is compatible with the balancing automorphism of $\text{Rep}_\hbar(G)$.*

Proof. The balancing in $\text{Rep}_\hbar(G)$ is induced by the action of the ribbon element $c_\hbar = \exp(\hbar H_\rho) u_\hbar$ of $U_\hbar(\mathfrak{g})$, see [CP95, Section 8.3.F]. Here, $H_\rho = \sum_{i=1}^n \mu_i H_{\alpha_i}$ with coefficients $\mu_i = \sum_{j=1}^n a_{i,j}^{-1}$ and $u_\hbar = m_\hbar(S_\hbar \otimes \text{id})\mathcal{R}_{2,1}$ with m_\hbar and S_\hbar the multiplication and antipode in $U_\hbar(\mathfrak{g})$ respectively. It follows from Proposition 2.2.4 that a Dynkin diagram automorphism $\kappa \in \text{Aut}(\Pi)$ preserves the element u_\hbar . So it is left to show that κ preserves the element H_ρ . Since the Cartan matrix is invariant under the Dynkin diagram automorphism, we have $\mu_i = \sum_{j=1}^n a_{i,j}^{-1} = \sum_{j=1}^n a_{\kappa(i), \kappa(j)}^{-1} = \sum_{j=1}^n a_{\kappa(i), j}^{-1} = \mu_{\kappa(i)}$ and thus $\kappa.H_\rho = H_\rho$. \square

Let $q \in \mathbb{C}^\times$ be a non-zero complex number which is not a root of unity and let $U_q(\mathfrak{g})$ be the corresponding quantum group as defined in [CP95, Section 9]. We denote by $\text{Rep}_q(G)$ the category of locally-finite integrable $U_q(\mathfrak{g})$ -modules. Strictly speaking, $U_q(\mathfrak{g})$ is not quasi-triangular. However, its representation category admits a braiding [CP95, Section 10.1.D]. On a representation $V \otimes V' \in \text{Rep}_q(G)$, the braiding is defined by the so-called quasi R-matrix $\Theta_{V,V'} = \tau \circ E_{V,V'} \widehat{\mathcal{R}}_{V,V'}$, where τ is the map swapping the tensor factors and $E_{V,V'}$ is an invertible operator on $V \otimes V'$ acting on the subspace $V_\lambda \otimes V'_\mu$ by the scalar $q^{(\lambda, \mu)}$, for $\lambda, \mu \in \Lambda$. Moreover, the standard ribbon element for $U_q(\mathfrak{g})$ acts on V_λ as the constant $q^{-(\lambda, \lambda) - 2(\lambda, \rho)}$ with ρ the half-sum of positive roots, giving rise to the balancing in $U_q(\mathfrak{g})$. Hence, we get the q -analog of Proposition 2.2.4:

Proposition 2.2.7. *The braided balanced tensor category $\text{Rep}_q(G)$ admits a left action of $\text{Out}(G)$.*

2.2.2. \boxtimes -Excision

Similarly to the case of oriented manifolds, factorization homology with tangential $D \times \mathrm{SO}(2)$ -structure satisfies excision [AF15, Lemma 3.18]. For a collar gluing $\Sigma = \Sigma_- \cup_{\Sigma_0} \Sigma_+$ of a D -decorated surface (Σ, φ) , together with a diffeomorphism of oriented manifolds $\theta: N \times (-1, 1) \xrightarrow{\cong} \Sigma_0$, the map $\theta^*(\varphi|_{\Sigma_0}): N \times (-1, 1) \rightarrow BD$ is not required to be constant along the interval $(-1, 1)$ of the collar, though it will always be homotopic to the constant map. Of course, this homotopy trivializes the map only locally. Globally, the bundles decoration induces a D -twist in the module structure coming from excision. We will make this more precise in Example 2.2.8 for the case of the D -decorated annulus. The case for more general surfaces is content of Proposition 2.2.10 below.

Example 2.2.8. Let $\mathrm{Ann}^d = (\mathrm{Ann}, \gamma_d)$ be an annulus decorated with a map $\gamma_d: \mathrm{Ann} \rightarrow BD$ which sends the free generator of $\pi_1(\mathrm{Ann})$ to the group element $d \in D$. We then choose a collar-gluing $\mathrm{Ann} \cong \Sigma_- \cup_{\Sigma_0} \Sigma_+$ for the annulus, as sketched on the right hand side of Figure 2.3a, and an equivalence in Man_2^D so that the maps to BD are constant on $\Sigma_- \setminus \Sigma_0$ and $\Sigma_+ \setminus \Sigma_0$ and is given by the loop γ_d on a fixed open interval in Σ_0 , which is depicted by the red interval in Figure 2.3a.

We denote by $I^+ = (-1, 1)$ the open interval with positive orientation and by I^- the same interval but with negative orientation. We have a diffeomorphism $\theta: (I^+ \sqcup I^-) \times \mathbb{R} \xrightarrow{\cong} \Sigma_0$ of oriented manifolds. And we can choose the map γ'_d such that its pullback along θ is constant in radial direction and given by γ_d on $(-\frac{1}{2}, \frac{1}{2}) \subset I^+$. Even though $\theta^*(\gamma'_d|_{\Sigma_0})$ is not constant along I^+ , it will be homotopic to the constant map at the base point $* \in BD$. We now fix such a homotopy $H: \theta^*(\gamma'_d|_{\Sigma_0}) \Rightarrow *$: the homotopy H is constant along I^- and on I^+ it is given by

$$H: I^+ \times [0, 1] \longrightarrow BD, \quad (c, t) \longmapsto \begin{cases} *, & c \geq \frac{1}{2} \\ \gamma_d(c + \frac{1}{2} + t(\frac{1}{2} - c)), & c \in (-\frac{1}{2}, \frac{1}{2}) \\ \gamma_d(t), & c \leq -\frac{1}{2} \end{cases} \quad (2.6)$$

as illustrated in Figure 2.3b. The equivalence $((I^+ \sqcup I^-) \times \mathbb{R}, *) \xrightarrow{(\theta, H)} (\Sigma_0, \gamma'_d|_{\Sigma_0})$ in Man_2^D induces equivalences of categories

$$\int_{(\Sigma_0, \gamma'_d|_{\Sigma_0})} \mathcal{A} \cong \int_{((I^+ \sqcup I^-) \times \mathbb{R}, *)} \mathcal{A} \cong \mathcal{A} \boxtimes \mathcal{A} \quad (2.7)$$

for any framed \mathbf{E}_2 -algebra $\mathcal{A} \in \mathrm{Pres}_{\mathbb{K}}$ with D -action. For notational convenience we will denote $C = ((I^+ \sqcup I^-) \times \mathbb{R}, *)$ in the following.

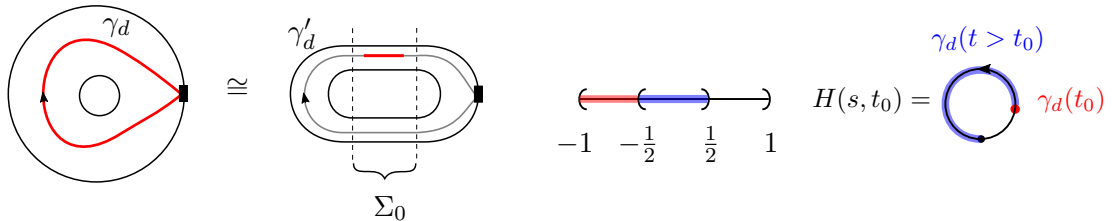

(a) Collar gluing for D -decorated annulus. (b) Sketch of the homotopy H for some fixed $t_0 \in [0, 1]$.

Figure 2.3.

2. Twisted character varieties

Next, we will deduce the $\int_C \mathcal{A}$ -module structure on $\int_{(\Sigma_-, \gamma'_d|_{\Sigma_-})} \mathcal{A}$ and $\int_{(\Sigma_+, \gamma'_d|_{\Sigma_+})} \mathcal{A}$. To that end, we fix oriented embeddings:

$$\begin{array}{ccc}
 \begin{array}{c} \text{---} \\ -1 \quad 1 \end{array} & \begin{array}{c} \text{---} \\ -1 \quad 1 \end{array} & \xrightarrow{\mu_+} & \begin{array}{c} \text{---} \\ -1-\frac{1}{2} \quad \frac{1}{2} \quad 1 \end{array} & \begin{array}{c} \text{---} \\ -1 \quad 1 \end{array} & \begin{array}{c} \text{---} \\ -1 \quad 1 \end{array} & \xrightarrow{\mu_-} & \begin{array}{c} \text{---} \\ -1-\frac{1}{2} \quad \frac{1}{2} \quad 1 \end{array}
 \end{array}$$

Using the equivalence (θ, H) we can lift these embeddings to maps $\text{act}_-: (\Sigma_-, \gamma'_d|_{\Sigma_-}) \sqcup C \rightarrow (\Sigma_-, \gamma'_d|_{\Sigma_-})$ and $\text{act}_+: C \sqcup (\Sigma_+, \gamma'_d|_{\Sigma_+}) \rightarrow (\Sigma_+, \gamma'_d|_{\Sigma_+})$ of D -structured manifolds. The non-trivial part of the homotopies for the left, respectively right, C -module structures can be deduced from Figure 2.4. Explicitly, the non-trivial part of the homotopy $h_+: (*, \gamma'_d) \Rightarrow \text{act}_+^* \gamma'_d$ for the left action is

$$\begin{array}{ll}
 h_+: (-1, 1) \times [0, 1] \longrightarrow BD & h_+: (-1, 1] \times [0, 1] \longrightarrow BD \\
 (c, t) \longmapsto \gamma_d^{-1}(t) & (m, t) \longmapsto H(m, t)
 \end{array}$$

and the non-trivial part of the homotopy $h_-: (\gamma'_d, *) \Rightarrow \text{act}_-^* (\gamma'_d)$ for the right action is

$$h_-: [-1, 1) \times [0, 1] \longrightarrow BD, \quad (m, t) \longmapsto \begin{cases} \gamma_d^{-1}(t), & m \geq \frac{1}{2} \\ \gamma_d(m + \frac{1}{2} - t(\frac{1}{2} + m)), & m \in (-\frac{1}{2}, \frac{1}{2}) \\ *, & m \leq -\frac{1}{2} \end{cases} \quad (2.8)$$

Note that h_- is constant along the open interval $(-1, 1)$.

Denote by Σ_-^* and Σ_+^* two objects in Man_2^D diffeomorphic to Σ_- and Σ_+ , with collars $[-1, 1) \times \mathbb{R}$ and $(-1, 1] \times \mathbb{R}$, whose maps to BD are assumed to be constant. The value of factorization homology on these manifolds naturally defines module categories \mathcal{M}_- and \mathcal{M}_+ over the tensor category $\int_C \mathcal{A}$ from (2.7). In order to obtain an explicit description of the module structures obtained by excision, note that the homotopy H from (2.6) can be used to construct an equivalence $(\theta_+, H_+): (\Sigma_+^*, *) \xrightarrow{\cong} (\Sigma_+, \gamma'_d|_{\Sigma_+})$. Explicitly, the homotopy H_+ agrees with H on $\Sigma_+^* \cap (I_+ \times \mathbb{R})$ and is constant else. We use this equivalence to identify $\int_{(\Sigma_+, \gamma'_d|_{\Sigma_+})} \mathcal{A} \cong \mathcal{M}_+$ as categories. This equivalence can be promoted to an equivalence of $\int_C \mathcal{A}$ -module categories, i.e. the following diagram is commutative

$$\begin{array}{ccc}
 C \sqcup \Sigma_+ & \xrightarrow{(\text{act}_+, h_+)} & \Sigma_+ \\
 \text{id} \sqcup (\theta_+, H_+) \downarrow & & \downarrow (\theta_+, H_+) \\
 C \sqcup \Sigma_+^* & \xrightarrow{\text{act}_+^*} & \Sigma_+^*
 \end{array}$$

$$\begin{array}{ccc}
 \begin{array}{c} \text{---} \\ \downarrow \text{id} \sqcup (\theta, H) \end{array} & \begin{array}{c} \text{---} \\ \uparrow (\theta, H)^{-1} \end{array} & \begin{array}{c} \text{---} \\ \downarrow (\theta, H) \sqcup \text{id} \end{array} & \begin{array}{c} \text{---} \\ \uparrow (\theta, H)^{-1} \end{array} \\
 \begin{array}{c} \text{---} \\ \downarrow \text{id} \sqcup (\theta, H) \end{array} & \begin{array}{c} \text{---} \\ \uparrow (\theta, H)^{-1} \end{array} & \begin{array}{c} \text{---} \\ \downarrow (\theta, H) \sqcup \text{id} \end{array} & \begin{array}{c} \text{---} \\ \uparrow (\theta, H)^{-1} \end{array} \\
 \begin{array}{c} \text{---} \\ \downarrow \text{id} \sqcup (\theta, H) \end{array} & \begin{array}{c} \text{---} \\ \uparrow (\theta, H)^{-1} \end{array} & \begin{array}{c} \text{---} \\ \downarrow (\theta, H) \sqcup \text{id} \end{array} & \begin{array}{c} \text{---} \\ \uparrow (\theta, H)^{-1} \end{array}
 \end{array}$$

(a) Left module structure

(b) Right module structure

Figure 2.4.: Left- and right disk action on a disk decorated with a map to BD that agrees with γ_d on the blue interval and is constant everywhere else.

2. Twisted character varieties

where act_+^* is the map inducing the regular action on the level of the factorization homologies

$$\text{reg}: (\mathcal{A} \boxtimes \mathcal{A}) \boxtimes \mathcal{M}_+ \longrightarrow \mathcal{M}_+, \quad (a_1 \boxtimes a_2) \boxtimes b \longmapsto a_1 \otimes a_2 \otimes b \quad .$$

where $\mathcal{M}_+ \cong \mathcal{A}$ as categories.

Note that we can not use H again to obtain an equivalence of Σ_- with Σ_-^* since the homotopy H is not constant near $\{-1\} \times \mathbb{R}$ on the collar. But we will use the homotopy h_- from (2.8) instead: we get an equivalence $(\theta_-, H_-): (\Sigma_-^*, *) \xrightarrow{\cong} (\Sigma_-, \gamma'_d|_{\Sigma_-})$, where H_- agrees with h_- on the collar and is constant else. Then, the following diagram is commutative in Man_2^D :

$$\begin{array}{ccc} \Sigma_- \sqcup C & \xrightarrow{(\text{act}_-, h_-)} & \Sigma_- \\ (\theta_-, H_-) \sqcup (\text{id}, \gamma_d^{-1}) \downarrow & & \downarrow (\theta_-, H_-) \\ \Sigma_-^* \sqcup C & \xrightarrow{\text{act}_-^*} & \Sigma_-^* \end{array}$$

From the horizontal maps we deduce that the module structure relevant for excision is obtained by twisting the regular action by the D -action:

$$\mathcal{M}_- \boxtimes (\mathcal{A} \boxtimes \mathcal{A}) \xrightarrow{\text{id} \boxtimes (\vartheta(d^{-1}) \boxtimes \text{id})} \mathcal{M}_- \boxtimes (\mathcal{A} \boxtimes \mathcal{A}) \xrightarrow{\text{reg}} \mathcal{A} \quad (2.9)$$

where again as categories we have $\mathcal{M}_- \cong \mathcal{A}$. In summary, we find

$$\int_{(\text{Ann}, \gamma_d)} \mathcal{A} \cong \mathcal{M}_d \boxtimes_{\mathcal{A} \boxtimes \mathcal{A}} \mathcal{A}$$

where \mathcal{M}_d is the category \mathcal{A} with the d -twisted regular action (2.9).

Remark 2.2.9. Notice that alternatively we could have chosen a trivialization of Σ_0 which extends to Σ_- rather than Σ_+ , which would have resulted in a twisting of \mathcal{M}_+ by $\vartheta(d)$ instead. In this sense the module structures featuring in excision on D -decorated surfaces are not unique, though the value of the relative tensor product is.

△

The following proposition is a generalization of the previous example, see also [KM23, Example 2.11].

Proposition 2.2.10. Let $(\Sigma, \varphi) \in \text{Man}_2^D$, $\Sigma \cong \Sigma_- \cup_{\Sigma_0} \Sigma_+$ a collar-gluing and let $\theta: \Sigma_0 \cong N \times (-1, 1)$ be a diffeomorphism. Assume that φ is such that its restriction $\varphi|_{\Sigma_- \setminus \Sigma_0}$ as well as $\varphi|_{\Sigma_+ \setminus \Sigma_0}$ agree with the constant map to the base point $*$ of BD and

$$(\theta^{-1})^* \varphi(n, t) = \begin{cases} *, & \text{for } t \notin (-\frac{1}{2}, \frac{1}{2}) \\ \gamma_{d^{-1}}(t + \frac{1}{2}), & \text{for } t \in (-\frac{1}{2}, \frac{1}{2}) \end{cases}$$

as illustrated in Figure 2.5. Let $\mathcal{C} = \int_{(N \times (-1, 1), *)} \mathcal{A}$, $\mathcal{M}_+ = \int_{(\Sigma_+, *)} \mathcal{A}$ and $\mathcal{M}_- = \int_{(\Sigma_-, *)} \mathcal{A}$. Then, we have an equivalence

$$\int_{(\Sigma, \varphi)} \mathcal{A} \cong \mathcal{M}_{-, d} \boxtimes_{\mathcal{C}} \mathcal{M}_+ \quad ,$$

where $\mathcal{M}_{-, d}$ denotes the category \mathcal{M}_- with d -twisted \mathcal{C} -action:

$$\text{act}_{-, d}: \mathcal{M}_- \boxtimes \mathcal{C} \xrightarrow{\text{id} \boxtimes \vartheta(d)} \mathcal{M}_- \boxtimes \mathcal{C} \xrightarrow{\text{act}_-} \mathcal{M}_- \quad .$$

2. Twisted character varieties

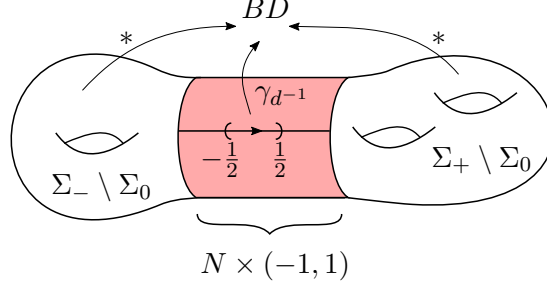

Figure 2.5.: The map φ on a collar-gluing.

2.2.3. Reconstruction for rigid balanced braided tensor categories with D -action

We say that a braided tensor category \mathcal{A} is *rigid* if all compact objects have duals.

For $d \in D$, consider the right $\mathcal{A}^{\boxtimes 2}$ -module category \mathcal{M}_d , whose underlying category is \mathcal{A} and the action is

$$\text{reg}^d: \mathcal{M}_d \boxtimes \mathcal{A} \boxtimes \mathcal{A} \xrightarrow{\text{id} \boxtimes \text{id} \boxtimes \vartheta(d)} \mathcal{M}_d \boxtimes \mathcal{A} \boxtimes \mathcal{A} \xrightarrow{T^3} \mathcal{M}_d, \quad (2.10)$$

where T^3 is the iterated tensor product functor $x \boxtimes y \boxtimes z \mapsto x \otimes y \otimes z$. This is the module structure from Example 2.2.8 obtained via factorization homology of the d -decorated annulus.

The internal endomorphism algebra $\underline{\text{End}}_{\mathcal{A}^{\boxtimes 2}}(1_{\mathcal{A}})$ of the monoidal unit $1_{\mathcal{A}}$ can be explicitly described by the coend

$$\int^{V \in \text{cmp}(\mathcal{A})} V^\vee \boxtimes \vartheta(d^{-1}).V, \quad (2.11)$$

where V^\vee is the dual of V and the colimit is taken over a generating set of compact objects in \mathcal{A} . In the above we used that the twisted regular action is the pre-composition of the regular action with the automorphism $\text{id} \boxtimes \vartheta(d)$ whose adjoint is $\text{id} \boxtimes \vartheta(d^{-1})$. Together with the coend formula for the right adjoint of the regular action.

Applying the tensor product functor $T: \mathcal{A} \boxtimes \mathcal{A} \rightarrow \mathcal{A}$ to the internal endomorphism algebra $\underline{\text{End}}_{\mathcal{A}^{\boxtimes 2}}(1_{\mathcal{A}})$ we get the *twisted coend algebra*:

$$\mathcal{F}_{\mathcal{A}}^d = \int^{V \in \text{cmp}(\mathcal{A})} V^\vee \otimes \vartheta(d^{-1}).V. \quad (2.12)$$

Using the canonical maps $V^\vee \otimes \vartheta(d^{-1}).V \xrightarrow{\iota_V} \mathcal{F}_{\mathcal{A}}^d$ we can express the multiplication in $\mathcal{F}_{\mathcal{A}}^d$ by means of the following diagram

$$\begin{array}{ccc} (V \otimes W)^\vee & \vartheta(d^{-1}).(V \otimes W) & \\ \begin{array}{c} \text{---} \\ \diagdown \quad \diagup \\ \text{---} \end{array} & \begin{array}{c} \text{---} \\ \diagdown \quad \diagup \\ \text{---} \end{array} & \begin{array}{c} \text{---} \\ | \\ \text{---} \end{array} \\ V^\vee \otimes \vartheta(d^{-1}).V & W^\vee \otimes \vartheta(d^{-1}).W & \end{array} \quad (2.13)$$

At the identity element $e \in D$, the coend algebra (2.12) agrees with Lyubashenko's coend $\int V^\vee \otimes V$ [Lyu95b], which in particular is a braided Hopf algebra in \mathcal{A} . We will discuss this special case in some more details in the following example:

2. Twisted character varieties

Example 2.2.11. Let H be a ribbon Hopf algebra with D -action, meaning that an element $d \in D$ acts on H by Hopf algebra automorphisms and preserves the universal R-matrix, $\mathcal{R} \in (H \otimes H)^D$, and the ribbon element $\nu \in H^D$. Let $H\text{-Mod}$ be the rigid balanced braided tensor category of locally-finite left modules over H on which the elements $d \in D$ act through pulling back representations along d^{-1} .

Let's first consider the coend (2.12) at the identity element $e \in D$. For every finite-dimensional H -module V , there is a linear map

$$i_V: V^\vee \otimes V \longrightarrow H^\circ, \quad \varphi \otimes v \longmapsto \overset{V}{\mathcal{C}}_v^\varphi .$$

to the restricted dual H° spanned by matrix coefficients. We wrote $\overset{V}{\mathcal{C}}_v^\varphi$ for the linear function on H defined by $\overset{V}{\mathcal{C}}_v^\varphi(h) = \varphi(h \triangleright v)$ for any $h \in H$. The linear map i_V is a map of H -modules if H° is endowed with the coadjoint H -module structure:

$$\text{ad}^*: H \otimes H^\circ \longrightarrow H^\circ, \quad h \otimes \psi \longmapsto \psi(S(h_{(1)})(-)h_{(2)}) .$$

The family of maps $(V^\vee \otimes V \xrightarrow{i_V} H^\circ)_{V \in H\text{-Mod}^{\text{fd}}}$ satisfies the universal property of the coend $H^\circ \cong \int V^\vee \otimes V$, see for example [Lyu95a, Theorem 3.3.1] and references therein. The multiplication (2.13) endows the coend with the structure of an algebra in $H\text{-Mod}$, which is called the braided dual of H , also known as the *reflection equation algebra* (RE-algebra).

The RE-algebra can be obtained from the so-called *Faddeev-Reshetikhin-Takhtajan algebra* (FRT-algebra) via twisting by a cocycle defined in terms of the universal R-matrix [DM03]. In more detail, the FRT-algebra is identified with the coend

$$\mathcal{F}_{\text{FRT}} = \int^{V \in H\text{-Mod}^{\text{fd}}} V^\vee \boxtimes V \in H\text{-Mod}^{\text{op}} \boxtimes H\text{-Mod} ,$$

where $H\text{-Mod}^{\text{op}}$ is the category with the opposite monoidal product, with multiplication m_{FRT} induced by the canonical maps

$$(V^\vee \boxtimes V) \otimes (W^\vee \boxtimes W) = (V^\vee \otimes^{\text{op}} W^\vee) \boxtimes (V \otimes W) \cong (W \otimes V)^\vee \boxtimes (W \otimes V) \xrightarrow{\iota_{V \otimes W}} \mathcal{F}_{\text{FRT}} .$$

Thus, for $\phi, \psi \in H^\circ$ we have $m_{\text{FRT}}(\phi \otimes \psi)(h) = \phi(h_{(1)})\psi(h_{(2)})$ for any $h \in H$. The RE-algebra is the image of the FRT-algebra under the composite functor

$$H\text{-Mod}^{\text{op}} \boxtimes H\text{-Mod} \xrightarrow{(\text{id}, \sigma) \boxtimes \text{id}} H\text{-Mod} \boxtimes H\text{-Mod} \xrightarrow{T} H\text{-Mod} , \quad (2.14)$$

where (id, σ) denotes the identity functor, equipped with a non-trivial tensor structure $\sigma = \tau \circ (\mathcal{R} \triangleright)$ in $H\text{-Mod}$.

In the decorated case, we pre-compose the functor in (2.14) with the automorphism $1 \boxtimes \vartheta(d)$. Then, for any $d \in D$, the underlying vector space of $\mathcal{F}_{H\text{-Mod}}^d$ is identified again with H° via

$$\iota_V: V^\vee \otimes d^*V \longrightarrow H^\circ, \quad \phi \otimes v \longmapsto \phi(- \triangleright (d^{-1})^*v) ,$$

for any $V \in H\text{-Mod}^{\text{fd}}$, but H° is now equipped with the twisted coadjoint action $\text{ad}_d^*(h \otimes \psi) = \psi(S(h_{(1)})(-)d.h_{(2)})$. The multiplication on the coend algebra was already defined in (2.13). Explicitly, writing $\mathcal{R} = \mathcal{R}^1 \otimes \mathcal{R}^2$ for the universal R-matrix, the product of $\phi, \psi \in \mathcal{F}_{H\text{-Mod}}^d$ is

$$m_{\text{RE}}^d(\phi \otimes \psi) = m_{\text{FRT}}(\phi(\mathcal{R}^1(-)d.\mathcal{R}^1) \otimes \psi(S(\mathcal{R}^2)\mathcal{R}^2(-))) , \quad (2.15)$$

where we used primes to distinguish different copies of the R-matrix. In the language of [DM03], we say that $\mathcal{F}_{H\text{-Mod}}^d$ is obtained from (H°, ad_d^*) by twisting with the cocycle $\mathcal{R}^1 \otimes d.\mathcal{R}^1 \otimes \mathcal{R}^2 \mathcal{R}^2 \otimes 1$. △

2. Twisted character varieties

Example 2.2.12. The category of integrable finite-dimensional $U_q(\mathfrak{g})$ -modules is a braided tensor category via the quasi R-matrix Θ . The quantized coordinate algebra $\mathcal{O}_q(G)$ is then defined as the algebra of matrix coefficients of finite-dimensional integrable representations. Given an automorphism $\kappa \in \text{Out}(G)$, the twisted coend algebra (2.12) takes the form

$$\mathcal{F}_{\text{Rep}_q(G)}^\kappa = \bigoplus_{V(\lambda), \lambda \in \mathbf{P}_+} V(\lambda)^\vee \otimes \kappa^* V(\lambda)$$

where the sum runs over the irreducible highest weight modules. By a quantum version of the Peter–Weyl theorem (see for example [KS97, Section 11]) we get an identification $\bigoplus_{V(\lambda)} V(\lambda)^\vee \otimes \kappa^* V(\lambda) \cong \mathcal{O}_q(G)$ as algebras in $\text{Rep}_q(G)$, where $\mathcal{O}_q(G)$ is equipped with the κ -twisted multiplication m_{RE}^κ from (2.15). \triangle

2.3. Computations on punctured surfaces with principal bundles

In this section we will show that factorization homology on a surface with boundary and D -bundles decoration can be computed as the category of modules over an algebra defined in purely combinatorial terms. This result relies on \boxtimes -excision of factorization homology and monadic reconstruction techniques for abelian module categories.

Throughout we consider connected oriented surfaces with at least one boundary component. We will pick a ciliated ribbon graph model with one vertex for the surfaces, which in [BZBJ18a] is conveniently defined via a *gluing-pattern*, that is a bijection

$$P: \{1, 1', \dots, n, n'\} \rightarrow \{1, \dots, 2n\} \quad ,$$

such that $P(i) < P(i')$. Here, n is the number of edges of the ribbon graph model of Σ . Given a gluing pattern P , we can reconstruct Σ as depicted in Figure 2.6b, namely by gluing n disks $\mathbb{D}_{\blacksquare, \blacksquare}$ with two marked intervals each to a disk $\mathbb{D}_{\blacksquare, \blacksquare}^{2n}$ with $2n + 1$ marked intervals, thereby gluing the intervals i and i' to $P(i)$ and $P(i')$, respectively.

Definition 2.3.1. A D -labeled gluing pattern is a gluing pattern $P: \{1, 1', \dots, n, n'\} \rightarrow \{1, \dots, 2n\}$ together with n elements $d_1, \dots, d_n \in D$.

Since the fundamental group of a genus g surface with r boundary components is free on $n = 2g + r - 1$ generators, a D -labeled gluing pattern determines a principal D -bundle on the surface constructed from the gluing pattern. Furthermore, up to equivalence all principal D -bundles on surfaces with at least one boundary arise in this way.

For a D -labeled gluing pattern $(P, d_1 \dots d_n)$ we are going to define an algebra $a_P^{d_1, \dots, d_n} \in \mathcal{A}$. As an object in \mathcal{A} , it is defined by the tensor product

$$a_P^{d_1, \dots, d_n} = \bigotimes_{i=1}^n \mathcal{F}_{\mathcal{A}}^{d_i} \quad , \quad (2.16)$$

where the $\mathcal{F}_{\mathcal{A}}^{d_i}$ are defined by the coend in Equation (2.12). The gluing pattern can be used to define an algebra structure on this object in complete analogy with [BZBJ18a]. To that end, we will use the following terminology: two labeled disks $\mathbb{D}_{\blacksquare, \blacksquare}^{d_i}$ and $\mathbb{D}_{\blacksquare, \blacksquare}^{d_j}$ with $i < j$ are called

2. Twisted character varieties

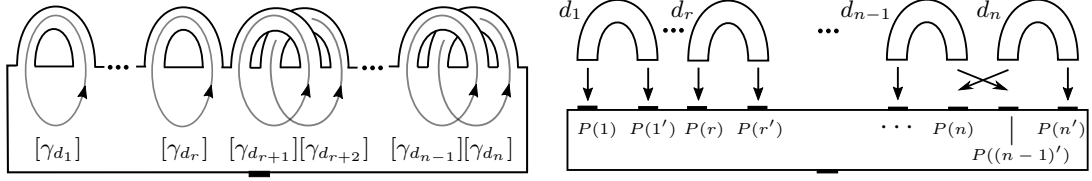

(a) Generators of the homotopy group $\pi_1(\Sigma)$. (b) Gluing a surface from a decorated gluing pattern.

Figure 2.6.

- *positively (negatively) linked* if $P(i) < P(j) < P(i') < P(j')$ ($P(j) < P(i) < P(j') < P(i')$)
- *positively (negatively) nested* if $P(i) < P(j) < P(j') < P(i')$ ($P(j) < P(i) < P(i') < P(j')$)
- *positively (negatively) unlinked* if $P(i) < P(i') < P(j) < P(j')$ ($P(j) < P(j') < P(i) < P(i')$)

The corresponding ciliated ribbon graphs were previously sketched in Figure 1.2. To each of the above cases, we assign a crossing morphism as depicted in Figure 2.7 below.

$$\begin{array}{ccc}
 \begin{array}{c} \mathcal{F}_A^{d_j} \quad \mathcal{F}_A^{d_i} \\ \text{---} \\ \text{---} \\ \text{---} \\ \text{---} \\ \mathcal{F}_A^{d_i} \quad \mathcal{F}_A^{d_j} \\ \text{---} \\ \text{---} \\ \text{---} \\ \text{---} \\ \mathcal{F}_A^{d_i} \quad \mathcal{F}_A^{d_j} \\ \text{---} \\ \text{---} \\ \text{---} \\ \text{---} \\ \mathcal{F}_A^{d_i} \quad \mathcal{F}_A^{d_j} \\ \text{---} \\ \text{---} \\ \text{---} \\ \text{---} \\ \mathcal{F}_A^{d_i} \quad \mathcal{F}_A^{d_j} \end{array} &
 \begin{array}{c} \mathcal{F}_A^{d_j} \quad \mathcal{F}_A^{d_i} \\ \text{---} \\ \text{---} \\ \text{---} \\ \text{---} \\ \mathcal{F}_A^{d_i} \quad \mathcal{F}_A^{d_j} \\ \text{---} \\ \text{---} \\ \text{---} \\ \text{---} \\ \mathcal{F}_A^{d_i} \quad \mathcal{F}_A^{d_j} \\ \text{---} \\ \text{---} \\ \text{---} \\ \text{---} \\ \mathcal{F}_A^{d_i} \quad \mathcal{F}_A^{d_j} \\ \text{---} \\ \text{---} \\ \text{---} \\ \text{---} \\ \mathcal{F}_A^{d_i} \quad \mathcal{F}_A^{d_j} \end{array} &
 \begin{array}{c} \mathcal{F}_A^{d_j} \quad \mathcal{F}_A^{d_i} \\ \text{---} \\ \text{---} \\ \text{---} \\ \text{---} \\ \mathcal{F}_A^{d_i} \quad \mathcal{F}_A^{d_j} \\ \text{---} \\ \text{---} \\ \text{---} \\ \text{---} \\ \mathcal{F}_A^{d_i} \quad \mathcal{F}_A^{d_j} \\ \text{---} \\ \text{---} \\ \text{---} \\ \text{---} \\ \mathcal{F}_A^{d_i} \quad \mathcal{F}_A^{d_j} \\ \text{---} \\ \text{---} \\ \text{---} \\ \text{---} \\ \mathcal{F}_A^{d_i} \quad \mathcal{F}_A^{d_j} \end{array} \\
 L^+ & N^+ & U^+ \\
 \text{+-linked} & \text{+-nested} & \text{+-unlinked}
 \end{array} \tag{2.17}$$

Figure 2.7.: Definition of crossing morphisms $L^+, N^+, U^+ : \mathcal{F}_A^{d_i} \otimes \mathcal{F}_A^{d_j} \rightarrow \mathcal{F}_A^{d_j} \otimes \mathcal{F}_A^{d_i}$ for positively linked, nested and unlinked decorated disks. Notice that we read the diagrams from bottom to top.

Now, for each pair of indices $1 \leq i < j \leq n$, the restriction of the multiplication to $\mathcal{F}_A^{d_i} \otimes \mathcal{F}_A^{d_j} \subset d_P^{d_1, \dots, d_n}$ is defined by

$$\mathcal{F}_A^{d_i} \otimes \mathcal{F}_A^{d_j} \otimes \mathcal{F}_A^{d_i} \otimes \mathcal{F}_A^{d_j} \xrightarrow{\text{id} \otimes C \otimes \text{id}} \mathcal{F}_A^{d_i} \otimes \mathcal{F}_A^{d_i} \otimes \mathcal{F}_A^{d_j} \otimes \mathcal{F}_A^{d_j} \xrightarrow{m \otimes m} \mathcal{F}_A^{d_i} \otimes \mathcal{F}_A^{d_j},$$

where C is either L^\pm, N^\pm or U^\pm , depending on whether the decorated disks $\mathbb{D}_{\blacksquare, \blacksquare}^{d_i}$ and $\mathbb{D}_{\blacksquare, \blacksquare}^{d_j}$ are \pm -linked, \pm -nested or \pm -unlinked.

Finally, given a D -labeled gluing pattern, we wish to describe the module structure induced by gluing the marked disks $\mathbb{D}_{\blacksquare, \blacksquare}^{d_i}$ to the disk ${}_{\blacksquare, 2n} \mathbb{D}_{\blacksquare}$ as sketched in Figure 2.6b. To that end, we look at the example of a sphere with three punctures $(\mathbb{S}^2)_3$ and a D -bundle described by the map $\varphi : \pi_1((\mathbb{S}^2)_3) \rightarrow D$ sending the two generators of the fundamental group to d_1 and d_2 , respectively. The corresponding gluing pattern is $P(1, 1', 2, 2') = (1, 2, 3, 4)$, decorated by the tuple $(d_1, d_2) \in D \times D$. We then choose a

2. Twisted character varieties

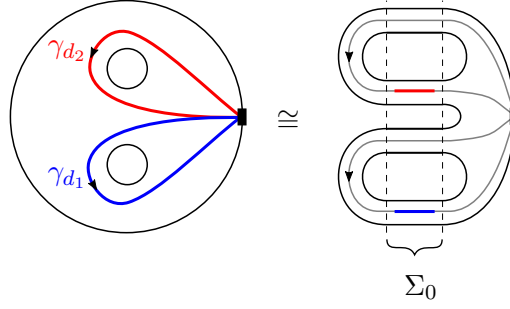

Figure 2.8.: Example: D -decorated sphere with three punctures.

collar-gluing $(\mathbb{S}^2)_3 \cong \Sigma_- \cup_{\Sigma_0} \Sigma_+$ for the punctured sphere, as sketched on the right hand side of Figure 2.8, and an equivalence in Man_D^D , so that the maps to BD are constant on $\Sigma_- \setminus \Sigma_0$ and $\Sigma_+ \setminus \Sigma_0$ and agree with the loops γ_{d_1} and γ_{d_2} on fixed open intervals in Σ_0 , which are depicted by the red and blue intervals in Figure 2.8. We immediately see that we are in a situation similar to Proposition 2.2.10: the right $\mathcal{A} \boxtimes \mathcal{A}$ -module structure on $\int_{\mathbb{D}_{\blacksquare, \blacksquare}^{d_i}} \mathcal{A}$, for $i = 1, 2$, comes from the twisted regular action reg^{d_i} from (2.10). The module structure for more general decorated gluing patterns can be worked out analogously.

Theorem 2.3.2. *Let \mathcal{A} be a rigid balanced braided abelian category in $\text{Pres}_{\mathbb{K}}$. Let Σ be a surfaces with at least one boundary component and a marked interval in $\partial\Sigma$. Fix a principal D -bundle $\varphi: \Sigma \rightarrow BD$ on Σ and a corresponding D -labeled gluing pattern (P, d_1, \dots, d_n) . There is an equivalence of categories*

$$\int_{(\Sigma, \varphi)} \mathcal{A} \cong a_P^{d_1, \dots, d_n} \text{-Mod}_{\mathcal{A}} \quad . \quad (2.18)$$

Proof. The following is an extension of the proof of [BZBJ18a, Theorem 5.14] to surfaces with D -bundles. We have seen that for a d -labeled disk $\mathbb{D}_{\blacksquare, \blacksquare}^d$ with two marked intervals we have $\int_{\mathbb{D}_{\blacksquare, \blacksquare}^d} \mathcal{A} \cong \mathcal{A}$ as categories, with the markings inducing the structure of a right $\mathcal{A}^{\boxtimes 2}$ -module category with module structure being the twisted regular action reg^d . Now, $\int_{\sqcup_i \mathbb{D}_{\blacksquare, \blacksquare}^{d_i}} \mathcal{A} \cong \mathcal{A}^{\boxtimes n}$ has the structure of a right $\mathcal{A}^{\boxtimes 2n}$ -module category. Indeed, using the decorated gluing pattern (P, d_1, \dots, d_n) we have an action:

$$\begin{aligned} \text{reg}_P^{d_1, \dots, d_n} : (x_1 \boxtimes \dots \boxtimes x_n) \boxtimes (y_1 \boxtimes \dots \boxtimes y_{2n}) &\longmapsto (x_1 \otimes y_{P(1)} \otimes \vartheta(d_1).y_{P(1)}) \boxtimes \dots \\ &\dots \boxtimes (x_n \otimes y_{P(n)} \otimes \vartheta(d_n).y_{P(n)}) \end{aligned}$$

We denote the resulting right module category by $\mathcal{M}_P^{d_1, \dots, d_n}$.

On the other hand, we have the disk $\mathbb{D}_{\blacksquare^{2n}, \blacksquare}$ with $2n$ marked intervals to the left and one marked interval to the right. This turns $\int_{\mathbb{D}_{\blacksquare^{2n}, \blacksquare}} \mathcal{A} \cong \mathcal{A}$ into a $(\mathcal{A}^{\boxtimes 2n}, \mathcal{A})$ -bimodule via the iterated tensor product

$$(x_1 \boxtimes \dots \boxtimes x_{2n}) \boxtimes y \boxtimes z \longmapsto x_1 \otimes \dots \otimes x_{2n} \otimes y \otimes z.$$

We denote the resulting bimodule category by ${}_{\mathcal{A}^{\boxtimes 2n}} \mathcal{A}_{\mathcal{A}}$. Using excision, we then have

$$\int_{(\Sigma, \varphi)} \mathcal{A} \cong \mathcal{M}_P^{d_1, \dots, d_n} \boxtimes_{\mathcal{A}^{\boxtimes 2n}} \mathcal{A}_{\mathcal{A}} \quad .$$

2. Twisted character varieties

Let $\tau_P: \{1, \dots, 2n\} \rightarrow \{1, \dots, 2n\}$ be the bijection given by postcomposing the map defined by $2k-1 \mapsto k$, $2k \mapsto k'$ with P . Notice that the map τ_P^{-1} is part of the action $\text{reg}_P^{d_1, \dots, d_2}$. Now we use that the unit $1_{\mathcal{A}}$ is a progenerator for the right regular action [BZBJ18a, Proposition 4.15]. Since $\vartheta(d)$ is an automorphism of \mathcal{A} , it is also a progenerator for the twisted regular action. So we can apply monadic reconstruction as in Theorem 1.3.20 to identify $\mathcal{M}_P^{d_1, \dots, d_n}$ with modules over an algebra $\underline{\text{End}}_{\mathcal{A}^{\boxtimes 2n}}(1_{\mathcal{A}^{\boxtimes n}})_P^{d_1, \dots, d_n} \in \mathcal{A}^{\boxtimes 2n}$, obtained from $\underline{\text{End}}_{\mathcal{A}^{\boxtimes 2}}(1_{\mathcal{A}})^{d_1} \boxtimes \dots \boxtimes \underline{\text{End}}_{\mathcal{A}^{\boxtimes 2}}(1_{\mathcal{A}})^{d_n}$ by acting with τ_P . Applying Corollary 1.3.22 to the dominant tensor functor $T^{2n}: \mathcal{A}^{2n} \rightarrow \mathcal{A}$, we thus get

$$\int_{\Sigma} \mathcal{A} \cong T^{2n}(\underline{\text{End}}_{\mathcal{A}^{\boxtimes 2n}}(1_{\mathcal{A}^{\boxtimes n}})_P^{d_1, \dots, d_n})\text{-Mod}_{\mathcal{A}}$$

as right \mathcal{A} -module categories.

Let us write $T^{2n}(\underline{\text{End}}_{\mathcal{A}^{\boxtimes 2n}}(1_{\mathcal{A}^{\boxtimes n}})_P^{d_1, \dots, d_n}) = \tilde{a}_P$ for brevity. We want to show that there is an isomorphism of algebras $\tilde{a}_P \cong a_P^{d_1, \dots, d_n}$. To that end, consider the subalgebras

$$\mathcal{F}_{\mathcal{A}}^{(i, i')} = \underline{\text{End}}_{\mathcal{A}_{P(i)} \boxtimes \mathcal{A}_{P(i')}}(1_{\mathcal{A}})^{d_i} \in \mathcal{A}^{\boxtimes 2n}$$

and their images under the tensor functor $\mathcal{F}_{\mathcal{A}}^{(i)} = T^{2n}(\mathcal{F}_{\mathcal{A}}^{(i, i')}) \in \mathcal{A}$. By embedding each $\mathcal{F}_{\mathcal{A}}^{(i)}$ into \tilde{a}_P we get a map

$$\tilde{m}_P: \mathcal{F}_{\mathcal{A}}^{(1)} \otimes \dots \otimes \mathcal{F}_{\mathcal{A}}^{(n)} \hookrightarrow \tilde{a}_P^{\otimes n} \xrightarrow{\tilde{m}} \tilde{a}_P \quad ,$$

where \tilde{m} is the multiplication in \tilde{a}_P . This map establishes the isomorphism on the level of objects in \mathcal{A} . The restriction of the multiplication to the image of one of the $\mathcal{F}_{\mathcal{A}}^{(i)}$ agrees with the multiplication m in $\mathcal{F}_{\mathcal{A}}^{d_i}$. So it is left to show that for each pair of indices $1 \leq i < j \leq n$ the composition

$$\mathcal{F}_{\mathcal{A}}^{(i)} \otimes \mathcal{F}_{\mathcal{A}}^{(j)} \otimes \mathcal{F}_{\mathcal{A}}^{(i)} \otimes \mathcal{F}_{\mathcal{A}}^{(j)} \xrightarrow{\text{id} \otimes C \otimes \text{id}} \mathcal{F}_{\mathcal{A}}^{(i)} \otimes \mathcal{F}_{\mathcal{A}}^{(i)} \otimes \mathcal{F}_{\mathcal{A}}^{(j)} \otimes \mathcal{F}_{\mathcal{A}}^{(j)} \xrightarrow{m \otimes m} \mathcal{F}_{\mathcal{A}}^{(i)} \otimes \mathcal{F}_{\mathcal{A}}^{(j)} \xrightarrow{\tilde{m}_P} \tilde{a}_P,$$

for C being L^{\pm}, N^{\pm} or U^{\pm} , agrees with $\tilde{m}_P|_{(\mathcal{F}_{\mathcal{A}}^{(i)} \otimes \mathcal{F}_{\mathcal{A}}^{(j)})^{\otimes 2}}$. To that end, consider the following diagram

$$\begin{array}{ccc} & T^4(\mathcal{F}_{\mathcal{A}}^{(i, i')} \otimes \mathcal{F}_{\mathcal{A}}^{(j, j')}) = T^4(\mathcal{F}_{\mathcal{A}}^{(j, j')} \otimes \mathcal{F}_{\mathcal{A}}^{(i, i')}) & \\ \begin{array}{c} \text{---} S_{i,j} \text{---} \\ \text{---} S_{j,i} \text{---} \end{array} & \downarrow T^4(m) & \\ \mathcal{F}_{\mathcal{A}}^{(i)} \otimes \mathcal{F}_{\mathcal{A}}^{(j)} & & \mathcal{F}_{\mathcal{A}}^{(j)} \otimes \mathcal{F}_{\mathcal{A}}^{(i)} \\ \begin{array}{c} \text{---} \tilde{m}_P \text{---} \\ \text{---} \tilde{m}_P \text{---} \end{array} & \downarrow & \\ & \tilde{a}_P & \end{array}$$

where the label $T^4(m)$ on the vertical arrow means applying the tensor functor to the multiplication in $\underline{\text{End}}_{\mathcal{A}^{\boxtimes 2n}}(1_{\mathcal{A}^{\boxtimes n}})_P^{d_1, \dots, d_n}$. The dashed arrows, making the above diagram commute, are described by exhibiting the tensor structure of the iterated tensor product functor

$$S_{i,j}: \mathcal{F}_{\mathcal{A}}^{(i)} \otimes \mathcal{F}_{\mathcal{A}}^{(j)} = T^4(\mathcal{F}_{\mathcal{A}}^{(i, i')}) \otimes T^4(\mathcal{F}_{\mathcal{A}}^{(j, j')}) \xrightarrow{\cong} T^4(\mathcal{F}_{\mathcal{A}}^{(i, i')} \otimes \mathcal{F}_{\mathcal{A}}^{(j, j')})$$

2. Twisted character varieties

defined by the shuffle braiding¹. As an example, consider the gluing pattern $P(1, 1', 2, 2') = (1, 3, 4, 2)$ describing positively nested handles. The corresponding shuffle braiding is

$$S_{1,2} = (1 \otimes 1 \otimes \sigma) \circ (1 \otimes \sigma \otimes 1), \quad S_{2,1} = (\sigma \otimes 1 \otimes 1) \circ (1 \otimes \sigma \otimes 1),$$

and we observe that the composition $S_{1,2}^{-1} \circ S_{2,1}$ agrees with the nested crossing morphism $N_{1,2}^+ : \mathcal{F}_{\mathcal{A}}^{d_2} \otimes \mathcal{F}_{\mathcal{A}}^{d_1} \rightarrow \mathcal{F}_{\mathcal{A}}^{d_1} \otimes \mathcal{F}_{\mathcal{A}}^{d_2}$. From commutativity of the above diagram, we then get that $\tilde{m}_P|_{\mathcal{F}_{\mathcal{A}}^{d_2} \otimes \mathcal{F}_{\mathcal{A}}^{d_1}} = \tilde{m}_P|_{\mathcal{F}_{\mathcal{A}}^{d_1} \otimes \mathcal{F}_{\mathcal{A}}^{d_2}} \circ N_{1,2}^+$, which finishes the proof for the positively nested case. The other five cases can be worked out analogously. \square

Remark 2.3.3. *The result of Theorem 2.3.2 holds in the \mathbb{K} -linear, abelian setting. For coefficients in the $\mathbb{C}[[\hbar]]$ -linear setting we find the following. Let $\mathcal{V} = \mathbb{C}[[\hbar]]\text{-Mod}$ be the category of complete $\mathbb{C}[[\hbar]]$ -modules (see § A.1.1 of the appendix) and \mathcal{C} a small balanced braided monoidal \mathcal{V} -enriched category with a D -action. We will assume that all objects in \mathcal{C} have duals. An example to have in mind is the category $\text{Rep}_{\hbar}(G)^{\text{fd}}$ of topologically free $U_{\hbar}(\mathfrak{g})$ -modules of finite rank with the $\text{Out}(G)$ -action described in Proposition 2.2.4. Then, the free cocompletion $\widehat{\mathcal{C}} \in \mathcal{V}\text{-Pres}$ with its induced D -action is a Disk_2^D -algebra in $\mathcal{V}\text{-Pres}$.*

Given a decorated gluing pattern $(P, \{d_1, \dots, d_n\})$ for a surface Σ with D -bundle φ and a marked interval in $\partial\Sigma$, we get an adjunction in $\mathcal{V}\text{-Pres}$

$$\text{act}_{\mathcal{O}_{\Sigma}} : \widehat{\mathcal{C}} \cong \int_{\mathbb{D}} \widehat{\mathcal{C}} \xleftarrow{\cong} \int_{(\Sigma, \varphi)} \widehat{\mathcal{C}} \cong \mathcal{M}_P^{d_1, \dots, d_n} \boxtimes_{\widehat{\mathcal{C}}^{\boxtimes 2n}} \widehat{\mathcal{C}} : \text{act}_{\mathcal{O}_{\Sigma}}^R, \quad ,$$

induced by the embedding of a disk along the marked interval. As in the proof of Theorem 2.3.2, $\mathcal{M}_P^{d_1, \dots, d_n} \cong \widehat{\mathcal{C}}^{\boxtimes n}$ as plain categories and with $\widehat{\mathcal{C}}^{\boxtimes 2n}$ -module structure determined by the decorated gluing pattern. The adjunction determines a canonical algebra in $\widehat{\mathcal{C}}$, namely $\underline{\text{End}}_{\widehat{\mathcal{C}}}(\mathcal{O}_{\Sigma}) \cong \text{act}_{\mathcal{O}_{\Sigma}}^R(\text{act}_{\mathcal{O}_{\Sigma}}(1))$. By the same reasoning as in the proof of Theorem 2.3.2, we get an isomorphism of algebras

$$\underline{\text{End}}_{\widehat{\mathcal{C}}}(\mathcal{O}_{\Sigma}) \cong a_{\widehat{\mathcal{C}}, P}^{d_1, \dots, d_n}, \quad ,$$

where the algebra $a_{\widehat{\mathcal{C}}, P}^{d_1, \dots, d_n}$ is defined in the same way as in the \mathbb{K} -linear case. We thus get a functor

$$\text{act}_{\mathcal{O}_{\Sigma}}^R : \int_{(\Sigma, \varphi)} \widehat{\mathcal{C}} \longrightarrow a_{\widehat{\mathcal{C}}, P}^{d_1, \dots, d_n}\text{-Mod}_{\widehat{\mathcal{C}}}.$$

However, since the category $\widehat{\mathcal{C}}$ is not abelian, we can not apply the reconstruction result from § 1.3.4 to deduce if this functor is an equivalence. Extending the monadic reconstruction results to the $\mathbb{C}[[\hbar]]$ -linear setting will be content of future work.

2.3.1. The case of the D -decorated annulus

Throughout this section let $\mathcal{A} \in \text{Pres}_{\mathbb{K}}$ be a ribbon category. We want to explore the algebraic structures that arise on the collection of the factorization homologies

$$\int_{(\mathbb{S}^1 \times \mathbb{R}, \varphi)} \mathcal{A}$$

¹The shuffle braiding $S : a_1 \otimes \dots \otimes a_n \otimes b_1 \otimes \dots \otimes b_n \xrightarrow{\cong} a_1 \otimes b_1 \otimes \dots \otimes a_n \otimes b_n$ is $S = \sigma_{a_n, b_{n-1}} \circ \dots \circ \sigma_{a_3 \otimes \dots \otimes a_n, b_2} \circ \sigma_{a_2 \otimes \dots \otimes a_n, b_1}$, where σ is the braiding of \mathcal{A} .

2. Twisted character varieties

for varying decoration $\varphi: \mathbb{S}^1 \times \mathbb{R} \rightarrow BD$. More precisely, we will see that the factorization homologies assemble into an algebra over the little bundles operad, as defined by Müller–Woike [MW20]. We then compute the components of the resulting categorical algebra by means of twisted Drinfeld centers introduced in [FSS17].

We first recall that in the undecorated case, $\int_{\mathbb{S}^1 \times \mathbb{R}} \mathcal{A}$ has a monoidal structure coming from the pair of pants: evaluating factorization homology on the pair of embeddings sketched in Figure 2.9 gives rise to a diagram

$$\int_{\mathbb{S}^1 \times \mathbb{R}} \mathcal{A} \boxtimes \int_{\mathbb{S}^1 \times \mathbb{R}} \mathcal{A} \xrightarrow{(\iota_1 \sqcup \iota_2)_*} \int_{\text{Pants}} \mathcal{A} \xleftarrow{\iota_{\text{out}}^*} \int_{\mathbb{S}^1 \times \mathbb{R}} \mathcal{A} \quad (2.19)$$

in $\text{Pres}_{\mathbb{K}}$. The composition $(\iota_{\text{out}}^*)^R \circ (\iota_1 \sqcup \iota_2)_*$ defines an \mathbf{E}_2 -algebra structure \otimes_{Pants} on $\int_{\mathbb{S}^1 \times \mathbb{R}} \mathcal{A}$.

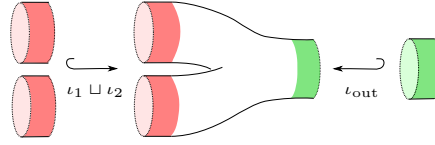

Figure 2.9.: The maps inducing the monoidal structure \otimes_{Pants} .

In the D -decorated setting, the situation is different since the annulus may be endowed with non-constant maps into BD . These maps induce an interesting algebraic structure on the collection of factorization homologies, namely the structure of an algebra over the *operad of little D -bundles*. The little D -bundles operad \mathbf{E}_2^D is colored over the space of maps $\varphi: \mathbb{S}^1 \rightarrow BD$. Its space of operations $\mathbf{E}_2^D\left(\begin{smallmatrix} \psi \\ (\varphi_1, \dots, \varphi_r) \end{smallmatrix}\right)$ may be pictured as a bordism $(\mathbb{S}^1)^{\sqcup r} \rightarrow \mathbb{S}^1$, which is decorated with a map to BD whose restriction to the ingoing boundary agrees with $(\varphi_1, \dots, \varphi_r)$ and to the outgoing boundary with ψ (we refer to [MW20] for a detailed definition of the little bundles operad and its algebras). The main result of [MW20, Theorem 4.13] identifies categorical algebras over the little D -bundles operad with braided D -crossed categories as defined by Turaev [Tur10] and recalled below.

Definition 2.3.4. *A braided D -crossed category is a D -graded monoidal category $\mathcal{A}^D = \bigoplus_{d \in D} \mathcal{A}_d$, such that $\otimes: \mathcal{A}_d \boxtimes \mathcal{A}_{d'} \rightarrow \mathcal{A}_{dd'}$, together with a D -action ρ on \mathcal{A}^D and a D -braiding c . The action is such that the image of the component \mathcal{A}_d under $\rho(h)$ lies in $\mathcal{A}_{hdh^{-1}}$. The D -braiding consists of natural isomorphisms $c_{X,Y}: X \otimes Y \rightarrow d.Y \otimes X$ for $X \in \mathcal{A}_d$, satisfying natural coherence conditions.*

In summary, we find the following:

Proposition 2.3.5. *The collection of the factorization homologies on $\mathbb{S}^1 \times \mathbb{R}$ equipped with a decoration by D -bundles has the structure of a braided D -crossed category.*

We will now describe the components $\int_{(\mathbb{S}^1 \times \mathbb{R}, \gamma_d)} \mathcal{A}$ of the D -crossed category defined by factorization homology, where γ_d denotes the map corresponding to the loop $d \in \pi_1(BD) = D$ and which is constant in the radial direction. To that end, recall that for an \mathcal{A} -bimodule category $\mathcal{M} \in \text{Pres}_{\mathbb{K}}$, the *bimodule trace* of \mathcal{M} is defined as the relative tensor product

$$\text{Tr}_{\mathcal{A}}(\mathcal{M}) = \mathcal{M} \underset{\mathcal{A} \boxtimes \mathcal{A}^{\text{op}}}{\boxtimes} \mathcal{A} \quad ,$$

2. Twisted character varieties

where \mathcal{A}^{op} denotes the category \mathcal{A} with the opposite monoidal structure: $x \otimes^{\text{op}} y = y \otimes x$ for $x, y \in \mathcal{A}$.

For an undecorated annulus, we have an equivalence

$$\int_{\mathbb{S}^1 \times \mathbb{R}} \mathcal{A} \cong \mathcal{A} \boxtimes_{\mathcal{A} \boxtimes \mathcal{A}^{\text{op}}} \mathcal{A} \quad . \quad (2.20)$$

Thus factorization homology on the annulus computes Hochschild homology, or the monoidal trace, of the balanced braided tensor category \mathcal{A} . The monoidal trace (2.20) can be understood as the categorical counterpart of the co-center $A/[A, A]$ of an associative algebra A . On the other hand, the Drinfeld center $\mathcal{Z}(\mathcal{A})$ of the tensor category \mathcal{A} is the categorical equivalent of the center $Z(A)$ of the algebra A . If \mathcal{A} is rigid, one may identify [DSPS13, Lemma 2.4.5 and Corollary 2.4.11]

$$\mathcal{Z}(\mathcal{A}) = \text{Hom}_{\mathcal{A} \boxtimes \mathcal{A}^{\text{op}}}(\mathcal{A}, \mathcal{A}) \cong {}_{\langle \mathbb{I} \rangle} \mathcal{A} \boxtimes_{\mathcal{A} \boxtimes \mathcal{A}^{\text{op}}} \mathcal{A} \quad ,$$

where $\mathbb{I}: \mathcal{A} \rightarrow \mathcal{A}^{\text{op}}$ is the monoidal equivalence sending each compact object $x \in \text{cmp}(\mathcal{A})$ to its left dual ${}^{\vee}x$ and ${}_{\langle \mathbb{I} \rangle} \mathcal{A}$ is the bimodule whose left action is pulled back along \mathbb{I} . But \mathcal{A} is a ribbon category, in particular this means that we have a natural monoidal isomorphism $\alpha: \text{id}_{\mathcal{A}} \Rightarrow \mathbb{I}$ which allows to identify ${}_{\mathcal{A}} \mathcal{A}_{\mathcal{A}} \cong {}_{\langle \mathbb{I} \rangle} ({}_{\mathcal{A}} \mathcal{A}_{\mathcal{A}})$ as bimodule categories. We thus see that the rigidity together with the pivotal structure allow to identify the monoidal trace with the Drinfeld center.

In the decorated setting, we will need the following: for a monoidal functor $F: \mathcal{A} \rightarrow \mathcal{A}$ denote by $M_{\langle F \rangle}$ the bimodule whose right action is pulled back along F . Then, the F -twisted Drinfeld center $\mathcal{Z}^F(\mathcal{A})$ is defined to be center of the bimodule category $\mathcal{M}_{\langle F \rangle}$, see [FSS17, Definition 2.12]. We can now relate the components of the D -crossed category defined by factorization homology on annuli with D -bundles to twisted Drinfeld centers:

Proposition 2.3.6. *Let \mathcal{A} be a ribbon category with D -action. For each $d \in D$, there is an equivalence*

$$\int_{(\mathbb{S}^1 \times \mathbb{R}, \gamma_d)} \mathcal{A} \cong \text{Tr}_{\mathcal{A}(\vartheta(d))} \mathcal{A} \quad ,$$

of the factorization homology on the d -decorated annulus and the bimodule trace of \mathcal{A} with the d -twisted left regular action. Furthermore, we have an identification

$$\text{Tr}_{\mathcal{A}(\vartheta(d))} \mathcal{A} \cong \mathcal{Z}^{\vartheta(d^{-1})}(\mathcal{A})$$

of the bimodule trace with the $\vartheta(d^{-1})$ -twisted Drinfeld center of \mathcal{A} .

Proof. The first assertion follows directly from Example 2.2.8. For the second statement, we apply the monadicity Theorem 1.3.20 to describe ${}_{\vartheta(d)} \mathcal{A}$ internal to $\mathcal{A} \boxtimes \mathcal{A}^{\text{op}}$

$${}_{\vartheta(d)} \mathcal{A} \cong \underline{\text{End}}^{\vartheta(d)}(1_{\mathcal{A}})\text{-Mod}_{\mathcal{A} \boxtimes \mathcal{A}^{\text{op}}} \quad ,$$

where $\underline{\text{End}}^{\vartheta(d)}(1_{\mathcal{A}})$ is the endomorphism algebra of the monoidal unit in $\mathcal{A} \boxtimes \mathcal{A}^{\text{op}}$ with respect to the $\vartheta(d)$ -twisted canonical right $\mathcal{A} \boxtimes \mathcal{A}^{\text{op}}$ -action.

We will denote by $\mathfrak{r}: \mathcal{A} \rightarrow \mathcal{A}^{\text{op}}$ the monoidal equivalence sending a compact object $x \in \text{cmp}(\mathcal{A})$ to its right dual x^{\vee} . Then, a categorical version of the Eilenberg-Watts

2. Twisted character varieties

theorem [BJS21, Lemma 5.7] gives the first equivalence in the following sequence of identifications:

$$\begin{aligned} \underline{\text{End}}^{\vartheta(d)}(1_{\mathcal{A}})\text{-Mod}_{\mathcal{A}} &\cong \text{Hom}_{\mathcal{A}\boxtimes\mathcal{A}^{\text{op}}}(\text{Mod}_{\mathcal{A}\boxtimes\mathcal{A}^{\text{op}}}\text{-}\underline{\text{End}}^{\vartheta(d)}(1_{\mathcal{A}}), \mathcal{A}) \\ &\cong \text{Hom}_{\mathcal{A}\boxtimes\mathcal{A}^{\text{op}}}(\langle \vartheta(d-1) \rangle, \mathcal{A}_{\langle \text{tr} \rangle}, \mathcal{A}) \\ &\cong \mathcal{Z}^{\vartheta(d-1)}(\mathcal{A}) \quad . \end{aligned}$$

The second equivalence is again by monadic reconstruction and the last equivalence is [FSS17, Lemma 2.13] together with the fact that \mathcal{A} is a ribbon category. \square

2.4. Quantization of the twisted Fock–Rosly Poisson structure

We will now re-examine the moduli spaces from § 2.1 from the point of view of $\text{Out}(G)$ -structured factorization homology with coefficients in $\text{Rep}(G)$. We explain how one obtains a deformation quantization of the twisted Fock–Rosly Poisson structure from gluing the local categorical quantizations, i.e. $\text{Rep}_q(G)$ with an $\text{Out}(G)$ -action, over the surface with its $\text{Out}(G)$ -bundle decoration.

2.4.1. Twisted character stack

Throughout this section, Σ is an oriented surface with boundary and a fixed $\text{Out}(G)$ -bundle $\varphi: \pi(\Sigma) \rightarrow \text{Out}(G)$. With the tools developed in the preceding sections we can now compute the category of quasi-coherent sheaves on the twisted character stack $\text{Char}_{\varphi}(\Sigma, G)$ via $\text{Out}(G)$ -structured factorization homology:

Proposition 2.4.1. *Given a decorated gluing pattern $(P, \kappa_1, \dots, \kappa_n)$ for (Σ, φ) , there is an isomorphism $\mathcal{O}(G^{2g+r-1})_{\varphi} \cong a_P^{\kappa_1, \dots, \kappa_{2g+r-1}}$ of algebras in $\text{Rep}(G)$.*

Proof. To establish the isomorphism on the level of vector spaces, we use the algebraic Peter–Weyl theorem:

$$\mathcal{O}(G) \cong \bigoplus_V V^{\vee} \otimes V \quad ,$$

where the sum on the right hand side is over all irreducible representations of G and $\mathcal{O}(G)$ is the Hopf algebra of matrix coefficients of irreducible G -representations. Next we take into account the twist by an automorphism $\kappa \in \text{Out}(G)$: a group element $h \in G$ acts on $\phi \in \mathcal{O}(G)_{\kappa}$ via $h \triangleright \phi = \phi(h^{-1}(-)\kappa(h))$. As explained in Example 2.2.11, we thus get an isomorphism $\mathcal{F}_{\text{Rep}(G)}^{\kappa} = \bigoplus_V V^{\vee} \otimes \kappa^*V \cong \mathcal{O}(G)_{\kappa}$ compatible with the G -action. \square

In combination with Theorem 2.3.2, the above result shows that $\int_{(\Sigma, \varphi)} \text{Rep}(G)$ agrees with the category of quasi-coherent sheaves on the φ -twisted character stack.

2.4.2. Deformation quantization

In § 2.3 we constructed an algebra $a_P^{\kappa_1, \dots, \kappa_n}$, $n = 2g + r - 1$, from a combinatorial presentation (P, d_1, \dots, d_n) of the decorated surface Σ . In order to show that these algebras provide a deformation quantization of $(\text{Char}(\Sigma, G), \Pi_{FR}^{\varphi})$ from Proposition 2.1.1, we consider $a_P^{\kappa_1, \dots, \kappa_n}$ as an object in the category $\text{Rep}_{\hbar}(G)$ of topologically-free modules over $U_{\hbar}(\mathfrak{g})$. Explicitly, the algebra is the tensor product $\bigotimes_{i=1}^n \mathcal{O}_{\hbar}(G)_{\kappa_i}$, where each $\mathcal{O}_{\hbar}(G)_{\kappa_i}$ is a κ_i -twisted RE-algebra of quantized algebraic functions. The multiplication on the tensor product is defined in terms of the crossing morphisms depicted in Figure 2.7. We

2. Twisted character varieties

will show in Theorem 2.4.3 below that for all elements $f_h^{\kappa_i} \in \mathcal{O}_h(G)_{\kappa_i}$ and $g_h^{\kappa_j} \in \mathcal{O}_h(G)_{\kappa_j}$ we have

$$\frac{[f_h^{\kappa_i}, g_h^{\kappa_j}]}{\hbar} \bmod(\hbar) = \{f^{\kappa_i}, g^{\kappa_j}\} \quad ,$$

where $\{-, -\}$ is the twisted Fock–Rosly Poisson structure and $f^{\kappa_i} = f_h^{\kappa_i} \bmod(\hbar) \in \mathcal{O}(G)_{\kappa_i}$, and similarly for g^{κ_j} .

Remark 2.4.2. *Equivalently, we could directly work with the algebras $a_{\widehat{\text{Rep}}_h(G)^{\text{fd}}, P}^{\kappa_1, \dots, \kappa_n}$ obtained in the formal setting as described in Remark 2.3.3. Indeed, we have the following identifications as objects in $\widehat{\text{Rep}}_h(G)^{\text{fd}}$ (see Proposition A.2.12 and Remark A.2.13 of the appendix for more on coend algebras in free cocompletions):*

$$\begin{aligned} \mathcal{F}_{\widehat{\text{Rep}}_h(G)^{\text{fd}}}^e &= \int^{V \in \text{Rep}_h(G)^{\text{fd}}} Y_{V^*} \otimes_{\text{Day}} Y_V \\ &\cong \bigoplus_{V_\lambda, \lambda \in \mathbf{P}^+} \text{Map}_{U(\mathfrak{g})\text{-Mod}^{\text{fd}}}(-, V_\lambda^* \otimes V_\lambda)[[\hbar]] \\ &\cong \text{Map}_{U(\mathfrak{g})\text{-Mod}^{\text{lf}}}(\iota(-), \bigoplus_{V_\lambda, \lambda \in \mathbf{P}^+} V_\lambda^* \otimes V_\lambda)[[\hbar]] \\ &\cong \text{Map}_{\text{Rep}_h(G)^{\text{lf}}}(\iota(-), \bigoplus_{V_\lambda, \lambda \in \mathbf{P}^+} V_\lambda^*[[\hbar]] \widehat{\otimes} V_\lambda[[\hbar]]) \end{aligned}$$

where $\iota: U(\mathfrak{g})\text{-Mod}^{\text{fd}} \rightarrow U(\mathfrak{g})\text{-Mod}^{\text{lf}}$ is the inclusion of finite-dimensional $U(\mathfrak{g})$ -modules into the category of locally-finite $U(\mathfrak{g})$ -modules, and similarly for the categories of topologically-free $U_h(\mathfrak{g})$ -modules. We also used that $U_h(\mathfrak{g}) \cong U(\mathfrak{g})[[\hbar]]$ as algebras over $\mathbb{C}[[\hbar]]$. Along the same lines, we find that the κ -twisted coend algebras admit the following description (suppressing the restricted Yoneda embeddings from the notation)

$$\mathcal{F}_{\widehat{\text{Rep}}_h(G)^{\text{fd}}}^\kappa \cong \bigoplus_{V_\lambda, \lambda \in \mathbf{P}^+} V_\lambda[[\hbar]] \widehat{\otimes} \kappa^* V_\lambda[[\hbar]] \quad .$$

In summary, we find that $a_{\widehat{\text{Rep}}_h(G)^{\text{fd}}}^{\kappa_1, \dots, \kappa_n}$ is the image of $a_P^{\kappa_1, \dots, \kappa_n}$ under the embedding of $\text{Rep}_h(G)^{\text{lf}} \rightarrow \widehat{\text{Rep}}_h(G)^{\text{fd}}$.

Theorem 2.4.3. *The algebra $a_P^{\kappa_1, \dots, \kappa_{2g+r-1}}$ is a deformation quantization of the twisted Fock–Rosly Poisson structure on $\text{Rep}(\Sigma, G) \cong G^{2g+r-1}$. Its subalgebra of $U_h(\mathfrak{g})$ -invariants is a quantization of the induced Poisson structure on the character variety $\text{Char}(\Sigma, G)$ which is independent of the chosen gluing pattern P .*

Proof. First, we show that the semi-classical limit of the commutator of two quantized functions in $\mathcal{O}_h(G)_\kappa$ agrees with the κ -twisted STS Poisson structure Π_{STS}^κ . We recall from Example 2.2.11 that the multiplication in the κ -twisted RE-algebra $\mathcal{O}_h(G)_\kappa$ is related to the multiplication in the FRT-algebra via a twisting cocycle defined in terms of R-matrices. The commutator in the (untwisted) FRT-algebra H° , $H = U_h(\mathfrak{g})$, can be computed by acting with

$$(1 \otimes^{\text{op}} 1) \boxtimes (1 \otimes 1) - ((\mathcal{R}^2)^{-1} \otimes^{\text{op}} (\mathcal{R}^1)^{-1}) \boxtimes (\mathcal{R}'^2 \otimes \mathcal{R}'^1)$$

on the components $V^\vee \otimes^{\text{op}} W^\vee \boxtimes V \otimes W$, for $V, W \in \text{Rep}_h(G)$, since the multiplication in the FRT-algebra is given by the Hopf pairing $\langle -, - \rangle$ between H° and H :

$$\langle m_{\text{FRT}}(\phi\psi), h \rangle = \langle \phi \otimes \psi, \Delta(h) \rangle, \quad \phi, \psi \in H^\circ, h \in H$$

2. Twisted character varieties

and $\Delta(-) = \mathcal{R}^{-1}\Delta^{\text{op}}(-)\mathcal{R}$. Now we take into account the twist by κ , as well as the twisting cocycle $\mathcal{R}^1 \otimes \kappa.\mathcal{R}^1 \otimes \mathcal{R}'^2\mathcal{R}^2 \otimes 1$, to compute the commutator in $\mathcal{O}_{\hbar}(G)_{\kappa}$ component-wise by acting with

$$(\mathcal{R}'^1 \otimes^{\text{op}} \mathcal{R}'^2\mathcal{R}^2) \boxtimes (\kappa.\mathcal{R}^1 \otimes 1) - C \circ (\mathcal{R}'^2\mathcal{R}^2 \otimes^{\text{op}} \mathcal{R}'^1) \boxtimes (1 \otimes \kappa.\mathcal{R}^1) \quad (2.21)$$

$$\text{where } C = ((\mathcal{R}^2)^{-1} \otimes^{\text{op}} (\mathcal{R}^1)^{-1}) \boxtimes (\kappa.\mathcal{R}'^2 \otimes \kappa.\mathcal{R}'^1)$$

on $V^{\vee} \otimes^{\text{op}} W^{\vee} \boxtimes V \otimes W$. To compute the semi-classical limit of the action (2.21), we use that the R-matrix has the following \hbar -expansion: $\mathcal{R} = 1 + \hbar r + \mathcal{O}(\hbar^2)$, where $r = r^1 \otimes r^2 \in \mathfrak{g}^{\otimes 2}$ is the classical r-matrix. Explicitly, the semi-classical limit of (2.21) is

$$r_{3(\kappa),2} + r_{1,2} - r_{4(\kappa),1} - r_{2,1} + r_{2,1} - r_{4,3} \in U(\mathfrak{g})^{\otimes 4} \quad ,$$

where for instance $r_{3(\kappa),2} = 1 \otimes r^2 \otimes \kappa_* r^1 \otimes 1 \in U(\mathfrak{g})^{\otimes 4}$. More explicitly, the first two copies of $U(\mathfrak{g})^{\otimes 4}$ act on $\mathcal{O}(G)_{\kappa}$ via $x \mapsto x^R$, for $x \in \mathfrak{g}$, and the last two copies act via $x \mapsto -\kappa_* x^L$. Thus, we find that the semi-classical limit of the commutator is the following bivector field on G :

$$\begin{aligned} -r^{L(\kappa),R} + r^{R,R} + r_{2,1}^{R,L(\kappa)} - r_{2,1}^{L,L} &= \omega^{\text{ad}(\kappa),\text{ad}(\kappa)} + t^{R,L(\kappa)} - t^{L(\kappa),R} \\ &= \Pi_{\text{STS}}^{\kappa} \quad . \end{aligned}$$

In the above we used that $r^{R,R} - r_{2,1}^{L,L} = \omega^{R,R} + \omega^{L,L}$.

Next, we prove the claim for two positively unlinked edges $\alpha < \beta$. We recall that the crossing morphism for two unlinked edges $\alpha < \beta$ is given by acting on $\mathcal{O}_{\hbar}^{\kappa\beta}(G) \otimes \mathcal{O}_{\hbar}^{\kappa\alpha}(G)$ with

$$\begin{aligned} U^+ &= \tau_{12,34} \circ (\mathcal{R}^1 \otimes 1 \otimes 1 \otimes \kappa_{\alpha}.\mathcal{R}^2)(1 \otimes \kappa_{\beta}.\mathcal{R}^1 \otimes 1 \otimes \kappa_{\alpha}.\mathcal{R}^2) \\ &\quad (\mathcal{R}^1 \otimes 1 \otimes \mathcal{R}^2 \otimes 1)(1 \otimes \kappa_{\beta}.\mathcal{R}^1 \otimes \mathcal{R}^2 \otimes 1) \\ &= \tau_{12,34} \circ \tilde{U}^+ \end{aligned}$$

Hence, the commutator on components $\phi \otimes \kappa_{\alpha}^* v \in \mathcal{O}_{\hbar}^{\kappa\alpha}(G)$ and $\psi \otimes \kappa_{\beta}^* w \in \mathcal{O}_{\hbar}^{\kappa\beta}(G)$ can be computed via

$$(m_{\mathcal{O}_{\hbar}^{\kappa\alpha}(G)} \otimes m_{\mathcal{O}_{\hbar}^{\kappa\beta}(G)}) \circ (1 - (U^+)_{7,8,1,2})(\phi \otimes \kappa_{\alpha}^* v \otimes 1^{\otimes 4} \otimes \psi \otimes \kappa_{\beta}^* w) \quad .$$

Taking the semi-classical limit of this action thus amounts to

$$\frac{1 - \tau(\tilde{U}^+)}{\hbar} \text{ mod }(\hbar) = -r_{3,2(\kappa_{\alpha})} - r_{4(\kappa_{\beta}),2(\kappa_{\alpha})} - r_{3,1} - r_{4(\kappa_{\beta}),1} \in U(\mathfrak{g})^{\otimes 4} \quad , \quad (2.22)$$

where this time the first and third copy in $U(\mathfrak{g})^{\otimes 4}$ act via $x \mapsto x^R$ and the second and the forth copy via $x \mapsto -\kappa_* x^L$, so that the right hand side of (2.22) acts on $\mathcal{O}^{\kappa\alpha}(G) \otimes \mathcal{O}^{\kappa\beta}(G)$ via $-r_{2,1}^{\text{ad}(\kappa_{\alpha}),\text{ad}(\kappa_{\beta})}$, which agrees with $\Pi_{\alpha,\beta}$ from Equation (2.3) as claimed. Similarly, for two positively linked edges we have

$$\frac{1 - \tau(\tilde{L}^+)}{\hbar} \text{ mod }(\hbar) = r_{2(\kappa_{\alpha}),3} - r_{4(\kappa_{\beta}),2(\kappa_{\alpha})} - r_{3,1} - r_{4(\kappa_{\beta}),1} \quad ,$$

which differs from the unlinked case by adding a term $-2t^{L(\kappa_{\alpha}),R}$, which agrees with the Poisson bivector from (2.3). Lastly, for two positively nested edges we find

$$\frac{1 - \tau(\tilde{N}^+)}{\hbar} \text{ mod }(\hbar) = r_{2(\kappa_{\alpha}),3} + r_{2(\kappa_{\alpha}),4(\kappa_{\beta})} - r_{3,1} - r_{4(\kappa_{\beta}),1} \quad ,$$

2. Twisted character varieties

which differs from the linked case by adding the term $2t^{L(\kappa_\alpha), L(\kappa_\beta)}$, in agreement with (2.3), which ends the proof for the positively unlinked, linked and nested case. The remaining three cases can be worked out analogously. \square

2.5. Closed and marked surfaces with D -bundles

In the preceding sections, all surfaces were assumed to have at least one boundary component. We can close up a surface with boundary by gluing in disks. In this section we will discuss how to compute D -structured factorization homology on the resulting closed surfaces. We will also allow for certain stratifications on the closed surfaces, namely point defects.

2.5.1. Closed surfaces

Let Σ be a closed surface equipped with a map $\varphi: \Sigma \rightarrow BD$. We use a decomposition of Σ into a surface Σ° with one boundary component and a disk \mathbb{D} , see Figure 2.10. We denote $\varphi^\circ = \varphi|_{\Sigma^\circ}$. The bundle φ° has trivial holonomy around the boundary $\partial\Sigma^\circ$ since the bundle extends to Σ .

Then, we can use excision to compute factorization homology on the closed decorated surface (Σ, φ) as the relative tensor product:

$$\int_{(\Sigma, \varphi)} \mathcal{A} \cong \int_{(\Sigma^\circ, \varphi^\circ)} \mathcal{A} \boxtimes_{\int_{(\text{Ann}, *)} \mathcal{A}} \mathcal{A} . \quad (2.23)$$

For a combinatorial presentation (P, d_1, \dots, d_{2g}) of the decorated surface Σ° , we showed in Theorem 2.3.2 that one obtains identifications

$$\int_{(\Sigma^\circ, \varphi^\circ)} \mathcal{A} \cong a_P^{d_1, \dots, d_{2g}}\text{-Mod}_{\mathcal{A}}, \quad \int_{(\text{Ann}, *)} \mathcal{A} \cong \mathcal{F}_{\mathcal{A}}^e\text{-Mod}_{\mathcal{A}} ,$$

internal to the disk category $\int_{\mathbb{D}} \mathcal{A} \cong \mathcal{A}$. For the case of closed surfaces we will have to describe the categorical factorization homology internal to the annulus category $\int_{\text{Ann}} \mathcal{A}$ instead. The techniques to do so were developed in [BZBJ18b, Section 4]. In the following paragraph we review the main results that will be used to compute factorization homology on a closed D -decorated surface via the relative tensor product (2.23).

We first recall the notion of a quantum moment map from [Saf21a, Section 3]. We will write $\mathcal{F} = \mathcal{F}_{\mathcal{A}}^e$ for the (untwisted) reflection equation algebra in \mathcal{A} . For every $V \in \mathcal{A}$ there is a natural isomorphism, the so-called “*field goal*” transformation [BZBJ18b, Section 4.2]

$$\tau_V: \mathcal{F} \otimes V \longrightarrow V \otimes \mathcal{F}, \quad \tau_V = \begin{array}{c} V \quad \mathcal{F} \\ \diagdown \quad | \\ \quad \quad \diagup \\ \mathcal{F} \quad V \end{array} , \quad (2.24)$$

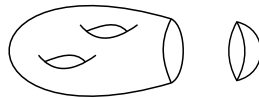

Figure 2.10.: The surface Σ° obtained from Σ by removing a disk \mathbb{D} .

2. Twisted character varieties

yielding a monoidal functor $\mathcal{F}\text{-Mod}_{\mathcal{A}} \rightarrow (\mathcal{F}, \mathcal{F})\text{-Bimod}_{\mathcal{A}}$ by sending a left \mathcal{F} -module to a bimodule for which the right \mathcal{F} -module structure is obtained via τ . Now let B be an algebra in \mathcal{A} . A *quantum moment map* is an algebra map $\mu_B: \mathcal{F} \rightarrow B$ in \mathcal{A} , making the following diagram commute

$$\begin{array}{ccc}
 B \otimes \mathcal{F} & \xrightarrow{\text{id} \otimes \mu_B} & B \otimes B \\
 \tau_B \downarrow & & \searrow^m \\
 \mathcal{F} \otimes B & \xrightarrow{\mu_B \otimes \text{id}} & B \otimes B \\
 & & \nearrow_m
 \end{array} \quad (2.25)$$

It is shown in [Saf21a, Proposition 3.7] that for a right $(\mathcal{F}\text{-Mod}_{\mathcal{A}})$ -module category \mathcal{M} and an object $m \in \mathcal{M}$ having an internal endomorphism algebra $\underline{\text{End}}_{\mathcal{A}}(m)$ in \mathcal{A} , there exists a quantum moment map $\mu: \mathcal{F} \rightarrow \underline{\text{End}}_{\mathcal{A}}(\mathcal{O})$. We will explain how to obtain this quantum moment map for the situation at hand and how to use it to compute factorization homology on closed surfaces.

Let $\mathcal{M} = \int_{(\Sigma^\circ, \varphi^\circ)} \mathcal{A}$, which is naturally a right $\int_{\text{Ann}} \mathcal{A}$ -module category via the embedding of the annulus into the boundary $\partial\Sigma^\circ$. Recall that the module category \mathcal{M} is pointed via the inclusion of the empty manifold and we denote the resulting distinguished object by $\mathcal{O}_{\Sigma^\circ} \in \mathcal{M}$. We have the following weakly commuting diagram of embeddings:

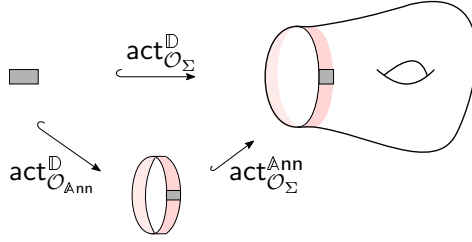

Figure 2.11.: Weakly commuting diagram of embeddings.

By the commutativity (up to homotopy) of the embeddings in Figure 2.11 one gets an algebra morphism

$$\begin{aligned}
 \underline{\text{End}}_{\mathcal{A}}(\mathcal{O}_{\Sigma^\circ}) &= (\text{act}_{\mathcal{O}_{\Sigma^\circ}}^{\text{D}})^R \circ \text{act}_{\mathcal{O}_{\Sigma^\circ}}^{\text{D}}(1_{\mathcal{A}}) \\
 &\cong (\text{act}_{\mathcal{O}_{\text{Ann}}}^{\text{D}})^R \circ (\text{act}_{\mathcal{O}_{\Sigma^\circ}}^{\text{Ann}})^R \circ \text{act}_{\mathcal{O}_{\Sigma^\circ}}^{\text{Ann}} \circ \text{act}_{\mathcal{O}_{\text{Ann}}}^{\text{D}}(1_{\mathcal{A}}) \\
 &\xleftarrow{\eta} (\text{act}_{\mathcal{O}_{\text{Ann}}}^{\text{D}})^R \circ \text{act}_{\mathcal{O}_{\text{Ann}}}^{\text{D}}(1_{\mathcal{A}}) \\
 &\cong \mathcal{F} \ ,
 \end{aligned}$$

where η is the unit of the adjunction induced by the embedding of the annulus into the marked boundary component. Under the equivalence $\int_{\text{Ann}} \mathcal{A} \cong \mathcal{F}\text{-Mod}_{\mathcal{A}}$ for the annulus category, the functor $\text{act}_{\mathcal{O}_{\text{Ann}}}^{\text{D}}$ identifies with the free \mathcal{F} -module functor $\text{free}_{\mathcal{F}}: \mathcal{A} \rightarrow \mathcal{F}\text{-Mod}_{\mathcal{A}}$ with right adjoint given by the forgetful functor U . In particular, we have

$$U(\underbrace{\underline{\text{End}}_{\mathcal{F}\text{-Mod}_{\mathcal{A}}}(\mathcal{O}_{\Sigma^\circ})}_B) \cong \underline{\text{End}}_{\mathcal{A}}(\mathcal{O}_{\Sigma^\circ}) \ .$$

Since B is an algebra in $\mathcal{F}\text{-Mod}_{\mathcal{A}}$ it follows that the map $\mu: \mathcal{F} \rightarrow \underline{\text{End}}_{\mathcal{A}}(\mathcal{O}_{\Sigma^\circ})$ given by the image of the unit map $\eta: 1 \rightarrow B$ under the forgetful functor U makes Diagram (2.25) commute and hence is a quantum moment map.

2. Twisted character varieties

More generally, we have the following:

Proposition 2.5.1. *An algebra in $\mathcal{F}\text{-Mod}_{\mathcal{A}}$ is the same as an algebra in \mathcal{A} with a quantum moment map.*

Proof. An algebra $B \in \mathcal{F}\text{-Mod}_{\mathcal{A}}$ has a \mathcal{F} -balanced multiplication

$$B \otimes_{\mathcal{F}} B \longrightarrow B, \quad b \otimes b' \longmapsto bb' \quad ,$$

which is a left \mathcal{F} -module map, as well as a right \mathcal{F} -module map for the right module structure defined by the half-braiding $\tau_B: \mathcal{F} \otimes B \rightarrow B \otimes \mathcal{F}$. One can easily check that the map

$$\mu: \mathcal{F} \longrightarrow B, \quad \lambda \longmapsto \lambda \triangleright 1_B$$

is a quantum moment map. Conversely, the pair (A, μ) , with A an algebra in \mathcal{A} and $\mu: \mathcal{F} \rightarrow A$ a quantum moment map, defines an algebra in the category of $(\mathcal{F}, \mathcal{F})$ -bimodules via

$$\lambda \triangleright a = \mu(\lambda)a, \quad a \triangleleft \lambda = a\mu(\lambda)$$

for $\lambda \in \mathcal{F}$ and $a \in A$. Since μ makes Diagram (2.25) commute, we have $A \in \mathcal{F}\text{-Mod}_{\mathcal{A}} \subset (\mathcal{F}, \mathcal{F})\text{-Bimod}_{\mathcal{A}}$. \square

It then follows from the previous discussion, together with the fact that an \mathcal{A} -progenerator is also an $\int_{\mathbb{A}\text{nn}} \mathcal{A}$ -progenerator [BZBJ18b, Theorem 4.3], that there is an equivalence

$$\int_{\Sigma^\circ} \mathcal{A} \cong \underline{\text{End}}_{\mathcal{A}}(\mathcal{O}_{\Sigma^\circ})\text{-Mod}_{\int_{\mathbb{A}\text{nn}} \mathcal{A}} \quad (2.26)$$

of $\int_{\mathbb{A}\text{nn}} \mathcal{A}$ -module categories, where $\underline{\text{End}}_{\mathcal{A}}(\mathcal{O}_{\Sigma^\circ})$ is equipped with the algebra structure coming from the quantum moment map. Under the above identification, the right action of $\int_{\mathbb{A}\text{nn}} \mathcal{A}$ on $\int_{\Sigma^\circ} \mathcal{A}$ is given by the relative tensor product

$$V \boxtimes X \longmapsto V \otimes_{\mathcal{F}} X \quad ,$$

where one uses the quantum moment map and the field goal transformation to form the relative tensor product.

Applying the previous discussion to the reconstruction result from Theorem 2.3.2, we get quantum moment maps

$$\mu_{\Sigma^\circ}: \mathcal{F} \longrightarrow a_P^{d_1, \dots, d_{2g}} \quad \text{and} \quad \mu_{\mathbb{D}}: \mathcal{F} \longrightarrow 1_{\mathcal{A}} \quad , \quad (2.27)$$

which endow $a_P^{d_1, \dots, d_{2g}}$ and $1_{\mathcal{A}}$ with the structure of algebras in $\mathcal{F}\text{-Mod}_{\mathcal{A}}$, leading to the following result:

Proposition 2.5.2. *We have an equivalence of categories*

$$\int_{(\Sigma, \varphi)} \mathcal{A} \cong (a_P^{d_1, \dots, d_{2g}}, 1_{\mathcal{A}})\text{-Bimod}_{\mathcal{F}\text{-Mod}_{\mathcal{A}}} \quad , \quad (2.28)$$

between the factorization homology for a closed decorated surface (Σ, φ) and the category of $(a_P^{d_1, \dots, d_{2g}}, 1_{\mathcal{A}})$ -bimodules internal to the annulus category $\int_{\mathbb{A}\text{nn}} \mathcal{A}$.

2. Twisted character varieties

Proof. Using the identification (2.26) and excision we get

$$\int_{(\Sigma, \varphi)} \mathcal{A} \cong a_P^{d_1, \dots, d_{2g}} \text{-Mod}_{\int_{\text{Ann}} \mathcal{A}} \boxtimes_{\int_{\text{Ann}} \mathcal{A}} 1_{\mathcal{A}} \text{-Mod}_{\int_{\text{Ann}} \mathcal{A}} .$$

Applying monadic reconstruction for relative tensor products as in [BZBJ18a, Theorem 4.12] we get the equivalence stated in the proposition. \square

We end this section with an explicit example of a quantum moment map for the algebras obtained via monadic reconstruction from factorization homology on D -decorated surfaces.

Example 2.5.3. Throughout, let $\mathcal{A} = \text{Rep}_q(G)$ and $D = \text{Out}(G)$. Let us first consider the undecorated case. For $\Sigma = \mathbb{P}\text{ants}$ described by the gluing pattern $P(1, 1', 2, 2') = (1, 2, 3, 4)$, we have $\int_{\mathbb{P}\text{ants}} \mathcal{A} \cong a^P \text{-Mod}_{\mathcal{A}}$ and an algebra map $\Delta: \mathcal{F} \rightarrow a^P = \mathcal{F} \otimes \mathcal{F}$ which is the coproduct of the bialgebra \mathcal{F} defined on components by:

$$V^\vee \otimes V \xrightarrow{\text{id} \otimes \text{coev}_V \otimes \text{id}} V^\vee \otimes V \otimes V^\vee \otimes V \xrightarrow{\iota_V \otimes \iota_V} \mathcal{F} \otimes \mathcal{F} . \quad (2.29)$$

The map Δ also satisfies the quantum moment map condition (2.25). It quantizes the classical multiplicative moment map sending a discrete connection $(m_1, m_2) \in G \times G$ to its holonomy around the marked boundary component, i.e. $\mu^{\text{cl}}(m_1, m_2) = m_1 m_2$.

Now, we decorate P by the tuple (d, d^{-1}) describing a D -bundle φ on $\mathbb{P}\text{ants}$. By Theorem 2.3.2 we find

$$\int_{(\mathbb{P}\text{ants}, \varphi)} \mathcal{A} \cong a_P^{d, d^{-1}} \text{-Mod}_{\mathcal{A}} \cong \mathcal{F}^d \otimes \widetilde{\mathcal{F}}^d \text{-Mod}_{\mathcal{A}} \quad (2.30)$$

where

$$\mathcal{F}^d = \int^{X \in \text{cmp}(\mathcal{A})} X^\vee \otimes \vartheta(d^{-1}).X, \quad \widetilde{\mathcal{F}}^d = \int^{X \in \text{cmp}(\mathcal{A})} \vartheta(d^{-1}).X^\vee \otimes X .$$

The second identification in (2.30) comes from the $\mathcal{A} \boxtimes \mathcal{A}$ -module equivalence $\langle \text{id} \boxtimes \vartheta(d) \rangle \mathcal{A} \cong \langle \vartheta(d^{-1}) \boxtimes \text{id} \rangle \mathcal{A}$.

Proposition 2.5.4. *The following defines a quantum moment map for $\mathcal{F}^d \otimes \widetilde{\mathcal{F}}^d$:*

$$V^\vee \otimes V \xrightarrow{\text{id} \otimes \text{coev}_{\vartheta(d^{-1}).V} \otimes \text{id}} V^\vee \otimes \vartheta(d^{-1}).V \otimes \vartheta(d^{-1}).V^\vee \otimes V \rightarrow \mathcal{F}^d \otimes \widetilde{\mathcal{F}}^d . \quad (2.31)$$

Proof. In order for (2.31) to be an algebra map, the following has to commute

$$\begin{array}{ccc} V^\vee \otimes V \otimes W^\vee \otimes W & \xrightarrow{m_{\text{RE}}} & (V \otimes W)^\vee \otimes (V \otimes W) \\ \downarrow (\text{id} \otimes \text{coev}_{\vartheta(d^{-1})} \otimes \text{id})^{\otimes 2} & & \downarrow \text{id} \otimes \text{coev}_{\vartheta(d^{-1}).(V \otimes W)} \otimes \text{id} \\ V^\vee \otimes V \otimes V^\vee \otimes V \otimes W^\vee \otimes W \otimes W^\vee \otimes W & \xrightarrow{(m_{\mathcal{F}^d} \otimes m_{\widetilde{\mathcal{F}}^d}) \circ (\text{id} \otimes C \otimes \text{id})} & \mathcal{F}^d \otimes \widetilde{\mathcal{F}}^d \end{array}$$

where C is the unlinked crossing morphism from Figure 2.7. Commutativity of the above diagram will follow from the observation that for any element $h \in U_q(\mathfrak{g})$ and

2. Twisted character varieties

$v \in V$ we have

$$\begin{aligned}
 h \triangleright \text{coev}_{\vartheta(d-1), V}(1)(1 \otimes v) &= h \triangleright d^* e_i \otimes d^* f^i(1 \otimes v) \\
 &= d.h_{(1)} \triangleright d^* e_i \otimes d^* f^i(S(d.h_{(2)})) \triangleright v \\
 &= (d.h)_{(1)}(S((d.h)_{(2)})) \triangleright v \\
 &= d.\epsilon(h)\text{coev}_{\vartheta(d-1), V}(1)(1 \otimes v)
 \end{aligned}$$

together with the relations $(\text{id} \otimes \epsilon)\mathcal{R} = 1 \otimes 1 = (\epsilon \otimes \text{id})\mathcal{R}$, $\mathcal{R}_{1,3}\mathcal{R}_{1,2} = (\text{id} \otimes \Delta)\mathcal{R}$ and $\mathcal{R}_{1,3}\mathcal{R}_{2,3} = (\Delta \otimes \text{id})\mathcal{R}$ for the universal R-matrix \mathcal{R} . By the same relations one can also proof that the map (2.31) makes Diagram (2.25) commute. \square

On a classical level, multiplicative moment maps that are equivariant with respect to *twisted conjugation* were studied in [Mei17, Zer21]. Writing G^κ for the group G viewed as a G -space under κ -twisted conjugation, an example of such a moment map is provided by the identity map $\text{id}: G^\kappa \rightarrow G^\kappa$. More interesting examples may be constructed via fusion: for $(G^\kappa, \Phi = \text{id})$ and $(G^{\kappa'}, \Phi' = \text{id})$, their fusion product is the G -space $G^\kappa \otimes G^{\kappa'} = G^\kappa \times \kappa^* G^{\kappa'}$, where the notation means that the G -action on the second copy is pulled back along κ , i.e. $g.(a, b) = (ga\kappa(g^{-1}), \kappa(g)b\kappa'(g)^{-1})$. Then, $\mu^{\text{cl}} = \Phi \cdot \Phi'$ is a $G^{\kappa\kappa'}$ -valued moment map. The moment map μ from (2.31) is thus a quantization of the fusion product $G^\kappa \otimes G^{\kappa'}$ in the special case that $\kappa' = \kappa^{-1}$. \triangle

Remark 2.5.5. *The quantum moment maps in Example 2.5.3 are defined in purely algebraic terms. We end this section with a (informal) discussion relating them to the quantum moment maps previously obtained via the embeddings depicted in Figure 2.11. For simplicity we will do so only for the case of the (undecorated) pair of pants $\Sigma = \mathbb{P}\text{ants}$ discussed in the beginning of Example 2.5.3.*

For the topological point of view on quantum moment maps it will be convenient to use the identification of the reflection equation algebra \mathcal{F} with the so-called internal skein algebra of Ann [GJS21, Proposition 2.26]. An element in the latter may be represented by an internal skein

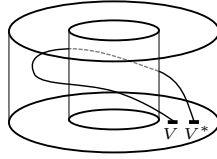

for $V \in \mathcal{A}$ a compact projective generator. Moreover, the internal skein algebra of $\mathbb{P}\text{ants}$, presented by the gluing pattern P as in Example 2.5.3, is isomorphic to the algebra $a^P = \mathcal{F} \otimes \mathcal{F}$ [GJS21, Proposition 2.29]. The embedding of the annulus into the marked boundary component of $\mathbb{P}\text{ants}$ then induces an algebra map $\mathcal{F} \rightarrow a^P$. The image of the internal skein depicted above under this embedding is

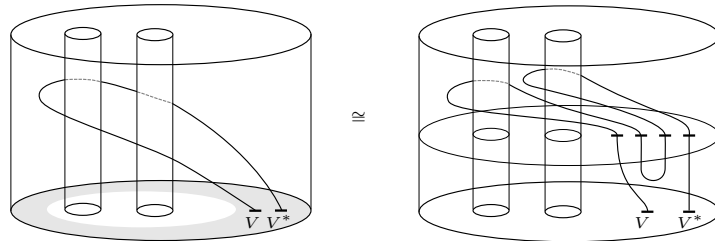

2. Twisted character varieties

where on the right hand side we have the coevaluation $\mathbb{K} \xrightarrow{\text{coev}_V} V \otimes V^*$, relating the topological picture to the quantum moment map defined in (2.29).

2.5.2. Point defects

For surfaces without D -bundles decoration, factorization homology on surfaces with marked points was discussed in § 1.3.1. In the categorical setting, point defects

$$\mathcal{F}: \text{Disk}_{2,*}^{\text{of}} \longrightarrow \text{Pres}_{\mathbb{K}}$$

are classified by so-called balanced braided module categories [BZBJ18b] (see also § 3.2.4 for a definition).

Including the decoration by D -bundles, the objects in the marked disk category $\text{Disk}_{2,*}^D$ are on the one hand unmarked disks equipped with constant maps $*$: $\mathbb{D} \rightarrow BD$ to the base point and on the other hand marked disks \mathbb{D}_*^d equipped with a map

$$\gamma_d: \mathbb{D}_* \setminus * \longrightarrow BD$$

with holonomy d . The categorical description of the corresponding point defects

$$\mathcal{F}: \text{Disk}_{2,*}^D \longrightarrow \text{Pres}_{\mathbb{K}}$$

was worked out in [KM23, Section 3.4.2] by means of a combinatorial model for the topological operad whose envelope is the disk category $\text{Disk}_{2,*}^D$. The result is the following:

Proposition 2.5.6. [KM23, Definition 3.17 and Proposition 3.18] *In the D -decorated setting, point defects $\mathcal{F}: \text{Disk}_{2,*}^D \rightarrow \text{Pres}$ are classified by pairs $(\mathcal{A}, \mathcal{M})$, where \mathcal{A} is a balanced braided tensor category with a D -action $\vartheta_{\mathcal{A}}$, and \mathcal{M} is a D -equivariant balanced braided module category over \mathcal{A} . The latter is a D -graded category $\mathcal{M} = \bigoplus_{d \in D} \mathcal{M}_d$ together with*

- a D -action $\vartheta_{\mathcal{M}}(d): \mathcal{M} \rightarrow \mathcal{M}$, such that the image of the component \mathcal{M}_d under $\vartheta_{\mathcal{M}}(d)$ lies in $\mathcal{M}_{dd^{-1}}$
- a D -equivariant \mathcal{A} -action $\bar{\otimes}: \mathcal{M} \boxtimes \mathcal{A} \rightarrow \mathcal{A}$
- natural isomorphisms

$$\mathcal{E}^d: - \bar{\otimes} - \Rightarrow (- \bar{\otimes} -) \circ (- \boxtimes \vartheta_{\mathcal{A}}(d)(-)), \quad \varphi^d: \text{id} \Rightarrow \vartheta_{\mathcal{M}}(d) ,$$

such that for all $d \in D$, $M \in \mathcal{M}_d$ and $X, Y \in \mathcal{A}$ we have:

$$\mathcal{E}_{M \bar{\otimes} X, Y}^d = (\text{id}_M \bar{\otimes} \sigma_{\vartheta_{\mathcal{A}}(d).Y,X}) \circ (\mathcal{E}_{M,Y}^d \bar{\otimes} \text{id}_X) \circ (\text{id} \bar{\otimes} \sigma_{X,Y}) \quad (2.32)$$

$$\begin{aligned} \mathcal{E}_{M,X \otimes Y}^d &= (\text{id}_M \bar{\otimes} \sigma_{\vartheta(d).X, \vartheta(d).Y}) \circ (\mathcal{E}_{M,Y}^d \bar{\otimes} \text{id}_{\vartheta(d).X}) \\ &\quad \circ (\text{id}_M \bar{\otimes} \sigma_{\vartheta(d).X,Y}) \circ (\mathcal{E}_{M,X} \bar{\otimes} \text{id}_Y) \end{aligned} \quad (2.33)$$

$$\varphi_{M \bar{\otimes} X}^d = \mathcal{E}_{\vartheta_{\mathcal{M}}(d).M, X}^d \circ (\varphi_M^d \bar{\otimes} \theta_X) , \quad (2.34)$$

where θ is the balancing in \mathcal{A} . Note that we suppressed coherence isomorphisms.

Remark 2.5.7. *Given Relations (2.32) and (2.34), one can check that the remaining Relation (2.33) is automatically satisfied and does therefore not appear in the definition of a D -equivariant braided module category in [KM23].*

2. Twisted character varieties

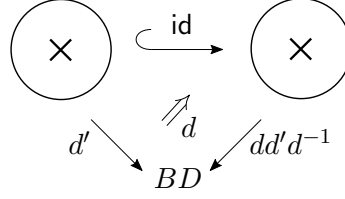

Figure 2.12.: Identity embedding of a marked disk with homotopy $d: d' \rightarrow dd'd^{-1}$.

The topological origin of the D -action on the D -graded category \mathcal{M} is sketched in Figure 2.12. The \mathcal{A} -action comes from embedding a unmarked disk \mathbb{D} into a marked disk \mathbb{D}_*^d for any $d \in D$. The family of natural isomorphisms $\{\mathcal{E}^d\}_{d \in D}$ and $\{\varphi^d\}_{d \in D}$ come from the loops in the space of D -structured embeddings, dragging the disk \mathbb{D} around the marked point in \mathbb{D}_*^d and rotating the marked disk \mathbb{D}_*^d about 2π , respectively. See also [KM23, Figure 12].

Having specified the local categorical data, let now $\text{Man}_{2,*}^D$ be the $(2,1)$ -category whose objects are oriented surfaces Σ , together with a collection of marked points $\bar{x} = \{x_1, \dots, x_r\} \subset \Sigma$ and a continuous map $\varphi: \Sigma \setminus \bar{x} \rightarrow BD$. Morphisms are embeddings of surfaces, mapping marked points bijectively onto marked points, which are compatible with the morphisms into BD . Let \mathcal{M} be an equivariant balanced braided module category over \mathcal{A} . As in the undecorated case, factorization homology $\int_{(\Sigma, \varphi, \bar{x})} (\mathcal{A}, \mathcal{M})$ is defined via left Kan extension [AFT17]. Let Σ° be the surface obtained from Σ by removing a small disk \mathbb{D}_{d_i} around each marked point x_i , where the label d_i indicates that the holonomy of φ around the i -th boundary component $\partial_i \Sigma^\circ$ is determined by the group element $d_i \in D$. Applying excision, we may express factorization homology over the marked surface Σ via the following relative tensor product:

$$\int_{(\Sigma, \varphi, \bar{x})} (\mathcal{A}, \mathcal{M}) \cong \int_{(\Sigma^\circ, \varphi|_{\Sigma^\circ})} \mathcal{A} \left(\int_{(\text{Ann}, \gamma_{d_1})} \mathcal{A} \boxtimes \dots \boxtimes \int_{(\text{Ann}, \gamma_{d_r})} \mathcal{A} \right) \left(\mathcal{M}_{d_1} \boxtimes \dots \boxtimes \mathcal{M}_{d_r} \right) .$$

We will end this section by giving a representation theoretic example for point defects in the D -equivariant setting.

Example 2.5.8. We fix $D = \mathbb{Z}_2$. Let H be a ribbon Hopf algebra with an involution $\phi: H \rightarrow H$, i.e. a \mathbb{Z}_2 -action preserving the universal R-matrix and the ribbon element. Let A be a right coideal subalgebra of H , meaning that $A \subseteq H$ is a subalgebra for which $\Delta(A) \subset A \otimes H$. This turns $A\text{-Mod}$ into a module category over $H\text{-Mod}$. Furthermore, we assume that A is equipped with a so-called ϕ -universal K-matrix. The latter was introduced in [BK19, Definition 4.10] and [Kol19, Definition 2.7] and recalled in what follows. We write $\mathcal{R}^\phi = (\text{id} \otimes \phi)\mathcal{R}$ for the ϕ -twisted universal R-matrix $\mathcal{R} \in H \otimes H$. Then, a ϕ -universal K-matrix for A is an invertible element $\mathcal{K} \in A \otimes H$ such that

$$\mathcal{K}\Delta(a) = (\text{id} \otimes \phi)\Delta(a)\mathcal{K}, \quad \text{for all } a \in A \quad (2.35)$$

$$(\Delta \otimes \text{id})\mathcal{K} = \mathcal{R}_{3,2}^\phi \mathcal{K}_{1,3} \mathcal{R}_{2,3} \quad (2.36)$$

$$(\text{id} \otimes \Delta)\mathcal{K} = \mathcal{R}_{3,2} \mathcal{K}_{1,3} \mathcal{R}_{2,3}^\phi \mathcal{K}_{1,2} \quad (2.37)$$

The ϕ -universal K-matrix turns $A\text{-Mod}$ into an equivariant balanced braided module category over $H\text{-Mod}$. Indeed, the natural isomorphism $\mathcal{E}: - \otimes - \Rightarrow (- \otimes -) \circ (\text{id} \boxtimes \phi)$

2. Twisted character varieties

is defined by acting with the universal K-matrix. This is an A -module map due to Equation (2.35). We also see that Relation (2.32) is satisfied due to Equation (2.35). Lastly, Relation (2.33) follows from Equation (2.37) together with the ϕ -invariance of \mathcal{R} . \triangle

The above example is of particular interest in the situation where the pair (H, A) is a quantum symmetric pair $(U_q(\mathfrak{g}), \mathcal{B}_q)$. Intuitively, quantum symmetric pairs are quantum-analogs of Lie algebra involutions and their fixed-point subalgebras. In more details, $U_q(\mathfrak{g})$ is a quantized universal enveloping algebra of a complex semi-simple Lie algebra \mathfrak{g} with an involution $\theta: \mathfrak{g} \rightarrow \mathfrak{g}$. Let $\mathfrak{g}^\theta = \{x \in \mathfrak{g} \mid \theta(x) = x\}$ be the Lie subalgebra of fixed points. Then $\mathcal{B}_q = \mathcal{B}_q(\theta)$ is a coideal subalgebra of $U_q(\mathfrak{g})$ that specializes to $U(\mathfrak{g}^\theta)$ as $q \rightarrow 1$.² It was shown in [Kol19, Theorem 3.11] that there exists a ϕ -universal K-matrix³ for the pair $(U_q(\mathfrak{g}), \mathcal{B}_q)$, turning the category of representations of the coideal subalgebra \mathcal{B}_q into a \mathbb{Z}_2 -equivariant braided module category over $\text{Rep}_q(G)$.

Remark 2.5.9. *The topological origin of quantum symmetric pairs was first studied by Weelinck in [Wee18b] by means of categorical algebras over an operad of involutive little disks, which are classified by so-called \mathbb{Z}_2 -braided pairs. In the situation of Example 2.5.8, our notion of a \mathbb{Z}_2 -equivariant braided module category is very closely related to the notion of a \mathbb{Z}_2 -braided pair from [Wee18b, Definition 3.1]: the latter consists of a braided category \mathcal{A} endowed with an anti-monoidal braided involution $\Phi: \mathcal{A} \rightarrow \mathcal{A}^{\text{op}}$, $t: \Phi^2 \cong \text{id}$, together with a \mathcal{A} -module category \mathcal{M} and a family of natural isomorphisms $-\bar{\otimes}- \Rightarrow -\bar{\otimes}\Phi(-)$, satisfying certain coherence relations. As was already noted in [Wee18b, Remark 3.6], given a balanced braided (strict) involution $\Phi: \mathcal{A} \rightarrow \mathcal{A}$, one can define an anti-involution by (Φ, σ) and the balancing provides the natural isomorphism $\Phi^2 \cong \text{id}$. In this way, a \mathbb{Z}_2 -equivariant module category \mathcal{M} over \mathcal{A} defines a \mathbb{Z}_2 -braided pair.*

²Quantum symmetric pairs usually carry multi-indices since there is a family of coideal subalgebras of $U_q(\mathfrak{g})$ quantizing $U(\mathfrak{g}^\theta)$. Since we are not going into details here, we decided to drop the multi-indices from the notation.

³The involution ϕ depends on a chosen diagram automorphism τ , which enters the definition of $\theta: \mathfrak{g} \rightarrow \mathfrak{g}$.

3. Dynamical character varieties

In this chapter we will compute factorization homology on surfaces with point defects coming from the theory of dynamical quantum groups [EV98b, Eti02]. Given a marked surface $\{v_1, \dots, v_k\} \subset \Sigma$, the local coefficients describing the bulk will be representation categories of ribbon Hopf algebras, for example (quantum) group representations, and the point defects $\{v_1, \dots, v_k\}$ will be governed by dynamical twists coming from solutions to the quantum dynamical Yang–Baxter equation (DYBE). We will make use of a categorical framework established by Donin–Mudrov [DM05] in which notions such as the quantum dynamical Yang–Baxter equation and dynamical twists may be formulated in terms of dynamical extensions of monoidal categories. A prominent example is the universal fusion matrix $\mathcal{J}(\lambda)_{V,W} \in \mathcal{O}(H) \otimes \text{End}(V \otimes W)$, $V, W \in \text{Rep}_q(G)$, introduced by Etingof–Varchenko in [EV99], which satisfies the quantum DYBE over the base algebra $\mathcal{O}(H)$ of rational functions on a maximal torus $H \subset G$. The dynamical twist $\mathcal{J}(\lambda)$ is also the unique solution to the linear Arnaudon–Buffenoir–Ragoucy–Roche (ABRR) equation [ABRR98], which in particular will allow us to consider $\mathcal{J}(\lambda)$ as a point defect in oriented factorization homology.

In [BZBJ18a], categorical factorization homology with local coefficients in $\text{Rep}_q(G)$ was used to construct a functorial quantization of the moduli space of flat G -connections (see § 1.3). Here, we will use factorization homology on marked surfaces to study and quantize *dynamical moduli spaces*, by which we mean the following. Let $\{\mathfrak{h}_i \subset \mathfrak{g}\}_{i=1, \dots, k}$ be a family of Lie sub-bialgebras and $H_i \subset G$ subgroups with Lie algebra \mathfrak{h}_i . For each $i = 1, \dots, k$, fix a so-called Poisson \mathfrak{h}_i -base space L_i , which is a smooth variety endowed with an action of the double $\mathfrak{D}(\mathfrak{h})$ (see § 3.1.1 for a precise definition). Let $\Gamma = (V, E)$ be a ciliated ribbon graph, for which we select a subset of vertices $\{v_1, \dots, v_k\} \subset V$ and assign to each v_i the data of a classical dynamical r-matrix $r(\lambda_i): L_i \rightarrow \mathfrak{g} \otimes \mathfrak{g}$. We then define a dynamical representation variety

$$\text{Rep}_{\text{dyn}}(G, \Gamma) = \prod_{v_i} L_i \times G^E \quad ,$$

which gets a natural action of the dynamical lattice gauge group $\prod_{v_i} H_i \times G^{V \setminus \{v_i\}}$. We will show that $\text{Rep}_{\text{dyn}}(G, \Gamma)$ admits a dynamical Fock–Rosly type Poisson structure, which moreover descends to the dynamical moduli space, i.e. to the quotient with respect to the dynamical lattice gauge group action. If the classical dynamical r-matrices $r(\lambda_i)$ admit twist quantizations, we will show that we may glue these local quantizations via categorical factorization homology to obtain a global quantization of the dynamical moduli space.

A geometric example is the following: let $H \subset G$ be a maximal torus and consider the moduli space of flat G -connections on the marked surface $\{v_1, \dots, v_k\} \subset \Sigma$ together with a reduction of the structure group from G to H over each small loop γ_i wrapping around the marked point v_i . Assuming that Σ has at least one boundary component, we may describe this moduli space by

$$\mathcal{M}_{H \subset G}(\Sigma, \{v_i\}) = \mathcal{A}_{H \subset G}(\Sigma, \{v_i\}) / H^{\times k} \quad ,$$

3. Dynamical character varieties

where $\mathcal{A}_{H \subset G}(\Sigma, \{v_i\}) \cong H^{\times k} \times G^{\times 2g+r+k-2}$ is the space of flat connections together with a trivialization over each marked point v_i . This is an example of a dynamical representation variety endowed with an action of the reduced lattice gauge group H^k .

Another example of a dynamical moduli space has previously appeared in Chern–Simons theory coupled to point-like sources as studied by Buffenoir–Roche in [BR05]. In *loc. cit.*, a Hamiltonian analysis is carried out for Chern–Simons theory on the product manifold $\Sigma \times [0, 1]$, where Σ has k punctures v_1, \dots, v_k corresponding to the location of the sources. The coupling term for the sources is described by assigning a regular semi-simple element $\chi_i \in \mathfrak{h}^{\text{reg}}$ to each puncture, where $\mathfrak{h} \subset \mathfrak{g}$ is a Cartan subalgebra. It is found that the algebra of boundary-boundary holonomies along the curves

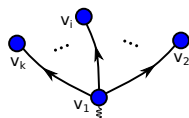

has a Poisson structure explicitly described in terms of classical dynamical r-matrices $r(\tilde{\chi}_1), \dots, r(\tilde{\chi}_k)$ defined on open subsets of the commutative base \mathfrak{h} , generalizing the Fock–Rosly Poisson structure to the dynamical setting¹. The algebra of dynamical boundary-boundary holonomies may also be understood as the algebra of functions on the dynamical representation variety

$$\text{Rep}_{\text{dyn}}(G, \Gamma) = \prod_i U_i \times G^{\times(k-1)}, \quad U_i \subset \mathfrak{h}, \quad \tilde{\chi}_i \in U_i$$

for the graph $\Gamma = (\{v_1, \dots, v_k\}, E)$ depicted above, which carries an action of the group $H^{\times k}$. In [BR05], these Poisson algebras were quantized along the lines of the combinatorial quantization formalism via quantum dynamical R-matrices. We will show how to recover some of the quantization results from [BR05] using factorization homology on marked surfaces.

Outline Throughout, let \mathbb{K} denote a field of characteristic zero, usually $\mathbb{K} = \mathbb{C}$. By G we mean a semi-simple algebraic group over \mathbb{C} .

In § 3.1 we recollect background material on the classical dynamical Yang–Baxter equation formulated over Poisson base spaces. We then introduce the notion of a dynamical representation variety and show that it admits a Fock–Rosly type Poisson structure defined in terms of a decorated ribbon graph and classical dynamical r-matrices over Poisson base spaces.

Having established the (semi-)classical setup, we review in § 3.2 the categorical setting in which the quantum dynamical Yang–Baxter equation can be formulated, following the work of Donin–Mudrov [DM05] and the more recent work of Kalmykov–Safronov [KS20]. We then introduce the notion of *quasi-reflection datum*, encompassing the data of a dynamical twist over a general base algebra, whose representation categories give rise to point defects in categorical factorization homology. A prominent example of a quasi-reflection datum arises from the linear ABRR-equation [ABRR98] satisfied by the universal fusion matrix [EV99]. The construction of the universal fusion matrix was

¹When studying Chern–Simons theory on the punctured sphere $\mathbb{S}_{v_1, \dots, v_k}^1$, an additional flatness constraint will have to be taken into account [BR05, Section 3.2].

3. Dynamical character varieties

originally done by Etingof–Varchenko in representation theoretic terms and more recently by Kalmykov–Safronov [KS20] employing a more categorical language. In § 3.2.3, we will study the topological aspects of the construction due to Kalmykov–Safronov by computing factorization homology on annuli with circular line defects prescribed by the $(\mathrm{Rep}_q(G), \mathrm{Rep}_q(H))$ -central algebra $\mathrm{Rep}_q(B)$, that is, the representation category of a quantum borel subalgebra $U_q(\mathfrak{b}) \subset U_q(\mathfrak{g})$.

In § 3.3, we compute factorization homology on surfaces with marked points categorically described by *dynamical point defects*. By this we mean point defects coming from the theory of dynamical quantum groups. More precisely, for each marked point, the local categorical data is given by a pair $(\mathcal{A}, \mathcal{C}_{\mathcal{L}})$, where \mathcal{A} is a balanced braided tensor category and $\mathcal{C}_{\mathcal{L}}$ is the *dynamical extension* of a monoidal category \mathcal{C} over a commutative algebra $\mathcal{L} \in \mathcal{Z}(\mathcal{C})$ in the Drinfeld center, called the *base algebra*. The \mathcal{A} -module structure on the dynamical extension comes from a dynamical twist $\mathcal{J}(\lambda)$, i.e. from a monoidal functor

$$F_{\lambda}: \mathcal{A} \xrightarrow{F} \mathcal{C} \xrightarrow{\mathrm{free}_{\mathcal{L}}} \mathcal{C}_{\mathcal{L}}, \quad \mathcal{J}(\lambda)_{X,Y} \in \mathcal{L} \otimes \mathrm{Hom}(F(X) \otimes F(Y), F(X \otimes Y)) \ .$$

Given an oriented, connected surface $\Sigma = \Sigma_{g,r}$, $r > 0$, with a collection of marked points $\{v_1, \dots, v_k\} \subset \Sigma$, we may combinatorially describe Σ by means of a ciliated ribbon graph $\Gamma = (V, E)$ with a collection of decorated vertices $\{v_1, \dots, v_k\} \subset V$ describing the marked points. Picking such a combinatorial model allows one to define an algebra internal to the dynamical extension $(\mathcal{C}_1 \boxtimes \dots \boxtimes \mathcal{C}_k)_{\mathcal{L}_1 \boxtimes \dots \boxtimes \mathcal{L}_k}$:

$$a_{\lambda_1, \dots, \lambda_k}^{\Gamma} = (F_{\lambda_1} \boxtimes \dots \boxtimes F_{\lambda_k}) \left(\otimes_{i=1}^{|E|} \mathcal{F}^{(i)} \right) \ ,$$

where the components $\mathcal{F}^{(i)}$ of the tensor algebra are either given by the coend algebra $\int^{X \in \mathcal{A}^{\mathrm{cp}}} X^{\vee} \boxtimes X \in \mathcal{A} \boxtimes \mathcal{A}$ or the reflection equation algebra $\int^{X \in \mathcal{A}^{\mathrm{cp}}} X^{\vee} \otimes X \in \mathcal{A}$. We then show in Theorem 3.3.3 that for suitable coefficients, factorization homology on marked surfaces with dynamical point defects is characterized by the category of modules over the algebra $a_{\lambda_1, \dots, \lambda_k}^{\Gamma}$:

$$\int_{(\Sigma, \{v_1, \dots, v_k\})} (\mathcal{A}, \{(\mathcal{C}_i)_{\mathcal{L}_i}\}_{i=1, \dots, k}) \cong a_{\lambda_1, \dots, \lambda_k}^{\Gamma} \text{-Mod}_{\mathcal{C}_1 \boxtimes \dots \boxtimes \mathcal{C}_k} \ .$$

The equivalence is established using monadic reconstruction techniques. The algebras $a_{\lambda_1, \dots, \lambda_k}^{\Gamma}$ provide examples of so-called *dynamical associative algebras*, which are quantizations of Poisson dynamical algebras [DM05]. We will also show that for certain coefficients \mathcal{A} , the algebras $a_{\lambda_1, \dots, \lambda_k}^{\Gamma}$ are module algebras over quantum groupoids introduced in [DM06].

In § 3.4, we first show that the algebras $a_{\lambda_1, \dots, \lambda_k}^{\Gamma}$ obtained from Theorem 3.3.3 give an equivariant deformation quantization of the algebra of functions on the dynamical representation variety in the direction of the dynamical Fock–Rosly Poisson structure. We then describe the category of quasi-coherent sheaves on the dynamical moduli stack

$$\mathrm{QCoh} \left(\left[\Pi_i^k V_i \times G^E / \Pi_i^k H_i \right] \right), \quad V_i \subseteq H_i$$

via the factorization homologies on a covering. This allows us to construct a dynamical quantum moduli stack via factorization homology with dynamical point defects. As an application, we then relate our results to the classical and quantum Chern–Simons theory with point-like sources as studied by Buffenoir–Roche [BR05].

3.1. Dynamical Poisson spaces

The quantum dynamical Yang–Baxter equation (DYBE) plays an important role in various areas of mathematics and physics. It first appeared in the context of integrable models of conformal field theory in the work of Gervais–Neveu [GN84] and was later rediscovered by Felder [Fel95]. Similarly to how solutions to the quantum Yang–Baxter equation are related to the theory of Hopf algebras and quantum groups, Etingof–Varchenko [EV98b, EV99] and Xu [Xu01] showed that one can interpret solutions to the quantum DYBE in terms of Hopf algebroids and quantum groupoids. A categorical interpretation of the Hopf algebroids arising in this way was given in [DM06]. For an extensive review of the literature and background on the quantum DYBE we refer to [ES02b].

On the classical level, the dynamical Yang–Baxter equation was first introduced by [Fel95]. Solutions to the classical DYBE are so-called classical dynamical r -matrices, recalled in what follows. Let $\mathfrak{l} \subset \mathfrak{g}$ be a pair of finite-dimensional Lie algebras and let $\Omega_{\mathfrak{l}^*}^\bullet(\mathfrak{g}^*)$ be the subspace of differential forms $\Omega^\bullet(\mathfrak{g}^*)$ that are constant on the fibers of the natural projection map $\mathfrak{g}^* \rightarrow \mathfrak{l}^*$, i.e. we have that $\Omega_{\mathfrak{l}^*}^\bullet(\mathfrak{g}^*) \cong \mathcal{O}(\mathfrak{l}^*) \otimes \wedge^\bullet \mathfrak{g}$. The Schouten bracket $\llbracket -, - \rrbracket$, together with the de Rham differential d_{dR} , turn $\Omega_{\mathfrak{l}^*}^\bullet(\mathfrak{g}^*)$ into a dg Lie algebra. Then, a *triangular dynamical r -matrix* over \mathfrak{l} is a Maurer–Cartan element $\omega(\lambda)$ in $(\Omega_{\mathfrak{l}^*}^2(\mathfrak{g}^*))^{\mathfrak{l}}$, $\llbracket -, - \rrbracket, d_{dR}$. Note that upon fixing a basis $(h_i)_{i \in I}$ for \mathfrak{l} , with dual basis $(\lambda^i)_{i \in I}$, the Maurer–Cartan equation $d_{dR}\omega(\lambda) + \frac{1}{2}\llbracket \omega(\lambda), \omega(\lambda) \rrbracket = 0$ reads

$$\sum_i \partial h_i \wedge \frac{\omega(\lambda)}{\partial \lambda^i} - \underbrace{[\omega(\lambda)_{12}, \omega(\lambda)_{13}] + [\omega(\lambda)_{12}, \omega(\lambda)_{23}] + [\omega(\lambda)_{13}, \omega(\lambda)_{23}]}_{\text{CYB}(\omega(\lambda))} = 0$$

which coincides with the form of the classical DYBE as usually presented in literature. Similarly, $r(\lambda) = \omega(\lambda) + t \in (\mathcal{O}(\mathfrak{l}^*) \otimes \mathfrak{g} \otimes \mathfrak{g})^{\mathfrak{l}}$, such that $t \in \text{Sym}^2(\mathfrak{g})$ is constant and \mathfrak{g} -invariant, is called *classical dynamical r -matrix* if it satisfies $d_{dR}r(\lambda) - \text{CYB}(r(\lambda)) = 0$. The classical DYBE for a pair of Lie algebras $\mathfrak{l} \subset \mathfrak{g}$ was extensively studied by Etingof, Schiffmann and Varchenko [ES01, EV98a, Sch98].

One may further generalize to consider dynamical r -matrices over Poisson–Lie groups [FM02, EEM04]. Let $L \subset G$ be a pair of Poisson–Lie groups with Lie bialgebras \mathfrak{l} and \mathfrak{g} respectively. Similarly to the Lie algebra case, let $\Omega_{L^*}^\bullet(G^*)$ be the space of forms constant on the fibers of the natural projection $G^* \rightarrow L^*$. Note that using a trivialization $T^*G^* \cong \mathfrak{g} \times G^*$, we have $\Omega_{L^*}^\bullet(G^*) \cong \mathcal{O}(H^*) \otimes \wedge^\bullet \mathfrak{g}$. The co-bracket δ extends to a differential $\delta: \mathcal{O}(L^*) \otimes \wedge^\bullet \mathfrak{g} \rightarrow \mathcal{O}(L^*) \otimes \wedge^{\bullet+1} \mathfrak{g}$, turning $(\Omega_{L^*}^\bullet(G^*))^{\mathfrak{l}}$, $\llbracket -, - \rrbracket, d_{dR} + \delta$ into a dg Lie algebra. The notion of a (triangular) classical dynamical r -matrix over L^* can now be formulated in complete analogy to the Lie algebra case.

In this thesis, we will work with a version of the classical (quantum) dynamical Yang–Baxter equation formulated over Poisson base spaces (base algebras) as developed in [DM05], such that examples include both the case of base spaces given by Lie subalgebra $\mathfrak{l} \subset \mathfrak{g}$, as well as the case of Poisson–Lie dynamical r -matrices. To that end, we will begin this section by recalling the main definitions of [DM05]. We will then use classical dynamical r -matrices over Poisson base spaces to introduce dynamical generalizations of Fock–Rosly type Poisson structures. The quantum picture will be addressed in the next section.

3. Dynamical character varieties

3.1.1. Dynamical r-matrices over Poisson base spaces

Throughout we fix a finite-dimensional complex semi-simple Lie algebra \mathfrak{g} with Lie bialgebra structure δ . We also fix a Lie sub-bialgebra $\mathfrak{h} \subseteq \mathfrak{g}$. Let $\mathfrak{D}(\mathfrak{h}) = \mathfrak{h} \oplus \mathfrak{h}_{\text{op}}^*$ be the classical double of \mathfrak{h} , where $\mathfrak{h}_{\text{op}}^*$ has opposite Lie bracket. One can extend the Lie algebra structures on \mathfrak{h} and \mathfrak{h}^* to the double, such that the natural bilinear form on $\mathfrak{D}(\mathfrak{h})$ is ad-invariant:

$$[h_i, h_j] = f_{ij}^k h_k, \quad [h_i, \eta^j] = -c_i^{jk} h_k - f_{ik}^j \eta^k, \quad [\eta^i, \eta^j] = -c_k^{ij} \eta^k, \quad (3.1)$$

where $(h_i)_{i \in I}$ is a basis for \mathfrak{h} , $(\eta^i)_{i \in I}$ its dual basis. The double has a canonical quasi-triangular r-matrix

$$r_{\mathfrak{D}(\mathfrak{h})} = (0, \eta^i) \otimes (h_i, 0) \in \mathfrak{D}(\mathfrak{h})^{\otimes 2},$$

where the summation over repeated indices is understood. The following definition is from [DM05, Definition 3.14]:

Definition 3.1.1. *Given a smooth algebraic variety L , we call $\mathcal{L}_0 = \mathcal{O}(L)$ a Poisson \mathfrak{h} -base algebra if it is equipped with a left $\mathfrak{D}(\mathfrak{h})$ -action generated by the vector fields*

$$\mathfrak{D}(\mathfrak{h}) \rightarrow \mathfrak{X}(L), \quad X \mapsto \overrightarrow{X}$$

such that the canonical invariant symmetric tensor $\overrightarrow{r_{\mathfrak{D}(\mathfrak{h})}} + \overrightarrow{(r_{\mathfrak{D}(\mathfrak{h})})_{21}}$ vanishes on \mathcal{L}_0 . We refer to L as Poisson \mathfrak{h} -base space.

The reason for the terminology is the following: L is a Poisson variety with Poisson bivector

$$\Pi_L = \frac{1}{2} \overrightarrow{\eta^i} \wedge \overrightarrow{h_i} = \frac{1}{2} \left(\overrightarrow{r_{\mathfrak{D}(\mathfrak{h})}} - \overrightarrow{(r_{\mathfrak{D}(\mathfrak{h})})_{2,1}} \right) \quad (3.2)$$

Moreover, Π_L is $\mathfrak{D}(\mathfrak{h})$ -invariant. As we will see later in § 3.4, \mathfrak{h} -base algebras have natural quantum analogs: if $U_q(\mathfrak{h})$ is a quantized universal enveloping algebra for $U(\mathfrak{h})$, a quantization of the \mathfrak{h} -base algebra \mathcal{L}_0 will be a commutative algebra in the Drinfeld center of $U_q(\mathfrak{h})\text{-Mod}$.

Example 3.1.2. Assume that \mathfrak{h} is a quasi-triangular Lie bialgebra with cobracket given by a classical r-matrix $r = \omega + t \in \mathfrak{h} \otimes \mathfrak{h}$, where t is an invariant symmetric 2-tensor. The r-matrix defines a linear map

$$\underline{r}: \mathfrak{h}^* \rightarrow \mathfrak{h}, \quad \underline{r}(\eta) = r^{ij} \eta(h_i) h_j.$$

Furthermore, the maps $\underline{r}_+ = \underline{r} + t$ and $\underline{r}_- = \underline{r} - t$ are Lie-algebra morphisms $\mathfrak{h}^* \rightarrow \mathfrak{h}$. Let $H \subset G$ be a subgroup with Lie algebra \mathfrak{h} . Then, H has a left \mathfrak{h} -action induced by conjugation

$$\mathfrak{h} \rightarrow \mathfrak{X}(H), \quad h \mapsto \overrightarrow{h} = h^R - h^L.$$

It also has a left $\mathfrak{h}_{\text{op}}^*$ -action:

$$\mathfrak{h}_{\text{op}}^* \rightarrow \mathfrak{X}(H), \quad \eta \mapsto \overrightarrow{\eta} = \underline{r}_+(\eta)^L - \underline{r}_-(\eta)^R.$$

One can check that the induced action of the canonical symmetric tensor $t_{\mathfrak{D}(\mathfrak{h})}$ vanishes due to ad-invariance of t and that $\mathcal{O}(H)$ is a Poisson \mathfrak{h} -base space whose Poisson bivector (3.2) agrees with the STS-Poisson structure [STS94].

3. Dynamical character varieties

The following special case will be of particular interest to us: let $\mathfrak{h} \subset \mathfrak{g}$ be a Cartan subalgebra with invariant symmetric tensor $t \in \text{Sym}^2(\mathfrak{h})^{\mathfrak{h}}$ coming from the Killing form and giving an identification $\mathfrak{h}^* \cong \mathfrak{h}$. In this case the left \mathfrak{h} -action is trivial and

$$\mathfrak{h}_{\text{op}}^* \rightarrow \mathfrak{X}(H), \quad \eta^i \mapsto \overrightarrow{\eta^i} = 2h_i^R .$$

In this case the \mathfrak{h} -base space H has trivial Poisson bracket. △

Let $\text{Alt} \in \text{End}(\mathfrak{g}^{\otimes 3})$ denote the linear map

$$x_1 \otimes x_2 \otimes x_3 \mapsto x_1 \otimes x_2 \otimes x_3 - x_2 \otimes x_1 \otimes x_3 + x_2 \otimes x_3 \otimes x_1$$

for all $x_1, x_2, x_3 \in \mathfrak{g}$.

Definition 3.1.3 (Donin–Mudrov). *Let L be a Poisson \mathfrak{h} -base space. A regular function*

$$r(\lambda): L \rightarrow \mathfrak{g} \otimes \mathfrak{g}$$

is called classical dynamical r-matrix over L if

- $r(\lambda)$ is quasi \mathfrak{h} -invariant:

$$[h \otimes 1 + 1 \otimes h, r(\lambda)] + \overrightarrow{h} . r(\lambda) = \delta(h)$$

for all $h \in \mathfrak{h}$

- the symmetric part $t = \frac{1}{2}(r(\lambda)_{1,2} + r(\lambda)_{2,1})$ is \mathfrak{g} -invariant and constant
- $r(\lambda)$ satisfies the classical dynamical Yang–Baxter equation

$$\text{Alt}(h_i \otimes \overrightarrow{\eta^i} . r(\lambda)) = \text{CYB}(r(\lambda)) , \quad (3.3)$$

where $\text{CYB}(r(\lambda)) = [r(\lambda)_{12}, r(\lambda)_{13}] + [r(\lambda)_{12}, r(\lambda)_{23}] + [r(\lambda)_{13}, r(\lambda)_{23}]$ is the classical Yang–Baxter operator, $(h_i)_{i \in I}$ is a basis for \mathfrak{h} , $(\eta^i)_{i \in I}$ is its dual basis and we used implicit summation notation.

We will often use the notation $r(\lambda) = r^0 \otimes r^1 \otimes r^2 \in \mathcal{O}(L) \otimes \mathfrak{g} \otimes \mathfrak{g}$ for dynamical r-matrices and denote by t its symmetric part and by $\omega(\lambda)$ its antisymmetric part.

3.1.2. Poisson structures from dynamical r-matrices

Let Y be a left G -space, $\rho: G \times Y \rightarrow Y$, and let L be a Poisson \mathfrak{h} -base space. The action ρ extends to a map

$$\begin{aligned} \rho_*: \mathcal{O}(L) \otimes \mathfrak{g} \otimes \mathfrak{g} &\rightarrow \mathcal{O}(L) \otimes \mathfrak{X}(Y) \otimes \mathfrak{X}(Y) \\ a \otimes x_1 \otimes x_2 &\mapsto a \otimes x_1^{\rho} \otimes x_2^{\rho} . \end{aligned}$$

The following proposition shows how Lie algebra actions together with the data of a dynamical r-matrix give rise to Poisson structures on $L \times Y$. This can be understood as an extension of Proposition 1.1.14 to the dynamical setting.

Proposition 3.1.4. *Let $r(\lambda) = \omega(\lambda) + t$ be a dynamical r-matrix over the Poisson \mathfrak{h} -base space (L, Π_L) . If $\rho_*(t) = 0$ then*

$$\Pi_{r(\lambda)} = \rho_* r(\lambda) + (\overrightarrow{\eta^i}, 0) \wedge (0, h_i^{\rho}) + \Pi_L$$

is a Poisson bivector on $L \times Y$. Moreover, if the \mathfrak{h} -action on $\mathcal{O}(L)$ comes from a left H -action on L , the pair $(L \times Y, \Pi_{r(\lambda)})$ is a Poisson H -space for the diagonal H -action.

3. Dynamical character varieties

Proof. Multi-vector fields on $L \times Y$ are bigraded: elements in $\mathfrak{X}(L)$ are of degree (1,0) and elements in $\mathfrak{X}(Y)$ of degree (0,1). Denote $\Theta = (\overrightarrow{\eta^i}, 0) \wedge (0, h_i^\rho)$. The Schouten bracket then reads

$$\begin{aligned} & \llbracket \Pi_{r(\lambda)}, \Pi_{r(\lambda)} \rrbracket \\ &= \llbracket \Pi_L, \Pi_L \rrbracket + \llbracket \rho_* r(\lambda), \rho_* r(\lambda) \rrbracket + \llbracket \Theta, \Theta \rrbracket + 2\llbracket \rho_* r(\lambda), \Theta \rrbracket + 2\llbracket \Pi_L, \rho_* r(\lambda) \rrbracket + 2\llbracket \Pi_L, \Theta \rrbracket \end{aligned}$$

Clearly, the first term vanishes since Π_L is a Poisson bivector on L . We have

$$\begin{aligned} \llbracket \rho_* r(\lambda), \rho_* r(\lambda) \rrbracket + 2\llbracket \Theta, \rho_* r(\lambda) \rrbracket^{(0,3)} &= 2\rho_* \text{CYB}(\omega(\lambda)) - 2\rho_* \text{Alt}(h_i \otimes \overrightarrow{\eta^i} \cdot r(\lambda)) \\ &= -2\rho_* \text{CYB}(t) = 0 \end{aligned}$$

where in the last line we used the classical DYBE (3.3) and Proposition 1.1.14, where we showed that if $\rho_*(t) = 0$, then also $\rho_* \text{CYB}(t) = 0$. Next, we compute

$$\begin{aligned} \llbracket \Theta, \Theta \rrbracket^{(2,1)} + 2\llbracket \Pi_L, \Theta \rrbracket &= \overrightarrow{\eta^i} \wedge \overrightarrow{\eta^k} \wedge [h_i, h_k]^\rho + [\overrightarrow{\eta^i}, \overrightarrow{\eta^k}] \wedge \overrightarrow{h_i} \wedge h_k^\rho - [h_i, \overrightarrow{\eta^k}] \wedge \overrightarrow{\eta^i} \wedge h_k^\rho \\ &= 0 \end{aligned} \quad (3.4)$$

which is zero by Definition (3.1) of the Lie bracket on the double $\mathfrak{D}(\mathfrak{h})$. Lastly, we have

$$\begin{aligned} & \llbracket \Theta, \Theta \rrbracket^{(1,2)} + 2\llbracket \Pi_L, \rho_* r(\lambda) \rrbracket + 2\llbracket \Theta, \rho_* r(\lambda) \rrbracket^{(1,2)} \quad (3.5) \\ &= [\overrightarrow{\eta^i}, \overrightarrow{\eta^k}] \wedge h_i^\rho \wedge h_k^\rho - \frac{1}{2} \iota_{d\omega^0}(\overrightarrow{\eta^i} \wedge \overrightarrow{h_i}) \wedge (\omega^1)^\rho \wedge (\omega^2)^\rho + \omega^0 \wedge \overrightarrow{\eta^i} \wedge [h_i, \omega^1]^\rho \wedge (\omega^2)^\rho \\ &\quad + \omega^0 \wedge \overrightarrow{\eta^i} \wedge (\omega^1)^\rho \wedge [h_i, \omega^2]^\rho \\ &= -\overrightarrow{\eta^i} \wedge c_i^{mn} h_m^\rho \wedge h_n^\rho + \overrightarrow{\eta^i} \wedge \overrightarrow{h_i} \cdot \omega^0 (\omega^1)^\rho \wedge (\omega^2)^\rho + \overrightarrow{\eta^i} \wedge \omega^0 ([h_i, \omega^1]^\rho \wedge (\omega^2)^\rho \\ &\quad + (\omega^1)^\rho \wedge [h_i, \omega^2]^\rho) . \end{aligned} \quad (3.6)$$

In the above, the c_i^{mn} denote the structure constants for the co-bracket of the Lie bialgebra \mathfrak{h} and we identified the interior product $\iota_{d\omega^0}(\overrightarrow{\eta^i} \wedge \overrightarrow{h_i})$ with $-2(\overrightarrow{h_i} \cdot \omega^0) \overrightarrow{\eta^i}$ using that $\mathcal{O}(L)$ is an \mathfrak{h} -base algebra. We thus see that the term (3.5) vanishes due to quasi \mathfrak{h} -invariance of the dynamical r-matrix.

Denote σ the diagonal H -action on $L \times Y$. The induced action vector field is $h^\sigma = (\overrightarrow{h}, 0) + (0, h^\rho)$. For any basis element $h_k \in \mathfrak{h}$ we have

$$\begin{aligned} \llbracket h_k^\sigma, \rho_* r(\lambda) \rrbracket &= \rho_* (\overrightarrow{h_k} \cdot r(\lambda) + [h_k \otimes 1 + 1 \otimes h_k, r(\lambda)]) \\ &= \rho_* \delta(h_k) \end{aligned}$$

again by quasi \mathfrak{h} -invariance of $r(\lambda)$. The Lie algebra structure (3.1) on the Drinfeld double is such that

$$[h_k, \overrightarrow{\eta^i}] \wedge h_i + \overrightarrow{\eta^i} \wedge [h_k, h_i] = c_k^{ij} h_i \wedge h_j .$$

Using the above, one can show that

$$\llbracket \overrightarrow{h_k}, \Pi_L \rrbracket = \overrightarrow{\delta(h_k)}, \quad \llbracket h_k^\sigma, \Theta \rrbracket = c_k^{ij} (\overrightarrow{h_i}, 0) \wedge (0, h_j^\rho) .$$

By Proposition 1.1.10 this shows that the H -action is indeed Poisson. \square

3. Dynamical character varieties

As a first application we will give a dynamical generalization of the Poisson structure on G from Example 1.1.11. To that end, we consider the group G as a left $G \times G$ -space via $\rho: (G \times G) \times G \rightarrow G$, $\rho(g_1, g_2, h) = g_1 h g_2^{-1}$.

Proposition 3.1.5. *Let $\mathfrak{h}_1, \mathfrak{h}_2 \subset \mathfrak{g}$ be two Lie sub-bialgebras and let L_1, L_2 be Poisson \mathfrak{h}_1 -, respectively \mathfrak{h}_2 -base spaces. Given two dynamical r -matrices $r(\lambda_i): L_i \rightarrow \mathfrak{g} \otimes \mathfrak{g}$ such that their symmetric parts agree, the following defines a Poisson structure on $X = L_1 \times G \times L_2$:*

- For $\varphi \in \mathcal{O}(L_k)$ and $\psi \in \mathcal{O}(L_m)$:

$$\{\varphi, \psi\} = \delta_{km} \{\varphi, \psi\}_{L_k} \quad (3.7)$$

- For $\varphi \in \mathcal{O}(L_1)$, $\psi \in \mathcal{O}(L_2)$ and $f \in \mathcal{O}(G)$:

$$\{\varphi, f\} = \overrightarrow{(\eta(1)^i \cdot \varphi)}(h_i(1)^R \triangleright f) \quad \{\psi, f\} = -\overrightarrow{(\eta(2)^i \cdot \psi)}(h_i(2)^L \triangleright f) \quad (3.8)$$

where for $k = 1, 2$, $(h(k)_i)_{i \in I}$ is a basis for \mathfrak{h}_k and $(\eta(k)^i)_{i \in I}$ its dual basis.

- For $f, g \in \mathcal{O}(G)$:

$$\begin{aligned} \{f, g\} &= \omega(\lambda_1)^0 \otimes ((\omega(\lambda_1)^1)^R \triangleright f) ((\omega(\lambda_1)^2)^R \triangleright g) \otimes 1 \\ &\quad + 1 \otimes ((\omega(\lambda_2)^1)^L \triangleright f) ((\omega(\lambda_2)^2)^L \triangleright g) \otimes \omega(\lambda_2)^0 \\ &= (\omega(\lambda_1)^{R,R} + \omega(\lambda_2)^{L,L}) \triangleright (f \otimes g) \end{aligned} \quad (3.9)$$

Proof. The following is a dynamical r -matrix for $(\mathfrak{g}^{\oplus 2}, \mathfrak{h}_1 \oplus \mathfrak{h}_2, L_1 \times L_2)$:

$$\tilde{r}(\lambda) = (r(\lambda_1)^0 \otimes 1) \otimes (r(\lambda_1)^1, 0) \otimes (r(\lambda_1)^2, 0) - (1 \otimes r(\lambda_2)^0) \otimes (0, r(\lambda_2)^2) \otimes (0, r(\lambda_2)^1) .$$

The symmetric part of $\tilde{r}(\lambda)$ is $\tilde{t} = (t, 0) - (0, t)$ and $\rho_*(\tilde{t}) = 0$ due to \mathfrak{g} -invariance of t . So, by Proposition 3.1.4, $\Pi_{\tilde{r}(\lambda)}$ is a Poisson bivector, namely the one given in Equations (3.7)–(3.9). \square

We will write $(X, \Pi_{\text{dyn}}^{L_1, L_2})$ for the dynamical Poisson space defined by (3.7)–(3.9). For linear Poisson \mathfrak{h} -base spaces given by the dual \mathfrak{h}^* , there are closely related examples that are very well-known. Namely, the dynamical Poisson–Lie groupoids introduced by Etingof–Varchenko [EV98a], which we will discuss next:

Example 3.1.6. Similarly to how Poisson–Lie groups are related to the classical YBE, The classical DYBE admits a geometric interpretation in terms of Poisson–Lie groupoids [Wei88]. In more details, let $\mathfrak{h} \subset \mathfrak{g}$ be a Cartan subalgebra, $H \subset G$ a subgroup with Lie algebra \mathfrak{h} and $U \subset \mathfrak{h}^*$ an open subset. Etingof–Varchenko constructed a Poisson–Lie groupoid structure on $X = U \times G \times U$ whose source and target maps are defined by the two natural projections $\pi_1, \pi_2: U \times G \times U \rightarrow U$ and the multiplication comes from the multiplication in G : $m((u_1, g, u), (u, g', u_2)) = (u_1, gg', u_2)$. The group $H \times H$ acts on the groupoid via

$$(H \times H) \times X \rightarrow X, \quad ((h_1, h_2), (u_1, g, u_2)) \mapsto (u_1, h_1 g (h_2)^{-1}, u_2) .$$

Given a function $r(\lambda): U \rightarrow \mathfrak{g} \otimes \mathfrak{g}$ with ad-invariant and constant symmetric part $t \in \text{Sym}^2(\mathfrak{g})^{\mathfrak{g}}$, $r(\lambda)$ satisfies the classical DYBE if and only if the following defines a Poisson–Lie groupoid structure on X :

$$\{f, g\} = (\omega(\lambda_1)^{L,L} - \omega(\lambda_2)^{R,R}) \triangleright (f \otimes g)$$

3. Dynamical character varieties

$$\{h_i^{(1)}, f\} = h_i^L \triangleright f, \quad \{h_i^{(2)}, f\} = h_i^R \triangleright f$$

for $f, g \in \mathcal{O}(G)$ and $h_i^{(1)} = h_i \in \mathcal{O}(U_{(1)})$, $h_i^{(2)} = h_i \in \mathcal{O}(U_{(2)})$, where $U_{(1)}$ denotes the first copy of U in X and $U_{(2)}$ the second copy and $(h_i)_{i \in I}$ is a basis of \mathfrak{h} . Note that one may replace the Cartan subalgebra \mathfrak{h} by any Lie subalgebra in \mathfrak{g} by adding the corresponding linear Poisson brackets between the functions on \mathfrak{h}^* . \triangle

3.1.3. Fusion

Let (M, ρ) be a $G^{\times n}$ -space and let $\mathfrak{h}_1, \dots, \mathfrak{h}_l \subseteq \mathfrak{g}$ be Lie sub-bialgebras with corresponding Poisson base spaces L_1, \dots, L_l for some $l \leq n$. We will assume that the \mathfrak{h}_i -action on $\mathcal{O}(L_i)$ comes from a left H_i -action on L_i . We also fix dynamical r-matrices $r(\lambda_i): L_i \rightarrow \mathfrak{g} \otimes \mathfrak{g}$ together with a sign function $\epsilon: \{1, \dots, n\} \rightarrow \{-1, 1\}$. We define a direct product dynamical r-matrix for $\mathfrak{g}^{\oplus n}$ over $L_1^{\times c_1} \times \dots \times L_l^{\times c_l}$, where $\sum_i c_i = n$, as follows:

$$r^{(n)}(\lambda) = \sum_{i=1}^l \left(\sum_{a=1}^{c_i} \omega(\lambda_i)^0 (\omega(\lambda_i)^1)_{(a_i)} \otimes (\omega(\lambda_i)^2)_{(a_i)} - \epsilon(a) (t^1)_{(a_i)} \otimes (t^2)_{(a_i)} \right) . \quad (3.10)$$

The notation $x_{(a)}$ denotes the image of $x \in \mathfrak{g}$ under the embedding $\mathfrak{g} \hookrightarrow \mathfrak{g}^{\oplus n}$ as a -th summand and for lighter notation we introduced the notation a_i for the integer $a + \sum_{j=1}^{i-1} c_j$.

We assume that the symmetric part of the direct product dynamical r-matrix in (3.10) vanishes under the pushforward map ρ_* , so that $\rho_* r^{(n)}(\lambda)$ defines a bivector field on M , and by Proposition 3.1.4 the following is a Poisson bivector on $\prod_{i=1}^l L_i^{c_i} \times M$:

$$\Pi_{r^{(n)}(\lambda)} = \Pi_{L_1^{c_1}} + \Theta_{L_1^{c_1}} + \dots + \Pi_{L_l^{c_l}} + \Theta_{L_l^{c_l}} + \rho_* r^{(n)}(\lambda) , \quad (3.11)$$

As an example, note that the Poisson spaces $(L_1 \times L_2 \times G, \Pi_{L_1, L_2}^{\text{dyn}})$ from Proposition 3.1.5 is of this type.

Given a Poisson structure as in (3.11), will now define an operation called the *dynamical fusion*

$$(L_1^{c_1} \times \dots \times L_l^{c_l} \times M, \Pi_{r^{(n)}(\lambda)}) \rightsquigarrow (L_1 \times \dots \times L_l \times M, \Pi^{\text{fus}}) ,$$

which yields a new dynamical Poisson space which is such that the respective diagonal H_i -actions are Poisson. Dynamical fusion gives a generalization of the fusion product for Poisson spaces defined by classical r-matrices from [LM17] to Poisson spaces defined via dynamical classical r-matrices.

Similarly to the non-dynamical case, we will need to modify the direct product dynamical r-matrix $r^{(n)}(\lambda)$ giving rise to the Poisson structure in (3.11) in order to define a dynamical Poisson structure compatible with the diagonal H_i -actions. This is done as follows:

Proposition 3.1.7. *The bivector field*

$$\Pi^{\text{fus}} = \Pi_{L_1} + \Theta_{L_1}^{(c_1)} + \dots + \Pi_{L_l} + \Theta_{L_l}^{(c_l)} + \rho_* r^{(n)}(\lambda) + \rho_* \text{Mix}^n(r(\lambda))$$

where

$$\text{Mix}^n(r(\lambda)) = \sum_{i=1}^l \left(\sum_{1 \leq a < b \leq c_i} r(\lambda_i)^0 (r(\lambda_i)^1)_{(a_i)} \wedge (r(\lambda_i)^2)_{(b_i)} \right) ,$$

3. Dynamical character varieties

and $\Theta_{L_i}^{(c_i)} = \sum_{a=1}^{c_i} \overrightarrow{\eta^j} \wedge (h_{j,(a_i)})^\rho$, where (h_j) and (η^j) are dual bases for \mathfrak{h}_i and \mathfrak{h}_i^* , respectively, defines a Poisson structure on $L_1 \times \cdots \times L_l \times M$ which is such that for each $i = 1, \dots, l$ the diagonal H_i -action is Poisson.

Proof. We will consider the following bigrading for polyvector fields: elements in $\mathfrak{X}(L_1^{c_1} \times \cdots \times L_l^{c_l})$ are of degree $(1, 0)$ and elements in $\mathfrak{X}(M)$ of degree $(0, 1)$. Clearly, the degree $(3, 0)$ -part of the Schouten bracket $[[\Pi^{\text{fus}}, \Pi^{\text{fus}}]]$ vanishes since the Π_{L_i} are Poisson bivectors on the base spaces. The degree $(2, 1)$ -part has contributions from the brackets

$$\sum_{i=1}^l \sum_{a=1}^{c_i} 2[[\Pi_{L_i}, \overrightarrow{\eta^j} \wedge (h_{j,(a_i)})^\rho]] + [[\overrightarrow{\eta^j} \wedge (h_{j,(a_i)})^\rho, \overrightarrow{\eta^j} \wedge (h_{j,(a_i)})^\rho]] .$$

The vanishing of the above is as detailed in Equation (3.4) of the proof to Proposition 3.1.4. The degree $(1, 2)$ -part has the following contributions: for each $1 \leq i \leq l$

$$\begin{aligned} \sum_{a,b=1}^{c_i} [[\overrightarrow{\eta^j} \wedge (h_{j,(a_i)})^\rho, \overrightarrow{\eta^j} \wedge (h_{j,(b_i)})^\rho]] + 2[[\overrightarrow{\eta^j} \wedge (h_{j,(a_i)})^\rho + \Pi_{L_i}, \rho_*(\omega(\lambda_i)^1)_{(b_i)} \wedge (\omega(\lambda_i)^2)_{(b_i)}]] \\ + \sum_{a=1}^{c_i} \sum_{1 \leq r < s \leq c_i} 2[[\overrightarrow{\eta^j} \wedge (h_{j,(a_i)})^\rho + \Pi_{L_i}, \rho_*(r(\lambda_i)^1)_{(r_i)} \wedge (r(\lambda_i)^2)_{(s_i)}]] \end{aligned}$$

One then uses quasi \mathfrak{h}_i -invariance as in (3.5) to show that the second term cancels the $(a = b)$ -part of the first term and the third term cancels the $(a \neq b)$ -part. Lastly, the degree $(0, 3)$ -terms come from the brackets

$$\begin{aligned} [[\rho_* r^{(n)}(\lambda), \rho_* r^{(n)}(\lambda)]] + [[\rho_* \text{Mix}^n(r(\lambda)), \rho_* \text{Mix}^n(r(\lambda))]] + 2[[\rho_* r^{(n)}(\lambda), \rho_* \text{Mix}^n(r(\lambda))]] \\ + \sum_{i=1}^n 2[[\Theta^{c_i}, \rho_* r^{(n)}(\lambda) + \rho_* \text{Mix}^n(r(\lambda))]] \end{aligned}$$

The above vanishes due to the classical DYBE.

For lighter notation, we assume that Π^{fus} is the Poisson structure on $L \times M$ obtained via dynamical fusion from $L^n \times M$. The more general case from the statement in the Proposition can be worked out in complete analogy. Denote by σ the diagonal H -action on $L \times M$. The induced action vector field is $h^\sigma = (\overrightarrow{h}, 0) + (0, (h_{(1)})^\rho) + \cdots + (0, (h_{(n)})^\rho)$. For any basis element $h_k \in \mathfrak{h}$ we find

$$\begin{aligned} [[h_k^\sigma, \rho_* \text{Mix}^n(r(\lambda))]] \\ = \sum_{1 \leq a < b \leq n} (\overrightarrow{h}_k \cdot r^0)(r_{(a)}^1)^\rho \wedge (r_{(b)}^2)^\rho + r^0([h_k, r^1]_{(a)})^\rho \wedge (r_{(b)}^2)^\rho + r^0(r_{(a)}^1)^\rho ([h_k, r^2]_{(b)})^\rho \\ = \sum_{a < b} \dot{c}_k^{ij}(0, (h_{i,(a)})^\rho, 0) \wedge (0, 0, (h_{j,(b)})^\rho) , \end{aligned}$$

where in the last line we used quasi \mathfrak{h} -invariance of $r(\lambda)$. The other Schouten brackets can be figured out along the same lines as in the proof of Proposition 3.1.4 and we find that

$$[[h_k^\sigma, \Pi^{\text{fus}}]] = \sigma_* \delta(h_k) ,$$

showing that the diagonal H -action is indeed Poisson. \square

3. Dynamical character varieties

Remark 3.1.8. Let M be a G^n -space. In the special case that $L = *$ and $\mathfrak{h} = 0$, the notion of a dynamical r -matrix coincides with that of an ordinary classical r -matrix. When in this situation, the Poisson space from (3.11) takes the form $(M, \Pi = \rho_* r^{(n)})$, where $r^{(n)} \in \mathfrak{g}^n \otimes \mathfrak{g}^n$ is the direct product r -matrix described in [Mou17, Section 2]. The fusion procedure described above then turns M into the Poisson G -space $(M, \Pi^{\text{fus}} = \Pi - \rho_* \text{Mix}^n(r))$, which coincides with the one in [Mou17].

We will now give an instructive example of fusion for dynamical Poisson spaces that will be generalized in the upcoming section.

Example 3.1.9. Let $X = L_1 \times L_2 \times G$ and $X' = L'_1 \times L'_2 \times G$ be two dynamical Poisson spaces as given in Proposition 3.1.5 with Poisson bivectors $\Pi_{\text{dyn}}^{L_1, L_2}$ and $\Pi_{\text{dyn}}^{L'_1, L'_2}$. We shall represent the dynamical Poisson spaces X and X' by the following two graphs:

$$X : \begin{array}{ccc} \bullet & \xrightarrow{\alpha} & \bullet \\ v_1 & & v_2 \end{array} \qquad X' : \begin{array}{ccc} \bullet & \xrightarrow{\beta} & \bullet \\ v'_1 & & v'_2 \end{array}$$

where the set of vertices $(v_a)_{a \in \{1,2\}}$ and $(v'_a)_{a \in \{1,2\}}$ represent the Poisson \mathfrak{h}_a -spaces $(L_a)_{a \in \{1,2\}}$ and the Poisson \mathfrak{h}'_a -spaces $(L'_a)_{a \in \{1,2\}}$ respectively. Given the two graphs X and X' we may obtain new graphs by identifying two of the vertices v_a and v'_b as illustrated in Figure 3.1, where the vertex v_0 is now a stand-in for the common base space $L_0 = L_a = L'_b$. On the level of algebraic varieties, fusion of the graphs X and X' corresponds to taking the pullback

$$\begin{array}{ccc} X \odot_{a,b}^{\text{fus}} X' & \longrightarrow & X \\ \downarrow & & \downarrow \pi_a \\ X' & \xrightarrow{\pi'_b} & L_0 \end{array}$$

where for $a \in \{1, 2\}$, $\pi_a: X = L_1 \times L_2 \times G \rightarrow L_a$ are the natural projection maps.

Given a graph $\Gamma_{a,b}$ as in Figure 3.1, we define the following bivector on the space $X \odot_{a,b}^{\text{fus}} X'$:

$$\begin{aligned} \Pi_{a,b}^{\text{fus}} = & \sum_{v_k \in V} (\Pi_{L_{v_k}} + \sum_{\substack{\delta \in E, \\ s(\delta) \vee t(\delta) = v_k}} \overrightarrow{\eta(k)}^i \wedge y(k)_i(\delta) + \frac{1}{2} \omega(\lambda_{v_k})^{ij} x_i(\delta) \wedge x_j(\delta)) \\ & + r(\lambda_{v_0})^{ij} x_i(\alpha) \wedge x_j(\beta) \end{aligned} \quad (3.12)$$

where

$$y(k)_i(\delta) = \begin{cases} h(k)_i^R(\delta), & \delta \text{ is incoming at } v_k \\ -h(k)_i^L(\delta), & \delta \text{ is outgoing at } v_k \end{cases}$$

and

$$x_i(\delta) = \begin{cases} e_i^R(\delta), & \delta \text{ is incoming at } v_k \\ -e_i^L(\delta), & \delta \text{ is outgoing at } v_k \end{cases}$$

for $\delta \in \{\alpha, \beta\}$, where the notation $x(\delta)$ means that $x \in \mathfrak{X}(G)$ is embedded into the δ -component of $\mathfrak{X}(G \times G)$. According to Proposition 3.1.7, this defines a dynamical Poisson structure on the fusion product $X \odot_{a,b}^{\text{fus}} X'$, which is such that the diagonal H_0 -action is Poisson.

3. Dynamical character varieties

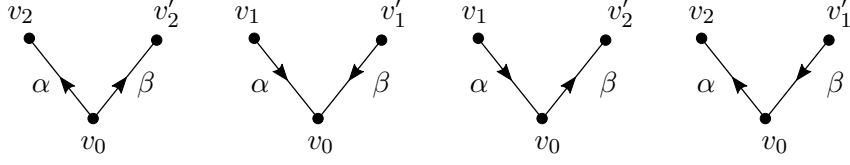

Figure 3.1.: Graphs $\Gamma_{a,b}$ representing the fusion of v_a with v'_b in the dynamical Poisson spaces $X = L_1 \times L_2 \times G$ and $X' = L'_1 \times L'_2 \times G$.

△

3.1.4. Dynamical Fock–Rosly Poisson structure

Let $\Gamma = (E, V)$ be a ciliated ribbon graph. We select a subset $\{v_1, \dots, v_k\} \subseteq V$ of vertices for which we fix Lie sub-bialgebras $\mathfrak{h}_i \subseteq \mathfrak{g}$, $i = 1, \dots, k$, and corresponding Poisson \mathfrak{h}_i -base spaces L_i . Let H_i be a group with Lie algebra \mathfrak{h}_i . Throughout we will assume that the \mathfrak{h}_i -action on $\mathcal{O}(L_i)$ comes from a left action of H_i on L_i .

Given such a decorated ciliated ribbon graph $\Gamma = (V, E, \{L_i, \mathfrak{h}_i\}_{i=1, \dots, k})$ we define a smooth algebraic variety called the *dynamical representation variety* by

$$\text{Rep}_{\text{dyn}}(\Gamma, G) = \prod_{v_i} L_i \times G^E$$

Let $V' = V \setminus \{v_1, \dots, v_k\}$. There is a natural action of the group $\prod_{v_i} H_i \times G^{V'}$ on the dynamical representation variety:

$$\rho_{\{v_1, \dots, v_k\}}^\Gamma : \left(\prod_{v_i} H_i \times G^{V'} \right) \times \left(\prod_{v_i} L_i \times G^E \right) \rightarrow \prod_{v_i} L_i \times G^E \quad (3.13)$$

$$\left((a_v)_{v \in V} = ((h_{v_i})_{v_i}, (g_{x_i})_{x_i \in V'}), (l_i)_{v_i}, (g_\gamma)_{\gamma \in E} \right) \mapsto \left((h_{v_i} \triangleright l_i)_{v_i}, (a_{t(\gamma)} g a_{s(\gamma)}^{-1})_{\gamma \in E} \right)$$

where $s(\gamma)$ is the starting and $t(\gamma)$ the target vertex of γ and \triangleright is the left H_i -action on the \mathfrak{h}_i -base spaces. Note that in the special case that $V' = V$, we recover the action of the lattice gauge group G^V on the ordinary representation variety $\text{Rep}(\Gamma, G) \cong G^E$.

Theorem 3.1.10. *Given a decorated ciliated ribbon graph $(\Gamma, \{\mathfrak{h}_i, L_i\}_{i=1, \dots, k})$, for each $m = 1, \dots, k$ fix a dynamical r -matrix $r(\lambda_m) : L_m \rightarrow \mathfrak{g} \otimes \mathfrak{g}$ and for each undecorated vertex $x_n \in V'$ an ordinary classical r -matrix $r_n \in \mathfrak{g} \otimes \mathfrak{g}$. We assume that all dynamical as well as ordinary classical r -matrices have common invariant symmetric part $t \in \text{Sym}^2(\mathfrak{g})^{\mathfrak{g}}$. Then, the following defines a Poisson bracket on the dynamical representation variety:*

- For $\varphi \in \mathcal{O}(L_m)$ and $\psi \in \mathcal{O}(L_n)$:

$$\{\varphi, \psi\} = \delta_{m,n} \{\varphi, \psi\}_{L_m} \quad (3.14)$$

- For $\varphi \in \mathcal{O}(L_m)$ and $f \in \mathcal{O}(G^E)$:

$$\{\varphi, f\} = \sum_{s(\alpha)=v_m} -(\overline{\eta(m)^i} \cdot \varphi)(h(m)_i^L(\alpha) \triangleright f) + \sum_{t(\alpha)=v_m} (\overline{\eta(m)^i} \cdot \varphi)(h(m)_i^R(\alpha) \triangleright f) \quad (3.15)$$

where for $m = 1, \dots, k$, $(h(m)_i)_{i \in I}$ is a basis for \mathfrak{h}_m and $(\eta(m)^i)_{i \in I}$ its dual basis, and for any $x \in \mathfrak{g}$ the action of $x^R(\alpha)$ and $x^L(\alpha)$ on elements in $\mathcal{O}(G^E)$ is as defined in (1.4).

3. Dynamical character varieties

- For $f, g \in \mathcal{O}(G^E)$:

$$\{f, g\} = \Pi_{FR}(\lambda)(df \wedge dg) \quad (3.16)$$

$$\begin{aligned} \Pi_{FR}(\lambda) = & \sum_{x_n \in V'} \left(\sum_{\alpha \prec \beta} r_n^{ij} x_i(\alpha) \wedge x_j(\beta) + \frac{1}{2} \sum_{\alpha} r_n^{ij} x_i(\alpha) \wedge x_j(\alpha) \right) \\ & + \sum_{v_m \in \{v_1, \dots, v_k\}} \left(\sum_{\alpha \prec \beta} r(\lambda_m)^{ij} x_i(\alpha) \wedge x_j(\beta) + \frac{1}{2} \sum_{\alpha} r(\lambda_m)^{ij} x_i(\alpha) \wedge x_j(\alpha) \right) \end{aligned}$$

where α, β run over the set of half-edges \widehat{E} based at the given vertex $v \in V$ and

$$x_i(\alpha) = \begin{cases} e_i^R(\alpha), & \alpha \text{ is incoming at } v \\ -e_i^L(\alpha), & \alpha \text{ is outgoing at } v \end{cases}$$

Moreover, the $\Pi_{v_i} H_i \times G^{V'}$ -action on the dynamical representation variety $\text{Rep}_{\text{dyn}}(\Gamma, G)$ is Poisson.

Proof. We may consider the vertices $x_n \in V'$ as decorated by the trivial Lie sub-bialgebra $\mathfrak{h}_n = 0$ and base space $L_n = *$. Note that in this case the notion of a dynamical classical r-matrix reduces to the one of an ordinary classical r-matrix. This observation allows us to phrase everything in terms of dynamical Poisson structures.

Recall that the combinatorial data of the ciliated ribbon graph Γ allows to define a $G^{\widehat{E}}$ -action on G^E :

$$\begin{aligned} \rho^\Gamma : G^{\widehat{E}} \times G^E &\rightarrow G^E \\ ((h_\alpha)_{\alpha \in \widehat{E}_v}, (g_\gamma)_{\gamma \in E}) &\mapsto (h_{t(\gamma)} g_\gamma h_{s(\gamma)}^{-1})_{\gamma \in E} . \end{aligned}$$

We also use Γ to define a dynamical r-matrix for the direct product Lie bialgebra $\mathfrak{g}^{\widehat{E}}$. To that end, let \widehat{E}_{v_i} be the ordered set of half-edges bases at $v_i \in V$ and define

$$r^{\widehat{E}}(\lambda) = \sum_{v_i \in V} \left(\sum_{\alpha \in \widehat{E}_{v_i}} \omega(\lambda_i)^0 (\omega(\lambda_i)^1)_{(\alpha_i)} \otimes (\omega^2(\lambda_i))_{(\alpha_i)} - \epsilon(\alpha) (t^1)_{(\alpha_i)} \otimes (t^2)_{(\alpha_i)} \right) ,$$

where $x_{(\alpha_i)}$ denotes the embedding of $x \in \mathfrak{g}$ into $\mathfrak{g}^{\widehat{E}}$ at position $\alpha_i = \alpha + \sum_{j=1}^{i-1} c_j$ for $c_j = |\widehat{E}_{v_j}|$ and the sign function is:

$$\epsilon(\alpha) = \begin{cases} 1, & \alpha \text{ is outgoing at } v_i \\ -1, & \alpha \text{ is incoming at } v_i . \end{cases}$$

We have that $\rho_*^\Gamma(r_{1,2}^{\widehat{E}}(\lambda) + r_{2,1}^{\widehat{E}}(\lambda)) = 0$ due to ad -invariance of t , and so by Proposition 3.1.4 the following is a Poisson space

$$(L_1^{c_1} \times \dots \times L_l^{c_l} \times G^E, \Pi_{r^{\widehat{E}}}(\lambda)), \quad \Pi_{r^{\widehat{E}}}(\lambda) = \Pi_{L_1^{c_1}} + \Theta_{L_1^{c_1}} \dots + \Pi_{L_l^{c_l}} + \Theta_{L_l^{c_l}} + \rho_*^\Gamma r^{\widehat{E}}(\lambda) .$$

We may now apply dynamical fusion to the above Poisson space, where one more time we use the linear ordering on \widehat{E} to define

$$\Pi^{\text{fus}} = \Pi_{L_1} + \Theta_{L_1}^{(c_1)} + \dots + \rho_*^\Gamma(r^{\widehat{E}}(\lambda)) + \text{Mix}^{\widehat{E}, \prec} r(\lambda)$$

3. Dynamical character varieties

with

$$\text{Mix}^{(\widehat{E}, \prec)} r(\lambda) = \sum_{v_i \in V} \left(\sum_{\alpha \prec \beta \in \widehat{E}_{v_i}} r(\lambda_i)^0 (r(\lambda_i)^1)_{\alpha_i} \wedge (r(\lambda_i)^2)_{\beta_i} \right)$$

One can check that the bivector obtained from dynamical fusion agrees with the dynamical Fock–Rosly bivector in (3.14)–(3.16), which then by Proposition 3.1.7 is Poisson. Moreover, it follows from the same proposition, together with the corresponding result from [FR99] for the undecorated vertices V' , that the diagonal $\Pi_{v_i} H_i \times G^{V'}$ -action spelled out in (3.13) is Poisson. \square

Remark 3.1.11. *It was brought to the author’s attention that the type of dynamical Fock–Rosly spaces described in Theorem 3.1.10 have previously appeared in [Spi20, Section 5.2] for Poisson base spaces given by open non-empty subsets $U \subseteq \mathfrak{h}^*$, for $\mathfrak{h} \subseteq \mathfrak{g}$.*

Remark 3.1.12. *For dynamical r -matrices over commutative base \mathfrak{h} , the dynamical generalization of the Fock–Rosly Poisson structure has for instance appeared in the work of Buffenoir–Roche [BR05] on Chern–Simons theory with sources, as we will recall in § 3.4.3. The commutative case is also discussed in [Meu21].*

Dynamical character variety/stack For a lighter exposition we will now restrict to graphs $\Gamma = (E, V)$ where all vertices $\{v_1, \dots, v_k\} = V$ are decorated by a Lie subalgebras $\mathfrak{h}_i \subseteq \mathfrak{g}$, $i = 1, \dots, k$, and corresponding Poisson \mathfrak{h}_i -base spaces L_i .

We have seen in § 1.1.2 that the Fock–Rosly Poisson structure on the (ordinary) representation variety is compatible with the lattice gauge group action and thus descends to the character variety, i.e. to the algebra of G^V -invariant functions on $\text{Rep}(\Gamma, G) \cong G^E$. In the previous section, we have reduced the lattice gauge group to the subgroup $\Pi_i H_i \subset G^V$ and defined a compatible Poisson structure on the dynamical representation variety. In this section we will define the corresponding dynamical character varieties and dynamical character stacks.

Since the Poisson \mathfrak{h}_i -base spaces L_i are not necessarily affine, the algebra of $\Pi_i H_i$ -invariants on the dynamical character variety might not capture accurately the geometry of the quotient space $\text{Rep}_{\text{dyn}}(\Sigma, G)/\Pi_i H_i$. We will thus take the following assumptions: each L_i admits a covering by affines $(U_a^i)_{a \in J}$, such that each U_a^i is H_i -invariant. We obtain an affine cover $(\Pi_i U_{a_i}^i)_{a_1, \dots, a_k}$ for the product $\Pi_i L_i$ and thus for dynamical representation variety. The cover is $\Pi_i H_i$ -invariant for the action (3.13). For each invariant affine open we may form the affine quotient and then glue the resulting affines to form the quotient

$$\text{Char}_{\text{dyn}}(\Gamma, G) = \text{Rep}_{\text{dyn}}(\Gamma, G)/\Pi_i H_i \quad ,$$

which we will call the *dynamical character variety*.

Example 3.1.13. *Let $H \subset G$ be a maximal torus, and $U \subset H$ an open subset considered as a Poisson \mathfrak{h} -base space as in Example 3.1.2. Then, the conjugation action by H on U is trivial, and any cover of U by affines will be invariant.*

Second, we define the *dynamical character stack* to be the stacky quotient of the dynamical representation variety by the reduced lattice gauge group:

$$\text{Char}_{\text{dyn}}(\Gamma, G) = [\text{Rep}_{\text{dyn}}(\Gamma, G)/\Pi_i H_i] \quad .$$

Note that in this case we do not need to impose any assumptions on the Poisson base spaces.

3. Dynamical character varieties

Lastly, we will discuss under which circumstances the dynamical Fock–Rosly structure induces a Poisson structure on the $\Pi_i H_i$ -invariant functions on G^E . To that end, we will need the following:

Proposition 3.1.14. *[Donin–Mudrov] Let (M, ρ) be a left G -space and $L \times M$ a dynamical Poisson space with Poisson bracket*

$$\Pi = \Pi_L + \overrightarrow{\eta^i} \wedge h_i^\rho + \pi(\lambda) \quad , \quad (3.17)$$

for $\pi(\lambda) \in \mathcal{O}(L) \otimes \wedge^2 TM$, which is such that the diagonal H -action is Poisson. Let $\lambda_0 \in L$ be a stable point for the H -action. Then $\pi(\lambda_0)$ induces a Poisson bracket on the subalgebra of H -invariants in $\mathcal{O}(M)$.

Proof. Compatibility with the H -action implies:

$$\overrightarrow{h} \cdot (\pi(\lambda)(f, g)) + h^\rho \triangleright (\pi(\lambda)(f, g)) - \pi(\lambda)(h^\rho \triangleright f, g) - \pi(\lambda)(f, h^\rho \triangleright g) = \rho_* \delta(h)(f, g)$$

for $h \in \mathfrak{h}$ and $f, g \in \mathcal{O}(M)$. Thus, we see that at an \mathfrak{h} -stable point λ_0 , the bracket π descends to the algebra of invariant functions, i.e. $h^\rho \triangleright (\pi(\lambda_0)(f, g)) = 0$. Moreover, the Schouten bracket of $\pi(\lambda)$ is given by

$$\llbracket \pi(\lambda), \pi(\lambda) \rrbracket = \text{Alt}(h_i^\rho \otimes \overrightarrow{\eta^i} \pi(\lambda))$$

and thus vanishes on elements of $\mathcal{O}(M)^H$. \square

Remark 3.1.15. *The function $\pi(\lambda): L \rightarrow \wedge^2 TM$, such that $L \times M$ equipped with the bivector (3.17) is a Poisson H -space, is called a Poisson dynamical bracket.*

Example 3.1.16. *Let $H \subset G$ be a maximal torus and consider $\mathcal{O}(H)$ as an \mathfrak{h} -base algebra with trivial Poisson bracket, as detailed in Example 3.1.2. Every point in H is stable under the adjoint action and thus $\pi(\lambda)$ induces a bracket on the algebra of H -invariants in $\mathcal{O}(M)$.*

Let's return to the combinatorial Poisson structures of the previous section. Given a decorated ribbon graph $\Gamma = (V, E, \{L_i, \mathfrak{h}_i\})$ and consider the coset space:

$$G^E / (\Pi_{v_i} H_i) \quad .$$

We can now apply Proposition 3.1.14 to the dynamical Poisson structure on the representation variety from Theorem 3.1.10:

Corollary 3.1.17. *Given a decorated ribbon graph model $\Gamma = (V, E, \{L_i, \mathfrak{h}_i\})$, assume that $\lambda_0 \in \Pi_i L_i$ is a stable point for the $\Pi_i H_i$ -action. Then, the dynamical Fock–Rosly Poisson bivector $\Pi_{FR}(\lambda_0)$ from (3.9) descends to the coset space $G^E / (\Pi_{v_i} H_i)$.*

Example 3.1.18. Consider a graph $\Gamma: x_1 \xrightarrow{\alpha} x_2$ as in Example 3.1.9. We decorate the vertex x_1 with the Poisson \mathfrak{h} -base space L and fix a dynamical r-matrix $r(\lambda): L \rightarrow \mathfrak{g} \otimes \mathfrak{g}$ together with an ordinary classical r-matrix r for the non-decorated vertex x_2 . The dynamical representation variety $\text{Rep}_{\text{dyn}}(\Gamma, G) = L \times G$ has left $H \times G$ -action:

$$\rho^\Gamma: (H \times G) \times (L \times G) \rightarrow L \times G, \quad ((h, a), (l, g)) \mapsto (h \triangleright l, agh^{-1})$$

By Theorem 3.1.10, the Poisson brackets on the dynamical representation variety are:

$$\{\varphi, f\} = -(\overrightarrow{\eta^i} \cdot \varphi)(h^{i,L} \triangleright f), \quad \{f, g\} = (\omega(\lambda)^{L,L} + \omega^{R,R}) \triangleright (f \otimes g)$$

for $\varphi \in \mathcal{O}(L)$ and $f, g \in \mathcal{O}(G)$. Suppose that $\lambda_0 \in L$ is an \mathfrak{h} -stable point. Then, the bivector field $\omega(\lambda_0)^{L,L} + \omega^{R,R}$ is a Poisson structure on the coset space G/H . Moreover, the remaining G -action by right-invariant vector fields is Poisson. Thus, the Poisson space $(G/H, \Pi_{FR}(\lambda_0))$ is an example of a Poisson homogeneous space. \triangle

3.2. Point defects and dynamical quantum groups

In this section we will specify the local categorical data coming from the theory of dynamical quantum groups that will be used to compute factorization homology on marked surfaces. To that end, we are going to present the categorical framework in which notions such as dynamical twists and the quantum DYBE can be naturally formulated.

3.2.1. Base algebras

In the (semi-)classical setting we formulated the classical DYBE over Poisson \mathfrak{h} -base algebras which were defined as module algebras over the Drinfeld double $\mathfrak{D}(\mathfrak{h})$. A quantization of the Lie bialgebra \mathfrak{h} is a quantization of its universal enveloping algebra to the Hopf algebra $U_q(\mathfrak{h})$. Accordingly, the quantum version of a Poisson \mathfrak{h} -base algebra should be an algebra in the Drinfeld center of the category of modules over $U_q(\mathfrak{h})$. These observations motivate the following definition taken from [DM05]:

Definition 3.2.1. *Let \mathcal{C} be a monoidal category. A base algebra \mathcal{L} in \mathcal{C} is a commutative algebra in the Drinfeld center $\mathcal{Z}(\mathcal{C})$, that is an algebra object $(\mathcal{L}, m_{\mathcal{L}}) \in \mathcal{C}$ together with a family of natural isomorphisms $(\gamma_X: \mathcal{L} \otimes X \rightarrow X \otimes \mathcal{L})_{X \in \mathcal{C}}$ such that $\gamma_{X \otimes Y} = (\text{id} \otimes \gamma_Y) \circ (\gamma_X \otimes \text{id})$ and the following diagrams are commutative*

$$\begin{array}{ccc}
 \mathcal{L} \otimes \mathcal{L} \otimes X & \xrightarrow{(\gamma_X \otimes \text{id}) \circ (\text{id} \otimes \gamma_X)} & X \otimes \mathcal{L} \otimes \mathcal{L} \\
 m_{\mathcal{L}} \otimes \text{id} \downarrow & & \downarrow \text{id} \otimes m_{\mathcal{L}} \\
 \mathcal{L} \otimes X & \xrightarrow{\gamma_X} & \mathcal{L} \otimes X
 \end{array}
 \qquad
 \begin{array}{ccc}
 \mathcal{L} \otimes \mathcal{L} & \xrightarrow{\gamma_{\mathcal{L}}} & \mathcal{L} \otimes \mathcal{L} \\
 m_{\mathcal{L}} \searrow & & \swarrow m_{\mathcal{L}} \\
 & \mathcal{L} &
 \end{array}
 \tag{3.18}$$

We now give some explicit examples for base algebras. Their role as quantizations of Poisson base algebras will be discussed in more details later on in § 3.4.

Example 3.2.2. Let \mathcal{A} be a rigid braided monoidal category and $\mathcal{F}_{\text{RE}} = \int^{X \in \text{cmp}(\mathcal{A})} X^{\vee} \otimes X$ the reflection-equation (RE) algebra (see also Example 2.2.11). It is a commutative algebra in the Drinfeld center $\mathcal{Z}(\mathcal{A})$ if endowed with the half-braiding given by the field goal transformation:

$$\gamma_X: \mathcal{F}_{\text{RE}} \otimes X \rightarrow X \otimes \mathcal{F}_{\text{RE}}, \quad \gamma_X = \begin{array}{c} X \quad \mathcal{F}_{\text{RE}} \\ \text{---} \\ \text{---} \\ \text{---} \\ \mathcal{F}_{\text{RE}} \quad X \end{array}$$

for all $X \in \mathcal{A}$. △

Example 3.2.3. Let B be a Hopf algebra. As was noticed in [DM05, Example 4.4], a base algebra \mathcal{L} for the category $B\text{-Mod}$ can be described as follows. \mathcal{L} is a left B -module and left B -comodule algebra such that the coaction $\delta: \mathcal{L} \rightarrow B \otimes \mathcal{L}$, $\lambda \mapsto \lambda^{(-1)} \otimes \lambda^{(0)}$, satisfies

$$\delta(b \triangleright \lambda) = b_{(1)} \lambda^{(-1)} S(b_{(3)}) \otimes b_{(2)} \triangleright \lambda^{(0)}, \tag{3.19}$$

where we wrote $\Delta(b) = b_{(1)} \otimes b_{(2)}$ for the coproduct in B , and the multiplication of \mathcal{L} is such that

$$m_{\mathcal{L}}(\lambda \otimes \mu) = \lambda \mu = (\lambda^{(-1)} \triangleright \mu) \lambda^{(0)} \tag{3.20}$$

3. Dynamical character varieties

for all $\lambda, \mu \in \mathcal{L}$. Note that a left B -module and comodule satisfying (3.19) is called a Yetter–Drinfeld module. We call \mathcal{L} a B -base algebra. The corresponding half-braiding $\gamma_X: \mathcal{L} \otimes X \rightarrow X \otimes \mathcal{L}$ is defined for every $X \in B\text{-Mod}$ using the coaction

$$\gamma_X: \lambda \otimes x \mapsto \lambda^{(-1)} \triangleright x \otimes \lambda^{(0)} \quad .$$

Equation (3.19) guarantees that this is a B -module map, and Equation (3.20) that \mathcal{L} is commutative with respect to the half-braiding $\gamma_{\mathcal{L}, \mathcal{L}}$, i.e. that the diagram on the right in (3.18) commutes. The diagram on the left in (3.18) is commutative since δ is an algebra map. Lastly, note that the left B -comodule \mathcal{L} admits also a right B -coaction defined by:

$$\delta^R: \mathcal{L} \rightarrow \mathcal{L} \otimes A, \quad \lambda \mapsto \lambda^{[0]} \otimes \lambda^{[1]} = \lambda^{(0)} \otimes S^{-1}(\lambda^{(-1)}) \quad . \quad (3.21)$$

△

The following was one of the motivating examples for Donin–Mudrov to introduce the notion of base algebras. As we will see later on, it is related to the formulation of the quantum DYBE over non-abelian base spaces due to Xu [Xu02].

Example 3.2.4. [DM05, Example 3.5] Let $\mathfrak{l} \subseteq \mathfrak{g}$ be a Lie subalgebra, $U \subset \mathfrak{l}^*$ an \mathfrak{l} -stable open subset and let $\mathcal{O}(U)$ be the algebra of regular functions on U . The subset $U \subset \mathfrak{l}^*$ should be thought of as the open region where the dynamical r-matrices with base \mathfrak{l}^* does not have poles. The linear Poisson structure on \mathfrak{l}^* admits a quantization by the PBW star-product $(\mathcal{O}(\mathfrak{l}^*)[[\hbar]], \star)$ [Gut83]. The latter is a $U(\mathfrak{l})$ -module via the coadjoint action, as well as a comodule via the map

$$\delta: f(\mu) \mapsto f(\mu + \hbar h^{(1)}), \quad \mu \in \mathfrak{l}^*$$

with $f(\mu + \hbar h^{(1)}) = f(\mu) \otimes 1 + \hbar \sum_i \frac{\partial f(\mu)}{\partial \mu^i} \otimes l_i + \mathcal{O}(\hbar^2)$, where (l_i) is a basis for \mathfrak{l} and (μ^i) the induced coordinate system on \mathfrak{l}^* . One can check that this turns $\mathcal{O}(U)[[\hbar]]$ equipped with the PBW star-product into a base algebra in the category $U(\mathfrak{l})\text{-Mod}[[\hbar]]$. △

The main example for us will be the following:

Example 3.2.5. Let $H \subset G$ be a maximal torus and \mathfrak{h} the Lie algebra of H . The algebra $\mathcal{O}(H)$ is a $U(\mathfrak{h})[[\hbar]]$ -comodule algebra

$$\delta_{\hbar}: \mathcal{O}(H) \rightarrow U(\mathfrak{h}) \otimes \mathcal{O}(H)[[\hbar]], \quad \delta_{\hbar} f(e^\lambda) = f(e^{\lambda + \hbar h^{(1)}}), \quad e^\lambda \in H \quad ,$$

where

$$f(e^{\lambda + \hbar h^{(1)}}) = 1 \otimes f(e^\lambda) + \hbar h_i \otimes \sum_i h_i^L \triangleright f(e^\lambda) + \frac{\hbar^2}{2} \sum_{i,j} h_i h_j \otimes h_i^L \triangleright h_j^L \triangleright f(e^\lambda) + \dots \quad (3.22)$$

for (h_i) a basis of \mathfrak{h} . The left $U(\mathfrak{h})[[\hbar]]$ -module structure is the trivial one. The right $U_{\hbar}(\mathfrak{h})$ -comodule structure is

$$\delta_{\hbar}^R f(e^\lambda) = f(e^{\lambda - \hbar h^{(2)}}) = f(e^\lambda) \otimes 1 - \hbar \sum_i h_i^L \triangleright f(e^\lambda) \otimes h_i + \mathcal{O}(\hbar^2) \quad . \quad (3.23)$$

For applications we may want to work with a localization of $\mathcal{O}(H)$. Let $S \subset \mathcal{O}(H)$ be a multiplicative subset and denote by $\mathcal{O}(H)_S$ the localization at S .

3. Dynamical character varieties

Proposition 3.2.6. *The localization $\mathcal{L} = \mathcal{O}(H)_S$ is a $U(\mathfrak{h})[[\hbar]]$ -base algebra.*

Proof. We will use the universal property of localizations to show that we can extend δ to a comodule map

$$\delta_{\hbar,S}^R: \mathcal{O}(H)_S \rightarrow \mathcal{O}(H)_S \otimes U(\mathfrak{h})[[\hbar]] \quad .$$

To that end, consider the composition

$$\mathcal{O}(H) \xrightarrow{\delta_{\hbar}^R} \mathcal{O}(H) \otimes U(\mathfrak{h})[[\hbar]] \rightarrow \mathcal{O}(H)_S \otimes U(\mathfrak{h})[[\hbar]] \quad ,$$

where $\mathcal{O}(H) \rightarrow \mathcal{O}(H)_S$ is the map $f \mapsto \frac{f}{1}$. We claim that every element in S is mapped to an invertible element in $\mathcal{O}(H)_S \otimes U(\mathfrak{h})[[\hbar]]$. Indeed, we have $\delta_{\hbar}^R(S) - S \otimes 1 = 0 \pmod{\hbar}$ and we can thus write $\delta_{\hbar}^R(S) = S \otimes 1 + \sum_i x_i \otimes y_i$ with $y_i \in U(\mathfrak{h})^{\geq 1}[[\hbar]]$ with respect to the \hbar -adic filtration. Now, we observe that $\delta_{\hbar}^R(S)(S^{-1} \otimes 1)$ is invertible in $\mathcal{O}(H)_S \otimes U(\mathfrak{h})[[\hbar]]$ with inverse given by

$$1 \otimes 1 - \sum_i x_i S^{-1} \otimes y_i + \sum_{i,j} x_i S^{-1} x_j S^{-1} \otimes y_i y_j - \dots \quad .$$

Hence, $\delta_{\hbar}^R(S)$ is an invertible element and we get an extension $\delta_{\hbar,S}^R: \mathcal{O}(H)_S \rightarrow \mathcal{O}(H)_S \otimes U(\mathfrak{h})[[\hbar]]$. □

△

Quantum moment maps Let \mathcal{L} be a base algebra in a monoidal category \mathcal{C} and (A, m) an algebra object in \mathcal{C} . In § 2.5, we recalled the notion of quantum moment maps for the RE-algebra \mathcal{F}_{RE} in a braided monoidal category \mathcal{A} , following [Saf21a]. The definition naturally generalizes to base algebras in monoidal categories: a *quantum moment map* is an algebra map $\mu: \mathcal{L} \rightarrow A$, such that the following diagram commutes

$$\begin{array}{ccc} \mathcal{L} \otimes A & \xrightarrow{\mu \otimes \text{id}} & A \otimes A \\ \gamma_A \downarrow & & \searrow m \\ & & A \\ & & \nearrow m \\ A \otimes \mathcal{L} & \xrightarrow{\text{id} \otimes \mu} & A \otimes A \end{array} \quad (3.24)$$

Proposition 3.2.7. *An algebra in $\mathcal{L}\text{-Mod}_{\mathcal{C}}$ is an algebra in \mathcal{C} equipped with a quantum moment map.*

Proof. Let $A \in \mathcal{L}\text{-Mod}_{\mathcal{C}}$ be an algebra with left \mathcal{L} -action \triangleright , right action $\triangleleft = \triangleright \circ \gamma_A^{-1}$ and multiplication $m: A \otimes_{\mathcal{L}} A \rightarrow A$, $a \otimes b \mapsto ab$. Define $\mu: \mathcal{L} \rightarrow A$ by $\mu(\lambda) = \lambda \triangleright 1_A$. This is a quantum moment map since the multiplication m is balanced and a \mathcal{L} -module map. Conversely, let A be an algebra in \mathcal{C} and $\mu: \mathcal{L} \rightarrow A$ a quantum moment map. This defines an algebra in the category of $(\mathcal{L}, \mathcal{L})$ -bimodules via

$$\lambda \triangleright a = \mu(\lambda)a, \quad a \triangleleft \lambda = a\mu(\lambda)$$

for $\lambda \in \mathcal{L}$ and $a \in B$. Since μ makes Diagram (3.24) commute, we have $(A, \mu) \in \mathcal{C}_{\mathcal{L}} \subset (\mathcal{L}, \mathcal{L})\text{-Bimod}_{\mathcal{C}}$. □

3. Dynamical character varieties

3.2.2. Dynamical twists

From a categorical point of view, solutions to the quantum YBE can be understood as monoidal functors from a rigid braided tensor category \mathcal{A} to the category of \mathbb{K} -vector spaces: for a monoidal functor $F: \mathcal{A} \rightarrow \mathbf{Vect}_{\mathbb{K}}$ we define linear maps $\mathcal{R}_{X,Y}: F(X) \otimes F(Y) \xrightarrow{\cong} F(X) \otimes F(Y)$ of vector spaces by the following commutative diagram

$$\begin{array}{ccc} F(X) \otimes F(Y) & \xrightarrow{\tau \circ \mathcal{R}_{X,Y}} & F(Y) \otimes F(X) \\ \downarrow \cong & & \cong \uparrow \\ F(X \otimes Y) & \xrightarrow{F(\sigma_{X,Y})} & F(Y \otimes X) \end{array} ,$$

where τ is the permutation $\tau(v \otimes w) = w \otimes v$. Intuitively, the linear map $\mathcal{R}_{X,Y}$ measures the failure of F to preserve the braiding. The natural isomorphism $\mathcal{R}: F(-) \otimes F(-) \Rightarrow F(-) \otimes F(-)$ satisfies the quantum Yang–Baxter equation

$$\mathcal{R}_{X,Y} \mathcal{R}_{X,Z} \mathcal{R}_{Y,Z} = \mathcal{R}_{Y,Z} \mathcal{R}_{X,Z} \mathcal{R}_{X,Y}$$

in $\mathbf{End}_{\mathbb{K}}(F(X) \otimes F(Y) \otimes F(Z))$, which is a consequence of σ being a braiding in \mathcal{A} . In the case where \mathcal{A} is the category of modules over some Hopf algebra H , the structure induced on H by the monoidal functor is that of a quasi-triangular Hopf algebra.

Donin–Mudrov in [DM05], and Kalmykov–Safronov in [KS20], have extended this categorical viewpoint to encompass solutions to the quantum DYBE. The latter no longer takes place in the category of vector spaces, but in some dynamical extension of a monoidal category. More precisely, for a cocomplete monoidal category \mathcal{C} and a base algebra $\mathcal{L} \in \mathcal{Z}(\mathcal{C})$, we define the *dynamical extension* of \mathcal{C} over \mathcal{L} to be the category

$$\mathcal{C}_{\mathcal{L}} = \mathcal{L}\text{-Mod}_{\mathcal{C}}$$

of \mathcal{L} -modules internal to \mathcal{C} .

The dynamical extension $\mathcal{C}_{\mathcal{L}}$ is a monoidal category under the relative tensor product $X \otimes_{\mathcal{L}} Y$ defined by the colimit of the diagram

$$X \otimes \mathcal{L} \otimes Y \xrightarrow[\triangleleft]{\triangleright} X \otimes Y \quad ,$$

where X is made into a right \mathcal{L} -module via the half-braiding γ_X . If $\mathcal{C}_{\mathcal{L}}$ is equipped with the relative tensor product monoidal structure, the free module functor $\mathbf{free}: \mathcal{C} \rightarrow \mathcal{C}_{\mathcal{L}}$ is monoidal:

$$(\mathcal{L} \otimes X) \otimes_{\mathcal{L}} (\mathcal{L} \otimes Y) \xrightarrow{(\triangleright \circ \mathbf{id}_Y) \circ (\gamma_{\mathcal{L} \otimes X}^{-1} \circ \mathbf{id}_Y)} \mathcal{L} \otimes X \otimes Y \quad .$$

Proposition 3.2.8. *Let $\mathcal{C} \in \mathbf{Pres}_{\mathbb{K}}$. Assume that \mathcal{C} has a strong generator consisting of compact-projective objects. Then, $\mathcal{C}_{\mathcal{L}}$ has a strong generator given by the free \mathcal{L} -modules $\mathcal{L} \otimes X$ for $X \in \mathcal{C}^{\text{cp}}$. Moreover, the objects $\mathcal{L} \otimes X$ for $X \in \mathcal{C}^{\text{cp}}$ are compact-projective.*

Proof. The dynamical extension is equivalent to the category of algebras over the monad $\mathcal{L} \otimes (-): \mathcal{C} \rightarrow \mathcal{C}$. This monad preserves colimits by the assumption that \mathcal{C} is a monoidal category in \mathbf{Pres} . The forgetful functor $U: \mathcal{C}_{\mathcal{L}} \rightarrow \mathcal{C}$ is thus colimit preserving and $\mathcal{L} \otimes X$ for $X \in \mathcal{C}^{\text{cp}}$ is compact-projective. The forgetful functor is also conservative and thus the $\{\mathcal{L} \otimes X\}_{X \in \mathcal{C}^{\text{cp}}}$ form a strong generator. \square

3. Dynamical character varieties

Remark 3.2.9. In [KS20], the category $\mathcal{C}_{\mathcal{L}}$ is called the category of Harish-Chandra bimodules. We will reserve this name for the case when we work with representation categories of groups or quantum groups. In the original reference [DM05], the notion of a dynamical extension of \mathcal{C} refers only to the full subcategory of free \mathcal{L} -modules. However, motivated by the fact that $\mathcal{C}_{\mathcal{L}}$ is generated under colimits by the free modules, we will stick to the same terminology.

Now, assume that $\mathcal{C} = B\text{-Mod}$ for a Hopf algebra B and let (\mathcal{A}, σ) be a braided monoidal category. Solutions to the quantum DYBE over the base algebra \mathcal{L} are obtained from monoidal functors:

$$\mathcal{A} \xrightarrow{F} B\text{-Mod} \xrightarrow{\text{free}} B\text{-Mod}_{\mathcal{L}} .$$

More precisely, define $\mathcal{R}(\lambda)_{X,Y} \in \mathcal{L} \otimes \text{End}(F(X) \otimes F(Y))$ by the following commutative diagram:

$$\begin{array}{ccc} \mathcal{L} \otimes F(X) \otimes F(Y) & \xrightarrow{(\text{id}_{\mathcal{L}} \otimes \tau) \circ \mathcal{R}(\lambda)_{X,Y}} & \mathcal{L} \otimes F(Y) \otimes F(X) \\ \mathcal{J}(\lambda)_{X,Y} \downarrow & & \uparrow \mathcal{J}(\lambda)_{Y,X}^{-1} \\ \mathcal{L} \otimes F(X \otimes Y) & \xrightarrow{\text{id}_{\mathcal{L}} \otimes F(\sigma_{X,Y})} & \mathcal{L} \otimes F(Y \otimes X) \end{array} \quad (3.25)$$

Compatibility with the B -action implies that the elements $\mathcal{R}(\lambda)_{X,Y}$ are B -equivariant. Moreover, it follows from σ being a braiding in \mathcal{A} that the collection of element

$$(\mathcal{R}(\lambda)_{X,Y})_{X,Y \in \mathcal{A}}$$

satisfies the quantum DYBE

$$\mathcal{R}(\lambda)_{Y,Z} \mathcal{R}(\lambda)_{X,Z}^{[Y]} \mathcal{R}(\lambda)_{X,Y} = \mathcal{R}(\lambda)_{X,Y}^{[Z]} \mathcal{R}(\lambda)_{X,Z} \mathcal{R}(\lambda)_{Y,Z}^{[X]} \quad (3.26)$$

in $\mathcal{L} \otimes \text{End}(F(X) \otimes F(Y) \otimes F(Z))$, where we wrote for example $\mathcal{R}(\lambda)_{X,Z}^{[Y]}$ to mean that the B -component of the right coaction $\delta^R: \mathcal{L} \rightarrow \mathcal{L} \otimes B$ acts on $F(Y)$. We call $\mathcal{R}(\lambda)$ a *dynamical R -matrix* and the monoidal structure

$$\mathcal{J}(\lambda)_{X,Y} \in \mathcal{L} \otimes \text{Hom}(F(X) \otimes F(Y), F(X \otimes Y))$$

from Diagram (3.25) is called a *dynamical twist*.

In the case where $\mathcal{A} = H\text{-Mod}$ and $\mathcal{C} = B\text{-Mod}$ for a pair of Hopf algebras $B \subseteq H$, the monoidal functor F is given by restricting an H -module to the Hopf subalgebra B and the data of a dynamical twist can be expressed as follows:

Definition 3.2.10. A universal dynamical twist for the pair $B \subseteq H$ over the base algebra \mathcal{L} is an invertible element $\mathcal{J}(\lambda) = \mathcal{J}^0 \otimes \mathcal{J}^1 \otimes \mathcal{J}^2 \in \mathcal{L} \otimes H \otimes H$ that satisfies the following equations:

- *B -equivariance:*

$$b_{(1)} \triangleright \mathcal{J}^0 \otimes b_{(2)(1)} \mathcal{J}^1 \otimes b_{(2)(2)} \mathcal{J}^2 = \mathcal{J}^0 \otimes \mathcal{J}^1 b_{(1)} \otimes \mathcal{J}^2 b_{(2)} ,$$

for all $b \in B$.

- *Dynamical cocycle equation:*

$$((\text{id} \otimes \Delta \otimes \text{id}) \mathcal{J}(\lambda)) \mathcal{J}(\lambda)_{1,2} = ((\text{id} \otimes \text{id} \otimes \Delta) \mathcal{J}(\lambda)) (\delta^R \otimes \text{id} \otimes \text{id}) \mathcal{J}(\lambda) \quad (3.27)$$

in $\mathcal{L}_{\text{op}} \otimes H \otimes H \otimes H$.

3. Dynamical character varieties

- *Normalization:* $(\text{id} \otimes \epsilon \otimes \text{id}) \mathcal{J}(\lambda) = 1 \otimes 1 \otimes 1 = (\text{id} \otimes \text{id} \otimes \epsilon) \mathcal{J}(\lambda)$.

Remark 3.2.11. In [DM05], Donin–Mudrov define a universal dynamical twist to be a B -equivariant element $\mathcal{K}(\lambda) \in H \otimes H \otimes \mathcal{L}$ satisfying

$$(\Delta \otimes \text{id})\mathcal{K}(\lambda)(\text{id} \otimes \text{id} \otimes \delta)\mathcal{K}(\lambda) = (\text{id} \otimes \Delta)\mathcal{K}(\lambda)\mathcal{K}(\lambda)_{2,3} \quad (3.28)$$

in $H \otimes H \otimes H \otimes \mathcal{L}$. This differs from Definition 3.2.10 in the following way: an element $\mathcal{K}(\lambda)$ satisfying Equation (3.28) is equivalent to the data of a monoidal structure on the functor

$$\mathcal{A} \rightarrow \mathcal{C} \xrightarrow{\text{free}_{\mathcal{L}}} \text{Mod}_{\mathcal{C}-\mathcal{L}}, \quad \mathcal{A} = H\text{-Mod}, \quad \mathcal{C} = B\text{-Mod} \quad ,$$

into the category of right \mathcal{L} -modules internal to \mathcal{C} , whereas we consider the case of left \mathcal{L} -modules. The two definitions are equivalent in the following way. There is a commutative diagram

$$\begin{array}{ccccc} & & \mathcal{L}\text{-Mod}_{\mathcal{C}} & & \\ & \nearrow^{\text{free}_{\mathcal{L}}} & & \searrow & \\ \mathcal{A} & \rightarrow & \mathcal{C} & & (\mathcal{L}, \mathcal{L})\text{-Bimod}_{\mathcal{C}} \\ & \searrow_{\text{free}_{\mathcal{L}}} & & \nearrow & \\ & & \text{Mod}_{\mathcal{C}-\mathcal{L}} & & \end{array}$$

$\Downarrow \gamma$

where $\gamma: \mathcal{L} \otimes (-) \Rightarrow (-) \otimes \mathcal{L}$ is the half-braiding for the base algebra $\mathcal{L} \in \mathcal{C}$. Then, the natural isomorphism $\gamma_{F(-)} = \gamma \circ F$ allows to transport a monoidal structure on the functor $\mathcal{A} \rightarrow \mathcal{L}\text{-Mod}_{\mathcal{C}}$ to one on $\mathcal{A} \rightarrow \text{Mod}_{\mathcal{C}-\mathcal{L}}$ and vice versa.

Example 3.2.12. [DM05, Example 5.8] For a pair of Lie algebras $\mathfrak{l}: \mathfrak{l} \subseteq \mathfrak{g}$, $U \subset \mathfrak{l}^*$ an \mathfrak{l} -stable open subset and the base algebra $\mathcal{L} = (\mathcal{O}(U)[[\hbar]], \star)$ from Example 3.2.4, a dynamical twist is a monoidal structure on the functor

$$U(\mathfrak{g})\text{-Mod}[[\hbar]] \xrightarrow{\iota^*} U(\mathfrak{l})\text{-Mod}[[\hbar]] \xrightarrow{\text{free}_{\mathcal{L}}} (U(\mathfrak{l})\text{-Mod}[[\hbar]])_{\mathcal{L}} \quad .$$

These dynamical twists have been explicitly constructed for various classes of Lie subalgebras $\mathfrak{l} \subseteq \mathfrak{g}$. For example, in [EV98b, EV99] Etingof–Varchenko constructed a dynamical twist for $\mathfrak{h} \subset \mathfrak{g}$ being a Cartan subalgebra. Their construction was further generalized in [DM05] to the case where \mathfrak{h} is replaced with a Levi subalgebra $\mathfrak{l} \subset \mathfrak{g}$. More examples can be found in [EE05]. \triangle

The rest of this section concerns our main example for applications in factorization homology, namely the universal fusion matrix of Etingof–Varchenko [EV99]. This is a dynamical twist $(\mathcal{J}(\lambda)_{V,W} \in \text{End}(V \otimes W))_{V,W \in \text{Rep}_q(G)}$ depending rationally on a parameter $\lambda \in H$ for $H \subset G$ a maximal torus. More recently, a categorical construction of $\mathcal{J}(\lambda)$ was done by Kalmykov–Safronov in [KS20], which we will briefly review in Example 3.2.13 below. In § 3.2.3, we will give an interpretation of their construction in terms of factorization homology on stratified annuli.

Example 3.2.13. [KS20] The dynamical twist $\mathcal{J}(\lambda)$ originates in a quantization of the bimodule category

$$\text{QCoh}([G/G]) \curvearrowright \text{QCoh}([B/B]) \curvearrowright \text{QCoh}([H/H]) \quad (3.29)$$

3. Dynamical character varieties

induced by the correspondence $[G/G] \leftarrow [B/B] \rightarrow [H/H]$. The categories of quasi-coherent sheaves on $[G/G]$ and $[H/H]$ are quantized by the following categories of quantum Harish-Chandra bimodules:

$$\mathrm{HC}_q(G) = U_q(\mathfrak{g})^{\mathrm{lf}}\text{-Mod}_{\mathrm{Rep}_q(G)}, \quad \mathrm{HC}_q(H) = U_q(\mathfrak{h})\text{-Mod}_{\mathrm{Rep}_q(H)} . \quad (3.30)$$

In the above, $U_q(\mathfrak{g})^{\mathrm{lf}}$ is the locally-finite part of $U_q(\mathfrak{g})$ with respect to the adjoint action. A quantization of the bimodule category $\mathrm{QCoh}([B/B])$ is given by the universal quantum category \mathcal{O} , which is the full subcategory $\mathcal{O}_q^{\mathrm{univ}}$ of $U_q(\mathfrak{g})$ -modules internal to $\mathrm{Rep}_q(H)$ whose $U_q(\mathfrak{n})$ -action is locally finite.

Acting on the distinguished object $M^{\mathrm{univ}} = U_q(\mathfrak{g}) \otimes_{U_q(\mathfrak{b})} U_q(\mathfrak{h})$ in $\mathcal{O}_q^{\mathrm{univ}}$ induces a lax monoidal functor

$$\mathrm{res}: \mathrm{HC}_q(G) \xrightarrow{\mathrm{act}_{M^{\mathrm{univ}}}^L} \mathcal{O}_q^{\mathrm{univ}} \xrightarrow{\mathrm{act}_{M^{\mathrm{univ}}}^R} \mathrm{HC}_q(H), \quad X \mapsto (X \otimes_{\mathcal{O}_q(G)} M^{\mathrm{univ}})^{U_q(\mathfrak{n})} , \quad (3.31)$$

called *quantum parabolic restriction*. When restricting to the locus of generic weights², the induced functor $\mathrm{res}^{\mathrm{gen}}$ is strong monoidal and fits in the commutative square [KS20, Theorem 4.35]:

$$\begin{array}{ccc} \mathrm{Rep}_q(G) & \xrightarrow{\mathrm{free}_{\mathcal{O}_q(G)}} & \mathrm{HC}_q(G) \\ \downarrow & & \downarrow \mathrm{res}^{\mathrm{gen}} \\ \mathrm{Rep}_q(H) & \xrightarrow{\mathrm{free}_{\mathcal{O}(H)^{\mathrm{gen}}}} & \mathrm{HC}_q(H)^{\mathrm{gen}} \end{array} \quad (3.32)$$

This has the following interpretation: the monoidal structure on $\mathrm{res}^{\mathrm{gen}}$ induces a dynamical twist

$$\mathcal{J}(\lambda)_{V,W} \in \mathcal{O}(H)^{\mathrm{gen}} \otimes \mathrm{Hom}_{\mathrm{Rep}_q(H)}(V \otimes W, V \otimes W), \quad V, W \in \mathrm{Rep}_q(G) ,$$

which is a rational function on H which is regular on H^{gen} . The algebra $\mathcal{O}(H)^{\mathrm{gen}}$ is a base algebra in $\mathrm{Rep}_q(H)$ with half-braiding $(V \otimes \mathcal{O}(H)^{\mathrm{gen}} \xrightarrow{\cong} \mathcal{O}(H)^{\mathrm{gen}} \otimes V)_{V \in \mathrm{Rep}_q(H)}$ defined by

$$v \otimes f(\lambda) \mapsto f(\lambda q^{-\mu}) \otimes v$$

for any $v \in V$ of weight μ and $\lambda \in H^{\mathrm{gen}}$. \triangle

Remark 3.2.14. *In Example 3.2.13, the dynamical twist $\mathcal{J}(\lambda)$ is defined for quantum groups $U_q(\mathfrak{g})$ with generic parameter $q \in \mathbb{C}^\times$, or more precisely for their integrable representations. We have seen that the construction involves the localization of $\mathcal{O}(H)$ at the multiplicative set generated by $\{q^{(\lambda, \alpha) + \frac{n(\alpha, \alpha)}{2}} - 1 \mid \alpha \in \Delta, n \in \mathbb{Z}\}$ for $q^{(\lambda, -)} \in \mathrm{Hom}(\Lambda, \mathbb{C}^\times) \cong H$. Since this is a set generated by infinitely many polynomials, the resulting subset $H^{\mathrm{gen}} \subset H$ on which the dynamical twist is regular might not again be an algebraic variety. In contrast, when working in the formal setting, i.e. in the case $q = e^{\hbar}$ for \hbar a formal parameter, the dynamical twist is a regular function on an open*

²A weight for a $U_q(\mathfrak{g})$ -module is a character for the Cartan part $U_q(\mathfrak{h})$ of $U_q(\mathfrak{g})$. Since $U_q(\mathfrak{h}) \cong \mathbb{K}[\Lambda]$, the character group may be identified with $\mathrm{Hom}(\Lambda, \mathbb{K}^\times) \cong H$. For an element $\lambda \in \mathfrak{h}$ we write the associated elements of $\mathrm{Hom}(\Lambda, \mathbb{K}^\times)$ as q -exponentials:

$$\Lambda \rightarrow \mathbb{K}^\times, \quad \mu \mapsto q^{(\lambda, \mu)} .$$

Then, the weight λ is called *generic* if $q^{(\lambda, \alpha)} \notin \pm q_{\alpha}^{\mathbb{Z}}$. We will write $H^{\mathrm{gen}} \subset H$ for the subset of generic weights and $\mathcal{O}(H)^{\mathrm{gen}}$ for the rational functions that are regular on H^{gen} .

3. Dynamical character varieties

subset $H^{\text{reg}} \subset H$. More precisely, it was shown in [EEM04, Proposition 5.1] that the functional part of the dynamical twist lives in a localization $\mathcal{O}(H)_S[[\hbar]]$, where S is the multiplicative set generated by the finite set of polynomials $\{k_\beta^2 - 1 \mid \beta \in \Delta_+\}$, where for any positive root $\beta = \sum_{i=1}^r n_i \alpha_i$ we have set $k_\beta = \prod_{i=1}^r e^{\hbar n_i \alpha_i}$. This observation will allow us to carry out certain constructions locally on an affine cover for H^{reg} , which will for instance prove useful when defining quantum dynamical character stacks in § 3.4.2.

3.2.3. Digression - Dynamical twist from factorization homology on stratified annulus

This section is concerned with topological aspects of constructing dynamical twists. More precisely, we will use factorization homology on annuli with circular line defects to quantize the bimodule (3.29) which gives rise to the dynamical twist $\mathcal{J}(\lambda)$ constructed by Kalmykov–Safronov. The content of this section is still work in progress and may be read independently from the rest of this chapter.

Line defects and decorated surfaces A surface with one-dimensional defects is an oriented surface Σ together with an oriented one-dimensional submanifold Υ , such that $\partial\Upsilon \subset \partial\Sigma$ and $\Upsilon \setminus \partial\Upsilon \cap \partial\Sigma = \emptyset$. We may decorate the stratified surface Σ as follows: each connected component of the bulk $\Sigma \setminus \Upsilon$ carries a label from the set $\{\mathcal{G}, \mathcal{H}\}$. The labeling is such that two bulk regions meeting at a connected component $\Upsilon_i \subset \Upsilon$ have to carry distinct labels. One could of course label each connected component of Υ by different defect data, however we only consider the case where all Υ_i carry the same data.

Definition 3.2.15. $\text{Man}_2^{\text{or}, \text{str}}$ is the $(2, 1)$ -category whose

- objects are oriented surfaces with one-dimensional defects and a $\{\mathcal{H}, \mathcal{G}\}$ -labeling of the bulk
- 1-morphisms are embeddings respecting the decorations and stratification
- 2-morphisms are stratified isotopies

The full symmetric monoidal subcategory $\mathbb{D}\text{isk}_2^{\text{or}, \text{str}}$ of decorated oriented disks with one-dimensional defects and disjoint unions thereof has three generating objects, the decorated disks $\mathbb{D}_{\mathcal{G}}$ and $\mathbb{D}_{\mathcal{H}}$ and the stratified disk $\mathbb{D}_{\mathcal{G}|\mathcal{H}}$:

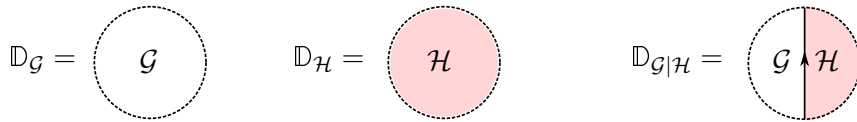

The local categorical data governing algebras on the decorated, stratified disk category $\mathbb{D}\text{isk}_2^{\text{or}, \text{str}}$ are so-called central algebras over braided categories [BJS21]:

Definition 3.2.16. Let \mathcal{A} and \mathcal{B} be braided tensor categories and \mathcal{C} a tensor category. A $(\mathcal{A}, \mathcal{B})$ -central algebra structure on \mathcal{C} is a braided functor

$$F: \mathcal{A} \boxtimes \mathcal{B}^{\text{op}} \rightarrow \mathcal{Z}(\mathcal{C}) \quad ,$$

into the Drinfeld center of \mathcal{C} , where \mathcal{B}^{op} is the category \mathcal{B} with the opposite braiding.

3. Dynamical character varieties

Following [AFT17], stratified factorization homology with coefficients in a given $\mathbb{D}\text{isk}_2^{\text{or},\text{str}}$ -algebra \mathcal{F} is the functor

$$\int_{(-)} \mathcal{F}: \text{Man}_2^{\text{or},\text{str}} \rightarrow \text{Pres}_{\mathbb{K}}$$

defined as the left Kan extension of \mathcal{F} along the inclusion $\mathbb{D}\text{isk}_2^{\text{or},\text{str}} \hookrightarrow \text{Man}_2^{\text{or},\text{str}}$.

We will use the following local categorical data, coming from the Hopf algebra maps

$$j: U_q(\mathfrak{b}) \hookrightarrow U_q(\mathfrak{g}), \quad p: U_q(\mathfrak{b}) \cong U_q(\mathfrak{n}) \otimes U_q(\mathfrak{h}) \xrightarrow{\epsilon \otimes \text{id}} U_q(\mathfrak{h}) ,$$

where ϵ is the counit map. More precisely, we have tensor functors

$$j^*: \text{Rep}_q(G) \rightarrow \text{Rep}_q(B), \quad p^*: \text{Rep}_q(H) \rightarrow \text{Rep}_q(B)$$

on the corresponding representation categories. The maps j^* and p^* induce a $(\text{Rep}_q(G), \text{Rep}_q(H))$ -central structure on $\text{Rep}_q(B)$ as follows: for each $V \in \text{Rep}_q(G)$ and $U \in \text{Rep}_q(H)$ define a half-braiding in $\text{Rep}_q(B)$ by

$$\gamma_{j^*(V) \otimes p^*(U), X}(v \otimes u \otimes x) = (\sigma_{\text{Rep}_q(G)} \text{id}) \circ (\text{id} \otimes \sigma_{\text{Rep}_q(H)})(v \otimes u \otimes x) ,$$

where $\sigma_{\text{Rep}_q(G)}$ and $\sigma_{\text{Rep}_q(H)}$ denote the braiding in $\text{Rep}_q(G)$ and $\text{Rep}_q(H)$ respectively. The half-braiding is well-defined since $\sigma_{\text{Rep}_q(G)}$ comes from the action of the (quasi) R-matrix of $U_q(\mathfrak{g})$ which lives in a completion of $U_q(\mathfrak{b}^-) \otimes U_q(\mathfrak{b})$. Also, one can easily check that the half-braiding γ is compatible with the $U_q(\mathfrak{b})$ -action. We will write $\text{Rep}_q(G \curvearrowright B \curvearrowright H)$ for the data of the $(\text{Rep}_q(G), \text{Rep}_q(H))$ -central algebra $\text{Rep}_q(B)$.

Remark 3.2.17. The $\mathbb{D}\text{isk}_2^{\text{or},\text{str}}$ -algebra $\text{Rep}_q(G \curvearrowright B \curvearrowright H)$ recently featured in [JLSS21] in the construction of quantum decorated character stacks via stratified factorization homology, thereby generalizing the cluster quantization approach due to Fock–Goncharov.

Factorization homology on annuli with circular $\text{Rep}_q(G \curvearrowright B \curvearrowright H)$ -defects We will work with the following decorated surface. The annulus with a circular defect line, with the inside of the defect labeled by $\text{Rep}_q(H)$, the outside of the defect labeled by $\text{Rep}_q(G)$, and the defect line by $\text{Rep}_q(B)$. We also consider the two $\text{Rep}_q(G)$ -, respectively $\text{Rep}_q(H)$ -labeled annuli without line defects:

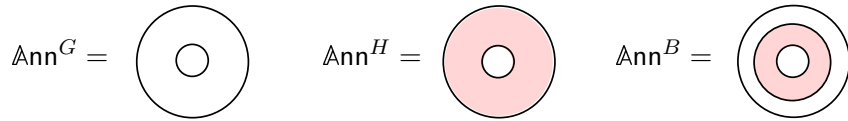

Factorization homology on the stratified annulus with coefficients in the E_1 -algebra $\mathcal{B} = \text{Rep}_q(B)$ admits the following descriptions:

$$\int_{\text{Ann}^B} \mathcal{B} \cong \text{Tr}(\text{Rep}_q(B)) \cong \underline{\text{End}}_{\mathcal{B} \circ \mathcal{B}}(1_{\mathcal{B}})\text{-Mod}_{\mathcal{B}} . \quad (3.33)$$

We recall that $\text{Tr}(\mathcal{B}) = \mathcal{B} \boxtimes_{\mathcal{B} \circ \mathcal{B}} \mathcal{B}$ and the internal endomorphism algebra of the monoidal unit is the canonical coend algebra:

$$\begin{aligned} \underline{\text{End}}_{\mathcal{B} \circ \mathcal{B}}(1_{\mathcal{B}}) &\cong \int^{V \in \text{Rep}_q(B)^{\text{fd}}} V^{\vee} \boxtimes V \\ &= \mathcal{F}_{\mathcal{B}} . \end{aligned}$$

3. Dynamical character varieties

The first equivalence in (3.33) is due to the excision property of factorization homology, whereas the second equivalence is due to monadic reconstruction for relative tensor products in $\text{Pres}_{\mathbb{K}}$ [BZBJ18a, Theorem 4.12], where one uses that $\text{Rep}_q(B)$ is rigid and $1_{\mathcal{B}}$ is a progenerator for the natural $\mathcal{B}^{\text{op}} \boxtimes \mathcal{B}$ -action

$$\triangleleft: \mathcal{B} \boxtimes (\mathcal{B}^{\text{op}} \boxtimes \mathcal{B}) \rightarrow \mathcal{B}, \quad c \boxtimes (b_1 \boxtimes b_2) \mapsto c \triangleleft (b_1 \boxtimes b_2) = b_1 \otimes c \otimes b_2 \quad ,$$

and similarly for the left $\mathcal{B}^{\text{op}} \boxtimes \mathcal{B}$ -action \triangleright . Via excision and base-change, we further get the following equivalences for the factorization homologies on the unstratified annuli:

$$\int_{\text{Ann}^G} \text{Rep}_q(G) \cong \mathcal{O}_q(G)\text{-Mod}_{\text{Rep}_q(G)}, \quad \int_{\text{Ann}^H} \text{Rep}_q(H) \cong \mathcal{O}(H)\text{-Mod}_{\text{Rep}_q(H)} \quad (3.34)$$

These are equivalences of $\text{Rep}_q(G)$, respectively $\text{Rep}_q(H)$ -module categories. To establish the equivalences (3.34), one uses the fact that both $\text{Rep}_q(G)$ and $\text{Rep}_q(H)$ are rigid balanced braided tensor categories. In particular, we use the following: there is a $\text{Rep}_q(G)^{\text{op}} \boxtimes \text{Rep}_q(G)$ -module equivalence between $\text{Rep}_q(G)$ with the canonical left action (we will abbreviate $\mathcal{G} = \text{Rep}_q(G)$)

$$(\mathcal{G}^{\text{op}} \boxtimes \mathcal{G}) \boxtimes \mathcal{G} \rightarrow \mathcal{G}, \quad (x_1 \boxtimes x_2) \boxtimes y \mapsto x_2 \otimes y \otimes x_1$$

and \mathcal{G} with left $\mathcal{G}^{\text{op}} \boxtimes \mathcal{G}$ -action defined by

$$(\mathcal{G}^{\text{op}} \boxtimes \mathcal{G}) \boxtimes \mathcal{G} \xrightarrow{(\text{id}, \sigma) \boxtimes \text{id} \boxtimes \text{id}} (\mathcal{G} \boxtimes \mathcal{G}) \boxtimes \mathcal{G} \xrightarrow{T^3} \mathcal{G}, \quad (x_1 \boxtimes x_2) \boxtimes y \mapsto x_1 \otimes x_2 \otimes y$$

where (id, σ) is the identity functor with monoidal structure given by the braiding σ of \mathcal{G} . The module equivalence is established using the braiding σ . The case of $\text{Rep}_q(H)$ follows along the same lines.

The algebra $\mathcal{O}_q(G) \cong \bigoplus_{\lambda \in \mathbf{P}^+} V(\lambda)^\vee \otimes V(\lambda)$ in (3.34) is the reflection equation algebra. Note that for G semi-simple and simply-connected this algebra is isomorphic, as a left $U_q(\mathfrak{g})$ -module algebra, to the locally finite part $U_q(\mathfrak{g})^{\text{lf}}$ of the quantum group [Jos95, Proposition 7.1.23], see also [VY20, Theorem 2.113]. Moreover, our conventions (see § 1.2.2) are such that $\mathcal{O}(H) = U_q(\mathfrak{h})$. We thus get the following identifications

$$\int_{\text{Ann}^G} \text{Rep}_q(G) \cong \text{HC}_q(G), \quad \int_{\text{Ann}^H} \text{Rep}_q(H) \cong \text{HC}_q(H) \quad , \quad (3.35)$$

where $\text{HC}_q(G)$ and $\text{HC}_q(H)$ are the quantum Harish-Chandra bimodules from (3.30) considered in [KS20].

Notation 3.2.18. *To ease notation we write $\mathcal{G} = \text{Rep}_q(G)$, $\mathcal{H} = \text{Rep}_q(H)$ and $\mathcal{B} = \text{Rep}_q(B)$.*

We have embeddings $\text{Ann}^H \hookrightarrow \text{Ann}^B$ and $\text{Ann}^G \hookrightarrow \text{Ann}^B$, which on the level of factorization homology give rise to the following diagram of categories

$$\int_{\text{Ann}^G} \mathcal{G} \begin{array}{c} \xrightarrow{\text{act}_{\text{Dist}}^{\mathcal{G}}} \\ \xleftarrow{\text{act}_{\text{Dist}}^{\mathcal{H}}} \end{array} \int_{\text{Ann}^B} \mathcal{B} \begin{array}{c} \xrightarrow{\text{act}_{\text{Dist}}^{\mathcal{H}}} \\ \xleftarrow{\text{act}_{\text{Dist}}^{\mathcal{G}}} \end{array} \int_{\text{Ann}^H} \mathcal{H} \quad ,$$

in $\text{Pres}_{\mathbb{K}}$, where $\text{Dist} \in \int_{\text{Ann}^B} \mathcal{B}$ is the distinguished objects coming from the inclusion of the empty set into the \mathcal{B} -decorated annulus and the dashed arrows denote the right adjoints to the functors induced by the embeddings. We will now provide explicit descriptions of these functors.

3. Dynamical character varieties

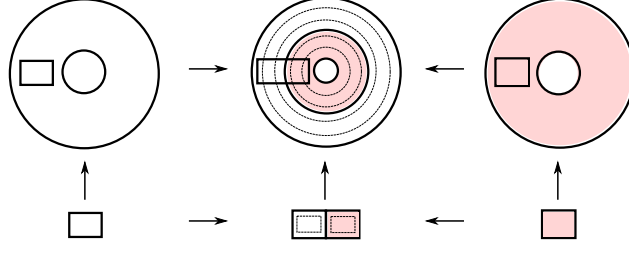

Figure 3.2.: Embeddings of colored annuli Ann^G and Ann^H into the colored annulus Ann^B and their pullbacks along the disk embeddings $\mathbb{D}^G \hookrightarrow \mathbb{D}^B$ and $\mathbb{D}^H \hookrightarrow \mathbb{D}^B$.

Consider the embeddings in Figure 3.2, which constitute two weakly commuting diagrams. On the level of factorization homology, they induce the following diagram in $\text{Pres}_{\mathbb{K}}$ with commuting left and right square:

$$\begin{array}{ccccc}
 \int_{\text{Ann}^G} \mathcal{G} & \xrightarrow{\text{act}_{\text{Dist}}^G} & \int_{\text{Ann}^B} \mathcal{B} & \xleftarrow{\text{act}_{\text{Dist}}^H} & \int_{\text{Ann}^H} \mathcal{H} \\
 \uparrow & \xleftarrow{(\text{act}_{\text{Dist}}^G)^R} & \uparrow & \xleftarrow{(\text{act}_{\text{Dist}}^H)^R} & \uparrow \\
 \mathcal{G} & \xrightarrow{j^*} & \mathcal{B} & \xleftarrow{p^*} & \mathcal{H}
 \end{array} \quad (3.36)$$

Using (3.33) and (3.34), we may identify the vertical maps with the free module functors for the corresponding monads. For instance, the functor $\mathcal{G} \rightarrow \int_{\text{Ann}} \mathcal{G} \cong \mathcal{O}_q(G)\text{-Mod}_{\mathcal{G}}$ is naturally isomorphic to the free $\mathcal{O}_q(G)$ -module functor $\text{free}_{\mathcal{O}_q(G)}(V) = \mathcal{O}_q(G) \otimes V$. Similarly, $\mathcal{B} \rightarrow \int_{\text{Ann}} \mathcal{B} \cong \mathcal{F}_{\mathcal{B}}\text{-Mod}_{\mathcal{B}}$ is naturally isomorphic to $\text{free}_{\mathcal{F}_{\mathcal{B}}}(X) = \mathcal{F}_{\mathcal{B}} \triangleright X$. By abuse of notation, we will denote the composition

$$\mathcal{O}_q(G)\text{-Mod}_{\mathcal{G}} \cong \int_{\text{Ann}^G} \mathcal{G} \xrightarrow{\text{act}_{\text{Dist}}^G} \int_{\text{Ann}^B} \mathcal{B} \cong \mathcal{F}_{\mathcal{B}}\text{-Mod}_{\mathcal{B}}$$

again by $\text{act}_{\text{Dist}}^G$ and similarly for $\text{act}_{\text{Dist}}^H$. These functors admit the following explicit description:

Proposition 3.2.19. *We have the following identifications*

$$\text{act}_{\text{Dist}}^G \cong \mathcal{F}_{\mathcal{B}} \otimes_{(j^* \boxtimes j^*) \text{End}_{\mathcal{G}^{\text{op}} \boxtimes \mathcal{G}}(1)} j^*(-), \quad \text{act}_{\text{Dist}}^H \cong \mathcal{F}_{\mathcal{B}} \otimes_{(p^* \boxtimes p^*) \text{End}_{\mathcal{H}^{\text{op}} \boxtimes \mathcal{H}}(1)} p^*(-) . \quad (3.37)$$

Proof. We will only discuss the first identification, the second one can be worked out analogously. Let $U(\mathcal{G}) = \mathcal{G}^{\text{op}} \boxtimes \mathcal{G}$ and $U(\mathcal{B}) = \mathcal{B}^{\text{op}} \boxtimes \mathcal{B}$. We first note that we have an algebra homomorphism $(j^* \boxtimes j^*) \text{End}_{U(\mathcal{G})}(1) \rightarrow \text{End}_{U(\mathcal{B})}(1) = \mathcal{F}_{\mathcal{B}}$, given by the adjoint to the natural algebra map

$$\text{act}_{1_{\mathcal{G}}}^R \text{act}_{1_{\mathcal{G}}}(1_{U(\mathcal{G})}) \xrightarrow{\eta_{j^*}} \text{act}_{1_{\mathcal{G}}}^R \circ (j^*)^R \circ j^* \circ \text{act}_{1_{\mathcal{G}}}(1_{U(\mathcal{G})}) \cong (j^* \boxtimes j^*)^R \text{act}_{1_{\mathcal{B}}}^R \text{act}_{1_{\mathcal{B}}}(1_{U(\mathcal{B})}) ,$$

coming from the commuting diagram (see also [BZBJ18a, Theorem 4.10])

$$\begin{array}{ccc}
 \mathcal{G} & \xrightarrow{j^*} & \mathcal{B} \\
 \text{act}_{1_{\mathcal{G}}} \uparrow & & \uparrow \text{act}_{1_{\mathcal{B}}} \\
 \mathcal{G} \boxtimes \mathcal{G}^{\text{op}} & \xrightarrow{j^* \boxtimes j^*} & \mathcal{B} \boxtimes \mathcal{B}^{\text{op}}
 \end{array}$$

3. Dynamical character varieties

By Proposition 3.2.8, the category $\mathcal{O}_q(G)\text{-Mod}_{\text{Rep}_q(G)}$ is generated under colimits by free $\mathcal{O}_q(G)$ -modules. Since all functors involved are colimit-preserving, it is enough to prove the claim for free modules. We have

$$\begin{aligned} \mathcal{F}_B \otimes_{(j^* \boxtimes j^*) \text{End}_{U_q(\mathfrak{g})}} j^* \text{free}_{\mathcal{O}_q(G)}(M) &\cong \mathcal{F}_B \otimes_{(j^* \boxtimes j^*) \text{End}_{U_q(\mathfrak{g})}} (j^* \boxtimes j^*) \text{End}_{U_q(\mathfrak{g})} \triangleright j^* M \\ &\cong \mathcal{F}_B \triangleright j^* M \quad , \end{aligned}$$

where we used that j^* is a tensor functor. Finally, commutativity of the left square in Diagram (3.36) implies that also $\text{act}_{\text{Dist}}^{\mathcal{G}} \circ \text{free}_{\mathcal{O}_q(G)} \cong \text{free}_{\mathcal{F}_B} \circ j^*(-)$, which shows the claim. \square

The right adjoints to the functors in (3.37) are

$$(\text{act}_{\text{Dist}}^{\mathcal{G}})^R \cong \text{Hom}_{U_q(\mathfrak{b})}(U_q(\mathfrak{g}), (-)), \quad (\text{act}_{\text{Dist}}^{\mathcal{H}})^R \cong \text{Hom}_{U_q(\mathfrak{b})}(U_q(\mathfrak{h}), (-)) \cong (-)^{U_q(\mathfrak{n})} \quad ,$$

where we suppressed the restriction functors along the algebra maps $(j^* \boxtimes j^*) \text{End}_{U_q(\mathfrak{g})}(1) \rightarrow \mathcal{F}_B$ and $(p^* \boxtimes p^*) \text{End}_{U_q(\mathfrak{h})}(1) \rightarrow \mathcal{F}_B$. In summary, we find that the embeddings depicted in Figure 3.2 into the $\text{Rep}_q(G \curvearrowright B \curvearrowright H)$ -decorated annulus induce the following functor

$$\begin{aligned} (\text{act}_{\text{Dist}}^{\mathcal{H}})^R \circ \text{act}_{\text{Dist}}^{\mathcal{G}} : \mathcal{O}_q(G)\text{-Mod}_{\text{Rep}_q(G)} &\rightarrow \mathcal{O}(H)\text{-Mod}_{\text{Rep}_q(H)} \\ X &\mapsto (\mathcal{F}_B \otimes_{(j^* \boxtimes j^*) \text{End}_{U_q(\mathfrak{g})}(1)} j^* X)^{U_q(\mathfrak{n})} \quad . \end{aligned}$$

which we will denote by $F_{G \curvearrowright B \curvearrowright H}$. In particular, on free modules we have

$$F_{G \curvearrowright B \curvearrowright H}(\text{free}_{\mathcal{O}_q(G)}(M)) = (\mathcal{F}_B \triangleright j^* M)^{U_q(\mathfrak{n})} \cong (j^* M \otimes \mathcal{O}_q(B))^{U_q(\mathfrak{n})} \quad , \quad (3.38)$$

where $\mathcal{O}_q(B) = \int^{V \in \text{Rep}_q(B)^{\text{fd}}} V \otimes V^\vee$, and the second identification is established using the half-braiding in $\text{Rep}_q(G)$.

In the next paragraph we will show (for the case of $G = \text{SL}_2$) that when restricted to the subcategory of free $\mathcal{O}_q(G)$ -modules in $\text{Rep}_q(G)$, the functor $F_{G \curvearrowright B \curvearrowright H}$ agrees with the parabolic restriction functor (3.31) from [KS20]. This provides a first step towards establishing a topological picture for the construction of the universal fusion matrix $\mathcal{J}(\lambda)$.

Equivalence with parabolic restriction functor Making use of the equivalences (3.35), $F_{G \curvearrowright B \curvearrowright H}$ induces a functor $\text{HC}_q(G) \rightarrow \text{HC}_q(H)$ between the respective categories of quantum Harish-Chandra bimodules. We expect the resulting functor to be isomorphic to the parabolic restriction functor res from (3.31), constructed in purely categorical terms by Kalmykov–Safronov. A detailed proof of the equivalence between the two functors and their monoidal structure will be content of future work. For the time being, we will just give some first results for the case $G = \text{SL}_2$.

For $U_q(\mathfrak{g}) = U_q(\mathfrak{sl}_2)$, let $U_q(\mathfrak{b})$ and $U_q(\mathfrak{b}^-)$ be the positive and negative quantum Borel subalgebras generated by $\{(K_\lambda)_{\lambda \in \mathbb{Z}}, E\}$ and $\{(K_\lambda)_{\lambda \in \mathbb{Z}}, F\}$, respectively. Also let $U_q(\mathfrak{n})$ and $U_q(\mathfrak{n}^-)$ be the subalgebras of $U_q(\mathfrak{g})$ generated by E and F , respectively. We recall that there exist a unique skew-pairing of Hopf algebras (in the conventions of [KS97, Section 6.3.1])

$$\tau : U_q(\mathfrak{b}) \otimes U_q(\mathfrak{b}^-) \rightarrow \mathbb{K}$$

which for the case $\mathfrak{g} = \mathfrak{sl}_2$ is determined by:

$$\tau(K_\alpha, K_\beta) = q^{-(\alpha, \beta)}, \quad \tau(E, F) = -\frac{1}{q - q^{-1}}, \quad \tau(F, K_\alpha) = 0 = \tau(K_\beta, E) \quad . \quad (3.39)$$

See also [VY20, Section 2.8] for more details.

3. Dynamical character varieties

Proposition 3.2.20. *The pairing (3.39) induces an isomorphism $\iota: U_q(\mathfrak{b}^-) \xrightarrow{\cong} \mathcal{O}_q(B) \subset U_q(\mathfrak{b})^*$ of \mathbb{K} -vector spaces.*

Proof. Let $\varphi = \iota(YK^s) \in U_q(\mathfrak{b})^*$ for some $Y \in U_q(\mathfrak{b}^-)_{-b}$, $b \in \mathbb{N}_0$ and $s \in \mathbb{Z}$. Then, the pairing (3.39) is such that for any $X \in U_q(\mathfrak{b})_a$, $a \in \mathbb{N}_0$, we have

$$\begin{aligned} \varphi(XK^r) &= q^{-rs} \tau(X, Y) \\ &= \delta_{ab} q^{-rs} \varphi(X) \end{aligned} \quad (3.40)$$

since $\tau(Y, X) = 0$ for $a \neq b$. We have to show that the set of functionals $\varphi \in U_q(\mathfrak{b})^*$ satisfying (3.40) agrees with the algebra of matrix coefficients of integrable finite-dimensional $U_q(\mathfrak{b})$ -representations. To that end, we note that the category $\mathbf{Rep}_q(B)$ is generated by the finite-dimensional $U_q(\mathfrak{b})$ -modules $V(m, n)$ with $m, n \in \mathbb{Z}$ and $m \leq n$, where $V(m, n)$ has a basis $\{v_m, v_{m+2}, \dots, v_n\}$ of weight vectors, i.e. $K \triangleright v_i = q^i v_i$, such that $E \triangleright v_i = v_{i+2}$. Then, $\mathcal{O}_q(B)$ is the algebra of matrix coefficients of the representations $V(m, n)$. In more details, the matrix coefficients $c_j^i = c_{v_{-j}^*}^{v_i}$, $m \leq i, j \leq n$, are of the following form

$$c_{i+2b}^i(XK^r) = \begin{cases} q^{ri} c_{i+2b}^i(X), & \text{if } X \in U_q(\mathfrak{b})_b \\ 0, & \text{else} \end{cases}, \quad b \in \mathbb{N}_0, r \in \mathbb{Z}$$

and $c_j^i = 0$ if $j < i$. Therefore, $c_{i+2b}^i = \iota(YK^{-i})$ for some $Y \in U_q(\mathfrak{b}^-)_{-b}$. Conversely, for any φ satisfying (3.40) there exists a representation $V(m, n)$ so that $\varphi = \alpha c_{-s+2b}^{-s}$ for some $\alpha \in \mathbb{K}^\times$ and $m \leq -s < -s + 2b \leq n$. \square

Remark 3.2.21. *Let $F_q(G)$ be the Hopf algebra of matrix coefficients of finite-dimensional integrable $U_q(\mathfrak{g})$ -representations (i.e. $F_q(G)$ is the FRT-algebra). Let $F_q(B)$ be the image of $F_q(G)$ under the natural projection $U_q(\mathfrak{g})^* \rightarrow U_q(\mathfrak{b})^*$. In more details, $F_q(B) = \bigoplus_{a \in \mathbb{N}_0, j \in \mathbb{Z}} B_{a,j}$ with $B_{a,j} = \{c_\varphi^w \mid w \in V(\lambda)_{-j}, \varphi \in V(\lambda)_{j-2a}^*\}$, where $V(\lambda)$ is some integrable $U_q(\mathfrak{g})$ -module of highest weight $\lambda \in \mathbb{N}_0$. Note that up to rescaling, a given matrix coefficients $c_\varphi^w \in B_{a,j}$ agrees with c_{-j+2a}^{-j} as defined above in the proof of Proposition 3.2.20, for some integrable $U_q(\mathfrak{b})$ -module $V(m, n)$ with $m \leq -j < -j + 2a \leq n$.*

For \mathfrak{g} any finite-dimensional semi-simple Lie algebra over \mathbb{C} , it was shown in [Jos95, Section 9.2.12], see also [VY20, Proposition 2.106], that the Drinfeld pairing $\tau: U_q(\mathfrak{b}) \otimes U_q(\mathfrak{b}^-) \rightarrow \mathbb{K}$ induces a Hopf algebra isomorphism $U_q(\mathfrak{b}^-) \cong F_q(B)$. Thus, we may expect the result in Proposition 3.2.20 to hold as well in this more general context.

In [KS20], the parabolic restriction functor is defined using the left- and right action of the quantum Harish-Chandra bimodules on the distinguished object $M^{\text{univ}} \in \mathcal{O}_q^{\text{univ}}$ given by the universal Verma module $M^{\text{univ}} = U_q(\mathfrak{g}) \otimes_{U_q(\mathfrak{b})} U_q(\mathfrak{h})$. By the PBW-isomorphism, we have an identification $M^{\text{univ}} \cong U_q(\mathfrak{b}^-)$, and by Proposition 3.2.20 we thus have an isomorphism between the distinguished objects M^{univ} and $\mathcal{O}_q(B)$ on the level of vector spaces.

The map $U_q(\mathfrak{b}^-) \rightarrow M^{\text{univ}}$, $X \mapsto X \otimes 1$, is also an isomorphism of left $U_q(\mathfrak{n})$ -modules if we endow $U_q(\mathfrak{b}^-)$ with the following $U_q(\mathfrak{n})$ -module structure

$$\triangleright: U_q(\mathfrak{n}) \otimes U_q(\mathfrak{b}^-) \xrightarrow{m} U_q(\mathfrak{g}) \xrightarrow{\text{PBW}} U_q(\mathfrak{b}^-) \otimes U_q(\mathfrak{n}) \xrightarrow{\text{id} \otimes \epsilon} U_q(\mathfrak{b}^-) \quad .$$

The $U_q(\mathfrak{n})$ -action on M^{univ} is given by left multiplication. We will also need the following:

Proposition 3.2.22. *The pairing (3.39) induces an isomorphism*

$$(U_q(\mathfrak{b}^-))^{U_q(\mathfrak{n})} \cong (\mathcal{O}_q(B))^{U_q(\mathfrak{n})} \quad .$$

3. Dynamical character varieties

Proof. In $U_q(\mathfrak{b}^-)$ we have for any $b \in \mathbb{N}_0$ and $r \in \mathbb{Z}$:

$$E \triangleright F^b K^s = [b] F^{b-1} \left(\frac{q^{-(b-1)} K - q^{b-1} K^{-1}}{q - q^{-1}} \right) K^s .$$

Using again that $\tau(E^i K^m, F^j K^n) = q^{-mn} \tau(E^i, F^j)$ and $\tau(E^i, F^j) = 0$ if $i \neq j$, we find that $\iota(E \triangleright F^b K^s)$ has kernel $\{E^a K^r\}_{r \in \mathbb{Z}}^{a \neq b-1}$. On the other hand, recall that the left $U_q(\mathfrak{n})$ -action on $\mathcal{O}_q(B)$ is given

$$\blacktriangleright : U_q(\mathfrak{n}) \otimes \mathcal{O}_q(B) \rightarrow \mathcal{O}_q(B), \quad X \otimes f \mapsto f(S(X_{(1)})(-)X_{(2)}) .$$

The Hopf algebra structure on $U_q(\mathfrak{sl}_2)$ is such that $\Delta(E) = E \otimes K + 1 \otimes E$ and $S(E) = -EK^{-1}$, and we have for any $b \in \mathbb{N}_0$ and $s \in \mathbb{Z}$:

$$E \blacktriangleright \iota(F^b K^s) = -\tau(EK^{-1}(-)K, F^b K^s) .$$

Thus, $E \blacktriangleright \iota(F^b K^s)$ also has kernel $\{E^a K^r\}_{r \in \mathbb{Z}}^{a \neq b-1}$ and $\iota(E \triangleright F^b K^s) = \alpha E \blacktriangleright \iota(F^b K^s)$ for some $\alpha \in \mathbb{K}^\times$. Similarly, one can show that $E^n \triangleright F^b K^s = \alpha E^n \blacktriangleright \iota(F^b K^s)$ for some $\alpha \in \mathbb{K}^\times$, and in particular the subspaces of $U_q(\mathfrak{n})$ -invariants agree. \square

Next, recall that M^{univ} has a left and right $U_q(\mathfrak{h})$ -action defined by left and right multiplication, giving rise to an integrable diagonal $U_q(\mathfrak{h})$ -action. Similarly, $U_q(\mathfrak{b}^-)$ may be considered as an object in $\text{HC}_q(H)$ with actions

$$K \leftarrow X = KX, \quad \text{and} \quad K \triangleright X = KXS(K)$$

for any $X \in U_q(\mathfrak{b}^-)$. We also recall that $\mathcal{O}_q(B)$ is an object in $\text{HC}_q(H)$ with an integrable left $U_q(\mathfrak{h})$ -action

$$K \blacktriangleright \varphi = \varphi(S(K)(-)K)$$

for any $\varphi \in \mathcal{O}_q(B)$, and a left $\mathcal{O}(H)$ -action

$$f \rightarrow \varphi = (f \circ p) * \varphi,$$

for any $f \in \mathcal{O}(H)$, where $p: U_q(\mathfrak{b}) \rightarrow U_q(\mathfrak{h})$ and $*$ denotes multiplication in the algebra of matrix coefficients $\mathcal{O}_q(B)$.

Proposition 3.2.23. *The isomorphism $\iota: U_q(\mathfrak{b}^-) \xrightarrow{\cong} \mathcal{O}_q(B)$ from Proposition 3.2.20 is a map in $\text{HC}_q(H)$.*

Proof. We have on the one hand

$$\begin{aligned} \iota(K \triangleright F^b K^r)(X) &= \tau(X, K(F^b K^r)K^{-1}) \\ &= \begin{cases} q^{-b} q^{-sr} \tau(E^b, F^b), & \text{if } X = E^b K^s \\ 0, & \text{else} \end{cases} \end{aligned}$$

for any $s \in \mathbb{Z}$. On the other hand we have

$$\begin{aligned} K \blacktriangleright \iota(F^b K^r)(X) &= \tau(K^{-1} X K, F^b K^r) \\ &= \begin{cases} q^{-b} q^{-sr} \tau(E^b, F^b), & \text{if } X = E^b K^s \\ 0, & \text{else} \end{cases} \end{aligned}$$

For the other action we find

$$\iota(K \leftarrow X) = \tau(-, KX) = \tau(-, K) * \tau(-, X) .$$

which is precisely $K \rightarrow \iota(X)$. \square

3. Dynamical character varieties

Propositions 3.2.20, 3.2.22 and 3.2.23 together imply that for any $X \in \text{Rep}_q(G)$ we have an isomorphism

$$(X \otimes M^{\text{univ}})^{U_q(\mathfrak{n})} \cong (X \otimes \mathcal{O}_q(B))^{U_q(\mathfrak{n})}$$

in $\text{HC}_q(H)$ establishing the equivalence between the parabolic restriction functor (3.31) and $F_{G \curvearrowright B \curvearrowright H}$ from (3.38) when restricted to the subcategory of free modules in $\text{HC}_q(G)$. A more in depth comparison of the two functors, as well as their (lax) monoidal structures, will be content of future work.

3.2.4. Braided modules and quasi-reflection data

In § 1.3.1 we saw that point defects in categorical factorization homology are defined as symmetric monoidal functors $\text{Disk}_{2,*}^{\text{or}} \rightarrow \text{Pres}$ from the category of marked disks to the category of locally presentable categories. The categorical data required to extend factorization homology for oriented surfaces to oriented surfaces with marked point is given by E_2 -modules over braided monoidal categories:

Definition 3.2.24. [Gin15] *An E_2 -module for a braided monoidal category \mathcal{A} is a right module over the annulus category $\int_{\text{Ann}} \mathcal{A}$, where the latter is equipped with the tensor structure induced by stacking annuli.*

In [BZBJ18b, Theorem 3.11] it was shown that the E_2 -modules classifying point defects in categorical factorization homology admit a more algebraic description in terms of *braided module categories with a balancing*. Braided module categories were first introduced in [Enr08, Bro12, Bro13] and their definition is recalled below. Throughout \mathcal{A} is a balanced braided tensor category with braiding σ and balancing θ . For a right \mathcal{A} -module category \mathcal{M} , we will write $\bar{\otimes}: \mathcal{M} \boxtimes \mathcal{A} \rightarrow \mathcal{M}$ for the action and $\eta_{M,X,Y}: (M \bar{\otimes} X) \bar{\otimes} Y \xrightarrow{\cong} M \bar{\otimes} (X \otimes Y)$ for the module associativity constraint.

Definition 3.2.25. *A balanced braided module category over \mathcal{A} is an \mathcal{A} -module category \mathcal{M} equipped with an automorphism*

$$\mathcal{E}: - \bar{\otimes} - \Rightarrow - \bar{\otimes} -$$

of the action bifunctor which is such that $\mathcal{E}_{M,1} = \text{id}_M$ for all $M \in \mathcal{M}$, together with an automorphism $\varphi: \text{id}_{\mathcal{M}} \Rightarrow \text{id}_{\mathcal{M}}$ of the identity functor on \mathcal{M} , called the balancing on $(\mathcal{M}, \mathcal{E})$, satisfying

$$\varphi_{M \bar{\otimes} X} = \mathcal{E}_{M,X} \circ (\varphi_M \bar{\otimes} \theta_X) . \quad (3.41)$$

The automorphism \mathcal{E} has to satisfy the following two relations

$$\mathcal{E}_{M \bar{\otimes} X, Y} = \eta_{M, X, Y}^{-1} (\text{id} \bar{\otimes} \sigma_{X, Y}^{-1}) \eta_{M, Y, X} (\mathcal{E}_{M, Y} \bar{\otimes} \text{id}) \eta_{M, Y, X}^{-1} (\text{id} \bar{\otimes} \sigma_{Y, X}^{-1}) \eta_{M, X, Y} \quad (3.42)$$

and

$$\mathcal{E}_{M, X \otimes Y} = \eta_{M, X, Y} (\mathcal{E}_{M, X} \bar{\otimes} \text{id}) \eta_{M, X, Y}^{-1} (\text{id} \bar{\otimes} \sigma_{X, Y}^{-1}) \eta_{M, Y, X} (\mathcal{E}_{M, Y} \bar{\otimes} \text{id}) \eta_{M, Y, X}^{-1} (\text{id} \bar{\otimes} \sigma_{X, Y}) \quad (3.43)$$

Topologically, the automorphism \mathcal{E} is induced by the loop in the space of embeddings $\text{Emb}(\mathbb{D}_* \sqcup \mathbb{D}, \mathbb{D}_*)$ coming from moving the disk around the marked point, while the balancing on \mathcal{M} is induced by the isotopy rotating a marked disk about 2π , as illustrated in Figure 3.3. Similarly to the unmarked case, the balancing ensures that we can compute factorization homology on oriented surfaces.

3. Dynamical character varieties

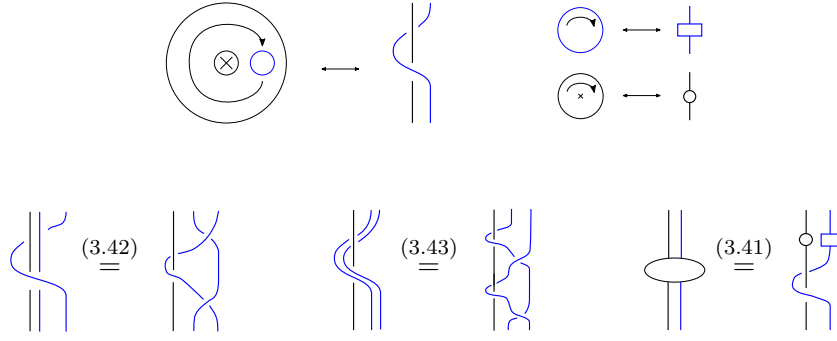

Figure 3.3.: *Top row:* Topological operations inducing the automorphism \mathcal{E} (on the left) and the two balancings φ and θ (on the right) in a balanced braided module category together with the corresponding string diagrams. *Bottom row:* Relations in a balanced braided module category.

Remark 3.2.26. *As was noted in [BZBJ18b, Theorem 3.12], if \mathcal{A} is a balanced braided tensor category and \mathcal{M} a module category for \mathcal{A} satisfying Relations (3.42) and (3.43), then \mathcal{M} admits a canonical balancing automorphism coming from the loop in the space of oriented embeddings given by rotating the annulus about 2π , together with the factorization $\mathcal{A} \rightarrow \int_{\text{Ann}} \mathcal{A} \rightarrow \text{End}(\mathcal{M})$ of the \mathcal{A} -module structure on \mathcal{M} .*

Before we describe the algebraic structures relating the quantum DYBE and to braided module categories, we can already give a first example:

Example 3.2.27. Let $\mathfrak{l} \subseteq \mathfrak{g}$ be a pair of finite-dimensional complex Lie algebras and $U \subset \mathfrak{l}^*$ an \mathfrak{l} -stable open subset. The dynamical twists from Example 3.2.12 turns the dynamical extension $U(\mathfrak{l})\text{-Mod}[[\hbar]]_{\mathcal{O}(U)[[\hbar]]}$ into a braided module category over the symmetric monoidal category $U(\mathfrak{g})\text{-Mod}[[\hbar]]$ with the identity natural transformation as automorphism \mathcal{E} . Note however that this example is not in Pres. \triangle

Point defects from quasi-reflection data Throughout we fix the data of a quasi-triangular Hopf algebra H with universal R-matrix \mathcal{R} , a Hopf subalgebra $B \subseteq H$ together with a B -base algebra \mathcal{L} as defined in Example 3.2.3 of the previous section. In the following we introduce the notion of a quasi-reflection datum, which is closely related to that of a quasi-reflection algebra from [Enr08], see Remark 3.2.29 below.

Definition 3.2.28. *A quasi-reflection datum is a tuple $(B \subseteq H, \mathcal{L}, \mathcal{J}(\lambda), E(\lambda))$, where $\mathcal{J}(\lambda)$ is universal dynamical twist for the pair $B \subseteq H$ over the base algebra \mathcal{L} and $E(\lambda) \in \mathcal{L} \otimes H$ is an invertible element satisfying the following equations:*

- *Octagon equation:*

$$(\delta^R \otimes \text{id})E(\lambda) = \mathcal{J}(\lambda)^{-1} \mathcal{R}_{2,1} \mathcal{J}(\lambda)_{2,1} E(\lambda)_2 \mathcal{J}(\lambda)_{2,1}^{-1} \mathcal{R} \mathcal{J}(\lambda) . \quad (3.44)$$

- *Pentagon equation:*

$$(\text{id} \otimes \Delta)E(\lambda) = \mathcal{J}(\lambda) ((\delta^R \otimes \text{id})E(\lambda)) E(\lambda)_1 \mathcal{J}(\lambda)^{-1} . \quad (3.45)$$

- *B -equivariance:*

$$b_{(1)} \triangleright E^0 \otimes b_{(2)} E^1 = E^0 \otimes E^1 b ,$$

for all $b \in B$.

3. Dynamical character varieties

Both the octagon and pentagon equations take place in $\mathcal{L}_{\text{op}} \otimes H \otimes H$.

Remark 3.2.29. A quasi-reflection algebra, as defined in [Enr08, Definition 4.1], is a comodule algebra B over a quasi-triangular bialgebra H , together with invertible B -invariant elements $\Psi \in B \otimes H \otimes H$ and $E \in B \otimes H$ subjected to a cocycle equation for Ψ and an octagon relation for E . Our definition of a quasi-reflection datum almost recovers that of a quasi-reflection algebra in the special case that $\mathcal{L} = B$ considered as a base algebra over itself with coaction given by the coproduct Δ_B , and the H -comodule structure on B comes from the inclusion $B \subseteq H$. The difference is in that equation (3.44) holds in $B_{\text{op}} \otimes H \otimes H$, whereas the octagon equation in [Enr08] takes place in $B \otimes H \otimes H$ (see Remark 3.2.30 below). Note that the pentagon equation is missing from the definition of a quasi-reflection algebra.

As explained in § 3.2.2, the data of a dynamical twist gives rise to a monoidal structure on the functor $H\text{-Mod} \rightarrow B\text{-Mod} \rightarrow B\text{-Mod}_{\mathcal{L}}$, turning the dynamical extension $B\text{-Mod}_{\mathcal{L}}$ into a right module category over $H\text{-Mod}$:

$$\bar{\otimes}: B\text{-Mod}_{\mathcal{L}} \boxtimes H\text{-Mod} \rightarrow B\text{-Mod}_{\mathcal{L}}, \quad M \bar{\otimes} X = M \otimes_{\mathcal{L}} \text{free}_{\mathcal{L}}(X) \quad .$$

The associator $\eta_{M,X,Y}: (M \bar{\otimes} X) \bar{\otimes} Y \xrightarrow{\cong} M \bar{\otimes} (X \otimes Y)$ is defined by the dynamical twist $\mathcal{J}(\lambda)$:

$$M \otimes_{\mathcal{L}} \text{free}_{\mathcal{L}}(X) \otimes_{\mathcal{L}} \text{free}_{\mathcal{L}}(Y) \cong M \otimes_{\mathcal{L}} \mathcal{L} \otimes X \otimes Y \quad (3.46)$$

$$\begin{aligned} & \xrightarrow{\text{id} \otimes_{\mathcal{L}} \mathcal{J}(\lambda)_{X,Y}} M \otimes_{\mathcal{L}} \mathcal{L} \otimes X \otimes Y = M \otimes_{\mathcal{L}} \text{free}_{\mathcal{L}}(X \otimes Y) \\ m \otimes_{\mathcal{L}} \lambda \otimes x \otimes y & \mapsto m \otimes_{\mathcal{L}} \lambda \mathcal{J}^0 \otimes \mathcal{J}^1 \triangleright x \otimes \mathcal{J}^2 \triangleright y \end{aligned}$$

Remark 3.2.30. The appearance of the opposite base algebra \mathcal{L}_{op} in the Dynamical Cocycle Equation (B.10) has to do with the fact that the dynamical extension $\mathcal{C}_{\mathcal{L}}$ is defined as the category of left \mathcal{L} -modules in \mathcal{C} . More precisely, when defining the associator η in terms of the universal dynamical twist as in (3.46), we have to multiply with \mathcal{J}^0 from the right to get an \mathcal{L} -module map.

If the dynamical twist is part of a quasi-reflection datum $(\mathcal{J}(\lambda), E(\lambda))$, the invertible element

$$\mathcal{E}(\lambda) = E(\lambda)^{-1}(1 \otimes \theta^{-1})$$

defines an automorphism \mathcal{E} of the action functor $-\bar{\otimes}-$ via

$$\begin{aligned} M \bar{\otimes} X & \xrightarrow{\mathcal{E}_{M,X}} M \bar{\otimes} X \\ m \otimes_{\mathcal{L}} \lambda \otimes x & \mapsto m \otimes_{\mathcal{L}} \lambda \mathcal{E}^0 \otimes \mathcal{E}^1 \triangleright x \end{aligned} \quad (3.47)$$

where we used the notation $\mathcal{E}(\lambda) = \mathcal{E}^0 \otimes \mathcal{E}^1 \in \mathcal{L} \otimes H$. This is well-defined due to B -equivariance of E .

Proposition 3.2.31. The automorphism \mathcal{E} from (3.47) endows the dynamical extension $B\text{-Mod}_{\mathcal{L}}$ with the structure of a braided module category over $H\text{-Mod}$.

Proof. We have to check that Relations (3.42) and (3.43) hold. For the former, we have that

$$\begin{aligned} \mathcal{E}_{M \bar{\otimes} X, Y}(m \otimes_{\mathcal{L}} \lambda \otimes x \otimes_{\mathcal{L}} \mu \otimes y) & = m \otimes_{\mathcal{L}} \lambda \otimes x \otimes_{\mathcal{L}} \mu E^0 \otimes E^1 \triangleright y \\ & \cong m \otimes_{\mathcal{L}} \lambda (\mu \mathcal{E}^0)^{[0]} \otimes (\mu \mathcal{E}^0)^{[1]} \triangleright x \otimes \mathcal{E}^1 \triangleright y \quad . \end{aligned}$$

3. Dynamical character varieties

Thus, in order for Relation (3.42) to hold, $\mathcal{E}(\lambda)$ has to satisfy the following equation:

$$(\delta^R \otimes \text{id})\mathcal{E}(\lambda) = \mathcal{J}(\lambda)^{-1}\mathcal{R}^{-1}\mathcal{J}(\lambda)_{2,1}\mathcal{E}(\lambda)_2\mathcal{J}(\lambda)_{2,1}^{-1}\mathcal{R}_{2,1}^{-1}\mathcal{J}(\lambda) \quad .$$

But this is the case since $\mathcal{E}(\lambda) = E(\lambda)^{-1}(1 \otimes \theta^{-1})$, and $E(\lambda)$ satisfies Equation 3.44. For the second relation, we compute

$$\begin{aligned} (\text{id} \otimes \Delta)(E(\lambda)^{-1}(1 \otimes \theta^{-1})) \\ \stackrel{(3.45)}{=} \mathcal{J}(\lambda)E(\lambda)_1^{-1}\mathcal{J}(\lambda)^{-1}\mathcal{R}^{-1}\mathcal{J}(\lambda)_{2,1}E(\lambda)_2^{-1}\mathcal{J}(\lambda)_{2,1}^{-1}\mathcal{R}_{2,1}^{-1}(1 \otimes \Delta(\theta)^{-1}) \end{aligned}$$

and the result follows since θ is a ribbon element, in particular $\Delta(\theta) = (\mathcal{R}_{2,1}\mathcal{R})^{-1}(\theta \otimes \theta)$. \square

Quasi-reflection datum and the ABRR-equation In [ABRR98], Arnaudon–Buffenoir–Ragoucy–Roche introduce a dynamical twist $\mathcal{J}(\lambda)$ living in a completion of $U_q(\mathfrak{g})^{\otimes 2}$ and depending rationally on a dynamical parameter $e^\lambda \in H$. It is the unique solution of the form $1 + U_q(\mathfrak{n}) \otimes U_q(\mathfrak{n}_-)$ to the equation

$$\mathcal{J}(\lambda)B(\lambda)_2 = \mathcal{R}^{-1}\Omega B(\lambda)_2\mathcal{J}(\lambda) \quad (\text{ABRR})$$

with $B(\lambda) = q^{2\lambda + \sum_i (C^{-1})_{ij} H_i H_j}$, where $(H_i)_{\alpha_i}$ are the simple coroots, (C_{ij}) is the symmetrized Cartan matrix and $\Omega = q^{\sum_i (C^{-1})_{i,j} H_i \otimes H_j}$ is the Cartan part of the universal R-matrix \mathcal{R} . The dynamical twist satisfying the linear ABRR-equation agrees with the universal fusion matrix of Etingof–Varchenko, see for example [ES02b, Theorem 8.1].

We now set $q = e^\hbar$ and make a change of variable $\lambda \mapsto \lambda/\hbar$.

Proposition 3.2.32. *Solutions to the ABRR-equation give rise to a quasi-reflection datum $(\mathcal{J}(\lambda)_{2,1}, B(\lambda))$ for the pair $U_\hbar(\mathfrak{h}) \subset U_\hbar(\mathfrak{g})^{\text{op}}$.*

Proof. By Example 3.2.5, we have $(\delta^R \otimes \text{id})(B(\lambda)) = B(\lambda + \hbar h^{(1)})_2$. Hence, the element $B(\lambda)$ satisfies the relation

$$\begin{aligned} (\text{id} \otimes \Delta)(B(\lambda)) &= \Omega^2 B(\lambda)_1 B(\lambda)_2 \\ &= B(\lambda)_1 (\delta^R \otimes \text{id})(B(\lambda)) \quad , \end{aligned}$$

which agrees with Equation 3.45 due to \mathfrak{h} -invariance of the dynamical twist. Moreover, we have

$$\begin{aligned} \mathcal{J}(\lambda)_{2,1}^{-1} \mathcal{R} \mathcal{J}(\lambda) B(\lambda)_2 \mathcal{J}(\lambda)^{-1} \mathcal{R}_{2,1} \mathcal{J}(\lambda)_{2,1} \\ \stackrel{\text{ABRR}}{=} \mathcal{J}(\lambda)_{2,1}^{-1} \mathcal{R} \mathcal{R}^{-1} \Omega B(\lambda)_2 \mathcal{J}(\lambda) \mathcal{J}(\lambda)^{-1} \mathcal{R}_{2,1} \mathcal{J}(\lambda)_{2,1} \\ = \mathcal{J}(\lambda)_{2,1}^{-1} \Omega B(\lambda)_2 \mathcal{R}_{2,1} \mathcal{J}(\lambda)_{2,1} \\ \stackrel{\text{ABRR}}{=} \mathcal{J}(\lambda)_{2,1}^{-1} \Omega B(\lambda)_2 \Omega B(\lambda)_1 \mathcal{J}(\lambda)_{2,1} B(\lambda)_1^{-1} \\ = \mathcal{J}(\lambda)_{2,1}^{-1} \Delta(B(\lambda)) \mathcal{J}(\lambda)_{2,1} B(\lambda)_1^{-1} \\ = \Omega^2 B(\lambda)_2 \end{aligned}$$

where the last equality is again by \mathfrak{h} -invariance of the dynamical twist. This shows that the pair $(\mathcal{J}(\lambda)_{2,1}, B(\lambda))$ is a quasi-reflection datum for $U_\hbar(\mathfrak{h}) \subset U_\hbar(\mathfrak{g})^{\text{op}}$ over the base algebra $\mathcal{O}(H^{\text{reg}})[[\hbar]]$ and $U_\hbar(\mathfrak{g})^{\text{op}}$ is the quantum universal enveloping algebra with opposite coproduct and universal R-matrix $\mathcal{R}_{2,1}$. \square

3. Dynamical character varieties

The element $B(\lambda)$ featuring in the ABRR-equation thus corresponds in the topological picture (Figure 3.3) to the loop in the space of disk embeddings $\text{Emb}(\mathbb{D}_* \sqcup \mathbb{D}, \mathbb{D}_*)$ coming from moving the unmarked disk around the marked point.

Conversely, one can recover an ABRR-type equation from the categorical construction of the dynamical twist $\mathcal{J}(\lambda)$ due to Kalmykov–Safronov, as we will show in Proposition 3.2.33 below. First, we note that the commutativity of Diagram (3.32) gives a factorization

$$\begin{array}{ccc} \text{Rep}_q(G) & \xrightarrow{(\text{free} \circ i^*, \mathcal{J}(\lambda))} & \text{HC}_q(H)^{\text{gen}} \\ & \searrow \text{free} & \nearrow \text{res}^{\text{gen}} \\ & \text{HC}_q(G) & \end{array} \quad (3.48)$$

turning $\text{HC}_q(H)^{\text{gen}}$ into an \mathbf{E}_2 -module over $\text{Rep}_q(G)$. The characterization of \mathbf{E}_2 -modules in terms of braided module categories implies that there is an automorphism of the action bifunctor, that is, for any $M \in \text{HC}_q(H)^{\text{gen}}$ and $X \in \text{Rep}_q(G)$ an isomorphism

$$\mathcal{E}_{M,X}: M \otimes_{\mathcal{L}} \text{free}_{\mathcal{L}}(X) \xrightarrow{\cong} M \otimes_{\mathcal{L}} \text{free}_{\mathcal{L}}(X), \quad \mathcal{L} = \mathcal{O}(H)^{\text{gen}},$$

natural in M and X , satisfying Relation (3.42) and (3.43).

Proposition 3.2.33. *The dynamical twist from Example 3.2.13 satisfies the ABRR-type equation*

$$\mathcal{J}(\lambda)_{W,V} E(\lambda)_W^{-1} = \mathcal{R}_{W,V}^{-1} \Omega_{W,V} E(\lambda)_W^{-1} \mathcal{J}(\lambda)_{W,V},$$

in $\mathcal{O}(H)^{\text{gen}} \otimes \text{End}(V \otimes W)$, where $E(\lambda)_W = \mathcal{E}_{\mathcal{L},W} \in \mathcal{O}(H)^{\text{gen}} \otimes \text{End}(W)$ for $V, W \in \text{Rep}_q(G)$.

Proof. First, we rewrite Equation (3.42) in the following form

$$(\text{id} \bar{\otimes} \sigma_{X,Y}^{-1}) \eta_{M,X,Y} \mathcal{E}_{M \bar{\otimes} X, Y} \eta_{M,X,Y}^{-1} = \eta_{M,Y,X} (\mathcal{E}_{M,Y} \bar{\otimes} \text{id}) \eta_{M,Y,X}^{-1} (\text{id} \bar{\otimes} \sigma_{Y,X}^{-1}), \quad (3.49)$$

where $M \bar{\otimes} X = M \otimes_{\mathcal{L}} \text{free}_{\mathcal{L}}(X)$, the associator η is defined by the dynamical twist $\mathcal{J}(\lambda)$ as in (3.46) and the braiding σ is defined by the quantum R-matrix $\sigma_{X,Y} = \tau \circ \mathcal{R} \triangleright X \otimes Y$.

In [KS20, Proposition 4.37] it is shown that the dynamical twist $\mathcal{J}(\lambda)$ is related to the universal fusion matrix $\mathcal{J}_{EV}(\lambda)$ of Etingof–Varchenko via $\mathcal{J}(\lambda) = \mathcal{J}_{EV}(\lambda)_{2,1}$. The universal fusion matrix is of the form

$$\mathcal{J}_{EV}(\lambda)_{X,Y}(x \otimes y) = x \otimes y + \sum_i a_i \otimes b_i$$

where $\text{wt}(a_i) < \text{wt}(x)$ and $\text{wt}(b_i) > \text{wt}(y)$ for all x, y in $X, Y \in \text{Rep}_q(G)$. Since the quasi R-matrix of $\text{Rep}_q(G)$ (in the conventions of [KS20]) lives in a completion of $U_q(\mathfrak{b}) \otimes U_q(\mathfrak{b}_-)$, we see that in order for Equation (3.49) to hold, the left- and right-hand side have to agree with their respective weight zero parts. This yields in particular the following equation

$$\eta_{M,Y,X} (\mathcal{E}_{M,Y} \bar{\otimes} \text{id}) \eta_{M,Y,X}^{-1} (\text{id} \bar{\otimes} \sigma_{Y,X}^{-1}) = (\mathcal{E}_{M,Y} \bar{\otimes} \text{id}) \Omega_{Y,X}^{-1}, \quad (3.50)$$

where Ω denotes the Cartan part of the quantum R-matrix \mathcal{R} . We now specialize to the case $M = \mathcal{L}$. Equation (3.50) then implies the following:

$$\begin{aligned} \mathcal{J}(\lambda)_{Y,X} E(\lambda)_Y \mathcal{J}(\lambda)_{Y,X}^{-1} \mathcal{R}_{Y,X}^{-1} &= E(\lambda)_Y \Omega_{Y,X}^{-1} \\ &\Downarrow \\ \mathcal{J}(\lambda)_{Y,X} E(\lambda)_Y^{-1} &= \mathcal{R}_{Y,X}^{-1} \Omega E(\lambda)_Y^{-1} \mathcal{J}(\lambda)_{Y,X}. \end{aligned}$$

Thus, we recover an ABRR-type equation for the dynamical twist from the braided module structure on $\text{HC}_q(H)^{\text{gen}}$. \square

3. Dynamical character varieties

Remark 3.2.34. *The relationship between the ABRR-equation and braided module categories has already appeared in [Bro12], where an algebraic analog of the ABRR-equation was used to construct a quasi-reflection algebra (Ψ_h, E_h) , where $\Psi_h \in U_h(\mathfrak{h}) \otimes U_h(\mathfrak{g})^{\otimes 2}$ is an algebraic dynamical twist (called pseudo-twist in [Enr08]), giving rise to a braided module structure on $U_h(\mathfrak{h})\text{-Mod}$ over $U_h(\mathfrak{g})\text{-Mod}$.*

Dynamical point defects We will use the following terminology:

Definition 3.2.35. *Let \mathcal{L} be a base algebra in a monoidal category \mathcal{C} and let \mathcal{A} be a balanced braided category. A dynamical point defect for oriented factorization homology is the data of a functor $\mathcal{A} \xrightarrow{F} \mathcal{C} \xrightarrow{\text{free}_{\mathcal{L}}} \mathcal{C}_{\mathcal{L}}$ and a dynamical twist*

$$\mathcal{J}(\lambda)_{X,Y} \in \mathcal{L} \otimes \text{Hom}(F(X) \otimes F(Y), F(X \otimes Y)), \quad X, Y \in \mathcal{A}$$

together with a factorization

$$\begin{array}{ccc} \mathcal{A} & \xrightarrow{F} & \mathcal{C} & \xrightarrow{\text{free}_{\mathcal{L}}} & \mathcal{C}_{\mathcal{L}} \\ & \searrow & & \nearrow & \\ & & \int_{\Delta^{\text{nn}}} \mathcal{A} & & \end{array}$$

In the \mathbb{K} -linear setting, we have the following examples.

Example 3.2.36. Let $H \subset G$ be a maximal torus. Let $\text{Rep}_q(G)$ and $\text{Rep}_q(H)$ the representation categories of $U_q(\mathfrak{g})$ and $U_q(\mathfrak{h})$ respectively as defined in § 1.2.2. Then, the dynamical twist $\mathcal{J}(\lambda)_{V,W} \in \mathcal{O}(H)^{\text{gen}} \in \text{End}(V \otimes W)$, for $V, W \in \text{Rep}_q(G)$, constructed by Kalmykov–Safronov makes Diagram (3.48) commute and thus defines a dynamical point defect for factorization homology with values in $\text{Pres}_{\mathbb{K}}$. \triangle

Example 3.2.37. Let G be a finite group and $A \subset G$ an abelian subgroup. Let A^* be the abelian group of characters, that is, $A^* = \text{Map}(A, \mathbb{K}^\times)$. In [EN01], Etingof–Nikshych construct dynamical twists $\mathcal{J}(\lambda) \in \text{Fun}(A^*) \otimes \mathbb{K}[G] \otimes \mathbb{K}[G]$ with values in the group algebra of G . The algebra $\text{Fun}(A^*)$ is a base algebra in $\text{Rep}(A)$ with half-braiding defined by

$$\gamma_V: f(\lambda) \otimes v \mapsto v \otimes f(\lambda + \mu), \quad V \in \text{Rep}(A)$$

for $v \in V$ of weight μ and $\lambda \in A^*$. Since the group algebra $\mathbb{K}[G]$ is trivially quasi-triangular, the module category defined by the functor

$$\text{Rep}(G) \rightarrow \text{Rep}(A) \xrightarrow{\text{free}_{\text{Fun}(A^*)}} \text{Rep}(A)_{\text{Fun}(A^*)},$$

with monoidal structure $\mathcal{J}(\lambda)$ is trivially a braided module category and thus defines a dynamical point defect for factorization homology in $\text{Pres}_{\mathbb{K}}$. \triangle

In the $\mathcal{V} = \widehat{\mathbb{C}[[\hbar]]}\text{-Mod}$ -enriched setting we have the following example.

Example 3.2.38. Let $\text{Rep}_{\hbar}(G)^{\text{fd}}$ be the category of topologically-free $U_{\hbar}(\mathfrak{g})$ -modules of finite rank and let $\text{Rep}_{\hbar}(H)^{\text{fd}}$ be the category of topologically-free, finite rank $U_{\hbar}(\mathfrak{h})$ -modules with integral weights. Let $\mathcal{A} = \widehat{\text{Rep}_{\hbar}(G)^{\text{fd}}}$ and $\mathcal{C} = \widehat{\text{Rep}_{\hbar}(H)^{\text{fd}}}$ be their respective free cocompletions. These are monoidal categories under the Day convolution product, see § A.2.2. We will denote by $\iota: \text{Rep}_{\hbar}(H)^{\text{fd}} \rightarrow \text{Rep}_{\hbar}(H)^{\text{lf}}$ the inclusion into the category of locally-finite, topologically-free modules. Then, the presheaf

$$\mathcal{L} = \text{Map}_{\text{Rep}_{\hbar}(H)^{\text{lf}}}(\iota(-), \mathcal{O}(H^{\text{reg}})[[\hbar]])$$

3. Dynamical character varieties

is an algebra in \mathcal{C} . Indeed, $\mathcal{O}(H^{\text{reg}})[[\hbar]]$ is trivial as a $U_{\hbar}(\mathfrak{h})$ -module, i.e. the action is induced by pulling back along $\epsilon: U_{\hbar}(\mathfrak{h}) \rightarrow \mathbb{K}[[\hbar]]$. We can thus write the $U_{\hbar}(\mathfrak{h})$ -module $\mathcal{O}(H^{\text{reg}})[[\hbar]]$ as a filtered colimit $\text{colim}_i V_i[[\hbar]]$ of the finite dimensional subspaces $V_i \subset \mathcal{O}(H^{\text{reg}})$. With this observation we have the following

$$\begin{aligned}
& \mathcal{L} \otimes_{\text{Day}} \mathcal{L} \\
&= \int^{X, Y \in \text{Rep}_{\hbar}(H)^{\text{fd}}} \text{Map}_{\text{Rep}_{\hbar}(H)^{\text{fd}}}(-, X \otimes Y) \widehat{\otimes} \mathcal{L}(X) \widehat{\otimes} \mathcal{L}(Y) \\
&\cong \int^{X, Y \in \text{Rep}_{\hbar}(H)^{\text{fd}}} \text{Map}_{\text{Rep}_{\hbar}(H)^{\text{fd}}}(-, X \otimes Y) \widehat{\otimes} \text{Map}_{U(\mathfrak{h})\text{-Mod}^{\text{lf}}}(X_0, \text{colim}_i V_i)[[\hbar]] \\
&\quad \widehat{\otimes} \text{Map}_{U(\mathfrak{h})\text{-Mod}^{\text{lf}}}(Y_0, \text{colim}_j V_j)[[\hbar]] \\
&\cong \text{colim}_{(i,j)} \int^{X, Y \in \text{Rep}_{\hbar}(H)^{\text{fd}}} \text{Map}_{\text{Rep}_{\hbar}(H)^{\text{fd}}}(-, X \otimes Y) \widehat{\otimes} \text{Map}_{\text{Rep}_{\hbar}(H)^{\text{fd}}}(X, V_i[[\hbar]]) \\
&\quad \widehat{\otimes} \text{Map}_{\text{Rep}_{\hbar}(H)^{\text{fd}}}(Y, V_j[[\hbar]]) \\
&\cong \text{Map}_{\text{Rep}_{\hbar}(H)^{\text{lf}}}(\iota(-), \mathcal{O}(H^{\text{reg}})[[\hbar]]) \widehat{\otimes} \mathcal{O}(H^{\text{reg}})[[\hbar]] \\
&\xrightarrow{(m_{\mathcal{O}(H^{\text{reg}})[[\hbar]])_*}} \mathcal{L}
\end{aligned}$$

where we used that $X \cong X_0[[\hbar]]$ in $\text{Rep}_{\hbar}(H)^{\text{fd}}$ and we find that the algebra structure is the one induced by the multiplication in $\mathcal{O}(H^{\text{reg}})$. Similarly, we find that for any $V \in \text{Rep}_{\hbar}(H)^{\text{fd}}$

$$\mathcal{L} \otimes_{\text{Day}} Y_V \cong \text{Map}_{\text{Rep}_{\hbar}(H)^{\text{lf}}}(\iota(-), \mathcal{O}(H^{\text{reg}})[[\hbar]]) \otimes V \in \mathcal{C} \quad .$$

Using the above, one can show that \mathcal{L} is a base algebra in \mathcal{C} through the $U_{\hbar}(\mathfrak{h})$ -base algebra structure on $\mathcal{O}(H^{\text{reg}})[[\hbar]]$ from Example 3.2.5. By abuse of notation we will sometimes simply write $\mathcal{O}(H^{\text{reg}})[[\hbar]]$ for the base algebra \mathcal{L} . The braided module structure of $\mathcal{C}_{\mathcal{L}}$ over \mathcal{A} comes from the dynamical twist $\mathcal{J}(\lambda)$ being a solution to the ABRR-equation and the corresponding quasi-reflection datum $(\mathcal{J}(\lambda)_{2,1}, B_{\hbar}(\lambda))$ from Proposition 3.2.32. \triangle

3.3. Factorization homology on surfaces with dynamical point defects

In this section we compute factorization homology for surfaces with marked points and coefficients given by dynamical point defects. We show that one can identify the resulting categories with modules over algebras $a_{\lambda_1, \dots, \lambda_k}^{\Gamma}$ defined in combinatorial terms from certain decorated ribbon graph models $(\Gamma, \{v_1, \dots, v_k\})$. We will see that the algebras $a_{\lambda_1, \dots, \lambda_k}^{\Gamma}$ give rise to examples of so-called dynamical associative algebras, which are quantum analogs of the Poisson dynamical bracket from § 3.1.4 (see Remark 3.1.15). In particular, we recover a dynamical version of the FRT-algebra via factorization homology. Lastly, we show that for certain coefficients the algebras $a_{\lambda_1, \dots, \lambda_k}^{\Gamma}$ are examples of module algebras over so-called twisted quantum groupoids from [DM06].

3.3.1. Combinatorial algebras

Let $\Sigma = \Sigma_{g,r}$ be a connected oriented surface of genus g with r boundary components, $r > 0$, together with k marked points $\{v_1, \dots, v_k\} \subset \Sigma$. We will distinguish two cases: Σ

3. Dynamical character varieties

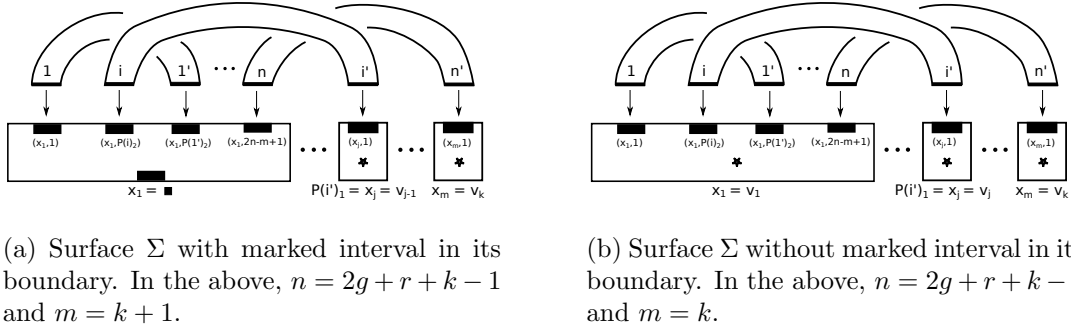

Figure 3.4.: Surface Σ with k marked points $\{v_1, \dots, v_k\} \subset \Sigma$ constructed from a given gluing pattern.

has either one or zero marked intervals in its boundary. It will be convenient to describe such surfaces combinatorially in terms of gluing patterns with multiple basepoints introduced in what follows. Note that these gluing patterns will be particular instances of ciliated ribbon graph models for surfaces with markings.

A gluing pattern $(P, \{x_1, \dots, x_m\})$ with m basepoints is a bijections of sets

$$P: \{1, 1', 2, 2', \dots, n, n'\} \xrightarrow{\cong} \{(x_1, 1), (x_1, 2), \dots, (x_1, 2n - m + 1), (x_2, 1), (x_3, 1), \dots, (x_m, 1)\} \quad ,$$

such that, writing $P(i) = (P(i)_1, P(i)_2)$, the following holds:

- $P(i)_1 = x_1$ for all $1 \leq i \leq n$,
- if $P(i)_1 = P(i')_1 = x_1$ then $P(i)_2 < P(i')_2$.

We will let $\mathbf{P}(\mathbf{i})$ and $\mathbf{P}(\mathbf{i}')$ denote the position of $P(i)$ and $P(i')$ in the set $\{(x_1, 1), (x_1, 2), \dots, (x_m, 1)\}$. We also introduce the notation $(P, \blacksquare, \{v_1, \dots, v_k\})$ for a gluing pattern with $m = k + 1$ basepoints, with distinguished first basepoint.

A given gluing pattern $(P, \blacksquare, \{v_1, \dots, v_k\})$, or $(P, \{v_1, \dots, v_k\})$, determines a marked surface $\Sigma(P)$ with or without marked interval in the boundary. For the former, consider $n = 2g + r + k - 1$ disks $\mathbb{D}_{\blacksquare, \blacksquare}$ with two marked intervals i and i' each, and a disjoint union $\blacksquare_{2n-k} \mathbb{D}_{\blacksquare, \blacksquare} \sqcup \blacksquare_{\blacksquare} \mathbb{D}_{*} \sqcup \dots \sqcup \blacksquare_{\blacksquare} \mathbb{D}_{*}$, where the first disk has $2n - k + 1$ marked intervals labeled $(x_1, 0), (x_1, 1), \dots, (x_1, 2n - k)$ and the others are once-marked disks \mathbb{D}_{*} with one labeled interval $(x_j, 1)$ each. Then, glue the interval i to the interval $P(i)$ and i' to $P(i')$, respectively. A sketch of this procedure is given in Figure 3.4a. For the case of the gluing pattern $(P, \{v_1, \dots, v_k\})$ without the distinguished first basepoint, the procedure is similar, except that we glue the $n = 2g + r + k - 2$ handles $\mathbb{D}_{\blacksquare, \blacksquare}$ to a disjoint union of once-marked disks $\blacksquare_{2n-k+1} \mathbb{D}_{*} \sqcup \blacksquare_{\blacksquare} \mathbb{D}_{*} \sqcup \dots \sqcup \blacksquare_{\blacksquare} \mathbb{D}_{*}$, see Figure 3.4b.

Throughout, let $\mathcal{A} \in \text{Pres}$ be a rigid balanced braided category with a strong generator consisting of compact-projective objects. Let $T: \mathcal{A} \boxtimes \mathcal{A} \rightarrow \mathcal{A}$ be the tensor product functor. We have the following two canonical algebras. First, the algebra $\mathcal{F} = T^R(1_{\mathcal{A}})$, which admits the following colimit formula:

$$\mathcal{F} = \int^{X \in \mathcal{A}^{\text{cp}}} X^{\vee} \boxtimes X \in \mathcal{A} \boxtimes \mathcal{A} \quad ,$$

with multiplication

$$(X^{\vee} \boxtimes X) \otimes (Y^{\vee} \boxtimes Y) = X^{\vee} \otimes Y^{\vee} \boxtimes X \otimes Y \xrightarrow{\sigma \boxtimes \text{id}} Y^{\vee} \otimes X^{\vee} \boxtimes X \otimes Y \xrightarrow{\iota_{X \otimes Y}} \mathcal{F} \quad .$$

3. Dynamical character varieties

Note that the algebra \mathcal{F} is the image of the FRT-algebra $\mathcal{F}_{\text{FRT}} = \int^X X^\vee \boxtimes X \in \mathcal{A}^{\text{op}} \boxtimes \mathcal{A}$ under the tensor functor $(\text{id}, \sigma): \mathcal{A}^{\text{op}} \rightarrow \mathcal{A}$ which is the identity on objects with tensor structure given by the braiding in \mathcal{A} . We will denote by $\mathcal{F}^{P(i')}$ the image under the embedding

$$\mathcal{A} \boxtimes \mathcal{A} \hookrightarrow \mathcal{A}^{\boxtimes m}, \quad a \boxtimes b \mapsto a \boxtimes 1 \cdots \boxtimes \underbrace{b}_{P(i')_1} \boxtimes \cdots \boxtimes 1 .$$

Second, the reflection equation (RE) algebra

$$\mathcal{F}_{\text{RE}} = \int^{X \in \mathcal{A}^{\text{cp}}} X^\vee \otimes X \in \mathcal{A} ,$$

which was already introduced in Example 2.2.11. We will also denote by \mathcal{F}_{RE} the image of the RE-algebra under the embedding $\mathcal{A} \hookrightarrow \mathcal{A}^{\boxtimes m}$, $a \otimes b \mapsto a \otimes b \boxtimes 1 \cdots \boxtimes 1$.

Now, given a gluing pattern P with multiple basepoints $\{v_1, \dots, v_m\}$, we will define an algebra object a^P in $\mathcal{A}^{\boxtimes m}$. As an object in $\mathcal{A}^{\boxtimes m}$, a^P is defined by the tensor product

$$a^P = \bigotimes_{i=1}^n \mathcal{F}^{P(i,i')}, \quad \mathcal{F}^{P(i,i')} = \begin{cases} \mathcal{F}^{P(i')}, & \text{if } P(i)_1 \neq P(i')_1 \\ \mathcal{F}_{\text{RE}}, & \text{else} \end{cases} \quad (3.51)$$

Similarly to the case of gluing patterns with only one basepoint [BZBJ18a, Section 5], the algebra structure on a^P is specified in terms of crossing morphisms $C_{ji}: \mathcal{F}^{P(j,j')} \otimes \mathcal{F}^{P(i,i')} \rightarrow \mathcal{F}^{P(i,i')} \otimes \mathcal{F}^{P(j,j')}$ for each pair $i < j$, such that the multiplication $m|_{\mathcal{F}^{P(i,i')} \otimes \mathcal{F}^{P(j,j')}}$ is given by:

$$\begin{aligned} \mathcal{F}^{P(i,i')} \otimes \mathcal{F}^{P(j,j')} \otimes \mathcal{F}^{P(i,i')} \otimes \mathcal{F}^{P(j,j')} &\xrightarrow{\text{id} \otimes C_{ji} \otimes \text{id}} (\mathcal{F}^{P(i,i')})^{\otimes 2} \otimes (\mathcal{F}^{P(j,j')})^{\otimes 2} \\ &\xrightarrow{m_{\mathcal{F}^{P(i,i')}} \otimes m_{\mathcal{F}^{P(j,j')}}} \mathcal{F}^{P(i,i')} \otimes \mathcal{F}^{P(j,j')} \end{aligned}$$

For each pair $1 \leq i < j \leq n$, we have to distinguish the following cases:

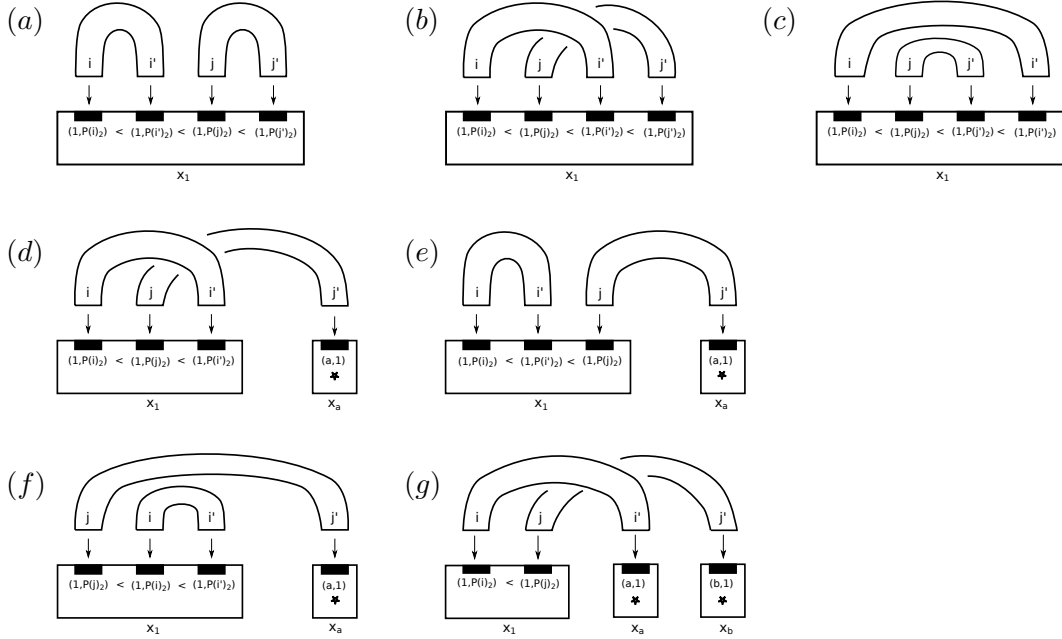

Figure 3.5.: List of gluing patterns for $1 \leq i < j \leq n$, together with the cases one obtains by exchanging $i \leftrightarrow j$ in the pictures above.

3. Dynamical character varieties

The crossing morphisms for cases (a)–(c) in Figure 3.5 were already defined in Figure 2.7 if one specializes to the case of trivial bundles decoration. The crossing morphisms for the remaining cases are

$$\begin{array}{cccc}
 (d) & \mathcal{F}_{\text{RE}} \otimes \mathcal{F}^{P(j')} & (e) & \mathcal{F}_{\text{RE}} \otimes \mathcal{F}^{P(j')} & (f) & \mathcal{F}_{\text{RE}} \otimes \mathcal{F}^{P(j')} & (g) & \mathcal{F}^{P(i')} \otimes \mathcal{F}^{P(j')} \\
 & \uparrow & & \uparrow & & \uparrow & & \uparrow \\
 & V^\vee \otimes V \otimes W^\vee \boxtimes W & & V^\vee \otimes V \otimes W^\vee \boxtimes W & & V^\vee \otimes V \otimes W^\vee \boxtimes W & & V^\vee \otimes W^\vee \boxtimes W \boxtimes W \\
 & \begin{array}{c} \text{---} \\ \diagup \quad \diagdown \\ \text{---} \end{array} & & \begin{array}{c} \text{---} \\ \diagup \quad \diagdown \\ \text{---} \end{array} & & \begin{array}{c} \text{---} \\ \diagup \quad \diagdown \\ \text{---} \end{array} & & \begin{array}{c} \text{---} \\ \diagup \quad \diagdown \\ \text{---} \end{array} \\
 & W^\vee \otimes V^\vee \otimes V \boxtimes W & & W^\vee \otimes V^\vee \otimes V \boxtimes W & & W^\vee \otimes V^\vee \otimes V \boxtimes W & & W^\vee \otimes V^\vee \boxtimes \underbrace{W}_n \boxtimes \underbrace{V}_m
 \end{array}$$

Figure 3.6.: Definition of crossing morphisms.

To each basepoint x_i in the gluing pattern $(P, \{x_1, \dots, x_m\})$ we assign the categorical data of a dynamical extension $(\mathcal{C}_i)_{\mathcal{L}_i} \in \text{Pres}$ together with a monoidal functor

$$F_{\lambda_i}: \mathcal{A} \xrightarrow{F_i} \mathcal{C} \xrightarrow{\text{free}_{\mathcal{L}_i}} (\mathcal{C}_i)_{\mathcal{L}_i}, \quad \mathcal{L} \otimes F_i(X) \otimes^{\mathcal{C}} F_i(Y) \xrightarrow{\mathcal{J}(\lambda_i)} \mathcal{L} \otimes F_i(X \otimes^{\mathcal{A}} Y),$$

given by means of a dynamical twist $\mathcal{J}(\lambda_i)$, defining a dynamical point defect. We then define the tensor functor

$$F_{\lambda_1, \dots, \lambda_m} = F_{\lambda_1} \boxtimes \dots \boxtimes F_{\lambda_m}: \mathcal{A}^{\boxtimes m} \rightarrow (\mathcal{C}_1)_{\mathcal{L}_1} \boxtimes \dots \boxtimes (\mathcal{C}_m)_{\mathcal{L}_m}, \quad (3.52)$$

and the corresponding algebra object

$$a_{\lambda_1, \dots, \lambda_m}^P = F_{\lambda_1, \dots, \lambda_m}(a^P). \quad (3.53)$$

in $(\mathcal{C}_1)_{\mathcal{L}_1} \boxtimes \dots \boxtimes (\mathcal{C}_m)_{\mathcal{L}_m}$. The algebras $a_{\lambda_1, \dots, \lambda_k}^P \in \mathcal{C}_1 \boxtimes \dots \boxtimes \mathcal{C}_k$ have quantum moment maps

$$\mu^{(i)}: \mathcal{L}_i \cong 1 \boxtimes \dots \boxtimes \mathcal{L}_i \otimes 1 \boxtimes \dots \boxtimes 1 \xrightarrow{\iota_{1 \boxtimes \dots \boxtimes 1}} a_{\lambda_1, \dots, \lambda_k}^P \quad (3.54)$$

Example 3.3.1. Consider a gluing pattern with two basepoints given by $P(1, 1') = ((\blacksquare, 1), (v, 1))$. In this case we have that $a^P = \mathcal{F}$. To the basepoint \blacksquare we attach the trivial dynamical extension $\text{id}: \mathcal{A} \rightarrow \mathcal{A}$, i.e. the base algebra $\mathcal{L} = 1_{\mathcal{A}}$ is given by the monoidal unit in \mathcal{A} . Let $F_\lambda: \mathcal{A} \rightarrow \mathcal{C}_{\mathcal{L}}$ be the dynamical data for the second basepoint v . Then, we have:

$$a_{\blacksquare, \lambda}^P = \int^{X \in \mathcal{A}^{\text{cp}}} X^\vee \boxtimes \mathcal{L} \otimes F(X),$$

with multiplication:

$$\begin{aligned}
 (X^\vee \boxtimes \mathcal{L} \otimes F(X)) \otimes (Y^\vee \boxtimes \mathcal{L} \otimes F(Y)) &= X^\vee \otimes Y^\vee \boxtimes (\mathcal{L} \otimes F(X) \otimes_{\mathcal{L}} \mathcal{L} \otimes F(Y)) \\
 &\xrightarrow{\cong} X^\vee \otimes Y^\vee \boxtimes \mathcal{L} \otimes F(X) \otimes F(Y) \xrightarrow{\text{id} \boxtimes \mathcal{J}(\lambda)_{X, Y}} X^\vee \otimes Y^\vee \boxtimes \mathcal{L} \otimes F(X \otimes Y) \\
 &\xrightarrow{\sigma_{X^\vee, Y^\vee} \boxtimes \text{id}} (X \otimes Y)^\vee \boxtimes \mathcal{L} \otimes F(X \otimes Y) \xrightarrow{\iota_{X \otimes Y}} a_{\blacksquare, \lambda}^P,
 \end{aligned}$$

where for the purpose of lighter notation we wrote \otimes for both the monoidal product in \mathcal{A} and \mathcal{C} . △

3.3.2. Computations on surfaces with point defects

In this section we will assume that the local categorical data to compute factorization homology in $\mathbf{Pres}_{\mathbb{K}}$ on a surface with marked points $\{v_1, \dots, v_k\}$ is given by

- A balanced braided abelian category \mathcal{A} which is equivalent to the free cocompletion of a small \mathbb{K} -linear category.
- A collection $\{(\mathcal{C}_1)_{\mathcal{L}_1}, \dots, (\mathcal{C}_k)_{\mathcal{L}_k}\}$ of abelian braided \mathcal{A} -module categories, each given by the dynamical extension of a category $\mathcal{C}_i \in \mathbf{Pres}_{\mathbb{K}}$ over a base algebra \mathcal{L}_i , where \mathcal{C}_i is equivalent to the free cocompletion of a small \mathbb{K} -linear category.

Example 3.3.2. The category $\mathcal{A} = \mathbf{Rep}_q(G)$ of integrable $U_q(\mathfrak{g})$ -modules and $\mathcal{C} = \mathbf{Rep}_q(H)$ the category of Λ -graded vector spaces are both of the above form. \triangle

We will comment on factorization homology on marked surfaces with coefficients in $\mathbb{C}[[\hbar]]$ -Mod-enriched categories in Remark 3.3.4.

Theorem 3.3.3. *Given an oriented surface $\Sigma = \Sigma_{g,r}$, $r > 0$, with marked points $\{v_1, \dots, v_k\} \subset \Sigma$ together with a marked interval $\blacksquare \in \partial\Sigma$. Let $(P, \blacksquare, \{v_1, \dots, v_k\})$ be a gluing pattern with multiple basepoints for Σ . We have an equivalence of categories*

$$\int_{\Sigma(P, \blacksquare, \{v_1, \dots, v_k\})} (\mathcal{A}, \{(\mathcal{C}_1)_{\mathcal{L}_1}, \dots, (\mathcal{C}_k)_{\mathcal{L}_k}\}) \cong a_{\blacksquare, \lambda_1, \dots, \lambda_k}^P \text{-Mod}_{\mathcal{A} \boxtimes \mathcal{C}_1 \boxtimes \dots \boxtimes \mathcal{C}_k} .$$

If the surface Σ has no marked interval in its boundary, and is described by the gluing pattern $(P, \{v_1, \dots, v_k\})$, then we have an equivalence of categories

$$\int_{\Sigma(P, \{v_1, \dots, v_k\})} (\mathcal{A}, \{(\mathcal{C}_1)_{\mathcal{L}_1}, \dots, (\mathcal{C}_k)_{\mathcal{L}_k}\}) \cong a_{\lambda_1, \dots, \lambda_k}^P \text{-Mod}_{\mathcal{C}_1 \boxtimes \dots \boxtimes \mathcal{C}_k} .$$

Proof. Given a gluing pattern P with m basepoints, we have a right $\mathcal{A}^{\boxtimes 2n}$ -action on $\mathcal{A}^{\boxtimes n}$:

$$\text{reg}^P : (b_1 \boxtimes \dots \boxtimes b_n) \boxtimes (a_1 \boxtimes \dots \boxtimes a_{2n}) \mapsto (b_1 \otimes a_{\mathbf{P}(1)} \otimes a_{\mathbf{P}(1')}) \boxtimes \dots \boxtimes (b_n \otimes a_{\mathbf{P}(n)} \otimes a_{\mathbf{P}(n')}) ,$$

and we denote the resulting right module category by \mathcal{M}_P . On the other hand, we have a left $\mathcal{A}^{\boxtimes 2n}$ -module $\mathcal{A}^{\boxtimes m}$:

$$\begin{aligned} \text{reg}^{x_1, \dots, x_m} : (a_1 \boxtimes \dots \boxtimes a_{2n}) \boxtimes (b_1 \boxtimes \dots \boxtimes b_m) \\ \mapsto (a_1 \otimes \dots \otimes a_{2n-m+1} \otimes b_1) \boxtimes (a_{2n-m+2} \otimes b_2) \boxtimes \dots \boxtimes (a_{2n} \otimes b_m) . \end{aligned}$$

Composition of the resulting tensor functor $T^{x_1, \dots, x_m} = \text{reg}_{\mathcal{A} \boxtimes \dots \boxtimes \mathcal{A}}^{x_1, \dots, x_m}$ with the monoidal functor $F_{\lambda_1, \dots, \lambda_m}$ from (3.52) yields a left $\mathcal{A}^{\boxtimes 2n}$ -module category which we denote by \mathcal{N}_P . If $P = (P, \blacksquare, \{v_1, \dots, v_k\})$, we have $\mathcal{N}_P = \mathcal{A} \boxtimes (\mathcal{C}_1)_{\mathcal{L}_1} \boxtimes \dots \boxtimes (\mathcal{C}_k)_{\mathcal{L}_k}$, whereas for the gluing pattern without distinguished basepoint we have $\mathcal{N}_P = (\mathcal{C}_1)_{\mathcal{L}_1} \boxtimes \dots \boxtimes (\mathcal{C}_k)_{\mathcal{L}_k}$. In the following we will simply stick to working with a general gluing pattern $(P, \{x_1, \dots, x_m\})$ from which we can deduce the two cases of the theorem.

Using \boxtimes -excision for the collar-gluing described by the gluing pattern $(P, \{x_1, \dots, x_m\})$ (Figure 3.4a and Figure 3.4b), we find that

$$\int_{\Sigma} \mathcal{A} \cong \mathcal{M}_P \boxtimes_{\mathcal{A}^{\boxtimes 2n}} \mathcal{N}_P . \quad (3.55)$$

3. Dynamical character varieties

Let $\tau_P: \{1, 2, \dots, 2n\} \rightarrow \{(x_1, 1), (x_1, 2) \dots, (x_m, 1)\}$ be the bijection given by post-composing the map defined by $2k + 1 \mapsto k$, $2k \mapsto k'$ with P . Since the monoidal unit is a progenerator for the regular action ([BZBJ18a, Proposition 4.15]), we may now apply monadic reconstruction to identify \mathcal{M}_P with modules over an algebra $\underline{\text{End}}_{\mathcal{A}^{\boxtimes 2n}}(1_{\mathcal{A}^{\boxtimes n}})_P \in \mathcal{A}^{\boxtimes 2n}$, obtained from $\mathcal{F}^{\boxtimes n}$ by acting with τ_P .

We can apply the base-change formula from Theorem 1.3.22 to the relative tensor product in (3.55) to get an equivalence

$$\int_{\Sigma} \mathcal{A} \cong F_{\lambda_1, \dots, \lambda_m} \left(\underbrace{T^{x_1, \dots, x_m}(\underline{\text{End}}_{\mathcal{A}^{\boxtimes 2n}}(1_{\mathcal{A}^{\boxtimes n}})_P)}_{=B} \right) \text{-Mod}_{(C_1)_{\mathcal{L}_1} \boxtimes \dots \boxtimes (C_m)_{\mathcal{L}_m}}, \quad (3.56)$$

of categories.

Next, we have to show that B and a^P are isomorphic as algebras in $\mathcal{A}^{\boxtimes m}$. To that end, we follow the strategy presented in the proof of [BZBJ18a, Theorem 5.14]. First, we define algebras $\mathcal{F}^{(i, i')} = \underline{\text{End}}_{\mathcal{A}^{(P(i))} \boxtimes \mathcal{A}^{(P(i'))}}(1_{\mathcal{A}})$ in $\mathcal{A}^{\boxtimes 2n}$, where we denote by $\mathcal{A}^{(j)}$ the image under the embedding $\mathcal{A} \hookrightarrow \mathcal{A}^{\boxtimes 2n}$ into the j -th tensor factor. Define $\mathcal{F}^{(i)} = T^{x_1, \dots, x_m}(\mathcal{F}^{(i, i')})$. Clearly, as objects in $\mathcal{A}^{\boxtimes m}$ we have $\mathcal{F}^{(i)} \cong \mathcal{F}^{P(i, i')}$ as defined in (3.51). Consider the map

$$\tilde{m}: \mathcal{F}^{(1)} \otimes \dots \otimes \mathcal{F}^{(m)} \hookrightarrow B^{\otimes m} \xrightarrow{m_B} B$$

where m_B is the multiplication in the algebra B . The map \tilde{m} establishes the isomorphism $a^P \cong B$ on the level of objects. In order to show that it is an isomorphism of algebras in $\mathcal{A}^{\boxtimes m}$, one needs to show that $\tilde{m}|_{\mathcal{F}^{(j)} \otimes \mathcal{F}^{(i)}} = \tilde{m}|_{\mathcal{F}^{(i)} \otimes \mathcal{F}^{(j)}} \circ C_{ji}$. To that end, note that the tensor structure on T^{x_1, \dots, x_m} is

$$\begin{aligned} a_1^{(1)} \otimes \dots \otimes a_{2n-m+1}^{(1)} \otimes b_1^{(1)} \otimes \dots \otimes b_{2n-m+1}^{(1)} \boxtimes a^{(2)} \otimes b^{(2)} \boxtimes \dots \boxtimes a^{(m)} \otimes b^{(m)} \\ \xrightarrow{S} a_1^{(1)} \otimes b_1^{(1)} \otimes \dots \otimes a_{2n-m+1}^{(1)} \otimes b_{2n-m+1}^{(1)} \boxtimes \dots \boxtimes a^{(m)} \otimes b^{(m)} \end{aligned}$$

where S is the shuffle braiding given by $S = \sigma_{a_{2n-m+1}, b_{2n-m}} \circ \dots \circ \sigma_{a_3 \otimes \dots \otimes a_{2n-m+1}, b_2} \circ \sigma_{a_2 \otimes \dots \otimes a_{2n-m+1}, b_1}$, where σ is the braiding of \mathcal{A} . Then we consider the commutative diagram

$$\begin{array}{ccc} T^{x_1, \dots, x_m}(\mathcal{F}^{(i, i')} \otimes \mathcal{F}^{(j, j')}) & = & T^{x_1, \dots, x_m}(\mathcal{F}^{(j, j')} \otimes \mathcal{F}^{(i, i')}) \\ \swarrow S_{ij} & & \nwarrow S_{ji} \\ \mathcal{F}^{(i)} \otimes \mathcal{F}^{(j)} & \xrightarrow{\tilde{m}} & B \xleftarrow{\tilde{m}} \mathcal{F}^{(j)} \otimes \mathcal{F}^{(i)} \end{array},$$

$\downarrow T^{x_1, \dots, x_m}(m)$

where the dashed arrows are the natural isomorphisms encoding the tensor structure on T^{x_1, \dots, x_m} and the label $T^{x_1, \dots, x_m}(m)$ on the vertical arrow means applying the tensor functor to the multiplication in $\underline{\text{End}}_{\mathcal{A}^{\boxtimes 2n}}(1_{\mathcal{A}^{\boxtimes n}})_P$. As an example, consider the gluing pattern $P(1, 1', 2, 2') = ((x_1, 1), (x_2, 1), (x_1, 2), (x_3, 1))$ as in Figure 3.5 (g). We have

$$\mathcal{F}^{(1)} = \int^{V \in \mathcal{A}^{\text{cp}}} (V^{\vee} \otimes 1) \boxtimes V \boxtimes 1, \quad \mathcal{F}^{(2)} = \int^{W \in \mathcal{A}^{\text{cp}}} (1 \otimes W^{\vee}) \boxtimes 1 \boxtimes W$$

and the corresponding shuffle braiding on components of the coend is

$$S_{1,2} = \text{id} \boxtimes \text{id} \boxtimes \text{id}, \quad S_{2,1} = \sigma_{W^{\vee}, V^{\vee}} \boxtimes \text{id} \boxtimes \text{id},$$

3. Dynamical character varieties

and we observe that the composition $S_{12}^{-1} \circ S_{21}$ agrees with the crossing morphism in Figure 3.6 (g). As a second example, consider the gluing pattern $P(1, 1', 2, 2') = ((x_1, 1), (x_1, 2), (x_1, 3), (x_2, 1))$ from Figure 3.5 (e). In this case we have

$$\mathcal{F}^{(1)} = \int^{V \in \mathcal{A}^{\text{cp}}} V^\vee \otimes V \otimes 1 \boxtimes 1, \quad \mathcal{F}^{(2)} = \int^{W \in \mathcal{A}^{\text{cp}}} 1 \otimes 1 \otimes W^\vee \boxtimes W$$

and

$$S_{12} = \text{id} \boxtimes \text{id}, \quad S_{21} = (\text{id}_{V^\vee} \otimes \sigma_{W^\vee, V}) \circ (\sigma_{W^\vee, V^\vee} \otimes \text{id}_V) \boxtimes \text{id}$$

so that $S_{12}^{-1} \circ S_{21}$ indeed agrees with the crossing morphism from Figure 3.6 (e). The other cases can be worked out analogously.

Lastly, for each $i = 1, \dots, m$ we have a monoidal functor $\text{free}_{\mathcal{L}_i}: \mathcal{C}_i \rightarrow (\mathcal{C}_i)_{\mathcal{L}_i}$ with right adjoint given by the forgetful functor, which is colimit preserving. We then recall that the equivalence in (3.56) is established by the monadicity theorem for the monad defined through the adjunction $(\boxtimes_i (\mathcal{C}_i)_{\mathcal{L}_i}) \rightleftarrows \mathcal{M}_P \boxtimes_{\mathcal{A}^{\boxtimes 2n}} (\boxtimes_i (\mathcal{C}_i)_{\mathcal{L}_i})$. Since $(\mathcal{C}_1)_{\mathcal{L}_1} \boxtimes \dots \boxtimes (\mathcal{C}_m)_{\mathcal{L}_m} \cong (\mathcal{C}_1 \boxtimes \dots \boxtimes \mathcal{C}_m)_{\mathcal{L}_1 \boxtimes \dots \boxtimes \mathcal{L}_m}$, composition with the adjunction $\text{free}_{\boxtimes_i \mathcal{L}_i} \dashv U$, where U is the forgetful functor, results in a new monadic adjunction establishing the equivalences stated in the theorem. \square

Remark 3.3.4. *As was already noted in Remark 2.3.3, we are still missing monadic reconstruction results for $\mathcal{V} = \mathbb{C}[[\hbar]]\text{-Mod}$ -enriched locally presentable categories that would allow us to give an analog to Theorem 3.3.3 in this setting. Nevertheless, given a marked surface Σ with boundary described by a gluing pattern $(P, \{v_1, \dots, v_k\})$ and dynamical point defects $(\mathcal{A}, \mathcal{C}_{\mathcal{L}})$ in $\mathcal{V}\text{Pres}$, we can still extract algebraic data as will be described in what follows. For an example of a dynamical point defect in the formal setting see Example 3.2.38.*

To ease notation we consider the case where all marked points are described by the same categorical data $(\mathcal{A}, \mathcal{C}_{\mathcal{L}})$. Let \mathcal{O}_{Σ} be the image of $\mathcal{L}^{\boxtimes k}$ under the map induced by the embedding of k marked disks $\mathbb{D}_*^{\sqcup k}$ into $(\Sigma, \{v_1, \dots, v_k\})$. We can compute the following algebras

$$\begin{aligned} \text{End}_{\int_{\Sigma(P, \{v_1, \dots, v_k\})} (\mathcal{A}, \mathcal{C}_{\mathcal{L}})} (\mathcal{O}_{\Sigma}) &\cong \text{End}_{\mathcal{A}^{\boxtimes n} \boxtimes_{\mathcal{A}^{\boxtimes 2n}} (\mathcal{C}_{\mathcal{L}})^{\boxtimes k}} \left(1_{\mathcal{A}^{\boxtimes n}} \boxtimes_{\mathcal{A}^{\boxtimes 2n}} \mathcal{L}^{\boxtimes k} \right) \\ &\cong \text{Hom}_{(\mathcal{C}_{\mathcal{L}})^{\boxtimes k}} \left(\mathcal{L}^{\boxtimes k}, \underline{\text{End}}_{\mathcal{A}^{\boxtimes 2n}} (1_{\mathcal{A}})_P \triangleright \mathcal{L}^{\boxtimes k} \right) \\ &\cong \text{Hom}_{(\mathcal{C}_{\mathcal{L}})^{\boxtimes k}} \left(\mathcal{L}^{\boxtimes k}, F_{\lambda_1, \dots, \lambda_k} (T^{v_1, \dots, v_k} (\underline{\text{End}}_{\mathcal{A}^{\boxtimes 2n}} (1_{\mathcal{A}})_P)) \right) \\ &\cong \text{Hom}_{(\mathcal{C}_{\mathcal{L}})^{\boxtimes k}} \left(\mathcal{L}^{\boxtimes k}, a_{\lambda_1, \dots, \lambda_k}^P (\mathcal{V}) \right) \\ &\cong \text{Hom}_{\mathcal{C}^{\boxtimes k}} \left(1_{\mathcal{C}}^{\boxtimes k}, a_{\lambda_1, \dots, \lambda_k}^P (\mathcal{V}) \right) \end{aligned}$$

where $a_{\lambda_1, \dots, \lambda_k}^P (\mathcal{V})$ is the combinatorial algebra defined in (3.53). In the above we used that the right adjoint to the iterated tensor product functor is monadic (see § A.2.3 of the appendix). The proof that

$$F_{\lambda_1, \dots, \lambda_k} (T^{v_1, \dots, v_k} (\underline{\text{End}}_{\mathcal{A}^{\boxtimes 2n}} (1_{\mathcal{A}})_P)) \cong a_{\lambda_1, \dots, \lambda_k}^P (\mathcal{V})$$

as algebras in $(\mathcal{C}_{\mathcal{L}})^{\boxtimes k}$ is analogous to the one given as part of the proof of Theorem 3.3.3. We thus get a ‘global section functor’

$$\text{Hom}(\mathcal{O}_{\Sigma}, -): \int_{\Sigma(P, \{v_1, \dots, v_k\})} (\mathcal{A}, \mathcal{C}_{\mathcal{L}}) \rightarrow \text{Hom}_{\mathcal{C}^{\boxtimes k}} \left(1_{\mathcal{C}}^{\boxtimes k}, a_{\lambda_1, \dots, \lambda_k}^P (\mathcal{V}) \right) \text{-Mod} .$$

3.3.3. Dynamical algebras

Let $B \subseteq H$ be a pair of Hopf algebras over \mathbb{K} and let \mathcal{L} be a B -base algebra. Following [DM05], we call a left B -module A^{dyn} a *dynamical associative algebra* over the base algebra \mathcal{L} if it is equipped with a B -equivariant map $\odot: A^{\text{dyn}} \otimes A^{\text{dyn}} \rightarrow \mathcal{L} \otimes A^{\text{dyn}}$ such that the following diagram is commutative

$$\begin{array}{ccccc}
 A^{\text{dyn}} \otimes \mathcal{L} \otimes A^{\text{dyn}} & \xrightarrow{\gamma_{A^{\text{dyn}}}^{-1} \otimes \text{id}} & \mathcal{L} \otimes A^{\text{dyn}} \otimes A^{\text{dyn}} & \xrightarrow{\text{id} \otimes \odot} & \mathcal{L} \otimes \mathcal{L} \otimes A^{\text{dyn}} & \xrightarrow{m_{\mathcal{L}} \otimes \text{id}} & \mathcal{L} \otimes A^{\text{dyn}} \\
 \uparrow \text{id} \otimes \odot & & & & & & \uparrow m_{\mathcal{L}} \otimes \text{id} \\
 A^{\text{dyn}} \otimes A^{\text{dyn}} \otimes A^{\text{dyn}} & \xrightarrow{\odot \otimes \text{id}} & \mathcal{L} \otimes A^{\text{dyn}} \otimes A^{\text{dyn}} & \xrightarrow{\text{id} \otimes \odot} & \mathcal{L} \otimes \mathcal{L} \otimes A^{\text{dyn}} & &
 \end{array}$$

where $\gamma_{A^{\text{dyn}}}: \mathcal{L} \otimes A^{\text{dyn}} \rightarrow A^{\text{dyn}} \otimes \mathcal{L}$ is the half-braiding of the B -base algebra \mathcal{L} .

Let $F_{\lambda}: H\text{-Mod} \xrightarrow{F} B\text{-Mod} \xrightarrow{\text{free}_{\mathcal{L}}} B\text{-Mod}_{\mathcal{L}}$ be a functor with monoidal structure given by a dynamical twist $\mathcal{J}(\lambda)$. If A is an associative algebra in $H\text{-Mod}$, then $F_{\lambda}(A) = \mathcal{L} \otimes F(A)$ is an associative algebra in the dynamical extension. In particular, the multiplication in the dynamical extension restricts to a dynamical associative algebra structure on $A^{\text{dyn}} = F(A) \subset \mathcal{L} \otimes F(A)$. Following [DM06], we will say that the dynamical algebra A^{dyn} over \mathcal{L} is obtained from A by the dynamical twist $\mathcal{J}(\lambda)$.

We now give two examples of dynamical algebras obtained via Theorem 3.3.3 from factorization homology on surfaces with dynamical point defects.

Example 3.3.5. Consider the disk with two marked points $\{v_1, v_2\}$ described by the gluing pattern $P(1, 1') = ((v_1, 1), (v_2, 1))$. Applying Theorem 3.3.3, we get an equivalence $\int_{\mathbb{D}_{*,*}}(\mathcal{A}, \mathcal{C}_{\mathcal{L}}) \cong \mathcal{F}_{\lambda_1, \lambda_2}\text{-Mod}_{\mathcal{C}_{\mathcal{L}} \boxtimes \mathcal{C}_{\mathcal{L}}}$ identifying factorization homology on the marked disk with modules over the following algebra:

$$\mathcal{F}_{\lambda_1, \lambda_2} = \int^{X \in H\text{-Mod}^{\text{fd}}} \mathcal{L} \otimes F(X^{\vee}) \boxtimes \mathcal{L} \otimes F(X) \in \mathcal{C}_{\mathcal{L}} \boxtimes \mathcal{C}_{\mathcal{L}} .$$

By Proposition 3.2.7, $\mathcal{F}_{\lambda_1, \lambda_2}$ is an algebra in $\mathcal{C} \boxtimes \mathcal{C}$ with quantum moment maps

$$\mu_1 \boxtimes \mu_2: \mathcal{L} \boxtimes \mathcal{L} \cong \mathcal{L} \otimes 1 \boxtimes \mathcal{L} \otimes 1 \rightarrow \mathcal{F}_{\lambda_1, \lambda_2} .$$

Multiplication in $\mathcal{F}_{\lambda_1, \lambda_2}$ is given by

$$\begin{aligned}
 & (\mathcal{L} \otimes F(X^{\vee}) \boxtimes \mathcal{L} \otimes F(X)) \otimes_{\mathcal{L}} (\mathcal{L} \otimes F(Y^{\vee}) \boxtimes \mathcal{L} \otimes F(Y)) & (3.57) \\
 & \cong \mathcal{L} \otimes F(X^{\vee}) \otimes F(Y^{\vee}) \boxtimes \mathcal{L} \otimes F(X) \otimes F(Y) \\
 & \xrightarrow{\mathcal{J}(\lambda)_{X^{\vee}, Y^{\vee}} \boxtimes \mathcal{J}(\lambda)_{X, Y}} \mathcal{L} \otimes F((Y \otimes X)^{\vee}) \boxtimes \mathcal{L} \otimes F(X \otimes Y) \\
 & \xrightarrow{F_{\lambda}(\sigma_{X, Y}) \boxtimes \text{id}} \mathcal{L} \otimes F((X \otimes Y)^{\vee}) \boxtimes \mathcal{L} \otimes F(X \otimes Y) \rightarrow \mathcal{F}_{\lambda_1, \lambda_2} .
 \end{aligned}$$

Note that as a (B, B) -bimodule we may identify $\mathcal{F}_{\lambda_1, \lambda_2}$ with the tensor product $\mathcal{L} \otimes \mathcal{L} \otimes \mathcal{F}$, where $\mathcal{F} = H^{\circ}$ as (H, H) -bimodules. Recall that we denote by H° the restricted dual of the Hopf algebra H given by matrix coefficients of finite-dimensional representations endowed with the left- and right-coregular H -action. In the language of [DM06], the multiplication (3.57) turns \mathcal{F} into a dynamical associative algebra \mathcal{F}^{dyn} over the base $\mathcal{L} \otimes \mathcal{L}$ obtained from \mathcal{F} by the dynamical twist $\mathcal{J}(\lambda_1) \otimes \mathcal{J}(\lambda_2)$.

3. Dynamical character varieties

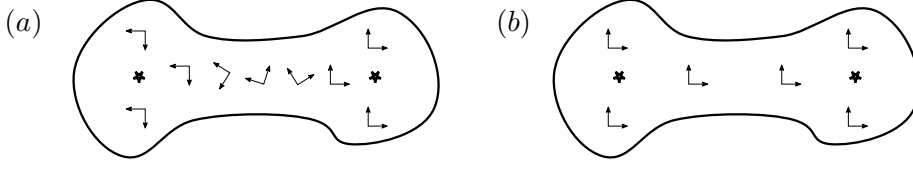

Figure 3.7.: Framed surfaces which give rise to (a) the algebra $\mathcal{F}_{\lambda_1, \lambda_2}$, (b) the dynamical FRT-algebra $\mathcal{F}_{\lambda_1, \lambda_2}^{\text{FRT}}$, upon applying factorization homology.

The algebra $\mathcal{F}_{\lambda_1, \lambda_2}$ is closely related to the so-called dynamical FRT-algebra, or dual quantum groupoid, which is a dynamical analog to the FRT-algebra H° and was previously defined in [DM06, Section 8]. Since our conventions for the dynamical twist differ from the one in [DM06] (see Remark 3.2.11), we give a detailed definition of the dynamical FRT-algebra in § B.1.1 of the appendix, matching our conventions. We may present the dynamical FRT-algebra via the following coend:

$$\mathcal{F}_{\lambda_1, \lambda_2}^{\text{FRT}} = \int^{X \in H\text{-Mod}^{\text{fd}}} \mathcal{L} \otimes F(X^\vee) \boxtimes \mathcal{L} \otimes F(X) \in (\mathcal{C}_{\mathcal{L}})^{\text{op}} \boxtimes \mathcal{C}_{\mathcal{L}} .$$

Note that $(\mathcal{C}_{\mathcal{L}})^{\text{op}} \cong \mathcal{C}_{\mathcal{L}^{\text{op}}}^{\text{op}}$, where $\mathcal{C}^{\text{op}} = B^{\text{op}}\text{-Mod}$ and B^{op} is the Hopf algebra B with opposite coproduct. The multiplication in $\mathcal{F}_{\lambda_1, \lambda_2}^{\text{FRT}}$ is such that it turns the (ordinary) FRT-algebra H° into a dynamical associative algebra $(H^\circ)^{\text{dyn}}$ via the twist $\mathcal{K}(\lambda_1) \otimes \mathcal{J}(\lambda_2)$, where $\mathcal{K}(\lambda) = \bar{\mathcal{J}}^0 \otimes S^{-1}(\bar{\mathcal{J}}^1) \otimes S^{-1}(\bar{\mathcal{J}}^2) \in \mathcal{L}_{\text{op}} \otimes H^{\text{op}} \otimes H^{\text{op}}$ is a universal dynamical twist for $(\mathcal{C}_{\mathcal{L}})^{\text{op}}$. The following is proven in § B.1.1 of the appendix:

Proposition 3.3.6. *The dynamical FRT-algebra $\mathcal{F}_{\lambda_1, \lambda_2}^{\text{FRT}}$ is a left bialgebroid over the base algebra \mathcal{L} .*

We may interpret a dynamical FRT-algebra as the quantum analog of a Poisson–Lie groupoid (see Example 3.1.6).

From a topological viewpoint, the category

$$\mathcal{F}_{\lambda_1, \lambda_2}\text{-Mod}_{\mathcal{C}_{\mathcal{L}} \boxtimes \mathcal{C}_{\mathcal{L}}}$$

computes factorization homology on the framed surface in Figure 3.7 (a), whereas the category

$$\mathcal{F}_{\lambda_1, \lambda_2}^{\text{FRT}}\text{-Mod}_{(\mathcal{C}_{\mathcal{L}})^{\text{op}} \boxtimes \mathcal{C}_{\mathcal{L}}}$$

comes from a surface with framing as sketched in Figure 3.7 (b). Note however that for local coefficients given by *oriented* marked disk-algebras their factorization homologies are, up to equivalence, independent of the framing and the two categories will in fact be equivalent. \triangle

Example 3.3.7. Let $\mathbb{D}_{\blacksquare, v}$ be the disk with one marked point v and a marked interval in its boundary described by the gluing pattern $P(1, 1') = ((\blacksquare, 1), (v, 1))$. By Theorem 3.3.3, we have an identification

$$\int_{\mathbb{D}_{\blacksquare, v}} (\mathcal{A}, \mathcal{C}_{\mathcal{L}}) \cong a_{\blacksquare, \lambda}^P\text{-Mod}_{\mathcal{A} \boxtimes \mathcal{C}_{\mathcal{L}}} ,$$

where $a_{\blacksquare, \lambda}^P$ is the algebra from Example 3.3.1. In this case, we get a dynamical associative algebra \mathcal{F}^{dyn} over \mathcal{L} , obtained from \mathcal{F} via the dynamical twist $1 \otimes \mathcal{J}(\lambda)$. We will come

3. Dynamical character varieties

back to this example in the next section when discussing deformation quantization of dynamical Poisson spaces, in particular we will see that the algebra plays a role in the quantization of Poisson homogeneous spaces. \triangle

3.3.4. Module algebras over twisted bialgebroids

We will use the following algebraic setup. Let $B \subset H$ be a pair of finite-dimensional Hopf algebras over \mathbb{K} . We assume that $H\text{-Mod}$ is braided and that \mathcal{L} is a base algebra in $B\text{-Mod}$. Let $\mathcal{D}B = B \bowtie B_{\text{op}}^*$ be the double cross product as defined in [Maj95, Section 7], where B_{op}^* is the dual of B with opposite multiplication. The category of modules over the double $\mathcal{D}B$ is braided: the braiding is given by acting with the universal R -matrix $\Theta = e^i \otimes e_i$, where $(e_i)_{i \in I}$ is a basis of B and $(e^i)_{i \in I}$ its dual in B_{op}^* . The algebra \mathcal{L} has a natural $\mathcal{D}B$ -base algebra structure, see § B.2.1 for details. In [DM06], Donin–Mudrov establish a connection between twists for the tensor product bialgebroid $H \otimes \mathcal{D}B_{\mathcal{L}}$ and solutions of the dynamical Yang–Baxter equation. The bialgebroid $\mathcal{D}B_{\mathcal{L}}$ is a quantum groupoid, that is a quasi-triangular bialgebroid, defined by a quotient of the smash product $\mathcal{L} \rtimes \mathcal{D}B$, see § B.1. In Proposition B.2.5 of the appendix we give the analogous results for the dynamical twists from Definition 3.2.10. In more details, we show that

$$\Psi = (1 \otimes 1 \otimes \mathcal{J}^1 S^{-1}(\Theta^2)) \otimes_{\mathcal{L}} (\mathcal{J}^0 \otimes \Theta^1 \otimes \mathcal{J}^2) \in \mathfrak{B} \otimes_{\mathcal{L}} \mathfrak{B} \quad (3.58)$$

is a twist for the tensor product bialgebroid

$$\mathfrak{B}_{\mathcal{L}}^B = \left(\mathcal{D}B_{\mathcal{L}_{\text{op}}}^{\text{op}} \otimes H^{\text{op}} \right)^{\text{op}} .$$

The bialgebroid twist defines an automorphism of the monoidal category of $\mathfrak{B}_{\mathcal{L}}^B$ -modules and thus transforms a \mathfrak{B} -module algebra into another algebra, with respect to the new coproduct. More explicitly, in Proposition B.2.6 we show that for an H -module algebra A , the tensor product $\mathcal{L} \otimes A$ is a module algebra over the bialgebroid \mathfrak{B} . The dynamical twist $\mathcal{J}(\lambda)$ then induces a new multiplication $*$ on $\mathcal{L} \otimes A$ (Proposition B.2.7):

$$\begin{aligned} a * b &= \mathcal{J}^0 \otimes m_A \left((\mathcal{J}^1.a) \otimes (\mathcal{J}^2.b) \right), & \lambda * \mu &= m_{\mathcal{L}}(\lambda \otimes \mu) \\ a * \lambda &= \Theta^1 \blacktriangleright \lambda \otimes S^{-1}(\Theta^2).a, & \lambda * a &= \lambda \otimes a \end{aligned} \quad (3.59)$$

for all $a, b \in A$ and $\lambda, \mu \in \mathcal{L}$, making $(\mathcal{L} \otimes A, *)$ a module algebra over the twisted bialgebroid \mathfrak{B} .

We now apply the previous discussion to the algebras obtained in Theorem 3.3.3. Let $\mathcal{A} = H\text{-Mod}$, $\mathcal{C}_i = B_i\text{-Mod}$ for $i = 1, \dots, k$ and let $\mathcal{L}_i \in \mathcal{Z}(B_i\text{-Mod})$ be base algebras with corresponding dynamical twists $\mathcal{J}(\lambda_i)$ defining dynamical point defects, see for Example 3.2.37. In the language of module algebras over bialgebroids, we then have the following:

Proposition 3.3.8. *The algebras $a_{\lambda_1, \dots, \lambda_k}^P$ from Theorem 3.3.3 are module algebras over the twisted $\mathcal{L}_1 \otimes \dots \otimes \mathcal{L}_k$ -bialgebroid \mathfrak{B} with*

$$\mathfrak{B} = \mathfrak{B}_{\mathcal{L}_1}^{B_1} \otimes \dots \otimes \mathfrak{B}_{\mathcal{L}_k}^{B_k}$$

and twist defined by

$$\begin{aligned} \Psi &= \left((1 \otimes 1 \otimes \mathcal{J}^1(\lambda_1) S^{-1}(\Theta_{B_1}^2)) \otimes \dots \otimes (1 \otimes 1 \otimes \mathcal{J}^1(\lambda_k) S^{-1}(\Theta_{B_k}^2)) \right) \\ &\quad \otimes_{\mathcal{L}_1 \otimes \dots \otimes \mathcal{L}_k} \left((\mathcal{J}^0(\lambda_1) \otimes \Theta_{B_1}^1 \otimes \mathcal{J}^2(\lambda_1)) \otimes \dots \otimes (\mathcal{J}^0(\lambda_k) \otimes \Theta_{B_k}^1 \otimes \mathcal{J}^2(\lambda_k)) \right) \end{aligned}$$

where Θ_{B_i} is the universal R -matrix of the double $\mathcal{D}B_i$.

3. Dynamical character varieties

Proof. The algebras $a_{\lambda_1, \dots, \lambda_k}^P$ are defined as the image of the algebra a^P from (3.51) under the monoidal functor $F_{\lambda_1, \dots, \lambda_m}$ from (3.52). In the proof of Theorem 3.3.3 we show that a^P is an algebra object in $\mathcal{A}^{\boxtimes k} \cong (H^{\otimes k})\text{-Mod}$. By Proposition B.2.6, $F_{\lambda_1, \dots, \lambda_m}(a^P)$ is thus a module algebra over \mathfrak{B} . The multiplication in the algebra $a_{\lambda_1, \dots, \lambda_k}^P$ is of the form (3.59) and thus a module algebra over the twisted bialgebroid $\tilde{\mathfrak{B}}$. \square

Remark 3.3.9. *We expect the above result to hold true even in the infinite dimensional case when working over the ring $\mathbb{C}[[\hbar]]$ of formal power series.*

3.4. Quantization of dynamical Poisson spaces

We will now show that the algebras we obtained in the previous section via factorization homology on surfaces with dynamical point defects quantize the dynamical character varieties from § 3.1.4. To that end, we will first make precise what it means for a base algebra \mathcal{L}_\hbar to deformation quantize a Poisson base space and recall how dynamical twists over such base algebras give rise to quantum dynamical R-matrices $\mathcal{R}(\lambda) \in \mathcal{L}_\hbar \otimes U_\hbar(\mathfrak{g}) \otimes U_\hbar(\mathfrak{g})$.

Let \mathfrak{h} be a Lie bialgebra and $U_\hbar(\mathfrak{h})$ a quantum universal enveloping algebra that quantizes \mathfrak{h} [CP95, Section 6.2]. We will say that a $U_\hbar(\mathfrak{h})$ -base algebra $(\mathcal{L}_\hbar, \star)$ (see Example 3.2.3 for the definition of a base algebra over a Hopf algebra) is a quantization of the Poisson \mathfrak{h} -base algebra \mathcal{L}_0 (Definition 3.1.1) if it is a $U_\hbar(\mathfrak{h})$ -equivariant deformation quantization of \mathcal{L}_0 with multiplication

$$\lambda \star \mu = \lambda\mu + \mathcal{O}(\hbar), \quad \lambda \star \mu - \mu \star \lambda = \hbar(\overrightarrow{\eta^j} \cdot \lambda)(\overrightarrow{h_j} \cdot \mu) + \mathcal{O}(\hbar^2) \quad , \quad (3.60)$$

where $(h_j)_{j \in I}$ is a basis for \mathfrak{h} and $(\eta^j)_{j \in I}$ its dual basis, and left coaction $\mathcal{L}_\hbar \rightarrow U_\hbar(\mathfrak{h}) \otimes \mathcal{L}_\hbar$ of the form

$$\delta(\lambda) = 1 \otimes \lambda + \hbar h_j \otimes \overrightarrow{\eta^j} \cdot \lambda + \mathcal{O}(\hbar^2) \quad (3.61)$$

for $\lambda, \mu \in \mathcal{L}_\hbar$.

Assume that $\mathfrak{h} \subset \mathfrak{g}$ is a Lie sub-bialgebra of a quasi-triangular Lie bialgebra \mathfrak{g} with classical r-matrix $r \in \mathfrak{g} \otimes \mathfrak{g}$. Given a universal dynamical twist $\mathcal{J}(\lambda)$ over \mathcal{L}_\hbar , we have seen that the element $\mathcal{R}(\lambda) = \mathcal{J}(\lambda)_{2,1}^{-1} \mathcal{R} \mathcal{J}(\lambda) \in \mathcal{L}_\hbar \otimes U_\hbar(\mathfrak{g})^{\otimes 2}$ is a quantum dynamical R-matrix satisfying the quantum dynamical Yang–Baxter equation

$$\mathcal{R}(\lambda)_{0,1,2} \mathcal{R}(\lambda)_{02,1,3} \mathcal{R}(\lambda)_{0,2,3} = \mathcal{R}(\lambda)_{01,2,3} \mathcal{R}(\lambda)_{0,1,3} \mathcal{R}(\lambda)_{03,1,2} \quad , \quad (3.62)$$

where for example $\mathcal{R}(\lambda)_{02,1,3} = (\mathcal{R}(\lambda)^0)^{[0]} \otimes \mathcal{R}(\lambda)^1 \otimes (\mathcal{R}(\lambda)^0)^{[1]} \otimes \mathcal{R}(\lambda)^2$.

Proposition 3.4.1. *Let the base algebra \mathcal{L}_\hbar be a quantization of a Poisson \mathfrak{h} -base algebra \mathcal{L}_0 . Assume that $\mathcal{R}(\lambda)$ is of the form $\mathcal{R}(\lambda) = 1 + \hbar r(\lambda) + \mathcal{O}(\hbar^2)$. Then its semi-classical limit $r(\lambda)$ is a classical dynamical r-matrix over \mathcal{L}_0 .*

Proof. To first order in \hbar , the $U_\hbar(\mathfrak{h})$ -invariance of $\mathcal{R}(\lambda)$ reads:

$$\overrightarrow{\hbar} \cdot r(\lambda) + [h \otimes 1 + 1 \otimes h, r(\lambda)] = \frac{1}{\hbar} (\Delta_\hbar(h) - \Delta_\hbar^{\text{op}}) \pmod{\hbar} \quad .$$

for all $h \in \mathfrak{h}$. Since $U_\hbar(\mathfrak{h})$ is a quantization of the Lie bialgebra (\mathfrak{h}, δ) we have that the right hand side agrees with $\delta(h)$ and we recover the quasi \mathfrak{h} -equivariance for $r(\lambda)$. Expanding the quantum DYBE to second order in \hbar , together with Equation (3.61) for the coaction, implies the classical DYBE for $r(\lambda)$. \square

3. Dynamical character varieties

Example 3.4.2. Let's revisit the dynamical base algebra $\mathcal{O}(H)_S[[\hbar]]$ from Example 3.2.5. To that end, let $U_\hbar(\mathfrak{h}) \cong U(\mathfrak{h})[[\hbar]]$ be the Cartan part of the formal quantum group. The algebra $\mathcal{O}(H)[[\hbar]]$ is a right $U_\hbar(\mathfrak{h})$ -comodule:

$$\delta_\hbar^R: \mathcal{O}(H)[[\hbar]] \rightarrow \mathcal{O}(H)[[\hbar]] \otimes U_\hbar(\mathfrak{h}), \quad \delta_\hbar(f)(e^\lambda \otimes 1) = f(e^{\lambda - \hbar h^{(2)}}) . \quad (3.63)$$

We have seen that the comodule structure also extends to the localized algebra $\mathcal{O}(H)_S[[\hbar]]$. Recalling the expansion of $f(e^{\lambda - \hbar h^{(2)}})$ from Equation (3.23), together with the definition of the \mathfrak{h}^* -action from Example 3.1.2, we find that

$$f(e^{\lambda - \hbar h^{(2)}}) = f(e^\lambda) - \hbar \sum_i \overrightarrow{\eta^i} \cdot f(e^\lambda) \otimes h_i + \mathcal{O}(\hbar^2) .$$

Using Relation (3.21) between left and right comodule structure, we find that the $U_\hbar(\mathfrak{h})$ -coaction of $\mathcal{O}(H)_S[[\hbar]]$ is of the form (3.61). \triangle

3.4.1. Deformation quantization

Let \mathfrak{g} be a quasi-triangular Lie bialgebra with classical r-matrix $r \in \mathfrak{g} \otimes \mathfrak{g}$. For each $i = 1, \dots, k$, let $\mathfrak{h}_i \subset \mathfrak{g}$ be a Lie sub-bialgebra and $U_\hbar(\mathfrak{h}_i)$ a quantum universal enveloping algebra that quantizes \mathfrak{h}_i . Let $\text{Rep}_\hbar(H_1 \times \dots \times H_k)$ be the category of topologically-free modules over $\otimes_{i=1}^k U_\hbar(\mathfrak{h}_i)$. Throughout, all $U_\hbar(\mathfrak{h}_i)$ -base algebras $\mathcal{L}_{i,\hbar}$ are assumed to be quantizations of Poisson \mathfrak{h}_i -base spaces L_i . We will consider the algebras $a_{\lambda_1, \dots, \lambda_k}^P$ from § 3.3, Equation (3.53), as algebra objects

$$a_{\hbar, \lambda_1, \dots, \lambda_k}^P \in \text{Rep}_\hbar(H_1 \times \dots \times H_k) .$$

As $\mathbb{C}[[\hbar]]$ -modules we have

$$a_{\hbar, \lambda_1, \dots, \lambda_k}^P \cong \bigotimes_{i=1}^k \mathcal{L}_{\hbar, i} \otimes \mathcal{O}_\hbar(G)^{\otimes n}, \quad n = 2g + r + k - 1 .$$

We let $F: \text{Rep}_\hbar(G) \rightarrow \text{Rep}_\hbar(H_i)$ be the forgetful functor coming from the inclusion $U_\hbar(\mathfrak{h}_i) \hookrightarrow U_\hbar(\mathfrak{g})$. To ease notation, we will assume that for all $i = 1, \dots, k$ we have $\mathfrak{h}_i = \mathfrak{h} \subseteq \mathfrak{g}$ and that all base algebras agree; $\mathcal{L}_{\hbar, i} = \mathcal{L}_\hbar$. The general case can be worked out in complete analogy.

Theorem 3.4.3. *The algebra $a_{\hbar, \lambda_1, \dots, \lambda_k}^P$ is a $U_\hbar(\mathfrak{h})^{\otimes k}$ -equivariant deformation quantization of the dynamical representation variety $\text{Rep}_{\text{dyn}}((P, \{v_1, \dots, v_k\}), G)$ in the direction of the dynamical Fock–Rosly Poisson bracket.*

Proof. We first settle some notation. We will denote $\mathcal{L}_\hbar^{(m)}$ the image of \mathcal{L}_\hbar under the quantum moment map $\mu^{(m)}$ from (3.54). By abuse of notation we will again write $\mathcal{F}_\hbar^{P(i)}$ for the image of the algebra defined in (3.51) under the embedding into $a_{\hbar, \lambda_1, \dots, \lambda_k}^P$. We will denote by

$$(\mathcal{L} \otimes F(V^\vee \otimes V))^{(i)} = \mathcal{L} \otimes F(1 \otimes \dots \otimes \underbrace{V^\vee \otimes V}_i \otimes 1 \dots \otimes 1) \boxtimes 1 \boxtimes \dots \boxtimes 1$$

the components of the coend algebra $\mathcal{F}_{\text{RE}, \hbar}^{(i)} \subset a_{\hbar, \lambda_1, \dots, \lambda_k}^P$ and write

$$\begin{aligned} & (\mathcal{L} \otimes F(W^\vee) \boxtimes \mathcal{L} \otimes F(W))^{(i, i')} \\ &= \mathcal{L} \otimes F(1 \otimes \dots \otimes \underbrace{W^\vee}_i \otimes \dots \otimes 1) \boxtimes 1 \boxtimes \dots \boxtimes \underbrace{\mathcal{L} \otimes F(W)}_{P(i')_1} \boxtimes \dots \boxtimes 1 \end{aligned}$$

3. Dynamical character varieties

for the components of $\mathcal{F}_\hbar^{(i,i')} \subset a_{\hbar,\lambda_1,\dots,\lambda_k}^P$. Also, note that both coend algebras \mathcal{F}_\hbar and $\mathcal{F}_{\text{RE},\hbar}$ (defined in § 3.3.1) are identified as $\mathbb{C}[[\hbar]]$ -modules with the quantized algebra $\mathcal{O}_\hbar(G)$ of functions on G , however their respective multiplications differ and thus they quantize two different Poisson structures.

We now compute the semi-classical limit of the commutator bracket $[X_\hbar, Y_\hbar]$ for $X_\hbar, Y_\hbar \in a_{\hbar,\lambda_1,\dots,\lambda_k}^P$ and show that it coincides with the dynamical Fock–Rosly Poisson structure from Theorem 3.1.10. To that end, we have to distinguish the following cases:

Case 1: $X_\hbar \in \mathcal{F}_\hbar^{P(i)}, Y_\hbar \in \mathcal{F}_\hbar^{P(j)}$. For a fixed pair of indices $2 \leq i < j \leq n$ we consider:

- $X_\hbar \in \mathcal{F}_{\text{RE},\hbar}^{(i)}, Y_\hbar \in \mathcal{F}_{\text{RE},\hbar}^{(j)}$ with $P(i)_2 < P(i')_2 < P(j)_2 < P(j')_2$ (Figure 3.5 (a)):

On the one hand we have

$$\begin{aligned} (1 \otimes F(V^\vee \otimes V))^{(i)} \otimes_{\mathcal{L}} (1 \otimes F(W^\vee \otimes W))^{(j)} &\cong 1 \otimes F((V^\vee \otimes V)^{(i)}) \otimes F((W^\vee \otimes W)^{(j)}) \\ \xrightarrow{\mathcal{J}(\lambda)_{V^\vee \otimes V, W^\vee \otimes W}} \mathcal{L} \otimes F(V^\vee \otimes V \otimes W^\vee \otimes W) &\rightarrow a_{\hbar,\lambda_1,\dots,\lambda_k}^P \end{aligned}$$

and on the other hand

$$\begin{aligned} (1 \otimes F(W^\vee \otimes W))^{(j)} \otimes_{\mathcal{L}} (1 \otimes F(V^\vee \otimes V))^{(i)} &\cong 1 \otimes F((W^\vee \otimes W)^{(j)}) \otimes F((V^\vee \otimes V)^{(i)}) \\ \xrightarrow{\mathcal{J}(\lambda)_{W^\vee \otimes W, V^\vee \otimes V}} \mathcal{L} \otimes F((W^\vee \otimes W)^{(j)}) \otimes (V^\vee \otimes V)^{(i)} \\ \xrightarrow{F(C_{j,i})=F(\mathcal{R}_{W^\vee \otimes W, V^\vee \otimes V})} \mathcal{L} \otimes F(V^\vee \otimes V \otimes W^\vee \otimes W) &\rightarrow a_{\hbar,\lambda_1,\dots,\lambda_k}^P, \end{aligned}$$

where $C_{j,i}$ is the crossing morphism for the positively unlinked case from Figure 2.7. Hence, the semi-classical limit of the commutator is given

$$\frac{[X_\hbar, Y_\hbar]}{\hbar} \bmod(\hbar) = r(\lambda_1)_{2,1}^{\text{ad},\text{ad}} \triangleright (X \otimes Y)$$

where $r(\lambda) = -j(\lambda)_{2,1} + r + j(\lambda)$ and $X = X_\hbar/(\hbar) \in \mathcal{O}(G)$, $Y = Y_\hbar/(\hbar) \in \mathcal{O}(G)$. This agrees with the dynamical FR-bracket from Theorem 3.1.10.

- $X_\hbar \in \mathcal{F}_{\text{RE},\hbar}^{(i)}, Y_\hbar \in \mathcal{F}_\hbar^{(j,j')}$ with $P(i)_2 < P(j)_2 < P(i')_2$ (Figure 3.5 (d)):

Similarly to the previous case, we can compute the commutator by acting with

$$\mathcal{J}(\lambda)_{V^\vee \otimes V, W^\vee} - F(\mathcal{R}^{-1})_{V, W^\vee} \circ F(\mathcal{R}_{2,1})_{V^\vee, W^\vee} \circ (\mathcal{J}(\lambda)_{2,1})_{V^\vee \otimes V, W^\vee}$$

on the components $(1 \otimes F(V^\vee \otimes V))^{(i)} \otimes_{\mathcal{L}} (1 \otimes F(W^\vee) \boxtimes 1 \otimes F(W))^{(j,j')}$ of the two coend algebras. Note that $F(\mathcal{R}^{-1})_{V, W^\vee} \circ F(\mathcal{R}_{2,1})_{V^\vee, W^\vee} = F(C_{j,i})$, where $C_{j,i}$ is the crossing morphism from Figure 3.6 (d), and we find that the semi-classical limit of the commutator is

$$\frac{[X_\hbar, Y_\hbar]}{\hbar} \bmod(\hbar) = -(r(\lambda_1)_{2,1}^{R,R} + r(\lambda_1)^{L,R}) \triangleright (X \otimes Y) .$$

- $X_\hbar \in \mathcal{F}_\hbar^{(i,i')}, Y_\hbar \in \mathcal{F}_\hbar^{(j,j')}$ with $P(i)_2 < P(j)_2$ (Figure 3.5 (g)):

3. Dynamical character varieties

In this case, we can compute the commutator by acting with

$$\mathcal{J}(\lambda)_{V^\vee, W^\vee} - (F(\mathcal{R}_{2,1}) \circ \mathcal{J}(\lambda)_{2,1})_{V^\vee, W^\vee}$$

on the components $(1 \otimes F(V^\vee) \boxtimes 1 \otimes F(V))^{(i,i')} \otimes_{\mathcal{L}} (1 \otimes F(W^\vee) \boxtimes 1 \otimes F(W))^{(j,j')}$ of the two coend algebras. In the above $F(\mathcal{R}_{2,1})_{V^\vee, W^\vee} = F(C_{j,i})$ with $C_{j,i}$ the crossing morphism from Figure 3.6 (g). The semi-classical limit of the commutator is

$$\frac{[X_{\hbar}, Y_{\hbar}]}{\hbar} \bmod(\hbar) = -r(\lambda_1)^{R,R} \triangleright (X \otimes Y) .$$

The remaining cases can be worked out analogously.

Case 2: $X_{\hbar}, Y_{\hbar} \in \mathcal{F}^{(i,i')}$. First, note that in \mathcal{F}_{\hbar} the following commutation relations hold. For two elements $\varphi, \psi \in \mathcal{O}_{\hbar}(G) \cong \mathcal{F}_{\hbar}$ we have

$$m_{\mathcal{F}_{\hbar}}(\varphi \otimes \psi) = m_{\mathcal{F}_{\hbar}}(\psi(S(\mathcal{R}^2)(-)(\mathcal{R}^1)^{-1}) \otimes \varphi(S(\mathcal{R}^1)(-)(\mathcal{R}^2)^{-1}) .$$

Then, we can compute the commutator of X_{\hbar} and Y_{\hbar} on components of the coend algebras as follows:

$$\begin{aligned} & 1 \otimes F(V^\vee) \otimes F(W^\vee) \boxtimes (1 \otimes F(V) \otimes F(W))^{(n)} \\ & \xrightarrow{(\mathcal{J}(\lambda_1) - \mathcal{J}(\lambda_1)_{2,1})_{V^\vee, W^\vee} \boxtimes (\mathcal{J}(\lambda_m) - \mathcal{J}(\lambda_m)_{2,1})_{V, W}} \mathcal{L} \otimes F(V^\vee \otimes W^\vee) \boxtimes (\mathcal{L} \otimes F(V \otimes W))^{(n)} \\ & \xrightarrow{\text{id}_{\mathcal{L}} \otimes F((1 - \mathcal{R}_{2,1})_{V^\vee, W^\vee}) \boxtimes \text{id}_{\mathcal{L}} \otimes F((1 - \mathcal{R}^{-1})_{V, W})} \mathcal{L} \otimes F((W \otimes V)^\vee) \boxtimes (\mathcal{L} \otimes F(V \otimes W))^{(n)} \\ & \xrightarrow{m_{\mathcal{F}_{\hbar}} - m_{\mathcal{F}_{\hbar}}} a_{\hbar, \lambda_1, \dots, \lambda_k}^P \end{aligned}$$

where $n = P(i')_1$. The semi-classical limit of this expression is:

$$\begin{aligned} \frac{[X_{\hbar}, Y_{\hbar}]}{\hbar} \bmod(\hbar) &= (-r(\lambda_1)^{R,R}_{2,1} + r(\lambda_m)^{L,L}) \triangleright (X \otimes Y) \\ &= (\omega(\lambda_1)^{R,R} + \omega(\lambda_m)^{L,L}) \triangleright (X \otimes Y) , \end{aligned}$$

where $X = X_{\hbar}/(\hbar) \in \mathcal{O}(G)$ and $Y = Y_{\hbar}/(\hbar) \in \mathcal{O}(G)$. This agrees with the bracket (3.9) from Proposition 3.1.5, and thus also with the Poisson bracket of Theorem 3.1.10.

Case 3: $X_{\hbar}, Y_{\hbar} \in \mathcal{F}_{\text{RE}, \hbar}^{(i)}$. This can be worked out in the same way as Case 2, using the commutation relations in the RE-algebra:

$$m_{\text{RE}}(\varphi(\mathcal{R}^2(-)\mathcal{R}^1) \otimes \psi(\mathcal{R}^1\mathcal{R}^2(-))) = m_{\text{RE}}(\psi((-)\mathcal{R}^2\mathcal{R}^1) \otimes \varphi((\mathcal{R}^2(-)\mathcal{R}^1)) .$$

Case 4: $X_{\hbar} \in \mathcal{L}_{\hbar}^{(m)}, Y_{\hbar} \in \mathcal{F}_{\hbar}^{P(i)}$.

- $X_{\hbar} \in \mathcal{L}_{\hbar}^{(m)}, Y_{\hbar} \in \mathcal{F}_{\hbar}^{(i,i')}$ with $m = P(i')_1$:

On the one hand we have

$$\begin{aligned} X_{\hbar}^{(m)} \otimes_{\mathcal{L}} (1 \otimes F(V^\vee) \boxtimes 1 \otimes F(V))^{(i,i')} &\cong 1 \otimes F((V^\vee)^{(i)}) \boxtimes ((X_{\hbar} \otimes 1) \otimes_{\mathcal{L}} (1 \otimes F(V)))^{(m)} \\ &\cong 1 \otimes F(V^\vee) \boxtimes (X_{\hbar} \otimes F(V))^{(m)} \rightarrow a_{\hbar, \lambda_1, \dots, \lambda_k}^P \end{aligned}$$

3. Dynamical character varieties

and on the other hand

$$(1 \otimes F(V^\vee) \boxtimes 1 \otimes F(V))^{(i,i')} \otimes_{\mathcal{L}} X_h^{(m)} \cong 1 \otimes F((V^\vee)^{(i)}) \boxtimes ((1 \otimes F(V)) \otimes_{\mathcal{L}} (X_h \otimes 1))^{(m)} \\ \xrightarrow{\text{id} \boxtimes \gamma} 1 \otimes F(V^\vee) \boxtimes (\mathcal{L} \otimes F(V))^{(m)} \rightarrow a_{\hbar, \lambda_1, \dots, \lambda_k}^P$$

where $\gamma(1 \otimes F(V) \otimes_{\mathcal{L}} X_h \otimes 1) = X_h^{[0]} \otimes X_h^{[1]} \triangleright F(V) \otimes 1$ is the tensor structure on the free \mathcal{L} -module functor. By taking the semi-classical limit of the right coaction $\delta^R: \mathcal{L}_\hbar \rightarrow \mathcal{L}_\hbar \otimes U_\hbar(\mathfrak{h})$ on the quantized base algebra as given in (3.61) we thus find that

$$\frac{[X_\hbar, Y_\hbar]}{\hbar} \text{ mod }(\hbar) = (\overrightarrow{\eta^j} \cdot X)(h_j^L \triangleright Y)$$

where $X = X_\hbar/(\hbar) \in \mathcal{L}_0$ and $Y = Y_\hbar/(\hbar) \in \mathcal{O}(G)$. This agrees with the second bracket in (3.8) from Proposition 3.1.5, and thus with the Poisson bracket of Theorem 3.1.10.

- $X_\hbar \in \mathcal{L}_\hbar^{(1)}$, $Y_\hbar \in \mathcal{F}_\hbar^{(i,i')}$:

Similarly to the previous case, we compute the commutator by acting with

$$X_\hbar \otimes_{\mathcal{L}} \text{id} - X_\hbar^{[0]} \otimes_{\mathcal{L}} F((X_\hbar^{[1]})_{V^\vee})$$

on the components $\mathcal{L}_\hbar^{(1)} \otimes_{\mathcal{L}} (1 \otimes F(V^\vee) \boxtimes 1 \otimes F(V))$ of the coend algebras resulting in:

$$\frac{[X_\hbar, Y_\hbar]}{\hbar} \text{ mod }(\hbar) = -(\overrightarrow{\eta^j} \cdot X)(h_j^R \triangleright Y) \quad ,$$

which agrees with the first bracket in (3.8) from Proposition 3.1.5, and thus with the Poisson bracket of Theorem 3.1.10.

- $X_\hbar \in \mathcal{L}_\hbar^{(1)}$, $Y_\hbar \in \mathcal{F}_{\text{RE}, \hbar}^{(i)}$:

Similarly to the previous case, the commutator is given by the action of

$$X_\hbar \otimes_{\mathcal{L}} \text{id} - X_\hbar^{[0]} \otimes_{\mathcal{L}} F((X_\hbar^{[1]})_{V^\vee \otimes V})$$

on $\mathcal{L}_\hbar^{(1)} \otimes_{\mathcal{L}} (1 \otimes F(V^\vee \otimes V))$ resulting in the semi-classical limit:

$$\frac{[X_\hbar, Y_\hbar]}{\hbar} \text{ mod }(\hbar) = (\overrightarrow{\eta^j} \cdot X)(h_j^L \triangleright Y) - (\overrightarrow{\eta^j} \cdot X)(h_j^R \triangleright Y) \quad .$$

Case 5: $X_\hbar, Y_\hbar \in \mathcal{L}_\hbar^{(m)}$. In this case we have

$$X_\hbar^{(m)} \otimes Y_\hbar^{(m)} = ((X_\hbar \otimes 1) \otimes_{\mathcal{L}} (Y_\hbar \otimes 1))^{(m)} \quad \text{and} \quad Y_\hbar^{(m)} \otimes X_\hbar^{(m)} = ((Y_\hbar \otimes 1) \otimes_{\mathcal{L}} (X_\hbar \otimes 1))^{(m)} \\ \cong (X_\hbar * Y_\hbar \otimes 1)^{(m)} \rightarrow a_{\hbar, \lambda_1, \dots, \lambda_k}^P \quad \cong (Y_\hbar * X_\hbar \otimes 1)^{(m)} \rightarrow a_{\hbar, \lambda_1, \dots, \lambda_k}^P$$

Since \mathcal{L}_\hbar is a deformation quantization of \mathcal{L}_0 we find by (3.60):

$$\frac{[X_\hbar, Y_\hbar]}{\hbar} \text{ mod }(\hbar) = (\overrightarrow{\eta^j} \cdot X)(\overrightarrow{h_j} \cdot Y) \quad ,$$

where $X_\hbar/(\hbar) = X \in \mathcal{L}_0$ and $Y_\hbar/(\hbar) = Y \in \mathcal{L}_0$, which agrees with the Poisson bracket on the base algebra \mathcal{L}_0 . \square

3. Dynamical character varieties

Corollary 3.4.4. *The sub-algebra of invariants $\mathrm{Hom}_{U_{\hbar}(\mathfrak{h})^{\otimes k}}(1, a_{\hbar, \lambda_1, \dots, \lambda_k}^P)$ is a deformation quantization of the dynamical character variety.*

We now discuss in more details the two examples from § 3.3.3:

Example 3.4.5. The algebra $\mathcal{F}_{\hbar, \lambda_1, \lambda_2}$ from Example 3.3.5 quantizes the dynamical Poisson structure $\Pi_{\mathrm{dyn}}^{L, L}$ on $L \times G \times L$ from Proposition 3.1.5. \triangle

Example 3.4.6. The algebra $a_{\hbar, \blacksquare, \lambda}^P$ from Example 3.3.1 is a $U_{\hbar}(\mathfrak{g}) \otimes U_{\hbar}(\mathfrak{h})$ -equivariant quantization of the Poisson structure $\Pi(\lambda)$ on $L \times G$ from Example 3.1.18. On the semi-classical level we have seen that for \mathfrak{h} -stable points $\lambda_0 \in L$, the bivector field $\Pi(\lambda_0)$ induces a Poisson G -space structure on the quotient G/H . The quantum analog to an \mathfrak{h} -stable point λ_0 is a $U_{\hbar}(\mathfrak{h})$ -invariant character χ^{λ_0} on \mathcal{L}_{\hbar} . Existence of invariant characters for a given stable point is proven in [DM05]. Explicitly, every \mathfrak{h} -stable point λ_0 defines an invariant character by $\chi^{\lambda_0}(\varphi) = \varphi(\lambda_0)$ for $\varphi \in \mathcal{L}_{\hbar}$.

Given the dynamical associative algebra $\mathcal{F}_{\hbar}^{\mathrm{dyn}} = (\mathcal{O}_{\hbar}(G), \odot) \subset a_{\hbar, \blacksquare, \lambda}^P$ from Example 3.3.7, we thus obtain a new algebra

$$\mathcal{F}_{\hbar}^{\mathrm{dyn}} \otimes \mathcal{F}_{\hbar}^{\mathrm{dyn}} \xrightarrow{\odot} \mathcal{L}_{\hbar} \otimes \mathcal{F}_{\hbar}^{\mathrm{dyn}} \xrightarrow{\chi^{\lambda_0} \otimes \mathrm{id}} \mathcal{F}_{\hbar}^{\mathrm{dyn}},$$

quantizing the Poisson structure $\Pi(\lambda_0)$ on G/H . \triangle

3.4.2. Classical and quantum dynamical character stacks

Let G be a semi-simple algebraic group and $H \subset G$ a subgroup. We have a commuting diagram

$$\begin{array}{ccc} [H/H] & \longrightarrow & [G/G] \\ \downarrow & & \downarrow \\ BH & \longrightarrow & BG \end{array}$$

where $BG = [pt/G]$ and $BH = [pt/H]$, the horizontal arrows are induced by the inclusions $\iota: H \subset G$ and the vertical arrows by the projections $G \rightarrow pt$ and $H \rightarrow pt$. Consider the induced diagram

$$\begin{array}{ccc} \mathrm{Rep}(G) & \xrightarrow{\mathrm{free}_{\mathcal{O}(H)} \circ \iota^*} & \mathcal{O}(H)\text{-Mod}_{\mathrm{Rep}(H)} \\ \mathrm{free}_{\mathcal{O}(G)} \downarrow & \nearrow & \\ \mathcal{O}(G)\text{-Mod}_{\mathrm{Rep}(G)} & & \end{array} \quad (3.64)$$

where $\mathrm{Rep}(G) \cong \mathrm{QCoh}(BG)$, $\mathcal{O}(G)\text{-Mod}_{\mathrm{Rep}(G)} \cong \mathrm{QCoh}([G/G])$ and $\mathcal{O}(H)\text{-Mod}_{\mathrm{Rep}(H)} \cong \mathrm{QCoh}([H/H])$.

For any H -invariant open subset $V \subset H$ we may further compose the above with the colimit preserving and monoidal functor $\mathcal{O}(H)\text{-Mod}_{\mathrm{Rep}(H)} \rightarrow \mathcal{O}(V)\text{-Mod}_{\mathrm{Rep}(H)}$. In summary, we obtain the following point defects for computing factorization homology

$$\mathrm{Rep}(G) \xrightarrow{i^*} \mathrm{Rep}(H) \xrightarrow{\mathrm{free}_{\mathcal{O}(V)}} \mathrm{Rep}(H)_{\mathcal{O}(V)}.$$

Given a surface $\Sigma = \Sigma_{g,r}$ with $r > 0$ boundary components and $\{v_1, \dots, v_k\} \subset \Sigma$ a collection of marked points, we may pick a decorated ribbon graph model $\Gamma =$

3. Dynamical character varieties

$(E, V, \{V_i, \mathfrak{h}_i\}_{i=1, \dots, k})$ for Σ whose set of vertices is $V = \{v_1, \dots, v_k\}$. The corresponding dynamical character stack is:

$$\mathbf{Char}_{\text{dyn}}(\Gamma, G) = \left[\prod_i V_i \times G^E / \prod_i H_i \right] . \quad (3.65)$$

We will make the following assumptions: each V_i admits an H_i -invariant étale cover by affines. By the latter we mean a family $\{U_a^i \hookrightarrow V_i\}_{a \in J}$ of affine H_i -invariant open subsets covering V_i , such that

$$f: \coprod_a U_a^i \rightarrow V_i$$

is an H_i -equivariant étale morphism. We shall write $\mathcal{U}^i = \coprod_a U_a^i$ and denote by \mathcal{U}_\bullet^i the simplicial diagram given by the Čech nerve of the cover f . We will write \underline{a}_n for a tuple of element $a_1, \dots, a_n \in J$ and $U_{\underline{a}_n} = U_{a_1} \cap \dots \cap U_{a_n}$.

Proposition 3.4.7. *For the situation described above, the category of quasi-coherent sheaves on the dynamical character stack (3.65) is equivalent to*

$$\begin{aligned} & \text{QCoh}(\mathbf{Char}_{\text{dyn}}(\Gamma, G)) \quad (3.66) \\ & \cong \lim_{[n] \in \Delta} \prod_{\underline{a}_n} \int_{(\Sigma, \{v_1, \dots, v_k\})} (\text{Rep}(G), \{\mathcal{O}(U_{\underline{a}_n}^i)\text{-Mod}_{\text{Rep}(H_i)}\}_{i=1, \dots, k}) , \end{aligned}$$

where the bilimit is computed in $\text{Pres}_{\mathbb{K}}$ over the cosimplicial diagram coming from the Čech nerve of the cover $\mathcal{U}^1 \times \dots \times \mathcal{U}^k \rightarrow V_1 \times \dots \times V_k$.

Proof. We will need the following. Given a linear algebraic group H , a smooth variety X with H -action and an H -invariant étale cover $\mathcal{U} = \sqcup_a U_a \rightarrow X$, consider the diagram

$$\begin{array}{ccc} \mathcal{U} & \xrightarrow{f} & X \\ \downarrow & & \downarrow \\ [\mathcal{U}/H] & \xrightarrow{\bar{f}} & [X/H] . \end{array}$$

The map f and the vertical maps are effective epimorphisms, and therefore so is \bar{f} . The vertical maps are flat and locally of finite presentation (lfp). Indeed, the projection $\text{pr}: H \times X \rightarrow X$ is flat and lfp since it is obtained by base change from the morphism $H \rightarrow \text{Spec}(\mathbb{K})$ having these properties. Moreover, the action $\text{act}: H \times X \rightarrow X$ fits into a commutative diagram

$$\begin{array}{ccc} H \times X & \xrightarrow{u} & H \times X \\ & \searrow \text{act} & \downarrow \text{pr} \\ & & X \end{array}$$

where $u(h, x) = (h, \text{act}(h, x))$, which has an inverse $u^{-1}(h, x) = (h, \text{act}(h^{-1}, x))$. It follows that the action morphism is flat and lfp since the projection is so. Then, by [Sta21, Tag 06FH], $X \rightarrow [X/H]$ is flat and lfp and similarly for $\mathcal{U} \rightarrow [\mathcal{U}/H]$. From the above observations and [Sta21, Tag 0CIQ] we deduce that \bar{f} is étale.

Given the étale cover $[\mathcal{U}_\bullet/H] \rightarrow [X/H]$, by descent for categories of quasi-coherent sheaves on algebraic stacks [Hol07], we have:

$$\text{QCoh}([X/H]) \cong \lim_{\Delta} \text{QCoh}([\mathcal{U}_\bullet/H]) .$$

3. Dynamical character varieties

On the right, the bilimit is computed in $\text{Pres}_{\mathbb{K}}$ over the cosimplicial diagram coming from the Čech nerve of the cover. Moreover, we have:

$$\text{QCoh}([U/H]) \cong \prod_a \mathcal{O}(U_a)\text{-Mod}_{\text{Rep}(H)} \quad .$$

Let's now specialize to the case where $X = V_1 \times \cdots \times V_k \times G^E$, $H = H_1 \times \cdots \times H_k$ and $U = \mathcal{U}_1 \times \cdots \times \mathcal{U}_k \times G^E$. By Theorem 3.3.3 we find that for any element $\Pi_i U_{\underline{a}_n}^i$ in the nerve of the cover we have an equivalence

$$\begin{aligned} \int_{\Sigma(\Gamma, \{v_1, \dots, v_k\})} \left(\text{Rep}(G), \{ \mathcal{O}(U_{\underline{a}_n}^i)\text{-Mod}_{\text{Rep}(H_i)} \}_{i=1, \dots, k} \right) \\ \cong \bigotimes_{i=1}^k \mathcal{O}(U_{\underline{a}_n}^i) \otimes \mathcal{O}(G)^{\otimes E}\text{-Mod}_{\text{Rep}(H_1 \times \cdots \times H_k)} \quad , \end{aligned}$$

from which Equation (3.66) follows. In the above we used that $\text{Rep}(H_i) \cong \mathcal{O}(H_i)\text{-Comod}$ and $\mathcal{O}(H_1)\text{-Comod} \boxtimes \cdots \boxtimes \mathcal{O}(H_k)\text{-Comod} \cong \mathcal{O}(H_1 \times \cdots \times H_k)\text{-Comod}$ [EGNO15, Proposition 1.11.2]. \square

Quantum dynamical character stack Let us now restrict to the special case where $H \subset G$ is a maximal torus. Let $H^{\text{reg}} \subset H$ be the open subset where the dynamical twist $\mathcal{J}_h(\lambda)$ is regular. Note for every open subset $V \subset H^{\text{reg}}$, the algebra $\mathcal{O}(V)[[\hbar]]$ is again a $U_{\hbar}(\mathfrak{h})$ -base algebra with the $U_{\hbar}(\mathfrak{h})$ -comodule structure from Example 3.2.5. The following composition

$$\widehat{\text{Rep}}_h(G)^{\text{fd}} \longrightarrow \widehat{\text{Rep}}_h(H)^{\text{fd}} \xrightarrow{\text{free}_{\mathcal{O}(V)[[\hbar]]}} \mathcal{O}(V)[[\hbar]]\text{-Mod}_{\widehat{\text{Rep}}_h(H)^{\text{fd}}}$$

with monoidal structure coming from the dynamical twist $\mathcal{J}_h(\lambda) \in \mathcal{O}(V)[[\hbar]] \otimes U_{\hbar}(\mathfrak{g})^{\otimes 2}$ is thus a dynamical point defect (see Example 3.2.38). Keeping the same notation as in the previous section, we define the quantum dynamical character stack by:

$$\begin{aligned} \text{QCoh}_h(\mathbf{Char}_{\text{dyn}}(\Gamma, G)) \\ = \lim_{[n] \in \Delta} \prod_{\underline{a}_n, \dots, \underline{a}_n^k} \int_{(\Sigma, \{v_1, \dots, v_k\})} \left(\widehat{\text{Rep}}_h(G), \{ \mathcal{O}(U_{\underline{a}_n}^i)[[\hbar]]\text{-Mod}_{\widehat{\text{Rep}}_h(H)} \}_{i=1, \dots, k} \right) \quad . \end{aligned}$$

Going forward, we would like to characterize the quantum character stack in terms of categories of modules over the algebras $a_{\lambda_1, \dots, \lambda_k}^P$ defined on a cover of H^{reg} . To that end, we will have to develop monadic reconstruction techniques for factorization homology in the $\mathbb{C}[[\hbar]]$ -linear setting.

3.4.3. Chern–Simons theory with sources

In [BR05], Buffenoir–Roche study the quantization of Chern–Simons (CS) theory coupled to dynamical sources. By carrying out a Hamiltonian analysis for the classical CS-action functional coupled to a source term, Buffenoir–Roche find Poisson algebras of dynamical holonomies expressed in terms of classical dynamical r-matrices of trigonometric type, leading to the appearance of dynamical quantum groups upon quantization of the theory. The resulting quantum algebras and their representations were independently studied in [BF96]. The goal of this section is to understand the Poisson algebras found by Buffenoir–Roche and their quantization from a factorization homology point of view.

3. Dynamical character varieties

CS-action functional with sources Let $\Sigma = \Sigma_{0,k}$ be the sphere with k punctures v_1, \dots, v_k . The latter represent point-like sources in the spatial slice Σ . Let $\mathfrak{h} \subset \mathfrak{g}$ be a Cartan subalgebra of a semi-simple Lie algebra. To each v_i , one assigns a regular semi-simple element $\chi_i \in \mathfrak{h}$. Let $\mathcal{M} \cong \Sigma \times [0, 1]$, so that the mapping $v_i: [0, 1] \rightarrow \mathcal{M}$ may be interpreted as the world-line of the i -th particle. The action for the point-like sources coupled to Chern–Simons theory with symmetry group G is given by

$$\mathcal{S}[A, M_1, \dots, M_r] = \theta \int_{\mathcal{M}} \langle A \wedge dA + \frac{2}{3} A \wedge A \wedge A \rangle + \sum_{i=1}^p \int_{t_1}^{t_2} \langle \chi_i, M_i^{-1} (\frac{d}{dt} + A|_{x_i}) M_i \rangle dt \ ,$$

where $\langle -, - \rangle$ is the Killing form of \mathfrak{g} , $\theta \in \mathbb{R}$ is the coupling constant, $A \in \Omega^1(\mathcal{M}, \mathfrak{g})$ is the connection 1-form and the $M_i: [0, 1] \rightarrow G$ are the dynamical variables. Buffenoir–Roche regularize the action functional \mathcal{S} at the location of the sources, which involves removing a small disk \mathbb{D}_i containing the puncture v_i for each $i = 1, \dots, k$. We will write $\bar{\Sigma}$ for the resulting surface. We refer to [BR05, Section 3.1] for details on the regularization procedure. Subsequently, a Hamiltonian analysis of the regularized action functional is carried out, leading to the Poisson algebras described in what follows.

Dynamical boundary-boundary holonomies Adopting the notation of [BR05], let $(\lambda^j)_{j \in I}$ be a basis of \mathfrak{h} and $(h_{\alpha_j})_{j \in I}$ its dual with respect to the Killing form $\langle -, - \rangle$. For each $i = 1, \dots, k$, let x_i be a marked point on the boundary component $\partial_i \bar{\Sigma} \cong \mathbb{S}^1$ and fix $(k-1)$ paths γ_i going from x_1 to x_i . Then, $\bar{\Sigma}^\circ = \bar{\Sigma} \setminus \mathbb{D}$ is the punctured disk as pictured in Figure 3.8a. The orientation of $\bar{\Sigma}^\circ$ induces a linear ordering \prec on the set of curves. After relabeling of the marked points, one can assume that $\gamma_2 \prec \dots \prec \gamma_k$. Let $U_i \subset \mathfrak{h}$ be a neighborhood of $\chi_i \in \mathfrak{h}$. Buffenoir–Roche compute the Poisson brackets for the algebra of matrix coefficients of the holonomies along the curves γ_i and the coordinate functions

$$\langle h_{\alpha_j}, - \rangle_i: U_i \rightarrow \mathbb{C}, \quad \tilde{\chi}_i \mapsto \langle h_{\alpha_j}, (\tilde{\chi}_i)_{\alpha_l} \lambda^l \rangle = (\tilde{\chi}_i)_{\alpha_j} \ ,$$

on the $U_i \subset \mathfrak{h}$ assigned to the sources. The Poisson algebra of *dynamical boundary-boundary holonomies* from [BR05, Section 3.2] is (the notation is adapted to match our conventions)

$$\begin{aligned} \{V(l), \langle h_{\alpha_j}, - \rangle_1\} &= h_{\alpha_j}^L \triangleright V(l), \quad \{V(l), \langle h_{\alpha_j}, - \rangle_i\} = -\delta_{i,l} \left(h_{\alpha_j}^R \triangleright V(l) \right) \\ \{V(i), V(j)\} &= -r_{2,1}^\theta(\tilde{\chi}_1)^{L,L} \triangleright V(j) \otimes V(i), \quad \text{for } i < j \\ \{V(i), V'(i)\} &= \left(\omega^\theta(\tilde{\chi}_1)^{L,L} + \omega^\theta(\tilde{\chi}_i)^{R,R} \right) \triangleright V(i) \otimes V'(i) \end{aligned} \quad (3.67)$$

where $V(i), V'(i) \in \mathcal{O}(G)$ are matrix coefficients for the holonomies along γ_i and $\omega^\theta(\tilde{\chi})$ is the anti-symmetric part of the trigonometric solution

$$r^\theta(\tilde{\chi}) = \frac{1}{4\theta} \left(t + \sum_{\alpha \in \Delta^+} e_\alpha \wedge e_{-\alpha} \left(\frac{2}{e^{\frac{\tilde{\chi}(\alpha)}{2\theta}} - 1} + 1 \right) \right) \quad (3.68)$$

to the classical DYBE over the commutative base \mathfrak{h} with coupling constant $\epsilon = \frac{1}{2\theta}$. In the above, $\frac{1}{4\theta}t$ is the symmetric part of the standard solution of the ordinary Yang–Baxter equation. Note that for each $i = 1, \dots, k$ the dynamical r-matrix $r(\tilde{\chi}_i)$ is considered as a holomorphic function on the open subsets $U_i \subset \mathfrak{h}$ containing the fixed elements $\chi_i \in U_i$.

3. Dynamical character varieties

We may regard the algebra of dynamical boundary-boundary holonomies as the algebra of functions on the following dynamical representation variety

$$\text{Rep}_{\text{dyn}}(G, \mathbb{S}^2 \setminus \mathbb{D}, \{v_1, \dots, v_k\}) = \prod_{i=1}^k U_i \times G^{\times k-1} \quad ,$$

equipped with the Poisson bracket (3.67). We want to stress that in the work of Buffenoir–Roche, the classical dynamical r-matrices were not part of the input data, but appear naturally when carrying out the Hamiltonian analysis.

Dynamical bulk-boundary holonomies As before, let $\bar{\Sigma}^\circ = \bar{\Sigma} \setminus \mathbb{D}$ and let $x_0 \in \partial \bar{\Sigma}^\circ$ be a marked interval in the new boundary component. The surface $\bar{\Sigma}^\circ$ may be described by a ciliated ribbon graph with edges given by k paths $\tilde{\gamma}_i$ running from x_i to the distinguished vertex x_0 , see Figure 3.8b. Up to relabeling of the marked points, we may assume that the linear ordering is $\tilde{\gamma}_1 \prec \dots \prec \tilde{\gamma}_k$. Buffenoir–Roche compute the Poisson brackets for the resulting algebra of *dynamical bulk-boundary holonomies* given by matrix coefficients of the holonomies along the paths $\tilde{\gamma}_i$ and the coordinate functions on the $\{U_i\}_{i=1, \dots, k}$ assigned to the sources. The resulting brackets are

$$\begin{aligned} \{W(l), \langle h_{\alpha_j}, - \rangle_i\} &= \delta_{l,i} \left(h_{\alpha_j}^L \triangleright W(l) \right) \\ \{W(i), W(j)\} &= -(r_{2,1}^\theta)^{R,R} \triangleright W(i) \otimes W(j), \quad \text{for } i < j \\ \{W(i), W'(i)\} &= \left(\omega^\theta(\tilde{\chi}_i)^{L,L} + (\omega^\theta)^{R,R} \right) \triangleright W(i) \otimes W'(i) \end{aligned} \quad (3.69)$$

where $W(i), W'(i) \in \mathcal{O}(G)$ are matrix coefficients for the holonomies along $\tilde{\gamma}_i$ and $r^\theta = \omega^\theta + \frac{1}{4\theta}t$ is the standard solution to the ordinary Yang–Baxter equation, again with coupling constant $\epsilon = \frac{1}{2\theta}$.

Flatness In order to obtain the algebra $\text{Hol}(\mathbb{S}^2, \{v_1, \dots, v_k\})$ of dynamical holonomies on the punctured sphere $(\mathbb{S}^2, \{v_1, \dots, v_k\})$, an additional flatness condition has to be imposed. This is done in [BR05] by taking the Poisson algebra of dynamical boundary-boundary holonomies (3.67) and modding out the Poisson ideal generated by $(Y - 1)$,



(a) Combinatorial presentation of $\bar{\Sigma} \setminus \mathbb{D}$ used to compute the algebra of dynamical boundary-boundary holonomies.

(b) Combinatorial presentation of $\bar{\Sigma} \setminus \mathbb{D}$ used to compute the algebra of dynamical bulk-boundary holonomies.

Figure 3.8.

3. Dynamical character varieties

where

$$\Upsilon = e^{\frac{-\tilde{\chi}_1}{2\theta}} \prod_{j=k}^2 V(j)^{-1} e^{\frac{-\tilde{\chi}_j}{2\theta}} V(j), \quad \tilde{\chi}_i \in U_i .$$

The second approach laid out in [BR05] is to start from the Poisson algebra of dynamical bulk-boundary holonomies (3.69). To that end, it will be convenient to use the following presentation for the dynamical bulk-boundary holonomies:

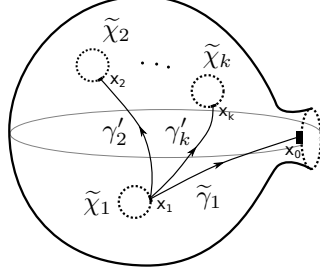

There is a natural G -action on the holonomies along $\tilde{\gamma}_1$ by left multiplication. Taking invariants with respect to this action, one obtains the algebra (3.67) of dynamical boundary-boundary holonomies. Subsequently, one imposes the flatness constraint to recover the algebra $\text{Hol}(\mathbb{S}^2, \{v_1, \dots, v_k\})$.

Quantum algebras In [BR05], a quantization of the Poisson algebras (3.67) and (3.69) is obtained by means of a quantization of the classical dynamical r -matrix defining the Poisson brackets. Such a quantization is provided by the dynamical twist $\mathcal{J}(\lambda)$ from [ABRR98, EV99], or more precisely by the dynamical quantum R -matrix defined by it

$$\mathcal{R}(\lambda) = \mathcal{J}(\lambda)_{2,1}^{-1} \mathcal{R} \mathcal{J}(\lambda), \quad \mathcal{R}(\lambda) = 1 + \hbar r(\lambda) + \mathcal{O}(\hbar^2) .$$

In a first step, Buffenoir–Roche quantize the algebra of dynamical boundary-boundary and bulk-boundary holonomies and in a second step implement the conditions of flatness of the connection. With the framework established in this chapter, quantization of the dynamical algebras of boundary-boundary and bulk-boundary holonomies (before implementing the flatness constraint) can also be understood via factorization homology on a marked surface, as stated in Proposition 3.4.8 below. Implementing the flatness constraint will be content of future work.

Let $(\Sigma^\circ, \{\blacksquare, v_1, \dots, v_k\})$ be the surface $\Sigma^\circ = \mathbb{S}^2 \setminus \mathbb{D}$ with k marked points $v_i \in \Sigma^\circ$ and a marked interval $\blacksquare \in \partial\Sigma^\circ$ in its boundary. We choose a gluing pattern as sketched in Figure 3.10 as a combinatorial model for the marked surface.

Categorically, we describe the marked points v_i by the dynamical point defects from Example 3.2.38, that is, to the bulk we assign the free-cocompletion of $\text{Rep}_\hbar(G)^{\text{fd}}$, and the defects are governed by the quasi-reflection datum³ $(\mathcal{J}(\lambda)_{2,1}, B(\lambda))$ for the pair $U_\hbar(\mathfrak{h}) \subset U_\hbar(\mathfrak{g})^{\text{op}}$. Let $a_{\blacksquare, \lambda_1, \dots, \lambda_k}^P$ be the algebra computed via factorization homology on $(\Sigma^\circ, \{\blacksquare, v_1, \dots, v_k\})$ as in Remark 3.3.4. We have

$$a_{\blacksquare, \lambda_1, \dots, \lambda_k}^P \cong \mathcal{O}(H^{\text{reg}})[[\hbar]]^{\otimes k} \otimes \mathcal{O}_\hbar(G)^{\otimes k+1}$$

where the right hand-side should be understood as the image under the restricted Yoneda embedding of topologically-free and locally-finite $U_\hbar(\mathfrak{h})^{\otimes k} \otimes U_\hbar(\mathfrak{g})$ -modules. For each

³For the quasi-reflection datum to define a dynamical point defect, we have to define $\text{Rep}_\hbar(G)^{\text{fd}}$ to be the category of $U_\hbar(\mathfrak{g})$ -modules with opposite coproduct Δ^{op} and universal R -matrix $(\mathcal{R}_\hbar)_{2,1}$

3. Dynamical character varieties

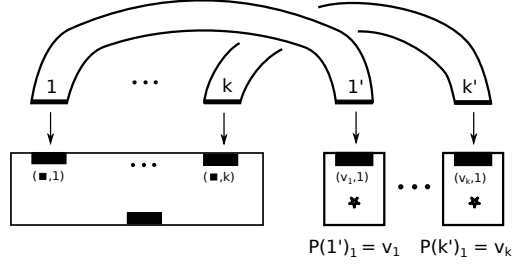

Figure 3.9.: Gluing pattern for surface $S^2 \setminus \mathbb{D}$ with marked points $\{v_1, \dots, v_k\}$.

$i = 1, \dots, k$, let $U_i \subset \mathfrak{h}$ be a neighborhood of χ_i chosen such that the exponential map $\exp: U_i \rightarrow \exp(U_i)$ is an isomorphism. In order to relate the formalism established in this chapter to the quantization of the Poisson algebras described in [BR05], we have to work in the complex analytic setting. To that end, we consider the algebra morphisms

$$f_{U_i}: \mathcal{O}(H^{\text{reg}})[[\hbar]] \rightarrow \mathcal{O}(H^{\text{reg}})^{\text{an}}[[\hbar]] \xrightarrow{(\iota \circ \exp)^*} \mathcal{O}(U_i)^{\text{an}}[[\hbar]], \quad i = 1, \dots, k$$

where $\iota: \exp(U_i) \subset H^{\text{reg}}$. The algebra $\mathcal{O}(U_i)^{\text{an}}[[\hbar]]$ is again a $U_{\hbar}(\mathfrak{h})$ -algebra with coaction

$$\delta_{\hbar}^R: f(e^\lambda) \mapsto \sum_{n=0}^{\infty} \frac{(-\hbar)^n}{n!} \frac{\partial^n f(e^\lambda)}{\partial \lambda^{i_1} \dots \partial \lambda^{i_n}} \otimes h_{\alpha_{i_1}} \cdots h_{\alpha_{i_n}}$$

where $(\lambda^i)_{i \in I}$ is a basis for \mathfrak{h} and $(h_{\alpha_i})_{i \in I}$ its dual with respect to the Killing form $\langle -, - \rangle$. We define the algebras

$$a_{\hbar, \blacksquare, U_1, \dots, U_k}^{P, \text{an}} = \bigotimes_{i=1}^k \mathcal{O}(U_i)^{\text{an}}[[\hbar]] \otimes \mathcal{O}_{\hbar}(G)^{\otimes k+1}$$

as the image of $a_{\hbar, \blacksquare, \lambda_1, \dots, \lambda_k}^P$ under the induction functor along the f_{U_i} . With this setup, we find the following:

Proposition 3.4.8. *The algebra $a_{\hbar, \blacksquare, U_1, \dots, U_k}^{P, \text{an}}$ is a quantization of the Poisson algebra (3.69) of bulk-boundary holonomies.*

Proof. By Theorem 3.4.3, we have that $a_{\hbar, \blacksquare, \lambda_1, \dots, \lambda_k}^P$ is a deformation quantization of the dynamical Fock–Rosly Poisson structure Π_{FR} from Theorem 3.1.10 on $(H^{\text{reg}})^{\times k} \times G^{\times k}$. Let $\mathcal{J}(\lambda)$ be the dynamical twist used to defined the dynamical point defects. When pulled-back along the composition $\iota \circ \exp$, its semi-classical limit is $\mathcal{J}(\tilde{\chi}_i) = 1 + \hbar r(\tilde{\chi}_i) + \mathcal{O}(\hbar^2)$, with classical dynamical r-matrix as defined in (3.68). We claim that the isomorphism $\exp^{-1} \times \text{id}: (\Pi_i \exp(U_i) \times G^k, \Pi_{FR}) \xrightarrow{\cong} (\Pi_i U_i \times G^k, (3.69))$ is one of Poisson algebras. To that end, we have to consider the following three cases.

- $\langle h_{\alpha_j}, - \rangle_i \in \mathcal{O}(U_i)$ and $W(i) \in \mathcal{O}(G)$:

By Theorem 3.1.10 we have (see (3.15)):

$$\begin{aligned} \{W(i), \langle h_{\alpha_j}, - \rangle_i \circ \exp^{-1}\}_{\Pi_i \exp(U_i) \times G^k} &= - \sum_l \left(\overrightarrow{\eta}^l \cdot \langle h_{\alpha_j}, - \rangle_i \circ \exp^{-1} \right) (h_{\alpha_l}^L \triangleright W(i)) \\ &= - \sum_l \left((\lambda^l)^L \triangleright \langle h_{\alpha_j}, - \rangle_i \circ \exp^{-1} \right) (h_{\alpha_l}^L \triangleright W(i)) \\ &= \delta_{lj} h_{\alpha_l}^L \triangleright W(i) \quad , \end{aligned}$$

3. Dynamical character varieties

where we took into account that here we consider the algebra $a_{\blacksquare, \lambda_1, \dots, \lambda_k}^P$ defined in terms of the opposite coproduct for $U_{\hbar}(\mathfrak{g})$. The above agrees with the pullback of the bracket $\{W(l), \langle h_{\alpha_j}, - \rangle_i\}$ from (3.69).

- $W(i), W(j) \in \mathcal{O}(G)$ with $i < j$:

For the linear ordering $\tilde{\gamma}_i \prec \tilde{\gamma}_j$ we find (see (3.16)):

$$\{W(i), W(j)\} = -r_{2,1}^{R,R} \triangleright (W(i) \otimes W(j))$$

which agrees with the bracket from (3.69).

- $W(i), W'(i) \in \mathcal{O}(G)$:

We have (see (3.16)):

$$\{W(i), W'(i)\} = (\omega(\tilde{\chi}_i)^{L,L} + \omega(\tilde{\chi}_i)^{R,R}) \triangleright (W(i) \otimes W'(i))$$

where $\omega(\tilde{\chi}_i)$ is the antisymmetric part of the dynamical r-matrix (3.68), and therefore agrees with the bracket defined in (3.69). \square

Remark 3.4.9. *The case of the dynamical boundary-boundary holonomies can be worked out analogously, starting from a marked surface $(\Sigma^\circ, \{v_1, \dots, v_k\})$ without marked point in the boundary.*

Outlook In this chapter, we have computed factorization homology with dynamical point defects on surfaces having at least one boundary component. If we want to implement the flatness constraint for the quantum algebras of dynamical holonomies described in this section, we will have to extend our framework to include marked surfaces without boundary. Most of the tools to do so have been previously developed in [BZBJ18b]. For example, for an unmarked closed surface Σ it was shown in [BZBJ18b, Theorem 5.4] that there is an isomorphism

$$\text{End}(\mathcal{O}_\Sigma) \cong \text{Hom}_{\text{Rep}_q(G)}(1, A_{\Sigma^\circ} \otimes_{\mathcal{O}_q(G)} 1)$$

between the endomorphism algebra of the distinguished object \mathcal{O}_Σ of the surface and the quantum Hamiltonian reduction of the algebra A_{Σ° associated to the surface $\Sigma^\circ = \Sigma \setminus \mathbb{D}$ along the canonical quantum moment map $\mu: \mathcal{O}_q(G) \rightarrow A_{\Sigma^\circ}$ (see also § 2.5).

For the situation at hand, we can present the closed marked surface $\{v_1, \dots, v_k\} \subset \mathbb{S}^2$ by the collar-gluing depicted in Figure 3.10. Describing the quantum algebra of dynamical holonomies for the marked sphere via factorization homology will involve finding an explicit quantum moment map $\mu: \mathcal{O}_q(G) \rightarrow A_{(\mathbb{S}^2)^\circ_{v_1, \dots, v_k}}$ induced by the embedding of the annulus into the marked boundary component.

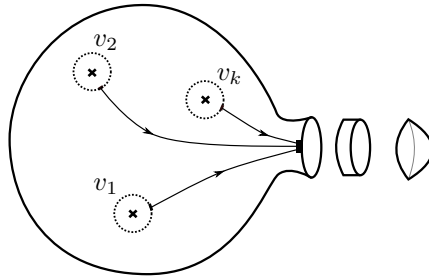

Figure 3.10.: Collar-gluing for marked surface $(\mathbb{S}^2, \{v_1, \dots, v_k\})$.

A. Background material on enriched presentable categories

The material presented in this appendix is part of joint work in progress with Eilind Karlsson, Lukas Müller and Jan Pulmann on categorical deformation quantization via factorization homology [KKMP].

A.1. The 2-category \mathcal{V} -Cat

Throughout \mathcal{V} is a complete and cocomplete closed symmetric monoidal category. For a \mathcal{V} -enriched category \mathcal{C} we write $\mathbf{Map}_{\mathcal{C}}(c, c') \in \mathcal{V}$ for the \mathcal{V} -object of morphisms from c to c' . Given a morphism $f: 1_{\mathcal{V}} \rightarrow \mathbf{Map}_{\mathcal{C}}(c, c')$ precomposition with f is the map $f^*: \mathbf{Map}_{\mathcal{C}}(c', d) \rightarrow \mathbf{Map}_{\mathcal{C}}(c, d)$ in \mathcal{V} defined by

$$\mathbf{Map}_{\mathcal{C}}(c', d) \xrightarrow{\cong} 1_{\mathcal{V}} \otimes \mathbf{Map}_{\mathcal{C}}(c', d) \xrightarrow{f \otimes \text{id}} \mathbf{Map}_{\mathcal{C}}(c, c') \otimes \mathbf{Map}_{\mathcal{C}}(c', d) \xrightarrow{\text{comp}} \mathbf{Map}_{\mathcal{C}}(c, d) .$$

Postcomposition f_* is defined in a similar way.

We denote by $\mathcal{V}\text{-Cat}$ the 2-category of \mathcal{V} -enriched categories whose

- objects are \mathcal{V} -categories
- 1-morphisms are \mathcal{V} -functors $F: \mathcal{C} \rightarrow \mathcal{D}$ consisting of a function $\text{Ob}(\mathcal{C}) \rightarrow \text{Ob}(\mathcal{D})$ together with morphisms

$$F_{c,c'}: \mathbf{Map}_{\mathcal{C}}(c, c') \longrightarrow \mathbf{Map}_{\mathcal{D}}(F(c), F(c'))$$

in \mathcal{V} , satisfying the obvious compatibility with composition and units.

- 2-morphisms are \mathcal{V} -natural transformations $\alpha: F \Rightarrow G$ between $F, G: \mathcal{C} \rightarrow \mathcal{D}$, with components $\alpha_c: 1_{\mathcal{V}} \rightarrow \mathbf{Map}_{\mathcal{D}}(F(c), G(c))$, for every $c \in \mathcal{C}$, making the following diagram commute

$$\begin{array}{ccc} \mathbf{Map}_{\mathcal{C}}(c, c') & \xrightarrow{F_{c,c'}} & \mathbf{Map}_{\mathcal{D}}(F(c), F(c')) \\ G_{c,c'} \downarrow & & \downarrow (\alpha_{c'})_* \\ \mathbf{Map}_{\mathcal{D}}(G(c), G(c')) & \xrightarrow{\alpha_c^*} & \mathbf{Map}_{\mathcal{D}}(F(c), G(c')) \end{array}$$

The set of \mathcal{V} -natural transformations $\alpha: F \Rightarrow G$ will be denoted by $\mathcal{V}\text{-Nat}(F, G)$.

The 2-category $\mathcal{V}\text{-Cat}$ admits a natural tensor product: for two \mathcal{V} -categories \mathcal{C}, \mathcal{D} define $\mathcal{C} \times \mathcal{D}$ to be the \mathcal{V} -category whose

- objects are pairs $(c, d) \in \text{Ob}(\mathcal{C}) \times \text{Ob}(\mathcal{D})$
- morphisms are defined to be the following objects in \mathcal{V} :

$$\mathbf{Map}_{\mathcal{C} \times \mathcal{D}}((c, d), (c', d')) = \mathbf{Map}_{\mathcal{C}}(c, c') \otimes \mathbf{Map}_{\mathcal{D}}(d, d') .$$

A. Background material on enriched presentable categories

In [Kel05, Section 2.3] it is shown that the 2-category $\mathcal{V}\text{-Cat}$ is closed under the tensor product \times , i.e. there is an equivalence of categories

$$\mathrm{Hom}_{\mathcal{V}\text{-Cat}}(\mathcal{C} \times \mathcal{D}, \mathcal{E}) \cong \mathrm{Hom}_{\mathcal{V}\text{-Cat}}(\mathcal{C}, [\mathcal{D}, \mathcal{E}]) \quad ,$$

2-natural in the \mathcal{V} -categories $\mathcal{C}, \mathcal{D}, \mathcal{E}$. In the above, $[\mathcal{D}, \mathcal{E}]$ is the \mathcal{V} -category whose

- objects are \mathcal{V} -functors $F: \mathcal{D} \rightarrow \mathcal{E}$
- morphisms are defined by the objects

$$\mathcal{V}\text{-Nat}(F, G) = \int_{d \in \mathcal{D}} \mathrm{Map}_{\mathcal{D}}(F(d), G(d)) \in \mathcal{V} \quad ,$$

where the right hand side is a \mathcal{V} -enriched end.

Note that the set of \mathcal{V} -natural transformations $F \Rightarrow G$ is $\mathrm{Hom}_{\mathcal{V}}(1_{\mathcal{V}}, \mathcal{V}\text{-Nat}(F, G))$.

A.1.1. Example of enriching category: complete $\mathbb{C}[[\hbar]]$ -modules

Let M be a left module over $\mathbb{C}[[\hbar]]$. Consider the submodules $(\hbar^n M)_{n \in \mathbb{N}}$ and denote $M_n = M/\hbar^n M$. There are canonical projections

$$p_n: M_n \longrightarrow M_{n-1} \quad ,$$

and $(M_n, p_n)_{n \in \mathbb{N}}$ is an inverse system of $\mathbb{C}[[\hbar]]$ -modules. Hence, we can consider the inverse limit

$$\widehat{M} = \varprojlim_n M_n = \left\{ (x_n) \in \prod_n M_n \mid p_n(x_n) = x_{n-1} \right\} \quad .$$

The left $\mathbb{C}[[\hbar]]$ -module \widehat{M} is called the \hbar -adic completion of M .

Definition A.1.1. *The $\mathbb{C}[[\hbar]]$ -module M is complete if the canonical map $M \rightarrow \widehat{M}$ is an isomorphism.*

For lighter notation, denote $K = \mathbb{C}[[\hbar]]$. Let $\widehat{K\text{-Mod}}$ be the category of \hbar -adically complete K -modules and $\widehat{(-)}$ the completion functor, sending an K -module to $\widehat{M} = \varprojlim_n M/\hbar^n M$.

Proposition A.1.2. *[Pos17, Theorem 5.8] $\iota: \widehat{K\text{-Mod}} \hookrightarrow K\text{-Mod}$ is a reflective subcategory, where the left adjoint to the inclusion¹ ι is given by the completion functor $\widehat{(-)}$. In particular, $\widehat{K\text{-Mod}}$ is complete and cocomplete. Limits are calculated in $K\text{-Mod}$, and colimits are calculated by completing the colimits in $K\text{-Mod}$.*

Proof. Let $M \in K\text{-Mod}$ and $C \in \widehat{K\text{-Mod}}$. We have the following sequence of bijections

$$\begin{aligned} \mathrm{Hom}_{K\text{-Mod}}(M, C) &\cong \{\mathrm{Hom}_{K\text{-Mod}}(M/\hbar^n M, C/\hbar^n C)\}_{n \geq 1} \\ &\stackrel{(*)}{\cong} \{\mathrm{Hom}_{K\text{-Mod}}(\widehat{M}/\hbar^n \widehat{M}, C/\hbar^n C)\}_{n \geq 1} \\ &\cong \mathrm{Hom}_{\widehat{K\text{-Mod}}}(\widehat{M}, C) \quad . \end{aligned}$$

The first equivalence is due to the fact that giving a map $M \rightarrow C$ is equivalent to specifying a family of maps $\{M \rightarrow C/\hbar^n C\}_{n \geq 1}$, since $C \cong \widehat{C}$. For each n , the $\mathbb{C}[[\hbar]]$ -module map $M \rightarrow C/\hbar^n C$ factors through $M \rightarrow M/\hbar^n M$. For $(*)$ one uses that $\hbar^n \widehat{M} = \mathrm{Ker}(\widehat{M} \rightarrow M/\hbar^n M)$ [Sta21, Lemma 10.96.3, Tag 00M9]. \square

¹In what follows, we will usually suppress ι from the notation.

A. Background material on enriched presentable categories

Write $\otimes = \otimes_K$. Let M and N be two K -modules. We define their tensor product as the \hbar -adic completion of $M \otimes N$:

$$\begin{aligned} M \widehat{\otimes} N &= \widehat{M \otimes N} \\ &= \varprojlim_{n>0} (M \otimes N) / \hbar^n (M \otimes N) \quad . \end{aligned}$$

Proposition A.1.3. $(\widehat{K\text{-Mod}}, \widehat{\otimes})$ is a symmetric monoidal closed category.

Proof. We will first show that if C is a \hbar -adically complete module then $\text{Hom}_{K\text{-Mod}}(M, C)$ is \hbar -adically complete. To that end, first assume that M is a finitely presented K -module. Choose a representation $K^m \rightarrow K^n \rightarrow M \rightarrow 0$, applying $\text{Hom}_{K\text{-Mod}}(-, C)$ we get an exact sequence

$$0 \longrightarrow \text{Hom}_{K\text{-Mod}}(M, C) \longrightarrow C^m \longrightarrow C^n \quad .$$

Since $\widehat{K\text{-Mod}}$ is closed under products and kernels, $\text{Hom}_{K\text{-Mod}}(M, C)$ is complete. Moreover, every module is a colimit over its finitely presented submodules, and so we have that

$$\text{Hom}_{K\text{-Mod}}(N, C) = \text{Hom}_{K\text{-Mod}}(\text{colim}_i N_i, C) = \lim_i \text{Hom}_{K\text{-Mod}}(N_i, C)$$

is complete.

By Proposition A.1.2 we then have for $M, N, C \in \widehat{K\text{-Mod}}$

$$\begin{aligned} \text{Hom}_{\widehat{K\text{-Mod}}}(M \widehat{\otimes} N, C) &\cong \text{Hom}_{K\text{-Mod}}(M \otimes N, C) \\ &\cong \text{Hom}_{K\text{-Mod}}(M, \text{Hom}_{K\text{-Mod}}(N, C)) \\ &\cong \text{Hom}_{\widehat{K\text{-Mod}}}(M, \text{Hom}_{K\text{-Mod}}(N, C)) \quad . \end{aligned}$$

□

A.2. Locally presentable enriched categories

The definition of locally presentable categories dates back to the work of Gabriel and Ulmer [GU71]. Its generalization to the enriched world was done in [Kel82] and further developed in [BQR98]. Here, we will recall some of the main definitions that allow generalizations of fundamental results for locally presentable categories to the enriched context.

A.2.1. Basic definitions

Let α_0 be a regular cardinal. A symmetric monoidal closed category \mathcal{V} is said to be a *locally α_0 -presentable base category* if \mathcal{V} is locally α_0 -presentable as an ordinary category and the full subcategory of α_0 -compact objects is closed under the monoidal product and must contain the monoidal unit. When working over such \mathcal{V} , there is a good theory of locally α -presentable enriched categories for any $\alpha \geq \alpha_0$.

Throughout we fix a locally α_0 -presentable base \mathcal{V} and a regular cardinal $\alpha \geq \alpha_0$. Recall that in the unenriched setting, an object $c \in \mathcal{C}$ is called *α -compact* if $\text{Hom}_{\mathcal{C}}(c, -)$ preserves α -filtered colimits. In order to define the notion of an α -compact object in the enriched world, we will use the following:

Definition A.2.1. [BQR98, Definition 2.1] A weight $W: \mathcal{D} \rightarrow \mathcal{V}$ for a \mathcal{V} -limit or \mathcal{V} -colimit is α -small when

A. Background material on enriched presentable categories

- \mathcal{D} has strictly less than α objects
- for all objects $c, d \in \mathcal{D}$, the object $\mathrm{Map}_{\mathcal{D}}(c, d) \in \mathcal{V}$ is α -compact
- for every object $d \in \mathcal{D}$, the object $W(d) \in \mathcal{V}$ is α -compact

Definition A.2.2. [BQR98, Definition 2.3] A α -filtered \mathcal{V} -colimit is one that is indexed by a weight $W: \mathcal{D} \rightarrow \mathcal{V}$ whose left Kan extension along the Yoneda embedding $\mathrm{Lan}_Y W: [\mathcal{D}^{\mathrm{op}}, \mathcal{V}] \rightarrow \mathcal{V}$ preserves α -small \mathcal{V} -limits, that is, limits indexed by an α -small weight.

Let $\mathcal{C} \in \mathcal{V}\text{-Cat}$ and let $I: \mathcal{D} \rightarrow \mathcal{C}$ be a diagram. For a weight $W: \mathcal{D}^{\mathrm{op}} \rightarrow \mathcal{V}$ we will write $W * I$ for the W -weighted colimit of I . Similarly, for a weight $W': \mathcal{D} \rightarrow \mathcal{V}$ we write $\{W', I\}$ for the W' -weighted limit of I . For a diagram $J: \mathcal{D}' \times \mathcal{D} \rightarrow \mathcal{V}$ let $J_{\mathcal{D}}: \mathcal{D} \rightarrow [\mathcal{D}', \mathcal{V}]$ and $J_{\mathcal{D}'}: \mathcal{D}' \rightarrow [\mathcal{D}, \mathcal{V}]$ be its adjoints. We say that W -weighted colimits in \mathcal{V} commute with W' -weighted limits if the comparison morphism

$$W * \{W', J_{\mathcal{D}'}\} \longrightarrow \{W', W * J_{\mathcal{D}}\}$$

is an isomorphism.

Proposition A.2.3. In analogy to the unenriched case, α -filtered \mathcal{V} -colimits commute with α -small \mathcal{V} -limits in \mathcal{V} .

Proof. Let W be an α -filtered weight and W' an α -small weight. We have

$$\begin{aligned} W * \{W', J_{\mathcal{D}'}\} &\cong \mathrm{Lan}_Y W (\{W', J_{\mathcal{D}'}\}) \\ &\cong \{W', \mathrm{Lan}_Y W \circ J_{\mathcal{D}'}\} \\ &\cong \{W', W * J_{\mathcal{D}}\} \end{aligned}$$

where we used that $W * (-) \cong \mathrm{Lan}_Y W(-)$ [Kel05, Section 4.1]. □

Definition A.2.4. An object $c \in \mathcal{C}$ is called α -compact (in the enriched sense) if the functor

$$\mathrm{Map}_{\mathcal{C}}(c, -): \mathcal{C} \longrightarrow \mathcal{V}$$

preserves α -filtered \mathcal{V} -colimits. We say that $c \in \mathcal{C}$ is α -compact projective if $\mathrm{Map}_{\mathcal{C}}(c, -)$ preserves all colimits.

We will also need the notion of a strong \mathcal{V} -generator as defined in [Kel05, Section 3.6]:

Definition A.2.5. Let \mathcal{C} be a small \mathcal{V} -category and $F: \mathcal{A} \rightarrow \mathcal{B}$ a \mathcal{V} -functor. Define

$$\tilde{F}: \mathcal{B} \longrightarrow [\mathcal{A}^{\mathrm{op}}, \mathcal{V}], \quad \tilde{F}(b) = \mathrm{Map}_{\mathcal{B}}(F(-), b)$$

We say that F is strongly generating if \tilde{F} is conservative².

Now, the main definition in this section is the following [Kel82, BQR98]:

Definition A.2.6. A \mathcal{V} -category \mathcal{C} is locally α -presentable (as an enriched category) if it has all \mathcal{V} -colimits and admits a strongly \mathcal{V} -generating family $(X_i)_{i \in I}$ of α -compact objects.

²A \mathcal{V} -functor is said to be *conservative* if the underlying ordinary functor is conservative

A. Background material on enriched presentable categories

The main example for us will be the following: set $K = \mathbb{C}[[\hbar]]$ and let $\widehat{K\text{-Mod}}$ be the category of \hbar -adically complete modules from the previous section.

Proposition A.2.7. *The category $\widehat{K\text{-Mod}}$ is locally finitely ($\alpha = \aleph_0$) presentable as a category enriched over itself. As an ordinary category, $\widehat{K\text{-Mod}}$ is locally α -presentable for $\alpha > \aleph_0$.*

Proof. By Proposition A.1.3 we have that the adjunction $(-)\dashv\iota$ is $\widehat{K\text{-Mod}}$ -enriched. Since $\widehat{K\text{-Mod}} \hookrightarrow K\text{-Mod}$ is a reflective subcategory, weighted colimits in $\widehat{K\text{-Mod}}$ are computed by completing the ones in $K\text{-Mod}$.

The functor $\text{Hom}_{K\text{-Mod}}(K, -)$ is conservative since an isomorphism in $K\text{-Mod}$ is an isomorphism of the underlying vector space which is compatible with the K -action. By Proposition A.1.2 we have that $\text{Hom}_{\widehat{K\text{-Mod}}}(K, -) \cong \text{Hom}_{K\text{-Mod}}(K, -) \circ \iota$. Since ι is fully faithful the composite is conservative and K is a strong generator in $\widehat{K\text{-Mod}}$.

Finally we need to show that K is \aleph_0 -compact in the enriched sense. Let $W: \mathcal{D}^{\text{op}} \rightarrow \widehat{K\text{-Mod}}$ be a filtered weight and $F: \mathcal{D} \rightarrow \widehat{K\text{-Mod}}$ a diagram and write $\widehat{W * F}$ for its colimit in $\widehat{K\text{-Mod}}$. We have

$$\begin{aligned} \text{Map}_{\widehat{K\text{-Mod}}}(K, \widehat{W * F}) &\cong \text{Map}_{K\text{-Mod}}(K, \widehat{W * F}) \\ &\cong \widehat{W * F} \\ &\cong (W * \text{Map}_{\widehat{K\text{-Mod}}}(K, F))^\wedge \end{aligned}$$

showing that the unit K is compact in the enriched sense. However, K is only ($\alpha > \aleph_0$)-compact if we consider $\widehat{K\text{-Mod}}$ as an ordinary category. Indeed, for any α -filtered diagram $F: \mathcal{D} \rightarrow \widehat{K\text{-Mod}}$ of complete K -modules the following holds in $K\text{-Mod}$:

$$\begin{aligned} \widehat{\text{colim} F} &\cong \lim_{n \in \mathbb{N}} \text{colim} F / \hbar^n \text{colim} F \\ &\cong \text{colim}_{n \in \mathbb{N}} F / \hbar^n F \\ &\cong \text{colim} F \quad . \end{aligned}$$

We used that the completion functor is idempotent and that α -filtered colimits commute with finite limits. Hence for $\alpha > \aleph_0$ we have

$$\begin{aligned} \text{Map}_{\widehat{K\text{-Mod}}}(K, \widehat{\text{colim} F}) &\cong \text{Map}_{K\text{-Mod}}(K, \text{colim} F) \\ &\cong \text{colim} F \\ &\cong \text{colim} \text{Map}_{\widehat{K\text{-Mod}}}(K, F) \end{aligned}$$

showing that K is α -compact. □

We recall that for $\mathcal{C}, \mathcal{D} \in \mathcal{V}\text{-Cat}$, an *adjoint pair* $F \dashv G$ is a pair $F: \mathcal{C} \rightarrow \mathcal{D}$, $G: \mathcal{D} \rightarrow \mathcal{C}$ of \mathcal{V} -enriched functors, such that there is a \mathcal{V} -natural isomorphism

$$\text{Map}_{\mathcal{D}}(F(-), -) \cong \text{Map}_{\mathcal{C}}(-, G(-)) \quad .$$

One important feature of working with locally presentable \mathcal{V} -categories is the following:

Proposition A.2.8. *A cocontinuous \mathcal{V} -functor $F: \mathcal{C} \rightarrow \mathcal{D}$ between locally presentable \mathcal{V} -categories admits a right adjoint.*

A. Background material on enriched presentable categories

Proof. A locally α -presentable \mathcal{V} -category \mathcal{C} is equivalent to the \mathcal{V} -category

$$\mathbf{Lex}_\alpha(\mathcal{C}_\alpha^{\text{op}}, \mathcal{V}) \subset [\mathcal{C}_\alpha^{\text{op}}, \mathcal{V}]$$

of presheaves on the subcategory $\mathcal{C}_\alpha \subseteq \mathcal{C}$ of α -compact objects, preserving α -small limits [BQR98, Theorem 6.3]. We thus have the following commuting triangle

$$\begin{array}{ccc} \mathcal{C} & \xrightarrow{F} & \mathcal{D} \\ & \searrow \cong & \nearrow \tilde{F} \\ & \mathbf{Lex}_\alpha(\mathcal{C}_\alpha^{\text{op}}, \mathcal{V}) & \end{array}$$

where the \mathcal{V} -equivalence is induced by the restricted Yoneda embedding

$$\mathcal{C} \rightarrow [\mathcal{C}_\alpha^{\text{op}}, \mathcal{V}], \quad c \mapsto \mathbf{Map}_{\mathcal{C}}((-)|_{\mathcal{C}_\alpha}, c) .$$

It is shown in [Kel05, Theorem 4.51] that a cocontinuous functor $\tilde{F}: [\mathcal{C}_\alpha^{\text{op}}, \mathcal{V}] \rightarrow \mathcal{D}$ has a right adjoint defined by

$$\tilde{F}^R(d) = \mathbf{Map}_{\mathcal{D}}(\tilde{F} \circ Y(-), d) ,$$

where $Y: \mathcal{C}_\alpha \rightarrow [\mathcal{C}_\alpha^{\text{op}}, \mathcal{V}]$ is the Yoneda embedding. The image of \tilde{F}^R preserve α -small limits because F is cocontinuous, thus factoring through $\mathbf{Lex}_\alpha(\mathcal{C}_\alpha^{\text{op}}, \mathcal{V})$ as desired. \square

Assume that \mathcal{C} is tensored over \mathcal{V} . In this case, we will often make use of the following coend formula for the right adjoint to a cocontinuous functor $F: \mathcal{C} \rightarrow \mathcal{D}$ between locally presentable \mathcal{V} -categories:

$$F^R(d) \cong \int^{c \in \mathcal{C}_\alpha} \mathbf{Map}_{\mathcal{D}}(F(c), d) \otimes c . \quad (\text{A.1})$$

The above formula follows from the \mathcal{V} -natural Yoneda isomorphism [Kel05, Section 3.1] together with Proposition A.2.8.

A.2.2. Free cocompletion

Many of the locally presentable \mathcal{V} -categories that we will encounter in this thesis are obtained from small \mathcal{V} -enriched categories via free cocompletion, which is defined as follows:

Definition A.2.9. *Let \mathcal{C} be a small \mathcal{V} -enriched category. The free cocompletion $\widehat{\mathcal{C}}$ is the enriched functor category*

$$\widehat{\mathcal{C}} = [\mathcal{C}^{\text{op}}, \mathcal{V}] . \quad (\text{A.2})$$

The free cocompletion has the following universal property:

Proposition A.2.10. *[Kel05, Theorem 4.51] Let \mathcal{C} be a small \mathcal{V} -enriched category and \mathcal{D} a cocomplete \mathcal{V} -category. There is an equivalence of \mathcal{V} -categories*

$$\mathbf{Cocont}[\widehat{\mathcal{C}}, \mathcal{D}] \cong [\mathcal{C}, \mathcal{D}] ,$$

where $\mathbf{Cocont}[\widehat{\mathcal{C}}, \mathcal{D}] \subset [\widehat{\mathcal{C}}, \mathcal{D}]$ is the full subcategory of colimit-preserving functors. The equivalence sends $F \in \mathbf{Cocont}[\widehat{\mathcal{C}}, \mathcal{D}]$ to $F \circ Y$, where $Y: \mathcal{C} \rightarrow \widehat{\mathcal{C}}$ is the enriched Yoneda embedding. The inverse sends $G: \mathcal{C} \rightarrow \mathcal{D}$ to the left Kan extension $\mathbf{Lan}_Y G$ of G along Y .

A. Background material on enriched presentable categories

In the following we will denote the enriched Yoneda embedding by

$$Y: \mathcal{C} \longrightarrow [\mathcal{C}^{\text{op}}, \mathcal{V}], \quad c \longmapsto Y_c = \text{Map}_{\mathcal{C}}(-, c) \ .$$

Proposition A.2.11. *The free cocompletion $\widehat{\mathcal{C}}$ is locally presentable as a \mathcal{V} -enriched category.*

Proof. Colimits in presheaf categories are computed pointwise, thus $[\mathcal{C}^{\text{op}}, \mathcal{V}]$ has all \mathcal{V} -colimits. By the enriched Yoneda lemma [Kel05, Section 2.3] we have $\mathcal{V}\text{-Nat}(Y_c, F) \cong F(c)$. So for any colimit $W * F$ in $\widehat{\mathcal{C}}$ we have

$$\begin{aligned} \mathcal{V}\text{-Nat}(Y_c, W * F) &\cong (W * F)(c) \\ &\cong W * F(c) \\ &\cong W * \mathcal{V}\text{-Nat}(Y_c, F) \end{aligned}$$

showing that the representable \mathcal{V} -functors are compact in $[\mathcal{C}^{\text{op}}, \mathcal{V}]$ ³. The enriched Yoneda embedding is strongly \mathcal{V} -generating in $[\mathcal{C}^{\text{op}}, \mathcal{V}]$ and therefore we conclude that $[\mathcal{C}^{\text{op}}, \mathcal{V}]$ is a locally presentable in the enriched sense. \square

If (\mathcal{C}, \otimes) is a monoidal \mathcal{V} -category, there exist a tensor product on $\widehat{\mathcal{C}}$ given by Day convolution: for any $F, G \in \widehat{\mathcal{C}}$ their tensor product is defined by

$$(F \otimes_{\text{Day}} G)(c) = \int^{c_1, c_2 \in \mathcal{C}} \text{Map}_{\mathcal{C}}(c, c_1 \otimes c_2) \otimes^{\mathcal{V}} F(c_1) \otimes^{\mathcal{V}} G(c_2) \ ,$$

where $\otimes^{\mathcal{V}}$ is the tensor product in \mathcal{V} . Then, the Yoneda embedding is a strong monoidal functor $Y: (\mathcal{C}, \otimes) \rightarrow (\widehat{\mathcal{C}}, \otimes_{\text{Day}})$.

Dualizability Not all objects in the free cocompletion $\widehat{\mathcal{C}}$ are dualizable. However, the compact projective generators $\{Y_c\}_{c \in \mathcal{C}}$ are dualizable if all objects in \mathcal{C} are dualizable. This follows from $Y: \mathcal{C} \rightarrow \widehat{\mathcal{C}}$ being a strong monoidal functor.

Let $(\mathcal{C}, \otimes, \sigma)$ be a small braided monoidal \mathcal{V} -category whose objects are dualizable and let

$$T: \widehat{\mathcal{C}} \boxtimes \widehat{\mathcal{C}} \longrightarrow \widehat{\mathcal{C}}, \quad (F, G) \longmapsto F \otimes_{\text{Day}} G \tag{A.3}$$

be the monoidal functor given by the Day convolution product in $\widehat{\mathcal{C}}$, where \boxtimes is the tensor product of locally \mathcal{V} -presentable categories defined in § 1.3.2. By Proposition A.2.8 the functor T admits a right adjoint which has the following explicit formula.

Proposition A.2.12. *Let $\widehat{\mathcal{C}}$ the free cocompletion of a small \mathcal{V} -enriched braided monoidal category \mathcal{C} whose objects are dualizable. Then, the right adjoint to the tensor product functor (A.3) admits the following coend formula*

$$T^R(F) \cong \int^{c \in \mathcal{C}} (F \otimes_{\text{Day}} Y_{c^{\vee}}) \boxtimes Y_c$$

and in particular

$$T^R(1) \cong \int^{c \in \mathcal{C}} Y_{c^{\vee}} \boxtimes Y_c$$

³Since $\mathcal{V}\text{-Nat}(Y_c, -)$ actually preserves *all* weighted colimit, the representable \mathcal{V} -functors are compact projective in $[\mathcal{C}^{\text{op}}, \mathcal{V}]$

A. Background material on enriched presentable categories

Proof. Since the representables are compact projective generators, Equation (A.1) for the right adjoint reads

$$\begin{aligned} T^R(F) &\cong \int^{(c,d) \in \mathcal{C} \times \mathcal{C}} \text{Map}_{\widehat{\mathcal{C}}}(Y_c \otimes_{\text{Day}} Y_d, F) \otimes Y_c \boxtimes Y_d \\ &\cong \int^{(c,d) \in \mathcal{C} \times \mathcal{C}} \text{Map}_{\widehat{\mathcal{C}}}(Y_c, F \otimes_{\text{Day}} Y_{d^\vee}) \otimes Y_c \boxtimes Y_d \\ &\cong \int^{d \in \mathcal{C}} (F \otimes_{\text{Day}} Y_{d^\vee}) \boxtimes Y_d . \end{aligned}$$

□

Remark A.2.13. We often drop the Yoneda embedding in our notation and simply write

$$T^R(1) \cong \int^{c \in \mathcal{C}} c^\vee \boxtimes c \in \widehat{\mathcal{C}} \boxtimes \widehat{\mathcal{C}} .$$

The above coend is naturally an algebra since T^R is lax monoidal. Taking the image under the tensor functor T we obtain Lyubashenko's coend algebra [Lyu95b, Lyu95a]:

$$TT^R(1) \cong \int^{c \in \mathcal{C}} c^\vee \otimes c \in \widehat{\mathcal{C}} .$$

A.2.3. Enriched monadicity theorem

Let $F: \mathcal{A} \rightarrow \mathcal{M}$ be a colimit preserving functor between locally presentable \mathcal{V} -categories with right adjoint F^R . The adjoint pair induces a \mathcal{V} -monad $\mathcal{T} = F^R \circ F$ on \mathcal{A} . The right adjoint F^R is called *monadic* if the \mathcal{V} -comparison functor

$$\begin{aligned} \widetilde{F}^R: \mathcal{M} &\longrightarrow \mathcal{T}\text{-Mod}_{\mathcal{A}} \\ m &\longmapsto (F^R(m), \epsilon) , \end{aligned}$$

is an equivalence of \mathcal{V} -categories, where ϵ is the counit of the adjunction $F \dashv F^R$. Monadic functors are characterized by Beck's monadicity theorem, formulated in the \mathcal{V} -enriched context by Dubuc [Dub70, Theorem II.2.1]. In the presentable setting, the monadicity theorem guarantees that if $F^R: \mathcal{M} \rightarrow \mathcal{A}$ is conservative and preserves certain colimits then it is monadic.

Let (\mathcal{C}, \otimes) be a small \mathcal{V} -enriched category whose objects are dualizable, $\widehat{\mathcal{C}}$ its free cocompletion and $T: \widehat{\mathcal{C}} \boxtimes \widehat{\mathcal{C}} \rightarrow \widehat{\mathcal{C}}$ the tensor product functor from (A.3). We then have the following:

Proposition A.2.14. *The right adjoint T^R is monadic.*

Proof. For a weighted colimit $W \star F$ in $\widehat{\mathcal{C}}$ we have

$$\begin{aligned} T^R(W \star F) &\cong \int^{c \in \mathcal{C}} (W \star F) \otimes_{\text{Day}} Y_{c^\vee} \boxtimes Y_c \\ &\cong W \star \int^{c \in \mathcal{C}} (F \otimes_{\text{Day}} Y_{c^\vee}) \boxtimes Y_c \\ &\cong W \star T^R(F) . \end{aligned}$$

A. Background material on enriched presentable categories

This is due to Proposition A.2.12 and \otimes_{Day} preserving weighted colimits in each variable. Next, we show that T^R is conservative. Let $Y: \widehat{\mathcal{C}} \times \widehat{\mathcal{C}} \rightarrow [\widehat{\mathcal{C}} \times \widehat{\mathcal{C}}, \mathcal{V}]$, $F \mapsto \text{Map}_{\widehat{\mathcal{C}} \times \widehat{\mathcal{C}}}(-, F)$. Then, consider the composition

$$\begin{aligned} Y \circ T^R &= \text{Map}_{\widehat{\mathcal{C}} \boxtimes \widehat{\mathcal{C}}}((-), T^R(-)) \\ &\cong \text{Map}_{\widehat{\mathcal{C}}}((-) \otimes_{\text{Day}} (-), (-)) \quad . \end{aligned}$$

The composition is conservative since $Y_c \otimes_{\text{Day}} Y_d \cong Y_{c \otimes d}$, where we recall that $Y_c = \text{Map}_{\widehat{\mathcal{C}}}(-, c)$, together with the fact that the tensor product functor $(- \otimes -)$ is essentially surjective. It follows that T^R is conservative, since conservative functors reflect conservativity. \square

The tensor product functor T has a natural structure of a $\widehat{\mathcal{C}} \boxtimes \widehat{\mathcal{C}}$ -module functor

$$T((c_1 \boxtimes c_2) \triangleleft (d_1 \boxtimes d_2)) = T(c_1 \otimes d_1 \boxtimes c_2 \otimes d_2) \xrightarrow{\cong} T(c_1 \boxtimes c_2) \triangleleft (d_1 \boxtimes d_2) = c_1 \otimes c_2 \otimes d_1 \otimes d_2$$

defined by the braiding. The same is true for the right adjoint, which follows from the next proposition.

Proposition A.2.15. *Assume $\mathcal{A}, \mathcal{C}, \mathcal{D} \in \mathcal{V}\text{-Pres}$ are free cocompletions of \mathcal{V} -enriched categories whose objects are dualizable. Let $F: \mathcal{C} \rightarrow \mathcal{D}$ be an \mathcal{A} -module functor in $\mathcal{V}\text{-Pres}$ which preserves compact projective objects and has a colimit-preserving right adjoint $F^R: \mathcal{D} \rightarrow \mathcal{C}$. Then F^R has a canonical structure of an \mathcal{A} -module functor.*

Proof. We want to show that $\text{Map}(c, F^R(d \triangleleft a)) \cong \text{Map}(c, F^R(d) \triangleleft a)$ for any $c \in \mathcal{C}$, $d \in \mathcal{D}$ and $a \in \mathcal{A}$. We may write any $c = \text{colim}_i c_i$, where each c_i is compact projective, and similarly $a = \text{colim}_j a_j$. It then follows from the assumptions in the proposition that:

$$\begin{aligned} \text{Map}(c, F^R(d \triangleleft a)) &= \text{Map}(\text{colim}_i c_i, F^R(d \triangleleft \text{colim}_j a_j)) \\ &\cong \text{colim}_j \lim_i \text{Map}(c_i, F^R(d \triangleleft a_j)) \\ &\cong \text{colim}_j \lim_i \text{Map}(F(c_i), d \triangleleft a_j) \\ &\cong \text{colim}_j \lim_i \text{Map}(F(c_i) \triangleleft a_j^\vee, d) \\ &\cong \text{colim}_j \lim_i \text{Map}(F(c_i) \triangleleft a_j^\vee), d) \\ &\cong \text{colim}_j \lim_i \text{Map}(c_i \triangleleft a_j^\vee, F^R(d)) \\ &\cong \text{colim}_j \lim_i \text{Map}(c_i, F^R(d) \triangleleft a_j) \\ &\cong \text{Map}(\lim_i c_i, F^R(d) \triangleleft \text{colim}_j a_j) \\ &= \text{Map}(c, F^R(d) \triangleleft a) \end{aligned}$$

\square

B. Bialgebroids

In this appendix we recollect basics about bialgebroids. We will mainly focus on the relation between bialgebroids over base algebras (as defined in Example 3.2.3) and solutions to the quantum DYBE, which was established in [DM06].

B.1. Definitions and examples

Throughout, k denotes either a field \mathbb{K} of characteristic zero or a ring $\mathbb{K}[[\hbar]]$ of formal power series.

Definition B.1.1. [Lu96] *Let \mathcal{L} be a k -algebra. A bialgebroid over base \mathcal{L} is an associative k -algebra \mathfrak{B} together with the following data:*

- *Source map: an algebra morphism $s: \mathcal{L} \rightarrow \mathfrak{B}$,*
- *Target map: an algebra morphism $t: \mathcal{L}_{\text{op}} \rightarrow \mathfrak{B}$,*

turning \mathfrak{B} into a \mathcal{L} -bimodule with actions $\lambda \triangleright b = s(\lambda)b$ and $b \triangleleft \lambda = t(\lambda)b$, for all $\lambda \in \mathcal{L}$ and $b \in \mathfrak{B}$.

- *Coproduct: a coassociative $(\mathcal{L}, \mathcal{L})$ -bimodule map $\Delta: \mathfrak{B} \rightarrow \mathfrak{B} \otimes_{\mathcal{L}} \mathfrak{B}$. Here, $\mathfrak{B} \otimes_{\mathcal{L}} \mathfrak{B} = \mathfrak{B} \otimes \mathfrak{B}/I$, where I is the left ideal generated by $t(\lambda) \otimes 1 - 1 \otimes s(\lambda)$ for $\lambda \in \mathcal{L}$. We require that*
 - Δ *factors through $N(I)/I$, where $N(I) = \{a \in \mathfrak{B} \otimes \mathfrak{B} \mid [a, I] \subset I\}$,*
 - $\Delta: \mathfrak{B} \rightarrow N(I)/I$ *is an algebra morphism.*
- *Counit: a $(\mathcal{L}, \mathcal{L})$ -bimodule map $\epsilon: \mathfrak{B} \rightarrow \mathcal{L}$ such that $\epsilon(1_{\mathfrak{B}}) = 1_{\mathcal{L}}$ and*

$$(\epsilon \otimes_{\mathcal{L}} \text{id}_{\mathfrak{B}}) \circ \Delta = \text{id}_{\mathfrak{B}} = (\text{id}_{\mathfrak{B}} \otimes_{\mathcal{L}} \epsilon) \circ \Delta \quad . \quad (\text{B.1})$$

and

$$\epsilon(a(s \circ \epsilon)b) = \epsilon(ab) = \epsilon(a(t \circ \epsilon)b) \quad (\text{B.2})$$

for all $a, b \in \mathfrak{B}$.

We will use the notation $\Delta(a) = a_{(1)} \otimes a_{(2)}$ for the coproduct. The following are examples of bialgebroids that will play a role later on:

Example B.1.2 (Tensor product bialgebroid). For $i = 1, 2$, let \mathfrak{B}_i be a bialgebroid over base \mathcal{L}_i . Then, the tensor product $\mathfrak{B}_1 \otimes \mathfrak{B}_2$ is a bialgebroid over base $\mathcal{L}_1 \otimes \mathcal{L}_2$. The source, target, and counit maps are $s_1 \otimes s_2$, $t_1 \otimes t_2$, and $\epsilon_1 \otimes \epsilon_2$, respectively. The coproduct for the tensor product bialgebroid is defined by

$$\Delta(a \otimes b) = (a_{(1)} \otimes b_{(1)}) \otimes_{\mathcal{L}_1 \otimes \mathcal{L}_2} (a_{(2)} \otimes b_{(2)}) \quad .$$

△

B. Bialgebroids

Example B.1.3 (Bialgebras). A bialgebra over k is a bialgebroid over base k . \triangle

Example B.1.4 (Coopposite bialgebroid). Let $(\mathfrak{B}, s, t, \Delta, \epsilon)$ be a bialgebroid over \mathcal{L} . Then, there is a bialgebroid \mathfrak{B}^{op} over \mathcal{L}_{op} with the same multiplication but opposite coproduct $\Delta^{\text{op}}(b) = b_{(2)} \otimes b_{(1)}$ and counit $\iota \circ \epsilon: \mathfrak{B}^{\text{op}} \rightarrow \mathcal{L}_{\text{op}}$, where $\iota: \mathcal{L} \rightarrow \mathcal{L}_{\text{op}}$ is the anti-homomorphism given by the identity map. The source and target maps are $s^{\text{op}} = t$ and $t^{\text{op}} = s$, respectively. \triangle

Let H be a Hopf algebra over k . In what follows, we will assume that \mathcal{L} is an H -base algebra. This means that \mathcal{L} is an H -module algebra $H \otimes \mathcal{L} \xrightarrow{\triangleright} \mathcal{L}$ and a left H -comodule algebra $\delta: \mathcal{L} \rightarrow H \otimes \mathcal{L}$, $\lambda \mapsto \lambda^{(-1)} \otimes \lambda^{(0)}$, making \mathcal{L} a Yetter–Drinfeld module over H , that is

$$\delta(h \triangleright \lambda) = h_{(1)} \lambda^{(-1)} S(h_{(3)}) \otimes h_{(2)} \triangleright \lambda^{(0)} \quad (\text{B.3})$$

for all $h \in H$ and $\lambda \in \mathcal{L}$. Moreover, \mathcal{L} is assumed to be a commutative algebra in the category of Yetter–Drinfeld modules over H , that is

$$\lambda \mu = (\lambda^{(-1)} \triangleright \mu) \lambda^{(0)} \quad (\text{B.4})$$

for all $\lambda, \mu \in \mathcal{L}$. If H is quasi-triangular with universal R-matrix \mathcal{R} , we will assume that the H -comodule structure on \mathcal{L} is of the form

$$\delta(\lambda) = \lambda^{(-1)} \otimes \lambda^{(0)} = \mathcal{R}^2 \otimes \mathcal{R}^1 \triangleright \lambda$$

for all $\lambda \in \mathcal{L}$.

Example B.1.5 (Smash product bialgebroid). Let \mathcal{L} and H be as above. Consider the associative algebra $\mathcal{L} \rtimes H$, which is $\mathcal{L} \otimes H$ as a k -module, endowed with the smash product multiplication

$$(\lambda \otimes h)(\mu \otimes k) = \lambda h_{(1)} \triangleright \mu \otimes h_{(2)} k \quad .$$

The source and target maps are defined by

$$s(\lambda) = \lambda \otimes 1, \quad t(\lambda) = \bar{\mathcal{R}}^1 \triangleright \lambda \otimes \bar{\mathcal{R}}^2 \quad , \quad (\text{B.5})$$

where $\bar{\mathcal{R}} = \mathcal{R}^{-1}$. The coproduct is

$$\Delta(\lambda \otimes h) = (\lambda \otimes h_{(1)}) \otimes_{\mathcal{L}} (1 \otimes h_{(2)}) \quad ,$$

where $\Delta_H(h) = h_{(1)} \otimes h_{(2)}$ is the coproduct for the Hopf algebra H , and the counit is

$$\epsilon(\lambda \otimes h) = \lambda \epsilon_H(h) \quad .$$

\triangle

Example B.1.6 (Quantum groupoid). Let H be a quasi-triangular Hopf algebra and $\mathcal{L} \rtimes H$ the smash-product bialgebroid from Example B.1.5. Note that there are two target maps for the bialgebroid $\mathcal{L} \rtimes H$: one was defined in (B.5), and is related to the coproduct $\delta(\lambda) = \lambda^{(-1)} \otimes \lambda^{(0)} = \mathcal{R}^2 \otimes \mathcal{R}^1 \triangleright \lambda$ by

$$t(\lambda) = \lambda^{(0)} \otimes S^{-1}(\lambda^{(-1)}) = \bar{\mathcal{R}}^1 \triangleright \lambda \otimes \bar{\mathcal{R}}^2 \quad .$$

B. Bialgebroids

But if \mathcal{R} is a quasi-triangular structure for H , then so is $\tau \circ \bar{\mathcal{R}}$, giving rise to an alternative H -base algebra structure on \mathcal{L} with coaction $\delta'(\lambda) = \bar{\mathcal{R}}^1 \otimes \bar{\mathcal{R}}^2 \triangleright \lambda$. The corresponding target map is:

$$t'(\lambda) = \mathcal{R}^2 \triangleright \lambda \otimes \mathcal{R}^1 .$$

We will write $(\mathcal{L} \rtimes H)'$ for the bialgebroid with target map t' .

In [DM06], Donin–Mudrov introduce a bialgebroid $H_{\mathcal{L}}$ which is defined as a quotient of $\mathcal{L} \rtimes H$, or equivalently of $(\mathcal{L} \rtimes H)'$, which eliminates the distinction between the two bialgebroid structures on the smash product. In more details, the bialgebroid $H_{\mathcal{L}}$ is defined as the quotient

$$H_{\mathcal{L}} = (\mathcal{L} \rtimes H)/J = (\mathcal{L} \rtimes H)'/J$$

by the biideal¹ J generated by $\bar{\mathcal{R}}^1 \triangleright \lambda \otimes \bar{\mathcal{R}}^2 - \mathcal{R}^2 \triangleright \lambda \otimes \mathcal{R}^1$ for all $\lambda \in \mathcal{L}$. The resulting bialgebroid $H_{\mathcal{L}}$ is called *quantum groupoid* since it has a quasi-triangular structure induced from the one on H (we refer to [DM06, Definition 3.12] for the definition of a quasi-triangular structure on a bialgebroid). \triangle

We will also need the following:

Proposition B.1.7. *If \mathcal{L} is an H -base algebra with left H -action \triangleright and left H -coaction δ . Then, \mathcal{L}_{op} is an H^{op} -base algebra with the same action $\triangleright_{H^{\text{op}}} = \triangleright$ and H^{op} -comodule structure*

$$\delta_{H^{\text{op}}}(\lambda) = S^{-1}(\lambda^{(-1)}) \otimes \lambda^{(0)} ,$$

where we used the notation $\delta(\lambda) = \lambda^{(-1)} \otimes \lambda^{(0)}$.

Proof. \mathcal{L}_{op} is an H^{op} -module algebra:

$$\begin{aligned} h \triangleright (\lambda \cdot^{\text{op}} \mu) &= h \triangleright (\mu \lambda) \\ &= (h_{(1)} \triangleright \mu)(h_{(2)} \triangleright \lambda) \\ &= (h_{(2)} \triangleright \lambda) \cdot^{\text{op}} (h_{(1)} \triangleright \mu) . \end{aligned}$$

It is also an H^{op} -comodule algebra:

$$\begin{aligned} \delta_{H^{\text{op}}}(\lambda \cdot^{\text{op}} \mu) &= S^{-1}((\mu \lambda)^{(-1)}) \otimes (\mu \lambda)^{(0)} \\ &= S^{-1}(\lambda^{(-1)}) S^{-1}(\mu^{(-1)}) \otimes \lambda^{(0)} \cdot^{\text{op}} \mu^{(0)} . \end{aligned}$$

Next, we have to show that \mathcal{L}_{op} is a Yetter–Drinfeld module with respect to \triangleright and $\delta_{H^{\text{op}}}$, which will amount to show that $\delta_{H^{\text{op}}}(h \triangleright \lambda) = h_{(3)} S^{-1}(\lambda^{(-1)}) S^{-1}(h_{(1)}) \otimes h_{(2)} \triangleright \lambda^{(0)}$. We have

$$\begin{aligned} \delta_{H^{\text{op}}}(h \triangleright \lambda) &= S^{-1}((h \triangleright \lambda)^{(-1)}) \otimes (h \triangleright \lambda)^{(0)} \\ &= (S^{-1} \otimes \text{id})(h_{(1)} \lambda^{(-1)} S(h_{(3)})) \otimes h_{(2)} \triangleright \lambda^{(0)} \\ &= h_{(3)} S^{-1}(\lambda^{(-1)}) S^{-1}(h_{(1)}) \otimes h_{(2)} \triangleright \lambda^{(0)} , \end{aligned}$$

¹A \mathcal{L} -bimodule $J \subset \mathfrak{B}$ is called *biideal* if it is a two-sided ideal in the algebra \mathfrak{B} and $\Delta(J) \subset J \otimes_{\mathcal{L}} \mathfrak{B} + \mathfrak{B} \otimes_{\mathcal{L}} J$ and $\epsilon(J) = 0$.

B. Bialgebroids

where we used Equation (B.3) for the Yetter–Drinfeld module \mathcal{L} over H . Lastly, we have

$$\begin{aligned}
(S^{-1}(\lambda^{(-1)}) \triangleright \mu) \cdot^{\text{op}} \lambda^{(0)} &= \lambda^{(0)}(S^{-1}(\lambda^{(-1)}) \triangleright \mu) \\
&= (\lambda^{(0)(-1)} S^{-1}(\lambda^{(-1)}) \triangleright \mu) \lambda^{(0)(0)} \\
&= (\lambda_{(2)}^{(-1)} S^{-1}(\lambda_{(1)}^{(-1)}) \triangleright \mu) \lambda^{(0)} \\
&= (\epsilon(\lambda^{(-1)}) \triangleright \mu) \lambda^{(0)} \\
&= \lambda \cdot^{\text{op}} \mu \ ,
\end{aligned}$$

where we used Equation (B.4) for the base algebra \mathcal{L} , making \mathcal{L}_{op} a H^{op} -base algebra. \square

B.1.1. Dynamical FRT-algebra

In [DM06, Section 8], Donin–Mudrov introduce a bialgebroid which may be interpreted as a dynamical version of the FRT-algebra and is constructed using dynamical twists. Since our conventions for dynamical twists differ from the one in [DM06], we will here redo the construction due to Donin–Mudrov using our conventions and also fill in some details that are omitted in the original reference (see Remark 3.2.11 for how our definition of a dynamical twist compares to the one of Donin–Mudrov).

The restricted dual H° is a left $H^{\text{op}} \otimes H$ -module via

$$(h' \otimes h) \triangleright \varphi = h \rightharpoonup \varphi \leftarrow S(h') \ ,$$

where

$$h \rightharpoonup \varphi = \langle h, \varphi_{(2)} \rangle \varphi_{(1)} \ , \quad \varphi \leftarrow h = \langle h, \varphi_{(1)} \rangle \varphi_{(2)} \ ,$$

for all $h \in H$. We endow H° with a multiplication defined via duality with H , that is

$$\langle \varphi \cdot \psi, h \rangle = \langle \varphi, h_{(1)} \rangle \langle \psi, h_{(2)} \rangle$$

for all $\varphi, \psi \in H^\circ$ and $h \in H$. The resulting algebra is called *FRT-algebra* [DM03]. We are now going to define a dynamical version of the FRT-algebra.

Let $B \subseteq H$ a Hopf subalgebra and \mathcal{L} a B -base algebra. The underlying k -module of the *dynamical FRT-algebra* is the tensor product $\mathcal{L}_{\text{op}} \otimes \mathcal{L} \otimes H^\circ$. Let $\mathcal{J}(\lambda) = \mathcal{J}^0 \otimes \mathcal{J}^1 \otimes \mathcal{J}^2 \in \mathcal{L} \otimes H \otimes H$ be a dynamical twist for the pair $B \subseteq H$ over base \mathcal{L} , as defined in § 3.2.2. One can check that the following is a dynamical twist over the B^{op} -base algebra \mathcal{L}_{op} :

$$\mathcal{K}(\lambda) = \bar{\mathcal{J}}^0 \otimes S^{-1}(\bar{\mathcal{J}}^1) \otimes S^{-1}(\bar{\mathcal{J}}^2) \in \mathcal{L}_{\text{op}} \otimes H^{\text{op}} \otimes H^{\text{op}} \ , \quad \bar{\mathcal{J}}(\lambda) = \mathcal{J}(\lambda)^{-1} \ .$$

Then, we endow $\mathcal{L}_{\text{op}} \otimes \mathcal{L} \otimes H^\circ$ with the following multiplication

$$\begin{aligned}
(\lambda \otimes \mu \otimes \varphi) * (\nu \otimes \rho \otimes \psi) & \tag{B.6} \\
&= \lambda \cdot^{\text{op}} \nu^{[0]} \cdot^{\text{op}} \mathcal{K}^0 \otimes \mu \rho^{[0]} \mathcal{J}^0 \otimes (\mathcal{K}^1 S^{-1}(\nu^{[1]}) \otimes \mathcal{J}^1 \rho^{[1]}) \triangleright \varphi \cdot (\mathcal{K}^2 \otimes \mathcal{J}^2) \triangleright \psi \ ,
\end{aligned}$$

where the map $\lambda \mapsto \lambda^{[0]} \otimes \lambda^{[1]}$ is the right H -comodule structure on the base algebra \mathcal{L} . The above defines an associative product on $\mathcal{L}_{\text{op}} \otimes \mathcal{L} \otimes H^\circ$, which is a consequence of $\mathcal{J}(\lambda)$ and $\mathcal{K}(\lambda)$ being dynamical twists.

B. Bialgebroids

Proposition B.1.8. *The algebra $\mathcal{L}_{\text{op}} \otimes \mathcal{L} \otimes H^\circ$ with multiplication (B.6) is a bialgebroid over base \mathcal{L} with source and target maps defined by*

$$s: \lambda \mapsto 1 \otimes \lambda \otimes 1, \quad t: \lambda \mapsto \lambda \otimes 1 \otimes 1 .$$

The coproduct is defined by

$$\Delta(\lambda \otimes \mu \otimes \varphi) = (1 \otimes \mu \otimes \varphi_{(2)}) \otimes_{\mathcal{L}} (\lambda \otimes 1 \otimes \varphi_{(1)})$$

and the counit by $\epsilon(\lambda \otimes \mu \otimes \varphi) = \epsilon(\varphi)\lambda \cdot^{\text{op}} \mu$.

Proof. We first show that the coproduct is compatible with the multiplication. On the one hand we have

$$\begin{aligned} & \Delta((\lambda \otimes \mu \otimes \varphi) * (\nu \otimes \rho \otimes \psi)) \\ &= \left(1 \otimes \mu \rho^{[0]} \mathcal{J}^0 \otimes \left((\mathcal{K}^1 S^{-1}(\nu^{[1]}) \otimes \mathcal{J}^1 \rho^{[1]}) \triangleright \varphi \right)_{(2)} \cdot ((\mathcal{K}^2 \otimes \mathcal{J}^2) \triangleright \psi)_{(2)} \right) \\ & \quad \otimes_{\mathcal{L}} \left(\lambda \cdot^{\text{op}} \nu^{[0]} \cdot^{\text{op}} \mathcal{K}^0 \otimes 1 \otimes \left((\mathcal{K}^1 S^{-1}(\nu^{[1]}) \otimes \mathcal{J}^1 \rho^{[1]}) \triangleright \varphi \right)_{(1)} \cdot ((\mathcal{K}^2 \otimes \mathcal{J}^2) \triangleright \psi)_{(1)} \right) \\ &= \left(1 \otimes \mu \rho^{[0]} \mathcal{J}^0 \otimes (1 \otimes \mathcal{J}^1 \rho^{[1]}) \triangleright \varphi_{(2)} \cdot (1 \otimes \mathcal{J}^2) \triangleright \psi_{(2)} \right) \\ & \quad \otimes_{\mathcal{L}} \left(\lambda \cdot^{\text{op}} \nu^{[0]} \cdot^{\text{op}} \mathcal{K}^0 \otimes 1 \otimes (\mathcal{K}^1 S^{-1}(\nu^{[1]}) \otimes 1) \triangleright \varphi_{(1)} \cdot (\mathcal{K}^2 \otimes 1) \triangleright \psi_{(1)} \right) \end{aligned}$$

In the above we used that for all $a \otimes b \in H^{\text{op}} \otimes H$ and $\varphi \in H^\circ$ we have

$$\begin{aligned} \Delta((a \otimes b) \triangleright \varphi) &= \langle S(a), \varphi_{(1)} \rangle \langle b, \varphi_{(4)} \rangle \varphi_{(2)} \otimes \varphi_{(3)} \\ &= (a \otimes 1) \triangleright \varphi_{(1)} \otimes (1 \otimes b) \triangleright \varphi_{(2)} . \end{aligned}$$

On the other hand we find

$$\begin{aligned} & ((1 \otimes \mu \otimes \varphi_{(2)}) * (1 \otimes \rho \otimes \psi_{(2)})) \otimes_{\mathcal{L}} ((\lambda \otimes 1 \otimes \varphi_{(1)}) * (\nu \otimes 1 \otimes \psi_{(1)})) \\ &= \left(\mathcal{K}^0 \otimes \mu \rho^{[0]} \mathcal{J}^0 \otimes (\mathcal{K}^1 \otimes \mathcal{J}^1 \rho^{[1]}) \triangleright \varphi_{(2)} \cdot (\mathcal{K}^2 \otimes \mathcal{J}^2) \triangleright \psi_{(2)} \right) \\ & \quad \otimes_{\mathcal{L}} \left(\lambda \cdot^{\text{op}} \nu^{[0]} \cdot^{\text{op}} \mathcal{K}^0 \otimes \mathcal{J}^0 \otimes (\mathcal{K}^1 S^{-1}(\nu^{[1]}) \otimes \mathcal{J}^1) \triangleright \varphi_{(1)} \cdot (\mathcal{K}^2 \otimes \mathcal{J}^2) \triangleright \psi_{(1)} \right) \\ &= \left(\mathcal{J}^0 \cdot^{\text{op}} \bar{\mathcal{J}}^0 \otimes \mu \rho^{[0]} \mathcal{J}^0 \otimes (S^{-1}(\bar{\mathcal{J}}^1) \otimes \mathcal{J}^1 \rho^{[1]}) \triangleright \varphi_{(2)} \cdot (S^{-1}(\bar{\mathcal{J}}^2) \otimes \mathcal{J}^2) \triangleright \psi_{(2)} \right) \\ & \quad \otimes_{\mathcal{L}} \left(\lambda \cdot^{\text{op}} \nu^{[0]} \cdot^{\text{op}} \mathcal{K}^0 \otimes 1 \otimes (\mathcal{K}^1 S^{-1}(\nu^{[1]}) \otimes \mathcal{J}^1) \triangleright \varphi_{(1)} \cdot (\mathcal{K}^2 \otimes \mathcal{J}^2) \triangleright \psi_{(1)} \right) \end{aligned}$$

But for any invertible element $a \in H$ and any $\varphi \in H^\circ$ we have

$$\begin{aligned} (1 \otimes a) \triangleright \varphi_{(1)} \otimes (S^{-1}(\bar{a}) \otimes 1) \triangleright \varphi_{(2)} &= \langle a, \varphi_{(2)} \rangle \varphi_{(1)} \otimes \langle \bar{a}, \varphi_{(3)} \rangle \varphi_{(4)} \\ &= \langle a\bar{a}, \varphi_{(2)} \rangle \varphi_{(1)} \otimes \varphi_{(3)} \\ &= \varphi_{(1)} \otimes \varphi_{(2)} , \end{aligned}$$

where we wrote $\bar{a} = a^{-1}$ and used that $\langle 1, \varphi \rangle = \epsilon(\varphi)$, showing compatibility of the multiplication and the coproduct.

Next we have to show that Equations (B.1) and (B.2) hold. For the former, we compute

$$\begin{aligned} (\epsilon \otimes_{\mathcal{L}} \text{id}) \circ \Delta(\lambda \otimes \mu \otimes \varphi) &= \epsilon(1 \otimes \mu \otimes \varphi_{(2)}) \otimes_{\mathcal{L}} (\lambda \otimes 1 \otimes \varphi_{(1)}) \\ &= \epsilon(\varphi_{(2)}) \mu \otimes_{\mathcal{L}} (\lambda \otimes 1 \otimes \varphi_{(1)}) \\ &= \lambda \otimes \mu \otimes \varphi , \end{aligned}$$

B. Bialgebroids

where in the last step we used the source map $s(\mu) = 1 \otimes \mu \otimes 1$. The other equality in (B.1) can be checked along the same lines. In order to verify Equation (B.2) we first compute

$$\begin{aligned} \epsilon((\lambda \otimes \mu \otimes \varphi) * (s \circ \epsilon)(\nu \otimes \rho \otimes \psi)) &= \epsilon(\psi) \left(\lambda \otimes \mu(\rho\nu)^{[0]} \otimes \left(1 \otimes (\rho\nu)^{[1]} \right) \triangleright \varphi \right) \\ &= \epsilon(\psi) \epsilon \left((\rho\nu)^{[1]} \triangleright \varphi \right) \lambda \cdot^{\text{op}} (\rho\nu)^{[0]} \cdot^{\text{op}} \mu . \end{aligned}$$

Similarly we find

$$\epsilon((\lambda \otimes \mu \otimes \varphi) * (t \circ \epsilon)(\nu \otimes \rho \otimes \psi)) = \epsilon(\psi) \epsilon \left(\varphi \triangleleft (\rho\nu)^{[1]} \right) \lambda \cdot^{\text{op}} (\rho\nu)^{[0]} \cdot^{\text{op}} \mu$$

The two agree since

$$\begin{aligned} \left((\rho\nu)^{[1]} \triangleright \varphi \right) (1) &= \left\langle (\rho\nu)^{[1]}, \varphi_{(2)} \right\rangle \epsilon(\varphi_{(1)}) \\ &= \left\langle (\rho\nu)^{[1]}, \varphi \right\rangle \\ &= \left\langle (\rho\nu)^{[1]}, \varphi_{(1)} \right\rangle \epsilon(\varphi_{(2)}) \\ &= \left(\varphi \triangleleft (\rho\nu)^{[1]} \right) (1) \end{aligned}$$

Lastly, we compute

$$\begin{aligned} \epsilon((\lambda \otimes \mu \otimes \varphi) * (\nu \otimes \rho \otimes \psi)) \\ = \left(\lambda \cdot^{\text{op}} \nu^{[0]} \cdot^{\text{op}} \rho^{[0]} \cdot^{\text{op}} \mu \right) \epsilon \left(\left(\mathcal{K}^1 S^{-1}(\nu^{[1]}) \otimes \mathcal{J}^1 \rho^{[1]} \right) \triangleright \varphi \right) \epsilon \left((\mathcal{K}^2 \otimes \mathcal{J}^2) \triangleright \psi \right) \end{aligned}$$

but

$$\begin{aligned} \epsilon \left((\mathcal{K}^2 \otimes \mathcal{J}^2) \triangleright \psi \right) &= \left\langle \mathcal{J}^2, \psi_{(3)} \right\rangle \left\langle \bar{\mathcal{J}}^2, \psi_{(2)} \right\rangle \epsilon(\psi_{(2)}) \\ &= \epsilon(\psi) \end{aligned}$$

and

$$\begin{aligned} \epsilon \left(\left(\mathcal{K}^1 S^{-1}(\nu^{[1]}) \otimes \mathcal{J}^1 \rho^{[1]} \right) \triangleright \varphi \right) &= \left\langle \nu^{[1]} \bar{\mathcal{J}}^1, \varphi_{(1)} \right\rangle \left\langle \mathcal{J}^1 \rho^{[1]}, \varphi_{(3)} \right\rangle \epsilon(\varphi_{(2)}) \\ &= \left\langle \nu^{[1]} \bar{\mathcal{J}}^1 \mathcal{J}^1 \rho^{[1]}, \varphi \right\rangle \\ &= \left\langle (\rho\nu)^{[1]}, \varphi \right\rangle , \end{aligned}$$

and thus Equation (B.2) holds. □

B.2. Twists of bialgebroids

Let $(\mathfrak{B}, s, t, \Delta, \epsilon)$ be a bialgebroid over \mathcal{L} .

Definition B.2.1. [Xu01] An element $\Psi = \Psi^1 \otimes \Psi^2 \in \mathfrak{B} \otimes_{\mathcal{L}} \mathfrak{B}$ is called a bialgebroid twist, or twisting cocycle, if it satisfies

$$\Delta(\Psi^1) \Psi \otimes_{\mathcal{L}} \Psi^2 = \Psi^1 \otimes_{\mathcal{L}} \Delta(\Psi^2) \Psi \tag{B.7}$$

and $(\epsilon \otimes_{\mathcal{L}} \text{id}) \Psi = 1 \otimes_{\mathcal{L}} 1 = (\text{id} \otimes_{\mathcal{L}} \epsilon) \Psi$.

B. Bialgebroids

Let Ψ be a bialgebroid twist. One may equip \mathcal{L} with a new multiplication defined in terms of Ψ by

$$\lambda *_{\Psi} \mu = (\Psi^1 \vdash \lambda) * (\Psi^2 \vdash \mu) \quad ,$$

where \vdash is the \mathfrak{B} -module structure on \mathcal{L} defined in terms of the counit and source or target map:

$$b \vdash \lambda = \epsilon(bs(\lambda)) = \epsilon(bt(\lambda))$$

for all $b \in \mathfrak{B}$ and $\lambda \in \mathcal{L}$. Let \mathcal{L}_{Ψ} be the resulting algebra. Using the twist, one can further define the following algebra morphisms

$$\begin{aligned} s_{\Psi}: \mathcal{L}_{\Psi} &\rightarrow \mathfrak{B}, & t_{\Psi}: \mathcal{L}_{\Psi}^{\text{op}} &\rightarrow \mathfrak{B} \\ \lambda &\mapsto s(\Psi^1 \vdash \lambda)\Psi^2 & \lambda &\mapsto t(\Psi^2 \vdash \lambda)\Psi^1 \end{aligned}$$

The twist Ψ defines a linear map

$$\mathfrak{B} \otimes_{\mathcal{L}_{\Psi}} \mathfrak{B} \rightarrow \mathfrak{B} \otimes_{\mathcal{L}} \mathfrak{B}, \quad a \otimes b \mapsto \Psi^1 a \otimes \Psi^2 b \quad . \quad (\text{B.8})$$

Definition B.2.2. *A bialgebroid twist Ψ is called invertible if the map (B.8) is an isomorphism.*

Theorem B.2.3. *[Xu01] Let \mathfrak{B} be a bialgebroid over base \mathcal{L} and $\Psi \in \mathfrak{B} \otimes_{\mathcal{L}} \mathfrak{B}$ an invertible bialgebroid twist. Define*

$$\Delta_{\Psi}: \mathfrak{B} \rightarrow \mathfrak{B} \otimes_{\mathcal{L}_{\Psi}} \mathfrak{B}, \quad a \mapsto \Psi^{-1} \Delta(a) \Psi \quad . \quad (\text{B.9})$$

Then, the tuple $\tilde{\mathfrak{B}} = (\mathfrak{B}, s_{\Psi}, t_{\Psi}, \Delta_{\Psi}, \epsilon)$ is a bialgebroid over base \mathcal{L}_{Ψ} .

Let (A, \cdot) be a module algebra over the bialgebroid \mathfrak{B} . Then, a twist of the bialgebroid induces a twist of its module algebra:

Proposition B.2.4. *The algebra A_{Ψ} with multiplication defined by*

$$x \cdot_{\Psi} y = (\Psi^1 \triangleright x) \cdot (\Psi^2 \triangleright y)$$

is a module algebra over the twisted bialgebroid $\tilde{\mathfrak{B}}$.

Proof. Since A is a \mathfrak{B} -module algebra we have $b \triangleright (x \cdot y) = (b_{(1)} \triangleright x) \cdot (b_{(2)} \triangleright y)$ for all $b \in \mathfrak{B}$ and $x, y \in A$. Thus, we have

$$\begin{aligned} b \triangleright (x \cdot_{\Psi} y) &= b \triangleright ((\Psi^1 \triangleright x) \cdot (\Psi^2 \triangleright y)) \\ &= (b_{(1)} \Psi^1 \triangleright x) \cdot (b_{(2)} \Psi^2 \triangleright y) \\ &= (\bar{\Psi}^1 b_{(1)} \Psi^1 \triangleright x) \cdot_{\Psi} (\bar{\Psi}^2 b_{(2)} \Psi^2 \triangleright y) \quad , \end{aligned}$$

where $\bar{\Psi} = \Psi^{-1}$. □

B.2.1. Bialgebroid twists from dynamical twists

The relation between bialgebroid twists and dynamical ones, i.e. solutions to the quantum DYBE, was previously established in [Xu01] for dynamical twists over commutative base and in [DM06] for dynamical twists over more general base algebras. In more details, given a pair of Hopf algebras $B \subseteq H$ and a B -base algebra \mathcal{L} , Donin–Mudrov show that one can construct a twisted \mathcal{L} -bialgebroid $H \widetilde{\otimes} \mathcal{DB}_{\mathcal{L}}$ by means of a dynamical twist, where DB is the double and $\mathcal{DB}_{\mathcal{L}}$ the quantum groupoid from Example B.1.6. Here, we will mimic the construction of Donin–Mudrov to construct bialgebroid twists in terms of the dynamical twists defined in § 3.2.2.

B. Bialgebroids

The double Let B be a finite-dimensional² \mathbb{K} -algebra. Assume \mathcal{L} is a B -base algebra with left B -action \triangleright and left B -coaction δ . Let $\mathcal{DB} = B \bowtie B_{\text{op}}^*$ be the double cross product [Maj95, Section 7], where B_{op}^* is the dual of B with opposite multiplication. The double is quasi-triangular with universal R-matrix $\Theta = \sum e^i \otimes e_i \in \mathcal{DB} \otimes \mathcal{DB}$, where $(e_i)_{i \in I}$ is a basis in B and $(e^i)_{i \in I}$ its dual in B_{op}^* .

With the above assumptions, one can check that the algebra \mathcal{L} is also a \mathcal{DB} -base algebra with left B_{op}^* -module structure defined by

$$\varphi \blacktriangleright \lambda = \langle \lambda^{(-1)}, \varphi \rangle \lambda^{(0)}$$

and with \mathcal{DB} -coaction given by δ , expressed through the universal R-matrix:

$$\delta: \lambda \mapsto \Theta^2 \otimes \Theta^1 \blacktriangleright \lambda \ .$$

The bialgebroid In § 3.2.2 we have defined a dynamical twist as a B -equivariant element $\mathcal{J}(\lambda) \in \mathcal{L} \otimes H \otimes H$ satisfying the dynamical cocycle equation

$$(\text{id} \otimes \Delta \otimes \text{id}) \mathcal{J}(\lambda) \mathcal{J}(\lambda)_{1,2} = (\text{id} \otimes \text{id} \otimes \Delta) \mathcal{J}(\lambda) (\delta^R \otimes \text{id} \otimes \text{id}) \mathcal{J}(\lambda) \quad (\text{B.10})$$

in $\mathcal{L}_{\text{op}} \otimes H \otimes H \otimes H$. The appearance of opposite base algebra \mathcal{L}_{op} in the dynamical cocycle equation leads us to establish a connection between $\mathcal{J}(\lambda)$ and a twist in the tensor bialgebroid $\mathfrak{B} = \left(\mathcal{DB}_{\mathcal{L}_{\text{op}}}^{\text{op}} \otimes H^{\text{op}} \right)^{\text{op}}$.

It will be convenient to first spell out the bialgebroid structure on $(\mathcal{L}_{\text{op}} \bowtie \mathcal{DB}^{\text{op}} \otimes H^{\text{op}})^{\text{op}}$, which follows from combining Proposition B.1.7 with Examples B.1.2, B.1.3, B.1.4 and B.1.5. Namely, the source and target maps are

$$\begin{aligned} s(\lambda) &= t_{\mathcal{L}_{\text{op}} \bowtie \mathcal{DB}^{\text{op}}}(\lambda) \otimes 1_H & t(\lambda) &= s_{\mathcal{L}_{\text{op}} \bowtie \mathcal{DB}^{\text{op}}}(\lambda) \otimes 1_H \\ &= \Theta^2 \triangleright \lambda \otimes S(\Theta^1) \otimes 1_H & &= \lambda \otimes 1_{\mathcal{DB}_{\text{op}}} \otimes 1_H \ . \end{aligned}$$

and the coproduct is

$$\Delta(\lambda \otimes \beta \otimes h) = (1 \otimes \beta_{(1)} \otimes h_{(1)}) \otimes_{\mathcal{L}} (\lambda \otimes \beta_{(2)} \otimes h_{(2)}) \ ,$$

for $\lambda \in \mathcal{L}_{\text{op}}$, $\beta \in \mathcal{DB}^{\text{op}}$ and $h \in H^{\text{op}}$. The bialgebroid \mathfrak{B} is then defined as the quotient of this bialgebroid by the biideal generated by $\bar{\Theta}^2 \triangleright \lambda \otimes \bar{\Theta}^1 - \Theta^1 \triangleright \lambda \otimes \Theta^2$ for all $\lambda \in \mathcal{L}_{\text{op}}$ as in Example B.1.6.

The bialgebroid twist

Proposition B.2.5. *Let $B \subseteq H$ be a Hopf subalgebra and \mathcal{L} a B -base algebra. Let $\mathcal{J}(\lambda) = \mathcal{J}^0 \otimes \mathcal{J}^1 \otimes \mathcal{J}^2 \in \mathcal{L} \otimes H \otimes H$ be a dynamical twist over \mathcal{L} satisfying Equation (B.10). The element*

$$\Psi = (1 \otimes 1 \otimes \mathcal{J}^1 S^{-1}(\Theta^2)) \otimes_{\mathcal{L}} (\mathcal{J}^0 \otimes \Theta^1 \otimes \mathcal{J}^2) \quad (\text{B.11})$$

is a bialgebroid twist for $(\mathcal{L}_{\text{op}} \bowtie \mathcal{DB}^{\text{op}} \otimes H^{\text{op}})^{\text{op}}$.

²The case for an infinite dimensional algebra B can be worked out analogously if one works over a ring $\mathbb{K}[[\hbar]]$ of formal power series and replaces duals with the restricted Hopf dual.

B. Bialgebroids

Proof. The left hand side of Equation (B.9) reads

$$\begin{aligned}
& \Delta(\Psi^1) \Psi \otimes_{\mathcal{L}} \Psi^2 \\
&= \left((1 \otimes 1 \otimes \mathcal{J}_{(1)}^1 \Theta_{(1)}^2) \otimes_{\mathcal{L}} (1 \otimes 1 \otimes \mathcal{J}_{(2)}^1 \Theta_{(2)}^2) \right) \Psi \otimes_{\mathcal{L}} (\mathcal{J}^0 \otimes S(\Theta^1) \otimes \mathcal{J}^2) \\
&= (1 \otimes 1 \otimes \mathcal{J}_{(1)}^1 \Theta_{(1)}^2 \mathcal{J}'^1 \Theta'^2) \otimes_{\mathcal{L}} (\mathcal{J}'^0 \otimes S(\Theta^1) \otimes \mathcal{J}_{(2)}^1 \Theta_{(2)}^2 \mathcal{J}'^2) \otimes_{\mathcal{L}} (\mathcal{J}^0 \otimes S(\Theta^1) \otimes \mathcal{J}^2)
\end{aligned}$$

where here and in what follows primes are used to distinguish different copies of the dynamical twist or the R-matrix Θ . The right hand side of Equation (B.9) is

$$\begin{aligned}
& \Psi^1 \otimes_{\mathcal{L}} \Delta(\Psi^2) \Psi \\
&= (1 \otimes 1 \otimes \mathcal{J}^1 S^{-1}(\Theta^2)) \otimes_{\mathcal{L}} \left((1 \otimes \Theta_{(1)}^1 \otimes \mathcal{J}_{(1)}^2) \otimes_{\mathcal{L}} (\mathcal{J}^0 \otimes \Theta_{(2)}^1 \otimes \mathcal{J}_{(2)}^2) \right) \Psi \\
&= (1 \otimes 1 \otimes \mathcal{J}^1 S^{-1}(\Theta^2)) \otimes_{\mathcal{L}} \left(1 \otimes \Theta_{(1)}^1 \otimes \mathcal{J}_{(1)}^2 \mathcal{J}'^1 S^{-1}(\Theta'^2) \right) \\
&\quad \otimes_{\mathcal{L}} \left(\mathcal{J}^0 \text{.op } \Theta_{(2)(2)}^1 \triangleright \mathcal{J}'^0 \otimes \Theta_{(2)(1)}^1 \Theta'^1 \otimes \mathcal{J}_{(2)}^2 \mathcal{J}'^2 \right) \\
&= (1 \otimes 1 \otimes \mathcal{J}^1 S^{-1}(\Theta'^2) S^{-1}(\Theta''^2) S^{-1}(\Theta^2)) \otimes_{\mathcal{L}} \left(1 \otimes \Theta^1 \otimes \mathcal{J}_{(1)}^2 \mathcal{J}'^1 S^{-1}(\Theta'''^2) \right) \\
&\quad \otimes_{\mathcal{L}} \left(\mathcal{J}^0 \text{.op } \Theta'^1 \triangleright \mathcal{J}'^0 \otimes \Theta''^1 \Theta'''^1 \otimes \mathcal{J}_{(2)}^2 \mathcal{J}'^2 \right)
\end{aligned}$$

where we used that

$$\Theta_{(1)}^1 \otimes \Theta_{(2)}^1 \otimes \Theta_{(3)}^1 \otimes \Theta^2 = \Theta^1 \otimes \Theta''^1 \otimes \Theta'^1 \otimes \Theta^2 \Theta''^2 \Theta'^2$$

since Θ is a universal R-matrix. Now, we use the dynamical cocycle equation to rewrite the above as

$$\begin{aligned}
& \Psi^1 \otimes_{\mathcal{L}} \Delta(\Psi^2) \Psi \\
&= \left(1 \otimes 1 \otimes \underline{\mathcal{J}^1 S^{-1}(\Theta'^2)} S^{-1}(\Theta''^2) S^{-1}(\Theta^2) \right) \otimes_{\mathcal{L}} \left(1 \otimes \Theta^1 \otimes \underline{\mathcal{J}_{(1)}^2} \mathcal{J}'^1 S^{-1}(\Theta'''^2) \right) \\
&\quad \otimes_{\mathcal{L}} \left(\underline{\mathcal{J}^0 \text{.op } \Theta'^1} \triangleright \mathcal{J}'^0 \otimes \Theta''^1 \Theta'''^1 \otimes \underline{\mathcal{J}_{(2)}^2} \mathcal{J}'^2 \right) \\
&= \left(1 \otimes 1 \otimes \underline{\mathcal{J}_{(1)}^1} \mathcal{J}'^1 S^{-1}(\Theta''^2) S^{-1}(\Theta^2) \right) \otimes_{\mathcal{L}} \left(1 \otimes \Theta^1 \otimes \underline{\mathcal{J}_{(2)}^1} \mathcal{J}'^2 S^{-1}(\Theta'^2) \right) \\
&\quad \otimes_{\mathcal{L}} \left(\underline{\mathcal{J}^0 \text{.op } \mathcal{J}'^0} \otimes \Theta''^1 \Theta'^1 \otimes \underline{\mathcal{J}^2} \right) \\
&= \left(1 \otimes 1 \otimes \mathcal{J}_{(1)}^1 \mathcal{J}'^1 \Theta''^2 \Theta^2 \right) \otimes_{\mathcal{L}} \left(1 \otimes S(\Theta^1) \otimes \mathcal{J}_{(2)}^1 \mathcal{J}'^2 \Theta'^2 \right) \\
&\quad \otimes_{\mathcal{L}} \left(\mathcal{J}^0 \text{.op } \mathcal{J}'^0 \otimes S(\Theta^1 \Theta''^1) \otimes \mathcal{J}^2 \right) \\
&= \left(1 \otimes 1 \otimes \mathcal{J}_{(1)}^1 \mathcal{J}'^1 \Theta_{(1)}'^2 \Theta^2 \right) \otimes_{\mathcal{L}} \left(1 \otimes S(\Theta^1) \otimes \mathcal{J}_{(2)}^1 \mathcal{J}'^2 \Theta_{(2)}'^2 \right) \\
&\quad \otimes_{\mathcal{L}} \left(\mathcal{J}^0 \text{.op } \mathcal{J}'^0 \otimes S(\Theta^1) \otimes \mathcal{J}^2 \right) \\
&= \left(1 \otimes 1 \otimes \mathcal{J}_{(1)}^1 \Theta_{(2)}'^2 \mathcal{J}'^1 \Theta^2 \right) \otimes_{\mathcal{L}} \left(1 \otimes S(\Theta^1) \otimes \mathcal{J}_{(2)}^1 \Theta_{(3)}'^2 \mathcal{J}'^2 \right) \\
&\quad \otimes_{\mathcal{L}} \left(\mathcal{J}^0 \text{.op } \Theta_{(1)}'^2 \triangleright \mathcal{J}'^0 \otimes S(\Theta^1) \otimes \mathcal{J}^2 \right)
\end{aligned}$$

where in the second to last line we used that

$$\Theta^1 \otimes \Theta_{(1)}^2 \otimes \Theta_{(2)}^2 = \Theta^1 \Theta'^1 \otimes \Theta^2 \otimes \Theta^2 \quad .$$

B. Bialgebroids

and in the last line we used B -equivariance of the dynamical twist. Next, we will use one more time that Θ is a universal R-matrix to obtain

$$\begin{aligned} \Psi^1 \otimes_{\mathcal{L}} \Delta(\Psi^2) \Psi &= \left(1 \otimes 1 \otimes \mathcal{J}_{(1)}^1 \Theta_{(1)}^2 \mathcal{J}^1 \Theta^2\right) \otimes_{\mathcal{L}} \left(1 \otimes S(\Theta^1) \otimes \mathcal{J}_{(2)}^1 \Theta_{(2)}^2 \mathcal{J}^2\right) \\ &\quad \otimes_{\mathcal{L}} \underbrace{\left(\mathcal{J}^0 \cdot^{\text{op}} \Theta^{\prime 2} \triangleright \mathcal{J}^0 \otimes S(\Theta^{\prime 1}) S(\Theta^1) \otimes \mathcal{J}^2\right)}_{=t(\mathcal{J}^0)s(\mathcal{J}^0)(1 \otimes S(\Theta^1) \otimes \mathcal{J}^2)} \end{aligned}$$

Since the images of the source and target maps commute, we find:

$$\begin{aligned} &\Psi^1 \otimes_{\mathcal{L}} \Delta(\Psi^2) \Psi \\ &= \left(1 \otimes 1 \otimes \mathcal{J}_{(1)}^1 \Theta_{(1)}^2 \mathcal{J}^1 \Theta^2\right) \otimes_{\mathcal{L}} \left(1 \otimes S(\Theta^1) \otimes \mathcal{J}_{(2)}^1 \Theta_{(2)}^2 \mathcal{J}^2\right) \\ &\quad \otimes_{\mathcal{L}} s(\mathcal{J}^0) t(\mathcal{J}^0) \left(1 \otimes S(\Theta^1) \otimes \mathcal{J}^2\right) \\ &= \left(1 \otimes 1 \otimes \mathcal{J}_{(1)}^1 \Theta_{(1)}^2 \mathcal{J}^1 \Theta^2\right) \otimes_{\mathcal{L}} t(\mathcal{J}^0) \left(1 \otimes S(\Theta^1) \otimes \mathcal{J}_{(2)}^1 \Theta_{(2)}^2 \mathcal{J}^2\right) \\ &\quad \otimes_{\mathcal{L}} \left(\mathcal{J}^0 \otimes S(\Theta^1) \otimes \mathcal{J}^2\right) \\ &= \Delta(\Psi^1) \Psi \otimes_{\mathcal{L}} \Psi^2 \quad . \end{aligned}$$

□

The bialgebroid morphism $(\mathcal{L}_{\text{op}} \times \mathcal{DB}^{\text{op}} \otimes H^{\text{op}})^{\text{op}} \xrightarrow{\pi} \left(\mathcal{DB}_{\mathcal{L}_{\text{op}}}^{\text{op}} \otimes H^{\text{op}}\right)^{\text{op}}$ induces a bialgebroid twist $(\pi \otimes_{\mathcal{L}} \pi) \Psi$ on the quotient \mathfrak{B} [DM06, Remark 3.18]. In the following we will be suppressing the projection π from the notation. In other words, we will understand calculations in \mathfrak{B} as those in $(\mathcal{L}_{\text{op}} \times \mathcal{DB}^{\text{op}} \otimes H^{\text{op}})^{\text{op}}$ done modulo the biideal J defining $\mathcal{DB}_{\mathcal{L}_{\text{op}}}^{\text{op}}$.

Module algebras Let A be an H -module algebra. For any $a \in A$ and $h \in H$ we will write $h \otimes a \mapsto h.a$ for the H -action. We equip the tensor product $\mathcal{L} \otimes A$ with the multiplication

$$m_{\mathcal{L} \otimes A}((\lambda \otimes a) \otimes (\mu \otimes b)) = m_{\mathcal{L}}(\lambda \otimes \mu) \otimes m_A(\lambda \otimes \mu) \quad ,$$

for all $\lambda, \mu \in \mathcal{L}$ and $a, b \in A$. As above, let \mathcal{L} be a B -base algebra. We will write \triangleright for the induced left \mathcal{DB} -action.

Proposition B.2.6. $\mathcal{L} \otimes A$ is a module algebra over $\mathfrak{B} = \left(\mathcal{DB}_{\mathcal{L}_{\text{op}}}^{\text{op}} \otimes H^{\text{op}}\right)^{\text{op}}$ for the action defined by

$$(\lambda \otimes \alpha \otimes h) \rightarrow (\mu \otimes a) = \lambda \cdot^{\text{op}} (\alpha \triangleright \mu) \otimes h.a$$

for any $\lambda \otimes \alpha \in \mathcal{DB}_{\mathcal{L}_{\text{op}}}^{\text{op}}$, $h \in H^{\text{op}}$ and $\mu \otimes a \in \mathcal{L} \otimes A$.

Proof. On the one hand we have

$$\begin{aligned} (\lambda \otimes \alpha \otimes h) \rightarrow (\mu \nu \otimes ab) &= \lambda \cdot^{\text{op}} (\alpha \triangleright \mu \nu) \otimes h.ab \\ &= \lambda \cdot^{\text{op}} \alpha_{(2)} \triangleright \nu \cdot^{\text{op}} \alpha_{(1)} \triangleright \mu \otimes (h_{(1)}.a) (h_{(2)}.b) \end{aligned}$$

and on the other hand we have

$$\begin{aligned} m_{\mathcal{L} \otimes A}(\Delta_{\mathfrak{B}}(\lambda \otimes \alpha \otimes h) \rightarrow (\mu \otimes a) \otimes (\nu \otimes b)) \\ &= m_{\mathcal{L} \otimes A} \left((1 \otimes \alpha_{(1)} \otimes h_{(1)}) \otimes_{\mathcal{L}} (\lambda \otimes \alpha_{(2)} \otimes h_{(2)}) \rightarrow (\mu \otimes a) \otimes (\nu \otimes b) \right) \\ &= m_{\mathcal{L} \otimes A} \left((\alpha_{(1)} \triangleright \mu \otimes h_{(1)}.a) \otimes (\lambda \cdot^{\text{op}} \alpha_{(2)} \triangleright \nu \otimes h_{(2)}.b) \right) \\ &= (\alpha_{(1)} \triangleright \mu) (\lambda \cdot^{\text{op}} \alpha_{(2)} \triangleright \nu) \otimes (h_{(1)}.a) (h_{(2)}.b) \end{aligned}$$

B. Bialgebroids

□

Proposition B.2.7. *Let Ψ be the bialgebroid twist from (B.11). Then, $\mathcal{L} \otimes A$ with multiplication*

$$\begin{aligned} a * b &= \mathcal{J}^0 \otimes m_A (\mathcal{J}^1.a \otimes \mathcal{J}^2.b) & \lambda * \mu &= m_{\mathcal{L}} (\lambda \otimes \mu) \\ a * \lambda &= \Theta^1 \triangleright \lambda \otimes S^{-1} (\Theta^2).a & \lambda * a &= \lambda \otimes a \end{aligned} \quad (\text{B.12})$$

for $a, b \in A$, $\lambda, \mu \in \mathcal{L}$, is a module algebra over the twisted bialgebroid $\tilde{\mathfrak{B}}$

Proof. By Propositions B.2.6 we know that $\mathcal{L} \otimes A$ is a module algebra over the untwisted bialgebroid \mathfrak{B} . Then, it follows from Proposition B.2.4 that $\mathcal{L} \otimes A$ with the Ψ -twisted multiplication is a module algebra over the Ψ -twisted bialgebroid. Explicitly, for any $a, b \in A$, the twisted multiplication is

$$\begin{aligned} a * b &= m_{\mathcal{L} \otimes A} (\Psi^1 \rightharpoonup (1 \otimes a) \otimes \Psi^2 \rightharpoonup (1 \otimes b)) \\ &= m_{\mathcal{L} \otimes A} ((1 \otimes \mathcal{J}^1 S^{-1} (\Theta^2).a) \otimes ((\Theta^1 \triangleright 1) \mathcal{J}^0 \otimes \mathcal{J}^2.b)) \\ &= m_{\mathcal{L}} (1 \otimes \mathcal{J}^0) \otimes m_A (\mathcal{J}^1.a \otimes \mathcal{J}^2.b) \end{aligned}$$

where we used that $\Theta^1 \triangleright 1 = \epsilon (\Theta^1)$. This agrees with the formula in (B.12). For $a \in A$ and $\lambda \in \mathcal{L}$ we have

$$\begin{aligned} a * \lambda &= m_{\mathcal{L} \otimes A} (\Psi^1 \rightharpoonup (1 \otimes a) \otimes \Psi^2 \rightharpoonup (\lambda \otimes 1)) \\ &= m_{\mathcal{L} \otimes A} ((1 \otimes \mathcal{J}^1 S^{-1} (\Theta^2).a) \otimes ((\Theta^1 \triangleright \lambda) \mathcal{J}^0 \otimes \mathcal{J}^2.1)) \\ &= m_{\mathcal{L}} (1 \otimes \Theta^1 \triangleright \lambda) \otimes m_A (S^{-1} (\Theta^2).a \otimes 1) \quad , \end{aligned}$$

where this time we used that A is an H -module algebra and therefore $\mathcal{J}^2.1 = \epsilon (\mathcal{J}^2)$, together with $\mathcal{J}^0 \otimes \mathcal{J}^1 \otimes \epsilon (\mathcal{J}^2) = 1 \otimes 1 \otimes 1$ which holds for any dynamical twist. The other cases can be worked out similarly. □

Bibliography

- [AB83] M. F. Atiyah and R. Bott. The Yang–Mills equations over Riemann surfaces. *Philosophical Transactions of the Royal Society of London. Series A, Mathematical and Physical Sciences*, 308(1505):523–615, 1983.
- [ABRR98] D. Arnaudon, E. Buffenoir, E. Ragoucy, and P. Roche. Universal solutions of quantum dynamical Yang–Baxter equations. *Letters in Mathematical Physics*, 44(3):201–214, 1998.
- [AF15] F. Ayala and J. Francis. Factorization homology of topological manifolds. *Journal of Topology*, 8(4):1045–1084, 2015.
- [AF19] F. Ayala and J. Francis. A factorization homology primer. 2019. *arXiv:1903.10961*.
- [AFT17] F. Ayala, J. Francis, and H. L. Tanaka. Factorization homology of stratified spaces. *Selecta Mathematica*, 23(1):293–362, 2017.
- [AGS95] A. Alekseev, H. Grosse, and V. Schomerus. Combinatorial quantization of the Hamiltonian Chern–Simons theory I. *Communications in Mathematical Physics*, 172(2):317–358, 1995.
- [AGS96] A. Alekseev, H. Grosse, and V. Schomerus. Combinatorial quantization of the Hamiltonian Chern–Simons theory II. *Communications in Mathematical Physics*, 174(3):561–604, 1996.
- [AKSM00] A. Alekseev, Y. Kosmann-Schwarzbach, and E. Meinrenken. Quasi-Poisson manifolds. *Canadian Journal of Mathematics*, 54(1):3–29, 2000.
- [Ati88] M. Atiyah. Topological quantum field theories. *Publications Mathématiques de l’Institut des Hautes Etudes Scientifiques*, 68:175–186, 1988.
- [Aud97] M. Audin. Lectures on gauge theory and integrable systems. In *Gauge theory and symplectic geometry*, volume 488 of *NATO Adv. Sci. Inst. Ser. C Math. Phys. Sci.*, pages 1–48. Kluwer Academic Publishers, Dordrecht, 1997.
- [BCJF15] M. Brandenburg, A. Chirvasitu, and T. Johnson-Freyd. Reflexivity and dualizability in categorified linear algebra. *Theory and Applications of Categories*, 30(23):808–835, 2015.
- [BD95] J. Baez and J. Dolan. Higher-dimensional algebra and topological quantum field theory. *Journal of Mathematical Physics*, 36(11):6073–6105, 1995.
- [BD04] A. Beilinson and V. G. Drinfeld. *Chiral algebras*. American Mathematical Society, Providence, RI, 2004.
- [BF96] A. G. Bytsko and L. D. Faddeev. $(T^*\mathcal{B})_q$, q -analogue of model space and CGC generating matrices. *Journal of Mathematical Physics*, 37(12):6324–6348, 1996.
- [Bir84] G. J. Bird. Limits in 2-categories of locally-presentable categories. 1984. Ph.D. Thesis, University of Sydney.
- [BJS21] A. Brochier, D. Jordan, and N. Snyder. On dualizability of braided tensor categories. *Compositio Mathematica*, 157(3):435–483, 2021.
- [BK19] M. Balagović and S. Kolb. Universal K-matrix for quantum symmetric pairs. *Journal für die reine und angewandte Mathematik*, 2019(747):229–353, 2019.
- [BQR98] F. Borceux, C. Quinteiro, and J. Rosicky. A theory of enriched sketches. *Theory and Applications of Categories*, 4(3):47–72, 1998.
- [BR95] E. Buffenoir and P. Roche. Two dimensional lattice gauge theory based on a quantum group. *Communications in Mathematical Physics*, 170(3):669–698, 1995.
- [BR96] E. Buffenoir and P. Roche. Link invariants and combinatorial quantization of Hamiltonian Chern–Simons theory. *Communications in Mathematical Physics*, 181(2):331–365, 1996.
- [BR05] E. Buffenoir and P. Roche. Chern–Simons theory with sources and dynamical quantum groups I: Canonical analysis and algebraic structures. 2005. *arXiv:hep-th/0505239*.
- [Bro12] A. Brochier. A Kohno-Drinfeld theorem for the monodromy of cyclotomic KZ connections. *Communications in Mathematical Physics*, 311, 2012.

Bibliography

- [Bro13] A. Brochier. Cyclotomic associators and finite type invariants for tangles in the solid torus. *Algebraic and Geometric Topology*, 13:3365–3409, 2013.
- [BZBJ18a] D. Ben-Zvi, A. Brochier, and D. Jordan. Integrating quantum groups over surfaces. *Journal of Topology*, 11(4):874–917, 2018.
- [BZBJ18b] D. Ben-Zvi, A. Brochier, and D. Jordan. Quantum character varieties and braided module categories. *Selecta Mathematica*, 24(5):4711–4748, 2018.
- [Cam19] A. Campbell. How strict is strictification? *Journal of Pure and Applied Algebra*, 223(7):2948–2976, 2019.
- [Car93] P. Cartier. Construction combinatoire des invariants de Vassiliev–Kontsevich des nœuds. *Les rencontres physiciens-mathématiciens de Strasbourg - RCP25*, 45:1–10, 1993.
- [CG21] G. Costello and O. Gwilliam. *Factorization algebras in quantum field theory*. Cambridge University Press, Cambridge, 2021.
- [CJF13] A. Chirvasitu and T. Johnson-Freyd. The fundamental pro-groupoid of an affine 2-scheme. *Applied Categorical Structures*, 21:469–522, 2013.
- [CP95] V. Chari and N. Pressley. *A guide to quantum groups*. Cambridge University Press, Cambridge, 1995.
- [CPT⁺17] D. Calaque, T. Pantev, B. Toën, M. Vaquié, and G. Vezzosi. Shifted Poisson structures and deformation quantization. *Journal of Topology*, 10(2):483 – 584, 2017.
- [DM03] J. Donin and A. Mudrov. Reflection equation, twist, and equivariant quantization. *Israel Journal of Mathematics*, 136:11–28, 2003.
- [DM05] J. Donin and A. Mudrov. Dynamical Yang–Baxter equation and quantum vector bundles. *Communications in Mathematical Physics*, 254:719–760, 2005.
- [DM06] J. Donin and A. Mudrov. Quantum groupoids and dynamical categories. *Journal of Algebra*, 296(2):348–384, 2006.
- [Dri89a] V. G. Drinfeld. Almost cocommutative Hopf algebras. *Algebra i Analiz*, 1(2):30–46, 1989. (*translation in Leningrad Mathematical Journal*, 1990, 1:2, 321–342).
- [Dri89b] V. G. Drinfeld. Quasi-Hopf algebras and Knizhnik–Zamolodchikov equations. In *Problems of Modern Quantum Field Theory*, Research Reports in Physics, pages 1–13. Springer, Berlin, Heidelberg, 1989.
- [Dri90] V. G. Drinfeld. On quasitriangular quasi-Hopf algebras and on a group that is closely connected with $\text{Gal}(\overline{\mathbb{Q}}/\mathbb{Q})$. *Algebra i Analiz*, 2(4):149–181, 1990. (*translation in Leningrad Mathematical Journal*, 1991, 2:4, 829–860).
- [Dri00] V. G. Drinfeld. Hamiltonian structures on Lie groups, Lie bialgebras and the geometric meaning of the classical Yang–Baxter equation. In *Yang–Baxter Equation in Integrable Systems*, volume 10 of *Advances Series in Mathematical Physics*, pages 222–225. World Scientific, Singapore, 2000.
- [DSPS13] C. L. Douglas, C. Schommer-Pries, and N. Snyder. Dualizable tensor categories. 2013. *arXiv:1312.7188*.
- [Dub70] E. J. Dubuc. *Kan extensions in enriched category theory*. Lecture Notes in Mathematical Physics. Springer, Berlin, 1970.
- [EE05] B. Enriquez and P. Etingof. Quantization of classical dynamical r-matrices with nonabelian base. *Communications in Mathematical Physics*, 254:603–650, 2005.
- [EEM04] B. Enriquez, P. Etingof, and I. Marshall. Quantization of some Poisson–Lie dynamical r-matrices and Poisson homogeneous spaces. 2004. *arXiv:math/0403283*.
- [EGNO15] P. Etingof, S. Gelaki, D. Nikshych, and V. Ostrik. *Tensor categories*. Mathematical Surveys and Monographs, Volume 205. American Mathematical Society, Providence, RI, 2015.
- [EN01] P. Etingof and D. Nikshych. Dynamical twists in group algebras. *International Mathematics Research Notices*, 2001(13):679–701, 2001.
- [Enr08] B. Enriquez. Quasi-reflection algebras and cyclotomic associators. *Selecta Mathematica*, 13:391–463, 2008.
- [ES01] P. Etingof and O. Schiffmann. On the moduli space of classical dynamical r-matrices. *Mathematical Research Letters*, 8(2):157–170, 2001.

Bibliography

- [ES02a] P. Etingof and O. Schiffmann. *Lectures on quantum groups*. Lectures in Mathematical Physics. International Press, Somerville, MA, 2002.
- [ES02b] P. Etingof and O. Schiffmann. Lectures on the dynamical Yang–Baxter equations. In *Quantum Groups and Lie Theory*, London Mathematical Society Lecture Note Series, page 89–129. Cambridge, 2002.
- [Eti02] P. Etingof. On the dynamical Yang–Baxter equation. *Proceedings of the ICM, Beijing*, 2:555–570, 2002.
- [EV98a] P. Etingof and A. Varchenko. Geometry and classification of solutions of the classical dynamical Yang–Baxter equation. *Communications in Mathematical Physics*, 192:77–120, 1998.
- [EV98b] P. Etingof and A. Varchenko. Solutions of the quantum dynamical Yang–Baxter equation and dynamical quantum groups. *Communications in Mathematical Physics*, 196(3):591–640, 1998.
- [EV99] P. Etingof and A. Varchenko. Exchange dynamical quantum groups. *Communications in Mathematical Physics*, 205(1):19–52, 1999.
- [Fel95] G. Felder. Conformal field theory and integrable systems associated to elliptic curves. In *Proceedings of the International Congress of Mathematicians*, pages 1247–1255. Birkhäuser, Basel, 1995.
- [FM02] L. Fehér and I. Marshall. On a Poisson–Lie analogue of the classical dynamical Yang–Baxter equation for self-dual Lie algebras. *Letters in Mathematical Physics*, 62:51–62, 2002.
- [FR93] V. V. Fock and A. A. Rosly. Flat connections and polyubles. *Theoretical and Mathematical Physics*, 95(2):526–534, 1993.
- [FR99] V. V. Fock and A. A. Rosly. Poisson structure on moduli of flat connections on Riemann surfaces and the r -matrix. In *Moscow Seminar in Mathematical Physics*, volume 191 of *Amer. Math. Soc. Transl. Ser. 2*, pages 67–86. American Mathematical Society, Providence, RI, 1999.
- [Fra13] I. L. Franco. Tensor products of finitely cocomplete and abelian categories. *Journal of Algebra*, 396(15):207–219, 2013.
- [FSS17] J. Fuchs, G. Schaumann, and C. Schweigert. A trace for bimodule categories. *Applied Categorical Structures*, 25:227–268, 2017.
- [Gin15] G. Ginot. Notes on factorization algebras, factorization homology and applications. In *Mathematical Aspects of Quantum Field Theories*, pages 429–552. Springer, Cham, 2015.
- [GJS21] S. Gunningham, D. Jordan, and P. Safronov. The finiteness conjecture for skein modules. 2021. *arXiv:1908.05233v3*.
- [GN84] J.-L. Gervais and A. Neveu. Novel triangle relation and absence of tachyons in Liouville string field theory. *Nuclear Physics B*, 238:125–141, 1984.
- [Gol84] W. M. Goldman. The symplectic nature of fundamental groups of surfaces. *Advances in Mathematics*, 54(2):200–225, 1984.
- [GPS95] R. Gordon, A. J. Powers, and R. Street. *Coherence for tricategories*. American Mathematical Society, Providence, RI, 1995.
- [GTZ14] G. Ginot, T. Tradler, and M. Zeinalian. Higher Hochschild homology, topological chiral homology and factorization algebras. *Communications in Mathematical Physics*, 326:635–686, 2014.
- [GU71] P. Gabriel and F. Ulmer. *Lokal präsentierbare Kategorien*, volume 221 of *Lecture Notes in Mathematics*. Springer-Verlag, Berlin, 1971.
- [Gut83] S. Gutt. An explicit $*$ -product on the cotangent bundle of a Lie group. *Letters in Mathematical Physics*, 7:249–258, 1983.
- [Hau17] R. Haugseng. The higher Morita category of E_n -algebras. *Geometry & Topology*, 21(3):1631–1730, 2017.
- [Hol07] S. Hollander. Descent for quasi-coherent sheaves on stacks. *Algebraic & Geometric Topology*, 7(1):411–437, 2007.
- [Hum90] J. E. Humphreys. *Reflection groups and Coxeter groups*. Cambridge University Press, Cambridge, 1990.

Bibliography

- [JFS17] T. Johnson-Freyd and C. Scheimbauer. (Op)lax natural transformations, twisted quantum field theories, and “even higher” Morita categories. *Advances in Mathematics*, 307:147–223, 2017.
- [JLSS21] D. Jordan, I. Le, G. Schrader, and A. Shapiro. Quantum decorated character stacks. 2021. *arXiv:2102.12283*.
- [Jos95] A. Joseph. *Quantum groups and their primitive ideals*, volume 29 of *Ergebnisse der Mathematik und ihrer Grenzgebiete*. Springer, Berlin, 1995.
- [Kas95] C. Kassel. *Quantum groups*. Springer, New York, 1995.
- [Kel82] G. M. Kelly. Structures defined by finite limits in the enriched context, I. *Cahiers de topologie et géométrie différentielle catégoriques*, 23(1):3–42, 1982.
- [Kel89] G. M. Kelly. Elementary observations on 2-categorical limits. *Bulletin of the Australian Mathematical Society*, 39(2):301–317, 1989.
- [Kel05] G. M. Kelly. Basic concepts of enriched category theory. *Reprints in Theory and Applications of Categories*, (10):1–136, 2005.
- [KKMP] E. Karlsson, C. Keller, L. Müller, and J. Pulmann. Deformation quantization and categorical factorization homology. In preparation.
- [KM23] C. Keller and L. Müller. Finite symmetries of quantum character stacks. *Theory and Applications of Categories*, 39(3):51–97, 2023.
- [Kol19] S. Kolb. Braided module categories via quantum symmetric pairs. *Proceedings of the London Mathematical Society*, 121(1):1–31, 2019.
- [KS97] A. Klimyk and K. Schmüdgen. *Quantum groups and their representations*. Texts and Monographs in Physics. Springer, Berlin, 1997.
- [KS04] Y. Kosmann-Schwarzbach. Lie bialgebras, Poisson–Lie groups and dressing transformations. In *Integrability of Nonlinear Systems*, Lecture Notes in Physics, Second Edition, pages 107–173. Springer, 2004.
- [KS20] A. Kalmykov and P. Safronov. A categorical approach to dynamical quantum groups. 2020. *arXiv:2008.09081*.
- [LM17] J.-H. Lu and V. Mouquin. Mixed product Poisson structures associated to Poisson–Lie groups and Lie bialgebra. *International Mathematics Research Notices*, 2017(19):5919–5976, 2017.
- [Lu96] J.-H. Lu. Hopf algebroids and quantum groupoids. *International Journal of Mathematics*, 7:47–70, 1996.
- [Lur] J. Lurie. Higher algebra. Preprint available at: <https://www.math.ias.edu/~lurie/>.
- [Lur09] J. Lurie. On the classification of topological field theories. *Current Developments in Mathematics*, 2008:129–280, 2009.
- [LW90] J.-H. Lu and A. Weinstein. Poisson–Lie groups, dressing transformations and Bruhat decomposition. *Journal of Differential Geometry*, 31:501–526, 1990.
- [Lyu95a] V. Lyubashenko. Invariants of 3-manifolds and projective representations of mapping class groups via quantum groups at roots of unity. *Communications in Mathematical Physics*, 172(3):467–516, 1995.
- [Lyu95b] V. Lyubashenko. Modular transformations for tensor categories. *Journal of Pure and Applied Algebra*, 98(3):279–327, 1995.
- [Maj95] S. Majid. *Foundations of quantum group theory*. Cambridge University Press, Cambridge, 1995.
- [Mei17] E. Meinrenken. Convexity for twisted conjugation. *Mathematical Research Letters*, 24:1797–1818, 2017.
- [Meu21] C. Meusburger. Poisson–Lie groups and gauge theory. *Symmetry*, 13(8), 2021.
- [Mou17] V. Mouquin. The Fock–Rosly Poisson structure as defined by a quasi-triangular r-matrix. *Symmetry, Integrability and Geometry: Methods and Applications*, 13, 2017.
- [MSS22] L. Müller, L. Szegedy, and R. J. Szabo. Symmetry defects and orbifolds of two-dimensional Yang–Mills theory. *Letters in Mathematical Physics*, 112(2), 2022.

Bibliography

- [MW20] L. Müller and L. Woike. The little bundles operad. *Algebraic & Geometric Topology*, 20(4):2029–2070, 2020.
- [Ost03] V. Ostrik. Module categories, weak Hopf algebras and modular invariants. *Transformation Groups*, 8:177–206, 2003.
- [Pos17] L. Positselski. Contraadjusted modules, contramodules and reduced cotorsion modules. *Moscow Mathematical Journal*, 17(3):385–455, 2017.
- [Saf21a] P. Safronov. A categorical approach to quantum moment maps. *Theory and Applications of Categories*, 37(24):818–862, 2021.
- [Saf21b] P. Safronov. Poisson–Lie structures as shifted Poisson structures. *Advances in Mathematics*, 381, 2021.
- [Sch98] O. Schiffmann. On classification of dynamical r-matrices. *Mathematical Research Letters*, 5(1):13–30, 1998.
- [Sch14] C. Scheimbauer. Factorization homology as a fully extended topological field theory. 2014. Ph.D. Thesis, ETH Zürich.
- [Seg04] G. Segal. The definition of conformal field theory. In *Topology, geometry and quantum field theory*, volume 308 of *London Math. Soc. Lect. Note Ser.*, pages 421–577. Cambridge University Press, Cambridge, 2004.
- [Spi20] A. Spies. Poisson analogues of Kitaev models and Poisson structures associated with ribbon graphs. 2020. Ph.D. Thesis, Friedrich-Alexander-Universität Erlangen-Nürnberg.
- [Sta21] The Stacks project authors. The stacks project. <https://stacks.math.columbia.edu>, 2021.
- [STS94] M. A. Semenov-Tian-Shansky. Poisson–Lie groups, quantum duality principle, and the quantum double. *Contemporary Mathematics*, 175:219–248, 1994.
- [SW03] P. Salvatore and N. Wahl. Framed discs operads and Batalin–Vilkovisky algebras. *The Quarterly Journal of Mathematics*, 54(2):213–231, 2003.
- [Tur10] V. Turaev. *Homotopy quantum field theory*. European Mathematical Society, 2010. *With appendices by M. Müger and A. Virelizier*.
- [VY20] C. Voigt and R. Yuncken. *Complex semisimple quantum groups and representation theory*. Lecture Notes in Mathematics. Springer, Cham, 2020.
- [Wee18a] T. A. N. Weelinck. Equivariant factorization homology of global quotient orbifolds. 2018. *arXiv:1810.12021*.
- [Wee18b] T. A. N. Weelinck. A topological origin of quantum symmetric pairs. 2018. *arXiv:1804.02315*.
- [Wei88] A. Weinstein. Coisotropic calculus and Poisson groupoids. *Journal of the Mathematical Society of Japan*, 40(4):705–727, 1988.
- [Xu01] P. Xu. Quantum groupoids. *Communications in Mathematical Physics*, 216:539–581, 2001.
- [Xu02] P. Xu. Quantum dynamical Yang–Baxter equation over a nonabelian base. *Communications in Mathematical Physics*, 226:475–495, 2002.
- [Zer21] A. J. Zerouali. Twisted moduli spaces and Duistermaat–Heckman measures. *Journal of Geometry and Physics*, 161, 2021.
- [Zhe87] D. P. Zhelobenko. Extremal cocycles of Weyl groups. *Functional Analysis and its Applications*, 21:183–192, 1987.