



**HAL**  
open science

# Smart and Resilient Mobility Under Restrictions: Application to the Palestinian Territories

Hala Aburas

► **To cite this version:**

Hala Aburas. Smart and Resilient Mobility Under Restrictions: Application to the Palestinian Territories. Civil Engineering. Laboratoire Génie Civil et géo-Environnement; Lille University, 2023. English. NNT: . tel-04398098

**HAL Id: tel-04398098**

**<https://theses.hal.science/tel-04398098>**

Submitted on 16 Jan 2024

**HAL** is a multi-disciplinary open access archive for the deposit and dissemination of scientific research documents, whether they are published or not. The documents may come from teaching and research institutions in France or abroad, or from public or private research centers.

L'archive ouverte pluridisciplinaire **HAL**, est destinée au dépôt et à la diffusion de documents scientifiques de niveau recherche, publiés ou non, émanant des établissements d'enseignement et de recherche français ou étrangers, des laboratoires publics ou privés.

Copyright

University of Lille  
Doctoral School of Engineering and System Sciences  
Laboratory of Civil and Geo-Environmental Engineering

## **THESIS**

submitted to obtain the

**Doctoral Degree (Ph.D.)**

Specialty: **Civil Engineering**

By

**Hala ABURAS**

## **Smart and Resilient Mobility Under Restrictions: Application to the Palestinian Territories**

Defended on November 14<sup>th</sup>, 2023, in front of the jury composed of:

<b>Isam SHAHROUR</b>	Professor, University of Lille, France	Director
<b>Marwan SADEK</b>	MCF-HDR, University of Lille, France	Co-Director
<b>Rani ELMEOUCHE</b>	Professor, HDR, ESTP-Paris, France	Reporter
<b>Ihab HIJAZI</b>	Associate professor, An-Najah National University, Palestine	Reporter
<b>Carlo GIGLIO</b>	Associate professor, Mediterranean University of Reggio Calabria, Italy	Invited
<b>Shaker KHALIL</b>	MCF, An-Najah National University, Palestine	Invited
<b>Marwan ALHEIB</b>	Research director, Ineris, France	Examiner
<b>Sawsan SADEK</b>	Professor, Lebanese University, Lebanon	Examiner
<b>Sana OUNAIES</b>	MCF, University of Lille, France	Examiner
<b>Slim HAMMADI</b>	Professor, Centrale Lille, France	President

Université de Lille  
Ecole doctorale Science de l'ingénierie et des systèmes  
Laboratoire Génie Civil et géo-Environnement

## THÈSE

soumise pour l'obtention du  
**Grade de Docteur**  
Discipline: **Génie Civil**

Par

**Hala ABURAS**

# **Mobilité Intelligente et Résiliente Sous Contraintes: Application aux Territoires Palestiniens**

Soutenue le 14 Novembre 2023 devant le jury composé de:

<b>Isam SHAHROUR</b>	Professeur, Université de Lille, France	Directeur
<b>Marwan SADEK</b>	MCF-HDR, Université de Lille, France	Co-Directeur
<b>Rani ELMEOUCHE</b>	Professeure, HDR, ESTP-Paris, France	Rapporteur
<b>Ihab HIJAZI</b>	Professeure associée, Université Nationale An-Najah, Palestine	Rapporteur
<b>Carlo GIGLIO</b>	Professeure associée, Université de la Méditerranée de Reggio de Calabre, Italie	Invité
<b>Shaker KHALIL</b>	MCF, Université nationale An-Najah, Palestine	Invité
<b>Marwan ALHEIB</b>	Directeur de recherche, Ineris, France	Examinateur
<b>Sawsan SADEK</b>	Professeur, Université Libanaise, Lebanon	Examinatrice
<b>Sana OUNAIES</b>	MCF, Université de Lille, France	Examinatrice
<b>Slim HAMMADI</b>	Professeur, Ecole Centrale de Lille, France	Président

## Acknowledgment

First and foremost, I express my profound gratitude to God, whose guidance and strength have been my constant companions throughout this journey.

I extend my heartfelt appreciation to my supervisor, Professor. Isam Shahrour, for his patience, determined support, invaluable insights, and mentorship. His dedication to my academic growth has played a pivotal role in shaping this research. I would also like to acknowledge the support of my co-supervisor, Dr. Marwan SADEK.

I am truly thankful to the committee members for their thoughtful reviews and contributions that have enriched my research. My appreciation to Campus France for granting me the invaluable opportunity to pursue my PhD thesis through the French government scholarship. This support not only enables me to delve deeper into my research but also signifies a profound investment in my academic journey.

My gratitude also extends to the members of LGCgE for their engaging discussions, encouragement, and constructive feedback. I am grateful to my friends who provided encouragement and shared laughter, making this academic journey not only bearable but also enjoyable.

I owe a debt of gratitude that words cannot adequately convey to my family. To my parents, your firm belief in me has been my greatest motivation. To my husband, Mohammed, your love, patience, and constant support sustained me during the most challenging times. To my brothers and sisters, your encouragement and belief in my abilities have been an endless source of inspiration.

Lastly, to all those who have crossed my path, directly or indirectly contributing to my academic journey, I offer my heartfelt thanks. Your presence in my life has been a blessing.

## Abstract

This thesis aims at developing a smart mobility solution to enhance the travel experience of individuals facing mobility restrictions due to the occupation in Palestine, West Bank. The research resulted in the Smart and Resilient Mobility Services Platform (SRMS), powered by spatial crowdsourcing technology to provide integrated mobility services. These services include real-time mapping of mobility restrictions, prompt notifications system, informal route mapping, and alternative path suggestions to optimize safety, travel time, and distance. The study begins by assessing the adverse impacts of traffic disruptions caused by mobility restrictions, considering socioeconomic and environmental sustainability in Palestine. Subsequently, the research explores existing strategies and smart technologies to address mobility disruptions, identifying gaps in the literature. The outcome is the development of the SRMS platform, addressing these gaps through a methodology that includes problem definition, conceptualization, and design based on a four-layer system, prototyping, ethical considerations, and testing. The SRMS is tailored to the Palestinian context, meeting user needs and aligning with available data sources and the local context.

**Keywords:** Mobility, restrictions, traffic disruption, smart, crowdsourcing, GIS, machine learning, Palestine.

## Résumé

Cette thèse a porté sur le développement d'une solution de mobilité intelligente pour améliorer faire face aux restrictions de mobilité dues à l'occupation en Palestine. Elle a permis la création d'une plateforme de services de mobilité intelligente et résiliente (SRMS), alimentée par une technologie de crowdsourcing spatial fournissant des services de mobilité intégrés. Ces services comprennent une cartographie en temps réel des restrictions de mobilité, un système de notifications rapides, une cartographie informelle des itinéraires et des suggestions de chemins alternatifs pour optimiser la sécurité, le temps de trajet et la distance. La recherche commence par évaluer les impacts négatifs des perturbations de la circulation causées par les restrictions de mobilité, en tenant compte de la durabilité socio-économique et environnementale. Par la suite, la recherche explore les stratégies existantes et les technologies intelligentes pour faire face aux perturbations de la mobilité, en identifiant les lacunes dans la littérature. Le résultat est le développement de la plateforme SRMS, comblant ces lacunes grâce à une méthodologie qui comprend la définition du problème, la conceptualisation et la conception basée sur un système à quatre couches, le prototypage, les considérations éthiques et les tests. Le SRMS est adapté au contexte palestinien, répondant aux besoins des utilisateurs et s'alignant sur les sources de données disponibles et le contexte local.

**Mots-clés:** Mobilité, restrictions, perturbations du trafic, smart, crowdsourcing, SIG, machine learning, Palestine.

# Table of Contents

Acknowledgment .....	III
Abstract .....	IV
Résumé.....	V
Table of Contents .....	VI
List of Figures .....	IX
List of Tables .....	XII
Abbreviations .....	XIII
General Introduction .....	1
Chapter 1. State of the Art .....	4
Introduction.....	4
1.1. Impacts of Manmade and Natural Traffic Disruptive Events .....	4
1.2. Recent Smart Strategies for Managing Traffic Disruptions.....	6
1.2.1. Real-time road traffic data monitoring and data collection .....	7
1.2.2. Traffic predictive models .....	8
1.2.3. Traffic control and signal optimization.....	10
1.2.4. Dynamic route guidance and navigation.....	11
1.2.5. Communication and information dissemination.....	12
1.3. Enabling Smart Technologies for Traffic Disruptions Management .....	13
1.3.1. Smart Sensors and IoT for Traffic Disruptive Management .....	15
1.3.2. Artificial Intelligence AI for Traffic Disruptive Management .....	16
1.3.3. Geospatial Technologies for Traffic Disruptive Management .....	19
1.4. Research Analysis and Research Gap .....	22
1.5. Conclusion.....	29
Chapter 2. Research Methodology.....	30
Introduction.....	30
2.1. Mobility Restrictions in West Bank .....	30
2.1.1. Mobility in the West Bank: Oslo Accords to the Second Intifada (1993-1999).....	30
2.1.2. Mobility in the West Bank: From the Second Intifada to the Present Day (2000-Present) .....	32
2.1.3. Impact of Mobility Restrictions on the Population and Sustainability in WB .....	34
2.2. Research Methodology.....	36
2.2.1. Overview .....	36
2.2.2. The outcome of the literature review .....	37

2.2.3.	Developing a Smart and Resilient Mobility Services (SRMS) Platform.....	39
2.2.4.	Implementation SRMS platform in the Palestinian Context, West Bank.....	46
2.3.	Conclusion.....	46
Chapter 3. Methodology for Developing the Architecture of Smart and Resilient Mobility Services (SRMS) Platform.....		47
Introduction.....		47
3.1.	Layers of the SRMS System .....	47
3.1.1.	First Layer: Urban Mobility Infrastructure .....	48
3.1.2.	Second Layer: Data Collection and Transmission.....	51
3.1.3.	Third Layer: Data Processing .....	53
3.1.4.	Fourth Layer: Service/Application .....	58
3.2.	Data Quality and Privacy .....	58
3.2.1.	User Quality .....	59
3.2.2.	Data Quality .....	60
3.2.3.	Data Privacy.....	61
3.3.	SRMS Web App Mobile .....	63
3.3.1.	SRMS User-Centered Design .....	65
3.4.	General Framework for the Platform Operating System .....	68
3.5.	Conclusion.....	70
Chapter 4. Methodology for Developing SRMS Services.....		71
Introduction.....		71
4.1.	Real-time Mapping of Mobility Restrictions and Traffic Conditions Service.....	71
4.1.1.	Overview.....	71
4.1.2.	Data Sources and Collection.....	73
4.1.3.	Data Processing and Analysis.....	76
4.1.4.	Service Publishing .....	81
4.2.	Mapping Informal Routes .....	82
4.2.1.	Overview.....	82
4.2.2.	Data Sources and Collection.....	83
4.2.3.	Data Processing and Analysis.....	85
4.2.4.	Service Publishing .....	87
4.3.	Route Planning Service .....	87
4.3.1.	Overview.....	87
4.3.2.	Data Sources and Collection.....	91
4.3.3.	Data Processing and Analysis.....	93
4.3.4.	Service Publishing .....	103



4.4. Conclusion.....	103
Chapter 5. Application the Smart and Resilient Mobility Services (SRMS) Platform to the Palestinian Context, West Bank.....	105
Introduction.....	105
5.1. Mitigating the Impacts of Mobility Restrictions.....	105
5.1.1. National Level.....	106
5.1.2. Local Level.....	106
5.1.3. Community and Individual Level.....	107
5.2. Application of SRMS in West Bank, Palestine.....	112
5.2.1. Overview.....	112
5.2.2. SRMS User-Centered Design.....	112
5.2.3. SRMS Mobile Web App.....	116
5.2.4. SRMS Services.....	121
5.3. Conclusion.....	147
General Conclusion.....	149
References.....	151

## List of Figures

Figure 1.1. Smart strategies for managing traffic disruptions .....	7
Figure 1.2. Enabling technologies for traffic disruption management .....	14
Figure 1.3. The interaction of the technologies for delivering optimal mobility service .....	15
Figure 1.4. Observed research gap.....	28
Figure 2.1. Area A, B, and C according to Oslo Accords.....	31
Figure 2.2. Time series of mobility restrictions erection and restriction types (ARIJ, 2019b)	32
Figure 2.3. Movement obstacles by type (OCHA, 2020a) .....	33
Figure 2.4. Distribution of mobility restrictions (Separation Wall and Checkpoints).....	34
Figure 2.5. General methodology of evaluating the environmental impacts of mobility restrictions.....	35
Figure 2.6. Distribution of checkpoints in Qalqilya Governorate .....	36
Figure 2.7. General Research Methodology .....	37
Figure 2.8. Methodology for creating the SRMS Platform .....	40
Figure 2.9. Layers of SRMS Platform .....	41
Figure 3.1. Architecture of smart and resilient mobility services platform (SRMS).....	48
Figure 3.2. Power-Interest graph for SRMS stakeholders .....	51
Figure 3.3. Data sources and collection methods .....	53
Figure 3.4. Data processing components in SRMS .....	54
Figure 3.5. The structured data and their corresponding schema within the crowd-context database.....	57
Figure 3.6. SRMS’s methods of ensuring data, user quality and data privacy .....	59
Figure 3.7. Event clustering (Ansari et al., 2020).....	61
Figure 3.8. Methodology of creating SRMS platform design using UCD .....	66
Figure 3.9. A MoLIC diagram for event reporting service in SRMS platform .....	68
Figure 3.10. SRMS Operating system .....	69
Figure 4.1. Data sources of mapping mobility restrictions service.....	74
Figure 4.2. Methodology of processing Telegram data in the SRMS .....	78
Figure 4.3. Data storage and real-time processing in ArcGIS Online .....	80
Figure 4.4. Method of developing RNS service .....	81

Figure 4.5. Workflow of mapping the informal route on the SRMS platform .....	85
Figure 4.6. Components of informal route processing .....	86
Figure 4.7. The general methodology of route planning service in SRMS Platform .....	91
Figure 4.8. The random forest models .....	99
Figure 4.9. Methodology of creating waiting time prediction model using RF .....	100
Figure 4.10. Methodology of building the route planning model.....	101
Figure 5.1. The route from Salfit to Nablus using an alternative route, multimodal shift, and wayfaring .....	109
Figure 5.2. Increase in the Telegram group membership for sharing road traffic news and mobility restrictions, (Ahwaltareq, 2022) adapted by the author .....	111
Figure 5.3. Participants personal profile .....	114
Figure 5.4. Participants traveling characteristics .....	115
Figure 5.5. Significance of mobility issues and proposed solutions from participants' points of view.....	116
Figure 5.6. The final version of SRMS UI architecture and the real application .....	117
Figure 5.7. SRMS terms of use and privacy policy .....	120
Figure 5.8. Basemap data attributes .....	120
Figure 5.9. Reported mobility restrictions .....	121
Figure 5.10. Reporting page, submission confirmation message, and reporting results in SRMS application .....	122
Figure 5.11. Restriction reports submitted to the SRMS platform .....	123
Figure 5.12. Distribution of stability of observed clusters.....	124
Figure 5.13. Spatial clustering of traffic congestion reports.....	124
Figure 5.14. Buffer area with radius 250 around the reference mobility restrictions.....	125
Figure 5.15. Results of the validation process for checkpoint, and road gate reports .....	126
Figure 5.16. Message retrieving phase and its application .....	127
Figure 5.17. Message processing phase and its application.....	127
Figure 5.18. Text analysis phase and its application .....	128
Figure 5.19. Geocoding checkpoint names.....	129
Figure 5.20. Checkpoints mapping on ArcGIS Online.....	130
Figure 5.21. Geocoded checkpoints on SRMS application .....	130
Figure 5.22. Telegram test dataset and data analysis results .....	131

Figure 5.23. Geocoding process results .....	132
Figure 5.24. RNS subscription system and the email body sent to RNS subscribers.....	133
Figure 5.25. Mapping informal route service .....	134
Figure 5.26. Route planning service application area.....	135
Figure 5.27. Graph model of road sample study.....	136
Figure 5.28. Example on the descriptive data from B'TSELEM database, (B'Tselem, 2022) .....	138
Figure 5.29. Arij field survey for checkpoint waiting time (ARIJ, 2019a) .....	138
Figure 5.30. Total waiting time and queue time at Yizhar-Huwara Checkpoint.....	142
Figure 5.31. RF waiting time prediction model at the checkpoints in the study area and the related feature importance ranking .....	144
Figure 5.32. Loading risk values for each edge .....	145
Figure 5.33. Illustration of the proposed Scenario.....	145
Figure 5.34. Loading travel time values for each edge.....	146
Figure 5.35. Results of NA analysis, the shortest, safest, and fastest routes .....	146
Figure 5.36. Route Planning Service in SRMS platform.....	147

## List of Tables

Table 1.1. Summary of the observed smart mobility platforms/ application for traffic disruption management .....	24
Table 3.1. SRMS's data sources, types, and format .....	52
Table 3.2. Comparison of native, hybrid, and web apps based on technical and non-technical consideration .....	64
Table 4.1. Sources of data for mapping the mobility restrictions in real-time .....	75
Table 4.2. Comparison between the common route planning applications and RPS in SRMS .....	89
Table 4.3. Data categories and sources in terms of each alternative route category .....	91
Table 4.4. The evaluation criteria and the derived index for evaluating the risk on the road section .....	94
Table 5.1. Basemap data, sources, attributes, and formats .....	118
Table 5.2. Data sources of route planning service .....	136
Table 5.3. Descriptive Statistics.....	139
Table 5.4. Weights of cost risk index .....	140
Table 5.5. Risk values of the graph edges .....	141
Table 5.6. Descriptive statistics of dataset.....	142
Table 5.7. Correlation of waiting time at the checkpoint and other variables to develop predictive models .....	143
Table 5.8. Costs of categorised observed routes .....	147

# Abbreviations

ICT	Information And Communication Technology
IoT	Internet Of Things
AI	Artificial Intelligence
JPY	Japanese Yen
GDP	Gross Domestic Product
USD	United States Dollar
CO	Carbon Monoxide
HC	Hydrocarbons
NO <sub>x</sub>	Nitrogen Oxides
PM <sub>2.5</sub>	Fine particulate matter
ARDAD	Automated Road Defect and Anomaly Detection
ML	Machine Learning
VISSIM	Verkehr In Städten – SIMulationsmodell/ Traffic in cities - simulation model
TIM	Traffic Incident Management
Microsoft Power BI	Microsoft Power Business Intelligence
CNN	Convolutional Neural Network
LSTM	Long Short-Term Memory
NLP	Natural Language Processing
GIS	Geographic Information Systems
VSL	Varying Speed Limit
GA	Genetic Algorithm
RL-TPVR	Reinforcement Learning-Based Approach for Predictive Vehicle Routing
ATIS	Advanced Traveler Information System
MOD	Motorcycle Object Detection
RFID	Radio-Frequency Identification
GPS	Global Positioning Systems
DL	Deep Learning
RL	Reinforcement Learning
CV	Computer Vision
DBN	Deep Belief Networks
RNN	Recurrent Neural Networks
V2V	Vehicle to Vehicle Communication
V2I	Vehicle to Infrastructure Communication
RS	Remote Sensing
SC	Spatial Crowdsourcing
OSM	Open Street Map
GPT	Google Popular Times
PA	Palestinian Authority
IDF	Israeli Defense Forces
WB	West Bank
OCHA	Coordination Of Humanitarian Affairs
NGOs	Non-Governmental Organizations

SRMS	Smart and Resilient Mobility Services
SaaS	Software As A Service
IaaS	Infrastructure As A Service
PaaS	Platform As A Service
PWA	Progressive Web Apps
CSS	Cascading Style Sheets
UCD	User-Centered Design
ESDB	External Spatial Database
CCDB	Crowd-Context Database
u	User probability
qu	User Quality
MV	Majority Voting
DP	Differential Privacy
SEO	Search Engine Optimization
UI	User Interface
UX	User Experience
MoLIC	Modeling Language for Interaction as a Conversation
d	Designer
WFS	Web Feature Service
MPWH	Ministry of Public Work and Housing
MoT	Ministry of Transport
POS	Part-Of-Speech
3W	What, Where, When
Regex/regexp	Regular Expression
RNS	Restriction Notification System
HMDA	Human Mobility Data Analysis
RPS	Routing Planning Service
RPM	Route Planning Model
FUCOM	Full Consistency Method
$R_i$	The Comprehensive Risk Score
SWARA	Stepwise Weight Assessment Ratio Analysis
AHP	Analytic Hierarchy Process
EWM	Entropy Weight Method
S	Maximum speed
SW	Safety Weight
TCI	Traffic Congestion Index
$T_w$	Waiting Time at Mobility Restrictions
RF	Random Forests
SVM	Support Vector Machines
AW	Weighted Travel Time
r	Number of mobility restrictions along road section
Dist	Length of the road section
V	Set of nodes
E	Set of edges
G	Graph model
NA	Network Analyst

ACO	Ant Colony Optimization
NTMP	National road And Transportation Master Plan
MTIT	Ministry Of Telecom and Information Technology
MOLG	Ministry of Local Government
ITS	Intelligent Transportation Systems
OCHA	Office for the Coordination of Humanitarian Affairs
SNS	Social Network Sites
GeoMolg	Geospatial Web Mapping Application of The Ministry of Local Government
HDBSCAN	Hierarchical Density-Based Spatial Clustering of Applications with Noise



# General Introduction

This Ph.D. thesis aims to develop a smart solution to enhance the traveling of people experiencing mobility restrictions related to occupation in the Palestinian territories, West Bank (WB). The primary objective is to create a comprehensive platform that offers integrated mobility services powered by smart technology, namely the Smart and Resilient Mobility Services Platform (SRMS). The SRMS's services include (i) real-time mapping of mobility restrictions such as road closures, traffic congestion, checkpoints, and violent actions, (ii) restrictions notification system; (iii) mapping of informal routes; (iv) providing alternative path suggestions to optimize safety, travel time, and distance.

Around 33% of WB residents are interurban commuting (PCBS, 2022b), experiencing daily or semi-daily long-term mobility restrictions related to the Israeli occupation. These restrictions started around thirty years ago with the installation of checkpoints (Habbas & Berda, 2021) (Griffiths & Repo, 2021), separation wall (Habbas & Berda, 2021), and settlers-related violent incidents (B'Tselem, 2022). These restrictions stand as obstacles for achieving the United Nations agendas for safe people mobility (Goal 11.2) and providing access to essential services, economic opportunities, and a better quality of life for individuals and communities facing mobility restrictions (Goal 10.2) (United Nations, 2023).

Mobility restrictions have severe economic consequences, they increase costs, create uncertainty, and reduce employment opportunities, working days, and wages (Calì & Miaari, 2018). These restrictions also lead to significant economic losses, estimated at around USD 1.7 million per day for a 50-day increase in border closures (Adnan, 2015). Socially, they disrupt the social fabric of Palestinian communities, limiting cultural exchange (Boussauw & Vanin, 2018). These restrictions lead to long queues, arbitrary rule implementation, and violence, negatively impacting daily life and well-being (Braverman, 2011) (Rijke & Minca, 2019). Also, incidents of violence from settlers against travelers have eroded the prospects for a peaceful and just society (Amira, 2021).

Environmentally, mobility restrictions have significantly increased travel time, energy consumption, and CO<sub>2</sub> emissions. This increase in travel time due to checkpoints can be up to 27 times longer, resulting in time loss, anxiety, and additional expenses for the population. Additionally, they significantly increase energy consumption and CO<sub>2</sub> emissions, which are estimated at 275% for gasoline vehicles, and 358% for diesel vehicles (Aburas & Shahrour, 2021).

While recent smart strategies have demonstrated efficiency in tackling specific mobility challenges such as event detection, optimizing routes, real-time monitoring, and alert notifications, they didn't provide a comprehensive and integrated framework to address traffic disruption events holistically. Furthermore, these smart solutions present minimal engagement of citizens and heavily rely on the deployment of smart infrastructure in data capturing, which presents challenges when installing such infrastructure in complex governance urban environments with limited technological resources and unstable transportation ecosystems such as WB.

Even when citizen engagement is considered in traffic disruption management, it often relies on crowdsourcing through direct reporting or mining social data from Twitter. There's a notable

gap in having a robust data quality strategy that integrates data from both sources and explores alternative social platforms since Twitter's suitability for event data collection varies across different environments.

In response to these challenges and gaps in current smart mobility strategies, this research presents an innovative approach to holistically manage traffic disruptions. This approach includes; (i) developing a comprehensive platform that offers integrated mobility services, enabling effective incident management throughout all phases of disruption; (ii) enhancing citizens' engagements in the developed solution by utilizing the power of spatial crowdsourcing in the data collection process considering multi-source data integration; (iii) introducing a novel dimension by incorporating social data mining from Telegram, an alternative social media source for traffic event management.

This research contributed to the scientific production of traffic disruption management by developing a holistic traffic disruption management approach, providing solutions to handle traffic incidents from detection to resolution. Also, it responds to the recommendations of the recent literature for the need to have citizen-centric smart solution perspectives (Paiva et al., 2021a) (Clarival & Dumas, 2023). Furthermore, it provides a novel contribution to the quality of the crowdsourced data by introducing diverse data sources, including user reporting and social data mining from telegram as promising potential data sources in the social sensing domain during emergencies and disruptions. Additionally, this research satisfies technological inclusivity by applying smart mobility solutions in areas with limited technological resources and complex urban environments, which corresponds to the Sendai Framework, and the UN report calls for investing in telecommunication and technological advances in managing disruption events (United Nations Economic Commission for Europe, 2020).

Furthermore, the research findings provide a transformative humanitarian contribution to the travelers in the WB, by empowering them to make informed decisions that efficiently optimize their travel experiences under mobility restrictions while minimizing risk, travel distances, and waiting time. Also, these findings provide insights to Palestinian transportation authorities and policymakers on how to effectively leverage smart technology to address long-standing urban development barriers inherent in mobility restrictions, within the context of limited resources and complex governance regulations. This work can be considered the first empirical step towards implementing the ongoing smart transportation strategic framework for Palestine (2019-2024) as outlined by the Ministry of Transport (Ministry of Transport MOT, 2018).

This thesis is structured in five chapters:

**Chapter 1** provides an overview of existing smart strategic approaches and enabling technologies used for managing traffic disruptions. It highlights the limitations and gaps in previous research and outlines the contributions of this study in addressing these gaps.

**Chapter 2** outlines the research methodology, introducing a novel smart solution aimed at filling the existing gaps by designing a smart and resilient platform to assist citizens in coping with mobility restrictions. It also discusses the implementation of this platform in the Palestinian territories, specifically the West Bank. Insights into mobility restrictions and their impacts on Palestinian life and sustainability are provided.

**Chapter 3** provides the comprehensive methodology used to develop the architecture of the proposed smart solution, the Smart and Resilient Mobility Services (SRMS) platform. It

presents the layered architecture of SRMS and describes the tools, processes, and techniques employed in its development.

**Chapter 4** details the specific methodology for creating the services offered by the SRMS platform. It explains the systematic approach used to develop each service, starting with an overview of state-of-the-art methods, service objectives, and requirements. It then discusses data collection, processing, analysis, and the final step of making the services available to the public.

**Chapter 5** presents the practical implementation of the SRMS platform in the Palestinian territories, with a focus on the West Bank. It assesses the capacity and potential of the Palestinian community to adopt and utilize the developed solution. Additionally, it offers an application and validation of each SRMS service considering human-centered design approach and includes the final layout of the SRMS web mobile application.

# Chapter 1. State of the Art

## Introduction

This chapter aims to explore the state of the art about the use of smart technology for the management of traffic disruptions to develop a framework and tools to help Palestinians deal with traffic restrictions related to the occupation.

The management of traffic disruptions has become an increasingly critical concern in urban planning, transportation engineering, and disaster management realms due to the complex consequences it has on the individual and community as a whole. This chapter investigates the recent research contributions in this domain through subsequent sections.

The first section discusses the adverse socioeconomic and societal impacts of disruption events. These events range from natural disasters to construction projects and mobility restrictions. The section offers tangible case studies along with statistical data to emphasize the severity of these disruptions, emphasizing their extensive impact that goes beyond immediate repercussions.

The second section investigates the recent smart strategies to tackle the challenges of traffic disruptions. These strategies are observed from reviewing case studies and categorized into five key domains, each representing a pivotal aspect of disruption management: real-time traffic data monitoring, predictive modeling, traffic control optimization, dynamic route guidance, and communication and information dissemination. This section provides researchers' contributions in these domains in the form of platforms, applications, frameworks, and models to provide solutions for addressing the disruptive events' complexities.

The third section concerns the role of Information and Communication Technologies (ICTs) in managing traffic disruptions. It presents the observed enabling technologies that effectively contribute to developing smart strategies for managing traffic disruptions. These technologies including the Internet of Things (IoT), Artificial Intelligence (AI), Big Data analysis, and Geospatial Technologies, offer novel solutions for data-driven decision-making and efficient responses to disruptions. This section provides the strengths of these technologies through successful empirical case studies and presents the challenges and limitations that should be considered in any future solution leveraging these technologies.

In the final section, an in-depth analysis is conducted on the reviewed literature and case studies to assess the capabilities and constraints of the employed approaches in addressing the challenge of traffic disruptions. The primary objective of this section is to identify and extract the limitations and gaps observed within the literature. These identified shortcomings are intended to serve as a pivotal catalyst for developing innovative solutions that can effectively bridge the existing gaps and offer novel contributions to the field.

### 1.1. Impacts of Manmade and Natural Traffic Disruptive Events

Nonrecurrent events, including natural disasters like floods, earthquakes, wildfires, and debris falls, as well as man-made events such as traffic crashes, construction projects, checkpoints,

mobility restrictions policies, and violent actions, not only yield immediate consequences such as infrastructure damage and loss of human lives but also initiate cascading significant disruptive traffic effects (Gu et al., 2022) (Arrighi et al., 2021).

One of these effects is the emergence of non-recurrent traffic congestion, leading to delays and longer waiting times for travelers (Arrighi et al., 2021). This, in turn, can result in higher travel costs as individuals spend more time and resources to reach their destinations (Karaer et al., 2020). In most cases, the overall impact of traffic disruptions caused by nonrecurrent events can surpass the direct losses incurred (B. Liu et al., 2021). For example, data from the United States Department of Transportation indicates that 25% of the total traffic delay in the United States is attributed to traffic accidents (FHWA, 2019).

(Harleman et al., 2023) examined the impacts of roadway construction on traffic congestion in Texas, the study revealed that over the period during construction, widening construction projects increases the delay by 42%. (Zhang & Chen, 2019) quantified the impact of weather events on travel time and general transportation reliability. It is observed that snow events impose a more significant impact on travel times than rain events. Rain affects travel time by 4-14%, 15-35%, and 22.5% in free-flow, moderately congested, and heavily congested conditions, respectively. Snow has a more severe impact, resulting in a 14-20%, 20-40%, and over 40% increase in travel time for the same conditions.

Studies have demonstrated that traffic disruptive events adversely impact the economic productivity of individuals and society as a whole. For example, the heavy rain disaster in Hiroshima in 2018 cost a monetary loss of 6 billion JPY due to an increase in travel time resulting from route detours (Safitri & Chikaraishi, 2022). (Kurth et al., 2020) highlighted the impact of random disruptive events on the road network on the GDP in different cities in the USA. The results show there is a direct correlation between travel time delay and a decline in GDP. For example, in San Francisco, when a traffic disruption occurred on just 3% of road segments, travel time increased by 34%, leading to a notable 6.64% decrease in GDP.

Furthermore, in 2019, drivers in the U.S. collectively lost 99 hours due to congestion, resulting in costs exceeding \$88 billion (Karaer et al., 2020). (Abrahams, 2021) (Fratto, 2019) declared that checkpoints affect employment opportunities, working days, and wages. For example, (Cali & Miaari, 2018) found that installing a checkpoint just ten minutes away from a Palestinian area reduced employment opportunities by 0.14 percentage points and working days by 0.22 percentage points. Furthermore, (Adnan, 2015) estimated that a 50-day increase in border closures per quarter results in an economic cost of around USD 1.7 million per day in the following quarter.

In addition to their economic impact, traffic disruptions pose obstacles to long-term social sustainability. Waiting times and delays exert adverse effects on both drivers and passengers, presenting heightened stress and increased frustration (Yap & Cats, 2021) (R. I. Sarker et al., 2019). The road closure occurred due to specific traffic events such as traffic crashes, earthquakes, debris falls, etc. undermines the humanitarian emergency supply and evacuation process (Anuar et al., 2021).

The introduction of road barriers, including checkpoints, influences the social dynamics and fosters a prevailing sense of stigma within communities. An investigation carried out by (Martén & Boano, 2021) shed light on the consequences of installing official and criminal checkpoints in the Juárez border region between the United States and Mexico. The study disclosed that such installations not only resulted in instances of violence but also redefined

the notions of security and stability (Amira, 2021). This underscores how these measures can disrupt social cohesion and reshape perceptions of safety within communities.

Similar findings were reported in (Boussauw & Vanin, 2018). The study noted that checkpoints in the Palestinian territories tend to create closed social systems, leading to adverse impacts on cultural exchange, and the long queues adversely impacted the quality of daily life and general well-being (Rijke & Minca, 2019).

(O. J. Walther et al., 2020) investigated the effects of borders and checkpoint delays on the accessibility of West Africa. The study declared that eliminating waiting times at the borders in this region could result in a 14% increase in the accessibility of border cities. Moreover, in specific regions, this increase could be as high as one-third. Furthermore, the removal of roadside checkpoints could yield an average regional accessibility increase of 12% for border cities. In certain key centers situated along the Gulf of Guinea, the increase could even surpass 50%. These insights highlight the profound influence that border delays and checkpoints can have on accessibility and regional connectivity.

The delays in travel, waiting times, nonrecurrent congestion, and travel detours resulting from traffic disruptions lead to adverse environmental implications, primarily presented in increased fuel consumption and air pollution. A study by (X. Chen et al., 2022) sought to quantify on-road vehicle emissions during traffic congestion using real-world traffic monitoring data in China.

The study's findings revealed that typical traffic congestions, characterized by vehicle speeds below 5 km/h can lead to emissions that are 5 to 9 times higher than those observed on uncongested roads with vehicle speeds exceeding 50 km/h. In the absence of traffic congestion, emissions of CO, HC, and NO<sub>x</sub> were lowered by 12 to 28%. This shows how traffic disruptions can significantly exacerbate air pollution levels and contribute to increased fuel consumption, especially during congested conditions.

Additionally, traffic congestion leads to inefficient fuel combustion in motor vehicle engines. When cars move at slower speeds, frequent starting and stopping not only increase fuel consumption and energy inefficiency but also generate heightened levels of automobile exhaust emissions, exacerbating air pollution.

An experiment conducted by Beijing Jiaotong University in 2013 aimed to examine the impact of frequent starting and stopping on fuel consumption and vehicle exhaust emissions. The results demonstrated that PM<sub>2.5</sub> emissions from idling cars were five times higher under congested conditions. Furthermore, investigations into pollution sources revealed that motor vehicle emissions contribute to 31% of the total local pollution emissions, with emissions under congested conditions being 50% higher compared to normal traffic scenarios (J. Lu et al., 2021).

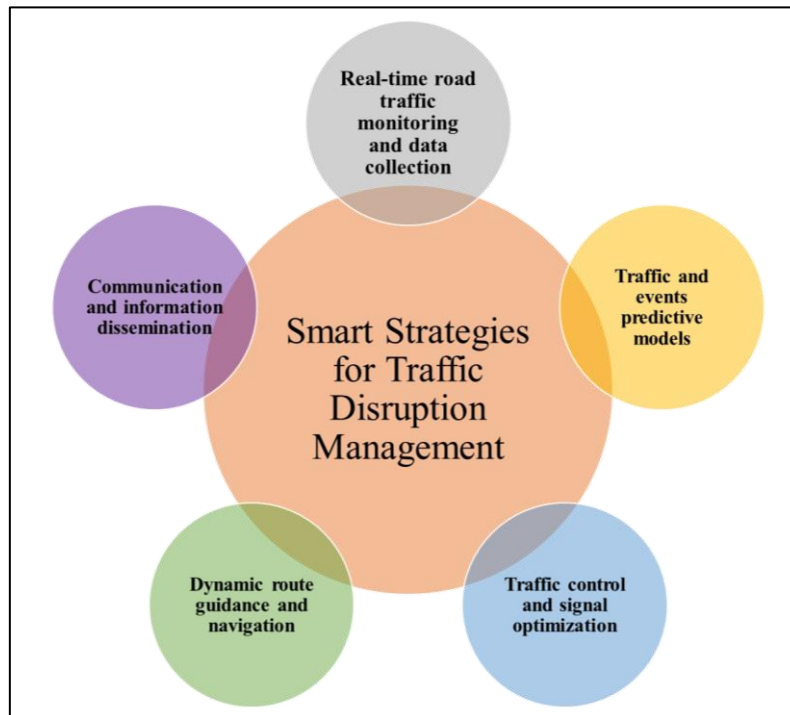
## **1.2. Recent Smart Strategies for Managing Traffic Disruptions**

In recent years, the socio-economic and environmental consequences of traffic disruptions have intensified due to the expansion of the motor industry and urbanization (Lyons, 2018). The digital age has advanced rapidly over the past two decades, offering remarkable technological

potential. The digital connectivity of people, locations, and objects derived innovative solutions for traffic disruption management (Song et al., 2022).

From the comprehensive literature review, five areas were identified for dealing with traffic disruptive events using the smart solutions illustrated in Figure 1.1. These areas include, (i) real-time traffic data monitoring and data collection, (ii) predictive modeling; (iii) traffic control and signal optimization; (iv) dynamic route guidance and navigation; and (v) communication and information dissemination.

This section highlights these five domains, by providing a brief explanation of each application, their roles in addressing the traffic disruption events, and support the used case studies.



**Figure 1.1.** Smart strategies for managing traffic disruptions

### 1.2.1. Real-time road traffic data monitoring and data collection

Real-time road traffic data monitoring and data collection refer to the tracking of traffic conditions on roadways using advanced technologies (Khazukov et al., 2020). This involves the deployment of sensors, cameras, GPS devices, connected vehicles, and other data-gathering instruments to capture real-time information about vehicle movement, speeds, congestion, and disruptions (Rathee et al., 2023).

The collected data is then processed and analyzed to provide prompt insights into the current state of traffic, enabling authorities to swiftly respond to disruptions, implement dynamic traffic management strategies, and communicate relevant information to commuters. This approach serves as a foundation for informed decision-making and proactive measures in addressing traffic disruptive events (Gupta et al., 2023).

For example, analysis of real-time data using advanced algorithms and big data techniques helps in identifying abnormal events, enabling automated road defect and anomaly detection (ARDAD) that can disrupt traffic flow (Rathee et al., 2023). These events include accidents, road hazards (Y. Kong et al., 2022), road failure (Musa et al., 2022), or unexpected congestion (Chan et al., 2021).

In these applications, images of road sections are taken and analyzed to detect anomalies using image processing (Bhatlawande et al., 2022). However, to infer meaningful information from the images and videos, computer vision with various AI approaches such as ML (Kim et al., 2023), ensemble learning (Meena et al., 2019), and 3D imaging methods (Shankar et al., 2020) are utilized.

According to (Rathee et al., 2023) comprehensive literature review, while the existing detection methods may efficiently identify anomalies in real-time traffic data, they often fail to provide clear insights into the potential safety risks posed to drivers on the road.

Real-time monitoring of road traffic also contributes to the development of traffic simulation and visualization platforms. These platforms utilize data collected from various sources, such as vehicle GPS trajectories, loop detectors (C. Lee et al., 2020), or video detectors (S. Chen et al., 2019). By leveraging these datasets, simulation and visualization platforms offer a range of uses, including informing the general public and decision-making authorities about current road traffic conditions and future predictions.

For example, (Jung et al., 2023) introduced an open-sourced real-time web-based platform that connects micro traffic simulation results to dashboards using VISSIM. This platform collects traffic flow data and individual vehicle locations from camera detectors and stores them in the cloud at regular intervals. In real-time, the data is presented based on temporal and spatial characteristics to create the dashboard layout. The results help in traffic management and making an informed decision.

Other scholars extend the use of traffic simulation and visualization dashboards for traffic incidents and emergency response (Zhang et al., 2021). They developed an interactive Traffic Incident Management (TIM) dashboard using the Microsoft Power BI platform. This dashboard was specifically designed to enhance incident response in the Kentucky Transportation Cabinet (KYTC). By establishing TIM measures, the dashboard continuously tracks and analyzes these metrics. The purpose is to enable authorities to make timely decisions and optimize incident response strategies for improved traffic flow and safety.

Similarly, (Zerafa et al., 2021) introduced ExTraVis, a unique visualization system tailored for exploring and analyzing incident data. This system targets traffic management controllers, providing them with valuable tools to make informed decisions and gain a deeper understanding of past incidents' impact on traffic patterns. Additionally, ExTraVis facilitates predictive analysis, empowering controllers to anticipate potential future incidents and plan proactive measures to mitigate their impact on traffic flow.

### **1.2.2. Traffic predictive models**

Traffic predictive models involve the application of data-driven algorithms and historical traffic data to forecast potential disruptions and events that might impact traffic flow (Yap &



Cats, 2021). By analyzing patterns and trends from historical and real-time data, these models can anticipate occurrences such as accidents, road closures, and congestion points. These predictions enable authorities to proactively allocate resources, create contingency plans, and optimize traffic management strategies to mitigate the effects of disruptive events (Shetab-Boushehri et al., 2022). Predictive models enhance decision-making by providing valuable insights into future traffic conditions, allowing for more effective and timely interventions (C. Chen et al., 2020).

For example, (Aljuaydi et al., 2023) developed machine learning-based prediction models for freeway traffic flow under non-recurrent events. They employed various models including convolutional neural networks (CNN), long short-term memory (LSTM), CNN-LSTM, and Autoencoder LSTM networks to forecast traffic flow during road crashes and rainy conditions. (Nigam & Srivastava, 2023) examined the impact of adverse weather conditions, such as fog, rainfall, and snowfall, on traffic flow and how to accurately predict traffic variables like speed and flow in these conditions using deep learning models.

Other scholars mined the traffic data from social network services, and with the help of Machine learning and Natural Language Processing (NLP), they built prediction models for traffic event detection (Kang et al., 2020), and traffic flow predictions (Essien et al., 2021). For example, (Salazar-carrillo et al., 2021) proposed a methodology to geocode traffic-related events that are collected from Twitter and he built a model that produces spatiotemporal information regarding traffic congestions with a spatiotemporal analysis. These results are presented as a heat map using the Web-GIS application. (Capela et al., 2022) developed an AI model for identifying publications related to traffic events in a specific road, based on publications shared on social networks. A predictive model was obtained by training a deep learning model for the detection of publications related to road incidents.

Existing prediction models focus on predicting traffic congestion resulting from non-recurrent events. This includes predicting post-accident congestion (Fukuda et al., 2020) or estimating the time for post-accident clearance (Y. Lin & Li, 2020). However, these studies often attribute non-recurring congestion mainly to traffic crashes, somewhat overlooking other disruptive events like road obstacles, weather conditions, disasters, or planned events, which according to (Kumar & Raubal, 2021), could be better explored through scenario-based studies.

Some scholars focus on predicting event occurrences rather than traffic outcomes, using risk prediction methodologies encompassing severity, frequency, and duration. For example, (Ma et al., 2021) proposed a comprehensive analytic framework using deep learning to predict traffic accident injury severity based on contributing factors. Other studies extend beyond crash counts in their risk prediction models, incorporating human, vehicle, and environmental (road) factors.

(Gu et al., 2022) presented a network-based risk prediction model to understand potential risk propagation and minimize the chances of cascade failures, considering local and global structural information along with attribute data. (Shaik et al., 2021) examined various neural network techniques and learning algorithms within the context of road crash injury severity prediction models. They also delved into the array of factors contributing to road accidents.

Existing predictive models for disruptive events, whether concerning traffic congestion or the incidents themselves, predominantly focus on traffic crashes (J. Wang et al., 2022). Additionally, there is a notable limitation in their scope, as they predominantly overlook other disruptive occurrences, like forecasting travel delays arising from non-recurrent events or

estimating waiting durations at specific road obstacles. Although (M. Xu & Liu, 2021) have made some progress by introducing a flexible deep learning-aware framework for predicting travel times in the context of non-recurrent traffic events, there is still a noticeable gap in addressing these limitations comprehensively.

### **1.2.3. Traffic control and signal optimization**

Traffic control and signal optimization refer to the application of smart technologies to manage traffic flow and alleviate congestion through real-time adjustments of traffic signals and control systems (Gupta et al., 2023). These systems use data from various sources, including real-time traffic monitoring, to dynamically alter signal timings and prioritize traffic movement based on current conditions (Qadri et al., 2020). By optimizing signal phasing and timing, authorities can reduce delays, minimize congestion, and respond effectively to disruptive events.

Several studies have implemented real-time adaptive approaches for traffic control and adjustments to vehicle speed limits, which are activated in response to specific traffic events. These strategies serve to ensure dynamic traffic management and enhance emergency responsiveness. This concept is observed in (Espitia et al., 2020) work. They developed event-triggered boundary control strategies for freeway segments with varying speed limits (VSL). The primary objective of their work is to mitigate the common occurrence of stop-and-go traffic oscillations. This is achieved by regulating the velocities of vehicles as they exit these freeway segments. Importantly, the regulated velocity signal is updated exclusively when predefined triggering conditions are satisfied.

(Gupta et al., 2023) used real-time live video feeds from intersection cameras to promptly calculate traffic congestion levels through image processing and vehicle detection using the EfficientDet architecture and TensorFlow Lite. The main objective is to address traffic congestion and mitigate accidents by employing algorithms that adjust signal lights based on road vehicle density and priority for emergency vehicles. This approach enhances transportation safety, decreases fuel consumption, and minimizes waiting times.

Concerning traffic signal management, (Z. Lu et al., 2019) examined the adaptation of pre-timed traffic signal control parameters during adverse weather conditions to enhance traffic efficiency and road safety. The study investigated the advantages of employing weather-specific signal control plans for both uncoordinated intersections and coordinated corridors. In related work, (Mao et al., 2022) developed an innovative approach to optimize traffic signal timings at urban intersections during non-recurrent traffic incidents. Their method combines fast-running machine learning algorithms with reliable Genetic Algorithms (GA), to enable efficient and reliable decision-making processes.

The optimization studies related to traffic signal management during traffic events are limited by their reliance on fixed-time control mechanisms rather than real-time control, as highlighted in a thorough review by (Qadri et al., 2020). Furthermore, some of these studies depend on simulation-based optimization methods rather than real-world experimental investigations.

#### 1.2.4. Dynamic route guidance and navigation

Dynamic route guidance and navigation involve the use of real-time traffic data and advanced navigation technologies to provide commuters with optimal route choices, particularly during disruptive events. These systems consider current traffic conditions, road closures, and congestion to suggest alternative routes that help drivers avoid areas with disruptions, minimize travel time, and enhance user safety.

The authors have made significant contributions in this field by developing intelligent platforms that assist individuals and authorities in route planning. For example, (Alkhabbas et al., 2022) introduced the ROUTE framework, which offers customizable smart mobility planning for diverse stakeholders within dynamic smart city ecosystems. The framework supports multimodal planning, considering traveler preferences and responding to city-specific constraints set by authorities. Similarly, (Al-Rahamneh et al., 2021) created an urban data platform that integrates data from sensors and various sources. This platform caters to multimodal smart mobility planning by incorporating context-awareness, user preferences, and environmental factors.

Other efforts were directed toward developing vehicle routing algorithms for providing reliable navigation services during uncertain traffic environments. (D. Lee et al., 2022) introduced the RL-TPVR algorithm, a reinforcement learning-based approach for predictive vehicle routing. By utilizing predictive state representation and reward modeling, the algorithm aims to minimize travel time variability. In the context of emergencies, like medical emergencies, scholars such as (Shetab-Boushehri et al., 2022) proposed heuristic algorithms to model location allocation for emergency service stations and ambulance routing. These algorithms take into account event variability and recurrent traffic congestion.

In the evacuation scenarios, (Tamakloe et al., 2021) proposed a vehicle evacuation algorithm that employs a link-based centrality metric. This metric identifies efficient evacuation routes by considering network link characteristics and spatio-temporal traffic congestion changes. Furthermore, these efforts extend to evacuation planning during disruptive events like hurricanes (K. Feng & Lin, 2022) (Kutela et al., 2023), wildfires (Melendez et al., 2021) (Rohaert et al., 2023), and flood hazards (Borowska-Stefańska et al., 2022). Collectively, these researches contribute to the development of innovative solutions for efficient and adaptable transportation and evacuation strategies under various challenging circumstances.

A common theme observed in previous literature is that route planning algorithms typically focus on providing an optimal route for specific uncertain environments or humanitarian operations, resulting in single-objective route solutions. These objectives might involve ensuring smooth evacuation procedures, facilitating emergency supply distribution, or achieving other specific goals. However, this limitation narrows the use of these applications in particular situations (Anuar et al., 2021). To better deal with the complexities of decision-making in routing problems, it is crucial to optimize for multiple objectives simultaneously (Zajac & Huber, 2021).

Some researchers have taken steps to overcome this limitation by developing route planning models that consider multiple travel objectives. For example, (Venkatraman et al., 2021) conducted a study that examined the behavior of individual travelers within a simulated environment. They incorporated real-time local congestion information while considering various travel objectives. These objectives included scenarios such as shopping trips (with no

specific arrival time but penalties for lateness), work trips (with fixed arrival times and penalties for both early and late arrivals), social trips (with fixed arrival times and milder penalties), and airport trips (with strict penalties for lateness and fixed arrival times).

### **1.2.5. Communication and information dissemination**

Communication and information dissemination involves effective sharing of relevant data, during disruptive events. Utilizing digital platforms, mobile apps, dynamic road signs, and social media, this approach provides real-time information about disruptions, alternate routes, and recommended actions. Keeping commuters and the community informed will promote informed decision-making and alleviate potential confusion and congestion.

From the insights gathered in the literature, this domain predominantly comprises two key applications; (i) real-time traffic updates; and (ii) emergency alerting and notification systems. Real-time traffic updates involve delivering real-time traffic updates to users through various digital channels. These updates provide real-time information on traffic conditions, disruptions, road closures, and detours, enabling drivers to make informed decisions and adjust their routes accordingly.

Scholars have introduced real-time traffic updates through the implementation of an advanced traveler information system (ATIS). This system utilizes information and communication technology (ICT) to disseminate traveler-related information to commuters, aiding them in planning their journeys and providing navigation guidance. The information offered by ATIS encompasses various aspects, such as road construction and demonstrations, traffic conditions (which may be presented in queue length, delay, or travel time) and, stormy weather which may disrupt traffic (Ackaah, 2019).

Various smart simulation tools were developed to address the problem of providing users and authorities with recent traffic updates with the aid of ATIS. For example, Simulation of Urban Mobility (SUMO) (Behrisch et al., 2011) is an open-source microscopic simulator that is especially suitable for representing traffic road networks at the city level. It offers a wide range of features in traffic modeling, from route choice and traffic light management algorithms to simulating vehicular communication (Behrisch et al., 2011) (Cruz et al., 2019). HERMS is another tool to facilitate the evaluation of road networks through simulation with different ATIS and with different levels of information percolation among users to develop travel time and road utilization (Cruz et al., 2019).

Other scholars developed a mapping-based platform for real-time traffic anomaly detection, as discussed earlier in the real-time road traffic data monitoring section, and incident mapping in real-time. For example, (D. Chen et al., 2022) developed real-time mapping for road potholes through vibration signals analysis and spatiotemporal trajectory fusion. (Chaudhuri et al., 2023) provided a study for traffic risk mapping on the road network through spatial and temporal variation in traffic crashes and related injuries.

Another application that emerged in this domain is developing an alerting system to inform drivers or passengers about any detected traffic event observed in order to save people's lives. This approach is witnessed in (Indukuri & Kottursamy, 2021) (Chaudhari et al., 2021) (Patil et

al., 2020) works. (Indukuri & Kottursamy, 2021) developed a real-time system for monitoring and tracking the bus to ensure better safety of the public using IoT. The system is about providing passengers safety from fatal crashes in winter fog/smoke and providing information on emergency case such as accidents, breakdowns, and fire accidents by immediately sharing the location and images of the inside environment of the bus to the concerned authorities by email alert.

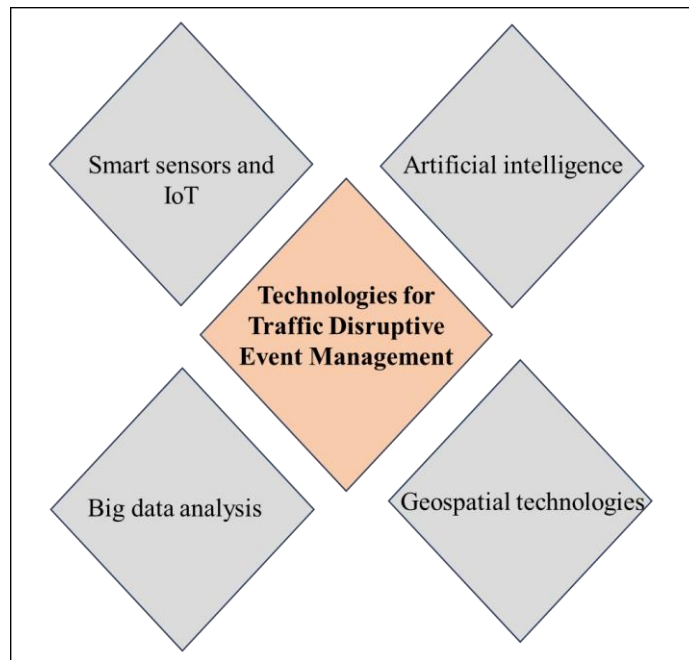
Similarly, using a similar method, (Patil et al., 2020) and (Chaudhari et al., 2021) created a smart system that detects traffic accidents and alerts the user's emergency contacts. When an accident occurs, the vehicle's sensors quickly identify it and send an SMS to emergency contacts, family members, hospitals, or the rescue team, sharing the location where the accident happened.

Different approaches were observed in (Najib et al., 2023) study. They developed a Motorcycle Object Detection (MOD) system using a pre-trained neural network model called EfficientNet-Lite0. This system uses an 8MP camera to identify hazards like potholes and barriers approaching from the opposite direction within the motorcyclist's view. MOD focuses on a specific region, reducing false alerts and noise. It alerts motorcyclists with audible and visual warnings through a helmet speaker and handlebar light.

### **1.3. Enabling Smart Technologies for Traffic Disruptions Management**

The rapid progress of Information and Communication Technologies (ICTs) and their synergistic integration paves the way for pioneering solutions that can create a transformative impact in the future. These solutions promise the introduction of novel services, advanced data processing algorithms, and techniques that yield valuable insights for citizens, ultimately enriching their quality of life. In the context of traffic events and disruptions to mobility, making decisions informed by data becomes evident, serving to optimize people traveling and provide a prompt and effective response.

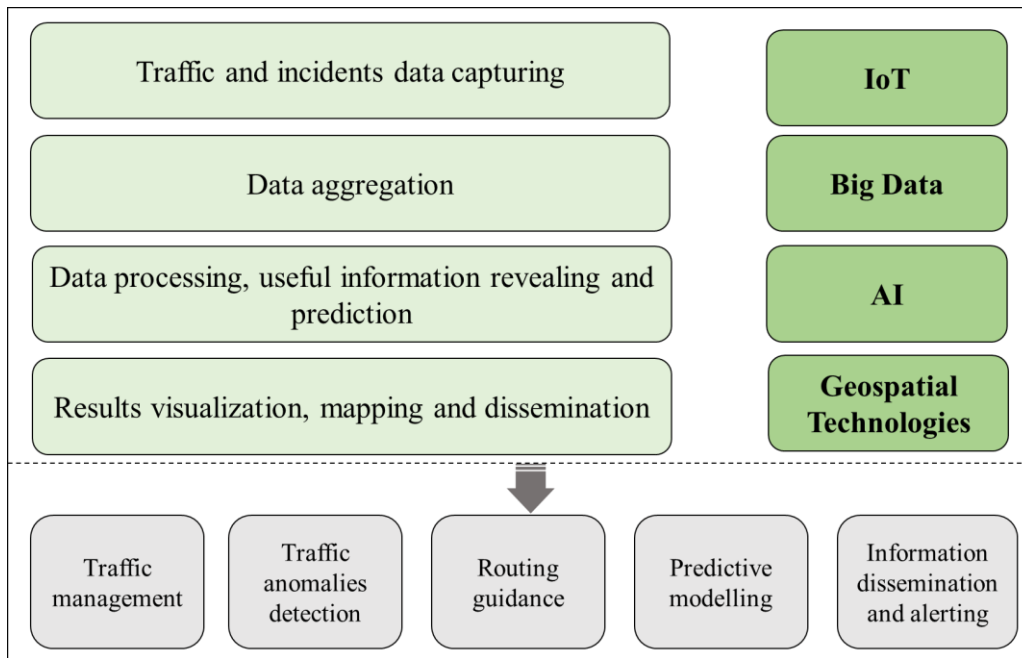
Based on the previous literature review of the recent strategies for addressing traffic disruption, the smart solutions can be summarized as follows (Figure 1.2): (i) Internet of Things (IoT); (ii) Artificial Intelligence (AI); (iii) Big Data analysis; and (iv) Geospatial Technologies.



**Figure 1.2.** Enabling technologies for traffic disruption management

These technologies interact with each other to optimize delivering the mobility service, starting from the hardware-level gathering data based on an IoT layer composed of several traffic data capturing devices on multiple levels; next, an aggregation layer with Big Data and the creation of datasets with a huge amount of data; and the processing of the gathered information using AI that will also allow the prediction of trends, valuable information revealing to support decision making. Finally, these results will be visualized and mapped on a sharable map-based platform using geospatial technologies. Figure 1.3 provides an illustration of the smart technology interaction in the realm of traffic disruption management.

This section discusses how advanced smart technologies contribute to the development of smart mobility services and the enhancement of strategies for managing disruptive traffic events. Our focus will primarily revolve around three key areas: (i) smart sensors and IoT, (ii) artificial intelligence (AI), and (iii) geospatial technologies. Notably, we won't address big data analysis techniques as a separate technology, as they are inherently integrated with most IoT and AI-based solutions. This approach allows us to delve into the selected technologies in depth while acknowledging the underlying significance of big data analysis within the context of IoT.



**Figure 1.3.** The interaction of the technologies for delivering optimal mobility service

### 1.3.1. Smart Sensors and IoT for Traffic Disruptive Management

The deployment of intelligent and energy-efficient sensor technology proves highly effective in sensing and gathering real-time data regarding traffic and mobility patterns for both vehicles and people. Recent research efforts in intelligent transport systems show that the IoT paradigm can play an important role in traffic management by connecting physical devices over the internet to exchange information, track, and monitor traffic movement (Qian et al., 2019) (Sarrab et al., 2020).

Based on the literature review, this technology significantly contributes to real-time traffic monitoring applications. For example, (C. Lee et al., 2020) (S. Chen et al., 2019) utilized global positioning systems, sensors, probe vehicles, and vehicle-to-infrastructure communication to collect real-time traffic data. These datasets are gathered and processed using big data analysis techniques. Additionally, AI-powered analysis expanded the technology's capabilities beyond monitoring, aiding traffic management and control (Gupta et al., 2023) (Espitia et al., 2020), and creating prediction models (Najib et al., 2023).

Sensors designed for traffic and event monitoring and detection, such as acoustic and magnetic sensors, stand out for their affordability, low power consumption, and widespread usage in contemporary vehicle monitoring solutions (Niture et al., 2021). These sensors have been applied in various contexts, including developing alerting systems for passengers (Indukuri & Kottursamy, 2021), drivers (Najib et al., 2023), and medical emergencies (Patil et al., 2020) (Chaudhari et al., 2021).

Regardless of the diverse applications of IoT in traffic disruption management, a shared architecture with four distinct layers has been identified (Naghieb et al., 2023). This architecture comprises four layers, including (i) a sensing layer with active things and sensors, (ii) a network layer that represents the mode of communication and protocols, (iii) a service layer that

indicates the data analysis and storage, and (iv) application layer describe the end-user applications.

The sensing layer is established through the deployment of data collection devices, including Radio-Frequency Identification (RFID) tags, sensors, Global Positioning Systems (GPS), Geographic Information Systems (GIS), drives, actuators, and mobile phones. These devices gather real-time traffic data and related traffic incident information. The network layer, encompassing protocols and gateways, facilitates communication within the IoT ecosystem among intelligent devices, gateways, and the cloud.

The service layer is situated within the IoT cloud, taking charge of tasks like data storage, processing, analysis, and decision-making. The application layer, residing in end-user devices and services, delivers desired mobility services. These services encompass functions such as roadside traffic information (Sarrab et al., 2020), and notifications on mobile devices (Sanislav et al., 2021).

### IoT Challenges and Open Issues

Although IoT technology is widely recognized for its effectiveness in managing traffic in usual scenarios and during emergencies, there remain certain challenges and unresolved issues in its application for traffic disruption management. Multiple sources of literature have discussed these challenges. As highlighted by (Romero et al., 2016), these challenges primarily revolve around security and privacy concerns. The large amount of data collected through IoT devices and sensors might contain sensitive information about individuals' travel patterns and behaviors. Ensuring the privacy and security of this data is essential to prevent unauthorized access, data breaches, and misuse of personal information.

(Santana et al., 2017) focused on the IoT challenges related to data volume and scalability. The massive amount of data generated by IoT devices can overwhelm existing infrastructure and storage systems. Handling and processing this high volume of data in real-time while maintaining system performance can be a significant technical challenge. He added that infrastructure and connectivity are another challenge. IoT devices and sensors depend on reliable network connectivity to transmit data. In areas with poor connectivity or network congestion, data transmission delays can impact the timeliness of information, affecting the effectiveness of disruption management.

(E. Ahmed et al., 2017) explained the regulatory and legal challenges associated with the implementation of IoT technology. The regulatory requirements and legal frameworks regarding data collection, storage, and usage can be complex, especially when dealing with sensitive data.

### **1.3.2. Artificial Intelligence AI for Traffic Disruptive Management**

Artificial Intelligence (AI) has emerged as a cutting-edge technology, harnessed in recent years to deliver advanced mobility solutions. It achieves this by facilitating instant analysis of vast amounts of data received from various sources, including sensors, cameras, and IoT devices. Based on the review of the smart strategies to manage disruptive traffic using AI, we can state



that there is no specific number of AI algorithms that can be used in this scope domain. However, the choice of the algorithm depends on the specific use cases and requirements (Alahi et al., 2023).

Nevertheless, the prevailing AI algorithms extensively explored for addressing traffic disruption events can be categorized into five primary groups, encompassing: (i) Machine Learning (ML); (ii) Deep Learning (DL); (iii) Natural Language Processing (NLP); (iv) Reinforcement Learning (RL); (v) Genetic Algorithms (GA); and (vi) Computer Vision (CV). This section will discuss these AI algorithms in the realm of traffic disruptive management.

#### i. Machine Learning (ML)

Machine Learning (ML) algorithms are employed based on mathematical principles that enable machines to learn and improve their performance in specific tasks using data, without needing explicit programming. A range of ML algorithms has been applied to various aspects of traffic management, such as traffic flow prediction during normal conditions (Fukuda et al., 2020), event prediction (Shaik et al., 2021), and abnormal event detection (Kim et al., 2023) (Meena et al., 2019). ML is notably popular for traffic flow prediction due to its ability to build models with less prior knowledge about different traffic patterns' relationships, flexibility in prediction tasks, and capability to capture nonlinear features (Barredo Arrieta et al., 2020).

#### ii. Deep Learning (DL)

Deep Learning (DL) is a subset of Machine Learning that utilizes artificial neural networks to tackle complex problems by extracting insights from data (Alahi et al., 2023). DL models consist of interconnected layers of nodes that process different aspects of input data and pass the results to subsequent layers (Sree et al., 2019). This hierarchical structure enables them to capture intricate patterns and attributes within the data. Prominent DL architectures include Convolutional Neural Networks (CNNs), Deep Belief Networks (DBNs), and Recurrent Neural Networks (RNNs). DL finds application in smart city contexts, optimizing traffic flow by predicting traffic patterns (Aljuaydi et al., 2023) (Nigam & Srivastava, 2023), developing network-based risk prediction models (Shaik et al., 2021) (Gu et al., 2022), estimating travel time during the nonrecurrent event (M. Xu & Liu, 2021), and managing traffic congestion due to traffic events (Gupta et al., 2023).

#### iii. Natural Language Processing (NLP)

Natural Language Processing (NLP) is a branch of AI that concentrates on using human language for seamless communication and interaction between computers and people (Tyagi & Bhushan, 2023). NLP algorithms are designed to process and examine extensive amounts of natural language data, encompassing text, speech, and even emojis. They possess the capability to perform diverse tasks like sentiment analysis, language translation, speech recognition, and text summarization (Tyagi & Bhushan, 2023). In recent times, NLP has been harnessed to analyze data from social networks and other text-based sources to identify traffic safety concerns and issues, such as events leading to traffic congestion (Salazar-carrillo et al., 2021) and traffic flow (Essien et al., 2021).

The investigated studies focused on using NLP algorithms for managing traffic disruptions primarily relying on geo-tagged content, often sourced from Twitter's social network. Moreover, many of the event detection solutions built using NLP remain disconnected from

comprehensive platforms that could optimize their findings for broader mobility services. These services could encompass event mapping, alerting messages, and route planning that takes into account the identified events. Additionally, predictive models developed using NLP often rely on historical datasets for analyzing specific traffic events, rather than utilizing real-time data for enabling swift responses.

#### iv. Reinforcement Learning (RL)

Reinforcement learning (RL), is a type of ML that involves an agent learning through trial-and-error interactions with its environment to maximize a cumulative reward signal (D. Lee et al., 2022). The agent takes action in the background, and the environment responds with a positive or negative reward signal, and the agent learns from this feedback. Most of the observed RL application in traffic disruption management was in the route planning studies (Yao et al., 2018), and emergency response (Elfahim et al., 2021).

#### v. Genetic Algorithms (GA)

Genetic Algorithms (GAs) are optimization techniques inspired by the principles of natural selection. These algorithms are frequently employed in AI and ML to tackle complex optimization challenges that traditional methods cannot address (Katoch et al., 2021). GA is used in traffic flow optimization to find the best timing for traffic lights (Mao et al., 2022). However, a potential challenge when using GAs in smart mobility applications is the computational complexity of the optimization task (Reddy et al., 2020). The scale of the problem and the complexity of the function can make finding an optimal solution within a reasonable timeframe quite demanding.

#### vi. Computer Vision (CV)

Computer vision (CV), is a field within AI that involves a variety of mathematical and computational methods to enable machines to analyze and understand visual data from their environment (Kothadiya et al., 2021). These algorithms have the capability to identify patterns and characteristics within images, videos, and other visual data, and utilize this knowledge to make informed decisions and predictions. CV finds substantial application in detecting abnormal traffic events (Bhatlawande et al., 2022), and real-time traffic monitoring.

### AI Challenges and Open Issues

While AI algorithms have brought advancements to traffic disruption management and their incorporation into diverse smart mobility services, they also pose challenges and unresolved issues. One major concern stems from the expansion of big data resulting from the IoT's advancement in traffic monitoring. Despite the potential benefits that deep neural networks can gain from this data influx, it concurrently presents challenges for machine learning applications. Dealing with the substantial volume, speed, diversity, and accuracy of big data becomes a crucial task that requires resolution (Gures et al., 2022).

Furthermore, challenges related to the robustness, security, and privacy of AI and ML models. Adversarial attacks, like data poisoning, evasion attacks, and model extraction, can weaken ML algorithms. Data poisoning adds corrupted data to databases, leading to inaccurate

outcomes. Evasion attacks mask harmful content to penetrate systems, while model extraction aims to form concealed models. These attacks bring different risks to various ML types, especially reinforcement learning. Agents in reinforcement learning could perform inadequately under tough conditions or adversarial attacks, influencing immediate decision-making (Yazici et al., 2023).

Moreover, there is a challenge tied to energy consumption and computation costs. Particularly, machine learning algorithms, deep learning, and deep reinforcement learning algorithms necessitate extensive data and high-capacity models, thus requiring substantial hardware capacity. Additionally, the challenge of security and privacy is pivotal. The use of corrupt or insecure data in ML and AI processes could lead to catastrophic outcomes across various traffic management applications.

Furthermore, the hurdle of real-time or near-real-time decision-making is significant in numerous machine learning and AI applications. Examples such as dynamic routing guidance, traffic signal optimization, or V2I/V2V communications in intelligent transportation systems demand rapid decision-making capabilities.

### **1.3.3. Geospatial Technologies for Traffic Disruptive Management**

Geospatial technology refers to a set of advanced tools, techniques, and methodologies that collect, process, analyze, map, and deploy geolocated information (Paiva et al., 2021b). This technology encompasses various components, including geographic information systems (GIS), global positioning systems (GPS), remote sensing, and location-based services.

Geospatial technologies have played a significant role in disaster risk management, particularly in addressing natural hazards (Kumsa & Feyisso, 2022) such as earthquakes (Wahid et al., 2018), landslides (B. Ahmed et al., 2018), floods (Y. Feng et al., 2020) (Borowska-Stefańska et al., 2022), fires (Forkuo & Quayeballard, 2014), tsunami (Ashar et al., 2018), etc. Geographic Information Systems (GIS) and Remote Sensing (RS) have emerged as dominant tools in this field. They are employed to assess the severity and impact of damage caused by these disasters. In rescue and evacuation operations, GIS in combination with GPS plays a pivotal role. Additionally, geospatial technology enables the creation of disaster maps, offering critical insights into the spatial distribution of disaster-related phenomena (Gutierrez, 2019).

Inspired by the successful applications of geospatial technologies in addressing natural hazards, scholars have adapted these tools to tackle man-made disruptions, particularly in the domain of traffic disruption events and traffic management. For example, (Partheeban et al., 2022) used historical census data to develop a prediction model for road traffic noise. This model was developed using ArcGIS 10.3, and the collected data includes traffic volume, speed, and noise level in lateral and vertical directions in Chennai, India.

Other scholars used geospatial technologies in traffic risk mapping, hotspot analysis (S.Lakshmi et al., 2019), and emergency route planning (Almoshaogeh et al., 2021). For example, (Audu et al., 2021) established a digital road network database to facilitate rapid emergency responses to road traffic accidents in Nigeria. The development of this database involved the utilization of ArcGIS 10.3, encompassing database creation, data analysis, and

result visualization. To map high-risk areas, a kernel density estimation tool was employed to perform spatial search and network analysis. Furthermore, within the ArcGIS Network Analysis framework, Dijkstra's shortest path algorithm was applied to determine the nearest health facility relative to the scene of the road traffic crash.

Geospatial technologies have other applications in creating spatially informative dashboards designed for traffic management. A prime example is the work of (Van Gheluwe et al., 2020), who developed a framework for geospatial dashboards tailored for Traffic Management as a Service (TMaaS) in Ghent, Belgium. TMaaS stands as a pioneering web platform offering a multi-modal traffic management solution for smaller urban centers. Through this platform, diverse urban mobility data is aggregated from multiple stakeholders and public service providers and subsequently presented in an intuitive and customizable interface. This interface caters to both traffic operators and citizens, facilitating effective visualization and understanding of traffic patterns and disruptions.

Another significant spatial technology with transformative potential in traffic disruption management, not covered in the geospatial technologies review publications (Paiva et al., 2021b), is spatial crowdsourcing (SC). SC revolutionizes the acquisition of spatial data by harnessing the presence of individuals during events (Lizut et al., 2019) (Tong, Zhou, et al., 2019).

Spatial crowdsourcing empowers people to contribute real-time spatial data from any location at any given time (Helmrich et al., 2021). This paradigm shift in data collection opens up new opportunities for enhancing traffic disruption management. Through the collective input of individuals using smartphones (Aljoufie & Tiwari, 2022), wearable devices (Bandeira et al., 2020), and online platforms (Biljecki et al., 2023), a wealth of data can be rapidly gathered and utilized for real-time analysis and decision-making.

This innovative approach contributed to traffic disruption management through various applications, including quick detection of traffic disruptions, accidents, road closures, and congestion by benefitting from the immediate observations of people on the ground. This can be observed in the Waze application (Waze, 2023). A navigation application that leverages crowdsourced user reports for providing service. Users can report traffic crashes, congestion, hazards, or police traps on the road (Amin-Naseri et al., 2018). Another popular application follows the same approach found in the FixMyStreet Platform. It is an open-source platform for reporting common road problems such as potholes and broken street lights to an appropriate authority (Fujihara, 2019).

Supplementing traditional geospatial technologies with spatial crowdsourcing enables authorities to obtain real-time insights, improving the accuracy and timeliness of their responses to traffic disruptions and emergencies (Amin-Naseri et al., 2018). Many crowdsourcing platforms have become the main data source for conducting different traffic studies. One popular example is the OpenStreetMap (OSM) platform (Biljecki et al., 2023), which is used in traffic flow analysis (Po et al., 2019), and traffic disruption pattern prediction (Camargo et al., 2020). Registered users in OSM can input spatial content in an open-access database, building a free editable map of the world. Spatial content can comprise nodes, ways, or relations. Nodes refer to points of interest, ways refer to routes, and relations refer to the grouping of objects together. OpenStreetMap digital road maps can be imported into traffic simulation packages.

In the study conducted by (Camargo et al., 2020), OSM was employed as the primary data source to estimate traffic disruption patterns. The study utilized OSM features as predictors in linear regression models to analyze traffic disruption counts and traffic volume at 6,500 points within the road network across 112 regions in Oxfordshire, UK. Another crowdsourced data source used is Google Popular Times (GPT). (Bandeira et al., 2020) utilized GPT to explore the correlations between traffic volume, travel times, pollutant emissions, and noise levels across different regions and time periods.

The advancement of data mining techniques and natural language processing has introduced a new emerging spatial data source within spatial crowdsourcing, which involves social network services and social media (Y. Feng et al., 2020) (Z. Xu et al., 2020). Geolocated data shared on social media platforms like Twitter offers valuable opportunities for various studies in traffic disruption management, particularly during emergencies (Paule et al., 2019). This encompasses tasks such as traffic congestion prediction (Salazar-carrillo et al., 2021), traffic event detection (Kang et al., 2020) (Alkhatib et al., 2019), traffic flow predictions (Essien et al., 2021), managing emergency situations (Zuo et al., 2018) (Z. Xu et al., 2020).

(Alkhatib et al., 2019) introduced a framework designed for monitoring incidents and events within smart cities. This framework utilizes techniques like text mining, text classification, and named entity recognition, employing a mixed corpus of Modern Standard Arabic and Dialect Arabic. The framework focuses on extracting, processing, and analyzing Arabic Twitter feeds related to specific topics, producing real-time city intelligence reports about events. These reports encompass details such as event type, scope, impact level, and environmental conditions at the incident site. On the other hand, (Paule et al., 2019) used Twitter's social media platform to propose a real-time traffic incident detection method. Their approach involves fine-grained geolocation using geotagged tweets from two cities, Chicago and New York.

## Geospatial Technologies Challenges and Open Issues

The effectiveness of geospatial technologies relies on their capacity to seamlessly integrate data from various sources, process and analyze it, and then present the valuable insights derived from this data promptly. However, effectively visualizing and analyzing massive amounts of data in the context of big data presents a challenge. It involves determining how to extract relevant knowledge by merging geospatial and numerical data, as well as how to enhance decision-making efficiency for smart mobility services through geospatial insights (Jing et al., 2019).

Moreover, achieving efficient decision-making requires the utilization of geospatial knowledge and the ability to present results in an adaptable manner to different stakeholders, including citizens, authorities, transport service providers, and rescue teams. This involves balancing between providing detailed insights and presenting information in a user-friendly and understandable manner, which is critical for informed decision-making in traffic disruption management and smart mobility services (Clarival & Dumas, 2023) (Sobral et al., 2019).

Another challenge related to the reliability of the collected data from geospatial technologies encompasses factors such as accuracy, scalability, and timely availability. Geospatial data, acquired through GPS and crowdsourcing, can potentially carry inherent inaccuracies and

errors. These inaccuracies could lead to misinformed decision-making and service provision, undermining the effectiveness of traffic disruption management strategies (Kitchin & McArdle, 2017) (Tong, Zhou, et al., 2019).

Additionally, issues concerning data privacy and security are prominent in the geospatial domain. Geospatial data often contains sensitive details about individuals' locations and movements. Balancing the utilization of this data for traffic management while upholding privacy and security standards is a critical concern (Tong, Zhou, et al., 2019) (H. Lin et al., 2021).

## **1.4. Research Analysis and Research Gap**

The significant socio-economic and social consequences resulting from traffic disruptive events, whether caused by natural or human factors, have catalyzed various scholars to develop innovative strategies for managing these disruptions. These strategies harness smart enabling technologies and advancements in information and communication technology (ICT).

One fundamental approach observed in the literature involves real-time monitoring and data collection for road traffic. This method provides up-to-date insights into the current state of traffic and enables rapid response to disruption detection. Furthermore, the development of predictive models for both traffic patterns and potential traffic events contributes to proactive resource allocation and optimized traffic management plans. By predicting traffic flows and events such as crashes, authorities can allocate resources strategically, optimizing the deployment of personnel and infrastructure to mitigate the effects of disruptive incidents.

Other scholars considered another crucial aspect of these strategies, which is dynamic traffic control and signal optimization. By adjusting traffic signals and control systems in real time based on the prevailing conditions, authorities can prioritize traffic movement, minimize delays, and alleviate congestion. Additionally, dynamic route guidance and navigation systems play a pivotal role in managing traffic disruptions. These systems provide travelers with real-time information about optimal route choices during disruptive events. By suggesting alternative routes that minimize travel time and enhance safety, these systems help individuals navigate through disruptions more efficiently.

Effective communication and information dissemination are also central to these strategies. Platforms such as dashboards, mobile apps, social media channels, and dynamic road signs facilitate the spread of crucial information to both travelers and decision-makers. This empowers individuals to make informed choices, take appropriate actions, and contribute to the alleviation of potential congestion or disruptions.

These strategies have leveraged advancements in data capture devices, big data analysis techniques, and other enabling smart technologies such as IoT and AI, which have evolved alongside the development of ICTs and the complexity of the challenge. The smart technologies employed to address traffic disruption management play integrated roles in an optimized scenario. It begins with the collection of traffic and event data using IoT devices, sensors, and actuators. The massive data is gathered and processed using big data analysis techniques and then analyzed using AI algorithms to extract valuable insights and facilitate information-driven decision-making. Finally, geospatial visualization and mapping

technologies like GIS are employed to present this information in an intuitive and tailored manner.

Table 1.1 summarizes the observed smart mobility platforms and applications for addressing traffic disruption issue, categorizing each smart application or platform based on their architectures, target users, data sources, type of data availability (real-time or static), the concerned mobility issues, followed smart strategies, and whether the application is accompanied by a real-world implementation.

**Table 1.1.** Summary of the observed smart mobility platforms/ application for traffic disruption management

<b>Smart Mobility App/Platform</b>	<b>Architecture</b>	<b>Target users</b>	<b>Data source</b>	<b>Data Availability</b>	<b>Mobility Issue</b>	<b>Smart Strategy</b>	<b>Real-Application</b>	<b>Reference</b>
<b>TMaas</b>	4 layers: licensing check, standardization, integration, visualization data.	Traffic operators. Citizens.	National and local public transport providers. Navigation and traffic information providers.	Real-time.	Multi-modal traffic management solution.	Information dissemination.	Not provided.	(Van Gheluwe et al., 2020)
<b>ROUTE</b>	Multi-tier architecture.	Local authorities. Traffic operators. Travelers.	IoT: Camera surveillance, sensors, actuators.	Real-time.	Multimodal Travel planning	Route guidance.	Not provided.	(Alkhabbas et al., 2022)
<b>City Platform</b>	Five layers perception, communication, acquisition, management, application layer.	Travelers.	IoT: sensors, actuators.	Real-time.	Multimodal travel planning	Real-time traffic monitoring/information dissemination.	Based on a case study.	(Al-Rahamneh et al., 2021)



<b>Waze</b>	Not Provided.	Travelers.	Users reporting data. Historical data. Governmental data.	Real-time.	Navigation and traffic information	Route guidance/ Information dissemination.	Provided.	(Waze, 2023)
<b>SMART JEDDH</b>	Not Provided.	Local authorities. Citizens.	Citizen's smartphones.	Static.	Parking availability, and PM2.5 emissions.	Information dissemination.	Provided.	(Aljoufie & Tiwari, 2022)
<b>S<sup>2</sup>-Move</b>	Three layers: Presentation layer, core layer, and data layer.	Citizens.	Citizen's smartphones. Vehicles probes.	Real-time	Traffic monitoring, Smart parking, Warning and fleet management.	Real-time traffic monitoring.	Simulation provided.	(Marchetta et al., 2016)
<b>Framework for incidents and events monitoring in smart cities</b>	Text analysis process: Automatic data extraction, text mining, text classification, named entity recognition,	Rescue services.	Arabic Social media feeds: Twitter.	Real-time.	Incidents and emergency management in smart city.	Event prediction model/ Information dissemination.	Provided.	(Alkhatib et al., 2019)

stemming, and data analysis rules.

**Application framework for emergency reporting system**

Three layers: Data layer, application layer, and client layer.

Rescue services.

Citizen's smartphones.

Real-time.

Emergency management.

Information dissemination.

Provided.

(Jilani et al., 2019)

**Open-sourced real-time visualization**

Simulation environment, visualization environment.

Public users.

Camera detectors.

Real-time.

Traffic simulation at intersections

Real-time traffic monitoring/information dissemination.

Based on a case study.

(Jung et al., 2023)

**TIM**

Not provided.

Transport operators.

Historical crash data records.

Static.

Highway traffic crashes management

Event prediction model/Information dissemination.

Based on a case study.

(Zhang et al., 2021)

**ExTraVis**

Three parts: back-end, gateway and front-end.

Local authorities.

Historical crash data records.

Static.

Traffic crashes management

Event prediction model/Information dissemination.

Based on a case study.

(Zerafa et al., 2021)

## Research Limitations and Gaps

While smart technology has proven to be efficient in addressing traffic disruptions, several challenges and open issues still need consideration. These challenges revolve around the dependence on smart technology's efficiency in capturing the sheer volume of data. This data collection enhances the accuracy of AI-developed models and subsequently provides high-quality services.

Another limitation is related to the heavy reliance on capturing devices, which are often considered the primary data source in many observed studies, encompassing devices such as cameras, loop detectors, traffic sensors, and smart street furniture. However, this approach introduces challenges associated with hardware defects, potential damage, and the need for continuous maintenance, especially within dynamic urban mobility systems. Moreover, regulatory and legal challenges pose additional hurdles. The deployment of such devices often requires adherence to a legal framework governing data collection, sharing, storage, and usage. This becomes particularly complex in environments with poor urban governance and unclear institutional hierarchies.

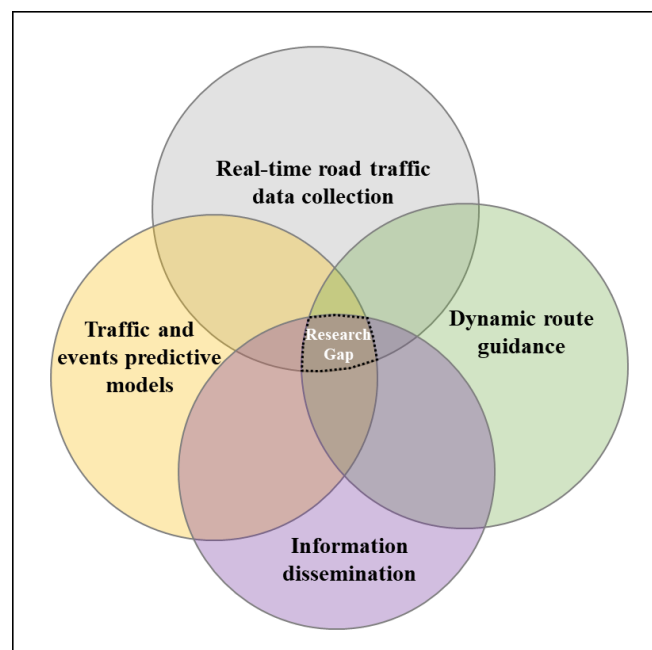
Existing strategies for managing disruptive events often address specific challenges in isolation, leading to fragmented approaches. For example, certain researchers concentrate on creating systems to detect events and send out early notifications. Meanwhile, others develop route guidance and travel planning platforms that take context into account, aiding users in discovering alternate routes during or after such events. Additionally, some scholars employ geospatial technologies and map-based platforms to map and visualize data. This disjointed approach can result in suboptimal solutions that fail to comprehensively address the complex nature of traffic disruption management.

Another observation is the limited involvement of citizens in the development of smart solutions, which has the potential to enhance the acceptance and effectiveness of these solutions (X. Kong et al., 2019). To bridge this gap, some researchers have proposed integrating crowdsourcing technology as a supplementary data collection method for traffic management. For example, the concept of Crowd-IoT combines crowdsourced data with the Internet of Things (IoT) (Ang et al., 2022), while others explore the combination of deep learning and blockchain to empower spatial crowdsourcing, known as DB-SCS (H. Lin et al., 2021). Despite these efforts, there remains a limitation in developing comprehensive smart mobility solutions for traffic disruption management that effectively leverage spatial crowdsourcing as a primary data source.

Spatial crowdsourcing, when carefully designed with considerations for data quality and privacy protocols, has the potential to address certain challenges associated with the use of IoT in customized environments with complex regulations and limited resources. Numerous studies have leveraged spatial crowdsourcing in their smart mobility solutions, focusing either on direct citizen observations through mobile app reporting or mining data shared on social media platforms, which is Twitter as the dominant platform.

Interestingly, the combination of both approaches to tackle traffic management issues was not commonly observed in the reviewed studies. Incorporating both direct citizen observations and social media data could significantly enhance the quality and accuracy of the collected data, leading to more effective traffic management solutions.

Based on the previous research synthesis, several gaps and areas for future investigation within the realm of traffic disruption management can be identified. Firstly, there is a need for a more comprehensive and integrated approach to addressing traffic disruptions, Figure 1.4. While current solutions often target isolated challenges, such as event detection, predictive modeling, route guidance, and communication strategies, there is a lack of cohesive strategies that bring these elements together.



**Figure 1.4.** Observed research gap

Developing a holistic approach that combines real-time monitoring, predictive modeling, route guidance, and effective communication could lead to effective and efficient traffic disruption management solutions. This integration could potentially lead to better coordination, resource allocation, and decision-making, ultimately enhancing the overall response to disruptive events.

Furthermore, there is a need to enhance travelers' and citizens' engagement in this process by adopting a spatial crowdsourcing approach as the main data source for traffic conditions and potential events. While spatial crowdsourcing holds promise, it should also address existing limitations associated with relying solely on a single data source. Presently, this commonly entails direct reporting via mobile smartphones or extracting geolocated data from the Twitter platform.

To overcome these constraints, a novel approach should merge these two methods to augment the quality of shared data. Moreover, consideration should be given to establishing a universal

data mining approach applicable to various social platforms, extending beyond the confines of Twitter. Such an enhancement in data collection and analysis methods could significantly elevate the efficacy of traffic disruption management strategies.

## **1.5. Conclusion**

This chapter presented the state of the art about the use of smart technology for the management of traffic disruptions to use this analysis to develop a framework and tools to help Palestinians deal with traffic restrictions related to the occupation.

The state of the art highlighted main approaches used in managing traffic disruptions including real-time monitoring and data collection, predictive modeling, traffic control, routing guidance, and information dissemination emerge as fundamental techniques for addressing traffic disruptions. By anticipating traffic patterns and potential events, authorities can allocate resources and optimize traffic management plans, ultimately mitigating the impact of disruptions.

The chapter emphasized the importance of combining real-time monitoring, predictive modeling, route guidance, and communication strategies into comprehensive approaches. Involving travelers through spatial crowdsourcing is crucial, though existing limitations need to be addressed. The combination of direct citizen observations and social media data could improve the quality of collected information.

Finally, the chapter concluded by identifying key research gaps for our research concerning helping Palestinians deal with traffic restrictions related to the occupation. The call for a holistic approach, bridging various elements of disruption management, remains essential. Likewise, enhancing travelers' engagement through spatial crowdsourcing and developing universal data mining approaches are vital steps forward. Implementing these suggestions could significantly enhance the effectiveness of traffic disruption management strategies, contributing to more resilient and responsive urban mobility systems

The following chapters will successively present our general research methodology, the development of smart and resilient mobility services (SRMS), and the application of the SRMS to the Palestinian context in the West Bank.

## Chapter 2. Research Methodology

### Introduction

This chapter presents the methodology followed in this research, which aims to develop a smart solution to help citizens' mobility under severe restrictions or disruptive events. The solution is based on smart technology because this technology offers a high capacity to (i) collect data from both citizens and sensors, (ii) analyze these data in real-time using artificial intelligence to understand the disruptive event and its impact, and (iii) to propose the best scenario to help citizens to overcome the disruptive event. This solution is used to help Palestinians face the mobility restrictions related to the occupation.

The chapter discusses first the mobility restrictions in Palestine and their impact on the Palestinians' lives and sustainability. Then it presents the methodology used in this research, including the outcome of the literature review, the design of a smart and resilient platform to help citizens face mobility restrictions, and the implementation of this platform to help Palestinians in the West Bank.

### 2.1. Mobility Restrictions in West Bank

The West Bank, a small region situated in the Middle East, is nestled between coastal Israel on its northern, southern, and western borders, with Jordan to its east, Figure 2.1. Its width spans approximately 56 km, while its length stretches around 133 km (Abrahams, 2021). According to the Palestinian Central Bureau of Statistics (PCBS, 2022a), the West Bank has a total population of approximately 3.2 million people residing in 11 governorates.

WB is experiencing long-term mobility restrictions related to the Israeli occupation; these restrictions started around thirty years ago with the installation of permanent or temporary checkpoints (Weizman, 2007) (Braverman, 2011) (Vermote et al., 2014) (Rijke & Minca, 2019) (Habbas & Berda, 2021) (Cali & Miaari, 2018) (Griffiths & Repo, 2021), the construction of a separation wall (Weizman, 2007) (Habbas & Berda, 2021) (Gugerell & Netsch, 2017), and settlers-related violent incidents.

This section provides a historical overview of the state of mobility in the WB under the development of mobility restrictions, divided into two temporal periods, (i) The period from the Oslo Accords to the Second Intifada (1993-1999); (ii) The period from the Second Intifada to the present day (2000-Present). This section aims to understand the causes of erecting these restrictions and identify their types and severity.

#### 2.1.1. Mobility in the West Bank: Oslo Accords to the Second Intifada (1993-1999)

This phase witnessed a notable decrease in violence between Israelis and Palestinians, as the Oslo Accords promised a political resolution to the long-standing conflict (Abrahams, 2021). These accords were designed as an interim agreement to gradually transfer authority from the Israeli Civil Administration to the newly established Palestinian Authority (PA) (ARIJ, 2019b).

Simultaneously, the Israeli Defense Forces (IDF) were to redeploy to areas surrounding the semi-autonomous regions, which would eventually come under PA control. In order to implement the Oslo Accords effectively, the West Bank (WB) was divided into three distinct areas, each with varying levels of control (Singer, 2021). These areas, depicted in Figure 2.1, are delineated as follows:

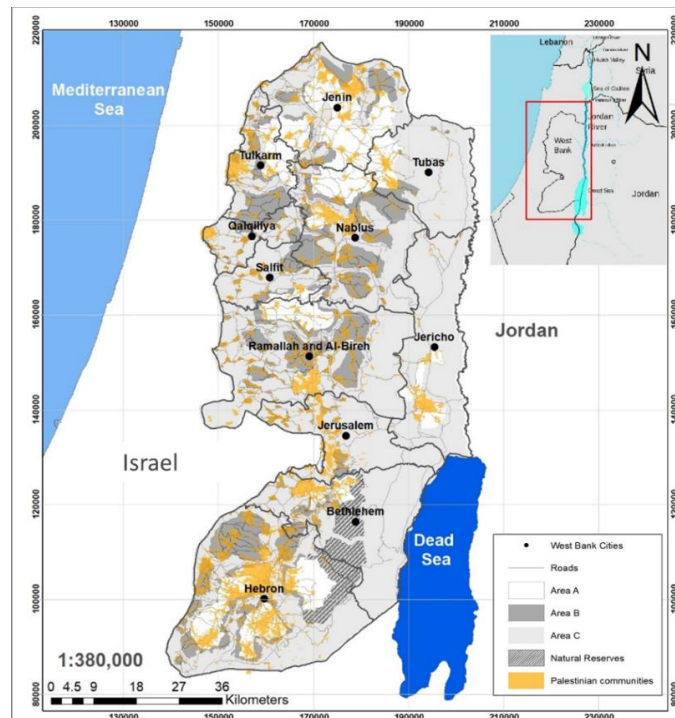
**Area A:** This region constitutes 17.5% of the WB and is under the full civil and security control of the PA.

**Area B:** Covering 18.5% of the WB, Area B is under the civil control of the PA, while security control remains with the IDF.

**Area C:** The largest portion, comprising 61% of the West Bank. In this area, both civil and security control remain firmly under the jurisdiction of Israel.

Contrary to expectations, Palestinian movement restrictions intensified during the Oslo Accords. In March 1993, Israel introduced access restrictions to "East Jerusalem"; this was the first instance of such restrictions being imposed (ARIJ, 2019b). Israel employed a combination of checkpoints and a permit system to gradually hinder Palestinian access to their significant hub, encompassing their cultural, religious, institutional, economic, and commercial activities throughout history.

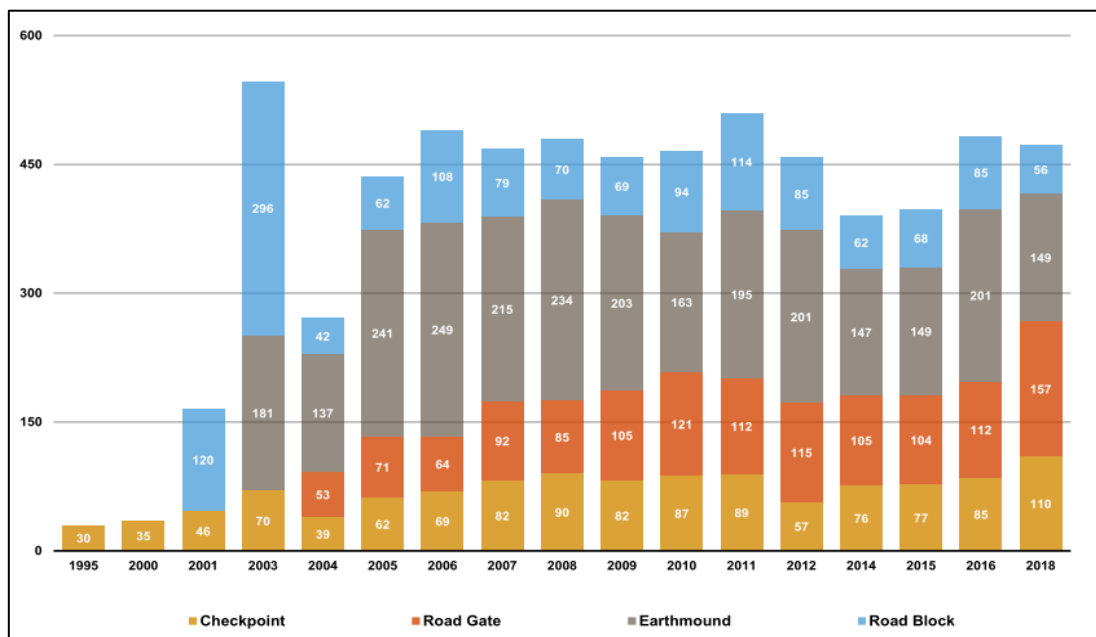
In 1995, Israel erected 30 permanent checkpoints across the WB (ARIJ, 2019b). These checkpoints served as physical barriers and limited the freedom of movement for Palestinians in the WB. They caused severe disturbances in the daily life of the population, with such adverse effects as anxiety, increased physical risk, time losses, and decreased employment opportunities.



**Figure 2.1.** Area A, B, and C according to Oslo Accords

### 2.1.2. Mobility in the West Bank: From the Second Intifada to the Present Day (2000-Present)

In September 2000, a mass Palestinian uprising known as the Second Intifada erupted following the breakdown of the Camp David talks. During this period, movement restrictions within the West Bank intensified (Weizman, 2007) (ARIJ, 2019b), as depicted in Figure 2.2. The Israeli military implemented a range of measures, including checkpoints, road gates, roadblocks, and earthmounds, which significantly curtailed the freedom of movement for Palestinians. This comprehensive system, referred to by Jeff Halper as the Matrix of Control (Halper, 2000), composes a network of interconnected mechanisms that enable Israel to dominate various aspects of Palestinian life in the WB with a minimal physical presence.



**Figure 2.2.** Time series of mobility restrictions erection and restriction types (ARIJ, 2019b)

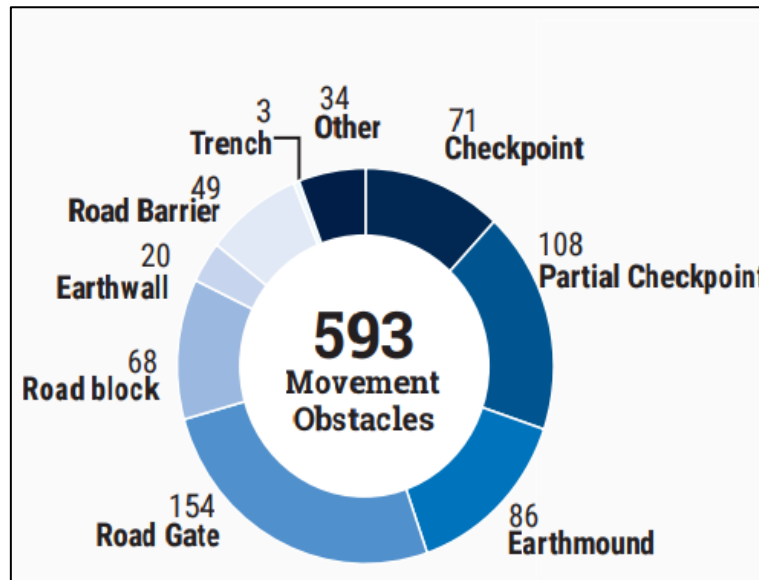
According to a recent survey conducted by OCHA, there are approximately 593 movement obstacles in the West Bank. Among these obstacles, 26% are road gates, 30% are checkpoints, and the remaining 54% are earthmounds, roadblocks, road barriers, and other types of barriers (OCHA, 2020a), as illustrated in Figure 2.3. BTSELEM further classified these checkpoints based on their staffing status. They can be permanently staffed, intermittently, or unstaffed (BTSELEM, 2019). They are also classified according to their location, distinguishing between internal checkpoints along the West Bank's internal roads and checkpoints at the Separation Wall, serving as the final checkpoint link between the West Bank and Israel.

In addition to movement restrictions, the construction of the Israeli separation wall, initiated in 2002, has significantly hindered mobility within the West Bank, Figure 2.4. The International Court of Justice has declared this wall illegal (International Court of Justice, 2003), as it cuts through nine out of the West Bank's 11 governorates, isolating an area of 705 km<sup>2</sup>, which accounts for 12.7% of its territory. Moreover, the wall separates over 90 communities (Isaac et



al., 2015), leading to significant disruptions in travel and trade routes (Gugerell & Netsch, 2017).

Once the Wall is fully completed, its total length will be 771 km, with 82.5% of it situated within the West Bank rather than on Israeli territory. The most affected roads will be the main roads, with a percentage of 54%, regional roads at 45%, and local roads at 43%. This means the separation wall will severely affect interurban commuting in WB (Abu-Eisheh, 2004). As of June 2018, approximately 63% of the barrier has already been constructed, 3.5% is currently under construction, and 33.5% remains in the planning stage (ARIJ, 2019b).

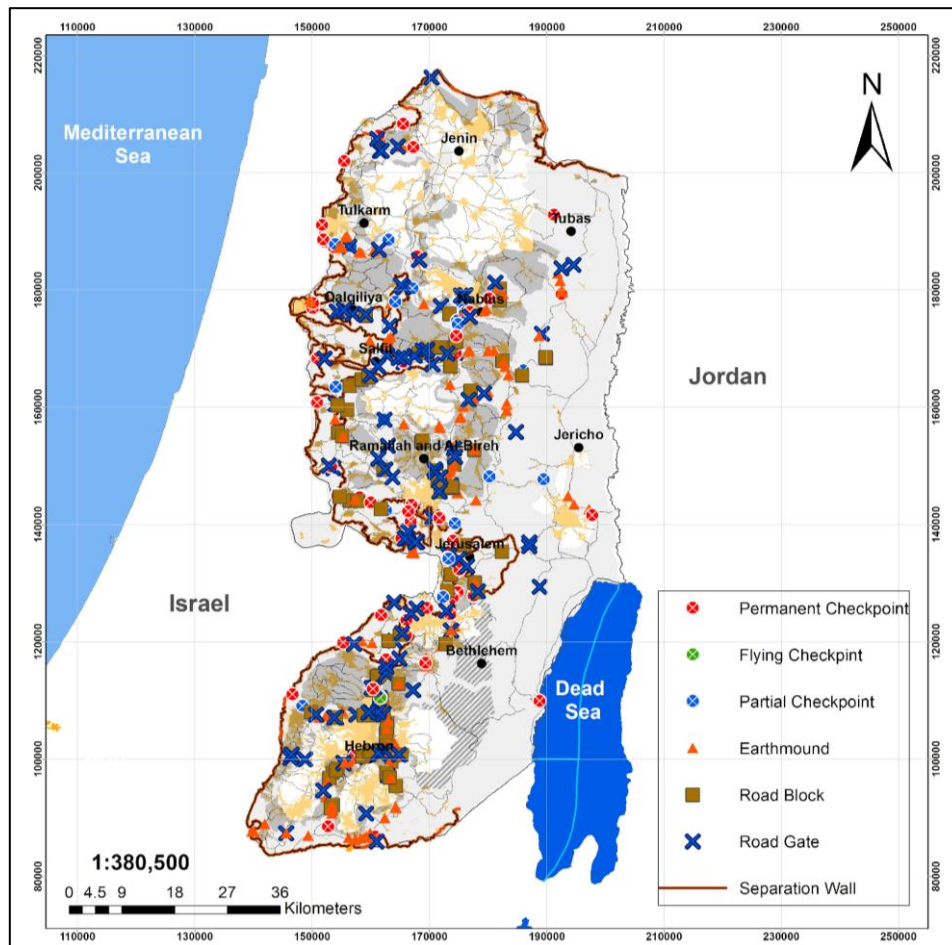


**Figure 2.3.** Movement obstacles by type (OCHA, 2020a)

Another mobility restriction that emerged after the Intifada was the regime of Forbidden Roads (B'tselem, 2004), specifically affecting particular roads in Area C and preventing Palestinian travelers from using them. While these measures are implemented for security reasons, they have profoundly impacted the daily lives of Palestinians, impeding their access to work, education, healthcare, and other essential services (Sletten & Pedersen, 2003) (UN, 2003). According to the last updated data published by B'tselem (B'tselem, 2017), the total length of the completely prohibited roads from crossing Palestinian vehicles is 46.94 km distributed in the North WB, East Jerusalem, and South WB. The partially prohibited roads have a 19 km distance distributed in the central WB and East Jerusalem.

In recent years, a new form of mobility restriction has emerged that poses a safety threat to travelers in the West Bank. This is known as settlers-related violent incidents, which involve acts of violence or aggression performed by Israeli settlers living in Israeli settlements within the West Bank against Palestinian travelers. These violent actions range from road blockages and stone-throwing at vehicles to physical attacks on travelers and even the use of live ammunition. According to a report by OCHA, the year 2022 witnessed an unusual increase in settlers' violence, with an average of 6.6 injuries occurring daily (OCHA, 2023). Approximately 21% of all settlers-related incidents were related to violence targeting vehicles, drivers, passengers, and road blockages (B'Tselem, 2022). This settlers' violence represents a

dynamic risk that threatens Palestinian mobility and can potentially cause physical harm and loss of life (UNHRC, 2021).



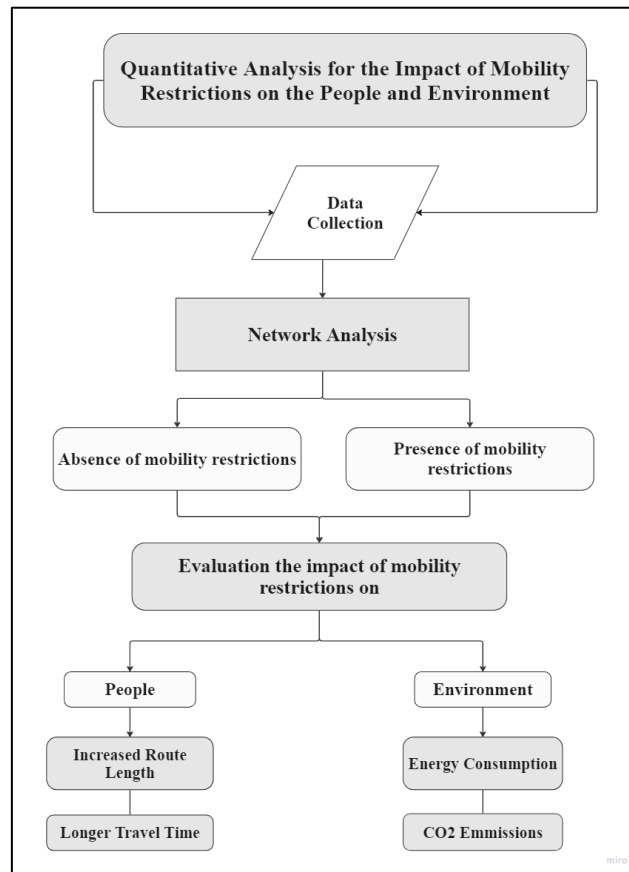
**Figure 2.4.** Distribution of mobility restrictions (Separation Wall and Checkpoints)

### 2.1.3. Impact of Mobility Restrictions on the Population and Sustainability in WB

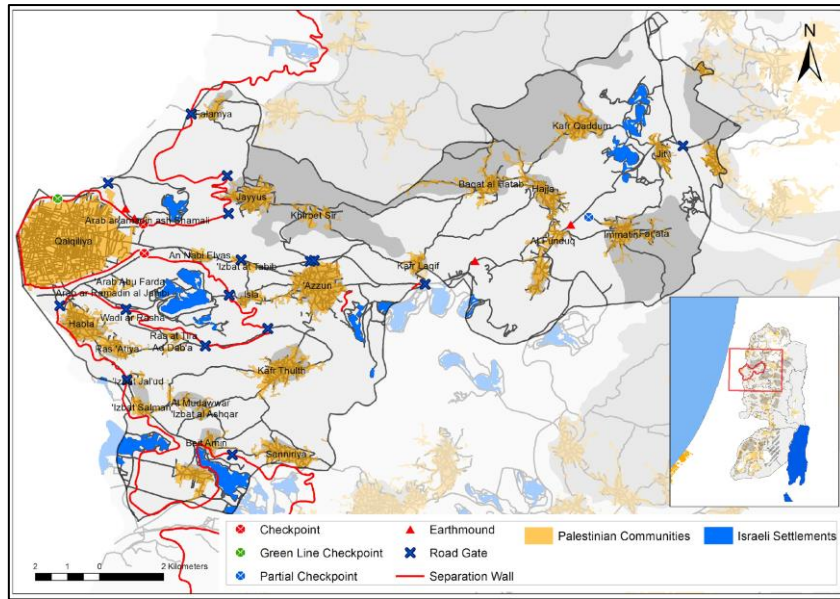
The impact of mobility restrictions on the population and sustainability in WB was analyzed by (Aburas & Shahrour, 2021) according to a methodology including three phases, as depicted in Figure 2.5. The first phase concerned data collection about the inter-urban mobility infrastructure and restrictions. Data was collected from different sources, mainly governmental authorities and non-governmental organizations (NGOs).

The second phase used network analysis to determine the best route (Al Shammass et al., 2023) under two conditions: the absence of mobility restrictions and the presence of those restrictions. The last phase analyzed the impact of the mobility restrictions on (i) the population, with a focus on increases in route length and travel time, and (ii) the environment, with emphasis on the additional energy consumption and CO<sub>2</sub> emissions.

This study showed the adverse impact of mobility restrictions on travel time, energy consumption, and CO<sub>2</sub> emissions. This impact was assessed for the Qalqilya Governorate, Figure 2.6. For this governorate, the ratio between travel time with and without mobility restrictions ranged from 5.93 to 27.01, with an average of 14.08. This increased travel time results in time loss, anxiety, and additional expenses for the population. Additionally, mobility restrictions significantly increase energy consumption, with gasoline vehicles experiencing an average of 275%. Similarly, CO<sub>2</sub> emissions follow a similar increasing trend. The impact on diesel vehicles is even more pronounced, with CO<sub>2</sub> emissions increasing with an average rise of 358%.



**Figure 2.5.** General methodology of evaluating the environmental impacts of mobility restrictions



**Figure 2.6.** Distribution of checkpoints in Qalqilya Governorate

## 2.2. Research Methodology

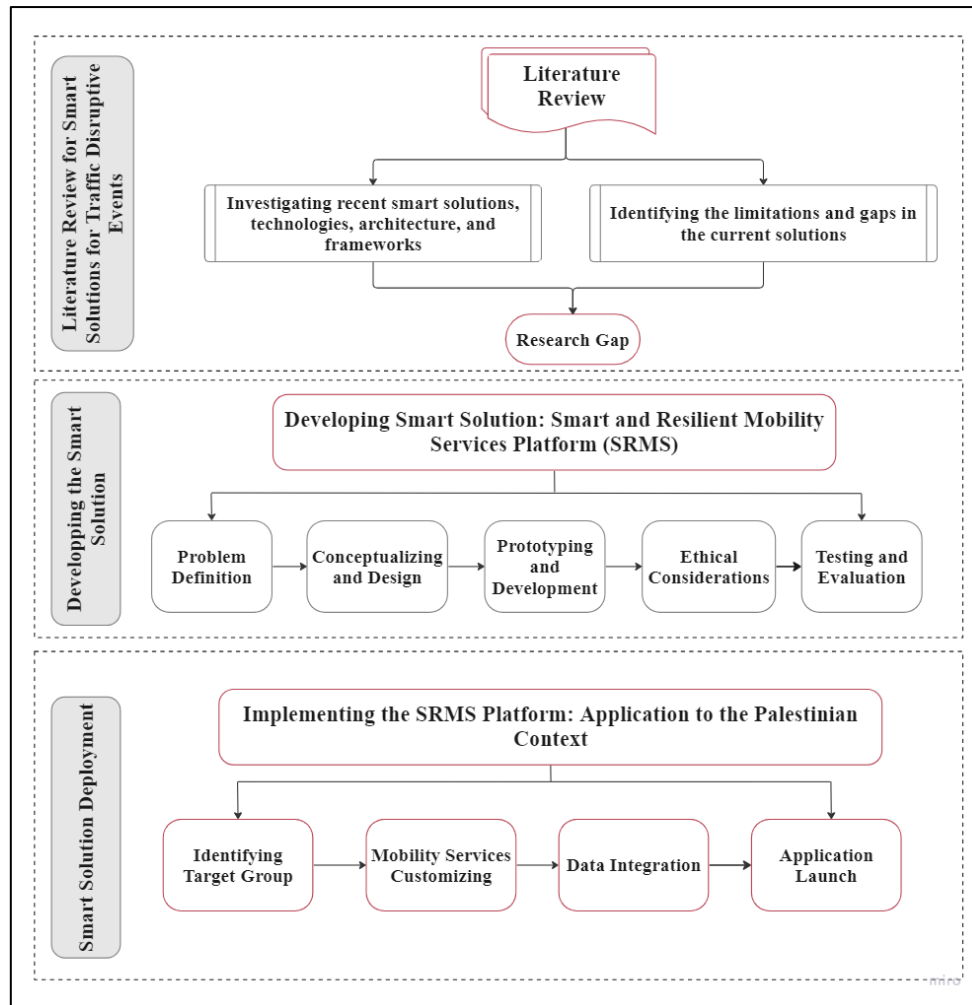
### 2.2.1. Overview

This research aims at creating a smart and resilient solution to help Palestinians face the mobility restrictions imposed by the occupation. Figure 2.7 illustrates the steps followed for the creation of this solution. They include three phases:

The first step concerns a literature review to explore previous research on using smart technology to improve mobility under restrictions or disruptive events. This literature review aims at (i) understanding the current state, (ii) identifying existing strategies, applications, frameworks, and architectures, (iii) and exploring their strengths, limitations, and gaps.

The second phase is dedicated to developing a smart solution that addresses the identified gap in the literature. It includes designing and implementing a novel approach or system to tackle the specific challenges or limitations identified during the literature review. It introduces the Smart and Resilient Mobility Services (SRMS) Platform, which provides innovative features and functionalities for resilient mobility.

The third phase concerns implementing and deploying the developed smart solution in a real-world Palestinian context, specifically the West Bank.



**Figure 2.7.** General Research Methodology

### 2.2.2. The outcome of the literature review

An extensive review of the existing literature shows that scholars have widely embraced smart solutions and harnessed various enabling technologies for disruptive traffic event management. The forefront of these technologies includes the Internet of Things (IoT), Artificial Intelligence (AI), Geospatial Technologies, and Big Data. The applications of these technologies play a significant role in addressing the challenges of disruptive traffic events.

One primary application is real-time data collection, where IoT devices and sensors gather data on traffic flow, road conditions, and environmental factors. This data is processed through big data analysis techniques for traffic monitoring and anomaly detection, allowing authorities to identify abnormal incidents that may disrupt the traffic flow.

Traffic and events predictive models were developed using Machine Learning (ML) techniques to analyze historical and real-time data to predict traffic disruptions and identify potential hotspots for incidents. These models help proactive planning and resource allocation to mitigate the impact of disruptive events.

Furthermore, early detection and alerting systems are being developed to notify users and authorities instantly about potential disruptions. These systems use the IoT and AI algorithms to identify abnormal events, such as accidents or road closures, and alert relevant stakeholders, permitting immediate response. Another significant application is the development of decision support systems, such as route guidance systems, which utilize geospatial technologies, deep learning, and big data to optimize traffic routing during disruptive events. These systems provide alternative routes and suggestions to drivers, minimizing congestion and facilitating traffic flow.

Current solutions for managing disruptive events usually target isolated challenges, resulting in fragmented approaches. For example, some scholars focused on developing travel planner platforms that incorporate context awareness to assist users in finding alternative routes during or after the events (Jevinger & Persson, 2019) (Alkhabbas et al., 2022). These platforms aim to provide personalized suggestions and optimize travel plans based on real-time data and user preferences.

On the other hand, efforts were directed toward event detection and early notification systems. These applications utilize various data sources, such as traffic sensors, social media, and crowdsourced information, to detect and instantly alert users or authorities about disruptive events (Ur Rehman et al., 2021) (Sathya et al., 2023). The goal is to enable quick response to minimize the impact of such events on traffic flow. Geospatial technology applications are also utilized to map events on shareable base maps, facilitating better visualization and understanding (Tavra et al., 2021).

However, there is a notable gap in comprehensive solutions that integrate and combine different features to address disruptive events holistically. While individual solutions may effectively tackle specific aspects, there is a need for more integrated approaches that consider multiple dimensions of the problem. A comprehensive solution should contain real-time event detection, early notification and alerting, routing guidance, geospatial mapping, and other features to manage disruptive events.

Despite the significant advancements in information and communication technology (ICT) in addressing disruptive traffic, there are limitations in recent smart solutions when involving citizens in the process. Citizen engagement is crucial for accepting innovative solutions, but limited participation exists. In response to this gap, recent calls have highlighted the potential of integrating the (IoT) and Machine Learning (ML) with crowdsourcing or crowdsensing in smart mobility applications (Ang et al., 2022).

However, the contribution of crowdsourcing in disruptive traffic management is still in its infancy. Some crowdsourcing applications enhanced commuter safety, facilitated event evacuation, determined traffic patterns, and detected events. These applications rely on participatory or opportunistic reporting via mobile devices and analyze text data from social media platforms. However, it is important to note that most existing studies on crowdsourcing and disruptive traffic events predominantly rely on Twitter as the primary source of information.

This assumption is based on the widespread use of Twitter. However, it should be acknowledged that this may not be the case in all environments, and other social media platforms may be more prevalent in certain regions or communities. Therefore, it is essential

for future research to explore and incorporate a broader range of social media platforms to ensure a comprehensive understanding of disruptive traffic events across various contexts.

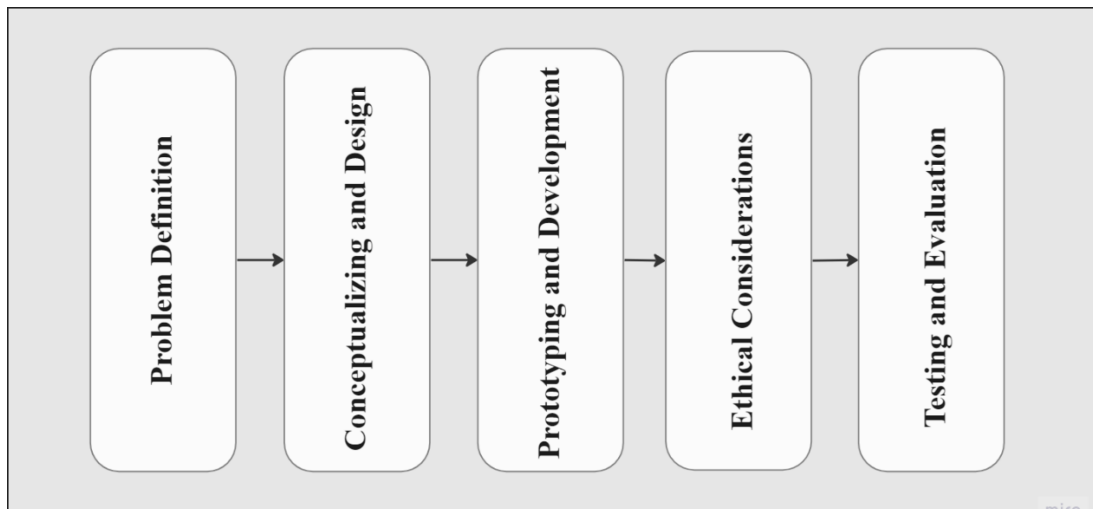
Therefore, this research aims to address the identified gaps in the literature on managing disruptive traffic events by pursuing the following contributions:

- Develop a platform that provides comprehensive mobility services to effectively manage incidents during all disruptive phases: Platform services include real-time mapping of mobility restrictions and traffic events, a notification system for personalized alerts based on user interests, and a route planning service that includes multiple categories of alternative routes.
- Utilize crowdsourcing for enhanced data collection: The research aims to leverage the power of crowdsourcing by actively involving citizens in the data collection process of traffic events. This approach aims to improve the accuracy and comprehensiveness of the gathered data, providing more reliable and insightful information for managing disruptive events.
- Explore alternative social data sources for traffic event management: The research seeks to explore and utilize alternative data sources beyond the common use of Twitter in social sensing studies.
- Enable informed decision-making for authorities: The SRMS aims to not only provide direct mobility services to individuals but also support authorities in making informed decisions. By providing historical data on mobility restrictions and traffic congestion, the research aims to assist authorities in understanding past events and trends, enabling them to implement effective strategies for managing future disruptive events.

This research focuses on developing a Smart and Resilient Mobility Service (SRMS) Platform to achieve the stated objectives. The SRMS is designed to offer a range of mobility services to facilitate and optimize users' travel experiences while minimizing socioeconomic costs.

### **2.2.3. Developing a Smart and Resilient Mobility Services (SRMS) Platform**

This section presents the methodology for creating the SRMS Platform, which consists of a series of sequential steps, including (i) identifying the problem that the platform is designed to address; (ii) developing the conceptual design for the SRMS platform; (iii) prototyping and development; (iv) ethical consideration related to data privacy and quality; (v) testing and evaluation to ensure its functionality. Figure 2.8 depicts the steps of creating the SRMS platform.



**Figure 2.8.** Methodology for creating the SRMS Platform

i. Problem Definition

This phase focuses on developing the SRMS Platform as a smart solution to address the identified gap in the previous literature. The platform aims to provide comprehensive services facilitating travel for individuals in communities affected by disruptive traffic events. This includes real-time event mapping, prompt notification and alert messages to users, and proposing alternative routes aware of context and user preferences.

Additionally, the SRMS platform aims to advance knowledge of crowdsourcing for traffic disruptive event management. It relies on the community as the primary data source, using spatial participatory crowdsourcing and social data mining to provide real-time and near-real-time data.

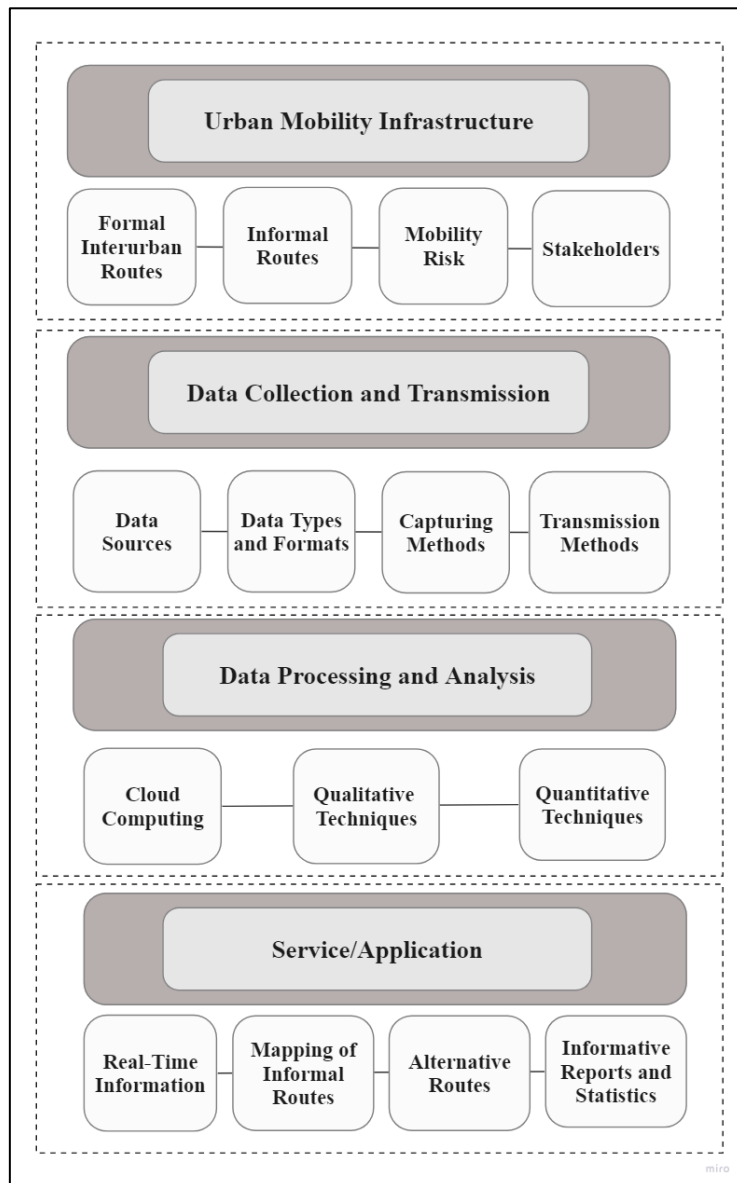
ii. Conceptualizing and Design

The second phase of the research focuses on conceptualization and design to generate ideas and concepts for the structure and services of the SRMS platform. This phase comprehensively reviews approaches, architectures, and frameworks in other semi-similar smart mobility and smart city platforms. A framework for the SRMS platform is developed by analyzing and synthesizing these existing solutions. The architecture of the SRMS platform consists of four layers that interact with each other to provide the final services, including (i) the urban mobility infrastructure layer; (ii) data collection and transmission; (iii) data processing and analysis; and (iv) service layer. Figure 2.9 illustrates the four layers of SRMS platform.

- *Urban Mobility Infrastructure Layer*

This layer is the data source for creating the SRMS Platform services. It includes formal interurban routes, informal routes, mobility risk as a type of mobility disruptive vent, and stakeholder involvement. By incorporating these elements, the SRMS can proactively manage disruptions and enhance resilience with the wide engagement of the community.





**Figure 2.9.** Layers of SRMS Platform

- *Data Collection and Transmission Layer*

This section is designed to answer the following questions; (i) what are the available data sources that are needed to provide SRMS services, (ii) what are the types of obtained data; (iii) what are the data formats; (iv) what are the methods observed for capturing and gathering these data; and (v) how the captured data will be transmitted to the SRMS processing layer.

Data in the SRMS is captured from various sources, including high governmental authorities, local authorities, NGOs, and the community. These sources can be classified into three

categories, including (i) open sources accessible by the public, (ii) authorized database that is only available for authorized people, and (iii) crowdsourcing data, which is generated by the people (crowd) through participatory reporting via mobile devices and sharing road information on social media, such as Telegram social platform.

The selection of Telegram as a data source for social data related to mobility restrictions is justified by several factors. Firstly, Telegram has a large user base of around 550 million active monthly users, surpassing the number of Twitter users, which stands at approximately 436 million (Statista, 2022). This indicates the popularity and widespread adoption of Telegram as a messaging platform. Secondly, Telegram offers the feature of pure instant messaging, enabling real-time communication and updates. This attribute makes it an ideal source for obtaining accurate and timely data on mobility restrictions, which can be fed into the SRMS system to provide up-to-date information to users.

Additionally, mining Telegram data for mobility restrictions represents a novel approach within social media mining studies (Khaund et al., 2021). By leveraging the unique characteristics of Telegram channels and public groups, this research has explored the extraction of mobility restrictions and road traffic data using the Telegram API (Anand et al., 2022) (Dongo et al., 2020). This demonstrates the innovative use of Telegram as a valuable data source in the context of mobility-related studies.

- *Data Processing and Analysis*

This layer concerns processing and storing the collected data to generate a mobility service decision based on evidence. The data processing layer uses the development of cloud computing as a next-generation computing infrastructure (Phuttharak & Loke, 2019). The advantages of using cloud computing are the ability of the system to deal with large-scale spatial data, improve data storage and computational pressure effectively, ability to integrate and process real-time data and social network data, support real-time inquiries, and support the filtering data to preserve the data quality (X. Kong et al., 2019).

This research employed the Software as a Service (SaaS) cloud computing model to develop the SRMS platform. The use of SaaS was recommended by (Chnar & Subhi, 2021), who compared SaaS with other cloud computing services such as Infrastructure as a Service (IaaS) and Platform as a Service (PaaS). SaaS enables users to run software programs over the internet without installing them on their devices, simplifying operations and reducing maintenance costs.

Hence, this study utilizes ArcGIS Online as a cloud-based Software as a Service (SaaS) platform. Choosing ArcGIS Online as a platform service stands for several factors, including (i) providing scalable and flexible computing resources (Esri, 2023h); (ii) users can access their maps and data from anywhere with an internet connection, which can help facilitate remote work and collaboration (Esri, 2021b); (iii) ArcGIS Online provides the capability of streamlining the application development and deployment; (iv) it allows utilizing application templates, access hosted APIs and software development kit components, and connect to shared widgets and add-ins (Esri, 2023h).

The data analysis in the processing layer follows a mixed methods approach, combining qualitative and quantitative techniques. This approach allows for a comprehensive

understanding of the research topic and facilitates the integration of different data types, perspectives, and research techniques (Timans et al., 2019). The qualitative approach involves mining the Telegram data for thematic analysis and topic identification to identify various mobility restrictions. This method provides insights into the qualitative aspects of the data and helps understand the nature and context of the mobility restrictions.

On the other hand, quantitative techniques are employed to analyze crowdsourced data, such as GPS data and geotrace lines, using geospatial analysis. Also, quantitative methods using machine learning techniques are applied to develop predictive models, ensuring data and user quality and quantifying risks on the road network. Furthermore, they contribute to developing route planning models that optimize travel routes based on the available data.

- *Service Layer*

This layer represents the interface through which the SRMS platform interacts with users and provides services. The services of the SRMS platform were identified from the research problems and observed gaps. It includes functionalities such as real-time mapping of mobility restrictions, notification, and alerting systems, mapping the informal route, personalized routing alternatives based on user preferences, and an informative dashboard on the recent current events and time series of traffic congestion reports.

The application layer provides users with up-to-date information about mobility restrictions, such as road closures, traffic congestion, checkpoints, and violent actions. Users can view this information on a map interface and stay informed about any updates or changes to the restrictions. Another essential service the application layer provides is the mapping of informal routes. These routes, which may not be included in traditional navigation systems, offer alternative paths and shortcuts based on user-reported information. Users can explore different routes and optimize their travel experience by incorporating informal routes into their navigation options.

The application layer also plays a crucial role in providing alternative path suggestions to optimize safety, travel time, and distance. The platform can recommend alternative routes that suit individual user preferences and priorities by leveraging previous layers' available data and analysis. The SRMS platform's application layer also generates informative reports and statistics related to restrictions activation and traffic congestions in a time series. These reports offer valuable insights into mobility restrictions and conditions during the time of the day and day of the week. This will help users and stakeholders make informed decisions.

### iii. Prototyping and Development

This phase concerns creating a prototype of the SRMS platform. It involves developing a software application and designing the interface. The SRMS platform was initially developed as a mobile web application that can be accessed through a mobile web browser. One of the key advantages of using a mobile web app is its compatibility across different devices and operating systems, making it a flexible and cost-effective choice for developers aiming to reach a wide user base (Rochim et al., 2023) (Tandel & Jamadar, 2018). In contrast, native apps are typically coded in device-specific programming languages for specific devices or operating systems.

The decision to develop the SRMS platform as a mobile web app was made after considering various factors, such as the current state of mobile app development, available resources, time constraints, and technical and non-technical considerations. This choice was informed by a review of different comparison studies that assessed mobile web apps with native apps, hybrid apps, interpreted apps, and widget-based apps (Tandel & Jamadar, 2018) (Shah et al., 2019) (Rochim et al., 2023). Considered factors included installation process, updates, app size, offline access, user experience, push notifications, development cost, security, ease of updates, implementation complexity, licensing, programming language, and discoverability. The comprehensive evaluation of these factors ultimately led to the selection of a mobile web app as the most suitable solution for the SRMS platform.

The SRMS platform can benefit from being a mobile web app in several ways. Firstly, it offers enhanced accessibility to a wider user base, as it can be accessed on various devices without platform restrictions. Secondly, it is a cost-effective solution as it utilizes standard web technologies that are widely available such as HTML, CSS, and JavaScript, and can be used across multiple platforms. Hence, reducing the need for specialized resources (Tandel & Jamadar, 2018). Thirdly, it allows for responsive development, enabling developers to quickly address user feedback and make necessary updates. This responsiveness is crucial for spatial crowdsourcing projects that require frequent modifications to meet evolving user needs (Shah et al., 2019).

However, it is important to note that when comparing web apps to other types, there may be challenges related to limited user interface and experience. To tackle these challenges, the design of the SRMS mobile web app was partially inspired by the principles of Progressive Web Apps (PWA) as outlined by (Fauzan et al., 2022).

PWAs combine the strengths of both web and mobile apps, providing a rich user experience close to native apps. Several PWA principles were applied in the design of the SRMS web app. Firstly, responsiveness: The design of the SRMS web app is adaptive and responsive, catering to various screen sizes, orientations, and resolutions. Using cascading style sheets (CSS), different styles are rendered based on the device, ensuring a user-friendly experience across various devices (Serrano et al., 2013). This adaptability enhances usability, allowing users to comfortably interact with the app regardless of their device (Jobe, 2013).

Secondly, app-like experience: The SRMS web app aims to provide a modern interface and a flexible design framework to deliver an ultimate user experience and interaction (Esri, 2023a). By incorporating contemporary design principles, the app aims to emulate the feel and functionality of native apps, offering users a seamless and immersive experience. Additionally, the SRMS web app incorporates a push notification system to inform users about updates related to specific mobility restrictions.

During the design phase of the SRMS mobile web app, the User-Centered Design (UCD) approach was adopted to ensure high user interaction and increase acceptance among users. The UCD approach focuses on prioritizing the needs and limitations of end-users in the design process (Blackett, 2021) (Vallet et al., 2020). In software engineering, UCD involves deeply understanding the users' goals, motivations, and frustrations. This understanding helps inform the design of intuitive and user-friendly applications that effectively meet their needs (Lopes et al., 2018).

This involved qualitative methods, including conducting investigative surveys among potential SRMS users. The survey aims to gather information from different perspectives, such as personal profiles, commuting modes, and traveling costs. The goal was to understand users' needs, preparedness, and interests related to their interurban mobility. The survey also gathered insights into users' preferences for the listed application features. By understanding users' preferences, the design phase could prioritize the most desired features and ensure they align with users' expectations. Simultaneously, the survey assessed the users' willingness to interact with the proposed features, providing valuable feedback on the potential usage and acceptance of the app.

#### iv. Ethical Considerations

This section addresses the ethical considerations of the developed SRMS platform, specifically focusing on data privacy, security, and user trust. To address these concerns, the SRMS platform incorporates a Data Privacy and Quality Control Module during the data processing and analysis phase. The platform implements data quality protocols and measures to ensure the validity and accuracy of user-submitted data. These measures help assess the quality of the data and identify any potential issues. Reputation models and other quality assurance techniques are employed to establish the trustworthiness of users and their contributions to the platform.

Regarding privacy, the SRMS platform adopts privacy-preserving techniques to protect user data and respect their privacy preferences. This includes implementing measures such as data anonymization and access controls to safeguard sensitive information. The platform considers available privacy methods applied in crowdsourcing applications and considers their limitations, advantages, and relevance to the context of this research.

#### v. Testing and Evaluation

The developed SRMS web mobile application was tested by users regularly encountering mobility restrictions. This testing phase aimed to evaluate the application's performance, functionality, and user interface experience. The primary goal was to gather user feedback to identify areas that require improvement and refinement.

During the testing process, users interacted with the application and performed various tasks related to reporting and navigating through disruptive traffic events. Their experiences and feedback were collected, allowing for an assessment of the application's usability, responsiveness, and effectiveness in addressing their needs.

The feedback obtained from the users played a crucial role in identifying any issues or challenges they encountered while using the application. This feedback was valuable input for further enhancing the application's performance, functionality, and user interface. By incorporating the users' perspectives and addressing their concerns, the final version of the SRMS application is prepared and ready for deployment.

#### **2.2.4. Implementation SRMS platform in the Palestinian Context, West Bank**

This phase concerns the implementation and deployment phase of the SRMS application in the West Bank context. WB environment is particularly suitable due to the frequent exposure to mobility restrictions. Additionally, there are facilitating factors such as widespread internet and smartphone access and the common use of social media for sharing road network information. Further, the absence of existing applications addressing real-time data on mobility restrictions highlights the need for such a solution.

This phase encompasses identifying the target group and customizing the mobility services platform to align with the specific environment. Also, integrate the platform with relevant data sources, such as road network physical data from the Ministry of Transport. Finally, launch the application among the target groups, monitor the system performance, and collect relevant data concerning user interaction and service performance.

### **2.3. Conclusion**

This chapter highlighted the research methodology which aims to develop a smart solution to help citizens' mobility under severe restrictions or disruptive events. The chapter started by highlighting the impact of mobility restrictions on the Palestinians due to the Israeli occupation. The studies revealed that these restrictions significantly impact the daily lives of Palestinians, restricting their freedom of movement, longer travel distances, travel time, access to essential services, economic opportunities, and social interactions. These mobility restrictions have profound socio-economic and environmental effects, undermining the region's sustainability pillars.

To address these challenges and promote sustainability in the West Bank, the chapter outlined a comprehensive approach that embraced smart solutions to mitigate the adverse impacts of mobility restrictions. It provided a literature review that served as a foundation for understanding existing research and identifying gaps in the field of using smart technologies to manage traffic disruption. Then, it introduced the SRMS Platform as a novel and comprehensive solution to bridge the identified gaps. It aims to provide integrated services, including real-time event mapping, personalized alerts, and alternative route suggestions.

SRMS platform based on crowdsourcing to enhance data collection and explores alternative social data sources, such as Telegram, to improve the accuracy of information. The methodology described the technical aspects of creating the SRMS Platform, from problem definition to conceptualization, design, prototyping, development, and ethical considerations.

Finally, the methodology addressed the implementation of the SRMS Platform in the West Bank context, emphasizing the suitability of the environment and the need for such a solution. It involves customizing the platform to align with the specific needs of the region, integrating relevant data sources, and launching the application among the target user groups.

## **Chapter 3. Methodology for Developing the Architecture of Smart and Resilient Mobility Services (SRMS) Platform**

### **Introduction**

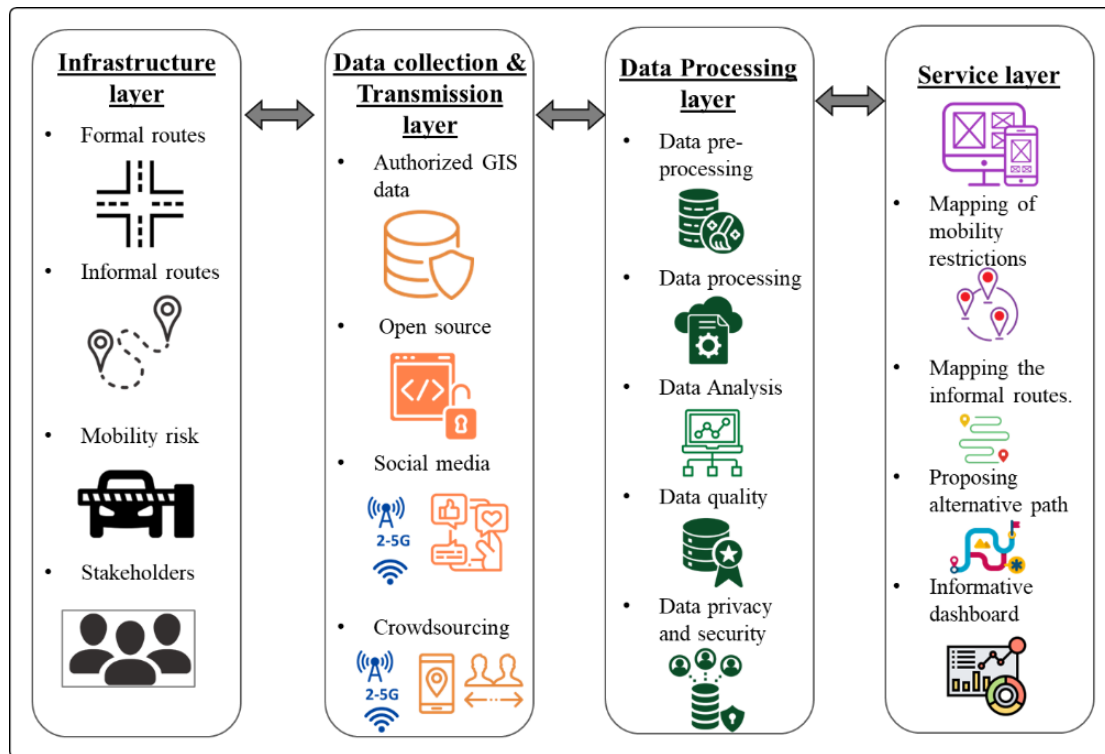
Developing and designing a Smart and Resilient Mobility Services (SRMS) requires a systematic approach to ensure its effectiveness in addressing mobility restrictions issues, particularly in constrained environments. This chapter introduces a comprehensive methodology that outlines the tools, processes, and techniques used during the development of the SRMS. The research methodology is based on the smart system approach.

The methodology includes four parts. The first part provides a general method for developing the SRMS platform. It provides a roadmap, guiding the development process and ensuring the successful creation of smart mobility services that embrace the community as a primary data source and deliver these services to the users.

The second part highlights protocols and measures to assess the validity and accuracy of user-submitted data, user trustworthiness techniques, and privacy-preserving techniques to protect users' privacy. The third part presents developing a mobile web app considering the user-centered design principles to offer mobility service attractively and ensure high user engagement. The last part provides a general overview of the developed framework by providing the operating system of the SRMS platform.

### **3.1. Layers of the SRMS System**

Defining the architectural model is essential for any technology, it will have a standard to follow. SRMS, as a novel smart solution to address the mobility restrictions challenges, follows the concept of smart city architecture layers (Shahrour & Xie, 2021) (Haque et al., 2022). SRMS is composed of four layers: urban mobility infrastructure, data collection and transmission, data processing layer, and services layers, as depicted in Figure 3.1.



**Figure 3.1.** Architecture of smart and resilient mobility services platform (SRMS)

### 3.1.1. First Layer: Urban Mobility Infrastructure

The first layer in the SRMS system is the infrastructure of the urban mobility system. It is the foundation for designing a resilient and smart mobility service. It constitutes the data source in the smart system (Shahrour & Xie, 2021). This layer includes (i) formal interurban routes, (ii) informal routes, (iii) mobility risk, and (iv) stakeholders involved in the SRMS.

#### i. Formal Interurban Routes

The formal interurban routes concern routes used by interurban travelers. They are characterized by short travel time and high speed, making them suitable for interurban mobility. Formal interurban routes are mainly composed of roads and could be connected to tunnels or bridges. The roads in the formal routes are highly hierarchical road classifications, with different names and descriptions according to the road classification system of the country and its national urban context (Paraphantakul, 2014). For example, the high level of road classification in Toronto is an expressway, major arterials, and minor arterials (City of Toronto, 2013). In comparison, road classification in South Africa is principal urban arterial, major urban arterial, and minor urban arterial (Committee of Transport Officials-COTO, 2012).

Regardless of the difference in the names of road classifications, they share common characteristics, including (i) primary function is mobility; (ii) high-speed limits (more than 50 km/h); (iii) high traffic volume; (iv) intended to uninterrupted traffic except at signals or crosswalks, (v) limited property access; (vi) limited transit facilities; (vii) limited regulations on heavy traffic, etc. (City of Toronto, 2013). Due to high traffic volume and high traveling



speed, formal routes have increased exposure to disruptive risks such as traffic crashes (Al-Sahili & Dwaikat, 2019), hazardous material accidents (Huang et al., 2018), and natural disaster consequences (Arrighi et al., 2021). Hence, the formal routes require regular monitoring and maintenance to avoid failure in providing mobility service, which entails massive traffic interruption, traffic congestion, and physical and human loss (B. Liu et al., 2016).

The formal route plays a significant role in creating a smart and resilient mobility system. The role of the formal route includes (i) the backbone of the mobility system; it is considered the main infrastructure for transportation. It forms the base map of the SRMS and acts as a reference for all SRMS services, including real-time reports and data collection related to informal routes; (ii) crucial input for creating routing planning models and conducting network analysis within the SRMS. These models utilize information about the formal route network to generate alternative routes based on different criteria, such as safety, speed, and distance. By considering the characteristics of the formal route, the SRMS can offer users categorized alternative routes, including the safest route, fastest route, and shortest route; (iii) publishing and updating the formal routes database via the SRMS platform helps transport authorities in infrastructure management and minimize failures and prevent disruptions that could lead to traffic interruptions and congestion.

#### ii. Informal Routes

The informal routes emerge in mobility systems subjected to physical or natural hazards, leading to blockage in the main roads and traffic congestion. Informal routes have a significant role in the SRMS platform, including (i) providing flexible and adaptable mobility patterns. Unlike formal routes, informal routes may consist of various paths and passages that are not officially designated for transportation purposes. They emerge based on local knowledge, community preferences, and evolving transportation patterns; (ii) enhancing the community resilience (Bishara, 2015), which takes different shapes depending on the community context and available resources (Lwanga-Ntale & Owino, 2020) (Sajjad, 2021); (iii) enhancing the routing planning model, since it will expand the available alternative routes to manage specific traffic disruptions; (iv) providing a contemporary perspective of resilient urban mobility.

While existing literature on urban mobility resilience focused on engineering perspectives (Sohouenou et al., 2021) (Arrighi et al., 2021) (Leobons et al., 2019), the experience of travelers dealing with road restrictions and traffic interruptions, especially in conflict areas, has not been widely addressed (Samper, 2012) (Dunckel Graglia, 2016). Introducing informal routes into the urban mobility system offers a novel perspective for enhancing resilience. It recognizes the dynamic nature of informal routes and allows new strategies to cope with traffic interruptions based on the specific risks and socio-economic context.

#### iii. Mobility Risk

The mobility risk could be predictable or non-predictable events that induce traffic disruption. In this research, the mobility risk is related to the mobility restrictions that could be physical or intangible restrictions that impede people's movement. Physical mobility restrictions have different shapes, such as checkpoints, roadblocks, road gates, and violent actions. Intangible mobility restrictions could be policies prohibiting the use of certain roads. By integrating

mobility risk considerations into the system, the SRMS becomes better prepared to handle disruptions and ensure the efficient and resilient operation of the urban mobility network.

Considering mobility risks in the infrastructure of urban mobility has different advantages. Firstly, risk management and informed decision-making. By recognizing and understanding potential mobility restrictions and disruptions, the system can proactively plan and implement measures to mitigate risks and minimize their impact on the overall mobility network. This includes establishing alternative routes and implementing real-time reporting and notification systems.

Secondly, resilience enhancement is achieved by identifying the timeline of the operation mechanism of the mobility restrictions, whether they are planned, random, or conditional. This will provide insights into their predictability and managing potential disruptions. Thirdly, assessing the socio-economic and environmental impacts involves understanding these restrictions' broader effects on individuals, communities, and the environment. Lastly, provide visual presentation and mapping within the urban mobility system. This allows for a better understanding of the spatial distribution of these restrictions and aids in decision-making processes.

#### iv. Stakeholders

Stakeholders include the formal and informal groups involved in a resilient mobility system. They include individuals, governmental authorities, and non-governmental organizations (NGOs). Stakeholders' involvement in developing the smart and resilient system is crucial for the success of the system (Jayasena et al., 2019) (Lindenau & Böhler-Baedeker, 2014).

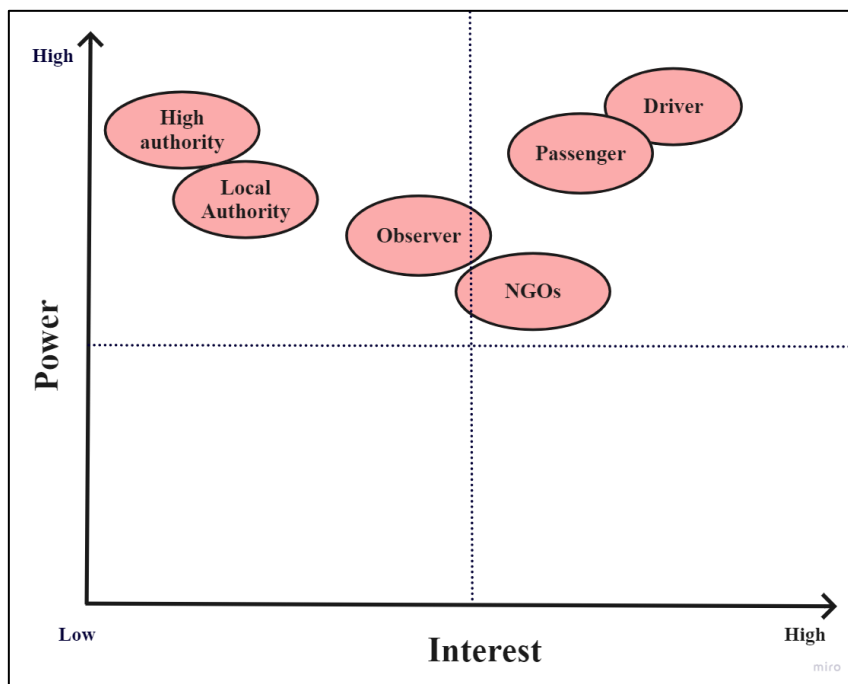
Each stakeholder is a potential source of static and dynamic data (Shahrour & Xie, 2021). Hence, it is necessary to ensure a well-organized data collection and sharing procedure among stakeholders and ensure data security, integrity, and access rights protection. Figure 3.2. shows the power-interest graph for the SRMS stakeholder. It is a common tool to map the stakeholders according to their power and interest (Lindenau & Böhler-Baedeker, 2014). According to Figure 3.2, SRMS stakeholders could be classified into three groups, including (i) high power-high interest group, (ii) high power-low interest group, and (iii) medium power-medium interest group.

The high power-high interest group includes drivers and passengers who use the interurban mobility network. They are considered mobile sensors on the road network (Phuttharak & Loke, 2019). They capture and feed the system with real-time localized data about traffic conditions and mobility restrictions, and share their experience in informal traveling using spatial crowdsourcing technology. Also, they are the primary users and beneficiaries of SRMS who will be able to plan their interurban traveling with minimum risk and cost.

The high power-lower interest group includes the governmental organizations who have power in the SRMS through providing transportation infrastructure data but do not directly benefit from the SRMS compared with the first group. The higher governmental authority, such as the Ministry of Transport, is the source of high-classified roads, including road characteristics, maintenance needs, physical condition, mapping, etc. The local governmental authority, such as the municipality, is a source for low-classified roads inside the locality. To maintain an

inclusive, updated transportation database, we need coordination to share data between two hierarchal levels.

The medium power-medium interest group includes residents of localities adjacent to formal roads and non-governmental organizations (NGOs). They play the role of observers in the SRMS by reporting traffic data and mobility restrictions on the nearby formal roads. They do not have high benefits compared with the first group. Residents can provide data in the areas not accessible by travelers in the usual situation, such as alternative routes or paths linked with the formal routes, so they could be considered sources for informal routes. NGOs play different roles in urban mobility according to the urban community context. However, NGOs in SRMS play the role of monitoring the risk on the interurban road network by describing the tangible and intangible mobility restrictions, their categories and functioning mechanism, mapping, etc.



**Figure 3.2.** Power-Interest graph for SRMS stakeholders

### 3.1.2. Second Layer: Data Collection and Transmission

This section concerns the following questions, (i) what are the available data sources for the SRMS services, (ii) what are the types of obtained data, (iii) what are the data formats, (iv) what are the methods observed for capturing and gathering these data, and (v) how the captured data will be transmitted to the SRMS processing layer.

Data is the core of the SRMS, as all the decisions are based on the analysis of the collected and captured data from the mobility infrastructure (Haque et al., 2022). According to (Shahrour & Xie, 2021), the data sources of the smart urban system are classified into (i) IoT data, including sensors, cameras, RFID, GPS, etc.; (ii) authorized data from public authorities such as traffic

information; (iii) open data, which is generally shared by public authorities and NGOs; and (iv) crowdsourcing, which includes people's active and passive data.

Data in the SRMS is captured from various sources, including high governmental authorities, local authorities, NGOs, and the community. The data could be obtained from (i) open sources accessible by the public, (ii) authorized database that is only available for authorized people, and (iii) crowdsourcing data, which is generated by the people (crowd) through the SRMS platform and social media. The obtained data has different types, such as spatial data in the form of Esri vector data storage format (Shapefile), which is common spatial data storage that stores the location, shape, and attributes (Esri, 2023g), feature service, mobile device GPS sensing data, tabular data, and text data. Table 3.1 presents the data used in the SRMS for each infrastructure category and describes the data sources, types, and formats.

**Table 3.1.** SRMS's data sources, types, and format

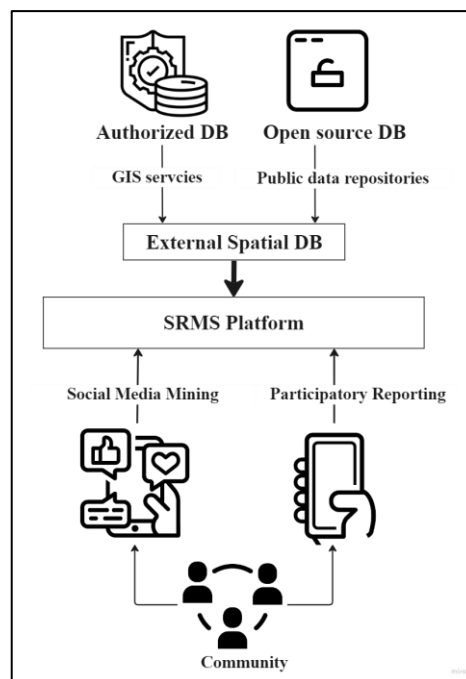
<b>Infrastructure Category</b>	<b>Data Source</b>	<b>Source description</b>	<b>Data type</b>	<b>Data Format</b>
Formal routes	High governmental authority: Ministries.	Authorized transportation database.	GIS spatial database.	Spatial data Esri Shapefile: SHP, .DBF, .SHX, etc.
Informal routes	Community experience and observations.	Spatial crowdsourcing.	Crowdsourcing data using the GPS of mobile device.	Spatial data Hosted feature layer (Feature service).
Mobility restrictions	NGOs.	Open source.	Descriptive textual data. Tabular data.	Text. Image. Excel file (.xlsx).
	Community observations.	Spatial crowdsourcing.  Social media.	Crowdsourcing data using the GPS of mobile device.  Crowdsourcing data: processed text data.	Spatial data Hosted feature layer (Feature service).  Text.

Methods used to obtain the above-mentioned data are summarized in Figure 3.3. The authorized data is obtained through formal communication with related authorities to provide access to their GIS services using login data (ID and password). Open-source data, such as those published by NGOs, is gathered through public data repositories. These repositories often provide direct download links or APIs to access the data. The authorized and open-source data will be processed, filtered, and stored in a cloud external spatial database (ESDB).

The community provides the SRMS platform with real-time spatial data about traffic conditions, mobility restrictions, and informal routes using participatory spatial crowdsourcing

SC (Phuttharak & Loke, 2019) (X. Kong et al., 2019) (Helmrich et al., 2021), where users directly report on the SRMS platform. SRMS platform is designed using Web GIS, ensuring interactive public access to geospatial data, real-time data integration and transmission, and platform-independent GIS analysis (Agrawal & Gupta, 2017). For collecting the community data, SRMS deployed the Survey123 data collection tool (Jordan et al., 2019) using automatic pre-filed location, date, and time data. So, once the users access the reporting section in the SRMS platform, they are asked to permit the activation of their location detection using the GPS data of the mobile device.

The second method for collecting data from the community is using social media (Salazar-carrillo et al., 2021). The community provides near real-time data regarding traffic conditions and restrictions through instant messaging on social media applications such as WhatsApp and Telegram. SRMS applies social media mining techniques to gather people's observations at each specific time interval, and using natural language techniques, the insights, and useful information will be extracted (R. Q. Wang et al., 2018) (Kang et al., 2020).



**Figure 3.3.** Data sources and collection methods

Following capturing data from its sources, data will be transferred to the processing cloud ArcGIS server through the transmission layer. Data transmission from the community is based mainly on a mobile connection. Data transmission from other sources will be based on the internet connection.

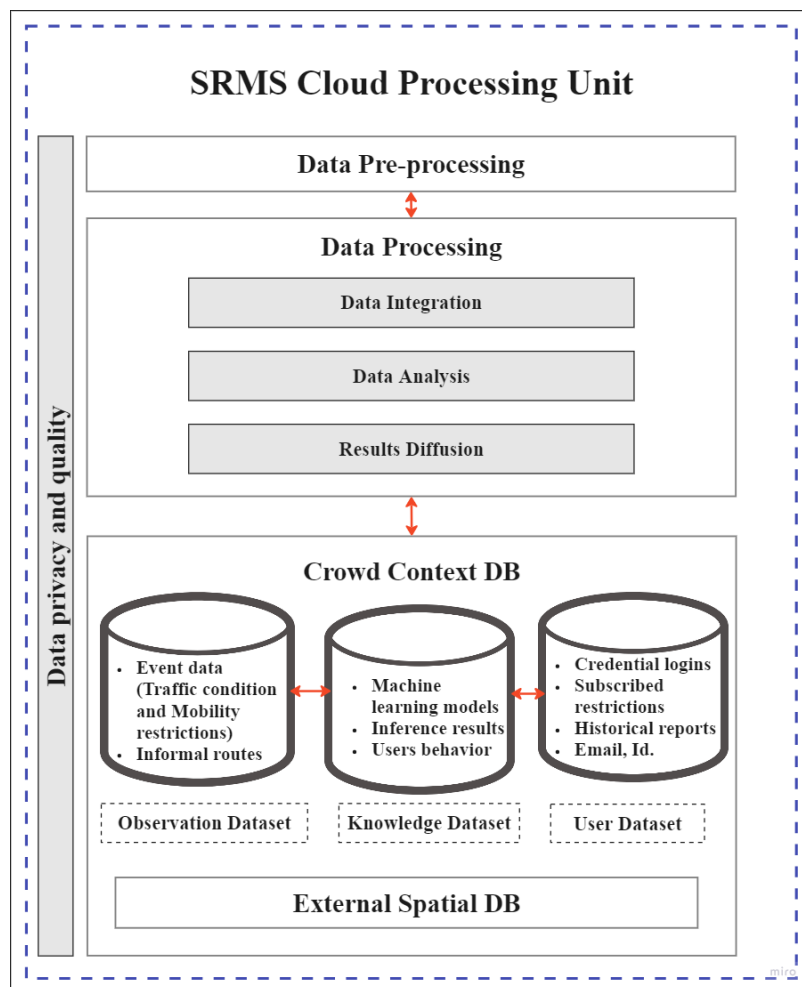
### 3.1.3. Third Layer: Data Processing

This layer concerns processing and storing the collected data to generate a mobility service decision. The data processing layer uses cloud computing (Phuttharak & Loke, 2019). Data

processing was applied using one of the Web-GIS advancements, ArcGIS Online. Web-GIS integrates the capability of GIS in capturing, storing, analyzing, flexible retrieving, attractive presentation, and interactive data display with internet (Budi Sunaryo et al., 2019) (Agrawal & Gupta, 2017) (Karnatak, 2012).

Web-GIS advancements resolved the issue of traditional GIS, a complex and costly system requiring specialized skills and heavy investment in setup (Agrawal & Gupta, 2017), by making it available to the common public easily and efficiently (Green & Bossomaier, 2002). It overcomes the shortcomings related to gathering a sheer volume of data, such as lack of communication and duplication of efforts (Green & Bossomaier, 2002) by providing the analysis and manipulation capabilities of a large amount of data in real-time.

The processing layer is composed of four components that communicate with each other to provide a suitable mobility service including (i) data pre-processing; (ii) data processing; (iii) crowd-context database; and (iv) privacy and security control as illustrated in Figure 3.4.



**Figure 3.4.** Data processing components in SRMS

i. Data Pre-processing

This phase concerns data cleaning. One of the SRMS platform challenges is the heterogeneity of data sources. The system relies on various data sources (social media, mobile devices, open sources, etc.), which could include noises (duplicate data, data with transmission errors, incomplete data, etc.). For data homogenization, it is proposed to remove data noises through a middleware platform between the transmission and processing layer (X. Kong et al., 2019) that maintains the collaboration among different data sources (Ang et al., 2022) (X. Kong et al., 2019) (Corral-Plaza et al., 2020). The Pre-processing phase uses a combination of automated and manual methods to clean and filter the data. For example, it removes outliers, detects and corrects errors in GPS coordinates, and removes duplicate reports.

ii. Data Processing

This concerns processing and analyzing the pre-processed data through various mathematical analyses and machine learning algorithms to provide mobility services. The data processing includes; data integration, data analysis, and results diffusion.

*a. Data integration*

This phase concerns extracting and transforming the pre-processed data from a large crowd into an internal data structure as raw data stored in a conventional database. For example, the social media content will be processed using Natural Language Processing (NLP) and text analysis (R. Q. Wang et al., 2018) (Zou et al., 2018) to integrate with the data reported via SRMS; this will reinforce the data quality.

*b. Data analysis*

This component plays a significant role in providing SRMS mobility services through conducting mathematical and artificial intelligence tools to extract the main features of collected data, ensure data quality, and develop predictive models and alternative routes in response to the mobility system's real-time context. For example, real-time mapping of mobility restrictions will be provided by analyzing the crowdsourced GPS data to extract insights about mobility restrictions and traffic conditions. The data is then aggregated and updated in real-time, allowing SRMS to provide its users with the most up-to-date information (Sattar et al., 2018) (R. A. Sarker et al., 2021).

Moreover, the data analysis applies machine learning techniques and shortest path algorithms to offer alternative routes, taking into account the gathered data. By leveraging historical data, real-time reports, and factors like time of day and day of the week, the system can predict waiting times at mobility restrictions. When the SRMS detects significant delays at a particular restriction, it could suggest alternative routes to users, helping them avoid congested areas. Additionally, the application employs shortest-path algorithms to determine the optimal route based on criteria such as time, distance, or safety.

Within the data analysis process, an essential aspect involves collaborating with the data quality manager to manage the quality of reported data. Since SRMS relies on user-reported data, there is a possibility of encountering low-quality data due to intentional or unintentional system

misuse. Detecting such low-quality data can be challenging during the pre-processing and processing phases. To address this issue, data analysis conducts a final quality check on the reported data before storing it in the crowd context database. This is achieved by implementing data quality management protocols, which will be elaborated upon in a subsequent section.

### *c. Results diffusion*

This component concerns preparing the processed results of previously explained computational analysis to be classified and stored in the crowd context database. Integrating the results with the crowd context database will facilitate their transmission to the service layer.

### iii. Crowd-Context Database (CCDB)

CCDB plays a crucial role in delivering various SRMS services. The data within CCDB is securely stored and processed to ensure the privacy, accuracy, and reliability of information provided to users. (Y. Zhao et al., 2022).

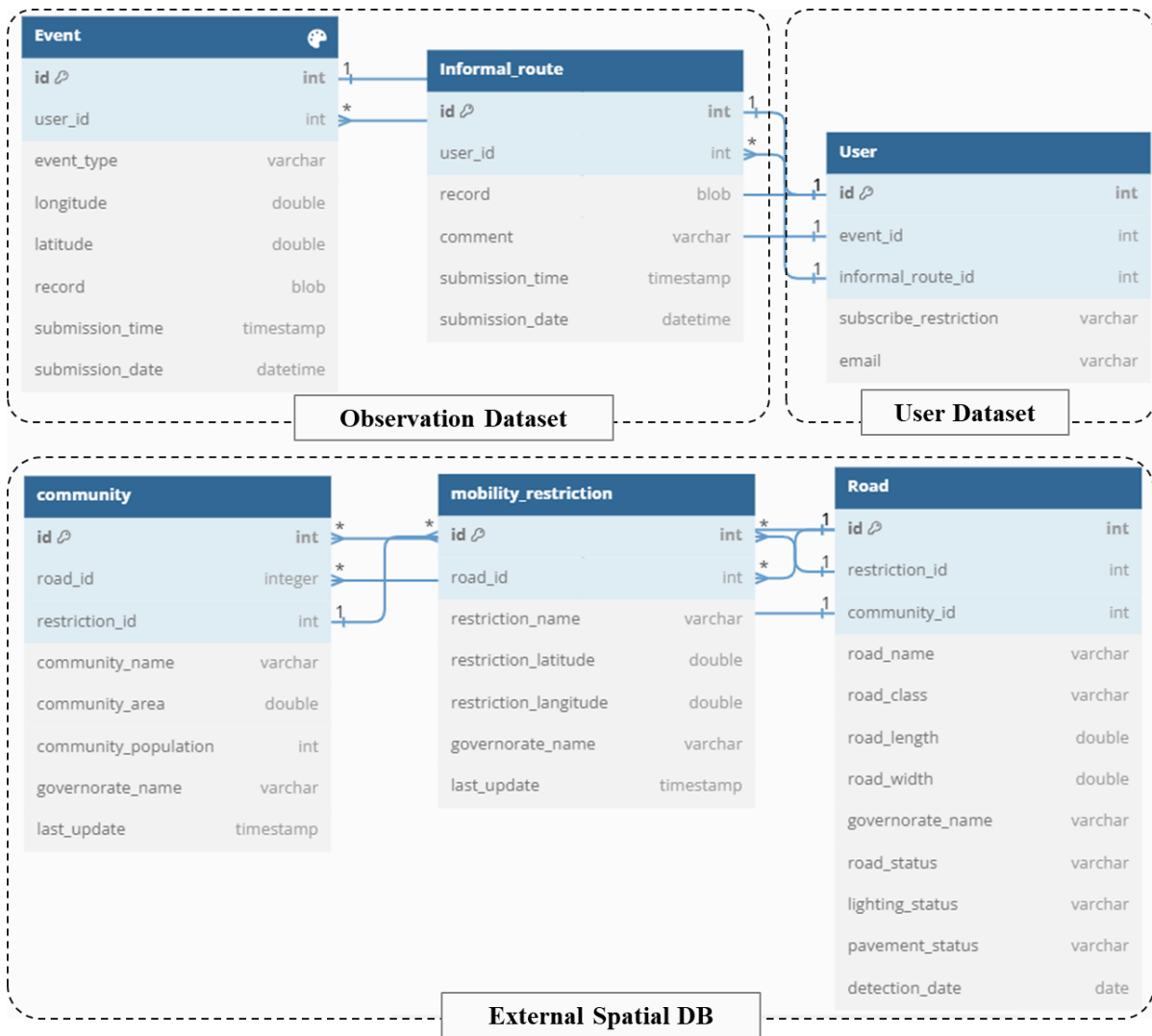
Data stored in the crowd-context database contains both structured and unstructured data, as illustrated in Figure 3.4. Structured data, originating from user-generated content, includes information such as the location of informal routes and mobility restrictions, the type of restriction, the time of reporting, the user's login credentials, emails, etc. User-generated data is stored in the Observation Dataset and the User Dataset (Figure 3.5), which consists of different tables representing specific types of information, with each field holding relevant data (Phuttharak & Loke, 2019).

The observation dataset contains two tables: The Event table and the Informal Route table. The event table has a set of fields that describe the event reported by the platform's users, such as the location of an incident, the type of incident, and the time it was reported. The informal route table has fields describing the observed route, such as route location, comments about the route, and the reporting time. These structured data help in data filtering, searching, statistical analysis, and applying machine learning algorithms to extract insights and identify trends.

The User dataset stores user information like login credentials (username and password), user ID, email addresses, the historical reported events and informal routes, and subscribed mobility restrictions. The user dataset plays a crucial role in ensuring the accuracy and reliability of shared data (Tong, Zhou, et al., 2019) and providing a personalized experience for users of SRMS. It enables customized features and tailored services based on individual preferences and subscribed restrictions.

Another structure data that the CCDB has is the External Spatial Database (ESDB). ESDB is the repository of processing and storing open source and authorized data. It contains tables describing the external environmental context, such as road networks, built-up areas, and permanent mobility restrictions. It forms the base map of the SRMS platform. The external spatial database independently processed the spatial data using GIS capabilities, including georeferencing, digitizing, classifying, converting, geoprocessing, and removing duplication and missing data. Then, the data is tabulated for fast and efficient querying and analysis. Figure 3.5 presents the structured data and their connections within the crowd-context database.





**Figure 3.5.** The structured data and their corresponding schema within the crowd-context database

The unstructured data in the crowd-context database is presented in the data generated from the algorithm and models such as restriction-waiting time predictions models, social media data processed using natural language processing, and other text analysis techniques to extract valuable information about road conditions and stored in text files. The unstructured data includes the inference results from machine learning models, such as users' behavior and reliability. This data is used to improve the quality, accuracy, and performance of the SRMS services. The unstructured data will be stored in the Knowledge dataset, which is crucial in the crowd context; it is the repository for long-term data in the SRMS.

iv. Privacy and Security Control

The Data Privacy and Quality Control module integrated into the processing unit includes measures for assessing the validity and accuracy of user-submitted data. Its objective is to ensure the trustworthiness of user information by implementing a reputation model and other

quality assurance mechanisms. Also, the module employs protective techniques to preserve user privacy. More details about this will be discussed in the following section.

#### **3.1.4. Fourth Layer: Service/Application**

The application layer plays a crucial role in providing services to users (Haque et al., 2022). This layer presents the analyzed data from the previous layers as user-friendly and ensures the use of attractive tools to enhance user interactivity with the provided services (Shahrour & Xie, 2021). The SRMS service layer encompasses various services that aim to ease people's mobility during disruptive events to minimize the adverse socioeconomic impacts and save lives.

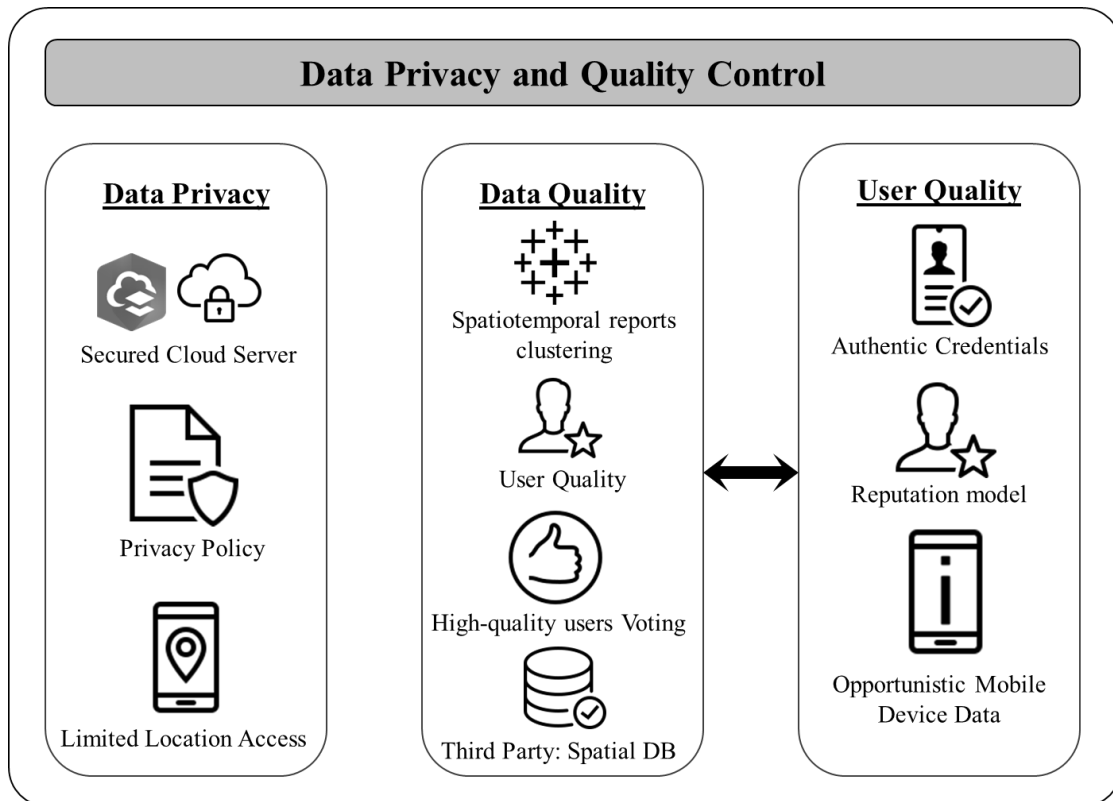
These services include (i) real-time mapping of mobility restrictions and traffic conditions; (ii) mapping of informal routes; (iii) providing alternative path suggestions to optimize safety, travel time, and distance; (iv) generating informative reports and statistics related to restrictions activation and traffic congestions in a time series. These reports offer valuable insights into mobility restrictions and conditions during the time of the day and day of the week.

### **3.2. Data Quality and Privacy**

The SRMS platform depends on people's observations and reports. Ensuring the quality of these shared data constitutes a big challenge for crowdsourcing applications (Y. Zheng et al., 2016) (Tong, Zhou, et al., 2019). Since the users in the SRMS are not trusted equally, this will affect the quality of the reported data, in sequence, undermine the accuracy of provided services, and cause a failure in the smart system as a whole. For example, false submissions, inaccurate data due to the failure of networks (or devices), or users reporting incorrect data generate misleading results (X. Kong et al., 2019).

Quality-aware crowdsourcing has been studied from different perspectives. Some studied the truthful inference mechanism for quality the crowdsourced data where users have private participation (H. Jin et al., 2015) (H. Jin et al., 2016). Others focused on learning the data quality from the users' data (D. Lee et al., 2015). However, the quality of both users and data is significant to ensure the accuracy of any crowdsourcing platform (Moayedikia et al., 2019). Another challenge for the spatial crowdsourcing application is protecting the privacy of users' data from any breach or abuse. The collection of geolocated data raises serious privacy concerns (Alatrística-Salas et al., 2022). Any leakage in this data leads to the loss of the users' trust in the crowdsourcing application (W. Feng et al., 2022).

The Data Privacy and Quality Control module incorporates quality control measures to assess the validity and accuracy of the data users submit ( Figure 3.6). It ensures the quality and trustworthiness of users by implementing a reputation model and other quality assurance measures. The data privacy and quality module employs preservative techniques to safeguard user privacy. This ensures that user data is protected and handled in a manner that respects privacy preferences.



**Figure 3.6.** SRMS’s methods of ensuring data, user quality and data privacy

### 3.2.1. User Quality

SRMS, like any crowdsourcing application, could be threatened by malicious users who report false data to mislead the system and other users (Y. Zheng et al., 2016). False data could also happen due to accidental errors without malicious agendas, called spammers users (Y. Zheng et al., 2016). Different scholars discussed the methods used to assess user quality. For example, (Tong, Chen, et al., 2019) use the single-value user probability ( $u$ ) model. In the user probability approach, the value is a single real number (between 0 and 1) to model the user quality ( $qu$ )  $\in [0, 1]$ . The single value could be the user’s confidence (Li et al., 2014), experience, reputation, and accuracy. A large value of ( $qu$ ) means a high user quality (Y. Zheng et al., 2016).

The user probability value was determined using user historical accuracy, which indicates the history of users in reporting actual and accurate events (Olsson et al., 2017). Another approach used to calculate the user probability value is the qualification test, either through a direct task assigned to the user (golden task) or a hidden test. The quality will be measured based on the user's answer. However, (Y. Zheng et al., 2016) revealed that the user qualification test is time and money-consuming and may not reveal users' quality. (Tong, Zhou, et al., 2019) declared that the single-valued quality may not characterize the users' quality sufficiently.

Other scholars covered the shortcomings of the single value quality approach by proposing a multi-dimensional approach, such as the confusion matrix (Xin et al., 2023), confidence model

(Y. Zheng et al., 2016), and the diverse skills approach (Z. Zhao et al., 2015). These approaches are compatible with tasking crowdsourcing platforms designed to assign oriented tasks to different users, such as Amazon's Mechanical Turk (Phuttharak & Loke, 2019).

These approaches consider multiple variables in defining the quality of users' such as accuracy, precision, time response, etc. For example, in the confusion matrix approach, users' reported data are compared with the true data to measure the quality of users. The diverse skills approach considers the differentiation in the users' skills in task completion. The confidence model effectively measures user trust by answering plenty of tasks, and the high number of tasks accomplished indicates high user quality (Y. Jin et al., 2020).

It is worth noting that while these approaches are applicable to tasking crowdsourcing platforms, they may not be directly suitable for SRMS. Unlike tasking platforms, SRMS does not assign specific tasks to users based on their location. Instead, any registered user from any location can report any listed event. Therefore, task-answer approaches like the confidence model and confusion matrix are not well-suited for ensuring user quality in the SRMS platform. Instead, SRMS adopts hybrid quality measures, including user verification to ensure authenticity and the accuracy and frequency of users' historical data (Tong, Zhou, et al., 2019).

SRMS employs user verification during the registration process, requiring an email address and activation to confirm that accounts belong to real users. This helps ensure that all users on the platform are real users. Additionally, SRMS utilizes machine learning to create a reputation model based on user behavior (Bang et al., 2012), analyzing the quality and quantity of user interactions with the platform. Users with higher accuracy and frequency in their historical data have a higher reputation score compared to those with lower accuracy and frequency (Bhattacharjee et al., 2017) (Xia et al., 2020). Furthermore, SRMS opportunistically collects information about users' mobile devices, such as time zones, to detect malicious users operating outside the designated areas.

### **3.2.2. Data Quality**

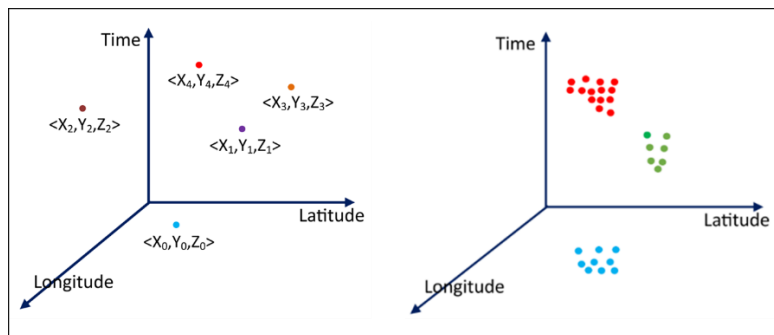
The quality of received data significantly affects the performance of the platform and the quality of the provided services (X. Kong et al., 2019). Different approaches have been proposed to improve the data quality submitted by the participants. Most researchers use user incentive mechanisms to ensure the quality of submitted data (Y. Zhao et al., 2022) (X. Kong et al., 2019). Other scholars introduced the redundancy-based strategy (Y. Zheng et al., 2016), which aggregates the data from all users. The most redundant data is considered high quality or through the Majority Voting approach (MV) (Cao et al., 2012), which takes the answer given by the majority of users as the truth. (Sumner et al., 2020) validates the crowdsourced data via institutional honest-third party or other data from the surrounding environment (R. Q. Wang et al., 2018).

However, these methods have limitations. For example, incentive or reward approaches can be costly and may introduce unintended consequences in specific crowdsourcing applications. In the case of SRMS, the platform aims to provide traffic information to the entire community without needing dedicated incentives based on user interaction with the service. The redundancy-based strategy and majority voting (MV) methods assume all users have the same

level of reliability, which may not accurately reflect the actual quality of the data. To address these limitations, SRMS combines multiple mechanisms to ensure inclusive data quality assurance.

The SRMS platform adopts an approach that considers the quality of individual users when evaluating the reported data. This means that the data quality is closely tied to the quality of the users, and a mutual relationship exists between them. By considering the reliability and accuracy of the users, a more precise assessment of the data quality can be achieved (Y. Jin et al., 2020).

Additionally, SRMS incorporates a spatiotemporal event clustering approach, which leverages unsupervised analysis in machine learning to group large datasets based on spatial and temporal similarities. These groupings allow for a more structured representation of the data (Ansari et al., 2020), as depicted in Figure 3.7. Each event in SRMS is stored as a triplet consisting of longitude, latitude, and timestamp, providing information about the location and time associated with the recording. The clustering of events reveals the truth of the data.



**Figure 3.7.** Event clustering (Ansari et al., 2020)

The third approach for data quality consists of using the high-quality user voting technique. This method develops the majority voting technique (Cao et al., 2012). Still, instead of depending on the majority voting, it relies on the votes of high-quality users to confirm the accuracy and reliability of the reported data. By incorporating the input of trusted and reliable users, the SRMS platform can enhance the overall data quality.

Another method the SRMS platform employs is using a spatial third party to verify the accuracy of reports inspired by the (H. Hu et al., 2016) method. In this approach, the external spatial database (ESDB), which contains spatial data related to the surrounding environment and serves as the base map of the platform, can act as a third-party checker. By leveraging the information stored in the ESDB, potential areas of reporting, such as permanent checkpoints, road gates, and other vulnerable locations, can be identified and verified.

### 3.2.3. Data Privacy

SRMS collects and processes the user's location and the real-time reported data about mobility restrictions, traffic conditions, and informal paths. Leakage in the users' location and the content of reported data are common challenges in spatial crowdsourcing (Yuan et al., 2020). Disclosing individual locations has profound privacy implications. For example, the leaked

locations of other users could be collected and shared without users' consent (Ansari et al., 2020) leading to a breach of sensitive information such as health information, lifestyle, and political and religious preferences (To & Shahabi, 2018).

However, knowing users' location can stage attacks such as physical surveillance, stalking, and identity theft. (G. Wang et al., 2016) show that Sybil's attacks on Waze could lead to stalking other users by creating fake events or traffic congestion. Hence, users may not agree to engage in spatial crowdsourcing and lose the users' trust in the provided services (Haque et al., 2022); thus, ensuring location privacy is an immediate success for any spatial crowdsourcing application (G. Wang et al., 2016). In this study, the privacy measures hypothesize that privacy leakage could happen due to untrustworthy mobile crowdsourcing participants or unreliable/curious crowdsourcing servers.

Privacy leakage in the SC platform could happen due to malicious or untrusted participants. This threat could come in different shapes, including (i) identity forging by some users; (ii) gaining undesired access to data; (iii) conflicting behavior attacks; and (iv) collusion attacks. In the conflicting behavior attack, malicious participants provide partially correct and partially false information to deceive the crowdsourcing system. In a collusion attack, malicious users collude to provide completely false information (J. Hu et al., 2018) (Sodagari, 2022).

The user's privacy is at risk when the server cannot be trusted (internal attack) or is vulnerable to cyber-attacks and hacking, especially in real-time crowdsourcing (Z. Wang et al., 2019). In such cases, servers can abuse sensitive information for profit by selling data to advertisers and private investigators (Z. Wang et al., 2019). Sometimes the server is trusted and provides accurate data but has the curiosity to discover the users' private information (Jiang et al., 2021). In both cases, the server should neither gain access to the raw private data of participants nor use it for data aggregation.

SRMS is a centralized crowdsourcing platform where the data aggregation, processing, and preparation occur in a cloud server. The centralized platform is subjective to a single point of failure or internal attack (Yuan et al., 2020) (Z. Wang et al., 2019) (Sodagari, 2022). Since users' location is the most sensitive data, (Jiang et al., 2021) provided a general survey on popular methods to preserve users' location data privacy. They include (i) privacy policy-based mechanisms, (ii) obfuscation-based mechanisms, (iii) cryptography-based mechanisms, and (iv) cooperation and Caching-based mechanisms.

Privacy policy-based mechanisms use common privacy management rules and trusted privacy agreements, constraining the service provider and the third party to fairly and securely access, store, and use the location information submitted by users. The obfuscation-based mechanism depends on distorting the users' information, such as (i) performing location generalization using the cloaking technique (Tong, Zhou, et al., 2019). For example (Galdames et al., 2019) proposed a cloaking regions approach to preserve location privacy and safety requirement; (ii) location perturbation using differential privacy (J. Xu et al., 2013) (Dwork, 2006) (Z. Wang et al., 2019). Differential privacy (DP) was introduced in (Dwork, 2006). DP is a semantic model based on noise injection in the dataset to protect against realistic adversaries with access to background information (To et al., 2014); (iii) location spoofing using dummy locations; (iv) anonymization using path confusion and mix zones. In such methods, anonymization prevents an attacker from tracking the user's trajectory.

DP requires a large dataset to make the noise injection more effective, while this approach will not work properly in the tiny dataset. (Xiao et al., 2011), (J. Xu et al., 2013), (Z. Wang et al., 2019), and (Yuan et al., 2020) show that DP provides a guarantee of privacy for one-time data more than real-time data.

The cryptography-based mechanism makes the sensitive information invisible to the server by using encryption techniques instead of distorting data directly. For example, (Yuan et al., 2020) proposed a grid-based location protection that protects users' locations while keeping distance-aware information on the protected locations so that the between reports and users can be quantified. Cooperation and caching-based mechanisms aim to decrease the probability of exposure to untrusted servers, where users cache historical service data locally and use their own or a neighbor's cached data to answer future queries (Jiang et al., 2021).

SRMS platform ensures preservative privacy measures through the following: Firstly, It is hosted on the ArcGIS Online cloud server trusted server (Yuan et al., 2020) (Z. Wang et al., 2019), a certified trusted server. According to the ArcGIS Trust Center documentation (Esri, 2023b), ArcGIS Online privacy assurance is boosted by the Products and Services Privacy Statement Supplement. It uses other additional items such as ISO 27018 cloud infrastructure privacy, security, and the privacy assurance of FedRAMP third-party validation (Esri, 2023b). Also, ArcGIS Online utilizes the cloud infrastructure of Microsoft Azure and Amazon Web Services (AWS); therefore, users' data may flow through these systems or be stored within them. Secondly, SRMS has developed a privacy-based policy (SRMS, 2023a), that explains the rules for using the users' data and sharing information and security.

The third data privacy measure is tightening the accessibility of sensitive user data, such as users' location, for reporting purposes only, so the live location of the users is not necessary for the platform's operation. Hence, prevents an attacker from tracking the user's trajectory. The reported data will be presented as anonymous users with random IDs without revealing the users' identities.

In future work, a new approach could be considered to preserve data privacy and address the single point of failure (server). (Ibba et al., 2017) (Turkanović et al., 2018) (H. Lin et al., 2021) (Kamali et al., 2021) proposed a decentralized operation framework for crowdsourcing called blockchain, which ensures a high level of security for the system. Blockchain nodes can rent their computing resources to crowdsensing applications for information integrity against misbehaving participants and data aggregation verification. Integration of SRMS with blockchains for data storage and sharing provides higher security and reduces the cost of a server authority to manage the communications between the users, minimizes the vulnerability to a single point of failure (caused by a centralized server), and vulnerability to external attacks and device failure.

### **3.3. SRMS Web App Mobile**

The SRMS platform was initially developed as a mobile web application, which can be accessed through a mobile web browser without needing installation. (Tandel & Jamadar, 2018) compared the mobile web app method with the native app, considering factors such as installation, updates, size, offline access, user experience, push notifications, and

discoverability. The findings revealed that native apps necessitate downloading and installation from app stores, while web apps can be directly accessed through web browsers without installation requirements.

Regarding updates, native apps must be submitted to app stores for approval and subsequent downloads, whereas web apps and their updates are instantly accessible through the web browser. Regarding size, native apps tend to be larger and may take longer to download, whereas web apps are lightweight and load quickly. Native apps offer a seamless user experience and support push notifications for user engagement. However, native apps necessitate optimization for discoverability within app stores. Contrarily, web apps rely on search engine optimization (SEO) to improve discoverability and can provide a satisfactory user experience if designed effectively.

(Shah et al., 2019) and (Rochim et al., 2023) compared web apps with other cross-platform mobile app types, including hybrid, interpreted, and widget-based apps. The comparison involved evaluating technical and non-technical aspects such as user interface and experience (UI/UX), potential user base, development cost, security, ease of updates, implementation complexity, required development environment, licensing, programming language, and publishing to marketplaces. This analysis aimed to thoroughly assess the strengths and limitations of each type of cross-platform mobile app, enabling a better understanding of their respective capabilities and considerations.

Hybrid apps are mobile web applications packaged and presented as native apps. Users can install them from a web store and access native app capabilities, yet they are developed using the same tools and technologies as web applications (Serrano et al., 2013). On the other hand, interpreted apps replicate the user interface and interaction of native apps but differ in their execution method. They employ an interpreter to execute the source code at runtime, eliminating the need for pre-compilation into machine code. This interpretation process occurs directly on the mobile device (Shah et al., 2019). In widget-based apps, the user interface is constructed entirely using widgets as building blocks. These widgets offer specific functionality, provide information, or grant users quick access to app features without necessitating the opening of the complete application (Wu, 2018).

The comparison of different mobile app types revealed that web apps are a convenient option when the app does not require extensive resources or complexity but still needs user interaction. Web apps are particularly suitable if the developer's primary concerns are ease of implementation and development time. Based on the literature sources (Jobe, 2013) (Wu, 2018) (Shah et al., 2019) (Tandel & Jamadar, 2018) (Rochim et al., 2023), a comprehensive summary of the technical and non-technical considerations for native, hybrid, and web apps is presented in Table 3.2. This table provides valuable insights into the different aspects to be considered when deciding on the suitable app type for a particular project or purpose.

**Table 3.2.** Comparison of native, hybrid, and web apps based on technical and non-technical consideration

<b>Considerations</b>	<b>Native</b>	<b>Web</b>	<b>Hybrid</b>
Effort of supporting platforms and versions.	High	Low	Moderate
UI/UX.	Excellent	Moderate	Moderate



Potential Users.	Limited	Maximum	Large
Development Cost.	High	Low	Low
Ease of Update.	Low	High	Varying
Implementation Complexity.	High	Low	Moderate
Device capabilities access.	Full	Partial	Full
Performance.	High	High	High
Approval cycle.	Mandatory	Not required	Varying
Monetization in app store.	Available	Not available	Available

The SRMS platform can benefit from being a mobile web app in several ways. Firstly, it offers enhanced accessibility as it can be accessed on various devices without platform restrictions. Secondly, it is a cost-effective solution that utilizes widely available web technologies, reducing the need for specialized resources. Thirdly, the responsive development allows for quick updates and addressing user feedback, which is crucial for spatial crowdsourcing projects.

To overcome limited user interface and experience in web apps, the SRMS mobile web app design draws inspiration from Progressive Web Apps (PWA) principles. The app is adaptive and responsive, catering to different screen sizes and orientations. Cascading style sheets (CSS) are used to render different styles based on the device, ensuring a user-friendly experience. The app also aims to provide a modern interface and a flexible design framework, emulating the feel and functionality of native apps. It incorporates a push notification system to inform users about specific mobility restrictions updates.

Regarding the challenge of device capability access, the SRMS mobile web app only requires access to the device's microphone for recording audio reports and the GPS sensor. By limiting the app's access to these specific functionalities, the SRMS platform maintains a streamlined approach while still fulfilling the necessary requirements for spatial crowdsourcing activities.

### 3.3.1. SRMS User-Centered Design

Accepting crowdsourcing applications and user interaction depends on considering the users' needs (Rahmanian & Davis, 2014). This approach was addressed in the term User-Centered Design (UCD) (Blackett, 2021) (Vallet et al., 2020) (Bano & Zowghi, 2015). UCD, in the context of software engineering, is an approach to designing applications that prioritizes the end-users needs and limitations (Lopes et al., 2018). It involves understanding who the users are, their goals, motivations, and frustrations, and designing intuitive, easy-to-use applications that meet their needs.

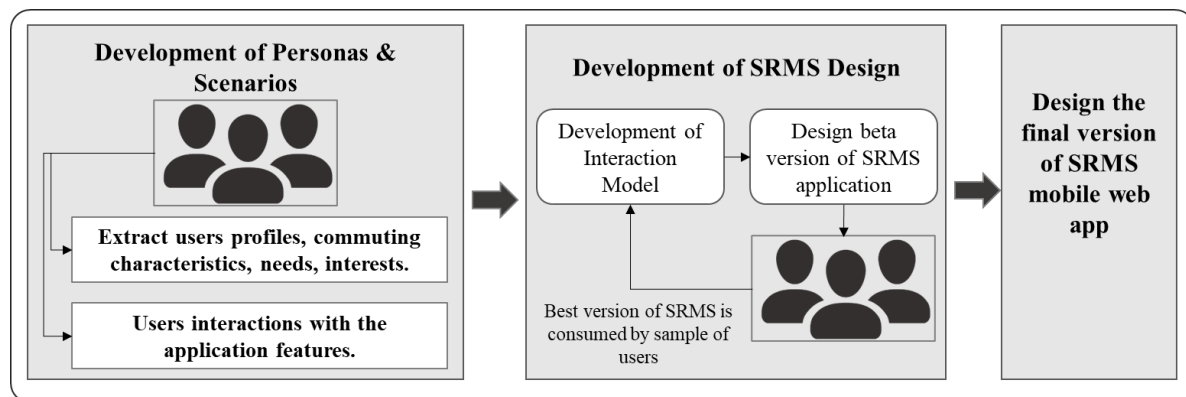
The user-centered design was applied in SRMS using the Scenario Personarrative method (Vallet et al., 2020) (Lopes et al., 2018). Personas techniques presented initially by Alan Cooper (Cooper, 1999) were used to create fictitious representations of target users based on the real data gathered from research. Scenarios describing interactions between systems and

users were first discussed by (Carroll & Rosson, 1992). They can be employed to illustrate how a user might accomplish particular tasks with the system. Scenarios aim to create a realistic and relatable story that captures the user's needs, motivations, and behaviors in a specific context.

The personas techniques were applied by designing an online survey aimed to investigate information about the SRMS potential users from different perspectives (Sim & Brouse, 2015), including; (i) personal profile (age, education, profession, living and working place, etc.), (ii) commuting mode and traveling cost (travel time, travel cost, commuting frequency, mode of transport, etc.); (iii) understand their need, preparedness, and interests concerning their interurban mobility (level of interest in application's topic compared to other topics, internet access, needs, and concerns).

Scenario techniques were applied using the same method of personas, an online survey method. The scenario techniques were developed using a set of scenario questions to measure the users' preferences for listed application features and, simultaneously, the level of the users' willingness to interact with the proposed feature. This will indicate a preference-behavior gap for the application features; the minimum gap shows high user interaction. Figure 3.8 depicts the methodology of applying UCD in designing the SRMS platform.

Following an understanding of the users' background, potentials, needs, concerns, and interaction scenarios with the application features, the interaction model for the SRMS design was created. The interaction model is a design model that defines how all objects and actions of an application interrelate in ways that mirror and support real-life user interactions (Fernandes et al., 2021) (Marques et al., 2016). Interaction models aim to create a clear and intuitive design that allows users to accomplish their goals efficiently and effectively.



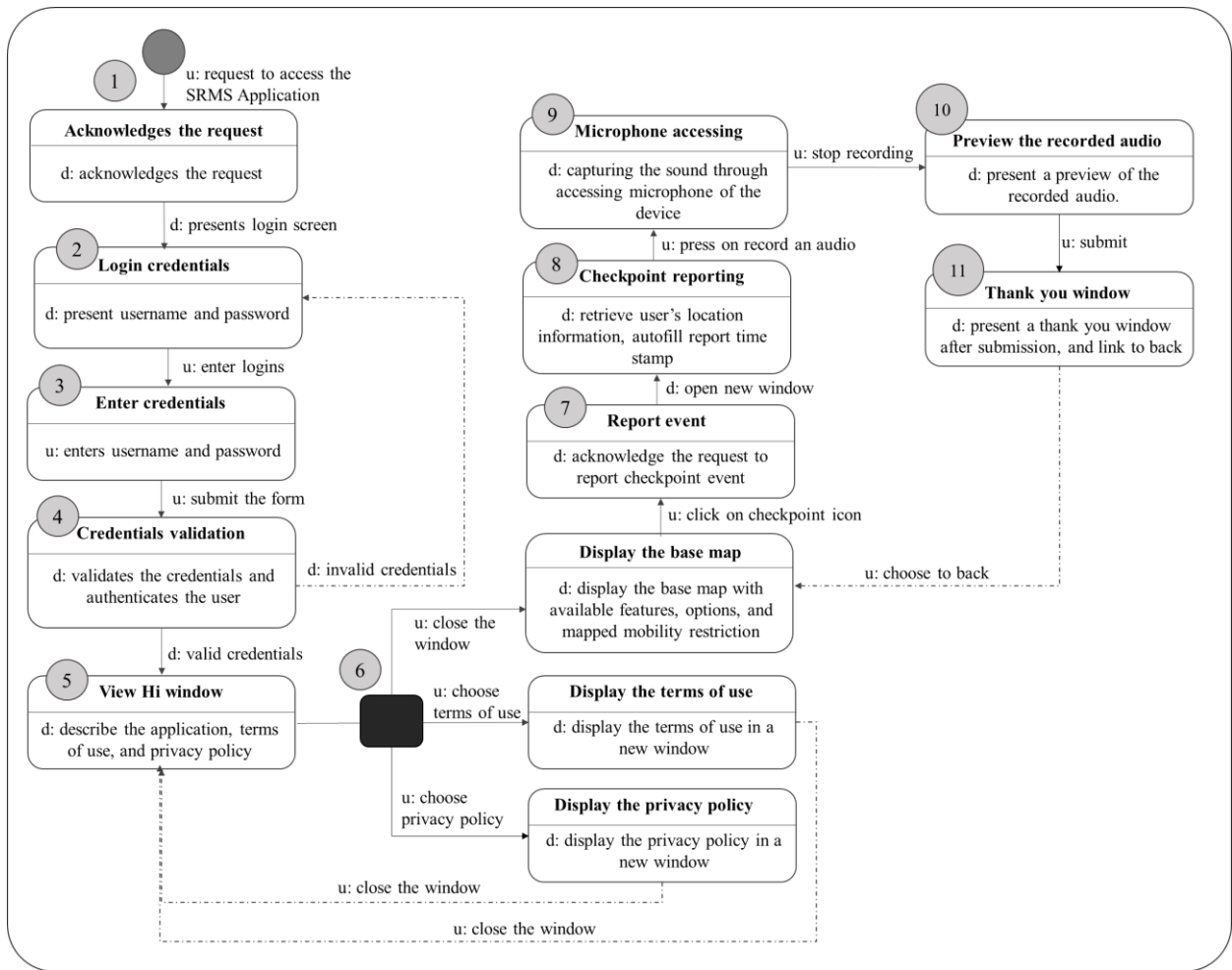
**Figure 3.8.** Methodology of creating SRMS platform design using UCD

Interaction models can take various forms, including flowcharts, wireframes, and diagrams. They typically include information about the user's goals, the actions they can take, and the feedback they receive from the system. An interaction model was developed for the SRMS platform using Modeling Language for Interaction as a Conversation (MoLIC) (Fernandes et al., 2021) (Lopes et al., 2018). MoLIC is a language to model the interaction between the user and the designer proposed by (Barbosa & De Paula, 2003). It represents all interaction paths, including alternative paths for the user to reach the same goal (Lopes et al., 2015). Figure 3.9

illustrates the MoLIC diagram for reporting checkpoint events for an SRMS-registered user. The basic elements of the presented MoLIC diagram are the following:

- a. The opening point in the interaction is represented by a filled black circle, indicating where the user accesses the system.
- b. The scene, depicted as a rounded rectangle, represents the moment in the interaction where the user decides how the conversation should proceed. The top compartment contains the topic and the user's goal, while the second compartment contains the dialogue details, specifying whether the user (u) or the designer's deputy (d) is emitting the sign.
- c. User transition utterance is indicated by an arrow labeled with a user utterance indicator (u:), representing the user's intent to continue the conversation in a certain direction.
- d. Designer transition utterance is the response to a user utterance, typically provided after a system process. It is depicted by an arrow labeled with a designer utterance indicator (d:).
- e. The system process is represented by a black box and signifies the internal processing of a user request, which generates feedback to the user when different outcomes are possible.
- f. Breakdown recovery utterance is used to assist the user in recovering from a communication breakdown. It is depicted by a dashed directed line in the diagram, accompanied by the corresponding utterance, such as "invalid credentials" in Figure 3.9.

The MoLIC model was utilized to design the user's interaction with various SRMS services. Based on this model, a beta version of the SRMS mobile web app was developed and tested by a sample of users. Their feedback regarding their experience, comments, suggestions, and issues related to omissions, ambiguity, and unclear presentation was collected.



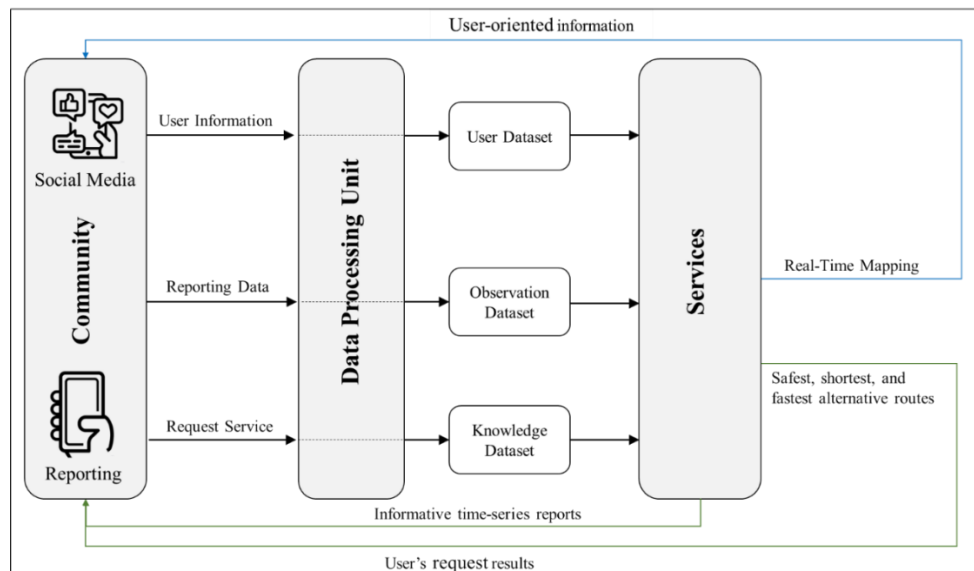
**Figure 3.9.** A MoLIC diagram for event reporting service in SRMS platform

### 3.4. General Framework for the Platform Operating System

The SRMS platform aims to facilitate people's traveling along interurban roads during mobility restrictions. To achieve this, the platform maps out real-time data on mobility restrictions. It offers alternative routes that prioritize safety and travel time, ultimately reducing delay and minimizing the environmental and socioeconomic costs of travel. SRMS platform offers three primary services, including (i) publicly accessible real-time information on mobility restrictions and traffic conditions on interurban roads, (ii) allowing the public to create and share the informal alternative routes; (iii) providing alternative routes upon request, categorized by safety, emergency, and speed; and (iv) providing informative reports about the mobility restrictions operation and traffic congestion.

The SRMS platform considers the community as a principal dynamic data source, that can share travelers' observations on the roads and knowledge of the informal routes with other travelers using spatial crowdsourcing (SC). The community's interaction with the SRMS platform could be direct through reporting on the platform or indirect through publishing the road information on social media.

The community-data-driven will interact with other SRMS layers to provide the optimal mobility service. To illustrate the interaction between different layers of SRMS, a diagram of the SRMS operating system was created. It shows the community data flow within other layers. The operating system for the SRMS platform is given in Figure 3.10. It consists of the community as input, the data processing unit performing processing and analysis, and the service as output.



**Figure 3.10.** SRMS Operating system

The community (Input) provides the necessary inputs for the system operation. The data analysis and services are provided according to the provided inputs. These inputs include user information profiles such as username, ID, login credentials, subscribed restriction, etc. Community reporting data include mobility restriction reports, traffic congestion reports, and informal route data. Request a particular service, such as querying for the safest, fastest, or shortest route to a destination, and request a time series report. These reports provide historical data on past restrictions and their durations. These requests trigger specific data analysis processes to provide the desired service.

The Data Processing Unit is considered the backbone of the SRMS, where all the computational and inference analysis occurs in the cloud. Data processing includes applying real-time processing for the events reported via the platform, quality control techniques, and artificial intelligence to extract the distinct features in the reported events. Also, it applies the optimal path algorithms to find the best alternative that optimizes the safety, time, or length. Processing and analysis of the data is tailored based on the input data, and the processing results are classified and stored in the crowd context database, which includes three primary datasets.

First is the Observation dataset, a repository for short-term analysis results such as reports of mobility restriction data and traffic conditions. Second, the user profile dataset includes user information and behavior. Third, the knowledge dataset is the core of data processing where all the inference analysis results triggered by users' requests, and long-term data are stored, such as best route alternatives and knowledge related to user reliability, including the accuracy and frequency of users' historical data and data quality assurance protocols. The data processing

unit includes an external, continuously updated spatial database ESDB that forms the SRMS platform's base map. It contains data obtained by connecting to authorized and public sources.

The services (Output) serve travelers (drivers, passengers, decision makers) who commonly deal with the interurban network under the threat of restrictions. It ensures accessible real-time data about mobility restrictions updates and traffic conditions and sends alert messages to the users regarding any changes detected in a particular restriction type. Also, SRMS publishes a dataset of informal routes based on user experience and provides various categorized alternative routes, in light of real-time mobility restrictions and traffic conditions, with a minimum risk, time, or length cost. The system will monitor the behavior of users regarding the provided results to evaluate the quality level of provided services.

### **3.5. Conclusion**

This chapter provided a general methodology for developing the Smart and Resilient Mobility Services Platform (SRMS) based on the smart layering system. The first layer is the urban mobility infrastructure, which includes formal interurban routes, informal routes, mobility risk considerations, and stakeholder involvement. It describes the potential data sources for developing the SRMS services. The second layer ensures the availability of diverse and reliable data for real-time decision-making. It involves identifying data sources, capturing different types of data from authorities, open sources, and the community, and transferring the collected data to the processing cloud.

Cloud computing, specifically ArcGIS Online, is used in the third layer for data processing. It encompasses pre-processing, processing, and analyzing the data using mathematical and artificial intelligence tools to extract valuable information, develop predictive models, and provide real-time mapping of mobility restrictions and alternative routes.

The fourth layer, the application layer, offers various services including real-time mapping of mobility restrictions and traffic conditions, mapping of informal routes, providing alternative path suggestions, and historical data and reports about mobility restrictions and traffic conditions. The application layer presents the analyzed data from previous layers, ensuring interactivity and attractive user tools.

The data quality and privacy control unit employs data quality protocols to assess the validity and accuracy of user-submitted data. Reputation models and other quality assurance measures are implemented to ensure the trustworthiness of users. Privacy-preserving techniques are used to protect user data and respect their privacy preferences.

SRMS platform is presented as a mobile web application that ensures accessibility, cost-effectiveness, and user experience over other types of applications. User-centered design (UCD) principles are applied to ensure that the SRMS platform meets the needs and preferences of its users. The SRMS platform operating system is illustrated emphasizing the role of the community as a dynamic data source through spatial crowdsourcing.

The following chapter will provide a detailed methodology for delivering SRMS mobility services.

## **Chapter 4. Methodology for Developing SRMS Services**

### **Introduction**

This section provides a detailed methodology for creating the services of the SRMS platform. A systematic approach is followed to develop each service, ensuring its effectiveness and reproducibility. The methodology begins with the state-of-the-art methods used to create the service, objectives, and requirements of the specific service being developed. Following this, the data collection process is initiated. This includes gathering historical and real-time data on mobility restrictions, users, and surrounding environments.

The next step involves data processing and analysis. It aims to generate reliable results that can provide optimal services to users. After the data analysis, the service publishing begins. It involves deploying the service on the SRMS platform, making it accessible to users. The deployment process involves integrating the service with the platform's architecture, configuring the necessary settings, and ensuring seamless interaction.

### **4.1. Real-time Mapping of Mobility Restrictions and Traffic Conditions**

#### **Service**

##### **4.1.1. Overview**

Real-time mapping applications have emerged in urban emergency events for human safety, such as health emergency services (Hamrouni et al., 2019), explosions evacuation (Zuo et al., 2018), flood mapping (Castro et al., 2019) (Y. Feng et al., 2020) (Helmrich et al., 2021), fire evacuation (Tavra et al., 2021) (Oliveira et al., 2019), and traffic congestion (Salazar-carrillo et al., 2021) (X. Kong et al., 2019).

Most services provided during urban emergency events depend on crowdsourced data. Crowdsourcing is a powerful approach for collecting data from the crowd. It incorporates people's wisdom using their mobile devices to solve a problem (Phuttharak & Loke, 2019). Sometimes, people's wisdom evolves from their vicinity to a specific urban event, which is called Spatial Crowdsourcing SC (Tong, Zhou, et al., 2019) (To & Shahabi, 2018) (Kazemi & Shahabi, 2012). The knowledge of people that evolved due to their spatiotemporal data is valuable for other decision-making.

In the context of smart cities, mobile users or crowds (Hamrouni et al., 2019) can provide a vast amount of opportunistic or participatory data that can contribute to problem-solving (Phuttharak & Loke, 2019). In the opportunistic approach, users are not aware of the data collection process (Phuttharak & Loke, 2019) (X. Kong et al., 2019), which can involve gathering data from mobile device sensors such as GPS, Accelerometer, and Gyroscope to map the motion of the vehicle (R. A. Sarker et al., 2021). For example, during the 2011 East Japan Earthquake, real-time traffic data was collected using the GPS sensor from moving vehicles to

create high-fidelity road passage maps to identify the blocked roads, facilitating disaster recovery activities (Song et al., 2022).

In the participatory approach, users are actively involved in data collection, such as capturing photos of a flood event in specific areas to identify the flood severity (Y. Feng et al., 2020) (Castro et al., 2019), or reporting road closure using a mobile application (Phuttharak & Loke, 2019). For example, (Hamrouni et al., 2019) used the participatory approach to develop a real-time health emergency response framework. They incorporate the volunteer's vicinity of an incident to trigger an alert notification to the rescue services with crucial information such as location coordinates, type of incident, and the number of victims. Following the same approach, (Castro et al., 2019) have developed a flood alerting system that enables people to map and receive alerts of nearby flooding events.

Recently, with the rapid development of mobile internet, social network services like Facebook and Twitter are another participatory sensing mode (Zuo et al., 2018) (Phuttharak & Loke, 2019) (Heinzelman & Waters, 2010) to form a collective intelligence through analyzing and integrating the data from a large crowd (Castillo, 2018). In this case, users become social sensors whose postings react to the conditions they are experiencing as the crisis evolves.

Several applications were found in using social media data as a participatory approach. For the sample, (Salazar-carrillo et al., 2021) proposed a methodology to geocode traffic-related events collected from Twitter and create a model for spatial-temporal traffic congestion. (Z. Xu et al., 2020) created a flood alerting system using social media mining. They adopted the 5W communication model (What, Where, When, Who, and Why) on the Weibo platform, which enables people to report and receive alerts of nearby flooding events.

Both approaches of spatial crowdsourcing enable real-time mapping of emergency events and support data-driven emergency response, which improves community resilience through visualization and GIS mapping (Rahman et al., 2017). However, most real-time mapping applications based on spatial crowdsourcing are focused on urban challenges related to natural hazards, such as flooding, earthquakes, and wildfires. The use of spatial crowdsourcing technology for real-time mapping in mobility is still relatively new, and few studies have explored mapping traffic hazards using this approach. (Y. Lin & Li, 2020) used crowdsourcing data for developing real-time traffic accident predictions using machine learning algorithms.

The SRMS platform contributes to the advancement of research on utilizing spatial crowdsourcing (SC) by implementing this approach in real-time mapping mobility restrictions. It will enhance urban mobility performance and promote community resilience in the face of disruptive events on the road network. It aims to ensure equal cognitive distribution for the mobility restrictions updates to all platform users, thereby increasing their response efficiency and optimizing their traveling safety and cost.

Providing real-time information is crucial (Arbib et al., 2019) (Hamrouni et al., 2019) as it can reduce environmental, physical, and human costs (Aburas, 2020). For example, mapping the closure or congestion in a specified location will lead people to take an alternative route, optimizing traveling time and reducing energy. Similarly, mapping violent incidents in a specific section of the road can minimize travelers' exposure to danger, potentially saving lives.



Furthermore, mapping the mobility restrictions will enrich the mobility infrastructure spatial database by creating a database of mobility restrictions and traffic conditions. This database is beneficial when traffic data is limited or inaccessible (T. Wang et al., 2021). It will help transport authorities make informed decisions and traffic risk mitigation strategies.

This section outlines the methodology used to create the real-time mapping of mobility restrictions and traffic information, which includes three main steps: (i) identifying the data sources and collection methods; (ii) processing and analyzing the data; and (iii) publishing the service. The service also includes a restriction-notification system (RNS) that can be delivered to subscribed users interested in a specific type of restriction. For example, daily commuters concerned about checkpoint restrictions can receive regular updates through the RNS.

#### **4.1.2. Data Sources and Collection**

Real-time mapping of mobility restriction requires event description, location, and time. Hence, the system relies on two sources to gather this dynamic data: SRMS mobile application data and social media data, as shown in Figure 4.1. The two data sources play a mutual role in reinforcing the quality of the reported event through the redundancy of reported events simultaneously, called spatiotemporal-based strategy (Y. Zheng et al., 2016).

SRMS mobile application data is generated by using the embedded crowdsourcing tool in the SRMS platform. Due to the massive growth in IT, several options have come into existence for crowdsourcing tools, along with a variety of software, mobile applications, and cloud-based data collection tools (Bokonda et al., 2020) (Lakshminarasimhappa, 2021). Crowdsourcing platform has increasingly been used to report traffic accidents, natural disasters, and other incidents. These platforms allow users to report real-time events using their mobile devices. The reports can include text descriptions, localized data, photos, videos, etc. (Hamrouni et al., 2020).

One famous example of a crowdsourcing platform is Ushahidi, created in 2008 in Kenya, which employs digital cartography and often crowdsourced data to provide alternative narratives and spaces for communication and action (Gutierrez, 2019). It was embraced in several humanitarian initiatives. For example, during the Haiti Earthquake, the International Network of Crisis Mappers launched a map visualizing tweets and Facebook comments using Ushahidi (Norheim-Hagtun & Meier, 2010). Also, Ushahidi has contributed to developing vehicular mobility (Guillén et al., 2011). They developed a crowdsourcing platform that received the participation of Mexico City's society in traffic congestion on the road.

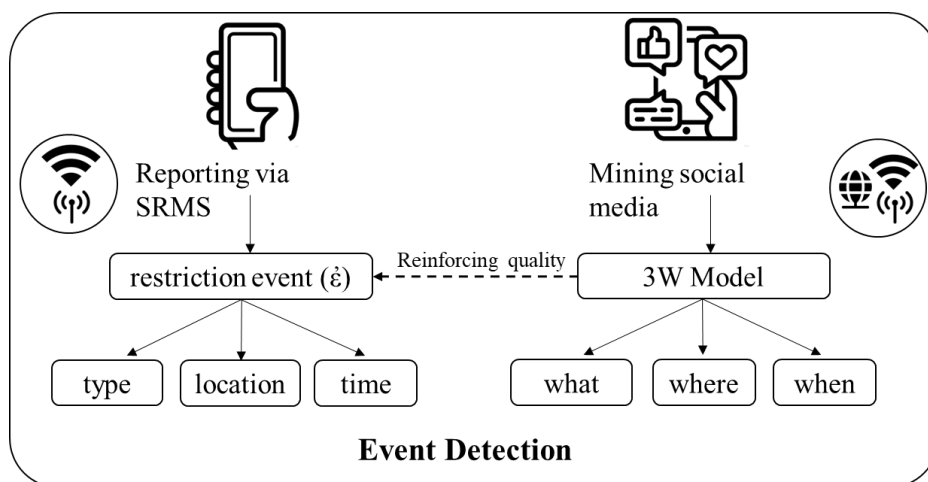
While Ushahidi can map a large volume of geo-reports, it has limitations when it comes to reporting real-time data (Ushahidi, 2022). This is because Ushahidi requires administrator approval to publish the data, which can cause a delay in the reporting process.

This research adopted a crowdsourcing platform that addresses the shortcomings of the Ushahidi platform by using ArcGIS Survey123. Survey123 was developed by Esri in 2015 (Esri, 2023c), released in 2016, and has been used sparingly as a GIS data collection tool ever since (Jordan et al., 2019) (Esri, 2023c). It is a simple and intuitive form-centric data-gathering tool with the power of publishing results in real-time through the Web Feature Service (WFS)

in the web GIS. Survey123 contributed to the participatory crowdsourcing approach in various domains, including health and wellness (Fornace et al., 2018), urban development (S. C. Walther & Gurung, 2019), and tourist planning (Jordan et al., 2019). However, this study proposes a novel application of Survey123 by integrating it with the SRMS platform to share traffic data and enhance community resilience during mobility incidents.

ArcGIS Survey123 has confirmed its efficiency and capability in data collection, analysis, and visualization compared with other crowdsourcing applications. (Jay et al., 2019) compared map-based crowdsourced applications, including Ushahidi, Maptionnaire, Survey123, Open Data Kit, and GIS Cloud, considering categories such as data input, management, analysis, visualization, and costs. The study revealed that Survey123 is the only platform offering web and mobile applications that support Android and IOS devices. From a data management perspective, Survey123 has superiority over other applications in providing a built-in database, supports the removal and editing of single data entries, mass deletions, sorting and filtering, and many supported format options. Also, Survey123 offers data analysis and provides high visualization options compared with other crowdsourced applications.

The users report the data via an embedded crowdsourcing platform in the SRMS platform and permit the system to access their location data (GPS sensor on their mobile devices) (Phuttharak & Loke, 2019) (X. Kong et al., 2019). Hence, when the user participatory reports an event, the event's location is inherently known to the SRMS platform, and the time of the event is considered the time of reporting.



**Figure 4.1.** Data sources of mapping mobility restrictions service

The second data source is mining social media data. Social media is an effective source for providing and disseminating information referencing mobility restrictions occurring at or affecting specific locations. Most social media data mining research relies on Twitter as a data source due to the advantages of being GPS-enabled, real-time publishing, and broad audience (Zou et al., 2018). Sometimes Twitter isn't a suitable data source for observing particular urban issues that need direct messaging (Martí et al., 2019).

Twitter isn't popular in the MENA region (Statista, 2022). Statistics conducted by (Statista, 2022) for the leading countries in the usage of Twitter show that the USA, Japan, and India, with percentages of 76.9%, 58.9%, and 23.6%, respectively, are the leading countries in the

use of Twitter, while in other countries such as Egypt, only 5% of social media users use Twitter. Facebook and YouTube are the most popular social network platforms worldwide, while Twitter has the third lowest ranking of the 17 social networks listed (Statista, 2022).

SRMS platform needs a source of instant messaging information that ensures near-real-time road information updates. Hence, the methodology of this study depends on the Telegram platform as a source of mobility restriction data. Telegram has around 550 million active monthly users compared with 436 million Twitter users (Statista, 2022). Also, Telegram provides the feature of pure instant messaging, which will feed the SRMS system with accurate update data. Furthermore, mining the Telegram data as a source of mobility restrictions data is a novel approach in social media mining studies (Khaund et al., 2021). So, the mobility restrictions and road traffic data were extracted from Telegram channels and public groups using Telegram API (Anand et al., 2022) (Dongo et al., 2020). Telegram API allows programmatically interacting with Telegram data and services and benefits from many functionalities.

Besides the dynamic data source needed to deliver event real-time mapping, the system relies on static data to (i) verify the crowdsourced data, (ii) and form the base map for the SRMS User Interface UI. Hence, the platform depends on the External Spatial Database ESDB. ESDB is a repository for the processing and storing of open-source and authoritative data. The open-source data is presented in the monitoring information provided by NGOs to describe the mobility restrictions. The monitoring reports describe fixed mobility restrictions, locations, photos, and operation mechanisms.

The authoritative data is presented mainly in the spatial data that forms the base map of SRMS, including inter-urban road networks and population communities. The authoritative data is obtained from a higher governmental transportation body, such as the Ministry of Transport (MoT) and the Ministry of Public Work and Housing (MPWH). The open-source and authoritative data was obtained in the Shapefile format. Table 4.1 shows the datasets used in the real-time mapping of mobility restriction.

**Table 4.1.** Sources of data for mapping the mobility restrictions in real-time

<b>Dataset</b>	<b>Source</b>	<b>Data type</b>	<b>Description</b>	<b>Dataset purpose</b>
Crowd-SRMS data	SRMS Application	Crowdsourcing	Citizen’s entries with time, location, and description.	Mapping
Social media data	Telegram	Crowdsourcing	Messages contain selected keywords related to the event, location, and time.	Mapping
Mobility restriction reports	NGOs	Open-source data	Textual and spatial data contains a description for fixed restrictions, photos, location, operation mechanism.	Mapping, verification

Mobility infrastructure	High governmental transportation bodies	Authoritative data	Spatial data of the transportation infrastructure and the built environment.	Mapping, verification
-------------------------	---	--------------------	--	-----------------------

### 4.1.3. Data Processing and Analysis

This phase concerns processing the captured restriction events from Telegram and the SRMS application. It involves preparing the data in ArcGIS Online to be mapped and published to the SRMS users. Processing the captured data varies depending on the type of data source. Telegram data processing involves using natural language processing libraries and text analysis techniques. The reported data via SRMS requires instant processing and visualization on the platform.

#### 4.1.3.1. Telegram data processing

The methodology of processing Telegram data in the SRMS adopts the “3W” communication model, as illustrated in Figure 4.2. It concerns capturing the spatiotemporal event data through three main questions (what, where, when) from road traffic news Telegram channels and public groups. The first use of a communication model was presented in Lasswell's "5W" model in 1948, which depends on the main five questions "Who (says) What (to) Whom (in) Which channel (with) What effect (Wenxiu, 2015). The "5W" communication model in crowdsourcing has been customized to meet real-time data needs. For example, (Z. Xu et al., 2020) used the communication model "5W" methodology: what, where, when, who, and why to describe the urban emergency event from social media.

The "5W" model of (Z. Xu et al., 2020) obtains spatial and temporal information from social media and investigates the actors and reasons causing the emergency event. However, this model has some limitations; for example, the methodology was exclusively applied to the Weibo Chinese application. Weibo application provides prepared real-time information for urban events and localized data, which is not the case in most social media platforms. Also, the data of the (Who) element could undermine the privacy of the system's users.

Compared to the 5W model (Z. Xu et al., 2020), this methodology preserves user privacy by adopting only three questions (What, Where, When), which are sufficient to provide accurate actual time data about mobility restrictions and traffic conditions without revealing the identity of the users and the reasons behind that event. Also, this methodology could be reproduced on any social media platform. It is composed of the following:

- i. *Text preprocessing*

This phase involves processing the retrieved messages using the Natural Language Toolkit (NLTK) modules for Arabic text processing. NLTK is a prominent Python package designed

for working with human language data (Kang et al., 2020). This phase encompasses the development of a text processing function that performs the following tasks: (a) removing numbers and special characters using a regular expression module; (b) tokenizing the text into individual words; (c) eliminating stopwords from the list using Arabic stopwords. It is important to note that the removal of special characters excludes the question mark to preserve the integrity of questions.

ii. *Data processing and analysis*

This phase involves further textual analysis to extract valuable information from the Telegram pre-processed text. To do this, the Telegram data are analyzed using the "3W" communication model, which concerns extracting useful information from the text based on three main questions (what, where, when) to capture the spatiotemporal data event from textual data.

Based on the "3W" communication model, the relevant keywords will be identified using one of the most important NLP disciplines (Chiche & Yitagesu, 2022), regular expression module. As demonstrated by (Z. Xu et al., 2020) (Zou et al., 2018), regular expression (regex or regexp) are powerful tools for extracting information from text, as they can search for one or more matches of a specific search pattern (L.-X. Zheng et al., 2021).

The components of the 3W communication model used in the SRMS will be processed as follows:

**What:** This element concerns detecting the general status of the mobility restriction. The status information includes expressions that present the adjectives of a restriction, such as (open, closed, and congested) and their related synonyms. To do so, regular expressions techniques will be used to extract the name and status of the restriction discussed in the conversation, as demonstrated by (Z. Xu et al., 2020) (Zou et al., 2018). Regular expression (regex or regexp) are powerful tools for extracting information from text, as they can search for one or more matches of a specific search pattern (L.-X. Zheng et al., 2021).

**Where:** Concerns about revealing the location information of that event. The location data in social media comes in different forms, including check-ins, geolocation information, and textual location information (Stefanidis et al., 2013). However, despite the novelty of using Telegram as a data source, limited geolocalized data is challenging. Hence, the textual information related to traffic restrictions should be geocoded to its identified coordinates.

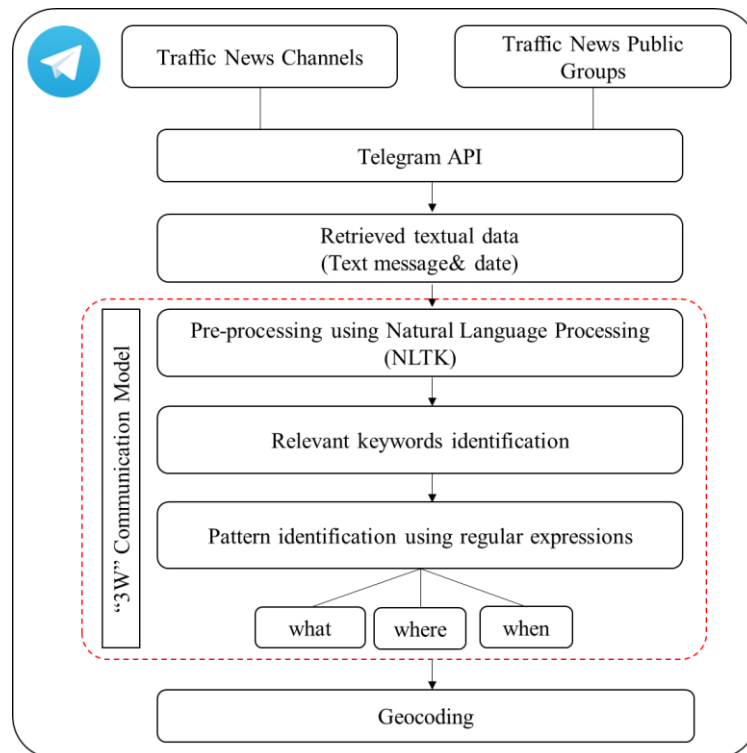
The Geocoding process aims to convert human-readable location names into latitude and longitude value pairs. This transformation is crucial for visually mapping the restrictions observed earlier and conducting efficient spatial analysis (Serere et al., 2023). The geocoding process relies on a reference list of community and location names where restrictions are likely to be situated. This reference data was obtained from the governmental authorities in the form of a CSV file, serving as a gazetteer for deducing restriction locations. The geocoding process entails matching the location names with the detected restrictions, thereby assigning geographical coordinates to them.

For geocoding, we employed the Nominatim geocoding service, an open-source software developed by the OpenStreetMap (OSM) project. Nominatim is available in the 'geopy' Python

package, which offers compatibility with several popular geocoding services. It includes training data for OSM Nominatim, Google Geocoding API, and various other geocoding services (Verma, 2022). Nominatim utilizes data from OSM for geocoding operations.

In a study by (Serere et al., 2021), a comparison of Nominatim with other geocoding services demonstrated that the method using the Nominatim geocoding service identified a greater number of locations. Furthermore, Nominatim is widely recognized and commonly used for geocoding services (Serere et al., 2023).

When: The value of the extracted data is increased by obtaining near real-time data (Kang et al., 2020). Therefore, when obtaining Telegram data, it is essential to include a timestamp for each written piece of information and ensure that the timestamps are relatively recent. In addition to providing valuable information about the timing of a restriction, the 'When' data is also useful in creating a timeline of the restriction event. By analyzing the volume of near-timestamp messages regarding the same event, it is possible to estimate the duration of the event. Furthermore, the clearance time of a restriction can be identified by the emergence of a new status for the same restriction at the same location. Figure 4.2 summarizes the methodology of retrieving and processing the Telegram data.



**Figure 4.2.** Methodology of processing Telegram data in the SRMS

Telegram's obtained (what, where, when) data will be integrated with the reported data from the SRMS platform (event type, location, time) to reinforce the reported event quality using the event's spatiotemporal redundancy. ST redundancy-based strategy is a data quality protocol applied by the Data Privacy and Quality unit to ensure high data quality. The data will be stored as temporary data in the Observation dataset, a temporary data storage in the Crowd Context database (CCDB) (Phuttharak & Loke, 2019).

The Observation dataset will collaborate with the data privacy and quality unit to create an Event table that stores truth events related to traffic conditions and mobility restrictions inferred from spatiotemporal redundancy reports with similar types, locations, and timestamps. The data within the Observation dataset will consist of a quadruplet of information, which includes the type of event, longitude and latitude coordinates, and timestamp, as described by (Ansari et al., 2020).

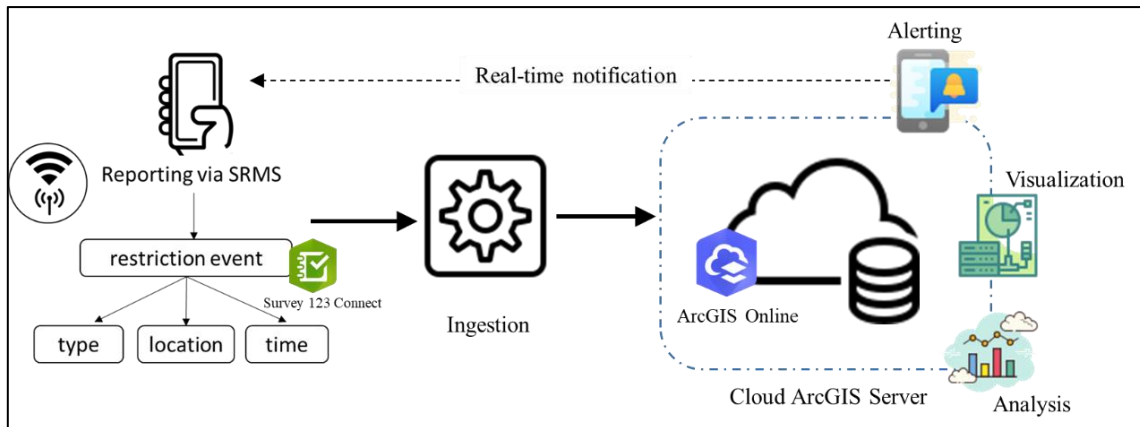
#### 4.1.3.2. SRMS data processing and analysis

The reports submitted by the SRMS users trigger mapping the restriction event; hence, processing, analyzing, and visualizing the captured data in real-time is necessary. Real-time processing is applied to deal with data with minimal latency to generate real-time (or near-real-time) reports (X. Liu et al., 2014). The architecture of real-time processing of SRMS is composed of the components; (i) real-time data ingestion; (ii) real-time analysis; (iii) real-time visualization; and (iv) real-time alerting (Microsoft, 2023), as depicted in Figure 4.3.

Users of SRMS will ingest the real-time spatial data to ArcGIS Online using the embedded Survey123 crowdsourcing platform. Survey123 allows users to report real-time events using their mobile devices easily. The reports can include autogenerated timestamps, localized mobility restriction type, and recorded voice. The architecture of the reporting form was designed considering the quick and easy report aspects.

The data submitted via Survey123 will be stored in a point-hosted feature layer, which is ideal for storing event information data because it enables adding, editing, and deleting data in real time. The hosted feature service will process the reported data in real-time through configuring the instant filtering and validation rules (Esri, 2023e). For example, the reports with missing or manipulated or those transmitted from malicious users will be detected and ignored by the service. Validated reports from authenticated users will be visualized on the SRMS base map (Esri, 2021a) with specific symbology based on the type of mobility restriction, and each report will include event type, time stamp, and audio data for further description. Figure 4.3 illustrates the processing of SRMS data in ArcGIS Online.

Additionally, SRMS has developed the Restriction Notification System (RNS), which enables the application to send email notifications to subscribed SRMS users, informing them about restriction incidents or event updates.



**Figure 4.3.** Data storage and real-time processing in ArcGIS Online

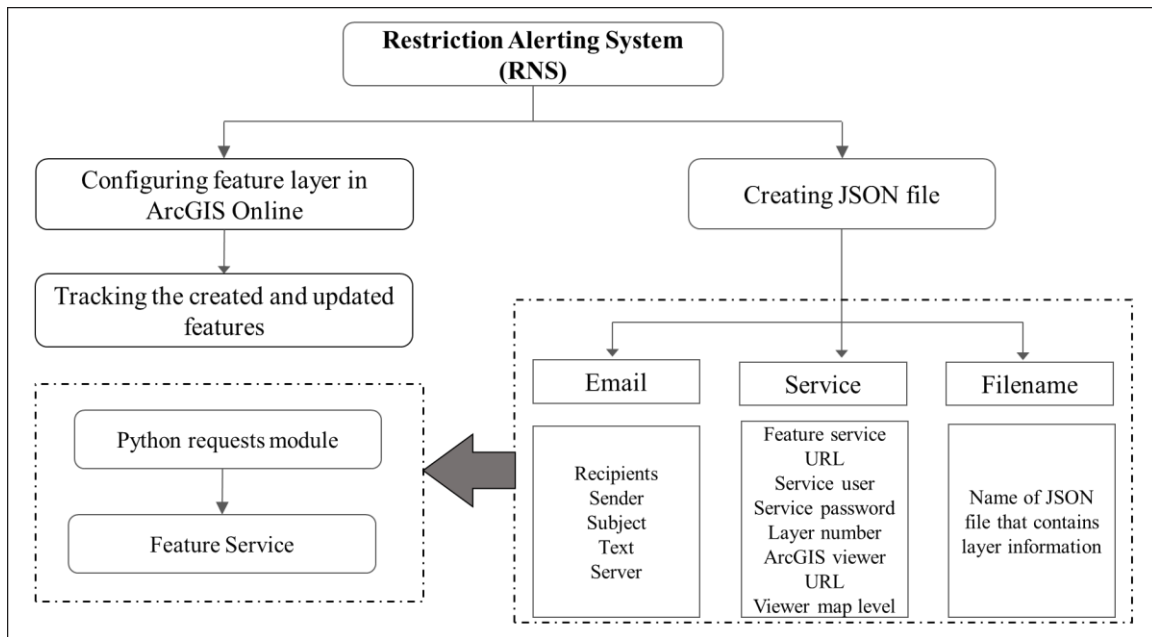
#### 4.1.3.3. Restriction Notification System (RNS)

The service of mapping restrictions is optimized by developing the Restriction Notification System (RNS). RNS aims to inform SRMS users of updates regarding one or multiple restriction types they have subscribed to. The RNS service sends email notifications to users when new reports related to mobility restrictions are added, deleted, or modified. To do so, the Observation dataset interacts with the user dataset to retrieve relevant user information, including their email addresses and the type of mobility restrictions they are interested in. This information is used to tailor user notifications based on their preferences.

Following this, the RNS service will be developed using a Python script and a JSON configuration file (Esri, 2017). The script uses the Requests Python module to send HTTP requests (python, 2023) to a feature service endpoint and retrieves the maximum date and time of edits in the feature service. It compares this with the last edit detected by the script and sends email notifications to recipients listed in the configuration file if there are any new edits.

The configuration file is a JSON object that contains information related to an email, a service, and a filename. The email section includes; (i) the list of subscribed users' emails that will be notified; (ii) the email of the sender, which could be a person or organization; (iii) the server, which contains settings for configuring the email server connection, including the host of email server which can be specified by hostname or IP address, port of the server; (iv) the mail text and subject. The service section includes the feature service URL, the service username and password, the layer number, and the viewer URL and level. Filename contains the name of a JSON file that contains the layer information. The development methodology for the RNS service is depicted in Figure 4.4.





**Figure 4.4.** Method of developing RNS service

#### 4.1.4. Service Publishing

This section concerns disseminating and visualizing the processed data stored in the hosted feature layer for public use. This phase will enable users to access information about mobility restrictions and adjust their travel plans accordingly. The hosted feature service configuration is required for sharing the reported data with the public. It includes configuring the accessibility of the users to the data by assigning the feature service to support public data collection, which enables users to add or modify their data.

The real-time mapping service will be published as a reporting widget on the SRMS web mobile application. The published data includes information about the location, time, descriptive audio, and type of mobility restriction or traffic congestion. Users can access this information through the SRMS mobile application, which displays an interactive map with icons representing reported incidents. Users can access detailed information about the incident by clicking on these icons.

The Restricted Notification Service (RNS) is a button in the SRMS application. When clicked, it opens a subscription form where users can choose the types of mobility restrictions they are interested in and provide their email address to receive notifications regarding those restrictions.

## 4.2. Mapping Informal Routes

### 4.2.1. Overview

Mapping the informal route is a novel approach to developing an urban mobility system in the communities, especially those subjected to continuous natural hazards or physical stress (Davis, 2012). It aims to harness the people's experience in traveling through the landscape or the unknown route and share it with the public community. Mapping the individuals traveling through the landscape, which is called 'Wayfaring' according to (Tim Ingold, 2007) is an action of resilience (Bishara, 2015) that aims to convert the individual experience in maneuvering mobility obstacles into sharable knowledge to maintain community-level activities (Ribeiro & Pena Jardim Gonçalves, 2019).

The concept of free people's mobility is closely associated with the idea of urban resilience, which has received attention from researchers and local authorities (Ribeiro & Pena Jardim Gonçalves, 2019). To address physical, social, and economic challenges faced by cities, The Rockefeller Foundation launched the 100 Resilient Cities initiative, which aims to build resilience by ensuring the free flow of people, information, and goods (Admiraal & Cornaro, 2020). This initiative is one of the most popular urban resilience initiatives in the world, and it has helped many cities around the globe to become more resilient by addressing mobility-related issues and creating a more interconnected, accessible, and sustainable urban environment (100 Resilient Cities, 2013).

In the context of resilience studies in conflict-prone communities, limited research has been found to address the challenge of people's mobility under conflict circumstances. However, (Bryson, 2011) highlights, among other aspects, the dangerous commuting in peripheral areas in Bogota, Colombia. She introduced spatial, sociopolitical, and economic security strategies followed by residents to avoid violence and insecurity areas. As a community adaptation technique to mitigate the risk in the community, the residents use the strategy of alteration and limitation of transport patterns. For example, all residents rely on public and private buses to travel to locations throughout the city and sometimes use multi-vehicle modes during one trip.

In a related study, (Dunckel Graglia, 2016) discussed building capacity for women commuters in Mexico City. He ended up with a solution of women-only transportation as a resilience action to avoid fear and violence. (Davis, 2012) in his book highlights the resilience measures to increase the resilience in violent cities and conflict areas, including Medellin, Johannesburg, and Mexico City. He stated that the spatial fabric and built environment are highly related to the resilience of the communities. Also, he added that institutional foundations and capacity building play a leading role in increasing the community's resilience.

The challenge of safe mobility in conflict-prone communities has not yet fully utilized technological advances and data generated by commuters. While some previous studies, such as (Bryson, 2011), used cognitive maps to map informal travel patterns, these methods were limited by manual mapping and a lack of sharing among the community. However, recent advancements in smartphone technology and embedded sensors have allowed for the development of applications, such as the one by (R. A. Sarker et al., 2021), that utilize mobile sensors like GPS, Accelerometer, Gyroscope, and Magnetometer to map routes in unreachable areas and share them with the community. However, this study is limited by its focus on

pedestrian users and the application is only available for the Android operating system. Additionally, there is a lack of experimental data obtained from drivers' mobile devices.

In this study, a novel contribution is made toward developing urban resilience mobility for stress-exposure communities. Utilizing the SRMS platform, enables drivers and passengers to map alternative routes in case of failure in the main road network. This service leverages crowdsourcing to transform individual experiences into collective community knowledge. This study addresses gaps in previous literature by (i) promoting mobility resilience in risk-exposure communities through IT advancement and smartphone capabilities, which has yet to be addressed in studies on conflict areas and colonial studies (Samper, 2012) (Dunckel Graglia, 2016); (ii) demonstrating the use of human mobility data in strengthening urban resilience, an area that has been poorly understood (Haraguchi et al., 2022); (iii) ensuring accessibility to the service regardless of the type of smartphone operating system; (iv) implementing quality control on reported routes before publication; and (v) focusing on data generated by motorized travelers instead of active users.

The mapping of informal routes is a crucial component of the SRMS platform, as it provides additional data for updating and expanding the urban mobility infrastructure beyond the primary road network and mobility restrictions. This, in turn, improves the efficiency of the SRMS platform by suggesting alternative routes where there may be limited infrastructural solutions available.

The emerging informal route could take different shapes depending on the community context and available resources (Lwanga-Ntale & Owino, 2020) (Sajjad, 2021) such as a path through the mountains, hills, fields, dirt route, agricultural route, or a combination of these four types (Bishara, 2015). The informal route component is a dynamic element. So, there will be room for new synergies strategies to cope with traffic interruption depending on the risk and the socio-economic context. This section will provide an overview of the mapping informal route service in the SRMS platform, including the identification of data sources and collection techniques, the methodology for processing and storing the data, and the publication of the service to users.

#### **4.2.2. Data Sources and Collection**

Rapid advances in information technology and mobile devices enable us to capture, integrate, and store data associated with any event, making human mobility an essential data source. For example, smartphone sensing technologies, such as the global navigation satellite system, enable us to monitor human movement at high temporal and spatial resolutions (Haraguchi et al., 2022) (Nishino et al., 2016). Analyzing people's mobility during any emergency was introduced in a research branch called Human Mobility Data Analysis (HMDA) (Haraguchi et al., 2022).

HMDA was widely integrated to address various urban challenges, including public health (Oliver et al., 2015), transportation management (Ilbeigi, 2019), evacuation modeling (J. Chen et al., 2020) (Oliveira et al., 2019), and other applications. The role of HMDA has become increasingly important during the COVID-19 pandemic. (Chang et al., 2021) conducted research using human mobility data in the U.S. during COVID-19. He has predicted higher

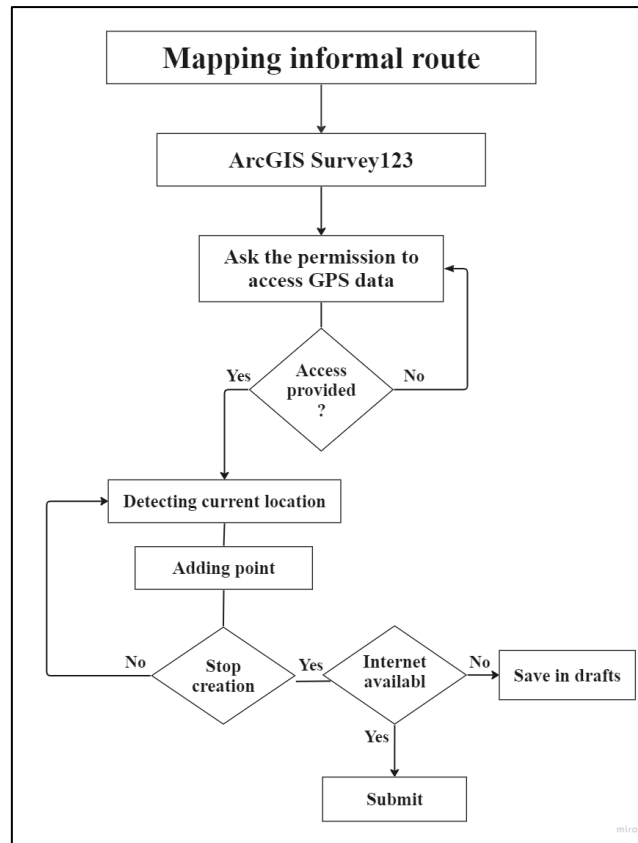
infection rates among disadvantaged racial and socioeconomic groups solely due to differences in mobility. From the literature, we can conclude that HMDA intersects with the technique of Spatial Crowdsourcing (SC), where the spatial data of the Crowd (human) are valuable and considered a main data source for decision-making (Y. Zhao & Han, 2016).

The mapping of informal routes relies on the mobility of motorized travelers who share GPS data from their mobile devices while traveling along the observed routes. The SRMS platform will embed the ArcGIS Survey123 form to collect GPS participatory data. Using Survey123 for data collection ensures consistency in the captured data, facilitating processing and analysis. This tool is particularly suitable for harsh environments (Esri, 2023c); it allows capturing data offline and syncing it back to the collection server, making it ideal for collecting informal route data.

The SRMS platform will request users' permission to collect GPS data from their mobile devices to create a geotrace, a type of geometry data representing a connected sequence of lines or paths traveled by a user or vehicle (Buthpitiya et al., 2011). To enhance the information obtained from GPS data, the SRMS platform may also utilize voice documentation to capture additional details about the observed route, such as the route's slope level (plain, moderate, or steep). This information can help drivers make informed decisions about their travel route, considering their vehicle's capabilities. Figure 4.5 shows the framework for mapping informal routes in the SRMS platform.

Various literature suggests using mobile device sensors to determine road surface conditions, such as accelerometer sensors for pavement condition diagnosis. (R. A. Sarker et al., 2021) introduced a system that uses smartphone sensors (including accelerometer, gyroscope, magnetometer, and GPS) to create route maps for unreached areas; this study collects route surface information from recorded voices submitted by travelers. Additionally, SRMS displays a topographic base map on the user interface, providing an indication of the area's topography and slope.

Future work could expand the mapping of informal routes to include other motion sensors, such as the accelerometer and gyroscope, available in low-end smartphone devices and are commonly used to measure vehicle acceleration, speed, and surface condition (Staniek, 2021) (R. A. Sarker et al., 2021). However, considering the research's scope, the surface topographic map and user-submitted data are adequate to provide information about the route surface, avoiding complex calculations.



**Figure 4.5.** Workflow of mapping the informal route on the SRMS platform

### 4.2.3. Data Processing and Analysis

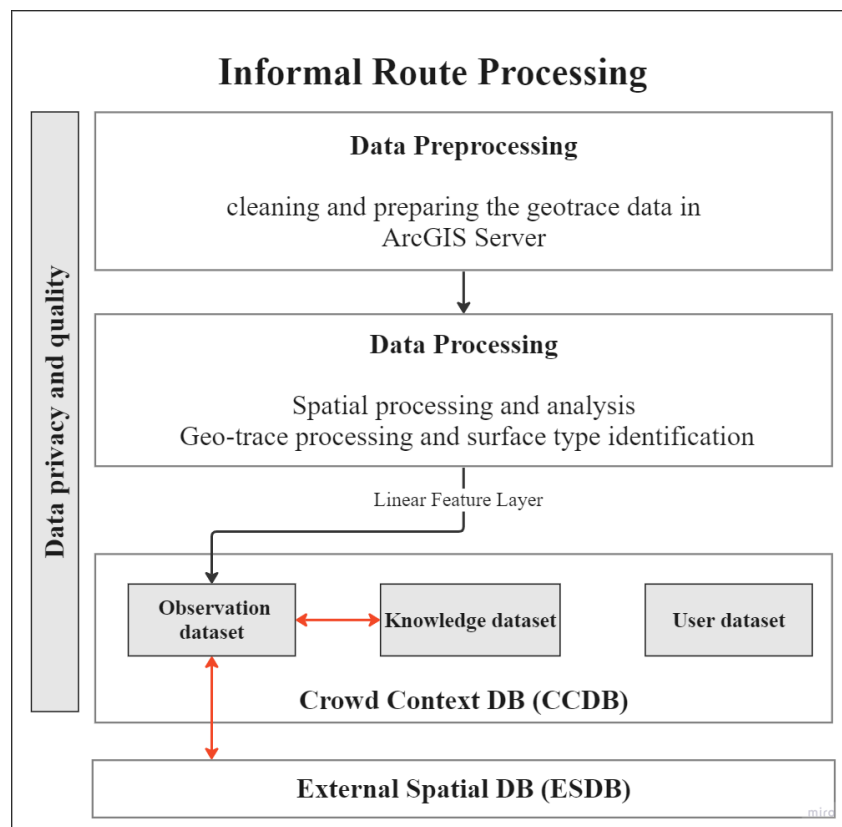
The methodology of processing and analyzing the collected informal route data follows a general structure that is commonly used in processing other services of the SRMS platform. This structure includes three main stages: data preprocessing, data processing, and data publishing and visualization. The first stage is data preprocessing, which involves cleaning and filtering the collected data to remove any noise or incomplete data that may affect the quality of the analysis. Once the data is collected from the Survey123, SRMS processing unit will process the geotrace data. To ensure the accuracy and completeness of the data, it undergoes validation to detect and correct any errors such as missing points and incorrect coordinates.

The second stage is data processing, which involves integrating, analyzing, and preparing the cleaned data for further use. After validation, the processed geotrace data is stored as a line feature layer in the Observation dataset. A line feature layer effectively manages and stores linear spatial data, such as road networks, rivers, pipelines, etc. (Esri, 2023e). It serves as the primary storage mechanism for geotrace data in the SRMS platform. This stage involves using spatial analysis tools to identify patterns in the reported data and extract information about the routes, such as their length, surface type, and connections to other routes. In this phase, the observation dataset will collaborate with the Data Privacy and Quality unit and Knowledge

dataset to create an informal route table that stores truth data inferred from the analysis of the received records.

The third stage is preparing the analyzed data for publishing as a service in the SRMS platform; it involves storing the informal route data as a sub-dataset in the Observation dataset in the Crowd context database. The informal route table includes (route location (latitudes, longitude), route length, surface type, community name, user ID, route ID, time stamp, and voice data).

Figure 4.6 illustrates the processing phase of the informal route; it shows that the Observation dataset interacts vertically and horizontally. Horizontally, it interacts with the Knowledge dataset in the CCDB to ensure the quality of the reported data. Vertically, it interacts with the ESDB, considered a base map in the SRMS. So, it is the reference for mapping any new informal route. As a result of interaction, the Observation dataset will generate attributes of the informal route shapefile, including (informal route ID, user ID, community, surface type, and submission date).



**Figure 4.6.** Components of informal route processing

#### **4.2.4. Service Publishing**

This section concerns disseminating and visualizing the processed data stored in the hosted feature layer for public use. This phase will enable users to access information about informal routes and adjust their travel plans accordingly. The hosted feature service configuration is required for sharing the reported data with the public. It includes configuring the accessibility of the users to the data by assigning the feature service to support public data collection, which enables users to add or modify their data.

The informal route mapping service will be published as a widget on the SRMS web mobile application. The published data includes information about the route surface type, submission time and date, and voice records. Users can access this information through the SRMS mobile application, which displays an interactive map as lines representing the drawn routes. Users can access detailed information about the route by clicking on these lines.

### **4.3. Route Planning Service**

#### **4.3.1. Overview**

Route planning received its significance from the people's need to optimize their traveling socio-economic or environmental costs (Aburas & Shahrour, 2021) and from complex traffic environment characterized by imprecise future information (Pamucar & Cirovic, 2018), making the routing decision-making problem need to be solved urgently (Peng et al., 2022).

Several applications were developed to cover the need of planning users' routes, such as Google Map, Apple Map, Waze, Doroob, and MapQuest. These navigation applications suggest multiple alternative paths from a source to a given destination based on travel time and distance. The dominance of these two parameters in most commercial route planning applications is because route choice is typically related to the people's desire to minimize travel distance and time or to maximize route reliability (Lam & Small, 2001).

Recent studies reported that drivers prefer a daily commute path that is not necessarily the shortest or fastest route. The preferred path is typically chosen due to the driver's familiarity with the area's traffic and physical road conditions (Sarraaf & McGuire, 2020). (Papinski & Scott, 2011) tested around 237 home-to-work trips based on real-world GPS data in Halifax, Canada. The study revealed that the paths taken by drivers are significantly longer than the shortest distance and fastest path alternatives. Hence, considering the conventional parameters of route planning under certain circumstances is not the preferable criterion for travelers.

Recent studies introduced the safety factor as a significant parameter in route planning. (Sarraaf & McGuire, 2020) and (Liao et al., 2022) developed a navigation system that considers the road segment's safety level while suggesting the path. These studies rely on historical traffic crash data and a real-time monitoring system. (Ikeda & Inoue, 2016) proposed route guidance system for post-natural disasters that uses participatory sensing to estimate safe routes and generate an evacuation map by collecting GPS and accelerometer data from pedestrians' smartphones. (Domínguez & Sanguino, 2021) developed an app tracing and guiding safe routes in pedestrian areas using an optimization algorithm. (Mehdi Shah et al., 2020) developed a safe routing system for urban cycling. (Nouredine & Ristic, 2019) developed a methodology for

finding the optimal route for transporting hazardous materials based on multi-criteria decision-making.

In addition to safety considerations, other scholars have also integrated sustainability parameters into route planning. For example, (Kırdar & Ardiç, 2020) promoted people's behavior toward sustainable mobility by designing a platform that suggests alternative paths considering sustainability parameters, including environmental quality, personal health status, commuting duration, and travel modes. Furthermore, in 2021, Google Map App launched the feature of eco-friendly routing to minimize CO<sub>2</sub> emissions, although this feature is currently only available in limited countries (Google, 2021).

Based on the previous literature, recent approaches to route planning have increasingly considered sustainability and safety considerations. Safety consideration is crucial in the complex urban mobility system. It has been introduced in route planning studies from different perspectives, such as the routing evacuation model (Ikeda & Inoue, 2016), safe active mode traveling (Mehdi Shah et al., 2020) (Domínguez & Sanguino, 2021), safe route for hazardous material transportation (Noureddine & Ristic, 2019), and route planning considering traffic crashes (Sarraf & McGuire, 2020) (Liao et al., 2022). However, there are limitations to these previous studies. For example, most safe route planning for motorized vehicles tends to consider traffic crashes the only traffic risk while ignoring other risk factors. Furthermore, the planning solutions often propose a single optimal route, which may lead to congestion drift from the original route to the newly planned route (Arnott et al., 1991).

Safety is a crucial factor that guides our daily lives, yet individuals often lack sufficient information about the safety level of certain roads, particularly when traveling to unfamiliar areas. Unfortunately, most commercial routing products prioritize optimizing distance, time or, cost without considering the critical safety criterion. As urban mobility becomes increasingly complex, citizens urgently require a service prioritizing safe routing. While some cities, such as New York City, provide a rough safety heat map by pinning occurs crimes in a city map, such a map only offers a limited safety score for a district.

This study adds to the existing research on route planning by introducing new safety parameters beyond traffic crashes, such as mobility restrictions, violence directed toward travelers, and the physical environment. These factors pose significant risks to travelers' lives and safety, and their inclusion in route planning can help mitigate them. The study also developed a risk quantification model that could be applied to any road network exposed to risk events, allowing for more effective and efficient route planning considering a wider range of safety considerations.

The model considers multiple safety factors, including mobility restriction risk, violence directed towards travelers, and the physical environment, to evaluate road safety comprehensively. The model considers the spatial and temporal distribution of road risk to generate a risk score for each road segment. It allows for the identification of high-risk areas and the recommendation of safer routes. By integrating the risk score into route planning, the model can suggest a safer route for travelers, potentially reducing the risk of violence and other safety-related incidents.

Designing the risk quantification model to consider violent actions against travelers is a novel contribution to safe route planning. Unfortunately, violent incidents while using the



transportation system are common and can occur in public and private transport settings (Couto et al., 2011). Scholars have been paying increasing attention to crime and safety perception in transit environments since 2010 (Ceccato et al., 2022).

Reports from developed countries indicate that between 19-70% of taxi drivers experience verbal and physical violence. In Turkey, for example, physical violence against Taxi drivers reaches 35.2% (Aytac, 2017). In Australia, taxi driving was considered one of the highest-risk jobs, with at least one taxi driver murdered yearly (Mayhew & Graycar, 2000). In the US, 2019 has recorded more than 1500 crime events in the transportation sector (Statista, 2019).

Additionally, the route planning model proposed in this study stands out from other models by offering users multiple route options categorized according to specific features such as safety, speed, and emergency. While recent studies have considered different objectives in route planning, they typically provide a single optimal route for users, a relative definition based on their preferences. This study aims to respect user preferences by providing multiple alternatives that do not compromise their safety. The following are the definitions for each route alternative:

**The safest route** prioritizes safety as the primary objective and avoids high-risk areas or roads with a history of violence. It is designated to the route free from mobility restrictions, including checkpoints, road gates, and violence. This route entails a high travel time or long distance. This route is optimal for non-daily travelers interested in safely arriving regardless of traveling time, travelers with anxiety-related restrictions, and drivers with limited experience traveling under restrictions.

**The fastest route** is designed to minimize travel time while still ensuring the direct safety of the user. This route is optimal for daily commuters concerned about arriving at work or home without significant delay. It is also helpful for travelers familiar with the mobility restrictions and can navigate them safely.

**The emergency route** is the shortest route without considering the risk of mobility restrictions. It is intended for emergency or evacuation situations where humanitarian needs precede mobility restrictions or waiting time risks. This route is ideal for emergency service providers, such as ambulances, civil defense units, and others.

Table 4.2 provides a comparison between the available route planning applications and SRMS application. It is considered various criteria and technical considerations make the RPS in SRMS a novel contribution to the route planning studies.

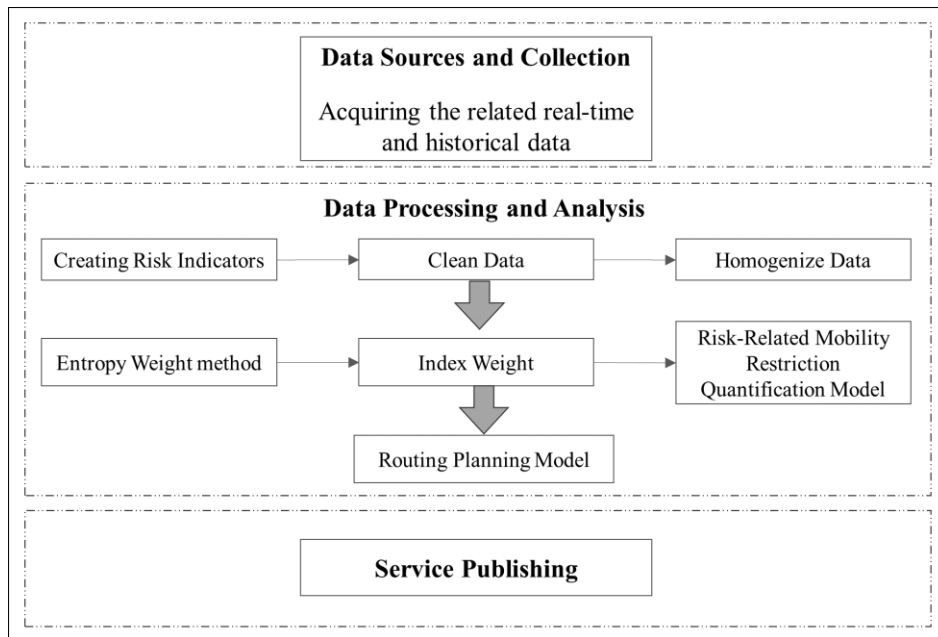
**Table 4.2.** Comparison between the common route planning applications and RPS in SRMS

	<b>Criteria</b>	<b>Waze</b>	<b>Google Map</b>	<b>Doroob</b>	<b>Apple Map</b>	<b>SRMS</b>
1	Real-time Traffic Information	✓	✓	✓	✓	✓
2	Mobility Restriction Notifications	✗	✗	✗	✗	✓
3	User-Centered Design	✗	✓	✗	✓	✓

4	Spatial crowdsourcing	✓	Limited	✓	Limited	✓
5	Social Media as data source	✗	✗	✗	✗	✓
6	Privacy Protection	✓	✓	✓	✓	✓
	Data Accuracy	User contributed	Reliable	User contributed	Reliable	User contributed
7	Offline Navigation	✓	✓	✓	✓	✗
8	Safety Factors	Traffic crashes	Traffic crashes	Traffic crashes	No factors	Restriction, violence, physical environment
9	Routing Options	Fastest, shortest, ecofriendly	Fastest, shortest, eco friendly	Fast	Fastest, shortest	Safest, Fastest, Emergency
10	Informal Route Mapping	✗	✗	✗	✗	✓
11	Cross-Platform Availability	✓	✓	✓	✓	✓

The SRMS platform will provide various route options using its routing planning service (RPS). The RPS relies on the route planning model (RPM) incorporated in its knowledge dataset, which acts as an expert in identifying the fastest, safest, and emergency routes. The RPM collects historical and real-time data from different sources to generate three route alternatives. To determine the least costly path, the RPM uses Dijkstra's algorithm on three weighted graphs. Each graph's weight represents the risk, travel time, and travel distance costs of delivering the least-risk, time, and distance paths, respectively. This study's graph model depicts the road network's edges and nodes and is integrated with a validated informal route to provide multiple options under limited transportation infrastructure conditions.

The process of developing the routing planning service in the SRMS platform begins by identifying the necessary data and their sources, then data processing and analysis to create the route planning model based on the risk quantification model, following the results will be published as a routing layer in the SRMS platform. Figure 4.7 illustrates the overall methodology for creating a routing planning service within the SRMS platform.



**Figure 4.7.** The general methodology of route planning service in SRMS Platform

#### 4.3.2. Data Sources and Collection

The required data for the routing planning service will be collected from two main sources: the crowd context CCDB and external spatial databases ESDB. The CCDB will supply real-time and permanent data, including the Observation, and Knowledge datasets. The Observation dataset will offer event-based real-time data that will be incorporated as a restriction in the route planning model and provide data on the informal route, which will be considered a component of the routing model. The knowledge dataset will be utilized to get inference data, such as inferred-user feedback, which presents deviations from the advised route and indicates the quality of provided services.

In addition to the CCDB, the external spatial database (ESDB) will be used to obtain various data related to the physical environment, such as road network geometry, prohibited roads, speed limits, road quality, historical mobility restrictions, and historical violent actions toward drivers. This data will play a crucial role in quantifying the risk on different road segments.

Table 4.3 provides a comprehensive overview of the different datasets, sources, data types, descriptions, and purposes within each alternative route category, including the safest, fastest, and emergency Routes. The table includes general data applicable to all routing models, such as road network geometry data obtained from an authoritative source and the informal path geometry dataset collected through crowdsourcing from SRMS users.

**Table 4.3.** Data categories and sources in terms of each alternative route category

Dataset	Source in SRMS	Data type	Description	Dataset purpose
<b>General Data common in three routing models</b>				

Road network geometry	ESDB	Authoritative data	Road network representation/quality	Risk quantification model, Route planning model
Informal path geometry	Observation dataset	Crowdsourcing	Informal paths reported by SRMS users.	Route planning model
<b>Safest Route</b>				
Restrictions-related waiting	Observation dataset	Real-time crowdsourcing	GPS data of traffic restrictions caused waiting	Identified as prohibited restriction
	ESDB	Authoritative data	GIS data	Risk quantification model, Route planning model
Restrictions - related violence	Observation dataset	Real-time crowdsourcing	GPS data of violence locations	Identified as prohibited restriction
	ESDB	Authoritative data	GPS data of violence locations	Risk quantification model, Route planning model
<b>Fastest Route</b>				
Speed limits	ESDB	Open-Source	The maximum travelling speed on the roads	Calculating travelling time, Route planning model
Restrictions-related waiting	Observation dataset	Real-time crowdsourcing	GPS data of traffic restrictions caused waiting	Route planning model
	ESDB	Authoritative data	Historical average waiting time at the restrictions	Calculating weighted waiting time at restrictions
Restrictions - related violence	Observation dataset	Real-time crowdsourcing	GPS data of violence locations	Identified as prohibited restriction
<b>Emergency Route: Shortest Path</b>				
Speed limits	ESDB	Open-Source	The maximum travelling speed on the roads	Calculating travelling time

### 4.3.3. Data Processing and Analysis

This phase consists of three arranged steps to process and analyze the collected data to construct the route planning model. It starts with creating the risk quantification model by creating and weighting risk indices and then calculating the travel time by considering the waiting time prediction at mobility restrictions. The last phase concerns creating the routing planning model to find multi-categorized routes.

#### 4.3.3.1. Risk Quantification Model

This phase composes of the following; (i) creating a list of risk criteria; (ii) using the entropy weight method to establish a quantitative risk cost model and calculate index weights; (iii) determination of a comprehensive risk score for each road segment ( $R_i$ ). Each phase is detailed in the following:

##### *i. Creating Risk Indices*

The safety evaluation value entails considering different criteria based on the purpose of the route planning model. For example (Ikeda & Inoue, 2016) developed an evacuation route planning model after a natural disaster. He used the safety evaluation method, which considered mainly the average walking speed, pedestrian traffic per hour, and the distance between two nodes. (Domínguez & Sanguino, 2021) developed a mobile app based on integrating smartphone sensors and a fuzzy logic strategy for finding a safe route for pedestrians considering the elements of zebra crossings, pedestrian streets, and walkways.

(Liao et al., 2022) (Sarraf & McGuire, 2020) quantified the risk on the road section considering historical and real-time data of traffic crashes. (Sarraf & McGuire, 2020) calculated the road segment safety weight in terms of travel time and weighted crash rate, which considers the crash severity presented in the number of fatalities, injuries, and property damage.

(Liao et al., 2022) extended the severity of traffic crashes to include other parameters related to the driver, vehicle, road, and the environment. (Noureddine & Ristic, 2019) performed a study about route planning for hazardous material, he used multi-criteria decision-making evaluation criterion. Then he calculated the weighting coefficient using the Full Consistency Method (FUCOM) subjective method.

The previous literature has quantified the safety value in the real world using single or multi-criteria methods. Finding the optimal safe route considers traffic crashes a primary threat to people's safety, and road quality comes in the second level. Restraining road safety in traffic crashes undermines the comprehensiveness of the road safety evaluation model. This study expands the perspective of safety on the road network by considering new risk criteria, including (i) mobility restrictions; (ii) violent events that threaten travelers' lives; (iii) the built environment; and (iv) the physical characteristics of the road.

(Essenberg, 2003) declared that violent actions against private or public motorized vehicles are determined by the presence of opportunities for violence related to the quality of the built environment, the political situation, and other sociodemographic factors. For example, the lack of formal and informal surveillance allows violent action (Essenberg, 2003). (Couto et al.,

2011) declared that there is a significant correlation between violent action on the road and the incapability of the driver to access the information.

The literature shows that the root causes of violent actions refer to different aspects, including a gender perspective, such as abusive practices against women (Borker, 2021), the violence of workplace perspective, which is related to socioeconomic factors (Richardson & Windau, 2003), and the geopolitical perspective, which presented in the violent practices against the civilians, especially in the armed conflict areas (Balcells & Stanton, 2021).

In this study, the operation definition of violence is the physical threat involving actual physical violence, such as using an object (stones, bottles, sticks, etc.) or a weapon against travelers (Couto et al., 2011). This type of violence is prevalent in unstable geopolitical environments where there is a constant threat to people's lives (Balcells & Stanton, 2021). For example, (Essenberg, 2003) showed that most road passenger transport sector workers in several conflict-prone countries have reported experiencing violence from armed forces, police officials, and customs agents at roadblocks or border posts.

The evaluation indices are selected based on the literature review and report discussing the severity of the violent action on the travelers on the road. The index used to evaluate the severity of violent action against travelers on the route includes the number of previous violent acts against the travelers (Couto et al., 2011), the time the violence occurred (Mayhew & Graycar, 2000), the category of the adjacent built-up area to the road section (Dunckel Graglia, 2016). The index used to evaluate the physical road characteristics are the physical road condition and the road segment's lighting condition (Essenberg, 2003). The number of mobility restrictions on the road section was used as an index for the mobility restriction criteria. Table 4.4 shows the evaluation criteria and the derived index for the risk on the road section.

**Table 4.4.** The evaluation criteria and the derived index for evaluating the risk on the road section

No.	Index	Definition	Description
1	NO_RIST	No. of permanent mobility restrictions	No. of permanent restrictions = 1, 2, 3, no mobility restriction = 0
2	NO_VIO	No. of historical violence actions against vehicles	No. of violent actions against the drivers = 1, 2, 3, no record = 0
3	TOD	Time of day	Daytime = 1, night time = 2
4	DOW	Day of week	Weekday = 1, weekend = 2
5	LGT_CON	Light condition	Available = 1, not available = 0
6	ROAD_CON	Roadway surface condition	Quality of road surface: good=1, moderate=2, bad=3

7	ADJ_BUILTUP	Type of the adjacent built-up area	Rural = 1, Urban = 2
---	-------------	------------------------------------	----------------------

---

ii. *Index weight calculation*

The pre-identified indices' contribution determines the comprehensive cost on the road section, which is called the comprehensive risk score  $R_i$  (Liao et al., 2022), Equation (4.1). However, these identified risk indices have different weights on the comprehensive risk level  $R_i$ , so the weight of each index was calculated using the objective weight entropy method (WEM).

$$R_i = \sum_{j=1}^m d_{ij} w_j \quad (4.1)$$

Where  $R_i$  is the comprehensive risk score of the  $i^{\text{th}}$  road section ( $i = 1, 2, 3, \dots, n$ );  $d_{ij}$  is the actual data of the  $j^{\text{th}}$  index corresponding to the  $i^{\text{th}}$  road section;  $w_j$  is the weight of the  $j^{\text{th}}$  index.

Several methods can be used to calculate index weights, including subjective, objective, and combined methods (Ding et al., 2017) (Zhu et al., 2020). In the subjective method, the weight is based on the opinion of experts or expert groups representing the views of various stakeholders such as AHP, SWARA, etc. The main problem with the subjective weighting method is the consistency of expert opinions (Zhu et al., 2020). Hence, to avoid the interference of human factors, the objective method was used: The entropy weight method (EWM) (Ding et al., 2017). (Liao et al., 2022) declared that EWM has higher reliability and accuracy than subjective weighting, and it can deeply reflect the distinguishing ability of indicators and determine better weights.

EWM is an important weight model that has been extensively practiced (Liao et al., 2022) (Zhu et al., 2020), and recently used in decision-making (Yan et al., 2016). The EWM evaluates value by measuring the degree of differentiation. The higher the degree of dispersion of the measured value, the higher the degree of differentiation of the index, and more information can be derived. Moreover, a higher weight should be given to the index and vice versa (Zhu et al., 2020). This method is more suitable for describing the impact of abnormal values in restrictions, violence, and physical environment indicators on the severity of the risk on the road section. For example, for several risk indexes, if the value of one index changes greatly while the value of other indexes does not change, it indicates that the index has led to a difference in risk severity, and a greater weight can be taken.

In this method,  $m$  indexes and  $n$  samples are set in the evaluation, and the measured value of the  $j^{\text{th}}$  index in the  $i^{\text{th}}$  sample is recorded as  $X_{ij}$ . It includes the following steps:

- (1) Normalize indexes for the homogenization of heterogeneous indexes:

Positive index:

$$x_{ij} = \frac{x_{ij} - \min \{x_{1j}, \dots, x_{nj}\}}{\max \{x_{1j}, \dots, x_{nj}\} - \min \{x_{1j}, \dots, x_{nj}\}} \quad (4.2)$$

Negative index:

$$x_{ij} = \frac{\max \{x_{1j}, \dots, x_{nj}\} - x_{ij}}{\max \{x_{1j}, \dots, x_{nj}\} - \min \{x_{1j}, \dots, x_{nj}\}} \quad (4.3)$$

(2) Calculate the proportion of the  $i^{\text{th}}$  sample value under the  $j^{\text{th}}$  index (Liao et al., 2022) (Zhu et al., 2020) :

$$P_{ij} = \frac{x_{ij}}{\sum_{i=1}^n x_{ij}} \quad (4.4)$$

$$i = 1, \dots, n,$$

$$j = 1, \dots, m.$$

(3) Calculate the entropy of the  $j^{\text{th}}$  index (Liao et al., 2022) (Zhu et al., 2020):

$$e_j = -k \sum_{i=1}^n P_{ij} \ln(P_{ij}) \quad (4.5)$$

$$j = 1, \dots, m.$$

Where  $K = 1/\ln(n) > 0$ , meeting  $e_j \geq 0$ . The range of entropy value  $e_i$  is  $[0, 1]$ . The larger the  $e_i$  is, the greater the dispersion degree of index  $j$  is, and more information can be derived. Hence, a higher weight should be given to the index (Zhu et al., 2020).

(4) Calculate information entropy redundancy (difference):

$$d_j = 1 - e_j \quad (4.6)$$

$$j = 1, \dots, m.$$

(5) Calculate the weight of each index:

$$W_j = \frac{d_j}{\sum_{i=1}^m d_j} \quad (4.7)$$

$$j = 1, \dots, m.$$

It should be noted that the entropy value of a zero index cannot be calculated in practical application. So, when an index value was zero, a value of 0.00001 was added to the evaluation



index data of this group; adding such a small increment not only enabled the data group to be valid but also ensured a small impact on the difference of each index (Cai et al., 2020).

#### 4.3.3.2. Travel Time

In the single-objective route planning models, most developed algorithms find the optimal routes considering the commonly used metric, travel time (Du & Ding, 2021) (Peng et al., 2022). The primary goal in the single objective route planning model is the fastest route. It is calculated by the given distance between two nodes (Yao et al., 2018). The travel time presents the actual weight of the road segment (AW) as in Equation (4.8) (Sarraf & McGuire, 2020).

$$AW_{(n_i, n_j)} = \frac{\text{Dist}(n_i, n_j) \times 3600}{S(n_i, n_j)} \quad (4.8)$$

Where  $n$  is the node,  $S$  is the maximum speed in km/hour, and 3600 is the number of seconds in an hour.

Having access to sufficient information regarding travel time is of utmost importance for enabling informed decision-making by road users and traffic authorities before and during their journeys. The determination of travel time has been advanced through various data-driven models. For example, (H. Wang et al., 2019) introduced a method known as the neighbor-based approach, which estimates travel time between two points by leveraging historical trajectories of neighboring trips with similar origins and destinations.

Other developed travel time prediction models, including parametric methods such as linear regression (Laoide-Kemp & O'Mahony, 2020), Bayesian Nets (Prokhorchuk et al., 2020), and Time Series models (Serin et al., 2021). Additionally, non-parametric models like Artificial Neural Network models (Mokhtarimousavi et al., 2020) and machine learning methods like K-Nearest Neighbors (J. Zhao et al., 2018), Support Vector Regression (Bachu et al., 2021), and Random Forest regression (Taghipour et al., 2020).

One of the most important factors in choosing a method for estimating or predicting travel time is the available data. Most commonly observed travel time prediction models rely on traffic-related variables to construct their predictive models. These models gather real-time traffic data through various data-capturing devices such as probe vehicles, loop detectors, video cameras, etc. However, some models incorporate additional environmental variables when determining travel time. For example, (Taghipour et al., 2020) introduced factors like weather conditions, road accidents, roadwork, special events, and sun glare into the travel time estimation process.

Nevertheless, when access to real-time and historical traffic data is limited, and mobility restrictions exist, predicting travel time becomes a challenging task. However, this study offers a novel perspective on addressing travel time estimation with limited data availability. It achieves this by determining the travel time by introducing the prediction of waiting times at mobility restrictions ( $T_w$ ) Equation **Error! Reference source not found.** as an innovative approach to overcome these limitations.

$$AW_{(n_i, n_j)} = \frac{\text{Dist}(n_i, n_j) \times 3600}{S(n_i, n_j)} + \sum_{r=1}^b T_w \quad (4.9)$$

The problem of predicting waiting times has been widely studied in queueing theory, which considers customers' waiting times before receiving service in contexts such as banks (Kyritsis & Deriaz, 2019) and health clinic services (Curtis et al., 2017). However, it hasn't been observed in the route planning or in the transportation studies. Various methods have been developed for predicting wait times, including average wait time, queueing theory, and machine learning (ML) models.

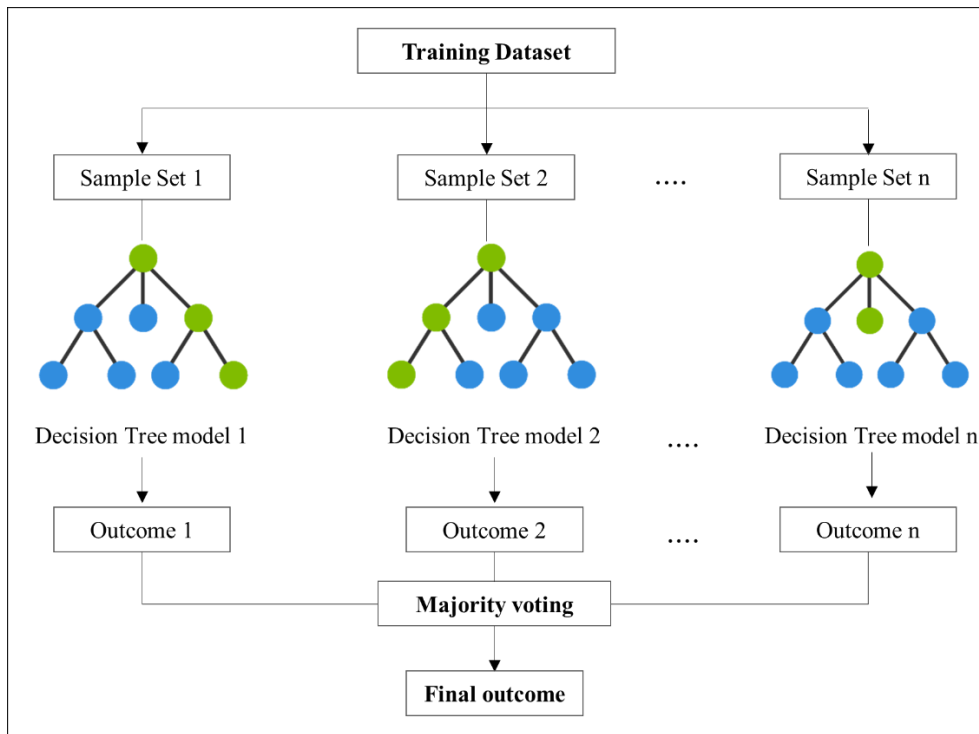
(Sanit-in & Saikaew, 2019) conducted a comparative study for the waiting time prediction approaches, including Queueing Theory, Average time, and Random Forest on two ear nose and throat clinic dataset and the Khon Kaen University post office datasets. The experimental results indicated that the supervised learning algorithm, Random Forest, achieved the highest accuracy at 85.76% of the ear, nose, and throat clinic dataset and 81.7% of the Khon Kaen University post office dataset compared with the other two approaches.

ML prediction models have approved its efficiency and accuracy in dealing with the extreme complexity and randomness of waiting time patterns (Curtis et al., 2017). ML provides efficient data mining and modeling tools, especially for large and imperfect data sets. This study used a random forest regression (RF) machine learning model to predict the waiting time at a restriction using real-time and historical data.

#### *Predicting waiting time at mobility restrictions using Random Forest Regression*

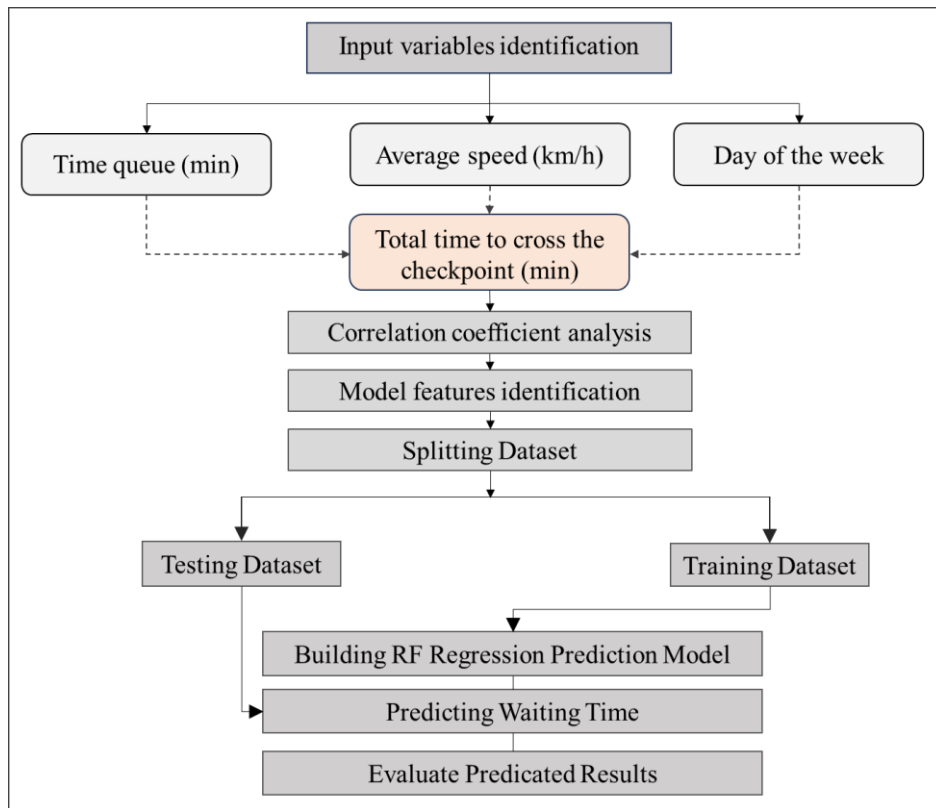
Random forest regression is a supervised learning algorithm used for regression or classification prediction (Anand et al., 2022). The random forest algorithm takes a dataset with input features and corresponding labels or outcomes, and then it creates a large number of decision trees, each using a random subset of the data and a random subset of the input features. Each decision tree independently makes a prediction based on its subset of data and features. When a new data point needs to be predicted, it passes through each decision tree, and each tree provides its prediction. The final prediction is determined by combining the predictions from all the decision trees, usually through voting or averaging (Sipper & Moore, 2021). Figure 4.8 illustrates the workflow of the Random Forest Algorithm.

RF regression method performs better than other machine learning methods, especially when predicting short-period congestion due to an event (Y. Lin & Li, 2020). RF Regression is a suitable algorithm for the border crossing time case and for developing the short-term prediction algorithm (Sharma et al., 2021). (Taghipour et al., 2020) conducted short-term travel time prediction using an Artificial Neural Network, K-Nearest Neighbors, and Random Forest, the results show that RF presents satisfying results compared with other ML models. Randomness in the algorithm helps to prevent overfitting and ensures diversity among the decision trees, leading to more accurate and robust predictions. Also, It has the feature importance technique, using mean decreasing accuracy to evaluate the predictive error and feature significance (Sanit-in & Saikaew, 2019).



**Figure 4.8.** The random forest models

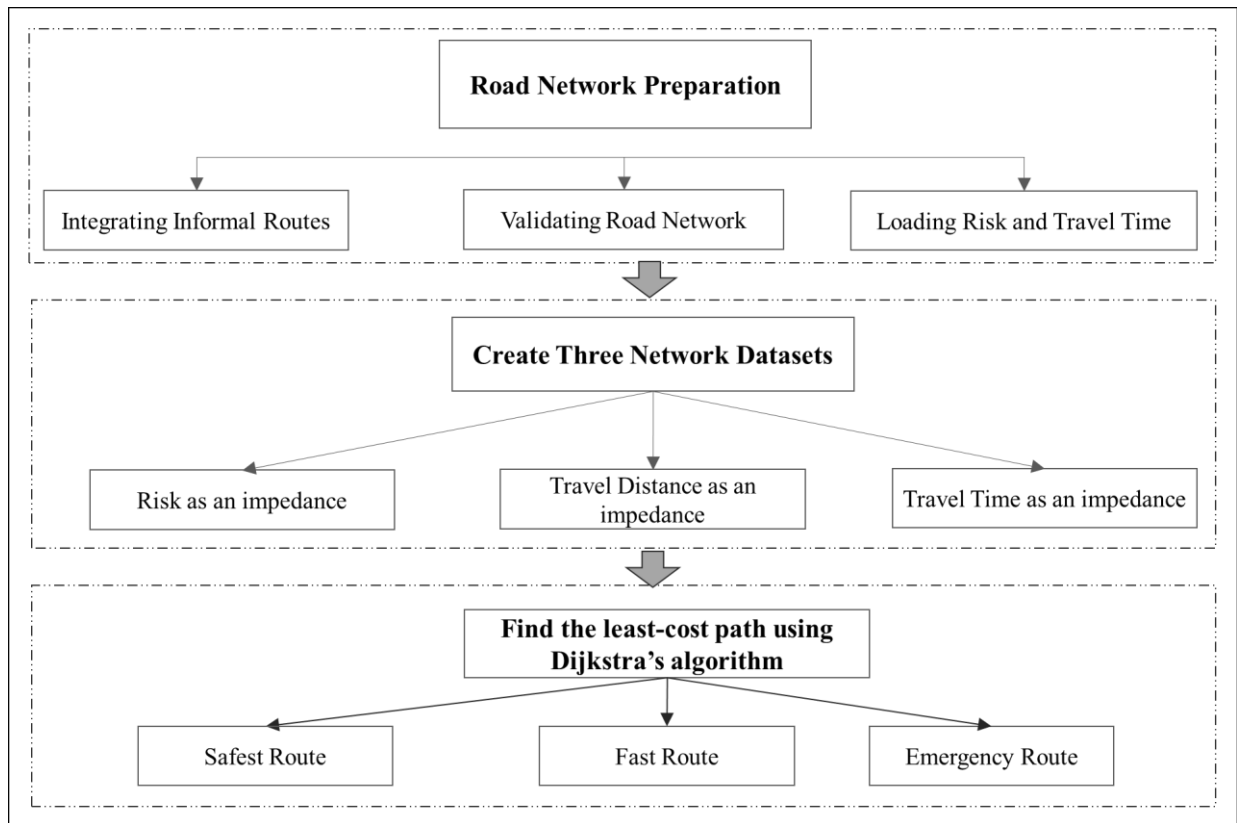
Hence, this study applied RF regression using historical records obtained from an extensive field survey to determine the waiting time at different mobility restrictions. The methodology of creating the RF waiting time prediction model is composed of the following; (i) data cleaning and preparation, (ii) applying correlation coefficient analysis to identify the input variables (model features) based on correlation with the output variable (time to cross the checkpoint); the input variables are the vehicle waiting time at the queue, vehicle speed near 750 m of the checkpoint, and day of the week (iii) building the predictive model by splitting the dataset randomly into a training dataset and testing dataset, RF uses the training dataset to build the predictive model while the testing datasets used predicting the waiting time, and finally (iii) evaluation the predicted outcomes and testing the accuracy of the model. Figure 4.9 illustrates the methodology of creating a waiting time prediction model using RF.



**Figure 4.9.** Methodology of creating waiting time prediction model using RF

#### 4.3.3.3. Construction of Route Planning Model

This section describes the methodology of applying the routing planning model to find multi-categorized routes, Figure 4.10. It includes (i) preparing the road network as a major input in the route planning model; (ii) validating the prepared road network using network topology technique; (iii) loading risk, travel time, and distance parameters to the road network; (iv) building the graph model and applying the Dijkstra's algorithm to find the least risk, travel time, and distance route separately.



**Figure 4.10.** Methodology of building the route planning model

*i. Road Network Preparation*

The routing planning model includes (i) integrating the informal route; (ii) validating and verifying the road network; and (iii) loading the risk and travel time to the road network. Unlike most traditional routing models with a static road network architecture (Noureddine & Ristic, 2019), the road network in this study is updated continuously as it includes the validated informal routes, along with the formal road network. The segments of informal routes will be integrated into the road network to optimize the route planning service by continuously expanding alternative routes that meet user preferences.

*ii. Road Network Validation*

This phase comprises two steps: (i) identifying the permanent prohibited roads and inaccessible due to permanently blockades and prohibition policies, these roads will be excluded from the route planning model to enhance high accessibility and usability to the road networks; (ii) utilizing network topology to ensure the connectivity of network elements, which include nodes and edges essential for the route planning model (S. Ahmed et al., 2017). Network topology serves as a fundamental quality assurance technique (Esri, 2023f) used to identify and rectify errors within network connections. These errors may include dangling edges, overlapping edges, and inaccuracies within the road network.

### *iii. Loading Risk, Travel Time, and Distance*

After verifying the road network, the road segments will be fed by the evaluation parameters used in the route planning model. These evaluation parameters are: (i) the comprehensive score of the risk quantification model ( $R_i$ ), (ii) the determined weighted travel time ( $AW$ ), (iii) the length of the road section ( $Dist$ ); (iv) speed limit for each road section ( $S$ ).

Each evaluation parameter ( $R_i$ ,  $AW$ ,  $Dist$ ) is considered an impedance in the routing planning model. Impedance definition, according to the GIS dictionary (Esri, 2023d) is “a measure of the cost required to traverse a network path or move from one element in the network to another”. Higher impedance values indicate more resistance to movement, and a value of zero indicates no resistance. The optimal path in a network is the path with the lowest impedance, also known as the least-cost path. For instance,  $R_i$  is considered an impedance in determining the safest route, which is the least-cost risk path;  $Dist$  is an impedance in identifying the shortest route, which is the least-cost travel distance path (emergency route); and  $AW$  is an impedance in finding the fastest route, which is the least-cost travel time path.

### *iv. Building the Graph Model and Applying Route Analysis using Dijkstra's Algorithm*

The research methodology was applied to the road graph represented by  $G = (V, E)$ , where  $V$  is the set of nodes, and  $E$  is the set of edges. The graph model was created using the capabilities of ArcGIS Pro 3.1 by creating a network dataset from the previously prepared road network. This step includes assigning the attribute cost (impedance) that will be used in evaluating the most suitable path. However, three network data sets will be created to provide the three categories of alternatives (safest, shortest, and fastest); each network has risk, distance, and travel time costs, separately.

After completing the three network datasets, a suitable path will be found using a modified Dijkstra algorithm to find the least-cost route. Dijkstra's algorithm was applied using ArcGIS Network Analyst (NA) module (ArcGIS Pro 3.1). The ArcGIS NA module has been widely used to derive optimal routes in different studies (Peng et al., 2022) (S. Ahmed et al., 2017) (Sanjeevi & Shahabudeen, 2016).

The Dijkstra algorithm is a widely used algorithm for finding the shortest path from the origin to all other nodes on a weighted graph (E. W. Dijkstra, 1959). Different algorithms have been proposed since Dijkstra such as  $A^*$  (Peter E. Hart, Nils J. Nilsson, 1968),  $D^*$  (Stentz, 1995),  $D^*$  Lite (Koenig & Likhachev, 2002), ant colony optimization (ACO) (Dorigo & Gianni, 1992), Dijkstra's algorithm remains an efficient and effective algorithm for reducing computational time and power needed to find the shortest path (Peng et al., 2022) (Karadimas et al., 2007).

Choosing Dijkstra's algorithm to find routes is justified by its reputation as the most famous algorithm used for this purpose and its deterministic method, which can provide reliable results in a fully observed environment (Peng et al., 2022). It is also suitable for simple route planning objectives such as safety, travel time, and distance. Moreover, recent modifications have been made to the algorithm to improve performance and respect user settings, such as one-way restrictions, restrictions, and barriers, which aligns with the purposes of this study (esri, 2023).

To find the shortest path from a starting location,  $s$ , to a destination location,  $t$ , Dijkstra's algorithm maintains a set of nodes,  $V$ , whose final shortest path from  $s$  has already been computed. The algorithm repeatedly finds a junction in the set of junctions that has the minimum shortest-path estimate, adds it to the set of junctions  $V$ , and updates the shortest-path estimates of all neighbors of this junction that are not in  $V$ . The algorithm continues until the destination junction is added to  $V$  (Rachmawati & Gustin, 2020).

#### **4.3.4. Service Publishing**

This section explains the final step of making the route planning service (RPS) available to users on the SRMS platform. After creating the route planning model, it can be published as a web service on ArcGIS Online. The Share Web Layer tool in ArcGIS Pro facilitates this process by converting the model into a web service that can be accessed over the internet by other applications and users. Once the web service is created, it can be published on ArcGIS Online for integration into the SRMS platform.

Next, the service is configured for public use within the SRMS application. This involves establishing a connection between the SRMS platform application and the web service. The connection requires specifying the web service's URL and adding the necessary authentication settings. Once the service is configured, users of the SRMS platform application can input their starting and ending points, and the application will utilize the service to calculate the optimal route based on predefined criteria in the route planning model. The results are then displayed in the SRMS platform application, alongside other data layers and analysis outcomes, assisting users in making well-informed travel decisions.

#### **4.4. Conclusion**

This chapter presented the methodology for developing the services of the Smart and Resilient Mobility Services platform (SRMS), focusing on three key services: real-time mapping of mobility restrictions and traffic conditions with a notification system, mapping of informal routes, and route planning service. These services are designed to enhance urban mobility performance and safety, promote community resilience and support data-driven decision-making for individuals and transport authorities.

The methodology adopted a systematic approach to address the identified gaps in the literature and introduce novel techniques for developing each service. It began with identifying the data sources and collection methods, which involved real-time crowd-sourced data using the Survey123 crowdsourcing platform, near real-time social media data through the Telegram API, and historical spatial data. These data sources provide information on mobility restrictions, traffic conditions, and the built environment.

The data processing phase involved preprocessing and analyzing the collected data to extract valuable information for delivering optimal services. This included applying various analysis techniques, including machine learning algorithms such as natural language processing and prediction models, routing algorithms, and quantification models. These techniques enable the

extraction of insights from the data and support the development of accurate and effective services.

The last phase of the methodology focused on publishing the services for public use. This involved configuring the accessibility of the services to users by assigning the feature service to support public data collection. This enables users to add or modify their data, contributing to a dynamic and collaborative platform.



# **Chapter 5. Application the Smart and Resilient Mobility Services (SRMS) Platform to the Palestinian Context, West Bank**

## **Introduction**

This chapter shows the practical implementation of the Smart and Resilient Mobility Services (SRMS) platform in the Palestinian territories, specifically in the West Bank. It starts with highlighting the Palestinian coping strategies related to the status de facto of mobility restrictions at national, local, and community scales.

The chapter introduces the application of SRMS in the West Bank, exploring a user-centered design approach using personas and scenario techniques to tailor the platform to the characteristics and users' needs. An online survey targeting Palestinian travelers in the West Bank was conducted to gain insights into their preferences, interests, and willingness to engage with the proposed smart solution. The survey sample provided valuable information about the profiles and travel characteristics of the participants, helping shape the design and features of the SRMS platform.

Furthermore, the chapter highlights the SRMS web mobile app, designed using ArcGIS Experience Builder. It offers services, including real-time mapping of mobility restrictions, and presents data on checkpoints, road gates, settlers' violence, and traffic congestion. Users can report mobility restrictions through the app, providing essential information for visualizing and addressing restrictions in the area. The application of real-time mapping using Telegram data is also explored, demonstrating the utilization of the Telegram Public group as a data source for sharing mobility restrictions and road information.

Furthermore, the SRMS app offers mapping services for informal routes, allowing users to report explored routes directly on the app. The route planning service is another feature of the SRMS app, designed to optimize users' travel with minimal risk, time, and distance cost. It employs a route planning model considering real-time information, historical data, and an external spatial database. The model incorporates a Risk Quantification Model and Weighted Travel Time to find multi-categorized routes based on risk, travel time, and distance factors. The model accurately predicts waiting times and offers efficient routes for travelers in the study area.

### **5.1. Mitigating the Impacts of Mobility Restrictions**

The long-term experience of hard traveling and disruptive traffic due to mobility restrictions has catalyzed various national, local, and individual practices that enhance the resilience of the mobility system. This section discusses these practices to establish strategies that address mobility restrictions.

### **5.1.1. National Level**

The Ministry of Transport (MOT) has prepared the National Road and Transportation Master Plan (NTMP), which aims to develop a vision for the future of the transportation sector in Palestine. The plan addresses economic growth and meets the increasing travel demand by considering spatial, operational, legal, regulatory, and financial aspects (Abu-Eisheh et al., 2020).

The NTMP can potentially address and mitigate the adverse impact of mobility restrictions. It reduces road-based travel time by improving existing roads and introducing new ones where needed, enhancing regional accessibility and alleviating congestion caused by mobility restrictions. It also highlights the importance of separating local and regional traffic to minimize interference and congestion, leading to more efficient transportation flows and reduced delays. Additionally, the plan includes implementing rest areas along major roads, providing necessary amenities, and ensuring traveler comfort and convenience despite the challenges posed by mobility restrictions (Ministry of Transport MOT, 2016b).

In 2018, the Ministry of Transport (MOT), in collaboration with other ministries such as the Ministry of Telecom and Information Technology (MTIT), Local Government (MoLG), Public Works and Housing (MPWH), etc., established a council to develop a strategic framework for Intelligent Transportation Systems (ITS) (Ministry of Transport MOT, 2018). The ITS strategic framework aims to harness technological advancements to address urban mobility challenges such as road safety, traffic congestion, public transport utilization, and pollutant emissions. Although the framework does not directly address mobility restrictions in the West Bank, it recognizes these restrictions as a significant challenge to implementing the framework.

However, some of the strategies proposed in the ITS framework for 2019-2024 will partially contribute to mitigating the adverse impacts of mobility restrictions. These strategies encompass: (i) using advanced systems for public transportation information management to enhance traffic safety, manage traffic congestion, and facilitate passenger mobility, (ii) developing emergency management systems to better respond to events related to transportation and mobility; (iii) encouraging the use of electric and hybrid vehicles as a means to reduce environmental pollution.

Based on previous projects, the proposed national initiatives could mitigate the impact of mobility restrictions in the West Bank. These initiatives encompass national policies to reduce pollutant emissions, develop transportation infrastructure, and improve traffic management. However, these initiatives do not explicitly consider mobility restrictions as a primary challenge. This can be seen as a root for other challenges, such as traffic congestion, pollutant emissions, and safety concerns. To achieve more effective and comprehensive solutions, it is crucial to prioritize the challenges of mobility restrictions within the framework of national transportation strategies.

### **5.1.2. Local Level**

NGOs have played a crucial role in addressing the challenges of mobility restrictions at the local level. They took proactive measures to cope with restrictions and mitigate their impact,

including (i) establishing spatial and statistical databases based on the daily monitoring reports and fieldwork. The databases document the distribution and operation of mobility restrictions, such as checkpoints and road gates, as well as incidents of settlers' violence (B'Tselem, 2022) (OCHA, 2020b); (ii) preparing impact assessment studies to evaluate the consequences of mobility restrictions (ARIJ, 2019a); (iii) advocacy and awareness for the rights of affected communities and raise awareness about the challenges posed by mobility restrictions; (iv) collaborative partnership with local authorities; and (v) international support and funding.

Private sectors and local authorities have also contributed to addressing the challenge of mobility restrictions by collaborating with the Ministry of Local Government (MoLG) to prepare strategic and master plans to develop the transportation infrastructure in the restrictions-affected areas. Palestinian startups have also ventured into developing their applications to share road traffic data, such as *Doroob* (*Doroob*, 2019). This location-based application provides navigation services based on reporting road traffic information, such as traffic crashes and police activity. However, this application is not suitable to be used in the context of sharing mobility restrictions information since it does not explicitly address the reporting of incidents related to mobility restrictions, such as checkpoints, road gates, or settler violence.

The local initiatives show efforts in creating spatial and statistical databases documenting the distribution and operation of restrictions and tailored applications for road traffic data. However, there is a lack of a comprehensive platform or application that addresses and provides real-time reporting and information on mobility restrictions.

### **5.1.3. Community and Individual Level**

This section highlights initiatives to overcome mobility restrictions at the community and individual levels. These initiatives can be classified into two categories. The first focuses on resilience strategies adopted by the community, such as utilizing alternative routes and shared traveling. The second category encompasses innovative solutions driven by advancements in information and communication technology, which is presented mainly in the use of social media.

#### **5.1.3.1. Resilience Strategies: Alternative Routes and Shared Travelling**

Since the Second Intifada, WB witnessed high exposure to interurban mobility interruption due to mobility restrictions, which evoked various shapes of self and collective coping mechanisms to alleviate the severity of restrictions (Wick, 2011).

The collective and individual resilience actions include; (i) alternative routes, where travelers utilize the internal roads within villages and towns to bypass specific checkpoints and reach their desired destinations; (ii) multimodal shift, where individuals switch between different modes of transportation during their journey. This can involve transitioning between public transport, private vehicles, and active modes such as walking, cycling, or animal transportation (UN, 2003).

The third shape of resilience action is (iii) wayfaring, a mode of travel that emphasizes active engagement with the surrounding landscape. It involves traversing informal routes and pathways, including dirt roads, abandoned agricultural routes, hills, fields, and mountains (Bishara, 2015). Wayfaring is contrasted with a purely destination-oriented approach to transportation and emphasizes a more exploratory experience of the territory (Tim Ingold, 2007).

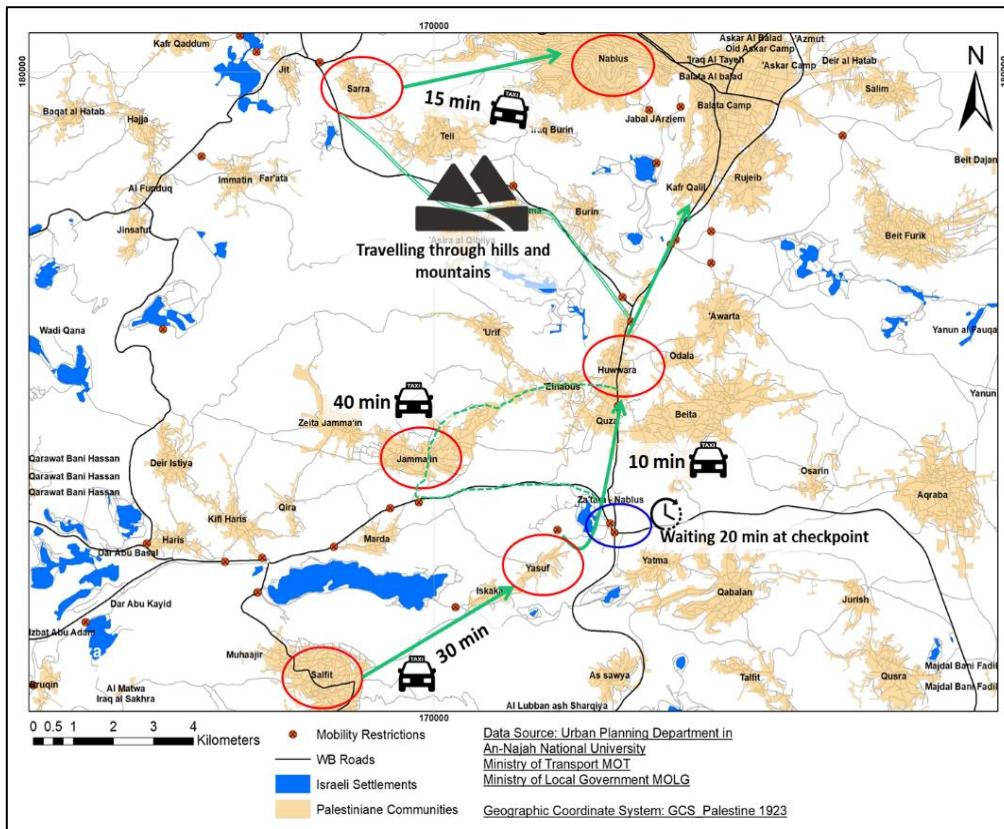
During the Second Intifada, Palestinian travelers experienced severe road closure due to the fixed and flying checkpoints (UN, 2003). So, they must often use informal routes over hills (Bishara, 2015), fields, or dirt routes (Sletten & Pedersen, 2003). The United Nations Office for the Coordination of Humanitarian Affairs (OCHA) documented various case studies highlighting these three coping mechanisms during the Second Intifada (OCHA, 2003), including the journey from Salfit to Nablus.

Before the Second Intifada, the Salfit-Nablus trip could be completed in 25 minutes along Road 60. However, with the implementation of mobility restrictions, the journey time increased to one and a half hours. The new route begins with a 30-minute taxi trip from Salfit to Yasouf earthmound near Tappuah junction. At the earth mound, permit-holders continue to Tappuah, wait 20 minutes at the checkpoint, then take another taxi to Huwwara; this takes 10 min. Travelers without permits take a 40-minute trip along the Jamma'in dirt road to the Huwwara checkpoint (hashed green line). After the checkpoint, they take a 15-minute taxi journey to Nablus or take the 8-kilometer hike through the hills, followed by a 15-minute taxi journey from Sara Road to Nablus. Figure 5.1 illustrates the journey including the three coping mechanisms.

Another resilience action observed among Palestinians was the adoption of shared traveling mode and carpooling to overcome mobility restrictions (Wick, 2011). In response to the challenges posed by mobility restrictions, commuters organized themselves into groups to share a vehicle and reach their destinations collectively rather than individually driving their private vehicles. This approach provided several advantages, including heightened safety and exchanging road knowledge and experiences during road closures.

Shared traveling commonly involves shared taxis, the most frequently utilized mode of public transportation in the West Bank (Ministry of Transport MOT, 2016a). Alternatively, individuals with similar starting points and destinations coordinated their journeys by sharing private vehicles. This enabled convenient planning and coordination while navigating road closures and checkpoints. By traveling together in groups, Palestinians were better equipped to handle the challenges they encountered, offering support and assistance to one another during difficult situations.

While there may not have been an official representative for carpooling or private shared traveling mode in the WB, the practice itself had significant positive impacts. Beyond offering a practical solution to the challenges of individual mobility, it fostered a sense of community and solidarity among travelers. By sharing vehicles and traveling together, Palestinians could establish connections and build relationships with fellow commuters (Bishara, 2015). Commuters shared insights about the best routes, alternative paths to bypass obstacles, and current road conditions. This information sharing enabled individuals to stay informed about potential obstacles and plan their journeys more effectively.



**Figure 5.1.** The route from Salfit to Nablus using an alternative route, multimodal shift, and wayfaring

### 5.1.3.2. Smart Strategies: Using Social Media Platforms

The advancements in ICT, including the availability of 2G and 3G networks, the rise of social media platforms, and the widespread use of smartphones, have enabled the near real-time dissemination of valuable information that can be shared publicly among travelers. In the West Bank (WB), social media has emerged as a recent and effective approach for promptly obtaining road traffic updates and information Champ (youth Media Center, 2023) about mobility restrictions.

Social network sites (SNS) such as Facebook, WhatsApp, and Telegram have become common tools for sharing road traffic and restrictions information in the WB. These platforms allow users to share updates, images, videos, and other relevant content related to road conditions and mobility issues. By leveraging the power of social media and the widespread use of smartphones, travelers can access this information conveniently and stay informed about the current state of the roads. According to (IPOKE, 2022), 74.6% of WB users use social media to be informed about news and recent updates.

In 2019, internet usage in the WB was approximately 2.08 million people, representing around 91.1% of the population aged ten years and above (PCBS, 2020). The widespread accessibility of smartphones is notable, with 72% of the WB population aged ten and above owning smartphones and around 69.3% of households in the WB having internet access through cellular phones (PCBS, 2019). This high level of smartphone usage and internet accessibility creates a significant opportunity for Palestinian travelers to become a valuable source of volunteered geographic information (Tavra et al., 2021) by sharing road traffic and mobility restrictions information through social media platforms like Facebook, WhatsApp, Telegram, and Twitter.

According to (IPOKE, 2022), Facebook and WhatsApp are WB's most popular social media platforms regarding user engagement, with approximately 92% of internet users utilizing Facebook and 90% using WhatsApp. Regarding sharing information about road traffic and mobility restrictions, Palestinian social media users have gradually shifted their preferences based on the recent updates and features offered by different platforms. Several key principles contribute to achieving users' trust and satisfaction, including:

- Privacy, since sharing road traffic and mobility restrictions information can sometimes involve sensitive details; users seek platforms ensuring that their shared information remains secure and accessible only to the intended audience.
- Organized Architecture. The ease of finding recent updates becomes essential for users seeking real-time information about road conditions and mobility restrictions.
- Wide Reachability. The ability to reach a broad audience is crucial for disseminating information on road traffic and mobility restrictions.

In the case of Facebook, users find that Facebook becomes an unsuitable platform for sharing road traffic and mobility restrictions information for several reasons. Firstly, the reach of shared information on Facebook is subject to algorithms that control visibility (Bucher, 2012). This means that the reach of shared content, including sensitive information, can be restricted, resulting in reduced effectiveness in disseminating information. Palestinian content has experienced numerous violations, with 52% occurring on Youth (youth Media Center, 2023).

Additionally, Facebook's features, such as public and private groups, may not be optimal for sharing real-time updates, including information on mobility restrictions. Users may need to refresh their news feeds manually or rely on notifications, potentially causing delays in accessing critical information. Moreover, Facebook's privacy settings and restrictions can limit the accessibility of road traffic updates. Also, information shared within closed or private groups may not reach a wider audience or individuals who could benefit from the updates (Facebook Help Center, 2023).

Given the limitations of Facebook, alternative social media platforms such as WhatsApp have become famous for sharing information about road traffic and mobility restrictions. WhatsApp offers features that prioritize privacy, including end-to-end encryption of messages and calls and a message disappearing feature (WhatsApp, 2022). It also provides real-time updates through instant messaging (Purkayastha & Chanda, 2018), allowing users to share text, photos, videos, and voice messages. As a result, Palestinian small groups are formed among frequent commuters, sometimes dedicated to sharing traffic information for specific origin-destination routes or roads.

While WhatsApp offers instant and private traffic data-sharing advantages, it is also subject to certain limitations. These include a group size limitation, with a maximum limit of 1024 members per group (Schroeder, 2022). This constraint can pose challenges when attempting to reach a wider audience. Additionally, WhatsApp's search capabilities are limited, making it difficult to find specific information within large group conversations quickly. Retrieving past updates or obtaining specific details about road closures or alternative routes may be time-consuming and inefficient.

In late 2013, the Telegram App was officially launched for public use, and simultaneously, a new public channel dedicated to sharing road traffic information and mobility restrictions emerged in WB. This led to a collective migration from WhatsApp to Telegram; the interaction rate with the Telegram application reached 37.3% of the total internet users in Palestine (IPOKE, 2022), indicating a significant adoption compared to other social media platforms. For example, in the public Telegram group, the members reached 81,000 users quickly. Figure 5.2 shows the statistics of a public Telegram group for sharing road traffic and mobility restrictions.



**Figure 5.2.** Increase in the Telegram group membership for sharing road traffic news and mobility restrictions, (Ahwaltareq, 2022) adapted by the author

Telegram's popularity in Palestine is attributed to its capacity to address the shortcomings of other platforms. Unlike Facebook, Telegram provides better privacy protection, minimizing concerns about information leakage and content restrictions. Additionally, Telegram overcomes WhatsApp's limited group size limitation, allowing for better organization and larger-scale information sharing. Moreover, Telegram offers improved search capabilities, making it easier to locate and retrieve specific information within conversations (Khaund et al., 2021). Therefore, using Telegram for sharing road traffic information is marked as the most organized and effective action to cope with mobility restrictions in the West Bank.

Generally, using social media to share road traffic and mobility restrictions has limitations, including limited access to geolocated data as most of the transmitted data is textual or image-based, limited coverage as the data is limited to users who actively participate in the groups and chats, lack of structure, which makes it challenging to gather and analyze data consistently, and limited data analysis since social media groups and chats do not provide transportation authorities with a centralized platform to collect and analyze road traffic data. This makes it challenging to monitor traffic patterns and make informed decisions about traffic management.

The previous discussion revealed that despite the technological capacity of individuals and communities in the Palestinian territories, humble efforts were dedicated to using smart technologies to tackle the challenge of mobility restrictions. No platform or application was developed to comprehensively address this issue, which could provide mobility services during the restrictions event. Hence, the methodology of developing smart solutions presented in the smart and resilient mobility service (SRMS) platform will be applied in the Palestinian territories, West Bank, as will be elaborated in the following section.

## **5.2. Application of SRMS in West Bank, Palestine**

### **5.2.1. Overview**

The application of the Smart and Resilient Mobility Services (SRMS) platform in the West Bank's mobility system is driven by the ongoing high mobility restrictions and their significant impact on the population's lives. These restrictions result in long travel distances, delays, safety concerns, and adverse socioeconomic and environmental consequences. By implementing SRMS, the aim is to alleviate the negative effects of mobility restrictions and enhance the resilience and well-being of interurban mobility in the region.

The West Bank possesses several factors that make it suitable for successfully implementing a spatial crowdsourcing application like SRMS. Firstly, there is high accessibility to smartphones, with approximately 72% of the West Bank population aged 10 and above owning smartphones equipped with GPS sensors (PCBS, 2019). Secondly, there is a significant level of digital knowledge, with 51.4% of the population capable of sending photos and videos via the Internet. Thirdly, there is high accessibility to the Internet, around 91.1% of West Bank residents aged 10 and above use the Internet at least once a day, with approximately 98% accessing the Internet through smartphones. Fourthly, cellular internet access is widely available, with around 35.4% of WB residents connected to Third-generation mobile phone networks (3G), and 34% connected through Israeli cellular companies (PCBS, 2019).

### **5.2.2. SRMS User-Centered Design**

This section highlights the application of the user-centered design (UCD) approach using personas and scenario techniques. An online survey was conducted in early 2021 to implement this approach, targeting Palestinian travelers in the West Bank. The decision to use an online



survey was driven by several factors, including the physical distance of the researcher from the study area, cost-effectiveness, convenience, high accessibility, and the ability to ensure data accuracy (Braun et al., 2021).

This survey aimed to investigate information about the SRMS potential users from different perspectives (Sim & Brouse, 2015), including; (i) personal profile (age, education, profession, etc.), (ii) traveling characteristics including (cost, frequency, time, and mode); (iii) travelers need and preparedness, this includes (traffic information sources, cellular internet access, main mobility issues, interests in smart solutions to overcome these issues, willingness to engage with the proposed solutions). This will tailor the design and features of the proposed smart solution.

The survey sample size was determined based on the population size, expected proportion, and desired confidence level to achieve a representative sample that can generalize the findings to the larger population. For this study, the population for this survey consists of Palestinian interurban travelers experiencing mobility restrictions while traveling for working or studying purposes in the West Bank.

Finding the proportion of commuters in the WB excludes travelers from Jericho and Jerusalem due to limitations in obtaining information. In addition, it excludes the commuters to the settlement and Israel since the study focused on interurban mobility in the WB. Hence, the population size was reported to be 592,966, which formed a proportion of 9% according to statistics obtained from the Palestinian Central Bureau of Statistics (PCBS, 2022b). Based on these parameters, the survey sample size was calculated to be 126 to ensure a 95% confidence level. This means that if the survey was repeated multiple times, 95% of the time the results would fall within a certain margin of error, providing reasonable confidence in the findings.

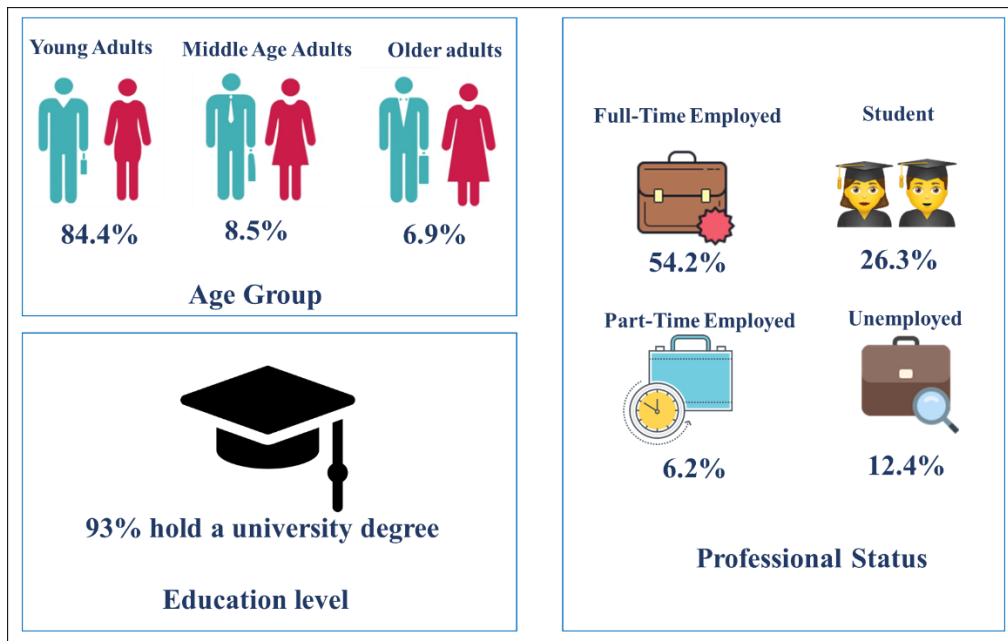
Around 185 responses were collected and preprocessed. Preprocessing involved eliminating incomplete and inconsistent responses. By removing these responses, the dataset was refined to include only valid and reliable data, 129 responses.

#### 5.2.2.1. Travelers profile

The survey sample is classified into three age groups, including (i) young adults aged 20-35, accounting for 84.4%, (ii) middle-aged adults aged 36-55, make up 8.5% of the sample, while (iii) older adults aged 56 and above comprise 6.9%. Regarding the educational level, the majority of the sample, 93%, have a university education, while 7% have finished secondary school. The professional status could be summarized as more than half are full-time, 54.2%, 6.2% are part-time, and 12.4% are unemployed. Around 26.3% of the sample consists of students. Figure 5.3 shows the travelers' profile information.

From the general profile, the sample comprises mainly active young adults, well-educated and working professionals. This means that this category has specific preferences and expectations compared with other age groups when tailoring the design and features of the SRMS platform. They are typically enthusiastic, familiar with smart technology, and comfortable with digital platforms. These characteristics refined the design and features of the proposed SRMS platform. It should include intuitive user interfaces, interactive elements, mobile compatibility,

social sharing capabilities, and easy navigation and access to its features even with limited time.



**Figure 5.3.** Participants personal profile

#### 5.2.2.2. Traveling characteristics

Figure 5.4 shows the traveling characteristics, including traveling cost, time, frequency, and mode of transportation. Most of the sample, 62.9%, commute at least once per week: 39.6% traveling daily and 23.3% traveling weekly. 14% of the sample reported traveling monthly, while 23.1% traveled less frequently than that.

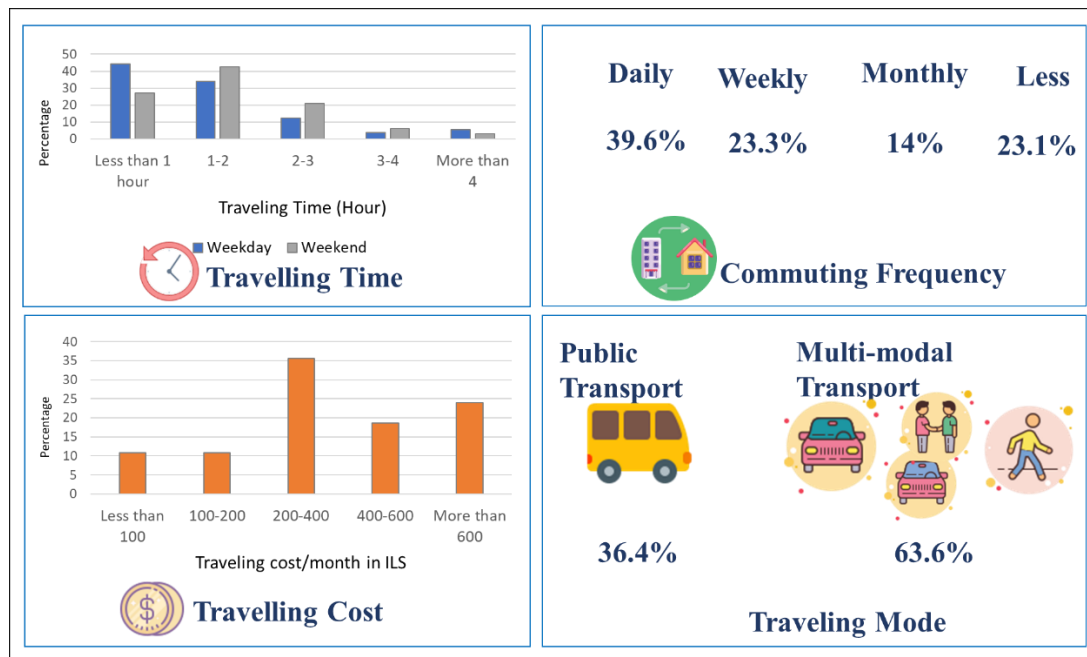
Regarding traveling time during weekdays, 44% of the sample reported traveling for less than an hour. This percentage decreases to 27% during weekends. Approximately 34% of the respondents spend 1-2 hours traveling on weekdays, which increases to 42.6% during the weekend. For 12.4% of the sample, weekday traveling time exceeded 3 hours, while it reached 21% during weekends. Around 9.2% traveled more than 3 hours, with a similar percentage on weekends.

The traveling cost could be classified into four categories, including (i) majority spending range, forms 35% who are spending between 200-400 ILS, which could be considered moderate travel cost; (ii) higher spending range, around 24% of the sample spends more than 600 ILS, which is considered expensive commute, (iii) intermediate spending range, around 18.6% spend between 400-600 ILS; (iv) lower spending range, forms 21.6% of the sample spend less than 200 ILS. Overall, these findings indicate that the survey sample exhibits varying traveling costs.

Regarding the traveling mode, around 36.4% used public transportation only, including (bus, shared taxi, and cab taxis), while the majority used multi-modes, including private cars,

carpooling, public transport, and active modes with variate percentages 44.8%, 28.7%, and 15.1%, and 11.4% respectively. These findings indicate that the survey participants utilize diverse transportation modes, with multi-modal travel being the most common approach.

These findings indicate that most participants regularly travel either daily or weekly. Also, results show that the commuting times differ between weekdays and weekends, with longer commutes during weekends. This suggests that the platform features should provide continuous information for travelers, such as real-time information on traffic conditions and route planning, which helps optimize traveling time effectively. Additionally, when designing the SRMS platform, it's important to consider the needs of users who engage in multi-modal travel, providing features that facilitate planning and coordination across different modes.



**Figure 5.4.** Participants traveling characteristics

### 5.2.2.3. Travelers' interests and willingness

This section investigates participants' interest in urban mobility issues and the proposed solutions. Some of these are related to the SRMS objectives. This will provide insight into the participants' expectations. Also, this section investigates the participants' willingness to interact with the proposed solution. The platform features were included among these solutions, such as using the mobile app for real-time information about mobility restrictions.

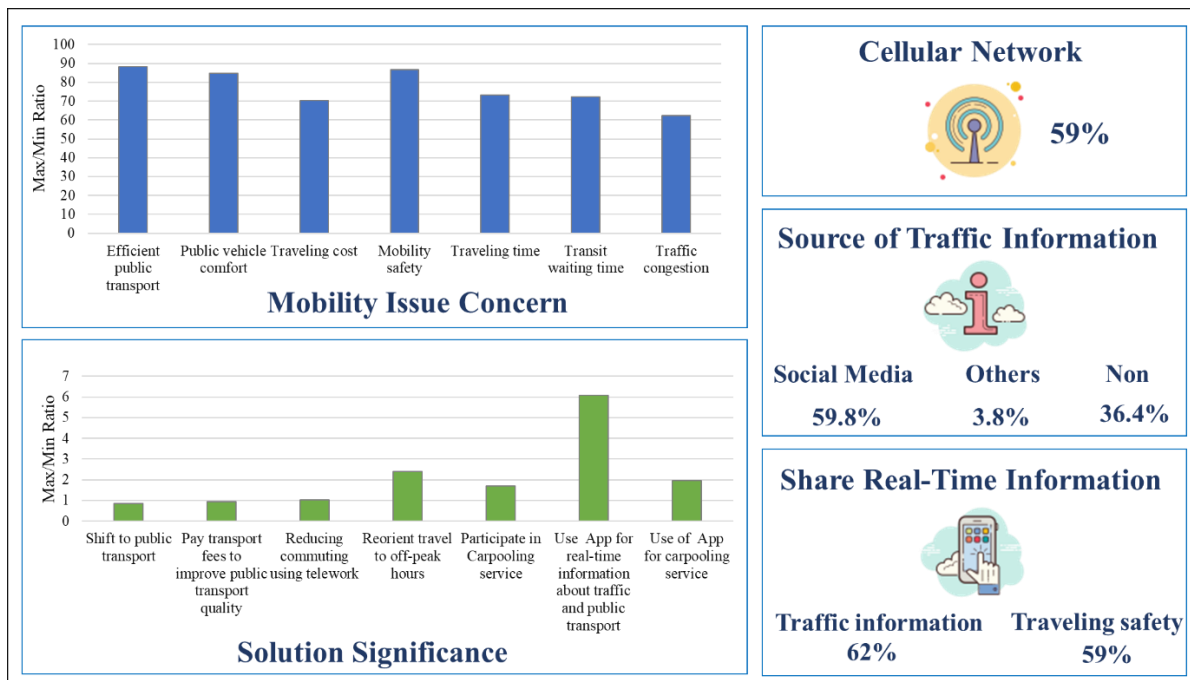
The survey used a significance ranking approach, ranging from 1 (less significance) to 5 (high significance). However, considering the frequency of responses and the proximity of results, the maximum-to-minimum value ratio was considered. The outcomes are depicted in Figure 5.5. The participants' viewpoint reveals that the most mobility concerns are efficient public transport and comfort, traveling safety, traveling time, and waiting time at transit public

stations. Subsequently, there is a notable emphasis on the importance of real-time information about traffic and public transport.

Based on the ranking of significance solutions, the notable solution identified by participants is the need for a mobile app that can provide real-time information about traffic and public transport. Approximately 73% of the participants rated this solution highly significant, with ratings of 4 and 5. Regarding the participants' preparedness for these proposed solutions, more than half (59%) own smartphones, indicating a high level of technological readiness to utilize mobile apps for urban mobility purposes.

Furthermore, 62% expressed willingness to share real-time traffic information, while 59% were willing to share traveling safety information. This indicates a positive attitude towards actively participating in providing and receiving relevant information to improve the overall urban mobility experience.

Additionally, the study found that no common mobile app is used for providing real-time information. Instead, approximately 60% of participants rely on social media platforms for accessing such information.



**Figure 5.5.** Significance of mobility issues and proposed solutions from participants' points of view

### 5.2.3. SRMS Mobile Web App

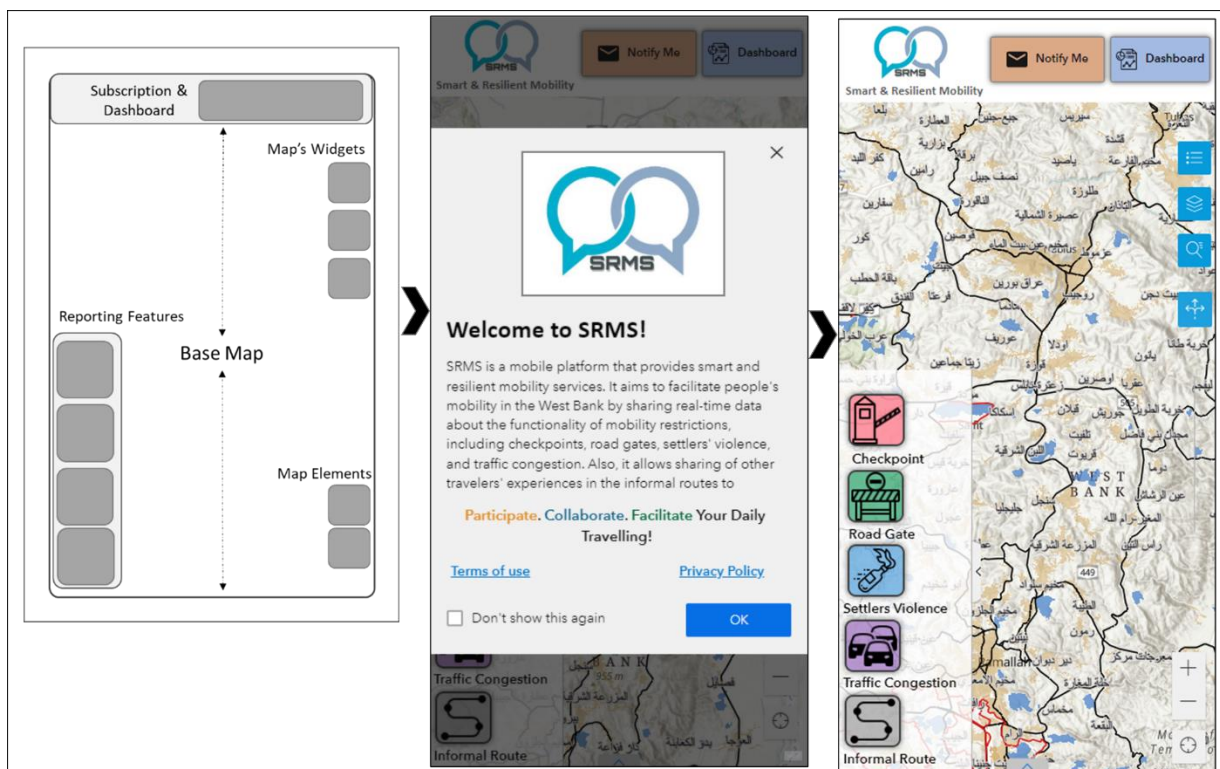
The SRMS was designed using ArcGIS Experience Builder. This user-friendly web development platform allows users to create and share web applications, maps, and dashboards without extensive coding knowledge (Esri, 2023a). While there exist alternative solutions for crafting web applications for data visualization, such as Google Data Studio, Bubble, and

Mapbox, these options do come with certain limitations. They may lack the capability to perform geospatial analysis tasks and efficiently retrieve and integrate GIS data. On the other hand, Esri's ArcGIS Online offers several web application builders, including Web AppBuilder, as well as other configurable applications. However, it's worth noting that ArcGIS Experience Builder stands out in its ability to efficiently create customized widgets and seamlessly integrate with ArcGIS Survey123.

ArcGIS Experience Builder is a compatible design solution due to the following capabilities; (i) providing the principles of Progressive Web Apps (PWA), including flexible, responsive design framework and modern interactive interface based on widgets, (ii) providing mobile optimization with the mobile adaptive design; (iii) easily integrated with the GIS data to provide location-based services; (iv) engage user in real-time through configurable widgets that can interact with data and content to optimize the end-user experience.

The design of the SRMS web mobile app was based on the user-centered design (UCD) approach and interaction model (MoLIC) that was previously explained in the methodology. The first version of the web mobile app was created and shared with a sub-group of potential users to receive their comments and recommendations. Considering their feedback, the final version of SRMS was designed. The architecture of the SRMS UI design is depicted in Figure 5.6 The user interface was designed as a foldable template featuring a simple interface focused on the map.

Using the ArcGIS Experience builder, the architecture of SRMS UI was converted into a real-web mobile application, as illustrated in Figure 5.6. The main components and features of the application are the following:



**Figure 5.6.** The final version of SRMS UI architecture and the real application

- The anchored welcoming window provides the users with a summary of the SRMs platform and its objectives, and it includes the terms of use (SRMS, 2023b) and privacy policy (SRMS, 2023a) as a privacy and quality protocol in the SRMS app, Figure 5.7.
- Base Map: SRMS basemap is a web map with various geographical elements sourced from an external spatial database. These elements include a topographic map of West Bank (WB), Palestinian communities, WB road networks, Israeli settlements, prohibited roads (Israeli roads), fixed mobility restrictions, tunnels, and the separation wall, as illustrated in Figure 5.8.

The sources of these elements were obtained from open and authoritative sources. Open sources such as the Israeli Information Center for Human Rights in the Occupied Territories (B'TSELEM) and The United Nations Office for the Coordination of Humanitarian Affairs (OCHA) both sources are non-profit organizations for monitoring the violation of human rights in the WB. The authoritative sources are presented in the Ministry of Transport (MoT), Ministry of Public Work and Housing (MPWH), and the Geospatial web mapping application of the Ministry of Local Government (Geomolg) (Geomolg, 2012).

The basemap provides an informative environment and acts as a repository for the spatial database, with updated attributes (back to the year 2018) for each element that can assist decision-makers in planning development. Table 5.1 shows the data of the SRMS base map, source attributes, and formats.

**Table 5.1.** Basemap data, sources, attributes, and formats

<b>Geographic element</b>	<b>Data Source</b>	<b>Attributes</b>	<b>Data Format</b>
WB Road	MoT, MPWH	Name, start and end, classification (local, regional, main), length, width, governorate, technical specification (expansion, maintenance, pavement, lighting, traffic signal, painting, notes), detection date.	Esri linear Shapefile: SHP.
Palestinian Communities	GeoMoLG	Name, governorate, area.	Esri polygon Shapefile: SHP.
Israeli Settlement	GeoMoLG	Name, governorate, population, establishment year, area.	Esri polygon Shapefile: SHP.
Mobility Restriction	OCHA, B'Tselem	Name, type (checkpoint, flying checkpoint, road gate), governorate.	Esri point Shapefile: SHP.

Separation Wall	OCHA	Status, type (fence, concrete), length.	Esri linear Shapefile: SHP.
Tunnel	MoT	Name, description, status.	Esri point Shapefile: SHP.

---

- **Reporting Features:** Widgets designated for reporting different types of mobility restrictions, including checkpoints, road gates, settlers' violence, and traffic congestion. It also allows reporting of informal routes. These reporting widgets are linked to the spatial crowdsourcing tool, ArcGIS Survey123, enabling the mapping of reported mobility restrictions and informal routes.
- **Maps widgets:** Widgets used for interacting with the map, such as a legend, basemap layers, search functionality, and a direction widget. The direction widget enables route planning with three different categories: safest, fastest, and emergency routes.
- **Subscription and dashboard buttons:** Located in the upper panel, the subscription button allows users to subscribe to the Restriction Notification System (RNS). The RNS is connected to a form-centric data system that collects users' information, such as their interest restrictions and email addresses. The dashboard button leads to an informative web page displaying a summary of the reported data during the day and the temporal distribution of traffic congestion.
- **Map elements:** Necessary map tools for facilitating the navigation with the basemap, including zooming in and out and detecting the user's current location.

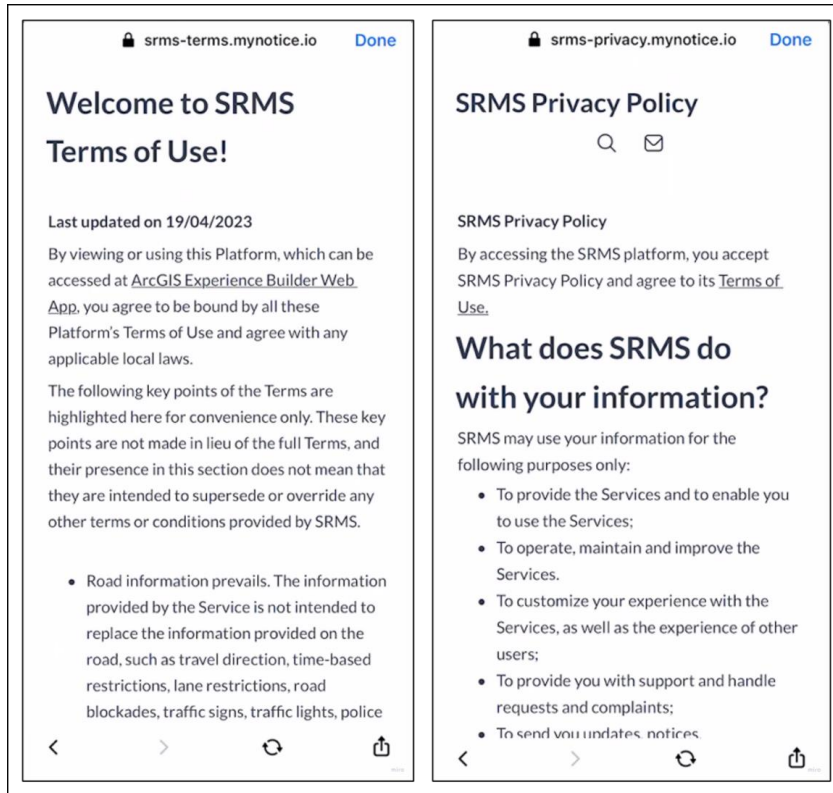


Figure 5.7. SRMS terms of use and privacy policy

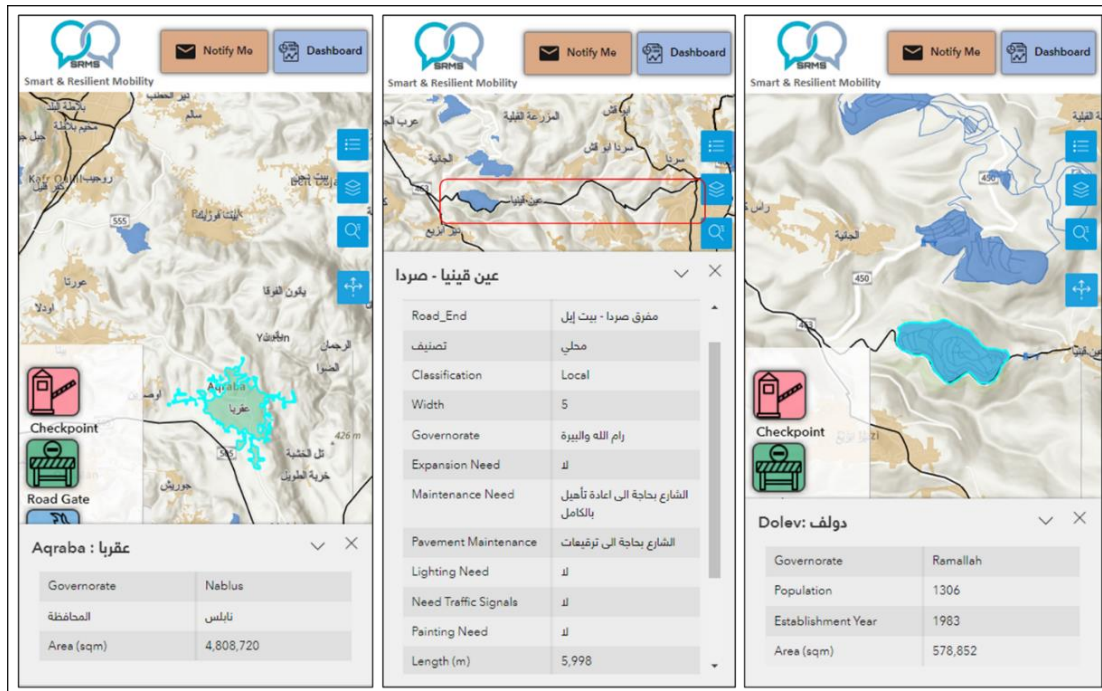


Figure 5.8. Basemap data attributes



## 5.2.4. SRMS Services

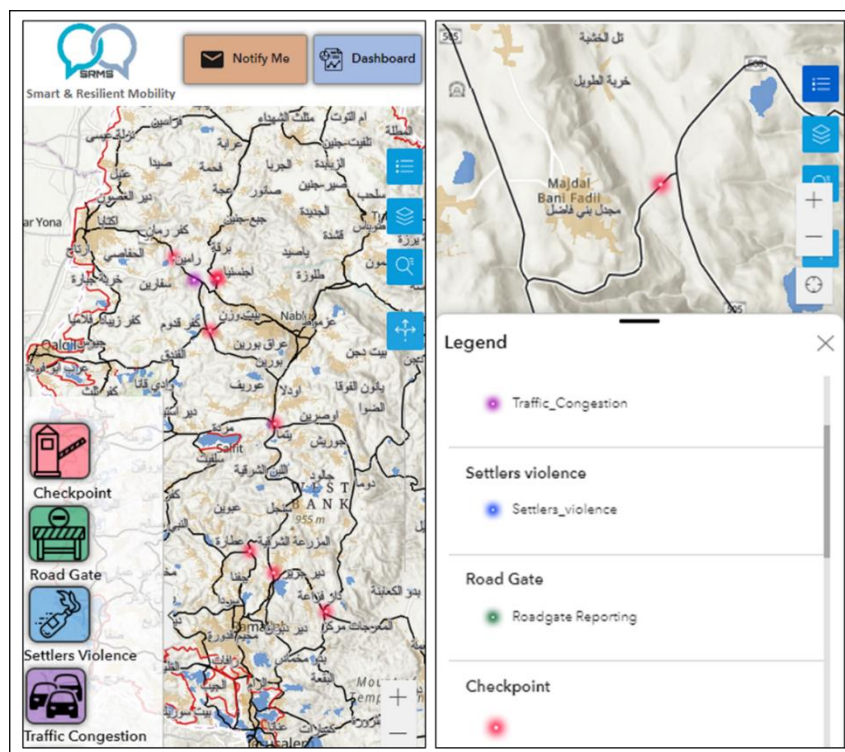
This section focuses on SRMS services, including (i) real-time mapping of mobility restriction and notification system; (ii) mapping the informal routes; (iii) route planning service.

### 5.2.4.1. Real-Time Mapping of Mobility Restriction and Restriction Notification System (RNS)

The real-time mapping of mobility restrictions relies on collecting event descriptions, locations, and times from data obtained through the SRMS mobile application and Telegram data. The first subsection of this chapter demonstrates the real-time mapping of restrictions using the SRMS platform. The second part presents the application of real-time mapping of mobility restrictions using Telegram data. The third subsection introduces a validation technique for real-time mapping using Telegram data. The final subsection discusses the implementation of the Restriction Notification System (RNS).

#### *i. Real-Time Mapping of Mobility Restriction Using SRMS web mobile app*

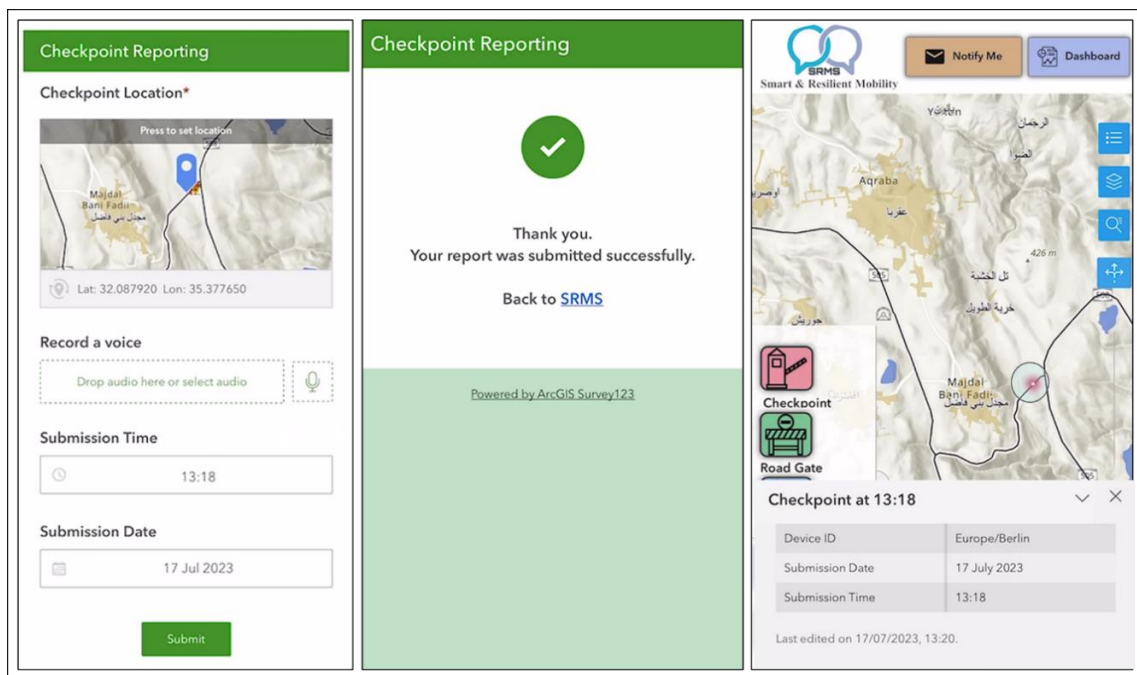
Users can access the mapping service by visiting the SRMS, where reported data is visualized with custom colors based on the event types (checkpoint: red, road gate: green, settlers' violence: blue, traffic congestion: purple) as shown in Figure 5.9. The map displays real-time events reported by users and remains visible for 24 hours before being removed. Users can zoom in and out of the map to view events at different scales and filter events by type using the interactive layer widget on the right side of the screen.



**Figure 5.9.** Reported mobility restrictions

To report a mobility restriction, users can select one of the restriction-type icons provided in the reporting features of the SRMS platform. This action will redirect them to a reporting page developed using ArcGIS Survey123. The reporting page captures essential information about the mobility restrictions, including the restrictions' description, location, and time.

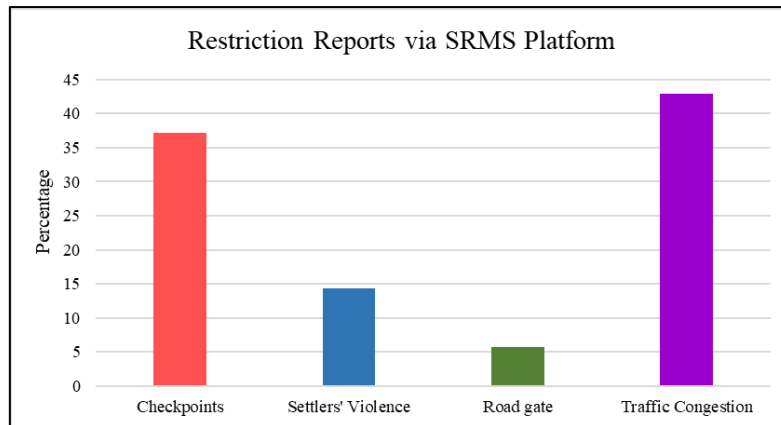
The reporting page is designed to minimize user intervention. The date and time fields are auto-filled with read-only features to ensure the accuracy of timestamp data. This reduces the chances of user error or manipulation. Additionally, with the user's permission, the location field is auto-detected based on the GPS mobile data. This feature saves users from manually inputting their location and helps ensure the accuracy of the reported event's location information. Figure 5.10 visualizes this reporting page and its features. Additionally, users can record a voice note to provide additional details about the reported event.



**Figure 5.10.** Reporting page, submission confirmation message, and reporting results in SRMS application

ii. *Validation of Real-Time Mapping of Mobility Restriction Using SRMS Data*

Although the SRMS platform has not been officially released to the public, it was shared with a group of daily commuters experiencing various mobility restrictions for a two-week for service validation purposes. During this time, the platform received 35 reports related to checkpoints, settlement violence, road gates, and traffic congestion. The distribution of these reports is depicted in Figure 5.11.

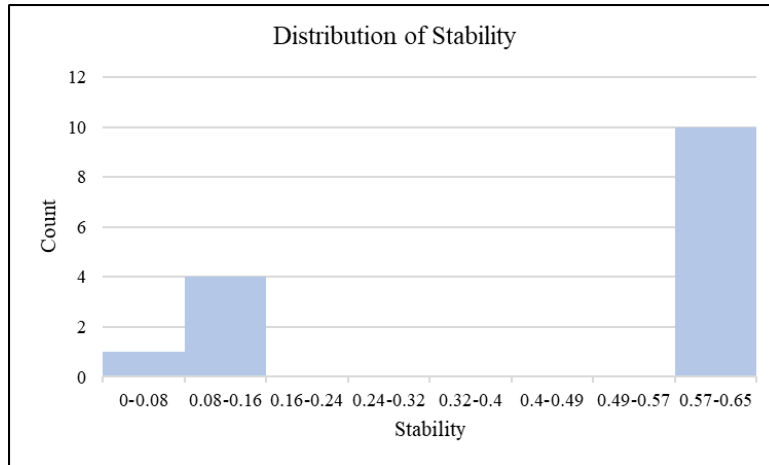


**Figure 5.11.** Restriction reports submitted to the SRMS platform

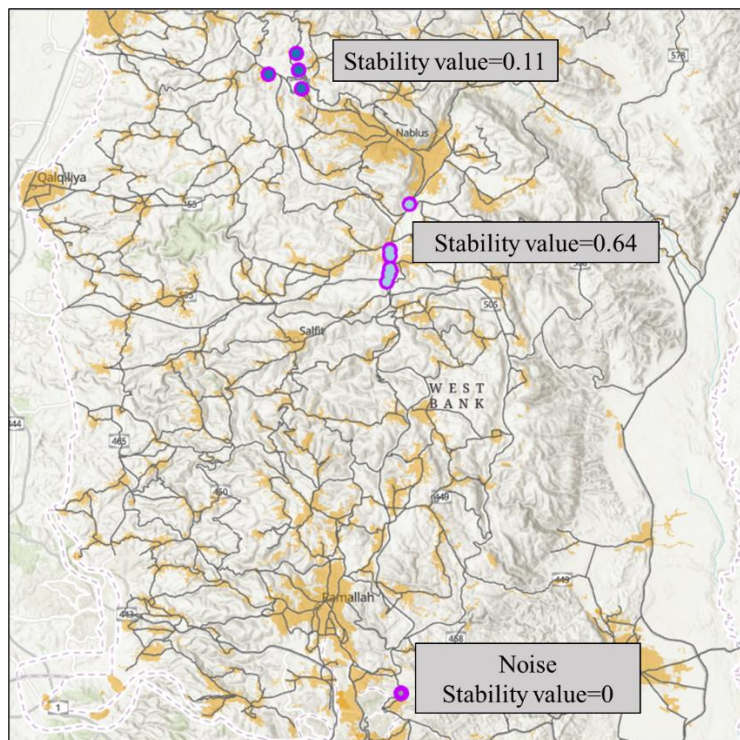
The validation of these reports involved the application of two data quality assurance methods: the spatial clustering method and the third-party database method. The spatial clustering method was used for reports related to traffic congestion, while the third-party database method was applied to reports related to checkpoints, road gates, and settler violence. Both methods were implemented using the geoprocessing capabilities of ArcGIS Pro 3.1.

For the spatial clustering of traffic congestion reports, the HDBSCAN (Hierarchical Density-Based Spatial Clustering of Applications with Noise) algorithm was employed (Ye et al., 2021). This method constructs a hierarchy of clusters with varying levels of granularity, ranging from fine-grained to coarse-grained clusters. HDBSCAN utilizes a cluster stability measure to determine the optimal number of clusters within the data. This measure assists in identifying clusters that are robust and well-defined, while clusters that fail to meet the stability criteria are classified as noise (L. Wang et al., 2021).

The analysis results indicated the presence of two main clusters and one noise. The first cluster, characterized by a high stability value of 0.64, comprised 10 submitted reports, accounting for 67% of the total reports. The second cluster, with a stability value of 0.11, consisted of 4 reports, representing 27% of the submitted reports. The remaining 6% of the submitted reports were classified as noise, as depicted in Figure 5.12, and visualized in Figure 5.13. It is worth noting that while the analysis focused on spatial clustering, the inclusion of temporal aspects in the analysis was limited due to the availability of data. In future work, once the platform is launched for public use, the spatiotemporal analysis will be conducted.



**Figure 5.12.** Distribution of stability of observed clusters



**Figure 5.13.** Spatial clustering of traffic congestion reports

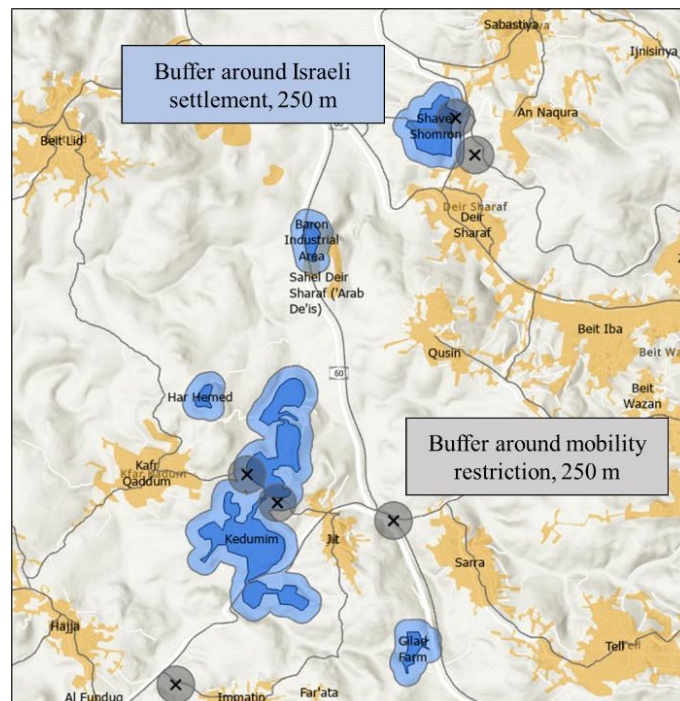
For the third-party spatial database method, the spatial distribution of fixed and temporary checkpoints, road gates, and settlement polygons served as the spatial reference for validating SRMS reports related to checkpoints, road gates, and settler violence. Given the available SRMS data, this method was deemed sufficient for validating the real-time mapping of mobility restrictions.

The validation process began by creating a buffer zone around each type of referencing mobility restriction and Israeli settlements, as depicted in Figure 5.14. The purpose of this buffer was to define an acceptable spatial distance within which each report should fall to be considered valid. This distance depends on various factors, including stopping distance and

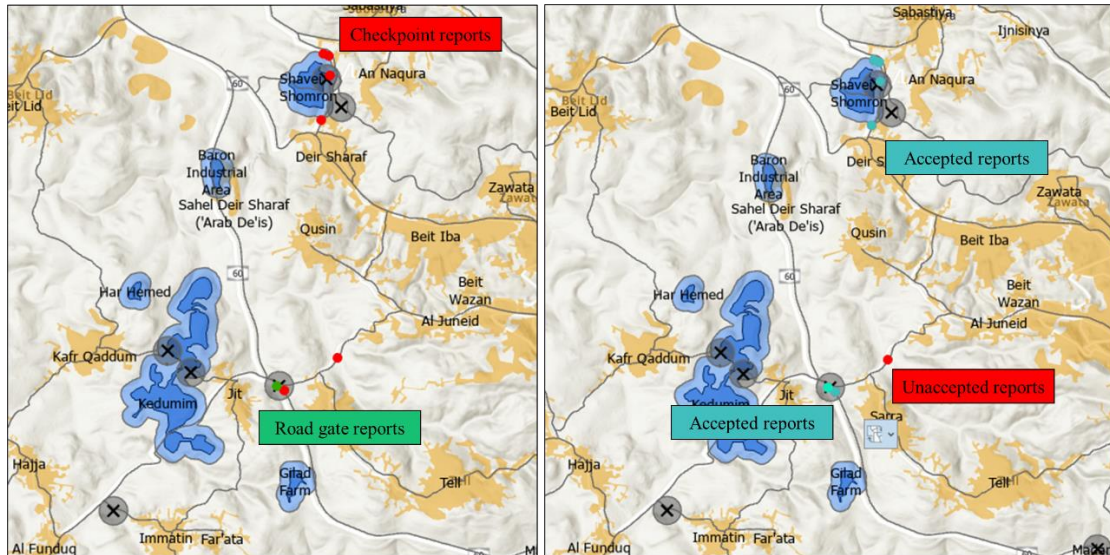
visibility conditions that influence drivers' or passengers' perceptions. In this particular study, the buffer distance was set to 250 meters from both the mobility restrictions and settlements. As a result, reports located within this buffer zone or touching its boundaries in relation to the mobility restrictions were deemed validated reports, Figure 5.15.

The analysis results for the 20 submitted reports reveal that (i) for checkpoint reports, 11 out of 13 reports were located within the accepted buffer distance, representing an 85% validation rate; (ii) for road gate reports, all three submitted reports were located within the accepted buffer distance, resulting in a 100% validation rate, (iii) regarding settler violence reports, only one out of four reports were located within the buffer distance, accounting for a 25% validation rate.

It's worth noting that the lower validation rate for settler violence reports may be attributed to the nature of the restriction being assessed, as settlers typically have a mobile nature, which differs from the fixed and stationary nature of road gates or checkpoints. This mobility can make it more challenging to accurately capture and validate reports related to settler violence.



**Figure 5.14.** Buffer area with radius 250 around the reference mobility restrictions



**Figure 5.15.** Results of the validation process for checkpoint, and road gate reports

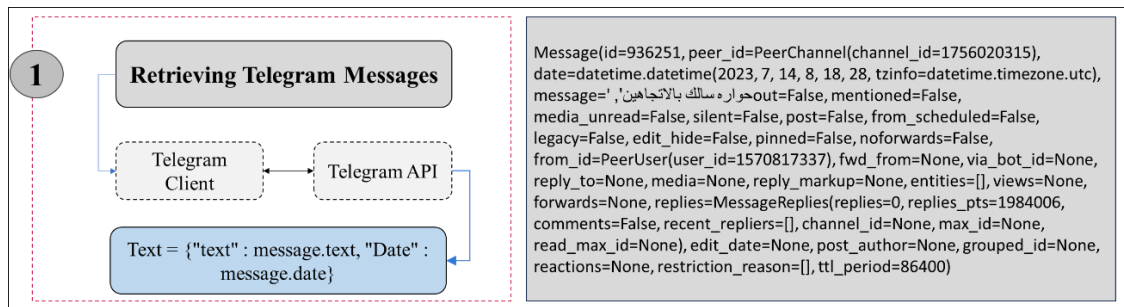
iii. *Real-Time Mapping of Mobility Restriction Using Telegram Data*

The application of real-time mapping of mobility restrictions using Telegram data involves using the Telegram Public group "Ahwaltareq" (Ahwaltareq, 2022) for sharing mobility restrictions and road information. This group has a significant number of members, reaching around 100,000, making it a valuable data source.

The application involves developing a Python script using libraries and modules, including language processing, Telethon, geocoding, and mapping services. The script, which performs Telegram text analysis and mapping, can be found on GitHub in the repository by the author (Aburas, 2023a). The developed Python script comprises five sequential steps, including (i) message retrieving; (ii) text processing; (iii) text analysis and truth revealing; (iv) geocoding the extracted checkpoints; (v) mapping of geocoded checkpoints.

a. *Message Retrieving*

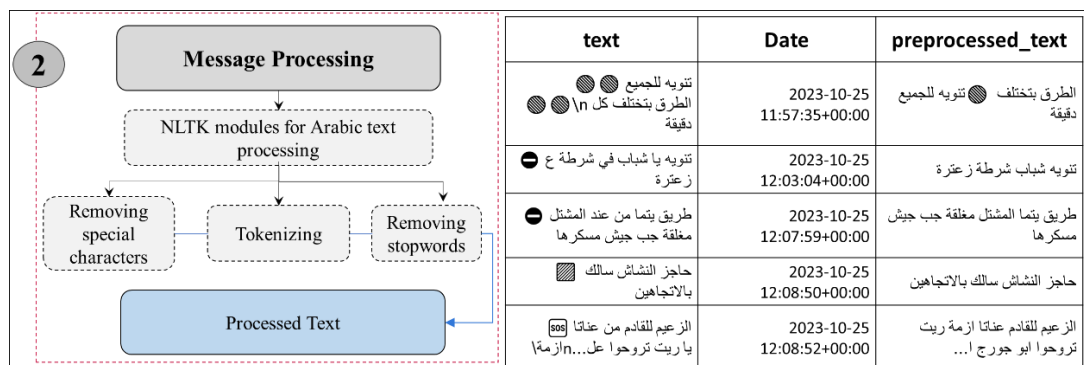
This is the initial step to retrieve the messages from the Telegram public group. It used the Telethon library (*Telethon's Documentation*, 2023), which allows interaction with the Telegram API to get messages from the group. The code uses a specific time range, which is one hour, to get the relevant data to get the near-real-time messages and avoid unnecessary computational processing, the messages will be retrieved with their time stamp, and then they will be stored in a dictionary for further processing and analysis, as illustrated in Figure 5.16.



**Figure 5.16.** Message retrieving phase and its application

### b. Text Processing

This phase concerns processing and analyzing the retrieved messages using Natural Language Toolkit (NLTK) modules for Arabic text processing. NLTK is a leading Python package for working with human language data (Kang et al., 2020). This phase includes developing a function for text processing, which does the following (a) removing the numbers and special characters using a regular expression module; (b) tokenizing the text into individual words, (c) removing stopwords from the list of words. It is worth mentioning that removing the special characters excludes the question mark to conserve the integrity of the question. Figure 5.17 illustrates the message processing phase and its outputs.



**Figure 5.17.** Message processing phase and its application

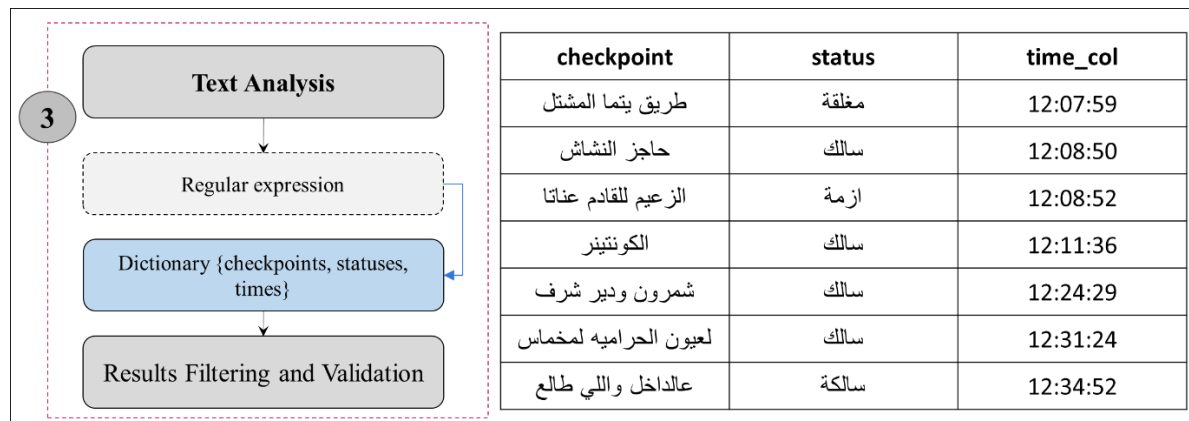
### c. Text Analysis

Text analysis extracts valuable information from the processed text. It uses regular expressions to detect patterns in the Arabic text, specifically those with a checkpoint name followed by its status (e.g., open, closed, congested, etc.). this phase involves creation keywords to be used in the regular expressions. A list of keywords was subsequently compiled, containing the top words used to describe status and its synonyms. These words comprise a mix of both Modern Standard Arabic (MSA), the official Arabic language used in literature (such as books, newspapers, and magazines), and Dialectal Arabic (DA), which represents the spoken language used by Arabs in their informal daily communications. It's worth noting that DA varies from one community to another (Alkhatib et al., 2019).

For example, the word 'open' may appear in messages under different synonyms, combining MSA and PA (Palestinian Arabic) words, such as 'salik,' 'salkeh,' and 'maftouh,' all of which mean 'open' in MSA and Palestinian DA. Similarly, the closed status includes terms like 'mughlaq,' 'mughlaqa,' 'ighlaq,' 'msakkar,' 'msakkreh,' and others. Congestion status is represented by words like 'azmeh,' 'ma'azem,' 'mazem,' 'sayie',' 'sayie'a,' and more. In cases of violence incidents, words like 'muwajahat' and 'mustawtineen' are identified. The list of keywords will be continually updated and expanded as new words come into use.

After creating the keywords, a dictionary is established to store the latest status for each unique restriction name. To achieve this, regular expressions are employed to detect patterns in Arabic text, specifically those indicating a mobility restriction followed by its status. In this phase, the code runs a loop over all the processed text's listed rows to search for patterns in the text data. When a match is found, it captures both the restriction's name (via 'match.group(1)'), which can include one, two, or three words, and the restriction's status (via 'match.group(2)').

The extracted restriction names are checked for repetition, and if duplicates are found, the timestamps are compared to ensure that the most recent timestamp is added to the dictionary. Based on the data in the dictionary, three lists are created: 'checkpoints,' 'statuses,' and 'times'. Figure 5.18 provides a visual representation of this process.



**Figure 5.18.** Text analysis phase and its application

#### d. Geocoding Checkpoint Names

After extracting the information from the text, the code proceeds to geocode the extracted restriction names, which converts textual location information into geographic coordinates (latitude and longitude) (Salazar-carrillo et al., 2021). This step is necessary for accurately mapping the extracted checkpoints onto a geographical map. However, it is important to note that due to limitations in the availability of data within geocoding services, certain geographic locations, particularly checkpoints and road gates in the Palestinian territories, may not be found in the service database.

To address this challenge, the methodology leverages the characteristics of restriction names in the Palestinian territories, where most restrictions are typically named based on their proximity to adjacent communities. For instance, you have checkpoints like the Huwara checkpoint near the Huwara town, the Za'tara checkpoint near the Za'tara village, the Azzoun

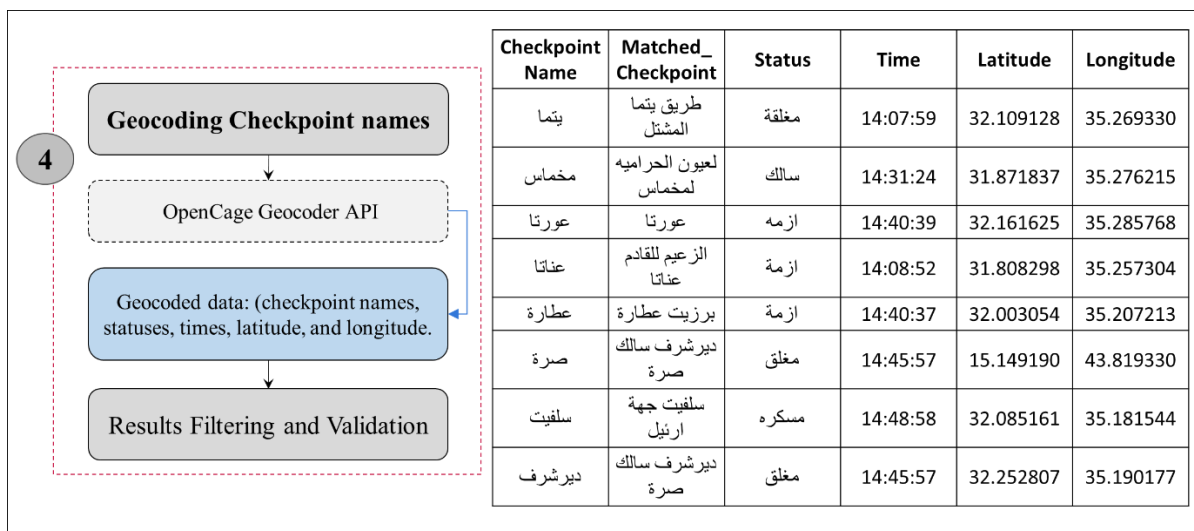


gate near Azzoun village, and so forth. This naming convention greatly assists in identifying the locations of these restrictions.

As a result, the geocoding process relies on a reference list of community and location names where these restrictions might be situated. This reference data has been extracted from the Ministry of Local Government (MoLG) in the form of a CSV file, which serves as a gazetteer for deducing restriction locations. The process involves matching the location names to the detected restrictions, thereby geolocating them. The code has been developed to search for matches between the names in the CSV file and the previously generated list. For each matched checkpoint name, the most recent status is determined by sorting the associated timestamps in descending order.

For geocoding, we utilized the Nominatim geocoding service, an open-source software developed by the OpenStreetMap (OSM) project. Nominatim is available in the 'geopy' Python package and supports several popular geocoding services. It includes geocoded training data for OSM Nominatim, Google Geocoding API, and various other geocoding services (Verma, 2022). Nominatim is available in the 'geopy' Python package and supports several popular geocoding services.

To ensure the accuracy of geocoded points, the geocoding process was bounding with lower latitudes and longitude and upper longitude and latitude of the West Bank region, which are (34.925884, 31.343141, 35.554562, 32.549246). The restriction name, matched restriction name, status, timestamp, latitude, and longitude.

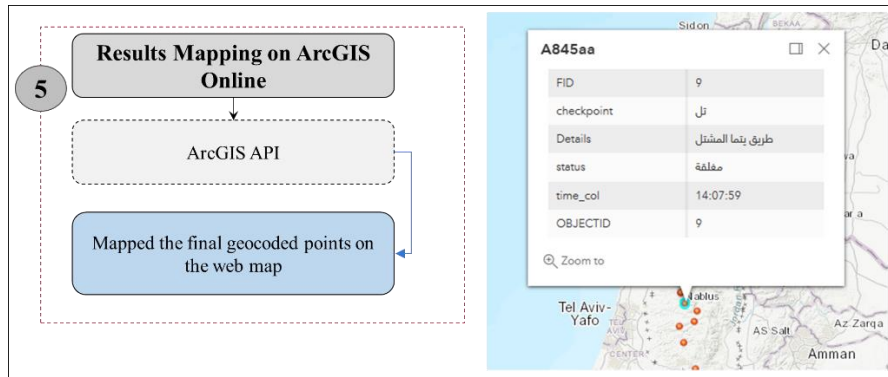


**Figure 5.19.** Geocoding checkpoint names

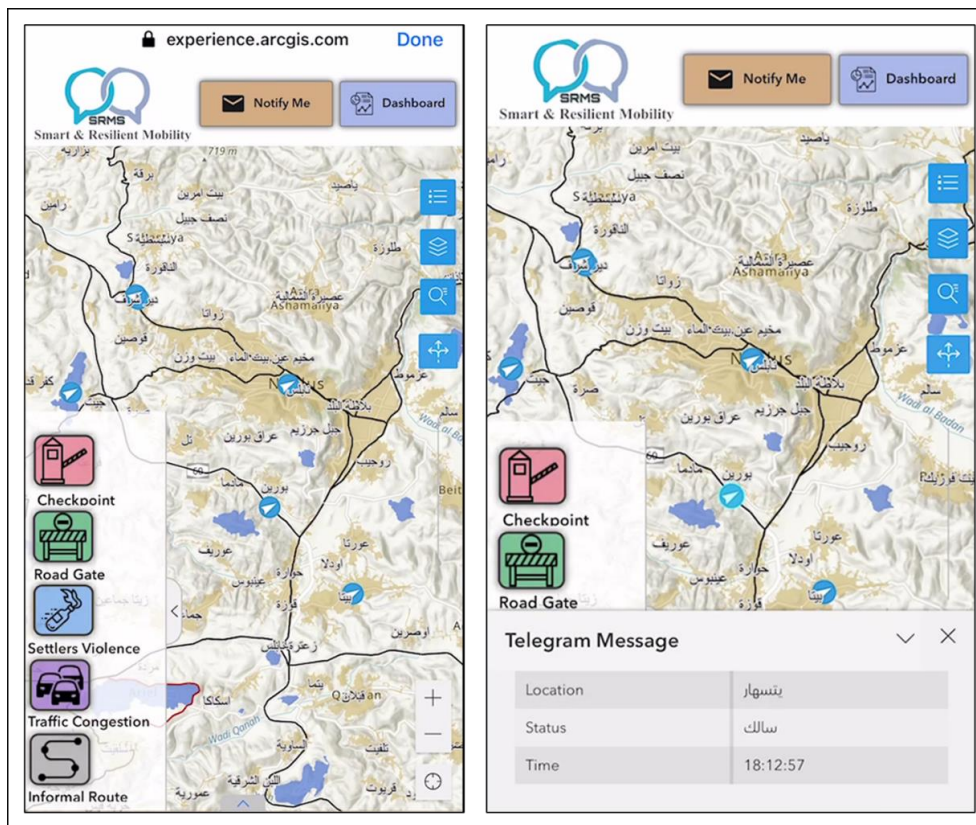
#### e. Checkpoint Mapping

The last phase focuses on mapping the results obtained from the previous steps to ArcGIS Online using the ArcGIS API. The code is designed to create a web map and add the geocoded results as points on the map. The geocoded results are transformed into a dictionary format with the required geometry (latitude and longitude) and attributes. The geometry dictionary utilizes the spatial reference system Palestine1923 (WKID:4281) to ensure accurate positioning of the points on the map.

The dictionary format is then converted into a feature that serves as a web map layer. The feature contains the geometry and attributes of each geocoded point. Adding the feature layer to the web map makes the geocoded checkpoints visualized on a map within ArcGIS Online. Once the geocoded checkpoints are visualized on ArcGIS Online, they will be linked to the SRMS application on the ArcGIS Experience Builder. Figure 5.20 illustrates the process and application of checkpoint mapping. Figure 5.21 visualizes the final layout of geocoded checkpoints on SRMS application.



**Figure 5.20.** Checkpoints mapping on ArcGIS Online



**Figure 5.21.** Geocoded checkpoints on SRMS application

iv. Validation of Real-Time Mapping of Mobility Restriction Using Telegram Data

Validation of the service of real-time mapping using Telegram data was conducted in two phases; (i) validation of the Telegram data analysis; and (ii) validation of the geocoding processing. Validation of the performance of the developed Telegram data analysis code was applied by preparing the test dataset as cross-reference data, which contains the sample of Telegram messages returned for the time 14:39-15:39 on 15th of July, 2023. The Telegram test dataset included 27 messages with different checkpoint names, statuses, and time stamps, as illustrated in Figure 5.22.

According to the developed code, the shaded rows are expected to be detected by the script since these 11 rows of data present unique checkpoint names (not duplicated) with the most recent time stamp and its status. After running the code on the test dataset, each message was processed to extract the checkpoint information. The results are illustrated in Figure 5.22, which shows that the code detected eight checkpoints with their status and time stamps. By comparing the detected results with the expected results, the accuracy of the code could be assessed, which is 73%.

Regarding the validation of the geocoding process, it is expected that the detected checkpoints listed on the right of Figure 5.22 will be geocoded to their coordinates (latitude, longitude). However, the geocoding process assigns coordinates to only five out of eight locations, resulting in an accuracy rate of 62.5%, as illustrated in Figure 5.23. The challenge in the geocoding process arises from using names familiar among Palestinian travelers. Still, it cannot be found in the geocoding service, such as abbreviations for Israeli settlements or checkpoints. This difficulty in geocoding such names impacts the overall accuracy of the geocoding process.

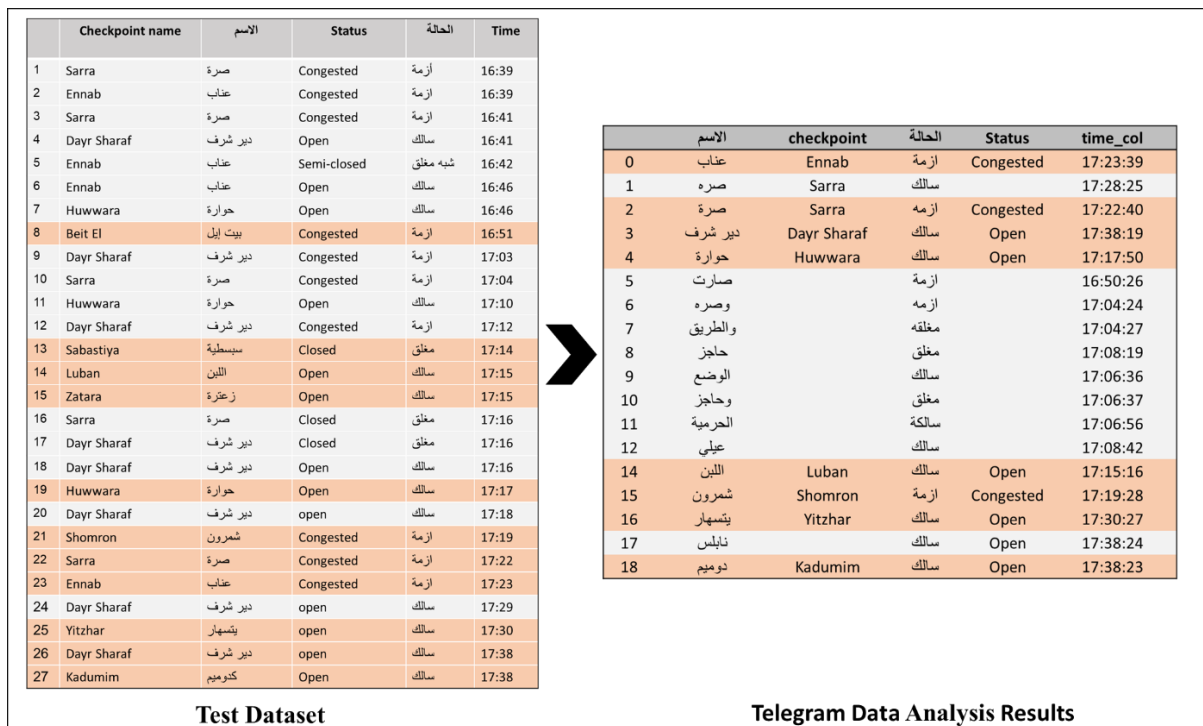


Figure 5.22. Telegram test dataset and data analysis results

To address this challenge and improve geocoding accuracy, it is proposed to create a dictionary or lookup table for commonly used geographic names by travelers. This dictionary can include mappings between the familiar names in the text data and the corresponding official names or geographic coordinates. By incorporating this additional reference information, the geocoding process can achieve a higher level of accuracy by properly identifying and mapping these commonly used locations.

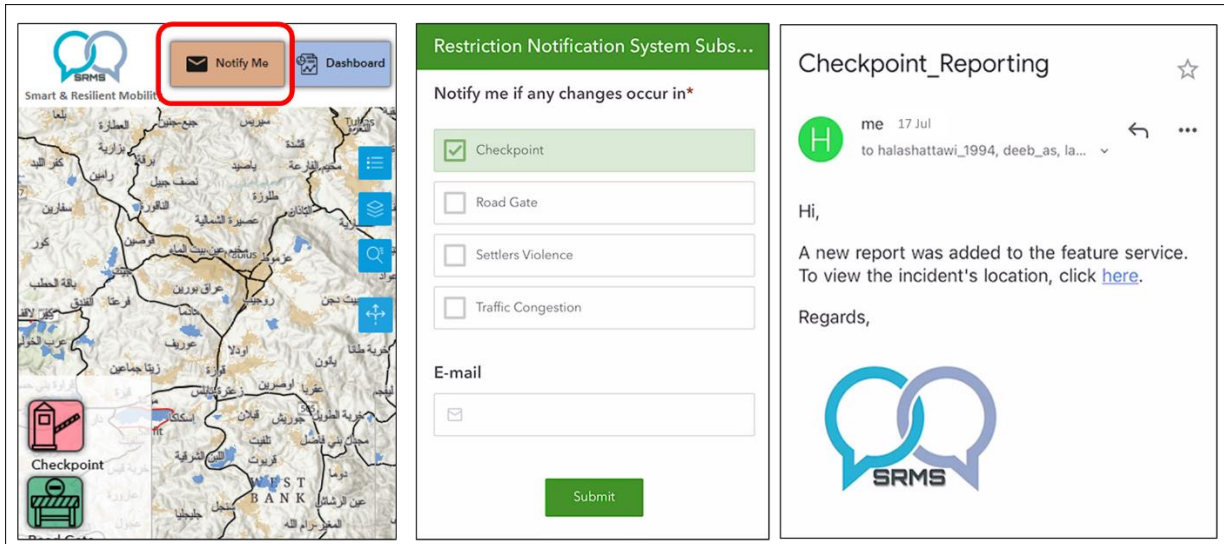
checkpoint	latitude	longitude	
0	دقيقه	NaN	NaN
1	بقول	NaN	NaN
2	صره	NaN	NaN
3	عذاب	NaN	NaN
4	صره	NaN	NaN
5	دير شرف	32.254059	35.189112
6	حواره	32.534559	35.892594
7	صارت	NaN	NaN
8	وصره	NaN	NaN
9	والطريق	NaN	NaN
10	حاجز	NaN	NaN
11	الوضع	NaN	NaN
12	وحاجز	NaN	NaN
13	الحرمة	NaN	NaN
14	الان	NaN	NaN
16	عيلي	32.069501	35.262480
17	حواره	32.534559	35.892594
18	اللين	31.823991	35.961684
19	مش	NaN	NaN
20	بالإتجاهين	NaN	NaN
21	شمرون	NaN	NaN
22	كانت	NaN	NaN
23	بحكو	NaN	NaN
24	للخارج	NaN	NaN
25	بضهران	32.174703	35.248616

**Figure 5.23.** Geocoding process results

v. *Restriction Notification System (RNS)*

The RNS service was created using Python 3.11. The Python script and configuration file are hosted on a Desktop computer that runs continuously. To maintain the continuous operation of the RNS service, it is necessary to host both the Python script and the configuration file on a machine that is constantly connected to the internet. To automate the execution of the script, the Windows operating system's Task Scheduler runs the script automatically every 5 minutes. This ensures that the script is regularly executed to check for updates in subscribed restrictions.

To subscribe to the RNS service, users can select the icon on the UI (Notify Me) in Figure 5.24 and choose one or more restriction types. Whenever a change occurs in the subscribed restrictions, an email will be sent to the subscribed users, showing the type of updated restriction and its location, as illustrated in Figure 5.24.

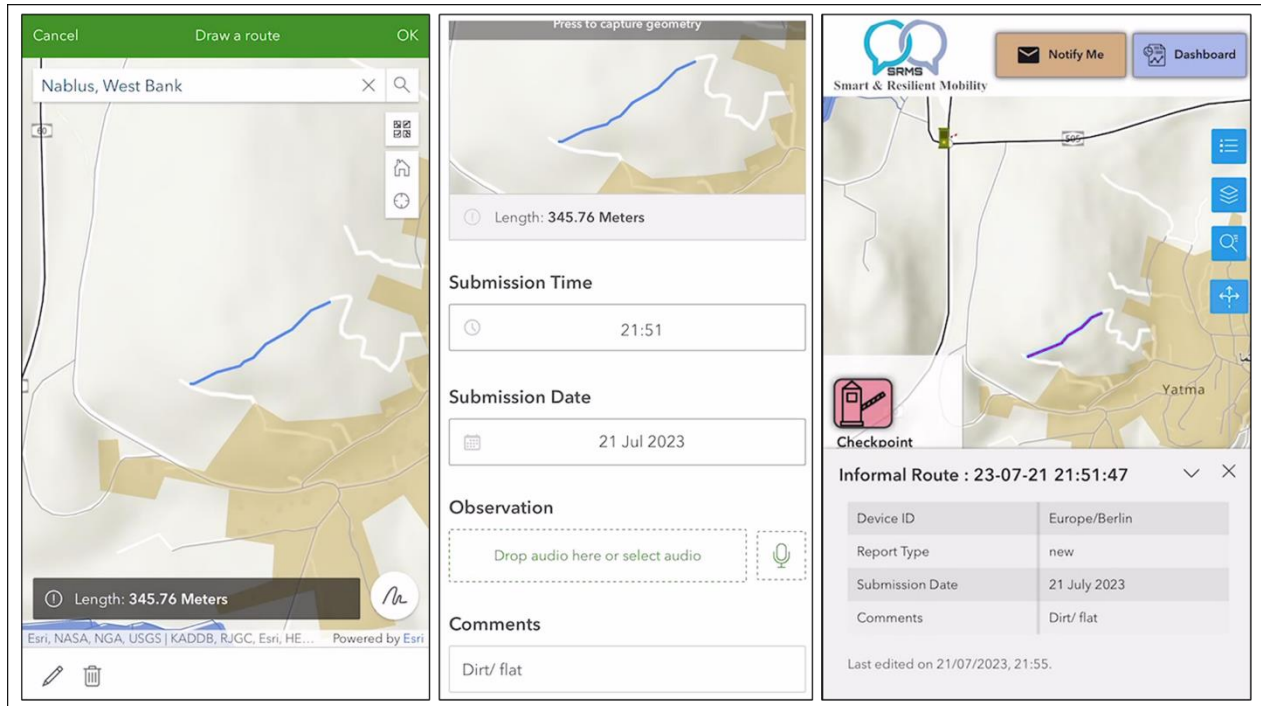


**Figure 5.24.** RNS subscription system and the email body sent to RNS subscribers

#### 5.2.4.2. Mapping of Informal Routes

Mapping informal routes is closely similar to mapping mobility restrictions in the SRMS. To access the mapping informal route service, users can visit the SRMS platform to visualize the pre-drawn routes, as shown in Figure 5.25. These routes are accompanied by relevant information, such as the report type (new or modified), device ID, timestamp, and reporting date. This service is designed to function offline, allowing users to save the routes within the application. Later, when internet connectivity becomes available, the saved routes can be easily submitted.

To start the route mapping process, users must select the informal route icon within the reporting features of the SRMS platform. This action will redirect them to a dedicated drawing page created using ArcGIS Survey123. Users can input essential information about the informal route on this page, including the auto-filled detailed reporting description and the observation time. Additionally, users can record a voice note or write comments, providing further context and details about the reported event. Figure 5.25 illustrates the layout of this drawing page and its various features.



**Figure 5.25.** Mapping informal route service

#### 5.2.4.3. Route Planning Service

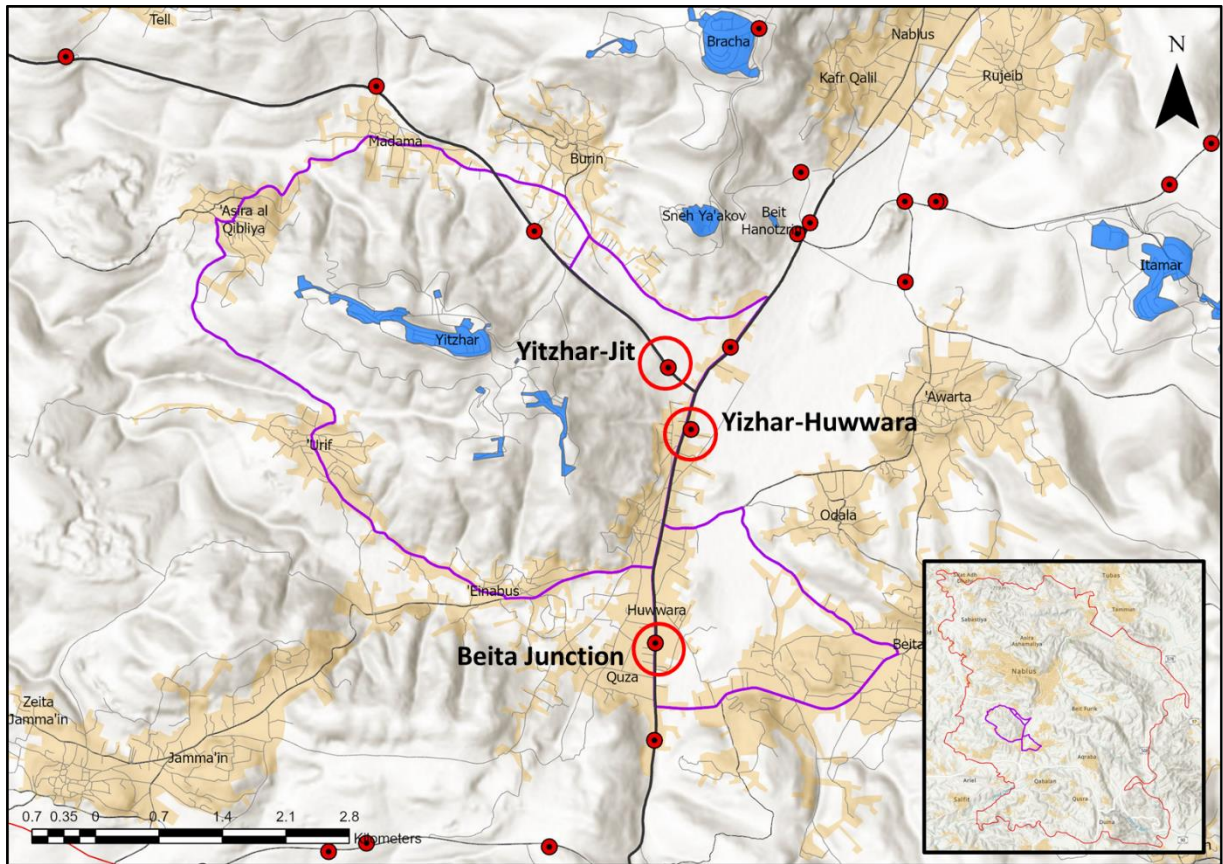
This section focuses on applying the SRMS's third service, the route planning service, which aims to optimize users' travel by minimizing risk, time, and distance costs. The section begins by introducing the application area of this service and outlining the necessary data along with their respective sources. Following, it presents the data processing and analysis phase, which concerns the construction of the route planning model to determine three categorized routes: the emergency route, the safest route, and the fastest route.

##### i. Application Area

This study concerned the network of Nablus Governorate, Figure 5.26. This part of the road network witnesses a high-risk rate presented in the risk of settlers-related violent incidents and mobility restrictions. According to the OCHA report (OCHA, 2023), the Nablus governorate witnessed the highest risk of settlers-related incidents against Palestinian civilians. From 2021 till early 2023, Nablus governorate forms around 30% of Palestinian fatalities from settlers-related incidents. The severity of this risk became more significant with the heavy traffic volume (Al-Sahili & Dwaikat, 2019) since it includes part of Road 60, a main road connecting the north of the WB with the south (black line) in Figure 5.26.

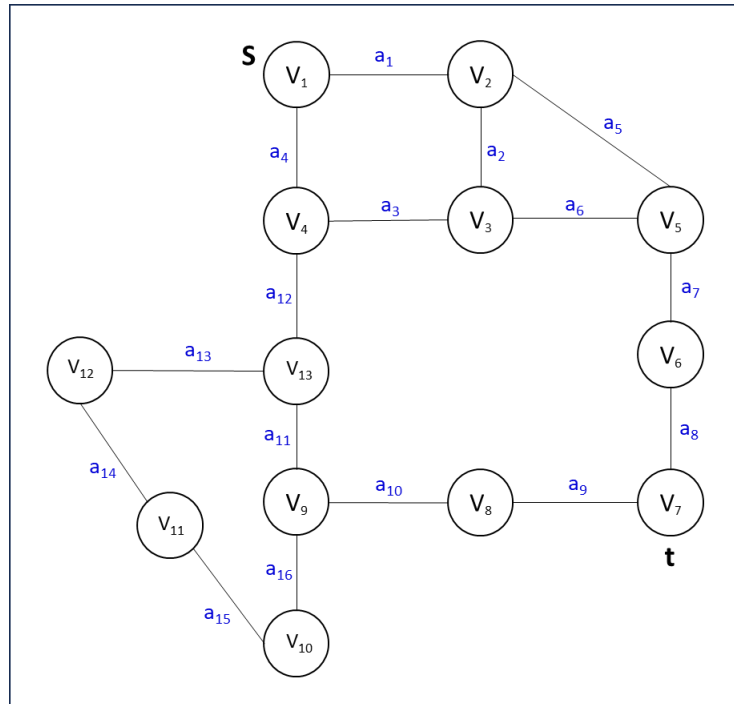
Besides the risk-related settler violence, this area is exposed to risk-related mobility restrictions related to three permanent checkpoints (Yizhar-Huwwara, Yitzhar-Jit, and Beita Junction), as illustrated in Figure 5.26. Also, the study area is exposed to various movement restrictions,

such as flying checkpoints, road gates, roadblocks, and earth mounds. So, this part of the road is a representative sample study of mobility along the road network in the WB.



**Figure 5.26.** Route planning service application area

For facilitating further processing and analysis, the road sample was converted into a graph model  $G = (V, E)$ , where  $V$  is the set of nodes, and  $E$  is the set of edges. The graph model was created using the capabilities of ArcGIS Pro 3.1, as illustrated in Figure 5.27. The graph composes of 16 edges ( $a_1, a_2, a_3, a_4, \dots, a_{16}$ ) and 13 nodes ( $v_1, v_2, v_3, v_4, \dots, v_{13}$ ).



**Figure 5.27.** Graph model of road sample study

ii. Data Sources and Collection

The route planning service relies on various data sources. Firstly, the Observation dataset supplies real-time reported information, including checkpoints, road gates, settlers’ violence, and traffic congestion. This data is used to identify restrictions as obstacles in the route planning model. Additionally, the dataset includes permanent data related to informal routes, which becomes an essential component of the routing model. Secondly, the knowledge dataset provides the users' feedback to indicate the quality of the provided services through the deviation from the advised routes.

Thirdly, the service depends on the external spatial database (ESDB) to obtain data from open and authoritative sources. ESDB includes physical and environmental road data, historical mobility restrictions, and settler-related violence. This data will be crucial in quantifying the risk on different road segments. Table 5.2 provides the needed data and sources for applying the route planning service. Table 5.2 provides the needed data and sources for applying the route planning service.

**Table 5.2.** Data sources of route planning service

<b>Data Storage</b>	<b>Data Description</b>	<b>Data Source</b>	<b>Data Format</b>
CCDB: Observation Dataset	Real-time reported mobility restrictions: Checkpoints, settlers’ violence, road gate, traffic congestion.	SRMS’s User	Point feature layer



	Informal route.	SRMS's User	Linear feature layer
CCDB: Knowledge Dataset	Users feedback	SRMS's User	GPS points data
ESDB	WB road network geometry	MoT	Esri linear Shapefile: SHP.
	Settler-related violence	B'TSELEM	Textual descriptive data
	Mobility restrictions	OCHA	Esri linear Shapefile: SHP.
	Waiting time at restriction.	ARIJ	GPS records in Excel sheets
	Physical and environmental road characteristics	MoT	Tabulated data in a linear shapefile.

It is worth mentioning that the route planning service was implemented without running the SRMS platform since the SRMS platform is relatively new. Hence, there is no data available in the knowledge and observation datasets. As a result, the route planning service primarily relies on the data from the external spatial database (ESDB).

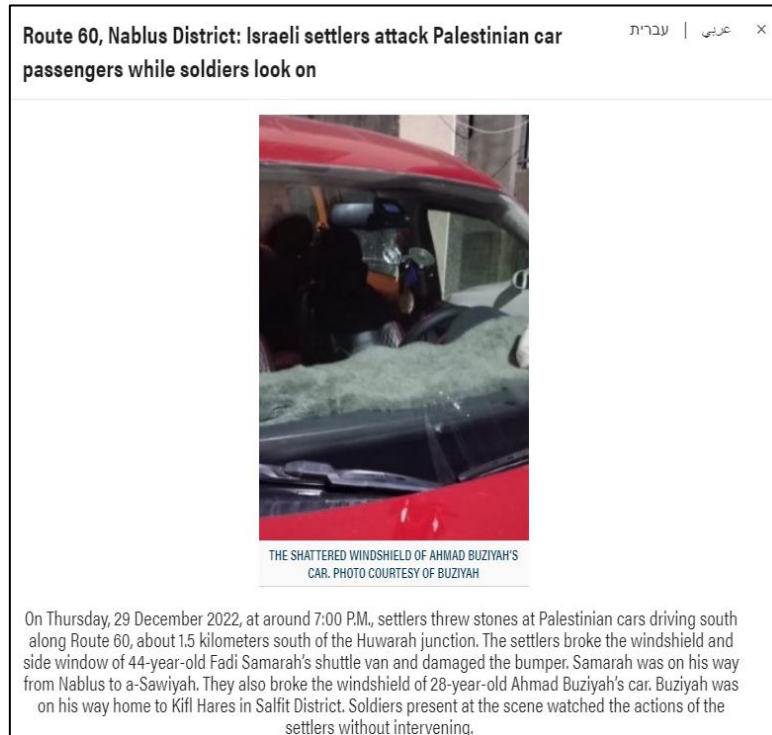
The physical and environmental data, such as road geometry, condition, light condition, road type, road lengths, speed limit, and type of adjacent built-up area, was obtained from the Palestinian Ministry of Transport (MOT) database as shapefile data. The settler-related violence data was obtained from B'TSELEM. In early 2021, B'TSELEM created an open-source database for monitoring different settler-related incidents, such as house attacks, damage to agricultural and non-agricultural properties, attacks on travelers and vehicles, etc. However, for this study, the focus is specifically on incidents involving travelers, vehicles, and road closures. As a result, data for the years 2021 and 2022 were gathered for analysis and examination.

The acquired settler-related data was descriptive textual data containing (incident description, location, time, date, and photo), as illustrated in Figure 5.28. To use this data for spatial analysis, geolocation was performed based on the provided incident locations using ArcGIS Pro 3.1, then stored in a shapefile.

Data regarding mobility restrictions were obtained from OCHA's recently updated spatial database for 2020 in a shapefile format containing attributes, including the name of the restriction and types. The average waiting time at restriction was obtained from the Applied Research Institute-Jerusalem (ARIJ) database. ARIJ has applied a field study to calculate the average waiting times at permanent checkpoints in the WB using a record reading of GPS points (ARIJ, 2019a).

Arij installed 70 vehicle tracking devices on cars, taxis, buses, and trucks, which collected data for six months (January – July 2018) (ARIJ, 2019a). These vehicles used all major transport

routes in the West Bank that were obstructed by checkpoints, flying checkpoints, and physical barriers. More than 18.5 million records were registered and stored in a Microsoft SQL database. Due to a massive amount of data, the institute has faced difficulty retrieving the data for the researcher from the server for six months. However, they provided detailed CSV files for June, with 20233 GPS records, illustrated in Figure 5.29.



**Figure 5.28.** Example on the descriptive data from B'TSELEM database, (B'Tselem, 2022)

Each row presents the GPS record, and the columns are the captured data, including vehicle location (x,y), average speed, the creation date, the average number of vehicles in the queue, and the average waiting time in the queue, and total waiting time (ARIJ, 2019a).

D	E	F	G	H	I	J	K	L	M	N	O
point_x	point_y	checkpoint_name	total_time	trip_id	count_gps_poi	avg_speed	time_queue	count_time_que	Radius	DOY	DATE
730794.865	3565978.16	Hamra	1.67	21_2018_152_17.43_18.79	13	62	0	0	750	152	01/06/2018
730794.865	3565978.16	Hamra	1.67	21_2018_152_5.32_6.48	11	58	0	0	750	152	01/06/2018
730794.865	3565978.16	Hamra	1.67	68_2018_152_11.85_13.56	13	59	0	0	750	152	01/06/2018
730794.865	3565978.16	Hamra	1.5	68_2018_152_5.98_8.13	10	67	0	0	750	152	01/06/2018
730794.865	3565978.16	Hamra	1.67	11_2018_152_11.32_13.48	12	65	0	0	750	152	01/06/2018
730794.865	3565978.16	Hamra	1.67	11_2018_152_6.29_9.09	11	60	0	0	750	152	01/06/2018
730794.865	3565978.16	Hamra	1.5	51_2018_153_9.55_12.59	12	64	0	0	750	153	02/06/2018
730794.865	3565978.16	Hamra	1.83	35_2018_153_6.92_8.12	12	62	0	0	750	153	02/06/2018
730794.865	3565978.16	Hamra	1.48	68_2018_153_6.28_8.34	10	68	0	0	750	153	02/06/2018
730794.865	3565978.16	Hamra	1.5	51_2018_153_6.06_8.41	10	62	0	0	750	153	02/06/2018
730794.865	3565978.16	Hamra	1.5	35_2018_153_12.62_14.18	12	69	0	0	750	153	02/06/2018
730794.865	3565978.16	Hamra	1.5	68_2018_153_8.9_11.82	12	66	0	0	750	153	02/06/2018
730794.865	3565978.16	Hamra	2.15	21_2018_154_10.25_12.58	14	45	0.63	4	750	154	03/06/2018

**Figure 5.29.** Arij field survey for checkpoint waiting time (ARIJ, 2019a)

iii. Data processing and analysis

This phase applies three arranged steps to process and analyze the collected data to construct the route planning model. It starts with creating the risk quantification model for the road edges of the study area by creating and weighting risk indices and then calculating the travel time by considering the waiting time prediction at mobility restrictions located at road edges. The last phase concerns creating the routing planning model to find multi-categorized routes.

a. Risk Quantification Model

This phase is composed of the following; (i) creating a list of risk criteria; (ii) using the entropy weight method to establish a quantitative risk cost model and calculate index weights; (iii) determining a comprehensive risk score for each road segment (R<sub>i</sub>). Each phase is detailed in the following:

- Creating Risk Indices

In this section, the application of a list of seven indexes is discussed to evaluate the risk on each edge in G and determine the risk comprehensive score (R<sub>i</sub>). The evaluation criteria considered for calculating R<sub>i</sub> include (i) mobility restrictions; (ii) settlers-related violence; (iii) the built environment; and (iv) the physical characteristics of the road edges. The previously developed evaluation criteria and indices in Table 4.4 are utilized to find the statistical value of each index in the graph model edges (E), as illustrated in Table 5.3.

Table 5.3 describes the proportion of each index value on the graph model. Around 37.5% of edges have mobility restrictions, and there is variation in the violent incidents that could reach five incidents in a specific area. The violent incidents occurred in an equal ratio in the daytime and nighttime. However, around 67% of violent incidents occurred during the week of the day and 33.3% during the weekend. The variation in the violent incident rate during the week could be interpreted by the change in the daily average traffic volume, which reached 27.2 thousand on a weekday and 15.2 thousand on the weekend on a section of Road 60, which part intersects the study area, for the year 2020 (Statistics, 2022).

The general physical characteristics of the E present acceptable conditions; half of the road edges have moderate status, 67% of edges are lightened, and around 69% of road edges are located in urban areas and passing near the Palestinian built-up urban areas. Table 5.3 shows the statistical value of each index.

**Table 5.3.** Descriptive Statistics

No.	Index	Statical Value (Proportion)
1	NO_RIST	1= 37.5%, 0= 62.5%
2	NO_VIO	1= 18.6%, 3= 6.3%, 4= 6.3%, 5= 6.3%, 0= 62.5%
3	TOD	1= 50%, 2= 50%

4	DOW	1= 66.7%, 2= 33.3%
5	LGT_CON	1= 56.2%, 0= 43.8%
6	ROAD_CON	1= 3%, 2= 56.2%, 3= 18.8%
7	ADJ_BUILTUP	1= 31.2%, 2= 68.8%

- Index weight calculation

The pre-identified indices were used to determine the comprehensive cost on each road edge, which is called the comprehensive risk score  $R_i$ , Equation (4.1). However, these identified risk indices have different weights on the comprehensive risk level  $R_i$ , so the weight of each index was calculated using the objective weight entropy method (WEM).

$$R_i = \sum_{j=1}^m d_{ij} w_j \quad (5.1)$$

Where  $R_i$  is the comprehensive risk score of the  $i^{\text{th}}$  road section ( $i = 1, 2, 3, \dots, 16$ );  $d_{ij}$  is the actual data of the  $j^{\text{th}}$  index corresponding to the  $i^{\text{th}}$  road section;  $w_j$  is the weight of the  $j^{\text{th}}$  index.

Using Equations (4.4)-(4.7), the entropy weighting method (EWM) was applied to determine the weight of each index. The index entropy and weights were calculated using historical accident data to realize the objective weighting. As mentioned earlier, the smaller the entropy of the index, the greater the weight. Table 5.4 shows that the indicator of NO\_VIO (number of previous violence) has the smallest entropy and the largest weight. Therefore, the road edges witnessed violent settler incidents will significantly impact the road risk. In contrast, the indicators of road physical conditions have the lowest weights.

**Table 5.4.** Weights of cost risk index

No.	Index	$e_j$	$W_j$
1	NO_RIST	0.646	0.148
2	NO_VIO	0.570	0.180
3	TOD	0.625	0.157
4	DOW	0.625	0.158
5	LGT_CON	0.701	0.125
6	ROAD_CON	0.876	0.051
7	ADJ_BUILTUP	0.580	0.176

- Determination of a comprehensive risk score ( $R_i$ )

Following determining the weight of each index, Equation (4.1) was applied to calculate the  $R_i$  for each road edge, as illustrated in Table 5.5.

**Table 5.5.** Risk values of the graph edges

<b>Road Edge</b>	<b>NO_RIS T</b>	<b>NO_VI O</b>	<b>TOD</b>	<b>DOW</b>	<b>LGT_C ON</b>	<b>ROA D_C ON</b>	<b>ADJ_ BUIL TUP</b>	<b>R<sub>i</sub></b>
a <sub>1</sub>	0.00001	0.00001	0.00001	0.00001	0.00001	1	1	0.229
a <sub>2</sub>	1	1	1	2	1	1	1	1.158
a <sub>3</sub>	1	3	2	1	1	1	2	1.696
a <sub>4</sub>	1	0.00001	0.00001	0.00001	1	3	1	0.607
a <sub>5</sub>	0.00001	0.00001	0.00001	0.00001	0.00001	2	1	0.281
a <sub>6</sub>	1	1	2	1	1	1	2	1.334
a <sub>7</sub>	0.00001	1	1	1	0.00001	2	1	0.777
a <sub>8</sub>	0.00001	0.00001	0.00001	0.00001	0.00001	2	2	0.458
a <sub>9</sub>	0.00001	0.00001	0.00001	0.00001	0.00001	2	1	0.281
a <sub>10</sub>	0.00001	0.00001	0.00001	0.00001	0.00001	3	1	0.333
a <sub>11</sub>	0.00001	0.00001	0.00001	0.00001	1	2	1	0.406
a <sub>12</sub>	1	4	2	2	1	3	1	1.962
a <sub>13</sub>	0.00001	0.00001	0.00001	0.00001	0.00001	2	2	0.458
a <sub>14</sub>	0.00001	0.00001	0.00001	0.00001	1	2	2	0.583
a <sub>15</sub>	0.00001	0.00001	0.00001	0.00001	1	2	1	0.406
a <sub>16</sub>	1	5	1	1	1	2	1	1.776

#### b. Travel Time

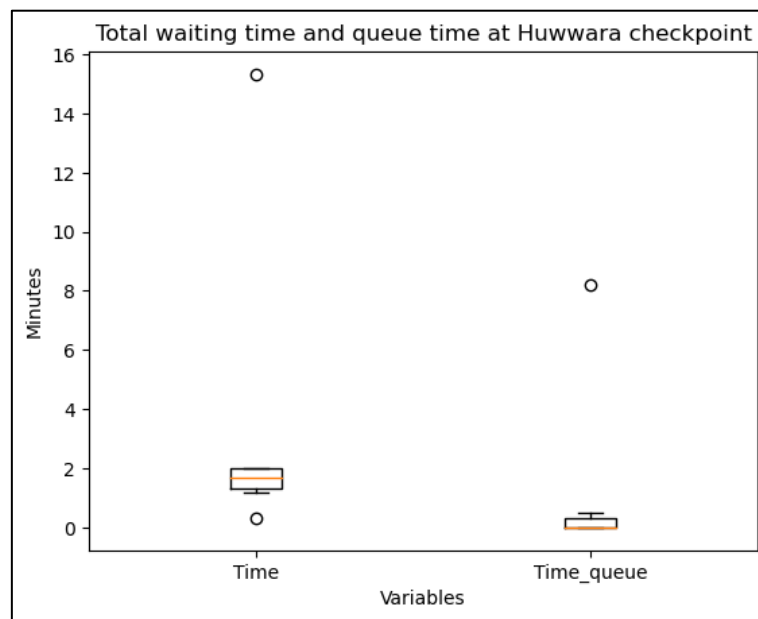
This section concerns determining the weighted travel time ( $AW$ ) along the study area road edges ( $n_1, n_{16}$ ) considering the factors affecting the travel time, including traveling distance ( $Dist$ ), the posted speed limits ( $S$ ), and the predicted waiting time at restriction ( $T_w$ ), Equation (4.9).  $Dist$  and  $S$  data are already known based on the MOT database. However, the predicted waiting time ( $T_w$ ) is determined by applying the RF prediction model methodology. The waiting time prediction model was applied for each mobility restriction in the study area separately to enhance the accuracy of the prediction results. This application includes applying the RF prediction model on the Yizhar-Huwara checkpoint, this methodology could be applied to the other two checkpoints on the road sample study; Yitzhar-Jit and Beita Junction.

The dataset of the Yizhar-Huwara checkpoint has 2275 records, including the waiting time in the queue in minutes ( $Time\_queue$ ), the average speed within 750 m distance from the Yizhar-

Huwara checkpoint (km per hour), the total waiting time in minutes to cross the Yizhar-Huwara checkpoint (Time), and the day of the week (DOW). Table 5.6 provides the descriptive statistics of the numerical variables of the dataset. The total waiting time to cross the checkpoint Tw is the output variable the machine learning model is trained to predict. The dataset has a mean waiting time value to cross the Yizhar-Huwara checkpoint of 1.8, a median of 1.6, and a standard deviation of 1 minute. The box plot of time variables (total waiting time to cross checkpoint and queue waiting time) is presented in Figure 5.30.

**Table 5.6.** Descriptive statistics of dataset

	<b>Time</b>	<b>Speed</b>	<b>Time_queue</b>
<b>mean</b>	1.8	51.8	0.1
<b>std</b>	1.0	14.4	0.5
<b>min</b>	0.3	0.0	0.0
<b>50%</b>	1.6	53.0	0.0
<b>max</b>	15.3	101.0	8.2



**Figure 5.30.** Total waiting time and queue time at Yizhar-Huwara Checkpoint

The Random Forest regression applied the waiting time prediction model using Python 3.9.13 and the Scikit-learn software library, which contains various classification, clustering, and regression algorithms (Sharma et al., 2021). The developed code can be found on the GitHub repository (Aburas, 2023b). This prediction model incorporates several variables, including waiting time in the queue, vehicle speed, and the day of the week (DOW). The real-time data on traffic flow can significantly influence waiting time predictions (Sharma et al., 2021). However, due to the unavailability of real-time data about the traffic flow, the initial step involves constructing the prediction model using historical data.

To avoid overfitting or reduced model performance caused by including numerous variables, a correlation coefficient analysis was performed (Mour et al., 2017). The purpose was to identify the most relevant variables significantly affecting waiting time to construct an optimized waiting time prediction model for the checkpoint. Table 5.7 shows the correlation coefficient of variables with the waiting time. The time the vehicle spends in the queue has a high positive correlation with the waiting time to cross the checkpoint, and the vehicle speed has a strong negative correlation with the waiting time. The day of the week variable has a very weak correlation with the waiting time, so it will not be used for training the model.

**Table 5.7.** Correlation of waiting time at the checkpoint and other variables to develop predictive models

<b>Correlation Coefficient</b>	<b>Time in the queue</b>	<b>Vehicle Speed</b>	<b>DOW</b>
Waiting Time at checkpoint	0.85	-0.74	-0.13

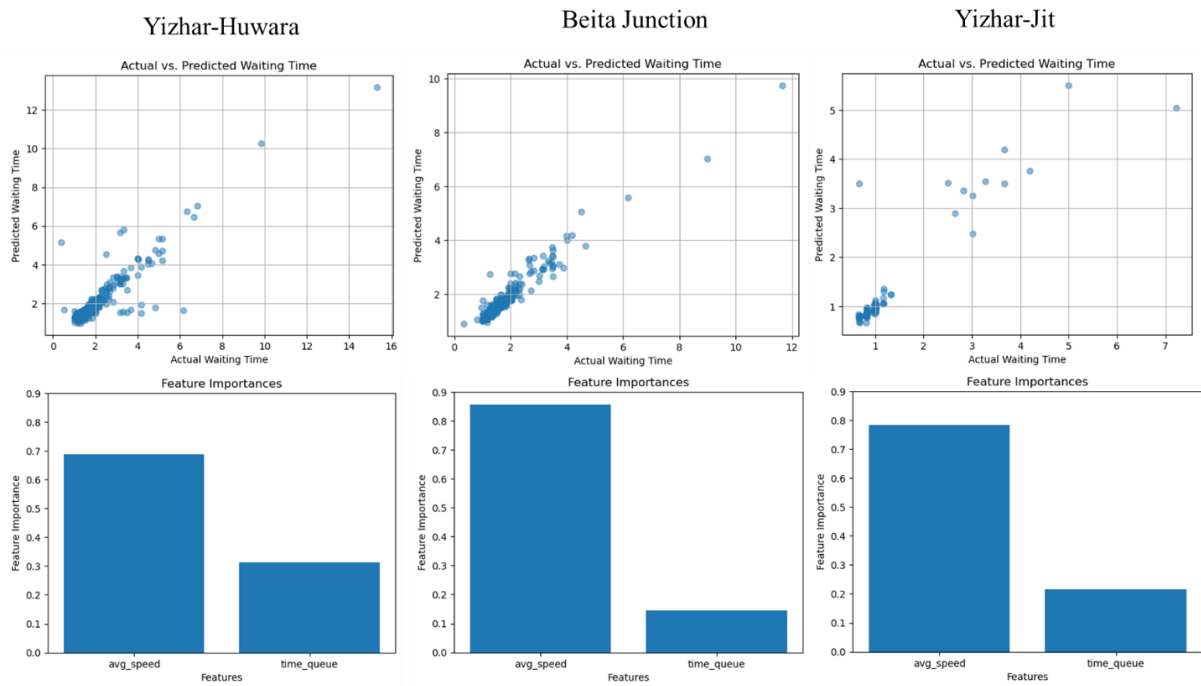
Following this, the RF regression model was created by identifying the time in the queue and vehicle speed as model features. The dataset was split into a training set (80%) and a testing set (20%) to evaluate the model's performance. The waiting time of the Yizhar-Huwara checkpoint has a training dataset of 1820 records and a testing dataset of 455 records. The model was created using the default Scikit Learn 100 decision trees (estimators) and random states of 42 (Pedregosa et al., 2011). The scatter plot was used to show the tested and predicted values. It presented a linear pattern indicating convergent values between the predicted and actual data, as illustrated in Figure 5.31.

For evaluating the model performance, Mean Squared Error (MSE) and R-squared (R2) were used. The results show an MSE of 0.25, which is a relatively low value that indicates that the model's predictions are quite close to the actual values. R2 score which measures the proportion of the variance in the dependent variable (waiting time) that is predictable from the independent variables (speed and time queue). The results show that R2 is 0.80, which means that about 80% of the variance in the waiting time can be explained by the model. These metrics provide a good indication that the developed prediction model has successfully predicted and explained the waiting time at the checkpoint.

For understanding the variables' participation in the model accuracy, the Scikit Learn library provides the features' relevance. It shows that the speed of the vehicles in the queue has a higher relevance in predicting the waiting time, as illustrated in Figure 5.31. The analysis proposes that if the model was recreated, considering the vehicle speed as the only parameter would lead to higher accuracy. This is because vehicle speed is a strong indicator of traffic flow and congestion, and it can be easily captured or measured from various sources like GPS sensors on the driver's mobile devices.

Figure 5.31. presents the application of the RF waiting time prediction model on the Yizhar-Huwara, Beita junction, and Yitzhar Jit checkpoints, which show good performance where

92% and 83% of the variance in the waiting time at Beit junction, and Yizhar-Jit can be explained by the model, respectively.



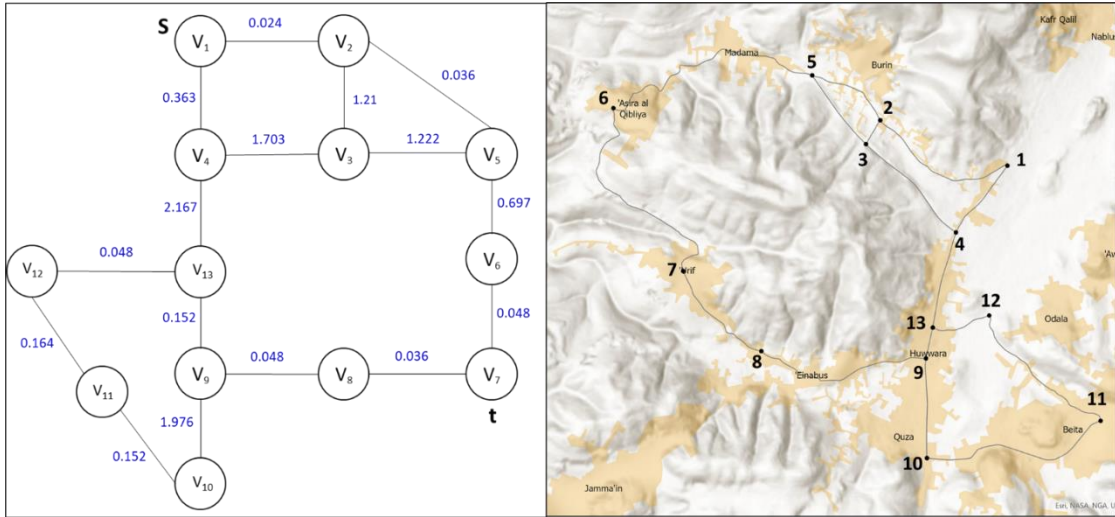
**Figure 5.31.** RF waiting time prediction model at the checkpoints in the study area and the related feature importance ranking

### c. Construction of Route Planning Model

This section applies the routing planning model to find multi-categorized routes. It includes (i) preparing the road network study area using ArcGIS Pro 3.1; (ii) filtering the road network by removing the prohibited road, which is the road where Palestinian drivers are forbidden to travel along including settlement roads, and roads located behind the separation wall (ARIJ, 2019a); (iii) validating the prepared road network using network topology technique provided by ArcGIS Network Analyst (NA) module (Peng et al., 2022); (iv) loading  $R_i$ , travel time, and distance parameters to the graph edges; and (v) applying the Dijkstra's algorithm to find the least risk, travel time, and distance route separately.

Figure 5.32 illustrates the filtered validated road network results from applying network analysis techniques, and it shows the  $R_i$  values for each edge of the graph model.





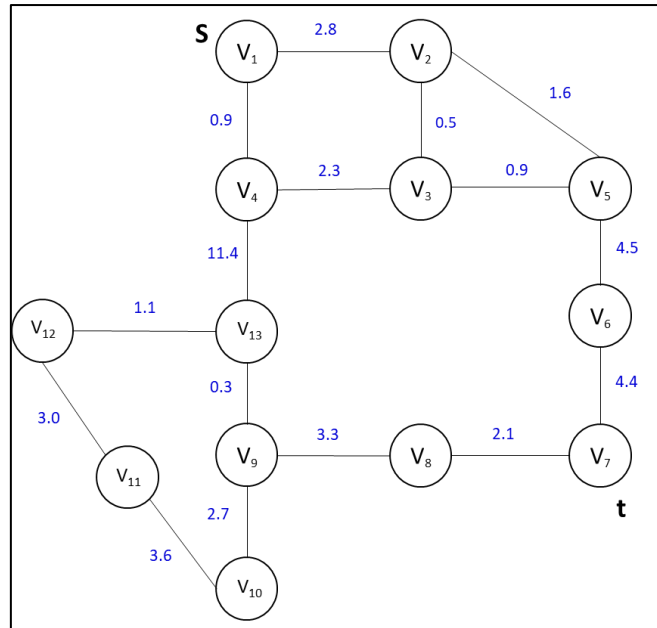
**Figure 5.32.** Loading risk values for each edge

The application of the route planning model involves proposing a scenario where there is a vehicle queue near the Yizhar-Huwara checkpoint with an average speed limit of 10 km/h. Additionally, there is a risk of settlers' violence near the Yitzhar-Huwara checkpoint that was reported in real-time using the SRMS platform, as illustrated in Figure 5.33.

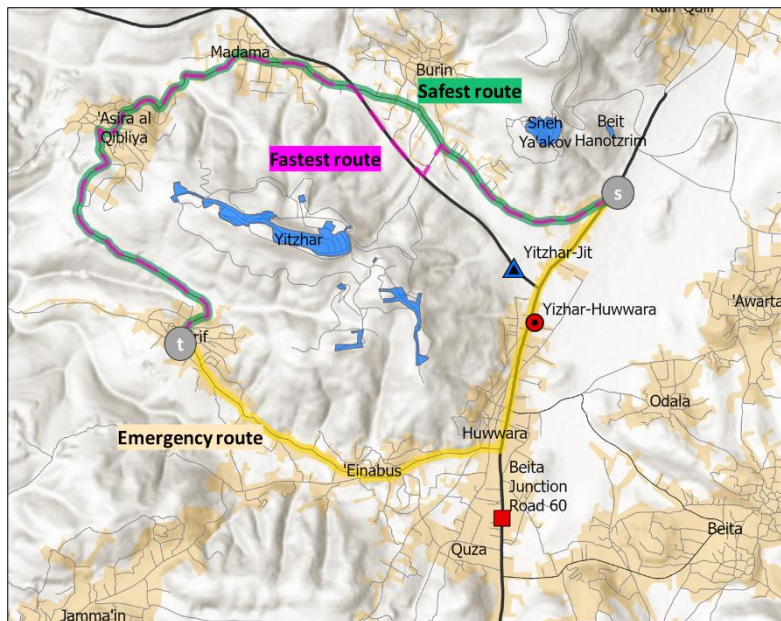


**Figure 5.33.** Illustration of the proposed Scenario

Considering the proposed scenario, the waiting time at the Yizhar-Huwara checkpoint has been forecasted to be 9.5 minutes. Subsequently, the travel time for each edge was loaded in accordance with the Equation (4.9), as depicted in Figure 5.34. Following loading the risk, travel time, and distance values on the graph edges, Dijkstra's algorithm between the starting point s and ending point t to find the three categorized routes is applied. Figure 5.35 presents the results of the NA analysis.



**Figure 5.34.** Loading travel time values for each edge



**Figure 5.35.** Results of NA analysis, the shortest, safest, and fastest routes

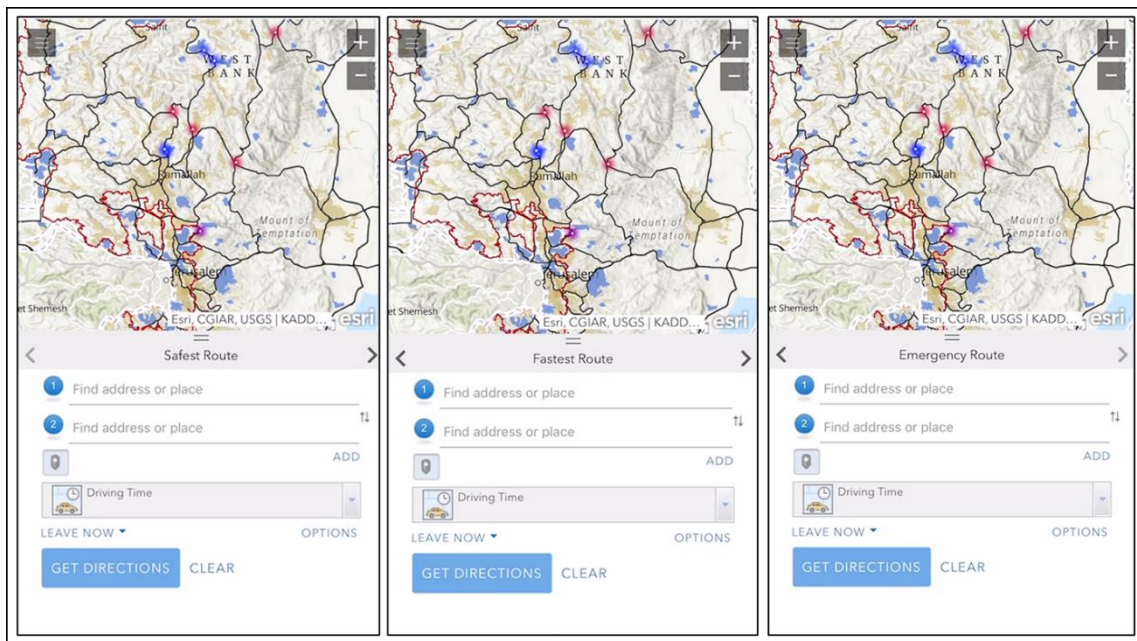
The observed routes are categorized and presented in Table 5.8. It is worth noting that the emergency route exhibits the shortest distances, making it the most efficient in terms of distance. On the other hand, the safest route is characterized by minimal risk factors, ensuring a secure journey. Meanwhile, the fastest route boasts the lowest travel time, offering the quickest arrival at the destination.

**Table 5.8.** Costs of categorised observed routes

	Time Cost (min)	Risk Cost	Length Cost (m)
<b>Emergency</b>	10.6	3.58	6689
<b>Safest</b>	13.5	1.74	9412
<b>Fastest</b>	13.1	3.95	9782

iv. Service Publishing to SRMS Platform

The final step concerns publishing the prepared route planning model to be publicly used via the SRMS platform. This includes publishing the prepared network analysis layer presented in the route planning model from ArcGIS Pro to ArcGIS Online as a web map service and then integrating this service to the SRMS platform as a route planning service, illustrated in Figure 5.36.



**Figure 5.36.** Route Planning Service in SRMS platform

### 5.3. Conclusion

This chapter focuses on the practical implementation of the SRMS (Smart and Resilient Mobility Services) platform in the West Bank. It explores historical and recent coping strategies employed by Palestinians to address mobility restrictions, emphasizing the evolving

use of communication tools. Telegram emerged as a key tool for sharing traffic and mobility restriction information due to its privacy features and effectiveness.

The chapter discusses the operational aspects of SRMS implementation, presenting statistics that highlight Palestinian travelers' engagement capacity. It also describes a user-centered design approach using surveys to understand traveler preferences and needs, leading to tailored SRMS services.

The chapter further described the design of the SRMS web mobile app, which was developed using ArcGIS Experience Builder and followed a User-Centered Design (UCD) approach and the MoLIC interaction model. It detailed the application of the offered services, which encompassed real-time mapping of mobility restrictions, a restriction notification system, and mapping of informal routes using tools such as ArcGIS Survey123, ArcGIS Online, ArcGIS Experience Builder, ArcGIS Pro 3.1, and Python 3.11. The service's reliability was validated through spatial clustering, third-party spatial DB, and data cross-referencing from multiple sources.

Additionally, the chapter provided insights into the application of a route planning service in a sample study area with a high exposure to mobility risks related to checkpoints and settler violence. It presented the necessary data, their descriptions, sources, types, and formats. The data processing and analysis steps, including risk quantification, travel time estimation, and route planning model construction, were discussed. The chapter concluded by detailing the publishing of the developed service to the SRMS platform.

## General Conclusion

This doctoral thesis addressed the pressing issue of disruptive traffic events and their significant impact on the social well-being of individuals and the overall prosperity of communities, particularly in complex urban environments subjected to various mobility restrictions. The research has contributed to this challenge by developing a comprehensive smart platform known as the Smart and Resilient Mobility Services (SRMS) platform, specifically designed to manage mobility restrictions associated with occupation in the West Bank.

This contribution was originated by identified gaps in the existing literature regarding smart approaches and technologies for managing traffic disruptions, particularly the absence of comprehensive strategies and meaningful engagement of travelers in the management process. The study developed the architectural framework of the SRMS platform, employing a layered system providing integrated services and enhancing the citizen's engagement.

The research implemented the proposed SRMS architecture in the Palestinian territories, where mobility restrictions related to occupation are a daily challenge. It assessed the feasibility of the Palestinian community adopting SRMS as an innovative solution through investigative survey studies targeting potential users. These surveys explored citizens needs and preferences, shaping the design of the SRMS web mobile application from a human-centered design perspective. The provided services were customized accordingly using the capabilities of Web-GIS, ArcGIS Pro, and machine learning.

The research findings indicate that the SRMS platform is well adapted to the West Bank (WB) because of several factors, including (i) widespread smartphone accessibility among Palestinian residents; (ii) high level of digital knowledge and familiarity with digital tools; (iii) cellular internet access is widely available; (iv) wide usage of internet while traveling; (v) the absence of existing mobility services applications providing real-time data on traffic and mobility restrictions; (vi) high demand for customized optimal route suggestions that consider the context and unique circumstances.

The final layout of the SRMS web mobile app has received the acceptance of the potential users and the offered services have demonstrated their capacity to efficiently manage mobility restrictions. The validation process of the SRMS platform revealed promising results in terms of report accuracy. While traffic congestion reports showed a 67% accuracy rate using spatial clustering, checkpoint and road gate reports achieved higher validation rates, at 85% and 100% respectively. However, settler violence reports had a lower validation rate of 25%, likely due to the mobile nature of this restriction.

The real-time mapping of mobility restriction using Telegram data had an accuracy rate of up to 73%. Furthermore, the SRMS reporting features and its associated restriction notification system facilitated efficient and prompt information visualization and dissemination. Also, the route planning service delivers efficient route suggestions, especially when validating under specific closure scenarios.

This research faced some limitations concerning the limited dissemination of the platform among the public hindered its widespread usage and interaction. This limitation impacted the

volume of data received, which, in turn, constrained further validation, and data and user quality analysis. Another limitation concerns time, which restricted the ability to investigate the long-term impacts of the SRMS platform on mobility patterns in the Palestinian territories. Additionally, it limited the development of more robust temporal prediction models.

To ensure the continuous improvement of the developed SRMS solution, the following recommendations have been identified to enhance the value and impact of the achieved work:

**Partnership and Collaboration:** It is recommended to establish cooperation with key governmental entities in Palestine, such as the Ministry of Transport (MoT) and the Ministry of Telecom and Information Technology (MTIT). These partnerships can facilitate the adoption and promotion of the SRMS platform through hosting the platform on their servers, data privacy and accuracy can be ensured. This collaboration can also make the SRMS platform as a valuable data source for national transportation and traffic disruption management plans.

Furthermore, collaboration with academic institutions and private companies is essential for the continued development of the platform. For example, creating a mobile application that functions offline and implementing a feedback mechanism allowing users to report issues and suggest improvements can significantly enhance the platform's functionality.

**Community Awareness:** Increasing awareness within the Palestinian community regarding the valuable usage of SRMS as a spatial crowdsourcing application in their daily travel. Initiatives should be taken to inform and educate individuals about the benefits of actively using the platform.

**Integration with Local Services:** To maximize the benefits of SRMS, consider integrating the platform with other local services such as health services, civil defense agencies, and transportation authorities, to create a more efficient and responsive services.

This thesis paves the way for diverse avenues of future research to develop and extend the benefits of the SRMS platform. This includes applying the spatiotemporal clustering methods to ensure the quality of the shared data and exploring the integration of blockchain technology to enhance the application of spatial crowdsourcing by ensuring the quality and privacy of shared sensitive data, especially in the Palestinian context. Also, developing a specialized dictionary for the Palestinian dialect and geographic names to improve geocoding services and support future Arabic language-based sensing studies. Furthermore, research and developing machine learning models for converting vocal messages shared on platforms like Telegram into text to expand the platform's data sources and accessibility. Additionally, comprehensive impact assessment studies evaluate the effects of SRMS on Palestinian well-being, the environment, and the economy. Finally, it is interesting to apply the SRMS platform in different urban contexts that may have unique types of mobility restrictions.

## References

1. *100 Resilient Cities*. (2013). 100 Resilient Cities. <https://www.rockefellerfoundation.org/100-resilient-cities/>
2. Abrahams, A. S. (2021). Hard traveling: Unemployment and road infrastructure in the shadow of political conflict. *Political Science Research and Methods*, *10*(3), 545–566. <https://doi.org/10.1017/psrm.2021.8>
3. Abu-Eisheh, S. (2004). The Impacts of the Segregation Wall on the Sustainability of Transportation Systems and Services in the Palestinian Territories. *An-Najah National University Journal for Research*, *18*(2), 24. [https://journals.najah.edu/media/journals/full\\_texts/impacts-segregation-wall--sustainability-transportation-systems-and-services-palestinian-territo.pdf](https://journals.najah.edu/media/journals/full_texts/impacts-segregation-wall--sustainability-transportation-systems-and-services-palestinian-territo.pdf)
4. Abu-Eisheh, S., Kuckshinrichs, W., & Dwaikat, A. (2020). Strategic Planning for Sustainable Transportation in Developing Countries: The Role of Vehicles. *Transportation Research Procedia*, *48*, 3019–3036. <https://doi.org/10.1016/j.trpro.2020.08.184>
5. Aburas, H. (2020). *Impacts of Spatial Interventions on Mobility in Palestinian Territories* (Issue February). Lille University.
6. Aburas, H. (2023a). *Telegram-Text-Retrieving-Analysis-and-Geocoding*. <https://github.com/hala-aburas/Telegram-Messages-Retrieving-Analysis-and-Geocoding-Mapping.git>
7. Aburas, H. (2023b). *waiting-time-prediction-using-RF-model*. <https://github.com/hala-aburas/waiting-time-prediction-using-RF-model.git>
8. Aburas, H., & Shahrou, I. (2021). Impact of the mobility restrictions in the palestinian territory on the population and the environment. *Sustainability (Switzerland)*, *13*(23). <https://doi.org/10.3390/su132313457>
9. Ackaah, W. (2019). Exploring the use of advanced traffic information system to manage traffic congestion in developing countries. *Scientific African*, *4*, e00079. <https://doi.org/10.1016/j.sciaf.2019.e00079>
10. Admiraal, H., & Cornaro, A. (2020). Future cities, resilient cities – The role of underground space in achieving urban resilience. *Underground Space (China)*, *5*(3), 223–228. <https://doi.org/10.1016/j.undsp.2019.02.001>
11. Adnan, W. (2015). Who gets to cross the border? The impact of mobility restrictions on labor flows in the West Bank. *Labour Economics*, *34*, 86–99. <https://doi.org/https://doi.org/10.1016/j.labeco.2015.03.016>
12. Agrawal, S., & Gupta, R. D. (2017). Web GIS and its architecture : a review. *Arabian Journal of Geosciences*.
13. Ahmed, B., Rahman, M. S., Islam, R., Sammonds, P., Zhou, C., Uddin, K., & Al-Hussaini, T. M. (2018). Developing a dynamic web-GIS based landslide early warning system for the Chittagong metropolitan area, Bangladesh. *ISPRS International Journal of Geo-Information*, *7*(12). <https://doi.org/10.3390/ijgi7120485>
14. Ahmed, E., Yaqoob, I., Hashem, I. A. T., Khan, I., Ahmed, A. I. A., Imran, M., & Vasilakos, A. V. (2017). The role of big data analytics in Internet of Things. *Computer Networks*, *129*, 459–471. <https://doi.org/10.1016/j.comnet.2017.06.013>
15. Ahmed, S., Ibrahim, R. F., & Hefny, H. A. (2017). GIS-based network analysis for the

- roads network of the Greater Cairo area. *International Conference on Applied Research in Computer Science and Engineering ICAR'17*, 2144(July), 1–9. <http://ceur-ws.org>
16. Ahwaltareq. (2022). <http://t.me/Ahwaltareq>
  17. Al-Rahamneh, A., Astrain, J. J., Villadangos, J., Klaina, H., Guembe, I. P., Lopez-Iturri, P., & Falcone, F. (2021). Enabling Customizable Services for Multimodal Smart Mobility with City-Platforms. *IEEE Access*, 9, 41628–41646. <https://doi.org/10.1109/ACCESS.2021.3065412>
  18. Al-Sahili, K., & Dwaikat, M. (2019). Modeling Geometric Design Consistency and Road Safety for Two-Lane Rural Highways in the West Bank, Palestine. *Arabian Journal for Science and Engineering*, 44(5), 4895–4909. <https://doi.org/10.1007/s13369-018-3610-7>
  19. Al Shammass, T., Gullón, P., Klein, O., & Escobar, F. (2023). Development of a GIS-based walking route planner with integrated comfort walkability parameters. *Computers, Environment and Urban Systems*, 103(June 2022). <https://doi.org/10.1016/j.compenvurbsys.2023.101981>
  20. Alahi, M. E. E., Sukkuea, A., Tina, F. W., Nag, A., Kurdthongmee, W., Suwannarat, K., & Mukhopadhyay, S. C. (2023). Integration of IoT-Enabled Technologies and Artificial Intelligence (AI) for Smart City Scenario: Recent Advancements and Future Trends. *Sensors*, 23(11). <https://doi.org/10.3390/s23115206>
  21. Alatrística-Salas, H., Montalvo-García, P., Nunez-del-Prado, M., & Salas, J. (2022). *Geolocated Data Generation and Protection Using Generative Adversarial Networks BT - Modeling Decisions for Artificial Intelligence* (V. Torra & Y. Narukawa (Eds.); pp. 80–91). Springer International Publishing.
  22. Aljoufie, M., & Tiwari, A. (2022). Citizen sensors for smart city planning and traffic management: crowdsourcing geospatial data through smartphones in Jeddah, Saudi Arabia. *GeoJournal*, 87(4), 3149–3168. <https://doi.org/10.1007/s10708-021-10423-4>
  23. Aljuaydi, F., Wiwatanapataphee, B., & Wu, Y. H. (2023). Multivariate machine learning-based prediction models of freeway traffic flow under non-recurrent events. *Alexandria Engineering Journal*, 65, 151–162. <https://doi.org/10.1016/j.aej.2022.10.015>
  24. Alkhabbas, F., De Sanctis, M., Bucchiarone, A., Cicchetti, A., Spalazzese, R., Davidsson, P., & Iovino, L. (2022). ROUTE: A Framework for Customizable Smart Mobility Planners. *Proceedings - IEEE 19th International Conference on Software Architecture, ICSA 2022*, 169–180. <https://doi.org/10.1109/ICSA53651.2022.00024>
  25. Alkhatib, M., El Barachi, M., & Shaalan, K. (2019). An Arabic social media based framework for incidents and events monitoring in smart cities. *Journal of Cleaner Production*, 220, 771–785. <https://doi.org/10.1016/j.jclepro.2019.02.063>
  26. Almoshaogeh, M., Abdulrehman, R., Haider, H., Alharbi, F., Jamal, A., Alarifi, S., & Shafiquzzaman, M. D. (2021). Traffic accident risk assessment framework for qassim, saudi arabia: Evaluating the impact of speed cameras. *Applied Sciences (Switzerland)*, 11(15). <https://doi.org/10.3390/app11156682>
  27. Amin-Naseri, M., Chakraborty, P., Sharma, A., Gilbert, S. B., & Hong, M. (2018). Evaluating the Reliability, Coverage, and Added Value of Crowdsourced Traffic Incident Reports from Waze. *Transportation Research Record*, 2672(43), 34–43. <https://doi.org/10.1177/0361198118790619>
  28. Amira, S. (2021). The slow violence of Israeli settler-colonialism and the political



- ecology of ethnic cleansing in the West Bank. *Settler Colonial Studies*, 11(4), 512–532. <https://doi.org/10.1080/2201473X.2021.2007747>
29. Anand, A., Patel, R., & Rajeswari, D. (2022). A Comprehensive Synchronization by Deriving Fluent Pipeline and Web Scraping through Social Media for Emergency Services. *Proceedings - IEEE International Conference on Advances in Computing, Communication and Applied Informatics, ACCAI 2022, January*. <https://doi.org/10.1109/ACCAI53970.2022.9752629>
  30. Ang, K. L. M., Seng, J. K. P., & Ngharamike, E. (2022). Towards Crowdsourcing Internet of Things (Crowd-IoT): Architectures, Security and Applications. *Future Internet*, 14(2). <https://doi.org/10.3390/fi14020049>
  31. Ansari, M. Y., Ahmad, A., Khan, S. S., Bhushan, G., & Mainuddin. (2020). Spatiotemporal clustering: a review. *Artificial Intelligence Review*, 53(4), 2381–2423. <https://doi.org/10.1007/s10462-019-09736-1>
  32. Anuar, W. K., Lee, L. S., Pickl, S., & Seow, H. V. (2021). Vehicle routing optimisation in humanitarian operations: A survey on modelling and optimisation approaches. *Applied Sciences (Switzerland)*, 11(2), 1–70. <https://doi.org/10.3390/app11020667>
  33. Arbib, C., Arcelli, D., Dugdale, J., Moghaddam, M. T., Arbib, C., Arcelli, D., Dugdale, J., Moghaddam, M. T., Real-time, H. M., Arbib, C., Arcelli, D., Dugdale, J., & Muccini, H. (2019). *Real-time Emergency Response through Performant IoT Architectures To cite this version : HAL Id : hal-02091586 Real-time Emergency Response through Performant IoT Architectures*.
  34. ARIJ. (2019a). *ASSESSING THE IMPACTS OF ISRAELI MOVEMENT RESTRICTIONS ON THE MOBILITY OF PEOPLE AND GOODS*.
  35. ARIJ. (2019b). *Assessing The Impacts of Israeli Movement Restrictions on the Mobility on People and Goods in The West Bank*. <http://www.arij.org/publications/special-reports/305-special-reports-2019/955-assessing-the-impacts-of-israeli-movement-restrictions-on-the-mobility-of-people-and-goods-in-the-west-bank-2019.html>
  36. Arnott, R., de Palma, A., & Lindsey, R. (1991). Does providing information to drivers reduce traffic congestion? *Transportation Research Part A: General*, 25(5), 309–318. [https://doi.org/10.1016/0191-2607\(91\)90146-H](https://doi.org/10.1016/0191-2607(91)90146-H)
  37. Arrighi, C., Pregnotato, M., & Castelli, F. (2021). Indirect flood impacts and cascade risk across interdependent linear infrastructures. *Natural Hazards and Earth System Sciences*, 21(6), 1955–1969. <https://doi.org/10.5194/nhess-21-1955-2021>
  38. Ashar, F., Amaratunga, D., & Haigh, R. (2018). Tsunami Evacuation Routes Using Network Analysis: A case study in Padang. *Procedia Engineering*, 212(2017), 109–116. <https://doi.org/10.1016/j.proeng.2018.01.015>
  39. Audu, A. A., Iyiola, O. F., Popoola, A. A., Adeleye, B. M., Medayese, S., Mosima, C., & Blamah, N. (2021). The application of geographic information system as an intelligent system towards emergency responses in road traffic accident in ibadan. *Journal of Transport and Supply Chain Management*, 15, 1–17. <https://doi.org/10.4102/jtscm.v15i0.546>
  40. Aytac, M. (2017). Work-Related Violence and Stress : The Case of Taxi Drivers in Turkey. *Finance & Management Sciences*, August, 1–9.
  41. B'tselem. (2004). *Forbidden Roads: Israel's Discriminatory Road Regime in the West Bank*. [https://www.btselem.org/download/200408\\_forbidden\\_roads\\_eng.pdf](https://www.btselem.org/download/200408_forbidden_roads_eng.pdf)
  42. B'tselem. (2017). *West Bank roads on which Palestinian vehicles are completely*

- prohibited*. [https://www.btselem.org/freedom\\_of\\_movement/forbidden\\_roads](https://www.btselem.org/freedom_of_movement/forbidden_roads)
43. B'Tselem. (2022). *Settler Violence in the WB*. [https://www.btselem.org/settler\\_violence\\_updates\\_list?f%5B2%5D=nf\\_district%3A181&f%5B3%5D=nf\\_type%3A173&f%5B4%5D=date%3A%28min%3A1640995200%2Cmax%3A1672444800%29&page=1](https://www.btselem.org/settler_violence_updates_list?f%5B2%5D=nf_district%3A181&f%5B3%5D=nf_type%3A173&f%5B4%5D=date%3A%28min%3A1640995200%2Cmax%3A1672444800%29&page=1)
  44. Bachu, A. K., Reddy, K. K., & Vanajakshi, L. (2021). Bus travel time prediction using support vector machines for high variance conditions. *Transport*, 36(3), 221–234. <https://doi.org/10.3846/transport.2021.15220>
  45. Balcells, L., & Stanton, J. A. (2021). Violence against Civilians during Armed Conflict: Moving beyond the Macro- And Micro-Level Divide. *Annual Review of Political Science*, 24, 45–69. <https://doi.org/10.1146/annurev-polisci-041719-102229>
  46. Bandeira, J. M., Tafidis, P., MacEdo, E., Teixeira, J., Bahmankhah, B., Guarnaccia, C., & Coelho, M. C. (2020). Exploring the Potential of Web Based Information of Business Popularity for Supporting Sustainable Traffic Management. *Transport and Telecommunication*, 21(1), 47–60. <https://doi.org/10.2478/ttj-2020-0004>
  47. Bang, Y., Lee, D. J., Bae, Y. S., & Ahn, J. H. (2012). Improving information security management: An analysis of ID-password usage and a new login vulnerability measure. *International Journal of Information Management*, 32(5), 409–418. <https://doi.org/10.1016/j.ijinfomgt.2012.01.001>
  48. Bano, M., & Zowghi, D. (2015). A systematic review on the relationship between user involvement and system success. *Information and Software Technology*, 58, 148–169. <https://doi.org/10.1016/j.infsof.2014.06.011>
  49. Barbosa, S. D. J., & De Paula, M. G. (2003). Designing and evaluating interaction as conversation: A modeling language based on semiotic engineering. *Lecture Notes in Computer Science (Including Subseries Lecture Notes in Artificial Intelligence and Lecture Notes in Bioinformatics)*, 2844(June 2003), 16–33. [https://doi.org/10.1007/978-3-540-39929-2\\_2](https://doi.org/10.1007/978-3-540-39929-2_2)
  50. Barredo Arrieta, A., Díaz-Rodríguez, N., Del Ser, J., Bennetot, A., Tabik, S., Barbado, A., Garcia, S., Gil-Lopez, S., Molina, D., Benjamins, R., Chatila, R., & Herrera, F. (2020). Explainable Artificial Intelligence (XAI): Concepts, taxonomies, opportunities and challenges toward responsible AI. *Information Fusion*, 58, 82–115. <https://doi.org/10.1016/j.inffus.2019.12.012>
  51. Behrisch, M., Bieker, L., Erdmann, J., & Krajzewicz, D. (2011). electronic library - SUMO – Simulation of Urban MObility: An Overview. *SIMUL 2011, The Third International Conference on Advances in System Simulation, May 2014*, 101–107. <http://elib.dlr.de/71460/>
  52. Bhatlawande, S., Deshpande, A., Deshpande, S., & Shilaskar, S. (2022). Proactive Detection of Pothole and Walkable Path for Safe Mobility of Visually Challenged. *2022 3rd International Conference for Emerging Technology (INCET)*, 1–5. <https://doi.org/10.1109/INCET54531.2022.9824637>
  53. Bhattacharjee, S., Ghosh, N., Shah, V. K., & Das, S. K. (2017). QnQ: A reputation model to secure mobile crowdsourcing applications from incentive losses. *2017 IEEE Conference on Communications and Network Security, CNS 2017, 2017-Janua(November)*, 1–9. <https://doi.org/10.1109/CNS.2017.8228635>
  54. Biljecki, F., Chow, Y. S., & Lee, K. (2023). Quality of crowdsourced geospatial building information: A global assessment of OpenStreetMap attributes. *Building and*

- Environment*, 237(April), 110295. <https://doi.org/10.1016/j.buildenv.2023.110295>
55. Bishara, A. (2015). Driving while Palestinian in Israel and the West Bank: The politics of disorientation and the routes of a subaltern knowledge. *American Ethnologist*, 42(1), 33–54. <https://doi.org/10.1111/amet.12114>
  56. Blackett, C. (2021). *Human-Centered Design in an Automated World BT - Intelligent Human Systems Integration 2021* (D. Russo, T. Ahram, W. Karwowski, G. Di Bucchianico, & R. Taiar (Eds.); pp. 17–23). Springer International Publishing.
  57. Bokonda, P. L., Ouazzani-Touhami, K., & Souissi, N. (2020). A Practical Analysis of Mobile Data Collection Apps. *International Journal of Interactive Mobile Technologies*, 14(13), 19–35. <https://doi.org/10.3991/ijim.v14i13.13483>
  58. Borker, G. (2021). Safety First: Perceived Risk of Street Harassment and Educational Choices of Women. *Working Paper*, July. [https://girijaborker.files.wordpress.com/2017/11/borker\\_jmp.pdf](https://girijaborker.files.wordpress.com/2017/11/borker_jmp.pdf)
  59. Borowska-Stefańska, M., Balážovičová, L., Goniewicz, K., Kowalski, M., Kurzyk, P., Masný, M., Wiśniewski, S., Žoncová, M., & Khorram-Manesh, A. (2022). Emergency management of self-evacuation from flood hazard areas in Poland. *Transportation Research Part D: Transport and Environment*, 107, 103307. <https://doi.org/https://doi.org/10.1016/j.trd.2022.103307>
  60. Boussauw, K., & Vanin, F. (2018). Constrained sustainable urban mobility: the possible contribution of research by design in two Palestinian cities. *Urban Design International*, 23(3), 182–199. <https://doi.org/10.1057/s41289-018-0059-y>
  61. Braun, V., Clarke, V., Boulton, E., Davey, L., & McEvoy, C. (2021). The online survey as a qualitative research tool. *International Journal of Social Research Methodology*, 24(6), 641–654. <https://doi.org/10.1080/13645579.2020.1805550>
  62. Braverman, I. (2011). Civilized Borders: A Study of Israel's New Crossing Administration. *Antipode*, 43(2), 264–295. <https://doi.org/10.1111/j.1467-8330.2010.00773.x>
  63. Bryson, A. (2011). *Survival Cities : Adaptive Approaches to Violence and Insecurity on the Periphery of Bogota By*.
  64. BTSELEM. (2019). *List of military checkpoints in the West Bank and Gaza Strip*. [https://www.btselem.org/freedom\\_of\\_movement/checkpoints\\_and\\_forbidden\\_roads](https://www.btselem.org/freedom_of_movement/checkpoints_and_forbidden_roads)
  65. Bucher, T. (2012). Want to be on the top? Algorithmic power and the threat of invisibility on Facebook. *New Media & Society*, 14(7), 1164–1180. <https://doi.org/10.1177/1461444812440159>
  66. Budi Sunaryo, Ricki Hardi, Rohmat Taufiq, Vicente Aquino Pitogo, Trisya Septiana, Riska Amelia, & Jack Febrian Rusdi. (2019). Mapping Mining Potential Using WebGIS. *SciTech Framework*, 1(1), 41–46.
  67. Buthpitiya, S., Zhang, Y., Dey, A. K., & Griss, M. (2011). Geo-trace Modeling. *Proceedings of the 9th International Conference on Pervasive Computing*, 97–114.
  68. Cai, X., Lei, C., Peng, B., Tang, X., & Gao, Z. (2020). Road Traffic Safety Risk Estimation Method Based on Vehicle Onboard Diagnostic Data. *Journal of Advanced Transportation*, 2020. <https://doi.org/10.1155/2020/3024101>
  69. Calì, M., & Miaari, S. H. (2018). The labor market impact of mobility restrictions: Evidence from the West Bank. *Labour Economics*, 51, 136–151. <https://doi.org/10.1016/j.labeco.2017.12.005>
  70. Camargo, C. Q., Bright, J., McNeill, G., Raman, S., & Hale, S. A. (2020). Estimating

- Traffic Disruption Patterns with Volunteered Geographic Information. *Scientific Reports*, 10(1), 1–8. <https://doi.org/10.1038/s41598-020-57882-2>
71. Cao, C. C., Shej, J., Tong, Y., & Chen, L. (2012). Whom to ask? Jury selection for decision making tasks on micro-blog services. *Proceedings of the VLDB Endowment*, 5(11), 1495–1506. <https://doi.org/10.14778/2350229.2350264>
  72. Capela, S., Pereira, V., Duque, J., & Filipe, V. (2022). A deep learning model for detection of traffic events based on social networks publications. *Procedia Computer Science*, 204(2021), 91–98. <https://doi.org/10.1016/j.procs.2022.08.011>
  73. Carroll, J. M., & Rosson, M. B. (1992). Getting around the Task-Artifact Cycle: How to Make Claims and Design by Scenario. *ACM Trans. Inf. Syst.*, 10(2), 181–212. <https://doi.org/10.1145/146802.146834>
  74. Castillo, C. (2018). *Big Crisis Data*.
  75. Castro, U., Avila, J., Sustaita, C. V., Hernandez, M. A., Larios, V. M., Villanueva-Rosales, N., Mondragon, O., Cheu, R. L., & Maciel, R. (2019). Towards smart mobility during flooding events in urban areas using crowdsourced information. *5th IEEE International Smart Cities Conference, ISC2 2019, Isc2 2019*, 154–159. <https://doi.org/10.1109/ISC246665.2019.9071781>
  76. Ceccato, V., Gaudelet, N., & Graf, G. (2022). Crime and safety in transit environments: a systematic review of the English and the French literature, 1970–2020. In *Public Transport* (Vol. 14, Issue 1). Springer Berlin Heidelberg. <https://doi.org/10.1007/s12469-021-00265-1>
  77. Chan, R., Lis, K., Uhlemeyer, S., Blum, H., Honari, S., Siegwart, R., Fua, P., Salzmann, M., & Rottmann, M. (2021). SegmentMeIfYouCan: A Benchmark for Anomaly Segmentation. *Part of Proceedings of the Neural Information Processing Systems Track on Datasets and Benchmarks 1 (NeurIPS Datasets and Benchmarks 2021) Round2*.
  78. Chang, S., Pierson, E., Koh, P. W., Gerardin, J., Redbird, B., Grusky, D., & Leskovec, J. (2021). Mobility network models of COVID-19 explain inequities and inform reopening. *Nature*, 589(7840), 82–87. <https://doi.org/10.1038/s41586-020-2923-3>
  79. Chaudhari, A., Agrawal, H., Poddar, S., Talele, K., & Bansode, M. (2021). Smart Accident Detection And Alert System. *2021 IEEE India Council International Subsections Conference (INDISCON)*, 1–4. <https://doi.org/10.1109/INDISCON53343.2021.9582163>
  80. Chaudhuri, S., Saez, M., Varga, D., & Juan, P. (2023). Spatiotemporal modeling of traffic risk mapping: A study of urban road networks in Barcelona, Spain. *Spatial Statistics*, 53, 100722. <https://doi.org/10.1016/j.spasta.2022.100722>
  81. Chen, C., Li, K., Teo, S. G., Zou, X., Li, K., & Zeng, Z. (2020). Citywide Traffic Flow Prediction Based on Multiple Gated Spatio-Temporal Convolutional Neural Networks. *ACM Trans. Knowl. Discov. Data*, 14(4). <https://doi.org/10.1145/3385414>
  82. Chen, D., Chen, N., Zhang, X., & Guan, Y. (2022). Real-Time Road Pothole Mapping Based on Vibration Analysis in Smart City. *IEEE Journal of Selected Topics in Applied Earth Observations and Remote Sensing*, 15, 6972–6984. <https://doi.org/10.1109/JSTARS.2022.3200147>
  83. Chen, J., Pei, T., Li, M., Song, C., Ma, T., Lu, F., & Shaw, S. L. (2020). An enhanced model for evacuation vulnerability assessment in urban areas. *Computers, Environment and Urban Systems*, 84(September 2019), 101540.

- <https://doi.org/10.1016/j.compenvurbsys.2020.101540>
84. Chen, S., Zhai, C., Li, Z., Zhang, J., & Pan, X. (2019). Integrated Design of Traditional Traffic Information Acquisition Device. *Proceedings - 2019 International Conference on Smart Grid and Electrical Automation, ICSGEA 2019*, 132–135. <https://doi.org/10.1109/ICSGEA.2019.00038>
  85. Chen, X., Jiang, L., Xia, Y., Wang, L., Ye, J., Hou, T., Zhang, Y., Li, M., Li, Z., Song, Z., Li, J., Jiang, Y., Li, P., Zhang, X., Zhang, Y., Rosenfeld, D., Seinfeld, J. H., & Yu, S. (2022). Quantifying on-road vehicle emissions during traffic congestion using updated emission factors of light-duty gasoline vehicles and real-world traffic monitoring big data. *Science of The Total Environment*, 847, 157581. <https://doi.org/https://doi.org/10.1016/j.scitotenv.2022.157581>
  86. Chiche, A., & Yitagesu, B. (2022). Part of speech tagging: a systematic review of deep learning and machine learning approaches. *Journal of Big Data*, 9(1), 10. <https://doi.org/10.1186/s40537-022-00561-y>
  87. Chnar, M., & Subhi, Z. (2021). Sufficient Comparison Among Cloud Computing Services: IaaS, PaaS, and SaaS: A Review. *Science and Business*, 5(2), 17–30. <https://doi.org/10.5281/zenodo.4450129>
  88. City of Toronto. (2013). *City of Toronto Road Classification System*.
  89. Clarinval, A., & Dumas, B. (2023). Intra-City Traffic Data Visualization : A Systematic Literature Review Intra-City Traffic Data Visualization : A Systematic Literature Review. *IEEE Transactions on Intelligent Transportation Systems*.
  90. Committee of Transport Officials-COTO. (2012). South African Road Classification and Access Management Manual. *South African Road Classification and Access Management Manual*, 1(August), 89. [http://www.roadsandtransport.gpg.gov.za/legislation/Documents/SA\\_Road\\_Classification\\_and\\_Access\\_Manual.pdf](http://www.roadsandtransport.gpg.gov.za/legislation/Documents/SA_Road_Classification_and_Access_Manual.pdf)
  91. Cooper, A. (1999). The Inmates are Running the Asylum. In K. Arend, Udo AND Eberleh, Edmund AND Pitschke (Ed.), *Software-Ergonomie '99: Design von Informationswelten* (Vol. 43, Issue 1, p. 17). B.G.Teubner. <https://doi.org/10.1109/tpc.2000.826426>
  92. Corral-Plaza, D., Medina-Bulo, I., Ortiz, G., & Boubeta-Puig, J. (2020). A stream processing architecture for heterogeneous data sources in the Internet of Things. *Computer Standards and Interfaces*, 70(June 2019), 103426. <https://doi.org/10.1016/j.csi.2020.103426>
  93. Couto, M., Lawoko, S., & Svanström, L. (2011). Violence Against Drivers and Conductors in the Road Passenger Transport Sector in Maputo, Mozambique. *African Safety Promotion: A Journal of Injury and Violence Prevention*, 7(2), 17–36. <https://doi.org/10.4314/asp.v7i2.70414>
  94. Cruz, A., Carneiro, E., Fontes, X., Kokkinogenis, Z., & Rossetti, R. J. F. (2019). HERMES: A tool for mesoscopic simulation of advanced traveller information systems. *5th IEEE International Smart Cities Conference, ISC2 2019, Isc2 2019*, 638–643. <https://doi.org/10.1109/ISC246665.2019.9071673>
  95. Curtis, C., Liu, C., Bollerman, T. J., & Pianykh, O. S. (2017). Machine Learning for Predicting Patient Wait Times and Appointment Delays. *Journal of the American College of Radiology, ML*, 1–7. <https://doi.org/10.1016/j.jacr.2017.08.021>
  96. Davis, D. (2012). *Urban Resilience in Situations of Chronic Violence: Book*. May, 1–

34. <http://web.mit.edu/cis/urbanresiliencereport2012.pdf>
97. Ding, X., Chong, X., Bao, Z., Xue, Y., & Zhang, S. (2017). Fuzzy Comprehensive Assessment Method Based on the Entropy Weight Method and Its Application in the Water Environmental Safety Evaluation of the Heshangshan Drinking Water Source Area, Three Gorges Reservoir Area, China. *Water (Switzerland)*, 9(5). <https://doi.org/10.3390/w9050329>
98. Domínguez, J. M. L., & Sanguino, T. de J. M. (2021). Walking secure: Safe routing planning algorithm and pedestrian's crossing intention detector based on fuzzy logic app. *Sensors*, 21(2), 1–22. <https://doi.org/10.3390/s21020529>
99. Dongo, I., Cadinale, Y., Aguilera, A., Martínez, F., Quintero, Y., & Barrios, S. (2020). *Web Scraping versus Twitter API*. 263–273. <https://doi.org/10.1145/3428757.3429104>
100. Dorigo, M., & Gianni, D. C. (1992). Ant Colony Optimization: A New Meta-Heuristic. In *In Proceedings of the 1999 congress on evolutionary computation-CEC99 (Cat. No. 99TH8406)* (pp. 1470–1477).
101. *Doroob*. (2019). <http://www.doroob.net>
102. Du, W., & Ding, S. (2021). A survey on multi-agent deep reinforcement learning: from the perspective of challenges and applications. *Artificial Intelligence Review*, 54(5), 3215–3238. <https://doi.org/10.1007/s10462-020-09938-y>
103. Dunckel Graglia, A. (2016). Finding mobility: women negotiating fear and violence in Mexico City's public transit system. *Gender, Place and Culture*, 23(5), 624–640. <https://doi.org/10.1080/0966369X.2015.1034240>
104. Dwork, C. (2006). Differential Privacy. *SpringerBriefs in Computer Science*, 5–11. [https://doi.org/10.1007/978-3-030-96398-9\\_2](https://doi.org/10.1007/978-3-030-96398-9_2)
105. E. W. Dijkstra. (1959). A note on two problems in connexion with graphs. *Numerische Mathematik*, 1(1), 269–271. <https://doi.org/10.1037/h0066879>
106. Elfahim, O., Laoula, E. M. Ben, Youssfi, M., Barakat, O., & Mestari, M. (2021). Reinforcement Learning-based Unpredictable Emergency Events. *2021 Fifth International Conference On Intelligent Computing in Data Sciences (ICDS)*, 1–7. <https://doi.org/10.1109/ICDS53782.2021.9626720>
107. Espitia, N., Yu, H., & Krstic, M. (2020). Event-triggered Varying Speed Limit Control of Stop-and-go Traffic. *IFAC-PapersOnLine*, 53(2), 7509–7514. <https://doi.org/https://doi.org/10.1016/j.ifacol.2020.12.1343>
108. esri. (2023). *Algorithms used by Network Analyst*. <https://pro.arcgis.com/en/pro-app/latest/help/analysis/networks/algorithms-used-by-network-analyst.htm>
109. Esri. (2017). *A simple e-mail notification system for Survey123 for ArcGIS*. <https://community.esri.com/t5/arcgis-survey123-blog/a-simple-e-mail-notification-system-for-survey123/ba-p/895031>
110. Esri. (2021a). *ArcGIS Online*. <https://www.esri.com/en-us/arcgis/products/arcgis-online/overview>
111. Esri. (2021b). *ArcGIS Trust Center*. <https://trust.arcgis.com/en/security/cloud-options.htm#:~:text=ArcGIS Online is a cloud,being mobile in the field.>
112. Esri. (2023a). *ArcGIS Experience Builder*. <https://www.esri.com/en-us/arcgis/products/arcgis-experience-builder/overview>
113. Esri. (2023b). *ArcGIS Online privacy assurance*. <https://trust.arcgis.com/en/privacy/privacy-tab-intro.htm>

114. Esri. (2023c). *ArcGIS Survey123*. <https://doc.arcgis.com/en/survey123/reference/whatisurvey123.htm#:~:text=Survey123 Connect provides the survey,the survey and its behavior>
115. Esri. (2023d). *GIS Dictionary*. <https://support.esri.com/en-us/gis-dictionary/impedance>
116. Esri. (2023e). *Hosted feature layers*. <https://developers.arcgis.com/documentation/mapping-apis-and-services/data-hosting/hosted-feature-layers/>
117. Esri. (2023f). *Network topology*. <https://pro.arcgis.com/en/pro-app/latest/help/data/utility-network/about-network-topology.htm>
118. Esri. (2023g). *Shapefile*. <https://doc.arcgis.com/en/arcgis-online/reference/shapefiles.htm#:~:text=A shapefile is an Esri,and contains one feature class.>
119. Esri. (2023h). *Why Use Cloud Infrastructure for ArcGIS?* <https://www.esri.com/news/arcnews/summer11/articles/why-use-cloud-infrastructure-for-arcgis.html>
120. Essenberg, B. (2003). *SECTORAL ACTIVITIES PROGRAMME Working Paper Violence and stress at work in the transport sector*.
121. Essien, A., Petrounias, I., Sampaio, P., & Sampaio, S. (2021). A deep-learning model for urban traffic flow prediction with traffic events mined from twitter. *World Wide Web*, 24(4), 1345–1368. <https://doi.org/10.1007/s11280-020-00800-3>
122. Facebook Help Center. (2023). *Facebook privacy settings*. <https://www.facebook.com/help/193677450678703/>
123. Fauzan, R., Krisnahati, I., Nurwibowo, B. D., & Wibowo, D. A. (2022). A Systematic Literature Review on Progressive Web Application Practice and Challenges. *IPTEK The Journal for Technology and Science*, 33(1), 43. <https://doi.org/10.12962/j20882033.v33i1.13904>
124. Feng, K., & Lin, N. (2022). Modeling and analyzing the traffic flow during evacuation in Hurricane Irma (2017). *Transportation Research Part D: Transport and Environment*, 110(August), 103412. <https://doi.org/10.1016/j.trd.2022.103412>
125. Feng, W., Yan, Z., Yang, L. T., & Zheng, Q. (2022). Anonymous Authentication on Trust in Blockchain-Based Mobile Crowdsourcing. *IEEE Internet of Things Journal*, 9(16), 14185–14202. <https://doi.org/10.1109/JIOT.2020.3018878>
126. Feng, Y., Brenner, C., & Sester, M. (2020). Flood severity mapping from Volunteered Geographic Information by interpreting water level from images containing people: A case study of Hurricane Harvey. *ISPRS Journal of Photogrammetry and Remote Sensing*, 169(June), 301–319. <https://doi.org/10.1016/j.isprsjprs.2020.09.011>
127. Fernandes, U. da S., Prates, R. O., Chagas, B. A., & Barbosa, G. A. R. (2021). Analyzing MoLIC's Applicability to Model the Interaction of Conversational Agents: A Case Study on ANA Chatbot. *Proceedings of the XX Brazilian Symposium on Human Factors in Computing Systems*. <https://doi.org/10.1145/3472301.3484367>
128. FHWA, U. S. D. of transportation. (2019). *Reducing Non-Recurring Congestion*. [https://ops.fhwa.dot.gov/program\\_areas/reduce-non-cong.html](https://ops.fhwa.dot.gov/program_areas/reduce-non-cong.html)
129. Forkuo, E. K., & Quayeballard, J. A. (2014). *GIS Based Fire Emergency Response System. December*.

130. Fornace, K. M., Surendra, H., Abidin, T. R., Reyes, R., Macalinao, M. L. M., Stresman, G., Luchavez, J., Ahmad, R. A., Supargiyono, S., Espino, F., Drakeley, C. J., & Cook, J. (2018). Use of mobile technology - based participatory mapping approaches to geolocate health facility attendees for disease surveillance in low resource settings. *International Journal of Health Geographics*, 1–10. <https://doi.org/10.1186/s12942-018-0141-0>
131. Fratto, C. (2019). The reallocative effects of mobility restrictions on workers and firms : A West Bank application. *IDEAS*, 1–56.
132. Fujihara, A. (2019). Proposing a System for Collaborative Traffic Information Gathering and Sharing Incentivized by Blockchain Technology. In *Lecture Notes on Data Engineering and Communications Technologies* (Vol. 23). Springer International Publishing. [https://doi.org/10.1007/978-3-319-98557-2\\_16](https://doi.org/10.1007/978-3-319-98557-2_16)
133. Fukuda, S., Uchida, H., Fujii, H., & Yamada, T. (2020). Short-term prediction of traffic flow under incident conditions using graph convolutional recurrent neural network and traffic simulation. *IET Intelligent Transport Systems*, 14(8), 936–946. <https://doi.org/10.1049/iet-its.2019.0778>
134. Galdames, P., Gutierrez-Soto, C., & Curiel, A. (2019). Batching Location Cloaking Techniques for Location Privacy and Safety Protection. *Mobile Information Systems, 2019*. <https://doi.org/10.1155/2019/9086062>
135. Geomolg. (2012). *Geomolg*. <https://geomolg.ps/L5/index.html?viewer=A3.V1>
136. Google. (2021). *Google Maps Eco-Friendly Routing*. <https://sustainability.google/empowering-individuals/>
137. Green, D., & Bossomaier, T. (2002). Online GIS and Spatial Metadata. In *Online GIS and Spatial Metadata* (p. 219). Taylor & Francis.
138. Griffiths, M., & Repo, J. (2021). Women and checkpoints in Palestine. *Security Dialogue*, 52(3), 249–265. <https://doi.org/10.1177/0967010620918529>
139. Gu, S., Li, K., Feng, T., Yan, D., & Liu, Y. (2022). The prediction of potential risk path in railway traffic events. *Reliability Engineering and System Safety*, 222(2022), 108409. <https://doi.org/10.1016/j.ress.2022.108409>
140. Gugerell, K., & Netsch, S. (2017). Planning in the face of power. Experiencing power dimensions in a visioning process in the west bank and the Gaza strip. *Urban Planning*, 2(1), 41–52. <https://doi.org/10.17645/up.v2i1.862>
141. Guillén, K. I. L., Mendoza, U. F., & Santos, L. W. (2011). Crowdmap and Ushahidi: To obtain and visualize traffic congestion information in Mexico City. *4th ACM SIGSPATIAL International Workshop on Computational Transportation Science 2011, CTS'11, in Conjunction with ACM SIGSPATIAL GIS 2011*, 24–27. <https://doi.org/10.1145/2068984.2068989>
142. Gupta, M., Miglani, H., Deo, P., & Barhatte, A. (2023). Real-time traffic control and monitoring. *E-Prime - Advances in Electrical Engineering, Electronics and Energy*, 5(June), 100211. <https://doi.org/10.1016/j.prime.2023.100211>
143. Gures, E., Shayea, I., Ergen, M., Azmi, M. H., & El-Saleh, A. A. (2022). Machine Learning-Based Load Balancing Algorithms in Future Heterogeneous Networks: A Survey. *IEEE Access*, 10, 37689–37717. <https://doi.org/10.1109/ACCESS.2022.3161511>
144. Gutierrez, M. (2019). Maputopias: cartographies of communication, coordination and action—the cases of Ushahidi and InfoAmazonia. *GeoJournal*, 84(1),



- 101–120. <https://doi.org/10.1007/s10708-018-9853-8>
145. Habbas, W., & Berda, Y. (2021). Colonial management as a social field: The Palestinian remaking of Israel's system of spatial control. *Current Sociology*, 2–28. <https://doi.org/10.1177/00113921211024695>
146. Halper, J. (2000). The 94 percent solution a matrix of control. *Middle East Report*, 216(216), 14–19. <https://doi.org/10.2307/1520209>
147. Hamrouni, A., Ghazzai, H., Frikha, M., & Massoud, Y. (2019). A Photo-Based Mobile Crowdsourcing Framework for Event Reporting. *Midwest Symposium on Circuits and Systems, 2019-Augus*, 198–202. <https://doi.org/10.1109/MWSCAS.2019.8884949>
148. Hamrouni, A., Ghazzai, H., Frikha, M., & Massoud, Y. (2020). A Spatial Mobile Crowdsourcing Framework for Event Reporting. *IEEE Transactions on Computational Social Systems*, 7(2), 477–491. <https://doi.org/10.1109/TCSS.2020.2967585>
149. Haque, A. K. M. B., Bhushan, B., & Dhiman, G. (2022). Conceptualizing smart city applications: Requirements, architecture, security issues, and emerging trends. *Expert Systems*, 39(5), 1–23. <https://doi.org/10.1111/exsy.12753>
150. Haraguchi, M., Nishino, A., Kodaka, A., Allaire, M., Lall, U., Kuei-Hsien, L., Onda, K., Tsubouchi, K., & Kohtake, N. (2022). Human mobility data and analysis for urban resilience: A systematic review. *Environment and Planning B: Urban Analytics and City Science*, 49(5), 1507–1535. <https://doi.org/10.1177/23998083221075634>
151. Harleman, M., Harris, L., Willis, M. D., Ritz, B., Hystad, P., & Hill, E. L. (2023). Changes in traffic congestion and air pollution due to major roadway infrastructure improvements in Texas. *Science of The Total Environment*, 898, 165463. <https://doi.org/https://doi.org/10.1016/j.scitotenv.2023.165463>
152. Heinzelman, J., & Waters, C. (2010). Crowdsourcing Crisis Information in Disaster- Affected Haiti. *United States Institute of Peace*.
153. Helmrich, A. M., Ruddell, B. L., Bessem, K., Chester, M. V., Chohan, N., Doerry, E., Eppinger, J., Garcia, M., Goodall, J. L., Lowry, C., & Zahura, F. T. (2021). Opportunities for crowdsourcing in urban flood monitoring. *Environmental Modelling and Software*, 143, 105124. <https://doi.org/10.1016/j.envsoft.2021.105124>
154. Hu, H., Zheng, Y., Bao, Z., Li, G., Feng, J., & Cheng, R. (2016). Crowdsourced POI labelling: Location-aware result inference and Task Assignment. *2016 IEEE 32nd International Conference on Data Engineering, ICDE 2016, 1*, 61–72. <https://doi.org/10.1109/ICDE.2016.7498229>
155. Hu, J., Lin, H., Guo, X., & Yang, J. (2018). DTCS: An Integrated Strategy for Enhancing Data Trustworthiness in Mobile Crowdsourcing. *IEEE Internet of Things Journal*, 5(6), 4663–4671. <https://doi.org/10.1109/IIOT.2018.2801559>
156. Huang, X., Wang, X., Pei, J., Xu, M., Huang, X., & Luo, Y. (2018). Risk assessment of the areas along the highway due to hazardous material transportation accidents. *Natural Hazards*, 93(3), 1181–1202. <https://doi.org/10.1007/s11069-018-3346-4>
157. Ibba, S., Pinna, A., & Pani, F. E. (2017). CitySense : blockchain-oriented Smart Cities. *XP '17 Workshops*, 5. <https://doi.org/1145/3120459.3120472>
158. Ikeda, Y., & Inoue, M. (2016). An Evacuation Route Planning for Safety Route Guidance System after Natural Disaster Using Multi-objective Genetic Algorithm.

- Procedia Computer Science*, 96, 1323–1331.  
<https://doi.org/10.1016/j.procs.2016.08.177>
159. Ilbeigi, M. (2019). Statistical process control for analyzing resilience of transportation networks. *International Journal of Disaster Risk Reduction*, 33, 155–161. <https://doi.org/10.1016/j.ijdr.2018.10.002>
  160. Indukuri, C. L., & Kottursamy, K. (2021). *Advanced Accident Avoiding, Tracking and SOS Alert System Using GPS Module and Raspberry Pi BT - Artificial Intelligence Techniques for Advanced Computing Applications* (D. J. Hemanth, G. Vadivu, M. Sangeetha, & V. E. Balas (Eds.); pp. 167–178). Springer Singapore.
  161. International Court of Justice. (2003). *Legal Consequences of the Construction of a Wall in the Occupied Palestinian Territory*. <https://www.icj-cij.org/case/131>
  162. IPOKE. (2022). *الواقع الرقمي الفلسطيني*.
  163. Jay, B., Alberta, S., & Royal, M. (2019). The tools of citizen science: An evaluation of map-based crowdsourcing platforms Chickadee Technology. *Spatial Knowledge and Information Canada*, 7(4).
  164. Jayasena, N. S., Mallawaarachchi, H., & Waidyasekara, K. G. A. S. (2019). Stakeholder Analysis For Smart City Development Project: An Extensive Literature Review. *MATEC Web of Conferences*, 266, 06012. <https://doi.org/10.1051/mateconf/201926606012>
  165. Jevinger, Å., & Persson, J. A. (2019). Potentials of context-aware travel support during unplanned public transport disturbances. *Sustainability (Switzerland)*, 11(6). <https://doi.org/10.3390/su11061649>
  166. Jiang, H., Li, J., Zhao, P., Zeng, F., Xiao, Z., & Iyengar, A. (2021). Location Privacy-preserving Mechanisms in Location-based Services. *ACM Computing Surveys*, 54(1). <https://doi.org/10.1145/3423165>
  167. Jilani, M. T., Ur Rehman, M. Z., & Abbas, M. A. (2019). An application framework of crowdsourcing based emergency events reporting in smart cities. *2019 International Symposium on Networks, Computers and Communications, ISNCC 2019*, 1–5. <https://doi.org/10.1109/ISNCC.2019.8909146>
  168. Jin, H., Su, L., Chen, D., Nahrstedt, K., & Xu, J. (2015). Quality of Information Aware Incentive Mechanisms for Mobile Crowd Sensing Systems. *Proceedings of the 16th ACM International Symposium on Mobile Ad Hoc Networking and Computing*, 167–176. <https://doi.org/10.1145/2746285.2746310>
  169. Jin, H., Su, L., Xiao, H., & Nahrstedt, K. (2016). INCEPTION: Incentivizing Privacy-Preserving Data Aggregation for Mobile Crowd Sensing Systems. *Proceedings of the 17th ACM International Symposium on Mobile Ad Hoc Networking and Computing*, 341–350. <https://doi.org/10.1145/2942358.2942375>
  170. Jin, Y., Carman, M., Zhu, Y., & Xiang, Y. (2020). A technical survey on statistical modelling and design methods for crowdsourcing quality control. *Artificial Intelligence*, 287. <https://doi.org/10.1016/j.artint.2020.103351>
  171. Jing, C., Du, M., Li, S., & Liu, S. (2019). Geospatial dashboards for monitoring smart city performance. *Sustainability (Switzerland)*, 11(20). <https://doi.org/10.3390/su11205648>
  172. Jobe, W. (2013). Native Apps Vs. Mobile Web Apps. *International Journal of Interactive Mobile Technologies (IJIM)*, 7(4), 27. <https://doi.org/10.3991/ijim.v7i4.3226>

173. Jordan, E. J., Moran, C., Godwyll, J. M., Jordan, E. J., Moran, C., Godwyll, J. M., Survey, A., & Jordan, E. J. (2019). Current Issues in Tourism Does tourism really cause stress ? A natural experiment utilizing ArcGIS Survey123. *Current Issues in Tourism*, 0(0), 1–15. <https://doi.org/10.1080/13683500.2019.1702001>
174. Jung, J., Oh, T., Kim, I., & Park, S. (2023). Open-sourced real-time visualization platform for traffic simulation. *Procedia Computer Science*, 220, 243–250. <https://doi.org/10.1016/j.procs.2023.03.033>
175. Kamali, M., Malek, M. R., Saeedi, S., & Liang, S. (2021). A blockchain-based spatial crowdsourcing system for spatial information collection using a reward distribution. *Sensors*, 21(15). <https://doi.org/10.3390/s21155146>
176. Kang, Y., Cai, Z., Tan, C. W., Huang, Q., & Liu, H. (2020). Natural language processing (NLP) in management research: A literature review. *Journal of Management Analytics*, 7(2), 139–172. <https://doi.org/10.1080/23270012.2020.1756939>
177. Karadimas, N. V., Kolokathi, M., Defteraiou, G., & Loumos, V. (2007). Ant Colony System vs ArcGIS Network Analyst: The Case of Municipal Solid Waste Collection. *5th WSEAS International Conference on Environment, Ecosystems and Development*, May, 128–134. <https://doi.org/10.13140/2.1.3676.9600>
178. Karaer, A., Ulak, M. B., Ozguven, E. E., & Sando, T. (2020). Reducing the Non-Recurrent Freeway Congestion with Detour Operations: Case Study in Florida. *Transportation Engineering*, 2(September), 100026. <https://doi.org/10.1016/j.treng.2020.100026>
179. Karnatak, H. (2012). Spatial mashup technology and real time data integration in geo-web application using open source GIS – a case study for disaster management. *Geocarto International*, October. <https://doi.org/10.1080/10106049.2011.650651>
180. Katoch, S., Chauhan, S. S., & Kumar, V. (2021). A review on genetic algorithm: past, present, and future. *Multimedia Tools and Applications*, 80(5), 8091–8126. <https://doi.org/10.1007/s11042-020-10139-6>
181. Kazemi, L., & Shahabi, C. (2012). *GeoCrowd : Enabling Query Answering with Spatial Crowdsourcing*. c, 189–198.
182. Khaund, T., Hussain, M. N., Shaik, M., & Agarwal, N. (2021). Telegram: Data Collection, Opportunities and Challenges. In *Information Management and Big Data*. Springer.
183. Khazukov, K., Shepelev, V., Karpeta, T., Shabiev, S., Slobodin, I., Charbadze, I., & Alferova, I. (2020). Real-time monitoring of traffic parameters. *Journal of Big Data*, 7(1), 84. <https://doi.org/10.1186/s40537-020-00358-x>
184. Kim, S., Anagnostopoulos, G., Barmponakis, E., & Geroliminis, N. (2023). Visual extensions and anomaly detection in the pNEUMA experiment with a swarm of drones. *Transportation Research Part C: Emerging Technologies*, 147(March 2022), 103966. <https://doi.org/10.1016/j.trc.2022.103966>
185. Kitchin, R., & McArdle, G. (2017). Urban data and city dashboards: Six key issues. *Data and the City*, October, 111–126. <https://doi.org/10.4324/9781315407388>
186. Kırdar, G., & Ardiç, S. İ. (2020). A design proposal of integrated smart mobility application for travel behavior change towards sustainable mobility. *Civil Engineering and Architecture*, 8(5), 1095–1106. <https://doi.org/10.13189/cea.2020.080536>
187. Koenig, S., & Likhachev, M. (2002). D\* Lite. *AAAI-02 Proceedings*, 15, 476–

483. <https://doi.org/10.1145/1982185.1982483>
188. Kong, X., Liu, X., Jedari, B., Li, M., Wan, L., & Xia, F. (2019). Mobile Crowdsourcing in Smart Cities: Technologies, Applications, and Future Challenges. *IEEE Internet of Things Journal*, 6(5), 8095–8113. <https://doi.org/10.1109/JIOT.2019.2921879>
189. Kong, Y., Guan, M., Li, X., Zhao, J., & Yan, H. (2022). Bi-Linear Laws Govern the Impacts of Debris Flows, Debris Avalanches, and Rock Avalanches on Flexible Barrier. *Journal of Geophysical Research: Earth Surface*, 127(11), e2022JF006870. <https://doi.org/https://doi.org/10.1029/2022JF006870>
190. Kothadiya, D., Chaudhari, A., Macwan, R., Patel, K., & Bhatt, C. (2021). The Convergence of Deep Learning and Computer Vision: Smart City Applications and Research Challenges. *Proceedings of the 3rd International Conference on Integrated Intelligent Computing Communication & Security (ICIIC 2021)*, 4(Iciic), 14–22. <https://doi.org/10.2991/ahis.k.210913.003>
191. Kumar, N., & Raubal, M. (2021). Applications of deep learning in congestion detection, prediction and alleviation: A survey. *Transportation Research Part C: Emerging Technologies*, 133(November), 103432. <https://doi.org/10.1016/j.trc.2021.103432>
192. Kumsa, A., & Feyisso, F. (2022). Applications of Geospatial Science and Technology in Disaster Risk Management. *Robotics and Automation Research*, 3(3), 270–281.
193. Kurth, M., Kozłowski, W., Ganin, A., Mersky, A., Leung, B., Dykes, J., Kitsak, M., & Linkov, I. (2020). Lack of resilience in transportation networks: Economic implications. *Transportation Research Part D: Transport and Environment*, 86, 1–14. <https://doi.org/10.1016/j.trd.2020.102419>
194. Kutela, B., Msechu, K. J., Kidando, E., Das, S., & Kitali, A. E. (2023). Eliciting the influence of roadway and traffic conditions on hurricane evacuation decisions using regression-content analysis approach. *Travel Behaviour and Society*, 33, 100623. <https://doi.org/https://doi.org/10.1016/j.tbs.2023.100623>
195. Kyritsis, A. I., & Deriaz, M. (2019). A machine learning approach to waiting time prediction in queueing scenarios. *Proceedings - 2019 2nd International Conference on Artificial Intelligence for Industries, AI4I 2019*, 17–21. <https://doi.org/10.1109/AI4I46381.2019.00013>
196. Lakshminarasimhappa, M. C. (2021). Web-Based and Smart Mobile App for Data Collection: Kobo Toolbox / Kobo Collect. *The Journal of Indian Library Association (JILA)*, 57(2), 1–603.
197. Lam, T. C., & Small, K. A. (2001). The value of time and reliability: Measurement from a value pricing experiment. *Transportation Research Part E: Logistics and Transportation Review*, 37(2–3), 231–251. [https://doi.org/10.1016/S1366-5545\(00\)00016-8](https://doi.org/10.1016/S1366-5545(00)00016-8)
198. Laoide-Kemp, D., & O'Mahony, M. (2020). Dealing with latency effects in travel time prediction on motorways. *Transportation Engineering*, 2(April). <https://doi.org/10.1016/j.treng.2020.100009>
199. Lee, C., Kim, Y., Jin, S., Kim, D., Maciejewski, R., Ebert, D., & Ko, S. (2020). A Visual Analytics System for Exploring, Monitoring, and Forecasting Road Traffic Congestion. *IEEE Transactions on Visualization and Computer Graphics*, 26(11),

- 3133–3146. <https://doi.org/10.1109/TVCG.2019.2922597>
200. Lee, D., Kim, J., Lee, H., & Jung, K. (2015). Reliable Multiple-Choice Iterative Algorithm for Crowdsourcing Systems. *Proceedings of the 2015 ACM SIGMETRICS International Conference on Measurement and Modeling of Computer Systems*, 205–216. <https://doi.org/10.1145/2745844.2745871>
201. Lee, D., Tak, S., & Kim, S. (2022). Development of Reinforcement Learning-Based Traffic Predictive Route Guidance Algorithm Under Uncertain Traffic Environment. *IEEE Access*, 10, 58623–58634. <https://doi.org/10.1109/ACCESS.2022.3179383>
202. Leobons, C. M., Gouvêa Campos, V. B., & Mello Bandeira, R. A. De. (2019). Assessing Urban Transportation Systems Resilience: A Proposal of Indicators. *Transportation Research Procedia*, 37(September 2018), 322–329. <https://doi.org/10.1016/j.trpro.2018.12.199>
203. Li, Q., Li, Y., Gao, J., Su, L., Zhao, B., Demirbas, M., Fan, W., & Han, J. (2014). A confidence-aware approach for truth discovery on long-tail data. *Proceedings of the VLDB Endowment*, 8(4), 425–436. <https://doi.org/10.14778/2735496.2735505>
204. Liao, X., Zhou, T., Wang, X., Dai, R., Chen, X., & Zhu, X. (2022). Driver Route Planning Method Based on Accident Risk Cost Prediction. *Journal of Advanced Transportation*, 2022(1). <https://doi.org/10.1155/2022/5023052>
205. Lin, H., Garg, S., Hu, J., Kaddoum, G., Peng, M., & Shamim Hossain, M. (2021). Blockchain and Deep Reinforcement Learning Empowered Spatial Crowdsourcing in Software-Defined Internet of Vehicles. *IEEE Transactions on Intelligent Transportation Systems*, 22(6), 3755–3764. <https://doi.org/10.1109/TITS.2020.3025247>
206. Lin, Y., & Li, R. (2020). Real-time traffic accidents post-impact prediction: Based on crowdsourcing data. *Accident Analysis & Prevention*, 145, 105696. <https://doi.org/https://doi.org/10.1016/j.aap.2020.105696>
207. Lindenau, M., & Böhler-Baedeker, S. (2014). Citizen and Stakeholder Involvement: A Precondition for Sustainable Urban Mobility. *Transportation Research Procedia*, 4, 347–360. <https://doi.org/10.1016/j.trpro.2014.11.026>
208. Liu, B., Han, X., Qin, L., Xu, W., & Fan, J. (2021). Multi-hazard risk mapping for coupling of natural and technological hazards. *Geomatics, Natural Hazards and Risk*, 12(1), 2544–2560. <https://doi.org/10.1080/19475705.2021.1969451>
209. Liu, B., Siu, Y. L., & Mitchell, G. (2016). Hazard interaction analysis for multi-hazard risk assessment: A systematic classification based on hazard-forming environment. *Natural Hazards and Earth System Sciences*, 16(2), 629–642. <https://doi.org/10.5194/nhess-16-629-2016>
210. Liu, X., Lftikhar, N., & Xie, X. (2014). Survey of real-time processing systems for big data. *ACM International Conference Proceeding Series*, 356–361. <https://doi.org/10.1145/2628194.2628251>
211. Lizut, J., Ocha, L., Marzano, G., Lizut, J., & Siguencia, L. O. (2019). Crowdsourcing solutions for supporting urban mobility. *Procedia Computer Science*, 149(March), 542–547. <https://doi.org/10.1016/j.procs.2019.01.174>
212. Lopes, A., Marques, A., Conte, T., & Barbosa, S. D. J. (2015). MoLVERIC: An inspection technique for MoLIC diagrams. *Proceedings of the International Conference on Software Engineering and Knowledge Engineering, SEKE, 2015-*

- Janua*(July), 13–17. <https://doi.org/10.18293/SEKE2015-069>
213. Lopes, A., Valentim, N., Moraes, B., Zilse, R., & Conte, T. (2018). Applying user-centered techniques to analyze and design a mobile application. *Journal of Software Engineering Research and Development*, 6(1), 1–23. <https://doi.org/10.1186/s40411-018-0049-1>
  214. Lu, J., Li, B., Li, H., & Al-Barakani, A. (2021). Expansion of city scale, traffic modes, traffic congestion, and air pollution. *Cities*, 108(December 2019). <https://doi.org/10.1016/j.cities.2020.102974>
  215. Lu, Z., Kwon, T. J., & Fu, L. (2019). Effects of winter weather on traffic operations and optimization of signalized intersections. *Journal of Traffic and Transportation Engineering (English Edition)*, 6(2), 196–208. <https://doi.org/10.1016/j.jtte.2018.02.002>
  216. Lwanga-Ntale, C., & Owino, B. O. (2020). Understanding vulnerability and resilience in Somalia. *Jamba: Journal of Disaster Risk Studies*, 12(1), 1–9. <https://doi.org/10.4102/JAMBA.V12I1.856>
  217. Lyons, G. (2018). Getting smart about urban mobility – Aligning the paradigms of smart and sustainable. *Transportation Research Part A: Policy and Practice*, 115, 4–14. <https://doi.org/10.1016/j.tra.2016.12.001>
  218. Ma, Z., Mei, G., & Cuomo, S. (2021). An analytic framework using deep learning for prediction of traffic accident injury severity based on contributing factors. *Accident Analysis & Prevention*, 160, 106322. <https://doi.org/https://doi.org/10.1016/j.aap.2021.106322>
  219. Mao, T., Mihaita, A. S., Chen, F., & Vu, H. L. (2022). Boosted Genetic Algorithm Using Machine Learning for Traffic Control Optimization. *IEEE Transactions on Intelligent Transportation Systems*, 23(7), 7112–7141. <https://doi.org/10.1109/TITS.2021.3066958>
  220. Marchetta, P., Natale, E., Pescape, A., Salvi, A., & Santini, S. (2016). A map-based platform for smart mobility services. *Proceedings - IEEE Symposium on Computers and Communications, 2016-Febru*, 19–24. <https://doi.org/10.1109/ISCC.2015.7405448>
  221. Marques, A. B., Barbosa, S. D. J., & Conte, T. (2016). A Comparative Evaluation of Interaction Models for the Design of Interactive Systems. *Proceedings of the 31st Annual ACM Symposium on Applied Computing*, 173–180. <https://doi.org/10.1145/2851613.2851679>
  222. Martín, R., & Boano, C. (2021). Checkpoint urbanism: Violent infrastructures and border stigmas in the Juárez border region. *Urban Studies*, 59(3), 526–547. <https://doi.org/10.1177/00420980211048414>
  223. Martí, P., Serrano-Estrada, L., & Nolasco-Cirugeda, A. (2019). Social Media data: Challenges, opportunities and limitations in urban studies. *Computers, Environment and Urban Systems*, 74, 161–174. <https://doi.org/https://doi.org/10.1016/j.compenvurbsys.2018.11.001>
  224. Mayhew, C., & Graycar, A. (2000). Violent assaults on taxi drivers : incidence patterns and risk factors. *Trends and Issues in Crime and Criminal Justice Series*, 178, 1–6.
  225. Meena, K., Viji, A., Athanesious, J. J., & Vaidehi, V. (2019). Detecting abnormal event in traffic scenes using unsupervised deep learning approach. *2019*

- International Conference on Wireless Communications, Signal Processing and Networking, WiSPNET 2019*, 355–362.  
<https://doi.org/10.1109/WiSPNET45539.2019.9032774>
226. Mehdi Shah, Liu, T., Chauhan, S., Qi, L., & Xuyun Zhang. (2020). CycleSafe: Safe Route Planning for Urban Cyclists. *Springer Nature*, 322, 312–327.
227. Melendez, B., Ghanipoor Machiani, S., & Nara, A. (2021). Modelling traffic during Lilac Wildfire evacuation using cellular data. *Transportation Research Interdisciplinary Perspectives*, 9, 100335.  
<https://doi.org/10.1016/j.trip.2021.100335>
228. Microsoft. (2023). *Real-time processing*. Event Hubs.  
<https://learn.microsoft.com/en-us/azure/architecture/data-guide/big-data/real-time-processing>
229. Ministry of Transport MOT. (2016a). *Annex1-ROAD AND TRANSPORTATION MASTER PLAN*. file:///C:/Master 2019-2020/LGCE/Annex 1 – Diagnostic Transport Sector in West Bank and Gaza Strip.pdf
230. Ministry of Transport MOT. (2016b). *ROAD AND TRANSPORTATION MASTERPLAN*. [http://www.mot.gov.ps/ntmp/wp-content/uploads/2018/08/NTMP\\_5.pdf](http://www.mot.gov.ps/ntmp/wp-content/uploads/2018/08/NTMP_5.pdf)
231. Ministry of Transport MOT. (2018). *الاطار الاستراتيجي لنظم النقل الذكية*.
232. Moayedikia, A., Yeoh, W., Ong, K. L., & Boo, Y. L. (2019). Improving accuracy and lowering cost in crowdsourcing through an unsupervised expertise estimation approach. *Decision Support Systems*, 122(May), 113065.  
<https://doi.org/10.1016/j.dss.2019.05.005>
233. Mokhtarimousavi, S., Anderson, J. C., Azizinamini, A., & Hadi, M. (2020). Factors affecting injury severity in vehicle-pedestrian crashes: A day-of-week analysis using random parameter ordered response models and Artificial Neural Networks. *International Journal of Transportation Science and Technology*, 9(2), 100–115.  
<https://doi.org/10.1016/j.ijst.2020.01.001>
234. Mour, R., Carvalho, R., Carvalho, R., & Ramos, G. (2017). *Predicting Waiting Time Overflow on Bank Teller Queues*. 842–847.  
<https://doi.org/10.1109/ICMLA.2017.00-51>
235. Musa, A., Hamada, M., & Hassan, M. (2022). A Theoretical Framework Towards Building a Lightweight Model for Pothole Detection using Knowledge Distillation Approach. *SHS Web of Conferences*, 139, 03002.  
<https://doi.org/10.1051/shsconf/202213903002>
236. Naghib, A., Jafari Navimipour, N., Hosseinzadeh, M., & Sharifi, A. (2023). A comprehensive and systematic literature review on the big data management techniques in the internet of things. In *Wireless Networks* (Vol. 29, Issue 3). Springer US.  
<https://doi.org/10.1007/s11276-022-03177-5>
237. Najib, S. M., S Mirin, S. N., Harman, A. I. Bin, Rahimi, M. Q. F. B. M., Rahim, M. D. Bin, Azhari, N. H. B., & Khang, A. (2023). Road Hazard Detection for the Motorcycle based on EfficientNet-Lite0. *2023 IEEE 13th Symposium on Computer Applications & Industrial Electronics (ISCAIE)*, 101–105.  
<https://doi.org/10.1109/ISCAIE57739.2023.10165333>
238. Nigam, A., & Srivastava, S. (2023). Hybrid deep learning models for traffic stream variables prediction during rainfall. *Multimodal Transportation*, 2(1), 100052.

- <https://doi.org/10.1016/j.multra.2022.100052>
239. Nishino, A., Nakajima, M., & Kohtake, N. (2016). GNSS-based M2M Early Warning System for the improved reach of information. *IEEE Aerospace Conference Proceedings, 2016-June*(March 2021). <https://doi.org/10.1109/AERO.2016.7500880>
  240. Niture, D. V., Dhakane, V., Jawalkar, P., & Bamnote, A. (2021). Smart Transportation System using IOT. *International Journal of Engineering and Advanced Technology, 10*(5), 434–438. <https://doi.org/10.35940/ijeat.e2870.0610521>
  241. Norheim-Hagtun, I., & Meier, P. (2010). Crowdsourcing for Crisis Mapping in Haiti. *Innovations: Technology, Governance, Globalization, 5*(4), 81–89. [https://doi.org/10.1162/inov\\_a\\_00046](https://doi.org/10.1162/inov_a_00046)
  242. Noureddine, M., & Ristic, M. (2019). Route planning for hazardous materials transportation: Multi-criteria decision-making approach. *Decision Making: Applications in Management and Engineering, 2*(1), 66–85. <https://doi.org/10.31181/dmame1901066n>
  243. OCHA. (2003). *OCHA Humanitarian Update Occupied Palestinian Territories*. <https://reliefweb.int/report/israel/ocha-humanitarian-update-occupied-palestinian-territories-1-15-nov-2003>
  244. OCHA. (2020a). West bank Access Restrictions. *Ocha*, 200. [https://www.ochaopt.org/sites/default/files/westbank\\_a0\\_25\\_06\\_2020\\_final.pdf](https://www.ochaopt.org/sites/default/files/westbank_a0_25_06_2020_final.pdf)
  245. OCHA. (2020b). *West bank Access Restrictions*. *Ocha*. [https://www.ochaopt.org/sites/default/files/westbank\\_a0\\_25\\_06\\_2020\\_final.pdf](https://www.ochaopt.org/sites/default/files/westbank_a0_25_06_2020_final.pdf)
  246. OCHA. (2023). *Data on casualties*. <https://www.ochaopt.org/data/casualties>
  247. Oliveira, A. C. M., Botega, L. C., Saran, J. F., Silva, J. N., Melo, J. O. S. F., Tavares, M. F. D., & Neris, V. P. A. (2019). Crowdsourcing, data and information fusion and situation awareness for emergency Management of forest fires: The project DF100Fogo (FDWithoutFire). *Computers, Environment and Urban Systems, 77*. <https://doi.org/10.1016/j.compenvurbsys.2017.08.006>
  248. Oliver, N., Matic, A., & Frias-Martinez, E. (2015). Mobile Network Data for Public Health: Opportunities and Challenges. *Frontiers in Public Health, 3*(August), 1–12. <https://doi.org/10.3389/fpubh.2015.00189>
  249. Olsson, J., Hellström, D., Pålsson, H., Zhang, L., Hu, T., Min, Y., Wu, G., Zhang, J., Feng, P., Gong, P., & Ye, J. (2017). A taxi order dispatch model based on combinatorial optimization. *Proceedings of the ACM SIGKDD International Conference on Knowledge Discovery and Data Mining, Part F1296*(24), 2151–2159.
  250. Paiva, S., Ahad, M. A., Tripathi, G., Feroz, N., & Casalino, G. (2021a). *Enabling Technologies for Urban Smart Mobility : Recent Trends , Opportunities and Challenges Enabling Technologies for Urban Smart Mobility: Recent Trends , Opportunities and Challenges*. *April*. <https://doi.org/10.3390/s21062143>
  251. Paiva, S., Ahad, M. A., Tripathi, G., Feroz, N., & Casalino, G. (2021b). Enabling technologies for urban smart mobility: Recent trends, opportunities and challenges. *Sensors, 21*(6), 1–45. <https://doi.org/10.3390/s21062143>
  252. Pamucar, D., & Cirovic, G. (2018). Vehicle route selection with an adaptive neuro fuzzy inference system in uncertainty conditions. *Decision Making: Applications in Management and Engineering, 1*(1), 13–37. <https://doi.org/10.31181/dmame180113p>
  253. Papinski, D., & Scott, D. M. (2011). A GIS-based toolkit for route choice



- analysis. *Journal of Transport Geography*, 19(3), 434–442. <https://doi.org/10.1016/j.jtrangeo.2010.09.009>
254. Paraphantakul, C. (2014). Review of Worldwide Road Classification Systems. *Proceedings of the 9th National Transportation Conference, Bangkok, Thailand, November 2014*, 20–21. <https://doi.org/10.13140/RG.2.1.4579.7843>
255. Partheeban, P., Karthik, K., Elamparithi, P. N., Somasundaram, K., & Anuradha, B. (2022). Urban road traffic noise on human exposure assessment using geospatial technology. *Environmental Engineering Research*, 27(5), 0–3. <https://doi.org/10.4491/eer.2021.249>
256. Patil, S., Patil, K., Dhabekar, S., Nirgude, M., & Renushe, S. (2020). Accident identification and alerting system. *International Research Journal of Modernization in Engineering Technology and Science*, 02(07), 196–201. <https://doi.org/10.1063/5.0113317>
257. Paule, J. D. G., Sun, Y., & Moshfeghi, Y. (2019). On fine-grained geolocalisation of tweets and real-time traffic incident detection. *Information Processing and Management*, 56(3), 1119–1132. <https://doi.org/10.1016/j.ipm.2018.03.011>
258. PCBS. (2019). *Household Survey on Information and Communications Technology, 2019 Main Findings Report*. <https://www.pcbs.gov.ps/PCBS-Metadata-ar-v4.3/index.php/catalog/476>
259. PCBS. (2020). *Statistical Yearbook of Palestine 2020*. <http://www.pcbs.gov.ps>
260. PCBS. (2022a). *Palestinian Labour Force Survey Annual Report*.
261. PCBS. (2022b). *العاملون حسب المحافظة في مكان العمل 2022*.
262. Pedregosa, F., Varoquaux, G., Gramfort, A., Michel, V., & Thirion, B. (2011). Scikit-learn: Machine Learning in Python Fabian. *Journal Of Machine Learning Research* 12, 12, 2825–2830. <https://doi.org/10.1289/EHP4713>
263. Peng, N., Xi, Y., Rao, J., Ma, X., & Ren, F. (2022). Urban Multiple Route Planning Model Using Dynamic Programming in Reinforcement Learning. *IEEE Transactions on Intelligent Transportation Systems*, 23(7), 8037–8047. <https://doi.org/10.1109/TITS.2021.3075221>
264. Peter E. Hart, Nils J. Nilsson, B. R. (1968). HeuristicAStar-Hart68.pdf. In *IEEE Transactions on Systems Science and Cybernetics* (Vol. 4, Issue 2, pp. 100–107).
265. Phuttharak, J., & Loke, S. W. (2019). A Review of Mobile Crowdsourcing Architectures and Challenges: Toward Crowd-Empowered Internet-of-Things. *IEEE Access*, 7(April 2019), 304–324. <https://doi.org/10.1109/ACCESS.2018.2885353>
266. Po, L., Rollo, F., Bachechi, C., & Corni, A. (2019). From sensors data to urban traffic flow analysis. *5th IEEE International Smart Cities Conference, ISC2 2019*, 478–485. <https://doi.org/10.1109/ISC246665.2019.9071639>
267. Prokhorchuk, A., Dauwels, J., & Jaillet, P. (2020). Estimating Travel Time Distributions by Bayesian Network Inference. *IEEE Transactions on Intelligent Transportation Systems*, 21(5), 1867–1876. <https://doi.org/10.1109/TITS.2019.2899906>
268. Purkayastha, N., & Chanda, A. (2018). WHATSAPP AS A MEANS OF SHARING INFORMATION AMONG LIS PROFESSIONALS OF NORTH-EAST INDIA : A STUDY Received : 22 Sep 2018 ABSTRACT Accepted : 29 Sep 2018. *IMPACT: International Journal of Research in Applied, Natural and Social Sciences*,

- 6(9), 69–82.
269. python. (2023). *Requests: HTTP for Humans*. <https://docs.python-requests.org/en/latest/index.html>
  270. Qadri, S. S. S. M., Gökçe, M. A., & Öner, E. (2020). State-of-art review of traffic signal control methods: challenges and opportunities. *European Transport Research Review*, *12*(1), 1–23. <https://doi.org/10.1186/s12544-020-00439-1>
  271. Qian, Y., Wu, D., Bao, W., & Lorenz, P. (2019). The Internet of Things for Smart Cities: Technologies and Applications. *IEEE Network*, *33*(2), 4–5. <https://doi.org/10.1109/MNET.2019.8675165>
  272. Rachmawati, D., & Gustin, L. (2020). Analysis of Dijkstra’s Algorithm and A\* Algorithm in Shortest Path Problem. *Journal of Physics: Conference Series*, *1566*(1). <https://doi.org/10.1088/1742-6596/1566/1/012061>
  273. Rahman, M. S., Di1, L., & Esraz-Ul-Zanna, M. (2017). THE ROLE OF BIG DATA IN DISASTER MANAGEMENT. *International Conference on Disaster ...*, *September*, 1–5. <https://datafloq.com/read/the-role-of-big-data-in-iot/3089>
  274. Rahmanian, B., & Davis, J. G. (2014). User interface design for crowdsourcing systems. *Proceedings of the Workshop on Advanced Visual Interfaces AVI*, 405–408. <https://doi.org/10.1145/2598153.2602248>
  275. Rathee, M., Bačić, B., & Dobarjeh, M. (2023). Automated Road Defect and Anomaly Detection for Traffic Safety: A Systematic Review. *Sensors*, *23*(12), 5656. <https://doi.org/10.3390/s23125656>
  276. Reddy, K. H. K., Luhach, A. K., Pradhan, B., Dash, J. K., & Roy, D. S. (2020). A genetic algorithm for energy efficient fog layer resource management in context-aware smart cities. *Sustainable Cities and Society*, *63*, 102428. <https://doi.org/https://doi.org/10.1016/j.scs.2020.102428>
  277. Ribeiro, P. J. G., & Pena Jardim Gonçalves, L. A. (2019). Urban resilience: A conceptual framework. *Sustainable Cities and Society*, *50*(May). <https://doi.org/10.1016/j.scs.2019.101625>
  278. Richardson, S., & Windau, J. (2003). Fatal and nonfatal assaults in the workplace, 1996 to 2000. *Clinics in Occupational and Environmental Medicine*, *3*(4), 673–689. [https://doi.org/10.1016/S1526-0046\(03\)00127-4](https://doi.org/10.1016/S1526-0046(03)00127-4)
  279. Rijke, A., & Minca, C. (2019). Inside Checkpoint 300: Checkpoint Regimes as Spatial Political Technologies in the Occupied Palestinian Territories. *Antipode*, *51*(3), 968–988. <https://doi.org/10.1111/anti.12526>
  280. Rochim, R. V., Rahmatulloh, A., Akbar, R. R. El, & Rizal, R. (2023). *Innovation in Research of Informatics ( INNOVATICS ) Performance Comparison of Response Time Native , Mobile and Progressive Web Application Technology. 1*, 36–43.
  281. Rohaert, A., Kuligowski, E. D., Ardinge, A., Wahlqvist, J., Gwynne, S. M. V., Kimball, A., Bénichou, N., & Ronchi, E. (2023). Traffic dynamics during the 2019 Kincade wildfire evacuation. *Transportation Research Part D: Transport and Environment*, *116*(May 2022). <https://doi.org/10.1016/j.trd.2023.103610>
  282. Romero, C. D. G., Barriga, J. K. D., & Molano, J. I. R. (2016). Big Data Meaning in the Architecture of IoT for Smart Cities Christian. *Data Mining and Big Data*, 457–465. <https://doi.org/10.1007/978-3-319-40973-3>
  283. S.Lakshmi, Srikanth, I., & Arockiasamy, M. (2019). Identification of Traffic

- Accident Hotspots using Geographical Information System (GIS). *International Journal of Engineering and Advanced Technology*, 9(2), 4429–4438. <https://doi.org/10.35940/ijeat.b3848.129219>
284. Safitri, N. D., & Chikaraishi, M. (2022). Impact of transport network disruption on travel demand: A case study of the July 2018 heavy rain disaster in Japan. *Asian Transport Studies*, 8(July 2021), 100057. <https://doi.org/10.1016/j.eastsj.2022.100057>
  285. Sajjad, M. (2021). Disaster resilience in Pakistan: A comprehensive multi-dimensional spatial profiling. *Applied Geography*, 126(April 2020), 102367. <https://doi.org/10.1016/j.apgeog.2020.102367>
  286. Salazar-carrillo, J., Torres-ruiz, M., Davis, C. A., Quintero, R., Moreno-ibarra, M., & Guzmán, G. (2021). Traffic congestion analysis based on a web-gis and data mining of traffic events from twitter. *Sensors*, 21(9). <https://doi.org/10.3390/s21092964>
  287. Samper, J. (2012). *Urban Resilience in Situations of Chronic Violence: Case study of Medellín, Colombia. October.* <http://web.mit.edu/cis/urbanresiliencereport2012.pdf>
  288. Sanislav, T., Mois, G. D., Zeadally, S., & Folea, S. C. (2021). Energy Harvesting Techniques for Internet of Things (IoT). *IEEE Access*, 9, 39530–39549. <https://doi.org/10.1109/ACCESS.2021.3064066>
  289. Sanit-in, Y., & Saikaew, K. R. (2019). *Prediction of Waiting Time in One-Stop Service.* 9(3). <https://doi.org/10.18178/ijmlc.2019.9.3.805>
  290. Sanjeevi, V., & Shahabudeen, P. (2016). Optimal routing for efficient municipal solid waste transportation by using ArcGIS application in Chennai. *Waste Management and Research*, 34(1), 11–21. <https://doi.org/10.1177/0734242X15607430>
  291. Santana, E. F. Z., Chaves, A. P., Gerosa, M. A., Kon, F., & Milojevic, D. S. (2017). Software platforms for smart cities: Concepts, requirements, challenges, and a unified reference architecture. *ACM Computing Surveys*, 50(6). <https://doi.org/10.1145/3124391>
  292. Sarker, R. A., Biswas, P., Dadon, S. H., & Imam, T. (2021). *An Efficient Surface Map Creation and Tracking Using Smartphone Sensors and An Efficient Surface Map Creation and Tracking Using Smartphone Sensors and Crowdsourcing. October.* <https://doi.org/10.3390/s21216969>
  293. Sarker, R. I., Kaplan, S., Mailer, M., & Timmermans, H. J. P. (2019). Applying affective event theory to explain transit users' reactions to service disruptions. *Transportation Research Part A: Policy and Practice*, 130(September), 593–605. <https://doi.org/10.1016/j.tra.2019.09.059>
  294. Sarrab, M., Pulparambil, S., & Awadalla, M. (2020). Development of an IoT based real-time traffic monitoring system for city governance. *Global Transitions*, 2, 230–245. <https://doi.org/https://doi.org/10.1016/j.glt.2020.09.004>
  295. Sarraf, R., & McGuire, M. P. (2020). Integration and comparison of multi-criteria decision making methods in safe route planner. *Expert Systems with Applications*, 154, 113399. <https://doi.org/10.1016/j.eswa.2020.113399>
  296. Sathya, R., Ananthi, S., Abirame, M. R. S., Nikalya, R., Madhupriya, A., & Prithiusha, M. (2023). A Novel Approach for Vehicular Accident Detection and Rescue Alert System using IoT with Convolutional Neural Network. *2023 9th International Conference on Advanced Computing and Communication Systems (ICACCS)*, 1, 1643–1647. <https://doi.org/10.1109/ICACCS57279.2023.10113043>

297. Sattar, S., Li, S., & Chapman, M. (2018). Road surface monitoring using smartphone sensors: A review. *Sensors (Switzerland)*, 18(11). <https://doi.org/10.3390/s18113845>
298. Schroeder, S. (2022). *WhatsApp increases group size to 1,024 people*. <https://mashable.com/article/whatsapp-group-1000#:~:text=Finally!&text=WhatsApp> has always been a, size has been doubled again.
299. Serere, H. N., Resch, B., & Havas, C. R. (2023). Enhanced geocoding precision for location inference of tweet text using spaCy, Nominatim and Google Maps. A comparative analysis of the influence of data selection. *PLoS ONE*, 18(3 March), 1–19. <https://doi.org/10.1371/journal.pone.0282942>
300. Serere, H. N., Resch, B., Havas, C. R., & Petutschnig, A. (2021). Extracting and Geocoding Locations in Social Media Posts: A Comparative Analysis. *GI\_Forum*, 9(2), 167–173. [https://doi.org/10.1553/giscience2021\\_02\\_s167](https://doi.org/10.1553/giscience2021_02_s167)
301. Serin, F., Alisan, Y., & Kece, A. (2021). Hybrid time series forecasting methods for travel time prediction. *Physica A: Statistical Mechanics and Its Applications*, 579, 126134. <https://doi.org/https://doi.org/10.1016/j.physa.2021.126134>
302. Serrano, N., Hernantes, J., & Gallardo, G. (2013). *Software technology Mobile Web Apps*. [www.ludei.com/games/](http://www.ludei.com/games/)
303. Shah, K., Sinha, H., & Mishra, P. (2019). Analysis of Cross-Platform Mobile App Development Tools. *2019 IEEE 5th International Conference for Convergence in Technology, I2CT 2019*, 1–7. <https://doi.org/10.1109/I2CT45611.2019.9033872>
304. Shahrou, I., & Xie, X. (2021). Role of internet of things (IoT) and crowdsourcing in smart city projects. *Smart Cities*, 4(4), 1276–1292. <https://doi.org/10.3390/smartcities4040068>
305. Shaik, M. E., Islam, M. M., & Hossain, Q. S. (2021). A review on neural network techniques for the prediction of road traffic accident severity. *Asian Transport Studies*, 7(November), 100040. <https://doi.org/10.1016/j.eastsj.2021.100040>
306. Shankar, K., Wang, P., Xu, R., Mahgoub, A., & Chaterji, S. (2020). JANUS: Benchmarking Commercial and Open-Source Cloud and Edge Platforms for Object and Anomaly Detection Workloads. *IEEE International Conference on Cloud Computing, CLOUD, 2020-October*, 590–599. <https://doi.org/10.1109/CLOUD49709.2020.00088>
307. Sharma, S., Kang, D. H., Montes de Oca, J. R., & Mudgal, A. (2021). Machine learning methods for commercial vehicle wait time prediction at a border crossing. *Research in Transportation Economics*, 89(December 2020), 101034. <https://doi.org/10.1016/j.retrec.2021.101034>
308. Shetab-Boushehri, S. N., Rajabi, P., & Mahmoudi, R. (2022). Modeling location–allocation of emergency medical service stations and ambulance routing problems considering the variability of events and recurrent traffic congestion: A real case study. *Healthcare Analytics*, 2(March), 100048. <https://doi.org/10.1016/j.health.2022.100048>
309. Sim, W. W., & Brouse, P. S. (2015). Developing Ontologies and Persona to Support and Enhance Requirements Engineering Activities – A Case Study. *Procedia Computer Science*, 44, 275–284.
310. Singer, J. (2021). The Israel-PLO Mutual Recognition Agreement. *International Negotiation*, 26(3), 366–390. <https://doi.org/10.1163/15718069-bja10026>

311. Sipper, M., & Moore, J. H. (2021). Conservation machine learning: a case study of random forests. *Scientific Reports*, 11(1), 3629. <https://doi.org/10.1038/s41598-021-83247-4>
312. Sletten, P., & Pedersen, J. (2003). Coping with Conflict: Palestinian Communities Two Years into the Intifada. In *FAFO Report, No. 408* (Issue January 2003).
313. Sobral, T., Galvão, T., & Borges, J. (2019). Visualization of urban mobility data from intelligent transportation systems. *Sensors (Switzerland)*, 19(2). <https://doi.org/10.3390/s19020332>
314. Sodagari, S. (2022). Trends for Mobile IoT Crowdsourcing Privacy and Security in the Big Data Era. *IEEE Transactions on Technology and Society*, 3(3), 199–225. <https://doi.org/10.1109/tts.2022.3191515>
315. Sohounou, P. Y. R., Neves, L. A. C., Christodoulou, A., Christidis, P., & Lo Presti, D. (2021). Using a hazard-independent approach to understand road-network robustness to multiple disruption scenarios. *Transportation Research Part D: Transport and Environment*, 93(February), 102672. <https://doi.org/10.1016/j.trd.2020.102672>
316. Song, X., Zhang, H., Akerkar, R., Huang, H., Guo, S., Zhong, L., Ji, Y., Opdahl, A. L., Purohit, H., Skupin, A., Pottathil, A., & Culotta, A. (2022). Big Data and Emergency Management: Concepts, Methodologies, and Applications. *IEEE Transactions on Big Data*, 8(2), 397–419. <https://doi.org/10.1109/TBDDATA.2020.2972871>
317. Sree, S. R., Vyshnavi, S. B., & Jayapandian, N. (2019). Real-World Application of Machine Learning and Deep Learning. *2019 International Conference on Smart Systems and Inventive Technology (ICSSIT)*, 1069–1073. <https://doi.org/10.1109/ICSSIT46314.2019.8987844>
318. SRMS. (2023a). *SRMS Privacy Policy*. <https://app.notice.studio/editor?workspace=25406a57-a1d7-471d-9d93-758a388f5fdf&project=6c2f34d6-9ec4-4013-b176-950c76172e89&page=6c2f34d6-9ec4-4013-b176-950c76172e89>
319. SRMS. (2023b). *Terms of use*. <https://app.notice.studio/editor?workspace=25406a57-a1d7-471d-9d93-758a388f5fdf&project=d4f2b6aa-d169-4e62-a8b4-2ebc69ba717f&page=d4f2b6aa-d169-4e62-a8b4-2ebc69ba717f>
320. Staniek, M. (2021). Road pavement condition diagnostics using smartphone-based data crowdsourcing in smart cities. *Journal of Traffic and Transportation Engineering (English Edition)*, 8(4), 554–567. <https://doi.org/10.1016/j.jtte.2020.09.004>
321. Statista. (2019). *Number of crime events in the public transportation systems in the United States in 2019*. <https://www.statista.com/statistics/1295845/number-crime-events-public-transit-us-by-type/>
322. Statista. (2022). Leading countries based on number of Twitter users as of October 2020. In *Statista*.
323. Statistics, C. B. of. (2022). *Traffic volume on Judea and Samaria*. <https://www.cbs.gov.il/en/Statistics/Pages/Tools-and-Databases.aspx>
324. Stefanidis, A., Crooks, A., & Radzikowski, J. (2013). Harvesting ambient

- geospatial information from social media feeds. *GeoJournal*, 78(2), 319–338. <https://doi.org/10.1007/s10708-011-9438-2>
325. Stentz, A. (1995). Optimal and efficient path planning for unknown and dynamic environments. *International Journal of Robotics and Automation*, 10(3), 89–100.
  326. Sumner, J. L., Farris, E. M., & Holman, M. R. (2020). Crowdsourcing Reliable Local Data. *Political Analysis*, 28(2), 244–262. <https://doi.org/10.1017/pan.2019.32>
  327. Taghipour, H., Parsa, A. B., & Mohammadian, A. (Kouros). (2020). A dynamic approach to predict travel time in real time using data driven techniques and comprehensive data sources. *Transportation Engineering*, 2(July), 100025. <https://doi.org/10.1016/j.treng.2020.100025>
  328. Tamakloe, R., Hong, J., Tak, J., & Park, D. (2021). Finding evacuation routes using traffic and network structure information. *Transportation Research Part D: Transport and Environment*, 95, 102853. <https://doi.org/https://doi.org/10.1016/j.trd.2021.102853>
  329. Tandel, S. S., & Jamadar, A. (2018). Impact of progressive web apps on web app development. *International Journal of Innovative Research in Science, Engineering and Technology*, 7(9), 9439–9444. <https://doi.org/10.15680/IJIRSET.2018.0709021>
  330. Tavra, M., Racetin, I., & Peroš, J. (2021). The role of crowdsourcing and social media in crisis mapping: a case study of a wildfire reaching Croatian City of Split. *Geoenvironmental Disasters*, 8(1). <https://doi.org/10.1186/s40677-021-00181-3>
  331. *Telethon's Documentation*. (2023). GitHub. <https://docs.telethon.dev/en/stable/>
  332. Tim Ingold. (2007). *Lines* (pp. 9–25).
  333. Timans, R., Wouters, P., & Heilbron, J. (2019). Mixed methods research: what it is and what it could be. *Theory and Society*, 48(2), 193–216. <https://doi.org/10.1007/s11186-019-09345-5>
  334. To, H., Ghinita, G., & Shahabi, C. (2014). Framework for protecting worker location privacy in spatial crowdsourcing. *Proceedings of the VLDB Endowment*, 7(10), 919–930. <https://doi.org/10.14778/2732951.2732966>
  335. To, H., & Shahabi, C. (2018). Location privacy in spatial crowdsourcing. *Handbook of Mobile Data Privacy*, 167–194. [https://doi.org/10.1007/978-3-319-98161-1\\_7](https://doi.org/10.1007/978-3-319-98161-1_7)
  336. Tong, Y., Chen, L., Zhou, Z., Jagadish, H. V., Shou, L., & Lv, W. (2019). SLADE: A smart large-scale task decomposer in crowdsourcing. *Proceedings - International Conference on Data Engineering, 2019-April*, 2133–2134. <https://doi.org/10.1109/ICDE.2019.00261>
  337. Tong, Y., Zhou, Z., Zeng, Y., Chen, L., & Shahabi, C. (2019). Spatial crowdsourcing: a survey. *The VLDB Journal*. <https://doi.org/10.1007/s00778-019-00568-7>
  338. Turkanović, M., Hölbl, M., & Košič, K. (2018). *EduCTX: A Blockchain-Based Higher Education Credit Platform*. 6. <https://doi.org/10.1109/ACCESS.2018.2789929>
  339. Tyagi, N., & Bhushan, B. (2023). Demystifying the Role of Natural Language Processing (NLP) in Smart City Applications: Background, Motivation, Recent Advances, and Future Research Directions. *Wireless Personal Communications*, 130(2), 857–908. <https://doi.org/10.1007/s11277-023-10312-8>

340. UN. (2003). *Twenty-Seven Months – Intifada, Closures and Palestinian Economic Crisis*. <https://www.un.org/unispal/document/auto-insert-205621/>
341. UNHRC. (2021). *UN experts alarmed by rise in settler violence in occupied Palestinian territory*. <https://www.ohchr.org/en/press-releases/2021/11/un-experts-alarmed-rise-settler-violence-occupied-palestinian-territory>
342. United Nations. (2023). *UN SDGs*. <https://sdgs.un.org/goals/goal11>
343. United Nations Economic Commission for Europe. (2020). *Urban Transport Statistics - Promoting Data Quality*.
344. Ur Rehman, S., Khan, S. A., Arif, A., & Khan, U. S. (2021). IoT-based Accident Detection and Emergency Alert System for Motorbikes. *AIMS 2021 - International Conference on Artificial Intelligence and Mechatronics Systems*, 0–4. <https://doi.org/10.1109/AIMS52415.2021.9466055>
345. Ushahidi. (2022). *Ushahidi*. <https://www.ushahidi.com/features/>
346. Vallet, F., Puchinger, J., Millonig, A., Lamé, G., & Nicolai, I. (2020). Tangible futures: Combining scenario thinking and personas - A pilot study on urban mobility. *Futures*, 117(January), 102513. <https://doi.org/10.1016/j.futures.2020.102513>
347. Van Gheluwe, C., Semanjski, I., Hendrikse, S., & Gautama, S. (2020). Geospatial Dashboards for Intelligent Multimodal Traffic Management. *2020 IEEE International Conference on Pervasive Computing and Communications Workshops, PerCom Workshops 2020*. <https://doi.org/10.1109/PerComWorkshops48775.2020.9156231>
348. Venkatraman, R., Boyles, S. D., James, R., Unnikrishnan, A., & Patil, P. N. (2021). Adaptive routing behavior with real-time information under multiple travel objectives. *Transportation Research Interdisciplinary Perspectives*, 10, 100395. <https://doi.org/10.1016/j.trip.2021.100395>
349. Verma, I. (2022). Service Providers for Home Appliances. *Journal of Positive School Psychology*, 6(3), 7215–7219. <https://journalppw.com/index.php/jpsp/article/view/4491%0Ahttps://journalppw.com/index.php/jpsp/article/download/4491/2979>
350. Vermote, L., Macharis, C., Boeykens, F., Schoolmeester, C., & Putman, K. (2014). Traffic-restriction in Ramallah (Palestine): Participatory sustainability assessment of pedestrian scenarios using a simplified transport model. *Land Use Policy*, 41, 453–464. <https://doi.org/10.1016/j.landusepol.2014.06.005>
351. Wahid, M. A. A., Maulud, K. N. A., Rahman, M. A., Bahri, M. A. S., & Jaafar, O. (2018). Integrated infrastructure management using web-gis application. *Proceedings of the Pakistan Academy of Sciences: Part A*, 55(3), 35–44.
352. Walther, O. J., Dambo, L., Koné, M., & van Eupen, M. (2020). Mapping travel time to assess accessibility in West Africa: The role of borders, checkpoints and road conditions. *Journal of Transport Geography*, 82. <https://doi.org/10.1016/j.jtrangeo.2019.102590>
353. Walther, S. C., & Gurung, K. (2019). *Using GIS and Remote Sensing to Map Grassroots Sustainable Development for a Small NGO in Nepal*. February.
354. Wang, G., Wang, B., Wang, T., Nika, A., Zheng, H., & Zhao, B. Y. (2016). Poster: Defending against sybil devices in crowdsourced mapping services. *MobiSys 2016 Companion - Companion Publication of the 14th Annual International Conference on Mobile Systems, Applications, and Services*, 146.

- <https://doi.org/10.1145/2938559.2938610>
355. Wang, H., Tang, X., Kuo, Y. H., Kifer, D., & Li, Z. (2019). A Simple Baseline for Travel Time Estimation using Large-scale Trip Data. *ACM Transactions on Intelligent Systems and Technology*, *10*(2), 1–22. <https://doi.org/10.1145/3293317>
  356. Wang, J., Song, H., Fu, T., Behan, M., Jie, L., He, Y., & Shangguan, Q. (2022). Crash prediction for freeway work zones in real time: A comparison between Convolutional Neural Network and Binary Logistic Regression model. *International Journal of Transportation Science and Technology*, *11*(3), 484–495. <https://doi.org/10.1016/j.ijtst.2021.06.002>
  357. Wang, L., Chen, P., Chen, L., & Mou, J. (2021). Ship ais trajectory clustering: An hdbscan-based approach. *Journal of Marine Science and Engineering*, *9*(6). <https://doi.org/10.3390/jmse9060566>
  358. Wang, R. Q., Mao, H., Wang, Y., Rae, C., & Shaw, W. (2018). Hyper-resolution monitoring of urban flooding with social media and crowdsourcing data. *Computers and Geosciences*, *111*, 139–147. <https://doi.org/10.1016/j.cageo.2017.11.008>
  359. Wang, T., Xie, X., Cao, X., Pedersen, T. B., Wang, Y., & Xiao, M. (2021). On Efficient and Scalable Time-Continuous Spatial Crowdsourcing. *2021 IEEE 37th International Conference on Data Engineering (ICDE)*, 1212–1223. <https://doi.org/10.1109/ICDE51399.2021.00109>
  360. Wang, Z., Pang, X., Chen, Y., Shao, H., Wang, Q., Wu, L., Chen, H., & Qi, H. (2019). Privacy-Preserving Crowd-Sourced Statistical Data Publishing with An Untrusted Server. *IEEE Transactions on Mobile Computing*, *18*(6), 1356–1367. <https://doi.org/10.1109/TMC.2018.2861765>
  361. Waze. (2023). <https://www.waze.com/about>
  362. Weizman, E. (2007). Hollow Land: Israel’s Architecture of Occupation. In *VERSO* (Vol. 84, Issue 1). [https://doi.org/10.1111/j.1467-923x.2013.2424\\_1.x](https://doi.org/10.1111/j.1467-923x.2013.2424_1.x)
  363. Wenxiu, P. (2015). Analysis of New Media Communication Based on Lasswell’s “5W” Model. *Journal of Educational and Social Research*, *5*(3), 245–250. <https://doi.org/10.5901/jesr.2015.v5n3p245>
  364. WhatsApp. (2022). *WhatsApp Privacy*. <https://www.whatsapp.com/privacy>
  365. Wick, L. (2011). The practice of waiting under closure in Palestine. *City and Society*, *23*(SUPPL.1), 24–44. <https://doi.org/10.1111/j.1548-744X.2011.01054.x>
  366. Wu, W. (2018). *Flutter Vs React* (Issue March) [Metropolia University of Applied Sciences Bachelor of Engineering]. <https://www.theseus.fi/bitstream/handle/10024/146232/thesis.pdf?sequence=1>
  367. Xia, X., Xiao, Y., Liang, W., & Zheng, M. (2020). GTHI: A Heuristic Algorithm to Detect Malicious Users in Smart Grids. *IEEE Transactions on Network Science and Engineering*, *7*(2), 805–816. <https://doi.org/10.1109/TNSE.2018.2855139>
  368. Xiao, X., Bender, G., Hay, M., & Gehrke, J. (2011). *iReduct*. 229. <https://doi.org/10.1145/1989323.1989348>
  369. Xin, H., Ye, Y., Na, X., Hu, H., Wang, G., Wu, C., & Hu, S. (2023). Sustainable Road Pothole Detection: A Crowdsourcing Based Multi-Sensors Fusion Approach. *Sustainability (Switzerland)*, *15*(8), 1–23. <https://doi.org/10.3390/su15086610>
  370. Xu, J., Zhang, Z., Xiao, X., Yang, Y., Yu, G., & Winslett, M. (2013). Differentially private histogram publication. *VLDB Journal*, *22*(6), 797–822. <https://doi.org/10.1007/s00778-013-0309-y>



371. Xu, M., & Liu, H. (2021). A flexible deep learning-aware framework for travel time prediction considering traffic event. *Engineering Applications of Artificial Intelligence*, 106, 104491. <https://doi.org/https://doi.org/10.1016/j.engappai.2021.104491>
372. Xu, Z., Liu, Y., Yen, N. Y., Mei, L., Luo, X., Wei, X., & Hu, C. (2020). Crowdsourcing Based Description of Urban Emergency Events Using Social Media Big Data. *IEEE Transactions on Cloud Computing*, 8(2), 387–397. <https://doi.org/10.1109/TCC.2016.2517638>
373. Yan, F., Qiao, D., Qian, B., Ma, L., Xing, X., Zhang, Y., & Wang, X. (2016). Improvement of CCME WQI using grey relational method. *Journal of Hydrology*, 543, 316–323. <https://doi.org/10.1016/j.jhydrol.2016.10.007>
374. Yao, Y., Peng, Z., & Xiao, B. (2018). Parallel Hyper-Heuristic Algorithm for Multi-Objective Route Planning in a Smart City. *IEEE Transactions on Vehicular Technology*, 67(11), 10307–10318. <https://doi.org/10.1109/TVT.2018.2868942>
375. Yap, M., & Cats, O. (2021). Predicting disruptions and their passenger delay impacts for public transport stops. *Transportation*, 48(4), 1703–1731. <https://doi.org/10.1007/s11116-020-10109-9>
376. Yazici, İ., Shayea, I., & Din, J. (2023). A survey of applications of artificial intelligence and machine learning in future mobile networks-enabled systems. *Engineering Science and Technology, an International Journal*, 44. <https://doi.org/10.1016/j.jestch.2023.101455>
377. Ye, J. Y., Yu, C., Husman, T., Chen, B., & Trikala, A. (2021). Novel strategy for applying hierarchical density-based spatial clustering of applications with noise towards spectroscopic analysis and detection of melanocytic lesions. *Melanoma Research*, 31(6), 526–532. <https://doi.org/10.1097/CMR.0000000000000771>
378. youth Media Center. (2023). *واقع الإعلام الرقمي في فلسطين*.
379. Yuan, D., Li, Q., Li, G., Wang, Q., & Ren, K. (2020). PriRadar: A Privacy-Preserving Framework for Spatial Crowdsourcing. *IEEE Transactions on Information Forensics and Security*, 15(1), 299–314. <https://doi.org/10.1109/TIFS.2019.2913232>
380. Zajac, S., & Huber, S. (2021). Objectives and methods in multi-objective routing problems: a survey and classification scheme. *European Journal of Operational Research*, 290(1), 1–25. <https://doi.org/10.1016/j.ejor.2020.07.005>
381. Zerafa, J., Islam, M. R., Kabir, M. A., & Xu, G. (2021). ExTraVis: Exploration of Traffic Incidents Using a Visual Interactive System. *Proceedings of the International Conference on Information Visualisation, 2021-July(Iv)*, 48–53. <https://doi.org/10.1109/IV53921.2021.00018>
382. Zhang, X., & Chen, M. (2019). Quantifying the Impact of Weather Events on Travel Time and Reliability. *Journal of Advanced Transportation*, 2019. <https://doi.org/10.1155/2019/8203081>
383. Zhang, X., Souleyrette, R. R., Green, E., Wang, T., Chen, M., & Ross, P. (2021). Collection, analysis, and reporting of kentucky traffic incident management performance. *Transportation Research Record*, 2675(9), 167–181. <https://doi.org/10.1177/03611981211001077>
384. Zhao, J., Gao, Y., Tang, J., Zhu, L., & Ma, J. (2018). Highway Travel Time Prediction Using Sparse Tensor Completion Tactics and K -Nearest Neighbor Pattern Matching Method. *Journal of Advanced Transportation*, 2018.

- <https://doi.org/10.1155/2018/5721058>
385. Zhao, Y., Gong, X., & Chen, X. (2022). Privacy-Preserving Incentive Mechanisms for Truthful Data Quality in Data Crowdsourcing. *IEEE Transactions on Mobile Computing*, 21(7), 2518–2532. <https://doi.org/10.1109/TMC.2020.3040138>
  386. Zhao, Y., & Han, Q. (2016). *Spatial Crowdsourcing : Current State and Future Directions*. July, 102–107.
  387. Zhao, Z., Wei, F., Zhou, M., Chen, W., & Ng, W. (2015). Crowd-selection query processing in crowdsourcing databases: A task-driven approach. *EDBT 2015 - 18th International Conference on Extending Database Technology, Proceedings*, 397–408. <https://doi.org/10.5441/002/edbt.2015.35>
  388. Zheng, L.-X., Ma, S., Chen, Z.-X., & Luo, X.-Y. (2021). Ensuring the Correctness of Regular Expressions: A Review. *International Journal of Automation and Computing*, 18(4), 521–535. <https://doi.org/10.1007/s11633-021-1301-4>
  389. Zheng, Y., Li, G., Li, Y., Shan, C., & Cheng, R. (2016). Truth inference in crowdsourcing: Is the problem solved? *Proceedings of the VLDB Endowment*, 10(5), 541–552. <https://doi.org/10.14778/3055540.3055547>
  390. Zhu, Y., Tian, D., & Yan, F. (2020). Effectiveness of Entropy Weight Method in Decision-Making. *Mathematical Problems in Engineering*, 2020, 1–5. <https://doi.org/10.1155/2020/3564835>
  391. Zou, L., Lam, N. S. N., Cai, H., & Qiang, Y. (2018). Mining Twitter Data for Improved Understanding of Disaster Resilience. *Annals of the American Association of Geographers*, 108(5), 1422–1441. <https://doi.org/10.1080/24694452.2017.1421897>
  392. Zuo, F., Kurkcu, A., Ozbay, K., & Gao, J. (2018). Crowdsourcing incident information for emergency response using open data sources in smart cities. *Transportation Research Record*, 2672(1), 198–208. <https://doi.org/10.1177/0361198118798736>