



HAL
open science

Intégration de concepts de gestion de chaîne logistique en boucle fermée (CLSCM) et d'analyse du cycle de vie (ACV) : contribution à l'économie circulaire et application aux batteries au plomb

Magno Angel Gonzalez Rodriguez

► To cite this version:

Magno Angel Gonzalez Rodriguez. Intégration de concepts de gestion de chaîne logistique en boucle fermée (CLSCM) et d'analyse du cycle de vie (ACV) : contribution à l'économie circulaire et application aux batteries au plomb. Génie des procédés. Institut National Polytechnique de Toulouse - INPT, 2020. Français. NNT : 2020INPT0114 . tel-04411970

HAL Id: tel-04411970

<https://theses.hal.science/tel-04411970>

Submitted on 14 Feb 2024

HAL is a multi-disciplinary open access archive for the deposit and dissemination of scientific research documents, whether they are published or not. The documents may come from teaching and research institutions in France or abroad, or from public or private research centers.

L'archive ouverte pluridisciplinaire **HAL**, est destinée au dépôt et à la diffusion de documents scientifiques de niveau recherche, publiés ou non, émanant des établissements d'enseignement et de recherche français ou étrangers, des laboratoires publics ou privés.



Université
de Toulouse

THÈSE

En vue de l'obtention du

DOCTORAT DE L'UNIVERSITÉ DE TOULOUSE

Délivré par :

Institut National Polytechnique de Toulouse (Toulouse INP)

Discipline ou spécialité :

Génie des Procédés et de l'Environnement

Présentée et soutenue par :

M. MAGNO ANGEL GONZALEZ RODRIGUEZ

le mardi 27 octobre 2020

Titre :

Intégration de concepts de gestion de chaîne logistique en boucle fermée (CLSCM) et d'analyse du cycle de vie (ACV): contribution à l'économie circulaire et application aux batteries au plomb

École doctorale :

Mécanique, Énergétique, Génie civil, Procédés (MEGeP)

Unité de recherche :

Laboratoire de Génie Chimique (LGC)

Directeur(s) de Thèse :

MME CATHERINE AZZARO-PANTEL

Rapporteurs :

M. BRUNO LACARRIERE, IMT ATLANTIQUE NANTES

M. JOSE MARIA PONCE ORTEGA,

Membres du jury :

M. PASCAL MAUSSION, TOULOUSE INP, Président

M. ALBERTO ALFONSO AGUILAR LASSERRE, INSTITUT TECHNOLOGIQUE ORIZABA, Membre

M. ANTONIN PONSICH, UNIVERSIDAD AUTONOMA METROPOLITANA MEXICO, Membre

MME CATHERINE AZZARO-PANTEL, TOULOUSE INP, Membre

MME MARIE BONNIN, POLYTECH ANGERS, Membre

"Quand les gens vous disent que c'est impossible, souriez et comprenez que la réalité que vous êtes sur le point de créer, ils ne peuvent même pas l'imaginer "

- David Copperfield (Illusionniste)-

REMERCIEMENTS

Tout d'abord, je tiens à remercier le gouvernement mexicain pour le soutien financier reçu par CONACYT, qui m'a donné les moyens de réaliser cette thèse. Je remercie également Catherine AZZARO-PANTEL pour m'avoir donné l'opportunité de réaliser mon rêve de faire un doctorat et pour m'avoir acceptée dans son équipe, pour avoir toujours été disponible et avoir eu confiance en moi. Je voudrais également remercier les membres du jury de ma soutenance, pour avoir accepté l'examen de mon travail et pour avoir valorisé ma recherche, leurs commentaires et leurs questions m'ont encouragée à approfondir certains aspects et m'ont ouvert de nouvelles perspectives.

Je voudrais remercier tout le personnel du LGC qui m'a aidé au quotidien, pour résoudre des problèmes ou simplement pour discuter dans les couloirs et un merci tout particulier à Alain et Dany, pour tout le temps que nous avons partagé et pour leur amitié honnête et sincère.

Je remercie également les doctorants et les post-doctorants qui m'ont accueilli à mon arrivée à Toulouse, Marco Miranda, René et sa femme, Fernando, Philippe, Manuel, Anh. Aux doctorants que j'ai rencontrés pendant mon séjour au LGC, Mathieu, Guillaume, Lucile, Zhya, Qing, Floriant, Florent, Yosra, Alexandre, Sid Ahmed, Benoit, Michelle, Paul Brou, Pierre, Sabine, Alessandro, Hambin, Claire Salomé, Vincent, Lucas, Pierre Albrand, certains m'ont manqué mais ils ont fait partie de mon séjour dans le laboratoire.

Aux personnes qui m'ont guidé lors de mon arrivée et de mes premières démarches en France, Sofia et Marian.

A l'équipe d'Alambique de 2017, Silvia, Leticia, Flavie, Jesus, Paul, Helene, Claire Malafosse, Melissa, Emmanuel.

Les doctorants et les amis latinos avec lesquels j'ai passé le plus de temps dans différentes activités, ce qui m'a permis de me sentir chez moi : Lauren, Marco, Chucho, Eduardo, Lucero, Andres, Caro, Freddy, Belén, Carlos Montilla, Manuel, Ceci, Pablo et Amy, ainsi que mes collègues de bureau Anupam, Hammid, Carlos Murillo et Santiago, dont le "Oiga..." se perpétue encore aujourd'hui.

No puedo dejar de agradecer el apoyo invaluable de mi papá, hermana, el resto de mi familia, cuyo amor, paciencia y ánimo incondicional fueron mi roca durante este el desarrollo de este logro. Se que mayormente no soy tan expresivo, pero quiero que sepan que parte de este triunfo les pertenece.

Cette thèse est dédiée à la mémoire de ma mère Grindelia, qui m'a toujours encouragé à étudier et qui est maintenant mon ange gardien.

Abstract

Over the past decade, the supply chain concept has undergone significant evolution, transitioning toward an integrated approach that considers both upstream and downstream chains simultaneously. This evolution has led to the development of the closed-loop supply chain (CLSC), aimed at optimizing material utilization across various manufacturing processes. While progress in managing and designing CLSCs has been notable, most research approaches have primarily focused on economic aspects, often addressing environmental concerns as an afterthought or separately via life cycle assessment (LCA). The closure of the supply chain loop typically results in a more intricate system compared to traditional supply chains. Consequently, there is an urgent need for specifically tailored quantitative methods and models to assist managers and professionals in creating more efficient, cost-effective, and sustainable closed-loop systems.

The overarching scientific objective of this study is to conduct an integrated analysis that combines CLSC management concepts and Life Cycle Assessment, exploring their interdependence. This investigation will be supported by the increased utilization of lead-acid batteries in motor vehicles, especially in the context of electric vehicles, considered a promising future vehicle option.

The model formulation relies on a mixed-variable linear mathematical programming procedure (MILP), incorporating a multi-criteria approach focused on cost minimization and environmental impact. This formulation considers five tiers in the forward network (suppliers, producers, distributors, wholesalers, and retailers) and seven tiers in the reverse network (collection and recycling centers, product disposal, disassembly plant, raw material disposal, third parties, and remanufacturing). The multi-level multi-period strategy involves initially identifying and reducing significant criteria applicable in the multi-objective (in this case, bi-objective) optimization procedure. Two crucial criteria emerged: the total cost of the supply chain and total greenhouse gas emissions, which were recognized as conflicting, warranting the implementation of an epsilon-constraint procedure.

The first application of decision support methods (M-TOPSIS and TOPSIS) facilitated the identification of potential supply chain configurations. Subsequently, a life cycle assessment was conducted on the Pareto front-end solutions, enabling a comprehensive multi-criteria analysis involving the selected impact analysis method (Impact 2002+) and the cost criterion. This step revealed solutions that outperformed those previously identified, validating the approach.

Strategically, this required the development of environmental submodules for the supply chain blocks to consistently compute environmental indicators. This involved extracting data from the EcoInvent database and utilizing impact factors pertinent to the study's analysis method.

Lastly, a sensitivity study highlighted that, for the case study: (i) an increase in the percentage of raw materials recovered from a product designated for recycling, (ii) an improved recovery rate, and (iii) enhancements in the manufacturing/remanufacturing process regarding GHG emissions, are particularly significant in improving the performance of all indicators.

Keywords: *Closed Loop Supply Chain, Life Cycle Assessment, recycling, supply chain management, lead-acid battery, MILP, epsilon-constraint, TOPSIS*

Résumé

Durant les dix dernières années, le concept de chaîne d'approvisionnement a évolué vers une approche intégrée considérant simultanément les chaînes d'approvisionnement amont et aval. Cette évolution a donné naissance à la chaîne d'approvisionnement en boucle fermée (CLSC), visant à optimiser l'utilisation des matériaux issus de divers processus de fabrication. Malgré les avancées notables dans la gestion et la conception des CLSC, la plupart des approches de recherche ont surtout mis l'accent sur les aspects économiques, laissant souvent de côté ou traitant séparément les préoccupations environnementales via l'analyse du cycle de vie (ACV). La fermeture de la boucle de la chaîne d'approvisionnement conduit généralement à un système plus complexe que la chaîne d'approvisionnement traditionnelle. Ainsi, il est impératif de développer des méthodes quantitatives et des modèles spécifiques pour aider les gestionnaires et professionnels à créer des systèmes en boucle fermée plus efficaces, rentables et durables. L'objectif scientifique majeur de ce travail consiste à développer une analyse intégrée des concepts de gestion des CLSC et d'analyse du cycle de vie en explorant l'effet miroir qui existe entre ces deux domaines. Le cas d'étude des batteries au plomb dans les véhicules automobiles, en particulier pour les véhicules électriques, vient appuyer ces travaux. La formulation du modèle est établie sur une procédure de programmation mathématique linéaire en variables mixtes (MILP) avec une approche multicritère liée à la minimisation des coûts et à l'impact environnemental, considérant cinq échelons (fournisseurs, producteurs, distributeurs, grossistes et détaillants) dans le réseau amont et sept échelons (centres de collecte et de recyclage, élimination des produits, démontage, élimination des matières premières, tiers et recyclage) dans le réseau aval. La stratégie multi-niveaux et multi-périodes consiste d'abord à identifier et réduire les critères significatifs qui peuvent être utilisés dans la procédure d'optimisation multi-objectifs (dans ce cas, bi-objectifs). Deux critères majeurs ont émergé : le coût total de la chaîne d'approvisionnement et les émissions totales de gaz à effet de serre, reconnus comme étant contradictoires, justifiant ainsi la mise en œuvre d'une procédure d'épsilon-contrainte. La première application d'une méthode d'aide à la décision (M-TOPSIS et TOPSIS) a permis d'identifier les configurations candidates de la chaîne d'approvisionnement. Une analyse du cycle de vie a ensuite été réalisée sur l'ensemble des solutions du front de Pareto afin de mener une analyse multicritère sur tous les critères de la méthode d'analyse d'impact sélectionnée (Impact 2002+) et le critère de coût. Cette étape a révélé des solutions plus intéressantes concernant ce groupe de critères que celles identifiées au niveau précédent, validant ainsi la démarche. Du point de vue stratégique, cela a nécessité le développement de sous-modules environnementaux pour les blocs de la chaîne d'approvisionnement afin de calculer systématiquement les indicateurs environnementaux à partir de l'extraction de la base de données EcoInvent et des facteurs d'impact de la méthode d'analyse utilisée dans l'étude. Enfin, une étude de sensibilité a montré que pour l'étude de cas, (i) une augmentation du pourcentage d'utilisation des matières premières récupérées d'un produit à recycler, (ii) une augmentation du taux de récupération, (iii) une amélioration du processus de fabrication/refabrication vis-à-vis des émissions de GES sont des paramètres particulièrement significatifs pour améliorer de la performance de tous les indicateurs.

Mots-clés : Chaîne logistique en boucle fermée, Analyse du cycle de vie, recyclage, management de la chaîne logistique, batterie au plomb, MILP, epsilon-contrainte, TOPSIS

Index

Abstract.....	i
Résumé	ii
Index	iii
Chapter 1 Introduction and problem definition.....	1
1.1 Introduction.....	2
1.2 Research problem and research questions	3
Chapter 1 Introduction et définition du problème	8
1.1 Introduction.....	9
1.2 Problématique et questions de recherche.....	10
Chapter 2 CLSC and LCA, how to explore the mirror effect: application to Lead-Acid Batteries (LABs).	16
2.1 Introduction.....	18
2.2 The concept of supply chain management (SCM).....	18
2.2.1 SCM as a Management Philosophy	20
2.2.2 SCM as a Set of Activities to Implement a Management Philosophy	20
2.2.3 SCM as a Set of Management Processes	21
2.3 Closed-loop supply chain.....	23
2.3.1 Integrating forward and reverse supply chains	23
2.3.2 Optimization methods for CLSC management problem solution.	28
2.3.3 Collection/recycling/recovery/recyclability indicators	29
2.4 Life Cycle Assessment (LCA) methodology.....	31
2.5 Similarities and Differences between CLSCM and LCA	38
2.6 Lead.acid batteries (LAB).....	39
2.6.1 European and French legislation.....	40
2.6.2 Organization of the battery French sector.....	41
2.6.3 French market.....	42
2.7 Conclusions.....	42
Chapter 3 Life Cycle Assessment (LCA) of Lead-acid batteries (LAB)	43
3.1 Introduction.....	46
3.2 Literature review	47
3.2.1 Environmental assessment of batteries.	47
3.2.2 Global overview of environmental assessment techniques.	49
3.2.3 Closed-loop supply chain (CLSC).....	51
3.2.3.1 Raw material and extraction stage.	52
3.2.3.2 Manufacturing stage.	54
3.2.3.3 Distribution.....	56
3.2.3.4 Recycling stage.....	57
3.2.4 Conclusions.	63
3.3 LCA study for lead-acid batteries.....	63
3.3.1 Goal and scope definition	63
3.3.2 Inventory analysis.....	65
3.3.3 Impact assessment	70

3.5 Lead tracking	81
3.6 Conclusion	83
Chapter 4 A Multi-objective framework for closed-loop supply chain design: Application to lead-acid battery network	84
4.1 Introduction.....	93
4.2 Methodology	94
4.2.1 Problem formulation.....	95
4.2.2 Data collection.....	97
4.2.3 Assumptions	97
4.2.4 Decision variables	98
4.3 Mathematical model.....	99
4.3.1 Retailer constraints	99
4.3.2 Wholesaler constraints.....	100
4.3.3 Distributor constraints	101
4.3.4 Manufacturing plant constraints	102
4.3.5 Supplier constraints	103
4.3.6 Recollection constraints.....	104
4.3.7 Disposal battery constraints.....	105
4.3.8 Disassembly constraints	106
4.3.9 Remanufacturing plant constraints (Recycling process)	108
4.4 Cost contributions in the CLSC model.....	110
4.4.1 Distribution cost	111
4.4.2 Inventory cost.....	112
4.4.3 Operational cost.....	112
4.4.4 Cost objective	113
4.5 Environmental objective	114
4.5.1 GHG emissions due to transportation	115
4.5.2 GHG emissions due to operation	116
4.5.3 Environmental impact objective	116
4.6 Solution strategy: methods and tools.....	117
4.6.1 Single-objective optimization (Tier # 1).....	118
4.6.2 Multi-objective optimization (Tier # 2)	119
4.6.2.1 Principle	119
4.6.2.2 Multi-objective optimization methods.....	119
4.6.2.3 Choice of the multi-objective optimization method.....	124
4.6.3 Multiple Criteria Decision Making (MCDM) (Tier # 3).....	124
4.6.3.1 TOPSIS	125
4.6.3.2 M-TOPSIS.....	127
4.6.4 LCA assessment with SimaPro (Tier #4).....	127
4.6.5 Multiple Criteria Decision Making (MCDM)(Tier # 5):.....	128
4.6.6 Result assessment and interpretation (Tier # 6)	128
4.7 Conclusions.....	128
Chapter 5 Using the methodological framework for optimizing the battery Closed-Loop Supply Chain	129
5.1 Introduction.....	131
5.2 Optimization strategy	132
5.3 Single-objective optimization cases	133
5.3.1 Minimizing the total cost of the CLSC network.	134
5.3.2 Minimizing global warming potential (GWP) of the whole CLSC.....	135

5.4 Multi-objective optimization cases.....	137
5.5 Life Cycle Assessment of the Pareto front solutions	149
5.6 Sensitivity analysis.....	159
5.7 Conclusions.....	164
Chapter 165 Conclusions and recommendations for future research	165
Conclusions and perspectives	166
Bibliography	174
List of Figures	181
List of Tables	184
Appendix A: Application example of TOPSIS and M-TOPSIS	186
Appendix B. Data used in the Closed-Loop Supply Chain configuration.....	191
Appendix C. Results by period obtained in the MILP multi-objective optimization	202
Appendix D. Values of variables in the best result in the MILP optimization.....	205

Chapter

1

Introduction and problem definition

1.1 Introduction

Over the past half-century, the rapid development of technologies, the demand in growth, and the shortening of product life cycle resulted not only in waste increase but also in the depletion of natural resources. In most countries, insufficient facilities are available for the proper management of waste materials (Periathamby et al. 2009). Additionally, the inadequate enforcement of policies and the lack of proper technologies result in indiscriminate disposal (Chen and Taylor 2011; Pacheco et al. 2012; Periathamby et al. 2009). This kind of waste disposal has caused serious problems with pollution extension far beyond its borders, health threats of urban residents, and destruction of natural resources (Boadi and Kuitunen 2005; Liu et al. 2009; Odewabi et al. 2013). A major challenge for collection centers is then to collect, recycle, treat, and dispose of increasing waste (Periathamby et al. 2009; Saleh and Ansari, 2012). The waste minimization techniques following the 4R concept which encompasses reducing, reuse, recycle, and recovery have thus been identified as significant action levers towards sustainable waste management and not only can reduce the number of waste, but also can produce new products from old materials, thus benefiting both environment and economy (Aliu et al. 2014; Saleh and Ansari 2012).

In particular, recycling has become a fundamental issue as it allows the reduction of the amount of waste and should become economically profitable, and different recycling processes have been implemented to recover used products after the end of their life cycle. In that context, the supply chain concept has evolved towards an integrated approach considering both forward and reverse supply chains simultaneously, leading to the so-called closed-loop supply chain (CLSC) that is used to enhance the utilization of the materials of different manufacturing processes. The CLSC management (CLSCM) topic responds to EU research priorities identified in the recent Horizon 2020 program that stresses the need for increased product life-spans, material reuse, recycling, recovery, and industrial symbiosis leading to closed-loop processes.

Despite the observed progress in CLSC management and design, the different research approaches mainly consider their economic aspects, while environmental issues are treated either with hindsight or separately by using Life Cycle Assessment (LCA). It is worth mentioning that the concept of a closed-loop supply chain network is sustainability-oriented by its intrinsic nature by improving economic and environmental goals simultaneously.

Yet several studies have emphasized the same underlying systems creating a kind of mirror effect between supply chain management (Blass & Corbett, 2018) (in general, and not specifically in the case of CLSC) and Life Cycle Assessment even if the modeling is generally tackled through different perspectives in the respective scientific communities. On the one hand, there is a substantial community focusing on Life Cycle Assessment with corresponding tools and methods. On the other hand, within the field of supply chain management, the community has focused efforts on sustainable supply chains. In numerous works, CLSC is seen as a strategy towards achieving sustainability in the supply chain resulting in developing more eco-friendly products, reducing carbon emissions associated with the manufacturing and transportation of goods (Olugu et al. 2010), so that an only partial application of LCA concepts focusing on Greenhouse gas emissions is implemented without a complete mapping of all the environmental indicators (Blass & Corbett, 2018).

To bridge the gap, the general scientific motivation of this work is to carry out an integrated analysis considering both issues to propose a methodological framework for the development of efficient strategies for rational waste management to achieve the goals of sustainable development.

1.2 Research problem and research questions

Over the last ten years, closed-loop supply chains (CLSC) have attracted increasing attention in supply chain and operations management research, as emphasized by the number of publications in scientific journals that have been published in recently years. More than 1800 papers were identified based on an initial search in Web of Science™ (WoS) using the keywords “closed-loop supply chain” (see Figure 1. 1) from 2000 to 2020.

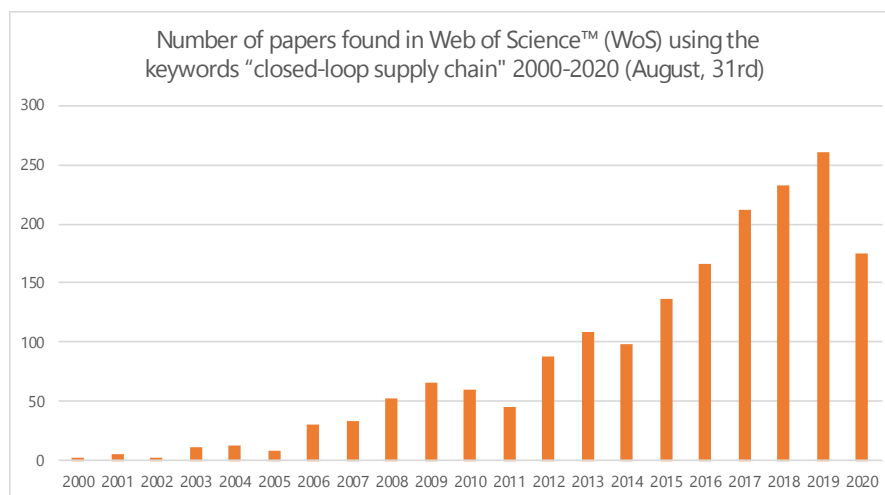

Figure 1. 1 Number of papers based on an initial search in Web of Science™ (WoS) using the keywords “closed-loop supply chain”

Closed-loop supply chains couple the conventional forward supply chain processes with reverse logistics processes that manage product recovery, remanufacturing, disassembly, and part reusing (Guide & Van Wassenhove, 2009). Closing the loop of the supply chain generally drives to obtain a more complex system than the traditional supply chain and there is a need more than ever before for quantitative methods and models specifically developed and adapted to the management of closed-loop supply chain systems and their performance to help managers and practitioners in creating more efficient, lower cost and sustainable closed-loop systems. For the environmental performance of the system, the potential of Life Cycle Assessment (LCA) methodology that can be viewed as a mature, normative, and systemic approach will be explored in this work in an integrative viewpoint with CLSC management methods and tools.

To address significant theoretical and practical issues in this field, typical topics include, but are not limited to, the use of analytical methods, computational tools, optimization approaches, decision support systems, and case studies. Even if this works has methodological implications for CLSC-LCA modeling and coupling, it must be supported by a significant case study.

The increased use of lead-acid batteries in automotive vehicles, in particular for electric vehicles, which can be considered as one of the most promising vehicle options in the future will support our analysis. Such vehicles consumed high amounts of lead and lead products, especially the lead-acid batteries (LABs) (Sun et al. 2016).

These power sources are broadly used around the world mainly due to their low price, high unit voltage, stable performance, and capability to operate at extreme temperatures (Chang et al. 2009). The market size of the LAB was expected to expand globally from 46.6 billion dollars in 2015 to 84.5 as reported in Grand View Research (2017). The LAB industry has to cope with severe environmental and public health problems, especially the emission of lead, known as one of the top-heavy metal pollutants (Sun et al. 2016).

Surprisingly, as recently reported in (Davidson et al. 2016), relatively few LCAs have been conducted and made available for the assessment of the environmental impact of lead production and that of lead products, although lead is one of the most recycled materials in widespread use and has the highest end-of-life recycling rate of all commonly used metals: the collection and recycling rates of lead automotive and industrial batteries and lead sheet in Europe are 99 and 95% respectively.

The literature related to LCA of LABs generally takes place in upstream or downstream stages of lead-acid batteries lifecycle, focusing on the manufacturing or in the recycling stage, even if some recent works have been devoted to the whole process (Wang et al. 2018).

From a supply chain vision point of view, several works have been devoted to the CLSC modeling of LABs. They will be presented in more detail, in this manuscript, in the dedicated chapter. However, a trend emerges that follows the guidelines developed in one of the first reported models (Daniel et al. 2003; Kannan et al. 2010; Salomone et al. 2005), that only considers the modeling of material flows in an optimization formulation with an exclusively economic criterion. i.e., the total supply chain cost (Kuo et al. 2010; W. Liu et al. 2015).

The research questions that will be addressed in this manuscript can this be formulated as follows:

Research Question 1:

How to integrate the reverse supply chain with the forward supply chain from a network modeling viewpoint?

Closed-loop supply chain (CLSC) has gained an extensive importance today, in the world of increasing environmental concerns and strict regulations on the wastage caused right from the inception of a product, through its life period and after it. A CLSC consists of both the forward supply chain and the reverse supply chain. The forward supply chain essentially involves the movement of goods/products from the upstream suppliers to the downstream customers. The reverse supply chain involves the movement of used/unsold products from the customer to the upstream supply chain, for possible recycling and reuses. The reverse supply chain should be a part of the forward supply chain integration, as it can contribute to lowering overall costs and meeting governmental/environmental regulations. Hence, there is a need to model and analyze closed-loop supply chains as a system in total, without splitting into distinct parts of forward and reverse supply chains.

Research Question 2:

How to integrate perspectives from Life Cycle Assessment and Closed-Loop Supply Chain Management or in other words, how to explore the mirror effect of LCA and CLSC?

One application of LCA is to weigh products' environmental, economic, and social consequences appropriately, since agencies need to understand the full impacts of products when considering new regulations. Appropriate design of product take-back legislation, including whether to focus on recycling or remanufacturing, requires an appreciation of the full range of environmental impacts throughout the supply chain. Besides, customers are asking suppliers to disclose more information about their products and processes, individually or through trade associations.

If CLSC is innately in the Green Supply Chain (GSC) shift, how could the environmental impact be optimized with the economic criteria?

Research Question 3:

How to develop a methodology that combines several criteria over several periods?

In other words, what are the most appropriate methods and tools that could be used to develop an integrated framework to overcome the challenges of CLSC and LCA?

Research Question 4:

How to define efficient strategies for CLSC management, in particular for lead-acid batteries?

The review of the general literature clearly shows that the management of the lead-acid battery supply chain involves a multi-criteria formulation, in which cost and environmental impact must be considered simultaneously. For this purpose, how to define efficient strategies that considers these compromise situations?

The doctoral research presented in this manuscript was conducted at the Laboratory of Chemical Engineering, LGC UMR CNRS 5503 INPT/UPS in the "Process and Systems Engineering" (PSI) department.

The project is part of the complementary work carried out within the PSE department, in particular, the PhDs of:

- Sofia De León Almaraz, *Multi-objective optimization of a hydrogen supply chain*, PhD thesis INPT, 2014,
- Jesus Ochoa Robles, *Multi-objective optimization strategies for design and deployment of hydrogen supply chains*, 2018.

Both dedicated to the hydrogen supply chain design

- Marie Bonnin: *Multi-criteria optimization for global resource management: application to the copper cycle in France*, PhD thesis INPT, 2013, dedicated to copper recycling on a national scale.

-
- Marco Miranda: *Multi-objective optimization for Green Supply Chain Management and Design: application to the orange juice agro-food cluster*, PhD thesis INPT, 2015 who integrated the principles of the Green supply chain for the Orange Juice supply chain.

And finally, the work of:

- Anh Vo Dong : *Multi-objective optimization for ecodesign of aerospace CFRP waste supply chains*, 2017, mainly dedicated to the CFRP (Carbon Fiber Reinforced Polymer) recycling supply chain.

Other works in INPT have also been devoted to the reuse of components (batteries) such as the PhD of:

- Bunthern Kim: *Contribution to the design and optimal control of a hybrid electric power generation system based on renewable energies and recycled components to supply a remote village in a developing country*, PhD thesis INPT, 2019 in LAPLACE laboratory. The environmental assessment has been addressed in cooperation with LGC.

This dissertation intends to complement and extend the scientific field of supply chain management and, in particular, the contributions that were previously addressed in our research team. It aims to propose a contribution towards the development of a methodological framework for closed-loop supply chain management (CLSCM) with Life Cycle Assessment (LCA) integration and also the definition of strategies that could be used from it.

The PhD manuscript is organized into six chapters. A brief description of the content of each chapter is presented hereafter (Figure 1. 2).

Chapter 1 has presented the aims and objectives of this research.

Chapter 2 will present the different concepts that will be the core of this PhD thesis: CLSC, LCA, and LABs. This state-of-the-art chapter will have the objective to highlight the mirror effects between these two methodological concepts and the application case. Specific emphasis will be put on CLSC modeling. We will show how it developed from a narrow, technically focused niche area to a fully recognized subfield of supply chain management. We will explore several of the parallels that exist between CLSCM and LCA that will be further used in the manuscript. At the risk of overgeneralizing, it can be said at first sight that LCA tends to be more geared toward measuring sustainability impacts and trade-offs for decision-making within the ISO 14040 standard guidelines, while conversely, work in SCM is more oriented toward making specific business decisions or implementing decision rules. The case study of LABs will be justified.

Chapter 3: its objective is clearly to show how LCA could be beneficial to CLSC concepts, with a specific focus on lead-acid batteries.

- The common concepts of LCA and CLSC will be presented, i.e. various echelons and technological bricks involved in the closed-loop supply chain of lead-acid batteries.
- The life cycle assessment (LCA) for in-depth consideration of the environmental impact of lead-acid batteries will be conducted.
- A sensitivity analysis based on the amount of recycled lead in the production of a battery will be performed, so that the key processes that contribute to the various environmental indicators can be identified.

Finally, LCA will be viewed as a powerful tool to examine the environmental impact of a product through its entire life cycle and to show that there is a place for optimization to manage the compromise between all the echelons of the supply chain and reduce the environmental impact of the battery production process.

Chapter 4 is devoted to the modeling of the multistep multi-period CLSC supply chain for LABs. Mixed Integer Linear Programming model was formulated to design the CLSC network that included five echelons (i.e. suppliers, producers, distributors, wholesalers, and retailers) in the forward direction and seven echelons (i.e. collection & recycling centers, disposal of the product, disassembly plant, disposal of raw material, third party and remanufacturing) in the reverse direction.

Chapter 5 is dedicated to the use strategy of the methodological framework for the battery closed-loop supply chain. It will present the data used as input for model operation, as well as the results of the CLSC management model solved with the methodology presented in the previous chapter. The model solution involves a multistep strategy with a combination of multi-objective optimization, Multiple Criteria Decision-Making tools, and Life Cycle Assessment with SimaPro software.

Finally, **Chapter 6** presents some general conclusions related to the proposed strategy, as well as a perspective for future work that derives from these findings.

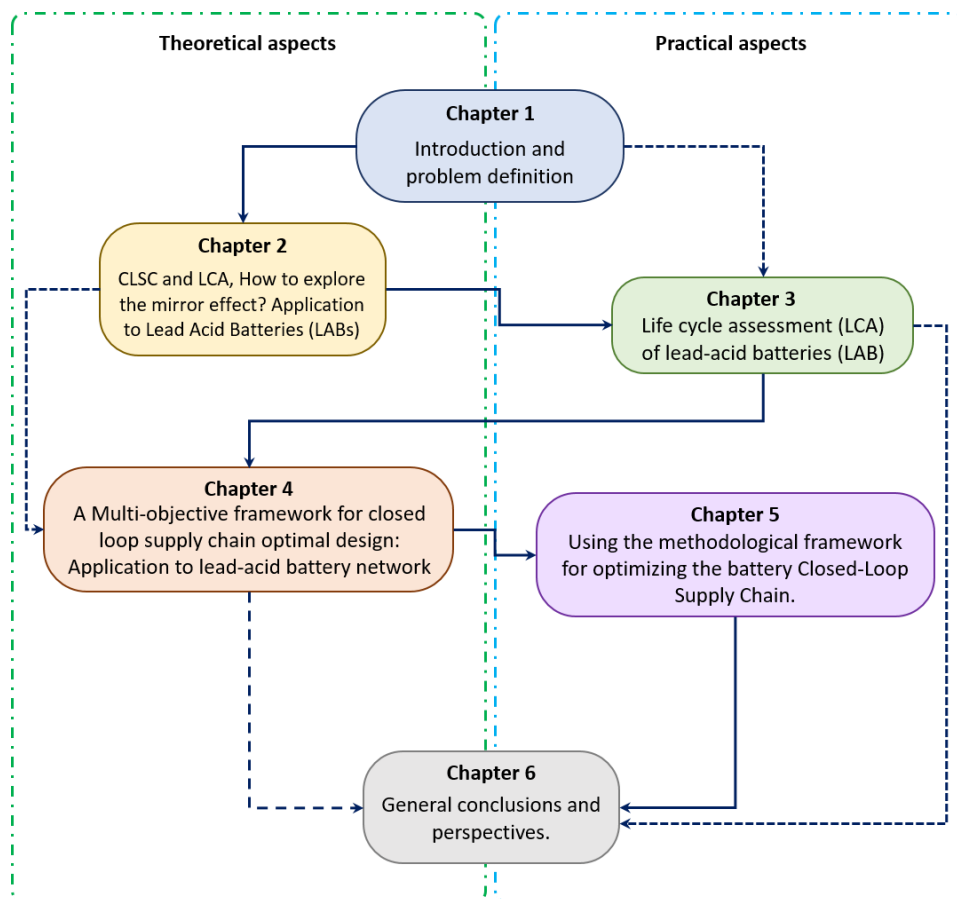

Figure 1. 2 Thesis layout and overview

Chapitre



Introduction et définition du
problème

1.1 Introduction

Durant le dernier demi-siècle, le développement rapide des technologies, la croissance exponentielle de la demande, et la diminution de la durée de vie des produits ont engendré non seulement une augmentation des déchets, mais également l'épuisement des ressources naturelles. Dans la plupart des pays, les installations pour une gestion appropriée des déchets demeurent insuffisantes (Periathamby et al. 2009).

De plus, l'application inadéquate des politiques et le manque de technologies appropriées entraînent une élimination sans discernement (Chen and Taylor 2011; Pacheco et al. 2012; Periathamby et al. 2009). Ce type d'élimination des déchets a causé de graves problèmes de propagation de la pollution, mettant en danger la santé des habitants urbains et provoquant la destruction des ressources naturelles (Boadi and Kuitunen 2005; Liu et al. 2009; Odewabi et al. 2013).

Un défi majeur pour les centres de collecte est alors de collecter, recycler, traiter et éliminer des déchets de plus en plus nombreux (Periathamby et al. 2009; Saleh and Ansari, 2012). Les techniques de réduction des déchets suivant le concept des 4R - réduire, réutiliser, recycler et récupérer - ont ainsi été identifiées comme des leviers d'action importants pour une gestion durable des déchets. Elles permettent non seulement de réduire la quantité de déchets, mais aussi de créer de nouveaux produits à partir de matériaux usagés, offrant ainsi des avantages à la fois pour l'environnement et l'économie (Aliu et al. 2014; Saleh and Ansari 2012).

En particulier, le recyclage est devenu un enjeu crucial, car il permet de réduire la quantité de déchets et devrait économiquement devenir rentable. Différents processus de recyclage ont été mis en œuvre pour récupérer des produits usagers après la fin de leur cycle de vie. Dans ce contexte, le concept de chaîne d'approvisionnement a évolué vers une approche intégrée considérant simultanément les chaînes d'approvisionnement en amont et en aval, ce qui a conduit à ce que l'on appelle la chaîne d'approvisionnement en boucle fermée (CLSC) visant à optimiser l'utilisation des matériaux dans différents processus de fabrication. La gestion des CLSC (CLSCM) répond aux priorités de recherche de l'UE définies dans le récent programme Horizon 2020, soulignant la nécessité d'une durée de vie prolongée des produits, du réemploi des matériaux, du recyclage, de la récupération et de la symbiose industrielle pour des processus en boucle fermée.

Malgré les avancées observées dans la gestion et la conception des CLSC, les différentes approches de recherche se concentrent principalement sur leurs aspects économiques, reléguant souvent les questions environnementales à une position secondaire ou les abordant séparément à travers une analyse du cycle de vie (ACV). Il convient de mentionner que, par sa nature intrinsèque, le concept de réseau de chaîne d'approvisionnement en boucle fermée est axé sur la durabilité, améliorant simultanément les objectifs économiques et environnementaux.

Pourtant, plusieurs études ont mis l'accent sur les mêmes systèmes sous-jacents, créant une sorte d'effet miroir entre la gestion de la chaîne d'approvisionnement (Blass & Corbett, 2018) (en général, et pas spécifiquement dans le cas des CLSC) et de l'analyse du cycle de vie même si la modélisation est généralement abordée à travers des perspectives différentes dans les communautés scientifiques respectives. D'une part, une communauté importante est dédiée à l'analyse du cycle de vie avec ses outils et méthodes correspondants. D'autre part, dans le domaine de la gestion de la chaîne d'approvisionnement, la communauté se concentre sur des chaînes

d'approvisionnement durables. ans de nombreuses études, le CLSC est considéré comme une stratégie pour atteindre la durabilité dans la chaîne d'approvisionnement, visant à développer des produits écologiques et à réduire les émissions de carbone liées à la fabrication et au transport des marchandises (Olugu et al. 2010). Cependant, cela implique souvent une application partielle seulement des concepts de l'ACV, axée principalement sur les émissions de gaz à effet de serre, en négligeant d'autres indicateurs environnementaux essentiels (Blass & Corbett, 2018).

Pour combler cette lacune, la motivation scientifique générale de ce travail est de réaliser une analyse intégrée de ces deux problématiques afin de proposer un cadre méthodologique pour développer des stratégies efficaces de gestion rationnelle des déchets en vue d'atteindre les objectifs du développement durable.

1.2 Problématique et questions de recherche

Dans les dix dernières années, les chaînes d'approvisionnement en boucle fermée (CLSC) ont suscité un intérêt croissant dans la recherche sur la gestion des chaînes d'approvisionnement, comme en témoigne le nombre croissant de publications dans les revues scientifiques ces dernières années. Plus de 1800 articles ont été recensés lors d'une première recherche sur le site web of Science™ (WoS) en utilisant les mots-clés "chaîne d'approvisionnement en boucle fermée" (voir Figure 1. 3) de 2000 à 2020.

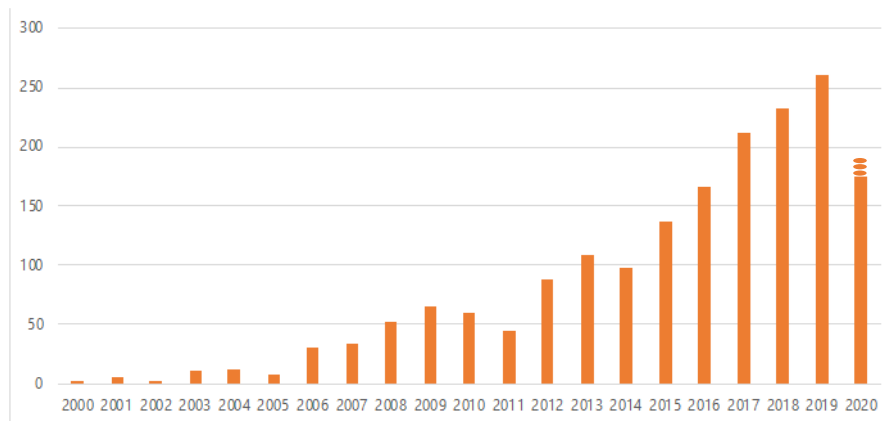

Figure 1. 3 Nombre d'articles identifiés lors d'une première recherche sur le site web of Science™ (WoS) à l'aide des mots clés "closed-loop supply chain" (chaîne d'approvisionnement en boucle fermée)

Les chaînes d'approvisionnement en boucle fermée intègrent les processus conventionnels de la chaîne d'approvisionnement avec des opérations de logistique inverse, englobant la récupération des produits, leur remise en état, le démontage et la réutilisation des pièces (Guide & Van Wassenhove, 2009). Fermer cette boucle dans la chaîne d'approvisionnement entraîne généralement un système plus complexe que celui d'une chaîne d'approvisionnement traditionnelle. Il est donc devenu plus crucial que jamais de disposer de méthodes quantitatives et de modèles spécifiquement conçus et adaptés à la gestion des systèmes de chaîne d'approvisionnement en boucle fermée, ainsi qu'à leur performance, afin d'aider les gestionnaires et les professionnels à concevoir des systèmes en boucle fermée plus efficaces, économiques et durables.

Concernant la performance environnementale du système, nous explorerons le potentiel de la méthodologie de l'analyse du cycle de vie, considérée comme une approche mature, normative et systémique, dans une perspective intégrée avec les méthodes et les outils de gestion des CLSC.

Pour aborder les questions théoriques et pratiques importantes dans ce domaine, les sujets typiques comprennent, sans s'y limiter, l'utilisation de méthodes analytiques, d'outils de calcul, d'approches d'optimisation, de systèmes d'aide à la décision et d'études de cas. Même si ce travail a des implications méthodologiques pour la modélisation et le couplage des CLSC-LCA, il doit être étayé par une étude de cas significative.

L'utilisation accrue des batteries au plomb dans les véhicules automobiles, en particulier pour les véhicules électriques, considérée comme l'une des options de véhicules les plus prometteuses à l'avenir, viendra soutenir notre analyse. Ces véhicules consomment des quantités considérables de plomb et de produits à base de plomb, particulièrement les batteries au plomb (LAB) (Sun et al. 2016).

Ces batteries sont largement utilisées dans le monde entier, principalement en raison de leur coût modéré, de leur tension unitaire élevée, de leurs performances stables et de leur capacité à fonctionner à des températures extrêmes (Chang et al. 2009). La taille du marché des LAB devrait croître à l'échelle mondiale, passant de 46,6 milliards de dollars en 2015 à 84,5, selon les données Grand View Research (2017). Cependant, l'industrie des LAB doit faire face à de graves problèmes d'environnement et de santé publique, en particulier l'émission de plomb, connu comme l'un des principaux métaux lourds polluants (Sun et al. 2016).

Il est surprenant de constater que, comme indiqué récemment dans (Davidson et al. 2016), relativement peu d'ACV ont été réalisées et mises à disposition pour évaluer l'impact environnemental de la production de plomb et de celui des produits à base de plomb, bien que le plomb soit l'un des matériaux les plus largement recyclés et présente le taux de recyclage en fin de vie le plus élevé de tous les métaux couramment utilisés : les taux de collecte et de recyclage des batteries automobiles et industrielles au plomb et des feuilles de plomb en Europe sont respectivement de 99 et 95 %.

La littérature portant sur l'ACV des LAB se concentre généralement en amont ou en aval du cycle de vie des batteries au plomb, se focalisant sur la fabrication ou sur le recyclage, même si certains travaux récents ont porté sur l'ensemble du processus (Wang et al. 2018).

Du point de vue de la vision de la chaîne d'approvisionnement, plusieurs travaux ont été consacrés à la modélisation CLSC des LAB. Ils seront présentés plus en détail, dans ce manuscrit, dans le chapitre dédié. Cependant, une tendance se dessine qui suit les lignes directrices développées dans un des premiers modèles rapportés (Daniel et al. 2003; Kannan et al. 2010; Salomone et al. 2005), qui ne considère que la modélisation des flux de matières dans une formulation d'optimisation avec un critère exclusivement économique, à savoir le coût total de la chaîne d'approvisionnement (Kuo et al. 2010; W. Liu et al. 2015).

Les questions de recherche qui seront abordées dans ce manuscrit peuvent être formulées comme suit:

Question de recherche 1 :

Comment intégrer la chaîne d'approvisionnement inverse à la chaîne d'approvisionnement amont du point de vue de la modélisation du réseau ?

La chaîne d'approvisionnement en boucle fermée (CLSC) revêt une grande importance de nos jours, dans un monde où les préoccupations environnementales s'intensifient et où les réglementations sur le gaspillage, dès la création jusqu'à la fin de vie d'un produit, sont de plus en plus strictes. Une CLSC englobe à la fois la chaîne d'approvisionnement amont et aval. La chaîne d'approvisionnement amont concerne principalement le déplacement des biens et des produits des fournisseurs vers les clients. La chaîne d'approvisionnement inverse implique quant à elle le retour des produits utilisés ou excédentaires du client vers la chaîne d'approvisionnement amont, en vue d'un recyclage potentiel et d'une réutilisation. L'intégration de la chaîne d'approvisionnement inverse au sein de la chaîne d'approvisionnement aval est cruciale, car elle peut contribuer à réduire les coûts globaux et à respecter les réglementations gouvernementales et environnementales. Ainsi, il est essentiel de modéliser et d'analyser les chaînes d'approvisionnement en boucle fermée comme un système intégré, sans les diviser en parties distinctes de chaînes d'approvisionnement amont et aval.

Question de recherche 2 :

Comment intégrer les résultats de l'analyse du cycle de vie et de la gestion des chaînes d'approvisionnement en boucle fermée ou, en d'autres termes, comment explorer l'effet miroir de l'ACV et du CLSC ?

L'une des applications de l'ACV consiste à évaluer de manière précise les conséquences environnementales des produits, pouvant être combinée à des données économiques et sociales. Les agences doivent comprendre l'ensemble des impacts des produits lorsqu'elles envisagent de nouvelles réglementations. Une élaboration appropriée de la législation sur la reprise des produits, incluant la question de privilégier le recyclage ou le reconditionnement, nécessite une évaluation complète de tous les impacts environnementaux le long de la chaîne d'approvisionnement. De plus, les clients exigent des fournisseurs une plus grande transparence concernant leurs produits et leurs procédés, soit individuellement soit par le biais d'associations professionnelles.

Si le CLSC s'inscrit naturellement dans la dynamique de la chaîne d'approvisionnement verte (Green Supply Chain - GSC), comment pourrait-on optimiser l'impact environnemental tout en respectant des critères économiques ?

Question de recherche 3 :

Comment développer une méthodologie qui combine plusieurs critères sur plusieurs périodes ?

En d'autres termes, quels sont les méthodes et outils les plus appropriés à utiliser pour élaborer un cadre intégré visant à relever les défis des CLSC et des ACV ?

Question de recherche 4 :

Comment définir des stratégies efficaces pour la gestion des CLSC, en particulier pour les batteries au plomb ?

La revue générale de la littérature démontre clairement que la gestion de la chaîne d'approvisionnement des batteries au plomb implique une formulation multicritère où le coût et l'impact environnemental doivent être considérés simultanément.

La recherche doctorale présentée dans ce manuscrit a été menée au Laboratoire de génie chimique, LGC UMR CNRS 5503 INPT/UPS dans le département "Procédés et Systèmes Industriels" (PSI).

Ce projet s'inscrit dans le cadre des travaux complémentaires menés au sein du département PSI, en particulier, les doctorats de:

- Sofia De León Almaraz, *Optimisation multi-objectifs d'une chaîne d'approvisionnement en hydrogène* (thèse de doctorat, INPT, 2014) ;
- Jesus Ochoa Robles, *Stratégies d'optimisation multi-objectifs pour la conception et le déploiement des chaînes d'approvisionnement en hydrogène* (thèse de doctorat INPT, 2018).

Ces deux thèses ont été consacrées à la conception de la chaîne d'approvisionnement en hydrogène.

- Marie Bonnin : *Optimisation multicritères pour la gestion globale des ressources : application au cycle du cuivre en France*, (thèse de doctorat INPT, 2013) consacrée au recyclage du cuivre à l'échelle nationale.
- Marco Miranda : *Optimisation multi-objectifs pour la gestion et la conception de la chaîne d'approvisionnement verte : Application au cluster agroalimentaire du jus d'orange*, (thèse de doctorat INPT, 2015) qui a intégré les principes de la chaîne d'approvisionnement verte pour la chaîne d'approvisionnement du jus d'orange.

Citons enfin, les travaux de :

- Anh Vo Dong : *Optimisation multiobjectifs pour l'écoconception des chaînes d'approvisionnement de déchets CFRP de l'aérospatiale*, (thèse de doctorat INPT, 2017) principalement dédiés à la chaîne d'approvisionnement de recyclage des CFRP (Carbon Fiber Reinforced Polymer).

D'autres travaux de l'INPT ont également été consacrés à la réutilisation des composants (batteries), comme le doctorat de :

- Bunthern Kim: *Contribution à la conception et la commande optimale d'un système hybride génération d'énergie électrique à base d'énergies renouvelables et de constituants recyclés en vue de l'alimentation d'un village isolé dans un pays en voie de développement* (thèse de doctorat INPT, 2019) au laboratoire LAPLACE. L'évaluation environnementale a été réalisée en collaboration avec le LGC.

Cette thèse vise à compléter et à étendre le champ scientifique de la gestion de la chaîne d'approvisionnement et, en particulier, les contributions qui ont été précédemment abordées dans notre équipe de recherche. Elle aspire à proposer une contribution au développement d'un cadre méthodologique pour la gestion de la chaîne d'approvisionnement en boucle fermée (CLSCM) avec intégration de l'Analyse du Cycle de Vie (ACV) et également la définition de stratégies qui pourraient en découler.

Ce manuscrit est organisé en six chapitres. Une brève description du contenu de chaque chapitre est présentée ci-après (Figure 1. 4).

Le **Chapitre 1** a exposé les buts et objectifs de la thèse.

Le **Chapitre 2** présentera les éléments centraux de cette thèse de doctorat : les CLSC, l'ACV et les LAB. Ce chapitre, axé sur l'état de l'art, cherchera à mettre en lumière l'interrelation entre ces deux concepts méthodologiques. Il justifiera également l'étude de cas portant sur les batteries au plomb. Une attention particulière sera portée à la modélisation des CLSC. Nous examinerons les nombreux parallèles existant entre le CLSCM et l'ACV, qui seront exploités dans le manuscrit. À première vue, l'ACV semble davantage axée sur la mesure des impacts de durabilité et des compromis pour la prise de décision conformément aux lignes directrices de la norme ISO 14040, alors que le travail dans le domaine de la gestion de la chaîne logistique est plutôt orienté vers des décisions spécifiques ou la mise en place de règles de décision. L'étude de cas sur les LAB sera ainsi justifiée.

Le **Chapitre 3** vise à montrer explicitement comment l'ACV pourrait être bénéfique aux concepts de CLSC, en mettant l'accent sur les batteries au plomb :

- Les concepts communs d'ACV et de CLSC seront présentés, c'est-à-dire les différents échelons et briques technologiques impliqués dans la chaîne d'approvisionnement en boucle fermée des batteries au plomb.
- Il exposera mes résultats d'une ACV pour examiner en détail l'impact environnemental des batteries au plomb.
- Une analyse de sensibilité fondée sur la quantité de plomb recyclé dans la production d'une batterie sera réalisée, afin d'identifier les processus clés qui contribuent aux différents indicateurs environnementaux.

Enfin, nous montrerons tout l'intérêt de l'ACV pour évaluer l'impact environnemental d'un produit tout au long de son cycle de vie et pour montrer que l'optimisation a toute sa place pour arbitrer les compromis entre tous les échelons de la chaîne d'approvisionnement et réduire l'impact environnemental du processus de production des batteries.

Le **Chapitre 4** est consacré à la modélisation de la chaîne d'approvisionnement multi-étapes et multi-périodes des CLSC pour les LAB. Il fait intervenir une formulation linéaire en variables mixtes (MILP, Mixed Integer Linear Programming) pour concevoir le réseau des CLSC qui comprend cinq échelons (c'est-à-dire les fournisseurs, les producteurs, les distributeurs, les grossistes et les détaillants) dans le sens direct et sept échelons (c'est-à-dire les centres de collecte et de recyclage, l'élimination du produit, l'usine de désassemblage, l'élimination de la matière première, la tierce partie et la refabrication) dans le sens inverse.

Le **Chapitre 5** est dédié à la stratégie d'utilisation du cadre méthodologique de la chaîne d'approvisionnement en boucle fermée pour les batteries. Il présente les données utilisées comme intrants dans le modèle ainsi que les résultats générés avec la méthodologie présentée dans le chapitre précédent. La solution du modèle implique une stratégie en plusieurs étapes avec une combinaison d'optimisation multi-objectifs, d'outils de prise de décision multi-critères et d'analyse du cycle de vie avec le logiciel SimaPro.

Enfin, le **Chapitre 6** présente les conclusions générales issues de la stratégie proposée et dresse des perspectives sur les travaux à entreprendre à la suite de ce travail de recherche.

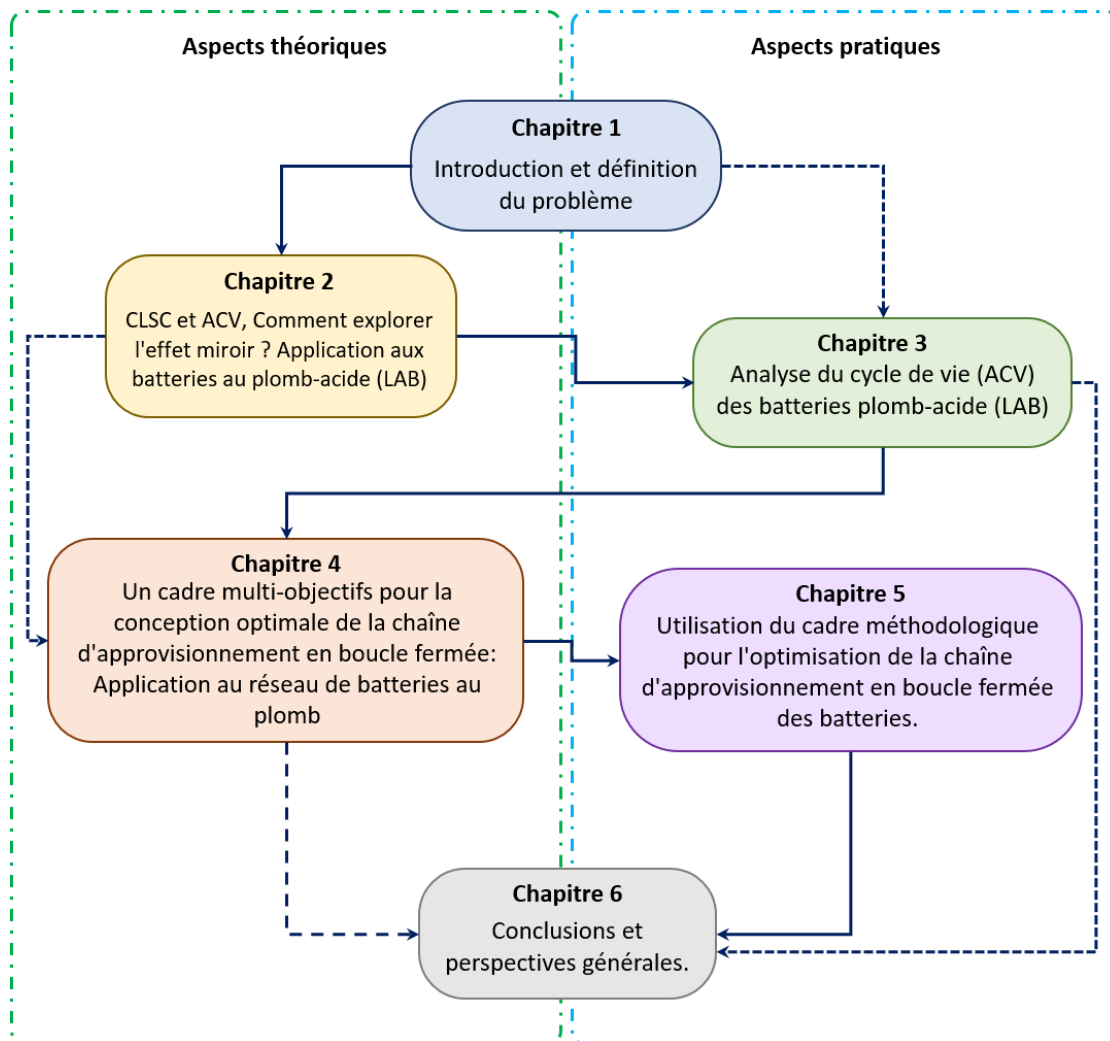

Figure 1. 4 Présentation de la thèse

Chapter

2

CLSC and LCA, how to explore the
mirror effect:

application to Lead-Acid Batteries
(LABs).

Abstract

The objective of this chapter is to introduce the principles and approaches utilized in supply chain management, focusing on CLSCM (Closed-Loop Supply Chain Management) and LCA (Life Cycle Assessment). Both perspectives complement each other, offering valuable insights into the same subject. The intention is to demonstrate how collaboration between these two communities can mutually benefit. The analysis will be supported by a case study involving lead-acid batteries.

Résumé

L'objectif de ce chapitre est de présenter les principes et les approches utilisés dans la gestion de la chaîne d'approvisionnement, en mettant l'accent sur la gestion de la chaîne d'approvisionnement en boucle fermée (CLSCM) et l'analyse du cycle de vie (ACV). Ces deux perspectives se complètent mutuellement, offrant des perspectives précieuses sur le même sujet. L'objectif est de démontrer comment la collaboration entre ces deux communautés peut être mutuellement bénéfique. L'analyse sera étayée par une étude de cas portant sur les batteries plomb-acide.

2.1 Introduction

The manuscript's introduction underscores the pivotal role of recycling in waste reduction and its potential for economic viability. It highlights the adoption of diverse recycling methods to recover used products after their lifecycle ends.

Within this context, the supply chain concept has evolved towards an integrated approach, considering both forward and reverse supply chains simultaneously, leading to the so-called closed-loop supply chain (CLSC). The concept of a closed-loop supply chain network is particularly interesting since it is intrinsically sustainability-oriented by improving economic and environmental goals simultaneously.

In this perspective, the concept of Life Cycle Assessment is particularly relevant to be integrated into the CLSC management for environmental assessment of the proposed solution. Yet, several studies have emphasized the same underlying systems, thus creating a kind of mirror effect between supply chain management (Blass & Corbett, 2018) in general, and not specifically in the case of CLSC and Life Cycle Assessment even if the modeling is generally tackled through different perspectives in their respective scientific communities.

This chapter aims to present the concepts and methods used in supply chain management, in particular those related to Closed Loop Supply Chain Management (CLSCM) on the one hand and those related to LCA on the other hand. These two perspectives do not conflict with each other, but shed additional light on the same object of study. The aim is to show how both communities can enrich each other through closer interaction. The case study of lead-acid batteries will then support the analysis.

2.2 The concept of supply chain management (SCM)

Originally, (Oliver & Webber, 1982) explained the difference between logistics and supply chain management (SCM) by the holistic view and strategic nature of SCM, aiming at integrating companies in a system creating a more robust business model. As they point out, the aim is to balance resources so that “an integrated system strategy that reduces the level of business vulnerability is developed and implemented.”

According to (Stevens, 1989), the integration of activities is a prerequisite for SCM with four levels of integration ranging from the non-integrated company, to semi-integrated, full internal integration, and finally integration across the organizational boundary. Only this latter level refers to SCM.

According to (Cooper & Ellram, 1993), SCM is defined as “an integrative philosophy to manage the total flow of a distribution channel from the supplier to the ultimate user.”

While this definition more or less assimilates SCM with the traditional logistics concept, (Handfield & Nichols, 1998) define supply chains as encompassing “all activities associated with the flow and transformation of goods from the raw materials stage, through to the end-users, as well as the associated information flows. Material and information flow both up and down the supply chain; SCM is the integration of these activities through supply chain relationships, to achieve sustainable competitive advantage.”

For (Mentzer et al. 2001), a supply chain is “a set of three or more entities (organizations or individuals) directly involved in the upstream and downstream flows of products, services, finances, and/or information from a source to a customer.” In this definition, the authors distinguish between a “direct supply chain”, an “extended supply chain”, and an “ultimate supply chain”. The direct chain encompasses the company, a supplier, and a customer.

In the SCM paradigm, a central or focal company (FC) as proposed in (Seuring & Müller, 2008) is characterized by being the designer or owner of the product or service offered, governing the supply chain, and having contact with all SC stakeholders including the customers.

A direct supply chain consists of a company, a supplier, and a customer involved in the upstream and/or downstream flows of products, services, finances, and/or information (Figure 2.1a). An extended supply chain includes suppliers of the immediate supplier and customers of the immediate customer, all involved in the upstream and/or downstream flows of products, services, finances, and/or information (Figure 2.1b). An ultimate supply chain includes all the organizations involved in all the upstream and downstream flows of products, services, finances, and information from the ultimate supplier to the ultimate customer (Figure 2.1c).

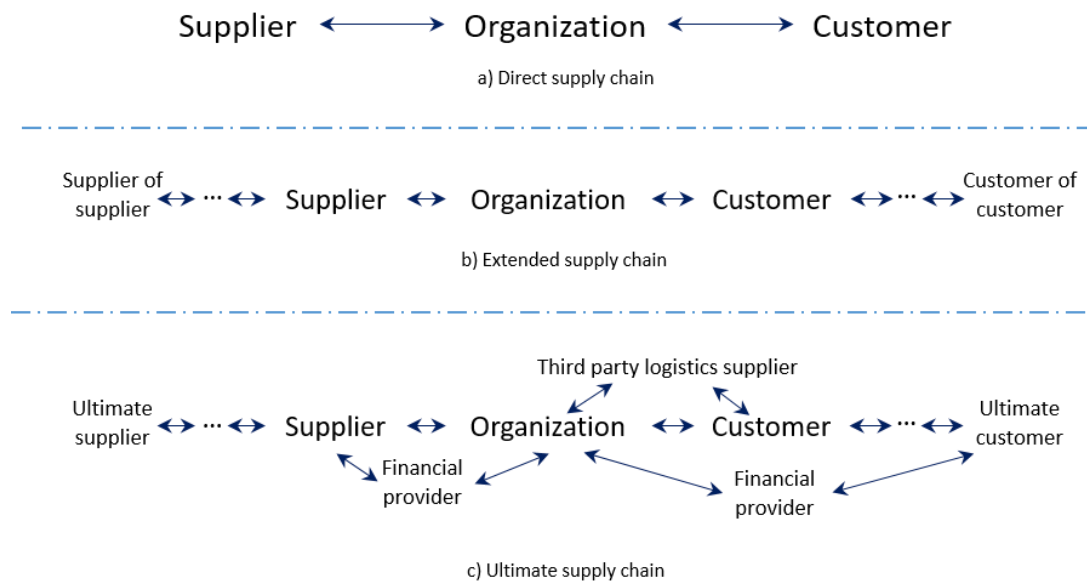

Figure 2. 1 Types of channel relationships.

The definition of SCM is classified into three categories: a management philosophy, an implementation of management philosophy, and a set of management processes (Mentzer et al. 2001). Although the focus of SCM definitions varies, they all have three things in common:

- The focus on the efficient flow of materials, finances, and information between firms in the chain/network.
- The process orientation of the participating firms.
- The integration of processes across company boundaries.

2.2.1 SCM as a Management Philosophy

As a philosophy, SCM takes a systems approach to viewing the supply chain as a single entity, rather than as a set of fragmented parts, each one performing its own function (Ellram & Cooper, 1990; Houlihan, 1988; Tyndall et al. 1998). In other words, the philosophy of supply chain management extends the concept of partnerships into a multi-firm effort to manage the total flow of goods from the supplier to the ultimate customer (Ellram, 1990; Jones & Riley, 1985). Thus, SCM is a set of beliefs that each firm in the supply chain, directly and indirectly, affects the performance of all the other supply chain members, as well as the ultimate, overall supply chain performance (Cooper et al. 1997).

Based on the literature review, SCM can be viewed as a management philosophy with the following characteristics:

- A systems approach to visualize the supply chain as a whole, and to manage the total flow of goods inventory from the supplier to the ultimate customer.
- A strategic orientation toward cooperative efforts to synchronize and convergence of intra-company and inter-company operations and strategic capabilities into a unified whole.
- A customer focus to create unique and individualized sources of customer value, leading to customer satisfaction.

2.2.2 SCM as a Set of Activities to Implement a Management Philosophy

In adopting a supply chain management philosophy, the firms must establish management practices that permit them to act or behave consistently with the philosophy. As such, many authors have focused on the activities that constitute supply chain management. Various activities have been identified as necessary to successfully implement a SCM philosophy (see Table 2. 1) (Mentzer et al. 2001).

1. Integrated Behavior	Incorporating customers and suppliers: this set of activities is a coordinated effort called supply chain management between the supply chain partners, such as suppliers, carriers, and manufacturers, to dynamically respond to the needs of the end customer
2. Mutually Sharing Information	Open sharing of information such as inventory levels, forecasts, sales promotion strategies, and marketing strategies: the aim is to reduce the uncertainty between supply partners and results in enhanced performance
3. Mutually Sharing Risks and Rewards	Risk and reward sharing is important for long-term focus and cooperation among the supply chain members
4. Cooperation	similar or complementary, coordinated activities performed by firms in a business relationship to produce superior mutual outcomes or singular outcomes that are mutually expected over time
5. The Same Goal and the Same Focus on Serving Customers	Establishing the same goal and the same focus among supply chain members is a form of policy integration.
6. Integration of Processes	Integration can be accomplished through cross-functional teams, in-plant supplier personnel, and third-party service providers
7. Partners to Build and Maintain Long-Term Relationships	The relationship time horizon extends beyond the life of the contract, perhaps indefinitely and, at the same time, the number of partners should be small to facilitate increased cooperation

Table 2. 1 Activities in the SCM philosophy

2.2.3 SCM as a Set of Management Processes

As opposed to a focus on the activities that constitute supply chain management, other authors have focused on management processes. (Davenport & Young, 1993) define processes as a structured and measured set of activities designed to produce a specific output for a particular customer or market. (La Londe & Masters, 1994) propose that SCM is the process of managing relationships, information, and materials flow across enterprise borders to deliver enhanced customer service and economic value through synchronized management of the flow of physical goods and associated information from sourcing to consumption. (Ross, 1998) defines supply chain process as the actual physical business functions, institutions, and operations that characterize the way a particular supply chain moves goods and services to market through the supply pipeline.

The focus on sustainable development and green economics that has been growing in the past two decades has led to a great deal of research performed in the fields connected with supply chains and logistics involving Green Supply Chain Management (GSCM). GSCM can be defined as “green procurement + green manufacturing + green distribution + reverse logistics”: the principal idea is to eliminate or minimize waste (energy, emissions, chemical/hazardous, solid wastes) along the supply chain (Hervani et al. 2005). GSCM has emerged as an important innovation that helps organizations develop “win-win” strategies that achieve profit and market share objectives by lowering their environmental risks and impacts while raising their ecological efficiency (Van Hoek, 1999). The activities that make part of the GSCM are illustrated in Figure 2. 2.

A. Green Procurement

Green procurement is defined as an environmental purchasing consisting of involvement in activities that include the reduction, reuse, and recycling of materials in the process of purchasing. Besides, green procurement is a solution for environmentally concerned and economically conservative businesses and a concept of acquiring a selection of products and services that minimizes environmental impact (Asif Salam, 2008).

B. Green Manufacturing

Green manufacturing is defined as production processes which use inputs with relatively low environmental impacts, which are highly efficient, and which generate little or no waste or pollution. Green manufacturing can lead to lower raw material costs, production efficiency gains, reduced environmental and occupational safety expenses, and improved corporate image (Atlas & Florida, 1998).

C. Green Distribution

The green distribution consists of green packaging and green logistics. Packaging characteristics such as size, shape, and materials have an impact on distribution because of their effect on the transport characteristics of the product. Better packaging, along with rearranged loading patterns, can reduce materials usage, increase space utilization in the warehouse and the trailer, and reduce the amount of handling required (Ho et al. 2009).

D. Reverse Logistics

Reverse logistics is the process of retrieving the product from the end consumer to capture value or proper disposal. These activities include collection, a combined process of inspection, selection, and sorting, re-processing or direct recovery, redistribution, and disposal.

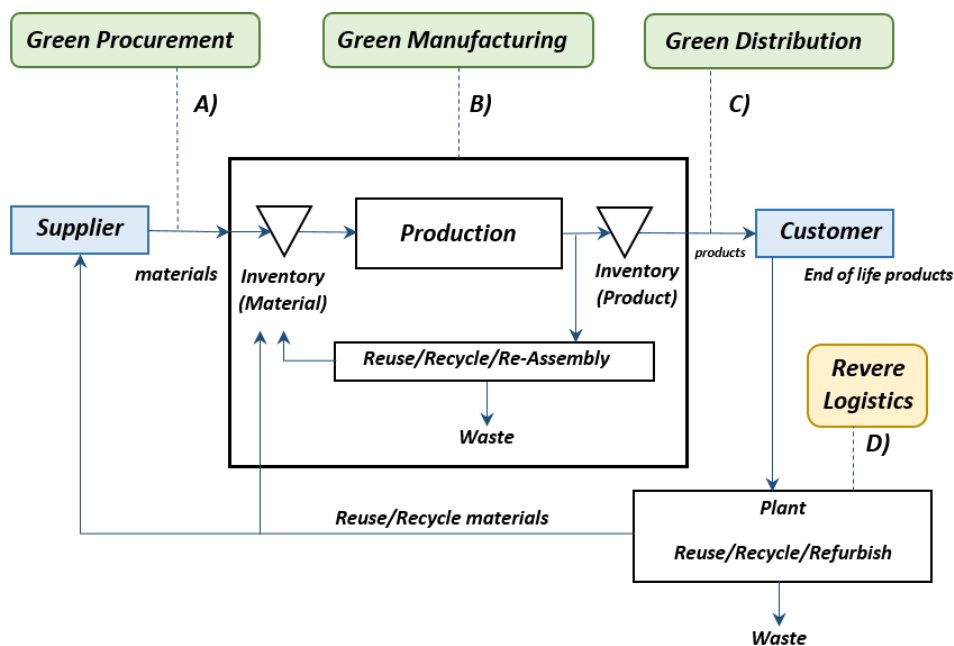

Figure 2. 2 Activities in green supply chain management.

The recoverable product environment, that GSCM is creating, “is a closed-loop system incorporating traditional logistics forward flows with logistics channels reversed” (Jayaraman et al. 1999). In this vision, remanufacturing is the “heart” of the recoverable manufacturing system.

2.3 Closed-loop supply chain

Closed-loop supply chains vary significantly from forward supply chains in numerous aspects. These distinctions are not widely understood across various contexts, and the situation is further complicated by various types of product returns. Progress is sluggish as closed-loop supply chains are seldom perceived as value-generating systems, with much focus placed on operational aspects rather than broader strategic issues. To address this, there is a necessity for the development of new business models through collaboration between industry and academia that adopt a life-cycle approach to products.

2.3.1 Integrating forward and reverse supply chains

The forward supply chain is a network of facilities and distribution options that performs the functions of procurement of materials, the transformation of these materials into intermediate and finished products, and the distribution of these finished products to customers (Figure 2. 3). Supply chains exist in both service and manufacturing organizations, although the complexity of the chain may vary greatly from industry to industry and firm to firm. Optimizing the supply chain networks in the real world business environment is a very difficult task because the supply chain leader usually refers to the manufacturer along the supply chain, and has to deal with uncertainties in supply and demand with conflicting objectives and tradeoffs along with the different elements along the chain.



Figure 2. 3 Framework of a forward supply chain.

However, a closed-loop supply chain includes the return processes and the manufacturer has the intent of capturing additional value and further integrating all supply chain activities. Therefore, closed-loop supply chains include traditional forward supply chain activities and the additional activities of the reverse supply chain. These additional activities include:

- product acquisition to obtain the products from the end-users.
- reverse logistics to move the products from the points of use to a point(s) of disposition.
- testing, sorting, and disposition to determine the product’s condition and the most economically attractive reuse option.
- refurbishing to enable the most economically attractive of the options: direct reuse, repair, remanufacture, recycle, or disposal.
- remarketing to create and exploit markets for refurbished goods and distribute them.

A reverse supply chain is the process of planning, implementing, and controlling the efficient and cost-effective flow of raw materials, in-process inventory, finished goods, and related information from the point of consumption to the point of origin to recapture value or proper disposal (Rogers et al. 2012). Also, it prevents pollution by reducing the environmental charge of End of Life (EOL) at its source: this process can take place through the original forward channel, through a separate reverse channel, or combinations of both forward and reverse channels. The fundamentals of the Reverse supply chain (Reverse Logistics) could begin by analyzing the topic from four essential viewpoints: why, what, how, and who. Previous studies have highlighted that these types of characteristics are relevant to characterizing reverse logistics (Fleischmann et al. 1997; Thierry et al. 1995; Zhiquiang, 2003) (Figure 2. 4).

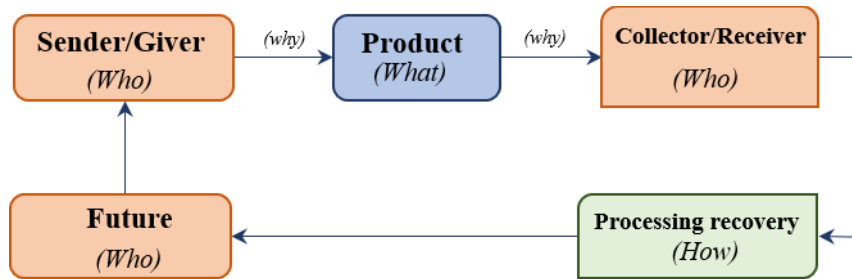

Figure 2. 4 Why, how, what and who basic interactions (Thierry et al. 1995).

Figure 2.4 highlights several issues that need to be addressed. There are three driven forces for reverse logistics: 1) Economics, 2) Legislation and 3) Corporate citizenship. In summary, companies become active in reverse logistics 1) because they can profit from it, or/and 2) because they have to, or/and 3) because they “feel” socially motivated to do it (Figure 2. 5).

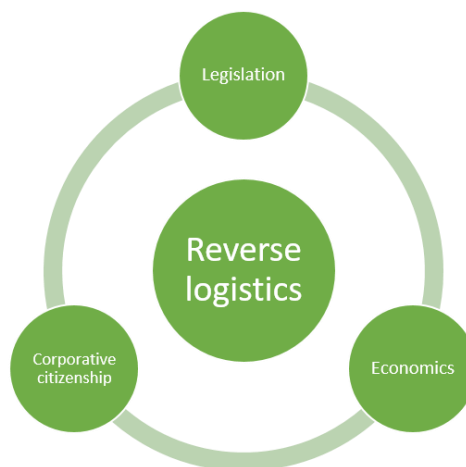

Figure 2. 5 Driving cycle for reverse logistics.

The reasons for returns can be categorized based on three stages of the supply chain: 1) manufacturing returns, encompassing surplus raw materials, quality control issues, and leftover or byproduct from production, 2) distribution returns, involving product recalls, returns due to commercial agreements (B2B "business to business" returns), internal stock adjustments, and functional returns, 3) customer returns, which include refunds, warranty claims, service returns, end-of-use, and end-of-life returns (Figure 2. 6).

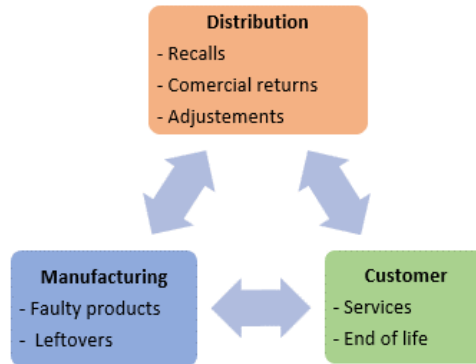

Figure 2. 6 Return reasons cycle for reverse logistics.

What is being returned: in this respect, the overall activities involved in a reverse logistics process have to be described with special attention to recovery options (Figure 2. 7).

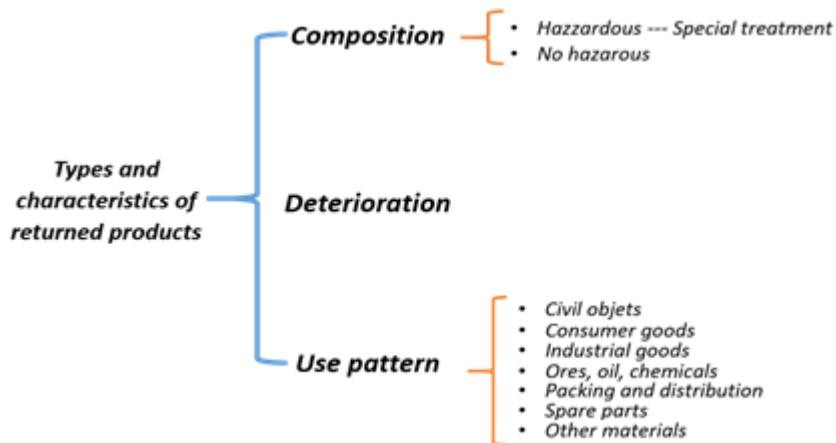

Figure 2. 7 Classification of returned objects

In terms of product characteristics, three primary product features influence reverse logistics: 1) the product composition, 2) the degradation process, and 3) the usage pattern. Based on various pattern types, as outlined by (Fleischmann et al. 1997), and product classification, the following categories were distinguished: 1) civilian items, 2) consumer goods, 3) industrial products, 4) ores, oils, and chemicals, 5) packaging and distribution materials, 6) spare parts, and 7) other materials (such as pulp, glass, and scraps).

How Reverse Logistics works in practice: such an analysis involves, on the one hand, crucial product characteristics for reverse logistics, and on the other hand, a classification of product types (Figure 2. 8).

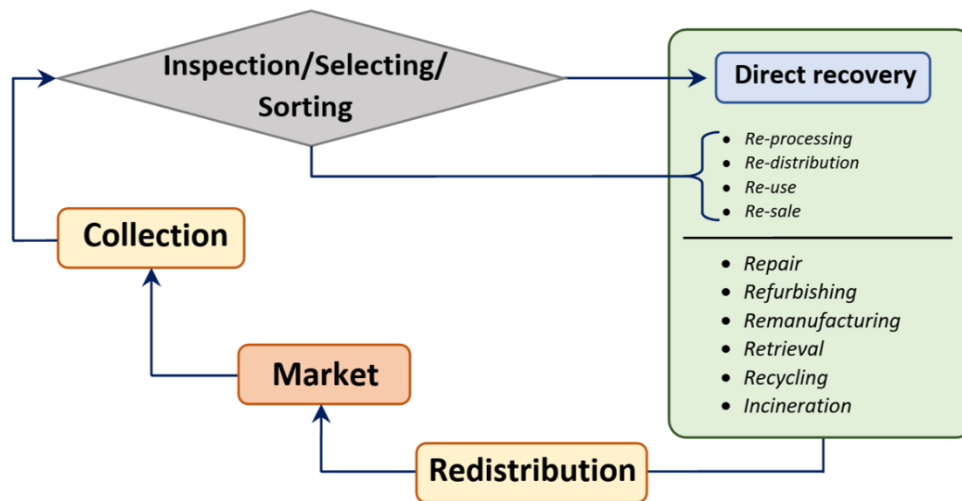

Figure 2. 8 Reverse logistic processes.

In general, reverse supply chain activities are confined to 1) collection, followed by 2) inspection /selection /sorting process, 3) re-processing, and finally 4) redistribution. The re-processing can be more or less light. Two groups can be distinguished:

- Direct recovery involves returned products that are in such good condition that they can be reused, resold, or redistributed directly.
- Re-processing recovery involves more elaborate re-processing. When delving into re-processing, distinct recovery options are identified (Thierry et al. 1995), which include: 1) product level (repair), 2) module level (refurbishing), 3) component level (remanufacturing), selective part level (retrieval), material level (recycling), and energy level (incineration).

Who is implementing reverse logistic activities: here, the inquiry is on the actors and their role in implementing reverse logistics (Figure 2. 9).

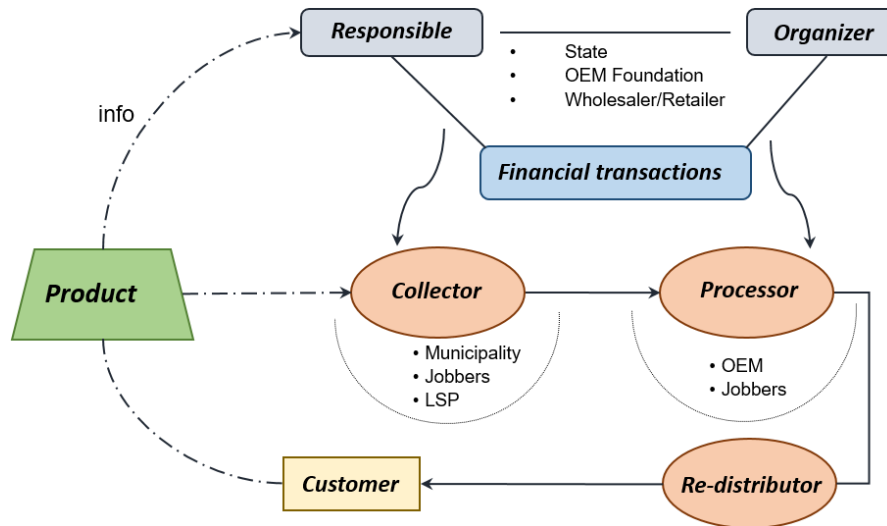

Figure 2. 9 Who is who in reverse logistics.

The actors in reverse supply chain systems can be divided into three groups: 1) typical forward supply chain actors (manufacturers, wholesalers, retailers), 2) specialized reverse chain players (jobbers, remanufacturers, original equipment manufacturers (OEM), logistics service providers ‘LSP’), and 3) opportunistic players (such as charities).

Designing, planning, and controlling a reverse supply chain demands careful attention. It is essential to highlight that while standard activities for reverse supply chains exist, these activities are usually context-specific, varying in complexity and managerial significance based on the scenario. Adding complexity, users may return products at various stages of the product life cycle: during active use (commercial returns), at the end of use, and at the end of life. Each return type may necessitate a tailored reverse supply chain that aligns with the characteristics of the returned products to optimize value recovery.

Corporate managers view forward supply chains as important, pay attention to them, and create supporting services to make these processes fluid and effective from end to end. For a long time, the reverse supply chain has not been considered as a business process. Instead, they look at it as a series of fairly independent activities, that is, they use a silo approach to reverse supply chains, considering each activity isolated without considering the integrated nature of reverse supply chains.

Towards a circular economy

These concerns have spurred the transition from a linear to a circular economy (CE) promoted by the Ellen MacArthur Foundation (EMF) (2014) as an industrial system whose design is restorative and regenerative.

A growing number of national and international regulations and guidelines aim to close the loop in the life cycle of products through increased recycling, remanufacturing, and reuse, to benefit both the environment (by promoting energy conservation, greenhouse gas emission reduction, and resource efficiency) and the economy (green job creation).

In this context, the field of closed-loop supply chain management is gaining importance in both academic literature and industrial practice (Battini et al. 2017) and according to these authors, the

transition towards a circular economy could be accelerated by better synchronization of environmental and economic gains of closed-loop supply chain practices.

2.3.2 Optimization methods for CLSC management problem solution.

The CLSC management problem is generally solved by optimization methods. There are two main families of optimization problems: those that can be formulated linearly (LP: Linear Programming) and those with a non-linear formulation (NLP: Non-linear Programming). If the problems involve decision variables, the problem is mainly formulated as MILP (Mixed-Integer Linear Programming) or MINLP (Mixed-Integer Non-Linear Programming). Deterministic and stochastic methods (in particular evolutionary ones) can be used based on the complexity of the problem. Figure 2. 10 illustrates the most common optimization methods (Battini et al. 2017) (Garcia et al. 2005).

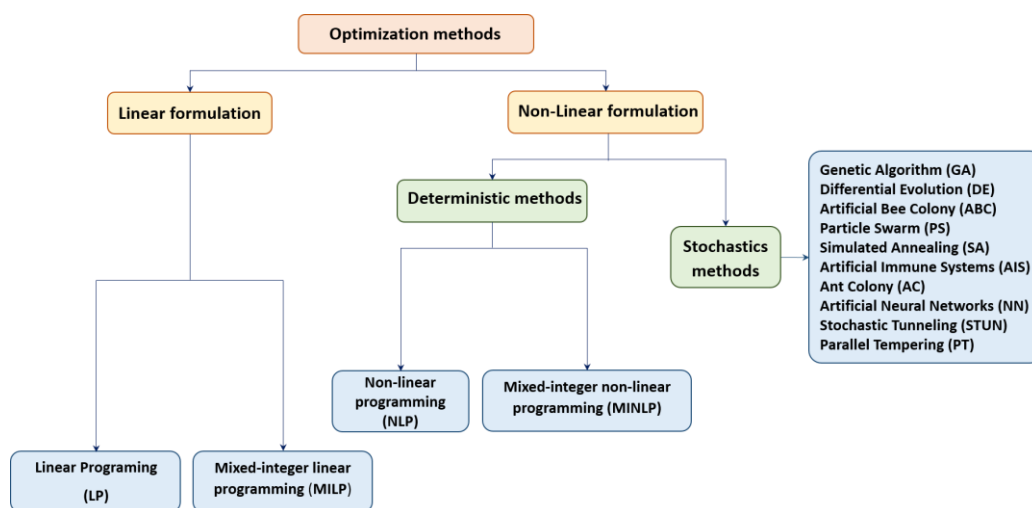

Figure 2. 10 Primary Optimization Methods and Classification by Family

- Deterministic methods

The LP and MILP methods are adapted to single-objective optimization and assure finding the minimum or maximum overall value swiftly, especially for well-described and linear problems.

Deterministic methods like NLP or MINLP are frequently employed for single-objective issues, resulting in a singular optimal solution. These approaches find common use in designing or enhancing industrial processes due to their ability to handle problems with non-linear constraints and various variable types, such as whole, binary, and continuous variables.

However, they converge less efficiently compared to linear problems, resulting in longer calculation times and posing a risk of solely identifying a local optimum.

- Stochastic methods

Stochastic methods are well-suited for "black box" problems where the mathematical properties of the problem are not known or are only partially understood, as well as for handling multi-objective problems. These methods involve evolving a set of initial parameters using probabilistic rules, often derived from observations of natural processes.

2.3.3 Collection/recycling/recovery/recyclability indicators

Due to increasing environmental awareness and the limited capacity of landfill sites, global legislation has incorporated resource recovery and abiotic resource depletion over the past two decades to address the escalating volumes of household and industrial solid waste. To establish effective recycling management, many countries have adopted the concept of Extended Producer Responsibility (EPR). Under an EPR system, manufacturers are accountable for either physically implementing or financially managing product recycling systems.

Performance indicators for resource recycling programs have been deliberated in countries promoting recycling initiatives. Each recycling system proposes various indicators with differing definitions. For instance, the Waste Electrical and Electronic Equipment (WEEE) recycling directive of the European Union mandated each member state to retrieve 4 kg per inhabitant of electrical and electronic equipment by 2006. However, due to varying purchasing powers among EU member states and disparities in electronic and electrical product needs per inhabitant, lower-income countries, purchasing fewer such products, faced challenges in meeting the WEEE collection targets compared to higher-income nations (Lin, 2008).

The WEEE directive also established distinct targets for reuse, recycling, and recovery rates across different product categories and stages. Reuse, recycling, and recovery might hold differing connotations within different social contexts or EU countries. Within the literature, terms like Recycling, Reuse, Reclamation, Regeneration, and Energy recovery are frequently employed to assess recycling program efficacy. Of these, Recovery and Recycling can be confusing and used interchangeably. Recycling usually denotes the conversion of waste into secondary materials, whereas Recovery encompasses energy recovery as well. However, Recovery is also commonly utilized as an indicator to assess a nation's overall solid waste management, indicating the percentage of waste diverted from landfilling or incineration. While these terms serve as indicators, their percentage format, such as the Recycling Rate, remains a subject for discussion and a target to comply with regulations.

Collection rate

The collection rate refers to the percentage of used batteries successfully collected for recycling or proper disposal. This metric indicates the effectiveness of a system designed to gather spent batteries, preventing them from ending up in landfills where they could leak harmful substances into the environment (Eq. 2. 1),

$$C_i = \frac{Q_i}{S_i} \quad (\text{Eq. 2. 1})$$

with

C_i = collection rate for product i

Q_i = total collected waste amount of product i

S_i = total generated waste amount of product i

Recycling rate

The Recycling Rate is defined as the percentage of regenerated resources retrieved from a unit of product taken back, such as the percentage of secondary materials recycled from the waste product. The definition is denoted as (Eq. 2. 2):

$$r_i = \frac{M_1 + M_2 + \dots + M_n}{Q_i} \quad (\text{Eq. 2. 2})$$

with

r_i = recycling rate for product i

M_n = regenerated amount of resource n from the recycling of Product i

Q_i = total waste amount of product i collected

Q_i = the total waste amount of product i collected

Recovery rate

The Recovery Rate indicates the overall performance of a country based on calculating the percentage of waste diverted from incineration or landfilling, such as the collected amount of recyclable materials and kitchen waste divided by the total waste amount generated in a society during a certain period, denoted by (Eq. 2. 3):

$$R = \frac{\sum_{i=1}^n Q_i}{\sum_{i=1}^n S_i} = \frac{Q_1 + Q_2 + \dots + Q_n}{S_1 + S_2 + \dots + S_n} \quad (\text{Eq. 2. 3})$$

with

R = overall recovery rate

Q_i = total waste amount of product i collected

S_i = total waste amount of product generated

Recyclability rate

The impact assessment results are used in the recyclability benefit rate (RBR) indicator concept (Ardente & Mathieux, 2014). This indicator is defined as the ratio of the potential environmental savings that can be achieved from recycling the product over the environmental burdens of virgin production followed by disposal (Eq. 2. 4):

$$RBR_n = \frac{\sum_{j=1}^p \sum_{i=1}^N m_{i,j} RCR_{i,j} (V_{n,i,j} + D_{n,i,j} - R_{n,i,j})}{\left(\sum_{j=1}^p \sum_{i=1}^N m_{i,j} V_{n,i,j} + M_n + U_n + \sum_{j=1}^p \sum_{i=1}^N m_{i,j} D_{n,i,j} \right)} \quad (\text{Eq. 2. 4})$$

with

RBR_n = recyclability benefit rate for the impact category

m_{ij} = mass of the material of the part of the product (kg)

D_{nij} = impact of disposing 1kg of the material of the j part (unit/kg)

V_{nij} = impact of producing 1kg of the virgin material of the j part (unit/kg)

R_{nij} = impact of producing 1kg of the i recycled material of the part (unit/kg)

M_n = impact of manufacturing the product (unit)

U_n = impact of the use phase of the product (unit)

N = number of materials in the j part of the product
 P = number of parts of the product
 RCR_{ij} = recycling rate of the i material of the j part.

2.4 Life Cycle Assessment (LCA) methodology.

Sustainability assessment is a complex appraisal method that needs to be conducted for supporting decision-making and policy in an environmental, economic, and social context.

Achieving sustainable development thus requires methods and tools to help quantify and compare the environmental impacts of providing goods and services (“products”) to our societies. These products are created and used because they fulfill a need, be it an actual or a perceived one. Every product has a “life” starting with the design/development of the product, followed by resource extraction, production (production of materials, as well as manufacturing/provision of the product), use/consumption, and finally end-of-life activities (collection/sorting, reuse, recycling, waste disposal) (Rebitzer et al. 2004).

These steps are identical to the echelons involved in the CLSC.

Life Cycle Assessment (LCA) specifically addresses this aspect as an environmental management tool that evaluates the environmental impacts of a product or system throughout its entire life cycle, from production through use to disposal. LCA is a widely employed technical approach that utilizes data derived from investigations conducted at various stages of the life cycle. It assesses impacts across a spectrum of environmental concerns, encompassing measurements such as the production of greenhouse gases contributing to global warming, the embodied energy, and the depletion of raw materials resulting from the analyzed product or system.

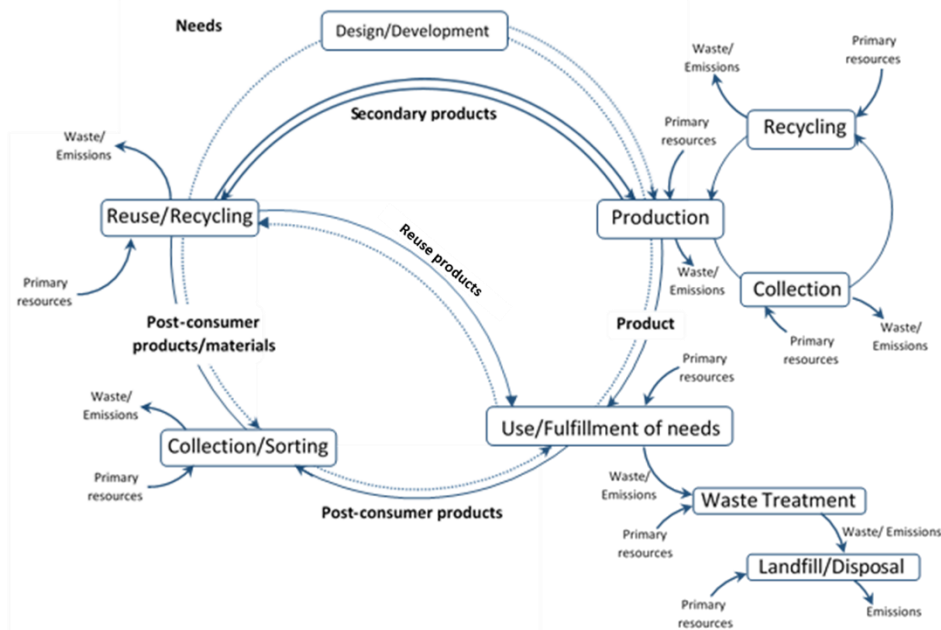

Figure 2. 11 Schematic representation of a generic life cycle of a product (the full arrows represent material and energy flows, while the dashed arrows represent information flows). Source (Rebitzer et al. 2004).

For the reasons previously explained, the LCA can be applied to different products over their whole life cycle (Figure 2. 12). This normalized tool allows us to obtain comparable results and to identify the pollution movement from one stage of the life cycle to another. The basis of this method is to analyze energy consumption and the potential environmental impact of products considering a system of specific boundaries, providing sources for result evaluation (Liang et al. 2017). The LCA results allow the analysis of different aspects linked to environmental issues or of different scenarios, and the comparison of the environmental impact of different technologies involved in the whole supply chain.

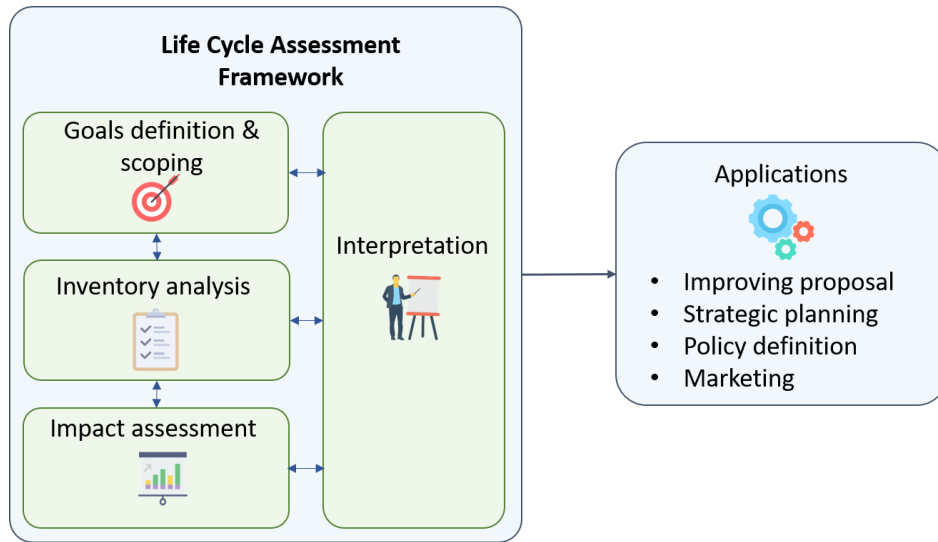

Figure 2. 12 Life Cycle Assessment Framework. Source (ISO:14040, 2006).

➤ Goal and Scope definition

The objective of an LCA study is to demonstrate the intended application without any ambiguity. The reasons for carrying out the study and the intended audience, i.e., to whom the results of the study are intended to be communicated, defining the scope of an LCA study, the following items shall be considered and clearly described:

- The functions of the product system or systems.
- The functional unit.
- The product system to be studied.
- The product system boundaries.
- Allocation procedures.
- Types of impact and methodology of impact assessment to be used.
- Data requirements.
- Assumptions.
- Limitations.
- Initial data quality requirements.
- Type of critical review.
- Type and format of the report required for the study.

The scope should be sufficiently well-defined to ensure that the depth and the detail of the study are consistent and sufficient to address the stated goal. LCA is an iterative technique. Therefore, the scope of the study may need to be modified while the study is being conducted as additional information is collected.

➤ Inventory analysis

Life cycle inventory (LCI) analysis involves data collection and calculation procedures to quantify relevant input and output flow of the production systems. The LCI phase requires the highest efforts and resources of an LCA:

Data collection: consists of the identification and quantification of relevant inputs and outputs for each unit process of a specific product system, considering the Functional Unit (FU).

Functional unit: is a measure of the performance of the functional outputs of the product system. The primary purpose of a functional unit is to provide a reference to which the inputs and outputs are related. This reference is necessary to ensure the comparability of LCA results.

Data for each unit process within the system boundary include energy and raw material flows, products and co-products, waste, and emissions to air, water, and soil (Figure 2. 13)

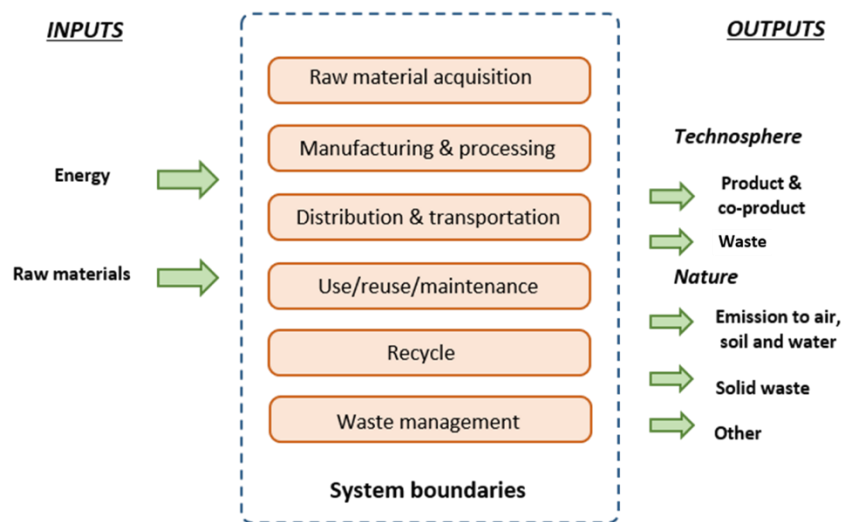

Figure 2. 13 Life cycle inventory scheme.

➤ Impact assessment

Life Cycle Impact Assessment (LCIA) uses the life cycle inventory (LCI) results to evaluate the significance of potential environmental impacts. In general, this process involves associating inventory data with specific environmental impacts and attempting to understand those impacts. The structure of this phase distinguishes between mandatory and optional elements (Figure 2. 14).

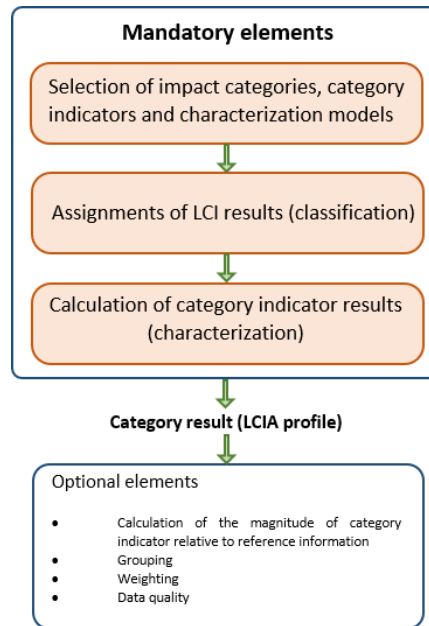

Figure 2. 14 Elements of LCIA Source (ISO 14042:2000).

- Selection of impact categories and characterization models

In this section, the selection of impact categories must encompass all relevant environmental issues related to the analyzed system. Two main schools of methods have been developed, depending on the level of analysis along the cause-effect chain (Finnveden et al. 2009; Jolliet et al. 2003). The primary effects represent the direct result of activities studied, for instance, Greenhouse gas emissions. They can be distinguished from side effects, which are the consequences of primary effects. For example, the ozone layer depletion generates the growth of UV radiation that reaches the ground, this situation increasing the human health problems.

- Problem-oriented methods, known as midpoint methods, model the relatively early stages in the cause-effect chain to limit uncertainties.
- Damage-oriented methods, i.e. endpoint methods, try to consolidate the impact on the final results, as far as possible in the cause-effect chain. They provide accurate information, but they remain somehow uncertain.

The methods for the analysis of the impacts have been widely described in the literature. These methods are the result of several years of work, and each has its specificities. In 2010, the European Commission (European Commission, Joint Research Center, & Institute for Environment and Sustainability, 2010) published a guide with the description of some of these methods. In this publication, an analysis of the strengths, particularities, methodology used, and impact categories pre-selected of each method was made.

Methodology	Impact modeling depth				
	Develop by	Midpoint	Endpoint	Normalization	Source
CML 2002	CML (Netherlands)	X		X	(de Bruijn, et al. 2002)
Eco-indicator 99	PRé (Netherlands)		X	X	(Goedkoop & Spriensma, 2001)
IMPACT 2002+	École Polytechnique Fédérale de Lausanne (Switzerland)	X	X	X	(Jolliet et al. 2003)
ReCiPe	Radboud University Nijmegen + PRé + CML + RIVM (Netherlands)	X	X	X	(Goedkoop et al. 2009)

Table 2. 2 Methods for LCIA Source: (European Commission et al. 2010).

➤ Impacts and damage classification

In this phase, the emission and extraction flow obtained in the LCI are assigned to the impact categories selected; some emissions or extractions can contribute to several categories. According to the characterization method selected, the classification of impacts is different because of the impact categories pre-selected. Impact categories include climate change, stratospheric ozone depletion, photo oxidant formation (smog), eutrophication, acidification, water use, noise, etc. (Pennington et al. 2004) It is possible to elaborate a damage classification (endpoint). Three major groups commonly referred to as areas of protection (European Commission et al. 2010; Goedkoop et al. 2009; Pennington et al. 2004) are considered for the classification of damages: resource use, human health consequences, and ecological consequences.

- Characterization of impacts and damages

From the life cycle inventory, a quantitative characterization factor is assigned for each category to which the flow relevantly contributes. This factor expresses how much that flow contributes to the impact category indicator (at midpoint level) or damage category indicator (at endpoint level).

The characterization of each impact category is the sum of the product of the mass of the substances listed at the LCI classified by impact category and their characterization factor (Eq. 2. 5).

$$SI_i = \sum_S FI_{S,i} \times M_S \quad (\text{Eq. 2. 5})$$

with

SI_i = score for the impact category i

i = impact category

S = substance

FI = factor of the substance S in the impact category i

M_S = mass of the substance S from LCI

The impact categories can be grouped into the damage categories. Each impact category has a higher or lower contribution to the selected damage category. Therefore, a damage characterization factor is needed.

Similarly, the damage score is obtained by multiplying the intermediate score by the damage characterization factor (see (Eq. 2. 6); **Error! No se encuentra el origen de la referencia.**). The characterization factors differ from one characterization method to another. They are available in the literature, in the form of databases, as well as in LCA support software tools.

$$SD_d = \sum_i FD_{i,d} \times SI_i \quad (\text{Eq. 2. 6})$$

with

SD_d = Damage score for the damage category d

i = impact category

d = damage category

FD = damage characterization factor for the impact category i in the damage category d

SI_i = Score for the impact category i

To interpret LCIA results, it is necessary to analyze the results provided in the abovementioned steps, based on the objectives and scope of the study previously defined. So that areas for improvement can be highlighted for decision-making.

The interpretation involves three primary activities:

1. Identifying significant issues: This step involves analyzing and organizing the results to pinpoint the main contributors to the LCIA results (such as processes and elementary flows) and the most relevant impact categories. It involves critical choices like assumptions, foreground and background data used for deriving process inventories, and the LCIA methods employed.
2. Assessing the impact of significant issues on the overall LCA results: This evaluation closely interacts with identifying significant issues to ascertain the reliability and robustness of the outcomes. It includes a completeness check, sensitivity analysis using scenarios, and potentially includes uncertainty and consistency checks.
3. Formulating conclusions and recommendations from the LCA study: Recommendations stemming from the study's conclusions should be logical, reasonable, and practical. They should be rooted in the findings and directly correspond to the intended applications as outlined in the study's objectives.

➤ Limitations

Several limitations in the LCA are generally observed:

- An LCA study, because of its “holistic” nature, requires a lot of time and economic resources.
- For a more detailed LCA, the study will be more time-consuming and expensive. High costs are partly caused by the need for professional consultation and expert knowledge in the stages of impact and improvement analyses.
- LCA is a tool based on linear modeling, so it regards all processes as linear; some progress is being made in reducing this limitation.
- There is no unique LCA methodology, even if the main steps are regulated and guided by the ISO norm. Each impact assessment method has its impact and/or damage categories, characterization factors, and reference values for the normalization. This situation makes difficult the comparison of LCA studies between products or processes if they were not made under the same impact assessment method. This will be the case in this study. Yet, the choice of using IMPACT 2002+ and ReCiPe has been motivated by two main reasons:
 - They both share a midpoint approach
 - They share a set of indicators that will be intuitively consistent for the battery study.
- The use of the two methods is useful due to the uncertainty attributed to the characterization factor.
- The assumptions made in such studies (for example, the boundary determination, the source of data, and the impact assessment choice) might be subjective.
- The accuracy of an LCA study depends on the quality and the availability of the relevant data, and if these data are not accurate enough, the accuracy of the study is limited.
- Because LCA studies are focused on a national and regional level, they might not be suitable for local applications.
- The availability, customization, and updating of the database is another problem.
- The LCA approach cannot replace the decision-making process. It only provides information for decision support.

➤ LCA software tools

Many LCA software tools have been developed based on the methodology of LCA; most of them include several databases and impact assessment methods. These tools make easy the estimation of total emissions and extraction for the LCI as well as the calculation of characterization, damage, and normalized score. Some of them generate a report with the results obtained through graphs. The evaluation of scenarios and sensitivity analysis are other optional features of these software tools. Table 2. 3 shows several LCA software tools that are currently available on the market.

Software name	Supplier	Website
TEAM	ECOBILAN- PricewaterhouseCoopers	http://ecobilan.pwc.fr/fr/boite-a-outils/team.jhtml
GaBi Software	PE INTERNATIONAL	http://www.gabi-software.com/france/software/Umberto
Umberto	ifu Hamburg GmbH	http://www.umberto.de/en/
SimaPro	PRé Consultants	http://www.pre-sustainability.com/simapro-lca-software
OpenLCA	GreenDelta GmbH	http://www.openlca.org/openlca

Table 2. 3 Typical LCA software tools

.2. 5 Similarities and Differences between CLSCM and LCA

The previous sections show that Life Cycle Assessment (LCA) can be seen as an instrument of Closed-Loop Supply Chain Management (CLSCM), which can be used to structure supply chains to improve their environmental performance. Some aspects are worth emphasizing:

The functional unit is a key element of LCA that has to be clearly defined, serving as a measure of the function of the studied system and a reference to which the inputs and outputs can be related. Studies in LCA typically assume (usually implicitly) that impacts are proportional to the quantity of functional units. That is, twice as many functional units will need twice as many inputs and cause impacts that are twice as high. However, supply chains are more complex, and an increase in production can result in different trajectories with different emissions

It is also known that the nonlinear structure of supply chains means that averages are misleading, and the linear models used to construct the life cycle inventory may limit the range within which the findings apply. Ideally, studies in LCA have to include these nonlinear effects, and the CLSC model could contribute to improving the situation.

Supply chain management involves material flows that form an integral part of the Life Cycle Inventory stage. These material flows are an essential part of computing both the economic contribution (by Life Cycle Costing) and the environmental contribution (by LCA).

Supply chains almost always involve many stakeholders. Although studies in LCA can recognize the existence of these actors, the actors' decisions are not directly integrated into the modeling (rather a posteriori to test different strategies).

The importance of including uncertainty in LCA has been long recognized. Methods such as Monte Carlo simulation are increasingly used to quantify that uncertainty. While it is important to recognize and model uncertainty in LCA studies, there are other levels of uncertainty that may occur, particularly in the reverse flows. Uncertainty is also one of the main concerns in CLSC management due to demand, landfilling, and recovery rates, among others, which are three important factors contributing to uncertainty (Subulan et al. 2015).

Furthermore, the decision-maker must also be guided based on economic information. The results of an LCA should also be analyzed and presented in the context of the whole situation, rather than in the context of the functional unit chosen for the study (Blass & Corbett, 2018).

Table 2. 4 summarizes the approaches underlying Life Cycle Assessment and supply chain management, highlighting the differences in modeling approaches and how the two perspectives differ, and how the integration of the two could learn from each other.

	Closed-Loop Supply chain management perspective (CLSCM)	Life cycle assessment perspective (LCA)
Objective of the study	Defining a: - Set of Activities to Implement a Management Philosophy - Set of Management Processes in a Closed Loop structure (generally based on optimization formulation)	Environmental assessment, comparison of alternatives
Performance evaluation	Mainly economic assessment If environmental consideration is included, the indicator is mainly based on Greenhouse Gas emissions	Indicators of impact assessment step (mid and endpoint categories)
Scope of the system considered	Limited to the stages of the supply chain	Broader system boundary including different life cycle stages (allocation procedure for instance)
Environmental impact	If included, generally one Single impact (Greenhouse gas emissions)	Multicriteria
Impact of the production function	Nonlinear	Linear
Economic structure of the model	Multiple agents	No usable
Dealing with uncertainty	Robustness of decision	Intervals for impacts
Normalization	No	ISO 14040

Table 2. 4 Mirror effect of CLSCM and LCA

2.6 Lead acid batteries (LAB)

A lead-acid battery CLSC network is a classical example of a CLSC structure. Management of returned products such as lead-acid batteries (LAB) is a challenge for communities. There is a great deal of concern related to battery recycling. Hence, a comprehensive plan to collect returned LAB is required; otherwise discarded batteries in the environment may damage habitat with severe consequences on health due to the presence of toxic materials. Accordingly, configuring the CLSC network focusing on the recovery of used batteries has become a necessary part of the business.

In 2018, approximately 72% of the world's rechargeable battery capacity (in GWh) was provided by LABs.

Approximately 65% of the global demand for LABs is currently driven by automotive applications (starter, light, and ignition (SLI) functions of a vehicle). The other uses are as industrial batteries, with lead-based batteries for off-grid energy renewable storage used in developing countries as a key enabling technology.

LABs will be employed in cars, including EVs, for many years and the global market for them is expected to further grow, although at a significantly slower rate than the lithium-ion market.

Lead is a toxic heavy metal that can accumulate in the environment. Inappropriate management of lead can therefore result in contamination and damage to ecosystems. Critically, even at relatively low exposures, lead has been reported to cause neurological damage, cardiovascular disease, anemia, and other health problems (children are particularly vulnerable). About 680 million children, about one-third of all children globally, have lead exposures of concern, with the main source of these exposures being traced to improper ULAB (used lead-acid battery) recycling in several regions.

The environmentally sound management of LABs through their life cycle is thus crucial. In mature economies, such as those in Europe and North America, used lead batteries are managed very well today: they operate in perfectly closed loops with up to 99% of used batteries collected via efficient point of sale return systems, transported and recycled by highly regulated operations with high standards for worker safety. As such, LABs can be considered a good example of a well-functioning circular economy with end-of-life products being used to create value through effective recycling into new batteries, thus reducing the demand for virgin resources. The same cannot be said in many economies in transition, however, where appropriate and environmentally sound collection and recycling systems are often lacking. In several countries, up to 50% of end-of-life lead batteries are recycled in informal, or below standard, facilities, leading to substantial releases of lead into the environment and high levels of lead exposure (World Economic Forum, 2019) (Figure 2. 15).

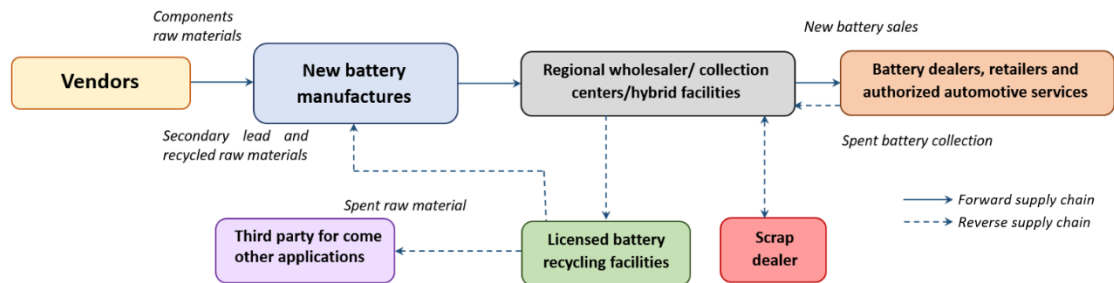

Figure 2. 15 CLSC network for the lead-acid battery.

2.6.1 European and French legislation

In the EU market, the principal legislation that deals with all the batteries and accumulators is the “Battery Directive (2006/66/EC)”, which establishes the settings requirements on batteries and accumulators to minimize their negative impacts on the environment, thus contributing to the protection, preservation, and improvement of the quality of the natural resources of the planet, this directive gives specifications to get these two goals:

- Collecting rate: 85% in 2016 for cell phone waste.
- Recycling rate: per technology in average weight waste: 90% for lead batteries, 75% for nickel-cadmium, and 50% for other kinds of batteries.

This Directive also restricts the use of Cadmium (maximum 0.002% of Cadmium per weight) in portable batteries and accumulators (Hervani et al., 2005).

From a qualitative point of view, legislation defines three types of batteries:

- Portable batteries (Button cell, battery pack or accumulator sealed, that can be hand-carried).
- Automobile batteries (Lead acid battery “Wet cell”, silver calcium battery, enhanced flooded battery).
- Industrial batteries (Lead acid, lithium-ion, flow batteries, sodium nickel chloride).

Concerning the French regulation, decree n°2009-1139 allows the improvement of the following points (Redmer & Warren, 2016) :

- Battery waste classification upon collection.
- The creation of a national register of battery producers, as well as a mandatory list of the different actors involved in post-collection battery treatment.

2.6.2 Organization of the battery French sector

The distribution of different actors in the battery supply chain is determined by the primary activities conducted throughout the supply chain (Table 2. 5).

Stage of lifecycle	Actors
Market launch	Producers
Collection	Producers, retailers, and eco-organizations
Treatment of use batteries	Recyclers

Table 2. 5 Main stakeholders of the battery supply chain in France. Source (ADEME, 2016).

In geographical terms, the set of 15 actors involved in waste treatment are distributed on the territory (Figure 2. 16).

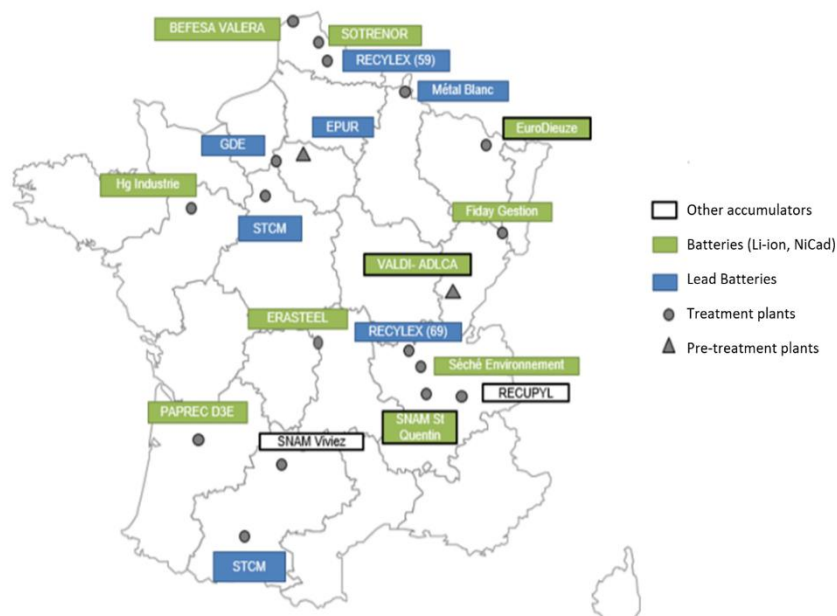

Figure 2. 16 Map of recyclers in France.

2.6.3 French market

The global market demand is dominated by Li-ion and lead batteries, and the French market follows this upward trend (Figure 2. 17).

In general, there are two explanations for this reality;

- Lead battery technology is traditional and well-developed, known for its established performance.
- The new Li-ion battery technology, although still in development, surpasses other batteries available on the market. For instance, the energy density of these batteries differs significantly. Regarding production, lithium-ion batteries are the most energy-intensive.

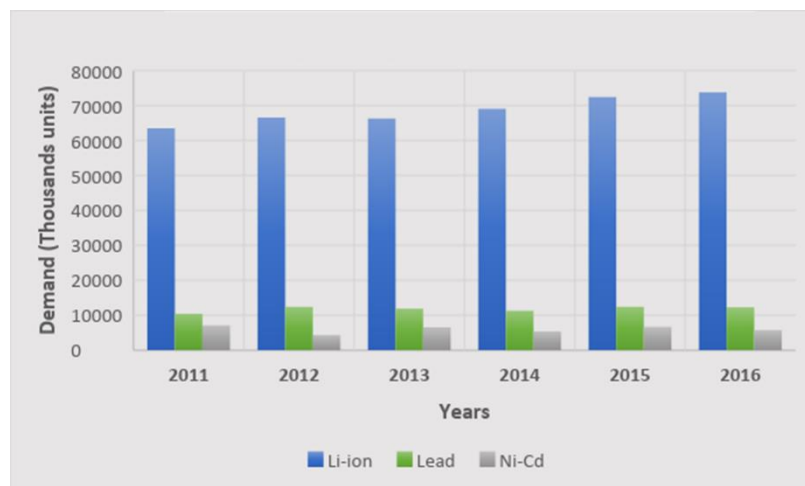

Figure 2. 17 Evolution of french demand.

2.7 Conclusions

This chapter aimed to outline the concepts and methodologies within supply chain management, specifically focusing on CLSCM and LCA. Both areas exhibit several similarities that facilitate their interaction. However, it is within their differences that the potential for collaboration truly emerges. These differences serve as complementary elements that can be effectively utilized. The subsequent chapters will delve into the integration of these concepts. The case study involving lead-acid batteries will serve as the framework for this scientific exploration. The upcoming chapter will emphasize and explore the enhanced collaboration between these domains, aiming to expand the practical application of LCA while providing a solid foundation in sustainable SCM. This integration aims to offer a comprehensive understanding of the environmental implications associated with operational decisions.

Chapter

3

Life Cycle Assessment (LCA) of Lead-Acid Batteries (LAB)

Abstract

The primary goals of this chapter encompass:

- *Conducting a comprehensive literature review that centers on environmental assessment methodologies, specifically targeting lead-acid batteries and the principles of Green Supply Chain Management (GSC).*
- *Presenting the technological stages and components integral to the closed-loop supply chain of lead-acid batteries.*
- *Employing Life Cycle Assessment (LCA) to conduct a thorough examination of the environmental implications associated with lead-acid batteries.*
- *Conducting a sensitivity analysis based on the percentage of recycled lead used in battery production.*
- *Identifying the key processes that significantly influence various environmental indicators.*
- *Demonstrating the efficacy of LCA as a robust tool for quantifying the environmental footprint of lead-acid batteries across their entire life cycle. This analysis can be integrated into the associated supply chain model to optimize battery production and recycling processes, thereby reducing their environmental impact.*

Résumé

Les principaux objectifs de ce chapitre sont les suivants :

- *Réaliser une analyse bibliographique complète centrée sur les méthodologies d'évaluation environnementale, en ciblant spécifiquement les batteries au plomb et les principes de la gestion de la chaîne d'approvisionnement verte (GSC).*
- *Présenter les étapes technologiques et les composants faisant partie intégrante de la chaîne d'approvisionnement en boucle fermée des batteries plomb-acide.*
- *Utiliser l'analyse du cycle de vie (ACV) pour procéder à un examen approfondi des implications environnementales associées aux batteries plomb-acide.*
- *Réaliser une analyse de sensibilité basée sur le pourcentage de plomb recyclé utilisé dans la production des batteries.*
- *Identifier les processus clés qui influencent de manière significative les différents indicateurs environnementaux.*
- *Démontrer l'efficacité de l'ACV en tant qu'outil robuste pour quantifier l'empreinte environnementale des batteries plomb-acide tout au long de leur cycle de vie. Cette analyse peut être intégrée dans le modèle de chaîne d'approvisionnement associé afin d'optimiser les processus de production et de recyclage des batteries, réduisant ainsi leur impact sur l'environnement.*

Nomenclature

Acronyms

ADEME	Agence de l'Environnement et de la Maîtrise de l'Énergie (Environment and Energy Management Agency)
CLSC	Closed-loop supply chain
EIA	Environmental Impact Assessment
EPS	Evaluated with priority strategies
ERA	Environmental Risk Assessment
ET	Environmental theme
EU	European Union
FL	Forward logistics
GSC	Green supply chain
GWP	Global Warming Potential
HAP	Hazardous air pollutants
ILA	International Lead Association
KgCO₂eq	Kilogram equivalent of carbon dioxide
LAB	Lead-acid battery
LC	Life Cycle
LCA	Life-Cycle Assessment
LCI	Life-cycle inventory
LCIA	Life cycle impact assessment
Li-ion	Lithium-ion
LIPB	Lithium iron phosphate battery
LMD	Lithium manganese battery
MFA	Material Flow Analysis
MIPS	Material Intensity Per unit Service
Ni-Cd	Nickel-cadmium
Pb	Lead
RL	Reverse logistics
SC	Supply chain
SCM	Supply chain management
WHO	World Health Organization

3.1 Introduction

Nowadays, sustainability is an increasing social concern, demanding an active organization's posture. Within such a context, logistics organizations play a crucial role, due to their importance in society. The design, plan, and operation of sustainable logistics systems are then a challenge for the involved companies that must be addressed considering economic, environmental, social, and political objectives. Due to the complexity involved in the associated decision levels, tools that may support the decision-making process are required in the design of supply chains. Among the available techniques coping with the environmental pillar, Life Cycle Assessment (LCA) is a standardized methodology that allows the qualitative and quantitative analysis of environmental impact by taking the life cycle of products, processes, and activities into account. LCA can thus be applied to different products and systems and different parts or the entire life cycle of these. This normalized tool allows us to compare scenarios and identify the pollution movement from one stage of the life cycle to another one. The basis of this method is both to analyze primary energy source and raw material extraction as well as the potential environmental impact of products considering a system of specific boundaries, providing sources for result evaluation (Liang et al. 2017).

One great challenge of the circular economy is thus to reduce the extraction of virgin materials from the earth and extend the life cycle of virgin resources through reduction, reuse, and recycling (Geng et al. 2013) which can alleviate pressure on ecosystems.

This chapter discusses the environmental assessment through Life Cycle Assessment of lead-acid batteries (LAB) that are a broadly used power source around the world mainly due to their low price, high unit voltage, stable performance, and capability to operate at extreme temperatures (Chang et al. 2009). The market size of the LAB is expected to expand globally from 46.6 billion dollars in 2015 to 84.5 in 2025, as reported in Grand View Research (2017). The LAB industry has to cope with severe environmental and public health problems, especially the emission of lead, known as one of the top-heavy metal pollutants (Liang et al. 2017).

Surprisingly, as recently reported in (Davidson et al. 2016), relatively few LCAs have been conducted and made available for the assessment of the environmental impact of lead production and that of lead products, although lead is one of the most recycled materials in widespread use and has the highest end-of-life recycling rate of all commonly used metals: the collection and recycling rates of lead automotive and industrial batteries and lead sheet in Europe are 99 and 95% respectively.

Moreover, the information available in the literature may be difficult to analyze for several reasons: (i) some studies only analyze some of the process stages of the whole supply chain (SC); (ii) the functional unit, which enables the system inputs/outputs to be quantified and assessed is not generally the same in all the reported studies (per kilogram or watt-hour capacity basis, per kg of refined lead at the gate) and makes the comparison among several studies difficult.

In this chapter, a literature review of some of the most common techniques for environmental assessment will be first presented to better position the LCA technique for the case study of lead-acid batteries. The fundamentals and principles of LCA will also be described. Specific attention will be paid to Global Warming Potential (GWP) due to the high-energy consumption of pyrometallurgical lead recovery, and its resulting CO₂ emissions on one hand, and to lead

emissions, considering the catastrophic health implications of lead exposure from lead-to-air emissions on the other hand.

The environmental model will be considered as the basis for the integration of environmental analysis in multi-objective optimization of a Closed-Loop Supply Chain (CLSC) of batteries.

The key objectives of this chapter are to:

- conduct a literature survey based on environmental assessment methods, focusing on lead-acid batteries and on the Green Supply Chain (GSC) management concept;
- present the echelon and technological bricks involved in the closed-loop supply chain of lead-acid batteries;
- use life cycle assessment (LCA) for in-depth consideration of the environmental impact of lead-acid batteries;
- perform a sensitivity analysis based on the proportion of recycled lead in the production of a battery;
- identify the key processes that contribute to the various environmental indicators;
- demonstrate that LCA is a powerful tool to examine the environmental impact of a product through its entire life cycle and to show that there is a place for optimization to manage the compromise between all the echelons of the supply chain and to reduce the environmental impact of the battery production process.

3.2 Literature review

Based on the comprehensive literature on the intersection between environmental factors and supply chain management, this review will cross environmental assessment methods, in particular, those used for lead-acid battery to be addressed first as the core of this work with the related Green Supply Chain (GSC) management concept which is viewed as an efficient strategy to implement this goal.

3.2.1 Environmental assessment of batteries.

The literature related to the environmental assessment of lead-acid batteries generally takes place in upstream or downstream stages of the life cycle of lead-acid batteries, focusing on the manufacturing or recycling stages.

It must be first highlighted that the main literature sources refer to Life Cycle Assessment (LCA) for lead-acid batteries. LCA has generally been conducted on a comparative basis with other kinds of batteries using several impact assessment methods.

(Robertson et al. 1997) analyzed the lead-acid battery cycle using the LCA applying a “gate-to-gate” approach. In this work, only the first stage of the reverse supply chain is studied (collection and transportation). A comparison between different transportation scenarios is examined, studying different alternatives and evaluating the most convenient one in environmental terms.

The work developed in (Rydh, 1999) evaluated the environmental impact of the vanadium redox and lead-acid batteries using an LCA approach. In this study, the net energy storage capacity and the availability of vanadium and lead resources are compared. The inventory phase corresponds to the manufacturing and recycling of both batteries. The resulting environmental impacts have been evaluated using Environmental Priority Strategies (EPS) and the Environmental theme (ET-long terms goals) methods.

(Rydh & Karlström, 2002) carried out an LCA approach to identify the Ni-Cad life cycle stages with a significant environmental impact with a “cradle to gate” approach (excluding the user phase). (Daniel et al. 2003) applied the LCA to lead the battery reverse supply chain to identify the stages in the life cycle, which have the most significant environmental impact. A comparison between two alternatives of end-of-life scenarios was carried out. The work presented in (Wang et al., 2010) is based on the work of (Daniel et al. 2003) about the LCA of reverse supply chains for China context. The purpose of this paper is to determine, with a theoretical approach, the main activities with a negative environmental influence. (Unterreiner et al. 2016) have shown that the recycling and reuse phase with an optimal integration of the recycling process can achieve a lower ecological impact. (McManus, 2012) used LCA to analyze the manufacturing inventory data of six types of batteries (Lead, Nickel-Cadmium, Lithium with NMP (N-Methyl 2-pyrrolidone) as a solvent, Lithium with water, nickel-metal hydride, and sodium Sulfur) to understand the key impacts in battery production.

The study of (Davidson et al. 2016) is based on three LCA studies carried out by the International Lead Association. One of the main conclusions of this study is that mining and smelting have a significant environmental impact on the raw materials stage. Another work presented by (Liu et al. 2015) refers to lead extraction results in the context of an LCA for lead-acid batteries used for the production of electric bikes in China. However, in both papers, no inventory data were reported.

Only a few studies present in detail the inventory phase of LCA. According to (Gaines, 2014), the increased use of lead-acid batteries has pushed up the demand for lead, so that used batteries have been identified as an essential source of lead recycling. Besides, the recycling operation has been identified as profitable, mainly because recycled lead is of high quality. (Wang et al. 2018) applied LCA to analyze and compare the environmental impact of lead-acid battery (LAB), lithium manganese battery (LMB), and lithium iron phosphate battery (LIPB) within the system boundary of “cradle-to-gate”. The inventory data is presented in detail for both production and recycling.

(Sullivan & Gaines, 2012) conducted a review of the existing inventory results (LCI) for cradle-to-gate environmental approaches for five types of batteries. Based on the information of this work, a similar LCA study was conducted by (Premrudee et al. 2013) for the case of lead-acid batteries in Thailand. In their work, the boundaries of the system only included the stage of battery production. The previous works mentioned excluding the metal extraction phase, while (Davidson et al. 2016) and (Liu et al. 2015) conducted LCA studies including metal production.

The literature review shows that the battery manufacturing and recycling of raw materials are closely linked (Ellis & Mirza, 2010) and that the environmental influence of the metal extraction process is significant and must be considered. This presents works has thus the objective of reconciling the forward and reverse supply chains for the case study of lead-acid batteries. The metal's emission inventory of the entire life cycle, life cycle assessment, and scenario analysis must be combined to gain a better understanding of the interaction. In this sense, considering that the reuse of materials is involved in a cradle-to-cradle method, the modeling of the network combining the forward and reverse supply chains for lead-acid batteries has been identified as necessary (Masoudipour et al. 2017) (Subulan et al. 2015).

Specific attention will be paid to lead emissions since batteries contain a large amount of lead either as solid metal or lead-oxide powder, i.e., an average battery can contain up to 10 kilograms of lead. The consumption of lead for the production of lead-acid batteries mainly used in motorized vehicles, storage of energy generated by photovoltaic cells and wind turbines, and for back-up power supplies which represent approximately 85% of the total global demand (ILA & Wilson, 2018). The increasing demand for motor vehicles as countries undergo economic development and growth in the use of renewable energy sources with the need for storage batteries is directly proportional to the increasing demand for lead-acid batteries (WHO, 2017).

3.2.2 Global overview of environmental assessment techniques.

According to (Sadler et al. 1996), environmental assessment is defined as:

“A systematic process for evaluating and documenting information on the potentials, capacities, and functions of natural systems and resources to facilitate sustainable development planning and decision making in general, and to anticipate and manage the adverse effects and consequences of proposed undertakings in particular”.

Environmental assessment can be defined as the process of identifying and evaluating the environmental impacts of existing and proposed projects through environmental studies. Its goal is to mitigate any relevant negative effects before making decisions. Numerous procedures and methods exist to assess the environmental issues or impacts of plans, projects, and programs, with the most important and widely used highlighted in Table 3. 1.

<i>Method</i>	<i>Description</i>
<p>Cost-benefit (CBA)</p> <p>(Burgess and Brennan 2001; Pearce et al. 2006)</p>	<p>Constitutes an “environmental economics” approach. `</p> <p>Estimates the economic value of any loss (cost) or gain (benefit) of environmental quality to use these values in the traditional costs and benefits evaluation of a project.</p> <p>Determines whether and how much a project can contribute to national economic welfare, which of several options should be selected for action.</p>
<p>Environmental Impact Assessment (EIA)</p> <p>(Burgess and Brennan 2001; Manuilova et al. 2009)</p>	<p>Analyses and evaluates the positive and negative impacts that human activities can have on the environment.</p> <p>Considers all possible environmental and socio-economic issues associated with the proposed project, qualitatively and quantitatively.</p> <p>EIA has three major phases: screening and scoping of the project, environmental impact assessment, and decision-making.</p>
<p>Life Cycle Assessment (LCA)</p> <p>(Ayres & Ayres, 2002; Manuilova et al. 2009)</p>	<p>Identifies and quantifies the process flows and systems, which are significant contributors to environmental degradation.</p> <p>Guided by the ISO 14041 norm.</p> <p>Four main steps are involved: goal and scope definition, inventory analysis, impact assessment, and interpretation.</p>
<p>Material flow analysis (MFA)</p> <p>(Ayres & Ayres, 2002; Brunner & Rechberger, 2005)</p>	<p>Delivers a complete and consistent set of information about all flows and stocks of a particular material within a system.</p> <p>Usually involves four steps: goal and system definition, process chain analysis, accounting and balancing, modeling, and evaluation.</p>
<p>Material intensity per unit service (MILP)</p> <p>(Brunner & Rechberger, 2005; Rebitzer et al. 2004)</p>	<p>Measures the total mass flow of material caused by production consumption and waste disposal of defined service units or products.</p> <p>Only uses the inputs flow (considers input flows equal to output flows).</p> <p>All material consumption during manufacture, used, and recycling or disposal is calculated back to resource consumption by using simple calculation factors expressed in kg or ton.</p>

Table 3. 1 Some classical methods used to evaluate the environmental issues or impacts of plans, projects, and programs.

Many studies have indicated that LCA can complete and add value to other techniques (Finnveden et al. 2009) (Manuilova et al. 2009). The application of LCA requires an inventory of the flow of materials and substances as MFA (Material Flow Analysis), some methods evaluate the human health impact using the ERA principles (Environmental Risk Assessment). LCA shares, with EIA (Environmental Impact Assessment) and MIPS (Material Intensity Per unit Service), the use of characterization indicators and impact factors. Each method has its own advantages and disadvantages related to scope, applicability, maturity, feasibility, among other criteria.

Among these methods, LCA is one of the most well-known and powerful tools (Finnveden et al. 2009; Guinée et al. 2011; Manuilova et al. 2009). Although there is no single tool or approach to address all the problems of environmental management, it provides an especially useful framework for GSC, as a normative, systemic, and quantitative environmental method.

The parallels between LCA and SCM lie in their approach to framing the product life cycle: both methodologies emphasize the interconnectedness of each step, as they involve the exchange of material flows in upward and forward links. Additionally, the comprehensive scope of LCA, spanning from raw materials to consumption, aligns with the SCM model. The taxonomy in SCM seamlessly accommodates LCA without any need for adaptation or limitation. This elucidates, among other reasons outlined in detail throughout the thesis, why LCA was chosen as the optimal environmental assessment tool for the problem under study.

3.2.3 Closed-loop supply chain (CLSC).

Recently, the importance of reverse supply chain management has increased with growing environmental and social concerns, as well as environmental regulations. Consequently, there has been an increasing amount of research on the intersection between supply chain management and environmental factors (Jabali et al. 2012). The Green Supply Chain (GSC) management is now suggested as an efficient strategy to achieve this goal.

Following the basis of the 3Rs, recycling, reuse, and recovery, in GSC management, a green company puts an effort to prevent any wastage of materials from the life cycle of a product.

Forward Logistics (FL) follows the product from the raw materials until the end user.

Logistics (RL), follows the product from its disposal until its reincorporation into the process of itself.

Closed-Loop Supply Chain (CLSC) is the joint use, which facilitates the 3R processes. The scheme of the lead-acid battery closed-loop supply chain used in this LCA study is illustrated in Figure 3. 1.

According to the definition proposed in (Wassenhove, 2009), closed-loop supply chain management refers to "the design, control, and operation of a system to maximize value creation over the entire life cycle of a product with the dynamic recovery of value from different types and volumes of returns over time".

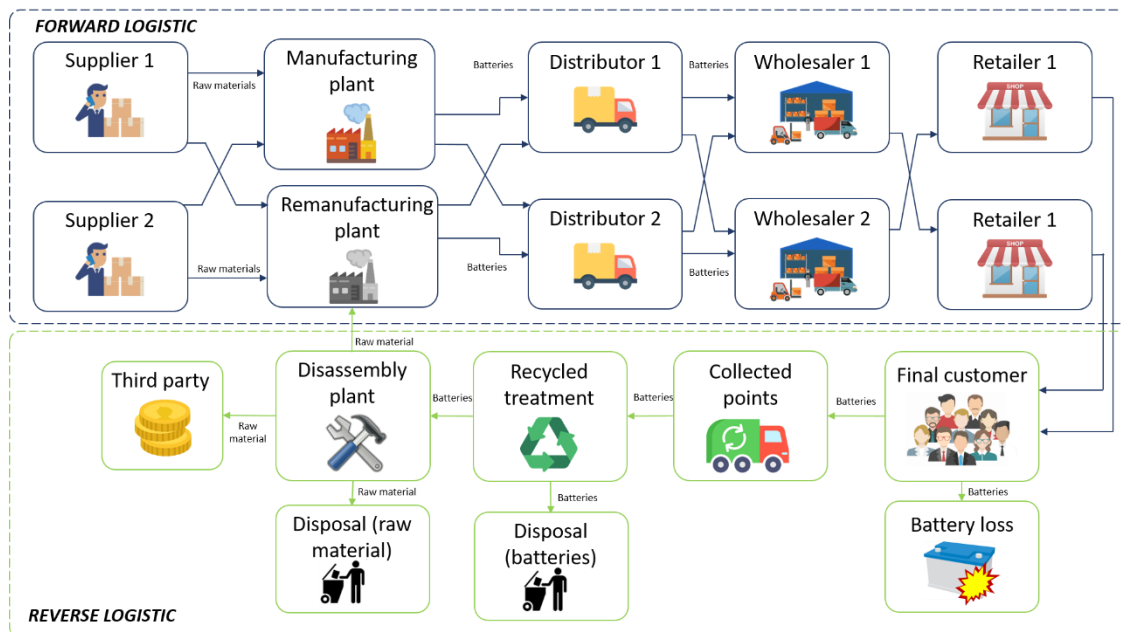

Figure 3. 1 Scheme of a CLSC used for lead-acid batteries.

The CLSC is divided into three sections as is presented in Figure 3. 2.

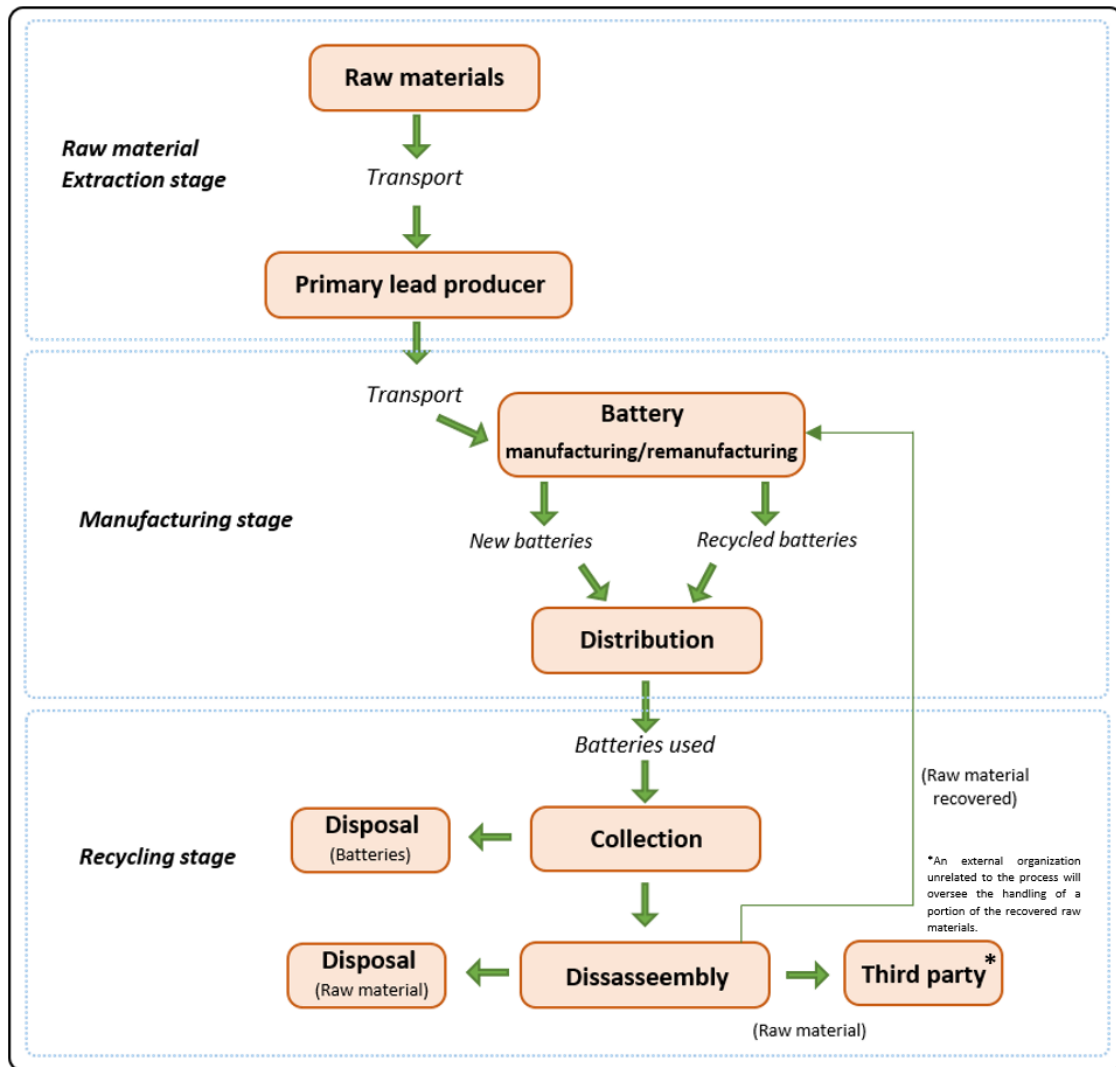

Figure 3. 2 Sections of the CLSC.

3.2.3.1 Raw material and extraction stage.

Lead is a metal used by humans over an extensive period. Because of its high toxicity, a gradual phasing out of the production process has been occurring for some industrial applications such as pigments, gasoline, and electrical products, as well as electronic devices. Nevertheless, lead is still considered as one of the top toxic threats worldwide. However, even in this context, almost 80% of global refined lead is used in lead-acid batteries (LABs) because, despite the emergence of new battery technologies like Ni-Cd and Li-ion, LABs are still used extensively owing to their maturity, cost, safety, and applicability (Liu et al. 2015).

The most common lead minerals found in the earth's crust are galena (PbS), cerussite ($PbCO_3$), and anglesite ($PbSO_4$). Usually, the lead ore currently mined commonly contains zinc, silver, and copper ore, as well as precious metals. Therefore, it is necessary to separate the minerals. The technical process used for primary lead refining is known as smelting.

In this section, only the primary production of lead is presented. The production of refined metallic lead involves the following steps (Thornton et al, 2001).

Mineral extraction - mining and separation of the lead-rich mineral (ore) from the other extracted materials to produce a lead concentrate.

Primary production - production of metallic lead from lead ore concentrates involves the following process steps:

Smelting: is the process of separating the metal from impurities by heating the concentrate to a high temperature to cause the metal to melt. Smelting the raw material produces a metal or a high-grade metallic mixture, along with a solid waste product called slag.

Lead Smelting is the process of reducing the complex form of Lead in to free metallic Lead using heat, chemicals & suitable reducing agents in furnaces. The raw material for the smelting operation can be:

- Lead Ore
- Lead Concentrate
- Lead Sinters
- Other forms of Lead Scrap (Batteries etc.)

Lead and zinc can be produced by pyrometallurgical or hydrometallurgical processes, depending on the type of ore used as a charge. In the pyrometallurgical process, ore concentrate containing Lead, zinc, or both is fed, in some cases after sintering, into a primary smelter. Lead concentrations can be 50–70%, and the sulfur content of sulfide ores is in the range of 15–20%. Ores with a mixture of lead and zinc concentrate usually have lower respective metal concentrations. During sintering, a blast of hot air or oxygen is used to oxidize the sulfur present in the feed to sulfur dioxide (SO₂)

Refining: In the process of refining, a pyrometallurgical process is used, for producing lead with a purity level of 99.97%. Pyrometallurgical refining is performed in the liquid state, meaning thereby that the crude Lead needs to be melted at temperatures between 327°C (fusion point of lead) and 650°C. The process is generally performed in batches of 20-200 tons depending on the capacity of the plant by the addition of specific reagents to the molten lead at appropriate temperatures. These reagents help remove the unwanted metals in a specific order, according to the process for which they are added.

The impurities present in the crude lead are sulfur, copper, nitrogen, arsenic, antimony, bromine, silver, gold and tin etc. The refining process, as mentioned earlier, is done in several steps in the ovens with the addition of specific reagents. Alternatively, smaller quantities can be produced via electrolytic refining. If the smelting plant stops in the fusion reduction phase, it will lead to a hard antimonial lead. If the plant is meant to produce soft lead, the crude Lead needs to be refined. The basic objective of refining is to remove almost all traces of Cu, Sb, As, since, as per specifications, soft lead cannot have more than 10 grams per ton of these impurities by element. copper (Cu) is the first element to be removed along with Sulfur (S) in a two-phase procedure. At the first stage, almost all of the copper is removed as copper sulphide (CuS) when elementary sulfur is added at a temperature of 450°C. The next step is to remove the remaining residual copper by adding small amounts of elementary sulfur at 330°C until the reaction stops.

Tin (Sn) is the next to be removed through oxidation by Chlorine or Ammonium Chloride (NH₄Cl). The addition of Chlorine to the molten lead at 550°C produces Tin Chloride (SnCl₂) which can be mechanically removed. Simultaneously small amounts of Antimony (Sb) and Arsenic (As) are also removed by oxidation.

3.2.3.2 Manufacturing stage.

The first stage is the production of anode and cathode, stemming from raw materials and energy necessary for the process. The manufacturing process starts by applying a paste of lead oxide on a lead alloy grid. Once the cells are assembled, the next step is to make the stack. It is also necessary to envelop the cell with a casing, usually made of polypropylene or polyethylene. The final stage is to fill the battery with electrolyte (sulfuric acid) and close it (see Figure 3. 3).

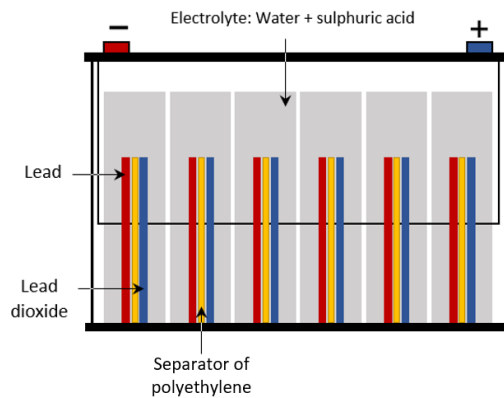

Figure 3. 3 Lead-acid battery constitution.

More precisely, the manufacturing process for a lead-acid battery can be divided into the following sections (Dahodwalla & Herat, 2000) (see Figure 3. 4).

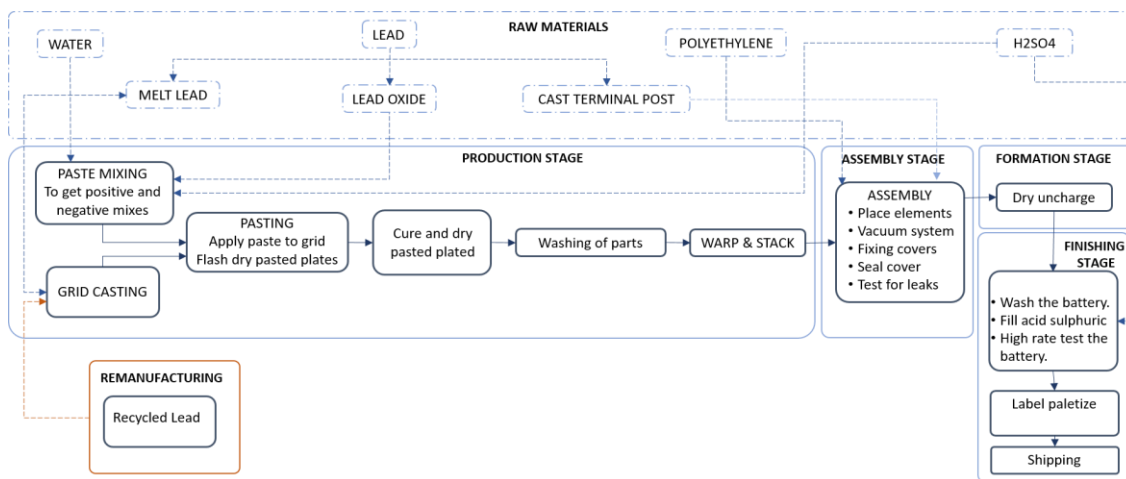

Figure 3. 4 Lead battery manufacturing process adapted from (Dahodwalla & Herat, 2000).

Production stage:

Bars of the lead alloy are melted in a lead melting pot. The molten lead is then pumped into the grid molds, which is then cooled by using cooling water. The mold after cooling the alloy opens to discharge the grid. The molded grid is then trimmed to remove the excess lead. The cuttings are then recycled into the lead pot. All these operations take place in an automatic machine. During this process, different types of lead alloys are used for the casting of grids. Grids having different thickness are manufactured using these alloys. Grids are classified based on the type of alloy used and the thickness of the grid cast. Melting of the lead causes dross formation as well as the generation of some solid wastes. Rejected grids are re-melted in the lead melting pot.

In the pasting zone, two types of paste are manufactured, one for positive plates and the other for negative plates. The materials required for paste manufacture are lead oxide, sulfuric acid, water, and other additives. These additives are different for positive and negative pastes. The above-mentioned ingredients are mixed in a fixed ratio (ratio of various ingredients depends upon the type of grid to be used for plate manufacture), in the paste mixer to form the paste which is then pasted on the grids. Lead oxide is the major ingredient used in paste manufacture, with the paste containing about 85% of lead oxide. Evaporative losses occur during paste formation. The vapors are treated in a scrubber and then discharged through a stack.

Plates are formed as a result of applying paste into grids. Grid pasting is done using machines. The grids are fed into the conveyor belt, by a feeding mechanism and paste applied on it and the pasted grid is passed between rollers where even spread of paste occurs. The paste is then dried quickly and the dried plates are collected and stacked at the end of the pasting machine. The plates are moved into the different sections, namely, pasting, drying, and collection thanks to the belt conveyor system. The plates are classified depending upon the thickness of paste on a particular type of grid. Reject plates and the excess paste applied into the grids are regenerated in this section. Also, the washing of equipment generates wastewater, which is contaminated with “paste”, which essentially contains lead. The washings are collected in the trade waste treatment facility on site.

Assembly and formation stage:

The first operation in this area is the enveloping of positive plates in a polythene sheet. This envelope acts as a separator that electrically isolates the positive and negative electrode. A mechanical vacuum system is used for feeding positive and negative plates for automatic stacking. The positive and negative plates are stacked in the desired sequence and placed in a plastic case. The number of positive and negative plates in each battery depends upon the type of battery being manufactured. Also, the type of positive or negative plates used depends upon the type of battery manufactured. The vacuum system generates lead dust due to the feeding of plates, which is discharged to the atmosphere through a bag house filter. The battery undergoes several further processes such as brushing of the tabs, casting of the tabs, casting of the strap, welding between cells and fixing of the covers. All these operations are carried out before the plates are dropped in the plastic container. After the plates are assembled in the container, they are mounted on a conveyor for the finishing operations which involve a shear test, heat sealing, terminal burning, and leak testing. The product at this stage is called a dry, uncharged battery. The activities in this section generate rejects of plates, dross, and lead dust.

Finishing stage:

The dry, uncharged battery now needs to be charged by the addition of sulfuric acid. The battery is filled with sulfuric acid and placed on tables, and then cooled with water. The positive and negative terminals of the battery are connected to electric connections. The electric current is passed for a fixed duration of time, during which the battery is charged. Different batteries have different currents for charging and different charging systems are used for it.

The operations of filling and emptying sulfuric acid from the battery are performed automatically using machines. Acid is filled by gravity flow into the cell to a level considerably above the plate tops. Charging is complete when there is no change in specific gravity over a 3h period. The sulfuric acid is then emptied from the batteries, a new solution of sulfuric acid is filled, and the battery is washed, labeled, tested, and packed. The quantity of sulfuric acid-filled in a battery varies with the type of battery manufactured. The wet charged battery is now ready for distribution and use. Wastewater is generated in this section as a result of charging and washing the batteries. This wastewater is acidic and contains sulfuric acid.

It must be highlighted that recycling lead shares these steps with manufacturing. In this work, scenarios both with 100% virgin lead and with recycled lead for the batteries will be explored.

3.2.3.3 Distribution

Distribution is a complex issue, including all the transportation used during all the phases of the supply chain, from the extraction of raw materials to the use phase and from use to recycling. The cost of transporting products through a reverse supply chain is often higher than moving the original product from the manufacturer to the consumer. Several authors have highlighted that well-organized reverse logistics networks, especially transportation, can lead to saving cost, increase revenue, and customer satisfaction (Chen et al. 2012; Govindan et al, 2012; Siriruttanaruk & Sumrit, 2020; Subulan et al. 2015). The modes of transportation that can be used in lead-acid batteries are presented in Table 3. 2

The transportation of batteries is likely to play a major role in the supply chain because the production of batteries is generally not ubicated in Europe.





<i>Name of transport</i>	<i>Representative image</i>	<i>Description</i>
Freight lorry >32 metric tons		Designed to transport cargo. Trucks vary greatly in size, power, and configuration; smaller varieties may be mechanically similar to some automobiles.
Inland waterways barge		A barge is flat-shaped on its bottom, just like a raft. The main reason for this particular shape is to ensure that the cargo-carrying capacity is enhanced, and more bulk can be hauled and transferred.
Light commercial vehicle		Vehicles with at least four wheels, used for the carriage of goods. Mass given in tons (metric tons) is used as a limit between light commercial vehicles and heavy trucks. This limit depends on national and professional definitions and varies between 3.5 and 7 tons.
Municipal waste collector service 21 metric tons		These trucks are used for picking up waste and then moving it to landfills or other places where waste materials are managed and treated.

Table 3. 2 Different types of transportation used in the distribution/collection of the lead-acid batteries.

3.2.3.4 Recycling stage.

Collection/Recuperation mode

The reverse chain begins with the collection of used batteries, which are stored at several points. The collection concerns the raw material (used battery), which is required for the stage of processing. Then, transportation of used batteries takes place, either directly from the collection points or intermediate recovery and storage facilities to the processing (recycling) unit.

Disaggregation

The disaggregation activity includes removal of the rubber casing, which is either recycled or disposed of, and recovery of the components containing lead.

Battery recycling includes two processes that are pre-treatment and treatment. The pre-treatment consists of the partial removal of metal and nonmetal contaminants from the battery. This step includes the stages that are illustrated in (Figure 3. 5).



Figure 3. 5 General recycling process. Source (Sánchez, 2018).

Recovery is the most critical stage of the process for any existing battery, a typical flow sheet for secondary lead recycling is presented in Figure 3. 6. Two methods exist, that is the pyrometallurgical route and the hydrometallurgical one.

The production of refined metal by processing lead scrap is known as Secondary production, in which scrap lead is simply re-melt, with very little extra processing. However, compounds of lead (such as battery pastes) require smelting. Refining is often needed to remove any unwanted contamination and alloying additions in the feed material.

The processes are similar to those outlined for primary processing, but in general, fewer operations are required.

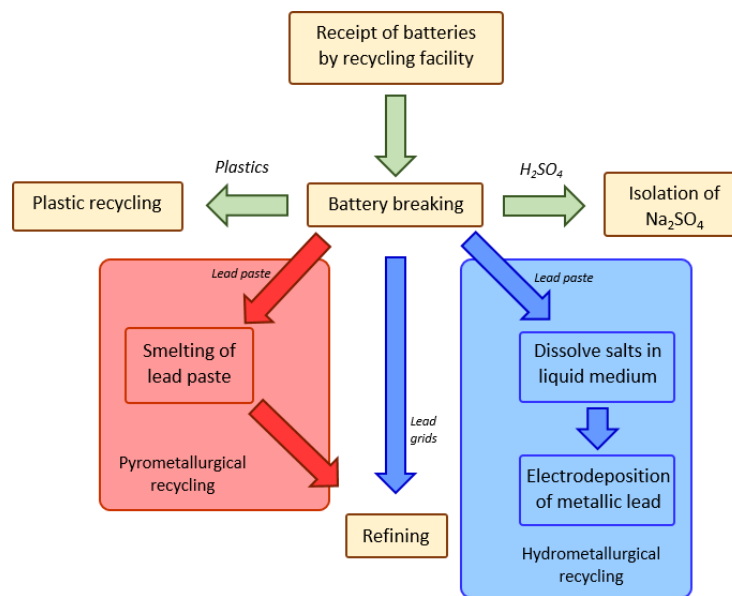

Figure 3. 6 Flow diagram showing pyrometallurgical and hydrometallurgical lead recycling process (Ballantyne et al. 2018).

Pyrometallurgical recycling

The pyrometallurgical carbothermic reduction of $PbO_2/PbSO_4$

Pyrometallurgy is the predominant methodology for the recycling of spent lead-acid batteries. This is accomplished in a two-stage process producing SO_2 . Pyrometallurgical systems, which are commonly referred to as smelting, are the dominant methods used in the recycling of batteries throughout the world, while only a small tonnage is recovered by the hydrometallurgical pathway.

Although smelters appear to have different operations depending on the furnace type, the overall basic chemical reactions are the same (ADEME 2017). This process involves the introduction of the pretreating final materials in a furnace (usually rotatory). The thermal separation of the metals by condensation based on the differences in their corresponding density is then involved (Redmer & Warren, 2016). Figure 3. 7 shows the typical stages of pyrometallurgical treatment.

Pyro metallurgical process

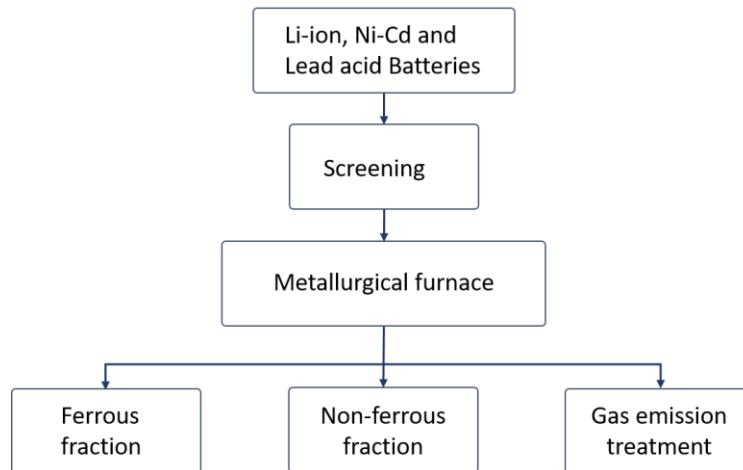

Figure 3. 7 General processes of pyro-metallurgical recycling (ADEME 2017).

Producing SO₂ from the pyrometallurgical carbothermic process

The battery paste consisting of a mixture of lead oxides and sulfates is carbothermically reduced, generally by the following reactions in either a single batch rotary furnace or a continuous smelting furnace of the reverberatory, blast, or Isa-smelt/Aus-smelt type (Morachevskii et al, 2001). The basics of this process can be followed by inspection of the following Ellingham diagram which outlines the thermodynamics of the process (Figure 3. 8).

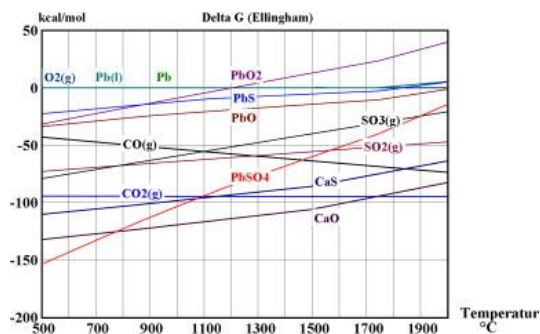
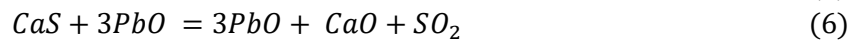

Figure 3. 8 Ellingham diagram of secondary lead smelting.

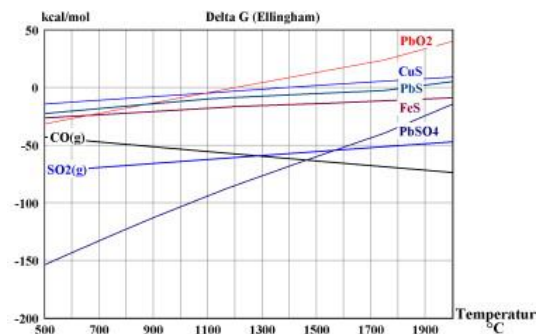

Figure 3. 9 Ellingham diagram showing the PbS–FeS matter.

The Ellingham diagram indicates that a temperature greater than 1500 °C is necessary to reduce PbSO₄ to form lead, PbS, and SO₂, if not driven by Le Châtelier's principle. Lime (CaO) is essential in eliminating the SO₂ from the PbSO₄ input to the furnace. A sufficient quantity of lime must be added to evolve sulfur as SO₂. Adding excess carbon does not help to produce more lead from PbSO₄ because carbon promotes the formation of PbS by reaction (8) below. It does not involve the formation of lead and does not eliminate the sulfur. It produces yet matte (PbS) and slags with high lead content. The Ellingham diagram in (Figure 3. 9), shows that PbS is stable over the entire temperature range from 500 to 2000 °C.



Sulfur capture by scrubbing SO₂

The SO₂ from the pyrometallurgical operation is captured in off-gas scrubbing by reaction with carbonates or hydroxide in aqueous solution, as outlined in reactions (9) – (13). The normal cation for the carbonates and/or hydroxide is sodium or calcium to produce Na₂SO₄ or CaSO₄ as byproducts for sale or disposal. Sulfur dioxide in flue gases is dissolved in an aqueous, alkaline solution, producing water with high concentrations of sodium sulfite.

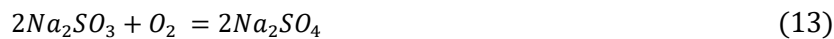
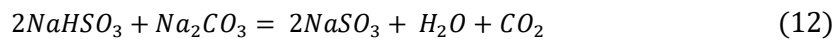
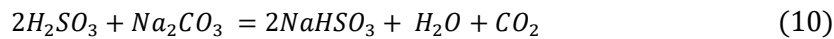

Sulfite salts are oxygen scavengers which are stable in basic solutions; they are unstable in acid solutions, decomposing to SO₂. At lower concentrations, sulfite is easily oxidized by oxygen to sulfate. The formation of sulfite is reversible with pH, while the formation of sulfate reaction is not. Although the Eh (volts)–pH diagram for the S–Na–H₂O system, Figure 3. 10, indicates Na₂SO₄ as the predominant species over the pH range from pH 2 to 14, the sulfite oxidation reactions listed here apply to alkaline scrubbers only when the sulfur loading on the scrubber is less than the rate of sulfite oxidation.

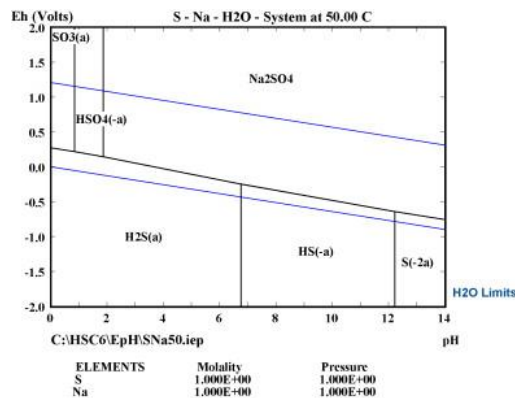

Figure 3. 10 Eh–pH diagram for SO₂ scrubbing system.

When the sulfur loading is greater than the rate of sulfide oxidation, the classic sulfite oxidation chemistry seldom applies. In this case, the difficulty is to oxidize metastable sulfur oxy-anions such as bisulfite, disulfite, trithionate, tetrathionate, and dithionate will form but are not represented in the equilibrium Eh–pH diagram for the S–Na–H₂O system. The Eh–pH diagram was constructed for 50°C because sulfite oxidation is exothermic and the temperature of the oxidation tanks is typically superior to 50 °C.

Several drawbacks of the pyrometallurgical Pb recycling process have been highlighted, primarily related to operational and environmental concerns. Smelting is a very intensive process due to the high operating temperatures, while the use of carbon as fuel leads to CO₂ emissions, thus leading to a high global warming potential (GWP), approximately 0.55 kg CO₂ (kg Pb)⁻¹ compared to refining which has a GWP of approximately 0.12 kg CO₂ (kg Pb)⁻¹. In addition to the release of CO₂ from the oxidation of coke, there are other highly toxic emissions from the smelting process, i.e. metal hazardous air pollutants (HAPs), such as lead, antimony, arsenic, some other metal compounds. Lead compounds constitute approximately 70% by weight of HAP emissions (EPA, 1994) which, when considering the health implications discussed earlier, is a significant potential source of harm to the environment.

Hydrometallurgical desulfurization of PbSO₄

Hydrometallurgical Processes (Thornton et al. 2001), which include electrolytic processes, constitute an alternative approach to obtaining and purifying metallic lead. Unlike traditional smelting, harmful lead fume and sulfur-containing gases are not evolved although in modern plants, pollution control systems can reduce emissions to low levels.

The hydrometallurgical process is a chemical treatment carried out by dissolving the electrodes in an acidic solution. After this stage, different metals can be obtained by separating them using methods such as pH modification of the solution, addition of reaction agents to generate metallic salts precipitation, electrolysis, and liquid-liquid extraction steps. They are generally regarded as an environmentally favorable and may become important in the future, Figure 3. 11, presents the general steps of this process.

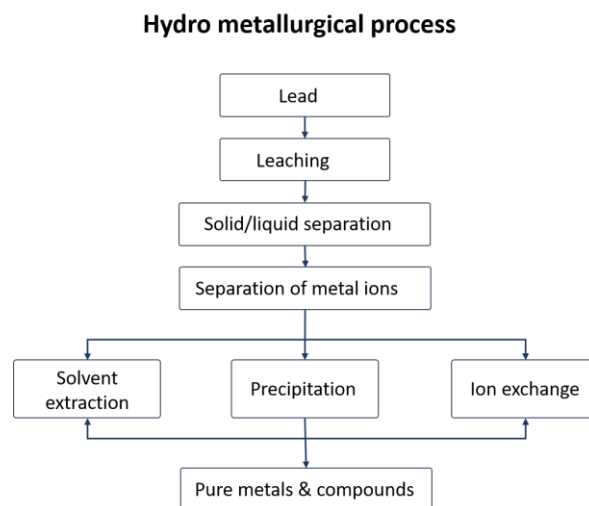

Figure 3. 11 General processes of hydrometallurgical recycling. Source (ADEME 2017).

Hydrometallurgical processes, where the smelting operation is replaced with one where the Pb-containing salts are processed in solution, offer a method to minimize the release of contaminants.

Hydrometallurgical removal of sulfur involves the conversion of lead sulfate to carbonate, hydroxide, or hydroxycarbonate (Morachevskii, 2001), $Pb_3(CO_3)_2(OH)_2$ without evolving SO_2 by reactions (14) – (17). The following reactions are based on the fact that $Pb(OH)_2$ or $PbCO_3$ have much lower solubility compared to $PbSO_4$. As is clear from the Eh–pH diagram below, $PbCO_3$ is the predominant equilibrium species at $pH > 5$ and $Pb(OH)_2$ at $pH > 13$ (Figure 3. 12 and Figure 3. 13)(Ellis & Mirza, 2010).

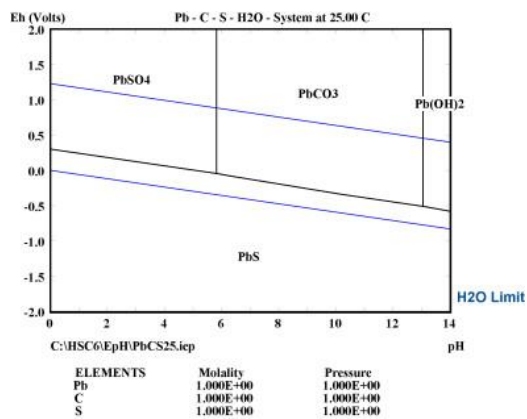
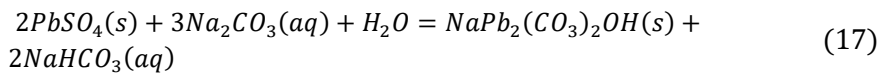
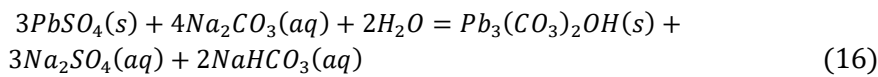
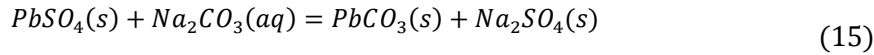
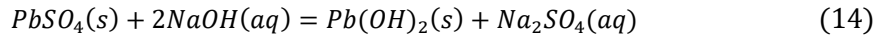

Figure 3. 12 Eh–pH diagram of $PbSO_4$ desulfurization w/ $Na_2CO_3/NaOH$.

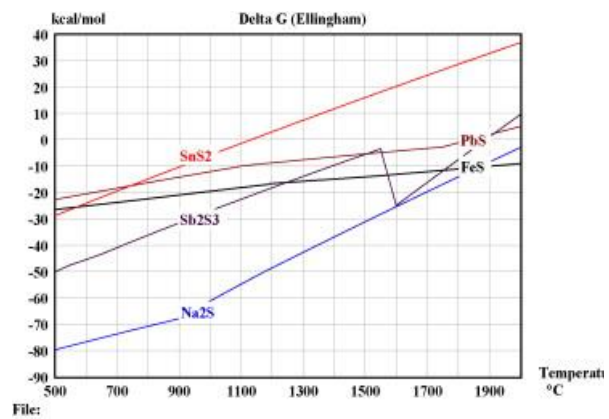

Figure 3. 13 Ellingham diagram showing the slag species.

Disposal

In this work, the disposal is considered as the end-of-life as part of the reverse logistics of the battery based on the study of (Daniel et al. 2003). A fraction of used batteries, which were previously collected at the different storage points, are considered. This phase mainly involves both solid and liquid (liquid electrolyte) waste: solid waste can be further subdivided into metallic and non-metallic elements. The disposal focuses on the treatment of solid wastes, i.e. metal components, including the grid and lead plates in which both lead and lead-containing compounds are the major contributors. Typical values will be adopted in the scenario, based on (ADEME & L'énergie, 2017) and are presented in Table 3. 3.

<i>Scenario (new lead battery)</i>	<i>Battery disposal (% of battery collection)</i>	<i>Recycling process</i>	<i>Percentage of material recovered from the disassembly of a battery</i>
100%	2% of the collection	No	Not applicable
50%	2% of the collection	Yes	30% of each battery
10%	2% of the collection	Yes	30% of each battery

Table 3. 3 Percentage of material recovered from the disassembly of a battery.

3.2.4 Conclusions.

This literature survey has revealed that there are still a few LCA studies that aimed at analyzing the environmental burdens associated with both forward and reverse logistics activities forming the closed-loop supply chain of lead-acid batteries.

The forward and reverse activities have been presented from a process viewpoint. Due to the domination of pyrometallurgical processing in industrial lead recycling, only this process will be considered in the lead supply chain.

LCA seems particularly attractive as an assessment tool to identify those stages in the battery life cycle that give rise to the greatest environmental burdens, and to assess the effects of changes in the cycle on those burdens. In what follows, the whole supply chain will be examined through the spectrum of LCA

3.3 LCA study for lead-acid batteries.

The LCA methodology is now applied to the case study of lead-acid batteries. The lead-acid battery closed-loop supply chain used in this LCA study follows the scheme presented in Figure 2. 12, Figure 3. 1. With the utilization of the SimaPro software tool (8.5.2.0) with the EcoInvent database v3 was selected for conducting the LCA for LABs.

3.3.1 Goal and scope definition

The objective of this study is to identify and evaluate the overall environmental impacts associated with a lead-acid battery. The assessment mainly focuses on energy and material flows for all stages involved in the CLSC, and the system boundaries proposed in Figure 3. 2 are considered in this study. The system boundary excludes the use phase of the battery.

The functional unit used for this LCA is a lead-acid battery weighing 13.5 kg, as identified in the study by (Jolly & Rhin, 1994). These batteries are predominantly used in small cars known for their versatile design, fuel efficiency, and practicality. The main components of the lead-acid battery are presented in Table 3. 4. Despite the age of this study, the provided data are presented in detail to facilitate the conduct of the life cycle inventory .

The LABs, have been in use for more than a century, primarily as an automotive starter battery. Even if they have undergone steady improvements in efficiency, durability, and lifetime, the chemistry remains unchanged. The main components of the battery are: a cathode comprised of lead peroxide on a lead lattice for support; an anode made of sponge lead, also on a lead lattice; an electrolyte of water and sulfuric acid; fiberglass mat (with some polymeric binders) separators that keep the anode and cathode apart; and a containment case, typically made of polypropylene.

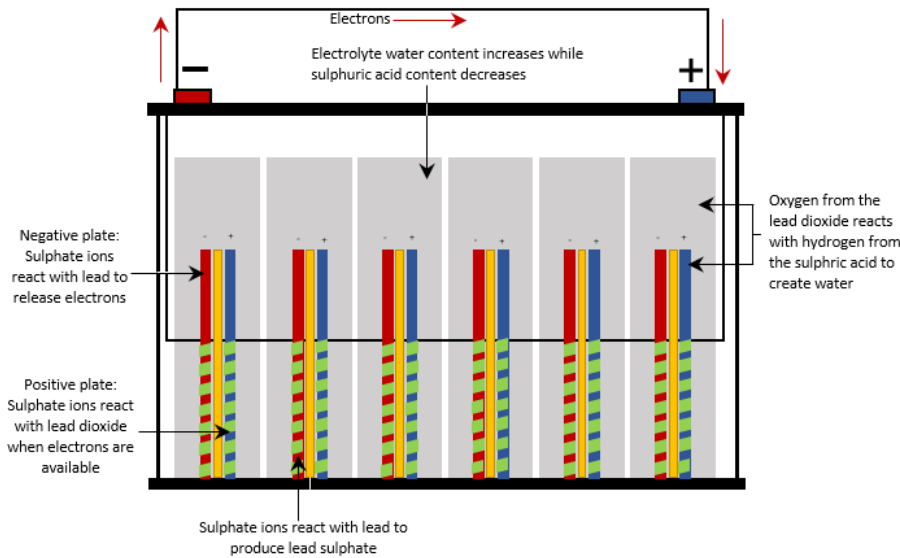
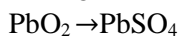
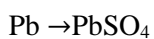

Figure 3. 14 Schema of battery discharge from (off-grid-europe.com).

During discharge, lead at the cathode is reduced (Figure 3. 14)



whereas at the anode it is oxidized



<i>Component</i>	<i>(in Kg)</i>
Acid (H ₂ SO ₄)	3.85
Lead	8.64
Grid (metallic)	(3.00)
Connexions (metallic)	(0.80)
Battery paste (oxide, sulfate)	(4.84)
Box (polypropylene)	0.67
Other materials (plastic, paper, wood, PVC...)	0.34
Total	13.50

Table 3. 4 Composition of the battery used in this study (Jolly & Rhin, 1994).

3.3.2 Inventory analysis

The inventory data was compiled from LCA literature (Daniel et al. 2003; Liu et al. 2015; McManus, 2012; Wang et al. 2018; Yu et al. 2012) and French agency reports (ADEME) reference and will be presented in detail in what follows. The main issue was to find consistent information for the entire process. As already mentioned, Life Cycle Inventory (LCI) is a key part of LCA according to ISO 14040 standard. LCI provides inputs (e.g., materials and energies), outputs, and environmental releases throughout all life cycle phases.

Lead, being a traditional mineral for extraction, poses challenges in sourcing comprehensive data for conducting an LCA inventory. To address this limitation, the SimaPro 8.5.2.0 and Ecoinvent v3 databases were utilized.

- Lead virgin: for this material, “Lead {GLO} primary lead production from concentrate | APOS” has been used. The prefix "APOS" refers to an allocation approach that expands production systems to circumvent internal allocation within treatment systems.
- Lead recycled: for this material, “Lead {RER} treatment of scrap acid battery, re-melting, Cut-off” has been used. Cut-off means that if a material is recycled, the primary producer does not receive any credit for the provision of any recyclable materials.

Three scenarios were studied for LCI:

- Scenario 1: production of 100% virgin lead without recycling process,
- Scenario 2: production of batteries formed by 50% virgin lead and 50% recycled lead.
- Scenario 3: production of batteries formed by 10% virgin lead and 90% recycled lead.

LCI Raw materials Bat 100% virgin lead			
	Raw Material	Manufacturing	Disposal (batteries)
Resources			
Carbon (Kg)	0	0	0
Oil (Kg)	0	0	0
Antimony (Kg)	0.101	0	0.101
Copper (Kg)	0	0	0
Materials/fuels			
Antimony (Kg)	0.101	0	0.101
Arsine (Kg)	0.004	0	0
Copper (Kg)	0.001	0	0.017
Glass fiber (Kg)	0.028	0	0.000
Lead virgin (Kg)	8.641	0	8.641
Lead recycled (Kg)	0.000	0	0
Oxygen liquid (Kg)	0.420	0	0
Polyethylene high density (Kg)	0.259	0	0
Polyethylene granulate (Kg)	0.953	0	0
Sulfuric acid (kg)	1.464	0	0
Petroleum (Kg)	0	0	0.031
Water deionized (kg)	2.400	0	0
Electricity/heat			
Liquid fuel (MJ)	0	9.2	1.4
Electrical energy (MJ)	0	65.1	0
Heat (MJ)	0	89.4	0
Emission to water			
Lead (Kg)	0	6.81E-05	0
Sulfuric acid (Kg)	0	0	1.45
Emission to air			
Carbon monoxide (g)	0	0	2.537
Sulfur dioxide (g)	0	0	0
Nitrogen dioxide (g)	0	0	1.174
Particulates (g)	0	0	0.128
Volatile organic compounds (g)	0	0	0.371
Lead (g)	0	0	0
Final waste flows			
Bulk, waste unspecific (Kg)	0	0	6.41
Waste, toxic (Kg)	0	0	2.59

Table 3. 5 LCI for Battery manufacturing 100% virgin lead (Scenario 1).

<i>LCI Raw materials Bat 50% virgin lead 50% recycled lead</i>					
	Raw Material	Manufacturing Remanufacturing	Distribution	Disassembly	Disposal
Resources					
Carbon (Kg)	0	0	0.000	0	0.000
Oil (Kg)	0	0	0.067	0	0
Antimony (Kg)	0	0	0.000	0	0.096
Copper (Kg)	0	0	0.000	0	0.015
Materials/fuels					
Antimony (Kg)	0.096	0	0	0	0.000
Arsine (Kg)	0.004	0	0	0	0.000
Copper (Kg)	0.001	0	0	0	0.000
Glass fiber (Kg)	0.027	0	0	0	0.000
Lead virgin (Kg)	4.32	0	0	0	0.000
Lead recycled (Kg)	4.32	0	0	0	0.000
Oxygen liquid (Kg)	0.400	0	0	0	1.351
Polyethylene high density (Kg)	0.247	0	0	0	0.029
Polyethylene granulate (Kg)	0.908	0	0	0	0.000
Sulfuric acid (kg)	1.396	0	0	0	13.514
Water deionized (kg)	2.288	0			0.000
Electricity/heat					
Liquid fuel (MJ)	0	8.78	3.11	0	1.36
Electrical energy (MJ)	0	62.03	0.	2.780	4.05E-03
Heat (MJ)	0	85.27	0.	0	0
Emission to water					
Lead (Kg)	0	6.50E-05	0	0	0
Emission to air					
Sulfuric acid (g)	0	0	0	0	0
Carbon dioxide (Kg)	0	0	2.3E-02	0	0
Carbon monoxide (g)	0	0	4.76	0	2.419
Sulfur dioxide (g)	0	0	0	0	0
Nitrogen dioxide (g)	0	0	2.63	0	1.120
Particulates (g)	0	0	0.28	0	0.122
Volatile organic compounds (g)	0	0	0.85	0	0.354
Lead (g)	0	1.68E-05	0	0	0
Final waste flows					
Bulk, waste unspecific (Kg)	0	0	0	6.117	6.130
Waste, toxic (Kg)	0	0	0	0.459	2.475

Table 3. 6 LCI Battery manufacturing 50% virgin lead and 50% recycled lead. (Scenario 2).

LCI Raw materials Bat 10% virgin lead 90% recycled lead						
	Raw material	Manufacturing Remanufacturing	Distribution	Disposal (bat)	Disassembly	Disposal (raw material)
Resources						
Carbon (Kg)	0	0	0.000	0	0	0
Oil (Kg)	0	0	0.067	0	0	0
Antimony (Kg)	0	0	0.000	9.65E-02	0	0
Copper (Kg)	0	0	0.000	1.51E-02	0	0
Materials/fuels						
Antimony (Kg)	1.01E-01	0	0	1.01E-01	0	0
Arsine (Kg)	4.25E-03	0	0	0	0	0
Copper (Kg)	1.42E-03	0	0	0	0	0
Calcium (Kg)	2.83E-02	0	0	0	0.135	0
Lead virgin (Kg)	0.86	0	0	0.864	0	0
Lead recycled (Kg)	7.777	0	0	0.776	0	0
Oxygen liquid (Kg)	0.4	0	0	0	0	0
Polyethylene high density (Kg)	0.259	0	0	0	0	0
Polyethylene granulate (Kg)	0.953	0	0	0	0	0
Sulfuric acid (kg)	1.464	0	0	0	0	0
Petroleum (Kg)	0	0	0	3.06E-02	0	0
Water deionized (kg)	2.400	0	0	0	7.51E-03	0
Polyethylene scrap (Kg)	0	0	0	0	0	0
Energy						
Liquid fuel (MJ)	0	9.213	3.11	1.426	0	7.09E-01
Electrical energy (MJ)	0	6.506	0.	0	2.916	0
Heat (MJ)	0	89.440	0.	4.25E-03	0	1.70E-02
Emission to water						
Lead (Kg)	0	1.08E-51	0	0	0	0
Emission to air						
Sulfuric acid (g)	0	0	0	0	0	0
Carbon dioxide (Kg)	0	0	2.3E-02	0	0.342	0
Carbon monoxide (g)	0	0	4.76	0	0	0
Sulfur dioxide (g)	0	3.19E-02	0	0	1.203	0
Nitrogen dioxide (g)	0	3.40E-03	2.63	0	4.03E-01	0
Particulates (g)	0	2.40E-22	0.28	0	0.149	0
Volatile organic compounds (g)	0	0	0.85	0	0	0
Lead (g)	0	7.25E-05	0	0	0	0
Final waste flows						
Bulk, waste unspecific (Kg)	0	0	0	6.415	6.416	0
Waste, toxic (Kg)	0	0	0	2.596	0.481	0

Table 3. 7 LCI Battery manufacturing 10% virgin lead and 90% recycled lead (Scenario3).

Table 3. 8 outlines the various scenarios employed for transportation across different locations within the supply chain. Notably, a tonne-kilometer, denoted as 'tkm', quantifies freight transport as the conveyance of one tonne of goods (inclusive of packaging and tare weights of intermodal transport units) via a specific transport mode (e.g., road, rail, air, sea, inland waterways, pipeline, etc.) over a distance of one kilometer.

Transportation												
Origin Location	Supplier	Manufacturing plant	Distributor	Wholesaler	Retailer	Client	Collecting points	Recycling center	Disassembly plant to	Disassembly	Disassembly	Disassembly
	China	China	France	France	France	France	France	France	France	France	France	France
Destination Location	Manufacturing plant	Distributor	Wholesaler	Retailer	Client	Collecting points	Recycling center	Disposal (Batteries)	Disassembly plant	Disposal (Raw material)	3 rd party	Remanufacturing plant
	China	France	France	France	France	France	France	France	France	France	France	France
Scenario (100%)												
Type of transport	Freight lorry >32 metric tons	Inland waterways barge	Freight lorry >32 metric tons	Light commercial vehicle	Light commercial vehicle	Light commercial vehicle	Municipal waste collector service 21 metric tons	Municipal waste collector service 21 metric tons				
Distance	200 Km	15150 Tkm (tonne kilometre)	950 Km	10 Tkm	10 Tkm	10 Tkm	100 km					
Scenario (50%)												
Type of transport	Freight lorry >32 metric tons	Inland waterways barge	Freight lorry >32 metric tons	Light commercial vehicle	Light commercial vehicle	Light commercial vehicle	Municipal waste collector service 21 metric tons	Municipal waste collector service 21 metric tons	Municipal waste collector service 21 metric tons	Municipal waste collector service 21 metric tons	Light commercial vehicle	Light commercial vehicle
Distance	200 Km	15150 Tkm (tonne kilometre)	950 Km	10 Tkm	10 Tkm	20 tkm	50 tkm	100 tkm	30 tkm	75 tkm	80 tkm	320 tkm
Scenario (10%)												
Type of transport	Freight lorry >32 metric tons	Inland waterways barge	Freight lorry >32 metric tons	Light commercial vehicle	Light commercial vehicle	Light commercial vehicle	Municipal waste collector service 21 metric tons	Municipal waste collector service 21 metric tons	Municipal waste collector service 21 metric tons	Municipal waste collector service 21 metric tons	Light commercial vehicle	Light commercial vehicle
Distance	200 Km	15150 Tkm (tonne kilometre)	950 Km	10 Tkm	10 Tkm	20 Tkm	50 tkm	100 tkm	30 tkm	75 tkm	80 tkm	320 tkm

Table 3. 8 Distance, location, and type of transportation used in each phase of the supply chain.

3.3.3 Impact assessment

The third step in the LCA methodology involves the assessment of environmental allocation caused by the emissions of the phases described above.

In this work, two impact methods have been selected: IMPACT 2002+ and RecipePoint (H) approach.

- IMPACT 2002+ is a combined midpoint/damage approach linking all types of life cycle inventory results via 14 midpoint categories (human toxicity, respiratory effects, ionizing radiation, ozone layer depletion, photochemical oxidation, aquatic ecotoxicity, terrestrial ecotoxicity, terrestrial acidification/nutrification, aquatic acidification, aquatic eutrophication, land occupation, global warming, non-renewable energy, mineral extraction) to four damage categories (Jolliet et al., 2003) (human health, ecosystem quality, climate change, resources) IMPACT 2002+ takes advantages both from midpoint-based indicators such as CML (Guinée et al., 2001) and from damage-based methodologies as Eco-indicator 99 (Goedkoop & Spriensma, 2000).
- ReCiPe is also an LCIA method (Goedkoop et al. 2009) that presents results at both midpoint and endpoint levels. For the midpoint level – individual factors for all three distinguished perspectives (i.e. Individualist (I), Egalitarian (E), and Hierarchies (H)) have been implemented. These perspectives represent a set of choices on issues like time or expectations that proper management or future technology development can avoid future damages
 - *Individualist*: short term, optimism that technology can avoid many problems in the future.
 - *Hierarchist*: consensus model, as often encountered in scientific models, this is often considered to be the default model.
 - *Egalitarian*: long term based on precautionary principle thinking.

In this study, Recipe at midpoint level (18 midpoint environmental indicators) with a Hierarchist perspective (Goedkoop et al. 2009) has been used. **¡Error! No se encuentra el origen de la referencia.** Table 3.9; **¡Error! No se encuentra el origen de la referencia.** presents the midpoints and damage categories for the IMPACT 2002+. **¡Error! No se encuentra el origen de la referencia.** and **¡Error! No se encuentra el origen de la referencia.** the damage categories for ReCiPe.

Midpoint Category	Midpoint reference flow (Kg _{eq} substance x)	Damage category
Human Toxicity (carcinogens + non-carcinogens)	Kg _{eq} chloroethylene into air	Human Health
Respiratory effects (inorganic)	Kg _{eq} PM2.5 into air	
Ionizing radiation	Bq _{eq} carbon-14 into air	
Ozone layer depletion	Kg _{eq} Chlorinated and brominated compounds (CFC-11 into air	
Photochemical oxidation (Respiratory organics)	Kg _{eq} ethylene into air	
Aquatic ecotoxicity Terrestrial ecotoxicity Terrestrial acid/nutri Land occupation Aquatic acidification Aquatic eutrophication	Kg _{eq} triethylene glycol Kg _{eq} triethylene glycol into soil Kg _{eq} SO ₂ into air M ² _{eq} organic arable land-year Kg _{eq} SO ₂ into air Kg _{eq} PO ₄ ³⁻ into water	Ecosystem quality
Global warming	Kg _{eq} CO ₂ into air	Climate change
Non-renewable energy Mineral extraction	MJ Total primary non-renewable or Kg _{eq} crude oil (860kg/m ³) MJ additional energy or kg eq iron	Resources

Table 3. 9 Characterization reference substances and reference flow used in IMPACT 2002 Source:(Joliet et al. 2003) Note that Kg_{eq} Substance x (kg equivalent of a reference substance x)

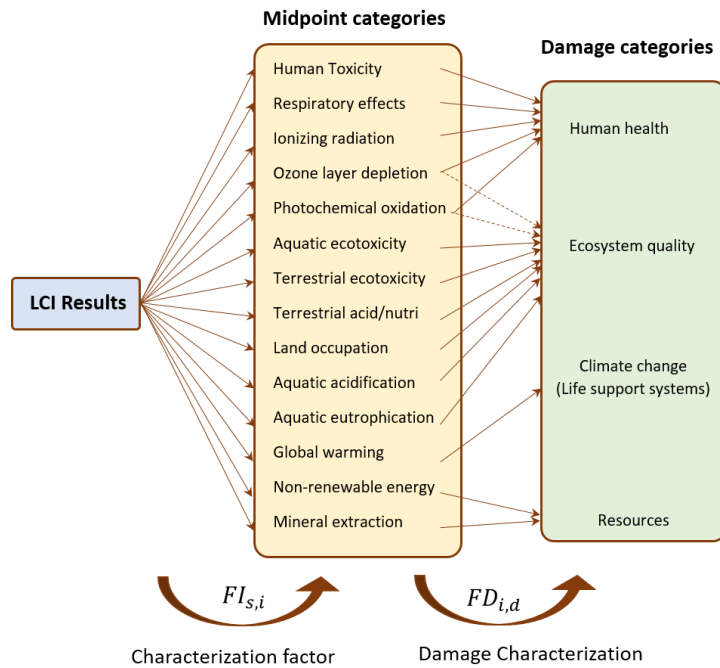

Figure 3. 15 From LCI results to midpoints and final impact categories in IMPACT 2002+.

Midpoint Category	Midpoint reference flow	Damage category
Fine particulate matter formation Ozone formation, Human health Ionizing radiation Stratospheric ozone depletion Human carcinogenic toxicity Human non-carcinogenic toxicity Global warming Water consumption	K _{geq} Particulate Matter (PM) 2.5 to air K _{geq} Nitrogen oxides (NOx) to air kBq Co-60 to air K _{geq} Chlorinated and brominated compounds (CFC)-11 to air K _{geq} 1,4- Dichlorobenzene (DCB) to urban air K _{geq} 1,4- Dichlorobenzene (DCB) to urban air	Human Health
Freshwater ecotoxicity Freshwater eutrophication Ozone formation, Terrestrial ecosystems Terrestrial ecotoxicity Terrestrial acidification Land use Marine ecotoxicity Marine eutrophication	K _{geq} 1,4-Dichlorobenzene (DCB) to freshwater K _{geq} P to freshwater K _{geq} Nitrogen oxides (NOx) to air K _{geq} 1,4- Dichlorobenzene (DCB) to industrial soil K _{geq} SO ₂ to air m ² a crop annual cropland K _{geq} 1,4- Dichlorobenzene (DCB) to marine water K _{geq} N to marine water	Ecosystems
Mineral resource scarcity Fossil resource scarcity	K _{geq} Cu K _{geq} oil	Resources

Table 3. 10 Characterization reference substances and reference flow used in ReCiPe Source (Huijbregts et al. 2017).

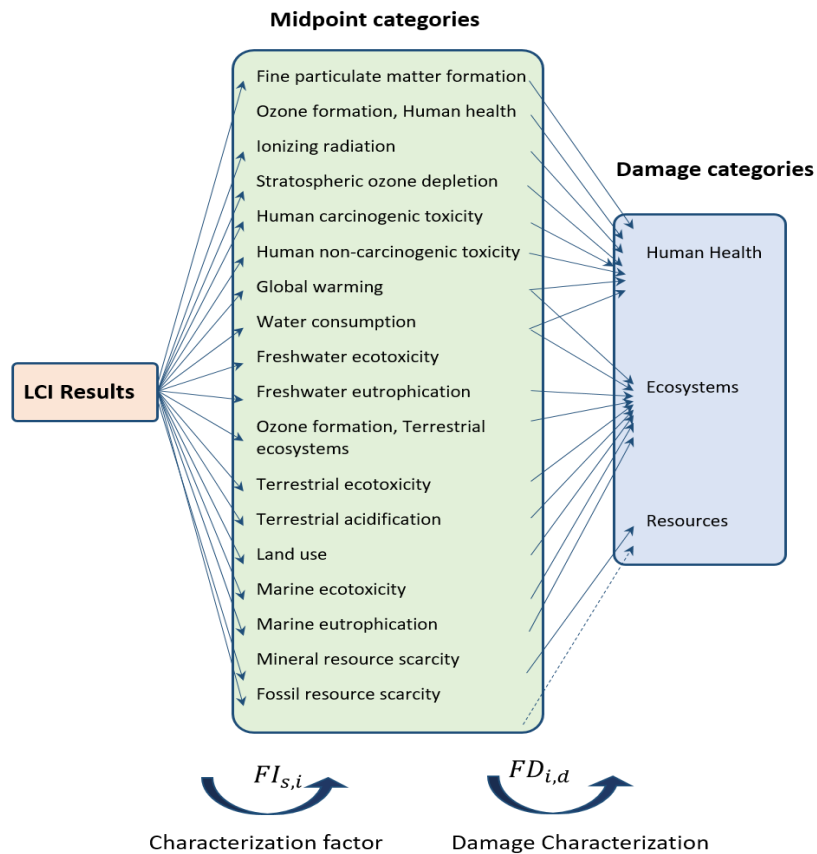

Figure 3. 16 General approaches of LCIA of emissions on the major categories of environmental damage in ReCiPe.

Scenario comparison

The scenario comparison serves as a sensitivity analysis by altering the percentage of virgin lead in battery production. The values of the indicators obtained for each scenario with IMPACT 2002+ and ReCiPe midpoint (H) model are presented in Table 3. 11 and Table 3. 12, respectively. To further analyze the contribution of environmental impact categories, it must be emphasized that the results were also normalized by dividing each impact value by the maximum value of each category. These normalized values are also presented in Table 3. 11 and Table 3. 12, facilitating the comparison between the three different scenarios of battery production.

<i>Method IMPACT 2002+</i>		Scenario % of virgin lead			Scenario % of virgin lead (normalized results)		
<i>Impact category</i>	<i>Units</i>	<i>100%</i>	<i>50%</i>	<i>10%</i>	<i>100%</i>	<i>50%</i>	<i>10%</i>
Carcinogens	kg C ₂ H ₃ Cl eq	7.21	4.13	1.47	1	0.573	0.204
Non-carcinogens	kg C ₂ H ₃ Cl eq	59.52	33.15	7.54	1	0.557	0.127
Respiratory inorganics	kg PM _{2.5} eq	0.126	0.114	0.093	1	0.912	0.737
Ionizing radiation	Bq C-14 eq	672.772	816.510	827.255	0.813	0.987	1
Ozone layer depletion	kg CFC-11 eq	4.91E-06	7.32E-06	8.68E-06	0.566	0.843	1
Respiratory organics	kg C ₂ H ₄ eq	2.97E-02	2.88E-02	2.52E-02	1	0.967	0.848
Aquatic ecotoxicity	kg TEG water	2.84E+04	1.80E+04	7.60E+03	1	0.633	0.267
Terrestrial ecotoxicity	kg TEG soil	7.81E+03	5.00E+03	2.17E+03	1	0.641	0.278
Terrestrial acid/nutri	kg SO ₂ eq	2.58	2.26	1.79	1	0.876	0.693
Land occupation	m ² org.arable	1.26	1.22	1.09	1	0.964	0.863
Aquatic acidification	kg SO ₂ eq	5.84	6.68	6.51	0.874	1	0.976
Aquatic eutrophication	kg PO ₄ P-lim	9.49E-02	7.09E-02	4.60E-02	1	0.747	0.484
Global warming	kg CO ₂ eq	56.70	54.30	48.6	1	0.958	0.858
Non-renewable energy	MJ primary	847.200	830.869	801.672	1	0.981	0.946
Mineral extraction	MJ surplus	72.57	41.13	10.31	1	0.567	0.142

Table 3. 11 Results of all the scenarios with the IMPACT 2002+ model.

<i>Method ReCiPe Midpoint</i>		Scenario % of virgin lead			Scenario % of virgin lead (normalized results)		
<i>Impact category</i>	<i>Units</i>	<i>100%</i>	<i>50%</i>	<i>10%</i>	<i>100%</i>	<i>50%</i>	<i>10%</i>
Global warming	kg CO ₂ eq	60.46	57.38	51.20	1	0.949	0.847
Stratospheric ozone depletion	kg CFC11 eq	4.80E-05	4.33E-05	3.54E-05	1	0.903	0.738
Ionizing radiation	kBq Co-60 eq	5.51	6.68	6.75	0.816	0.99	1
Ozone formation, Human health	kg NOx eq	0.3148	0.2880	0.2398	1	0.915	0.762
Fine particulate matter formation	kg PM2.5 eq	0.242	0.210	0.165	1	0.868	0.682
Ozone formation, Terrestrial ecosystems	kg NOx eq	0.3201	0.2931	0.2443	1	0.916	0.763
Terrestrial acidification	kg SO ₂ eq	0.713	0.603	0.458	1	0.845	0.642
Freshwater eutrophication	kg P eq	9.26E-02	7.28E-02	5.05E-02	1	0.786	0.545
Marine eutrophication	kg N eq	2.47E-03	2.32E-03	1.97E-03	1	0.94	0.798
Terrestrial ecotoxicity	kg 1,4-DCB	613.6	434.2	234.5	1	0.708	0.382
Freshwater ecotoxicity	kg 1,4-DCB	26.46	25.04	21.17	1	0.946	0.8
Marine ecotoxicity	kg 1,4-DCB	20.95	15.81	10.35	1	0.755	0.494
Human carcinogenic toxicity	kg 1,4-DCB	5.84	4.57	3.12	1	0.783	0.535
Human non-carcinogenic toxicity	kg 1,4-DCB	638.79	445.45	249.16	1	0.697	0.39
Land use	m ² a crop eq	1.74	1.61	1.37	1	0.926	0.787
Mineral resource scarcity	kg Cu eq	5.53	3.14	0.79	1	0.567	0.143
Fossil resource scarcity	kg oil eq	16.14	15.39	14.74	1	0.954	0.913
Water consumption	m ³	0.649	0.523	0.493	1	0.807	0.76

Table 3. 12 Results of all the scenarios with ReCiPe midpoint (H) model.

The lower value of the indicator, the better. Figure 3. 17 and Figure 3. 18 compare the three scenarios for each assessment method.

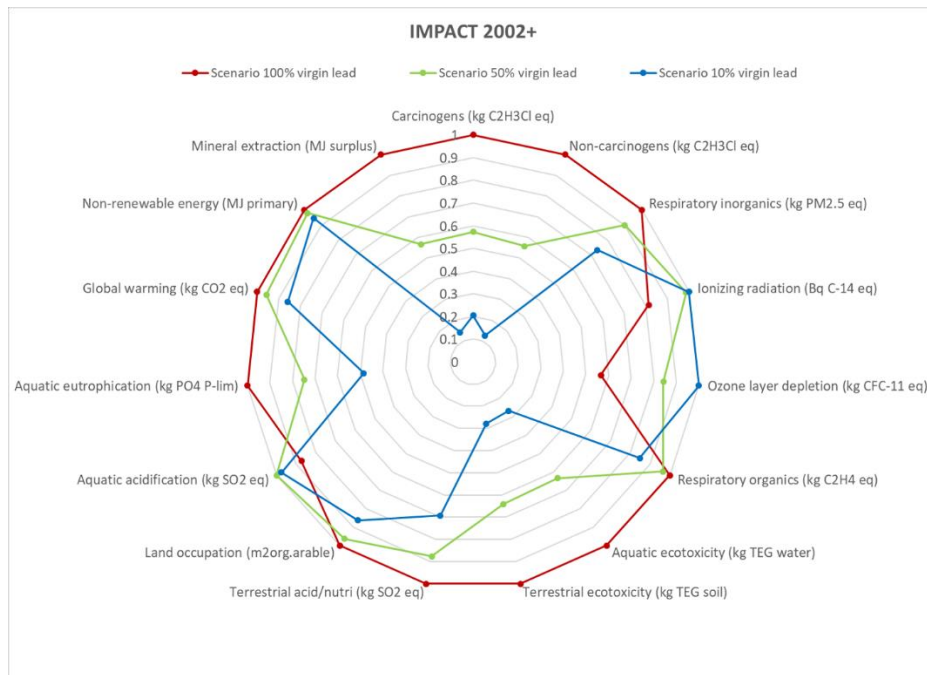

Figure 3. 17 Radar representation of the normalized environmental midpoint impacts for the different scenarios with IMPACT 2002+model.

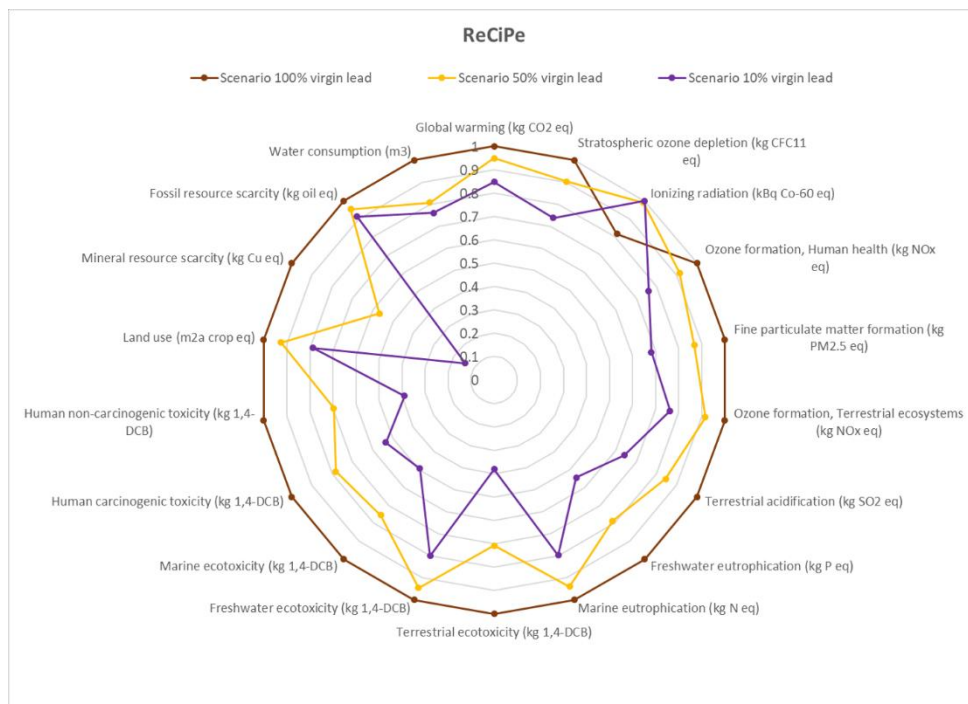

Figure 3. 18 Radar representation of the environmental midpoint impacts for the different scenarios with ReCiPe midpoint (H) model.

Globally, both methods follow the same trends: recycling reduces the impact except for some indicators: ionizing radiation for Impact 2002+ and ReCiPe and ozone layer depletion and aquatic acidification only for Impact 2002+.

It must be highlighted that both methods share several indicators and present also some specific ones, thus giving complementary information such as water consumption for instance.

Even with the indicators that are common between them, some differences can be observed i.e. for ozone layer depletion. They can be related to the assumptions involved in the environmental mechanism even (note that in both methods Impact 2002+ and Recipe - Hierarchist scenario – a time horizon of 100 years was considered in the model.

Concerning Global Warming Potential (GWP) (see Figure 3. 17 and Figure 3. 18), the order of magnitude is the same with both methods.

A 5% (respectively 15%) reduction in GWP is observed, when the recycling rate is increased, i.e. with 50% virgin lead (10% respectively). Concerning GWP, which plays a central role in all emissions accounting and reporting systems, the comparison with the results obtained with other works is difficult since the functional unit is not the same. Based on the work of (Liu et al. 2015), a value of GWP for a functional unit of a 35 kg lead-acid battery has been found equal to approximately 40% of 338 KgCO₂eq, over the same steps of the life cycle, thus giving approximately the same order of magnitude for a 13,5 kg lead-acid battery.

A very strong reduction is observed with an increase in recycling rate for several indicators such as terrestrial and aquatic ecotoxicity (up to 73% for 10% virgin lead) which is mainly due to the strong toxicity of lead, in conjunction with a strong reduction in carcinogens (up to 73% for 10% virgin lead). This result is also consistent with the strong decrease in mineral extraction for the explored scenarios.

It must be also observed that the use of recycling also reduces the amount of freshwater consumption, up to 25% with 90% recycled lead.

Key process identification

Figure 3. 19 to Figure 3. 24 represent the contribution of each phase in the supply chain, focusing on Global Warming Potential using both impact assessment methods, i.e., Impact 2002+ and ReCiPe midpoint (H) model.

Using both impact assessment methods, raw materials extraction is identified as the key process with the greatest impact on the environment in a 100% virgin lead scenario (Figure 3. 19 and Figure 3. 20), which occupies 30 % of the overall environmental impact load. Its contribution is divided by a factor 2 with 10% virgin lead, whereas the distribution proportion has slightly less than doubled.

The contributions from the various steps being roughly equivalent, the discussion will now focus solely on the viewpoint offered by the IMPACT 2002+ method.

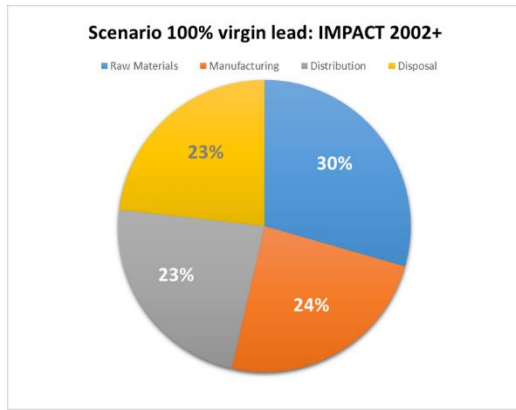

Figure 3. 19 Contribution of each phase in scenario 1 (IMPACT 2002+).

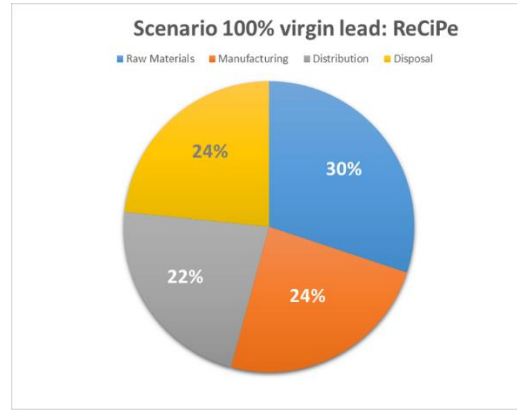

Figure 3. 20 Contribution of each phase in scenario 1 (ReCiPe midpoint (H) model).

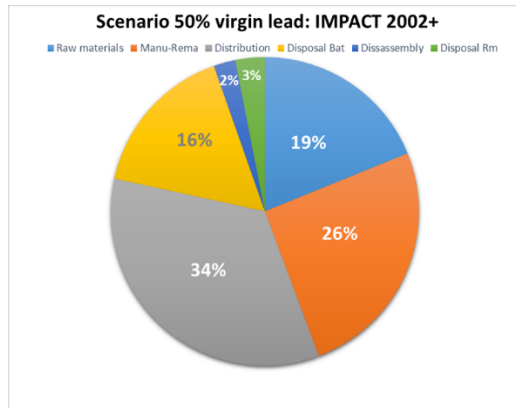

Figure 3. 21 Contribution of each phase in scenario 2 (IMPACT 2002+).

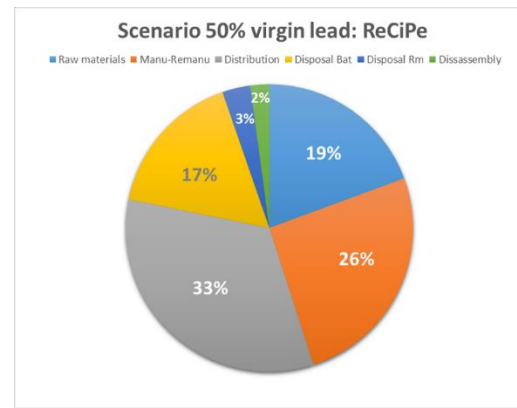

Figure 3. 22 Contribution of each phase in scenario 2 (ReCiPe midpoint (H) model).

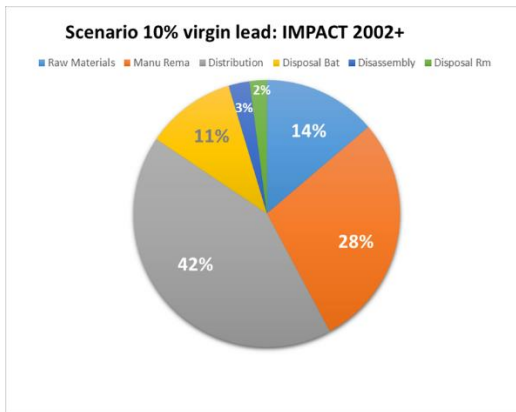

Figure 3. 23 Contribution of each phase in scenario 3 (IMPACT2002+).

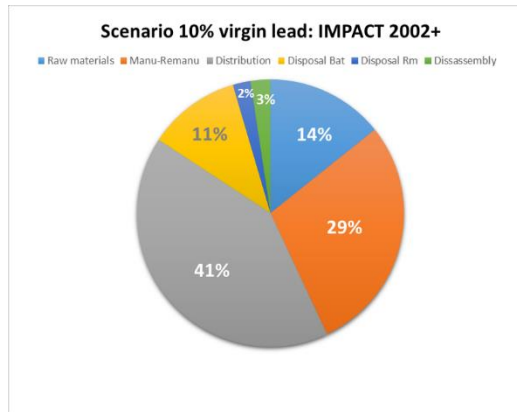

Figure 3. 24 Contribution of each phase in scenario 3 (ReCiPe midpoint (H) model).

Scenario S1: using Impact 2002+, the raw materials' extraction process is identified as the key process with the greatest impact on the environment in the S1 scenario (see Figure 3. 25) for 10 of the 15 midpoint categories (more than 50% for 5 impacts, i.e. carcinogens, non-carcinogens, aquatic and terrestrial ecotoxicity, and aquatic acidification). Manufacturing has also a great impact (64 %) on ionizing radiation, mainly due to the high temperatures involved in the process. Distribution has a significant impact on ozone layer depletion (43%), respiratory inorganics (33%), terrestrial acidification/nitrification (28%), land occupation (44%), global warming (23%) and on non-renewable energy (23%). Not surprisingly, battery disposal has a huge effect on carcinogens (43%), non-carcinogens (49%), respiratory inorganics (32%), aquatic and terrestrial ecotoxicity (44%), aquatic eutrophication (33%), mineral extraction (50%) and is largely predominant on aquatic acidification (91%).

Scenario S2: raw materials extraction process is still identified as the key process with the greatest impact on the environment in the S2 scenario (see Figure 3. 25) for 6 among the 15 midpoint categories (more than 50% for aquatic eutrophication (61%) with the same order of magnitude as in S1). Manufacturing/remanufacturing has also a great impact (64 %) on ionizing radiation, mainly for the same reason as previously mentioned for the manufacturing process. Distribution has still a significant impact on ozone layer depletion (41%), respiratory inorganics (56%). A greater impact is now observed on terrestrial acidification/nitrification (39%), land occupation (44%), global warming (34%), and non-renewable energy (33%). Not surprisingly, the effect of battery disposal is now reduced for carcinogens (38%), non-carcinogens (44%), respiratory inorganics (24%), aquatic and terrestrial ecotoxicity (35%), and mineral extraction (45%). Yet, an increase in the contribution of aquatic acidification is now observed (78 %).

The impact of disassembly is nearly negligible in all midpoint impacts and the contribution of the disposal of raw materials is less than that 5% for 9 indicators and greater than 10% for the same indicators with the same order of magnitude ionizing radiation (11%) and aquatic acidification (15%).

Scenario S3: In this scenario (Figure 3. 25), raw material extraction has the largest proportion of 35%, 47%, 49%, and 47%, 70% for carcinogens, non-carcinogens, aquatic ecotoxicity, terrestrial ecotoxicity, and aquatic eutrophication respectively.

As previously, manufacturing/remanufacturing has also a great impact (63%) on ionizing radiation and a significant contribution to global warming and non-renewable energy, 29%, and 36% respectively. The contribution of distribution exhibits the same order of magnitude on ozone layer depletion (41%) and is far higher than in the previous case for respiratory inorganics (71%). A greater impact is now observed on terrestrial acidification/nitrification (52%), land occupation (64%), global warming (42%), and non-renewable energy (39%). The effect of battery disposal is more reduced for carcinogens (24%), non-carcinogens (41%), respiratory inorganics (18%), aquatic and terrestrial ecotoxicity (215%), and mineral extraction (43%). Yet, the contribution of aquatic acidification remains at the same level (79 %).

As previously observed for scenario S2, the impact of disassembly is nearly negligible in all midpoint impacts and the contribution of the disposal of raw materials is less than 5% for 13 indicators and greater than 10% for only two indicator ionizing radiation (13%) and aquatic acidification (15%).

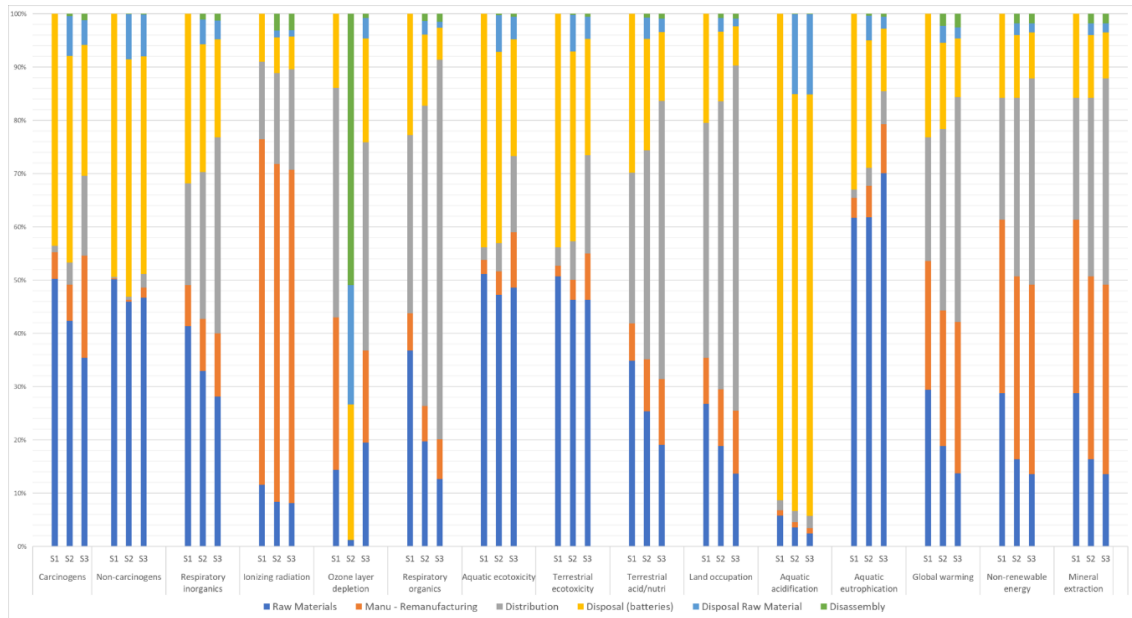

Figure 3. 25 Key process analysis of environmental impact.

From the quantitative results obtained, it can be shown that the ionizing radiation impact increases with recycling due to the increase in the contribution of remanufacturing and distribution echelons that outperforms the manufacturing and distribution steps of scenario S1. The same trend is observed for ozone layer depletion and in aquatic acidification at the same steps but also the additional echelons related to the disposal of both batteries and raw materials, as well as at the disassembly step.

Scenario	Phase	Carcinogens	Non-carcinogens	Respiratory inorganics	Ionizing radiation	Ozone layer depletion	Respiratory organics	Aquatic ecotoxicity	Terrestrial ecotoxicity	Terrestrial acid/nutri	Land occupation	Aquatic acidification	Aquatic eutrophication	Global warming	Non-renewable energy	Mineral extraction
S1	Raw Materials	3.62	29.86	5.2E-02	77.99	7.0E-07	1.1E-02	14546.98	3964.10	9.0E-01	3.4E-01	3.4E-01	5.8E-02	16.70	244.16	35.86
S2		1.75	15.22	3.7E-02	68.47	1.3E-06	5.6E-03	8506.35	2317.27	5.7E-01	2.3E-01	2.4E-01	4.4E-02	10.24	136.33	18.20
S3		5.2E-01	3.52	2.6E-02	67.52	1.7E-06	3.2E-03	3695.73	1003.51	3.4E-01	1.5E-01	1.6E-01	3.2E-02	6.69	108.84	4.07
S1	Manufacturing Manu- Remanufacturin g	3.6E-01	1.4E-01	9.7E-03	436.56	1.4E-06	2.1E-03	740.97	154.40	1.8E-01	1.1E-01	5.6E-02	3.5E-03	13.68	275.67	2.5E-01
S2		2.8E-01	1.4E-01	1.1E-02	517.74	1.5E-06	1.9E-03	789.69	189.47	2.2E-01	1.3E-01	6.5E-02	4.2E-03	13.82	285.03	2.9E-01
S3		2.8E-01	1.4E-01	1.1E-02	517.74	1.5E-06	1.9E-03	789.69	189.47	2.2E-01	1.3E-01	6.5E-02	4.2E-03	13.82	285.03	2.9E-01
S1	Distribution	8.8E-02	1.2E-01	2.4E-02	98.03	2.1E-06	1.0E-02	670.47	267.78	7.3E-01	5.6E-01	1.1E-01	1.5E-03	13.14	194.03	2.2E-01
S2		1.7E-01	1.7E-01	3.1E-02	139.38	3.0E-06	1.6E-02	961.55	360.34	8.8E-01	6.6E-01	1.4E-01	2.4E-03	18.51	278.46	4.8E-01
S3		2.2E-01	1.9E-01	3.4E-02	155.91	3.4E-06	1.8E-02	1084.68	399.04	9.3E-01	7.1E-01	1.5E-01	2.8E-03	20.54	310.50	6.2E-01
S1	Disposal (batteries)	3.14	29.41	4.0E-02	60.19	6.8E-07	6.8E-03	12865.48	3423.70	7.7E-01	2.6E-01	5.33	3.1E-02	13.16	133.33	36.24
S2		1.60	14.78	2.7E-02	55.12	1.3E-06	3.8E-03	6467.95	1784.77	4.7E-01	1.6E-01	5.23	1.7E-02	8.80	97.92	18.58
S3		3.6E-01	3.08	1.7E-02	51.06	1.7E-06	1.5E-03	1669.91	473.63	2.3E-01	8.1E-02	5.15	5.4E-03	5.32	69.59	4.46
S2	Disposal Raw Material	3.1E-01	2.83	5.2E-03	10.53	2.4E-07	7.3E-04	1236.10	341.09	9.0E-02	3.1E-02	1.00	3.3E-03	1.68	18.71	3.55
S3		6.9E-02	5.9E-01	3.2E-03	9.76	3.3E-07	2.9E-04	319.14	90.52	4.5E-02	1.6E-02	9.8E-01	1.0E-03	1.02	13.30	0.85
S2	Disassembly	1.7E-02	9.1E-03	1.2E-03	25.27	6.9E-08	3.8E-04	42.24	11.22	1.6E-02	9.6E-03	5.2E-03	2.5E-04	1.24	14.41	1.9E-02
S3		1.7E-02	9.1E-03	1.2E-03	25.27	6.9E-08	3.8E-04	42.24	11.22	1.6E-02	9.6E-03	5.2E-03	2.5E-04	1.24	14.41	1.9E-02
S1		7.21	59.53	0.13	672.77	4.88E-06	0.03	28423.90	7809.98	2.58	1.27	5.84	0.09	56.68	847.19	72.57
S2	Total	4.13	35.15	0.11	816.51	7.41E-06	0.03	18003.88	5004.16	2.25	1.22	6.68	0.07	54.29	830.86	41.12
S3		1.47	7.53	0.09	827.26	8.70E-06	0.03	7601.39	2167.39	1.78	1.10	6.51	0.05	48.63	801.67	10.31
	Units	kg C ₂ H ₃ Cl eq	kg C ₂ H ₅ Cl eq	kg PM _{2.5} eq	Bq C-14 eq	kg CFC-11 eq	kg C ₂ H ₄ eq	kg TEG water	kg TEG soil	kg SO ₂ eq	m ² org. stable	kg SO ₂ eq	kg PO ₄ P-lim	kg CO ₂ eq	MJ primary	MJ surplus

Table 3. 13 Results of all midpoint impacts with IMPACT 2002+ for all the scenarios (S1: scenario 1, S2: scenario 2, S3: scenario 3).

3.5 Lead tracking

The primary exposure routes to lead during the recycling of used lead-acid batteries stem from environmental emissions occurring at different phases in the recycling process. Improper recycling practices result in substantial releases of lead particles and fumes into the atmosphere, subsequently depositing onto soil, water bodies, and various surfaces. These emissions have adverse effects on both environmental integrity and human health.

In this study, four types of lead emission were identified, in raw materials' extraction through releases from mining lead and other metals, and from factories that make or use lead, lead alloys, or lead compounds. Lead is also released into the air during coal or oil burning or into water or soil, as a part of the process of battery production and recycling. Lead emissions are presented in Table 3. 14, for the three scenarios, and the respective contributions of the raw materials, air, water, and soil are presented in Figure 3. 26.

According to the results of LCA, although 8.23 kg of Pb is consumed in producing 1 battery, there is still 720 g of Pb released to the environment for scenario S3. Given that Pb is a poisonous element for humans, emission of this heavy metal poses a serious risk to public health.

As recycling materials to produce new batteries can decrease the lead pollution, the secondary lead industry also generates an increase in lead emissions at the remanufacturing step, yet largely compensated by the gain obtained during raw materials' extraction.

These results suggest that there is a large place for improvement to meet the growing requirements by optimizing the whole supply chain: increasing the lead recovery rate while producing the same capacity of LABs, replacing the pyrometallurgical process in smelting by using clean energy, and developing new technologies to reduce Pb emissions, especially in the raw materials extraction phase.

Scenario S1: 100% virgin lead			Phase						
Substance	Compartment	Units	Raw Mat	Manufacturing	Distribution	Disposal Bat	Disposal rm	Disassembly	Total
Lead	Raw	kg	2.38	1.4E-04	2.6E-04	2.38			4.76
Lead	Air	g	2.15	2.3E-02	9.9E-04	2.13			4.30
Lead	Water	mg	813.71	86.93	1.66	558.45			1460.76
Lead	Soil	µg	194.04	67.17	419.46	148.52			829.19
Scenario S2: 50% virgin lead			Phase						
Substance	Compartment	Units	Raw Mat	Manufacturing	Distribution	Disposal Bat	Disposal rm	Disassembly	Total
Lead	Raw	kg	1.19	1.6E-04	3.2E-04	1.19	1.19	1.0E-05	3.57
Lead	Air	g	1.10	9.4E-02	1.7E-03	1.08	1.08	3.5E-04	3.36
Lead	Water	mg	542.77	91.56	2.34	290.00	290.00	1.44	1218.11
Lead	Soil	µg	153.12	78.79	496.45	112.99	112.99	2.99	957.33
Scenario S3: 10% virgin lead			Phase						
Substance	Compartment	Units	Raw Mat	Manufacturing	Distribution	Disposal Bat	Disposal rm	Disassembly	Total
Lead	Raw	kg	2.4E-01	1.6E-04	3.2E-04	2.4E-01	2.4E-01	1.0E-05	0.72
Lead	Air	g	2.6E-01	9.4E-02	1.7E-03	2.4E-01	2.4E-01	3.5E-04	0.85
Lead	Water	mg	328.00	91.56	2.34	75.24	75.24	1.44	573.82
Lead	Soil	µg	125.05	78.79	496.45	84.57	84.57	2.99	872.42

Table 3. 14 Values of lead emission for scenarios S1, S2, and S3.

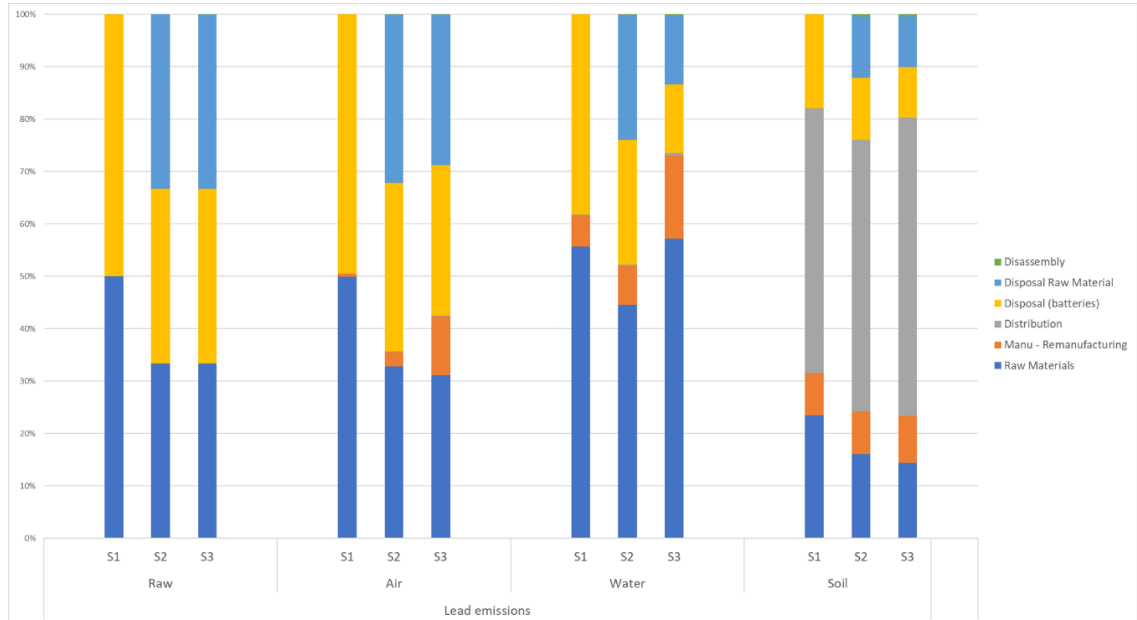

Figure 3. 26 Contribution of lead emissions for scenarios S1, S2, and S3.

3.6 Conclusion

Using LCA, the environmental impact of LABs in the stage of “cradle-to-gate” is analyzed and compared. It has been shown through the three scenarios tested that high recycling rates reduce the environmental impacts of batteries considerably in a closed-loop system. From an end-of-life perspective, this chapter shows that collection and recycling schemes drastically reduce the need for the production of additional primary lead – the dominant source of environmental impact in the life cycle of the batteries.

Even in the most favorable scenario, S3 (10% virgin lead), the largest environmental burden predominantly stemmed from raw material extraction: 35% to 70% across various impact categories, such as carcinogens, non-carcinogens, aquatic and terrestrial ecotoxicity, and aquatic eutrophication.

With the IMPACT 2002+ assessment method, compared to the virgin lead scenario (S1) and 50% virgin lead scenario (S2), manufacturing/remanufacturing has also a great impact (63%) on ionizing radiation and a significant contribution to global warming and non-renewable energy, 29%, and 36% respectively. The contribution of distribution is yet high on ozone layer depletion (41%), and respiratory inorganics (71%). A greater impact is now observed on terrestrial acidification/nutrication (52%), land occupation (64%), global warming (42%), and non-renewable energy (39%). The effect of battery disposal is reduced for carcinogens (24%), non-carcinogens (41%), respiratory inorganics (18%), aquatic and terrestrial ecotoxicity (215%), and mineral extraction (43%). Yet, the contribution of aquatic acidification remains at the same level (79 %).

In line with previous observations for scenario S2, disassembly minimally affected midpoint impacts, and raw material disposal contributed less than 5% to most indicators, except for ionizing radiation (13%) and aquatic acidification (15%).

LCA has confirmed to be a powerful tool to examine the environmental impact of a product through its entire life cycle. For lead-acid batteries, the “cradle to grave” LCA study that was performed covers the mining and extraction of raw materials, their fabrication, use, and recycling/disposal, and includes energy and transportation considerations and all the other product supplies required.

LCA will now be embedded in the supply chain optimization as the environmental model to quantify the environmental indicators. The results prove that there is a place for optimization to manage the compromise between all the echelons of the supply chain and reduce the environmental impact of the battery production/remanufacturing processes.

Chapter

4

A multi-objective framework for
closed-loop supply chain design:
application to lead-acid battery
network

Abstract :

This chapter focuses on modeling the multistep, multi-period Closed-Loop Supply Chain (CLSC) concerning lead battery production and recycling. The model adopts a mixed integer linear programming approach considering both economic factors (total supply chain cost) and environmental impacts (specifically, greenhouse gas emissions) in its optimization formulation. Following the multi-objective optimization phase utilizing epsilon-constraint and AUGMECON methods, a multi-criteria decision support system (TOPSIS and M-TOPSIS) is employed to identify the optimal solution among the Pareto front solutions.

Subsequently, the CLSC configurations from the Pareto front undergo evaluation using the Life Cycle Assessment (LCA) approach with Impact2002+ impact analysis. This comprehensive assessment encompasses environmental criteria and overall cost for each configuration. The resulting environmental and cost-related factors are subjected to a multi-criteria analysis. This combined methodology aims to equip decision-makers with enhanced insights into the supply chain, aiding in selecting an optimal solution.

Résumé :

Ce chapitre est consacré à la modélisation de la chaîne logistique CLSC multi-échelons multi-périodes pour une application liée à la production et au recyclage de batteries au plomb. Elle est établie sur une formulation de type programmation linéaire en variables mixtes. Un critère économique (coût total de la chaîne logistique) et un impact environnemental (gaz à effet de serre) sont pris en compte dans la formulation du problème d'optimisation. L'étape d'optimisation multi-objectifs (méthode combinant epsilon-contraintes et AUGMECON) est suivie par l'utilisation d'une méthode d'aide à la décision multicritère (TOPSIS et M-TOPSIS) qui consiste à trouver la meilleure solution du front de Pareto. Les configurations de CLSC du front de Pareto sont également évaluées en mettant en œuvre la démarche d'Analyse du Cycle de Vie à travers la méthode d'analyse d'impact Impact2002+. L'ensemble des critères environnementaux ainsi que le critère lié au coût global de chaque configuration sont ensuite soumis à l'analyse multicritère. Cette approche complémentaire doit permettre d'aider le décideur à choisir une solution en intégrant plus de connaissances sur la chaîne logistique.

Nomenclature

Abbreviations

CLSC	Closed-loop supply chain
LCA	Life cycle analysis
GWP	Global warming points
MCDM	Multiple criteria decision making
MILP	Mixed-integer linear programming
EoL	End of life
CRC	Centralized return center
GHG	Greenhouse gases
LAB	Lead acid battery
GAMS	General algebraic modeling system
AUGMECON	Augmented ϵ -constraint method for solving multi-objective linear programming problems
RHS	Parametrical variation in the right-hand-side
TOPSIS	Technique for order of preference by similarity to ideal solution

Indices

i:	raw materials /i1/
s:	suppliers of raw materials / s1, s2/
j:	manufacturing plant /j1/ remanufacturing plant /j2/
d:	distributors of finished products /d1, d2/
w:	wholesalers of finished products / w1, w2/
r:	retailers of finished products /r1, r2/
x:	collecting points of returned products/ x1 * x5/
y:	disposal battery site /y1/ disposal raw material site /y2/
z:	disassembly plant /z1/
p:	products /p1, p2/
t:	periods /1*5/

Parameters

Retailer

$Demand_{rpt}$	Demand at the retailer 'r' of product 'p' at the time period 't' (unites).
WRC_{wrpt}	Transportation cost per unit from wholesaler 'w' to retailer 'r' for product 'p' at the period 't' (€ euros).
SCR_{rt}	The storage capacity of the retailer 'r' at the period 't' (unites).

Wholesaler	
DWC_{dwpt}	Transportation cost per unit from distributor 'k' to wholesaler 'l' for product 'p' at the period 't' (€ euros).
SCW_{wt}	The storage capacity of the wholesaler 'w' at time period 't' (unites).
IW_{wpt}	Final inventory of product 'p' at the wholesaler 'w' during the time period 't'(unites).
IWC_{wpt}	Inventory carrying cost per unit per period of product 'p' at the wholesaler 'w' during the time period 't' (€ euros).
Distributor	
$MpDC_{jdpt}$	Transportation cost per unit from manufacturing plant 'j' to distributor 'k' for product 'p' at time period 't' (€ euros).
SCD_{dt}	The storage capacity of the distributor 'd' (unites).
ID_{dpt}	Final inventory of product 'p' at the distributor 'd' during the time period 't' (unites).
IDC_{dpt}	Inventory carrying cost per unit per period of product 'p' at the distributor 'd' during the time period 't' (€ euros).
Manufacturing/Remanufacturing Plant	
PC_{jpt}	Processing cost per product of 'p' at the manufacturing plant 'j' at time period 't' (€ euros).
$SCMp_{jt}$	Finished goods storage capacity at the manufacturing plant 'j' at time period 't' (unites).
IMp_{jpt}	Finished goods inventory of product 'p' at the manufacturing plant 'j' during the time period 't' (unites).
$IMpC_{jpt}$	Inventory carrying cost per unit per period for finished goods of product 'p' at the manufacturing plant 'j' during the time period 't' (€ euros).
$IRmMp_{ijt}$	Raw material inventory 'i' at the manufacturing plant 'j' during the time period 't' (unites).
$IRmMpC_{ijt}$	Inventory carrying cost per unit per period of raw material 'i' at the manufacturing plant 'j' during the time period 't' (€ euros).
$RdMat_{ipt}$	Quantity of raw material 'i' necessary for the elaboration of product 'p' during the time period 't' (unites).
Suppliers	
UMC_{isjt}	Purchasing cost of one unit of raw material 'i' from supplier 's' during time period 't' (€ euros).
SCS_{ist}	The supply capacity of supplier 's' at time period 't' (unites).

Recollection

RRC_{xpt}	Recollecting rate of returned items of product 'p' collected at the initial collection points 'x' during the time period 't' (rate).
$RCCapa_{xpt}$	Recollected products 'p' storage capacity at the recollection center 'x' at time period 't' (unites).
RCC_{xpt}	Collection cost per item of returned products of 'p' at the initial collection point 'x' during the time period 't' (€ euros).
$RCTC_{xpt}$	Transportation cost per unit from the initial collection point 'x' to the centralized return center of product 'p' at time period 't' (€ euros).
$IRPC_{pt}$	Returned product inventory of product 'p' at the centralized return center during the time period 't'(unites).
$IRPCC_{pt}$	Inventory carrying cost per unit per period for returned products of product 'p' during the time period 't' (€ euros).

Disposal

$DispR_{pt}$	Disposal rate of product 'p' at the time period 't' (rate).
$SCDisp_{ypt}$	The capacity of the disposal site 'y' for product 'p' at time period 't' (unites).
$DispC_{ypt}$	Disposal cost per unit of the useless returned product of 'p' to the disposal site 'y' at the time period 't' (€ euros).

Centralized return center

IRP_{pt}	Returned product inventory of product 'p' at the centralized return center during the time period 't' (unites).
------------	---

Disassembly

$DissC_{ipt}$	Disassembly-reclaiming cost per unit for the returned product of 'p' at the disassembly-recycling plant 'z' during the period 't' (€ euros).
$DissTC_{zpt}$	Transportation cost per unit of product 'p' from the centralized return center to the disassembly-recycling plant 'z' at period 't' (€ euros).
$PContRm_{it}$	Percentage of contribution of raw material 'i' for the returned product 'p' (rate).
$RecCRm_{izt}$	Recycling cost of one unit of raw material 'i' sold to the third party from the disassembly plant 'z' during period 't' (€ euros).
$RecRReRm_{izt}$	Recycling rate of the required raw material 'i' to be reclaimed for new battery production at the disassembly-recycling plant 'z' during the period 't' (rate).
$TRRmCost_{izjt}$	Transportation cost per unit of the required reclaimed raw material 'i' transported from the disassembly-recycling plant 'z' to the manufacturing plant 'j' during the period 't' (€ euros).

CO₂ Emissions

$GWP_{BatP_{jpt}}$	Amount of CO ₂ generated in the production phase of product 'p' at manufacturing plant 'j' during period 't' (kgCO ₂ eq/battery).
$GWPColl_{xpt}$	Amount of CO ₂ generated in the recollection phase of products 'p' at the initial collection point 'x' during the period 't' (kgCO ₂ eq/battery).
$GWPDiss_{zpt}$	Amount of CO ₂ generated in the disassembly phase of returned products of 'p' transported from the centralized return center to the disassembly-recycling plant 'z' at period 't' (kgCO ₂ eq/battery).
$GWPDisp_{ypt}$	Amount of CO ₂ generated in the disposal phase
$GWPRema_{pt}$	Amount of CO ₂ generated for the remanufactured products 'p' at the period 't' (kgCO ₂ eq/battery).
$GWPD_{pt}$	Amount of CO ₂ generated in the distribution of a product 'p' at the period 't' (kgCO ₂ eq/battery).
$GWPdMpD_{jdpt}$	Amount of CO ₂ generated in the distribution from manufacturing plant to distributor of product 'p' at the period 't' phase (kgCO ₂ eq/battery).
$GWPdDW_{dwpt}$	Amount of CO ₂ generated in the distribution from distributor to wholesaler of product 'p' at the period 't' phase (kgCO ₂ eq/battery).
$GWPdWR_{wrpt}$	Amount of CO ₂ generated in the distribution from wholesaler to retailer of product 'p' at the period 't' phase (kgCO ₂ eq/battery).
$GWPSupp_{isjt}$	Amount of CO ₂ generated by the suppliers by the extraction of the raw materials (kgCO ₂ eq/battery).

Variables

TC	Total cost of CLSC (€ euros).
GWP	Total amount of CO ₂ generated (kgCO ₂ eq/battery).
$CPur$	Total purchasing costs of virgin raw material (€ euros).
$CProd$	Total processing costs involved in all manufacturing plants (€ euros).
$CtMpD$	Total transportation costs from each manufacturing plant to all distributors (€ euros).
$CtDW$	Total transportation costs from each distributor to all wholesalers (€ euros).
$CtWR$	Total transportation costs from each wholesaler to all retailers (€ euros).

<i>CiRawM</i>	Total inventory carrying costs of handling the raw material inventory at the manufacturing plant (€ euros).
<i>CiMp</i>	Total inventory carrying costs of holding the finished goods inventory at the manufacturing plant (€ euros).
<i>CiD</i>	Total inventory carrying costs of handling the inventory at the distributor (€ euros).
<i>CiW</i>	Total inventory carrying costs of handling the inventory at the wholesaler (€ euros).
<i>CColl</i>	Total collection costs of returned products at the initial collection points (€ euros).
<i>CtCollP</i>	Total transportation costs from all the initial collection points to the centralized return center (€ euros).
<i>CDisp</i>	Total of disposal costs (€ euros).
<i>CtDiss</i>	Total transportation costs from the centralized return center to the disassembly/recycling plant (€ euros).
<i>CiCRC</i>	Total inventory carrying costs of handling the returned products inventory at the centralized return center (€ euros).
<i>CDiss</i>	Total disassembly/reclaiming costs involved in all the disassembly/recycling plant (€ euros).
<i>C3Party</i>	Total recycling cost from the disassembly/recycling plant sold to the third party for other applications (€ euros).
<i>CtDissMp</i>	Total transportation costs from the disassembly/recycling plant to the manufacturing plant (€ euros).
<i>CO2Supp</i>	Total of CO ₂ generated by the suppliers in all the supply chain (kgCO ₂ eq/battery).
<i>EmiProd</i>	Total of CO ₂ generated in the production phase in all the supply chain (kgCO ₂ eq/battery).
<i>EmiD</i>	Total of CO ₂ generated in the distribution of a product in all the supply chain (kgCO ₂ eq/battery).
<i>EmiMpD</i>	Total of CO ₂ generated in the distribution from manufacturing plant to distributor of product in all the supply chain (kgCO ₂ eq/battery).
<i>EmiDW</i>	Total of CO ₂ generated in the distribution from distributor to wholesaler of product in all the supply chain (kgCO ₂ eq/battery).

$EmiWR$	Total of CO ₂ generated in the distribution from wholesaler to retailer of product in all the supply chain (kgCO ₂ eq/battery).
$EmiReco$	Total of CO ₂ generated in the recollection phase of products in all the supply chain (kgCO ₂ eq/battery).
$EmiDiss$	Total of CO ₂ generated in the disassembly phase of returned products of 'p' in all the supply chain (kgCO ₂ eq/battery).
Decision Variables	
$AMat_{isjt}$	Amount of raw material 'i' purchased from supplier 's' to the manufacturing plant 'j' during period 't' (kg).
$ARecyRm_{izt}$	Amount of recycled raw material 'i' from the disassembly-recycling plant 'z' sold to the third party during the period 't' (kg).
$ARec3p_{izt}$	Amount of raw material 'i' recovered from the disassembly-recycling plant 'z' during period 't' that is not used in the remanufacturing process and is sold to the third-party customers (kg).
$AREcla_{izjt}$	Amount of required reclaimed raw material 'i' for new battery production transported from the disassembly-recycling plant 'z' to the manufacturing plant 'j' during the period 't'(kg).
$QProc_{jpt}$	Quantity processed of product 'p' at manufacturing plant 'j' during period 't' (units).
$QtJD_{jdpt}$	Quantity transported from manufacturing plant 'j' to distributor 'd' of product 'p' at period 't'(units).
$QtDW_{dwpt}$	Quantity transported from distributor 'd' to wholesaler 'w' of product 'p' at period 't'(units).
$QtWR_{wrpt}$	Quantity transported from wholesaler 'w' to retailer 'r' of product 'p' at period 't' (units).
$QBad_{ypt}$	Quantity of useless returned products of 'p' transported from the centralized return center to the disposal site 'y' at the period 't' (units).
$QRecy_{zpt}$	Quantity of useful (recyclable) returned products of 'p' transported from the centralized return center to the disassembly-recycling plant 'z' at period 't' (units).
$QRetu_{ipt}$	Quantity of returned products of 'p' processed (recycling) at the disassembly-recycling plant 'z' at the period 't' (units).

$ARec3P_{izp}$	Amount of recycled raw material 'i' from the disassembly-recycling plant 'z' sold to the third party during the period 't' (units).
$ARecla_{izjt}$	Amount of required reclaimed raw material 'i' for new battery production transported from the disassembly-recycling plant 'z' to the manufacturing plant 'j' during the period 't'(units).

4.1 Introduction

Economic growth, population expansion, and urban development are contributing significantly to the generation of substantial waste in cities. In many countries, inadequate waste management facilities, weak policies, and insufficient technologies result in unregulated disposal practices (Periathamby et al, 2009)(Chen and Taylor, 2011). Recognizing the importance of recycling in waste reduction and its economic benefits, supply chain modeling has evolved to incorporate both forward and reverse supply chains concurrently, known as the closed-loop supply chain (CLSC).

This chapter aims to develop a comprehensive framework for optimizing the design of a CLSC tailored to process industries, focusing on waste management strategies and recycling options. The approach takes into account the multi-echelon, multi-objective, and multi-period nature of the problem, considering various stakeholders. The analysis will be supported by a case study focusing on lead-acid batteries, which are particularly relevant due to their highest end-of-life recycling rate among commonly used metals (Davidson et al, 2016). The increasing demand for lead resulting from the widespread use of lead-acid batteries has highlighted the significance of used batteries as a crucial source of recycled lead. Additionally, the profitability of recycling operations has been underscored, primarily attributed to the high quality of recycled lead (Gaines, 2014).

CLSC is the union of forward and reverse logistics, which focuses on taking back products from customers and recovering added value by reusing the entire product, and/or some of its modules, components, and parts. This kind of supply chain management has been identified as “the design, control, and operation of a system composed of different echelons to maximize value creation over the entire life cycle of a product with the dynamic recovery of value from different types and volumes of returns over time”(Wassenhove 2002).

The CLSC supply chain has been receiving increased attention for several years. A review of some models for reverse logistics has been carried out, for example in (Govindan et al, 2015) where the lack of multi-objective approaches has been clearly emphasized despite the interest of simultaneously considering economic and environmental objectives.

Within the existing literature, two main streams of research are notable concerning lead-acid battery recycling. One stream focuses on CLSC design models primarily aimed at minimizing a single economic criterion, namely the total supply chain cost (Kannan et al, 2010). Conversely, another line of research delves into environmental concerns, leveraging the Life Cycle Assessment (LCA) methodology (Wang et al, 2010) (O'Donnell, 2007). The preceding chapter emphasized the maturity of LCA as a comprehensive analytical tool, offering a systemic assessment of potential impacts throughout a product or service's life cycle. The findings indicated an opportunity for optimization to harmonize environmental indicators in the battery production process. To achieve this, LCA concepts will be integrated into supply chain optimization, serving as the environmental framework to quantify these indicators.

The objective of the proposed work is thus to embed in one generic formulation a multi-echelon multi-objective formulation of CLSC design which focuses on the simultaneous optimization of economic and environmental criteria. The multi-objective optimization step is then followed by a multiple criteria decision making (MCDM) procedure that consists in finding the best alternative from a pool of feasible options.

Subsequently, the development of a decision-support system to automate the framework's components is delineated in the subsequent sections.

This chapter is divided into nine sections. Section 4.2 presents the methodological framework with the studied system and main assumptions. Section 4.3 is devoted to the model formulation, Sections 4.4 and 4.5 are related to the cost objective in the supply chain. Section 4.6 and 4.7 explain the environmental aspect in the supply chain. The solution strategy is the core of Section 4.8. Finally, Section 4.9 presents the conclusions of this methodological chapter.

4.2 Methodology

The system under scrutiny, aimed at optimizing the design of a Closed-Loop Supply Chain (CLSC) for process industries, encompasses recycling waste management strategies involving multiple stakeholders, as illustrated in Figure 4. 1.

1. The *forward supply chain* involves the main raw materials such as lead, plastic, and sulfuric acid from different suppliers. The batteries are then produced in the manufacturing plants and distributed through distributors, wholesalers, retailers and, then customers.
2. After their End of Life (EoL), the used batteries (*reverse logistics*) are collected at the collection points and transshipped to the centralized return centers, where returned products are inspected for quality failure and sorted for potential repair or recycling. The useless batteries are disposed off and reusable batteries are transported to disassembly/recycling plants where the batteries are separated into different components (lead, plastic, acid etc.). Except lead, the remaining components are sold to third party for some other applications. The recycled lead is transported to the battery (re)manufacturing plants for new battery production (see Figure 4. 1).

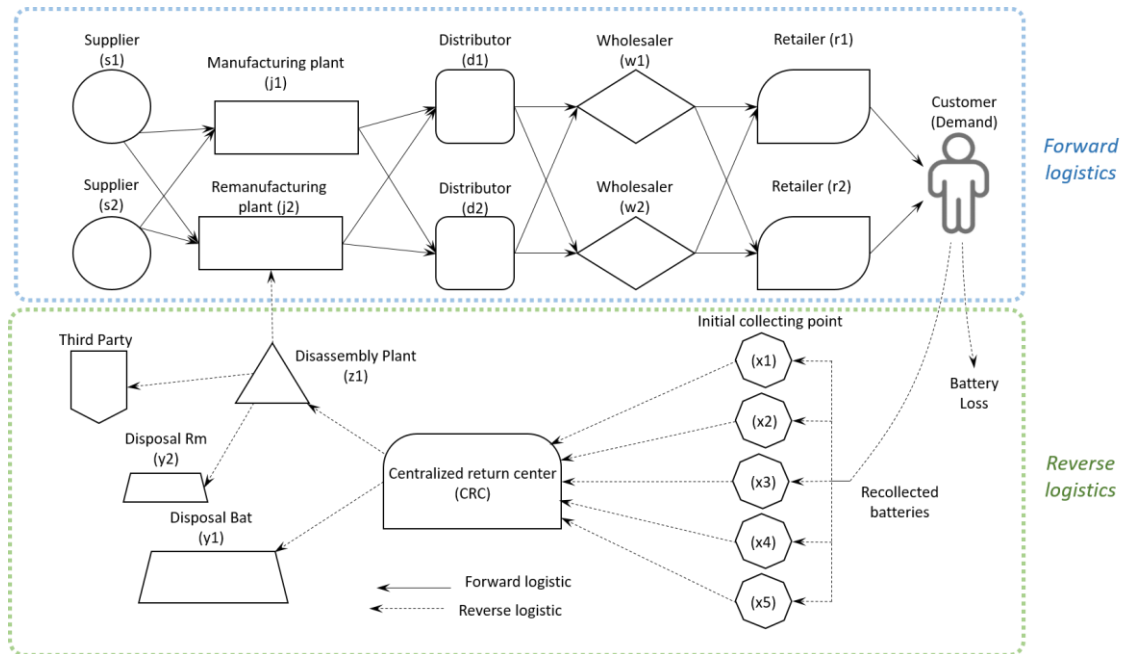

Figure 4. 1 CLSC scheme used in this work (Disposal Bat: Disposal of batteries; Disposal Rm: Disposal of Raw materials).

4.2.1 Problem formulation

The problem addressed here is to design a multi-echelon, multi-period, and multi-objective closed-loop supply chain model to minimize the total supply chain cost comprising procurement, production, distribution, inventory, collection, disposal, disassembly, and recycling cost as well the total carbon dioxide emissions of the whole supply chain. The previous chapter has shown that the CLSC problem is at the intersection of LCA and supply chain management. The idea is clearly to show both communities can enrich each other by closer interaction.

The model is illustrated by the lead-acid battery case study and data collection has been performed by using the annual report of ADEME (Agence de l'Environnement et de la Maîtrise de l'Energie) of 2016 (ADEME, 2016)

The framework considers as inputs:

- i: type of raw materials.
- s: number of suppliers.
- j: number of manufacturing plants / remanufacturing plants.
- d: number of distributors.
- w: number of wholesalers.
- r: number of retailers.
- x: number of initial collection points.
- y: number of disposal battery sites/disposal of raw material sites.
- z: number of disassembly plants.
- p: number of products.
- t: number of periods.

The goal is to identify the optimal system setup that minimizes both the overall cost of the closed-loop supply chain (CLSC) and its environmental impact, particularly focusing on global warming potential (GWP). As highlighted in Chapter 2, life cycle assessment (LCA) encompasses a multi-criteria approach, evaluating various indicators like GWP, acidification, eutrophication, land-use, among others. However, our current multi-objective optimization framework concentrates solely on GWP. The LCA's system-oriented approach to environmental assessment will be expanded to include other criteria within the Multiple criteria decision making (MCDM) stages of the methodology.

The methodological framework of the study is proposed in Figure 4. 2. The *input* block corresponds to all the databases, assumptions, and scenarios. The integration of the mathematical model and the multi-objective optimization approach constitutes the core of the approach. The snapshots and the results concerning the decision variables and objective functions are the main *outputs*.

The model proposed by (Kannan et al. 2010) and its erratum (Ramkumar et al. 2011) serves as a basis for constraint definition.

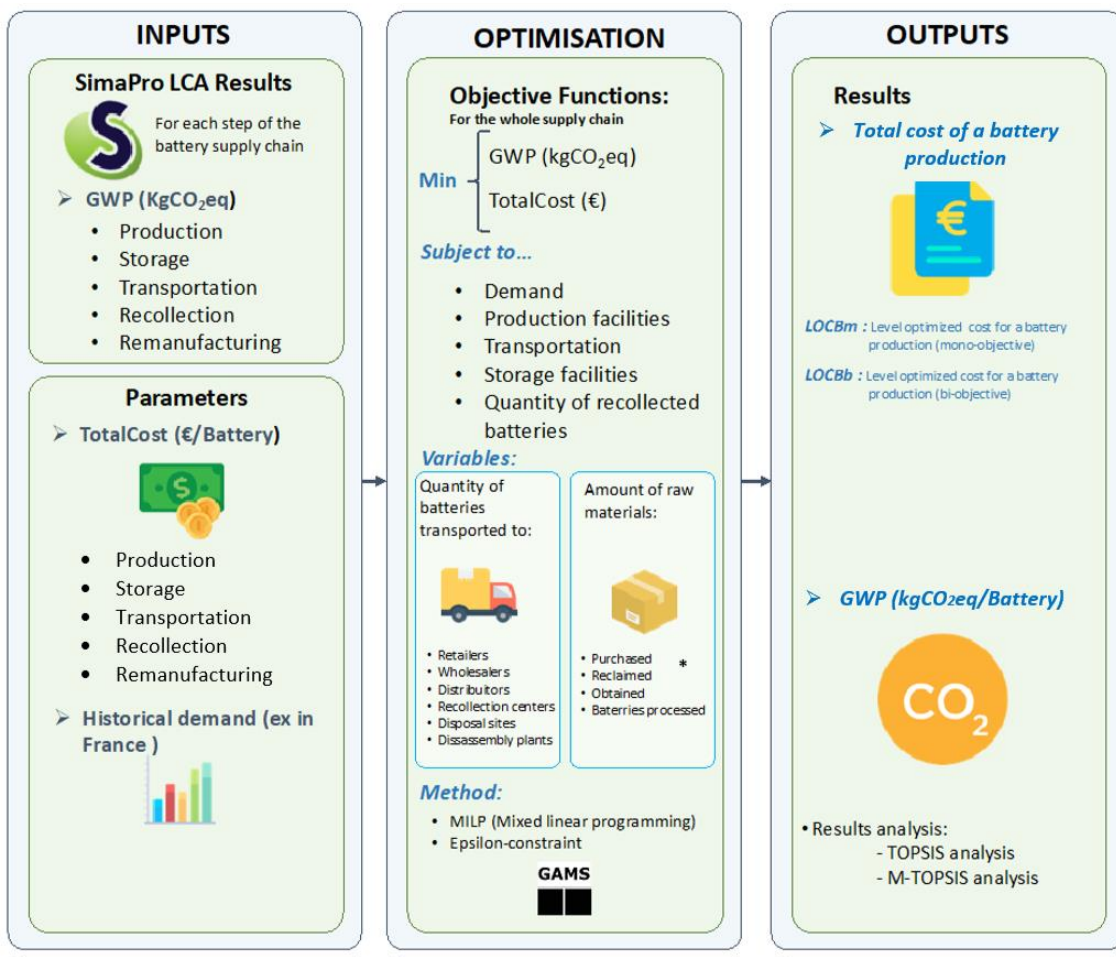

Figure 4. 2 Section and data of the proposed model.

4.2.2 Data collection

The data set includes information related to battery demand, technical, environmental, and economic parameters associated with each component of the CLSC. Some values have been collected from dedicated literature, including scientific papers and reports (ADEME). The environmental data has been obtained mainly from the EcoInvent database. They have been presented in detail in the previous chapter.

The demand for batteries is assumed to be fixed, based on the historical analysis of the battery market proposed in the ADEME report, as presented in Figure 4. 3

The problem is defined as a multi-period and the whole horizon is split into five 12-month periods (from 2012 to 2016).

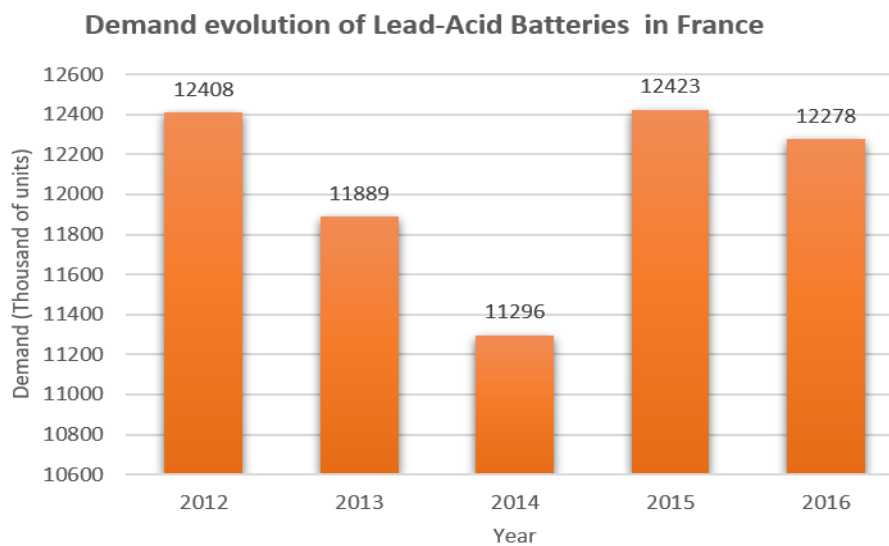

Figure 4. 3 Evolution of lead-acid batteries demand (ADEME 2016).

4.2.3 Assumptions

The various assumptions involved in this chapter are described below.

- Some phases of the CLSC could have an inventory of products.
- Stored products and stored raw materials have the priority to be used to satisfy the demand.
- The inventory carrying cost per product per period at each plant, each distributor, and each wholesaler remains the same throughout the period of study.
- The utilization of reclaimed raw material reduces the quantity of new raw material demand.
- The transportation cost per product between phases changes according to the period.
- A percentage of the total production of the period is recollected for the reverse supply chain.

- A percentage of the recollected batteries is considered unusable for recycling and is thus directly disposed of.
- A single centralized return center (CRC) with unlimited capacity is taken into account.
- The disposal of raw materials pertains to the quantity lost during the disassembly phase.
- A portion of the recycled raw materials isn't utilized in the remanufacturing process; instead, it is sold to a third party for other applications.
- The recycled materials are presumed to meet the necessary quality standards for the recycled batteries.

4.2.4 Decision variables

The decision variables involved in the model formulation are based on the number of final products, capacity, production, storage of facilities as well the flow rate of units between the different units of the CLSC. A detailed description of each variable (either continuous or integer) is proposed hereafter (Figure 4. 21). The model is thus captured in a mixed-integer linear programming (MILP) framework.

Decision Variables:

Continuous variables

$AMat_{isjt}$ Amount of raw material 'i' purchased from supplier 's' to the manufacturing plant 'j' during period 't' (kg).

$ARec3p_{izt}$ Amount of raw material 'i' recovered from the disassembly-recycling plant 'z' during period 't' that is not used in the remanufacturing process and is sold to the third-party customers (kg).

$ARecla_{izjt}$ Amount of required reclaimed raw material 'i' for new battery production transported from the disassembly-recycling plant 'z' to the manufacturing plant 'j' during the period 't' (kg).

- Integer variables:

$QProc_{jpt}$ Quantity processed of product 'p' at manufacturing plant 'j' during period 't' (units).

$QtJD_{jdpt}$ Quantity transported from manufacturing plant 'j' to distributor 'd' of product 'p' at period 't'(units).

$QtDW_{dwpt}$ Quantity transported from distributor 'd' to wholesaler 'w' of product 'p' at period 't'(units).

$QtWR_{wrpt}$ Quantity transported from wholesaler 'w' to retailer 'r' of product 'p' at period 't' (units).

$QBad_{ypt}$	Quantity of useless returned products ‘p’ transported from the centralized return center to the disposal site ‘y’ at period ‘t’ (units).
$QRecy_{zpt}$	Quantity of useful (recyclable) returned products ‘p’ transported from the centralized return center to the disassembly-recycling plant ‘z’ at period ‘t’ (units).
$QRetu_{ptz}$	Quantity of returned products ‘p’ processed (recycling) at the disassembly-recycling plant ‘z’ at period ‘t’ (units).

4.3 Mathematical model

¡Error! No se encuentra el origen de la referencia. A color code is utilized in the model presentation to simplify the identification of the data types or variables used. This color system is outlined in Table 4. 1. The battery demand-oriented model is segmented into two interrelated sections—specifically, the forward and reverse logistics.

<i>Color</i>	<i>Type of data or variable</i>	<i>Description</i>
■ Red	Decision variable	These variables will fluctuate based on the considered period and will affect the objective function."
■ Green	Auxiliary operation	This denotes operations utilized to streamline certain calculations.
■ Brown	Condition	These represent constraints within certain operations based on process information.
■ Blue	Cost data	This contains economic-related information pertaining to the process.
■ Yellow	Infrastructure information	This section pertains to the characteristics of the companies involved in battery manufacturing and recycling.
■ Orange	GWP Data	This encompasses environmental information associated with the process.
■ Purple	Data related to process and product demand	Data associated with product recipes, inventory levels, recycling rates, and product demand.

Table 4. 1 Color code used in the formulation of the mathematical model

Section: Forward logistics

4.3.1 Retailer constraints

The *Demand* of the product (p) in period (t), has first to be satisfied by the retailers (r). The retailers (r) have to order the amount of product (p) in the period (t), from their wholesalers (w) to cover the *Demand*. The value $QtWR$ is the Quantity sent from the wholesalers (w) to retailers(r) of the product (p) in the period (t) (Eq. 4. 1). Constraint (Eq. 4. 2) guarantees that the sum of $QtWR$ must not be greater than the capacity SCR of retailer (r) in period (t).

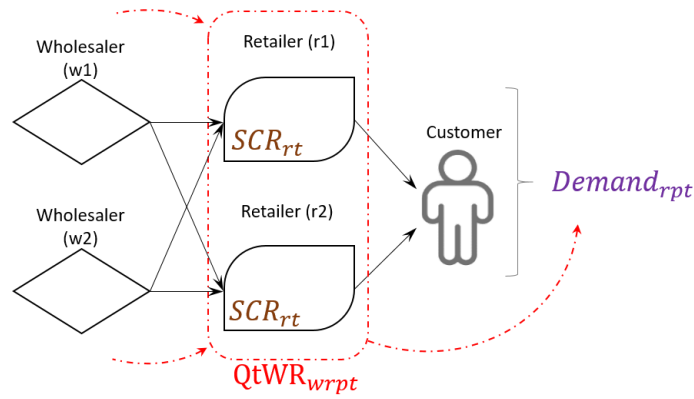

$$\sum_{w \in W} \sum_{r \in R} QtWR_{wrpt} = \sum_{r \in R} Demand_{rpt}$$

$$\forall t \in T, p \in P$$

(Eq. 4. 3)

$$\sum_{w \in W} \sum_{p \in P} QtWR_{wrpt} \leq SCR_{rt}$$

$$\forall t \in T, r \in R$$

(Eq. 4. 4)

4.3.2 Wholesaler constraints

Once the value $QtWR$ is known, the quantity of product (p) in period (t) that the wholesalers (w), are going to order from the distributors (d), i.e. $QtDW$ will be calculated. This calculation considers an inventory IW of the product (p) in the period (t) in the warehouse of the wholesalers (w). For this purpose, the sum of inventory values (IW) and the quantity to be ordered from the distributor ($QtDW$), must be equal to the quantity that must be given to the retailer ($QtWR$) (Eq. 4. 3) Constraint (Eq. 4. 4), demonstrates that the sum of the quantity of product required $QtDW$ plus the inventory IW does not exceed the the capacity SCW of wholesaler(w) in period (t).

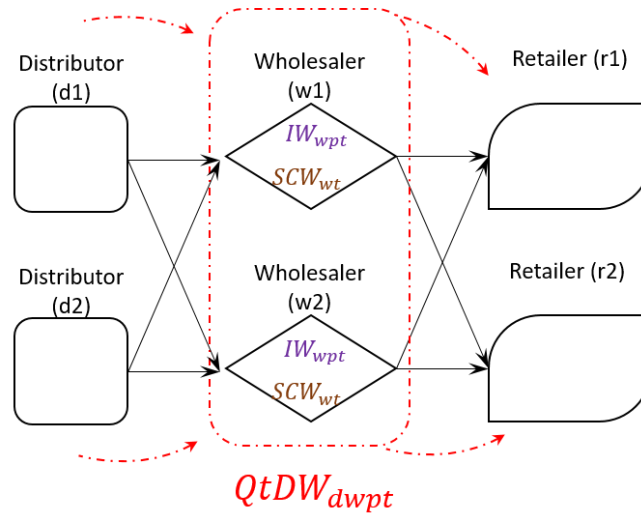

$$\sum_{d \in D} \sum_{w \in W} QtDW_{dwpt} + \sum_{w \in W} IW_{wpt} = \sum_{w \in W} \sum_{r \in R} QtWR_{wrpt}$$

$$\forall t \in T, p \in P$$

(Eq. 4. 5)

$$\sum_{d \in D} \sum_{p \in P} QtDW_{dwpt} + \sum_{p \in P} IW_{wpt} \leq SCW_{wt}$$

$$\forall t \in T, w \in W$$

(Eq. 4. 6)

4.3.3 Distributor constraints

The quantity of product (p) in period (t) ordered from the distributors (d) by the wholesalers (w), i.e., $QtDW$ has to be satisfied by the quantity of product (p) in period(t) ordered from the manufacturing plant (j) by the distributors (d) $QtJD$; an inventory ID of the product (p) in period (t) may exist in the distributor centers (d). For this purpose, the sum of inventory values (ID) and the quantity to be ordered from the manufacturing plant (j) must be equal to the quantity that must be sent to the distributor ($QtDW$) (Eq. 4. 5). Constraint (Eq. 4. 6). states that the sum of the quantity of product required $QtJD$ and the inventory ID is not greater than the capacity SCD of the distributor (d) in period (t).

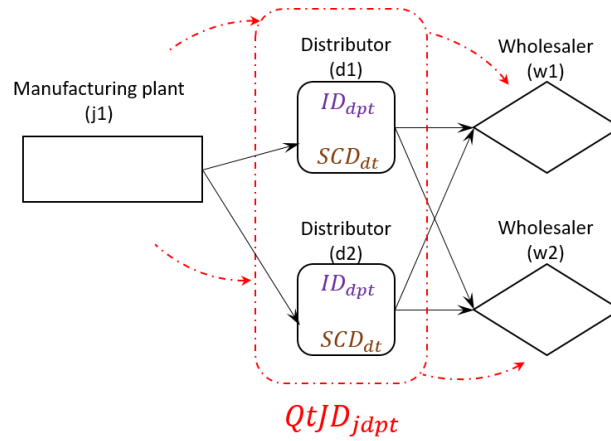

$$\sum_{j \in J} \sum_{d \in D} QtJD_{jdpt} + \sum_{d \in D} ID_{dpt} = \sum_{d \in D} \sum_{w \in W} QtDW_{dwpt}$$

$$\forall t \in T, p \in P \quad (\text{Eq. 4. 7})$$

$$\sum_{j \in J} \sum_{p \in P} QtJD_{jdpt} + \sum_{p \in P} ID_{dpt} \leq SCD_{at}$$

$$\forall t \in T, d \in D \quad (\text{Eq. 4. 8})$$

For sections 4.3.4 and 4.3.5, the following explanation is only valid for the first period of the model because the recycling process is not yet considered in the manufacturing process.

4.3.4 Manufacturing plant constraints

A manufacturing plant (j) must produce the required quantity of product (p) in period (t), i.e. $QProc$. At this step, an inventory of products IMp of the product (p) in period (t) may exist in the manufacturing plant (j) to satisfy the order of the products coming from the distributors (d), i.e. $QtJD$ in addition to the amount $QProc$ (Eq. 4. 9). Similarly to the already mentioned steps, the quantity of product that is manufactured $QProc$ plus the inventory IMp must not exceed the capacity $SCMp$ of the manufacturing plant (j) in period (t). (Eq. 4. 8).

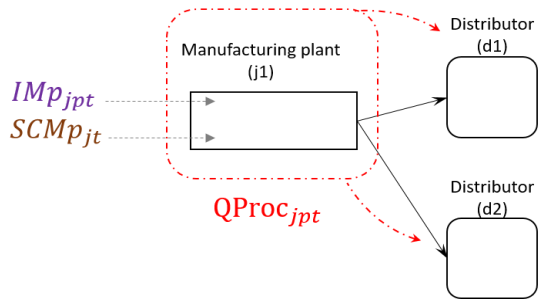

$$QProc_{jpt} + IMP_{jpt} = \sum_{d \in D} QtJD_{jdpt}$$

$$\forall t \in \mathbf{1}, p \in P, j \in J \quad (\text{Eq. 4. 10})$$

$$\sum_p QProc_{jpt} + \sum_p IMP_{jpt} \leq SCM_{pjt}$$

$$\forall t \in T, j \in J \quad (\text{Eq. 4. 11})$$

4.3.5 Supplier constraints

The number of processed products (batteries in this case) $QProc$ requires a given amount of raw material ($RdMat$). This value depends on the product composition in the process involved (i.e. the amount of raw material (i) required for the production of a product (p) in period (t) and thus defining the recipe of the product (p)).

An auxiliary variable, i.e. $DemandRawMat$ represents the amount of raw material (i) used in manufacturing plant (j) in period (t) (see(Eq. 4. 12)).

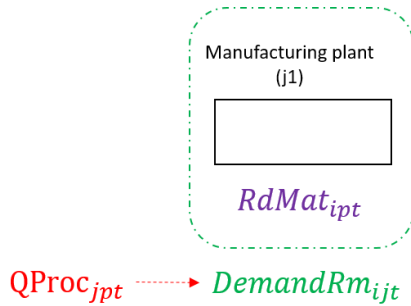

$$\sum_{p \in P} (QProc_{jpt} \times RdMat_{ipt}) = DemandRm_{ijt}$$

$$\forall t \in T, j \in J, i \in I \quad (\text{Eq. 4. 12})$$

A decision variable $AMat$ (and an auxiliary variable, $AMat2$) represent the amount of raw material (i) that is ordered from the supplier (s) to be used in manufacturing plant (j) in period (t) (Eq. 4. 13) and (Eq. 4. 14).

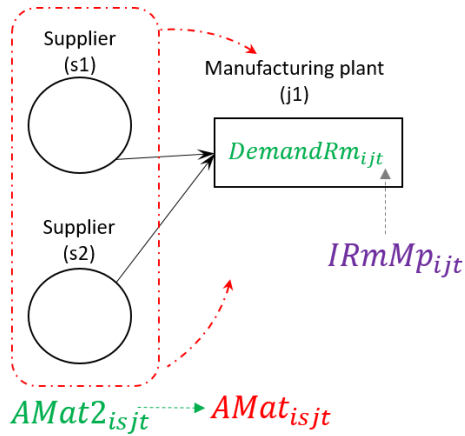

$$\sum_{s \in S} AMat2_{isjt} + IRmMp_{ijt} = DemandRm_{ijt}$$

$$\forall t \in 1, j \in J, i \in I \quad (Eq. 4. 13)$$

$$\sum_{j \in J} \sum_{s \in S} AMat2_{isjt} = \sum_{j \in J} \sum_{s \in S} AMat_{isjt}$$

$$\forall t \in 1, j \in I \quad (Eq. 4. 14)$$

Section: Reverse logistics

4.3.6 Recollection constraints

Reverse logistics begins with the collection of products at their end of life and their reintegration into the manufacturing process. In the case of recollection, the *Demand* provided by the customer is taken into account to generate the quantity of recollected batteries (*QtyReco*). This value multiplied by the rate of recollection (*RRC*) provides us the quantity of recollected products (*p*), in period (*t*) (Eq. 4. 15). The quantity of lost batteries (*QtyLost*) can then be easily deduced from it (Eq. 4. 16).

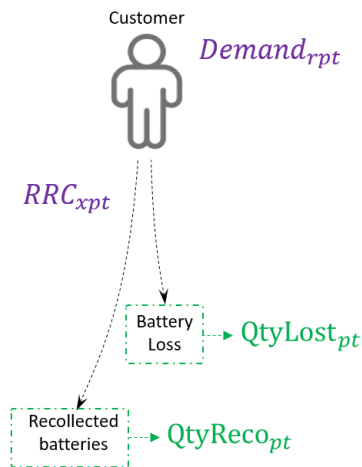

$$\sum_{r \in R} Demand_{rpt} \times RRC_{xpt} = QtyReco_{pt}$$

$$\forall t \in T, p \in P, x \in X \quad (Eq. 4. 15)$$

$$\sum_{r \in R} Demand_{rpt} \times (1 - RRC_{xpt}) = QtyLost_{pt}$$

$$\forall t \in T, p \in P, x \in X \quad (Eq. 4. 16)$$

The quantity of recollected batteries *QtyReco* is then distributed among the collection points (*ACenter*) of the product (*p*) in period (*t*) (Eq. 4. 17). Constraint (Eq. 4. 18) specifies that the quantity of the recollected product in each center must not exceed *RCCapa*, which is the capacity of each initial recollecting point (*x*) in period (*t*).

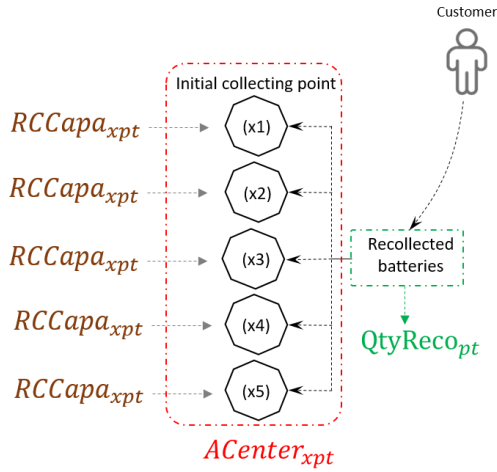

$$\sum_{x \in X} ACenter_{xpt} = QtyReco_{pt}$$

$$\forall t \in T, p \in P \quad (Eq. 4. 17)$$

$$ACenter_{xpt} \leq RCCapa_{xpt}$$

$$\forall t \in T, p \in P, x \in X \quad (Eq. 4. 18)$$

4.3.7 Disposal battery constraints

The products are then transported from the recollection centers $ACenter$ to the Centralized return center (CRC) which separates the different parts of the batteries. An elimination rate ($DispR$) is introduced so that the amount $QBad$ of non-compliant products (p) in period (t) can be calculated for disposal site (y) for the product (p) in period (t) (Eq. 4. 19).

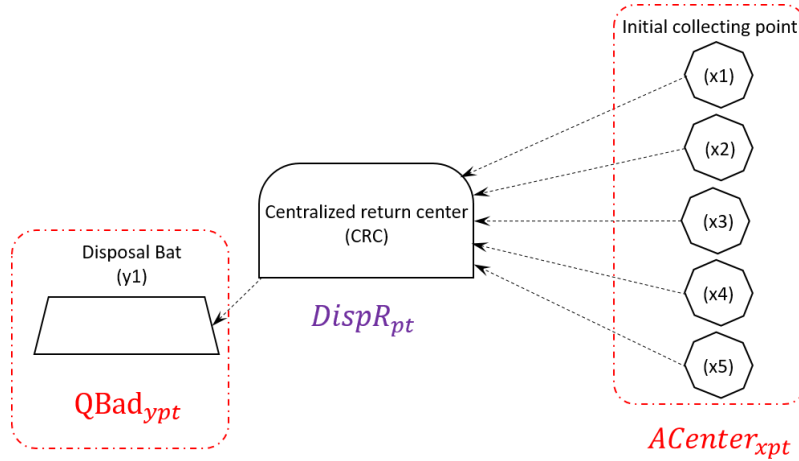

$$\sum_{x \in X} ACenter_{xpt} \times DispR_{pt} = \sum_{y \in Y} QBad_{ypt}$$

$$\forall t \in T, p \in P \quad (Eq. 4. 19)$$

4.3.8 Disassembly constraints

The quantity of returned products ready to be recycled ($QRetu$) for the product (p) in disassembly plant (z) in period(t) (Eq. 4. 20) can thus be calculated considering the inventory in the centralized return center (IRP) of product (p) in period (t).

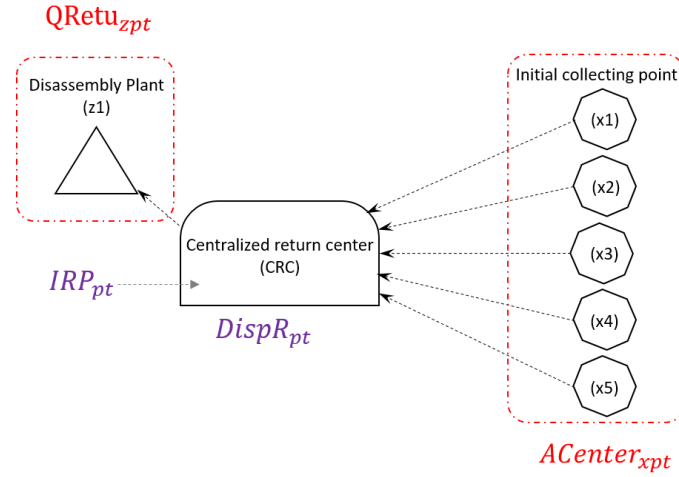

$$\left(\sum_{x \in X} ACenter_{xpt} \times (1 - DispR_{pt}) \right) + IRP_{pt} = \sum_{z \in Z} QRetu_{zpt}$$

$\forall t \in T, p \in P$ (Eq. 4. 20)

The amount ($QRecy$) of raw material (i) for the product (p), in period (t) is then calculated considering the composition of raw materials ($RdMat$) (i) of the product (p) in period (t) and a recycling rate ($RecRat$), which indicates the percentage of raw material(i) that can be recovered from disassembly plant (z) in period (t) (Eq. 4. 21).

Similarly, the amount ($QBadRm$) of raw material(i) for the product (p), in period (t) that is discarded can be calculated (Eq. 4. 22).

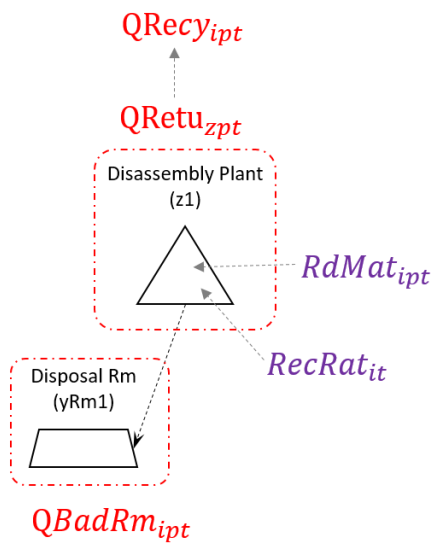

$$\sum_{z \in Z} QRetu_{zpt} \times RdMat_{ipt} \times RecRat_{izt} = QRecy_{ipt}$$

$$\forall t \in T, p \in P, i \in I \quad (\text{Eq. 4. 21})$$

$$\sum_{z \in Z} QRetu_{zpt} \times RdMat_{ipt} \times (1 - RecRat_{izt}) = QBadRm_{ipt}$$

$$\forall t \in T, p \in P, i \in I \quad (\text{Eq. 4. 22})$$

The amount of the recovered raw materials is then used in the remanufacturing plant ($j2$).

The amount ($AREcla$) corresponds to the number of raw materials(i), coming from the disassembly plant (z), that is reclaimed for being used in the remanufacturing plant ($j2$) in period(t). It is calculated by multiplying the quantity of recycled raw material ($QRecy$) by a contribution percentage ($PorCont$), which represents the ratio of raw materials (i) recovered in the disassembly plant (z) in period (t) (Eq. 4. 23).

The other part is sold to a third party ($AREc3$) (see (Eq. 4. 24)).

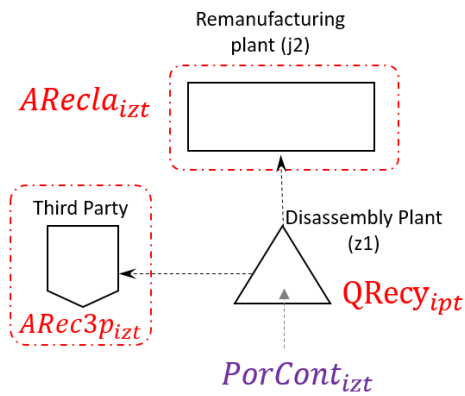

$$\sum_{p \in P} QRecy_{ipt} \times PorCont_{izt} = \sum_{j \in J} \sum_{z \in Z} AREcla_{izjt}$$

$$\forall t \in T, \quad z \in Z, i \in I, j \in J \quad (\text{Eq. 4. 23})$$

$$\sum_{p \in P} QRecy_{ipt} \cdot (1 - PorCont_{izt}) = \sum_{z \in Z} AREc3p_{izt}$$

$$\forall t \in T, p \in P, z \in Z, i \in I \quad (\text{Eq. 4. 24})$$

4.3.9 Remanufacturing plant constraints (Recycling process)

The decision variable $ARecla$ (and its auxiliary variables $IRmRecla$ and $QProcAux$) represents the inventory of raw material (i), in disassembly plant (z) in period (t). It contains the raw materials reclaimed from the previous period.

The decision variable $QProc$ (and its auxiliary variable $QProcAux$) represents the quantity of product (p) in manufacturing plant (j) in period (t). In both cases, these auxiliary variables are used so that the subsequent equations in the mathematical model remain unchanged (Eq. 4. 25) and (Eq. 4. 26).

To meet the demand of the subsequent period, an additional order of batteries must be made ($ProNew$) (Eq. 4. 27).

$$QProc_{jpt} = QProcAux_{jpt}$$

$$ARecla_{izt} = IRmRecla_{izt}$$

$$\forall t \in T - \{1\}, i \in I, z \in Z \quad (Eq. 4. 25)$$

$$QProc_{jpt} = QProcAux_{jpt}$$

$$\forall t \in T - \{1\}, p \in P, j \in J \quad (Eq. 4. 26)$$

$$ProNew_{pt} = \sum_{j \in J} QProcAux_{jpt} - ProRecy_{pt}$$

$$\forall t \in T - \{1\}, p \in P, j \in J \quad (Eq. 4. 27)$$

To initiate the production with remanufacturing and calculate the number of batteries that can be produced from the reverse logistics chain ($ProRecy$) (Eq. 4. 28), a constraint has been formulated related to the recycling rate of lead in the recycled LABs. It is indirectly expressed via (Eq. 4. 29) in which the $RdMatN_{ipt}$ (input parameter) represents the unitary amount of recycled lead (in kg per battery) that each battery must contain (each battery contains a given amount of raw material $RdMat$ (input data)).

Lead makeup is then ordered for the remanufacturing step so that the required amount of lead for the battery can be available for the process. It must be emphasized that after the manufacturing/remanufacturing step, the products are undifferentiated regarding their lead mix composition (either recycled or virgin). After this step, an effective recycling rate ($RecyRateEffective_{it}$) per period which indicates the percentage of recycling relative to raw materials (i), in period (t) can be calculated (Eq. 4. 32)

This effective recycling rate ($RecyRateEffective$), is calculated by dividing the requirement of new raw material (i) for a recycled product (p) between, the sum of all the new raw material used in the CLSC, it is worth mentioning that some values of new raw material (i) are only valid for some periods (t) (Eq. 4. 32).

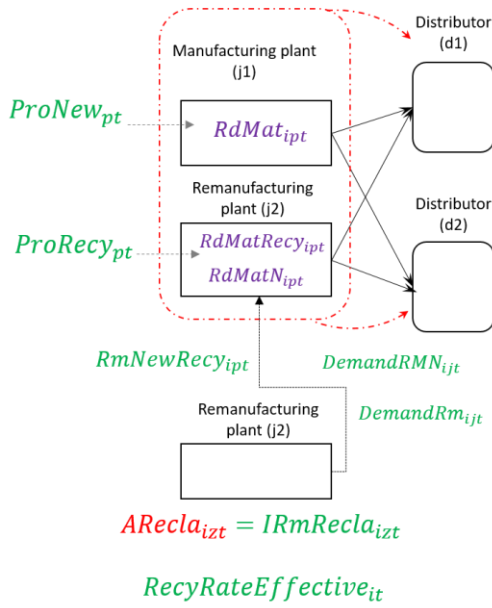

$$\sum_{z \in Z} \sum_{i \in I} \left(\frac{IRmRecla_{izt}}{RdMatRecy_{ipt}} \right) = ProRecy_{pt}$$

$$\forall t \in T - \{1\}, p \in P, i \in I, z \in Z \quad (Eq. 4. 28)$$

$$RdMatN_{ipt} = RdMat_{ipt} - RdMatRecy_{ipt}$$

$$\forall t \in T - \{1\}, p \in P, i \in I, \quad (Eq. 4. 29)$$

$$\sum_{p \in P} RdMatN_{ipt} \cdot ProRecy_{pt} = RmNewRecy_{it}$$

$$\forall t \in T - \{1\}, i \in I, \quad (Eq. 4. 30)$$

$$\sum_{p \in P} ProNew_{pt} \cdot RdMat_{ipt} = DemandRMN_{ijt}$$

$$\forall t \in T - \{1\}, j \in J, i \in I \quad (Eq. 4. 31)$$

$$RecyRateEffective_{it} = \frac{\sum_{z \in Z} IRmRecla_{izt}}{\sum_{j \in J} DemandRMN_{ijt} + \sum_{z \in Z} IRmRecla_{izt} + RmNewRecy_{it}} \quad (Eq. 4. 32)$$

The quantity of new raw materials (i) $AMat2$ ordered from the suppliers (s) for a new product (p) in period (t) for the manufacturing plant (j) can be calculated as expressed in. (Eq. 4. 33).

Finally, the amount of new raw materials (i) $AMat$ ordered from suppliers (s) for the manufacturing plant (i) in period (t) is determined by the sum of the value $AMat2$, representing the virgin raw material required for the production of a new product and the value $RmNewRecy$ which represents the new raw material needed as lead make up for the production of recycled products (Eq. 4. 34).

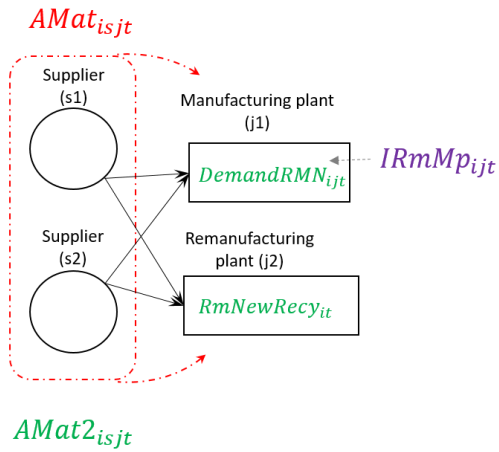

$$\sum_{s \in S} AMat2_{isjt} = DemaRMN_{ijt} - IRmMp_{ijt}$$

$$\forall t \in T - \{1\}, \quad j \in \mathbf{1}, i \in \mathbf{I}, \quad (Eq. 4. 33)$$

$$\sum_{j \in J} \sum_{s \in S} AMat2_{isjt} + RmNewRecy_{it}$$

$$= \sum_{j \in J} \sum_{s \in S} AMat_{isjt}$$

$$\forall t \in T - \{1\}, i \in \mathbf{I}, \quad (Eq. 4. 34)$$

The equation set (Eq. 4. 3- (Eq. 4. 34) constitutes the set of equalities and inequalities of the CLSC.

4.4 Cost contributions in the CLSC model

Figure 4. 4, encompasses the different distances (D) covered by the distributors to transport the involved raw materials and finished products, the steps with an inventory of raw materials or products (Inv), and the different echelons (manufacturing, disassembly, disposal) that are involved in the supply chain and identified by (C).

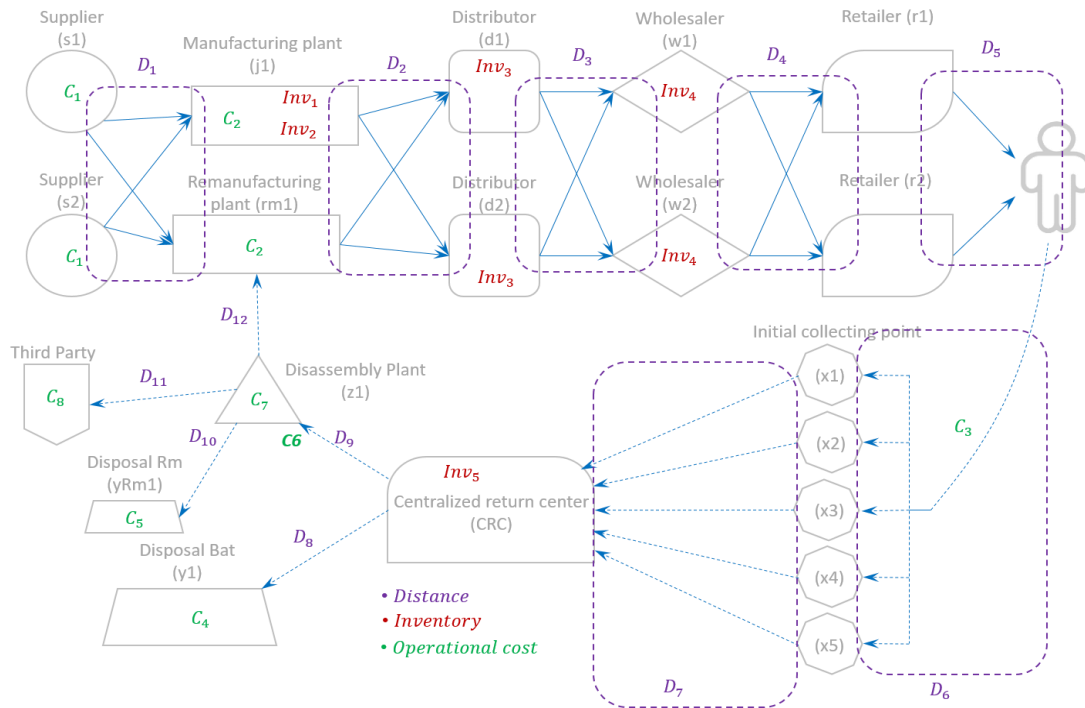

Figure 4. 4 Distances (D), inventory steps (Inv), and echelons (C) involved in the CLSC.

4.4.1 Distribution cost

Table 4. 2 presents the variables required for the calculation of the distribution cost and the unitary cost (relative to one product or raw material in each phase of the distribution). The distribution cost is calculated by multiplying the value of the decision variable (either product or raw material) by the unitary cost (see Eq 4.32).

D_i	<i>From</i>	<i>To</i>	<i>Unit</i>	<i>Decision Variable involved</i>	<i>Cost of distribution (cost by unit)</i>	<i>Cost of distribution D_i</i>
D_1	Suppliers	Manufacturing-remanufacturing	Raw material	$AMat_{ijsjt}$	$CtRawM_{ijpt}$	CD_1
D_2	Manufacturing-remanufacturing	Distributor	Finished product	$QtJD_{jdpt}$	$CtJD_{jdpt}$	CD_2
D_3	Distributor	Wholesaler	Finished product	$QtDW_{dwpt}$	$CtDW_{dwpt}$	CD_3
D_4	Wholesaler	Retailer	Finished product	$QtWR_{wrpt}$	$CtWR_{wrpt}$	CD_4
D_5	Retailer	Customer	Finished product	$QtWR_{wrpt}$	$CtWRcus_{wrpt}$	CD_5
D_6	Customer	Initial collecting points	Finished product	$QCenter_{xpt}$	$CtACent_{xpt}$	CD_6
D_7	Initial collecting points	CRC	Finished product	$QCenter_{xpt}$	$CtACRC_{xpt}$	CD_7
D_8	CRC	Disposal battery	Finished product	$QBad_{ypt}$	$CtBad_{ypt}$	CD_8
D_9	CRC	Disassembly plant	Finished product	$QRetu_{ipt}$	$CtRetu_{ipt}$	CD_9
D_{10}	Disassembly plant	Disposal Raw material	Raw material	$ABadRm_{ipt}$	$CtBadRm_{ipt}$	CD_{10}
D_{11}	Disassembly plant	3 party	Raw material	$ARec3p_{izt}$	$CtBadRm_{izt}$	CD_{11}
D_{12}	Disassembly plant	Remanufacturing	Raw material	$ARecla_{izt}$	$CtAREcla_{izt}$	CD_{12}

Table 4. 2 Set of variables involved in the distribution cost of the CLSC.

The total distribution cost along the CLSC is given by:

$$CostDist = \sum_{i=1}^{12} CD_i \quad (Eq. 4. 35)$$

4.4.2 Inventory cost

Table 4. 3 presents the location of inventory in the CLSC and the unitary inventory carrying cost. The inventory carrying cost is the product of the unitary inventory carrying cost by the value of the inventory level (Eq. 4. 36).

Inv_i	Inventory location	Units	Existing inventory	Unitary inventory carrying cost	Inventory carrying cost
Inv_1	Manufacturing plant	Raw material (Kg)	$IRmMp_{ijt}$	$IRmMpC_{ijt}$	IN_1
Inv_2	Manufacturing plant	Product (Battery)	IMp_{jpt}	$IMpC_{jpt}$	IN_2
Inv_3	Distributor	Product (Battery)	ID_{dpt}	IDC_{dpt}	IN_3
Inv_4	Wholesaler	Product (Battery)	IW_{wpt}	IWC_{wpt}	IN_4
Inv_5	Centralized return center (CRC)	Product (Battery)	$IRPC_{pt}$	$IRPCC_{pt}$	IN_5

Table 4. 3 Set of the variables involved in the inventory carrying cost.

The total inventory carrying cost (in €) in for the whole CLSC is given by:

$$CostCarryInv = \sum_{i=1}^5 IN_i \quad (Eq. 4. 36)$$

4.4.3 Operational cost

Table 4. 4 presents the variables required for the calculation of the operational cost involved in the CLSC. Similarly, the operational cost is obtained by multiplying the unitary operational cost by the adequate variable (Eq 4.34) for all the steps involved.

C_i	Location	Operation	Decision Variable involved	Unitary operational cost (cost by unit)	Operational Cost CO_i
C_1	Supplier	Raw material purchase	$AMat_{isjt}$	UMC_{isjt}	CO_1
C_2	Manu-Remanufacturing plant	Battery production	$QProc_{jpt}$	PC_{jpt}	CO_2
C_3	Initial collecting points	Recollecting	$ACenter_{xpt}$	RCC_{xpt}	CO_3
C_4	Battery disposal	Battery disposal	$QBad_{ypt}$	$DispC_{ypt}$	CO_4
C_5	Disposal Raw material	Raw material disposal	$QBadRm_{ipt}$	$DispRm_{ypt}$	CO_5
C_6	Disassembly	Battery disassembly	$QRecy_{ipt}$	$DissC_{ipt}$	CO_6
C_7	Disassembly	Reclaimed raw material	$AREcla_{izt}$	$DissRecla_{izt}$	CO_7
C_8	Third-Party	Raw material sent to the third party	$AREc3p_{izt}$	$Diss3p_{izt}$	CO_8

Table 4. 4 Set of variables involved in the operational cost of the CLSC.

The total operational expenditure for the whole CLSC is given by:

$$CostOpe = \sum_{i=1}^8 CO_i \quad (Eq. 4. 37)$$

4.4.4 Cost objective

The economic function considered in the mathematical formulation focuses on the minimization of the total cost of the CLSC, as presented in (Eq. 4. 38):

$$MIN TotalCost = CostOpe + CostCarryInv + CostDist \quad (Eq. 4. 38)$$

The following parameters and variables are involved in the expression of the objective function:

TotalCost: Total cost of battery production (€).

CostOpe: Total cost of the operations in battery production (€).

CostCarryInv: Total cost of carrying inventory along the CLSC(€).

CostDist: Total cost of the distribution or transportation of batteries and raw materials along the CLSC (€).

4.5 Environmental objective

As shown in the previous chapter of this PhD manuscript, LCA methodology is particularly sound since it is closely aligned as a complement to supply chain management. It has also been highlighted that several environmental indicators need to be tracked for battery supply chains.

Consequently, CLSC design must have to consider the set of environmental objectives, generally around 15 when carrying out Life Cycle Assessment. Multi-objective optimization methods are yet applied only to problems having a lower number of objectives. The major impediments in handling numerous objectives related to numerical difficulties, stagnation of the search process, increased dimensionality of Pareto-optimal front, large computational cost, and difficulty in the visualization of the objective space (Perez Gallardo, 2013). Furthermore, several objectives are redundant so that a multi-objective strategy is not, strictly speaking, necessary for all of them.

This explains why the environmental criterion that will be optimized is based on the total amount of GHG, emitted by the supply chain, as one of the most popular metrics for measuring environmental impact (Eskandarpour et al. 2015).

Figure 4. 5 illustrates the location of environmental impact (i.e. Global Warming Potential) along the supply chain, i.e. transportation and operation. The corresponding emissions are identified by (De) for distribution and (Ce) for operation steps.

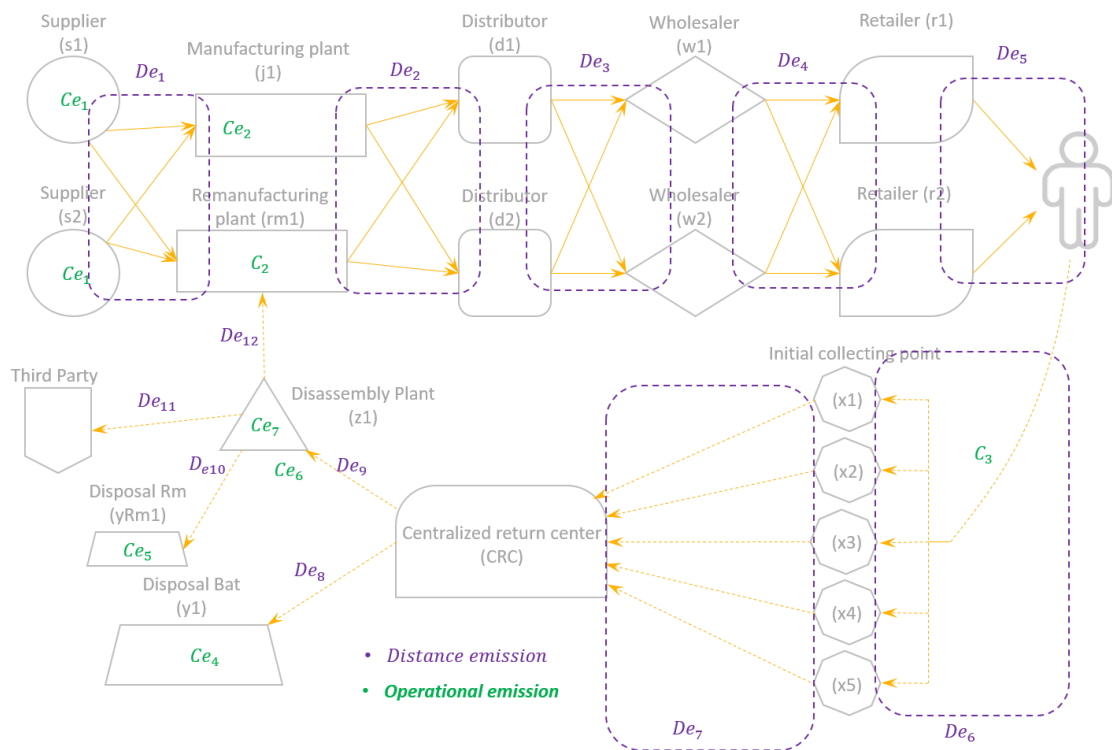

Figure 4. 5 Location of Global Warming Potential Emissions in the CLSC.

4.5.1 GHG emissions due to transportation

Table 4. 5 presents the variables required for the calculation of the environmental impact, i.e. Global Warming Potential. The unitary value of GWP has been obtained in the LCA study (see Chapter 3) (Eq. 4. 39).

De_i	<i>From</i>	<i>To</i>	<i>Unit</i>	<i>Decision Variable involved</i>	<i>Unitary Global Warming Potential (GWpt by unit)</i>	<i>Global Warming Potential due to distributoon ED_i</i>
De_1	Suppliers	Manufacturing-remanufacturing	Raw material	$AMat_{isjt}$	$EmRawM_{ijpt}$	ED_1
De_2	Manufacturing-remanufacturing	Distributor	Finished product	$QtJD_{jdpt}$	$EmJD_{jdpt}$	ED_2
De_3	Distributor	Wholesaler	Finished product	$QtDW_{dwpt}$	$EmDW_{dwpt}$	ED_3
De_4	Wholesaler	Retailer	Finished product	$QtWR_{wrpt}$	$EmWR_{wrpt}$	ED_4
De_5	Retailer	Customer	Finished product	$QtWR_{wrpt}$	$EmWRcus_{wrpt}$	ED_5
De_6	Customer	Initial collecting points	Finished product	$ACenter_{xpt}$	$EmACent_{xpt}$	ED_6
De_7	Initial collecting points	CRC	Finished product	$ACenter_{xpt}$	$EmACRC_{xpt}$	ED_7
De_8	CRC	Disposal battery	Finished product	$QBad_{ypt}$	$EmBad_{ypt}$	ED_8
De_9	CRC	Disassembly plant	Finished product	$QRetu_{ipt}$	$EmRetu_{ipt}$	ED_9
De_{11}	Disassembly plant	Remanufacturing	Raw material	$AREcla_{izt}$	$EmAREcla_{izt}$	ED_{11}

Table 4. 5 Set of the variables involved in the calculation of GWP due to distribution.

The total GHG emissions due to distribution along the CLSC expressed in (kgCO₂eq) is given by:

$$EmiDist = \sum_{i=1}^{12} ED_i \quad (Eq. 4. 39)$$

4.5.2 GHG emissions due to operation

Table 4. 6 presents the variables required for the calculation of the GHG emissions involved in the CLSC.

Ce_i	Phase located	Operation	Decision Variable involved	Unitary Global Warming Potential (GWP by unit)	The operational emission of EO_i
Ce_1	Supplier	Purchase Raw material	$AMat_{isjt}$	$EmUMC_{isjt}$	EO_1
Ce_2	Manu-Remanufacturing plant	Battery production	$QProc_{jpt}$	$EmPC_{jpt}$	EO_2
Ce_3	Initial collecting points	Recollecting cost	$ACenter_{xpt}$	$EmRCC_{xpt}$	EO_3
Ce_4	Disposal Bat	Disposal of battery	$QBad_{ypt}$	$EmDispC_{ypt}$	EO_4
Ce_5	Disposal Raw material	Disposal Raw material	$QBadRm_{ipt}$	$EmDispRm_{ypt}$	EO_5
Ce_6	Disassembly	Disassembly of battery	$QRecy_{ipt}$	$EmDisSc_{ipt}$	EO_6

Table 4. 6 Set of the variables involved in the calculation of GWP due to operation in the CLSC.

The total GHG emissions due to the operations of the CLSC expressed in (KgCO₂eq) is given by:

$$EmiOpe = \sum_{i=1}^7 EO_i \quad (Eq. 4. 40)$$

4.5.3 Environmental impact objective

The environmental objective function considered in the mathematical formulation focuses on the minimization of the total Global Warming Potential (Total GWP) of the CLSC, as presented in (Eq. 4. 38).

$$MIN TotalGWP = EmiOpe + EmiDist \quad (Eq. 4. 41)$$

The following parameters and variables are involved in the expression of the objective function:

TotalGWP: Total cost of environmental emissions GWP (KgCO₂eq).

EmiOpe: Total GHG emissions of the operations in the manufacturing of products (KgCO₂eq).

EmiDist: Total of emissions of the distribution or transportation of products and raw materials across the supply chain (KgCO₂eq).

4.6 Solution strategy: methods and tools

The CLSC model relies on a Mixed Integer Linear Programming (MILP) approach, which concurrently optimizes both forward and reverse supply chains. Two primary scenarios will undergo analysis: single objective and multi-objective optimization. The proposed solution strategy follows a multistep methodology outlined in Figure 4. 6.. Each step will be thoroughly presented in the subsequent sections.

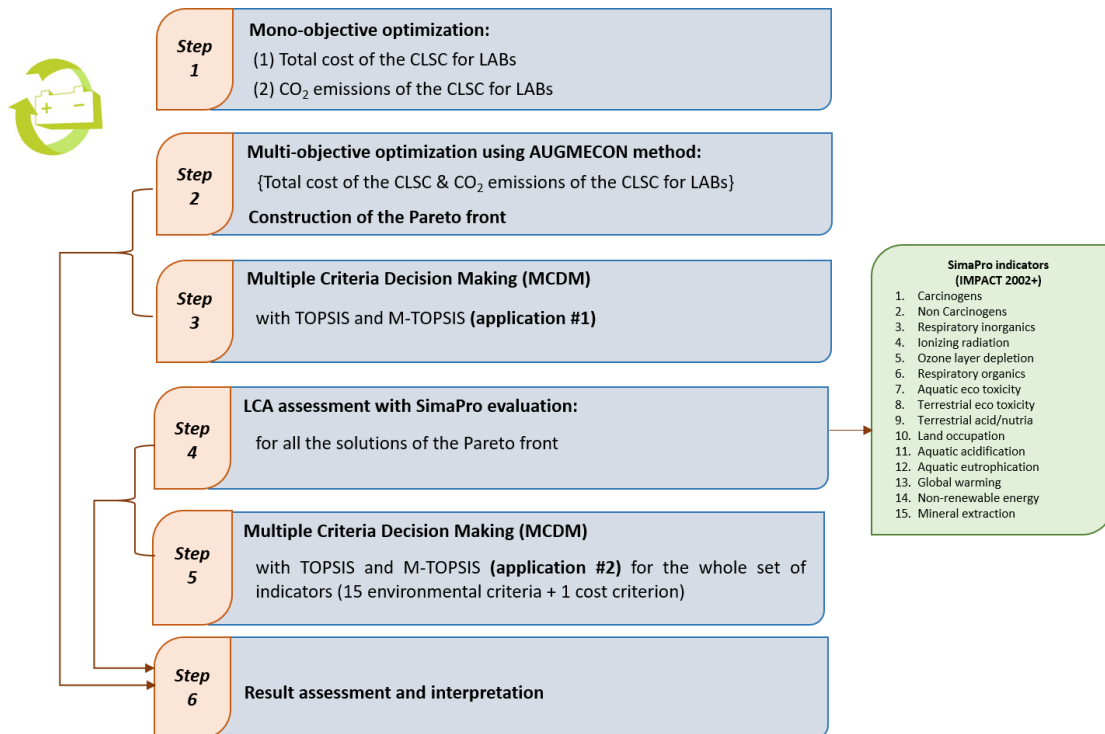

Figure 4. 6 Methodology of the model solution.

4.6.1 Single objective optimization (Tier # 1)

Single objective problems that will be considered will involve either the total cost (see section 4.4) or the environmental impact of the CLSC (see section 4.5) respectively as the optimization criterion (Bierlaire 2006):

$$\begin{aligned}
 & \text{Min } f(x) && \text{(Eq. 4. 42)} \\
 & \text{st} \\
 & g(x) \leq 0 \\
 & h(x) = 0
 \end{aligned}$$

where f is a function $R^{n1} \times [0,1]^{n2}$ in R , $g(x) \in \mathfrak{R}^m$, $h(x) \in \mathfrak{R}$, $x \in S$

In the abovementioned expression, $f(x)$ is the objective function; vectors $g(x)$ and $h(x)$ represent m inequality constraints and p equality constraints, respectively. Here, x belongs to set S , delineating the constraints that define the limited search space for the optimal solution. This optimization problem involves both continuous and discrete variable types.

For this study, the mathematical model was formulated using the GAMS environment (General Algebraic Modeling System), renowned as a high-level system for mathematical programming and optimization. GAMS employs an algebraic modeling language, streamlining the programming of optimization problems by closely aligning them with their mathematical formulations. This feature enables quick and flexible modifications to the models.

GAMS includes a large number of well-known algorithms for the solution of MILP (Geletu, 2008): Branch & Bound, Benders Decomposition, Cutting Plane (Gomory) algorithm, and Branch & Cut. Usually, these algorithms are used with the simplex algorithm and/or the interior-point method. For instance, some of the solvers that can solve MILP problems are BARON, BDMLP, LINDO GLOBAL, MOSEK, OSL, XPRESS, and CPLEX (Mansini et al., 2015). In this study, the CPLEX 12 solver has been used following the expertise acquired in LGC (de Leon Almaraz, 2014; Ochoa Robles, 2018).

Single objective optimization has been conducted for each objective function. From the optimized value of the cost criterion, a Levelized Cost Of Battery (LCOB) has been deduced. LCOB can be viewed as the average value of the price of a battery produced that would be required to recover the costs of building and operating the supply chain during an assumed period. Calculating LCOB involves dividing the total cost by the total number of batteries released to meet market demand.

Similarly, the value $L_{CO_2}EOB$ (Levelized CO₂ Emissions Of Battery) has been calculated by dividing the total eqCO₂ emissions generated by the supply chain over the studied by the total number of batteries released to meet market demand.

4.6.2 Multi-objective optimization (Tier # 2)

4.6.2.1 Principle

In a multi-criteria framework, this type of optimization aims to find a compromise among various objectives due to conflicts among antagonist criteria. The general formulation of a multi-objective optimization problem is as follows:

$$\text{Min}[f_1(x), f_2(x), \dots, f_{1k}(x)] \quad (\text{Eq. 4. 43})$$

st

$$g(x) \leq 0$$

$$h(x) = 0$$

$$x \in S$$

where f_i with $i=1, k$ is a function of $R^{n_l} \times [0,1]^{n_2}$ in R , $g(x) \in \mathfrak{R}^m$, $h(x) \in \mathfrak{R}^p$ and x is an element of S .

This optimization scheme is applied when conflicts arise between two or more objectives (such as the trade-off between recycling, which may reduce environmental impact but requires significant capital investment). Due to this trade-off, this class of problem doesn't have a singular solution, but rather a collection of non-dominated solutions known as the Pareto front. A solution within the Pareto front is considered Pareto-optimal if there are no other solutions that can simultaneously better satisfy all the objectives. Enhancing one objective inevitably worsens at least one other objective. This principle can be mathematically expressed as follows:

A feasible solution $x^* \in S$ is called efficient or Pareto optimal if there is no other $x \in S$ such that $f(x^*) > f(x)$ and $f(x) \neq f(x^*)$ (Khorram et al. 2010).

4.6.2.2 Multi-objective optimization methods

Several solution methods have been developed for multi-objective optimization problems, wherein the concept of optimality is substituted with Pareto optimality. These methods can be classified as *a priori*, *a posteriori*, and *hybrid* methods (Collette & Siarry, 2003) including scalar, interactive, fuzzy, and meta-heuristic methods (see Figure 4. 7).

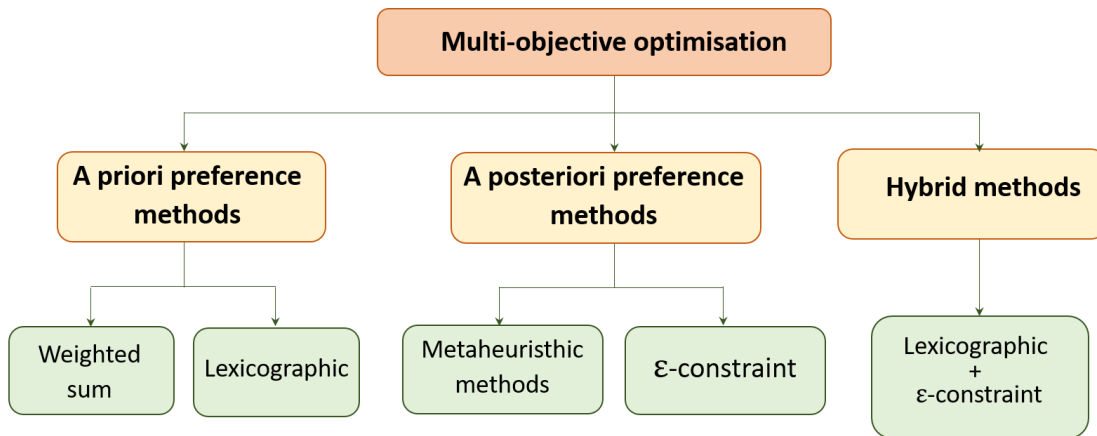

Figure 4. 7 Multiobjective optimization methods (de Leon Almaraz, 2014).

- A priori methods

With these methods, the decision-maker defines the trade-off to be applied (preferences) before running the optimization method. The aggregation methods belong to this family (where the objective functions are gathered into one objective function). More precisely, the weighted-sum, goal programming, and lexicographic methods (among others) can be mentioned (Collette & Siarry, 2003). The drawback is that the decision-maker never sees the whole picture (the set of efficient solutions) or an approximation of it.

- Weighted sum: the goal of the weighted sum is to transform the problem so that it turns into a single-objective optimization problem, for which there exist various methods of solution. A weight is allocated to each initial objective function, and a new objective function is built by considering a weighted sum of objective functions. The weighting factors are first assigned a priori, are then iteratively modified to obtain the Pareto front, with all non-dominated solutions. The major problem with this method is the variation of the weighting factors, which often leads to Pareto fronts with a low density of solutions (Hernandez-Rodriguez, 2011). It can only be used when the feasible space of values of the objective function is convex. In the weighting method, the weighted sum of the objective functions is optimized. The problem is stated as follows:

$$\text{Min } (w_1 \times f_1(x) + w_2 \times f_2(x) + \dots + w_p \times f_p(x)) \quad (\text{Eq. 4. 44})$$

st

$$g(x) \leq 0$$

$$h(x) = 0$$

$$x \in S$$

By varying the weights w_i it is possible to obtain different efficient solutions.

- Lexicographic method: with this method, the objectives are considered in a hierarchical manner (Khorram et al. 2010). This method can be viewed as an “a priori” approach with aggregation using constraints in a decoupled method. In the lexicographic ordering, the objectives are ranked according to the order of importance. Generally, the optimization process starts minimizing the most important objective and proceeds according to the assigned order of importance of the criteria. One disadvantage of this method is that it tends to favor certain objectives, making the Pareto front converge to a particular region. The main advantage is its simplicity and computational efficiency, making it competitive with the weighted sum of objectives (Collette & Siarry, 2003). In general, the lexicographic problem can be expressed as follows:

$$\text{LexMin } \{f_1(x), f_2(x), \dots, f_r(x)\} \quad (\text{Eq. 4. 45})$$

st

$$g(x) \leq 0$$

$$h(x) = 0$$

$$x \in S$$

To solve (Eq. 4. 45), the following procedure known as the sequential method is adopted. First, minimise $f_1(x)$, and determines an optimal solution x^* ($f_1(x^*) = \beta_1$). Next, the problem is solved minimizing $f_2(x)$ subject to $f_1(x^*) = \beta_1$, and so on at the q iteration:

$$\text{LexMin } \{f_q(x): f_i(x) \leq \beta_i, i=1, \dots, q-1\} \quad (\text{Eq. 4. 46})$$

st

$$g(x) \leq 0$$

$$h(x) = 0$$

$$x \in S$$

If either (Eq. 4. 46) has a unique optimum or $q = r$, then the optimal solution to (Eq. 4. 43), is a pre-emptive optimum. Otherwise, one proceeds to iteration $q + 1$, (Khorram et al., 2010).

- *A posteriori methods*

With these methods, the decision-maker chooses the solution by examining solutions computed by the optimization model. Methods that belong to this family produce, at the end of the optimization, a trade-off surface (Collette & Siarry, 2003). The aim is to generate the full set of trade-off solutions and not to present only one single “best” alternative. From the set of alternatives, the decision-maker can then further investigate interesting trade-offs and ultimately select a particular strategy that satisfies his/her willingness to compromise (Hugo et al. 2005). In an a posteriori method, the solutions to the problem are generated, and then the decision-maker is involved to select the most preferred one among them.

- *Metaheuristic methods*: Metaheuristic methods: they are particularly useful to treat problems known as "black box" where no mathematical property of the problem is known. This category includes genetic algorithms, tabu search, simulated annealing, ant colonies, neural networks, etc.
- In the case of the CLSC, and more generally in supply chain problems, the linear constraints of the problem formulation do not require such methods that could be computationally expensive.

Yet, it must be mentioned that a genetic algorithm has been used in the work proposed by (Kannan et al. 2010)

- With the ε -constraint method, introduced by (Haimes et al. 1971) all but one objective is converted into constraints by setting an upper or lower bound to each of them, and only one objective is to be optimized (S. Liu & Papageorgiou, 2013).

In the ε -constraint method, one of the objective functions is optimized using the other objective functions as constraints, incorporating them in the constraint part of the model as shown below:

$$\begin{aligned}
 &\text{Min } f_1(x) && \text{(Eq. 4. 47)} \\
 &\text{st} \\
 &f_1(x) \leq \varepsilon_2 \\
 &f_2(x) \leq \varepsilon_3 \\
 &f_p(x) \leq \varepsilon_p \\
 &x \in S
 \end{aligned}$$

By parametrical variation in the right-hand-side (RHS) of the constrained objective functions (ϵ), the efficient solutions of the problem are obtained. This method is yet easy to implement but in some cases, intensive computation time is required. Despite its easy implementation, three major difficulties are generally highlighted:

- the estimation of the range of objective functions over the efficient set.
- the guarantee of efficiency of the obtained solutions.
- the increased solution time for problems with more than two objectives.

- *Hybrid methods*

To address these three issues, a hybrid method, i.e. the augmented ϵ -constraint method (AUGMECON) has been proposed by (Mavrotas 2009 and 2007)

To determine utopia (ideal) and nadir (worst) points in the classical ϵ -constraint method, the most common approach is to take upper and lower bounds from the payoff table (the table with the results from the individual optimization of the p objective functions). In a minimization problem, the nadir value is usually approximated with the maximum of the corresponding column, even in this case, we must be sure that the obtained solutions from the individual optimization of the objective functions are indeed Pareto optimal solutions.

The AUGMECON method proposes the use of lexicographic optimization for every objective function to construct the payoff table with only Pareto optimal solutions. A simple remedy to bypass the difficulty of estimating the nadir values of the objective functions is to define reservation values for the objective functions. The reservation value acts like a lower (or upper for minimization objective functions) bound. Values worse than the reservation value are not allowed.

The lexicographic optimization is applied as follows. The first objective function (of higher priority), is optimized so that $\max(f_1) = z1^*$. Then the second objective function is optimized by adding the constraint $f_1 \geq z1^*$, to keep the optimal value of the first optimization. Let us consider $\max(f_2) = z2^*$. Subsequently, the third objective function is optimized by adding the two constraints $f_1 \geq z1^*$ and $f_2 \geq z2^*$ to keep the previous optimal values, and the process continues until no more objective function has to be treated.

The second point is that the optimal solution of the conventional ϵ -constraint is guaranteed to be an efficient solution only if all the $(p-1)$ objective functions' constraints are binding; otherwise, if there are alternative optima (that may improve at least one of the non-binding constraints that correspond to an objective function), the obtained optimal solution of the problem is not efficient but is a weakly efficient solution. To overcome this ambiguity, (Mavrotas, 2009) transforms the objective function constraints to equalities by introducing slack or surplus variables. At the same time, these slack or surplus variables are used as a second term (with lower priority) in the objective function to force the model to produce only efficient solutions (Mavrotas, 2009), develops a strategy for these slack variables to improve the generation of efficient solutions also adds an innovative addition to the algorithm, i.e., the early exit from the nested loops when the problem becomes infeasible.

Practically, the AUGMECON method is implemented as follows: from the payoff table, the range of each $(p-1)$ objective function that will be used as a constraint. Then the range of the i -th objective function is divided into q_i equal intervals using q_i-1 intermediate equidistant grid points. Thus, a total of q_i-1 grid points that are used to vary parametrically the RHS of the i -th objective function. Therefore, the total number of single-objective models (runs) becomes $(q_2+1) \times (q_3+1) \times \dots \times (q_p+1)$.

4.6.2.3 Choice of the multi-objective optimization method

The weighted-sum method was not selected in this work because some preliminary optimization runs lead to Pareto fronts with too low a density of solutions. The lexicographic method minimizing the most important objective and then proceeding according to the assigned rank of importance of the criteria can be an interesting option because of its simplicity and computational efficiency, but its efficiency is better when coupled to another method to obtain the Pareto Front. The CLSC model has been formulated as a deterministic MILP, involving a set of inequality constraints and equality ones (mass balances that must be rigorously solved). These are the main reasons to discard metaheuristic methods. The main difficulty related to the ϵ -constraint method lies in determining Nadir points (where the criteria take their worst values) but the work of (Mavrotas, 2007, 2009) shed new light on this problem by combining this method with the lexicographic one which can easily be coupled to the ϵ -constraint method to create a hybrid method which could result in fair solutions. This multi-objective strategy has thus been adopted in what follows.

At the end of this stage, a set of m optimal solutions are identified. Despite their different values in each objective function, they do not have any superiority over each other

4.6.3 Multiple Criteria Decision-Making (MCDM) (Tier # 3)

In the previous tier, the Pareto curve was first obtained by solving the multi-objective models by AUGMECON. Secondly, decision-makers preferences for sustainability factors will be considered by adopting a Multiple Criteria Decision-Making technique (MCDM), based on the optimal solutions in the Pareto set.

MCDM approaches are major parts of decision theory and analysis, alternatives. The objective is to help decision-makers to learn about the problems they face, and to identify a preferred course of action for a given problem. A large variety of approaches have been proposed in the dedicated literature (Mardani et al., 2015). Among them, TOPSIS (Technique for Order of Preference by Similarity to Ideal Solution) (Hwang & Yoon, 1981) is a common method used in engineering problems. Its main advantage over other methods is the reduced number of parameters involved in its implementation, thus limiting subjectivity. A modified TOPSIS (M-TOPSIS) evaluation (Ren et al. 2007). Is based on the original concept of TOPSIS and proposed by (Hwang & Yoon, 1981). is used. It chooses an alternative that should simultaneously have the closest distance from the positive ideal solution and the farthest distance from the negative ideal solution, solving the rank reversal and the evaluation failure problem presented in the original TOPSIS technique (Maleki & Zahir, 2013).

4.6.3.1 TOPSIS

TOPSIS performs an evaluation of a given set of alternative data without direct comparison between alternatives, with the result expressed as a mark on a scale between the values of the ideal and the negative ideal solution. The alternative closest to the ideal solution and farthest from the negative ideal solution is the best one. The basic algorithm of the TOPSIS method evaluates the decision matrix, in which ‘ m ’ alternatives are evaluated by ‘ n ’ criteria, as shown in Figure 4. 8. The general methodology is presented here, but to help understanding it is applied on a simplified example presented in Appendix A.

Step 1: Build the decision matrix. Establish a matrix that shows ‘ m ’ alternatives evaluated by n criteria.

		$j=1$	$j=2$	$j=3$...	$j=n$
		C1	C2	C3		Cn
$i=1$	A1	X_{ij}	X_{ij}	X_{ij}	...	X_{ij}
$i=2$	A2	X_{ij}	X_{ij}	X_{ij}	...	X_{ij}
$i=3$	A3	X_{ij}	X_{ij}	X_{ij}	...	X_{ij}
\vdots	\vdots	\vdots	\vdots	\vdots	\vdots	\vdots
$i=m$	Am	X_{ij}	X_{ij}	X_{ij}	...	X_{ij}

Figure 4. 8 Generic decision matrix for application of the TOPSIS method.

Step 2: since different criteria have different dimensions, the values in the decision matrix are first transformed into normalized, non-dimensional values under the equation (Eq. 4. 48) (Antuchevičienė et al. 2010).

$$a_{ij} = \frac{x_{ij}}{\sqrt{\sum_{j=1}^n x_{ij}^2}} \quad (\text{Eq. 4. 48})$$

where: a_{ij} stands for the normalized value; $i = 1, 2, \dots, m, j = 1, 2, \dots, n$.

Step 3: Coefficient vector of the importance of the criteria. This step allows decision-makers to assign weights of importance to a criterion relative to others. The weighted normalized matrix V is calculated by multiplying each value within the individual criterion in the normalized matrix A by the weight of this criterion (Eq. 4. 49).

$$v_{ij} = w_i \cdot a_{ij} \quad (\text{Eq. 4. 49})$$

where: w_i stands for the weight of the individual criterion i ; $i = 1, 2, \dots, m; j = 1, 2, \dots, n$.

Step 4. Determine the positive ideal and negative ideal solution from the matrix A . The ideal solution (A^+) is the group of weighted normalized criteria values, which indicates the ideal criteria values (for instance a maximum value for benefit criteria and minimum value for cost criteria). The negative ideal solution, defined by a set of weighted normalized criteria values in (Eq. 4. 51) represents the negative ideal criterion values. (for instance minimum value for benefit criteria and maximum value for cost and GWP criteria) (Eq. 4. 50):

$$A^+ = \{v_{1+}, \quad v_{2+}, \dots v_{n+}\} \quad (\text{Eq. 4. 50})$$

$$A^- = \{v_{1-}, \quad v_{2-}, \dots v_{n-}\} \quad (\text{Eq. 4. 51})$$

Thereafter, using the Euclidean distance, the distances to the ideal solution S_{i+} and to the negative ideal solution S_{i-} are calculated for each alternative, (Eq. 4. 52) and (Eq. 4. 53):

$$S_{i+} = \sqrt{\sum_{j=1}^n (v_{j+} - v_{ij})^2} \text{ for } i = 1, 2, \dots, m, \quad (\text{Eq. 4. 52})$$

and

$$S_{i-} = \sqrt{\sum_{j=1}^n (v_{j-} - v_{ij})^2}, \text{ for } i = 1, 2, \dots, m, \quad (\text{Eq. 4. 53})$$

Where: $v_{j+} = \min_i v_{ij}$ and $v_{j-} = \max_i v_{ij}$

Since S_{i+} and S_{i-} represent each alternative in a S^+S^- plane, distances from those two points to the relative proximity to the ideal solution are calculated according to the classical TOPSIS method (Antuchevičienė et al., 2010) (Eq. 4. 54).

Subsequently, a ranking of alternatives is created in descending order based on the value of C_i . The best alternative is the one whose TOPSIS coefficient C_i approaches closest to 0.

$$C_i = \frac{S_{i-}}{(S_{i+} + S_{i-})} \quad (\text{Eq. 4. 54})$$

Where $1 \geq C_i \geq 0$ and $i = 1, 2, \dots, m$

4.6.3.2 M-TOPSIS

M-TOPSIS modifies this calculation in such a way as to firstly set the optimized ideal reference point ($\min (S_i^+)$, $\max (S_i^-)$) and then calculate the distance from each alternative to that point according to the approach presented in (Ren et al. 2007), (Eq. 4. 55).

$$C_i^M = \sqrt{(S_i^+ - \min (S_i^+))^2 + (S_i^- - \max (S_i^-))^2} \quad (\text{Eq. 4. 55})$$

where $i = 1, 2, \dots, m$.

The best alternative is the one that has the M-TOPSIS coefficient C_i^M nearest to 0.

4.7.4 LCA assessment with SimaPro (Tier #4)

To enhance the mapping of Pareto solutions, each CLCS configuration of the Pareto front has been evaluated to obtain the environmental indicators. Following the guidelines of the LCA performed in Chapter 3, the IMPACT 2002+ method has been considered (Figure 4. 9).

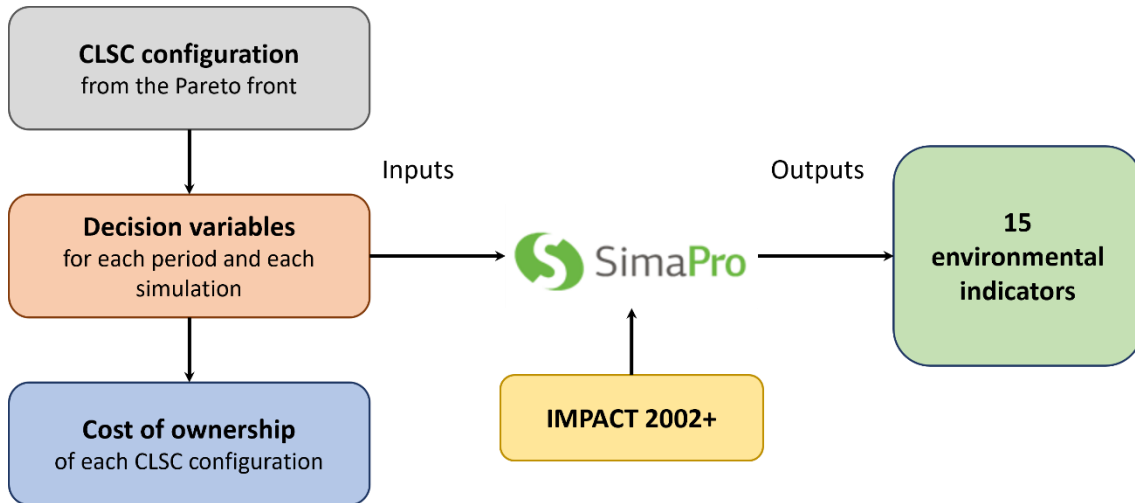

Figure 4. 9 Evaluation of each Pareto-CLSC configuration by SimaPro.

4.6.5 Multiple Criteria Decision-Making (MCDM)(Tier # 5):

An additional MCDM step is then implemented, considering the whole set of indicators (Table 4.7), the set of environmental impacts, and the cost criterion. Different scenarios with weight varying will be considered.

<i>Indicator</i>
Cost indicator
Carcinogens
Non-carcinogens
Respiratory inorganics
Ionizing radiation
Ozone layer depletion
Respiratory organics
Aquatic ecotoxicity
Terrestrial ecotoxicity
Terrestrial acid/nutri
Land occupation
Aquatic acidification
Aquatic eutrophication
Global warming
Non-renewable energy
Mineral extraction

Table 4.7 Indicators considered for the evaluation.

4.7.6 Result assessment and interpretation (Tier # 6)

The main idea is to highlight if the bi-objective optimization followed by MCDM performed on only two criteria is sufficient, or if the whole cartography brings new insight into the interpretation. This will be explored in the application chapter.

4.7 Conclusions

A CLSC network for a lead-acid battery case study was modeled by using a Mixed Integer Linear Programming model. A CLSC network was modeled for a lead-acid battery case study using a Mixed Integer Linear Programming model. This network encompassed five echelons in the forward direction (suppliers, producers, distributors, wholesalers, and retailers) and seven echelons in the reverse direction (collection & recycling centers, product disposal, disassembly plant, raw material disposal, third party, and remanufacturing). The model solution followed a multistep strategy:

- Single objective optimization aimed at separately minimizing two criteria: (1) Total cost of the CLSC for LABs and (2) GHG emissions of the CLSC for LABs.
- Multi-objective optimization employing the AUGMECON method to derive a Pareto front based on paired objectives.
- Multiple Criteria Decision-Making (MCDM) using TOPSIS and M-TOPSIS (application #1).
- LCA assessment conducted through SimaPro evaluation for all solutions within the Pareto front, using the Impact 2002+ impact assessment method.
- A second application of Multiple Criteria Decision-Making (MCDM) encompassing the entire set of indicators (15 environmental criteria + 1 cost criterion) (application #2).

The proposed methodology is now applied to a LAB case study.

Chapter

Using the methodological framework
for optimizing the battery closed-
loop supply chain.

Abstract :

This chapter is dedicated to outlining the methodology employed in managing the battery closed-loop supply chain. It encompasses the input data utilized for model operation and the outcomes derived from solving the CLSC management model using the methodology previously introduced. The approach adopted here is multi-tiered. Initially, it involves identifying pivotal criteria applicable in the multi-objective (in this case, bi-objective) optimization procedure, specifically focusing on the total cost of the supply chain and the environmental criterion based on overall greenhouse gas emissions. The initial use of decision support methods (M-TOPSIS and TOPSIS) facilitated the identification of potential supply chain configurations.

Subsequently, a life cycle assessment was conducted on the set of Pareto front-end solutions to perform a comprehensive multi-criteria analysis considering all Impact 2002+ criteria and the cost criterion. This step unveiled solutions that proved more promising across all criteria compared to those previously identified.

To systematically compute environmental indicators, environmental submodules for the supply chain blocks were developed, drawing data from the EcoInvent database and utilizing impact factors derived from Impact2002+. Additionally, the study reaffirmed the consistency of results obtained through the M-TOPSIS method across the entire strategy, enhancing its robustness over the TOPSIS method.

Lastly, a sensitivity analysis highlighted three parameters crucial for enhancing the performance of all indicators: (i) the percentage of raw materials recovered from products slated for recycling, (ii) the recovery rate, and (iii) improvements in the manufacturing/remanufacturing process concerning GHG emissions.

Résumé :

Ce chapitre est consacré à la stratégie d'utilisation du cadre méthodologique pour la chaîne d'approvisionnement en boucle fermée des batteries. Il présentera les données utilisées comme entrée pour fonctionner le modèle ainsi que les résultats du modèle de gestion des CLSC résolus avec la méthodologie présentée dans le chapitre précédent. La stratégie adoptée implique une approche à plusieurs niveaux. Elle consiste d'abord à identifier les critères significatifs qui peuvent être utilisés dans la procédure d'optimisation multi-objectifs (dans ce cas, bi-objectifs), principalement le coût total de la chaîne d'approvisionnement ainsi que le critère environnemental établi sur les émissions totales de gaz à effet de serre. La première application d'une méthode d'aide à la décision (M-TOPSIS et TOPSIS) a permis d'identifier les configurations candidates de la chaîne d'approvisionnement. Une analyse du cycle de vie a ensuite été réalisée sur l'ensemble des solutions du front de Pareto afin de mener une analyse multicritères sur tous les critères d'Impact 2002+ et le critère de coût. Cette étape a permis d'identifier des solutions plus intéressantes du point de vue de l'ensemble des critères que celles identifiées au niveau précédent. Des sous-modules environnementaux ont été développés pour les blocs de la chaîne d'approvisionnement afin de calculer de manière systématique les indicateurs environnementaux en utilisant les données extraites de la base EcoInvent et les facteurs d'impact d'Impact2002+. L'étude a également confirmé que la méthode M-TOPSIS produisait des résultats du même ordre de grandeur dans toute la stratégie, ce qui rend son utilisation plus robuste que la méthode TOPSIS. Enfin, une étude de sensibilité a montré que trois paramètres sont particulièrement importants pour améliorer la performance de tous les indicateurs : (i) le pourcentage de matières premières récupérées pour le recyclage, (ii) le taux de récupération et (iii) la performance du processus de fabrication/refabrication en termes d'émissions de gaz à effet de serre (GES).

5.1 Introduction

The previous chapters introduced the theoretical framework for supply chain network modeling, tailored to the objective of reducing environmental emissions and emphasizing the integration of raw material recycling in supply chain design and development. These concepts form the foundation of the closed-loop supply chain model (CLSC), a widely adopted alternative capable of globally fulfilling these objectives.

To address environmental considerations, Chapter 3 provided an extensive view of indicators integrating environmental impact (specifically, lead-acid batteries) through a life cycle assessment, employing methodologies such as Impact 2002+ and ReCiPe midpoint. As similar trends were observed with both methods, Impact 2002+ served as the reference for subsequent sections. It's important to note that the functional unit considered here involves the market release of a battery produced and subsequently recycled.

Chapter 4 was dedicated to the development of a mathematical model for supply chain optimization. This involved considering criteria optimized both separately and simultaneously.

chapter focuses on implementing the methodological framework for the battery closed-loop supply chain. It will present the data used as input for model operation as well as the results of the CLSC management model solved with the methodology presented in chapter 4, specifying the cases that correspond to different technical and environmental criteria for CLSC network modeling. Initially, the methodology is applied to two single-criterion optimization scenarios: The former minimizes the total cost of all the CLSC and the latter uses the results obtained in the life cycle assessment carried out in Chapter 3 with a specific focus on the minimization of GHG emissions generated in the CLSC.

Subsequently, multi-objective optimization, targeting the simultaneous minimization of both CLSC objectives, is then conducted using the software GAMS with the CPLEX solver employing the augmented epsilon constraint strategy, following the work of (Mavrotas & Florios, 2013).

The set of compromise solutions on the Pareto front are then evaluated on two levels:

- firstly, the best solution is obtained by applying the TOPSIS and M-TOPSIS decision support methods with the abovementioned two criteria.
- in a second step, a life cycle assessment of all the solutions is performed, integrating the results of GAMS into the SimaPro software. The TOPSIS and M-TOPSIS decision support methods are then applied to all criteria.

A sensitivity analysis is also carried out to emphasize the pivotal parameters of the key indicators.

5.2 Optimization strategy

The mathematical model is embedded within the software GAMS version 24 (Brooke et al. 1988) and solved using CPLEX, according to the formulation presented in Chapter 4, with the following assumptions:

- Recollection rate of end-of-life products : 85%
- The recycling rate of returned products : 90%
- The recovery rate of raw materials from a product :70%
- The ratio of recovered raw materials that are sent to the third party : 30%

The mathematical model with the constraints of the CLSC problem was described through the set of Equations from (Eq. 4. 3) to (Eq. 4. 24) in Section 4.3.

The whole set of data related to the configuration of the stages of the supply chain is presented in Appendix B.

Figure 5. 1 and 5.2 encompass the elements corresponding to the cost and emission data in the first period of the CLSC.

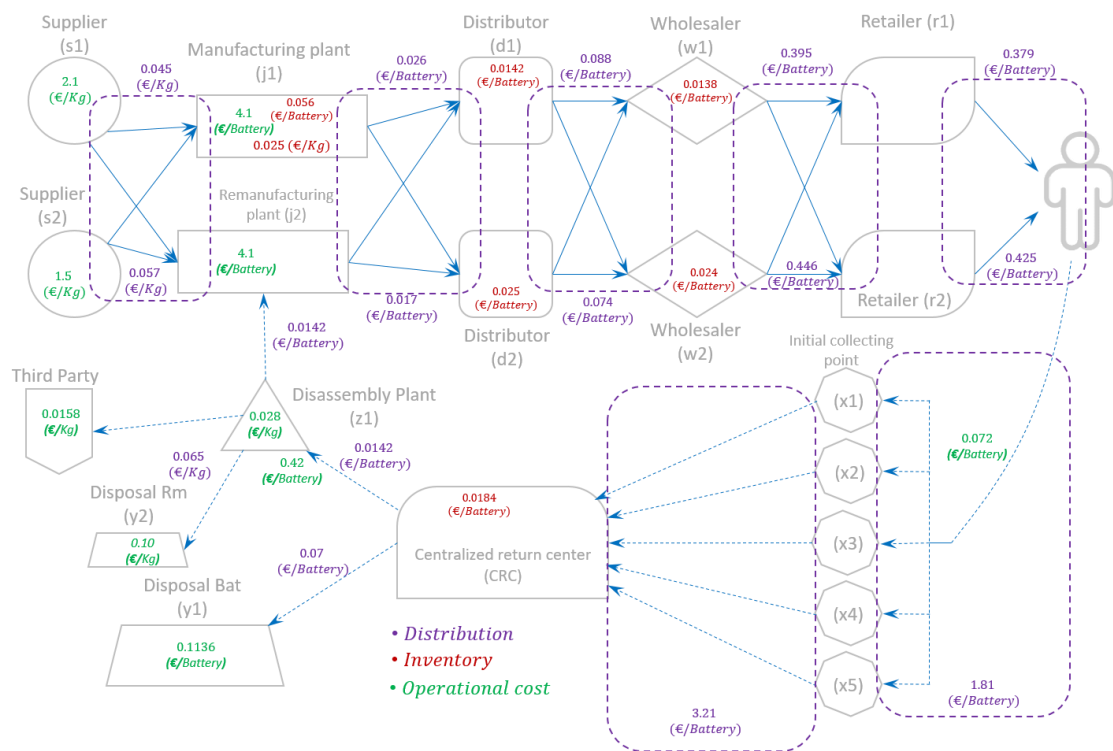

Figure 5. 1 Cost involved in the first period of the CLSC.

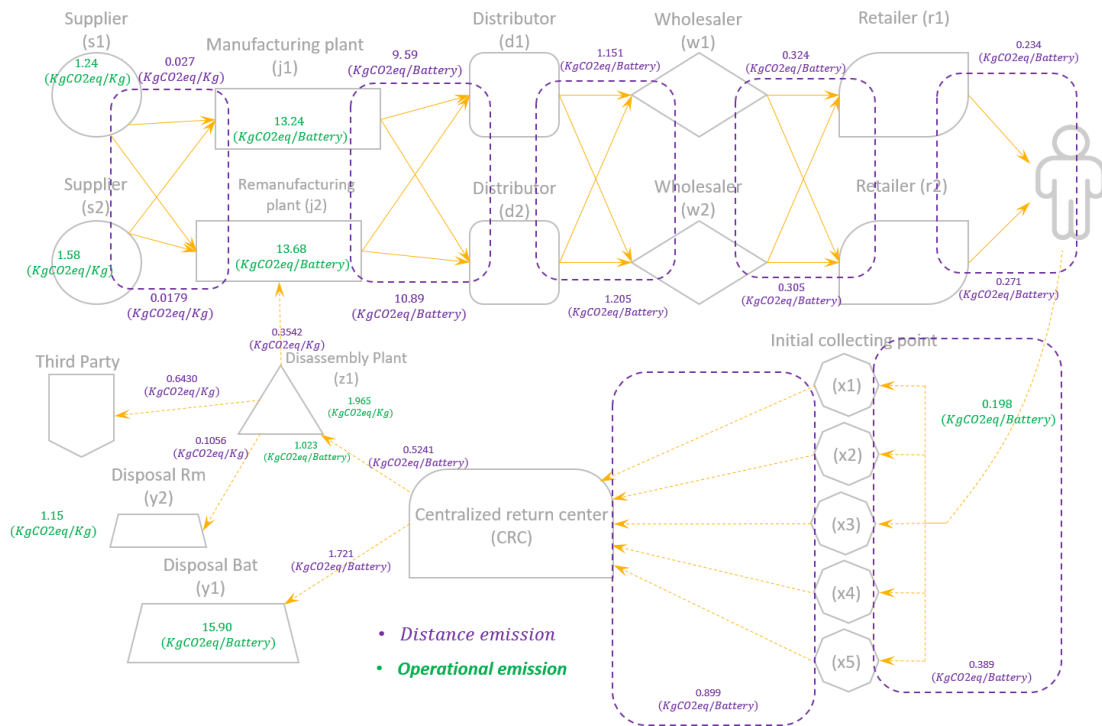

Figure 5. 2 Emissions involved in the first period of the CLSC.

5.3 Single-objective optimization cases

The proposed methodology developed in Chapter 4 is solved with the parameters described in Section 4.1 for two single-objective cases:

- The minimization of the total cost of the CLSC of lead-acid batteries ;
- The optimization of CO₂ emissions generated into the atmosphere for the whole CLSC.

Single-objective optimization was conducted for each objective function. As mentioned in the previous chapter, the Levelized Cost Of Battery (LCOB_m) has been computed from the optimized value of the cost criterion. LCOB_m can be viewed as the average price of a produced battery that would be required to recover the expenses associated with constructing and operating the supply chain over a specified timeframe. This metric is derived by dividing the total cost by the overall quantity of batteries released to meet market demand.

Similarly, the value $L_{CO_2}EOB$ (Levelized CO₂ Emissions Of a Battery) has been calculated by dividing the total eqCO₂ emissions generated by the supply chain over the studied period by the total number of batteries released on the market to satisfy the demand.

5.3.1 Minimizing the total cost of the CLSC network.

The single-objective optimization of the total cost of the CLSC network is first performed across the five periods, considering the first period as the production start-up, meaning that only virgin lead serves as raw materials, with recycling taking place from the second period upwards. Table 5. 1 gives the value of the optimized criterion with the corresponding value of the environmental criterion.

	Production (5 periods)
<i>Total Cost (€)</i>	1,294,147,100
<i>GWP (KgCO₂eq)</i>	2,337,442,500
<i>Demand (Batteries)</i>	58,434,000
<i>LCOB_m (€/Battery)</i>	22.15
<i>L_{CO₂}EOB (KgCO₂eq/Battery)</i>	40.00

Table 5. 1 Results of single-objective optimization of the total cost of the CLSC.

Further detailed results for each period are outlined in Table 5. 2. These results are to be interpreted considering the specific demand profile in each period. Notably, the demand is at its lowest in period 1, consequently resulting in the highest cost per battery and emissions output.

Both cost and emissions are contingent upon the demand for batteries and the quantity of lead required to fulfill that demand.

<i>Period</i>	1	2	3	4	5
<i>Total Cost (€)</i>	271,692,300	283,481,300	208,588,400	237,059,400	293,325,700
<i>GWP (KgCO₂eq)</i>	473,558,800	494,582,400	438,011,100	455,168,500	476,121,700
<i>Demand (Batteries)</i>	10,418,000	12,408,000	11,889,000	11,296,000	12,423,000
<i>LOCB_m (€/Battery)</i>	26.08	22.85	17.54	20.99	23.61
<i>GWP (KgCO₂eq/Battery)</i>	45.46	39.86	36.84	40.29	38.33
<i>Lead virgin used in the period production (Kg of virgin lead)</i>	90,003,140	59,929,480	46,420,570	43,652,130	56,077,620

Table 5. 2 Results of single-objective optimization of the total cost of the CLSC by period.

5.3.2 Minimizing global warming potential (GWP) of the whole CLSC

The single-objective optimization of GWP was performed according to the formulation presented from (Eq. 4. 3) to (Eq. 4. 24) in Section 4.3. Equation (4.38) in Section 4.7 expresses the objective function to be minimized. In this case, optimization leads to the best value in terms of GWP and the lowest value in terms of cost. The results obtained are therefore consistent with the results of the previous optimization (Table 5. 3).

	Production (5 periods)
<i>GWP (KgCO₂eq)</i>	2,153,795,600
<i>Total Cost (€)</i>	1,615,740,800
<i>Demand (Batteries)</i>	58,434,000
<i>L_{CO₂}EOB (KgCO₂eq/Battery)</i>	36.86
<i>LCOB_m (€/Battery)</i>	27.65

Table 5. 3 Results of single-objective optimization of GWP of the CLSC.

Following a similar approach, more detailed results for each period are presented in Table 5. 3), **¡Error! No se encuentra el origen de la referencia.** Figure 5. 1 and Figure 5. 1, should be analyzed according to the respective demand in each period. The demand profile is lowest in period 1, leading to both the highest cost per battery and the highest emissions results compared to the other periods. These results consistently align from one period to the next, in line with the outcomes achieved through cost optimization.

<i>Period</i>	1	2	3	4	5
<i>GWP (KgCO₂eq/Battery)</i>	424,731,800	463,975,900	421,517,600	401,870,300	441,700,000
<i>Total Cost (€)</i>	337,216,100	326,809,000	279,413,500	309,599,600	362,702,600
<i>Demand (Batteries)</i>	10,418,000	12,408,000	11,889,000	11,296,000	12,423,000
<i>L_{CO₂}EOB GWP (KgCO₂eq/Battery)</i>	40.77	37.39	35.45	35.58	35.56
<i>LCOB_m (€/Battery)</i>	32.37	26.34	23.50	27.41	29.20
<i>Lead virgin used in the period production (Kg of virgin lead)</i>	90,003,140	59,929,480	46,420,570	43,652,130	56,077,620

Table 5. 4 Results of single-objective optimization of the total GWP of the CLSC by period.

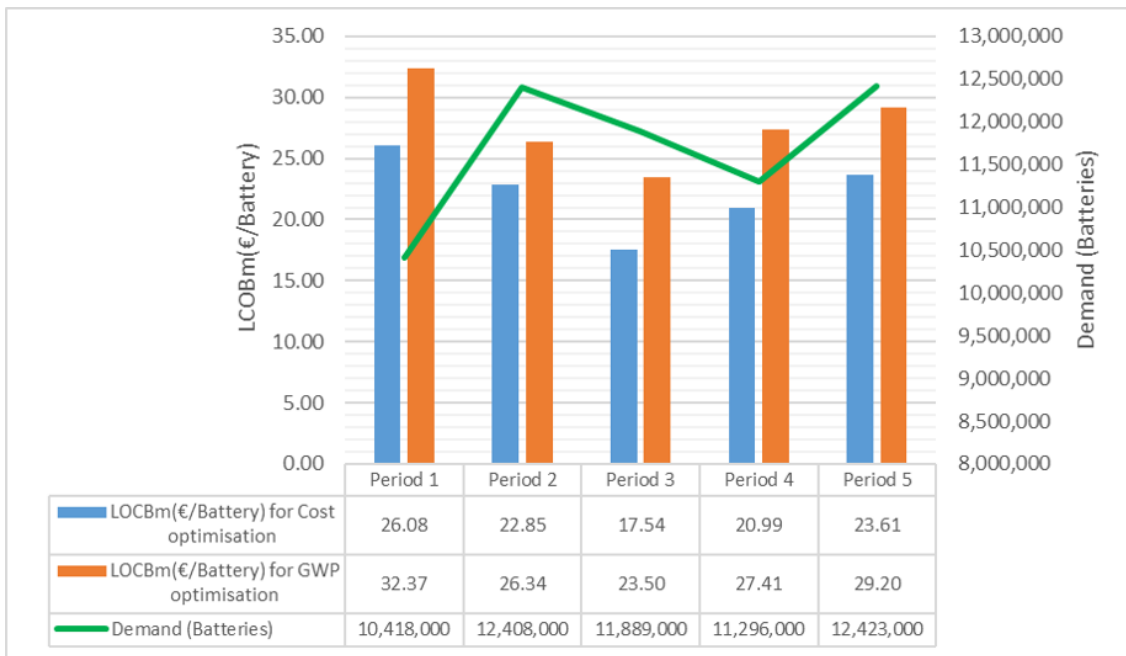

Figure 5. 3 Evolution of best and worst solutions for cost criterion according to the single-objective optimizations.

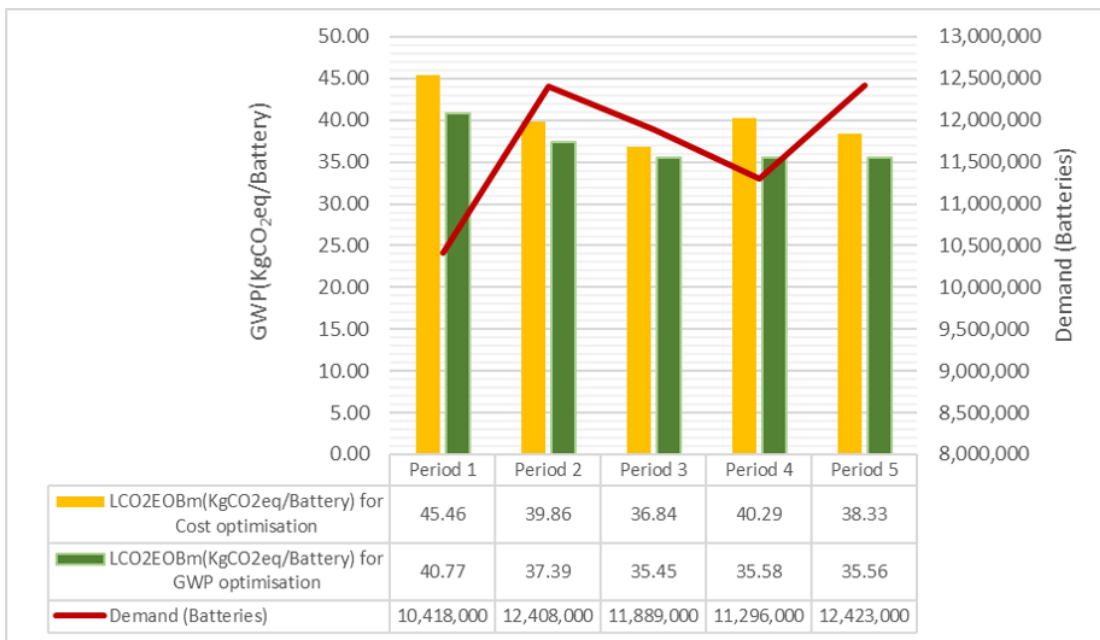

Figure 5. 4 Evolution of best and worst solutions for GWP criterion according to the single-objective optimizations

5.4 Multi-objective optimization cases

The ϵ -constraint method was applied as described in section 4.8.2.2 for the lexicographic optimization of the total cost and GWP. Subsequently, the pay-off tables were generated (Table 5. 5), showcasing the minimum and maximum values of each objective function. These values account for the total demand of 58,434,000 batteries over the 5 periods, along with the corresponding values for each battery.

Period	Cost	GWP
Total Cost (€)	1,294,147,100	2,337,442,500
TOTAL GWP (kgCO ₂ eq)	1,615,740,800	2,153,795,700
<hr/>		
LOCB _b (€/Battery)	22.15	40.00
L _{CO₂} EOB _b (kgCO ₂ eq/Battery)	27.65	36.86

Table 5. 5 Pay-off table of the total cost and GWP of the whole CLSC.

Through the augmented ϵ -constraint method, a collection of 100 solutions forming the Pareto front has been derived, representing various supply chain configurations (refer to Figure 5. 5). Each solution is numbered from 1 to 100, arranged from left to right.

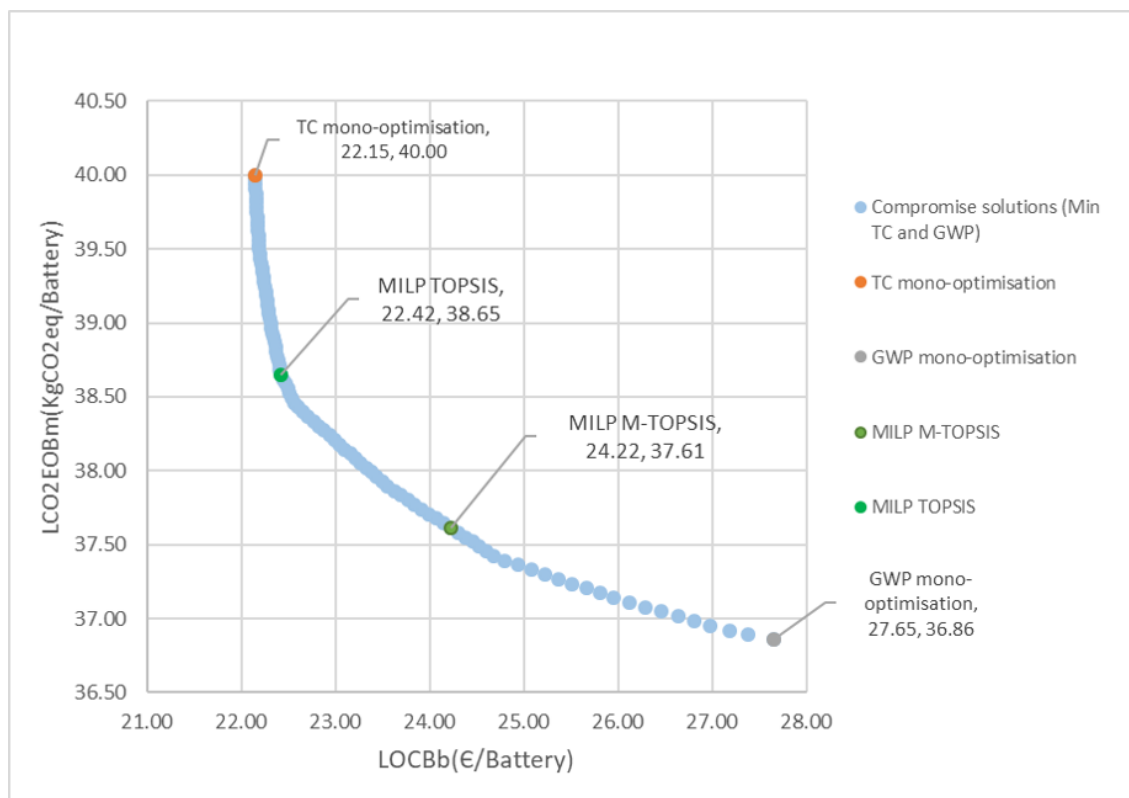

Figure 5. 5 Pareto solutions obtained for the multi-objective model using the ϵ -constraint method.

Two MCDM methods, namely TOPSIS and M-TOPSIS, were subsequently employed to select compromise solutions, with an equal weight attributed to both cost and GWP criteria (see Figure 5. 5).

To facilitate multi-criteria decision-making post Pareto front generation, a dedicated module featuring TOPSIS and M-TOPSIS was integrated. The fundamental principle behind TOPSIS involves choosing a solution closest to the ideal (favorable across all criteria) while distancing from the worst (negatively impacting all criteria) (Marković, 2010). The modified M-TOPSIS method introduced by (Ren et al., 2007) aims to prevent rank reversals and address evaluation issues arising when alternatives exhibit symmetry, a common occurrence in the original TOPSIS approach. Different MCDM methods may produce varying ranking orders for alternatives, as observed in prior studies (Morales-Mendoza, 2013).

In this scenario, as our focus is primarily on prioritizing the environmental aspect, the solution recommended by M-TOPSIS (highlighted for its superior environmental perspective) was selected for further analysis (solution 77). For visual representation, the solution derived from the application of the M-TOPSIS methodology is outlined in Table 5. 6.

Period	1	2	3	4	5	Total (5 periods)
Total Cost (€)	333,667,800	291,737,900	219,418,100	273,056,800	297,497,700	1,309,744,100
GWP (KgCO₂eq)	425,420,300	469,578,700	432,215,100	414,704,400	455,952,400	2,257,657,300
Demand (Batteries)	10,418,000	12,408,000	11,889,000	11,296,000	12,423,000	58,434,000
LOCBb (€/Battery)	32.03	23.51	18.46	24.17	23.95	22.41
L_{CO₂}EOBb (KgCO₂eq/Battery)	40.84	37.84	36.35	36.71	36.70	38.64
Lead virgin used in the period production (Kg of virgin lead)	90,003,140	59,929,480	46,420,570	43,652,130	56,077,620	296,082,940

Table 5. 6 Analysis of the solution selected by M-TOPSIS (solution 77).

The obtained results fall within the range delineated by the optimal values of each criterion, optimized individually. This observation holds true when considering both the overall perspective across all periods and for each individual period (see; **Error! No se encuentra el origen de la referencia.** Figure 5. 7 and Figure 5. 7).

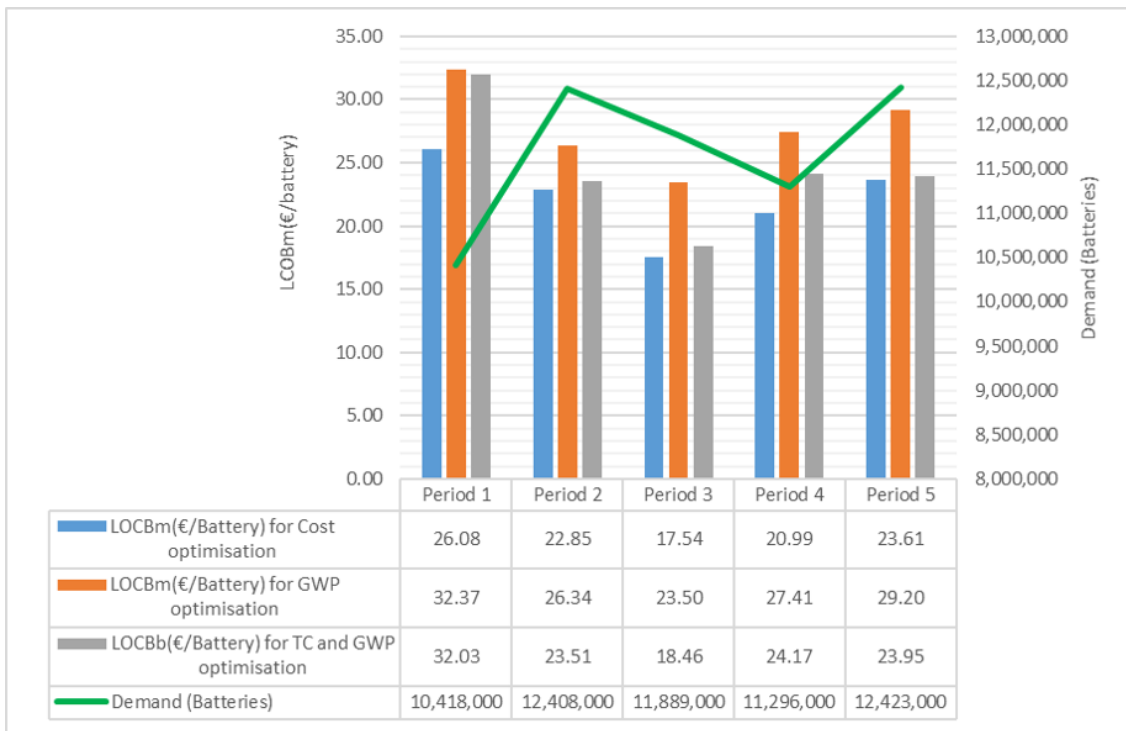

Figure 5. 6 Comparison of M-TOPSIS solution with best single-objective solutions for cost criterion.

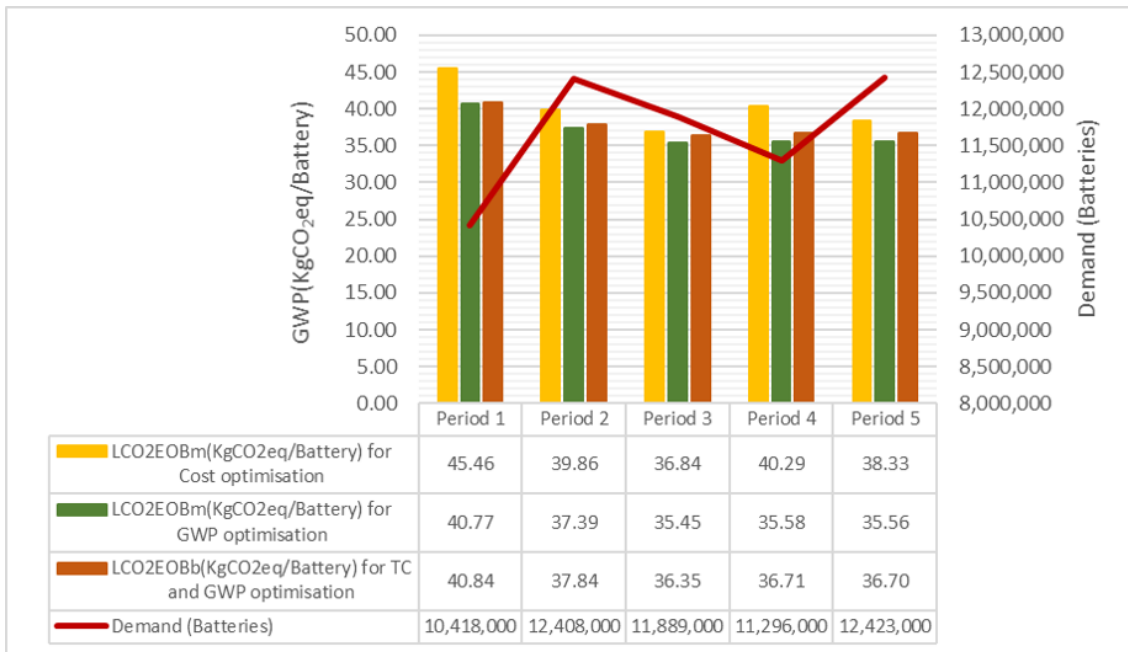

Figure 5. 7 Comparison of M-TOPSIS solution with best single-objective solutions for GWP criterion.

Figure 5. 8 illustrates the cost distribution across periods, encompassing inventory carrying expenses, distribution costs, and operational expenses associated with the chosen solution via M-TOPSIS (solution 77). Notably, the inventory cost is nearly negligible, with the operational cost representing the majority of the total expense. Furthermore, the proportion of operational costs decreases with rising demand.

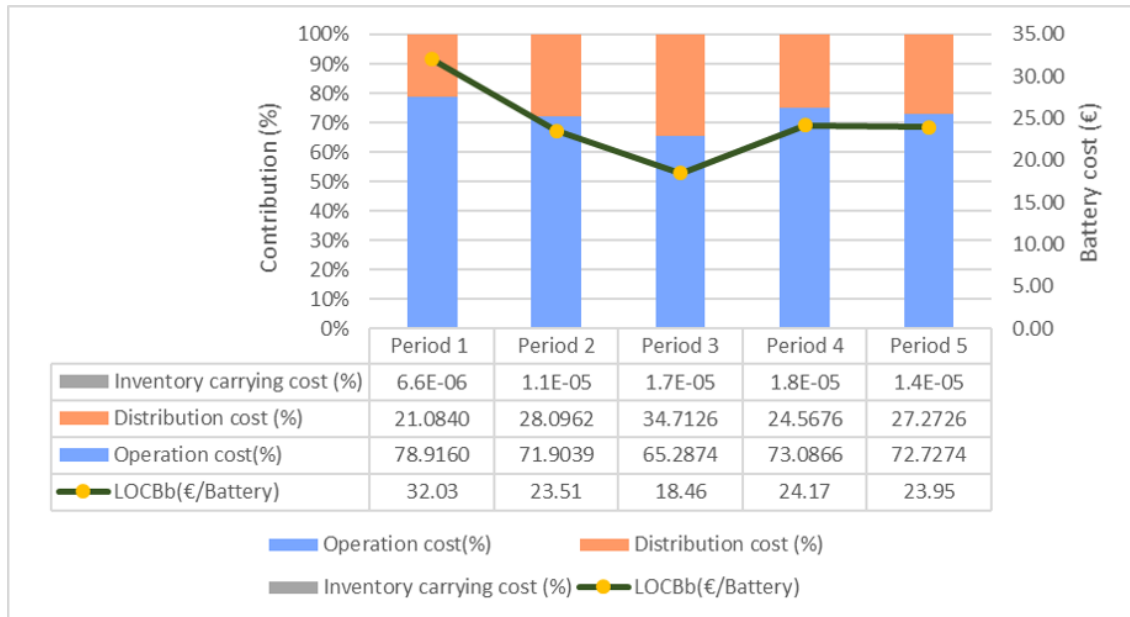

Figure 5. 8 Cost distribution among the items of the CLSC.

Figure 5. 9 depicts a detailed breakdown of operational costs, showcasing the reduction in the purchase expenses of virgin materials, predominantly lead, attributed to the incorporation of recycling practices over the observed period. Additionally, there is an evident escalation in the costs associated with battery remanufacturing and the disposal of raw materials post battery disassembly. Notably, the cost of a battery fluctuates based on the expense of new raw materials. This means that an increased reliance on virgin raw materials in battery production leads to higher battery costs. Interestingly, the cost of the manufacturing-remanufacturing process shows relatively minimal influence across the 5 periods (refer to Appendix C, Section 1).

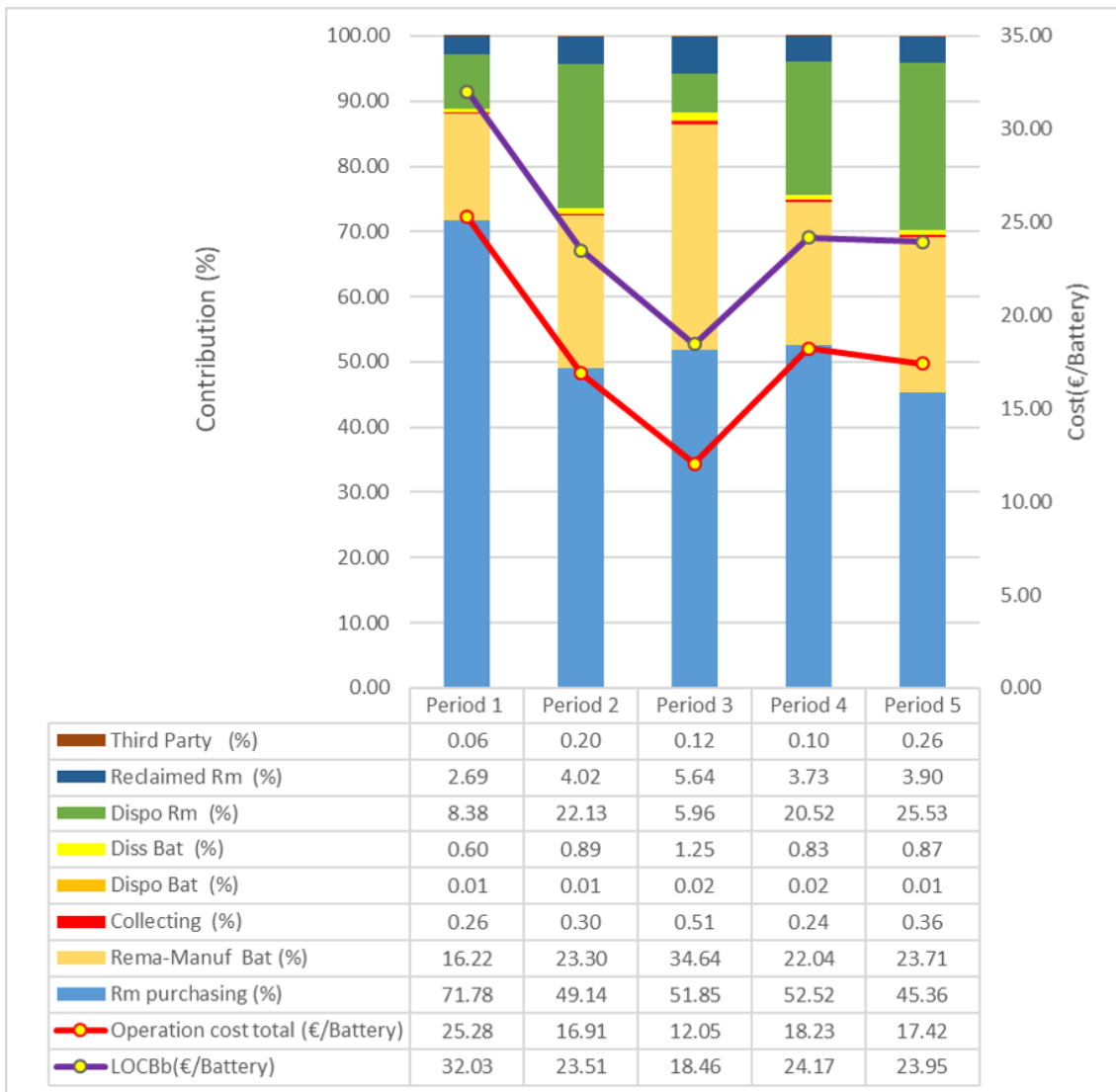

Figure 5. 9 Cartography of the operation cost in the CLSC.

Figure 5. 10 showcases the distribution costs within the CLSC. Notably, it's observed that whether utilizing recycled raw materials or not, the distribution cost remains almost consistent across all periods in the case study. It's important to note that this observation lacks generalizability and specific value outside the presented case study (refer to Appendix C, section 1 for the dataset).

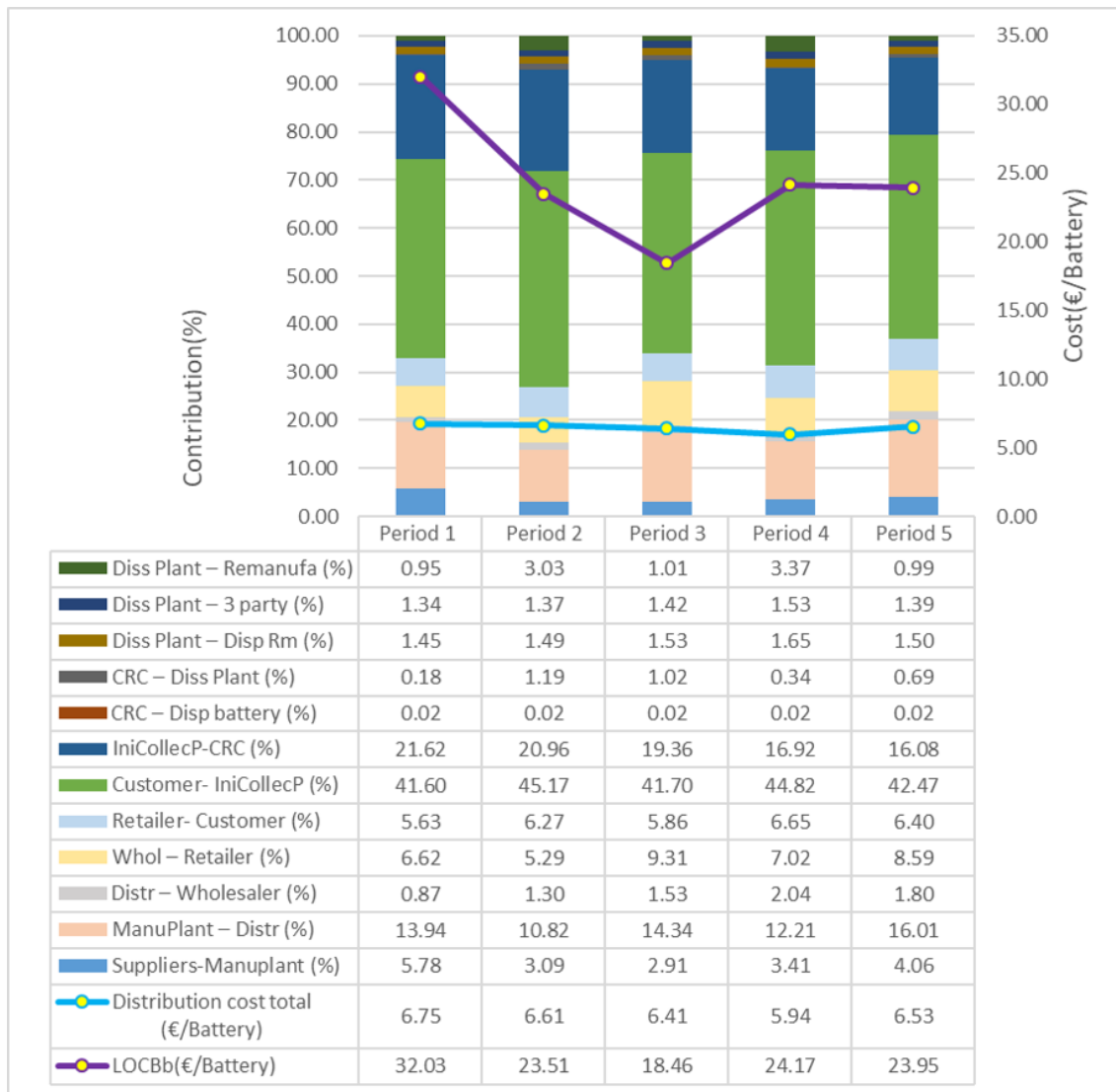

Figure 5. 10 Cartography of the distribution cost in the CLSC.

Given the insignificance of inventory costs (less than 1%), a detailed analysis akin to that conducted for operating and distribution costs is deemed unnecessary.

Figure 5. 11 illustrates the contribution of two types of GWP emissions (from operational and distribution stages) for the configuration derived from the Pareto front following the application of M-TOPSIS (solution 77). Notably, each step demonstrates a similar magnitude of contribution across the periods, accounting for over 60% of the total emissions. There is a slightly higher contribution from the operational steps during the initial period, attributed to zero recycling practices.

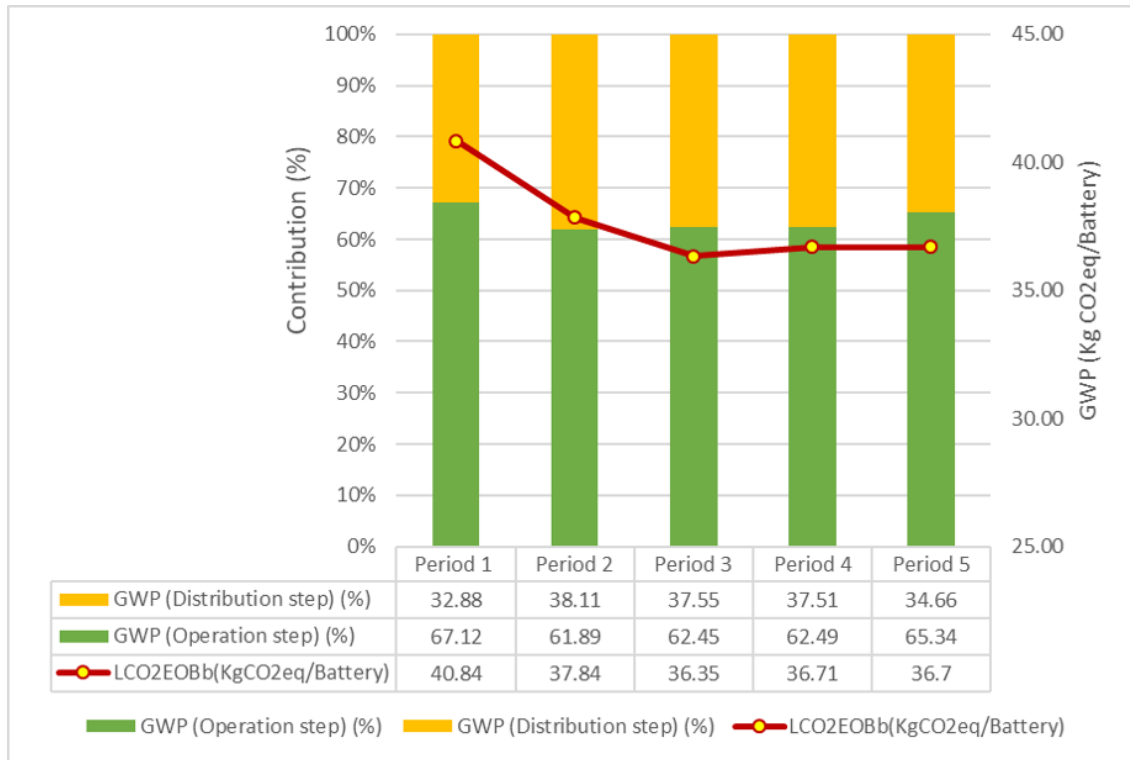

Figure 5. 11 GWP contribution.

Figure 5. 12 displays the emissions associated with operational steps in battery production. The findings highlight the environmental benefits of recycling in greenhouse gas emissions. Notably, the contribution linked to the extraction of virgin raw materials (such as lead) is lower for periods 2 to 5 compared to the initial period. Variations observed in periods 2 to 5 are attributed to demand fluctuations across these periods, impacting detailed emissions (refer to Appendix C, Section 2). However, an overarching observation indicates a slightly lower contribution from virgin raw material extraction and manufacturing/remanufacturing with recycling implementation. This positive trend validates the adoption of recycling practices from a GWP perspective.

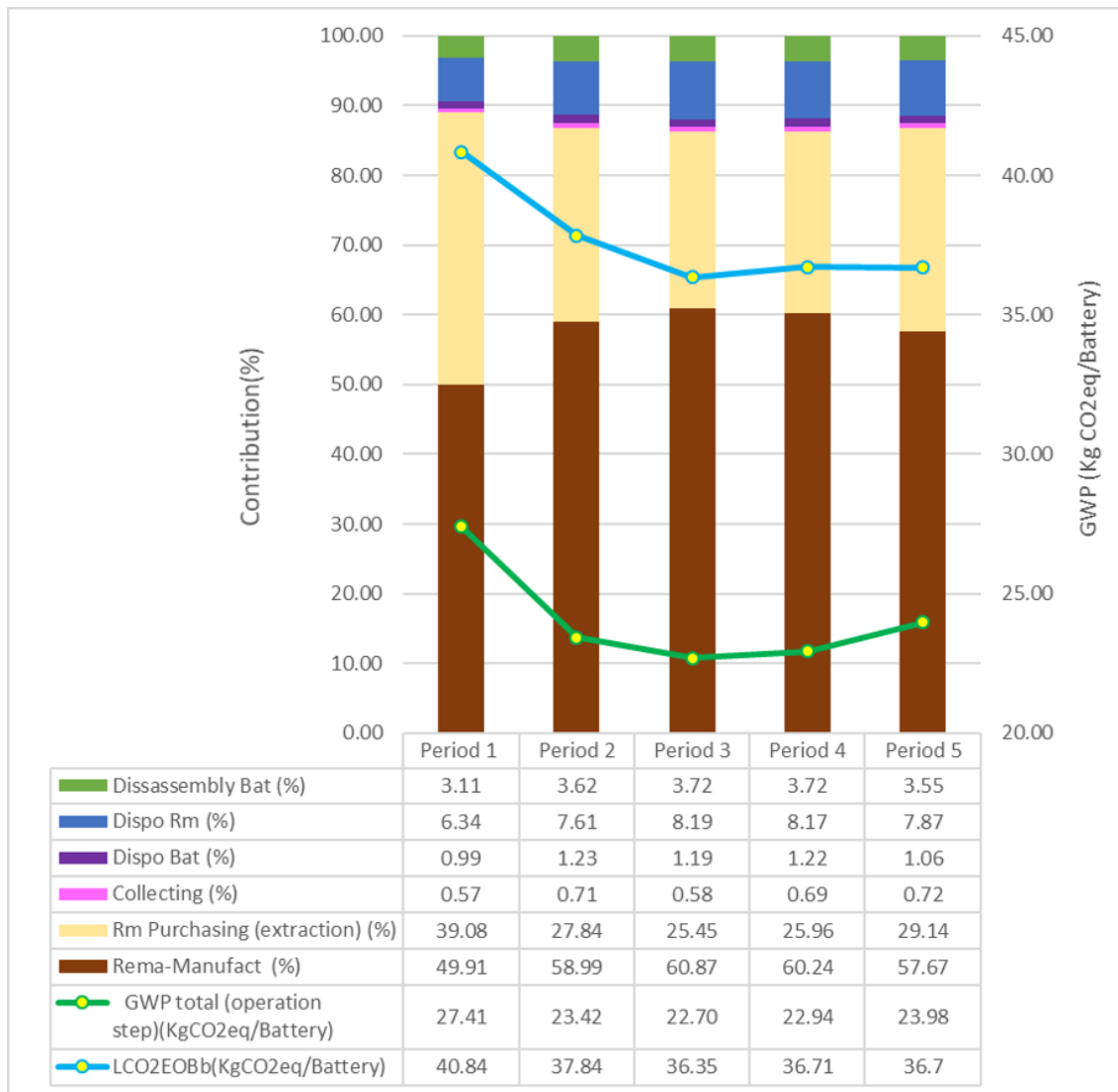

Figure 5. 12 Cartography of GWP for the operation steps in the CLSC.

Figure 5. 13 presents the emissions related to the distribution steps in the CLSC. It can be observed that recycling has little influence since the contribution of the different steps is approximately the same along the periods. It can also be observed that 70% of the emissions stem from the distribution stage after manufacturing (data related to the location of production units in China - one of the main manufacturers of lead-acid batteries were considered).

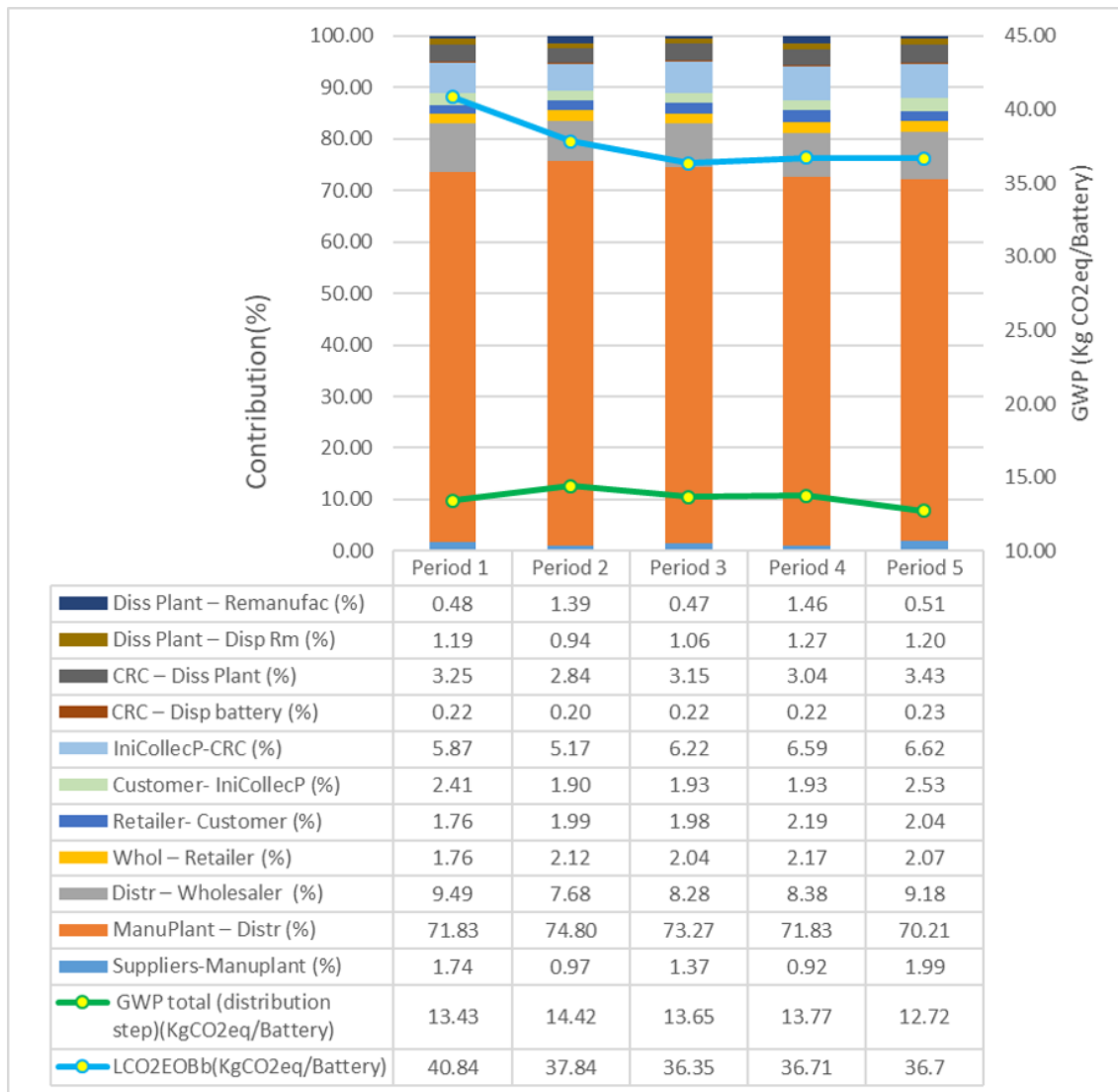

Figure 5. 13 Cartography of GWP for the distribution steps in the CLSC.

We have considered that recycled batteries are made up of 90% recycled lead and 10% virgin lead. Figure 5. 14 incorporates details regarding the utilization of raw materials (both virgin and recycled) across the 5 periods. To enhance comprehension, the components are itemized in Table 5. 7.







Component	Color	Comment
The total demand for Raw material for period production (Kg of lead) (Blue line).		The total demand for raw materials required to satisfy the battery manufacturing: this amount can be provided either by virgin or recycled raw materials.
Qty of Rm New used in the production (Kg of lead) (Grey bar).		Raw materials that are obtained directly from the supplier, this means that the extraction of natural resources has to be carried out to supply the demand for raw materials
Reclaimed raw material at the end of the period (Kg of lead) (Purple line).		At the culmination of each period, a portion of recovered raw materials from the recycling process is utilized to meet the subsequent period's raw material demand.
Qty of Rm recycled used for the recycling products in the production (Kg of lead) (Green bar).		An amount previously obtained from recycled raw materials is used to cover a part of the total demand of raw materials for battery manufacturing in a given period: it is worth mentioning that the recycled battery uses 90% of recycled raw materials.
Qty of Rm virgin used to complement the recycling products in the production (Kg of lead) (Orange bar).		Recycled batteries predominantly utilize 90% recycled raw materials. However, 10% of virgin raw materials are required to complement the production of recycled batteries. This 10% proportion of raw materials is acquired from suppliers, involving the extraction of resources from nature.
Effective recycling rate (%) (Red Line)		This ratio obtained for each period is based on the use of recycled raw materials regarding the total of raw materials required to satisfy the needs of a period.

Table 5. 7 Components of the recycling rate.

In the initial period that launches the supply chain operation, all raw material demand (represented by the blue line) was fulfilled solely by virgin raw materials (depicted in the gray bar), resulting in an effective recycling rate of 0 (indicated by the red line). Raw materials reclaimed (shown in the purple line) in period 1 will be utilized in the subsequent period.

Starting from the second period, the total raw material demand (blue line) is met through three components: recycled raw materials (displayed in the green bar), acquired from the previous period (illustrated by the purple line); supplementary virgin raw materials (depicted in the orange bar), complementing the recycled product; and any shortfall in the total raw material demand is covered by virgin materials provided by the supplier (shown in the gray bar).

Across periods 2 to 5, the effective recycling rate, contingent upon the demand profile, fluctuates between 44% and 55%.

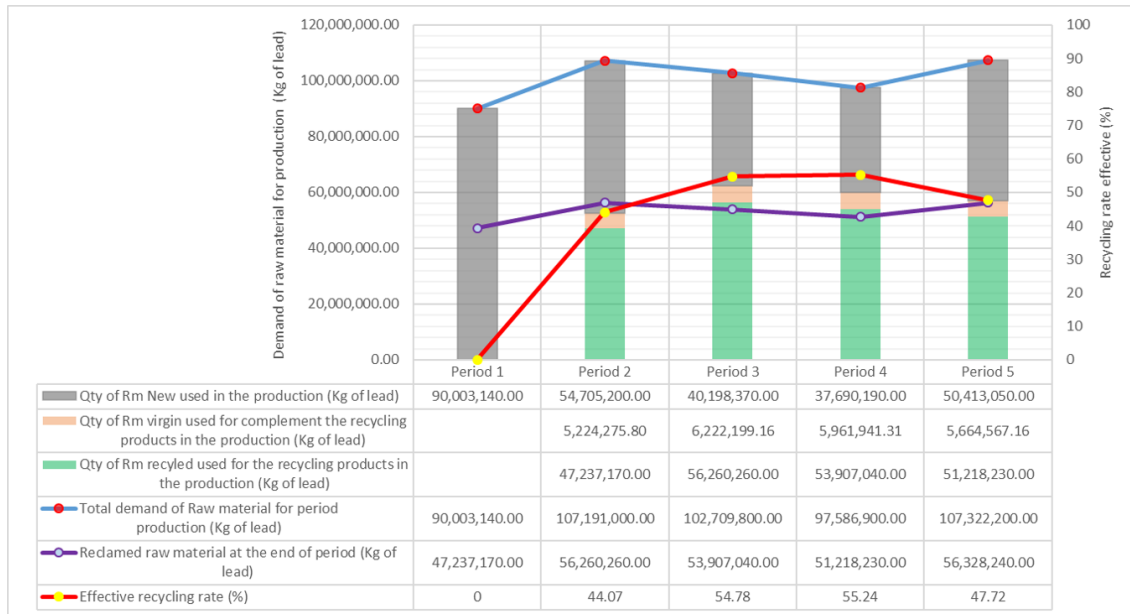

Figure 5. 14 Recycling rate for each period.

Table 5. 8 presents the evolution of the configuration of the post-optimal solution along the periods. In period 1, the supply chain does not yet form a loop, since only virgin raw materials are used to manufacture the batteries. From period 2 upwards, the chain closes with a loop structure. Interestingly, achieving a cost-optimal solution considering emissions is not straightforward. The optimization strategy serves as effective decision support. Each consecutive period reveals diverse resource mobilization and pathways adopted to derive the final solution. Detailed material flows can be found in Appendix D.

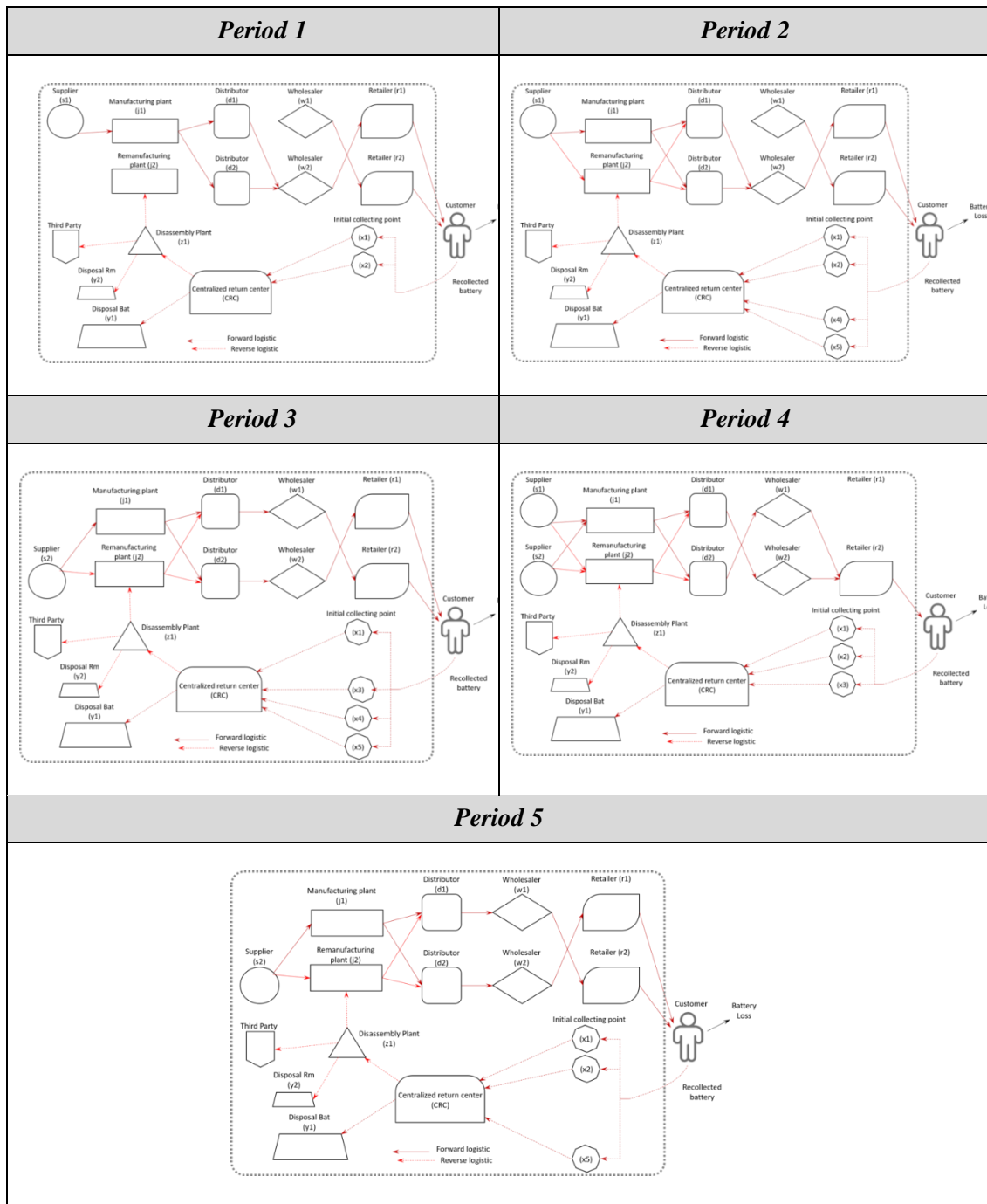

Table 5. 8 Structure of the CLSC for the lead-acid batteries production (period 1 to 5).

5.5 Life Cycle Assessment of the Pareto front solutions

Each solution on the Pareto front undergoes a comprehensive environmental assessment, involving the calculation of LCA indicators, to achieve a holistic understanding. The objective is to determine if the ranking established by M-TOPSIS for the two optimization criteria remains consistent when all indicators are considered (Figure 5. 15).

Each solution is dissected into its structure and decision variables across each period. These decision variables are then utilized to assess the environmental impact across all indicators for each period. The average impact value for each potential indicator is subsequently computed across all periods. The MCDM method is then applied, encompassing the entire array of indicators (15 environmental and 1 economic).

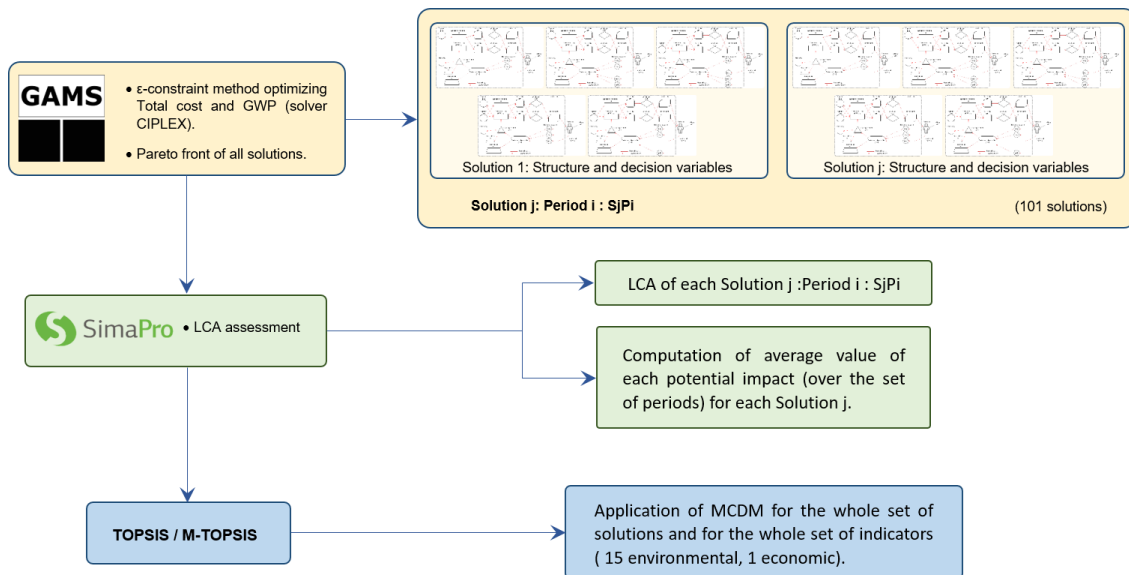

Figure 5. 15 Generation of a complete mapping of each solution.

To generate diversity in the solutions generated along the periods and from a component of a given step to another one, environmental submodules derived from the basic solution adopted in Chapter 3 were generated. These submodules, integrated into the SimaPro software, were initially transferred to an Excel sheet for automatic computation of environmental indicators at various supply chain steps.

The impact factors of the various components are assumed to follow the same fluctuations as the value of the impact factor of GWP values (see Appendix B) within the Impact 2002+ method.

Each solution is then assessed with the environmental submodules, considering the variables involved at each step respectively (Table 5. 9) and the rolling horizon of the five periods.

The comprehensive dataset contributing to the creation of environmental submodules is provided in Appendix D. A color code is adopted to indicate increasing (higher intensity) or decreasing (lower intensity) impact factors compared to the base case (period 1), as highlighted in Table 5. 9.

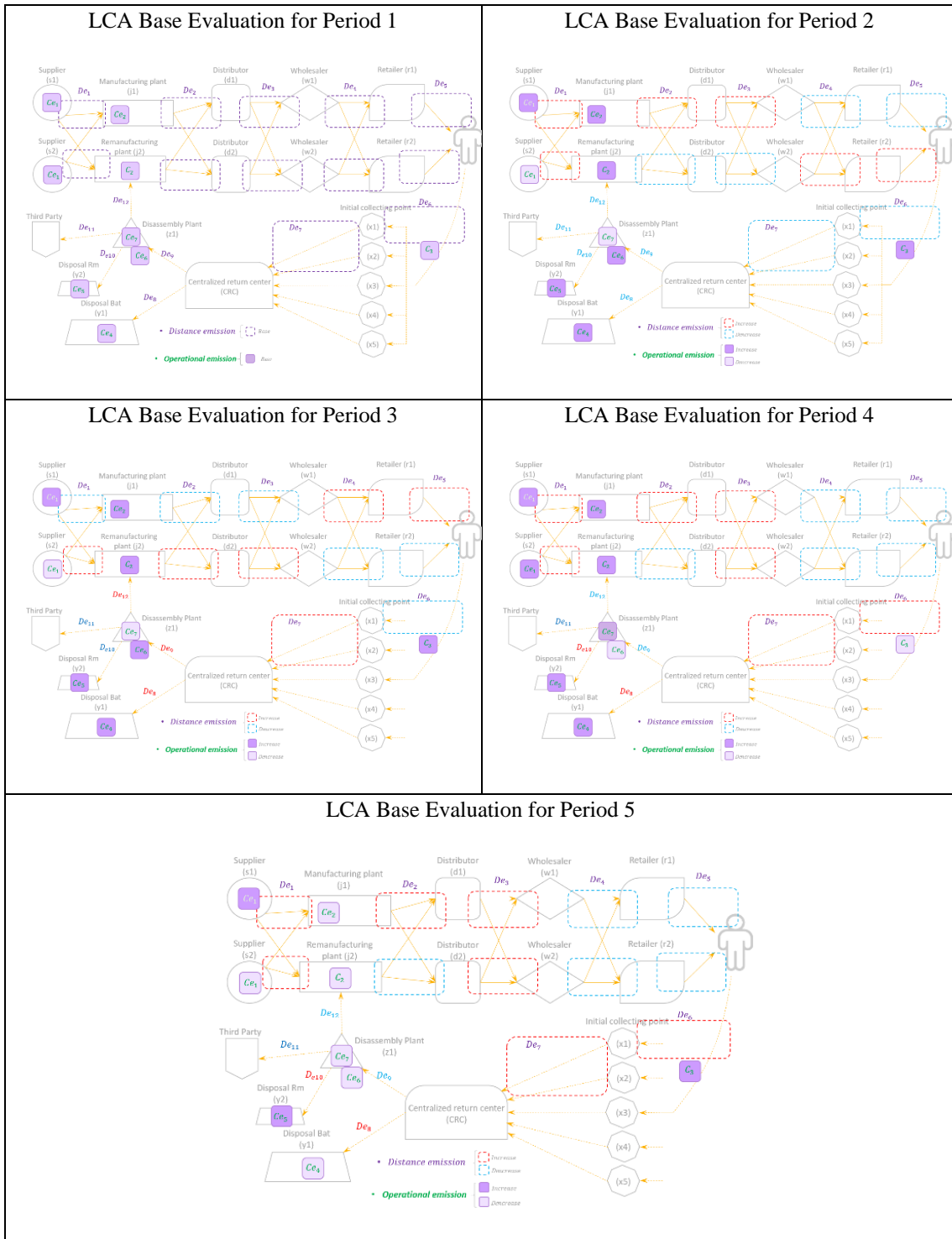

Table 5.9 Colour code for the environmental submodules involving increasing (higher intensity) or decreasing (lower intensity) impact factors compared to the base case (period 1)

Decision Variable	Identification	Distribution emissions	Operation Emissions
Amount of raw material 'i' purchased from supplier 's' to the manufacturing plant 'j' during period 't' (kg).	AMat	x	x
Quantity processed of product 'p' at manufacturing plant 'j' during period 't' (battery).	QProc		x
Quantity transported from manufacturing plant 'j' to distributor 'd' of product 'p' at period 't'(battery).	QtJD	x	
Quantity transported from distributor 'd' to wholesaler 'w' of product 'p' at period 't'(battery).	QtDW	x	
Quantity transported from wholesaler 'w' to retailer 'r' of product 'p' at period 't' (battery).	QtWR	x	
Quantity transported of product 'p' from retailer 'r' to the customer at period 't' (battery).	QtRCus	x	
Quantity of useless returned products of 'p' transported from the centralized return center to the disposal site 'y' at period 't' (battery).	QBad	x	x
Quantity of returned products of 'p' processed (recycling) at the disassembly-recycling plant 'z' at period 't' (battery).	QRetu	x	
Amount of recycled raw material 'i' from the disassembly-recycling plant 'z' sold to the third party during the period 't' (kg).	QBadRm	x	x
Amount of recycled raw material 'i' from the disassembly-recycling plant 'z' sold to the third party during the period 't' (kg).	ARec3p		x
Quantity of useful (recyclable) returned products of 'p' transported from the centralized return center to the disassembly-recycling plant 'z' at period 't' (units).	QRecy		x
Quantity of product "p" recollected transported from the customer to the initial recollecting point "x" at period 't' (battery)	AmountCenter		x

Table 5. 10 Decision variables involved in each step of the CLSC.

As previously, the solutions are re-evaluated using both TOPSIS and M-TOPSIS with consideration of the whole set of indicators (15 environmental and 1 economic based on the LCOE of the battery). For this purpose, equal weight is considered for economic (0.5) and environmental (0.5) pillars, with an equal contribution of each environmental component.

The resulting solutions, termed LCA TOPSIS and LCA M-TOPSIS, are depicted in Figure 5. 16. This allows for direct comparison with the earlier solutions.

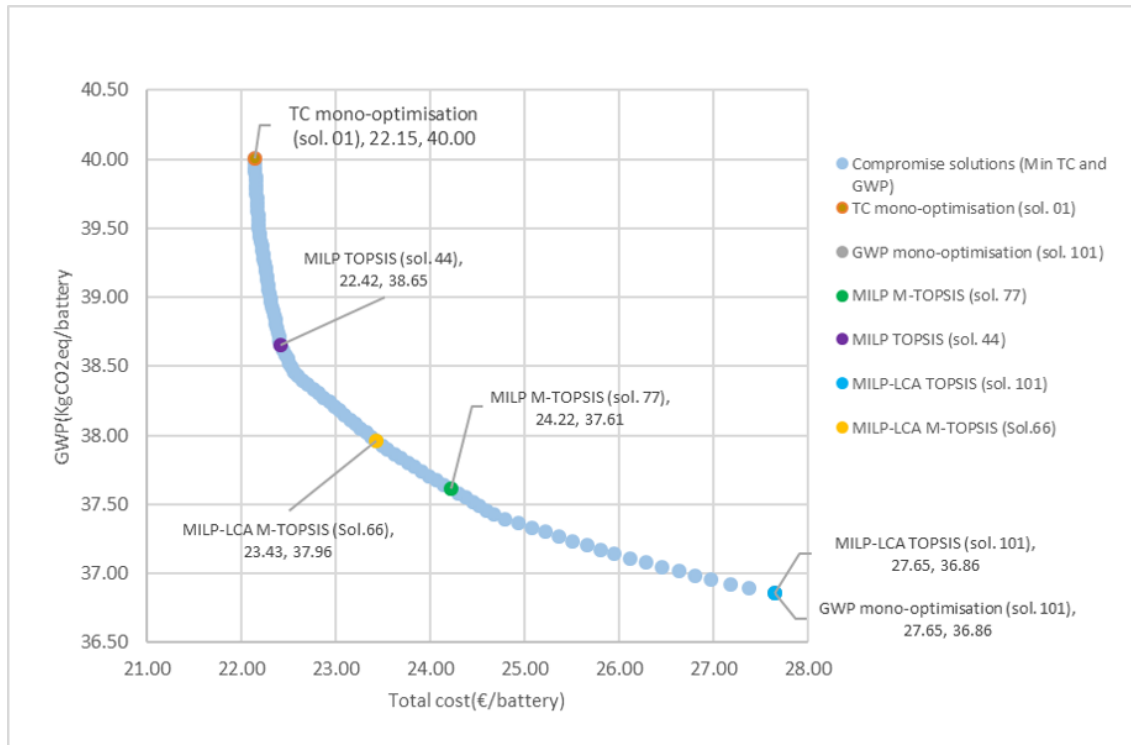

Figure 5.16 Pareto solutions obtained for the multi-objective model using the ϵ -constraint method (LCA evaluation included)

The solutions identified through TOPSIS and M-TOPSIS differ from the previous selections. TOPSIS aligns closely with the single-objective resolution (GWP optimization). Conversely, M-TOPSIS closely resembles the solution derived immediately after the bi-objective optimization step (Figure 5.16). Table 5.11 presents the environmental indicator values for both solutions, considering the functional unit of a lead-acid battery.

These normalized solutions, employing the same methodology as previously outlined, are displayed in Table 5.11 and visually represented in a radar graph in Figure 5.17. The application of MILP-LCA TOPSIS and MILP-LCA M-TOPSIS reveals that the TOPSIS alternative generally outperforms the M-TOPSIS option across most environmental indicators, showing equivalent performance only for ozone layer depletion and terrestrial acidification.

To aid comparison, both selection methods present the best and worst ranks following TOPSIS or M-TOPSIS application, along with a median solution representing the median rank among the alternatives generated by the MCDM solution. These results, classified by the corresponding solution number from the initial Pareto front, are detailed in Table 5.11, including the normalized values.

	Indicator	Unit	Best MILP-LCA TOPSIS solution (sol. 101)	Median MILP-LCA TOPSIS solution (sol. 52)	Worst MILP-LCA TOPSIS solution (sol. 1)	Best MILP-LCA M- TOPSIS solution (sol. 66)	Median MILP-LCA M-TOPSIS solution (sol. 35)	Worst MILP-LCA M-TOPSIS solution (sol. 6)
1	Carcinogens	kg C ₂ H ₃ Cl eq	2.39	2.671	2.691	2.573	2.684	2.692
2	Non-carcinogens	kg C ₂ H ₃ Cl eq	16.640	18.927	19.026	18.119	19.011	19.031
3	Respiratory inorganics	kg PM _{2.5} eq	0.070	0.074	0.077	0.073	0.075	0.078
4	Ionizing radiation	Bq C-14 eq	598.308	606.435	618.569	604.423	610.264	620.235
5	Ozone layer depletion	kg CFC-11 eq	2.484	2.467	2.467	2.467	2.467	2.467
6	Respiratory organics	kg C ₂ H ₄ eq	0.018	0.019	0.020	0.019	0.019	0.020
7	Aquatic ecotoxicity	kg TEG water	9136.152	10268.451	10406.317	9875.991	10328.195	10430.397
8	Terrestrial ecotoxicity	kg TEG soil	2563.175	2878.306	2944.215	2772.200	2893.346	2965.587
9	Terrestrial acid/nutri	kg SO ₂ eq	32.627	32.489	32.577	32.465	32.520	32.586
10	Land occupation	m ² org.arable	0.872	0.910	0.994	0.902	0.932	1.011
11	Aquatic acidification	kg SO ₂ eq	1.011	1.040	1.054	1.030	1.045	1.055
12	Aquatic eutrophication	kg PO ₄ P-lim	0.035	0.040	0.040	0.038	0.040	0.040
13	Global warming	kg CO ₂ eq	36.876	38.433	40.030	37.993	38.960	40.233
14	Non-renewable energy	MJ primary	605.486	628.555	652.607	622.151	636.121	656.087
15	Mineral extraction	MJ surplus	25.477	28.190	28.312	27.219	28.296	28.314
16	Cost	EURO	27.651	22.653	22.147	23.434	22.331	22.156
Normalized values								
1	Carcinogens	kg C ₂ H ₃ Cl eq	0.88822	0.99208	0.99961	0.95566	0.99709	1.00000
2	Non-carcinogens	kg C ₂ H ₃ Cl eq	0.87435	0.99455	0.99973	0.95208	0.99893	1.00000
3	Respiratory inorganics	kg PM _{2.5} eq	0.90067	0.95718	0.99586	0.93923	0.97097	1.00000
4	Ionizing radiation	Bq C-14 eq	0.96465	0.97775	0.99731	0.97451	0.98392	1.00000
5	Ozone layer depletion	kg CFC-11 eq	1.00000	0.99300	0.99300	0.99300	0.99300	0.99300
6	Respiratory organics	kg C ₂ H ₄ eq	0.88996	0.94276	0.99260	0.92891	0.95836	1.00000
7	Aquatic ecotoxicity	kg TEG water	0.87592	0.98447	0.99769	0.94685	0.99020	1.00000
8	Terrestrial ecotoxicity	kg TEG soil	0.86431	0.97057	0.99279	0.93479	0.97564	1.00000
9	Terrestrial acid/nutri	kg SO ₂ eq	1.00000	0.99578	0.99849	0.99505	0.99674	0.99874
10	Land occupation	m ² org.arable	0.86273	0.90066	0.98389	0.89260	0.92208	1.00000
11	Aquatic acidification	kg SO ₂ eq	0.95796	0.98544	0.99876	0.97637	0.99050	1.00000
12	Aquatic eutrophication	kg PO ₄ P-lim	0.87844	0.99110	0.99944	0.95144	0.99644	1.00000
13	Global warming	kg CO ₂ eq	0.91657	0.95525	0.99496	0.94432	0.96837	1.00000
14	Non-renewable energy	MJ primary	0.92287	0.95804	0.99470	0.94828	0.96957	1.00000
15	Mineral extraction	MJ surplus	0.89980	0.99561	0.99993	0.96132	0.99935	1.00000
16	Cost	EURO	1.00000	0.81926	0.80096	0.84750	0.80760	0.80129

Table 5. 11 Values of the different indicators for the TOPSIS and M-TOPSIS for MILP-LCA solutions.

The radar graph (Figure 5. 17) shows the evolution of the alternative solutions from the Pareto front and the improvements achieved in environmental impacts. Considering only the environmental pillar, solution 101 (MILP-LCA-TOPSIS) is top-ranked in particular for the ecotoxicity indicators. A good compromise solution is also obtained with solution 66 (MILP-LCA-M-TOPSIS), considering both environmental and economic aspects.

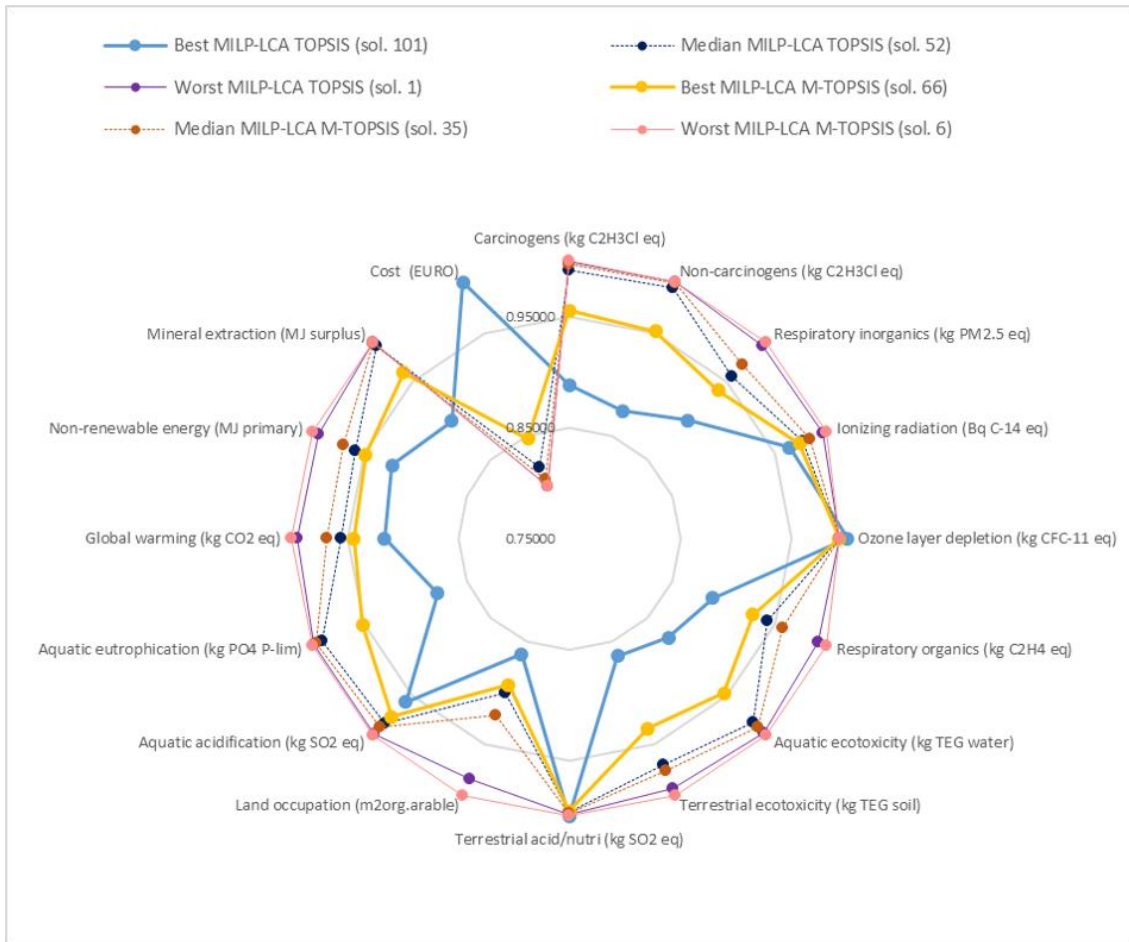

Figure 5. 17 Values of the different indicators for the TOPSIS and M-TOPSIS for MILP-LCA solutions.

These solutions are now compared with those previously obtained just after the bi-optimization step followed by the application of MCDM (either TOPSIS or M-TOPSIS) (Table 5. 12 and Figure 5. 18).

Notably, the solutions from both stages of the strategy align closely with M-TOPSIS. This observation substantiates the chosen strategy, which aimed to optimize only two criteria (cost and GWP). The multi-objective optimization strategy proved to be computationally efficient, with a resolution time of 18.47 seconds for each simulation set, underscoring the importance of reducing the problem with two conflicting objectives.

With M-TOPSIS, the behavior of both solutions obtained is quite similar (solutions 66 and 77).

However, TOPSIS presents contrasting behaviors between the solutions obtained before and after evaluating all environmental indicators.

	Indicator	Unit	MILP-LCA TOPSIS (sol. 101)	MILP-LCA M-TOPSIS (sol. 66)	MILP M-TOPSIS (sol. 77)	MILP TOPSIS (sol. 44)
1	Carcinogens	kg C ₂ H ₃ Cl eq	2.39	2.671	2.691	2.573
2	Non-carcinogens	kg C ₂ H ₃ Cl eq	16.640	18.927	19.026	18.119
3	Respiratory inorganics	kg PM2.5 eq	0.070	0.074	0.077	0.073
4	Ionizing radiation	Bq C-14 eq	598.308	606.435	618.569	604.423
5	Ozone layer depletion	kg CFC-11 eq	2.484	2.467	2.467	2.467
6	Respiratory organics	kg C ₂ H ₄ eq	0.018	0.019	0.020	0.019
7	Aquatic ecotoxicity	kg TEG water	9136.152	10268.451	10406.317	9875.991
8	Terrestrial ecotoxicity	kg TEG soil	2563.175	2878.306	2944.215	2772.200
9	Terrestrial acid/nutri	kg SO ₂ eq	32.627	32.489	32.577	32.465
10	Land occupation	m ² org.arable	0.872	0.910	0.994	0.902
11	Aquatic acidification	kg SO ₂ eq	1.011	1.040	1.054	1.030
12	Aquatic eutrophication	kg PO ₄ P-lim	0.035	0.040	0.040	0.038
13	Global warming	kg CO ₂ eq	36.876	38.433	40.030	37.993
14	Non-renewable energy	MJ primary	605.486	628.555	652.607	622.151
15	Mineral extraction	MJ surplus	25.477	28.190	28.312	27.219
16	Cost	EURO	27.651	22.653	22.147	23.434
Normalized values						
1	Carcinogens	kg C ₂ H ₃ Cl eq	0.89154	0.95924	0.94093	1.00000
2	Non-carcinogens	kg C ₂ H ₃ Cl eq	0.87539	0.95321	0.93241	1.00000
3	Respiratory inorganics	kg PM2.5 eq	0.93411	0.97410	0.96197	1.00000
4	Ionizing radiation	Bq C-14 eq	0.98375	0.99380	0.99053	1.00000
5	Ozone layer depletion	kg CFC-11 eq	1.00000	0.99300	0.99300	0.99300
6	Respiratory organics	kg C ₂ H ₄ eq	0.93663	0.97762	0.96520	1.00000
7	Aquatic ecotoxicity	kg TEG water	0.88566	0.95738	0.93816	1.00000
8	Terrestrial ecotoxicity	kg TEG soil	0.88690	0.95922	0.94046	1.00000
9	Terrestrial acid/nutri	kg SO ₂ eq	1.00000	0.99505	0.99449	0.99624
10	Land occupation	m ² org.arable	0.94787	0.98070	0.97077	1.00000
11	Aquatic acidification	kg SO ₂ eq	0.96943	0.98806	0.98261	1.00000
12	Aquatic eutrophication	kg PO ₄ P-lim	0.88230	0.95563	0.93576	1.00000
13	Global warming	kg CO ₂ eq	0.95325	0.98210	0.97316	1.00000
14	Non-renewable energy	MJ primary	0.95782	0.98418	0.97613	1.00000
15	Mineral extraction	MJ surplus	0.90057	0.96215	0.94528	1.00000
16	Cost	EURO	1.00000	0.84750	0.87599	0.81097

Table 5. 12 Values of the different indicators for the TOPSIS and M-TOPSIS applied to the MILP and MILP-LCA solutions.

Figure 5. 18 presents the solutions found by TOPSIS and M-TOPSIS after MILP and MILP-LCA evaluations. It can be seen that the MILP-M-TOPSIS leads to slightly more optimistic results than MILP-LCA-M-TOPSIS

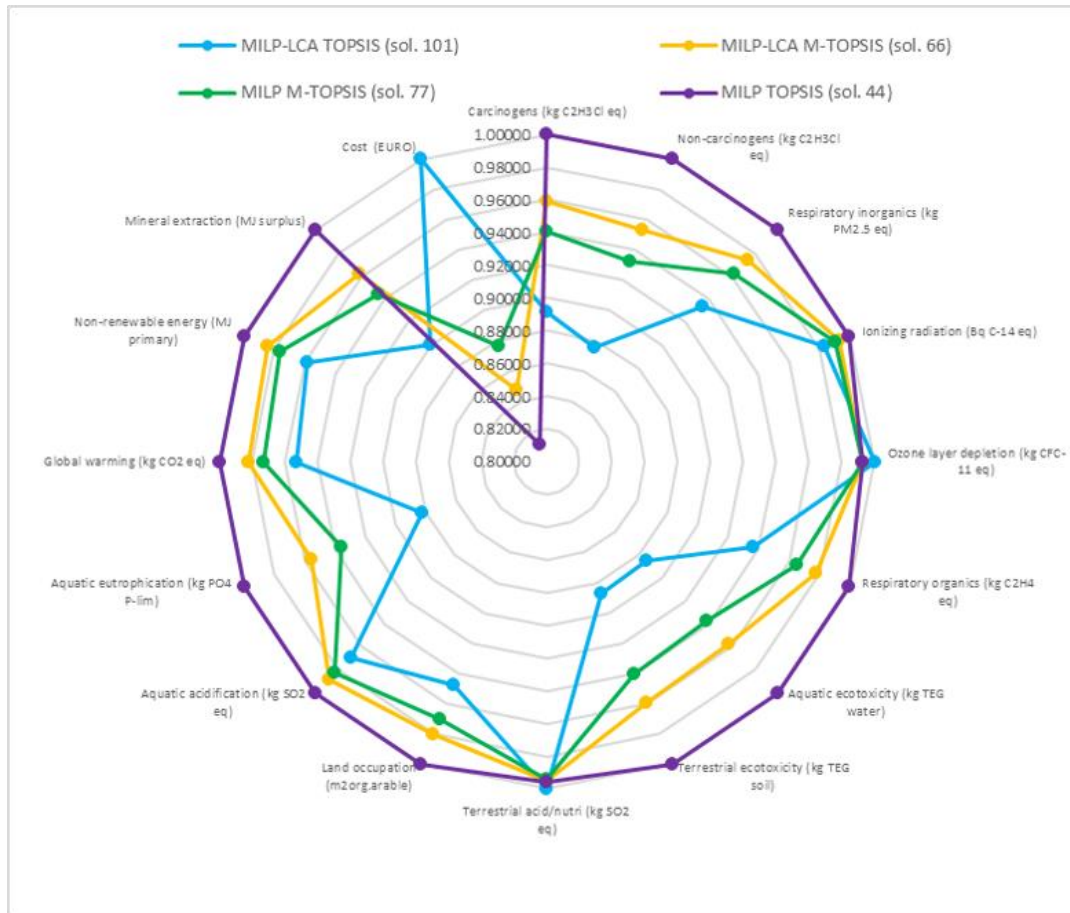

Figure 5. 18 Radar graphs obtained with TOPSIS and M-TOPSIS after MILP and MILP-LCA evaluation.

Table 5. 13 contains the economic and environmental indicators related to each period of the configuration obtained through the use of TOPSIS and M-TOPSIS after MILP and MILP-LCA. The results can also be visualized in Figure 5. 19.

	Period					Total (5 periods)
	1	2	3	4	5	
Sim 44 (MILP TOPSIS)						
Total Cost (€)	272,576,100.00	289,764,600.00	208,844,900.00	244,012,100.00	295,122,400.00	1,310,320,100.00
GWP (KgCO ₂ eq)	466,775,800.00	470,610,200.00	437,206,100.00	426,665,500.00	457,216,800.00	2,258,474,400.00
Sim 77 (MILP M-TOPSIS)						
Total Cost (€)	333,667,800.00	291,737,900.00	219,418,100.00	273,056,800.00	297,497,700.00	1,415,378,300.00
GWP (KgCO ₂ eq)	425,420,300.00	469,578,700.00	432,215,100.00	414,704,400.00	455,952,400.00	2,197,870,900.00
Sim 66 (MILP LCA M-TOPSIS)						
Total Cost (€)	330,945,600.00	290,088,000.00	208,844,900.00	244,012,100.00	295,457,300.00	1,369,347,900.00
GWP (KgCO ₂ eq)	426,953,800.00	470,314,300.00	437,206,100.00	426,665,500.00	456,932,400.00	2,218,072,100.00
Sim 101 (MILP LCA TOPSIS)						
Total Cost (€)	337,216,100.00	326,809,000.00	279,413,500.00	309,599,600.00	362,702,600.00	1,615,740,800.00
GWP (KgCO ₂ eq)	424,731,800.00	463,975,900.00	421,517,600.00	401,870,300.00	441,700,000.00	2,153,795,600.00
	1	2	3	4	5	Total (5 periods)
Demand (Batteries)	10418000	12408000	11889000	11296000	12423000	58434000
LOCBb (€/Battery) Sim 44	26.16	23.35	17.57	21.60	23.76	22.49
LCO2EOBb (KgCO ₂ eq/Battery) Sim 44	44.80	37.93	36.77	37.77	36.80	38.82
LOCBb (€/Battery) Sim 77	32.03	23.51	18.46	24.17	23.95	24.42
LCO2EOBb (KgCO ₂ eq/Battery) Sim 77	40.84	37.84	36.35	36.71	36.70	37.69
LOCBb (€/Battery) Sim 66	31.77	23.38	17.57	21.60	23.78	23.62
LCO2EOBb (KgCO ₂ eq/Battery) Sim 66	40.98	37.90	36.77	37.77	36.78	38.04
LOCBb (€/Battery) Sim 101	32.37	26.34	23.50	27.41	29.20	27.76
LCO2EOBb (KgCO ₂ eq/Battery) Sim 101	40.77	37.39	35.45	35.58	35.56	36.95
Lead virgin used (Kg of virgin lead)	90,003,140	59,929,480	46,420,570	43,652,130	56,077,620	296,082,940

Table 5. 13 Analysis of the best solutions found by TOPSIS and M-TOPSIS after MILP and MILP-LCA evaluation (sol. 44, 77, 66, and 101).

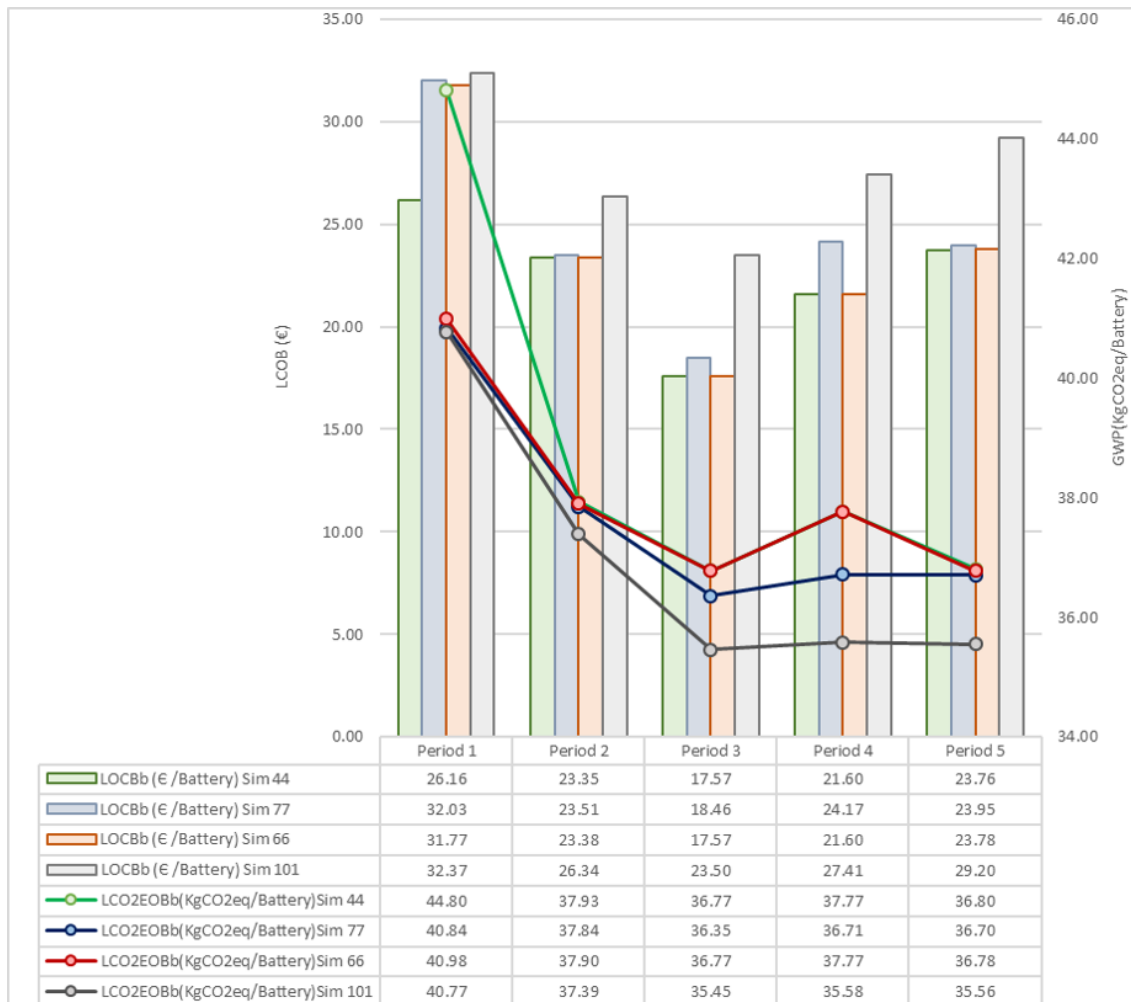

Figure 5. 19 Representation of the best solutions found by TOPSIS and M-TOPSIS after MILP and MILP-LCA evaluation (sol. 44, 77, 66, and 101)

This type of analysis provides new insights for decision-making by considering each period of the global horizon. The initial phase, seen as the deployment period, emerges as crucial, where cost plays a significant role.

Considering solutions derived from the complete MILP-LCA-MCDM strategy, solutions 66 (M-TOPSIS) and 101 (TOPSIS) display nearly equivalent cost performances initially. However, the economic advantage of the M-TOPSIS solution becomes apparent over time as recycling practices are established.

Upon comparing solutions before and after the LCA methodology application, the study underscores the importance of comprehensive insight into all indicators across consecutive periods. The M-TOPSIS-derived solutions exhibit relatively consistent values from one period to the next (solutions 66 and 77), emphasizing the robustness of the multi-tiered strategy with the M-TOPSIS method.

5.6 Sensitivity analysis

A life cycle assessment (LCA) computes the environmental impact of a product from its inception to disposal. LCAs involve numerous input parameters, many of which harbor uncertainties. Consequently, a sensitivity analysis becomes a crucial component of the final interpretation. While ISO 14040:2006 standards for LCA acknowledge this importance, they do not provide specific guidance on the methodology or selection criteria for conducting a sensitivity analysis.

A sensitive parameter is one whose alteration significantly influences the results or contributes to output variance. Conducting a sensitivity analysis aids in recognizing parameters requiring precise data for accurate conclusions. Additionally, it helps identify non-sensitive parameters, allowing their variance to be fixed within a specific range, simplifying the model – a practice commonly referred to as "factor-fixing" (Satelli et al. 2008).

Sensitivity analysis in LCA often involves employing a one-at-a-time approach (OAT), where a subset of input parameters is individually adjusted, either within its specified range or using arbitrary values, to assess its impact on the results. While this method offers simplicity and ease of comprehension, it becomes time-intensive for larger systems and may not comprehensively consider all parameters, potentially missing out on sensitive ones.

To address this, sensitivity analyses often utilize sampling-based approaches that consistently evaluate each model parameter. In this scenario, an MILP simulation coupled with an LCA assessment was implemented to conduct the sensitivity analysis. The parameters modified for this analysis include:

- The recollection rate of products at the end of their life refers to the percentage of products collected at the end of their life cycle, based on the production of that period, measured in percentage (%).
- The recycling rate indicates the percentage of recycled material that a product being remanufactured can contain, also measured in percentage (%)
- The recovery rate of raw material from a product refers to the percentage of raw material that can be reclaimed based on the amount of raw material that is required to be manufactured (%).
- The percentage of utilization is the percentage of raw materials recovered from a product that has finished its useful life, which is reprocessed for reintegration into the supply chain of the selected product (%).
- The percentage dedicated to "Third-party": is the amount of raw material recovered from a product that ended its life, which is sold to an individual or company outside the CLSC, this is the complement to 100% of the utilization rate. (%).
- Emission of manufacturing/remanufacturing: these are the emissions generated by the operations carried out for the manufacturing of a product, whether it is constituted of virgin or recycled raw materials (kgCO₂eq/Battery). The pyrometallurgical process has been considered as a basic scenario (period 1). The idea is to explore the potential of improvement (or degradation) of the process on the whole supply chain regarding GHG emissions. A $\pm 25\%$ variation of GHG emissions is considered for analysis.

The sensitivity analysis involved 13 scenarios, detailed in Table 5. 14. Scenario 1 is the basic scenario used in this thesis. A color code highlights the change implemented in a parameter.

Value	Scenario													
	1	2	3	4	5	6	7	8	9	10	11	12	13	
Recollection rate (%)	85	80	90	95	85	85	85	85	85	85	85	85	85	
Recycling rate (%)	90	90	90	90	85	80	75	90	90	90	90	90	90	
Recovery rate (%)	70	70	70	70	70	70	70	70	70	70	70	75	65	
Percentage of utilization (%)	70	70	70	70	70	70	70	85	75	70	70	70	70	
Percentage to 3 rd party (%)	30	30	30	30	30	30	30	15	25	30	30	30	30	
Emission in Battery Manu/remanufacturing (KgCO ₂ eq/Battery)	13.6 8	13.6 8	13.6 8	13.6 8	13.6 8	13.6 8	13.6 8	13.6 8	13.6 8	13.6 8	17.1 6	10.2 6	13.6 8	13.6 8
	Results													
Cost (€/Battery)	24.2 2	24.2 0	24.2 5	24.2 7	24.6 9	25.0 7	25.4 6	23.2 9	23.8 9	23.9 7	23.8 9	23.8 9	23.8 9	24.5 4
GWP(KgCO ₂ eq/Battery)	37.6 1	37.6 1	37.6 2	37.6 2	37.8 8	38.1 8	38.4 8	35.7 7	37.0 5	40.4 7	33.6 1	37.0 5	38.1 2	

Table 5. 14 Different scenarios implemented for the sensitivity analysis.

The sensitivity assessment followed the same methodology as previously. Each scenario underwent a bicriteria optimization run, and the resulting Pareto front can be visualized in Figure 5. 20.

- *Increase in the recollection rate (Scenarios 2, 1, 3, 4):* the curve is composed of two parts, a first part where, for a given GWP, an increase in the collection rate leads to a slight increase in the cost of the battery, then a second part that is merged for all the curves where the solutions are not dependent on the recollection rate.
- *Increase in the recycling rate (Scenarios 7, 6, 5, 1):* the study shows the beneficial effect of recycling, which reduces costs and GHG emissions.
- *Increase in the recovery rate (Scenarios 13, 1, 12):* the study shows a stronger effect of the influence of the recovery rate in reducing costs and GHG emissions compared to scenario 1.
- *A decrease in the percentage of utilization (or increase in the percentage to 3rd party) (Scenarios 8, 9, 1):* a decrease in the percentage of utilization increases GWP and cost.
- *Influence of GHG emission (Scenarios 10, 1, 11):* the most pronounced effect is observed on the reduction of greenhouse gases. A 10% reduction in manufacturing/remanufacturing reduces global emissions by 10%.

This mapping can be very useful for the practitioner to define the parameters of the closed-loop supply chain. Table 5. 14, also presents the M- TOPSIS solution found after the bicriteria optimization, and the results can be visualized in Figure 5. 21 in more detail.

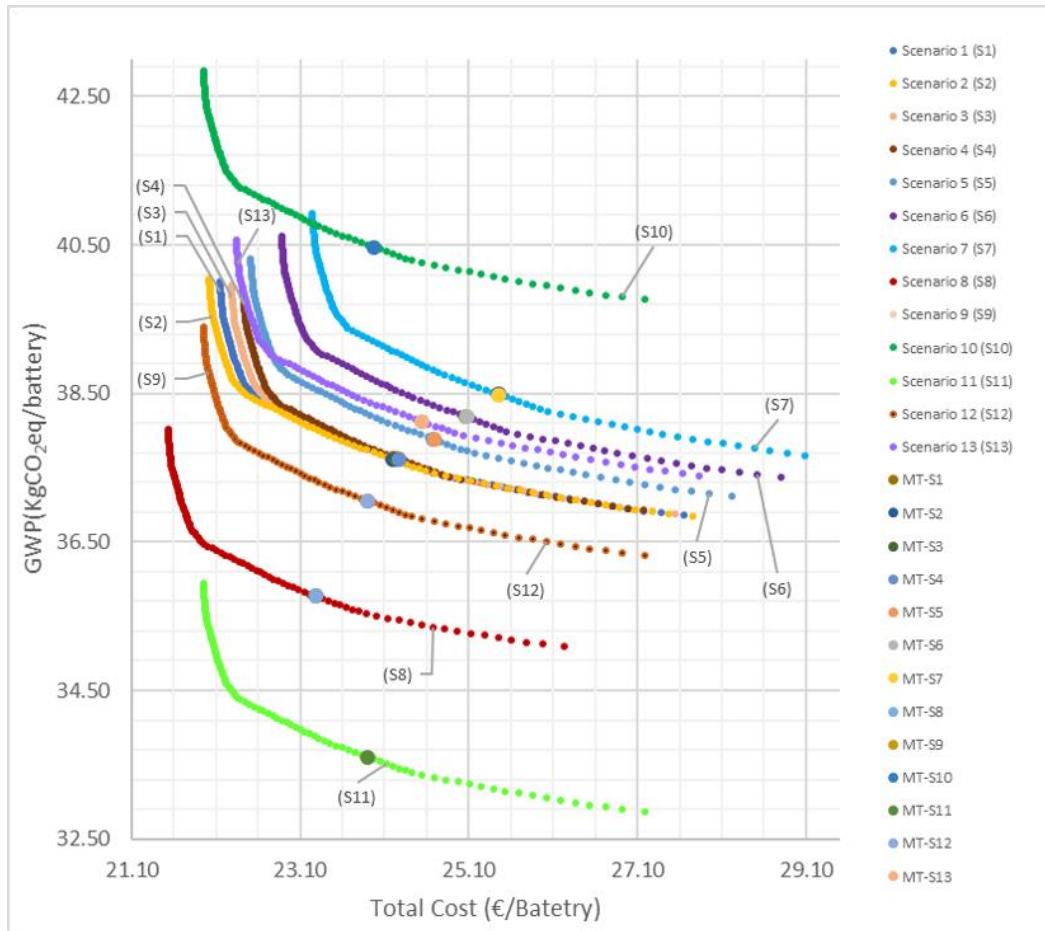

Figure 5. 20 Pareto Front of different scenarios and M-TOPSIS top-ranked solution.

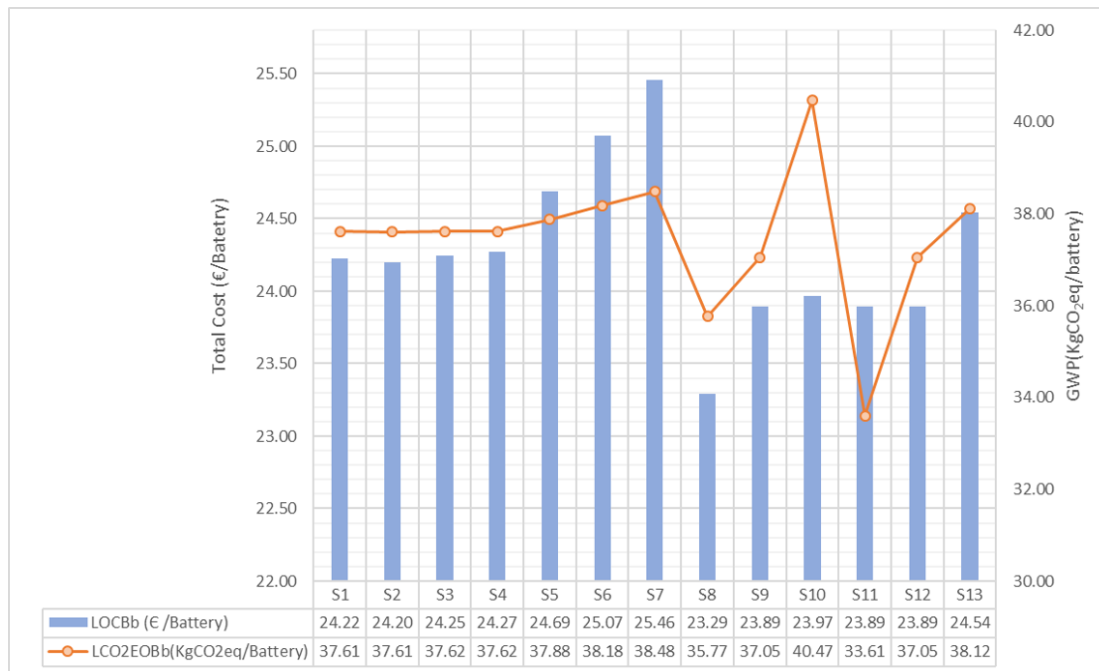

Figure 5. 21 Behavior of the optimal solution of each scenario.

From Figure 5. 21, the Pareto ranking showcases the best solutions obtained for these 13 scenarios, specifically solutions from scenarios 2, 8, 9, 10, 11, and 12. For comparative purposes, alternative 1, which was used as a reference, is also analyzed.

Each alternative has been assessed from an LCA perspective and all the mapping of environmental indicators has been carried out. The M-TOPSIS was then applied to the whole set of solutions.

We used an equal weighting for the cost impact, the environmental impact, and the effective recycling rate (calculated from the second period), which is a key element of the CLSC. Table 5. 15, presents the solutions obtained after MILP-LCA-M-TOPSIS evaluation for each scenario, as well as their normalized values.

Figure 5. 22 presents the radar graph of the best solution for each scenario, selected after MILP-LCA-M-TOPSIS evaluation.

Impact category	Unit	Scenario							
		1 (sol. 77)	2 (sol. 77)	8 (sol. 78)	9 (sol. 77)	10 (sol. 78)	11 (sol. 77)	12 (sol. 78)	
Carcinogens	(kg C2H3Cl eq)	2.52	2.55	2.12	2.40	2.40	2.40	2.40	
Non-carcinogens	(kg C2H3Cl eq)	17.72	17.95	14.20	16.66	16.61	16.66	16.66	
Respiratory inorganics	(kg PM2.5 eq)	0.07	0.07	0.07	0.07	0.07	0.07	0.07	
Ionizing radiation	(Bq C-14 eq)	602.43	601.47	594.29	599.98	599.83	599.98	599.82	
Ozone layer depletion	(kg CFC-11 eq)	2.467	2.326	2.467	2.467	2.467	2.467	2.467	
Respiratory organics	(kg C2H4 eq)	0.02	0.02	0.02	0.02	0.02	0.02	0.02	
Aquatic ecotoxicity	(kg TEG water)	9677.75	9800.06	8065.54	9190.09	9164.59	9190.09	9188.87	
Terrestrial ecotoxicity	(kg TEG soil)	2717.99	2749.44	2275.66	2584.22	2577.15	2584.22	2583.79	
Terrestrial acid/nutri	(kg SO2 eq)	32.45	30.67	32.35	32.42	32.41	32.42	32.42	
Land occupation	(m2org.arable)	0.89	0.89	0.86	0.88	0.88	0.88	0.88	
Aquatic acidification	(kg SO2 eq)	1.02	0.99	0.77	0.95	0.95	0.95	0.95	
Aquatic eutrophication	(kg PO4 P-lim)	0.04	0.04	0.03	0.04	0.04	0.04	0.04	
Global warming	(kg CO2 eq)	37.65	37.64	35.85	37.10	40.52	33.65	37.08	
Non-renewable energy	(MJ primary)	617.06	617.65	593.99	610.01	609.56	610.01	609.70	
Mineral extraction	(MJ surplus)	26.74	26.71	22.47	25.46	25.40	25.46	25.46	
Cost	(EURO)	24.22	24.20	23.29	23.89	23.97	23.89	23.89	
Effective Recycling Rate	(%)	50.45	47.48	61.26	54.06	54.06	54.06	54.06	
Normalized values									
Carcinogens	(kg C2H3Cl eq)	0.988	1.000	0.831	0.941	0.938	0.941	0.940	
Non-carcinogens	(kg C2H3Cl eq)	0.987	1.000	0.791	0.928	0.926	0.928	0.928	
Respiratory inorganics	(kg PM2.5 eq)	1.000	0.998	0.922	0.977	0.975	0.977	0.976	
Ionizing radiation	(Bq C-14 eq)	1.000	0.998	0.986	0.996	0.996	0.996	0.996	
Ozone layer depletion	(kg CFC-11 eq)	1.000	0.943	1.000	1.000	1.000	1.000	1.000	
Respiratory organics	(kg C2H4 eq)	1.000	0.995	0.939	0.982	0.981	0.982	0.981	
Aquatic ecotoxicity	(kg TEG water)	0.988	1.000	0.823	0.938	0.935	0.938	0.938	
Terrestrial ecotoxicity	(kg TEG soil)	0.989	1.000	0.828	0.940	0.937	0.940	0.940	
Terrestrial acid/nutri	(kg SO2 eq)	1.000	0.945	0.997	0.999	0.999	0.999	0.999	
Land occupation	(m2org.arable)	0.998	1.000	0.958	0.986	0.985	0.986	0.985	
Aquatic acidification	(kg SO2 eq)	1.000	0.965	0.753	0.931	0.931	0.931	0.931	
Aquatic eutrophication	(kg PO4 P-lim)	0.985	1.000	0.841	0.941	0.938	0.941	0.941	
Global warming	(kg CO2 eq)	0.929	0.929	0.885	0.916	1.000	0.831	0.915	
Non-renewable energy	(MJ primary)	0.999	1.000	0.962	0.988	0.987	0.988	0.987	
Mineral extraction	(MJ surplus)	1.000	0.999	0.840	0.952	0.950	0.952	0.952	
Cost	(EURO)	1.000	0.999	0.961	0.986	0.990	0.986	0.986	
Effective Recycling Rate	(%)	0.824	0.775	1.000	0.882	0.882	0.882	0.882	

Table 5. 15 Solutions obtained after MILP-LCA-M-TOPSIS evaluation for each scenario, as well as their normalized values.

To quantitatively compare the scenarios, Table 5. 16 contains an increase or decrease in the indicator value compared to the basic scenario (1). The maximum gain is also computed.

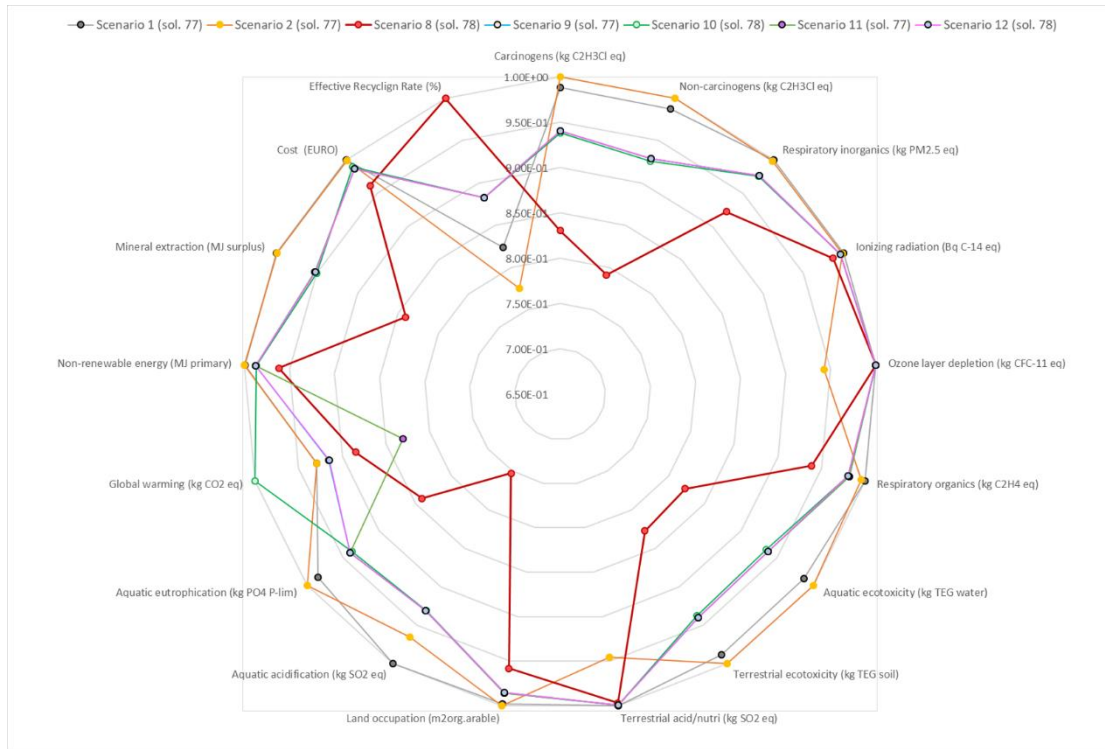

Figure 5. 22 Graphic radar of the critical scenarios in the MILP-LCA evaluation.

		Profit or loss (%)							
		Scenario							
Impact category	Unit	1 (sol. 77)	2 (sol. 77)	8 (sol. 78)	9 (sol. 77)	10 (sol. 78)	11 (sol. 77)	12 (sol. 78)	
Carcinogens	(kg C2H3Cl eq)	2.52	1.19	-15.96	-4.82	-5.07	-4.82	-4.84	
Non-carcinogens	(kg C2H3Cl eq)	17.72	1.27	-19.88	-5.98	-6.27	-5.98	-5.98	
Respiratory inorganics	(kg PM2.5 eq)	0.07	-0.20	-7.75	-2.35	-2.48	-2.35	-2.38	
Ionizing radiation	(Bq C-14 eq)	602.43	-0.16	-1.35	-0.41	-0.43	-0.41	-0.43	
Ozone layer depletion	(kg CFC-11 eq)	2.47	-5.73	0.00	0.00	0.00	0.00	0.00	
Respiratory organics	(kg C2H4 eq)	0.02	-0.46	-6.11	-1.84	-1.95	-1.84	-1.93	
Aquatic ecotoxicity	(kg TEG water)	9677.75	1.26	-16.66	-5.04	-5.30	-5.04	-5.05	
Terrestrial ecotoxicity	(kg TEG soil)	2717.99	1.16	-16.27	-4.92	-5.18	-4.92	-4.94	
Terrestrial acid/nutri	(kg SO2 eq)	32.45	-5.46	-0.31	-0.09	-0.10	-0.09	-0.10	
Land occupation	(m2org.arable)	0.89	0.21	-4.00	-1.21	-1.29	-1.21	-1.27	
Aquatic acidification	(kg SO2 eq)	1.02	-3.50	-24.72	-6.86	-6.92	-6.86	-6.87	
Aquatic eutrophication	(kg PO4 P-lim)	0.04	1.51	-14.62	-4.51	-4.78	-4.51	-4.52	
Global warming	(kg CO2 eq)	37.65	-0.01	-4.78	-1.44	7.63	-10.60	-1.50	
Non-renewable energy	(MJ primary)	617.06	0.09	-3.74	-1.14	-1.22	-1.14	-1.19	
Mineral extraction	(MJ surplus)	26.74	-0.12	-15.96	-4.80	-5.03	-4.80	-4.80	
Cost	(EURO)	24.22	-0.09	-3.85	-1.36	-1.05	-1.36	-1.36	
Effective Recyclign Rate	(%)	50.45	-2.97	10.81	3.60	3.60	3.60	3.60	
		TOTAL Gain		-12.00	-166.17	-50.37	-43.04	-59.53	-50.76

■ Loss in percentage
■ Profit in percentage
 *in the effective recycling rate, the profit of the percentage is better

Table 5. 16 Increase or decrease in the indicators after MILP-LCA-M-TOPSIS evaluation.

The results indicate that scenarios 8, 11, and 12 exhibit the best performances and emphasize the significance of some parameters on the performance of CLSC management:

- Increase in the percentage of utilization of raw materials recovered from a product to be recycled in 15% (scenario 8).
- A 5% ncrease in the recovery rate (scenario 12).
- An improvement in the manufacturing/remanufacturing process regarding GHG emissions, that reduces the emission by 25% (scenario 11).

Enhancing any of these parameters proves beneficial across all indicators, offering actionable insights for decision-makers.

5.7 Conclusions

This chapter demonstrated how the methodological framework developed in the previous chapter could optimize the management of the CLSC for lead-acid batteries, employing a multi-level approach.

Initially, the strategy focused on identifying and streamlining significant criteria suitable for the multi-objective (in this case, bi-objective) optimization. Both the cost criterion, based on the total supply chain cost, and the environmental criterion, centered on greenhouse gas emissions, emerged as critical factors in this stage. Recognized as conflicting criteria, this justified implementing an epsilon-constraint procedure.

The initial application of decision support methods (M-TOPSIS and TOPSIS) facilitated the identification of potential supply chain configurations. Subsequently, a life cycle assessment was conducted on the Pareto front-end solutions, performing a comprehensive multi-criteria analysis encompassing Impact 2002+ criteria alongside the cost criterion.

This step revealed solutions more favorable across all criteria compared to those identified previously, validating the approach's efficacy. Strategically, this necessitated the development of environmental submodules for supply chain blocks to systematically compute environmental indicators using the EcoInvent database and the impact factors of the analysis method employed in the study.

Moreover, the study confirmed the consistent performance of the M-TOPSIS method throughout the strategy, solidifying its robustness over TOPSIS. Additionally, the sensitivity study highlighted that enhancing (1) the percentage of utilized raw materials recovered from products for recycling (scenario 8), (2) the recovery rate, and (3) improving the manufacturing/remanufacturing process concerning GHG emissions significantly improves the performance across all indicators.

Chapter



Conclusions and recommendations
for future research

Conclusions and perspectives

The primary scientific motivation of this work was to develop an integrated analysis combining Closed-Loop Supply Chain Management (CLSCM) concepts and Life Cycle Assessment (LCA). The goal was to devise a methodological framework for crafting efficient strategies in rational waste management, ultimately aligned with the objectives of sustainable development.

This concluding chapter firstly outlines what this research has investigated and what has been omitted. It hereby justifies why and how these delineations were. First, the research questions will be reviewed, and the chapter demonstrates how the research has developed and extended the discipline of closed-loop supply chain management.

Some recommendations for future work will also be presented.

This dissertation investigated **four research questions**.

The **first research question** was about *how to integrate the reverse supply chain with the forward supply chain from a network modeling viewpoint*. It is a central research issue of this work and can be found in the different chapters from different perspectives.

Chapter 1 highlighted that the concept of a «Closed-loop supply chain» (CLSC) refers to supply chains that serve the «circular economy». It has gained considerable attention in industry and academia, in a global context where climate change and resource scarcity have become major issues. A CLSC integrates a forward supply chain with a reverse supply chain and aims to maximize economic, ecological, and societal value creation over the entire technology lifecycle of a good with a dynamic recovery of value after each usage cycle.

To identify appropriate methods to support this integration, the literature review has shown that the environmental impacts need to be considered simultaneously in the forward and reverse logistics.

Chapter 2 has clearly shown that the system under study is the same in a Life Cycle Assessment perspective than in a Closed-Loop Supply chain, and that these complementary approaches could contribute to this integration.

In this work, economic and environmental pillars have been addressed as part of the integration.

Chapter 3 explores this integration from the environmental viewpoint through Life Cycle Assessment and the application case of Lead-Acid Batteries.

The case study of Lead-Acid Batteries serves as a support of the methodology, since it has been explored both in the LCA community and by researchers from the CLSC field. Yet, it must be emphasized that this case study has often been studied with forward and reverse networks considered separately, thus leading to suboptimal results.

Chapter 4 is the core of the answer to this research question from the methodological viewpoint. In the closed-loop supply chain management that is the focus of this, the following activities taking place in CLSCM: collection, inspection/separation, re-processing, disposal, and re-distribution have to be modeled. The remanufacturing, which is the “heart” of the recoverable manufacturing system, can reduce waste and the objective of the optimization is to find solutions that can be both profitable and environmentally conscious.

CLSC modeling and optimization have been embedded in one generic multi-echelon multi-objective formulation of CLSC for the case study of Lead-Acid Batteries (LAB) which focuses on the simultaneous optimization of economic and environmental criteria.

The Mixed Integer Linear Programming model was formulated to design a CLSC network. The presented CLSC network included five echelons (i.e., suppliers, producers, distributors, wholesalers, and retailers) in the forward direction and seven echelons (i.e., collection & recycling centers, disposal of the product, disassembly plant, disposal of raw material, third party and remanufacturing) in the reverse direction. The model solution involves a multistep strategy:

- Single-objective optimization with two criteria to be minimized separately (1) Total cost of the CLSC for LABs and (2) GHG emissions of the CLSC for LABs
- Multi-objective optimization using the AUGMECON method, with the pair of objectives leading to the Pareto front.
- Multiple Criteria Decision-Making (MCDM) with TOPSIS and M-TOPSIS
- LCA assessment for all the solutions of the Pareto front with Impact 2002+ impact assessment method.
- The second application of Multiple Criteria Decision-Making (MCDM) over the whole set of indicators

Chapter 5 answers the research question from an application viewpoint. The multi-tier strategy involves first identifying and reducing the significant criteria that can be used in the multi-objective (in this case, bi-objective) optimization procedure. The cost criterion based on the total cost of the supply chain as well as the environmental criterion based on the total greenhouse gas emissions have emerged as relevant criteria to be considered in the procedure. They were identified at this level as being conflicting criteria, thus justifying the implementation of an epsilon-constraint procedure.

The first application of a decision support method (M-TOPSIS and TOPSIS) allowed the identification of candidate supply chain configurations.

A life cycle assessment was then carried out on the set of Pareto front-end solutions to conduct a multi-criteria analysis on all the criteria of the selected impact analysis method (Impact 2002+) and the cost criterion.

This step made it possible to identify more interesting solutions concerning all the criteria than those identified at the previous level, which justifies the validity of the approach.

From a strategic point of view, this required the development of environmental submodules for the supply chain blocks to systematically calculate the environmental indicators based on the extraction of the EcoInvent database and the impact factors of the analysis method used in the study.

The study also confirmed that the M-TOPSIS method produced results of the same order of magnitude throughout the strategy, which makes its use more robust than the TOPSIS method.

The *second research question* was about *the way the perspectives from Life Cycle Assessment and Closed-Loop Supply Chain Management could be integrated*. The answer is also found through the various chapters.

These perspectives have been tackled through the example of Lead-Acid Batteries. Even if the conclusions are example-dependent, the methodology has been developed to be replicated to other case studies.

Chapter 2 has presented the parallel of LCA and CLSCM conceptual approaches to answer the question from the environmental viewpoint, as previously discussed. Life Cycle Assessment is particularly important in supply chain management and allows the appreciation of the full range of environmental impacts throughout the supply chain to focus on recycling or remanufacturing actions. All components have supply chain wide implications. This approach extends the product-level carbon footprint often regarded as a special case of LCA, limited to the GWP impact category (Weidema et al. 2008; Finkbeiner, 2009) and excluding all other environmental impacts.

Chapter 3 has explored the parallel of LCA and CLSCM applied to the case study of Lead-Acid Batteries.

In particular, this chapter presents the technological steps and building blocks involved in the closed-loop supply chain of lead-acid batteries.

It shows that Life Cycle Assessment (LCA) for an in-depth study of the environmental impact of lead-acid batteries is mandatory to acquire knowledge of the studied example before performing optimization.

This kind of study is particularly sound to perform to identify the most significant parameters via sensitivity analysis based on the recycled lead content in the production of a battery. It also helps to identify the main processes that contribute to the various environmental indicators.

This chapter demonstrated that LCA is a powerful tool for quantifying the environmental impact of the lead-acid battery throughout its life cycle that can be integrated into the associated supply chain model for its optimization to reduce the environmental impact of the battery production/recycling process.

Chapter 4 has shown how the environmental impact can be integrated into the optimal procedure and

In Chapter 5, the different procedures are combined to select the most appropriate CLSCC, both from an economic and environmental viewpoint.

The third research question was about *the development of a methodology for CLSCM that considers several criteria simultaneously over several periods.*

The CLSC model has been formulated as a deterministic Mixed Integer Linear Programming (MILP) approach, involving a set of inequality constraints and equality ones (mass balances that must be rigorously solved, so that metaheuristic methods have been discarded due to their difficulty in constraint management). In this study, the mathematical model has been then formulated using the GAMS environment (General Algebraic Modeling System). This choice is motivated as the use of algebraic modeling language in GAMS facilitates the programming of optimization problems close to their mathematical formulations with flexible and fast modifications. Due to its efficiency that has reported in many similar works and following the expertise acquired in LGC (de Leon Almaraz, 2014; Ochoa Robles, 2018), the CPLEX 12 solver has been used.

The multi-objective aspect has been addressed by the AUGMECON method proposed (Mavrotas, 2007, 2009), which improved upon the classical ϵ -constraint method and integrated a lexicographic method.

The methodology also involves the use of Multiple Criteria Decision-Making (MCDM) tools after the implementation of the multi-objective strategy. Among the large variety of approaches that have been proposed in the dedicated literature (Mardani et al., 2015), TOPSIS-oriented techniques (Technique for Order of Preference by Similarity to Ideal Solution) (Hwang & Yoon, 1981) widely used in engineering problems have been selected (in particular M-TOPSIS, modified TOPSIS (Ren et al, 2007)) due to their reduced number of parameters involved in their implementation thus limiting subjectivity. M-TOPSIS chooses an alternative that should simultaneously have the closest distance from the positive ideal solution and the farthest distance from the negative ideal solution, solving the rank reversal and the evaluation failure problem presented in the original TOPSIS technique (Maleki & Zahir, 2013).

The fourth research question was about *the definition of efficient strategies for CLSC management, in particular for lead-acid batteries.*

It was addressed in Chapter 4 from a methodological viewpoint and further discussed in Chapter 5 from a practical perspective.

The initial step involves identifying and narrowing down the significant criteria suitable for the multi-objective (in this case, bi-objective) optimization procedure. Both the cost criterion, based on the total supply chain expenses, and the environmental criterion, rooted in total greenhouse gas emissions, emerged as pivotal criteria for consideration. They were identified as conflicting criteria, which justified the implementation of the aforementioned epsilon-constraint procedure.

The initial application of decision support methods (M-TOPSIS and TOPSIS) facilitated the identification of potential supply chain configurations. Subsequently, a life cycle assessment was conducted on the Pareto front-end solutions to conduct a comprehensive multi-criteria analysis, encompassing the criteria of the chosen Impact 2002+ analysis method and the cost criterion.

This stage led to the identification of more compelling solutions across all criteria compared to those identified previously, thus validating the approach. The study also confirmed the consistency of results obtained using the M-TOPSIS method throughout the strategy, indicating its robustness compared to the TOPSIS method.

The results underscored the significance of certain parameters in CLSC management:

- Increase in the percentage of utilization of raw materials recovered from a product to be recycled;
- Increase in the recovery rate ;
- Improvement in the manufacturing/remanufacturing process regarding GHG emissions,
- An increase in one of these parameters is profitable for all indicators, thus suggesting directions for improvement for decision-makers.

Finally, the different contributions can be summarized in Figure 6. 1.

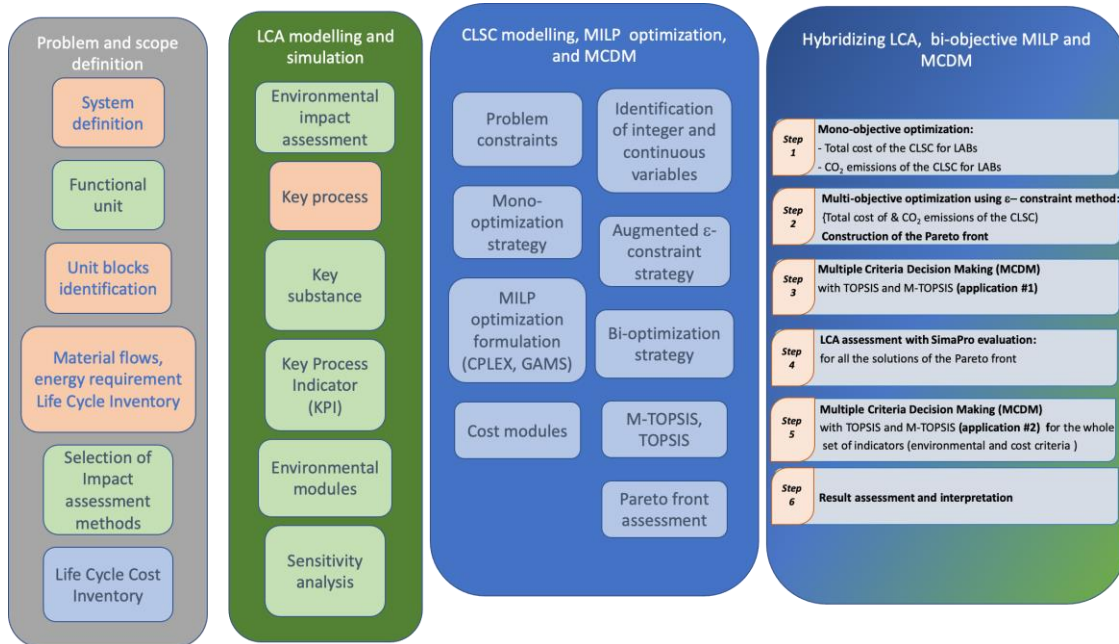

Figure 6. 1 Building blocks of the proposed methodology: Integration of Closed-Loop Supply Chain Management (CLSCM) and Life Cycle Assessment (LCA): application to lead-acid batteries

Perspectives

During this research work, different questions arose that fell near the edge of the scope of the work but could not be covered. These questions and observations remain outstanding and could motivate future research:

Other products to be recycled/recovered

The lead-acid battery is a complex industrial product, constituted by several different materials. The recycling process first separates these battery components, to recover further valuable products such as polypropylene (Martin & Siegmund, 2013). This could be added to the CLSC network.

Other battery supply chains

The proposed methodology can be very useful to study other battery supply chains such as nickel-cadmium batteries or lithium-ion ones (LIB) that rapidly outpaced the conventional Lead-acid battery in the electric vehicle (EV) and grid storage sectors due to technological advancement and reduced cost of LIBs. With the increasing market demand for lithium-ion batteries, further research about the holistic performance of the chain is needed.

Other manufacturing/remanufacturing processes

Pyrometallurgical smelting to produce metallic lead is currently the dominant process used in the recovery of secondary lead due to its adaptability to raw materials and large capacity (Rand et al. 2004). Yet, pyrometallurgical smelting creates key environmental problems, such as the emission of lead dust and SO₂ (Tian et al. 2017; Zhang et al. 2016).

The emphasis is currently placed on the recycling of lead and lead-containing compounds and the elimination of sulfur emissions. However, process and technological problems still challenge the scientific community. More studies need to be conducted to optimize the operating conditions and reduce the costs associated with large-scale manufacturing. In particular, the process integration of current techniques with the newly developed techniques will open a new direction for the recycling of LABs.

In this work, only the pyrometallurgical process was studied with Life Cycle Inventory data from existing literature and EcoInvent database. Process modeling could be very useful to assess the performance of pyrometallurgical and hydrometallurgical processes based on mass balances. This would make it possible to set up inventory databases to produce environmental models that could then be integrated into the framework that has just been presented.

Using clean battery production and technology

The battery value chain uses fossil fuels for a number of its processes, which could be electrified, (such as the electrode drying process during cell manufacturing that still uses gas). Another example is the use of diesel-powered trucks in mining, which could be switched to hydrogen or battery-electric trucks.

A second lever is the increased use of renewable energies in the value chain. For example, mining is often undertaken in remote areas without grid access, where electricity is produced from natural gas turbines or diesel generators. Using solar panels can be an economic alternative.

The integration of clean energy processes could also be evaluated using the framework.

Managing risks and uncertainties

From a methodological standpoint, integrating uncertainty into the model framework using fuzzy or stochastic methods holds significant promise. These approaches can effectively address the random events and fluctuations inherent in Closed-Loop Supply Chain (CLSC) operations, especially concerning loop closure and uncertainties in the business environment such as product demand fluctuations. Developing robust and resilient supply chain structures becomes imperative to ensure that network configurations consistently outperform others, particularly in scenarios involving high risks and uncertainties. It is crucial to note that uncertainties not only elevate the complexity of CLSC management but also pose challenges in optimizing models (Peng et al. 2020).

From Closed-Loop Supply Chains to Circular Closed-Loop Supply Chains

As shown in the application of lead-acid batteries, the closed-loop supply chain improves environmental performance by bringing back goods to the producer to recover value (Wassenhove, 2002). Yet, a CLSC still generates substantial amounts of waste as it is rarely feasible to reuse/recycle all products within the same supply chain.

Finally, the superstructure of the chain could be improved in a circular supply chain vision that can recover value from waste by collaborating with other organizations within the industrial sector (open loop, same sector), or with different industrial sectors (open loop, cross-sector) (Weetman, 2017; Farooque et al. 2019) (Figure 6. 2).

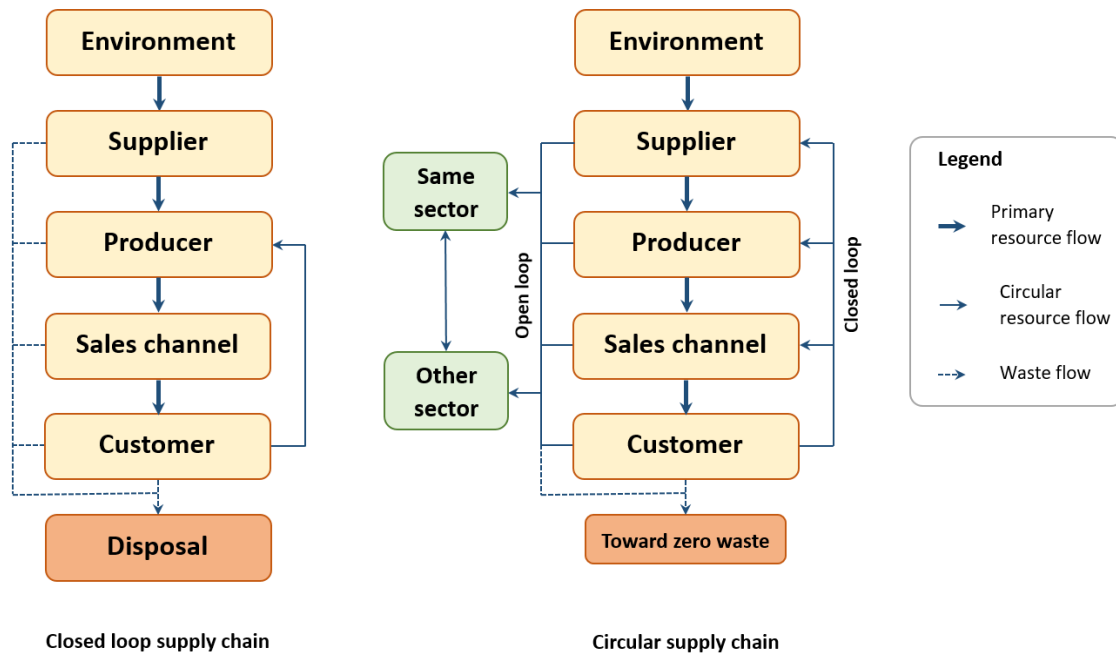

Figure 6. 2 Structure of the supply chains (Weetman, 2017).

Bibliography

- ADEME, & L'énergie, A. de l'environnement et de la maîtrise de. (2016). *PILES ET ACCUMULATEURS RAPPORT ANNUEL*.
- ADEME, & L'énergie, A. de l'environnement et de la maîtrise de. (2017). *Piles et accumulateurs rapport annuel*.
- Aliu, I. R., Adeyemi, O. E., & Adebayo, A. (2014). Municipal household solid waste collection strategies in an African megacity: Analysis of public-private partnership performance in Lagos. *Waste Management & Research*, 32(9_suppl), 67–78. <https://doi.org/10.1177/0734242X14544354>
- Antuchevičienė, J., Zavadskas, E. K., & Zakarevičius, A. (2010). Multiple criteria construction management decisions considering relations between criteria. *Technological and Economic Development of Economy*, 16(1), 109–125. <https://doi.org/10.3846/tede.2010.07>
- Ardente, F., & Mathieux, F. (2014). Identification and assessment of product's measures to improve resource efficiency: The case-study of an Energy using Product. *Journal of Cleaner Production*, 83, 126–141. <https://doi.org/10.1016/j.jclepro.2014.07.058>
- Asif Salam, A. M. (2008). *Green Procurement Adoption in Manufacturing Supply Chain*. Indonesia.
- Atlas, M., & Florida, R. (1998). Green manufacturing. *Handbook of Technology Management*.
- Ayres, R. U., & Ayres, L. (2002). *A handbook of industrial ecology*. Edward Elgar Pub.
- Battini, D., Bogataj, M., & Choudhary, A. (2017). Closed-Loop Supply Chain (CLSC): Economics, Modelling, Management, and Control. *International Journal of Production Economics*, 183, 319–321. <https://doi.org/10.1016/j.ijpe.2016.11.020>
- Bierlaire, & Michel. (2006). *Introduction à l'optimisation différentiable*.
- Blass, V., & Corbett, C. J. (2018). Same Supply Chain, Different Models: Integrating Perspectives from Life Cycle Assessment and Supply Chain Management. *Journal of Industrial Ecology*, 22(1), 18–30. <https://doi.org/10.1111/jiec.12550>
- Boadi, K. O., & Kuitunen, M. (2005). Environmental and health impacts of household solid waste handling and disposal practices in Third World cities: The case of the Accra Metropolitan Area, Ghana. *Journal of Environmental Health*.
- Brunner, P., & Rechberger, H. (2005). *Practical Handbook of Material Flow Analysis*.
- Burgess, A. A., & Brennan, D. J. (2001). Application of life cycle assessment to chemical processes. *Chemical Engineering Science*, 56(8), 2589–2604. [https://doi.org/10.1016/S0009-2509\(00\)00511-X](https://doi.org/10.1016/S0009-2509(00)00511-X)
- Chang, Y., Mao, X., Zhao, Y., Feng, S., Chen, H., & Finlow, D. (2009). Lead-acid battery use in the development of renewable energy systems in China. *Journal of Power Sources*, 191(1), 176–183. <https://doi.org/10.1016/j.jpowsour.2009.02.030>
- Chen, H. C., Chiou, C. Y., Yeh, C. Y., & Lai, H. L. (2012). A Study of the Enhancement of Service Quality and Satisfaction by Taiwan MICE Service Project. *Procedia - Social and Behavioral Sciences*, 40, 382–388. <https://doi.org/10.1016/j.sbspro.2012.03.204>
- Chen, L., & Taylor, D. (2011a). Public Awareness and Performance Relating to the Implementation of a Low-Carbon Economy in China: A Case Study from Zhengzhou. *Low Carbon Economy*, 02(02), 54–61. <https://doi.org/10.4236/lce.2011.22009>
- Chen, L., & Taylor, D. (2011b). Public Awareness and Performance Relating to the Implementation of a Low-Carbon Economy in China: A Case Study from Zhengzhou. *Low Carbon Economy*, 02(02), 54–61. <https://doi.org/10.4236/lce.2011.22009>
- Collette, Y., & Siarry, P. (2003). *Multiobjective Optimization: Principles and Case Studies*. Springer.
- Cooper, M. C., & Ellram, L. M. (1993). Characteristics of Supply Chain Management and the Implications for Purchasing and Logistics Strategy. *The International Journal of Logistics Management*, 4(2), 13–24. <https://doi.org/10.1108/09574099310804957>
- Cooper, M. C., Lambert, D. M., & Pagh, J. D. (1997). Supply Chain Management: More Than a New Name for Logistics. *The International Journal of Logistics Management*, 8(1), 1–14. <https://doi.org/10.1108/09574099710805556>
- Dahodwalla, H., & Herat, S. (2000). Cleaner production options for lead-acid battery manufacturing industry. *Journal of Cleaner Production*, [https://doi.org/10.1016/S0959-6526\(99\)00314-5](https://doi.org/10.1016/S0959-6526(99)00314-5)

- Daniel, S. E., Pappis, C. P., & Voutsinas, T. G. (2003). Applying life cycle inventory to reverse supply chains: a case study of lead recovery from batteries. *Resources, Conservation and Recycling*, 37(4), 251–281. [https://doi.org/10.1016/S0921-3449\(02\)00070-8](https://doi.org/10.1016/S0921-3449(02)00070-8)
- Daniel, V., Guide, R., & Van Wassenhove, L. N. (2002). Closed-loop Supply Chains (pp. 47–60). https://doi.org/10.1007/978-3-642-56183-2_4
- Davenport, T. H., & Young, E. &. (1993). *Process Innovation: Reengineering Work through Information Technology*. (C. for I. T. and Strategy, Ed.). Boston, Massachusetts: Harvard Business School Press.
- Davidson, A. J., Binks, S. P., & Gediga, J. (2016a). Lead industry life cycle studies: environmental impact and life cycle assessment of lead battery and architectural sheet production. *The International Journal of Life Cycle Assessment*, 21(11), 1624–1636. <https://doi.org/10.1007/s11367-015-1021-5>
- Davidson, A. J., Binks, S. P., & Gediga, J. (2016b). Lead industry life cycle studies: environmental impact and life cycle assessment of lead battery and architectural sheet production. *International Journal of Life Cycle Assessment*. <https://doi.org/10.1007/s11367-015-1021-5>
- Davidson, A. J., Binks, S. P., & Gediga, J. (2016c). Lead industry life cycle studies: environmental impact and life cycle assessment of lead battery and architectural sheet production. *The International Journal of Life Cycle Assessment*, 21(11), 1624–1636. <https://doi.org/10.1007/s11367-015-1021-5>
- de Bruijn, H., van Duin, R., & Huijbregts, M. A. J. (2002). *Handbook on Life Cycle Assessment*. (J. B. Guinee, M. Gorree, R. Heijungs, G. Huppes, R. Kleijn, A. de Koning, ... H. A. Udo de Haes, Eds.) (Vol. 7). Dordrecht: Springer Netherlands. <https://doi.org/10.1007/0-306-48055-7>
- de Leon Almaraz, S. (2014). Multi-objective optimisation of a hydrogen supply chain.
- Ellis, T. W., & Mirza, A. H. (2010). The refining of secondary lead for use in advanced lead-acid batteries. *Journal of Power Sources*, 195(14), 4525–4529. <https://doi.org/10.1016/j.jpowsour.2009.12.118>
- Ellram, L. M. (1990). The Supplier Selection Decision in Strategic Partnerships. *Journal of Purchasing and Materials Management*, 26(4), 8–14. <https://doi.org/10.1111/j.1745-493X.1990.tb00515.x>
- ELLRAM, L. M., & Cooper, M. C. (1990). *SUPPLY CHAIN MANAGEMENT, PARTNERSHIPS, AND THE SHIPPER-THIRD PARTY RELATIONSHIP* (Vol. 22).
- EPA, U. S. E. P. A. (1994). *Secondary Lead Smelting Background Information Document for Proposed Standards*.
- Eskandarpour, M., Dejax, P., Miemczyk, J., & Péton, O. (2015). Sustainable supply chain network design: An optimization-oriented review. *Omega*, 54, 11–32. <https://doi.org/10.1016/j.omega.2015.01.006>
- European Commission, Joint Research Centre, & I. for E. and S. (2010). *International Reference Life Cycle Data System (ILCD) Handbook - Analysis of existing methodologies for use in Life Cycle Assessment*. <https://doi.org/10.2788/38479>
- Farooque, M., Zhang, A., Thürer, M., Qu, T., & Huisinigh, D. (2019). Circular supply chain management: A definition and structured literature review. *Journal of Cleaner Production*, 228, 882–900. <https://doi.org/10.1016/j.jclepro.2019.04.303>
- Finkbeiner, M. (2009). Carbon footprinting—opportunities and threats. *The International Journal of Life Cycle Assessment*, 14(2), 91–94. <https://doi.org/10.1007/s11367-009-0064-x>
- Finnveden, G., Hauschild, M. Z., Ekvall, T., Guinée, J., Heijungs, R., Hellweg, S., ... Suh, S. (2009). Recent developments in Life Cycle Assessment. *Journal of Environmental Management*, 91(1), 1–21. <https://doi.org/10.1016/j.jenvman.2009.06.018>
- Fleischmann, M., Bloemhof-Ruwaard, J. M., Dekker, R., van der Laan, E., van Nunen, J. A. E. E., & Van Wassenhove, L. N. (1997). Quantitative models for reverse logistics: A review. *European Journal of Operational Research*, [https://doi.org/10.1016/S0377-2217\(97\)00230-](https://doi.org/10.1016/S0377-2217(97)00230-)
- Gaines, L. (2014). The future of automotive lithium-ion battery recycling: Charting a sustainable course. *Sustainable Materials and Technologies*, 1–2, 2–7. <https://doi.org/10.1016/j.susmat.2014.10.001>
- Garcia, J. S., D., S. L. À., & Carpes, W. P. (2005). Introduction to Optimization Methods: a Brief Survey of Methods. *EEE Multidisciplinary Engineering Education Magazine*.
- Geletu, A. (2008). *GAMS - Modeling and Solving Optimization Problems*. Ilmenau University of Technology: Institute of Mathematics. Department of Operations Research & Stochastic.

- Geng, Y., Sarkis, J., Ulgiati, S., & Zhang, P. (2013). Measuring China's Circular Economy. *Science*, 339(6127), 1526–1527. <https://doi.org/10.1126/science.1227059>
- Goedkoop, M., Heijungs, R., Huijbregts, M., Schryver, A. De, Struijs, J., & Zelm, R. van. (2009). *ReCiPe 2008 A life cycle impact assessment method which comprises harmonised category indicators at the midpoint and the endpoint level*.
- Goedkoop, M., & Spriensma, R. (2001). *The Eco-indicator 99 A damage oriented method for Life Cycle Impact Assessment*.
- Govindan, K., Palaniappan, M., Zhu, Q., & Kannan, D. (2012). Analysis of third-party reverse logistics provider using interpretive structural modeling. *International Journal of Production Economics*, 140(1), 204–211. <https://doi.org/10.1016/j.ijpe.2012.01.043>
- Govindan, K., Soleimani, H., & Kannan, D. (2015). Reverse logistics and closed-loop supply chain: A comprehensive review to explore the future. *European Journal of Operational Research*, 240(3), 603–626. <https://doi.org/10.1016/j.ejor.2014.07.012>
- Guide, V. D. R., & Van Wassenhove, L. N. (2009). OR FORUM—The Evolution of Closed-Loop Supply Chain Research. *Operations Research*, 57(1), 10–18. <https://doi.org/10.1287/opre.1080.0628>
- Guinée, J. B., Heijungs, R., Huppes, G., Zamagni, A., Masoni, P., Buonamici, R., ... Rydberg, T. (2011). Life Cycle Assessment: Past, Present, and Future †. *Environmental Science & Technology*, 45(1), 90–96. <https://doi.org/10.1021/es101316v>
- Haimes, Y., Lasdon, L., & Wismer, D. (1971). On a Bicriterion Formulation of the Problems of Integrated System Identification and System Optimization. *IEEE Transactions on Systems, Man, and Cybernetics*, 1(3), 296–297. <https://doi.org/10.1109/tsmc.1971.4308298>
- Handfield, R. B., & Nichols, E. L. (1998). *Introduction to Supply Chain Management*.
- Hernandez-Rodriguez, G. (2011). Multiobjective optimization of natural gas transportation networks.
- Hervani, A. A., Helms, M. M., & Sarkis, J. (2005). Performance measurement for the green supply chain management. *Benchmarking: An International Journal*, 12(4), 330–353. <https://doi.org/10.1108/14635770510609015>
- Ho, J. C., Shalishali, M. K., Tseng, T.-L. (Bill), & Ang, D. S. (2009). *Opportunities in green supply chain management*.
- Houlihan, J. B. (1988). International Supply Chains: A New Approach. *Management Decision*, 26(3), 13–19. <https://doi.org/10.1108/eb001493>
- HUGO, A., RUTTER, P., PISTIKOPOULOS, S., AMORELLI, A., & ZOIA, G. (2005). Hydrogen infrastructure strategic planning using multi-objective optimization. *International Journal of Hydrogen Energy*, 30(15), 1523–1534. <https://doi.org/10.1016/j.ijhydene.2005.04.017>
- Hwang, C.-L., & Yoon, K. (1981). Methods for Multiple Attribute Decision Making (pp. 58–191). https://doi.org/10.1007/978-3-642-48318-9_3
- ILA, I. L. A., & Wilson, B. (2018). The Environmentally Sound Management of Used Lead Acid Batteries and the Use and Application of the Benchmarking Assessment Tool Workshop.
- Jabali, O., Van Woensel, T., & de Kok, A. G. (2012). Analysis of Travel Times and CO₂ Emissions in Time-Dependent Vehicle Routing. *Production and Operations Management*, 21(6), 1060–1074. <https://doi.org/10.1111/j.1937-5956.2012.01338.x>
- Jayaraman, V., Guide, V. D. R., & Srivastava, R. (1999). A closed-loop logistics model for remanufacturing. *Journal of the Operational Research Society*, 50(5), 497–508. <https://doi.org/10.1057/palgrave.jors.2600716>
- Jolliet, O., Margni, M., Charles, R., Humbert, S., Payet, J., Rebitzer, G., & Rosenbaum, R. (2003). IMPACT 2002+: A new life cycle impact assessment methodology. *The International Journal of Life Cycle Assessment*, 8(6), 324–330. <https://doi.org/10.1007/BF02978505>
- Jolly, R., & Rhin, C. (1994). The recycling of lead-acid batteries: production of lead and polypropylene. *Resources, Conservation and Recycling*, 10(1–2), 137–143. [https://doi.org/10.1016/0921-3449\(94\)90046-9](https://doi.org/10.1016/0921-3449(94)90046-9)
- Jones, T. C., & Riley, D. W. (1985). Using Inventory for Competitive Advantage through Supply Chain Management. *International Journal of Physical Distribution & Materials Management*, 15(5), 16–26. <https://doi.org/10.1108/eb014615>
- Kannan, G., Sasikumar, P., & Devika, K. (2010a). A genetic algorithm approach for solving a closed-loop supply chain model: A case of battery recycling. *Applied Mathematical Modelling*, 34(3), 655–670. <https://doi.org/10.1016/j.apm.2009.06.021>

- Kannan, G., Sasikumar, P., & Devika, K. (2010b). A genetic algorithm approach for solving a closed-loop supply chain model: A case of battery recycling. *Applied Mathematical Modelling*, 34(3), 655–670. <https://doi.org/10.1016/j.apm.2009.06.021>
- Khorram, E., Zarepisheh, M., & Ghaznavi-ghosoni, B. A. (2010). Sensitivity analysis on the priority of the objective functions in lexicographic multiple objective linear programs. *European Journal of Operational Research*, 207(3), 1162–1168. <https://doi.org/10.1016/j.ejor.2010.05.016>
- Kuo, R. J., Wang, Y. C., & Tien, F. C. (2010). Integration of artificial neural network and MADA methods for green supplier selection. *Journal of Cleaner Production*, 18(12), 1161–1170. <https://doi.org/10.1016/j.jclepro.2010.03.020>
- La Londe, B. J., & Masters, J. M. (1994). Emerging Logistics Strategies. *International Journal of Physical Distribution & Logistics Management*, 24(7), 35–47. <https://doi.org/10.1108/09600039410070975>
- Lin, C. (2008). A model using home appliance ownership data to evaluate recycling policy performance. *Resources, Conservation and Recycling*, 52(11), 1322–1328. <https://doi.org/10.1016/j.resconrec.2008.07.015>
- Liang, Y., Su, J., Xi, B., Yu, Y., Ji, D., Sun, Y., ... Zhu, J. (2017). Life cycle assessment of lithium-ion batteries for greenhouse gas emissions. *Resources, Conservation and Recycling*, 117, 285–293. <https://doi.org/10.1016/J.RESCONREC.2016.08.028>
- Liu, Q., Li, H. ming, Zuo, X. li, Zhang, F. Fei, & Wang, L. (2009). A survey and analysis on public awareness and performance for promoting circular economy in China: A case study from Tianjin. *Journal of Cleaner Production*, 17(2), 265–270. <https://doi.org/10.1016/j.jclepro.2008.06.003>
- Liu, S., & Papageorgiou, L. G. (2013). Multiobjective optimization of production, distribution and capacity planning of global supply chains in the process industry. *Omega*, 41(2), 369–382. <https://doi.org/10.1016/j.omega.2012.03.007>
- Liu, W., Sang, J., Chen, L., Tian, J., Zhang, H., & Olvera Palma, G. (2015a). Life cycle assessment of lead-acid batteries used in electric bicycles in China. *Journal of Cleaner Production*, 108, 1149–1156. <https://doi.org/10.1016/j.jclepro.2015.07.026>
- Liu, W., Sang, J., Chen, L., Tian, J., Zhang, H., & Olvera Palma, G. (2015b). Life cycle assessment of lead-acid batteries used in electric bicycles in China. *Journal of Cleaner Production*, 108, 1–8. <https://doi.org/10.1016/j.jclepro.2015.07.026>
- Maleki, H., & Zahir, S. (2013). A Comprehensive Literature Review of the Rank Reversal Phenomenon in the Analytic Hierarchy Process. *Journal of Multi-Criteria Decision Analysis*, 20(3–4), 141–155. <https://doi.org/10.1002/mcda.1479>
- Manuilova, A., Suebsiri, J., & Wilson, M. (2009). Should Life Cycle Assessment be part of the Environmental Impact Assessment? Case study: EIA of CO2 Capture and Storage in Canada. *Energy Procedia*, 1(1), 4511–4518. <https://doi.org/10.1016/j.egypro.2009.02.269>
- Mardani, A., Jusoh, A., MD Nor, K., Khalifah, Z., Zakwan, N., & Valipour, A. (2015). Multiple criteria decision-making techniques and their applications – a review of the literature from 2000 to 2014. *Economic Research-Ekonomska Istraživanja*, 28(1), 516–571. <https://doi.org/10.1080/1331677X.2015.1075139>
- Marković, Z. (2010). MODIFICATION OF TOPSIS METHOD FOR SOLVING OF MULTICRITERIA TASKS. *Yugoslav Journal of Operations Research*, 20, 117–143. <https://doi.org/10.2298/YJOR1001117M>
- Martin, G., & Siegmund, A. (2013). Recovery of Polypropylene from Lead-Acid Battery Scrap. In *Recycling of Metals and Engineered Materials* (pp. 93–101). Hoboken, NJ, USA: John Wiley & Sons, Inc. <https://doi.org/10.1002/9781118788073.ch8>
- Masoudipour, E., Amirian, H., & Sahraeian, R. (2017). A novel closed-loop supply chain based on the quality of returned products. *Journal of Cleaner Production*, 151, 344–355. <https://doi.org/10.1016/j.jclepro.2017.03.067>
- Mavrotas, G. (2007). Generation of efficient solutions in multiobjective mathematical programming problems using GAMS, effective implementation of the ϵ -constraint method.
- Mavrotas, G. (2009). Effective implementation of the ϵ -constraint method in Multi-Objective Mathematical Programming problems. *Applied Mathematics and Computation*, 213(2), 455–465. <https://doi.org/10.1016/j.amc.2009.03.037>

- Mavrotas, G., & Florios, K. (2013). An improved version of the augmented ϵ -constraint method (AUGMECON2) for finding the exact Pareto set in multi-objective integer programming problems. *Applied Mathematics and Computation*, 219(18), 9652–9669. <https://doi.org/10.1016/j.amc.2013.03.002>
- McManus, M. C. (2012). Environmental consequences of the use of batteries in low carbon systems: The impact of battery production. *Applied Energy*, 93, 288–295. <https://doi.org/10.1016/j.apenergy.2011.12.062>
- Mentzer, J. T., DeWitt, W., Keebler, J. S., Min, S., Nix, N. W., Smith, C. D., & Zacharia, Z. G. (2001). Defining supply chain management. *Journal of Business Logistics*, 22(2), 1–25.
- Mentzer, John T., DeWitt, W., Keebler, J. S., Min, S., Nix, N. W., Smith, C. D., & Zacharia, Z. G. (2001). DEFINING SUPPLY CHAIN MANAGEMENT. *Journal of Business Logistics*, 22(2), 1–25. <https://doi.org/10.1002/j.2158-1592.2001.tb00001.x>
- Morachevskii, A. G., Vaisgant, Z. I., Rusin, A. I., & Khabachev, M. N. (2001). Removal of sulfur from the active mass of lead battery scrap. *Russian Journal of Applied Chemistry*, 74(7), 1103–1105. <https://doi.org/10.1023/A:1013050414173>
- Morales-Mendoza, L. F. (2013). *ECOCONCEPTION DE PROCÉDES : APPROCHE SYSTEMIQUE COUPLANT MODELISATION GLOBALE, ANALYSE DU CYCLE DE VIE ET OPTIMISATION MULTIOBJECTIF*. Institut National Polytechnique de Toulouse (INP Toulouse).
- O'Donnell, C. (2007). *Total effect on the environment of electric/hybrid electric vehicle batteries*.
- Ochoa Robles, J. (2018). Multi-objective optimization strategies for the design and deployment of hydrogen supply chains.
- Odewabi, A. O., Ogundahunsi, O. A., & Ekor, M. (2013). Effect of exposure to solid wastes concerning employment duration on some important markers of health and disease in waste management workers of Ogun State in southwest Nigeria. *Human & Experimental Toxicology*, 32(12), 1231–1244. <https://doi.org/10.1177/0960327113488612>
- Oliver, R. K., & Webber, M. D. (1982). *Supply chain management: logistics catches up with a strategy*.
- Olugu, E. U., Wong, K. Y., & Shaharoun, A. M. (2010). A Comprehensive Approach in Assessing the Performance of an Automobile Closed-Loop Supply Chain. *Sustainability*, 2(4), 871–889. <https://doi.org/10.3390/su2040871>
- Pacheco, E. B. A. V., Ronchetti, L. M., & Masanet, E. (2012). An overview of plastic recycling in Rio de Janeiro. *Resources, Conservation and Recycling*, 60, 140–146. <https://doi.org/10.1016/j.resconrec.2011.12.010>
- Pearce, D., Atkinson, G., & Mourato, S. (2006). ANALYSE COÛTS-BÉNÉFICES ET ENVIRONNEMENT Développements récents Analyse coûts-bénéfices et environnement.
- Peng, H., Shen, N., Liao, H., Xue, H., & Wang, Q. (2020). Uncertainty factors, methods, and solutions of the closed-loop supply chain — A review for the current situation and prospects. *Journal of Cleaner Production*, 254, 120032. <https://doi.org/10.1016/j.jclepro.2020.120032>
- Pennington, D. W., Potting, J., Finnvedenc, G., Lindeijerd, E., Jolliet, O., Rydberga, T., & Rebitzer, G. (2004). Life cycle assessment Part 2: Current impact assessment practice. <https://doi.org/10.1016/j.envint.2003.12.009>
- Perez Gallardo, J. (2013). Ecodesign of large-scale photovoltaic (PV) systems with multi-objective optimization and Life-Cycle Assessment (LCA)
- Periathamby, A., Hamid, F. S., & Khidzir, K. (2009a). Evolution of solid waste management in Malaysia: impacts and implications of the solid waste bill, 2007. *Journal of Material Cycles and Waste Management*, 11(2), 96–103. <https://doi.org/10.1007/s10163-008-0231-3>
- Periathamby, A., Hamid, F. S., & Khidzir, K. (2009b). Evolution of solid waste management in Malaysia: Impacts and implications of the solid waste bill, 2007. *Journal of Material Cycles and Waste Management*, 11(2), 96–103. <https://doi.org/10.1007/s10163-008-0231-3>
- Premrudee, K., Jantima, U., Kittinan, A., Naruetep, L., Kittiwat, K., & Sudkla, B. (2013). Life cycle assessment of lead-acid battery. Case study for Thailand. *Environment Protection Engineering*, Vol. 39(nr 1).

- Ramkumar, N., Subramanian, P., Narendran, T. T., & Ganesh, K. (2011). Erratum to “A genetic algorithm approach for solving a closed-loop supply chain model: A case of battery recycling” [Appl. Math. Modell. 34 (2010) 655–670]. *Applied Mathematical Modelling*, 35(12), 5921–5932. <https://doi.org/10.1016/j.apm.2011.05.026>
- Rand, D. A. J., Moseley, P. T., Garche, J., & Parker, C. D. (2004). Valve-Regulated Lead-Acid Batteries. Rebitzer, G., Ekvall, T., Frischknecht, R., Hunkeler, D., Norris, G., Rydberg, T., ... Pennington, D. W. (2004). Life cycle assessment. *Environment International*, 30(5), 701–720. <https://doi.org/10.1016/j.envint.2003.11.005>
- Redmer, R., & Warren, W. W. (2016). Piles et acummulaterus -rapporte annuel. *Piles et Acummulaterus -Rapporte Annuel*.
- Ren, L., Zhang, Y., Wang, Y., & Sun, Z. (2007). Comparative Analysis of a Novel M-TOPSIS Method and TOPSIS. *Applied Mathematics Research Express*. <https://doi.org/10.1093/amrx/abm005>
- Rogers, D. S., Melamed, B., & Lembke, R. S. (2012). Modeling and Analysis of Reverse Logistics. *Journal of Business Logistics*, 33(2), 107–117. <https://doi.org/10.1111/j.0000-0000.2012.01043.x>
- Ross, D. F. (1998). *Competing Through Supply Chain Management: Creating Market-Winning Strategies Through Supply Chain Partnerships*.
- Rydh, C. J. (1999). Environmental assessment of vanadium redox and lead-acid batteries for stationary energy storage. *Journal of Power Sources*, 80(1–2), 21–29. [https://doi.org/10.1016/S0378-7753\(98\)00249-3](https://doi.org/10.1016/S0378-7753(98)00249-3)
- Rydh, C. J., & Karlström, M. (2002). Life cycle inventory of recycling portable nickel-cadmium batteries. *Resources, Conservation and Recycling*, 34(4), 289–309. [https://doi.org/10.1016/S0921-3449\(01\)00114-8](https://doi.org/10.1016/S0921-3449(01)00114-8)
- Sadler, B., & Verheem, R. (1996). *Strategic Environmental Assessment. Status, challenges, and future directions*. The Hague.
- Saleh, M., & Ansari, A. (2012). Municipal solid waste management systems in the Kingdom of Bahrain. *International Journal of Water Resources and Environmental Engineering*, 4(5), 150–161. <https://doi.org/10.5897/IJWREE12.022>
- Salomone, R., Mondello, F., Lanuzza, F., & Micali, G. (2005). An Eco-balance of a Recycling Plant for Spent Lead–Acid Batteries. *Environmental Management*, 35(2), 206–219. <https://doi.org/10.1007/s00267-003-0099-x>
- Satellite, A., Ratto, M., Andres, T., Campolongo, F., Cariboni, J., Gatelli, D., ... Tarantola, S. (2008). *Global Sensitivity Analysis: The Primer*.
- Seuring, S., & Müller, M. (2008). From a literature review to a conceptual framework for the sustainable supply chain management. *Journal of Cleaner Production*, 16(15), 1699–1710. <https://doi.org/10.1016/j.jclepro.2008.04.020>
- Siriruttanaruk, & Sumrit. (2020). Optimal Transportation Cost for End-of-Life Lead- Acid Battery Reverse Logistics: A Case Study of Thailand. *Proceedings*, 39(1), 9. <https://doi.org/10.3390/proceedings2019039009>
- Stevens, G. C. (1989). Integrating the Supply Chain. *International Journal of Physical Distribution & Materials Management*, 19(8), 3–8. <https://doi.org/10.1108/EUM00000000000329>
- Subulan, K., Baykasoğlu, A., Özsoydan, F. B., Taşan, A. S., & Selim, H. (2015). A case-oriented approach to a lead/acid battery closed-loop supply chain network design under risk and uncertainty. *Journal of Manufacturing Systems*, 37, 340–361. <https://doi.org/10.1016/j.jmsy.2014.07.013>
- Sullivan, J. L., & Gaines, L. (2012). Status of life cycle inventories for batteries. *Energy Conversion and Management*, 58, 134–148. <https://doi.org/10.1016/j.enconman.2012.01.001>
- Sun, L., Zhang, C., Li, J., & Zeng, X. (2016). Assessing the sustainability of lead utilization in China. *Journal of Environmental Management*, 183, 275–279. <https://doi.org/10.1016/j.jenvman.2016.05.063>
- Thierry, M., Salomon, M., Van Nunen, J., & Van Wassenhove, L. (1995). Strategic Issues in Product Recovery Management. *California Management Review*, 37(2), 114–136. <https://doi.org/10.2307/41165792>
- Thornton, I., Rautiu, R., & Brush, S. (2001). *LEAD the facts*.

- Tian, X., Wu, Y., Hou, P., Liang, S., Qu, S., Xu, M., & Zuo, T. (2017). Environmental impact and economic assessment of secondary lead production: Comparison of main spent lead-acid battery recycling processes in China. *Journal of Cleaner Production*, *144*, 142–148. <https://doi.org/10.1016/j.jclepro.2016.12.171>
- Tyndall, G., Gopal, C., Partsch, W., & Kamauff, J. (1998). *Supercharging Supply Chains: New Ways to Increase Value Through Global Operational Excellence*. Wiley; 1st Edición.
- Unterreiner, L., Jülch, V., & Reith, S. (2016). Recycling of Battery Technologies – Ecological Impact Analysis Using Life Cycle Assessment (LCA). *Energy Procedia*, *99*, 229–234. <https://doi.org/10.1016/j.egypro.2016.10.113>
- Van Hoek, R. I. (1999). From reversed logistics to green supply chains. *Supply Chain Management*, *4*(3), 129–134. <https://doi.org/10.1108/13598549910279576>
- Van Wassenhove, L. N., & Guide, V. D. R. (2002). *The reverse supply chain*.
- Wang, Q., Liu, W., Yuan, X., Tang, H., Tang, Y., Wang, M., ... Sun, J. (2018). Environmental impact analysis and process optimization of batteries based on life cycle assessment. *Journal of Cleaner Production*, *174*, 1262–1273. <https://doi.org/10.1016/j.jclepro.2017.11.059>
- Wang, Y., Yu, J., Zhao, X., Lu, T., Du, J., & Huang, X. (2010). Research on the Life Cycle Analysis of the Reverse Supply Chain of the Lead Acid Batteries. In *2010 4th International Conference on Bioinformatics and Biomedical Engineering* (pp. 1–6). IEEE. <https://doi.org/10.1109/ICBBE.2010.5518110>
- Weetman, C. (2017). *A Circular Economy Handbook for Business and Supply Chains: Repair, Remake, Redesign, Rethink*.
- Weidema, B. P., Delgado, L., & Eder, P. (2008). *Environmental improvement potentials of meat and dairy products*.
- WHO, W. H. O. (2017). Recycling used lead-acid batteries: health considerations, 47.
- World Economic Forum, W. (2019). A Vision for a Sustainable Battery Value Chain in 2030 | World Economic Forum. Retrieved September 11, 2020, from <https://www.weforum.org/reports/a-vision-for-a-sustainable-battery-value-chain-in-2030>
- Yu, Y., Wang, X., Wang, D., Huang, K., Wang, L., Bao, L., & Wu, F. (2012). Environmental characteristics comparison of Li-ion batteries and Ni–MH batteries under the uncertainty of cycle performance. *Journal of Hazardous Materials*, *229–230*, 455–460. <https://doi.org/10.1016/j.jhazmat.2012.06.017>
- Zhang, W., Yang, J., Wu, X., Hu, Y., Yu, W., Wang, J., ... Kumar, R. V. (2016). A critical review on secondary lead recycling technology and its prospect. *Renewable and Sustainable Energy Reviews*, *61*, 108–122. <https://doi.org/10.1016/j.rser.2016.03.046>
- Zhiqiang, L. U. (2003). *Hierarchical planning and optimization of logistics with reverse flows*. Universite de Nantes.

List of Figures

Figure 1. 1 Number of papers based on an initial search in Web of Science™ (WoS) using the keywords “closed-loop supply chain”	3
Figure 1. 2 Thesis layout and overview	7
Figure 1. 3 Nombre d'articles identifiés lors d'une première recherche sur le site web Science™ (WoS) à l'aide des mots clés "closed-loop supply chain" (chaîne d'approvisionnement en boucle fermée)	10
Figure 1. 4 Présentation de la thèse	15
Figure 2. 1 Types of channel relationships.	19
Figure 2. 2 Activities in green supply chain management.	22
Figure 2. 3 Framework of a forward supply chain.	23
Figure 2. 4 Why, how, what and who basic interactions (Thierry et al. 1995).	24
Figure 2. 5 Driving cycle for reverse logistics.	24
Figure 2. 6 Return reasons cycle for reverse logistics.	25
Figure 2. 7 Classification of returned objects	25
Figure 2. 8 Reverse logistic processes.	26
Figure 2. 9 Who is who in reverse logistics.	27
Figure 2. 10 Primary Optimization Methods and Classification by Family	28
Figure 2. 11 Schematic representation of a generic life cycle of a product (the full arrows represent material and energy flows, while the dashed arrows represent information flows). Source (Rebitzer et al. 2004).	31
Figure 2. 12 Life Cycle Assessment Framework. Source (ISO:14040, 2006).	32
Figure 2. 13 Life cycle inventory scheme.	33
Figure 2. 14 Elements of LCIA Source (ISO 14042:2000).	34
Figure 2. 15 CLSC network for the lead-acid battery.	40
Figure 2. 16 Map of recyclers in France.	41
Figure 2. 17 Evolution of french demand.	42
Figure 3. 1 Scheme of a CLSC used for lead-acid batteries.	51
Figure 3. 2 Sections of the CLSC.	52
Figure 3. 3 Lead-acid battery constitution.	54
Figure 3. 4 Lead battery manufacturing process adapted from (Dahodwalla & Herat, 2000).	54
Figure 3. 5 General recycling process. Source (Sánchez, 2018).	57
Figure 3. 6 Flow diagram showing pyrometallurgical and hydrometallurgical lead recycling process	58
Figure 3. 7 General processes of pyro-metallurgical recycling (ADEME 2017).	59
Figure 3. 8 Ellingham diagram of secondary lead smelting.	59
Figure 3. 9 Ellingham diagram showing the PbS–FeS matter.	59
Figure 3. 10 Eh–pH diagram for SO ₂ scrubbing system.	60
Figure 3. 11 General processes of hydrometallurgical recycling. Source (ADEME 2017).	61
Figure 3. 12 Eh–pH diagram of PbSO ₄ desulfurization w/Na ₂ CO ₃ /NaOH.	62
Figure 3. 13 Ellingham diagram showing the slag species.	62
Figure 3. 14 Schema of battery discharge from (off-grid-europe.com).	64
Figure 3. 15 from LCI results to midpoints and final impact categories in IMPACT 2002+.	71
Figure 3. 16 General approaches of LCIA of emissions on the major categories of environmental damage in ReCiPe.	72

Figure 3. 17 Radar representation of the normalized environmental midpoint impacts for the different scenarios with IMPACT 2002+model	75
Figure 3. 18 Radar representation of the environmental midpoint impacts for the different scenarios with ReCiPe midpoint (H) model.	75
Figure 3. 19 Contribution of each phase in scenario 1 (IMPACT 2002+).....	77
Figure 3. 20 Contribution of each phase in scenario 1 (ReCiPe midpoint (H) model).	77
Figure 3. 21 Contribution of each phase in scenario 2 (IMPACT 2002+).....	77
Figure 3. 22 Contribution of each phase in scenario 2 (ReCiPe midpoint (H) model).	77
Figure 3. 23 Contribution of each phase in scenario 3 (IMPACT2002+).	77
Figure 3. 24 Contribution of each phase in scenario 3 (ReCiPe midpoint (H) model).	77
Figure 3. 25 Key process analysis of environmental impact.....	79
Figure 3. 26 Contribution of lead emissions for scenarios S1, S2, and S3.....	82
Figure 4. 1 CLSC scheme used in this work (Disposal Bat: Disposal of batteries; Disposal Rm: Disposal of Raw materials).	95
Figure 4. 2 Section and data of the proposed model.	96
Figure 4. 3 Evolution of lead-acid batteries demand (ADEME 2016).....	97
Figure 4. 4 Distances (D), inventory steps (Inv), and echelons (C) involved in the CLSC.	110
Figure 4. 5 Location of Global Warming Potential Emissions in the CLSC.....	114
Figure 4. 6 Methodology of the model solution.	117
Figure 4. 7 Multiobjective optimization methods (de Leon Almaraz, 2014).	120
Figure 4. 8 Generic decision matrix for application of the TOPSIS method.	125
Figure 4. 9 Evaluation of each Pareto-CLSC configuration by SimaPro.	127
Figure 5. 1 Cost involved in the first period of the CLSC.	132
Figure 5. 2 Emissions involved in the first period of the CLSC.....	133
Figure 5. 3 Evolution of best and worst solutions for cost criterion according to the single-objective optimizations.	136
Figure 5. 4 Evolution of best and worst solutions for GWP criterion according to the single-objective optimizations	136
Figure 5. 5 Pareto solutions obtained for the multi-objective model using the ϵ -constraint method. ...	137
Figure 5. 6 Comparison of M-TOPSIS solution with best single-objective solutions for cost criterion. ...	139
Figure 5. 7 Comparison of M-TOPSIS solution with best single-objective solutions for GWP criterion...	139
Figure 5. 8 Cost distribution among the items of the CLSC.	140
Figure 5. 9 Cartography of the operation cost in the CLSC.	141
Figure 5. 10 Cartography of the distribution cost in the CLSC.....	142
Figure 5. 11 GWP contribution.....	143
Figure 5. 12 Cartography of GWP for the operation steps in the CLSC.....	144
Figure 5. 13 Cartography of GWP for the distribution steps in the CLSC.....	145
Figure 5. 14 Recycling rate for each period.	147
Figure 5. 15 Generation of a complete mapping of each solution.	149
Figure 5. 16 Pareto solutions obtained for the multi-objective model using the ϵ -constraint method (LCA evaluation included	152
Figure 5. 17 Values of the different indicators for the TOPSIS and M-TOPSIS for MILP-LCA solutions...	154
Figure 5. 18 Radar graphs obtained with TOPSIS and M-TOPSIS after MILP and MILP-LCA evaluation...	156
Figure 5. 19 Representation of the best solutions found by TOPSIS and M-TOPSIS after MILP and MILP-LCA evaluation (sol. 44, 77, 66, and 101).....	158

Figure 5. 20 Pareto Front of different scenarios and M-TOPSIS top-ranked solution.	161
Figure 5. 21 Behavior of the optimal solution of each scenario.	161
Figure 5. 22 Graphic radar of the critical scenarios in the MILP-LCA evaluation.	163
Figure 6. 1 Building blocks of the proposed methodology: Integration of Closed-Loop Supply Chain Management (CLSCM) and Life Cycle Assessment (LCA)	171
Figure 6. 2 Structure of the supply chains (Weetman, 2017).	173

List of Tables

Table 2. 1 Activities in the SCM philosophy.....	21
Table 2. 2 Methods for LCIA Source: (European Commission et al. 2010).....	35
Table 2. 3 Typical LCA software tools.....	38
Table 2. 4 Mirror effect of CLSCM and LCA	39
Table 2. 5 Main stakeholders of the battery supply chain in France. Source (ADEME, 2016).	41
Table 3. 1 Some classical methods used to evaluate the environmental issues or impacts of plans, projects, and programs.....	50
Table 3. 2 Different types of transportation used in the distribution of the lead-acid batteries.	57
Table 3. 3 Percentage of material recovered from the disassembly of a battery.	63
Table 3. 4 Composition of the battery used in this study (Jolly & Rhin, 1994).	64
Table 3. 5 LCI for Battery manufacturing 100% virgin lead (Scenario 1).....	66
Table 3. 6 LCI Battery manufacturing 50% virgin lead and 50% recycled lead. (Scenario 2).	67
Table 3. 7 LCI LCI Battery manufacturing 10% virgin lead and 90% recycled lead (Scenario3).....	68
Table 3. 8 Distance, location, and type of transportation used in each phase of the supply chain.	69
Table 3. 9 Characterization reference substances and reference flow used in IMPACT 2002	71
Table 3. 10 Characterization reference substances and reference flow used in ReCiPe Source	72
Table 3. 11 Results of all the scenarios with the IMPACT 2002+ model.	73
Table 3. 12 Results of all the scenarios with ReCiPe midpoint (H) model.....	74
Table 3. 13 Results of all midpoint impacts with IMPACT 2002+ for all the scenarios (S1: scenario 1, S2: scenario 2, S3: scenario 3).	80
Table 3. 14 Values of lead emission for scenarios S1, S2, and S3.	82
Table 4. 1 Color code used in the formulation of the mathematical model.....	99
Table 4. 2 Set of variables involved in the distribution cost of the CLSC.	111
Table 4. 3 Set of the variables involved in the inventory carrying cost.	112
Table 4. 4 Set of variables involved in the operational cost of the CLSC.	112
Table 4. 5 Set of the variables involved in the calculation of GWP due to distribution.	115
Table 4. 6 Set of the variables involved in the calculation of GWP due to operation in the CLSC.	116
Table 4. 7 Indicators considered for the evaluation.	128
Table 5. 1 Results of single-objective optimization of the total cost of the CLSC.	134
Table 5. 2 Results of single-objective optimization of the total cost of the CLSC by period.....	134
Table 5. 3 Results of single-objective optimization of GWP of the CLSC.	135
Table 5. 4 Results of single-objective optimization of the total GWP of the CLSC by period.	135
Table 5. 5 Pay-off table of the total cost and GWP of the whole CLSC.....	137
Table 5. 6 Analysis of the solution selected by M-TOPSIS (solution 77).	138
Table 5. 7 Components of the recycling rate.....	146
Table 5. 8 Structure of the CLSC for the lead-acid batteries production (period 1 to 5).	148
Table 5. 9 Colour code for the environmental submodules involving increasing (higher intensity) or decreasing (lower intensity) impact factors compared to the base case (period 1)	150

Table 5. 10 Decision variables involved in each step of the CLSC.....	151
Table 5. 11 Values of the different indicators for the TOPSIS and M-TOPSIS for MILP-LCA solutions.	153
Table 5. 12 Values of the different indicators for the TOPSIS and M-TOPSIS applied to the MILP and MILP-LCA solutions.	155
Table 5. 13 Analysis of the best solutions found by TOPSIS and M-TOPSIS after MILP and MILP-LCA evaluation (sol. 44, 77, 66, and 101).	157
Table 5. 14 Different scenarios implemented for the sensitivity analysis.	160
Table 5. 15 Solutions obtained after MILP-LCA-M-TOPSIS evaluation for each scenario, as well as their normalized values.....	162
Table 5. 16 Increase or decrease in the indicators after MILP-LCA-M-TOPSIS evaluation.	163

Appendix



Appendix A: Application example of
TOPSIS and M-TOPSIS

TOPSIS evaluates a given set of alternative data without direct comparison between alternatives, with the result expressed as a mark on a scale between the values of the ideal and the negative ideal solution. The alternative closest to the ideal solution and farthest from the negative ideal solution is the best one.

The basic algorithm of the TOPSIS method evaluates the decision matrix, in which ‘*m*’ alternatives are evaluated by ‘*n*’ criteria, as shown in Figure A. 1.

		<i>j=1</i>	<i>j=2</i>	<i>j=3</i>	...	<i>j=n</i>
		C1	C2	C3		Cn
<i>i=1</i>	A1	<i>X_{ij}</i>	<i>X_{ij}</i>	<i>X_{ij}</i>	...	<i>X_{ij}</i>
<i>i=2</i>	A2	<i>X_{ij}</i>	<i>X_{ij}</i>	<i>X_{ij}</i>	...	<i>X_{ij}</i>
<i>i=3</i>	A3	<i>X_{ij}</i>	<i>X_{ij}</i>	<i>X_{ij}</i>	...	<i>X_{ij}</i>
⋮	⋮	⋮	⋮	⋮	⋮	⋮
<i>i=m</i>	A <i>m</i>	<i>X_{ij}</i>	<i>X_{ij}</i>	<i>X_{ij}</i>	...	<i>X_{ij}</i>

Figure A. 1 Generic decision matrix for application of the TOPSIS method.

		<i>j=1</i>	<i>j=2</i>	<i>j=3</i>	<i>j=4</i>
		C1	C2	C3	C4
<i>i=1</i>	A1	2.4189	16.3500	0.1036	660.6800
<i>i=2</i>	A2	2.2643	15.2672	0.0976	622.9614
<i>i=3</i>	A3	2.3777	16.0559	0.1021	651.3015
<i>i=4</i>	A4	2.3301	15.7245	0.1002	639.4160

Figure A. 2 Decision matrix of example for the application of the TOPSIS method.

Since different criteria have different dimensions, the values in the decision matrix are first transformed into normalized, non-dimensional values, under the equation Eq. (4.45) (Antuchevičienė et al. 2010). Figure A. 3 presents the normalized decision matrix.

$$a_{ij} = \frac{x_{ij}}{\sqrt{\sum_{j=1}^n x_{ij}^2}} \tag{Eq. 4. 56}$$

where: *a_{ij}* stands for the normalized value; *i* = 1, 2, ..., *m*, *j* = 1, 2, ..., *n*.

	C1	C2	C3	C4
A1	0.5150	0.5156	0.5134	0.5132
A2	0.4821	0.4815	0.4837	0.4839
A3	0.5062	0.5063	0.5059	0.5059
A4	0.4961	0.4959	0.4966	0.4966

Figure A. 3 Normalized decision matrix for the application of method TOPSIS.

The weighted normalized matrix is calculated in such a way that each value within the individual criterion in the normalized matrix is multiplied by the weight of this criterion Eq. (4.46):

$$v_{ij} = w_i \cdot a_{ij} \quad (\text{Eq. 4. 57})$$

where: w_i stands for the weight of the individual criterion i ; $i = 1, 2, \dots, m$; $j = 1, 2, \dots, n$.

$w_i =$	0.25	0.25	0.25	0.25
	C1	C2	C3	C4
A1	0.1288	0.1289	0.1283	0.1283
A2	0.1205	0.1204	0.1209	0.1210
A3	0.1266	0.1266	0.1265	0.1265
A4	0.1240	0.1240	0.1241	0.1242

Figure A. 4 Normalized decision matrix for the application of method TOPSIS.

An ideal solution is a group of weighted normalized criteria values, which indicates the ideal criteria values, Eq. (4.47):

$$A^+ = \{v_{1+}, v_{2+}, \dots, v_{n+}\} \quad (\text{Eq. 4. 58})$$

And the negative ideal solution is a group of weighted normalized criteria values, which indicates the negative ideal criteria values Eq. (4.48).

$$A^- = \{v_{1-}, v_{2-}, \dots, v_{n-}\} \quad (\text{Eq. 4. 59})$$

	C1	C2	C3	C4
MIN	0.1205	0.1204	0.1209	0.1210
MAX	0.1288	0.1289	0.1283	0.1283

Figure A. 5 Minimum and maximum, of the weighted normalized criteria values.

Thereafter, using the Euclidean distance, the distances to the ideal solution S_{i+} and to the negative ideal solution S_{i-} are calculated for each alternative, Eq. (4.49) and Eq. (4.50):

$$S_{i+} = \sqrt{\sum_{j=1}^n (v_{j+} - v_{ij})^2} \text{ for } i = 1, 2, \dots, m, \tag{Eq. 4. 60}$$

and

$$S_{i-} = \sqrt{\sum_{j=1}^n (v_{j-} - v_{ij})^2}, \text{ for } i = 1, 2, \dots, m, \tag{Eq. 4. 61}$$

Where: $v_{j+} = \max_i v_{ij}$ and $v_{j-} = \min_i v_{ij}$

	S_{i+}	S_{i-}
A1	0.0158	0.0000
A2	0.0000	0.0158
A3	0.0117	0.0041
A4	0.0068	0.0090

Figure A. 6 Separation measures of the decision matrix of the example.

Thereafter, an M-TOPSIS modification is introduced. Since S_{i+} and S_{i-} represent each alternative in a S^+S^- plane, the distances from those two points to the relative proximity to the ideal solution are calculated according to the classic TOPSIS method (Antuchevičienė et al., 2010) Eq. (4.51). A rank of alternatives is then created in decreasing order according to the value of C_i . The best alternative is the one having the TOPSIS coefficient C_i nearest to 0 according to the example previously taken the result is presents in Figure A. 7:

$$C_i = \frac{S_{i-}}{(S_{i+} + S_{i-})} \tag{Eq. 4. 62}$$

Where $1 \geq C_i \geq 0$ and $i = 1, 2, \dots, m$

	C_i	Rank
A1	0.000	4
A2	1.000	1
A3	0.261	3
A4	0.571	2

Figure A. 7 Ranking of the alternatives according to the TOPSIS method.

M-TOPSIS is an evaluation method often used to solve multiple-choice decision-maker (MCDM) problems, such as comparison of company performances, financial ratio performance within a specific industry, and financial investment in advanced manufacturing systems, etc. M-TOPSIS modifies this calculation in such a way as to firstly set the optimized ideal reference point, ($\min(S_i^+)$, $\max(S_i^-)$) and then calculate the distance from each alternative to that point according to the research of (Ren et al., 2007) (Eq. (4.52)):

$$C_i^M = \sqrt{(S_i^+ - \min(S_i^+))^2 + (S_i^- - \max(S_i^-))^2} \quad (\text{Eq. 4. 63})$$

where $i = 1, 2, \dots, m$.

The best alternative is the one that has the M-TOPSIS coefficient C_i^M nearest to 0 ranked in increasing order, according to the value according to the example previously taken the result is presented in Figure A. 8.

	C_i^M	Rank
A1	0.0223	4
A2	0.0000	1
A3	0.0165	3
A4	0.0096	2

Figure A. 8 Ranking of the alternatives according to the M-TOPSIS method.

Appendix



Appendix B. Data used in the Closed-
Loop Supply Chain configuration.

Appendix B.1 Data of the configuration of the closed-loop supply chain.

- Demand: Demand at the retailer “r” product “p” in the period “t”, unit (batteries).

	1	2	3	4	5
r1.p1	3,121,000	4,134,000	3,760,000	3,721,000	4,052,000
r2.p1	7,297,000	8,274,000	8,129,000	7,575,000	8,371,000

- StorCapaReta: Storage capacity of product “p” in the wholesaler “w” at the period “t”, unit (batteries).

	1	2	3	4	5
r1.p1	10,000,000	10,000,000	10,000,000	10,000,000	10,000,000
r2.p1	11,000,000	11,000,000	11,000,000	11,000,000	11,000,000

- StorCapaWhol: Storage capacity of product “p” in the retailer “r” at the period “t”, unit (batteries).

	1	2	3	4	5
w1.p1	15,000,000	15,000,000	15,000,000	15,000,000	15,000,000
w2.p1	17,000,000	17,000,000	17,000,000	17,000,000	17,000,000

- InveWhol: Final inventory of product “p” in the wholesaler “w” at the period “t”, unit (batteries).

	1	2	3	4	5
w1.p1	500	760	606	509	460
w2.p1	270	690	540	501	740

- StorCapaDist: Storage capacity of product “p” in the distributor “d” at the period “t”, unit (batteries).

	1	2	3	4	5
d1.p1	10,000,000	10,000,000	10,000,000	10,000,000	10,000,000
d2.p1	10,000,000	10,000,000	10,000,000	10,000,000	10,000,000

- InveDist: Final inventory of product “p” in the distributor “d” at the period “t”, unit (batteries).

	1	2	3	4	5
d1.p1	30	70	70	60	80
d2.p1	90	80	40	90	90

- StoCapaManuPlant: Final inventory of product “p” in the manufacturing plant “j” at the period “t”, unit (batteries).

	1	2	3	4	5
J1.p1	50,000,000	50,000,000	50,000,000	50,000,000	50,000,000

- InveManuPlant: Final inventory of product “p” in the manufacturing plant “j” at the period “t”, unit (batteries).

	1	2	3	4	5
j1.p1	80	40	40	60	80

- InveRwManuPlant: Final inventory of raw material “i” in the manufacturing plant “j” at the period “t”, unit (kg of lead).

	1	2	3	4	5
j1.i1	10	5	15	20	10

- RequiredMat: Amount of raw material “i” required to produce one item of product “p” at the period “t”, unit (kg of lead).

	1	2	3	4	5
i1.p1	8.64	8.64	8.64	8.64	8.64

- RequiredMatRecy: Amount of raw material “i” recycled required to produce one item of product “p” at the period “t”, unit (kg of lead).

	1	2	3	4	5
i1.p1	7.776	7.776	7.776	7.776	7.776

- RequiredMatnewRecy: Amount of raw material virgin “i” required to produce one item of product “p” at the period “t” (complement of the recycling raw material), unit (kg of lead).

	1	2	3	4	5
i1.p1	0.86	0.86	0.86	0.86	0.86

- StorCapaSup: Storage capacity of raw material “i” in the supplier “s” at the period “t”, unit (kg of lead).

	1	2	3	4	5
s1.i1	80,000,000	80,000,000	80,000,000	80,000,000	80,000,000
s2.i1	75,000,000	75,000,000	75,000,000	75,000,000	75,000,000

- IndexReco: Index of recollection of product “p” which life cycle is over in period “t”, unit (Percentage % of production).

	1	2	3	4	5
p1	0.85	0.85	0.85	0.85	0.85

- RecoCentCapa: Storage capacity of product “p” in the initial recollection center “x” at the period “t”, unit (batteries).

	1	2	3	4	5
x1.p1	5,000,000	5,000,000	5,000,000	5,000,000	5,000,000
x2.p1	4,000,000	4,000,000	4,000,000	4,000,000	4,000,000
x3.p1	3,900,000	3,900,000	3,900,000	3,900,000	3,900,000
x4.p1	1,000,000	1,000,000	1,000,000	1,000,000	1,000,000
x5.p1	1,900,000	1,900,000	1,900,000	1,900,000	1,900,000

- InveRetuPro: Final inventory of product “p” in the centralized recollected center, at period “t”, unit (batteries).

	1	2	3	4	5
p1	5	15	8	13	10

- DispRate: Disposal rate of product “p” from the recollected products, that goes to the disposal site, (Percentage % of recollected products).

	1	2	3	4	5
p1	0.02	0.02	0.02	0.02	0.02

- StorCapaDispo: Storage capacity of product “p” in the disposal site “y1” at the period “t”, unit (batteries).

	1	2	3	4	5
y1.p1	2,000,000	2,000,000	2,000,000	2,000,000	2,000,000

- PorcContRm: Percentage of the contribution of raw material “i” of the returned products “p” from the returned products in the centralized center, (Percentage % of returned product products).

	1	2	3	4	5
p1	0.7	0.7	0.7	0.7	0.7

- RecyRateReqRm: Percentage of raw material “i” obtained from the contribution of raw material from the returned products “p” that is going to be reclaimed to be reprocessed for the remanufacturing of a new product. (Percentage % of raw material recollected).

	1	2	3	4	5
p1	0.9	0.9	0.9	0.9	0.9

Appendix B.2 Data of the configuration related to cost in the closed-loop supply chain.

- RetaCustomerTransCost: Transportation cost per unit of product “p” from the retailer “r” to the customer at the period “t” (Euro €) (Use in the distance cost CD5).

	1	2	3	4	5
r1.p1	0.379934	0.389934	0.429934	0.479934	0.389934
r2.p1	0.425106	0.415106	0.365106	0.395106	0.425106

- WholRetaCost: Transportation cost per unit of product “p” from the wholesaler “w” to the retailer “r” at the period “t” (Euro €) (Use in the distance cost CD4).

	1	2	3	4	5
w1.r1.p1	0.395503	0.594365	0.414365	0.664365	0.395503
w1.r2.p1	0.564365	0.305503	0.605503	0.395503	0.564365
w2.r1.p1	0.446813	0.346813	0.546813	0.446813	0.546813
w2.r2.p1	0.353398	0.483398	0.383398	0.583398	0.373398

- DistWholTransCost: Transportation cost per unit of product “p” from the distributor “d” to the wholesaler “w” at the period “t” (Euro €) (Use in the distance cost CD3).

	1	2	3	4	5
d1.w1.p1	0.088334	0.068334	0.098334	0.068334	0.108334
d1.w2.p1	0.058272	0.098272	0.058272	0.108272	0.058272
d2.w1.p1	0.053128	0.083128	0.073128	0.123128	0.073128
d2.w2.p1	0.074768	0.054768	0.094768	0.054768	0.154768

- InveWholCost: Inventory carrying cost per unit of product “p” in the wholesaler “w” at the period “t” (Euro €) (Use in the Inventory cost IN4).

	1	2	3	4	5
w1.p1	0.0142	0.0213	0.0171	0.0498	0.0183
w2.p1	0.0268	0.0102	0.0399	0.0299	0.0279

- **ManuPlanDistCost:** Transportation cost per unit of product “p” from the manufacturing plant “j” to the distributor “d” at the period “t” (Euro €) (Use in the distance cost CD3).

	1	2	3	4	5
j1.d1.p1	0.976825	0.076825	1.076825	0.096825	1.076825
j1.d2.p1	0.088153	0.868437	0.081649	0.806836	0.917031

- **InveDistlCost:** Inventory carrying cost per unit of product “p” in the distributor “d” at the period “t” (Euro €) (Use in the Inventory cost IN3).

	1	2	3	4	5
d1.p1	0.0142	0.0284	0.029	0.0349	0.0226
d2.p1	0.0255	0.0388	0.01	0.0212	0.0398

- **ProcessingCost:** Processing cost per product “p” in the manufacturing plant “j” at the period “t” (Euro €) (Use in the processing cost CO2).

	1	2	3	4	5
j1.p1	4.10042	3.94022	4.17466	4.01989	4.12912

- **InveManuPlantCost:** Inventory carrying cost per unit of the product “p” in the manufacturing plant “j” at the period “t” (Euro €) (Use in the processing cost CO2).

	1	2	3	4	5
j1.p1	0.0568	0.071	0.0636	0.0573	0.0609

- **InveRmManuPlantCost:** Inventory carrying cost per unit of raw material “i” in the manufacturing plant “j” at the period “t” (Euro €) (Use in the inventory cost IN1).

	1	2	3	4	5
j1.i1	0.0256	0.0526	0.0248	0.0579	0.0596

- **CostUnitMate:** Purchasing cost of one unit of raw material “i” from supplier “s” at the period “t” (Euro €) (Use in the operation cost CO1).

	1	2	3	4	5
d1.p1	2.1	1.72	2.8	1.81	2.9
d2.p1	1.5	2.21	1.6	3.1	1.75

- **UnitMateTransCost:** Transportation cost per unit of raw material “i” from the supplier “s” to the manufacturing plant “j” at the period “t” (Euro €) (Use in the distance cost CD1).

	1	2	3	4	5
i1.s1.p1	0.0452	0.0422	0.0532	0.0552	0.0432
i1.s2.p1	0.0578	0.0578	0.0478	0.0498	0.0588

- **RecoCentCost:** Collection cost per unit of recollected products “p” in the initial recollecting point “x” at the period “t” (Euro €) (Use in the operation cost CO3).

	1	2	3	4	5
x1.p1	0.0826	0.0415	0.0876	0.0489	0.0851
x2.p1	0.0723	0.0591	0.0781	0.0556	0.0735
x3.p1	0.0665	0.0622	0.0617	0.0609	0.0674
x4.p1	0.0532	0.0786	0.0800	0.0703	0.0580
x5.p1	0.0453	0.0880	0.0404	0.0863	0.0446

- **RecoCentTransCost:** Transportation cost per unit of recollected products “p” from the initial recollecting point “x” to the centralized recollection center at the period “t” (Euro €) (Use in the distribution cost CD6).

	1	2	3	4	5
x1.p1	1.7083	1.8083	1.4083	1.1083	1.1083
x2.p1	1.7297	1.7097	1.9097	1.2097	1.2097
x3.p1	1.8162	1.7162	1.7162	1.6162	1.7162
x4.p1	1.9404	1.6404	1.2404	1.5404	1.9404
x5.p1	1.9105	1.1105	1.4105	1.7105	1.7105

- **CustoRCTransCost:** Transportation cost per unit of recollected products “p” from the customer to the initial recollecting point “x” at the period “t” (Euro €) (Use in the distribution cost CD7).

	1	2	3	4	5
x1.p1	3.216545	3.765745	3.016545	3.116545	3.216545
x2.p1	3.419411	3.519411	3.919411	3.119411	3.419411
x3.p1	3.532320	3.432320	3.432320	3.332320	3.132320
x4.p1	3.880762	3.280762	3.180762	3.980762	3.880762
x5.p1	3.920924	3.120924	3.120924	3.720924	3.010924

- **InveRetuProdCost:** Inventory carrying cost per unit of the product “p” in the recollected center at the period “t” (Euro €) (Use in the inventory cost IN5).

	1	2	3	4	5
p1	0.0184	0.0284	0.0384	0.0584	0.0884

- **DispCost:** Disposal cost of one unit of product “p” in the disposal site “y1” at the period “t” (Euro €) (Use in the operation cost CO4).

	1	2	3	4	5
y1.p1	0.1136	0.142	0.1343	0.187	0.1324

- **DispTransCost:** Transportation cost of one unit of product “p” in the disposal site “y1” at the period “t” (Euro €) (Use in the distribution cost CD8).

	1	2	3	4	5
y1.p1	0.07	0.07	0.07	0.07	0.07

- **DissTransCost:** Transportation cost of one unit of product “p” in the disassembly plant “z” at the period “t” (Euro €) (Use in the distribution cost CD9).

	1	2	3	4	5
z1.p1	0.0142	0.0942	0.0782	0.0242	0.0542

- **DissCost:** Disassembly cost of one unit of product “p” into the raw material in the disassembly plant “z” at the period “t” (Euro €) (Use in the operation cost CO5).

	1	2	3	4	5
z1.p1	0.4206	0.7426	0.1426	0.7426	0.8826

- **RecyRmCost:** Recycling cost of one unit of raw material “i” sold to the third party from the disassembly plant “z” at the period “t” (Euro €) (Use in the operation cost CO6).

	1	2	3	4	5
i1.z1	0.0284	0.0655	0.0284	0.0355	0.0884

- **ReclamedRmCost:** Recycling cost of one unit of raw material “i” used for the remanufacture of the recycled product “p” in the disassembly plant “z” at the period “t” (Euro €) (Use in the operation cost CO7).

	1	2	3	4	5
i1.z1	0.15	0.15	0.15	0.15	0.15

- **ReclamedRmTransCost:** Transportation cost of one unit of raw material “i” in the disassembly plant “z” to the remanufacture plant “j2” at the period “t” (Euro €) (Use in the distribution cost CD11).

	1	2	3	4	5
z1.j2.i1	0.0142	0.0442	0.0142	0.0442	0.0142

- **DispRmCost:** Disposal cost of one unit of raw material “i” sent to the disposal of raw material “y2” from the disassembly plant “z” at the period “t” (Euro €) (Use in the operation cost CO5).

	1	2	3	4	5
i1.z1.y2	0.1	0.1	0.1	0.1	0.1

- DispRmTransCost: Transportation cost of one unit of raw material “i” from the disassembly plant “z” to the disposal of raw material site “y2” at the period “t” (Euro €) (Use in the distribution cost CD10).

	1	2	3	4	5
z1.j2.i1	0.065	0.065	0.065	0.065	0.065

Appendix B.3 Data of the configuration related to the CO₂ emission in the closed-loop supply chain.

- EmTraRawMat: Emission generates by the transport of raw material “i” from suppliers “s” to the manufacturing plant “j” at the period “t” (KgeqCO₂/kg of lead) (Use in the distribution emission ED1).

	1	2	3	4	5
i1.s1.j1	0.02706	0.02886	0.01806	0.04798	0.01791
i1.s2.j1	0.01796	0.01916	0.04796	0.01896	0.05596

- EmTraJD: Emission generates by the transport of unit of product “p” from the manufacturing plant “j” to the distributor “d” at the period “t” (KgeqCO₂/kg of lead) (Use in the distribution emission ED2).

	1	2	3	4	5
J1.d1.p1	9.59248	12.66154	9.91054	12.12439	8.61538
J1.d2.p1	10.89230	10.33854	10.49582	9.60520	10.23487

- EmTraDW: Emission generates by the transport of the unit of product “p” from distributor “d” to the wholesaler “w” at the period “t” (KgeqCO₂/Battery) (Use in the distribution emission ED3).

	1	2	3	4	5
d1.w1.p1	1.1518	1.6806	1.1406	1.8006	1.1406
d1.w2.p1	1.2778	1.1254	1.5854	1.1554	1.7754
d2.w1.p1	1.6833	1.1033	1.7833	1.1533	1.6833
d2.w2.p1	1.2054	1.3278	1.0778	1.5778	1.2778

- EmTraWR: Emission generates by the transport of the unit of product “p” from wholesaler “w” to the retailer “r” at the period “t” (KgeqCO₂/Battery) (Use in the distribution emission ED4).

	1	2	3	4	5
w1.r1.p1	0.3243	0.2864	0.3143	0.2864	0.3243
w1.r2.p1	0.2575	0.3151	0.2853	0.3051	0.2753
w2.r1.p1	0.2364	0.3343	0.2464	0.3243	0.2164
w2.r2.p1	0.3051	0.2753	0.3051	0.2553	0.3051

- EmTraWRCus: Emission generates by the transport of the unit of product “p” from retailer “r” to the customer at the period “t” (KgeqCO₂/Battery) (Use in the distribution emission ED5).

	1	2	3	4	5
r1.p1	0.3243	0.2764	0.3143	0.2564	0.3043
r2.p1	0.2364	0.3043	0.2464	0.3343	0.2764
r1.p1	0.2753	0.3051	0.2753	0.3051	0.2553
r2.p1	0.3051	0.2153	0.3051	0.2753	0.3051

- EmTraCent: Emission generates by the transport of the unit of product “p” from the customer to the initial recollection center “x” at the period “t” (KgeqCO₂/Battery) (Use in the distribution emission ED6).

	1	2	3	4	5
x1.p1	0.3892	0.3397	0.2433	0.319	0.4143
x2.p1	0.3681	0.2572	0.3858	0.302	0.3392
x3.p1	0.4292	0.4508	0.4505	0.3327	0.2569
x4.p1	0.3443	0.3591	0.3136	0.292	0.2891
x5.p1	0.4321	0.403	0.3195	0.2919	0.3652

- EmTraCentCRC: Emission generates by the transport of the unit of product “p” from the initial recollection center “x” to the centralized recollection center at the period “t” (KgeqCO₂/Battery) (Use in the distribution emission ED7).

	1	2	3	4	5
x1.p1	0.91784	0.85135	1.07981	1.10035	1.00823
x2.p1	0.93907	0.86279	0.82614	1.04909	0.95081
x3.p1	0.86077	0.95997	0.8768	0.92054	0.9168
x4.p1	0.99294	0.83296	0.88331	0.84992	0.8657
x5.p1	0.89904	0.97766	0.99163	0.97361	1.041

- EmTraBad: Emission generates by the transport of the unit of product “p” from the centralized recollection center to the disposal site “y1” at the period “t” (KgeqCO₂/Battery) (Use in the distribution emission ED8).

	1	2	3	4	5
y1.p1	1.721549	1.714655	1.767446	1.757241	1.737912

- EmTraRetu: Emission generates by the transport of the unit of product “p” from the centralized recollection center to the disassembly plant “z” at the period “t” (KgeqCO₂/Battery) (Use in the distribution emission ED9).

	1	2	3	4	5
z1.p1	0.524199	0.492293	0.516465	0.502815	0.523152

- EmBadRm: Emission generates by the transport of unit of raw material “i” from the disassembly plant to the disposal of raw material “y2” at the period “t” (KgeqCO₂/Kg of lead) (Use in the distribution emission ED10).

	1	2	3	4	5
y2.i1	0.10564162	0.08964162	0.09564162	0.11564162	0.10064162

- EmBadRm: Emission generates by the transport of unit of raw material “i” from the disassembly plant to the remanufacturing plant “j2” at the period “t” (KgeqCO₂/Kg of lead) (Use in the distribution emission ED11).

	1	2	3	4	5
z1.i1.j2	0.6430873	0.6354064	0.628776	0.6104112	0.6746196

Appendix

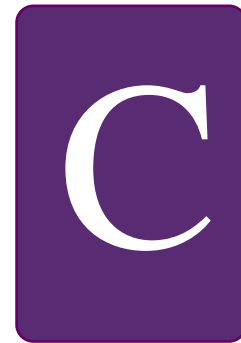

Appendix C. Results by period
obtained in the MILP multi-objective
optimization

Section 1: Optimal costs obtained in the MILP multi-objective optimization (solution 77).

Period	1	2	3	4	5
Operations costs					
Cost purchasing (€)	189,006,600.00	103,078,700.00	74,272,900.00	108,177,100.00	98,135,830.00
Rema-Manuf Bat (€)	42,714,230.00	48,883,770.00	49,627,090.00	45,403,830.00	5.13E+07
Collecting (€)	691,738.19	633,542.20	730,848.61	503,537.44	789,055.93
Dispo Bat (€)	20,119.24	29,952.91	27,143.78	35,909.98	27961.69
Diss Bat (€)	1,574,572.43	1,875,341.89	1,796,901.38	1,707,274.20	1,877,608.07
Dispo Rm (€)	22,075,510.00	46,420,960.00	8,541,271.24	42,260,730.00	55,239,230.00
Reclaimed Rm (€)	7,085,575.92	8,439,038.49	8,086,056.22	7,682,733.88	8,449,236.32
Third Party (€)	149,059.52	409,449.65	170,106.66	202,027.45	553,268.51
Distribution costs					
Suppliers-Manuplant (€)	4,068,141.89	2,529,024.00	2,218,903.03	2,287,503.88	3,297,364.02
ManuPlant – Distr (€)	9,804,988.18	8,869,177.37	10,922,310.00	8,193,673.20	12,988,940.00
Distr – Wholesaler (€)	613,914.76	1,067,772.47	1,162,244.15	1,371,487.24	1,458,153.32
Whol – Retailer (€)	4,654,960.44	4,336,776.73	7,088,000.25	4,711,022.39	6,968,581.98
Retailer- Customer (€)	3,958,174.66	5,140,361.24	4,463,162.80	4,463,113.78	5,195,883.00
Customer- IniCollecP (€)	29,265,580.00	37,021,080.00	31,763,740.00	30,065,090.00	34,456,050.00
IniCollecP-CRC (€)	15,210,010.00	17,183,660.00	14,747,190.00	11,352,610.00	13,047,910.00
CRC – Disp battery (€)	12,397.42	14,765.52	14,147.91	13,442.24	14,783.37
CRC – Diss Plant (€)	123,230.43	973,639.80	774,458.16	227,711.84	560,881.60
Diss Plant – Disp Rm (€)	1,023,472.08	1,218,972.23	1,167,985.90	1,109,728.23	1,220,445.25
Diss Plant – 3 party (€)	944,743.46	1,125,205.13	1,078,140.83	1,024,364.52	1,126,564.84
Diss Plant – Remanufac (€)	670,767.85	2,486,703.34	765,479.99	2,263,845.58	799,861.04
Inventory cost					
Manufac plant Rm (€)	0.256	0.263	0.372	1.158	0.596
Manufac plant Bat (€)	4.544	2.84	2.544	3.438	4.872
Distirbutor(€)	2.721	5.092	2.43	4.002	5.39
Wholesaler (€)	14.336	23.226	31.909	40.328	29.064
CRC (€)	0.092	0.426	0.307	0.759	0.884
Summary					
Cost Operations (€)	263,317,400.00	209,770,800.00	143,252,300.00	199,567,900.00	216,362,200.00
Cost Distribution (€)	70,350,381.17	81,967,137.83	76,165,763.01	67,083,592.90	81,135,418.42
Cost Carry inventory (€)	21.95	31.85	37.56	49.69	40.81
Total cost (€)	333,667,800	291,737,900	219,418,100	273,056,800	297,497,700
Demand (Batteries)	10,418,000	12,408,000	11,889,000	11,296,000	12,423,000
LOCBb (€ /Battery)					
LOCBb (€ /Battery)	32.03	23.51	18.46	24.17	23.95

Table B. 1 Data cost obtained in the multi-objective optimization (solution 77).

Section 2: Optimal GWP obtained in the MILP multi-objective optimization (solution 77).

Period	1	2	3	4	5
Operations emissions (KgCO2eq)					
<i>Purchasing</i>	111,603,900.00	80,904,800.00	68,702,440.00	67,268,870.00	86,920,310.00
<i>Rema-Manuf Bat</i>	142,505,000.00	171,455,900.00	164,288,100.00	156,093,900.00	1.72E+08
<i>Collecting</i>	1,636,919.34	2,050,171.84	1,556,979.10	1,797,063.36	2,149,002.84
<i>Dispo Bat</i>	2,815,985.40	3,564,818.40	3,203,491.05	3,168,528.00	3157305.45
<i>Dispo Rm</i>	18,107,580.00	22,129,030.00	22,101,890.00	21,170,200.00	23,470,100.00
<i>Dissassembly Bat</i>	8,877,797.58	10,532,260.00	10,052,110.00	9,635,409.92	10,576,030.00
Distribution emissions (KgCO2eq)					
<i>Suppliers-Manuplant</i>	2,435,484.95	1,729,564.75	2,226,330.32	1,438,289.19	3,138,103.58
<i>ManuPlant – Distr</i>	100,468,100.00	133,854,300.00	118,918,900.00	111,751,300.00	110,939,000.00
<i>Distr – Wholesaler</i>	13,280,930.00	13,741,330.00	13,440,730.00	13,029,230.00	14,500,580.00
<i>Whol – Retailer</i>	2,462,825.75	3,802,243.05	3,318,473.17	3,381,894.15	3,277,364.29
<i>Retailer- Customer</i>	2,462,834.65	3,557,801.05	3,218,467.11	3,407,803.97	3,222,707.49
<i>Customer- IniCollecP</i>	3,365,135.93	3,392,417.96	3,130,795.33	3,003,152.32	3,997,847.66
<i>IniCollecP-CRC</i>	8,209,596.57	9,246,377.18	10,100,370.00	10,251,910.00	10,467,880.00
<i>CRC – Disp battery</i>	304,896.67	361,682.37	357,223.89	337,446.60	367,031.38
<i>CRC – Diss Plant</i>	4,549,106.21	5,088,276.42	5,114,837.88	4,731,276.99	5,413,768.63
<i>Diss Plant – Disp Rm</i>	1,663,403.76	1,681,086.77	1,718,585.52	1,974,319.47	1,889,655.11
<i>Diss Plant – Remanufac)</i>	670,767.85	2,486,703.34	765,479.99	2,263,845.58	799,861.04
<i>GWP Operations</i>	111,603,900.00	80,904,800.00	68,702,440.00	67,268,870.00	86,920,310.00
<i>GWP Distribution</i>	139,873,082.35	178,941,782.89	162,310,193.22	155,570,468.26	158,013,799.17
GWP Total (KgCO2eq/Battery)	425,420,300.00	469,578,700.00	432,215,100.00	414,704,400.00	455,952,400.00
Demand (Batteries)	10,418,000.00	12,408,000.00	11,889,000.00	11,296,000.00	12,423,000.00
LOEBb (KgCO2eq/Battery)	40.84	37.84	36.35	36.71	36.70

Table B. 2 Data emissions obtained in the multi-objective optimization (solution 77).

Appendix



Appendix D. Values of variables in the
best result in the MILP optimization

Decision Variables in MILP M-TOPSIS (solution 77) section 5.4

$AMat_{isjt}$ Amount of raw material 'i' purchased from supplier 's' to the manufacturing plant 'j' during period 't' (unites).

	1	2	3	4	5
S1	90003140	59929480		21042210	
S2			46420570	22609920	56077620

$QProc_{jpt}$ Quantity processed of product 'p' at manufacturing plant 'j' during period 't' (unites).

	1	2	3	4	5
J1	10417030	12406360	11887700	11294780	12421550

$QtJD_{jdpt}$ Quantity transported from manufacturing plant 'j' to distributor 'd' of product 'p' at period 't'(unites).

	1	2	3	4	5
J1.d1	9999970	2406480	9999930	1294930	9999920
J1.d2	417140	9999920	1887814	9999910	2421710

$QtDW_{dwpt}$ Quantity transported from distributor 'd' to wholesaler 'w' of product 'p' at period 't'(unites).

	1	2	3	4	5
D1.w1			10000000		10000000
D1.w2	10000000	2406550		1294990	
D2.w1		10000000		10000000	
D2.w2	417230		1887854		2421800

$QtWR_{wrpt}$ Quantity transported from wholesaler 'w' to retailer 'r' of product 'p' at period 't' (unites).

	1	2	3	4	5
w1.r1		408000			
w1.r2	500	9592760	10000610	10000510	10000460
w2.r1	10417500		1888394		2422540
w2.r2		2407240		1295491	

$QBad_{ypt}$ Quantity of useless returned products of 'p' transported from the centralized return center to the disposal site 'y' at the period 't' (unites).

	1	2	3	4	5
Y1	177106	210936	202113	192032	211191

$QRecy_{zpt}$ Quantity of useful (recyclable) returned products of 'p' transported from the centralized return center to the disassembly-recycling plant 'z' at period 't' (unites).

	1	2	3	4	5
CRC	8678199	10335880	9903557	9409580	10348370

$QRetu_{ipt}$ Quantity of returned products of 'p' processed (recycling) at the disassembly-recycling plant 'z' at the period 't' (unites).

	1	2	3	4	5
Z1	52485750	62511400	59896710	56909140	62586940

$ARecyRm_{izp}$ Amount of raw material 'i' from the disassembly-recycling plant 'z' send to disposal site during the period 't' (kg).

	1	2	3	4	5
Y2	15745720	18753420	17969010	17072740	18776080

$3Party_{izp}$ Amount of recycled raw material 'i' from the disassembly-recycling plant 'z' sold to the third party during the period 't' (kg).

	1	2	3	4	5
Y2	5248574.755	6251139.619	5989671.27	5690913.98	6258693.571

$AREcla_{izjt}$ Amount of required reclaimed raw material 'i' for new battery production transported from the disassembly-recycling plant 'z' to the manufacturing plant 'j' during the period 't'(kg).

	1	2	3	4	5
Z1	47237170	56260260	53907040	51218230	56328240

QtyReco Quantity of recoleldted batteries in period “t” (unites).

	1	2	3	4	5
Batteries recollected	8855300	10546800	10105650	9601600	10559550

ProdNew Quantity of batteries made with virgin lead produced in period “t” (unites).

	1	2	3	4	5
Batteries Virgin lead	10417030	6331620.7	4652588.7	4362290.1	5834844

ProdRecy Quantity of batteries made with recycling lead produced in period “t” (unites).

	1	2	3	4	5
Batteries recycled lead		6074739.3	7235115.3	6932489.9	6586706

