



HAL
open science

Méthodologie pour anticiper et évaluer les impacts en avance combiner l'ACV sociale et l'argumentation multicritère

Romy Lynn Chaib

► **To cite this version:**

Romy Lynn Chaib. Méthodologie pour anticiper et évaluer les impacts en avance combiner l'ACV sociale et l'argumentation multicritère. Génie des procédés. Montpellier SupAgro, 2023. Français. NNT : 2023NSAM0022 . tel-04448150

HAL Id: tel-04448150

<https://theses.hal.science/tel-04448150>

Submitted on 9 Feb 2024

HAL is a multi-disciplinary open access archive for the deposit and dissemination of scientific research documents, whether they are published or not. The documents may come from teaching and research institutions in France or abroad, or from public or private research centers.

L'archive ouverte pluridisciplinaire **HAL**, est destinée au dépôt et à la diffusion de documents scientifiques de niveau recherche, publiés ou non, émanant des établissements d'enseignement et de recherche français ou étrangers, des laboratoires publics ou privés.

THÈSE POUR OBTENIR LE GRADE DE DOCTEUR DE L'INSTITUT AGRO MONTPELLIER ET DE L'UNIVERSITE DE MONTPELLIER

En Génie des Procédés

École doctorale GAIA – Biodiversité, Agriculture, Alimentation, Environnement, Terre, Eau
Portée par

ITAP UMR 1463
et IATE UMR 1208

**Methodology to anticipate and evaluate impacts in
advance: combining social LCA with multi criteria
argumentation**

Présentée par Romy Lynn CHAIB
Le 08 septembre 2023

Sous la direction de Catherine MACOMBE
et Rallou THOMOPOULOS

Devant le jury composé de

Carole SINFORT, Professeure, Institut Agro Montpellier

Rickard ARVIDSSON, Professeur, Chalmers University of Technology

Pierre SANS, Professeur, Ecole Nationale Vétérinaire de Toulouse

Catherine MACOMBE, Ingénieure général des ponts, des eaux et forêts, HdR, INRAE

Rallou THOMOPOULOS, Directrice de recherche, INRAE

Erwan ENGEL, Directeur de recherche, INRAE

Ghada BOUILLASS, Chercheure, CentraleSupélec Université Paris Saclay

Présidente du jury

Rapporteur

Rapporteur

Directrice de thèse

Directrice de thèse

Examineur

Invitée



UNIVERSITÉ
DE MONTPELLIER



L'INSTITUT
agro Montpellier

“There is too much bad news to justify complacency. There is too much good news to justify despair.”

Donella Meadows

“Sustainability is a new idea to many people, and many find it hard to understand. But all over the world there are people who have entered into the exercise of imagining and bringing into being a sustainable world. They see it as a world to move toward not reluctantly, but joyfully, not with a sense of sacrifice, but a sense of adventure. A sustainable world could be very much better than the one we live in today.”

Donella Meadows, Jorgen Randers, Dennis Meadows, Limits to Growth: The 30-Year Update, 1990

Abstract

English

When it comes to implementing changes in agri-food value chains, the final decision to take must be accepted by all the direct and indirect actors of the value chain and it must also take into account several economic, social, environmental (including health) aspects. It is therefore a multi actor and multi criteria decision. To take the best possible decision and ensure a viable and sustainable value chain it is necessary to anticipate and evaluate the possible important impacts that the change envisioned might have on the value chain and its stakeholders. The work shown throughout this manuscript is driven by the motivation to know how to do that.

Changes in agri-food value chains do not have predefined and pre-categorized impacts. It is therefore necessary that the method used is inclusive of all possible impacts. Plus, to guarantee that the impacts identified and evaluated are relevant to the value chain, it is important that the people potentially impacted by the change as well as experts of the value chain are engaged in the process, hence the use of participatory methods. The objective is to identify a potential future state scenario with the least unfavorable externalities possible.

Here, several methods are combined to optimize the process of anticipating and evaluating the impacts of changes in agri-food value chains. Participatory prospective methods are used to anticipate the possible evolutions of the value chain. After that, multi criteria argumentation is combined with type II social LCA to identify and evaluate the most important impacts based on stakeholder interviews.

The work of this thesis is carried out within the framework of project SENTINEL: the actors of the French pork sector will be confronted with collective choices, concerning the implementation of new tools for PCBs detection. This value chain is taken as an example for project Sentinel. The method developed can however be applied to all sorts of value chains undergoing all sorts of changes. The main necessary criteria to fulfill is to have stakeholders or experts willing to discuss the matter. In fact, for several reasons stated throughout the Sections, the method elaborated is used to anticipate and evaluate the impacts of a potential crisis in the French pork value chain.

French

Lorsqu'il s'agit de mettre en œuvre des changements dans les filières agroalimentaires, la décision finale à prendre doit être acceptée par tous les acteurs directs et indirects de la filière et elle doit également prendre en compte plusieurs aspects économiques, sociaux, environnementaux, sanitaires, etc. Il s'agit donc d'une décision multi acteurs et multi critères. Pour prendre la meilleure décision possible et garantir une filière viable et durable, il est nécessaire d'anticiper et d'évaluer les éventuels impacts importants que le changement envisagé pourrait avoir sur la filière et ses parties prenantes. Le travail discuté tout au long de ce manuscrit présente une manière de faire cela.

Les changements dans les filières agroalimentaires n'ont pas d'impacts prédéfinis et pré catégorisés. Il est donc nécessaire que la méthode utilisée tienne compte de tous les impacts possibles. De plus, pour garantir que les impacts identifiés et évalués soient pertinents pour la filière, il est important que les personnes potentiellement impactées par le changement ainsi que les experts soient impliqués dans le processus, d'où l'utilisation de méthodes participatives. L'objectif est d'identifier un scénario d'un potentiel état futur avec les conséquences les moins défavorables possibles.

Plusieurs méthodes sont combinées pour optimiser le processus d'anticipation et d'évaluation des impacts des changements dans les filières agroalimentaires. Des méthodes de prospective participative sont utilisées pour anticiper les évolutions possibles. Ensuite, l'argumentation multi critère est combinée à l'analyse de cycle de vie (ACV) sociale de type II pour identifier et évaluer les impacts les plus importants sur la base d'entretiens avec les parties prenantes.

Les travaux de cette thèse sont menés dans le cadre du projet SENTINEL : les acteurs de la filière porcine française seront confrontés à des choix collectifs, concernant la mise en place de nouveaux outils de détection des PCB (contaminants chimiques issus de l'environnement et qui sont perturbateurs endocriniens). Cette filière est prise comme exemple pour le projet Sentinel. La méthode développée peut cependant être appliquée à toutes sortes de filières subissant toutes sortes de changements. Le principal critère nécessaire à remplir est d'avoir des parties prenantes ou des experts prêts à discuter. Pour plusieurs raisons énoncées tout au long des chapitres, la méthode élaborée permet d'anticiper et d'évaluer les impacts d'une crise potentielle dans la chaîne de valeur porcine française.

Scientific productions

Journals

✓ *Economia agro-alimentare (Food economy)*

Chaib, R. L., Macombe, C., & Thomopoulos, R. (2022). Adapting a participatory modelling method to prospect scenarios of food systems: case study on the pork value chain. *Economia Agro-Alimentare / Food Economy*, 24(3). doi:10.3280/ecag2022oa14448

✓ *Frontiers in artificial intelligence*

Chaib, R. L., Macombe, C., & Thomopoulos, R. (2022). Structuring ontologies from natural language for collaborative scenario modeling in agri-food systems. *Front. Artif. Intell.* 5:1056989. doi: 10.3389/frai.2022.1056989

In review

✓ *Viandes et produits carnés :*

Chaib, R. L., Macombe, C., & Thomopoulos, R. (2023). Scénarios possibles d'évolution de la filière porcine française. Submitted to *Viandes et produits carnés*.

✓ *Frontiers in sustainability :*

Chaib, R. L., Macombe, C., & Thomopoulos, R. (2023). Achieving a sustainable transition of food systems through impact evaluation: example of the French pork value chain. Submitted to *Frontiers in Sustainability*.

Conferences

✓ *FRCCS (paper)*

Chaib, R.L., Macombe, C. and Thomopoulos, R. (2021). Adaptation of a Participatory System-Modeling Method to the Constraints of Remote Working. In *Conference on Complex Systems-France (FRCCS 2021)*, Dijon, France, May 2021. EasyChair preprint n°6305, 20 pages. <https://easychair.org/publications/preprint/18VF>

✓ *FoodSim (paper)*

Chaib, R.L., Macombe, C. and Thomopoulos, R. (2022). Designing the future of agri-food chains: comparison of prospective analysis built 40 years ago and today. In *FoodSim 2022*, Ghent, Belgium, April 2022.

✓ *IN-OVIVE (paper)*

Chaib, R.L., Macombe, C. and Thomopoulos, R. (2022). Structuring ontologies in a context of collaborative system modelling. In *IN-OVIVE workshop (Integration of heterogeneous*

sources/masses of data and ontologies, in the field of life sciences and the environment),
PFIA conference, Saint-Etienne, France, June 2022.

✓ ***SLCA (abstract)***

Chaib, R.L., Macombe, C. and Thomopoulos, R. (2022). Prioritizing the systemic impacts of a crisis situation: example of the difficulties of the French pork value chain. In *International Conference on Social LCA*, Aachen, Germany, September 2022.

Remerciements

A Catherine et Rallou, je tiens à exprimer ma profonde gratitude pour votre soutien, votre guidage et votre expertise tout au long de ma thèse. Votre dévouement et votre engagement envers mon travail de recherche ont été inestimables et ont grandement contribué à mon développement académique et personnel. Votre expérience et votre passion pour votre domaine d'expertise ont été une source d'inspiration constante et ont éveillé en moi une curiosité intellectuelle toujours croissante. Vous avez su créer un environnement propice à l'apprentissage et à la collaboration, et j'ai été honorée de faire partie de votre équipe de recherche. Je tiens également à vous remercier pour votre disponibilité et votre générosité. Vos précieux commentaires et vos discussions approfondies ont enrichi mes réflexions et ont contribué à la qualité de mon travail. Je suis honorée d'avoir eu la chance de vous avoir comme guides dans cette aventure académique. Je souhaite sincèrement que notre collaboration puisse se poursuivre à l'avenir et j'espère que vous saurez quel impact significatif vous avez eu sur ma vie et ma carrière.

A Erwan Engel et les partenaires de Sentinel, merci de m'avoir accordé l'opportunité de travailler avec vous. Ce fut un plaisir de vous rencontrer à Clermont Ferrand. J'espère qu'on aura l'occasion de se recroiser dans le cadre d'autres projets !

A Denis et Eric, je me souviens du jour où vous avez semé l'idée de faire une thèse dans ma tête. Merci pour votre encouragement et merci d'avoir cru en moi. Denis, merci d'avoir persévéré pour me trouver une opportunité. Je suis très reconnaissante et j'espère qu'on aura d'autres occasions de travailler ensemble.

Catherine, Carolina, Coralie, Jean-Marc, Lucile, Fabrice et le reste de l'ODM et GECO, merci pour la bonne humeur et tous les bons moments passés, merci pour toutes les bonnes bouteilles bues et les bons desserts mangés.

A Anaïs, merci de t'être battue pour nous trouver des bureaux. Merci pour ta bonne humeur. Le monde de l'ACV sociale est petit, on aura certainement l'occasion de retravailler ensemble !

A mes parents, sans vous rien de tout ça ne serait possible parce que je n'existerai même pas. Merci pour tout ce que vous nous apporté à Pia et moi. Merci pour tous les choix et sacrifices que vous avez dû faire pour que je puisse venir étudier en France et construire ma carrière. Votre force et votre persévérance ne cessent de m'impressionner, et j'espère que c'est génétique ! Merci de m'avoir transmis vos valeurs et de m'avoir inondé d'amour, merci pour

votre soutien infaillible et votre accompagnement. Merci d'avoir cru en moi et de m'avoir fait confiance même quand certaines idées et projets que j'avais vous paraissaient farfelus.

A ma sœur, malgré la distance, merci d'avoir toujours été là pour moi et de m'avoir encouragé. Merci d'être pleine de vie et de toujours être positive malgré les circonstances de la vie. Je ferai de mon mieux pour être là pour toi.

A Lily, ma sœur de cœur, merci pour ton soutien durant toutes ces années, tu me motivais énormément pendant mes années de prépa et après aussi. You are my home away from home malgré le fait qu'on ne se voit pas souvent. Merci pour les soirées passées chez toi à discuter et à refaire le monde, le temps passe si vite quand on se retrouve. Merci d'avoir gardé des valises entières de papiers et de notes chez toi pour une durée (toujours) indéterminée (promis je vais les reprendre un jour !). Je t'aime, et je te souhaite plein de bonheur et d'amour dans les aventures que tu vas vivre.

A Carine, Christiane, Theresia, Michelle et Angela mes amies d'enfance, mon autre raison de vouloir rentrer au Liban, je vous aime de tout mon cœur. Les occasions de retrouvailles se font rares mais elles deviennent de plus en plus précieuses à mes yeux. Je tiens énormément à vous, et c'est aussi grâce à vous que je suis la personne que je suis et que j'ai pu arriver ici. Je suis fière des femmes fortes, persévérantes et indépendantes que vous êtes devenues.

A Julien, mon amour, merci d'avoir cru en moi, de m'avoir soutenu et merci d'avoir été à mes côtés pendant toutes ces années et toutes les épreuves. Tu me pousses à donner le meilleur de moi-même. Merci pour toutes les aventures et les voyages qu'on a fait ensemble. Tu es une personne incroyable et j'ai tellement de chance de t'avoir dans ma vie. J'ai hâte de continuer à découvrir la vie à tes côtés et de construire pleins de nouveaux souvenirs avec toi. J'espère que tous nos projets se concrétiseront et qu'on vivra notre meilleure vie, où que l'on soit. Je t'aime pour toujours !

A Christine, Jean-Pierre, Marine, Manu, François et Jacqueline merci de m'avoir accueilli dans la famille. Merci d'être là pour Julien et moi. On a hâte de nous rapprocher de Bordeaux pour être plus souvent avec vous. Je vous aime énormément !

A Dorian, tu es le frère que j'ai toujours rêvé d'avoir. Merci pour tous les bons moments partagés ensemble depuis les débuts de nos aventures à BSA. Merci pour ta gentillesse incroyable et ton optimisme infaillible. Merci pour les millions de fois où tu dis que c'est dans

la tête, tu nous montres que des choses qui paraissent impossibles sont parfois possibles (et parfois c'est faux mais ça fait de bonnes histoires à raconter).

A Mélina et Laurane, ma famille choisie. Vous êtes pour moi une source d'inspiration et de motivation au quotidien. Mélina, ma partenaire de sport, mais surtout de cocktails en vérité. Tu es géniale, et je te souhaite tout le bonheur du monde. Et Laurane, ma râleuse préférée qui ne râle même plus trop. You saved my liiife, je t'aime toi. Et reviens vers Bordeaux stp. J'espère qu'on aura de plus en plus l'occasion de se retrouver.

A Marie-Agnès et Hervé, merci d'avoir été à nos côtés pendant nos années à Montpellier, merci de nous avoir hébergé chez vous plusieurs fois le temps qu'on trouve notre appartement. Merci pour votre gentillesse rayonnante et merci d'avoir pris soins de nos plantes lorsque l'on n'était pas chez nous. C'est aussi grâce à vous si elles (et nous aussi) se portent si bien !

Et biensûr, pour finir, merci à toutes les personnes qu'on a pu interviewer pour faire cette thèse !

Table of contents

ABSTRACT	3
SCIENTIFIC PRODUCTIONS	5
REMERCIEMENTS.....	7
ABBREVIATIONS	15
LIST OF FIGURES	17
LIST OF TABLES	21
CHAPTER 1. GENERAL INTRODUCTION.....	23
SECTION I. SOCIAL CONTEXT	23
1. A GROWING CONCERN FOR SUSTAINABILITY	23
<i>a. A historical emergence of sustainability and its pillars.....</i>	<i>23</i>
<i>b. Questioning sustainability and growth.....</i>	<i>23</i>
2. A GROWING CONCERN FOR SOCIAL BOUNDARIES AND IMPACTS	27
<i>a. Integrating social boundaries on a worldwide scale</i>	<i>27</i>
<i>b. What is a social impact?</i>	<i>30</i>
3. ZOOMING IN ON THE SOCIAL SUSTAINABILITY OF AGRI-FOOD VALUE CHAINS.....	31
SECTION II. SCIENTIFIC CONTEXT.....	33
1. EXISTING TOOLS TO ASSESS SUSTAINABILITY OF A DEFINED SYSTEM.....	33
2. GAPS IN SOCIAL SUSTAINABILITY ASSESSMENTS	34
3. CONSTRUCTING THE RESEARCH QUESTION	35
CHAPTER 2. STATE OF THE ART.....	38
SECTION III. DEFINING AND MODELLING AGRI-FOOD VALUE CHAINS	39
1. A ONE-DIMENSIONAL APPROACH: VALUE CHAIN, <i>FILIÈRE</i> AND LIFE CYCLE	39
<i>a. Similarities and differences in concepts</i>	<i>39</i>
<i>b. Describing a one dimensional agri-food value chain</i>	<i>42</i>
2. A TWO-DIMENSIONAL APPROACH: VALUE CHAIN VS AND WITH OTHER VALUE CHAINS	46
3. A THREE-DIMENSIONAL APPROACH: VALUE CHAIN VS AND WITH OTHER VALUE CHAINS THROUGH TIME⁴⁸	
CONCLUSION: DESCRIBING AN AGRI-FOOD VALUE CHAIN	49
SECTION IV. EVALUATING SOCIAL IMPACTS OF CHANGES IN AGRI-FOOD VALUE CHAINS	51
1. THE EVALUATION PROCESS	51

a. Identifying the problem/ issue	51
b. Defining the system to study and determining its perimeters	52
c. Selecting the criteria that measure the achievement of objectives	53
d. Evaluating actions in a value chain at different stages of implementation	53
e. Evaluating the criteria	56
f. Consulting the results of the evaluation and developing an action plan	56
2. SOCIAL EVALUATION IN AGRI-FOOD VALUE CHAINS	57
a. SLCA: past, present and future	57
b. Type II SLCA as a tool to evaluate social impacts in agri-food value chains	58
CONCLUSION: CHOOSING TYPE II SLCA AS AN EX-ANTE METHOD TO ANTICIPATE IMPACTS OF CHANGES	63

SECTION V. HIERARCHY OF IMPACTS IN AGRI-FOOD VALUE CHAINS: HOW TO DETERMINE IF AN IMPACT IS IMPORTANT OR NOT 66

1. IMPORTANCE OF IMPACT HIERARCHY.....	66
2. HOW TO DETERMINE IF AN IMPACT IS IMPORTANT OR NOT	67
a. Prioritization based on interviews	67
b. Prioritization based on multi criteria methods	68
c. Crossing argumentation with MCDA methods to prioritize impacts.....	70
CONCLUSION: CHOOSING MULTI CRITERIA ARGUMENTATION METHODS FOR EX-ANTE ASSESSMENT OF THE SOCIAL IMPACTS	70

CONCLUSION OF CHAPTER 2: STATE OF THE ART AND SCIENTIFIC GAPS .. 72

CHAPTER 3. RESEARCH DESIGN AND METHODS..... 74

SECTION VI. METHODOLOGICAL ELEMENTS 75

1. GENERALITIES ABOUT RESEARCH PARADIGMS.....	75
2. EPISTEMOLOGICAL POSITIONS ADOPTED THROUGHOUT THE STUDY	76
a. Chosen paradigms	77
b. Objectivity VS subjectivity.....	78
c. Qualitative VS quantitative methods.....	79
3. THEORETICAL FRAMEWORK AND APPROACH TO FILL THE SCIENTIFIC GAPS	80
a. Core theories for our approach in type II social LCA.....	81
b. Core theories for our approach in multi criteria argumentation decision making	81
c. Core theories for our approach using participatory methods.....	82
d. Core theories for our approach in prospective methods	83
CONCLUSION: ARTICULATING SEVERAL THEORIES TO FILL SCIENTIFIC GAPS	83

SECTION VII. USING PARTICIPATORY METHODS IN SOCIAL LCA CONTEXTS 88

1. THE NEED FOR PARTICIPATORY METHODS IN EX-ANTE EVALUATIONS	88
a. What is participation, and why is it important ?	88
b. Different types of participatory methods	89
2. PARTICIPATION IN A CONTEXT OF REMOTE WORKING.....	93
3. PROPER PARTICIPATION THROUGH STAKEHOLDER ANALYSIS.....	95
CONCLUSION: INTERVIEWING STAKEHOLDERS AND GETTING BACK TO THEM THROUGHOUT THE EVALUATION PROCESS	101

SECTION VIII. USING PROSPECTIVE METHODS IN TYPE II SLCA.....	103
1. DIFFERENT SCENARIO TYPES AND PROSPECTIVE METHODS.....	103
2. DIFFERENT TYPES OF PROSPECTIVE METHODS.....	104
3. THE GODET METHOD.....	105
a. <i>The structural analysis</i>	106
b. <i>The morphological analysis</i>	108
4. USING THE GODET METHOD TO CREATE DETAILED SCENARIOS.....	109
CONCLUSION: USING THE GODET PROSPECTIVE METHOD.....	111

SECTION IX. USING MULTI CRITERIA ARGUMENTATION TO COMPLETE IMPACT ANTICIPATION AND EVALUATION..... 113

1. WHAT IS MULTI CRITERIA ARGUMENTATION?.....	113
a. <i>Constructing the arguments</i>	115
b. <i>Evaluating the strength of each argument</i>	116
c. <i>Identifying conflicts between arguments</i>	117
d. <i>Evaluating arguments' acceptabilities and comparing the outcomes</i>	118
e. <i>Classifying the scenarios</i>	120
2. COMBINING MULTI CRITERIA ARGUMENTATION AND TYPE II SLCA.....	121
a. <i>Anticipating the impacts in MyChoice</i>	122
b. <i>Evaluating the impacts</i>	124
c. <i>Prioritizing the impacts to act on</i>	124
CONCLUSION: THE USE OF MULTI CRITERIA ARGUMENTATION IN TYPE II SOCIAL LCA.....	126

CONCLUSION OF CHAPTER 3: RESEARCH DESIGN AND PROCESS..... 127

CHAPTER 4. CASE STUDY AND RESULTS 132

SECTION X. CASE STUDY PRESENTATION 133

1. A BRIEF HISTORY OF THE FRENCH PORK VALUE CHAIN.....	133
2. GENERAL PRESENTATION OF THE FRENCH PORK VALUE CHAIN TODAY.....	134
a. <i>French breeders</i>	134
b. <i>Transformation and distribution of pork meat in France</i>	135
3. DEFINING THE SYSTEM PERIMETER.....	136
CONCLUSION: SUMMARY OF THE FRENCH PORK VALUE CHAIN.....	138

SECTION XI. USING PARTICIPATORY PROSPECTIVE METHODS TO CREATE SCENARIOS..... 139

1. CHOICE OF THE STAKEHOLDERS AND CONDUCTING THE INTERVIEWS.....	139
2. PROSPECTIVE STUDY OF THE FRENCH PORK VALUE CHAIN: FROM IDENTIFYING KEY VARIABLES TO DESCRIBING THE SCENARIOS OBTAINED.....	141
a. <i>Adapting the Godet method to a context of remote working</i>	141
b. <i>Results of the prospective study done on the French pork value chain</i>	144
3. USING MYCHOICE FOR REMOTE PROSPECTIVE PURPOSES.....	152
a. <i>Parallel nomenclatures between the adapted Godet method and the MyChoice tool for multi criteria argumentation</i>	153
b. <i>Using MyChoice to confirm the results of the adapted Godet method</i>	155
c. <i>Using MyChoice to identify key variables for remote prospectives</i>	160
CONCLUSION OF SECTION XI.....	163

SECTION XII. APPLYING MULTI CRITERIA ARGUMENTATION FOR IMPACT ANTICIPATION AND EVALUATION IN THE FRENCH PORK VALUE CHAIN . 165

1. ANTICIPATING AND EVALUATING THE IMPACTS OF CHANGE IN THE FRENCH PORK VALUE CHAIN USING MULTI CRITERIA ARGUMENTATION.....	166
<i>a. From anticipating and evaluating impacts of new PCB detection tools...</i>	166
<i>b. ...to anticipating and evaluating the impacts of a crisis in a value chain</i>	166
2. ADAPTING MYCHOICE TO EASILY EVALUATE AND PRIORITIZE IMPACTS	174
<i>a. Developing MyChoice for impact anticipation and evaluation</i>	174
<i>b. Establishing impact pathways based on stakeholder interviews</i>	175
CONCLUSION OF SECTION XII.....	178

CONCLUSION OF CHAPTER 4: MAIN RESULTS AND FINDINGS..... 180

CHAPTER 5. CONTRIBUTIONS TO THE FIELD, PERSPECTIVES AND CONCLUSION..... 183

SECTION XIII. SCIENTIFIC AND MANAGERIAL CONTRIBUTIONS 184

1. SCIENTIFIC CONTRIBUTIONS.....	184
2. MANAGERIAL CONTRIBUTIONS	185
<i>a. Contributions specific to the knowledge of the French pork value chain.....</i>	186
<i>b. Contributions to decision-making in agri-food value chains in general</i>	186
CONCLUSION: SUMMARY OF THE MAIN CONTRIBUTIONS.....	187

SECTION XIV. GENERAL CONCLUSION AND PERSPECTIVES..... 189

1. FILLING THE SCIENTIFIC GAPS	189
2. LIMITS OF THE WORK DONE	190
3. ZOOMING OUT: BACK TO THE SOCIAL SUSTAINABILITY OF AGRI-FOOD VALUE CHAINS	192

REFERENCES..... 194

ANNEX 0: PROJECT SENTINEL 212

ANNEX 1: RESEARCH PARADIGMS 214

ANNEX 2: METHODOLOGICAL ADAPTATIONS OF THE SCENARIO METHOD 215

ANNEX 3: DELPHI-TYPE QUESTIONNAIRE 223

ANNEX 4: MIND MAPS OF SOME OF THE INTERVIEWS (NO DISTINCTION IS MADE BETWEEN DOCUMENTS OR INTERVIEWEES)..... 225

ANNEX 5: IMPACT PATHWAYS OF PURSUING BUSINESS AS USUAL IN THE FRENCH PORK VALUE CHAIN 230

ANNEX 6: MYCHOICE OPINIONS – SCENARIOS MODULE 231

ANNEX 7: MYCHOICE OPINIONS – IMPACTS MODULE 233

Abbreviations

AHP: Analytic hierarchy process

AOP: Appellation d'origine protégée

BAU: Business as usual

CSR: Corporate social responsibility

DA: Decision analysis

ELCA: Environmental life cycle assessment

ELECTRE: Elimination et choix traduisant la réalité [elimination and choice translating reality]

FICT: French federation of industrial charcutiers, caterers, meat processors

GDP: Gross domestic product

HIA: Health impact assessment

IFIP: Institut français du porc

IGP: Indication géographique protégée

LCA: Life cycle assessment (usually environmental)

LCC: Life cycle costing

MADM: Multiple attribute decision-making

MAUM: Multi-attribute utility methods

MAUT: Multi-attribute utility theory

MAVT: Multi-attribute value theory

MCA: Multi criteria argumentation

MCDA: Multi criteria decision aiding

MODM: Multiple objective decision-making

PAR: Participatory action research

PCB: Polychlorobiphenyls

PO: Producer organizations

PRA: Participatory rural appraisal

PROMETHEE: Preference ranking organization method for enrichment evaluations

SDG: Sustainable development goals

SELCA: Social and environmental life cycle assessment

SETAC: Society of environmental toxicology and chemistry

SIA: Social impact assessment

SLCA: Social life cycle assessment

SMCE: Social multi criteria evaluation

SME: Small and mi-sized enterprises

UN: United Nations

UNEP: United Nations environmental program

List of figures

Figure 1: social and planetary boundaries from Raworth (2012)

Figure 2: shortfalls and overshoots of social and planetary boundaries on a worldwide scale (for over 140 countries) in 1992 (a) and 2015 (b). From Fanning et al, 2022.

Figure 3: number of social thresholds achieved vs number of biophysical boundaries transgressed. From Fanning et al, 2022.

Figure 4: steps, stakeholders and relations in a simple value chain model

Figure 5: technical stages of the pork products production in France (Source: ANSES, 2018)

Figure 6: overview of all the stakeholders and actors according to the *Tchayo* method (2015) adapted to the case of the pork value chain.

Figure 7: defining an agri-food value chain according to its drivers and feedbacks. Adapted from Kopainsky & Stave (2014)

Figure 8: example of a strategic arena and value net models of the pork value chain. Adapted from Lagarde & Macombe (2013)

Figure 9: example of a systematic competitive model of the pork value chain. Adapted from Lagarde & Macombe (2013)

Figure 10: social LCA through time

Figure 11: difference between type I and type II SLCA

Figure 12: some process of impact evaluation through type II social LCA developed in Montpellier

Figure 13: different general steps to anticipate and evaluate impacts

Figure 14: classification of major MCDA methods

Figure 15: scientific gaps when evaluating important social impacts *ex-ante*

Figure 16: explanation of how the thought process embodies the research paradigms chosen

Figure 17: how we choose to use quantitative and qualitative information to anticipate and evaluate social impacts.

Figure 18: juxtaposition of the different theories on which the work is based

Figure 19: relationship between interpretativist paradigm and method. Inspired by Iofrida et al. (2018)

Figure 20: relationship between post-modern paradigm and methods. Inspired by Iofrida et al. (2018)

Figure 21: categorization of participatory methods useful when anticipating and evaluating important impacts (inspired by Bousset et al., 2005)

Figure 22: categorization of participatory methods according the targeted output, the motivations and the stakeholders' degree of participation

Figure 23: Mitchell, Agle and Wood's classification of the stakeholders according to the three attributes of power, urgency and legitimacy

Figure 24: participatory methods through the process of anticipating, evaluating and prioritizing impacts

Figure 25: different types of scenarios and the methods in which they intervene

Figure 26: positioning variables (mathematical translation of the factors) according to their influence and dependence scores as they are attributed by the stakeholders

Figure 27: different possible scenarios obtained by combining the modalities of the key variables.

Figure 28: summary of the steps required to create reference scenarios

Figure 29: details of the prospective approach used when anticipating and evaluating impacts

Figure 30: possible conflicts between arguments according to Amgoud & Prade (2009)

Figure 31: possible conflicts between arguments concerning impacts of changes in agri-food value chains

Figure 32: steps to anticipate, evaluate and prioritize impacts through multi criteria argumentation

Figure 33: complete research design and process by integrating multi criteria argumentation in a context of type II social LCA

Figure 34: advantages of using multi criteria argumentation and type II social LCA so anticipate, evaluate and interpret results concerning impacts of changes in agri-food value chains.

Figure 35: evolution of the average consumption of meats per sector. From FranceAgriMer, 2021.

Figure 36: summary of the material flows and key numbers between the different stakeholders of the value chain

Figure 37: situating the results presented in this section in the research design and process presented earlier

Figure 38: stakeholders interviewed and classification of Mitchell, Agle and Wood (1997)

Figure 39: summary of the steps followed in the morphological phase of the adapted Godet method

Figure 40: distribution of the 12 variables according to their influence and dependence rates calculated as shown in annex 2

Figure 41: eliminating and combining scenarios

Figure 42: similarities in nomenclatures between the adapted Godet method and the MyChoice tool

Figure 43: number of positive and negative arguments and attitudes associated with each variable

Figure 44: visual representation of the number of arguments per variable

Figure 45: classification of the variables using the adapted Godet method

Figure 46: weighted variances of each variable

Figure 47: classifying the variables based on table 14

Figure 48: steps that can be done by using multi criteria argumentation

Figure 49: impact pathways identified based on table 18, according to the information extracted from the interviews done

Figure 50: summary of the approach used when anticipating, evaluating and prioritizing the impacts of changes in the French pork value chain

Figure 51: summary of the different possible uses of the MyChoice tool

Figure 52: how multi criteria argumentation contributes to social LCA

In annexes

Figure 53: Squared matrix of direct links identified in an interview between 12 variables.

Figure 54: How indirect links of first order are calculated for each variable.

Figure 55: How we obtain the final squared matrix of indirect links of first order based of the squared matrix of direct links identified in an interview.

Figure 56: Summary of how we obtain a final squared matrix using the adapted Godet method

Figure 57: Mind map of interview 1

Figure 58: Mind map of interview 2

Figure 59: Mind map of interview 3

Figure 60: Mind map of interview 4

Figure 61: Mind map of interview 5

Figure 62: Mind map of interview 6

Figure 63: Mind map of interview 7

Figure 64: Mind map of interview 8

Figure 65: Mind map of interview 9

Figure 66: Mind map of interview 10

Figure 67: Mind map of interview 11

Figure 68: all the impact pathways of pursuing business as usual in the French pork value chain according to the interviewees' opinions

Figure 69: what we would see when using MyChoice opinions – Scenarios module

Figure 70: what we would see when using MyChoice opinions - Impacts module

Figure 71: examples of pathways potentially identifiable using information through MyChoice opinions – Impacts module

Figure 72: possible representations of impact pathways based on stakeholder opinions according to the attitudes regarding the causal relation (a) and to the number of arguments given (b)

List of tables

Table 1: summary of the people involved and the tools used in the structural analysis phase of the Godet method (Chaib et al, 2022)

Table 2: different types of arguments in favor and against a scenario

Table 3: examples of practical arguments

Table 4: revisiting Feschet and Bockstaller's results by considering multi criteria argumentation methods (MAM)

Table 5: examples of French logical connectors when talking about impacts extracted from (*Charton & Torres-Moreno, 2011*)

Table 6: how information is entered using the MyChoice tool

Table 7: summary of how we interpret the results based on the attitudes and the number of arguments

Table 8: tools used in each step of the "Constructing the base" stage of the adapted and classic methods. The main tools are highlighted in bold (Chaib et al, 2022a)

Table 9: list of the 12 variables obtained using the adapted Godet method

Table 10: modalities of the key variables

Table 11: results of the Delphi questionnaire sent to the interviewed stakeholders

Table 12: How information is entered using the MyChoice tool when the aim is to identify key variables.

Table 13: using the conditions column in the MyChoice spreadsheet to mark influence and dependence relations between variables

Table 14: using the conditions column in the MyChoice spreadsheet to mark influence and dependence relations between variables

Table 15: attitudes reflecting interviewees' perceptions of impacts on stakeholders of the French pork value chain

Table 16: number of positive and negative arguments (positive/negative) given by stakeholders for each impact category by impacted stakeholder

Table 17: classifying the impacts to act on by order of intervention

Table 18: number of arguments obtained by cross-analyzing impacts with their causes

Table 19: main scientific and managerial contribution of the work shown in the manuscript

In annexes

Table 20: positions adopted in research paradigms

Table 21: reorganizing the MyChoice spreadsheet for the scenarios module and adding information

Table 22: reorganizing the MyChoice spreadsheet for the impacts module and adding information

Table 23: example of what the results would look like when cross-analyzing impacts and their causes in the MyChoice opinions-Impacts module

Chapter 1. General introduction

Section I. Social context

1. A growing concern for sustainability

a. A historical emergence of sustainability and its pillars

Historical roots and origins of the sustainability concept are hard to trace back (Kidd, 1992). The modern broad concept of sustainability however emerged in the late 20th century in ‘The Limits to Growth’ report to the Club of Rome which pleads for a “world system that is sustainable” (Meadows et al., 1972). Even though the world agreed on the paradigm of sustainable development^{1,2}, and ‘sustainability science’ is seen as a distinct field (Purvis et al., 2019; Schoolman et al., 2012), there is little to no consensus on what sustainable development actually means as there are multiple interpretations and context-specific understandings (Kidd, 1992; Purvis et al., 2019). Over the years, one description of sustainability and sustainable development prevailed: it employs three pillars which encompass economic, social and environmental goals (Basiago, 1995; Gibson, 2006; Pope et al., 2004; Purvis et al., 2019). The social component consists of the “continued satisfaction of basic human needs”, the environmental pillar focuses on the “continued productivity and functioning ecosystems” and the “protection of genetic resources and the conservation of biological diversity”, whereas the economic principle supposes we resolve “the limitations that a sustainable society must place on economic growth” (Brown et al., 1987). Sustainable development is often modelled as three intersecting circles (society, environment and economy), sustainability being the intersection of the three (Barbier, 1987).

b. Questioning sustainability and growth

From the day the concept of sustainability emerged, scientific panels agreed that our industrial ways of living are not sustainable (Meadows et al., 1972; The Ecologist, 1972), at least not on a finite planet, meaning that the development which meets the needs of the present compromises

¹ The International Union for Conservation of Nature (IUCN) first introduced the term ‘sustainable development’ in 1980.

² Bergen Declaration on Sustainable Development resulted in the establishment of the ‘precautionary principle’ meaning that, theoretically, we have to protect the future against the harmful actions of the present. The earth summit held in Rio de Janeiro in 1992 gathered over 120 nations, which agreed that sustainable development is the most important economic and environmental policy for the 21st century.

the ability of future generations to meet their own needs (Brundtland, 1985). The economic growth preached during the post-war period was questioned (Meadows et al., 1972): it was once seen as key to solving environmental and social problems whereas it is fundamentally incompatible with environmental and social dimensions and inconsiderate of them (Arndt, 1987; Brundtland, 1985; Caldwell, 1984; Tulloch, 2013; Tulloch & Neilson, 2014; Van Der Heijden, 1999).

Sustainability remains a complex notion that is context specific and ontologically open. To make the concept a reality, the United Nations has sought to refine Sustainable Development Goals. Those are “integrated and indivisible and balance the three dimensions of sustainable development: the economic, social and environmental” (UN, 2015). One of the aims was to clearly define what is put behind the term sustainability and how it can be reached. Those SDGs are encouraging, nevertheless, some issues regarding the feasibility and attainability of sustainability can emerge (Purvis et al., 2019). In those 17 SDGs, the UN talk about promoting “sustainable agriculture” as well as “sustained, inclusive and sustainable economic growth, full and productive employment and decent work for all” (objective 8) and “sustainable industrialization”, while combatting climate change. The UN hopes for a sustainable development while sustainably using our resources. It all looks so very encouraging on paper. However, in certain cases, those SDGs are not always feasible and attainable. They can also be used in certain cases as a symbolic strategy for controversial companies and industries that are environmentally problematic (García-Meca & Martínez-Ferrero, 2021). Several authors talk about the ‘myth’ of sustainable development. This can for example be the case for forest governance (Delabre et al., 2020) and for human rights (Pogge & Sengupta, 2016).

Plus, the SGDs aim for a reconciliation of human development and ecological growth. Some of the goals call for a protection of the planet and for “harmony with nature” (goals 6, 12, 13 and 14) while another goal calls for global economic growth (goal 8) to be able to achieve the human development objectives (UN, 2015). Those can be two contradictory things as Hickel (2019) argues. In fact, he shows that “existing empirical evidence suggests that even with aggressive policy measures and optimistic assumptions about efficiency improvements, it is not feasible to achieve any reductions in global material footprint in the context of existing rates of GDP growth” (Hickel, 2019, p. 879). Yoichi Kaya, a prominent Japanese economist and professor at the University of Tokyo, also proves through multiple studies with his colleagues (Kaya, 1995; Kaya & Suzuki, 1974; Kaya & Yokobori, 1997; Yamaji et al., 1993) that limitations of our finite planet will unquestionably impede economic progress as they affect the earth’s

atmosphere. Kaya & Yokobori (1997) and Yamaji et al. (1993) proceed to prove that it is urgent to reduce global greenhouse gas emissions in all countries to limit climate change and its effects on human populations.

All those concepts can be summarized in Kaya's equation (Kaya & Yokobori, 1997). This equation shows that reducing global greenhouse gas emissions while increasing domestic GDP is contradictory. The simplicity of this equation is actually disturbing. To calculate global CO₂ emissions, multiplying four factors in a certain order is enough: the world population, the GDP per capita, the CO₂ content of energy and the energy intensity of the economy.

$$\text{CO}_2 \text{ emissions} = \frac{\text{CO}_2}{\text{TEP}} \times \frac{\text{TEP}}{\text{GDP}} \times \frac{\text{GDP}}{\text{POP}} \times \text{POPulation}$$

Carbonic gas content of energy *Energy intensity of the economy* *GDP per person*

- The carbonic gas content of energy is the amount of carbon that each of the energies we consume releases. It reflects the total energy used, that is to say, all sources of energy (nuclear, solar, oil, coal, etc.). Schematically, it is close to zero for renewable and nuclear energies, high enough for gas, very high for oil, considerable for coal.
- The energy intensity of the economy measures how energy-intensive the economy is to produce value. In other words, it is the number of Kilowatt-hours (kWh) necessary to manufacture a product or provide a service. We also talk about energy efficiency, for example how much a vehicle consumes gas, a coffee machine consumes electricity, etc.
- And finally, GDP per person is the world average of purchasing power.

During the climate negotiations in Paris in 2015, a relative consensus was established that the increase in temperature must not exceed 1.5°C worldwide by 2050. To remain under the threshold of +1.5°C, “net global GHG emissions are projected to fall by 43% below 2019 levels by 2030, 60% by 2035, 69% by 2040” (IPCC, 2023, p.56). This means that at least on the short term (by 2030) greenhouse gas emissions must be divided by three at least. Studies even

advocate CO₂ neutrality by 2050 while the window for action shrinks over the years, even months (IPCC, 2018, 2023)

The Kaya equation is presented as a mathematical equality, which implies that in order to reduce CO₂ emissions it is necessary to reduce one (or more) of the four other terms. That is, either reduce the population (POPulation), or the GDP per person (GDP/POP), or improve the energy efficiency (TEP/GDP) or even decarbonize the energy produced³.

For the population

It seems inconceivable to drastically reduce the world's population by three in a democratic and desirable way. Only wars, diseases and famines have caused such demographic recessions. The problem is that the UN estimates that we will be around 9.6 billion by 2050⁴. This considerable growth requires dividing at least one among the other terms of the equation by four rather than only by three.

For the GDP per person

The GDP per person has been increasing for decades until 2015 for European Union countries. Without it, the purchasing power would fall, leading to social riots and conflicts. Besides, reducing this factor goes against the sustainable development goals of reducing poverty (objective 1), decent work and economic growth (objective 8), reducing inequalities (objective 10) and encouraging sustainable consumption (objective 12). A 2% increase in GDP per person means that this term is multiplied by 2.2 in 2050. Reducing CO₂ emissions would then necessitate that the other two terms of the equation be divided by nine in total⁵.

For the energy intensity of the economy

Global energy efficiency has already increased by 30% in 35 years; the prolongation of this trend would lead to a decrease of 35% in energy intensity. This is however highly optimistic as the first efforts are the easiest to make, and an energy gain is often lost by an increase in uses⁵.

For the carbonic gas content of energy

³ This mathematical equality is subject to criticism, in particular by the use in the equation of more or less "objective" terms. First, there are certain limitations concerning the accuracy of the census carried out in some countries to assess their population. On the other hand, the use of certain indicators is open to criticism. Indeed the GDP is a market value, extremely vague, which does not include negative externalities, such as damage to the environment, or the happiness of a country's inhabitants (Affagard et al., 2019). However, this equation remains key to understanding past and present analyses of climate, as well as conjecture about future trajectories. It helps in defining climate policies, but also helps to understand the links between climate and economy.

⁴ [ONU : la population mondiale devrait atteindre 9,6 milliards en 2050 | Nations Unies](#)

⁵ « Qu'est-ce que l'équation de Kaya ? », published 02/01/2014 on Jancovici.com

As for decarbonisation, it requires considerable investment in renewables and nuclear. Even though the interest in renewable energies is highly increasing, according to specialists, these levers will not be enough to limit warming to 1.5°C (IPCC, 2018, 2023).

“Just as there are planetary boundaries beyond which lies environmental degradation that is dangerous for humanity, so too there are social boundaries below which lie resource deprivations that endanger human well-being” (Leach et al., 2013, p.85).

2. A growing concern for social boundaries and impacts

a. Integrating social boundaries on a worldwide scale

There are social boundaries that are analogous to planetary boundaries, and the former are less known than the latter. Raworth (2012) states that “policies aiming for sustainability can exacerbate poverty” because of “poor policy design and implementation” (p.16). She advocates for an alternative economic model in her book “Doughnut Economics” (Raworth, 2017). On a global scale, she proposed 11 social boundaries based on the SDGs that were elaborated during the Rio Conference on sustainable development in 2012. By combining the social boundaries with the environmental ones, she came up with a doughnut-shaped representation as shown in figure 1 below.

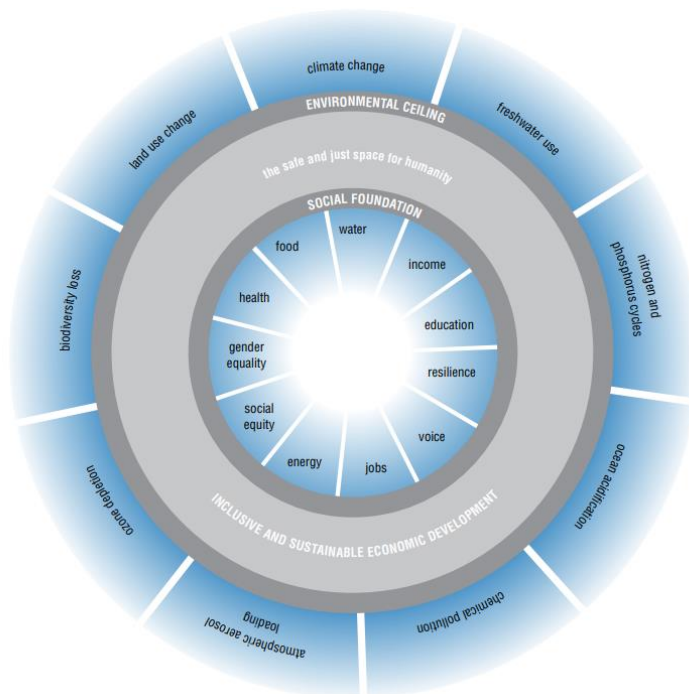

Figure 1: social and planetary boundaries from Raworth (2012)

Through that representation, Raworth (2012) and Leach et al (2013) insist on the importance of bringing together social and natural scientists from different fields. The role of social scientists is thus to characterize actors, systems, limits and boundaries, and comprehend the political, economic, social or other phenomena that influence current orientations. Leach et al (2013) also insist on the need to incorporate the knowledge and expertise of citizens, stakeholders and policymakers. Bousset et al. (2005) in fact state that “policies for managing sustainability will be effective only if they have the moral support of a great mass of people”, and to make sure of that, the people should be included in the process of defining what is important or not.

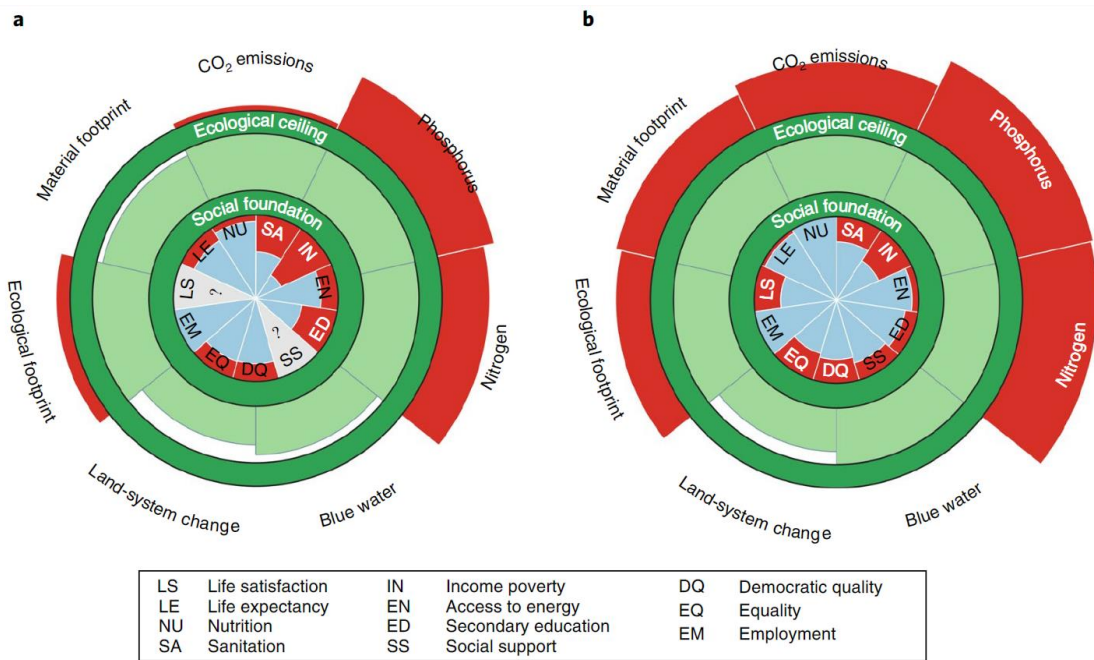

Figure 2: shortfalls and overshoots of social and planetary boundaries on a worldwide scale (for over 140 countries) in 1992 (a) and 2015 (b). From Fanning et al, 2022.

Figure 2 above maps out the current shortfalls and overshoots on a global scale for over 140 countries (Fanning et al. 2022). Fanning et al’s study shows that even though some improvements were made from 1992 to 2015, currently, no country meets all the basic needs of its population at levels of resource use that can be scaled sustainably to all people in the world. They also projected current trends to 2050: their study shows that major changes are needed to protect the health of people and the planet. They proceed to classify the countries studied according to the number of biophysical boundaries transgressed and the number of social thresholds achieved. Figure 3 below is extracted from their study. It clearly shows that

no country in the 140 ones studied has managed to achieve low environmental overshoot while reducing social shortfalls at the same time.

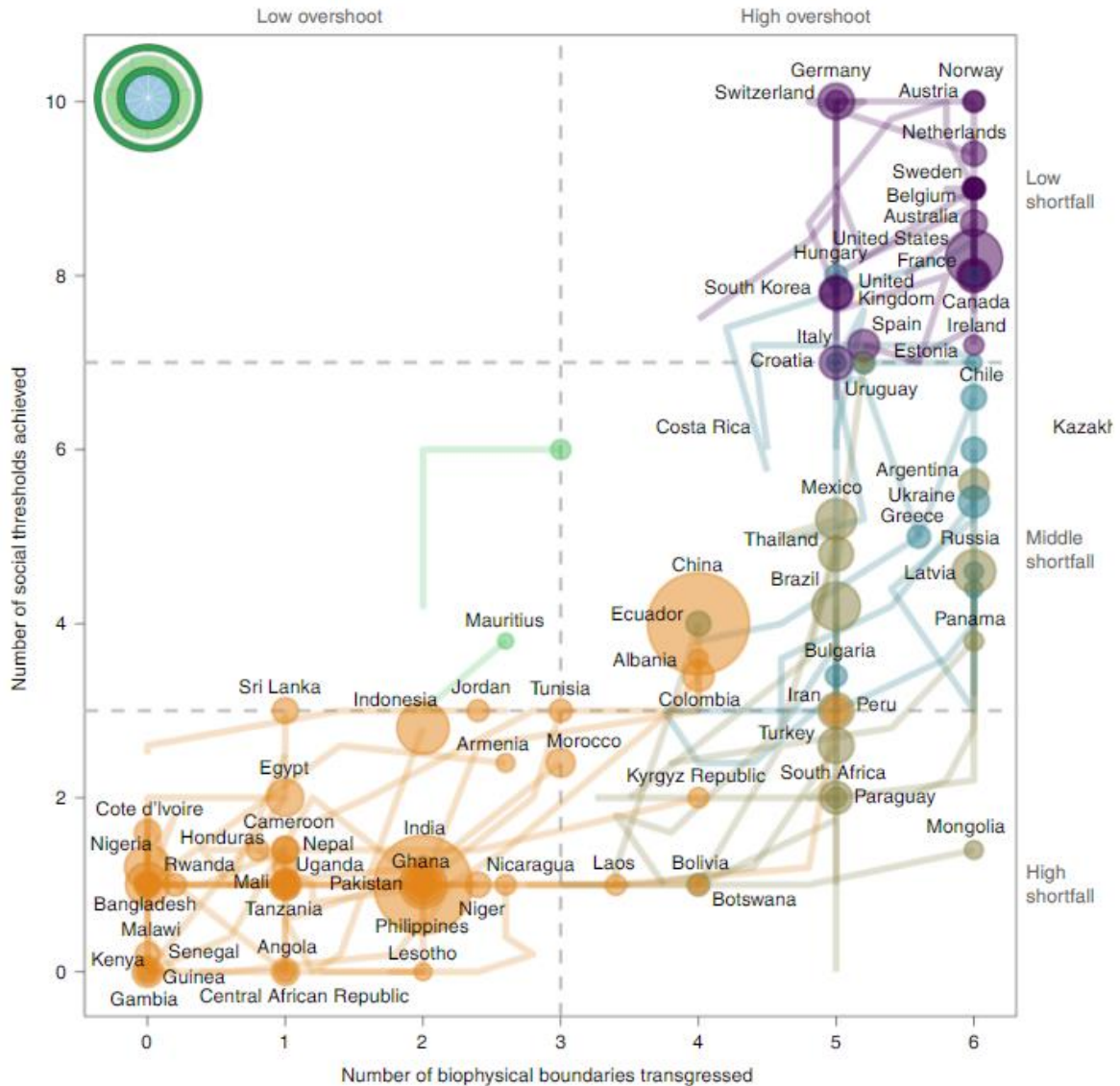

Figure 3: number of social thresholds achieved vs number of biophysical boundaries transgressed. From Fanning et al, 2022.

This representation of economics shows that social phenomena and environmental criteria are deeply intertwined and that it is impossible to deal with one of them without taking the other into consideration. It also proves what is said in 1.b that it seems impossible to reconcile economic growth and a reduction of CO2 emissions. Current trends only deepen the ecological crisis without necessarily addressing the social deficit (Fanning et al., 2022).

Hence the importance of integrating social boundaries and taking into account social impacts. But what are social impacts specifically? We talk about them in the following section.

b. What is a social impact?

An impact is a consequence of a change. Social impacts can be defined as “the consequences to human populations of any public or private actions that alter the ways in which people live, work, play, relate to one another, organize to meet their needs and generally cope as members of society. The term also includes cultural impacts involving changes to the norms, values and beliefs that guide and rationalize their cognition of themselves and their society” (Vanclay, 2002; International Committee on Guidelines & Principles for Social Impact Assessment (ICGP), 2003). Vanclay (2002) classifies the social impacts in eight categories (Vanclay, 2002, p. 185-186). Those general impact categories are not specific to value chains.

- ways of life: how people regularly work, play, and interact with one another
- culture: includes people’s common values, beliefs, and language or dialect
- community: its nature, coherence, stability, services, and amenities
- political systems: the degree to which people may influence decisions that have an impact on their life, the degree of democratization occurring and the resources allocated for this goal
- environment: the standard of the water and air people utilize, as well as the quantity and quality of the food they consume, their exposure to pollution and their physical safety as well as their access to sanitation and resources
- health and well-being: where ‘health’ is understood in a manner similar to the World Health Organisation definition: “a state of complete physical, mental, and social well-being, not merely the absence of disease or infirmity”
- personal and property rights: as in civil rights and liberties and economic states
- fears and aspirations: how safety is perceived, what the fears and aspirations for the future are for the people and their families (Vanclay, 2002, p. 185-186)

As for Juslén (1995), he classifies them in 6 other different categories in his case study on land-use and road planning in Finland.

- The standard social impacts concerning noise level, pollution, and so on. Basically like the environment and health and well being categories defined by Vanclay
- The psychosocial impacts which resemble the impact categories ‘ways of life’, ‘culture’ and ‘community’

- The anticipatory fear as in the ‘fears and aspirations’ category presented above
- The impacts of carrying out the assessment, which has no equivalent in Vanclay’s classification
- The impacts on state and private services
- The impacts on mobility (such as transportation, safety, obstacles).

Even though some impact categories can be found in several social assessments of value chains, authors agree that it is impossible to clearly define what a social impact is, and that it is frankly ineffective and unrealistic to have a predefined list of social impacts to apply to all sorts of assessments (Macombe, 2013; Macombe & Loeillet, 2017a). In fact, the natures of the impacts identified are usually very context dependent. It is also unlikely we will be able to detail all social impacts caused by a change. To make things even more complicated, “social change has a way of creating other changes” (Vanclay, 2002, p. 185). Because of that, we will be forced to focus on the most important social impacts of a change. We talk more about impact hierarchisation in section V.

The considerations above regarding sustainability, growth and social impacts concern the world as a whole. Defining sustainability is very difficult on a global scale. Talking about sustainability makes more sense when boundaries are predefined. In our case, we choose to focus on value chain sustainability, more specifically, agri-food value chains. So, what about assessing the sustainability of a value chain?

3. Zooming in on the social sustainability of agri-food value chains

Value chains encompass all the activities involved from the production of primary matter to the final delivery of a product to consumers (Adli, 2002; Terpend, 1997). Value chains are integral part of a social and economic environment, not to mention that they are dependent of and highly influence the environment in itself (Fearne et al., 2012; Kopainsky & Stave, 2014; Lançon et al., 2017; Linkov et al., 2020; Loeillet & Macombe, 2017). A sustainable value chain thus presupposes that it preserves the environment in the literal sense as well as the socio-economic environment.

To date, value chain analysis has primarily focused on economic and environmental sustainability. Environmental sustainability is quantified through environmental life cycle assessment (ELCA) (Guinée et al., 2011) whereas economic sustainability is the object of life cycle costing (Fearne et al., 2012; Finnveden et al., 2009; Guinée et al., 2011). More and more

concerns about social sustainability of agri-food value chains are emerging (Arce-Gomez et al., 2015; Dreyer et al., 2006; Macombe, 2013; Macombe & Loeillet, 2017b; Mattila et al., 2018).

There are several ways to define social sustainability as Iofrida (2016) shows through her table on page 24 of her manuscript.

Social sustainability in value chains is a holistic approach referring to the consideration of the social impacts caused by the existence of a product or a service throughout its life cycle. There are several decisions that are taken to make agri-food value chains more socially sustainable. For example, fair trade certifications were put in the objective of ensuring as much as possible that farmers receive a fair price for their products and that they are treated fairly (Arnould et al., 2009; Blackman & Rivera, 2011; Food and Agriculture Organization (FAO), 2021; Van Rijn et al., 2016). Such certifications could also promote social sustainability by supporting community development and worker rights (Arnould et al., 2009; Blackman & Rivera, 2011). Agri-food value chains that aim to be socially sustainable can also support community development initiatives by investing in local infrastructures, education and health-care programs (Delgado & Canters, 2011; Falk et al., 2022). Those value chains can also promote gender equality by ensuring equal access to resources, education and employment opportunities (Barrientos, 2014). Agri-food value chains can also promote social sustainability by ensuring that workers are treated fairly with dignity and respect, and have access to basic human rights such as health care, education, fair wages and safe working conditions (Gravelle & Sutton, 2009).

Despite the growing interest in sustainability assessment, there is still a lack of knowledge and a need for other methods to be developed to assess social impacts more easily, hence the work done through this thesis.

Section II. Scientific context

1. Existing tools to assess sustainability of a defined system

In general, authors who assess the sustainability of a system do not share their thoughts on the theoretical foundations of their proposals. There are, however, exceptions. In most cases, the authors implicitly rely on the axioms of Ecological Modernization (Mol & Spaargaren, 2000) to propose sustainability indicators.

Numerous techniques and instruments have been created during the last few decades to evaluate the overall sustainability of food systems (Alrøe et al., 2016; Peano et al., 2014; Schader et al., 2014). There are various conditions to differentiate them from one another.

- **Object of study:** some methods are used on a *product* level to assess its sustainability throughout its life cycle. Such methods include Life Cycle Assessment (LCA), Life Cycle Costing (LCC) or type I Social Life Cycle Assessment (type I SLCA). Other approaches aim to evaluate sustainability on a *farm* scale IDEA (Indicateurs de Durabilité des Exploitations Agricoles) (Zahm et al., 2019), RISE (Response Inducing Sustainability Evaluation) (Grenz et al., 2009; Hani et al., 2003) are some examples. Other methods assess sustainability on a more global *value chain* level (CAPRI for Common Agricultural Policy Regional Impact Analysis) (Helming, 2005) or even on a *regional* level (SPA for Sustainability Potential Analysis) (Lang et al., 2007).
- **Purposes:** assessing sustainability of a system can either be for *research* purposes, for *fast screening assessments* or for *advising* either farm owners or policy makers.
- **Evaluated criteria:** most sustainability approaches focus on environmental criteria. In fact, authors often refer to “sustainability assessment” even when only environmental aspects are assessed (Schader et al., 2014). Some approaches, like LCCs, cover only economic criteria, while others try to include social aspects as well.
- **Sector specificity:** the approaches can either be *specific to certain sectors* (e.g. AVIBIO for poultry products by Pottiez et al., 2012 or DairySAT for dairy farms by England & White, 2009), or they can be *adapted to several ones*.
- **Information sources:** most approaches and tools for assessing food system sustainability rest on pre-defined criteria, databases and models. For example, for environmental assessments, sustainability assessment uses carbon footprint emissions or other numerical data as inputs in pre-made models that give an end result. Social

impact assessment is usually carried out in practice by the evaluation of “social performance”, which essentially means that past or current states of a system are instantly assessed using the UNEP/ SETAC guidelines (Macombe, 2013; Parent et al., 2010; UNEP, 2020; UNEP/SETAC, 2009, 2013). Fewer approaches and methods are based on stakeholder opinions. Nevertheless, as Alrøe et al. (2016) said, “if the key stakeholders are not given a responsible and full role in the development of any assessment tool, it is less likely to be fit for their purpose and they are unlikely to take ownership or have confidence in it”. Indeed, when stakeholder involvement is insufficient, the tools used can fail to become widely adopted (Alrøe et al., 2016). Stakeholders of the agri-food value chain are in the best position to say what is working or not in terms of sustainability of the food system and what criteria should be taken into consideration in the phases of assessment, advising and monitoring, provided those to involve are wisely chosen. Stakeholder participation is detailed in section VII of the manuscript.

A single tool cannot claim to have the right answer to assessing sustainability of a defined system (Alrøe et al., 2016; Schader et al., 2014), on one hand because specific dimensions of sustainability are usually addressed, and on another hand, the evaluated criteria are mostly predefined when adopting sustainability assessment approaches. Most of the time, assessing a food system’s sustainability thus requires combining several tools and methods that are appropriate to the context and to the desired purposes.

2. Gaps in social sustainability assessments

Social sustainability assessment is a complex and interdisciplinary field. Despite the progress made, there are still scientific gaps that need to be addressed to improve the quality, accuracy and relevance of social sustainability assessment (Arce-Gomez et al., 2015; Dreyer et al., 2006; Iofrida et al., 2018; Macombe, 2014).

1. Lack of consensus on impact assessment methods: there is still no consensus on the best methods for assessing the social impacts of a product or service. Different studies use different impact assessment methods, which can lead to inconsistent results. Further research is needed to develop and validate impact assessment methods that are scientifically robust and widely accepted.
2. Data availability and quality: social LCA requires data on a wide range of social indicators, such as labor conditions, human rights, and community health and safety.

However, such data is often scarce or of poor quality, especially for small and medium-sized enterprises (SMEs) and developing countries.

3. Lack of transparency and stakeholder engagement: social LCA studies often lack transparency and do not involve key stakeholders, such as workers, local communities, and civil society organizations. This can lead to a lack of trust and credibility in the results.
4. Limited consideration of social context: social LCA studies often focus on the social impacts of a product or service in isolation, without considering the broader social context. For example, the impacts of a product on labor conditions may be different in different regions or countries, depending on the prevailing social and economic conditions.

Addressing these gaps is necessary to improve the quality and relevance of social LCA for social assessments.

3. Constructing the research question

The work shown throughout this manuscript is driven by the motivation to know how to better assess and evaluate important social impacts of changes before they are implemented in agri-food value chains. Thus, the general question raised is **which methodologies should we use to anticipate and evaluate important social impacts in agri-food value chains?** By answering the question, the hope is that some of the gaps in social sustainability assessment could be partially breached.

The final decision concerning the change must be acceptable for all the direct and indirect actors of the value chain and it must also take into account several economic, social, environmental (including health and safety) aspects. It is therefore a multi-actor and multi-criteria decision. To take the (hopefully) best possible decision and ensure a viable and sustainable value chain it is necessary to anticipate and evaluate the possible important impacts. This is crucial for the identification of the ones to prioritize and bring to the attention of the stakeholders (Arce-Gomez et al., 2015).

The method developed has to be adapted to value chains, more specifically agri-food value chains. For that reason, in section III, we first start by defining what is meant through the term value chain. Section IV discusses more in depth the evaluation process and how social LCA helps in evaluating social impacts. Because social impacts are numerous and of different nature, it is preferred to determine the most important social impacts to take into consideration. For

that reason in section V, the different ways to prioritize impacts are stated. To ensure a viable and useful approach, it is important to engage participants by “using their knowledge and local expertise to identify community-level impacts” (Becker et al., 2003); they are in the best position to tell us what could happen and how the food system could evolve. This guarantees that the impacts identified are relevant to the food system’s stakeholders (Arce-Gomez et al., 2015; Becker et al., 2003, 2004), and that they are also as diverse as possible so that we do not neglect any important aspect and especially any stakeholders. Ultimately, it helps improve knowledge of all dimensions of sustainability (Peano et al., 2014). For those reasons, after presenting our research position in section VI, the need for participatory methods when anticipating and evaluating social impacts is debated in section VII. The state of which the impacts are studied is a future state. In consequence, we need to anticipate the evolutions of the food system through a prospective approach, which we talk about in section VIII. The objective is to identify a scenario with the least unfavorable externalities possible in order to better inform decision-makers and stakeholders of the system studied. Changes in agri-food value chains do not have predefined and pre-categorized impacts. It is therefore necessary that the method used is inclusive of all possible impacts. Multi criteria argumentation therefore seems to be a good way to remedy these difficulties: by construction, multi criteria argumentation takes into account all types of impacts, and it incorporates stakeholder perspectives and opinions (which is essential as we’ve said before), producing a more relevant and sustainable decision-making process (Estévez et al., 2013; Freeman & McVea, 2001; Sohn et al., 2020). This method and the tool used are disclosed in section IX.

The method proposed in this manuscript is applied to the French pork value chain⁶. This value chain is briefly presented in section X. Then, in sections XI and XII, the results of application are presented.

⁶ The work presented in this manuscript is financed by the National Research Agency project Sentinel. This project emanated after the European Parliament has called on Member States to strengthen their food safety systems. The French government therefore launched in July 2018 a new surveillance platform led by the Directorate General for Food (DGAL). This platform involves 14 key partners including ministries (health, agriculture, economy), research institutes (ANSES, INRA, ACTA, ACTIA), professional organizations and control laboratories. Sentinel aims to strengthen the current food chemical safety monitoring system. This project uses polychlorinated biphenyls (PCBs) in meat as study models. The French pork value chain is taken as an example. To this end, high-speed, sensitive and cost-controlled screening tools will be developed in order to:

- increase the effectiveness of regulatory inspections of health authorities;
- facilitate industrial self-checks;
- to enable preventive monitoring of PCBs at sub-regulatory levels.

The manuscript concludes in chapter 5 with the scientific and managerial contributions of the work done (section XIII) and the work perspectives as well as a general conclusion and discussion (section XIV).

To ensure a good implementation of those new PCB detection tools and to make sure they add value to the value chain, implementing a cost/ benefit analysis while anticipating and evaluating the potential impacts that those tools may have on the value chain is necessary.

Chapter 2. State of the art

Treated concepts: value chain, filière, life cycle, *ex-ante* evaluation, SLCA, prioritization

Our research question is “*which methodologies should we use to anticipate and evaluate important social impacts in agri-food value chains?*”. To answer this question, it is ineluctable that we start by introducing the four main concepts on which we based the work done throughout those three years. Those four predominant notions are the *anticipation*, the *evaluation*, the social impacts, the *hierarchy* of impacts to identify the most important ones and the *agri-food value chains*.

In this chapter, we first start by outlining what we imply when we talk about an *agri-food value chain*. We continue by discussing the different ways of *anticipating* and *evaluating* impacts – and more specifically social ones- in a value chain approach. Being that social impacts are very diverse and complex to identify and evaluate, evaluating all of them is an unattainable goal. *Hierarchisation* is thus key to identify important impacts to evaluate primarily.

Section III. Defining and modelling agri-food value chains

Before tackling the social sustainability aspect of a system, it is important we first clearly define it, and model it. In fact, modelling approaches help us cut through the complexity of a system, in order to better understand key features and the way it works (Taylor, 2005). This allows us to identify issues and improvement opportunities related to material and non-material flows, which eventually helps us identify strategic actions to take at strategic times and places.

Defining the system to take into account and its boundaries when assessing social impacts is very important because it formally delimitates what features are included/excluded by the study, yet most of the time in SLCA studies, it is unclear how authors do so. A system's boundaries are sometimes considered equivalent in ELCA and in SLCA (Hunkeler & Rebitzer, 2005; O'Brien et al., 1996). Even though Reap et al. (2008) consider this approach as fundamental when doing a social impact assessment, they still mention that “the selection of key common structural elements may prove less than straightforward” as there is a “potential to miss important relationships” (p.296) between the stakeholders. In fact, the life cycle approach inherited from environmental LCA does not take into account the network of organizations neither does it consider the stakeholders' strategies. Describing a socially sustainable food sector requires a global value chain approach as well as a consideration of the competitive dynamics overtime.

The aim of this section is to review the different ways of defining and modelling agri-food value chains in order to find the model that is most effective when it comes to evaluating and anticipating impacts of changes in such systems.

1. A one-dimensional approach: value chain, *filière* and life cycle

a. Similarities and differences in concepts

Value chain VS filière

The concept of '**value chain**' first emerged in the global North countries with the evolution of the agri-food sector and the rise of mass distribution. Porter (1985) defined the value chain as a succession of activities that allow a product or service to go from production phases to being delivered to the final consumers. This definition is value-oriented. It quickly became a tool to analyze business strategies and competitive advantages in a context of globalization and transnational exchanges, meaning it served for strategic management (Porter, 1985).

The notion of '*filière*' was first conceptualized by French agricultural institutions as an input/output model describing the different flows connecting actors to each other (Chait, 1949). It also refers to the succession of organizations from the production of primary matter to the consumption of the final product. However this notion is a bit more complex than 'value chain' as it allows stakeholders and decision makers to grasp the complexity of the economic reality as well as the complexity of relations between stakeholders (Lagarde & Macombe, 2013; Lançon et al., 2017).

Through the years, both value chain and *filière* concepts were adopted by many actors of different horizons –economists, agronomists, politicians, etc...- and the distinction between those two notions became blurry; defining a 'value chain' thus became harder and harder. Some authors use the term value chain instead of *filière*, and they talk about 'Value Chain Thinking': it is "the process of understanding how to look at value networks from a broader perspective and look at how the overall pattern of the various components in the value network influence one another as a unit" (Simatupang et al., 2017, p. 8). Since there is no equivalent of *filière* in English, the term value chain is usually used with the same notion in mind. That is in fact what we also did throughout the manuscript: we talk about value chain, but what we really mean is *filière*.

A value chain in our terms consequently refers to the process through which a company sources raw unprocessed materials, adds value through production, manufacturing and other operations to produce a final product that is sold to consumers. Value chain is thus a concept that summarizes the linked sequence of technical, logistical, commercial and social activities that are necessary to produce and distribute a product or a service (Lançon et al., 2017; Malassis, 1979; Simatupang et al., 2017; Taylor, 2005). It is not to be confused with 'supply-chain' that is more of an operational management perspective. Supply-chain refers to the process of supplying the product to the customer. This notion includes the flow of information, products, materials and funds between different stages of selling a product to an end user.

Analyzing value chains

The value chains analysis was originally conceived to identify hotspots of value creation or destruction in order to improve competitive advantages. A value chain approach is beneficial for several other reasons (Lagarde & Macombe, 2013; Lançon et al., 2017; Porter, 1985; Simatupang et al., 2017).

- It allows for a better vision of the value chain in its entirety, while taking into account the influence relationships between all players
- It widens the time frame during which a study can take place while paying careful attention to the scale
- It allows stakeholders to seize unexpected opportunities by accentuating the value chain's flexibility, thus allowing a better understanding of how to improve a value chain throughout the time.
- Changes can be implemented after elaborating a detailed plan and a thorough visualization of how the value chain could become

The life cycle concept

In certain contexts (e.g. impact assessment), the notions of value chain and *filière* are not sufficient. The concept of '*life cycle*' refers to a third viewpoint of the same system as value chain and *filière*. This notion is derived from the engineering science field. It considers the whole life cycle of a product, before its production until its consumption or its recycling. The main advantages of a life cycle approach are the following (Lagarde & Macombe, 2013):

- It allows us to identify and represent transfer of impacts from one step of the life cycle to another, from one impact to another and from one group of people to another.
- It searches for cause and effect relationships.

When tackling social impacts, both notions of value chain as in *filière* and life cycle are essential. We need both because we want to look at the system as a network of organizations linked by the process of producing a product, and it is also essential that we take into account actor's strategies to be able to assess the different impacts. Because the value-chain can be translated into a life cycle, we can use life cycle approaches. Those will be discussed in section IV.

In the rest of the manuscript, **we use the term value chain since it is an explicit term in the English language, but what we really mean is a mix of life cycle and *filière***. Indeed, we aim to take into account the technical, logistical, commercial and social activities that are necessary to produce and distribute a product or a service and we also want to identify, anticipate and evaluate the transfer of impacts. If the thesis is ever translated in French, the term to use is *filière*.

b. Describing a one dimensional agri-food value chain

There are several approaches to define an agri-food value chain. They can be distinguished in the literature, depending on how the value chain is broken down into substructures and depending on the approach adopted (technical, social or economic). Figure 4 represents the material (produce) and non-material flows (e.g financial flows, contracts) throughout the various steps of the value chain as well as the influence relations of external factors on them. It also shows the different production steps proper to each stakeholder.

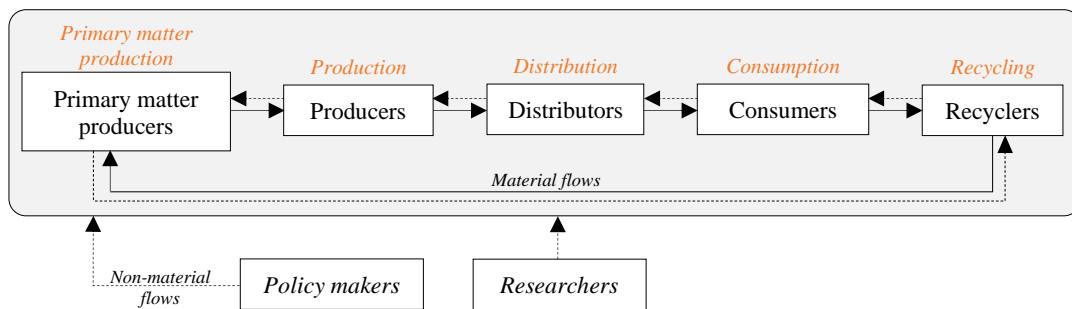

Figure 4: steps, stakeholders and relations in a simple value chain model

Even though the main structure of a value chain is similar everywhere, in reality, value chains are much more complex than the system represented above in figure 4. This complexity unfolds through the number of stakeholders involved in a value chain. Indeed, in some cases, it happens that a single stakeholder in the value chain can perform several functions and therefore represent several links. Those are short supply chains, legally defined by the characteristic of mobilizing a maximum of one intermediary between the producer and the consumer (LAW No. 2014-344⁷). On the contrary, a value chain can include dozens of stakeholders: large-scale value chains or those that are implemented in northern countries generally depend on more technologies, more energy and inputs meaning that many steps and stakeholders are required for a product to reach the consumer (Kopainsky & Stave, 2014). Complexity is raised even more as the representation of a value chain highly depends on the perspective taken, whether it is social, technical, economic, environmental, etc.

In most cases, an extended value chain analysis is necessary as it takes into account the material, financial and intangible flows that link all stakeholders together. The extended models can

⁷ LAW No. 2014-344 of 17 March 2014 on consumption (1), Section V: Modernization of the means of control of the administrative authority responsible for consumer protection and adaptation of the sanctions regime, chapter 4: Implementation of administrative sanctions

either be represented from a technical point of view, from a sociological point of view, from a ‘drivers and feedbacks’ standpoint or from other aspects.

A technical model of an agri-food value chain

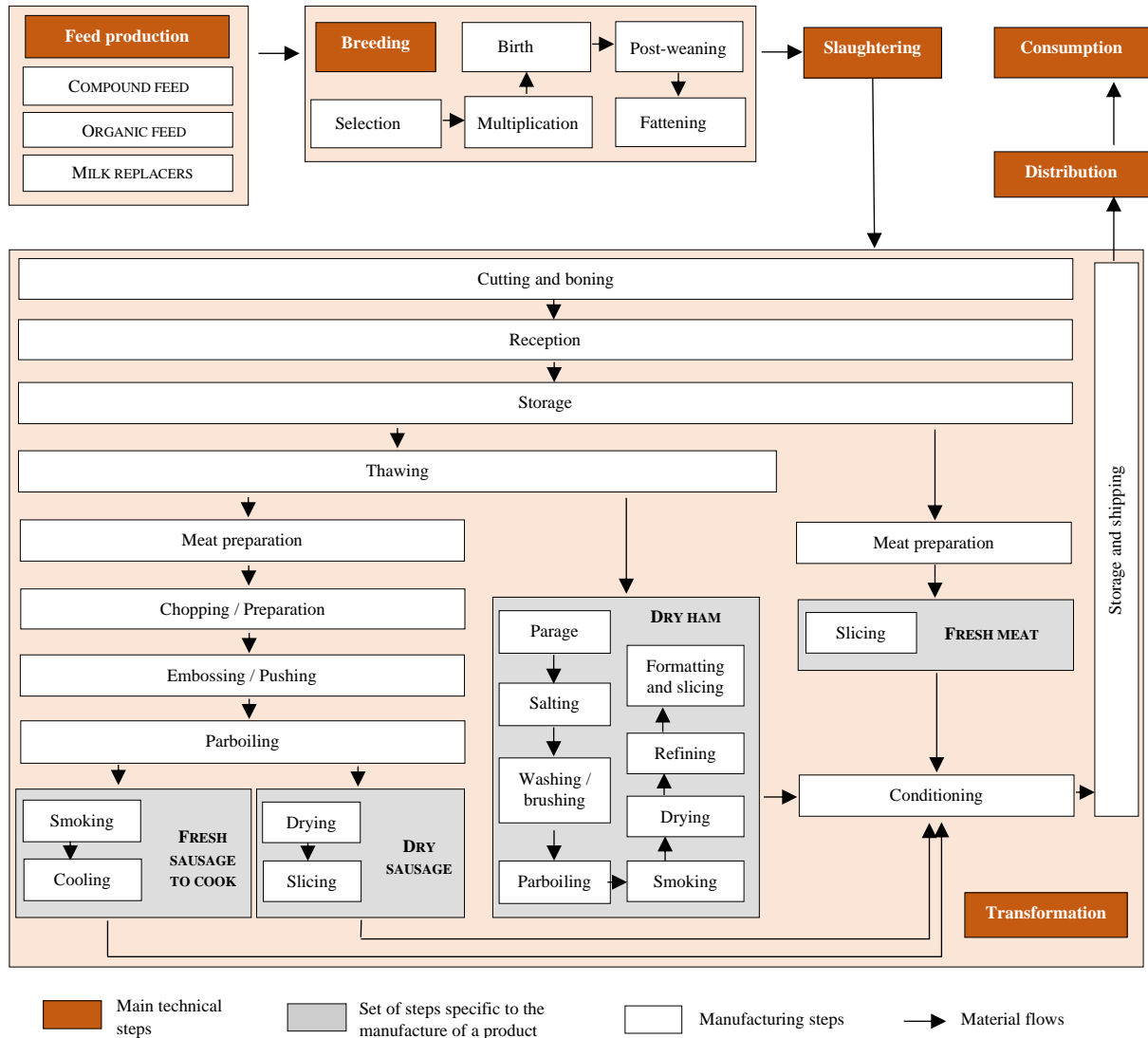

Figure 5: technical stages of the pork products production in France (Source: ANSES, 2018)

From the technical point of view, the value chain is described according to the different stages that follow one another, often chronologically. It represents a succession of actions carried out by stakeholders, through the different phases of primary matter production, product production, consumption of the final product and disposal after use (Kaplinsky & Morris, 2001; Terpend, 1997). This sequence of actions is influenced by certain policies (political, certifications, governance, etc...) and research advancements.

An actor/ organization based depiction of an agri-food value chain

Another description of the value chain can be done according to the various stakeholders, actors⁸ or organizations involved (producers, consumers, technical centers, cooperatives, managers, research, etc.). Multi-actor work applies this type of modeling (Bourguet et al., 2013; Croitoru et al., 2016). Figure 6 is a representation of the French pork value chain according to the different stakeholders that make it up. In this portrait of the value chain, material flows from one stakeholder to another are represented. Financial and contractual flows are also depicted.

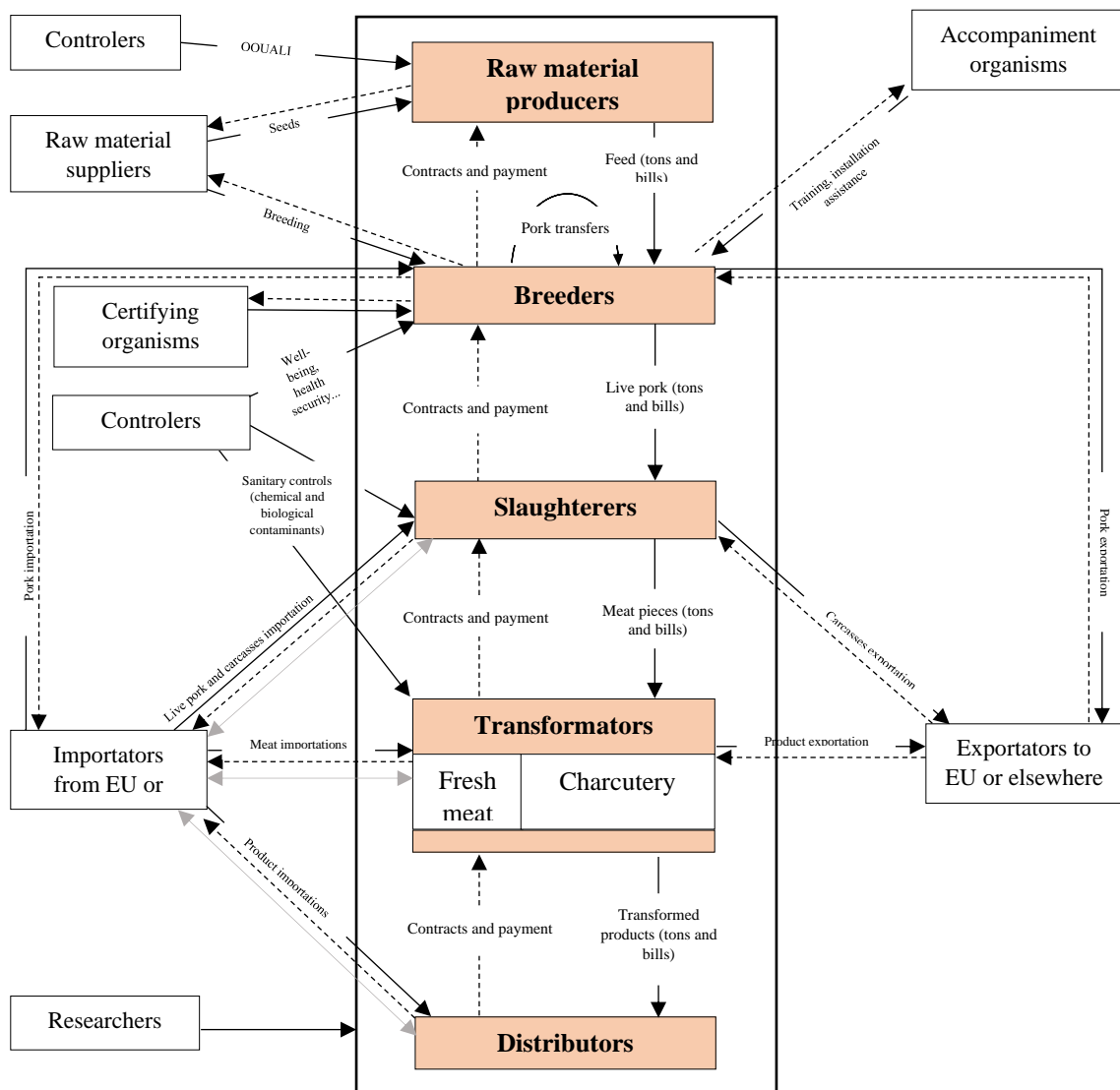

Figure 6: overview of all the stakeholders and actors according to the *Tchayo* method (2015) adapted to the case of the pork value chain.

⁸ Actors are people, groups or organizations acting within a system of interest. Stakeholders are people, groups or organizations that are affected by the project, interested in the project and/ or able to affect the project. Stakeholders are actors whereas actors are not necessarily stakeholders.

Intangible flows such as the competition between French stakeholders and foreign ones are also represented through the importations.

A driver and feedback outlook on an agri-food value chain

The value chain can also be described according to different expected quality criteria (environmental, economic, social, health, etc.). It is thus represented according to its drivers and its feedback (figure 7).

This image of a value chain is applicable in work that uses multi criteria evaluations (Gésan-Guiziou et al., 2020) and/or different variables (yield, input prices, etc.) as well as in systems modelling (Kopainsky & Stave, 2014; Thomopoulos, 2018).

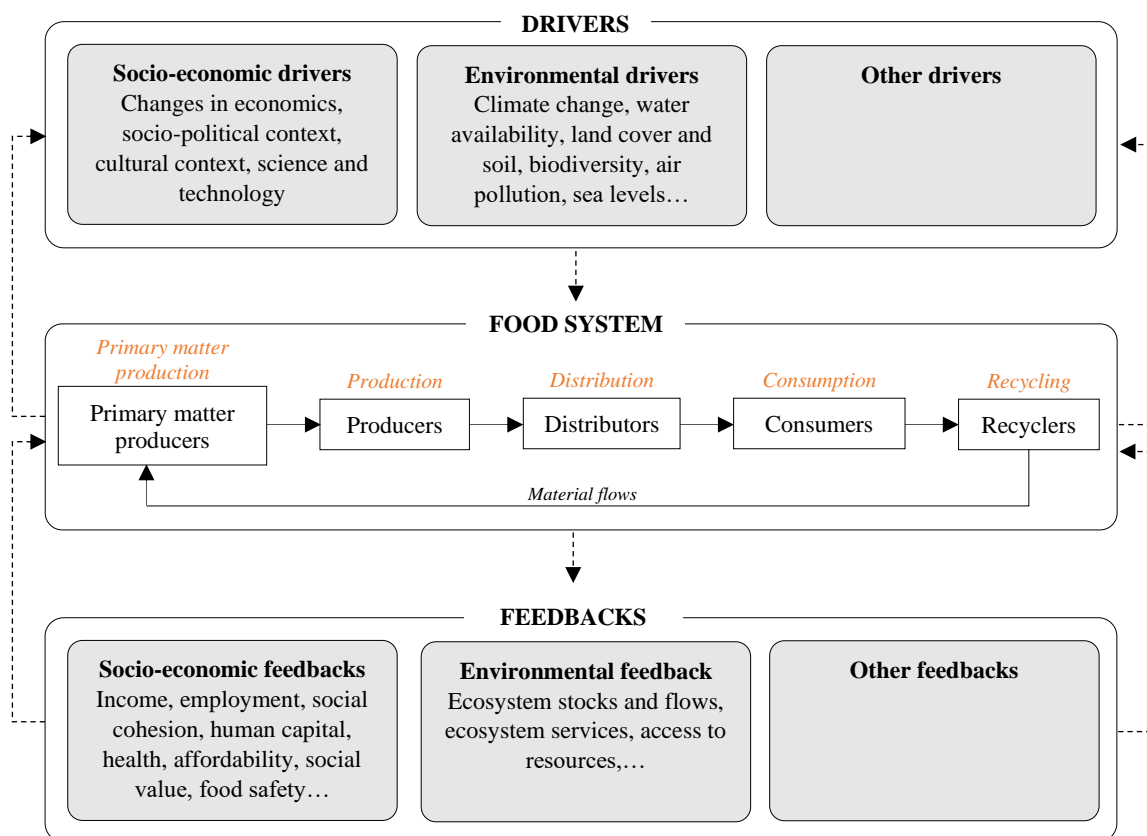

Figure 7: defining an agri-food value chain according to its drivers and feedbacks.

Adapted from Kopainsky & Stave (2014)

All three models of agri-food value chains presented above are interesting and useful in different cases depending on the objective. They are complementary and must be federated in a vision that is both analytical and operative. The first model helps us understand how the value chain functions and how the product is created. The second actor-based model is important to

clearly identify stakeholders of the value chain and the relations between them; it also helps in capturing which stakeholders are essential to operate the project. It is a model that can be used to represent all likely organizations that may enter in the boundaries of social impact assessment, meaning that it simplifies the identification of stakeholders that could be socially impacted by a change in the value chain. Last but not least, the third model is quite practical when trying to understand the social, economic and environmental ecosystem in which the value chain is encased. It helps us to better grasp the real underlying issues a value chain faces and it also helps us identify the stakeholders' true needs and expectations.

Nevertheless, the social life cycle of a product according to Dreyer et al (2006) is an aggregation of individual companies' assessments. Indeed, "social impacts on people in the life cycle of a product have a more clear relation to the conduct of the companies involved in the product chain – and to the way the companies organize and manage their business" (Dreyer et al., 2006, p. 89). **The social life cycle of a product is thus defined according to organizations.** Those organizations are linked by physical flows (material, product or energy) but they are also connected to each other through flows of services (technical, economic, intellectual). This is reminiscent of the definition of the actor-based '*filière*' and the definition of value chain above we choose to use in this document. In consequence, **the one-dimensional actor-based model is retained and extended in the following sections.** This representation remains however linear, and one value chain cannot be considered without taking into account the parallel ones that are directly or indirectly linked to it (Lagarde & Macombe, 2013), especially when it comes to anticipating and evaluating impacts of changes, which is our main driver. For that reason, even though the one-dimensional approach is our base, it is not sufficient when assessing social impacts.

2. A two-dimensional approach: value chain VS and with other value chains

The two-dimensional approach of a value chain takes into account competition as well as the collaboration between two or more sectors. Competing sectors are the ones that propose goods or services that are in competition with the goods and services proposed by the central firm of the studied sector. In consequence, they respond to the same economic demand. Bidault (1988) talks about 'strategic arena' that groups all competing industries. Nalebuff et al. (1996) add to that strategic arena concept the complementary industries that independently make products or services that develop in synergy with the studied system. They talk about co-opetition (meaning

the combination of competition and complementarity between firms) and they thus introduce the concept of value-net models.

According to Nalebuff et al. (1996), there are four types of players that can interact with the main value chain. The first two are competitors: they can either be producers of direct or indirect substitutes for the product of the value chain, or they can be in direct or indirect competition for the resources used by the central firm. As for the complementary sectors, either they use the product of the central firm or they provide resources to consumers for using the main product. For example in the case of the French pork value chain, competing value chains may be European or international pork producing value chains, whereas complementary value chains would be barbecue sellers for instance (figure 8).

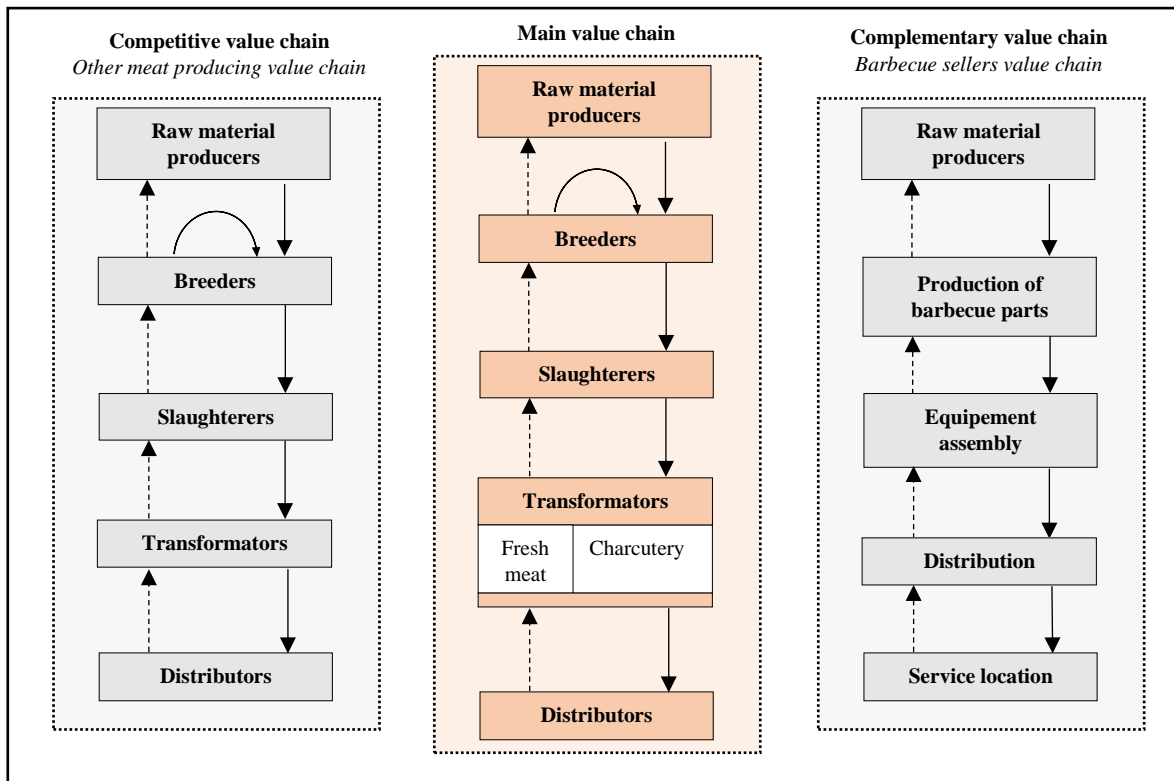

Figure 8: example of a strategic arena and value net models of the pork value chain.

Adapted from Lagarde & Macombe (2013)

Taking into account the value chain's competitors and complementors through the strategic arena and value-net models allows for a better vision of who might be impacted if a change was to take place in the central value chain. The strategic arena remains a vertical and horizontal analysis of a value chain. However, the value-net model has other advantages than accounting for the co-opetition phenomenon: it takes into consideration the time dynamics within the

network of value chains (Lagarde & Macombe, 2013), which leads to a more extended and complex modelisation of a value chain presented in the following paragraph.

3. A three-dimensional approach: value chain VS and with other value chains through time

Lagarde and Macombe state that “it is important to build a model that describes all of the relevant present and future players, as well as their own value chains and their dynamics” (Lagarde et Macombe, 2013, p. 176). They describe a three-dimensional model called ‘systematic competitive model’. The basis of the model is the one-dimensional *filière* model. To that are added competitive value chains according to the strategic arena approach. In addition to that, the value-net model elevates the description by adding the complementary value chains, as described in the previous paragraph. The value-net approach takes the

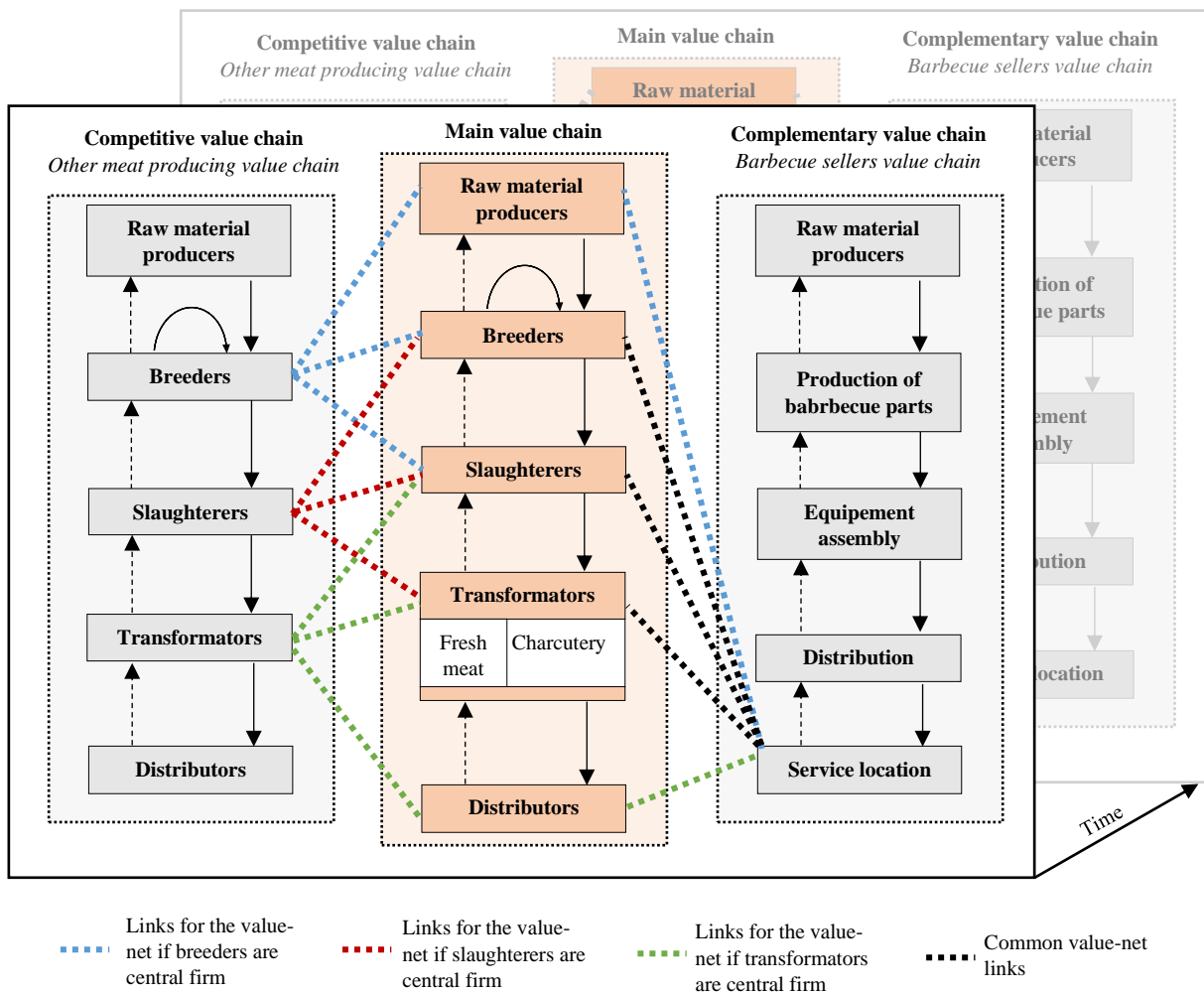

Figure 9: example of a systematic competitive model of the pork value chain. Adapted from Lagarde & Macombe (2013)

description of a value chain up a notch as it takes into account the dynamics between each value chain. All of this is looked at across a pre-determined time frame.

Figure 9 above represents the systematic competitive model of the French pork value chain. In it are represented the main French pork value chain, a general model of its competing meat value chains and a complementary value chain (i.e. barbecue sellers' value chain). All three are represented through time.

Conclusion: describing an agri-food value chain

In this section, we saw that there are several ways to define an agri-food value chain.

- Value chain: it is a set of activities that ensure a product or service is delivered to an end user. This notion is value-oriented as its name implies.
- Filière: it refers to the chain of organizations from the production of primary materials to the consumption of final products. The term captures the complexity of economic realities and the complexity of relationships between parties.
- Life cycle: it examines the entire product life cycle, from product manufacture to consumption or recycling. This notion simplifies the search for causal relationships and the identification of impact transfers (between actors, steps of manufacturing, etc...).

The approaches to model agri-food value chains are summarized below:

- ✓ A one dimensional approach
 - A technical model: describing the value chain according the different steps
 - An actor-based model: describing a value chain according to the different stakeholders that make it up
 - A drivers and feedbacks model: describing a value chain according to its drivers and feedbacks
- ✓ A two-dimensional approach: takes into consideration complementary and competitive value chains

- ✓ A three-dimensional approach: takes into account complementary and competitive value chains and the evolutions through time

Take-away from this Section

“It is important to build a model that describes all of the relevant present and future players, as well as their own value chains and their dynamics” (Lagarde et Macombe, 2013, p. 176)

⇒ Systematic competitive model is the most adapted when it comes to anticipating and evaluating the impacts of changes in agri-food value chains.

When anticipating and evaluating impacts of changes, it is thus important to take into consideration the value chains’ organizations, the competitive value chains as well as the complementary ones, all of that through a determined time frame.

Section IV. Evaluating social impacts of changes in agri-food value chains

In the previous section, we talked about the different ways to define an agri-food value chain. In those systems, change is inevitable, whether we choose it or not and whether we like it or not, especially in uncertain contexts. However, what happens when changes occur in the value chain? How can social sustainability be favored in the value chain after the change occurs? To do so, we can start by anticipating the likely impacts a change could have on the concerned value chain and evaluate those impacts. In this section, we talk more precisely about the evaluation process (1) and more specifically about social evaluations (2).

1. The evaluation process

Evaluation is the process of assessing the effectiveness, efficiency, and outcomes of a program, policy, or project. It involves systematically gathering and analyzing data to determine the extent to which an initiative has achieved its intended goals and objectives (Gullickson, 2020; Rossi et al., 2018; Scriven, 1991). Evaluation is important for several reasons. It helps improve the quality of programs and policies by identifying strengths and weaknesses: it can thus be used to inform evidence-based decision-making (Filstead, 1981; Rossi et al., 2018). It provides a way of testing assumptions and theories, and generating new knowledge about what works and what does not. Through it, decision-makers can make more informed and effective decisions (Rossi et al., 2018).

Evaluation methods and technologies constantly evolve, reflecting a growing demand for accountability and effectiveness in public and private organizations (Dahler-Larsen, 2011). The evaluation process involves several tasks and several people (Dahler-Larsen, 2011; Rossi et al., 2018).

a. Identifying the problem/ issue

During this preliminary reflection phase, it is important to determine who are the evaluators, what is evaluated and why the evaluation is taking place. It is important to identify the issue or problem leading to the need for an assessment.

b. Defining the system to study and determining its perimeters

Before beginning the evaluation of impacts of changes in agri-food value chain, the system studied has to be defined. This calls for a delimitation of the spatial-temporal perimeters as well as the perimeters of effects (at which levels the impacts of the product are taken into account) (Macombe & Loeillet, 2017).

i. Determining the spatial perimeters of the study

The spatial perimeter consists of determining all organizations included in the life cycle, which are sensitive to the product (Lagarde & Macombe, 2013), it means whose social behaviors could change because of the change under scrutiny. They might be in the value chain itself (one-dimensional approach) or in other complementary or competing value chains (two-dimensional approach of a value chain). Delimiting the spatial perimeter of a social life cycle starts by defining the different value chains to take into account as discussed in section III.

ii. Determining the temporal perimeters

It is very important to pre-determine the temporal perimeter as some effects could be put aside depending on the time necessary for them to be visible. This is already inferred in the three-dimensional model of the value chain. Some impacts are visible after a few years -i.e. the impacts of economic revenues on infant mortality rates (Bocoum et al., 2015)- whereas other impacts are immediate (i.e. job creation or suppression). Because most social impacts are not immediate, Lagarde & Macombe (2013) talk about a “temporal horizon at which one will assess the impacts”. The temporal horizon depends on the impact studied. However, how do we proceed when there is no specific social impact in mind? The criteria to take into account are the duration of the competition between an organization and its competitors, and the duration necessary for a change to be implemented in the value chain. The duration may also be specified by project sponsors as it depends on the commissioner’s interests. Usually the time frame is set to 3 to 5 years to guarantee that data can be gathered when discussing the change with stakeholders.

iii. Determining the perimeter of effects

There are two main ways of conceptualizing and determining the perimeters of effects when it comes to anticipating and evaluating impacts in agri-food value chains. The first one is described in the UNEP guidelines for assessing social performance and the second one is presented in Lagarde & Macombe (2013). The main difference between both methods is whether we predefine the impacted stakeholders or not.

The Guidelines' approach

In the guidelines' approach, the categories potentially impacted by the life cycle of a product are usually predetermined. In other words, we define the system as we have shown in the previous section, according to the different stakeholders involved. To that are added four other stakeholder categories which are the local community, the national or global society and the workers in a value chain (UNEP/SETAC, 2009). Those stakeholders are considered as primary (Clarkson, 1995). Other stakeholder categories or subcategories of impacted people are added, depending on the kind of impact and on the position of the stakeholder in the value chain. Even though the guidelines are aware that determining a system's perimeter in social LCA should not be shifted from the environmental LCA boundaries, the same risk is still taken when using this approach: certain affected stakeholders might be disregarded.

Lagarde and Macombe's approach

Lagarde and Macombe (2013) believe that describing a system and fixing its boundaries "precedes and conditions the choice of actors affected" (p. 173). This means that it is irrelevant and counterproductive to emit a list of impacted stakeholders *a priori*. Those are determined as the study goes on, after the system's perimeters are clearly defined, at the same time as the nature of each important impact is identified.

c. Selecting the criteria that measure the achievement of objectives

This step involves the establishment of a collection of information that must be processed and interpreted to serve directly to understand the objective of the study set. This information then allows the construction of criteria representative of the objective of the decision-makers (Crane, 1988; Fournier, 1995; Rousval, 2005). The aim of this work is to evaluate social impacts. Nevertheless, other impacts can be highlighted by project sponsors (in the case of project Sentinel, sanitary, economic and regulatory impacts are also demanded). Plus, since it is quite difficult to define social impacts (as seen in the general introduction), it is safer if the method developed takes into account several types of impacts, just in case!

d. Evaluating actions in a value chain at different stages of implementation

There are different times to evaluate actions amongst an agri-food value chain. When it comes to evaluating impacts of changes in an organization, the judgment can be made either before the project's implementation (*ex-ante* assessment), during the project (*in-itinere* assessment) or after the project's implementation for *ex-post* assessment (Macombe et al., 2015). In the following paragraphs, we give some examples to the different types of evaluation in

chronological order in relation to the implementation of a change (or lack of change) in the value chain.

i. *Ex-ante* evaluation methods

In *ex-ante* evaluation methods, the goal is to assess impacts of a change (or no change) before it is implemented in the system. Some non-exhaustive examples of *ex-ante* evaluation methods are predictions on the future based on the past with or without consensus (Macombe et al., 2015). When there is no need for consensus, the basic assumption is that if something occurred in the past, there is a high probability of it occurring again in the future. For example, some forecasts predicted an increase in life expectancy if added value increased in the value chain (Preston pathway in Feschet et al, 2013) or if inequalities were reduced (Wilkinson pathways in Bocoum et al., 2015). The way this is done is generally through the establishment of impact pathways, based on elaborated calculations and econometric data. However, the necessary calculations are in some cases really complicated, and are very case and scale specific. Plus numerous predefined conditions must be met for them to be valid, or else the pathway could be misleading (Macombe et al., 2015). Methods with consensus are usually based on wide sets of unknowns and assumptions, requiring consensus between researchers so that choices can be made (Macombe & Loeillet, 2017). For example, a ‘human health’ impact can be calculated using this kind of method, by utilizing data gathered for environmental life cycle assessment. We distinguish two types of approaches for those consensual predictions: the ‘problem-oriented approach’ tackles midpoint impacts responsible for damage to human health (Guinée, 2002), and the ‘damage-oriented approach’ uses pathways developed by Goedkoop et al. (2001), which identify and quantify the effects of five main environmental factors (amongst others) on human health. Some studies combine both approaches for more results (Goedkoop et al., 2009). The process remains however quite demanding in data and can be complicated to implement.

ii. *In-itinere* evaluation methods

In-itinere evaluation methods consist of observing and monitoring a change while it is being implemented in the value chain. Those monitoring methods are based on criteria that reflect the situation at the time of the assessment (Macombe & Loeillet, 2017). Those criteria are then checked to make sure that the plan is still on track. It is mainly the performance that is measured by using monitoring methods. Examples of such methods can be ad-hoc monitoring (the selected criteria of evaluation are specific to the change implemented in the value-chain), general dashboards (the criteria of evaluation are relevant across sectors and value-chains), etc.

iii. *Ex-post* evaluation methods

Ex-post assessment takes place after the effects and impacts of the change start to be noticed. There are certain conditions to meet when doing this type of evaluation. Indeed, the baseline state should be clearly differentiated from the state of the system at the time of the evaluation; one must be sure that the only cause that could explain the changes in the system and the impacts observed is the change under scrutiny in itself (Macombe & Loeillet, 2017). Examples of *ex-post* methods are monitoring through change. Monitoring provides information at various time intervals after the change is enforced. Only short and medium term effects can be captured through monitoring, plus those methods do not exclude the need for stakeholder consultation so that they can say exactly what happened and why there is or isn't a difference between the baseline and the end state (Macombe & Loeillet, 2017). Other *ex-post* evaluation methods can require reconstructing the baseline. This type of *ex-post* evaluation method is useful when there is no information about the starting state. Reconstructing the past is however inevitable when it comes to evaluating the impacts of changes during a long time lapse (Macombe & Loeillet, 2017).

The examples given above for *ex-ante*, *in-itinere* and *ex-post* evaluations are not necessarily participatory. However, it is important to note that for all three timelines, the evaluation process can be, and in certain cases is recommended to be, participatory.

Participatory approaches require the involvement of stakeholders of the value chain. And who better to talk about the value chain than the people who belong to it? They supposedly know best what is working or not, what should change or not and what the consequences of changing (or not) will be on them and their peers. Participatory methods give access to multiple perspectives as well as divergent opinions, which in theory allows decision makers to take the best possible decision based on what stakeholders or experts of the value chain say. This means that the gap between science and policy making is diminished (Filstead, 1981; Funtowicz & Ravetz, 2003; Hirsch et al., 2010; Stringer et al., 2006). Cousins and Whitmore (2007) in King et al. (2007) suggest two principal streams of participatory evaluation: practical participatory evaluation and transformative participatory evaluation. The former supports organizational decision-making and problem solving; in that case stakeholder participation is supposed to enhance the evaluation's relevance and utility (King et al., 2007). The latter calls for principles and actions to democratize social change. The aim of such evaluation methods is to empower people through participation and through their understanding of the links between knowledge, power and control (Freire, 1982; King et al., 2007). Freire talks about "conscientization".

Despite the different central goals and historical roots (which we will not get into because it is not the main subject of this work), both practical and transformative participatory evaluation overlap (practical participatory evaluation can contribute to the empowerment of program practitioners and both streams can add considerable practical value in project development and implementation).

Once the type of assessment to do is chosen, it is time to evaluate the criteria as discussed in the following section.

e. Evaluating the criteria

The criteria chosen can be evaluated either qualitatively or quantitatively.

To quantify a criterion is to assign a numerical value to it, in general according to a consensually recognized measurement standard (i.e. kilogram, liter, etc...). Some may argue that numbers are rigorous, as they highlight the objectivity of the study by forcing the evaluators to put aside their interests.

To qualify a criterion usually means to assign a certain non-numerical value to it. However, qualification of a criterion can also mean assigning a certain value to it, the value being non consensually recognized, but sufficiently 'objective' and replicable to be able to address all qualifications in the same manner. Indeed, numbers are more and more important when it comes to decision-making, especially since they offer a way of perceiving and understanding things in a precise and exhaustive way (Paradeise, 2013). This explains why they knew a huge success with the emergence of evaluation methods. Attributing values makes it possible to distance subjective information and objectify it, allowing a comparison of things that normally can't be compared together as they are of different nature.

Because quantitative methods are quite rare in social evaluations, the methods and tools chosen to anticipate and evaluate impacts through this work are qualitative. Qualitative methods have the particularity of being adaptable to several contexts of discovery. The process followed through such methods is usually iterative and time consuming. The evaluation is intended to be as rigorous as possible.

f. Consulting the results of the evaluation and developing an action plan

“Decisions about programs are too often made without systematically or transparently accessing and appraising relevant research evidence and without adequate evaluation of their impacts. We need to make better use of what we already know and we need to evaluate better

the impacts of what we do” (Oxman et al., 2010, p.4). Impact evaluation could thus play a big role when it comes to approving, adjusting or rejecting certain projects or public policy decisions as Oxman et al insinuate. We can thus imagine it could also be useful for decision making in agri-food value chains. It could help in grasping the challenges across all stages of the value chain as well as the potential primary areas that decision-makers can affect (Maestre et al., 2017).

The evaluation results obtained will then be used to make decisions on the changes to be implemented in the sector. Indeed, decision-making is a necessary condition that distinguishes evaluation from mere appraisal and the search for information (Gullickson, 2020; Rossi et al., 2018; Rousval, 2005).

2. Social evaluation in agri-food value chains

There is a wide diversity of evaluation methods, depending on the objective of the evaluator and on the object evaluated. If the aim is to evaluate projects, actions or program policies, or on-site specific impacts, then the methods used are impact assessment methods like environmental or social impact assessment (SIA) (Lehmann et al., 2013; Vanclay, 2002) or health impact assessment (HIA) (Quigley & Taylor, 2004).

For organizations, the method usually consists of filling in indicators of corporate social responsibility (CSR) or social auditing. When the object of study is a community, the methods are either participatory action research (PAR) (Boyle, 2012), including participatory rural appraisal (PRA) when it comes in rural settings (Chambers, 1994).

For the organizations of a value chain (easy to translate into the organizations of a life cycle), the favorite method is social life cycle assessment. Social LCA ambitions to focus on the evaluation of products and services all along their life cycle (Lehmann et al., 2011; Macombe et al., 2013; O’Brien et al., 1996; UNEP/SETAC, 2013).

a. SLCA: past, present and future

SLCA was first conceived by researchers in the ELCA field. O’Brien et al (1996) state that at the time, there was no specific methodology to assess social impacts. Social impact assessment was thus highly inspired by environmental impact assessment and even integrated in it. Nevertheless, the dimensions used for social or environmental assessments are different (Dreyer et al., 2006; O’Brien et al., 1996; Weidema, 2006). In consequence, in 2006, some authors stressed the need to develop an approach specific to the assessment of social impacts; the

UNEP/SETAC taskforce was thus created. Its aim was to standardize and conceptualize social LCA (Benoît et al., 2010). This led to the development of the “UNEP/SETAC guidelines for social LCA”, published in 2009. Those guidelines describe a framework similar to that of ELCA: definition of goal and scope, life cycle inventory analysis, life cycle impact assessment and interpretation of results (UNEP/SETAC, 2009). They were a big step forward in the SLCA field as they provided methodological sheets and databases devoted to facilitate the work of researchers and practitioners. Nevertheless, in the following years, the application of those guidelines was questioned as they only allowed the evaluation of social performances, and not the evaluation of impacts of a change. A distinction between two types of social LCA thus emerges (Norris, 2006). Those differences are presented in the next sub-section.

Figure 10 below shows the main different events and advances in SLCA from the first time it was mentioned until today.

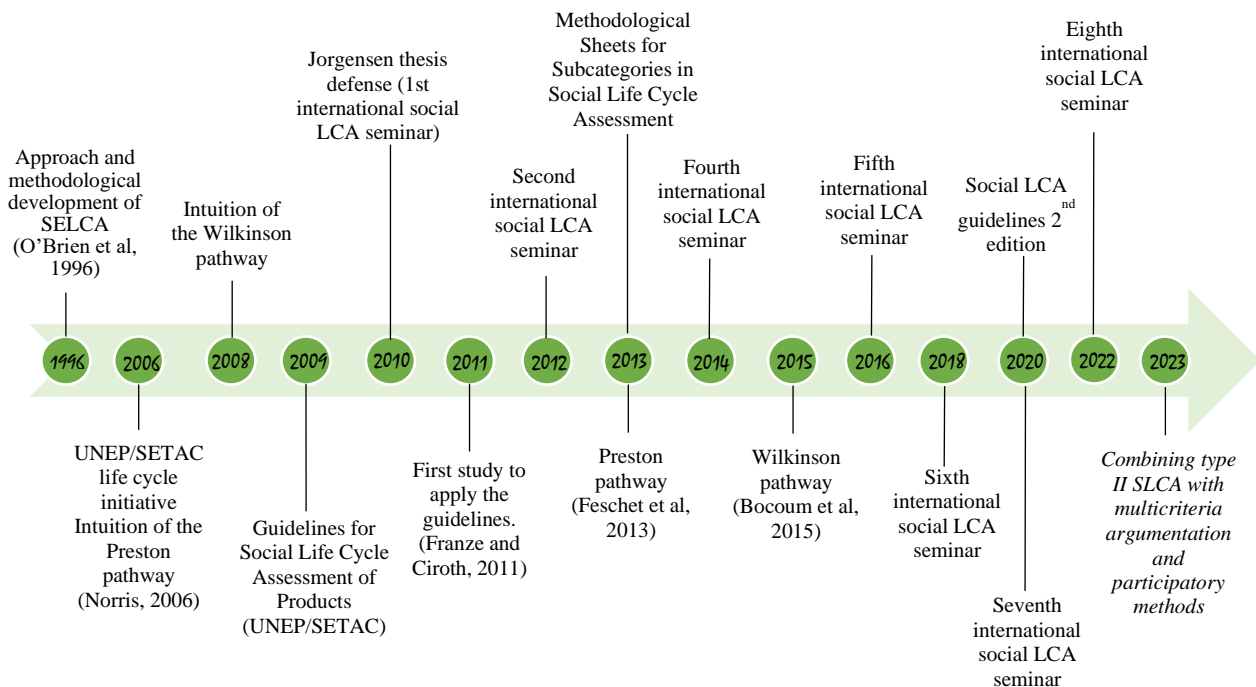

Figure 10: social LCA through time

b. Type II SLCA as a tool to evaluate social impacts in agri-food value chains

Life cycle assessments are part of the many analytical tools developed to assess the sustainability of a product or project. In all life cycle assessments, Environmental Life Cycle Assessment (ELCA or LCA) is the most commonly applied. It is a method of assessing certain environmental impacts of a product and/or service throughout its life cycle. LCA is regulated

by the ISO standards 14040 (1997) and 14041 to 14044 (2006)⁹. Life cycle Costing (LCC) is not yet a standardized economic and evaluation tool but is still used and finally Social Life Cycle Assessment (SLCA) is the latest approach conceived and is still under development.

Social LCA evaluates the social impacts of a product's existence or project on the different actors involved (De Luca et al., 2017; Iofrida, 2016). In accordance with the "life cycle" spirit, social LCA focuses on the organizations of a product's value chain (Dreyer et al., 2009).

Doing Type I Social LCA essentially means that we instantly assess past or current states of the system (Macombe, 2013; Parent et al., 2010; UNEP/SETAC, 2009, 2013) through predefined criteria. Given the difficulty of defining a social impact as said previously in the introduction, up until now, there is no consensus on what the impact categories or sub-categories should be when assessing social performances. The list of criteria provided by UNEP/SETAC (2013) is thus consistently supplemented with various other criteria to which sometimes, certain important criteria are added after surveying a panel of experts on the subject studied (Di Cesare et al., 2018; Jørgensen et al., 2008; Lehmann et al., 2013; Maister et al., 2020; Sureau et al., 2018). There are a few databases developed in order to calculate and assess social impacts of products throughout their life cycles. In 2013, the Methodological Sheets for Subcategories were published (UNEP/SETAC, 2013), clarifying the use and objective of type I SLCA even more. Product Social Impact Life Cycle Assessment Database (PSILCA, <https://psilca.net/>) (Maister et al., 2020) and Social Hotspot Database (SHDB, socialhotspot.org) (Norris et al., 2014) are two of the few platforms existing.

Even though the use of the Guidelines became more and more popular, some authors proposed other ways of applying social LCA. Some indicators were extracted from ELCA (e.g. the Disability Adjusted Life-years (DALY) indicator) (Arvidsson et al., 2018). Since social LCA deals with a lot of qualitative data, one of the main challenges is quantifying the social data. Type II social LCA tries to do so.

Type II social LCA is rather an impact pathway approach (O'Brien et al., 1996; Parent et al., 2010), and can be an explorative ex-ante/ anticipatory LCA¹⁰ method according to the

⁹ ISO 14040 describes the essential features of environmental LCA as well as its basis. ISO standards 14041 to 14044 are destined for practitioners as they describe how to technically implement an LCA methodology

¹⁰ There are several Life Cycle Assessment (LCA) approaches which, according to Guinée et al. (2018) can be divided into two main groups.

- Attributional LCA (A-LCA) is a way of modelling a situation in the past, present or future (explorative LCA), without any changes happening in the value chain.

nomenclatures used in environmental LCA (Arvidsson et al., 2023; Guinée et al., 2018): one of its objectives (and main characteristics) is to anticipate the future social impacts of changes in product life cycles (Macombe & Loeillet, 2013), by comparing different scenarios. This is the main reason why type II social LCA is a decision support tool (Macombe, 2013). The objective is to identify a scenario with the least unfavorable externalities possible in order to better inform decision-makers and stakeholders of the system studied. Until now, social LCA was used to evaluate health impacts of changes in both existing (Feschet et al., 2013) and new value chains (Bocoum et al., 2015). It was also used to assess the effects of a certain public policy on a value chain, as was the case for the Croatian pork value chain (Lagarde & Macombe, 2013), or even the biofuel sector (Blom & Solmar, 2009; Ekener et al., 2018).

-
- Explorative LCA (X-LCA) explores scenarios of possible futures by modeling the life cycle. X-LCA is a “multi-model multi-paradigm approach” (Guinée et al., 2018) which necessitates an explicit formulation of the research question and object of analysis. In X-LCA we can find the following methods among others. They are presented in alphabetical order: anticipatory LCA (N-LCA) is a non-predictive tool that includes prospective modelling tools and considerable stakeholder engagement. Backcasting LCA (B-LCA) explores ways to attain sustainability. Consequential LCA (C-LCA) provides information on the direct and indirect impacts occurring as consequences of a decision taken. Decision LCA (D-LCA) is based on C-LCA but uses financial and contractual data as inputs. Integrated LCA (I-LCA) is an LCA integrated with other modelling approaches (e.g. input-output analysis). Prospective LCA (P-LCA) estimates future impacts by using scenarios.

When the aim is to evaluate consequences of changes by comparing several scenarios of implementation and non-implementation, it is quite difficult to place ourselves in a specific LCA mode. For sure, we are not in an A-LCA context but rather in an X-LCA one; however, we can be in either a C-LCA, P-LCA, N-LCA or Sb-LCA context. Given the plurality of options, it can be difficult to identify in which X-LCA model we fit. Indeed, assessing impacts of changes in advance falls in the scope of C-LCA; but to do that, we need to compare scenarios, which falls either in the scope of N-LCA or P-LCA. Arvidsson et al. (2023) classify different LCA approaches according to a temporal positionality (retrospective LCA for the past, contemporary LCA for the present and prospective LCA for the future), and according to a ‘technology maturity’ scale. Ex-ante LCA is thus an LCA that considers a currently immature technology as mature in the future. It is a specific type of prospective LCA and it is identical to anticipatory LCA (Arvidsson et al, 2023). Ex-post LCAs are studies that consider a mature technology at the present time unlike lab-scale LCA that considers an immature technology at the present time.

The difference between type I and type II SLCA is explicitly shown in figure 11 below.

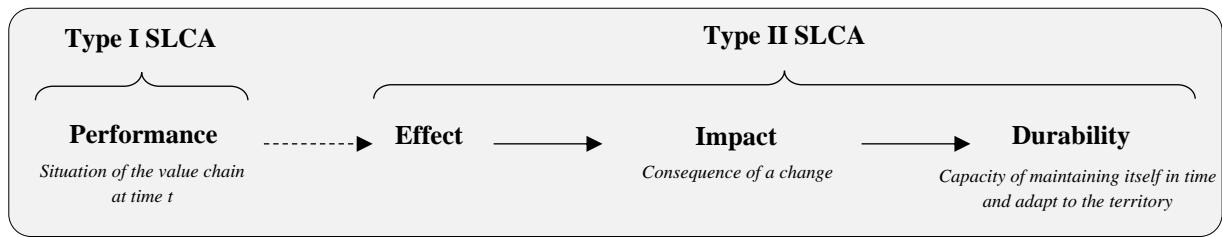

Figure 11: difference between type I and type II SLCA

The link between a performance and an effect is not always known nor valid.

Even though type I SLCA can be used to monitor the level of performance criteria over time, it remains inadequate when the aim is to anticipate and evaluate social impacts of changes *ex-ante*. Type II social LCA is more adapted in that case.

Evaluation process when using type II SLCA

Figure 12 below summarizes the general different steps followed when doing a type II social evaluation of changes in agri-food value chains, according to the processes developed in Montpellier. Indeed, just like in a basic evaluation process, after identifying the problem that needs to be addressed, it is important that the screening phase takes place. It supposes that the study perimeters as well as the stakeholders to involve in the study are pre-defined (more on

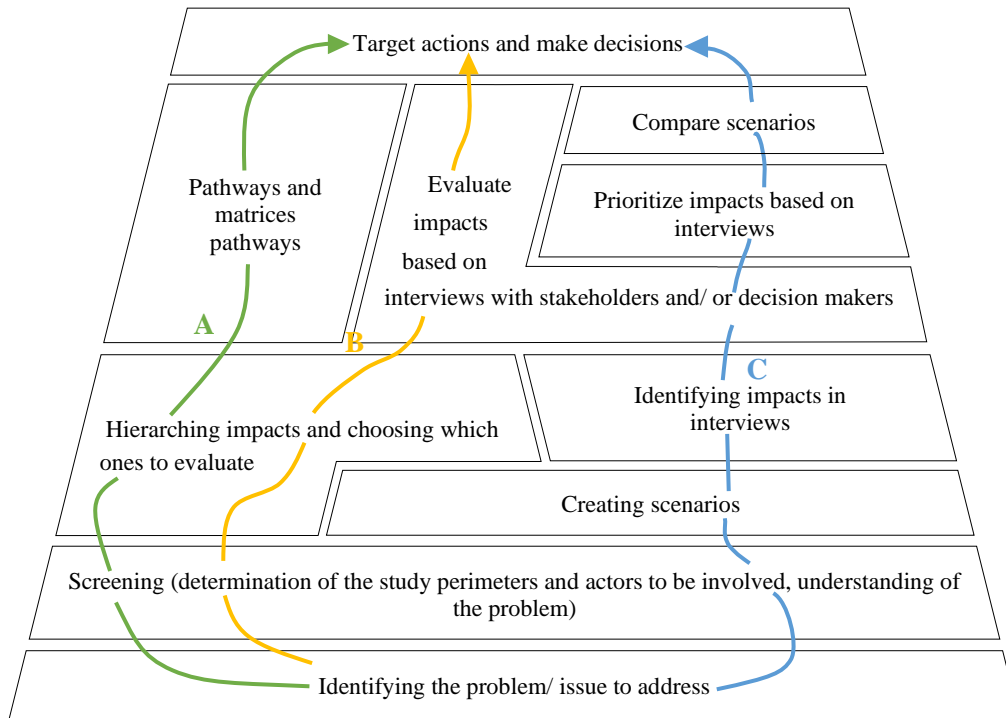

Figure 12: some processes of impact evaluation through type II social LCA developed in Montpellier

Example for trajectory A: Bocoum et al (2015), Feschet et al (2013)

Example for trajectory B: Falk et al (2022)

Example for trajectory C: the work shown in this manuscript

that in chapter 3 section VII). Once that is done, if type II social LCA is used as a tool for *ex-ante* assessment¹¹, it requires anticipating the impacts and thus potentially anticipating the evolution of the concerned value chain (more on that in chapter 3 section VIII). The aim is in fact to compare different scenarios that have the same rendered service. The ‘creating scenarios’ phase is however not a requirement, it depends on the type of study done. For instance, Falk et al. (2022) developed the ‘Neighbour’ method that allows an assessment of decent living standards in Southern countries; it is considered as a type II SLCA method that does not require the use of scenarios. Once that is done, and since it is quite difficult to evaluate all possible social impacts, it is essential that they are either hierarchized or at least identified in interviews with stakeholders. This is discussed in the following section V. The evaluation process thus continues with impact pathways, but it can also be done through analyzing interviews with

¹¹ Type II social LCA is not specific for *ex-ante* assessment. It can be used to assess past, present and future impacts. The specificity of the work shown in the manuscript is that type II social LCA is used for *ex-ante* assessment.

stakeholders (for the participatory *ex-ante* assessment). The results of the evaluation could make it possible to prioritize furthermore the impacts that were identified, potentially simplifying decision-making for policy makers and stakeholders of the value chain.

Conclusion: choosing type II SLCA as an *ex-ante* method to anticipate impacts of changes

The steps of an evaluation are summarized below:

- ✓ Identifying the problem/ issue
- ✓ Defining the system and its perimeters
 - Determining the spatial perimeters: the aim is to evaluate the social impacts (amongst others) of changes in agri-food value chains on the stakeholders. Defining such systems is already discussed in section III chapter 1.
 - Determining the temporal perimeters: the temporal perimeter when anticipating and evaluating social impacts is usually set to 3 to 5 years, because above that time frame, it can be difficult for people to grasp the challenges.
 - Determining the perimeter of effects: the impacted stakeholders are not predetermined, but rather identified at the same time as the nature of the important impacts, as the study goes on.
- ✓ Selecting the criteria: the aim is to focus on social impacts. Other impacts are bonuses.
- ✓ Deciding when to evaluate: the most adapted methods for the study carried are *ex-ante* methods, more specifically participatory methods. When *in-itinere* and *ex-post* evaluation are done (ideally they should be), mainly it is too late to modify again the value chain. *Ex-ante* life cycle assessment is a way of determining possible future impacts at an early stage of research or implementation. It is useful since it allows a reorientation of the change envisioned if needed (Cucurachi et al., 2018; Tsoy et al., 2020). A tool for *ex-ante* evaluations is type II social LCA. *Ex-ante* evaluation implies however anticipation, hence the prospective studies discussed (section VIII) and used (section XI).
- ✓ Evaluating the criteria: in *ex-ante* evaluation methods, participatory approaches seem to be most adapted to our goals. This will be discussed later on in chapter 3 section VII. Even though those methods are mainly viewed as qualitative, they can be combined with quantitative approaches that allow an anticipation and evaluation of impacts of

changes in agri-food value chains in a more concrete and visual way. We base our work on interviews with experts and stakeholders as we'll see in chapter 3.

- ✓ Developing an action plan. This part of the evaluation process supposes that actions are targeted and decisions are taken.

Take-away from this Section

Figure 13 below summarizes the different steps required to anticipate and evaluate social impacts through type II SLCA. As you read along the manuscript, you will see this figure evolving as we dig deeper into the subject. The evaluation process can be iterative, especially when implementing *in-itinere* and *ex-post* evaluation. The dotted arrows going back from developing an action plan to prioritizing impacts to act on, to evaluating impacts and anticipating them represent that iterative process.

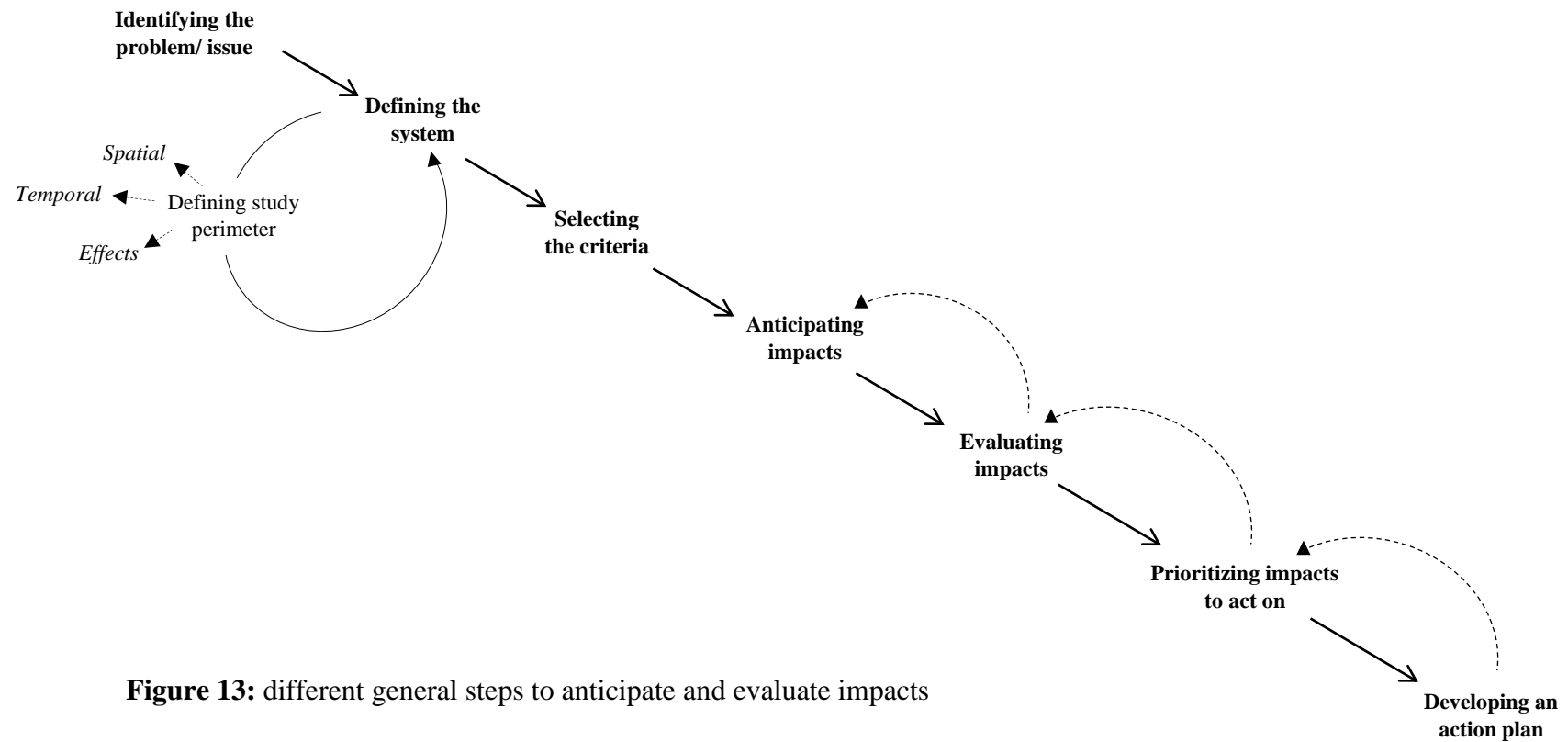

Figure 13: different general steps to anticipate and evaluate impacts

Section V. Hierarchy of impacts in agri-food value chains: how to determine if an impact is important or not

We previously saw that the social impacts across the life cycle of a product can be numerous and of different nature. When it comes to anticipating and evaluating the impacts in a type II social LCA approach, we first have to identify the impacts and then evaluate them. The identification phase can be quite difficult, so is the evaluation phase.

Clearly, it is impossible to evaluate all social impacts. Prioritizing them thus seems inevitable to identify the most important ones to take into consideration. However, how can we do so knowing that attributing weights to the impacts is a delicate task as they are experienced differently by the stakeholders? How do we define important impacts: is it either according to the impacted stakeholders, are the important impacts the ones we can act on, or are they determined through pair comparisons? In this section, we talk about the different ways social impacts can be prioritized to determine which ones are the most important.

1. Importance of impact hierarchy

Hierarchizing impacts is important as it helps ensure that actions, policies and decisions take into account the principal effects on people and communities. It is particularly important for businesses, governments and non-profit organizations where decisions can have a wide range of consequences on a lot of people (Bouillass et al., 2021; Fuentes & Cinner, 2010; Lœillet & Macombe, 2016).

Prioritizing impacts has several advantages:

- It allows organizations to focus their material and non-material resources on the outcomes that are most aligned with their missions and goals, which can lead to greater efficiency.
- It promotes social sustainability since it encourages organizations to take responsibility for their actions.
- It also increases accountability by making it clear what the important outcomes of an organization are and how progress will be measured.
- It can mitigate negative impacts. Indeed, by considering the important social impacts in advance, organizations can identify potential negative consequences and take steps to alleviate them. This helps in minimizing harm and preventing unintended consequences.

In the following paragraph, different ways of prioritizing social impacts are presented.

2. How to determine if an impact is important or not

In type I SLCA prioritizing impacts can be done by using the social hotspot database at nation scale. Nevertheless, because the aim is to anticipate the impacts of changes, at the value chain scale, the SHDB is not so relevant in our case.

There are several ways to determine if an impact is important or not in type II social LCA. Some methods are based on stakeholder interviews or surveys of the general population and thus rank the impacts according to the opinions, feelings and representations of those concerned. Other methods are based on experts' opinions and experience, reports, social norms and guidelines (i.e. WHO's "social determinants of health", the pyramids method¹²). And a third category of methods is based on computer modeling or use multi criteria methods such as AHP or ELECTRE. The data used for this third category of methods emanates from scientific papers, books and databases. To identify the most important social impacts a change could have on the stakeholders of a value chain, the most adapted methods seem to be the ones based on the opinions and representations of the first people concerned by the change. Multi criteria methods are also presented in this section as they have a purpose for impact anticipation and evaluation as we'll see later on in the manuscript.

a. Prioritization based on interviews

In those methods, the impacts are prioritized either according to the people interviewed or according to the project sponsors as they can pinpoint which impacts they can tackle. Prioritizing impacts based on interviews engages stakeholders by ensuring they are involved in the process of selecting and prioritizing outcomes.

It is quite difficult to identify a general method used when prioritizing criteria based on interviews. The fields of application are endless. Bouillass et al. (2021) for example use a participatory approach to select relevant impact subcategories concerning electrical and conventional vehicles on a micro-economic scale. Falk et al. (2022) on another hand propose to prioritize impacts based on a client's ability to take actions.

¹² The pyramid method aims to identify and classify social determinants based on scientific results and on the personal experience of members of the Commission for Social Determinants of Health (Lœillet & Macombe, 2016; WHO, 2009) . This can be done at a macro-scale (national) or at a micro-scale (village). This method is however in theory only adapted to poor countries since it has only been tested there. A disadvantage of it is that despite hierarchizing the social impacts, it does not quantify them.

It is important to note that depending on the scale of the study, the methods and tools chosen can differ. Nevertheless, we will not go into details since the only scale we are interested in for this work is the meso-economic scale, meaning that of a value chain.

b. Prioritization based on multi criteria methods

Multiple criteria decision aid (MCDA) is a research field within decision analysis (DA). There are a high number of different MCDA methods (figure 14). Like social LCA, these methods assist in complex decision-making, particularly when it comes to choosing, sorting and ranking information. They are particularly useful in case of conflicting objectives that stakeholders and decision makers may view differently (Belton & Stewart, 2002).

Different types of MCDA methods

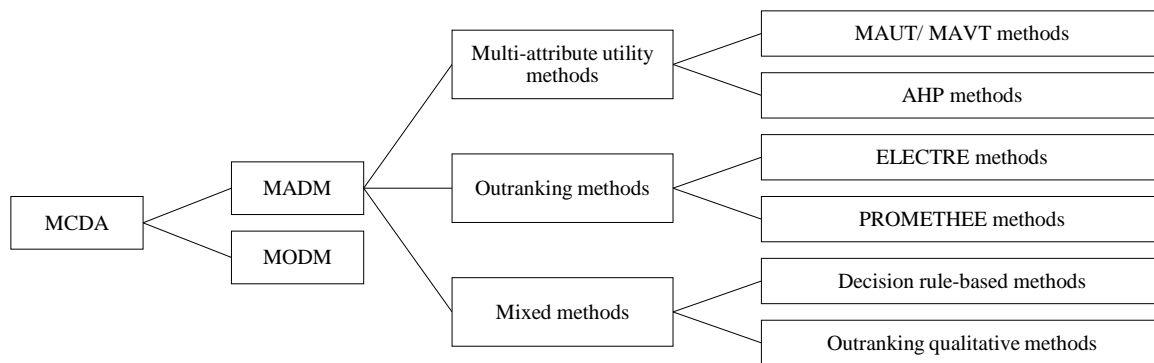

Figure 14: classification of major MCDA methods

There are several ways of classifying MCDA methods and one of the most integrative taxonomies is the Hwang & Yoon's one (1981). They make a distinction between multiple-attribute decision-making methods (MADM) and multiple-objective decision-making methods (MODM). The former is used in cases where the number of alternatives considered is limited and the criteria are conflicting, whereas the latter are usually used in cases of large or even infinite number of possibilities.

When studies refer to MCDA methods, they usually mean MADM methods (Sadok et al., 2008). Those can be separated into 3 categories.

The first one is for *multi-attribute utility methods (MAUT)*. If the criteria used in the process of decision-making are known, then we talk about multi-attribute value theory (MAVT). During

this process, the performance of each alternative considered is evaluated; after that, weights are attributed to each criterion, based on the decision-maker's priorities; finally, the values are aggregated and the alternatives are ranked. The analytic hierarchy process (AHP) is another major approach developed by Saaty (1987). It consists of disaggregating a complex issue into subcategories presented in a decision tree (the objective of the decision, the criteria and sub-criteria as well as the alternatives). Pair comparisons in each subcategory result in sets of scores and weights between each criteria and between each alternative; the weights calculated for each branch of the tree are aggregated for each alternative and based on those comparisons, priorities are derived (Piton et al., 2018). The most relevant alternative is chosen. AHP is the most frequently used weighting technique.

The second category of MADM methods are *outranking methods*, originally conceived by Roy (1968). The objective of such methods is to define binary relationships by comparing every possible pair of options. Each decision-maker defines his or her individual priorities and preferences. Based on that information, partial binary relationships are calculated for all criteria and are then translated into weights. The preference relationships are then combined, unlike MAUT methods, which score the alternatives. The most commonly used outranking methods are the ELECTRE (ELimination Et Choix Traduisant la REalité [elimination and choice translating reality]) and PROMETHEE (Preference Ranking Organisation METHod for Enrichment Evaluations) methods.

The third category of MADM methods is a *mixed category*. In the mixed category, we can distinguish two sub-groups. The first consists of decision rule-based models. Those are particularly useful in cases when the problem is so complex, it is impossible to restrict the analysis to the use of conventional mathematical tools (Sadok et al., 2008). The prioritization of criteria and the “decision rules are formulated on the basis of expert factual-heuristic knowledge (derived from interviews and literature) and/or with the help of data-mining and knowledge discovery tools” (Sadok et al., 2008, p. 166). The second concerns outranking qualitative methods. Those methods have the particularity of dealing with a mix of qualitative and quantitative criteria. The preference model used to rank the criteria and the alternatives is different of those used in the MAUT and outranking methods.

MCDA methods as a framework for participatory approaches to prioritize impacts

Because MCDA can be combined with participatory approaches, it is widely used as a tool to support multi-stakeholder decision-making processes and is a practical way to address the social dimensions of conflict (Banville et al., 1998; Munda, 2004).

Estévez et al. (2013) identified 119 studies that use multi criteria methods to analyze social impacts. In most of the studies, it was the stakeholders that rated the impacts (whose nature were defined by the researchers beforehand). In other approaches, it is the stakeholders themselves that define the nature of the impacts, and the researchers that code, categorize and score them (Estévez et al., 2013; Ortiz et al., 2018). It is the latter approach that seems more interesting to us. In fact, “a participatory process helps to identify impacts that decision-makers or experts may not have considered; likewise, iterative processes that refine objectives and alternatives according to stakeholders’ values may improve final solutions” (Estévez et al., 2013, p. 613).

c. Crossing argumentation with MCDA methods to prioritize impacts

The MCDA methods presented above rank the different possible alternatives according to expert’s preferences and the valued criteria. Nevertheless, a weakness that can be attributed to those methods is that generally, they do not take into account the debate between the experts, nor do they consider the reasons behind the opinions stated (Morente-Molinera et al., 2021). This can hinder the understanding of the ranking process as well as the decision making process as some background information can be missing. It thus seems necessary to focus on the arguments given by the stakeholders and the experts interviewed and it becomes quite crucial to be aware of their reasoning process and their thoughts. Thomopoulos (2018) suggests using Multi Criteria Argumentation (MCA) with this objective in mind. It is a method for processing data from representations of individuals (interview, documents, report or other). More information about this method and the tool associated are presented in section IX.

Conclusion: choosing multi criteria argumentation methods for *ex-ante* assessment of the social impacts

Social impacts are numerous and it is quite difficult to list them all (section I). Once the impacts are identified, the big quantities of information can make it difficult for decision makers to decide which path to follow in priority.

MCDA has several advantages when it comes to prioritizing impacts. On one hand, it allows prioritization in mutli stakeholder and multi criteria contexts. On another hand, such methods

can rank and logically evaluate the different impacts a change could have on the value chain. Nevertheless, MCDA approaches alone are insufficient to clearly understand the prioritization process. Understanding stakeholders' perspectives and opinions is necessary. In fact, participatory multi criteria methods “guarantee a participative and transparent decision-making process while simultaneously facilitating the learning process and the dialogue among stakeholders on the relative merits of different options” (Ortiz et al., 2018, p. 8). For that reason, multi criteria methods can be combined with argumentation approaches. Multi criteria argumentation seems to be adapted to the objective of evaluating the most important impacts.

Conclusion of chapter 2: state of the art and scientific gaps

The aim of this chapter was to present a state of the art of the key concepts that appear in the general research question *“which methodologies should we use to anticipate and evaluate important social impacts in agri-food value chains?”* Those concepts are: anticipation, evaluation, importance and agri-food value chains. First, the system studied is defined, then *ex-ante* evaluation methods that allow for an anticipation of impacts of changes in value chains are used, and since future social impacts are essentially looked for, we use type II social LCA.

There are tremendous gaps to fill in that combination of *ex-ante* evaluation methods with type II social LCA. There are even big scientific gaps within type II social LCA itself. Several questions arise from the main one.

The first one is how can we anticipate the impacts of a change in a value chain? *Doesn't it suppose we also anticipate the evolution of the value chain itself in a Business-as-usual (BAU) scenario?* We need reference scenarios because the changes' impacts will be evaluated according to a reference state of the value chain at a same time *t* in the future. So how do we create those reference scenarios?

Second of all, in Type II social LCA, it is quite difficult to identify the different social impacts that the change will have on the stakeholders. What is the best way to identify the impacts of changes on a value chain? Who better to tell us those changes than the stakeholders themselves and/ or the experts of the value chain. In the evaluation and prioritization of impacts, it is possible and preferred to use participatory methods for the reasons stated in the previous section. However, *which type of participatory methods is best to use? And how do we choose who we want to include?*

Third, in type II social LCA, there is a big scientific gap when it comes to aggregating results since the impacts are of different nature and not all of them can be quantifiable. So *which methods and tools could we use to explicitly aggregate outputs?* And *how do we identify the most 'urgent' and important ones?* We know that we would like to combine MCDA methods with arguments extracted from interviews with experts and stakeholders. So how does multi criteria argumentation help us answer the questions stated above in the paragraph?

Despite having the main framework of what should be done, there is nevertheless a lot of unknown factors and gaps to fill as we've shown through the questions asked in the previous paragraphs. Those gaps are summarized in figure 15 as they are placed all along the evaluation

process. In the following sections, we will talk about the different methods that answer those question. Before doing that, we will first start by detailing our epistemic positions adopted throughout the study. It is that vision of the subject and the matter at hand that allow us to answer the questions the way we chose to, and to bring elements to fill those scientific gaps presented in this chapter.

In the rest of the manuscript, we will detail the research position adopted to fill the scientific gaps, and we will see how multi criteria argumentation and type II social LCA can be combined to anticipate and evaluate the important social impacts of changes in agri-food value chains.

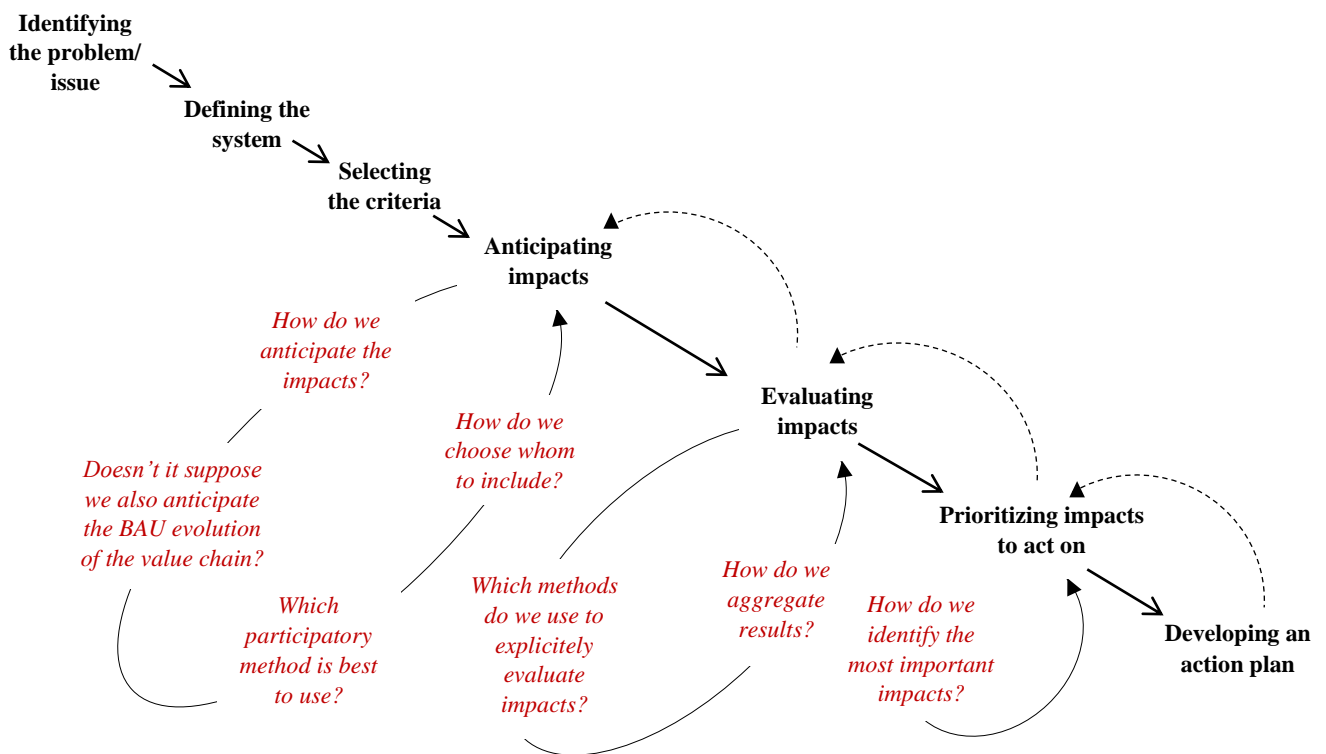

Figure 15: scientific gaps when evaluating important social impacts *ex-ante*

Chapter 3. Research design and methods

Treated concepts: Research paradigms, theories, participatory methods, prospective methods, multi criteria argumentation, stakeholder analysis, *ex-ante* evaluations.

There are several possible ways to answer the questions presented in the conclusion of chapter 2. Nevertheless, one specific way was chosen to answer each of those questions. Chapter 3 presents the methodological elements that allow us to bridge the gaps between the different elements discussed in chapter 2.

Section VI unveils the epistemological positions adopted throughout the study. It then resumes with the presentation of all theories grounding the work presented in the rest of the manuscript. In the rest of chapter 3, the key methodologies are presented in section VII, VIII and IX.

Section VII answers the following question: *which type of participatory methods is best to use when anticipating and evaluating impacts of changes in agri-food value chains? And how to choose which stakeholders to include in the study?* The different possible participatory methods are thus presented, and different ways of choosing whom to include in the study are also discussed.

Section VIII resolves this two-part question: *how can the impacts of changes in a value chain be anticipated and what does anticipation require?* To do that, the different scenario types and the different prospective methods are rapidly presented. A few of those scenario types and one specific prospective method is chosen in order to anticipate what could happen.

Section IX digs deeper into the subject of evaluation by answering those questions: *which methods and tools could be used to concretely evaluate impacts? And how can the most 'urgent' and important ones be identified?* Since S-LCA has some scientific gaps, combining it with multi criteria argumentation (which is based in the analysis of interviews) is attempted. It improves the evaluation process and allows an identification of the most important impacts according to the interviewees.

Section VI. Methodological elements

In this section, we will be discussing the research paradigms inspiring the work done. For that the ontological, epistemic and methodological standpoints are presented. Then the theories predicating the methods chosen and presented in the rest of the chapter are shown.

1. Generalities about research paradigms

Research paradigms are sets of ideas, beliefs and understandings providing a philosophical and conceptual framework for an organized study of the world (Filstead, 1981). Every research paradigm has three pillars:

- Ontologies, which question the nature of the reality we aim to know.
- Epistemology, which questions the nature of the produced knowledge; knowledge being the representation of reality.
- Methodology, which deals with how knowledge is produced, justified and validated.

From an ontological point of view

On one hand, **essentialism** considers that reality exists and has its proper essence even when there is no knowledge about it and/ or it is not described and/ or it is not believed in (Thiétart, 2014). For example, the durkheimian notion of “social constraint” supposes that our ways of acting and thinking go beyond us as individuals but are rather dictated by something bigger than us.

On another hand, in a **non-essentialist** approach, reality is rather constructed and not given. This does not mean that the realities in this case do not exist, it just means that they do not have their proper essence, they are rather undeniably dependent on the contingencies that govern their existence (Thiétart, 2014). In short, reality is constantly changing and the world is full of possibilities.

From an epistemic point of view

On one hand, **objectivism** supposes that knowledge is a representation of reality. It rests on two hypothesis: the essentialist ontology hypothesis presented previously and the second hypothesis that a subject is capable of generating knowledge about objects external to itself (Thiétart, 2014). A researcher in this posture develops a methodology while making both the researcher and the methodology are factual, empirical and observational.

On another hand, **relativism** supposes that knowledge is relative. Is it so either because it is impossible to prove the prevalence of one scientific theory on another, or because science is not justifiably superior to other forms of knowledge. Relativist constructivist paradigms thus rely on the following hypothesis: a non-essentialist ontology approach and the incapacity of a subject to produce knowledge on a system external to itself (Thiéart, 2014).

From a methodological point of view

Questioning the nature of knowledge integrates the dual questions of value and validity. Valid knowledge means that we can clearly establish the conditions in which it is true.

There are several validity criteria

- Verifiability: knowledge is either analytical or synthetic. It is empirically verifiable;
- Confirmability: the knowledge are likely to be true, but sometimes need to be confirmed experimentally depending on the case study.
- Refutability: this means that we can never confirm that a theory is (always) true, but we can affirm that it is sometimes false. In this sense, the criteria to say that knowledge is scientific, is that it allows certain other results to challenge it (Popper, 1959 in Thiéart, 2014). Theory is thus considered by the authors as the most refined form of knowledge.
- Adequacy: knowledge is relative to the conception of truth.

2. Epistemological positions adopted throughout the study

Anticipating and evaluating the important social impacts that a change can have on the agri-food value chain is our specific aim. Evaluation is usually derived from the realist positivist paradigm as it intends to provide certainty concerning a specific issue (Patton, 1980) meaning that the truth about a change is essential, objective and empirically verifiable or confirmable. However, over the past few decades, evaluation started to take a constructivist paradigmatic approach, especially by seeking to involve actors that are directly concerned by the project. In our case, our goal is not to discover a general truth about the impacts of changes within an agri-food value chain. Our goal is rather to understand the social reality of the food system to see how a change can modify it and how the stakeholders perceive it. We want to grasp the challenges of the food system, the problems it has to face as well as its stakeholders' motivations and needs through their own representations.

Our research does not however fall in the scope of one exclusive research paradigm.

a. Chosen paradigms

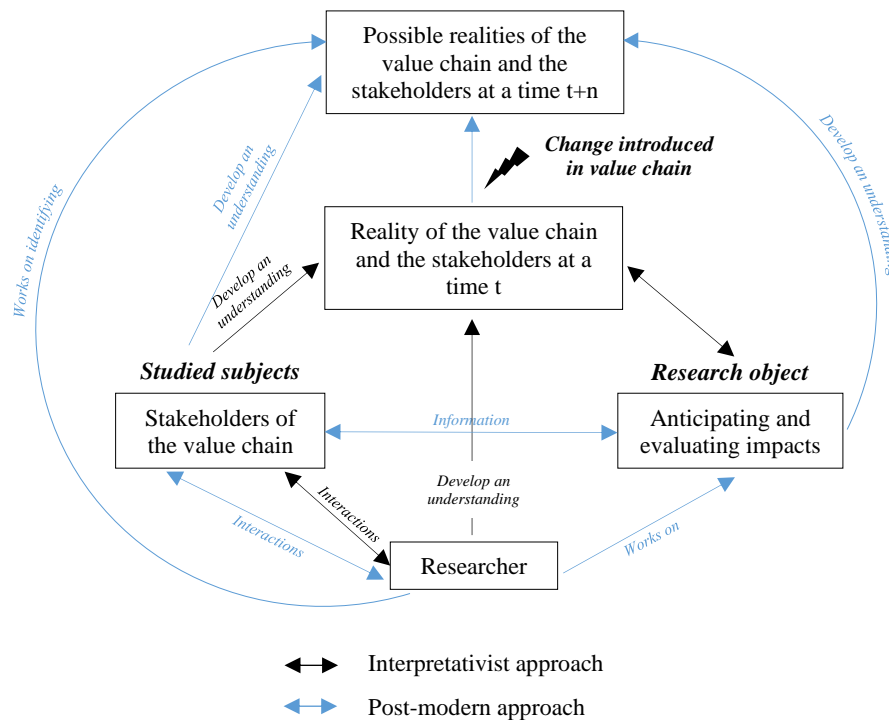

Figure 16: explanation of how the thought process embodies the research paradigms chosen

We first adopt an interpretativist approach for a social construction of reality (Berger & Luckmann, 1966). Before we start evaluating impacts of changes, we need to construct the reality of the studied value chain at the present time through a comprehensive approach. For that, we interact with the value chain's stakeholders to be able to identify what is working for them and what can be improved. We want the knowledge produced to be idiographic, meaning it is specifically related to the value chain and its stakeholders. This allows for both the researcher and the stakeholders to develop an understanding of the value chain and its issues (figure 16). In section X, we start indeed by presenting a state of the art of the French pork value chain, by discussing with its stakeholders.

The reality we are trying to understand is nevertheless constantly changing. The knowledge produced is relative to each stakeholder of the value chain and it highly depends on when the information is gathered. In addition, agri-food value chains are known to be unstable and constantly shifting. Human and social reality depends on the social environment in which it is constructed, as it is the product of our senses, experiences, interactions (Thiétart, 2014; Tsoukas & Chia, 2002). The knowledge produced is thus certainly relative. In fact, Chia (1995) insists

on the impossibility of defining a fundamental reality of a system made up of a myriad of interactions, especially since the system is part of a fragmented and diverse ecosystem. There are unfortunately things that happen that we cannot control, and those things constantly influence the food system we are studying. Our posture in relation to all this is to try to understand how the system evolves and to see during these evolutions, how the representations of the actors are impacted. For that reason, we shift from the interpretativist paradigm to the post-modern one. The post-modern approach suggests indeed that the social reality is diverse, pluralistic and constantly evolving (Lyotard, 1979). Through it, we are able to develop an understanding about the different possible evolutions of the value chain. This approach also helps stakeholders grasp the shifting reality of a value chain, especially when a change is introduced at a certain time t (figure 16). The unstable state of the value chain does not prevent us from anticipating and evaluating the impacts of the change in the value chain, on the contrary, it forces us to consider several options.

b. Objectivity VS subjectivity

Objectivity usually means that we separate the object of the study from the observer. On another hand, subjectivity takes into account the relations between the evaluator and the evaluated. Since the value chain is by definition a complex system that is constantly evolving and interdependent of its socio-economic environment, sustaining complete objectivity can become quickly difficult. We are aware that the reality concerning either the evolution of the value chain or the impacts a change could have on its stakeholders can be perceived subjectively. Nevertheless, the interpretation of the data is not that of the researcher, but that of the stakeholders themselves (Erickson, 1986). We still however seek objective answers by trying to recognize and deal with possible biases emanating from our ideas and knowledge. Classically, to counter the excessive intervention of subjectivity, discussions with other researchers are used.

Nevertheless, this is almost never the case. In fact, “saying that an indicator is objective does not mean that it expresses the reality of things or a natural truth. [...] as naturalized as they are, indicators carry and elaborate conventional, socially constructed visions of reality” (Paradeise, 2013, p. 80-81). They are thus a distortion of reality.

Rajouter schema avec les différentes étapes plus les subjectivités et ce qu'on fait pour remédier (avec les chapitres correspondants).

c. Qualitative VS quantitative methods

Generally, one considers that a quantitative approach guarantees a better objectivity, which is why it is anchored in the positivist paradigm (Thiéart, 2014). Qualitative methods are normally attributed to subjectivity. To anticipate and evaluate impacts of changes in agri-food value chains, we essentially analyse qualitative information. “The strengths of qualitative methods are that they generate rich, detailed, valid process data that usually leave the study participants’ perspectives intact” (Steckler et al., 1992, p.1). However, a constructivist subjectivist qualitative approach does not discredit the use of numerical data, since as Reichardt & Cook (1980) state in their article, “the option of combining qualitative and quantitative methods is not only available but there are several reasons to recommend it” (p. 229). This has already been proven for example in Bocoum et al. (2015) and Feschet et al. (2013) as they have shown that social phenomena related to human health can be explicated through legitimate reasonable equations called pathways. We do not claim to develop an impact pathway through this work, nonetheless, we will see throughout sections IX and XI that even though we base our work on stakeholder interviews, we tend to treat the qualitative information in a quantitative way. In other words, we assign a numerical value allowing us to treat all the verbatim from all the interviews in the most objective way. Not only does this enrich our analysis and interpretation of stakeholder opinions, but it also allows us to have clear and apparent information when it comes to evaluating impacts. It is easier to look at a final value rather than looking back at everything the stakeholders said throughout the interviews. Moreover, this allows us later on to compare information from different interviews. “Quantification is key since it enables rigorous comparison and assessments [and] also brings the advantages of rapid computational methods. Such simulations allow alternatives to be quickly evaluated” (Jiménez-González and Woodley, 2010, p. 1012). Figure 17 below summarizes the qualitative evaluation process.

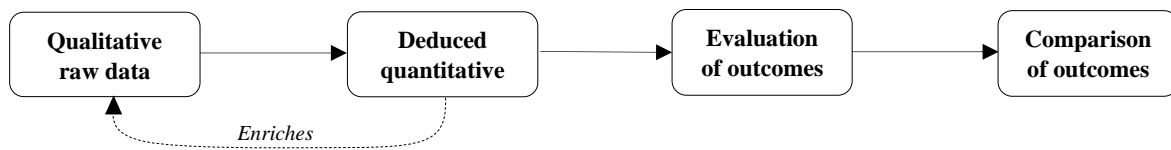

Figure 17: how we choose to use quantitative and qualitative information to anticipate and evaluate social impacts.

Our departure point is qualitative data (interviews with stakeholders) that already serves as results per say. Nevertheless, those interviews can also serve us to generate quantitative data that enriches the initial information we have (e.g., hierarchize the impacts), and also serves as proof to decision makers and project sponsors. Qualitative data can also be referred to when evaluating and presenting the results to decision makers.

3. Theoretical framework and approach to fill the scientific gaps

Now that we have established our view of the matter concerning the anticipation and evaluation of important social impacts, it is time to present the fundamental theories on which we ground our work.

According to Lakatos (1976), a scientific theory can be divided into two components:

- A hard core of principles or hypotheses that form the basis of the theory. If these change, the theory is abandoned in favor of a new one.
- Auxiliary hypotheses that can be modified to make the theory compatible with new experimental results, while maintaining the basic assumptions of the theory.

In a research work, auxiliary theories are those that are put to the test, while a hard core of principles or hypotheses brings together theories that are taken for granted and that allow the development of research design. No attempt is made to disprove these hard core theories.

Indeed, in this part, the goal is to present the articulated core theories taken as being true and factual based on the research design and paradigm that we talked about earlier in this section. Those theories act as a starting point for the course of action and the rest of the reasoning of the thesis, allowing for an anticipation and evaluation of social impacts in agri-food value chains. We follow that with a presentation of how we articulate those theories to answer our research question. It is important to note that there are hundreds more theories than the ones presented

here. However, those theories highly contributed to our vision of impact anticipation and evaluation. That is why they are the ones we talk about.

a. Core theories for our approach in type II social LCA

Critical theory in management

The critical theory in management is a theoretical current in management studies inspired by the critical theories (Alvesson & Willmott, 1992). It advocates for a reconsideration of the way things are usually done as it aims to understand and manage while taking into consideration all types of externalities : indeed, it considers that people's behaviors are not regulated by standards and norms but rather inscribed in a perpetual unstable state dictated by societal structures and cultural assumptions (Allard-Poesi & Loilier, 2009). Studied systems are thus more complex than anticipated and a stakeholder cannot be considered without taking into account his/her socio-economic environment. Implementing social LCA studies is specifically taking in consideration types of externalities that are usually overlooked. It is a core theory on which we base our approach of type II social LCA since this tool aims to assess the impacts of an economic activity in a different way than what is currently done.

Political ecology

This theory is derived from the political science field. In short, its aim is to explain the causes of conflict linked to natural resources' availability and the environment (Benjaminsen & Svarstad, 2009). In political ecology, researchers focus on human rights and justice by adopting a normative point of view. In other words, they defend the opinions of marginalized or oppressed groups of people without biasing their vision of the state of the world (Benjaminsen & Svarstad, 2009). Studies made thanks to SLCA bear the *a priori* to pay specific attention to the most oppressed groups of stakeholders. In practice, they are often the workers in the organizations of the life cycle. In agri-food concerns, they are often the farmers and the agricultural workers.

b. Core theories for our approach in multi criteria argumentation decision making

Normative decision-making theory

Decision-making theory is derived from applied probability theory. The normative decision-making theory is one of the three branches (normative, descriptive and prescriptive) of decision theory. The aim of using this theory is to identify optimal decisions. The practical use of this theory consists in decision analysis as it aims to find tools, methodologies and possibly even

softwares and decision support systems that help people make better decisions (MacCrimmon, 1968).

Argumentative theory of reasoning

There are two main ideas evoked in this theory (Mercier & Sperber, 2011). The first one is about reasoning, meaning how arguments are exchanged and processed. It is based on the construction and evaluation of interacting arguments (Bourguet et al., 2013). The second founding idea is about the use of reasoning. Argumentative reasoning theories are ones that allow us to understand situations in which information is contradictory and possibly incoherent (different stakeholders, different priorities, different opinions), which is why it is particularly interesting in cases linked to agri-food value chains.

Expectancy-value theory

The expectancy-value theory stems from the social choice theory, which depicts the framework of analyzing combinations of individual opinions, preferences, and interests in order to reach a collective decision and social well-being. Two factors are central in this theory as its name states (Vroom, 1964).

- Expectancy: it reflects the probability that a (desired) outcome is achieved
- Values: it translates the value attributed to the (desired) outcome

In consequence, individuals make choices according to the most desirable outcome. Motivation thus equals ‘expectancy*value’. The expectancy-value theory inspires what Thomopoulos et al., (2020) call “collective attitude”. It is a global evaluation of the acceptabilities of arguments that can help assess the social impacts of changes in agri-food value chains more clearly, according to the views of the people involved.

The theories relevant to social LCA and multi criteria argumentation methods ground our work. Nevertheless, other theories are necessary in order to better articulate the flow of steps necessary to answer the general research question.

c. Core theories for our approach using participatory methods

Stakeholder theory

Stakeholder theory explains that the stakeholders of a company must be considered and tells a new narrative of what is possible to do when joining the interests of all stakeholders of a value chain (Freeman, 1984). This theory has been developing for the last 40 years. It departs from the need to think about something other than profitability to measure the total performance and impact of a company, especially since the current way of thinking about business has a very

narrow idea of what a human being is. The main question it tries to answer is: how do we create value for customers, suppliers, employees, communities, transformers, etc. Since “the purpose of developing and using the social life cycle assessment (SLCA) is to improve the social conditions for the stakeholders affected by the assessed product’s life cycle” (Jørgensen et al., 2010, p. 376), it seems that stakeholder theory is a foundation of the work as stakeholder’s needs are put at the beginning of any action.

Deliberative democracy

Deliberative democracy means that decisions taken should be the fruit a public consultation and a debate between the different participants favoring joint action (Bousset et al., 2005; Mathe, 2014; Nielsen et al., 2004).

d. Core theories for our approach in prospective methods

Strategic planning theory

Hasan Ozbekhan is at the origin of a theory of planning in which scenarios play an important role. “The main debates in planning theory during the last fifteen years have been commonly described as ‘communicative’, ‘deliberative’ or ‘discursive’, focusing on finding analytical and normative frameworks to understand and mobilize planners... and debating thorny issues such as power, consensus, communication, empowerment and multiculturalism” (Yiftachel, 2006, p.212–213). “Strategic planning helps determine the direction and scope of an organization over the long term, matching its resources to its changing environment and, in particular, its markets, customers and clients, so as to meet stakeholder expectations” (Johnson and Scholes, 1993)

Conclusion: articulating several theories to fill scientific gaps

The work done throughout does not in any case claim to have discovered or developed a new theory. The novelty is that in an interpretativist, post-modern approach, several already-existing theories are combined to enable the anticipation and evaluation of social impacts of changes in agri-food value chains. Figure 18 below attempts to show how these theories are combined.

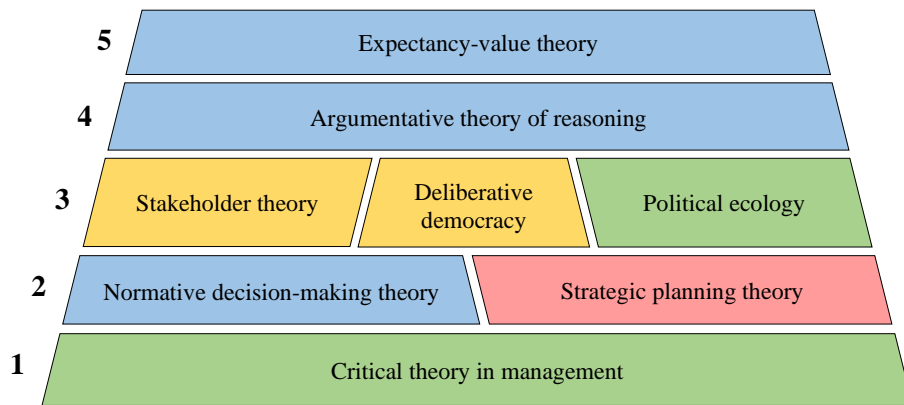

Figure 18: juxtaposition of the different theories on which the work is based

Color codes:

Green: theories for social LCA

Blue: theories for multi criteria argumentation

Red: theories for prospective approaches

Yellow: theories for participation

The following paragraph is an explanation of figure 18.

Level 1: the work is first and foremost inspired by the critical theory in management as it aims to do things differently from what is usually done.

Level 2: anticipating and evaluating social impacts is done to aid decision makers in their decision making process. Strategic planning theory is in consequence key when it comes to anticipating impacts. Since the work focuses on developing a methodology allowing an easier assessment and evaluation process, normative decision-making theory is taken into account as it strengthens the foundation of the work shown in the manuscript.

Level 3: the work is highly derivative of the stakeholder theory, the political ecology theory and the deliberative democracy one. Indeed, it aims to incorporate stakeholders in the study (stakeholder theory) as well as the most marginalized ones (political ecology), while making sure everyone has a say in the matters discussed (deliberative democracy).

Level 4: once the stakeholders to involve are chosen, they are encouraged to argue their points of view (argumentative theory of reasoning).

Level 5: the expectancy-value theory is used as an inspiration because it aligns with the objectives of the work as well as with the normative decision-making theory.

Based on the states of the art of the different ways to anticipate and evaluate social impacts, the main methods chosen are type II social LCA and multi criteria argumentation methods. Those are based on the following concepts or theories: life cycle thinking, political ecology, critical theory in management and expectancy-value theory.

Including stakeholders inevitably means that we will come across several opinions that are divergent and contradictory, we also put in action theories for argumentation.

Figures 21 and 22 below show the relationships between the paradigms, the theories and the methods and tools chosen to answer the research questions.

In the following sections, we will be talking more specifically about the different methods chosen for stakeholder participation, for the prospective study and the methods and tools chosen to combine multicriteria argumentation and type II social LCA.

Take-away 1 from this Section

Figure 19 below summarizes the interpretivist epistemological position adopted, the theories engaged and the method chosen to establish a state of the art of the value chain.

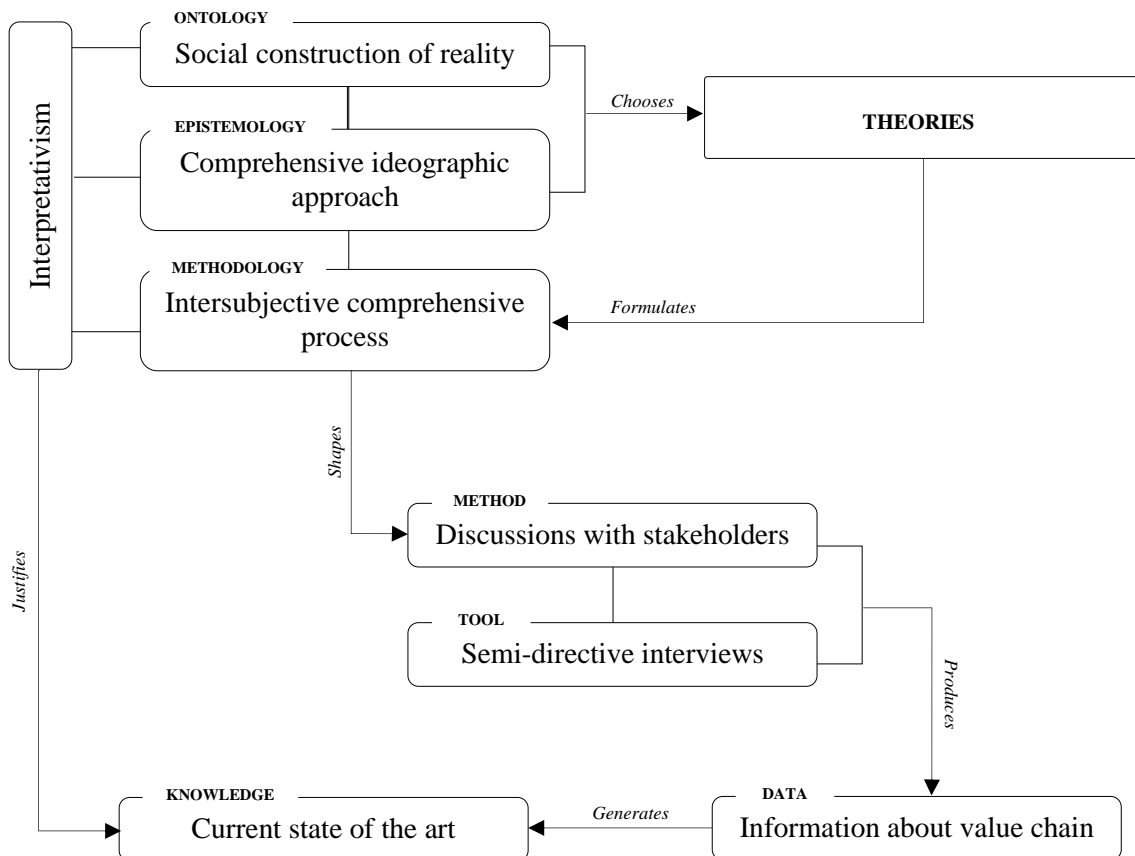

Figure 19: relationship between interpretivist paradigm and method. Inspired by Iofrida et al. (2018)

Take-away 2 from this Section

Figure 20 below is a summary of the post modern approach, the theories used and the methods and tools selected to anticipate, evaluate and prioritize impacts based on stakeholder interviews

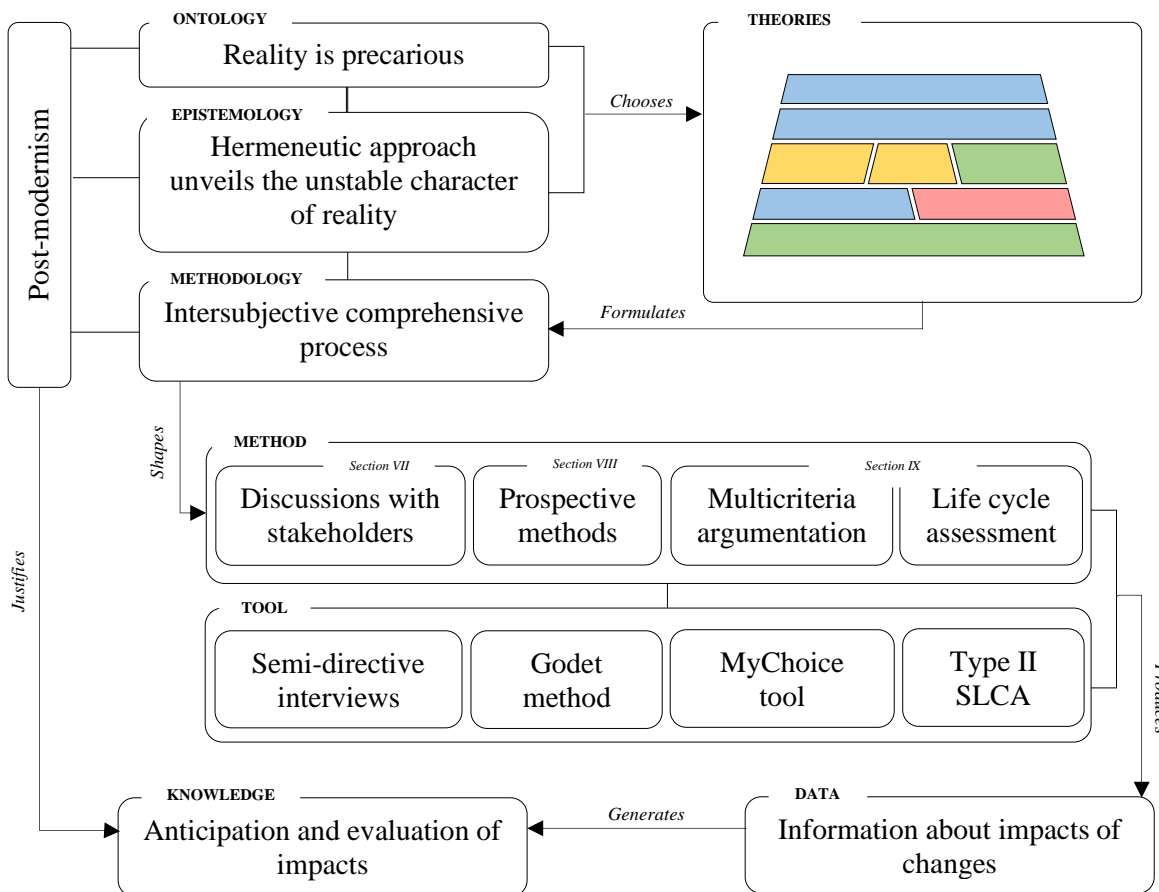

Figure 20: relationship between post-modern paradigm and methods. Inspired by Iofrida et al. (2018)

Section VII. Using participatory methods in social LCA contexts

The epistemological positions we chose to adopt throughout the study and that we discussed in the previous section place the stakeholders at the center of the work. It is their representations of the value chain that is sought, whether it is to grasp the state of the value chain or to better understand the consequences of change. Participation is thus key. In this section we dig deeper into why participation is so important and how it can be used.

1. The need for participatory methods in *ex-ante* evaluations

Engaging participants by “using their knowledge and local expertise to identify community-level impacts” is very important (Becker et al., 2003, p. 369). This guarantees that the impacts identified are relevant to the food system’s stakeholders (Arce-Gomez et al., 2015; Becker et al., 2003, 2004). Mathé (2014) adds that “if the aim of the evaluation is not merely to inform but also to assist the decision-making process to promote sustainability, stakeholders’ opinions must be integrated through participatory approaches” (p. 1507).

a. What is participation, and why is it important ?

Agri-food value chains are considered as complex systems. Indeed, they involve several stakeholders who interact with each other and with their environments. Stakeholders’ behaviors are intrinsically difficult to model and predict (Bar-Yam, 2002; Croitoru et al., 2016), and they often have divergent opinions and priorities related to different criteria (economic, social, environmental, sensory, technical, sanitary, etc...) (Funtowicz et al., 1999; Rosen, 1977). In addition, their actions are mostly distributed, poorly coordinated and constantly evolving as they are constrained by the pressure of production upstream and consumption downstream (Balman et al., 2006; Croitoru et al., 2016; Handayati et al., 2015). Describing a system as complex usually means that “the relevant aspects of a particular problem cannot be captured using a single perspective” (Munda, 2004, p.663). Thus, when dealing with complex and reflexive systems, participatory methods are crucial (Brugha & Varvasovszky, 2000; Munda, 2004), especially since they are coordinated, allowing for stakeholders to collaborate and take joint actions (Basco-Carrera et al., 2017).

Participation in a literal sense means the act of participating or being involved in an assessment or a decision making process. In this manuscript, participatory methods are defined as they were in Bousset et al. (2005), meaning they are “methods to structure group processes in which

participants play an active role and articulate their knowledge, values and preferences for different goals” (p.25). To insure a just and fruitful debate, stakeholders are exposed to the same information and problems faced, and they are encouraged to discuss and exchange their points of view (Arce-Gomez et al., 2015; Basco-Carrera et al., 2017; Bousset et al., 2005; Mathé, 2014).

The stakeholder participatory approach can be quite complex, especially when they are encouraged to go beyond creating a space where everyone can comment and information is gathered (Arce-Gomez et al., 2015). Ideally, stakeholders should go beyond just participating and being involved in the study. It is preferred if they collaborate, consult each other, discuss to eventually reach consensus, co-design and co-decide what is best for the value chain they belong to (Basco-Carrera et al., 2017; Mathé, 2014). Besides, it is best to avoid the case scenario where powerful, antagonistic and well connected stakeholders highly bias decisions and impose their opinions, jeopardizing the viability of a decision-making process (Freeman & McVea, 2001; Reed et al., 2009). Indeed, “successful strategies integrate the perspectives of all stakeholders rather than offsetting one against another [...] All stakeholders will not benefit all the time [...] it is just as important for management to develop strategies that distribute harms in a way that ensures the long-term support of all the stakeholders” (Freeman et al, 2001, p.16). Having a “peer community” is therefore essential to guarantee a better and transparent process; integrating experts from various fields of the value chain improves the quality of an assessment and brings contextual and relevant knowledge and various opinions (Bousset et al., 2005; Lane et al., 1997). By doing so, participation is an extremely beneficial preventive approach when it comes to implementing changes in value chains (Sonesson et al., 2016; Von Geibler et al., 2006). It is a way of improving overall sustainability (Bousset et al., 2005).

b. Different types of participatory methods

Stakeholders are encouraged to take part in information exchanges and decision-making as much as possible. It is a core principle in participatory collaborative approaches.

There are several ways of classifying participatory approaches. Two of them are discussed below.

Bousset et al. (2005) was inspired by Van Asselt et al (2001) and classify those participatory collaborative methods according to two axis: a ‘motivation axis’ and a ‘targeted output axis’.

For the motivation axis: **democratization** means that the exchanges are to be used in the decision making process. **Advising** means that the exchanges are decision-support tools and may or may not influence the final decision taken (Bousset et al., 2005).

For the targeted output axis: **mapping out diversity** means that the methods focus on the divergence of opinions, whereas **reaching consensus** supposes stakeholders converge their opinions by compromising.

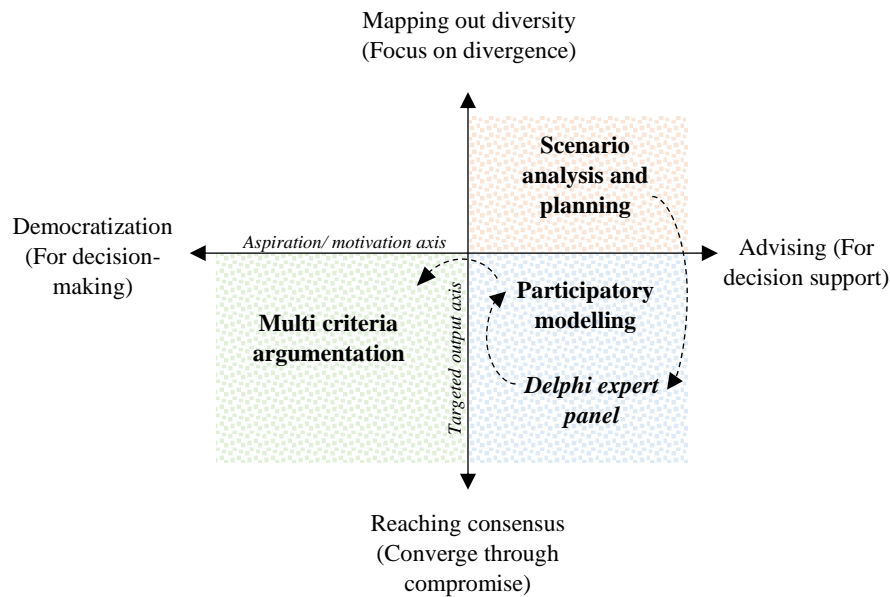

Figure 21: categorization of participatory methods useful when anticipating and evaluating important impacts. Inspired by Bousset et al. (2005)

This leads to four categories of methods in which one (‘democratization through mapping out diversity’) is a participatory process organized by the stakeholders. Only the participatory processes initiated by researchers are discussed in the following paragraphs. According to Bousset et al. (2005) and van Asselt et al (2001), there are three types of methods initiated by researchers, which necessitate stakeholder participation:

- *Advising methods that aim to map out diversity* (in orange on figure 21 and 24). This means that the aim is to identify various information by revealing stakeholders’ knowledge, values and ideas from different fields. This information is later on used for decision support.

- *Consensus reaching methods that aim at advising* (in blue on figure 21 and 24). Through those methods, the objective is to single out one option or decision by revealing stakeholders' knowledge, values and ideas.
- *Reaching consensus by democratization methods* (in green on figure 21 and 24). One option is singled out amongst those created by the stakeholders' knowledge. This option highly influences the decision made in the end.

It is a bit tricky to identify oneself in one method category, as the work done requires several approaches, even more so since the global pandemic hit (more on that in VII.2). The methods that are useful when anticipating and evaluating social impacts of changes in agri-food value chains¹³ are presented in figure 21 inspired by that of Bousset et al. (2005). The following paragraph explains the figure with the arrows linking the different methods.

Anticipating the impacts of change in an agri-food value chain requires in some cases the use of scenarios. This supposes that the evolution of the value chain itself is also anticipated, hence the use of scenario analysis methods. The aim is to map out the diversity of possibilities and the divergences in opinions to be able to use that later on for decision support. This is called scenario planning (see section VIII for more detail). Scenario planning can be categorized in the advising methods that map out diversities. Following scenario planning, to confirm certain results if needed (for example in case of remote working as we will see later on in the section), a Delphi type expert panel can be used. It must be adapted to fit the objectives and means of the study. We thus move to the lower section in the graph of figure 21. Once the different scenarios are created, the aim is to reach a consensus concerning the scenarios to choose and the changes to implement. Participatory modelling methods are perfect for that. Indeed, consensus is key for decision support and especially for decision-making. Methods for democratization then need to be used. Multi criteria argumentation is a great way of reflecting a certain consensus established between the participants (see section IX for more detail).

Now that we have established the different types of participation, it is time to present the different degrees of participation. Basco-Carrera et al. (2017) classify those participatory approaches according to a ladder of participation (from consulting the stakeholders to including them).

¹³ There are several methods that allow the evaluation of social impacts. All of them are not presented in figure 21 because they are not always specific to agri-food value chains.

The lowest stage of stakeholder participation is *consultation*. The stakeholders in this case are indeed just asked what their opinion of a certain matter is and what they think is best. This does not necessarily affect the project outcome; the rest is indeed taken in charge by project sponsors or by the researchers. A step further in participation is the *discussion*. In this case, stakeholders are not only asked what their opinion is, but they are also encouraged to exchange their information, views and arguments with other participants. Their opinion can possibly change at the end of the discussion. A farther step for stakeholder participation is stakeholder *involvement*: this means that not only do stakeholders meet and discuss their opinions, but they should also reach consensus at the end so they can make a unique decision concerning a change in the value chain. *Engagement* goes beyond involvement: it supposes that the stakeholders have personal interest in the project at hand and is very important to them. Participation does not necessarily imply engagement; however, if a stakeholder is engaged in the project at hand, it is best if they could be involved in all stages.

Figure 22 below crosses the classifications of Bousset et al. (2005) with that of Basco-Carrera et al. (2017). On it are placed the different methods that can be useful when it comes to anticipating and evaluating the social impacts of changes in agri-food value chains.

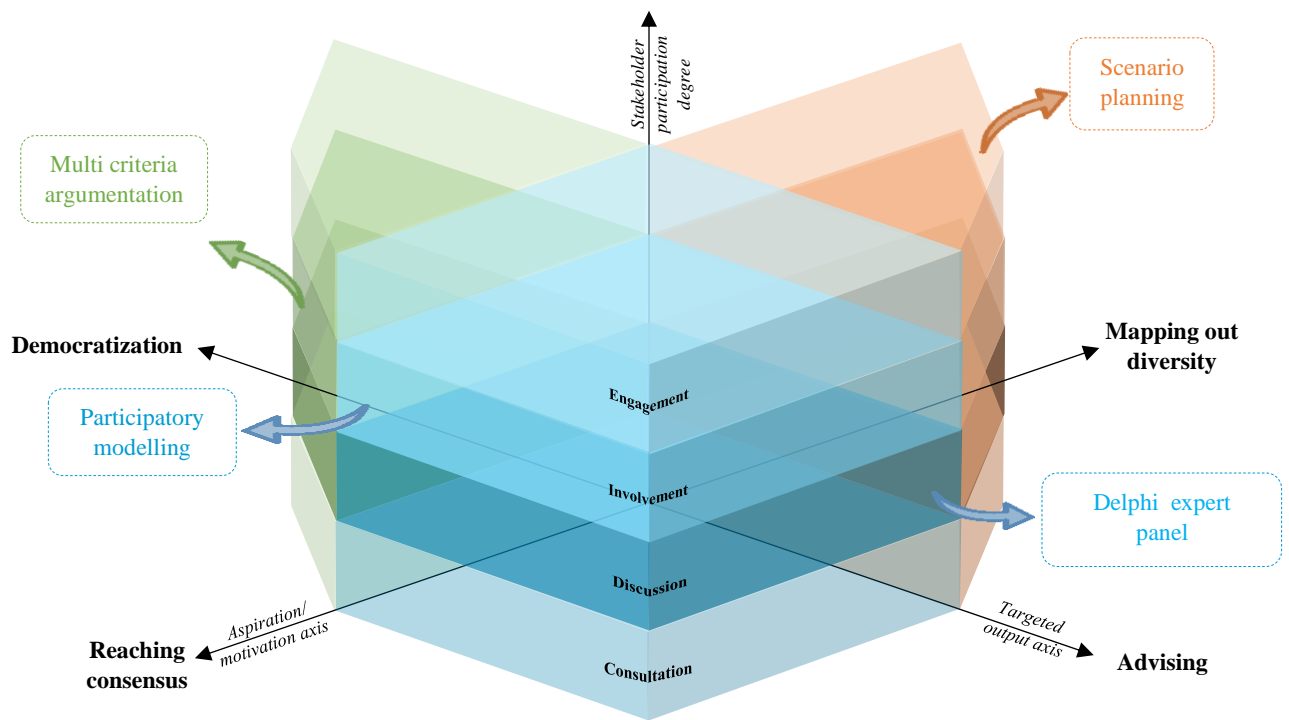

Figure 22: categorization of participatory methods according the targeted output, the motivations and the stakeholders' degree of participation

2. Participation in a context of remote working

Working remotely dates back to decades especially in certain fields: in the scientific literature, from the latest decades, international collaboration has become increasingly frequent in nuclear science, where several papers have reported technical architectures and tools supporting remote participation (Krämer-Flecken et al., 2010; Stepanov et al., 2011; Sun et al., 2017). Nevertheless, other sectors are absent from the scene. Most importantly, feedback on the remote feasibility of participatory tasks and on the pros and cons of remote working to perform them is almost nonexistent. Users' experience in the fusion sector was addressed in 2002 by Suttrop et al. (2002). In medical education, remote participation was very recently addressed by Kopp et al. (2021) in the context of the COVID-19 pandemic. Although the sectors and considerations of these two latter studies strongly differ, both converge on several points and in particular: (i) personal communication remained of good quality and (ii) large meetings were to be excluded in the remote context.

Keep in mind that ideally it is preferred to **involve** the stakeholders in all stages of the study by reuniting them so that they discuss matters freely, face to face. Nevertheless, things usually never go to plan. In some cases, involving the stakeholders in an evaluation process can be quite difficult. In that case, other methods and tools can be used to compensate the ‘lack of participation’. Several options are discussed below.

Replacing collective face-to-face sessions by collective remote sessions, such as collective video calls.

This is the most straightforward replacement for collective face-to-face meetings. However, it presents several disadvantages.

- **Availability:** when working remotely, it might seem easier to find common slots suitable for everyone, but it is not the case in reality. In practice the constraints related to remote work can reduce availability for reasons ranging from the management of the domestic daily life (children, meals, shopping with constrained schedules, etc) to the lack of motivation and a decrease in the implication in long distance projects. Also, the ease of last-minute cancellation is not to be overlooked.
- **Technical:** possible connection problems can prevent the reunion, or prolong its duration and thus affect people’s concentration (Roos et al., 2020).
- **Concentration:** remote discussions can hamper productivity. The longer the reunion, the less effective it can be. Long distance discussions can also affect people’s ability to understand others’ opinions especially when body language is important (Simons et al., 2000).
- **Involvement:** when the number of participants in remote meetings is quite high, prospects may feel less involved (Simons et al, 2000).
- **Confidence:** confidence can be degraded since the risk of losing information is higher in long distance reunions (Roos et al, 2020).

Multiplying the diversity of sources

In general, in evaluation approaches, researchers look for experts in various fields, in order to sweep the fields of possibilities. Ultimately, if researchers interviewed only experts with the same background, they would likely provide the same information, which would constitute impoverishment. To mitigate this effect, interviewing stakeholders (in the broadest sense) of the supply chain with backgrounds and opinions as diverse as possible is encouraged. The different ways of choosing those stakeholders are presented in paragraph 3. The diversity of sources can also be manifested through the use of documents from literature reviews which

provide factual and substantial information about the agri-food chain studied. In this case, each document read can be considered as an interview done.

Replacing collective face-to-face sessions by multiple individual remote sessions (video calls) whilst using other tools to complete the analysis of the interviews.

The semi-structured interview¹⁴ method is indeed often used in sociology studies (Chevalier & Meyer, 2018). This approach has two main advantages, which are stated below.

- It allows the interviewee to structure his/her view according to his vision of the matter : concepts are thus defined by him/her and not the interviewer (Chevalier & Meyer, 2018).
- Individual interviews make it easy to interact with the interviewee who reciprocally has a higher confidence when sharing information with the interviewer (Kopp et al., 2021; Suttrop et al., 2002). He or she is also more at ease when it comes to sharing some opinions that they would not have dared to share in a collective session. In fact, as (Oliver, 1991) explains it in the “stakeholder multiplicity” theory defined as “the degree of multiple, conflicting, constituent expectations exerted on an organization” (here the value chain), when gathered all together, some stakeholders might inflict conflicting pressures on others in order to maximize their benefits, whereas others might succumb to the constraints.

Semi-directive interviews can be quite complex to analyze and put in place, especially when consensus is needed to pursue a study. For that reason, it can be combined with other tools, hence the Delphi type questionnaire that allows for a little more in-depth review among the stakeholders. In that case, we talk about a ‘simili consensus’.

3. Proper participation through stakeholder analysis

The notion of stakeholder is not new neither to the field of MCDA nor for the field of social LCA. It is however unclear in most cases how this notion is concretely integrated within the framework of MCDA or social LCA. In their paper ‘A stakeholder approach to MCDA’, Banville et al. (1998) insist on the need to incorporate meaningfully stakeholders in MCDA

¹⁴ Interviews in some cases are not considered as participatory methods per say, they are a « standard social science technique » (Bousset et al., 2005, p. 25) that can be used to make stakeholders participate.

methods. Keeney (1992) uses focus groups for example in the cases of MAUT methods. Roy (1985) insists on the need for the criteria to be fully understood and accepted by various actors involved in the study. Saaty (1984) also discusses the inclusion of several groups of participants. They talk about stakeholders as if they were clearly defined and there was no need to go deeper into that notion, and they do not clearly show how the integration of stakeholders impacts the evaluation, prioritization and decision-making process.

In the mid 90's and up until now, decades after Freeman defined what a stakeholder is, understandings of the notion are numerous and sometimes even conflicting (Griffin, 2017). Various ways of classifying stakeholders exist : they are either defined according to their interests (Weber, 1992), their claims (Donaldson & Preston, 1995), their responsibilities (Clarkson, 1995), their goals (Rowley, 1997), their commitments (Sobczak & Girard, 2006) or their attributes (Mitchell et al., 1997), etc... "Overall, no single classification schema determining who or what is a stakeholder dominates" (Griffin, 2017, p.333). It thus seems natural that we should define what a stakeholder is. According to Freeman & McVea (2001), a stakeholder is "a group or individual who can affect or is affected by the achievement of an organization's objectives".

But how do we create a selected sample of stakeholders? There are mainly three approaches (Mathé, 2014; Wijnberg, 2000) that can be adopted when classifying stakeholders to wisely choose the ones to incorporate in our study:

- The descriptive approach describes whether the stakeholders' interests are taken into account. Mason & Mitroff's classification (1981) is an example of such a descriptive approach. They define stakeholders as "all those claimants inside and outside the firm who have a vested interest in the problem and its solution" (p. 43). Through this method, stakeholders are identified if they have revealed an interest in the value chain (the imperative procedure) or according to their position (the positional procedure). Those stakeholders can be nominated by other stakeholders (the reputational procedure). Other stakeholders can come through when participating in activities related to the value chain (social participation procedure) whereas others openly influence the opinions of the direct stakeholders involved in the value chain (the opinion-leadership procedure). A demographic approach can help identify stakeholders according to certain characteristics (age, sex, race, occupation). And last but not least the organizational procedure consists of listing all stakeholders who have an important relationship with the organizational units considered in the value chain. All of those seven procedures and

approaches should be used at the same time according to Mason and Mitroff. This allows for an extended but still non exhaustive list of stakeholders.

Mason and Mitroff's classification is one of the most detailed ones (Banville et al., 1998). Nevertheless, taking into account all those criteria leads to a big list of people to include in the study, and the high number of criteria makes it difficult to answer them all. Certain criteria are also irrelevant in certain cases. For all those reasons, this classification does not seem quite adapted to the goal of anticipating and evaluating social impacts in agri-food value chains. A simpler classification is needed, yet it should still guarantee a diversity of opinions.

- The instrumental approach describes stakeholders according to the impact they have on a value chain. The aim is to reduce any risk that the value chain could face while increasing its performance. For example, Clarkson (1995) defines stakeholders as either primary or secondary: primary stakeholders are those whose continuing participation is required if an organization is to survive (ex: investors, employees, customers, and suppliers), secondary stakeholders are those who influence or affect, or are affected by, the corporation, but are not essential for its survival (Clarkson, 1995). However, this classification does not take into consideration the public stakeholders such as government officials and the community: they are nevertheless legitimate and crucial for any decision making process and they have to be considered as stakeholders at all costs. For that reason, this classification still does not satisfy the criteria required to evaluate social impacts in agri-food value chains.
- The normative approach considers that all stakeholders are equal when it comes to their interests and they are all valid. It is this approach that seems most adapted and most complete when it comes to identifying stakeholders to involve in impact anticipation and evaluation. Mitchell, Agle and Wood (1997) classify stakeholders according to their attributes: power, urgency and legitimacy. Power is the ability to affect the system's survival despite what other stakeholders could do. Legitimacy of the actor and of his claim is an important factor to take into account when it comes to stakeholder organization. An entity is legitimate if its actions are desirable and appropriate within the socially constructed norms, values and beliefs for the value chain (Friedman & Miles, 2006; Griffin, 2017; Mitchell et al., 1997). The urgency criteria is the degree to which a stakeholder's claims call for immediate actions. Looking at those three attributes, stakeholders are either dormant if they only have a lot of power, urgent if they are only very sensitive to the project's needs, discretionary if they are only

legitimate to act on the project. Stakeholders can also be either dangerous, dependent, dominant or pervasive if they have two attributes or more. The more a group of stakeholder has attributes, the more important it is to pay attention and respond to their individual claims (Crane, 2020; Mitchell et al., 1997). Nevertheless, “each attribute is a variable, not a steady state, and can change for any particular entity or stakeholder-manager relationship. Second, the existence (or degree present) of each attribute is a matter of multiple perceptions and is a constructed reality rather than an “objective” one. Third, an individual or entity may not be “conscious” of possessing the attribute or, if conscious of possession, may not choose to enact any implied behaviors” (Mitchell et al., 1997, p. 868). Those stakeholder categories are presented in figure 23 below and explained in the following paragraphs.

Dormant stakeholders

Dormant stakeholders are the ones that only have power. Because they do not have the urgency or the legitimacy, their power remains often unused.

Urgent or demanding stakeholders

Demanding stakeholders have urgent claims but they do not have the power or the legitimacy to take action.

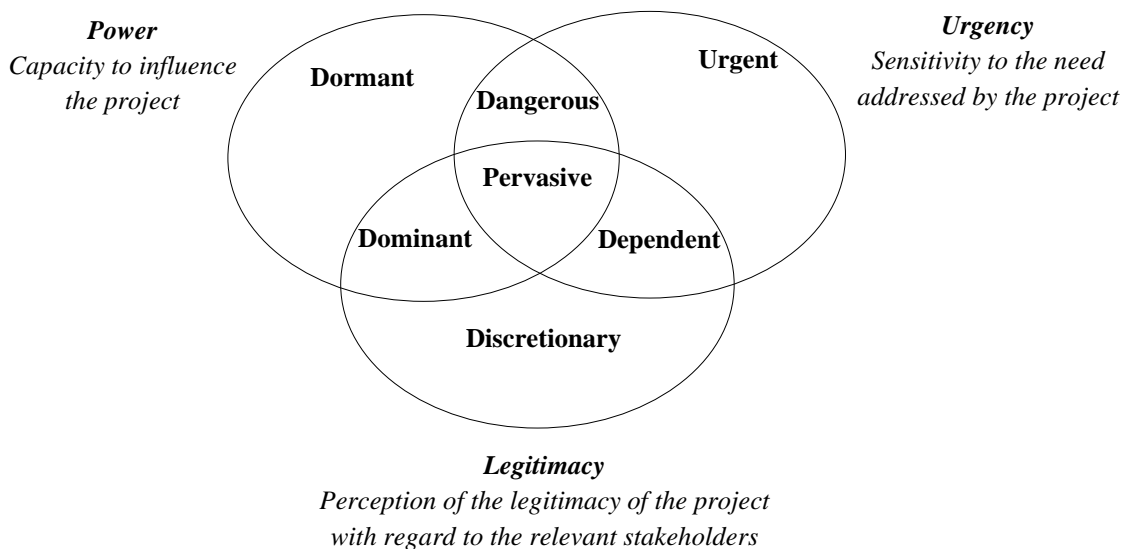

Figure 23: Mitchell, Agle and Wood’s classification of the stakeholders according to the three attributes of power, urgency and legitimacy

Discretionary stakeholders

Discretionary stakeholders have the legitimacy but not the power nor the urgency to take actions in the value chain.

Dangerous stakeholders

These stakeholders use formal channels to make changes in the value chain. They may resort to coercive tactics to call for attention to their claims. They are able to gather support and obtain global persuasion, which can lead to them imposing their ideals on the future of the value chain. The term ‘dangerous’ makes it seem like a collaboration between those stakeholders and the others is impossible, which is not always the case (Currie et al., 2009).

Dependent stakeholders

Dependent stakeholders are legitimate and urgent. However they are highly dependent of other stakeholders if they were to take actions in the value chain.

Dominant stakeholders

They have the power and the legitimacy to take actions. They most definitely can influence the value chain. According to Mitchell et al, this category corresponds to scholars’ definition of stakeholders and is thus usually the only category taken into account in other classifications. Indeed those stakeholders expect and receive much attention but the others are important to take into account as well.

Pervasive stakeholders

Pervasive or definitive stakeholders are normally the ones who have the highest salience since they are powerful, legitimate and urgent all at once.

Two important principals drive a stakeholder analysis (Bousset et al., 2005):

1. ***Inclusiveness***: it is vital to promote equity in decision-making and to ensure social justice by including all types of different stakeholders. By doing so, the decisions taken are adequate to the needs and demands of the concerned stakeholders and actions taken are appropriate.
2. ***Relevance***: guarantying a successful approach requires choosing stakeholders who are involved and committed to the project. This allows a maximization of stakeholders’ contributions. Identifying the role and potential contribution of the different stakeholders is thus fundamental to ensure proper representation of all criteria relevant to the study (e.g. profession and expertise, gender, localization, values and ethics, norms etc...) (Barney & Harrison, 2020; Bousset et al., 2005; Freeman, 1984).

The strength of Mitchell, Agle and Wood’s classification is that it is inclusive since it integrates all kinds of stakeholders’ perspectives of the studied system. The aim is to include all types of stakeholders simultaneously in the impact evaluation process, so that they can reach an

understanding of the problems faced, discuss with each other and reach a consensus about what to do despite their different backgrounds and insights (Griffin, 2017; Habermas, 1984; Reed et al., 2009).

It is important to note that it is not statistical representation that is sought, but rather social representativeness, which is why a large sample is not required, as long as all categories of stakeholders are represented. The objective is to obtain robust results by selecting a sample of diverse stakeholders (Thiéart, 2014). Finding common ground when analyzing interviews with stakeholders from different backgrounds and opinions takes the analysis and interpretation of results one step further: we can then say that the variables obtained are truly key or that the x or z impacts are important because they were mentioned by a lot of the stakeholders from the selected sample.

One thing all of the classification methods presented previously have in common is that they are analytical top-down categorizations instead of being reconstructive bottom-up categorizations (Reed et al., 2009). In other words, stakeholders are categorized by those who are conducting the study. The risk with all of those methods is that some stakeholders -which may have knowledge and different perspectives of the issue- could be forgotten and that the choice of stakeholders could be biased and consequently so is the analysis of the problem (Reed et al., 2009). Nevertheless, those risks are reduced when a two-way dialogue is established between the researchers and the stakeholders. In the end, there is no real consensus on “who and what really counts” (Crane, 2020; Freeman, 1984; Freeman et al., 2010; Mitchell et al., 1997). However, like Dreyer et al. (2006) and Kruse et al. (2009) state, a combined top-down and bottom-up approach is essential when it comes to identifying stakeholders, meaning that even though some are preselected, the ones interviewed redirect researchers to other stakeholders of the value chain that they deem important and inescapable.

Conclusion: interviewing stakeholders and getting back to them throughout the evaluation process

Take-away 1 from this Section

Integrating stakeholders in the process of anticipating, evaluating and prioritizing impacts of changes in the agri-food value chain is essential since they are the first concerned. One of the most complete representations of stakeholders is the Mitchell, Agle and Wood classification, as it guarantees a diversity of opinions while making sure no important categories of actors are left behind.

Once the stakeholders are identified, ideally they should be involved in all phases of the study. In cases where this is not possible (e.g. remote working) other options can fill the gap. For that, the main tool used is semi-directive interviews. To reduce the bias, this tool can be combined with other ones such as a Delphi type questionnaire.

In a framework of social LCA, for the approach we choose to use, we can distinguish two main phases for participation: the first one is the participatory prospective phase (section VIII) and the second one is the impact evaluation phase (section IX). The participatory methods to keep in mind for the rest of the manuscript are the following:

- Scenario planning (see Section VIII)
- Participatory modelling (see Section XI.2.a)
- Delphi-type expert panel (see Section XI.2.a)
- Multi criteria argumentation (see Section IX)

Take-away 2 from this Section

Figure 24 below details a bit more the process followed when anticipating and evaluating the social impacts of changes within an agri-food value chain. Steps in green represent the added value throughout this Section. Also, it shows where participation is needed throughout the evaluation process.

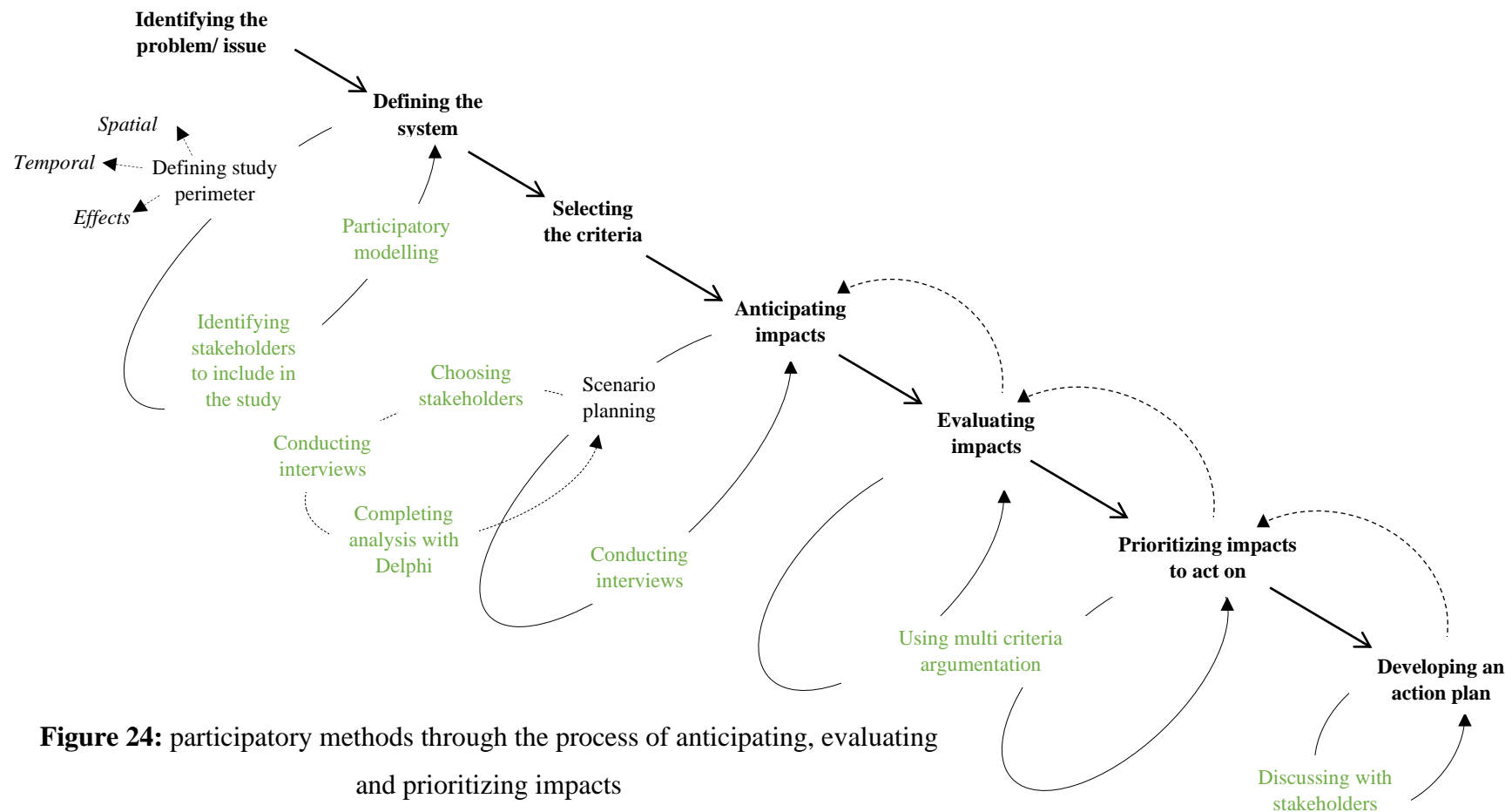

Figure 24: participatory methods through the process of anticipating, evaluating and prioritizing impacts

Section VIII. Using prospective methods in type II SLCA

In the previous section, the different participatory approaches were presented. We saw through figure 24 that participation is key all throughout the ex-ante evaluation process and that it is implicitly key when it comes to anticipating the impacts of changes. In this section, we will be discussing specifically this anticipation phase that requires the use of prospective methods. Those methods put anticipation at the service of action (Godet & Durance, 2001).

1. Different scenario types and prospective methods

Prospective studies first emerged in France in the early 1950s. Prospective is a discipline that aims to have a vision of a desired future so that stakeholders and decision makers act better in the present and question paradigms of thought. It comes as an opposition to the term ‘retrospective’, which consists of looking to the past.

Prospective methods use scenarios. Those are conditions of important variables at a given time and they consist of the evolution from current conditions to other futures (Pesonen et al., 2000). The term scenario is usually misused as it sometimes refers to a succession of hypotheses. However, these hypotheses, in order to be able to constitute a scenario, must simultaneously meet five conditions: relevance, coherence, plausibility, importance and transparency (Godet & Durance, 2001). Scenarios are not a future reality. They are rather a means of representing a possible future reality to highlight actions to take in the present, in light of possible and desirable futures.

There are different types of scenarios (Börjeson et al., 2006; Marini & Blanc, 2014) :

- Predictive scenarios for trends: those scenarios are a continuation of current trends without major breaks
- Explorative scenarios that answer the question ‘what can happen?’ Usually in an exploratory approach, we start from a known situation and explore the future gradually. Qualitative methods such as Delphi and other types of questionnaires can be included in exploratory methods. Quantitative methods using econometric data and expert reports are also used to describe the future.

- Normative scenarios answer the question ‘how can a specific target be reached?’ In a normative approach, a possible future is described to then come back to the present situation.

When it comes to evaluating *ex-ante* the impacts of a change in an agri-food value chain, comparing different scenarios is useful. This comparison should always be done according to the ‘business-as-usual’ (BAU) scenario, meaning the trend scenario. However, the value chain’s context can be so unstable and changing that it can be quite difficult to know what the BAU scenario will be¹⁵. Indeed, the state of the agri-food value chain whether it is with or without the changes is uncertain and can be controversial, especially when a wide diversity of stakeholders are involved, thus the multiplicity of upheavals within the sector makes it necessary to consider several equiprobable but divergent developments. The types of scenarios that are thus useful for our case are trend scenarios and normative ones.

2. Different types of prospective methods

Several methods use normative scenarios.

- Backcasting¹⁶ methods consist of describing a desired future and then describing the path required to get there (Börjeson et al., 2006; Oluwarotimi Akintan, 2014).
- Visioning means that after analyzing the current state, a possible and desirable future is described and new data is generated. The vision is then revised according to the information found (Börjeson et al., 2006).
- Scenario planning is the third method category that uses normative scenarios. It supposes that several possible futures are described using quantitative and qualitative information. The scenarios obtained should be fundamentally different. This type of method is very effective in uncertain and controversial contexts (Barré, 2000; De Jouvenel, 1964; Mermet, 2004; Schoemaker, 1993, 1995)

To make the analysis of impacts even more interesting, it is best to have different contrasted scenarios that describe several paths from the present situation to a future one. For those reasons, scenario-planning methods seem to be the most adapted ones.

¹⁵ This is the case for the French pork value chain as we’ll see in chapter 4.

¹⁶ In his book “On the Cusp of Global Collapse? Updated Comparison of The Limits of Growth with Historical Data” (2012) Graham Turner uses backcasting differently. He backcasts on the forecasts for the period 1972-2012 that were made by “The limits to growth” Meadows report. In other words, G. Turner shows how the 40 years since 1972 are consistent with the trend scenario.

There are two big families in scenario planning. The English methods and the French ones (Godet et al., 2008). Both explore breakthrough hypotheses. However, the difference is that in English methods, the different contrasting scenarios are predefined, or described by the stakeholders themselves, whereas in French methods, various scenarios that the stakeholders do not necessarily think of are created. Those scenarios are usually very specific to the value chain studied unlike predefined scenarios that can be broad. As we said earlier when explaining our epistemic positions, we want the knowledge produced to be idiographic, meaning it is specifically related to the value chain and its stakeholders. For those reasons, the French prospective scenario planning normative methods are most interesting to us.

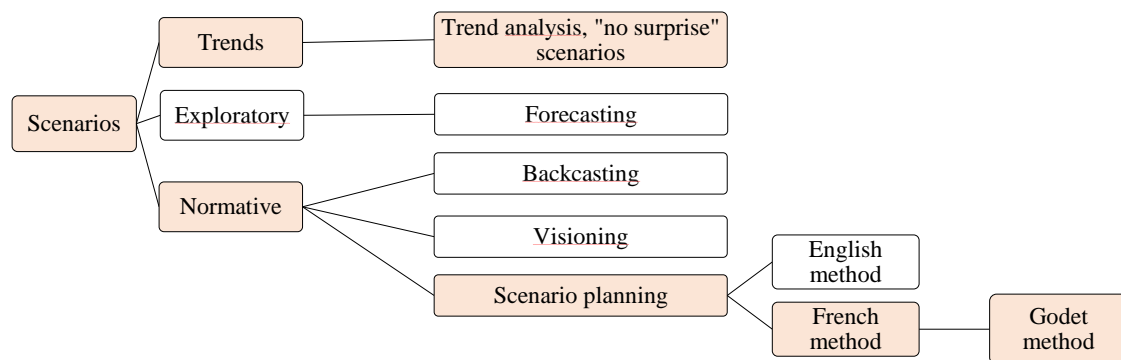

Figure 25: different types of scenarios and the methods in which they intervene

Figure 25 above summarizes the different types of scenarios and the corresponding prospective methods. The scenarios and methods marked in orange are the ones we use.

3. The Godet method

“The [Godet] scenario method aims to construct possible representations of the future, as well as the means to achieve strategic objectives. The goal of these representations is to reveal the prevailing trends and the seeds of possible ruptures in the competitive business environment” (Godet & Durance, 2001)

The Godet method of the CNAM (Conservatoire National des Arts et Métiers) is a French prospective method with the particularity of creating scenarios that the actors have not necessarily thought of. We can distinguish two main phases when using the Godet method. Those are the structural analysis and morphological analysis phases that are thoroughly detailed in Godet and Durance (2001).

a. The structural analysis

The structural analysis phase of the French prospective Godet method is based on discussions between stakeholders. Godet & Durance (2001) do not specify a method to use when it comes to choosing stakeholders to involve in the study. Their approach is to gather a large number of people, emitting the hypothesis that the pool selected is surely representative of all the population and that all different opinions will come up. Nevertheless, it is quite difficult to reunite a large group of prospects and even if it can be done, it is not possible to guarantee at a hundred percent that all opinions will surface. We made the choice of choosing stakeholders according to Mitchell, Agle and Wood's classification (1997) for the reasons stated in section VII (stakeholder positions, power balance, possible convergence and divergence of objectives, etc...).

After the stakeholders to include in the study are chosen, they are normally all reunited in one place. They are incited to discuss of the factors that could influence the future of the value chain or be influenced by it. Once those factors are identified, the stakeholders attribute influence and dependence scores to each one of them by drawing all the relationships - cause to effect - between all the pairs of factors. Consensus is key when using the Godet method. All stakeholders must agree on the variables identified and on the relationships between all the pairs of variables. Because of the number of links between variables, two scores (of dependence and of influence) are attributed to each of those variables. Once consensus is reached, the results are represented through a graph similar to the following one in figure 26, to sort out the different factors according to their future role.

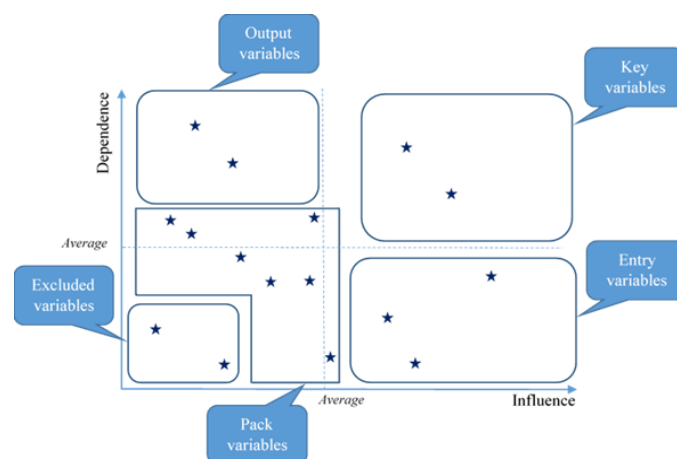

Figure 26: positioning variables (mathematical translation of the factors) according to their influence and dependence scores as they are attributed by the stakeholders

If the variables are very influent and little dependent, they are the input or “entry variables”, so the built scenarios use them at the beginning of the prevision. On the contrary, the very dependent and little influential variables are “output variables”: their value is given at the end of the scenario elaboration. “Pack variables” are moderately dependent and influent, so they are seldom included in the scenarios. As for the “excluded variables” they are neither very dependent nor very influential, either because they constitute major trends that do not modify the dynamics of the system, or because they are independent of the value chain and develop relatively autonomously. Their exclusion can therefore be considered without consequences for the analysis, so they are not taken into account when constructing the scenarios. Finally, the “key variables” have the particularity of being both more influential and more dependent than the averages calculated. Consequently, it is impossible to anticipate in which direction they will evolve. They represent factors of instability. This means that they represent important issues, since despite fairly small changes, they can make the situation evolve in very different directions.

Table 1 is a summary of the different sub-steps of the structural analysis phase. It also indicates the people involved in each phase and the tools that are normally used in the Godet method (Chaib et al., 2022a).

Step	Who does what?	Tools used in the classic method
1. Delimiting the system, choosing stakeholders and conducting interviews	<p><i>Researchers:</i> identifying the prospects.</p> <p><i>Researchers:</i> make individual and collective interviews with specialists.</p> <p><i>Prospects:</i> provide variables influencing the system evolution.</p>	<p>No specific method.</p> <p>Brainstorming, workshops, etc. to determine the main variables influencing the system evolution.</p>
2. Determining the key variables and their modalities	<p><i>Researchers:</i> make a list of the variables quoted by the prospects; merge the variables standing for the same concept; organize groups (e.g. 3 groups of 10 prospects).</p> <p><i>Prospects:</i> each group of prospects builds a consensus about the relationships between the variables.</p> <p><i>Researchers:</i> build the matrix of relationships between variables for each group, and provide a synthesis matrix to be discussed by the group of prospects as a whole; select the key variables as those which are at the same time more influential than the average, and more influenced than the average (see Fig. 1); implement new surveys of experts if reduction of the number of key variables is needed.</p>	<p>The relationships between variables (influences and dependences) are built by consensus during collective workshops, by small groups, then all together.</p> <p>'Survey of experts' methods such as Delphi, Régnier's Abacus, or Smic-Prob-Expert allow the team to reduce the number of key variables.</p>
3. Elaborating the base scenarios	<p><i>Prospects:</i> build a consensus about the main modalities that can be taken by each key variable.</p> <p><i>Researchers:</i> envision the different possible combinations of modalities.</p>	<p>Collective workshops.</p> <p>The general base scenarios are built as combinations of the possible modalities for all key variables.</p>

Table 1: summary of the people involved and the tools used in the structural analysis phase of the Godet method (Chaib et al, 2022a)

b. The morphological analysis

Once the key variables to take into account are identified, the reunited stakeholders identify the modalities of each key variable, meaning the values that each key variable can take. Depending on the number of key variables and the number of modalities, several scenarios can be created by combining each modality of each variable together. They are represented in a possibility tree. Figure 27 is an example of what is obtained if we have 3 key variables, 2 of which have 2 modalities and one that has three modalities.

Once we have that possibility tree, the aim is to search for incompatibilities between modalities. Those incompatibilities do not always exist. However, when they do, the scenarios that integrate them are eliminated as they can't be possibly realizable.

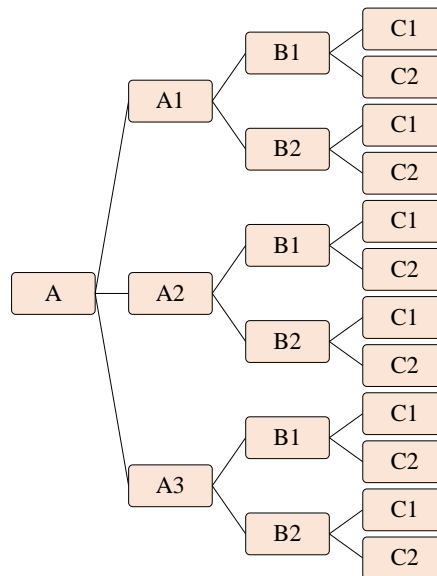

Figure 27: different possible scenarios obtained by combining the modalities of the key variables.

4. Using the Godet method to create detailed scenarios

Once the structural and morphological phases are complete, a third phase, which is not specific to the Godet method, can be initiated. It is called the diachronic phase. It consists in describing the paths leading from the current situation to the final images remaining after the morphological analysis. Godet does not specify a certain way to do so; neither does he specify exactly what should be done with the scenarios and how many we should keep.

The following process is proposed. Once we have all the possible scenarios, they are all briefly described in broad outline. They are then presented to the interviewed stakeholders. Depending on the time available to finish the study, on the means provided and on the objective of the study, some or all scenarios can be detailed. In our case, because that is what is planned in project Sentinel, the researchers are asked to choose two contrasted reference scenarios, which are later on detailed. The transition to the detailed scenario is delicate because it involves a significant amount of subjectivity and depends closely on the participants' knowledge of how the sector works. The objective is to explain/unroll/quantify how the value chain will evolve from the current situation to that described in the framework scenario in the years to come¹⁷.

¹⁷ This highly depends on the spatio-temporal perimeter described before starting the study. In our case, the scenarios are elaborated for the 3 to 5 years to come because beyond that time scope, anticipating evolution of the value chain becomes difficult for the interviewees.

The method proposed to detail the scenarios is the following. It is not specific to the Godet method as it is described in Godet (2007, 2008):

- It involves evaluating the efforts required (e.g. training of young people) to arrive to the framework scenario.
- It requires collective reflection: all ideas are welcome and deserve debate, including from people who think they know nothing about the value chain. Similarly, all questions are taken into account.
- Everyone brings their expertise and ideas.
- One single scenario is detailed at first.
- The list of variables obtained through the structural analysis phase are used, whether they are input, output or excluded variables. The question to ask is “how will this variable evolve?”
- Limiting factors in the reference scenarios are looked for. Taking into account these constraints allows the quantification of the main characteristics of the corresponding detailed scenario.
- The data needed to verify the feasibility of the ideas proposed is gathered.
- Consistency of the suggestions with developments in society is needed.
- Everything that can be quantified is quantified.

Once the chosen reference scenarios are detailed, the change envisioned in the value chain is introduced in each scenario. The stakeholders and/or experts are then asked what they think the impacts of that change could be in the scenario studied. In the following sections, the identification and evaluation of those impacts are thoroughly detailed.

Conclusion: using the Godet prospective method

Take-away 1 from this Section

Figure 28 below is a summary of the different steps required to create reference scenarios, throughout the structural, morphological and diachronic phase.

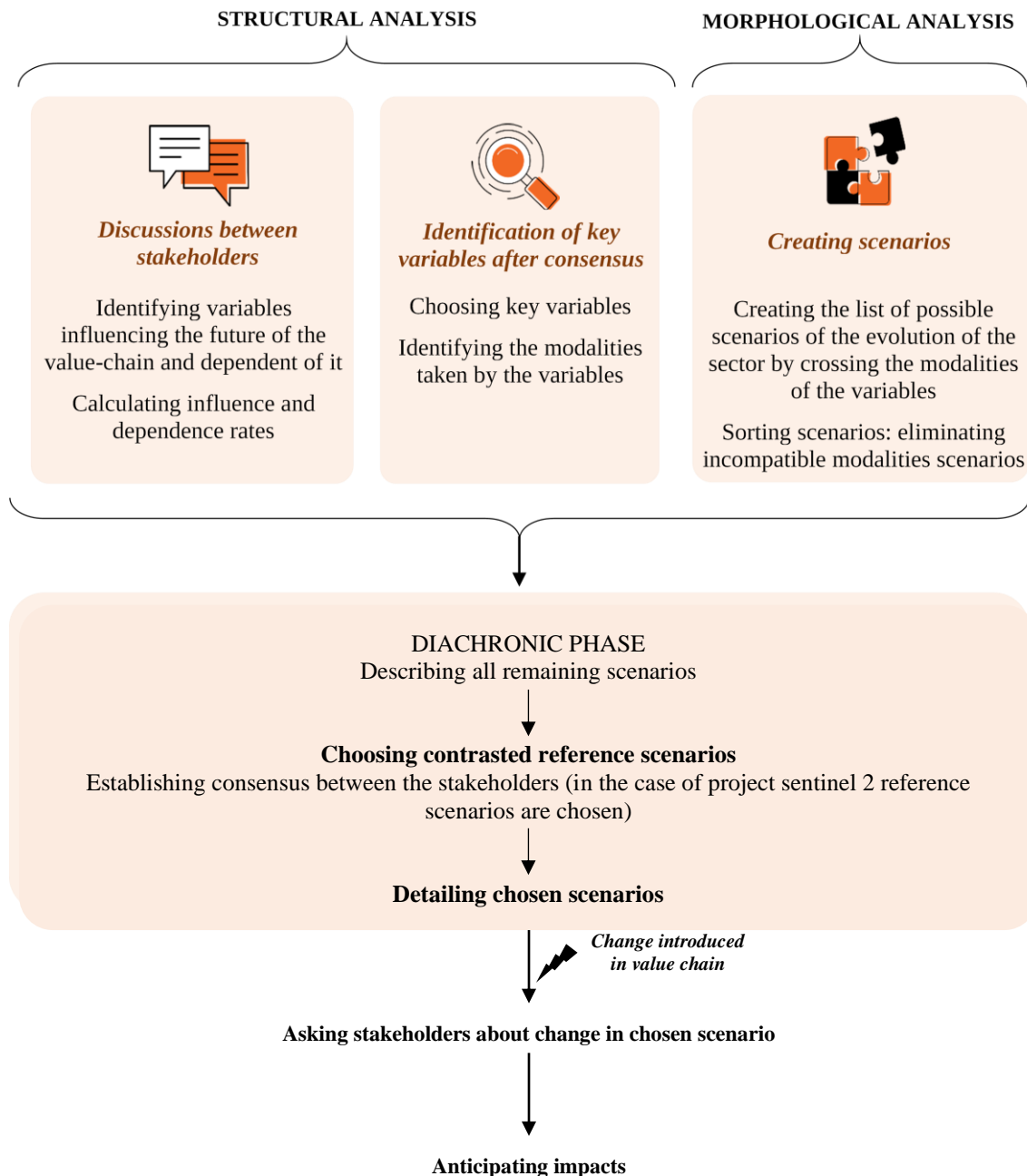

Figure 28: summary of the steps required to create reference scenarios

Take-away 2 from this Section

Figure 29 below details a bit more the process followed when anticipating and evaluating the social impacts of changes within an agri-food value chain. Steps in green represent the added value throughout this Section.

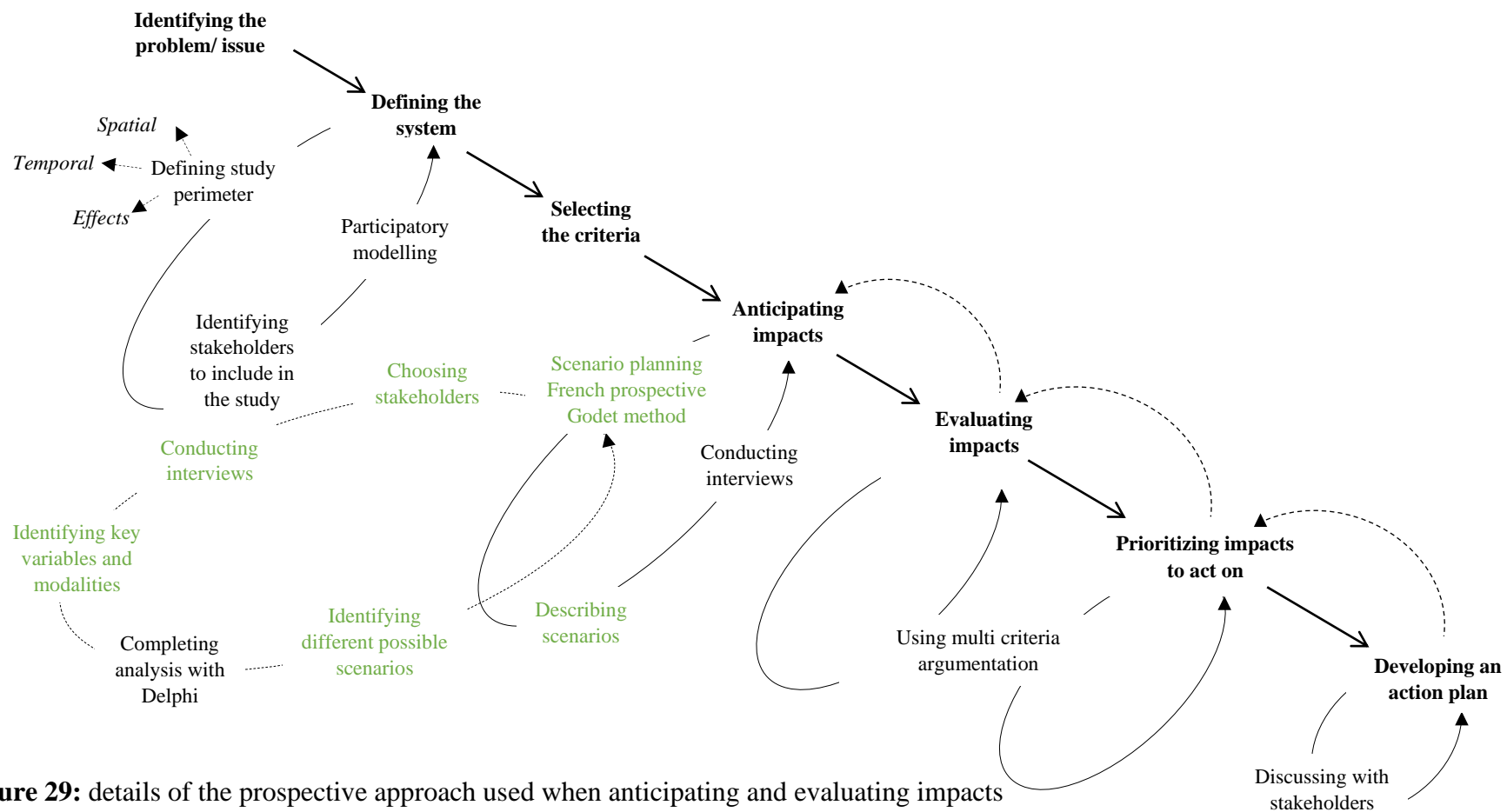

Figure 29: details of the prospective approach used when anticipating and evaluating impacts

Section IX. Using multi criteria argumentation to complete impact anticipation and evaluation

Identifying and evaluating the impacts is crucial for the choice of the ones to prioritize and bring to the attention of the stakeholders (Arce-Gomez et al., 2015). To ensure a viable and useful approach, it is important we engage participants by “using their knowledge and local expertise to identify community-level impacts” (Becker et al., 2003); they are in the best position to tell us what could happen and how the food system could evolve. This guarantees that the impacts identified are relevant to the food system’s stakeholders (Arce-Gomez et al., 2015; Becker et al., 2003, 2004), and that they are also as diverse as possible so that we do not neglect any impact category and especially any stakeholders. In this section, we explain why multi criteria argumentation-based approaches are adapted to the objective set.

1. What is multi criteria argumentation?

“Argumentation is a reasoning model based on the construction and the evaluation of interacting arguments” (Amgoud et Prade, 2009, p. 4). In decision-oriented approaches such as the latter, an argument is a statement that justifies or counters an alternative in order to accomplish an objective; in multi criteria oriented works, such as those considering food chain analysis, this objective refers to a criterion (Thomopoulos et al, 2020).

Dung's work is a precursor to today's methods of argumentation. His theory is based on an abstract argumentation system, highlighting binary relations between arguments (attack relation) to return sets of good arguments called extensions (Dung, 1995) as well as arguments without conflicts. The notion of defense is defined by Dung as the attack of a possible assailant of the argument to be defended. There are four types of attacking relations between arguments. The first is when doubts are raised through asking critical questions. The second one is when an argument’s hypothesis is questioned. The third attack relation consists of proving the irrelevance of an argument as to the conclusion made. Last but not least, the fourth attack relation that Dung talks about is when an argument supporting an opposite conclusion is presented; in that final case, it is the consequential relation (or implication or causal relation) between a hypothesis and the conclusion of an argument that is attacked¹⁸. Non-conflicting

¹⁸ An example of this type of attack would be providing a case where the same assumption leads to the opposite conclusion of what is meant to be defended.

arguments according to Dung are arguments that do not attack each other. Dung's work is seminal and has opened the way to various theoretical and applied works. It has also led to different currents of thought (abstract, logical, structured...) when it comes to argumentation. Despite it being very rational and theoretically coherent, Dung's theory has nevertheless its limits:

- It lacks certain notions when applied to real life situations. Dung indeed described the intuitive meaning behind what we call an argument. Nevertheless, in real life, it is much more difficult than that to describe abstract arguments stated by stakeholders in a decision-making process (Salliou & Thomopoulos, 2018). Plus, the relations between those arguments are also much more complex than the four stated above. This makes it quite complex to trace all types of relations between arguments, even more so since a high number of arguments is usually given in a statement. Additional features have to be linked to the argument (the decision also referred to as 'action' or 'alternative', the goal or 'target' and the actor) (Salliou & Thomopoulos, 2018)
- It gives equal weights to all arguments. However, an argument is built from several pieces of information that are more or less important depending on the actors and the sources. It is unlikely that the arguments raised carry the same weight (Bourguet, 2010).

When it comes to making a change in a value chain, several criteria must be taken into consideration and several actors are involved, making the decision-making process quite difficult. A way of alleviating this complex task is by combining argumentation with multi criteria approaches. That way we technically have the best of both worlds: we take into account the different criteria, while also making sure all stakeholders have a say and all opinions are represented. Several authors proposed different ways of incorporating argumentation in multi criteria approaches in the aim of providing an explanation behind the decisions taken (Bisquert et al., 2017; Bourguet et al., 2013; Salliou & Thomopoulos, 2018; Thomopoulos, 2018; Thomopoulos et al., 2020)

Multi criteria argumentation consists of analyzing arguments which express stakeholders' opinions about different alternatives pursued (Thomopoulos et al., 2020). The aim is to measure the acceptability of the alternatives in order to help deciders make the best choice possible when it comes to implementing change in the value chain.

Multi criteria argumentation is based on three concepts:

- Multi criteria approaches: it consists of evaluating a set of pre-fixed alternatives (e.g. pursuing business as usual) according to several criteria (e.g social, economic, etc..). Those evaluations are made based on attributes which describe the alternative (i.e. gain is not distributed fairly amongst the stakeholders of the value chain) meaning they elicit certain ‘values’ of a criterion (Belton & Stewart, 2002; Thomopoulos et al., 2020).
- Argumentation: analyzing stakeholders’ opinions is indeed very important when looking at alternative scenarios for the value chain (Bisquert et al., 2017; Thomopoulos et al., 2020), which is a reason why we base our methodology on stakeholders’ arguments, meaning their expression of an opinion concerning the studied alternative.
- Social psychology: stakeholders’ opinions are translated in a value called attitude: a stakeholder’s attitude towards an aim (i.e. distributing value fairly) in an alternative (i.e. pursuing business as usual) is the proportion of arguments given in favor of this aim in this alternative weighted by the proportion of all arguments given for this aim in all alternatives explored (Fishbein, 1967; Thomopoulos et al., 2020). This attitude reflects the stakeholders’ acceptabilities of the alternative considered.

The following paragraphs show how things usually work in an argumentation-based multi criteria process.

a. Constructing the arguments

Based on the work done by Amgoud & Prade (2009), Bourguet et al. (2013), Salliou & Thomopoulos (2018), an argument is a combination of all the following elements:

- An actor proposing the argument
- A source i.e. where the argument comes from. This can be a journal, a face to face interview, an official report, etc...
- A criterion: the argument given can usually be categorized in criteria (e.g. economic, environmental, social, technical, political, etc...)
- A type: generally there are two main types of arguments. Arguments in favor reflect that the actor expects positive impacts of a change whereas arguments against refer to negative impacts.

Table 2 below shows the different sub-categories of those arguments that we might encounter when interviewing stakeholders concerning impacts of changes in agri-food value chains.

Arguments in favor of a scenario	Arguments against a scenario
Arguments that point out the existence of positive impacts (PP)	Arguments that point out the absence of positive impacts (PC)
Arguments that point out the absence of negative impacts (NP)	Arguments that point out the existence of negative impacts (NC)

Table 2: different types of arguments in favor and against a scenario

- A statement: this means that the arguments given are usually based on certain beliefs or conclusions. We can thus distinguish between epistemic and practical arguments (Amgoud & Prade, 2009). Epistemic arguments are solely based on beliefs whereas practical ones are based on beliefs but also highly depend on the interviewee's goals and concrete knowledge (Amgoud & Prade, 2009).
- A hypothesis: this corresponds to the rationale behind the argument, i.e. the knowledge the actor can give to support that argument.

Table 3 below shows two examples of arguments, one positive and one negative.

Actor	Source	Criterion	Type	Statement	Rationale
Producer	Interview	Economic	-	Investing for better pork production	Investments needed for better respect of animal welfare
Researcher	Interview	Production ways	+	Improving production ways	Change in transformation processes

Table 3: examples of practical arguments

The arguments can thus be structured by associating all this detailed descriptive data (Thomopoulos, 2018). Multicriteria argumentation is in consequence a structured argumentation.

b. Evaluating the strength of each argument

After the different arguments are identified and constructed, their strength is evaluated. Indeed, arguments are not necessarily of the same strength.

Epistemic arguments are considered strong when the beliefs on which they are based are founded and can be proven; we then talk about certainty. On another hand, practical arguments'

strength is measured according to certainty but also according to two other elements: importance of the criteria to which it refers and the (dis)satisfactions level associated to the criteria (Amgoud et al., 2005).

In our case, we will see in the next sections that the notion of strength of an argument is deduced from the repetition of this argument in the sources of information consulted.

c. Identifying conflicts between arguments

Conflicts amongst arguments are identified. This step is very important. In fact, from the start, divergent opinions are searched for; it is therefore logical that contrasting and conflicting arguments concerning a same change will emerge. Besnard & Hunter (2007) defined two kinds of attack relations between arguments:

- Rebutting: this means that an argument A_1 is the opposite of another argument A_2 . A_1 and A_2 's statements are contradicting. "Using classical logic, if A_1 has the claim α , and A_2 has the claim $-\alpha$, then A_1 and A_2 rebut each other" (Besnard et Hunter, 2007, p. 4)
- Undercutting means that an argument attacks the assumptions insinuated by another argument concerning either the statement or the logical inference between the argument's statement and its hypothesis. "Assuming classical logic, suppose an argument has a support that includes the information that β holds, and the information that $\beta \rightarrow \alpha$ holds, and the claim that α holds, then an example of an undercutting argument would be an argument with a claim that is the negation of β (i.e. $-\beta$) or the negation of $\beta \rightarrow \alpha$ (i.e. $-(\beta \rightarrow \alpha)$)" (Besnard et Hunter, 2007, p. 4-5)

From those conflicting relationships, we can identify counter arguments. A_2 is a counter argument of A_1 if A_2 rebuts or undercuts A_1 .

Dung in "Computational Models of Argument" (2006) talks about a third attack relation between arguments based on assumption. It basically mean that attacking an argument can be done through attacking its assumptions.

According to Amgoud & Prade (2009), epistemic arguments can be used to validate, rebut or undercut beliefs on which practical arguments are based. They can also be used to challenge the knowledge on which a practical argument is based, especially when the knowledge is inconsistent. Beliefs can also attack other beliefs, meaning that there can be conflicts between epistemic arguments.

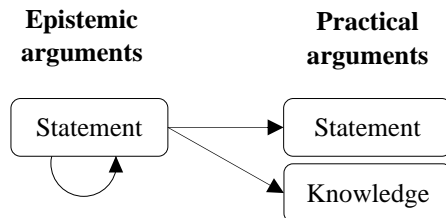

Figure 30: possible conflicts between arguments according to Amgoud & Prade (2009)

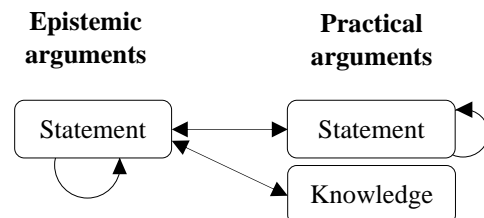

Figure 31: possible conflicts between arguments concerning impacts of changes in agri-food value chains

As for the practical arguments, Amgoud and Prade consider that those cannot conflict because they point out to certain advantages or disadvantages of a decision. We do not necessarily agree with that. Practical arguments can be counter-arguments of other practical arguments as well as counter-arguments of epistemic ones. It is very important that all those arguments be listed, as all potential conflicting information is relevant in the decision process. Plus, this distinction between epistemic arguments that can attack other arguments and practical ones that cannot is not always taken up (e.g. Thomopoulos, 2018) as it is not necessarily operational in case studies. Indeed, when discussing matters with stakeholders, they do not necessarily make a distinction between practical or epistemic arguments, which is a main reason why in the rest of the manuscript, no distinction is made between those two types either. All arguments given by the stakeholders are important. They are all listed regardless of them being practical or epistemic.

d. Evaluating arguments' acceptabilities and comparing the outcomes

The problem that needs to be solved is the following: in a set of alternatives (i.e. implementing the change in the value chain or keeping things as is, implementing the change at different times and places etc...), the different impacts of that change need to be examined (from stakeholders' opinions) to determine the best decision to be taken. When talking about that change with the chosen interviewees, they will give arguments and justifications to why they think such alternative is best. The aim is not to ask for a general vote on what everyone thinks should be done but rather to combine the qualitative argumentative preferences with an implicit voting

method. This process can be translated through the notion of ‘attitude’ or ‘acceptability’. Bisquert et al. (2017) proposed such a framework relying on the aggregation of individual preferences to compute a collective preference. Thomopoulos et al. (2020) also described a way of evaluating argument’s acceptabilities based on the principles of social psychology theory. It is a numerical way of evaluating the perception of stakeholders’ opinions, “derived from the perceived likelihood that the choice is associated with a number of key outcomes, weighted by the evaluation of those outcomes” (Thomopoulos et al., 2020). Arguments in favor or against the change are indeed collected from a variety of sources and stakeholders. An attitude is then calculated according to the formula described in Vivas et al. (2022)

$$\text{Collective attitude (s)} = \frac{1}{n} \sum_c n_c \frac{n_{s,c}^+ + 1}{n_{s,c} + 2}$$

- ✓ n is the total number of arguments for all scenarios and all criteria
- ✓ C is the number of criteria considered
- ✓ n_c is the total number of arguments (positive and negative) for all scenarios considered according to a criterion c
- ✓ $n_{s,c}^+$ is the number of positive arguments in favor of a scenario s according to a criterion c
- ✓ $n_{s,c}$ is the total number of arguments (positive and negative) for scenario s according to the criterion c

The following paragraphs explains the logic behind this formula. In the beginning, before any arguments are given the attitude equals 0.5. In fact even though there are no arguments given there are still two initialization arguments that are kind of ‘hidden’ in the backstage. The first argument is a positive one suggesting that the absence of negative arguments is a positive argument itself. The second argument is a negative one implying that the absence of positive arguments is a negative argument itself. This case is thus valid when there is a total ignorance of the matter at hand. Nevertheless, as interviewees give arguments, the value of the attitude changes. Let’s deconstruct the formula to make the notion of attitude clearer:

$\frac{n_{s,c}^+ + 1}{n_{s,c} + 2}$ is the proportion of positive arguments for a given criterion and a specific scenario, the +1 being there because of the ‘hidden’ positive argument, and the +2 being the sum of both ‘hidden’ arguments. For the criterion considered, multiplying that value by n_c allows us to weigh the criterion. In consequence, $n_c \frac{n_{s,c}^+ + 1}{n_{s,c} + 2}$ is the value reflecting the attitude of the interviewees concerning the criterion c for a scenario s . To obtain the collective (global)

attitude, all the attitudes of all criteria are summed and then weighed by the total number of arguments for all scenarios and all criteria¹⁹.

The attitude obtained is a number between 0 (total rejection) and 1 (total approval). Those two values are however never attained (because of the two underlying arguments we talked about above). An attitude equal to 0.5 in cases where arguments are given, reflects an uncertainty regarding a scenario or a criterion.

One of the main advantages of Thomopoulos et al.'s approach (2020) is that it can be carried on at an early stage of the debate and the measure is updated with the arrival of new arguments. It also allows an analysis of the results at different scales, for one specific criterion, or one specific stakeholder. The different outcomes can then be compared, leading up to a classification of the different scenarios.

e. Classifying the scenarios

The scenarios are then classified to identify the best possible decision. The decision should be in favor of the outcome with the most supportive arguments and/ or with the least disproving arguments logically. This means that the most favorable outcome should logically be the one with the attitude closest to 1.

The advantages of using argumentation-based multi criteria approaches can be summed up in the following points (Amgoud et al., 2005; Thomopoulos, 2018)

- Deals with qualitative or qualitatively perceived criteria
- Models close to the way people think
- Useful in uncertain contexts as it provides a unified setting where all arguments are treated the same way. Multi criteria argumentation is essential when the information gathered during interviews is sometimes inconsistent and when we have several sources of information with different priorities (Thomopoulos, 2018)
- Diverse information concerning economic, social, environmental and other objectives are integrated and the conflicting aspects of all those criteria are handled objectively according to the views and opinions of the individuals involved. This allows for a more realistic assessment (Sadok et al., 2008, p. 163)

¹⁹ We assume that the more a criterion is mentioned/discussed in our information sources, the more important it becomes. This is how the weighting of criteria is defined. This has the advantage of having a palpable and measurable meaning, compared to many multi criteria methods where weights are arbitrarily attributed by the decision-maker.

- It includes the positive impacts as well as the negative ones which is very important according to Di Cesare et al. (2018)
- Attributes values to the consequences of decisions taken

2. Combining multi criteria argumentation and type II SLCA

Multi criteria decision aiding and LCA have been combined several times in many research fields related to the environment. Multi criteria argumentation is however a relatively new research field. It has been combined with environmental LCA once in Sohn et al. (2020). In fact they used multi criteria argumentation to better interpret the results of LCA in order to better communicate the results of it. The goal is to eventually aid stakeholders in their decision-making processes. The tool used is the Argumentation Corrected Context Weighting-LCA (Argcw-LCA).

Multi criteria argumentation and social LCA have never been combined before. There were some tentatives at combining MCDA with SLCA but they were unfruitful. Indeed, the conclusion of Feschet & Bockstaller (2014) was that the multi-criteria assessment methods of agricultural systems analysed are not very compatible with social LCA taking into consideration the context of the study and the perimeter and scale fixed. We believe that multi criteria methods, more specifically multi criteria argumentation, is compatible with social LCA and that the benefits of combining those two approaches could be the same as the ones obtained in the Sohn et al.'s study (2020). Some advantages also exceed our expectations as we'll see later on in chapters 4 and 5 regarding the perspectives of our work. Table 4 below summarizes the conclusions of Feschet & Bockstaller's work which we take back to show that if a certain context is pre-defined, multi criteria argumentation methods (MAM) and social LCA are compatible.

Feschet & Bockstaller (2014)	This manuscript
Multi criteria methods are not specific to social impacts.	Multi criteria methods are not specific to social impacts, but they do take them into consideration.
Indicators take into account practices but do not consider the consequences on people.	Indicators of MCA take into account practices and consider the consequences on people.
Results are usually reported on a small spatial scale : difficulties in comparing scenarios.	Results can be reported on various scales: possibility of comparing scenarios.

Evaluation perimeter restricted to a farm and does not take into consideration stakeholders upstream and down stream breeding.	Evaluation perimeter is not restricted to one group of stakeholders and does take into account upstream and downstream stakeholders.
--	---

Table 4: revisiting Feschet and Bockstaller’s results by considering multi criteria argumentation methods (MCA)

If we take back what was said in Feschet’s study, even though multi criteria methods are not specific to social impacts, we do take them into consideration and it is possible to focus solely on them if we want to, by using this specific method. The indicators extracted take into account practices and consider the consequences on people since multi criteria argumentation is based on the arguments given by stakeholders. So if the question we ask them is “what are the consequences according to you?” it seems logical that the answers we will have concern consequences. Feschet’s study was not conclusive since it was at a very small scale. Our results can be reported on various scales and we have a possibility of comparing scenarios. This highly depends on the questions we ask our experts. Finally, the evaluation perimeter is not restricted to one group of stakeholders since we aim to get a high diversity of experts that have diverse and divergent opinions. Multi criteria argumentation therefore seems to be a good way to remedy the difficulties highlighted by Feschet et al.: it incorporates stakeholders’ perspectives and opinions, making the decision-making process more relevant (Estévez et al., 2013; Freeman & McVea, 2001; Sohn et al., 2020).

The tool chosen for this process is the MyChoice tool. It is a multi-criteria decision support tool for analyzing, comparing and evaluating the acceptability of different alternatives. Of course screening and prospective phases are necessary too. We’ve already talked about that in the previous sections. We will only talk about how to anticipate, evaluate and prioritize the impacts in the following paragraphs.

a. Anticipating the impacts in MyChoice

Speaking and writing is based on grammatical rules which demand the use of logical connectors; these tool words can be used alone or in combination with other words, in order to establish logical relationships, describing a cause or a consequence when it comes to expressing impacts (Charton & Torres-Moreno, 2011).

When interviewing the stakeholders about the value chain, interviewees intuitively construct arguments in favor or against the matter discussed (here a change in the agri-food value chain). Some of the words they use to highlight impacts of pursuing a scenario are shown in table 5. Those are the words we look for during our analysis. Since the interviews and the documents read are in French, the words in table 5 are also in French.

Category	Preposition	Subordination conjunction	Conjunctions and coordination adverbs	Verbs
Cause	A cause de, à la suite de, en raison de...	Parce que, puisque, comme, vu que...	Car, en effet...	Venir de, découler de, résulter de
Consequence	Au point de, de peur de,...	De telle sorte que, de telle manière que, si bien que...	Donc, aussi, c'est pourquoi...	Impliquer, entraîner, causer, susciter...

Table 5: examples of French logical connectors when talking about impacts extracted from (*Charton & Torres-Moreno, 2011*)

Words such as impact, consequence, cause, and any other synonyms are also highlighted. In addition, the way the verbs are conjugated in French can highlight potential impacts. Even though there are specific words and phrases to look for, it is still necessary to proof-read the interviews again, just to make sure we haven't missed any impacts cited; language and words could in fact be used differently from one stakeholder to another.

After the impacts in the texts are identified, it is time to enter the information in the MyChoice tool spreadsheet as shown in table 6. Each line corresponds to one argument. The impacts identified can be on different scales.

Name Stakeholder	Name Alternative	Type Pro Con	Name Criterion	Aim	Name Property	Value	Condition	Is Prospective	Name Source
Stakeholder impacted by change	Evaluated scenario	Whether the impact is perceived positively or negatively by the stakeholder	Category of impact	What impact is desired	Real impact	Strong, probable, possible, impossible	Cause of the impact cited	1 if related to 'Business as usual', 0 if not	Stakeholder interviewed

Table 6: how information is entered using the MyChoice tool

b. Evaluating the impacts

The values attributed to an impact cited by a stakeholder are marked in the column 'Type Pro Con' as either '+' if the impact is positive on 'Name Stakeholder' according to the 'Name Source'. The value is '-' if the former is not true.

The acceptabilities/ attitudes are calculated automatically in MyChoice by looking at information quantities of arguments pro and con. The equation used to do so is the collective attitude equation presented on page 119. If the final value is lower than 0.5, this means that by pursuing 'Name alternative', the 'Aim' I is not met. But if the attitude exceeds 0.5 it means the opposite. However, if the attitude equals 0.5 there are two possibilities: either the number of arguments is very low and stakeholders are not sure about the importance of this impact, or the number of arguments given is very high, and the stakeholders agree that the impact is highly important but its evolution is uncertain. In the latter case the contradictions between arguments are deduced, allowing the identification of different but robust points of view (Thomopoulos et al., 2020).

Once all the information from all the interviews conducted is sorted into the MyChoice spreadsheet columns, an aggregated attitude is calculated the same way the partial ones are. It reflects the global view of the stakeholders concerning the evolution of the value chain. We can choose to analyze the attitude values according to the 'Name Stakeholder' category or according to the 'Name Criterion' category. We choose to do a cross-analysis of both at the same time in our case.

c. Prioritizing the impacts to act on

The attitudes are marked in a table with color gradients going from dark red to dark green. This allows us to identify the major challenges, which the value chain will have to face as well as the stakeholders who experience or will experience the impacts more than the others.

Nevertheless, the attitudes are not enough to analyze and prioritize the impacts to act on. We have to cross the information of attitudes with that of the number of arguments. And so, each of those three categories of attitudes can be divided again into three sub-categories, depending on the number of arguments given. Those categories are presented below and summarized in table 7. We assume that:

- If the total number of arguments is lower than the median we talk about tendencies rather than a certainty that something is wrong or right

- If the total number of arguments is between the median and the upper quartile, than there is a bit more to say about the impacts, but the assumptions should be taken with a grain of salt.
- If the number of arguments is high enough (higher than the upper quartile), it means that the assumptions made are more founded and truly reflect the stakeholders' positions.

Number of Arguments Attitude]0; Median[[Median; Q1]]Q1; Q3[
]0; 0.4]	Negative tendencies	Probable negative impact	Certainty of negative impact
]0.4; 0.6[Can't say much	Doubtful impact	Mitigation reflecting impact could go either way
]0.6; 1[Positive tendencies	Probable positive impact	Certainty of positive impacts

Table 7: summary of how we interpret the results based on the attitudes and the number of arguments

The notions of tendency and certainty are relative to the stakeholders' opinions. Certain impact categories affect stakeholders unquestionably according to the interviewees.

The results of this classification crossing attitudes/ acceptabilities with the number of arguments given for each impact category are presented in the next few sections of chapter 4. It is important to note that this approach allows us to prioritize impact categories rather than impacts. However, because MyChoice is a structured argumentation, we can easily identify the impacts in each category. This means that prioritizing impact categories allows us to prioritize the impacts as well, based on stakeholder interviews.

Conclusion: the use of multi criteria argumentation in type II social LCA

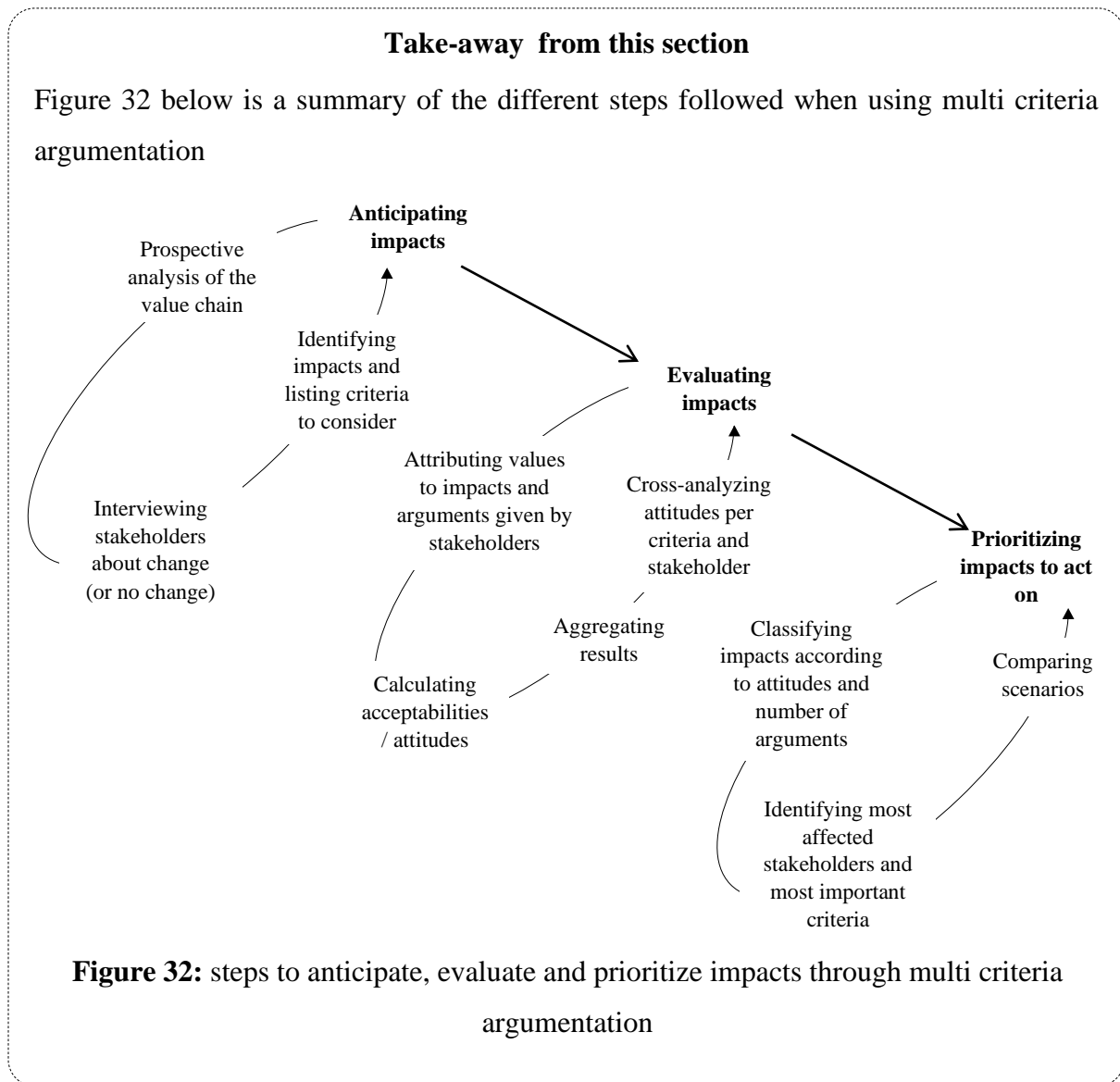

Conclusion of chapter 3: research design and process

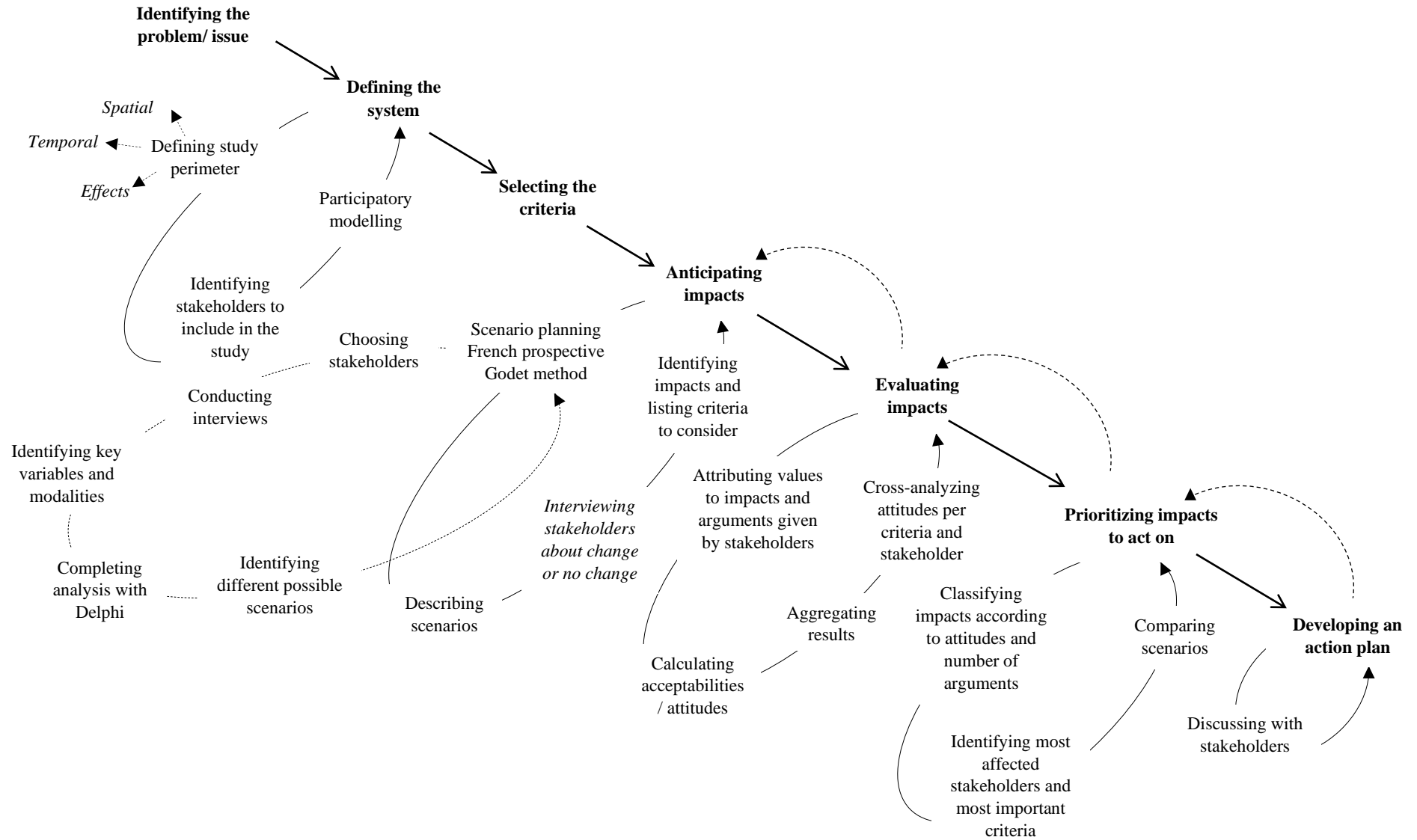

Figure 33: complete research design and process by integrating multi criteria argumentation in a context of type II social

The process followed when doing a type II social life cycle assessment through the prism of multicriteria argumentation can be divided into five main phases:

- i. *Identifying the problem/ issue*
- ii. *Defining the system*
- iii. *Determining criteria to take into account*
- iv. *Anticipating potential impacts*
- v. *Evaluating those impacts*
- vi. *Interpreting results and prioritizing the impacts*
- vii. *Informing and developing an action plan*

Figure 33 is a summary of all steps and sub-steps of each phase. In the following paragraphs, we recap the steps followed to conduct a thorough and complete analysis of the potential impacts.

Identifying the problem/ issue

Describing the current state of the art as well as the potential change

After establishing the current state of the art, the change envisioned in the value chain needs to be detailed: what type of change, when, at what stage of the value chain etc...

It is also necessary to define what we mean by value chain. We talked about this in the previous sections and Sections.

Defining the question(s) to evaluate

It is important to know what type of change we are dealing with.

Defining the system

Defining study perimeter

A screening phase is necessary before starting any study: we have to determine the study perimeter as it highly influences the choice of stakeholders as well as the impacts that will be considered later on (Macombe, 2019).

Identifying stakeholders to involve in the study

The choice of stakeholders to integrate in the study is very important so that the impacts evaluated are relevant (Mathé, 2014; Mendoza & Prabhu, 2000). One thing is for sure, it is important to incorporate a plurality of stakeholders to make sure a diversity of viewpoints is integrated when making a decision (Macombe, 2019; Renn et al., 1993). It is indeed “essential to integrate the opinions not only of those affected by the impacts but also of those such as public decision-makers who affect the evolution of these impacts through regulatory measures”

(Mathé, 2014). Mitchell, Agle and Wood's classification is particularly useful in cases where divergent opinions and a wide variety of stakeholders are needed as mentioned previously.

Participatory modelling of the value chain

Once the stakeholders are identified, the current state of the value chain is established with them. This acts as a starting point for the rest of the study.

Determining the criteria to take into account

It is possible to have a set of criteria to evaluate in mind before starting the evaluation process. This usually depends on the project sponsors. It is however important to keep an open mind as the study goes on, to not exclude any criteria that could be important for the stakeholders of the value chain.

Anticipating potential impacts

Prospective analysis of the value chain

Prospective methods are not part per se of the social LCA methodology. However, it is necessary to conduct a prospective study of the value chain when aiming to do a type II social analysis requiring an anticipation of social impacts. The stakeholders are asked what they think are the key factors that influence the future of the value chain and depend on it. After the interviews are analyzed, the key factors (translated into variables) are identified as well as their modalities that we use to construct the different possible scenarios of evolution of the value chain. The method used is inspired by the French prospective Godet method.

Interviewing stakeholders about change or no change

After that, there are two possibilities. Either we interview stakeholders about what will be the impacts of introducing a certain change in the value chain (or not changing it, in the case of pursuing business as usual) in the future. Or we let them spontaneously describe the impacts of the scenario we are discussing on (e.g. the business as usual)²⁰. In both cases, the interviews done are then transcribed (since verbatim accurately reflect the interviewee's reflections) and analyzed through the MyChoice tool.

Identifying impacts and listing criteria

²⁰ We will see in the next Sections that for certain reasons that are stated, we did not interview the stakeholders again concerning a change in the value chain. We used their spontaneous answers to apply the method explained in this section.

Interviewees argue or support a defended statement. After we have identified the impacts in the texts, we enter the information in the MyChoice tool spreadsheet. Each line corresponds to one argument. The impacts identified can affect different scales.

Evaluating the impacts

Attributing values to arguments given by stakeholders

Calculating the acceptabilities (attitudes)

Aggregating results

Cross-analyzing attitudes per criteria and stakeholder

Details for all four main steps of an evaluation are presented in Section IX.2.b. But to summarize in a few sentences, based on the interviews with stakeholders and experts of the value chain, values and weights (attitudes) are attributed to the arguments given per criterion and per stakeholder. By looking at the values obtained, we can identify positive, negative or mitigated impacts; we can clearly identify who is impacted as well.

Prioritizing the impacts to act on

Details are presented in Section IX.2.c. In short, the attitudes obtained through the evaluation process crossed with the number of arguments given by the stakeholders allow a prioritization of the impact categories thus the impacts when looking at the structured arguments.

Developing an action plan

Based on the results obtained during the previous steps, the impacts that need immediate action or more attention than the others can be identified. Those results should then be presented to decision-makers in hopes that they make the best possible decision considering the time and means available. The verbatim of stakeholders can also be used to pinpoint more clearly what should be done or not later on.

Also, figure 34 below summarizes the advantages of combining multi criteria argumentation (in orange) with type II social LCA (in blue).

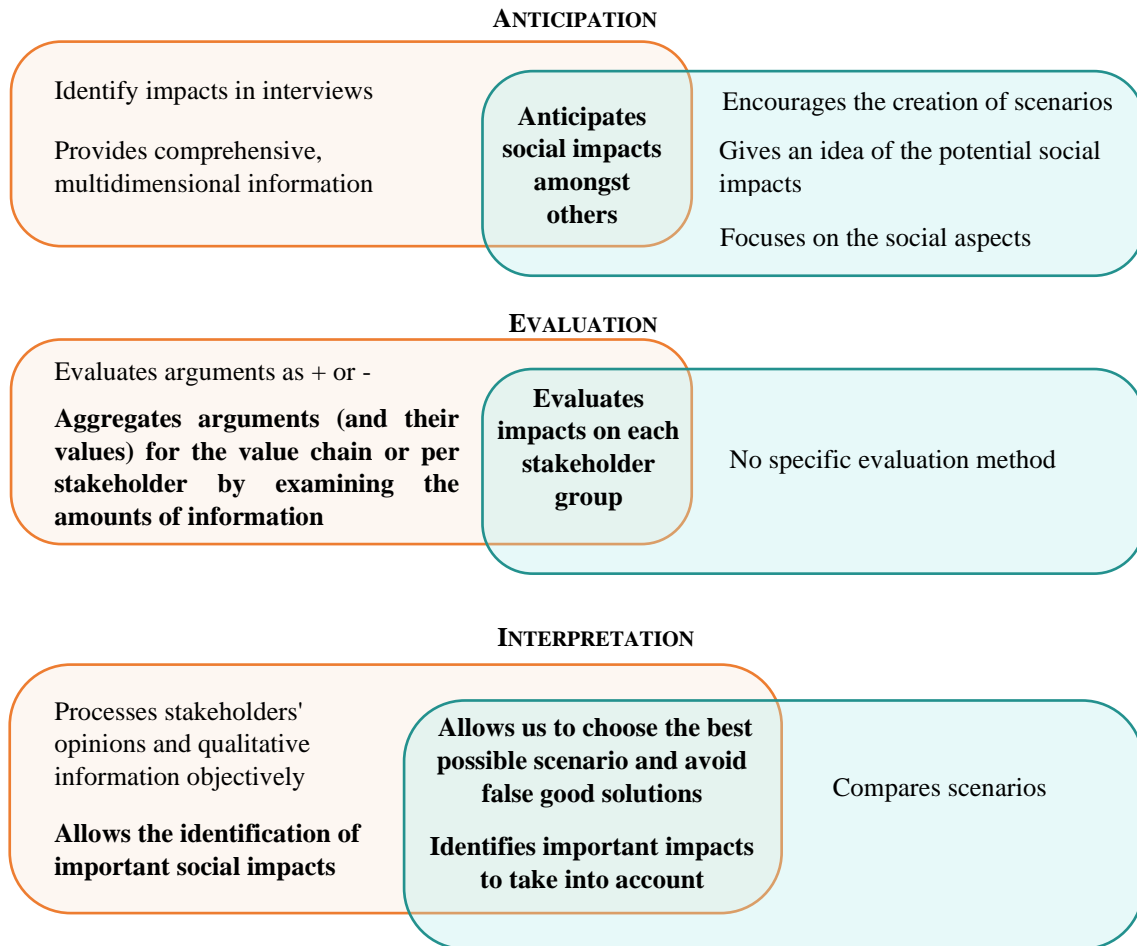

Figure 34: advantages of using multi criteria argumentation and type II social LCA so anticipate, evaluate and interpret results concerning impacts of changes in agri-food value chains.

Chapter 4. Case study and results

In this section, the method presented in chapter 3 is applied to the French pork value chain. In Section X, the value chain is briefly presented and the study perimeters are fixed. In Section XI, we talk about how we used the prospective Godet method to create reference scenarios of the French pork value chain. We will see that there is a difference between the theoretical method and its concrete application, as we had to face some constraints due to the sanitary context. Section XII shows the results obtained when using multi criteria argumentation to anticipate, evaluate and prioritize the impacts of pursuing business as usual, based on the information extracted from interviews with experts and stakeholders of the value chain. In both Sections XI and XII, we discuss potential adaptations of the MyChoice tool. Those results emanated from the search to modify the present method, so that it is applied more easily in other projects.

Section X. Case study presentation

Before diving into the results of the anticipation and evaluation of impacts of changes in the French pork value chain, it is essential we first start by presenting some generalities about this sector and how it works in France. This is the aim of this Section.

1. A brief history of the French pork value chain

Pigs are omnivorous monogastrics. Traditionally, they recover organic household waste, as well as lactoserum, a by-product of cheese processing. They can also feed on acorns, chestnuts and other fruits and berries. Pigs were considered as processors of neglected resources, which is why they were found in many households. After the Second World War, following the growing demand and needs of the population, many farmers specialized in raising pigs to generate a sufficient income. It was then that a national pig industry was really born in most European countries.

In France, following the agricultural orientation laws of 1960 to 1962, producer organizations (POs) were created, which gave producers more market power (Le Clerc, 2019). POs have three main functions: they allow an extension and densification of the product offer, they promote the diversification and segmentation of production, and they encourage farmers to invest and integrate the upstream links (raw materials, food) or downstream (processing) of livestock to “control a larger part of the value chain” (Le Clerc, 2019). In France, in 2019, there were 32 active POs recognized by the Ministry of Agriculture and Food. Since pigs consume a large amount of feed (for example, a sow consumes 1.2 tons of feed per year), the profitability of breeding is closely dependent on the cost of this primary matter. Feed traders took an early interest in this sector, while pig farmers came together to order feed (e.g. boats bringing soybean meal from Brazil) and set up various collective forms of supply (EIG Economic Interest Groups, cooperatives, etc.). In addition, the various feed brands (e.g. Sanders, Purina, Soreal) and breeders' cooperatives have organized the production and marketing of gilts (future breeding sows) and verrassons (future breeding boars), as well as the supply of veterinary products and specific equipment for pig breeding. Therefore, a professional supply chain was set up, with highly specialized players, whose interests are associated with those of breeders and processors (slaughterers, cutting, salting industrialists, butchers-caterers, etc.).

Nevertheless, there has never been a common market organization for pigs in Europe. Prices vary a lot, and often unpredictably. However, in the long term, it is one of the most profitable animal productions.

In France, in 2017, the Etats Généraux de l'Alimentation were held, the purpose of which was to rebalance the share of benefits between the actors of all the French agri-food sectors. However, market imbalances – between the many producers and increasingly centralised industries – have become more pronounced.

2. General presentation of the French pork value chain today

a. French breeders

French pig farming is mainly located in the western quarter of France (68%), in the Brittany and Pays de Loire regions (FranceAgriMer, 2022). It is mainly of industrial type. It represents about 14,500 farms, about 90% of which belong to producer organizations (POs) with about 8,400 members. These POs concentrate 89% of French pork production, which amounts to almost 23 million per year of pork sold.

French breeders are essentially breeder-fatteners (42%) which means that they own a herd of sows and practice pig breeding in all its stages (weaning, post-weaning, fattening) from birth to slaughter of animals.

In France, there are three main types of pig housing:

- The majority (90% of farms) are buildings on partial or integral gratings. The advantage of this type of soil is that it allows the evacuation of droppings and washing water in slurry pits. Crawl spaces are made after each “flock” of pigs in the most frequent case of “flocking”. It is in this type of building that the densities (number of pigs per m²) are the highest, in proportion to the slatted surface area compared to the possible solid floor area (about 0.5 to 0.6 m² per pig for fattening).
- About 5% of farms take place on solid and mulched soil, which is more frequently found in the breeding part. This type requires more labor to regularly change the straw, but it is reputed to be more comfortable for animals as they have more room (about 1 m² per pig for fattening). Crawl spaces are easy to achieve in this type of building when the breeding is conducted in strips.
- There are also open-air farms with mulched shelters. Pigs are sensitive to temperature variations and sunburn, which is why they always have shelter. Often only part of the

herd is raised in the open air (for example, mothers with their piglets). In this case, health precautions consist in establishing a rotation of the plots on which the sows' huts are placed. For obvious reasons of climate, this last category of livestock is mainly represented in the south-west of the France.

It should be noted that organic farms must provide all animals with outdoor access with protective awning and mulched bedding. When the slatted floor is chosen for rest areas, it must not exceed half of the surfaces of these areas (FNAB, 2018).

b. Transformation and distribution of pork meat in France

France slaughtered around 23.3 million pigs in 2020, for a volume of 2.2 million tce (tonnes of carcass equivalent), corresponding to 9% of the European production. There are in France 167 slaughter sites. The ten largest groups (e.g. Cooperl Arc Atlantique, Socopa, ITM) slaughter 85% of total national production in 24 sites. Slaughter takes place when the pigs are 5-6 months old (around the age of one year for local breeds, at an intermediate age for pigs conducted in organic farming). A first cutting takes place at the slaughterhouse, and the 2nd cutting often takes place immediately, in premises adjacent to the slaughterhouse, or in remote rooms, after the meat has been frozen and thawed.

Of the 2.2 million tce of pigs slaughtered in France, 0.7 million tce are exported in 2020 (FranceAgriMer, 2022). The exports are essentially front parts (breast, loin) and directed mainly to Europe (Italy, Spain, Belgium) (54% of exports in 2020) and China²¹ (28,7%) since 2017 (FranceAgriMer, 2022).

Imports represent tonnages almost identical to exports, but their value is much higher, since they are processed parts, mainly ham, mainly from Spain (46,8%) (FranceAgriMer, 2022). Indeed, the French have the particularity of consuming much more ham than their European neighbors consume.

70% of the pork produced in France is processed in France (FranceAgriMer, 2022). Since 1969, because of the pressure from distributors, the “Code of Practice for Charcuterie, Salting and

²¹ Because of a surge in African Swine Fever in 2020, China's imports of meat of swine (fresh, frozen or chilled) from France almost doubled in volume according to the trade statistics for international business development. France also exported more than 780 tons of live pork to China whereas normally, such transactions do not take place. Exports of live pork to Russia until 2012 were around 500 tons. Those volumes drastically plummeted in 2014: Moscow had in fact decreed an embargo on European pork, officially motivated by the discovery of some cases of African swine fever in dead wild boars in Lithuania and Poland. In 2020 however, because of structural deficiencies, a few tons of live pork and pork grease and offals were exported to Russia. (information from trademap.org)

Canned Meat” has been created to harmonize the characteristics of finished products (450 products). For each manufacture, the code defines the list of usable ingredients (all other ingredients are banned) as well as the level of criteria to be achieved (microbiological, organoleptic, sugar content, humidity etc.) on the finished product. There is no rule restricting the origin of ingredients, except in the case of sausages labelled by IGP (Indication Géographique Protégée) or AOP (Appellation d’Origine Protégée). On the other hand, manufacturing can be carried out anywhere in the world, as long as it respects the code of practices.

A third of the carcass volume is processed into cooking sausages, cured hams, sausages, rillettes, grattons, andouilles and many local specialties. Cooked products (especially cooked ham) represent 29% of the total.

Most French processors are united in the French Federation of Industrial Charcutiers, Caterers, Meat Processors (FICT), which has about 300 member companies. Most are family-owned SMEs with local expertise, with less than 50 employees, and which develop on one or a small number of deli specialties. About a dozen companies have more than 250 employees, plus a few subsidiaries of large agri-food groups. Intermarché, Casino and Leclerc have their own charcuterie factories.

Downstream, the main outlet is large-scale distribution. Then come the wholesalers, who supply artisan butchers and collective catering (FranceAgriMer, 2022). In practice, the market for most sausage products is almost regional (with the exception of dry sausage and Frankfurt sausage), which explains the relatively small size of SMEs in this sector.

3. Defining the system perimeter

In Section IV, we saw that a major step in the evaluation process is the delimitation of the system perimeters, which are the spatial perimeters, the temporal perimeters as well as the perimeters of effects.

Concerning the *temporal perimeters*, they are fixed to around three to five years in the future (Section XI and XII).

Determining the *spatial perimeter* consists entails identifying all organizations involved in the life cycle of pork products, whether they are in the value chain itself or in competing or complementary value chains. About the foreign competing countries, we decided to limit the spatial perimeter to the French pork value chain’s organizations considering that the quantities

exported and imported are globally equivalent (FranceAgriMer, 2022). As for the other meat value chains that could be in competition with the French pork value chain, we choose not to take them into account for several reasons:

- 1) Because of the particularity of charcuterie: the average pork consumption of a French person is 31.5 kg (in 2020), making pork meat the most consumed meat in France (figure 35), 3/4 of which are charcuterie products. Such consumptions are even higher and more regular in rural areas (FranceAgriMer, 2021, 2022)
- 2) Pork products' prices are very low compared to other meats²². This makes pork a very popular meat amongst the French compared to red meats for instance.

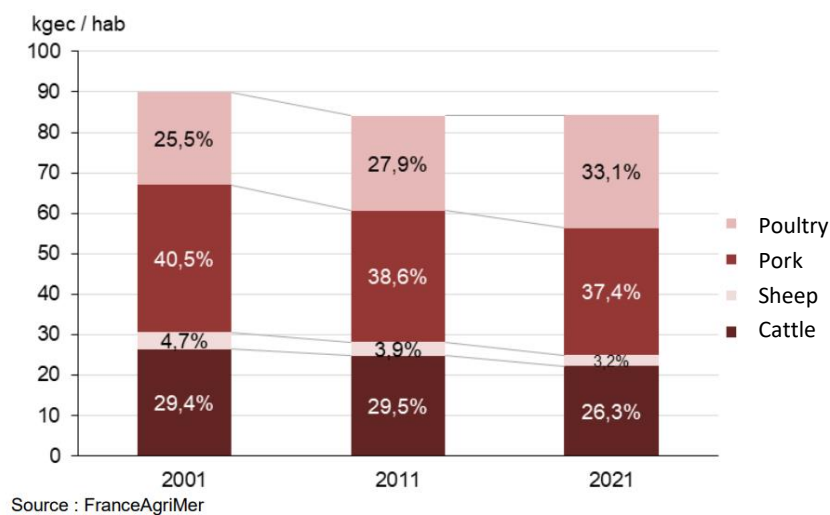

Figure 35: evolution of the average consumption of meats per sector. From FranceAgriMer, 2021.

- 3) As for the perimeter of effects it is determined as the study goes on, according to Lagarde and Macombe's approach (2013). By construction, it is restricted to the actors taken into account by the interviews and the documents analyzed.

²² Pork is the most consumed animal protein in France, just ahead of poultry. This meat also serves as a safe haven in times of inflation. Between 1 January and 31 May 2022 and the same period in 2023, the average purchase price of fresh pork increased by 13.6% to €8.5/kg, household purchases decreased by 3.6%. In beef, the price increase was more contained (+8.2%). However, faced with a product purchased on average at 17.2 € / kg, household purchases were down 5.2% according to Kantar Worldpanel. (Source [Porc : combien dépensent les ménages ? | Réussir Les Marchés \(reussir.fr\)](#) and [PORCINS - RNM - prix cours marché - Viande \(franceagrimer.fr\)](#))

Conclusion: summary of the French pork value chain

Take-away from this section

Figure 36 below summarizes the main information about the French pork value chain. The spatial perimeter consists of the different organizations of the French pork value chain. The temporal perimeter is set to 3-5 years in the future, and the perimeter of effects will be determined as the study goes on.

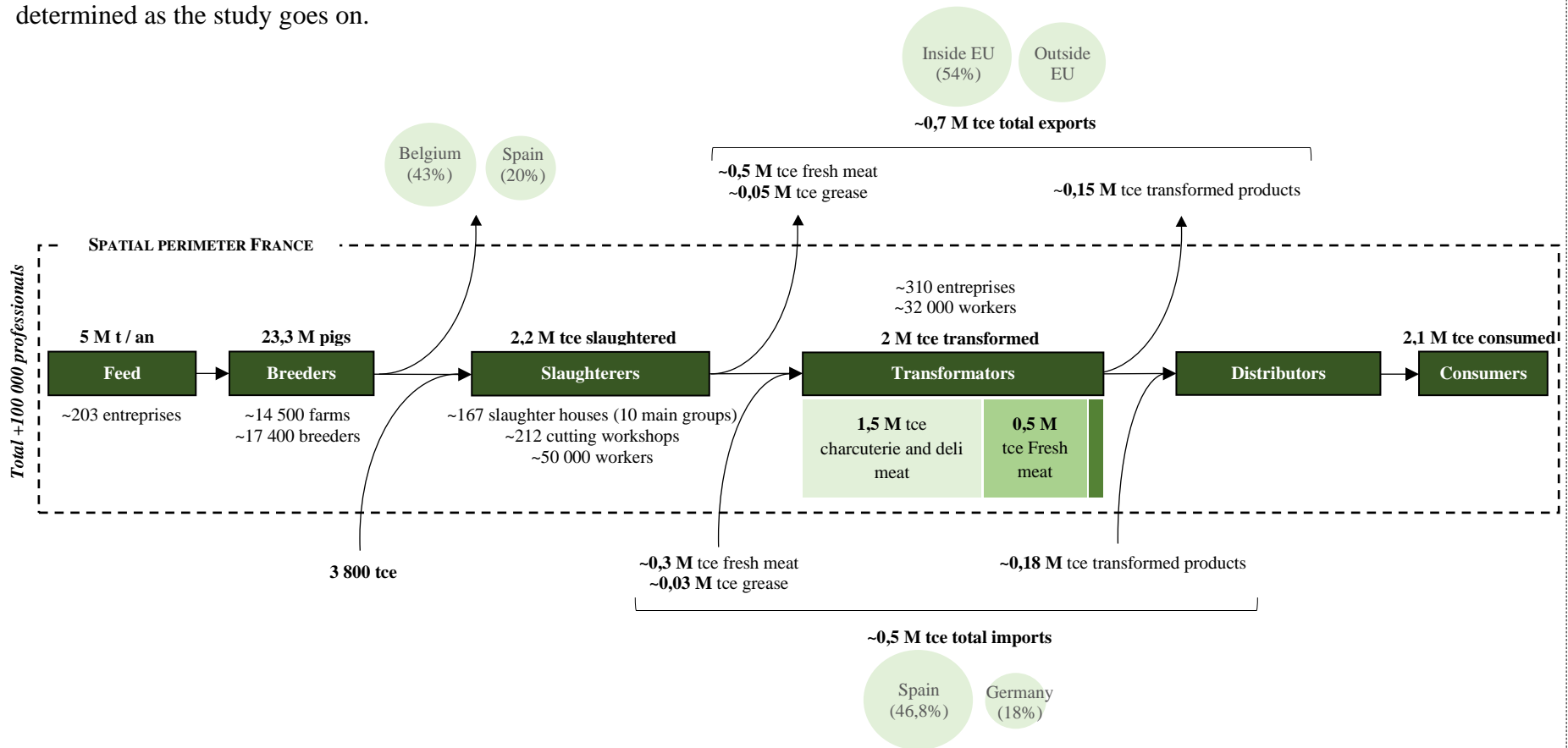

Figure 36: summary of the material flows and key numbers between the different stakeholders of the value chain

Section XI. Using participatory prospective methods to create scenarios

In this Section, we focus on the first segment of the method: the anticipation phase. This means that we essentially provide the results of the prospective study done on the French pork value chain. First, the stakeholders chosen are presented (1) and after that, we depict more specifically the results of the prospective study. In the research design and process figure, the results displayed in this Section correspond to the steps marked in green for the anticipation phase (figure 37).

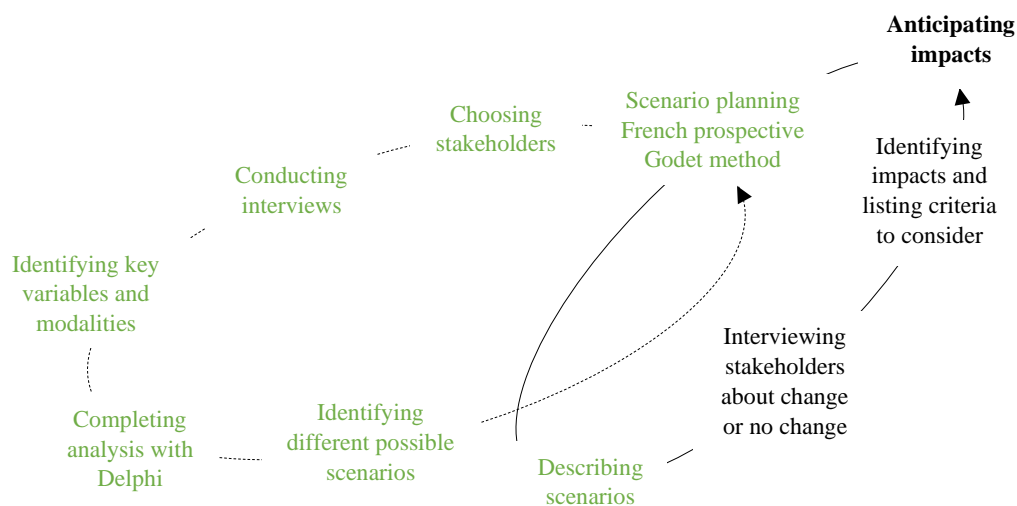

Figure 37: situating the results presented in this section in the research design and process presented earlier

1. Choice of the stakeholders and conducting the interviews

In section VII.3, different ways of choosing stakeholders are presented. The stakeholders were initially chosen according to the contacts provided by project Sentinel. We then checked with Mitchell, Agle and Wood's classification to check the missing categories. After that we searched for new people to interview so that in the end, all seven categories of the classification are addressed. At least one stakeholder of each category was interviewed.

As said earlier, it is better to involve the stakeholders in all phases of the study, and this requires us to reunite them so that they can discuss matters freely with each other (section VII.1).

However, because of the sanitary context related to the Covid-19 pandemic, this was not possible. We were thus restricted in the means available and the time allotted. We chose to replace those collective sessions with remote semi-directive interviews (section VII.2).

We contacted twenty-four people, however only twelve agreed to be interviewed. The interviews are done with different stakeholders and experts of the value chain, asking them how they thought the value chain would evolve and which factors influence its future or depend on it. The interviews lasted on average around an hour and a half.

Because some of the stakeholders were quite difficult to reach (no responses after several reminders by mail or phone, unavailable because of heavy workload, not wanting to express themselves concerning the pork value chain, etc...), nine documents from literature reviews, interviews or official documents from the public policy makers and the IFIP were also analyzed (Barberis et al., 2020; Delanoue & Roguet, 2014; Hofmann, 2021a, 2021b, 2021c; Hoste, 2020; INAPORC, 2020; Ramos et al., 2021; Shift Project, 2020). Each document read deals with the future of the French pork value chain, and is considered as an interview done.

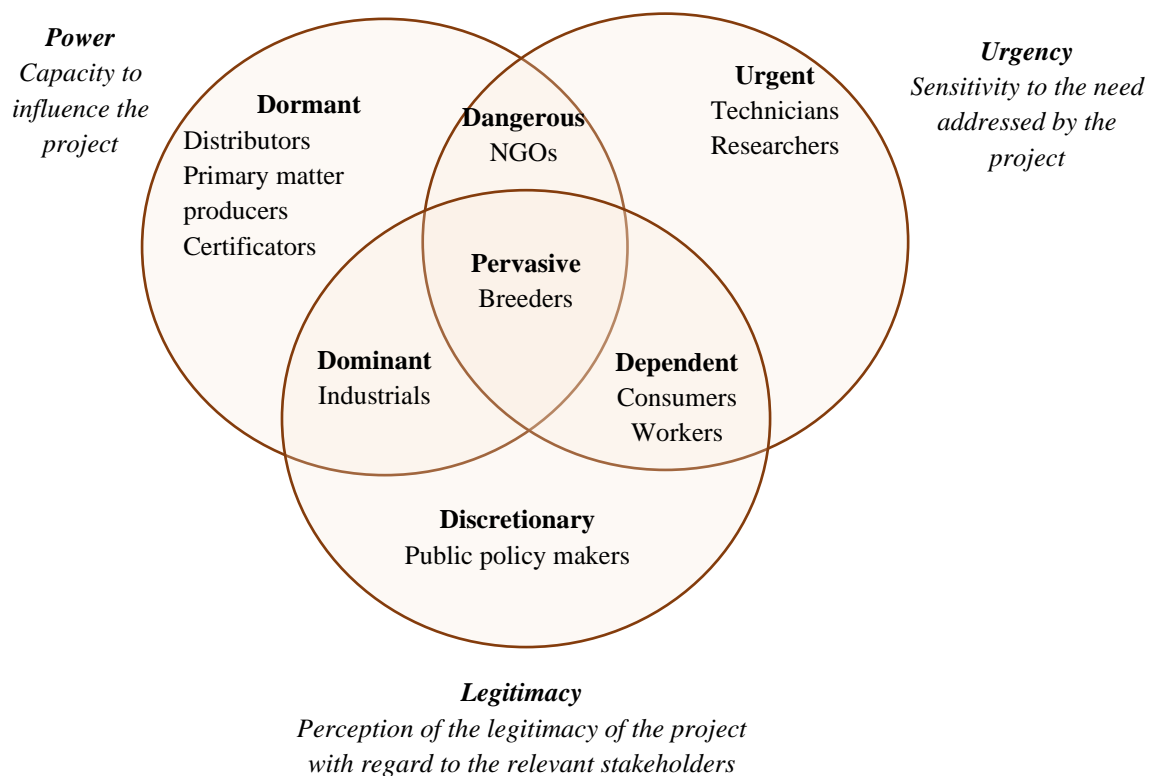

Figure 38: stakeholders interviewed and classification of Mitchell, Agle and Wood (1997)

We thus consider that we did twenty-one interviews in total. Figure 38 above shows the actors in the different stakeholder categories that were interviewed.

No names are mentioned throughout the manuscript since we guaranteed anonymity to the interviewees so that they feel free to say whatever they want.

2. Prospective study of the French pork value chain: from identifying key variables to describing the scenarios obtained

As stated earlier in the manuscript, doing *ex-ante* evaluations requires an anticipation phase, which is why we use prospective methods. In section VIII, the types of scenarios are presented and one of the scenarios that interests us is the “business-as-usual” scenario, that is to say the one that would happen if the sector continued its path following the major trends of its past, without major new intervention. Moreover, because the French pork sector is at a crossroad, the current multiple upheavals force us to consider several divergent developments. This is why we want to develop several possible reference scenarios by using the French scenario planning prospective Godet method.

This method presented in section VIII.3 assumes we must identify the major factors that will evolve the French pork sector over the next 3 to 5 years. These major factors of evolution are both the most influential factors on the life of the sector, but also the most dependent on other factors (figure 26 in section VIII.3.a). They are “stakes” in the etymological sense (what we risk losing or winning). However, only experts can identify and describe the issues that will shape their sector in the near future. The classic scenario method is indeed based on collective sessions, as it seeks to reach a consensus so that choices can be made. Nevertheless, remote work was a necessity considering the sanitary context. Because we could not reunite the prospects in the same place at the same time, we were obligated to adapt the ‘classic’ Godet method so that it can be done entirely remotely.

a. Adapting the Godet method to a context of remote working

Aside from the main research question, an additional question arose: how can we adapt Godet's prospective method to remote working? Therefore, how can we determine the key variables without bringing together experts of the value chain in one place?

Our specific problem concerns the identification of the key variables and their modalities, the identification of the different possible scenarios and their description. Those steps are indeed

particularly problematic because they require mutual interactions between prospects in addition to the interactions between us researchers and the prospects.

Step	Tools implemented by researchers in the adapted method	Tools used in the classic method
1. Delimiting the system, choosing stakeholders and conducting interviews	<p>Identification of the stakeholders by the tool of Mitchell et al. (1997).</p> <p>Remote individual interviews.</p> <p>Analysis of existing documents (treated as interviews) on the matter.</p>	<p>No specific method.</p> <p>Brainstorming, workshops, etc. to determine the main variables influencing the system evolution.</p>
2. Determining the key variables and their modalities	<p>List of the sub-concepts quoted by the sources (prospects and documents). Merging of the sub-concepts standing for the same concept.</p> <p>Conversion of each interview into a cognitive map to visualize influence relationships between the concepts identified.</p> <p>Grouping concepts into variables.</p> <p>Construction of partial squared matrices of variables. We can thus identify the partial influence and dependence of each variable. But we do not account for the indirect links, that is different from the classic method.</p> <p>Construction of the global set of variables by merging all partial sets of variables together.</p> <p>Merging of all partial squared matrices into a global one by summing partial influences and dependences of all variables.</p> <p>Identification of the key variables by two ways:</p> <ul style="list-style-type: none"> - whose influence and dependence are higher than the average, 	<p>The relationships between variables (influences and dependences) are built by consensus during collective workshops, by small groups, then all together.</p> <p>'Survey of experts' methods such as Delphi, Régnier's Abacus, or Smic-Prob-Expert allow the team to reduce the number of key variables.</p>
2.bis Completing analysis with Delphi	<p>- and analysis of the answers from the Delphi type questionnaire following the submission of the list of variables and their modalities.</p>	
3. Elaborating the base scenarios	<p>The preliminary scenarios are built by scientists as combinations of the possible modalities of all key variables</p> <p>The scenarios presenting incompatible modalities are discarded</p>	<p>Collective workshops.</p> <p>The general base scenarios are built as combinations of the possible modalities for all key variables.</p>

Table 8: Tools used in each step of the “Constructing the base” stage of the adapted and classic methods. The main tools are highlighted in bold (Chaib et al, 2022a).

Different choices had to be made to adapt the classic scenario method. They are briefly presented in table 8. Figure 39 also briefly shows the process followed throughout the adapted

Godet method. In annex 2, we thoroughly detail the calculations followed so that the adapted method can be verified and reproduced.

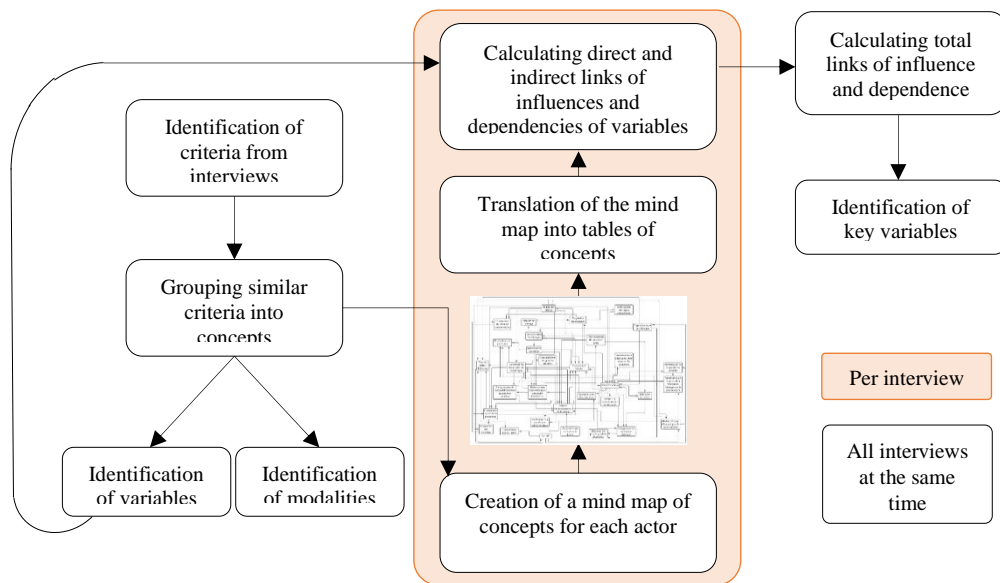

Figure 39: summary of the steps followed in the morphological phase of the adapted Godet method

In the original Godet method, actors discuss together the relationships between variables. They then decide which variables are key through a reached consensus. However, this consensus-building step is not part of the adapted method. We tried to make our process as participatory as possible. We therefore thought it would be interesting to look at which variables would have been considered important if each actor had been able to know the variables identified as such by the other participants. We thus multiplied the exchanges with the interviewed stakeholders and we tried to re-create some sort of debate by using a Delphi type questionnaire. We have taken up the principle of the Delphi method²³, which concerns high-stakes social issues. Our goal was not for the stakeholders to reach consensus, our goal was rather to find the key variables and compare the answers stakeholders gave us a year apart. The objective is to try and reduce the risk of giving a misleading analysis and interpretation of stakeholders' opinions. In fact, even though individual long distance interviews seem more efficient, when treated separately they do not suffice to determine the key variables: it is possible that a variable cited just a few times can be deemed crucial if thoroughly discussed within the group of experts.

²³ Technically, in our case, the first phase of the Delphi is considered to be the interview phase. The second phase is when we send the questionnaire.

In the Delphi, there are usually two steps. First, experts of the subject are interviewed. Their opinions are then compiled in a synthesis document, which is returned to all the interviewees, so that everyone knows what the others have responded. The experts are then questioned a second time, in order to allow them to adapt (or not) their answers while incorporating considerations drawn from the opinions of the colleagues.

We constructed a questionnaire (annex 3), intended to be self-administered, which was sent to all interviewees. For the sake of clarity, we only asked expert actors to indicate five variables that they considered “important” or “very important”. The ‘importance’ in the questionnaire refers to salient variables, which can be key, output or input variables, in the terminology of the Godet method. We gave them the possibility to argument their choices by text or by phone.

b. Results of the prospective study done on the French pork value chain

Although the number of interviews can be considered as small, it should be noted that the concepts discussed in the last interviews were redundant with those already identified in the previous ones, suggesting that some completion has been achieved.

Identifying the key variables

Following our discussions with the actors and thanks to the documents analyzed (21 in total), we identified twelve variables using the adapted method. These are presented in table 9. Of these twelve variables, four have indices of dependence and influence above the average of the variables, as shown in figure 40. It should be noted that it seemed prudent to draw a “zone of instability” on this diagram, i.e. an area in which variables that could change category by the addition of one single additional interview (or text) are found. Those “unstable” variables are not used when constructing the reference scenarios, they are however taken into consideration when describing it.

A	Social acceptability	G	Evolution of job attractivity
B	Production and transformation processes	H	Institutional context
C	Pork meat consumption	I	Energy consumption
D	Production costs	J	Communication
E	Technical and technological progress	K	Value chain structure
F	Access to market	L	Product prices

Table 9: list of the 12 variables obtained using the adapted Godet method

The four variables located in the top right area –and so the variables that are key- are: G “evolution of job attractivity”; A “social acceptability”, E “technical and technological progress” and K “value chain structure” (essentially its distribution over the territory). The only output variable, D, concerns production costs.

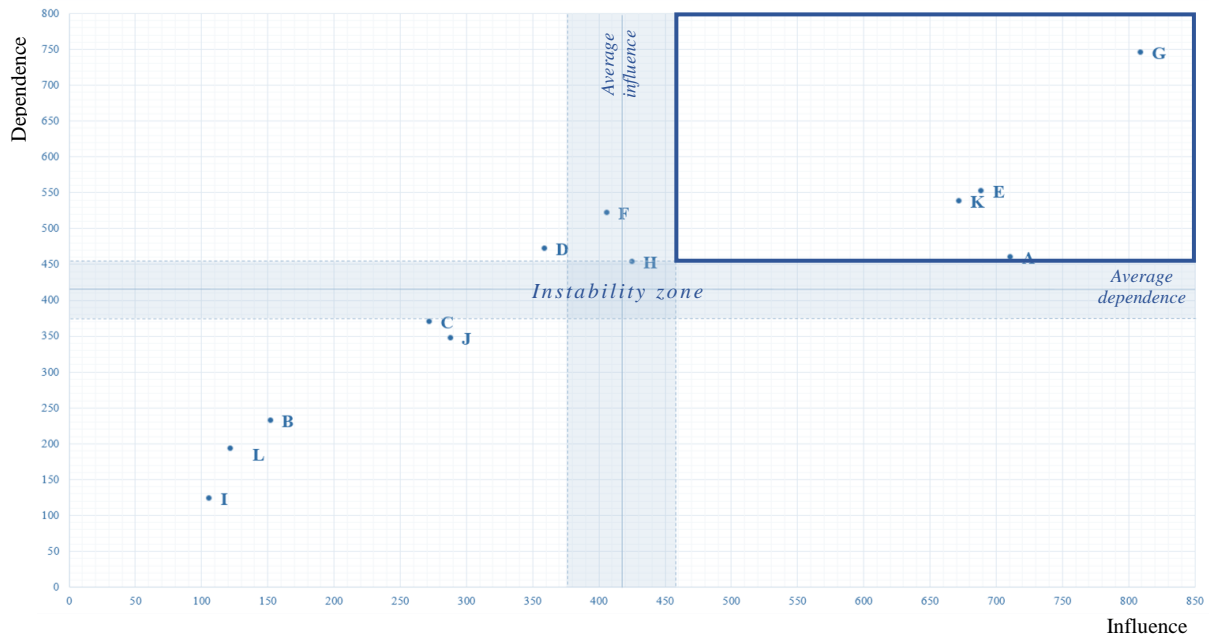

Figure 40: distribution of the 12 variables according to their influence and dependence rates calculated as shown in annex 2

Other variables such as I (energy), L (product price), C (consumption modes), J (communication) and B (production ways) appear quite important based on their names and we could have imagined they would be central drivers for the success of the pork value-chain. However, according to what the stakeholders say, the other 5 variables mentioned above (A, E, G, K and D) are more important as they have a bigger influence on the value-chain according to the stakeholder and they are very dependent of it too. We are only analyzing what the stakeholders say. However, even though those variables C, J, B, L and I are excluded, it just means that they are not used to construct the scenarios, they are however inevitably used when describing the scenarios thoroughly as we’ll see further in the manuscript.

Identifying the key variables’ modalities

For each key variable, at least one modality was identified in the interviews of the stakeholders. If another one wasn’t mentioned, it was deduced by opposition to the one stated. There are two modalities per key variable, denoted G1 and G2 for variable G, A1 and A2 for variable A etc.

The modalities of the four key variables (and explanations from the sub-modalities) are shown in table 10.

Modalities		Explanation
A1	Rejection of pig breeding as it is today	Society demands a major change in the production model in the name of animal welfare, respect for the environment and public health. Consumers have a bad image of the current value chain and reject livestock farming as it is today. They are willing to eat less pork but pay more for it, if the value chain is transformed.
A2	Accepting the current value chain	At the cost of some adjustments (increase in the area devoted to spreading, methanization of surpluses, reduction of environmental pollution, respect for animal welfare), a consensus was reached with society without upsetting the current model. However, it is still difficult to set up new farms.
E1	Improving techniques and technologies	Innovation and increased technicality within the value chain make it possible to optimize processing and logistics, improve animal health and product quality, better processing food, and improve traceability. Losses and waste are reduced. The value chain is competitive and mastered at all levels. Less labor force is needed.
E2	Stagnation in technical progress	Technological improvements remain marginal. The new tools are poorly optimized and poorly automated. The value chain does not know any revolutionary event from this point of view.
G1	Unattractive value chain	The pork value chain is less and less attractive, few people set up in pig farming, which leads to a decrease in the number of breeders and a concentration of farms. It is increasingly difficult to find an agricultural or downstream worker (slaughter, cutting, processing).
G2	The value chain proposes attractive jobs	The renewal of French pig farmers is assured, in particular thanks to the interest of young people and the development of training in the profession of pig farmer and processing professions. This guarantees the maintenance of French know-how and a valuation of production.
K1	Restructuring the value chain	The value chain is undergoing a structural transformation: small and medium enterprises in processing and livestock farming are developing throughout the territory, local raw materials are privileged, proximity between the actors in the value chain is favored (for example by the development of intermediate slaughterhouses). The European and international market is also being restructured in close proximity to consumers.
K2	No structural change in the value chain	Production remains concentrated in the west of the France. Farms are growing and livestock farms are intensifying

Table 10: modalities of the key variables

These are the key variables' modalities that will make it possible to develop the scenarios.

Analysing results from the Delphi questionnaire

Despite numerous reminders, the feedback questionnaires were delayed. Their reception took more than six months (so by the end of 2022). We finally received ten out of twelve questionnaires, the results of which are presented and discussed below. Table 11 shows that the key variables A and G are well identified as important again. Similarly, the position of the output variable D is confirmed, meaning that it can remain an output variable as it was deduced

when using the adapted Godet method. C (pork consumption) and J (communication) are next, whereas these two variables were very close to the zone of instability that leads to the quadrant of “output variables”.

Variables	Very important	Important	Total
A: Social acceptability	6	3	9
G: evolution of job attractiveness	2	5	7
L: product prices	3	4	7
D: production costs	2	4	6
J: communication	1	4	5
C: pork meat consumption	4	1	5
F: access to market	2	1	3
H: institutional context	0	3	3
B: production and transformation processes	2	1	3
I: energy costs	2	0	2
K: value chain structure	1	1	2
E: technical and technological progress	0	0	0

Table 11: results of the Delphi questionnaire sent to the interviewed stakeholders

The importance of variable L (product prices) can also be attributed to the fact that it would be an output variable, but its status was “excluded variable” in the adapted Godet method. This is therefore a new concern that emerged after we conducted the interviews. Variable K (value chain structure) receives a score of only two mentions, but the stakeholders may have thought that the key variable A (social acceptability) contained it. In addition, the stakeholders believe that this variable K, although important, will not change the sector over the next five years.

The surprise comes from variable E (technical and technological progress), which receives a score of zero, while it was one of the key variables in the first analysis. We do not know how to interpret this result. Does it mean that all stakeholders find other variables more important or very important? Does it mean that the players who had highlighted technological advances a year earlier have changed their minds? Or that new concerns - such as energy costs and sources (I) - have taken their place? In any case, it seems that the stakeholders let themselves be influenced by the news of the period in which they are interviewed. This is why we highlight our great difficulties in obtaining the Delphi questionnaires in return. The answers reached us

over a period of more than six months, and are highly biased by the very busy news for the pork sector at that time (i.e. the increase in feed prices²⁴).

We decided to keep the key variables obtained by analyzing the interviews using the adapted Godet method. However, when describing in detail the scenarios that are chosen by the actors, we emphasize the variables that are important to the stakeholders according to their responses to the Delphi-type questionnaire.

Creating the different possible scenarios

From four key variables each presenting two modalities, we obtain 2^4 scenarios, by combining the modalities of the different key variables. However, all sixteen scenarios will not be retained for two reasons:

- There are sometimes incompatible modalities
- It is customary to merge similar scenarios, to avoid cognitively burdening the decision-makers to whom the scenarios will be presented.

²⁴ In February 2023, the price of pork feed decreased slightly compared to January 2023 (-1.1%) but increased by 19.9% year-on-year, compared to February 2022. In February 2023, the producer price of pork increased by 9.4% compared to January 2023 and by 58.7% year-on-year, compared to February 2022. In this context, the ratio of pig producer price (PPPI) to pig feed is up, to 76.9 in February 2023 (Source Agreste. Indice des prix des aliments pour porcins (IPAMPA)). However, the price of pork meat does not increase in the same proportion, so sales can be made below the "compensation price", which is the price at which pigs would have to be sold to balance input costs (Source Insee, Agreste conjuncture, April 2022).

We considered that modality A1 was incompatible with modality K2, and that modality A2 was incompatible with modality K1 (see table 10 for reference)²⁵. This choice means that if the rejection of the value chain (and specifically of industrial farming) is as strong as in the A1 modality, then it is not possible for the structure (increasing pig farms in the Western part of

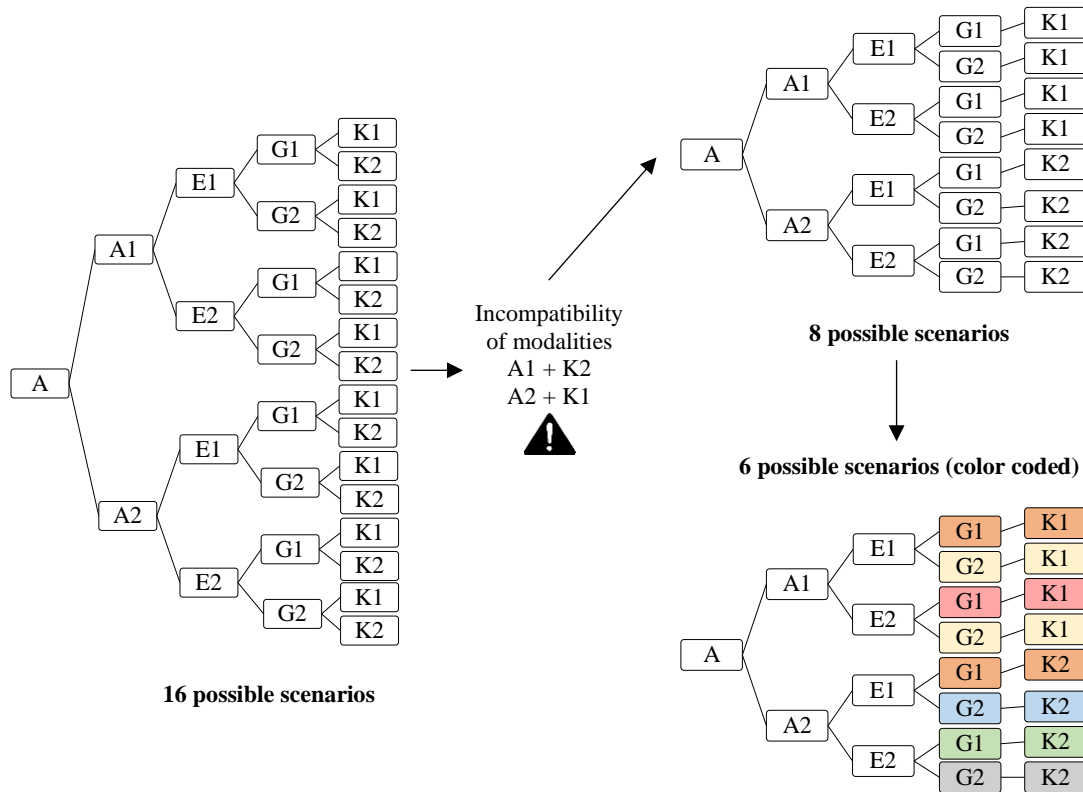

Figure 41: eliminating and combining scenarios

²⁵ We do not consider that modalities A1 and G2 are incompatible. Even though we could say that if the current pig breeding is rejected, few people would find such jobs attractive, we consider that there is no seal between society and the agricultural world. This means that we will certainly not have installations outside the framework, however, young people in agricultural high schools do not necessarily have the same vision as the rest of the society. Hence the fact that these two modalities are considered to be compatible. In 2021, more than 216,500 young people have taken the path of agricultural education. Public schools cater for 39 per cent of pupils, 58 per cent of long-term higher education students and 61 per cent of apprentices in agricultural education. 41% of high school agricultural students say they are willing to work as pig farm employees (results of a survey conducted for the Chamber of Agriculture of Brittany by students of Agrocampus Rennes among more than 1,000 students in 51 classes (from the first to the second year) of 21 agricultural establishments). The profession of employee in pig farming or other production is described as "neutral" for 50% of them. And only 12% consider that salaried pig farming has a "demeaning" image, while 25% consider it valuable. Source: [Enseignement agricole : les 10 chiffres à retenir | Portail Réussir \(reussir.fr\)](#) and [Les élèves en lycée agricole ont une image plutôt bonne du porc | Réussir porc - Tech porc \(reussir.fr\)](#)

France) of this value chain to remain identical. It is however possible that the structure of the sector remains the same (K2) provided that the acceptance of the value chain improves (A2) at the cost of some progress. In the classic Godet method, the incompatibilities are discussed between the stakeholders. In our case, weekly meeting with the team working on the prospective resulted in the identification of those incompatibilities between the modalities. Figure 41 shows the process of elimination and concentration of scenarios.

The six framework scenarios resulting from the use of the adapted Godet method are briefly described below. They are listed in the order of introduction of the least to the most changes compared to the current situation.

A2 E2 G1 K2: the 'business as usual' scenario

The pork value chain does not change its model, it remains unattractive for new farmers and workers because of the continuous expansion of farms (which are becoming too expensive to be taken over), the low selling prices of carcasses and finished products (because of competition with imports) and its poor image in society. The stakeholders of the value chain make some efforts in terms of animal welfare, health and the environment. Advances in technologies actually adopted do not change the situation. The value chain remains concentrated in the Great West. Production costs remain volatile and continue to rise in trend, while selling prices remain affordable for consumers. The quantities produced in France are gradually eroding.

A2/1 E1 G1 K2/1: the 'technologies to the rescue' scenario

The jobs offered by the value chain remain unattractive, and the image of the value chain in society remains poor. Major efforts are being made to reduce pollution (methanization, etc.) and eliminate nitrites in meat, with the aim of easing social demands. Techniques and technologies (robotics, digital) are increasingly efficient, and lead to the automation of many tasks (e.g. breeding, slaughtering, cutting), which increases hourly productivity. Their introduction requires however expensive investments. Many workstations are robotized. The intensification and concentration of production continues. Costs are rising, but the increase is modulated by productivity gains linked to the use of technology. Prices for the consumer remain reasonable, and the quantities produced are stable or slightly increasing when export markets are opened.

A2 E1 G2 K2: the 'attractive value chain' scenario

The value chain has succeeded in making its professions more attractive, among other things through inter- and intra-link communication. Some aspects of animal welfare and other

environmental and health aspects are improved, making consumers more accepting of pig farming. The techniques and technologies used greatly improve the working conditions of all actors in the value chain, at the cost of fairly heavy investments. The sector remains intensive and concentrated in the Western region. Costs are rising while prices for the consumer remain reasonable. This puts the most fragile players in the value chain in difficulty, but the succession is nevertheless assured. The quantities produced remain stable.

A2 E2 G2 K2: the 'regional magnet and compromise' scenario

Communication with consumers and potential future farmers and actors in the value chain has succeeded in making the sector attractive, which improves the transmission and survival of very large pig farms. It is easier to find trained workers in the meat trades. Following a strengthening of standards and regulations (environment, animal welfare and health) at national and European level, the pork sector has managed to forge a new compromise with society. Consumers are willing to pay more for pork, which allows for higher selling prices and better remuneration for all players. Without significant technological progress, the sector remains concentrated in the large areas of current pig production, with a stabilization of the quantities produced. Production costs continue to rise in trend, but selling prices follow.

A1 E1/2 G2 K1: the 'two-faced value chain' scenario

The strong demands of society towards the pork value chain (organic, animal welfare, less pollution, etc.) lead to a new distribution on the territory: large structures towards the West develop little, while small to medium-sized farms are deployed throughout the territory, using multi-species slaughterhouses and local processing workshops. The jobs in this short livestock sector are becoming more attractive, which encourages future breeders and processors to set up. The West invests in digital and robotization technologies and continues to export when opportunities arise. Direct sales in short circuits are developing, with high prices, while prices remain moderate for products from intensive structures in the West. Overall, the quantities produced are stable. Production costs remain reasonable. On average, the consumer consumes less pork, and pays more for it. Consumer markets persist internationally.

A1 E2 G1 K1: the 'stop in the West' scenario

The current value chain is becoming less and less attractive: large pig farms do not find a buyer, especially since institutional support is not adapted to the problem. It becomes impossible to install a new building in the great West. Society totally rejects pig farming as it is today, demanding straw farming in the name of animal welfare, and because of green algae issues in Bretagne. As a result, the sector is undergoing drastic regulations, and a profound

transformation (new distribution of livestock throughout France, growth in the number of small/medium-sized farms, short circuits, etc.) without significantly modifying the techniques and technologies used. The quantities produced are falling very sharply and rapidly. Pork and cold cuts are becoming scarce and expensive commodities, and consumers are reducing their purchases. There are no more "basic" commodities for major international markets. Some niche markets for renowned artisanal transformations (e.g. Bayonne ham, rillettes) continue to develop for export.

Choosing the two reference scenarios

The 6 framework scenarios obtained were presented to our project Sentinel colleagues. They were asked to indicate their preferences for the two scenarios to be further detailed in the rest of the project. The only condition was that these two scenarios should be contrasted. Ideally, the choice of reference scenarios would have been made by the interviewed stakeholders. Nevertheless, because it is quite difficult to get them to respond, because we cannot reunite them all at the same place at the same time and because one of the conditions that we set before interviewing them was for them to remain anonymous (or else some of them would not have talked to us), we decided to ask our colleagues.

The consensus was very easily reached, in favor of the two framework scenarios named "regional magnet and compromise" and "a two-faced value chain". These two scenarios were chosen because they presented an optimistic evolution of the sector (in particular in terms of attractiveness of the professions) unlike the other four.

Following the classic way of detailing the scenarios as it was presented in section VIII.4., we started detailing the "two-faced value chain" scenario. The objective was then to introduce the new PCB detection tools within the two framework scenarios, to then evaluate the impacts they have on the value chain and its stakeholders.

3. Using MyChoice for remote prospective purposes

We are aware that the adapted Godet method can be very time consuming and quite complex to reuse in other cases. As the study went on, we realized it could be possible to use MyChoice for prospective purposes, in order to improve this work done remotely. The first section discusses the parallels of nomenclatures between the adapted Godet method and the MyChoice tool so that the analysis and comparison of both methods is coherent. In the second section, we talk about the first idea that came to mind when reflecting on how to alleviate the adapted Godet method by using the MyChoice tool. The third section highlights the idea of completely

replacing the adapted Godet method by using only the MyChoice tool for prospective studies. This would require the development of a MyChoice module (MyChoice scenarios) discussed in annex 6.

- a. Parallel nomenclatures between the adapted Godet method and the MyChoice tool for multi criteria argumentation

Ontologies represent the semantics used by people as well as the relationships between them (Maedche & Staab, 2000; Nebot & Berlanga, 2009). They are very important when it comes to structuring knowledge and building information models (Maedche & Staab, 2000), especially since they introduce certain standards allowing the use of formalized information and vocabularies in various studies (Nebot & Berlanga, 2009). To do a prospective study using MyChoice, it is necessary that the nomenclatures and information extracted are similar to that already used in the prospective studies. In this part of the manuscript we talk about those parallels to try and homogenize those two methods so that they can be either combined, or better so that MyChoice replaces the adapted Godet method.

For the adapted Godet method, an ontology was constructed manually based on the interviews and the documents used. However, doing so is very time consuming, and gaining time would be valuable. The multi criteria argumentation tool MyChoice²⁶ (Thomopoulos et al., 2020) can maybe help alleviate the disadvantages of the adapted Godet method (Chaib et al., 2022c).

For the model to be able to help stakeholders, whether it consists of the adapted Godet method or the MyChoice tool model, it first has to be constructed: for that we need inputs which are then analysed in order to have outputs.

Inputs: data from interviews and documents

Every decision-making process relies on the analysis of information sourced. Whether it is for the adapted Godet method or for MyChoice, information comes from transcribed interviews with different stakeholders of the value chain and from documents.

The vocabulary and language used in transcription emerges from spontaneous discussions with participants. Each stakeholder sees, analyzes, and interprets things differently, so the vocabulary used may change from interview to interview, but the main idea remains the same. Apart from the fact that there are differences in interviews, the vocabulary used in the

²⁶ URL : <https://ico.iate.inra.fr/MyChoice/>. Logiciel INRAE MyChoice. Dépôt APP n° IDDN.FR.001.280002.000.R.P.2020.000.20900

documents is also different. Indeed, authors have time to proofread and homogenize words and phrases, especially those intended to reflect a single idea. Stakeholders on another hand have maximum a few minutes to clear their thoughts when interviewed. It can become difficult to extract a limited sample of ideas from a fairly large sample of words and phrases.

Outputs

The outputs obtained following the interviews are double: those obtained using the adapted Godet method, and on another hand, those obtained using the MyChoice tool for multi criteria argumentation. Both methods were initially created with different objectives in mind: the Godet method aims to identify key variables that are used for the creation of scenarios, whereas the MyChoice tool originally serves to pinpoint what may be the strengths and weaknesses of the value chain.

Outputs of the adapted Godet method

The adapted Godet method consists of extracting words and phrases (which we call criteria) from the interviews and the documents. Similar criteria are then manually grouped into concepts by following an ontology matching procedure (Chaib et al., 2022a; Thomopoulos et al., 2013).

Depending on the explanations given during the interviews or in the documents, a concept can either be found in only one variable (which is the case for most of them) or in two variables or more. It is important to note that the variables and their

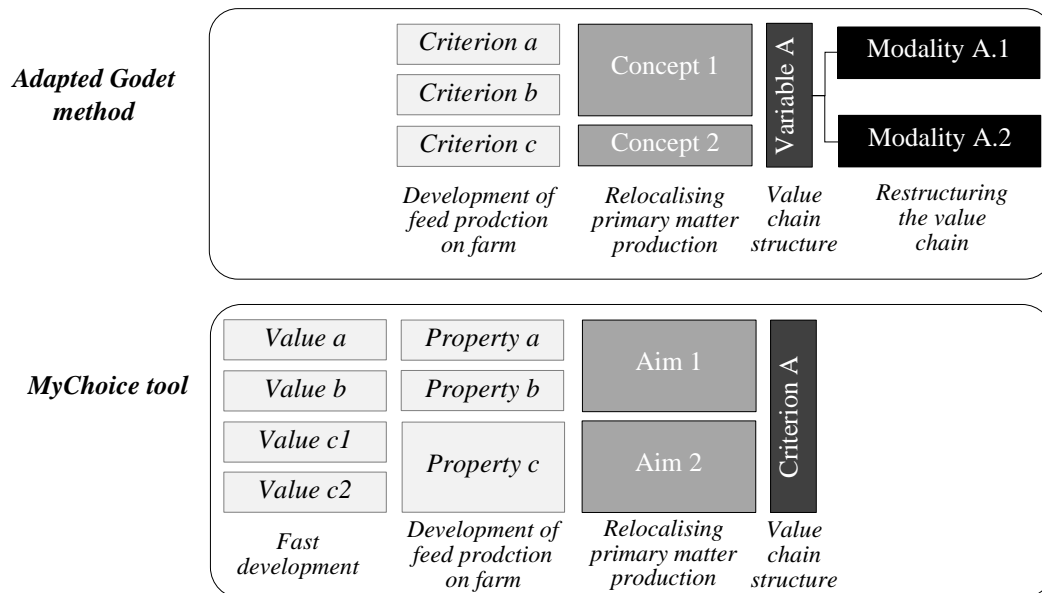

Figure 42: similarities in nomenclatures between the adapted Godet method and the MyChoice tool

modalities are identified in the list of concepts. The identified concepts are linked to each other by influence and dependence relations identified in the transcriptions and documents and represented in mind maps (annex 2 and 4). The outputs obtained then have to be confirmed by the stakeholders interviewed.

Outputs of the MyChoice tool

Through MyChoice, we obtain a list of properties. Those properties are similar to what we call criteria in the adapted Godet method. Each property is attributed to an aim (which resembles the concepts of the adapted Godet method) and the aims are grouped into what is called criteria in the MyChoice tool but really is the variables of the adapted Godet method. The parallel between the denominations of each method is shown in figure 42 above (Chaib et al., 2022b).

There are two main differences to note between Godet and MyChoice when it comes to properties and aims. The first one is that in MyChoice, a property can take several values but is still considered as a single property, whereas in the adapted Godet method we would consider that there are as many criteria as values a property can take. The second difference is that each aim can only be attributed to one single criterion, when in the adapted Godet method, a concept can be attributed to one, two or more variables.

In the following section, when talking about prospective, we will be using the terms of the Godet method, meaning that we use the terms ‘criterion’, ‘concept’ and ‘variable’. We will discuss how the MyChoice tool could maybe help replace the analysis made by the adapted Godet method.

b. Using MyChoice to confirm the results of the adapted Godet method

The initial thought we had was to use MyChoice to confirm the results obtained through the adapted method since we faced certain difficulties when reaching out again to the interviewees asking them to reply to our Delphi type questionnaire.

We went through the interviews again to try and fill the MyChoice spreadsheet with the objective of identifying key variables. Table 12 below shows how the information is entered.

Name Stakeholder	Name Alternative	Type Pro Con	Name Criterion	Aim	Name Property	Value
Stakeholder interviewed	Pursuing Business as usual	If the influence of the variable on the future of the value chain is perceived as positive or negative	Variable	Concept	Criteria	Nature of influence relation (very influential, strong, getting stronger, etc...)

Table 12: How information is entered using the MyChoice tool when the aim is to identify key variables.

In the first column, the name or position of the interviewed stakeholder is entered to easily recognize who talked about which variable. For prospective studies, since the aim is to identify the variables that could influence the future of the value chain and those that depend on it, the ‘name alternative’ is “Pursuing business as usual”²⁷. The advantage of MyChoice is that we enter the information in details, like for example if the influence is perceived as positive or negative on the value chain. We disregard this information in the classic and the adapted Godet method. However, by using MyChoice, we expand the possibilities of interpretation. Of course, we need to enter the variable as well as the details described by the interviewees (concept and criteria). Finally, we enter the value (if given by the interviewees). This last piece of information is not determining for our analysis.

²⁷ In fact, the experts and stakeholders of the value chain are asked what are the factors that influence the current value chain for it to reach other future states. The name alternative considered is “business-as-usual” because no other scenarios are conceived when starting a prospective using the French Godet method.



Figure 43: number of positive and negative arguments and attitudes associated with each variable

Variables in yellow are key according to the adapted Godet method

When entering the information in MyChoice, it is important to make sure that each concept and criteria are specific to one variable. This forces us to detail the name of the variables. For example, the ‘social acceptability’ variable in the adapted Godet method corresponds to 4 variables which are ‘societal’, ‘ethical’, ‘environmental’, ‘psychological’ in MyChoice²⁸. Another variable we distinguished from the others using MyChoice is the ‘sanitary/ safety’ variable. In the adapted Godet method, some of the concepts related to this variable are attributed to the broader variables of ‘social acceptability’, ‘technical and technological progress’, ‘market options’ and ‘institutional’.

Since our aim is to compare the results obtained using MyChoice with those we obtained through the adapted method, a preliminary work is done to homogenize the variables. The equivalences are shown in figure 43 above. In this figure the number of positive and negative arguments are represented in respectively green and red circles²⁹. For each Godet variable, we have the corresponding MyChoice variable. Because the variables are more detailed in MyChoice, some of the arguments from those ‘surplus’ variables (i.e. sanitary) are attributed to their more broad corresponding Godet variables (hence the arrows). This homogenization could have been avoided if the adapted Godet method and the analysis through MyChoice were done at the same time. The variables of the Godet method would have been detailed more. We suppose we would have obtained the same number of variables and the same number of arguments for each variable using both methods. Nonetheless, we still consider that those results are sufficient to compare the results obtained using both methods.

The visual representations in figures 43 and 44 allows us to clearly identify if the influence of a variable is positive or negative. It also allows us to identify which variables were mentioned more than the others. This gives us a hint of which variables are the most important according

²⁸ The variables can either be mentioned as is by the stakeholder. If not, it is something we determine based on what the stakeholders say

²⁹ Those differences could slightly alter the final values of influence and dependence of each variable when comparing both methods in our case. In fact, because the analysis from the adapted Godet method and the one using MyChoice were done a year apart (ideally, both analysis should be done at the same time, , there are slight changes in the vocabularies used during the analysis (in a year, my vocabulary possibly changed as it was tainted with the information I already knew), hence the minor differences in the number of concepts/aims (Chaib et al., 2022b). However, those differences are insignificant and do not change the final result of which variables are key or not. Ideally, if we want to pursue this research field to see if MyChoice can be used to extract key variables when doing a prospective study, someone should review the parallels done and the ontology created to enrich it for future use on other case studies.

to the stakeholders (variables with a yellow background are key according to the adapted Godet method).

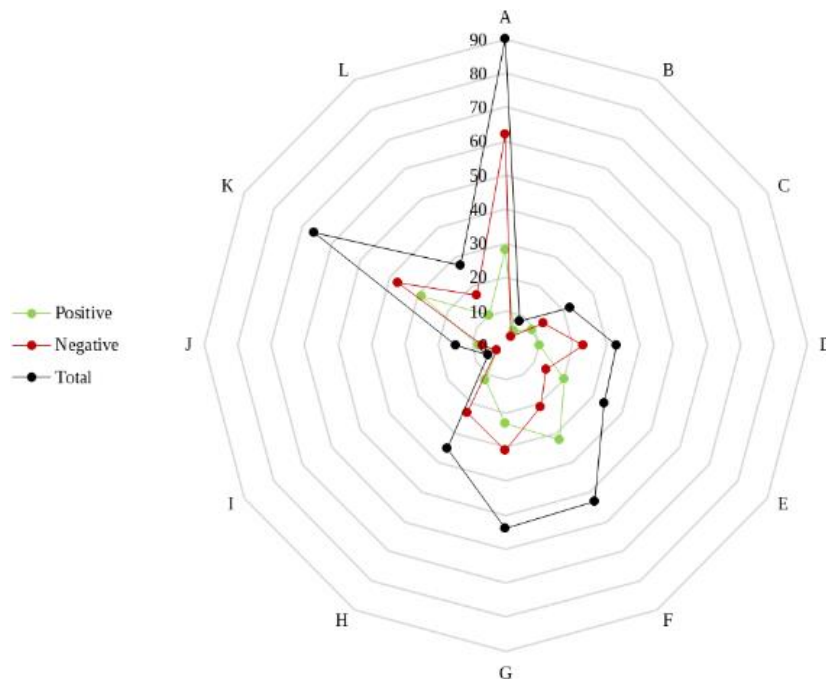

Figure 44: visual representation of the number of arguments per variable

We then decided to calculate weighted variances (figure 46) to see if by doing so we could emit hypothesis on how to distinguish key variables from output or entry variables.

$$\text{Weighted variance} = \text{Variance} * \frac{\text{no of stakeholders mentioning the variable}}{\text{total nb of arguments per variable}}$$

- If the variance is small there are two possibilities:
 - o Either the variable is little mentioned (few arguments and few actors). In this case we can assume that the actors have either forgotten to mention it, or do not necessarily see the importance in relation to the evolution of the sector
 - o Either the variable is strongly mentioned (by many actors who give many arguments) and in this case a low variance would reflect an achievement or a 'similar-consensus' of the actors concerning the importance of the variable for the evolution of the sector

- If the variance is high: this reflects a lack of agreement and consensus for the variables.

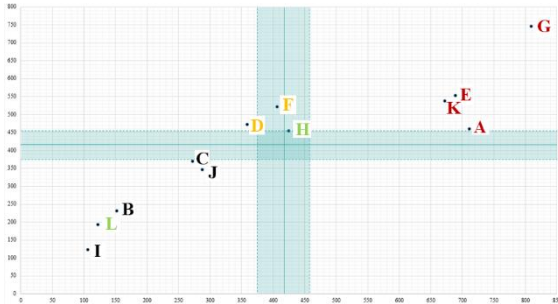

Figure 45: classification of the variables using the adapted Godet method

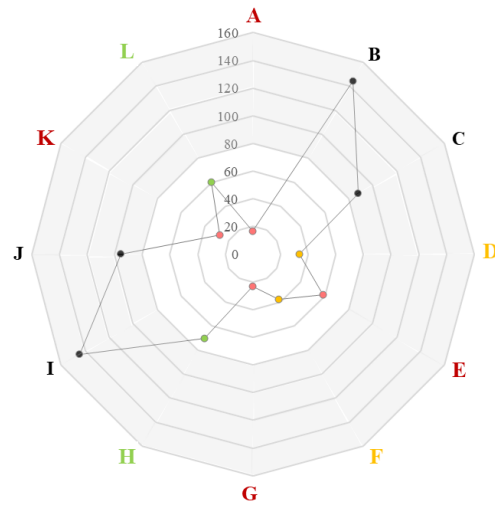

Figure 46: weighted variances of each variable

One could have assumed that the important variables (keys, output and input) would have low variances: this is the case for the key variables A, G, K and the variable 'Economy' which includes the output variable D. Those are the 4 variables with the lowest variances.

By looking at those results (comparing the variables' positions between figure 45 and 46), we see that it is difficult to draw a conclusion. It seems that the important variables (with some exceptions for variable L, which is excluded when applying the adapted Godet method) are the ones with variances lower than 80 in our case. This threshold depends however on the number of arguments and the number of stakeholders interviewed, so it probably will not be the same in other case studies. Once we have determined the important variables, it is difficult to distinguish the key variables from the rest. The results obtained could only be used to confirm the results of the adapted Godet method. This procedure could hypothetically replace the Delphi type questionnaire (i.e. in cases where it is impossible to get a hold of the interviewed stakeholders again). Because the aim is to highly simplify the remote prospective method, other alternatives were explored as discussed in the following paragraphs.

c. Using MyChoice to identify key variables for remote prospectives

With the idea of replacing the adapted Godet method in mind, we explored another option.

Principle and objective of this option

In this second option, MyChoice could be used to create different (rough) framework scenarios from the opinions of different actors. The software would serve to analyze the chains of causality present in the speeches of actors to extract the “key variables” of the system studied.

In addition to identifying key variables, adapting the use of MyChoice for prospective purposes by analyzing cause-consequence relations between variables would allow us to:

- Create plausible framework scenarios for the evolution of an activity, a sector etc., rather in the short or medium term;
- Give an idea of the probability of occurrence of the scenarios (according to actors’ opinions) by calculating the ‘attitudes’³⁰.

Data to collect and questions to ask

The data from which MyChoice creates the scenarios are the answers given by the actors interviewed to the question: “For you, what are the main factors of evolution of your activity / sector / within 3 to 5 years?” (same as in the adapted Godet method). These answers can be obtained either by interviewing people directly, or by finding texts that answer the same question, or by using both sources (interviews and text search).

To guarantee the quality of the outputs of the software, it is necessary to ensure the quality of the inputs. This is why these two conditions must be met, same as in the adapted Godet method:

- The interviews are aimed at actors who know the activity/value chain etc. and/or who are directly affected by its developments; when it comes to texts, they must come from sources that meet the same conditions;
- Ensure variety of opinions from sources. A “stakeholder analysis” may be conducted to verify that at least one person (or at least one text) has been successfully interviewed per stakeholder category.

Forms of raw data

Input data may be such as interview transcripts (verbatim), interview notes (taken during the interview, they take into account the interviewee's ideas but may use different vocabulary), audio recordings, academic or popular texts. All these documents must answer the same

³⁰ In that case, the attitude calculated would reflect the stakeholders’ opinion concerning the nature of influence the variable could have on the future of the value-chain. This influence could thus either be positive, negative or mitigated. We could imagine a classification similar to that of table 7 in section IX.2.c, depending also on the number of arguments given for each variable.

question (above). Responses to open or closed questionnaires would probably be insufficient to obtain quality outputs.

Name Stakeholder	Name Alternative	Type Pro Con	Name Criterion	Aim	Name Property	Value	Condition
Stakeholder interviewed	Pursuing Business as usual	If the influence of the variable on the future of the value chain is perceived as positive or negative	Variable	Concept	Criteria	Nature of influence relation (very influential, strong, getting stronger, etc...)	Influenced variable

Table 13: using the conditions column in the MyChoice spreadsheet to mark influence and dependence relations between variables

The information found in the transcripts and in the documents are then entered in MyChoice as shown in table 13 above. The difference between the variance approach and this approach is the column ‘condition’. The key here is to note the variables influenced by the main variable the stakeholders are talking about.

The idea is to create a table like the one below:

Variable \ Influence	Influence						Total influence
	A	B	C	D	E	F	
A	5	10		9		3	27
B	2		6	1	20		29
C		3	2		2		12
D			7				7
E	15				2	6	23
F		25		30	5		60
Total dependence	22	38	15	40	29	9	

Table 14: using the conditions column in the MyChoice spreadsheet to mark influence and dependence relations between variables

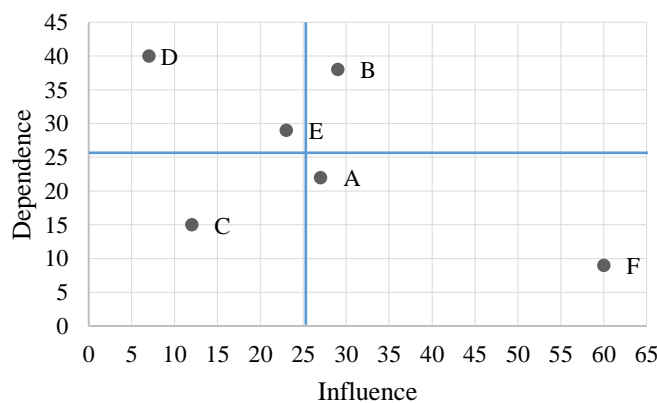

Figure 47: classifying the variables based on table 14

The table 14 can then be translated into a graph like in figure 47. This allows us to differentiate key variables from input variables, output ones and excluded variables, just like when using the adapted Godet method.

The advantages of using MyChoice to do a prospective remotely are the following:

- It is simpler to use than the adapted Godet method
- The results are (or will be once the module is developed) visual
- The prospective study can be done by researchers, by stakeholders, by consultants or by anyone, provided they are taught how to use the tool and enter the information correctly.

Annex 6 talks about the potential development of a MyChoice module we choose to name “MyChoice Opinion – Scenarios module” to facilitate the creation of reference scenarios describing the possible evolution of a value chain.

To make sure that the adapted Godet method can be replaced by using MyChoice, other case studies are necessary to confirm the potential compatibility of prospective methods with multi criteria argumentation. This should however be done under certain conditions. The first condition is that we need to have people willing to talk to us about the future of the studied value-chain. The second condition is to have two people working simultaneously on identifying the key variables. One person does it by using the adapted Godet method, and the other person does it by analyzing the interviews through MyChoice. Of course, to have comparable results, the nomenclatures used should be the same. This thus requires creating an ontology of the different variables, concepts and criteria that could be extracted from the interviews.

Conclusion of section XI

Only stakeholders and experts can identify and describe the issues that will shape their sector in the near future. For the quality of research, it is very important to ensure that sufficiently diverse experts have been identified. That is why after choosing the stakeholders and experts, we make sure we have diverse opinions based on Mitchell, Agle and Wood’s classification (1997).

The global pandemic that started early 2020 in France rapidly changed the way people worked. Remote work was not only an option, it was a necessity considering the sanitary context. However, since the scenario method is primarily based on face-to-face interactions, adjustments had to be made throughout the stages of the classic Godet method.

We were able to conduct 12 interviews, and identify 9 relevant documents. Twelve variables were identified following the analysis of those interviews and document. Four of those variables turned out to be key: social acceptability (A), technical and technological progress (E), job evolution (G) and value chain structure (K). By combining the modalities of those variables (2 per key variable), we obtain sixteen possibilities, of which eight are illogical, and 2 pairs are similar. Six scenarios were presented to project Sentinel partners and two were retained.

The adapted method that is presented in this section and in annex 2 is very time consuming and quite difficult to put in place. Another option using the MyChoice tool to identify key variables is looked into and presented in this section and in annex 6. This annex talks a bit more about the perspectives of developing the MyChoice module for prospective purposes. We call that module “MyChoice opinions – Scenarios module”.

Section XII. Applying multi criteria argumentation for impact anticipation and evaluation in the French pork value chain

This section presents the results of an application of the methodology described in chapter 3 concerning the anticipation, evaluation and prioritization of impacts of changes in agri-food value chains. The results concern the anticipation and evaluation of the impacts of pursuing business as usual in the French pork value chain (1.b). The reason for that is explained in the beginning of the section (1.a). When using multi criteria argumentation, it struck us that we could use it for several purposes to simplify the application of the method allowing the anticipation and evaluation of impacts. In the previous section, we talked about how MyChoice could be used for prospective purposes. In part 2 of this section XII, we show how adapting this tool in another way can help us push our analysis further when prioritizing impacts. Figure 48 below shows more specifically which steps are developed.

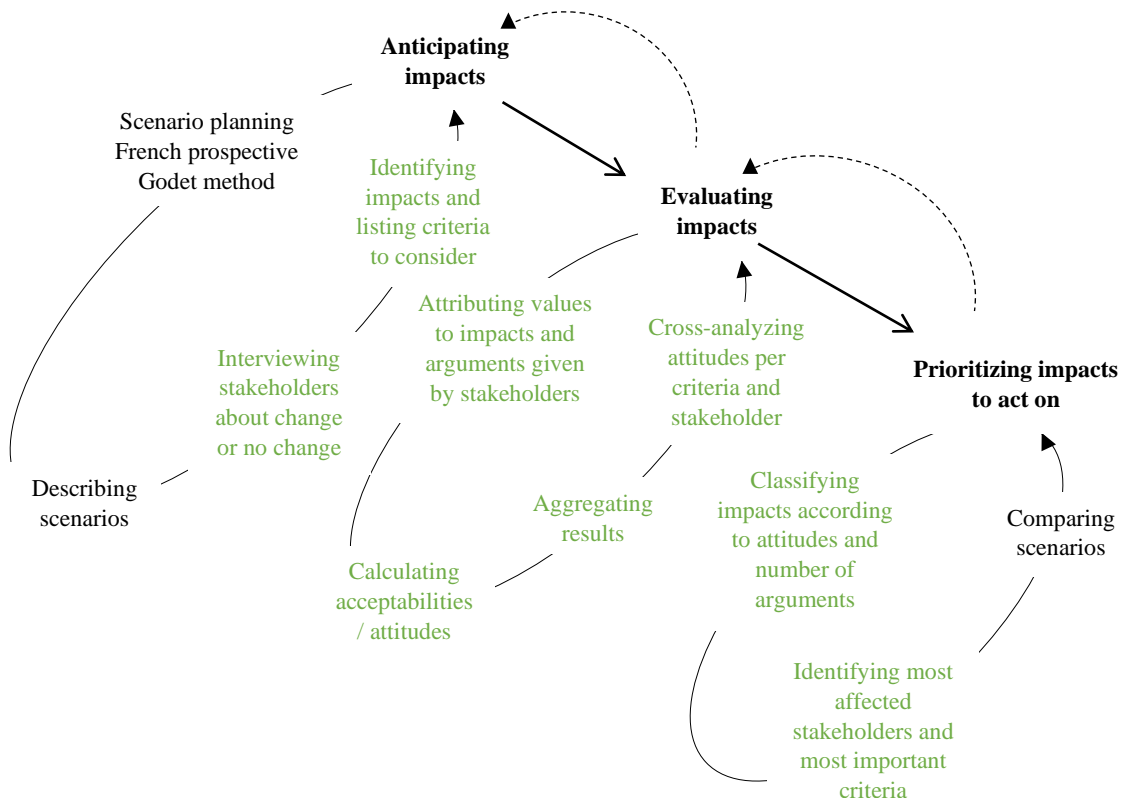

Figure 48: steps that can be done by using multi criteria argumentation

1. Anticipating and evaluating the impacts of change in the French pork value chain using multi criteria argumentation

a. From anticipating and evaluating impacts of new PCB detection tools...

The initial change that was considered as an application for this work was the implementation of new PCB detection tools in the French pork value chain³¹. Thus, the initial case study concerned the evaluation of the impact of those new tools.

Unfortunately for us, we did not get the information necessary (if and how the new PCBs detection tools would work) in time to assess the impacts that implementing those tools will have on the French pork value chain. Nevertheless, this does not discredit the work done since the main objective of the thesis is to develop a general methodology allowing the anticipation and evaluation of impacts of any change in any value chain. The French pork value chain and the PCB detection tools are merely an example of application. On another hand, it is not very problematic for project Sentinel, as the methodology is now available. All that is left to do is to apply it to that specific case.

b. ...to anticipating and evaluating the impacts of a crisis in a value chain

In the interviews done, we had spontaneous comments on the foreseeable impacts of business-as-usual. That is why we decided to work on those data, in order to provide an anticipation and evaluation of the impacts of pursuing “business as usual” in the French pork value chain. The following paragraphs are organized according to the different steps shown in figure 49, starting from the interviews with the stakeholders.

i. Anticipating the impacts

Interviewing stakeholders about change or no change

When discussing with the 12 stakeholders of the French pork value chain, they naturally and spontaneously talked about the impacts of pursuing business as usual. After establishing the state of the art of this *filière*, it strucked us that the value chain is possibly at the verge of a crisis based on what was said.

Several factors are at the origin of this assumption: pork consumption is gradually declining, because people consider pig farms as dangerous to the environment and to their health. People no longer support installing nearby farms. Pork production fell in 2022 by 2.2%. This decline

³¹ Because the thesis is financed by project Sentinel as mentioned in Section II.

is twice as large as in 2021 and compared to the ten-year average according to Agreste. Scandals at the slaughterhouse and environmental problems have further exacerbated the situation in the food system. Slaughtering fell by 1.4% in one year in terms of the number of animals (Agreste, 2022). Pork is considered one of the cheapest meats in France, however, with the recent inflation pork meat prices increased. Between 1 January and 31 May 2022 and the same period in 2023, the average purchase price of fresh pork increased by 13.6% to €8.5/kg, while household purchases decreased by 3.6%. Most recently, in August 2023, the price of French pork has fallen to such an extent that it is approaching the two euros mark³². Production costs keep increasing as access to feed, energy and other commodities is threatened. In May 2023, the producer price of pork decreased by 5.6% compared to April 2023 but increased by 26.3% year-on-year, compared to May 2022 according to the Ministry of Agriculture and Food Sovereignty³³. Imports increased by 7.8% in 2022, mainly from Germany (+9.1%) and Italy (+26.5%), while exports decreased by 6%. Moreover, the value chain is having difficulty recruiting new workers, because it is highly unattractive to potential new farmers as well as consumers according to the interviewed stakeholders and the literature (Jolly et al., 2023).

There is an unconscionable discordance between the nature of the value chain and the societal, institutional and environmental demands. Looking at that information, we decided it would be quite interesting (and possibly a motor of change) to evaluate the impacts of pursuing business as usual imagined by the interviewees. The change of which the impacts are evaluated in the rest of this section is the crisis that the value chain might face.

Identifying impacts and listing criteria to consider

It is important throughout the study to consider all kinds of arguments. A list of practical arguments helps to fill the decision-maker's lack of knowledge and reduces uncertainty about the decision taken. Suppressing some arguments because they are less "strong" than others can bias the results and may prompt the decision-maker to make a decision that is not necessarily the right or best (Amgoud, 2008). For that reason, and because we assume that verbatim accurately reflect the interviewee's reflections, the twelve interviews are recorded and then transcribed. This also avoid any possible loss of information as all the statements of experts are listed in a table.

³² [Cotation | Le cours du porc français frôle les 2€/kg | Réussir Les Marchés \(reussir.fr\)](#)

³³ [Indices filière porcine | Ministère de l'Agriculture et de la Souveraineté alimentaire](#)

The arguments given concerning the impacts of pursuing business as usual are identified in the texts based on what is explained in section IX.2.a. They are then entered in MyChoice as shown in table 6 (section IX.2.a). After sorting the arguments from the interviews in the MyChoice tool, a total of 282 impacts are identified, classified in 16 impact categories. Six stakeholder categories are impacted by the pursuit of business as usual, and some of the impacts identified also concern the ecosystems, the environment or the global value chain³⁴.

ii. Evaluating the impacts

Attributing values to the arguments and calculating acceptabilities

The impact categories are cross-analyzed with the stakeholder groups: this allows us to identify the attitudes concerning an impact category for each stakeholder of the value chain, at least those that are mentioned by the interviewees (so those that we assume are the most important to them). The results are presented in table 15 below.

	Communication	Consumption modes	Energy	Environmental	Institutional	Market options	Political	Product price	Production costs	Production ways	Sanitary	Social	Value chain perception	Value chain structure	Economic	Technical and technological
Intakes providers	-	-	0,33	-	-	0,25	-	-	-	-	-	-	-	0,67	-	-
Producers	-	0,33	0,25	-	0,44	0,29	-	0,33	0,3	0,69	0,33	0,35	0,23	0,5	0,19	0,62
Processors	-	0,39	-	-	0,67	0,56	-	-	-	0,63	-	0,33	0,33	0,44	-	-
Employees	-	-	-	-	-	-	-	-	-	-	-	0,24	-	-	-	-
Consumers	0,25	0,38	-	0,25	-	0,67	-	0,54	-	0,67	0,33	0,44	0,23	-	-	-
Value chain	0,33	0,5	0,33	-	0,67	0,38	-	0,67	-	0,51	0,5	0,39	0,44	0,34	0,31	0,6
Ecosystems	-	-	-	0,33	-	-	-	-	-	-	-	-	-	-	-	-
Institutions	-	-	-	-	0,33	-	0,25	-	-	-	-	-	-	-	-	-
Average attitudes	0,29	0,40	0,30	0,29	0,53	0,43	0,25	0,51	0,30	0,63	0,39	0,35	0,31	0,49	0,25	0,61

Table 15: attitudes reflecting interviewees' perceptions of impacts of "Business-as-usual" on stakeholders of the French pork value chain

The 16 impact categories identified are presented in columns. Those impact categories were either directly given by the stakeholders during the interviews or they were deduced based on what was said and following an ontology-matching procedure (by going from detailed

³⁴ In some cases, it can be difficult for certain stakeholders to pinpoint exactly which stakeholders will be impacted by a change. In other cases, or other stakeholders, they can talk about the value-chain in general because they see themselves as part of a structured system: if one stakeholder is impacted, they consider the whole value-chain as impacted as well.

information to larger broad categories³⁵). In lines, we have the stakeholders impacted. The values marked in the table are the attitudes which reflect the interviewees' perceptions of how the impact affects the stakeholders³⁶.

iii. Prioritizing the impacts to act on

Classifying impacts according to attitudes

The different attitudes are presented in a gradient of colors going from dark red (very negatively perceived) to dark green (perceived very positively). We can thus distinguish three categories of attitudes regarding the impacts

- The ones which are negative (0.4 and below)
- The ones which are positive (0.6 and above).
- The ones which are mitigated (between 0.4 and 0.6). The impacts following a crisis situation have certain characteristics and capturing them may be difficult since most of them are not evidently positive or negative and highly depend on the stakeholder's perception (Vanclay, 2002).

For example, it is clear that the interviewees think that by pursuing business-as-usual, the French pork producers will be highly negatively impacted economically speaking (attitude 0.19, well below 0.5). Stakeholders are more mitigated when it comes to the impacts of the value chain structure on the producers (attitude equals 0.5).

Just by looking at the table, we can see that there are more shades of red than there are green, meaning there is a tendency to anticipate more negative impacts if business continues as usual. The final aggregated attitude for all stakeholders and all criteria combined is 0.39 (< 0.5), which confirms that the value chain is not on the right track, at least according to the experts interviewed. However as we said earlier in chapter 3 section IX, the analysis of the attitudes alone is insufficient.

³⁵ Some of these terms, such as “social”/”societal”, “energy”, and “institutional” are very broad for an SLCA. They are useful in a sense of identifying the general type of impact and to simplify the presentation of results to decision-makers and stakeholders. However, for decision-making purposes, it is imperative that we look at the details of what was said by the stakeholders to identify the real impacts, not only the impact categories.

³⁶ The absence of an attitude value in certain boxes is also a result in itself. It means that the stakeholders do not view that impact category as significant for the concerned stakeholder. According to the collective attitude equation, the corresponding attitude for those boxes would be 0.5, however their analysis cannot be pushed further than that.

Identifying most affected stakeholders and most important criteria

	Communication	Consumption modes	Energy	Environmental	Institutional	Market options	Political	Product price	Production costs	Production ways	Sanitary	Social	Value chain perception	Value chain structure	Economic	Technical and technological
Intakes providers			0/1			0/2									1/0	
Producers		0/2	0/2		4/7	0/4		1/4	2/6	13/3	0/1	3/11	0/4	13/14	1/15	3/1
Processors		1/2			1/0	2/1				3/1		0/1	0/1	1/2		
Employees												1/7				
Consumers	0/2	2/6		0/2		1/0		3/2		1/0	0/1	2/4	0/4			
Value chain	0/2	3/3	0/1		3/0	4/8		1/0		6/5	3/3	1/2	2/3	14/31	1/6	2/1
Ecosystems				0/2												
Institutions					0/1		0/2									

Table 16: number of positive and negative arguments (positive/negative) given by stakeholders for each impact category by impacted stakeholder

By applying the rules depicted in table 7 to the values already present in table 15, we obtain the following results in table 16 below. The color attributed to current tendencies is light grey. For probable and certain impacts, the colors' significance are still the same, however, for probable impacts, the colors are lighter than those of certain ones (i.e. a probable negative impact is marked in light red, whereas a certain negative impact is marked in dark red)³⁷.

Therefore, concretely when it comes to prioritizing the impacts to act on, ideally, this is what is preferred: first, the most urgent impacts to act on would be the certain negative impacts (dark red in table 16) and the mitigated impacts that could go either way (dark yellow in table 16). After that, the focus should be on the impacts that are probably negative (light red) and those that we are unsure how they could go (light yellow). Finally, the impacts to act on would be the possible negative tendencies (light grey in table 16 and in the shades of red to yellow in table 15). The impacts on which we cannot say much are to tackle but after the rest is dealt with. Ideally, all of those impacts should be taken into account at the same time. However, since usually time is pressing and budgets are restricted, this classification could help target actions wisely.

³⁷ In the table 16, the number of arguments is sometimes limited for certain actors/criteria, the method proposes a representation even in a situation of "ignorance" (in case where no arguments are given, the attitude is 0.5).

Positive impacts are very important to consider when implementing changes in agri-food value chain. Indeed, it is desirable that positive impacts do not transform into negative ones. For that reason, it is difficult to classify the action to take on them as they should be taken into account all along the impact evaluation and decision-making processes. Table 17 below summarizes the priorities given to each impact category. The * symbol refers to the impacts to take into account throughout the whole process.

Number of Arguments \ Attitude]0; Median[[Median; Q1]]Q1; Q3[
]0; 0.4]	5	3
]0.4; 0.6[6	4	2
]0.6; 1[*	*	*

Table 17: classifying the impacts to act on by order of intervention

According to the results obtained in tables 15, 16 and 17 above, the priorities for the results on pursuing business as usual are presented below as such: impact type, impacted stakeholder (attitude- total number of arguments). The classifications presented above allow us to identify the most important impact categories based on stakeholders’ opinions. However, for decision makers, determining the impact categories is insufficient, it is necessary to look at the details of what the impacts are in each impact category. This is what we did in the paragraphs below. The terms used are derived from the interviews themselves. The impact categories are classified from the lowest to the highest attitudes, and therefore from the most negative to the most positive ones (at least as perceived by the interviewees), the number of arguments being higher than the median anyway.

• ***Economic, on producers (0.19- 16 arguments)***

A potential crisis in the value chain means that producers won’t be able to have decent income, especially organic breeders. They will have difficulties in finding finances. Even though –until now- the pork production is considered as the most cost-effective agricultural production on the long term, constant fluctuations will discourage the breeders, especially since higher investments will be needed (for better respect of animal welfare and environmental regulations). Producers will have to invest more to find workers willing to help them on farms that keep getting bigger and bigger.

• ***Social, on employees of the value chain (0.24- 8 arguments)***

Some of the difficulties faced by breeders also concern employees of the value chain, from the production of primary matter, to the transformation and distribution of pork products. Keeping up with the value chain model as it is today could lead to a crisis in employment: certain employees risk being laid off, unemployment rates will become greater, and for the people employed, they may have to accept cheap salaries. Some other jobs could be created, they will however be of different nature, possibly more related to technical management.

• ***Production costs, on producers (0.3- 8 arguments)***

The main concern is for producers to maintain a cost-effective production. Despite having bigger farms and possibly higher revenues, producers who do not produce their own feed could face difficulties. Production costs will increase which could lead to certain producers being in debt.

• ***Value chain structure, on the rest of the value chain (0.34- 45 arguments)***

Stakeholders interviewed discussed the impact of the current structure on the whole value chain. According to them, the value chain is unable to change, the organic value chain will be incapable of developing any further, and the production system will remain irrational. Pig breeding will remain concentrated in the West because the value chain is stuck in a vicious circle, meaning that there will be less and less breeders in regions other than those specialized in pork. The value chain will become more and more fragile as certain slaughterhouses could be shut down while pork production become more dense in places where slaughterhouses are still functioning.

• ***Social, on producers (0.35- 14 arguments)***

Producers will be ‘professionals’ in the next few years according to some stakeholders. Nevertheless, knowledge transmission from one producer to another is not guaranteed as there is a high risk of closing down certain breeding farms and there is less and less people willing to work in the sector. Maintaining and creating jobs for breeders in the French pork value chain and transferring farms to new buyers will become quite difficult. On top of that, the work force could potentially be replaced by an excessive use of technologies

• ***Market options, on the value chain (0.38- 12 arguments)***

The market if it continues on the same track will allow the value chain to diversify its sources. There will however be a stronger competition of France with other European pork producing countries. Access to certain markets could become limited as certain markets will saturate and economic gains could become uncertain. However, some opportunities of new markets could emerge.

• ***Consumption modes, on consumers (0.38- 8 arguments)***

If business remains as usual, according to the interviewed stakeholders, consumers will have ‘access to meat of better quality’ and ‘local products’. However, consumers there will essentially experience a ‘reduction of pork consumption’ and even in some cases according to stakeholders, ‘boycott’ of industrial meat production.

• ***Institutional, on producers (0.44- 11 arguments)***

Institutional criteria will negatively impact producers in a sense that future or potential breeders will be discouraged as they could be incapable to ‘conform to new rules’ which will be reinforced. Future breeders could also have complications in investing. Aids for alternative breeders will also be lacking. However, reinforcing rules and regulations could force breeders to respect the environment and prioritize their feed autonomy.

• ***Value chain structure, on producers (0.5- 27 arguments)***

Maintaining a similar structure of the French pork value chain could result in producers not being able to have access to primary matter. Even though there might be a growing interest in alternative production systems, pork breeders possibly won’t be able to maintain or develop alternative models, since probably according to the stakeholders, farms will keep getting bigger and bigger resulting in harder management tasks and requirements. Intensive production could be discriminated in the future as a result of a strong segmentation of the market. Because the value chain and thus the producers are highly dependent of other European countries, more and more breeders will launch a feed and fertilizer production activity to produce their own intakes. This will help them gain a partial independence from the global market.

• ***Production ways, on the rest of the value chain (0.51- 11 arguments)***

As for the value chain, the interviewees were a bit more mitigated as to the impacts of the “business-as-usual” scenario. Even though some stakeholders argue that the value chain will witness an improve in production ways (respect of animal welfare and environmental regulations) and will be able to ensure sufficient volumes, others believe

this won't necessarily happen and the value chain will suffer from a 'weak logic of convenience'.

• ***Production ways, on producers (0.69- 16 arguments)***

Production ways will highly improve according to the interviewees if business continues as usual. Productivity gains will be very important and producers will benefit from better production techniques.

In the case of the French pork value chain, the actions to take in priority would be institutional, economic and social to alleviate the negative impacts on producers (to have more detail on what to do the visuals of MyChoice can be useful). Social strategies could also be developed to limit the negative impacts on the value chain's employees and consumers. And finally, structural change is inevitable if the value chain is to improve. The strategies to implement are to be specified according to the decision makers and depending on what they are capable of doing.

By doing the work manually to determine which impacts need to be taken into account, it struck us that developing MyChoice module to do the work automatically would be of great help when it comes to decision making. In the rest of the section, the idea behind a possible MyChoice module for impact anticipation is presented.

2. Adapting MyChoice to easily evaluate and prioritize impacts

a. Developing MyChoice for impact anticipation and evaluation

Principle and objective

The novelty of the work discussed here is that we choose to use the MyChoice tool to anticipate and evaluate the main impacts of a scenario according to the opinions of different actors, and quantifies their acceptability (by impact, by actor). The impacts identified by the software are based on the opinions of stakeholders.

Adapting the use of MyChoice to this purpose would allow us to:

- Identify impacts of any kind cited by actors on a recurring basis, rather in the short or medium term and classify them;
- Calculate the acceptability of each impact (per actor, per impact) or impact category.
- Highlight the impact paths between cause and effect.

Data to collect and questions to ask

The data from which MyChoice identifies and evaluates the impacts of the change envisioned in a scenario are the answers given by the actors interviewed to the question: “For you, what are the main impacts of the change in this scenario in 3 to 5 years?”. It is advisable to spend time accurately describing the scenario being considered so that the interviewee understands it clearly.

This can be the “business-as-usual” scenario (i.e. if the trends at work continue to evolve in the same direction without proactive action to the contrary). This may be a scenario that the interviewee has just described himself/herself. Very often, to compare the impacts of several scenarios, it will also be necessary to know the impacts envisaged by the interviewee for the “business-as-usual” scenario. For that reason, we will ask two questions to each interviewee: one on the impacts of the “business-as-usual” scenario, the other on the impacts of the scenario that interests us. These answers can be obtained either by interviewing people directly, or by finding texts that answer the same question, or by using both sources (interviews and text search). From this data, the software will identify impacts deemed important in the short or medium term, because actors rarely have enough visibility to decide on significant impacts beyond this time horizon.

To guarantee the quality of the outputs of the software, it is necessary to ensure the quality of the inputs. This is why the same conditions stated previously for MyChoice scenarios (section XI.3.c) (p.160) are necessary here as well.

All the raw data gathered above must be converted into text. In these texts, we try to identify phrases and words that indicate impacts, just as we’ve shown previously. A non-exhaustive list is given in table 5 in section IX.2.a. (p. 123). It remains essential to reread the entire text to be sure to have a list of all the impacts cited. Once the impacts are identified in the text, the information must be entered into the MyChoice software like in table 6 in section IX.2.a (p. 123).

b. Establishing impact pathways based on stakeholder interviews

Establishing impact pathways is not always easy, especially when multiple actors are involved and many criteria are evaluated in the short, medium and long term (the criteria are indeed adapted to the problem encountered and to the needs of project sponsors and they are not pre-determined).

Certain columns in the MyChoice tool spreadsheet could help us identify causes of impacts and potentially the impact pathway.

When looking to establish those pathways, the most important columns for us are ‘Name Criterion’ for the impact category, ‘Name Property’ for the real impact, and ‘Conditions’ for the cause of the impact (see table 6 section IX.2.a p.123).

By filtering the information in the MyChoice spreadsheet according to the causes of impacts and the impact categories, we obtain the following table 18 below:

Impacts Causes	Communication	Consumption modes	Energy	Environmental	Institutional	Market options	Political	Product price	Production costs	Production ways	Sanitary	Social	Value chain perception	Value chain structure	Economic	Technical and technological	Impacts
Communication		1			1	1		1		3			2	1			9
Consumption modes	1	4				3		1		3				3	1		16
Energy				1					1					1	2		5
Environmental			1			1				3	1	2		2			10
Institutional					3			3	2	2		2		5	1	3	21
Market options		2			2	3		2	2	5	5	3	2	7	5		38
Political						1	2							2	1		6
Product price								1		2				4			7
Production costs						2			2	1		1		1	2		9
Production ways	1	1		2		1				2		4	1	10		1	23
Sanitary					1	3				4	1	2		4			15
Social	1	3	1		3	2		2	1	5		3		14	3		38
Value chain perception		6										5	4	3	1		19
Value chain structure				1	2	3			1			8	3	10	4	1	33
Economic	1		1			3		1	1	1		3		7	1	1	20
Technical and technological					1					4	1	1	2		1	1	11
Is impacted	4	17	3	4	13	23	2	11	10	34	8	34	14	74	22	7	

Table 18: number of arguments obtained by cross-analyzing impacts with their causes

Boxes in dark blue are represented in figure 49

For example, table 18 above can be read as follows (following the green arrow): market options impact production ways and five arguments were given for that impact relation by the interviewees (for more details concerning the exact nature of impacts it is necessary to refer to the MyChoice spreadsheet). It is important to note that the number and nature of causes is not necessarily identical to the number and nature of the impacts themselves. In table 18 we chose

to show the impacts and causes of same nature because that is what was prevalent in the interviews. However, sometimes, the stakeholders were not specific about a cause or they did not mention it. We labeled it as “other causes” and we made the choice of not representing it in table 18 to simplify it as much as possible.

To make the results more visual, table 18 can be shown as a mindmap representing the pathways. The full mindmap is presented in annex 5. Figure 49 below shows only certain impact

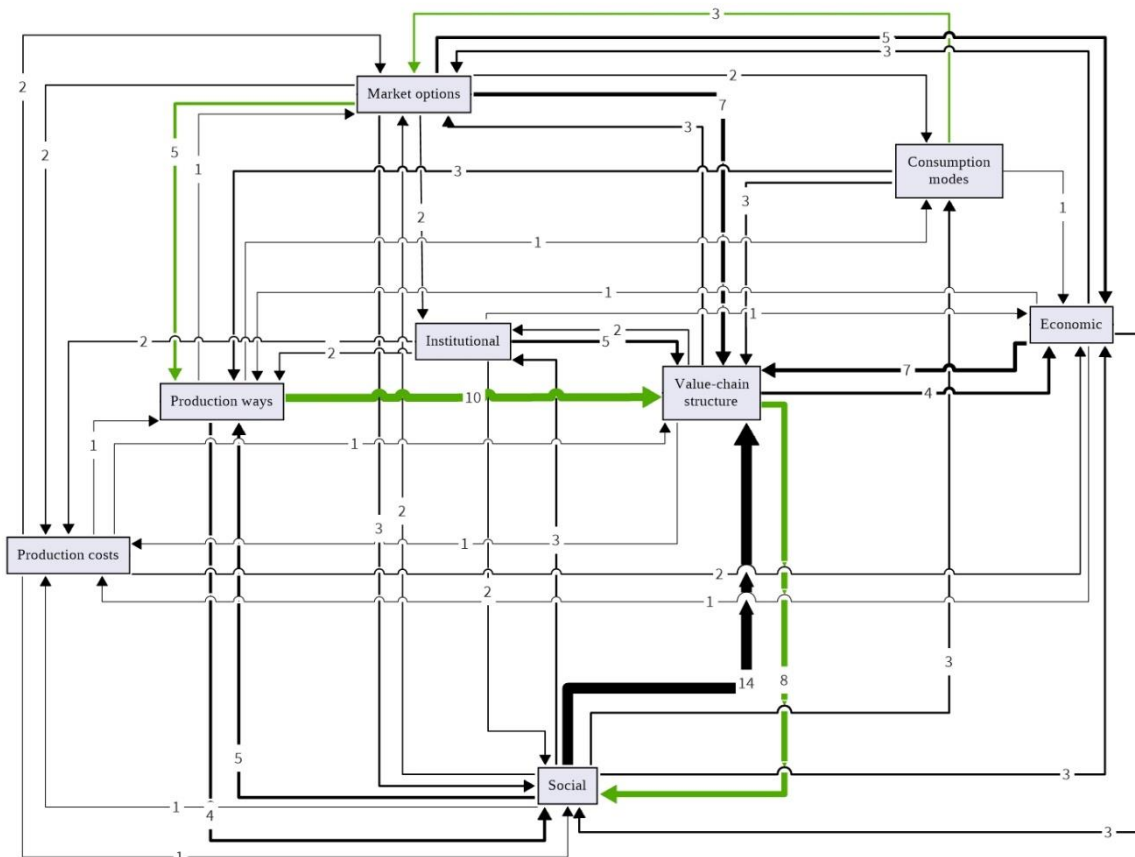

Figure 49: impact pathways identified based on table 18, according to the information extracted from the interviews done

pathways. Indeed, based on the results obtained in table 16 we chose to show the impact categories that are somewhat certain (certainly impacting at least one stakeholder category) according to the interviewees and table 7. Those impacts are institutional, economic, structural (value chain structure) and social. The impacts on consumption modes, market options, production costs and ways are also represented. Keep in mind that not all causes of those impacts are presented for visual purposes.

In the figure above, the arrows between impacts refer to a causality link. They are represented in several thicknesses, depending on the number of arguments identified in the interviews (the number of arguments is marked on each arrow). An example of a general impact pathway is represented in green. The explanation that follows is based on what the stakeholders said: because of a higher demand of pork of better quality (e.g. respect of animal welfare) this could impact market options and force them to be more diversified (e.g. market segmentation). If this happens, it could encourage producers and transformers to change their production ways, inevitably making a change in the value chain structure (e.g. more SMEs), which could eventually improve the workers' conditions. Those are general pathways that could be identified.

Looking at a mind map like the one presented in figure 49 can make easier to identify "hotspots". We could also imagine a representation of those relations according to the attitudes of the stakeholders: negative impacts would be translated in red arrows, positive ones in green arrows and mitigated impacts in yellow. This could help decision-makers see which category is impacted the most negatively, and it could help identify strategic actions to take based on the means available. The objective is to then go into the details of the nature, type and explanation of the causality links between the different impacts in each impact category.

Annex 7 talks about the potential development of a MyChoice module we choose to name "MyChoice Opinion – Impacts module" that would facilitate the anticipation and evaluation of important impacts of changes in value chains. This module, if developed, would allow us to obtain tables 14, 16, 18 and figure 49 (or annex 5) automatically.

Conclusion of section XII

In this section, we showed the results of anticipating, evaluating and prioritizing the impacts of pursuing business as usual in the French pork value chain. The results presented are from analyzing the twelve semi-directive interviews done with stakeholders and experts of the value chain. After identifying the arguments, those were entered in the MyChoice tool to cross analyze the attitudes per stakeholder category and per criteria. The identified impacts were then classified according to the attitudes, but also according to the number of arguments. Globally, and unsurprisingly, if business is pursued as usual, it is said that the most affected stakeholders are the producer. The value chain as a whole will also be impacted but it is a bit complicated for stakeholders to always detail their thoughts and arguments and it can be difficult for them to pinpoint exactly who will be affected and how.

The MyChoice tool can be adapted to facilitate the anticipation and evaluation of impacts. This tool, if adapted, could also help prioritize impacts automatically. Annex 7 talks a bit more about the perspectives of developing the MyChoice module for impact anticipation and evaluation. We call the corresponding MyChoice module “MyChoice opinions – Impacts module”.

Conclusion of chapter 4: main results and findings

In this chapter, we presented the results obtained when applying the method discussed in chapter 3. Figure 50 below is a quick summary of the approach used. After determining the spatial (French pork value chain) and temporal (3 to 5 years) perimeters, we started by choosing which stakeholders to involve in the prospective study of the value chain and in the impacts anticipation and evaluation phases. Those stakeholders were chosen according to Mitchell Agle and Wood's classification.

For the prospective study, 21 interviews were done (12 semi-directive interviews and 9 documents that completed the analysis mainly because we were obliged to do a remote prospective). Twelve variables that could influence the future of the value chain were identified, four of which were key (social acceptability, technical and technological progress, job evolution and value chain structure). By combining those variables' modalities, six scenarios were created and briefly described. Two of those scenarios were retained for the study of the impacts in the case of project Sentinel.

Those scenarios are however not referred to in the next sections as we did not have enough information about the tools for PCBs detection and how they would work. Nevertheless, the 12 stakeholders that were interviewed for the prospective study spontaneously cited impacts of pursuing business as usual. For that reason, we decided that it would be interesting to apply the method to anticipate, evaluate and prioritize the impacts of pursuing business as usual, the change considered being a possible crisis in the value chain based on what emanated from the interviews. Sixteen impact categories were identified, and 6 potentially impacted stakeholder groups were identified as well. By cross-analyzing the attitudes with the number of arguments, we were able to identify the impacts that are certain according to the interviewees, as well as the probable impacts that would result by pursuing business as usual in the French pork value chain. Turns out that the most affected stakeholders on case of a potential crisis in the value chain are the producers.

To facilitate the anticipation and evaluation phase, the MyChoice tool can be used differently. It can also be used to identify impact pathways based on stakeholder opinions. This could help prioritize impacts even further to better target the actions to take in the value chain.

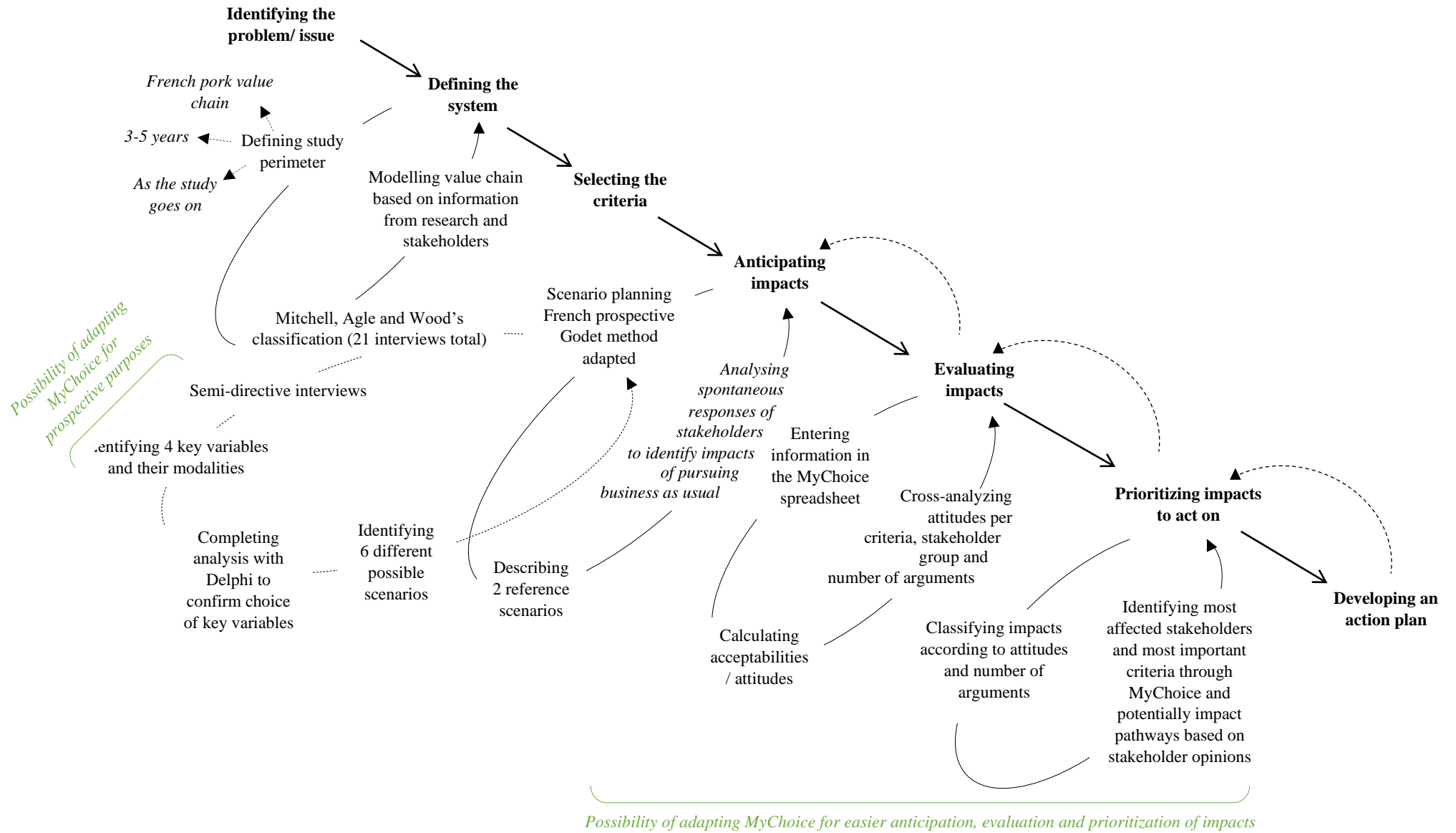

Figure 50: summary of the approach used when anticipating, evaluating and prioritizing the impacts of changes in the French pork value chain

Figure 51 below is a summary of the different ways the MyChoice tool can be used. The initial use that was intended for this tool (1) was for it to help anticipate, evaluate and (if possible) prioritize the impacts of a change in a value-chain. The work shown in this manuscript proves that MyChoice can be used to anticipate, evaluate and prioritize impacts based on stakeholder interviews. By using this tools, other possible applications of it emerged, depending on how the information is entered, and depending on the criteria used for the analysis. Thus is seems possible that the tool could be used to identify general impact pathways (and more specific ones if intended) (2). This tool could also be useful to simplify the adapted Godet method (3) or to even replace it (4). More works and research is necessary for options 2, 3 and 4.

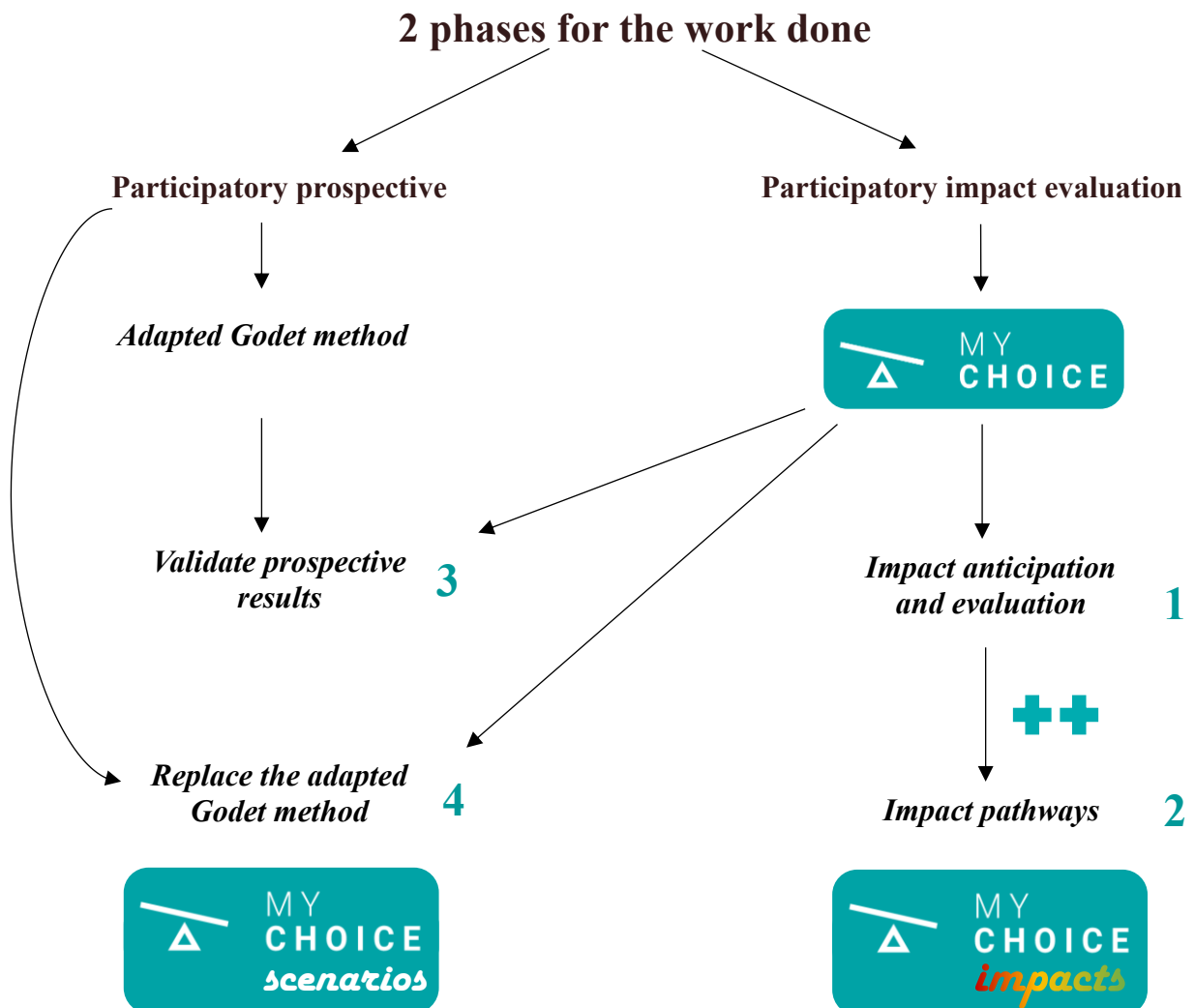

Figure 51: summary of the different possible uses of the MyChoice tool

Chapter 5. Contributions to the field, perspectives and conclusion

This chapter serves as a conclusion for the work shown in this manuscript. In it we present the different scientific and managerial contributions that this work could bring (section XIII). We finish with a general conclusion in section XIV through which we discuss the contributions to answering the scientific gaps noted in chapter 2.

Section XIII. Scientific and managerial contributions

Throughout the manuscript, we discussed the methods used to anticipate and evaluate the impacts of changes in agri-food value chains. In this section, the potential scientific and managerial contributions of that work are presented.

1. Scientific contributions

The principal scientific contributions of the work shown throughout the manuscript concern social LCA and multi criteria argumentation.

The main issue stems from the need to anticipate and evaluate impacts (especially social ones) beyond the usual economic way. There is in fact a need to question management practices including the ways to account for performances and to use something other than profitability to measure the performance and impact of a value chain. One of the aims is indeed to create value for the different stakeholders involved in transferring a product from primary matter production to its consumption. The value that is looked at through the work described in this manuscript is limiting negative impacts and reinforcing positive ones.

Many different stakeholders are included in the study and they all have a say as to what is working for them or not. By using Mitchell, Agle and Wood's classification, whether it is to create reference scenarios of the evolution of the value chain or to anticipate and evaluate the impacts, all stakeholder groups, especially the most marginalized ones (farmers, breeders, workers, etc...) are taken into account and given a voice. The fact that we did individual semi-directive interviews reinforces that too. The work don can be separated into two main phases: participatory prospective and participatory impact evaluation. For the first phase, the adapted normative approach for the Godet prospective method helps determine the scope and direction of an agri-food value chain. It could thus help in bettering decision-making processes by encouraging stakeholders and experts to consider and envision all possible futures of the value-chain, with and without the potential change. As for the second phase, cross-analyzing impact categories with impacted stakeholders and looking at the attitudes and number of arguments given makes prioritizing impacts possible. Mathe's work (2014) already addressed the use of participation to evaluate impacts using SLCA. However, the added value of our work is that the impacts are not defined *a priori* which is more in line the the type II social LCA approach. Impacts are defined by the stakeholders and the experts as the study goes on, and the use of MyChoice tool for multi criteria argumentation helps us do so.

We believe that MyChoice brings a lot for the SLCA field and its versatility could aid in making more fruitful decisions to better the functioning of agri-food value-chains. The approach developed can also be applied to other types of value-chains and life cycles, as long as people are willing to talk.

Figure 52 below summarizes the main scientific contributions of the work done. It shows how multicriteria argumentation complements type II social LCA.

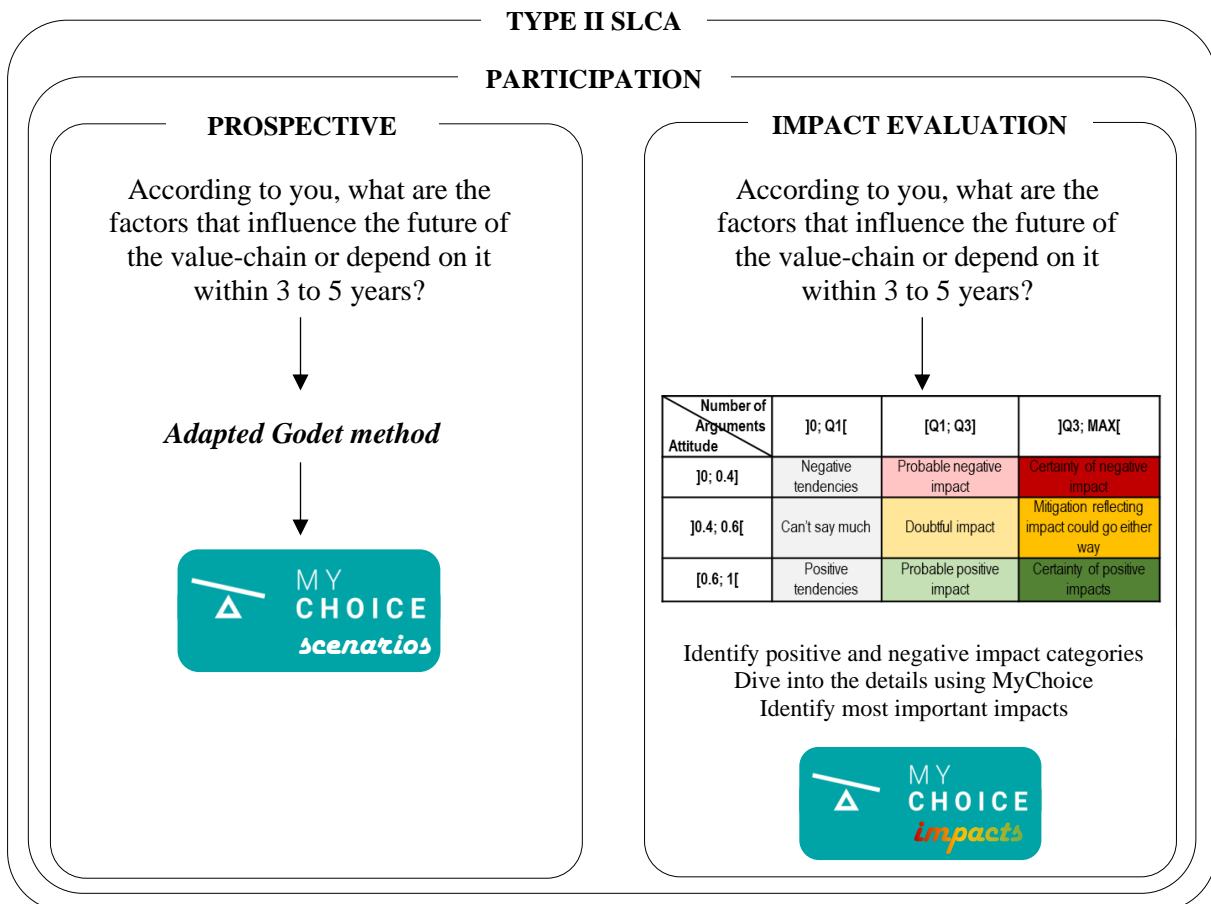

Figure 52: how multi criteria argumentation contributes to social LCA

2. Managerial contributions

The managerial contributions are addressed to the stakeholders of agri-food value chains and to the decision-makers and possibly consultants who would like to provide expert opinions, analysis and recommendations to organizations or individuals by anticipating and evaluating impacts of changes in all sorts of value chains.

a. Contributions specific to the knowledge of the French pork value chain

Creating reference scenarios of the French pork value chain

From a business perspective, one of the main managerial contributions of the thesis is that scenarios that no one had entirely considered before for the French pork value chain were generated. It brings to the attention of the stakeholders and decision makers some issues with the value chain and helps them think of solutions to reach a desired future. For example, the excess pollution, linked to the concentration of livestock in the Great West is automatically “managed” in the hypothesis of a more balanced distribution of farms throughout the national territory. A presentation of the different scenarios resulting from the prospective done is planned with the professionals (including the IFIP), precisely to make them react to contrasting scenarios.

Anticipating and evaluating the impacts of a potential crisis in the value chain

Anticipating and evaluating the impacts of pursuing business as usual in the French pork value chain was not our initial goal. However, the stakeholders naturally talked about what would happen if nothing changes. Therefore, we thought that it would be beneficial for the value chain to have access to that kind of information: in other words, we thought that by anticipating the impacts of the business-as-usual scenario, and by presenting the results to the stakeholders, it would be a motor for potential change.

Another trigger was a paper we read about a prospective study that was done 40 years ago on the French pork value chain, using the Godet method. Perfect opportunity for a comparison (Chaib et al., 2022b). The results showed that even though there were changes (e.g. an improvement in the use of techniques and technologies, which is logical), some of the changes were not in favor of the value chain (e.g. an increase in the importance attributed by experts to social acceptability), and for the most part, the main structure of the value chain did not change at all. The value chain was not and still is not attractive, which is quite problematic, and its structure is not improving for the better. By reinforcing what was already implicitly said 40 years ago, we hope that the prospective study done and the evaluation of impacts of maintaining things as is can maybe serve as a wakeup call for the stakeholders and decision makers. Just as with the prospective scenarios, a meeting with professionals on the impacts of pursuing business as usual is planned.

b. Contributions to decision-making in agri-food value chains in general

Remote prospectives

Because of the sanitary context, it was necessary that the French prospective Godet method be adapted. However, for reasons other than sanitary ones, prospective studies might have to be done remotely more often. The adapted Godet method, and especially the MyChoice opinion module for prospective is a contribution that could help simplify this time-consuming task.

Both those tools and methods serve as a way of tackling hyper-sensitive themes (e.g. pollution of waterways, hyper-intensification, animal welfare) without provoking a sterile confrontation of stakeholders. The problems are considered actively (what scenario could we put in place?) and no longer defensively. The main limitation for business is that it is necessary to force oneself to gather (virtually) stakeholders of the value chain whose opinions differ profoundly on “what to do”. It is tempting to consult only those with whom the profession is used to working, and whose “business” values are common. In the latter case, the approach would probably be very disappointing, and the scenarios not very innovative.

The remote prospective method can be applied to all kinds of value chains, provided that different categories of stakeholders can be identified and interviewed.

Anticipation and evaluation of all sorts of impacts in agri-food value chains based on stakeholders’ opinions

The method elaborated and detailed in the previous sections to anticipate and evaluate impacts of changes is general and can be applied to all sorts of value chains as long as the right people are interviewed. It helps identify all sorts of potential impacts and thus shed light on all potential issues that might emerge in the short, medium or long term, depending on the temporal perimeters fixed before starting the study. An important limitation here is that if there are impacts that stakeholders do not perceive or know how to name. In that case, those impacts could not be taken into account in the assessment. This is why it is important to ensure that macroeconomic impacts such as changes in population health, income inequalities, etc. are also taken into account by using other methods (i.e. impact pathways).

Conclusion: summary of the main contributions

Scientific contributions	Managerial contributions
Adapting the French prospective Godet method	Creating reference scenarios of the French pork value chain and presenting contrasting scenarios to professionals
Alternative method to anticipate and evaluate important impacts of changes in agri-food value chains	Anticipating and evaluating impacts of pursuing business as usual in the French pork value chain and presenting results to professionals and decision-makers

Adapting the MyChoice tool to facilitate its use	Tackling hypersensitive themes without provoking sterile confrontation thanks to the adapted Godet method
Developing MyChoice modules	Anticipating and evaluating impacts of all types in all sorts of value chains to improve decision-making

Table 19: main scientific and managerial contribution of the work shown in the manuscript

Table 19 above summarizes the main scientific and managerial contributions of the work discussed throughout the sections of the manuscript.

Section XIV. General conclusion and perspectives

This section concludes the study by summarizing the key research findings in relation to the research aims and questions. It will also review the limitations of the study.

The study aimed to investigate a possible method to anticipate and evaluate important social impacts in agri-food value chains. After defining what we mean by agri-food value chains (section III), specifying how a general evaluation process occurs (section IV) and how in existing methods important impacts are identified (section V), there were numerous gaps and questions that arose.

The post-modern and interpretativist research postures that were adopted throughout the study (section VI) contributed in answering each of the questions that were key to having a complete and coherent process to anticipate and evaluate important social impacts. In the following paragraphs we will be summarizing how we chose to fill the different gaps.

1. Filling the scientific gaps

The first questions that emanated were *how can we anticipate the impacts of a change in a value chain?* And *how do we create reference scenarios of the value chain?* (section VIII). Indeed, because we want to anticipate the impacts of changes, the evaluation process is qualified as *ex-ante*, implicitly inquiring an anticipation phase. Anticipating impacts requires nevertheless anticipating the possible evolutions of the system studied, in our case the agri-food value chain. For that reason, it is quite important that a prospective study takes place. Several reference scenarios are then created thanks to the interviewed stakeholders who indicated the main factors of evolution according to them. In those scenarios, the introduction of the change would be simulated and its impacts are studied. This can result in a comparison of the different possible scenarios in order to help decision-makers make the best choice, i.e. the one with the least negative externalities and/ or the most positive ones.

But then *what is the best way to identify the impacts of changes on a value chain?* The method proposed to identify the impacts are participatory argumentation based methods. But *which type of participatory methods is best to use? And how do we choose who we want to include?* First of all, identifying impacts would require discussing with stakeholders and experts of the value chain. This implies that we have a good and easy way of identifying the most relevant stakeholders (section VII). We chose to use Mitchell, Agle and Wood's classification. Once this goal is achieved, the stakeholders are asked in individual semi-directive interviews what

they think the impacts of said change would be on the value chain in x or y years (depending on the temporal perimeter fixed beforehand). This is what is usually done. In our case, the interviewees spontaneously talked about the impacts of pursuing business as usual, which is why we decided to anticipate and evaluate the impacts of that scenario, the change considered being a potential crisis in the value chain. The interviews are then transcribed to ensure no loss of information. The given arguments are detected and then analyzed meticulously through the use of the multi criteria argumentation tool MyChoice (section IX). In fact, this tool allows us to *concretely aggregate outputs* by calculating attitudes. Those numbers are analyzed per stakeholder group and per impact category. By looking at those attitudes and at the number of arguments given for each category, we can *prioritize the impacts to act on and identify the most 'urgent' and important ones*. Those would be first and foremost the certain negative impacts, as they can be considered as the most urgent ones.

The process proposed in this manuscript combines several theories that up until now were never combined together, to our knowledge. Although this method was developed in the project Sentinel context, it is definitely not specific to it. The whole point of the thesis is to find general ways of anticipating, evaluating and prioritizing impacts. As long as we have people to talk to and as long as we identify the most relevant ones, this method is applicable to any type of value chain that could undergo any type of change.

In order to take into account all opinions without disregarding certain ones, and in order to manage that diversity of opinions, we expect to have shown that using multi criteria argumentation for prospective purposes is a good solution. Visually everyone can see what is said, it makes it possible to do the prospective remotely and the information can also be entered anonymously to ensure a safe space for each interviewee to speak up and say out loud what they would normally keep to themselves in group reunions.

The method and its application still however have certain limitations and would require other case studies to improve or validate certain results (i.e. the hypothesis of using variances to confirm whether a variable is important or not for prospective scenarios).

2. Limits of the work done

Limits in the method

The method developed is based on stakeholders and experts' interviews. Despite that being a strength, it is also a weakness. It can be difficult sometimes to reach the wanted stakeholders for several reasons that were briefly stated in section VII. Plus, transcribing the interviews is

very time consuming. In addition, the method itself, if done remotely can require a lot of time, especially for the prospective part (section VIII). That is why we think that by developing the two MyChoice modules presented in annex 6 and 7, some of the current disadvantages could be alleviated. Another disadvantage of the method can be the fact that information is entered by us researchers instead of being entered by the stakeholders themselves, which would be ideal and would guarantee a transcription of the ideas in the words of stakeholders. This however would require additional work such as the creation of an ontology specific to impacts of changes in agri-food value chains. This would also require teaching stakeholders, decision-makers, consultants, etc. to use the MyChoice tool properly.

Limits in the results

We believe that the results presented previously show real a tendency of evolution of the French pork value chain. However, they can also be discussed.

In the previous chapter, we stated that the most important impacts to act on to favor a sustainable transition of the French pork value chain are the ones that were mentioned the most by the stakeholders. We added that the focus should be in priority on the negative and mitigated impacts. Indeed, the aim of such a study is to encourage decision makers to take actions that limit the negative consequences that a crisis can have on the stakeholders of the food system. As for the mitigated impacts (attitudes of 0.5 and high number of arguments), they are also quite important as they can be tipping points for the value chain, meaning they could go either way and they make the value-chain even more unstable.

The highest number of arguments was in fact given to the ‘value chain structure’ criteria with an attitude of 0.5: according to the interviews conducted, it seems that if the value chain structure improves, many of the issues could fade away. However, this topic is quite delicate and stakeholders do not believe that the value chain structure could change anytime soon³⁸. Intervention plans cannot be deployed in this case. Mitigation strategies should therefore be developed to reduce the negative impacts or to provide compensation to the affected parties. In other words, other alternatives have to be considered. Stakeholders and policy makers could choose impact categories that are a bit easier to act on. Those can be the other impact categories

³⁸ Even though the stakeholders do not believe that the value-chain structure can change, it is not necessarily the case, and some of them don’t always have the the current trends and facts in mind. As researchers, it is our duty to take into consideration what the stakeholders say. However it is also necessary that we proof check the facts they give us and compare their information with a literature review. And by doing so concerning the structure of the French pork value-chain, we can see that even tough stakeholders do not think the value-chain will change in the next 3-5 years, it is already undergoing a deep change (see chapter 4 section XII.1.b)

that we mentioned earlier (e.g. actions could be taken to limit the economic impact on breeders if the crisis occurs; breeders and employees of the value chain can be better accompanied in prevention of the crisis, etc...).

To push the study further and widen the range of actions to take, additional data can be gathered concerning the impact categories that were cited during the interviews (for the grey and light blue cells of table 16 in section XII). The relatively low number of arguments for some categories does not however refute the work done, because we do have 282 arguments extracted from only 12 interviews. The low number of arguments attributed to certain impact categories could thus just be a reflection of what is important or not according to the stakeholders interviewed. Furthermore, the number of empty boxes in tables 14 and 16 can also be critiqued. We believe that those empty criteria were not mentioned by the stakeholders because they do not prioritize them: in other words, taking into consideration the diversity of stakeholders interviewed, at least one of the interviewees would have mentioned those impacts if they were of high importance. However, to make sure that those criteria are of relatively low importance, we can either choose to do additional interviews or we can add documents which discuss the impacts of pursuing business as usual in the French pork value chain (Chaib et al., 2022a). The results obtained are however proper to the timeline during which we did the interviews. In other words, if the interviews are done today, other important impacts could emerge such as the impact of an increase in energy prices, especially on producers of pork or primary matter and breeders.

Another debatable point is the ‘value chain’ category in table 15 (section XII.1.a p.161). We think that it is normal for stakeholders to not always make the distinction between impacted stakeholder categories. Those results are of high importance because they highlight the fact that the whole value chain will be affected and not only certain stakeholder groups, which accentuates even more the urge to take action. Despite the limits acknowledged in the previous paragraphs, the work of this thesis highlights different tools to assess social sustainability of agri-food value chains as discussed in the following paragraph.

3. Zooming out: back to the social sustainability of agri-food value chains

The work done does not claim to have found a way of making agri-food value chains sustainable; however, it can be seen as a potential contribution to characterizing and evaluating sustainability of systems, beyond the theory, as long as spatial and functional boundaries are explicated in advance.

Section II of the introduction described the specific gaps that need to be filled when assessing the social sustainability of the agri-food value chain. Some of these limitations relate to data availability and quality, others to the lack of transparency and involvement of key parties. Another limitation is the lack of consideration of the larger social background. The work discussed in this manuscript, hopes to bring certain elements of response to maybe in some way fill certain gaps in social LCA. In fact, we believe that by choosing stakeholders to involve in the anticipation and evaluation of impacts, we can make sure that the key stakeholders are taken into consideration. In addition, to make sure that a wide range of social impacts and indicators are considered, the impacts are not listed beforehand but rather discovered as the process goes on. By interviewing stakeholders and experts of the value chain, we can hope that the bigger picture is seized as the interviewees are aware of the environment they belong to and their responses are highly dependent of it.

One of the main gaps in social LCA is that usually, the impacts dealt with are of different nature and are quite diverse. Aggregating them can seem impossible and comparing certain results could be inadequate. We believe that the use of the MyChoice tool for multi criteria argumentation could be a huge asset to social LCA as it could reduce some of the gaps. Indeed, by using MyChoice to anticipate and evaluate impacts, we can aggregate results of different nature and present a single score to decision makers, which could maybe simplify the decision-making process when it comes to choosing between numerous scenarios. The MyChoice tool is not specific for social impacts: it can help in capturing the bigger picture and positioning social impacts amongst others.

We hope that by combining those tools and methods, we can add our brick to the edifice that is the evaluation of value chain sustainability.

To simplify things even more, we hope that the two MyChoice modules that are presented in sections XI, XII and annexes 6 and 7 can be developed.

References

- A dialectic procedure for sceptical, assumption-based argumentation. (2006). In *Computational Models of Argument* (P.E. Dunne and T.J.M. Bench-Capon). COMMA 2006, Amsterdam ; Washington, DC. IOS Press.
- Adli, P. Z. H. (2002). *L'approche filière en économie agroalimentaire : Fondements théoriques et intérêts pratiques : Application aux entreprises de transformation de la filière blé en Algérie*.
- Affagard, T., De Lassalle, P. M., & Renou, G. (2019). *Les Collapsologues : Étude cartographique des espaces de structuration des discours de l'Effondrement en France*. Institut d'études politiques de Strasbourg.
- Agreste. (2022). *Agreste conjoncture Animaux de boucherie Porcins* (Agreste infos rapides 2022-153). https://agreste.agriculture.gouv.fr/agreste-web/download/publication/publie/IraAbo22153/2022_153_InforapPorcins.pdf
- Allard-Poesi, F., & Loilier, T. (2009). Qu'est-ce que la critique en Sciences du Management ? Que pourrait-elle être ? *Economies & Sociétés*, 1975-1999.
- Alrøe, H. F., Møller, H., Læssøe, J., & Noe, E. (2016). Opportunities and challenges for multicriteria assessment of food system sustainability. *Ecology and Society*, 21(1), art38. <https://doi.org/10.5751/ES-08394-210138>
- Alvesson, M., & Willmott, H. (1992). On the idea of emancipation in management and organization studies. *Academy of management review*, 17(3), 432-464.
- Amgoud, L., Bonnefon, J.-F., & Prade, H. (2005). An Argumentation-Based Approach to Multiple Criteria Decision. In L. Godo (Éd.), *Symbolic and Quantitative Approaches to Reasoning with Uncertainty* (p. 269-280). Springer Berlin Heidelberg.
- Amgoud, L., & Prade, H. (2009). Using arguments for making and explaining decisions. *Artificial Intelligence*, 173(3-4), 413-436. <https://doi.org/10.1016/j.artint.2008.11.006>
- Arce-Gomez, A., Donovan, J. D., & Bedggood, R. E. (2015). Social impact assessments : Developing a consolidated conceptual framework. *Environmental Impact Assessment Review*, 50, 85-94. <https://doi.org/10.1016/j.eiar.2014.08.006>
- Arndt, H. W. (1987). *Economic development : The history of an idea*.
- Arnould, E. J., Plastina, A., & Ball, D. (2009). Does Fair Trade Deliver on Its Core Value Proposition? Effects on Income, Educational Attainment, and Health in Three Countries. *Journal of Public Policy & Marketing*, 28(2), 186-201. <https://doi.org/10.1509/jppm.28.2.186>
- Arvidsson, R., Hildenbrand, J., Baumann, H., Islam, K. M. N., & Parsmo, R. (2018). A method for human health impact assessment in social LCA : Lessons from three case studies. *The International Journal of Life Cycle Assessment*, 23(3), 690-699. <https://doi.org/10.1007/s11367-016-1116-7>
- Arvidsson, R., Sandén, B. A., & Svanström, M. (2023). *Prospective, Anticipatory and Ex-Ante – What's the Difference ? Sorting Out Concepts for Time-Related LCA*. SETAC Europe 33rd Annual Meeting, Dublin, Ireland.

- Balman, A., Dautzenberg, K., Happe, K., & Kellermann, K. (2006). On the Dynamics of Structural Change in Agriculture : Internale Frictions, Policy Threats and Vertical Integration. *Outlook on Agriculture*, 35(2), 115-121. <https://doi.org/10.5367/000000006777641543>
- Banville, C., Landry, M., Martel, J.-M., & Boulaire, C. (1998). A stakeholder approach to MCDA. *Systems Research and Behavioral Science*, 15(1), 15-32. [https://doi.org/10.1002/\(SICI\)1099-1743\(199801/02\)15:1<15::AID-SRES179>3.0.CO;2-B](https://doi.org/10.1002/(SICI)1099-1743(199801/02)15:1<15::AID-SRES179>3.0.CO;2-B)
- Barberis, E., Freddi, D., Giammetti, R., Polidori, P., Teobaldelli, D., & Viganò, E. (2020). Trade Relationships in the European Pork Value Chain : A Network Analysis. *Economia Agro-Alimentare*, 1, 1-23. <https://doi.org/10.3280/ecag1-2020oa10070>
- Barbier, E. B. (1987). The Concept of Sustainable Economic Development. *Environmental Conservation*, 14(2), 101-110. <https://doi.org/10.1017/S0376892900011449>
- Barney, J. B., & Harrison, J. S. (2020). Stakeholder Theory at the Crossroads. *Business & Society*, 59(2), 203-212. <https://doi.org/10.1177/0007650318796792>
- Barré, R. (2000). *Le foresight britannique. Un nouvel instrument de gouvernance ?* 5-24.
- Barrientos, S. (2014). Gender and Global Value Chains : Challenges of Economic and Social Upgrading in Agri-Food. *SSRN Electronic Journal*. <https://doi.org/10.2139/ssrn.2503391>
- Bar-Yam, Y. (2002). General Features of Complex Systems. *UNESCO Encyclopedia of Life Support Systems*.
- Basco-Carrera, L., Warren, A., Van Beek, E., Jonoski, A., & Giardino, A. (2017). *Collaborative modelling or participatory modelling? A framework for water resources management | Elsevier Enhanced Reader*. <https://doi.org/10.1016/j.envsoft.2017.01.014>
- Basiago, A. D. (1995). Methods of defining 'sustainability'. *Sustainable Development*, 3(3), 109-119. <https://doi.org/10.1002/sd.3460030302>
- Becker, D. R., Harris, C. C., McLaughlin, W. J., & Nielsen, E. A. (2003). A participatory approach to social impact assessment : The interactive community forum. *Environmental Impact Assessment Review*, 23(3), 367-382. [https://doi.org/10.1016/S0195-9255\(02\)00098-7](https://doi.org/10.1016/S0195-9255(02)00098-7)
- Becker, D. R., Harris, C. C., Nielsen, E. A., & McLaughlin, W. J. (2004). A comparison of a technical and a participatory application of social impact assessment. *Impact Assessment and Project Appraisal*, 22(3), 177-189. <https://doi.org/10.3152/147154604781765932>
- Belton, V., & Stewart, T. J. (2002). Problem structuring and multiple criteria decision analysis. In *Multiple criteria decision analysis : An integrated approach* (p. 209-239). Kluwer Academic Publishers.
- Benjaminsen, T. A., & Svarstad, H. (2009). Qu'est-ce que la "political ecology "? *Natures Sciences Sociétés*, 17(1), 3-11. <https://doi.org/10.1051/nss/2009002>
- Benoît, C., Norris, G. A., Valdivia, S., Ciroth, A., Moberg, A., Bos, U., Prakash, S., Ugaya, C., & Beck, T. (2010). The guidelines for social life cycle assessment of products : Just in time! *The International Journal of Life Cycle Assessment*, 15(2), 156-163. <https://doi.org/10.1007/s11367-009-0147-8>
- Berger, P., & Luckmann, T. (1966). The social construction of reality. In *Social Theory Re-Wired* (p. 110-122). Routledge.

- Besnard, P., & Hunter, A. (2007). *Elements of Argumentation* (Vol. 47). https://doi.org/10.1007/978-3-540-75256-1_3
- Bidault, F. (1988). *Le champ stratégique de l'entreprise*. Economica.
- Bisquert, P., Croitoru, M., & Karanikolas, N. (2017). *A Qualitative Decision-Making Approach Overlapping Argumentation and Social Choice*. 344-349.
- Blackman, A., & Rivera, J. (2011). Producer-Level Benefits of Sustainability Certification : Benefits of Sustainability Certification. *Conservation Biology*, 25(6), 1176-1185. <https://doi.org/10.1111/j.1523-1739.2011.01774.x>
- Blom, M., & Solmar, C. (2009). *How to socially assess biofuels: A case study of the UNEP/SETAC Code of Practice for social- economical LCA: Vol. Independent thesis Advanced level (professional degree)* [Student thesis]. DiVA. <http://urn.kb.se/resolve?urn=urn:nbn:se:ltu:diva-46146>
- Bocoum, I., Macombe, C., & Revéret, J.-P. (2015). Anticipating impacts on health based on changes in income inequality caused by life cycles. *The International Journal of Life Cycle Assessment*, 20(3), 405-417. <https://doi.org/10.1007/s11367-014-0835-x>
- Börjeson, L., Höjer, M., Dreborg, K.-H., Ekvall, T., & Finnveden, G. (2006). Scenario types and techniques: Towards a user's guide. *Futures*, 38(7), 723-739. <https://doi.org/10.1016/j.futures.2005.12.002>
- Bouillass, G., Blanc, I., & Perez-Lopez, P. (2021). Step-by-step social life cycle assessment framework: A participatory approach for the identification and prioritization of impact subcategories applied to mobility scenarios. *The International Journal of Life Cycle Assessment*, 26(12), 2408-2435. <https://doi.org/10.1007/s11367-021-01988-w>
- Bourguet, J.-R. (2010). *Contribution aux méthodes d'argumentation pour la prise de décision. Application à l'arbitrage au sein de la filière céréalière*. (p. 155 p.) [Phdthesis, Université Montpellier II - Sciences et Techniques du Languedoc]. <https://theses.hal.science/tel-00553266>
- Bourguet, J.-R., Thomopoulos, R., Mugnier, M.-L., & Abécassis, J. (2013). An artificial intelligence-based approach to deal with argumentation applied to food quality in a public health policy. *Expert Systems with Applications*, 40(11), 4539-4546. <https://doi.org/10.1016/j.eswa.2013.01.059>
- Bousset, J.-P., Macombe, C., & Taverne, M. (2005). *Participatory methods, guidelines and good practice guidance to be applied throughout the project to enhance problem definition, co-learning, synthesis and dissemination*.
- Boyle, M. (2012). *Research in action: A guide to Participatory Action Research*. Canberra, Department of Social Services.
- Brown, B. J., Hanson, M. E., Liverman, D. M., & Merideth, R. W. (1987). Global sustainability: Toward definition. *Environmental Management*, 11(6), 713-719. <https://doi.org/10.1007/BF01867238>
- Brugha, R., & Varvasovszky, Z. (2000). Stakeholder analysis: A review. *Health Policy and Planning*, 15(3), 239-246. <https://doi.org/10.1093/heapol/15.3.239>
- Brundtland, G. (1985). World Commission on environment and development. *Environmental Policy and Law*, 14(1), 26-30. [https://doi.org/10.1016/S0378-777X\(85\)80040-8](https://doi.org/10.1016/S0378-777X(85)80040-8)

- Caldwell, L. K. (1984). Political Aspects of Ecologically Sustainable Development. *Environmental Conservation*, 11(4), 299-308.
- Chaib, R. L., Macombe, C., & Thomopoulos, R. (2022a). Adapting a participatory modelling method to forecast food system scenarios : A case study on the pork value-chain. *Economia agro-alimentare/Food Economy-Open Access*.
- Chaib, R. L., Macombe, C., & Thomopoulos, R. (2022b). *Designing the Future of Agri-Food Chains : Comparison of Prospective Analysis Built 40 Years Ago and Today.*, FoodSim Conference, Ghent, Belgium.
- Chaib, R. L., Macombe, C., & Thomopoulos, R. (2022c). Structuring ontologies from natural language for collaborative scenario modeling in agri-food systems. *Frontiers in Artificial Intelligence*, 5, 1056989. <https://doi.org/10.3389/frai.2022.1056989>
- Chait, B. (1949). La loi de divergence. *Econometrica: Journal of the Econometric Society*, 117-123.
- Chambers, R. (1994). Participatory rural appraisal (PRA): Challenges, potentials and paradigm. *World development*, 22(10), 1437-1454.
- Charton, E., & Torres-Moreno, J.-M. (2011). *Modélisation automatique de connecteurs logiques par analyse statistique du contexte*. 35(3), 21.
- Chevalier, F., & Meyer, V. (2018). Chapitre 6. Les entretiens. In *Les méthodes de recherche du DBA* (p. 108-125). EMS Editions; Cairn.info. <https://doi.org/10.3917/ems.cheva.2018.01.0108>
- Chia, R. (1995). From modern to postmodern organizational analysis. *Organization studies*, 16(4), 579-604.
- Clarkson, M. E. (1995). A Stakeholder Framework for Analyzing and Evaluating Corporate Social Performance. *Academy of Management Review*, 20(1), 92-117. <https://doi.org/10.5465/amr.1995.9503271994>
- Crane, B. (2020). Revisiting Who, When, and Why Stakeholders Matter : Trust and Stakeholder Connectedness. *Business & Society*, 59(2), 263-286. <https://doi.org/10.1177/0007650318756983>
- Crane, J. A. (1988). Evaluation as Scientific Research. *Evaluation Review*, 12(5), 467-482. <https://doi.org/10.1177/0193841X8801200501>
- Croitoru, M., Buche, P., Charnomordic, B., Fortin, J., Jones, H., Neveu, P., Symeonidou, D., & Thomopoulos, R. (2016). A Proposal for Modelling Agrifood Chains as Multi Agent Systems. In J. P. Carvalho, M.-J. Lesot, U. Kaymak, S. Vieira, B. Bouchon-Meunier, & R. R. Yager (Éds.), *Information Processing and Management of Uncertainty in Knowledge-Based Systems* (Vol. 610, p. 498-509). Springer International Publishing. https://doi.org/10.1007/978-3-319-40596-4_42
- Cucurachi, S., van der Giesen, C., & Guinée, J. (2018). Ex-ante LCA of Emerging Technologies. *Procedia CIRP*, 69, 463-468. <https://doi.org/10.1016/j.procir.2017.11.005>
- Dahler-Larsen, P. (2011). *The evaluation society*. Stanford University Press.
- De Jouvenel, B. (1964). *L'art de la conjoncture* (Edition Du Rocher).

- De Luca, A. I., Iofrida, N., Leskinen, P., Stillitano, T., Falcone, G., Strano, A., & Gulisano, G. (2017). Life cycle tools combined with multi-criteria and participatory methods for agricultural sustainability: Insights from a systematic and critical review. *Science of The Total Environment*, 595, 352-370. <https://doi.org/10.1016/j.scitotenv.2017.03.284>
- Delabre, I., Boyd, E., Brockhaus, M., Carton, W., Krause, T., Newell, P., Wong, G. Y., & Zelli, F. (2020). Unearthing the myths of global sustainable forest governance. *Global Sustainability*, 3, e16. <https://doi.org/10.1017/sus.2020.11>
- Delanoue, E., & Roguet, C. (2014). *Acceptabilité sociale de l'élevage*. <https://www.ifip.asso.fr/sites/default/files/pdf-documentations/delanoue2015-gisrapport.pdf>
- Delgado, M. E. M., & Canters, F. (2011). Measuring the accessibility of different household income groups to basic community services in upland Misamis Oriental, Northern Mindanao, Philippines: Accessibility of services in upland Philippines. *Singapore Journal of Tropical Geography*, 32(2), 168-184. <https://doi.org/10.1111/j.1467-9493.2011.00427.x>
- Di Cesare, S., Silveri, F., Sala, S., & Petti, L. (2018). Positive impacts in social life cycle assessment: State of the art and the way forward. *The International Journal of Life Cycle Assessment*, 23(3), 406-421. <https://doi.org/10.1007/s11367-016-1169-7>
- Donaldson, T., & Preston, L. E. (1995). The Stakeholder Theory of the Corporation: Concepts, Evidence, and Implications. *Academy of Management Review*, 20(1), 65-91. <https://doi.org/10.5465/amr.1995.9503271992>
- Dreyer, L. C., Danmarks Tekniske Universitet, & DTU Management. (2009). *Inclusion of social aspects in life cycle assessment of products: Development of a methodology for social life cycle assessment: thesis for the degree of Philosophiae Doctor: industrial PhD thesis*. DTU Management Engineering.
- Dreyer, L., Hauschild, M., & Schierbeck, J. (2006). A Framework for Social Life Cycle Impact Assessment (10 pp). *The International Journal of Life Cycle Assessment*, 11(2), 88-97. <https://doi.org/10.1065/lca2005.08.223>
- Dung, P. M. (1995). On the acceptability of arguments and its fundamental role in nonmonotonic reasoning, logic programming and n-person games*. *Proceedings ZJCAI-93*, 321-357. [https://doi.org/10.1016/0004-3702\(94\)00041-X](https://doi.org/10.1016/0004-3702(94)00041-X)
- Ekener, E., Hansson, J., & Gustavsson, M. (2018). Addressing positive impacts in social LCA—discussing current and new approaches exemplified by the case of vehicle fuels. *The International Journal of Life Cycle Assessment*, 23(3), 556-568. <https://doi.org/10.1007/s11367-016-1058-0>
- England, D., & White, S. M. (2009). Industry development: Involving the whole industry in practice change. *Extension Farming Systems Journal*, 5(1), 207-211.
- Erickson, F. (1986). *Qualitative methods in research on teaching*. In M. C. Wittrock (Ed.), *Handbook of research on teaching* (pp. 119-161).
- Estévez, R. A., Walshe, T., & Burgman, M. A. (2013). Capturing social impacts for decision-making: A Multicriteria Decision Analysis perspective. *Diversity and Distributions*, 19(5-6), 608-616. <https://doi.org/10.1111/ddi.12058>

- Falk, A., Macombe, C., Loeillet, D., & Deboin, J.-M. (2022). How Can a Company Assess Social Needs to Reduce Poverty among Its Workers? The Case of the Export Banana Industries. *Sustainability*, 14(17), 10794. <https://doi.org/10.3390/su141710794>
- Fanning, A. L., O'Neill, D. W., Hickel, J., & Roux, N. (2022). The social shortfall and ecological overshoot of nations. *Nature Sustainability*, 5(1), Article 1. <https://doi.org/10.1038/s41893-021-00799-z>
- Fearne, A., Garcia, M., & Dent, B. (2012). Dimensions of sustainable value chains : Implications for value chain analysis. *Supply Chain Management: An International Journal*, 17, 575-581. <https://doi.org/10.1108/13598541211269193>
- Feschet, P., & Bockstaller, C. (2014). *Méthodes d'évaluation multicritère des systèmes agricoles et ACV sociale, quelle complémentarité ?* 8.
- Feschet, P., Macombe, C., Garrabé, M., Loeillet, D., Saez, A. R., & Benhmad, F. (2013). Social impact assessment in LCA using the Preston pathway: The case of banana industry in Cameroon. *The International Journal of Life Cycle Assessment*, 18(2), 490-503. <https://doi.org/10.1007/s11367-012-0490-z>
- Filstead, W. J. (1981). Using qualitative methods in evaluation research : An illustrative bibliography. *Qualitative and quantitative methods in evaluation research*, 5(2), 259-268.
- Finnveden, G., Hauschild, M. Z., Ekvall, T., Guinée, J., Heijungs, R., Hellweg, S., Koehler, A., Pennington, D., & Suh, S. (2009). Recent developments in Life Cycle Assessment. *Journal of Environmental Management*, 91(1), 1-21. <https://doi.org/10.1016/j.jenvman.2009.06.018>
- Fishbein, M. (1967). A behavior theory approach to the relations between beliefs about an object and the attitude towards the object. *Mathematical models in marketing*, 87-88. https://link.springer.com/content/pdf/10.1007/978-3-642-51565-1_25.pdf
- FNAB. (2018). Élever des porcs en bio—Un guide pour construire son projet. *Produire Bio*. <https://www.produire-bio.fr/articles-pratiques/elever-des-porcs-en-bio-un-guide-pour-construire-son-projet/>
- Food and Agriculture Organization (FAO). (2021). *World Banana Forum, Projects, Living Wage Advocacy Initiative (LIWIN)*. <https://www.fao.org/world-banana-forum/projects/living-wage-advocacy-initiative-liwin/en/>
- Fournier, D. M. (1995). Establishing evaluative conclusions : A distinction between general and working logic. *New Directions for Evaluation*, 1995(68), 15-32. <https://doi.org/10.1002/ev.1017>
- FranceAgriMer. (2021). *Consommation des produits carnés en 2021*. https://www.franceagrimer.fr/fam/content/download/69357/document/STA-VIA-Consommation_des_produits_carn%C3%A9s_en_2021.pdf?version=2
- FranceAgriMer. (2022). *Fiche filière porcine 2022*. <https://www.franceagrimer.fr/fam/content/download/68229/document/FICHE%20FILIERE%20PORCINE%202022.pdf?version=4>
- Freeman, R. E. (1984a). *Strategic Management: A Stakeholder Approach*. Cambridge University Press.

- Freeman, R. E. (1984b). Strategic management : A stakeholder theory. *Journal of Management Studies*, 39(1), 1-21.
- Freeman, R. E. E., & McVea, J. (2001). A Stakeholder Approach to Strategic Management. *SSRN Electronic Journal*. <https://doi.org/10.2139/ssrn.263511>
- Freeman, R. E., Harrison, J. S., Wicks, A. C., Parmar, B. L., & Colle, S. de. (2010). *Stakeholder Theory : The State of the Art*. Cambridge University Press.
- Freire, P. (1982). Creating alternative research methods : Learning to do it by doing it. *Creating knowledge: A monopoly*, 29-37.
- Friedman, A. L., & Miles, S. (2006). *Stakeholders : Theory and practice*. Oxford University Press.
<http://www.dawsonera.com/depp/reader/protected/external/AbstractView/S9780191533556>
- Fuentes, M. M. P. B., & Cinner, J. E. (2010). Using expert opinion to prioritize impacts of climate change on sea turtles' nesting grounds. *Journal of Environmental Management*, 91(12), 2511-2518. <https://doi.org/10.1016/j.jenvman.2010.07.013>
- Funtowicz, S. O., Martinez-Alier, J., Munda, G., & Ravetz, J. R. (1999). *Information tools for environmental policy under conditions of complexity*. 35.
- Funtowicz, S., & Ravetz, J. (2003). Post-normal science. *International society for ecological economics*, 25(7), 739-755.
- García-Meca, E., & Martínez-Ferrero, J. (2021). Is SDG reporting substantial or symbolic? An examination of controversial and environmentally sensitive industries. *Journal of Cleaner Production*, 298, 126781. <https://doi.org/10.1016/j.jclepro.2021.126781>
- Gibson, R. B. (2006). Beyond the pillars : Sustainability assessment as a framework for effective integration of social, economic and ecological considerations in significant decision-making. *Journal of Environmental Assessment Policy and Management*, 08(03), 259-280. <https://doi.org/10.1142/S1464333206002517>
- Godet, M. (2007). *Manuel de prospective stratégique-Tome 1-3ème édition-Une indiscipline intellectuelle*. dunod.
- Godet, M. (2008). *Strategic foresight : Use and misuse of scenario building*.
- Godet, M., & Durance, P. (2001). *La prospective stratégique pour les entreprises et les territoires* (Dunod).
- Godet, M., Durance, P., & Gerber, A. (2008). Strategic foresight la prospective. *Cahiers du LIPSOR*, 143.
- Goedkoop, M., Effting, S., Spriensma, R., & Collignon, M. (2001). *The Eco-indicator 99 : A Damage Oriented Method for Life-cycle Impact Assessment : Manual for Designers*. PRÉ Consultants. <https://books.google.fr/books?id=CCW5RAAACA AJ>
- Goedkoop, M., Heijungs, R., Huijbregts, M., Schryver, A., Struijs, J., & Zelm, R. (2009). *Recipe 2008. A life*.
- Gravelle, H., & Sutton, M. (2009). Income, relative income, and self-reported health in Britain 1979-2000. *Health Economics*, 18(2), 125-145. <https://doi.org/10.1002/hec.1354>

- Grenz, J., Thalmann, C., Stämpfli, A., Studer, C., & Häni, F. (2009). *RISE – a method for assessing the sustainability of agricultural production at farm level*. 5-9.
- Griffin, J. J. (2017). Tracing stakeholder terminology then and now : Convergence and new pathways: GRIFFIN. *Business Ethics: A European Review*, 26(4), 326-346. <https://doi.org/10.1111/beer.12158>
- Guinée, J. B. (2002). *Handbook on Life Cycle Assessment : Operational Guide to the ISO Standards*. Springer Science & Business Media.
- Guinée, J. B., Cucurachi, S., Henriksson, P. J. G., & Heijungs, R. (2018). Digesting the alphabet soup of LCA. *The International Journal of Life Cycle Assessment*, 23(7), 1507-1511. <https://doi.org/10.1007/s11367-018-1478-0>
- Guinée, J. B., Heijungs, R., Huppes, G., Zamagni, A., Masoni, P., Buonamici, R., Ekvall, T., & Rydberg, T. (2011). Life Cycle Assessment : Past, Present, and Future. *Environmental Science & Technology*, 45(1), 90-96. <https://doi.org/10.1021/es101316v>
- Gullickson, A. M. (2020). The whole elephant : Defining evaluation. *Evaluation and Program Planning*, 79, 101787. <https://doi.org/10.1016/j.evalprogplan.2020.101787>
- Habermas, J. (1984). *The theory of communicative action. Volume 1: Reason and rationalisation of society*.
- Handayati, Y., Simatupang, T. M., & Perdana, T. (2015). Agri-food supply chain coordination : The state-of-the-art and recent developments. *Logistics Research*, 8(1), 5. <https://doi.org/10.1007/s12159-015-0125-4>
- Hani, F., Braga, F. S., Stampfli, A., Keller, T., Fischer, M., & Porsche, H. (2003). RISE, a tool for holistic sustainability assessment at the farm level. *International food and agribusiness management review*, 6(1030-2016-82562), 78-90.
- Helming, J. (2005). *A Model of Dutch Agriculture Based on Positive Mathematical Programming with Regional and Environmental Applications—ProQuest*. <https://www.proquest.com/openview/e84452262822d759a7e159cfcfdef86a/1?cbl=44156&pq-origsite=gscholar&parentSessionId=ZQ811FdQZLqCoY2xSvpX1rp3Bj5%2BD87AArB%2BcA3%2FFKg%3D>
- Hickel, J. (2019). The contradiction of the sustainable development goals : Growth versus ecology on a finite planet. *Sustainable Development*, 27(5), 873-884. <https://doi.org/10.1002/sd.1947>
- Hirsch, D., Abrami, G., Giordano, R., Liersch, S., Matin, N., & Schlüter, M. (2010). Participatory Research for Adaptive Water Management in a Transition Country—A Case Study from Uzbekistan. *Ecology and Society*, 15(3), art23. <https://doi.org/10.5751/ES-03549-150323>
- Hofmann, F. (2021a). *Culture Viande s'interroge sur l'avenir de la filière*. <https://www.porcimag.com/filiere/politique/culture-viande-s-interroge-sur-l-avenir-de-la-filiere>
- Hofmann, F. (2021b). *Jean-Jacques Riou : « Nos groupements ne peuvent pas mener une lutte frontale »*. <https://www.porcimag.com/enjeux/bien-etre-animal/jean-jacques-riou-nos-groupements-ne-peuvent-pas-mener-une-lutte-frontale>

- Hofmann, F. (2021c). *Prix du porc : Le coup de gueule de la FNP*. <https://www.porcimag.com/filiere/politique/prix-du-porc-le-coup-de-gueule-de-la-fnp>
- Hoste, R. (2020). *International comparison of pig production costs 2018 : Results of InterPIG*. Wageningen Economic Research. <https://doi.org/10.18174/511876>
- Hunkeler, D., & Rebitzer, G. (2005). The Future of Life Cycle Assessment. *The International Journal of Life Cycle Assessment*, 10(5), 305-308. <https://doi.org/10.1065/lca2005.09.001>
- Hwang, C.-L., & Yoon, K. (1981). Methods for multiple attribute decision making. In *Multiple attribute decision making* (p. 58-191). Springer.
- INAPORC. (2020). *Un secteur porteur*. leporc.com. <https://www.leporc.com/emploi/un-secteur-porteur.html>
- Iofrida, N. (2016). *Paradigmatic stances and methodological issues in Social Life Cycle Assessment. Comparison of two different methodological proposals applied to agricultural products*.
- Iofrida, N., Strano, A., Gulisano, G., & De Luca, A. I. (2018). Why social life cycle assessment is struggling in development? *The International Journal of Life Cycle Assessment*, 23(2), 201-203. <https://doi.org/10.1007/s11367-017-1381-0>
- IPCC. (2018). *Global Warming of 1.5°C : IPCC Special Report on Impacts of Global Warming of 1.5°C above Pre-industrial Levels in Context of Strengthening Response to Climate Change, Sustainable Development, and Efforts to Eradicate Poverty* (1^{re} éd.). Cambridge University Press. <https://doi.org/10.1017/9781009157940>
- IPCC. (2023). *Synthesis report of the IPCC sixth assessment report (AR6)*. https://report.ipcc.ch/ar6syr/pdf/IPCC_AR6_SYR_LongerReport.pdf
- Jolly, C., Flamand, J., Cousin, C., & Eidelman, A. (2023). *Les métiers en 2030 quelles perspectives de recrutement en région—Le rapport.pdf* (p. 196). DARES. <https://dares.travail-emploi.gouv.fr/sites/default/files/5f8c3051f69759a0a71c9c9db99fba2d/Les%20m%C3%A9tiers%20en%202030%20quelles%20perspectives%20de%20recrutement%20en%20r%C3%A9gion%20-%20Le%20rapport.pdf>
- Jørgensen, A., Le Bocq, A., Nazarkina, L., & Hauschild, M. (2008). Methodologies for social life cycle assessment. *The International Journal of Life Cycle Assessment*, 13(2), 96-103. <https://doi.org/10.1065/lca2007.11.367>
- Juslén, J. (1995). Social impact assessment : A look at Finnish experiences. *Project Appraisal*, 10(3), 163-170. <https://doi.org/10.1080/02688867.1995.9726990>
- Kaplinsky, R., & Morris, M. (2001). *A handbook for value-chain research*. 114.
- Kaya, Y. (1995). The role of CO2 removal and disposal. *Energy Conversion and Management*, 36(6-9), 375-380. [https://doi.org/10.1016/0196-8904\(95\)00025-9](https://doi.org/10.1016/0196-8904(95)00025-9)
- Kaya, Y., & Suzuki, Y. (1974). Global constraints and a new vision for development—I. *Technological Forecasting and Social Change*, 6, 277-297. [https://doi.org/10.1016/0040-1625\(74\)90028-6](https://doi.org/10.1016/0040-1625(74)90028-6)
- Kaya, Y., & Yokobori, K. (1997). *Environment, energy, and economy : Strategies for sustainability*. United Nations University Press Tokyo.

- Keeney, R. L. (1992). On the foundations of prescriptive decision analysis. *Utility theories: Measurements and applications*, 57-72.
- Kidd, C. V. (1992). The evolution of sustainability. *Journal of Agricultural and Environmental Ethics*, 5(1), 1-26. <https://doi.org/10.1007/BF01965413>
- King, J. A., Cousins, J. B., & Whitmore, E. (2007). Making sense of participatory evaluation : Framing participatory evaluation. *New Directions for Evaluation*, 2007(114), 83-105. <https://doi.org/10.1002/ev.226>
- Kopainsky, B., & Stave, K. (2014). *Dynamic thinking about food system vulnerabilities in highly developed countries : Issues and initial analytic structure for building resilience*. https://www.researchgate.net/publication/281280683_Dynamic_thinking_about_food_system_vulnerabilities_in_highly_developed_countries_Issues_and_initial_analytic_structure_for_building_resilience
- Kopp, A. R., Rikin, S., Cassese, T., Berger, M. A., Raff, A. C., & Gendlina, I. (2021). Medical student remote eConsult participation during the COVID-19 pandemic. *BMC Medical Education*, 21(1), 120. <https://doi.org/10.1186/s12909-021-02562-6>
- Krämer-Flecken, A., Krom, J., Landgraf, B., & Lambertz, H. T. (2010). Remote Participation tools at TEXTOR. *Fusion Engineering and Design*, 85(3-4), 625-627. <https://doi.org/10.1016/j.fusengdes.2010.02.008>
- Kruse, S. A., Flysjö, A., Kasperczyk, N., & Scholz, A. J. (2009). Socioeconomic indicators as a complement to life cycle assessment—An application to salmon production systems. *The International Journal of Life Cycle Assessment*, 14(1), 8-18. <https://doi.org/10.1007/s11367-008-0040-x>
- Lagarde, V., & Macombe, C. (2013). Designing the social life cycle of products from the systematic competitive model. *The International Journal of Life Cycle Assessment*, 18(1), 172-184. <https://doi.org/10.1007/s11367-012-0448-1>
- Lakatos, I. (1976). *Falsification and the methodology of scientific research programmes*. Springer.
- Lançon, F., Temple, L., & Biénabe, E. (2017). The Concept of Filière or Value Chain : An Analytical Framework for Development Policies and Strategies. In E. Biénabe, A. Rival, & D. Loeillet (Éds.), *Sustainable Development and Tropical Agri-chains* (p. 17-28). Springer Netherlands. https://doi.org/10.1007/978-94-024-1016-7_2
- Lane, M., Ross, H., & Dale, A. (1997). Social Impact Research : Integrating the Technical, Political, and Planning Paradigms. *Human Organization*, 56(3), 302-310. <https://doi.org/10.17730/humo.56.3.kg628w2t626216h0>
- Lang, D. J., Scholz, R. W., Binder, C. R., Wiek, A., & Stäubli, B. (2007). Sustainability potential analysis (SPA) of landfills—a systemic approach : Theoretical considerations. *Journal of Cleaner Production*, 15(17), 1628-1638.
- Le Clerc, L. (2019). *Organisations de producteurs et outils d'organisation économique*. IFIP. <https://ifip.asso.fr/documentations/597-organisations-de-producteurs-et-outils-dorganisation-economique/>

- Leach, M., Raworth, K., & Rockström, J. (2013). Between social and planetary boundaries : Navigating pathways in the safe and just space for humanity. In *World Social Science Report 2013 : Changing Global Environments* (p. 84-89). OECD Publishing. <https://doi.org/10.1787/9789264203419-10-en>
- Lehmann, A., Russi, D., Bala, A., Finkbeiner, M., & Fullana-i-Palmer, P. (2011). Integration of Social Aspects in Decision Support, Based on Life Cycle Thinking. *Sustainability*, 3(4), 562-577. <https://doi.org/10.3390/su3040562>
- Lehmann, A., Zschieschang, E., Traverso, M., Finkbeiner, M., & Schebek, L. (2013). Social aspects for sustainability assessment of technologies—Challenges for social life cycle assessment (SLCA). *The International Journal of Life Cycle Assessment*, 18(8), 1581-1592. <https://doi.org/10.1007/s11367-013-0594-0>
- Linkov, I., Carluccio, S., Pritchard, O., Ní Bhreasail, Á., Galaitzi, S., Sarkis, J., & Keisler, J. M. (2020). The case for value chain resilience. *Management Research Review*, 43(12). <https://doi.org/10.1108/MRR-08-2019-0353>
- Lœillet, D., & Macombe, C. (2016). Deciphering the Pyramids. In *Social LCA Researcher school book* (p. 112-129).
- Lœillet, D., & Macombe, C. (2017). Why and How to Assess the Contribution of an Agri-Chain to Sustainable Development? In E. Biénabe, A. Rival, & D. Lœillet (Éds.), *Sustainable Development and Tropical Agri-chains* (p. 225-236). Springer Netherlands. https://doi.org/10.1007/978-94-024-1016-7_18
- Lytard, J. (1979). F.(1984). The postmodern condition : A report on knowledge. *Trans. Geoff Bennington and Brian Massumi. Minneapolis: University of Minnesota Press.*
- MacCrimmon, K. R. (1968). *Descriptive and normative implications of the decision-theory postulates.* 3-32.
- Macombe, C. (2013). How can one predict social effects and impacts. In *Social LCAs* (p. 141).
- Macombe, C. (2014). *Les méthodes en cycle de vie d'évaluation de la dimension sociale des aliments et produits bio-sourcés.* 25.
- Macombe, C. (2019). Social Life Cycle Assessment for Industrial Biotechnology. In M. Fröhling & M. Hiete (Éds.), *Sustainability and Life Cycle Assessment in Industrial Biotechnology* (Vol. 173, p. 205-230). Springer International Publishing. https://doi.org/10.1007/10_2019_99
- Macombe, C., Leskinen, P., Feschet, P., & Antikainen, R. (2013). Social life cycle assessment of biodiesel production at three levels : A literature review and development needs. *Journal of Cleaner Production*, 52, 205-216. <https://doi.org/10.1016/j.jclepro.2013.03.026>
- Macombe, C., & Lœillet, D. (2017a). Instruments to Assess the Social Impacts of Value Chains. In E. Biénabe, A. Rival, & D. Lœillet (Éds.), *Sustainable Development and Tropical Agri-chains* (p. 257-265). Springer Netherlands. https://doi.org/10.1007/978-94-024-1016-7_20
- Macombe, C., & Lœillet, D. (2017b). Instruments to Assess the Social Impacts of Value Chains. In E. Biénabe, A. Rival, & D. Lœillet (Éds.), *Sustainable Development and Tropical*

- Agri-chains* (p. 257-265). Springer Netherlands. https://doi.org/10.1007/978-94-024-1016-7_20
- Macombe, C., Loeillet, D., Di Cesare, S., & Feschet, P. (2015). *Methodological support for analysis and development of inclusive and sustainable value chains*.
- Maedche, A., & Staab, S. (2000). Mining Ontologies from Text. In R. Dieng & O. Corby (Éds.), *Knowledge Engineering and Knowledge Management Methods, Models, and Tools* (Vol. 1937, p. 189-202). Springer Berlin Heidelberg. https://doi.org/10.1007/3-540-39967-4_14
- Maestre, M., Poole, N., & Henson, S. (2017). Assessing food value chain pathways, linkages and impacts for better nutrition of vulnerable groups. *Food Policy*, 68, 31-39. <https://doi.org/10.1016/j.foodpol.2016.12.007>
- Maister, K., Di Noi, C., Ciroth, A., & Srocka, M. (2020). *PSILCA, a Product Social Impact Life Cycle Assessment Database version 3 Documentation*. 124.
- Malassis, L. (1979). Economie agricole, agro-alimentaire et rurale. *Économie rurale*, 131(1), 3-10. <https://doi.org/10.3406/ecoru.1979.2629>
- Marini, C., & Blanc, I. (2014). Towards Prospective Life Cycle Assessment : How to Identify Key Parameters Inducing Most Uncertainties in the Future? Application to Photovoltaic Systems Installed in Spain. In B. Murgante, S. Misra, A. M. A. C. Rocha, C. Torre, J. G. Rocha, M. I. Falcão, D. Taniar, B. O. Aduhan, & O. Gervasi (Éds.), *Computational Science and Its Applications – ICCSA 2014* (Vol. 8581, p. 691-706). Springer International Publishing. https://doi.org/10.1007/978-3-319-09150-1_51
- Mason, R. O., & Mitroff, I. I. (1981). *Challenging strategic planning assumptions : Theory, cases, and techniques*. John Wiley & Sons Incorporated.
- Mathe, S. (2014a). Integrating participatory approaches into social life cycle assessment : The SLCA participatory approach. *The International Journal of Life Cycle Assessment*, 19(8), 1506-1514. <https://doi.org/10.1007/s11367-014-0758-6>
- Mathe, S. (2014b). Integrating participatory approaches into social life cycle assessment : The SLCA participatory approach. *The International Journal of Life Cycle Assessment*, 19(8), 1506-1514. <https://doi.org/10.1007/s11367-014-0758-6>
- Mattila, T. J., Judl, J., Macombe, C., & Leskinen, P. (2018). Evaluating social sustainability of bioeconomy value chains through integrated use of local and global methods. *Biomass and Bioenergy*, 109, 276-283. <https://doi.org/10.1016/j.biombioe.2017.12.019>
- Meadows, D. H., Meadows, D. L., Randers, J., & Behrens, W. W. (1972). *The limits to growth* (Universe Books).
- Mendoza, G. A., & Prabhu, R. (2000). Development of a Methodology for Selecting Criteria and Indicators of Sustainable Forest Management : A Case Study on Participatory Assessment. *Environmental Management*, 26(6), 659-673. <https://doi.org/10.1007/s002670010123>
- Mercier, H., & Sperber, D. (2011). Why do humans reason ? Arguments for an argumentative theory. *Behavioral and brain sciences*, 34(2), 57-74.
- Mermet, L. (2004). *Prospective un objet d'étude pour les SIC*. 1(38), 207-214. <https://doi.org/10.4267/2042/9451>

- Mitchell, R. K., Agle, B. R., & Wood, D. J. (1997). *Toward a Theory of Stakeholder Identification and Salience: Defining the Principle of Who and What Really Counts*. 22(4), 853-886.
- Mol, A. P. J., & Spaargaren, G. (2000). Ecological modernisation theory in debate: A review. *Environmental Politics*, 9(1), 17-49. <https://doi.org/10.1080/09644010008414511>
- Morente-Molinera, J. A., Kou, G., Samuylov, K., Cabrerizo, F. J., & Herrera-Viedma, E. (2021). Using argumentation in expert's debate to analyze multi-criteria group decision making method results. *Information Sciences*, 573, 433-452. <https://doi.org/10.1016/j.ins.2021.05.086>
- Munda, G. (2004). Social multi-criteria evaluation: Methodological foundations and operational consequences. *European Journal of Operational Research*, 158(3), 662-677. [https://doi.org/10.1016/S0377-2217\(03\)00369-2](https://doi.org/10.1016/S0377-2217(03)00369-2)
- Nalebuff, B. J., Brandenburger, A., & Maulana, A. (1996). *Co-opetition*. HarperCollinsBusiness London.
- Nebot, V., & Berlanga, R. (2009). Building tailored ontologies from very large knowledge resources. *Proceedings of the 11th International Conference on Enterprise Information*, 144-151. <https://doi.org/10.5220/0001984001440151>
- Nielsen, A. P., Lassen, J., & Sandøe, P. (2004). Involving the Public—Participatory Methods and Democratic Ideals. *Global Bioethics*, 17(1), 191-201. <https://doi.org/10.1080/11287462.2004.10800859>
- Norris, C., Norris, G., & Aulisio, D. (2014). Efficient Assessment of Social Hotspots in the Supply Chains of 100 Product Categories Using the Social Hotspots Database. *Sustainability*, 6(10), 6973-6984. <https://doi.org/10.3390/su6106973>
- Norris, G. A. (2006). Social impacts in product life cycles-towards life cycle attribute assessment. *The International Journal of Life Cycle Assessment*, 11, 97-104.
- O'Brien, M., Doig, A., & Clift, R. (1996). Social and environmental life cycle assessment (SELCA): Approach and methodological development. *The International Journal of Life Cycle Assessment*, 1(4), 231-237. <https://doi.org/10.1007/BF02978703>
- Oliver, C. (1991). Strategic Responses to Institutional Processes. *Institutional Processes*, "Academy of Management Review", 16-145.
- Oluwarotimi Akintan, F. (2014). *A systematic literature review of the backcasting method in futures studies* [Master's Thesis in Futures Studies]. Turku School of Economics.
- Ortiz, G., Domínguez-Gómez, J. A., Aledo, A., & Urgeghe, A. M. (2018). Participatory multi-criteria decision analysis for prioritizing impacts in environmental and social impact assessments. *Sustainability: Science, Practice and Policy*, 14(1), 6-21. <https://doi.org/10.1080/15487733.2018.1510237>
- Oxman, A. D., Bjørndal, A., Becerra-Posada, F., Gibson, M., Block, M. A. G., Haines, A., Hamid, M., Odom, C. H., Lei, H., Levin, B., Lipsey, M. W., Littell, J. H., Mshinda, H., Ongolo-Zogo, P., Pang, T., Sewankambo, N., Songane, F., Soydan, H., Torgerson, C., ... Wibulpolprasert, S. (2010). A framework for mandatory impact evaluation to ensure well informed public policy decisions. *The Lancet*, 375(9712), 427-431. [https://doi.org/10.1016/S0140-6736\(09\)61251-4](https://doi.org/10.1016/S0140-6736(09)61251-4)

- Paradeise, C. (2013). Le sens de la mesure. La gestion par les indicateurs est-elle gage d'efficacité? : How Much is Enough? Does Indicator-Based Management Guarantee Effectiveness? *Revue d'économie du développement*, Vol. 20(4), 67-94. <https://doi.org/10.3917/edd.264.0067>
- Parent, J., Cucuzzella, C., & Revéret, J.-P. (2010). Impact assessment in SLCA : Sorting the sLCIA methods according to their outcomes. *The International Journal of Life Cycle Assessment*, 15(2), 164-171. <https://doi.org/10.1007/s11367-009-0146-9>
- Patton, M. Q. (1980). Making methods choices. *Evaluation and Program Planning*, 3(4), 219-228. [https://doi.org/10.1016/0149-7189\(80\)90036-1](https://doi.org/10.1016/0149-7189(80)90036-1)
- Peano, C., Migliorini, P., & Sottile, F. (2014). A methodology for the sustainability assessment of agri-food systems : An application to the Slow Food Presidia project. *Ecology and Society*, 19(4), art24. <https://doi.org/10.5751/ES-06972-190424>
- Pesonen, H.-L., Ekvall, T., Fleischer, G., Huppes, G., Jahn, C., Klos, Z. S., Rebitzer, G., Sonnemann, G. W., Tintinelli, A., Weidema, B. P., & Wenzel, H. (2000). Framework for scenario development in LCA. *The International Journal of Life Cycle Assessment*, 5(1), 21. <https://doi.org/10.1007/BF02978555>
- Piton, G., Philippe, F., Tacnet, J.-M., & Gourhand, A. (2018). Aide à la décision par l'application de la méthode AHP (Analytic Hierarchy Process) à l'analyse multicritère des stratégies d'aménagement du Grand Bûech à la Faurie: *Sciences Eaux & Territoires*, Numéro 26(2), 54-57. <https://doi.org/10.3917/set.026.0054>
- Pogge, T., & Sengupta, M. (2016). Assessing the sustainable development goals from a human rights perspective. *Journal of International and Comparative Social Policy*, 32(2), 83-97. <https://doi.org/10.1080/21699763.2016.1198268>
- Pope, J., Annandale, D., & Morrison-Saunders, A. (2004). Conceptualising sustainability assessment. *Environmental Impact Assessment Review*, 24(6), 595-616. <https://doi.org/10.1016/j.eiar.2004.03.001>
- Popper, K. (1959). *Logik der Forschung; translated as The Logic of Scientific Discovery*.
- Porter, M. E. (1985). Technology and competitive advantage. *Journal of business strategy*.
- Pottiez, E., Lescoat, P., & Bouvarel, I. (2012). *AVIBIO: a method to assess the sustainability of the organic poultry industry*. 1-7.
- Purvis, B., Mao, Y., & Robinson, D. (2019). Three pillars of sustainability : In search of conceptual origins. *Sustainability Science*, 14(3), 681-695. <https://doi.org/10.1007/s11625-018-0627-5>
- Quigley, R. J., & Taylor, L. C. (2004). Evaluating health impact assessment. *Public Health*, 118(8), 544-552.
- Ramos, R., Bessot-Ballot, B., & Crouzet, M. (2021). *Rapport d'information par la commission des affaires économiques sur les sels nitrités dans l'industrie agroalimentaire* (Rapport de l'assemblée nationale 3731; p. 105).
- Raworth, K. (2012). *A Safe and Just Space for Humanity : Can we live within the doughnut?* Oxfam.

- Raworth, K. (2017). *Doughnut Economics: Seven Ways to Think Like a 21st-Century Economist*. Chelsea Green Publishing.
- Reap, J., Roman, F., Duncan, S., & Bras, B. (2008). A survey of unresolved problems in life cycle assessment. *Int J Life Cycle Assess*, 15.
- Reed, M. S., Graves, A., Dandy, N., Posthumus, H., Hubacek, K., Morris, J., Prell, C., Quinn, C. H., & Stringer, L. C. (2009). Who's in and why? A typology of stakeholder analysis methods for natural resource management. *Journal of Environmental Management*, 90(5), 1933-1949. <https://doi.org/10.1016/j.jenvman.2009.01.001>
- Reichardt, C. S., & Cook, T. D. (1980). "Paradigms lost": Some thoughts on choosing methods in evaluation research. *Evaluation and Program Planning*, 3(4), 229-236. [https://doi.org/10.1016/0149-7189\(80\)90037-3](https://doi.org/10.1016/0149-7189(80)90037-3)
- Renn, O., Webler, T., Rakel, H., Dienel, P., & Johnson, B. (1993). Public participation in decision making: A three-step procedure. *Policy Sciences*, 26(3), 189-214. <https://doi.org/10.1007/BF00999716>
- Roos, G., Oláh, J., Ingle, R., Kobayashi, R., & Feldt, M. (2020). Online conferences – Towards a new (virtual) reality. *Computational and Theoretical Chemistry*, 1189, 112975. <https://doi.org/10.1016/j.comptc.2020.112975>
- Rosen, R. (1977). Complexity as a system property. *International Journal of General Systems*, 3(4), 227-232. <https://doi.org/10.1080/03081077708934768>
- Rossi, P. H., Lipsey, M. W., & Henry, G. T. (2018). *Evaluation: A systematic approach*. Sage publications.
- Rousval, B. (2005). *Aide multicritère à l'évaluation de l'impact des transports sur l'environnement*. Université Paris Dauphine.
- Rowley, T. J. (1997). Moving Beyond Dyadic Ties: A Network Theory of Stakeholder Influences. *Academy of Management Review*, 22(4), 887-910. <https://doi.org/10.5465/amr.1997.9711022107>
- Roy, B. (1968). *Classement et choix en présence de points de vue multiples*. 2(6), 57-75.
- Saaty, R. W. (1987). The analytic hierarchy process—What it is and how it is used. *Mathematical Modelling*, 9(3-5), 161-176. [https://doi.org/10.1016/0270-0255\(87\)90473-8](https://doi.org/10.1016/0270-0255(87)90473-8)
- Sadok, W., Angevin, F., Bergez, J.-É., Bockstaller, C., Colomb, B., Guichard, L., Reau, R., & Doré, T. (2008). Ex ante assessment of the sustainability of alternative cropping systems: Implications for using multi-criteria decision-aid methods. A review. *Agronomy for Sustainable Development*, 28(1), 163-174. <https://doi.org/10.1051/agro:2007043>
- Salliou, N., & Thomopoulos, R. (2018). *Modelling multicriteria argument networks about reduced meat consumption*.
- Schader, C., Grenz, J., Meier, M. S., & Stolze, M. (2014). Scope and precision of sustainability assessment approaches to food systems. *Ecology and Society*, 19(3), art42. <https://doi.org/10.5751/ES-06866-190342>
- Schoolman, E. D., Guest, J. S., Bush, K. F., & Bell, A. R. (2012). How interdisciplinary is sustainability research? Analyzing the structure of an emerging scientific field. *Sustainability Science*, 7(1), 67-80. <https://doi.org/10.1007/s11625-011-0139-z>

Scriven, M. (1991). *Evaluation Thesaurus*. SAGE.

Shift Project. (2020). *Shift project : Vers un plan de transformation de l'économie française en faveur du climat et de la résilience*. <https://theshiftproject.org/wp-content/uploads/2021/04/TSP-PTEF-V1-FL-Agriculture.pdf>

Simatupang, T. M., Piboonrunroj, P., & Williams, S. J. (2017). The emergence of value chain thinking. *International Journal of Value Chain Management*, 8(1), 40. <https://doi.org/10.1504/IJVCM.2017.082685>

Simons, P. R.-J., Admiraal, W., Akkerman, S., van de Groep, J., & de, M. (2000). *How people in virtual groups and communities (fail to) interact*. 12.

Sobczak, A., & Girard, C. (2006). Des parties prenantes aux parties engagées : Pour une nouvelle lecture de la théorie des stakeholders. In *1er Congrès du Réseau International de recherche sur les Organisations et le Développement Durable (RIODD)*. <https://hal.archives-ouvertes.fr/hal-00757948>

Sohn, J., Bisquert, P., Buche, P., Hecham, A., Kalbar, P. P., Goldstein, B., Birkved, M., & Olsen, S. I. (2020). Argumentation Corrected Context Weighting-Life Cycle Assessment : A Practical Method of Including Stakeholder Perspectives in Multi-Criteria Decision Support for LCA. *Sustainability*, 12(6), 2170. <https://doi.org/10.3390/su12062170>

Sonesson, U. G., Lorentzon, K., Andersson, A., Barr, U.-K., Bertilsson, J., Borch, E., Brunius, C., Emanuelsson, M., Göransson, L., Gunnarsson, S., Hamberg, L., Hessle, A., Kumm, K.-I., Lundh, Å., Nielsen, T., Östergren, K., Salomon, E., Sindhøj, E., Stenberg, B., ... Wall, H. (2016). Paths to a sustainable food sector : Integrated design and LCA of future food supply chains: the case of pork production in Sweden. *The International Journal of Life Cycle Assessment*, 21(5), 664-676. <https://doi.org/10.1007/s11367-015-0969-5>

Steckler, A., McLeroy, K. R., Goodman, R. M., Bird, S. T., & McCormick, L. (1992). Toward Integrating Qualitative and Quantitative Methods : An Introduction. *Health Education Quarterly*, 19(1), 1-8. <https://doi.org/10.1177/109019819201900101>

Stepanov, D., Abla, G., Ciarlette, D., Fredian, T., Greenwald, M., Schissel, D. P., & Stillerman, J. (2011). Remote participation in ITER exploitation—Conceptual design. *Fusion Engineering and Design*, 86(6-8), 1302-1305. <https://doi.org/10.1016/j.fusengdes.2011.01.120>

Stringer, L. C., Dougill, A. J., Fraser, E., Hubacek, K., Prell, C., & Reed, M. S. (2006). Unpacking “Participation” in the Adaptive Management of Social–ecological Systems : A Critical Review. *Ecology and Society*, 11(2). <https://www.jstor.org/stable/26266023>

Sun, X., Wang, F., Wang, Y., & Li, S. (2017). Data Handling in EAST Remote Participation. *IEEE Transactions on Nuclear Science*, 64(11), 2891-2894. <https://doi.org/10.1109/TNS.2017.2756631>

Sureau, S., Mazijn, B., Garrido, S. R., & Achten, W. M. J. (2018). Social life-cycle assessment frameworks : A review of criteria and indicators proposed to assess social and socioeconomic impacts. *The International Journal of Life Cycle Assessment*, 23(4), 904-920. <https://doi.org/10.1007/s11367-017-1336-5>

Suttrop, W., Kinna, D., Farthing, J., Hemming, O., How, J., & Schmidt, V. (2002). Remote participation at JET Task Force work : Users' experience. *Fusion Engineering and Design*, 60(3), 459-465. [https://doi.org/10.1016/S0920-3796\(02\)00047-9](https://doi.org/10.1016/S0920-3796(02)00047-9)

- Taylor, D. H. (2005). Value chain analysis : An approach to supply chain improvement in agri-food chains. *International Journal of Physical Distribution & Logistics Management*, 35(10), 744-761. <https://doi.org/10.1108/09600030510634599>
- Terpend, N. (1997). *Guide pratique de l'approche filière*. 34.
- The Ecologist. (1972). *A blueprint for survival*. 2(1), 1-43.
- Thiétart, R.-A. (2014). *Méthodes de recherche en management-4ème édition*. Dunod.
- Thomopoulos, R. (2018). A practical application approach to argumentation for multicriteria analysis and decision support. *EURO Journal on Decision Processes*, 6(3-4), 237-255. <https://doi.org/10.1007/s40070-018-0087-2>
- Thomopoulos, R., Baget, J.-F., & Haemmerlé, O. (2007). Conceptual Graphs as Cooperative Formalism to Build and Validate a Domain Expertise. In U. Priss, S. Polovina, & R. Hill (Éds.), *Conceptual Structures : Knowledge Architectures for Smart Applications* (Vol. 4604, p. 112-125). Springer Berlin Heidelberg. https://doi.org/10.1007/978-3-540-73681-3_9
- Thomopoulos, R., Cufi, J., & Le Breton, M. (2020). A Generic Software to Support Collective Decision in Food Chains and in Multi-Stakeholder Situations. *FoodSim 2020 - 11th Biennial FOODSIM Conference*. <https://hal.archives-ouvertes.fr/hal-02484363>
- Thomopoulos, R., Destercke, S., Charnomordic, B., Johnson, I., & Abécassis, J. (2013). An iterative approach to build relevant ontology-aware data-driven models. *Information Sciences*, 221, 452-472. <https://doi.org/10.1016/j.ins.2012.09.015>
- Todorov, K., Geibel, P., & Kühnberger, K.-U. (2010). Mining concept similarities for heterogeneous ontologies. *Industrial Conference on Data Mining*, 86-100.
- Tsoukas, H., & Chia, R. (2002). On Organizational Becoming : Rethinking Organizational Change. *Organization Science*, 13(5), 567-582. <https://doi.org/10.1287/orsc.13.5.567.7810>
- Tsoy, N., Steubing, B., van der Giesen, C., & Guinée, J. (2020). Upscaling methods used in ex ante life cycle assessment of emerging technologies : A review. *The International Journal of Life Cycle Assessment*, 25(9), 1680-1692. <https://doi.org/10.1007/s11367-020-01796-8>
- Tulloch, L. (2013). On Science, Ecology and Environmentalism. *Policy Futures in Education*, 11(1), 100-114. <https://doi.org/10.2304/pfie.2013.11.1.100>
- Tulloch, L., & Neilson, D. (2014). The Neoliberalisation of Sustainability. *Citizenship, Social and Economics Education*, 13(1), 26-38. <https://doi.org/10.2304/csee.2014.13.1.26>
- UN. (2015). *Transforming our world : The 2030 agenda for sustainable development. Resolution adopted by the general assembly on 25 September 2015 (A/RES/70/1)*. A/RES/70/1.
- UNEP. (2020). *Guidelines for Social Life Cycle Assessment of Products and Organizations 2020*. <https://www.lifecycleinitiative.org/wp-content/uploads/2021/01/Guidelines-for-Social-Life-Cycle-Assessment-of-Products-and-Organizations-2020-22.1.21sml.pdf>
- UNEP/SETAC. (2009). *Guidelines for Social Life Cycle Assessment of products*. 978-992.
- UNEP/SETAC. (2013). *The Methodological Sheets for Sub-Categories in Social Life Cycle Assessment (S-LCA)*. [lifecycleinitiative.org. https://www.lifecycleinitiative.org/wp-content/uploads/2013/11/S-LCA_methodological_sheets_11.11.13.pdf](https://www.lifecycleinitiative.org/wp-content/uploads/2013/11/S-LCA_methodological_sheets_11.11.13.pdf)

- Van Der Heijden, H. (1999). Environmental movements, ecological modernisation and political opportunity structures. *Environmental Politics*, 8(1), 199-221. <https://doi.org/10.1080/09644019908414444>
- Van Rijn, F., Judge, L., Fort, R., Koster, T., Waarts, Y., & Ruben, R. (2016). *Fairtrade certification in the banana hired labour sector* (Numéros 2015-056). LEI Wageningen UR.
- Vanclay, F. (2002). *Conceptualising social impacts*. 22, 183-211. [https://doi.org/10.1016/S0195-9255\(01\)00105-6](https://doi.org/10.1016/S0195-9255(01)00105-6)
- Vivas, C., Planche, C., Macombe, C., Engel, E., & Thomopoulos, R. (2022). *Une analyse systémique et interdisciplinaire de scénarios de développement durable basés sur l'entomoconversion*.
- von Geibler, J., Liedtke, C., Wallbaum, H., & Schaller, S. (2006). Accounting for the social dimension of sustainability : Experiences from the biotechnology industry. *Business Strategy and the Environment*, 15(5), 334-346. <https://doi.org/10.1002/bse.540>
- Vroom, V. (1964). *Work and motivation* (Wiley).
- Weber, J. (1992). Operationalizing the Stakeholder Theory of the Firm : Establishing Classification Schemas for the Matrix Dimension. *Proceedings of the International Association for Business and Society*, 3, 400-409. <https://doi.org/10.5840/iabsproc1992326>
- Weidema, B. P. (2006). The Integration of Economic and Social Aspects in Life Cycle Impact Assessment. *The International Journal of Life Cycle Assessment*, 11(S1), 89-96. <https://doi.org/10.1065/lca2006.04.016>
- WHO. (2009). Closing the gap in a generation : Health equity through action on the social determinants of health : Final report of the commission on social determinants of health. *Closing the Gap in a Generation : Health Equity through Action on the Social Determinants of Health : Final Report of the Commission on Social Determinants of Health*, 246.
- Wijnberg, N. M. (2000). *Normative Stakeholder Theory and Aristotle : The Link Between Ethics and Politics*. 14.
- Yamaji, K., Matsushashi, R., Nagata, Y., & Kaya, Y. (1993). A study on economic measures for CO2 reduction in Japan. *Energy Policy*, 21(2), 123-132. [https://doi.org/10.1016/0301-4215\(93\)90134-2](https://doi.org/10.1016/0301-4215(93)90134-2)
- Zahm, F., Alonso Ugaglia, A., Barbier, J. M., Boureau, H., Del'Homme, B., Gafsi, M., Gasselin, P., Girard, S., Guichard, L., Loyce, C., Manneville, V., Menet, A., & Redlingshofer, B. (2019). Évaluer la durabilité des exploitations agricoles : La méthode IDEA v4, un cadre conceptuel combinant dimensions et propriétés de la durabilité. *Cahiers Agricultures*, 28(5), 10. <https://doi.org/10.1051/cagri/2019004>

Annex 0: project Sentinel

Both industry and health authorities want to rely more on high-throughput, sensitive and inexpensive screening methods in order to strengthen the monitoring of priority food hazards. Huge advances in microbiological safety have been made in recent years thanks to advances in molecular biology. High-speed and low-cost technologies have been able to strengthen regulatory control mechanisms while providing manufacturers with effective means of self-control. In terms of chemical safety, this technical and societal transition has not yet taken place.

The French system is based on two approaches:

- monitoring and control plans used to detect possible non-conformities (exceeding the maximum level TM in a food);
- more ad hoc total diet studies assessing the overall risk of chronic dietary exposure to lower (infra-TM) levels of contaminants.

As MTRs are often very low, both approaches rely mainly on very sensitive but unfortunately very expensive and low-throughput methods limiting both the extent of regulatory oversight and the possibilities for industrial self-monitoring.

By using polychlorinated biphenyls (PCBs) in meat as study models, SENTINEL aims to strengthen the current food chemical safety monitoring system. To this end, high-speed, sensitive and cost-controlled screening tools will be developed in order to:

- increase the effectiveness of regulatory inspections of health authorities;
- facilitate industrial self-checks;
- to enable preventive monitoring of PCBs at sub-regulatory levels.

Their development will be based on the coupling between latest-generation detectors (mass spectrometry, biosensors, electronic noses) and innovative methods in marker search (omics), sample processing (mixing, extraction) or data processing (chemometrics, bioinformatics).

[Sentinel - Outil de surveillance de la sécurité chimique des aliments \(ifip.asso.fr\)](http://ifip.asso.fr)

The people working on the Sentinel project are divided into 5 Work Packages (WPs). WP0 takes care of the project management. WP1, WP2 and WP3 create the PCB detection tools. WP4, the WP to which we belong, aims to propose:

- Plausible solutions for the implementation of new chemical monitoring tools

- Extended cost-benefit analysis (including safety benefits, regulatory, economic and social consequences) two relevant and detailed implementation scenarios.

WP4 involves three categories of partners: first, specialists in new surveillance tools; secondly, specialists in the methods used in WP4 (scenarios, cost-benefit analysis, etc.); thirdly, the IFIP (Institut du Porc) whose role is essential on the one hand to model the current functioning of the value chain and its monitoring system. On the other hand to design probable scenarios for the evolution of the pork industry within the next 3 to 5 years. In addition, expert opinion and interviews will help to select and detail two of the plausible implementation scenarios. These will be subject to cost-benefit analysis.

Annex 1: research paradigms

Table 20 summarizes the different positions of the research paradigms according to the four pillars presented in Section VI (Thiéart, 2014).

Pillars	Conceptions	Realism		Constructivism		
		Positivism	Critical realism	Interpretativism	Engineering constructivism	Post-modernism
Ontologies	Essentialism	Reality has its own unchangeable and invariable laws.	3 stages of reality: - empirical reality (experience and impressions) - actualized reality (events state of facts) - Inaccessible Profound reality (forces, structures and mechanisms).	-	-	-
	Non essentialism	-	-	Social construction of reality: reality is based on the actor's intentions and constructed through the interactions (confrontations and sharing) between the actors.	There is no direct way to reach reality without the mediation of our senses, experiences, language or intentions. This however does not mean that reality does not exist.	Reality is precarious and depends on what an actor says, intentionally or not.
Epistemologies	Objectivism	Social facts are treated as objects external to us. They are observed and experimented. The nature of the object is unchanged by the observations.	Objects evolve. Therefore, qualitative methods are preferred over experiments and statistical investigations. Conjectures are elaborated, highlighting the mechanisms which generate the profound reality.	-	-	-
	Relativism	-	-	Comprehensive ideographic approach: knowledge is centered on a specific case. We cannot always generate universal laws from one case study. That is why knowledge is relative.	The subject is in no way independent of the object of his study. Knowledge is constructed as the study goes and several methodologies can be adopted. Knowledge is a process, not a result.	Hermeneutic approach unveils the unstable and shifting character of reality.
Methodologies		Truth is empirically verifiable or confirmable.		Knowledge is a result of an inter-subjective comprehension process between concerned actors. It is capable of guarantying the credibility of an interpretation.	Knowledge is valid if it is adapted to a certain context.	

Table 20: positions adopted in research paradigms

Annex 2: methodological adaptations of the scenario method

In this section, we will be detailing the calculations followed so that the adapted method can be verified and reproduced.

In the classic scenario method, collective sessions serve to identify the variables and to build consensus about relationships between variables, first of all by small groups then by joining all prospects together. From these group discussions about the relationships between each pair of variables, matrices of relationships are built for each group. From the consensus built between the different groups, all the relationships (direct and indirect) are summarized in a single matrix which is then discussed by all prospects, who have the final decision concerning the determination of the meaningful relationships. This whole process is called “structural analysis”.

Since this part of the classic method is based essentially on social interactions, skipping from collective to individual sessions had methodological repercussions.

In the adapted method, structural analysis is based on individual semi-directive discussions as we said previously in 2.2. As explained before, the interviews are carried on with experts who presumably have different views on the sector (political, social, economic, technological, environmental, etc.). It is therefore expected that the variables quoted as the main determinants of the system evolution differ from one actor to another.

In the following section, we discuss the different approaches used to determine the variables after extracting concepts from the interviews done with experts of the studied value chain.

1. Linguistic and mathematical approaches

In the classic as well as in the adapted method, we access and identify variables through interviews, discussions or document readings, that is to say, through natural language.

As we have said before, in the classic method, the variables -with their final denominations- are given directly by the prospects after establishing consensus. However, in the adapted method, variables are delivered by the sources -the prospects and the documents- with a given terminology, which differs from a source to another. That is why we distinguish concepts (linguistic approach) from variables (mathematical approach) and we combine the use of both.

- The notion of concepts belongs to the lexical domain. A concept $c \in \mathbf{C}$ (a set of concepts) can be extensively described by the set of sub-concepts denoted by \mathbf{C}_c composed of the various denominations (synonymous or more specific) of said concept: in other words, a sub-concept (or a denomination) is a word or a phrase extracted as is from the verbatim of the interviews or the documents. Thus, a concept is made up of one or more sub-concepts. So, for a concept

c , $C_c = \{c' \in C \mid c' \preceq c\}$ (Thomopoulos et al., 2013). All concepts together make up what Thomopoulos et al. (2013) call an ontology Ω defined as a tuple $\Omega = \{C, R\}$ where C is the set of concepts and R is a set of relations between concepts. R is here composed of the synonymy and specialization relations.

- Variables on another hand are used in mathematical approaches and are handled in the “scenario method”. Given a set of variables V , each variable $v \in V$ is associated with a concept $c \in C$ in the ontology Ω . Each variable can take several values which are called modalities.

The process followed below (Definitions 1, 2 and 3) is not automated, it is therefore a delicate and time consuming task. It is of course a subjective analysis of the interviews and the documents. Nevertheless, by involving several researchers and experts in the merging process and validating it at each step, the vocabulary defined becomes more relevant, and the process more efficient (Thomopoulos et al., 2013).

2. Definition 1: Concept-merging process to obtain the variables

After doing the interviews and perusing the documents found on the matter studied, the set of concepts C is extracted, and considered as distinct, for each interview or document. The experts -which have different opinions and different domains of expertise- can adopt different ontologies to describe similar things, however the underlying concepts can be common to two or more sources. That is why an ontology matching procedure is followed in order to limit the heterogeneity of the concepts used (Todorov et al., 2010). The ontology is built manually by merging concepts which have synonym denominations (Thomopoulos et al., 2007, 2013). Given two equivalent concept denominations $name(c1)$ and $name(c2)$, we deduce $c1 = c2$ which allows us to merge both concepts and thus reduce the cardinality of the set of concepts C .

Then, concepts which refer to the same global notion are grouped into a variable. We will denote by $var(c)$ the variable which concept c is associated with. So a variable v is a global notion made up of similar concepts which are explanations and descriptions of what it could be.

Example: In our case study, the concepts expressed as “Informing consumers about products” and “Informing consumers about farming” could be merged and associated with the variable labelled “Communication”. Similarly, the concepts ”Refusing all types of breedings near houses” and ”Criticism of the negative environmental impact of livestock farming” were both identified as concepts belonging to the variable “Social acceptability”.

Let us now define the elements handled respectively in the classic and in the adapted method in order to identify the key variables of the system studied.

3. **Definition 2: Partial versus global sets of variables, matrices, influences, dependences and key variables.**

- **In the classic method**, the global set of variables of the system, which we denote by \mathbf{V} , is built by collective consensus between the prospects. The influence and the dependence of each variable of \mathbf{V} is determined as follows. For each couple of variables (x, y) belonging to \mathbf{V} , we will denote by $n_{xy} \in \{0; 1\}$ the existence of an influence relationship from x to y , built by collective consensus between the prospects. There are two cases:

- $n_{xy} = 1$ if the prospects agree on the existence of an influence relationship from x to y
- $n_{xy} = 0$ otherwise.

These influence relationships are represented as a squared matrix which resumes the influence relationships between each couple of variables.

The influence of a variable $v \in \mathbf{V}$ is then computed as $I(v) = \sum_y n_{vy}$.

Similarly, the dependence of $v \in \mathbf{V}$ is computed as $D(v) = \sum_x n_{xv}$.

- **In the adapted method**, a partial source-by-source phase is followed by a global merging phase.

Partial source-by-source phase. For each source i , the following process is performed:

- A *partial* set of concepts is defined, which we will denote by \mathbf{C}_i valid for source i .
- Individual cognitive maps are created to formalize relationships between concepts cited spontaneously by each source.
- Cognitive maps are then converted into tables of concepts for each source i . For each couple of concepts (c, c') belonging to \mathbf{C}_i , we will denote by $n_{cc'i} \in \{-1; 0; 1\}$ the existence of an influence relationship from c to c' according to source i .

$n_{cc'i} = 1$ if c influences c' (and equivalently c' depends on c) according to source i ;

$n_{cc'i} = 0$ otherwise.

From these pairwise relationships, the *partial* influence of concept c according to source i can be defined by $I_i(c) = \sum_{c'} n_{cc'i}$, while the *partial* dependence of concept c according to source i can be defined by $D_i(c) = \sum_{c'} n_{c'ci}$.

- After merging the concepts into variables (Definition 1), a *partial* set of variables \mathbf{V}_i is defined for source i . The number of direct influence links $n_{vv'i}$ between two variables v and v' according to source i can be computed by summing the direct influence links between the concepts composing them: $n_{vv'i} = \sum_{c,c' | \text{var}(c)=v, \text{var}(c')=v'} n_{cc'i}$.
- A *partial* squared matrix representing the **direct links** between variables is created for each source i .

A *partial direct* influence $I_i^d(v)$ and a *partial direct* dependence $D_i^d(v)$ of each variable $v \in \mathbf{V}_i$ are calculated for each source i independently.

$$I_i^d(v) = \sum_{c|\text{var}(c)=v} I_i(c)$$

$$D_i^d(v) = \sum_{c|\text{var}(c)=v} D_i(c)$$

This squared matrix thus represents direct pairwise influences and dependences in the set of variables \mathbf{V}_i . Figure 53 is an example of the result obtained.

		Dépendance (-) Σ colonnes											
		A	B	C	D	E	F	G	H	I	J	K	L
Influence (I) Σ lignes	A	8	0	6	2	1	0	4	2	0	3	1	0
	B	0	0	0	0	0	0	0	0	0	0	0	0
	C	2	0	2	0	0	0	0	0	0	0	2	0
	D	0	0	0	0	0	0	0	1	0	0	0	0
	E	5	0	0	2	3	2	3	0	0	2	2	0
	F	0	0	0	0	0	2	4	0	0	0	1	0
	G	1	0	0	1	1	0	4	1	0	0	1	0
	H	0	0	0	0	1	0	0	0	1	0	0	0
	I	0	0	0	0	0	0	0	0	0	0	1	0
	J	3	0	3	0	3	1	0	0	0	2	0	0
	K	1	0	0	0	0	2	0	0	0	0	0	0
	L	0	0	0	0	0	0	0	0	0	0	0	0

Figure 53: Squared matrix of direct links identified in an interview between 12 variables.

- We also need to calculate **indirect links of first order** between the variables. In fact, the number of indirect links between two variables is higher than the number of direct links between them. This could change the final results of which variables are key.

Those indirect links of first order are calculated based on the partial matrix of direct links. The results are also squared matrices. For each variable, we obtain a specific squared matrix of first-order indirect links. Those squared matrices are then summed to obtain the final squared matrix of first-order indirect links for all variables on an interview. Figure 54 and 57 illustrate how we obtain the matrices of indirect links from the matrix of figure 53.

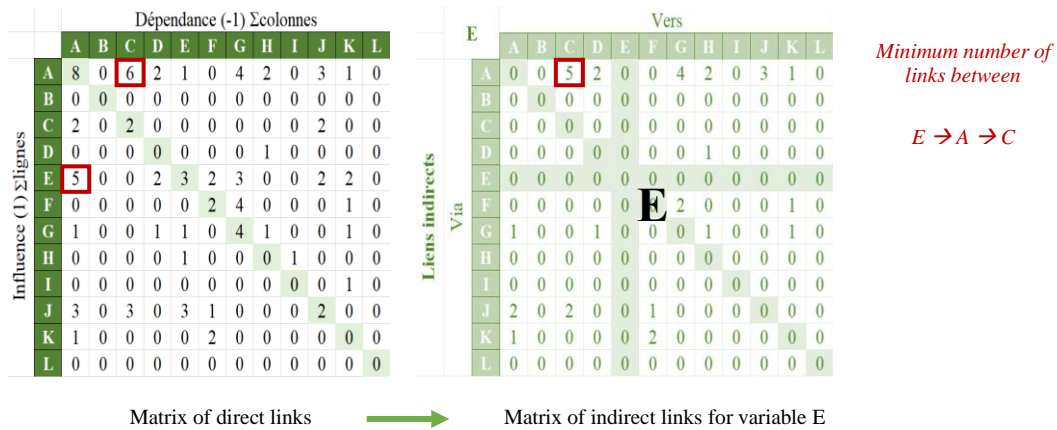

Figure 54: How indirect links of first order are calculated for each variable.

Variable E is taken as an example here. To compute the number of indirect links from E to C through A, we retain the minimum between the number of direct links from E to A (5 direct links) and the number of direct links from A to C (6 direct links). The minimum is 5, there are thus 5 first-order indirect links from E to C through A. The same computation has to be performed taking all other ways from E to C (through B, D, etc.), then from E to all other variables than C.

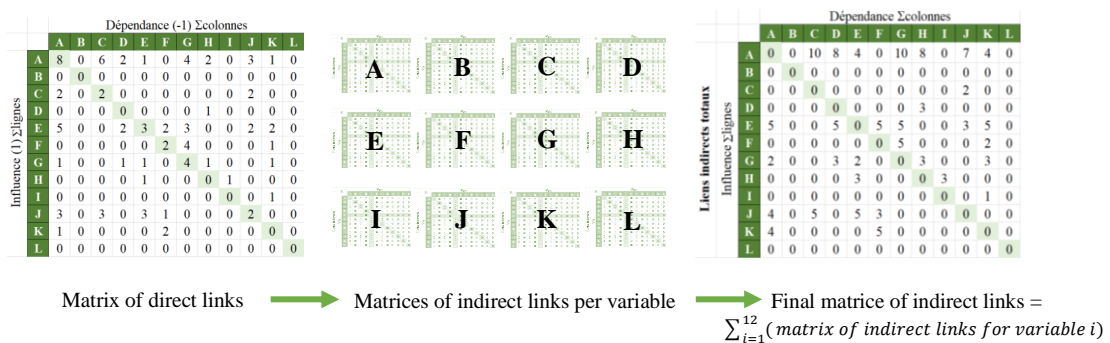

Figure 55: How we obtain the final squared matrix of indirect links of first order based of the squared matrix of direct links identified in an interview.

More generally, to obtain the number of indirect links between two variables v and v' according to source i , denoted by $I_i^{in}(vv')$, we proceed as follows:

$$I_i^{in}(vv') = \sum_z \min(n_{vzi}; n_{zv'i})$$

where $z \in \mathbf{V}_i$ is the intermediate variable between v and v'

After identifying the number of indirect links between each pair of variables, we obtain as many matrices as we have variables (as shown in figure 55). All those matrices are summed to obtain the final squared matrix of all indirect links. We denote by $I_i^{in}(v) = \sum_{v' \in \mathbf{V}_i} I_i^{in}(vv')$

and $D_i^{in}(v) = \sum_{v' \in V_i} I_i^{in}(v', v)$ the number of *partial* indirect influence and dependence links for each variable $v \in V_i$.

- Total influence and dependence values for each variable can be then calculated for each source i independently:

$$\begin{aligned} I_i(v) &= I_i^d(v) + I_i^{in}(v) \\ D_i(v) &= D_i^d(v) + D_i^{in}(v) \\ &\text{with } v \in V_i \end{aligned}$$

Partial key variables can be determined as in the classic method. They are the ones with $I_i(v)$ and $D_i(v)$ higher than the averages.

Global merging phase. From the partial sets of variables of all the sources i , we define the *global* set of variables \mathbf{V} by merging all the partial sets together:

$$\mathbf{V} = \cup_i V_i$$

If one variable appears several times in different partial sets, it is counted once in the global set.

From the partial influences stemming from all sources, we compute the *global* influence of variable v as the sum of its partial influences, for all sources which considered the variable v :

$$I(v) = \sum_i I_i(v) \text{ with } v \in V_i$$

Similarly, we compute the *global* dependence of variable v as the sum of its partial dependencies, for all sources which considered the variable v :

$$D_v = \sum_i D_i(v) \text{ with } v \in V_i$$

The results are represented in a final *global* square matrix. Figure 56 resumes all the process followed.

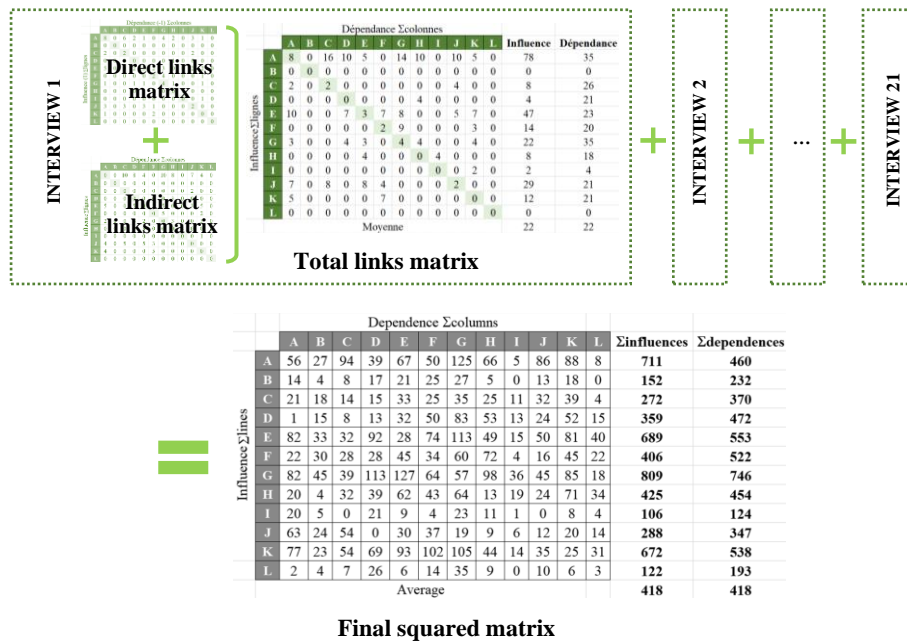

Figure 56: Summary of how we obtain a final squared matrix using the adapted Godet method

Finally, the *global* key variables are determined using the final squared matrix. The results obtained resemble those that would have been obtained using the classic Godet method (figure 1). The key variables are those that are more dependent and more influential than the average. However, the robustness of the identification of the key variables is a specific issue, especially in the adapted method because the prospects do not spontaneously agree about the determinants of the future. If we can perform hundreds of interviews, we could reasonably expect that the addition of one new interview to the former pool of results would not change the identification of the key variables. They would be “stabilized”. We are however committed to stabilizing the key variables without necessarily doing a huge number of interviews.

The rule we chose is therefore the following: in this foresight exercise, the key variables are those which are graphically determined and which are not threatened to become output, input or excluded variables by the addition of one new interview. For that reason, we calculate instability zones of influence and dependence:

$$Z_{\text{influence}} = \text{average of influence} \pm (R_{\text{MAX}}^{\text{D}} + R_{\text{MAX}}^{\text{IN}})$$

$$Z_{\text{dependence}} = \text{average of dependence} \pm (R_{\text{MAX}}^{\text{D}} + R_{\text{MAX}}^{\text{IN}})$$

With $R_{\text{MAX}}^{\text{D}}$ the maximum number of direct relations; $R_{\text{MAX}}^{\text{D}} = \text{Max}(I_i^{\text{d}}(v); D_i^{\text{d}}(v))$
 and $R_{\text{MAX}}^{\text{IN}}$ the maximum number of indirect relations; $R_{\text{MAX}}^{\text{IN}} = \text{Max}(I_i^{\text{in}}(v); D_i^{\text{in}}(v))$

with $v \in V_i$

The process for determining the values of R_{MAX}^D and R_{MAX}^{IN} is iterative: it's done after each interview as the values may change. We then decide to exclude from their status of key variables, those which could change their status (by becoming either output, input or excluded variables) by the addition of $(R_{MAX}^D + R_{MAX}^{IN})$ links or less. Graphically speaking, it means that the key variables positioned too close to one or the other of the average lines are not “stabilized” key variables. The rule is valid whatever the status of the variable is.

After determining the stabilized key variables, their modalities must be considered as defined in the next section of the main text.

4. Definition 3: Defining the modalities of the variables

The modalities of one given variable are the values that can be taken by this variable, according to the analysis of the interviews and documents included.

- **In the classic method**, the modalities of each key variable are chosen by consensus whilst choosing the key variables. It should be noted that it is necessary to limit the number of modalities (while 2 are the minimum), or it will generate an extremely high number of scenarios!
- **In the adapted method**, the modalities of variable v are extracted from the set of concepts C , c being the concept associated with variable v (see Section 2.3.1 in this Annex). The modalities of v are the concepts strictly more specific than c -synonyms are thus excluded. More precisely, we look at the list of concepts and keep the ones which describe some characteristics of the variable v . Some of those concepts can either be explicit modalities of the variable, or they can be “rebuilt” in a simpler brief manner - implied by the interviewee or the document- so that they are modalities of the variable. The number of modalities for each variable is also at best limited to two

Annex 3: Delphi-type questionnaire

Résultats des interviews sur l'évolution de la filière porcine française et questionnaire pour l'identification des variables clés

Objectif du questionnaire :

Bonjour, MERCI de nous avoir accordé une interview il y a quelques mois, au sujet **des variables qui vous paraissent les plus importantes pour guider l'avenir de la filière porcine française**. Ci-après les résultats de l'analyse de 11 interviews d'experts comme vous.

Nous vous proposons de remplir le questionnaire pour vous permettre de confirmer ou de nuancer vos choix.

L'objectif de notre groupe de travail est de recueillir des points de vue différents et contrastés sur la filière et ses tendances. Le but de ce questionnaire est donc d'identifier les variables clés pour pouvoir élaborer des scénarios de référence du futur de la filière porcine sur les 3-5 ans à venir. Ci-dessous vous retrouverez l'ensemble des variables et de leurs modalités (valeurs qui peuvent être prises par la variable) relevées lors des entretiens au sujet de l'évolution de la filière porcine.

Merci d'indiquer au maximum 5 variables dont l'importance est "Elevée" ou "Très élevée".

Aide au remplissage : 06 82 23 31 83 / 07 71 16 57 77

Les variables citées par les experts interviewés (et les 2 ou 3 modalités que peut prendre cette variable)	Importance de la variable				
	Très faible	Faible	Moyenne	Elevée	Très élevée
Acceptabilité du modèle de production actuel (Exigence de changement vis-à-vis de la filière OU BIEN acceptation de la filière porcine actuelle)					
Accès au marché (Facilité des échanges internationaux OU BIEN difficulté des échanges internationaux)					
Communication inter et intra maillon (Amélioration de la communication OU BIEN même niveau de communication)					
Contexte institutionnel (Faible soutien des administrations (voire obstacle) OU BIEN soutien fort venant des administrations)					

Coûts de production (Coûts de production maîtrisés OU BIEN coûts en hausse)					
Energie (Diminution de la dépendance aux énergies fossiles OU BIEN maintien du niveau actuel de la consommation d'énergie)					
Évolution de l'attractivité des métiers de la filière (Filière demeure non attractive OU BIEN les métiers de la filière deviennent attractifs)					
Consommation de viande de porc (Baisse de la consommation OU BIEN maintien de la consommation)					
Procédés de production et de transformation en charcuterie (Maintien des pratiques OU BIEN changement des pratiques)					
Progrès techniques et technologiques utilisés en élevage (Amélioration des techniques et des technologies OU BIEN stagnation dans les techniques et technologies)					
Répartition territoriale de la filière (Redéploiement sur tout le territoire OU BIEN la filière reste concentrée sur l'Ouest du pays)					
Variation des prix de vente au consommateur (Maintien de prix abordables OU BIEN prix élevés)					

Voulez-vous être tenu/es au courant de la suite du projet ?	Oui	Non
Remarques		

Figure 59: mind map of interview 3

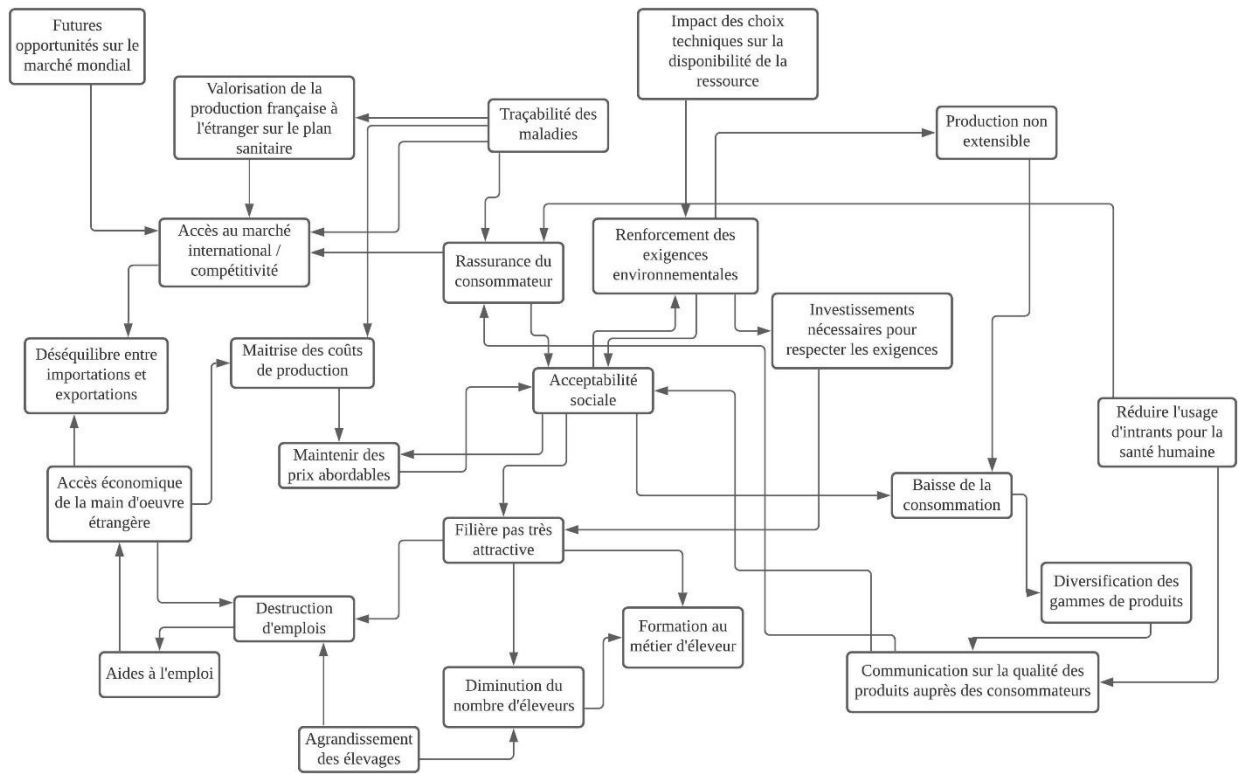

Figure 60: mind map of interview 4

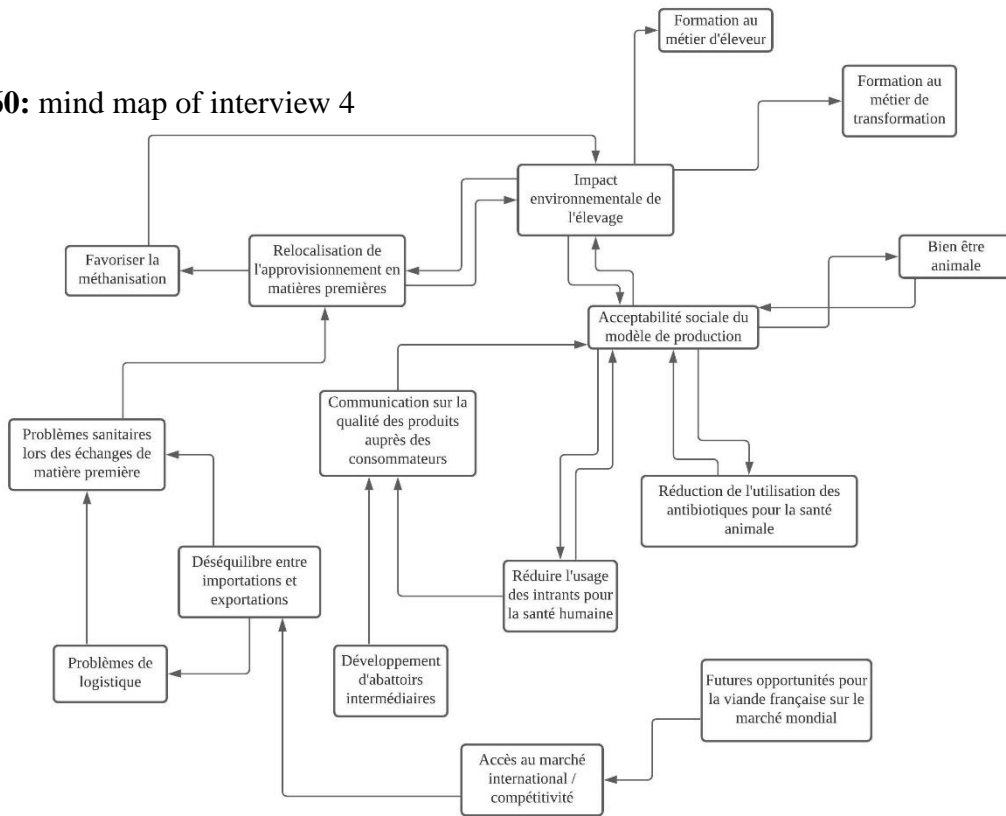

Figure 61: mind map of interview 5

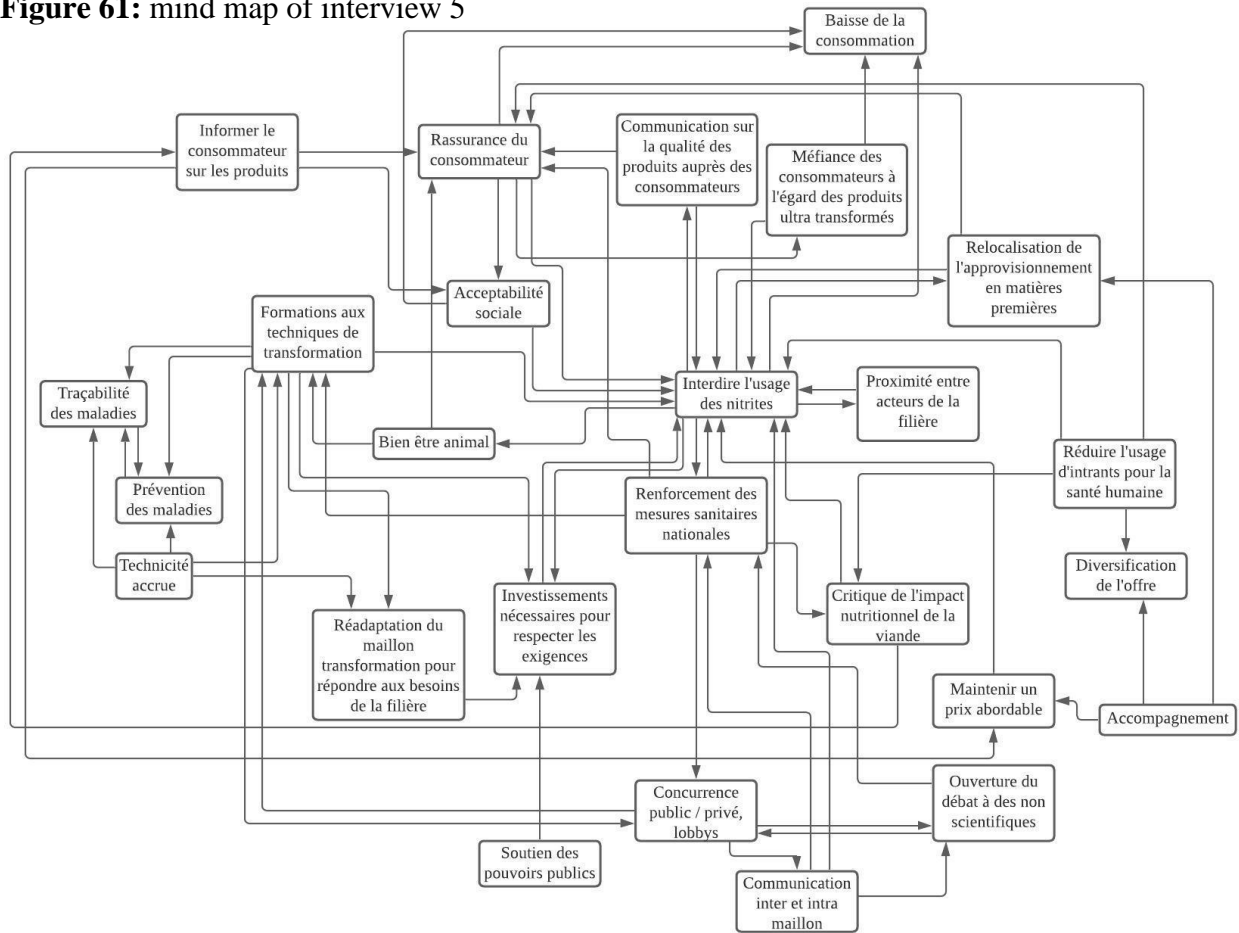

Figure 62: mind map of interview 6

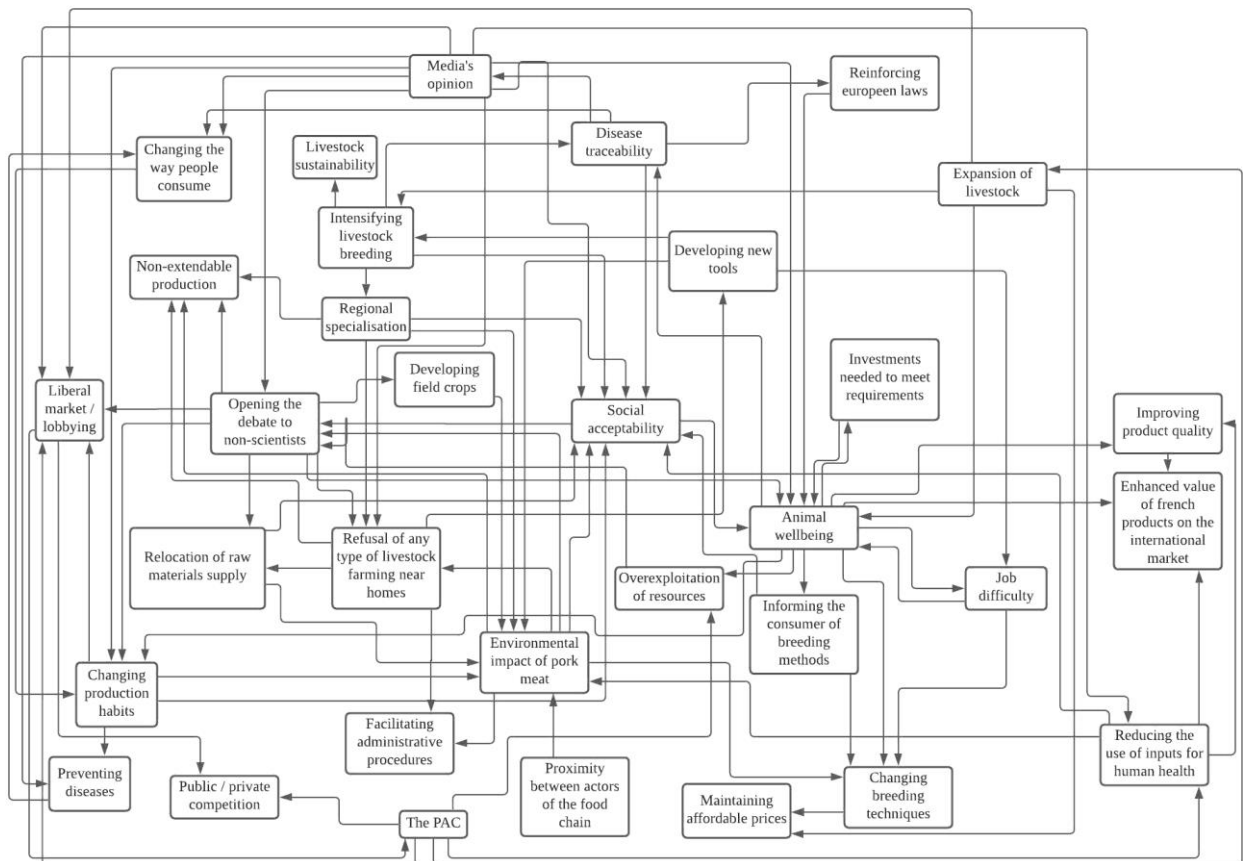

Figure 63: mind map of interview 7

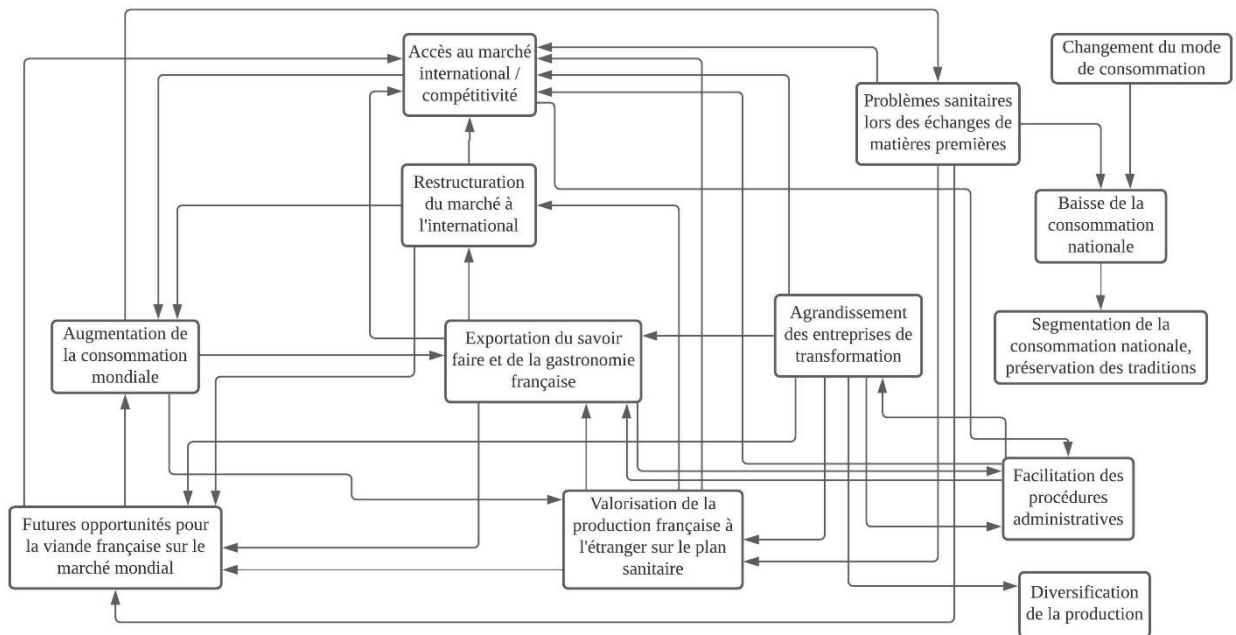

Figure 64: mind map of Interview 8

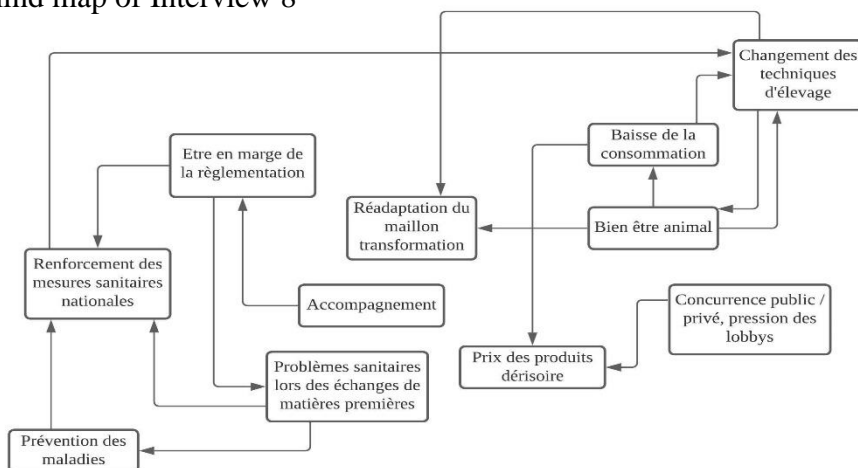

Figure 65: mind map of interview 9

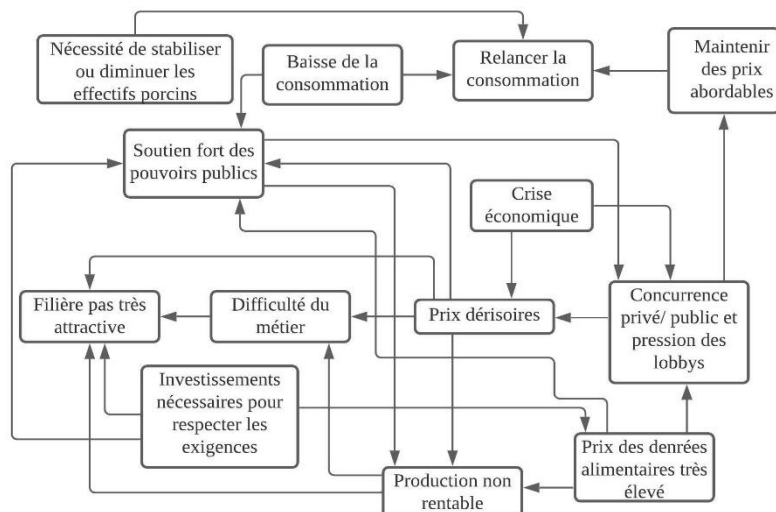

Figure 66: mind map of interview 10

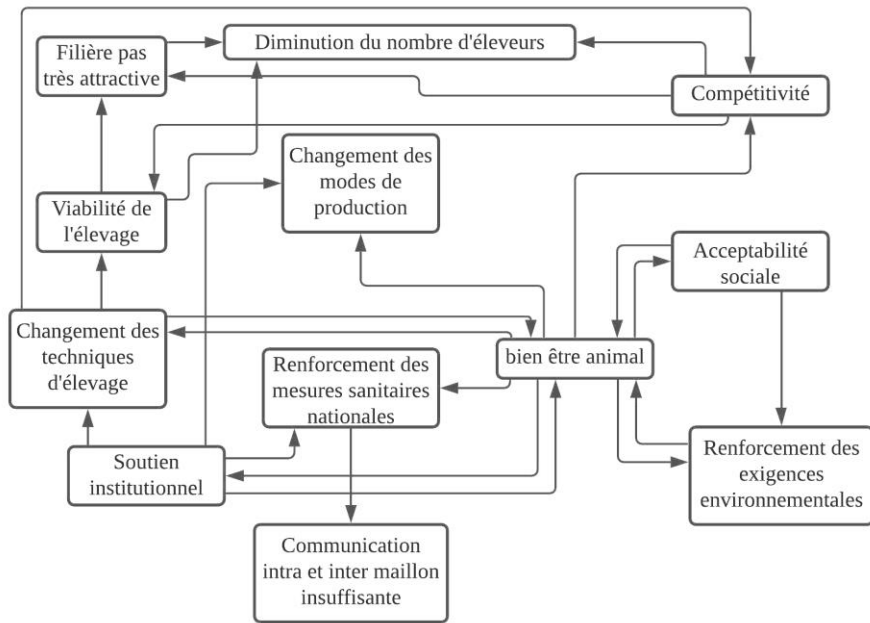
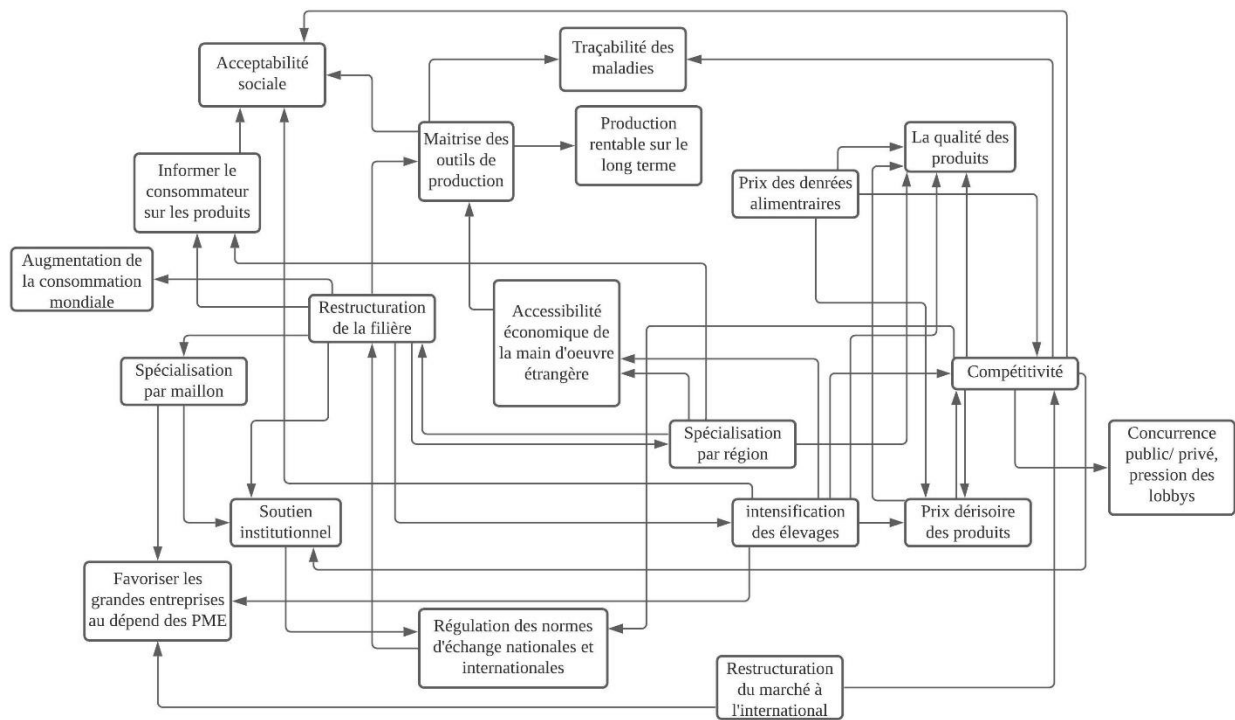

Figure 67: mind map of interview 11



Annex 5: impact pathways of pursuing business as usual in the French pork value chain

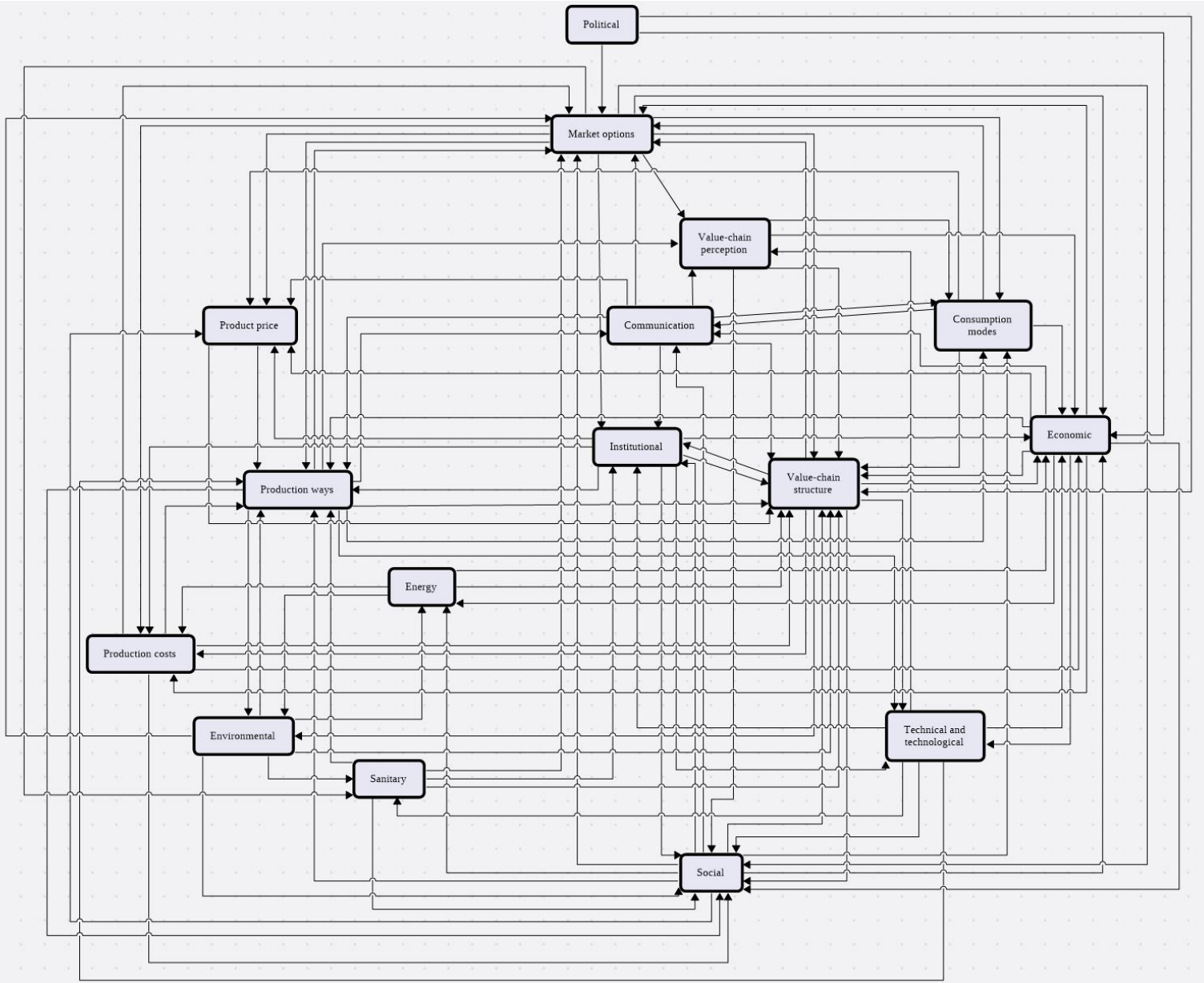

Figure 68: all the impact pathways of pursuing business as usual in the French pork value chain according to the interviewees' opinions

Annex 6: MyChoice opinions – Scenarios module



Entering the information in MyChoice

Table 13 in Section XI.3.c shows how we choose to enter the information in the MyChoice tool to use it for the creation of scenarios. To make the entry of information easier and faster in the software “MyChoice Opinion - Scenarios module”, we could create an ontology (fed as the projects are carried out) from which we can draw the different concepts and variables. This will avoid duplication to ensure correct and complete data analysis. We could also consider switching the columns of the spreadsheet and renaming them to make the input of information more intuitive. This is shown in table 21 below. In the rest of this annex, we will be using the “MyChoice scenarios titles”.

<i>MyChoice titles</i>	<i>Name Stakeholder</i>	<i>Name Alternative</i>	<i>Type Pro Con</i>	<i>Name Property</i>	<i>Aim</i>	<i>Name Criterion</i>	<i>Value</i>	-	<i>Condition</i>	<i>Explanation</i>	<i>Name Source</i>
MyChoice scenarios titles	Name Stakeholder	Name alternative	Factor Perception	Criteria	Concept	Variable	Value	Influenced concept	Influences	Cause explanation	Name Source
Information entered	Stakeholder group	Business as usual	If the factor influences the value chain positively or negatively	Criterion	Concept	Variable	Value given to the variable	Influenced concept	Variable influenced by the concept	Expliciting the influence relation if possible	Interviewed stakeholder

Table 21: reorganizing the MyChoice spreadsheet for the scenarios module and adding information

We would therefore start by entering the criterion, then the concept to finish with the variable and its influence (we note only the relations of influence, so if an actor speaks of a relationship of dependence (A depends on B) we reverse the information (B influence A)). If a concept belongs to two different variables, it is counted twice. For a variable, we have as many lines as relationships on different concepts.

We seek to identify the factors that would change the course of business as usual in the sector. The columns that will be used to identify this include the ‘**Variable / Name Criterion**’ and ‘**Influences / Condition**’ columns. It does not matter whether the relationship between the variables is positive or negative (‘**Factor perception / Type Pro Con**’), as long as it exists.

The visual

In Section XII, we talked about the results that we would like to obtain when using the MyChoice module. What we would like to see on MyChoice opinion – Scenarios module looks like what we see on MyChoice currently but with the column headings that are different. We would also have the ‘Influences’ column on the far right and the possibility to sort the information according to this column.

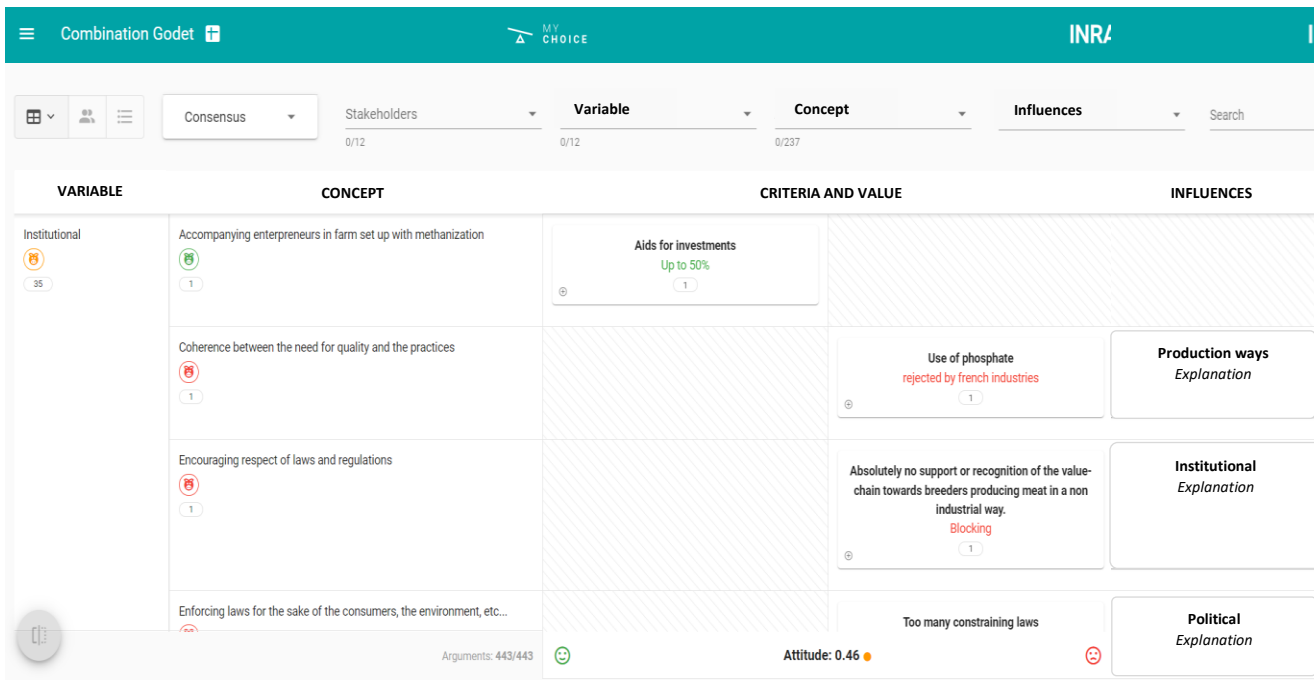

Figure 69: what we would see when using MyChoice opinions – Scenarios module

Data analysis

Besides the visual information, analyzing the data to improve the MyChoice tool is thoroughly discussed in the previous Section. Concretely, we would like to have additional buttons on the top left of the screen that would automatically give us the results resembling table 14 and figure 47 p.153.

Annex 7: MyChoice opinions – Impacts module



Entering information in MyChoice impacts

Information extracted from interviews or documents is entered as shown in table 22 below. The column headings could be changed for this MyChoice module for ease of use. To facilitate the entry of information into MyChoice, consideration could be given to using a pre-existing database (bibliography or other completed projects) that would grow as we go along. We would draw from the impact categories, the desired and actual impacts as well as the causes. This would avoid having duplicates during entries, but could also facilitate future comparisons of results, etc. It is important to note that if a real impact has two causes, it corresponds to two different arguments, so two separate lines in the spreadsheet.

<i>MyChoice titles</i>	<i>Name Stakeholder</i>	<i>Name Alternative</i>	<i>Type Pro Con</i>	<i>Name Criterion</i>	<i>Aim</i>	<i>Name Property</i>	<i>Value</i>	<i>Condition</i>	<i>Explanation</i>	<i>Name Source</i>
MyChoice impacts titles	Name stakeholder	Name alternative	Impact perception	Impact category	Desire d impact	Real impact	Value	Cause	Explanation	Name source
Information entered	Stakeholder impacted by change	Evaluated scenario	Whether the impact is perceived positively or negatively by the stakeholder	Category of impact	What impact is desired	Real impact	Strong, probable, possible, impossible	Cause of the impact cited	Explanation of causal relationship	Stakeholder interviewed

Table 22: reorganizing the MyChoice spreadsheet for the impacts module and adding information

The visual

We would like to be able to sort the information according to the causes and to calculate the corresponding attitudes in the same way that they are already calculated in the current version of MyChoice (Thomopoulos et al., 2020). For this module, we want to obtain the results shown in table 15 and 16 Section XII.1.b automatically without having to do it by hand. This would save us a lot of time and would also make it easier for researchers, stakeholders and consultants to use MyChoice to anticipate and evaluate impacts of changes before implementing them in the value chain. The visual results of MyChoice would be presented as in figure 70 below.

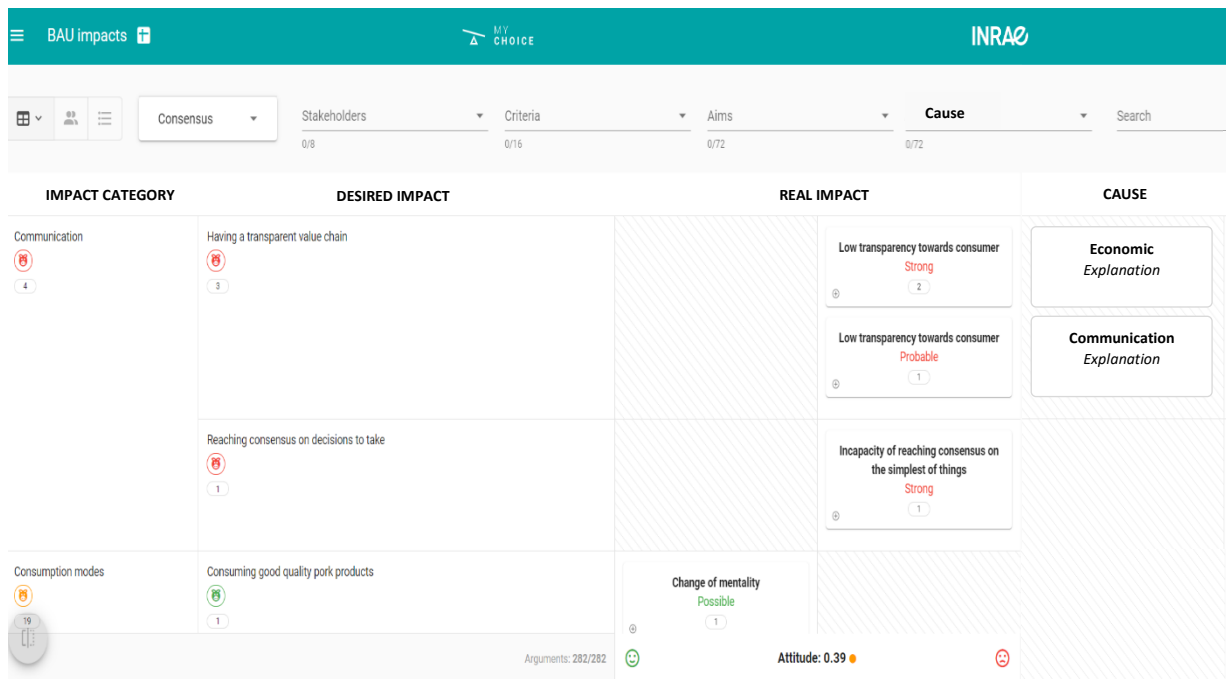

Figure 70: what we would see when using MyChoice opinions - Impacts module

Data analysis

To push the analysis further through the MyChoice tool, we would like to be able to obtain results similar to those of table 18 and figure 49. The impacts and their causes can be cross-analyzed to extract not only the number of arguments like in table 18, but also the attitudes. Those would be represented in a color gradient going from dark red to dark green. An example of how we imagine the results is presented in table 23 below. This would allow decision-makers to have a global view of the impacts and their causes : the results would be more easily understandable and visualized.

Impacts \ Causes	Impacts							Has most impact
	A	B	C	D	E	F	G	
A					16 0.19	2 0.3		18
B	7 0.25							7
C		2 0.5		10 0.2	1 0.7		10 0.5	23
D	2 0.3		3 0.15					5
E	2 0.6	20 0.15		1 0.4			1 0.4	24
F			5 0.2		5 0.55			10
Most impacted	11	22	8	11	22	2	11	

Table 23: example of what the results would look like when cross-analyzing impacts and their causes in the MyChoice opinions-Impacts module

This table can then be translated in a more visual way, explicating the impacts pathways based on stakeholder opinions as shown in figure 71 below. In figure 49 we had the main impact categories and their causes. If the MyChocie tool is adapted we hope that it could be possible to zoom in on each causal relation to extract the details (figure 71).

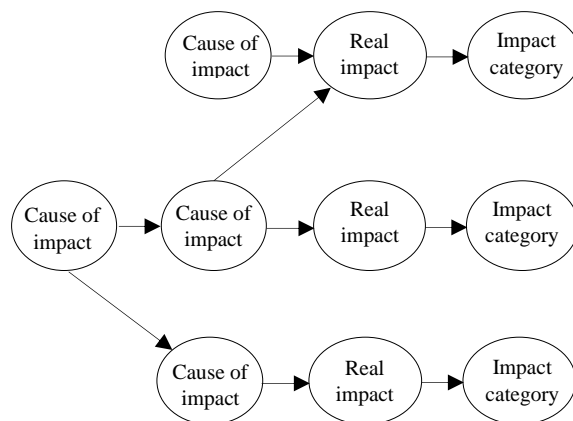

Figure 71: examples of pathways potentially identifiable using information through MyChoice opinions – Impacts module

We could also imagine that the impact pathways could be represented in the colors corresponding to the attitudes (figure 72 a) as well as the thicknesses corresponding to the number of arguments attributed to each causal relation (figure 72 b). By establishing such impact pathways, it makes it a bit easier for decision makers to identify key actions to take either to treat a problem at its source or to try to maintain positive actions along the value chain.

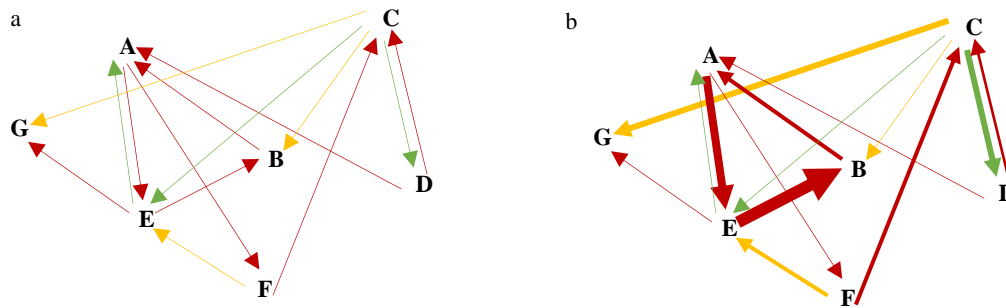

Figure 72: possible representations of impact pathways based on stakeholder opinions according to the attitudes regarding the causal relation (a) and to the number of arguments given (b)

Looking at the mind map without confronting it with the explanations given by the actors would not allow analyzing the information well. It is also necessary to take into account the fact that there are loops and that therefore targeting a place to act is not always obvious. The choice will be made by the decision-makers, according to the means available, the urgency of action, and the ease of implementation of the action. To trace back the why and how of the information, we would have to go to the visual part of MyChoice, sort the causes and impact categories and look at the explanations that stand out in the case of the cause (maybe put the explanations in boxes apart visually). That would give ideas of what should or should not be done.

The advantages of using MyChoice opinions impact module are thus the following:

- The results are obtained easier than by hand. They would be accessible by pressing a button on the top left of the screen
- The results are (or will be once the module is developed) visual
- Impacts can be anticipated, evaluated and prioritize either by researchers, consultants or any other person interested, as long as they know how to use MyChoice and how to enter the information correctly in the spreadsheet

It makes things a bit easier for decision makers, especially since all opinions are taken into account.