



**HAL**  
open science

## Wave propagation in quasi-periodic media

Pierre Amenoagbadji

► **To cite this version:**

Pierre Amenoagbadji. Wave propagation in quasi-periodic media. Analysis of PDEs [math.AP]. Institut Polytechnique de Paris, 2023. English. NNT : 2023IPPAE020 . tel-04452743

**HAL Id: tel-04452743**

**<https://theses.hal.science/tel-04452743>**

Submitted on 12 Feb 2024

**HAL** is a multi-disciplinary open access archive for the deposit and dissemination of scientific research documents, whether they are published or not. The documents may come from teaching and research institutions in France or abroad, or from public or private research centers.

L'archive ouverte pluridisciplinaire **HAL**, est destinée au dépôt et à la diffusion de documents scientifiques de niveau recherche, publiés ou non, émanant des établissements d'enseignement et de recherche français ou étrangers, des laboratoires publics ou privés.



INSTITUT  
POLYTECHNIQUE  
DE PARIS

NNT : 2023IPPAE020

Thèse de doctorat



# Wave propagation in quasiperiodic media

Thèse de doctorat de l'Institut Polytechnique de Paris  
préparée à l'École nationale supérieure de techniques avancées

École doctorale n°574 École doctorale de mathématiques Hadamard (EDMH)  
Spécialité de doctorat : Mathématiques appliquées

Thèse présentée et soutenue à Palaiseau, le 13 décembre 2023, par

**PIERRE AMENOAGBADJI**

Composition du Jury :

David Gérard-Varet Professeur, Université Paris Cité	Président
Eric Bonnetier Professeur, Université Grenoble-Alpes	Rapporteur
Antoine Levitt Professeur, Université Paris-Saclay	Rapporteur
Bérangère Delourme Maîtresse de conférences, Université Sorbonne Paris Nord	Examinatrice
Sébastien Guenneau Reader, Imperial College London	Examinateur
Claude Le Bris Professeur, ENPC	Examinateur
Sonia Fliss Professeure, ENSTA Paris	Directrice de thèse
Patrick Joly Directeur de Recherche, INRIA	Directeur de thèse



*À ma mère, “qui la première,  
m’ouvrit les yeux aux prodiges de la terre”*



# Remerciements

Au terme de cette aventure scientifique et humaine passionnante, je tiens à exprimer ma profonde gratitude envers mes directeurs de thèse, Sonia Fliss et Patrick Joly. Leur passion pour la recherche et leur enthousiasme communicatif ont été une source d'inspiration constante tout au long de ce périple académique. L'envie de faire une thèse a pris racine grâce à la pédagogie exceptionnelle de Sonia. Je lui dois beaucoup pour son intuition éclairée, son expertise, ainsi que pour sa bienveillance et son écoute. D'autre part, avoir été exposé à l'immense culture mathématique de Patrick, à sa rigueur et à son perfectionnisme, a été une chance inouïe. Sa disponibilité constante, rarement ébranlée même par des événements majeurs comme Roland-Garros ou la Ligue des Champions, ainsi que son attention particulière à la transmission du savoir, ont rendu cette expérience enrichissante. Je suis profondément reconnaissant d'avoir pu travailler sous leur direction conjointe, et les remercie sincèrement pour leur confiance, leurs conseils avisés, et pour leur soutien, sans lesquels ce travail n'aurait pas été possible.

J'aimerais remercier les rapporteurs de ma thèse, Eric Bonnetier et Antoine Levitt, pour le temps précieux qu'ils ont consacré à l'examen de ce manuscrit, malgré sa densité. Leurs questions et remarques toutes très pertinentes m'ont permis de voir mon travail sous un nouvel éclairage. Un merci tout particulier à David Gérard-Varet d'avoir accepté de présider le jury. Enfin, je remercie vivement Béran-gère Delourme, Sébastien Guenneau, et Claude Le Bris, qui m'ont fait l'honneur de faire partie de ce jury. Leur intérêt pour ma thèse et les nombreuses questions toutes très judicieuses qu'ils ont posées ont grandement enrichi cette expérience.

L'ambiance chaleureuse de l'UMA a joué un rôle central tout au long de ma thèse. Je souhaite remercier les permanents, tout d'abord pour la qualité de l'enseignement qu'ils m'ont dispensé pendant mes années étudiant à l'ENSTA, et pour leur accueil au cours de ces dernières années. Mes remerciements vont particulièrement à Anne-Sophie, Marc, Eliane, Marcella, Laurent, Stéphanie, Sourour, Luiz, Christophe, Frédéric, Jean-François, Pierre M., Axel, et Hadrien pour nos échanges et leur bienveillance. Un grand merci à Patrick C. pour son soutien, son écoute, et ses précieux conseils. Mes remerciements vont également à Maryna pour la confiance qu'elle m'a accordée en me proposant de co-organiser le séminaire POEMS. Les pauses déjeuner en compagnie de Jérôme ont été stimulantes, et je le remercie notamment de m'avoir initié à l'histoire des mathématiques. Un grand merci à Nicolas et à Maurice pour leur précieuse aide informatique. Je tiens à remercier Lucas pour sa bonne humeur, son écoute, et nos footings occasionnels. Je dois beaucoup à Corinne pour sa sympathie et sa grande aide sur le plan administratif, mais aussi pour m'avoir fait découvrir la peinture à l'huile. J'ai une pensée particulière pour Laure (et sa famille) pour sa grande sympathie, son soutien, et pour son amitié.

Mon intégration dans le labo s'est aussi faite par l'intermédiaire des nombreux doctorants, post-doctorants, et stagiaires, avec qui j'ai partagé d'agréables moments. Merci au doctorants qui m'ont

accueilli, à Emile, Damien, et Jean-François pour leur gentillesse, à la rayonnante Amandine pour son soutien, aux grand-frères Mahran et Christian, ainsi qu'à Akram, Sarah, Meryem, et Othmane. Ça été un véritable plaisir de commencer cette aventure avec Laura, Alice, Amond, et Zoé. Je salue les multiples efforts et initiatives de Laura et d'Alice pour maintenir le contact entre les non-permanents, notamment pendant le confinement. Merci à Amond pour ses remarquables discours lors des pots de thèse, à Clara, la lanceuse de missiles, à Alex, à Quentin, à Thibault le cynique (qui a fait de "*se défenestrer*" mon verbe favori), à Natalia, reine de Belle Épine, à Louise, reine des hair flips, aux sympatiques Aurélien, Morgane, Anh, Zheyi, Adrian, Dongchen, à Farah et ses irrésistibles pâtisseries, à Antonin, ses chouquettes, et son increvable Dahl, à Timothée, à Nouha et Rahma que j'ai parfois eu l'occasion de croiser, à Corentin, Aziz, Fabien, Cédric, Raphaël, et Sarah. Enfin, je suis profondément reconnaissant d'avoir eu comme compères de bureau Rose-Cloé et Simone. La gentillesse et les gestes attentionnés de Simone, ainsi que le soutien et la bonne humeur de Rose-Cloé ont fréquemment illuminé mes journées.

J'ai une pensée toute particulière pour mes anciens professeurs et camarades du lycée César Baggio, où j'ai étudié pendant mes premières années en France. Merci pour l'accueil chaleureux et les excellents moments que nous avons partagés, malgré le froid Lillois et la pression des concours.

Je tiens à remercier mes amis pour leur soutien tout au long de cette aventure. Etienne, j'ai partagé avec toi les joies et les déboires de la thèse. Je te suis reconnaissant pour tous les moments que nous avons passés, et pour m'avoir soutenu pendant les périodes difficiles, même quand tu faisais face à tes propres défis. Mathieu, merci pour nos discussions, pour ton écoute, tes encouragements, et pour m'avoir, entre autres, fait découvrir l'univers des manifestations. Merci Stiven pour tes nombreux encouragements et ta bonne humeur inébranlable. Merci à Alexandre et à Morgane pour les moments que nous avons partagés au détour de conférences. Merci à Thao et à Salah pour les rares mais précieux échanges que nous avons eus. J'ai également une pensée pour mes anciens camarades de l'ENSTA, en particulier Lamia, Raphaël, Thomas, Baptiste, Jahmal, et Christian.

Pour finir, je souhaite exprimer ma profonde reconnaissance envers ma famille, qui a été un véritable pilier tout au long de cette aventure académique. Mes premières pensées vont à ma mère, dont les nombreux sacrifices ont permis de me garantir une éducation de qualité. Le soutien généreux de ses sœurs Honorine, Akofa, et Klenam a été d'une aide précieuse dans cette lourde tâche. Mon oncle Yann, qui m'a offert la possibilité de poursuivre mes études en France, et sa famille ont été un soutien indéfectible, me traitant comme leur propre fils. À tous, je dois entre autres cette thèse, fruit de vos efforts et de votre soutien collectif. Merci pour tout.

# Contents

<b>I</b>	<b>Introduction</b>	<b>1</b>
1	Contexte et motivation	1
1.1	Cristaux et quasi-cristaux	1
1.2	Modélisation mathématique des quasi-cristaux	3
1.3	Milieux périodiques et quasi-périodiques	4
2	L'équation des ondes harmoniques et ses difficultés	5
2.1	Difficultés théoriques	7
2.2	Méthodes numériques	8
3	Organisation du manuscrit	9
4	Mise en garde sur le système de numérotation	11
<b>II</b>	<b>Quasiperiodic functions of one real variable</b>	<b>13</b>
1	Definition and elementary properties of quasiperiodicity	14
2	Assumptions on the lift and the cut vector	16
2.1	A $\mathbb{Z}^n$ -periodic lift	16
2.2	An irrational cut vector	17
3	Diophantine condition	21
3.1	Presentation	21
3.2	Link with the irrationality measure for $n = 2$	22
4	Generalized Fourier series	25
4.1	Fourier representation	25
4.2	Primitives of quasiperiodic functions : a small divisors problem	28
<b>III</b>	<b>Wave propagation in quasiperiodic media: The absorbing case</b>	<b>33</b>
1	Introduction and motivation	34
2	Quasiperiodicity	36
2.1	Locally perturbed quasiperiodic media	36
3	The half-line quasiperiodic problems	37
3.1	Lifting in a higher-dimensional periodic problem	37
3.2	Preliminary material	38
3.2.a	Anisotropic Sobolev spaces and trace theorems	39
3.2.b	Green's formulas	43
3.2.c	An oblique change of variables	45
3.3	Link with a periodic half-guide problem	48
4	Resolution of the half-guide problem	51



4.1	Structure of the solution	52
4.2	Characterization of the propagation operator: the Riccati equation	53
4.3	The DtN operator and the DtN coefficient	55
4.4	Spectral properties of the Riccati equation	56
4.5	Spectral properties of the propagation operator	58
5	Resolution algorithm and discretization issues for $n = 2$	60
5.1	A fully two-dimensional method	61
5.2	A quasi one-dimensional method	62
5.2.a	Presentation	62
5.2.b	Discretization	63
5.3	Approximation of the propagation operator	65
5.4	The DtN coefficient	66
5.5	Numerical results	66
5.5.a	The half-line and the half-guide solutions	66
5.5.b	The whole line problem	68
5.5.c	About the influence of the absorption on the accuracy	69
5.5.d	About the spectral approximation of the propagation operator	71
6	Perspectives	73
<b>IV Wave propagation in quasiperiodic media: Limiting absorption principle</b>		<b>75</b>
1	Presentation	76
1.1	The model problem and assumptions on the coefficients	76
1.2	Theoretical difficulties and limiting absorption principle	77
1.3	Objectives of the work and outline	79
2	The DtN approach is not adapted to limiting absorption	80
3	A Robin-to-Robin approach for the absorbing case	85
3.1	Robin half-line problems and their 2D lifting	85
3.2	The propagation and scattering operators	90
3.3	Local cell problems and reconstruction formula	92
3.4	Local RtR operators and Riccati system	94
3.5	RtR half-space operator and transparent boundary condition	97
4	Analysis of the Riccati system	98
4.1	Spectral description of the propagation operators	98
4.2	Spectral resolution of the Riccati system	103
4.3	Relationship between left and right half-waveguides	107
4.4	Resolution algorithm in the absorbing case	108
5	Towards limiting absorption : quasi-periodic spectrum	108
5.1	Quasiperiodic operators on the whole line	109
5.2	Quasiperiodic operator on a half-line	111
6	Limiting absorption principle	113
6.1	Convergence of the cell solutions and the associated RtR operators	113
6.2	Link between the spectrum of $\mathcal{A}_\theta$ and the Riccati spectrum	116
6.3	Case of evanescent frequencies: $\omega^2 \notin \sigma(\mathcal{A}_\theta)$	118
6.4	Case of propagative frequencies $\omega^2 \in \sigma(\mathcal{A}_\theta)$	118
6.4.a	Convergence assumption on the fundamental eigenpair	119
6.4.b	Notion of flux density	120
6.4.c	Convergence of the propagation operator	124

6.4.d	Limiting absorption for the half-line problem . . . . .	125
6.4.e	The limit Riccati system and spectral characterization of the limit propagation operator . . . . .	127
6.5	Problem in the bounded interval and definition of the physical solution . . . . .	131
6.6	Resolution algorithm . . . . .	132
7	Numerical results . . . . .	133
A	Invariance of spectra of differential operators . . . . .	138
<b>V</b>	<b>Transmission between periodic half-spaces: Model configurations</b>	<b>143</b>
1	Introduction . . . . .	144
2	Problem setting . . . . .	146
2.1	The transmission problem . . . . .	146
2.2	Two specific configurations . . . . .	147
3	The lifting procedure . . . . .	149
3.1	A hidden quasiperiodicity along the interface . . . . .	149
3.1.a	Extension for Configuration ( $\mathcal{A}$ ) . . . . .	149
3.1.b	Extension for Configuration ( $\mathcal{B}$ ) . . . . .	150
3.2	Formal presentation of the lifting approach . . . . .	151
4	Functional framework . . . . .	153
4.1	Anisotropic spaces of $\mathbb{Z}e_2$ -periodic functions . . . . .	154
4.2	Trace operator on transverse interfaces . . . . .	158
4.3	Normal trace operator and Green's formula for a strip . . . . .	159
4.4	Subspaces of $\mathbb{Z}e_1 + \mathbb{Z}e_2$ -periodic functions in a cylinder . . . . .	162
5	The solution of the augmented periodic problem . . . . .	164
5.1	The augmented strip problem and its quasi-2D structure . . . . .	164
5.2	Reduction to waveguide problems via the Floquet-Bloch transform . . . . .	168
5.2.a	The 1D Floquet-Bloch transform . . . . .	168
5.2.b	The partial Floquet-Bloch transform with respect to $z_1$ . . . . .	169
5.2.c	Application to the augmented strip problem . . . . .	170
5.3	The waveguide problem . . . . .	171
5.4	The half-guide problems . . . . .	172
5.4.a	Structure of the half-guide solution . . . . .	173
5.4.b	Local cell problems . . . . .	174
5.4.c	Characterization of the propagation operator via a Riccati equation . . . . .	175
6	Resolution algorithm and discretization . . . . .	176
6.1	Discretization issues . . . . .	176
6.1.a	Discretization with respect to the Floquet variable . . . . .	176
6.1.b	Semi-discretization with respect to the spatial variable . . . . .	177
6.2	A quasi-2D idea for resolution of the local cell problems . . . . .	178
6.2.a	Illustration of the method in a 2D case . . . . .	179
6.2.b	Extension to the 3D local cell problems . . . . .	180
7	Numerical results . . . . .	184
7.1	Validation in the homogeneous setting . . . . .	185
7.2	Validation in the rational setting . . . . .	186
7.3	Validation and results in the irrational setting . . . . .	187
8	An alternative approach for Configuration ( $\mathcal{A}$ ) . . . . .	189
8.1	Presentation . . . . .	190

8.1.a	The half-space problems . . . . .	190
8.1.b	Characterization of the DtN operators . . . . .	191
8.1.c	Truncation of the interface equation . . . . .	191
8.2	The algorithm and its discretization . . . . .	193
8.3	A qualitative validation . . . . .	194
A	Proof of Proposition 5.5 . . . . .	195
<b>VI</b>	<b>Transmission between periodic half-spaces: The general case</b>	<b>197</b>
1	Model problem and assumptions on the medium . . . . .	198
2	The lifting approach and its limitations . . . . .	200
2.1	Identification of an augmented structure . . . . .	200
2.2	Introduction of the augmented problem . . . . .	202
2.3	Resolution of the augmented problem and limitations . . . . .	203
3	An alternative approach: reformulation as an interface equation . . . . .	205
3.1	Lifting the half-space problem and the interface equation . . . . .	206
3.2	Characterization of the DtN operators using the Floquet-Bloch transform . . . . .	208
3.3	Truncation of the interface equation . . . . .	209
3.4	Resolution algorithm and discretization issues . . . . .	209
4	Numerical results . . . . .	212
4.1	Validation for the model configurations of Chapter V . . . . .	212
4.2	Generic configuration . . . . .	212
<b>VII</b>	<b>Perspectives</b>	<b>215</b>
1	The limiting absorption principle . . . . .	215
2	Numerical aspects . . . . .	216
3	Computation of guided modes . . . . .	216
4	Enriched homogenization in presence of a boundary . . . . .	217
	<b>Bibliography</b>	<b>228</b>

# Introduction

Cette thèse est consacrée à l'étude et à la résolution de l'équation des ondes harmoniques dans deux situations qui font intervenir de la quasi-périodicité. Nous nous intéressons plus précisément :

- aux milieux unidimensionnels quasi-périodiques et localement perturbés ;
- à la jonction de deux milieux périodiques bidimensionnels.

Cette étude tire ses motivations des cristaux et quasi-cristaux dont nous retraçons l'histoire, avant d'en évoquer les possibles applications à la section 1. Le problème modèle étudié est ensuite introduit en section 2, et le travail effectué pendant cette thèse est résumé à la section 3.

## 1 Contexte et motivation

### 1.1 Cristaux et quasi-cristaux

Présents dans la nature sous plusieurs formes (métaux, minéraux, neige, sels, gemmes, etc...), les cristaux se distinguent des autres solides par la nature **périodique** de leur structure : plus précisément, il s'agit de solides dont les constituants (atomes, molécules, ions) sont agencés de manière périodique dans les trois directions de l'espace. On doit cette découverte à l'abbé Haüy, dont l'ouvrage [Haü84] publié en 1784 posa les fondements de la cristallographie, ouvrant la voie à une approche essentiellement géométrique des cristaux qui s'étendra sur plus d'un siècle.

L'étude géométrique des cristaux fut par la suite complétée par une vision physique avec la première utilisation en 1913 par Friedrich, Knipping et Laue [FKL13], et par W.L. Bragg [Bra13] de la diffraction par rayons X. Ce procédé permet de mesurer une intensité de diffraction  $|\hat{v}_e|^2$ , où  $v_e$  désigne la *densité électronique* du solide étudié, qui décrit formellement la probabilité  $v_e(x) dx$  de trouver un électron dans un voisinage de taille infinitésimale  $dx$  de  $x \in \mathbb{R}^3$ , et où  $\hat{v}_e$  désigne la transformée de Fourier de  $v_e$ . Le graphe de l'intensité de diffraction projetée sur un écran donne un *diagramme de diffraction* (Figure 1a), dont l'étude permet d'extraire des informations sur la structure du solide. Pour un cristal idéal,  $v_e$  est périodique, et  $\hat{v}_e$  est de fait un réseau de mesures de Dirac, aussi appelés *pics de Bragg* (Figure 1b). Les solides dont le diagramme de diffraction présente des pics de Bragg sont dits **ordonnés**, par opposition aux solides *amorphes* (Figure 1c).

L'observation des solides à l'aide des procédés de diffraction renforça au fil des décennies l'idée que seuls les cristaux pouvaient admettre des pics de Bragg. Des premiers doutes s'installent au cours des

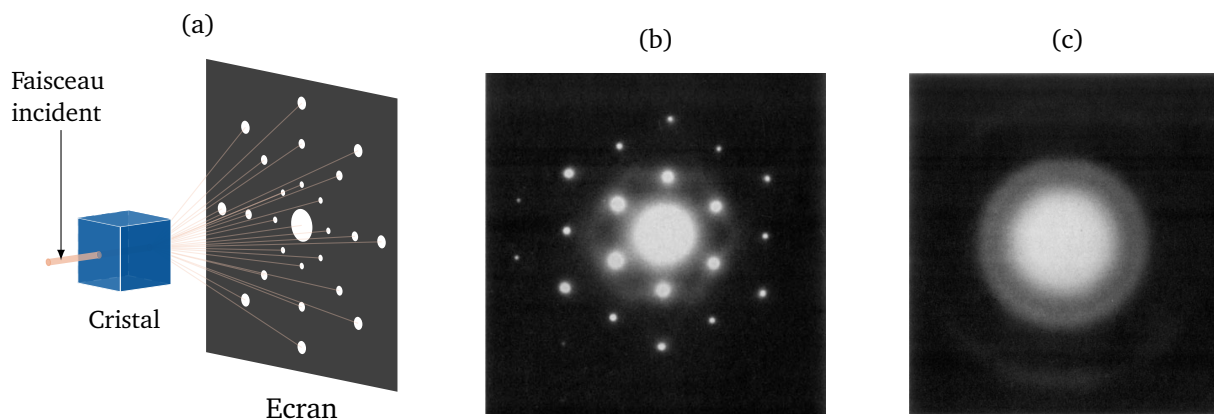

FIGURE 1 : De gauche à droite : Représentation schématique du principe de diffraction par rayons X ((1a)). Diagrammes de diffraction d'échantillons d'aluminium (1b) et de carbone amorphe (1c). Dans les trois cas, la grande tâche au centre du diagramme est issue du faisceau incident [Wil+96].

années 70 lorsque, dans un contexte plutôt récréatif (retracé par Gardner [Gar70]), Penrose [Pen74; Pen79] découvre un exemple simple de pavage<sup>1</sup> aperiodique du plan (Figure 2 à gauche). Bien que le pavage de Penrose soit aperiodique, Mackay [Mac82] démontre que l'intensité de diffraction associée à cette structure est un réseau de mesures de Dirac, suggérant par la même occasion la possibilité qu'il puisse exister des structures cristallines ordonnées sans être périodiques.

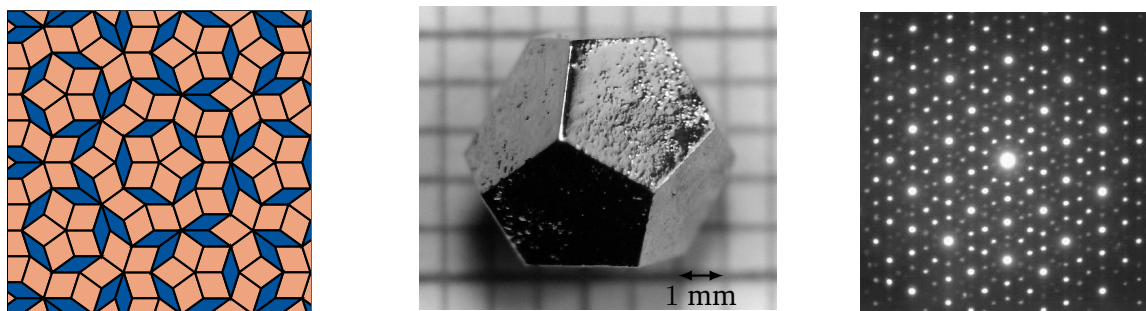

FIGURE 2 : De gauche à droite : le pavage de Penrose. Quasi-cristal Ho-Mg-Zn aux facettes pentagonales [Fis+99]. Diagramme de diffraction du quasi-cristal Ho-Mg-Zn [Mat10]

Le premier exemple concret confirmant la conjecture de Mackay est fourni par Shechtman [She+84], qui observe un alliage métallique dont le diagramme de diffraction possède des pics de Bragg, et qui pourtant ne jouit d'aucune propriété de périodicité. Cette découverte obligea non sans peine<sup>2</sup> la communauté cristallographique à étendre en 1992 la définition d'un cristal, ne retenant désormais que le critère ordonné [Sen06]. De nos jours, bien que le terme "cristal" reste consacré aux structures périodiques, celles qui sont ordonnées sans être périodiques sont appelées des **quasi-cristaux** [LS84]. La découverte de Shechtman fut par la suite répliquée à travers le monde, permettant de synthétiser d'autres quasi-cristaux. Signalons cependant que l'existence des quasi-cristaux n'est pas cantonnée aux laboratoires, puisque des exemples de quasi-cristaux naturels ont également été observés [Bin+12].

<sup>1</sup>Un pavage est un recouvrement disjoint du plan formé d'un ensemble fini de formes (deux pour le pavage de Penrose) répétées à l'infini

<sup>2</sup>Avant de lui valoir le prix Nobel 2011 de Chimie, la découverte de Shechtman fit dans un premier temps l'objet d'une opposition farouche chapeauté par le double Nobélisé Linus Pauling, à qui l'on doit la phrase "There is no such thing as quasicrystals, only quasi-scientists" [LE11].

## 1.2 Modélisation mathématique des quasi-cristaux

La description mathématique des quasi-cristaux s'appuie sur des outils plus anciens : les *fonctions quasi-périodiques*. Ces fonctions ont été introduites par P. Bohl [Boh93], avant d'être étendues par H. Bohr à la notion plus générale de *presque périodicité* [Boh47]. Une fonction continue  $f : \mathbb{R} \rightarrow \mathbb{C}$  est dite *quasi-périodique* d'ordre  $n \in \mathbb{N}^*$  si elle est la coupe d'une fonction  $F : \mathbb{R}^n \rightarrow \mathbb{C}$  continue et périodique par rapport à chacune de ses variables, suivant une droite dirigée par un vecteur  $\theta = (\theta_1, \dots, \theta_n)$  :

$$\forall x \in \mathbb{R}, \quad f(x) = F(\theta x) := F(\theta_1 x, \dots, \theta_n x). \quad (1.1)$$

Initialement, la théorie des fonctions quasi-périodiques est motivée par l'Astronomie où il est question de modéliser les phénomènes issus du couplage de plusieurs sources périodiques [Poi93; Esc04]. Cependant, le rapprochement avec les quasi-cristaux est implicitement suggéré en 1981 par De Bruijn [De 81], qui démontre que le pavage de Penrose (un modèle théorique de structure quasi-cristalline) peut être vu comme la coupe le long d'un hyperplan d'un pavage périodique de dimension 5. Le même constat est effectué par Kramer et Neri [KN84] au sujet d'autres structures quasi-cristallines.

C'est sur la base de ces travaux que suite à la découverte de Shechtman, Katz et Duneau [DK85], Kagulin, Kitaev, et Levitov [KKL85], et enfin Elser [Els86] proposent (de manière indépendante) la description d'un quasi-cristal comme la coupe d'un cristal de dimension supérieure. Néanmoins, comme les structures quasi-cristallines sont des réseaux discrets (à l'inverse des fonctions quasi-périodiques), l'étape de coupe s'accompagne d'une étape de projection : ainsi naît la représentation par **coupe et projection**, illustrée à la Figure 3 dans le cas unidimensionnel. Pour finir, mentionnons que les structures quasi-cristallines obtenues par coupe et projection sont des cas particuliers d'*ensembles de Meyer*, dont l'introduction par Meyer [Mey95; Mey06] remonte aux années 60. L'étude des ensembles de Meyer a permis d'établir un formalisme mathématique adapté à la diffraction des structures quasi-périodiques, comme le montrent les travaux recensés dans le survol [Moo00].

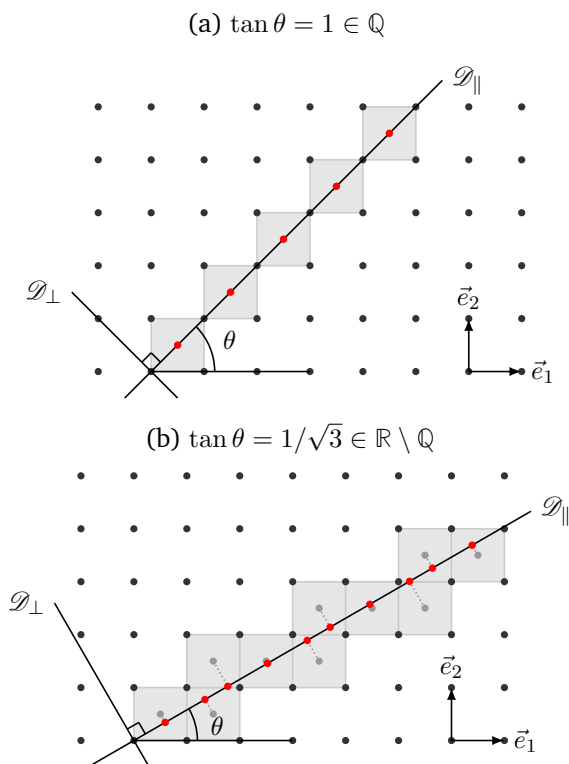

FIGURE 3 : Illustration de l'approche de coupe et projection (schéma inspiré de [KKL85]).

On considère un cristal bidimensionnel représenté par un réseau périodique d'atomes (points noirs) et qu'on coupe suivant une droite  $\mathcal{D}_{\parallel}$  d'orientation  $\theta \in [0, \pi/2]$ . Les centres des carrés intersectant  $\mathcal{D}_{\parallel}$  sont ensuite projetés sur la droite de coupe, produisant un réseau unidimensionnel d'atomes (points rouges) qui représente le cristal ou le quasi-cristal 1D obtenu.

Le réseau 1D obtenu par coupe et projection reste *périodique* si  $\tan \theta$  est *rationnel* (Figure 3a). En revanche, une orientation  $\theta$  dont la tangente est *irrationnelle* (Figure 3b) génère un *quasi-cristal*, c'est-à-dire un réseau non-périodique.

### 1.3 Milieux périodiques et quasi-périodiques

Les propriétés mécaniques ou électromagnétiques des cristaux ont inspiré la conception de matériaux périodiques dits *architourés* en élasticité, ou *photoniques* en électromagnétisme. Aussi appelées *métamatériaux*, ces structures artificielles sont caractérisées par une géométrie ou des caractéristiques physiques (comme les coefficients de Lamé en élasticité, ou encore la permittivité diélectrique et la perméabilité magnétique en optique) qui sont des fonctions périodiques d'une ou de plusieurs variables d'espace. Les métamatériaux occupent une place considérable dans le secteur de l'industrie en raison de leurs diverses propriétés.

En mécanique, on dispose par exemple des matériaux composites, qui résultent d'un empilement ou d'un tressage généralement périodique de deux ou plusieurs composants élémentaires (voir Figure 4 à gauche et [Chr79 ; Abo91 ; Mil22]). En jouant sur la nature et la disposition des matériaux associés, on peut conférer au matériau composite des propriétés inédites (de légèreté, de rigidité, de malléabilité, etc...) dont les matériaux élémentaires ne disposent pas. De fait, les matériaux composites ont plusieurs applications dans l'aéronautique, le transport maritime, l'aérospatial, ou encore le génie civil.

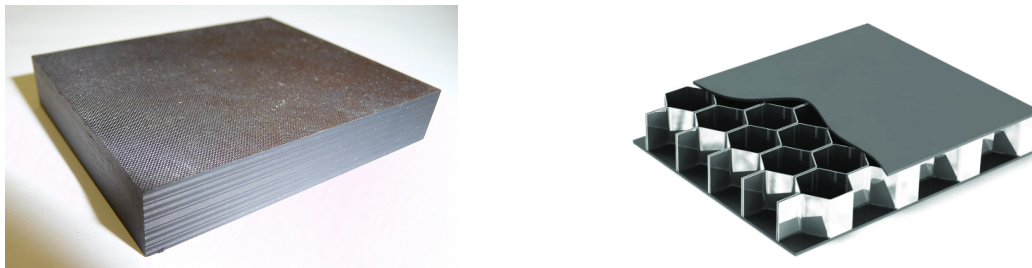

FIGURE 4 : Gauche : matériau composite issu de l'empilement de couches en fibre de carbone et en résine epoxy [Sim12]. Droite : Exemple de structure en nid d'abeille [KC17]

Les structures qui sont périodiques de par leur géométrie sont également très répandues en industrie. C'est le cas des structures en nid d'abeille, issues de l'agencement périodique de cellules cylindriques à section hexagonale, et généralement disposées entre deux plaques minces (voir Figure 4 à droite). Leur géométrie offre à ces structures une grande résistance en dépit de leur légèreté.

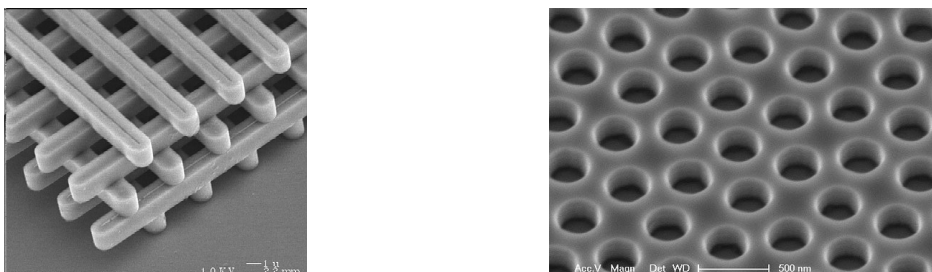

FIGURE 5 : Exemples de cristaux photoniques. Crédit : Sandia National Laboratories (gauche)

Un autre exemple illustrant l'intérêt croissant pour les milieux périodiques, cette fois-ci dans l'électromagnétisme, concerne les cristaux photoniques [Joa+95 ; Kuc01 ; Sak04] (voir Figure 5). Il s'agit de structures diélectriques au sein desquelles les ondes ne peuvent pas se propager pour certaines fréquences. Les intervalles formés par ces fréquences (également appelés *bandes interdites*) sont liés à la structure en bandes du spectre de l'opérateur différentiel utilisé pour modéliser la propagation

des ondes en milieux périodiques (on trouvera une description mathématique dans [Kuc93 ; Kuc04]). L'existence de telles bandes interdites fait des cristaux photoniques des structures de choix en nanotechnologies pour la conception de filtres optiques.

Par ailleurs, en introduisant volontairement des défauts localisés au sein d'un cristal photonique, il est possible de perturber l'opérateur différentiel associé pour créer des valeurs propres de multiplicité finie au sein des bandes interdites [FG97 ; FK97 ; FG98 ; KF98]. Ces valeurs propres correspondent à des modes qui sont localisés au voisinage des défauts, ce qui permet en pratique de concevoir des dispositifs de localisation des ondes.

Parmi les défauts rencontrés, un cas important pour cette thèse concerne les bi-cristaux. Ces structures résultent de la jonction de deux cristaux photoniques, ce qui peut s'apparenter à un défaut linéique. L'un des intérêts des bi-cristaux réside dans le fait qu'on puisse créer des modes guidés au voisinage de l'interface entre les deux cristaux. Pour pouvoir calculer les modes guidés, il est utile de pouvoir simuler de manière efficace la propagation des ondes dans les bi-cristaux. Il s'agit précisément de l'un des objectifs de cette thèse.

Par extension du cas périodique, nous entendrons par milieux quasi-périodiques des milieux dont la géométrie ou les propriétés physiques peuvent être représentées par des fonctions quasi-périodiques. Depuis la découverte des quasi-cristaux par Shechtman, les milieux quasi-périodiques n'ont cessé de susciter de l'engouement, en raison des surprenantes propriétés qui leur sont attribuées [JD98 ; Dub05]. Par exemple, contrairement à l'aluminium dont ils sont en grande partie constitués, la majorité des quasi-cristaux étudiés s'avèrent être de bons isolants thermiques dotés d'une grande dureté, et qui se mouillent très peu [Dub12]. Ces propriétés présentent un intérêt pour le revêtement de poêles ou d'outils chirurgicaux [Riv93]. Par ailleurs, à l'instar des cristaux photoniques mentionnés plus haut, une attention croissante est portée aux quasi-cristaux photoniques. Dans le cas unidimensionnel, ces structures sont obtenues en agençant des plaques diélectriques dans un ordre aperiodique (voir par exemple [AC03 ; SS07 ; PI10 ; VNA13]). Les quasi-cristaux photoniques disposent également de bandes interdites, bien que leurs propriétés spectrales (en termes de l'opérateur différentiel associé) soient plus complexes (une étude est menée dans [DM23] ; voir également la section 2.1).

De manière générale, les applications envisagées au sujet des milieux quasi-périodiques se heurtent à plusieurs difficultés. Pour commencer, la fabrication des quasi-cristaux requiert des procédés complexes qu'il n'est pas facile de déployer à l'échelle industrielle. De plus, les structures quasi-périodiques semblent présenter en pratique une grande fragilité [DS95 ; Mik+98 ; Zou+16] intrinsèque à leur structure. Mais surtout, ces milieux disposent de plusieurs propriétés encore peu comprises d'un point de vue théorique, en raison de leur complexité. Pour mieux appréhender les phénomènes sous-jacents et concevoir les applications évoquées, il est en particulier important d'avoir des méthodes numériques permettant d'étudier des phénomènes physiques comme la propagation d'ondes dans les milieux quasi-périodiques. La présente thèse s'inscrit dans ce contexte.

## 2 L'équation des ondes harmoniques et ses difficultés

La propagation des ondes acoustiques ou électromagnétiques (pour  $n \in \{1, 2\}$  ; voir Remarque 2.1) dans un domaine  $\Omega \subset \mathbb{R}^n$  est régie par l'équation des ondes temporelles

$$\rho(\mathbf{x}) \frac{\partial^2 \tilde{u}(\mathbf{x}, t)}{\partial t^2} - \operatorname{div}(\mathbb{A}(\mathbf{x}) \nabla \tilde{u}(\mathbf{x}, t)) = \tilde{f}(\mathbf{x}, t), \quad \mathbf{x} = (x_1, \dots, x_n) \in \Omega, \quad t > 0, \quad (2.1)$$



où l'inconnue  $\tilde{u}$  et la source  $\tilde{f}$  sont des fonctions de la variable d'espace  $\mathbf{x} \in \Omega$  et du temps  $t > 0$ . Le tenseur  $\mathbb{A} \in L^\infty(\Omega; \mathbb{R}^{n \times n})$  et le coefficient  $\rho \in L^\infty(\Omega; \mathbb{R})$  représentent les caractéristiques physiques du milieu au sein duquel l'onde se propage. Nous étudions dans cette thèse

- des milieux quasi-périodiques localement perturbés pour  $n = 1$  :  $\mathbb{A} =: \mu$  et  $\rho$  coïncident avec des fonctions quasi-périodiques (1.1) en dehors d'un domaine borné ;
- la jonction de deux milieux périodiques pour  $n = 2$  :  $\mathbb{A}$  (resp.  $\rho$ ) coïncide avec des fonctions périodiques différentes de part et d'autre d'une interface.

Nous supposons  $\mathbb{A}$  symétrique, et  $(\mathbb{A}, \rho)$  bornés inférieurement par des constantes strictement positives, hypothèses valables pour les milieux de propagation classiques. Enfin, il faut rajouter à (2.1) une condition initiale, et une condition aux limites si  $\partial\Omega \neq \emptyset$ .

**Remark 2.1.** L'équation (2.1) apparaît en électromagnétisme pour  $n = 2$ , lorsque le milieu est une section d'un milieu tridimensionnel invariant dans la direction  $x_3$ . Dans le cas d'une polarisation transverse électrique,  $\tilde{u}$  correspond à la composante suivant  $x_3$  du champ électrique, et  $\rho$  et  $\mathbb{A}$  représentent respectivement la permittivité électrique et l'inverse de la perméabilité magnétique.

Pour une source harmonique en temps  $\tilde{f}(\mathbf{x}, t) = f(\mathbf{x}) e^{-i\omega t}$  avec une fréquence  $\omega \geq 0$  fixée, il est naturel de chercher une solution de la forme  $\tilde{u}(\mathbf{x}, t) = u(\mathbf{x}) e^{-i\omega t}$  où  $u$  vérifie l'équation des ondes harmoniques ou **équation de Helmholtz**

$$-\operatorname{div}(\mathbb{A}(\mathbf{x}) \nabla u(\mathbf{x})) - \rho(\mathbf{x}) \omega^2 u(\mathbf{x}) = f(\mathbf{x}), \quad \mathbf{x} \in \Omega. \quad (2.2)$$

Le lien rigoureux entre la solution  $\tilde{u}$  de l'équation des ondes temporelles et la solution  $u$  de l'équation de Helmholtz est plus subtil, et correspond au *principe d'amplitude limite*, qui indique que  $\tilde{u}(\cdot, t)$  se comporte comme  $u e^{-i\omega t}$  en temps long (i.e. pour  $t \rightarrow +\infty$ ). Le principe d'amplitude limite est bien compris [TS48 ; Mor62 ; Iwa68 ; MW88 ; RZ92] pour les milieux homogènes (c'est-à-dire quand  $\mathbb{A}$  et  $\rho$  sont constants). La validité du principe d'amplitude limite est moins évidente pour les milieux hétérogènes, mais elle est intrinsèquement liée à celle du principe d'absorption limite pour l'équation de Helmholtz (voir plus loin, Section 2.1). De fait, l'étude de l'équation de Helmholtz constitue une première étape importante à laquelle cette thèse sera dédiée.

Dans la majorité des applications (comme celles évoquées précédemment), **la taille du domaine de propagation est très grande devant l'échelle caractéristique du milieu** représenté par  $\mathbb{A}$  et  $\rho$  (par exemple la période du milieu s'il est périodique). Aussi, résoudre directement l'équation de Helmholtz peut s'avérer très coûteux. Dans le cas des milieux périodiques avec un nombre fini de cellules, il existe des travaux [YL06 ; YL07 ; EHZ08 ; EZ08 ; YLA08] dédiés à la résolution efficace de l'équation (2.2) en tirant parti de la périodicité et surtout du caractère borné de la structure. La démarche adoptée dans cette thèse est différente, et consiste à **supposer le domaine infini** dans les directions de propagation. L'objectif d'une telle hypothèse est de réduire les calculs en exploitant le comportement de la solution et la nature du milieu (périodique ou quasi-périodique) à l'infini. Le caractère non-borné du domaine induit cependant un certain nombre de difficultés présentées aux prochaines sections.

Par ailleurs, lorsque l'échelle caractéristique du milieu (par exemple la période d'un milieu périodique) est très petite devant l'échelle des variations de la solution, la théorie de l'homogénéisation [DS73 ; BLP78 ; Pap79 ; OZ82 ; Ngu89 ; All92 ; JKO12] montre qu'on peut remplacer (à une erreur contrôlée près) le milieu hétérogène par un milieu homogène effectif. Cette théorie, initialement développée pour les milieux périodiques, a été étendue au cas des milieux quasi-périodiques, presque

périodiques, et aléatoires. Dans cette thèse, nous supposons que **l'échelle caractéristique du milieu est du même ordre que l'échelle des variations de la solution**, ce qui correspond au cadre d'étude des cristaux photoniques par exemple. Par conséquent, on ne peut pas appliquer la théorie de l'homogénéisation.

## 2.1 Difficultés théoriques

Pour des domaines  $\Omega$  non-bornés, il n'est pas facile de trouver un cadre fonctionnel garantissant le caractère bien posé de l'équation de Helmholtz. En effet, on s'attend à ce que la solution physique  $u$  n'appartienne pas à  $L^2(\Omega)$ , en raison de son caractère propagatif à l'infini. D'autre part, l'unicité d'une solution dans  $L^2_{loc}(\Omega)$  n'est en général pas assurée. Pour obtenir l'unicité, il est alors nécessaire de rajouter une condition dite de *radiation*, qui permet de prescrire le comportement de la solution physique à l'infini. Ces difficultés ont été beaucoup étudiées dans le cas des milieux homogènes, pour lesquels la *condition de radiation de Sommerfeld* [Som49] est utilisée. Cependant, dans le cas des milieux hétérogènes, les conditions de radiation sont beaucoup moins évidentes à obtenir. L'outil alors utilisé pour calculer la solution "physique" est le **principe d'absorption limite**, qui consiste à :

- (a). rajouter de l'absorption, ou plus précisément à supposer que  $\Im m \omega > 0$ , de sorte que le problème soit bien posé dans  $H^1(\Omega)$  ;
- (b). étudier le comportement de la solution  $u \equiv u(\omega)$  lorsque  $\Im m \omega \rightarrow 0$ .

La solution physique est alors définie comme la limite (si elle existe) de  $u(\omega)$  quand  $\Im m \omega \rightarrow 0$ , et peut être étudiée dans un second temps pour tenter d'obtenir une condition de radiation.

Le principe d'absorption limite est bien établi dans le cas des milieux homogènes et stratifiés [Wil66 ; Agm75 ; Eid86 ; Wed90]. Des travaux plus récents ont montré ce principe pour

- les guides fermés périodiques [Fli09 ; Hoa11 ; Naz14 ; FJ16 ; KL18a ; Sch19] :  $\Omega = S \times \mathbb{R}$  où  $S \subset \mathbb{R}^{n-1}$  est borné, et  $(\mathbb{A}, \rho)$  sont périodiques par rapport à  $x_n$  ;
- les couches périodiques [KL18b ; Kir22] :  $\Omega$  vaut  $\mathbb{R}^2$  ou  $\mathbb{R}^2_+$ , et  $(\mathbb{A}, \rho)$  sont périodiques par rapport à  $x_1$  et constantes en dehors d'une bande  $|x_2| > h$  ;
- les milieux périodiques dans tout  $\Omega = \mathbb{R}^n$  [Gér90 ; MT06 ; Rad15 ; Man19],

dérivant au passage des conditions de radiation pour les guides fermés et pour les couches périodiques. Toutefois, à notre connaissance, il n'existe pas de réponse au principe d'absorption d'absorption limite pour les situations quasi-périodiques que nous traitons. Pour comprendre les difficultés, prenons le cas où  $n = 1$ ,  $\Omega = \mathbb{R}$ , et  $\mathbb{A} := \mu$ . Le principe d'absorption limite est intimement lié aux propriétés spectrales de l'opérateur différentiel auto-adjoint

$$D(\mathcal{A}) := \left\{ u \in H^1(\mathbb{R}), -\frac{d}{dx} \left( \mu \frac{du}{dx} \right) \in L^2(\mathbb{R}) \right\} \quad \text{et} \quad \mathcal{A}u := -\frac{1}{\rho} \frac{d}{dx} \left( \mu \frac{du}{dx} \right) \quad \forall u \in D(\mathcal{A}).$$

Si  $\mu$  et  $\rho$  sont constantes, alors le spectre de  $\mathcal{A}$  correspond à la demi-droite  $\mathbb{R}_+$ . Lorsque  $\mu$  et  $\rho$  sont périodiques, la théorie de Floquet permet de montrer que le spectre de  $\mathcal{A}$  est absolument continu, et possède une structure en bandes [Kuc93 ; Kuc01]. Dans le cas où  $\mu$  et  $\rho$  sont quasi-périodiques, le spectre de  $\mathcal{A}$  s'avère beaucoup plus complexe (voir [Sim82 ; Las07]). En effet, si le spectre peut avoir une partie absolument continue [Eli92] ; [PF92, §16], il peut également admettre des valeurs propres plongées [Jec19 ; BK21] et une partie singulièrement continue (nous nous référons à [Pea78 ; FK02]

et à la série d'articles par Simon [DMS94 ; JS94 ; Sim95 ; Del+96 ; SS96])<sup>3</sup>. Par ailleurs, les travaux cités ci-dessus montrent également que certaines parties du spectre de  $\mathcal{A}$  peuvent être des ensembles de Cantor (*i.e.* des ensembles fermés sans points isolés, et de complémentaire dense ; voir également [Mos81]). En raison de la nature complexe du spectre, les outils théoriques généralement utilisés pour montrer le principe d'absorption limite (comme le développement en fonctions propres généralisées et la formule de Plemelj-Privalov [HL07], ou la théorie de Mourre [Mou81]) s'avèrent plus difficiles à mettre en oeuvre. Dans le cas des jonctions de demi-espaces périodiques, bien que le comportement de la solution physique à l'infini ait été étudiée dans certains cas lorsque  $\omega^2$  est dans un gap de l'opérateur différentiel sous-jacent [ABB01], le principe d'absorption limite semble avoir été tout aussi peu traité. Par conséquent, nous nous attacherons à développer une méthode numérique valable pour  $\Im \omega > 0$ , et qui reste stable lorsque l'absorption tend vers 0.

## 2.2 Méthodes numériques

Aux difficultés théoriques liées à l'étude de l'équation de Helmholtz en milieu non-borné, s'ajoute la question de sa résolution numérique. Cette question a fait l'objet de plusieurs travaux dans le cas des milieux homogènes (nous nous référons aux introductions des thèses [Fli09 ; Coa12] qui recensent ces travaux). Les méthodes dont s'inspire le travail effectué dans cette thèse consistent à restreindre les calculs à un domaine borné en construisant des conditions aux limites sur des bords artificiels, et qui transcrivent de manière exacte le comportement de la solution à l'infini. Ces conditions dites *transparentes* font intervenir des opérateurs de **Dirichlet-to-Neumann** (DtN) qui ont une expression analytique ou semi-analytique qu'on peut déterminer.

C'est aussi sur les opérateurs DtN que s'appuie la méthode développée par Joly, Li, et Fliss [JLF06] dans le cas des guides périodiques localement perturbés. Cependant, dans le cas périodique, ces opérateurs ne peuvent plus être calculés de manière exacte, et doivent de fait être approchés numériquement. La méthode DtN de Joly, Li, et Fliss permet d'obtenir les opérateurs DtN (et de construire la solution du problème de guide périodique) en résolvant des problèmes posés dans une cellule, ainsi qu'une équation de Riccati stationnaire. Ces idées ont été étendues aux milieux périodiques dans deux dimensions [FJ09 ; FJ12] avec une perturbation locale, et à la jonction entre un milieu homogène et un milieu périodique [FCB10].

Dans le cas des milieux quasi-périodiques, la méthode DtN décrite ci-dessus ne peut pas être directement appliquée, car elle repose essentiellement sur la périodicité du milieu (en dehors de la perturbation locale). Cependant, une idée inspirée de la définition de la quasi-périodicité et de l'approche de coupe et projection (Figure 3) consiste à voir l'équation aux dérivées partielles (EDP) qu'on cherche à résoudre comme la coupe le long d'un hyperplan d'une EDP *augmentée* posée en dimensions supérieures, et à coefficients périodiques. Nous appellerons par la suite cette approche la **méthode de relèvement**.

La méthode de relèvement a été utilisée pour l'homogénéisation en présence d'un demi-espace périodique par Gérard-Varet et Masmoudi [GM11 ; GM12], de la jonction de deux milieux périodiques par Blanc, Le Bris, et Lions [BLL15], et en présence de structures quasi-périodiques par Bouchitté, Guenneau, et Zolla [BGZ10], puis par Wellander, Guenneau, et Cherkaev [WGC19]. Cependant, cette méthode semble avoir été très peu exploitée en dehors du contexte de l'homogénéisation, et encore

<sup>3</sup>Toutes les références indiquées portent sur l'opérateur de Schrödinger quasi-périodique, mais en dimension 1 on peut toujours s'y ramener à l'aide de la transformation de Liouville si les coefficients  $\mu$  et  $\rho$  sont suffisamment réguliers.

moins à des fins numériques. A cet effet, notre objectif est le suivant :

**Utiliser la méthode de relèvement pour résoudre l'équation de Helmholtz dans des milieux quasi-périodiques.**

Le caractère périodique de l'EDP augmentée nous permet ensuite d'utiliser des outils adaptés comme l'approche DtN évoquée plus haut. En revanche, l'analyse et la résolution sont plus délicates, car cette EDP est elliptiquement dégénérée (au sens de la partie principale de son opérateur différentiel). La prise en compte de ces difficultés est au cœur du présent manuscrit.

### 3 Organisation du manuscrit

Le travail effectué pendant cette thèse est réparti en 5 chapitres.

Le **chapitre II** propose un aperçu de la théorie des fonctions quasi-périodiques. Nous y introduisons un certain nombre d'outils et de résultats classiques qui seront régulièrement utilisés dans les chapitres qui suivent. Par exemple, il est montré que dans la définition (1.1) d'une fonction quasi-périodique, on peut supposer sans perte de généralité le relèvement 1-périodique dans toutes les directions, et les composantes du vecteur de coupe  $\theta$  linéairement indépendantes dans  $\mathbb{Z}$ . La notion de condition diophantienne est également introduite, et est reliée à la notion de mesure d'irrationalité. Pour finir, on s'intéresse par souci de complétude à des outils importants comme la valeur moyenne et les séries de Fourier généralisées des fonctions quasi-périodiques, bien que ces outils ne soient pas utilisés dans le reste du manuscrit.

Le **chapitre III** est consacré à l'équation de Helmholtz (2.2) unidimensionnelle en **présence d'absorption**, avec  $\Omega = \mathbb{R}$  et des coefficients quasi-périodiques localement perturbés. L'objectif est de construire des conditions transparentes définies à partir de coefficients de Dirichlet-to-Neumann (DtN). Ces coefficients s'obtiennent en résolvant l'équation de Helmholtz posée sur une demi-droite avec des coefficients quasi-périodiques, et une condition de Dirichlet au bord. En utilisant la méthode de relèvement, ce problème de demi-droite est formellement écrit comme la coupe d'un problème dit **augmenté**, posé dans un demi-guide de dimension  $n > 2$  avec des coefficients périodiques. Du fait de son caractère elliptiquement dégénéré, l'étude du problème augmenté requiert un cadre fonctionnel approprié, apporté par des espaces de Sobolev anisotropes. L'étude de ces espaces directionnels permet de donner un sens au problème de demi-guide, et d'en montrer le caractère bien posé. Pour résoudre le problème de demi-guide périodique, nous adaptons la méthode DtN [JLF06], qui repose sur la résolution de **problèmes de cellule**  $nD$  posés en domaine borné, et sur la construction d'un **opérateur de propagation**, solution d'une **équation de Riccati** stationnaire. Une justification théorique de cette méthode est effectuée, mais s'avère plus délicate que dans le cas de l'équation de Helmholtz à partie principale elliptique, notamment en raison des propriétés spectrales radicalement différentes de l'opérateur de propagation, dues au caractère elliptiquement dégénéré du problème augmenté. Pour finir, la mise en œuvre de la méthode est abordée. En pratique, les problèmes de cellule peuvent être résolus directement par éléments finis. Bien que cette approche donne des résultats satisfaisants, il nous a cependant semblé judicieux d'introduire une autre approche, qualifiée de *quasi-unidimensionnelle* (ou **quasi-1D**), et qui permet d'exploiter la structure fibrée des problèmes de cellules pour se ramener à la résolution de problèmes de cellule 1D.

Dans le **chapitre IV**, il est question d'étendre la méthode du chapitre III au cas **sans absorption**, en faisant tendre l'absorption vers 0 dans l'esprit du principe d'absorption limite. Le passage à la limite

dans les étapes de la méthode entraîne plusieurs difficultés. Tout d'abord, en l'absence d'absorption, les problèmes de cellule issus de l'approche DtN se trouvent être mal posés pour un continuum non borné de fréquences. Pour contourner cette difficulté, l'alternative retenue est de remplacer l'approche DtN par une approche de type Robin-to-Robin (RtR), qui est en principe similaire bien que plus technique. La deuxième difficulté concerne l'équation de Riccati, à laquelle il est nécessaire d'ajouter une condition pour caractériser l'opérateur de propagation limite (si celui-ci existe). La condition proposée s'inspire du cas elliptique, et repose sur le calcul d'un **flux d'énergie**. Nous montrons que la condition sur le flux suffit à garantir l'unicité de l'opérateur de propagation limite (s'il existe) comme solution de l'équation de Riccati. Nous arrivons ainsi à définir de manière unique la solution physique à partir d'un problème posé en domaine borné avec des conditions transparentes de type RtR. Les coefficients RtR intervenant dans ces conditions sont la limite quand l'absorption tend vers 0 des coefficients RtR pour le cas avec absorption. Le principe d'absorption limite est ainsi démontré (pour la première fois nous semble-t-il pour les milieux quasi-périodiques) sous certaines hypothèses. La question d'explicitier un peu plus ces hypothèses nous semble importante, mais encore ouverte.

Le **chapitre V** porte sur l'équation de Helmholtz en dimension 2 en présence d'absorption, avec  $\Omega = \mathbb{R}^2$  et des coefficients dont les restrictions aux demi-plans  $\mathbb{R}_\pm \times \mathbb{R}$  sont des fonctions périodiques. Cette situation correspond à une jonction de deux milieux périodiques. Deux configurations particulières sont considérées dans ce chapitre : (a). le cas où les deux milieux sont périodiques le long de l'interface mais avec des périodes différentes, et (b). le cas où le milieu de gauche est homogène tandis que celui de droite est un milieu périodique coupé dans une direction quelconque. Dans chaque cas, le manque de périodicité le long de l'interface empêche l'utilisation directe des méthodes usuelles comme la transformée de Floquet-Bloch. Cependant, nous montrons que chacune de ces configurations s'écrit comme la coupe le long d'un plan d'une structure **3D** qui est périodique le long de l'interface. En conséquence, le problème étudié s'étend en un problème augmenté posé dans la tranche  $\mathbb{R}^2 \times (0, 1)$ . Comme au chapitre **III**, l'étude du problème augmenté nécessite des espaces de Sobolev anisotropes. Pour étudier ces espaces, nous utilisons une approche légèrement différente de (mais équivalente à) celle du chapitre **III**, qui consiste à interpréter les espaces étudiés en termes de régularités différentes dans chaque direction. Le problème de tranche est ensuite résolu en appliquant une transformée de Floquet-Bloch dans une direction, comme dans [FCB10], pour se ramener à une famille de problèmes de guide. A ces guides, l'approche DtN déjà présentée au chapitre **III** est appliquée, conduisant à des problèmes de cellule 3D et à une équation de Riccati. Une approche **quasi-2D** est également introduite, pour réduire la résolution des problèmes de cellule à celle d'une famille de problèmes 2D. Enfin, pour la configuration (a), nous proposons une alternative à la méthode de relèvement, consistant à appliquer une transformée de Floquet-Bloch avec des périodes différentes de part et d'autre de l'interface. L'avantage est qu'on peut résoudre directement des problèmes de demi-guide 2D. En revanche, cette approche conduit à une équation 1D non locale posée sur l'interface, et qu'il faut tronquer. Nous estimons l'erreur liée à la troncature en utilisant la présence d'absorption.

Dans le **chapitre VI**, on étudie l'équation de Helmholtz absorbante en dimension 2 avec  $\Omega = \mathbb{R}^2$ , en présence de demi-espaces périodiques arbitraires. Il s'agit de la situation générale qui englobe les configurations modèles du chapitre **V**. Pour obtenir de la périodicité le long de l'interface, cette configuration peut être relevée en une structure de dimension supérieure, mais en général, il n'est pas possible de trouver des structures augmentées de dimension inférieure à 5. Pour éviter de résoudre des problèmes 5D, nous proposons une extension de l'approche alternative introduite à la fin du chapitre **V**. L'idée est de résoudre indépendamment deux problèmes posés dans chaque demi-espace, et qui peuvent être relevés en des problèmes de dimension 3. Le lien entre ces deux problèmes de

demi-espace et le problème étudié se traduit par une famille d'équations posées sur l'interface 1D non-bornée. La résolution de ces équations d'interface nécessite à nouveau une troncature qui est justifiée à l'aide de la présence d'absorption.

## 4 Mise en garde sur le système de numérotation

Les chapitres sont divisés en sections, les sections en sous-sections, et les sous-sections en sous-sous-sections. Par exemple, **V-3.1.a** correspond à la sous-sous-section **a** de la sous-section **une** de la section **trois** du chapitre **cinq**. **3.1.a** du chapitre **V**. **Lorsqu'une section est citée dans son chapitre d'origine, nous omettons le préfixe du chapitre.** Ainsi la section **V-3.1.a** sera simplement notée Section **3.1.a** au sein du chapitre **V**. Il en va de même pour les définitions, théorèmes, propositions, lemmes, corollaires, exemples, équations, et figures.



# Quasiperiodic functions of one real variable

## Outline

---

1	Definition and elementary properties of quasiperiodicity . . . . .	14
2	Assumptions on the lift and the cut vector . . . . .	16
2.1	A $\mathbb{Z}^n$ -periodic lift . . . . .	16
2.2	An irrational cut vector . . . . .	17
3	Diophantine condition . . . . .	21
3.1	Presentation . . . . .	21
3.2	Link with the irrationality measure for $n = 2$ . . . . .	22
4	Generalized Fourier series . . . . .	25
4.1	Fourier representation . . . . .	25
4.2	Primitives of quasiperiodic functions : a small divisors problem . . . . .	28

---

## Introduction

The purpose of this chapter is to provide an overview of the theory of quasiperiodic functions of one real variable, and to introduce the formalism as well as the assumptions that will be used throughout the whole document.

The class of quasiperiodic functions seems to have been studied first in 1893 by P. Bohl [Boh93] in his thesis, but it appears to be Esclangon in 1904 [Esc04] who coined the term “*quasiperiodic function*”, as pointed out in the survey [GL11]. The introduction of quasiperiodic functions was then motivated by Astronomy and Mechanics, where the characterization of complex phenomena arising from the coupling of finitely many periodic sources remains an active research topic. This question is in fact discussed by Poincaré in his 1893 monograph [Poi93] which features the equation

$$-\frac{d^2u}{dt^2} - \rho(t)u = 0 \quad \text{with} \quad \rho(t) = 1 + \mu \sum_{i=1}^n a_i \sin(\alpha_i t + \beta_i),$$

and where the periods  $2\pi/\alpha_i$  are pairwise incommensurate. As we will see, the function  $\rho$  involved in this equation is quasiperiodic, although not periodic.

The theory of quasiperiodic functions was later extended in 1925 by H. Bohr<sup>1</sup>[Boh47] to a more

---

<sup>1</sup>Niels Bohr’s cadet, Harald Bohr, in addition to being a mathematician, was incidentally an eminent football player and



general class of functions known as *uniformly almost periodic functions*, and which have been the subject of numerous subsequent developments. Even though they are not the focus of our study, almost periodic functions have many insightful properties which we shall mention and derive for quasiperiodic functions. For a comprehensive study, we refer to the monographs [Bes32; Boh47; LZ82; Fin06].

## 1 Definition and elementary properties of quasiperiodicity

The set of real numbers is  $\mathbb{R}$ , while  $\mathbb{Z}$  represents the set of integers,  $\mathbb{N}$ , the set of non-negative integers, and  $\mathbb{N}^*$ , the set of positive integers. Given an integer  $n > 0$ , the generic  $n$ -dimensional variable is denoted by  $\mathbf{y} = (y_1, \dots, y_n)$ . The canonical basis of  $\mathbb{R}^n$  is  $(e_1, \dots, e_n)$ , where  $(e_j)_k = \delta_{j,k}$ . Given two points  $\mathbf{y}, \mathbf{z} \in \mathbb{R}^n$ , we denote their inner product by  $\mathbf{y} \cdot \mathbf{z} := y_1 z_1 + \dots + y_n z_n$ , and  $|\mathbf{y}| := \sqrt{\mathbf{y} \cdot \mathbf{y}}$  denotes the norm of  $\mathbf{y}$ .

Quasiperiodic functions of one variable are defined as follows.

### Definition 1.1

A continuous function  $f : \mathbb{R} \rightarrow \mathbb{C}$  is said to be **quasiperiodic** of order  $n > 0$  if there exist a continuous function  $F : \mathbb{R}^n \rightarrow \mathbb{C}$  which is  $(\tau_1, \dots, \tau_n)$ -periodic for some  $(\tau_1, \dots, \tau_n) \in \mathbb{R}^n$ :

$$\forall \mathbf{y} = (y_1, \dots, y_n) \in \mathbb{R}^n, \quad \forall j \in \llbracket 1, n \rrbracket, \quad F(\mathbf{y} + \tau_j \mathbf{e}_j) = F(\mathbf{y});$$

and a vector  $\boldsymbol{\theta} = (\theta_1, \dots, \theta_n) \in \mathbb{R}^n$  such that

$$\forall x \in \mathbb{R}, \quad f(x) = (F \circ \boldsymbol{\theta})(x) := F(\boldsymbol{\theta} x) := F(\theta_1 x, \dots, \theta_n x). \tag{1.1}$$

The function  $F$  is a periodic **extension** or **lift** of  $f$ ,  $\boldsymbol{\theta}$  is called a **cut vector**, and  $(F, \boldsymbol{\theta})$  is referred to as a **lifting pair** of  $f$ .

One geometrical interpretation of Definition 1.1 is to see the one-dimensional function  $f$  as the trace of a  $n$ -dimensional function  $F$  along the line passing through  $(0, 0)$  and parallel to the vector  $\boldsymbol{\theta}$ . This is illustrated in Figure 1 for  $n = 2$  and  $\boldsymbol{\theta} = (1, \sqrt{2})$ .

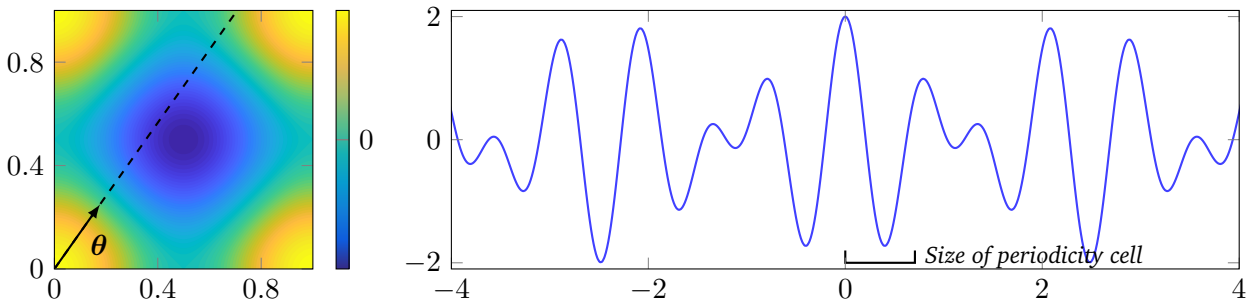

Figure 1: Function  $F : \mathbf{y} \mapsto \cos(2\pi y_1) + \cos(2\pi y_2)$  in its periodicity cell (left), and whose trace along  $\boldsymbol{\theta} = (1, \sqrt{2})$  leads to a quasiperiodic function (right).

In what follows,  $\mathcal{E}_{\text{QP}}^0(\mathbb{R})$  denotes the space of quasiperiodic functions.

---

a 1908 Summer Olympics silver medalist.

**Example 1.2.** *It can be easily seen that continuous periodic functions are also quasiperiodic. In fact, any  $\tau$ -periodic function  $f$  satisfies (1.1) with  $n = 1$ ,  $F = f$ , and  $\theta = 1$ . Other examples of quasiperiodic functions are finite sums or products of periodic functions: if  $f_1, f_2 \in \mathcal{C}^0(\mathbb{R})$  are periodic, then  $f_1 + f_2$  and  $f_1 f_2$  can be expressed under the form (1.1). Note that  $f_1 + f_2$  and  $f_1 f_2$  are not periodic if  $f_1$  and  $f_2$  have non-commensurate periods. For instance, if*

$$\forall x \in \mathbb{R}, \quad f_1(x) = \cos 2\pi x \quad \text{and} \quad f_2(x) = \cos 2\pi\sqrt{2}x,$$

then the sum  $f_1 + f_2$ , represented in Figure 1, is not periodic since it equals 2 only when  $x = 0$ .

**Remark 1.3.** *In Floquet theory, the term “quasiperiodic” is used to denote functions  $f$  that satisfy*

$$\forall x \in \mathbb{R}, \quad f(x + 1) = e^{2i\pi\xi} f(x), \quad (1.2)$$

for some fixed  $\xi \in \mathbb{R}$ . One says in particular that  $f$  is  $\xi$ -quasiperiodic. Although  $\xi$ -quasiperiodic functions are not periodic in general, they are quasiperiodic of order  $n = 2$  in the sense of Definition 1.1, where

$$\forall \mathbf{y} = (y_1, y_2) \in \mathbb{R}^2, \quad F(\mathbf{y}) := f(y_1) \exp(2i\pi(y_2 - \xi y_1)) \quad \text{and} \quad \theta := (1, \xi).$$

In fact, the cyclic property (1.2) satisfied by  $f$  implies that  $F$  is 1-periodic with respect to all its variables.

Quasiperiodicity induces a certain number of properties that are also satisfied by periodic functions.

#### Proposition 1.4

Let  $f$  be a quasiperiodic function of order  $n > 0$  with lift  $F : \mathbb{R}^n \rightarrow \mathbb{C}$ :

- (a).  $f$  is bounded and uniformly continuous;
- (b). for any continuous  $g : \overline{F(\mathbb{R}^n)} \rightarrow \mathbb{C}$ ,  $g \circ f$  is quasiperiodic;
- (c). if  $F \in \mathcal{C}^1(\mathbb{R}^n)$ , then  $f'$  is also quasiperiodic.

**Proof.** [(a)] Since the lift  $F$  is continuous and periodic with respect to all its variables, it is on one hand bounded, and on the other hand uniformly continuous, thanks to the Heine theorem. Thus,  $f$  is bounded and uniformly continuous as well.

[(b)]  $(g \circ f)(x) = (g \circ F)(\theta x)$  for  $x \in \mathbb{R}$ , where  $g \circ F \in \mathcal{C}^0(\mathbb{R}^n)$  has the same periods as  $F$ .

[(c)]  $f'(x) = [(\theta \cdot \nabla) F](\theta x)$  for  $x \in \mathbb{R}$ , where  $(\theta \cdot \nabla) F \in \mathcal{C}^0(\mathbb{R}^n)$  has the same periods as  $F$ . ■

**Remark 1.5.** *Choosing particular functions  $g$  in Proposition 1.4 shows that if  $f$  is quasiperiodic, then  $\lambda f$  ( $\lambda \in \mathbb{C}$ ),  $\bar{f}$  and  $f^2$  are quasiperiodic as well.*

As the next result shows, quasiperiodicity is stable by addition and by multiplication (in contrast to periodicity; see Example 1.2).

#### Proposition 1.6

If  $f_1$  and  $f_2$  are quasiperiodic functions, then  $f_1 + f_2$  and  $f_1 f_2$  are also quasiperiodic.

**Proof.** Assume that  $f_i = F_i(\theta_i \cdot)$  is quasiperiodic of order  $n_i > 0$  for  $i \in \llbracket 1, 2 \rrbracket$ . Let  $n := n_1 + n_2$ . Then any  $\mathbf{y} = (y_1, \dots, y_n) \in \mathbb{R}^n$  can be represented as  $\mathbf{y} = (\mathbf{y}_1, \mathbf{y}_2)$ , where  $\mathbf{y}_1 = (y_1, \dots, y_{n_1}) \in \mathbb{R}^{n_1}$  and  $\mathbf{y}_2 = (y_{n_1+1}, \dots, y_n) \in \mathbb{R}^{n_2}$ . Let  $\boldsymbol{\theta} := (\boldsymbol{\theta}_1, \boldsymbol{\theta}_2) \in \mathbb{R}^n$  be the concatenation of  $\boldsymbol{\theta}_1$  and  $\boldsymbol{\theta}_2$  and define

$$\forall \mathbf{y} = (\mathbf{y}_1, \mathbf{y}_2) \in \mathbb{R}^n, \quad F(\mathbf{y}) := F_1(\mathbf{y}_1) + F_2(\mathbf{y}_2) \quad \text{and} \quad G(\mathbf{y}) := F_1(\mathbf{y}_1) F_2(\mathbf{y}_2).$$

Then  $F$  and  $G$  are periodic with respect to their variables, and  $f_1 + f_2 = F \circ \boldsymbol{\theta}$  and  $f_1 f_2 = G \circ \boldsymbol{\theta}$ . ■

### Corollary 1.7

The set  $\mathcal{C}_{\text{QP}}^0(\mathbb{R})$  of quasiperiodic functions is a vector space.

**Remark 1.8.** The space of quasiperiodic functions is not closed with respect to the uniform norm. However, this space is included in the space of uniformly almost periodic functions mentioned in the introduction. A continuous function  $f$  is said to be *uniformly almost periodic* if for any  $\varepsilon > 0$ , it admits a translation number corresponding to  $\varepsilon$  (or an  $\varepsilon$ -almost period), that is, a number  $\tau_\varepsilon \in \mathbb{R}$  such that the following is satisfied:

$$\forall x \in \mathbb{R}, \quad |f(x + \tau_\varepsilon) - f(x)| \leq \varepsilon; \quad (1.3a)$$

and if the set  $E(f, \varepsilon) \subset \mathbb{R}$  of  $\varepsilon$ -almost periods of  $f$  is relatively dense:

$$\forall \varepsilon > 0, \quad \exists \ell_\varepsilon > 0 \quad \text{such that} \quad \forall a \in \mathbb{R}, \quad [a, a + \ell_\varepsilon] \cap E(f, \varepsilon) \neq \emptyset. \quad (1.3b)$$

The space of uniformly almost periodic functions can be characterized as the closure of  $\mathcal{C}_{\text{QP}}^0(\mathbb{R})$  with respect to the  $L^\infty$ -norm.

## 2 Assumptions on the lift and the cut vector

In this section, we introduce a series of assumptions with the purpose of reducing the set of lifting pairs associated to a quasiperiodic function.

### 2.1 A $\mathbb{Z}^n$ -periodic lift

Without any additional assumption in Definition 1.1, the pair  $(F, \boldsymbol{\theta})$  related to a quasiperiodic function  $f$  is not uniquely defined. In fact, given  $(\alpha_1, \dots, \alpha_n) \in \mathbb{R}^n$ , one can always rescale  $F$  to construct a continuous lift  $F_\alpha$  which is  $(\alpha_1, \dots, \alpha_n)$ -periodic. More precisely

$$\forall x \in \mathbb{R}, \quad f(x) := F(\boldsymbol{\theta} x) = F_\alpha(\boldsymbol{\theta}_\alpha x) \quad \text{with} \quad \begin{cases} F_\alpha(\mathbf{y}) := F((\tau_1/\alpha_1) y_1, \dots, (\tau_n/\alpha_n) y_n) \\ \boldsymbol{\theta}_\alpha := \left( \frac{\theta_1}{\tau_1/\alpha_1}, \dots, \frac{\theta_n}{\tau_n/\alpha_n} \right). \end{cases}$$

Consequently, by adjusting  $(\alpha_1, \dots, \alpha_n)$ , one can assume without any loss of generality that

- either the cut vector  $\boldsymbol{\theta}$  is equal to  $(1, \dots, 1)$ , that is,  $f(x) = F(x, \dots, x)$ ;
- or the lift  $F$  is  $\mathbb{Z}^n$ -periodic, that is, 1-periodic with respect to all its variables.

We restrict ourselves to the latter case: in what follows,

$$\boxed{\text{the extension } F \text{ is assumed to be } \mathbb{Z}^n\text{-periodic.}} \quad (\text{H.1})$$

The set of continuous and  $\mathbb{Z}^n$ -periodic functions is denoted by  $\mathcal{C}_{\text{per}}^0(\mathbb{R}^n)$ .

## 2.2 An irrational cut vector

Assumption (H.1) still offers some great latitude in choosing the pair  $(F, \theta)$ . For example, consider the function  $f$  defined by  $f(x) := \cos(2\pi x) + \cos(4\pi x)$  for  $x \in \mathbb{R}$ . Since  $f$  is periodic, it admits the expressions

$$f(x) = F(\theta x) = G(\theta x) \quad \text{with} \quad \theta := (1, 2) \quad \text{and} \quad \begin{cases} F(\mathbf{y}) := \cos(2\pi y_1) + \cos(4\pi y_1) \\ G(\mathbf{y}) := \cos(2\pi y_1) + \cos(2\pi y_2). \end{cases}$$

In order to prevent the lack of uniqueness highlighted in this example, we shall restrict ourselves to cut vectors that are *linearly independent* over  $\mathbb{Z}$ .

### Definition 2.1

A finite set of numbers  $\theta_1, \dots, \theta_n \in \mathbb{R}$  is said to be **linearly independent** over  $\mathbb{Z}$  (resp. over  $\mathbb{Q}$ ) if for any integers (resp. rationals)  $k_1, \dots, k_n$ , the equality

$$k_1 \theta_1 + \dots + k_n \theta_n = 0$$

implies that  $k_1 = \dots = k_n = 0$ . In this case, we also say that the vector  $\theta = (\theta_1, \dots, \theta_n) \in \mathbb{R}^n$  is **linearly independent** over  $\mathbb{Z}$  (resp. over  $\mathbb{Q}$ ).

Thanks to the following obvious result, one can refer to linear independence over  $\mathbb{Z}$  or over  $\mathbb{Q}$  without any ambiguity.

### Proposition 2.2

A set of numbers is linearly independent over  $\mathbb{Z}$  **iff** it is linearly independent over  $\mathbb{Q}$ .

**Remark 2.3.** For  $n = 2$ , the family  $\{\theta_1, \theta_2\}$  is linearly independent over  $\mathbb{Z}$  iff  $\theta_1$  and  $\theta_2$  are incommensurate, that is, iff the ratio  $\theta_1/\theta_2$  is an irrational number.

More generally, if the family  $\{\theta_1, \dots, \theta_n\}$  is linearly independent over  $\mathbb{Z}$ , then for any  $i \neq j$ , the ratio  $\theta_i/\theta_j$  is an irrational number. However, the converse is false for  $n > 2$ . For instance,  $\theta_1 = 1$ ,  $\theta_2 = \sqrt{2}$ , and  $\theta_3 = 1 + \sqrt{2}$  are pairwise incommensurate, but do not form a linearly independent set over  $\mathbb{Z}$ .

As pointed out in Remark 2.3, linear independence over  $\mathbb{Z}$  appears to be a generalization of the notion of irrationality. For this reason, a vector which is linearly independent over integers will be abusively referred to as an **irrational vector**.

**Example 2.4.** For  $n = 2$ , a straightforward example of irrational vector is given by  $\theta = (1, \delta)$  where  $\delta$  is an irrational number (e.g. [HW79, Chapter IV]  $\sqrt{a}$  where  $a \in \mathbb{N}^*$  is square-free,  $e$ ,  $\log 2$ ,  $\pi$ , ...). Note that the irrationality of vectors such as  $(e, \pi)$ ,  $(1, \pi + e)$ , or  $(1, \log \pi)$  is still an open question.

For  $n > 2$ , examples of irrational vectors include

- $\theta := (\log p_1, \dots, \log p_n)$ , where  $p_1, \dots, p_n$  are distinct primes [HW79, §23.4]: for  $k_1, \dots, k_n \in \mathbb{Z}^n$ ,

$$k_1 \log p_1 + \dots + k_n \log p_n = 0 \quad \implies \quad p_1^{k_1} \dots p_n^{k_n} = 1.$$

But according to the prime factorization theorem, any positive integer admits a unique representation as a product of prime powers. Therefore,  $k_1 = \dots = k_n = 0$ .

- $\theta := (1, \theta, \dots, \theta^{n-1})$  where  $\theta$  is a transcendental number: the identity  $k_0 + k_1 \theta + \dots + k_{n-1} \theta^{n-1}$  for some  $(k_0, \dots, k_{n-1}) \in \mathbb{Z}^n \setminus \{0\}$  means that  $\theta$  is a root of the non-zero polynomial with integer coefficients  $P(X) := k_0 + k_1 X + \dots + k_{n-1} X^{n-1}$ . This contradicts the transcendence of  $\theta$ .
- $\theta = (1, \sqrt{a_1}, \dots, \sqrt{a_{n-1}})$ , where  $a_1, \dots, a_{n-1} \in \mathbb{N}^*$  are distinct square-free numbers. Less straightforward, the proof relies on the theory of field extensions, and can be found as a particular case of a Besicovitch's result [Bes40].

Given a quasiperiodic function, it is always possible to lower the order of quasiperiodicity  $n$  and to change the periodic lift accordingly, so that the cut vector is irrational. In order to prove this statement which is the object of Proposition 2.7, we shall rely on the concept of a *rational basis*.

### Definition 2.5

A linearly independent family of real numbers  $\theta_1, \dots, \theta_n$  over  $\mathbb{Q}$  is said to be a **rational basis** of a set  $S \subset \mathbb{R}$  if any element of  $S$  can be expressed as linear combination of the  $\theta_j$  with rational coefficients:

$$\forall \alpha \in S, \quad \exists r_1, \dots, r_n \in \mathbb{Q}, \quad \alpha = r_1 \theta_1 + \dots + r_n \theta_n.$$

### Lemma 2.6: [LZ82, Chapter 2, §4.2]

From any finite set  $S \subset \mathbb{R}$ , one can always extract a family of numbers which forms a rational basis of  $S$ .

We can now state the main result of this section.

### Proposition 2.7

Let  $f$  be a quasiperiodic function of order  $m > 0$ . Then there exist an integer  $n \leq m$ , a function  $F \in \mathcal{C}_{per}^0(\mathbb{R}^n)$  and an **irrational** cut vector  $\theta \in \mathbb{R}^n$  such that  $f(x) = F(\theta x)$  for any  $x \in \mathbb{R}$ .

Note that in the definition of a quasiperiodic function, the cut vector  $\theta$  is not necessarily irrational. What Proposition 2.7 shows is that one can always assume  $\theta$  to be irrational.

**Proof.** This result seems to be well-known, but we did not find a full proof. The following constructive proof is therefore proposed for the sake of completeness.

Let  $f := G(\alpha \cdot)$  where  $G \in \mathcal{C}_{per}^0(\mathbb{R}^m)$  and  $\alpha = (\alpha_1, \dots, \alpha_m) \in \mathbb{R}^m$  with  $m > 0$ . If  $\alpha$  is irrational, then there is nothing to prove, given that  $n := m$ ,  $F := G$ , and  $\theta := \alpha$  provide the desired result. Otherwise, according to Lemma 2.6, the set  $S := \{\alpha_1, \dots, \alpha_m\}$  admits a basis of  $n < m$  elements included in itself. By applying the upcoming construction procedure multiple times, and thanks to index reordering, one can assume without loss of generality that this basis consists of the  $n := m - 1$

first elements of  $\alpha$ , that is:

$$\begin{aligned} (i). \quad & n = m - 1, \\ (ii). \quad & (\alpha_1, \dots, \alpha_{m-1}) \text{ is irrational,} \\ (iii). \quad & \alpha_m = r_1 \alpha_1 + \dots + r_{m-1} \alpha_{m-1}, \end{aligned} \tag{2.1}$$

for some  $(r_1, \dots, r_{m-1}) \in \mathbb{Q}^{m-1} \setminus \{0\}$ . Now let  $\ell \in \mathbb{N}^*$  denote the least common multiple of the denominators of the rationals  $r_j$ . Then by multiplying by  $\ell$  both sides of the expression of  $\alpha_m$  with respect to the coefficients  $\alpha_j$ ,  $j \in \llbracket 1, m-1 \rrbracket$ , it follows that

$$\ell \alpha_m = k_1 \alpha_1 + \dots + k_{m-1} \alpha_{m-1}, \quad \text{where } k_j := \ell r_j \in \mathbb{Z} \quad \forall j \in \llbracket 1, m-1 \rrbracket.$$

Consequently, one has

$$\forall x \in \mathbb{R}, \quad f(x) := G(\alpha x) = G\left(\ell \frac{\alpha_1}{\ell} x, \dots, \ell \frac{\alpha_{m-1}}{\ell} x, \sum_{j=1}^{m-1} k_j \frac{\alpha_j}{\ell} x\right).$$

This expression suggests to rename  $(\alpha_j/\ell)x$  as a new variable  $y_j$  for any  $j \in \llbracket 1, m-1 \rrbracket$  in the right-hand side, and to introduce the function  $F \in \mathcal{C}^0(\mathbb{R}^n)$  and the vector  $\theta \in \mathbb{R}^n$  defined by

$$\forall \mathbf{y} = (y_1, \dots, y_n) \in \mathbb{R}^n, \quad F(\mathbf{y}) := G\left(\ell y_1, \dots, \ell y_{m-1}, \sum_{j=1}^{m-1} k_j y_j\right) \quad \text{and} \quad \theta := \frac{1}{\ell}(\alpha_1, \dots, \alpha_n).$$

The  $\mathbb{Z}^m$ -periodicity of  $G$  implies that  $F$  is  $\mathbb{Z}^n$ -periodic, and the irrationality of  $\theta$  follows from (2.1). Finally, one clearly has  $f(x) = F(\theta x)$  for any  $x \in \mathbb{R}$ . ■

Thanks to Proposition 2.7, we can assume without any loss of generality that the cut vector  $\theta \in \mathbb{R}^n$  associated to a quasiperiodic function  $f := F \circ \theta$  is irrational, that is,

$$\boxed{\forall \mathbf{k} \in \mathbb{Z}^n, \quad \mathbf{k} \cdot \theta \implies \mathbf{k} = 0.} \tag{H.2}$$

A direct consequence of Assumption (H.2) is given by Kronecker's approximation theorem.

**Theorem 2.8: Kronecker's theorem** [HW79, Theorem 444]

*If  $\theta \in \mathbb{R}^n$  is an irrational vector, then the set  $\theta \mathbb{R} + \mathbb{N}^n$  is dense in  $\mathbb{R}^n$ .*

If  $\theta$  is an irrational vector, and if  $F \in \mathcal{C}_{per}^0(\mathbb{R}^n)$  satisfies  $F(\theta \mathbb{R}) = 0$ , then Theorem 2.8 implies that  $F = 0$ . In other words, under the linear independence assumption, any continuous  $\mathbb{Z}^n$ -periodic function  $F$  is uniquely determined by its restriction on the line  $\theta \mathbb{R}$ . Therefore, the next result holds.

**Corollary 2.9**

*Let  $F, G \in \mathcal{C}_{per}^0(\mathbb{R}^n)$  such that  $F(\theta x) = G(\theta x) \forall x \in \mathbb{R}$ , where  $\theta$  satisfies (H.2). Then  $F = G$ .*

Let  $\{x\}$  denote the fractional part of  $x$ , given by  $\{x\} := x - \lfloor x \rfloor$ . For  $n = 2$ , Kronecker's theorem 2.8

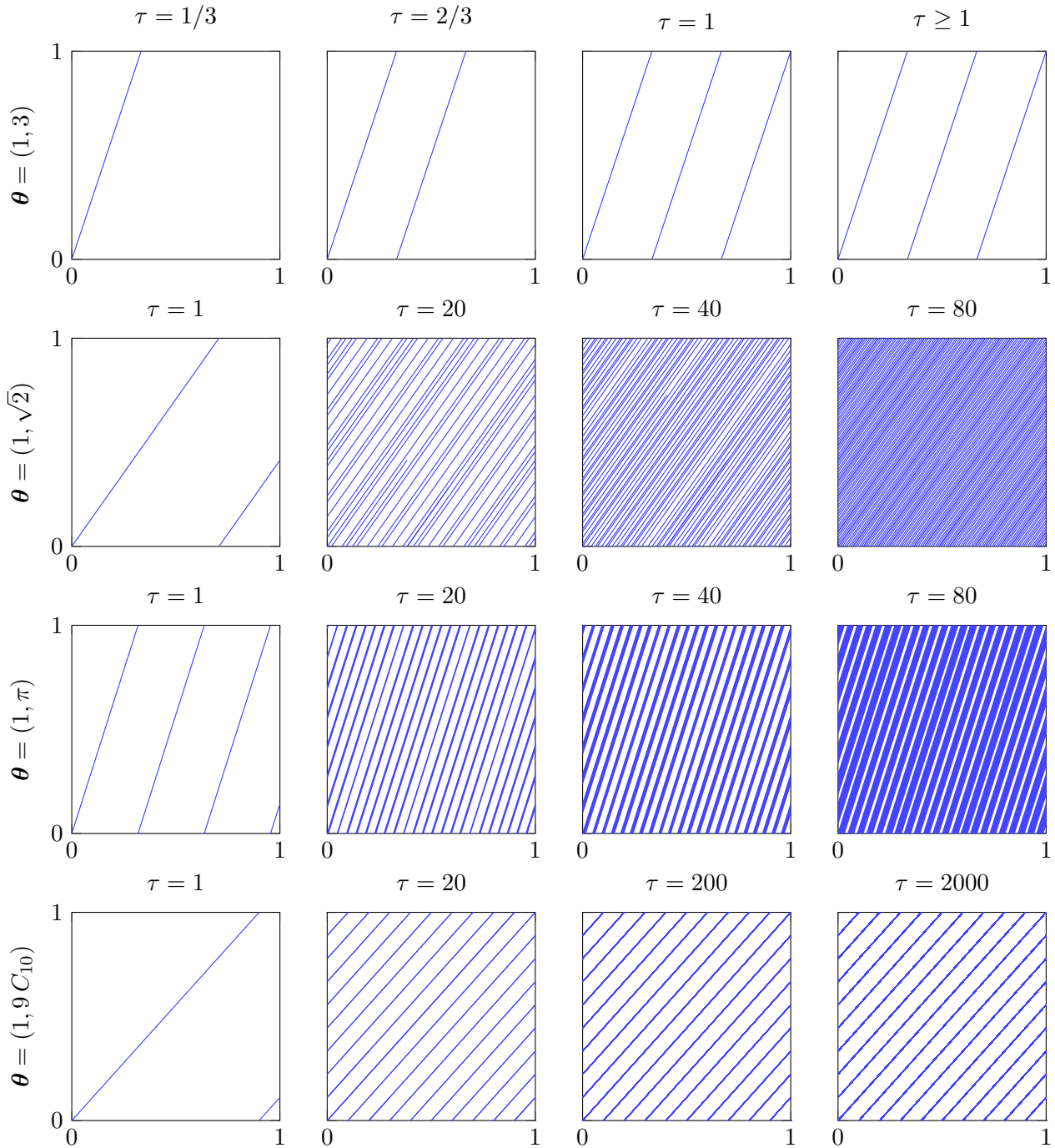

Figure 2: The set  $\mathcal{D}_{(0,\tau)}$  defined by (2.2) in the cell  $(0,1)^2$  for different values of  $\tau$ , when  $\theta_1/\theta_2 \in \mathbb{Q}$  (first row), and when  $\theta_1/\theta_2 \in \mathbb{R} \setminus \mathbb{Q}$  (second row for  $\theta = (1, \sqrt{2})$ , third row for  $\theta = (1, \pi)$ , and fourth row for  $\theta = (1, 9C_{10})$ ).

implies that given  $I := \mathbb{R}$ , the broken line

$$\mathcal{D}_I := \{(\{\theta_1 x\}, \{\theta_2 x\}) / x \in I\} \quad (2.2)$$

is dense in the unit cell  $(0,1)^2$ . To illustrate this result, Figure 2 represents the set  $\mathcal{D}_{(0,\tau)}$  in the unit cell for different values of  $\tau > 0$ . Two cases are considered for the vector  $\theta$ :

1.  $\theta_1/\theta_2 \in \mathbb{Q}$  (see the first row);

2.  $\theta_1/\theta_2 \in \mathbb{R} \setminus \mathbb{Q}$ : with  $\theta = (1, \sqrt{2})$  in second row, and  $\theta = (1, \pi)$  in third row. In addition, there is a fourth row devoted to  $\theta = (1, 9C_{10})$  (fourth row), where  $C_{10}$  is the *Champernowne constant*, whose decimal expansion is obtained by concatenating all consecutive integers in base 10:

$$C_{10} = 0.123456789101112131415\dots \quad (2.3)$$

This is a transcendental number which we shall return to in Example 3.10.

As  $\tau$  increases, in the first case,  $\mathcal{D}_{(0,\tau)}$  is reduced to a *finite* union of segments, contrary to the second case where it seems to fill the unit cell without ever passing through the same positions. It is also interesting to see that for  $\theta = (1, \sqrt{2})$ , the unit cell is in some sense filled uniformly, whereas for  $\theta = (1, 9C_{10})$ , the filling pattern is much closer to that of a rational case. The difference of behaviour seems to suggest that some irrationals (here  $C_{10}$ ) may be “closer” to rationals than others ( $\sqrt{2}$ ). This question is given further consideration in Section 3.2.

### 3 Diophantine condition

The purpose of this section is to introduce the notion of Diophantine condition for irrational vectors. We then link this condition in Section 3.2 with the approximation quality of an irrational by rationals.

#### 3.1 Presentation

An implication of the linear independence assumption (H.2) is the following density result.

##### Theorem 3.1: One-dimensional Kronecker’s theorem [HW79, Theorem 438]

Given  $n > 1$ , let  $\theta \in \mathbb{R}^n$  be such that two components of  $\theta$  are incommensurate, i.e.  $\theta_i/\theta_j \in \mathbb{R} \setminus \mathbb{Q}$  for some  $i \neq j$ . Then

$$\forall \zeta \in \mathbb{R}, \quad \forall \varepsilon > 0, \quad \exists \mathbf{k} \in \mathbb{Z}^n, \quad |\mathbf{k} \cdot \theta - \zeta| \leq \varepsilon.$$

For the present document, the main interest of this result lies in the case where  $\zeta = 0$ : even though the quantity  $|\mathbf{k} \cdot \theta|$  is non-zero for any integer vector  $\mathbf{k} \neq 0$ , it can become arbitrarily close to 0 for a well-chosen sequence  $(\mathbf{k}_j)_{j>0}$ . As we shall see in the following (cf. Section 4.2 for instance), some properties involving quasiperiodicity are closely related to how small  $|\mathbf{k} \cdot \theta|$  can be. This is the reason why we introduce the so-called *Diophantine condition* given  $\nu > 0$ :

$$\exists c \equiv c(\theta, \nu) > 0, \quad |\mathbf{k} \cdot \theta| \geq c|\mathbf{k}|^{-\nu}, \quad \forall \mathbf{k} \in \mathbb{Z}^n \setminus \{0\}, \quad (\mathbf{H}_\nu)$$

which amounts to ensuring that  $|\mathbf{k} \cdot \theta|$  does not tend to 0 faster than  $|\mathbf{k}|^{-\nu}$ . Assumption  $(\mathbf{H}_\nu)$  is generic in the sense of the next result, which is an application of Khintchine-Groshev theorem (see for instance the note [HY14] and references therein).

##### Theorem 3.2: Khintchine-Groshev theorem

Let  $n > 1$  and  $\nu > n - 1$ . The set of  $\theta \in \mathbb{R}^n$  that do not satisfy  $(\mathbf{H}_\nu)$  has Lebesgue measure zero.

Theorem 3.2 provides an information of the set of vectors  $\theta$  that satisfy  $(\mathbf{H}_\nu)$  for a *fixed*  $\nu$ . However, one may also fix  $\theta$ , and look for the reals  $\nu > 0$  for which  $(\mathbf{H}_\nu)$  holds. Finding the set of such  $\nu \equiv \nu(\theta)$



is not straightforward in general, but in the case where  $n = 2$  and  $\theta = (1, \delta)$ , this set is linked to the *irrationality measure* of  $\delta$ . This is the object of the next section.

### 3.2 Link with the irrationality measure for $n = 2$

In what follows, unless otherwise specified, any fraction  $k/\ell$  is always assumed to be irreducible, that is,  $(k, \ell) \in \mathbb{Z} \times \mathbb{N}^*$  are coprime.

If  $n = 2$  and  $\theta = (1, \delta)$  with  $\delta \in \mathbb{R} \setminus \mathbb{Q}$ , then Kronecker's theorem 3.1 taken for  $\zeta = 0$  reduces to the density of  $\mathbb{Q}$  in  $\mathbb{R} \setminus \mathbb{Q}$ :

$$\forall \varepsilon > 0, \quad \exists (k, \ell) \in \mathbb{Z} \times \mathbb{N}, \quad \left| \delta - \frac{k}{\ell} \right| \leq \varepsilon.$$

In that regard, it may be wondered how fast an irrational  $\delta$  can be approximated by a sequence of rationals. Furthermore, in practical applications, one is often interested in approximating  $\delta$  conveniently with rationals whose denominators are not too large. (See Remark V-2.1.b for instance). However, as the next lemma shows, if a sequence of rationals tends to an irrational number, then the sequence of denominators is necessarily unbounded.

#### Lemma 3.3

*Consider an irrational number  $\delta$  and a sequence of rationals  $(k_j/\ell_j)_{j>0}$  which converges to  $\delta$ . Then the sequences  $(k_j)_{j>0}$  and  $(\ell_j)_{j>0}$  are unbounded.*

**Proof.** We proceed by contradiction. Assume that  $(k_j/\ell_j)_{j>0}$  tends to  $\delta$  and that  $(\ell_j)_{j>0}$  is bounded. Then  $(k_j)_{j>0}$  is also bounded, meaning that  $(k_j)_{j>0}$  and  $(\ell_j)_{j>0}$  only take a finite number of values (since they are integer sequences). Therefore,  $(k_j/\ell_j)_{j>0}$  also takes a finite number of values, so that it is stationary and one has  $k_j/\ell_j = \delta$  for  $j$  large enough. This contradicts the irrationality of  $\delta$ , thus proving that  $(\ell_j)_{j>0}$  is unbounded. Since  $k_j \sim_j \delta \ell_j$ , it follows that  $(k_j)_{j>0}$  is unbounded as well. ■

The observations above lead to the following question:

*Can one always approximate an irrational number “efficiently” using rational numbers with “reasonably” large denominators?*

This question motivates the notion of *irrationality measure*.

#### Definition 3.4: [Bug12, Definition E.1]

Given  $\delta \in \mathbb{R}$ , let  $A_\delta$  denote the set of real numbers  $\eta \geq 0$  such that the inequality

$$0 < \left| \delta - \frac{k}{\ell} \right| < \frac{1}{\ell^\eta} \tag{3.1}$$

is satisfied by an infinity of coprime  $k \in \mathbb{Z}$  and  $\ell \in \mathbb{N}^*$ . The set  $A_\delta$  is non-empty as it contains 0. Moreover, if  $\eta \in A_\delta$ , then  $\eta' \in A_\delta$  for any  $\eta' \leq \eta$ . The supremum:

$$\eta(\delta) := \sup A_\delta \in \mathbb{R}_+ \cup \{+\infty\}$$

is called the *irrationality measure* of  $\delta$ .

As its definition shows, the irrationality measure of  $\delta \in \mathbb{R}$  indicates how well  $\delta$  can be approximated by rationals  $k/\ell \neq \delta$ . The greater  $\eta(\delta)$  is, the closer  $\delta$  is to rational numbers (other than  $\delta$  itself in case it is rational).

The irrationality measure admits multiple characterizations. The following characterization is useful to link the irrationality measure of an irrational number with the Diophantine condition  $(\mathbf{H}_\nu)$  introduced in the previous section.

**Proposition 3.5**

Given  $\delta \in \mathbb{R}$ , let  $B_\delta$  denote the set of real numbers  $\eta \geq 0$  such that

$$\exists c \equiv c(\delta, \eta) > 0, \quad \left| \delta - \frac{k}{\ell} \right| \geq \frac{c}{\ell^\eta}, \quad \forall k/\ell \in \mathbb{Q} \setminus \{\delta\}, \quad (3.2)$$

where  $\mathbb{Q} \setminus \{\delta\}$  is  $\mathbb{Q}$  if  $\delta$  is irrational. Then one has

$$\eta(\delta) = \inf B_\delta,$$

with  $\eta(\delta) = +\infty$  if and only if  $B_\delta$  is empty.

**Proof.** Note that  $B_\delta = \emptyset$  if and only if the set  $A_\delta$  introduced in Definition 3.4 is the half-line  $\mathbb{R}_+$ , and thus  $\eta(\delta) = +\infty$ . Otherwise, we rely on the observation

$$A_\delta^c := \mathbb{R}_+ \setminus A_\delta = \{\eta \geq 0 \mid (3.1) \text{ holds for finitely many } k/\ell \in \mathbb{Q}\},$$

so that  $\eta(\delta) = \inf A_\delta^c$ . We first show the inclusion  $B_\delta \subset A_\delta^c$ . For  $\eta \in A_\delta^c$ , the inequality (3.1) holds for a finite set  $S$  of rationals. If  $S = \emptyset$ , then (3.2) is satisfied with  $c(\delta, \eta) := 1$ . Otherwise, (3.2) still holds with  $c(\delta, \eta) := \min(1, c_\eta)$ , where  $c_\eta := \min_{k/\ell \in S} \ell^\eta |\delta - k/\ell|$  is positive since  $\delta$  is irrational. Hence,  $\eta \in B_\delta$ , so that  $\eta(\delta) \geq \inf B_\delta$ .

Conversely, for  $\eta \in B_\delta$ , let us prove that  $\eta + \varepsilon \in A_\delta^c$  for any  $\varepsilon > 0$ . If  $k/\ell \in \mathbb{Q}$  satisfies (3.1), then (3.2) implies that  $\ell^\varepsilon \leq c(\delta, \eta)$ . Therefore,  $\ell$  is bounded and thus can only take a finite number of values (since it is an integer). By using (3.1) again, we have  $|k| \leq |k - \ell\delta| + |\ell\delta| \leq \ell^{\eta-1} + |\ell\delta|$ , which proves that  $k$  is bounded as well, and thus can only take a finite number of values. Therefore,  $\eta + \varepsilon \in A_\delta^c$ , so that  $\inf B_\delta + \varepsilon \geq \eta(\delta)$ . As  $\varepsilon \rightarrow 0$ , it follows that  $\inf B_\delta \geq \eta(\delta)$ . Consequently,  $\eta(\delta) = \inf B_\delta$ . ■

The characterization in Proposition 3.5 leads directly to the following.

**Proposition 3.6**

Let  $\theta = (1, \delta)$ , where  $\delta$  is irrational. If  $\eta(\delta)$  is finite, then the Diophantine condition  $(\mathbf{H}_\nu)$  is satisfied by any  $\nu > \eta(\delta) - 1$ . If  $\eta(\delta) = +\infty$ , then  $(\mathbf{H}_\nu)$  holds for no real  $\nu > 0$ .

Rationals and irrationals have a different irrationality measure, as the next result shows.

**Proposition 3.7**

If  $\delta$  is a rational number, then  $\eta(\delta) = 1$ . If  $\delta$  is irrational, then  $\eta(\delta) \geq 2$ .

**Proof.** Proposition 3.7 is a well-known result whose proof is given only for the sake of completeness (see [HW79, Theorems 186 and 187], [Niv05, Theorem 7.7], or [Bug12, Theorem E.2]).

Let  $\delta \in \mathbb{R}$ . Since  $\{\ell\delta\} \in [0, 1)$ , one has  $0 < |\delta - \lfloor \ell\delta \rfloor / \ell| < 1/\ell$  for any  $\ell \in \mathbb{N}^*$ . Consequently, 1 belongs to the set  $A_\delta$  introduced in the definition 3.4 of the irrationality measure, so that  $\eta(\delta) := \sup A_\delta \geq 1$ .

If  $\delta \in \mathbb{Q}$  has the irreducible form  $a/b$ , then  $|\delta - k/\ell| = |a\ell - kb|/(\ell b) \geq 1/(\ell b)$  for any  $k/\ell \in \mathbb{Q} \setminus \{\delta\}$ . Hence, 1 belongs to the set  $B_\delta$  introduced in Proposition 3.5, so that  $\eta(\delta) = \inf B_\delta \leq 1$ . By double inequality,  $\eta(\delta) = 1$ .

If  $\delta$  is irrational, then it follows from Dirichlet's approximation theorem [HW79, Theorem 36] that the inequality  $0 < |\delta - k/\ell| < \ell^{-2}$  holds for infinitely many  $k/\ell \in \mathbb{Q}$ , meaning that  $\eta(\delta) \geq 2$ . ■

**Remark 3.8.** The fact that rational numbers have a smaller irrationality measure than irrationals may seem surprising, given that  $\eta(\delta)$  indicates how easily a real number  $\delta$  can be approximated by rationals. The subtlety lies in the fact that the rational approximants of  $\delta$  have to be different from  $\delta$  itself. From this viewpoint, Proposition 3.7 thus shows that an irrational number can be approximated more accurately by other rationals than a rational number.

As implied by Proposition 3.7, the most badly approximable irrationals are those with an irrationality measure equal to 2. The occurrence of such numbers is described in the next result (which can be seen as a particular case of Khintchine-Groshev's theorem 3.2).

**Proposition 3.9:** [HW79, Theorems 198, 199]

The set of irrational numbers with irrationality measure  $> 2$  has Lebesgue measure zero.

**Example 3.10.** We provide some examples that are summarized in Table II.1

(a). A number  $\delta \in \mathbb{R}$  is said to be **algebraic** if  $P(\delta) = 0$  for some non-zero polynomial  $P$  with integer coefficients. In particular, all rationals are algebraic. Other examples of algebraic numbers include  $a^{1/n}$  with  $a, n \in \mathbb{N}^*$ . The set of algebraic numbers is countable. A first result by Liouville [Lio44b] shows that if  $\delta$  is algebraic, then  $\eta(\delta) \leq n$ , where  $n$  is the degree of the minimal polynomial  $P$  such that  $P(\delta) = 0$ . This result was later improved, leading to the celebrated Thue-Siegel-Roth theorem [Rot55], which states that  $\eta(\delta) = 2$  for any algebraic number  $\delta \in \mathbb{R} \setminus \mathbb{Q}$ .

(b). Numbers that are not algebraic are called **transcendental numbers**. In particular, transcendental numbers are irrational. A valuable tool to find the irrationality measure of transcendental numbers is the continuous fraction expansion. This allows to show that the irrationality measure of  $e^{2/k}$  for  $k \in \mathbb{N}^*$  is 2 (see for instance [BB87, Corollary 11.1]). However, in general, it is not obvious to find the irrationality measure of transcendental numbers. For instance, the irrationality measure of numbers such as  $\pi$ ,  $\pi^2$  or  $\log(2)$  is still unknown, although some upper bounds are known.

(c). Numbers with an infinite irrationality measure are called **Liouville numbers**. As the name suggests, examples of such numbers were first constructed explicitly by Liouville [Lio44a]:

$$\delta := \sum_{k=1}^{+\infty} \frac{a_k}{b^{k!}} \quad \text{with } b \in \mathbb{N}, \quad b \geq 2 \quad \text{and} \quad a_k \in \llbracket 0, b-1 \rrbracket \quad \forall k \in \mathbb{N}^*. \quad (3.3)$$

These are typical numbers such that  $\theta := (1, \delta)$  does not satisfy  $(\mathbf{H}_\nu)$  for any  $\nu > 0$ .

(d). It is possible to construct explicitly numbers with a given irrationality measure. For instance, for any positive integers  $k$  and  $b \geq 2$ , let  $(k)_b$  be the representation of  $k$  in base  $b$  (e.g.  $(7)_2 = 111$ ). Then, as shown in [Amo91], numbers of the form

$$\delta := 0.(1)_b (2)_b (3)_b \dots (k)_b \dots \quad (3.4)$$

have an irrationality measure equal to  $b$ . The Champernowne constant  $C_{10}$  defined by (2.3) corresponds exactly to (3.4) with  $b := 10$ , so that  $\eta(C_{10}) = 10$ . We also refer to [Bug08] or [Bug12, §7.6–7.7] for similar constructions with non-integer irrationality measures.

$\delta$	rationals	algebraic numbers	$e^{2/k}$	Liouville numbers (e.g. (3.3))	(3.4)	$\pi, \log(2)$
$\eta(\delta)$	2	2	2	$\infty$	$b$	?

Table II.1: Examples of known and unknown irrationality measures

## 4 Generalized Fourier series

Fourier series are a fundamental tool for the study of purely periodic functions, and it is natural to wonder if they can be extended to quasiperiodic functions. This question was the initial motivation of Bohr's theory of uniformly almost periodic functions, which aims at characterizing functions that "are representable" by a trigonometric series of the form  $\sum A_k e^{i\lambda_n x}$  [Boh47]. This has led to a Parseval-type theorem called the *fundamental theorem of almost periodic functions*, and which we derive in this section for quasiperiodic functions (Proposition 4.4). For a quasiperiodic function  $f$ , the result is much simpler to obtain, since we can rely on the Fourier series of its periodic extension  $F$ .

### 4.1 Fourier representation

The valuable tool that will be used for deriving a Fourier representation is the notion of mean value.

#### Proposition 4.1

For any quasiperiodic function  $f := F \circ \theta$ , and for any  $\alpha \in \mathbb{R}$ , the limit

$$\lim_{T \rightarrow +\infty} \frac{1}{T} \int_{\alpha}^{\alpha+T} f(x) dx$$

exists and is independent of  $\alpha$ . This limit is called the mean value of  $f$ , and is denoted by  $M(f)$ . In addition, if  $\theta$  is an irrational vector, then

$$M(f) = \int_{(0,1)^n} F(\mathbf{y}) d\mathbf{y}, \quad (4.1)$$

and the convergence is uniform with respect to  $\alpha$ .

**Proof** (Idea of proof; see [Arn13, Chapter 10, §51.C] for details). Equation (4.1) is obtained easily when  $F$  is a trigonometric polynomial. It then extends to a general function  $F \in \mathcal{C}_{per}^0(\mathbb{R}^n)$  by density using Fejér's theorem (or the Weierstrass approximation theorem for trigonometric polynomials). ■

This result and more particularly the equality (4.1) can be compared with Figure 2 for  $n = 2$ . In fact,  $M(f)$  can be interpreted as the limit as  $\tau \rightarrow \infty$  of the mean value of  $F$  on the broken line  $\mathcal{D}_{(0,\tau)}$  defined by (2.2). In the cases where  $\theta$  is an irrational vector (second to fourth rows in Figure 2),  $\mathcal{D}_{(0,\tau)}$  fills the cell  $(0, 1)^2$  as  $\tau$  increases, hence reflecting the fact that the mean value on  $\mathcal{D}_{(0,\tau)}$  gets closer to the average on  $(0, 1)^2$ . Moreover, the fact that the whole cell is filled independently of the choice of the irrational vector  $\theta$  is consistent with the independence of  $M(f)$  with respect to  $\theta$ .

**Remark 4.2.** (a). If  $f$  is purely periodic with period  $\tau > 0$ , then one has

$$M(f) = \lim_{\ell \rightarrow +\infty} \frac{1}{\ell\tau} \int_0^{\ell\tau} f(x) dx = \lim_{\ell \rightarrow +\infty} \frac{1}{\ell\tau} \sum_{j=0}^{\ell-1} \int_{j\tau}^{(j+1)\tau} f(x) dx = \lim_{\ell \rightarrow +\infty} \frac{1}{\tau} \int_0^{\tau} f(x) dx = \frac{1}{\tau} \int_0^{\tau} f(x) dx.$$

In other words,  $M(f)$  coincides with the average of  $f$  on the periodicity interval  $(0, \tau)$ .

(b). If  $f$  is uniformly almost periodic in the sense of (1.3), then the mean value theorem states that  $M(f)$  exists, although it does no longer have an explicit expression such as (4.1).

Defined on the space  $\mathcal{C}_{\text{QP}}^0(\mathbb{R})$  of quasiperiodic functions, the mean value is a linear map, and it follows from (4.1) that  $M$  is positive definite in the sense that  $M(f) > 0$  for any  $f \in \mathcal{C}_{\text{QP}}^0(\mathbb{R})$ ,  $f > 0$ . In addition, for any  $f, g \in \mathcal{C}_{\text{QP}}^0(\mathbb{R})$ , the product  $f\bar{g}$  is also quasiperiodic (thanks to Proposition 1.6), and thus admits a mean value. From these observations, we deduce that the map

$$(\cdot, \cdot)_{M,2} : (f, g) \mapsto M(f\bar{g}) \quad (4.2)$$

defines a scalar product on  $\mathcal{C}_{\text{QP}}^0(\mathbb{R})$ . Moreover, the function  $e_\lambda : x \mapsto e^{i\lambda x}$  is quasiperiodic for any  $\lambda \in \mathbb{R}$ , and the family  $\{e_\lambda, \lambda \in \mathbb{R}\}$  forms an orthonormal system for the scalar product  $(\cdot, \cdot)_{M,2}$ :

$$(e_\lambda, e_\gamma)_{M,2} := \lim_{T \rightarrow +\infty} \frac{1}{T} \int_0^T e^{i(\lambda-\gamma)x} dx = \begin{cases} 1 & \text{if } \lambda = \gamma \\ 0 & \text{if } \lambda \neq \gamma. \end{cases} \quad (4.3)$$

The next proposition shows that for any  $f \in \mathcal{C}_{\text{QP}}^0(\mathbb{R})$ , the scalar product  $(f, e_\lambda)_{M,2}$  vanishes except at most for a countable set of values of  $\lambda$ .

### Proposition 4.3

Consider a quasiperiodic function  $f = F \circ \theta$  of order  $n > 0$  where  $\theta$  satisfies (H.2). Then  $f$  satisfies the following orthogonality relation:

$$\forall \lambda \in \mathbb{R}, (f, e_\lambda)_{M,2} = \begin{cases} c_{\mathbf{k}}(F) := \int_{(0,1)^n} F(\mathbf{y}) e^{-2i\pi \mathbf{k} \cdot \mathbf{y}} d\mathbf{y} & \text{if } \exists \mathbf{k} \in \mathbb{Z}^n, \lambda = 2\pi \mathbf{k} \cdot \theta, \\ 0 & \text{otherwise.} \end{cases} \quad (4.4)$$

**Proof.** Let  $\lambda \in \mathbb{R}$  and define  $S := \{2\pi \mathbf{k} \cdot \theta, \mathbf{k} \in \mathbb{Z}^n\}$ . We first assume that the periodic lift  $F$  of  $f$  is given by  $F(\mathbf{y}) := \exp(2i\pi \mathbf{p} \cdot \mathbf{y})$  for any  $\mathbf{y} \in \mathbb{R}^n$ , where  $\mathbf{p} \in \mathbb{Z}^n$ . In this case, we obtain

$$M(f \bar{e}_\lambda) = \lim_{T \rightarrow +\infty} \frac{1}{T} \int_0^T \exp(i(2\pi \mathbf{p} \cdot \theta - \lambda)x) dx = \begin{cases} 1 = c_{\mathbf{k}}(F) & \text{if } \lambda = 2\pi \mathbf{k} \cdot \theta \in S \\ 0 & \text{if } \lambda \notin S, \end{cases}$$

which is exactly (4.4). By linearity, (4.4) extends to the case where  $F$  is a trigonometric polynomial

of the form  $\sum_{|p| \leq N} \exp(2i\pi \mathbf{p} \cdot \mathbf{y})$ . Finally, thanks to Fejér's theorem (or Weierstrass approximation theorem for trigonometric polynomials), (4.4) extends by density to continuous extensions  $F$ . ■

The values  $\lambda_{\mathbf{k}} := 2\pi \mathbf{k} \cdot \boldsymbol{\theta}$ ,  $\mathbf{k} \in \mathbb{Z}^n$  are called the **Fourier exponents** of  $f$ , and the corresponding coefficients  $(f, e_{\lambda_{\mathbf{k}}})_{M,2} = c_{\mathbf{k}}(F)$  are called the **Fourier coefficients** of  $f$ . To  $f$ , we associate the series  $\sum_{\mathbf{k}} c_{\mathbf{k}}(F) e^{2i\pi \mathbf{k} \cdot \boldsymbol{\theta} x}$  which shall be referred to as the **Fourier series** of  $f$ . The exact link between  $f$  and its Fourier series takes shape in the next proposition, which incidentally shows the completeness of the family  $\{e_{\lambda}, \lambda \in \mathbb{R}\}$  in  $\mathcal{C}_{\text{QP}}^0(\mathbb{R})$  for the norm  $\sqrt{(\cdot, \cdot)_{M,2}}$ .

#### Proposition 4.4

Let  $f := F \circ \boldsymbol{\theta}$  be a quasiperiodic function of order  $n > 0$ , where  $\boldsymbol{\theta}$  satisfies (H.2). Then, one has the following Parseval theorem:

$$\sum_{\mathbf{k} \in \mathbb{Z}^n} |c_{\mathbf{k}}(F)|^2 = M(|f|^2). \quad (4.5)$$

Moreover, the series  $\sum c_{\mathbf{k}}(F) e^{2i\pi \mathbf{k} \cdot \boldsymbol{\theta} x}$  converges to  $f$  in the following sense:

$$\lim_{N \rightarrow +\infty} M\left(\left|f - \sum_{|\mathbf{k}| \leq N} c_{\mathbf{k}}(F) e^{2i\pi \mathbf{k} \cdot \boldsymbol{\theta} x}\right|^2\right) = 0. \quad (4.6)$$

**Proof.** One obtains (4.5) by applying the classical Parseval's theorem to  $F$  and by using the link  $\|F\|_{L^2(0,1)^2} = M(|f|^2)$  implied by Proposition 4.1. Since  $F \in \mathcal{C}_{\text{per}}^0(\mathbb{R}^n) \subset L^2(0,1)^n$ , it follows that

$$\lim_{N \rightarrow +\infty} \left\| F - \sum_{|\mathbf{k}| \leq N} c_{\mathbf{k}}(F) e^{2i\pi \mathbf{k} \cdot \mathbf{y}} \right\|_{L^2(0,1)^n} = 0.$$

Combining this convergence result with Proposition 4.1 leads to (4.6). ■

A key implication of Proposition 4.4 is the fact that a quasiperiodic function is uniquely determined by its Fourier series.

#### Corollary 4.5

Let  $f, g \in \mathcal{C}_{\text{QP}}^0(\mathbb{R})$  have the same Fourier series. Then  $f = g$ .

**Proof.** If  $f, g \in \mathcal{C}_{\text{QP}}^0(\mathbb{R})$  have the same Fourier series, then  $M(|f - g|^2) = 0$  according to the Parseval equality (4.5). Therefore,  $f = g$ . ■

**Remark 4.6.** (a). A  $\tau$ -periodic function  $f$  can be written as  $f = F \circ \boldsymbol{\theta}$  with  $F : y \mapsto f(y/\tau) \in \mathcal{C}_{\text{per}}^0(\mathbb{R})$  and where  $\boldsymbol{\theta} = \tau$ . The Fourier exponents and the Fourier coefficients of  $f$  are then given by

$$\forall k \in \mathbb{Z}, \quad \lambda_k = 2\pi k/\tau \quad \text{and} \quad c_k(F) = \int_0^1 F(y) e^{-2i\pi ky} dy = \frac{1}{\tau} \int_0^\tau f(x) e^{-2i\pi kx/\tau} dx.$$

In other words, the Fourier series of  $f$  in the sense of Propositions 4.3 and 4.4 is nothing but its Fourier series in the classical sense.

(b). If  $f$  is uniformly almost periodic in the sense of (1.3), then it remains true  $M(f \overline{e_\lambda})$  vanishes except for a countable set  $\{\lambda_\ell, \ell \in \mathbb{N}\}$ . These values are the Fourier exponents of  $f$ , whereas the coefficients  $M(f \overline{e_{\lambda_\ell}})$  are the Fourier coefficients of  $f$ . Proposition 4.4 then holds (although it is much less easy to prove). This shows how general the theory of almost periodic functions is, since the Fourier exponents of an almost periodic function are allowed to be completely arbitrary (in contrast with the Fourier coefficients of quasiperiodic functions, which have a certain structure).

## 4.2 Primitives of quasiperiodic functions: a small divisors problem

With the help of generalized Fourier series, we investigate whether the primitives of a quasiperiodic function are also quasiperiodic. This question is of particular interest because it corresponds to asking if the differential equation  $u' = f$  with  $f \in \mathcal{C}_{\text{QP}}^0(\mathbb{R})$  admits quasiperiodic solutions. This question is also related to the existence of quasiperiodic solutions of the equation  $u' = f u$ .

Throughout this section,  $f \in \mathcal{C}_{\text{QP}}^0(\mathbb{R})$  is given for any  $x \in \mathbb{R}$  by  $f(x) := F(\theta x)$ , where  $F \in \mathcal{C}_{\text{per}}^0(\mathbb{R}^n)$  and  $\theta \in \mathbb{R}^n$  is an irrational vector. Since primitives are equal to each other up to an additive constant, we can focus on one of them without any loss of generality. Let  $g \in \mathcal{C}^0(\mathbb{R})$  be defined by

$$\forall x \in \mathbb{R}, \quad g(x) := \int_0^x f(t) dt. \quad (4.7)$$

If  $f$  is  $\tau$ -periodic, then  $g$  is  $\tau$ -periodic if and only if  $f$  has zero mean value. In fact,

$$\forall x \in \mathbb{R}, \quad g(x + \tau) = g(x) \iff M(f) = \int_0^{x+\tau} f(t) dt - \int_0^x f(t) dt = 0.$$

This equivalence is no longer true for quasiperiodic functions. More precisely, we shall prove that the condition  $M(f) = 0$  is still necessary for the quasiperiodic nature of  $g$ , but is not sufficient. The fact that  $f$  must have zero mean value can be checked easily, as the next proposition shows.

### Proposition 4.7

If  $g$  is quasiperiodic, then  $M(f) = 0$ .

**Proof.** We note that

$$M(f) := \lim_{T \rightarrow +\infty} \int_0^T f(t) dt = \lim_{T \rightarrow +\infty} \frac{g(T)}{T}.$$

If  $g$  is quasiperiodic, then it is bounded (Proposition 1.4), so that  $M(f) = \lim_{T \rightarrow +\infty} g(T)/T = 0$ . ■

Before providing examples to illustrate that the zero mean value condition is not sufficient, let us first look for sufficient conditions for  $g$  to be quasiperiodic. The next result was shown by Bohl [Boh06], and was extended to almost periodic functions by Bohr [Boh47, §68].

### Proposition 4.8

If  $g$  is bounded, then  $g$  is quasiperiodic.

However, in practice, the boundedness of the primitive  $g$  can be difficult to verify since it is not explicit. An alternative viewpoint is to exploit the generalized Fourier series of  $f$ .

**Proposition 4.9**

If  $g$  is quasiperiodic, then its generalized Fourier series is given by

$$M(g) + \sum_{\mathbf{k} \neq 0} \frac{c_{\mathbf{k}}(F)}{2i\pi \mathbf{k} \cdot \boldsymbol{\theta}} e^{2i\pi \mathbf{k} \cdot \boldsymbol{\theta} x}. \quad (4.8)$$

**Proof.** We only present the idea of the proof which is adapted from [Boh47, §68]. By definition, if  $g$  is quasiperiodic, then according to Proposition 4.3, its Fourier exponents are the real numbers  $\lambda$  such that  $M(g \overline{e_\lambda}) := (g, e_\lambda)_{M,2} \neq 0$  (and the Fourier coefficients are the  $M(g \overline{e_\lambda})$ ), where  $e_\lambda : x \mapsto e^{i\lambda x}$ . Using integration by parts, one then easily checks the following

$$\forall \lambda \neq 0, \quad (g, e_\lambda)_{M,2} = \frac{(f, e_\lambda)_{M,2}}{i\lambda},$$

which leads to the desired result. ■

While providing a necessary condition for the quasiperiodicity of  $g$ , Proposition 4.9 implicitly suggests a sufficient condition as well: if

$$\sum_{\mathbf{k} \neq 0} \frac{c_{\mathbf{k}}(F)}{2i\pi \mathbf{k} \cdot \boldsymbol{\theta}} e^{2i\pi \mathbf{k} \cdot \mathbf{y}}$$

were the Fourier series of a function  $G \in \mathcal{C}_{per}^0(\mathbb{R}^n)$ , then one could show that  $g(x) = G(\boldsymbol{\theta} x)$  for  $x \in \mathbb{R}$ . However, proving the existence of  $G$  is not obvious, since it is linked to the behaviour of the coefficient  $c_{\mathbf{k}}(F)/(2i\pi \mathbf{k} \cdot \boldsymbol{\theta})$  at infinity. The delicate point is that since  $\boldsymbol{\theta}$  is an irrational vector, Kronecker's theorem 3.1 implies that  $\mathbf{k} \cdot \boldsymbol{\theta}$  is non-zero for  $\mathbf{k} \neq 0$ , but can become arbitrarily small. This is the reason why such a problem is called a *small divisors problem*.

In order to control the behaviour of  $\mathbf{k} \cdot \boldsymbol{\theta}$  near 0, we shall resort to the Diophantine condition  $(\mathbf{H}_\nu)$  introduced in Section 3. We recall from Khintchine-Groshev's theorem 3.2 that  $(\mathbf{H}_\nu)$  holds for almost any  $\boldsymbol{\theta} \in \mathbb{R}^n$ . On the other hand, the asymptotic behaviour of  $c_{\mathbf{k}}(F)$  is linked to the smoothness of  $F$ . We recall (see [KMK89, Chapter 8] for a detailed presentation in the case  $n = 1$ ) that:

$$\forall s \geq 0, \quad H_{per}^s((0,1)^n) := \left\{ F \in L^2((0,1)^n), \quad \|F\|_{H^s}^2 := \sum_{\mathbf{k} \in \mathbb{Z}^n} (1 + |\mathbf{k}|^2)^s |c_{\mathbf{k}}(F)|^2 < +\infty \right\},$$

with  $H_{per}^s((0,1)^n) = L^2((0,1)^n)$  for  $s = 0$ . By using the Cauchy-Schwarz inequality and by studying the convergence of the Riemann series  $\sum_{\mathbf{k} \neq 0} (1 + |\mathbf{k}|^2)^{-s}$ , one shows that if  $s > n/2$ , then the Fourier series of any  $F \in H_{per}^s((0,1)^n)$  converges absolutely and uniformly, so that  $F \in \mathcal{C}_{per}^0(\mathbb{R}^n)$ .

From the above observations, we deduce the following result.

**Proposition 4.10**

Consider a vector  $\boldsymbol{\theta} \in \mathbb{R}^n$  that satisfies the Diophantine condition  $(\mathbf{H}_\nu)$  for some  $\nu > n - 1$ , and let  $F \in H_{per}^s((0,1)^n)$  for  $s > \nu + n/2$ . Let  $f : x \mapsto F(\boldsymbol{\theta} x)$  and let  $g$  denote the primitive of  $f$  such that  $g(0) = 0$  (see (4.7)). Then there exists  $G \in H_{per}^{s-\nu}((0,1)^n) \subset \mathcal{C}_{per}^0(\mathbb{R}^n)$  such that

$$\forall x \in \mathbb{R}, \quad g(x) = M(f) x + G(\boldsymbol{\theta} x). \quad (4.9)$$



In particular, if  $M(f) = 0$ , then  $g$  is quasiperiodic.

**Proof.** In light of the above observations, we study the normal convergence of the Fourier series in Proposition 4.9. Let  $N \in \mathbb{N}^*$ . From the Cauchy-Schwarz inequality,

$$\begin{aligned} \left( \sum_{\mathbf{k} \neq 0, |\mathbf{k}| \leq N} \left| \frac{c_{\mathbf{k}}(F)}{\mathbf{k} \cdot \boldsymbol{\theta}} \right| \right)^2 &\leq \sum_{\mathbf{k} \neq 0, |\mathbf{k}| \leq N} |\mathbf{k}|^{2s} |c_{\mathbf{k}}(F)|^2 \sum_{\mathbf{k} \neq 0, |\mathbf{k}| \leq N} \frac{1}{|\mathbf{k}|^{2s} (\mathbf{k} \cdot \boldsymbol{\theta})^2} \\ &\leq \|F\|_{H^s}^2 \sum_{\mathbf{k} \neq 0, |\mathbf{k}| \leq N} \frac{1}{|\mathbf{k}|^{2s} (\mathbf{k} \cdot \boldsymbol{\theta})^2} \\ &\stackrel{(\mathbf{H}_\nu)}{\leq} c(\boldsymbol{\theta}, \nu) \|F\|_{H^s}^2 \sum_{\mathbf{k} \neq 0, |\mathbf{k}| \leq N} |\mathbf{k}|^{-2(s-\nu)} < +\infty \quad \text{because } s - \nu > n/2. \end{aligned}$$

It follows that the series  $\sum_{\mathbf{k} \neq 0} [c_{\mathbf{k}}(F)/(\mathbf{k} \cdot \boldsymbol{\theta})] e^{2i\pi \mathbf{k} \cdot \mathbf{y}}$  is normally convergent. Therefore, the limit

$$\forall \mathbf{y} \in \mathbb{R}^n, \quad G(\mathbf{y}) := c + \sum_{\mathbf{k} \neq 0} \frac{c_{\mathbf{k}}(F)}{2i\pi \mathbf{k} \cdot \boldsymbol{\theta}} e^{2i\pi \mathbf{k} \cdot \mathbf{y}}$$

is a continuous and  $\mathbb{Z}^n$ -periodic function, where the constant  $c \in \mathbb{R}$  is such that  $G(0) = 0$ . We even have  $G \in H_{per}^{s-\nu}((0, 1)^n)$ , due to the estimate

$$\forall \mathbf{k} \neq 0, \quad |\mathbf{k}|^{2(s-\nu)} |c_{\mathbf{k}}(G)|^2 := |\mathbf{k}|^{2(s-\nu)} \left| \frac{c_{\mathbf{k}}(F)}{2i\pi \mathbf{k} \cdot \boldsymbol{\theta}} \right|^2 \stackrel{(\mathbf{H}_\nu)}{\leq} c(\boldsymbol{\theta}, \nu) |\mathbf{k}|^{2s} |c_{\mathbf{k}}(F)|^2,$$

and because  $F \in H_{per}^s((0, 1)^n)$ . Moreover, since the Fourier series of  $F$  converges uniformly to  $F$ , we can differentiate the terms of the series defining  $G$ , to obtain  $\boldsymbol{\theta} \cdot \nabla G = F - c_0(F)$  on  $\mathbb{R}^n$ . Evaluating this relation on  $\boldsymbol{\theta} \mathbb{R}$  and using the chain rule then gives  $[G(\boldsymbol{\theta} x)]' = f(x) - M(f) = g'(x) - M(f)$ , which implies (4.9) since  $G(0) = g(0) = 0$ .  $\blacksquare$

**Remark 4.11.** Proposition 4.10 provides a valuable information on the asymptotic behaviour of the average of  $f$  on  $(0, T)$ . In fact, if  $f$  is such that  $M(f) = 0$  for simplicity, then one has

$$\left| \frac{1}{T} \int_0^T f(x) dx \right| = \frac{|g(T)|}{T}$$

If the assumptions of Proposition 4.10 are satisfied, then  $g$  is quasiperiodic, and therefore has no limit at infinity. Consequently, the average of  $f$  on  $(0, T)$  does not converge to  $M(f) = 0$  faster than  $T^{-1}$ . This order of convergence deteriorates when  $g$  is not quasiperiodic. In fact, in this case,  $g$  is unbounded according to Proposition 4.8.

In Proposition 4.10, one might think of the Diophantine condition  $(\mathbf{H}_\nu)$  and of the smoothness of  $F$  as technical assumptions that are dispensable. While these assumptions may be greatly relaxed, they still capture the non-trivial nature of the small divisors problem we are interested in. In fact, solving this type of problem requires an interplay between the smoothness of the periodic lift and the nature of the associated cut vector. To see this, we shall construct a counterexample for  $n = 2$  and  $\boldsymbol{\theta} = (1, \delta)$ , where  $\delta$  is an irrational number.

If  $\eta(\delta) \equiv \eta \geq 2$  denotes the irrationality measure of  $\delta$  defined in Section 3.2, then for  $\varepsilon > 0$ , we have

from Definition 3.4 the existence of coprime integers  $(k_j, \ell_j) \in \mathbb{Z} \times \mathbb{N}^*$  such that  $|k_j|, \ell_j \rightarrow +\infty$  and

$$\forall j \in \mathbb{N}^*, \quad \left| \delta - \frac{k_j}{\ell_j} \right| \leq \frac{1}{\ell_j^{\eta-\varepsilon}}.$$

On the other hand, the characterization in Proposition 3.5 of the irrationality measure implies that

$$\exists c \equiv c(\varepsilon) > 0, \quad \forall j \in \mathbb{N}^*, \quad \frac{c}{\ell_j^{\eta+\varepsilon}} \leq \left| \delta - \frac{k_j}{\ell_j} \right|.$$

By combining the two inequalities above, and by setting  $\nu := \eta - 1$  and  $\mathbf{k}_j := (-k_j, \ell_j)$ , we obtain the existence of two constants  $c_1, c_2$  with

$$\forall j \in \mathbb{N}^*, \quad c_1 |\mathbf{k}_j|^{-(\nu+\varepsilon)} \leq |\mathbf{k}_j \cdot \boldsymbol{\theta}| \leq c_2 |\mathbf{k}_j|^{-(\nu-\varepsilon)}. \quad (4.10)$$

Now we introduce the function

$$\forall \mathbf{y} \in \mathbb{R}^n, \quad F(\mathbf{y}) := \sum_{j>0} 2i\pi(\mathbf{k}_j \cdot \boldsymbol{\theta}) e^{2i\pi\mathbf{k}_j \cdot \mathbf{y}}. \quad (4.11)$$

This definition is still formal, for the behaviour of  $\mathbf{k}_j \cdot \boldsymbol{\theta}$  has not been prescribed yet. Given  $s \geq 0$ , we have from the estimate (4.10) that

$$\forall j \in \mathbb{N}^*, \quad c_1 |\mathbf{k}_j|^{-2(\nu-s+\varepsilon)} \leq |\mathbf{k}_j|^{2s} |\mathbf{k}_j \cdot \boldsymbol{\theta}|^2 \leq c_2 |\mathbf{k}_j|^{-2(\nu-s-\varepsilon)}. \quad (4.12)$$

Hence, using the convergence of Riemann series, it can be computed that

$$\begin{aligned} (i). \quad \nu > n + \varepsilon &\implies F \in H_{per}^s((0, 1)^n) \subset \mathcal{C}_{per}^0(\mathbb{R}^n) \quad \forall s \in (n/2, \nu - n/2 - \varepsilon) \\ (ii). \quad F \notin H_{per}^s((0, 1)^n) &\quad \forall s > \nu - n/2 + \varepsilon. \end{aligned} \quad (4.13)$$

In fact, if  $s < \nu - n/2 - \varepsilon$  then we have  $2(\nu - s - \varepsilon) > n$ , so that  $F \in H_{per}^s((0, 1)^n)$  thanks to the second inequality in (4.12). Furthermore, if  $s > n/2$ , then  $F$  is also continuous (hence the point (i)). On the other hand, if  $s > \nu - n/2 + \varepsilon$ , then we have  $2(\nu - s + \varepsilon) < n$ , so that  $F \notin H_{per}^s((0, 1)^n)$  due to the first inequality in (4.12) (hence the point (ii)). Finally, we note that the condition  $\nu > n + \varepsilon$  can be rewritten as  $\eta > 1 + n + \varepsilon = 3 + \varepsilon$ , where  $\eta$  is the irrationality measure of  $\delta$ . As Example 3.10.d shows, one can always find a number  $\delta$  whose irrationality measure  $\eta$  satisfies this condition.

In view of (4.13), we have a continuous and periodic function  $F$ , from which we define  $f : x \mapsto F(\boldsymbol{\theta} x)$ . Since  $\boldsymbol{\theta}$  is an irrational vector and  $\mathbf{k}_j \neq 0$  for any  $j > 0$ , we have that  $M(f) = c_0(F) = 0$ . However, it is worth noting that  $F$  does not satisfy the regularity assumptions of Proposition 4.10 due to the point (ii) in (4.13). If the primitive  $g$  of  $f$  were quasiperiodic, then according to Proposition 4.9 and to the definition (4.11) of  $F$ , its Fourier series would be

$$M(g) + \sum_{j>0} e^{2i\pi\mathbf{k}_j \cdot \mathbf{y}}, \quad \text{so that} \quad M(|g|^2) = |M(g)|^2 + \sum_{j>0} 1 = +\infty,$$

from Parseval's equality (4.5). The fact that  $M(|g|^2) = +\infty$  contradicts the quasiperiodic nature of  $g$ .



# Wave propagation in quasiperiodic media: The absorbing case

## Outline

---

1	Introduction and motivation . . . . .	34
2	Quasiperiodicity . . . . .	36
2.1	Locally perturbed quasiperiodic media . . . . .	36
3	The half-line quasiperiodic problems . . . . .	37
3.1	Lifting in a higher-dimensional periodic problem . . . . .	37
3.2	Preliminary material . . . . .	38
3.2.a	Anisotropic Sobolev spaces and trace theorems . . . . .	39
3.2.b	Green's formulas . . . . .	43
3.2.c	An oblique change of variables . . . . .	45
3.3	Link with a periodic half-guide problem . . . . .	48
4	Resolution of the half-guide problem . . . . .	51
4.1	Structure of the solution . . . . .	52
4.2	Characterization of the propagation operator: the Riccati equation . . . . .	53
4.3	The DtN operator and the DtN coefficient . . . . .	55
4.4	Spectral properties of the Riccati equation . . . . .	56
4.5	Spectral properties of the propagation operator . . . . .	58
5	Resolution algorithm and discretization issues for $n = 2$ . . . . .	60
5.1	A fully two-dimensional method . . . . .	61
5.2	A quasi one-dimensional method . . . . .	62
5.2.a	Presentation . . . . .	62
5.2.b	Discretization . . . . .	63
5.3	Approximation of the propagation operator . . . . .	65
5.4	The DtN coefficient . . . . .	66
5.5	Numerical results . . . . .	66
5.5.a	The half-line and the half-guide solutions . . . . .	66
5.5.b	The whole line problem . . . . .	68
5.5.c	About the influence of the absorption on the accuracy . . . . .	69
5.5.d	About the spectral approximation of the propagation operator . . . . .	71
6	Perspectives . . . . .	73

---

## 1 Introduction and motivation

We consider the Helmholtz equation

$$-\frac{d}{dx}\left(\mu \frac{du}{dx}\right) - \rho \omega^2 u = f \quad \text{in } \mathbb{R}, \quad (1.1)$$

where the coefficients  $\mu$  and  $\rho$  have positive upper and lower bounds:

$$\exists \mu_{\pm}, \rho_{\pm}, \quad \forall x \in \mathbb{R}, \quad 0 < \mu_- \leq \mu(x) \leq \mu_+ \quad \text{and} \quad 0 < \rho_- \leq \rho(x) \leq \rho_+. \quad (1.2)$$

The source term  $f$  belongs to  $L^2(\mathbb{R})$  and is assumed to have a compact support:

$$\exists a > 0, \quad \text{supp } f \subset (-a, a). \quad (1.3)$$

Equation (1.1) is encountered when one is looking for time-harmonic solutions  $u(x) e^{-i\omega t}$  of the linear wave equation in heterogeneous media. For real frequencies  $\omega$ , the well-posedness of this problem is unclear. In fact, on one hand, one expects that the physical solution  $u$ , if it exists, may not belong to  $H^1(\mathbb{R})$  due to possible wave propagation phenomena and a lack of decay at infinity. On the other hand, uniqueness of a solution in  $H_{loc}^1(\mathbb{R})$  does not hold in general. In this case, one needs a so-called *radiation condition* that imposes the behaviour of the solution at infinity. Such a condition can be obtained in practice using the *limiting absorption principle*, which consists in (i) adding some absorption – that is some imaginary part to  $\omega$ :  $\Im \omega > 0$ , and (ii) studying the limit of the solution  $u \equiv u(\omega)$  as the absorption tends to 0. The limiting absorption principle is a classical approach to study time-harmonic wave propagation problems in unbounded domains; see for instance [Wil66; Agm75; Eid86]. More recently, it has been successfully applied for locally perturbed periodic media [Fli09; Hoa11; Rad15; KL18a].

In this chapter, we will only address the case with absorption, that is

$$\text{the frequency } \omega \text{ satisfies } \Im \omega > 0. \quad (1.4)$$

Under these assumptions, (1.1) admits a unique solution in  $H^1(\mathbb{R})$  by Lax-Milgram's theorem. Moreover, it can be shown (using for instance an argument similar to the one in [CT73]) that this solution satisfies a sharp exponential decay property

$$\exists c, \alpha > 0, \quad \forall x \in \mathbb{R}, \quad |u(x)| \leq c e^{-\alpha \Im \omega |x|}. \quad (1.5)$$

Exploiting (1.5), a naive numerical method for treating the unboundedness would consist in truncating the computational domain (with homogeneous Dirichlet boundary conditions for instance) at a certain distance related to  $\Im \omega$ . However the cost and the accuracy of the method would deteriorate when  $\Im \omega$  tends to 0. Our objective in this chapter is to develop a numerical method which is robust when  $\Im \omega$  tends to 0, in the particular case of locally perturbed quasiperiodic media. More precisely, we solve the problem in the bounded domain  $(-a, a)$  (which is independent of  $\Im \omega$ ) by constructing transparent boundary conditions of Dirichlet-to-Neumann type:

$$\pm \mu \frac{du}{dx} + \lambda^{\pm} u = 0 \quad \text{on } x = \pm a, \quad (1.6)$$

where  $\lambda^\pm$  are called *Dirichlet-to-Neumann* (DtN) coefficients. These coefficients are given by

$$\lambda^\pm := \mp \left[ \mu \frac{du^\pm}{dx} \right] (\pm a), \quad (1.7)$$

where  $u^\pm$  is the unique solution in  $H^1(\pm a, \pm\infty)$  of

$$\begin{cases} -\frac{d}{dx} \left( \mu \frac{du^\pm}{dx} \right) - \rho \omega^2 u^\pm = 0, & \text{for } \pm x > a, \\ u^\pm(\pm a) = 1. \end{cases} \quad (1.8)$$

Knowing  $\lambda^\pm$ , one is then reduced to compute  $u|_{(-a,a)}$  by solving the problem

$$\begin{cases} -\frac{d}{dx} \left( \mu \frac{du^i}{dx} \right) - \rho \omega^2 u^i = f, & \text{for } x \in (-a, a), \\ \left[ \pm \mu \frac{du^i}{dx} + \lambda^\pm u^i \right] (\pm a) = 0. \end{cases} \quad (1.9)$$

The well-posedness of this problem is a direct consequence of the sign property

$$\Im \lambda^\pm < 0,$$

which, through a Green's formula, results itself from the presence of dissipation (1.4) in (1.8). Then the solution  $u$  of (1.1) is given by

$$\text{a. e. } x \in \mathbb{R}, \quad u(x) = \begin{cases} u^i(-a) u^-(x), & x < -a, \\ u^i(x), & x \in (-a, a), \\ u^i(a) u^+(x), & x > a. \end{cases} \quad (1.10)$$

In general, the problem is that computing  $\lambda^\pm$ , that is to say solving (1.8), is as difficult as the original problem. However, this is no longer true when the exterior medium (*i.e.* outside  $(-a, a)$ ) has a certain structure:

- if the exterior medium is homogeneous ( $\rho$  and  $\mu$  are constant), these coefficients can be computed explicitly;
- if the exterior medium is periodic ( $\rho$  and  $\mu$  are periodic), several methods for the computation of these DtN coefficients are developed in [JLF06; Fli09; KL18a];
- if the exterior medium is a weakly random perturbation of a periodic medium, the coefficients can be approximated via an asymptotic analysis; see [FG20].

Our main objective in this chapter is to compute the DtN coefficients for a quasiperiodic exterior medium, in order to develop a numerical method according to (1.8), (1.9), (1.10).

The outline of the rest of the chapter is as follows. In Section 2, we introduce the fundamental notion of quasiperiodic functions (in 1D) and define what is a locally perturbed quasiperiodic medium in the context of Problem (1.1). Sections 3 and 4 are the most important sections of the chapter. In Section 3, we link the solution of the 1D half-line problem with quasiperiodic coefficients to the solution of a degenerate directional Helmholtz equation defined in dimension  $n$ , with  $n > 1$  defined as in Section 2. This is the so-called lifting approach whose principle is presented in Section 3.1. More precisely, in

Section 3.3, we characterize the solution of the 1D quasiperiodic problem as the trace along a (broken) line of a  $n$ D problem posed in a domain with the geometry of a half-waveguide:  $(0, 1)^{n-1} \times \mathbb{R}_+$ . In between, we need to dedicate the (rather long) Section 3.2 to fix the notations used in the rest of the chapter and present some useful preliminary material about an adapted functional framework for the rigorous setting of our method. This concerns anisotropic Sobolev spaces with an emphasis on trace theorems and related Green's formula. In Section 4, we provide a method for solving the half-waveguide problem of Section 3.3. In Section 4.1, we describe the structure of the solution with the help of a propagation operator  $\mathcal{P}$  and local cell problems. In Section 4.2, we show that the operator  $\mathcal{P}$  is characterized as a particular solution of a Riccati equation. In Section 4.3, we first build a directional DtN operator  $\Lambda$  for the half-waveguide problem, from which we deduce the DtN coefficients  $\lambda^\pm$  we are looking for (cf. (1.7)). Finally, in Section 4.4, we analyze the Riccati equation from a spectral point of view and in Section 4.5 we describe the spectrum of  $\mathcal{P}$ . In Section 5 devoted to numerical results, we restrict ourselves to  $n = 2$  for the sake of simplicity. The first two subsections are devoted to the discretization of the cell problems evoked above. We have considered two approaches: one, natural but naive, consists in using 2D Lagrange finite elements (Section 5.1) while the other, called the quasi-1D method, is better fitted to the anisotropy of the problem (Section 5.2). In Section 5.3, we explain how we can construct a discrete propagation operator from a discrete Riccati equation that we choose to solve via a spectral approach, while Section 5.4 simply mimics Section 4.3 at the discrete level. Section 5.5 is devoted to numerical results. In the first three subsections, we provide various validations of our method for the half-line problem (Sections 5.5.a and 5.5.c) and the whole line problem (Section 5.5.b). At last, in Section 5.5.d, we address the question of the approximation of the spectrum of the propagation operator  $\mathcal{P}$  by the one of its discrete approximation.

**Particular notation used throughout the chapter.** In what follows,

1. the equality modulo 1 is denoted by

$$\forall y \in \mathbb{R}, \quad z = y[1] \iff z \in [0, 1) \text{ and } y - z \in \mathbb{Z}.$$

and for all  $p, q \in \mathbb{N}$ ,  $p < q$ , we set  $\llbracket p, q \rrbracket := \{j \in \mathbb{N}, p \leq j \leq q\}$ .

2. We denote  $\mathcal{C}_{per}(\mathbb{R}^n)$  as the space of continuous functions  $F : \mathbb{R}^n \rightarrow \mathbb{R}$  that are 1-periodic with respect to each variable, and  $\mathcal{C}_0^\infty(\mathcal{O})$  as the classic space of smooth functions that are compactly supported in  $\mathcal{O} \subset \mathbb{R}^n$ .
3. For  $i \in \llbracket 1, n \rrbracket$ , we denote by  $\vec{e}_i$  the  $i$ -th unit vector from the canonical basis of  $\mathbb{R}^n$ . For any element  $\mathbf{y} = (y_1, \dots, y_n)$  in  $\mathbb{R}^n$ , we define  $\hat{\mathbf{y}}$  as the vector  $(y_1, \dots, y_{n-1}) \in \mathbb{R}^{n-1}$ , so that  $\mathbf{y} = (\hat{\mathbf{y}}, y_n)$ . For  $\mathbf{y} = (y_1, \dots, y_n)$  and  $\mathbf{z} = (z_1, \dots, z_n)$ , the Euclidean inner product of  $\mathbf{y}$  and  $\mathbf{z}$  is denoted  $\mathbf{y} \cdot \mathbf{z} := y_1 z_1 + \dots + y_n z_n$ , and the associated norm is  $|\mathbf{y}| := \sqrt{\mathbf{y} \cdot \mathbf{y}}$ .

## 2 Quasiperiodicity

### 2.1 Locally perturbed quasiperiodic media

A locally perturbed quasiperiodic medium is a medium corresponding to functions  $\mu$  and  $\rho$  that satisfy (1.2) and that are quasiperiodic outside a bounded interval, which can be supposed to be  $(-a, a)$  (see

(1.3)) without any loss of generality. More precisely,

$$\mu(x) = \begin{cases} \mu_i(x) & x \in (-a, a) \\ \mu_p(x\boldsymbol{\theta}) & x \in \mathbb{R} \setminus (-a, a) \end{cases} \quad \text{and} \quad \rho(x) = \begin{cases} \rho_i(x) & x \in (-a, a) \\ \rho_p(x\boldsymbol{\theta}) & x \in \mathbb{R} \setminus (-a, a), \end{cases}$$

where the functions  $\mu_p, \rho_p$  belong to  $\mathcal{C}_{per}(\mathbb{R}^n)$  with  $n > 1$ , and  $\boldsymbol{\theta} \in \mathbb{R}^n$  is an irrational vector (see Condition II-H.2).

**Remark 2.1.** (a). Since  $\boldsymbol{\theta}$  is an irrational vector, Kronecker's theorem II-2.8 ensures that the functions  $\mu_p$  and  $\rho_p$  have the same lower and upper bounds as  $\mu$  and  $\rho$ .

(b). The present study can be extended without difficulty to the case where  $\mu$  (resp.  $\rho$ ) coincides with two different quasiperiodic functions in  $(-\infty, -a)$  and in  $(a, +\infty)$ :

$$\text{for } \pm x > a, \quad \mu(x) = \mu_p^\pm(\boldsymbol{\theta}^\pm x) \quad \text{and} \quad \rho(x) = \rho_p^\pm(\boldsymbol{\theta}^\pm x),$$

where  $\mu_p^\pm, \rho_p^\pm$  belong to  $\mathcal{C}_{per}(\mathbb{R}^{n^\pm})$  with  $n^\pm > 1$ , and where  $\boldsymbol{\theta}^\pm \in \mathbb{R}^{n^\pm}$  are irrational vectors.

### 3 The half-line quasiperiodic problems

We now focus on the half-line quasiperiodic problems (1.8). As these problems are very similar to each other, it is sufficient to study the half-line problem set on  $(a, +\infty)$  and suppose without loss of generality that  $a = 0$ . Let  $\mu_\theta := \mu_p(\boldsymbol{\theta} \cdot)$  and  $\rho_\theta := \rho_p(\boldsymbol{\theta} \cdot)$ . Therefore, the problem we consider in this section is the following:

$$\begin{cases} -\frac{d}{dx} \left( \mu_\theta \frac{du_\theta^+}{dx} \right) - \rho_\theta \omega^2 u_\theta^+ = 0, & \text{in } \mathbb{R}_+, \\ u_\theta^+(0) = 1. \end{cases} \quad (3.1)$$

**Remark 3.1.** The function  $u_\theta^+$  corresponds exactly to the solution  $u^+$  of (1.8) that was introduced in Section 1 for very general media. The reason why this solution is relabeled  $u_\theta^+$  is due to the fact that, because we consider here quasiperiodic media, the coefficients  $\mu$  and  $\rho$  that appear in (1.8) have been replaced by  $\mu_\theta$  and  $\rho_\theta$ .

#### 3.1 Lifting in a higher-dimensional periodic problem

We wish to exhibit some structure of the solution  $u_\theta^+$ . As the coefficients  $\mu_\theta$  and  $\rho_\theta$  in (3.1) are by definition traces of  $n$ -dimensional functions along the half-line  $\boldsymbol{\theta} \mathbb{R}_+$ , it is natural to seek  $u_\theta^+$  as the trace along the same line of a function  $\mathbf{y} \in \mathbb{R}^n \mapsto \tilde{U}_\theta^+(\mathbf{y})$ , that is to say:

$$\text{a. e. } x \in \mathbb{R}, \quad u_\theta^+(x) = \tilde{U}_\theta^+(\boldsymbol{\theta} x), \quad (3.2)$$

where  $\tilde{U}_\theta^+$  shall be characterized as the solution of a  $n$ -dimensional PDE (in some sense, an ‘‘augmented’’ problem in which  $\mathbf{y}$  is the augmented space variable) with periodic coefficients, as illustrated in Figure 1. This so-called *lifting approach* has been used in the homogenization setting for the analysis of some correctors in presence of periodic halfspaces [GM11; GM12] or periodic structures separated by an interface [BLL15], as well as for the homogenization of quasicrystals and Penrose tilings [BGZ10;



WGC19]. However, to our knowledge, very little seems to have been done in other contexts (such as wave propagation), and in particular for numerical analysis and simulation purposes.

To build a higher-dimensional PDE, one has to exploit the correspondence between the derivative of  $u_{\theta}^+$  and the partial derivatives of  $\tilde{U}_{\theta}^+$ : according to the chain rule, for any smooth enough function  $F : \mathbb{R}^n \rightarrow \mathbb{C}$ , one has

$$\forall x \in \mathbb{R}, \quad \frac{d}{dx}[F(\theta x)] = (D_{\theta} F)(\theta x), \quad \text{with} \quad D_{\theta} := \theta \cdot \nabla = \sum_{i=1}^n \theta_i \frac{\partial}{\partial y_i}. \quad (3.3)$$

This leads us to introduce the  $n$ -dimensional PDE set on a half-space (see Remark 3.2)

$$-D_{\theta} (\mu_p D_{\theta} \tilde{U}_{\theta}^+) - \rho_p \omega^2 \tilde{U}_{\theta}^+ = 0, \quad \text{for } y_n > 0, \quad (3.4a)$$

where we recall that the coefficients  $\mu_p, \rho_p : \mathbb{R}^n \rightarrow \mathbb{R}$  are continuous and 1-periodic with respect to each variable. In addition, the boundary condition in (3.1) can be lifted onto the inhomogeneous Dirichlet boundary condition

$$\tilde{U}_{\theta}^+ = \tilde{\varphi}, \quad \text{on } y_n = 0, \quad (3.4b)$$

where the data  $\tilde{\varphi} : \mathbb{R}^{n-1} \rightarrow \mathbb{C}$  could be chosen continuous and must satisfy  $\tilde{\varphi}(0) = 1$ , for the sake of consistency with the fact that  $u_{\theta}^+(0) = 1$ . Furthermore, to exploit the periodicity of the coefficients  $\mu_p$  and  $\rho_p$  with respect to the transverse variables  $y_j, j < n$ , we can impose the following:

$$\tilde{\varphi} \text{ is 1-periodic}, \quad (3.5)$$

so that it is natural to impose that

$$\tilde{U}_{\theta}^+(\varphi) \text{ is 1-periodic with respect to the transverse variables } y_j, j < n. \quad (3.6)$$

In Section 3.3, we show how to reduce the above to a half-guide problem with periodic coefficients. In order to do so, we shall need some preliminary materials, which is the object of the next section.

**Remark 3.2.** (a). *One could have defined the augmented problem (3.4) on other half-spaces  $\{\mathbf{y} \in \mathbb{R}^n, y_i > 0\}$ . The choice of the half-space  $\{\mathbf{y} \in \mathbb{R}^n, y_n > 0\}$  where  $y_n$  is privileged is purely arbitrary.*

(b). *At first glance, one could imagine restricting the whole study to a constant boundary data  $\tilde{\varphi} = 1$ . Though, in practice, this can be the case, the method used to solve the half-guide problem requires to investigate the structure of  $\tilde{U}_{\theta}^+(\tilde{\varphi})$  for any  $\tilde{\varphi}$  in an appropriate function space (see Remark 4.2).*

## 3.2 Preliminary material

The main objective of this section is to establish rigorously some Green's formulas that are formally obvious, such as the one of Proposition 3.9. This requires first to introduce the adapted functional framework and, since Green's formulas involve boundary integrals, to establish relevant trace theorems. Section 3.2.a is devoted to these trace theorems, while we present the corresponding Green's formulas in Section 3.2.b. Finally, Section 3.2.c highlights a simple but useful link between the derivative  $D_{\theta}$  and a single partial derivative with respect to one real variable, through a so-called oblique change of variables.

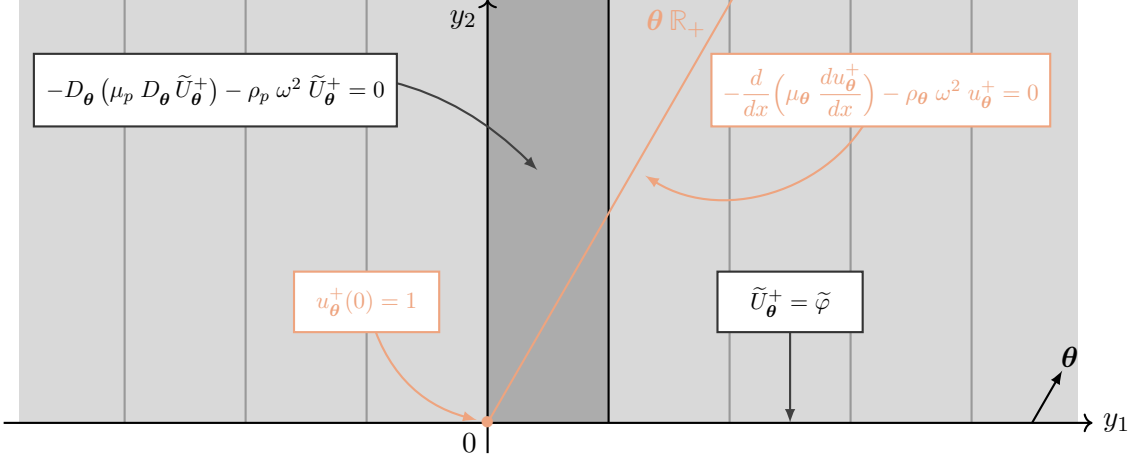
Figure 1: Illustration of the lifting approach for  $n = 2$ 

3.2.a. **Anisotropic Sobolev spaces and trace theorems.** For any open set  $\mathcal{O} \subset \mathbb{R}^n$ , let us first define the directional Sobolev space

$$H_{\theta}^1(\mathcal{O}) := \{U \in L^2(\mathcal{O}) / D_{\theta} U \in L^2(\mathcal{O})\}, \quad (3.7)$$

which is a Hilbert space, provided with the scalar product

$$(U, V)_{H_{\theta}^1(\mathcal{O})} := \int_{\mathcal{O}} (D_{\theta} U D_{\theta} \bar{V} + U \bar{V}).$$

Let us denote by  $\|\cdot\|_{H_{\theta}^1(\mathcal{O})}$  the induced norm. We begin with the following density property, whose proof can be found in [Tem68, Appendix 1].

**Proposition 3.3**

The space  $\mathcal{C}_0^{\infty}(\bar{\mathcal{O}})$  is dense in  $H_{\theta}^1(\mathcal{O})$ .

We denote the half-space  $\mathbb{R}_+^n := \{\mathbf{y} \in \mathbb{R}^n, y_n > 0\}$  and the half-cylinder  $\Omega^{\#} := (0, 1)^{n-1} \times \mathbb{R}^+$  in the following. Let us introduce also the sets, for  $a \in \{0, 1\}$  and for any integer  $i \in \llbracket 1, n \rrbracket$ ,

$$\Sigma_{i,a} := \{\mathbf{y} \in \mathbb{R}_+^n, y_i = a\} \quad \text{and} \quad \Sigma_{i,0}^{\#} := \{\mathbf{y} \in \Sigma_{i,a}, y_j \in (0, 1), j \in \llbracket 1, n-1 \rrbracket, j \neq i\}.$$

These definitions are illustrated in Figure 2 in dimensions  $n = 2$  and  $n = 3$ . Note that  $\Sigma_{n,a}^{\#}$  is bounded whereas  $\Sigma_{i,a}^{\#}$  for  $i \neq n$  is unbounded in the direction  $y_n$ . Moreover,

$$\partial\Omega^{\#} = \Sigma_{n,0}^{\#} \cup \left[ \bigcup_{i=1}^{n-1} (\bar{\Sigma}_{i,0}^{\#} \cup \bar{\Sigma}_{i,1}^{\#}) \right].$$

A trace operator can be defined from  $H_{\theta}^1(\mathbb{R}_+^n)$  on  $\Sigma_{i,a}$ . The idea for doing so is to use a one-dimensional trace theorem on the  $\theta$ -oriented line that starts from a point  $(z_1, \dots, z_{i-1}, a, z_{i+1}, \dots, z_n) \in \Sigma_{i,a}$ , to obtain an inequality which will be integrated with respect to  $z_j, j \neq i$ . The precise 1D trace theorem which will be used is the following.

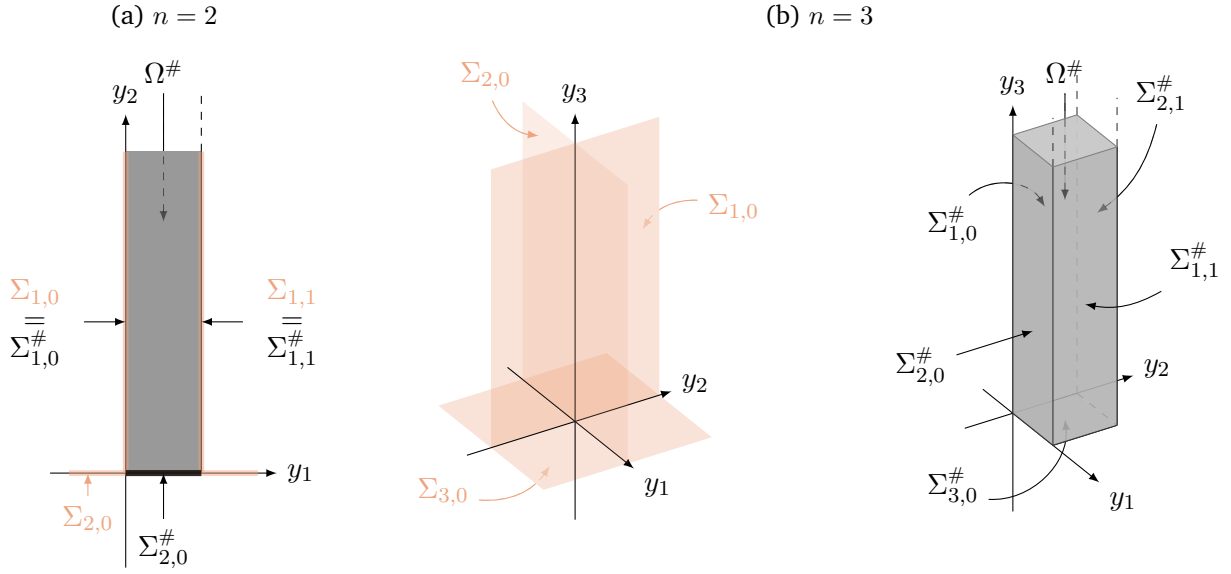

Figure 2: Domains  $\Omega^\#, \Sigma_{i,a}$  and  $\Sigma_{i,a}^\#$  for  $n = 2$  (a) and  $n = 3$  (b).

### Proposition 3.4

Let  $L \in [0, +\infty]$ . Then the mapping  $\gamma_L : u \mapsto u(0)$  is continuous from  $H^1(0, L)$  to  $\mathbb{C}$ . Moreover, the operator norm of  $\gamma_L$  is given by

$$\|\gamma_L\|^2 = \frac{e^L + e^{-L}}{e^L - e^{-L}} =: [\tanh L]^{-1} \quad \text{with} \quad \|\gamma_L\|_{L \rightarrow 0}^2 \sim L^{-1}. \quad (3.8)$$

**Proof.** The continuity property is a classical result which can be proved by density.

By definition,  $\|\gamma_L\| := \sup\{|u(0)|, \|u\|_{H^1(0,L)} = 1\}$ . This corresponds to a constrained optimization problem. Using the standard theory, this leads to introduce a Lagrange multiplier  $\lambda$  and to find a pair  $(\lambda, u_L) \in \mathbb{C} \setminus \{0\} \times H^1(0, L)$  such that  $\|u_L\|_{H^1(0,L)} = 1$  and

$$\forall v \in H^1(0, L) \quad \lambda u_L(0) \overline{v(0)} = \int_0^L \left( \frac{du_L}{dx} \frac{d\bar{v}}{dx} + u_L \bar{v} \right) dx, \quad (3.9)$$

in which case, we have  $\|\gamma_L\|^2 = \lambda$ . The explicit solution of this problem leads to the result.  $\blacksquare$

We are now able to define traces on  $\Sigma_{i,a}$  in the following sense.

### Proposition 3.5

Fix  $a \in \{0, 1\}$  and  $i \in \llbracket 1, n \rrbracket$ . The mapping  $\gamma_{i,a} : \mathcal{C}_0^\infty(\overline{\mathbb{R}_+^n}) \rightarrow \mathcal{C}_0^\infty(\Sigma_{i,a})$  defined by  $\gamma_{i,a}U = U|_{\Sigma_{i,a}}$  extends by continuity to a linear mapping still denoted  $\gamma_{i,a}$ , from  $H_\theta^1(\mathbb{R}_+^n)$  to  $L^2(\Sigma_{i,a})$ , and which satisfies the estimate

$$\forall U \in H_\theta^1(\mathbb{R}_+^n), \quad \|\gamma_{i,a}U\|_{L^2(\Sigma_{i,a})}^2 \leq \frac{1}{\theta_i} \|U\|_{H_\theta^1(\mathbb{R}_+^n)}^2. \quad (3.10)$$

**Proof.** One can simply prove the continuity estimate (3.10) for any function  $U \in \mathcal{C}_0^\infty(\overline{\mathbb{R}_+^n})$  and conclude using the density result of Proposition 3.3. Because the variable  $y_n$  plays a different role than  $y_i, i \neq n$ , the case  $i = n$  has to be distinguished from the case  $i \neq n$ .

(i) Case  $i \in \llbracket 1, n-1 \rrbracket$ : Without loss of generality, we set  $i = 1$ . Define

$$\Gamma_{1,a} := \{z = (z_2, \dots, z_n), \quad (a, z) \in \Sigma_{1,a}\} \equiv \mathbb{R}_+^{n-1}, \quad \text{where } (a, z) = (a, z_2, \dots, z_n). \quad (3.11)$$

For  $U \in \mathcal{C}_0^\infty(\overline{\mathbb{R}_+^n})$  and given any  $z = (z_2, \dots, z_n) \in \Gamma_{1,a}$ , consider the function

$$\forall x > 0, \quad u_{z,\theta}(x) := U(x\theta + (a, z)). \quad (3.12)$$

As  $u_{z,\theta}$  belongs to  $H^1(\mathbb{R}_+^*)$ , Lemma 3.4 for  $L = +\infty$  combined with an integration with respect to  $z \in \Gamma_{1,a}$  leads to

$$\int_{\Gamma_{1,a}} |u_{z,\theta}(0)|^2 dz \leq \int_{\Gamma_{1,a}} \|u_{z,\theta}\|_{H^1(\mathbb{R}_+^*)}^2 dz. \quad (3.13)$$

On the other hand, let us introduce the transformation

$$\mathbb{T} : \mathbf{y} \mapsto ((y_1 - a)/\theta_1, y_2 - (y_1 - a)\theta_2/\theta_1, \dots, y_n - (y_1 - a)\theta_n/\theta_1), \quad (3.14)$$

which defines a  $\mathcal{C}^1$ -diffeomorphism with a Jacobian determinant  $\det \mathbf{J}_{\mathbb{T}} = 1/\theta_1 \neq 0$ . Since the inverse image  $\{\mathbb{T}^{-1}(x, z), z \in \Gamma_{1,a}, x > 0\}$  is nothing but the polyhedron

$$\mathcal{Q}_{1,a} := \{\mathbf{y} \in \mathbb{R}_+^n, y_1 > a, y_n > (y_1 - a)\theta_n/\theta_1\} \subset \mathbb{R}_+^n,$$

it follows from the chain rule and from the change of variables  $\mathbf{y} \mapsto \mathbb{T} \mathbf{y}$  that

$$\frac{du_{z,\theta}}{dx}(x) = D_\theta U(x\theta + (a, z)) \quad \text{and} \quad \int_{\Gamma_{1,a}} \|u_{z,\theta}\|_{H^1(\mathbb{R}_+^*)}^2 dz = \frac{1}{\theta_1} \|U\|_{H_\theta^1(\mathcal{Q}_{1,a})}^2. \quad (3.15)$$

Finally, since  $u_{z,\theta}(0) = U(a, z_2, \dots, z_n)$ , Equations (3.13) and (3.15) imply

$$\|U\|_{L^2(\Sigma_{1,a})}^2 \leq \frac{1}{\theta_1} \|U\|_{H_\theta^1(\mathcal{Q}_{1,a})}^2 \leq \frac{1}{\theta_1} \|U\|_{H_\theta^1(\mathbb{R}_+^n)}^2, \quad (3.16)$$

which is exactly the desired estimate.

(ii) Case  $i = n$ : starting from the function  $u_{z,\theta}(x) := U(x\theta + (z, a))$  defined for  $x > 0$  and for any  $z = (z_1, \dots, z_{n-1})$  with  $(z, a) \in \Sigma_{n,a}$ , the proof uses the exact same arguments as above, except the inverse image under  $\mathbb{T}$  becomes the whole half-space  $\mathcal{Q}_{n,a} := \{\mathbf{y} \in \mathbb{R}_+^n, y_n > a\}$ . ■

The previous result does not hold in general for functions which are only  $H_\theta^1$  in sub-domains of the half-space  $\mathbb{R}_+^n$ . In particular when it comes to the half-cylinder  $\Omega^\#$ , one is led to apply the one-dimensional trace theorem on segments that become smaller in the neighbourhood of the ‘‘corners’’, i.e. the intersections of two faces (see Remark 3.7). To overcome this difficulty, let us consider the sets (see Figure 3)

$$\forall 0 < b < 1/2, \quad \Sigma_{i,a}^{\#,b} := \{\mathbf{y} \in \Sigma_{i,a}^\#, \quad \text{dist}(\mathbf{y}, \partial\Sigma_{i,a}^\#) := \inf_{z \in \partial\Sigma_{i,a}^\#} |\mathbf{y} - z| > b\}. \quad (3.17)$$

Using these domains, the traces on  $\Sigma_{i,a}^\#$  can be defined as locally integrable functions in the sense of the following proposition, which will be useful in particular for the Green’s formula in Proposition 3.11.

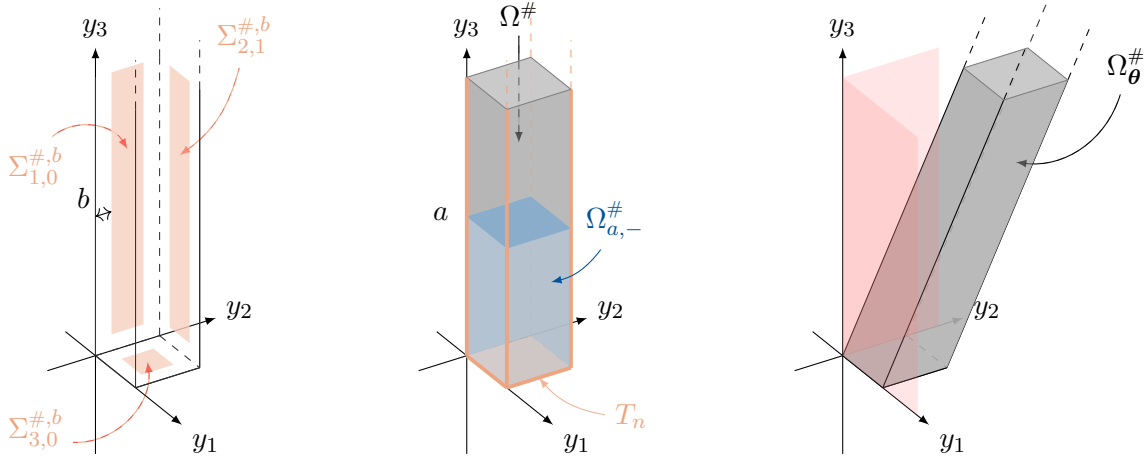

Figure 3: From left to right:  $\Sigma_{i,a}^{\#,b}$  (3.17),  $T_n$  (3.37),  $\Omega_{a,-}^{\#}$  (3.36), and  $\Omega_{\theta}^{\#}$  (3.40) represented for  $n = 3$ .

### Proposition 3.6

Let  $a \in \{0, 1\}$  and  $i \in \llbracket 1, n \rrbracket$ . The mapping  $\gamma_{i,a}^{\#} : \mathcal{C}_0^{\infty}(\overline{\Omega}^{\#}) \rightarrow \mathcal{C}_0^{\infty}(\Sigma_{i,a}^{\#})$  defined by  $\gamma_{i,a}^{\#} U = U|_{\Sigma_{i,a}^{\#}}$  extends by continuity to a linear mapping still denoted  $\gamma_{i,a}^{\#}$ , from  $H_{\theta}^1(\Omega^{\#})$  to  $L_{loc}^2(\Sigma_{i,a}^{\#})$ , and which satisfies the estimate

$$\forall 0 < b < 1/2, \quad \exists C_b > 0, \quad \forall U \in H_{\theta}^1(\Omega^{\#}), \quad \|\gamma_{i,a}^{\#} U\|_{L^2(\Sigma_{i,a}^{\#,b})}^2 \leq \frac{C_b}{\theta_i} \|U\|_{H_{\theta}^1(\Omega^{\#})}^2. \quad (3.18)$$

**Proof.** Using the density result stated in Proposition 3.3, one only has to show (3.18) for  $U \in \mathcal{C}_0^{\infty}(\overline{\Omega}^{\#})$ . Let us assume that  $i = 1$  and  $a = 0$ , the arguments in the following extending without any difficulty to  $i \in \llbracket 1, n \rrbracket$  and  $a \in \{0, 1\}$ . Define

$$\Gamma_{1,0}^{\#} := \{z = (z_2, \dots, z_n), \quad (0, z) \in \Sigma_{1,0}^{\#}\} \equiv (0, 1)^{n-1} \times \mathbb{R}_+. \quad (3.19)$$

We introduce the length function defined by

$$\forall z \in \Gamma_{1,0}^{\#}, \quad \lambda_{1,0}(z) := |\{\theta \mathbb{R} + (0, z)\} \cap \Omega^{\#}| = \sup\{x > 0, x \theta_1 \leq 1, x \theta_i + z_i \leq 1 \quad \forall i \in \llbracket 2, n-1 \rrbracket\}.$$

We deduce easily that

$$\lambda_{1,0}(z) = \min \left\{ \frac{1}{\theta_1}; \min_{2 \leq j \leq n-1} \left( \frac{1 - z_j}{\theta_j} \right) \right\}. \quad (3.20)$$

For  $U \in \mathcal{C}_0^{\infty}(\overline{\Omega}^{\#})$  and  $z \in \Gamma_{1,0}^{\#}$ , we define

$$\forall 0 < x < \lambda_{1,0}(z), \quad u_{z,\theta}(x) = U(x\theta + (0, z)). \quad (3.21)$$

Since  $u_{z,\theta} \in H^1(0, \lambda_{1,0}(z))$ , Lemma 3.4 and an integration with respect to  $z$  give

$$\int_{\Gamma_{1,0}^{\#}} w_{1,0}(z) |u_{z,\theta}(0)|^2 dz \leq \int_{\Gamma_{1,0}^{\#}} \|u_{z,\theta}\|_{H^1(0, \lambda_{1,0}(z))}^2 dz, \quad \text{with } w_{1,0}(z) = \tanh[\lambda_{1,0}(z)]. \quad (3.22)$$

On the other hand, consider the  $\mathcal{C}^1$ -diffeomorphism  $\mathbb{T}$  given by (3.14). The set  $\mathcal{Q}_{1,0}^{\#} := \{\mathbb{T}^{-1}(x, z), 0 < x < \lambda_{1,0}(z), z \in \Gamma_{1,0}^{\#}\}$  is clearly included in  $\Omega^{\#}$ . Thus, by analogy with (3.16) in the proof of

Proposition 3.5, we have from (3.21), the chain rule, and the change of variables  $\mathbf{y} \mapsto \mathbb{T} \mathbf{y}$  that

$$\int_{\Gamma_{1,0}^\#} w_{1,0}(\mathbf{z}) |U(0, \mathbf{z})|^2 d\mathbf{z} \leq \frac{1}{\theta_1} \|U\|_{H_\theta^1(\Omega^\#)}^2. \quad (3.23)$$

More generally, we have that  $\gamma_{i,a}^\#$  can be defined from  $H_\theta^1(\Omega^\#)$  to the weighted space  $L^2(\Sigma_{i,a}^\#, w_{i,a} d\mathbf{z})$ , where the weight  $w_{i,a}$  is given in (3.22) for  $i = 1$  and  $a = 0$ . Now, the expression (3.20) of  $\lambda_{1,0}$  implies that  $w_{1,0}$  degenerates at the neighbourhood of the corners  $z_j = 1$ . However, the weight  $w_{1,0}$  is bounded from below on  $\Sigma_{1,0}^{\#,b}$  with

$$\inf_{(0,\mathbf{z}) \in \Sigma_{1,0}^{\#,b}} w_{1,0}(\mathbf{z}) = \tanh \left[ \min \left\{ \frac{1}{\theta_1}; b \min_{2 \leq j \leq n-1} \frac{1}{\theta_j} \right\} \right] > 0. \quad (3.24)$$

If we set  $C_b := [\inf_{(0,\mathbf{z}) \in \Sigma_{1,0}^{\#,b}} w_{1,0}(\mathbf{z})]^{-1} > 0$ , then (3.18) follows directly from (3.23) by integrating with respect to  $\{\mathbf{z}, (0, \mathbf{z}) \in \Sigma_{1,0}^{\#,b}\}$ , instead of  $\Gamma_{1,0}^\#$ . ■

**Remark 3.7.** *The best constant in the previous proposition necessarily blows up when  $b$  tends to 0. The above proof shows that traces could be defined on the whole faces in appropriate weighted  $L^2$ -spaces. More details about traces in anisotropic spaces can be found in [Jol92].*

**3.2.b. Green's formulas.** Let us now define the set  $H_{\theta,\text{loc}}^1(\mathbb{R}_+^n)$  of functions which are  $H_\theta^1$  in any half-cylinder  $S \times \mathbb{R}_+$  where  $S$  is a bounded open set in  $\mathbb{R}^{n-1}$ . More rigorously, we define for any  $\varphi \in \mathcal{C}_0^\infty(\mathbb{R}^{n-1})$  the  $n$ -dimensional function  $\check{\varphi} \in \mathcal{C}^\infty(\mathbb{R}^n)$  such that

$$\check{\varphi}(y_1, \dots, y_{n-1}, y_n) := \varphi(y_1, \dots, y_{n-1}). \quad (3.25)$$

Note that for any  $U \in L_{\text{loc}}^2(\mathbb{R}_+^n)$ , the support of  $\check{\varphi}U$  is bounded in the directions  $y_j$ ,  $j \neq n$ . Starting from this remark, we define

$$H_{\theta,\text{loc}}^1(\mathbb{R}_+^n) := \left\{ U \in L_{\text{loc}}^2(\mathbb{R}_+^n), \check{\varphi}U \in H_\theta^1(\mathbb{R}_+^n) \forall \varphi \in \mathcal{C}_0^\infty(\mathbb{R}^{n-1}) \right\}. \quad (3.26)$$

Let us introduce a 1D cut-off function  $\chi \in \mathcal{C}_0^\infty(\mathbb{R})$  such that  $\chi = 1$  on  $(0, 1)$ , from which we define  $\check{\chi}_\# \in \mathcal{C}_0^\infty(\mathbb{R}^n)$  as

$$\check{\chi}_\#(y_1, \dots, y_{n-1}, y_n) := \chi(y_1) \dots \chi(y_{n-1}). \quad (3.27)$$

We have in particular that

$$\forall U \in H_{\theta,\text{loc}}^1(\mathbb{R}_+^n), \quad U|_{\Omega^\#} = (\check{\chi}_\# U)|_{\Omega^\#} \in H_\theta^1(\Omega^\#). \quad (3.28)$$

Thanks to this and Proposition 3.5, it is obvious that we can define without any ambiguity the trace map  $\gamma_{i,a}^\#$  to  $H_{\theta,\text{loc}}^1(\mathbb{R}_+^n)$  as follows

$$\forall U \in H_{\theta,\text{loc}}^1(\mathbb{R}_+^n), \quad \gamma_{i,a}^\# U := \gamma_{i,a}(\check{\chi}_\# U)|_{\Sigma_{i,a}^\#} \in L^2(\Sigma_{i,a}^\#). \quad (3.29)$$

For simplicity, when considering traces on  $\Sigma_{i,a}^\#$ , we shall write  $U$  instead of  $\gamma_{i,a}^\# U$ . We can now state the following Green's formula.

**Proposition 3.8**

For any  $U, V \in H_{\theta, \text{loc}}^1(\mathbb{R}_+^n)$ , we have the Green's formula

$$\int_{\Omega^\#} (D_\theta U \bar{V} + U D_\theta \bar{V}) \, d\mathbf{y} = \frac{1}{\theta_n} \int_{\Sigma_{n,0}^\#} U \bar{V} \, ds + \sum_{i=1}^{n-1} \frac{1}{\theta_i} \left( \int_{\Sigma_{i,1}^\#} U \bar{V} \, ds - \int_{\Sigma_{i,0}^\#} U \bar{V} \, ds \right). \quad (3.30)$$

**Proof.** Let  $U, V \in H_{\theta, \text{loc}}^1(\mathbb{R}_+^n)$ . By definition, for any  $\chi \in \mathcal{C}_0^\infty(\mathbb{R})$  such that  $\chi = 1$  on  $(0, 1)$ , the functions  $\check{\chi}_\# U$  and  $\check{\chi}_\# V$  belong to  $H_\theta^1(\mathbb{R}_+^n)$ , where  $\check{\chi}_\#$  is defined in (3.27). Since Proposition 3.3 ensures that  $\mathcal{C}_0^\infty(\mathbb{R}_+^n)$  is dense in  $H_\theta^1(\mathbb{R}_+^n)$ , there exist two sequences  $(U_k)_{k \in \mathbb{N}}, (V_k)_{k \in \mathbb{N}}$  of functions in  $\mathcal{C}_0^\infty(\mathbb{R}_+^n)$ , such that

$$U_k \rightarrow \check{\chi}_\# U \quad \text{and} \quad V_k \rightarrow \check{\chi}_\# V \quad \text{in} \quad H_\theta^1(\mathbb{R}_+^n), \quad k \rightarrow +\infty.$$

It follows from the usual Green's formula for smooth functions that  $U_k$  and  $V_k$  satisfy (3.30) for any  $k \in \mathbb{N}$ . Passing to the limit and using the trace continuity result stated in Proposition 3.5 imply that (3.30) is satisfied by  $\check{\chi}_\# U$  and  $\check{\chi}_\# V$ , i.e. by  $U$  and  $V$ , since  $\check{\chi}_\# = 1$  in  $\Omega^\#$ . ■

We next focus on functions which are periodic with respect to their  $(n - 1)$  first variables. More precisely, for any  $U \in L^2(\Omega^\#)$  and any  $\varphi \in L^2(\Sigma_{n,0}^\#)$ , we introduce the respective periodic extensions  $\tilde{U} \in L_{\text{loc}}^2(\mathbb{R}_+^n)$  and  $\tilde{\varphi} \in L_{\text{loc}}^2(\Sigma_{n,0})$  as defined for any  $i \in \llbracket 1, n - 1 \rrbracket$  by

$$\begin{cases} \text{a. e. } \mathbf{y} \in \mathbb{R}_+^n, & \tilde{U}(\mathbf{y} + \vec{e}_i) = \tilde{U}(\mathbf{y}) \quad \text{and} \quad \tilde{U}|_{\Omega^\#} = U. \\ \text{a. e. } \mathbf{s} \in \Sigma_{n,0}, & \tilde{\varphi}(\mathbf{s} + \vec{e}_i) = \tilde{\varphi}(\mathbf{s}) \quad \text{and} \quad \tilde{\varphi}|_{\Sigma_{n,0}^\#} = \varphi. \end{cases} \quad (3.31)$$

An appropriate functional framework is provided by the space

$$H_{\theta, \text{per}}^1(\Omega^\#) = \left\{ U \in L^2(\Omega^\#), \tilde{U} \in H_{\theta, \text{loc}}^1(\mathbb{R}_+^n) \right\} \subset H_\theta^1(\Omega^\#), \quad (3.32)$$

where the inclusion follows from (3.28) and (3.31). Note that for any  $U \in H_{\theta, \text{per}}^1(\Omega^\#)$ , as the periodic extension  $\tilde{U}$  belongs to  $H_{\theta, \text{loc}}^1(\mathbb{R}_+^n)$ , the trace of  $U$  on  $\Sigma_{i,a}^\#$  is well-defined in  $L^2$  thanks to (3.29). Moreover, using the continuity estimate (3.10) for  $\check{\chi}_\# U$ , we have

$$\gamma_{i,a}^\# \in \mathcal{L}(H_{\theta, \text{per}}^1(\Omega^\#), L^2(\Sigma_{i,a}^\#)). \quad (3.33)$$

In addition, one can show the following characterization:

$$H_{\theta, \text{per}}^1(\Omega^\#) = \left\{ U \in H_\theta^1(\Omega^\#), \quad \gamma_{i,0}^\# U = \gamma_{i,1}^\# U \quad \forall i \in \llbracket 1, n - 1 \rrbracket \right\}, \quad (3.34)$$

where the traces of functions in  $H_\theta^1(\Omega^\#)$  are defined in Proposition 3.6 and the equality of traces has to be understood up to the identification of functions on  $\Sigma_{i,0}^\#$  and  $\Sigma_{i,1}^\#$ . It is clear from (3.34) that  $H_{\theta, \text{per}}^1(\Omega^\#)$  is a closed subspace of  $H_\theta^1(\Omega^\#)$ , thus it is an Hilbert space when equipped with the norm of  $H_\theta^1(\Omega^\#)$ . From Proposition 3.8 and (3.34), we deduce the Green's formula on  $H_{\theta, \text{per}}^1(\Omega^\#)$ .

**Proposition 3.9**

For any  $U, V \in H_{\theta, \text{per}}^1(\Omega^\#)$ , we have the Green's formula

$$\int_{\Omega^\#} (D_\theta U \bar{V} + U D_\theta \bar{V}) d\mathbf{y} = \frac{1}{\theta_n} \int_{\Sigma_{n,0}^\#} U \bar{V} ds. \quad (3.35)$$

From the Green's formula (3.35), we can easily deduce the following result.

**Corollary 3.10**

Let  $a > 0$ , and define the sets with common boundary  $\Sigma_{n,a}^\#$  (see Figure 3):

$$\Omega_{a,+}^\# := \Omega^\# \cap \{y_n > a\} \quad \text{and} \quad \Omega_{a,-}^\# := \Omega^\# \cap \{y_n < a\}. \quad (3.36)$$

Consider a function  $U \in L^2(\Omega^\#)$  such that  $U_\pm := U|_{\Omega_{a,\pm}^\#} \in H_{\theta, \text{per}}^1(\Omega_{a,\pm}^\#)$ , where  $H_{\theta, \text{per}}^1(\Omega_{a,\pm}^\#)$  is defined as in (3.34). Then

$$U \in H_{\theta, \text{per}}^1(\Omega^\#) \iff \gamma_{n,a}^\# U_+ = \gamma_{n,a}^\# U_-.$$

We finish this section with a more technical Green's formula, used in the proof of Proposition 3.16, involving functions  $U$  that only belong to  $H_\theta^1(\Omega^\#)$ , provided that the test function  $V$  vanishes in the neighborhood of the skeleton  $T_n$  defined by

$$T_2 = \bar{\Sigma}_{2,0}^\# \quad \text{and} \quad T_n = \bar{\Sigma}_{n,0}^\# \cup \left[ \bigcup_{j=1}^{n-1} (\partial \Sigma_{j,0}^\# \cup \partial \Sigma_{j,1}^\#) \right] \quad \text{for } n \geq 3. \quad (3.37)$$

This domain is represented in Figure 3 for  $n = 3$ .

**Proposition 3.11**

For  $U \in H_\theta^1(\Omega^\#)$  and  $V \in \mathcal{C}_0^\infty(\bar{\Omega}^\# \setminus T_n)$ , the Green's formula (3.30) still holds.

**Proof.** Consider  $U \in H_\theta^1(\Omega^\#)$  and  $V \in \mathcal{C}_0^\infty(\bar{\Omega}^\# \setminus T_n)$ . Since by Proposition 3.3,  $\mathcal{C}_0^\infty(\bar{\Omega}^\#)$  is dense in  $H_\theta^1(\Omega^\#)$ , there exists a sequence  $(U_k)_{k \in \mathbb{N}}$  of functions in  $\mathcal{C}_0^\infty(\bar{\Omega}^\#)$  which tends to  $U$ . It follows from Green's formula in  $\Omega^\#$  for smooth functions that  $U_k$  and  $V$  satisfy (3.30) for any  $k \in \mathbb{N}$ . For  $0 < b < 1/2$ , let  $\Omega^{\#,b}$  be the domain

$$\Omega^{\#,b} = \{\mathbf{y} \in \Omega^\#, \quad \text{dist}(\mathbf{y}, T_n) := \inf_{\mathbf{z} \in T_n} |\mathbf{y} - \mathbf{z}| > b\}. \quad (3.38)$$

Since  $V \in \mathcal{C}_0^\infty(\bar{\Omega}^\# \setminus T_n)$ , there exists a real number  $0 < b < 1/2$  such that  $V|_{\Omega^{\#,b}} \in \mathcal{C}_0^\infty(\bar{\Omega}^{\#,b})$ . Consequently, for any  $i \in \llbracket 1, n-1 \rrbracket$ , the surface integral on  $\Sigma_{i,a}^\#$  is reduced to the set  $\Sigma_{i,a}^{\#,b}$  defined by (3.17). When  $k$  tends to  $+\infty$ , we can then use the trace continuity result stated in Proposition 3.6 on  $\Sigma_{i,a}^{\#,b}$ , to deduce that (3.30) is satisfied by  $U$  and  $V$ . ■

**3.2.c. An oblique change of variables.** Before stating Proposition 3.13 which is the main result of this section, let us introduce the change of variables in  $\mathbb{R}_+^n$ :

$$(s, x) \in \mathbb{R}_+^n \mapsto \mathbf{y} = (s, 0) + x \boldsymbol{\theta} \in \mathbb{R}_+^n, \quad (3.39)$$



and denote by  $\Omega_\theta^\#$  the image of  $\Omega^\#$  by the above transformation:

$$\Omega_\theta^\# := \{(s, 0) + \theta x, \quad s \in (0, 1)^{n-1}, \quad x > 0\}. \quad (3.40)$$

This is illustrated in Figure 3 for  $n = 3$  and in Figure 4 for  $n = 2$  and  $|\theta| = 1$ . The following easy lemma will be used in the sequel.

**Lemma 3.12**

For any  $V \in L^1(\Omega^\#)$ , we have

$$\int_{\Omega_\theta^\#} \tilde{V}(\mathbf{y}) \, d\mathbf{y} = \int_{\Omega^\#} \tilde{V}(\mathbf{y}) \, d\mathbf{y}, \quad (3.41)$$

where  $\tilde{V} \in L^1_{loc}(\mathbb{R}_+^n)$  denotes the periodic extension of  $V$ , defined by (3.31).

**Proof.** We will use the notation  $\mathbf{k} = (k_1, \dots, k_d) \in \mathbb{Z}^d$  for a vector of integers. For any set  $\mathcal{O} \subset \mathbb{R}^n$ , let  $\mathbb{1}_{\mathcal{O}}$  be the indicator function of  $\mathcal{O}$ . By density of  $\mathcal{C}_0^\infty(\Omega^\#)$  in  $L^1(\Omega^\#)$ , it suffices to prove (3.41) for  $V \in \mathcal{C}_0^\infty(\Omega^\#)$ . By additivity of integration,

$$\int_{\Omega_\theta^\#} \tilde{V}(\mathbf{y}) \, d\mathbf{y} = \int_{\mathbb{R}_+^n} \mathbb{1}_{\Omega_\theta^\#}(\mathbf{y}) \tilde{V}(\mathbf{y}) \, d\mathbf{y} = \sum_{\mathbf{k} \in \mathbb{Z}^{n-1}} \int_{\Omega^\# + (\mathbf{k}, 0)} \mathbb{1}_{\Omega_\theta^\#}(\mathbf{y}) \tilde{V}(\mathbf{y}) \, d\mathbf{y},$$

where the sum over  $\mathbf{k} \in \mathbb{Z}^{n-1}$  is finite because  $V$  is compactly supported. The change of variables  $z \mapsto z + (\mathbf{k}, 0)$  then leads to

$$\begin{aligned} \int_{\Omega_\theta^\#} \tilde{V}(\mathbf{y}) \, d\mathbf{y} &= \sum_{\mathbf{k} \in \mathbb{Z}^{n-1}} \int_{\Omega^\#} \mathbb{1}_{\Omega_\theta^\#}(z + (\mathbf{k}, 0)) \tilde{V}(z) \, dz \quad \text{because } \tilde{V} \text{ is periodic} \\ &= \int_{\Omega^\#} \left[ \sum_{\mathbf{k} \in \mathbb{Z}^{n-1}} \mathbb{1}_{\Omega_\theta^\# - (\mathbf{k}, 0)}(z) \right] \tilde{V}(z) \, dz, \end{aligned} \quad (3.42)$$

where we used the fact that  $\mathbb{1}_{\Omega_\theta^\#}(z + (\mathbf{k}, 0)) = \mathbb{1}_{\Omega_\theta^\# - (\mathbf{k}, 0)}(z)$ . Furthermore, by noticing that the collection of sets  $\{\Omega_\theta^\# - (\mathbf{k}, 0), \quad \mathbf{k} \in \mathbb{Z}^{n-1}\}$  forms a partition of  $\mathbb{R}_+^n$ , it follows that

$$\forall z \in \Omega^\#, \quad \sum_{\mathbf{k} \in \mathbb{Z}^{n-1}} \mathbb{1}_{\Omega_\theta^\# - (\mathbf{k}, 0)}(z) = \mathbb{1}_{\mathbb{R}_+^n}(z) = 1. \quad (3.43)$$

Combining (3.42) and (3.43) implies that (3.41) is satisfied for  $V \in \mathcal{C}_0^\infty(\Omega^\#)$ . ■

The inversion of the change of variables (3.39) leads us to introduce:

$$\forall \mathbf{y} \in \mathbb{R}^n, \quad \mathbf{s}_\theta(\mathbf{y}) := \hat{\mathbf{y}} - (y_n/\theta_n) \hat{\boldsymbol{\theta}} \in \mathbb{R}^{n-1}, \quad (3.44)$$

so that,

$$\mathbf{y} = (s, 0) + x \boldsymbol{\theta} \iff s = \mathbf{s}_\theta(\mathbf{y}) \quad \text{and} \quad x = y_n/\theta_n. \quad (3.45)$$

The next proposition emphasizes the fact that through the change of variables (3.39), the differential operator  $D_\theta$  simply becomes the partial derivative (in the sense of distributions) with respect to  $y_n$  (which is obvious for smooth functions).

**Proposition 3.13**

Let  $\Psi \in L^2(\Omega^\#)$ . The function  $\Psi_\theta$  whose periodic extension is given by

$$\text{a. e. } \mathbf{y} \in \mathbb{R}_+^n, \quad \tilde{\Psi}_\theta(\mathbf{y}) := \tilde{\Psi}(\mathbf{s}_\theta(\mathbf{y}), y_n/\theta_n), \quad (3.46)$$

belongs to  $L^2(\Omega^\#)$  and

$$\|\Psi_\theta\|_{L^2(\Omega^\#)} = \sqrt{\theta_n} \|\Psi\|_{L^2(\Omega^\#)}. \quad (3.47)$$

Moreover, if  $\partial_{y_n} \Psi \in L^2(\Omega^\#)$ , then  $\Psi_\theta$  belongs to  $H_{\theta, \text{per}}^1(\Omega^\#)$  with directional derivative

$$\text{a. e. } \mathbf{y} \in \mathbb{R}_+^n, \quad D_\theta \tilde{\Psi}_\theta(\mathbf{y}) = \frac{\partial \tilde{\Psi}}{\partial y_n}(\mathbf{s}_\theta(\mathbf{y}), y_n/\theta_n). \quad (3.48)$$

**Proof.** The map  $(s, x) \mapsto (s, 0) + x\theta$  from  $\Sigma_{n,0}^\# \times \mathbb{R}_+$  to  $\Omega_\theta^\#$  defines a  $\mathcal{C}^1$ -diffeomorphism with a non-vanishing Jacobian  $\theta_n \neq 0$ . Therefore, by using the definition (3.40) of  $\Omega_\theta^\#$ , the change of variables  $(s, x) \mapsto (s, 0) + x\theta$ , and the property  $\mathbf{s}_\theta((s, 0) + x\theta) = \mathbf{s}$ , we obtain that

$$\int_{\Omega_\theta^\#} |\tilde{\Psi}_\theta(\mathbf{y})|^2 d\mathbf{y} = \theta_n \int_{\Sigma_{n,0}^\#} \int_0^{+\infty} |\tilde{\Psi}_\theta((s, 0) + x\theta)|^2 dx ds = \theta_n \int_{\Sigma_{n,0}^\#} \int_0^{+\infty} |\tilde{\Psi}(s, x)|^2 dx ds.$$

We deduce from Lemma 3.12 that  $\Psi_\theta \in L^2(\Omega^\#)$ , and that (3.47) holds.

Now in order to derive the expression of  $D_\theta \tilde{\Psi}_\theta$  in the sense of distributions, consider a test function  $\Phi \in \mathcal{C}_0^\infty(\mathbb{R}_+^n)$ . The change of variables  $(s, x) \mapsto (s, 0) + x\theta$  combined with Fubini's theorem for integrable functions leads to

$$\int_{\mathbb{R}_+^n} \tilde{\Psi}_\theta(\mathbf{y}) D_\theta \Phi(\mathbf{y}) d\mathbf{y} = \theta_n \int_{\mathbb{R}^{n-1}} \int_0^{+\infty} \tilde{\Psi}(s, x) D_\theta \Phi((s, 0) + \theta x) dx ds. \quad (3.49)$$

Furthermore the 1D function  $\phi_{s,\theta}$  defined by  $\phi_{s,\theta}(x) := \Phi((s, 0) + \theta x)$  belongs to  $\mathcal{C}_0^\infty(\mathbb{R}_+)$  and we have  $[d\phi_{s,\theta}/dx](x) = D_\theta \Phi((s, 0) + \theta x)$  from the chain rule. Since  $\partial_{y_n} \Psi$  is in  $L^2$ , we can integrate by parts the inner integral in (3.49) to obtain

$$\begin{aligned} \int_{\mathbb{R}_+^n} \tilde{\Psi}_\theta(\mathbf{y}) D_\theta \Phi(\mathbf{y}) d\mathbf{y} &= -\theta_n \int_{\mathbb{R}^{n-1}} \int_0^{+\infty} \frac{\partial \Psi}{\partial y_n}(s, x) \phi_{s,\theta}(x) dx ds \\ &= - \int_{\mathbb{R}_+^n} \frac{\partial \Psi}{\partial y_n}(\mathbf{s}_\theta(\mathbf{y}), y_n/\theta_n) \Phi(\mathbf{y}) d\mathbf{y}, \end{aligned} \quad (3.50)$$

where the last equality comes from the change of variables  $\mathbf{y} \mapsto (\mathbf{s}_\theta(\mathbf{y}), y_n/\theta_n)$ . This gives the expression of  $D_\theta \tilde{\Psi}_\theta$  in (3.48) in the sense of distributions.  $\blacksquare$

**Remark 3.14.** It will be often useful to use (3.48) in the form

$$\text{a. e. } (s, x) \in \mathbb{R}_+^n, \quad D_\theta \tilde{\Psi}_\theta((s, 0) + x\theta) = \frac{\partial \tilde{\Psi}}{\partial y_n}(s, x). \quad (3.51)$$

The previous proposition allows in particular to deduce the surjectivity of the trace operator from  $H_{\theta, \text{per}}^1(\Omega^\#)$  to  $L^2(\Sigma_{n,0}^\#)$ .

**Corollary 3.15**

Let  $\varphi \in L^2(\Sigma_{n,0}^\#)$ , and  $\psi \in H^1(\mathbb{R}_+)$  such that  $\psi(0) = 1$ . Then the periodic function defined by

$$\text{a. e. } \mathbf{y} \in \mathbb{R}_+^n, \quad \mathcal{R}\varphi(\mathbf{y}) := \tilde{\varphi}(s_\theta(\mathbf{y})) \psi(y_n/\theta_n) \quad (3.52)$$

belongs to  $H_{\theta,per}^1(\Omega^\#)$ , and its trace is  $\mathcal{R}\varphi|_{\Sigma_{n,0}^\#} = \varphi$ . Moreover,  $\mathcal{R}$  defines a continuous map from  $L^2(\Sigma_{n,0}^\#)$  to  $H_{\theta,per}^1(\Omega^\#)$ .

**3.3 Link with a periodic half-guide problem**

For any boundary data  $\varphi \in L^2(\Sigma_{n,0}^\#)$ , we can now introduce  $U_\theta^+$  as the solution in  $H_\theta^1(\Omega^\#)$  of the half-guide problem

$$\left\{ \begin{array}{l} -D_\theta(\mu_p D_\theta U_\theta^+) - \rho_p \omega^2 U_\theta^+ = 0, \quad \text{in } \Omega^\#, \\ U_\theta^+|_{\Sigma_{n,0}^\#} = \varphi, \\ U_\theta^+|_{\Sigma_{i,0}^\#} = U_\theta^+|_{\Sigma_{i,1}^\#} \quad \forall i \in \llbracket 1, n-1 \rrbracket, \\ \mu_p D_\theta U_\theta^+|_{\Sigma_{i,0}^\#} = \mu_p D_\theta U_\theta^+|_{\Sigma_{i,1}^\#} \quad \forall i \in \llbracket 1, n-1 \rrbracket. \end{array} \right. \quad (3.53)$$

Note that the third equation in this problem implies that  $U_\theta^+ \in H_{\theta,per}^1(\Omega^\#)$ , the first one implies that  $\mu_p D_\theta U_\theta^+ \in H_\theta^1(\Omega^\#)$ , and finally the fourth one implies that  $\mu_p D_\theta U_\theta^+ \in H_{\theta,per}^1(\Omega^\#)$ , according to (3.34). The space of the boundary data can seem surprising compared to the Helmholtz equation with an elliptic principal part, but recall from Corollary 3.15 that the trace mapping on  $\Sigma_{n,0}^\#$  is surjective from  $H_{\theta,per}^1(\Omega^\#)$  to  $L^2(\Sigma_{n,0}^\#)$ .

With the functional framework introduced in the previous section, we can now show that Problem (3.53) is well-posed.

**Proposition 3.16**

For any  $\varphi \in L^2(\Sigma_{n,0}^\#)$ , (3.53) is equivalent to

$$\left\{ \begin{array}{l} \text{Find } U_\theta^+ \in H_{\theta,per}^1(\Omega^\#), \quad U_\theta^+|_{\Sigma_{n,0}^\#} = \varphi \\ \forall V \in H_{\theta,per}^1(\Omega^\#), \quad V|_{\Sigma_{n,0}^\#} = 0, \quad \int_{\Omega^\#} (\mu_p D_\theta U_\theta^+ D_\theta \bar{V} - \rho_p \omega^2 U_\theta^+ \bar{V}) = 0, \end{array} \right. \quad (3.54)$$

for which Lax-Milgram's theorem applies.

**Proof.** The variational formulation (3.54) is obtained by multiplying the first equation of (3.53) by  $V \in H_{\theta,per}^1(\Omega^\#)$ , and by using Green's formula (3.35). The application of the Lax-Milgram's theorem in  $\{V \in H_{\theta,per}^1(\Omega^\#), \gamma_{n,0}V = 0\}$  is direct, thanks to the surjectivity result in Corollary 3.15.

For the equivalence, as usual, one picks test functions  $V \in \mathcal{C}_0^\infty(\Omega^\#)$  to deduce that the solution  $U_\theta^+ \in H_{\theta,per}^1(\Omega^\#)$  of (3.54) satisfies the first equation of (3.53). This implies that  $\mu_p D_\theta U_\theta^+ \in H_\theta^1(\Omega^\#)$ . The real difficulty is to show that  $U_\theta^+$  satisfies the fourth equation in (3.53) or equivalently that

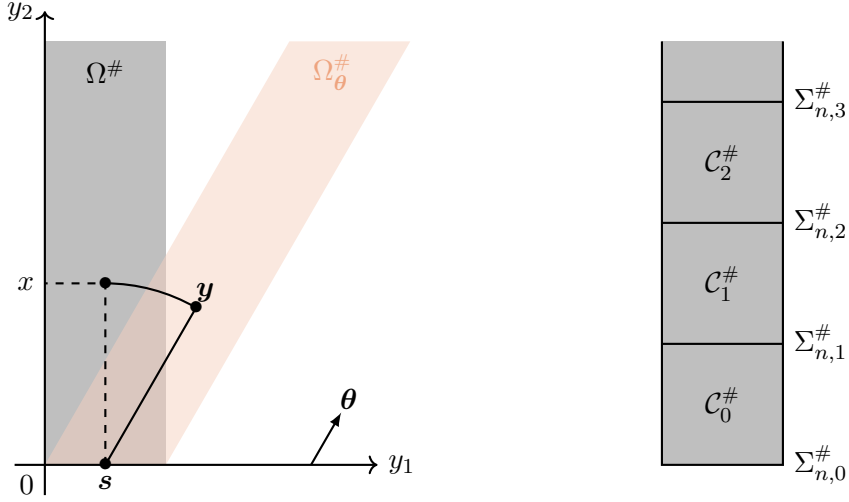

Figure 4: The half-cylinders  $\Omega^\#$  and  $\Omega_\theta^\#$  (left), and the domains  $\mathcal{C}_\ell^\#$  and  $\Sigma_{n,k}^\#$  (right) for  $n = 2$

$\mu_p D_\theta U_\theta^+ \in H_{\theta,per}^1(\Omega^\#)$ . According to Proposition 3.6, we have

$$\forall 1 \leq i \leq n-1, \quad \mu_p D_\theta U_\theta^+|_{\Sigma_{i,a}^\#} \in L_{loc}^2(\Sigma_{i,a}^\#).$$

Therefore, Proposition 3.11 allows us to use Green's formula (3.30) for  $U = \mu_p D_\theta U_\theta^+$  and for  $V \in \mathcal{C}_0^\infty(\overline{\Omega^\#} \setminus T_n) \cap H_{\theta,per}^1(\Omega^\#)$ , where  $T_n$  is the skeleton defined in (3.37). By combining this with the fact that  $U_\theta^+$  solves (3.54) and the first equation of (3.53), one obtains that for any integer  $i \in \llbracket 1, n-1 \rrbracket$ ,

$$\forall V \in \mathcal{C}_0^\infty(\overline{\Omega^\#} \setminus T_n) \cap H_{\theta,per}^1(\Omega^\#), \quad \left( \int_{\Sigma_{i,1}^\#} \mu_p D_\theta U_\theta^+ \bar{V} ds - \int_{\Sigma_{i,0}^\#} \mu_p D_\theta U_\theta^+ \bar{V} ds \right) = 0.$$

Furthermore,  $\mathcal{C}_0^\infty(\Sigma_{i,0}^\#)$  is included in  $\{V|_{\Sigma_{i,0}^\#}, V \in \mathcal{C}_0^\infty(\overline{\Omega^\#} \setminus T_n) \cap H_{\theta,per}^1(\Omega^\#)\}$ . In fact, any  $\psi \in \mathcal{C}_0^\infty(\Sigma_{i,0}^\#)$  admits the extension  $\Psi : \mathbf{y} \in \Omega^\# \mapsto \psi(y_1, \dots, y_{i-1}, y_{i+1}, \dots, y_n)$ , which belongs to  $\mathcal{C}_0^\infty(\overline{\Omega^\#} \setminus T_n) \cap H_{\theta,per}^1(\Omega^\#)$ . Finally, since  $\mathcal{C}_0^\infty(\Sigma_{i,0}^\#)$  is dense in  $L^2(\Sigma_{i,0}^\#)$ , it is easy to show that the fourth equation of (3.53) holds and that  $\mu_p D_\theta U_\theta^+|_{\Sigma_{i,1}^\#} \in L^2(\Sigma_{i,1}^\#)$  for any  $i \in \llbracket 1, n-1 \rrbracket$ . ■

We now make the link between  $U_\theta^+(\varphi)$  and the solution of the half-line problem (3.1) that fully justifies the introduction of the half-guide problem (3.53).

To do so, first, let us introduce the one-dimensional functions defined for any  $s \in \mathbb{R}^{n-1}$  by

$$\forall x \in \mathbb{R}, \quad \mu_{s,\theta}(x) := \mu_p((s, 0) + \theta x) \quad \text{and} \quad \rho_{s,\theta}(x) := \rho_p((s, 0) + \theta x), \quad (3.55)$$

as well as the one-dimensional problems

$$\left| \begin{array}{l} -\frac{d}{dx} \left( \mu_{s,\theta} \frac{du_{s,\theta}^+}{dx} \right) - \rho_{s,\theta} \omega^2 u_{s,\theta}^+ = 0, \quad \text{in } \mathbb{R}_+, \\ u_{s,\theta}^+(0) = 1. \end{array} \right. \quad (3.56)$$

Note that (3.1) corresponds to (3.56) taken with  $s = 0$ .

As for the problem (3.1) satisfied by  $u_\theta^+$ , under the assumptions (1.2) and (1.4), Problem (3.56) admits a unique solution  $u_{s,\theta}^+$  in  $H^1(\mathbb{R}_+)$  for any  $s \in \mathbb{R}^{n-1}$ . Moreover,  $u_{s,\theta}^+$  decays exponentially at

infinity, uniformly with respect to  $s$ , that is, there exist constants  $\alpha, c > 0$  depending only on  $\mu_{\pm}, \rho_{\pm}$  such that

$$\forall s \in \mathbb{R}^{n-1}, \quad \left\| e^{-\alpha \Im \omega x} u_{s,\theta}^+ \right\|_{H^1(\mathbb{R}^+)} \leq c. \quad (3.57)$$

Furthermore, thanks to the continuity of  $\mu_p$  and  $\rho_p$ , we can show that  $u_{s,\theta}^+$  is continuous with respect to  $s$ , as stated in the next proposition.

**Proposition 3.17**

*The mapping  $s \in \mathbb{R}^{n-1} \mapsto u_{s,\theta}^+$ , which associates with a real vector  $s$  the solution in  $H^1(\mathbb{R}_+)$  of Problem (3.56), defines a uniformly continuous function which is periodic of period 1 in each direction.*

**Proof.** To show that  $s \mapsto u_{s,\theta}^+$  is 1-periodic in each direction, one simply has to note that since  $\mu_{s,\theta}$  and  $\rho_{s,\theta}$  are 1-periodic with respect to each  $s_i$ , both  $u_{s,\theta}^+$  and  $u_{s+\vec{e}_i,\theta}^+$  satisfy the same half-line problem (3.56). Thus, by well-posedness of (3.56),  $u_{s,\theta}^+ = u_{s+\vec{e}_i,\theta}^+$ .

Now let us prove the regularity of  $s \mapsto u_{s,\theta}^+$ . For any  $s_1, s_2 \in \mathbb{R}^{n-1}$ , by writing the variational formulations satisfied by  $u_{s_1,\theta}^+$  and  $u_{s_2,\theta}^+$ , and by subtracting one from the other, we obtain

$$\begin{aligned} \forall v \in H_0^1(\mathbb{R}_+), \quad \int_{\mathbb{R}_+} \left[ \mu_{s_1,\theta} \frac{d}{dx} (u_{s_1,\theta}^+ - u_{s_2,\theta}^+) \frac{\overline{dv}}{dx} - \rho_{s_1,\theta} \omega^2 (u_{s_1,\theta}^+ - u_{s_2,\theta}^+) \overline{v} \right] = \\ \int_{\mathbb{R}_+} \left[ (\mu_{s_2,\theta} - \mu_{s_1,\theta}) \frac{du_{s_2,\theta}^+}{dx} \frac{\overline{dv}}{dx} - (\rho_{s_1,\theta} - \rho_{s_2,\theta}) \omega^2 u_{s_2,\theta}^+ \overline{v} \right]. \end{aligned}$$

Now choose  $v = u_{s_1,\theta}^+ - u_{s_2,\theta}^+ \in H_0^1(\mathbb{R}_+)$  in the above equality. The well-posedness of (3.56), a Cauchy-Schwarz inequality applied to the right-hand side and (3.57) imply that there exists a real number  $c > 0$  independent of  $s$  and  $\theta$  such that

$$\|u_{s_1,\theta}^+ - u_{s_2,\theta}^+\|_{H^1(\mathbb{R}_+)} \leq c \left( \|\mu_{s_2,\theta} - \mu_{s_1,\theta}\|_{\infty} + \|\rho_{s_2,\theta} - \rho_{s_1,\theta}\|_{\infty} \right). \quad (3.58)$$

Since the functions  $\mu_p$  and  $\rho_p$  are continuous and 1-periodic in each direction, it follows from Heine-Cantor theorem that they are uniformly continuous. Let us define the modulus of uniform continuity

$$\forall \mu \in \mathcal{C}^0(\mathbb{R}^n), \quad \forall \epsilon > 0, \quad \delta(\mu, \epsilon) = \sup_{\mathbf{y}, \mathbf{z}} \{ |\mu(\mathbf{y}) - \mu(\mathbf{z})|, |\mathbf{y} - \mathbf{z}| < \epsilon \}$$

As  $\mu$  is uniformly continuous,  $\delta(\mu, \epsilon)$  tends to 0 as  $\epsilon$  tends to 0. It follows from (3.58) that

$$\|u_{s_1,\theta}^+ - u_{s_2,\theta}^+\|_{H^1(\mathbb{R}_+)} \leq c \left( \delta(\mu_p, |s_1 - s_2|) + \delta(\rho_p, |s_1 - s_2|) \right).$$

Therefore,  $s \mapsto u_{s,\theta}^+$  is continuous from  $\mathbb{R}^{n-1}$  in  $H^1(\mathbb{R}_+)$ . ■

At last, we can show the next result, which highlights the link between the 2D half-guide solution  $U_{\theta}^+$  and the 1D half-line solution  $u_{\theta}^+$ .

**Proposition 3.18**

*Let  $s_{\theta}$  be the mapping defined by (3.44), and  $\tilde{U}_{\theta}^+$  (resp.  $\tilde{\varphi}$ ) be the periodic extension of  $U_{\theta}^+$*

(resp.  $\varphi$ ) the solution of (3.53). Then, we have

$$\text{a. e. } \mathbf{y} \in \mathbb{R}_+^n, \quad \tilde{U}_\theta^+(\tilde{\varphi})(\mathbf{y}) = \tilde{\varphi}(\mathbf{s}_\theta(\mathbf{y})) u_{\mathbf{s}_\theta(\mathbf{y}),\theta}^+(y_n/\theta_n), \quad (3.59)$$

or equivalently, thanks to the change of variables  $(\mathbf{s}, x) \mapsto ((\mathbf{s}, 0) + \theta x)$ ,

$$\text{a. e. } (\mathbf{s}, x) \in \mathbb{R}^{n-1} \times \mathbb{R}_+, \quad \tilde{U}_\theta^+(\tilde{\varphi})((\mathbf{s}, 0) + \theta x) = \tilde{\varphi}(\mathbf{s}) u_{\mathbf{s},\theta}^+(x). \quad (3.60)$$

Moreover if  $\tilde{\varphi}$  is continuous in the neighbourhood of 0 and satisfies  $\tilde{\varphi}(0) = 1$ , then

$$\text{a. e. } x \in \mathbb{R}, \quad u_\theta^+(x) = \tilde{U}_\theta^+(\tilde{\varphi})(\theta x) \quad (3.61)$$

**Proof.** We begin by proving (3.59). Let us denote for a. e.  $\mathbf{y} \in \mathbb{R}_+^n$ ,  $U_1(\mathbf{y})$  the right-hand side of (3.59). Note that  $\Psi : (\mathbf{s}, x) \mapsto \tilde{\varphi}(\mathbf{s}) u_{\mathbf{s},\theta}^+(x)$  is 1-periodic with respect to  $s$  (thanks to Proposition 3.17), and belongs to  $L^2(\Omega^\#)$  since

$$\|\Psi\|_{L^2(\Omega^\#)}^2 = \theta_n \int_{\Sigma_{n,0}^\#} |\varphi(\mathbf{s})|^2 \|u_{\mathbf{s},\theta}^+\|_{L^2(\mathbb{R}_+)}^2 d\mathbf{s} \leq \theta_n c^2 \|\varphi\|_{L^2(\Sigma_{n,0}^\#)}^2, \quad \text{with } c = \sup_{\mathbf{s}} \|u_{\mathbf{s},\theta}^+\|_{L^2(\mathbb{R}_+)}.$$

Moreover, since for all  $\mathbf{s}$ ,  $u_{\mathbf{s},\theta}^+ \in H^1(\mathbb{R}_+)$ ,  $\partial_{y_n} \Psi$  is also in  $L^2(\Omega^\#)$  (using similar inequalities to the above). By Proposition 3.13,  $U_1$  belongs to  $H_{\theta,per}^1(\Omega^\#)$  with

$$\text{a. e. } \mathbf{y} \in \mathbb{R}_+^n, \quad D_\theta \tilde{U}_1(\mathbf{y}) = \tilde{\varphi}(\mathbf{s}_\theta(\mathbf{y})) \frac{du_{\mathbf{s}_\theta(\mathbf{y}),\theta}^+}{dx}(y_n/\theta_n).$$

Finally, since  $u_{\mathbf{s},\theta}^+(0) = 1$ , it is clear that  $U_1|_{\Sigma_{n,0}^\#} = \varphi$ . By repeating the same argument, we can show that  $\mu_p D_\theta U_1$  belongs to  $H_{\theta,per}^1(\Omega^\#)$  with

$$\text{a. e. } \mathbf{y} \in \mathbb{R}_+^n, \quad D_\theta [\mu_p D_\theta \tilde{U}_1](\mathbf{y}) = \tilde{\varphi}(\mathbf{s}_\theta(\mathbf{y})) \frac{d}{dx} \left( \mu_{\mathbf{s}_\theta(\mathbf{y}),\theta} \frac{du_{\mathbf{s}_\theta(\mathbf{y}),\theta}^+}{dx} \right) (y_n/\theta_n).$$

Since  $u_{\mathbf{s},\theta}^+$  satisfies (3.56), it is clear that  $U_1$  satisfies (3.53). By well-posedness of (3.53), we have  $U_1 = U_\theta^+$ .

We have from Proposition 3.17 that  $\mathbf{s} \mapsto u_{\mathbf{s},\theta}^+$  is continuous. If in addition to that,  $\tilde{\varphi}$  is continuous in a neighbourhood of 0, then (3.60) becomes true for any  $\mathbf{s}$  in that neighbourhood. In particular, (3.60) can be written for  $\mathbf{s} = 0$ , thus leading to (3.61).  $\blacksquare$

**Remark 3.19.** The half-guide solution  $U_\theta^+$  depends on  $\varphi$  whereas  $u_{\mathbf{s},\theta}^+$  does not. Numerical results presented in Section 5.5.a will illustrate this property.

## 4 Resolution of the half-guide problem

The advantage of the lifting process lies in the periodic nature of (3.53), which allows us to exploit tools that are well-suited for periodic waveguides. In this chapter, we use a DtN-based method [JLF06; Fli09], developed for the elliptic Helmholtz equation  $-\nabla \cdot (\mu_p \nabla U) - \rho_p \omega^2 U = 0$  in unbounded

By elliptic Helmholtz equation, we refer to the Helmholtz equation with an elliptic principal part.

periodic waveguides. This method does not rely on decay properties, and therefore remains robust when the absorption tends to 0. As we essentially transpose this method to our directional Helmholtz equation, we will see below that the approach remains exactly the same, although the analysis has to be adapted. For information purposes, it is worth mentioning the *recursive doubling method* [YL07; EHZ08], suited for bounded periodic waveguides, and a method [Zha21] based on the Floquet-Bloch transform, although its extension to our non-elliptic equation seems unclear.

In what follows,  $\mathcal{C}_\ell^\#$  is the cell defined for every  $\ell \in \mathbb{N}$  by

$$\mathcal{C}_0^\# := (0, 1)^n \quad \text{and} \quad \mathcal{C}_\ell^\# := \mathcal{C}_0^\# + \ell \vec{e}_n, \quad \text{so that} \quad \Omega^\# = \bigcup_{\ell \in \mathbb{N}} \mathcal{C}_\ell^\#. \quad (4.1)$$

For  $\ell > 0$ , we call  $\Sigma_{n,\ell}^\#$  the interface between the cells  $\mathcal{C}_\ell^\#$  and  $\mathcal{C}_{\ell+1}^\#$ , that is,  $\Sigma_{n,\ell}^\# = \Sigma_{n,0}^\# + \ell \vec{e}_n$ . By periodicity, each cell  $\mathcal{C}_\ell^\#$  can be identified to  $\mathcal{C}_0^\#$ . Similarly, each interface  $\Sigma_{n,\ell}^\#$  can be identified to  $\Sigma_{n,0}^\#$ . The cells and interfaces are represented in Figure 4.

#### 4.1 Structure of the solution

The solution  $U_\theta^+(\varphi)$  of (3.53) has a particular structure that we explain in this section. Denote by  $\mathcal{P} \in \mathcal{L}(L^2(\Sigma_{n,0}^\#))$  the operator

$$\forall \varphi \in L^2(\Sigma_{n,0}^\#), \quad \mathcal{P}\varphi := U_\theta^+(\varphi)|_{\Sigma_{n,1}^\#}, \quad (4.2)$$

where  $L^2(\Sigma_{n,1}^\#)$  and  $L^2(\Sigma_{n,0}^\#)$  have been identified to each other in an obvious manner. This identification will be used systematically in what follows, even if not mentioned. Note that the operator  $\mathcal{P}$  is well-defined, due to the continuity of the trace operator on  $\Sigma_{i,a}^\#$  (3.33).

##### Proposition 4.1

For any  $\varphi$  in  $L^2(\Sigma_{n,0}^\#)$ , we have

$$\forall \ell \in \mathbb{N}, \text{ a. e. } \mathbf{y} \in \Omega^\#, \quad U_\theta^+(\varphi)(\mathbf{y} + \ell \vec{e}_n) = U_\theta^+(\mathcal{P}^\ell \varphi)(\mathbf{y}). \quad (4.3)$$

Moreover, the spectral radius of  $\mathcal{P}$  is strictly less than one.

**Proof.** We only present the outline of the proof, which is quite similar to the one in [JLF06; Fli09]. Given  $\varphi \in L^2(\Sigma_{n,0}^\#)$ , consider the function  $U_1$  defined in  $\Omega^\#$  by  $U_1(\mathbf{y}) = U_\theta^+(\varphi)(\mathbf{y} + \vec{e}_n)$  for almost any  $\mathbf{y} \in \Omega^\#$ . Since the coefficients  $\mu_p$  and  $\rho_p$  are periodic, one deduces that  $U_1$  satisfies the volume equation as well as the periodicity condition in (3.53). Furthermore,

$$U_1|_{\Sigma_{n,0}^\#} = U_\theta^+(\varphi)|_{\Sigma_{n,1}^\#} = \mathcal{P}\varphi.$$

Thus, by well-posedness of (3.53), we have (4.3) for  $\ell = 1$ . The result (4.3) for  $\ell \geq 2$  is proved by induction.

It remains to show that the spectral radius is strictly less than 1. To this end, by analogy with (3.57), one can show the existence of constants  $\alpha, c > 0$  such that

$$\forall \varphi \in L^2(\Sigma_{n,0}^\#), \quad \|e^{\alpha \Im m \omega y_n / \theta_n} U_\theta^+\|_{H_\theta^1(\Omega^\#)} \leq c \|\varphi\|_{L^2(\Sigma_{n,0}^\#)}. \quad (4.4)$$

Since  $\mathcal{P}^\ell \varphi = U_\theta^+(\varphi)(\cdot, \ell)$ , the estimate above implies that  $\|\mathcal{P}^\ell\| \leq c e^{-\alpha \Im \omega \ell / \theta_n}$ . Hence, using Gelfand's formula [Rud91, §10.3], the spectral radius can be estimated as follows:

$$\rho(\mathcal{P}) = \lim_{\ell \rightarrow +\infty} \|\mathcal{P}^\ell\|^{1/\ell} \leq e^{-\beta \Im \omega / \theta_n} < 1. \quad \blacksquare$$

**Remark 4.2.** Even if  $\varphi = 1$  on  $\Sigma_{n,0}^\#$ , the function  $\mathcal{P}^\ell \varphi$  is generally not constant. This is the reason why the study of the half-guide problem cannot be restricted to constant boundary datas, as explained in Remark 3.2.

The operator  $\mathcal{P}$  is called the *propagation operator*, as it describes how the solution of (3.53) evolves from one interface to another. Provided that  $\mathcal{P}$  is known, the solution  $U_\theta^+(\varphi)$  may then be constructed using *local cell problems*. Let us first introduce the appropriate functional framework in a periodicity cell

$$H_{\theta,per}^1(\mathcal{C}_0^\#) := \left\{ U \in H_\theta^1(\mathcal{C}_0^\#), \tilde{U} \in H_{\theta,loc}^1(\mathcal{B}_0) \right\}, \quad (4.5)$$

where  $\mathcal{B}_0 := \mathbb{R}_+^n \cap \{0 < y_n < 1\}$ , and where  $\tilde{U}$  is the periodic extension of  $U$  defined in (3.31). Similarly to Section 3.2.a, one can show that any function of  $H_{\theta,per}^1(\mathcal{C}_0^\#)$  has a  $L^2$  trace on the boundary of  $\mathcal{C}_0^\#$ . We can prove in particular that

$$H_{\theta,per}^1(\mathcal{C}_0^\#) = \left\{ U \in H_\theta^1(\mathcal{C}_0^\#) / U|_{y_i=0} = U|_{y_i=1}, \forall i \in \llbracket 1, n-1 \rrbracket \right\}.$$

We can now introduce the local cell problems: for  $\varphi \in L^2(\Sigma_{n,0}^\#)$  and  $j \in \{0, 1\}$ , let  $E^j(\varphi) \in H_{\theta,per}^1(\mathcal{C}_0^\#)$  satisfy

$$\begin{cases} -D_\theta(\mu_p D_\theta E^j) - \rho_p \omega^2 E^j = 0, & \text{in } \mathcal{C}_0^\#, \\ \mu_p D_\theta E^j|_{y_i=0} = \mu_p D_\theta E^j|_{y_i=1} \quad \forall i \in \llbracket 1, n-1 \rrbracket, \end{cases} \quad (4.6)$$

completed with the boundary conditions

$$\begin{cases} E^0|_{\Sigma_{n,0}^\#} = \varphi & \text{and} & E^0|_{\Sigma_{n,1}^\#} = 0, \\ E^1|_{\Sigma_{n,0}^\#} = 0 & \text{and} & E^1|_{\Sigma_{n,1}^\#} = \varphi. \end{cases} \quad (4.7)$$

A variational formulation can be derived as in Proposition 3.16, and the well-posedness follows once again from with Lax-Milgram's theorem in  $H_{\theta,per}^1(\mathcal{C}_0^\#)$ , thanks to the surjectivity of the trace operator (see Corollary 3.15).

Proposition 4.1 implies that  $U_\theta^+(\varphi)(\cdot + \ell \vec{e}_n)|_{\Sigma_{n,0}^\#} = \mathcal{P}^\ell \varphi$ . Hence, if the propagation operator  $\mathcal{P}$  is known, by linearity, the solution of the half-guide problem can be entirely constructed cell by cell as follows:

$$\forall \ell \in \mathbb{N}, \quad U_\theta^+(\varphi)(\cdot + \ell \vec{e}_n)|_{\mathcal{C}_0^\#} = E^0(\mathcal{P}^\ell \varphi) + E^1(\mathcal{P}^{\ell+1} \varphi). \quad (4.8)$$

## 4.2 Characterization of the propagation operator: the Riccati equation

In order to characterize the propagation operator  $\mathcal{P}$ , it is useful to introduce the *local DtN operators*  $\mathcal{T}^{jk} \in \mathcal{L}(L^2(\Sigma_{n,0}^\#))$ , defined for  $j, k = 0, 1$  by

$$\forall \varphi \in L^2(\Sigma_{n,0}^\#), \quad \mathcal{T}^{jk} \varphi := (-1)^{k+1} \theta_n [\mu_p D_\theta E^j(\varphi)]|_{\Sigma_{n,k}^\#}. \quad (4.9)$$



where  $E^j(\varphi)$  satisfies (4.6)–(4.7). By Green's formula (3.30), note that for all  $j, k = 0, 1$  and for  $(\varphi, \psi) \in L^2(\Sigma_{n,0}^\#)^2$ , these operators satisfy

$$\int_{\Sigma_{n,0}^\#} (\mathcal{T}^{jk} \varphi) \bar{\psi} = \int_{\mathcal{C}_0^\#} \left[ \mu_p D_{\boldsymbol{\theta}} E^j(\varphi) D_{\boldsymbol{\theta}} \overline{E^k(\psi)} - \rho_p \omega^2 E^j(\varphi) \overline{E^k(\psi)} \right]. \quad (4.10)$$

Before deriving other useful properties of the local DtN operators, we need to introduce some additional notations. For any closed operator  $\mathcal{A} \in \mathcal{L}(L^2(\Sigma_{n,0}^\#))$ , we denote  $\mathcal{A}^*$  the adjoint of  $\mathcal{A}$ , and  $\overline{\mathcal{A}}$  its «complex conjugate», that is,

$$\forall \varphi \in L^2(\Sigma_{n,0}^\#), \quad \overline{\mathcal{A}\varphi} := \overline{\mathcal{A}\overline{\varphi}}.$$

It is not difficult to see that  $\overline{\mathcal{A}^*} = \overline{\mathcal{A}}^*$ , and  $\overline{\overline{\mathcal{A}}} = \mathcal{A}$ .

### Proposition 4.3

The local DtN operators  $\mathcal{T}^{jk}$  satisfy

$$[\mathcal{T}^{00}]^* = \overline{\mathcal{T}^{00}}, \quad [\mathcal{T}^{11}]^* = \overline{\mathcal{T}^{11}}, \quad [\mathcal{T}^{01}]^* = \overline{\mathcal{T}^{10}}, \quad [\mathcal{T}^{10}]^* = \overline{\mathcal{T}^{01}}. \quad (4.11)$$

Furthermore, the operators  $\mathcal{T}^{00}$ ,  $\mathcal{T}^{11}$ , and  $\mathcal{T}^{00} + \mathcal{T}^{11}$  are invertible.

**Proof.** The property (4.11) follows from Green's formula applied to  $E^j(\varphi)$  and  $\overline{E^k(\psi)}$ , see [Fli09, Proposition 2.2.4] in the case of the Helmholtz equation with an elliptic principal part.

The operators  $\mathcal{T}^{00}$ ,  $\mathcal{T}^{11}$ , and  $\mathcal{T}^{00} + \mathcal{T}^{11}$  are bounded. We are going to show that they are also coercive. Their invertibility will then follow from Lax-Milgram's theorem. From (4.10), there exists a constant  $c \equiv c(\mu_-, \rho_-, |\omega|) > 0$  such that

$$-|\omega| \Im \left[ \frac{1}{\omega} \int_{\Sigma_{n,0}^\#} (\mathcal{T}^{kk} \varphi) \bar{\varphi} \right] \geq c \Im \omega \|E^k(\varphi)\|_{H_{\boldsymbol{\theta}}^1(\mathcal{C}_0^\#)}^2 \geq \tilde{c} \Im \omega \|\varphi\|_{L^2(\Sigma_{n,0}^\#)}^2,$$

since from (3.33), the trace application from  $H_{\boldsymbol{\theta},per}^1(\mathcal{C}_0^\#)$  to  $L^2(\Sigma_{n,0}^\#)$  is continuous. It follows that the operators  $\mathcal{T}^{00}$  and  $\mathcal{T}^{11}$  are coercive, and therefore invertible. The inequalities above summed for  $k = 0, 1$  imply the coercivity and hence the invertibility of  $\mathcal{T}^{00} + \mathcal{T}^{11}$  as well. ■

As seen earlier, the solution of the half-guide problem (3.53) is given by (4.8). Now let us use the characterization of  $H_{per,\boldsymbol{\theta}}^1(\Omega^\#)$ , namely, Corollary 3.10 with  $a = 1$ , so that  $\Omega_{a,-}^\# = \mathcal{C}_0^\#$  and  $\Omega_{a,+}^\# = \Omega^\# \setminus \mathcal{C}_0^\#$ . Since  $\mu_p D_{\boldsymbol{\theta}} U_{\boldsymbol{\theta}}^+(\varphi)$  belongs to  $H_{\boldsymbol{\theta},per}^1(\Omega^\#)$ , the directional derivative of  $U_{\boldsymbol{\theta}}^+(\varphi)$  is continuous across the interface  $\Sigma_{n,1}^\#$ , i.e.

$$[\mu_p D_{\boldsymbol{\theta}} U_{\boldsymbol{\theta}}^+(\varphi)]|_{\Sigma_{n,1}^\#} = [\mu_p D_{\boldsymbol{\theta}} U_{\boldsymbol{\theta}}^+(\varphi)((\cdot + \vec{e}_n))]|_{\Sigma_{n,0}^\#}, \quad (4.12)$$

or equivalently,

$$\begin{aligned} & [\mu_p D_{\boldsymbol{\theta}} E^0(\varphi)]|_{\Sigma_{n,1}^\#} + [\mu_p D_{\boldsymbol{\theta}} E^1(\mathcal{P}\varphi)]|_{\Sigma_{n,1}^\#} \\ &= [\mu_p D_{\boldsymbol{\theta}} E^0(\mathcal{P}\varphi)]|_{\Sigma_{n,0}^\#} + [\mu_p D_{\boldsymbol{\theta}} E^1(\mathcal{P}^2\varphi)]|_{\Sigma_{n,0}^\#}. \end{aligned} \quad (4.13)$$

By using the definition of the local DtN operators  $\mathcal{T}^{jk}$ , (4.13) leads to the following characterization.

**Proposition 4.4**

The propagation operator  $\mathcal{P}$  defined by (4.2) is the unique solution of the constrained Riccati equation

$$\left| \begin{array}{l} \text{Find } \mathcal{P} \in \mathcal{L}(L^2(\Sigma_{n,0}^\#)) \text{ such that } \rho(\mathcal{P}) < 1 \text{ and} \\ \mathcal{T}^{10}\mathcal{P}^2 + (\mathcal{T}^{00} + \mathcal{T}^{11})\mathcal{P} + \mathcal{T}^{01} = 0. \end{array} \right. \quad (4.14)$$

**Proof.** The proof is identical to the one for the elliptic Helmholtz equation [JLF06, Theorem 4.1]. We know from Proposition 4.1 that  $\mathcal{P}$  has a spectral radius which is strictly less than 1. Moreover (4.13) ensures that  $\mathcal{P}$  satisfies the Riccati equation.

In order to prove the uniqueness, let us consider an operator  $\mathcal{P}_1$  which satisfies (4.14). The function defined cell by cell by

$$\forall \varphi \in L^2(\Sigma_{n,0}^\#), \quad \forall \ell \in \mathbb{N}^*, \quad U_1(\varphi)(\cdot + \ell \vec{e}_n)|_{C_\ell^\#} = E^0(\mathcal{P}_1^\ell \varphi) + E^1(\mathcal{P}_1^{\ell+1} \varphi),$$

solves (3.53) in each cell  $C_\ell$  and is continuous across each interface  $\Sigma_{n,\ell}^\#$ , by definition (4.6), (4.7) of  $E^0$  and  $E^1$ . By Corollary 3.10,  $U_1$  is locally  $H_\theta^1$  in  $\Omega^\#$ .

Moreover, since  $\mathcal{P}_1$  satisfies (4.14), the directional derivative  $\mu_p D_\theta U_1$  is continuous across each interface. Thus, using Corollary 3.10, we deduce that  $U_1$  satisfies (3.53) in  $\Omega^\#$ .

Furthermore, given that  $\rho(\mathcal{P}_1) < 1$ , Gelfand's formula and the well-posedness of the cell problems ensure that there exist constants  $c, \rho_* > 0$ , with  $\rho_* < 1$  such that, for  $\ell \in \mathbb{N}$  large enough,

$$\|U_1(\varphi)\|_{H_\theta^1(C_\ell^\#)} \leq c \rho_*^\ell \|\varphi\|_{L^2(\Sigma_{n,0}^\#)}.$$

Hence  $U_1(\varphi)$  belongs to  $H_{\theta,per}^1(\Omega^\#)$  and satisfies the half-guide problem (3.53). By well-posedness of (3.53),  $U_1(\varphi)$  and  $U_\theta^+(\varphi)$  coincide, and thus have the same trace on  $\Sigma_{n,1}^\#$ , that is  $\mathcal{P}_1 \varphi = \mathcal{P} \varphi$  for any  $\varphi \in L^2(\Sigma_{n,0}^\#)$ . ■

As a consequence, the propagation operator can be obtained by solving the Riccati equation in (4.14), and by choosing the unique solution whose spectral radius is strictly less than 1. One important thing to retain from the above is that both the propagation operator and the solution of the half-guide problem only require the computation of  $E^0$ ,  $E^1$ , and the operators  $\mathcal{T}^{00}$ ,  $\mathcal{T}^{10}$ ,  $\mathcal{T}^{01}$ , and  $\mathcal{T}^{11}$ , which involve problems defined on a periodicity cell. However, the resolution of the constrained Riccati equation (4.14) is not obvious at all. The properties of this equation are investigated in further details in Section 4.4.

### 4.3 The DtN operator and the DtN coefficient

The goal of this part is to see how the half-guide problem and the local cell problems can be used to compute the DtN coefficient  $\lambda^+$ . We recall that

$$\lambda^+ := -\mu_\theta(0) \frac{du_\theta^+}{dx}(0).$$

Therefore, it is natural to introduce the DtN operator  $\Lambda \in \mathcal{L}(L^2(\Sigma_{n,0}^\#))$  defined by

$$\forall \varphi \in L^2(\Sigma_{n,0}^\#), \quad \Lambda \varphi := -\theta_n [\mu_p D_\theta U_\theta^+(\varphi)]|_{\Sigma_{n,0}^\#}. \quad (4.15)$$

This operator also has the following properties, whose proof is exactly identical to the one of Proposition 4.3.

**Proposition 4.5**

*One has  $\Lambda^* = \bar{\Lambda}$ . Moreover,  $\Lambda$  and  $\Lambda + \mathcal{T}^{11}$  are invertible operators.*

Taking the directional derivative of (4.8) (for  $\ell = 0$ ) on  $\Sigma_{n,0}^\#$  and using the definition (4.9) of the local DtN operators  $\mathcal{T}^{00}$  and  $\mathcal{T}^{10}$  leads to

$$\Lambda = \mathcal{T}^{00} + \mathcal{T}^{10} \mathcal{P}. \quad (4.16)$$

Besides, one can apply the directional derivative  $D_\theta$  to both sides of the link (3.59) between  $U_\theta^+$  and  $u_\theta^+$ , and use the oblique change of variables result (3.48), to obtain

$$\text{a. e. } \mathbf{y} \in \mathbb{R}_+^n, \quad D_\theta \tilde{U}_\theta^+(\tilde{\varphi})(\mathbf{y}) = \tilde{\varphi}(s_\theta(\mathbf{y})) \frac{du_{s_\theta(\mathbf{y}),\theta}^+}{dx}(y_n/\theta_n). \quad (4.17)$$

By multiplying this formula by  $\mu_p$  and by evaluating it for  $\mathbf{y} = (s, 0)$  so that  $s_\theta(\mathbf{y}) = s$ , we obtain from (4.15) that

$$\Lambda \varphi(s) = \theta_n \lambda_\theta(s) \varphi(s), \quad \text{with } \lambda_\theta(s) := -\left[ \mu_{s,\theta} \frac{du_{s,\theta}^+}{dx} \right](0). \quad (4.18)$$

Hence,  $\Lambda$  is a multiplication operator. We next deduce from (4.18) the DtN coefficient  $\lambda^+$ .

**Proposition 4.6**

*The function  $\lambda_\theta : \mathbb{R}^{n-1} \rightarrow \mathbb{C}$  defined by (4.18) is continuous. Moreover, if  $\varphi \in \mathcal{C}_{per}(\mathbb{R}^{n-1})$  is a given function which satisfies  $\varphi(0) = 1$ , then we have*

$$\lambda^+ = \lambda_\theta(0) = \frac{1}{\theta_n} (\Lambda \varphi)(0). \quad (4.19)$$

**Proof.** Using Green's formula, we have that for all  $s \in \mathbb{R}^{n-1}$

$$\lambda_\theta(s) = a_s(u_{s,\theta}^+, u_{s,\theta}^+), \quad \text{with } a_s(u, v) := \int_{\mathbb{R}_+} \left( \mu_{s,\theta} \frac{du}{dx} \frac{\overline{dv}}{dx} - \rho_{s,\theta} \omega^2 u \overline{v} \right).$$

The continuity of  $u \mapsto a_s(u, u)$  results directly from the properties of the coefficients  $\mu_p$  and  $\rho_p$ . Moreover, Proposition 3.17 ensures that the function  $s \mapsto u_{s,\theta}^+$  is continuous. Therefore, as the composition of these two functions,  $\lambda_\theta$  is also continuous.

If in addition  $\varphi$  is continuous, then  $\Lambda \varphi$  is also continuous. Hence,  $(\Lambda \varphi)(0) = \theta_n \lambda_\theta(0) \varphi(0)$  which yields (4.19).  $\blacksquare$

#### 4.4 Spectral properties of the Riccati equation

We now present some properties regarding Equation (4.14). These properties will be exploited for the numerical resolution of the Riccati equation, by constructing the operator  $\mathcal{P}$  from its eigenpairs (this

will be done in Section 5.3 after space discretization). For this reason, it is worthwhile to reformulate a spectral version (Proposition 4.8) of the Riccati equation that would characterize these eigenpairs, while taking into account the spectral radius constraint. This is precisely the purpose of this section.

Recall that  $\mathcal{T}(\mathcal{P}) = 0$ , where  $\mathcal{T}$  is the bounded operator defined by

$$\forall X \in \mathcal{L}(L^2(\Sigma_{n,0}^\#)), \quad \mathcal{T}(X) := \mathcal{T}^{10} X^2 + (\mathcal{T}^{00} + \mathcal{T}^{11})X + \mathcal{T}^{01}. \quad (4.20)$$

In the sequel, we will write  $\mathcal{T}(\lambda)$  for  $\mathcal{T}(\lambda I)$ . We begin with the following factorization lemma.

#### Lemma 4.7

Let  $\mathcal{P}$  be the propagation operator defined by (4.2). For any number  $\lambda \in \mathbb{C}$ ,

$$\mathcal{T}(\lambda) = (\lambda \overline{\mathcal{P}^*} - I) (\Lambda + \mathcal{T}^{11}) (\mathcal{P} - \lambda), \quad (4.21)$$

where  $\mathcal{T}^{11}$  is defined by (4.9) and  $\Lambda$  is defined by (4.15).

**Proof.** Let  $\lambda \in \mathbb{C}$ . Since the propagation operator satisfies  $\mathcal{T}(\mathcal{P}) = 0$ , one obtains that

$$\begin{aligned} \mathcal{T}(\lambda) &= \mathcal{T}(\lambda) - \mathcal{T}(\mathcal{P}) \\ &= [\mathcal{T}^{10}(\lambda + \mathcal{P}) + \mathcal{T}^{00} + \mathcal{T}^{11}] (\lambda - \mathcal{P}) \\ &= (\lambda \mathcal{T}^{10} + \Lambda + \mathcal{T}^{11}) (\lambda - \mathcal{P}), \quad \text{from (4.16)}. \end{aligned} \quad (4.22)$$

We use once again the fact that  $\mathcal{T}(\mathcal{P}) = 0$  which, by the expression (4.16), is equivalent to  $\mathcal{T}^{01} = -(\Lambda + \mathcal{T}^{11}) \mathcal{P}$ . By transposing this equation, and by taking the complex conjugate, one obtains that  $[\mathcal{T}^{01}]^* = -\overline{\mathcal{P}^*} (\Lambda + \mathcal{T}^{11})^*$ . Since  $[\mathcal{T}^{11}]^* = \overline{\mathcal{T}^{11}}$  and  $[\mathcal{T}^{01}]^* = \overline{\mathcal{T}^{10}}$  as ensured by Proposition 4.3, and since  $\Lambda^* = \overline{\Lambda}$  from Proposition 4.5, it follows that

$$\mathcal{T}^{10} = -\overline{\mathcal{P}^*} (\Lambda + \mathcal{T}^{11}).$$

Inserting this expression of  $\mathcal{T}^{10}$  in (4.22) therefore leads to

$$\mathcal{T}(\lambda) = [-\lambda \overline{\mathcal{P}^*} (\Lambda + \mathcal{T}^{11}) + \Lambda + \mathcal{T}^{11}] (\lambda - \mathcal{P}) = (I - \lambda \overline{\mathcal{P}^*}) (\Lambda + \mathcal{T}^{11}) (\lambda - \mathcal{P}).$$

which is the desired result. ■

The previous factorization lemma allows one to characterize the spectrum of the propagation operator as follows.

#### Proposition 4.8

For any complex number  $\lambda$ , one has

$$\lambda \in \sigma(\mathcal{P}) \iff 0 \in \sigma[\mathcal{T}(\lambda)] \text{ and } |\lambda| < 1. \quad (4.23)$$

**Proof.** Proving (4.23) amounts to showing that for any  $\lambda \in \mathbb{C}$  such that  $|\lambda| < 1$ ,  $\mathcal{P} - \lambda$  is invertible if and only if  $\mathcal{T}(\lambda)$  is invertible. To this end, as  $\mathcal{T}(\lambda) = (\lambda \overline{\mathcal{P}^*} - I) (\Lambda + \mathcal{T}^{11}) (\mathcal{P} - \lambda)$  according to Lemma 4.7, it is sufficient to prove that  $(\lambda \overline{\mathcal{P}^*} - I) (\Lambda + \mathcal{T}^{11})$  is an invertible operator for any  $\lambda \in \mathbb{C}$ ,  $|\lambda| < 1$ .

Proposition 4.5 ensures the invertibility of  $\Lambda + \mathcal{T}^{11}$  already. It thus remains to show that  $\lambda \overline{\mathcal{P}^*} - I$  is invertible, which is the case when  $|\lambda| < 1$ .

Indeed, if  $\lambda = 0$ , then  $\lambda \overline{\mathcal{P}^*} - I = -I$  is obviously invertible. If  $\lambda \neq 0$ , we use the fact that  $\mathcal{P}$  and  $\overline{\mathcal{P}^*}$  have the same spectrum. Hence, given that  $|1/\lambda| > 1 > \rho(\overline{\mathcal{P}^*})$ , it follows that  $1/\lambda$  does not belong to  $\sigma(\overline{\mathcal{P}^*})$ . In other words,  $\overline{\mathcal{P}^*} - (1/\lambda)I$  is an invertible operator. ■

**Remark 4.9.** Note that the property (4.23) can be proved easily (and without Lemma 4.7) for the point spectrum:

$$\lambda \in \sigma_p(\mathcal{P}) \iff 0 \in \sigma_p[\mathcal{T}(\lambda)] \text{ and } |\lambda| < 1. \quad (4.24)$$

This property was already proved in [JLF06] for the Helmholtz equation. In this context, this was sufficient since the operator  $\mathcal{P}$  was compact, which is no longer the case here.

Finally, it is worth noting that the values  $\lambda \neq 0$  for which  $0 \in \sigma[\mathcal{T}(\lambda)]$  can be paired in the following way.

#### Proposition 4.10

For any complex number  $\lambda \neq 0$ , one has the following equivalence:

$$0 \in \sigma[\mathcal{T}(\lambda)] \iff 0 \in \sigma[\mathcal{T}(1/\lambda)]. \quad (4.25)$$

**Proof.** Let  $\lambda \in \mathbb{C}^*$ . From the properties of the local DtN operators (see Proposition 4.3), we deduce that

$$\overline{[\mathcal{T}(\lambda)]^*} = \lambda^2 \mathcal{T}^{01} + \lambda(\mathcal{T}^{00} + \mathcal{T}^{11}) + \mathcal{T}^{10} = \lambda^2 \mathcal{T}(1/\lambda). \quad (4.26)$$

The operators  $\mathcal{T}(\lambda)$  and  $\overline{[\mathcal{T}(\lambda)]^*}$  have the same spectrum, hence the result. ■

**Remark 4.11.** As Proposition 4.10 shows, the values  $\lambda \neq 0$  for which

$$0 \in \sigma[\mathcal{T}(\lambda)]$$

come by pairs  $(\lambda, \lambda^{-1})$ . From a numerical point of view, it suffices to choose  $\lambda$  such that  $|\lambda| < 1$  and discard  $\lambda^{-1}$ .

## 4.5 Spectral properties of the propagation operator

This section, contrary to Section 4.4 is not related to the construction of our numerical method; it is of theoretical interest. On one hand, the result of this section, that is Proposition 4.12, is useful for interpreting some of the numerical results in Section 5.5.c. On the other hand, it emphasizes the differences between the spectral properties of  $\mathcal{P}$ , and the ones of the corresponding operator for classical waveguide problems. For the elliptic Helmholtz equation,  $\mathcal{P}$  is compact (see [JLF06, Theorem 3.1]) and its spectrum hence consists only in isolated eigenvalues which accumulate to 0. However, the picture is completely different in this case, because the spectrum has no isolated points.

One useful way to study the properties of the propagation operator (especially its spectrum) is through an analytic formula: by evaluating the link (3.60) between  $U_\theta^+$  and  $u_\theta^+$  for  $x = 1/\theta_n$  and  $\mathbf{s} \in \mathbb{R}^{n-1}$ ,  $\mathcal{P}$  can be expressed for all  $\varphi$  in  $L^2(\Sigma_{n,0}^\#)$  as follows:

$$\mathcal{P}\varphi(\mathbf{s}) = p_\theta(\mathbf{s}) \tilde{\varphi}(\mathbf{s} - \boldsymbol{\delta}), \quad \text{with } p_\theta(\mathbf{s}) := u_{\mathbf{s}-\boldsymbol{\delta},\theta}^+(1/\theta_n) \quad \text{and } \boldsymbol{\delta} := \hat{\boldsymbol{\theta}}/\theta_n \in \mathbb{R}^{n-1}. \quad (4.27)$$

Note that since  $\theta$  is an irrational vector,  $\delta$  is also an irrational vector.

The properties of the mapping  $s \mapsto u_{s,\theta}^+$  stated in Proposition 3.17 imply that the fonction  $p_\theta$  is continuous and 1-periodic in each direction.

Operators that can be written under the form (4.27) are known as *weighted shift operators*, and have been studied for instance in [Ant12]. In particular, the spectral properties of  $\mathcal{P}$  are given by the following result.

**Proposition 4.12**

Let  $p_\theta : \Sigma_{n,0}^\# \rightarrow \mathbb{C}$  be the function defined in (4.27). Then,  $p_\theta(s) \neq 0$  for all  $s$  in  $\Sigma_{n,0}^\#$  and the spectral radius of  $\mathcal{P}$  is given by

$$\rho(\mathcal{P}) = \exp \left( \int_{\Sigma_{n,0}^\#} \log |p_\theta(s)| \, ds \right). \quad (4.28)$$

Moreover, the spectrum of  $\mathcal{P}$  is a circle of radius  $\rho(\mathcal{P})$ .

This result can be found in [Ant12, Theorem 2.1] for  $n = 2$ . We give below the proof for  $n > 2$ , which requires the following lemma (see Theorem 6.1 and Example 6.1 of [KN12]), known as a particular case of Birkhoff's ergodic theorem for continuous functions.

**Lemma 4.13**

Let  $\psi : \Sigma_{n,0}^\# \rightarrow \mathbb{C}$  be continuous and 1-periodic in each direction. Let  $\alpha \in \mathbb{R}^{n-1}$  be an irrational vector. Then, we have the following uniform convergence:

$$\lim_{\ell \rightarrow +\infty} \left\| \frac{1}{\ell} \sum_{m=0}^{\ell-1} \psi(\cdot - m\alpha) - \int_{\Sigma_{n,0}^\#} \psi \right\|_\infty = 0.$$

**Proof** (Proof of Proposition 4.12). Let us first show by contradiction that  $p_\theta$  or equivalently the function  $s \mapsto u_{s,\theta}^+(1/\theta_n)$  is nowhere vanishing. To do so, we use an argument of unique continuation. In fact, assume that there exists  $s \in \Sigma_{n,0}^\#$  such that  $u_{s,\theta}^+(1/\theta_n) = 0$ . Then  $u_{s,\theta}^+$  belongs to  $H^1(1/\theta_n, +\infty)$  and satisfies the problem

$$-\frac{d}{dx} \left( \mu_{s,\theta} \frac{du_{s,\theta}^+}{dx} \right) - \rho_{s,\theta} \omega^2 u_{s,\theta}^+ = 0, \text{ in } (1/\theta_n, +\infty), \quad \text{and} \quad u_{s,\theta}^+(1/\theta_n) = 0.$$

From the well-posedness of this problem, it follows that  $u_{s,\theta}^+ = 0$  in  $(1/\theta_n, +\infty)$ . Therefore, by unique continuation, one deduces that  $u_{s,\theta}^+ = 0$  in  $\mathbb{R}_+$ , which contradicts the boundary condition  $u_{s,\theta}^+(0) = 1$ .

We now establish the expression of the spectral radius  $\rho(\mathcal{P})$ . One has  $\rho(\mathcal{P}) = \lim_{\ell \rightarrow +\infty} \|\mathcal{P}^\ell\|^{1/\ell}$  from Gelfand's formula, and by induction,  $\mathcal{P}^\ell$  can be expressed under the form

$$\mathcal{P}^\ell \varphi(s) = p_\theta^{(\ell)}(s) \varphi(s - \ell\delta), \quad \text{with} \quad p_\theta^{(\ell)}(s) = \prod_{m=0}^{\ell-1} p_\theta(s - m\delta).$$

Since the translation operator  $\varphi \mapsto \varphi(\cdot - \ell\delta)$  is isometric and bijective, the norm of  $\mathcal{P}^\ell$  is equal to the

norm of the multiplication operator  $\varphi \mapsto p_{\theta}^{(\ell)} \varphi$ , that is  $\|p_{\theta}^{(\ell)}\|_{\infty}$ . Hence, given that  $p_{\theta}(s) \neq 0$  for all  $s$ , one has

$$\rho(\mathcal{P}) = \lim_{\ell \rightarrow +\infty} \left\| \prod_{m=0}^{\ell-1} p_{\theta}(\cdot - m\delta) \right\|_{\infty}^{1/\ell} = \lim_{\ell \rightarrow +\infty} \exp \left\| \frac{1}{\ell} \sum_{m=0}^{\ell-1} \log(|p_{\theta}(\cdot - m\delta)|) \right\|_{\infty}$$

Since  $\theta$  is an irrational vector,  $\delta = \hat{\theta}/\theta_n$  is also an irrational vector. Therefore, Lemma 4.13 can be applied with  $\alpha = \delta$ , and  $\psi : s \mapsto \log |p_{\theta}(s)|$ , which is well-defined and continuous. Hence the spectral radius is given by

$$\rho(\mathcal{P}) = M_{\log(p_{\theta})} := \exp \left( \int_{\Sigma_{n,0}^{\#}} \log |p_{\theta}(s)| ds \right).$$

Let us now characterize the spectrum. To begin, note that the inverse of  $\mathcal{P}$  is well-defined, since  $p_{\theta}$  vanishes nowhere: for all  $\varphi \in L^2(\Sigma_{n,0}^{\#})$ ,  $\mathcal{P}^{-1}\varphi(s) := [p_{\theta}(s)]^{-1} \tilde{\varphi}(s + \delta)$ . Therefore, all the computations above can be applied to  $\mathcal{P}^{-1}$ , thus yielding

$$\rho(\mathcal{P}^{-1}) = M_{\log(p_{\theta}^{-1})} = \frac{1}{M_{\log(p_{\theta})}} = \frac{1}{\rho(\mathcal{P})}$$

Since the spectrum of  $\mathcal{P}$  is included in the annulus  $\rho(\mathcal{P}^{-1})^{-1} \leq |z| \leq \rho(\mathcal{P})$  (this is true for any operator), it follows that  $\sigma(\mathcal{P})$  is included in the circle  $|z| = \rho(\mathcal{P}) = M_{\log(p_{\theta})}$ .

Conversely, for  $\mathbf{k} \in \mathbb{Z}^{n-1}$ , let  $S_{\mathbf{k}}$  be the multiplication operator by  $s \in \mathbb{R}^{n-1} \mapsto \exp(2i\pi \mathbf{k} \cdot s)$ . From the expression (4.27) of the propagation operator, we obtain that

$$S_{\mathbf{k}} \mathcal{P} S_{\mathbf{k}}^{-1} = e^{2i\pi \mathbf{k} \cdot \delta} \mathcal{P}.$$

The operators  $\mathcal{P}$  and  $e^{2i\pi \mathbf{k} \cdot \delta} \mathcal{P}$  are similar, and thus have the same spectrum. Now consider an element  $\lambda_0$  of  $\sigma(\mathcal{P})$ . Then,  $|\lambda_0| = M_{\log(p_{\theta})}$ , and  $\lambda_{\mathbf{k}} := e^{2i\pi \mathbf{k} \cdot \delta} \lambda_0$  also belongs to  $\sigma(\mathcal{P})$  for all  $\mathbf{k} \in \mathbb{Z}^{n-1}$ . Since  $\delta$  is irrational, we have from Kronecker's theorem (Theorem II-2.8) that the set  $\{\lambda_{\mathbf{k}}, \mathbf{k} \in \mathbb{Z}^{n-1}\}$  is dense in the circle  $|z| = |\lambda_0| = M_{\log(p_{\theta})}$ . Consequently, this whole circle is included in the spectrum, since the latter is a closed set. ■

## 5 Resolution algorithm and discretization issues for $n = 2$

In order to compute the solution of Equation (1.1), the previous sections provide an algorithm which sums up as follows:

1. Compute the solution  $u_{\theta}^{+}$  of (1.8) and the DtN coefficient  $\lambda^{+}$  defined by (1.7) using the following procedure:
  - (a). for any boundary data  $\varphi \in L^2(\Sigma_{n,0}^{\#})$ , compute the solutions  $E^0(\varphi)$ ,  $E^1(\varphi)$  of the local cell problems (4.6);
  - (b). compute the local DtN operators  $(\mathcal{T}^{00}, \mathcal{T}^{01}, \mathcal{T}^{10}, \mathcal{T}^{11})$ , defined by (4.9)–(4.10);
  - (c). compute the propagation operator  $\mathcal{P}$  as the unique solution of the constrained Riccati equation (4.14);
  - (d). using an arbitrarily chosen boundary data  $\varphi \in \mathcal{C}_{per}(\mathbb{R}^{n-1})$  which satisfies  $\varphi(0) = 1$ ,
    - from (4.8), construct the solution  $U_{\theta}^{+}$  of the half-guide problem cell by cell;
    - deduce the half-line solution  $u_{\theta}^{+}$  via the formula (3.61);

- (e). compute the DtN operator  $\Lambda$  defined by (4.16), and deduce  $\lambda^+$  from (4.19).
2. Compute the solution  $u_\theta^-$  of (1.8) and the associated DtN coefficient  $\lambda^-$  defined by (1.7) using exactly the same procedure as in Step 1 (but independently from Step 1).
3. Finally, solve the interior problem (1.9) in  $(-a, a)$ , and extend the solution everywhere using (1.10), as well as Step 1 and Step 2.

Since this algorithm is defined at a continuous level, it has to be discretized in order to be implemented. For convenience sake, the quasiperiodicity order is set to  $n = 2$ . The most original aspects of the algorithm are the steps (1.a)–(1.d), and the rest of this section focuses on the discretization of these four steps. We present in Sections 5.1 and 5.2 two different methods that are linked to a choice of discretization of the step (1.a), which influences the implementation of the steps (1.b) and (1.d). The treatment of the step (1.c) is independent of this choice, and will be presented in Section 5.3.

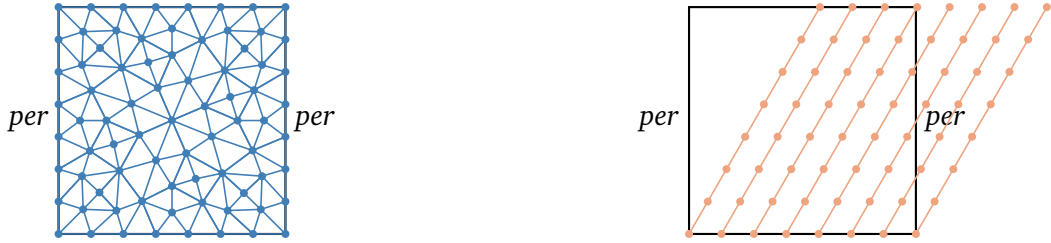

Figure 5: Two-dimensional mesh for the 2D method (left), and family of one-dimensional meshes for the quasi-1D method (right)

### 5.1 A fully two-dimensional method

The first method is inspired from the resolution of the elliptic Helmholtz equation (see [Fli09] for instance), and consists in solving directly the local cell problems on an unstructured mesh of the periodicity cell  $\mathcal{C}_0^\# = (0, 1)^2$  (see Figure 5 on the left).

We start from a triangular mesh  $\mathcal{T}_h(\mathcal{C}_0^\#)$  of  $\mathcal{C}_0^\# = (0, 1)^2$  with a mesh step  $h > 0$ . We assume that this mesh is *periodic*, in the sense that one can identify the mesh nodes on the boundary  $y_i = 0$  with those on  $y_i = 1$ , for  $1 \leq i \leq 2$ . In particular for  $i = 1$ , this condition allows us to handle the periodic boundary conditions.

Now let  $\mathcal{V}_h(\mathcal{C}_0^\#)$  be the usual  $H^1$ -conforming approximation by Lagrange finite elements of order  $d > 0$ . We also introduce

$$\mathcal{V}_{h,per}(\mathcal{C}_0^\#) := \{V \in \mathcal{V}_h(\mathcal{C}_0^\#) / V|_{y_1=0} = V|_{y_1=1}\}$$

as an internal approximation of  $H_{\theta,per}^1(\mathcal{C}_0^\#)$ . Finally, to approximate  $L^2(\Sigma_{2,0}^\#)$  and  $L^2(\Sigma_{2,1}^\#)$ , we consider the following subspaces:

$$\forall a \in \{0, 1\}, \quad \mathcal{V}_{h,per}(\Sigma_{2,a}^\#) := \{V_h|_{\Sigma_{2,a}^\#} / V_h \in \mathcal{V}_{h,per}(\mathcal{C}_0^\#)\}.$$

Since the mesh nodes on  $\Sigma_{2,0}^\#$  and  $\Sigma_{2,1}^\#$  can be identified to each other by periodicity of  $\mathcal{T}_h(\mathcal{C}_0^\#)$ , we can also make the identification  $\mathcal{V}_{h,per}(\Sigma_{2,0}^\#) \equiv \mathcal{V}_{h,per}(\Sigma_{2,1}^\#) \equiv \mathcal{V}_{h,per}(0, 1)$ , as in the continuous case. Set  $N := \dim \mathcal{V}_{h,per}(0, 1)$ , and consider a basis  $(\varphi_p)_{1 \leq p \leq N}$ .



For any data  $\varphi_h \in \mathcal{V}_{h,\text{per}}(0, 1)$ , we denote by  $E_h^0(\varphi_h), E_h^1(\varphi_h) \in \mathcal{V}_{h,\text{per}}(\mathcal{C}_0^\#)$  the discrete solutions defined via the standard finite element approximation of the local cell problems (4.6)–(4.7) in the space  $\mathcal{V}_{h,\text{per}}(\mathcal{C}_0^\#)$ . (We omit the details.) In practice, one has to compute  $E_h^j(\varphi_p)$ , where  $(\varphi_p)_{1 \leq p \leq N}$  is a basis of  $\mathcal{V}_{h,\text{per}}(0, 1)$ .

Similarly to the weak expression (4.10) of the continuous local DtN operators, the discrete local DtN operators  $\mathcal{T}_h^{jk} \in \mathcal{L}(\mathcal{V}_{h,\text{per}}(0, 1))$ ,  $j, k = 0, 1$ , are defined for any  $\varphi_h, \psi_h \in \mathcal{V}_{h,\text{per}}(0, 1)$  as follows:

$$\int_{\Sigma_{n,0}^\#} \mathcal{T}_h^{jk} \varphi_h \overline{\psi_h} := \int_{\mathcal{C}_0^\#} \left[ \mu_p D_{\boldsymbol{\theta}} E_h^j(\varphi_h) D_{\boldsymbol{\theta}} \overline{E_h^k(\psi_h)} - \rho_p \omega^2 E_h^j(\varphi_h) \overline{E_h^k(\psi_h)} \right]. \quad (5.1)$$

In practice, these operators are represented as  $N \times N$  matrices  $\mathbb{T}^{jk}$  whose components are given by  $\mathbb{T}_{pq}^{jk} = \int_{\Sigma_{n,0}^\#} \mathcal{T}_h^{jk} \varphi_q \overline{\varphi_p}$ , for  $p, q \in \llbracket 1, N \rrbracket$ .

Let  $\varphi_h \in \mathcal{V}_{h,\text{per}}(0, 1) \subset \mathcal{C}_{\text{per}}(\mathbb{R})$  such that  $\varphi_h(0) = 1$ . The computation of the propagation operator  $\mathcal{P}_h \in \mathcal{L}(\mathcal{V}_{h,\text{per}}(0, 1))$  is presented in Subsection 5.3. Once this operator is determined, the solution of the half-guide problem (3.53) can be approximated with the function defined cell by cell by

$$\forall \ell \in \mathbb{N}, \quad U_{\boldsymbol{\theta},h}^+(\varphi_h)(\cdot + \ell \vec{e}_n)|_{\mathcal{C}_0^\#} := E_h^0(\mathcal{P}_h^\ell \varphi_h) + E_h^1(\mathcal{P}_h^{\ell+1} \varphi_h).$$

Finally, a suitable approximation of the solution of the half-line problem 3.1 is provided by

$$\forall x \in \mathbb{R}, \quad u_{\boldsymbol{\theta},h}^+(x) := U_{\boldsymbol{\theta},h}^+(\varphi)(\boldsymbol{\theta} x).$$

## 5.2 A quasi one-dimensional method

Though easy to implement, the two-dimensional approach described in the previous section does not exploit the fibered properties of the directional derivative  $D_{\boldsymbol{\theta}}$ . However, the periodic half-guide problem can be seen as a concatenation in a certain sense of one-dimensional half-line problems. This fibered structure is the core of the method presented in this section.

**5.2.a. Presentation.** For any  $s \in \mathbb{R}$ , we consider the 1D cell problems in  $H^1(0, 1/\theta_2)$ :

$$\left\{ \begin{array}{l} -\frac{d}{dx} \left( \mu_{s,\boldsymbol{\theta}} \frac{de_{s,\boldsymbol{\theta}}^j}{dx} \right) - \rho_{s,\boldsymbol{\theta}} \omega^2 e_{s,\boldsymbol{\theta}}^j = 0, \quad \text{in } (0, 1/\theta_2) := I_{\boldsymbol{\theta}}, \\ e_{s,\boldsymbol{\theta}}^0(0) = 1 \quad \text{and} \quad e_{s,\boldsymbol{\theta}}^0(1/\theta_2) = 0, \\ e_{s,\boldsymbol{\theta}}^1(0) = 0 \quad \text{and} \quad e_{s,\boldsymbol{\theta}}^1(1/\theta_2) = 1. \end{array} \right. \quad (5.2)$$

Then, by analogy with Proposition 3.18, one easily shows that the local cell problems are concatenations of one-dimensional cell problems (up to periodicity), in the following sense.

### Proposition 5.1

For any boundary data  $\varphi$  in  $L^2(0, 1)$ , the solutions  $E^0(\varphi)$  and  $E^1(\varphi)$  of the local cell problems (4.6) are given by

$$\text{a. e. } \mathbf{y} \in \mathcal{C}_0^\#, \quad E^j(\varphi)(\mathbf{y}) = \tilde{\varphi}(s_{\boldsymbol{\theta}}(\mathbf{y}) + j\delta) e_{s_{\boldsymbol{\theta}}(\mathbf{y}),\boldsymbol{\theta}}^j \left( \frac{y_2}{\theta_2} \right), \quad (5.3)$$

with  $\delta := \theta_1/\theta_2$ , where  $e_{s,\theta}^j$  denotes the solution of the cell problems (5.2), and where  $\tilde{\varphi}$  denotes the periodic extension of  $\varphi$  on  $\mathbb{R}$ , defined by (3.31).

Proposition 5.1 also highlights the structure of the local DtN operators. To see this, let us introduce the *local DtN functions*  $t_{\theta}^{jk}$  defined for  $j, k = 0, 1$ , by

$$\forall s \in \mathbb{R}, \quad t_{\theta}^{jk}(s) := (-1)^{k+1} \theta_2 \left[ \mu_{s,\theta} \frac{de_{s,\theta}^j}{dx} \right] \left( \frac{k}{\theta_2} \right). \quad (5.4)$$

Note that by periodicity of  $\mu_p$  and  $\rho_p$ , the maps  $s \mapsto e_{s,\theta}^j$  and  $t_{\theta}^{jk}$  are 1-periodic.

By applying the directional derivative operator  $D_{\theta}$  to (5.3), and by using the relationship between  $D_{\theta} E^j(\varphi)$  and  $de_{s,\theta}^j/dx$  given by (3.51), it follows that the local DtN operators defined by (4.9) are weighted translation operators, similarly to the propagation operator.

### Proposition 5.2

The operators  $\mathcal{T}^{jk}$  can be written for  $\varphi \in L^2(0, 1)$  and  $s \in (0, 1)$  as

$$\begin{aligned} \mathcal{T}^{00}\varphi(s) &= t_{\theta}^{00}(s) \tilde{\varphi}(s) & \text{and} & & \mathcal{T}^{10}\varphi(s) &= t_{\theta}^{10}(s) \tilde{\varphi}(s + \delta), \\ \mathcal{T}^{11}\varphi(s) &= t_{\theta}^{11}(s - \delta) \tilde{\varphi}(s) & \text{and} & & \mathcal{T}^{01}\varphi(s) &= t_{\theta}^{01}(s - \delta) \tilde{\varphi}(s - \delta), \end{aligned} \quad (5.5)$$

with  $\delta := \theta_1/\theta_2$  and where  $\tilde{\varphi}$  denotes the periodic extension of  $\varphi$  on  $\mathbb{R}$ , defined by (3.31).

Finally, the solution  $u_{\theta}^+$  of the half-line problem (3.1) can be computed directly from  $e_{s,\theta}^j$  and from the propagation operator. In fact, given  $\varphi \in \mathcal{C}_{per}(\Sigma_{n,0}^{\#})$  such that  $\varphi(0) = 1$ , taking formally the trace along  $\theta \mathbb{R}$  in (4.8) leads to

$$\forall \ell \in \mathbb{N}, \quad u_{\theta}^+(\cdot + \ell/\theta_2)|_{I_{\theta}} = (\widetilde{\mathcal{P}^{\ell}\varphi})(\ell\delta) e_{\ell\delta,\theta}^0 + (\widetilde{\mathcal{P}^{\ell+1}\varphi})((\ell+1)\delta) e_{\ell\delta,\theta}^1, \quad (5.6)$$

where  $\widetilde{\mathcal{P}^{\ell}\varphi}$  is the periodic extension of  $\mathcal{P}^{\ell}\varphi$ ,  $\ell \in \mathbb{N}$ . The proof is similar to the one of (4.8).

Expressions (5.3), (5.5), and (5.6) form the basis of the *quasi one-dimensional* or *quasi-1D* strategy, which consists in approximating the solutions  $e_{s,\theta}^j$  as well as the functions  $t_{\theta}^{jk}$  and finally the local DtN operators  $\mathcal{T}^{jk}$ . Then once the propagation operator is computed by solving the constrained Riccati equation (4.14), the solution  $u_{\theta}^+$  may be constructed directly cell by cell using (5.6).

**5.2.b. Discretization.** The quasi-1D approach requires two distinct approximate spaces associated to the transverse and the  $\theta$ -oriented directions (see Figure 5 on the right).

**Transverse direction.** We begin with a one-dimensional mesh  $\mathcal{T}_h(0, 1)$  of  $\Sigma_{2,0}^{\#} \equiv (0, 1)$  with a mesh step  $h > 0$ . Let  $\mathcal{V}_h(0, 1)$  be the approximation space of  $H^1(0, 1)$  by Lagrange finite elements of order  $d > 0$ . We denote by  $(\varphi_p)_{0 \leq p \leq N}$  the usual nodal basis, which satisfies in particular  $\varphi_p(s_q) = \delta_{p,q}$ , where  $(s_p)_{0 \leq p \leq N}$  are usual interpolation points (they include the mesh vertices) with  $0 = s_0 < \dots < s_N = 1$ .

Then an internal approximation of  $L^2(0, 1)$  is

$$\mathcal{V}_{h,\text{per}}(0, 1) := \text{Span}\{\varphi_0 + \varphi_N, \varphi_1, \dots, \varphi_{N-1}\},$$

which is chosen so that  $\mathcal{V}_{h,\text{per}}(0, 1) \subset \mathcal{C}_{\text{per}}(0, 1)$ . In particular, from the definition of the basis functions  $\varphi_i$ , one has the following decomposition

$$\forall \varphi_h \in \mathcal{V}_{h,\text{per}}(0, 1), \quad \varphi_h = \sum_{p=0}^N \varphi_h(s_p) \varphi_p, \quad \text{with} \quad \varphi_h(s_0) = \varphi_h(s_N). \quad (5.7)$$

**$\theta$ -oriented direction.** Let  $\mathcal{T}_{h_\theta}(I_\theta)$  denote a mesh of the line segment  $I_\theta$  with a mesh step  $h_\theta > 0$ . Set  $\mathcal{V}_{h_\theta}(I_\theta)$  as the approximation space of  $H^1(I_\theta)$  by Lagrange finite elements of order  $d_\theta > 0$  and define  $\mathcal{V}_{h_\theta,0}(I_\theta) := \mathcal{V}_{h_\theta}(I_\theta) \cap H_0^1(I_\theta)$ .

The approximation of  $e_{s,\theta}^0$  and  $e_{s,\theta}^1$  can be seen as a two-step process. First, for any  $s \in \mathbb{R}$ , consider the solution  $e_{s,\theta,h_\theta}^j$  of the discrete variational formulation associated to (5.2).

In practice, the solution  $e_{s,\theta,h_\theta}^j$  can only be computed for a finite number of  $s \in (0, 1)$ . This is where the discretization in the transverse direction comes into play: given  $x \in I_\theta$ , the function  $s \mapsto e_{s,\theta,h_\theta}^j(x)$  shall be interpolated in  $\mathcal{V}_{h,\text{per}}(0, 1)$ . The interpolation process requires to compute the discrete solution  $e_{s,\theta,h_\theta}^j$  only for  $s = s_p$ ,  $p \in \llbracket 0, N-1 \rrbracket$ . Then, using the decomposition formula (5.7),  $e_{s,\theta}^j$  shall be approximated by

$$\forall (s, x) \in (0, 1) \times I_\theta, \quad e_{s,\theta,h}^j(x) = \sum_{p=0}^N e_{s_p,\theta,h_\theta}^j(x) \varphi_p(s), \quad \text{with} \quad \mathbf{h} = (h, h_\theta). \quad (5.8)$$

where  $e_{0,\theta,h_\theta}^j = e_{1,\theta,h_\theta}^j$  (because  $e_{s,\theta}^j$  is 1-periodic with respect to  $s$ ).

From the solutions  $e_{s,\theta,h}^j$ , we introduce the discrete local DtN functions

$$\forall s \in (0, 1), \quad t_{\theta,\mathbf{h}}^{jk}(s) := \theta_n \int_0^{1/\theta_n} \left( \mu_{s,\theta} \frac{de_{s,\theta,h}^j}{dx} \overline{\frac{de_{s,\theta,h}^k}{dx}} - \rho_{s,\theta} \omega^2 e_{s,\theta,h}^j \overline{e_{s,\theta,h}^k} \right),$$

which are inspired from the weak expression (5.4) of the local DtN functions  $t_\theta^{jk}$ . Then, by analogy with (5.1), we define the discrete DtN operators  $\mathcal{T}_{\mathbf{h}}^{jk} \in \mathcal{L}(\mathcal{V}_{h,\text{per}}(0, 1))$  for any  $\varphi_h, \psi_h \in \mathcal{V}_{h,\text{per}}(0, 1)$  as follows:

$$\int_{\Sigma_{n,0}^\#} \mathcal{T}_{\mathbf{h}}^{jk} \varphi_h \overline{\psi_h} := \int_0^1 t_{\theta,\mathbf{h}}^{jk}(s - k\delta) \tilde{\varphi}_h(s + (j - k)\delta) \overline{\psi_h(s)} ds, \quad (5.9)$$

with  $\tilde{\varphi}_h$  being the periodic extension of  $\varphi_h$  to  $\mathbb{R}$ , defined by (3.31). These discrete operators, when computed for  $\varphi_h, \psi_h$  being the basis functions of  $\mathcal{V}_{h,\text{per}}(0, 1)$ , are represented by  $N \times N$  matrices, where  $N = \dim \mathcal{V}_{h,\text{per}}(0, 1)$ . The integrals which appear in (5.9) are evaluated in practice using a specifically designed quadrature rule whose description is omitted here.

Finally, let  $\varphi_h \in \mathcal{V}_{h,\text{per}}(0, 1) \subset \mathcal{C}_{\text{per}}(\mathbb{R})$  such that  $\varphi_h(0) = 1$ . Then using (5.6), the solution of the

half-line problem (3.1) can be approximated with the function defined cell by cell by

$$\forall \ell \in \mathbb{N}, \quad u_{\theta, h}^+(\cdot + \ell/\theta_2)|_{I_\theta} = (\mathcal{P}_h^\ell \varphi_h)(\ell \delta) e_{\ell\delta, \theta, h}^0 + (\mathcal{P}_h^{\ell+1} \varphi_h)((\ell + 1)\delta) e_{\ell\delta, \theta, h}^1.$$

where  $\mathcal{P}_h \in \mathcal{L}(\mathcal{V}_{h, \text{per}}(0, 1))$  corresponds to a suitable discrete  $\mathbb{R}^{N \times N}$  approximation of  $\mathcal{P}$ . The computation of such an operator is the subject of the next subsection.

### 5.3 Approximation of the propagation operator

In order to find a suitable approximation  $\mathcal{P}_h \in \mathcal{L}(\mathcal{V}_{h, \text{per}}(0, 1))$  of the propagation operator  $\mathcal{P}$ , it is natural to introduce the discrete constrained Riccati equation

$$\left| \begin{array}{l} \text{Find } \mathcal{P}_h \in \mathcal{L}(\mathcal{V}_{h, \text{per}}(0, 1)) \text{ such that } \rho(\mathcal{P}_h) < 1 \text{ and } \mathcal{T}_h(\mathcal{P}_h) = 0, \text{ where} \\ \mathcal{T}_h(\mathcal{P}_h) := \mathcal{T}_h^{10} \mathcal{P}_h^2 + (\mathcal{T}_h^{00} + \mathcal{T}_h^{11}) \mathcal{P}_h + \mathcal{T}_h^{01}, \end{array} \right. \quad (5.10)$$

and where  $(\mathcal{T}_h^{00}, \mathcal{T}_h^{01}, \mathcal{T}_h^{10}, \mathcal{T}_h^{11})$  are obtained via one of the methods described in Sections 5.1 and 5.2 (cf. (5.1) or (5.9)). Using the same arguments as for the elliptic Helmholtz equation [Fli09], it can be proved that this discrete equation admits a unique solution.

In order to solve (5.10), two methods have been proposed in [JLF06]: a *spectral decomposition method*, and a *modified Newton method*. Here, we only describe the spectral approach.

The spectral decomposition method consists in characterizing  $\mathcal{P}_h$  by means of its eigenpairs  $(\lambda_i, \psi_i)$  of  $\mathcal{P}_h$ . Doing so however raises an important question: is  $\mathcal{P}_h$  completely defined by its eigenpairs? This is equivalent to wondering if  $\mathcal{P}_h$  is diagonalizable or not. The diagonalizability of  $\mathcal{P}_h$  is an open question, but for the sake of simplicity, we will assume in the sequel that this is the case, namely

The family of eigenfunctions  $(\psi_i)_{1 \leq i \leq N}$  forms a basis of  $\mathcal{V}_{h, \text{per}}(0, 1)$ .

In practice, this is the situation that we always have encountered. Moreover, in the case where this assumption fails to be true, one can still adapt the method, and recover  $\mathcal{P}_h$  through a Jordan decomposition. (See [Fli09, Section 2.3.2.3] for more details.)

The spectral approach relies on the results presented in Section 4.4, which remain true for the discrete equation. In particular, by analogy with Proposition 4.8,  $(\lambda_h, \psi_h) \in \mathbb{C} \times \mathcal{V}_{h, \text{per}}(0, 1)$  is an eigenpair of  $\mathcal{P}_h$  if and only if it satisfies

$$\mathcal{T}_h(\lambda_h) \psi_h = 0, \quad \text{with } \psi_h \neq 0 \quad \text{and} \quad |\lambda_h| < 1.$$

Solving the Riccati equation hence comes down to solving a quadratic eigenvalue problem:

$$\left| \begin{array}{l} \text{Find } (\lambda_h, \psi_h) \in \mathbb{C} \times \mathcal{V}_{h, \text{per}}(0, 1) \text{ such that } \psi_h \neq 0, |\lambda_h| < 1 \text{ and} \\ \lambda_h^2 \mathcal{T}_h^{10} \psi_h + \lambda_h (\mathcal{T}_h^{00} + \mathcal{T}_h^{11}) \psi_h + \mathcal{T}_h^{01} \psi_h = 0. \end{array} \right. \quad (5.11)$$

If one sets  $N = \dim \mathcal{V}_{h, \text{per}}(0, 1)$ , then (5.11) can be reduced to a  $2N \times 2N$  linear eigenvalue problem in a classical way [TM01], thus yielding  $2N$  eigenvalues. In order to pick the  $N$  eigenvalues of the propagation operator, we need a criterion. To do so, note that with the 2D or the quasi-1D method, the properties of the local DtN operators (Proposition 4.3) remain preserved for the discrete operators

$\mathcal{T}_h^{jk}$ . Hence Proposition 4.10 admits the following discrete version:

$$\text{Ker } \mathcal{T}_h(\lambda_h) \neq \{0\} \iff \text{Ker } \mathcal{T}_h(1/\lambda_h) \neq \{0\}.$$

Therefore, as already expected with Remark 4.11, the solutions of (5.11) can be grouped into pairs  $(\lambda_h, 1/\lambda_h)$ , where  $0 < |\lambda_h| < 1$ . Consequently, in order to compute  $\mathcal{P}_h$ , one can solve (5.11) (using for instance linearization techniques), and choose the  $N$  eigenpairs  $(\lambda_h, \psi_h)$  which satisfy  $|\lambda_h| < 1$ .

#### 5.4 The DtN coefficient

Finally, consider a function  $\varphi_h \in \mathcal{V}_{h,\text{per}}(0, 1) \subset \mathcal{C}_{\text{per}}(\mathbb{R})$  which satisfies  $\varphi_h(0) = 1$ . Then by analogy with (4.16), and in the spirit of Proposition 4.6, we define the discrete DtN operator and the discrete DtN coefficient as follows:

$$\Lambda_h = \mathcal{T}_h^{10} \mathcal{P}_h + \mathcal{T}_h^{00} \quad \text{and} \quad \lambda_h^+ = \frac{(\Lambda_h \varphi_h)(0)}{\theta_2},$$

where  $\mathcal{T}_h^{10}$  and  $\mathcal{T}_h^{00}$  are computed using one of the methods presented in Sections 5.1 and 5.2, and where  $\mathcal{P}_h$  is the solution of the discrete Riccati equation (5.10).

#### 5.5 Numerical results

We present some numerical results to validate the method, to illustrate its efficiency, and to compare the multi-dimensional and the quasi one-dimensional methods in the case where the order of quasiperiodicity is set to  $n = 2$ . Simulations will be carried out with the periodic coefficients  $\mu_p$  and  $\rho_p$ , defined for  $\mathbf{y} = (y_1, y_2) \in \mathbb{R}^2$  by

$$\mu_p(\mathbf{y}) = 1.5 + \cos(2\pi y_1) \cos(2\pi y_2) \quad \text{and} \quad \rho_p(\mathbf{y}) = 1.5 + 0.5 \sin(2\pi y_1) + 0.5 \sin(2\pi y_2).$$

We set  $\boldsymbol{\theta} = (\cos \pi/3, \sin \pi/3)$ . As the ratio  $\theta_2/\theta_1 = \sqrt{3}$  is irrational,  $\boldsymbol{\theta}$  is an irrational vector. For  $a = 1$ , the source term  $f$  is the cut-off function

$$\forall x \in \mathbb{R}, \quad f(x) = \exp\left(100\left(1 - 1/(1 - x^2)\right)\right) \chi_{(-1,1)},$$

and the local perturbations  $\mu_i$  and  $\rho_i$  are defined as piecewise constants, so that the coefficients  $\mu$  and  $\rho$  of the model problem (1.1) are represented in Figure 6.

**5.5.a. The half-line and the half-guide solutions.** The model problem (1.1) is solved by computing the solutions of the half-line problems (1.8), as well as the DtN coefficients  $\lambda^\pm$ . In this part, only results regarding the numerical resolution of Problem (3.1) are going to be presented on  $(a, +\infty)$  (with  $a = 0$  for simplicity), as the problem set on  $(-\infty, -a)$  provides the same overall results.

**Error analysis.** In order to validate the method, we introduce for  $L > 0$  large enough the unique function  $u_{\boldsymbol{\theta},L}^+$  in  $H^1(0, L)$  that satisfies Problem (3.1) on the truncated domain  $(0, L)$ , with  $u_{\boldsymbol{\theta},L}^+(L) = 0$ . Also let  $\Omega_L := (0, 1) \times (0, L)$ , and for  $\varphi \in L^2(\Sigma_{2,0}^\#)$ , let  $U_{\boldsymbol{\theta},L}^+(\varphi) \in H_{\boldsymbol{\theta}}^1(\Omega_L)$  denote the unique function that satisfies (3.53) on  $\Omega_L$ , with  $U_{\boldsymbol{\theta},L}^+(\varphi)|_{y_2=L} = 0$ .

In presence of absorption, the solutions  $u_{\boldsymbol{\theta}}^+$  and  $U_{\boldsymbol{\theta}}^+(\varphi)$  decay exponentially at infinity (see (3.57) and (4.4)), and by studying the problems satisfied by  $u_{\boldsymbol{\theta},L}^+ - u_{\boldsymbol{\theta}}^+$  and  $U_{\boldsymbol{\theta},L}^+(\varphi) - U_{\boldsymbol{\theta}}^+(\varphi)$ , it can be proved as

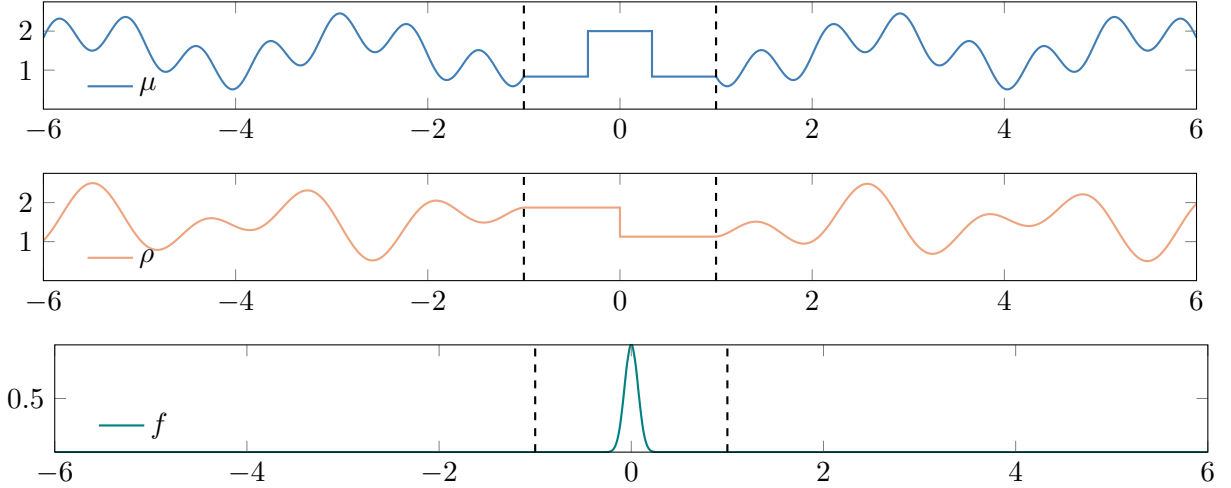

Figure 6: The locally perturbed quasiperiodic coefficients  $\mu$  and  $\rho$ , and the source term  $f$ .

in [FG20] that there exist constants  $\alpha, c > 0$  such that for any  $L > 0$ ,

$$\begin{aligned} \|u_{\theta,L}^+ - u_{\theta}^+\|_{H^1(0,L)} &\leq c e^{-\alpha \Im \omega L} \|u_{\theta}^+\|_{H^1(0,L)} \\ \|U_{\theta,L}^+(\varphi) - U_{\theta}^+(\varphi)\|_{H_{\theta}^1(\Omega_L)} &\leq c e^{-\alpha \Im \omega L} \|U_{\theta}^+(\varphi)\|_{H_{\theta}^1(\Omega_L)}. \end{aligned} \quad (5.12)$$

with  $\alpha = \sqrt{\rho_-/\mu_+}$ . In particular, if  $L$  is chosen large enough, then  $u_{\theta,L}^+$  and  $U_{\theta,L}^+(\varphi)$  can be viewed as suitable approximations of  $u_{\theta}^+$  and  $U_{\theta}^+(\varphi)$ , and thus can serve as reference solutions. In the upcoming results, to make the truncation errors in (5.12) negligible with respect to the errors induced by the numerical method, we choose  $L \equiv L(\omega)$  so that

$$\exp(-\sqrt{\rho_-/\mu_+} \Im \omega L) \leq 10^{-10}. \quad (5.13)$$

The corresponding solutions  $u_{\theta,L}^+$  and  $U_{\theta,L}^+(\varphi)$ , which will be denoted by  $u_{ref}^+$  and  $U_{ref}^+(\varphi)$  respectively, are computed via  $\mathbb{P}^1$  Lagrange finite elements. The mesh step  $h = 5 \times 10^{-4}$  is taken small enough to guarantee a suitable approximation even for the largest values of the frequency  $\Re \omega$  (cf. [IB95]).

In the following, the boundary data is fixed to  $\varphi = 1$ , and is omitted in the notation of  $U_{\theta}^+$  and  $U_{ref}^+$ . Also, we only plot relative errors corresponding to the 1D solution, as we have checked that the errors for the 2D solution behave similarly. In Figure 7, the relative error

$$\varepsilon(u_{\theta}^+) := \frac{\|u_{\theta,h}^+ - u_{ref}^+\|_{H^1(0,4/\theta_2)}}{\|u_{ref}^+\|_{H^1(0,4/\theta_2)}} \quad (5.14)$$

is represented with respect to the mesh step  $h$ , and for both the 2D and the quasi-1D method (with  $h_{\theta} = h$  for the quasi-1D method). The solutions are computed using Lagrange finite elements of degree 1.

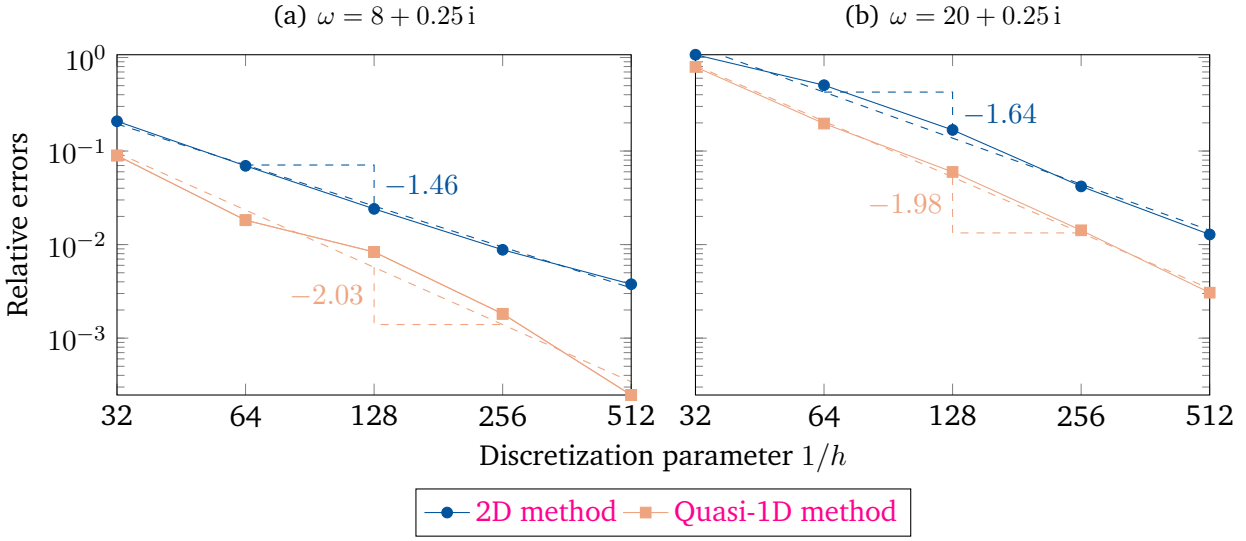

Figure 7: Relative error in  $H^1$  norm of the half-line solution for different values of  $\omega$ .

One sees that the errors tend to 0 as  $h$  at least, as expected for  $\mathbb{P}^1$  Lagrange finite elements. With the quasi-1D method however,  $\varepsilon(u_\theta^+)$  behaves as  $h^2$ . This is a special superconvergence phenomenon, which is probably due to the fact that the problems solved in practice with the quasi-1D method are one-dimensional. Note also that in general, the quasi-1D method appears to be more accurate than the 2D method.

For a fixed mesh step, the relative error increases with the real frequency  $\Re \omega$ . This is a well-known particularity of the Helmholtz equation: since  $\Re \omega$  represents the spatial frequency of the time-harmonic waves, the discretization parameter  $h$  has to be adapted in order to take the oscillations into account.

**Representation of the half-guide solution.** The half-guide solution is represented in Figure 8 for different values of  $\omega$ , when  $\varphi = 1$ . As expected,  $U_\theta^+$  oscillates more when  $\Re \omega$  increases (Figures 8a–8b), and it propagates more as  $\Im \omega$  decreases (Figures 8b–8c).

**Dependence with respect to the boundary data.** The goal of this part is to see how the half-line and the half-guide solutions depend on the boundary data  $\varphi$ . To do so, we choose three different datas:

$$\varphi_1(s) = 1, \quad \varphi_2(s) = \cos(2\pi s), \quad \text{and} \quad \varphi_3(s) = 1 - \mathbb{1}_{[1/3, 2/3]}(s). \quad (5.15)$$

We set  $\omega = 8 + 0.25i$ , and we display results obtained with the quasi-1D method, knowing that the 2D method yields the same conclusions. The computations are carried out using  $\mathbb{P}^1$  Lagrange finite elements, with mesh steps  $h = h_\theta = 2 \times 10^{-3}$ .

As expected, and as Figures 10 and 9a–9c show, the aspect of half-guide solution changes drastically with respect to the boundary data, whereas the half-line solution looks invariant.

**5.5.b. The whole line problem.** The solutions  $u_\theta^\pm$  of the half-line problems (1.8) allow one to compute the DtN coefficients  $\lambda^\pm$ , to solve (1.9), and then to compute the solution  $u$  of Problem (1.1) using (1.10). Recall that the coefficients  $\mu$ ,  $\rho$ , and the source term  $f$  are shown in Figure 6. The solution of (1.1) is represented in Figure 11 for different values of  $\omega$ .

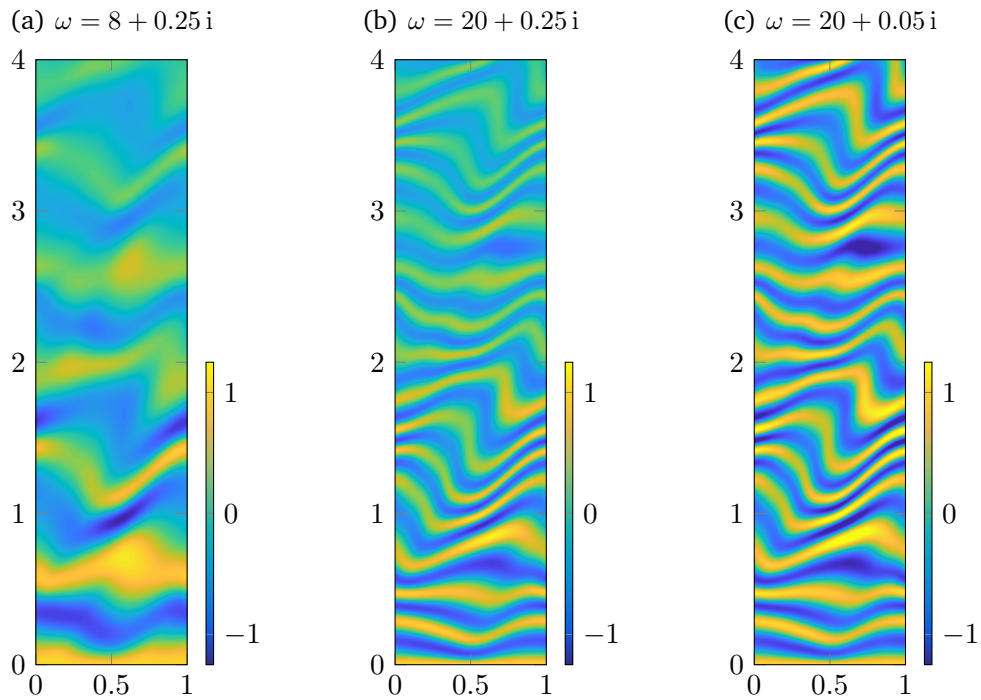

Figure 8: Real part of the half-guide solution computed using the quasi-1D approach, with  $\mathbb{P}^1$  Lagrange finite elements and  $h = 2 \times 10^{-3}$ , and for different values of  $\omega$ .

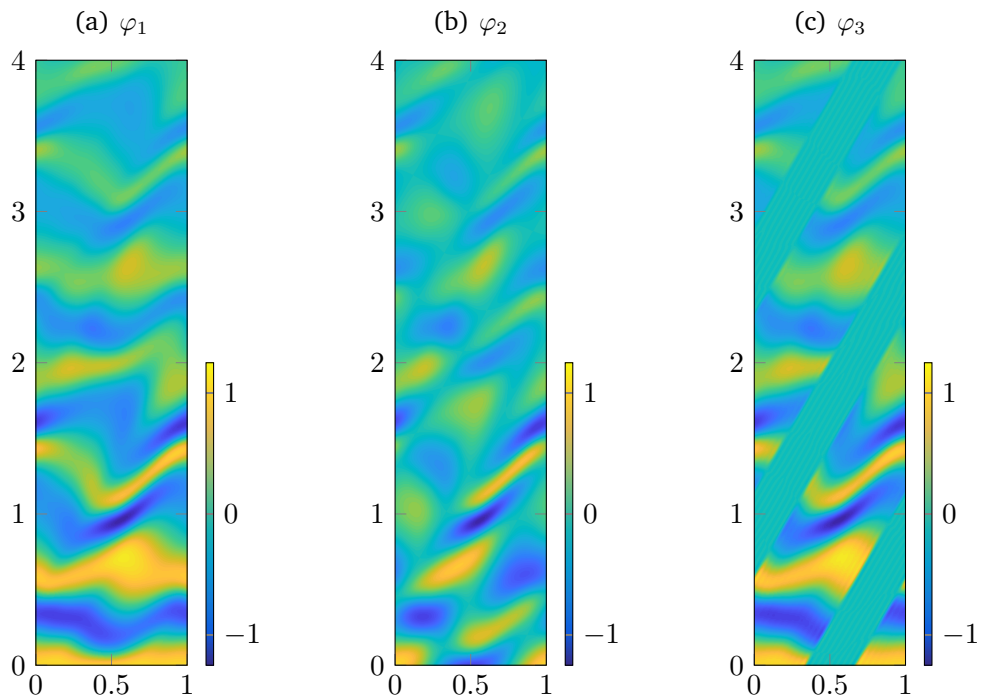

Figure 9: Real part of the half-guide solution computed using the quasi-1D approach, with  $\mathbb{P}^1$  Lagrange finite elements and  $h = 2 \times 10^{-3}$ , and for different values of  $\varphi$ .

**5.5.c. About the influence of the absorption on the accuracy.** We come back to the numerical resolution of Problem (3.1), and we study the convergence of the 2D and quasi-1D methods depending on the absorption, especially when it tends to 0. As in Section 5.5.a, the solutions are computed with



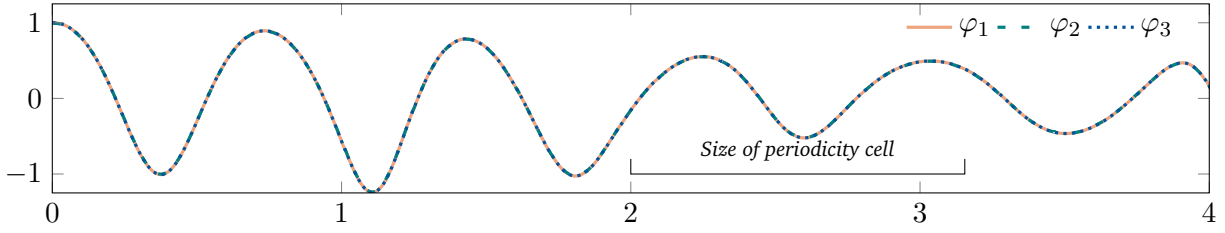

Figure 10: Real part of the half-line solution computed using the quasi-1D approach with  $\mathbb{P}^1$  Lagrange finite elements,  $h = 2 \times 10^{-3}$ , and for different  $\varphi$ .

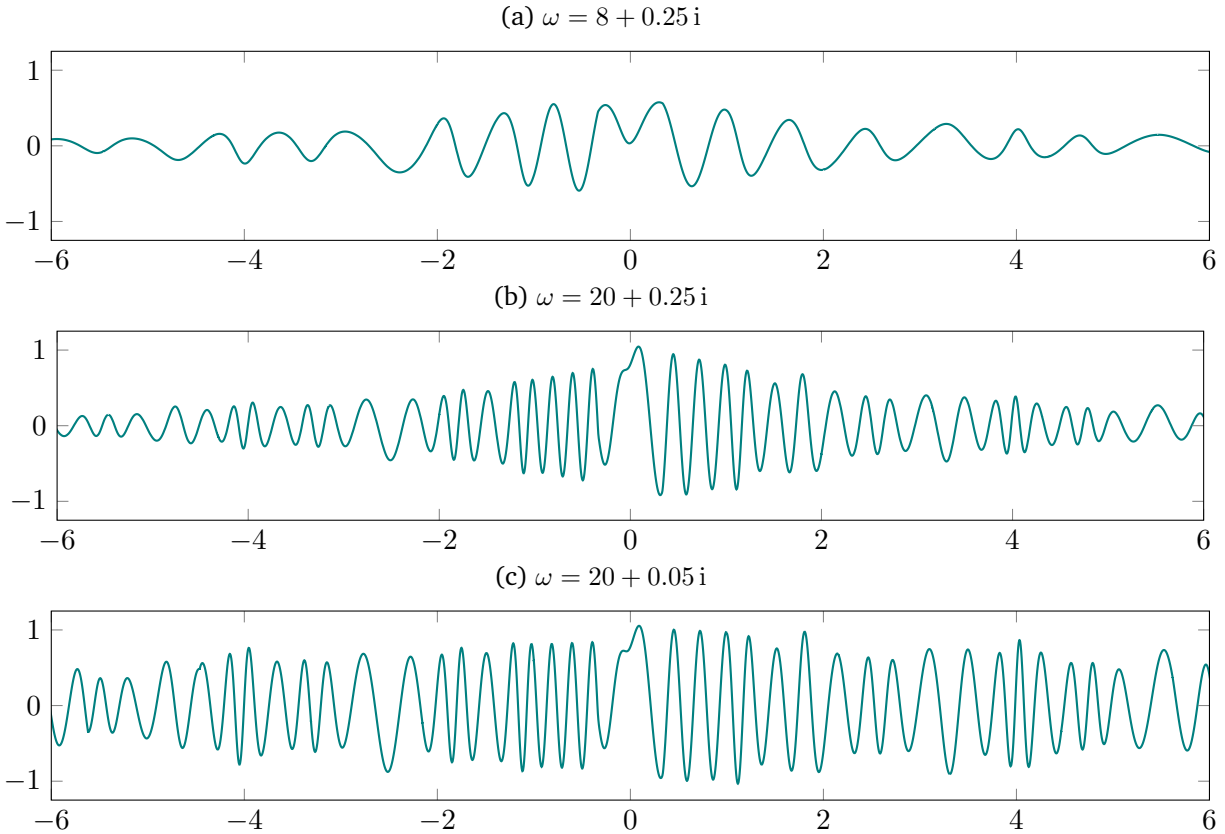

Figure 11: Real part of the solution of (1.1) computed using the quasi-1D approach with  $\mathbb{P}^1$  Lagrange finite elements,  $h = 2 \times 10^{-3}$ , and for different  $\omega$ .

Lagrange finite elements of degree 1. The relative error  $\varepsilon(u_\theta^+)$  defined (5.14) is represented in Figure 12 for both the 2D and the quasi-1D method, and for different values of  $\Im m \omega$ .

As Figure 12 shows, the error deteriorates with  $\Im m \omega$ . It would mean that the numerical method becomes less efficient as the absorption decreases. We believe that this issue is closely related to the well-posedness of the local cell problems with Dirichlet boundary conditions when  $\Im m \omega = 0$ . In fact, for the elliptic Helmholtz equation, it is known (see [Fli09, Section 3.2.1.1] for instance) that the local cell problems are well-posed except for a *countable* set of frequencies which correspond to the eigenvalues of the associated differential operator. In our case however, as the differential operator has a non-elliptic principal part, it also has a continuous spectrum, and one can show that when  $\mu_p$  and  $\rho_p$  are non-constant, the local cell problems are well-posed *only for frequencies in a bounded set* (that can even be empty). An alternative to avoid this problem is to use Robin-to-Robin operators

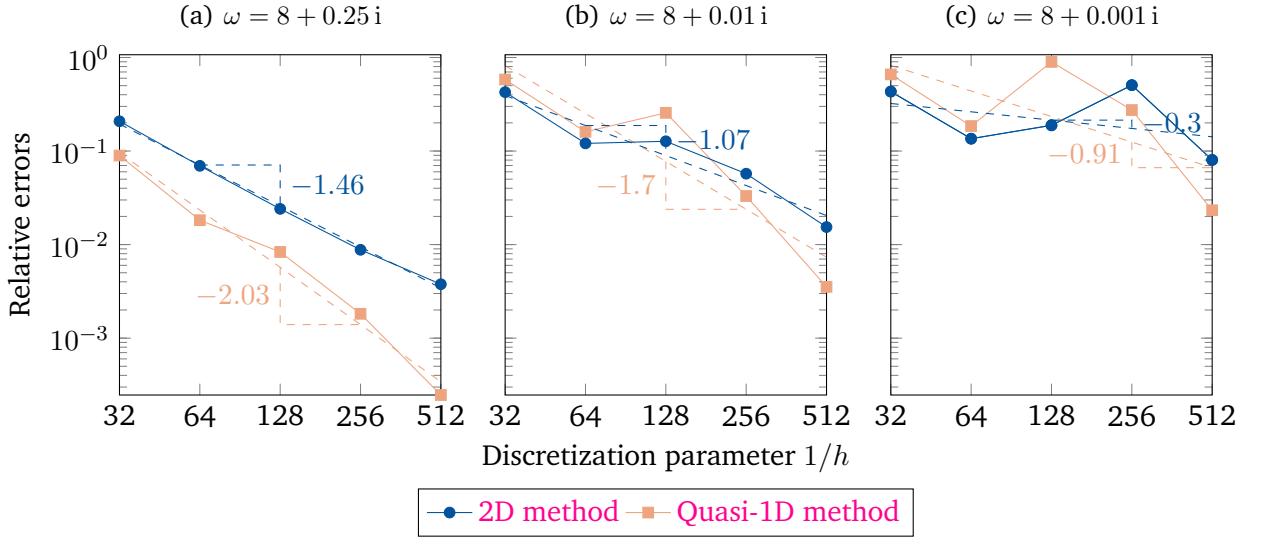

Figure 12: Relative error in  $H^1$  norm of the half-line solution for different values of  $\omega$ .

instead of the DtN operators, which would involve solving well-posed local cell problems with Robin boundary conditions, as it is done in [Fli09] for periodic media. This will be done in the next chapter.

**5.5.d. About the spectral approximation of the propagation operator.** As explained in Subsection 5.3, the discrete propagation operator  $\mathcal{P}_h$  is computed by means of its eigenpairs. In this section, the eigenvalues of  $\mathcal{P}_h$  are compared with the spectrum of the exact propagation operator which, according to Proposition 4.12, is a circle of radius

$$M_{\log}(p_\theta) = \exp\left(\int_0^1 \log |p_\theta(s)| ds\right), \quad \text{with } p_\theta(s) = u_{s-\delta, \theta}^+(1/\sin \theta_2).$$

To compute this radius,  $u_{s, \theta}^+$  is approximated by the unique function  $u_{s, \theta, L}^+$  that satisfies (3.56) on a truncated domain  $(0, L)$ , with  $u_{s, \theta, L}^+(L) = 0$ . One can show similar estimates to (5.12), and if  $L$  is chosen large enough (for instance, if  $L$  satisfies (5.13)), then  $u_{s, \theta, L}^+$  can be used as a reference solution. In practice,  $u_{s, \theta, L}^+$  is computed for several  $s$ , and finally the integral that defines  $M_{\log}(p_\theta)$  is evaluated using a rectangular quadrature rule.

The spectra of  $\mathcal{P}_h$  and  $\mathcal{P}$  are shown in Figure 14 for  $\omega = 8 + 0.25i$ , and for different values of the discretization parameter  $h$  (with  $h_\theta = h$  for the quasi-1D method). Figure 13 represents the number  $N_h$  of eigenvalues of  $\mathcal{P}_h$  that are close by 5% to  $\sigma(\mathcal{P})$ , namely

$$N_h = \#\left\{ \lambda_h \in \sigma(\mathcal{P}_h) \mid \left| \frac{|\lambda_h| - M_{\log}(p_\theta)}{M_{\log}(p_\theta)} \right| \leq 5\% \right\}. \quad (5.16)$$

In Figure 13, one sees that  $N_h$  increases with  $1/h$ , which means that more and more eigenvalues of  $\mathcal{P}_h$  are close to  $\sigma(\mathcal{P})$  when  $h$  decreases. In other words, a finer discretization leads as expected to a better approximation of the spectrum. The number  $N_h$  of such eigenvalues also seems to increase linearly with  $1/h$  (up to subsequences for the quasi-1D method). Finally, note that  $N_h$  is higher with the quasi-1D method than with the 2D method.

As Figure 14 shows, the eigenvalues of  $\mathcal{P}_h$  are all included in the disk of radius  $\rho(\mathcal{P})$ , but one observes

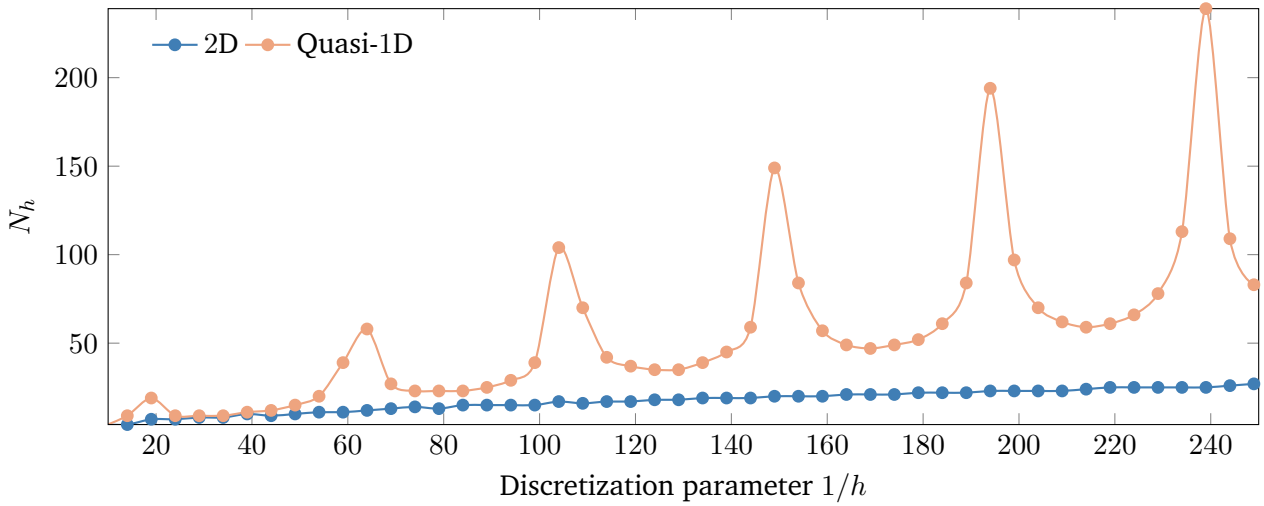

Figure 13: Number of eigenvalues of  $\mathcal{P}_h$  that are close by 5% to  $\sigma(\mathcal{P})$  with respect to  $h$ .

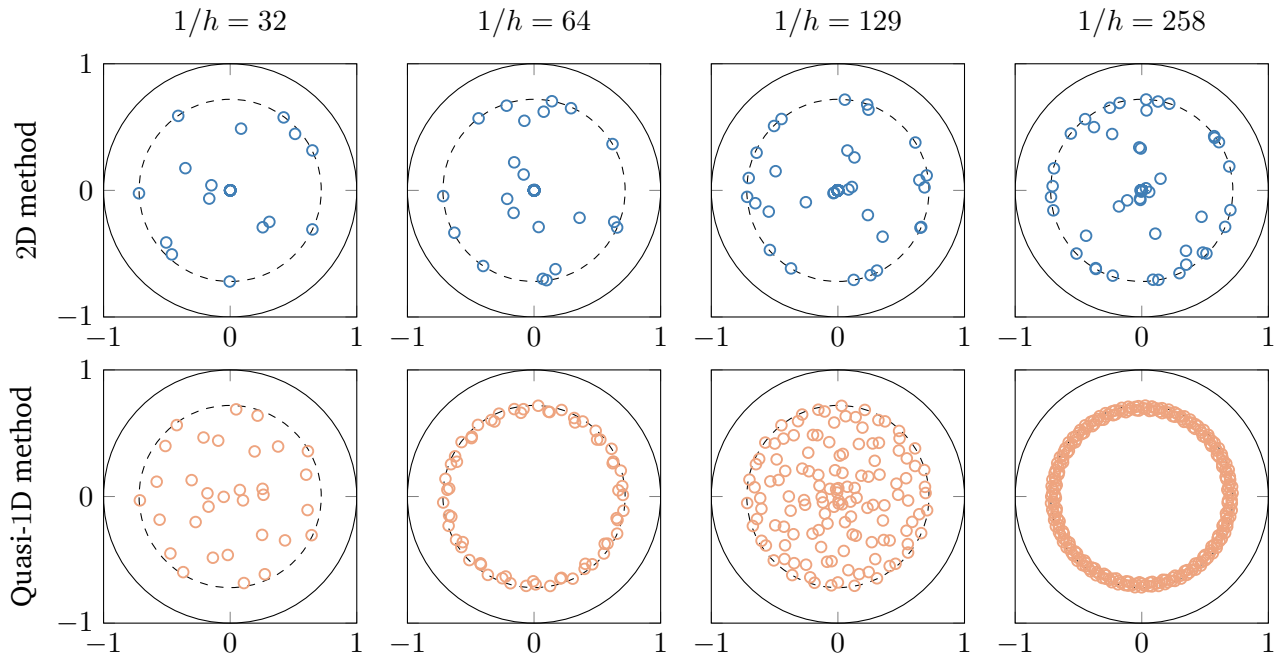

Figure 14: Eigenvalues of the discrete propagation operator (circle-shaped markers) compared to the spectrum of the exact propagation operator (circle in dashed line) for  $\omega = 8 + 0.25i$ , and for different values of the discretization parameter.

some spectral pollution. This is a classical phenomenon when one approximates the spectrum of an operator which is neither compact nor self-adjoint. What is striking however, is that the pollution behaviours are very different depending on the method used.

On one hand, the eigenvalues obtained with the 2D approach tend to accumulate to 0. A likely explanation for this phenomenon is that solving the local cell problems on 2D meshes does not take their directional structure into account. Since the location of the eigenvalues of  $\mathcal{P}_h$  is similar to the one obtained in the elliptic case, for which  $\mathcal{P}$  is compact (see [JLF06, Theorem 3.1]), we believe the 2D method somehow regularizes the half-guide problem (3.53) by introducing an elliptic (discrete) approximation of the corresponding differential operator.

On the other hand, with the quasi-1D approach, the spectrum of  $\mathcal{P}_h$  “oscillates” as the discretization

parameter  $h$  tends to 0. This phenomenon has to do with the particular nature of  $\mathcal{P}$  which is a weighted translation operator. We strongly suspect that one can extract a subsequence  $(\mathcal{P}_{h'})$  whose spectrum converges towards  $\sigma(\mathcal{P})$  in a sense to be defined precisely, as it is suggested by the peaks in Figure 13. The investigation of this assumption as well as the construction of such a subsequence are subject to ongoing works.

With both approaches, it has been observed numerically that the eigenfunctions associated to the spurious eigenvalues are highly oscillating functions, thus badly approximated by the discretization, whereas the components of the half-guide solution on these eigenfunctions are very small. This might explain why the spectral pollution does not have a visible influence on the approximation of the half-guide and the half-line solutions, as the errors in Figure 7 seem to suggest.

## 6 Perspectives

A numerical method has been proposed to solve the Helmholtz equation in 1D unbounded quasi-periodic media. Using the presence of absorption, we justified that this equation could be lifted onto a higher-dimensional problem which, in turn, can be solved using a Dirichlet-to-Neumann approach. For the discretization, we presented a multi-dimensional method, as well as a so-called quasi one-dimensional method. As shown by numerical simulations, both methods provide a suitable approximation of the solution as long as there is absorption. However, the quasi-1D method proved to be more efficient than the 2D method, as it takes the anisotropy of the problems involved into account.

The method presented opens up numerous perspectives, and raises multiple questions that are subject to ongoing works. For instance, it would be interesting to approximate efficiently the spectrum of the propagation operator, even though the spectral pollution seems to have no major impact on the efficiency of the overall method. Another key extension concerns the case where the absorption tends to 0. This extension, which will be presented in the next chapter, involves replacing the DtN method by a Robin-to-Robin method as explained in Section 5.5.a, and finding a way to characterize the propagation operator.



# Wave propagation in quasiperiodic media: Limiting absorption principle

## Outline

---

1	Presentation . . . . .	76
1.1	The model problem and assumptions on the coefficients . . . . .	76
1.2	Theoretical difficulties and limiting absorption principle . . . . .	77
1.3	Objectives of the work and outline . . . . .	79
2	The DtN approach is not adapted to limiting absorption . . . . .	80
3	A Robin-to-Robin approach for the absorbing case . . . . .	85
3.1	Robin half-line problems and their 2D lifting . . . . .	85
3.2	The propagation and scattering operators . . . . .	90
3.3	Local cell problems and reconstruction formula . . . . .	92
3.4	Local RtR operators and Riccati system . . . . .	94
3.5	RtR half-space operator and transparent boundary condition . . . . .	97
4	Analysis of the Riccati system . . . . .	98
4.1	Spectral description of the propagation operators . . . . .	98
4.2	Spectral resolution of the Riccati system . . . . .	103
4.3	Relationship between left and right half-waveguides . . . . .	107
4.4	Resolution algorithm in the absorbing case . . . . .	108
5	Towards limiting absorption : quasi-periodic spectrum . . . . .	108
5.1	Quasiperiodic operators on the whole line . . . . .	109
5.2	Quasiperiodic operator on a half-line . . . . .	111
6	Limiting absorption principle . . . . .	113
6.1	Convergence of the cell solutions and the associated RtR operators . . . . .	113
6.2	Link between the spectrum of $\mathcal{A}_\theta$ and the Riccati spectrum . . . . .	116
6.3	Case of evanescent frequencies: $\omega^2 \notin \sigma(\mathcal{A}_\theta)$ . . . . .	118
6.4	Case of propagative frequencies $\omega^2 \in \sigma(\mathcal{A}_\theta)$ . . . . .	118
6.4.a	Convergence assumption on the fundamental eigenpair . . . . .	119
6.4.b	Notion of flux density . . . . .	120
6.4.c	Convergence of the propagation operator . . . . .	124
6.4.d	Limiting absorption for the half-line problem . . . . .	125
6.4.e	The limit Riccati system and spectral characterization of the limit propagation operator . . . . .	127

6.5	Problem in the bounded interval and definition of the physical solution . . . . .	131
6.6	Resolution algorithm . . . . .	132
7	Numerical results . . . . .	133
A	Invariance of spectra of differential operators . . . . .	138

## 1 Presentation

### 1.1 The model problem and assumptions on the coefficients

We consider the Helmholtz equation

$$-\frac{d}{dx}\left(\mu \frac{du}{dx}\right) - \rho \omega^2 u = f \quad \text{in } \mathbb{R}, \quad (\mathcal{P})$$

where

- the coefficients  $\mu$  and  $\rho$  have positive upper and lower bounds:

$$\exists \mu_{\pm}, \rho_{\pm}, \quad \forall x \in \mathbb{R}, \quad 0 < \mu_- \leq \mu(x) \leq \mu_+ \quad \text{and} \quad 0 < \rho_- \leq \rho(x) \leq \rho_+, \quad (1.1)$$

and they are local perturbations of continuous quasiperiodic functions of order 2 (see below for the definition), namely  $\mu_{\theta}$  and  $\rho_{\theta}$ :

$$\exists a^l < a^r, \quad \text{supp}(\mu - \mu_{\theta}) \subset (a^l, a^r) \quad \text{and} \quad \text{supp}(\rho - \rho_{\theta}) \subset (a^l, a^r); \quad (1.2)$$

- the source term  $f$  belongs to  $L^2(\mathbb{R})$  and is assumed to have a compact support, which can be supposed to be  $(a^l, a^r)$  without any loss of generality:

$$\text{supp } f \subset (a^l, a^r). \quad (1.3)$$

Here and in what follows the superscript “ $l$ ”, *resp.* “ $r$ ”, stands for “left”, *resp.* “right”.

The functions  $\mu_{\theta}$  and  $\rho_{\theta}$  are supposed to be quasiperiodic of order 2, meaning (see Definition II-1.1) that there exist functions  $\mu_p, \rho_p : \mathbb{R}^2 \rightarrow \mathbb{R}$  which are continuous and 1-periodic with respect to each variable, and a vector  $\theta := (\theta_1, \theta_2) \in \mathbb{R}^2$  such that

$$\forall x \in \mathbb{R}, \quad \mu_{\theta} = \mu_p(\theta x) \quad \text{and} \quad \rho_{\theta} = \rho_p(\theta x).$$

In order to simplify the presentation, we choose  $a^l$  and  $a^r$  such that

$$a^l \theta_2 \in \mathbb{Z} \quad \text{and} \quad a^r \theta_2 \in \mathbb{Z}.$$

The interest of this assumption lies in the fact that

$$\mu_p|_{(0,1) \times (a^r \theta_2, a^r \theta_2 + 1)} = \mu_p|_{(0,1)^2} = \mu_p|_{(0,1) \times (a^l \theta_2, a^l \theta_2 + 1)},$$

and similarly for  $\rho_p$ .

**Remark 1.1.** *The present study can be extended without difficulty to the case where*

- $\mu_{\theta}$  and  $\rho_{\theta}$  are quasiperiodic functions of order  $n > 2$ : the periodic extensions  $\mu_p, \rho_p : \mathbb{R}^n \rightarrow \mathbb{R}$  would depend on  $n$  variables and the cut direction  $\theta$  would be a vector of dimension  $n$ .

- $\mu$  (resp.  $\rho$ ) coincides with a different quasiperiodic function in each of the half-lines  $I^l := (-\infty, a^l)$  and  $I^r := (a^r, +\infty)$ :

$$\forall j \in \{l, r\}, \quad \forall x \in I^j, \quad \mu(x) = \mu_p^j(\theta^j x) \quad \text{and} \quad \rho(x) = \rho_p^j(\theta^j x),$$

where  $\mu_p^j, \rho_p^j \in \mathcal{C}_{per}^0(\mathbb{R}^{n^j})$  with  $n^j > 1$ , and  $\theta^j \in \mathbb{R}^{n^j}$  for  $j \in \{l, r\}$ .

It is easy to check that if the ratio  $\delta := \theta_1/\theta_2$  is rational, then  $\mu_\theta$  and  $\rho_\theta$  are  $q/\theta_2$ -periodic, with  $q$  being the denominator of  $\delta$ . In this chapter, we shall assume the opposite, that is,

$$\delta := \frac{\theta_1}{\theta_2} \notin \mathbb{Q}, \quad (1.4)$$

so that  $\mu_\theta$  and  $\rho_\theta$  are not periodic in general.

As  $\delta$  is irrational, Kronecker's approximation theorem II-2.8 ensures that the functions  $\mu_p$  and  $\rho_p$  are entirely determined by their restrictions on the line  $\mathbb{R}\theta$ . In particular,  $\mu_p$  (resp.  $\rho_p$ ) has the same lower and upper bounds as  $\mu$  (resp.  $\rho$ ).

An important tool involved in our study is the notion of Diophantine condition, and more particularly of **irrationality measure** studied in Section II-3. We recall (see Definition II-3.4) that

$$\forall \delta \in \mathbb{R} \setminus \mathbb{Q}, \quad \eta(\delta) := \sup \left\{ \nu > 0 \mid \exists (p_n, q_n) \in \mathbb{N}^2, (p_n, q_n) \rightarrow +\infty, \left| \delta - \frac{p_n}{q_n} \right| \leq \frac{1}{q_n^\nu} \right\}. \quad (1.5)$$

Roughly speaking,  $\eta(\delta)$  is an indicator on "how far the irrational  $\delta$  is close to rationals". By Dirichlet's theorem (see also Proposition II-3.7), we have

$$\forall \delta \in \mathbb{R} \setminus \mathbb{Q}, \quad \eta(\delta) \geq 2.$$

The algebraic irrationals (for instance  $\sqrt{2}$ ) have a measure of irrationality equal to 2, which means that they are somehow the irrationals which are the furthest from the rationals (see Example II-3.10 and Table II.1 for other examples). On the other hand, numbers whose measure of irrationality is infinite are called *Liouville numbers*. The set of Liouville numbers will play an important role in our study. We note from Kintchine-Groshev's theorem (Proposition II-3.2) that this set has Lebesgue measure 0. Moreover, if  $\delta$  is not a Liouville number, then Proposition II-3.6 ensures that

$$\forall \nu > \eta(\delta), \quad \exists c \equiv c(\delta, \nu) > 0 \mid \forall (p, q) \in \mathbb{Z} \times \mathbb{N}^*, \quad \left| \delta - \frac{p}{q} \right| > \frac{c}{q^\nu}. \quad (1.6)$$

We say that  $\theta$  satisfies a Diophantine condition when  $\delta$  is not a Liouville number.

## 1.2 Theoretical difficulties and limiting absorption principle

Equation (P) is encountered when solving the linear wave equation with a source term that is harmonic in time  $f(x)e^{-i\omega t}$ , and when one is looking for a time-harmonic solution  $u(x)e^{-i\omega t}$ . For real frequencies  $\omega$ , the well-posedness of this problem is unclear. This is linked to the spectrum of the



non-negative self-adjoint operators

$$D(\mathcal{A}) := \left\{ u \in H^1(\mathbb{R}) / \mu \frac{du}{dx} \in H^1(\mathbb{R}) \right\} \quad \text{and} \quad \mathcal{A}u := -\frac{1}{\rho} \frac{d}{dx} \left( \mu \frac{du}{dx} \right) \quad \forall u \in D(\mathcal{A}), \quad (1.7)$$

and

$$D(\mathcal{A}_\theta) := \left\{ u \in H^1(\mathbb{R}) / \mu_\theta \frac{du}{dx} \in H^1(\mathbb{R}) \right\} \quad \text{and} \quad \mathcal{A}_\theta u := -\frac{1}{\rho_\theta} \frac{d}{dx} \left( \mu_\theta \frac{du}{dx} \right) \quad \forall u \in D(\mathcal{A}_\theta). \quad (1.8)$$

By Weyl's theorem [Kat13], we know that the spectrum of  $\mathcal{A}$  denoted  $\sigma(\mathcal{A})$  is the union of its discrete spectrum denoted  $\sigma_d(\mathcal{A})$  and the spectrum of  $\mathcal{A}_\theta$  denoted  $\sigma(\mathcal{A}_\theta)$ :

$$\sigma(\mathcal{A}) = \sigma_d(\mathcal{A}) \cup \sigma(\mathcal{A}_\theta). \quad (1.9)$$

If  $\omega^2 \notin \sigma(\mathcal{A})$ , then  $\mathcal{A} - \omega^2$  is invertible and for any  $f \in L^2(\mathbb{R})$ , there exists a unique solution  $u \in D(\mathcal{A})$  to  $(\mathcal{P})$ . When  $\omega^2 \in \sigma_d(\mathcal{A})$ , one could not expect existence and uniqueness of a solution to  $(\mathcal{P})$  unless  $f$  is orthogonal to the kernel of  $\mathcal{A} - \omega^2$ . Finally, if  $\omega^2 \in \sigma(\mathcal{A}_\theta)$ , the problem cannot be well-posed in  $H^1(\mathbb{R})$ . In fact, on one hand, one expects that the physical solution  $u$ , if it exists, may not belong to  $H^1(\mathbb{R})$  due to possible wave propagation phenomena and a lack of decay at infinity. On the other hand, uniqueness of a solution in  $H_{loc}^1(\mathbb{R})$  does not hold in general. In this case, one needs a so-called *radiation condition* that imposes the behaviour of the solution at infinity. Such a condition can be obtained in practice using the *limiting absorption principle*, which consists in

- adding some absorption denoted  $\varepsilon$  – that is replacing  $\omega^2$  by  $\omega^2 + i\varepsilon$  in  $(\mathcal{P})$  (see Remark 1.2);
- solving the problem with absorption, well-posed in  $H^1(\mathbb{R})$ :

$$-\frac{d}{dx} \left( \mu \frac{du_\varepsilon}{dx} \right) - \rho(\omega^2 + i\varepsilon) u_\varepsilon = f \quad \text{in } \mathbb{R}; \quad (\mathcal{P}_\varepsilon)$$

- studying the limit of the solution  $u_\varepsilon$  as the absorption  $\varepsilon$  tends to 0.

**Remark 1.2.** Unlike the other chapters, we do not assume that  $\Im \omega > 0$ , but rather that  $\Im(\omega^2) > 0$ . However, since we are interested in the case where  $\omega \geq 0$ , these two assumptions are equivalent.

The limiting absorption principle is a classical approach to study time-harmonic wave propagation problems in unbounded domains; see for instance [Wil66; Agm75; Eid86]. More recently, it has been successfully applied for locally perturbed periodic media [JLF06; Hoa11; Rad15; KL18a]. To our knowledge, it is an open question for quasiperiodic media. Indeed, the structure of the spectrum of  $\mathcal{A}_\theta$  could be intricate ([Sim82; Las07]): the spectrum has in general an absolutely continuous part (as for periodic media) [Eli92; PF92], but it can also have embedded eigenvalues [Jec19; BK21] and a singular continuous part [Pea78; Mos81; DMS94; JS94; Sim95; Del+96; SS96; FK02]. Moreover, in the aforementioned works, it is highlighted that some parts of the spectrum could even be a Cantor set, that is a closed set with no isolated points and with dense complement.

The objective of this chapter is to **prove that the limiting absorption principle holds provided some (indirect) assumptions on the frequency and the coefficients are satisfied**. We also propose a method to characterize and compute the physical solution. This is, as far as we know, the first result on the limiting absorption principle for quasi-periodic media.

### 1.3 Objectives of the work and outline

The method we have performed in Chapter III consists in restricting the problem ( $\mathcal{P}_\varepsilon$ ) to the bounded interval  $(a^l, a^r)$  by constructing transparent boundary conditions of Dirichlet-to-Neumann (DtN) type, featuring DtN coefficients defined thanks to problems set on the half-lines  $(-\infty, a^l)$  and  $(a^r, +\infty)$ . To solve these problems, we have used the lifting approach, which consists in introducing 2D periodic half-guide problems that can be solved using the solutions of local cell problems, as well as a propagation operator, which satisfies a constrained Riccati equation.

Our goal is to make the absorption  $\varepsilon$  tend to 0 in the computation of the DtN coefficients, in order to propose a limit problem set in the bounded interval  $(a^l, a^r)$ . If the DtN coefficients have a limit (under maybe some assumptions on the frequency) then the limit problem set in  $(a^l, a^r)$  will be Fredholm of index 0 in the sense of the associated operator: uniqueness then implies existence. Moreover, we can construct a limit solution on the whole line and show that it is indeed the limit of  $u_\varepsilon$ . This is exactly what is done in [JLF06; Fli09; FJL21] for the Helmholtz equation with locally perturbed periodic coefficients in dimension 1 or in waveguides.

However, this approach does not apply directly. Indeed, we show in Section 2 that in general, the solutions of the local Dirichlet cell problems (III-4.6, III-4.7) (which are involved in the construction of the DtN coefficients) have no limit when  $\varepsilon$  goes to 0, the limit Dirichlet cell problems being not well-posed when  $\omega^2$  lies in a semi-infinite interval of  $\mathbb{R}_+$ . This difficulty is directly linked to the fact that we want to construct DtN coefficients. Constructing so-called **Robin-to-Robin** (RtR) coefficients allows to circumvent this difficulty, as we show in Section 3. However, the construction of the associated Robin half-guide solution is more involved than the one described in the previous Chapter for the Dirichlet half-guide solutions, even if the underlying ideas are really similar. In Sections 3 and 4, we explain how to solve the Robin half-guide problem in presence of dissipation ( $\varepsilon > 0$ ). In Section 5, links between spectra of some differential operators are established. This corresponds to a preliminary section whose results will be used afterwards. Finally, under two main assumptions, we are able to study the limit of the Robin half-guide solutions and the associated RtR coefficients in Section 6. Section 7 provides some numerical results to illustrate the method.

**Notation used throughout the chapter** In what follows,

1. For all  $p, q \in \mathbb{N}$ ,  $p < q$ , we set  $\llbracket p, q \rrbracket := \{j \in \mathbb{N} / p \leq j \leq q\}$ .
2. For  $i \in \llbracket 1, 2 \rrbracket$ , we denote by  $\vec{e}_i$  the  $i$ -th unit vector from the canonical basis of  $\mathbb{R}^2$ . For any elements  $\mathbf{y} = (y_1, y_2)$  and  $\mathbf{z} = (z_1, z_2)$  in  $\mathbb{R}^2$ , the Euclidean inner product of  $\mathbf{y}$  and  $\mathbf{z}$  is denoted  $\mathbf{y} \cdot \mathbf{z} := y_1 z_1 + y_2 z_2$ , and the associated norm is  $|\mathbf{y}| := \sqrt{\mathbf{y} \cdot \mathbf{y}}$ .
3. We introduce  $\mathcal{C}_{per}^0(\mathbb{R}^2)$  as the space of continuous functions  $F : \mathbb{R}^2 \rightarrow \mathbb{R}$  that are 1-periodic with respect to each variable, and  $\mathcal{C}_0^\infty(\mathcal{O})$  as the space of smooth functions that are compactly supported in  $\mathcal{O} \subset \mathbb{R}^2$ .
4. In any domain  $D \subset \mathbb{R}^2$  of the form  $D = \mathbb{R} \times I$ , where  $I = (\alpha, \beta)$ ,  $(\alpha, +\infty)$  or  $(-\infty, \beta)$ , the notion of periodicity only makes sense with respect to  $y_1$  along which  $D$  is

$$D_\# := [0, 1] \times I.$$

Accordingly, we shall introduce the functional spaces of  $y_1$ -periodic functions

$$\left\{ \begin{array}{l} \mathcal{C}_{per}^0(D) := \{v \in \mathcal{C}^0(D) / v(\mathbf{y} + \vec{e}_1) = v(\mathbf{y}) \ \forall \mathbf{y} \in D\} \\ L_{per}^2(D) := \{v \in L_{loc}^2(D) / v(\mathbf{y} + \vec{e}_1) = v(\mathbf{y}) \ \text{for a. e. } \mathbf{y} \in D\} \end{array} \right.$$

As  $L_{per}^2(D)$  is trivially isomorphic to  $L^2(D_{\#})$  via the restriction operator from  $D$  to  $D_{\#}$ , it is naturally equipped with an Hilbert space structure with the  $L^2(D_{\#})$  inner product.

5. In the same way, for any line  $\Gamma := \mathbb{R} \times \{b\}$ , with  $b \in \mathbb{R}$ , we shall set  $\Gamma_{\#} := (0, 1) \times \{b\}$  and

$$L_{per}^2(\Gamma) := \{v \in L_{loc}^2(\Gamma) / v(\mathbf{y} + \vec{e}_1) = v(\mathbf{y}), \ \text{for a. e. } \mathbf{y} \in \Gamma\},$$

which we equip with an Hilbert space structure using the  $L^2(\Gamma_{\#})$  inner product. We will often make implicitly the trivial identifications  $\Gamma \equiv \mathbb{R}$  and  $L_{per}^2(\Gamma) \equiv L_{per}^2(\mathbb{R})$ .

6. We define the half-space  $\Omega := \{\mathbf{y} = (y_1, y_2) \in \mathbb{R}^2, y_2 > 0\}$  and the half-cylinder  $\Omega_{\#} := (0, 1) \times \mathbb{R}_+$  in the following. Let us introduce also the sets given for  $a \in \{0, 1\}$  and for any  $i \in \llbracket 1, n \rrbracket$  by,

$$\forall a > 0, \quad \Sigma_{\#}^a = \{\mathbf{y} \in \Omega_{\#}, y_2 = a\} \quad \text{and} \quad \forall \ell \in \{0, 1\}, \quad \Gamma_{\#}^{\ell} = \{\mathbf{y} \in \Omega, y_1 = \ell\}. \quad (1.10)$$

7. Given a vector  $\boldsymbol{\theta} = (\theta_1, \theta_2) \in \mathbb{R}^2$ , we consider the differential operator

$$D_{\boldsymbol{\theta}} := \boldsymbol{\theta} \cdot \nabla = \theta_1 \partial_{y_1} + \theta_2 \partial_{y_2}.$$

Let us also define for any open set  $\mathcal{O} \subset \mathbb{R}^n$ , the directional Sobolev space

$$H_{\boldsymbol{\theta}}^1(\mathcal{O}) := \{U \in L^2(\mathcal{O}) / D_{\boldsymbol{\theta}} U \in L^2(\mathcal{O})\}, \quad (1.11)$$

which is a Hilbert space provided with the scalar product

$$(U, V)_{H_{\boldsymbol{\theta}}^1(\mathcal{O})} := \int_{\mathcal{O}} \left( D_{\boldsymbol{\theta}} U D_{\boldsymbol{\theta}} \bar{V} + U \bar{V} \right).$$

The induced norm is denoted by  $\|\cdot\|_{H_{\boldsymbol{\theta}}^1(\mathcal{O})}$ .

## 2 The DtN approach is not adapted to limiting absorption

The first step in the method proposed in Chapter III is to solve the local cell problems:

$$\left\{ \begin{array}{l} -D_{\boldsymbol{\theta}} (\mu_p D_{\boldsymbol{\theta}} E_{\varepsilon}^{\ell, \text{D}}) - \rho_p (\omega^2 + i\varepsilon) E_{\varepsilon}^{\ell, \text{D}} = 0, \quad \text{in } \mathcal{C}_{\#}^{r, 0} = (0, 1)^2, \\ E_{\varepsilon}^{\ell, \text{D}} \text{ is periodic w.r.t } y_1, \end{array} \right. \quad (2.1)$$

with the boundary conditions

$$\left\{ \begin{array}{l} E_{\varepsilon}^{0, \text{D}}|_{\Sigma_{\#}^0} = \varphi \quad \text{and} \quad E_{\varepsilon}^{0, \text{D}}|_{\Sigma_{\#}^1} = 0, \\ E_{\varepsilon}^{1, \text{D}}|_{\Sigma_{\#}^0} = 0 \quad \text{and} \quad E_{\varepsilon}^{1, \text{D}}|_{\Sigma_{\#}^1} = \varphi, \end{array} \right. \quad (2.2)$$

where  $\Sigma_{\#}^j$  are given by (1.10), and where the superscript ‘‘D’’ refers to *Dirichlet* boundary conditions. For  $\varepsilon > 0$ , Problem (2.1, 2.2) admits a unique solution  $E_{\varepsilon}^{\ell, \text{D}} \in H_{\boldsymbol{\theta}}^1(\mathcal{C}_{\#}^{r, 0})$ . We recall that the definition

of the traces of functions in directional Sobolev spaces is really subtle. In this chapter, we use directly the results of Chapter III. In particular, we will write

$$V \text{ is periodic w.r.t } y_1 \iff V|_{y_1=0} = V|_{y_1=1} \text{ and } \mu_p D_{\theta} V|_{y_1=0} = \mu_p D_{\theta} V|_{y_1=1}. \quad (2.3)$$

If  $V \in H_{\theta}^1(C_{\#}^{r,0})$  is periodic with respect to  $y_1$  in the sense of (2.3), then we have from III–(3.33) that the trace and the directional trace on  $\Sigma_{\#}^a$ ,  $a \in [0, 1]$  of  $V$  belong to  $L^2(\Sigma_{\#}^a)$ .

In what follows, we focus on  $E_{\varepsilon}^{\text{D}} := E_{\varepsilon}^{0,\text{D}}(\varphi)$ . By passing formally to the limit  $\varepsilon \rightarrow 0$  in the Dirichlet cell problem (2.1, 2.2), we obtain that the formal limit solution  $E^{\text{D}} := \lim_{\varepsilon \rightarrow 0} E_{\varepsilon}^{\text{D}}$  satisfies the boundary value problem:

$$\left\{ \begin{array}{l} -D_{\theta} (\mu_p D_{\theta} E^{\text{D}}) - \rho_p \omega^2 E^{\text{D}} = 0, \quad \text{in } C_{\#}^{r,0}, \\ E^{\text{D}}|_{\Sigma_{\#}^0} = \varphi, \quad E^{\text{D}}|_{\Sigma_{\#}^1} = 0 \\ E^{\text{D}} \text{ is periodic w.r.t. } y_1, \end{array} \right. \quad (2.4)$$

which we would like to solve a priori, in the space  $H_{\theta}^1(C_{\#}^{r,0})$ . The reason why the DtN approach is not adapted to the limiting absorption process is that the above problem is ill-posed for “most” values of the frequencies  $\omega$ , as we are going to see.

To understand this, it suffices to observe that, assuming that  $\varphi$  is continuous for instance, the above problem is “equivalent” to a concatenation (or a family) of 1D Dirichlet problems along the lines

$$\{(s + \theta_1 x, \theta_2 x), \quad x \in [0, L_{\theta}]\} \quad \text{with} \quad L_{\theta} = 1/\theta_2. \quad (2.5)$$

More precisely, if we define the 1D functions  $\rho_{s,\theta}$  and  $\mu_{s,\theta}$  as the traces of the 2D functions  $\rho_p$  and  $\mu_p$  along the line  $\mathbb{R}\theta$ :

$$\forall x \in \mathbb{R}, \quad \mu_{s,\theta}(x) := \mu_p(s + \theta_1 x, \theta_2 x) \quad \text{and} \quad \rho_{s,\theta}(x) := \rho_p(s + \theta_1 x, \theta_2 x), \quad (2.6)$$

then the family of 1D problems consists for any  $s \in \mathbb{R}$  in finding  $e_s^{\text{D}} : [0, L_{\theta}] \rightarrow \mathbb{C}$  such that

$$\left\{ \begin{array}{l} -\frac{d}{dx} \left( \mu_{s,\theta} \frac{de_s^{\text{D}}}{dx} \right) - \rho_{s,\theta} \omega^2 e_s^{\text{D}} = f \quad \text{in } [0, L_{\theta}] \\ e_s^{\text{D}}(0) = \varphi(s) \quad \text{and} \quad e_s^{\text{D}}(L_{\theta}) = 0, \end{array} \right. \quad (2.7)$$

where it can be easily seen that  $s \mapsto e_s^{\text{D}}$  is 1-periodic.

The precise statement for the equivalence is the object of the next lemma, which will use the notion of periodic extension  $\tilde{E}^{\text{D}}$  of  $E^{\text{D}}$  to the strip  $C^{r,0} = \mathbb{R} \times [0, 1]$ :

$$\tilde{E}^{\text{D}} : C^{r,0} \rightarrow \mathbb{C}, \quad \tilde{E}^{\text{D}}(\cdot + \vec{e}_1) = E^{\text{D}}, \quad \tilde{E}^{\text{D}}|_{C_{\#}^{r,0}} = E^{\text{D}}. \quad (2.8)$$

### Lemma 2.1

The problems (2.4) and (2.7) are equivalent in the following sense:

(i) If  $E^{\mathbb{D}}$  is a solution of (2.4), then setting

$$e_s^{\mathbb{D}}(x) = \tilde{E}^{\mathbb{D}}(s + \theta_1 x, \theta_2 x), \quad x \in [0, L\theta], \quad s \in \mathbb{R} \quad (2.9)$$

the function  $e_s^{\mathbb{D}}$  is a solution of (2.7) for any  $s \in \mathbb{R}$ .

(ii) If  $e_s^{\mathbb{D}}$  is a solution of (2.7) for any  $s \in \mathbb{R}$ , and if  $\tilde{E}^{\mathbb{D}} : \mathcal{C}^{r,0} \rightarrow \mathbb{C}$  is given by

$$\tilde{E}^{\mathbb{D}}(y_1, y_2) = e_{y_1 - y_2 \delta}^{\mathbb{D}} \left( \frac{y_2}{\theta_2} \right), \quad (y_1, y_2) \in \mathcal{C}^{r,0}, \quad (2.10)$$

then the function  $E^{\mathbb{D}} = \tilde{E}^{\mathbb{D}}|_{\mathcal{C}_{\#}^{r,0}}$  is a solution of (2.4).

The proof can be found in Proposition III-5.1. A quite intuitive illustration of the result is provided by Figure 1.

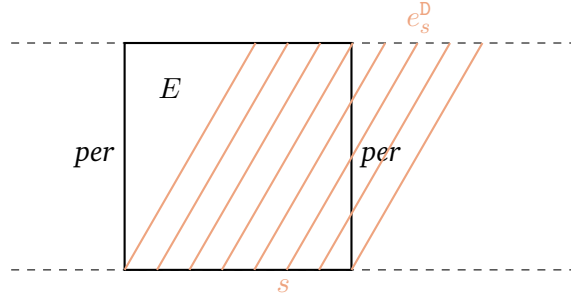

Figure 1: Illustration of Lemma 2.1

We deduce that Problem (2.4) will be ill-posed as soon as one of the 1D problems (2.7) is ill-posed. This will lead us to exclude from *admissible square frequencies*  $\omega^2$ , an infinite union over  $s \in [0, 1]$  of 1D Dirichlet cell eigenvalues, that we shall call the set  $\Omega_{\text{forb}}$  of *forbidden square frequencies*. More precisely, for any  $s \in [0, 1]$ , let us introduce the unbounded self-adjoint operator  $\mathcal{A}_s^{\text{cell}}$  defined by

$$D(\mathcal{A}_s^{\text{cell}}) = \left\{ u \in H_0^1(0, L\theta) / \mu_{s,\theta} \frac{du}{dx} \in H^1(0, L\theta) \right\}, \quad \mathcal{A}_s^{\text{cell}} u = -\frac{1}{\rho_{s,\theta}} \frac{d}{dx} \left( \mu_{s,\theta} \frac{du}{dx} \right) \quad \forall u \in D(\mathcal{A}_s^{\text{cell}}).$$

What we said above concerning the ill-posedness of Problem (2.4) can be rephrased in terms of the spectrum of  $\mathcal{A}_s^{\text{cell}}$ , denoted by  $\sigma(\mathcal{A}_s^{\text{cell}})$ :

$$(2.4) \text{ is ill-posed} \iff \omega^2 \notin \Omega_{\text{forb}} = \bigcup_{s \in [0,1]} \sigma(\mathcal{A}_s^{\text{cell}}).$$

As  $\mathcal{A}_s^{\text{cell}}$  is positive, self-adjoint and with compact resolvent for each  $s \in [0, 1]$ , each spectrum  $\sigma(\mathcal{A}_s^{\text{cell}})$  is a pure point spectrum

$$\sigma(\mathcal{A}_s^{\text{cell}}) = \{0 < \lambda_1(s) \leq \lambda_2(s) \leq \dots \leq \lambda_n(s) \leq \dots\}, \quad \lim_{n \rightarrow +\infty} \lambda_n(s) \rightarrow +\infty.$$

Moreover, from the regularity of  $\rho_p$  and  $\mu_p$ , we deduce that the maps  $s \in [0, 1] \rightarrow \rho_{s,\theta} \in \mathcal{C}^0(0, L\theta)$  are continuous. As a consequence, the functions  $s \rightarrow \lambda_n(s)$  are continuous and the set  $\Omega_{\text{forb}}$  of *forbidden*

square frequencies can be rewritten as a countable union of intervals

$$\Omega_{\text{forb}} = \bigcup_{n \geq 1} [a_n, b_n] \quad \text{where} \quad [a_n, b_n] := \lambda_n([0, 1]), \quad a_n > 0, \quad a_n \rightarrow +\infty. \quad (2.11)$$

Moreover, the intervals  $[a_n, b_n]$  may overlap and will generically do for  $n$  large enough, as explained in the following result. We introduce the function  $x \mapsto c_s(x)$ , namely the wave velocity along the line  $[0, L_\theta]$  (with  $L_\theta = 1/\theta_2$ ), and its harmonic mean

$$\forall x \in [0, L_\theta], \quad c_s(x) = \left( \frac{\mu_{s,\theta}(x)}{\rho_{s,\theta}(x)} \right)^{1/2} \quad \text{and} \quad \bar{c}_s^{-1} = L_\theta^{-1} \int_0^{L_\theta} c_s(x)^{-1} dx. \quad (2.12)$$

### Proposition 2.2

Let for all  $s \in [0, 1]$ ,  $\mu_{s,\theta} \in \mathcal{C}^1(\mathbb{R})$ . Then  $\lambda_n(s)$  behaves asymptotically as

$$\lambda_n(s) = \left( \frac{n \pi L_\theta}{\bar{c}_s} \right)^2 + \mathcal{O}(n) \quad \text{uniformly in } s. \quad (2.13)$$

As a consequence, with  $\bar{c}_+ = \sup_{s \in (0,1)} \bar{c}_s$  and  $\bar{c}_- = \inf_{s \in (0,1)} \bar{c}_s$ , the bounds  $a_n \leq b_n$  of the interval  $\lambda_n([0, 1])$  admit the asymptotic expansion

$$a_n = \left( \frac{n \pi L_\theta}{\bar{c}_+} \right)^2 + \mathcal{O}(n) \quad \text{and} \quad b_n = \left( \frac{n \pi L_\theta}{\bar{c}_-} \right)^2 + \mathcal{O}(n), \quad (2.14)$$

so that, as soon as  $\bar{c}_s$  is not constant,  $b_n > a_{n+1}$  for  $n$  large enough.

**Proof.** This is essentially a matter of applying known results from the spectral theory of Sturm-Liouville operators with smooth coefficients (see [Eas73, Chapter 4] for instance). We give some hints for the ease of the reader. The first basic is to rewrite the eigenvalue equation for  $\mathcal{A}_s^{\text{cell}}$ ,  $s \in [0, 1]$  as follows

$$-\frac{1}{\rho_{s,\theta}} \frac{d}{dx} \left( \mu_{s,\theta} \frac{du}{dx} \right) = \lambda u \quad \implies \quad -c_s^2 \frac{d^2 u}{dx^2} - \beta_s \frac{du}{dx} = \lambda u \quad \text{with} \quad \beta_s := \frac{\mu_{s,\theta}}{\rho_{s,\theta}} \quad (2.15)$$

where we have used the  $\mathcal{C}^1$ -regularity of  $\mu_{s,\theta}$ . Then, we apply a change of variables (known as the Prüfer transform) to get rid of the variable coefficient in factor of the second order derivative

$$\forall x \in [0, L_\theta], \quad t = \mathcal{T}(x) = \int_0^x \frac{d\xi}{c_s(\xi)} \in [0, L_\theta/\bar{c}_s] \quad (\text{travel time variable}).$$

Setting  $U(t) := u(\mathcal{T}^{-1}(t)) \iff u(x) = U(\mathcal{T}(x))$ , we observe that

$$\frac{du}{dx}(x) = c_s(x)^{-1} \frac{dU}{dt}(\mathcal{T}(x)) \quad \text{and} \quad \frac{d^2 u}{dx^2}(x) = c_s(x)^{-2} \left[ \frac{d^2 U}{dt^2}(\mathcal{T}(x)) - c'_s(x) \frac{dU}{dt}(\mathcal{T}(x)) \right].$$

Substituting this into (2.15), we get an eigenvalue equation for  $U(t)$

$$\begin{cases} -\frac{d^2 U}{dt^2} + a_s(t) \frac{dU}{dt} = \lambda U & \text{in } [0, L_\theta/\bar{c}_s], \\ U(0) = U(L_\theta/\bar{c}_s) = 0, \end{cases} \quad \text{with} \quad a_s(t) := \left[ c'_s - \frac{\mu'_{s,\theta}}{\rho_{s,\theta} c_s} \right] (\mathcal{T}^{-1}(t)),$$

which can be viewed as a (compact) perturbation of the Dirichlet eigenvalue problem for the operator  $U \mapsto -U''$  in the interval  $[0, L_\theta/\bar{c}_s]$ . For this unperturbed operator, the eigenvalues are

$$\{(n \pi \bar{c}_s/L_\theta)^2, \quad n \geq 1\}$$

which provide the dominant term in the asymptotics (2.13). One then concludes by a perturbation argument. ■

It follows from the above proposition that for  $\rho_p, \mu_p \in \mathcal{C}^1(\mathbb{R}^2)$ ,  $\Omega_{\text{forb}}$  contains a full semi-interval

$$[\omega_*^2, +\infty[ \subset \Omega_{\text{forb}}, \quad \omega_*^2 = a_N \quad \text{with} \quad N = \min\{n / a_{k+1} \leq b_k \quad \forall k \geq n\}. \quad (2.16)$$

Moreover, from (2.14), one sees that the larger the contrast  $\kappa = \bar{c}_+/\bar{c}_-$ , the lower  $\omega_*$ . Let us illustrate this, numerically, with the medium defined by

$$\rho_p(\mathbf{y}) = 1.5 + \alpha (\sin 2\pi y_1 + \sin 2\pi y_2), \quad \mu_p(\mathbf{y}) = 1, \quad \boldsymbol{\theta} = (\cos(\pi/3), \sin(\pi/3)), \quad 0 < \alpha < 3/2. \quad (2.17)$$

Note that a larger  $\alpha$  gives a larger contrast  $\kappa$  and then a lower  $\omega_*$ . In Figure 2, we represent for two values of  $\alpha$  (namely  $\alpha = 1/2$  and  $\alpha = 1$ ) the curves  $s \mapsto \lambda_n(s)$  for  $1 \leq n \leq 10$  (these eigenvalues have been computed numerically with finite elements) as well as the corresponding intervals of forbidden square frequencies. One clearly sees that the set  $\Omega_{\text{forb}}$  gets closer to  $\mathbb{R}_+$  as  $\alpha$  increases.

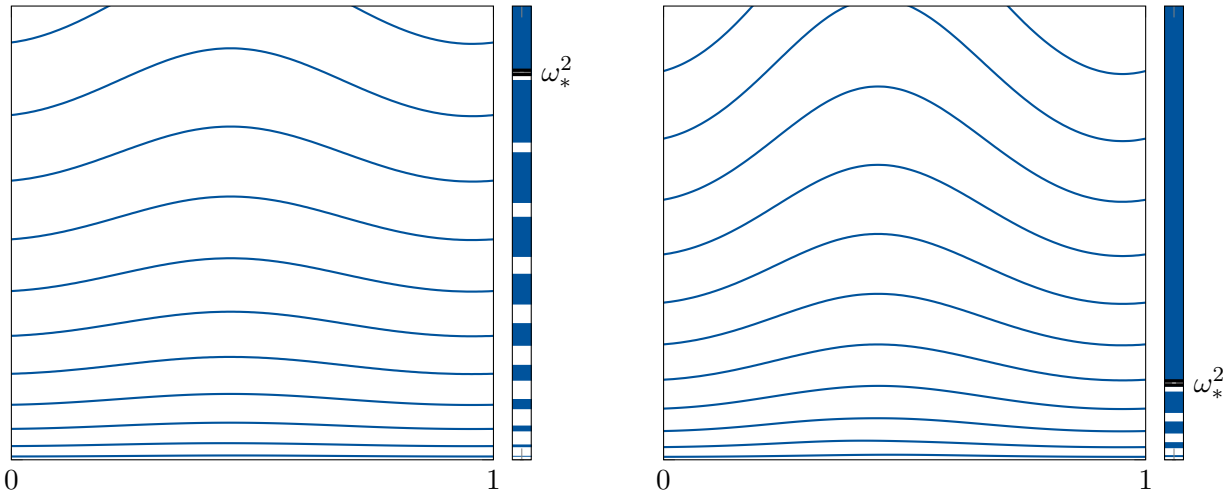

Figure 2: Curves  $s \mapsto \lambda_n(s)$  and forbidden frequencies for the medium given in (2.17) for  $\alpha = 1/2$  (left) and  $\alpha = 1$  (right).

**Remark 2.3.** When applying the DtN method to the elliptic Helmholtz equation  $-\operatorname{div} \mu_p \nabla u - \rho_p \omega^2 u = f$  with periodic coefficients (as done by [Fli09]) in the non-absorbing case, one also has to exclude forbidden frequencies associated to the Dirichlet local cell problems. However, the set  $\Omega_{\text{forb}}$  of such frequencies is merely discrete, and therefore, is not a limiting factor in practice.

**Remark 2.4.** In Section III-5.5.c, we mentioned that the quality of the numerical results obtained with the DtN method was clearly deteriorated when taking  $\varepsilon$  very small. This is linked to the ill-posedness issue presented in this section.

### 3 A Robin-to-Robin approach for the absorbing case

#### 3.1 Robin half-line problems and their 2D lifting

As an introductory material, we need to introduce two *outgoing Robin* differential operators for 1D functions  $u$ , associated with a given impedance  $z > 0$ , namely

$$R_+^j u := \nu^j \mu \frac{du}{dx} - izu \quad \forall j \in \{l, r\}, \quad \text{with } \nu^l := 1 \quad \text{and} \quad \nu^r := -1. \quad (3.1)$$

This allows us to introduce in the half-lines:

$$I^l := (-\infty, a^l) \quad \text{and} \quad I^r := (a^r, +\infty),$$

and two problems (replacing the Dirichlet half-line problems of Chapter III, namely III-(1.8)), defining two Robin half-line solutions  $u_\varepsilon^l$  and  $u_\varepsilon^r$  respectively : for  $j \in \{l, r\}$ , find  $u_\varepsilon^j \in H^1(I^j)$  such that

$$\left\{ \begin{array}{l} -\frac{d}{dx} \left( \mu_\theta \frac{du_\varepsilon^j}{dx} \right) - \rho_\theta (\omega^2 + i\varepsilon) u_\varepsilon^j = 0 \quad \text{in } I^j \\ R_+^j u_\varepsilon^j(a^j) = 1, \end{array} \right. \quad (\mathcal{P}_\varepsilon^j)$$

Note that for the boundary condition in these half-line problems, we impose the *outgoing Robin trace* with respect to  $I^j$  since  $\nu^j$  corresponds to the outgoing normal with respect to  $I^j$ . The choice of imposing the outgoing trace is essential for ensuring the well-posedness of Problem  $(\mathcal{P}_\varepsilon^j)$  in  $H^1(I^j)$ . Without entering the details, let us simply point out that the variational formulation of  $(\mathcal{P}_\varepsilon^j)$  involves the sesquilinear form

$$b_\varepsilon^j(u, v) := \int_{I^j} \left( \mu_\theta \frac{du}{dx} \frac{\overline{dv}}{dx} - \rho_\theta (\omega^2 + i\varepsilon) u \overline{v} \right) dx - izu(a^j) \overline{v(a^j)},$$

the key point being that the imaginary part of the corresponding quadratic form has a sign

$$-\Im b_\varepsilon^j(u, u) := \varepsilon \int_{I^j} \rho_\theta |u|^2 dx + z |u(a^j)|^2 \geq 0. \quad (3.2)$$

One interpretation is that the impedance  $z > 0$  brings an absorption term whose role is similar to the one due to  $\varepsilon > 0$ .

The following result can then be deduced without any difficulty.

#### Proposition 3.1

Let  $j \in \{l, r\}$  and  $\varepsilon > 0$ . Problem  $(\mathcal{P}_\varepsilon^j)$  admits a unique solution  $u_\varepsilon^j \in H^1(I^j)$ .

Let us now define for  $j \in \{l, r\}$  two *ingoing Robin* differential operators for 1D functions  $u$

$$R_-^j u := -\nu^j \mu \frac{du}{dx} - izu. \quad (3.3)$$

From the solutions  $u_\varepsilon^j$ ,  $j \in \{l, r\}$  we can introduce the *Robin-to-Robin* (RtR) coefficients  $\lambda_\varepsilon^j$ ,  $j \in \{l, r\}$



defined by

$$\lambda_\varepsilon^j := (R_-^j u_\varepsilon^j)(a^j). \quad (3.4)$$

This definition consists in evaluating the *ingoing Robin trace* (by opposition to *outgoing*) of the solution of a half-line problem where we have imposed the *outgoing Robin trace*. From  $\lambda_\varepsilon^j$ , the restriction  $u_\varepsilon^i$  of the solution  $u_\varepsilon$  of  $(\mathcal{P}_\varepsilon)$  in  $(a^l, a^r)$  can be characterized using two transparent boundary conditions at  $x = a^l$  and  $a^r$ , called Robin-to-Robin (RtR) conditions (that replace the DtN transparent boundary conditions of Chapter III, namely III-(1.6)):

$$\left| \begin{array}{l} -\frac{d}{dx} \left( \mu_\theta \frac{du_\varepsilon^i}{dx} \right) - \rho_\theta (\omega^2 + i\varepsilon) u_\varepsilon^i = 0 \quad \text{in } (a^l, a^r) \\ (R_-^l u_\varepsilon^i)(a^l) = \lambda_\varepsilon^l (R_+^l u_\varepsilon^i)(a^l), \\ (R_-^r u_\varepsilon^i)(a^r) = \lambda_\varepsilon^r (R_+^r u_\varepsilon^i)(a^r). \end{array} \right. \quad (\mathcal{P}_\varepsilon^{\text{int}})$$

Then,  $u_\varepsilon$  can be characterized as

$$\text{a. e. } x \in \mathbb{R}, \quad u(x) = \begin{cases} [R_+^l u_\varepsilon^i(a^l)] u_\varepsilon^l(x), & x < a^l, \\ u_\varepsilon^i(x), & x \in (a^l, a^r), \\ [R_+^r u_\varepsilon^i(a^r)] u_\varepsilon^r(x), & x > a^r. \end{cases} \quad (3.5)$$

**Remark 3.2.** Let  $j \in \{l, r\}$  and  $\varepsilon > 0$ . By definition (3.1) and (3.3) of the ingoing and outgoing Robin operators, one can rewrite the transparent conditions in  $(\mathcal{P}_\varepsilon^{\text{int}})$  in the following DtN form:

$$-\left[ \nu^j \mu \frac{du_\varepsilon}{dx} - iz u_\varepsilon \right](a^j) = \lambda_\varepsilon^j \left[ \nu^j \mu \frac{du_\varepsilon}{dx} - iz u_\varepsilon \right](a^j) \iff \left[ \nu^j \mu \frac{du_\varepsilon}{dx} \right](a^j) = \lambda_\varepsilon^{j,D} u_\varepsilon(a^j)$$

where  $\lambda_\varepsilon^{j,D}$  are the DtN coefficients defined in Chapter III, and are related to the RtR ones by

$$\lambda_\varepsilon^{j,D} = iz \left( \frac{\lambda_\varepsilon^j - 1}{\lambda_\varepsilon^j + 1} \right). \quad (3.6)$$

At this stage, as far as  $\varepsilon > 0$ , there is no clear interest of passing from Dirichlet half-line problems to Robin half-line problems and from DtN transparent conditions to RtR transparent conditions. The interest will appear more clearly when passing to the limit  $\varepsilon \rightarrow 0$ , in particular in the method for computing  $\lambda_\varepsilon^j$  that we shall develop in the next section. In particular, we shall not suffer any longer from the problems explained in Section 2.

Since the half-line problems satisfied by  $u_\varepsilon^l$  and  $u_\varepsilon^r$  are quite similar to each other, we **first restrict ourselves to the half-line problem satisfied by  $u_\varepsilon^r$** . To do so, we observe that the quasiperiodic half-line problem  $(\mathcal{P}_\varepsilon^j)$  with coefficients  $(\mu_\theta, \rho_\theta)$  belongs to a infinite family of similar quasiperiodic half-line problems parametrized by  $s \in \mathbb{R}$ , with the quasiperiodic coefficients  $(\mu_{s,\theta}, \rho_{s,\theta})$  defined by (2.6), that is

$$\left| \begin{array}{l} -\frac{d}{dx} \left( \mu_{s,\theta} \frac{du_{s,\varepsilon}^r}{dx} \right) - \rho_{s,\theta} (\omega^2 + i\varepsilon) u_{s,\varepsilon}^r = 0 \quad \text{in } \mathbb{R}_+, \\ R_{+,s}^r u_{s,\varepsilon}^r(0) = 1, \end{array} \right. \quad (\mathcal{P}_{\varepsilon,s}^r)$$

where  $R_{\pm,s}^r$  are 1D Robin differential operators for 1D functions:

$$R_{\pm,s}^r u := \pm \nu^r \mu_{s,\theta} \frac{du}{dx} - izu. \quad (3.7)$$

In fact, let us note that

$$\begin{aligned} \forall x \in \mathbb{R}_+, \quad \mu_{\theta}(x + a^r) &:= \mu_p(\theta_1(x + a^r), \theta_2(x + a^r)) \\ &= \mu_p(\theta_1(x + a^r), \theta_2 x) \quad \text{because } a^r \theta_2 \in \mathbb{Z} \quad (1.1) \end{aligned}$$

so that  $\mu_{\theta}(\cdot + a^r)$  corresponds to  $\mu_{s,\theta}$  for  $s = \theta_1 a^r$ . The same goes for  $\rho_{\theta}(\cdot + a^r)$ . Accordingly,

$$\text{a. e. } x \in \mathbb{R}_+, \quad u_{\varepsilon}^r(x + a^r) = u_{\varepsilon,s}^r(x) \quad \text{for } s = \theta_1 a^r. \quad (3.8)$$

The periodicity of  $s \mapsto (\mu_{s,\theta}, \rho_{s,\theta})$  (which follows from the periodicity of  $(\mu_p, \rho_p)$  with respect to  $y_1$ ) implies that

$$\forall s \in \mathbb{R}, \quad u_{s+1,\varepsilon}^r = u_{s,\varepsilon}^r. \quad (3.9)$$

Moreover, from the uniform continuity of  $s \mapsto (\mu_{s,\theta}, \rho_{s,\theta})$  (which results from the periodicity and the continuity of  $(\mu_p, \rho_p)$ ) and the well-posedness of  $(\mathcal{P}_{\varepsilon,s}^r)$ , it follows that  $s \mapsto u_{s,\varepsilon}^r$  defines a uniformly continuous function from  $\mathbb{R}$  to  $H^1(\mathbb{R}_+)$ . The proof is the same as the one of Proposition III-3.17. More generally, using the same arguments as in Proposition III-3.17, one shows that

$$\mu_p, \rho_p \in \mathcal{C}^m(\mathbb{R}^2) \implies s \mapsto u_{s,\varepsilon}^r \in \mathcal{C}^m(\mathbb{R}, H^1(\mathbb{R}_+)). \quad (3.10)$$

We now explain how to “lift” the half-line problems  $(\mathcal{P}_{\varepsilon}^j)$ , or more generally  $(\mathcal{P}_{\varepsilon,s}^r)$ , i.e. how their solutions can be seen as traces along a line of the solution of a 2D problem defined in half-spaces. Let us define the half-space and its boundary:

$$\Omega^r := \mathbb{R} \times \mathbb{R}_+ \quad \text{and} \quad \Sigma^r := \partial\Omega^r = \mathbb{R} \times \{0\}. \quad (3.11)$$

In the sequel we shall play with the change of variables in  $\mathbb{R}^2$

$$(s, x) \mapsto (y_1, y_2) = (s + x \theta_1, x \theta_2) \iff (y_1, y_2) \mapsto (s, x) = (y_1 - y_2 \theta_1/\theta_2, y_2/\theta_2), \quad (3.12)$$

which corresponds to seeing the plane  $\mathbb{R}^2$  with the following fibered structure

$$\mathbb{R}^2 := \bigcup_{s \in \mathbb{R}} (s \vec{e}_1 + \mathbb{R} \theta).$$

Note that the change of variables defined by (3.12) maps  $(s, x) \in \mathbb{R} \times \mathbb{R}_+$  into  $\Omega^r$ . Thus, through this change of variables, we can build from the half-line solutions  $u_{s,\varepsilon}^r$  and from a boundary function  $\varphi \in L_{loc}^2(\Sigma^r) \equiv L_{loc}^2(\mathbb{R})$ , a halfspace function  $U_{\varepsilon}^r : \Omega^r \rightarrow \mathbb{C}$  via the so-called lifting formula

$$\text{a.e. } (s, x) \in \mathbb{R} \times \mathbb{R}_+, \quad [U_{\varepsilon}^r(\varphi)](s + x \theta_1, x \theta_2) := \varphi(s) u_{s,\varepsilon}^r(x). \quad (3.13)$$

Roughly speaking,  $U_{\varepsilon}^r(\varphi)$  can be seen as a “weighted and oblique concatenation” of the 1D solutions  $u_{s,\varepsilon}^r$ . Then, using the chain rule,

$$\frac{d}{dx} [V(s + \theta_1 x, \theta_2 x)] = D_{\theta} V(s + \theta_1 x, \theta_2 x), \quad (3.14)$$

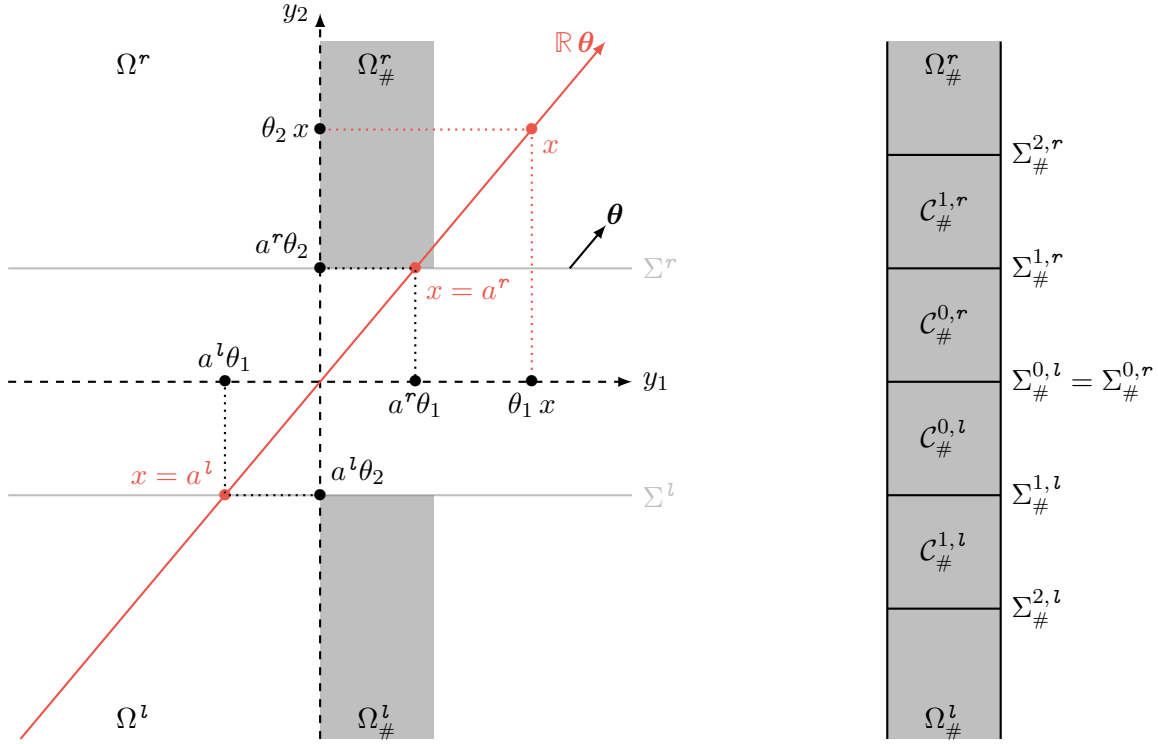

Figure 3: Notation introduced in Section 3.1

it is easy, by adapting the arguments developed in Chapter III, to characterize  $U_\varepsilon^r(\varphi)$  as the solution of a 2D boundary value problem in  $\Omega^r$  associated with the homogeneous partial differential equation

$$-D_\theta (\mu_p D_\theta U_\varepsilon^r) - \rho_p (\omega^2 + i\varepsilon) U_\varepsilon^r = 0 \quad \text{in } \Omega^r. \quad (3.15)$$

In order to associate boundary conditions to (3.15), we need to introduce directional Robin operators as 2D extensions of the 1D differential operators  $R_\pm^r$ ,  $j \in \{l, r\}$  defined in (3.1) and (3.3). We define the operators  $\mathcal{R}_\pm^r$  for 2D functions  $U$  as

$$\mathcal{R}_\pm^r U := \pm \nu^r \mu_p D_\theta U - izU. \quad (3.16)$$

The operator  $\mathcal{R}_+^r$  is the outgoing Robin one whereas  $\mathcal{R}_-^r$  is the ingoing one.

If  $\varphi$  is 1-periodic, then from the periodicity of  $s \mapsto u_{s,\varepsilon}^r$  (see (3.9)), the function  $U_\varepsilon^r(\varphi)$  is 1-periodic with respect to  $y_1$  and belongs to the space

$$H_{\theta,per}^1(\Omega^r) = \{U \in L_{per}^2(\Omega^r) / D_\theta U \in L_{per}^2(\Omega^r)\}. \quad (3.17)$$

Modulo an adaptation of the arguments developed in Section III-3.2, see also Remark 3.4, one easily proves the following result

**Proposition 3.3**

Let  $\varepsilon > 0$ . For any  $\varphi \in L_{per}^2(\mathbb{R})$ , the function  $U_\varepsilon^r := U_\varepsilon^r(\varphi)$  is the unique solution of the well-

posed 2D problem: Find  $U_\varepsilon^r \in H_{\theta,per}^1(\Omega^r)$  such that

$$\left| \begin{array}{l} -D_\theta (\mu_p D_\theta U_\varepsilon^r) - \rho_p (\omega^2 + i\varepsilon) U_\varepsilon^r = 0 \quad \text{in } \Omega^r, \\ \mathcal{R}_+^r U_\varepsilon^r|_{\Sigma^r} = \varphi. \end{array} \right. \quad (3.18)$$

**Remark 3.4.** In Section III-3.2, we develop in detail the functional analytic tools to give a rigorous sense to Problem (3.18). In particular, functions in  $H_{\theta,loc}^1(\Omega^r)$  have well-defined traces on  $\Sigma^r := \partial\Omega^r$  as elements of  $L_{loc}^2(\Sigma^r)$ . Note also that the PDE in (3.18) implies that  $\mu_p D_\theta U_\varepsilon^r \in H_{\theta,loc}^1(\Omega^r)$ . Thus, the trace of  $\mu_p D_\theta U_\varepsilon^r$  on  $\Sigma^r$  is well-defined in  $L_{loc}^2(\Sigma^r)$ , so that a proper sense can be given to the boundary condition in (3.18).

Using the definition (3.13) of  $U_\varepsilon^r(\varphi)$  and the uniform continuity of the map  $s \mapsto u_{s,\varepsilon}^r$ , we deduce the following result.

#### Corollary 3.5

Let  $\varepsilon > 0$ . If  $\varphi$  is continuous in the neighborhood of  $s = \theta_1 a^r$  and satisfies  $\varphi(\theta_1 a^r) = 1$ , then

$$\text{a. e. } x \in \mathbb{R}_+, \quad u_\varepsilon^r(x + a^r) = u_{a^r, \theta_1, \varepsilon}^r(x) = U_\varepsilon^r(\theta_1(x + a^r), \theta_2 x), \quad (3.19)$$

where  $U_\varepsilon^r = U_\varepsilon^r(\varphi)$ .

From Corollary 3.5, we deduce a framework for finding the solution  $U_\varepsilon^r$  of the half-line problem ( $\mathcal{P}_\varepsilon^j$ ):

- Choose a 1-periodic function  $\varphi$  which is continuous around  $\theta_1 a^r$ , and such that  $\varphi(\theta_1 a^r) = 1$  ( $\varphi = 1$  for instance);
- Compute the corresponding solution  $U_\varepsilon^r(\varphi)$  of (3.18);
- Deduce the function  $u_\varepsilon^r$  from the cut formula (3.19).

**Remark 3.6.** Based on the above algorithm, one could wonder whether it is necessary to consider functions other than  $\varphi = 1$ . Nevertheless, for the method that we shall develop in what follows, it is necessary to consider general functions  $\varphi \in L_{per}^2(\mathbb{R})$ .

A first trivial but important observation is that since  $U_\varepsilon^r(\varphi)$  is periodic in the  $\vec{e}_1$ -direction, it suffices to compute its restriction to the cylinder  $\Omega_\#^r := \{(y_1, y_2) \in \Omega^r / 0 < y_1 < 1\}$  (with  $\Sigma_\#^{r,0} := (0, 1) \times \{0\}$ ) by solving the problem: Find  $U_\varepsilon^r \in H_\theta^1(\Omega_\#^r)$  such that

$$\left| \begin{array}{l} -D_\theta (\mu_p D_\theta U_\varepsilon^r) - \rho_p (\omega^2 + i\varepsilon) U_\varepsilon^r = 0 \quad \text{in } \Omega_\#^r, \\ \mathcal{R}_+^r U_\varepsilon^r|_{\Sigma_\#^{r,0}} = \varphi, \\ U_\varepsilon^r \text{ is periodic w.r.t } y_1. \end{array} \right. \quad (3.20)$$

In the sequel, we will play alternatively with the two equivalent versions (3.18) and (3.20) of the same half-space problem. The form (3.18) will be used for analytical results, while (3.20) will be used for numerics.

As the domain  $\Omega_{\#}^r$  is still unbounded in the  $y_2$ -direction, one may wonder how to solve numerically (3.20). This is precisely the object of the next sections.

### 3.2 The propagation and scattering operators

Let us first introduce the lines

$$\forall m \in \mathbb{N}, \quad \Sigma^{r,m} := \{(y_1, y_2) \in \mathbb{R}^2 / y_2 = m\}, \quad (3.21)$$

the periodicity cells

$$\forall m \in \mathbb{N}, \quad \mathcal{C}_{\#}^{r,m} := \{(y_1, y_2) \in \Omega_{\#}^r / y_2 \in (m, m+1)\}, \quad (3.22)$$

and for any  $m \in \mathbb{N}$ , the interfaces  $\Sigma_{\#}^{r,m+1}$  between the cells  $\mathcal{C}_{\#}^{r,m}$  and  $\mathcal{C}_{\#}^{r,m+1}$ . These domains are shown in Figure 3. By periodicity, each cell  $\mathcal{C}_{\#}^{r,m}$  can be identified to  $\mathcal{C}_{\#}^{r,0} \equiv \mathcal{C}_{\#}^r$  and each interface  $\Sigma_{\#}^{r,m}$  to  $\Sigma_{\#}^{r,0} \equiv \Sigma_{\#}^r$ .

Proposition 3.3 defines a linear operator

$$\varphi \in L_{per}^2(\mathbb{R}) \mapsto U_{\varepsilon}^r(\varphi) \in H_{\theta,per}^1(\Omega^r) \text{ solution of (3.18),}$$

from which we introduce two operators  $(\mathcal{P}_{\varepsilon}^r, \mathcal{S}_{\varepsilon}^r) \in \mathcal{L}(L_{per}^2(\mathbb{R}))^2$  defined by

$$\mathcal{P}_{\varepsilon}^r \varphi := \mathcal{R}_{+}^r U_{\varepsilon}^r(\varphi)|_{\Sigma^{r,1}} \quad \text{and} \quad \mathcal{S}_{\varepsilon}^r \varphi := \mathcal{R}_{-}^r U_{\varepsilon}^r(\varphi)|_{\Sigma^{r,1}}, \quad (3.23)$$

where the two interfaces  $\Sigma^{r,0}$  and  $\Sigma^{r,1}$  are identified to  $\mathbb{R}$  in a trivial manner.

These operators play an important role in the structure of the solutions. In fact, using the same arguments as for the proof of Proposition III-4.1, one deduces in particular from the periodicity of the medium in the  $y_2$  direction, the following result.

#### Proposition 3.7

For any  $\varphi \in L_{per}^2(\mathbb{R})$ , the Robin traces of  $U_{\varepsilon}^r(\varphi)$  on the interfaces  $\Sigma^{r,m}$ ,  $\forall m \geq 1$ , satisfy

$$\mathcal{R}_{+}^r U_{\varepsilon}^r(\varphi)|_{\Sigma^{r,m}} = (\mathcal{P}_{\varepsilon}^r)^{m-1} \varphi \quad \text{and} \quad \mathcal{R}_{-}^r U_{\varepsilon}^r(\varphi)|_{\Sigma^{r,m}} = \mathcal{S}_{\varepsilon}^r (\mathcal{P}_{\varepsilon}^r)^{m-1} \varphi. \quad (3.24)$$

The operator  $\mathcal{P}_{\varepsilon}^r$  is called a **Robin propagation** operator because it expresses how the outgoing Robin trace, that is the trace of  $\mathcal{R}_{+}^r U_{\varepsilon}^r$ , propagates from one interface  $\Sigma^{r,m}$  to the next one  $\Sigma^{r,m+1}$ . The operator  $\mathcal{S}_{\varepsilon}^r$  transforms an outgoing Robin trace on  $\Sigma^{r,0}$  into an ingoing Robin trace on  $\Sigma^{r,1}$ . We call it a **scattering operator** by analogy with some terminology used in scattering theory.

As it can be expected, the fibered structure of the problem (3.18) provides a particular structure to the operators  $(\mathcal{P}_{\varepsilon}^r, \mathcal{S}_{\varepsilon}^r)$ . For what follows we recall the ratio

$$\delta := \theta_1 / \theta_2,$$

which will play the role of a shift parameter. We also introduce the functions

$$\forall s \in \mathbb{R}, \quad \text{a. e. } x \in \mathbb{R}_+, \quad \begin{cases} \mathbf{p}_\varepsilon^r(s, x) := (R_{+,s}^r u_{s,\varepsilon}^r)(x), & \mathbf{p}_\varepsilon^r(s) := \mathbf{p}_\varepsilon^r(s, 1/\theta_2), \\ \mathbf{s}_\varepsilon^r(s, x) := (R_{-,s}^r u_{s,\varepsilon}^r)(x), & \mathbf{s}_\varepsilon^r(s) := \mathbf{s}_\varepsilon^r(s, 1/\theta_2), \end{cases} \quad (3.25)$$

where  $R_{\pm,s}^r$  are the 1D outgoing and ingoing Robin operators, defined for all  $s \in \mathbb{R}$  in (3.7).

### Proposition 3.8

Let  $\varepsilon > 0$ . The functions  $(\mathbf{p}_\varepsilon^r(s, x), \mathbf{s}_\varepsilon^r(s, x))$  (resp.  $(\mathbf{s}_\varepsilon^r(s), \mathbf{p}_\varepsilon^r(s))$ ) are continuous with respect to  $s$  and  $x$  (resp. with respect to  $s$ ) and 1-periodic with respect to  $s$ . Moreover, we have

$$\mathbf{p}_\varepsilon^r(s, x) \neq 0 \quad \forall (s, x) \in \mathbb{R} \times \mathbb{R}_+ \quad \text{and} \quad \mathbf{p}_\varepsilon^r(s) \neq 0 \quad \forall s \in \mathbb{R}.$$

Finally, if  $\mu_p, \rho_p \in \mathcal{C}^m(\mathbb{R}^2)$ , then

$$s \mapsto \mathbf{p}_\varepsilon^r(s, \cdot), \mathbf{s}_\varepsilon^r(s, \cdot) \in \mathcal{C}^m(\mathbb{R}; H^1(\mathbb{R}_+)) \quad (\text{resp. } \mathbf{p}_\varepsilon^r, \mathbf{s}_\varepsilon^r \in \mathcal{C}^m(\mathbb{R}; \mathbb{C})). \quad (3.26)$$

**Proof.** The continuity properties are linked to the uniform continuity of  $s \mapsto u_{s,\varepsilon}^r$  and the to fact that  $u_{s,\varepsilon}^r \in H^1(\mathbb{R}_+) \subset \mathcal{C}^0(\mathbb{R}_+)$  for all  $s$ . The property (3.26) is linked to (3.10).

It remains to show that  $\mathbf{p}_\varepsilon^r(x, s) \neq 0$  for any  $s \in \mathbb{R}$  and  $x \in \mathbb{R}_+$  (this implies directly that  $\mathbf{p}_\varepsilon^r(s) \neq 0$  for any  $s \in \mathbb{R}$ ). Assume by contradiction that, for some  $x_0 \in \mathbb{R}_+$  and  $s_0 \in \mathbb{R}$ , we have  $\mathbf{p}_\varepsilon^r(x_0, s_0) = 0$ . Since  $\mathbf{p}_\varepsilon^r(x_0, s_0) := R_{+,s_0}^r u_{s_0,\varepsilon}^r(x_0)$  by definition (3.25), where  $u_{s_0,\varepsilon}^r$  is the solution of  $(\mathcal{P}_{\varepsilon,s}^r)$  for  $s = s_0$ , we have in particular that

$$\begin{cases} -\frac{d}{dx} \left( \mu_{s_0,\theta} \frac{du_{s_0,\varepsilon}^r}{dx} \right) - \rho_{s_0,\theta} (\omega^2 + i\varepsilon) u_{s_0,\varepsilon}^r = 0 & \text{in } (x_0, +\infty), \\ R_{+,s_0}^r u_{s_0,\varepsilon}^r(x_0) = 0, \end{cases} \quad (3.27)$$

By well-posedness of the above boundary problem for  $z > 0$  (see also (3.2) with  $x_0$  instead of 0), we deduce that  $u_{s_0,\varepsilon}^r = 0$  in  $(x_0, +\infty)$ . Since  $u_{s_0,\varepsilon}^r$  satisfies the PDE in (3.27) in all  $(x_0, +\infty)$ , by Cauchy uniqueness result  $u_{s_0,\varepsilon}^r = 0$  in  $\mathbb{R}_+$ , which contradicts the fact that  $R_{+,s_0}^r u_{s_0,\varepsilon}^r(0) = 1$ . ■

**Remark 3.9.** Contrary to  $\mathbf{p}_\varepsilon^r$ , the function  $\mathbf{s}_\varepsilon^r$  can vanish at certain points. For instance, if  $\mu_p = \rho_p = 1$  and if the impedance  $z$  is allowed to be a complex number with  $z := \sqrt{\omega^2 + i\varepsilon}$  and  $\Re z > 0$ , then it can be computed without difficulty that  $\mathbf{s}_\varepsilon^r = 0$ .

Similarly to the study in Section III-4.5, the propagation operator and the scattering operator have a particular structure, highlighted in the next result.

### Proposition 3.10

We have for all  $\varphi \in L_{per}^2(\mathbb{R})$ ,

$$\forall s \in \mathbb{R}, \quad \begin{cases} \mathcal{P}_\varepsilon^r \varphi(s) = \mathbf{p}_\varepsilon^r(s - \delta) \varphi(s - \delta), \\ \mathcal{S}_\varepsilon^r \varphi(s) = \mathbf{s}_\varepsilon^r(s - \delta) \varphi(s - \delta). \end{cases}$$

where  $\mathcal{P}_\varepsilon^r$  and  $S_\varepsilon^r$  are defined in (3.23) and  $\mathbf{p}_\varepsilon^r$  and  $\mathbf{s}_\varepsilon^r$  in (3.25). Moreover,  $\mathcal{P}_\varepsilon^r$  is bijective.

**Proof.** We give the proof of the first identity, the proof of the second one being identical. It follows from the fibered structure (3.13) of  $U_\varepsilon^r$  and from the definition of  $\mathbf{p}_\varepsilon^r$  that

$$\mathcal{R}_+^r U_\varepsilon^r(s + \theta_1 x, \theta_2 x) = \mathbf{p}_\varepsilon^r(s, x) \varphi(s), \quad s \in \mathbb{R}, x \in \mathbb{R}_+ \quad (3.28)$$

To evaluate the trace of  $\mathcal{R}_+^r U_\varepsilon^r$  on  $\Sigma^{r,1}$ , it suffices to take  $x = 1/\theta_2$  in the above expression, which gives

$$\mathcal{R}_+^r U_\varepsilon^r(s + \delta, 1) = \mathbf{p}_\varepsilon^r(s, 1/\theta_2) \varphi(s), \quad s \in \mathbb{R}, \quad (3.29)$$

that is to say, by definitions (3.23) and (3.25) of  $\mathcal{P}_\varepsilon^r$  and  $\mathbf{p}_\varepsilon^r$ ,

$$[\mathcal{P}_\varepsilon^r \varphi](s + \delta) = \mathbf{p}_\varepsilon^r(s) \varphi(s), \quad s \in \mathbb{R}, \quad (3.30)$$

which is nothing but the first identity after changing  $s \mapsto s + \delta$ .

The bijectivity of  $\mathcal{P}_\varepsilon^r$  is a direct consequence of Proposition 3.8 which states that  $\mathbf{p}_\varepsilon^r$  never vanishes. ■

Operators that have the form of  $\mathcal{P}_\varepsilon^r$  and  $S_\varepsilon^r$  are known in the literature (see [Ant12] for instance) as *weighted shift operators*. The function  $\mathbf{p}_\varepsilon^r$  (resp.  $\mathbf{s}_\varepsilon^r$ ) will be called the *symbol* of  $\mathcal{P}_\varepsilon^r$  (resp.  $S_\varepsilon^r$ ).

### 3.3 Local cell problems and reconstruction formula

To the periodicity cell  $\mathcal{C}_\#^{r,0} := (0, 1)^2$ , we associate two problems, given for a boundary data  $\varphi \in L_{per}^2(\mathbb{R})$ : Find  $E_\varepsilon^{r,0}(\varphi) \in H_\theta^1(\mathcal{C}_\#^{r,0})$  such that

$$\left\{ \begin{array}{l} -D_\theta (\mu_p D_\theta E_\varepsilon^{r,0}(\varphi)) - \rho_p (\omega^2 + i\varepsilon) E_\varepsilon^{r,0}(\varphi) = 0 \quad \text{in } \mathcal{C}_\#^{r,0}, \\ \mathcal{R}_+^r E_\varepsilon^{r,0}(\varphi)|_{\Sigma_\#^{r,0}} = \varphi \quad \text{and} \quad \mathcal{R}_-^r E_\varepsilon^{r,0}(\varphi)|_{\Sigma_\#^{r,1}} = 0, \\ E_\varepsilon^{r,0}(\varphi) \text{ is periodic w.r.t } y_1; \end{array} \right. \quad (3.31)$$

and Find  $E_\varepsilon^{r,1}(\varphi) \in H_\theta^1(\mathcal{C}_\#^{r,0})$  such that

$$\left\{ \begin{array}{l} -D_\theta (\mu_p D_\theta E_\varepsilon^{r,1}(\varphi)) - \rho_p (\omega^2 + i\varepsilon) E_\varepsilon^{r,1}(\varphi) = 0 \quad \text{in } \mathcal{C}_\#^{r,0}, \\ \mathcal{R}_+^r E_\varepsilon^{r,1}(\varphi)|_{\Sigma_\#^{r,0}} = 0 \quad \text{and} \quad \mathcal{R}_-^r E_\varepsilon^{r,1}(\varphi)|_{\Sigma_\#^{r,1}} = \varphi, \\ E_\varepsilon^{r,1}(\varphi) \text{ is periodic w.r.t } y_1. \end{array} \right. \quad (3.32)$$

Using Lax-Milgram lemma, one easily obtains the following result.

#### Proposition 3.11

Let  $\varepsilon > 0$ . The problems (3.31) and (3.32) are well-posed.

In the sequel, for any  $\varphi \in L_{per}^2(\mathbb{R})$ , we identify  $E_\varepsilon^{r,0}(\varphi)$  and  $E_\varepsilon^{r,1}(\varphi)$  with their periodic extensions with respect to  $y_1$ .

By linearity, if  $U \in H_{\theta}^1(\mathcal{C}_{\#}^{r,0})$  is periodic with respect to  $y_1$  and satisfies

$$-D_{\theta}(\mu_p D_{\theta} U) - \rho_p(\omega^2 + i\varepsilon) U = 0 \quad \text{in } \mathcal{C}_{\#}^{r,0}, \quad (3.33)$$

then

$$\mathcal{R}_+^r U|_{\Sigma_{\#}^{r,0}} = \varphi \quad \text{and} \quad \mathcal{R}_-^r U|_{\Sigma_{\#}^{r,1}} = \psi \quad \implies \quad U = E_{\varepsilon}^{r,0}(\varphi) + E_{\varepsilon}^{r,1}(\psi). \quad (3.34)$$

From this remark and by definition (3.23) of  $(\mathcal{P}_{\varepsilon}^r, \mathcal{S}_{\varepsilon}^r)$ , it is clear that the solution  $U_{\varepsilon}^r(\varphi)$  of (3.18) can be reconstructed cell by cell using  $E_{\varepsilon}^{r,0}(\varphi)$  and  $E_{\varepsilon}^{r,1}(\varphi)$ .

### Proposition 3.12

For any  $\varphi \in L_{per}^2(\mathbb{R})$ , the solution  $U_{\varepsilon}^r(\varphi)$  of (3.18) is given by

$$\text{a. e. } \mathbf{y} \in \mathcal{C}_{\#}^{r,0}, \quad [U_{\varepsilon}^r(\varphi)](\mathbf{y} + n \vec{e}_2) = [E_{\varepsilon}^{r,0}((\mathcal{P}_{\varepsilon}^r)^n \varphi) + E_{\varepsilon}^{r,1}(\mathcal{S}_{\varepsilon}^r((\mathcal{P}_{\varepsilon}^r)^n \varphi))](\mathbf{y}), \quad \forall n \in \mathbb{N}, \quad (3.35)$$

where the operators  $\mathcal{P}_{\varepsilon}^r$  and  $\mathcal{S}_{\varepsilon}^r$  are defined in (3.23).

Similarly to  $U_{\varepsilon}^r$ , the solutions  $(E_{\varepsilon}^{r,0}, E_{\varepsilon}^{r,1})$  of Problems (3.31) and (3.32) benefit from a quasi-1D structure. Indeed, let us introduce the two families  $(e_{s,\varepsilon}^{r,0})_{s \in \mathbb{R}}$  and  $(e_{s,\varepsilon}^{r,1})_{s \in \mathbb{R}}$  of functions in  $H^1(0, 1/\theta_2)$  which satisfy the 1D problems

$$\left\{ \begin{array}{l} -\frac{d}{dx} \left( \mu_{s,\theta} \frac{de_{s,\varepsilon}^{r,0}}{dx} \right) - \rho_{s,\theta}(\omega^2 + i\varepsilon) e_{s,\varepsilon}^{r,0} = 0 \quad \text{in } (0, 1/\theta_2), \\ R_{+,s}^r e_{s,\varepsilon}^{r,0}(0) = 1 \quad \text{and} \quad R_{-,s}^r e_{s,\varepsilon}^{r,0}(1/\theta_2) = 0, \end{array} \right. \quad (3.36)$$

and

$$\left\{ \begin{array}{l} -\frac{d}{dx} \left( \mu_{s,\theta} \frac{de_{s,\varepsilon}^{r,1}}{dx} \right) - \rho_{s,\theta}(\omega^2 + i\varepsilon) e_{s,\varepsilon}^{r,1} = 0 \quad \text{in } (0, 1/\theta_2), \\ R_{+,s}^r e_{s,\varepsilon}^{r,1}(0) = 0 \quad \text{and} \quad R_{-,s}^r e_{s,\varepsilon}^{r,1}(1/\theta_2) = 1 \end{array} \right. \quad (3.37)$$

We then have the next property, which shows the fibered structure of the cell problems.

### Proposition 3.13

Let  $\varepsilon > 0$ . The solutions  $E_{\varepsilon}^{r,0}(\varphi)$  and  $E_{\varepsilon}^{r,1}(\varphi)$  of the local cell problems (3.31) and (3.32) and the families  $(e_{s,\varepsilon}^{r,0})_{s \in \mathbb{R}}$  and  $(e_{s,\varepsilon}^{r,1})_{s \in \mathbb{R}}$  defined by (3.36) and (3.37) are related by :

$$\left\{ \begin{array}{l} E_{\varepsilon}^{r,0}(\varphi)(s + x\theta_1, x\theta_2) = \varphi(s) e_{s,\varepsilon}^{r,0}(x), \quad x \in (0, 1/\theta_2), s \in \mathbb{R}, \\ E_{\varepsilon}^{r,1}(\varphi)(s + x\theta_1, x\theta_2) = \varphi(s + \delta) e_{s,\varepsilon}^{r,1}(x), \quad x \in (0, 1/\theta_2), s \in \mathbb{R}. \end{array} \right. \quad (3.38)$$

Hence, the evaluation of  $E_{\varepsilon}^{r,0}(\varphi)$  and  $E_{\varepsilon}^{r,1}(\varphi)$  simply consist in solving a family of 1D-problems defined on a segment, namely (3.36) and (3.37). To conclude this section, we provide a 1D equivalent of the cell by cell reconstruction formula (3.35) in terms of the half-line solutions  $u_{s,\varepsilon}^r \in H^1(I^r)$ .



**Corollary 3.14**

Given  $\varphi \in \mathcal{C}_{per}^0(\mathbb{R})$  such that  $\varphi(s) \neq 0$  for any  $s \in \mathbb{R}$ , define

$$\forall n \in \mathbb{N}, \quad \varphi_n^\varepsilon := (\mathcal{P}_\varepsilon^r)^n \varphi \quad \text{and} \quad \psi_n^\varepsilon := \mathcal{S}_\varepsilon^r (\mathcal{P}_\varepsilon^r)^n \varphi.$$

Then for any  $s \in \mathbb{R}$ , the solution  $u_{s,\varepsilon}^r$  of the half-line problem  $(\mathcal{P}_{\varepsilon,s}^r)$  is given for  $x \in (0, 1/\theta_2)$  by

$$\varphi(s) u_{s,\varepsilon}^r(x + n/\theta_2) = \varphi_n^\varepsilon(s + n\delta) e_{s+n\delta,\varepsilon}^{r,0}(x) + \psi_n^\varepsilon(s + (n+1)\delta) e_{s+n\delta,\varepsilon}^{r,1}(x). \quad (3.39)$$

**Proof.** If  $x \in (0, 1/\theta_2)$ , then  $\mathbf{y} := (s + \theta_1 x, \theta_2 x)$  belongs to  $\mathbb{R} \times (0, 1)$ , so that by (3.35),

$$[U_\varepsilon^r(\varphi)](s + \theta_1 x, \theta_2 x + n) = [E_\varepsilon^{r,0}((\mathcal{P}_\varepsilon^r)^n \varphi) + E_\varepsilon^{r,1}(\mathcal{S}_\varepsilon^r (\mathcal{P}_\varepsilon^r)^n \varphi)](s + \theta_1 x, \theta_2 x),$$

where  $E_\varepsilon^{r,0}((\mathcal{P}_\varepsilon^r)^n \varphi)$ , and  $E_\varepsilon^{r,1}(\mathcal{S}_\varepsilon^r (\mathcal{P}_\varepsilon^r)^n \varphi)$  have been identified with their periodic extensions with respect to  $y_1$ . By using the fibered structure of  $U_\varepsilon^r$  (3.13) and  $E_\varepsilon^{r,0}, E_\varepsilon^{r,1}$  (Proposition 3.13), the above equality becomes

$$\varphi(s - n\delta) u_{\varepsilon,s-n\delta}^r(x + n/\theta_2) = [(\mathcal{P}_\varepsilon^r)^n \varphi](s) e_{s,\varepsilon}^{r,0}(x) + [\mathcal{S}_\varepsilon^r (\mathcal{P}_\varepsilon^r)^n \varphi](s + \delta) e_{s,\varepsilon}^{r,1}(x),$$

which corresponds to the desired equality, up to a translation  $s \mapsto s + n\delta$ .  $\blacksquare$

The only missing step for evaluating  $U_\varepsilon^r(\varphi)$  via the reconstruction formula (3.35) is the determination of the operators  $(\mathcal{P}_\varepsilon^r, \mathcal{S}_\varepsilon^r)$ . This is the object of the next section.

### 3.4 Local RtR operators and Riccati system

The cell by cell reconstruction formula (3.35) only ensures that  $U_\varepsilon^r(\varphi)$  satisfies the partial differential equation (3.15) in each cell  $\mathcal{C}_{\#}^{r,n}$ . For (3.15) to be satisfied in the whole half-space  $\Omega^r$  (or equivalently in the whole half-guide  $\Omega_{\#}^r$ ), we have to ensure that (3.15) is satisfied across each interface  $\Sigma_{\#}^{r,n}$ , which corresponds to the continuity of  $U_\varepsilon^r(\varphi)$  and  $\mu_p D_\theta U_\varepsilon^r(\varphi)$  across  $\Sigma_{\#}^{r,n}$ , or equivalently the continuity of the two Robin traces  $R_+^r U_\varepsilon^r(\varphi)$  and  $R_-^r U_\varepsilon^r(\varphi)$ . It is by writing these two continuity conditions that we will obtain two equations for  $(\mathcal{P}_\varepsilon^r, \mathcal{S}_\varepsilon^r)$ .

To this end, we introduce for  $\varepsilon > 0$  four local *Robin-to-Robin* (RtR) operators  $\mathcal{T}_\varepsilon^{r,\ell k} \in \mathcal{L}(L_{per}^2(\mathbb{R}))$  defined for  $\ell, k \in \{0, 1\}$  by

$$\begin{aligned} \mathcal{T}_\varepsilon^{r,00} \varphi &:= \mathcal{R}_-^r E_\varepsilon^{r,0}(\varphi)|_{\Sigma^{r,0}} & \text{and} & & \mathcal{T}_\varepsilon^{r,01} \varphi &:= \mathcal{R}_+^r E_\varepsilon^{r,0}(\varphi)|_{\Sigma^{r,1}}, \\ \mathcal{T}_\varepsilon^{r,10} \varphi &:= \mathcal{R}_-^r E_\varepsilon^{r,1}(\varphi)|_{\Sigma^{r,0}} & \text{and} & & \mathcal{T}_\varepsilon^{r,11} \varphi &:= \mathcal{R}_+^r E_\varepsilon^{r,1}(\varphi)|_{\Sigma^{r,1}}. \end{aligned} \quad (3.40)$$

**Remark 3.15.** As the understanding of the manipulations of  $\pm$  for the Robin differential operators is not immediate, it may be helpful to remember that in the cell problems we impose the outgoing Robin trace (outgoing with respect to the periodicity cell) while with the operators  $\mathcal{T}_\varepsilon^{r,\ell k}$ , we evaluate the ingoing Robin trace (ingoing with respect to the periodicity cell).

Proceeding as in the proof of Proposition 3.10, and using the fibered structure of the solutions  $E_\varepsilon^{r,0}$  and  $E_\varepsilon^{r,1}$  (see Theorem 3.13), one easily proves the following result.

**Proposition 3.16**

Let  $\varepsilon > 0$ . The operators  $\mathcal{T}_\varepsilon^{r,\ell k}$ ,  $\ell, k \in \{0, 1\}$ , are weighted shift operators

$$\forall \varphi \in L_{per}^2(\mathbb{R}), \quad \begin{cases} \mathcal{T}_\varepsilon^{r,00} \varphi(s) = \mathbf{t}_\varepsilon^{r,00}(s) \varphi(s), & \mathcal{T}_\varepsilon^{r,01} \varphi(s) = \mathbf{t}_\varepsilon^{r,01}(s - \delta) \varphi(s - \delta), \\ \mathcal{T}_\varepsilon^{r,10} \varphi(s) = \mathbf{t}_\varepsilon^{r,10}(s) \varphi(s + \delta), & \mathcal{T}_\varepsilon^{r,11} \varphi(s) = \mathbf{t}_\varepsilon^{r,11}(s - \delta) \varphi(s), \end{cases} \quad (3.41)$$

where the RtR symbols  $\mathbf{t}_\varepsilon^{r,k\ell}(s)$  are defined from  $e_{s,\varepsilon}^{r,0}$  and  $e_{s,\varepsilon}^{r,1}$  (see (3.36) and (3.37)) by :

$$\begin{cases} \mathbf{t}_\varepsilon^{r,00}(s) = R_{-,s}^r e_{s,\varepsilon}^{r,0}(0), & \mathbf{t}_\varepsilon^{r,01}(s) = R_{+,s}^r e_{s,\varepsilon}^{r,0}(1/\theta_2), \\ \mathbf{t}_\varepsilon^{r,10}(s) = R_{-,s}^r e_{s,\varepsilon}^{r,1}(0), & \mathbf{t}_\varepsilon^{r,11}(s) = R_{+,s}^r e_{s,\varepsilon}^{r,1}(1/\theta_2). \end{cases} \quad (3.42)$$

If  $B \in \mathcal{L}(L_{per}^2(\mathbb{R}))$ , its transpose  ${}^t B \in \mathcal{L}(L_{per}^2(\mathbb{R}))$  is defined by

$$\forall (\varphi, \psi) \in L_{per}^2(\mathbb{R})^2, \quad \int_0^1 {}^t B \varphi(s) \psi(s) ds = \int_0^1 \varphi(s) B \psi(s) ds \quad (3.43)$$

and is related to its adjoint  $B^*$  by conjugation:  ${}^t B \varphi = \overline{B^* \varphi}$ . Moreover,  $B$  and  ${}^t B$  have the same spectrum.

The operators  $\mathcal{T}_\varepsilon^{r,\ell k}$  are related between themselves by tranposition properties that reflect the formal symmetry of the operator  $D_\theta$  ( $\mu_p D_\theta$ ) and is closely related to the well known reciprocity principle in wave propagation.

**Lemma 3.17**

Let  $\varepsilon > 0$ . We have

$${}^t \mathcal{T}_\varepsilon^{r,00} = \mathcal{T}_\varepsilon^{r,00}, \quad {}^t \mathcal{T}_\varepsilon^{r,11} = \mathcal{T}_\varepsilon^{r,11}, \quad {}^t \mathcal{T}_\varepsilon^{r,01} = \mathcal{T}_\varepsilon^{r,10}. \quad (3.44)$$

**Proof.** If  $U, V \in H_\theta^1(\mathcal{C}_\#^{r,0})$  are periodic with respect to  $y_1$  and satisfy the PDE (3.33) in  $\mathcal{C}_\#^{r,0}$ , then using Green's formula III-(3.35) and the periodicity properties, it comes

$$\int_{\Sigma_\#^{r,0}} (\mu_p D_\theta U V - \mu_p D_\theta V U) = \int_{\Sigma_\#^{r,1}} (\mu_p D_\theta U V - \mu_p D_\theta V U)$$

As  $-2\mu_p D_\theta U = \mathcal{R}_+^r U - \mathcal{R}_-^r U$  and  $2izU = \mathcal{R}_+^r U + \mathcal{R}_-^r U$ , and the same replacing  $U$  by  $V$ , the above rewrites (we omit the details):

$$\int_{\Sigma_\#^{r,0}} (\mathcal{R}_+^r U \mathcal{R}_-^r V - \mathcal{R}_-^r U \mathcal{R}_+^r V) = \int_{\Sigma_\#^{r,1}} (\mathcal{R}_+^r U \mathcal{R}_-^r V - \mathcal{R}_-^r U \mathcal{R}_+^r V).$$

With  $U = E_\varepsilon^{r,0}(\varphi)$  and  $V = E_\varepsilon^{r,1}(\psi)$ , the above identity gives, identifying  $\Sigma_\#^{r,0}$  and  $\Sigma_\#^{r,1}$ ,

$$\int_{\Sigma_\#^{r,0}} (\mathcal{T}_\varepsilon^{r,10} \psi) \varphi = \int_{\Sigma_\#^{r,0}} (\mathcal{T}_\varepsilon^{r,01} \varphi) \psi, \quad \text{which yields } {}^t \mathcal{T}_\varepsilon^{r,10} = \mathcal{T}_\varepsilon^{r,01}$$

To obtain  ${}^t\mathcal{T}_\varepsilon^{r,00} = {}^t\mathcal{T}_\varepsilon^{r,00}$ , it suffices to take  $U = E_\varepsilon^{r,0}(\varphi)$  and  $V = E_\varepsilon^{r,0}(\psi)$  and to get  ${}^t\mathcal{T}_\varepsilon^{r,11} = {}^t\mathcal{T}_\varepsilon^{r,11}$ , it suffices to take  $U = E_\varepsilon^{r,1}(\varphi)$  and  $V = E_\varepsilon^{r,1}(\psi)$   $\blacksquare$

Using the definition (3.23) of the operators  $(\mathcal{P}_\varepsilon^r, \mathcal{S}_\varepsilon^r)$ , of the local RtR operators (see (3.40)) and the cell by cell expression of the solution of (3.18) in terms of the cell solutions defined in (3.31) and (3.32), we can show the following result.

**Lemma 3.18**

Let  $\varepsilon > 0$ . The pair  $(\mathcal{P}_\varepsilon^r, \mathcal{S}_\varepsilon^r)$  is solution of the following Riccati system

$$\left\{ \begin{array}{l} \text{Find } (P, S) \in \mathcal{L}(L_{per}^2(\mathbb{R}))^2 \text{ such that} \\ \begin{cases} P = \mathcal{T}_\varepsilon^{r,01} + \mathcal{T}_\varepsilon^{r,11} S, \\ S = \mathcal{T}_\varepsilon^{r,00} P + \mathcal{T}_\varepsilon^{r,10} S P. \end{cases} \end{array} \right. \quad (3.45)$$

Moreover, the spectral radius  $\rho(\mathcal{P}_\varepsilon^r)$  of  $\mathcal{P}_\varepsilon^r$  is strictly less than one.

**Proof.** Let  $\varphi \in L_{per}^2(\mathbb{R})$  and  $U_\varepsilon^r(\varphi)$  be the unique solution of (3.18). The cell by cell expression of  $U_\varepsilon^r$  taken for  $n = 0$  and  $n = 1$  gives:

$$\begin{aligned} \forall \mathbf{y} \in \mathcal{C}_\#^{r,0}, \quad [U_\varepsilon^r(\varphi)](\mathbf{y}) &= [E_\varepsilon^{r,0}(\varphi) + E_\varepsilon^{r,1}(\mathcal{S}_\varepsilon^r \varphi)](\mathbf{y}) \\ \forall \mathbf{y} \in \mathcal{C}_\#^1, \quad [U_\varepsilon^r(\varphi)](\mathbf{y}) &= [E_\varepsilon^{r,0}(\mathcal{P}_\varepsilon^r \varphi) + E_\varepsilon^{r,1}(\mathcal{S}_\varepsilon^r \mathcal{P}_\varepsilon^r \varphi)](\mathbf{y} - \vec{e}_2) \end{aligned} \quad (3.46)$$

By writing that  $\mathcal{R}_+^r U_\varepsilon^r(\varphi)$  and  $\mathcal{R}_-^r U_\varepsilon^r(\varphi)$  are continuous across the interface  $\Sigma_\#^{r,1}$ , we obtain respectively the first and second equations of (3.45).

The fact that  $\rho(\mathcal{P}_\varepsilon^r) < 1$  is a consequence of the exponential decay of the solution in the  $y_2$  direction (with a decay rate that degenerates when  $\varepsilon \rightarrow 0$ , the presence of absorption being essential). We refer to the proof of Proposition III-4.1 for more details.  $\blacksquare$

**Remark 3.19.** In the proof we only used the continuity conditions across  $\Sigma_\#^{r,1}$  to derive the Riccati system (3.45). However it is easy to check that if (3.45) is satisfied, the same continuity conditions are satisfied across any  $\Sigma_\#^n$ .

We call (3.45) a **Riccati system** because if one formally eliminates  $\mathcal{S}_\varepsilon^r$  in the system, one obtains a quadratic equation in  $\mathcal{P}_\varepsilon^r$ , as in the Dirichlet case. Note however that eliminating  $\mathcal{S}_\varepsilon^r$  involves inverting  $\mathcal{T}_\varepsilon^{r,11}$  which is not necessarily invertible. In fact, if  $\mu_p = \rho_p = 1$  for instance, and if  $z$  is allowed to be complex with  $z := \sqrt{\omega^2 + i\varepsilon}$  and  $\Re z > 0$ , then it can be computed without difficulty that  $\mathcal{T}_\varepsilon^{r,11} = 0$ .

**Proposition 3.20**

Let  $\varepsilon > 0$ . The pair  $(\mathcal{P}_\varepsilon^r, \mathcal{S}_\varepsilon^r)$  is the unique solution of the problem

$$\left\{ \begin{array}{l} \text{Find } (P, S) \in \mathcal{L}(L_{per}^2(\mathbb{R}))^2 \text{ such that } \rho(P) < 1 \text{ and} \\ \mathcal{T}_\varepsilon^{r,01} + \mathcal{T}_\varepsilon^{r,11} S = P, \\ S = \mathcal{T}_\varepsilon^{r,00} P + \mathcal{T}_\varepsilon^{r,10} S P. \end{array} \right. \quad (3.47)$$

**Proof.** We only sketch the proof since it is similar to the one of Proposition III–4.4. For the uniqueness result, we show that if  $(P, S)$  is a solution of (3.47), then for any  $\varphi \in L_{per}^2(\mathbb{R})$ , the function  $U(\varphi)$  defined cell by cell in the half-guide  $\Omega_\#$  by (we mimick (3.35))

$$\forall \mathbf{y} \in \mathcal{C}_\#^{r,n}, \quad [U(\varphi)](\mathbf{y}) = [E_\varepsilon^{r,0}(P^n \varphi) + E_\varepsilon^{r,1}(S P^n \varphi)](\mathbf{y} - n \vec{e}_2)$$

and extended by periodicity in the  $y_1$ -direction, belongs to  $H_{\theta,per}^1(\Omega)$  and is solution of the half-space problem (3.18). From the well-posedness of (3.18), we deduce the equality  $U(\varphi) = U_\varepsilon^\pm(\varphi)$ , which implies that  $P\varphi = \mathcal{P}_\varepsilon^r \varphi$  and  $S\varphi = \mathcal{S}_\varepsilon^r \varphi$ . ■

**3.5 RtR half-space operator and transparent boundary condition**

In link with the RtR coefficient  $\lambda_\varepsilon^r$  defined in (3.4), we introduce for  $\varepsilon > 0$  the RtR half-space operator  $\Lambda_\varepsilon^r \in \mathcal{L}(L_{per}^2(\mathbb{R}))$  defined by

$$\Lambda_\varepsilon^r \varphi := \mathcal{R}_-^r U_\varepsilon^r(\varphi)|_{\Sigma^{r,0}}. \quad (3.48)$$

From the cell by cell reconstruction formula (3.35) and the definition (3.40) of the RtR operators, we deduce

$$\Lambda_\varepsilon^r = \mathcal{T}_\varepsilon^{r,00} + \mathcal{T}_\varepsilon^{r,10} \mathcal{S}_\varepsilon^r. \quad (3.49)$$

Using the same arguments as in the proof of Lemma 3.17, we can show that

$${}^t \Lambda_\varepsilon^r = \Lambda_\varepsilon^r. \quad (3.50)$$

Moreover, using a Green's formula in (3.20) (by analogy with the proof of Proposition III–4.3), we obtain

$$\forall \varepsilon > 0, \quad \exists c > 0, \quad \forall \varphi \in L_{per}^2(\mathbb{R}), \quad \Im \int_{\Sigma_\#^{r,0}} \mu_p D_\theta U_\varepsilon^r(\varphi) \overline{U_\varepsilon^r(\varphi)} \geq c \|\varphi\|_{L^2(\Sigma_\#^{r,0})}^2$$

which implies by using the expressions  $-2\mu_p D_\theta U = (\mathcal{R}_+^r - \mathcal{R}_-^r) U$  and  $-2iz U = (\mathcal{R}_+^r + \mathcal{R}_-^r) U$  as well as the definition (3.40) of the RtR operators

$$\forall \varepsilon > 0, \quad \exists c > 0, \quad \forall \varphi \in L_{per}^2(\mathbb{R}), \quad \frac{1}{4z} \Re \int_{\Sigma_\#^{r,0}} (I - \Lambda_\varepsilon^r) \varphi \overline{(I + \Lambda_\varepsilon^r) \varphi} \geq c \|\varphi\|_{L^2(\Sigma_\#^{r,0})}^2. \quad (3.51)$$

From the fibered structure (3.13) of  $U_\varepsilon^r$ , it is immediate to see that  $\Lambda_\varepsilon^r$  is a multiplication operator

$$(\Lambda_\varepsilon^r \varphi)(s) = \lambda_\varepsilon^r(s) \varphi(s) \quad \text{with} \quad \lambda_\varepsilon^r(s) := R_{-,s}^r u_{s,\varepsilon}^r(0), \quad (3.52)$$

and where  $u_{s,\varepsilon}^r$  is defined for any  $s \in \mathbb{R}$  by the half-line problem  $(\mathcal{P}_{\varepsilon,s}^r)$ .

In particular, similarly to (3.19), the RtR coefficient  $\lambda_\varepsilon^r$  can be computed in practice thanks to

$$\lambda_\varepsilon^r = \lambda_\varepsilon^r(\theta_1 a^r) = (\Lambda_\varepsilon^r \varphi)(\theta_1 a^r) \text{ for any } \varphi \in \mathcal{C}_{per}^0(\mathbb{R}) \text{ satisfying } \varphi(\theta_1 a^r) = 1. \quad (3.53)$$

## 4 Analysis of the Riccati system

In this section, we provide some spectral results that will be used to derive the propagation operator and the scattering operator. Section 4.1 is devoted to describing the spectral structure of the propagation operator in terms of its eigenpairs. In particular, our analysis will heavily rely on the notion of **fundamental eigenpair** that we shall introduce below. We then reformulate the Riccati system (3.47) in terms of these eigenpairs in Section 4.2.

### 4.1 Spectral description of the propagation operators

The spectral theory of weighted shift operators has been thoroughly studied and detailed in [Ant12]. We shall extract the useful information to describe the spectral properties of  $\mathcal{P}_\varepsilon^r$  in the case where the ratio  $\delta := \theta_1/\theta_2$  is not a Liouville number, so that its irrationality measure (defined by (1.5)) is finite and the Diophantine condition (1.6) holds, namely

$$\forall \nu > \eta(\delta), \quad \exists c \equiv c(\delta, \nu) > 0 \quad / \quad \forall (p, q) \in \mathbb{Z} \times \mathbb{N}^*, \quad \left| \delta - \frac{p}{q} \right| > \frac{c}{q^\nu}. \quad (4.1)$$

We rely on the notion of *winding number* (also called index; see [Bea79, Chapter 7]).

#### Definition 4.1: Winding number

Let  $\mathcal{N}_{per}$  be the open subset of  $\mathcal{C}_{per}(\mathbb{R}; \mathbb{C})$  defined by

$$\mathcal{N}_{per} := \{f \in \mathcal{C}_{per}(\mathbb{R}; \mathbb{C}) \text{ such that } f(s) \neq 0, \forall s \in \mathbb{R}\}. \quad (4.2)$$

Given  $f \in \mathcal{N}_{per}$ , there exists a function  $s \mapsto \text{Arg } f(s) \in \mathcal{C}^0(\mathbb{R}; \mathbb{R})$ , where  $\text{Arg } f(s)$  denotes the argument of  $f(s)$ , such that

$$\forall s \in [0, 1], \quad f(s) = |f(s)| e^{i \text{Arg } f(s)} \quad (4.3)$$

and one can define the winding number  $\mathbf{w}(f)$  of  $f$  as

$$\mathbf{w}(f) = (\text{Arg } f(1) - \text{Arg } f(0))/2\pi \in \mathbb{Z}. \quad (4.4)$$

Moreover the map  $f \in \mathcal{N}_{per} \mapsto \text{Arg } f|_{[0,1]} \in \mathcal{C}^0(0, 1)$  is continuous.

In more geometrical (but less precise) terms,  $\mathbf{w}(f)$  is the number of turns around the origin made by the (closed) trajectory in the complex plane described by  $f(s)$  when  $s$  varies from 0 to 1 (hence its name). The turn counts positively (respectively negatively) when the trajectory travels counterclockwise (respectively clockwise) around the origin. It is easy to show the following result.

**Corollary 4.2**

For any  $f \in \mathcal{N}_{per}$ , one has the equivalences

$$\mathbf{w}(f) = 0 \iff \text{Arg } f \in \mathcal{C}_{per}^0(\mathbb{R}; \mathbb{R}) \iff f(s) = e^{g(s)}, \quad g \in \mathcal{C}_{per}(\mathbb{R}; \mathbb{C}).$$

**Lemma 4.3**

Let  $\varepsilon > 0$  and  $\mathbf{p}_\varepsilon^r(x, s)$  be the function defined by (3.25), then

$$\forall x \in \mathbb{R}_+, \quad \mathbf{p}_\varepsilon^r(x, \cdot) \in \mathcal{N}_{per} \quad \text{and} \quad \mathbf{w}(\mathbf{p}_\varepsilon^r(x, \cdot)) = 0.$$

In particular  $\mathbf{p}_\varepsilon^r \in \mathcal{N}_{per}$  and  $\mathbf{w}(\mathbf{p}_\varepsilon^r) = 0$ .

**Proof.** For  $x \in \mathbb{R}_+$ , from its definition (3.25) and Proposition 3.8, it is clear that the function  $\mathbf{p}_\varepsilon^r(x, \cdot)$  belongs to  $\mathcal{N}_{per}$  and thus has a winding number  $\mathbf{w}(\mathbf{p}_\varepsilon^r(x, \cdot))$ . Moreover, by continuity of  $x \mapsto \mathbf{p}_\varepsilon^r(x, \cdot)$  (Proposition 3.8), we deduce from Proposition 4.1 that  $x \mapsto \text{Arg } \mathbf{p}_\varepsilon^r(x, \cdot)$  is continuous. As a consequence,  $x \mapsto \mathbf{w}(\mathbf{p}_\varepsilon^r(x, \cdot))$  is a continuous and integer-valued function, which means that it is constant. In particular,  $\mathbf{w}(\mathbf{p}_\varepsilon^r(x, \cdot)) = \mathbf{w}(\mathbf{p}_\varepsilon^r(0, \cdot))$  for any  $x \in \mathbb{R}_+$ . But since  $\mathbf{p}_\varepsilon^r(0, s) = 1$  for any  $s \in \mathbb{R}$ , it follows that  $\mathbf{w}(\mathbf{p}_\varepsilon^r(0, \cdot)) = 0$ . ■

We can now state the main result of this section.

**Proposition 4.4**

Let  $\varepsilon > 0$ . Assume that  $\delta$  has a finite irrationality measure (so that the condition (4.1) is satisfied), and that the coefficients  $(\mu_p, \rho_p)$  have the regularity

$$\mu_p, \rho_p \in \mathcal{C}^m(\mathbb{R}^2) \quad \text{for some } m \in \mathbb{N} \text{ such that } m > \eta(\delta) \text{ (see (1.5)).} \quad (4.5)$$

Then there exists a unique pair  $(\lambda_{0,\varepsilon}^r, \varphi_{0,\varepsilon}^r) \in \mathbb{C} \times \mathcal{N}_{per}$  with  $r_\varepsilon := |\lambda_{0,\varepsilon}^r| < 1$  and  $\mathbf{w}(\varphi_{0,\varepsilon}^r) = 0$  such that

$$\mathcal{P}_\varepsilon^r \varphi_{0,\varepsilon}^r = \lambda_{0,\varepsilon}^r \varphi_{0,\varepsilon}^r \quad \text{and} \quad \varphi_{0,\varepsilon}^r(0) = 1, \quad (4.6)$$

or equivalently

$$\mathbf{p}_\varepsilon^r(s - \delta) \varphi_{0,\varepsilon}^r(s - \delta) = \lambda_{0,\varepsilon}^r \varphi_{0,\varepsilon}^r(s). \quad (4.7)$$

Moreover, if we define  $\varphi_{k,\varepsilon}^r \in \mathcal{N}_{per}$  for any  $k \in \mathbb{Z}$  by  $\varphi_{k,\varepsilon}^r(s) := e^{2i\pi ks} \varphi_{0,\varepsilon}^r(s)$ , then

$$\mathcal{P}_\varepsilon^r \varphi_{k,\varepsilon}^r = \lambda_{k,\varepsilon}^r \varphi_{k,\varepsilon}^r \quad \text{with} \quad \lambda_{k,\varepsilon}^r := e^{-2i\pi k\delta} \lambda_{0,\varepsilon}^r \quad (4.8)$$

The point spectrum of  $\mathcal{P}_\varepsilon^r$  is the countable set

$$\sigma_p(\mathcal{P}_\varepsilon^r) = \{\lambda_{k,\varepsilon}^r, k \in \mathbb{Z}\}, \quad (4.9)$$

where the eigenvalues  $\lambda_{k,\varepsilon}^r$  are all simple. Moreover, the point spectrum of  $\mathcal{P}_\varepsilon^r$  is a dense subset of the circle  $\mathcal{C}(0, r_\varepsilon)$  and its spectrum  $\sigma(\mathcal{P}_\varepsilon^r)$  is  $\mathcal{C}(0, r_\varepsilon)$ .

Finally, the eigenfunctions  $\{\varphi_{k,\varepsilon}^r, k \in \mathbb{Z}\}$  form an orthogonal basis of  $L_{per}^2(\mathbb{R})$  for the inner

product

$$(\varphi, \psi)_{\rho_\varepsilon^r} := \int_0^1 \varphi(s) \overline{\psi}(s) \rho_\varepsilon^r(s) ds \quad \text{where} \quad \rho_\varepsilon^r(s) := |\varphi_{0,\varepsilon}^r(s)|^{-2}, \quad (4.10)$$

where  $\rho_\varepsilon^r$  is bounded from below and above since  $\varphi_{0,\varepsilon}^r \in \mathcal{N}_{per}$ .

**Proof.** The proof that we are going to give is a slight adaptation of [Ant12].

**Step 1 : A preliminary observation about the structure of the spectrum of  $\mathcal{P}_\varepsilon^r$ .**

Let  $S_k, k \in \mathbb{Z}$  be the multiplication operator in  $L_{per}^2(\mathbb{R})$  by the 1-periodic function  $e^{2i\pi ks}$ ,

$$\forall \varphi \in L_{per}^2(\mathbb{R}), \quad (S_k \varphi)(s) := e^{2i\pi ks} \varphi(s),$$

which is unitary in  $L_{per}^2(\mathbb{R})$  with  $S_k^{-1} = S_{-k}$ . Since  $\mathcal{P}_\varepsilon^r$  is a weighted-shift operator (see Theorem 3.10), one checks immediately that

$$\forall k \in \mathbb{Z}, \quad S_{-k} \mathcal{P}_\varepsilon^r S_k = e^{2i\pi k\delta} \mathcal{P}_\varepsilon^r. \quad (4.11)$$

Let us now make an assumption which will be proven at the step 2 of the proof :

$$\text{The operator } \mathcal{P}_\varepsilon^r \text{ admits an eigenfunction } \varphi_{0,\varepsilon}^r \in \mathcal{N}_{per} \text{ such that } \mathbf{w}(\varphi_{0,\varepsilon}^r) = 0. \quad (4.12)$$

Let  $\lambda_{0,\varepsilon}^r \neq 0$  be the associated eigenvalue, with  $r_\varepsilon := |\lambda_{0,\varepsilon}^r| > 0$  since  $\mathcal{P}_\varepsilon^r$  is bijective (see Theorem 3.10). From the commutation property (4.11), we deduce that

$$\forall k \in \mathbb{Z}, \quad \text{Setting } \varphi_{k,\varepsilon}^r := e^{2i\pi ks} \varphi_{0,\varepsilon}^r, \quad \mathcal{P}_\varepsilon^r \varphi_{k,\varepsilon}^r = \lambda_{k,\varepsilon}^r \varphi_{k,\varepsilon}^r \quad \text{where} \quad \lambda_{k,\varepsilon}^r := e^{-2i\pi k\delta} \lambda_{0,\varepsilon}^r.$$

As  $\delta \in \mathbb{R} \setminus \mathbb{Q}$ , the eigenvalues  $\lambda_{k,\varepsilon}^r$  are distinct and  $\{\lambda_{k,\varepsilon}^r, k \in \mathbb{Z}\}$  is dense in the circle  $\mathcal{C}(0, r_\varepsilon)$ .

Moreover, from Fourier series theory in  $L^2(0, 1)$ , we deduce that  $\{\varphi_{k,\varepsilon}^r, k \in \mathbb{Z}\}$  is an orthonormal basis of  $L_{per}^2(\mathbb{R})$  for the inner product (4.10), in which  $\mathcal{P}_\varepsilon^r$  is diagonal in the sense that

$$\forall u \in L_{per}^2(\mathbb{R}), \quad u = \sum_{k \in \mathbb{Z}} (u, \varphi_{k,\varepsilon}^r)_{\rho_\varepsilon^r} \varphi_{k,\varepsilon}^r \implies \mathcal{P}_\varepsilon^r u = \sum_{k \in \mathbb{Z}} \lambda_{k,\varepsilon}^r (u, \varphi_{k,\varepsilon}^r)_{\rho_\varepsilon^r} \varphi_{k,\varepsilon}^r. \quad (4.13)$$

From (4.13), we deduce that the point spectrum of  $\mathcal{P}_\varepsilon^r$  is given by (4.9) and that its whole spectrum is the circle  $\mathcal{C}(0, r_\varepsilon)$ . Moreover, one sees that each eigenvalue is simple :  $\text{Ker}(\mathcal{P}_\varepsilon^r - \lambda_{k,\varepsilon}^r) = \text{Span}(\varphi_{k,\varepsilon}^r)$ .

**Step 2 : Existence of the fundamental eigenfunction  $\varphi_{0,\varepsilon}^r$ .**

Since, according to Lemma 4.3,  $\mathbf{p}_\varepsilon^r \in \mathcal{N}_{per}$  and  $\mathbf{w}(\mathbf{p}_\varepsilon^r) = 0$ , we know by Corollary 4.2, that

$$\mathbf{p}_\varepsilon^r(s) = e^{g_\varepsilon(s)} \quad \text{for some } g_\varepsilon \in \mathcal{C}_{per}^0(\mathbb{R}, \mathbb{C}). \quad (4.14)$$

Similarly, since we look for  $\varphi_{0,\varepsilon}^r \in \mathcal{N}_{per}$  with  $\mathbf{w}(\varphi_{0,\varepsilon}^r) = 0$  we can look for

$$\varphi_{k,\varepsilon}^r(s) = e^{v_\varepsilon(s)} \quad \text{where} \quad v_\varepsilon \in \mathcal{C}_{per}^0(\mathbb{R}, \mathbb{C}) \quad (4.15)$$

so that the existence of  $\varphi_{0,\varepsilon}^r$  is equivalent to the one of  $v_\varepsilon(s)$ . Substituting (4.14) and (4.15) into the eigenvalue equation, that is to say,

$$\mathbf{p}_\varepsilon^r(s - \delta) \varphi_{k,\varepsilon}^r(s - \delta) = \lambda_{0,\varepsilon}^r \varphi_{k,\varepsilon}^r(s) \quad (4.16)$$

naturally suggests to look for  $v_\varepsilon(s)$  as a solution of the following difference equation

$$g_\varepsilon(s - \delta) + v_\varepsilon(s - \delta) = \log \lambda_{0,\varepsilon}^r + v_\varepsilon(s). \quad (4.17)$$

Integrating (4.17) between 0 and 1, we obtain, by periodicity of  $v_\varepsilon$  (and  $g_\varepsilon$ ),

$$\log \lambda_{0,\varepsilon}^r = \int_0^1 g_\varepsilon(s) ds, \quad \text{thus} \quad \lambda_{0,\varepsilon}^r = \exp \int_0^1 g_\varepsilon(s) ds.$$

Multiplying (4.17) by  $e^{-2i\pi ks}$ , with  $k \neq 0$ , and integrating the result over  $[0, 1]$ , we obtain for the  $k$ -th Fourier coefficient  $v_{k,\varepsilon}$  of  $v_\varepsilon$  ( $g_{k,\varepsilon}$  being the one of  $g_\varepsilon$ ) the following equation

$$\forall k \in \mathbb{Z}, \quad v_{k,\varepsilon} (1 - e^{2i\pi k\delta}) = -g_{k,\varepsilon} \implies v_{k,\varepsilon} = \frac{g_{k,\varepsilon}}{e^{2i\pi k\delta} - 1}, \quad (4.18)$$

where the division by  $e^{2i\pi k\delta} - 1$  is possible because  $\delta \in \mathbb{R} \setminus \mathbb{Q}$ . To conclude, it remains to investigate the convergence, in  $\mathcal{C}_{per}^0(0, 1)$ , of the series

$$\sum_{k \neq 0} \frac{g_{k,\varepsilon}}{e^{2i\pi k\delta} - 1} e^{2i\pi ks}. \quad (4.19)$$

Note that this convergence is not obvious since, by density of  $\{e^{2i\pi k\delta}, k \in \mathbb{Z}\}$  in the unit circle,  $e^{2i\pi k\delta} - 1$  can be arbitrarily small for infinitely many  $k$ 's. This corresponds to a small divisors problem (such a problem also appears for instance when studying the primitives of quasiperiodic functions; see Section II-4.2 and [Ghy07] for a general exposition). This is where the regularity of the symbol  $\mathbf{p}_\varepsilon^r$ , through the one of the coefficients  $(\mu_p, \rho_p)$  will come into play to bound  $g_{k,\varepsilon}$ , as well as the measure of irrationality  $\eta(\delta)$  of  $\delta$  to get a lower bound for  $|e^{2i\pi k\delta} - 1|$ .

First, due to the regularity assumption, we know by (3.26) that  $\mathbf{p}_\varepsilon^r \in \mathcal{C}^m(\mathbb{R}, \mathbb{C})$ , thus  $g_\varepsilon \in \mathcal{C}^m(\mathbb{R}, \mathbb{C})$ , and we have the following upper bound for the coefficients  $g_{k,\varepsilon}$

$$\forall k \neq 0, \quad |g_{k,\varepsilon}| \leq \frac{C_m(g_\varepsilon)}{|k|^m}, \quad C_m(g_\varepsilon) := \sup_{s \in [0,1]} |g_\varepsilon^{(m)}(s)|. \quad (4.20)$$

To get a lower bound for  $|e^{2i\pi k\delta} - 1|$ , we use the concavity of the sine function in  $[0, \pi/2]$  to obtain

$$\forall \theta \in [-\pi, \pi], \quad |e^{i\theta} - 1| = 2 |\sin(\theta/2)| \geq 2 |\theta|/\pi \quad (4.21)$$

Next, for any  $k \in \mathbb{Z}$  such that  $k\delta \notin \mathbb{Z}$  and there exists  $n \equiv n(k) \in \mathbb{Z}$  such that  $|k\delta - n| < 1/2$ . Thus

$$|e^{2i\pi k\delta} - 1| = |e^{2i\pi(k\delta - n)} - 1| \geq 4 |k\delta - n|,$$

where the last inequality follows from (4.21), since  $\theta := 2\pi(k\delta - n) \in ]-\pi, \pi[$ . However, thanks to the Diophantine condition (4.1), we have for any  $\nu > \eta(\delta)$

$$|k\delta - n| = |k| |\delta - n/k| \geq \frac{C_\nu}{|k|^{\nu-1}} \quad \text{which yields} \quad |e^{2i\pi k\delta} - 1| \geq \frac{\tilde{C}_\nu}{|k|^{\nu-1}}. \quad (4.22)$$

Finally, by combining (4.20) and (4.22), we obtain the following uniform (in  $s$ ) bound for the general



term of the series (4.19)

$$\left| \frac{g_{k,\varepsilon}}{e^{2i\pi k\delta} - 1} \right| \leq \frac{C_m(g_\varepsilon)}{\tilde{C}_\nu} \frac{1}{|k|^{1+(m-\nu)}}, \quad (4.23)$$

which ensures the (normal) convergence of the series as soon as  $m > \eta(\delta)$  (since one can choose  $\eta(\delta) < \nu < m$ ) so that

$$v_\varepsilon(s) := \sum_{k \neq 0} \frac{g_{k,\varepsilon}}{e^{2i\pi k\delta} - 1} e^{2i\pi ks} \in \mathcal{C}_{\text{per}}^0(\mathbb{R}, \mathbb{C}). \quad (4.24)$$

We then take the exponential of  $v_\varepsilon$ , see (4.15), to construct  $\varphi_{0,\varepsilon}^r$ .

Note that, in the above construction of  $v_\varepsilon$ , the mean value  $v_{0,\varepsilon}$  of  $v_\varepsilon$  (an additive constant for  $v_\varepsilon$  which becomes a multiplicative constant for  $\varphi_{0,\varepsilon}^r$ ) is completely free. Since  $\varphi_{0,\varepsilon}^r$  never vanishes, we can thus build  $\varphi_{0,\varepsilon}^r$  so that  $\varphi_{0,\varepsilon}^r(0) = 1$  by construction. This concludes the proof.  $\blacksquare$

**Remark 4.5.** Note that since  $\mathbf{w}(\varphi_{k,\varepsilon}^r) = k$ , only  $\varphi_{0,\varepsilon}^r$  has a winding number 0, reason why it can be easily distinguished from the other eigenfunctions: we call it the **fundamental eigenfunction** of  $\mathcal{P}_\varepsilon^r$ . By extension,  $\lambda_{0,\varepsilon}^r$  and  $(\varphi_{k,\varepsilon}^r, \lambda_{0,\varepsilon}^r)$  are respectively the **fundamental eigenvalue** and the **fundamental eigenpair** of  $\mathcal{P}_\varepsilon^r$ .

From the proof of Proposition 4.4, one can show the following corollary (we omit the details).

#### Corollary 4.6

Assume that  $\delta$  is not a Liouville number and that the coefficients  $(\mu_p, \rho_p)$  have the regularity given in (4.5) with  $m > \eta(\delta) + k$  for a given  $k \in \mathbb{N}$ . Then the fundamental eigenfunction is such that  $\varphi_{0,\varepsilon}^r \in \mathcal{C}_{\text{per}}^k(\mathbb{R}, \mathbb{C})$ .

To each eigenfunction  $\varphi_{k,\varepsilon}^r$  of  $\mathcal{P}_\varepsilon^r$ , we can associate a *2D mode*, which is the solution of the half-space problem (3.18) taking this eigenfunction as the boundary data, namely

$$U_{k,\varepsilon}^r := U_\varepsilon^r(\varphi_{k,\varepsilon}^r). \quad (4.25)$$

Similarly to the cell by cell expression (3.39) of  $u_{s,\varepsilon}^r$ , one has the following result, which we shall use in Section 6.4.

#### Lemma 4.7: Fibered structure of $U_{k,\varepsilon}^r$

We introduce for  $k \in \mathbb{Z}, s \in \mathbb{R}$

$$\text{a. e. } x \in \mathbb{R}^+, \quad u_{s,k,\varepsilon}^r(x) := U_{k,\varepsilon}^r(s + \theta_1 x, \theta_2 x).$$

Note that  $u_{s,k,\varepsilon}^r$  is well-defined and belongs to  $H^1(\mathbb{R}_+)$ , because  $\varphi_{k,\varepsilon}^r$  is continuous. One has the following formula, with  $\psi_{k,\varepsilon}^r := \mathcal{S}_\varepsilon^r \varphi_{k,\varepsilon}^r$ :

$$u_{s,k,\varepsilon}^r(x + n/\theta_2) = (\lambda_{k,\varepsilon}^r)^n [\varphi_{k,\varepsilon}^r(s + n\delta) e_{s+n\delta,\varepsilon}^{r,0}(x) + \psi_{k,\varepsilon}^r(s + (n+1)\delta) e_{s+n\delta,\varepsilon}^{r,1}(x)]. \quad (4.26)$$

**Proof.** It suffices to use (3.39) for  $\varphi = \varphi_{k,\varepsilon}^r$  and remark that

$$(\mathcal{P}_\varepsilon^r)^n \varphi_{k,\varepsilon}^r = \lambda_{k,\varepsilon}^n \varphi_{k,\varepsilon}^r \quad \text{and} \quad \mathcal{S}_\varepsilon^r (\mathcal{P}_\varepsilon^r)^n \varphi_{k,\varepsilon}^r = (\lambda_{k,\varepsilon}^r)^n \psi_{k,\varepsilon}^r. \quad \blacksquare$$

**Remark 4.8** (Quasi-Floquet modes). *The 2D fields  $U_{k,\varepsilon}^r$  can be seen as the equivalent of (evanescent) Floquet modes associated to the classical Helmholtz equation in a periodic media. By analogy, the 1D functions  $u_{s,k,\varepsilon}^r$  can be called the **quasi-Floquet modes** associated to the quasi-periodic medium  $(\mu_{s,\theta}, \rho_{s,\theta})$ .*

## 4.2 Spectral resolution of the Riccati system

Let us suppose in this section that the assumptions of Theorem 4.4 are satisfied. We know that the operator  $\mathcal{P}_\varepsilon^r$  is entirely determined by its fundamental eigenpair  $(\lambda_{0,\varepsilon}^r, \varphi_{0,\varepsilon}^r)$ . Our goal now is to find this eigenpair from the Riccati system (3.45).

Let us introduce the two operators  $\mathcal{M}_\varepsilon^r, \mathcal{N}_\varepsilon^r \in \mathcal{L}(L_{per}^2(\mathbb{R}) \times L_{per}^2(\mathbb{R}))$ , defined in block form as

$$\mathcal{M}_\varepsilon^r = \begin{pmatrix} \mathcal{T}_\varepsilon^{r,01} & \mathcal{T}_\varepsilon^{r,11} \\ 0 & I \end{pmatrix} \quad \text{and} \quad \mathcal{N}_\varepsilon^r = \begin{pmatrix} I & 0 \\ \mathcal{T}_\varepsilon^{r,00} & \mathcal{T}_\varepsilon^{r,10} \end{pmatrix}, \quad (4.27)$$

where the local RtR operators  $\mathcal{T}_\varepsilon^{r,\ell k}$  are defined by (3.40). It is easy to see that for any solution  $(P, S)$  of the Riccati system (3.45), if  $P\varphi = \lambda\varphi$  with  $\varphi \in L_{per}^2(\mathbb{R}) \setminus \{0\}$  then

$$\mathcal{M}_\varepsilon^r \begin{pmatrix} \varphi \\ S\varphi \end{pmatrix} = \lambda \mathcal{N}_\varepsilon^r \begin{pmatrix} \varphi \\ S\varphi \end{pmatrix}$$

It is then natural to introduce the augmented (and generalized) eigenvalue problem

$$\text{Find } \lambda \in \mathbb{C} \text{ and } (\varphi, \psi) (\neq 0) \in L_{per}^2(\mathbb{R})^2 \text{ such that } \mathcal{M}_\varepsilon^r \begin{pmatrix} \varphi \\ \psi \end{pmatrix} = \lambda \mathcal{N}_\varepsilon^r \begin{pmatrix} \varphi \\ \psi \end{pmatrix} \quad (4.28)$$

and the corresponding point spectrum, called the **Riccati point spectrum**  $\sigma_{R,p,\varepsilon}^r$ , defined as the point spectrum of the pencil  $(\mathcal{M}_\varepsilon^r, \mathcal{N}_\varepsilon^r)$ :

$$\sigma_{R,p,\varepsilon}^r := \{ \lambda \in \mathbb{C} / 0 \in \sigma_p(\mathcal{M}_\varepsilon^r - \lambda \mathcal{N}_\varepsilon^r) \}. \quad (4.29)$$

We have noticed above that for any solution  $(P, S)$  of the Riccati system (3.45), one has the inclusion

$$\sigma_p(P) \subset \sigma_{R,p,\varepsilon}^r \quad (4.30)$$

In particular,  $\sigma_p(\mathcal{P}_\varepsilon^r) \subset \sigma_{R,p,\varepsilon}^r$ . The Riccati point spectrum is the one that we shall be able to compute numerically because it involves the RtR operators defined thanks to problems defined in a bounded domains, namely the cell  $\mathcal{C}_\#^{r,0} = (0, 1)^2$ .

**Remark 4.9.** *After discretization, the RtR operators will be approximated by matrices of dimension  $N$ . One then expects the approximated Riccati spectrum to contain  $2N$  elements while the approximated spectrum of the propagation operator contains only  $N$  elements.*

In order to extract  $\sigma_p(\mathcal{P}_\varepsilon^r)$  from  $\sigma_{R,p,\varepsilon}^r$ , we shall use a complete description the Riccati point spectrum.

This will be based on the factorization of  $\mathcal{M}_\varepsilon^r - \lambda \mathcal{N}_\varepsilon^r$ , which is the analogue of Lemma III-4.7. Note however that this factorization is more technical, due to the RtR operators.

**Proposition 4.10**

Given  $\varepsilon > 0$ , let  $\mathcal{P}_\varepsilon^r, \mathcal{S}_\varepsilon^r$  be the operators defined by (3.23). For any  $\lambda \in \mathbb{C}$ , we have

$$\mathcal{M}_\varepsilon^r - \lambda \mathcal{N}_\varepsilon^r = \begin{pmatrix} I & 0 \\ \lambda {}^t \mathcal{S}_\varepsilon^r & \lambda {}^t \mathcal{P}_\varepsilon^r - I \end{pmatrix} \mathcal{L}_\varepsilon^r \begin{pmatrix} \mathcal{P}_\varepsilon^r - \lambda & 0 \\ \mathcal{S}_\varepsilon^r & -I \end{pmatrix}, \quad \mathcal{L}_\varepsilon^r := \begin{pmatrix} I & -\mathcal{T}_\varepsilon^{r,11} \\ -\Lambda_\varepsilon^r & I \end{pmatrix}, \quad (4.31)$$

where  $\mathcal{T}_\varepsilon^{r,11}$  is defined in (3.40) and  $\Lambda_\varepsilon^r$  in (3.48). Moreover,  $\mathcal{L}_\varepsilon^r$  is invertible.

**Proof. Step 1: Factorization of  $\mathcal{M}_\varepsilon^r - \lambda \mathcal{N}_\varepsilon^r$ .** Let  $\lambda \in \mathbb{C}$ ; we have

$$\mathcal{M}_\varepsilon^r - \lambda \mathcal{N}_\varepsilon^r = \begin{pmatrix} \mathcal{T}_\varepsilon^{r,01} - \lambda & \mathcal{T}_\varepsilon^{r,11} \\ -\lambda \mathcal{T}_\varepsilon^{r,00} & I - \lambda \mathcal{T}_\varepsilon^{r,10} \end{pmatrix}.$$

We do not change the above expression by adding the two operators  $\mathcal{P}_\varepsilon^r - \mathcal{T}_\varepsilon^{r,01} - \mathcal{T}_\varepsilon^{r,11} \mathcal{S}_\varepsilon^r$  and  $\mathcal{T}_\varepsilon^{r,00} \mathcal{P}_\varepsilon^r + \mathcal{T}_\varepsilon^{r,10} \mathcal{S}_\varepsilon^r \mathcal{P}_\varepsilon^r - \mathcal{S}_\varepsilon^r$  respectively to the upper and lower left blocks: indeed, as  $(\mathcal{P}_\varepsilon^r, \mathcal{S}_\varepsilon^r)$  is solution of the Riccati system, these two operators are equal to 0. Doing so, we obtain

$$\mathcal{M}_\varepsilon^r - \lambda \mathcal{N}_\varepsilon^r = \begin{pmatrix} \mathcal{P}_\varepsilon^r - \lambda - \mathcal{T}_\varepsilon^{r,11} \mathcal{S}_\varepsilon^r & \mathcal{T}_\varepsilon^{r,11} \\ \mathcal{T}_\varepsilon^{r,00} (\mathcal{P}_\varepsilon^r - \lambda) + \mathcal{T}_\varepsilon^{r,10} \mathcal{S}_\varepsilon^r \mathcal{P}_\varepsilon^r - \mathcal{S}_\varepsilon^r & I - \lambda \mathcal{T}_\varepsilon^{r,10} \end{pmatrix},$$

an expression whose interest is to make appear  $\mathcal{P}_\varepsilon^r - \lambda$ . Thanks to the fact that  $\Lambda_\varepsilon^r = \mathcal{T}_\varepsilon^{r,00} + \mathcal{T}_\varepsilon^{r,10} \mathcal{S}_\varepsilon^r$  from (3.48), we note that  $\mathcal{T}_\varepsilon^{r,00} (\mathcal{P}_\varepsilon^r - \lambda) + \mathcal{T}_\varepsilon^{r,10} \mathcal{S}_\varepsilon^r \mathcal{P}_\varepsilon^r - \mathcal{S}_\varepsilon^r = \Lambda_\varepsilon^r (\mathcal{P}_\varepsilon^r - \lambda) + (\lambda \mathcal{T}_\varepsilon^{r,10} - I) \mathcal{S}_\varepsilon^r$ , so that

$$\mathcal{M}_\varepsilon^r - \lambda \mathcal{N}_\varepsilon^r = \begin{pmatrix} I \times (\mathcal{P}_\varepsilon^r - \lambda) - \mathcal{T}_\varepsilon^{r,11} \mathcal{S}_\varepsilon^r & I \times 0 - \mathcal{T}_\varepsilon^{r,11} (-I) \\ \Lambda_\varepsilon^r (\mathcal{P}_\varepsilon^r - \lambda) + (\lambda \mathcal{T}_\varepsilon^{r,10} - I) \mathcal{S}_\varepsilon^r & \Lambda_\varepsilon^r \times 0 + (\lambda \mathcal{T}_\varepsilon^{r,10} - I) (-I) \end{pmatrix},$$

an expression on which we recognize a first factorization of  $\mathcal{M}_\varepsilon^r - \lambda \mathcal{N}_\varepsilon^r$ , namely

$$\mathcal{M}_\varepsilon^r - \lambda \mathcal{N}_\varepsilon^r = \mathcal{D}_\varepsilon(\lambda) \begin{pmatrix} \mathcal{P}_\varepsilon^r - \lambda & 0 \\ \mathcal{S}_\varepsilon^r & -I \end{pmatrix} \quad \text{with} \quad \mathcal{D}_\varepsilon(\lambda) := \begin{pmatrix} I & -\mathcal{T}_\varepsilon^{r,11} \\ \Lambda_\varepsilon^r & \lambda \mathcal{T}_\varepsilon^{r,10} - I \end{pmatrix}. \quad (4.32)$$

Let us now factorize the operator  $\mathcal{D}_\varepsilon(\lambda)$ . We proceed essentially along the same lines as for the first step of the factorization. To make appear the transpose operators that arise in the first factor of (4.31), the trick is to transpose the Riccati system (3.45), and use the symmetry properties of the operators  $\mathcal{T}_\varepsilon^{r,\ell k}$  (Lemma 3.17), as well as the expression (3.49) of  $\Lambda_\varepsilon^r$  and the fact that  ${}^t \Lambda_\varepsilon^r = \Lambda_\varepsilon^r$  (see (3.50)) to obtain

$$\begin{cases} {}^t \mathcal{P}_\varepsilon^r - \mathcal{T}_\varepsilon^{r,10} + {}^t \mathcal{S}_\varepsilon^r \mathcal{T}_\varepsilon^{r,11} = 0, \\ {}^t \mathcal{S}_\varepsilon^r - {}^t \mathcal{P}_\varepsilon^r \Lambda_\varepsilon^r = 0. \end{cases}$$

Thus, we do not change anything by adding  $\lambda ({}^t \mathcal{P}_\varepsilon^r - \mathcal{T}_\varepsilon^{r,10} + {}^t \mathcal{S}_\varepsilon^r \mathcal{T}_\varepsilon^{r,11})$  and  $\lambda ({}^t \mathcal{S}_\varepsilon^r - {}^t \mathcal{P}_\varepsilon^r \Lambda_\varepsilon^r)$  respectively to the left and right lower blocks of  $\mathcal{D}_\varepsilon(\lambda)$  in (4.32). This leads to an expression that has the interest to make appear  $\lambda {}^t \mathcal{P}_\varepsilon^r - I$ , namely

$$\mathcal{D}_\varepsilon(\lambda) = \begin{pmatrix} I & -\mathcal{T}_\varepsilon^{r,11} \\ \lambda {}^t \mathcal{S}_\varepsilon^r - (\lambda {}^t \mathcal{P}_\varepsilon^r - I) \Lambda_\varepsilon^r & -\lambda {}^t \mathcal{S}_\varepsilon^r \mathcal{T}_\varepsilon^{r,11} + (\lambda {}^t \mathcal{P}_\varepsilon^r - I) \end{pmatrix}.$$

We then recognize, similarly to the first part of the proof, the factorization

$$\mathcal{D}_\varepsilon(\lambda) = \begin{pmatrix} I & 0 \\ \lambda {}^t \mathcal{S}_\varepsilon^r & \lambda {}^t \mathcal{P}_\varepsilon^r - I \end{pmatrix} \begin{pmatrix} I & -\mathcal{T}_\varepsilon^{r,11} \\ -\Lambda_\varepsilon^r & I \end{pmatrix}$$

which combined with (4.32) leads to the desired factorization of  $\mathcal{M}_\varepsilon^r - \lambda \mathcal{N}_\varepsilon^r$ .

**Step 2 : Invertibility of  $\mathcal{L}_\varepsilon^r$ .** We begin by showing that the invertibility of  $\mathcal{L}_\varepsilon^r$  is equivalent to the well-posedness of a certain problem. Given  $(f, g)$  in  $L_{per}^2(\mathbb{R})^2$ , we want to construct  $(\varphi, \psi) \in L_{per}^2(\mathbb{R})^2$  such that  $\mathcal{L}_\varepsilon^r(\varphi, \psi) = (f, g)$ , or equivalently

$$\begin{cases} \varphi - \mathcal{T}_\varepsilon^{r,11} \psi = f \\ -\Lambda_\varepsilon^r \varphi + \psi = g \end{cases} \iff \begin{cases} \varphi - \mathcal{R}_-^r E_\varepsilon^{r,1}(\psi)|_{\Sigma_\#^{r,1}} = f \\ -\Lambda_\varepsilon^r \varphi + \mathcal{R}_+^r E_\varepsilon^{r,1}(\psi)|_{\Sigma_\#^{r,1}} = g \end{cases}$$

where the equivalence follows from the definitions of  $E_\varepsilon^{r,1}(\psi)$  and  $\mathcal{T}_\varepsilon^{r,11}$ . Therefore, since  $\mathcal{R}_+^r - \mathcal{R}_-^r = -2\mu_p D_\theta$  and  $\mathcal{R}_+^r - \mathcal{R}_-^r = -2iz$ , we also have

$$\mathcal{L}_\varepsilon^r(\varphi, \psi) = (f, g) \iff \begin{cases} (I + \Lambda_\varepsilon^r)\varphi + 2iz E_\varepsilon^{r,1}(\psi) = f - g & \text{on } \Sigma_\#^{r,1} \\ (I - \Lambda_\varepsilon^r)\varphi - 2\mu_p D_\theta E_\varepsilon^{r,1}(\psi) = f + g & \text{on } \Sigma_\#^{r,1} \end{cases}$$

Consequently, if  $\mathcal{L}_\varepsilon^r(\varphi, \psi) = (f, g)$ , setting  $U := E_\varepsilon^1(\psi)$ , then the pair  $(\varphi, U)$  is a solution of the coupled problem: Find  $(\varphi, U) \in L_{per}^2(\mathbb{R}) \times H_\theta^1(\mathcal{C}_\#^{r,0})$  such that

$$\left\{ \begin{array}{ll} -D_\theta(\mu_p D_\theta U) - \rho_p(\omega^2 + i\varepsilon)U = 0, & \text{in } \mathcal{C}_\#^{r,0}, \\ \mathcal{R}_+ U = 0, & \text{on } \Sigma_\#^{r,0}, \\ (I + \Lambda_\varepsilon^r)\varphi + 2iz U = f - g, & \text{on } \Sigma_\#^{r,1}, \\ (I - \Lambda_\varepsilon^r)\varphi - 2\mu_p D_\theta U = f + g, & \text{on } \Sigma_\#^{r,1}, \\ U \text{ is periodic w.r.t } y_1. & \end{array} \right. \quad (4.33)$$

Conversely, if  $(\varphi, U)$  is a solution of (4.33), then by setting  $\psi := \mathcal{R}_-^r U|_{\Sigma_\#^{r,0}}$ , we obtain  $\mathcal{L}_\varepsilon^r(\varphi, \psi) = (f, g)$ . This proves the equivalence between the invertibility of  $\mathcal{L}_\varepsilon^r$  and the well-posedness of (4.33). Hence, it remains to prove that (4.33) is well-posed.

Problem (4.33) is equivalent to a variational problem involving the closed affine and linear subspaces  $\mathbf{V}(h) \subset \mathbf{V} := \subset L_{per}^2(\mathbb{R}) \times H_\theta^1(\mathcal{C}_\#^{r,0})$  defined for any  $h \in L_{per}^2(\Sigma_\#^{r,1})$  by

$$\mathbf{V}(h) := \{(\psi, V) \in \mathbf{V} / (I + \Lambda_\varepsilon^r)\psi + 2iz V = h \text{ on } \Sigma_\#^{r,1}\}, \quad \mathbf{V}_0 := \mathbf{V}(0).$$

Introducing the continuous sesquilinear forms

$$\left\{ \begin{array}{l} a_C(U, V) := \int_{\mathcal{C}_\#^{r,0}} (\mu_p D_\theta U \overline{D_\theta V} - \rho_p(\omega^2 + i\varepsilon)U \overline{V}) - iz \int_{\Sigma_\#^{r,0}} U \overline{V}, \quad \text{in } H_\theta^1(\mathcal{C}_\#^{r,0}) \\ a_\Sigma(\varphi, \psi) := -\frac{i}{4z} \int_{\Sigma_\#^{r,1}} (I - \Lambda_\varepsilon^r)\varphi \overline{(I + \Lambda_\varepsilon^r)\psi}, \quad \text{in } L^2(\Sigma_\#^{r,1}), \end{array} \right.$$

Problem (4.33) is equivalent to : finding  $(\varphi, U) \in \mathbf{V}(f - g)$  (for the third line of (4.33)) such that

$$a_{\mathcal{C}}(U, V) + a_{\Sigma}(\varphi, \psi) = \int_{\Sigma_{\#}^{r,0}} (f + g) \bar{V}, \quad \forall (\psi, V) \in \mathbf{V}_0. \quad (4.34)$$

The key point is that, since  $\varepsilon > 0$ , the sesquilinear form  $a_{\mathcal{C}}(\cdot, \cdot)$  is coercive in  $H_{\theta}^1(\mathcal{C}_{\#}^{r,0})$  while, thanks to the inequality (3.51) involving  $\Lambda_{\varepsilon}^r$ , the form  $a_{\Sigma}(\cdot, \cdot)$  is coercive in  $L^2(\Sigma_{\#}^{r,1})$ . Thus, Lax-Milgram theorem ensures the well-posedness of (4.33), which gives the invertibility of  $\mathcal{L}_{\varepsilon}^r$ . ■

The previous factorization allows to completely link the Riccati point spectrum to the point spectrum of  $\mathcal{P}_{\varepsilon}^r$  as follows.

#### Proposition 4.11

Let  $\varepsilon > 0$ . Referring to the notation of Proposition 4.4, the Riccati point spectrum  $\sigma_{R,p,\varepsilon}^r$  satisfies

$$\sigma_{R,p,\varepsilon}^r = \{\lambda_{k,\varepsilon}^r, k \in \mathbb{Z}\} \cup \{1/\lambda_{k,\varepsilon}^r, k \in \mathbb{Z}\}. \quad (4.35)$$

Moreover,

$$\text{Ker}(\mathcal{M}_{\varepsilon}^r - \lambda_{k,\varepsilon}^r \mathcal{N}_{\varepsilon}^r) = \text{Span} \begin{pmatrix} \varphi_{k,\varepsilon}^r \\ \mathcal{S}_{\varepsilon}^r \varphi_{k,\varepsilon}^r \end{pmatrix}. \quad (4.36)$$

**Proof.** For proving (4.35), we prove successively

$$(a) \sigma_{R,p,\varepsilon}^r \cap \{|\lambda| = 1\} = \emptyset, \quad (b) \sigma_{R,p,\varepsilon}^r \cap \{|\lambda| > 1\} = \{1/\lambda_{k,\varepsilon}^r\}, \quad (c) \sigma_{R,p,\varepsilon}^r \cap \{|\lambda| < 1\} = \{\lambda_{k,\varepsilon}^r\}.$$

We use all along this proof the following obvious observation that, in a Banach space  $E$ ,

$$\text{For } A, B, C \in \mathcal{L}(E), \quad A, B \text{ are invertible} \iff \begin{pmatrix} A & 0 \\ C & B \end{pmatrix} \text{ is invertible}, \quad (4.37)$$

(a) For  $|\lambda| = 1$ , we notice that, as  $\sigma_p({}^t\mathcal{P}_{\varepsilon}^r) = \sigma_p(\mathcal{P}_{\varepsilon}^r) \subset \mathcal{C}(0, r_{\varepsilon})$  with  $r_{\varepsilon} < 1$ , the operators  $\lambda {}^t\mathcal{P}_{\varepsilon}^r - I$  and  $\mathcal{P}_{\varepsilon}^r - \lambda I$  are invertible. Therefore, by (4.37), the three factors in the factorization (4.31) of  $\mathcal{M}_{\varepsilon}^r - \lambda \mathcal{N}_{\varepsilon}^r$  are invertible.

(b) For  $|\lambda| > 1$ , for the same reason as in (a),  $\mathcal{P}_{\varepsilon}^r - \lambda I$  is invertible. Thus by (4.37), the last two factors in (4.31) are invertible and only the first factor can have a kernel. In other words, by (4.37) again, we obtain

$$\text{Ker}(\mathcal{M}_{\varepsilon}^r - \lambda \mathcal{N}_{\varepsilon}^r) = \{0\} \iff \text{Ker}(\lambda {}^t\mathcal{P}_{\varepsilon}^r - I) = \{0\},$$

which proves (b).

(c) For  $|\lambda| < 1$ , for the same reason as in (a),  $\lambda {}^t\mathcal{P}_{\varepsilon}^r - I$  is invertible so that, by (4.37), the first two factors in (4.31) are invertible and only the third factor can have a kernel. In other words, by (4.37) again we obtain,

$$\text{Ker}(\mathcal{M}_{\varepsilon}^r - \lambda \mathcal{N}_{\varepsilon}^r) = \{0\} \iff \text{Ker}(\mathcal{P}_{\varepsilon}^r - \lambda I) = \{0\}, \quad \text{which proves (c)}$$

Moreover, in that case, the kernel of  $\mathcal{M}_{\varepsilon}^r - \lambda \mathcal{N}_{\varepsilon}^r$  coincides with the one of the third factor in (4.31)

which means nothing but (4.36). ■

### 4.3 Relationship between left and right half-waveguides

For now, we have analyzed the half-waveguide problem, the periodicity cells problems and all the associated solutions and associated operators, for  $j = r$  only. Note that up to some slight modifications, the results above can be extended to the half-line problem set on  $I^l$ , thus leading to solutions of local cell problems  $(E_\varepsilon^{l,0}, E_\varepsilon^{l,1})$ , local RtR operators  $(\mathcal{T}_\varepsilon^{l,00}, \mathcal{T}_\varepsilon^{l,10}, \mathcal{T}_\varepsilon^{l,01}, \mathcal{T}_\varepsilon^{l,11})$ , propagation and scattering operators  $(\mathcal{P}_\varepsilon^l, \mathcal{S}_\varepsilon^l)$ , and matrices  $(\mathcal{M}_\varepsilon^l, \mathcal{N}_\varepsilon^l)$  associated to the Riccati system. The goal of this section is to exhibit the links between the objects defined for  $j = l$  and  $j = r$  under the assumption (1.1), that is,  $a^r \theta_2, a^l \theta_2 \in \mathbb{Z}$ .

Under Assumption (1.1),  $(\mu_p, \rho_p)$  are equal in the periodicity cells  $\mathcal{C}_\#^{r,0} := (0, 1)^2$  and  $\mathcal{C}_\#^{l,0} := (0, 1) \times (-1, 0)$  in which  $(E_\varepsilon^{r,0}, E_\varepsilon^{r,1})$  and  $(E_\varepsilon^{l,0}, E_\varepsilon^{l,1})$  are respectively defined. By identifying these cells by symmetry, it is then easy to see that

$$\begin{aligned} \forall \varphi \in L_{per}^2(\mathbb{R}), \quad E_\varepsilon^{l,0}(\varphi) &= E_\varepsilon^{r,1}(\varphi), \quad E_\varepsilon^{l,1}(\varphi) = E_\varepsilon^{r,0}(\varphi), \\ \forall \ell, k \in \{0, 1\}, \quad \mathcal{T}_\varepsilon^{l,\ell k} &= \mathcal{T}_\varepsilon^{r,(1-\ell)(1-k)}. \end{aligned} \quad (4.38)$$

We deduce in particular that

$$\mathcal{M}_\varepsilon^l = \begin{pmatrix} \mathcal{T}_\varepsilon^{r,10} & \mathcal{T}_\varepsilon^{r,00} \\ 0 & I \end{pmatrix} \quad \text{and} \quad \mathcal{N}_\varepsilon^l = \begin{pmatrix} I & 0 \\ \mathcal{T}_\varepsilon^{r,11} & \mathcal{T}_\varepsilon^{r,01} \end{pmatrix}.$$

Therefore, from simple algebraic manipulations, it follows that for any  $\lambda \in \mathbb{C}$ ,  $\lambda \neq 0$

$$\mathcal{M}_\varepsilon^l - \lambda \mathcal{N}_\varepsilon^l = -\frac{1}{\lambda} \mathcal{J}^{-1} \left( \mathcal{M}_\varepsilon^r - \frac{1}{\lambda} \mathcal{N}_\varepsilon^r \right) \mathcal{J} \quad \text{with} \quad \mathcal{J} := \begin{pmatrix} 0 & I \\ I & 0 \end{pmatrix}. \quad (4.39)$$

This relations enables to show the following important result

#### Proposition 4.12

Let  $\varepsilon > 0$ , we have

$$\sigma_p(\mathcal{P}_\varepsilon^l) = \sigma_p(\mathcal{P}_\varepsilon^r) \quad \text{and} \quad \text{Ker} \left( \mathcal{M}_\varepsilon^j - \frac{1}{\lambda_{k,\varepsilon}^{j'}} \mathcal{N}_\varepsilon^j \right) = \text{Span} \begin{pmatrix} \mathcal{S}_\varepsilon^{j'} \varphi_{k,\varepsilon}^{j'} \\ \varphi_{k,\varepsilon}^{j'} \end{pmatrix} \quad \text{for } j \neq j' \in \{l, r\}.$$

**Proof.** Let  $\lambda_\varepsilon^l \in \sigma_p(\mathcal{P}_\varepsilon^l)$ . Then by Proposition 4.4, there exists  $k \in \mathbb{Z}$  such that  $\lambda_\varepsilon^l = \lambda_{k,\varepsilon}^l$ . Note that  $|\lambda_{k,\varepsilon}^l| < 1$ . Using (4.36) and (4.39), we deduce that

$$\text{Ker} \left( \mathcal{M}_\varepsilon^r - \frac{1}{\lambda_{k,\varepsilon}^l} \mathcal{N}_\varepsilon^r \right) = \text{Span} \begin{pmatrix} \mathcal{S}_\varepsilon^l \varphi_{k,\varepsilon}^l \\ \varphi_{k,\varepsilon}^l \end{pmatrix}$$

This implies that  $(\lambda_{k,\varepsilon}^l)^{-1} \in \sigma_{R,\varepsilon}^r$ , and therefore by (4.35),

$$\forall k \in \mathbb{Z}, \quad \exists k' \in \mathbb{Z} / \lambda_{k,\varepsilon}^l = \lambda_{k',\varepsilon}^r \in \sigma_p(\mathcal{P}_\varepsilon^l).$$

By inverting the roles of  $l$  and  $r$ , one shows that

$$\forall k \in \mathbb{Z}, \quad \exists k' \in \mathbb{Z} / \lambda_{k,\varepsilon}^r = \lambda_{k',\varepsilon}^l \in \sigma_p(\mathcal{P}_\varepsilon^r). \quad \blacksquare$$

#### 4.4 Resolution algorithm in the absorbing case

In order to compute the solution of  $(\mathcal{P}_\varepsilon)$ , the previous sections provide an algorithm which sums up as follows. We suppose here that (1.1) holds.

1. For any  $\varphi \in L_{per}^2(\Sigma^{r,0})$ , compute the solution  $E_\varepsilon^{r,0}(\varphi)$  and  $E_\varepsilon^{r,1}(\varphi)$  of respectively the local cell problems (3.31) and (3.32) for  $j = r$ . Note that  $E_\varepsilon^{l,0}(\varphi)$  and  $E_\varepsilon^{l,1}(\varphi)$  are obtained using the correspondence (4.38).
2. Compute the local RtR operators  $\mathcal{T}_\varepsilon^{r,\ell k}$  defined in (3.40) for  $\ell, k \in \{0, 1\}$ .
3. Solve the generalized eigenvalue problem (4.28) for  $j = r$ : for  $\lambda \in \sigma_{R,\varepsilon}^r$ , we denote by  $(\varphi_\lambda, \psi_\lambda) \in \text{Ker}(\mathcal{M}_\varepsilon^r - \lambda \mathcal{N}_\varepsilon^r)$  an associated eigenpair.
4. For the unique  $\lambda$ ,  $|\lambda| < 1$  such that  $\mathbf{w}(\varphi_\lambda) = 0$ , we have  $\lambda = \lambda_{0,\varepsilon}^r$  and  $\varphi_\lambda = \varphi_{0,\varepsilon}^r$  up to a multiplicative constant (see Proposition 4.11) and for the unique  $\lambda$ ,  $|\lambda| > 1$  such that  $\mathbf{w}(\psi_\lambda) = 0$  we have  $\lambda^{-1} = \lambda_{0,\varepsilon}^l$  and  $\psi_\lambda = \varphi_{0,\varepsilon}^l$  up to a multiplicative constant (see Proposition 4.12).
5. Compute  $\mathcal{P}_\varepsilon^r$  for  $j = l$  and  $r$  using Proposition 4.4. The operator  $\mathcal{P}_\varepsilon^l$  and the scattering operators  $\mathcal{S}_\varepsilon^j$  for  $j = r$  and  $j = l$  can then be computed using respectively Proposition 4.11 and Proposition 4.12.
6. For any  $\varphi \in L_{per}^2(\mathbb{R})$ , the solution  $U_\varepsilon^j(\varphi)$  can be reconstructed cell by cell using Proposition 3.12.
7. For each  $j \in \{l, r\}$ , pick a continuous function  $\varphi$  such that  $\varphi(\theta_1 a^j) = 1$  and take the trace of  $U_\varepsilon^j(\varphi)$  along the line  $\mathbb{R}\theta + a^j \vec{e}_1$  (3.19) to construct  $u_\varepsilon^j$ .
8. Compute the RtR operator  $\Lambda_\varepsilon^j$  using its expression (3.49) with respect to the local RtR operators and the scattering operator, and deduce the RtR coefficient  $\lambda_\varepsilon^j$  using the expression (3.53).
9. Finally, solve the interior problem  $(\mathcal{P}_\varepsilon^{\text{int}})$  in  $I^0 = (a^l, a^r)$ . Then the solution  $u_\varepsilon$  of  $(\mathcal{P}_\varepsilon)$  is given by (3.5).

**Remark 4.13.** Note that the algorithm presented in this chapter is slightly different from the one in Chapter III, in that we rely much more on the fundamental eigenpair of the propagation operator, and on the different correspondences between the objects defined from  $j = l$  and  $r$ .

## 5 Towards limiting absorption : quasi-periodic spectrum

As explained in Section 1.1, the problem  $(\mathcal{P})$  can be solved in  $H^1(\mathbb{R})$  only when  $\omega$  is not in  $\sigma(\mathcal{A})$ , the spectrum of the positive selfadjoint operator  $\mathcal{A}$ , see (1.7). On the other hand, the question of possible limiting absorption, in another space than  $H^1(\mathbb{R})$ , will be studied for values of  $\omega^2$  outside the discrete spectrum  $\sigma_d(\mathcal{A})$ : these values of  $\omega$ , that are related to the existence of possible trapped modes, will be excluded from this study. Thus, according to the decomposition (1.9) of  $\sigma(\mathcal{A})$ , we shall look at limiting absorption for  $\omega^2$  in the spectrum of the (purely quasiperiodic) operator  $\mathcal{A}_\theta$  defined by (1.8). But before doing so, we note that our study also involves the spectra of other differential operators,

such as the 2D periodic differential operator associated to  $\mathcal{A}_\theta$  (namely the operator  $\mathcal{A}_p$  defined in (5.6)), and its equivalent on the half-guide  $\Omega^r$  (with Robin boundary conditions; see (5.15) below). The goal of the present section is to exhibit for these spectra some equalities or inclusions that will be useful in Section 6.

### 5.1 Quasiperiodic operators on the whole line

In the spirit of the lifting method presented in our study, a fruitful point of view is to see  $\mathcal{A}_\theta$  as one particular element of a family of self-adjoint operators  $\mathcal{A}_{s,\theta}$ ,  $s \in \mathbb{R}$  with

$$D(\mathcal{A}_{s,\theta}) := \left\{ u \in H^1(\mathbb{R}) / \mu_{s,\theta} \frac{du}{dx} \in H^1(\mathbb{R}) \right\} \quad \text{and} \quad \mathcal{A}_{s,\theta} u := -\frac{1}{\rho_{s,\theta}} \frac{d}{dx} \left( \mu_{s,\theta} \frac{du}{dx} \right), \quad (5.1)$$

where we recall that the functions  $(\mu_{s,\theta}, \rho_{s,\theta})$  have been defined in (2.6) as the traces of the 2D periodic functions  $(\mu_p, \rho_p)$  along the line  $\theta \mathbb{R} + s \vec{e}_1$ . Obviously,  $s \mapsto \mathcal{A}_{s,\theta}$  is 1-periodic and according to its definition (1.8),  $\mathcal{A}_\theta$  coincides with  $\mathcal{A}_{s,\theta}$  for  $s = 0$ :

$$\mathcal{A}_\theta = \mathcal{A}_{0,\theta}. \quad (5.2)$$

We can build from the family  $\mathcal{A}_{s,\theta}$ ,  $s \in [0, 1)$ , a self-adjoint operator in  $L^2_{per}(\mathbb{R}, L^2(\mathbb{R}))$ , as

$$\mathcal{A}_\theta^{2D} = \int^{\oplus} \mathcal{A}_{s,\theta} ds \quad (5.3)$$

meaning that (see [MBR78, Section XIII.16] for instance for direct integrals of operators),

$$U \in D(\mathcal{A}_\theta^{2D}) \iff \forall s, \quad U(s, \cdot) \in D(\mathcal{A}_{s,\theta}) \quad \text{and} \quad \mathcal{A}_\theta^{2D} U(s, \cdot) = \mathcal{A}_{s,\theta}[U(s, \cdot)]. \quad (5.4)$$

It is known, see [MBR78, Theorem XIII.85], that the spectra of  $\mathcal{A}_\theta$  and the  $\mathcal{A}_{s,\theta}$  are related by

$$\sigma(\mathcal{A}_\theta^{2D}) = \bigcup_{s \in [0,1]} \sigma(\mathcal{A}_{s,\theta}). \quad (5.5)$$

The operator  $\mathcal{A}_\theta^{2D}$  is closely linked to the 2D self-adjoint operator  $\mathcal{A}_p$  corresponding to the augmented half-waveguide problems, that is,

$$D(\mathcal{A}_p) := \left\{ U \in H^1_{\theta,per}(\mathbb{R}^2) / \mu_p D_\theta U \in H^1_{\theta,per}(\mathbb{R}^2) \right\}, \quad \text{and} \quad \mathcal{A}_p U = -\frac{1}{\rho_p} D_\theta (\mu_p D_\theta U), \quad (5.6)$$

where we recall that  $H^1_{\theta,per}(\mathbb{R}^2) := \{ U \in L^2_{per}(\mathbb{R}^2) / D_\theta U \in L^2_{per}(\mathbb{R}^2) \}$ . More precisely, the chain rule (3.14) allows to show that  $\mathcal{A}_\theta^{2D}$  and  $\mathcal{A}_p$  are unitary equivalent in  $L^2_{per}(\mathbb{R}^2)$ :

$$\mathcal{A}_{s,\theta} = S_\theta \mathcal{A}_p S_\theta^{-1},$$

where  $S_\theta$  is the unitary operator from  $L^2_{per}(\mathbb{R}, L^2(\mathbb{R}))$  into  $L^2_{per}(\mathbb{R}^2)$  idefined by

$$\forall U \in L^2_{per}(\mathbb{R}^2), \quad (S_\theta U)(s, x) = U(s + \theta_1 x, \theta_2 x).$$

As a consequence, we deduce a first decomposition of the spectrum of  $\mathcal{A}_p$

$$\sigma(\mathcal{A}_p) = \bigcup_{s \in [0,1]} \sigma(\mathcal{A}_{s,\theta}). \quad (5.7)$$



Incidentally, the spectra  $\mathcal{A}_{s,\theta}$  all coincide if the ratio  $\delta$  is irrational, as the next result shows.

**Proposition 5.1**

As soon as  $\delta \in \mathbb{R} \setminus \mathbb{Q}$ , one has

$$\forall s \in \mathbb{R}, \quad \sigma(\mathcal{A}_{s,\theta}) = \sigma(\mathcal{A}_\theta). \quad (5.8)$$

In particular,  $\sigma(\mathcal{A}_\theta) = \sigma(\mathcal{A}_p)$ .

**Proof.** The key idea is to show that  $s \mapsto \sigma(\mathcal{A}_{s,\theta})$  is a continuous function (in the sense of the Hausdorff distance) which is both 1 and  $\delta$ -periodic. It is then the irrationality of  $\delta$  that allows to conclude. The proof is detailed in Appendix A, see Proposition A.2. ■

We shall now highlight another fibered structure for  $\mathcal{A}_p$  (similar to the structure (5.3) for  $\mathcal{A}_\theta^{2D}$ ) by means of the Floquet-Bloch transform in the  $y_2$ -direction. To begin, we introduce the space  $L_{per,2}^2(\mathbb{R}^2)$  of locally square-integrable functions that are periodic with respect to both  $y_1$  and  $y_2$  (this is to be distinguished from  $L_{per}^2(\mathbb{R}^2)$  that only imposes periodicity in the  $y_1$ -direction), as well as  $H_{\theta,per,2}^1(\mathbb{R}^2)$ , the space defined by:

$$\begin{cases} L_{per,2}^2(\mathbb{R}^2) := \{V \in L_{loc}^2(\mathbb{R}^2) / V(y_1 + 1, y_2) = V(y_1, y_2 + 1) = V(y_1, y_2)\}, \\ H_{\theta,per,2}^1(\mathbb{R}^2) := \{U \in L_{per,2}^2(\mathbb{R}^2) / D_\theta U \in L_{per,2}^2(\mathbb{R}^2)\}. \end{cases}$$

The Floquet-Bloch transform in the  $y_2$ -direction is defined by

$$\text{a. e. } (\mathbf{y}, \xi) \in \mathbb{R}^2 \times (-\pi, \pi), \quad \mathcal{F}U(\mathbf{y}, \xi) := \widehat{U}(\mathbf{y}, \xi) := \sqrt{\frac{p}{2\pi}} \sum_{n \in \mathbb{Z}} U(\mathbf{y} + n \vec{e}_2) e^{-i\xi(y_2+n)},$$

It is well-known [Kuc93] that  $\mathcal{F}$  defines a unitary map from  $L_{per}^2(\mathbb{R}^2)$  into  $L^2(-\pi, \pi; L_{per,2}^2(\mathbb{R}^2))$ , and from  $H_{per}^1(\mathbb{R}^2)$  to  $L^2(-\pi, \pi; H_{\theta,per,2}^1(\mathbb{R}^2))$ . Consider the self-adjoint operators defined for  $\xi \in [-\pi, \pi]$  as

$$\begin{cases} D(\mathcal{A}_p(\xi)) := \{U \in H_{\theta,per,2}^1(\mathbb{R}^2) / \mu_p D_\theta U \in H_{\theta,per,2}^1(\mathbb{R}^2)\}, \\ \mathcal{A}_p(\xi) U := -\frac{1}{\rho_p} (D_\theta + i\xi\theta_2) \mu_p (D_\theta + i\xi\theta_2) U, \end{cases} \quad (5.9)$$

From the properties of the Floquet-Bloch transform [Kuc93], it follows that the self-adjoint operator given by  $\widehat{\mathcal{A}}_p := \mathcal{F}\mathcal{A}_p\mathcal{F}^{-1}$  can be expressed as a direct integral

$$\widehat{\mathcal{A}}_p = \int^\oplus \mathcal{A}_p(\xi) d\xi, \quad (5.10)$$

meaning similarly to (5.4) that

$$\widehat{U} \in D(\widehat{\mathcal{A}}_p) \iff \forall \xi, \quad U(\xi, \cdot) \in D(\mathcal{A}_p(\xi)), \quad (\widehat{\mathcal{A}}_p \widehat{U})(\xi, \cdot) = \mathcal{A}_p(\xi) [\widehat{U}(\xi, \cdot)]. \quad (5.11)$$

As  $\widehat{\mathcal{A}}_p$  and  $\mathcal{A}_p$  are unitary equivalent, we deduce another decomposition of the spectrum of  $\mathcal{A}_p$

$$\sigma(\mathcal{A}_p) = \bigcup_{\xi \in [-\pi, \pi]} \sigma(\mathcal{A}_p(\xi)). \quad (5.12)$$

Note that contrary to elliptic operators,  $\mathcal{A}_p(\xi)$  does not have compact resolvent, and thus its spectrum is not discrete. Furthermore, similarly to Proposition 5.1, the next result shows that the spectrum of  $\mathcal{A}_p(\xi)$  is surprisingly independent of  $\xi$  if  $\delta$  is irrational.

**Proposition 5.2**

As soon as  $\delta \in \mathbb{R} \setminus \mathbb{Q}$ , one has the equality

$$\forall \xi \in [-\pi, \pi[, \quad \sigma(\mathcal{A}_p) = \sigma(\mathcal{A}_p(\xi)). \quad (5.13)$$

**Proof.** The proof, which is detailed in Appendix A (Proposition A.5), relies on showing that  $\xi \mapsto \sigma(\mathcal{A}_{p,\xi})$  is a continuous function (in the sense of the Hausdorff distance) which is both  $2\pi$  and  $2\pi\delta$ -periodic. One then concludes using the irrationality of  $\delta$ . ■

## 5.2 Quasiperiodic operator on a half-line

The RtR approach developed in Section 3 in the absorbing case involves the operators  $\mathcal{A}_{s,\theta}^r$ ,  $s \in \mathbb{R}$ , associated to the half-line problems  $(\mathcal{P}_{\varepsilon,s}^r)$ , namely

$$\begin{cases} D(\mathcal{A}_{s,\theta}^r) := \left\{ u \in H^1(\mathbb{R}_+) / \mu_{s,\theta} \frac{du}{dx} \in H^1(\mathbb{R}_+) \text{ and } R_{+,s}^r u = 0 \right\} \\ \mathcal{A}_{s,\theta}^r u := -\frac{1}{\rho_{s,\theta}} \frac{d}{dx} \left( \mu_{s,\theta} \frac{du}{dx} \right), \end{cases} \quad (5.14)$$

and the operator  $\mathcal{A}_p^r$  associated to the half-guide problem (3.18), namely

$$\begin{cases} D(\mathcal{A}_p^r) := \left\{ U \in H_{\theta,\text{per}}^1(\Omega^r) / \mu_p D_\theta U \in H_{\theta,\text{per}}^1(\Omega^r) \text{ and } \mathcal{R}_+^r U = 0 \right\} \\ \mathcal{A}_p^r U := -\frac{1}{\rho_p} D_\theta (\mu_p D_\theta U). \end{cases} \quad (5.15)$$

One defines similarly the operators  $\mathcal{A}_{s,\theta}^l$  and  $\mathcal{A}_p^l$ . For  $j \in \{l, r\}$ , note that Proposition 5.1 can be easily extended to these operators, to obtain  $\sigma(\mathcal{A}_{s,\theta}^j) = \sigma(\mathcal{A}_p^j)$  for any  $s \in \mathbb{R}$ . Furthermore, the next result holds.

**Proposition 5.3**

Let  $j \in \{l, r\}$ . One has  $\sigma(\mathcal{A}_{s,\theta}^j) \subset \sigma(\mathcal{A}_{s,\theta})$  for any  $s \in \mathbb{R}$ , and  $\sigma(\mathcal{A}_p^j) \subset \sigma(\mathcal{A}_p)$ .

**Proof.** Since  $\sigma(\mathcal{A}_{s,\theta}^j) = \sigma(\mathcal{A}_p^j)$  for  $j \in \{l, r, \emptyset\}$ , it is sufficient to prove the first part of the proposition, that is,  $\sigma(\mathcal{A}_{s,\theta}^j) \subset \sigma(\mathcal{A}_{s,\theta})$ . For clarity, we fix  $j = r$ , and we focus on  $(\mathcal{A}_\theta, \mathcal{A}_\theta^r) := (\mathcal{A}_{s,\theta}, \mathcal{A}_{s,\theta}^r)$  for  $s = 0$ . We proceed by contradiction: given  $\omega^2 \notin \sigma(\mathcal{A}_\theta)$ , we prove that  $\omega^2 \notin \sigma(\mathcal{A}_\theta^r)$ , or equivalently that the problem

$$\begin{cases} -\frac{d}{dx} \left( \mu_\theta \frac{du^r}{dx} \right) - \rho_\theta \omega^2 u^r = f & \text{in } \mathbb{R}_+, \\ R_+^r u^r(0) = 0, \end{cases} \quad (5.16)$$

admits a unique solution  $u^r \in H^1(\mathbb{R}_+)$  for any  $f \in L^2(\mathbb{R}_+)$ .

**Step 1: uniqueness.** This simply has to do with the Robin boundary condition. If  $\tilde{u}^r$  satisfies (5.16) with  $f = 0$ , then by taking the real and the imaginary parts of the Robin condition  $R_+^r \tilde{u}^r(0) = 0$ , it

follows that  $\tilde{u}^r(0) = (\tilde{u}^r)'(0) = 0$  which, from Cauchy uniqueness theorem, implies that  $\tilde{u}^r = 0$ .

**Step 2: existence.** Given  $f \in L^2(\mathbb{R}_+)$ , we consider its extension by 0 on  $\mathbb{R}$ , still called  $f \in L^2(\mathbb{R})$ . We begin by seeking  $u^r$  as

$$u^r = u_f|_{\mathbb{R}_+} - (R_+^r u_f(0)) u_1^r,$$

where  $u_f$  is the unique solution of the well-posed ( $\omega^2 \notin \sigma(\mathcal{A}_\theta$ ) problem

$$-\frac{d}{dx} \left( \mu_\theta \frac{du_f}{dx} \right) - \rho_\theta \omega^2 u_f = f \quad \text{in } \mathbb{R},$$

and where  $u_1^r$  is a correction term. For  $u^r$  to be the solution of (5.16),  $u_1^r$  should satisfy

$$\begin{cases} -\frac{d}{dx} \left( \mu_\theta \frac{du_1^r}{dx} \right) - \rho_\theta \omega^2 u_1^r = 0 & \text{in } \mathbb{R}_+, \\ R_+^r u_1^r(0) = 1. \end{cases} \quad (5.17)$$

In what follows, we construct  $u_1^r$  following the ideas of [Hoa11, Theorem 4.1, Lemma 4.2] (also used in [KL18a] and [FJL21], and which simplify greatly for our 1D operators). More precisely, we look for  $u_1^r$  under the form

$$u_1^r = \alpha (u_2^r + u_g|_{\mathbb{R}_+}), \quad (5.18)$$

where  $u_g$  satisfies the same equation as  $u_f$  on  $\mathbb{R}$ , but with  $g \in L^2(\mathbb{R})$  as a source term, and where  $u_2^r$  can also be viewed as a perturbation term, which shall be characterized as the solution of the coercive problem (with  $\kappa \in \mathbb{C}$  such that  $\omega^2 + \kappa \in \mathbb{C} \setminus \mathbb{R}_+$ ;  $\kappa$  will be fixed later depending on  $\omega$ )

$$\begin{cases} -\frac{d}{dx} \left( \mu_\theta \frac{du_2^r}{dx} \right) - \rho_\theta (\omega^2 + \kappa) u_2^r = 0 & \text{in } \mathbb{R}_+, \\ u_2^r(0) = 1. \end{cases} \quad (5.19)$$

Our goal is to find the pair  $(\alpha, g) \in \mathbb{C} \times L^2(\mathbb{R})$  such that the function  $u_1^r$  given by (5.18) satisfies (5.17). From (5.18) and from the equation verified by  $u_g$ , it follows that  $g$  must verify

$$0 = -\frac{d}{dx} \left( \mu_\theta \frac{du_1^r}{dx} \right) - \rho_\theta \omega^2 u_1^r = \alpha (\kappa \rho_\theta u_2^r + g|_{\mathbb{R}_+}), \quad \text{so that } g|_{\mathbb{R}_+} = -\kappa \rho_\theta u_2^r.$$

Aside from this condition,  $g$  can be extended arbitrarily on  $\mathbb{R}$ . We extend  $g$  by 0 on  $\mathbb{R}$ , and still call the extension  $g$ . It then remains to choose  $\alpha$  in order to satisfy the Robin boundary condition in (5.17). From the boundary condition satisfied by  $u_1^r$ , we deduce the equation

$$\alpha (R_+^r u_2^r(0) + R_+^r u_g(0)) = 1.$$

In order to conclude, the last point is to prove that  $R_+^r (u_2^r + u_g)(0) \neq 0$ , so that one can compute  $\alpha$ . We prove this by contradiction. If  $R_+^r (u_2^r + u_g)(0) = 0$ , then  $\tilde{u}^r := u_2^r + u_g|_{\mathbb{R}_+} \in H^1(\mathbb{R}_+)$  satisfies the ODE in (5.17) in  $\mathbb{R}_+$ , with the condition  $R_+^r \tilde{u}^r(0) = 0$ . Therefore, according to the Step 1, it follows that  $\tilde{u}^r = 0$ , or equivalently  $u_2^r = -u_g$  in  $\mathbb{R}_+$ . By multiplying the equality  $\bar{u}_2^r = -\bar{u}_g$  by  $\rho_\theta u_2^r$ , and by integrating over  $\mathbb{R}_+$  ( $u_2^r \in H^1(\mathbb{R}_+)$  and  $u_g \in H^1(\mathbb{R})$ ), we obtain

$$\int_{\mathbb{R}_+} \rho_\theta |u_2^r|^2 = \int_{\mathbb{R}_+} \rho_\theta u_2^r \bar{u}_g = \kappa^{-1} \int_{\mathbb{R}} g \bar{u}_g \quad \text{from the definition of } g$$

$$= \kappa^{-1} \int_{\mathbb{R}} \left( \mu_{\theta} \left| \frac{du_g}{dx} \right|^2 - \rho_{\theta} \omega^2 |u_g|^2 \right) \quad \text{from the equation satisfied by } u_g. \quad (5.20)$$

To obtain a contradiction, we need to distinguish between the cases  $\omega^2 \in \mathbb{R}$  and  $\omega^2 \in \mathbb{C} \setminus \mathbb{R}$ , and choose  $\kappa$  accordingly. If  $\omega^2 \in \mathbb{R}$ , then it suffices to choose  $\kappa := i$  (note that  $\omega^2 + \kappa \in \mathbb{C} \setminus \mathbb{R}_+$  and (5.19) is well-posed). In this case, taking the real part of (5.20) implies that  $u_2^r = 0$  in  $\mathbb{R}_+$ , which contradicts the condition  $u_2^r(0) = 1$ . If  $\omega^2 \in \mathbb{C} \setminus \mathbb{R}$ , then we choose  $\kappa^{-1} := 1$  (note that  $\omega^2 + \kappa \in \mathbb{C} \setminus \mathbb{R}_+$  and (5.19) is well-posed). Thus, taking the imaginary part of (5.20) implies  $u_g = 0$  on  $\mathbb{R}$ , that is  $u_2^r = -u_g = 0$  on  $\mathbb{R}_+$ , which contradicts the condition  $u_2^r(0) = 1$ . ■

## 6 Limiting absorption principle

We now study the limit when  $\varepsilon$  goes to 0 of the solution  $u_{\varepsilon}$  of  $(\mathcal{P}_{\varepsilon})$ . If the limit exists in a certain sense and if the limit satisfies  $(\mathcal{P})$ , we say that the limiting absorption principle holds and this limit is the physical solution. Since  $u_{\varepsilon}$  is constructed and characterized by the method described in Sections 3 and 4, our approach is to pass to the limit in each step of the method. When studying objects associated to the half-line problems set on  $I^j$ , we shall assume for simplicity that  $j = r$ .

### 6.1 Convergence of the cell solutions and the associated RtR operators

The first step is to characterize the limits of the cell solutions  $(E_{\varepsilon}^{r,0}(\varphi), E_{\varepsilon}^{r,1}(\varphi))$  defined by (3.31) and (3.32) for  $\varphi \in L_{\text{per}}^2(\mathbb{R})$ , and of the associated RtR operators  $\mathcal{T}_{\varepsilon}^{r,\ell k}$  defined in (3.40) for  $\ell, k \in \{0, 1\}$ .

Let us introduce the limit cell problems for  $\varphi \in L_{\text{per}}^2(\mathbb{R})$ : Find  $E^{r,0}(\varphi) \in H_{\theta}^1(\mathcal{C}_{\#}^{r,0})$  such that

$$\left\{ \begin{array}{l} -D_{\theta} (\mu_p D_{\theta} E^{r,0}(\varphi)) - \rho_p \omega^2 E^{r,0}(\varphi) = 0 \quad \text{in } \mathcal{C}_{\#}^{r,0}, \\ \mathcal{R}_{+}^r E^{r,0}(\varphi)|_{\Sigma_{\#}^{r,0}} = \varphi \quad \text{and} \quad \mathcal{R}_{-}^r E^{r,0}(\varphi)|_{\Sigma_{\#}^{r,1}} = 0, \\ E^{r,0}(\varphi) \text{ is periodic w.r.t } y_1; \end{array} \right. \quad (6.1)$$

and Find  $E^{r,1}(\varphi) \in H_{\theta}^1(\mathcal{C}_{\#}^{r,1})$  such that

$$\left\{ \begin{array}{l} -D_{\theta} (\mu_p D_{\theta} E^{r,1}(\varphi)) - \rho_p \omega^2 E^{r,1}(\varphi) = 0 \quad \text{in } \mathcal{C}_{\#}^{r,0}, \\ \mathcal{R}_{+}^r E^{r,1}(\varphi)|_{\Sigma_{\#}^{r,0}} = 0 \quad \text{and} \quad \mathcal{R}_{-}^r E^{r,1}(\varphi)|_{\Sigma_{\#}^{r,1}} = \varphi, \\ E^{r,1}(\varphi) \text{ is periodic w.r.t } y_1; \end{array} \right. \quad (6.2)$$

In addition, consider the 1D cell problems defined for any  $s \in \mathbb{R}$  by

$$\left\{ \begin{array}{l} -\frac{d}{dx} \left( \mu_{s,\theta} \frac{de_s^{r,0}}{dx} \right) - \rho_{s,\theta} \omega^2 e_s^{r,0} = 0 \quad \text{in } (0, 1/\theta_2), \\ R_{+,s}^r e_s^{r,0}(0) = 1 \quad \text{and} \quad R_{-,s}^r e_s^{r,0}(1/\theta_2) = 0, \end{array} \right. \quad (6.3)$$

and

$$\left\{ \begin{array}{l} -\frac{d}{dx} \left( \mu_{s,\theta} \frac{de_s^{r,1}}{dx} \right) - \rho_{s,\theta} \omega^2 e_s^{r,1} = 0 \quad \text{in } (0, 1/\theta_2), \\ R_{+,s}^r e_s^{r,1}(0) = 0 \quad \text{and} \quad R_{-,s}^r e_s^{r,1}(1/\theta_2) = 1. \end{array} \right. \quad (6.4)$$

One advantage of the 1D problems (6.3) and (6.4) is that Fredholm alternative can be applied in  $H^1(0, 1/\theta_2)$ . Moreover, thanks to the RtR boundary conditions, the uniqueness of the solutions can be proved easily. As a consequence, Problem (6.3) and (6.4) are well-posed. Using the same arguments as in Lemma 2.1, we can then deduce the well-posedness of the 2D cell problems (6.1) and (6.2) as well as the link between the 2D solutions  $(E^{r,0}(\varphi), E^{r,1}(\varphi))$  and the 1D ones  $(e_s^{r,0}, e_s^{r,1})$ .

### Lemma 6.1

The problem (6.1) (resp. (6.2)) is equivalent to the family of problems (6.3) (resp. (6.4)) parameterized by  $s \in \mathbb{R}$  in the following sense

- (i) If  $E^{r,0}, E^{r,1}$  are the respective solutions of (6.1) and (6.2) for  $\varphi = 1$ , and are identified with their periodic extensions with respect to  $y_1$ , then by setting for  $\ell = 0, 1$  and  $s \in \mathbb{R}$

$$e_s^{r,\ell}(x) = E^{r,\ell}(s + \theta_1 x, \theta_2 x), \quad x \in (0, 1/\theta_2), \quad (6.5)$$

the functions  $e_s^{r,0}$  and  $e_s^{r,1}$  are the respective solutions of (6.3) and (6.4).

- (ii) If  $e_s^{r,0}$  and  $e_s^{r,1}$  are the respective solutions of (6.3) and (6.4) for  $s \in \mathbb{R}$ , then by defining for all  $\varphi \in L^2_{\text{per}}(\mathbb{R})$ , the functions  $E^{r,0}(\varphi)$  and  $E^{r,1}(\varphi)$  as follows

$$\begin{cases} E^{r,0}(s + \theta_1 x, \theta_2 x) := \varphi(s) e_s^{r,0}(x), & x \in (0, 1/\theta_2), \quad s \in [0, 1), \\ E^{r,1}(s + \theta_1 x, \theta_2 x) := \varphi(s + \delta) e_s^{r,1}(x), & x \in (0, 1/\theta_2), \quad s \in [0, 1), \end{cases} \quad (6.6)$$

the functions  $E^{r,0}(\varphi), E^{r,1}(\varphi)$  are the respective solutions of (6.1) and (6.2).

In particular,

$$(6.1) \text{ (resp. (6.2)) is well-posed } \forall \varphi \in L^2_{\text{per}}(\mathbb{R}) \iff (6.3) \text{ (resp. (6.4)) is well-posed } \forall s \in \mathbb{R}.$$

To  $s \mapsto (e_s^{r,0}, e_s^{r,1})$  are associated the local RtR coefficients (defined similarly to (3.42))

$$\begin{cases} \mathbf{t}^{r,00}(s) = R_{-,s}^r e_s^{r,0}(0), & \mathbf{t}^{r,01}(s) = R_{+,s}^r e_s^{r,0}(1/\theta_2), \\ \mathbf{t}^{r,10}(s) = R_{-,s}^r e_s^{r,1}(0), & \mathbf{t}^{r,11}(s) = R_{+,s}^r e_s^{r,1}(1/\theta_2). \end{cases} \quad (6.7)$$

When  $\varepsilon \rightarrow 0$ , we can compute convergence estimates for  $(e_{s,\varepsilon}^{r,\ell}, \mathbf{t}_\varepsilon^{r,\ell k})$  towards  $(e_s^{r,\ell}, \mathbf{t}^{r,\ell k})$ .

### Proposition 6.2

There exists a constant  $C > 0$  (independent of  $s$ ) such that for any  $s \in \mathbb{R}$ ,

$$\begin{cases} \|e_s^{r,0} - e_{s,\varepsilon}^{r,0}\|_{H^1} + \|e_s^{r,1} - e_{s,\varepsilon}^{r,1}\|_{H^1} \leq C\varepsilon, & (i) \\ \forall \ell, k \in \{0, 1\}^2, \quad \|\mathbf{t}_\varepsilon^{r,\ell k} - \mathbf{t}^{r,\ell k}\|_\infty \leq C\varepsilon. & (ii) \end{cases} \quad (6.8)$$

**Proof.** One begins by writing the problem satisfied by the difference  $v := e_s^{r,0} - e_{s,\varepsilon}^{r,0}$ :

$$\begin{cases} -\frac{d}{dx}\left(\mu_{s,\theta}\frac{dv}{dx}\right) - \rho_{s,\theta}\omega^2 v = -\rho_{s,\theta}\varepsilon e_{s,\varepsilon}^{r,0} & \text{in } (0, 1/\theta_2), \\ R_{+,s}^r v(0) = R_{-,s}^r v(1/\theta_2) = 0. \end{cases} \quad (6.9)$$

From the well-posedness of this problem, we deduce the first line (i) of (6.8), with a constant  $C(s)$  which depend a priori on  $s$ . To show that the constant can be chosen independently from  $s$ , we assume by contradiction that there exists a point  $s^*$  and a sequence  $s_n$  such that  $s_n \rightarrow s^*$  and  $\|v_n\|_{H^1} \rightarrow +\infty$  as  $n \rightarrow +\infty$  with  $v_n := e_{s_n}^{r,0} - e_{s_n,\varepsilon}^{r,0}$ . Then,

$$\widehat{v}_n := \frac{v_n}{\|v_n\|_{H^1}} \in H^1(0, 1/\theta_2) \quad \text{with} \quad \|\widehat{v}_n\|_{H^1} = 1.$$

On the other hand,  $\widehat{v}_n$  satisfies Problem (6.9) with a volumic term that tends to 0 as  $n \rightarrow +\infty$ . Therefore, the uniform continuity of the maps  $s \mapsto (\mu_{s,\theta}, \rho_s)$  implies that  $v_n \rightarrow 0$ , which contradicts the equality  $\|\widehat{v}_n\|_{H^1} = 1$ . By extending these arguments to  $e_s^{r,1} - e_{s,\varepsilon}^{r,1}$ , we obtain (6.8)–(i). ■

The second line (ii) of (6.8) is a consequence the first one (i) combined with the continuity of the normal trace (and the boundedness of  $s \mapsto \mu_{s,\theta}$ ). ■

We finally deduce the convergence results for the solutions of the local cell problems (6.1) and (6.2), and the associated RtR operators.

### Proposition 6.3

There exists a constant  $C > 0$  such that

$$\begin{cases} \|E^{r,0} - E_\varepsilon^{r,0}\|_{H^1(C_\#^{r,0})} + \|E^{r,1} - E_\varepsilon^{r,1}\|_{H_\theta^1(C_\#^{r,0})} \leq C\varepsilon, & (i) \\ \forall \ell, k \in \{0, 1\}^2, \quad \|\mathcal{T}_\varepsilon^{r,\ell k} - \mathcal{T}^{r,\ell k}\|_{\mathcal{L}(L^2(0,1))} \leq C\varepsilon, & (ii) \end{cases}$$

where, similarly to (3.40), the limit RtR operators  $\mathcal{T}^{r,\ell k}$  are defined by

$$\begin{aligned} \mathcal{T}^{r,00} \varphi &:= \mathcal{R}_-^r E^{r,0}(\varphi)|_{\Sigma^{r,0}} & \text{and} & & \mathcal{T}^{r,01} \varphi &:= \mathcal{R}_+^r E^{r,0}(\varphi)|_{\Sigma^{r,1}}, \\ \mathcal{T}^{r,10} \varphi &:= \mathcal{R}_-^r E^{r,1}(\varphi)|_{\Sigma^{r,0}} & \text{and} & & \mathcal{T}^{r,11} \varphi &:= \mathcal{R}_+^r E^{r,1}(\varphi)|_{\Sigma^{r,1}}. \end{aligned} \quad (6.10)$$

**Proof.** The first line (i) follows by combining the fibered expression (6.6) with the first line (i) in (6.8) (where we use the oblique change of variables in Proposition III–3.13). To obtain the second line (ii), we exploit the observation that similarly to (3.41) for  $\varepsilon > 0$ , the operators  $\mathcal{T}^{r,\ell k}$  are weighted shift operators:

$$\forall \varphi \in L_{per}^2(\mathbb{R}), \quad \begin{cases} \mathcal{T}^{r,00} \varphi(s) = \mathbf{t}^{r,00}(s) \varphi(s), & \mathcal{T}^{r,01} \varphi(s) = \mathbf{t}^{r,01}(s - \delta) \varphi(s - \delta), \\ \mathcal{T}^{r,10} \varphi(s) = \mathbf{t}^{r,10}(s) \varphi(s + \delta), & \mathcal{T}^{r,11} \varphi(s) = \mathbf{t}^{r,11}(s - \delta) \varphi(s), \end{cases} \quad (6.11)$$

so that the second line (ii) in the estimate (6.8) allows to conclude. ■

An immediate consequence of Proposition 6.3 is that

$$\exists C > 0, \quad \|\mathcal{M}^r - \mathcal{M}_\varepsilon^r\|_{\mathcal{L}(L^2_{\text{per}}(\mathbb{R}))^2} + \|\mathcal{N}^r - \mathcal{N}_\varepsilon^r\|_{\mathcal{L}(L^2_{\text{per}}(\mathbb{R}))^2} \leq C \varepsilon,$$

where  $\mathcal{M}_\varepsilon^r$  and  $\mathcal{N}_\varepsilon^r$  are defined for  $\varepsilon > 0$  in (4.27) and

$$\mathcal{M}^r := \begin{pmatrix} \mathcal{T}^{r,01} & \mathcal{T}^{r,11} \\ 0 & I \end{pmatrix} \quad \text{and} \quad \mathcal{N}^r = \begin{pmatrix} I & 0 \\ \mathcal{T}^{r,00} & \mathcal{T}^{r,10} \end{pmatrix}. \quad (6.12)$$

## 6.2 Link between the spectrum of $\mathcal{A}_\theta$ and the Riccati spectrum

By analogy with the Riccati point spectrum  $\sigma_{R,p,\varepsilon}^r$  defined by (4.29), it is natural to introduce the Riccati point spectrum in the absence of absorption:

$$\sigma_{R,p}^r := \{ \lambda \in \mathbb{C} / 0 \in \sigma_p(\mathcal{M}^r - \lambda \mathcal{N}^r) \}. \quad (6.13)$$

For the main theorem of this section, namely Proposition 6.4, it is also useful to introduce the Riccati spectrum defined by

$$\sigma_R^r := \{ \lambda \in \mathbb{C} / 0 \in \sigma(\mathcal{M}^r - \lambda \mathcal{N}^r) \}. \quad (6.14)$$

It is worth recalling that the Riccati point spectrum is the one that we can compute numerically as soon as a discrete version of the cell problems are solved and the associated RtR operators deduced.

### Proposition 6.4

The spectra defined by (6.13, 6.14) are related to the one of  $\mathcal{A}_\theta$  via the two implications

$$\begin{aligned} \exists \lambda \in \mathbb{C}, \quad |\lambda| = 1, \quad \lambda \in \sigma_{R,p}^r &\implies \omega^2 \in \sigma(\mathcal{A}_\theta) & (i) \\ \omega^2 \in \sigma(\mathcal{A}_\theta) &\implies \exists \lambda \in \mathbb{C}, \quad |\lambda| = 1, \quad \lambda \in \sigma_R^r. & (ii) \end{aligned} \quad (6.15)$$

**Remark 6.5.** Note that in (6.15)–(i),  $\lambda \in \sigma_{R,p}^r \subset \sigma_R^r$ , whereas in (6.15)–(ii), we only have  $\lambda \in \sigma_R^r$  and nothing ensures that  $\lambda \in \sigma_{R,p}^r$ .

**Proof.** We are going to prove (6.15) using the operator  $\mathcal{A}_p(\xi)$  defined by (5.9) instead of  $\mathcal{A}_\theta$ . This can be done since from Propositions 5.1 and 5.2, we have  $\sigma(\mathcal{A}_p(\xi)) = \sigma(\mathcal{A}_\theta)$ .

**Point (i).** Let  $\lambda \in \mathbb{C}$  with  $|\lambda| = 1$  such that  $\lambda \in \sigma_{R,p}^r$ . Then there exists  $\xi \in [-\pi, \pi]$  such that  $\lambda = e^{i\xi}$  and  $(\varphi_\xi, \psi_\xi) \neq 0$  such that

$$\mathcal{M}^r \begin{pmatrix} \varphi_\xi \\ \psi_\xi \end{pmatrix} = e^{i\xi} \mathcal{N}^r \begin{pmatrix} \varphi_\xi \\ \psi_\xi \end{pmatrix}. \quad (6.16)$$

It can be easily checked, using the definitions (6.1, 6.2, 6.10) of the operators  $E^{r,\ell}$  and  $\mathcal{T}^{r,\ell k}$  that the function defined by

$$U_\xi := E^{r,0}(\varphi_\xi) + E^{r,1}(\psi_\xi) \in H_\theta^1(\mathcal{C}_\#^{r,0})$$

satisfies  $-D_\theta(\mu_p D_\theta U_\xi) - \rho_p \omega^2 U_\xi = 0$  in  $\mathcal{C}_\#^{r,0}$  and is 1-periodic with respect to  $y_1$ , while (6.16) ensures that

$$\mathcal{R}_+^r U_\xi|_{\Sigma^{r,1}} = e^{i\xi} \mathcal{R}_+^r U_\xi|_{\Sigma^{r,0}} \quad \text{and} \quad \mathcal{R}_-^r U_\xi|_{\Sigma^{r,1}} = e^{i\xi} \mathcal{R}_-^r U_\xi|_{\Sigma^{r,0}}.$$

By defining  $V_\xi := e^{-i\xi y_2} U_\xi \neq 0$ , we have that  $V_\xi$  is 1-periodic with respect to  $y_1$  and  $y_2$ , and

$$\mathcal{R}_+^r V_\xi|_{\Sigma^{r,1}} = \mathcal{R}_+^r V_\xi|_{\Sigma^{r,0}} \quad \text{and} \quad \mathcal{R}_-^r V_\xi|_{\Sigma^{r,1}} = \mathcal{R}_-^r V_\xi|_{\Sigma^{r,0}}.$$

Moreover, one computes that  $-(D_\theta + i\xi \theta_2) \mu_p (D_\theta + i\xi \theta_2) V_\xi - \rho_p \omega^2 V_\xi = 0$  in  $\mathcal{C}_\#^{r,0}$  from the definition of  $V_\xi$  and from the PDE satisfied by  $U_\xi$ . Consequently, by definition (5.9) of the operator  $\mathcal{A}(\xi)$ , we deduce the following

$$V_\xi \in D(\mathcal{A}_p(\xi)) \setminus \{0\} \quad \text{and} \quad \mathcal{A}_p(\xi) V_\xi = \omega^2 V_\xi,$$

which implies that  $\omega^2 \in \sigma_p(\mathcal{A}_p(\xi)) \subset \sigma(\mathcal{A}_p(\xi)) = \sigma(\mathcal{A}_\theta)$ .

**Point (ii).** Let us show the converse of the point (ii) in (6.15), namely

$$\forall \lambda \in \mathbb{C}, \quad |\lambda| = 1, \quad \mathcal{M}^r - \lambda \mathcal{N}^r \text{ is invertible} \quad \implies \quad \omega^2 \notin \sigma(\mathcal{A}_\theta).$$

Thanks to the equality of spectra  $\sigma(\mathcal{A}_p(\xi)) = \sigma(\mathcal{A}_\theta)$  which follows from Propositions 5.1 and 5.2, it is sufficient to find  $\xi \in [-\pi, \pi]$  such that  $\mathcal{A}_p(\xi) - \omega^2$  is invertible, that is,

$$\forall f \in L^2((0,1)^2), \quad \exists! V_\xi \in D(\mathcal{A}_p(\xi)) \quad / \quad \mathcal{A}_p(\xi) V_\xi - \omega^2 V_\xi = f,$$

Given  $\lambda$  such that  $|\lambda| = 1$ , we choose  $\xi$  such that  $\lambda = e^{i\xi}$ . Then for the existence of  $V_\xi$ , setting  $g := \rho_p f$ , we start from the unique solution  $U_g \in H_\theta^1(\mathcal{C}_\#^{r,0})$  of

$$\left\{ \begin{array}{l} -D_\theta (\mu_p D_\theta U_g) - \rho_p \omega^2 U_g = g \quad \text{in } \mathcal{C}_\#^{r,0}, \\ \mathcal{R}_+^r U_g|_{\Sigma_\#^{r,0}} = 0 \quad \text{and} \quad \mathcal{R}_-^r U_g|_{\Sigma_\#^{r,1}} = 0, \\ U_g \text{ is periodic w.r.t } y_1. \end{array} \right.$$

Note that this problem is well-posed for the same reasons as the local cell problems (6.1, 6.2).

Since  $\mathcal{M}^r - \lambda \mathcal{N}^r$  is invertible with  $\lambda = e^{i\xi}$ , there exists a unique pair  $(\varphi_\xi, \psi_\xi) \in L_{per}^2(\mathbb{R})^2$  such that

$$(\mathcal{M}^r - e^{i\xi} \mathcal{N}^r) \begin{pmatrix} \varphi_\xi \\ \psi_\xi \end{pmatrix} = \begin{pmatrix} -\mathcal{R}_+^r U_g|_{\Sigma^{r,1}} \\ e^{i\xi} \mathcal{R}_-^r U_g|_{\Sigma^{r,0}} \end{pmatrix}. \quad (6.17)$$

Then  $U := E^{r,0}(\varphi_\xi) + E^{r,1}(\psi_\xi) + U_g \in H_\theta^1(\mathcal{C}_\#^{r,0})$  clearly satisfies  $-D_\theta (\mu_p D_\theta U_\xi) - \rho_p \omega^2 U_\xi = g$  in  $\mathcal{C}_\#^{r,0}$ . On the other hand, by definition (6.12, 6.10) of  $(\mathcal{M}^r, \mathcal{N}^r)$  and of the local RtR operators  $\mathcal{T}^{r,\ell k}$ , one computes that for any  $(\varphi, \psi) \in L_{per}^2(\mathbb{R}^2)^2$ ,

$$(\mathcal{M}^r - e^{i\xi} \mathcal{N}^r) \begin{pmatrix} \varphi \\ \psi \end{pmatrix} = \begin{pmatrix} \mathcal{R}_+^r E^{r,0}(\varphi)|_{\Sigma^{r,1}} + \mathcal{R}_+^r E^{r,1}(\psi)|_{\Sigma^{r,1}} - e^{i\xi} \psi \\ \psi - e^{i\xi} \mathcal{R}_-^r E^{r,0}(\varphi)|_{\Sigma^{r,0}} - e^{i\xi} \mathcal{R}_-^r E^{r,1}(\psi)|_{\Sigma^{r,0}} \end{pmatrix} \quad (6.18)$$

Then taking the difference between (6.17) and (6.18) for  $(\varphi_\xi, \psi_\xi)$ , we obtain

$$\mathcal{R}_+^r U_\xi|_{\Sigma^{r,1}} = e^{i\xi} \mathcal{R}_+^r U_\xi|_{\Sigma^{r,0}} \quad \text{and} \quad \mathcal{R}_-^r U_\xi|_{\Sigma^{r,1}} = e^{i\xi} \mathcal{R}_-^r U_\xi|_{\Sigma^{r,0}}.$$

Then, it can be seen easily that the function defined by  $V_\xi := e^{-i\xi y_2} U_\xi$  in  $\mathcal{C}^{r,0}$  belongs to  $D(\mathcal{A}_p(\xi))$  and satisfies  $\mathcal{A}_p(\xi) V_\xi - \omega^2 V_\xi = f$ .



Finally, to prove that  $V_\xi$  is unique, assume that  $\mathcal{A}_p(\xi) V_\xi - \omega^2 V_\xi = 0$ . Then by defining  $\varphi_\xi := \mathcal{R}_+^r V_\xi|_{\Sigma^{r,0}}$  and  $\psi_\xi := \mathcal{R}_-^r V_\xi|_{\Sigma^{r,1}}$ , we obtain  $(\mathcal{M}^r - \lambda \mathcal{N}^r)^t(\varphi_\xi, \psi_\xi) = 0$ , which, thanks to the injectivity of  $\mathcal{M}^r - \lambda \mathcal{N}^r$ , leads to  $\varphi_\xi = \psi_\xi = 0$ . Hence, for almost any  $s \in (0, 1)$ , the cut  $v_s(x) := V_\xi(\theta_1 x + s, \theta_2 x)$  satisfies the same ODE as  $e_s^{r,0}$  and  $e_s^{r,1}$ , with  $R_{-,s}^r v(0) = R_{+,s}^r v_s(1/\theta_2) = 0$ . From Cauchy uniqueness theorem, we deduce  $v_s = 0$  for almost any  $s$ , which implies that  $V_\xi = 0$ . ■

### 6.3 Case of evanescent frequencies: $\omega^2 \notin \sigma(\mathcal{A}_\theta)$

If  $\omega^2 \notin \sigma(\mathcal{A}_\theta)$ , then according to Propositions 5.1 and 5.3,  $\omega^2$  does not belong to the spectrum of the 2D periodic differential operator  $\mathcal{A}_p^r$  defined by (5.15). Therefore, all the problems introduced in Section 3 (in particular the 2D periodic half-space problem (3.18) and the Riccati system (3.45)) remain well-posed for  $\varepsilon = 0$ , so that the approach and the results presented in Sections 3 and 4 are still valid for  $\varepsilon = 0$ . In consequence, we can use exactly the same algorithm as the one described in Section 4.4, until Step 8 included. For the last step of the algorithm (namely Step 9), we study the well-posedness of the interior problem in Section 6.5. Let us note from (4.35) and (6.15)–(i) that

$$\omega^2 \notin \sigma(\mathcal{A}_\theta) \implies \forall j \in \{\iota, r\}, \begin{cases} \sigma_{R,p}^j = \{\lambda_k^j, k \in \mathbb{Z}\} \cup \{1/\lambda_k^j, k \in \mathbb{Z}\}, \\ \overline{\sigma_{R,p}^j} = \sigma_R^j = \mathcal{C}(0, |\lambda_0^j|) \cup \mathcal{C}(0, 1/|\lambda_0^j|), \\ |\lambda_0^j| < 1, \end{cases} \quad (6.19)$$

where  $\sigma_R^j$  is the Riccati spectrum defined in (4.29) with  $\varepsilon = 0$  and  $\lambda_k^j$  is defined in Proposition 4.4 with  $\varepsilon = 0$ . These objects have been defined for  $j = r$ , but their definition extends to  $j = \iota$ .

It can also be shown that for  $\varepsilon = 0$ , the solution of the half-line problem  $(\mathcal{P}_\varepsilon^j)$  decays exponentially at infinity in the sense of the next result, with a rate of decay which is linked to the modulus of the fundamental eigenvalue  $\lambda_0^j$ . This is the reason why we refer to  $\omega$  as an **evanescent frequency**.

#### Proposition 6.6

Let  $U^r$  and  $u_\theta^r$  be the respective solutions of the half-space problem (3.18) and the half-line problem  $(\mathcal{P}_\varepsilon^r)$  for  $\varepsilon = 0$ . Then there exists a constant  $C > 0$  such that for any  $\varphi \in L_{\text{per}}^2(\mathbb{R})$ ,

$$\begin{cases} \|U^r(\varphi)(\cdot + n \vec{e}_2)\|_{H_\theta^1(\mathcal{C}_\#^{r,0})} \leq C |\lambda_0^r|^n \|\varphi\|_{L^2(0,1)}, & (i) \\ \|u_\theta^r(\cdot + a^r + n/\theta_2)\|_{H^1(0,1/\theta_2)} \leq C |\lambda_0^r|^n. & (ii) \end{cases} \quad (6.20)$$

**Proof.** The cell by cell expression (3.35) taken for  $\varepsilon = 0$  becomes

$$\text{a. e. } \mathbf{y} \in \mathcal{C}_\#^{r,0}, \quad [U^r(\varphi)](\mathbf{y} + n \vec{e}_2) = [E^{r,0}((\mathcal{P}^r)^n \varphi) + E^{r,1}(\mathcal{S}^r(\mathcal{P}^r)^n \varphi)](\mathbf{y}), \quad \forall n \in \mathbb{N}.$$

Since the spectral radius of  $\mathcal{P}^r$  is  $|\lambda_0^r|$ , Gelfand's formula  $|\lambda_0^r| = \lim_{n \rightarrow +\infty} \|(\mathcal{P}^r)^n\|^{1/n}$  and the well-posedness of the cell problems imply the point (i) in (6.20). The second one follows similarly using the 1D version (3.39) of the cell by cell expression of  $U^r$  above. ■

### 6.4 Case of propagative frequencies $\omega^2 \in \sigma(\mathcal{A}_\theta)$

Let us now focus on the case  $\omega^2 \in \sigma(\mathcal{A}_\theta)$ . Under two assumptions that will be explicitated in the next sections, we prove the existence of a limit for the half-guide solution  $U_\varepsilon^j$  and the half-line solution  $u_{s,\varepsilon}^j$ .

**6.4.a. Convergence assumption on the fundamental eigenpair.** In order to study the limit when  $\varepsilon$  goes to 0 of the half-guide solution  $U_\varepsilon^j(\varphi)$  (and subsequently of the associated half-line solutions  $u_{s,\varepsilon}^j$ ), it can be seen from the cell by cell reconstruction formula (3.35) that since we have convergence of  $(E_\varepsilon^{r,0}, E_\varepsilon^{r,1})$  by Proposition 6.3, the only missing result is the convergence of the propagation operator  $\mathcal{P}_\varepsilon$  and the scattering operator  $\mathcal{S}_\varepsilon$  defined in (3.23)

According to Theorem 4.4, a necessary condition for such a convergence is the existence of the limit of the fundamental pairs  $(\lambda_{0,\varepsilon}^r, \varphi_{0,\varepsilon}^r)$  when  $\varepsilon$  goes to 0. This observation motivates the following assumption.

**Assumption 6.7: Convergence of fundamental eigenpair**

Let  $j \in \{l, r\}$ . At least up to a subsequence of values of  $\varepsilon$  converging to 0, the sequence  $(\lambda_{0,\varepsilon}^j, \varphi_{0,\varepsilon}^j, \psi_{0,\varepsilon}^j)$ , with  $\psi_{0,\varepsilon}^j := \mathcal{S}_\varepsilon \varphi_{0,\varepsilon}^j$  converges in  $\mathbb{C} \times L^\infty(\mathbb{R})^2$ , that is,

$$\exists \lambda_0^j \in \mathbb{C}, \quad \lim_{\varepsilon \rightarrow 0} \lambda_{0,\varepsilon}^j = \lambda_0^j, \quad (6.21)$$

and

$$\exists (\varphi_0^j, \psi_0^j) \in \mathcal{C}_{per}^0(\mathbb{R}), \quad \lim_{\varepsilon \rightarrow 0} \|\varphi_{0,\varepsilon}^j - \varphi_0^j\|_{L^\infty(\mathbb{R})} = \lim_{\varepsilon \rightarrow 0} \|\psi_{0,\varepsilon}^j - \psi_0^j\|_{L^\infty(\mathbb{R})} = 0. \quad (6.22)$$

Of course, since  $|\lambda_{0,\varepsilon}^j| < 1$  and  $\varphi_{0,\varepsilon}^j(0) = 1$ , one deduces that

$$|\lambda_0^j| \leq 1 \quad \text{and} \quad \varphi_0^j(0) = 1, \quad \text{so that} \quad \varphi_0^j \neq 0.$$

Also, since  $(0, {}^t(\varphi_{0,\varepsilon}^j, \psi_{0,\varepsilon}^j))$  is an eigenpair of  $\mathcal{M}_\varepsilon^j - \lambda_{0,\varepsilon}^j \mathcal{N}_\varepsilon^j$  according to (4.36), we obtain the following as  $\varepsilon \rightarrow 0$ , using the limit (6.12) of  $(\mathcal{M}_\varepsilon^j, \mathcal{N}_\varepsilon^j)$ :

$$\mathcal{M}^j \begin{pmatrix} \varphi_0^j \\ \psi_0^j \end{pmatrix} = \lambda_0^j \mathcal{N}^j \begin{pmatrix} \varphi_0^j \\ \psi_0^j \end{pmatrix}. \quad (6.23)$$

Consequently,  $\lambda_0^j$  belongs to the Riccati point spectrum  $\sigma_{R,p}^j$ .

**Remark 6.8.** Considering the expression (4.13) for  $\mathcal{P}_\varepsilon^j$  with respect to its fundamental eigenpair, one may object that Assumption 6.7 is almost equivalent to assuming the existence of a limit  $\mathcal{P}^j$  for the propagation operator  $\mathcal{P}_\varepsilon^j$ , one difficulty being in which sense the convergence holds. This is in fact not completely immediate but we shall show that, with an additional assumption involving the notion of energy flux, there is convergence in  $\mathcal{L}(L_{per}^2(\mathbb{R}))$  (i.e. in operator norm).

**Remark 6.9.** The sequence  $(\lambda_{0,\varepsilon}^j)_\varepsilon$  being bounded, the convergence (6.21) is obvious. The convergence result (6.22) on the other hand is less obvious to establish since we are a priori missing compactness for  $(\varphi_{0,\varepsilon}^j, \psi_{0,\varepsilon}^j)$  in  $L^\infty(\mathbb{R})^2$ .

Such compactness would be restored if we normalized  $(\varphi_{0,\varepsilon}^j, \psi_{0,\varepsilon}^j)$  in a space that is compactly embedded in  $L^\infty(\mathbb{R})^2$ , for instance in Sobolev spaces (which is possible with sufficiently smooth coefficients  $(\mu_p, \rho_p)$ ). However, the property  $\varphi_0^j(0) = 1$  would be lost a priori and we would no longer have the guaranty that the limit  $(\varphi_0^j, \psi_0^j)$  would not be identically 0.

From the fundamental eigenpair  $(\lambda_0^j, {}^t(\varphi_0^j, \psi_0^j))$ , we can define

$$\forall k \in \mathbb{Z}, \quad \varphi_k^j := e^{2i\pi ks} \varphi_0^j \quad \text{and} \quad \psi_k^j := e^{2i\pi ks} \psi_0^j \quad (6.24)$$

so that, from (6.22),

$$\forall k \in \mathbb{Z}, \quad \lim_{\varepsilon \rightarrow 0} \|\varphi_{k,\varepsilon}^j - \varphi_k^j\|_{L^\infty(\mathbb{R})} = \lim_{\varepsilon \rightarrow 0} \|\psi_{k,\varepsilon}^j - \psi_k^j\|_{L^\infty(\mathbb{R})} = 0, \quad (6.25)$$

Moreover, using the same argument as for proving (6.23), we deduce

$$\mathcal{M}^j \begin{pmatrix} \varphi_k^j \\ \psi_k^j \end{pmatrix} = \lambda_k^j \mathcal{N}^j \begin{pmatrix} \varphi_k^j \\ \psi_k^j \end{pmatrix}, \quad \text{where} \quad \lambda_k^j := e^{-2i\pi \nu^j k \delta} \lambda_0^j \quad (6.26)$$

with  $\nu^l = -\nu^r = 1$ . This identity justifies calling  $(\varphi_k^j, \psi_k^j)$  a *Riccati eigenmode* associated to the Riccati eigenvalue  $\lambda_k^j$ .

**6.4.b. Notion of flux density.** In order to ensure that the limiting absorption principle holds, a natural assumption concerns the energy flux of the propagative modes, see for instance [JLF06; Fli09; FJ16; FJL21] for periodic problems. Indeed, the energy flux is a physical criterion which appears naturally when studying the limiting absorption principle, and which allows to determine if a propagative mode is an outgoing or an ingoing mode. If the energy flux of one of the propagative mode vanishes, the selection between outgoing and ingoing modes is not possible. Note that for certain situations, see for instance [FJ16] which deals with perfectly periodic waveguides, when the energy flux of one of the propagative mode vanishes, the limiting absorption principle does not hold and it can be shown that  $(u_\varepsilon)_\varepsilon$  diverges when  $\varepsilon$  tends to 0. Hence, it is natural to suppose that the energy flux of the propagative modes does not vanish. This is the assumption we make in this study but only for the fundamental eigenfunction. We will see that under this assumption, we are able to show that the limiting absorption holds for our problem.

For simplicity, let  $j = r$ . To define a good notion of flux, we return to the estimate (3.51) which, using the expression  $\Lambda_\varepsilon^r = \mathcal{T}_\varepsilon^{r,00} + \mathcal{T}_\varepsilon^{r,10} \mathcal{S}_\varepsilon$ , becomes

$$\forall \varphi \in L_{per}^2(\mathbb{R}) \setminus \{0\}, \quad \frac{1}{4z} \Re \int_{\Sigma_\#^{r,0}} (I - \mathcal{T}_\varepsilon^{r,00} - \mathcal{T}_\varepsilon^{r,10} \mathcal{S}_\varepsilon) \varphi \overline{(I + \mathcal{T}_\varepsilon^{r,00} + \mathcal{T}_\varepsilon^{r,10} \mathcal{S}_\varepsilon) \varphi} > 0.$$

Using the expression (3.41) of  $(\mathcal{T}_\varepsilon^{r,00}, \mathcal{T}_\varepsilon^{r,10})$  as weighted shift operators, i.e.  $\mathcal{T}_\varepsilon^{r,00} \varphi(s) = \mathbf{t}_\varepsilon^{r,00}(s) \varphi(s)$  and  $\mathcal{T}_\varepsilon^{r,10} \varphi(s) = \mathbf{t}_\varepsilon^{r,10}(s) \varphi(s + \delta)$  the inequality above simply rewrites

$$\int_0^1 Q_{s,\varepsilon}^r(\varphi, \mathcal{S}_\varepsilon \varphi) ds > 0, \quad (6.27)$$

where, for any  $s \in \mathbb{R}$ , the *flux density*  $Q_{s,\varepsilon}^r(\varphi, \psi)$  is defined for  $\varphi, \psi \in L_{per}^2(\mathbb{R})$  by

$$Q_{s,\varepsilon}^r(\varphi, \psi) := \Re \left[ (1 - \mathbf{t}_\varepsilon^{r,00}(s)) \varphi(s) - \mathbf{t}_\varepsilon^{r,10}(s) \psi(s + \delta) \right] \overline{\left[ (1 + \mathbf{t}_\varepsilon^{r,00}(s)) \varphi(s) + \mathbf{t}_\varepsilon^{r,10}(s) \psi(s + \delta) \right]}.$$

Since the functions  $(\mathbf{t}_\varepsilon^{r,00}, \mathbf{t}_\varepsilon^{r,10})$  have a limit as  $\varepsilon \rightarrow 0$  according to Proposition 6.2, it is natural to

introduce the limit flux density

$$Q_s^r(\varphi, \psi) := \Re \left[ (1 - \mathbf{t}^{r,00}(s)) \varphi(s) - \mathbf{t}^{r,10}(s) \psi(s + \delta) \right] \overline{\left[ (1 + \mathbf{t}^{r,00}(s)) \varphi(s) + \mathbf{t}^{r,10}(s) \psi(s + \delta) \right]}. \quad (6.28)$$

as well as the sesquilinear form  $(\Phi_1, \Phi_2) \mapsto q_s^r(\Phi_1, \Phi_2)$ , defined for  $\Phi_1 := (\varphi_1, \psi_1)$ ,  $\Phi_2 := (\varphi_2, \psi_2)$  as

$$q_s^r(\Phi_1, \Phi_2) := \frac{1}{2} \left( q_s^{r,*}(\Phi_1, \Phi_2) + \overline{q_s^{r,*}(\Phi_2, \Phi_1)} \right),$$

where we have defined

$$q_s^{r,*}(\Phi_1, \Phi_2) := \left[ (1 - \mathbf{t}^{r,00}(s)) \varphi_1(s) - \mathbf{t}^{r,10}(s) \psi_1(s + \delta) \right] \overline{\left[ (1 + \mathbf{t}^{r,00}(s)) \varphi_2(s) + \mathbf{t}^{r,10}(s) \psi_2(s + \delta) \right]}.$$

By construction,  $q_s^r(\cdot, \cdot)$  and  $Q_s^r(\cdot)$  are related by

$$\forall \Phi = (\varphi, \psi) \in L_{\text{per}}^2(\mathbb{R})^2, \quad Q_s^r(\varphi, \psi) = q_s^r(\Phi, \Phi).$$

For the sequel, it is useful to reformulate  $q_s^r(\cdot, \cdot)$  in terms of the function  $w_s^r(\Phi) \in H^1(0, 1/\theta_2)$  defined for any  $\Phi = (\varphi, \psi) \in L_{\text{per}}^2(\mathbb{R})^2$  by

$$w_s^r(\Phi) := \varphi(s) e_s^{r,0} + \psi(s + \delta) e_s^{r,1}. \quad (6.29)$$

This is the object of the next lemma.

**Lemma 6.10**

The sesquilinear form  $q_s^r(\cdot, \cdot)$  is given for  $\Phi_1, \Phi_2 \in L_{\text{per}}^2(\mathbb{R})^2$  by

$$q_s^r(\Phi_1, \Phi_2) = 2iz \left( \mu_{s,\theta} w_s^r(\Phi_1) \overline{\frac{dw_s^r(\Phi_2)}{dx}} - \mu_{s,\theta} \frac{dw_s^r(\Phi_1)}{dx} \overline{w_s^r(\Phi_2)} \right)(0). \quad (6.30)$$

**Proof.** This result is a pure matter of calculations. Let  $w_{s,1} := w_s^r(\Phi_1)$  and  $w_{s,2} := w_s^r(\Phi_2)$ . From the definition of  $R_{\pm,s}^r$ , one has

$$-2\mu_{s,\theta} \frac{dw_{s,1}}{dx} = (R_{+,s}^r - R_{-,s}^r) w_{s,1} \quad \text{and} \quad -2iz w_{s,2} = (R_{+,s}^r + R_{-,s}^r) w_{s,2}.$$

Therefore, by definition of  $w_{s,j} := w_s^r(\Phi_j)$  and of the RtR coefficients  $\mathbf{t}^{r,\ell k}(s)$  (see (6.7)), we obtain

$$\begin{cases} -2iz w_{s,1} = (1 + \mathbf{t}^{r,00}(s)) \varphi_1(s) + \mathbf{t}^{r,10}(s) \psi_1(s + \delta), \\ -2\mu_{s,\theta} \frac{dw_{s,2}}{dx} = (1 - \mathbf{t}^{r,00}(s)) \varphi_2(s) - \mathbf{t}^{r,10}(s) \psi_2(s + \delta) \end{cases}$$

so that

$$\left( \mu_{s,\theta} w_{s,1} \overline{\frac{dw_{s,2}}{dx}} \right)(0) = \frac{1}{4iz} \overline{q_s^{r,*}(\Phi_2, \Phi_1)}, \quad \text{and similarly,} \quad \left( \mu_{s,\theta} \frac{dw_{s,1}}{dx} \overline{w_{s,2}} \right)(0) = -\frac{1}{4iz} q_s^{r,*}(\Phi_1, \Phi_2).$$

Taking the difference between these two equality then leads to (6.30). ■

For the riccati eigenmodes  $(\varphi_k^r, \psi_k^r)$  defined in Section 6.4.a, the flux density has a particular form which we exhibit in the next result.

**Proposition 6.11**

Let  $\Phi_k := (\varphi_k^r, \psi_k^r)$  for any  $k \in \mathbb{Z}$ . Since  $\delta$  is irrational, one has

$$\begin{cases} |\lambda_0^r| < 1 & \implies \forall k, \ell \in \mathbb{Z}, \quad q_s^r(\Phi_k, \Phi_\ell) = 0, \\ |\lambda_0^r| = 1 & \implies \forall k, \ell \in \mathbb{Z}, \quad \exists \alpha_{k,\ell} \in \mathbb{C}, \quad q_s^r(\Phi_k, \Phi_\ell) = \alpha_{k,\ell} e^{2i\pi(k-\ell)s}. \end{cases} \quad (6.31)$$

**Proof. Step 1.** We begin by proving that

$$\forall k, \ell \in \mathbb{Z}, \quad q_{s+\delta}^r(\Phi_k, \Phi_\ell) = |\lambda_0^r|^2 e^{2i\pi(k-\ell)\delta} q_s^r(\Phi_k, \Phi_\ell). \quad (6.32)$$

To do so, the idea is to introduce for  $s \in \mathbb{R}$  and for any  $k \in \mathbb{Z}$  the limit as  $\varepsilon \rightarrow 0$  of the quasi-Floquet mode  $u_{s,k,\varepsilon}^r$  defined in Lemma 4.7, that is, for  $x \in (0, 1/\theta_2)$  and for any  $n \in \mathbb{N}$ ,

$$u_{s,k}^r(x + n/\theta_2) := (\lambda_k^r)^n [\varphi_k^r(s + n\delta) e_{s+n\delta}^{r,0}(x) + \psi_k^r(s + (n+1)\delta) e_{s+n\delta}^{r,1}(x)]. \quad (6.33)$$

From the ODE satisfied by  $(e_s^{r,0}, e_s^{r,1})$  and the property (6.26) of the Riccati eigenmodes  $(\varphi_k^r, \psi_k^r)$ , it follows that  $u_{s,k}^r$  satisfies the homogeneous differential equation

$$-\frac{d}{dx} \left( \mu_{s,\theta} \frac{du}{dx} \right) - \rho_{s,\theta} \omega^2 u = 0 \quad \text{in } \mathbb{R}_+. \quad (6.34)$$

since  $\omega^2 \in \mathbb{R}$ , another solution of (6.34) is  $\overline{u_{s,k}^r}$ .

Now let  $k, \ell \in \mathbb{Z}$ . Since  $u_{s,k}^r$  and  $\overline{u_{s,\ell}^r}$  are both solutions of (6.34), the Wronskian

$$[W(u_{s,k}^r, \overline{u_{s,\ell}^r})](x) := \left( \mu_{s,\theta} u_{s,k}^r \frac{d\overline{u_{s,\ell}^r}}{dx} - \mu_{s,\theta} \frac{du_{s,k}^r}{dx} \overline{u_{s,\ell}^r} \right)(x)$$

is constant with respect to  $x$ , and in particular

$$[W(u_{s,k}^r, \overline{u_{s,\ell}^r})](0) = [W(u_{s,k}^r, \overline{u_{s,\ell}^r})](1/\theta_2). \quad (6.35)$$

However, writing (6.33) for  $n = 0$  and for  $(k, \ell)$  shows directly that

$$u_{s,k}^r = w_s^r(\Phi_k) \quad \text{and} \quad u_{s,\ell}^r = w_s^r(\Phi_\ell) \quad \text{in } (0, 1/\theta_2),$$

with  $\Phi_k := (\varphi_k, \psi_k)$ ,  $\Phi_\ell := (\varphi_\ell, \psi_\ell)$ , and where  $w_s^r(\cdot)$  is defined by (6.29). Thus by Lemma 6.10, we deduce that  $[W(u_{s,k}^r, \overline{u_{s,\ell}^r})](0) = q_s^r(\Phi_k, \Phi_\ell)/(2iz)$ .

On the other hand, writing (6.33) for  $n = 1$  leads directly to

$$u_{s,k}^r(\cdot + 1/\theta_2) = \lambda_k^r w_{s+\delta}^r(\Phi_k) \quad \text{and} \quad u_{s,\ell}^r(\cdot + 1/\theta_2) = \lambda_\ell^r w_{s+\delta}^r(\Phi_\ell) \quad \text{in } (0, 1/\theta_2).$$

Therefore,  $[W(u_{s,k}^r, \overline{u_{s,\ell}^r})](1/\theta_2) = \lambda_k^r \overline{\lambda_\ell^r} q_{s+\delta}^r(\Phi_k, \Phi_\ell)/(2iz)$ . Then (6.32) follows from (6.35).

**Step 2.** (6.32) corresponds to an eigenvalue problem associated to the shift operator

$$\tau_\delta : \varphi \in L_{per}^2(\mathbb{R}) \mapsto \varphi(\cdot + \delta) \in L_{per}^2(\mathbb{R}).$$

Using a Fourier series expansion (in a similar but much simpler way as for Proposition 4.4), one shows that if  $\delta$  is irrational, then the eigenvalues of  $\tau_\delta$  are simple, and of the form  $e^{2i\pi k\delta}$  for  $k \in \mathbb{Z}$ , with associated eigenfunctions  $s \mapsto e^{2i\pi k s}$ . Therefore, if  $|\lambda_0^r| < 1$ , then  $q_s^r(\Phi_k, \Phi_\ell) = 0$ . On the other hand, if  $|\lambda_0^r| = 1$ , then  $s \mapsto q_s^r(\Phi_k, \Phi_\ell)$  is nothing but an eigenfunction of  $\tau_\delta$  corresponding to the eigenvalue  $e^{2i\pi(k-\ell)\delta}$ , hence the result. ■

Choosing  $k = \ell = 0$  in Proposition 6.11 leads directly to the following.

**Proposition 6.12**

As  $\delta$  is irrational, the density flux  $Q_s^r(\varphi_0^r, \psi_0^r)$  is independent of  $s$ :

$$\exists Q_0^r \geq 0, \quad Q_s^r(\varphi_0^r, \psi_0^r) = Q_0^r \quad \forall s \in [0, 1]. \quad (6.36)$$

Moreover, if  $|\lambda_0^r| < 1$ , then  $Q_0^r = 0$ .

**Remark 6.13.** Similarly,  $Q_s^r(\varphi_k^r, \psi_k^r)$  is independent of  $s$  for any  $k \in \mathbb{Z}$ . Moreover, by letting  $Q_k^r$  be this constant value, it can be shown, using the definition of  $Q_s^r(\varphi_k^r, \psi_k^r)$  that  $Q_k^r = Q_0^r$  for any  $k \in \mathbb{Z}$ .

By adapting all the above the half-line problem on  $I^l$ , we have a constant flux density  $Q_0^l$  associated to the fundamental eigenpair  $(\varphi_0^l, \psi_0^l)$ . Inspired by the positivity (6.27) of the energy flux in the absorbing case, our second assumption concerns the quantity  $Q_0^j$  for  $j \in \{l, r\}$ .

**Assumption 6.14: Positive flux**

Let  $j \in \{l, r\}$ . The flux density  $Q_0^j$  (introduced in Proposition 6.12 for  $j = r$ ) is positive, namely

$$Q_0^r > 0. \quad (6.37)$$

A frequency  $\omega$  such that Assumptions 6.7 and 6.14 are satisfied will be called a **regular frequency**. Note that under Assumption 6.14, we have  $|\lambda_0^r| = 1$ , by Proposition 6.12. Another consequence of this assumption is the following.

**Proposition 6.15**

Under Assumption 6.14,  $\varphi_0^r$  is bounded from below by a positive constant. In other words,

$$\exists c > 0, \quad \forall s \in \mathbb{R}, \quad |\varphi_0^r(s)| \geq c. \quad (6.38)$$

In particular  $\varphi_0^r \in \mathcal{N}_{per}$  and  $\mathbf{w}(\varphi_0^r) = 0$ .

**Proof.** Since  $(\lambda_0^r, (\varphi_0^r, \psi_0^r))$  is a Riccati eigenpair, we have  $\mathcal{T}^{r,00} \varphi_0^r + \mathcal{T}^{r,10} \psi_0^r = (\lambda_0^r)^{-1} \psi_0^r$ , which, using the weighted shift representation (6.11) leads to

$$\mathbf{t}^{r,00}(s) \varphi_0^r(s) + \mathbf{t}^{r,10}(s) \psi_0^r(s + \delta) = (\lambda_0^r)^{-1} \psi_0^r(s).$$

Substituting this relation in the expression (6.28) of  $Q_s^r(\varphi_0^r, \psi_0^r)$  gives

$$Q_s^r(\varphi_0^r, \psi_0^r) = \Re \left[ \varphi_0^r(s) - (\lambda_0^r)^{-1} \psi_0^r(s) \right] \overline{[\varphi_0^r(s) + (\lambda_0^r)^{-1} \psi_0^r(s)]}$$

$$= |\varphi_0^r(s)|^2 - |\lambda_0^r|^{-2} |\psi_0^r(s)|^2.$$

Therefore, if  $Q_s^r(\varphi_0^r, \psi_0^r) = Q^r(\varphi_0^r, \psi_0^r) > 0$ , then  $|\varphi_0^r(s)|^2 > 0$ . Since  $\varphi_0^r$  is continuous, we deduce that it is bounded from below by a positive constant. ■

Proposition 6.15 implies that for a regular frequency, the weight function

$$\rho^r := |\varphi_0^r(s)|^{-2}$$

is bounded from above and below by positive constants. As a consequence,

$$(\varphi, \psi)_{\rho^r} := \int_0^1 \varphi(s) \overline{\psi(s)} \rho^r(s) ds \quad (\text{with } \|\varphi\|_{\rho^r} := \sqrt{(\varphi, \varphi)_{\rho^r}}) \quad (6.39)$$

defines an inner product in  $L_{per}^2(\mathbb{R})$  whose associated norm  $\|\cdot\|_{\rho^r}$  is equivalent to the usual  $L^2$ -norm. Moreover, using Fourier series theory in  $L^2(0, 1)$ , one sees from the definition of  $\varphi_k^r$  that the family  $(\varphi_k)_{k \in \mathbb{Z}}$  is an orthonormal basis of  $L_{per}^2(\mathbb{R})$  for  $(\cdot, \cdot)_{\rho^r}$ . Finally, it follows from Proposition 6.11 that the Riccati eigenmodes  $(\varphi_k, \psi_k)$  satisfy a bi-orthogonality property related to the sesquilinear form  $q_s^r$ , and which will be exploited in the sequel.

#### Proposition 6.16

Let  $\Phi_k := (\varphi_k^r, \psi_k^r)$  for any  $k \in \mathbb{Z}$ . Since  $\delta$  is irrational, one has

$$\forall k \neq \ell, \quad \int_0^1 q_s^r(\Phi_k, \Phi_\ell) ds = 0. \quad (6.40)$$

**Proof.** This result follows directly by integrating the equality  $q_s^r(\Phi_k, \Phi_\ell) = \alpha_{k,\ell} e^{2i\pi(k-\ell)s}$  (given in Proposition 6.11). ■

**6.4.c. Convergence of the propagation operator.** Let  $j = r$ . Since the operator  $\mathcal{P}_\varepsilon^r$  is a weighted shift operator (see Proposition 3.10), and since this weight is linked to the fundamental eigenfunction (see (4.16)), it is natural to introduce the coefficient

$$\forall s \in \mathbb{R}, \quad \mathbf{p}^r(s) := \lambda_0^r \frac{\varphi_0^r(s + \delta)}{\varphi_0^r(s)}, \quad (6.41)$$

which is well-defined since  $\varphi_0^r$  never vanishes according to Proposition 6.15. We then define the following propagation operator

$$\forall \varphi \in L_{per}^2(\mathbb{R}), \quad \forall s \in \mathbb{R}, \quad \mathcal{P}^r \varphi(s) := \mathbf{p}^r(s - \delta) \varphi(s - \delta). \quad (6.42)$$

We have by definition of the pair  $(\lambda_k^r, \varphi_k^r)$  that

$$\forall k \in \mathbb{Z}, \quad \mathcal{P}^r \varphi_k^r = \lambda_k^r \varphi_k^r \quad \text{and} \quad \mathcal{P}^r \varphi = \sum_{k \in \mathbb{Z}} \lambda_k^r (\varphi, \varphi_k^r)_{\rho^r} \varphi_k^r.$$

Similarly, we introduce the weight

$$\forall s \in \mathbb{R}, \quad \mathbf{s}^r(s) := \lambda_0^r \frac{\psi_0^r(s + \delta)}{\varphi_0^r(s)}, \quad (6.43)$$

and we also define the operator  $\mathcal{S}^r$  as

$$\forall \varphi \in L^2_{per}(\mathbb{R}), \quad \forall s \in \mathbb{R}, \quad \mathcal{S}^r \varphi(s) := \mathbf{s}^r(s - \delta) \varphi(s - \delta). \quad (6.44)$$

If  $\omega$  is a regular frequency, then the next result can be shown.

**Proposition 6.17**

If  $\omega$  is a regular frequency, then up to a subsequence extraction, we have

$$\lim_{\varepsilon \rightarrow 0} \|\mathcal{P}_\varepsilon^r - \mathcal{P}^r\|_{\mathcal{L}(L^2_{per}(\mathbb{R}))} = 0 \quad \text{and} \quad \lim_{\varepsilon \rightarrow 0} \|\mathcal{S}_\varepsilon^r - \mathcal{S}^r\|_{\mathcal{L}(L^2_{per}(\mathbb{R}))} = 0.$$

Moreover, the pair  $(\mathcal{P}^r, \mathcal{S}^r)$  is solution of the following Riccati system

$$\left| \begin{array}{l} \text{Find } (P, S) \in \mathcal{L}(L^2_{per}(\mathbb{R}))^2 \text{ such that} \\ \left\{ \begin{array}{l} P = \mathcal{T}^{r,01} + \mathcal{T}^{r,11} S, \\ S = \mathcal{T}^{r,00} P + \mathcal{T}^{r,10} S P. \end{array} \right. \end{array} \right. \quad (6.45)$$

**Proof.** From the definitions of  $\mathcal{P}_\varepsilon^r$  and  $\mathcal{P}^r$  as weighted shift operators, we have

$$\forall \varphi \in L^2_{per}(\mathbb{R}), \quad \forall s \in \mathbb{R}, \quad (\mathcal{P}_\varepsilon^r - \mathcal{P}^r) \varphi(s) = [\mathbf{p}_\varepsilon^r - \mathbf{p}^r](s - \delta) \varphi(s - \delta),$$

so that  $\|\mathcal{P}_\varepsilon^r - \mathcal{P}^r\|_{\mathcal{L}(L^2_{per}(\mathbb{R}))} = \|\mathbf{p}_\varepsilon^r - \mathbf{p}^r\|_\infty$ . But since

$$\forall s \in \mathbb{R}, \quad \mathbf{p}_\varepsilon^r(s) := \lambda_{0,\varepsilon}^r \frac{\varphi_{0,\varepsilon}^r(s + \delta)}{\varphi_{0,\varepsilon}^r(s)} \quad \text{and} \quad \mathbf{p}^r(s) := \lambda_0^r \frac{\varphi_0^r(s + \delta)}{\varphi_0^r(s)},$$

and because  $\varphi_0^r$  is bounded from below by a positive constant, we deduce from Assumption 6.7 that  $\mathbf{p}_\varepsilon^r \rightarrow \mathbf{p}^r$  in  $L^\infty(\mathbb{R})$ , which implies that  $\mathcal{P}_\varepsilon^r \rightarrow \mathcal{P}^r$  in  $\mathcal{L}(L^2_{per}(\mathbb{R}))$  as  $\varepsilon \rightarrow 0$ . The convergence of  $\mathcal{P}_\varepsilon^r$  towards  $\mathcal{P}^r$  in operator norm is obtained similarly. Finally, since  $(\mathcal{P}_\varepsilon^r, \mathcal{S}_\varepsilon^r)$  is a solution of the Riccati system (3.45) and the RtR operators  $\mathcal{T}_\varepsilon^{r,\ell k}$  converge towards  $\mathcal{T}^{r,\ell k}$  (Proposition 6.3), it follows that  $(\mathcal{P}^r, \mathcal{S}^r)$  is solution of (6.45). ■

**6.4.d. Limiting absorption for the half-line problem.** We fix  $j = r$  for simplicity. Thanks to the limit propagation operator and scattering operator, we can now define for any  $\varphi \in L^2_{per}(\mathbb{R})$  the function

$$\text{a. e. } \mathbf{y} \in \mathcal{C}_\#^{r,0}, \quad [U^r(\varphi)](\mathbf{y} + n \vec{e}_2) = [E^{r,0}((\mathcal{P}^r)^n \varphi) + E^{r,1}(\mathcal{S}^r (\mathcal{P}^r)^n \varphi)](\mathbf{y}), \quad \forall n \in \mathbb{N}, \quad (6.46)$$

by analogy with the cell by cell expression (3.35) of the 2D solution  $U_\varepsilon^r(\varphi)$  for  $\varepsilon > 0$ . Thanks to the cell problems (6.1) and (6.2) satisfied by  $E^{r,0}$  and  $E^{r,1}$  respectively, one has that  $U^r(\varphi)$  satisfies the PDE  $-D_\theta(\mu_p D_\theta U^r(\varphi)) - \rho_p \omega^2 U^r(\varphi)$  in each cell  $\mathcal{C}_\#^{r,n}$  and is 1-periodic with respect to  $y_1$ . Furthermore, the Riccati system satisfied by  $(\mathcal{P}^r, \mathcal{S}^r)$  ensures that  $U^r(\varphi)$  and  $\mu_p D_\theta U^r(\varphi)$  are continuous across each interface  $\Sigma_\#^{r,n}$ . Consequently,

$$\left| \begin{array}{l} -D_\theta(\mu_p D_\theta U^r(\varphi)) - \rho_p \omega^2 U^r(\varphi) = 0 \quad \text{in } \Omega_\#^r, \\ \mathcal{R}_+^r U^r(\varphi)|_{\Sigma_\#^r} = \varphi, \\ U^r(\varphi) \text{ is periodic w.r.t } y_1. \end{array} \right. \quad (6.47)$$



In what follows,  $U^r(\varphi)$  is identified with its periodic extension with respect to  $y_1$ .

Let us also introduce the RtR operator

$$\Lambda^r = \mathcal{T}^{r,00} + \mathcal{T}^{r,10} \mathcal{S}^r. \quad (6.48)$$

**Proposition 6.18**

If  $\omega$  is a regular frequency, then up to a subsequence extraction, we have for  $(\varphi, n) \in L_{per}^2(\mathbb{R}) \times \mathbb{N}$

$$\lim_{\varepsilon \rightarrow 0} \|U_\varepsilon^r(\varphi) - U^r(\varphi)\|_{H_\delta^1(\mathcal{C}_\#^{r,n})} = 0 \quad \text{and} \quad \lim_{\varepsilon \rightarrow 0} \|\Lambda_\varepsilon^r - \Lambda^r\|_{\mathcal{L}(L_{per}^2(\mathbb{R}))} = 0. \quad (6.49)$$

Moreover, for any  $\varphi \in L_{per}^2(\mathbb{R}) \setminus \{0\}$ , the energy flux of  $U^r(\varphi)$  is positive:

$$Q^r(\varphi, \mathcal{S}^r \varphi) := \Re \int_{\Sigma_\#^{r,0}} (I - \Lambda^r) \varphi \overline{(I + \Lambda^r) \varphi} = Q_0^r \|\varphi\|_{\rho^r}^2 > 0 \quad (6.50)$$

where  $Q_0^r$  is the positive flux density of the fundamental eigenvalue (see Proposition 6.12 and Assumption 6.14), and where  $\|\cdot\|_{\rho^r}$  is the weighted  $L^2$ -norm defined in (6.39).

**Proof.** The convergence result (6.49) follows directly from the convergence of the cell solutions  $(E_\varepsilon^{r,0}, E_\varepsilon^{r,1})$  and the associated local RtR operators  $\mathcal{T}_\varepsilon^{r,\ell k}$  (Proposition 6.3), and from the convergence of the operators  $(\mathcal{P}_\varepsilon^r, \mathcal{S}_\varepsilon^r)$  (Proposition 6.17).

In order to derive the estimate (6.50), we expand  $\varphi \in L_{per}^2(\mathbb{R})$  in the basis  $(\varphi_k^r)_{k \in \mathbb{Z}}$ , and use the Proposition 6.12 as well as the bi-orthogonality relation in Proposition 6.16. By setting  $\Phi_k := (\varphi_k^r, \psi_k^r)$  and  $\alpha_k := (\varphi, \varphi_k^r)_{\rho^r}$ , the sesquilinearity of  $q^r$  leads to

$$\begin{aligned} Q^r(\varphi, \mathcal{S}^r \varphi) &= \int_0^1 q_s^r \left( \sum_{k \in \mathbb{Z}} \alpha_k \Phi_k, \sum_{\ell \in \mathbb{Z}} \alpha_\ell \Phi_\ell \right) ds = \sum_{k, \ell \in \mathbb{Z}} \alpha_k \overline{\alpha_\ell} \int_0^1 q_s^r(\Phi_k, \Phi_\ell) ds \\ &= \sum_{k \in \mathbb{Z}} |\alpha_k|^2 \int_0^1 q_s^r(\Phi_k, \Phi_k) ds \quad \text{from the bi-orthogonality relation in Proposition 6.16} \\ &= Q_0^r \sum_{k \in \mathbb{Z}} |\alpha_k|^2 \quad \text{from Proposition 6.12.} \end{aligned}$$

Parseval's theorem ensures that  $\sum_{k \in \mathbb{Z}} |\alpha_k|^2 = \|\varphi\|_{\rho^r}^2$ , thus leading to the desired result.  $\blacksquare$

In what follows, we define  $s^r := a^r \theta_1$ . Consider  $\varphi \in \mathcal{C}_{per}^0(\mathbb{R})$  such that with  $\varphi(s^r) = 1$ . Using the link between the 2D solutions  $(E^{r,0}(\varphi), E^{r,1}(\varphi))$  and the 1D functions  $(e_\varepsilon^{r,0}, e_\varepsilon^{r,1})$  in the cell by cell expression (6.46) of  $U^r(\varphi)$ , we deduce that  $U^r(\varphi)$  admits a trace along the line  $s^r \vec{e}_1 + \mathbb{R} \theta$ :

$$\text{a. e. } x \in \mathbb{R}_+, \quad u^r(x + a^r) := U^r(s^r + \theta_1 x, \theta_2 x). \quad (6.51)$$

Moreover, consider the RtR coefficient

$$\lambda^r := (R_{+,s^r}^r u^r)(a^r) = (\Lambda^r \varphi)(s^r). \quad (6.52)$$

It appears at first sight that  $(u^r, \lambda^r)$  depend on the choice of  $\varphi$ . To prove that this is not the case, let

us note that  $u^r$  can also be written cell by cell as

$$\forall n \in \mathbb{N}, \quad u^r(\cdot + a^r + n/\theta_2) = \varphi_n(s^r + n\delta) e_{s^r+n\delta}^{r,0} + \psi_n(s^r + (n+1)\delta) e_{s^r+n\delta}^{r,1} \quad \text{in } (0, 1/\theta_2), \quad (6.53)$$

with  $\varphi_n := (\mathcal{P}^r)^n \varphi$  and  $\psi_n := \mathcal{S}^r (\mathcal{P}^r)^n \varphi$ , in the spirit of (3.39). The 1D problems (6.3, 6.4) satisfied by  $(e_{s^r}^{r,0}, e_{s^r}^{r,1})$ , and the Riccati system satisfied by  $(\mathcal{P}^r, \mathcal{S}^r)$ , imply that  $u^r \in H_{loc}^1(I^r)$ , and is solution of

$$\left\{ \begin{array}{l} -\frac{d}{dx} \left( \mu_\theta \frac{du^r}{dx} \right) - \rho_\theta \omega^2 u^r = 0 \quad \text{in } I^r \\ R_+^r u^r(a^r) = 1. \end{array} \right. \quad (6.54)$$

Since this problem admits at most one solution (because of the Robin boundary condition), we deduce that  $(u^r, \lambda^r)$  does not depend on  $\varphi$ . Furthermore, the next result holds.

**Proposition 6.19**

*If  $\omega$  is a regular frequency, then up to a subsequence extraction, we have*

$$\lim_{\varepsilon \rightarrow 0} \|u_\varepsilon^r - u^r\|_{H^1(a^r+n/\theta_2, a^r+(n+1)/\theta_2)} = 0 \quad \text{and} \quad \lim_{\varepsilon \rightarrow 0} |\lambda_\varepsilon^r - \lambda^r| = 0. \quad (6.55)$$

*Moreover, the energy flux of  $u^r$  is positive:*

$$\Im \left( \mu_\theta \frac{du^r}{dx} \overline{u^r} \right) (a^r) = \frac{1}{4z} \Re \left[ (1 - \lambda^r) \overline{(1 + \lambda^r)} \right] > 0. \quad (6.56)$$

**Proof.** Similarly to the proof of Proposition 6.18, the convergence results in (6.55) are obtained using the cell by cell expression (6.53) of  $u^r$ , as well as the convergence of  $(e_{s,\varepsilon}^{r,0}, e_{s,\varepsilon}^{r,1})$  and the associated RrR coefficients  $t_\varepsilon^{r,\ell k}$ .

It remains to prove (6.56). Since  $u^r$  does not depend on the choice of  $\varphi$ , we consider the expression (6.53) for  $\varphi = \alpha \varphi_0^r$ , where  $\alpha$  is chosen such that  $\varphi(s^r) = 1$  (we recall that  $\varphi_0^r \neq 0$ ). Writing (6.53) for  $n = 0$  then shows that  $u^r$  is simply  $\alpha w_{s^r}(\Phi_0)$ , where  $w_s(\cdot)$  is defined by (6.29), with  $\Phi_0 := (\varphi_0, \mathcal{S}^r \varphi_0)$ . Consequently, according to Lemma 6.10, we have

$$\Im \left( \mu_\theta \frac{du^r}{dx} \overline{u^r} \right) (a^r) = \frac{|\alpha|^2}{2z} q_{s^r}^r(\Phi_0, \Phi_0) = Q_0^r,$$

where  $Q_0^r$  is the constant flux density identified in Proposition 6.12. Finally Assumption 6.14 corresponds to the positivity of  $Q_0^r$ , and therefore gives the desired result.  $\blacksquare$

**6.4.e. The limit Riccati system and spectral characterization of the limit propagation operator.**

The computation of the propagation operator and on the scattering operator, and the subsequent construction of the limit solutions exhibited in Section 6.4.d rely entirely on the pair  $(\lambda_0^r, {}^t(\varphi_0^r, \psi_0^r))$ . Similarly to the absorbing case (see Section 4.2), the practical computation of this pair is not direct: it has to be extracted from the larger set of Riccati eigenmodes (which is the one we are able to compute in practice). The goal of this section is therefore to characterize  $(\lambda_0^r, {}^t(\varphi_0^r, \psi_0^r))$  using a criterion which can be computed numerically.

Our starting point is the following result, which corresponds to Proposition 4.10 for  $\varepsilon = 0$  (although the proof is different).

**Proposition 6.20**

Given  $\varepsilon > 0$ , let  $\mathcal{P}^r, \mathcal{S}^r$  be the operators defined by (3.23). For any  $\lambda \in \mathbb{C}$ , we have

$$\mathcal{M}^r - \lambda \mathcal{N}^r = \begin{pmatrix} I & 0 \\ \lambda^t \mathcal{S}^r & \lambda^t \mathcal{P}^r - I \end{pmatrix} \mathcal{L}^r \begin{pmatrix} \mathcal{P}^r - \lambda & 0 \\ \mathcal{S}^r & -I \end{pmatrix}, \quad \mathcal{L}^r := \begin{pmatrix} I & -\mathcal{T}^{r,11} \\ -\Lambda^r & I \end{pmatrix}, \quad (6.57)$$

where  $\mathcal{T}^{r,11}$  is defined in (6.10) and  $\Lambda^r$  in (6.48). Also (and more importantly),  $\mathcal{L}^r$  is invertible.

**Proof.** All the operators in the factorization formula of Proposition 4.10 have been shown to have a limit as  $\varepsilon \rightarrow 0$ . Passing to the limit in this factorization formula then leads directly to (6.57).

The most delicate part of this result is the invertibility of  $\mathcal{L}$ . Similarly to the proof of Proposition 4.10, we construct for some  $(f, g) \in L_{per}^2(\mathbb{R})^2$  a vector  $(\varphi, \psi) \in L_{per}^2(\mathbb{R})^2$  such that  $\mathcal{L}^r(\varphi, \psi) = (f, g)$ , that is,

$$\begin{cases} \varphi - \mathcal{T}^{r,11} \psi = f \\ -\Lambda^r \varphi + \psi = g \end{cases} \iff \begin{cases} \varphi - \mathcal{R}_-^r E^{r,1}(\psi)|_{\Sigma_{\#}^{r,1}} = f \\ -\Lambda^r \varphi + \mathcal{R}_+^r E^{r,1}(\psi)|_{\Sigma_{\#}^{r,1}} = g \end{cases}$$

Similarly to the proof with  $\varepsilon > 0$ , this problem is equivalent to: Finding  $(\varphi, U) \in L_{per}^2(\mathbb{R}) \times H_{\theta}^1(\mathcal{C}_{\#}^{r,0})$  such that

$$\begin{cases} -D_{\theta}(\mu_p^r D_{\theta} U) - \rho_p^r \omega^2 U = 0, & \text{in } \mathcal{C}_{\#}^{r,0}, \\ \mathcal{R}_+ U = 0, & \text{on } \Sigma_{\#}^{r,0}, \\ (I + \Lambda^r)\varphi + 2izU = f - g, & \text{on } \Sigma_{\#}^{r,1}, \\ (I - \Lambda^r)\varphi - 2\mu_p^r D_{\theta} U = f + g, & \text{on } \Sigma_{\#}^{r,1}, \\ U \text{ is periodic w.r.t } y_1. \end{cases} \quad (6.58)$$

In fact, if  $\mathcal{L}^r(\varphi, \psi) = (f, g)$ , then by defining  $U := E^1(\psi)$ , the pair  $(\varphi, U)$  is a solution of (6.58). Conversely, if  $(\varphi, U)$  is a solution of (6.58), then by setting  $\psi := \mathcal{R}_-^r U|_{\Sigma_{\#}^{r,0}}$ . In other words, proving the invertibility of  $\mathcal{L}^r$  reduces to showing the well-posedness of the coupled problem (6.58).

Problem (6.58) is not of Fredholm type, but it is equivalent to a family of 1D problems defined for any  $s \in \mathbb{R}$  by: Find  $(\varphi_s, U_s) \in \mathbb{C} \times H^1(0, 1/\theta_2)$  such that

$$\begin{cases} -\frac{d}{dx} \left( \mu_{s,\theta} \frac{dU_s}{dx} \right) - \rho_{s,\theta} \omega^2 U_s = 0 & \text{in } (0, 1/\theta_2), \\ \mathcal{R}_{+,s}^r U_s(0) = 0, \\ (1 + \lambda_s^r) \varphi_s + 2iz U_s(1/\theta_2) = f_s - g_s, \\ (1 - \lambda_s^r) \varphi_s - 2\mu_{s,\theta} \frac{dU_s}{dx}(1/\theta_2) = f_s + g_s, \end{cases} \quad (6.59)$$

with  $f_s := f(s + \delta)$ ,  $g_s := g(s + \delta)$ , and where  $\lambda_s^r := (\Lambda^r \phi)(s)$ , with  $\phi = 1$ . For any  $s \in \mathbb{R}$ , Fredholm alternative holds for Problem (6.59), meaning that uniqueness implies existence and well-posedness of the problem. To prove the uniqueness, it suffices to consider the solution for  $f_s = g_s = 0$ . Using an

integration by parts formula, we obtain that

$$\begin{cases} \int_0^{1/\theta_2} \left( \mu_{s,\theta} \left| \frac{dU_s}{dx} \right|^2 - \rho_p \omega^2 |U_s|^2 \right) - iz |U_s(a^r)|^2 - \frac{i}{4z} (1 - \lambda_s^r) \overline{(1 - \lambda_s^r)} |\varphi_s|^2 = 0, & (i) \\ (1 + \lambda_s^r) \varphi_s + 2iz U_s(1/\theta_2) = 0. & (ii) \end{cases} \quad (6.60)$$

By adapting the arguments of Proposition 6.19, one shows that  $\Re \epsilon [(1 - \lambda^r) \overline{(1 + \lambda^r)}] > 0$ . Therefore, by taking the imaginary part in (6.60)–(i), we obtain that

$$\varphi_s = 0 \quad \text{and} \quad U_s(0) = U_s(1/\theta_2) = 0,$$

where the second equality follows from (6.60)–(ii). Furthermore, the last equation in (6.59) implies that  $(dU_s/dx)(1/\theta_2) = 0$ . Therefore, from Cauchy uniqueness theorem,  $U_s = 0$ .

Since (6.59) is well-posed for any  $s \in \mathbb{R}$ , it can be shown by contradiction (see for instance the proof of Proposition 6.2) that  $s \mapsto \varphi_s \in L_{per}^2(\mathbb{R}; \mathbb{C})$  and  $s \mapsto U_s \in L_{per}^2(\mathbb{R}; H^1(0, 1/\theta_2))$ . Consequently, the functions

$$\text{a. e. } (s, x) \in \mathbb{R} \times (0, 1/\theta_2), \quad \varphi(s) := \varphi_s \quad \text{and} \quad U(s + \theta_1 x, \theta_2 x) := U_s(x),$$

are well-defined in  $L_{per}^2(\mathbb{R})$  and  $H_{\theta, per}^1(\mathbb{C}^{r,0})$  respectively. Moreover, from the properties of  $(\varphi_s, U_s)$ , one has that  $(\varphi, U)$  is the unique solution of (6.58), and is continuous with respect to  $(f, g)$ . ■

### Proposition 6.21

The Riccati point spectrum  $\sigma_{R,p}^r$  is given by

$$\sigma_{R,p}^r = \{ \lambda_k^r, k \in \mathbb{Z} \} \cup \{ 1/\lambda_k^r, k \in \mathbb{Z} \}, \quad \text{with} \quad \text{Ker}(\mathcal{M}^r - \lambda_k^r \mathcal{N}^r) = \text{Span} \begin{pmatrix} \varphi_k^r \\ \psi_k^r \end{pmatrix}. \quad (6.61)$$

**Proof.** We begin by proving that  $\{ \lambda_k^r, k \in \mathbb{Z} \} \cup \{ 1/\lambda_k^r, k \in \mathbb{Z} \} \subset \sigma_{R,p}^r$ . Given  $k \in \mathbb{Z}$ , we already have from (6.26) that  $\lambda_k^r$  is a Riccati eigenvalue, with associated eigenfunction  ${}^t(\varphi_k^r \ \mathcal{S}^r \varphi_k^r)$ . Furthermore, using the symmetry properties of the operators  $\mathcal{T}^{r,\ell k}$  (which are the same as in Proposition 3.44), it can be computed without difficulty that

$${}^t(\mathcal{M}^r - \lambda \mathcal{N}^r) = \widetilde{\mathcal{F}}^{-1} \left( \mathcal{M}^r - \frac{1}{\lambda} \mathcal{N}^r \right) \widetilde{\mathcal{F}} \quad \text{with} \quad \widetilde{\mathcal{F}} := \begin{pmatrix} 0 & -\lambda I \\ I & 0 \end{pmatrix}.$$

Since  ${}^t(\mathcal{M}^r - \lambda \mathcal{N}^r)$  and  $\mathcal{M}^r - \lambda \mathcal{N}^r$  have the same eigenvalues, we get for any  $\lambda \neq 0$  the equivalence  $\lambda \in \sigma_{R,p}^r \iff 1/\lambda \in \sigma_{R,p}^r$ . Therefore,  $\{ 1/\lambda_k^r, k \in \mathbb{Z} \} \subset \sigma_{R,p}^r$ .

Conversely, let  $\lambda \in \sigma_{R,p}^r$  and consider an associated Riccati eigenmode  $(\varphi_\lambda, \psi_\lambda) \neq 0$ . If  $(\lambda, \varphi_\lambda)$  is an eigenpair of  $\mathcal{P}^r$ , then  $\lambda \in \{ \lambda_k^r, k \in \mathbb{Z} \}$ . Otherwise, since  $\mathcal{L}^r$  is invertible, we have

$$\begin{pmatrix} \widetilde{\varphi}_\lambda \\ \widetilde{\psi}_\lambda \end{pmatrix} := \mathcal{L}^r \begin{pmatrix} \mathcal{P}^r - \lambda & 0 \\ \mathcal{S}^r & -I \end{pmatrix} \begin{pmatrix} \varphi_\lambda \\ \psi_\lambda \end{pmatrix} \neq 0 \quad \text{and} \quad \begin{pmatrix} I & 0 \\ \lambda {}^t \mathcal{S}^r & \lambda {}^t \mathcal{P}^r - I \end{pmatrix} \begin{pmatrix} \widetilde{\varphi}_\lambda \\ \widetilde{\psi}_\lambda \end{pmatrix} = 0.$$

It then follows that  $\widetilde{\varphi} = 0$  and  $(\lambda {}^t \mathcal{P}^r - I) \widetilde{\psi}_\lambda = 0$  with  $\widetilde{\psi} \neq 0$  because  $(\widetilde{\varphi}, \widetilde{\psi}) \neq 0$ . Consequently,  $1/\lambda$  is an eigenvalue of  ${}^t \mathcal{P}^r$ . Since  $\mathcal{P}^r$  and  ${}^t \mathcal{P}^r$  have the same eigenvalues, we get  $\lambda \in \{ 1/\lambda_k^r, k \in \mathbb{Z} \}$ . ■

We recall that  $(E^{l,0}, E^{l,1})$  are the local cell solutions associated to the half-line problem on  $I^l$ , and that  $(\mathcal{T}^{l,00}, \mathcal{T}^{l,10}, \mathcal{T}^{l,01}, \mathcal{T}^{l,11})$  are the associated local RtR operators. Similarly to (4.38), we have the following, under the assumption (1.1) that  $a^l \theta_2, a^r \theta_2 \in \mathbb{Z}$ :

$$\begin{aligned} \forall \varphi \in L_{per}^2(\mathbb{R}), \quad E^{l,0}(\varphi) = E^{r,1}(\varphi), \quad E^{l,1}(\varphi) = E^{r,0}(\varphi), \\ \forall \ell, k \in \{0, 1\}, \quad \mathcal{T}^{l,\ell k} = \mathcal{T}^{r,(1-\ell)(1-k)}, \end{aligned} \quad (6.62)$$

and the next equality is obtained by making  $\varepsilon \rightarrow 0$  in (4.39): for any  $\lambda \in \mathbb{C}, \lambda \neq 0$

$$\mathcal{M}^l - \lambda \mathcal{N}^l = -\frac{1}{\lambda} \mathcal{J}^{-1} \left( \mathcal{M}^r - \frac{1}{\lambda} \mathcal{N}^r \right) \mathcal{J} \quad \text{with } \mathcal{J} := \begin{pmatrix} 0 & I \\ I & 0 \end{pmatrix}. \quad (6.63)$$

Consequently, we deduce the next result, which is the equivalent of Proposition 6.22 for  $\varepsilon = 0$  (the proof is also the same).

### Proposition 6.22

We have

$$\sigma_p(\mathcal{P}^l) = \sigma_p(\mathcal{P}^r) \quad \text{and} \quad \text{Ker} \left( \mathcal{M}^j - \frac{1}{\lambda_k^{j'}} \mathcal{N}^j \right) = \text{Span} \begin{pmatrix} \psi_k^{j'} \\ \varphi_k^{j'} \end{pmatrix} \quad \text{for } j \neq j' \in \{l, r\}.$$

We recall from Proposition 6.12 that if Assumption 6.14 holds, then  $|\lambda_0^r| = 1$ . This means according to Proposition 6.21 that **all** the Riccati eigenvalues lie on the unit circle. Thus contrary to the absorbing case, we cannot identify the eigenvalues of the propagation operator using their modulus. In order to characterize the fundamental eigenpair, we introduce a criterion using the flux.

### Proposition 6.23

For  $j \in \{l, r\}$ , let  $Q_s^l(\varphi, \psi)$  denote the flux density (defined by (6.28) for  $j = r$ ), and let  $Q_0^l$  be the constant flux density (introduced in Proposition 6.12 for  $j = r$ ). If  $\omega^2$  is a regular frequency, then we have

$$\forall k \in \mathbb{Z}, \quad \forall s \in \mathbb{R}, \quad Q_s^r(\varphi_k^r, \psi_k^r) = Q_0^r > 0 \quad \text{and} \quad Q_s^r(\psi_k^l, \varphi_k^l) = -Q_0^l < 0. \quad (6.64)$$

**Proof.** The first part of (6.64) is a direct consequence of Proposition 6.12 and Remark 6.13. For the second part, we begin by using the definitions (6.28) and (6.24) of  $Q_s^j(\varphi, \psi)$  and  $(\varphi_k^l, \psi_k^l)$ , which imply that  $Q_s^j(\psi_k^l, \varphi_k^l) = Q_s^j(\psi_0^l, \varphi_0^l)$  for any  $k \in \mathbb{Z}$ . Then, the property  ${}^t(\varphi_0^l, \psi_0^l) \in \text{Ker}(\mathcal{M}^l - \lambda_0^l \mathcal{N}^l)$  on one hand implies  $\mathcal{T}^{l,00} \psi_0^l + \mathcal{T}^{l,10} \varphi_0^l = (\lambda_0^l)^{-1} \psi_0^l$ , so that

$$\begin{aligned} Q_s^l(\psi_0^l, \varphi_0^l) &:= \Re \left[ (I - \mathcal{T}^{l,00}) \psi_0^l - \mathcal{T}^{l,10} \varphi_0^l \right] \overline{[(I + \mathcal{T}^{l,00}) \psi_0^l + \mathcal{T}^{l,10} \varphi_0^l]}(s) \\ &= |\varphi_0^l(s)|^2 - |\psi_0^l(s)|^2 \end{aligned}$$

where we have used  $|\lambda_0^l| = 1$ . On the other hand, the property  ${}^t(\psi_0^l, \varphi_0^l) \in \text{Ker}(\mathcal{M}^r - (\lambda_0^l)^{-1} \mathcal{N}^r)$  from Proposition 6.22 leads to  $\mathcal{T}^{l,00} \psi_0^l + \mathcal{T}^{l,10} \varphi_0^l = \lambda_0^l \varphi_0^l$ , so that

$$Q_s^r(\psi_0^l, \varphi_0^l) := \Re \left[ (I - \mathcal{T}^{r,00}) \psi_0^l - \mathcal{T}^{r,10} \varphi_0^l \right] \overline{[(I + \mathcal{T}^{r,00}) \psi_0^l + \mathcal{T}^{r,10} \varphi_0^l]}(s).$$

$$= |\psi_0^l(s)|^2 - |\varphi_0^l(s)|^2,$$

where we have also used  $|\lambda_0^l| = 1$ . We then deduce  $Q_s^r(\psi_0^l, \varphi_0^l) = -Q_s^l(\psi_0^l, \varphi_0^l) = -Q_0^l < 0$  by combining the above two equalities, and by using Proposition 6.12 and Assumption 6.14. ■

Thanks to Proposition 6.23, we can separate the Riccati eigenmodes.

#### Proposition 6.24

We have  $\sigma_{R,p}^r = \sigma_+^r \cup \sigma_-^r$ , where

$$\sigma_{\pm}^r := \left\{ \lambda \in \mathbb{C} \ / \ \exists \begin{pmatrix} \varphi \\ \psi \end{pmatrix} \in \text{Ker}(\mathcal{M}^r - \lambda \mathcal{N}^r) \ \text{such that} \ \pm Q^r(\varphi, \psi) > 0 \right\}. \quad (6.65)$$

Moreover,

$$\exists! (\lambda_{0,+} \begin{pmatrix} \varphi_{0,+} \\ \psi_{0,+} \end{pmatrix}) \in \sigma_+^r \times L_{per}^2(\mathbb{R})^2 \ \text{such that} \ \varphi_{0,+}(0) = 1 \ \text{and} \ \mathbf{w}(\varphi_{0,+}) = 0,$$

and

$$\exists! (\lambda_{0,-} \begin{pmatrix} \psi_{0,-} \\ \varphi_{0,-} \end{pmatrix}) \in \sigma_-^r \times L_{per}^2(\mathbb{R})^2 \ \text{such that} \ \varphi_{0,-}(0) = 1 \ \text{and} \ \mathbf{w}(\varphi_{0,-}) = 0.$$

### 6.5 Problem in the bounded interval and definition of the physical solution

We can now introduce the following problem in  $(a^l, a^r)$  using RtR boundary conditions

$$\left| \begin{array}{l} -\frac{d}{dx} \left( \mu_{\theta} \frac{du^i}{dx} \right) - \rho_{\theta} \omega^2 u^i = 0 \ \text{in} \ (a^l, a^r) \\ (R_-^l u^i)(a^l) = \lambda^l (R_+^l u^i)(a^l), \\ (R_-^r u^i)(a^r) = \lambda^r (R_+^r u^i)(a^r). \end{array} \right. \quad (\mathcal{P}^{\text{int}})$$

We show that this problem is well-posed provided that  $\omega^2$  is not in the discrete spectrum  $\sigma_d(\mathcal{A})$  of  $\mathcal{A}$ .

#### Proposition 6.25

Let  $\omega$  be a regular frequency. If  $\omega^2 \in \sigma(\mathcal{A}_{\theta})$  or if  $\omega^2 \notin \sigma(\mathcal{A}_{\theta}) \cup \sigma_d(\mathcal{A})$ , then Problem  $(\mathcal{P}^{\text{int}})$  is well-posed in  $H^1(a^l, a^r)$  and

$$\lim_{\varepsilon \rightarrow 0} \|u_{\varepsilon}^i - u^i\|_{H^1(a^l, a^r)} = 0$$

(the whole sequence converges).

**Proof.** It is easy to see that Fredholm alternative holds for  $(\mathcal{P}^{\text{int}})$ . Therefore, it suffices to show uniqueness to deduce well-posedness. The sesquilinear form associated with  $(\mathcal{P}^{\text{int}})$  is given for any  $u, v \in H^1(a^l, a^r)$  by

$$b^i(u, v) := \int_{a^l}^{a^r} \left( \mu \frac{du}{dx} \overline{\frac{dv}{dx}} - \rho \omega^2 u \bar{v} \right) dx - \frac{i}{4z} \sum_{j \in \{l, r\}} (1 - \lambda^j) R_+^j u(a^j) \overline{(1 + \lambda^j) R_+^j v(a^j)}$$

Suppose that  $b^i(u, v) = 0$  for all  $v \in H^1(a^l, a^r)$ , and let us show that  $u = 0$ .

**Case 1.** If  $\omega^2 \in \sigma(\mathcal{A}_\theta)$ , by choosing  $v = u$ , we obtain  $b^i(u, u) = 0$ , which implies that

$$0 = \Im(b^i(u, u)) = -\frac{i}{4z} \sum_{j \in \{l, r\}} \Re [(1 - \lambda^j) \overline{(1 + \lambda^j)}] |R_+^j u(a^j)|^2.$$

Since  $\Re [(1 - \lambda^j) \overline{(1 + \lambda^j)}] > 0$  according to Proposition 6.19, it follows that

$$R_+^l u(a^l) = R_+^r u(a^r) = 0 \quad \xRightarrow{\text{by } (\mathcal{P}^{\text{int}})} \quad R_-^l u(a^l) = R_-^r u(a^r) = 0.$$

This yields in particular  $u(a^r) = u'(a^r) = 0$  which, by Cauchy Lipchitz theorem, gives  $u = 0$  in  $(a^l, a^r)$ .

**Case 2.** If  $\omega \notin \sigma(\mathcal{A}_\theta)$ , we cannot conclude similarly. Instead, assume that there exists a solution  $u^i$  of the homogeneous version of  $(\mathcal{P}^{\text{int}})$ . We can then consider the function defined by

$$\text{a. e. } x \in \mathbb{R}, \quad u(x) := \begin{cases} [R_+^l u^i(a^l)] u^l(x), & x < a^l, \\ u^i(x), & x \in (a^l, a^r), \\ [R_+^r u^i(a^r)] u^r(x), & x > a^r. \end{cases}$$

Since  $\omega^2 \notin \sigma(\mathcal{A}_\theta)$ ,  $u$  belongs  $H^1(\mathbb{R})$  and is solution of the homogeneous version of  $(\mathcal{P})$ . In conclusion,  $u = 0$  except if  $\omega^2 \notin \sigma_d(\mathcal{A})$ .

**Case 3.** Let us now show that  $u_\varepsilon^i \rightarrow u^i$  in  $H^1(a^l, a^r)$ . It suffices to show that  $(u_\varepsilon^i)_\varepsilon$  is bounded in  $H^1(a^l, a^r)$ . Indeed, in this case, up to a subsequence extraction,  $u_\varepsilon^i \rightharpoonup u^*$  weakly in  $H^1(a^l, a^r)$  and  $u_\varepsilon^i \rightarrow u^*$  strongly in  $L^2(a^l, a^r)$ . We can then show that  $u^*$  satisfy  $(\mathcal{P}^{\text{int}})$ . But since  $(\mathcal{P}^{\text{int}})$  is well-posed,  $u^* = u^i$  and the whole sequence converges strongly in  $H^1(a^l, a^r)$ . To prove that  $(u_\varepsilon^i)_\varepsilon$  is bounded in  $H^1(a^l, a^r)$ , we proceed by contradiction. Let us suppose that  $\|u_\varepsilon^i\|_{H^1} \rightarrow +\infty$  and introduce  $\tilde{u}_\varepsilon^i := u_\varepsilon^i \|u_\varepsilon^i\|_{H^1}^{-1}$ . By linearity  $\tilde{u}_\varepsilon^i$  satisfies  $(\mathcal{P}_\varepsilon^{\text{int}})$  where the source  $f$  is replaced by  $f \|u_\varepsilon^i\|_{H^1}^{-1}$ . The sequence  $(\tilde{u}_\varepsilon^i)_\varepsilon$  is by definition bounded and  $f \|u_\varepsilon^i\|_{H^1}^{-1}$  tends to 0 when  $\varepsilon$  tends to 0. It then follows that  $\tilde{u}_\varepsilon^i \rightarrow 0$  strongly in  $H^1$ , which contradicts  $\|\tilde{u}_\varepsilon^i\|_{H^1} = 1$ . ■

At last, we are able to define the physical solution  $u$  of  $(\mathcal{P})$  as follows:

$$\text{a. e. } x \in \mathbb{R}, \quad u(x) = \begin{cases} [R_+^l u^i(a^l)] u^l(x), & x < a^l, \\ u^i(x), & x \in (a^l, a^r), \\ [R_+^r u^i(a^r)] u^r(x), & x > a^r, \end{cases} \quad (6.66)$$

where the convergence of  $u_\varepsilon$  to  $u$  in  $H_{loc}^1$  results from Propositions 6.19 and 6.25.

## 6.6 Resolution algorithm

In order to compute the solution of  $(\mathcal{P})$  defined by limiting absorption, the previous sections provide an algorithm which sums up as follows. We suppose here that  $\omega$  is a regular frequency, or equivalently that Assumptions (6.7) and (6.14) are satisfied.

1. For any  $\varphi \in L_{per}^2(\mathbb{R})$ , compute the respective solutions  $E^{r,0}(\varphi)$ ,  $E^{r,1}(\varphi)$  of the local cell problems

(6.1) and (6.2). Note that  $E^{\iota,0}(\varphi)$  and  $E^{\iota,1}(\varphi)$  can be deduced directly using (6.62).

2. Compute the local RtR operators  $\mathcal{T}^{r,\ell k}$ ,  $\ell, k \in \{0, 1\}$  defined by (6.10).
3. Compute the Riccati point spectrum (6.13). For  $\lambda \in \sigma_{R,p}^r$ , let  ${}^{\iota}(\varphi_\lambda, \psi_\lambda) \in \text{Ker}(\mathcal{M}^r - \lambda \mathcal{N}^r)$ :

(a) *If there is no  $\lambda \in \sigma_{R,p}^r$  such that  $|\lambda| = 1$ , then  $\omega^2 \notin \sigma(\mathcal{A}_\theta)$  according to (6.15)–(ii).*

For the unique  $\lambda \in \sigma_{R,p}^r$  such that  $|\lambda| < 1$  and  $\mathbf{w}(\varphi_\lambda) = 0$ , we have  $\lambda = \lambda_0^r$  and  $\varphi_\lambda = \varphi_0^r$  up to a multiplicative constant (Proposition 6.21), and for the unique  $\lambda \in \sigma_{R,p}^r$  such that  $|\lambda| > 1$  and  $\mathbf{w}(\psi_\lambda) = 0$ , we have  $\lambda^{-1} = \lambda_0^l$  and  $\psi_\lambda = \varphi_0^l$  up to a multiplicative constant (according to Proposition 6.22)

(b) *If there exists  $\lambda \in \sigma_{R,p}^r$  such that  $|\lambda| = 1$ , then  $\omega^2 \in \sigma(\mathcal{A}_\theta)$  according to (6.15)–(i).*

We decompose  $\sigma_R^r = \sigma_+^r \cup \sigma_-^r$ , see Definition (6.65). For the unique  $\lambda \in \sigma_{R,p}^r$  such that  $\mathbf{w}(\varphi_\lambda) = 0$ , we have  $\lambda = \lambda_0^r$  and  $\varphi_\lambda = \varphi_0^r$  up to a multiplicative constant (see Propositions 6.21 and 6.24) and for the unique  $\lambda \in \sigma_R^-$  such that  $\mathbf{w}(\psi_\lambda) = 0$  we have  $\lambda^{-1} = \lambda_0^l$  and  $\psi_\lambda = \varphi_0^l$  up to a multiplicative constant (see Propositions 6.22 and 6.24).

(c) *If there exist both  $\lambda \in \sigma_R^r$  such that  $|\lambda| = 1$  and  $\lambda' \in \sigma_{R,p}^r$  such that  $|\lambda'| < 1$ , then  $\omega^2 \in \sigma(\mathcal{A}_\theta)$  (6.15)–(i), whereas  $Q_0^r = 0$  (Proposition 6.12).*

In this case, we cannot identify  $\lambda_0^r$  or  $\lambda_0^l$  from  $\sigma_{R,p}^r$ .

4. We can then compute  $\mathcal{P}^j$  for  $j = \iota$  and  $r$  using (6.41) and (6.42). The operators  $\mathcal{S}^j$  for  $j = r$  and  $j = \iota$  can also be computed using (6.43) and (6.44).
5. For any  $\varphi \in L_{per}^2(\mathbb{R})$ , the solution  $U^j(\varphi)$  defined by limiting absorption can be reconstructed cell by cell using (6.46).
6. For each  $j \in \{\iota, r\}$ , pick a continuous function  $\varphi$  such that  $\varphi(a^j \theta_1) = 1$ , and use (6.51) to construct  $u^j$  and  $\lambda^j$  defined in (6.52).
7. Finally, solve ( $\mathcal{P}^{\text{int}}$ ) in  $(a^\iota, a^r)$  which is well-posed except if  $\omega^2 \in \sigma_a(\mathcal{A})$ . Then the physical solution  $u$  of ( $\mathcal{P}$ ) is given by (6.66).

## 7 Numerical results

The procedure developed in the previous sections is illustrated through a series of numerical results. Our goal is to compute the physical solution of Problem ( $\mathcal{P}$ ), where the coefficients  $\mu$  and  $\rho$  coincide with quasiperiodic functions outside an interval  $(a^\iota, a^r) := (-1, 1)$ , with periodic lifts

$$\forall \mathbf{y} \in \mathbb{R}^2, \quad \mu_p(\mathbf{y}) = 1.5 + \cos(2\pi y_1) \cos(2\pi y_2) \quad \text{and} \quad \rho_p(\mathbf{y}) = 1.5 + 0.5 \sin(2\pi y_1) + 0.5 \sin(2\pi y_2).$$

The cut vector is  $\boldsymbol{\theta} = (\cos \pi/3, \sin \pi/3)$ , so that the ratio  $\delta := \theta_1/\theta_2 = 1/\sqrt{3} \in \mathbb{R} \setminus \mathbb{Q}$  is not a Liouville number. Indeed, since  $\delta$  is algebraic, its irrationality measure is  $\eta(\delta) = 2$  [Rot55]. Inside  $(a^\iota, a^r)$ , the local perturbations are piecewise constants represented in Figure 4. The source  $f$  is the cut-off function

$$\forall x \in \mathbb{R}, \quad f(x) = \exp(100(1 - 1/(1 - x^2))) \chi_{(-1,1)},$$

also represented in Figure 4. Finally, the impedance is set to  $z = \omega$ .



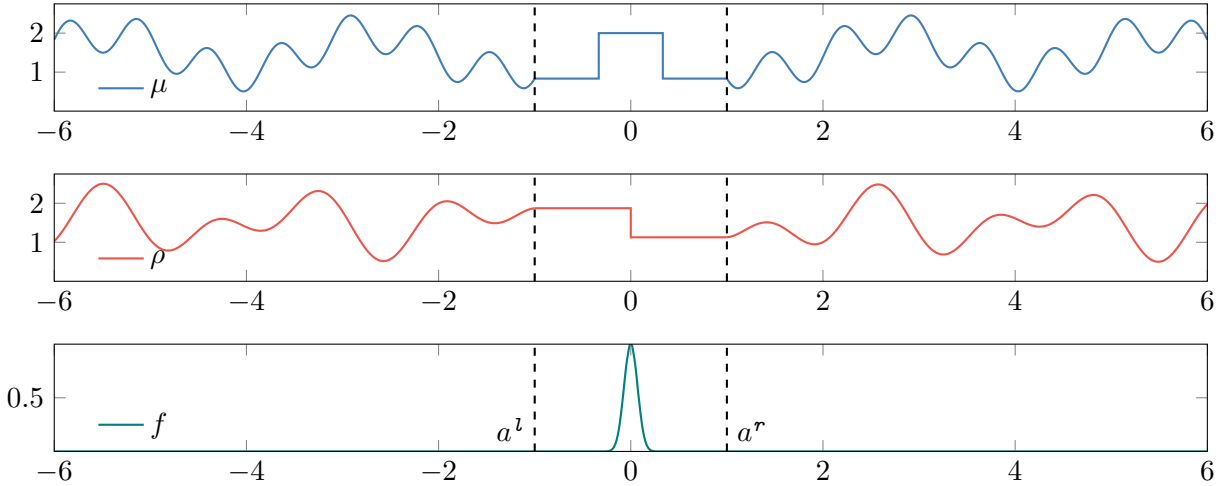

Figure 4: The locally perturbed quasiperiodic coefficients  $\mu$  and  $\rho$ , and the source term  $f$ .

Given a frequency  $\omega$ , we solve the problems (6.1, 6.2) defined in the cell  $C_{\#}^{r,0} := (0, 1)^2$  using Lagrange finite elements of order 1 with  $h = 5 \times 10^{-2}$ . We then compute discrete local RtR operators defined by (6.10) and deduce the Riccati point spectrum (6.13). We recall from Section 6.6 that if some element of the Riccati point spectrum is inside the unit circle, then  $\omega$  is an *evanescent frequency*. In this case, the fundamental eigenpair is the pair  $(\lambda, {}^t(\varphi_\lambda, \psi_\lambda))$  such that  $|\lambda| < 1$  and  $\varphi_\lambda$  has a zero winding number. On the other hand, if the Riccati point spectrum is included in the unit circle, then  $\omega$  is a *propagative frequency*. In this case, we look for the eigenpairs  $(\lambda, {}^t(\varphi_\lambda, \psi_\lambda))$  with a positive energy flux (see Proposition 6.24), and amongst them, the fundamental eigenpair is the one such that  $\varphi_\lambda$  has a zero winding number. It is worth noting that all the eigenpairs may have a zero energy flux, in which case we could not isolate the fundamental eigenpair. We refer to such a value of  $\omega$  as a *zero flux frequency*. If  $\omega$  is not a zero flux frequency, then the fundamental eigenpair allows to construct the propagation operator via (6.41, 6.42), the scattering operator via (6.43, 6.44), and finally the RtR coefficient associated to the half-line problem set on  $\mathbb{R}_+$ . Repeating this procedure allows to deduce the RtR coefficient associated to the half-line problem set on  $\mathbb{R}_-$ . Finally, we can solve the problem ( $\mathcal{P}^{\text{int}}$ ) set in the interior domain  $(a^l, a^r)$  if it is well-posed, and deduce the solution  $u$  of ( $\mathcal{P}$ ).

In what follows, we consider three evanescent frequencies:  $\omega_{1,e} = 4$ ,  $\omega_{2,e} = 7.912$ ,  $\omega_{3,e} = 11.647$  and three propagative frequencies:  $\omega_{1,p} = 5.642$ ,  $\omega_{2,p} = 11.5$ ,  $\omega_{3,p} = 20$ . These frequencies have been obtained from preliminary numerical tests, and are represented in Figure 5 with respect to the spectrum of the quasiperiodic differential operator  $\mathcal{A}_\theta$  (see (1.8)), which is also obtained numerically. Note that the computation of  $\sigma(\mathcal{A}_\theta)$  is not necessary for the method, and is only performed for illustration purposes.

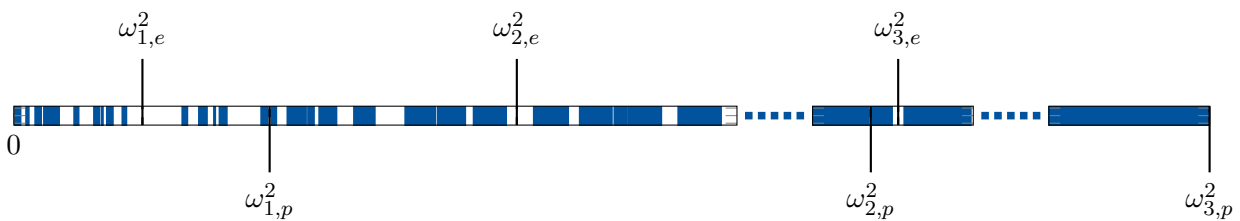

Figure 5: Position of the evanescent frequencies and of the propagative frequencies inside the spectrum of the quasiperiodic differential operator

In Figure 6, for each of the propagative and evanescent frequencies introduced above, we represent the fundamental eigenvalue, from which we reconstruct the Riccati point spectrum using Propositions 4.11 and 6.22.

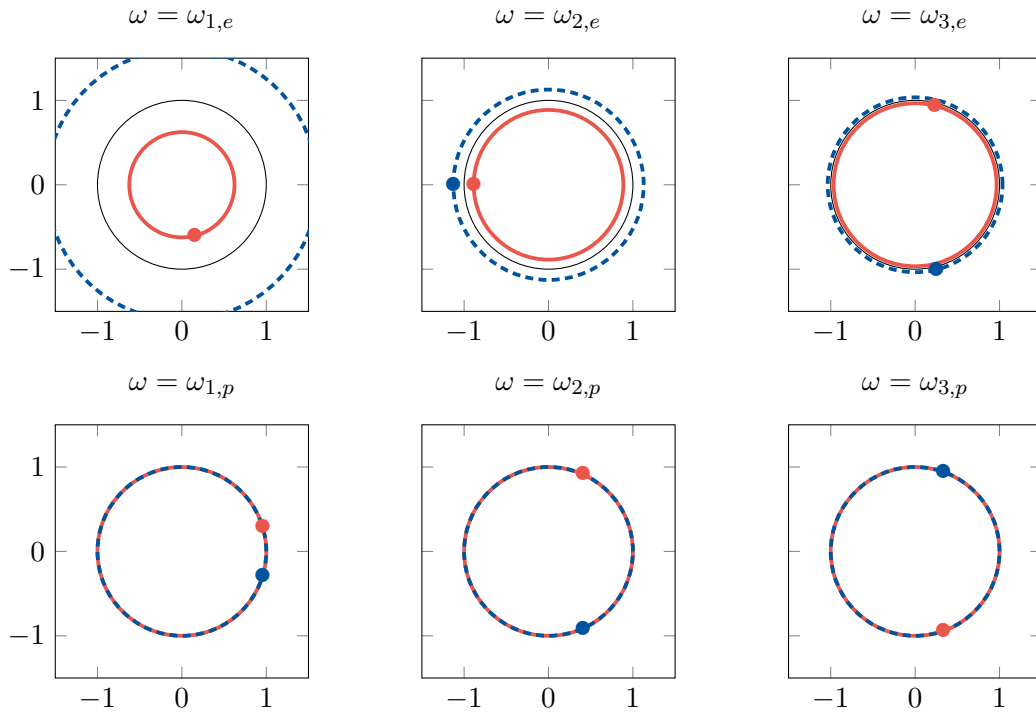

Figure 6: Riccati point spectrum reconstructed analytically from the fundamental eigenvalue (red filled circle) and its inverse (blue filled circle) for evanescent (first row) and propagative (second row) frequencies. The red circle corresponds to the spectrum of the propagation operator.

**The half-guide solution and the solution of  $(\mathcal{P})$**  For the evanescent frequencies  $(\omega_{1,e}, \omega_{2,e}, \omega_{3,e})$  and propagative frequencies  $(\omega_{1,p}, \omega_{2,p}, \omega_{3,p})$ , we represent the solution  $U^r$  of the limit 2D periodic half-guide problem (6.47) in Figure 8, and the solution  $u$  of  $(\mathcal{P})$  in Figure 7. To compute these solutions, we choose a boundary data  $\varphi = 1$ . A first seemingly surprising phenomenon is that  $U^r$  becomes smaller as  $\omega$  increases (note that in Figure 8, the color scale has been adjusted for  $\omega_{3,p}$ ). This is due to our choice of impedance  $z = \omega$ , which increases with  $\omega$ . In fact, by formally making  $z$  tend to  $\infty$  in the Robin boundary condition  $\mathcal{R}_+^r U^r = 1$ , we see that the trace of  $U^r$  on  $\Sigma^{r,0}$  becomes smaller as  $z$  increases. It can be observed that for the evanescent frequencies,  $U^r$  (resp.  $u$ ) decays when  $y_2 \rightarrow +\infty$  (resp. when  $x \rightarrow \pm\infty$ ). This corresponds to an exponential decay, whose rate is linked to the modulus of the fundamental eigenvalue  $|\lambda_0^j|$  (see Proposition 6.6). In particular, this decay can be seen clearly for  $\omega_{1,e}$ , whereas it is more difficult to observe for  $\omega_{2,e}$  and  $\omega_{3,e}$ , since in these cases,  $|\lambda_0^j|$  is close to 1 as Figure 6 shows. Moreover, the decay is absent for propagative frequencies. Note also that as expected, the solutions oscillate more as  $\omega$  increase.

**Convergence with respect to the absorption** In order to illustrate the estimates shown in Section 6, we represent the relative error

$$\varepsilon \mapsto \frac{\|u_\varepsilon - u\|_{H^1(a^l, a^r)}}{\|u\|_{H^1(a^l, a^r)}}$$

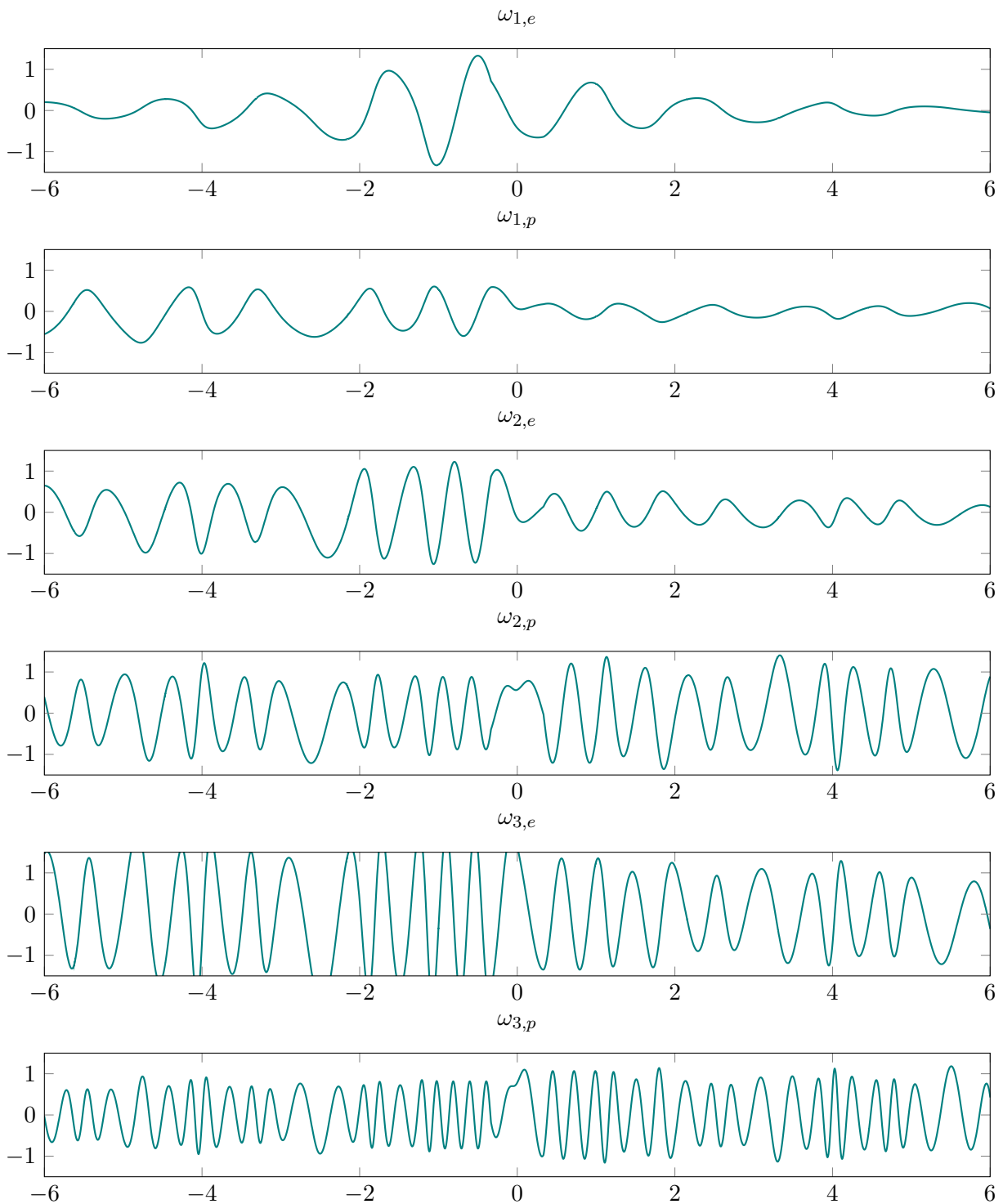

Figure 7: Real part of the solution of  $(\mathcal{P})$  computed using the quasi-1D approach, with  $\mathbb{P}^1$  Lagrange finite elements and  $h = 5 \times 10^{-2}$ , and for different evanescent frequencies and propagative frequencies.

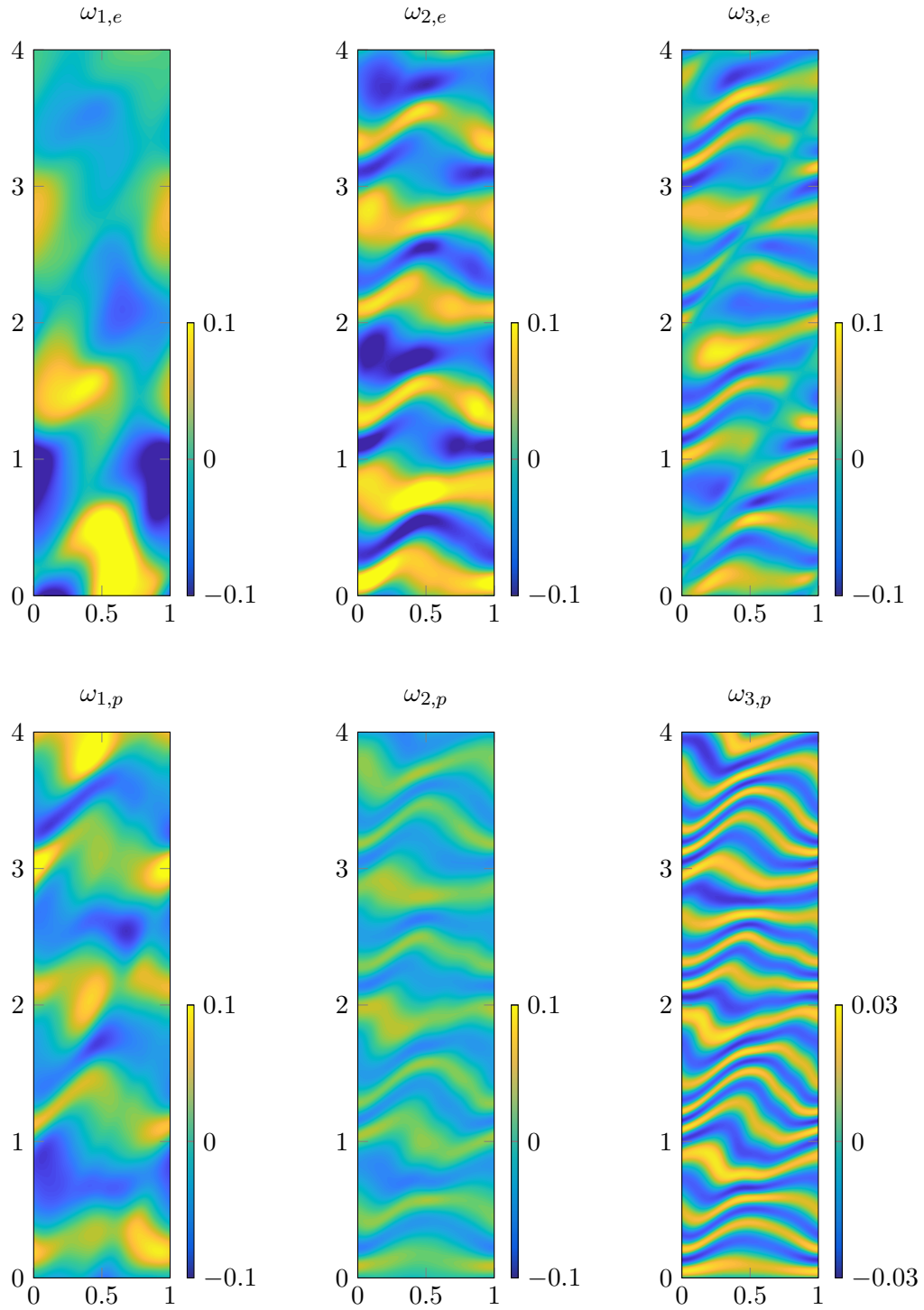

Figure 8: Real part of the half-guide solution computed using the quasi-1D approach, with  $\mathbb{P}^1$  Lagrange finite elements and  $h = 5 \times 10^{-2}$ , and for different evanescent frequencies (first row) and propagative frequencies (second row) (Note the change of color scale for  $\omega_{3,p}$ ).

where  $u$  is the solution of  $(\mathcal{P})$ , and where  $u_\varepsilon$  denotes the solution of  $(\mathcal{P}_\varepsilon)$ . This relative error is represented in Figure 9 for  $\omega_{2,e}$  and  $\omega_{2,p}$ . As expected, a linear convergence is observed.

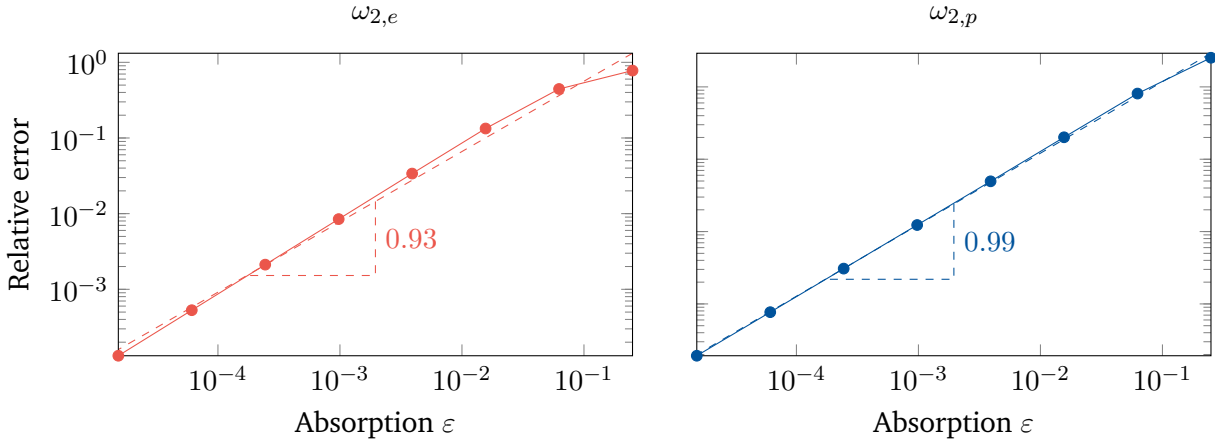

Figure 9: Relative error in  $H^1$  norm between the solutions of  $(\mathcal{P})$  and  $(\mathcal{P}_\varepsilon)$  for different values of  $\omega$ .

## A Invariance of spectra of differential operators

The goal of this appendix is to prove Proposition 5.1 (resp. Proposition 5.2) which states that the spectrum of  $\mathcal{A}_{s,\theta}$  (resp.  $\mathcal{A}_p(\xi)$ ) is independent of  $s$  (resp.  $\xi$ ). We first begin with the family of operators  $\mathcal{A}_{s,\theta}$  with  $\mathcal{A}_{0,\theta} = \mathcal{A}_\theta$ . Since  $\mathcal{A}_{s+1,\theta} = \mathcal{A}_{s,\theta}$  for all  $s \in \mathbb{R}$ , it suffices to study  $\mathcal{A}_{s,\theta}$  for  $s \in [0, 1)$ . Furthermore, they are linked to one another as follows.

### Lemma A.1

Let  $\tau_a$  be the translation operator defined by  $\tau_a \varphi = \varphi(\cdot + a)$ . Then we have the identity

$$\tau_{1/\theta_2}^{-1} \mathcal{A}_{s+\delta,\theta} \tau_{1/\theta_2} = \mathcal{A}_{s,\theta}. \quad (\text{A.1})$$

**Proof.** Since  $\rho_p$  is 1-periodic with respect to its second variable, for any  $(s, x) \in \mathbb{R}^2$ , we have

$$\begin{aligned} \rho_{s+\delta,\theta}(x) &= \rho_p\left(s + \frac{\theta_1}{\theta_2} + x\theta_1, x\theta_2\right) \\ &= \rho_p\left(s + \left(x + \frac{1}{\theta_2}\right)\theta_1, \left(x + \frac{1}{\theta_2}\right)\theta_2\right) = \rho_{s,\theta}\left(x + \frac{1}{\theta_2}\right). \end{aligned} \quad (\text{A.2})$$

and we have similarly  $\mu_{s+\delta,\theta} = \tau_{1/\theta_2} \mu_{s,\theta}$ . We deduce the following

$$\forall u \in D(\mathcal{A}_{s,\theta}), \quad \tau_{1/\theta_2} u \in D(\mathcal{A}_{s+\delta,\theta}) \quad \text{and} \quad \mathcal{A}_{s+\delta,\theta} u\left(\cdot + \frac{1}{\theta_2}\right) = [\mathcal{A}_{s,\theta} u](\cdot), \quad (\text{A.3})$$

which is the expected identity. ■

Proposition 5.1 which we recall and prove below is known to hold in a more general context, namely for Schrödinger operators with almost-periodic [Sim82] and random [Pas80] coefficients. In these references, the proof relies on the notion of spectral projections. Here for the sake of completeness, we propose an alternative proof which is specific to quasiperiodic functions, and which rely on more elementary objects.

### Proposition A.2

If  $\delta$  is irrational, then the spectrum of  $\mathcal{A}_{s,\theta}$  does not depend on  $s$ .

The proof of this result uses a perturbation result whose proof can be found in [Kat13, Theorem V.4.10]. The Hausdorff distance between two sets  $\Lambda_1, \Lambda_2 \in \mathbb{R}$  is defined by

$$\text{dist}_{\mathcal{H}}(\Lambda_1, \Lambda_2) := \max \left\{ \sup_{\lambda_1 \in \Lambda_1} \text{dist}(\lambda_1, \Lambda_2), \sup_{\lambda_2 \in \Lambda_2} \text{dist}(\lambda_2, \Lambda_1) \right\}, \quad (\text{A.4})$$

where  $\text{dist}(\xi, \Lambda) := \inf_{\lambda \in \Lambda} |\lambda - \xi|$  represents the distance from  $\xi \in \mathbb{R}$  to  $\Lambda \subset \mathbb{R}$ .

### Lemma A.3

Consider a self-adjoint operator  $B$  and a bounded symmetric operator  $T$ . Then  $B + T$  is also self-adjoint and  $\text{dist}_{\mathcal{H}}(\sigma(B + T), \sigma(B)) \leq \|T\|$ .

Now, let us prove Proposition A.2.

**Proof** (of Proposition A.2). Since  $\mathcal{A}_{s,\theta}$  is self-adjoint and positive, we can introduce the resolvent operator  $\mathcal{R}_{s,\theta} := (\mathcal{A}_{s,\theta} + 1)^{-1} \in \mathcal{L}(L^2(\mathbb{R}))$  for any  $s \in \mathbb{R}$ . Contrary to  $\mathcal{A}_{s,\theta}$ ,  $\mathcal{R}_{s,\theta}$  has the advantage to be *bounded*, hence allowing us to use the perturbation theorem stated in Lemma A.3. Furthermore, the spectra of  $\mathcal{R}_{s,\theta}$  and  $\mathcal{A}_{s,\theta}$  are related by the following characterization:

$$\lambda \in \sigma(\mathcal{A}_{s,\theta}) \iff \frac{1}{\lambda + 1} \in \sigma(\mathcal{R}_{s,\theta}). \quad (\text{A.5})$$

Therefore, proving Proposition A.2 is equivalent to proving that  $\sigma(\mathcal{R}_{s,\theta})$  does not depend on  $s$ . The idea to do so will be to show that  $s \mapsto \sigma(\mathcal{R}_{s,\theta})$  defines a (uniformly) continuous mapping (with respect to the Hausdorff distance) which is both 1-periodic and  $\delta$ -periodic. Since  $\delta$  is irrational, it will then follow from Kronecker's approximation theorem II-2.8 for instance that  $s \mapsto \sigma(\mathcal{R}_{s,\theta})$  is constant.

**Step 1 : Continuity of  $s \mapsto \sigma(\mathcal{R}_{s,\theta})$**  — Fix  $s, t \in \mathbb{R}$ , and let  $f \in L^2(\mathbb{R})$ . We can introduce the functions  $u_s, u_t \in D(\mathcal{A}_{s,\theta}) \equiv D(\mathcal{A}_{t,\theta})$  defined by

$$u_s := \mathcal{R}_{s,\theta} f \quad \text{and} \quad u_t := \mathcal{R}_{t,\theta} f.$$

By subtracting the variational formulations satisfied by  $u_s$  and  $u_t$ , we obtain

$$\begin{aligned} \forall v \in H^1(\mathbb{R}), \quad & \int_{\mathbb{R}} \mu_{s,\theta} \frac{d}{dx} (u_s - u_t) \frac{d\bar{v}}{dx} + \rho_{s,\theta} (u_s - u_t) \bar{v} \, dx \\ & = - \int_{\mathbb{R}} (\mu_{s,\theta} - \mu_t) \frac{du_t}{dx} \frac{d\bar{v}}{dx} - \int_{\mathbb{R}} (\rho_{s,\theta} - \rho_{t,\theta}) u_t \bar{v} + \int_{\mathbb{R}} (\rho_{s,\theta} - \rho_{t,\theta}) f \bar{v}. \end{aligned}$$

Now let us choose  $v = u_s - u_t$  in this equality. By using the boundedness of  $\rho_{s,\theta}$  and  $\mu_{s,\theta}$  from below on the left side as well as the Cauchy-Schwarz inequality on the right side, and by dividing both sides by  $\|u_s - u_t\|_{H^1(\mathbb{R})}$ , we obtain the existence of a constant  $c_1 > 0$  such that

$$c_1 \|u_s - u_t\|_{H^1(\mathbb{R})} \leq (\|\mu_s - \mu_{t,\theta}\|_{L^\infty(\mathbb{R})} + \|\rho_{s,\theta} - \rho_{t,\theta}\|_{L^\infty(\mathbb{R})}) \|u_t\|_{H^1(\mathbb{R})} + \|\rho_{s,\theta} - \rho_{t,\theta}\|_{L^\infty(\mathbb{R})} \|f\|_{L^2(\mathbb{R})}.$$

Furthermore, the fact that  $-1 \notin \sigma(\mathcal{A}_{t,\theta})$  (or equivalently the application of Lax-Milgram's theorem) leads to the estimate  $\|u_t\|_{H^1(\mathbb{R})} \leq c_2 \|f\|_{L^2(\mathbb{R})}$ , where  $c_2$  depends only on  $\rho_{\pm}$ . Consequently, there exists a constant  $c > 0$  such that

$$\|(\mathcal{R}_{s,\theta} - \mathcal{R}_{t,\theta}) f\|_{H^1(\mathbb{R})} = \|u_s - u_t\|_{H^1(\mathbb{R})} \leq c \|f\|_{L^2(\mathbb{R})} (\|\mu_s - \mu_{t,\theta}\|_{L^\infty(\mathbb{R})} + \|\rho_{s,\theta} - \rho_{t,\theta}\|_{L^\infty(\mathbb{R})}).$$

The advantage of working with the resolvent operator lies in the fact that  $\mathcal{R}_{s,\theta} - \mathcal{R}_{t,\theta}$  is *bounded*. This allows one to apply directly Lemma A.3 to  $B := \mathcal{R}_{t,\theta}$  and  $T := \mathcal{R}_{s,\theta} - \mathcal{R}_{t,\theta}$ , and to derive from the above that

$$\forall s, t \in \mathbb{R}, \quad \text{dist}_{\mathcal{H}}[\sigma(\mathcal{R}_{s,\theta}), \sigma(\mathcal{R}_{t,\theta})] \leq \|\mathcal{R}_{s,\theta} - \mathcal{R}_{t,\theta}\| \leq c (\|\mu_s - \mu_{t,\theta}\|_{L^\infty(\mathbb{R})} + \|\rho_{s,\theta} - \rho_{t,\theta}\|_{L^\infty(\mathbb{R})}).$$

But, as the functions  $\rho_p$  and  $\mu_p$  are continuous and 1-periodic in each direction, it follows from Heine's theorem that they are uniformly continuous. Therefore, the previous estimate implies in particular the (uniform) continuity of the mapping  $s \mapsto \sigma(\mathcal{R}_{s,\theta})$ , which can be expressed as follows:

$$\forall (s_n)_n \in \mathbb{R}^{\mathbb{N}}, \quad \forall s \in \mathbb{R}, \quad |s_n - s| \rightarrow 0 \implies \text{dist}_{\mathcal{H}}[\sigma(\mathcal{R}_{\theta,s_n}), \sigma(\mathcal{R}_{s,\theta})] \rightarrow 0, \quad n \rightarrow +\infty. \quad (\text{A.6})$$

**Step 2** — Since  $\mathcal{A}_{s+1,\theta} = \mathcal{A}_{s,\theta}$ , it is obvious that  $\sigma(\mathcal{A}_{s+1,\theta}) = \sigma(\mathcal{A}_{s,\theta})$ . Furthermore, according to Lemma A.1,  $\mathcal{A}_{s,\theta}$  and  $\mathcal{A}_{s+\delta,\theta}$  are equivalent for any  $s \in \mathbb{R}$ . Thus, they have the same spectrum, i.e.  $\sigma(\mathcal{A}_{s,\theta}) = \sigma(\mathcal{A}_{s+\delta,\theta})$ . These observations, combined with the link (A.5) between  $\sigma(\mathcal{A}_{s,\theta})$  and  $\sigma(\mathcal{R}_{s,\theta})$ , implies that  $s \mapsto \sigma(\mathcal{R}_{s,\theta})$  is both 1 and  $\delta$ -periodic, that is,

$$\forall s \in \mathbb{R}, \quad \forall (k, \ell) \in \mathbb{Z} \times \mathbb{N}, \quad \sigma(\mathcal{R}_{\theta,s+\ell\delta+k}) = \sigma(\mathcal{R}_{s,\theta}). \quad (\text{A.7})$$

But since  $\delta$  is irrational, Kronecker's theorem states that  $\mathbb{N}\delta + \mathbb{Z}$  is dense in  $\mathbb{R}$ . In particular,

$$\forall s, t \in \mathbb{R}, \quad \exists (k_n, \ell_n) \in (\mathbb{Z} \times \mathbb{N})^{\mathbb{N}}, \quad |\ell_n \delta + k_n + s - t| \rightarrow 0, \quad n \rightarrow +\infty. \quad (\text{A.8})$$

Now let  $s, t \in \mathbb{R}$ , and pick a sequence  $(k_n, \ell_n) \in (\mathbb{Z} \times \mathbb{N})^{\mathbb{N}}$  such that (A.8) is satisfied. From (A.7) and from the continuity (A.6) of  $s \mapsto \sigma(\mathcal{R}_{s,\theta})$ , we deduce the following

$$\text{dist}_{\mathcal{H}}[\sigma(\mathcal{R}_{s,\theta}), \sigma(\mathcal{R}_{t,\theta})] = \text{dist}_{\mathcal{H}}[\sigma(\mathcal{R}_{\theta,s+\ell_n\delta+k_n}), \sigma(\mathcal{R}_{t,\theta})] \rightarrow 0, \quad n \rightarrow +\infty,$$

which implies that  $\text{dist}_{\mathcal{H}}[\sigma(\mathcal{R}_{s,\theta}), \sigma(\mathcal{R}_{t,\theta})] = 0$ , or equivalently that  $\sigma(\mathcal{R}_{s,\theta}) = \sigma(\mathcal{R}_{t,\theta})$ . ■

Let us now study the family of operators  $\mathcal{A}_p(\xi)$  with  $\xi \in ]-\pi, \pi]$ . They are linked to one another as follows.

#### Lemma A.4

Let  $\xi \in (-\pi, \pi]$  and  $T_{\mathbf{k}}$  be the multiplication operator defined by

$$\forall \mathbf{k} := (k_1, k_2) \in \mathbb{Z}^2, \quad \forall u \in L^2((0, 1)^2), \quad T_{\mathbf{k}} u(\mathbf{y}) := e^{2i\pi \mathbf{k} \cdot \mathbf{y}} u(\mathbf{y}), \quad \text{a. e. } \mathbf{y} \in (0, 1)^2.$$

Then we have the identity

$$(T_{\mathbf{k}})^{-1} \mathcal{A}_p(\xi) T_{\mathbf{k}} = \mathcal{A}_p(\xi + 2\pi(k_1\delta + k_2)). \quad (\text{A.9})$$

**Proof.** Let us remark that if  $u \in D(\mathcal{A}_p(\xi))$  then  $T_{\mathbf{k}}u \in D(\mathcal{A}_p(\xi))$  where we recall that  $D(\mathcal{A}_p(\xi))$  is independent of  $\xi$ . Moreover, for any  $u \in D(\mathcal{A}_p(\xi))$

$$(D_{\theta} + i\xi\theta_2)(T_{\mathbf{k}}u)(\mathbf{y}) = ((2i\pi \mathbf{k} \cdot \theta + i\xi\theta_2) u(\mathbf{y}) + D_{\theta} u(\mathbf{y})) e^{2i\pi \mathbf{k} \cdot \mathbf{y}}, \quad \text{a. e. } \mathbf{y} \in (0, 1)^2$$

which implies that

$$\mathcal{A}_p(\xi) (T_{\mathbf{k}}u) = T_{\mathbf{k}} (\mathcal{A}_p(\xi + 2\pi(k_1\delta + k_2)) u),$$

which is the expected identity. ■

We can now show the following result, namely Proposition 5.2.

**Proposition A.5**

*If  $\delta$  is irrational, then the spectrum of  $\mathcal{A}_p(\xi)$  does not depend on  $\xi$ .*

**Proof.** The proof is really similar to the one of Proposition A.5. We first show that

$$\xi \mapsto \mathcal{R}_p(\xi) := (\mathcal{A}_p(\xi) + 1)^{-1} \text{ is continuous in operator norm,}$$

which implies that  $\xi \mapsto \sigma(\mathcal{A}_p(\xi))$  is continuous for the Hausdorff distance. Lemma A.4 implies that

$$\forall \xi \in (-\pi, \pi], \quad \forall (k_1, k_2) \in \mathbb{Z}^2, \quad \sigma(\mathcal{A}_p(\xi)) = \sigma(\mathcal{A}_p(\xi + 2\pi(k_1\delta + k_2))).$$

Since  $\delta \in \mathbb{R} \setminus \mathbb{Q}$ , it then follows that  $\xi \mapsto \sigma(\mathcal{A}_p(\xi))$  is independent of  $\xi$ . ■





# Transmission between periodic half-spaces: Model configurations

## Outline

---

1	Introduction . . . . .	144
2	Problem setting . . . . .	146
2.1	The transmission problem . . . . .	146
2.2	Two specific configurations . . . . .	147
3	The lifting procedure . . . . .	149
3.1	A hidden quasiperiodicity along the interface . . . . .	149
3.1.a	Extension for Configuration ( $\mathcal{A}$ ) . . . . .	149
3.1.b	Extension for Configuration ( $\mathcal{B}$ ) . . . . .	150
3.2	Formal presentation of the lifting approach . . . . .	151
4	Functional framework . . . . .	153
4.1	Anisotropic spaces of $\mathbb{Z}e_2$ -periodic functions . . . . .	154
4.2	Trace operator on transverse interfaces . . . . .	158
4.3	Normal trace operator and Green's formula for a strip . . . . .	159
4.4	Subspaces of $\mathbb{Z}e_1 + \mathbb{Z}e_2$ -periodic functions in a cylinder . . . . .	162
5	The solution of the augmented periodic problem . . . . .	164
5.1	The augmented strip problem and its quasi-2D structure . . . . .	164
5.2	Reduction to waveguide problems via the Floquet-Bloch transform . . . . .	168
5.2.a	The 1D Floquet-Bloch transform . . . . .	168
5.2.b	The partial Floquet-Bloch transform with respect to $z_1$ . . . . .	169
5.2.c	Application to the augmented strip problem . . . . .	170
5.3	The waveguide problem . . . . .	171
5.4	The half-guide problems . . . . .	172
5.4.a	Structure of the half-guide solution . . . . .	173
5.4.b	Local cell problems . . . . .	174
5.4.c	Characterization of the propagation operator via a Riccati equation . . . . .	175
6	Resolution algorithm and discretization . . . . .	176
6.1	Discretization issues . . . . .	176
6.1.a	Discretization with respect to the Floquet variable . . . . .	176
6.1.b	Semi-discretization with respect to the spatial variable . . . . .	177
6.2	A quasi-2D idea for resolution of the local cell problems . . . . .	178

	6.2.a	Illustration of the method in a 2D case . . . . .	179
	6.2.b	Extension to the 3D local cell problems . . . . .	180
7		Numerical results . . . . .	184
	7.1	Validation in the homogeneous setting . . . . .	185
	7.2	Validation in the rational setting . . . . .	186
	7.3	Validation and results in the irrational setting . . . . .	187
8		An alternative approach for Configuration ( $\mathcal{A}$ ) . . . . .	189
	8.1	Presentation . . . . .	190
		8.1.a The half-space problems . . . . .	190
		8.1.b Characterization of the DtN operators . . . . .	191
		8.1.c Truncation of the interface equation . . . . .	191
	8.2	The algorithm and its discretization . . . . .	193
	8.3	A qualitative validation . . . . .	194
A		Proof of Proposition 5.5 . . . . .	195

## 1 Introduction

This chapter is devoted to time-harmonic wave propagation in presence of two periodic half-spaces, as shown in Figure 1. This configuration, which arises for instance when studying diffraction at the surface of a photonic crystal, has been studied in [FCB10] where, in the spirit of [Fli09; FJ09; Bes+13], computations have been restricted to the interface between the two half-spaces by means of Dirichlet-to-Neumann (DtN) operators. The method however relies on the crucial assumption that the overall medium stays periodic in the direction of the interface, with commensurate periods on both sides. This is in fact needed in order to apply a Floquet-Bloch transform with respect to the variable along the interface, leading to a family of closed waveguide problems parameterized by the Floquet variable.

Our goal is to extend the method in [FCB10] to the case where the global medium is no longer periodic in the direction of the interface. We shall use the key (but non-obvious) observation that the medium has a *quasiperiodic* structure along the interface, namely, it is the restriction of a higher dimensional periodic structure. Accordingly, the idea is to interpret the partial differential equation (PDE) to be solved in presence of this medium as the “restriction” of an augmented PDE in higher dimensions, where periodicity along the interface is recovered. This so-called *lifting approach* allows one to adapt the ideas in [FCB10], but comes with the price that the augmented equation is degenerate (in the sense of the principal part of its differential operator), and therefore more complicated to analyse and approximate.

To our knowledge, it seems that the lifting approach has never been used for the study or the simulation of wave propagation in periodic half-spaces. It is our aim to do so.

In this chapter, a resolution procedure is developed for two specific transmission settings involving media that are periodic in 2 directions:

1. the case where both media are periodic along the interface, but with non-commensurate periods;
2. the case where one medium is constant while the other one is not periodic in the direction of the interface.

The common point between these two configurations is that they can be lifted into 3–dimensional structures, as it will be explicitly emphasized in Section 3.1. For the more general setting represented in Figure 1, the lifting process can still be used, but it is often impossible to find an augmented structure whose dimension is less than 5. The treatment of this setting is presented in Chapter VI.

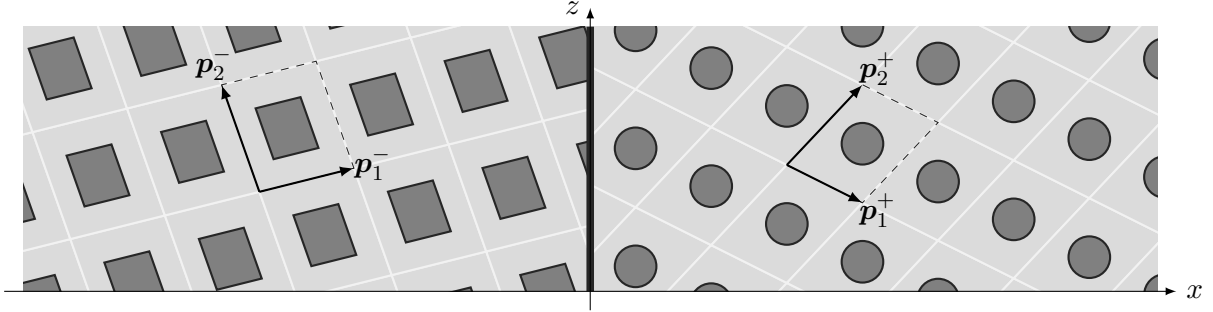

Figure 1: Juxtaposition of arbitrary periodic half-spaces

The chapter is structured as follows. In Section 2, the model problem is introduced together with the studied configurations. We show in Section 3 that these configurations can be lifted into 3D structures in order to recover periodicity along the interface, allowing us to lift the model problem into a 3D augmented problem. In Section 4, we set up the appropriate functional framework for the analysis of the augmented 3D problem. This problem is then solved in Section 5 using the Floquet-Bloch transform and the DtN approach presented in Chapter III. After describing the discretization process in Section 6, we provide some numerical results in Section 7 to illustrate the efficiency of the method. Finally, in Section 8, an alternative to the lifting approach is proposed for one of the studied configurations.

### Notation.

(1). Given  $n > 0$ , for  $\mathbf{y} = (y_1, \dots, y_n)$  and  $\mathbf{z} = (z_1, \dots, z_n)$  in  $\mathbb{R}^n$ , the Euclidean inner product between  $\mathbf{y}$  and  $\mathbf{z}$  is denoted by  $\mathbf{y} \cdot \mathbf{z} := y_1 z_1 + \dots + y_n z_n$ , and the associated norm is given by  $|\mathbf{y}|^2 := \mathbf{y} \cdot \mathbf{y}$ .

(2). For  $n > 0$ , we define

$$\mathbb{R}_{\pm}^n := \{(y_1, \dots, y_n) \in \mathbb{R}^n / \pm y_1 > 0\}. \quad (1.1)$$

We use the notation  $\mathcal{O}_{\nu} \subset \mathbb{R}^n$ ,  $\nu \in \{\emptyset, +, -\}$  to refer to any triple of the form  $\{\mathcal{O}, \mathcal{O}_+, \mathcal{O}_-\}$ , with the convention that  $\mathcal{O}_{\nu} = \mathcal{O}$  for  $\nu = \emptyset$ .

(3). The indicator function of an open set  $\mathcal{O} \subset \mathbb{R}^n$  is denoted by  $\mathbf{1}_{\mathcal{O}}$ .

(4). Given  $\mathbf{p}_1, \mathbf{p}_2 \in \mathbb{R}^2$ , we denote by  $\mathbb{Z}\mathbf{p}_1 + \mathbb{Z}\mathbf{p}_2$  the lattice  $\mathbb{Z}\mathbf{p}_1 + \mathbb{Z}\mathbf{p}_2 := \{n_1 \mathbf{p}_1 + n_2 \mathbf{p}_2 / n_1, n_2 \in \mathbb{Z}\}$ . Similarly, for  $\mathbf{p}_1, \mathbf{p}_2, \mathbf{p}_3 \in \mathbb{R}^3$ , we set  $\mathbb{Z}\mathbf{p}_1 + \mathbb{Z}\mathbf{p}_2 + \mathbb{Z}\mathbf{p}_3 = \{n_1 \mathbf{p}_1 + n_2 \mathbf{p}_2 + n_3 \mathbf{p}_3 / n_1, n_2, n_3 \in \mathbb{Z}\}$ .

(5). For  $\mathcal{O} \subset \mathbb{R}^n$ , the scalar product on  $L^2(\mathcal{O})$  is denoted by  $(\cdot, \cdot)_{L^2(\mathcal{O})}$ . We denote by  $\langle \cdot, \cdot \rangle_{\partial\mathcal{O}}$  the duality product between  $H^{-1/2}(\partial\mathcal{O})$  and  $H^{1/2}(\partial\mathcal{O})$ .

(6). Given two Banach spaces  $\mathcal{X}_1$  and  $\mathcal{X}_2$ , the space of bounded linear operators from  $\mathcal{X}_1$  to  $\mathcal{X}_2$  is denoted by  $\mathcal{L}(\mathcal{X}_1, \mathcal{X}_2)$ . We set  $\mathcal{L}(\mathcal{X}) := \mathcal{L}(\mathcal{X}, \mathcal{X})$ .

## 2 Problem setting

In this section, we introduce the model problem and the configurations that will be studied throughout the chapter. A generic point in  $\mathbb{R}^2$  is denoted by  $\mathbf{x} = (x, z)$ , and will be viewed as a column vector when there is no ambiguity. The canonical basis of  $\mathbb{R}^2$  is  $(\mathbf{e}_x, \mathbf{e}_z)$ , where  $\mathbf{e}_x := (1, 0)$  and  $\mathbf{e}_z := (0, 1)$ .

### 2.1 The transmission problem

Let  $\sigma := \{\mathbf{x} = (x, z) \in \mathbb{R}^2 / x = 0\}$  denote the interface between the half-spaces  $\mathbb{R}_+^2$  and  $\mathbb{R}_-^2$ . The model problem consists in finding  $u \in H^1(\mathbb{R}^2)$  such that

$$\begin{cases} -\operatorname{div} \mathbb{A} \nabla u - \rho \omega^2 u = 0 & \text{in } \mathbb{R}_+^2 \cup \mathbb{R}_-^2, \\ \llbracket \mathbb{A} \nabla u \cdot \mathbf{e}_x \rrbracket_\sigma = g & \text{on } \sigma, \end{cases} \quad (\mathcal{P})$$

where the presence of some (arbitrarily small) absorption is assumed (see Remark 2.1.b); namely

$$\text{the frequency } \omega \text{ satisfies } \Im \omega > 0. \quad (2.1)$$

The overall medium is modeled by the coefficient  $\rho \in L^\infty(\mathbb{R}^2)$  and the tensor  $\mathbb{A} \in L^\infty(\mathbb{R}^2; \mathbb{R}^{2 \times 2})$  which is assumed to be symmetric. We also assume the existence of constants  $a, r \in \mathbb{R}$  such that

$$\forall \mathbf{x}, \boldsymbol{\xi} \in \mathbb{R}^2, \quad 0 < a |\boldsymbol{\xi}|^2 \leq {}^t \boldsymbol{\xi} \mathbb{A}(\mathbf{x}) \boldsymbol{\xi} \quad \text{and} \quad 0 < r \leq \rho(\mathbf{x}). \quad (2.2)$$

Moreover,  $\llbracket \mathbf{w} \cdot \mathbf{e}_x \rrbracket_\sigma$  denotes the jump across  $\sigma$  of the normal components of a function  $\mathbf{w} \in L^2(\mathbb{R}^2)$  such that  $\mathbf{w}|_{\mathbb{R}_\pm^2} \in H(\operatorname{div}, \mathbb{R}_\pm^2)$ :

$$\llbracket \mathbf{w} \cdot \mathbf{e}_x \rrbracket_\sigma := (\mathbf{w}^- \cdot \mathbf{e}_x)|_\sigma - (\mathbf{w}^+ \cdot \mathbf{e}_x)|_\sigma, \quad \text{with } \mathbf{w}^\pm := \mathbf{w}|_{\mathbb{R}_\pm^2}, \quad (2.3)$$

and  $g \in H^{-1/2}(\sigma)$  is a given boundary data.

**Remark 2.1.** (a). *The approach developed in this chapter can be extended to the classical Helmholtz equation  $-\operatorname{div} \mathbb{A} \nabla u_0 - \rho \omega^2 u_0 = f$  in  $\mathbb{R}^2$  with a volume source term  $f \in L^2(\mathbb{R}^2)$  with a compact support in the  $x$ -direction.*

(b). *For real-valued frequencies  $\omega$ , it is delicate to define the physical outgoing solution of  $(\mathcal{P})$ . In fact, one expects that this solution may not belong to  $H^1(\mathbb{R}^2)$ , whereas uniqueness of a solution in  $H_{\text{loc}}^1(\mathbb{R}^2)$  does not hold in general. This is well-known in the “homogeneous case”, that is, when  $\mathbb{A}$  and  $\rho$  are constant. In the homogeneous case, for a compactly supported source term, uniqueness is recovered by adding the Sommerfeld radiation condition [Som12]. However, to our knowledge, such a radiation condition is not known in presence of unbounded periodic media.*

*The classical tool to define the physical solution is the limiting absorption principle, which consists in (1) adding an imaginary part to  $\omega$  (called absorption), and in (2) studying the limit process as  $\Im \omega \rightarrow 0$ . The limiting absorption principle is well-established for time-harmonic wave propagation problems in unbounded media that are homogeneous or stratified outside a bounded domain; see for instance [Wil66; Agm75; Eid86]. More recently, it has been successfully applied to periodic closed waveguides [Fli09; Hoa11; FJ16; FJL21], periodic layers [KL18a; KL18b; Kir22], and to  $n$ -dimensional fully periodic media with  $n \geq 2$  [MT06; Rad15]. However, as far as we know, there is no complete answer for transmission problems between periodic half-spaces. This is the reason why we assume the presence (2.1) of some absorption, which is an essential step in understanding the non-absorbing case.*

Under Assumptions (2.1) and (2.2), it follows from Lax-Milgram's theorem that Problem ( $\mathcal{P}$ ) admits a unique solution  $u \in H^1(\mathbb{R}^2)$ . Moreover, if  $g \in L^2(\sigma)$  is compactly supported, then, a Combes-Thomas estimate [CT73] allows to prove that this solution decays exponentially at infinity in all directions, namely

$$\exists c, \alpha > 0, \quad \left\| u \exp(\alpha \Im \omega |\mathbf{x}|) \right\|_{H^1(\mathbb{R}^2)} \leq c \|g\|_{H^{-1/2}(\sigma)}. \quad (2.4)$$

A naive approach relying on this decay estimate would then consist in truncating the computational domain at a certain distance related to  $\Im \omega$ , with homogeneous Dirichlet boundary conditions for instance. However the accuracy of such a method is prone to deterioration as  $\Im \omega \rightarrow 0$ . Worse, if  $g$  is not compactly supported, then only the exponential decay in the direction normal to the interface is guaranteed:

$$\exists c, \alpha > 0, \quad \left\| u \exp(\alpha \Im \omega |x|) \right\|_{H^1(\mathbb{R}^2)} \leq c \|g\|_{H^{-1/2}(\sigma)}. \quad (2.5)$$

Our goal is to develop for the transmission configurations that are presented in the next section a numerical method that allows to deal with the unboundedness of the domain, and which we hope will remain robust as  $\Im \omega$  tends to 0.

## 2.2 Two specific configurations

We assume that  $\mathbb{A}$  and  $\rho$  can be written as:

$$\text{a. e. } \mathbf{x} = (x, z) \in \mathbb{R}^2, \quad \mathbb{A}(\mathbf{x}) := \begin{cases} \mathbb{A}^-(\mathbf{x}) & \text{if } x < 0 \\ \mathbb{A}^+(\mathbf{x}) & \text{if } x > 0 \end{cases} \quad \text{and} \quad \rho(\mathbf{x}) := \begin{cases} \rho^-(\mathbf{x}) & \text{if } x < 0 \\ \rho^+(\mathbf{x}) & \text{if } x > 0, \end{cases} \quad (2.6)$$

where  $\mathbb{A}^\pm \in \mathcal{C}^0(\mathbb{R}^2; \mathbb{R}^{2 \times 2})$ ,  $\rho^\pm \in \mathcal{C}^0(\mathbb{R}^2)$ . We consider two specific classes of functions  $(\mathbb{A}^\pm, \rho^\pm)$ . (See also Remark 2.4.)

### 1. Configuration ( $\mathcal{A}$ ) — *The media are periodic along the interface*

This setting consists in  $\mathbb{A}^\pm$  and  $\rho^\pm$  being  $\mathbb{Z}e_x + \mathbb{Z}(p_z^\pm e_z)$ -periodic for some numbers  $p_z^\pm \neq 0$ , that is,

$$\forall \mathbf{x} \in \mathbb{R}^2, \quad \begin{aligned} \mathbb{A}^\pm(\mathbf{x} + e_x) &= \mathbb{A}^\pm(\mathbf{x}) & \text{and} & & \mathbb{A}^\pm(\mathbf{x} + p_z^\pm e_z) &= \mathbb{A}^\pm(\mathbf{x}), \\ \rho^\pm(\mathbf{x} + e_x) &= \rho^\pm(\mathbf{x}) & \text{and} & & \rho^\pm(\mathbf{x} + p_z^\pm e_z) &= \rho^\pm(\mathbf{x}). \end{aligned} \quad (2.7)$$

This is illustrated in Figure 2.

#### Remark 2.2.

(a). *If the ratio  $p_z^+/p_z^-$  is a rational number that can be written as  $k/\ell$  for some coprime  $(k, \ell) \in \mathbb{Z} \times \mathbb{N}^*$ , then  $(\mathbb{A}^+, \rho^+)$  and  $(\mathbb{A}^-, \rho^-)$  share a common period  $\tau := \ell p_z^+ = k p_z^-$  in the  $e_z$ -direction. It follows that the overall medium represented by  $(\mathbb{A}, \rho)$  is tangentially periodic, that is, periodic in the  $e_z$ -direction. Hence, as done in [FCB10], a Floquet-Bloch transform can be applied with respect to the variable  $z$  along the interface, reducing ( $\mathcal{P}$ ) to a family of waveguide problems set in  $\mathbb{R} \times (0, \tau)$ , and parameterized by the Floquet variable. However, this method becomes more costly as the denominator of  $p_z^+/p_z^-$ , and thus the period  $\tau$  increases.*

(b). *When  $p_z^+/p_z^-$  is irrational, the method in [FCB10] cannot be applied directly because  $\mathbb{A}$  and  $\rho$  are no longer periodic along the interface. In this case, one might be tempted to construct a rational approximation  $(k_n/\ell_n)_n$  of  $p_z^+/p_z^-$ , and to compute with [FCB10] the solution  $u_n$  of ( $\mathcal{P}$ ), obtained by replacing  $p_z^+/p_z^-$  by  $k_n/\ell_n$  for  $n$  large enough.*

*However, in addition to the theoretical questions that such a strategy raises (regarding for instance*

the convergence of  $(u_n)_n$  to  $u$ ), there are some numerical drawbacks. In fact, for a sequence of rationals  $(k_n/\ell_n)_n$  to converge to an irrational  $p_z^+/p_z^-$ , the sequence of denominators  $(\ell_n)_n$  must tend to infinity. Therefore, as explained in the first point, computational costs would inevitably increase with the periods  $(\tau_n)_n$  as  $(k_n/\ell_n)_n$  tends to  $p_z^+/p_z^-$ . Furthermore, the approximation quality would be strongly related to the irrationality measure of  $p_z^+/p_z^-$ , which indicates how efficiently it can be approximated by rational numbers. More detail about this last aspect on rational approximation can be found in Section II-3.2.

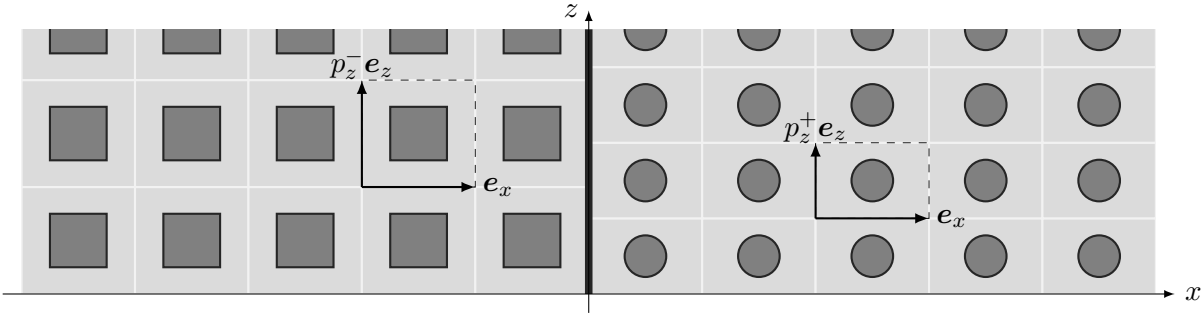

Figure 2: Configuration (A): Juxtaposition of two media that are periodic along the interface

## 2. Configuration (B) — Junction of a homogeneous medium and a periodic one

This corresponds to the case where  $\mathbb{A}^-$  and  $\rho^-$  are constant while  $\mathbb{A}^+$  and  $\rho^+$  are  $\mathbb{Z}e_x + \mathbb{Z}\mathbf{p}^+$ -periodic for some vector  $\mathbf{p}^+ = (p_x^+, p_z^+) \in \mathbb{R}^2$  such that  $p_z^+ \neq 0$ : for  $\mathbf{x} \in \mathbb{R}^2$ ,

$$\begin{aligned} \mathbb{A}^-(\mathbf{x}) &\equiv \mathbb{A}^- & \text{and} & & \mathbb{A}^+(\mathbf{x} + \mathbf{e}_x) &= \mathbb{A}^+(\mathbf{x}), & \mathbb{A}^+(\mathbf{x} + \mathbf{p}^+) &= \mathbb{A}^+(\mathbf{x}), \\ \rho^-(\mathbf{x}) &\equiv \rho^- & \text{and} & & \rho^+(\mathbf{x} + \mathbf{e}_x) &= \rho^+(\mathbf{x}), & \rho^+(\mathbf{x} + \mathbf{p}^+) &= \rho^+(\mathbf{x}), \end{aligned} \quad (2.8)$$

as illustrated in Figure 3.

**Remark 2.3.** Note that  $p_z^+ \mathbf{e}_z = \mathbf{p}^+ - p_x^+ \mathbf{e}_x$ . Therefore if  $p_x^+$  is rational with the irreducible form  $k/\ell$ ,  $(k, \ell) \in \mathbb{Z} \times \mathbb{N}^*$ , then  $\ell p_z^+ \mathbf{e}_z = \ell \mathbf{p}^+ - k \mathbf{e}_x$  and thus  $(\mathbb{A}^+, \rho^+)$  are  $\tau$ -periodic in the  $\mathbf{e}_z$ -direction with  $\tau := \ell p_z^+$ . Conversely, if  $p_x^+$  is irrational, then the medium is no longer periodic in the direction of the interface. In that regard, Remark 2.2 translates to Configuration (B) when  $p_z^+/p_z^-$  is replaced by  $p_x^+$ .

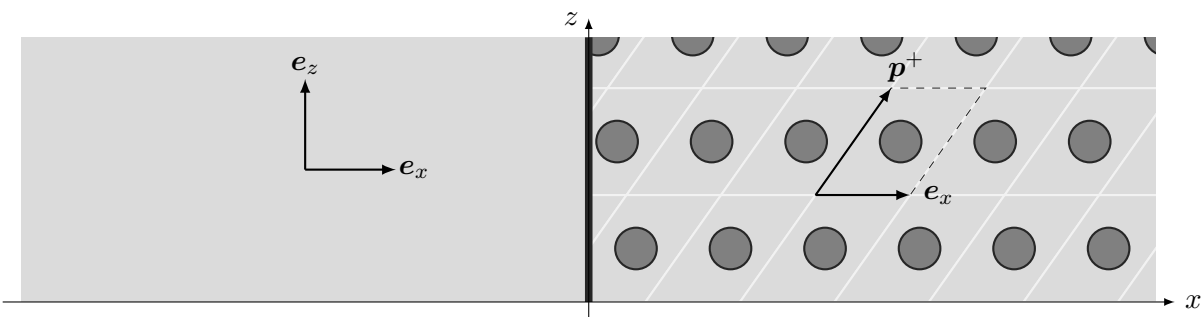

Figure 3: Configuration (B): Juxtaposition of a periodic medium and a homogeneous one

**Remark 2.4.** For both the configurations (A) and (B), the fact that we have assumed one of the periodicity vectors to be  $\mathbf{e}_x$  may seem restrictive. However, this assumption can be made without any loss of generality by means of some geometric transformations, as shown in Chapter VI (see Proposition VI-1.1).

### 3 The lifting procedure

In order to solve  $(\mathcal{P})$ , one has to take a closer look at the structure of the functions  $\mathbb{A}$  and  $\rho$  in the direction of the interface. This *quasiperiodic* structure is the core component of our method.

#### 3.1 A hidden quasiperiodicity along the interface

The goal of this section is to show that the functions  $\mathbb{A}$  and  $\rho$  given by Configurations  $(\mathcal{A})$  and  $(\mathcal{B})$  can be viewed as quasiperiodic along the interface  $\sigma$ , in the sense that they are restrictions to a hyperplane of 3-dimensional functions that are periodic along an interface containing  $\sigma$ . More precisely, we shall prove that

$$\text{a. e. } \mathbf{x} \in \mathbb{R}^2, \quad \mathbb{A}(\mathbf{x}) = \mathbb{A}_p(\Theta \mathbf{x}) \quad \text{and} \quad \rho(\mathbf{x}) = \rho_p(\Theta \mathbf{x}), \quad (3.1a)$$

where  $\mathbb{A}_p$  and  $\rho_p$  are defined for  $\mathbf{x} = (x, z_1, z_2) \in \mathbb{R}^3$  by

$$\mathbb{A}_p(\mathbf{x}) := \begin{cases} \mathbb{A}_p^+(\mathbf{x}), & x > 0 \\ \mathbb{A}_p^-(\mathbf{x}), & x < 0 \end{cases} \quad \text{and} \quad \rho_p(\mathbf{x}) := \begin{cases} \rho_p^+(\mathbf{x}), & x > 0 \\ \rho_p^-(\mathbf{x}), & x < 0 \end{cases} \quad (3.1b)$$

with  $\mathbb{A}_p^\pm, \rho_p^\pm \in \mathcal{C}^0(\mathbb{R}^3)$  which are  $\mathbb{Z}^3$ -periodic. Furthermore, the matrix  $\Theta \in \mathbb{R}^{3 \times 2}$ , which will be referred to as the *cut matrix*, has the following form:

$$\Theta = \begin{pmatrix} 1 & 0 \\ 0 & \theta_1 \\ 0 & \theta_2 \end{pmatrix} \quad \text{with} \quad \theta_1 \neq 0, \quad (3.1c)$$

the exact expression of  $\theta_1$  and  $\theta_2$  depending on the configuration.

Before expliciting the structure (3.1), we introduce some notations. The generic 3-dimensional space variable is denoted by  $\mathbf{x} = (x, z_1, z_2)$ . The canonical basis of  $\mathbb{R}^3$  is  $(\mathbf{e}_x, \mathbf{e}_1, \mathbf{e}_2)$ , where  $\mathbf{e}_x := (1, 0, 0)$ ,  $\mathbf{e}_1 := (0, 1, 0)$ , and  $\mathbf{e}_2 := (0, 0, 1)$ . Finally, let

$$\Sigma := \{\mathbf{x} = (x, z_1, z_2) \in \mathbb{R}^3 / x = 0\} \quad (3.2)$$

denote the interface between  $\mathbb{R}_+^3$  and  $\mathbb{R}_-^3$ .

**3.1.a. Extension for Configuration  $(\mathcal{A})$ .** To find  $(\mathbb{A}_p, \rho_p)$ , the formal idea is to split the tangential variable  $z$  into two variables  $z_1$  and  $z_2$ , where  $z_1$  is associated to the periodicity of the medium in  $\mathbb{R}_+^2$ , and where  $z_2$  is associated to the periodicity of the medium in  $\mathbb{R}_-^2$ . In addition, to ensure that the medium is 1-periodic with respect to  $z_1$  and  $z_2$ , this splitting comes with a rescaling:  $z_1$  will correspond to  $z/p_z^+$ , while  $z_2$  will correspond to  $z/p_z^-$ . This suggests to introduce

$$\begin{aligned} \mathbb{A}_p^+(x, z_1, z_2) &:= \mathbb{A}^+(x, p_z^+ z_1) & \text{and} & & \rho_p^+(x, z_1, z_2) &:= \rho^+(x, p_z^+ z_1) \\ \mathbb{A}_p^-(x, z_1, z_2) &:= \mathbb{A}^-(x, p_z^- z_2) & \text{and} & & \rho_p^-(x, z_1, z_2) &:= \rho^-(x, p_z^- z_2), \end{aligned} \quad (3.3)$$

where  $(\mathbb{A}_p^+, \rho_p^+)$  are 1-periodic in  $x$ , 1-periodic in  $z_1$ , and independent of  $z_2$ , while  $(\mathbb{A}_p^-, \rho_p^-)$  are 1-periodic in  $x$ , independent of  $z_1$ , and 1-periodic in  $z_2$ , as illustrated in Figure 4.

Now we define the extensions  $(\mathbb{A}_p, \rho_p)$  with respect to  $(\mathbb{A}_p^\pm, \rho_p^\pm)$  using (3.1b). Then since  $(\mathbb{A}_p^+, \rho_p^+)$  and



$(\mathbb{A}_p^-, \rho_p^-)$  have the same periods with respect to  $(z_1, z_2)$ , it follows that  $(\mathbb{A}_p, \rho_p)$  are periodic along the interface  $\Sigma$ .

Moreover, it follows from the expression (3.3) of  $\mathbb{A}_p^\pm$  and  $\rho_p^\pm$  that

$$\mathbb{A}^\pm(x, z) = \mathbb{A}_p^\pm(x, p_z^+ z, p_z^- z) \quad \text{and} \quad \rho^\pm(x, z) = \rho_p^\pm(x, p_z^+ z, p_z^- z). \quad (3.4)$$

This corresponds to (3.1a) and (3.1c) with

$$\theta_1 := 1/p_z^+ \neq 0 \quad \text{and} \quad \theta_2 := 1/p_z^- \neq 0. \quad (3.5)$$

Finally, note that  $\Theta \mathbb{R}_\pm^2 \subset \mathbb{R}_\pm^3$  and that  $\Theta \sigma$  is included in the interface  $\Sigma$  defined by (3.2).

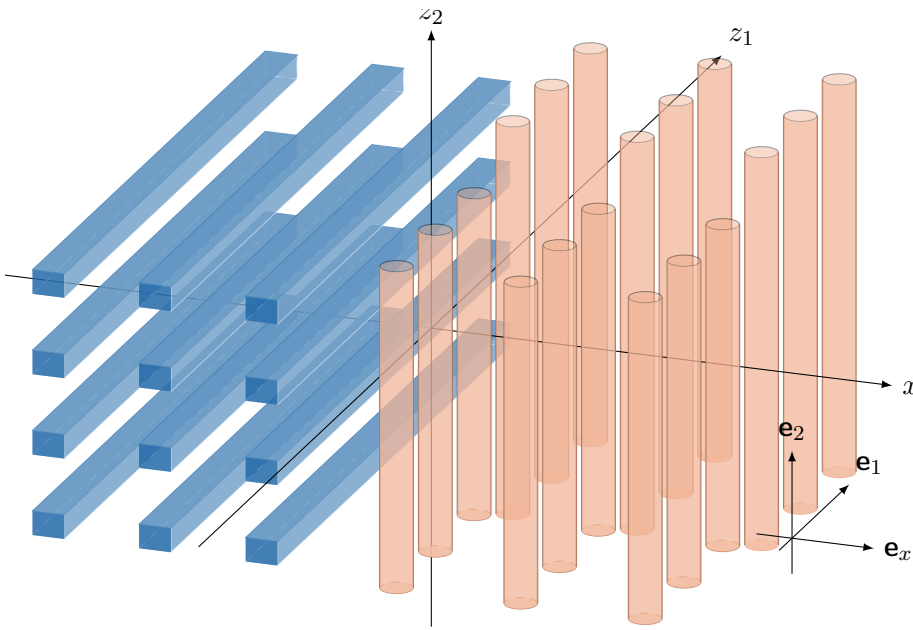

Figure 4: The augmented structure for Configuration (A)

**3.1.b. Extension for Configuration (B).** From the properties (2.8), we shall see that  $\mathbb{A}^+$  admits the expression (3.1a) although it is less obvious. It is useful to “look at  $\mathbb{A}^+$  in the basis  $\{e_x, \mathbf{p}^+\}$ ” by defining

$$\forall (\overset{\circ}{x}, \overset{\circ}{z}) \in \mathbb{R}^2, \quad \overset{\circ}{\mathbb{A}}^+(\overset{\circ}{x}, \overset{\circ}{z}) := \mathbb{A}^+(\overset{\circ}{x} \mathbf{e}_x + \overset{\circ}{z} \mathbf{p}^+) := \mathbb{A}^+(\overset{\circ}{x} + \overset{\circ}{z} p_x^+, \overset{\circ}{z} p_z^+). \quad (3.6)$$

Consider the change of variables

$$\left. \begin{array}{l} \overset{\circ}{x} + p_x^+ \overset{\circ}{z} = x \\ p_z^+ \overset{\circ}{z} = z \end{array} \right\} \iff \left\{ \begin{array}{l} \overset{\circ}{x} = x - (p_x^+/p_z^+) z \\ \overset{\circ}{z} = z/p_z^+, \end{array} \right. \quad (3.7)$$

which is well-defined because  $p_z^+ \neq 0$ . Then (3.6) can be “inverted” as

$$\forall \mathbf{x} = (x, z) \in \mathbb{R}^2, \quad \mathbb{A}^+(\mathbf{x}) = \overset{\circ}{\mathbb{A}}^+(x - (p_x^+/p_z^+) z, z/p_z^+). \quad (3.8)$$

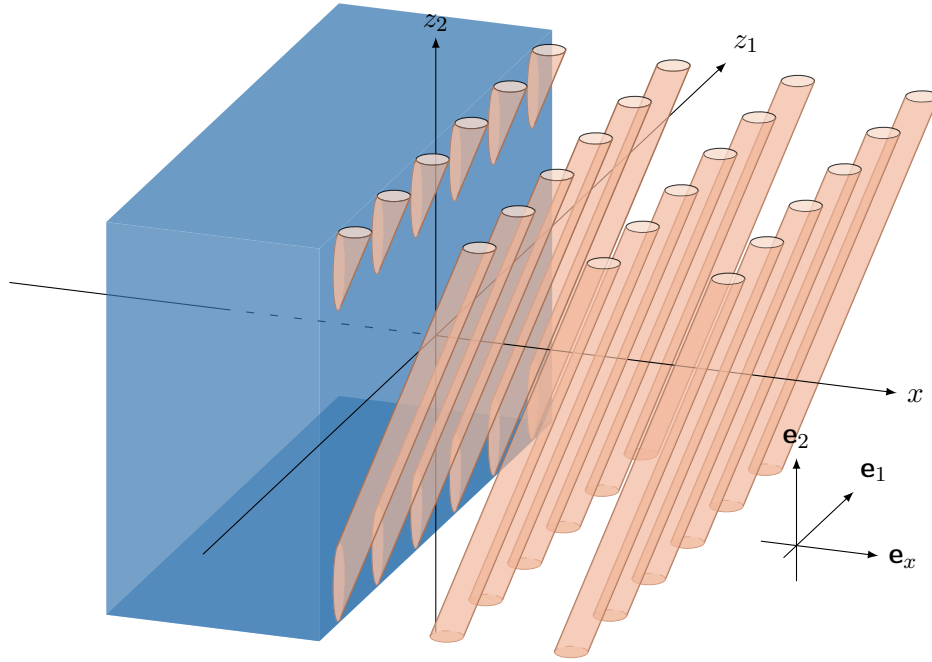
Figure 5: The augmented structure for Configuration ( $\mathcal{B}$ )

From the periodicity properties (2.8) of  $\mathbb{A}^+$ , it follows that  $\mathring{\mathbb{A}}^+$  is 1-periodic with respect to its variables. Thus, by considering  $x$  as a parameter, it is natural to define the function

$$\forall \mathbf{x} = (x, z_1, z_2) \in \mathbb{R}^3, \quad \mathbb{A}_p^+(\mathbf{x}) := \mathring{\mathbb{A}}^+(x + z_2, z_1), \quad (3.9)$$

where  $\mathbb{A}_p^+$  is  $\mathbb{Z}^3$ -periodic, and in particular periodic with respect to the variables  $(z_1, z_2)$  of the interface  $\Sigma$  defined by (3.2). Furthermore, (3.8) becomes

$$\forall \mathbf{x} = (x, z) \in \mathbb{R}^2, \quad \mathbb{A}^+(\mathbf{x}) = \mathbb{A}_p^+(x, z/p_z^+, -(p_x^+/p_z^+)z). \quad (3.10)$$

The same arguments can be applied to  $\rho$ , to define  $\rho_p^+$  similarly to (3.9). In addition,  $\mathbb{A}^-$  and  $\rho^-$  are extended as constant functions over  $\mathbb{R}^3$ . More precisely, we set

$$\forall \mathbf{x} = (x, z_1, z_2) \in \mathbb{R}^3, \quad \mathbb{A}_p^-(\mathbf{x}) := \mathbb{A}^- \quad \text{and} \quad \rho_p^-(\mathbf{x}) := \rho^-, \quad (3.11)$$

and we define  $\mathbb{A}_p$  and  $\rho_p$  as in (3.1b), so that (3.1a) and (3.1c) hold with

$$\theta_1 := 1/p_z^+ \neq 0 \quad \text{and} \quad \theta_2 := -p_x^+/p_z^+. \quad (3.12)$$

Finally, note that  $\Theta \mathbb{R}_{\pm}^2 \subset \mathbb{R}_{\pm}^3$  and that  $\Theta \sigma$  is included in  $\Sigma$ .

### 3.2 Formal presentation of the lifting approach

The quasiperiodic nature of  $\mathbb{A}$  and  $\rho$  (highlighted in Section 3.1) suggests seeking the solution  $u$  of ( $\mathcal{P}$ ) as the restriction of a 3-dimensional function  $U$  along the hyperplane  $\Theta \mathbb{R}^2$ , that is to say:

$$\forall \mathbf{x} \in \mathbb{R}^2, \quad u(\mathbf{x}) = U(\Theta \mathbf{x}). \quad (3.13)$$

The extension  $U$  shall be characterized as the solution of a 3D ‘‘augmented’’ problem with periodic coefficients  $\mathbb{A}_p$  and  $\rho_p$ . In order to construct such a problem for  $U$ , we formally use a chain rule which

enables us to link the partial derivatives of  $u$  with those of  $U$ . Let  $\nabla$  and  $\operatorname{div}$  denote respectively the 3-dimensional gradient and divergence operators:

$$\nabla := \begin{pmatrix} \partial_x \\ \partial_{z_1} \\ \partial_{z_2} \end{pmatrix} \quad \text{and} \quad \operatorname{div} := {}^t \nabla. \quad (3.14)$$

Then given  $F \in \mathcal{C}^\infty(\mathbb{R}^3)$ ,  $\mathbf{W} \in \mathcal{C}^\infty(\mathbb{R}^3)^2$ , for any  $\mathbf{x} \in \mathbb{R}^2$ , one has

$$\begin{aligned} [\nabla F(\Theta \cdot)](\mathbf{x}) &= [{}^t \Theta \nabla F](\Theta \mathbf{x}), & \text{with} \quad {}^t \Theta \nabla &= \begin{pmatrix} \partial_x \\ \theta_1 \partial_{z_1} + \theta_2 \partial_{z_2} \end{pmatrix} \\ [\operatorname{div} \mathbf{W}(\Theta \cdot)](\mathbf{x}) &= [\operatorname{div} \Theta \mathbf{W}](\Theta \mathbf{x}), & \text{with} \quad \operatorname{div}(\Theta \cdot) &= \begin{pmatrix} \partial_x & \theta_1 \partial_{z_1} + \theta_2 \partial_{z_2} \end{pmatrix}. \end{aligned} \quad (3.15)$$

By using the ansatz (3.13) and the derivation rule (3.15) in the volume equation satisfied by  $u$ , we introduce the following:

$$-\operatorname{div} \Theta \mathbb{A}_p {}^t \Theta \nabla U - \rho_p \omega^2 U = 0 \quad \text{in} \quad \mathbb{R}_+^3 \cup \mathbb{R}_-^3. \quad (3.16)$$

In addition, the jump condition ( $\mathcal{P}$ ) on the line  $\sigma$  may be formally lifted into a jump condition on  $\Sigma$ , the interface defined by (3.2), that is,

$$[[(\Theta \mathbb{A}_p {}^t \Theta \nabla U) \cdot \mathbf{e}_x]]_\Sigma = G. \quad (3.17)$$

Here,  $[[\Theta \mathbf{W} \cdot \mathbf{e}_x]]_\Sigma := (\Theta \mathbf{W}^- \cdot \mathbf{e}_x)|_\Sigma - (\Theta \mathbf{W}^+ \cdot \mathbf{e}_x)|_\Sigma$  with  $\mathbf{W}^\pm := \mathbf{W}|_{\mathbb{R}_\pm^3}$  for any  $\mathbf{W} : \mathbb{R}^3 \rightarrow \mathbb{C}$ , and the data  $G : \Sigma \rightarrow \mathbb{C}$  must formally satisfy the following condition

$$\text{a. e. } \mathbf{x} = (x, z) \in \sigma, \quad G(\Theta \mathbf{x}) = g(x), \quad (3.18)$$

by consistency with the jump condition in ( $\mathcal{P}$ ).

It is worth noticing that (3.18) offers some great latitude in choosing  $G$ . If  $g$  is smooth enough, then one obvious pick would be a  $G$  that is constant with respect to  $z_2$ , namely  $G(0, z_1, z_2) := g(0, z_1/\theta_1)$  for  $(z_1, z_2) \in \mathbb{R}^2$ . Although this might be the common choice in practice, we consider the more general class of extensions  $G$  that are roughly speaking 1-periodic with respect to  $z_2$ :

$$\text{a. e. } \mathbf{x} = (x, z_1, z_2) \in \Sigma, \quad \forall n \in \mathbb{Z}, \quad G(\mathbf{x} + n \mathbf{e}_2) = G(\mathbf{x}). \quad (3.19)$$

For such a data  $G$ , since  $\mathbb{A}_p$  and  $\rho_p$  are 1-periodic with respect to  $z_2$ , one can expect  $U$  to be 1-periodic with respect to  $z_2$  as well:

$$\text{a. e. } \mathbf{x} = (x, z_1, z_2) \in \mathbb{R}^3, \quad \forall n \in \mathbb{Z}, \quad U(\mathbf{x} + n \mathbf{e}_2) = U(\mathbf{x}). \quad (3.20)$$

Using these formal considerations,  $U$  can be expressed as the solution of a problem defined in the strip  $\mathbb{R} \times \mathbb{R} \times (0, 1)$ . Before introducing a proper version of this problem, we need to devote the next section to finding a suitable functional framework.

## 4 Functional framework

The advantage of the augmented equation (3.16) lies in its periodic nature, which allows to use tools that are well-suited for periodic PDEs, such as the Floquet-Bloch transform. Nevertheless, a difficulty is that the differential operator  $-\mathbf{div} \Theta \mathbb{A}_p \Theta \nabla$  is elliptically degenerate because the matrix  $\Theta$  given by (3.1c) is of rank 2. More precisely,

$${}^t \xi \Theta \mathbb{A}_p \Theta \xi = 0, \quad \forall \xi \in \text{Span} \begin{pmatrix} 0 \\ -\theta_2 \\ \theta_1 \end{pmatrix}.$$

As a consequence, the properties of (3.16) differ substantially from those of the classical Helmholtz equation given by  $-\mathbf{div} \mathbb{A}_p \nabla U - \rho \omega^2 U = 0$ . In particular, one needs an adapted functional framework that takes the anisotropic nature of (3.16) into account. This is the object of this section, which sets up the framework that will be used afterwards. More precisely, we prove some trace theorems and Green's formulas, which are the anisotropic versions of the classical trace results in Sobolev spaces.

To begin, let us define for any open set  $\mathcal{O} \subset \mathbb{R}^3$  the anisotropic Sobolev spaces

$$H_{\Theta}^1(\mathcal{O}) := \{U \in L^2(\mathcal{O}) / {}^t \Theta \nabla U \in L^2(\mathcal{O})^2\}, \quad (4.1)$$

$$H_{\Theta}(\mathbf{div}; \mathcal{O}) := \{\mathbf{W} \in L^2(\mathcal{O})^2 / \mathbf{div}(\Theta \mathbf{W}) \in L^2(\mathcal{O})\}.$$

These are Hilbert spaces when equipped with the respective scalar products

$$\begin{aligned} \forall U, V \in H_{\Theta}^1(\mathcal{O}), \quad (U, V)_{H_{\Theta}^1(\mathcal{O})} &:= \int_{\mathcal{O}} [U \bar{V} + ({}^t \Theta \nabla U) \cdot ({}^t \Theta \nabla \bar{V})], \\ \forall \mathbf{W}, \widetilde{\mathbf{W}} \in H_{\Theta}(\mathbf{div}; \mathcal{O}), \quad (\mathbf{W}, \widetilde{\mathbf{W}})_{H_{\Theta}(\mathbf{div}; \mathcal{O})} &:= \int_{\mathcal{O}} [\mathbf{W} \cdot \widetilde{\mathbf{W}} + \mathbf{div}(\Theta \mathbf{W}) \mathbf{div}(\Theta \widetilde{\mathbf{W}})]. \end{aligned}$$

Let  $\|\cdot\|_{H_{\Theta}^1(\mathcal{O})}$  and  $\|\cdot\|_{H_{\Theta}(\mathbf{div}; \mathcal{O})}$  denote the respective induced norms.

Due to the domains introduced throughout the chapter, a specific attention will be given to "rectangle"-based cylindrical domains in what follows. Let  $I_x, I_1$  be intervals which do not need to be bounded, and such that  $0 \in \overline{I_x}$ . We consider the 3-dimensional domain  $\Omega$  and the 2-dimensional transverse set  $\Sigma^\tau$  given by

$$\begin{aligned} \Omega &:= \{(x, z_1, z_2) \in \mathbb{R}^3 / x \in I_x, z_1 \in I_1, z_2 \in \mathbb{R}\}, \\ \forall \tau \in \overline{I_x}, \quad \Sigma^\tau &:= \{(x, z_1, z_2) \in \mathbb{R}^3 / x = \tau, z_1 \in I_1, z_2 \in \mathbb{R}\}, \end{aligned} \quad (4.2)$$

with  $\Sigma^\tau = \Sigma$  for  $\tau = 0$ . The above domains are unbounded in  $z_2$ . We will be interested in the "cell-domains", bounded in  $z_2$ :

$$\begin{aligned} \Omega_{\#} &:= \{(x, z_1, z_2) \in \Omega, / z_2 \in (0, 1)\}, \\ \forall \tau \in \overline{I_x}, \quad \Sigma_{\#}^{\tau} &:= \{(x, z_1, z_2) \in \Sigma^{\tau}, / z_2 \in (0, 1)\}, \end{aligned} \quad (4.3)$$

with  $\Sigma_{\#}^{\tau} = \Sigma_{\#}$  for  $\tau = 0$ , and where the subscript "#" refers to the boundedness of the domains in  $z_2$ . Still, note that  $\Omega_{\#}$  can be unbounded in the  $\mathbf{e}_x$  and  $\mathbf{e}_1$ -directions, while  $\Sigma_{\#}^{\tau}$  can be unbounded in the  $\mathbf{e}_1$ -direction. Figure 6 (left) represents these domains for  $I_x = \mathbb{R}_-$  and  $I_1 \subset \mathbb{R}_+$ .

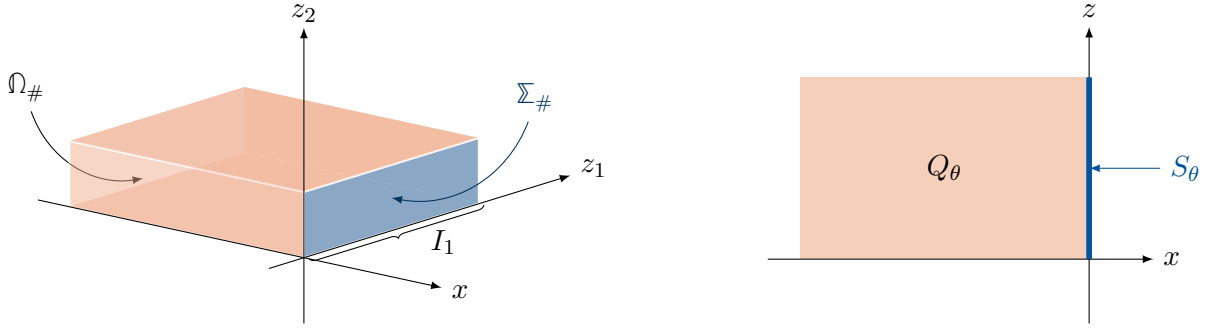

Figure 6: (Left): the rectangle-based cylindrical domain  $\Omega_{\#}$  and the lateral set  $\Sigma_{\#}$  given by (4.3). Right: the domains  $Q_{\theta}$  and  $S_{\theta}$  given by (4.5).  $I_x = \mathbb{R}_-$  and  $I_1 \subset \mathbb{R}_+$ .

#### 4.1 Anisotropic spaces of $\mathbb{Z}\mathbf{e}_2$ -periodic functions

Given numbers  $-\infty \leq a < b \leq +\infty$  and a Banach space  $(\mathcal{X}, \|\cdot\|_{\mathcal{X}})$ , we recall that

$$L^2(a, b; \mathcal{X}) := \left\{ \mathbf{V}_{\Theta} / \|\mathbf{V}_{\Theta}\|_{L^2(a, b; \mathcal{X})}^2 := \int_a^b \|\mathbf{V}_{\Theta}(\cdot, s)\|_{\mathcal{X}}^2 ds < +\infty \right\}. \quad (4.4)$$

In order to propose an appropriate framework, we would like to exploit the link (3.15) between the 3-dimensional operators  $({}^t\Theta \nabla, \operatorname{div} \Theta)$  and the 2-dimensional operators  $(\nabla, \operatorname{div})$ . To this end, it is useful to introduce the 2-dimensional domain  $Q_{\theta}$  and the edge  $S_{\theta}^{\tau}$  given by

$$\begin{aligned} Q_{\theta} &:= \{(x, z) \in \mathbb{R}^2 / x \in I_x, \theta_1 z \in I_1\}, \\ S_{\theta}^{\tau} &:= \{(x, z) \in \mathbb{R}^2 / x = \tau, \theta_1 z \in I_1\}, \end{aligned} \quad (4.5)$$

with  $S_{\theta}^{\tau} = S_{\theta}$  for  $\tau = 0$ . Note that these domains are well-defined, since for Configurations (A) and (B), we have  $\theta_1 \neq 0$ . Figure 6 (right) represents these domains for  $I_x = \mathbb{R}_-$  and  $I_1 \subset \mathbb{R}_+$ . Moreover, consider the transformation

$$\mathsf{T}_{\theta} : (\mathbf{x}, s) \in Q_{\theta} \times \mathbb{R} \mapsto \Theta \mathbf{x} + s \mathbf{e}_2 \in \Omega, \quad (4.6)$$

which is bijective from  $Q_{\theta} \times \mathbb{R}$  to  $\Omega$ , but also from  $S_{\theta}^{\tau} \times \mathbb{R}$  to  $\Sigma^{\tau}$ . Now let  $\Omega_{\#, \theta}$  (resp.  $\Sigma_{\#, \theta}^{\tau}$ ) denote the image of  $Q_{\theta} \times (0, 1)$  (resp.  $S_{\theta}^{\tau} \times (0, 1)$ ) by this transformation:

$$\Omega_{\#, \theta} := \mathsf{T}_{\theta}(Q_{\theta} \times (0, 1)) \quad \text{and} \quad \Sigma_{\#, \theta}^{\tau} := \mathsf{T}_{\theta}(S_{\theta}^{\tau} \times (0, 1)), \quad (4.7)$$

with  $\Sigma_{\#, \theta}^{\tau} = \Sigma_{\#, \theta}$  for  $\tau = 0$ . These domains are represented in Figure 7 in blue.

By definition,  $\mathsf{T}_{\theta}$  maps  $Q_{\theta} \times (0, 1)$  to  $\Omega_{\#, \theta}$ . By using the associated change of variables and the chain rule (3.15), it follows easily from Fubini's theorem that

$$H_{\Theta}^1(\Omega_{\#, \theta}) = \{V \in L^2(\Omega_{\#, \theta}) / V \circ \mathsf{T}_{\theta} \in L^2(0, 1; H^1(Q_{\theta}))\} \quad (4.8)$$

$$H_{\Theta}(\operatorname{div}; \Omega_{\#, \theta}) = \{\mathbf{W} \in L^2(\Omega_{\#, \theta}) / \mathbf{W} \circ \mathsf{T}_{\theta} \in L^2(0, 1; H(\operatorname{div}; Q_{\theta}))\}.$$

This is a convenient characterization which would be valuable to study  $H_{\Theta}^1(\Omega_{\#, \theta})$  and  $H_{\Theta}(\operatorname{div}; \Omega_{\#, \theta})$ . However, to propose a rigorous version of the augmented problem (3.16, 3.17, 3.20), we need to study  $H_{\Theta}^1$  or  $H_{\Theta}(\operatorname{div})$ -functions defined in  $\Omega_{\#}$  instead of  $\Omega_{\#, \theta}$ , and which are 1-periodic in the  $\mathbf{e}_2$ -direction.

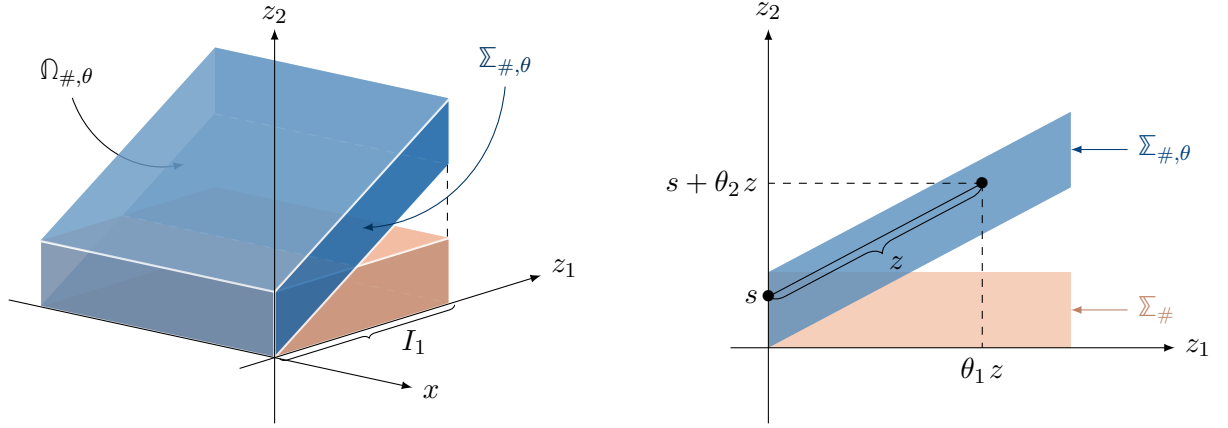

Figure 7: Left: The domains  $\Omega_{\#, \theta}$  and the lateral set  $\Sigma_{\#, \theta}$  given by (4.7). Right: Illustration of  $T_\theta(x, s)$  which is defined by (4.6) for some  $(x, s) \in Q_\theta \times (0, 1)$  and for  $|(\theta_1, \theta_2)| = 1$ .  $I_x = \mathbb{R}_-$  and  $I_1 \subset \mathbb{R}_+$ .

We shall regardless propose for these functions a characterization analogous to (4.8) by relying on the notion of *periodic extension*. In the sequel, let  $d \in \{1, 2\}$ . We use the notation  $\mathbf{V}$  (in bold) to refer to a  $\mathbb{C}^d$ -valued function.

#### Definition 4.1

Let  $p > 0$  and  $\mathbf{V} \in L^p(\Omega_{\#})^d$ . The periodic extension of  $\mathbf{V}$  in the  $\mathbf{e}_2$ -direction is the function  $E_{\#}^2 \mathbf{V} \in L_{loc}^p(\Omega)^d$  defined by:

$$\text{a. e. } \mathbf{x} = (x, z_1, z_2) \in \Omega_{\#}, \quad \forall n \in \mathbb{Z}, \quad E_{\#}^2 \mathbf{V}(\mathbf{x} + n \mathbf{e}_2) := \mathbf{V}(\mathbf{x}). \quad (4.9)$$

For any  $\Phi \in L^p(\Sigma_{\#})$ , we define  $E_{\#}^2 \Phi \in L_{loc}^p(\Sigma)$  similarly, by replacing  $\mathbf{x} \in \Omega_{\#}$  in (4.9) by  $\mathbf{x} \in \Sigma_{\#}$ .

The following easy but useful lemma links the integrals of  $E_{\#}^2 \mathbf{V}$  on  $\Omega_{\#}$  and  $\Omega_{\#, \theta}$  for  $\mathbf{V} \in L^1(\Omega_{\#})^d$ . We refer to Lemma III-3.12 for its proof.

#### Lemma 4.2

For any  $\mathbf{V} \in L^1(\Omega_{\#})^d$ , we have

$$\int_{\Omega_{\#}} \mathbf{V} = \int_{\Omega_{\#, \theta}} E_{\#}^2 \mathbf{V}, \quad (4.10)$$

where  $E_{\#}^2 \mathbf{V} \in L_{loc}^1(\Omega)^d$  is defined by (4.9).

Let  $\mathcal{C}_{0, \#}^\infty(\overline{\Omega_{\#}})$  denote the space of smooth functions in  $\overline{\Omega_{\#}}$  that are compactly supported in the  $\mathbf{e}_x$  and  $\mathbf{e}_1$ -directions, and 1-periodic in the  $\mathbf{e}_2$ -direction, that is,

$$\mathcal{C}_{0, \#}^\infty(\overline{\Omega_{\#}}) := \{V \in \mathcal{C}_0^\infty(\overline{\Omega_{\#}}) / E_{\#}^2 V \in \mathcal{C}^\infty(\Omega)\}. \quad (4.11)$$

Note that  $\mathcal{C}_{0, \#}^\infty(\overline{\Omega_{\#}})$  contains  $\mathcal{C}_0^\infty(\Omega_{\#})$ , and thus is dense in  $L^2(\Omega_{\#})$ .

The change of variables (4.6) combined with the periodic extension along  $\mathbf{e}_2$  in Definition 4.1 allows

us to introduce the shear transform defined by

$$\begin{aligned} \mathcal{S}_\Theta : \mathcal{C}_{0,\#}^\infty(\overline{\Omega_\#})^d &\longrightarrow \mathcal{C}^\infty(Q_\theta \times \mathbb{R})^d \\ \mathbf{V} &\longmapsto \mathbf{V}_\Theta \end{aligned}, \quad \mathbf{V}_\Theta(\mathbf{x}, s) := (\mathbf{E}_\#^2 \mathbf{V}) \circ \mathsf{T}_\theta(\mathbf{x}, s), \quad \forall (\mathbf{x}, s) \in Q_\theta \times \mathbb{R}. \quad (4.12)$$

Note that the definition of  $\mathbf{E}_\#^2$  implies that  $\mathcal{S}_\Theta \mathbf{V}(\cdot, s+1) = \mathcal{S}_\Theta \mathbf{V}(\cdot, s)$ . For this reason, the study of  $\mathcal{S}_\Theta$  will be restricted to  $s \in (0, 1)$ . Thanks to the next proposition,  $\mathcal{S}_\Theta$  extends to  $L^2$ -functions.

### Proposition 4.3

The mapping  $\mathcal{S}_\Theta$  defined in  $\mathcal{C}_{0,\#}^\infty(\overline{\Omega_\#})^d$  by (4.12) extends to a mapping defined from  $L^2(\Omega_\#)^d$  to  $L^2(0, 1; L^2(Q_\theta)^d)$ , with

$$\forall \mathbf{U}, \mathbf{V} \in L^2(\Omega_\#)^d, \quad \frac{1}{\theta_1} \int_0^1 \int_{Q_\theta} \mathcal{S}_\Theta \mathbf{U}(\mathbf{x}, s) \overline{\mathcal{S}_\Theta \mathbf{V}(\mathbf{x}, s)} \, d\mathbf{x} ds = \int_{\Omega_\#} \mathbf{U} \overline{\mathbf{V}}. \quad (4.13)$$

Moreover,  $\mathcal{S}_\Theta$  is an isomorphism from  $L^2(\Omega_\#)^d$  to the space  $L^2(0, 1; L^2(Q_\theta)^d)$ , and its inverse is given for any  $\mathbf{V}_\Theta \in L^2(0, 1; L^2(Q_\theta)^d)$  by

$$\text{a. e. } \mathbf{x} = (x, z_1, z_2) \in \Omega_\#, \quad \mathcal{S}_\Theta^{-1} \mathbf{V}_\Theta(\mathbf{x}) = \sqrt{\theta_1} \mathbf{E}_\#^s \mathbf{V}_\Theta(x, z_1/\theta_1, z_2 - z_1(\theta_2/\theta_1)), \quad (4.14)$$

where  $\mathbf{E}_\#^s \mathbf{V}_\Theta \in L_{loc}^2(Q_\theta \times \mathbb{R})$  denotes the periodic extension of  $\mathbf{V}_\Theta$  with respect to the variable  $s$ , defined for almost any  $(\mathbf{x}, s) \in Q_\theta \times (0, 1)$  and for any  $n \in \mathbb{Z}$  by  $\mathbf{E}_\#^s \mathbf{V}_\Theta(\mathbf{x}, s+n) := \mathbf{V}_\Theta(\mathbf{x}, s)$ .

**Proof.** The mapping  $\mathsf{T}_\theta : Q_\theta \times (0, 1) \rightarrow \Omega_{\#,\theta}$  is a  $\mathcal{C}^1$ -diffeomorphism with a non-vanishing Jacobian  $\theta_1 \neq 0$ . Therefore, the associated change of variables leads to

$$\forall \mathbf{U}, \mathbf{V} \in \mathcal{C}_{0,\#}^\infty(\overline{\Omega_\#})^d, \quad \frac{1}{\theta_1} \int_0^1 \int_{Q_\theta} \mathcal{S}_\Theta \mathbf{U}(\mathbf{x}, s) \overline{\mathcal{S}_\Theta \mathbf{V}(\mathbf{x}, s)} \, d\mathbf{x} ds = \int_{\Omega_{\#,\theta}} (\mathbf{E}_\#^2 \mathbf{U}) (\overline{\mathbf{E}_\#^2 \mathbf{V}}).$$

We then apply Lemma 4.2 to  $\mathbf{U} \overline{\mathbf{V}}$ , and we use the identity  $\mathbf{E}_\#^2 (\mathbf{U} \overline{\mathbf{V}}) = (\mathbf{E}_\#^2 \mathbf{U}) (\overline{\mathbf{E}_\#^2 \mathbf{V}})$ , to deduce (4.13) for  $\mathbf{U}, \mathbf{V} \in \mathcal{C}_{0,\#}^\infty(\overline{\Omega_\#})^d$ . Finally, the density of  $\mathcal{C}_{0,\#}^\infty(\overline{\Omega_\#})^d$  in  $L^2(\Omega_\#)^d$  leads to (4.13). Moreover, by choosing  $\mathbf{U} = \mathbf{V}$  in (4.13), it follows that  $\mathcal{S}_\Theta$  is bounded from  $L^2(\Omega_\#)^d$  to  $L^2(0, 1; L^2(Q_\theta)^d)$ .

The bijectivity of  $\mathcal{S}_\Theta$  results directly from the inverse of  $\mathsf{T}_\theta$ , which leads to the expression (4.14) of  $\mathcal{S}_\Theta^{-1}$ . The continuity of  $\mathcal{S}_\Theta^{-1}$  is then implied by (4.13).  $\blacksquare$

Now, inspired by (4.8), we define

$$\begin{aligned} H_{\Theta,\#}^1(\Omega_\#) &:= \{ \mathbf{V} \in L^2(\Omega_\#) / \mathcal{S}_\Theta \mathbf{V} \in L^2(0, 1; H^1(Q_\theta)) \}, \\ H_{\Theta,\#}(\mathbf{div}; \Omega_\#) &:= \{ \mathbf{W} \in L^2(\Omega_\#)^2 / \mathcal{S}_\Theta \mathbf{W} \in L^2(0, 1; H(\mathbf{div}; Q_\theta)) \}. \end{aligned} \quad (4.15)$$

It is not obvious from their definition that  $H_{\Theta,\#}^1(\Omega_\#)$  and  $H_{\Theta,\#}(\mathbf{div}; \Omega_\#)$  are respectively subspaces of  $H_\Theta^1(\Omega_\#)$  and  $H_\Theta(\mathbf{div}; \Omega_\#)$ . This is highlighted in the next proposition.

**Proposition 4.4**

Any  $V \in H_{\Theta\#}^1(\Omega_{\#})$  belongs to  $H_{\Theta}^1(\Omega_{\#})$  and

$$\text{a. e. } (\mathbf{x}, s) \in Q_{\theta} \times (0, 1), \quad \mathcal{S}_{\Theta}({}^t\Theta \nabla V)(\mathbf{x}, s) = \nabla_{\mathbf{x}}(\mathcal{S}_{\Theta} V)(\mathbf{x}, s). \quad (4.16)$$

Similarly, any  $\mathbf{W} \in H_{\Theta, \#}(\text{div}; \Omega_{\#})$  belongs to  $H_{\Theta}(\text{div}; \Omega_{\#})$  and

$$\text{a. e. } (\mathbf{x}, s) \in Q_{\theta} \times (0, 1), \quad \mathcal{S}_{\Theta}(\text{div } \Theta \mathbf{W})(\mathbf{x}, s) = \text{div}_{\mathbf{x}}(\mathcal{S}_{\Theta} \mathbf{W})(\mathbf{x}, s), \quad (4.17)$$

where  $\nabla_{\mathbf{x}}$  and  $\text{div}_{\mathbf{x}}$  are the gradient operator and the divergence operator with respect to  $\mathbf{x}$ .

**Proof.** We only prove (4.16) since the proof of (4.17) is very similar. The proof is merely a weak adaptation of the chain rule. Let  $V \in H_{\Theta\#}^1(\Omega_{\#})$ . In order to obtain the expression of  ${}^t\Theta \nabla V$  in the sense of distributions, consider a test function  $\mathbf{W} \in \mathcal{C}_0^{\infty}(\Omega_{\#})^2$  and let  $\mathbf{W}_{\Theta} := \mathcal{S}_{\Theta} \mathbf{W} \in \mathcal{C}_0^{\infty}(Q_{\theta} \times (0, 1))^2$ . Then  $E_{\#}^2 \mathbf{W} \in \mathcal{C}^{\infty}(\Omega_{\#})$  since  $\mathbf{W} \in \mathcal{C}_0^{\infty}(\Omega_{\#})^2$  and one easily computes using the chain rule that

$$\forall (\mathbf{x}, s) \in Q_{\theta} \times (0, 1), \quad \mathcal{S}_{\Theta}(\text{div } \Theta \mathbf{W})(\mathbf{x}, s) = \text{div}_{\mathbf{x}} \mathbf{W}_{\Theta}(\mathbf{x}, s). \quad (4.18)$$

Let also  $V_{\Theta} := \mathcal{S}_{\Theta} V$ . Using derivation in the sense of distributions with  $V \in L^2(\Omega_{\#})$  leads to:

$$\begin{aligned} \langle {}^t\Theta \nabla V, \mathbf{W} \rangle_{[\mathcal{C}_0^{\infty}(\Omega_{\#})^2]', \mathcal{C}_0^{\infty}(\Omega_{\#})^2} &= - \int_{\Omega_{\#}} V(\mathbf{x}) \overline{\text{div } \Theta \mathbf{W}(\mathbf{x})} \, d\mathbf{x} \\ &= - \frac{1}{\theta_1} \int_0^1 \int_{Q_{\theta}} \mathcal{S}_{\Theta} V(\mathbf{x}, s) \overline{\mathcal{S}_{\Theta}(\text{div } \Theta \mathbf{W})(\mathbf{x}, s)} \, d\mathbf{x} ds \quad \text{from (4.13)} \\ &= - \frac{1}{\theta_1} \int_0^1 \int_{Q_{\theta}} V_{\Theta}(\mathbf{x}, s) \overline{\text{div}_{\mathbf{x}} \mathbf{W}_{\Theta}(\mathbf{x}, s)} \, d\mathbf{x} ds \quad \text{from (4.18)}. \end{aligned} \quad (4.19)$$

But the definition of  $H_{\Theta\#}^1(\Omega_{\#})$  implies that  $V_{\Theta}(\cdot, s) \in H^1(Q_{\theta})$ , a. e.  $s \in (0, 1)$ . Thus in (4.19), we can apply the usual Green formula to  $V_{\Theta}(\cdot, s)$  and  $\mathbf{W}_{\Theta}(\cdot, s) \in \mathcal{C}_0^{\infty}(Q_{\theta})$  (with no boundary term since  $\mathbf{W}_{\Theta}(\cdot, s)$  is compactly supported) to obtain

$$\begin{aligned} \langle {}^t\Theta \nabla V, \mathbf{W} \rangle_{[\mathcal{C}_0^{\infty}(\Omega_{\#})^2]', \mathcal{C}_0^{\infty}(\Omega_{\#})^2} &= \int_0^1 \int_{Q_{\theta}} \nabla_{\mathbf{x}} V_{\Theta}(\mathbf{x}, s) \cdot \overline{\mathbf{W}_{\Theta}(\mathbf{x}, s)} \, d\mathbf{x} ds \\ &= \frac{1}{\theta_1} \int_{\Omega_{\#}} \mathcal{S}_{\Theta}^{-1} \nabla_{\mathbf{x}} V_{\Theta}(\mathbf{x}) \cdot \overline{\mathbf{W}(\mathbf{x})} \, d\mathbf{x} \quad \text{from (4.13)} \\ &= \langle \mathcal{S}_{\Theta}^{-1} \nabla_{\mathbf{x}} V_{\Theta}, \mathbf{W} \rangle_{[\mathcal{C}_0^{\infty}(\Omega_{\#})^2]', \mathcal{C}_0^{\infty}(\Omega_{\#})^2}. \end{aligned} \quad (4.20)$$

The identity (4.20) being true for any  $\mathbf{W} \in \mathcal{C}_0^{\infty}(\Omega_{\#})^2$  implies that  ${}^t\Theta \nabla V = \mathcal{S}_{\Theta}^{-1} \nabla_{\mathbf{x}} V_{\Theta}$  in the sense of distributions. But thanks to the bijectivity of  $\mathcal{S}_{\Theta}$  and to the fact that  $\nabla_{\mathbf{x}} V_{\Theta} \in L^2(0, 1; L^2(Q_{\theta})^2)$ , it follows that  $\mathcal{S}_{\Theta}^{-1} \nabla_{\mathbf{x}} V_{\Theta} \in L^2(\Omega_{\#})^2$ . Therefore,  ${}^t\Theta \nabla V$  also belongs to  $L^2(\Omega_{\#})^2$ , and one has

$$\text{a. e. } \mathbf{x} \in \Omega_{\#}, \quad {}^t\Theta \nabla V(\mathbf{x}) = \mathcal{S}_{\Theta}^{-1} \nabla_{\mathbf{x}} V_{\Theta}(\mathbf{x}). \quad (4.21)$$

Consequently,  $V \in H_{\Theta\#}^1(\Omega_{\#})$  and (4.16) follows by applying the transform  $\mathcal{S}_{\Theta}$  to (4.21).  $\blacksquare$

Let us equip  $H_{\Theta\#}^1(\Omega_{\#})$  with the scalar product  $(\cdot, \cdot)_{H_{\Theta\#}^1(\Omega_{\#})}$ , and  $H_{\Theta, \#}(\text{div}; \Omega_{\#})$  with the scalar product  $(\cdot, \cdot)_{H_{\Theta}(\text{div}; \Omega_{\#})}$ . Propositions 4.3 and 4.4 then provide the next result.



**Corollary 4.5**

The map  $\mathcal{S}_\Theta$  is an isomorphism from  $H_{\Theta, \#}^1(\Omega_\#)$  to  $L^2(0, 1; H^1(Q_\theta))$ , and from  $H_{\Theta, \#}(\mathbf{div}; \Omega_\#)$  to  $L^2(0, 1; H(\mathbf{div}; Q_\theta))$ .

In regards to Corollary 4.5, and following their definitions,  $H_{\Theta, \#}^1(\Omega_\#)$  and  $H_{\Theta, \#}(\mathbf{div}; \Omega_\#)$  are Hilbert spaces.

We finish this section with a density result which provides more insight on the nature of the spaces  $H_{\Theta, \#}^1(\Omega_\#)$  and  $H_{\Theta, \#}(\mathbf{div}; \Omega_\#)$  (see Remark 4.7).

**Proposition 4.6**

- (a). The space  $\mathcal{C}_{0, \#}^\infty(\overline{\Omega_\#})$  is dense in  $H_{\Theta, \#}^1(\Omega_\#)$ .  
 (b). The space  $\mathcal{C}_{0, \#}^\infty(\overline{\Omega_\#})^2$  is dense in  $H_{\Theta, \#}(\mathbf{div}; \Omega_\#)$ .

**Proof.** We only prove the first point, since the proof of the second one is very similar.

For any  $V \in H_{\Theta, \#}^1(\Omega_\#)$ ,  $\mathcal{S}_\Theta V \in L^2(0, 1; H^1(Q_\theta))$  by definition. Thus given  $\varepsilon > 0$ , since  $\mathcal{C}_0^\infty(\overline{Q_\theta})$  is dense in  $H^1(Q_\theta)$ , there exists  $V_{\Theta, 1}(\cdot, s) \in \mathcal{C}_0^\infty(\overline{Q_\theta})$  such that  $\|\mathcal{S}_\Theta V(\cdot, s) - V_{\Theta, 1}(\cdot, s)\|_{H^1(Q_\theta)} \leq \varepsilon/2$  for a. e.  $s \in (0, 1)$ . The uniform boundedness of  $(V_{\Theta, 1}(\cdot, s))_s$  in  $H^1(Q_\theta)$  with respect to  $s$  then implies that

$$V_{\Theta, 1} \in L^2(0, 1; \mathcal{C}_0^\infty(\overline{Q_\theta})) \quad \text{and} \quad \|\mathcal{S}_\Theta V - V_{\Theta, 1}\|_{L^2(0, 1; H^1(Q_\theta))} \leq \varepsilon/2.$$

Using a classical mollifying argument (see e.g. [Bre11, Corollary 4.23]) allows to prove the existence of a function  $V_{\Theta, 2} \in \mathcal{C}_0^\infty(Q_\theta \times (0, 1))$  such that  $\|V_{\Theta, 1} - V_{\Theta, 2}\|_{L^2(0, 1; H^1(Q_\theta))} \leq \varepsilon/2$ . To finish, from the properties (4.13, 4.16) of  $\mathcal{S}_\Theta$ , we deduce that  $V_\varepsilon := \mathcal{S}_\Theta^{-1} V_{\Theta, 2} \in \mathcal{C}_{0, \#}^\infty(\overline{\Omega_\#})$  and  $\|V - V_\varepsilon\|_{H_{\Theta, \#}^1(\Omega_\#)} \leq \varepsilon$ . ■

**Remark 4.7.** As Proposition 4.6 suggests,  $H_{\Theta, \#}^1(\Omega_\#)$  corresponds roughly speaking to the set of functions  $V$  in  $H_{\Theta, \#}^1(\Omega_\#)$  that satisfy  $V|_{z_2=0} = V|_{z_2=1}$ . However, we shall not need this characterization, which requires to define properly the traces of functions in  $H_{\Theta, \#}^1(\Omega_\#)$  on  $z_2 = 0$  and  $z_2 = 1$ . We refer to Section III-3.2 for similar considerations.

**4.2 Trace operator on transverse interfaces**

An important tool for the study of the augmented problem concerns the trace of functions  $V \in H_{\Theta, \#}^1(\Omega_\#)$  on the transverse set  $\Sigma_\#^\tau$  defined by (4.3) for  $\tau \in \overline{I_x}$ . Throughout the section, we assume that  $\tau = 0$  so that  $\Sigma_\#^\tau = \Sigma_\#$  (see Remark 4.10). Given that

$$\forall V \in H_{\Theta, \#}^1(\Omega_\#), \quad V, \partial_x V \in L^2(\Omega_\#),$$

the following preliminary result can be derived without any difficulty.

**Proposition 4.8**

The trace mapping  $\gamma_{0, \#}$  defined by  $\gamma_{0, \#} V := V|_{\Sigma_\#}$  for  $V \in \mathcal{C}_{0, \#}^\infty(\overline{\Omega_\#})$  extends by continuity to a linear map still denoted by  $\gamma_{0, \#}$ , and defined from  $H_{\Theta, \#}^1(\Omega_\#)$  to  $L^2(\Sigma_\#)$ .

In what follows, we will abusively write  $V|_{\Sigma_{\#}}$  instead of  $\gamma_{0,\#}V$  when referring to traces on  $\Sigma_{\#}$ .

We are interested in characterizing the image of the trace application  $\gamma_{0,\#}$ . To this end, let us begin by extending the definition of  $\mathcal{S}_{\Theta}$  to functions defined on  $\Sigma_{\#}$ . For  $\Phi \in \mathcal{C}_0^{\infty}(\overline{\Sigma_{\#}})$  such that  $E_{\#}^2 \Phi \in \mathcal{C}^{\infty}(\Sigma)$ , we can define  $\mathcal{S}_{\Theta} \Phi = \Phi_{\Theta}$  as in the volume case (4.12) by choosing  $(x, s) \in S_{\theta} \times \mathbb{R}$ , where  $S_{\theta}$  is the edge in (4.5). We emphasize that from its expression:

$$\forall x = (0, z) \in S_{\theta}, \quad \forall s \in \mathbb{R}, \quad \mathcal{S}_{\Theta} \Phi(x, s) := E_{\#}^2 \Phi(0, \theta_1 z, \theta_2 z + s),$$

$\mathcal{S}_{\Theta} \Phi(\cdot, s)$  is simply the trace of  $E_{\#}^2 \Phi$  along the line  $\{(\theta_1 z, \theta_2 z + s), z \in \mathbb{R}\}$ . Similarly to Proposition 4.3,  $\mathcal{S}_{\Theta}$  extends by density as an isomorphism from  $L^2(\Sigma_{\#})$  to  $L^2(0, 1; L^2(S_{\theta}))$ .

Consider the space

$$H_{\Theta\#}^{1/2}(\Sigma_{\#}) := \{\Phi \in L^2(\Sigma_{\#}) / \mathcal{S}_{\Theta} \Phi \in L^2(0, 1; H^{1/2}(S_{\theta}))\}, \quad (4.22)$$

which is equipped with the norm  $\Phi \mapsto \|\mathcal{S}_{\Theta} \Phi\|_{L^2(0,1;H^{1/2}(S_{\theta}))}$ . Then the next result holds.

#### Proposition 4.9

*The trace operator  $\gamma_{0,\#}$  is continuous and surjective from  $H_{\Theta\#}^1(\Omega_{\#})$  to  $H_{\Theta\#}^{1/2}(\Sigma_{\#})$ , and*

$$\forall V \in H_{\Theta\#}^1(\Omega_{\#}), \quad \forall s \in (0, 1), \quad \mathcal{S}_{\Theta}(V|_{\Sigma_{\#}})(\cdot, s) = \mathcal{S}_{\Theta} V(\cdot, s)|_{S_{\theta}}. \quad (4.23)$$

**Proof.** Equation (4.23) is obtained easily for smooth functions  $V \in \mathcal{C}_{0,\#}^{\infty}(\overline{\Omega_{\#}})$  using the definition of  $\mathcal{S}_{\Theta}$ . It extends to  $V \in H_{\Theta\#}^1(\Omega_{\#})$  using: (i) the density of  $\mathcal{C}_{0,\#}^{\infty}(\overline{\Omega_{\#}})$  in  $H_{\Theta\#}^1(\Omega_{\#})$ , (ii) the continuity of  $\mathcal{S}_{\Theta}$  from  $H_{\Theta\#}^1(\Omega_{\#})$  to  $L^2(0, 1; H^1(Q_{\theta}))$  (Corollary 4.5) and from  $H_{\Theta\#}^{1/2}(\Sigma_{\#})$  to  $L^2(0, 1; H^{1/2}(S_{\theta}))$  (by definition (4.22)), and finally (iii) the continuity of the following trace map from  $L^2(0, 1; H^1(Q_{\theta}))$  to the space  $L^2(0, 1; H^{1/2}(S_{\theta}))$ :

$$\forall V_{\theta} \in L^2(0, 1; H^1(Q_{\theta})), \quad \gamma_0 V_{\theta}(\cdot, s) := V_{\theta}(\cdot, s)|_{S_{\theta}},$$

which is a direct consequence of the classical trace theorem in  $H^1(Q_{\theta})$ .

The inverse  $\mathcal{S}_{\Theta}^{-1}$  applied to both sides of (4.23) gives  $\gamma_{0,\#} = \mathcal{S}_{\Theta}^{-1} \gamma_0 \mathcal{S}_{\Theta}$ . The continuity and surjectivity of  $\gamma_{0,\#}$  then result from the continuity of  $(\gamma_0, \mathcal{S}_{\Theta}, \mathcal{S}_{\Theta}^{-1})$  and the surjectivity of  $\gamma_0$ . ■

**Remark 4.10.** Let  $\tau \in \overline{I_x}$ . By applying the above arguments to  $V(\cdot + \tau \mathbf{e}_x)$  where  $V \in H_{\Theta\#}^1(\Omega_{\#})$ , one can define the trace of  $V$  on the face  $\Sigma_{\#}^{\tau}$  for any  $\tau \in \overline{I_x}$ .

### 4.3 Normal trace operator and Green's formula for a strip

In this section, we restrict ourselves to a strip, which corresponds to

$$I_1 = \mathbb{R}.$$

The domains  $\Omega_{\#}$ ,  $\Sigma_{\#}^{\tau}$ ,  $Q_{\theta}$ , and  $S_{\theta}^{\tau}$  defined by (4.3, 4.5) then become

$$\Omega_{\#} = I_x \times \mathbb{R} \times (0, 1), \quad \Sigma_{\#}^{\tau} = \{\tau\} \times \mathbb{R} \times (0, 1), \quad Q_{\theta} = I_x \times \mathbb{R} \quad \text{and} \quad S_{\theta}^{\tau} = \{\tau\} \times \mathbb{R}.$$

In what follows, we assume that  $I_x \neq \mathbb{R}$ , so that  $\partial I_x \neq \emptyset$ , and we consider  $\tau \in \partial I_x$ . Let  $\mathbf{n}$  (resp.  $\mathbf{n}$ ) denote the unit normal vector on  $\Sigma_{\#}^{\tau}$  (resp.  $S_{\theta}^{\tau}$ ) which is outward with respect to  $\Omega_{\#}$  (resp.  $Q_{\theta}$ ). Our objective is to define a normal trace operator on  $\Sigma_{\#}^{\tau}$ .

The topological dual space of  $H_{\Theta\#}^{1/2}(\Sigma_{\#}^{\tau})$  is denoted by  $H_{\Theta\#}^{-1/2}(\Sigma_{\#}^{\tau})$ , and is equipped with the dual norm for now. Let  $\langle \cdot, \cdot \rangle_{\Sigma_{\#}^{\tau}}$  denote the dual product between  $H_{\Theta\#}^{-1/2}(\Sigma_{\#}^{\tau})$  and  $H_{\Theta\#}^{1/2}(\Sigma_{\#}^{\tau})$ , defined as a natural extension of the  $L^2(\Sigma_{\#}^{\tau})$ -scalar product. In order to define a normal trace operator, we first extend the shear map  $\mathcal{S}_{\Theta}$  to functions in  $H_{\Theta\#}^{-1/2}(\Sigma_{\#}^{\tau})$ . This is achieved through duality, by extending the Parseval-like formula (4.13):

$$\begin{aligned} \forall \Psi \in H_{\Theta\#}^{-1/2}(\Sigma_{\#}^{\tau}), \quad \frac{1}{\theta_1} \langle \mathcal{S}_{\Theta} \Psi, \Phi_{\Theta} \rangle_{L^2(0,1;H^{1/2}(S_{\theta}^{\tau}))', L^2(0,1;H^{1/2}(S_{\theta}^{\tau}))} \\ := \langle \Psi, \mathcal{S}_{\Theta}^{-1} \Phi_{\Theta} \rangle_{\Sigma_{\#}^{\tau}}, \quad \forall \Phi_{\Theta} \in L^2(0,1;H^{1/2}(S_{\theta}^{\tau})). \end{aligned} \quad (4.24)$$

Note that this naturally extends  $\mathcal{S}_{\Theta}$  as an isomorphism from  $H_{\Theta\#}^{-1/2}(\Sigma_{\#}^{\tau})$  to  $L^2(0,1;H^{1/2}(S_{\theta}^{\tau}))'$ .

The next lemma provides a more convenient characterization of  $L^2(0,1;H^{1/2}(S_{\theta}^{\tau}))'$ .

#### Lemma 4.11

Given  $a < b \in \mathbb{R}$  and a Hilbert space  $(\mathcal{X}, \langle \cdot, \cdot \rangle_{\mathcal{X}})$ , one has  $[L^2(a,b;\mathcal{X})]' = L^2(a,b;\mathcal{X}')$  as well as the following identity: for any  $\Phi_{\Theta} \in L^2(a,b;\mathcal{X})$  and  $\Psi_{\Theta} \in L^2(a,b;\mathcal{X}')$ :

$$\langle \Psi_{\Theta}, \Phi_{\Theta} \rangle_{L^2(a,b;\mathcal{X}'), L^2(a,b;\mathcal{X})} = \int_a^b \langle \Psi_{\Theta}(\cdot, s), \Phi_{\Theta}(\cdot, s) \rangle_{\mathcal{X}', \mathcal{X}} ds, \quad (4.25)$$

where  $\langle \cdot, \cdot \rangle_{\mathcal{X}', \mathcal{X}}$  denotes the duality product between  $\mathcal{X}'$  and  $\mathcal{X}$ .

**Proof.** One checks without any difficulty that the inclusion  $[L^2(a,b;\mathcal{X})]' \supset L^2(a,b;\mathcal{X}')$  holds. Conversely, the inclusion  $[L^2(a,b;\mathcal{X})]' \subset L^2(a,b;\mathcal{X}')$  and (4.25) result from the Riesz representation theorem applied to  $\mathcal{X}$  and to the space  $L^2(0,1;\mathcal{X})$  equipped with the scalar product  $(\Phi_{\Theta}, \Psi_{\Theta}) \mapsto \int_0^1 (\Phi_{\Theta}(\cdot, s), \Psi_{\Theta}(\cdot, s))_{\mathcal{X}} ds$ . ■

From Lemma 4.11 applied with  $a = 0$ ,  $b = 1$ , and  $\mathcal{X} := H^{1/2}(S_{\theta}^{\tau})$ , we deduce that  $\mathcal{S}_{\Theta}$  is an isomorphism from  $H_{\Theta\#}^{-1/2}(\Sigma_{\#}^{\tau})$  to  $L^2(0,1;H^{-1/2}(S_{\theta}^{\tau}))$ . Moreover, the bijectivity of  $\mathcal{S}_{\Theta}$  implies that:

$$H_{\Theta\#}^{-1/2}(\Sigma_{\#}^{\tau}) = \{ \Psi / \mathcal{S}_{\Theta} \Psi \in L^2(0,1;H^{-1/2}(S_{\theta}^{\tau})) \}. \quad (4.26)$$

Finally, (4.24) combined with (4.25) leads for any  $\Psi \in H_{\Theta\#}^{-1/2}(\Sigma_{\#}^{\tau})$  to

$$\frac{1}{\theta_1} \int_0^1 \langle \mathcal{S}_{\Theta} \Psi(\cdot, s), \Phi_{\Theta}(\cdot, s) \rangle_{S_{\theta}^{\tau}} ds = \langle \Psi, \mathcal{S}_{\Theta}^{-1} \Phi_{\Theta} \rangle_{\Sigma_{\#}^{\tau}}, \quad \forall \Phi_{\Theta} \in L^2(0,1;H^{1/2}(S_{\theta}^{\tau})). \quad (4.27)$$

In what follows,  $H_{\Theta\#}^{-1/2}(\Sigma_{\#}^{\tau})$  is endowed with the norm  $\Psi \mapsto \|\mathcal{S}_{\Theta} \Psi\|_{L^2(0,1;H^{-1/2}(S_{\theta}^{\tau}))}$ .

At last, we are able to define the normal trace operator thanks to the next result.

**Proposition 4.12**

Given  $\tau \in \partial I_x$ , the normal trace application  $\gamma_{1,\#}^\tau$  defined by  $\gamma_{1,\#}^\tau \mathbf{W} := (\Theta \mathbf{W} \cdot \mathbf{n})|_{\Sigma_\#^\tau}$  for any  $\mathbf{W} \in \mathcal{C}_{0,\#}^\infty(\overline{\Omega_\#})^2$  extends by continuity to a linear and surjective map still denoted by  $\gamma_{1,\#}^\tau$ , and defined from  $H_{\Theta,\#}(\mathbf{div}; \Omega_\#)$  to  $H_{\Theta,\#}^{-1/2}(\Sigma_\#^\tau)$ .

Moreover, we have the Green formula: for any  $V \in H_{\Theta,\#}^1(\Omega_\#)$  and  $\mathbf{W} \in H_{\Theta,\#}(\mathbf{div}; \Omega_\#)$ ,

$$\int_{\Omega_\#} [\mathbf{div}(\Theta \mathbf{W}) \overline{V} + \mathbf{W} \cdot \overline{\Theta \nabla V}] = \sum_{\tau \in \partial I_x} \langle (\Theta \mathbf{W} \cdot \mathbf{n})|_{\Sigma_\#^\tau}, V|_{\Sigma_\#^\tau} \rangle_{\Sigma_\#^\tau}. \quad (4.28)$$

where we have written abusively  $(\Theta \mathbf{W} \cdot \mathbf{n})|_{\Sigma_\#^\tau}$  for  $\gamma_{1,\#}^\tau \mathbf{W}$ .

**Proof.** Similarly to the proof of Proposition 4.9, we begin by observing that  $\mathcal{S}_\Theta$  commutes with  $\gamma_{1,\#}^\tau$  in the sense that for any  $\mathbf{W} \in \mathcal{C}_{0,\#}^\infty(\overline{\Omega_\#})^2$  (with  $\mathbf{n} = \pm \mathbf{e}_x$ ),

$$\forall s \in (0, 1), \quad \mathcal{S}_\Theta((\Theta \mathbf{W} \cdot \mathbf{n})|_{\Sigma_\#^\tau})(\cdot, s) = (\mathcal{S}_\Theta \mathbf{W}(\cdot, s) \cdot \mathbf{n})|_{S_\theta^\tau}. \quad (4.29)$$

Equation (4.29) extends to  $\mathbf{W} \in H_{\Theta,\#}(\mathbf{div}; \Omega_\#)$  using (i) the density of  $\mathcal{C}_{0,\#}^\infty(\overline{\Omega_\#})^2$  in  $H_{\Theta,\#}(\mathbf{div}; \Omega_\#)$ , (ii) the continuity of  $\mathcal{S}_\Theta$  from  $H_{\Theta,\#}(\mathbf{div}; \Omega_\#)$  to  $L^2(0, 1; H(\mathbf{div}; Q_\theta))$  (Corollary 4.5) and from  $H_{\Theta,\#}^{-1/2}(\Sigma_\#)$  to the space  $L^2(0, 1; H^{-1/2}(S_\theta^\tau))$  (by definition (4.22)), and (iii) the continuity from  $L^2(0, 1; H(\mathbf{div}; Q_\theta))$  to  $L^2(0, 1; H^{-1/2}(S_\theta^\tau))$  of the following normal trace application:

$$\forall \mathbf{W}_\Theta \in L^2(0, 1; H(\mathbf{div}; Q_\theta)), \quad \gamma_1 \mathbf{W}_\Theta(\cdot, s) := (\mathbf{W}_\Theta(\cdot, s) \cdot \mathbf{n})|_{S_\theta^\tau},$$

which follows directly from the classical trace theorem in  $H(\mathbf{div}; Q_\theta)$ .

The inverse  $\mathcal{S}_\Theta^{-1}$  applied to both sides of (4.23) gives  $\gamma_{1,\#}^\tau = \mathcal{S}_\Theta^{-1} \gamma_1 \mathcal{S}_\Theta$ . The continuity and surjectivity of  $\gamma_{1,\#}^\tau$  then follows from the continuity of  $(\gamma_1, \mathcal{S}_\Theta, \mathcal{S}_\Theta^{-1})$  and from the surjectivity of  $\gamma_1$ .

To finish we prove the Green's formula (4.28). For  $V \in H_{\Theta,\#}^1(\Omega_\#)$  and  $\mathbf{W} \in H_{\Theta,\#}(\mathbf{div}; \Omega_\#)$ , the classical Green formula applied to  $(\mathcal{S}_\Theta V(\cdot, s), \mathcal{S}_\Theta \mathbf{W}(\cdot, s)) \in H^1(Q_\theta) \times H(\mathbf{div}; Q_\theta)$  for almost any  $s \in (0, 1)$  and integrated with respect to  $s$  leads to

$$\begin{aligned} \int_0^1 \int_{Q_\theta} [\mathbf{div}_x(\mathcal{S}_\Theta \mathbf{W}) \overline{\mathcal{S}_\Theta V} + \mathcal{S}_\Theta \mathbf{W} \cdot \overline{\nabla_x \mathcal{S}_\Theta V}](\mathbf{x}, s) \, d\mathbf{x} ds \\ = \sum_{\tau \in \partial I_x} \int_0^1 \langle (\mathcal{S}_\Theta \mathbf{W}(\cdot, s) \cdot \mathbf{n})|_{S_\theta^\tau}, \mathcal{S}_\Theta V(\cdot, s)|_{S_\theta^\tau} \rangle_{S_\theta^\tau} ds, \end{aligned}$$

where we recall that  $\langle \cdot, \cdot \rangle_{S_\theta^\tau}$  denotes the duality product between  $H^{-1/2}(S_\theta^\tau)$  and  $H^{1/2}(S_\theta^\tau)$ . To conclude, we use the properties (4.13, 4.16, 4.17) of  $\mathcal{S}_\Theta$  for the left-hand side, as well as the identity (4.27) for the right-hand side. ■

#### 4.4 Subspaces of $\mathbb{Z}\mathbf{e}_1 + \mathbb{Z}\mathbf{e}_2$ -periodic functions in a cylinder

In addition to the strip  $\Omega_{\#} = I_x \times \mathbb{R} \times (0, 1)$  and the interface  $\Sigma_{\#}^{\tau} = \{\tau\} \times \mathbb{R} \times (0, 1)$  defined in Section 4.3 for  $I_1 = \mathbb{R}$ , we also introduce the cylinder and the interface

$$\Omega_{\#^2} := I_x \times (0, 1) \times (0, 1) \quad \text{and} \quad \Sigma_{\#^2}^{\tau} := \{\tau\} \times (0, 1) \times (0, 1), \quad (4.30)$$

where the subscript " $\#^2$ " refers to the boundedness in the  $\mathbf{e}_1$  and the  $\mathbf{e}_2$ -directions. Note that  $\Omega_{\#^2}$  and  $\Sigma_{\#^2}^{\tau}$  correspond to the domains  $\Omega_{\#}$  and  $\Sigma_{\#}^{\tau}$  in (4.3) with  $I_1 = (0, 1)$ , so that one can use the spaces  $H_{\Theta_{\#}^1}^1(\Omega_{\#^2})$ ,  $H_{\Theta_{\#}^1}(\mathbf{div}; \Omega_{\#^2})$ ,  $H_{\Theta_{\#}^1}^{1/2}(\Sigma_{\#^2}^{\tau})$ , and  $H_{\Theta_{\#}^1}^{-1/2}(\Sigma_{\#^2}^{\tau})$ . In the sequel, we assume that  $I_x \neq \mathbb{R}$ , so that  $\partial I_x \neq \emptyset$ .

For the purpose of Sections 5.2 and 5.3, we want to define spaces of  $H_{\Theta}^1$  or  $H_{\Theta}(\mathbf{div})$ -functions in  $\Omega_{\#^2}$  which are formally speaking 1-periodic along  $\mathbf{e}_1$  and  $\mathbf{e}_2$ . To do so, let us begin with the following definition.

##### Definition 4.13

Let  $V \in L^2(\Omega_{\#^2})^d$ . The periodic extension of  $V$  in the  $\mathbf{e}_1$ -direction is defined in  $L_{loc}^2(\overline{\Omega_{\#^2}})^d$  by:

$$\text{a. e. } \mathbf{x} = (x, z_1, z_2) \in \Omega_{\#^2}, \quad \forall n \in \mathbb{Z}, \quad (E_{\#}^1 V)(\mathbf{x} + n\mathbf{e}_1) := V(\mathbf{x}). \quad (4.31)$$

For  $\Phi \in L^2(\Sigma_{\#^2}^{\tau})$ , we define  $E_{\#}^1 \Phi \in L_{loc}^2(\Sigma_{\#^2}^{\tau})$  similarly, with  $\mathbf{x} \in \Omega_{\#^2}$  instead of  $\mathbf{x} \in \Sigma_{\#^2}^{\tau}$ .

In addition, let  $\mathcal{C}_{0, \#^2}^{\infty}(\overline{\Omega_{\#^2}})$  be the space of smooth functions in  $\overline{\Omega_{\#^2}}$  that are compactly supported in the  $\mathbf{e}_x$ -direction and 1-periodic in the  $\mathbf{e}_1$  and  $\mathbf{e}_2$ -directions, namely

$$\mathcal{C}_{0, \#^2}^{\infty}(\overline{\Omega_{\#^2}}) := \{V \in \mathcal{C}_0^{\infty}(\overline{\Omega_{\#^2}}) / E_{\#}^1 V \in \mathcal{C}_{0, \#}^{\infty}(\overline{\Omega_{\#}})\}, \quad (4.32)$$

where  $\mathcal{C}_{0, \#}^{\infty}(\overline{\Omega_{\#}})$  is defined by (4.11). Note that  $\mathcal{C}_{0, \#^2}^{\infty}(\overline{\Omega_{\#^2}})$  contains  $\mathcal{C}_0^{\infty}(\Omega_{\#^2})$ , and therefore is dense in  $L^2(\Omega_{\#^2})$ .

Now, consider the spaces

$$\boxed{H_{\Theta_{\#^2}^1}^1(\Omega_{\#^2}) := \overline{\mathcal{C}_{0, \#^2}^{\infty}(\overline{\Omega_{\#^2}})}^{H_{\Theta}^1(\Omega_{\#^2})} \quad \text{and} \quad H_{\Theta_{\#^2}^1}(\mathbf{div}; \Omega_{\#^2}) := \overline{\mathcal{C}_{0, \#^2}^{\infty}(\overline{\Omega_{\#^2}})}^{H_{\Theta}(\mathbf{div}; \Omega_{\#^2})}} \quad (4.33)$$

which are respectively closed subspaces of  $H_{\Theta_{\#}^1}^1(\Omega_{\#^2})$  and  $H_{\Theta_{\#}^1}(\mathbf{div}; \Omega_{\#^2})$ , and hence Hilbert spaces. Using the trace operator on  $\Sigma_{\#^2}^{\tau}$ ,  $\tau \in \partial I_x$ , defined in Section 4.2 for functions in  $H_{\Theta_{\#}^1}^1(\Omega_{\#^2})$  enables us to introduce

$$H_{\Theta_{\#^2}^1}^{1/2}(\Sigma_{\#^2}^{\tau}) := \{V|_{\Sigma_{\#^2}^{\tau}} / V \in H_{\Theta_{\#}^1}^1(\Omega_{\#^2})\}, \quad (4.34)$$

to which we associate the graph norm. Let  $H_{\Theta_{\#^2}^1}^{-1/2}(\Sigma_{\#^2}^{\tau})$  be the topological dual space of  $H_{\Theta_{\#^2}^1}^{1/2}(\Sigma_{\#^2}^{\tau})$ , equipped with the dual norm. Finally, the dual product  $\langle \cdot, \cdot \rangle_{\Sigma_{\#^2}^{\tau}}$  between  $H_{\Theta_{\#^2}^1}^{-1/2}(\Sigma_{\#^2}^{\tau})$  and  $H_{\Theta_{\#^2}^1}^{1/2}(\Sigma_{\#^2}^{\tau})$  is defined as a natural extension of the  $L^2(\Sigma_{\#^2}^{\tau})$ -scalar product.

**Remark 4.14.** Similarly to Remark 4.7,  $H_{\Theta_{\#^2}^1}^1(\Omega_{\#^2})$  formally corresponds to the set of functions  $V$  in  $H_{\Theta}^1(\Omega_{\#^2})$  such that  $V|_{z_1=0} = V|_{z_1=1}$  and  $V|_{z_2=0} = V|_{z_2=1}$ . Showing this characterization requires the traces of functions in  $H_{\Theta}^1(\Omega_{\#^2})$  whose definition is delicate. (We refer to Section III-3.2 for similar

considerations.)

The density of  $\mathcal{C}_{0,\#^2}^\infty(\overline{\Omega_{\#^2}})$  in  $H_{\Theta,\#^2}^1(\Omega_{\#^2})$ , the density of  $\mathcal{C}_{0,\#^2}^\infty(\overline{\Omega_{\#^2}})^2$  in  $H_{\Theta,\#^2}(\mathbf{div}; \Omega_{\#^2})$ , and the continuity of the trace operator on  $\Sigma_{\#^2}^\tau$  lead directly to the next result.

**Proposition 4.15**

Given  $\tau \in \partial I_x$ , the normal trace application  $\gamma_{1,\#^2}^\tau$  defined by  $\gamma_{1,\#^2}^\tau \mathbf{W} := (\Theta \mathbf{W} \cdot \mathbf{n})|_{\Sigma_{\#^2}^\tau}$  for any  $\mathbf{W} \in \mathcal{C}_{0,\#^2}^\infty(\overline{\Omega_{\#^2}})^2$  extends by continuity to a linear and surjective map still denoted by  $\gamma_{1,\#^2}^\tau$ , and defined from  $H_{\Theta,\#^2}(\mathbf{div}; \Omega_{\#^2})$  to  $H_{\Theta,\#^2}^{-1/2}(\Sigma_{\#^2}^\tau)$ .

Moreover, we have the Green formula: for any  $V \in H_{\Theta,\#^2}^1(\Omega_{\#^2})$  and  $\mathbf{W} \in H_{\Theta,\#^2}(\mathbf{div}; \Omega_{\#^2})$ ,

$$\int_{\Omega_{\#^2}} [\mathbf{div}(\Theta \mathbf{W}) \bar{V} + \mathbf{W} \cdot \overline{t\Theta \nabla V}] = \sum_{\tau \in \partial I_x} \langle (\Theta \mathbf{W} \cdot \mathbf{n})|_{\Sigma_{\#^2}^\tau}, V|_{\Sigma_{\#^2}^\tau} \rangle_{\Sigma_{\#^2}^\tau}, \quad (4.35)$$

where we have abusively written  $(\Theta \mathbf{W} \cdot \mathbf{n})|_{\Sigma_{\#^2}^\tau}$  instead of  $\gamma_{1,\#^2}^\tau \mathbf{W}$ .

We finish with an anisotropic version of the jump rule, which will be used extensively in Section 5.3.

**Proposition 4.16**

Assume that  $\Omega_{\#^2} = \Omega_{\#^2}^1 \cup \Omega_{\#^2}^2$  where  $\Omega_{\#^2}^1$  and  $\Omega_{\#^2}^2$  are disjoint cylinders defined by

$$\Omega_{\#^2}^i := J_x^i \times (0, 1) \times (0, 1) \subset \Omega_{\#^2}, \quad \forall i \in \{1, 2\}.$$

where  $J_x^1 \cup J_x^2 = I_x$  and  $J_x^1 \cap J_x^2 = \emptyset$  (see Figure 8). Let  $\Sigma_{\#^2}^\tau := \overline{\Omega_{\#^2}^1} \cap \overline{\Omega_{\#^2}^2}$ .

(a). Let  $V_i \in H_{\Theta,\#^2}^1(\Omega_{\#^2}^i)$ ,  $i \in \{1, 2\}$ . Then the function defined by

$$\text{a. e. } \mathbf{x} \in \Omega_{\#^2}, \quad V(\mathbf{x}) := \begin{cases} V_1(\mathbf{x}) & \text{if } \mathbf{x} \in \Omega_{\#^2}^1 \\ V_2(\mathbf{x}) & \text{if } \mathbf{x} \in \Omega_{\#^2}^2 \end{cases}$$

belongs to  $H_{\Theta,\#^2}^1(\Omega_{\#^2})$  if and only if  $V_1|_{\Sigma_{\#^2}^\tau} = V_2|_{\Sigma_{\#^2}^\tau}$ .

(b). Let  $\mathbf{W}_i \in H_{\Theta,\#^2}(\mathbf{div}; \Omega_{\#^2}^i)$ ,  $i \in \{1, 2\}$ . Then the function given by

$$\text{a. e. } \mathbf{x} \in \Omega_{\#^2}, \quad \mathbf{W}(\mathbf{x}) := \begin{cases} \mathbf{W}_1(\mathbf{x}) & \text{if } \mathbf{x} \in \Omega_{\#^2}^1 \\ \mathbf{W}_2(\mathbf{x}) & \text{if } \mathbf{x} \in \Omega_{\#^2}^2 \end{cases}$$

belongs to  $H_{\Theta,\#^2}(\mathbf{div}; \Omega_{\#^2})$  if and only if  $(\Theta \mathbf{W}_1 \cdot \mathbf{n})|_{\Sigma_{\#^2}^\tau} = -(\Theta \mathbf{W}_2 \cdot \mathbf{n})|_{\Sigma_{\#^2}^\tau}$ .

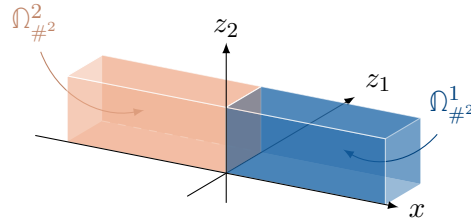

Figure 8: The domains  $\Omega_{\#2}^1$  and  $\Omega_{\#2}^2$  in Proposition 4.16 for  $I_x = \mathbb{R}$ ,  $J_x^1 = \mathbb{R}_+$ , and  $J_x^2 = \mathbb{R}_-$

## 5 The solution of the augmented periodic problem

The present section is the most important part of the chapter. A rigorous version of (3.16, 3.17, 3.20) is studied and is solved by exploiting the periodic nature of  $(\mathbb{A}_p, \rho_p)$ . The resolution procedure is divided into three steps, each of which is devoted to bounding the computational domain in one direction, as illustrated in Figure 9:

- In Section 5.1, using the periodicity of  $(\mathbb{A}_p, \rho_p)$  in  $z_2$  and the formal observation (3.20), we shall consider extensions of the jump data  $g$  which are 1-periodic in  $z_2$ , so that the solution of the augmented problem is defined in the strip  $\mathbb{R}^2 \times (0, 1)$ .
- In Section 5.2, we use a partial Floquet-Bloch transform with respect to  $z_1$  which, thanks to the periodicity of  $(\mathbb{A}_p, \rho_p)$  in  $z_1$ , leads to a family of problems defined in  $\mathbb{R} \times (0, 1)^2$ .
- At last, using the periodicity of  $(\mathbb{A}_p^\pm, \rho_p^\pm)$  in  $x$ , we resort in Section 5.3 to the DtN method developed in [JLF06; FJ09] to reduce computations to the periodicity cell  $(0, \pm 1) \times (0, 1)^2$ .

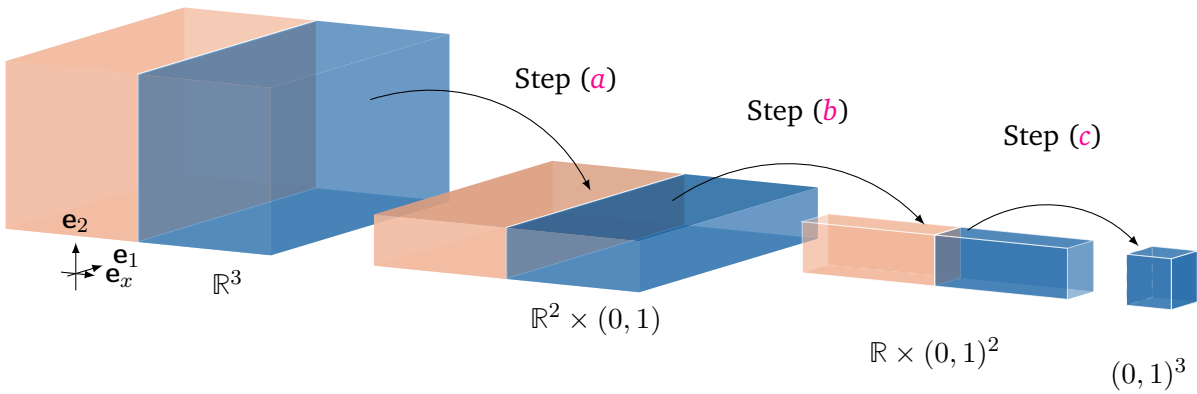

Figure 9: Reduction of the domains through the steps detailed in Section 5.

### 5.1 The augmented strip problem and its quasi-2D structure

We consider the 3-dimensional strips  $\Omega_{\#}, \Omega_{\#}^{\pm}$  and the 2-dimensional interface  $\Sigma_{\#}$  defined by

$$\begin{aligned} \Omega_{\#} &:= \{(x, z_1, z_2) \in \mathbb{R}^3 / z_2 \in (0, 1)\}, \\ \Omega_{\#}^{\pm} &:= \{(x, z_1, z_2) \in \Omega_{\#} / \pm x > 0\}, \\ \Sigma_{\#} &:= \{(x, z_1, z_2) \in \Omega_{\#} / x = 0\}. \end{aligned} \tag{5.1}$$

These domains are represented in Figure 10. We recall the use of the indexing  $\Omega_{\#}^{\nu}$ ,  $\nu \in \{\emptyset, +, -\}$  where by convention,  $\Omega_{\#}^{\nu} = \Omega_{\#}$  for  $\nu = \emptyset$ . Note that  $\Omega_{\#}^{\nu}$  and  $\Sigma_{\#}$  correspond respectively to the

domains  $\Omega_{\#} := I_x \times I_1 \times (0, 1)$  and  $\Sigma_{\#} := \{0\} \times I_1 \times (0, 1)$  defined by (4.3) with

$$I_x := \mathbb{R}_\nu, \quad I_1 := \mathbb{R}, \quad Q_\theta = \mathbb{R}_\nu \times \mathbb{R}, \quad \text{and} \quad S_\theta = \{0\} \times \mathbb{R}.$$

Therefore Sections 4.1, 4.2, and 4.3 enable us to use  $H_{\Theta_{\#}}^1(\Omega_{\#}^\nu)$ ,  $H_{\Theta_{\#}}(\mathbf{div}; \Omega_{\#}^\nu)$  which are defined by (4.15), the space  $H_{\Theta_{\#}}^{1/2}(\Sigma_{\#})$  given by (4.22) and its dual  $H_{\Theta_{\#}}^{-1/2}(\Sigma_{\#})$  characterized by (4.26), and the trace and normal trace applications on  $\Sigma_{\#}$ .

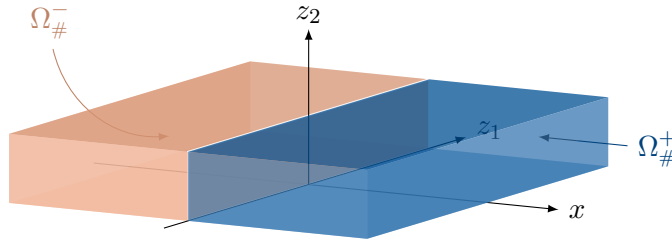

Figure 10: The half-strips  $\Omega_{\#}^+$  and  $\Omega_{\#}^-$  defined in (5.1)

Using the formal observations made in Section 3.2, we can introduce for any  $G \in H_{\Theta_{\#}}^{-1/2}(\Sigma_{\#})$  the strip problem: find  $U \in H_{\Theta_{\#}}^1(\Omega_{\#})$  such that

$$\begin{cases} -\mathbf{div} \Theta \mathbb{A}_p {}^t \Theta \nabla U - \rho_p \omega^2 U = 0 & \text{in } \Omega_{\#}^+ \cup \Omega_{\#}^-, \\ U \in H_{\Theta_{\#}}^1(\Omega_{\#}), \quad (\mathbb{A}_p {}^t \Theta \nabla U)|_{\Omega_{\#}^\pm} \in H_{\Theta_{\#}}(\mathbf{div}; \Omega_{\#}^\pm), \\ \llbracket (\Theta \mathbb{A}_p {}^t \Theta \nabla U) \cdot \mathbf{e}_x \rrbracket_{\Sigma_{\#}} = G. \end{cases} \quad (\mathcal{P}_{\#})$$

Note that from the first equation, one has  $(\mathbb{A}_p {}^t \Theta \nabla U)|_{\Omega_{\#}^\pm} \in H_{\Theta_{\#}}(\mathbf{div}; \Omega_{\#}^\pm)$ . Formally speaking, the second equation requires  $U$  and  $(\mathbb{A}_p {}^t \Theta \nabla U)|_{\Omega_{\#}^\pm}$  to be 1-periodic with respect to  $z_2$  (see Remark 4.7). Finally,  $\llbracket \Theta \mathbf{W} \cdot \mathbf{e}_x \rrbracket_{\Sigma_{\#}}$  is the jump across  $\Sigma_{\#}$  of the normal components of a function  $\mathbf{W} \in L^2(\Omega_{\#})$  which satisfies  $\mathbf{W}^\pm := \mathbf{W}|_{\Omega_{\#}^\pm} \in H_{\Theta_{\#}}(\mathbf{div}; \Omega_{\#}^\pm)$ :

$$\llbracket \Theta \mathbf{W} \cdot \mathbf{e}_x \rrbracket_{\Sigma_{\#}} := (\Theta \mathbf{W}^- \cdot \mathbf{e}_x)|_{\Sigma_{\#}} - (\Theta \mathbf{W}^+ \cdot \mathbf{e}_x)|_{\Sigma_{\#}}, \quad (5.2)$$

and the third equation holds in  $H_{\Theta_{\#}}^{-1/2}(\Sigma_{\#})$ .

In what follows, we shall study Problem  $(\mathcal{P}_{\#})$  and emphasize its fibered structure as a "concatenation" of 2-dimensional problems. For that latter purpose, it is useful to introduce the family of functions

$$\forall s \in \mathbb{R}, \quad \mathbb{A}_s(\mathbf{x}) := \mathbb{A}_p(\Theta \mathbf{x} + s \mathbf{e}_2) \quad \text{and} \quad \rho_s(\mathbf{x}) := \rho_p(\Theta \mathbf{x} + s \mathbf{e}_2), \quad \forall \mathbf{x} \in \mathbb{R}^2, \quad (5.3)$$

where  $\mathbb{A}_p, \rho_p$  are given by (3.3) for Configuration  $(\mathcal{A})$  and by (3.9, 3.11) for Configuration  $(\mathcal{B})$ . Note that the restrictions of  $\mathbb{A}_s$  and  $\rho_s$  to  $\mathbb{R}_{\pm}^2$  are well-defined and continuous since for both Configurations  $(\mathcal{A})$  and  $(\mathcal{B})$ ,  $\mathbb{A}_p$  and  $\rho_p$  depend in a simple manner on  $\mathbb{A}$  and  $\rho$  which are continuous on  $\mathbb{R}_{\pm}^2$ . Furthermore,  $s \mapsto \mathbb{A}_s$  and  $s \mapsto \rho_s$  are continuous from  $\mathbb{R}$  to  $L^\infty(\mathbb{R}^2; \mathbb{R}^{2 \times 2})$  and  $L^\infty(\mathbb{R}^2)$  respectively. Note also that for any  $s \in \mathbb{R}$ ,  $\mathbb{A}_s$  and  $\rho_s$  satisfy the ellipticity assumption (2.2), and we have  $\mathbb{A}_{s+1} = \mathbb{A}_s$  and  $\rho_{s+1} = \rho_s$ .



Given  $\psi \in H^{-1/2}(\sigma)$ , we consider the 2-dimensional problem: Find  $u_s \in H^1(\mathbb{R}^2)$  such that

$$\begin{cases} -\operatorname{div} \mathbb{A}_s(\mathbf{x}) \nabla u_s(\mathbf{x}) - \rho_s(\mathbf{x}) \omega^2 u_s(\mathbf{x}) = 0 & \text{for } \mathbf{x} \in \mathbb{R}_+^2 \cup \mathbb{R}_-^2, \\ \llbracket \mathbb{A}_s \nabla u_s \cdot \mathbf{e}_x \rrbracket_\sigma = \psi. \end{cases} \quad (\mathcal{P}_s)$$

**Remark 5.1.** One has  $\mathbb{A}_0 = \mathbb{A}$  and  $\rho_0 = \rho$ , and  $(\mathcal{P})$  corresponds to  $(\mathcal{P}_s)$  with  $s = 0$  and  $\psi = g$ .

Because of the ellipticity assumption (2.2) and the presence of absorption (2.1), Problem  $(\mathcal{P}_s)$  admits a unique solution  $u_s(\psi) \in H^1(\mathbb{R}^2)$ . Furthermore, the well-posedness of Problem  $(\mathcal{P}_\#)$  and the link between its solution  $U$  and the solutions  $u_s(\psi)$  is given by the following result.

### Proposition 5.2

For any  $G \in H_{\Theta\#}^{-1/2}(\Sigma_\#)$ , Problem  $(\mathcal{P}_\#)$  is equivalent to the variational problem

$$\left| \begin{array}{l} \text{Find } U \in H_{\Theta\#}^1(\Omega_\#) \text{ such that } \forall V \in H_{\Theta\#}^1(\Omega_\#), \\ \int_{\Omega_\#} [(\mathbb{A}_p \mathop{\mathrm{t}}\nabla U) \cdot \overline{(\mathop{\mathrm{t}}\nabla V)} - \rho_p \omega^2 U \overline{V}] = \langle G, V \rangle_{\Sigma_\#} \end{array} \right. \quad (\text{FV}_\#)$$

which is well-posed in  $H_{\Theta\#}^1(\Omega_\#)$ . Furthermore,

$$\text{a. e. } s \in (0, 1), \quad \mathbb{E}_\#^2 U(x, \theta_1 z, \theta_2 z + s) = u_s(x, z), \quad \text{a. e. } \mathbf{x} = (x, z) \in \mathbb{R}^2. \quad (5.4)$$

where  $U = U(G)$  and  $u_s = u_s(g_s)$  with  $g_s := \mathcal{S}_\Theta G(\cdot, s)$  are the respective solutions of Problems  $(\mathcal{P}_\#)$  and  $(\mathcal{P}_s)$ .

**Proof.** To obtain the variational formulation  $(\text{FV}_\#)$ , one multiplies the volume equation in  $(\mathcal{P}_\#)$  by  $V \in H_{\Theta\#}^1(\Omega_\#)$ , and integrates over  $\Omega_\#^+$  and  $\Omega_\#^-$  separately. Since  $(\mathbb{A}_p \mathop{\mathrm{t}}\nabla U)|_{\Omega_\#^\pm} \in H_{\Theta,\#}(\mathbf{div}; \Omega_\#^\pm)$ , we then apply Green's formula (4.28) on each domain  $\Omega_\#^+$  and  $\Omega_\#^-$ , add the corresponding identities, and we finally use the transmission condition (that is, the third equation in  $(\mathcal{P}_\#)$ ) to conclude.

The well-posedness of the variational formulation  $(\text{FV}_\#)$  is guaranteed by Lax-Milgram's theorem. In particular, the bilinear form  $\mathcal{A}$  associated to  $(\text{FV}_\#)$  satisfies

$$\forall V \in H_{\Theta\#}^1(\Omega_\#), \quad \Im \left[ \frac{\mathcal{A}(V, V)}{\omega} \right] = -\Im \omega \int_{\Omega_\#} \left[ \frac{1}{|\omega|^2} \mathbb{A}_p |\mathop{\mathrm{t}}\nabla V|^2 + \rho_p |V|^2 \right], \quad (5.5)$$

and therefore is coercive due to the presence of absorption (2.1), that is,  $\Im \omega > 0$ .

Now we shall prove (5.4), which will enable us to deduce the equivalence between  $(\text{FV}_\#)$  and  $(\mathcal{P}_\#)$  at last. To this end, given  $s \in (0, 1)$ , we show that  $\mathcal{S}_\Theta U(\cdot, s) \in H^1(\mathbb{R}^2)$  satisfies the same problem as  $u_s(\mathcal{S}_\Theta G(\cdot, s))$ . For  $V \in H_{\Theta\#}^1(\Omega_\#)$ , the properties (4.16, 4.13) of  $\mathcal{S}_\Theta$  combined with  $(\text{FV}_\#)$  and (4.27) imply that

$$\int_0^1 \int_{\mathbb{R}^2} [\mathbb{A}_s \nabla_x \mathcal{S}_\Theta U(\cdot, s) \cdot \overline{\nabla_x \mathcal{S}_\Theta V(\cdot, s)} - \rho_s \omega^2 \mathcal{S}_\Theta U(\cdot, s) \overline{\mathcal{S}_\Theta V(\cdot, s)}] d\mathbf{x} ds$$

$$\begin{aligned}
&= \theta_1 \int_{\Omega_{\#}} [(\mathbb{A}_p {}^t \Theta \nabla U) \cdot \overline{({}^t \Theta \nabla V)} - \rho_p \omega^2 U \bar{V}] \\
&= \theta_1 \langle G, V \rangle_{\Sigma_{\#}} = \int_0^1 \langle \mathcal{S}_{\Theta} G(\cdot, s), \mathcal{S}_{\Theta} V(\cdot, s)|_{\sigma} \rangle_{\sigma} ds.
\end{aligned} \tag{5.6}$$

Now we choose  $V$  such that  $\mathcal{S}_{\Theta} V(\mathbf{x}, s) = \varphi(s) v(\mathbf{x})$ , with  $\varphi \in L^2(0, 1)$  and  $v \in H^1(\mathbb{R}^2)$ . Then it follows that  $\nabla_{\mathbf{x}} \mathcal{S}_{\Theta} V(\mathbf{x}, s) = \varphi(s) \nabla v(\mathbf{x})$ , and (5.6) being true for any  $\varphi \in L^2(0, 1)$  implies for almost any  $s \in (0, 1)$  that

$$\forall v \in H^1(\mathbb{R}^2), \quad \int_{\mathbb{R}^2} [\mathbb{A}_s \nabla_{\mathbf{x}} \mathcal{S}_{\Theta} U(\cdot, s) \cdot \nabla \bar{v} - \rho_s \omega^2 \mathcal{S}_{\Theta} U(\cdot, s) \bar{v}] d\mathbf{x} = \langle \mathcal{S}_{\Theta} G(\cdot, s), v \rangle_{\sigma},$$

which is equivalent to the transmission problem  $(\mathcal{P}_s)$  satisfied by  $u_s(\mathcal{S}_{\Theta} G(\cdot, s))$ . From the uniqueness of the solution of  $(\mathcal{P}_s)$ , we then deduce  $\mathcal{S}_{\Theta} U(\cdot, s) = u_s(\mathcal{S}_{\Theta} G(\cdot, s))$  which is (5.4).

It remains to prove the equivalence between Problem  $(\mathcal{P}_{\#})$  and its variational formulation  $(\mathbf{FV}_{\#})$ . But we have shown in the last step that if  $U$  satisfies  $(\mathbf{FV}_{\#})$ , then  $(\mathcal{S}_{\Theta} U)(\cdot, s) = u_s((\mathcal{S}_{\Theta} G)(\cdot, s))$ . Combining this result with the properties (4.16, 4.17) of  $\mathcal{S}_{\Theta}$  thus leads to the first and second equations in  $(\mathcal{P}_{\#})$ , while the transmission condition (that is, the third equation in  $(\mathcal{P}_{\#})$ ) follows from (4.27) and from the transmission condition satisfied by  $u_s((\mathcal{S}_{\Theta} G)(\cdot, s))$  in  $(\mathcal{P}_s)$ . ■

To conclude this section, we propose in Proposition 5.4 a rigorous formulation of the ansatz (3.13). To begin, note that due to the uniform boundedness of  $(\mathbb{A}_s)_s$  and  $(\rho_s)_s$  in  $L^{\infty}(\mathbb{R}^2)$ ,  $(u_s(\psi))_s$  is bounded uniformly with respect to  $s$ :

$$\exists c > 0, \quad \forall s \in \mathbb{R}, \quad \|u_s(\psi)\|_{H^1(\mathbb{R}^2)} \leq c \|\psi\|_{H^{-1/2}(\sigma)}, \quad \forall \psi \in H^{-1/2}(\sigma). \tag{5.7}$$

By combining this property with the continuity of  $\mathbb{A}_s$  and  $\rho_s$  in  $L^{\infty}(\mathbb{R}^2)$  with respect to  $s$ , one can show that  $s \mapsto u_s(\psi)$  is a continuous application. This is the object of the next proposition, whose proof is similar to the proof of Proposition III-3.18.

### Proposition 5.3

For  $\psi \in H^{-1/2}(\sigma)$ ,  $s \mapsto u_s(\psi)$  is continuous from  $\mathbb{R}$  to  $H^1(\mathbb{R}^2)$  and is 1-periodic.

The next proposition shows how the solution  $u$  of  $(\mathcal{P})$  can be retrieved from the solution  $U(G)$  of the augmented problem  $(\mathcal{P}_{\#})$  for a well-chosen boundary data  $G$ .

### Proposition 5.4

Consider  $G \in H_{\Theta_{\#}}^{-1/2}(\Sigma_{\#})$  such that  $s \mapsto \mathcal{S}_{\Theta} G(\cdot, s) \in H^{-1/2}(\sigma)$  is continuous at 0, and that  $\mathcal{S}_{\Theta} G(\cdot, 0) = g$ , where  $g \in H^{-1/2}(\sigma)$  is the jump data in  $(\mathcal{P})$ . Then setting  $U = U(G)$ , the map  $s \mapsto (\mathcal{S}_{\Theta} U)(\cdot, s) \in H^1(\mathbb{R}^2)$  is continuous as well at 0, and

$$\text{a. e. } (x, z) \in \mathbb{R}^2, \quad u(x, z) = \mathbf{E}_{\#}^2 U(x, \theta_1 z, \theta_2 z). \tag{5.8}$$

**Proof.** Since  $\psi \mapsto u_s(\psi)$  is continuous from  $H^{-1/2}(\sigma)$  to  $H^1(\mathbb{R}^2)$  uniformly with respect to  $s$  (according to (5.7)) on one hand, and  $s \mapsto u_s(\psi)$  is continuous (according to Proposition 5.3) on the other hand, it follows that  $s \mapsto u_s(\mathcal{S}_\Theta G(\cdot, s))$  is continuous at 0 as a product of continuous maps. Consequently (5.4) becomes true for  $s = 0$ , and thus leads to (5.8). ■

## 5.2 Reduction to waveguide problems via the Floquet-Bloch transform

This section presents the first important tool to solve the augmented strip problem ( $\mathcal{P}_\#$ ), which is the Floquet-Bloch transform. The 1-dimensional Floquet-Bloch transform is introduced in Section 5.2.a in the spirit of [Kuc01] (see also [Kuc93, Section 2.2] and references therein), and is adapted in Section 5.2.b for functions that belong to  $H_{\Theta, \#}^1(\Omega_\#)$  or  $H_{\Theta, \#}(\text{div}; \Omega_\#)$ . Last, we apply this transform to ( $\mathcal{P}_\#$ ) in Section 5.2.c.

**5.2.a. The 1D Floquet-Bloch transform.** Let  $p > 0$ . The *Floquet-Bloch* transform with period  $p$  is the application  $\mathcal{F}_p$  defined from  $\mathcal{C}_0^\infty(\mathbb{R})$  to  $L_{loc}^2(\mathbb{R}^2)$  by

$$\forall \varphi \in \mathcal{C}_0^\infty(\mathbb{R}), \quad \forall (z, \xi) \in \mathbb{R}^2, \quad \mathcal{F}_p \varphi(z, \xi) = \widehat{\varphi}(z, \xi) := \sqrt{\frac{p}{2\pi}} \sum_{n \in \mathbb{Z}} \varphi(z + np) e^{-i\xi(z+np)}, \quad (5.9)$$

with the convention that  $\mathcal{F}_p \equiv \mathcal{F}$  for  $p = 1$ . Note that  $\widehat{\varphi}$  is periodic with respect to  $z$  and satisfies the following condition with respect to  $\xi$ : for any  $(z, \xi) \in \mathbb{R}^2$

$$\widehat{\varphi}(z + p, \xi) = \widehat{\varphi}(z, \xi) \quad \text{and} \quad \widehat{\varphi}(z, \xi + 2\pi/p) = e^{-2i\pi z/p} \widehat{\varphi}(z, \xi). \quad (5.10)$$

Therefore,  $\widehat{\varphi}$  can be fully constructed from its knowledge on the cell  $(0, p) \times K$  with  $K := (-\pi/p, \pi/p)$ . For this reason, the study of  $\widehat{\varphi}$  will be restricted to  $(0, p) \times K$ .

The operator  $\mathcal{F}_p$  extends to an isometry between  $L^2(\mathbb{R})$  and  $L^2(K; L^2(0, p))$ , with the Plancherel-like formula:

$$\forall \varphi, \psi \in L^2(\mathbb{R}), \quad \int_K \int_0^p (\mathcal{F}_p \varphi) \overline{(\mathcal{F}_p \psi)} = \int_{\mathbb{R}} \varphi \overline{\psi}.$$

Moreover,  $\mathcal{F}_p$  is an isomorphism, with the inversion formula:

$$\forall \widehat{\varphi} \in L^2(K), \quad \text{a. e. } z \in (0, p), \quad \forall n \in \mathbb{Z}, \quad \mathcal{F}_p^{-1} \varphi(z + np) = \sqrt{\frac{p}{2\pi}} \int_K \widehat{\varphi}(z, \xi) e^{i\xi(z+np)} d\xi, \quad (5.11)$$

What makes the Floquet-Bloch transform a valuable tool in the context of this chapter is its action on differential operators with periodic coefficients: on one hand

$$\forall \varphi \in H^1(\mathbb{R}), \quad \text{a. e. } \xi \in K, \quad \mathcal{F}_p \left( \frac{d\varphi}{dz} \right) (\cdot, \xi) = \left( \frac{\partial}{\partial z} + i\xi \right) (\mathcal{F}_p \varphi) (\cdot, \xi).$$

On the other hand, for any  $\mu \in L^\infty(\mathbb{R})$  such that  $\mu(\cdot + p) = \mu$ , one has

$$\forall \varphi \in L^2(\mathbb{R}), \quad \mathcal{F}_p (\mu \varphi) = \mu \mathcal{F}_p \varphi.$$

Finally, one shows that  $\mathcal{F}_p$  is an isomorphism from  $H^1(\mathbb{R})$  to  $L^2(K; H_\#^1(0, p))$ , where

$$H_\#^1(0, p) = \{ \varphi \in H^1(0, p) / \varphi(p) = \varphi(0) \},$$

and where  $L^2(a, b; \mathcal{X})$  is defined by (4.4). By duality,  $\mathcal{F}_p$  extends to  $H^{-1/2}(\mathbb{R})$ .

5.2.b. **The partial Floquet-Bloch transform with respect to  $z_1$ .** We begin by introducing

$$\begin{aligned}\Omega_{\#^2} &:= \{(x, z_1, z_2) \in \Omega_{\#} / z_1 \in (0, 1)\}, \\ \Omega_{\#^2}^{\pm} &:= \{(x, z_1, z_2) \in \Omega_{\#}^{\pm} / z_1 \in (0, 1)\}, \\ \Sigma_{\#^2} &:= \{(x, z_1, z_2) \in \Sigma_{\#} / z_1 \in (0, 1)\},\end{aligned}\tag{5.12}$$

where the subscript " $\#^2$ " indicates the boundedness of the domains in the  $\mathbf{e}_1$  and the  $\mathbf{e}_2$ -directions. These domains are represented in Figure 11. We recall the use of the indexing  $\Omega_{\#^2}^{\nu}$  for  $\nu \in \{\emptyset, +, -\}$ , with the convention that  $\Omega_{\#^2}^{\nu} = \Omega_{\#^2}$  if  $\nu = \emptyset$ . Note that  $\Omega_{\#^2}^{\nu}$  and  $\Sigma_{\#^2}$  correspond respectively to the domains  $\Omega_{\#^2} := I_x \times I_1 \times (0, 1)$  and  $\Sigma_{\#^2} := \{0\} \times I_1 \times (0, 1)$  defined by (4.30) with

$$I_x := \mathbb{R}_{\nu}, \quad I_1 := (0, 1), \quad Q_{\theta} = \mathbb{R}_{\nu} \times (0, 1/\theta_1), \quad \text{and} \quad S_{\theta} = \{0\} \times (0, 1/\theta_1).$$

Thus thanks to Section 4.4, we can use the spaces  $H_{\Theta_{\#^2}}^1(\Omega_{\#^2})$ ,  $H_{\Theta_{\#^2}}(\mathbf{div}; \Omega_{\#^2})$  given by (4.33) as well as the space  $H_{\Theta_{\#^2}}^{1/2}(\Sigma_{\#^2})$  defined by (4.34), its dual  $H_{\Theta_{\#^2}}^{-1/2}(\Sigma_{\#^2})$ , and the trace and normal trace operators on  $\Sigma_{\#^2}$ .

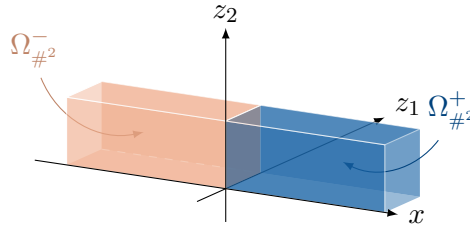

Figure 11: The half-cylinders  $\Omega_{\#^2}^+$  and  $\Omega_{\#^2}^-$  defined in (5.12)

Let  $d \in \{1, 2\}$ . The Floquet-Bloch transform in the  $\mathbf{e}_1$ -direction of  $\mathbf{V} \in \mathcal{C}_0^\infty(\overline{\Omega_{\#}})^d$  is the function

$$\forall \mathbf{x} = (x, z_1, z_2) \in \Omega_{\#}, \quad \forall \xi \in \mathbb{R}, \quad \mathcal{F}_{\mathbf{e}_1} \mathbf{V}(\mathbf{x}, \xi) := \widehat{\mathbf{V}}(\mathbf{x}, \xi) = \mathcal{F}[\mathbf{V}(x, \cdot, z_2)](z_1, \xi),\tag{5.13}$$

where  $\mathcal{F}$  is defined by (5.9) for  $p = 1$ . Using the properties of  $\mathcal{F}$  and Fubini's theorem, one obtains that the transform  $\mathcal{F}_{\mathbf{e}_1}$  extends as an isometry from  $L^2(\Omega_{\#})^d$  to  $L^2(-\pi, \pi; L^2(\Omega_{\#^2})^d)$ , with

$$\forall \mathbf{U}, \mathbf{V} \in L^2(\Omega_{\#})^d, \quad \int_{-\pi}^{\pi} \int_{\Omega_{\#^2}} \mathcal{F}_{\mathbf{e}_1} \mathbf{U}(\mathbf{x}, \xi) \overline{\mathcal{F}_{\mathbf{e}_1} \mathbf{V}(\mathbf{x}, \xi)} \, dx d\xi = \int_{\Omega_{\#}} \mathbf{U} \overline{\mathbf{V}}.\tag{5.14}$$

Moreover, we deduce from (5.11) that for any  $\widehat{\mathbf{U}} \in L^2(-\pi, \pi; L^2(\Omega_{\#^2})^d)$ ,

$$\text{a. e. } \mathbf{x} = (x, z_1, z_2) \in \Omega_{\#^2}, \quad \forall n \in \mathbb{Z}, \quad \mathcal{F}_{\mathbf{e}_1}^{-1} \widehat{\mathbf{U}}(\mathbf{x} + n \mathbf{e}_1) = \frac{1}{\sqrt{2\pi}} \int_{-\pi}^{\pi} \widehat{\mathbf{U}}(\mathbf{x}, \xi) e^{i\xi(z_1+n)} \, d\xi.\tag{5.15}$$

In addition, for  $\Phi \in \mathcal{C}^\infty(\Sigma_{\#^2})$ , we define  $\mathcal{F}_{\mathbf{e}_1}$  as in (5.13) by choosing  $\mathbf{x} \in \Sigma_{\#^2}$ . Then  $\mathcal{F}_{\mathbf{e}_1}$  extends as an isometry between  $L^2(\Sigma_{\#})$  and  $L^2(-\pi, \pi; L^2(\Sigma_{\#^2}))$ .

The next proposition gives the properties of  $\mathcal{F}_{\mathbf{e}_1}$  in  $H_{\Theta_{\#}}^1(\Omega_{\#})$ ,  $H_{\Theta_{\#}}(\mathbf{div}; \Omega_{\#})$ , and  $H_{\Theta_{\#}}^{1/2}(\Sigma_{\#})$ . Its proof is delayed to Appendix A.

**Proposition 5.5**

(a).  $\mathcal{F}_{\mathbf{e}_1}$  is an isomorphism from  $H_{\Theta\#}^1(\Omega_{\#})$  to  $L^2(-\pi, \pi; H_{\Theta\#^2}^1(\Omega_{\#^2}))$ , and for  $V \in H_{\Theta\#}^1(\Omega_{\#})$ ,

$$\text{a. e. } \xi \in (-\pi, \pi), \quad \mathcal{F}_{\mathbf{e}_1}({}^t\Theta \nabla V)(\cdot, \xi) = {}^t\Theta (\nabla + i\xi \mathbf{e}_1) \mathcal{F}_{\mathbf{e}_1} V(\cdot, \xi). \quad (5.16)$$

(b).  $\mathcal{F}_{\mathbf{e}_1}$  is an isomorphism from  $H_{\Theta, \#}(\mathbf{div}; \Omega_{\#})$  to the space  $L^2(-\pi, \pi; H_{\Theta, \#^2}(\mathbf{div}; \Omega_{\#^2}))$ , and for  $\mathbf{W} \in H_{\Theta, \#}(\mathbf{div}; \Omega_{\#})$ ,

$$\text{a. e. } \xi \in (-\pi, \pi), \quad \mathcal{F}_{\mathbf{e}_1}(\mathbf{div} \Theta \mathbf{W})(\cdot, \xi) = (\mathbf{div} + i\xi {}^t\mathbf{e}_1) \Theta \mathcal{F}_{\mathbf{e}_1} \mathbf{W}(\cdot, \xi). \quad (5.17)$$

(c).  $\mathcal{F}_{\mathbf{e}_1}$  is an isomorphism from  $H_{\Theta\#}^{1/2}(\Sigma_{\#})$  to  $L^2(-\pi, \pi; H_{\Theta\#^2}^{1/2}(\Sigma_{\#^2}))$ .

One consequence of Proposition 5.5 which will be useful in the next section is the following.

**Corollary 5.6**

For any  $U, V \in H_{\Theta\#}^1(\Omega_{\#})$ ,

$$\int_{-\pi}^{\pi} \int_{\Omega_{\#^2}} {}^t\Theta (\nabla + i\xi \mathbf{e}_1) \mathcal{F}_{\mathbf{e}_1} U(\mathbf{x}, \xi) \cdot \overline{{}^t\Theta (\nabla + i\xi \mathbf{e}_1) \mathcal{F}_{\mathbf{e}_1} V(\mathbf{x}, \xi)} \, d\mathbf{x} d\xi = \int_{\Omega_{\#}} {}^t\Theta \nabla U \cdot \overline{{}^t\Theta \nabla V}. \quad (5.18)$$

Finally,  $\mathcal{F}_{\mathbf{e}_1}$  extends by duality as an isomorphism from  $H_{\Theta\#}^{-1/2}(\Sigma_{\#})$  to  $L^2(-\pi, \pi; H_{\Theta\#^2}^{1/2}(\Sigma_{\#^2}))'$ :

$$\begin{aligned} \forall \Psi \in H_{\Theta\#}^{-1/2}(\Sigma_{\#}), \quad \langle \mathcal{F}_{\mathbf{e}_1} \Psi, \widehat{\Phi} \rangle_{L^2(-\pi, \pi; H_{\Theta\#^2}^{1/2}(\Sigma_{\#^2}))', L^2(-\pi, \pi; H_{\Theta\#^2}^{1/2}(\Sigma_{\#^2}))} \\ := \langle \Psi, \mathcal{F}_{\mathbf{e}_1}^{-1} \widehat{\Phi} \rangle_{\Sigma_{\#}}, \quad \forall \widehat{\Phi} \in L^2(-\pi, \pi; H_{\Theta\#^2}^{1/2}(\Sigma_{\#^2})). \end{aligned} \quad (5.19)$$

Since  $H_{\Theta\#^2}^{1/2}(\Sigma_{\#^2})$  is a Hilbert space, one has  $L^2(-\pi, \pi; H_{\Theta\#^2}^{1/2}(\Sigma_{\#^2}))' = L^2(-\pi, \pi; H_{\Theta\#^2}^{-1/2}(\Sigma_{\#^2}))$  thanks to Lemma 4.11, and for any  $\Psi \in H_{\Theta\#}^{-1/2}(\Sigma_{\#})$ ,

$$\int_{-\pi}^{\pi} \langle \mathcal{F}_{\mathbf{e}_1} \Psi(\cdot, \xi), \widehat{\Phi}(\cdot, \xi) \rangle_{\Sigma_{\#^2}} \, d\xi = \langle \Psi, \mathcal{F}_{\mathbf{e}_1}^{-1} \widehat{\Phi} \rangle_{\Sigma_{\#}}, \quad \forall \widehat{\Phi} \in L^2(-\pi, \pi; H_{\Theta\#^2}^{1/2}(\Sigma_{\#^2})). \quad (5.20)$$

**5.2.c. Application to the augmented strip problem.** Thanks to the properties of the Floquet-Bloch transform  $\mathcal{F}_{\mathbf{e}_1}$  given in Section 5.2.b, we deduce directly the following proposition.

**Proposition 5.7**

Let  $G \in H_{\Theta\#}^{-1/2}(\Sigma_{\#^2})$ . Then the solution  $U(G) \in H_{\Theta\#}^1(\Omega_{\#})$  of Problem  $(\mathcal{P}_{\#})$  is given by

$$\text{a. e. } \mathbf{x} = (x, z_1, z_2) \in \Omega_{\#^2}, \quad \forall n \in \mathbb{Z}, \quad U(G)(\mathbf{x} + n \mathbf{e}_1) = \frac{1}{\sqrt{2\pi}} \int_{-\pi}^{\pi} \widehat{U}_{\xi}(\widehat{G}_{\xi})(\mathbf{x}) e^{i\xi(z_1+n)} \, d\xi, \quad (5.21)$$

where  $\widehat{G}_\xi := \mathcal{F}_{\mathbf{e}_1} G(\cdot, \xi) \in H_{\Theta, \#^2}^{-1/2}(\Sigma_{\#^2})$  a. e.  $\xi \in (-\pi, \pi)$ , and where  $\widehat{U}_\xi(\widehat{G}_\xi) := \mathcal{F}_{\mathbf{e}_1} U(G)(\cdot, \xi)$  is the unique solution of the well-posed waveguide problem: find  $\widehat{U}_\xi \in H_{\Theta}^1(\Omega_{\#^2})$  such that

$$\left\{ \begin{array}{l} -(\operatorname{div} + i\xi {}^t\mathbf{e}_1) \Theta \mathbb{A}_p {}^t\Theta (\nabla + i\xi \mathbf{e}_1) \widehat{U}_\xi - \rho_p \omega^2 \widehat{U}_\xi = 0 \quad \text{in } \Omega_{\#^2}^+ \cup \Omega_{\#^2}^-, \\ \widehat{U}_\xi \in H_{\Theta, \#^2}^1(\Omega_{\#^2}), \quad (\mathbb{A}_p {}^t\Theta (\nabla + i\xi \mathbf{e}_1) \widehat{U}_\xi)|_{\Omega_{\#^2}^\pm} \in H_{\Theta, \#^2}(\mathbf{div}; \Omega_{\#^2}^\pm), \\ \llbracket (\Theta \mathbb{A}_p {}^t\Theta (\nabla + i\xi \mathbf{e}_1) \widehat{U}_\xi) \cdot \mathbf{e}_x \rrbracket_{\Sigma_{\#^2}} = \widehat{G}_\xi, \end{array} \right. \quad (\mathcal{P}_{\#^2})$$

whose variational formulation is given by

$$\left| \begin{array}{l} \text{Find } \widehat{U}_\xi \in H_{\Theta, \#^2}^1(\Omega_{\#^2}) \text{ such that } \forall V \in H_{\Theta, \#^2}^1(\Omega_{\#^2}), \\ \int_{\Omega_{\#^2}} [(\mathbb{A}_p {}^t\Theta (\nabla + i\xi \mathbf{e}_1) \widehat{U}_\xi \cdot {}^t\Theta (\nabla + i\xi \mathbf{e}_1) \overline{V} - \rho_p \omega^2 \widehat{U}_\xi \overline{V})] = \langle \widehat{G}_\xi, V \rangle_{\Sigma_{\#^2}}. \end{array} \right. \quad (\text{FV}_{\#^2})$$

**Proof.** On one hand, Proposition 5.5 applied to the strip problem  $(\mathcal{P}_{\#})$  shows that  $\widehat{U}_\xi(\widehat{G}_\xi) := \mathcal{F}_{\mathbf{e}_1} U(G)(\cdot, \xi)$  satisfies  $(\mathcal{P}_{\#^2})$ . On the other hand, Corollary 5.6 applied to the variational formulation  $(\text{FV}_{\#})$  implies that  $\widehat{U}_\xi$  satisfies  $(\text{FV}_{\#^2})$ . The equivalence between  $(\mathcal{P}_{\#^2})$  and  $(\text{FV}_{\#^2})$  then follows from the equivalence between the strip problem  $(\mathcal{P}_{\#})$  and its variational formulation  $(\text{FV}_{\#})$  (Proposition 5.2).  $\blacksquare$

Proposition 5.7 shows that  $U(G)$  can be reconstructed in the strip  $\Omega_{\#}$  provided that one knows how to solve the waveguide problem  $(\mathcal{P}_{\#^2})$  for any  $\xi \in (-\pi, \pi)$ . The resolution of this waveguide problem is the object of the next section.

### 5.3 The waveguide problem

In this section, the Floquet-Bloch variable  $\xi \in (-\pi, \pi)$  is fixed. This section investigates the resolution of the waveguide problem  $(\mathcal{P}_{\#^2})$  with solution  $\widehat{U}_\xi(\widehat{G}_\xi)$ . To do so, we shall characterize the restriction of  $\widehat{U}_\xi(\widehat{G}_\xi)$  on the interface  $\Sigma_{\#^2}$  as the solution of an equation featuring *Dirichlet-to-Neumann (DtN)* operators. The construction of these operators and the subsequent computation of  $\widehat{U}_\xi(\widehat{G}_\xi)$  require to introduce auxiliary half-guide problems defined in  $\Omega_{\#^2}^+$  and  $\Omega_{\#^2}^-$ .

Given a boundary data  $\Phi \in H_{\Theta, \#^2}^{1/2}(\Sigma_{\#^2})$ , we consider the half-guide problem: find  $\widehat{U}_\xi^\pm \in H_{\Theta}^1(\Omega_{\#^2})$  such that

$$\left\{ \begin{array}{l} -(\operatorname{div} + i\xi {}^t\mathbf{e}_1) \Theta \mathbb{A}_p {}^{\pm t}\Theta (\nabla + i\xi \mathbf{e}_1) \widehat{U}_\xi^\pm - \rho_p^\pm \omega^2 \widehat{U}_\xi^\pm = 0 \quad \text{in } \Omega_{\#^2}^\pm, \\ \widehat{U}_\xi^\pm \in H_{\Theta, \#^2}^1(\Omega_{\#^2}^\pm), \quad \mathbb{A}_p {}^{\pm t}\Theta (\nabla + i\xi \mathbf{e}_1) \widehat{U}_\xi^\pm \in H_{\Theta, \#^2}(\mathbf{div}; \Omega_{\#^2}^\pm), \\ \widehat{U}_\xi^\pm = \Phi \quad \text{on } \Sigma_{\#^2}. \end{array} \right. \quad (\mathcal{P}_{\#^2}^\pm)$$

Under Assumptions (2.1, 2.2), Lax-Milgram's theorem combined with a lifting argument ensures that  $(\mathcal{P}_{\#^2}^\pm)$  admits a unique solution  $\widehat{U}_\xi^\pm(\Phi) \in H_{\Theta, \#^2}^1(\Omega_{\#^2}^\pm)$ . Let  $\widehat{\Lambda}_\xi^\pm \in \mathcal{L}(H_{\Theta, \#^2}^{1/2}(\Sigma_{\#^2}), H_{\Theta, \#^2}^{-1/2}(\Sigma_{\#^2}))$  be the DtN operator defined by

$$\widehat{\Lambda}_\xi^\pm \Phi := (\Theta \mathbb{A}_p {}^{\pm t}\Theta (\nabla + i\xi \mathbf{e}_1) \widehat{U}_\xi^\pm(\Phi) \cdot \mathbf{n})|_{\Sigma_{\#^2}}.$$

or equivalently for  $\Phi, \Psi \in H_{\Theta \#^2}^{1/2}(\Sigma_{\#^2})$ :

$$\begin{aligned} & \langle \widehat{\Lambda}_\xi^\pm \Phi, \Psi \rangle_{\Sigma_{\#^2}} \\ &= \int_{\Omega_{\#^2}^\pm} [(\mathbb{A}_p^\pm \text{}^t \Theta (\nabla + i\xi \mathbf{e}_1) \widehat{U}_\xi^\pm(\Phi) \cdot \overline{{}^t \Theta (\nabla + i\xi \mathbf{e}_1) \widehat{U}_\xi^\pm(\Psi)} - \rho_p^\pm \omega^2 \widehat{U}_\xi^\pm(\Phi) \overline{\widehat{U}_\xi^\pm(\Psi)}]. \end{aligned} \quad (5.22)$$

The next result is a direct consequence of the well-posedness of  $(\mathcal{P}_{\#^2}^\pm)$  and of the continuity of the trace application on  $\Sigma_{\#^2}$ .

### Proposition 5.8

The operators  $\widehat{\Lambda}_\xi^+$ ,  $\widehat{\Lambda}_\xi^-$ , and  $\widehat{\Lambda}_\xi^+ + \widehat{\Lambda}_\xi^-$  are coercive and therefore invertible.

By linearity and by uniqueness of  $(\mathcal{P}_{\#^2})$  and  $(\mathcal{P}_{\#^2}^\pm)$ , the waveguide solution  $\widehat{U}_\xi(\widehat{G}_\xi)$  is given by

$$\text{a. e. } \mathbf{x} \in \Omega_{\#^2}^\pm, \quad \widehat{U}_\xi(\widehat{G}_\xi) = \begin{cases} \widehat{U}_\xi^+(\Phi_\xi)(\mathbf{x}) & \text{if } \mathbf{x} \in \Omega_{\#^2}^+ \\ \widehat{U}_\xi^-(\Phi_\xi)(\mathbf{x}) & \text{if } \mathbf{x} \in \Omega_{\#^2}^-, \end{cases} \quad (5.23)$$

where  $\Phi_\xi := \widehat{U}_\xi|_{\Sigma_{\#^2}}$  is characterized thanks to the last equation in  $(\mathcal{P}_{\#^2})$ :

$$\left| \begin{array}{l} \text{Find } \Phi_\xi \in H_{\Theta \#^2}^{1/2}(\Sigma_{\#^2}) \text{ such that for any } \Psi \in H_{\Theta \#^2}^{1/2}(\Sigma_{\#^2}), \\ \langle (\widehat{\Lambda}_\xi^+ + \widehat{\Lambda}_\xi^-) \Phi_\xi, \Psi \rangle_{\Sigma_{\#^2}} = \langle \widehat{G}_\xi, \Psi \rangle_{\Sigma_{\#^2}}. \end{array} \right. \quad (5.24)$$

Note that this equation is well-posed since  $\widehat{\Lambda}_\xi^+ + \widehat{\Lambda}_\xi^-$  is coercive according to Proposition 5.8. Figure 12 illustrates the link between  $\widehat{U}_\xi(\widehat{G}_\xi)$  and  $\widehat{U}_\xi^+(\Phi)$ .

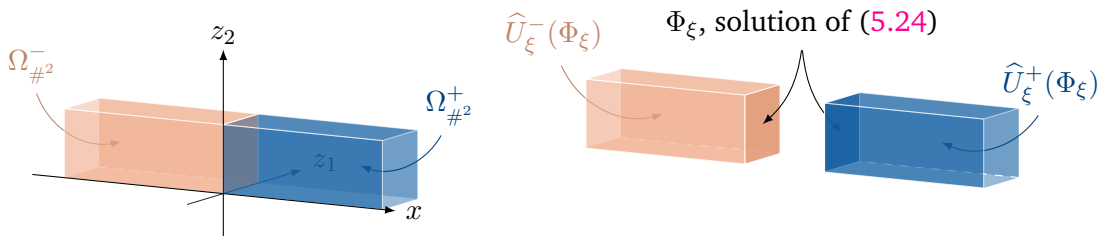

Figure 12: Expression (5.23) of the waveguide solution  $\widehat{U}_\xi$  with respect to  $\widehat{U}_\xi^\pm(\Phi)$ .

## 5.4 The half-guide problems

Our objective is to solve the half-guide problems  $(\mathcal{P}_{\#^2}^\pm)$  defined in  $\Omega_{\#^2}^+$  and  $\Omega_{\#^2}^-$  and to compute the DtN operators  $(\widehat{\Lambda}_\xi^+, \widehat{\Lambda}_\xi^-)$ . Since these problems are similar to each other, we will restrict ourselves to the resolution of the half-guide problem defined in  $\Omega_{\#^2}^+$  and the computation of  $\widehat{\Lambda}_\xi^+$ . We transpose the method developed in [JLF06; FJ09] for the elliptic Helmholtz equation  $-\text{div } \mathbb{A}_p \nabla U - \rho \omega^2 U = 0$  for periodic half-guides, and which relies on the periodicity of the coefficients  $\mathbb{A}_p^\pm$  and  $\rho_p^\pm$  in the  $\mathbf{e}_x$ -direction.

We also introduce some additional notation:

$$\mathcal{C}_{\#^2}^0 := (0, 1)^3 \quad \text{and} \quad \mathcal{C}_{\#^2}^n := \mathcal{C}_{\#^2}^0 + n \mathbf{e}_x, \quad \text{so that} \quad \Omega_{\#^2}^+ = \bigcup_{n \in \mathbb{N}} \mathcal{C}_{\#^2}^n. \quad (5.25)$$

The interface between the cells  $\mathcal{C}_{\#^2}^n$  and  $\mathcal{C}_{\#^2}^{n+1}$  is denoted by  $\Sigma_{\#^2}^n := \Sigma_{\#^2} + n \mathbf{e}_x$ . These domains are represented in Figure 13. By periodicity, one can identify each cell  $\mathcal{C}_{\#^2}^n$  with  $\mathcal{C}_{\#^2}^0 \equiv \mathcal{C}_{\#^2}$ , and each interface  $\Sigma_{\#^2}^n$  with  $\Sigma_{\#^2}^0 \equiv \Sigma_{\#^2}$ . Furthermore, note that  $\mathcal{C}_{\#^2}^n$  and  $\Sigma_{\#^2}^\tau$ ,  $\tau \in \{n, n+1\}$ , correspond respectively to the domains  $\Omega_{\#^2}$  and  $\Sigma_{\#^2}^\tau$  defined by (4.30) with

$$I_x := (n, n+1), \quad a_1 := 0, \quad b_1 := 1, \quad \tau := 0.$$

Thus Section 4.4 enables to use the space  $H_{\Theta_{\#^2}}^1(\mathcal{C}_{\#^2}^n)$  given by (4.33) as well as  $H_{\Theta_{\#^2}}^{1/2}(\Sigma_{\#^2}^\tau)$  which is defined by (4.34), its dual  $H_{\Theta_{\#^2}}^{-1/2}(\Sigma_{\#^2}^\tau)$ , and the trace and the normal trace applications on  $\Sigma_{\#^2}^\tau$ . In the sequel, we will systematically use the obvious identifications  $H_{\Theta_{\#^2}}^1(\mathcal{C}_{\#^2}^n) \equiv H_{\Theta_{\#^2}}^1(\mathcal{C}_{\#^2})$  and  $H_{\Theta_{\#^2}}^{1/2}(\Sigma_{\#^2}^n) \equiv H_{\Theta_{\#^2}}^{1/2}(\Sigma_{\#^2})$ , even when not mentioned.

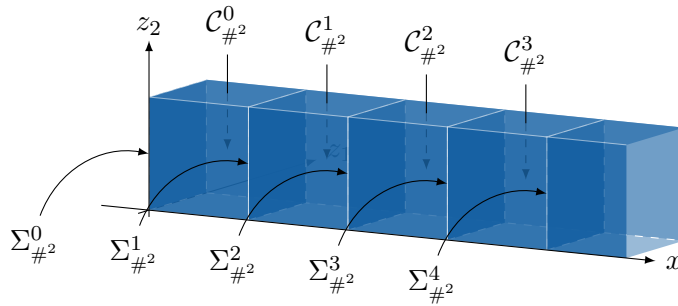

Figure 13: The cells  $\mathcal{C}_{\#^2}^n$  and the interfaces  $\Sigma_{\#^2}^n$  in (5.25)

5.4.a. **Structure of the half-guide solution.** Consider the operator  $\mathcal{P}_\xi \in \mathcal{L}(H_{\Theta_{\#^2}}^{1/2}(\Sigma_{\#^2}))$ :

$$\forall \Phi \in H_{\Theta_{\#^2}}^{1/2}(\Sigma_{\#^2}), \quad \mathcal{P}_\xi \Phi := \widehat{U}_\xi^+(\Phi)|_{\Sigma_{\#^2}^1}, \quad (5.26)$$

where the boundedness property stems from the well-posedness of  $(\mathcal{P}_{\#^2}^\pm)$  and from the continuity of the trace map on  $\Sigma_{\#^2}^1$  from  $H_{\Theta_{\#^2}}^1(\Omega_{\#^2}^+)$  to  $H_{\Theta_{\#^2}}^{1/2}(\Sigma_{\#^2}^1) \equiv H_{\Theta_{\#^2}}^{1/2}(\Sigma_{\#^2})$ . The operator  $\mathcal{P}_\xi$  is called the *propagation operator*, because it determines how the half-guide solution propagates from one interface to the other, as the next result shows.

### Proposition 5.9

For any  $\Phi \in H_{\Theta_{\#^2}}^{1/2}(\Sigma_{\#^2})$ , the solution  $\widehat{U}_\xi^+(\Phi)$  of Problem  $(\mathcal{P}_{\#^2}^\pm)$  satisfies

$$\forall n \in \mathbb{N}, \quad \text{a. e. } \mathbf{x} \in \Omega_{\#^2}, \quad \widehat{U}_\xi^+(\Phi)(\mathbf{x} + n \mathbf{e}_x) = \widehat{U}_\xi^+(\mathcal{P}_\xi^n \Phi)(\mathbf{x}). \quad (5.27)$$

Furthermore,  $\mathcal{P}_\xi$  has a spectral radius  $\rho(\mathcal{P}_\xi) < 1$ .

**Proof.** The proof is a direct adaptation of [JLF06, Theorem 3.1]. To prove (5.27), we begin with  $n = 1$  and we define  $\widetilde{U}(\Phi) := \widehat{U}_\xi^+(\Phi)(\cdot + \mathbf{e}_x)$ . Then one has  $\widetilde{U}(\Phi)|_{\Sigma_{\#^2}} = \mathcal{P}_\xi \Phi$ . Moreover, by using the change of variables  $\mathbf{x} \mapsto \mathbf{x} + \mathbf{e}_1$  in  $(\mathcal{P}_{\#^2}^\pm)$  and the periodicity of  $\mathbb{A}_p^+$  and  $\rho_p^+$  along  $\mathbf{e}_x$ , one obtains that



$\tilde{U}(\Phi)$  satisfies the same problem as  $\widehat{U}_\xi^+(\mathcal{P}_\xi \Phi)$ . Consequently, the uniqueness of  $(\mathcal{P}_{\#^2}^\pm)$  leads to (5.27) for  $n = 1$ . The extension to  $n > 1$  follows by induction.

To prove that  $\rho(\mathcal{P}_\xi) < 1$ , we use the following estimate whose proof is very similar to (2.5):

$$\exists c, \alpha > 0, \quad \|\widehat{U}_\xi^+(\Phi) \exp(\alpha \Im m \omega |x|)\|_{H_{\Theta_{\#^2}}^1(\Omega_{\#^2}^+)} \leq c \|\Phi\|_{H_{\Theta_{\#^2}}^{1/2}(\Sigma_{\#^2})}.$$

Since  $\mathcal{P}_\xi^n \Phi = \widehat{U}_\xi^+(\Phi)|_{\Sigma_{\#^2}^n}$  according to (5.27), the continuity of the trace application on  $\Sigma_{\#^2}^n$  leads to

$$\exists c', \alpha > 0, \quad \forall n \in \mathbb{N}, \quad \|\mathcal{P}_\xi^n\| \leq c' e^{-\alpha \Im m \omega n}.$$

One then concludes by raising both sides of the above inequality to the power of  $1/n$ , and by using the Gelfand formula  $\rho(\mathcal{P}_\xi) = \lim_{n \rightarrow +\infty} \|\mathcal{P}_\xi^n\|^{1/n}$ .  $\blacksquare$

Proposition 5.9 shows that the restrictions of  $\widehat{U}_\xi^+(\Phi)$  to the interfaces  $\Sigma_{\#^2}^n$  can be fully expressed with respect to the propagation operator  $\mathcal{P}_\xi$ :

$$\forall n \in \mathbb{N}, \quad \widehat{U}_\xi^+(\Phi)|_{\Sigma_{\#^2}^n} = \mathcal{P}_\xi^n \Phi. \quad (5.28)$$

Therefore, knowing  $\mathcal{P}_\xi$ , one can construct  $\widehat{U}_\xi^+(\Phi)$  using solutions of problems defined in one periodicity cell, as shown in the next section.

**5.4.b. Local cell problems.** Given a boundary data  $\Phi \in H_{\Theta_{\#^2}}^{1/2}(\Sigma_{\#^2})$  and  $j \in \{0, 1\}$ , let us introduce the local cell problems:

$$\begin{cases} -(\mathbf{div} + i\xi^t \mathbf{e}_1) \ominus \mathbb{A}_p^t \ominus (\nabla + i\xi \mathbf{e}_1) E_\xi^j - \rho_p \omega^2 E_\xi^j = 0 & \text{in } \mathcal{C}_{\#^2}, \\ E_\xi^j \in H_{\Theta_{\#^2}}^1(\mathcal{C}_{\#^2}), \quad \mathbb{A}_p^t \ominus (\nabla + i\xi \mathbf{e}_1) E_\xi^j \in H_{\Theta_{\#^2}}(\mathbf{div}; \mathcal{C}_{\#^2}), \end{cases} \quad (5.29a)$$

combined with the Dirichlet boundary conditions (see Figure 14)

$$\begin{aligned} E_\xi^0(\Phi)|_{\Sigma_{\#^2}^0} &= \Phi & \text{and} & & E_\xi^0(\Phi)|_{\Sigma_{\#^2}^1} &= 0 \\ E_\xi^1(\Phi)|_{\Sigma_{\#^2}^0} &= 0 & \text{and} & & E_\xi^1(\Phi)|_{\Sigma_{\#^2}^1} &= \Phi. \end{aligned} \quad (5.29b)$$

These problems are well-posed thanks to Lax-Milgram's theorem combined with a lifting argument. Moreover, using the structure of  $\widehat{U}_\xi^+(\Phi)$  given by Proposition 5.9, it follows by linearity that

$$\forall n \in \mathbb{N}, \quad \widehat{U}_\xi^+(\Phi)(\cdot + n \mathbf{e}_x)|_{\mathcal{C}_{\#^2}} = E_\xi^0(\mathcal{P}_\xi^n \Phi) + E_\xi^1(\mathcal{P}_\xi^{n+1} \Phi). \quad (5.30)$$

Therefore, if  $\mathcal{P}_\xi$  is known, then  $\widehat{U}_\xi^+(\Phi)$  can be constructed cell by cell using the solutions  $E_\xi^j(\Phi)$  of the local cell problems (5.29). On the other hand, these local cell problems are involved in the characterization of  $\mathcal{P}_\xi$ . This is the object of the next section.

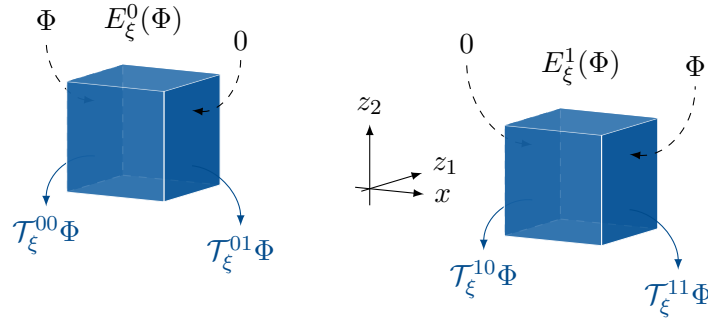

Figure 14: Dirichlet conditions satisfied by  $E_\xi^0$  and  $E_\xi^1$ , and the DtN operators  $\mathcal{T}_\xi^{jk}$  given by (5.31).

**5.4.c. Characterization of the propagation operator via a Riccati equation.** The goal of this section is to characterize  $\mathcal{P}_\xi$  using the *local DtN operators* defined for any  $\Phi \in H_{\Theta \#^2}^{1/2}(\Sigma_{\#^2})$  by

$$\mathcal{T}_\xi^{jk} \Phi = (-1)^{k+1} (\mathbb{A}_p \mathop{\text{t}}\! \Theta (\nabla + i\xi \mathbf{e}_1) E_\xi^j(\Phi) \cdot \mathbf{e}_x)|_{\Sigma_{\#^2}^k}.$$

The action of these operators is illustrated in Figure 14. From Green's formula (4.35), it follows that

$$\begin{aligned} & \langle \mathcal{T}_\xi^{jk} \Phi, \Psi \rangle_{\Sigma_{\#^2}} \\ & := \int_{\mathcal{C}_{\#^2}} [(\mathbb{A}_p \mathop{\text{t}}\! \Theta (\nabla + i\xi \mathbf{e}_1) E_\xi^j(\Phi) \cdot \overline{\mathop{\text{t}}\! \Theta (\nabla + i\xi \mathbf{e}_1) E_\xi^k(\Psi)} - \rho_p \omega^2 E_\xi^j(\Phi) \overline{E_\xi^k(\Psi)}]. \end{aligned} \quad (5.31)$$

By applying the second point of Proposition 4.16 to  $\mathcal{C}_{\#^2}^0$  and  $\mathcal{C}_{\#^2}^1$  in the cell by cell expression (5.30) of  $\widehat{U}_\xi^+$ , it follows that  $\mathbb{A}_p \mathop{\text{t}}\! \Theta (\nabla + i\xi \mathbf{e}_1) \widehat{U}_\xi^+ \cdot \mathbf{e}_x$  is continuous across the interface  $\Sigma_{\#^2}^1$ , that is,

$$(\mathbb{A}_p \mathop{\text{t}}\! \Theta (\nabla + i\xi \mathbf{e}_1) \widehat{U}_\xi^+(\Phi) \cdot \mathbf{e}_x)|_{\Sigma_{\#^2}^1} = (\mathbb{A}_p \mathop{\text{t}}\! \Theta (\nabla + i\xi \mathbf{e}_1) \widehat{U}_\xi^+(\Phi) \cdot \mathbf{e}_x)|_{\Sigma_{\#^2}^0},$$

or equivalently

$$\begin{aligned} & (\mathbb{A}_p \mathop{\text{t}}\! \Theta (\nabla + i\xi \mathbf{e}_1) E_\xi^0(\Phi) \cdot \mathbf{e}_x)|_{\Sigma_{\#^2}^1} + (\mathbb{A}_p \mathop{\text{t}}\! \Theta (\nabla + i\xi \mathbf{e}_1) E_\xi^1(\mathcal{P}_\xi \Phi) \cdot \mathbf{e}_x)|_{\Sigma_{\#^2}^1} \\ & = (\mathbb{A}_p \mathop{\text{t}}\! \Theta (\nabla + i\xi \mathbf{e}_1) E_\xi^0(\mathcal{P}_\xi \Phi) \cdot \mathbf{e}_x)|_{\Sigma_{\#^2}^0} + (\mathbb{A}_p \mathop{\text{t}}\! \Theta (\nabla + i\xi \mathbf{e}_1) E_\xi^1(\mathcal{P}_\xi^2 \Phi) \cdot \mathbf{e}_x)|_{\Sigma_{\#^2}^0}. \end{aligned} \quad (5.32)$$

The definition of the local DtN operators then leads to a so-called Riccati equation, which characterizes uniquely  $\mathcal{P}_\xi$  as stated by the following result.

**Proposition 5.10**

The propagation operator  $\mathcal{P}_\xi$  defined by (5.26) is the unique solution of the problem

$$\left| \begin{array}{l} \text{Find } P \in \mathcal{L}(H_{\Theta \#^2}^{1/2}(\Sigma_{\#^2})) \text{ such that } \rho(P) < 1 \text{ and} \\ \mathcal{T}_\xi^{10} P^2 + (\mathcal{T}_\xi^{00} + \mathcal{T}_\xi^{11}) P + \mathcal{T}_\xi^{01} = 0. \end{array} \right. \quad (5.33)$$

**Proof.** We only present the outline of the proof which is detailed in [JLF06, Theorem 4.1]. The existence is directly deduced from (5.32). On the other hand, the uniqueness is achieved by considering  $\widetilde{\mathcal{P}}_\xi$  which satisfies (5.33), and by showing that for  $\Phi$ , the function defined cell by cell by

$\tilde{U}(\Phi)(\cdot + n \mathbf{e}_x)|_{\mathcal{C}_{\#^2}} = E_\xi^0(\tilde{\mathcal{P}}_\xi^n \Phi) + E_\xi^1(\tilde{\mathcal{P}}_\xi^{n+1} \Phi)$  satisfies the same half-guide problem  $(\mathcal{P}_{\#^2}^\pm)$  as  $\widehat{U}_\xi^+(\Phi)$ , so that both solutions coincide and thus  $\tilde{\mathcal{P}}_\xi \Phi = \mathcal{P}_\xi \Phi$ . ■

One important point to note from the practical point of view is that the Riccati equation (5.33) only involves the local DtN operators  $\mathcal{T}_\xi^{\ell j}$  which are defined from the solutions of the local cell problems (5.29). These problems are computable numerically since they are defined in  $\mathcal{C}_{\#^2}$ .

Finally, we deduce from (5.30) the following expression:

$$\widehat{\Lambda}_\xi^+ = \mathcal{T}_\xi^{10} \mathcal{P}_\xi + \mathcal{T}_\xi^{00}. \quad (5.34)$$

## 6 Resolution algorithm and discretization

The method developed in the previous sections can be summarized in the following algorithm:

1. For any  $\xi \in (-\pi, \pi)$ ,
  - a. solve the local cell problems (5.29) and compute the local DtN operators  $\mathcal{T}_\xi^{jk}$  given by (5.31);
  - b. determine the propagation operator  $\mathcal{P}_\xi$  by solving the Riccati equation (5.33);
  - c. deduce the DtN operator  $\widehat{\Lambda}_\xi^+$  using (5.34);
  - d. adapt Steps 6.1.a – 6.1.c for the half-guide  $\Omega_{\#^2}^-$  in order to compute the DtN operator  $\widehat{\Lambda}_\xi^-$  thanks to cell problems defined in  $(-1, 0) \times (0, 1)^2$ ;
  - e. find the solution  $\Phi_\xi$  of the interface equation (5.24);
  - f. deduce the solution  $\widehat{U}_\xi(\widehat{G}_\xi)$  of (FV $_{\#^2}$ ) using (5.23) and the cell by cell expression (5.30) of  $\widehat{U}_\xi^\pm(\Phi)$ ;
2. apply the inverse Floquet-Bloch transform (5.21) to reconstruct the solution  $U(G)$  of the augmented strip problem  $(\mathcal{P}_{\#})$ ;
3. deduce the solution  $u$  of the 2D transmission problem  $(\mathcal{P})$  using (5.8).

Since this algorithm holds at a continuous level, it has to be discretized with respect to both the spatial and the Floquet variables. The next section describes the discretization procedure with a particular emphasis on Steps 6.1 and 6.2.

### 6.1 Discretization issues

**6.1.a. Discretization with respect to the Floquet variable.** We begin with the step 6.2, which yields the solution  $U(G)$  of the augmented strip problem  $(\mathcal{P}_{\#})$  using the inverse Floquet-Bloch transform (5.21). In this expression, the integrand involves  $\widehat{U}_\xi(\widehat{G}_\xi)$  which cannot be computed explicitly in general. Thus, this integrand can only be computed for a finite number of values of  $\xi$  (using Step 6.1), so that the integral with respect to  $\xi$  in (5.21) has to be evaluated using a quadrature rule.

To this end, we consider a regular mesh of  $(-\pi, \pi)$  consisting of  $N_\xi$  intervals of equal size  $\Delta\xi$ , and of  $N_\xi + 1$  equispaced points  $(\xi_j)_{0 \leq j \leq N_\xi}$ , with  $N_\xi > 0$  and  $\Delta\xi := 2\pi/N_\xi$ . The integral in (5.21) is

evaluated using a trapezoidal rule using  $\xi_j$  as quadrature points, leading to an approximate solution  $U_{\Delta\xi}(G)$  of the augmented transmission problem (FV<sub>#</sub>):

$$\text{a. e. } \mathbf{x} = (x, z_1, z_2) \in \Omega_{\#^2}, \quad \forall n \in \mathbb{Z}, \quad U_{\Delta\xi}(G)(\mathbf{x} + n \mathbf{e}_1) = \frac{\Delta\xi}{\sqrt{2\pi}} \sum_{j=0}^{N_\xi} \widehat{U}_{\xi_j}(\widehat{G}_{\xi_j})(\mathbf{x}) e^{i\xi_j(z_1+n)}$$

The choice of the trapezoidal rule is motivated in Remark 6.1.

**Remark 6.1.** *If  $\Im\omega > 0$  and  $g \in L^2(\sigma)$  is compactly supported, then similarly to (2.4), the solution  $U(G)$  of (P<sub>#</sub>) decays exponentially in the  $\mathbf{e}_1$ -direction. This implies thanks to Paley-Wiener-type theorems (see for instance [Kuc93, Theorem 2.2.2]) that the map  $\xi \mapsto \widehat{U}_\xi(\widehat{G}_\xi) := \mathcal{F}_{\mathbf{e}_1}U(G)(\cdot, \xi) \in H_{\Theta_{\#^2}}^1(\Omega_{\#^2})$  is real analytic. Moreover, from the property (5.10) of the Floquet-Bloch transform, it is clear that  $\xi \mapsto \widehat{U}_\xi(\widehat{G}_\xi)(\mathbf{x}) e^{i\xi(z_1+n)}$  is  $2\pi$ -periodic for any  $\mathbf{x} \in \Omega_{\#^2}$  and  $n \in \mathbb{Z}$ . This formal observation justifies the use of the trapezoidal rule, which is known to converge exponentially for smooth periodic integrands (see for instance [TW14]).*

In order to obtain a precise error estimate, it turns out that the function  $U_{\Delta\xi}(G)$  obtained using the trapezoidal rule can be reinterpreted as the solution of a boundary value problem defined in a domain which is bounded in the  $\mathbf{e}_1$ -direction. This approach has been studied in detail in [Coa12] for a different problem, but it can be extended to (P<sub>#</sub>), thus leading to a quadrature error of the form

$$\exists \alpha > 0, \quad \|U(G) - U_{\Delta\xi}(G)\|_{H_{\Theta_{\#^2}}^1(\Omega_{\#^2})} = \mathcal{O}(e^{-\alpha \Im\omega N_\xi}).$$

**6.1.b. Semi-discretization with respect to the spatial variable.** Now, let us fix  $\xi \in (-\pi, \pi)$ , and consider the discretization of Step 6.1. The discretization is a direct adaptation of the procedure described in [JLF06; Fli09; FJ16]. For this reason, we do not intend to go into details. We begin with a triangular mesh of  $\mathcal{C}_{\#^2} := (0, 1)^3$  with step  $h > 0$ . This mesh is assumed to be *periodic*, in the sense that one can identify the mesh nodes on the boundary  $x = 0$  (resp.  $z_j = 0$ ) to those on  $x = 1$  (resp.  $z_j = 1$ ) in a trivial manner. Then, using the classical  $H^1$ -conforming Lagrange finite element space of order  $d > 0$  which we call  $\mathcal{V}_h(\mathcal{C}_{\#^2})$ , an internal approximation of  $H_{\Theta_{\#^2}}^1(\mathcal{C}_{\#^2})$  and  $H_{\Theta_{\#^2}}^{1/2}(\Sigma_{\#^2}^j)$  is provided by the subspaces

$$\mathcal{V}_{h,\#^2}(\mathcal{C}_{\#^2}) := \{V \in \mathcal{V}_h(\mathcal{C}_{\#^2}) / V_h|_{z_j=0} = V_h|_{z_j=1} \quad \forall j \in \{1, 2\}\}.$$

$$\mathcal{V}_{h,\#^2}(\Sigma_{\#^2}^j) := \{V|_{\Sigma_{\#^2}^j} / V_h \in \mathcal{V}_h(\mathcal{C}_{\#^2})\}, \quad \forall j \in \{0, 1\}.$$

The periodicity of the mesh allows the identification  $\mathcal{V}_{h,\#^2}(\Sigma_{\#^2}^0) \equiv \mathcal{V}_{h,\#^2}(\Sigma_{\#^2}^1) \equiv \mathcal{V}_{h,\#^2}(\Sigma_{\#^2})$ , similarly to the continuous case. In what follows, let  $N_h := \dim \mathcal{V}_{h,\#^2}(\Sigma_{\#^2})$ .

For any  $\Phi_h \in \mathcal{V}_{h,\#^2}(\Sigma_{\#^2}^j)$ , we solve the discrete formulation of the local cell problems (5.29) with solutions  $E_{\xi,h}^j(\Phi_h) \in \mathcal{V}_{h,\#^2}(\mathcal{C}_{\#^2})$ ,  $j \in \{0, 1\}$ , and deduce finite-dimensional operators  $\mathcal{T}_{\xi,h}^{jk} \in \mathcal{L}(\mathcal{V}_{h,\#^2}(\Sigma_{\#^2}^j))$  using the discrete analog of (5.31). Note that these discrete DtN operators can be represented as  $N_h \times N_h$  matrices.

To approximate the propagation operator  $\mathcal{P}_\xi$ , it is natural to introduce the solution  $\mathcal{P}_{\xi,h}$  of the constrained Riccati equation (5.33) where  $\mathcal{T}_\xi^{jk}$  is replaced by  $\mathcal{T}_{\xi,h}^{jk}$ . As described in [JLF06], the resolution of the discrete Riccati equation can be handled using either (1) a *spectral* approach which consists in

characterizing  $\mathcal{P}_{\xi,h}$  by means of its eigenpairs which satisfy a quadratic eigenvalue problem, or (2) a modified *Newton* method, that is, a standard Newton method with an additional projection step in order to take the spectral radius constraint into account.

From  $\mathcal{P}_{\xi,h}$ , the discrete analog of (5.34) allows to define an approximate  $\widehat{\Lambda}_{\xi,h}^+ \in \mathcal{L}(\mathcal{V}_{h,\#^2}(\Sigma_{\#^2}^j))$ . We compute  $\widehat{\Lambda}_{\xi,h}^-$  similarly and write the discrete version of the interface equation (5.24) as a  $N_h \times N_h$  linear system. The corresponding solution  $\Phi_{\xi,h} \in \mathcal{V}_{h,\#^2}(\Sigma_{\#^2}^j)$  is then used to deduce an approximation  $\widehat{U}_{\xi,h}(\widehat{G}_\xi)$  of the waveguide solution of (FV $_{\#^2}$ ) thanks to (5.23) and the cell by cell expression (5.30).

**Remark 6.2.** (a). For  $\xi \in (-\pi, \pi)$  fixed, an error analysis can be performed for the approximation of the waveguide solution  $\widehat{U}_\xi(\widehat{G}_\xi)$ . To do so, the idea is to show as in [Fli09, Section 2.3.1] that the discrete solution  $\widehat{U}_{\xi,h}(\widehat{G}_\xi)$  satisfies a discrete waveguide problem on an infinite mesh of  $\Omega_{\#^2}$ . This observation then allows to use C ea’s lemma and to derive classical finite element estimates. In particular, for Lagrange finite elements of order 1, assuming that  $\mathbb{A}_p$  and  $\rho_p$  are smooth enough, one shows that

$$\|\widehat{U}_\xi(\widehat{G}_\xi) - \widehat{U}_{\xi,h}(\widehat{G}_\xi)\|_{L^2(\Omega_{\#^2})} = \mathcal{O}(h^2) \quad \text{and} \quad \|\widehat{U}_\xi(\widehat{G}_\xi) - \widehat{U}_{\xi,h}(\widehat{G}_\xi)\|_{H_{\Theta}^1(\Omega_{\#^2})} = \mathcal{O}(h).$$

(b). For Configuration (A), we recall that  $(\mathbb{A}_p^+, \rho_p^+)$  are independent of  $z_2$  while  $(\mathbb{A}_p^-, \rho_p^-)$  are independent of  $z_1$ . This property can be exploited for the resolution of the local cell problems. In fact, we could have used a semi-analytical method based on separation of variables, to reduce computations to a family of 2-dimensional local cell problems.

From the discrete solution  $\widehat{U}_{\xi,h}(\widehat{G}_\xi)$ , we compute an approximate solution  $U_h(G)$  of the strip problem using Section 6.1.a, with  $\mathbf{h} := (h, \Delta\xi)$ . Finally, for Step 6.3, an approximate solution  $u_h$  of the 2-dimensional problem (P) is given by  $u_h := E_{\#}^2 U_h(G)(\Theta \cdot)$ , in the spirit of (5.8).

## 6.2 A quasi-2D idea for resolution of the local cell problems

We now focus on the step 6.1.a of the resolution algorithm, that is, the computation of the local cell solutions  $E_\xi^j$  and the local DtN operators  $\mathcal{T}_\xi^{jk}$ . Although the local cell problems (5.29) can be solved directly using 3-dimensional finite elements as in Section 6.1, it is worth recalling that the differential operator  $-\rho_p^{-1} \operatorname{div} \Theta \mathbb{A}_p \Theta \nabla$  is strongly linked to the family of operators  $-\rho_s^{-1} \operatorname{div} \mathbb{A}_s \nabla$  ( $s \in \mathbb{R}$ ) by means of the chain rule (3.15). It is in particular this “fibered” link that leads to the expression (5.4) recalled below: for almost any  $(x, z, s) \in \mathbb{R}^2 \times (0, 1)$ ,

$$\widetilde{U}(x, \theta_1 z, \theta_2 z + s) = u_s(x, z), \tag{6.1}$$

where  $U = U(G)$  and  $u_s = u_s(g_s)$  (with  $g_s(0, z) := \widetilde{G}(0, \theta_1 z, \theta_2 z + s)$ ) are the respective solutions of (P $_{\#}$ ) and (P $_s$ ), and where  $\widetilde{U} := E_{\#}^2(U)$  and  $\widetilde{G} := E_{\#}^2(G)$  are respectively the periodic extensions of  $U$  and  $G$  in the  $\mathbf{e}_2$ -direction.

Up to now, in the context of the lifting approach, the relation (6.1) has been useful in practice to compute  $u_s(g_s)$  (in particular for  $s = 0$ ) from  $U(G)$ . The so-called *quasi 2-dimensional* (or *quasi-2D*) approach developed in this section relies on the converse: in the spirit of (6.1), our goal is to reduce the resolution of the local cell problems to that of a family of 2-dimensional decoupled cell problems.

This principle of the quasi-2D resolution method is very similar to the quasi-1D method developed in Section III-5.2 for the Helmholtz equation with quasiperiodic coefficients. However, this extension is

more delicate for our 3D problems, due to the periodicity conditions with respect to **both**  $z_1$  and  $z_2$ . To illustrate this difficulty, it is useful to consider the quasi-1D approach for a 2D cell problem with periodic conditions on all boundaries. This is the object of the next section.

**6.2.a. Illustration of the method in a 2D case.** The goal in this section is first to highlight the difficulty of the fibered approach in the case of a particular 2D cell problem with periodic conditions, and then to propose an alternative which will be extended to the 3D case. Throughout this section, the subscript “2D” is used to emphasize the fact that we are in a 2D case.

### The difficulty of the quasi-1D approach

We consider the problem defined in  $C := \{z = (z_1, z_2) \in (0, 1)^2\}$ : Find  $E_{2D} \in H^1_\theta(C)$  such that

$$\begin{cases} -D_\theta(\mu_{2D} D_\theta E_{2D}) - \rho_{2D} \omega^2 E_{2D} = f_{2D} & \text{in } C, \\ E_{2D}|_{z_j=0} = E_{2D}|_{z_j=1} & \text{and } (\mu_{2D} D_\theta E_{2D})|_{z_j=0} = (\mu_{2D} D_\theta E_{2D})|_{z_j=1} \quad \forall j \in \llbracket 1, 2 \rrbracket, \end{cases} \quad (6.2)$$

with  $\mu_{2D}, \rho_{2D}, f_{2D} \in \mathcal{C}_{per}^0(\mathbb{R}^2)$ , and where  $D_\theta := \theta \cdot \nabla = \theta_1 \partial_{z_1} + \theta_2 \partial_{z_2}$ . Since  $E_{2D}$  is periodic with respect to  $z_2$ , it follows that the function  $e_{2D,s} : z \mapsto \tilde{E}_{2D}(\theta z + s e_2)$  belongs to  $H^1(0, 1/\theta_1)$  for almost any  $s \in (0, 1)$ , where  $\tilde{E}_{2D}$  denotes the periodic extension of  $E_{2D}$  in the  $e_2$  direction. Moreover, because of the fibered property of the differential operator in (6.2) and the continuity of  $f_{2D}$ , one shows using the chain rule (Proposition III-3.13) that  $e_{2D,s}$  is well-defined for any  $s \in [0, 1]$ , and satisfies

$$-\frac{d}{dz} \left( \mu_{2D,s} \frac{de_{2D,s}}{dz} \right) - \rho_{2D,s} \omega^2 e_{2D,s} = f_{2D,s} \quad \text{in } (0, 1/\theta_1), \quad (6.3a)$$

with  $\mu_{2D,s}(z) := \mu_{2D}(\theta z + s e_2)$ ,  $\rho_{2D,s}(z) := \rho_{2D}(\theta z + s e_2)$ , and  $f_{2D,s}(z) := f_{2D}(\theta z + s e_2)$ . Conversely, by identifying the map  $s \mapsto e_{2D,s}$  with its periodic extension for  $s \in \mathbb{R}$ , we obtain that

$$\text{a. e. } z = (z_1, z_2) \in C, \quad E_{2D}(z) = e_{2D, z_2 - z_1 \delta}(z_1/\theta_1) \quad \text{with } \delta := \theta_2/\theta_1,$$

so that the periodicity of  $E_{2D}$  with respect to  $z_1$  leads to:

$$\forall s \in \mathbb{R}, \quad e_{2D,s}(0) = e_{2D, s-\delta}(1/\theta_1). \quad (6.3b)$$

which is illustrated in Figure 15. The coupling relation (6.3b) makes it impossible to compute the  $e_{2D,s}$  independently from each other, unlike for the Dirichlet cell problems in Section III-5.2.

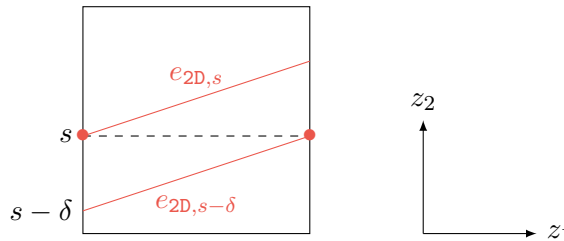

Figure 15: Illustration of the coupling relation (6.3b)

---

Compared to Chapter III, the roles of  $z_1$  and  $z_2$  have been swapped in the sense  $z_1 \leftrightarrow y_2$  and  $z_2 \leftrightarrow y_1$ . However the results in Chapter III can be easily extended to take this index inversion into account.

### Auxiliary local cell problems

To overcome the difficulty induced by the periodic coupling, one can reformulate  $E_{2D}$  in terms of the solutions of *auxiliary* local Dirichlet cell problems for which the quasi-1D method can be applied. For this purpose, we introduce an auxiliary unknown  $\varphi \in L^2(0, 1)$ , namely

$$\varphi := E_{2D}|_{z_1=0} = E_{2D}|_{z_1=1}.$$

With this choice, by introducing the well-posed cell problems: *Find*  $F_{2D} \in H_\theta^1(C)$  *such that*

$$\begin{cases} -D_\theta(\mu_{2D} D_\theta F_{2D}) - \rho_{2D} \omega^2 F_{2D} = 0 & \text{in } C, \\ F_{2D}|_{z_2=0} = F_{2D}|_{z_2=1} & \text{and } (\mu_{2D} D_\theta F_{2D})|_{z_2=0} = (\mu_{2D} D_\theta F_{2D})|_{z_2=1}, \\ F_{2D}|_{z_1=0} = \varphi & \text{and } F_{2D}|_{z_1=1} = \varphi \end{cases}$$

and: *Find*  $\mathcal{G}_{2D} \equiv \mathcal{G}_{2D}(f) \in H_\theta^1(C)$  *such that*

$$\begin{cases} -D_\theta(\mu_{2D} D_\theta \mathcal{G}_{2D}) - \rho_{2D} \omega^2 \mathcal{G}_{2D} = f_{2D} & \text{in } C, \\ \mathcal{G}_{2D}|_{z_2=0} = \mathcal{G}_{2D}|_{z_2=1} & \text{and } (\mu_{2D} D_\theta \mathcal{G}_{2D})|_{z_2=0} = (\mu_{2D} D_\theta \mathcal{G}_{2D})|_{z_2=1}, \\ \mathcal{G}_{2D}|_{z_1=0} = 0 & \text{and } \mathcal{G}_{2D}|_{z_1=1} = 0, \end{cases}$$

we obtain by linearity that

$$E_{2D} = F_{2D}(\varphi) + \mathcal{G}_{2D}(f). \quad (6.4)$$

The important difference between the problems satisfied by  $F_{2D}$ ,  $\mathcal{G}_{2D}$ , and the one satisfied by  $E_{2D}$  is that the periodic conditions on  $\{z_1 = 0\}$  and  $\{z_1 = 1\}$  have been replaced by Dirichlet boundary conditions. Hence,  $F_{2D}$  and  $\mathcal{G}_{2D}$  can be solved using the quasi-1D approach described in Section III-5.2.

It remains to obtain an equation for  $\varphi$ . By imposing the periodicity of  $\mu_{2D} D_\theta E_{2D}$  with respect to  $z_1$  in (6.4), we deduce that  $\varphi$  satisfies

$$(\Xi_{2D}^0 + \Xi_{2D}^1) \varphi = -(\Upsilon_{2D}^0 + \Upsilon_{2D}^1) f \quad (6.5)$$

where the auxiliary local DtN operators  $\Xi_{2D}^j$  and the right-hand sides  $\Upsilon_{2D}^j f$ ,  $j \in \{0, 1\}$  are given by

$$\begin{cases} \Xi_{2D}^j \varphi := (-1)^{j+1} (\mu_{2D} D_\theta F_{2D}(\varphi))|_{z_1=j}, \\ \Upsilon_{2D}^j f := (-1)^{j+1} (\mu_{2D} D_\theta \mathcal{G}_{2D}(f))|_{z_1=j}. \end{cases}$$

Conversely, it can be seen that if  $\phi$  is a solution of (6.5), then  $F_{2D}(\phi) + \mathcal{G}_{2D}(f)$  satisfies Problem (6.2). Therefore, the well-posedness of (6.5) follows from the well-posedness of the cell problem (6.2). Note also that by analogy with Proposition III-5.2, the operators  $\Xi_{2D}^j$  are sums of *weighted shift operators*, which allows them to be computed with the quasi-1D approach. Now, we extend this idea to the 3-dimensional cell problems.

**6.2.b. Extension to the 3D local cell problems.** In what follows, the Floquet variable  $\xi \in (-\pi, \pi)$  is fixed, and is omitted from the notations. We now address the case of the 3D local cell problems (5.29)

which are recalled under the formal form:

$$\left\{ \begin{array}{l} -(\mathbf{div} + i\xi^t \mathbf{e}_1) \Theta \mathbb{A}_p^t \Theta (\nabla + i\xi \mathbf{e}_1) E_\xi^j - \rho_p \omega^2 E_\xi^j = 0 \quad \text{in } \mathcal{C}_{\#^2}, \\ E_\xi^j \text{ is 1-periodic with respect to } z_1 \text{ and } z_2, \\ E_\xi^0(\Phi)|_{\Sigma_{\#^2}^0} = \Phi \quad \text{and} \quad E_\xi^0(\Phi)|_{\Sigma_{\#^2}^1} = 0, \\ E_\xi^1(\Phi)|_{\Sigma_{\#^2}^0} = 0 \quad \text{and} \quad E_\xi^1(\Phi)|_{\Sigma_{\#^2}^1} = \Phi, \end{array} \right. \quad (6.6)$$

where  $\Phi$  is a fixed data, which plays the role of the source term  $f$  in the previous section. By analogy with the previous section, it can be shown the traces of  $E_\xi^j$  along  $\Theta \mathbb{R}^2 + s \mathbf{e}_2$  satisfy a coupling relation which prevent them from being computed independently from one another. For this reason, we introduce auxiliary Dirichlet cell problems which are shown to have a fibered structure. The link between  $E_\xi^j$  and the solutions of these auxiliary problems is obtained using the trace of  $E_\xi^j$  on the interface  $\{z_1 = 1\}$ , which satisfies an equation similar to (6.5).

**The auxiliary cell problems** Consider  $E_\xi^0$  for simplicity. We introduce an additional unknown  $\mathcal{R}^0 \Phi$  defined by

$$\mathcal{R}^0 \Phi := E_\xi^0(\Phi)|_{z_1=0} = E_\xi^0(\Phi)|_{z_1=1}. \quad (6.7)$$

Then by considering the respective solutions  $F(\Psi)$  and  $\mathcal{G}^0(\Psi)$  of the well-posed Dirichlet cell problems:

$$\left\{ \begin{array}{l} -(\mathbf{div} + i\xi^t \mathbf{e}_1) \Theta \mathbb{A}_p^t \Theta (\nabla + i\xi \mathbf{e}_1) F - \rho \omega^2 F = 0 \quad \text{in } \mathcal{C}_{\#^2}, \\ F = F(\Psi) \text{ is 1-periodic with respect to } z_2, \\ F(\Psi)|_{x=0} = 0 \quad \text{and} \quad F(\Psi)|_{x=1} = 0, \\ F(\Psi)|_{z_1=0} = \Psi \quad \text{and} \quad F(\Psi)|_{z_1=1} = \Psi, \end{array} \right. \quad (6.8)$$

and

$$\left\{ \begin{array}{l} -(\mathbf{div} + i\xi^t \mathbf{e}_1) \Theta \mathbb{A}_p^t \Theta (\nabla + i\xi \mathbf{e}_1) \mathcal{G}^0 - \rho \omega^2 \mathcal{G}^0 = 0 \quad \text{in } \mathcal{C}_{\#^2}, \\ \mathcal{G}^0 = \mathcal{G}^0(\Phi) \text{ is 1-periodic with respect to } z_2, \\ \mathcal{G}^0(\Phi)|_{x=0} = \Phi \quad \text{and} \quad \mathcal{G}^0(\Phi)|_{x=1} = 0, \\ \mathcal{G}^0(\Phi)|_{z_1=0} = 0 \quad \text{and} \quad \mathcal{G}^0(\Phi)|_{z_1=1} = 0, \end{array} \right. \quad (6.9)$$

it follows by linearity that

$$E_\xi^0(\Phi) = F(\mathcal{R}^0 \Phi) + \mathcal{G}^0(\Phi). \quad (6.10)$$

Before highlighting the advantage of introducing  $F$  and  $\mathcal{G}^0$ , let us derive an equation to characterize  $\mathcal{R}^0 \Phi$ . The periodicity of  $E_\xi^0$  in  $z_1$  leads to the following equality

$$(\Theta \mathbb{A}_p^t \Theta (\nabla + i\xi \mathbf{e}_1) E_\xi^0(\Phi)) \cdot \mathbf{e}_1|_{z_1=0} = (\Theta \mathbb{A}_p^t \Theta (\nabla + i\xi \mathbf{e}_1) E_\xi^0(\Phi)) \cdot \mathbf{e}_1|_{z_1=1}.$$

which reformulates as

$$(\Xi^0 + \Xi^1) \mathcal{R}^0 \Phi = -(\Upsilon^{00} + \Upsilon^{01}) \Phi \quad (6.11)$$



with  $\Xi^k$  and  $\Upsilon^{0k}$ ,  $k \in \{0, 1\}$ , being the local auxiliary DtN operators defined by

$$\begin{cases} \Xi^k \Psi := (-1)^{k+1} (\Theta \mathbb{A}_p {}^t\Theta (\nabla + i\xi \mathbf{e}_1) F(\Psi)) \cdot \mathbf{e}_1|_{z_1=k}, \\ \Upsilon^{0k} \Phi := (-1)^{k+1} (\Theta \mathbb{A}_p {}^t\Theta (\nabla + i\xi \mathbf{e}_1) \mathcal{G}^0(\Phi)) \cdot \mathbf{e}_1|_{z_1=k}. \end{cases} \quad (6.12)$$

Conversely, if  $\Psi$  is such that  $(\Xi^0 + \Xi^1) \Psi = -(\Upsilon^{00} + \Upsilon^{01}) \Phi$ , then  $F(\Psi) + \mathcal{G}^0(\Phi)$  satisfies the local cell problem (6.6). Therefore, the well-posedness of (6.11) follows from the well-posedness of (6.6).

The above arguments extend naturally to  $E_\xi^1$ , to which we can associate  $\mathcal{R}^1 \Phi$ ,  $\mathcal{G}^1$ , and  $\Upsilon^{1k}$  by adapting respectively (6.7), (6.9), and (6.12). Then one has

$$E_\xi^1(\Phi) = F(\mathcal{R}^1 \Phi) + \mathcal{G}^1(\Phi), \quad \text{where} \quad (\Xi^0 + \Xi^1) \mathcal{R}^1 \Phi = -(\Upsilon^{10} + \Upsilon^{11}) \Phi. \quad (6.13)$$

Note that  $\mathcal{R}^0$  and  $\mathcal{R}^1$  define operators of Dirichlet-to-Dirichlet (DtD) type which are fully characterized by (6.11) and (6.13). From these operators, one can also deduce the local DtN operators  $\mathcal{T}_\xi^{jk}$  defined by (5.31). More precisely, it follows by linearity that

$$\forall j, k \in \{0, 1\}, \quad \mathcal{T}_\xi^{jk} = \tilde{\Upsilon}^{jk} + \tilde{\Xi}^k \mathcal{R}^j, \quad (6.14)$$

where  $\tilde{\Xi}^k$  and  $\tilde{\Upsilon}^{jk}$  are given by

$$\begin{cases} \tilde{\Xi}^k \Psi := (-1)^{k+1} (\Theta \mathbb{A}_p {}^t\Theta (\nabla + i\xi \mathbf{e}_1) F(\Psi)) \cdot \mathbf{e}_x|_{x=k}, \\ \tilde{\Upsilon}^{jk} \Phi := (-1)^{k+1} (\Theta \mathbb{A}_p {}^t\Theta (\nabla + i\xi \mathbf{e}_1) \mathcal{G}^j(\Phi)) \cdot \mathbf{e}_1|_{x=k}. \end{cases} \quad (6.15)$$

It is worth noting that the operators  $\Xi^j$ ,  $\tilde{\Xi}^k$ ,  $\Upsilon^{jk}$ ,  $\tilde{\Upsilon}^{jk}$  can all be obtained by computing  $F$  and  $\mathcal{G}^j$ , which satisfy cell problems with Dirichlet conditions on **both** the boundaries  $\{x = k\}$  and  $\{z_1 = j\}$ . We now highlight the structure of  $F$  and  $\mathcal{G}^j$ .

**The fibered structure of the auxiliary cell problems** Given  $s \in \mathbb{R}$ , using the definition (5.3) of  $(\mathbb{A}_s, \rho_s)$ , we introduce the 2D cell problems defined in  $Q_\theta := (0, 1) \times (0, 1/\theta_1)$  as

$$\begin{cases} -(\operatorname{div} + i\theta_1 \xi {}^t\mathbf{e}_z) \mathbb{A}_s (\nabla + i\theta_1 \xi \mathbf{e}_z) f_s - \rho_s \omega^2 f_s = 0 & \text{in } Q_\theta, \\ f_s|_{x=0} = 0 & \text{and } f_s|_{x=1} = 0 \\ f_s(\psi)|_{z=0} = \psi & \text{and } f_s(\psi)|_{z=1} = \psi, \end{cases} \quad (6.16)$$

and for  $j \in \{0, 1\}$ ,

$$\begin{cases} -(\operatorname{div} + i\theta_1 \xi {}^t\mathbf{e}_z) \mathbb{A}_s (\nabla + i\theta_1 \xi \mathbf{e}_z) \mathbf{g}_s^j - \rho_s \omega^2 \mathbf{g}_s^j = 0 & \text{in } Q_\theta, \\ \mathbf{g}_s^j(\varphi)|_{x=k} = \delta_{j,k} \varphi \\ \mathbf{g}_s^j(\varphi)|_{z=0} = 0 & \text{and } \mathbf{g}_s^j(\varphi)|_{z=1} = 0. \end{cases} \quad (6.17)$$

We also introduce  $\Gamma_{\#2}^k := (0, 1) \times \{k\} \times (0, 1)$  and the edges

$$S_k^X := \{k\} \times (0, 1/\theta_1), \quad \text{and} \quad S_k^Z := (0, 1) \times \{j/\theta_1\}.$$

Then, the link between the solution  $F$  (resp.  $\mathcal{G}^j$ ) of (6.8) (resp. (6.9) for  $j = 0$ ) and  $f_s$  (resp.  $\mathbf{g}_s^j$ ) is given by the next result.

**Proposition 6.3**

Let  $k \in \{0, 1\}$  and  $\Psi \in L^2(\Gamma_{\#^2}^k)$  such that  $\psi_s : x \mapsto \mathcal{S}_\Theta \Psi(x, s) := \mathbb{E}_{\#}^2 \Psi(x, k, s + k\delta) \in H^{1/2}(S_k^Z)$  for almost any  $s \in \mathbb{R}$ , with  $\delta := \theta_2/\theta_1$ . Then one has

$$\text{a. e. } (x, z, s) \in Q_\theta \times (0, 1), \quad \mathbb{E}_{\#}^2 F(x, \theta_1 z, \theta_2 z + s) = f_s(x, z), \quad (6.18)$$

where  $F = F(\Psi)$  and  $f_s = f_s(\psi_s)$  are the respective solutions of (6.8) and (6.16). Similarly, for any  $\Phi \in H_{\Theta \#^2}^{1/2}(\Sigma_{\#^2})$  with  $\varphi_s := \mathcal{S}_\Theta \Phi(\cdot, s)$  for almost any  $s \in (0, 1)$ , one has

$$\text{a. e. } (x, z, s) \in Q_\theta \times (0, 1), \quad \mathbb{E}_{\#}^2 \mathcal{G}^j(x, \theta_1 z, \theta_2 z + s) = \mathbf{g}_s^j(x, z), \quad (6.19)$$

where  $\mathcal{G}^j = \mathcal{G}^j(\Phi)$  and  $\mathbf{g}_s^j = \mathbf{g}_s^j(\varphi_s)$  are the respective solutions of (6.9) and (6.17).

Proposition 6.3 shows that computing  $(F, \mathcal{G}^j)$  reduces to finding  $(f_s, \mathbf{g}_s^j)$  for any  $s \in (0, 1)$ . The advantage in solving the problems satisfied by  $(f_s, \mathbf{g}_s^j)$  is that they are 2-dimensional, and can be solved independently from one another (with respect to  $s$ ), and therefore in parallel.

Finally, by analogy with Proposition III-5.2, the DtN operators  $\Xi^j, \tilde{\Xi}^k, \Upsilon^{jk}, \tilde{\Upsilon}^{jk}$  can be derived from the normal traces of  $f_s$  and  $\mathbf{g}_s^j$ . In fact, let  $t_s^k, \tilde{t}_s^k$ , and  $v_s^{jk}, \tilde{v}_s^{jk}$ ,  $j, k \in \{0, 1\}$  be the auxiliary edge DtN operators defined by

$$\left\{ \begin{array}{l} t_s^k \psi := (-1)^{k+1} (\mathbb{A}_s (\nabla + i\theta_1 \xi e_z) f_s(\psi)) \cdot e_z|_{z=k/\theta_1} \\ \tilde{t}_s^k \psi := (-1)^{k+1} (\mathbb{A}_s (\nabla + i\theta_1 \xi e_z) f_s(\psi)) \cdot e_x|_{x=k} \\ v_s^{jk} \varphi := (-1)^{k+1} (\mathbb{A}_s (\nabla + i\theta_1 \xi e_z) \mathbf{g}_s^j(\varphi)) \cdot e_z|_{z=k/\theta_1} \\ \tilde{v}_s^{jk} \varphi := (-1)^{k+1} (\mathbb{A}_s (\nabla + i\theta_1 \xi e_z) \mathbf{g}_s^j(\varphi)) \cdot e_z|_{x=k} \end{array} \right. \quad (6.20)$$

Then the next result follows directly from the weak forms of these operators and from the duality property (4.27) which can also be extended to the faces  $\Gamma_{\#^2}^k$ .

**Proposition 6.4**

For any  $k \in \{0, 1\}$ , let  $(\Phi^k, \Psi^k) \in L^2(\Sigma_{\#^2}^k) \times L^2(\Gamma_{\#^2}^k)$  be such that  $\varphi_s^k := \mathcal{S}_\Theta \Phi^k(\cdot, s) \in H^{1/2}(S_k^X)$

and  $\psi_s^k := \mathcal{S}_\Theta \Psi(\cdot, s) \in H^{1/2}(S_k^Z)$  for almost any  $s \in \mathbb{R}$ . Then for any  $j, k \in \{0, 1\}$ ,

$$\left\{ \begin{array}{l} \langle \Xi^k \Psi^j, \Psi^k \rangle_{\Gamma_{\#^2}^k} = \theta_1 \int_0^1 \langle t_s^k \psi_s^j, \psi_s^k \rangle_{S_k^Z} ds \\ \langle \tilde{\Xi}^k \Psi^j, \Phi^k \rangle_{\Sigma_{\#^2}^k} = \theta_1 \int_0^1 \langle \tilde{t}_s^k \psi_s^j, \varphi_s^k \rangle_{S_k^X} ds \\ \langle \Upsilon^{jk} \Phi^j, \Psi^k \rangle_{\Gamma_{\#^2}^k} = \theta_1 \int_0^1 \langle v_s^{jk} \varphi_s^j, \psi_s^k \rangle_{S_k^Z} ds \\ \langle \tilde{\Upsilon}^{jk} \Phi^j, \Phi^k \rangle_{\Sigma_{\#^2}^k} = \theta_1 \int_0^1 \langle \tilde{v}_s^{jk} \varphi_s^j, \varphi_s^k \rangle_{S_k^X} ds. \end{array} \right. \quad (6.21)$$

**The algorithm for the quasi-2D method** Let us summarize the quasi-2D method in the following algorithm.

- solve the 2D local cell problems (6.16, 6.17) and compute the auxiliary edge DtN operators  $t_s^k$ ,  $\tilde{t}_s^k$ , and  $v_s^{jk}$ ,  $\tilde{v}_s^{jk}$  given by (6.20) for any  $s \in [0, 1]$ ;
- Compute the auxiliary DtN operators  $\Xi^j$ ,  $\tilde{\Xi}^k$ ,  $\Upsilon^{jk}$ ,  $\tilde{\Upsilon}^{jk}$  using (6.21);
- Determine the DtD operator  $\mathcal{R}^j$ ,  $j \in \{0, 1\}$ , by solving the linear equation (6.11);
- Deduce  $E_\xi^j$ , and compute the local DtN operators  $\mathcal{T}_\xi^{jk}$  using their expression (6.14) with respect to  $\mathcal{R}^j$  and  $\Xi^j$ ,  $\tilde{\Xi}^k$ ,  $\Upsilon^{jk}$ ,  $\tilde{\Upsilon}^{jk}$ .

We do not describe the discretization of this algorithm, since it is an extension of the quasi-1D method III–5.2.b. We simply note that once the DtN operators  $\mathcal{T}_\xi^{jk}$  have been approximated, they can be used to derive the propagation operator  $\mathcal{P}_\xi$  (using the Riccati equation (5.33)), and the DtN operator  $\hat{\Lambda}_\xi^+$  (using (5.34)).

## 7 Numerical results

This section provides a series of numerical results with the goal to validate the method in various situations. For the sole sake of simplicity, simulations are performed with the tensor

$$\mathbb{A} = \begin{pmatrix} 1 & 0 \\ 0 & 1 \end{pmatrix}. \quad (7.1)$$

Unless otherwise specified, we use a cut-off function as the jump data  $g$  and the augmented data  $G$  is taken constant with respect to  $z_2$ :

$$\left\{ \begin{array}{l} \forall z \in \mathbb{R}, \quad g(0, z) := 100 \phi(2z), \quad \text{with} \quad \phi(z) := \exp(1 - 1/(1 - z^2)) \mathbf{1}_{[-1, 1]}(z), \\ \forall z_1 \in \mathbb{R}, \quad G(0, z_1, z_2) := g(0, z_1/\theta_1). \end{array} \right. \quad (7.2)$$

Simulations are carried out using Lagrange finite elements of order 1.

### 7.1 Validation in the homogeneous setting

In this first example, we consider the case where  $\rho$  is piecewise constant:

$$\forall \mathbf{x} \in \mathbb{R}^2, \quad \rho^+(\mathbf{x}) := 1 \quad \text{and} \quad \rho^-(\mathbf{x}) := 2.$$

This coefficient falls within the scope of both Configurations  $(\mathcal{A})$  and  $(\mathcal{B})$  with any periodicity parameter. For Configuration  $(\mathcal{A})$ , we choose  $p_z^+ := 1$  and  $p_z^- := \sqrt{2}/2$  to be the periods on both sides of the interface. For Configuration  $(\mathcal{B})$ , we choose  $\mathbf{p}^+ := (\sqrt{2}, 1)$  as the periodicity vector in  $\mathbb{R}_+^2$ . The jump data  $g$  and its extension  $G$  are given by (7.2).

The solution of  $(\mathcal{P})$  is computed using the method developed in this chapter for  $\omega = 8 + 0.25i$ . We choose a mesh step of  $h = 0.025$ , which corresponds approximately to 31 points per wavelength in  $\mathbb{R}_+^2$  and 22 points per wavelength in  $\mathbb{R}_-^2$ . The number of Floquet points is set to  $N_\xi + 1$ , with  $N_\xi = 64$ .

The reference solution  $u_{ref}$  we use in this context is obtained by applying the partial Fourier transform with respect to  $z$ , and by solving analytically a family of transmission problems defined on  $\mathbb{R}$  and parameterized by the Fourier variable. In fact, it can be computed that

$$\text{a. e. } (x, z) \in \mathbb{R}_\pm^2, \quad u_{ref}(x, z) = \frac{1}{2\pi} \int_{\mathbb{R}} \frac{\widehat{g}_\zeta}{r_\zeta^+ + r_\zeta^-} \exp(\mp r_\zeta^\pm + i\zeta z) d\zeta, \quad \text{with} \quad \widehat{g}_\zeta := \frac{1}{2\pi} \int_{\mathbb{R}} g(z) e^{-i\zeta z} dz$$

and where  $r_\zeta^\pm$  are defined by

$$\forall \zeta \in \mathbb{R}, \quad (r_\zeta^\pm)^2 = \zeta^2 - (\rho^\pm/\mu^\pm)\omega^2, \quad \Re r_\zeta^\pm \geq 0.$$

The solutions that follow from applying the lifting approach to Configurations  $(\mathcal{A})$  and  $(\mathcal{B})$  are compared in Figure 16 to  $u_{ref}$ . The similarity between the results validates the method in the homogeneous setting.

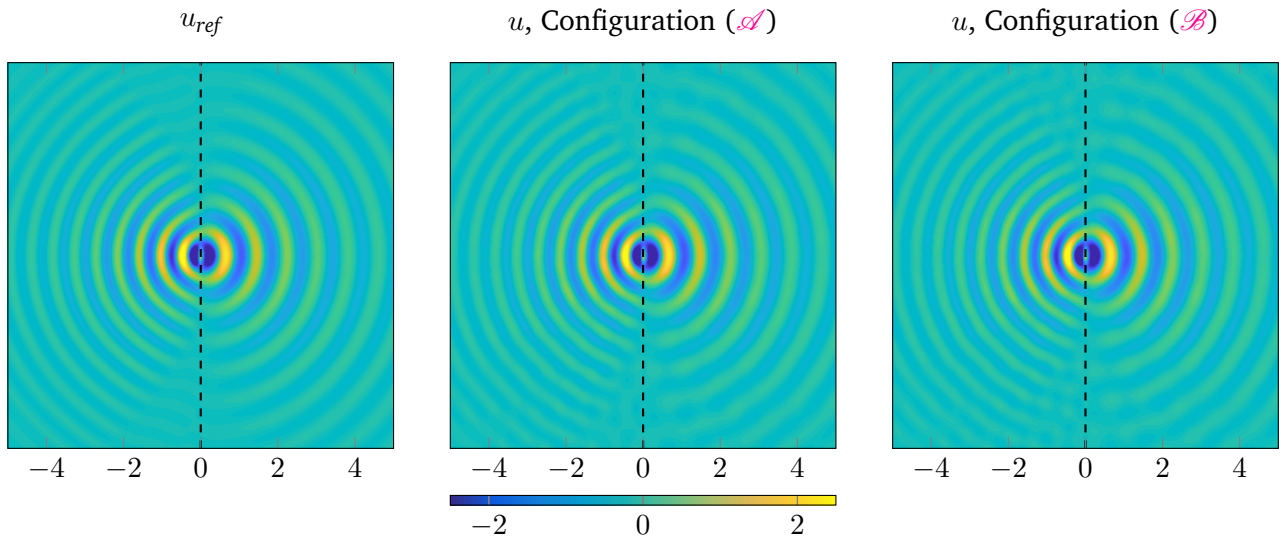

Figure 16: Real part of the approximate solution  $u_h$  computed for Configurations  $(\mathcal{A})$  and  $(\mathcal{B})$  using order 1 Lagrange finite elements with  $h = 0.025$  and  $N_\xi = 64$ .

In what follows, numerical experiments are performed with a variable coefficient  $\rho$ . Using the cut-off function  $\phi \in \mathcal{C}_0^\infty(\mathbb{R})$  defined in (7.2), we use the  $\mathbb{Z}^2$ -periodic functions defined in one cell of periodicity by

$$\forall \hat{\mathbf{x}} = (\hat{x}, \hat{z}) \in (0, 1)^2, \quad \hat{\rho}^-(\hat{\mathbf{x}}) := 0.5 + \phi(4\hat{x})\phi(4\hat{z}) \quad \text{and} \quad \hat{\rho}^+(\hat{\mathbf{x}}) := 0.5 + \phi(2.5|\hat{\mathbf{x}}|).$$

Then, for Configuration ( $\mathcal{A}$ ), we use

$$\forall \mathbf{x} = (x, z) \in \mathbb{R}^2, \quad \rho^\pm(\mathbf{x}) := \hat{\rho}^\pm(x, z/p_z^\pm), \quad (7.3)$$

which is  $p_z^\pm$ -periodic with respect to  $z$ . For Configuration ( $\mathcal{B}$ ), we set

$$\forall \mathbf{x} = (x, z) \in \mathbb{R}^2, \quad \rho^-(\mathbf{x}) = 1 \quad \text{and} \quad \rho^+(\mathbf{x}) := \hat{\rho}^+(x - (p_x^+/p_z^+)z, z/p_z^+), \quad (7.4)$$

so that  $\rho^+$  is  $\mathbb{Z}e_x + \mathbb{Z}\mathbf{p}^+$ -periodic with  $\mathbf{p}^+ = (p_x^+, p_z^+)$ . These coefficients are shown in Figure 17.

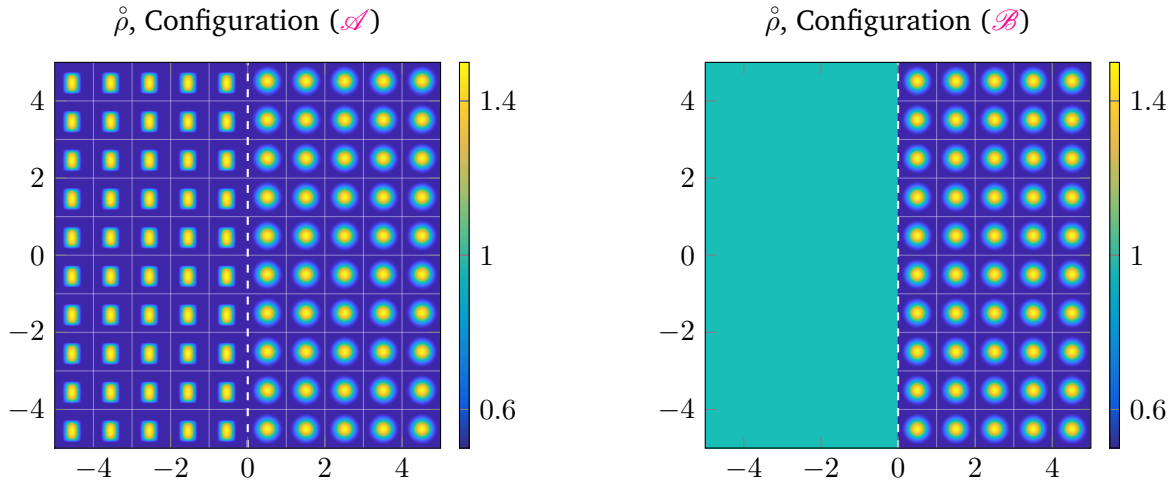

Figure 17: The  $\mathbb{Z}^2$ -periodic coefficients  $\hat{\rho}$  which are rescaled to construct  $\rho$ .

## 7.2 Validation in the rational setting

We consider a coefficient  $\rho$  which is 1-periodic in the direction of the interface (see Figures 18 and 19). In this case, as done in [FCB10], one can directly apply a Floquet-Bloch transform in the direction of the interface, leading a family of 2D transmission problems defined in  $\mathbb{R} \times (0, 1)$  and parameterized by the Floquet variable. Each of the waveguide problems can then be reduced to an interface equation featuring 2D DtN operators, which we obtain by computing the solution of half-guide problems defined in  $\mathbb{R}_\pm \times (0, 1)$ . Solving these half-guide problems involves 2D local cell problems and a propagation operator, similarly to Section 5.4. We use this approach to construct a reference solution  $u_{ref}$ , to which we compare the solution  $u$  obtained using the lifting approach. We fix  $\omega = 8 + 0.25i$ .

For Configuration ( $\mathcal{A}$ ), we define  $\rho$  using (7.3), with  $p_z^+ = p_z^- = 1$ . Figure 18 shows the solution  $u$  computed numerically using the lifting approach for a mesh step  $h = 0.025$  and  $N_\xi = 64$ . As expected, this solution is close to the reference solution  $u_{ref}$ .

For Configuration ( $\mathcal{B}$ ), we define  $\rho$  using (7.4), with  $\mathbf{p}^+ = (1/2, 1)$ . Figure 19 shows the solution  $u$  computed numerically using the lifting approach for a mesh step  $h = 0.025$  and  $N_\xi = 64$ . As expected,

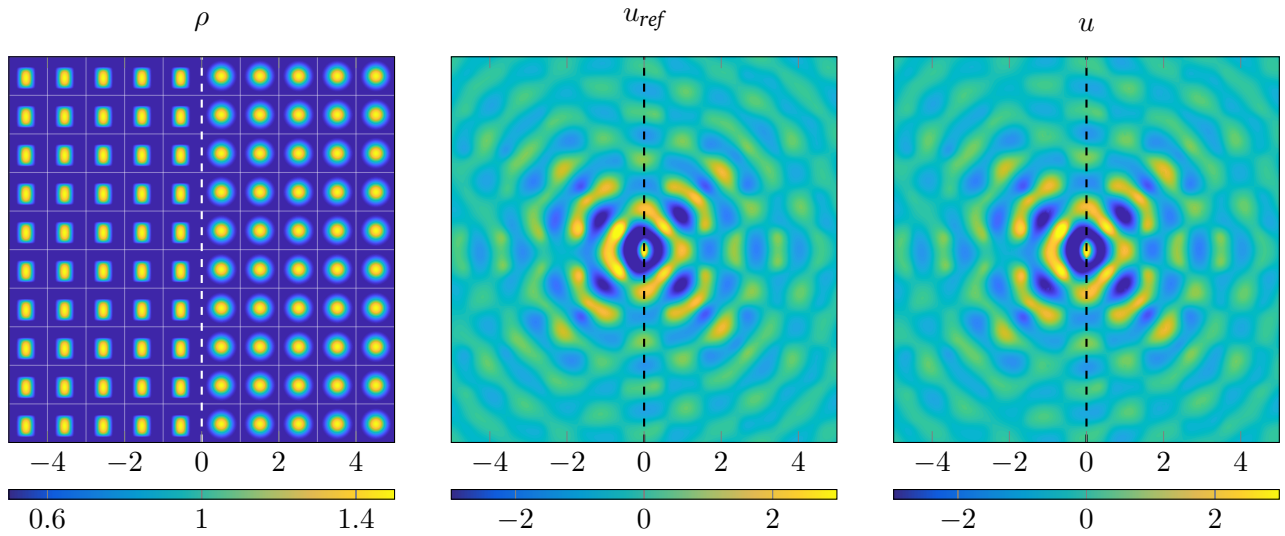

Figure 18: Real part of the approximate solution computed for Configuration (A) using order 1 Lagrange finite elements with  $h = 0.025$  and  $N_\xi = 64$ .

this solution is close to the reference solution  $u_{ref}$ .

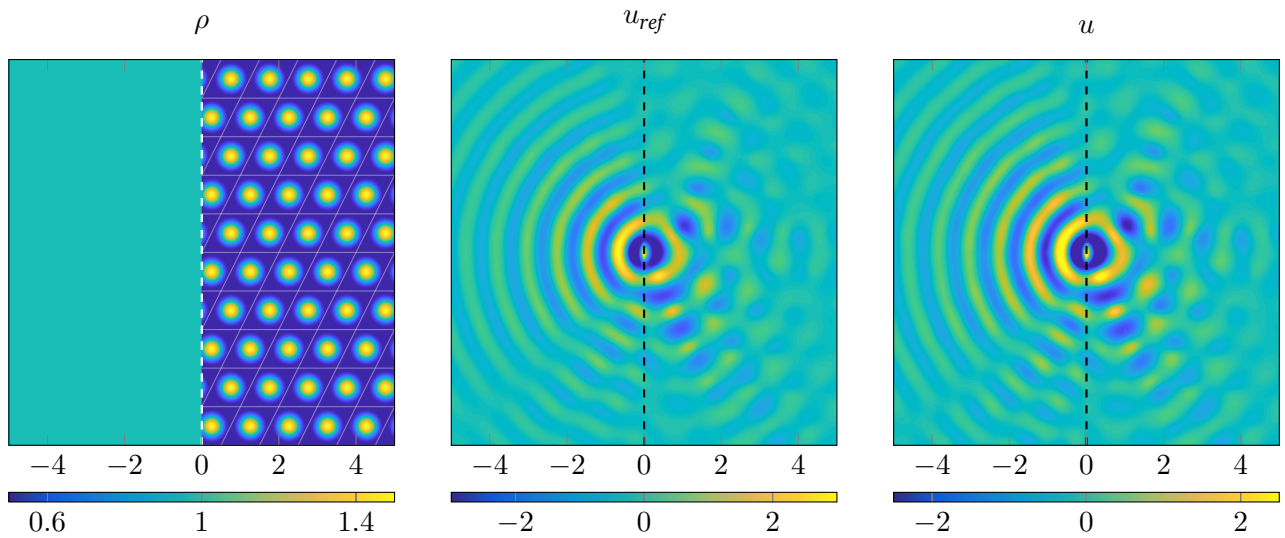

Figure 19: Real part of the approximate solution computed for Configuration (B) using order 1 Lagrange finite elements with  $h = 0.025$  and  $N_\xi = 64$ .

### 7.3 Validation and results in the irrational setting

This section is devoted to the case where  $(\mu, \rho)$  are not periodic with respect to the interface. For Configuration (A), we use the definition (7.3) with  $(p_z^+, p_z^-) = (1, \sqrt{2})$ , and for Configuration (B), we use the definition (7.4) with  $p^+ = (\cos \alpha, \sin \alpha)$ ,  $\alpha = 3\pi/5$ . The coefficient  $\rho$  is represented in Figure 20.

**Invariance with respect to the period** We only consider Configuration (A) for simplicity. As the coefficient  $\rho^\pm$  is  $p_z^\pm$ -periodic with respect to  $z$ , it is obvious that it is also  $k^\pm p_z^\pm$  with respect to  $z$  for

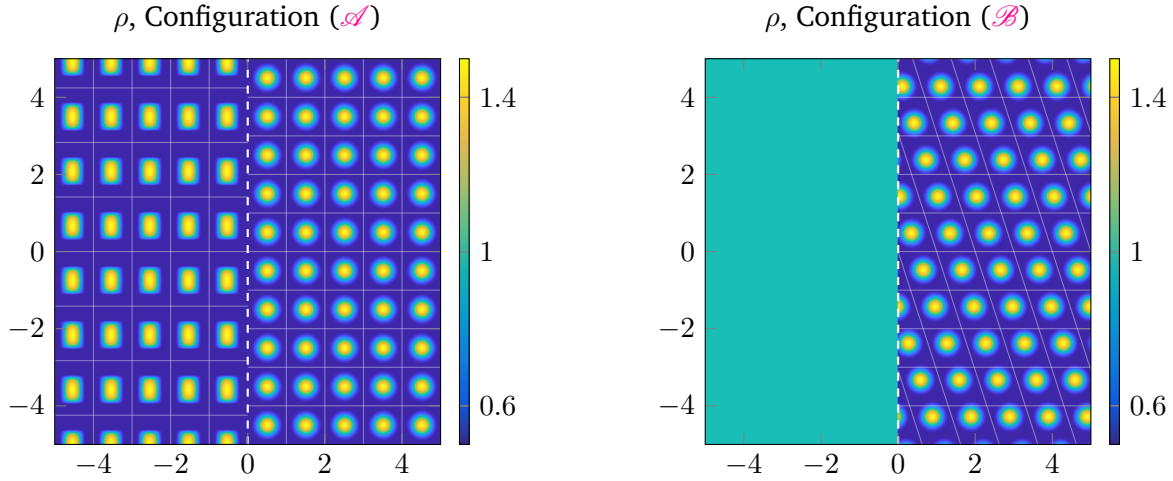

Figure 20: The coefficient  $\rho$  for Configurations  $(\mathcal{A})$  and  $(\mathcal{B})$ .

any  $k^\pm \in \mathbb{Z}^*$ . Choosing  $k^\pm p_z^\pm$  to be the period along the interface will not change the solution  $u$  of  $(\mathcal{P})$  (since  $(\mathbb{A}, \rho)$  are unchanged), whereas the solution  $U(G)$  of the augmented transmission problem  $(\mathcal{P}_\#)$  will be modified (due to the different expressions of the augmented coefficients  $(\mathbb{A}_p, \rho_p)$  and the cut matrix  $\Theta$ ). To see if the approximate solution  $u_h$  has the same invariances as  $u$  with respect to the periods, we compute  $u_h$  in Figure 21 for  $(p_z^+, p_z^-) = (1, \sqrt{2})$  (second figure) and  $(p_z^+, p_z^-) = (1, 2\sqrt{2})$  (first figure), with  $\omega = 8 + 0.25i$ ,  $h = 0.025$ , and  $N_\xi = 64$ . As expected,  $u_h$  remains the same for these two values of the period.

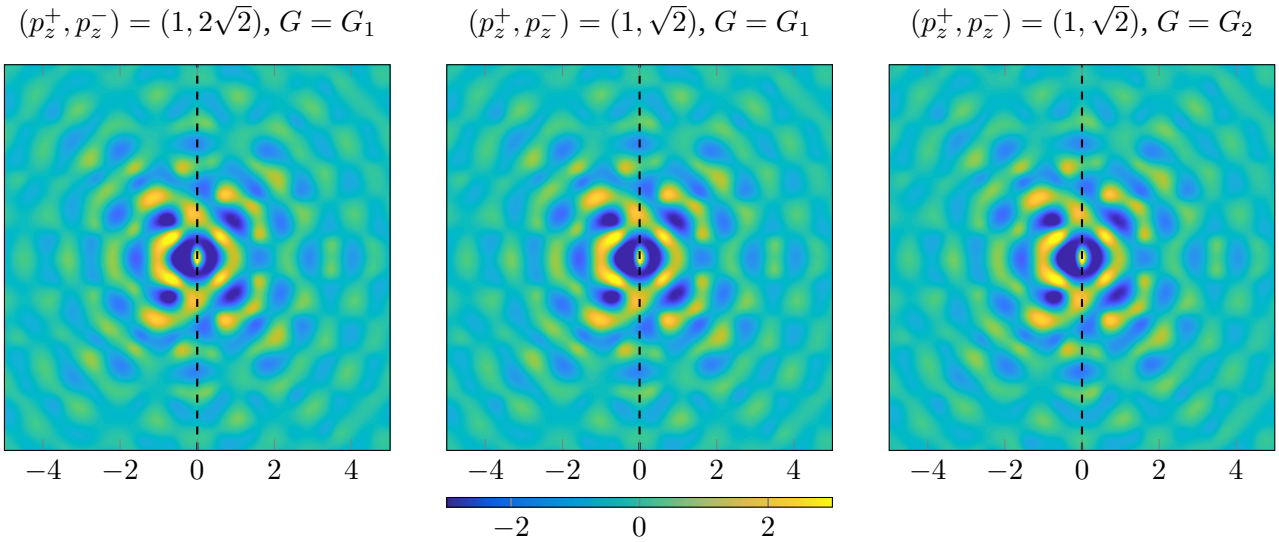

Figure 21: Real part of the approximate solution  $u_h$  computed for Configuration  $(\mathcal{A})$  using order 1 Lagrange finite elements with  $h = 0.025$  and  $N_\xi = 64$ . Different values are considered for the periods along the interface and for the augmented jump data.

**Invariance with respect to augmented jump data** We still consider Configuration  $(\mathcal{A})$  only for simplicity. Now, let us look at the invariance of the solution  $u_h$  with respect to the augmented jump data  $G$ . Since the data  $g$  used for our experiments is smooth, we recall that the assumptions on

the augmented jump data reduce to  $G$  satisfying  $G(0, \theta_1 z, \theta_2 z) = g(0, z)$  and  $G(\cdot + \mathbf{e}_2) = G$ . These requirements are satisfied by the following functions:

$$G_1(0, z_1, z_2) := g(0, z_1/\theta_1) \quad \text{and} \quad G_2(0, z_1, z_2) := \exp(2i\pi(z_2 - z_1\theta_2/\theta_1)) g(0, z_1/\theta_1).$$

Figure 21 (second and third figures) shows the solution  $u_h$  obtained for these two datas, with  $p_z^+ = 1$ ,  $p_z^- = \sqrt{2}$ ,  $h = 0.025$ ,  $N_\xi = 64$ , and  $\omega = 8 + 0.25i$ . As expected, the solution looks the same regardless of the augmented data used.

**Dependence with respect to the frequency** We finish by solving (P) for different values of  $\omega$ . As expected for the Helmholtz equation, the solution, represented in Figure 22, oscillates more as  $\Re \omega$  increases.

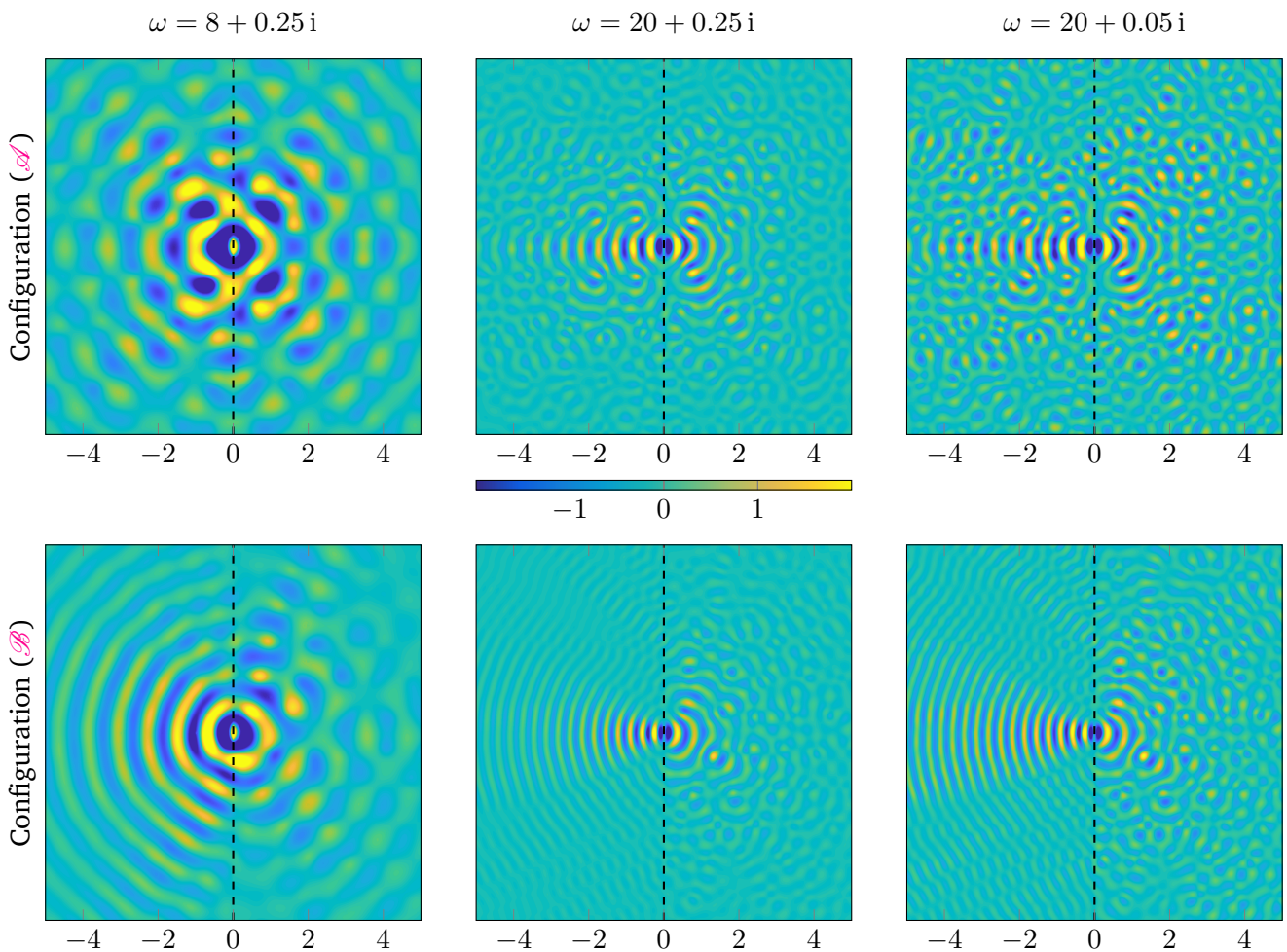

Figure 22: Real part of the approximate solution  $u_h$  computed using order 1 Lagrange finite elements with  $h = 0.025$  and  $N_\xi = 64$ . Different values are considered for  $\omega$ .

## 8 An alternative approach for Configuration (A)

In this section, an alternative approach is proposed to solve the 2D transmission problem (P) by decomposing the resolution domain into the half-spaces  $\mathbb{R}_+^2$  and  $\mathbb{R}_-^2$ . We introduce for any boundary



data  $\varphi \in H^{1/2}(\sigma)$  the half-space problems: Find  $u^\pm(\varphi) \in H^1(\mathbb{R}_\pm^2)$  such that

$$\begin{cases} -\operatorname{div} \mathbb{A}^\pm \nabla u^\pm(\varphi) - \rho^\pm \omega^2 u^\pm(\varphi) = 0 & \text{in } \mathbb{R}_\pm^2, \\ u^\pm(\varphi) = \varphi & \text{on } \sigma. \end{cases} \quad (\mathcal{P}^\pm)$$

These problems are well-posed due to the boundedness and the ellipticity of  $\mathbb{A}^\pm$  and  $\rho^\pm$  (cf. (2.2)), and because of absorption (2.1). Moreover, consider the DtN operators  $\lambda^\pm \in \mathcal{L}(H^{1/2}(\sigma), H^{-1/2}(\sigma))$  defined for any  $\varphi, \psi \in H^{1/2}(\sigma)$  by

$$\langle \lambda^\pm \varphi, \psi \rangle_\sigma := \int_{\mathbb{R}_\pm^2} [\mathbb{A}^\pm \nabla u^\pm(\varphi) \cdot \nabla u^\pm(\psi) - \rho^\pm \omega^2 u^\pm(\varphi) u^\pm(\psi)]. \quad (8.1)$$

From the presence of absorption, it follows that  $\lambda^\pm$  and  $\lambda^+ + \lambda^-$  are coercive, and therefore are invertible. Furthermore, the solution  $u$  of the transmission problem ( $\mathcal{P}$ ) can be expressed as

$$\text{a. e. } \mathbf{x} = (x, z) \in \mathbb{R}_\pm^2, \quad u(\mathbf{x}) = u^\pm(\varphi)(\mathbf{x}), \quad (8.2)$$

where  $\varphi := u|_\sigma$  is the unique solution of the equation:

$$\left| \begin{array}{l} \text{Find } \varphi \in H^{1/2}(\sigma) \text{ such that for any } \psi \in H^{1/2}(\sigma), \\ \langle (\lambda^+ + \lambda^-) \varphi, \psi \rangle_\sigma = \langle g, \psi \rangle_\sigma \end{array} \right. \quad (8.3)$$

In general, the resolution of ( $\mathcal{P}^\pm$ ) and the computation of the operators  $\lambda^\pm$  may be as difficult as solving ( $\mathcal{P}$ ). However, for Configuration ( $\mathcal{A}$ ), the tensor  $\mathbb{A}^\pm$  and the coefficient  $\rho^\pm$  are both periodic in the direction of the interface (with different periods  $p_z^\pm$ ). Thus for this configuration in particular, the half-space problems ( $\mathcal{P}^\pm$ ) may be solved directly by applying a Floquet-Bloch transform with different periods  $p_z^\pm$  along the interface. This is of particular interest, since one can avoid solving 3D problems as in the lifting approach. It then remains to solve the interface equation (8.3), which we shall reformulate using the Floquet-Bloch transform, and truncate for numerical purposes. This is presented in Section 8.1. The resolution algorithm and its discretization are described in Section 8.2, while Section 8.3 provides numerical results to illustrate the method.

## 8.1 Presentation

The operators  $\lambda^\pm$  are theoretical objects which cannot be computed directly, since they are defined on  $\sigma$  which is unbounded. Instead, they shall be expressed as integrals of operators involving bounded domains thanks to the Floquet-Bloch transform.

**8.1.a. The half-space problems.** We focus mainly on the half-space problem satisfied by  $u^+(\varphi)$ , since the one satisfied by  $u^-(\varphi)$  is very similar. Since  $\mathbb{A}^+$  and  $\rho^+$  are  $p_z^+$ -periodic according to (2.7), the structure of  $u^+(\varphi)$  can be exhibited by means of the 1D Floquet-Bloch transform  $\mathcal{F}_{p_z^+}$  presented in Section 5.2.a. Let us introduce the domains

$$Q^+ := \mathbb{R}_+ \times (0, p_z^+), \quad \sigma^+ := \{0\} \times (0, p_z^+), \quad \text{and} \quad K^+ := (-\pi/p_z^+, \pi/p_z^+).$$

In addition, define

$$\begin{aligned} H_{\#^2}^1(Q^+) &:= \{v \in H^1(Q^+), \quad v|_{z=0} = v|_{z=p_z^+}\} \\ H_{\#^2}^{1/2}(\sigma^+) &:= \{v|_{\sigma^+}, \quad v \in H_{\#^2}^1(Q^+)\}. \end{aligned} \quad (8.4)$$

Then it follows directly from the properties of  $\mathcal{F}_{p_z^+}$  in Section 5.2.a that for any  $n \in \mathbb{Z}$ ,

$$\text{a. e. } \mathbf{x} = (x, z) \in Q^+, \quad u^+(\varphi)(\mathbf{x} + np_z^+ \mathbf{e}_z) = \frac{1}{\sqrt{|K^\pm|}} \int_{K^+} \widehat{u}_\xi^+(\widehat{\varphi}_\xi)(\mathbf{x}) e^{i\xi(z+np_z^+)} d\xi, \quad (8.5)$$

where  $\widehat{\varphi}_\xi := [\mathcal{F}_{p_z^+} \varphi](\cdot, \xi) \in H_{\#^2}^{1/2}(\sigma^+)$ , a. e.  $\xi \in K^+$ , and where  $\widehat{u}_\xi^+(\widehat{\varphi}_\xi)$  is the unique solution of:

$$\left| \begin{array}{l} \text{Find } \widehat{u}_\xi^+(\widehat{\varphi}_\xi) \in H_{\#^2}^1(Q^+) \text{ such that } \widehat{u}_\xi^+(\widehat{\varphi}_\xi)|_{\sigma^+} = \widehat{\varphi}_\xi \text{ and } \forall v \in H_{\#^2}^1(Q^+), v|_{\sigma^+} = 0, \\ \int_{Q^+} [\mathbb{A}^+(\nabla + i\xi \mathbf{e}_z) \widehat{u}_\xi^+(\widehat{\varphi}_\xi) \cdot \overline{(\nabla + i\xi \mathbf{e}_z) v} - \rho^+ \omega^2 \widehat{u}_\xi^+(\widehat{\varphi}_\xi) \overline{v}] = 0. \end{array} \right. \quad (8.6)$$

Since  $\mathbb{A}^+$  and  $\rho^+$  are periodic with respect to  $x$ , this half-guide problem can be solved similarly to [JLF06; FJ09] (see also Section 5.3) by introducing local cell problems in  $(0, 1) \times (0, p_z^+)$  and a propagation operator which satisfies a Riccati equation. Then, using (8.5),  $u^+(\varphi)$  can be reconstructed in the half-space  $\mathbb{R}_+^2$  from  $\widehat{u}_\xi^+(\widehat{\varphi}_\xi)$ .

**8.1.b. Characterization of the DtN operators.** Using the solution  $\widehat{u}_\xi^+(\widehat{\varphi}_\xi)$  of (8.6), one can define the operator  $\widehat{\lambda}_\xi^+ \in \mathcal{L}(H_{\#^2}^{1/2}(\sigma^+), H_{\#^2}^{-1/2}(\sigma^+))$  for any  $\varphi, \psi \in H_{\#^2}^{1/2}(\sigma^+)$  as follows

$$\langle \widehat{\lambda}_\xi^+ \varphi, \psi \rangle_{\sigma^+} := \int_{Q^+} [\mathbb{A}^+(\nabla + i\xi \mathbf{e}_z) \widehat{u}_\xi^+(\varphi) \cdot (\nabla + i\xi \mathbf{e}_z) \widehat{u}_\xi^+(\psi) - \rho^+ \omega^2 \widehat{u}_\xi^+(\varphi) \widehat{u}_\xi^+(\psi)]. \quad (8.7)$$

From the definition of the Floquet-Bloch transform in  $H^{-1/2}(\sigma)$ , the DtN operator  $\lambda^+$  given by (8.1) is linked by to  $\widehat{\lambda}_\xi^+$  by the following: for  $\varphi, \psi \in H^{1/2}(\sigma)$ ,

$$\langle \lambda^+ \varphi, \psi \rangle_\sigma = \int_{K^+} \langle \widehat{\lambda}_\xi^+ [\mathcal{F}_{p_z^+} \varphi](\cdot, \xi), [\mathcal{F}_{p_z^+} \psi](\cdot, \xi) \rangle_{\sigma^+} d\xi. \quad (8.8)$$

By applying the Floquet-Bloch transform with period  $p_z^-$  to the solution  $u^-(\varphi)$  of ( $\mathcal{P}^\pm$ ) in  $\mathbb{R}_-^2$  and by introducing the corresponding analogues of (8.6) and (8.8), we obtain a similar expression for  $\lambda^-$ . The interface equation can then be reformulated as the following non-local equation:

$$\left| \begin{array}{l} \text{Find } \varphi \in H^{1/2}(\sigma) \text{ such that for any } \psi \in H^{1/2}(\sigma), \\ \sum_{\pm} \int_{K^\pm} \langle \widehat{\lambda}_\xi^\pm [\mathcal{F}_{p_z^\pm} \varphi](\cdot, \xi), [\mathcal{F}_{p_z^\pm} \psi](\cdot, \xi) \rangle_{\sigma^\pm} d\xi = \langle g, \psi \rangle_\sigma. \end{array} \right. \quad (8.9)$$

**8.1.c. Truncation of the interface equation.** Even though the DtN operators  $\lambda^\pm$  have been expressed in terms of operators  $\widehat{\lambda}_\xi^\pm$  defined on a bounded domain, the interface equation (8.9) remains defined on  $\sigma$  which is unbounded. To overcome this last difficulty, we introduce an approximate problem on the domain

$$\sigma_\tau := \{0\} \times (-\tau/2, \tau/2),$$

for  $\tau > 0$ . To this end, following the notation in [McL00, Theorem 3.33], we define the space

$$\widetilde{H}^{1/2}(\sigma_\tau) := \{\psi \in H^{1/2}(\sigma) / \psi = 0 \text{ on } \sigma \setminus \overline{\sigma_\tau}\}. \quad (8.10)$$

Note that in general,  $\widetilde{H}^{1/2}(\sigma_\tau)$  is strictly included in  $H^{1/2}(\sigma)$  (see [LM72, Remark 12.1]).

**Proposition 8.1**

*Equipped with the  $H^{1/2}$ -scalar product,  $\tilde{H}^{1/2}(\sigma_\tau)$  is a Hilbert space*

**Proof.** It is sufficient to prove that  $\tilde{H}^{1/2}(\sigma_\tau)$  is a closed subspace of  $H^{1/2}(\sigma)$  with respect to the  $H^{1/2}$ -norm. Consider a sequence  $(\psi_n)_n$  of functions in  $\tilde{H}^{1/2}(\sigma_\tau)$  such that  $\psi_n \rightarrow \psi \in H^{1/2}(\sigma)$ . In particular,  $\psi_n \rightarrow \psi$  in  $L^2(\sigma)$ , and thus  $\psi = 0$  on  $\sigma \setminus \overline{\sigma_\tau}$ . Hence,  $\psi \in \tilde{H}^{1/2}(\sigma_\tau)$ . ■

Now, in regards to (8.3), consider the problem:

$$\left| \begin{array}{l} \text{Find } \varphi \in \tilde{H}^{1/2}(\sigma_\tau) \text{ such that for any } \psi \in \tilde{H}^{1/2}(\sigma_\tau), \\ \langle (\lambda^+ + \lambda^-) \varphi_\tau, \psi \rangle_\sigma = \langle g, \psi \rangle_\sigma \end{array} \right. \quad (8.11)$$

From a practical perspective, (8.11) can be interpreted as a problem defined on  $\sigma_\tau$ . This can be seen formally by replacing in (8.11) the dual products by integrals on  $\sigma$ , and by using the fact that  $\psi$  vanishes outside of  $\sigma_\tau$ . This problem is well-posed thanks to Lax-Milgram's theorem, in particular because  $\lambda^+ + \lambda^-$  is coercive due to absorption. Moreover, the error  $\varphi - \varphi_\tau$  is studied in the next proposition whose proof relies on classical arguments.

**Proposition 8.2**

*Consider  $\tau > 0$  and let  $\varphi \in H^{1/2}(\sigma)$  and  $\varphi_\tau \in \tilde{H}^{1/2}(\sigma_\tau)$  be the respective solutions of (8.3) and (8.11):*

$$\exists c > 0, \quad \forall \tau > 0, \quad \|\varphi - \varphi_\tau\|_{H^{1/2}(\sigma)} \leq c \inf_{\psi \in \tilde{H}^{1/2}(\sigma_\tau)} \|\varphi - \psi\|_{H^{1/2}(\sigma)}. \quad (8.12)$$

*Furthermore, if  $g \in L^2(\sigma)$  is compactly supported, then*

$$\exists c', \alpha > 0, \quad \forall \tau > 0, \quad \|\varphi - \varphi_\tau\|_{H^{1/2}(\sigma)} \leq c' e^{-\alpha \Im m \omega \tau} \|g\|_{H^{-1/2}(\sigma)}. \quad (8.13)$$

**Proof.** Since (8.12) results directly from C ea's lemma, we focus on (8.13). Define  $Q_\tau := \mathbb{R} \times (0, \tau)$  and  $Q_\tau^\pm := \mathbb{R}^\pm \times (0, \tau)$ . We denote by  $\tilde{v} \in H^1(\mathbb{R}^2)$  the extension of  $v \in H_0^1(Q_\tau)$  by zero. Let  $\psi_\tau := (u_\tau)|_{\sigma_\tau}$ , where  $u_\tau \in H^1(Q_\tau)$  satisfy

$$\left\{ \begin{array}{l} -\operatorname{div} \mathbb{A} \nabla u_\tau - \rho \omega^2 u_\tau = 0 \quad \text{in } Q_\tau^+ \cup Q_\tau^-, \\ \llbracket \mathbb{A} \nabla u_\tau \cdot \mathbf{e}_x \rrbracket_{\sigma_\tau} = g \quad \text{on } \sigma_\tau, \\ u_\tau = 0 \quad \text{on } \partial Q_\tau. \end{array} \right.$$

Then  $\psi_\tau \in \tilde{H}^{1/2}(\sigma_\tau)$ , since  $\psi_\tau = \tilde{u}_\tau|_\sigma \in H^{1/2}(\sigma)$  where  $\tilde{u}_\tau$  is the extension by 0 of  $u_\tau$  to  $\mathbb{R}^2$ . Moreover, if  $g \in L^2(\sigma)$  is compactly supported, then the exponential decay estimate (2.4) combined with the continuity of the trace operator on  $\sigma$  and the well-posedness of the problem satisfied by  $u - u_\tau$  allow to deduce that

$$\exists c_1, c_2, \alpha > 0, \quad \|\varphi - \psi_\tau\|_{H^{1/2}(\sigma)} \leq c_1 \|u - \tilde{u}_\tau\|_{H^1(\mathbb{R}^2)} \leq c_2 e^{-\alpha \Im m \omega \tau} \|g\|_{H^{-1/2}(\sigma)}. \quad (8.14)$$

As  $\inf_{\psi_\tau \in \tilde{H}^{1/2}(\sigma_\tau)} \|\varphi - \psi_\tau\|_{H^{1/2}(\sigma)} \leq \|\varphi - \psi_\tau\|_{H^{1/2}(\sigma)}$ , (8.13) follows from (8.12) and (8.14). ■

To finish, note that from the link between  $\lambda^\pm$  and  $\widehat{\lambda}_\xi^\pm$ , it follows that (8.11) is equivalent to:

$$\left| \begin{array}{l} \text{Find } \varphi_\tau \in \widetilde{H}^{1/2}(\sigma_\tau) \text{ such that for any } \psi \in \widetilde{H}^{1/2}(\sigma_\tau), \\ \sum_{\pm} \int_{K^\pm} \langle \widehat{\lambda}_\xi^\pm [\mathcal{F}_{p_z^\pm} \varphi_\tau](\cdot, \xi), [\mathcal{F}_{p_z^\pm} \psi](\cdot, \xi) \rangle_{\sigma^\pm} d\xi = \langle g, \psi \rangle_\sigma. \end{array} \right. \quad (8.15)$$

## 8.2 The algorithm and its discretization

The following algorithm summarizes the approach presented in Section 8.1.

- For any  $\xi \in K^\pm$ , compute the DtN operators  $\widehat{\lambda}_\xi^\pm$  defined by (8.7).
- Find  $\varphi := u|_\sigma$  by solving (8.15) for  $\tau$  large enough, and compute  $\widehat{\varphi}_\xi^\pm := \mathcal{F}_{p_z^\pm} \varphi$  for  $\xi \in K^\pm$ .
- Deduce the solution  $\widehat{u}^\pm(\widehat{\varphi}_\xi^\pm)$  of the half-guide problem (8.6).
- Compute the solutions  $u^\pm(\varphi)$  of (8.6) using the inverse Floquet-Bloch transform (8.5), and deduce the solution  $u$  of ( $\mathcal{P}$ ) using (8.2).

The rest of the section is devoted to the discretization of these steps.

The discretization of Steps 8.2.a and 8.2.c requires a periodic mesh  $\mathcal{T}_{h^\pm}$  with step  $h^\pm > 0$  of the cell  $(0, \pm 1) \times (0, p_z^\pm)$ . We use Lagrange finite elements of order  $d > 0$  to construct an internal approximation  $\mathcal{V}_{h^\pm}(\sigma^\pm)$  of  $H^{1/2}(\sigma^\pm)$ . The approximation of  $\widehat{\lambda}_\xi^\pm$  and  $\widehat{u}_\xi^\pm(\varphi)$  will not be detailed, because it is very similar to the content of Section 6.1. We simply assume that given  $\xi \in K^\pm$  and  $\psi \in H^{1/2}(\sigma^\pm)$ , suitable approximations  $(\widehat{\lambda}_{\xi, h^\pm}^\pm, \widehat{u}_{\xi, h^\pm}^\pm)$  of  $(\widehat{\lambda}_\xi^\pm, \widehat{u}_\xi^\pm)$  can be obtained.

We now turn to the discretization of Steps 8.2.b and 8.2.d. In what follows,  $\tau > 0$  is fixed, and is supposed large enough (see Estimate (8.13)). The discretization process is divided into two steps: a semi-discretization with respect to the Floquet variable, and a discretization with respect to the spatial variable.

**Semi-discretization with respect to the Floquet variable** In order to solve (8.15), the integrals defined on  $K_+$  and  $K_-$  can only be evaluated with a quadrature rule, since their integrands do not have an explicit expression. To this end, consider a regular mesh of  $K^\pm$  made of  $N_\xi^\pm$  intervals of equal size  $\Delta\xi^\pm$  and of  $N_\xi^\pm + 1$  equispaced points  $\xi_j^\pm \in K^\pm$  for  $j \in \llbracket 1, N_\xi^\pm \rrbracket$ , where  $N_\xi^\pm > 0$  and  $\Delta\xi^\pm := |K^\pm|/N_\xi^\pm$ . The DtN operator  $\widehat{\lambda}_\xi^\pm$  is computed for  $\xi = \xi_j^\pm$ , and the integrals in (8.15) are evaluated using the trapezoidal rule (see Remark 8.3):

$$\int_{K^\pm} \langle \widehat{\lambda}_\xi^\pm [\mathcal{F}_{p_z^\pm} \varphi_\tau](\cdot, \xi), [\mathcal{F}_{p_z^\pm} \widetilde{\psi}](\cdot, \xi) \rangle_{\sigma^\pm} d\xi \simeq \Delta\xi^\pm \sum_{j=0}^{N_\xi^\pm} \langle \widehat{\lambda}_{\xi_j^\pm}^\pm [\mathcal{F}_{p_z^\pm} \varphi_\tau](\cdot, \xi_j^\pm), [\mathcal{F}_{p_z^\pm} \widetilde{\psi}](\cdot, \xi_j^\pm) \rangle_{\sigma^\pm},$$

so that one has to solve

$$\left| \begin{array}{l} \text{Find } \varphi_{\tau, \Delta\xi} \in \widetilde{H}^{1/2}(\sigma_\tau) \text{ such that for any } \psi \in \widetilde{H}^{1/2}(\sigma_\tau), \\ \sum_{\pm} \Delta\xi^\pm \sum_{j=0}^{N_\xi^\pm} \langle \widehat{\lambda}_{\xi_j^\pm}^\pm [\mathcal{F}_{p_z^\pm} \varphi_{\tau, \Delta\xi}](\cdot, \xi_j^\pm), [\mathcal{F}_{p_z^\pm} \widetilde{\psi}](\cdot, \xi_j^\pm) \rangle_{\sigma^\pm} = \langle g, \widetilde{\psi} \rangle_\sigma, \end{array} \right. \quad (8.16)$$

with  $\Delta\xi := (\Delta\xi^+, \Delta\xi^-)$ . We expect this equation to be well-posed in  $\tilde{H}^{1/2}(\sigma_\tau)$  for  $\Delta\xi^\pm$  small enough. The solution  $\varphi_{\tau, \Delta\xi}$  of this equation can then be used to define

$$\text{a. e. } \mathbf{x} = (x, z) \in Q^\pm, \quad u_{\tau, \Delta\xi}^\pm(\mathbf{x} + np_z^\pm \mathbf{e}_z) := \frac{\Delta\xi^\pm}{\sqrt{|K^\pm|}} \sum_{j=0}^{N_\xi^\pm} \hat{u}_{\xi_j^\pm}^\pm \left( (\mathcal{F}_{p_z^\pm} \varphi_{\tau, \Delta\xi})(\cdot, \xi_j^\pm) \right) (\mathbf{x}) e^{i\xi_j^\pm(z + np_z^\pm)}, \quad (8.17)$$

as well as the function

$$\text{a. e. } \mathbf{x} = (x, z) \in \mathbb{R}_\pm^2, \quad u_{\tau, \Delta\xi}(\mathbf{x}) = u_{\tau, \Delta\xi}^\pm(\mathbf{x}), \quad (8.18)$$

which corresponds to an approximate solution of  $(\mathcal{P})$ .

**Remark 8.3.** *We have chosen the trapezoidal rule because it converges exponentially if the function to be integrated is smooth [TW14], which is the case for the integrands in the interface equation (8.15). In fact, since  $\varphi_\tau$  and  $\tilde{\psi}$  are compactly supported in  $\sigma_\tau$ , Paley-Wiener type estimates [Kuc93, Theorem 2.2.2] ensure the smoothness of  $\xi \mapsto (\mathcal{F}_{p_z^\pm} \varphi_\tau(\cdot, \xi), \mathcal{F}_{p_z^\pm} \tilde{\psi}(\cdot, \xi))$ . In addition, it can be shown that  $\xi \mapsto \hat{\lambda}_\xi^\pm$  is real analytic due to the quadratic dependence of the half-guide problem (8.6) with respect to  $\xi$ .*

**Spatial discretization** Consider a mesh  $\mathcal{T}(\sigma_\tau)$  with mesh step  $h > 0$  of the segment  $\sigma_\tau$ . Let  $\mathcal{V}_h(\sigma_\tau)$  denote the approximation space of  $H^1(\sigma_\tau)$  by Lagrange finite elements of order  $d$ . The space

$$\tilde{\mathcal{V}}_h(\sigma_\tau) := \{\varphi \in \mathcal{V}_h(\sigma_\tau) \mid \varphi = 0 \text{ on } \partial\sigma_\tau\}.$$

defines an internal approximation of  $\tilde{H}^{1/2}(\sigma_\tau)$ . We would like to construct a fully discrete version of (8.16) defined in  $\tilde{\mathcal{V}}_h(\sigma_\tau)$ , where  $\hat{\lambda}_\xi^\pm$  is replaced by its discrete approximation  $\hat{\lambda}_{\xi, h^\pm}^\pm \in \mathcal{L}(\mathcal{V}_{h^\pm}(\sigma^\pm))$  for  $\xi = \xi_j^\pm$ . However,  $\mathcal{F}_{p_z^\pm} \tilde{\mathcal{V}}_h(\sigma_\tau) \subsetneq \mathcal{V}_{h^\pm}(\sigma^\pm)$  in general, so that  $\mathcal{F}_{p_z^\pm} \psi_h$  has to be projected onto  $\mathcal{V}_{h^\pm}(\sigma^\pm)$  for any  $\psi_h \in \tilde{\mathcal{V}}_h(\sigma_\tau)$ . This is the reason why we introduce the interpolation operator  $\Pi_{h^\pm}$  defined from the space  $\mathcal{F}_{p_z^\pm} \tilde{\mathcal{V}}_h(\sigma_\tau)$  to  $\mathcal{V}_{h^\pm}(\sigma^\pm)$ . Then, we can introduce the discrete problem

$$\left| \begin{array}{l} \text{Find } \varphi_{\tau, \mathbf{h}} \in \tilde{\mathcal{V}}_h(\sigma_\tau) \text{ such that for any } \psi \in \tilde{\mathcal{V}}_h(\sigma_\tau), \\ \sum_{\pm} \Delta\xi^\pm \sum_{j=0}^{N_\xi^\pm} \langle \hat{\lambda}_{\xi_j^\pm, h^\pm}^\pm \Pi_{h^\pm}[\mathcal{F}_{p_z^\pm} \tilde{\varphi}_{\tau, \mathbf{h}}](\cdot, \xi_j^\pm), \Pi_{h^\pm}[\mathcal{F}_{p_z^\pm} \tilde{\psi}](\cdot, \xi_j^\pm) \rangle_{\sigma^\pm} = \langle g, \tilde{\psi} \rangle_\sigma, \end{array} \right. \quad (8.19)$$

with  $\mathbf{h} := (h, h^+, h^-, \Delta\xi^+, \Delta\xi^-)$ . Note that (8.19) can be reformulated as a  $N_h \times N_h$  linear system, where  $N_h := \dim \tilde{\mathcal{V}}_h(\sigma_\tau)$ . Its solution can then be used to compute an approximate solution  $u_{\tau, \mathbf{h}}$  of  $(\mathcal{P})$  using (8.17, 8.18).

### 8.3 A qualitative validation

In what follows, the dual variable associated to Floquet-Bloch transform applied to  $(\mathcal{P}^\pm)$  is discretized using  $\lfloor 64/p_z^\pm \rfloor$  points. Each half-guide problem resulting from the Floquet-Bloch transform is discretized using Lagrange finite elements of order 1 with  $1/h^\pm = 60$ . We then solve the discrete interface equation (8.19) using Lagrange finite elements of order 1 with  $h = 0.025$  and  $\tau = 10$ . We choose  $\mathbb{A} = 1$ , and the coefficient  $\rho$  defined by (7.3) for  $(p_z^+, p_z^-) = (1, \sqrt{2})$  (see first image in Figure 23). The jump data is the smooth cut-off function defined by (7.2), and  $\omega = 20 + 0.25i$ . The solution of  $(\mathcal{P})$  computed via the alternative procedure in Section 8.2 is compared in Figure 23 to the solution obtained with the lifting approach. The similarity between these two solutions validates the alternative method.

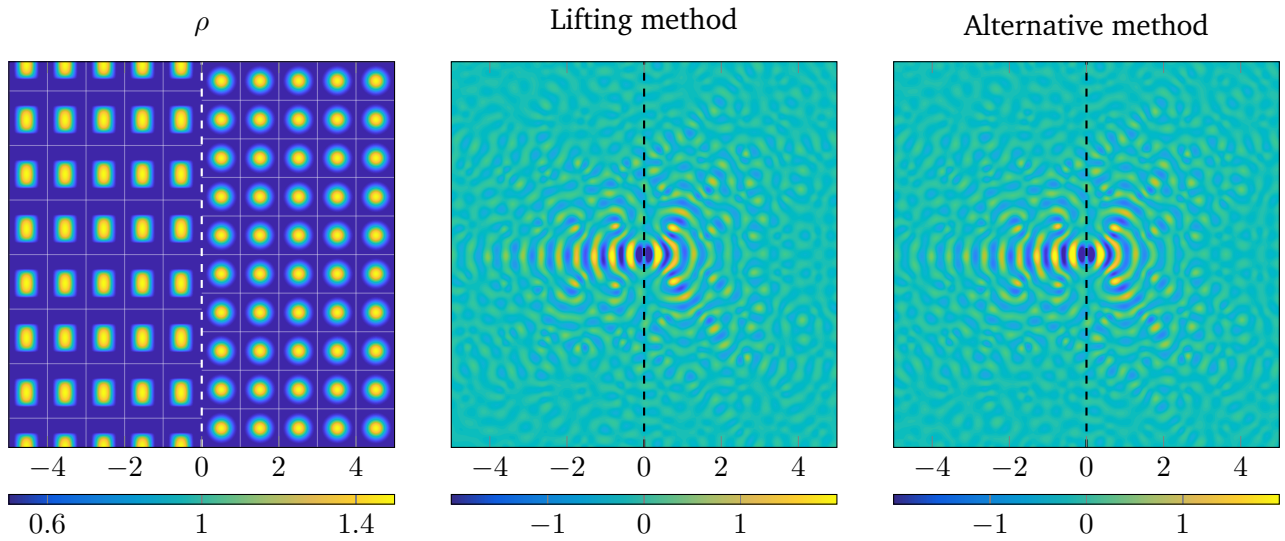

Figure 23: Real part of the approximate solution of (A) computed using the alternative approach presented in this section and the lifting approach.

## A Proof of Proposition 5.5

We prove in this part the properties of the Floquet-Bloch transform stated in Proposition 5.5.

**Proof.** *Point (a).*— We first show that  $\mathcal{F}_{\mathbf{e}_1}$  is continuous from  $H_{\Theta\#}^1(\Omega_{\#})$  to  $L^2(-\pi, \pi; H_{\Theta}^1(\Omega_{\#^2}))$  and satisfies (5.16). To begin, let us note that  $\mathcal{F}_{\mathbf{e}_1} V(\cdot, \xi) \in \mathcal{C}_{0,\#^2}^{\infty}(\overline{\Omega_{\#^2}}) \subset H_{\Theta\#^2}^1(\Omega_{\#^2})$  for  $\xi \in (-\pi, \pi)$  and  $V \in \mathcal{C}_{0,\#}^{\infty}(\overline{\Omega_{\#}})$ , where  $\mathcal{C}_{0,\#}^{\infty}(\overline{\Omega_{\#}})$  and  $\mathcal{C}_{0,\#^2}^{\infty}(\overline{\Omega_{\#^2}})$  are defined by (4.11) and (4.32) respectively. In addition, it is easy to show that (5.16) is satisfied for  $V \in \mathcal{C}_{0,\#}^{\infty}(\overline{\Omega_{\#}})$ . By combining these arguments with the fact that  $\mathcal{F}_{\mathbf{e}_1}$  is an isometry from  $L^2(\Omega_{\#})$  to  $L^2(-\pi, \pi; L^2(\Omega_{\#^2}))$ , it follows that it is continuous from  $\mathcal{C}_{0,\#}^{\infty}(\overline{\Omega_{\#}})$  (with the  $H_{\Theta}^1$ -norm) to  $L^2(-\pi, \pi; H_{\Theta\#^2}^1(\Omega_{\#^2}))$ . The density of  $\mathcal{C}_{0,\#}^{\infty}(\overline{\Omega_{\#}})$  in  $H_{\Theta\#}^1(\Omega_{\#})$  from Proposition 4.6 then leads to the conclusion.

It remains to show that  $\mathcal{F}_{\mathbf{e}_1}$  is an isomorphism. For isotropic Sobolev spaces, one classical way of proving this property is to use the jump rule which involves traces on the faces  $z_1 = 0$  and  $z_1 = 1$ . Nevertheless, since we have not defined these traces for functions in  $H_{\Theta\#}^1(\Omega_{\#})$  for simplicity, we shall instead resort to the Green formula (4.35). Let  $\widehat{V} \in L^2(-\pi, \pi; H_{\Theta\#^2}^1(\Omega_{\#^2}))$  and set  $V := \mathcal{F}_{\mathbf{e}_1}^{-1} \widehat{V} \in L^2(\Omega_{\#})$ . We begin by proving that  $V \in H_{\Theta\#}^1(\Omega_{\#})$ , or equivalently that  $V_{\Theta} := \mathcal{S}_{\Theta} V \in L^2(0, 1; H^1(\mathbb{R}^2))$ . To this end, consider  $\mathbf{W}_{\Theta} \in \mathcal{C}_0^{\infty}(\mathbb{R}^2 \times (0, 1))^2$  and  $\mathbf{W} := \mathcal{S}_{\Theta}^{-1} \mathbf{W}_{\Theta}$ . Then, derivation in the sense of distributions and the fact that  $V_{\Theta} \in L^2(0, 1; L^2(\mathbb{R}^2))$  lead to

$$\begin{aligned} \int_0^1 \langle \nabla_{\mathbf{x}} V_{\Theta}(\cdot, s), \mathbf{W}_{\Theta}(\cdot, s) \rangle_{[\mathcal{C}_0^{\infty}(\mathbb{R}^2)^2]', \mathcal{C}_0^{\infty}(\mathbb{R}^2)^2} ds &= - \int_0^1 \int_{\mathbb{R}^2} V_{\Theta}(\mathbf{x}, s) \overline{\operatorname{div}_{\mathbf{x}} \mathbf{W}_{\Theta}(\mathbf{x}, s)} dx ds \\ &= -\theta_1 \int_{\Omega_{\#}} V(\mathbf{x}) \overline{\operatorname{div}_{\Theta} \mathbf{W}(\mathbf{x})} dx = -\theta_1 \int_{-\pi}^{\pi} \int_{\Omega_{\#^2}} \widehat{V}(\mathbf{x}, \xi) \overline{(\operatorname{div} + i\xi^t \mathbf{e}_1)_{\Theta} \mathcal{F}_{\mathbf{e}_1} \mathbf{W}(\mathbf{x}, \xi)} dx d\xi \end{aligned}$$

where we have used (4.13) and (5.14) for the last two equalities. But the fact that  $\widehat{V}(\cdot, \xi) \in H_{\Theta\#^2}^1(\Omega_{\#^2})$  and  $\mathcal{F}_{\mathbf{e}_1} \mathbf{W}(\cdot, \xi) \in \mathcal{C}_{0,\#^2}^{\infty}(\overline{\Omega_{\#^2}})$  allows to use Green's formula (4.35) for almost any  $\xi \in (-\pi, \pi)$  to obtain

$$-\theta_1 \int_{-\pi}^{\pi} \int_{\Omega_{\#^2}} \widehat{V}(\mathbf{x}, \xi) \overline{(\operatorname{div} + i\xi^t \mathbf{e}_1)_{\Theta} \mathcal{F}_{\mathbf{e}_1} \mathbf{W}(\mathbf{x}, \xi)} dx d\xi \tag{A.1}$$

$$\begin{aligned}
&= \theta_1 \int_{-\pi}^{\pi} \int_{\Omega_{\#^2}} {}^t_{\Theta} (\nabla + i\xi \mathbf{e}_1) \widehat{V}(\mathbf{x}, \xi) \overline{\mathcal{F}_{\mathbf{e}_1} \mathbf{W}(\mathbf{x}, \xi)} dx d\xi \\
&= \theta_1 \int_{\Omega_{\#}} DV(\mathbf{x}) \overline{\mathbf{W}(\mathbf{x})} dx \quad \text{from (5.14), with } DV := \mathcal{F}_{\mathbf{e}_1}^{-1} [{}^t_{\Theta} (\nabla + i\xi \mathbf{e}_1) \widehat{V}] \\
&= \int_0^1 \int_{\mathbb{R}^2} \mathcal{S}_{\Theta} DV(\mathbf{x}, s) \overline{\mathbf{W}_{\Theta}(\mathbf{x}, s)} dx ds \\
&= \int_0^1 \langle \mathcal{S}_{\Theta} DV(\cdot, s), \mathbf{W}_{\Theta}(\cdot, s) \rangle_{\mathcal{C}_0^{\infty}(\mathbb{R}^2)', \mathcal{C}_0^{\infty}(\mathbb{R}^2)} ds \tag{A.2}
\end{aligned}$$

Finally, in (A.2), choose  $\mathbf{W}_{\Theta} : (\mathbf{x}, s) \mapsto \varphi(s) \mathbf{w}(\mathbf{x})$  with  $\varphi \in \mathcal{C}_0^{\infty}(0, 1)$  and  $\mathbf{w} \in \mathcal{C}_0^{\infty}(\mathbb{R}^2)^2$ . Then the density of  $\mathcal{C}_0^{\infty}(0, 1)$  in  $L^2(0, 1)$  leads to

$$\text{a. e. } s \in (0, 1), \quad \nabla_{\mathbf{x}} V_{\Theta}(\cdot, s) = \mathcal{S}_{\Theta} DV(\cdot, s) \quad \text{in } [\mathcal{C}_0^{\infty}(\mathbb{R}^2)^2]'$$

But  $\mathcal{S}_{\Theta} DV(\cdot, s) \in L^2(\mathbb{R}^2)^2$  thanks to the properties of  $\mathcal{F}_{\mathbf{e}_1}$  and  $\mathcal{S}_{\Theta}$ . Therefore,  $\nabla_{\mathbf{x}} V_{\Theta}(\cdot, s) \in L^2(\mathbb{R}^2)^2$ , and thus  $V_{\Theta} \in L^2(0, 1; H^1(\mathbb{R}^2))$ , or equivalently  $\mathcal{F}_{\mathbf{e}_1}^{-1} \widehat{V} \in H_{\Theta\#}^1(\Omega_{\#})$ . Moreover, by applying  $\mathcal{S}_{\Theta}^{-1}$  on both sides of the expression of  $\nabla_{\mathbf{x}} V_{\Theta}$ , one obtains that  ${}^t_{\Theta} \nabla V = DV$  almost everywhere in  $\Omega_{\#}$ , which shows that  $\mathcal{F}_{\mathbf{e}_1}^{-1}$  is continuous from  $L^2(-\pi, \pi; H_{\Theta\#^2}^1(\Omega_{\#^2}))$  to  $H_{\Theta\#}^1(\Omega_{\#})$ .

**Point (b).**— The proof is very similar to the one of the point (a), and therefore is omitted.

**Point (c).**— For the sake of clarity in this part, we highlight the distinction between the *volumic* Floquet-Bloch transform  $\mathcal{F}_{\mathbf{e}_1}^v$  for functions in  $\Omega_{\#}$  and the *surfacic* Floquet-Bloch transform  $\mathcal{F}_{\mathbf{e}_1}^s$  for functions on  $\Sigma_{\#}$ . In addition, let  $\gamma_{0,\#}$  (resp.  $\gamma_{0,\#^2}$ ) denote the trace operator on  $\Sigma_{\#}$  (resp.  $\Sigma_{\#^2}$ ). We begin by proving that the Floquet transform commutes with the trace operator in the following sense:

$$\forall V \in H_{\Theta\#}^1(\Omega_{\#}), \quad \mathcal{F}_{\mathbf{e}_1}^s(\gamma_{0,\#} V) = \gamma_{0,\#^2}(\mathcal{F}_{\mathbf{e}_1}^v V). \tag{A.3}$$

Note that (A.3) is straightforward for  $V \in \mathcal{C}_{0,\#}^{\infty}(\overline{\Omega_{\#}})$ . This relation then extends to  $V \in H_{\Theta\#}^1(\Omega_{\#})$  using the density of  $\mathcal{C}_{0,\#}^{\infty}(\overline{\Omega_{\#}})$  in  $H_{\Theta\#}^1(\Omega_{\#})$  (Proposition 4.6), the continuity of  $\gamma_{0,\#}$  and  $\gamma_{0,\#^2}$  (Proposition 4.9), the continuity of  $\mathcal{F}_{\mathbf{e}_1}^v$  from  $H_{\Theta\#}^1(\Omega_{\#})$  to  $L^2(-\pi, \pi; H_{\Theta\#^2}^1(\Omega_{\#^2}))$  (Point (a)), and finally the continuity of  $\mathcal{F}_{\mathbf{e}_1}^s$  from  $L^2(\Sigma_{\#})$  to  $L^2(-\pi, \pi; L^2(\Sigma_{\#^2}))$ .

Proving the point (c) consists in showing that the surfacic Floquet-Bloch transform  $\mathcal{F}_{\mathbf{e}_1}^s$  is an isomorphism from  $H_{\Theta\#}^{1/2}(\Sigma_{\#})$  to  $L^2(-\pi, \pi; H_{\Theta\#^2}^{1/2}(\Sigma_{\#^2}))$ . But thanks to the surjectivity of the trace applications  $\gamma_{0,\#}$  and  $\gamma_{0,\#^2}$ , there exist bounded operators  $\mathcal{R}_{\#} : H_{\Theta\#}^{1/2}(\Sigma_{\#}) \rightarrow H_{\Theta\#}^1(\Omega_{\#})$  and  $\mathcal{R}_{\#^2} : H_{\Theta\#^2}^{1/2}(\Sigma_{\#^2}) \rightarrow H_{\Theta\#^2}^1(\Omega_{\#^2})$  such that  $\gamma_{0,\#} \mathcal{R}_{\#} = I$  and  $\gamma_{0,\#^2} \mathcal{R}_{\#^2} = I$ . Thus (A.3) leads to

$$\mathcal{F}_{\mathbf{e}_1}^s = \gamma_{0,\#^2} \mathcal{F}_{\mathbf{e}_1}^v \mathcal{R}_{\#} \quad \text{and} \quad [\mathcal{F}_{\mathbf{e}_1}^s]^{-1} = \gamma_{0,\#} [\mathcal{F}_{\mathbf{e}_1}^v]^{-1} \mathcal{R}_{\#^2}.$$

Using Point (a) then allows to conclude. ■

# Transmission between periodic half-spaces: The general case

## Outline

---

1	Model problem and assumptions on the medium	198
2	The lifting approach and its limitations	200
2.1	Identification of an augmented structure	200
2.2	Introduction of the augmented problem	202
2.3	Resolution of the augmented problem and limitations	203
3	An alternative approach: reformulation as an interface equation	205
3.1	Lifting the half-space problem and the interface equation	206
3.2	Characterization of the DtN operators using the Floquet-Bloch transform	208
3.3	Truncation of the interface equation	209
3.4	Resolution algorithm and discretization issues	209
4	Numerical results	212
4.1	Validation for the model configurations of Chapter V	212
4.2	Generic configuration	212

---

## Introduction

The specific transmission settings studied in Chapter V could be lifted into 3-dimensional structures that are globally periodic in the direction of the interface. However, these model cases represent a tiny fraction of all possible transmission configurations between 2-dimensional periodic half-spaces. In this chapter, we address the general setting represented in Figure 1. This configuration can once again be lifted into a higher dimensional structure which is globally periodic along the interface, allowing the use of the Floquet-Bloch transform and the Dirichlet-to-Neumann approach, detailed in Chapter V, to solve the transmission problem we consider. However, we shall see that it is generally not possible to find an augmented structure with less than 5 dimensions. In that regard, the lifting approach, although correct in theory, appears to be difficult to use in practice, due to the dimension of the problems solved numerically.

To overcome the practical limitation evoked above, we extend the alternative approach proposed in Section V-8. More precisely, we construct DtN operators by solving *half-space* problems which can be lifted into 3-dimensional problems. These auxiliary problems are used to reformulate the transmission



problem as an interface equation, which we truncate using the presence of absorption. Numerical results are provided to illustrate the method.

## 1 Model problem and assumptions on the medium

We are interested in the Helmholtz equation with an absorbing term  $\Im \omega > 0$ :

$$\begin{cases} -\operatorname{div} \mathbb{A} \nabla u - \rho \omega^2 u = 0 & \text{in } \mathbb{R}_+^2 \cup \mathbb{R}_-^2, \\ \llbracket \mathbb{A} \nabla u \cdot \mathbf{e}_x \rrbracket_\sigma = g & \text{on } \sigma. \end{cases} \quad (\mathcal{P})$$

The boundedness and ellipticity assumptions on the tensor  $\mathbb{A} \in L^\infty(\mathbb{R}^2; \mathbb{R}^{2 \times 2})$  and on the coefficient  $\rho \in L^\infty(\mathbb{R}^2)$  are the same as in Chapter V (see V-(2.2)). For simplicity, we assume that

$$g \in L^2(\sigma).$$

Under these conditions,  $(\mathcal{P})$  admits a unique solution in  $H^1(\mathbb{R}^2)$ . The difficulties related to the resolution of  $(\mathcal{P})$  are explained in Section 2.1. Our purpose is to compute the solution of this problem in the case where  $\mathbb{A}$  and  $\rho$  are periodic functions in each half-space  $\mathbb{R}_\pm^2$ .

(a) Configuration studied in the chapter

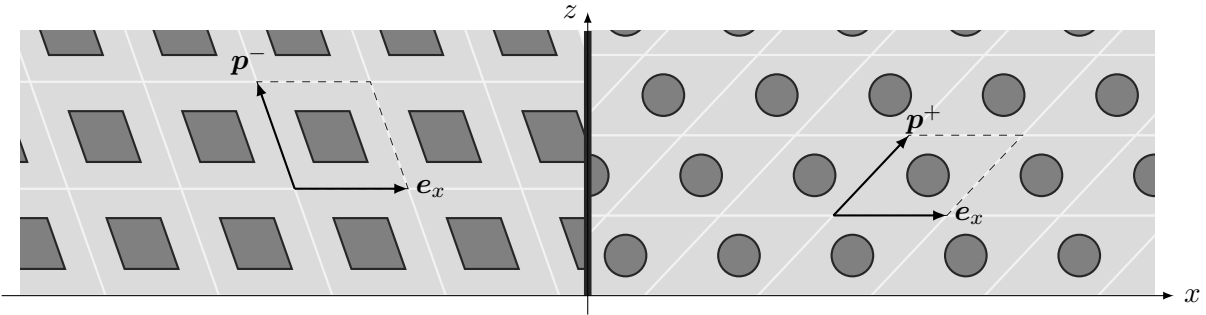

(b) A configuration which seems more general than Figure 1a, but which is equivalent (see Proposition 1.1)

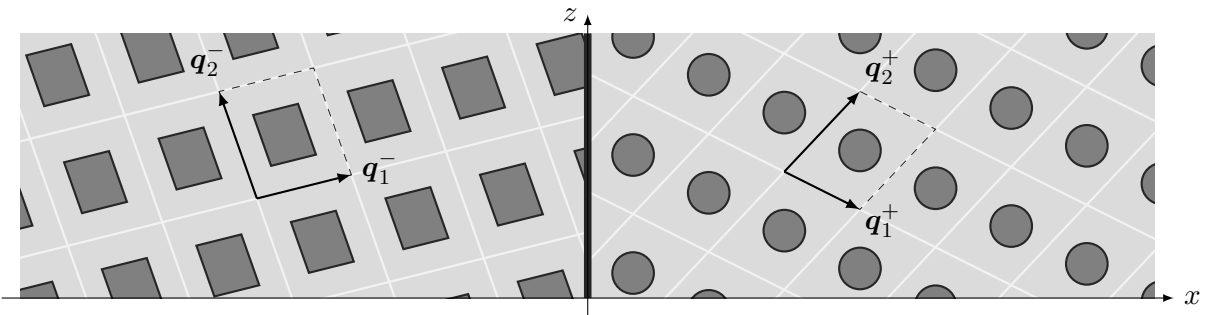

Figure 1: Juxtaposition of arbitrary periodic half-spaces

More precisely, we assume that  $\mathbb{A}$  (resp.  $\rho$ ) coincides on  $\mathbb{R}_\pm^2$  with a tensor  $\mathbb{A}^\pm \in \mathcal{C}^0(\mathbb{R}^2; \mathbb{R}^{2 \times 2})$  (resp. a coefficient  $\rho^\pm \in \mathcal{C}^0(\mathbb{R}^2)$ ). In this chapter, we consider the generic case of  $(\mathbb{A}^\pm, \rho^\pm)$  being  $\mathbb{Z}\mathbf{e}_x + \mathbb{Z}\mathbf{p}^\pm$ -periodic for some vector  $\mathbf{p}^\pm = (p_x^\pm, p_z^\pm) \in \mathbb{R}^2$  such that  $p_z^\pm \neq 0$ :

$$\forall \mathbf{x} \in \mathbb{R}^2, \quad \begin{aligned} \mathbb{A}^\pm(\mathbf{x} + \mathbf{e}_x) &= \mathbb{A}^\pm(\mathbf{x}) & \text{and} & & \mathbb{A}^\pm(\mathbf{x} + \mathbf{p}^\pm) &= \mathbb{A}^\pm(\mathbf{x}), \\ \rho^\pm(\mathbf{x} + \mathbf{e}_x) &= \rho^\pm(\mathbf{x}) & \text{and} & & \rho^\pm(\mathbf{x} + \mathbf{p}^\pm) &= \rho^\pm(\mathbf{x}). \end{aligned} \quad (1.1)$$

This is illustrated in Figure 1a.

We have assumed for simplicity that one of the periodicity vectors of  $(\mathbb{A}^\pm, \rho^\pm)$  is fixed to  $e_x$ . Although this assumption could seem surprising, it can be made without any loss of generality, as the next result shows.

**Proposition 1.1**

let  $v \in H^1(\mathbb{R}^2)$  denote the solution of

$$\begin{cases} -\operatorname{div} \mathbb{B}(\mathbf{x}) \nabla v(\mathbf{x}) - \varrho(\mathbf{x}) \omega^2 v(\mathbf{x}) = 0 & \text{for } \mathbf{x} \in \mathbb{R}_+^2 \cup \mathbb{R}_-^2, \\ \llbracket \mathbb{B} \nabla v \cdot \mathbf{e}_x \rrbracket_\sigma = g, \end{cases} \quad (1.2)$$

with functions  $\mathbb{B}$  and  $\varrho$  whose restrictions  $\mathbb{B}^\pm$  and  $\varrho^\pm$  to  $\mathbb{R}_\pm^2$  are  $\mathbb{Z}\mathbf{q}_1^\pm + \mathbb{Z}\mathbf{q}_2^\pm$ -periodic for some vectors  $\mathbf{q}_1^\pm, \mathbf{q}_2^\pm \in \mathbb{R}^2$  that are non-collinear as illustrated in Figure 1b. Then there exists a diffeomorphism  $\mathbb{T} : \mathbb{R}^2 \mapsto \mathbb{R}^2$  such that the function  $u : \mathbf{x} \mapsto v(\mathbb{T}^{-1}(\mathbf{x}))$  satisfies  $(\mathcal{P})$  with a tensor  $\mathbb{A}$  and a coefficient  $\rho$  that satisfy (1.1).

**Proof.** We assume that  $\mathbf{q}_1^\pm = (q_{1,x}^\pm, q_{1,z}^\pm)$  satisfies  $q_{1,x}^\pm \neq 0$ . This assumption can be made without any loss of generality: since  $\mathbf{q}_1^\pm$  and  $\mathbf{q}_2^\pm$  are non-collinear, at least one of them is not collinear with  $e_z$ . We will introduce a change of variables thanks to the matrix  $\mathbb{T}_\pm$  which satisfies

$$\mathbb{T}_\pm \mathbf{q}_1^\pm = \mathbf{e}_x \quad \text{and} \quad \mathbb{T}_\pm \mathbf{e}_z = \mathbf{e}_z.$$

This matrix is well-defined if and only if  $q_{1,x}^\pm \neq 0$ . Now consider the mapping  $\mathbb{T}$  and its Jacobian matrix  $\mathbb{J}_\mathbb{T}$  defined by

$$\forall \mathbf{x} = (x, z) \in \mathbb{R}^2, \quad \mathbb{T}(\mathbf{x}) := \begin{cases} \mathbb{T}_+ \mathbf{x} & \text{if } x > 0 \\ \mathbb{T}_- \mathbf{x} & \text{if } x < 0 \end{cases} \quad \text{and} \quad \mathbb{J}_\mathbb{T}(\mathbf{x}) = \begin{cases} \mathbb{T}_+ & \text{if } x > 0 \\ \mathbb{T}_- & \text{if } x < 0. \end{cases}$$

The mapping  $\mathbb{T}$  is a diffeomorphism, in particular because its Jacobian matrix  $\mathbb{J}_\mathbb{T}$  is continuous at the interface  $\sigma$  due to the equality  $\mathbb{T}_+ \mathbf{e}_z = \mathbb{T}_- \mathbf{e}_z = \mathbf{e}_z$ . Therefore, the function  $u$  defined by

$$u(\mathbf{x}) := v(\mathbb{T}^{-1}(\mathbf{x})) \quad (1.3)$$

belongs to  $H^1(\mathbb{R}^2)$ . Furthermore,  $u$  satisfies the volume equation in Problem  $(\mathcal{P})$  with

$$\forall \mathbf{x} \in \mathbb{R}^2, \quad \mathbb{A}(\mathbf{x}) := \mathbb{J}_\mathbb{T}(\mathbf{x}) \mathbb{B}(\mathbb{T}^{-1}(\mathbf{x})) {}^t \mathbb{J}_\mathbb{T}(\mathbf{x}) \quad \text{and} \quad \rho(\mathbf{x}) := \varrho(\mathbb{T}^{-1}(\mathbf{x})). \quad (1.4)$$

In order to obtain the jump condition, note that for  $\mathbf{x} \in \mathbb{R}^2$  and  $\tilde{\mathbf{x}} = \mathbb{T}^{-1}(\mathbf{x})$ ,

$$\begin{aligned} \mathbb{A}(\mathbf{x}) \nabla u(\mathbf{x}) \cdot \mathbf{e}_x &= [\mathbb{J}_\mathbb{T}(\mathbf{x}) \mathbb{B}(\mathbb{T}^{-1}(\mathbf{x})) {}^t \mathbb{J}_\mathbb{T}(\mathbf{x}) \nabla u(\mathbf{x})] \cdot \mathbf{e}_x && \text{from (1.4)} \\ &= [\mathbb{J}_\mathbb{T}(\mathbf{x}) \mathbb{B}(\mathbb{T}^{-1}(\mathbf{x})) \nabla v(\mathbb{T}^{-1}(\mathbf{x}))] \cdot \mathbf{e}_x && \text{from (1.3) and the chain rule} \\ &= [\mathbb{B}(\mathbb{T}^{-1}(\mathbf{x})) \nabla v(\mathbb{T}^{-1}(\mathbf{x}))] \cdot [{}^t \mathbb{J}_\mathbb{T}(\mathbf{x}) \mathbf{e}_x] = \mathbb{B}(\mathbb{T}^{-1}(\mathbf{x})) \nabla v(\mathbb{T}^{-1}(\mathbf{x})) \cdot \mathbf{e}_x, && (1.5) \end{aligned}$$

where we used the fact that  ${}^t \mathbb{J}_\mathbb{T}(\mathbf{x}) \mathbf{e}_x = \mathbf{e}_x$ . Consequently,  $u$  satisfies the jump condition in  $(\mathcal{P})$  with the same jump data  $g$  as  $v$ . Finally, one easily checks that  $\mathbb{A}$  and  $\rho$  satisfy (1.1) with  $\mathbf{p}^\pm := \mathbb{T}_\pm \mathbf{q}_2^\pm$ . ■

**Remark 1.2.** *The periodicity of  $(\mathbb{A}, \rho)$  with respect to the variable  $z$  of the interface depends on the four periodicity parameters:  $p_x^+$ ,  $p_z^+$ ,  $p_x^-$ , and  $p_z^-$ . First of all, by noting that  $p_z^+ \mathbf{e}_z = \mathbf{p}^+ - p_x^+ \mathbf{e}_x$ , it appears that if  $p_x^+$  is a rational number that admits the irreducible form  $k^+/\ell^+$  with  $(k^+, \ell^+) \in \mathbb{Z} \times \mathbb{N}^*$ , then*

$$\ell^+ p_z^+ \mathbf{e}_z = \ell^+ \mathbf{p}^+ - k^+ \mathbf{e}_x \in \mathbb{Z} \mathbf{e}_x + \mathbb{Z} \mathbf{p}^+.$$

*Consequently,  $(\mathbb{A}^+, \rho^+)$  are  $\tau$ -periodic in the  $\mathbf{e}_z$ -direction with  $\tau := \ell^+ p_z^+$ . Otherwise, if  $p_x^+$  is irrational, then  $(\mathbb{A}^+, \rho^+)$  are not necessarily periodic in the direction of the interface. The same goes for  $(\mathbb{A}^-, \rho^-)$ , whose periodicity in the  $\mathbf{e}_z$ -direction is guaranteed only if  $p_x^-$  is a rational number.*

*Now if  $p_x^+$  and  $p_x^-$  are both rational, then  $(\mathbb{A}^\pm, \rho^\pm)$  are  $\ell^\pm p_z^\pm$ -periodic with respect to  $z$ , but similarly to Configuration  $(\mathcal{A})$  in Chapter V, there is no guarantee that the overall medium represented by  $(\mathbb{A}, \rho)$  will be periodic with respect to  $z$ . In fact, if the ratio  $p_z^+/p_z^-$  is irrational, then the periods of  $(\mathbb{A}^+, \rho^+)$  and  $(\mathbb{A}^-, \rho^-)$  are non-commensurate, and therefore  $(\mathbb{A}, \rho)$  are not periodic in the  $\mathbf{e}_z$ -direction. We refer to Remarks 2.2 and 2.3 for further discussions.*

## 2 The lifting approach and its limitations

The first method we investigate is the lifting approach, which consists in finding an augmented  $m$ -dimensional medium ( $m > 2$ ) which is periodic along the interface, and whose cut along a hyperplane yields our 2-dimensional structure. More precisely, we shall see that

$$\text{a. e. } \mathbf{x} \in \mathbb{R}^2, \quad \mathbb{A}(\mathbf{x}) = \mathbb{A}_{5\text{D}}(\Theta_{5\text{D}} \mathbf{x}) \quad \text{and} \quad \rho(\mathbf{x}) = \rho_{5\text{D}}(\Theta_{5\text{D}} \mathbf{x}), \quad (2.1\text{a})$$

where  $\mathbb{A}_{5\text{D}} \in L^\infty(\mathbb{R}^5; \mathbb{R}^{2 \times 2})$  (resp.  $\rho_{5\text{D}} \in L^\infty(\mathbb{R}^5)$ ) coincides on  $\mathbb{R}_\pm^5$  with a tensor  $\mathbb{A}_{5\text{D}}^\pm \in \mathcal{C}^0(\mathbb{R}^5; \mathbb{R}^{2 \times 2})$  (resp. a coefficient  $\rho_{5\text{D}}^\pm \in \mathcal{C}^0(\mathbb{R}^5)$ ) which are  $\mathbb{Z}^5$ -periodic. In addition, the cut matrix  $\Theta_{5\text{D}} \in \mathbb{R}^{5 \times 2}$  we exhibit is of the following form:

$$\Theta_{5\text{D}} = \begin{pmatrix} 1 & 0 \\ 0 & \theta_1^+ \\ 0 & \theta_2^+ \\ 0 & \theta_1^- \\ 0 & \theta_2^- \end{pmatrix}. \quad (2.1\text{b})$$

Let us introduce a few notations. For some reasons that will become apparent later, the generic 5-dimensional space variable is denoted by  $\mathbf{x} := (x, z_1^+, z_2^+, z_1^-, z_2^-)$ . Accordingly, the canonical basis of  $\mathbb{R}^5$  is  $(\mathbf{e}_x, \mathbf{e}_1^+, \mathbf{e}_2^+, \mathbf{e}_1^-, \mathbf{e}_2^-)$ , where  $\mathbf{e}_x := (1, 0, 0, 0, 0)$ ,  $\mathbf{e}_1^+ := (0, 1, 0, 0, 0)$ ,  $\mathbf{e}_2^+ := (0, 0, 1, 0, 0)$ ,  $\mathbf{e}_1^- := (0, 0, 0, 1, 0)$  and  $\mathbf{e}_2^- := (0, 0, 0, 0, 1)$ . Finally, let

$$\Sigma^{5\text{D}} := \{0\} \times \mathbb{R}^4 \quad (2.2)$$

denote the interface between  $\mathbb{R}_+^5$  and  $\mathbb{R}_-^5$ .

In this section, we have chosen to be more formal to avoid the cumbersomeness of the functional framework. Nonetheless, the ideas that we present could be made rigorous.

### 2.1 Identification of an augmented structure

The construction of  $(\mathbb{A}_{5\text{D}}, \rho_{5\text{D}})$  and  $\Theta_{5\text{D}}$  relies on the arguments developed in Sections 3.1.a and 3.1.b for Configurations  $(\mathcal{A})$  and  $(\mathcal{B})$  respectively.

To begin, consider the functions  $(\mathbb{A}^+, \rho^+)$  associated to the medium in  $\mathbb{R}_+^2$ . Thanks to the mapping  $\mathbb{T}^+$  that satisfies  $\mathbb{T}^+ \mathbf{e}_x = \mathbf{e}_x$  and  $\mathbb{T}^+ \mathbf{p}^+ = \mathbf{e}_z$ , the tensor  $\mathbb{A}^+$  can be written as

$$\mathbb{A}^+(\mathbf{x}) = \mathring{\mathbb{A}}^+(x - (p_x^+/p_z^+)z, z/p_z^+), \quad \text{with} \quad \mathring{\mathbb{A}}^+(\mathring{x}, \mathring{z}) := \mathbb{A}^+(\mathring{x} \mathbf{e}_x + \mathring{z} \mathbf{p}^+) := \mathbb{A}^+(\mathring{x} + \mathring{z} p_x^+, \mathring{z} p_z^+). \quad (2.3)$$

The periodicity properties (1.1) of  $\mathbb{A}^+$  imply that  $\mathring{\mathbb{A}}^+$  is 1-periodic with respect to its variables. Hence, by fixing  $x$ , (2.3) reveals the quasiperiodic nature of  $z \mapsto \mathbb{A}^+(x, z)$ , with a  $\mathbb{Z}^3$ -periodic lift  $\mathbb{A}_p^+ \in \mathcal{C}^0(\mathbb{R}^3; \mathbb{R}^{2 \times 2})$  and a cut matrix  $\Theta^+ \in \mathbb{R}^{3 \times 2}$  given by:

$$\mathbb{A}^+(\mathbf{x}) = \mathbb{A}_p^+(\Theta^+ \mathbf{x}) \quad \text{with} \quad \begin{cases} \mathbb{A}_p^+(x, z_1, z_2) := \mathring{\mathbb{A}}^+(x + z_2, z_1) \\ \Theta^+ := \begin{pmatrix} 1 & 0 \\ 0 & 1/p_z^+ \\ 0 & -p_x^+/p_z^+ \end{pmatrix}. \end{cases} \quad (2.4)$$

For the sake of convenience, we will work in this section with a different (but equivalent) couple  $(\mathbb{B}_p^+, \mathbb{V})$  obtained by rescaling  $\mathbb{A}_p^+$  with respect to  $z_1$  and  $z_2$ :

$$\mathbb{A}^+(\mathbf{x}) = \mathbb{B}_p^+(\mathbb{V} \mathbf{x}) \quad \text{with} \quad \begin{cases} \mathbb{B}_p^+(x, z_1, z_2) := \mathbb{A}_p^+(x, z_1/p_z^+, (p_x^+/p_z^+)z_2) \\ \mathbb{V} := \begin{pmatrix} 1 & 0 \\ 0 & 1 \\ 0 & -1 \end{pmatrix}, \end{cases} \quad (2.5)$$

so that the cut matrix  $\mathbb{V}$  does not depend on the coefficients  $(\mathbb{A}^+, \rho^+)$ . On the other hand,  $\mathbb{B}_p^+$  is 1-periodic with respect to  $x$ , but  $\tau_j^+$ -periodic with respect to  $z_j$  for  $j \in \{1, 2\}$ , with

$$\tau_1^+ := p_z^+ \quad \text{and} \quad \tau_2^+ := p_z^+/p_x^+; \quad (2.6)$$

contrary to  $\mathbb{A}_p^+$  which is 1-periodic in all directions.

The same arguments apply to the medium in  $\mathbb{R}_-^3$ , showing that  $\mathbb{A}^-$  is the cut along the hyperplane  $\mathbb{V} \mathbb{R}^3$  of a tensor  $\mathbb{B}_p^- \in \mathcal{C}^0(\mathbb{R}^3; \mathbb{R}^{2 \times 2})$  which is 1-periodic with respect to  $x$  and  $\tau_j^-$ -periodic with respect to  $z_j$  for any  $j \in \{1, 2\}$ , where  $\tau_1^-, \tau_2^-$  are defined similarly to (2.6). Consequently,  $\mathbb{A}$  admits the expression

$$\forall \mathbf{x} \in \mathbb{R}^2, \quad \mathbb{A}(\mathbf{x}) = \mathbb{B}_p(\mathbb{V} \mathbf{x}) \quad \text{where} \quad \forall (x, z_1, z_2) \in \mathbb{R}^3, \quad \mathbb{B}_p(x, z_1, z_2) := \begin{cases} \mathbb{B}_p^+(x, z_1, z_2), & \text{if } x > 0 \\ \mathbb{B}_p^-(x, z_1, z_2), & \text{if } x < 0. \end{cases}$$

For  $j \in \{1, 2\}$ , each  $\mathbb{B}_p^\pm$  is periodic with respect to  $z_j$ , but the tensor  $\mathbb{B}_p$  is not necessarily periodic with respect to  $z_j$ , since the periods of  $\mathbb{B}_p^+$  and  $\mathbb{B}_p^-$  with respect to  $z_j$  may not be commensurate. This is exactly the issue encountered with Configuration (A) in Chapter V. Thus, similarly to Section 3.1.a, we “split”  $z_j$  into two new variables  $z_j^+$  and  $z_j^-$ , where  $z_j^\pm$  is associated to the medium in  $\mathbb{R}_\pm^3$ . Furthermore, for convenience, we also rescale the variables so that  $z_j^\pm$  corresponds to  $z_j/\tau_j^\pm$ . This suggests to introduce

$$\forall \mathbf{x} = (x, z_1^+, z_2^+, z_1^-, z_2^-) \in \mathbb{R}^5, \quad \begin{cases} \mathbb{A}_{5\text{D}}^+(\mathbf{x}) := \mathbb{B}_p^+(x, \tau_1^+ z_1^+, \tau_2^+ z_2^+), \\ \mathbb{A}_{5\text{D}}^-(\mathbf{x}) := \mathbb{B}_p^-(x, \tau_1^- z_1^-, \tau_2^- z_2^-), \end{cases} \quad (2.7)$$

so that  $\mathbb{A}_{5D}^+$  is 1-periodic with respect to  $(z_1^+, z_2^+)$  and constant with respect to  $(z_1^-, z_2^-)$ . Similarly,  $\mathbb{A}_{5D}^-$  is 1-periodic with respect to  $(z_1^-, z_2^-)$  and constant with respect to  $(z_1^+, z_2^+)$ . Therefore,  $\mathbb{A}_{5D}^\pm$  is  $\mathbb{Z}^5$ -periodic, and thus 1-periodic with respect to the variables  $(z_1^+, z_2^+, z_1^-, z_2^-)$  along the interface  $\Sigma^{5D}$  given by (2.2).

We define  $\rho_{5D}^\pm$  similarly to the above, by replacing  $\mathbb{A}$  by  $\rho$ . Finally, let  $(\mathbb{A}_{5D}, \rho_{5D})$  be given by

$$\mathbf{x} \in \mathbb{R}^5, \quad \mathbb{A}_{5D}(\mathbf{x}) := \begin{cases} \mathbb{A}_{5D}^+(\mathbf{x}), & \text{if } \mathbf{x} \in \mathbb{R}_+^5 \\ \mathbb{A}_{5D}^-(\mathbf{x}), & \text{if } \mathbf{x} \in \mathbb{R}_-^5 \end{cases} \quad \text{and} \quad \rho_{5D}(\mathbf{x}) := \begin{cases} \rho_{5D}^+(\mathbf{x}), & \text{if } \mathbf{x} \in \mathbb{R}_+^5 \\ \rho_{5D}^-(\mathbf{x}), & \text{if } \mathbf{x} \in \mathbb{R}_-^5, \end{cases} \quad (2.8)$$

so that (2.1) holds with

$$\forall j \in \llbracket 1, 2 \rrbracket, \quad \theta_j^+ := \tau_j^+ \quad \text{and} \quad \theta_j^- := \tau_j^-. \quad (2.9)$$

Finally, note that  $\Theta_{5D} \mathbb{R}_\pm^2 \subset \mathbb{R}_\pm^5$ , and that  $\Theta_{5D} \sigma$  is included in the interface  $\Sigma^{5D}$ .

## 2.2 Introduction of the augmented problem

Inspired by the quasiperiodic nature (2.1a) of  $(\mathbb{A}, \rho)$ , we seek the solution  $u$  of ( $\mathcal{P}$ ) under the form

$$\forall \mathbf{x} \in \mathbb{R}^2, \quad u(\mathbf{x}) = U_{5D}(\Theta_{5D} \mathbf{x}), \quad (2.10)$$

where  $U_{5D}$  is the solution of a 5-dimensional augmented problem with periodic coefficients  $(\mathbb{A}_{5D}, \rho_{5D})$ . To construct the problem satisfied by  $U_{5D}$ , we use a chain rule which links the partial derivatives of  $u$  with those of  $U_{5D}$ : by considering  $\nabla$  and  $\text{div}$ , the 5D gradient and divergence operators, one has for any  $F \in \mathcal{C}^\infty(\mathbb{R}^5)$ ,  $\mathbf{W} \in \mathcal{C}^\infty(\mathbb{R}^5)^2$ , and for  $\mathbf{x} \in \mathbb{R}^2$  that

$$[\nabla F(\Theta_{5D} \cdot)](\mathbf{x}) = [{}^t \Theta_{5D} \nabla F](\Theta_{5D} \mathbf{x}) \quad \text{and} \quad [\text{div } \mathbf{W}(\Theta_{5D} \cdot)](\mathbf{x}) = \text{div}(\Theta_{5D} \mathbf{W})(\Theta_{5D} \mathbf{x}). \quad (2.11)$$

Inserting the ansatz (2.10) and the chain rule (2.11) into ( $\mathcal{P}$ ) then suggests to introduce

$$\begin{cases} -\text{div} \Theta_{5D} \mathbb{A}_{5D} {}^t \Theta_{5D} \nabla U_{5D} - \rho_{5D} \omega^2 U_{5D} = 0 & \text{in } \mathbb{R}_+^5 \cup \mathbb{R}_-^5, \\ [(\Theta_{5D} \mathbb{A}_{5D} {}^t \Theta_{5D} \nabla U_{5D}) \cdot \mathbf{e}_x]_{\Sigma^{5D}} = G_{5D} & \text{on } \Sigma^{5D}, \end{cases} \quad (2.12)$$

where for  $\mathbf{W} : \mathbb{R}^5 \rightarrow \mathbb{C}$ , we define

$$[(\Theta_{5D} \mathbf{W} \cdot \mathbf{e}_x)]_{\Sigma^{5D}} := (\Theta_{5D} \mathbf{W}^- \cdot \mathbf{e}_x)|_{\Sigma^{5D}} - (\Theta_{5D} \mathbf{W}^+ \cdot \mathbf{e}_x)|_{\Sigma^{5D}},$$

with  $\mathbf{W}^\pm := \mathbf{W}|_{\mathbb{R}_\pm^5}$ , and where  $G_{5D} : \Sigma^{5D} \rightarrow \mathbb{C}$  denotes an extension of  $g$  in the following sense

$$\text{a. e. } \mathbf{x} = (x, z) \in \sigma, \quad G_{5D}(\Theta_{5D} \mathbf{x}) = g(\mathbf{x}),$$

by consistency with the jump condition in ( $\mathcal{P}$ ). There is an infinity of possible ways to construct  $G_{5D}$ , the easiest option being a data which is constant with respect to all variables except one, say  $z_1^+$ :

$$\text{a. e. } \mathbf{x} = (0, z_1^+, z_2^+, z_1^-, z_2^-) \in \Sigma^{5D}, \quad G_{5D}(\mathbf{x}_{5D}) := g(0, z_1^+/\theta_1^+).$$

More generally, it is sufficient to require that:

$$\forall \mathbf{v} \in \{\mathbf{e}_2^+, \mathbf{e}_1^-, \mathbf{e}_2^-\}, \quad \forall \mathbf{x} \in \Sigma^{5D}, \quad G_{5D}(\mathbf{x} + \mathbf{v}) = G_{5D}(\mathbf{x}),$$

so that, thanks to the 1-periodicity of  $\mathbb{A}_{5D}$  and  $\rho_{5D}$  in the  $\mathbf{e}_2^+$ ,  $\mathbf{e}_1^-$ , and  $\mathbf{e}_2^-$ -directions, one can expect the following:

$$\forall \mathbf{v} \in \{\mathbf{e}_2^+, \mathbf{e}_1^-, \mathbf{e}_2^-\}, \quad \forall \mathbf{x} \in \mathbb{R}^5, \quad U_{5D}(\mathbf{x} + \mathbf{v}) = U_{5D}(\mathbf{x}). \quad (2.13)$$

Now, consider the domains defined by

$$\begin{aligned} \Omega_{\#}^{5D} &:= \mathbb{R} \times \mathbb{R} \times (0, 1)^3, \\ \Omega_{\#}^{5D\pm} &:= \mathbb{R}^{\pm} \times \mathbb{R} \times (0, 1)^3, \\ \Sigma_{\#}^{5D} &:= \{0\} \times \mathbb{R} \times (0, 1)^3. \end{aligned}$$

Then in regard to the above, the restriction of  $U_{5D}$  to the strip  $\Omega_{\#}^{5D}$  can be characterized as the solution of the transmission problem:

$$\left\{ \begin{array}{l} -\operatorname{div} \Theta_{5D} \mathbb{A}_{5D} {}^t \Theta_{5D} \nabla U_{5D} - \rho_{5D} \omega^2 U_{5D} = 0 \quad \text{in } \Omega_{\#}^{5D+} \cup \Omega_{\#}^{5D-}, \\ U_{5D}|_{\mathbf{x} \cdot \mathbf{v}=0} = U_{5D}|_{\mathbf{x} \cdot \mathbf{v}=1}, \quad \forall \mathbf{v} \in \{\mathbf{e}_2^+, \mathbf{e}_1^-, \mathbf{e}_2^-\}, \\ (\Theta_{5D} \mathbb{A}_{5D} {}^t \Theta_{5D} \nabla U_{5D}) \cdot \mathbf{v}|_{\mathbf{x} \cdot \mathbf{v}=0} = (\Theta_{5D} \mathbb{A}_{5D} {}^t \Theta_{5D} \nabla U_{5D}) \cdot \mathbf{v}|_{\mathbf{x} \cdot \mathbf{v}=1}, \quad \forall \mathbf{v} \in \{\mathbf{e}_2^+, \mathbf{e}_1^-, \mathbf{e}_2^-\}, \\ \llbracket (\Theta_{5D} \mathbb{A}_{5D} {}^t \Theta_{5D} \nabla U_{5D}) \cdot \mathbf{e}_x \rrbracket_{\Sigma_{\#}^{5D}} = G_{5D} \quad \text{on } \Sigma_{\#}^{5D}. \end{array} \right. \quad (2.14)$$

**Remark 2.1.** One can give a proper sense to the jump condition and the periodicity condition in (2.14) thanks to anisotropic Sobolev spaces  $H_{\Theta_{5D} \#}^1(\Omega_{\#}^{5D})$ ,  $H_{\Theta_{5D} \#}^{-1/2}(\Sigma_{\#}^{5D})$  and  $H_{\Theta_{5D} \#}^{1/2}(\Sigma_{\#}^{5D})$  similar to those studied in Chapter V.

### 2.3 Resolution of the augmented problem and limitations

**Reduction to a family of waveguide problems** In this section, we describe the resolution of (2.14). Exploiting the periodicity of  $\mathbb{A}_{5D}$  and  $\rho_{5D}$  with respect to  $z_1^+$ , we apply a partial Floquet-Bloch transform in the  $\mathbf{e}_1^+$ -direction. First of all, define

$$\begin{aligned} \Omega_{\#^2}^{5D} &:= \mathbb{R} \times (0, 1)^4, \\ \Omega_{\#^2}^{5D\pm} &:= \mathbb{R}^{\pm} \times (0, 1)^4, \\ \Sigma_{\#^2}^{5D} &:= \{0\} \times (0, 1)^4. \end{aligned}$$

The partial Floquet-Bloch transform of  $U_{5D}$  is given for  $\mathbf{x} \in \Omega_{\#^2}^{5D}$  and  $\xi \in (-\pi, \pi)$  by:

$$\widehat{U}_{5D, \xi}(\mathbf{x}) := \mathcal{F}_{\mathbf{e}_1^+} U_{5D}(\mathbf{x}, \xi) := \frac{1}{\sqrt{2\pi}} \sum_{n \in \mathbb{Z}} U_{5D}(\mathbf{x} + n \mathbf{e}_1^+) e^{-i\xi(z_1^+ + n)}.$$

Then using the properties of the partial Floquet-Bloch transform  $\mathcal{F}_{\mathbf{e}_1^+}$  and the periodicity of  $\mathbb{A}_{5D}$  and  $\rho_{5D}$  with respect to  $z_1^+$ , one obtains for any  $\xi \in (-\pi, \pi)$  that

$$\left\{ \begin{array}{l} -(\mathbf{div} + i\xi^t \mathbf{e}_1^+) \mathbb{O}_{5D} \mathbb{A}_{5D}^t \mathbb{O}_{5D} (\nabla + i\xi \mathbf{e}_1^+) \widehat{U}_{5D,\xi} - \rho_{5D} \omega^2 \widehat{U}_{5D,\xi} = 0 \quad \text{in } \Omega_{\#^2}^{5D+} \cup \Omega_{\#^2}^{5D-}, \\ \widehat{U}_{5D,\xi}|_{z_j^\pm=0} = \widehat{U}_{5D,\xi}|_{z_j^\pm=1}, \quad \forall j \in \llbracket 1, 2 \rrbracket, \\ (\mathbb{O}_{5D} \mathbb{A}_{5D}^t \mathbb{O}_{5D} (\nabla + i\xi \mathbf{e}_1^+) \widehat{U}_{5D,\xi}) \cdot \mathbf{e}_j^\pm|_{z_j^\pm=0} = (\mathbb{O}_{5D} \mathbb{A}_{5D}^t \mathbb{O}_{5D} (\nabla + i\xi \mathbf{e}_1^+) \widehat{U}_{5D,\xi}) \cdot \mathbf{e}_j^\pm|_{z_j^\pm=1}, \quad \forall j \in \llbracket 1, 2 \rrbracket, \\ \llbracket (\mathbb{O}_{5D} \mathbb{A}_{5D}^t \mathbb{O}_{5D} (\nabla + i\xi \mathbf{e}_1^+) \widehat{U}_{5D,\xi}) \cdot \mathbf{e}_x \rrbracket_{\Sigma_{\#^2}^{5D}} = \widehat{G}_{5D,\xi} \quad \text{on } \Sigma_{\#^2}^{5D}. \end{array} \right. \quad (2.15)$$

where  $\widehat{G}_{5D,\xi} := \mathcal{F}_{\mathbf{e}_1^+} G_{5D}(\cdot, \xi)$ . The solution  $U_{5D}(G_{5D})$  of (2.14) can then be constructed from  $\widehat{U}_{5D,\xi}(\widehat{G}_{5D,\xi})$  using the inverse Floquet-Bloch transform:

$$\text{a. e. } \mathbf{x} \in \Omega_{\#^2}^{5D}, \quad \forall n \in \mathbb{Z}, \quad U_{5D}(G_{5D})(\mathbf{x} + n \mathbf{e}_1^+) = \frac{1}{\sqrt{2\pi}} \int_{-\pi}^{\pi} \widehat{U}_{5D,\xi}(\widehat{G}_{5D,\xi})(\mathbf{x}) e^{i\xi(z_1^+ + n)} d\xi. \quad (2.16)$$

Therefore, the computation of  $U_{5D}$  (and thus of the 2-dimensional  $u$ ) reduces to the resolution of the waveguide problem (2.15) parameterized by the Floquet variable  $\xi$ .

**Discretization issues related to the resolution of the waveguide problem** The method for solving (2.15) is the DtN approach presented in Section 5.3, which we do not detail here. We simply recall the resolution algorithm for  $\xi \in (-\pi, \pi)$  fixed:

a. Solve local problems defined in  $\mathcal{C}_{\#^2}^{5D+} := (0, 1)^5$  and deduce local DtN operators  $\mathcal{T}_{5D,\xi}^{00+}$ ,  $\mathcal{T}_{5D,\xi}^{01+}$ ,  $\mathcal{T}_{5D,\xi}^{10+}$  and  $\mathcal{T}_{5D,\xi}^{11+}$ .

b. Compute the propagation operator  $\mathcal{P}_{5D,\xi}^+$  by solving the constrained Riccati equation

$$\mathcal{T}_{5D,\xi}^{10+} [\mathcal{P}_{5D,\xi}^+]^2 + (\mathcal{T}_{5D,\xi}^{00+} + \mathcal{T}_{5D,\xi}^{11+}) \mathcal{P}_{5D,\xi}^+ + \mathcal{T}_{5D,\xi}^{01+} = 0 \quad \text{and} \quad \rho(\mathcal{P}_{5D,\xi}^+) < 1. \quad (2.17)$$

c. Compute the DtN operator  $\widehat{\Lambda}_{5D,\xi}^+ = \mathcal{T}_{5D,\xi}^{00+} + \mathcal{T}_{5D,\xi}^{10+} \mathcal{P}_{5D,\xi}^+$  associated to the half-guide  $\Omega_{\#^2}^{5D+}$ .

d. Adapt Steps 2.0.a – 2.0.c for the half-guide  $\Omega_{\#^2}^{5D-}$  in order to compute a DtN operator  $\widehat{\Lambda}_{5D,\xi}^-$  thanks to cell problems defined in  $\mathcal{C}_{\#^2}^{5D-} := (-1, 0) \times (0, 1)^4$ .

e. Seek the trace  $\Phi_{5D,\xi}$  of  $\widehat{U}_{5D,\xi}(\widehat{G}_{5D,\xi})$  at the interface  $\Sigma_{\#^2}^{5D}$  as the solution of the equation

$$(\widehat{\Lambda}_{5D,\xi}^+ + \widehat{\Lambda}_{5D,\xi}^-) \Phi_{5D,\xi} = \widehat{G}_{5D,\xi} \quad \text{on } \Sigma_{\#^2}^{5D}. \quad (2.18)$$

f. Construct the waveguide solution  $\widehat{U}_{5D,\xi}(\widehat{G}_{5D,\xi})$  using the local cell problems and the propagation operators  $\mathcal{P}_{5D,\xi}^\pm$ .

For the discretization of the algorithm above, we introduce a mesh of  $\mathcal{C}_{\#^2}^{5D\pm}$  with step  $h > 0$ . Let  $N_h$  denote the number of nodes per edge of this mesh. Assuming that Lagrange elements of order 1 are used, the operators  $\mathcal{T}_{5D,\xi}^{\ell j^\pm}$ ,  $\mathcal{P}_{5D,\xi}^\pm$ , and  $\widehat{\Lambda}_{5D,\xi}^\pm$  are represented as  $N_{\#^2}$ -sized matrices, where  $N_{\#^2} \sim N_h^4$  is the number of degrees of freedom (dof) on the 4-dimensional interface  $\Sigma_{\#^2}^{5D}$ .

In order to illustrate the high computational cost of the lifting approach, let us perform a naive complexity analysis for the resolution of the Riccati equation (2.17) and the interface equation (2.18).

Assuming that for the Riccati equation, we use the spectral method described in Section 2.3.1, one has to solve a quadratic eigenvalue problem with  $N_{\#^2}$ -sized matrices (the discrete versions of the  $\mathcal{T}_{5D,\xi}^{\ell j \pm}$  operators). Given that these matrices are dense, the cost is  $\mathcal{O}(N_{\#^2}^3)$ . The same complexity holds for the interface equation (2.18), leading to  $\mathcal{O}(N_h^{12})$  operations as well.

On the other hand, it can be shown that the approximation error of the waveguide solution  $\widehat{U}_{5D,\xi}(\widehat{G}_{5D,\xi})$  is  $\mathcal{O}(h^{-1})$  in  $H_{\mathbb{O}5D}^1$ -norm. Since  $N_h \sim \lfloor h^{-1} \rfloor$ , this means that for instance, an error in  $H_{\mathbb{O}5D}^1$ -norm of order  $10^{-2}$  requires  $\mathcal{O}(10^{24})$  operations to solve the Riccati equation (2.17) and the interface equation (2.18). This high cost is obviously due to the dimension of the problems solved in practice, and motivates the alternative method presented in the next section.

**Remark 2.2.** *In the complexity analysis, we have chosen not to include the local cell problems in the complexity analysis, since their resolution can be improved in many ways. In fact, one interesting feature shown in Section 2.1 is that, in the cell  $\mathcal{C}_{\#^2}^{5D+}$  for instance, the coefficients  $(\mathbb{A}_{5D}^+, \rho_{5D}^+)$  are constant with respect to  $(z_1^-, z_2^-)$ . This property can be exploited using separation of variables to solve a family of 3-dimensional problems. The same holds for  $(\mathbb{A}_{5D}^-, \rho_{5D}^-)$  which are constant with respect to  $(z_1^+, z_2^+)$ .*

*Furthermore, note that the 3D problems obtained using the invariance properties of  $(\mathbb{A}_{5D}^{\pm}, \rho_{5D}^{\pm})$  can in turn be solved using the quasi 2-dimensional approach presented in Section 6.2. This approach allows to solve a family of 2-dimensional problems. Therefore, it seems that the limitation of this method would not come from the resolution of the cell problems.*

### 3 An alternative approach: reformulation as an interface equation

Rather than lifting the overall transmission medium represented by  $(\mathbb{A}, \rho)$  into a 5-dimensional structure, the resolution domain of  $(\mathcal{P})$  can be decomposed into the half-spaces  $\mathbb{R}_+^2$  and  $\mathbb{R}_-^2$ . To each half-space is associated the problem: *Find  $u^{\pm}(\varphi) \in H^1(\mathbb{R}_{\pm}^2)$  such that*

$$\begin{cases} -\operatorname{div} \mathbb{A}^{\pm} \nabla u^{\pm}(\varphi) - \rho^{\pm} \omega^2 u^{\pm}(\varphi) = 0 & \text{in } \mathbb{R}_{\pm}^2, \\ u^{\pm}(\varphi) = \varphi & \text{on } \sigma := \partial \mathbb{R}_{\pm}^2. \end{cases} \quad (\mathcal{P}^{\pm})$$

Due to the boundedness and the ellipticity of  $\mathbb{A}^{\pm}$  and  $\rho^{\pm}$  (cf. (2.2)), and because of absorption  $\Im m \omega > 0$ ,  $(\mathcal{P}^{\pm})$  admits a unique solution  $u^{\pm}(\varphi) \in H^1(\mathbb{R}_{\pm}^2)$ . In addition, let  $\lambda^{\pm} \in \mathcal{L}(H^{1/2}(\sigma), H^{-1/2}(\sigma))$  denote the DtN operator defined for any  $\varphi, \psi \in H^{1/2}(\sigma)$  by

$$\langle \lambda^{\pm} \varphi, \psi \rangle_{\sigma} := \int_{\mathbb{R}_{\pm}^2} [\mathbb{A}^{\pm} \nabla u^{\pm}(\varphi) \cdot \nabla u^{\pm}(\psi) - \rho^{\pm} \omega^2 u^{\pm}(\varphi) u^{\pm}(\psi)]. \quad (3.1)$$

From the presence of absorption, it follows that  $\lambda^{\pm}$  and  $\lambda^+ + \lambda^-$  are coercive, and thus invertible. The solution  $u$  of the transmission problem  $(\mathcal{P})$  can then be expressed as

$$\text{a. e. } \mathbf{x} = (x, z) \in \mathbb{R}^2, \quad u(\mathbf{x}) = \begin{cases} u^+(\varphi)(\mathbf{x}) & \text{if } x > 0 \\ u^-(\varphi)(\mathbf{x}) & \text{if } x < 0, \end{cases} \quad (3.2)$$

where  $\varphi := u|_{\sigma}$  is obtained by expressing the continuity of the Neumann trace of  $u$  at the interface  $\sigma$ :

$$(\lambda^+ + \lambda^-) \varphi = g \quad \text{in } H^{-1/2}(\sigma). \quad (3.3)$$

As a consequence,  $u$  can be deduced from the resolution of  $(\mathcal{P}^{\pm})$  and of the interface equation (3.3).



The interest of considering the half-space problem  $(\mathcal{P}^\pm)$  rather than  $(\mathcal{P})$  lies in the fact that each pair  $(\mathbb{A}^\pm, \rho^\pm)$  admits a 3-dimensional periodic extension (unlike  $(\mathbb{A}, \rho)$  whose periodic extension is in general 5-dimensional). More precisely, (2.4) reveals the existence of  $\mathbb{Z}^3$ -periodic functions  $(\mathbb{A}_p^\pm, \rho^\pm) \in \mathcal{C}^0(\mathbb{R}^3)^2$  and of a cut matrix  $\Theta^\pm \in \mathbb{R}^{3 \times 2}$  such that

$$\mathbb{A}^\pm(\mathbf{x}) = \mathbb{A}_p^\pm(\Theta^\pm \mathbf{x}) \quad \text{and} \quad \rho^\pm(\mathbf{x}) = \rho_p^\pm(\Theta^\pm \mathbf{x}), \quad \text{with} \quad \Theta^\pm := \begin{pmatrix} 1 & 0 \\ 0 & \theta_1^\pm \\ 0 & \theta_2^\pm \end{pmatrix}. \quad (3.4)$$

As a consequence, each  $(\mathcal{P}^\pm)$  can be lifted into a 3-dimensional problem to which adapted tools such as the Floquet-Bloch transform can be applied. The method is described in the next sections.

In the following,  $\mathbf{x} = (x, z_1, z_2)$  is the generic 3-dimensional variable, and  $(\mathbf{e}_x, \mathbf{e}_1, \mathbf{e}_2)$  is the canonical basis of  $\mathbb{R}^3$ , with  $\mathbf{e}_x := (1, 0, 0)$ ,  $\mathbf{e}_1 := (0, 1, 0)$ , and  $\mathbf{e}_2 := (0, 0, 1)$ .

### 3.1 Lifting the half-space problem and the interface equation

The lifting approach for  $(\mathcal{P}^\pm)$  is quite similar to the content of Chapter V, and consequently will not be detailed. The idea is to seek  $u$  as the trace on the half-plane  $\Theta^\pm \mathbb{R}_\pm^2$  of a function that satisfies a 3-dimensional problem with coefficients  $(\mathbb{A}_p^\pm, \rho_p^\pm)$ . This problem involves the domains

$$\Omega_\#^\pm := \mathbb{R}^\pm \times \mathbb{R} \times (0, 1)$$

$$\Sigma_\# := \{0\} \times \mathbb{R} \times (0, 1),$$

as well as the anisotropic Sobolev spaces studied in Section 4. Let us simply recall that  $H_{\Theta^\pm \#}^1(\Omega_\#^\pm)$  denotes the space of functions in  $H_{\Theta^\pm}^1(\Omega_\#^\pm)$  that are 1-periodic with respect to  $z_2$ , that  $H_{\Theta^\pm \#}^{1/2}(\Sigma_\#)$  is the image of  $H_{\Theta^\pm \#}^1(\Omega_\#^\pm)$  by the trace map on  $\Sigma_\#$ , and that  $\langle \cdot, \cdot \rangle_{\Sigma_\#}$  is the dual product between  $H_{\Theta^\pm \#}^{1/2}(\Sigma_\#)$  and its topological dual,  $H_{\Theta^\pm \#}^{-1/2}(\Sigma_\#)$ . Note that  $H_{\Theta^\pm \#}^1(\Omega_\#^\pm)$  and  $H_{\Theta^\pm \#}^{j/2}(\Sigma_\#)$  are the respective preimages of  $L^2(0, 1; H^1(\mathbb{R}_\pm^2))$  and  $L^2(0, 1; H^{j/2}(\sigma))$ ,  $j \in \{-1, 1\}$ , by the shear map given by

$$\mathcal{S}_{\Theta^\pm} V(\mathbf{x}, s) := (\mathbb{E}_\#^2 V)(\Theta^\pm \mathbf{x} + s \mathbf{e}_2) \quad \text{a. e. } (\mathbf{x}, s) \in \mathbb{R}^2 \times \mathbb{R}, \quad (3.5)$$

$$\mathcal{S}_{\Theta^\pm}^{-1} V(\mathbf{x}) := (\mathbb{E}_\#^2 V)(x, z_1/\theta_1^\pm, z_2 - z_1 \theta_2^\pm/\theta_1^\pm) \quad \text{a. e. } \mathbf{x} := (x, z_1, z_2) \in \mathbb{R}^3,$$

where  $\mathbb{E}_\#^2 V$  denotes the periodic extension of  $V$  with respect to  $z_2$ .

In accordance with the quasiperiodic expression (3.4) of  $(\mathbb{A}^\pm, \rho^\pm)$  and with the problem  $(\mathcal{P}^\pm)$  satisfied by  $u^\pm$ , it is natural to introduce for  $\Phi \in H_{\Theta^\pm \#}^{1/2}(\Sigma_\#)$  the half-strip problem

$$\left| \begin{array}{l} \text{Find } U^\pm \in H_{\Theta^\pm \#}^1(\Omega_\#^\pm) \text{ such that } U^\pm|_{\Sigma_\#} = \Phi, \quad \text{and} \quad \forall V \in H_{\Theta^\pm \#}^1(\Omega_\#^\pm) \text{ with } V|_{\Sigma_\#} = 0, \\ \int_{\Omega_\#^\pm} [(\mathbb{A}_p^{\pm t} \Theta^\pm \nabla U^\pm) \cdot \overline{(\Theta^\pm \nabla V)} - \rho_p^\pm \omega^2 U^\pm \overline{V}] = 0, \end{array} \right. \quad (3.6)$$

which is well-posed due to the presence of absorption  $\Im m \omega > 0$ . Associated to this problem is the DtN operator defined for any  $\Phi, \Psi \in H_{\Theta^\pm \#}^{1/2}(\Sigma_\#)$  as

$$\langle \Lambda^\pm \Phi, \Psi \rangle_{\Sigma_\#} := \int_{\Omega_\#^\pm} [(\mathbb{A}_p^{\pm t} \Theta^\pm \nabla U^\pm(\Phi)) \cdot \overline{(\Theta^\pm \nabla U^\pm(\Psi))} - \rho_p^\pm \omega^2 U^\pm(\Phi) \overline{U^\pm(\Psi)}]. \quad (3.7)$$

The method we propose relies on the fibered structure of  $\Lambda^\pm$  which shall now be described. To this end, it is useful to consider for any  $s \in \mathbb{R}$  and  $\varphi \in H^{1/2}(\sigma)$  the problem: Find  $u_s^\pm(\varphi) \in H^1(\mathbb{R}_\pm^2)$  such that

$$\begin{cases} -\operatorname{div} \mathbb{A}_s^\pm \nabla u_s^\pm(\varphi) - \rho_s^\pm \omega^2 u_s^\pm(\varphi) = 0 & \text{in } \mathbb{R}_\pm^2, \\ u_s^\pm(\varphi) = \varphi & \text{on } \sigma, \end{cases} \quad (3.8)$$

where  $\mathbb{A}_s^\pm$  and  $\rho_s^\pm$  are respectively defined by:

$$\forall s \in \mathbb{R}, \quad \mathbb{A}_s^\pm(\mathbf{x}) := \mathbb{A}_p^\pm(\Theta^\pm \mathbf{x} + s \mathbf{e}_2) \quad \text{and} \quad \rho_s^\pm(\mathbf{x}) := \rho_p^\pm(\Theta^\pm \mathbf{x} + s \mathbf{e}_2), \quad \forall \mathbf{x} \in \mathbb{R}^2.$$

Furthermore, let  $\lambda_s^\pm$  be the DtN operator defined for  $s \in \mathbb{R}$  and for any  $\varphi, \psi \in H^{1/2}(\sigma)$  by

$$\langle \lambda_s^\pm \varphi, \psi \rangle_\sigma := \int_{\mathbb{R}_\pm^2} [\mathbb{A}_s^\pm \nabla u_s^\pm(\varphi) \cdot \nabla \overline{u_s^\pm(\psi)} - \rho_s^\pm \omega^2 u_s^\pm(\varphi) \overline{u_s^\pm(\psi)}].$$

The maps  $s \mapsto \mathbb{A}_s^\pm$  and  $s \mapsto \rho_s^\pm$  are 1-periodic, continuous from  $\mathbb{R}$  to  $L^\infty(\mathbb{R}^2)$ , and uniformly bounded, due to the continuity of  $\mathbb{A}^\pm$  and  $\rho^\pm$ . Therefore, it can be shown that  $s \mapsto u_s^\pm \in \mathcal{L}(H^{1/2}(\sigma), H^1(\mathbb{R}_\pm^2))$  and  $s \mapsto \lambda_s^\pm \in \mathcal{L}(H^{1/2}(\sigma), H^{-1/2}(\sigma))$  are continuous and 1-periodic, by analogy with Proposition 5.3. It is also worth noting that  $u_s^\pm = u^\pm$  and  $\lambda_s^\pm = \lambda^\pm$  for  $s = 0$ .

Similarly to the second part of Proposition 5.2, one has the expression:

$$\forall \Phi \in H_{\Theta^\pm \#}^{1/2}(\Sigma_\#), \quad \text{a. e. } s \in \mathbb{R}, \quad [\mathcal{S}_{\Theta^\pm} U^\pm(\Phi)](\cdot, s) = u_s^\pm(\mathcal{S}_{\Theta^\pm} \Phi(\cdot, s)), \quad (3.9)$$

which describes  $U^\pm$  as a ‘‘concatenation’’ of the solutions  $u_s^\pm$  of (3.8). In particular, if  $\Phi \in H_{\Theta^\pm \#}^{1/2}(\Sigma_\#)$  is such that  $s \mapsto \mathcal{S}_{\Theta^\pm} \Phi(\cdot, s)$  is continuous at 0, then the solution  $u^\pm$  of  $(\mathcal{P}^\pm)$  is given by

$$u^\pm(\mathcal{S}_{\Theta^\pm} \Phi(\cdot, 0)) = [\mathcal{S}_{\Theta^\pm} U^\pm(\Phi)](\cdot, 0). \quad (3.10)$$

More important for the resolution of the interface equation (3.3), is the link between  $\Lambda^\pm$  and  $\lambda^\pm$ . The duality property (4.27) of  $\mathcal{S}_{\Theta^\pm}$  implies that for  $\varphi_\bullet : s \mapsto \varphi_s$  and  $\psi_\bullet : s \mapsto \psi_s$  in  $L^2(0, 1; H^{1/2}(\sigma))$ ,

$$\int_0^1 \langle \lambda_s^\pm \varphi_s, \psi_s \rangle_\sigma ds = \theta_1^\pm \langle \Lambda^\pm \mathcal{S}_{\Theta^\pm}^{-1} \varphi_\bullet, \mathcal{S}_{\Theta^\pm}^{-1} \psi_\bullet \rangle_{\Sigma_\#}. \quad (3.11)$$

Since we use a weak formulation to define  $\Lambda^\pm$  and  $\lambda^\pm$ , it is not obvious to retrieve  $\lambda^\pm$  single-handedly from  $\Lambda^\pm$  as it was done in (3.9). Therefore, instead of solving the interface equation (3.3) individually, we shall instead solve the family of equations  $(\lambda_s^+ + \lambda_s^-) \varphi_s = g_s$  parameterized by  $s \in [0, 1)$ , where  $g_\bullet : s \mapsto g_s$  is a continuous and 1-periodic map with respect to  $s$ , and such that  $g_s = g$  for  $s = 0$ . This is equivalent to the variational formulation

Find  $\varphi_\bullet : s \mapsto \varphi_s \in L^2(0, 1; H^{1/2}(\sigma))$  such that for any  $\psi_\bullet : s \mapsto \psi_s \in L^2(0, 1; H^{1/2}(\sigma))$ ,

$$\int_0^1 \langle (\lambda_s^+ + \lambda_s^-) \varphi_s, \psi_s \rangle_\sigma ds = \int_0^1 \langle g_s, \psi_s \rangle_\sigma ds, \quad (3.12)$$

which can be interpreted as an augmented version of (3.3), since

$$\varphi = \varphi_s \quad \text{for } s = 0.$$

The idea of solving (3.12) instead of (3.3), although surprising at first sight, does not induce any additional computational cost over the lifting approach. In fact, using (3.11), Equation (3.12) can be reformulated in terms of  $\Lambda^\pm$ :

$$\left| \begin{array}{l} \text{Find } \varphi_\bullet : s \mapsto \varphi_s \in L^2(0, 1; H^{1/2}(\sigma)) \text{ such that for any } \psi_\bullet : s \mapsto \psi_s \in L^2(0, 1; H^{1/2}(\sigma)), \\ \sum_{\pm} \theta_1^\pm \langle \Lambda^\pm \mathcal{S}_{\Theta^\pm}^{-1} \varphi_\bullet, \mathcal{S}_{\Theta^\pm}^{-1} \psi_\bullet \rangle_{\Sigma_\#} = \int_0^1 \langle g_s, \psi_s \rangle_\sigma ds. \end{array} \right. \quad (3.13)$$

Moreover, using the periodicity of  $(\mathbb{A}_p^\pm, \rho_p^\pm)$ , we shall apply a Floquet-Bloch transform in the next section to provide an expression of  $\Lambda^\pm$  involving bounded domains.

### 3.2 Characterization of the DtN operators using the Floquet-Bloch transform

We cannot solve (3.6) or compute the DtN operator  $\Lambda^\pm$  directly, since these objects are defined on the domains  $\Omega_\#^\pm$  and  $\Sigma_\#$  which are infinite. Instead, we exploit the periodicity of  $(\mathbb{A}_p^\pm, \rho_p^\pm)$  with respect to  $z_1$  by applying a partial Floquet-Bloch transform. Consider the domains

$$\begin{aligned} \Omega_{\#^2}^\pm &:= \mathbb{R}^\pm \times (0, 1) \times (0, 1), \\ \Sigma_{\#^2}^\pm &:= \{0\} \times (0, 1) \times (0, 1). \end{aligned}$$

We recall that  $H_{\Theta^\pm \#^2}^1(\Omega_{\#^2}^\pm)$  denotes the space of functions in  $H_{\Theta^\pm}^1(\Omega_{\#^2}^\pm)$  which are 1-periodic with respect to  $z_1$  and  $z_2$ , that  $H_{\Theta^\pm \#^2}^{1/2}(\Sigma_{\#^2}^\pm)$  is the image of  $H_{\Theta^\pm \#^2}^1(\Omega_{\#^2}^\pm)$  by the trace map on  $\Sigma_{\#^2}^\pm$ , and that  $\langle \cdot, \cdot \rangle_{\Sigma_{\#^2}^\pm}$  is the dual product between  $H_{\Theta^\pm \#^2}^{1/2}(\Sigma_{\#^2}^\pm)$  and its topological dual,  $H_{\Theta^\pm \#^2}^{-1/2}(\Sigma_{\#^2}^\pm)$ .

By applying the partial Floquet-Bloch transform  $\mathcal{F}_{\mathbf{e}_1}$  with respect to  $z_1$  defined in Section 5.2.b and by using its properties (see Proposition 5.5 and Corollary 5.6), one obtains for any  $\xi \in (-\pi, \pi)$  that the Floquet-Bloch transform of  $U^\pm(\Phi)$  satisfies the half-guide problem

$$\left| \begin{array}{l} \text{Find } \widehat{U}_\xi^\pm \in H_{\Theta^\pm \#^2}^1(\Omega_{\#^2}^\pm) \text{ such that } \widehat{U}_\xi^\pm|_{\Sigma_{\#^2}^\pm} = \widehat{\Phi}_\xi \quad \text{and} \quad \forall V \in H_{\Theta^\pm \#^2}^1(\Omega_{\#^2}^\pm) \text{ with } V|_{\Sigma_{\#^2}^\pm} = 0, \\ \int_{\Omega_{\#^2}^\pm} [(\mathbb{A}_p^{\pm t} \Theta^\pm (\nabla + i\xi \mathbf{e}_1) \widehat{U}_\xi^\pm) \cdot \overline{(\Theta^\pm (\nabla + i\xi \mathbf{e}_1) V)} - \rho_p^\pm \omega^2 \widehat{U}_\xi^\pm \overline{V}] = 0, \end{array} \right. \quad (3.14)$$

where  $\widehat{\Phi}_\xi := \mathcal{F}_{\mathbf{e}_1} \Phi(\cdot, \xi) \in H_{\Theta^\pm \#^2}^{1/2}(\Sigma_{\#^2}^\pm)$ . The half-strip solution  $U^\pm(\Phi)$  can then be deduced from  $\widehat{U}_\xi^\pm(\widehat{\Phi}_\xi)$  using the inverse Floquet-Bloch transform:

$$\text{a. e. } \mathbf{x} = (x, z_1, z_2) \in \Omega_{\#^2}, \quad \forall n \in \mathbb{Z}, \quad U^\pm(\Phi) = \frac{1}{\sqrt{2\pi}} \int_{-\pi}^{\pi} \widehat{U}_\xi^\pm(\widehat{\Phi}_\xi)(\mathbf{x}) e^{i\xi(z_1+n)} d\xi. \quad (3.15)$$

Finally, consider the half-guide DtN operator defined for any  $\Phi, \Psi \in H_{\Theta^\pm \#^2}^{1/2}(\Sigma_{\#^2}^\pm)$  as

$$\langle \widehat{\Lambda}_\xi^\pm \Phi, \Psi \rangle_{\Sigma_\#} := \int_{\Omega_{\#^2}^\pm} [(\mathbb{A}_p^{\pm t} \Theta^\pm (\nabla + i\xi \mathbf{e}_1) \widehat{U}_\xi^\pm(\Phi)) \cdot \overline{(\Theta^\pm (\nabla + i\xi \mathbf{e}_1) \widehat{U}_\xi^\pm(\Psi))} - \rho_p^\pm \omega^2 \widehat{U}_\xi^\pm(\Phi) \overline{\widehat{U}_\xi^\pm(\Psi)}].$$

Then, by duality (5.19), we have the link:

$$\forall \Phi, \Psi \in H_{\Theta^{\pm\#}}^{1/2}(\Sigma_{\#}), \quad \langle \Lambda^{\pm} \Phi, \Psi \rangle_{\Sigma_{\#}} = \frac{1}{\sqrt{2\pi}} \int_{-\pi}^{\pi} \langle \widehat{\Lambda}_{\xi}^{\pm} [\mathcal{F}_{\mathbf{e}_1} \Phi](\cdot, \xi), [\mathcal{F}_{\mathbf{e}_1} \Psi](\cdot, \xi) \rangle_{\Sigma_{\#^2}}, \quad (3.16)$$

so that the interface equation (3.13) becomes:

Find  $\varphi_{\bullet} : s \mapsto \varphi_s \in L^2(0, 1; H^{1/2}(\sigma))$  such that for any  $\psi_{\bullet} : s \mapsto \psi_s \in L^2(0, 1; H^{1/2}(\sigma))$ ,

$$\sum_{\pm} \theta_1^{\pm} \int_{-\pi}^{\pi} \langle \widehat{\Lambda}_{\xi}^{\pm} [\mathcal{F}_{\mathbf{e}_1} \mathcal{S}_{\Theta^{\pm}}^{-1} \varphi_{\bullet}](\cdot, \xi), [\mathcal{F}_{\mathbf{e}_1} \mathcal{S}_{\Theta^{\pm}}^{-1} \psi_{\bullet}](\cdot, \xi) \rangle_{\Sigma_{\#^2}} d\xi = \int_0^1 \langle g_s, \psi_s \rangle_{\sigma} ds. \quad (3.17)$$

Given  $\xi \in (-\pi, \pi)$ , the solution of the half-guide problem (3.14) and the DtN operator  $\widehat{\Lambda}_{\xi}^{\pm}$  can be computed using the DtN approach presented in Section 5.3, which exploits the periodicity of  $(\mathbb{A}_p^{\pm}, \rho_p^{\pm})$  in the  $\mathbf{e}_x$ -direction. An important point is that in practice, computations are reduced to the resolution of local cell problems defined in  $C_{\#^2}^{\pm} := (0, \pm 1) \times (0, 1)^2$  and of a Riccati equation involving the interface  $\Sigma_{\#^2}$  which is bounded. The resolution algorithm is detailed in Section 6.

### 3.3 Truncation of the interface equation

Even though the DtN operators in (3.17) are defined on  $\Sigma_{\#^2}$  which is bounded, the solution  $\varphi_{\bullet}$ , the test function  $\psi_{\bullet}$ , and the dual product on the right-hand-side are all defined on  $\sigma := \{0\} \times \mathbb{R}$  which is unbounded. This is the reason why we truncate (3.17) on the domain

$$\sigma_{\tau} := \{0\} \times (-\tau/2, \tau/2),$$

for some  $\tau > 0$ . Considering the subspace  $\widetilde{H}^{1/2}(\sigma_{\tau})$  of  $H^{1/2}(\sigma)$  of functions that vanish on  $\sigma \setminus \sigma_{\tau}$  (see V-(8.10)), we introduce the truncated version of (3.17):

Find  $\varphi_{\bullet}^{\tau} : s \mapsto \varphi_s \in L^2(0, 1; \widetilde{H}^{1/2}(\sigma_{\tau}))$  such that for any  $\psi_{\bullet} : s \mapsto \psi_s \in L^2(0, 1; \widetilde{H}^{1/2}(\sigma_{\tau}))$ ,

$$\sum_{\pm} \theta_1^{\pm} \int_{-\pi}^{\pi} \langle \widehat{\Lambda}_{\xi}^{\pm} [\mathcal{F}_{\mathbf{e}_1} \mathcal{S}_{\Theta^{\pm}}^{-1} \varphi_{\bullet}^{\tau}](\cdot, \xi), [\mathcal{F}_{\mathbf{e}_1} \mathcal{S}_{\Theta^{\pm}}^{-1} \psi_{\bullet}](\cdot, \xi) \rangle_{\Sigma_{\#^2}} d\xi = \int_0^1 \langle g_s, \psi_s \rangle_{\sigma} ds. \quad (3.18)$$

Formally speaking, if  $\psi_s \in \widetilde{H}^{1/2}(\sigma_{\tau})$ , then the dual product on the right-hand side can be interpreted as a dual product on  $\sigma_{\tau}$ . By analogy with Proposition 8.2, if  $\Im \omega > 0$  and if  $g_s$  is compactly supported for any  $s \in \mathbb{R}$ , then one has the existence of constants  $c, \alpha > 0$  such that

$$\forall \tau > 0, \quad \int_0^1 \|\varphi_s - \widetilde{\varphi}_s^{\tau}\|_{H^{1/2}(\sigma)}^2 ds \leq c e^{-\alpha \Im \omega \tau} \int_0^1 \|g_s\|_{H^{-1/2}(\sigma)}^2 ds,$$

where  $\widetilde{\varphi}_s^{\tau}$  is the extension of  $\varphi_s^{\tau}$  by zero. In regards to the above estimate,  $\varphi_{\bullet}^{\tau}$  can be viewed as suitable approximation of  $\varphi_{\bullet}$  on  $\sigma_{\tau}$  if  $\tau$  is large enough.

### 3.4 Resolution algorithm and discretization issues

The resolution steps for ( $\mathcal{P}$ ) are given as follows:

- a. For any  $\xi \in (-\pi, \pi)$ , compute the DtN operator  $\widehat{\Lambda}_{\xi}^{\pm}$  using the solutions of local cell problems and a propagation operator, as explained in Chapter V, Section 5.3;

b. find the solution  $\varphi_\bullet \in L^2(0, 1; H^{1/2}(\sigma))$  of the interface equation (3.17) and deduce

$$\varphi := \varphi_\bullet, \quad \Phi^\pm := \mathcal{S}_{\Theta^\pm}^{-1} \varphi_\bullet, \quad \text{and} \quad \widehat{\Phi}_\xi^\pm := [\mathcal{F}_{\mathbf{e}_1} \Phi^\pm](\cdot, \xi) \quad \text{a. e. } \xi \in (-\pi, \pi);$$

c. for  $\xi \in (-\pi, \pi)$ , construct the half-guide solution  $\widehat{U}_\xi^\pm(\Phi_\xi^\pm)$  using the local cell solutions and the propagation operator already computed for Step a.

d. using the inverse Floquet-Bloch transform with (3.15), deduce the solution  $U^\pm(\Phi^\pm)$  of the half-strip problem (3.6);

e. compute the solution  $u^\pm(\varphi)$  of the halfspace problem using (3.10):  $u^\pm(\varphi) = [\mathcal{S}_{\Theta^\pm} U^\pm(\Phi^\pm)](\cdot, 0)$ ;

f. deduce the solution  $u$  of ( $\mathcal{P}$ ) from the concatenation (3.2) of  $u^+(\varphi)$  and  $u^-(\varphi)$ .

Since this algorithm holds at a continuous level, the rest of the section is dedicated to its discretization, with an emphasis on Steps a, b, c, and d.

The discretization of Steps a and c has been already presented in Section 6.1, and thus will not be detailed in this part. Let us simply recall that the discretization of these steps involves a mesh  $\mathcal{T}_{h^\pm}$  of the cell  $\mathcal{C}_{\#^2}^\pm := (0, \pm 1) \times (0, 1) \times (0, 1)$ , with mesh step  $h^\pm > 0$ . The mesh  $\mathcal{T}_{h^\pm}$  is assumed to be periodic, in the sense that one can identify the mesh nodes on  $x = 0$  with those on  $x = \pm 1$  using the trivial transformation  $\mathbf{x} \mapsto \pm \pm \mathbf{e}_x - x$ . We use Lagrange finite elements of order  $d > 0$  to construct

$$\mathcal{V}_{h^\pm}(\Sigma_{\#^2}^\pm), \text{ an internal approximation of } H_{\Theta^\pm \#^2}^{1/2}(\Sigma_{\#^2}). \quad (3.19)$$

Given  $\xi \in (-\pi, \pi)$  and  $\Psi \in H_{\Theta^\pm \#^2}^{1/2}(\Sigma_{\#^2})$ , we will assume using Section 6.1 that one can compute suitable approximations  $\widehat{\Lambda}_{\xi, h^\pm}^\pm \in \mathcal{L}(\mathcal{V}_{h^\pm}(\Sigma_{\#^2}^\pm))$  and  $U_{\xi, h^\pm}^\pm(\Psi_{h^\pm})$  of  $\widehat{\Lambda}_\xi^\pm$  and  $U_\xi^\pm(\Psi)$  respectively, where  $\Psi_{h^\pm}$  denotes the projection of  $\Psi$  onto  $\mathcal{V}_{h^\pm}(\Sigma_{\#^2}^\pm)$ .

We now focus on Step b. In practice for this step, we solve the truncated interface equation (3.18) for  $\tau$  large enough. The discretization process is divided into two steps: a semi-discretization with respect to the Floquet variable, and a discretization with respect to the space variable.

**Semi-discretization with respect to the Floquet variable** The resolution of Equation (3.18) requires to compute the integral with respect to  $\xi$ . Since  $\xi \mapsto \langle \widehat{\Lambda}_\xi^\pm [\mathcal{F}_{\mathbf{e}_1} \mathcal{S}_{\Theta^\pm}^{-1} \varphi^\tau](\cdot, \xi), [\mathcal{F}_{\mathbf{e}_1} \mathcal{S}_{\Theta^\pm}^{-1} \psi](\cdot, \xi) \rangle_{\Sigma_{\#^2}}$  does not have an explicit expression in general, this integrand can only be computed for a finite number of values of  $\xi$ . Therefore, the integral with respect to  $\xi$  which appears in (3.18) can only be evaluated using a quadrature rule.

We introduce a regular mesh of  $(-\pi, \pi)$  made of  $N_\xi$  intervals of equal size  $\Delta\xi$  and of  $N_\xi + 1$  equispaced points  $-\pi = \xi_0 < \xi_1 < \dots < \xi_{N_\xi} = \pi$  with  $N_\xi > 0$  and  $\Delta\xi := 1/N_\xi$ . The DtN operator  $\widehat{\Lambda}_\xi^\pm$  is computed using Step a for  $\xi = \xi_j$ ,  $j \in \llbracket 0, N_\xi \rrbracket$ , and the integral in (3.18) is evaluated using the trapezoidal rule (see Remark 3.1):

$$\begin{aligned} \int_{-\pi}^{\pi} \langle \widehat{\Lambda}_\xi^\pm [\mathcal{F}_{\mathbf{e}_1} \mathcal{S}_{\Theta^\pm}^{-1} \varphi^\tau](\cdot, \xi), [\mathcal{F}_{\mathbf{e}_1} \mathcal{S}_{\Theta^\pm}^{-1} \psi](\cdot, \xi) \rangle_{\Sigma_{\#^2}} d\xi \\ \simeq \Delta\xi \sum_{j=0}^{N_\xi} \langle \widehat{\Lambda}_{\xi_j}^\pm [\mathcal{F}_{\mathbf{e}_1} \mathcal{S}_{\Theta^\pm}^{-1} \varphi^\tau](\cdot, \xi_j), [\mathcal{F}_{\mathbf{e}_1} \mathcal{S}_{\Theta^\pm}^{-1} \psi](\cdot, \xi_j) \rangle_{\Sigma_{\#^2}}, \end{aligned}$$

so that one has to solve

$$\left| \begin{array}{l} \text{Find } \varphi_{\bullet}^{\tau, \Delta\xi} : s \mapsto \varphi_s \in L^2(0, 1; \tilde{H}^{1/2}(\sigma_\tau)) \text{ such that for any } \psi_{\bullet} : s \mapsto \psi_s \in L^2(0, 1; \tilde{H}^{1/2}(\sigma_\tau)), \\ \sum_{\pm} \theta_1^{\pm} \Delta\xi \sum_{j=0}^{N_\xi} \langle \hat{\Lambda}_{\xi_j}^{\pm} [\mathcal{F}_{\mathbf{e}_1} \mathcal{S}_{\Theta_{\pm}^1}^{-1} \varphi_{\bullet}^{\tau, \Delta\xi}](\cdot, \xi_j), [\mathcal{F}_{\mathbf{e}_1} \mathcal{S}_{\Theta_{\pm}^1}^{-1} \psi_{\bullet}](\cdot, \xi_j) \rangle_{\Sigma_{\#^2}} = \int_0^1 \langle g_s, \psi_s \rangle_{\sigma} ds. \end{array} \right. \quad (3.20)$$

We expect this equation to be well-posed in  $L^2(0, 1; \tilde{H}^{1/2}(\sigma_\tau))$  for  $\Delta\xi$  small enough.

**Remark 3.1.** *The choice of the trapezoidal rule is formally motivated by the fact that this quadrature rule converges exponentially for real analytic integrands [TW14]. For any  $\psi_{\bullet} \in L^2(0, 1; \tilde{H}^{1/2}(\sigma_\tau))$ , given that  $\psi_s$  is compactly supported in  $\sigma_\tau$ , it can be seen from the expression (3.5) of  $\mathcal{S}_{\Theta_{\pm}^1}^{-1}$  that  $\mathcal{S}_{\Theta_{\pm}^1}^{-1} \psi_{\bullet}$  is compactly supported as well in  $z_1$ . Therefore, using Paley-Wiener type estimates [Kuc93, Theorem 2.2.2], it follows that  $\xi \mapsto [\mathcal{F}_{\mathbf{e}_1} \mathcal{S}_{\Theta_{\pm}^1}^{-1} \psi_{\bullet}](\cdot, \xi)$  is real analytic. In addition, using the quadratic dependence of (3.14) with respect to  $\xi$ , it can be shown that  $\xi \mapsto \hat{\Lambda}_{\xi}^{\pm} \in \mathcal{L}(H_{\Theta_{\pm}^1 \#^2}^{1/2}(\Sigma_{\#^2}), H_{\Theta_{\pm}^1 \#^2}^{-1/2}(\Sigma_{\#^2}))$  is also real analytic, so that the integrand in (3.18) is smooth with respect to  $\xi$ .*

**Space discretization** We now describe the discretization with respect to  $(\mathbf{x}, s) \in \sigma_\tau \times (0, 1)$ . Starting from a mesh  $\mathcal{T}_{h_{\mathbf{x}}}(\sigma_\tau)$  of  $\sigma_\tau$  with mesh step  $h_{\mathbf{x}} > 0$ , we consider the classical  $H^1$ -conforming Lagrange finite element space of order  $d > 0$ , which is denoted by  $\mathcal{V}_{h_{\mathbf{x}}}(\sigma_\tau)$ . Then, an internal approximation of  $\tilde{H}^{1/2}(\sigma_\tau)$  is provided by the space  $\tilde{\mathcal{V}}_{h_{\mathbf{x}}}(\sigma_\tau) := \{\varphi \in \mathcal{V}_{h_{\mathbf{x}}}(\sigma_\tau) / \varphi = 0 \text{ on } \partial\sigma_\tau\}$  with basis functions  $\phi_\ell, \ell \in \llbracket 1, N_{\mathbf{x}} \rrbracket$ , where  $N_{\mathbf{x}} := \dim \tilde{\mathcal{V}}_{h_{\mathbf{x}}}(\sigma_\tau)$ .

In addition, consider a mesh  $\mathcal{T}_{h_s}(0, 1)$  of  $(0, 1)$  with mesh step  $h_s > 0$ , and let  $\mathcal{V}_{h_s}(0, 1)$  be the approximation space of  $L^2(0, 1)$ , with basis functions  $w_j, j \in \llbracket 1, N_s \rrbracket$ , where  $N_s := \dim \mathcal{V}_{h_s}(0, 1)$ . An internal approximation of  $L^2(0, 1; \tilde{H}^{1/2}(\sigma_\tau))$  is then given by

$$\mathcal{V}_h := \text{Span} \{ (\mathbf{x}, s) \mapsto w_j(s) \phi_\ell(\mathbf{x}), \quad (j, \ell) \in \llbracket 1, N_s \rrbracket \times \llbracket 1, N_{\mathbf{x}} \rrbracket \} \subset \mathcal{C}^0(\sigma_\tau \times (0, 1)), \quad h := (h_{\mathbf{x}}, h_s)$$

Our goal is to construct a fully discrete version of (3.20) set in  $\mathcal{V}_h$ , where the DtN operator  $\hat{\Lambda}_{\xi}^{\pm}$  is replaced by its approximation  $\hat{\Lambda}_{\xi, h_{\pm}}^{\pm} \in \mathcal{L}(\mathcal{V}_{h_{\pm}}(\Sigma_{\#^2}^{\pm}))$  obtained from the discretization of Step a. To this end, we approximate  $[\mathcal{F}_{\mathbf{e}_1} \mathcal{S}_{\Theta_{\pm}^1}^{-1} \varphi_{\bullet}](\cdot, \xi)$  with its interpolation onto the discrete space  $\mathcal{V}_{h_{\pm}}(\Sigma_{\#^2}^{\pm})$  introduced in (3.19), namely:

$$[\mathcal{F}_{\mathbf{e}_1} \mathcal{S}_{\Theta_{\pm}^1}^{-1} \varphi_{\bullet}](\cdot, \xi) \simeq \Pi_{h_{\pm}} [\mathcal{F}_{\mathbf{e}_1} \mathcal{S}_{\Theta_{\pm}^1}^{-1} \varphi_{\bullet}](\cdot, \xi) \in \mathcal{V}_{h_{\pm}}(\Sigma_{\#^2}^{\pm}), \quad \forall \varphi_{\bullet} \in \mathcal{V}_h, \quad (3.21)$$

where  $\Pi_{h_{\pm}}$  denotes the interpolation operator defined from  $\mathcal{C}^0(\sigma_\tau)$  to  $\mathcal{V}_{h_{\pm}}(\Sigma_{\#^2}^{\pm})$ . This allows to introduce the solution  $\varphi_{\bullet}^{\tau, h} \in \mathcal{V}_h$  which satisfies for any  $\psi_{\bullet} \in \mathcal{V}_h$

$$\sum_{\pm} \theta_1^{\pm} \Delta\xi \sum_{j=0}^{N_\xi} \langle \hat{\Lambda}_{\xi_j}^{\pm} \Pi_{h_{\pm}} [\mathcal{F}_{\mathbf{e}_1} \mathcal{S}_{\Theta_{\pm}^1}^{-1} \varphi_{\bullet}^{\tau, h}](\cdot, \xi_j), \Pi_{h_{\pm}} [\mathcal{F}_{\mathbf{e}_1} \mathcal{S}_{\Theta_{\pm}^1}^{-1} \psi_{\bullet}](\cdot, \xi_j) \rangle_{\Sigma_{\#^2}} = \int_0^1 \langle g_s, \psi_s \rangle_{\sigma} ds, \quad (3.22)$$

where  $\mathbf{h} := (h, h_+, h_-, \Delta\xi)$ . This equation can be written as a  $N_h \times N_h$  system with  $N_h := \dim \mathcal{V}_h$ .

**Remark 3.2.** *The interpolation error in (3.21) is linked to the smoothness of  $\hat{\Phi}_{\xi}^{\pm} = [\mathcal{F}_{\mathbf{e}_1} \mathcal{S}_{\Theta_{\pm}^1}^{-1} \varphi_{\bullet}](\cdot, \xi)$ . For some  $\varphi_{\bullet} \in \mathcal{V}_h$ , even though  $\hat{\Phi}_{\xi}^{\pm}$  is continuous, it is only piecewise smooth. In other words,  $\hat{\Phi}_{\xi}^{\pm}$  admits on  $\Sigma_{\#^2}^{\pm}$  singularity points, namely points where its derivatives are not well-defined. The location and the number of such points depend on the mesh  $\mathcal{T}_h(\Sigma_\tau)$  of  $\Sigma_\tau$ .*

We expect the interpolation error to be negligible with respect to the overall discretization if the singularity points of  $\widehat{\Phi}_\xi^\pm$  coincide with the degrees of freedom on  $\Sigma_{\#2}^\pm$ , or equivalently, if  $h^\pm$  is a multiple of  $h_x$ . Since this is not the case in general, we shall impose that the steps  $h^\pm$  are smaller than  $h_x$  and  $h_s$ , to ensure that (3.21) does not deteriorate the global discretization of the method.

## 4 Numerical results

In what follows, the approach developed in Section 3 is applied to different cases, with the purpose to illustrate its efficiency. For simplicity, simulations are carried out using a tensor  $\mathbb{A} = \mathbb{I}_2$ . The jump data  $g$  is a cut-off function, and  $g_\cdot : s \mapsto g_s$  is constant with respect to  $s$ :

$$\begin{cases} \forall z \in \mathbb{R}, & g(0, z) := 100 \phi(2z), \quad \text{with} \quad \phi(z) := \exp(1 - 1/(1 - z^2)) \mathbf{1}_{[-1,1]}(z), \\ \forall s \in [0, 1], & g_s := g \end{cases} \quad (4.1)$$

For the numerical results, we use order 1 Lagrange finite elements.

### 4.1 Validation for the model configurations of Chapter V

In this section, we solve ( $\mathcal{P}$ ) in the configurations ( $\mathcal{A}$ ) and ( $\mathcal{B}$ ) studied in Chapter V. The solution, computed using the approach described in this chapter, is compared to the solution obtained by lifting directly ( $\mathcal{P}$ ) into a 3D problem, as done in Chapter V.

Using the cut-off function  $\phi \in \mathcal{C}_0^\infty(\mathbb{R})$  defined in (4.1), we start from the  $\mathbb{Z}^2$ -periodic functions defined in one periodicity cell by

$$\forall \hat{\mathbf{x}} = (\hat{x}, \hat{z}) \in (0, 1)^2, \quad \hat{\rho}^-(\hat{\mathbf{x}}) := 0.5 + \phi(4\hat{x}) \phi(4\hat{z}) \quad \text{and} \quad \hat{\rho}^+(\hat{\mathbf{x}}) := 0.5 + \phi(2.5|\hat{\mathbf{x}}|).$$

Then, for Configuration ( $\mathcal{A}$ ), we use

$$\forall \mathbf{x} = (x, z) \in \mathbb{R}^2, \quad \rho^\pm(\mathbf{x}) := \hat{\rho}^\pm(x, z/p_z^\pm), \quad (4.2)$$

which is  $p_z^\pm$ -periodic with respect to  $z$ . For Configuration ( $\mathcal{B}$ ), we set

$$\forall \mathbf{x} = (x, z) \in \mathbb{R}^2, \quad \rho^-(\mathbf{x}) = 1 \quad \text{and} \quad \rho^+(\mathbf{x}) := \hat{\rho}(x - (p_x^+/p_z^+)z, z/p_z^+), \quad (4.3)$$

so that  $\rho^+$  is  $\mathbb{Z}e_x + \mathbb{Z}p^+$ -periodic with  $p^+ = (p_x^+, p_z^+)$ . These coefficients are shown in Figure 2 (left and middle).

Figure 3 shows the solutions obtained using Chapter V and the method presented in this chapter for Configuration ( $\mathcal{A}$ ) with  $p_z^- = 1$  and  $p_z^+ = \sqrt{2}$  (first row), and for Configuration ( $\mathcal{B}$ ) with  $p^- = e_z$  and  $p^+ = (\cos \alpha, \sin \alpha)$ ,  $\alpha = 3\pi/5$  (second row). The similarity of both solutions validates the method in each configuration.

### 4.2 Generic configuration

Now that the method has been validated, we perform one last experiment to show the behaviour of the solution of ( $\mathcal{P}$ ) with respect to the complex frequency. From the  $\mathbb{Z}^2$ -periodic coefficients defined

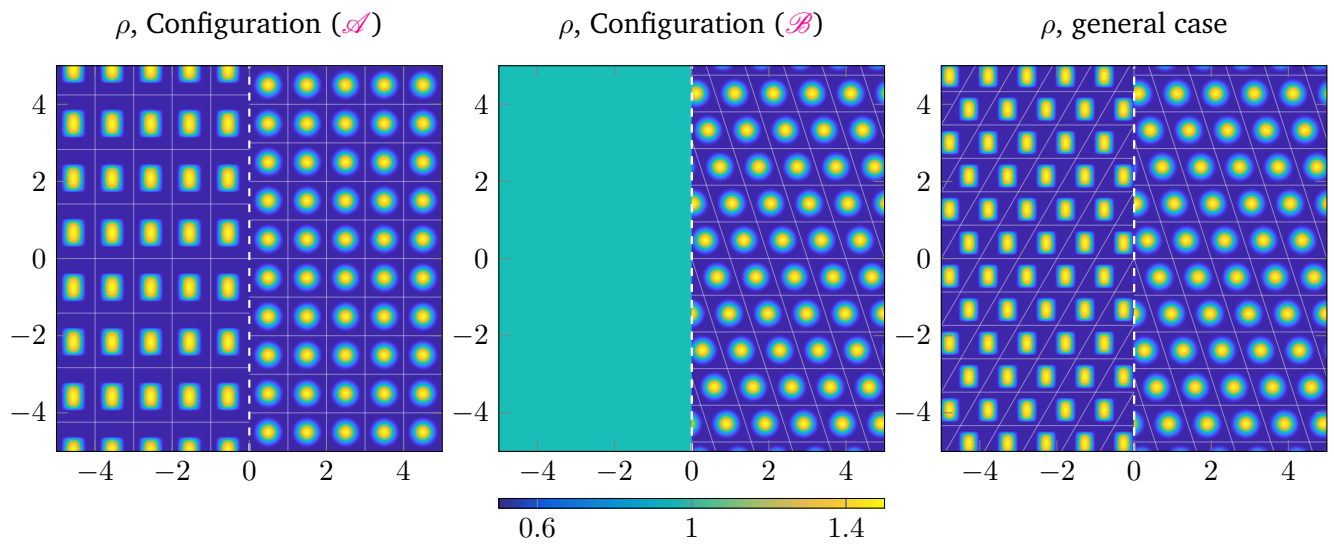

Figure 2: Left and middle: The coefficient  $\rho$  used in Section 4.1 for Configurations (A) (left) and (B) (middle). Right: Coefficient  $\rho$  used in Section 4.2.

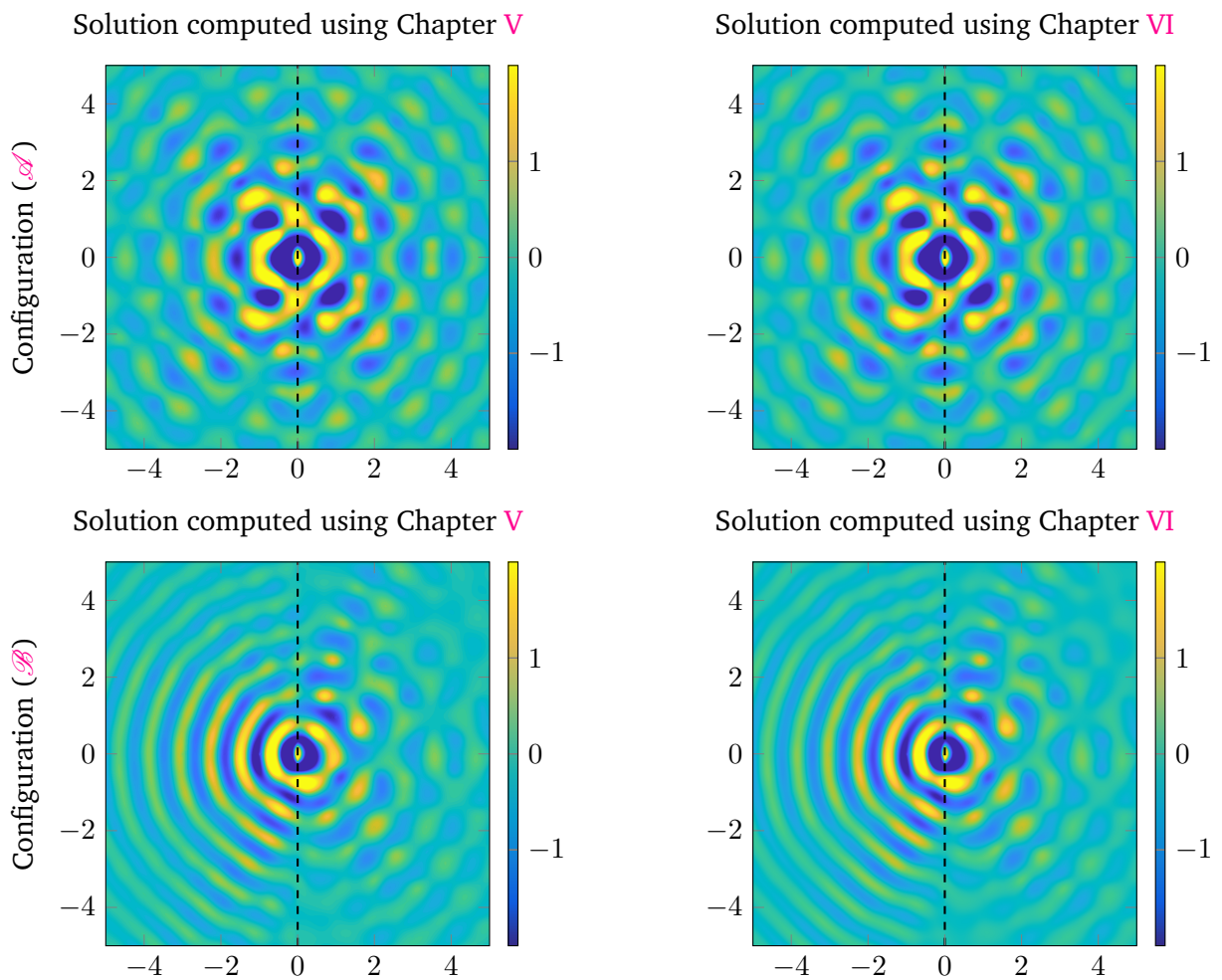

Figure 3: Real part of the solution of (P) obtained for Configuration (A) and (B) using the methods developed in Chapter V and VI.



in (4.2), we define

$$\forall \mathbf{x} = (x, z) \in \mathbb{R}^2, \quad \rho^\pm(\mathbf{x}) := \hat{\rho}(x - (p_x^\pm/p_z^\pm)z, z/p_z^\pm),$$

so that  $\rho^\pm$  is  $\mathbb{Z}e_x + \mathbb{Z}\mathbf{p}^\pm$ -periodic with  $\mathbf{p}^\pm := (p_x^\pm, p_z^\pm) \in \mathbb{R}^2$ . We choose  $\mathbf{p}^\pm := (\cos \alpha^\pm, \sin \alpha^\pm)$  with  $\alpha^- = \pi/3$  and  $\alpha^+ = 3\pi/5$ , which yields the coefficient represented in Figure 2 (right). The solution of ( $\mathcal{P}$ ) is computed using  $\tau = 10$ , and is represented in Figure 4 for different values of  $\omega$ . As expected for the Helmholtz equation, the solution oscillates more as  $\Re \omega$  increases, and decays less at infinity as  $\Im \omega$  decreases.

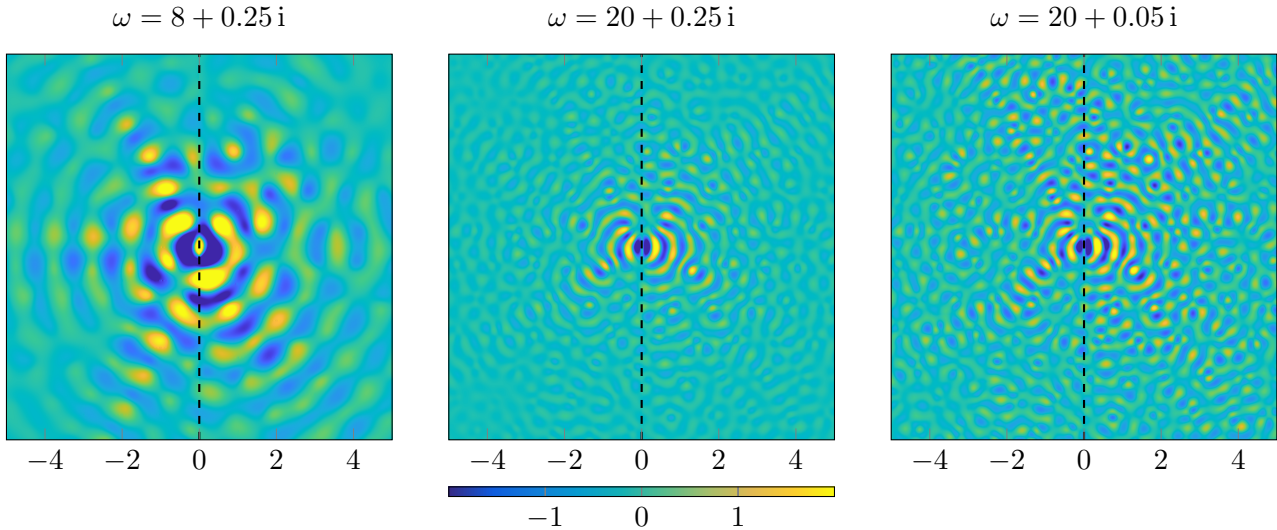

Figure 4: Real part of the approximate solution  $u_h$  computed using order 1 Lagrange finite elements. Different values are considered for  $\omega$ .

## Conclusion

The resolution of a transmission problem between two arbitrary periodic half-spaces has been studied in this Chapter. Rather than using directly the lifting approach which would have implied the resolution of 5-dimensional problems, we have proposed an alternative method which exploits separately the structure of each periodic half-space with respect to the interface. An exhaustive analysis of this method would be worthwhile in order to identify the influence of the discretization parameters involved. Another interesting question concerns the robustness of this method as the absorption tends to 0, and its extension to the non-absorbing case. We expect this question to be strongly linked to the behaviour at infinity of the solution in the direction of the interface.

## Perspectives

In this thesis, we have proposed a method to solve the time-harmonic wave equation

- in one-dimensional quasiperiodic media with a local perturbation;
- in presence of two-dimensional periodic half-spaces.

In each case, using the presence of *absorption*, we have justified that the problem considered can be lifted onto a higher-dimensional problem, to which one can apply tools that are well-suited for periodic media. In the one-dimensional locally perturbed quasiperiodic configuration with *no absorption*, we have shown that the limiting absorption principle holds under certain assumptions.

The method presented still leaves many questions unanswered, and opens up multiple perspectives. In what follows, we describe some questions that naturally arise from the study (Sections 1 and 2), as well as some possible extensions (Sections 3 and 4).

### 1 The limiting absorption principle

The main question that emerges from this work concerns the proof of the limiting absorption principle as well as the robustness of the method in the non-absorbing case.

#### One-dimensional quasiperiodic media

In the one-dimensional quasiperiodic case, the lifting approach and the DtN method have provided us a promising path of investigation, which relies on the peculiar spectral structure of the propagation operator, and more precisely on the existence of a so-called *fundamental eigenfunction*. For now, we have assumed that **the fundamental eigenfunction has a limit** as the absorption tends to 0, but it would be worth investigating the situations where this assumption holds.

Another crucial assumption we have made is the **positivity of the energy flux**, which guarantees that the fundamental eigenfunction at the limit does not vanish. For homogeneous media, the energy flux of plane waves is linked to their group velocity, and its sign allows to separate outgoing modes from ingoing (*non-physical*) ones. Similarly, for periodic media, the energy flux of Floquet modes is related to their group velocity (see [FJ16]). From what we have shown in the case of quasiperiodic media, it seems that from the limit of the fundamental eigenpair, one can construct the equivalent of a Floquet mode, that is a solution  $u_0 \in H_{loc}^1(\mathbb{R})$  such that  $\mathcal{A}_\theta u_0 = \omega^2 u_0$ , where  $\mathcal{A}_\theta$  is the studied quasiperiodic (unperturbed) differential operator. Now, if the limiting absorption principle holds for any  $\omega^2$  in an

interval  $I \subset \mathbb{R}$ , then it is shown in [RS78] for instance that  $I$  is included in the absolutely continuous spectrum of  $\mathcal{A}_\theta$ . In such a case, we strongly suspect a link between the energy flux and the group velocity of the “generalized” Floquet mode.

Furthermore, one may wonder (a) if energy flux is generically positive, and (b) what happens if this quantity vanishes. For periodic waveguides, it is showed in [FJ16] that there exist countably many values of  $\omega^2$  (called **cut-off frequencies**) for which a propagating Floquet mode has a zero energy flux. In this case, if there is no perturbation of the local structure, then the limiting absorption principle cannot hold. The answer to these questions in the case of quasiperiodic media is still an open question.

### Junction of periodic media

For junctions of periodic half-spaces, the limiting absorption principle seems far more challenging. Even in the case of a single periodic half-space cut in a direction of periodicity, there is no answer as far as we know. In fact, there may be guided modes at the interface: the solution may not be  $L^2$  (it may even be propagative in the direction of the interface), so that the Floquet-Bloch transform can no longer be applied. If the solution is  $L^2$  along the interface, one idea would then be to make the absorption tend to 0 in our method. However, the difficulty is that the waveguide problems obtained after applying the Floquet-Bloch transform may be ill-posed at the limit, thus forcing us to exclude a continuum of forbidden frequencies. This issue is already encountered for periodic half-spaces, as explained in [Fli09, §4.4]. Nevertheless, note that the method proposed may still be used numerically outside of these forbidden frequencies.

Associated to the above open question is the stability of the numerical methods developed in Chapters V and VI when the absorption tends to 0. Some aspects of these methods (in particular the ones in Sections V-8 and VI-3) will probably require some adaptation in order to remain efficient in the non-absorbing case.

## 2 Numerical aspects

An error analysis remains to be performed for the quasi-1D and the quasi-2D methods. In that regard, the numerical analysis of the Riccati equation is the most challenging step, because of its nonlinear nature. Let us also mention that the resolution of the Riccati equation using the spectral approach could be improved in practice. In fact, the quadratic eigenvalue problem associated to the Riccati equation is called a *palindromic* eigenvalue problem [HMM04; Mac+06], due to the symmetry properties of the local DtN operators. Using adapted algorithms to solve this eigenvalue problem may reduce the computational time.

## 3 Computation of guided modes

A natural counterpart of the scattering phenomena studied in this thesis is the computation of guided modes in the setting shown in Figure VI-1a, and studied in Chapters V and VI. By guided modes, we mean solutions of the homogeneous problem that can only propagate in the neighborhood of the interface between two periodic half-spaces, and decay in the direction orthogonal to the interface. Guided modes are a subject of interest, since they can be used for the design of efficient lasers, filters, optical fibers, and waveguides. In addition, the robustness of guided modes to perturbations of the interface is a question that arises for instance in the study of topological insulators [Moo10].

From a mathematical point of view, a guided mode  $u$  is a non-trivial solution of the eigenvalue problem related to Problem VI-( $\mathcal{P}$ ) (with associated eigenvalue  $\omega^2 \in \mathbb{R}$ ), and which **decay far from the interface**  $\sigma := \{0\} \times \mathbb{R}$ . In other words,

$$\begin{cases} -\operatorname{div} \mathbb{A} \nabla u - \rho \omega^2 u = 0 & \text{in } \mathbb{R}_+^2 \cup \mathbb{R}_-^2, \\ \llbracket \mathbb{A} \nabla u \cdot \mathbf{e}_x \rrbracket_\sigma = 0 & \text{on } \sigma, \\ |u(x, z)| \rightarrow 0 & \text{as } |x| \rightarrow \infty. \end{cases} \quad (3.1)$$

In order to complete this definition, one also needs to prescribe the behaviour of  $u$  in the direction of the interface. If the medium is periodic along  $\sigma$ , then the use of a partial Floquet-Bloch transform in that direction would typically suggest that in addition to (3.1), a guided mode should satisfy the  $\xi$ -**quasiperiodicity condition**:  $u(x, z + 1) = e^{i\xi} u(x, z)$ , for some  $\xi \in [0, 2\pi)$ . This is the definition used in general; see for instance [SA04; Fli13; Del+17; DF23].

In the case of media that are not periodic in the direction of the interface, guided modes are more difficult to study, because their very definition is not obvious. In fact, since one can no longer use the Floquet-Bloch transform along  $\sigma$ , the behaviour of a guided mode along the interface is not clear. This issue has been investigated in [FFW22] for a discrete Schrödinger model by means of rational approximations. Another idea in the continuous setting would be to use the lifting approach. In fact, considering for instance the settings ( $\mathcal{A}$ ) and ( $\mathcal{B}$ ) introduced in Chapter V (see Figures V-2, V-3), one could define a 2D guided mode  $u$  as the trace along a hyperplane of the solution  $U$  of a 3D eigenvalue problem, where periodicity is recovered along the interface, allowing to use Floquet theory. This also corresponds to looking for solutions  $u$  such that  $e^{i\xi z} u$  is not periodic with respect to  $z$ , but rather **quasiperiodic** in the sense of Definition II-1.1. It would be interesting to investigate the conditions under which such guided modes exist, and to propose a DtN-based method for their computation. This method in the 1D case could allow to compute the discrete spectrum of locally perturbed quasiperiodic structures (see [FK97] for a similar problem or [Fli13] for the use of the DtN method for this computation) or resonances [Duc+23].

## 4 Enriched homogenization in presence of a boundary

Another case to which this thesis could be applied concerns enriched homogenization in presence of boundary. Consider for instance the rescaled Helmholtz equation with absorption ( $\Im \omega > 0$ )

$$\begin{cases} -\operatorname{div} \left[ \mathbb{A} \left( \frac{\cdot}{\varepsilon} \right) \nabla u_\varepsilon \right] - \rho \left( \frac{\cdot}{\varepsilon} \right) \omega^2 u_\varepsilon = 0 & \text{in } \mathbb{R}_+^2, \\ u_\varepsilon = \varphi & \text{on } \sigma := \partial \mathbb{R}_+^2, \end{cases} \quad (4.1)$$

with  $\varepsilon > 0$  and where  $(\mathbb{A}, \rho)$  are periodic in two directions. The behaviour of  $u_\varepsilon$  as  $\varepsilon$  tends to 0 has been widely studied in the theory of homogenization. First, if one considers the PDE in (4.1) in the whole space  $\mathbb{R}^2$ , then it can be shown using a 2-scale expansion for instance that there exist functions  $u_0$  and  $u_1(\cdot, \cdot/\varepsilon)$  such that  $u_\varepsilon = u_0 + \varepsilon u_1(\cdot, \cdot/\varepsilon) + \mathcal{O}(\varepsilon)$  in  $H^1(\mathbb{R}^2)$ . The function  $u_0$  can be characterized as the solution of a *homogenized* Helmholtz equation whose coefficients are constant and can be computed by solving cell problems. These cell problems also allow to compute  $u_1$ .

For (4.1), it turns out that  $u_\varepsilon = u_0 + \varepsilon u_1(\cdot, \cdot/\varepsilon) + \mathcal{O}(\sqrt{\varepsilon})$  in  $H^1(\mathbb{R}_+^2)$ , whereas  $u_\varepsilon = u_0 + \varepsilon u_1(\cdot, \cdot/\varepsilon) + \mathcal{O}(\varepsilon)$  in  $H^1(D)$  for any  $D \Subset \mathbb{R}_+^2$ . This drop of convergence order near the interface is caused by a so-called

*boundary layer phenomenon*, which has been the object of theoretical studies for periodic half-spaces [BLP78; MV97; AA99; GM11] and for transmission problems [BP12; BLL15; Jos19].

From a numerical viewpoint, an idea investigated in [Ben21] consists in enriching the classical 2-scale expansion of  $u_\varepsilon$  by adding near-field terms which are expected to decay far from the interface. However, this *enriched homogenization* approach relies essentially on the periodicity of  $(\mathbb{A}, \rho)$  in the direction of the interface, as it allows to characterize the near-field terms as solutions of 2D Laplace problems defined in a strip, with periodicity conditions with respect to the variable of the interface. In the case where  $(\mathbb{A}, \rho)$  are no longer periodic along the interface, a quasiperiodic behaviour is expected from [GM11; BLL15]. Therefore, using the method developed in this thesis, the near-field terms could be seen as traces of solutions of 3D half-guide problems, to which the DtN approach can be applied. However many delicate questions have to be addressed, such as the well-posedness of the 3D problems, or the study of the error in presence of the near-field terms (see [GM11; GM12]).

# Bibliography

- [Häu84] R. J. Häüy. *Essai d'une théorie sur la structure des cristaux: appliquée à plusieurs genres de substances cristallisées*. Chez Gogué & Née de la Rochelle, 1784.
- [Lio44a] J. Liouville. "A propos de l'existence des nombres transcendants". In: *Comptesrendus de l'Académie des sciences* (1844).
- [Lio44b] J. Liouville. "Sur des classes très-étendues de quantités dont la valeur n'est ni algébrique ni même réductible à des irrationnelles algébriques". In: *CR Acad. Sci. Paris* 18 (1844), pp. 883–885.
- [Boh93] P. P. F. Bohl. *Ueber die darstellung von Functionen einer variabeln durch trigonometrische reihen mit mehreren einer variabeln Proportionalen argumenten...* Druck von C. Mattiesen, 1893.
- [Poi93] H. Poincaré. *Les méthodes nouvelles de la mécanique céleste*. Vol. 2. Gauthier-Villars et fils, imprimeurs-libraires, 1893.
- [Esc04] E. Esclangon. *Les fonctions quasi-périodiques*. Gauthier-Villars, 1904.
- [Boh06] P. Bohl. "Über eine Differentialgleichung der Störungstheorie." In: (1906).
- [Som12] A. Sommerfeld. "Die Greensche Funktion der Schwingungsgleichung." In: *Jahresbericht der Deutschen Mathematiker-Vereinigung* 21 (1912), pp. 309–352. URL: <http://eudml.org/doc/145344>.
- [Bra13] W. L. Bragg. "The Diffraction of Short Electromagnetic Waves by a Crystal". In: *Proceedings of the Cambridge Philosophical Society: Mathematical and physical sciences*. Vol. 17. Cambridge Philosophical Society. 1913, pp. 43–57.
- [FKL13] W. Friedrich, P. Knipping, and M. Laue. "Interferenzerscheinungen bei roentgenstrahlen". In: *Annalen der Physik* 346.10 (1913), pp. 971–988.
- [Bes32] A. S. Besicovitch. *Almost Periodic Functions*. 1932, pp. 891–921.
- [Bes40] A. S. Besicovitch. "On the linear independence of fractional powers of integers". In: *Journal of the London Mathematical Society* 1.1 (1940), pp. 3–6.
- [Boh47] H. Bohr. *Almost periodic functions (Translated from German)*. 1947.
- [TS48] A. Tikhonov and A. Samarskii. "The radiation principle". In: *Zhur. Eksptl. i Teoret. Fiz.* 18 (1948).
- [Som49] A. Sommerfeld. *Partial differential equations in physics*. Academic press, 1949.
- [Rot55] K. F. Roth. "Rational approximations to algebraic numbers". In: *Mathematika* 2.1 (1955), pp. 1–20.

- [Mor62] C. S. Morawetz. “The limiting amplitude principle”. In: *Communications on Pure and Applied Mathematics* 15.3 (1962), pp. 349–361.
- [Wil66] C. H. Wilcox. “Wave operators and asymptotic solutions of wave propagation problems of classical physics”. In: *Archive for Rational Mechanics and Analysis* 22.1 (1966), pp. 37–76.
- [Iwa68] N. Iwasaki. “On the principle of limiting amplitude”. In: *Publications of the Research Institute for Mathematical Sciences, Kyoto University. Ser. A* 3.3 (1968), pp. 373–392.
- [Tem68] R. Temam. “Sur la stabilité et la convergence de la méthode des pas fractionnaires”. In: *Annali di Matematica pura ed applicata* 79.1 (1968), pp. 191–379.
- [Gar70] M. Gardner. “Mathematical games”. In: *Scientific American* 222.6 (1970), pp. 132–140.
- [LM72] J.-L. Lions and E. Magenes. *Non-Homogeneous Boundary Value Problems and Applications*. Berlin, Heidelberg: Springer, 1972. URL: <http://link.springer.com/10.1007/978-3-642-65161-8>.
- [CT73] J.-M. Combes and L. C. Thomas. “Asymptotic behaviour of eigenfunctions for multiparticle Schrödinger operators”. In: *Communications in Mathematical Physics* 34.4 (1973), pp. 251–270.
- [DS73] E. De Giorgi and S. Spagnolo. “Sulla convergenza degli integrali dell’energia per operatori ellittici del secondo ordine”. In: *Bollettino della Unione Matematica Italiana* 8 (1973), pp. 391–411.
- [Eas73] M. S. P. Eastham. *The spectral theory of periodic differential equations*. Scottish Academic Press Ltd., 1973.
- [Pen74] R. Penrose. “The role of aesthetics in pure and applied mathematical research”. In: *Bulletin of the Institute of Mathematics and Its Applications* 10 (1974), pp. 266–271.
- [Agm75] S. Agmon. “Spectral properties of Schrödinger operators and scattering theory”. In: *Annali della Scuola Normale Superiore di Pisa-Classe di Scienze* 2.2 (1975), pp. 151–218.
- [BLP78] A. Bensoussan, J.-L. Lions, and G. Papanicolaou. *Asymptotic analysis for periodic structures*. Vol. 374. North-Holland Publishing Company, 1978. Rpt. as *Asymptotic analysis for periodic structures*. Vol. 374. American Mathematical Soc., 2011.
- [MBR78] R. Michael, S. Barry, and M. Reed. *Methods of modern mathematical physics. IV, Analysis of operators*. eng. New York San Francisco London: Academic Press, 1978.
- [Pea78] D. B. Pearson. “Singular continuous measures in scattering theory”. In: (1978).
- [RS78] M. Reed and B. Simon. *IV: Analysis of Operators*. Vol. 4. Elsevier, 1978.
- [Bea79] A. F. Beardon. *Complex analysis: The argument principle in analysis and topology*. Wiley, 1979.
- [Chr79] R. M. Christensen. “Mechanics of composite materials”. In: (Jan. 1979). URL: <https://www.osti.gov/biblio/5134072>.
- [HW79] G. H. Hardy and E. M. Wright. *An introduction to the theory of numbers*. Oxford university press, 1979.
- [Pap79] G. C. Papanicolaou. “Boundary value problems with rapidly oscillating random coefficients”. In: *Colloquia Math. Soc., Janos Bolyai*. Vol. 27. 1979, pp. 853–873.
- [Pen79] R. Penrose. “Pentaplexity a class of non-periodic tilings of the plane”. In: *The mathematical intelligencer* 2 (1979), pp. 32–37.

- [Pas80] L. A. Pastur. “Spectral properties of disordered systems in the one-body approximation”. In: *Communications in mathematical physics* 75.2 (1980), pp. 179–196.
- [De 81] N. G. De Bruijn. “Algebraic theory of Penrose’s non-periodic tilings of the plane. I, II: dedicated to G. Pólya”. In: *Indagationes mathematicae* 43.1 (1981), pp. 39–66.
- [Mos81] J. Moser. “An example of a Schrödinger equation with almost periodic potential and nowhere dense spectrum”. In: *Commentarii Mathematici Helvetici* 56.1 (1981), pp. 198–224.
- [Mou81] E. Mourre. “Absence of singular continuous spectrum for certain self-adjoint operators”. In: *Comm. Math. Phys* 78.3 (1981), pp. 391–408.
- [LZ82] B. M. Levitan and V. V. Zhikov. *Almost periodic functions and differential equations*. 1982.
- [Mac82] A. L. Mackay. “Crystallography and the Penrose pattern”. In: *Physica A: Statistical Mechanics and its Applications* 114.1-3 (1982), pp. 609–613.
- [OZ82] O. Oleinik and V. Zhikov. “On the homogenization of elliptic operators with almost-periodic coefficients”. In: *Rendiconti del Seminario Matematico e Fisico di Milano* 52.1 (1982), pp. 149–166.
- [Sim82] B. Simon. “Almost periodic Schrödinger operators: a review”. In: *Advances in Applied Mathematics* 3.4 (1982), pp. 463–490.
- [KN84] P. Kramer and R. Neri. “On periodic and non-periodic space fillings of  $E_m$  obtained by projection”. In: *Acta Crystallographica Section A: Foundations of Crystallography* 40.5 (1984), pp. 580–587.
- [LS84] D. Levine and P. J. Steinhardt. “Quasicrystals: a new class of ordered structures”. In: *Physical review letters* 53.26 (1984), p. 2477.
- [She+84] D. Shechtman, I. Blech, D. Gratias, and J. W. Cahn. “Metallic phase with long-range orientational order and no translational symmetry”. In: *Physical review letters* 53.20 (1984), p. 1951.
- [DK85] M. Duneau and A. Katz. “Quasiperiodic patterns”. In: *Physical review letters* 54.25 (1985), p. 2688.
- [KKL85] P. Kalugin, A. I. Kitaev, and L. Levitov. “Al 0.86 Mn 0.14: a six-dimensional crystal”. In: *ZhETF Pisma Redaktsiiu* 41 (1985), pp. 119–121.
- [Eid86] D. Eidus. “The limiting absorption and amplitude principles for the diffraction problem with two unbounded media”. In: *Communications in mathematical physics* 107.1 (1986), pp. 29–38.
- [Els86] V. Elser. “The diffraction pattern of projected structures”. In: *Acta Crystallographica Section A: Foundations of Crystallography* 42.1 (1986), pp. 36–43.
- [BB87] J. M. Borwein and P. B. Borwein. *Pi and the AGM: a study in the analytic number theory and computational complexity*. Wiley-Interscience, 1987.
- [MW88] K. Morgenröther and P. Werner. “On the principles of limiting absorption and limit amplitude for a class of locally perturbed waveguides. Part 1: Time-independent theory”. In: *Mathematical methods in the applied sciences* 10.2 (1988), pp. 125–144.
- [KMK89] R. Kress, V. Maz’ya, and V. Kozlov. *Linear integral equations*. Vol. 82. Springer, 1989.
- [Ngu89] G. Nguetseng. “A general convergence result for a functional related to the theory of homogenization”. In: *SIAM Journal on Mathematical Analysis* 20.3 (1989), pp. 608–623.



- [Gér90] C. Gérard. “Resonance theory for periodic Schrödinger operators”. In: *Bulletin de la Société mathématique de France* 118.1 (1990), pp. 27–54.
- [Wed90] R. Weder. *Spectral and scattering theory for wave propagation in perturbed stratified media*. Vol. 87. Springer Science & Business Media, 1990.
- [Abo91] J. Aboundi. “Mechanics of composite materials: Unified micromechanical approach”. In: (Dec. 1991). URL: <https://www.osti.gov/biblio/226944>.
- [Amo91] M. Amou. “Approximation to certain transcendental decimal fractions by algebraic numbers”. In: *Journal of Number Theory* 37.2 (1991), pp. 231–241.
- [Rud91] W. Rudin. *Functional Analysis*. International series in pure and applied mathematics. McGraw-Hill, 1991.
- [All92] G. Allaire. “Homogenization and two-scale convergence”. In: *SIAM Journal on Mathematical Analysis* 23.6 (1992), pp. 1482–1518.
- [Eli92] L.-H. Eliasson. “Floquet solutions for the 1-dimensional quasi-periodic Schrödinger equation”. In: *Communications in mathematical physics* 146 (1992), pp. 447–482.
- [Jol92] P. Joly. “Some trace theorems in anisotropic Sobolev spaces”. In: *SIAM journal on mathematical analysis* 23.3 (1992), pp. 799–819.
- [PF92] L. A. Pastur and A. Figotin. *Spectra of random and almost-periodic operators*. Vol. 297. Springer, 1992.
- [RZ92] G. Roach and B. Zhang. “The limiting-amplitude principle for the wave propagation problem with two unbounded media”. In: *Mathematical Proceedings of the Cambridge Philosophical Society*. Vol. 112. 1. Cambridge University Press. 1992, pp. 207–223.
- [Kuc93] P. A. Kuchment. *Floquet theory for partial differential equations*. Vol. 60. Springer Science & Business Media, 1993.
- [Riv93] N. Rivier. “Non-stick quasicrystalline coatings”. In: *Journal of non-crystalline solids* 153 (1993), pp. 458–462.
- [DMS94] R. Del Rio, N. Makarov, and B. Simon. “Operators with singular continuous spectrum: II. Rank one operators”. In: *Communications in Mathematical Physics* 165.1 (1994), pp. 59–67.
- [JS94] S. Jitomirskaya and B. Simon. “Operators with singular continuous spectrum: III. Almost periodic Schrödinger operators”. In: *Communications in Mathematical Physics* 165.1 (1994), pp. 201–205.
- [DS95] S. Dworkin and J.-I. Shieh. “Deceptions in quasicrystal growth”. In: *Communications in mathematical physics* 168 (1995), pp. 337–352.
- [IB95] F. Ihlenburg and I. Babuška. “Finite element solution of the Helmholtz equation with high wave number Part I: The h-version of the FEM”. In: *Computers & Mathematics with Applications* 30.9 (1995), pp. 9–37.
- [Joa+95] J. D. Joannopoulos, S. G. Johnson, J. N. Winn, and R. D. Meade. “Photonic Crystals: Molding the Flow of Light”. In: 1995. URL: <https://api.semanticscholar.org/CorpusID:117130101>.
- [Mey95] Y. Meyer. “Quasicrystals, Diophantine approximation and algebraic numbers”. In: *Beyond Quasicrystals: Les Houches, March 7–18, 1994*. Springer. 1995, pp. 3–16.

- [Sim95] B. Simon. “Operators with singular continuous spectrum: I. General operators”. In: *Annals of Mathematics* 141.1 (1995), pp. 131–145.
- [Del+96] R. Del Rio, S. Jitomirskaya, Y. Last, and B. Simon. “Operators with singular continuous spectrum, IV. Hausdorff dimensions, rank one perturbations, and localization”. In: *Journal d’Analyse Mathématique* 69.1 (1996), pp. 153–200.
- [SS96] B. Simon and G. Stolz. “Operators with singular continuous spectrum, V. Sparse potentials”. In: *Proceedings of the American Mathematical Society* 124.7 (1996), pp. 2073–2080.
- [Wil+96] D. B. Williams, C. B. Carter, D. B. Williams, and C. B. Carter. *The transmission electron microscope*. Springer, 1996.
- [FG97] A. Figotin and Y. A. Godin. “The computation of spectra of some 2D photonic crystals”. In: *Journal of computational physics* 136.2 (1997), pp. 585–598.
- [FK97] A. Figotin and A. Klein. “Localized classical waves created by defects”. In: *Journal of statistical physics* 86 (1997), pp. 165–177.
- [MV97] S. Moskow and M. Vogelius. “First-order corrections to the homogenised eigenvalues of a periodic composite medium. A convergence proof”. In: *Proceedings of the Royal Society of Edinburgh Section A: Mathematics* 127.6 (1997), pp. 1263–1299.
- [FG98] A. Figotin and V. Gorenstveig. “Localized electromagnetic waves in a layered periodic dielectric medium with a defect”. In: *Physical Review B* 58.1 (1998), p. 180.
- [JD98] C. Janot and J.-M. Dubois. *Les quasicristaux. Matière à paradoxes*. EDP Sciences, 1998.
- [KF98] A. Klein and A. Figotin. “Midgap defect modes in dielectric and acoustic media”. In: *SIAM Journal on Applied Mathematics* 58.6 (1998), pp. 1748–1773.
- [Mik+98] R. Mikulla, J. Stadler, F. Krul, H.-R. Trebin, and P. Gumbsch. “Crack propagation in quasicrystals”. In: *Physical Review Letters* 81.15 (1998), p. 3163.
- [AA99] G. Allaire and M. Amar. “Boundary layer tails in periodic homogenization”. In: *ESAIM: Control, Optimisation and Calculus of Variations* 4 (1999), pp. 209–243.
- [Fis+99] I. R. Fisher, K. O. Cheon, A. F. Panchula, P. C. Canfield, M. Chernikov, H. R. Ott, et al. “Magnetic and transport properties of single-grain  $R - \text{Mg} - \text{Zn}$  icosahedral quasicrystals [ $R = \text{Y}, (\text{Y}_{1-x}\text{Gd}_x), (\text{Y}_{1-x}\text{Tb}_x), \text{Tb}, \text{Dy}, \text{Ho}, \text{and Er}$ ]”. In: *Phys. Rev. B* 59 (1 Jan. 1999), pp. 308–321. URL: <https://link.aps.org/doi/10.1103/PhysRevB.59.308>.
- [McL00] W. C. H. McLean. *Strongly elliptic systems and boundary integral equations*. Cambridge university press, 2000.
- [Moo00] R. V. Moody. “Model sets: A survey”. In: *From Quasicrystals to More Complex Systems: Les Houches School, February 23–March 6, 1998*. Springer. 2000, pp. 145–166.
- [ABB01] H. Ammari, N. Béréux, and E. Bonnetier. “Analysis of the radiation properties of a planar antenna on a photonic crystal substrate”. In: *Mathematical methods in the applied sciences* 24.13 (2001), pp. 1021–1042.
- [Kuc01] P. Kuchment. “The mathematics of photonic crystals”. In: *Mathematical modeling in optical science*. SIAM, 2001. Chap. 7, pp. 207–272.
- [TM01] F. Tisseur and K. Meerbergen. “The quadratic eigenvalue problem”. In: *SIAM review* 43.2 (2001), pp. 235–286.

- [FK02] A. Fedotov and F. Klopp. “Anderson transitions for a family of almost periodic Schrödinger equations in the adiabatic case”. In: *Communications in Mathematical Physics* 227 (2002), pp. 1–92.
- [AC03] E. L. Albuquerque and M. G. Cottam. “Theory of elementary excitations in quasiperiodic structures”. In: *Physics reports* 376.4-5 (2003), pp. 225–337.
- [HMM04] A. Hilliges, C. Mehl, and V. Mehrmann. “On the solution of palindromic eigenvalue problems”. In: *Proceedings of the 4th European Congress on Computational Methods in Applied Sciences and Engineering (ECCOMAS), Jyväskylä, Finland*. 2004, p. 108.
- [Kuc04] P. Kuchment. “On some spectral problems of mathematical physics”. In: *Partial differential equations and inverse problems* 362 (2004), pp. 241–276.
- [Sak04] K. Sakoda. *Optical properties of photonic crystals*. Vol. 80. Springer Science & Business Media, 2004.
- [SA04] F. Santosa and H. Ammari. “Guided waves in a photonic bandgap structure with a line defect”. In: *SIAM Journal on Applied Mathematics* 64.6 (2004), pp. 2018–2033.
- [Dub05] J.-M. Dubois. *Useful quasicrystals*. World Scientific, 2005.
- [Niv05] I. Niven. *Irrational numbers*. 11. Cambridge University Press, 2005.
- [Fin06] A. M. Fink. *Almost periodic differential equations*. Vol. 377. Springer, 2006.
- [JLF06] P. Joly, J.-R. Li, and S. Fliss. “Exact boundary conditions for periodic waveguides containing a local perturbation”. In: *Commun. Comput. Phys* 1.6 (2006), pp. 945–973.
- [Mac+06] D. S. Mackey, N. Mackey, C. Mehl, and V. Mehrmann. “Structured polynomial eigenvalue problems: Good vibrations from good linearizations”. In: *SIAM Journal on Matrix Analysis and Applications* 28.4 (2006), pp. 1029–1051.
- [Mey06] Y. Meyer. *Nombres de Pisot, nombres de Salem et analyse harmonique: cours Peccot donné au Collège de France en avril-mai 1969*. Vol. 117. Springer, 2006.
- [MT06] M. Murata and T. Tsuchida. “Asymptotics of Green functions and the limiting absorption principle for elliptic operators with periodic coefficients”. In: *Journal of Mathematics of Kyoto University* 46.4 (2006), pp. 713–754.
- [Sen06] M. Senechal. “What is a quasicrystal”. In: *Notices of the AMS* 53.8 (2006), pp. 886–887.
- [YL06] L. Yuan and Y. Y. Lu. “An efficient bidirectional propagation method based on Dirichlet-to-Neumann maps”. In: *IEEE Photonics Technology Letters* 18.18 (2006), pp. 1967–1969.
- [Ghy07] É. Ghys. “Resonances and small divisors”. In: *Kolmogorov’s heritage in mathematics*. Springer, 2007, pp. 187–213.
- [HL07] C. Hazard and F. Loret. “Generalized eigenfunction expansions for conservative scattering problems with an application to water waves”. In: *Proceedings of the Royal Society of Edinburgh Section A: Mathematics* 137.5 (2007), pp. 995–1035.
- [Las07] Y. Last. “Exotic Spectra: A Review of Barry Simon’s”. In: *Spectral Theory and Mathematical Physics: A Festschrift in Honor of Barry Simon’s 60th Birthday* 76 (2007), p. 697.
- [SS07] W. Steurer and D. Sutter-Widmer. “Photonic and phononic quasicrystals”. In: *Journal of Physics D: Applied Physics* 40.13 (2007), R229.
- [YL07] L. Yuan and Y. Y. Lu. “A recursive-doubling Dirichlet-to-Neumann-map method for periodic waveguides”. In: *Journal of Lightwave Technology* 25.11 (2007), pp. 3649–3656.

- [Bug08] Y. Bugeaud. “Diophantine approximation and Cantor sets”. In: *Mathematische Annalen* 341.3 (2008), pp. 677–684.
- [EHZ08] M. Ehrhardt, H. Han, and C. Zheng. *Numerical simulation of waves in periodic structures*. WIAS, 2008.
- [EZ08] M. Ehrhardt and C. Zheng. “Exact artificial boundary conditions for problems with periodic structures”. In: *Journal of Computational Physics* 227.14 (2008), pp. 6877–6894.
- [YLA08] J. Yuan, Y. Y. Lu, and X. Antoine. “Modeling photonic crystals by boundary integral equations and Dirichlet-to-Neumann maps”. In: *Journal of Computational Physics* 227.9 (2008), pp. 4617–4629.
- [Fli09] S. Fliss. “Analyse mathématique et numérique de problèmes de propagation des ondes dans des milieux périodiques infinis localement perturbés”. Theses. Ecole Polytechnique X, May 2009. URL: <https://pastel.archives-ouvertes.fr/pastel-00005464>.
- [FJ09] S. Fliss and P. Joly. “Exact boundary conditions for time-harmonic wave propagation in locally perturbed periodic media”. In: *Applied Numerical Mathematics* 59.9 (2009), pp. 2155–2178.
- [BGZ10] G. Bouchitté, S. Guenneau, and F. Zolla. “Homogenization of dielectric photonic quasi crystals”. In: *Multiscale Modeling & Simulation* 8.5 (2010), pp. 1862–1881.
- [FCB10] S. Fliss, E. Cassan, and D. Bernier. “Computation of light refraction at the surface of a photonic crystal using DtN approach”. In: *Journal of the Optical Society of America B* 27.7 (2010), pp. 1492–1503.
- [Mat10] Materialschemist. *Electron diffraction pattern of an icosahedral Ho–Mg–Zn quasicrystal*. <https://commons.wikimedia.org/w/index.php?curid=10094837>. [CC BY-SA 3.0]. 2010.
- [Moo10] J. E. Moore. “The birth of topological insulators”. In: *Nature* 464.7286 (2010), pp. 194–198.
- [PI10] A. Poddubny and E. Ivchenko. “Photonic quasicrystalline and aperiodic structures”. In: *Physica E: Low-dimensional Systems and Nanostructures* 42.7 (2010), pp. 1871–1895.
- [Bre11] H. Brezis. *Functional Analysis, Sobolev Spaces and Partial Differential Equations*. en. New York, NY: Springer, 2011. URL: <https://link.springer.com/10.1007/978-0-387-70914-7>.
- [GM11] D. Gérard-Varet and N. Masmoudi. “Homogenization in polygonal domains”. In: *Journal of the European Mathematical society* 13.5 (2011), pp. 1477–1503.
- [GL11] J.-M. Ginoux and C. Letellier. “Des mouvements récurrents de Birkhoff aux régimes quasi-périodiques”. In: *Résumés des exposés de la 14e Rencontre du Non-Linéaire Paris 2011* (2011), p. 59.
- [Hoa11] V. Hoang. “The limiting absorption principle for a periodic semi-infinite waveguide”. In: *SIAM Journal on Applied Mathematics* 71.3 (2011), pp. 791–810.
- [LE11] P. Lannin and V. Ek. “Ridiculed crystal work wins Nobel for Israeli”. In: *Reuters* (Oct. 5, 2011). URL: <https://www.reuters.com/article/nobel-chemistry-idUSL5E7L51U620111005> (visited on 10/05/2011).
- [Ant12] A. Antonevich. *Linear functional equations. Operator approach*. Vol. 83. Birkhäuser, 2012.

- [BP12] N. S. Bakhvalov and G. Panasenko. *Homogenisation: averaging processes in periodic media: mathematical problems in the mechanics of composite materials*. Vol. 36. Springer Science & Business Media, 2012.
- [Bin+12] L. Bindi, J. M. Eiler, Y. Guan, L. S. Hollister, G. MacPherson, P. J. Steinhardt, et al. “Evidence for the extraterrestrial origin of a natural quasicrystal”. In: *Proceedings of the National Academy of Sciences* 109.5 (2012), pp. 1396–1401.
- [Bug12] Y. Bugeaud. *Distribution modulo one and Diophantine approximation*. Vol. 193. Cambridge University Press, 2012.
- [Coa12] J. Coatléven. “Helmholtz equation in periodic media with a line defect”. In: *Journal of Computational Physics* 231.4 (2012), pp. 1675–1704.
- [Dub12] J.-M. Dubois. “Properties and applications of quasicrystals and complex metallic alloys”. In: *Chemical Society Reviews* 41.20 (2012), pp. 6760–6777.
- [FJ12] S. Fliss and P. Joly. “Wave propagation in locally perturbed periodic media (case with absorption): Numerical aspects”. In: *Journal of Computational Physics* 231.4 (2012), pp. 1244–1271.
- [GM12] D. Gérard-Varet and N. Masmoudi. “Homogenization and boundary layers”. In: *Acta mathematica* 209.1 (2012), pp. 133–178.
- [JKO12] V. V. Jikov, S. M. Kozlov, and O. A. Oleinik. *Homogenization of differential operators and integral functionals*. Springer Science & Business Media, 2012.
- [KN12] L. Kuipers and H. Niederreiter. *Uniform Distribution of Sequences*. Dover Books on Mathematics. Dover Publications, 2012.
- [Sim12] Simon.white.1000. *This is a photo of a small piece of laminated uni-directional Carbon Fibre*. <https://commons.wikimedia.org/w/index.php?curid=19526520>. [CC BY-SA 3.0]. 2012.
- [Arn13] V. I. Arnol’d. *Mathematical methods of classical mechanics*. Vol. 60. Springer Science & Business Media, 2013.
- [Bes+13] C. Besse, J. Coatleven, S. Fliss, I. Lacroix-Violet, and K. Ramdani. “Transparent boundary conditions for locally perturbed infinite hexagonal periodic media.” In: *Communications in Mathematical Sciences* 11.4 (2013), pp. 907–938. URL: <https://hal.archives-ouvertes.fr/hal-00698916>.
- [Fli13] S. Fliss. “A Dirichlet-to-Neumann approach for the exact computation of guided modes in photonic crystal waveguides”. In: *SIAM Journal on Scientific Computing* 35.2 (2013), B438–B461.
- [Kat13] T. Kato. *Perturbation theory for linear operators*. Vol. 132. Springer Science & Business Media, 2013.
- [VNA13] Z. V. Vardeny, A. Nahata, and A. Agrawal. “Optics of photonic quasicrystals”. In: *Nature photonics* 7.3 (2013), pp. 177–187.
- [HY14] M. Hussain and T. Yusupova. “A note on the weighted Khintchine-Groshev Theorem”. In: *Journal de théorie des nombres de Bordeaux* 26.2 (2014), pp. 385–397.
- [Naz14] S. A. Nazarov. “Umov-Mandelshtam radiation conditions in elastic periodic waveguides”. In: *Sbornik: Mathematics* 205.7 (2014), p. 953.

- [TW14] L. N. Trefethen and J. Weideman. “The exponentially convergent trapezoidal rule”. In: *SIAM review* 56.3 (2014), pp. 385–458.
- [BLL15] X. Blanc, C. Le Bris, and P.-L. Lions. “Local profiles for elliptic problems at different scales: defects in, and interfaces between periodic structures”. In: *Communications in Partial Differential Equations* 40.12 (2015), pp. 2173–2236.
- [Rad15] M. Radosz. “New limiting absorption and limit amplitude principles for periodic operators”. In: *Zeitschrift für angewandte Mathematik und Physik* 66.2 (2015), pp. 253–275.
- [FJ16] S. Fliss and P. Joly. “Solutions of the time-harmonic wave equation in periodic waveguides: asymptotic behaviour and radiation condition”. In: *Archive for Rational Mechanics and Analysis* 219 (2016), pp. 349–386.
- [Zou+16] Y. Zou, P. Kuczera, A. Sologubenko, T. Sumigawa, T. Kitamura, W. Steurer, et al. “Superior room-temperature ductility of typically brittle quasicrystals at small sizes”. In: *Nature communications* 7.1 (2016), p. 12261.
- [Del+17] B. Delourme, S. Fliss, P. Joly, and E. Vasilevskaya. “Trapped modes in thin and infinite ladder like domains. Part 1: existence results”. In: *Asymptotic analysis* 103.3 (2017), pp. 103–134.
- [KC17] R. N. Kamaliev and R. V. Charkviani. “Creation of ultra-light spacecraft constructions made of composite materials”. In: *Procedia engineering* 185 (2017), pp. 190–197.
- [KL18a] A. Kirsch and A. Lechleiter. “A radiation condition arising from the limiting absorption principle for a closed full-or half-waveguide problem”. In: *Mathematical Methods in the Applied Sciences* 41.10 (2018), pp. 3955–3975.
- [KL18b] A. Kirsch and A. Lechleiter. “The limiting absorption principle and a radiation condition for the scattering by a periodic layer”. In: *SIAM Journal on Mathematical Analysis* 50.3 (2018), pp. 2536–2565.
- [Jec19] T. Jecko. “On Schrödinger and Dirac Operators with an Oscillating Potential”. In: *arXiv preprint arXiv:1905.07156* (2019).
- [Jos19] M. Josien. “Some quantitative homogenization results in a simple case of interface”. In: *Communications in Partial Differential Equations* 44.10 (2019), pp. 907–939.
- [Man19] R. Mandel. “The limiting absorption principle for periodic differential operators and applications to nonlinear Helmholtz equations”. In: *Communications in Mathematical Physics* 368.2 (2019), pp. 799–842.
- [Sch19] B. Schweizer. “Existence results for the Helmholtz equation in periodic wave-guides with energy methods”. In: (2019).
- [WGC19] N. Wellander, S. Guenneau, and E. Cherkaev. “Homogenization of quasiperiodic structures and two-scale cut-and-projection convergence”. In: *arXiv:1911.03560* (2019).
- [FG20] S. Fliss and L. Giovangigli. “Time harmonic wave propagation in one dimensional weakly randomly perturbed periodic media”. In: *SN Partial Differential Equations and Applications* 1 (2020), pp. 1–36.
- [Ben21] C. Beneteau. “Modeles homogénéisés enrichis en présence de bords: Analyse et traitement numérique”. PhD thesis. Institut polytechnique de Paris, 2021.
- [BK21] K. Bjerklöv and R. Krikorian. “Coexistence of absolutely continuous and pure point spectrum for kicked quasiperiodic potentials”. In: *Journal of Spectral Theory* 11.3 (2021), pp. 1215–1254.

- [FJL21] S. Fliss, P. Joly, and V. Lescarret. “A Dirichlet-to-Neumann approach to the mathematical and numerical analysis in waveguides with periodic outlets at infinity”. In: *Pure and Applied Analysis* 3.3 (2021), pp. 487–526.
- [Zha21] R. Zhang. “Numerical methods for scattering problems in periodic waveguides”. In: *Numerische Mathematik* 148.4 (2021), pp. 959–996.
- [FFW22] C. L. Fefferman, S. Fliss, and M. I. Weinstein. “Discrete honeycombs, rational edges and edge states”. In: *arXiv preprint arXiv:2203.03775* (2022).
- [Kir22] A. Kirsch. “A scattering problem for a local perturbation of an open periodic waveguide”. In: *Mathematical Methods in the Applied Sciences* (2022).
- [Mil22] G. W. Milton. *The theory of composites*. SIAM, 2022.
- [DM23] B. Davies and L. Morini. “Super band gaps and periodic approximants of generalised Fibonacci tilings”. In: *arXiv preprint arXiv:2302.10063* (2023).
- [DF23] B. Delourme and S. Fliss. “Guided modes in a hexagonal periodic graph like domain”. In: *arXiv preprint arXiv:2309.02023* (2023).
- [Duc+23] I. Duchemin, L. Genovese, E. Letournel, A. Levitt, and S. Ruget. “Efficient extraction of resonant states in systems with defects”. In: *Journal of Computational Physics* 477 (2023), p. 111928.





**Titre :** Propagation des ondes dans des milieux quasi-périodiques

**Mots clés :** Milieux quasi-périodiques, Equation des ondes harmoniques, Conditions aux limites transparentes

**Résumé :** L'objectif de la thèse est de développer des méthodes numériques originales pour la résolution de l'équation des ondes en régime harmonique dans des milieux quasi-périodiques localement perturbés, dans l'esprit des méthodes développées précédemment pour des milieux périodiques. L'idée est d'utiliser comme dans des travaux d'homogénéisation quasi-périodique le fait que l'étude d'une EDP elliptique avec des coefficients quasi-périodiques peut être ramenée à l'étude d'une EDP elliptiquement dégénérée en dimension supérieure, mais dont les coefficients

sont périodiques. Le caractère périodique permet d'utiliser des outils adaptés, mais le caractère non-elliptique rend toutefois l'analyse mathématique et numérique de l'EDP délicate. Une des applications étudiées dans ce manuscrit concerne des problèmes de transmission entre des demi-plans périodiques (typiquement des cristaux photoniques) quand (1) l'interface ne coupe pas les demi-plans périodiques dans une direction de périodicité, ou (2) quand les milieux périodiques n'ont pas des périodes commensurables le long de l'interface.

**Title :** Wave propagation in quasiperiodic media

**Keywords :** Quasiperiodic media, Time-harmonic Wave propagation, Transparent boundary conditions

**Abstract :** The goal of this thesis is to develop efficient numerical methods for the solution of the time-harmonic wave equation in locally perturbed quasiperiodic media, in the spirit of methods previously developed for periodic media. The goal is to use as in quasiperiodic homogenization the idea that an elliptic PDE with quasiperiodic coefficients can be interpreted as the cut of a higher-dimensional PDE which is elliptically degenerate, but with periodic coefficients. The periodicity pro-

perty allows to use adapted tools, but the non-elliptic aspect makes the mathematical and numerical analysis of the PDE delicate. One application concerns transmission problems between periodic half-spaces (typically photonic crystals) when (1) the interface does not cut the periodic half-spaces in a direction of periodicity, or (2) when the periodic media have noncommensurate periods along the interface.