



HAL
open science

Physiological consequences of respiratory system limitation in the master athlete, approaches through experiments and models

Valentin Mons

► **To cite this version:**

Valentin Mons. Physiological consequences of respiratory system limitation in the master athlete, approaches through experiments and models. Modeling and Simulation. Université Côte d'Azur, 2023. English. NNT: 2023COAZ4129 . tel-04509140

HAL Id: tel-04509140

<https://theses.hal.science/tel-04509140>

Submitted on 18 Mar 2024

HAL is a multi-disciplinary open access archive for the deposit and dissemination of scientific research documents, whether they are published or not. The documents may come from teaching and research institutions in France or abroad, or from public or private research centers.

L'archive ouverte pluridisciplinaire **HAL**, est destinée au dépôt et à la diffusion de documents scientifiques de niveau recherche, publiés ou non, émanant des établissements d'enseignement et de recherche français ou étrangers, des laboratoires publics ou privés.

$$\rho \left(\frac{\partial v}{\partial t} + v \cdot \nabla v \right) = -\nabla p + \nabla \cdot T + f$$

$$e^{i\pi} + 1 = 0$$

THÈSE DE DOCTORAT

Conséquences physiologiques de la limitation du système respiratoire chez le master athlète, approches par expériences et modèles

Valentin MONS

Laboratoire Jean-Alexandre Dieudonné - LJAD

Laboratoire Motricité Humaine Expertise Sport Santé - LAMHESS

**Présentée en vue de l'obtention
du grade de docteur en mathématiques
d'Université Côte d'Azur**

Dirigée par : Benjamin Mauroy et Grégory
Blain

Soutenu le : 11 décembre 2023

Devant le jury, composé de :

Grégory Blain, Professeur, Université Côte
d'Azur - Directeur

Mathieu Gruet, Professeur, Université de
Toulon - Examineur

Romuald Lepers, Professeur, Université de
Bourgogne – Examineur, Président du jury

Benjamin Mauroy, Directeur de recherche,
Université Côte d'Azur - Directeur

Aurélien Pichon, Professeur, Université de
Poitiers - Rapporteur

Yannick Privat, Professeur, Université de
Lorraine - Examineur

Samuel Vergès, Directeur de recherche
Université Grenoble-Alpes- Rapporteur

Conséquences physiologiques de la limitation du système respiratoire chez le master athlète, approches par expériences et modèles

Jury :

Rapporteurs

Aurélien Pichon, Professeur, Université de Poitiers

Samuel Vergès, Directeur de recherche CNRS, Université de Grenoble-Alpes

Examineurs

Mathieu Gruet, Professeur, Université de Toulon

Romuald Lepers, Professeur, Université de Bourgogne

Yannick Privat, Professeur, Université de Lorraine

Directeurs de thèse

Grégory Blain, Professeur, Université Côte d'Azur

Benjamin Mauroy, Directeur de Recherche CNRS, Université Côte d'Azur

Conséquences physiologiques de la limitation du système respiratoire chez le master athlète, approches par expériences et modèles

Résumé. Le système respiratoire sain est généralement surdimensionné par rapport à la demande imposée lors d'un exercice physique. Toutefois, les poumons s'adaptent peu à l'entraînement en endurance. Lors d'exercices réalisés à haute intensité, le système respiratoire des athlètes pourrait donc ne plus être surdimensionné face à une demande ventilatoire aussi élevée. Cela pourrait être accentué avec les altérations de la structure des poumons et de la fonction des muscles respiratoires liées à l'âge. Les personnes âgées entraînées en endurance, appelées master athlètes (> 60 ans), pourraient donc être particulièrement vulnérables aux limitations respiratoires pendant l'exercice. Cela nous amène à la question centrale : comment le système respiratoire limite-t-il l'exercice chez le master athlète ? Pour y répondre, une approche multidisciplinaire a été mise en œuvre combinant des mesures physiologiques avec une modélisation mathématique.

Nous avons d'abord étudié la limitation de débit expiratoire chez les athlètes jeunes et âgés, hommes et femmes. La limitation de débit expiratoire a été mesurée lors d'un test incrémental sur ergocycle en positionnant la boucle débit volume courant dans la courbe débit volume expiratoire maximale. Nous avons constaté que les master athlètes étaient davantage sujets à la limitation de débit et que cela était associé à la convexité de la courbe débit volume expiratoire maximale. Chez un plus grand groupe de master athlètes hommes, la forme de cette courbe était un indice majeur de la sévérité de la limitation de débit expiratoire. Ces résultats mettent en avant l'importance de prendre en compte le débit expiratoire et les caractéristiques des voies aériennes pour mieux comprendre les contraintes ventilatoires du master athlète.

L'objectif suivant était donc d'étudier les mécanismes physiques sous-jacents. Pour cela, nous avons analysé l'effet de la densité et de la viscosité du gaz avec l'utilisation d'héliox. Des principes de mécanique des fluides et des simulations de débits expiratoires dans un modèle d'arbre bronchique compliant ont été combinés avec des mesures expérimentales. Nos résultats détaillent le pattern du débit à travers les générations bronchiques avec de l'air et de l'héliox et indiquent où les flux laminaires et les turbulences apparaissent. L'héliox augmente le débit expiratoire, surtout quand les effets d'inertie sont dominants, et l'effet de l'héliox pourrait être amplifié chez les master athlètes en raison de leurs bronches âgées et donc plus étroites.

Les contraintes ventilatoires accroissent également la demande sur les muscles respiratoires. Dans une troisième étape, nous avons étudié l'effet du vieillissement sur l'interaction entre la fatigue musculaire respiratoire et locomotrice. Lors d'une tâche inspiratoire fatigante, la pression artérielle moyenne et les résistances vasculaires périphériques des master athlètes ont augmenté davantage

que chez les jeunes athlètes. Durant l'exercice sur ergocycle qui a suivi l'activation musculaire des quadriceps était réduite, entraînant une diminution du temps réalisé par rapport au même exercice effectué sans fatigue inspiratoire préalable. Cette chute de performance était amplifiée chez les master athlètes. Lorsque le même exercice a été effectué à temps égal, mais sans fatigue inspiratoire préalable, moins de fatigue a été observée au niveau des quadriceps, suggérant que la fatigue inspiratoire accélère la fatigue des quadriceps et ce, de manière amplifiée chez les master athlètes. En étudiant les différences liées au sexe entre les athlètes jeunes et master, l'augmentation plus prononcée liée à l'âge de la réponse cardiovasculaire à la fatigue inspiratoire était maintenue.

Pour conclure, les principaux résultats de cette thèse mettent en évidence le rôle crucial du système respiratoire dans la limitation de la performance à l'exercice chez les master athlètes.

Mots clés. Fatigue neuromusculaire, limitation de débit expiratoire, master athlètes, modélisation mathématique, système respiratoire

Physiological consequences of respiratory system limitation in the master athlete, approaches through experiments and models

Abstract. The healthy respiratory system is generally overbuilt for the demand imposed by physical exercise. Yet, lung adaptations to endurance training are limited. Therefore, during high-intensity exercise, the respiratory system of athletes may no longer be overbuilt to meet the unusually high ventilatory demand. This statement may be amplified in the elderly due to age-induced alterations of lungs structure and respiratory muscle function. Older endurance-trained individuals, called master athletes (>60 years old), thus emerge as particularly susceptible to respiratory limitations during exercise. Taken together, it brings us to the central question: how does the respiratory system limits exercise in master athletes? To answer this question, a multidisciplinary approach was implemented combining physiological measurements with mathematical modeling.

We first examined the phenomenon of expiratory flow limitation among young and master female and male athletes. Airflow limitation was measured during a graded cycling test to exhaustion by positioning the averaged tidal flow volume loop within the maximal expiratory flow volume curve. We mainly found that master athletes were more likely to experience flow limitation and that it was associated with maximal expiratory flow volume curvilinearity. For a larger group of male master athletes, the shape of this curve was a major index of the severity of expiratory flow limitation. These results highlight the importance of examining expiratory flow pattern and airway characteristics to understand ventilatory constraints in master athletes.

Therefore, in a second time, our aim was to investigate the physical mechanisms underlying expiratory flow in the lungs. We analyzed the effect of gas density and viscosity through heliox breathing in aging airways. Principles from fluid mechanics and simulations of expiratory flow in a compliant airway tree model were combined with experimental measurements. Our findings depicted flow pattern across airway generations with both air and heliox and provided insight of where laminarity and turbulences should be found. Heliox increases expiratory flow especially in branches where inertial effects are dominant and its effect may be enhanced in the master athletes because of their age-induced smaller airways.

Expiratory flow constraints in the lungs increases the demand upon respiratory muscles. Consequently, in a third step we aimed at evaluating the influence of aging on the interplay between respiratory and locomotor muscle fatigue. During a fatiguing inspiratory loaded task, male master athletes exhibited a greater elevation of mean arterial pressure and limb vascular resistance compared to young athletes. On a subsequent strenuous cycling exercise, the activation of the quadriceps muscle was reduced. It resulted in a decrease in time to exhaustion in comparison to a

cycling exercise performed with no prior induction of inspiratory muscle fatigue. Moreover, the reduction of exercise performance was greater in master athletes. When the cycling exercise was performed for the same duration without prior induction of inspiratory muscle fatigue, we found less neuromuscular fatigue in limb muscles, implying that inspiratory muscle fatigue accelerated limb muscle fatigue to a greater extent in master athletes.

Furthermore, when examining biological sex differences between young and master athletes, the greater age-related elevation of cardiovascular response to inspiratory muscle fatigue, was maintained.

In summary, the main findings of this thesis highlight the pivotal role of the respiratory system in limiting exercise performance in master athletes.

Key words. Expiratory flow limitation, master athletes, mathematical modeling, neuromuscular fatigue, respiratory system

Remerciements

La première fois que j'ai eu connaissance de la possibilité de faire cette thèse sur le système respiratoire du master athlète, j'étais allongé sur le petit lit d'une auberge de jeunesse à Cuzco au Pérou et je visitais les environs pour marquer la fin de mon stage de master réalisé au Chili. Je regardais tant bien que mal mes mails sur mon vieux téléphone incassable et c'est comme cela que j'ai postulé pour ce projet de doctorat qui correspondait parfaitement à mes intérêts de recherche. Quelques semaines plus tard, me voilà arrivé sur la côte d'azur, pour le début d'une thèse qui fut intense et riche en enseignements. Ces quelques années m'ont fait grandir, et m'ont amené à ce moment précis, où j'écris ces quelques lignes pour tenter de remercier à leur juste valeur, les personnes qui ont contribuées de près ou de loin à cette thèse.

Mes premiers remerciements sont pour ceux qui ont le plus largement contribué à la réalisation de ce travail de doctorat : mes directeurs.

J'adresse mes plus sincères remerciements à Grégory Blain pour tout ce qu'il m'a apporté au cours de cette thèse. Son éthique de travail et sa rigueur scientifique m'ont énormément fait grandir et sont de précieux enseignements qui me serviront toute ma carrière. Je me sens extrêmement reconnaissant d'avoir évolué en travaillant aux côtés d'un chercheur aussi enthousiaste, profondément bienveillant, et passionné par la recherche. Cette passion pour la science qui est communicative m'a servi de moteur dans les moments où j'en avais besoin. Je me sens extrêmement reconnaissant d'avoir également travaillé avec Benjamin Mauroy, pour sa grande bienveillance, sa patience, et son accompagnement tout au long de cette thèse, en restant toujours positif même lorsque j'étais des fois un peu perdu. Nos meetings ont toujours été des moments très agréables et constructifs et cela m'a permis de m'ouvrir à un monde que je ne connaissais alors pas vraiment. Ses chaleureux encouragements ont régulièrement fait beaucoup de bien et ont apporté de la sérénité dans mon travail. Quelques lignes ne pourront pas suffire pour tout dire, mais c'est un très sincère et profond sentiment de gratitude que je ressens aujourd'hui à leur égard.

Je souhaite ensuite remercier les membres de mon jury de thèse pour leur temps précieux consacré à l'expertise de mon travail. Je remercie le professeur Aurélien Pichon avec qui j'ai fait mes premiers pas dans la recherche, et le docteur Samuel Vergès d'avoir accepté d'être les rapporteurs de ma thèse. Je remercie également le professeur Mathieu Gruet, le professeur Romuald Lepers et le professeur Yannick Privat d'avoir accepté d'être les examinateurs de ma thèse.

Je souhaite également remercier particulièrement Olivier Meste qui a largement contribué à la bonne réalisation de cette thèse notamment grâce à son aide sur le traitement du signal et l'analyse de données. J'ai énormément apprécié son regard toujours bienveillant, sa pédagogie, et de manière générale nos échanges qui ont été d'une grande aide pour développer des compétences d'analyse qui me serviront longtemps.

Mes remerciements vont également aux membres du LJAD et du LAMHESS qui ont largement contribué à la bonne réalisation de cette thèse. Une pensée spéciale bien évidemment pour Colin, le plus azuréen des Canadiens qui est sûrement la personne avec qui j'ai passé le plus de temps au labo et donc le plus temps tout court. Son soutien pour les expérimentations de jour, et parfois de nuit, ont permis de réaliser toutes mes heures d'expérimentations dans de bonnes conditions. Thanks buddy, you're the man. I hope I will beat you one day on the col d'Eze!

Je souhaite également remercier les autres membres du labo comme Stephen pour ses figures du jardin et les discussions très enrichissantes que nous avons eu et auront encore je l'espère, merci à Clément, mon super voisin de bureau qui est déjà tellement passionné par la recherche et qui arrivera certainement un jour à soulever des objets grâce son signal EEG, merci à Flavio, le plus rayonnant des bretons, pour sa bonne humeur et son soutien précieux pour moi, merci à Aurélia pour toutes ces discussions sur le trail et pour le relais de l'UTCAM qui est un super souvenir, merci à Bapt' pour sa grinta toujours au rendez-vous, merci à François pour sa gentillesse les séances du muscu, merci à Dianita pour son soutien constant, merci à Valérie pour sa bonne humeur sans faille, merci à Meggy sur qui on peut toujours mais alors toujours compter, merci beaucoup à Stéphanie la gestionnaire du labo que je suis venu embêter bien souvent et qui a toujours été d'une grande aide et de bonne humeur. Un merci particulier également à Jonathan pour sa patience et sa bienveillance que j'ai beaucoup apprécié. Merci également à Toni pour toutes ces heures passées à se creuser les méninges sur l'analyse du code et sur tout le reste, nos échanges ont toujours été un vrai plaisir et j'espère que nous aurons encore plein de débats sur la science et sur le reste. Merci également aux autres membres du LJAD et du LAMHESS avec qui j'ai pris beaucoup de plaisir à échanger et à évoluer.

Je souhaite aussi remercier mes participants sans qui je n'aurais pas pu réaliser ce projet de recherche. Leur enthousiasme et leur implication dans les différentes études a très largement contribué à l'accomplissement de cette thèse.

Je souhaite remercier chaleureusement ma famille et mes amis, un grand merci à mon grand frère Mathieu, à ma sœur jumelle Mélanie et un immense merci à mes parents qui m'ont toujours soutenu pour partir à l'autre bout de la Terre ou à l'autre bout de la France même s'ils ne comprennent pas toujours ce que je fais. Un merci spécial également à papi Roger d'avoir été mon inspiration pour MT180. Merci beaucoup à mes amis de longue voire très longue date, merci notamment à Manon, Carine, Maxou et Geoffrey, merci aux BG d'IRHPM et un merci particulier à Angèle doctorante également qui a toujours été très encourageante et dont les appels ont été une bonne source de motivation pour la thèse.

Enfin, et pas des moindres, je souhaite remercier la personne qui m'a vu évoluer tout au long de cette thèse au quotidien, dans les bons et les moins bons moments : merci à Charlotte. Son soutien tout au long de cette thèse a été d'une valeur inestimable. Même si elle aussi ne comprenait pas toujours les jolis graphiques que je traçais sur mon ordi, elle a toujours été là et m'a permis de bien vivre ma thèse et de vivre pleinement tout court.

Liste des publications, communications et prix

Articles

En préparation

- **Mons V**, Stephano J, Haddad T, Meste O, Blain G.M. Mauroy, B. Heliox effect on expiratory flow in master athletes: a comprehensive analysis coupling experimental measures and computational modeling. *In preparation*
- **Mons, V**, Lavigne, C, Meste O, Mauroy, B, Blain, G.M. Effect of respiratory muscle fatigue on locomotor muscles fatigue and exercise performance in young and master athletes. *In preparation*
- **Mons, V**, Lavigne, C, Meste O, Mauroy, B, Blain, G.M. Expiratory flow limitation in young and master athletes men and women. *In preparation*

Accepté

- Haddad T, **Mons V**, Meste O, Dempsey J.A, Abiss C.R, Brisswalter J, Blain G.M. Breathing a low-density gas reduces respiratory muscle effort and improves exercise performance in master athletes. *Accepted Eur J Appl Physiol*

Communications orales

- **Mons, V**, Lavigne, C, Meste O, Mauroy, B, Blain, G.M. Effects of respiratory muscle fatigue on locomotor muscles fatigue and exercise performance in young and master athletes. Oral presentation, *ECSS Congress Paris 2023*
- **Mons V**, Haddad T, Meste O, Mauroy, Blain G.M. Dysanapsis is a determinant of expiratory flow limitation during exercise in master athletes. *Oral presentation, ECSS Congress Sevilla 2022*
- Lavigne C, Lovera M, **Mons V**, Blain G.M. Neuromuscular fatigue is determined by the amount of work performed above the critical power when cycling in the extreme intensity domain. *Oral presentation, ECSS Congress Sevilla 2022*

Prix

- Prix d'excellence académique catégorie "Prix de thèse 2023" de la Fondation Université Côte d'Azur (1000€)
- Ma Thèse en 180 secondes, Côte d'Azur finale, 1st prix du jury (400€). <https://www.youtube.com/watch?v=TUGSOJQZb0Q&t=40s>
- Travel grant école doctoral sciences fondamentales et appliquées (500€)

Table of content

PREFACE	- 19 -
THEORETICAL FRAMEWORK	- 23 -
THE LIMITATION OF EXERCISE CAPACITY IN MASTER ATHLETES	- 25 -
1. Master athletes are exemplars of successful aging.....	- 25 -
2. Mechanisms of exercise performance reduction in master athletes	- 27 -
3. Ventilatory limitation in master athletes	- 29 -
4. Interest & motivations of this thesis	- 30 -
THE VENTILATORY SYSTEM	- 33 -
1. General presentation of the ventilatory system	- 33 -
2. Methods of evaluation of the ventilatory system.....	- 38 -
3. The normal ventilatory system response during exercise.....	- 44 -
4. Expiratory flow limitation during exercise	- 51 -
5. The ventilatory limitation of performance / exercise capacity in the master athlete.....	- 58 -
EXERCISE INDUCED NEUROMUSCULAR FATIGUE	- 60 -
1. Definition of neuromuscular fatigue	- 60 -
2. Methodology of neuromuscular fatigue.....	- 61 -
3. Mechanisms of neuromuscular fatigue during exercise.....	- 66 -
4. Peripheral and central fatigue interaction: the role of group III-IV muscle afferents...-	- 69 -
5. Influence of intense, short-duration whole-body exercise on neuromuscular fatigue...-	- 74 -
6. The effect of aging on neuromuscular fatigue	- 75 -
7. Respiratory muscle fatigue and metaboreflex	- 76 -
MATHEMATICAL MODELING TO UNDERSTAND PHYSIOLOGICAL LIMITATIONS	- 82 -
1. Model of the human lung.....	- 82 -
2. Expiratory flow in a compliant airway tree.....	- 85 -
SUMMARY & RATIONALE	- 95 -
PERSONAL CONTRIBUTION	- 99 -
STUDY I. EXPIRATORY FLOW LIMITATION DURING EXERCISE IN MALE AND FEMALE, YOUNG AND MASTER ATHLETES	- 103 -

STUDY II. HELIOX EFFECT ON EXPIRATORY FLOW IN MASTER ATHLETES: A COMPREHENSIVE ANALYSIS COUPLING EXPERIMENTAL MEASURES AND COMPUTATIONAL MODELING	134
STUDY III. EFFECTS OF INSPIRATORY MUSCLES FATIGUE ON LOCOMOTOR MUSCLE FATIGUE AND EXERCISE PERFORMANCE IN YOUNG AND MASTER ATHLETES.....	- 168 -
GENERAL DISCUSSION.....	- 205 -
VENTILATORY SYSTEM LIMITATION IN MASTER ATHLETES.....	- 207 -
FUTURE DIRECTIONS	- 215 -
CONCLUSION OF THE THESIS.....	- 217 -
REFERENCES.....	- 217 -

List of tables and figures

Tables

Table 1. Mean values of healthy untrained and trained individuals cardiorespiratory response across work rates.

Table 2. Airway dimensions from (Lambert et al., 1982) across the first 16 generations.

Figures

Figure 1. 10km running time with advancing age.

Figure 2. Comparison of the drop in partial pressure of O₂ in the arterial blood (PaO₂) in young and master athletes.

Figure 3. Summarized scheme of the effects of the ventilatory response to high-intensity, sustained exercise on exercise performance.

Figure 4. Main mechanical components of the ventilatory system.

Figure 5. Representation of the human airways according to Weibel's geometry.

Figure 6. Interplay of the static volume and pressure in the respiratory system in a sitting position.

Figure 7. MEFV curve and spirometry values of a young healthy male.

Figure 8. Interplay of lung volumes and capacities.

Figure 9. Details of the method to determine SR from a MEFV curve.

Figure 10. Ventilatory work and respiratory muscle $\dot{V}O_2$ during exercise of increasing intensity plotted as a function of $\dot{V}E$ for sedentary men, active young females, and trained young and older men.

Figure 11. Typical changes in breathing pattern and operating lung volume during exercise in untrained and trained individuals.

Figure 12. Stylized model of expiratory flow limitation according to "Mead model".

Figure 13. Expiratory flow limitation during exercise in a male master athlete.

Figure 14. Limiting factor to exercise performance in untrained and trained individuals.

Figure 15. Effects of respiratory muscle work during exercise on cardiac output

Figure 16. Evolution of the predicted FEV₁ across age

Figure 17. Taxonomy of fatigue from an integrative perspective.

Figure 18. Characterization of the muscle twitch force in response to a single stimulation.

Figure 19. M-wave of the vastus lateralis in response to a single stimulation.

Figure 20. Sites which can contribute to neuromuscular fatigue.

Figure 21. Effect of group III-IV afferents blockade with fentanyl on muscle activation and power output during a 5km time trial.

Figure 22. Relationship between quadriceps fatigue and intramuscular metabolites after a 5km time trial.

Figure 23. Double-edged sword role of group III-IV muscle afferents in the development of neuromuscular fatigue and exercise performance.

Figure 24. Blood flow competition between locomotor and respiratory muscles.

Figure 25. Sternocleidomastoid (SCM, A), vastus lateralis (VL, B) and vastus medialis (VM, C) blood flow during a high-intensity constant workload exercise with modulated work of breathing (WOB).

Figure 26. Scheme of a cylindrical conduit.

Figure 27. Illustration of Laminar and turbulent flow in a conduit.

Figure 28. Flow regime with various Reynolds numbers in a conduit.

Figure 29. Gas flow through a cylindrical conduit.

Figure 30. Maximal flow-volume loops (solid lines) and exercise tidal flow-volume loops (dashed lines) during 5km time-trial when inhaling room air or Heliox in a representative subject.

PREFACE

Breathe better, perform better? Effortless breathing is a privilege usually taken for granted and most of us generally go about our daily lives without giving it a second thought. But beneath the apparent simplicity, breathing is a complex mechanism and research about the respiratory system is an area where many questions remain unanswered.

The function of the lung has been studied for more than a century thanks to the continuous efforts of a broad community of scientists, with the roots of this research dating back to 1905 with the seminal article by Haldane and J.G. Priestley entitled "The regulation of lung ventilation". Initially, studies related to the respiratory system were primarily the domain of physiologists and physicians. However, because certain events in the lung are not accessible experimentally, and because these events are the results of physical processes, the field has evolved over the decades into a confluence of biological and physical sciences. This shift involved a multidisciplinary approach in which questions related to physiological function were addressed through the lens of the underlying physics. As a result, theoretical models such as mathematical models which consist of a logical series of equations, not only served to make precise assumptions, but also provided a mean to explore the physiological or biological consequences of those assumptions. For example, the lung structure can be mimicked by a series of perfect cylinders. Within this framework, airflow is governed by idealized flow patterns, such as those described by Poiseuille's law. The overall system can thus be described by a set of mathematical equations. By resolving these equations, it is possible to unlock a deeper understanding of internal dynamics, including the variation of pressures across the branches of the respiratory system. On one hand, the experimental approach enables to assess the real response of the lungs, although they often provide a more limited comprehension of the underlying variables. On the other hand, mathematical models offer a complementary perspective by yielding insights into theoretical and sometimes unobservable aspects of the system. Thus, the synergy between mathematical modeling and physiological measurements provides a more complete picture of pulmonary mechanics.

This approach may greatly assist in answering questions related to the limitations of the respiratory system. Debates about the limiting factors of oxygen transport and exercise performance have historically focused solely on cardiovascular responses and muscle metabolism, portraying the respiratory system as overbuilt for the demands placed on it. As research has enriched our understanding of the remarkable precision and capacity of the healthy respiratory system to respond to exercise, a gradual accumulation of evidence simultaneously reported various scenarios in which this system was found underbuilt or associated with excessive biological cost. The

question of whether the healthy respiratory system is optimally built to meet the demands of exercise emerged as a topic of interest a few decades ago, as evidenced by Pr. Jerome Dempsey's review "Wolffe memorial lecture. Is the Lung Built for Exercise?" in 1986 (Dempsey, 1986). This paper provided an expert interpretation of the existing research and identified important unanswered questions that warranted further research. Notably, it was emphasized that the respiratory system remained unmalleable to endurance training. This implies that in situations where endurance trained athletes display very high respiratory demands, the respiratory capacity may no longer be able to accommodate the demands. When this scenario is coupled with the alterations in the respiratory system associated with healthy aging, master athletes emerge as particularly susceptible to respiratory limitation. However, most of the underlying mechanisms contributing to this vulnerability are unknown or unclear, and this topic still suffers from a lack of knowledge.

The purpose of this work is to fill part of this gap and answer questions that would aid better understand the functional consequences of the aging process of the respiratory system during exercise. By studying master athletes, who are exemplars of successful aging, we wanted to investigate how the respiratory system may be a limiting factor to exercise performance. The present work focuses specifically on airflow limitation, and how respiratory muscle function may accelerate the onset of quadriceps muscle fatigue. Overall, evolving from the question "Is the lung built for exercise?", this thesis seeks to answer, at least in parts, the question: "Is the respiratory system sufficiently built for exercise in master athletes?" As we aimed at studying how the limits of the ventilatory system would potentially be reached in this specific population, we also wanted to provide complementary insights into the physical mechanisms underlying the physiological responses we observed. Therefore, a multidisciplinary approach combining physiological measurements with mathematical modeling has been adopted in this thesis.

CHAPTER 1

**THEORETICAL
FRAMEWORK**

THE LIMITATION OF EXERCISE CAPACITY IN MASTER ATHLETES

Over the last century, the combination of the substantial rise in human life expectancy and the increases in global health care, has led to a significant aging of the population. The growing number of older adults has led to an increase in research interests dedicated to understanding and promoting the elements that contribute to the concept of successful aging (Cosco et al., 2017). In this thesis, we will focus on master athletes, and more specifically endurance trained individuals, who represent a model of this successful aging.

1. Master athletes are exemplars of successful aging

Individuals who reach age 60 or older are burdened with increasing levels of chronic disease and functional impairments (Christensen et al., 2009), which are in part explained by age-related physiological declines (López-Otín et al., 2013). The decline in physiological function associated with aging has been found to be largely the result of a prolonged sedentary lifestyle (Maharam et al., 1999). Increased physical fitness is associated with successful aging, and physical exercise appears to be a key strategy for limiting senescence in the general population in several ways (Maharam et al., 1999). The model of successful aging includes longevity, quality of life, life satisfaction and well-being (Havighurst, 1965). Within the older population, master athletes are the most physically active individuals (Trappe et al., 2013). Therefore, this population has been identified as a model of successful aging due to their remarkable athletic performance and physiological abilities (Brisswalter and Nosaka, 2013).

Endurance master athletes typically train and compete in long and short distance running, cycling, and swimming events (Ransdell et al., 2009). For example, among the 32 master athletes ($n = 21$ males, $n = 11$ females) recruited for this PhD thesis, 19 competed in triathlons (from M to XL distance), 10 competed in running events (from 10km to marathon with 1 ultra-endurance athlete), and 3 were trained cyclists.

The study of performance records can be used to examine the functional consequences of physiological aging on performance, without the confounding effects of deconditioning, increased body fat, or clinical disease that may occur in the elderly (Butler-Browne and Bigard, 2006; Lexell et al., 1995.; Porter et al., 1995). Throughout the world, master athletes have demonstrated a

remarkable ability to maintain their exercise performance and mitigate the decline in exercise performance despite the immutable age-related changes in muscle function. For example, using this approach, it has been shown that endurance running performance declines with age following a curvilinear pattern with a modest decline in performance (increased running time) from 35 to 50 years of age and a more pronounced decline thereafter which was more pronounced in women (see Figure 1).

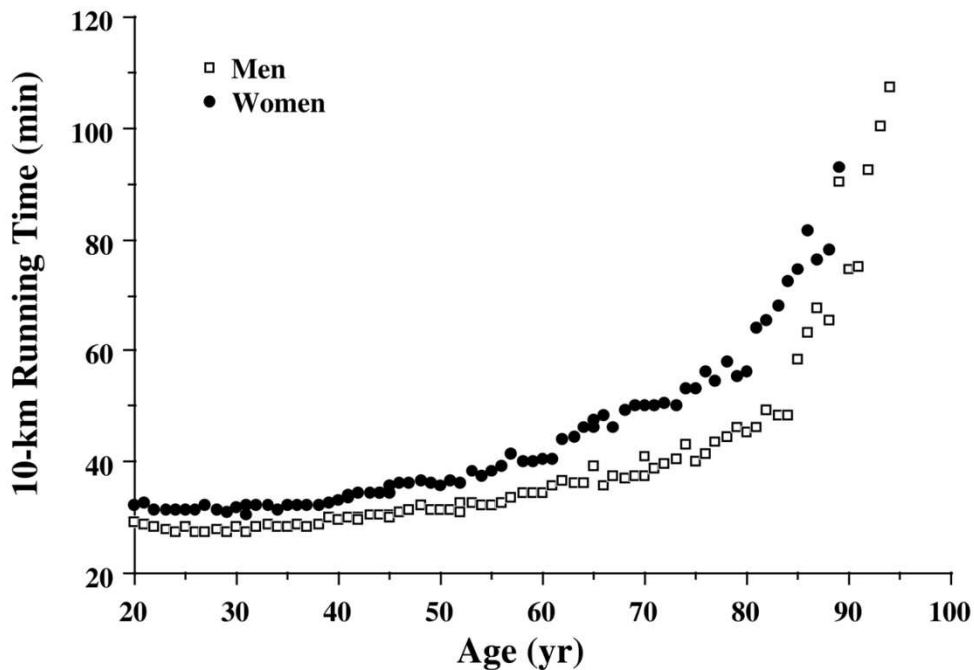

Figure 1. 10km running time with advancing age.

Running time increases exponentially with age and appears to steeply increase from ages 60-70. The discrepancy between male and female runners can be attributed to biological sex differences and selection bias as there are fewer female runners. *Figure from Tanaka and Higushi (1998).*

Considering all these elements, the study of master athletes seems to be particularly useful for the evaluation of the effect of aging on physiological functions. Indeed, research on this specific population makes it possible to isolate the physiological effects of aging without the confounding complications generally associated with aging such as sedentarity, obesity, diabetes, or muscular disorders (Butler-Browne and Bigard, 2006; Lexell et al., 1995.; Porter et al., 1995).

2. Mechanisms of exercise performance reduction in master athletes

Even if master athletes continue to train intensively, endurance performance inevitably declines with age. Endurance performance depends mainly on cardiovascular and metabolic factors such as cardiac output and maximal oxygen consumption ($\dot{V}O_{2\text{ MAX}}$), and muscular factors, such as the muscle fiber characteristics and the ability to generate force (Tanaka and Seals, 2003). Thus, the decline in exercise performance in master athletes can mainly be attributed to the decline in these physiological factors.

On the one hand, $\dot{V}O_{2\text{ MAX}}$ is a primary determinant of endurance performance and has been shown to decline with advancing age. Despite their commitment to endurance training, master athletes are no exception and exhibit even more significant declines in absolute $\dot{V}O_{2\text{ MAX}}$ compared to healthy, untrained counterparts (Pimentel et al., 2003). This decline could be attributed to the higher baseline fitness level of athletes (Wilson and Tanaka, 2000), an age-related decline in the training load or a greater increase in body weight with age (Tanaka and Seals, 2003). Based on the Fick equation, the decline in $\dot{V}O_{2\text{ MAX}}$ with advancing age could be caused by a reduction in maximal heart rate, maximal stroke volume, and/or maximal arteriovenous O_2 difference (A-v O_2) (Rowell et al., 1986). Age-related differences in maximal A-v O_2 and maximal heart rate have been shown to be similar in an endurance-trained group when compared with a sedentary group (Ogawa et al., 1992). Consequently, the greater absolute decline in $\dot{V}O_{2\text{ MAX}}$ in master athlete can be attributed to the larger decline in maximal stroke volume and, thus in maximal cardiac output (Tanaka and Seals, 2003).

On the other hand, the reduction in exercise performance may also be associated with the decline in locomotor muscle function (i.e., the capacity to generate force). Studies related to the decline in the muscle function of master athletes reported a 15-35% reduction in maximal voluntary force production capacity after the age of 60, with women experiencing a more significant decrease than men (Coggan et al., 1990; Macaluso and De Vito, 2004; Porter et al., 1995). More precisely, there is a slight decline of 5% in force production per decade beginning at age 40, followed by a steeper decline beginning at age 65 (Tzankoff and Norris, 1977). This age-related decrease in force production may occur due to changes both in the structure and function of the muscle.

First, from a structural perspective, the decline in muscle mass due to aging is a major factor in the decline of muscle strength. On average, total muscle mass decreases by ~40% between the ages of 20 and 80 years (Tanaka and Seals, 2003) and this decrease seems to be related to the loss of muscle fibers and motor units (Campbell et al., 1973). Notably, type II muscle fibers (i.e., fast twitch fibers or glycolytic fibers) seem to be particularly affected (Coggan et al., 1990). Nevertheless, regular endurance training seems to help retain the number of functional motor units despite advancing age, as evidenced by the greater number of motor units in master athletes as compared to sedentary people of the same age (Power et al., 2016). The age-related decline in the ability of master athletes to generate force, may be primarily associated with changes in muscle fiber type, or functional modifications. Lexell (1995) suggests that advancing age leads to progressive changes that favor type I fibers, and this change is more pronounced in endurance trained individuals (Coggan et al., 1990; Lexell et al., 1995). In addition to these structural changes, master athletes may also experience a decline in muscle strength because of the alteration of neural factors. For example, the age-related modification of sarcolemma permeability may negatively affect the exchange of potassium and sodium ions which are essential for muscle contraction (Desaphy et al., 2010) As a result, neuromuscular propagation may be altered. Other physiological modifications may also involve alteration of the sodium–potassium transport system, reduced concentrations of intracellular acetylcholine (Smith and Chapman, 1987), and a decrease in the number of acetylcholine receptors (Banker et al., 1983). The resulting decrease in neuromuscular excitability of locomotor muscles results in reduced motor unit discharge rate, which, in turn, reduces muscle fiber recruitment and ultimately reduces force production during muscle contraction (Bellemare et al., 1983). Finally, aging is associated with a decline in mechanical response to muscle activation caused by alterations in the excitation-contraction coupling resulting from weakened strength of the actin–myosin crossbridges, lower myofibrils sensitivity to calcium (Ca^{2+}), and reduced release of Ca^{2+} from the sarcoplasmic reticulum (Hogan et al., 1998).

Overall, the decline in exercise performance among master athletes may be influenced by both maximal oxygen consumption and the function of the locomotor muscles. The effect of aging on the ventilatory system may also have negative impacts on both $\dot{V}O_{2\text{ MAX}}$ and locomotor muscle function although, to date, it is not considered a limiting factor to exercise tolerance / performance.

3. Ventilatory limitation in master athletes

Evidence suggests that the ability of master athletes to push the limits of their cardiovascular system may lead them to reach the limits of their ventilatory system (Dempsey, 1986). The ventilatory system is believed to be overbuilt and finely regulated to meet the increased metabolic demands associated with physical exercise (Sheel and Romer, 2012). However, in healthy aging, various changes in the structure and properties of the lung (detailed later in this thesis) reduce the efficiency of the pulmonary system and thereby may increase the cost of breathing and/or impair O₂ transport to the locomotor muscles.

Healthy aging is associated with several structural and physiological changes to the pulmonary system, including a loss of lung elastic recoil, a stiffening of the chest wall and a decrease in respiratory muscle strength (Rizzato and Marazzini, 1970). Moreover, alveolar ventilation relative to pulmonary capillary perfusion is slightly increased, dead space ventilation is increased and there is an impairment of arterial oxygenation, diffusion capacity, and pulmonary capillary blood volume (Bachofen et al., 1973).

Despite the decline in lung function, older healthy individuals appear capable of maintaining blood gas homeostasis during exercise. This indicates that the healthy aged pulmonary system still has sufficient ventilatory reserve and that the aerobic capacity and pulmonary function decline proportionally. However, this is not always the case with older endurance trained male athletes. Dempsey et al., (1993) studied exercise induced arterial hypoxemia (EIAH) in older endurance trained male and observed a decrease in O₂ partial pressure in the arterial blood. Such results are unique to master athletes (and to a lesser extent to young athletes) because older untrained individuals did not show a similar decrease (Johnson et al., 1994). Additionally, male master athletes developed EIAH at lower intensities than their younger counterparts, suggesting that aging increases the incidence of EIAH in athletes (see Figure 2).

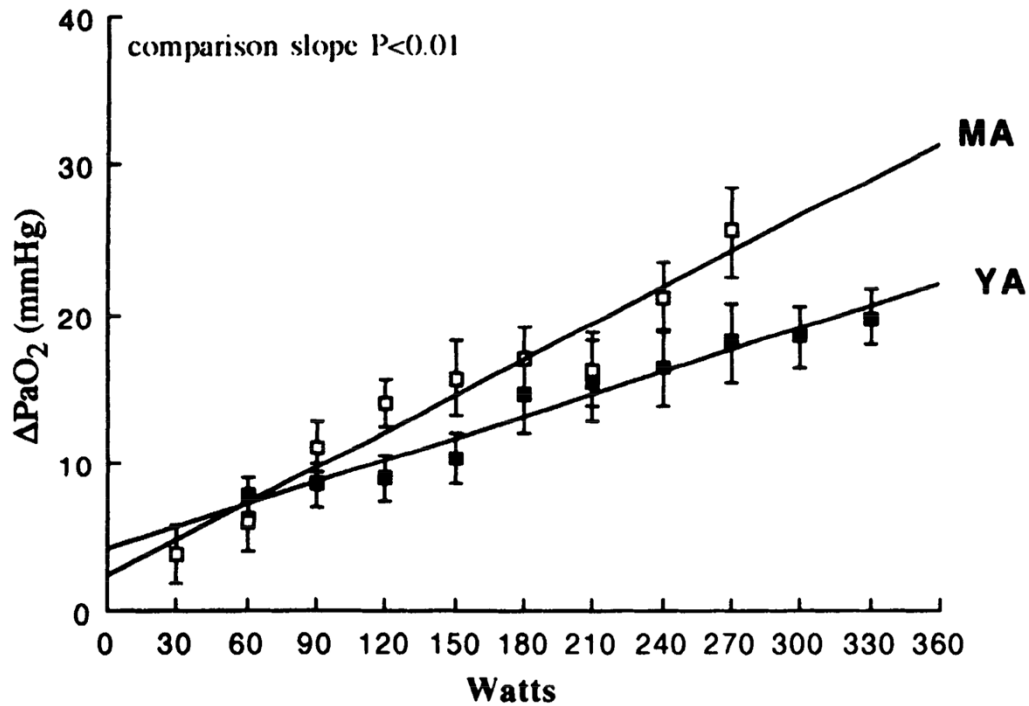

Figure 2. Comparison of the drop in partial pressure of O₂ in the arterial blood (PaO₂) in young and master athletes. ΔPaO₂ corresponded to the difference between resting PaO₂ and the actual PaO₂ at each exercise load. A significantly greater fall of PaO₂ was observed in master athletes at maximal but also at submaximal exercise. *Figure from (Prefaut et al., 1994).*

4. Interest & motivations of this thesis

The limited and limiting ventilatory response at the basis of EIAH has been suggested to be linked to expiratory flow limitation (EFL). EFL can be defined as the inability to increase expiratory flow despite extra effort (Derchak et al., 2000). Previous work found that older subjects (>60y) are more likely to develop EFL than younger subjects and that older women have a higher propensity toward EFL than older men (Molgat-Seon et al., 2018). In endurance trained individuals, most studies investigating EFL were conducted on young individuals (Cox et al., 2020; Guenette et al., 2007; Mota et al., 1999; Wilkie et al., 2015) and only few data are available in master athletes (Johnson et al., 1991b, 1991a). Moreover, the interaction effect of endurance training, biological sex, and aging is unknown, and no investigation has been conducted on EFL in women master athletes. Therefore, the effect of age and sex on EFL in athletes remains to be determined.

Another aspect that remains poorly understood is the resistance pattern in the lungs that leads to flow limitation. In fact, while evidence suggest that age-induced smaller airways may exacerbate resistance, we do not know the main sites of constraints in the lungs. The use of a low gas density

such as heliox (He-79%, O₂-21%) has been proposed to help address this issue by relieving some of the airway resistance to flow and alleviating EFL (D'Angelo et al., 2009; Mann et al., 2020; Wilkie et al., 2015). However, direct physiological assessment of the pulmonary function only provides limited answers at understanding the role of the lung at limiting expiratory flow because we can only measure flow, volume, and pressure at the mouth or in the esophagus. Physiological phenomena that occur within the lungs and across the airways remain inaccessible. Fortunately, the use of mathematical models may help in the comprehension of the physiological responses by determining the governing physical mechanisms. Specifically, in the context of modulating EFL using heliox breathing, a few studies have proposed mathematical explanations of the expiratory flow pattern in a simulated bronchial tree (Brighenti et al., 2007; Pozin et al., 2017). These studies focused on flow in constricted airways due to pathological conditions and did not isolate the effect of aging. Furthermore, the vast majority of studies that use mathematical models to explain physiological responses, do not directly compare their results with actual physiological measurements. Therefore, combining mathematical modeling with lung function assessment to study expiratory flow limitation in master athletes may provide valuable information to better understand the mechanisms of EFL in this population and determine appropriate countermeasures to this limitation.

In addition to EFL, older individuals have a higher O₂ cost of ventilation and an increased work of breathing compared to younger individuals (Molgat-Seon et al., 2018; Molgat-Seon et al., 2019; Rossi et al., 1996). Increased work of breathing has been shown to redirect blood flow from the locomotor muscles to the ventilatory vasculature (Harms et al., 1997). Therefore, it can be hypothesized that in master athletes, a greater proportion of cardiac output is redirected towards the ventilatory muscles at the expense of the working muscles (Johnson et al., 1994), thereby accelerating locomotor muscle fatigue and ultimately impairing exercise performance. Studying this phenomenon in master athletes would help to clarify whether respiratory muscle fatigue accelerates locomotor muscle fatigue to a greater extent with aging. However, although the interplay between respiratory and locomotor muscle fatigue has been investigated in young untrained individuals (Fulton et al., 2020; Romer et al., 2006; Taylor and Romer, 2008; Wüthrich et al., 2013), it remains unknown how it would modulate exercise performance in old endurance athletes.

The purpose of this thesis was thus to address some critical aspects that remain to be determined about our understanding of how the ventilatory system is a limiting factor to exercise performance in master athletes. First, we wanted to determine the prevalence and severity of EFL in aged endurance athletes. Since women master athletes may be particularly vulnerable to flow limitation

because of their narrower airways, we also wanted to include women and thus evaluate the effect of age, biological sex, and the combination of both on EFL in athletes. Second, we wanted to gain further insight into the physical mechanisms that might limit expiratory flow and increase airway resistance in master athletes. We chose a mathematical approach using an idealized model of the lung combined with physiological measurements of maximal expiratory flow breathing air and heliox to reach that goal. Finally, given the significant increase in the respiratory muscle work during exercise in the elderly, we aimed at evaluating the effect of aging on the interplay between respiratory and locomotor muscle fatigue during high-intensity exercise. This approach was inspired in part by the work of Dempsey et al., (2008) illustrated in Figure 3.

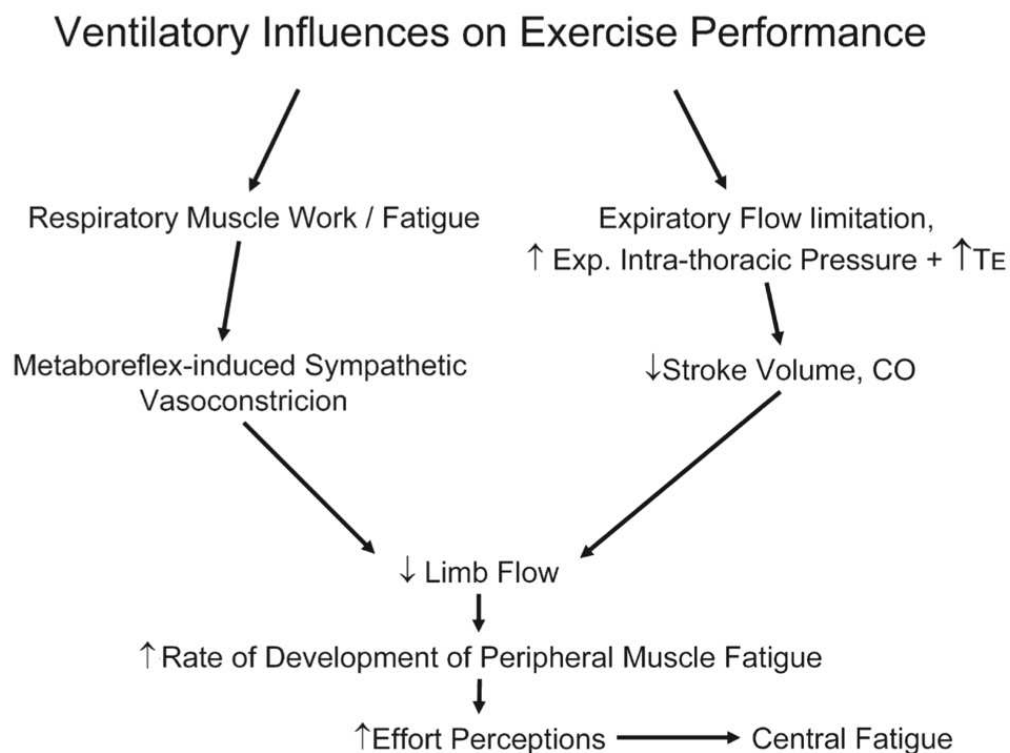

Figure 3. Summarized scheme of the effects of the ventilatory response to high-intensity, sustained exercise on exercise performance. CO, cardiac output. The ventilatory system may impair exercise performance mainly through expiratory flow limitation and respiratory muscle fatigue. These two aspects will be at the center of this PhD thesis. *Figure from (Dempsey et al., 2008a).*

THE VENTILATORY SYSTEM

The purpose of this chapter is to present the essential anatomy, physical mechanisms, and physiological processes that govern breathing. In addition, the pressure-volume relationships within the thorax and the effect of aging on these relationships will be reviewed.

1. General presentation of the ventilatory system

a) Anatomy of the breathing system

The respiratory system refers to the network of organs and tissues responsible for breathing (see Figure 4). It plays a pivotal role in maintaining the overall homeostasis of the body by reoxygenating the blood and eliminating excess carbon dioxide. Effective gas exchange in the respiratory system requires a well-coordinated process known as ventilation, in which the respiratory muscles play a central role. In the lungs configurations studied in this thesis, air can be considered as an incompressible gas. Thus, the relationship between airflow and pressure can be represented by the incompressible Navier-Stokes equations (Bates, 2009). Air enters the lungs thanks to the pulling action of the diaphragm. The contraction of the diaphragm pulls the lungs downward and the intercostal muscles pull the ribcage outward. The resulting air movement is associated to a negative pressure within the lung. During exercise, accessory muscles such as the sternocleidomastoid and the scalene muscles, are also recruited to support inspiration. At rest, expiration is passive, with the lungs deflating due to elastic recoil. However, during exercise, the increased ventilatory demand may require the use of the expiratory muscles such as abdominal muscles. The mechanical properties of the lungs involve overcoming the flow resistance of the airways and the elastic recoil forces of the lung tissues with each breath to ensure a constant supply of fresh air to the alveoli (West, 2012). Resistance in the airway tree is determined by the dimensions of its various branches, including the upper airways, such as the nose, mouth, and pharyngeal region, and the pulmonary airway tree, which branches from the trachea to the terminal bronchioles. Each bronchiole terminates in an acinus, often depicted as a cluster of grapes (i.e., alveoli) attached to branching twigs. Gas exchange between air and blood occurs primarily in these acini which are considered the basic ventilatory unit (West, 2012).

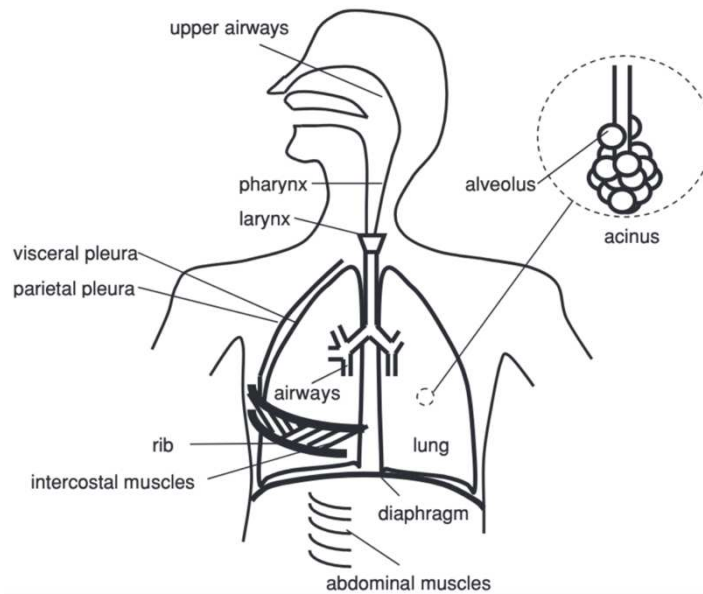

Figure 4. Main mechanical components of the ventilatory system. The lungs are attached to the chest wall by a structure called the pleura. Each lung is surrounded by a layer of visceral pleura, while the chest wall is lined with parietal pleura. Between these layers of pleurae is a space called the pleural cavity, which contains a thin layer of serous fluid that facilitates smooth respiratory movements. The upper airways include the nose, mouth, and throat. The nose warms and humidifies air and filters out contaminants through cilia and increased mucus secretion. *Figure from (Bates, 2009).*

b) The respiratory tract

The proper functioning of the pulmonary system depends on the mechanical properties of the respiratory tract. It comprises the upper airways, lungs, blood vessels, and respiratory muscles. It consists of two functional zones: the conducting zone, which includes the pathway from the nose to the bronchioles for gas conduction; and the respiratory zone, which extends from the terminal bronchioles to the alveoli where gas exchange occurs (West, 2012). The tracheobronchial tree, depicted in Figure 5, is responsible for gas transport and each branch is classified as one generation (Weibel, 1963). The tree undergoes 23 generations of dichotomous branching, beginning at the trachea (generation 0) and culminating at the terminal bronchioles (generation 22).

The conducting zone extends from the trachea to the terminal bronchioles and serves as air conduits. This area, also known as the "dead space volume," does not participate in gas exchange and occupies an average volume of approximately 150 mL in healthy young individuals (West, 2012). The trachea, measures about 10 to 12 cm long and 2 cm wide and displays a structure of horseshoe-shaped cartilage rings embedded in dense connective tissue. At its lower end, the trachea divides into the left and right main stem bronchi.

The transition from the conducting zone to the respiratory zone of an airway usually occurs toward the end of the 16th generation. The terminal bronchioles are the origin of the respiratory bronchioles or transitional bronchioles (generations 17–19). Further branching leads to alveolar ducts, entirely lined with alveoli, forming the acinus (generations 16–22). The acinus is a subpart of the bronchial tree consisting of approximately 6 generations and serves as the key site for gas exchange in the lung (Weibel, 1963). Alveolar ducts are thin tubular structures supported by a rich amount of elastic and collagen fibers that terminate in alveolar sacs containing numerous alveoli. Within the respiratory zone, alveolar capillaries enable effective gas exchange between air and blood. This blood-gas barrier is less than a micron thick, so it presents a very small impediment to the passage of gas molecules, and it has a substantial surface area measuring approximately 130 m², so that many gas molecules can cross it in parallel.

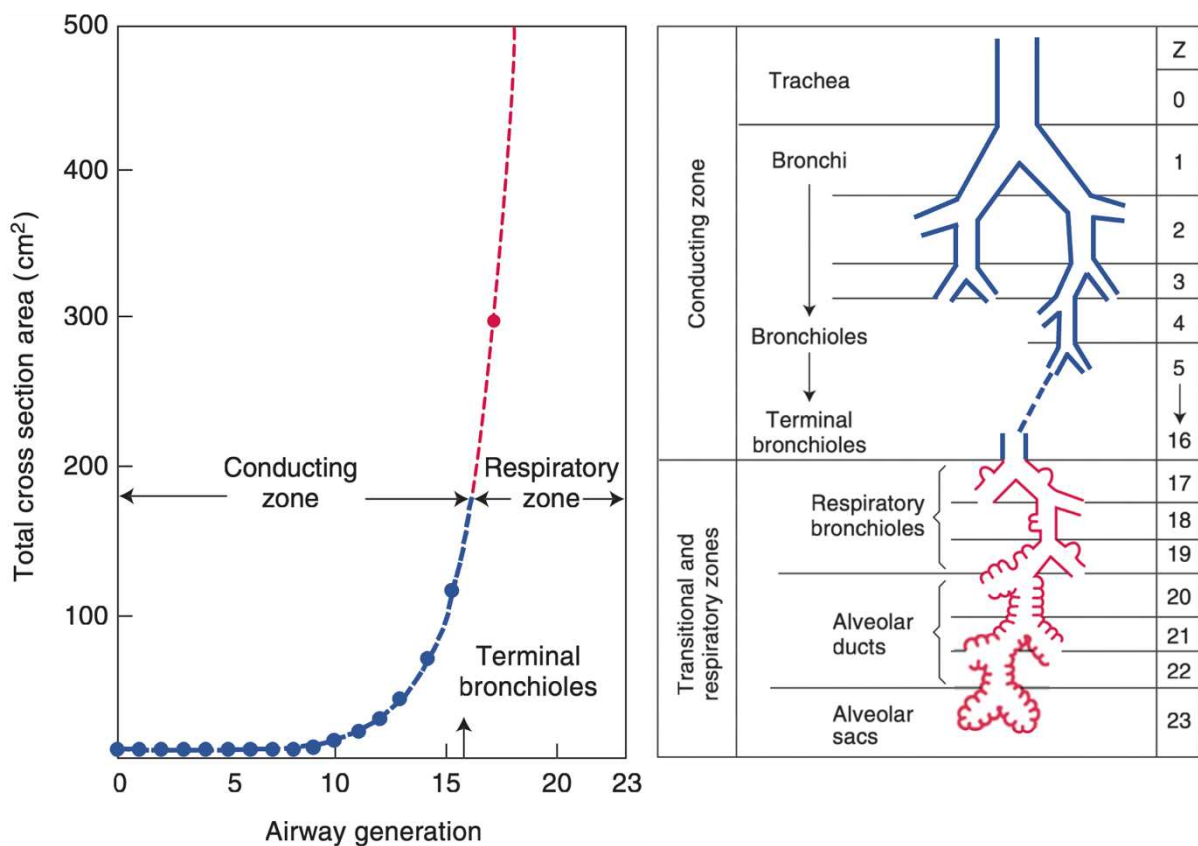

Figure 5. Representation of the human airways according to Weibel's geometry. The first 16 generations form the conducting airways, and the last 7 form the respiratory zone. There is a rapid increase in total cross-sectional area of the airways in the respiratory zone. The resulting forward gas velocity becomes very small in the acinus region, and gas diffusion becomes the primary mode of ventilation. *Adapted from (West, 2012).*

c) Lung pressure-volume relationship

Respiratory mechanics refers to the study of the physical principles and processes that govern the act of breathing. It involves the study of the interactions between different structures and forces, and the investigation of the interplay between critical pressures, flow rates, and volumes at appropriate sites. The chest wall (i.e., rib cage and abdomen) and the lungs are mechanically connected in series and the pressure-volume properties of each structure affect the other (see Figure 6). Pressure-volume relationship of the lungs and chest wall is important because it determines the work that must be performed by the respiratory muscles to induce a given change in volume. For example, when an individual breathes at a substantially high lung volume (~90% of total lung capacity, TLC), a greater pressure must be generated to produce a given volume change. In this matter several features play a critical role. Compliance refers to the ability of a structure to stretch and expand and is defined as the change in volume (ΔV) for a given change in pressure (ΔP):

$$C = \frac{\Delta V}{\Delta P} \quad (3)$$

Higher compliance means the structure can expand easily while lower compliance means the structure is stiffer and harder to expand. Elastance describes the tendency of the lung or chest wall to return to their original shape after being deformed, and thus refers to the stiffness or the recoil of the structure. Elastance is the reciprocal of compliance, $E = \frac{1}{C}$. The effort required to breathe, and the efficiency of ventilation are also determined by resistance, which refers to impediment to the flow of gas through the respiratory pathways.

Expiratory driving pressure (i.e., difference between alveolar pressure, P_A , and airway opening pressure, P_{ao}) at rest and during exercise, is determined by the strength of expiratory muscles, the inward elastic recoil of the lungs and the outward elastic recoil of the chest wall (Mead et al., 1967). The lung volume associated with the balance of inward and outward forces is the resting volume of the respiratory system (i.e., relaxation volume V_{REL}). At this volume, airway pressure is zero and it corresponds to the end of a spontaneous expiration during quiet breathing. Above this volume, both the chest wall and the lungs retract inward, while below this volume, the chest wall recoils outward (Rahn et al., 1946). Thus, the lung and the chest wall act like two opposing springs. Compliance, expressed in liters or milliliters per centimeter of water ($\text{mL}\cdot\text{cmH}_2\text{O}^{-1}$) in Figure 6, is

the slope of the static volume-pressure curve. During tidal volume breathing chest wall compliance C_W and lungs compliance C_L are similar. Because they are placed in series, their reciprocals can be summed:

$$\frac{1}{C_{RS}} = \frac{1}{C_W} + \frac{1}{C_L} \quad (4)$$

Similarly, the pressure of the respiratory system P_{RS} corresponds to the pressure exerted by the wall P_W and by the lungs P_L , while the change of volume ΔV of each part is similar when blood flow shifts are neglected:

$$P_{RS} = P_W + P_L \quad (5)$$

$$\Delta V_{RS} = \Delta V_W = \Delta V_L \quad (6)$$

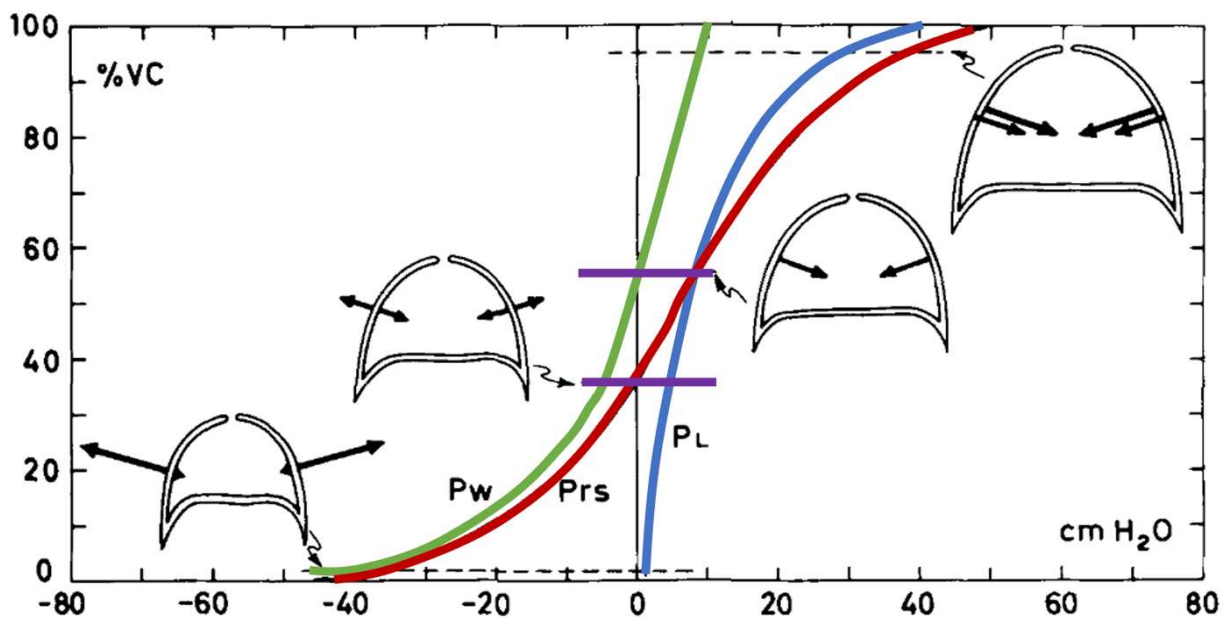

Figure 6. Interplay of the static volume and pressure in the respiratory system in a sitting position. Volume is represented on the y axis in % of vital capacity and pressure is represented on the x-axis in cmH_2O . Volume-pressure of the lungs P_L is represented with the blue curve, volume-pressure of the chest wall P_W is represented with the green curve, and volume-pressure of the respiratory system P_{RS} is represented with the red curve. Purple lines represent functional residual capacity (FRC), and the bottom line is V_{REL} . Bold arrows represent inward and outward static forces of lung and chest wall. The pressure of $0 \text{ cmH}_2\text{O}$ serves as the reference point. The horizontal deviation between a given point on the curve and this reference point, quantifies the pressure exerted intrinsically by the passive components of the respiratory system at a given volume. Conversely, this horizontal deviation also represents the pressure required by the respiratory muscles to maintain the lungs at that volume, assuming the airways are open. *Adapted from (Rahn et al., 1946).*

It is important to acknowledge that for simplification purposes, the pressures are presented as single values, but they are not uniformly distributed among the different sites mainly due to gravity. Considering the sigmoidal shape of the pressure-volume curve, the central, more linear portion represents the optimal range of lung volume where the least amount of effort is required to breathe (Rahn et al., 1946). In this range, the relation is almost straight and the volume change per 1 cmH₂O is -2% of FVC. At the onset of exercise, volume of each breath increases. However, it does not immediately shift to the upper ranges of the lung volume. This allows for a reserve capacity that can be tapped into later as exercise intensity increases. Thus, breathing around FRC during the beginning of exercise provides a mechanical advantage by balancing the opposing forces of the lungs and chest wall. Moreover, breathing at lower lung volumes during initial exercise enables more efficient functioning of respiratory muscles as they need to generate a relatively low pressure change to produce a given volumes change (i.e., highly compliant part of the respiratory system) (Rahn et al., 1946).

2. Methods of evaluation of the ventilatory system

a) Volume and flow measurements

The structural design of the respiratory tract is functionally important because it determines lung volume and airflow rates. Notably, airway size is a main determinant of expiratory flow rates because it influences the resistance to flow in the lungs. For example, during vigorous expiration, expiratory flow rates will be lower if the airways are smaller (Mead et al., 1967). The analysis of lung volume and airflow rates refers to the evaluation of lung function which is key in determining an individual's respiratory status (e.g., health or disease) and is particularly useful in tracking the decline of the pulmonary system with age. Spirometry is a physiological screening test that measures how an individual inhales and exhales.

The forced vital capacity maneuver is the most used lung function test. Subjects are globally required to inhale as deeply as possible and to exhale maximally as forcefully as they can. Several important variables can be deduced from this test and provide information about lung volumes and expiratory flow rates of the participant (see Figure 7). The forced vital capacity (FVC) is expressed in liters and corresponds to the maximum volume of air exhaled with maximum force

after a complete inspiration. The forced expiratory volume in one second (FEV_1) is expressed in liters and indicates the amount of air exhaled during the first second of the FVC maneuver. The peak expiratory flow (PEF) is expressed in liters per seconds and corresponds to the maximum flow at which the air was exhaled. PEF is linked to pleural pressure and is useful to assess the magnitude of effort during the initial portions of the maneuver. Instantaneous forced expiratory flows are expressed in liters per seconds and can be measured when X% of the FVC has been exhaled ($FEF_{X\%}$). The most commonly reported are FEF_{25} , FEF_{50} , FEF_{75} and the mean forced expiratory flow rate between 25% and 75% of FVC, FEF_{25-75} . The maximal expiratory flow volume (MEFV) curve can be drawn from pulmonary function testing data. This curve can also be built from several FVC maneuvers performed at increasing effort across lung volumes to account for the phenomenon of thoracic gas compression (Guenette et al., 2010).

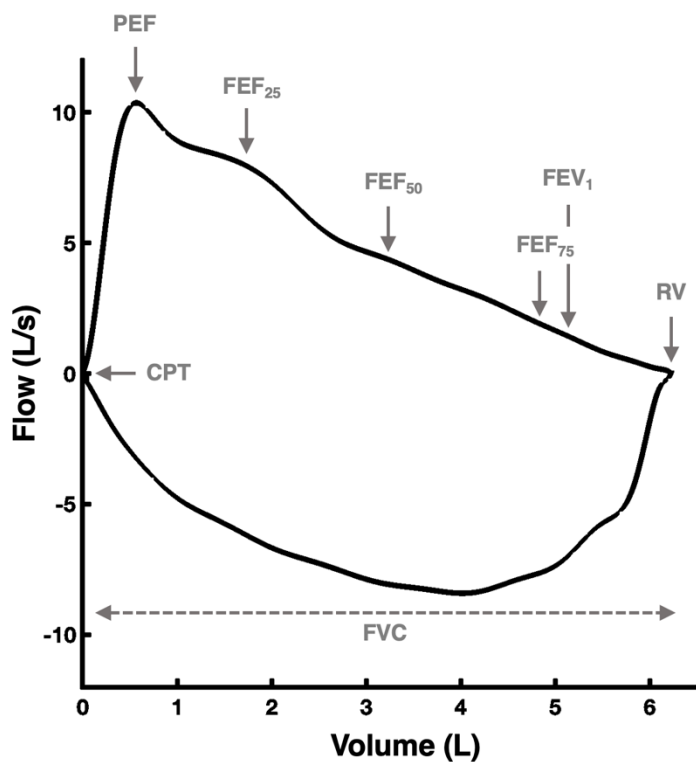

Variable	Value
FVC (L)	6.2
PEF (L/s)	10.4
FEV_1 (L)	4.9
FEF_{25} (L/s)	8.2
FEF_{50} (L/s)	4.5
FEF_{75} (L/s)	2.2
FEF_{25-75} (L/s)	4.2
Slope Ratio	1.2
Dysanapsis ratio	0.14

Figure 7. MEFV curve and spirometry values of a young healthy male. The subject is a healthy young athlete of 20 years. Data presented were collected in our lab with the subject exhaling with maximally forced effort from total lung capacity to residual volume and inhaling with maximally forced effort from residual capacity to total lung volume.

It is also possible to assess non-mobilizable lung volumes (see Figure 8) during a body plethysmography. The residual volume (RV) is the amount of air remaining in the lungs after a maximal exhalation to prevent alveoli from collapsing. Once RV is known, it can be summed with FVC to obtain total lung capacity (TLC) which is the maximum volume of air the lungs can hold after a maximal inhalation. TLC is determined by the static balance between the elastic and muscle force of the respiratory system (Mead et al., 1967). The functional residual capacity (FRC) is the combined volume of RV and the expiratory reserve volume (ERV). Essentially, FRC represents the volume of air remaining in the lungs following a standard exhalation. The gases that persist in the lungs post-expiration serve two main purposes: they prevent the alveoli from collapsing and ensure the continuous oxygenation of the blood as it flows through the pulmonary capillaries during that phase.

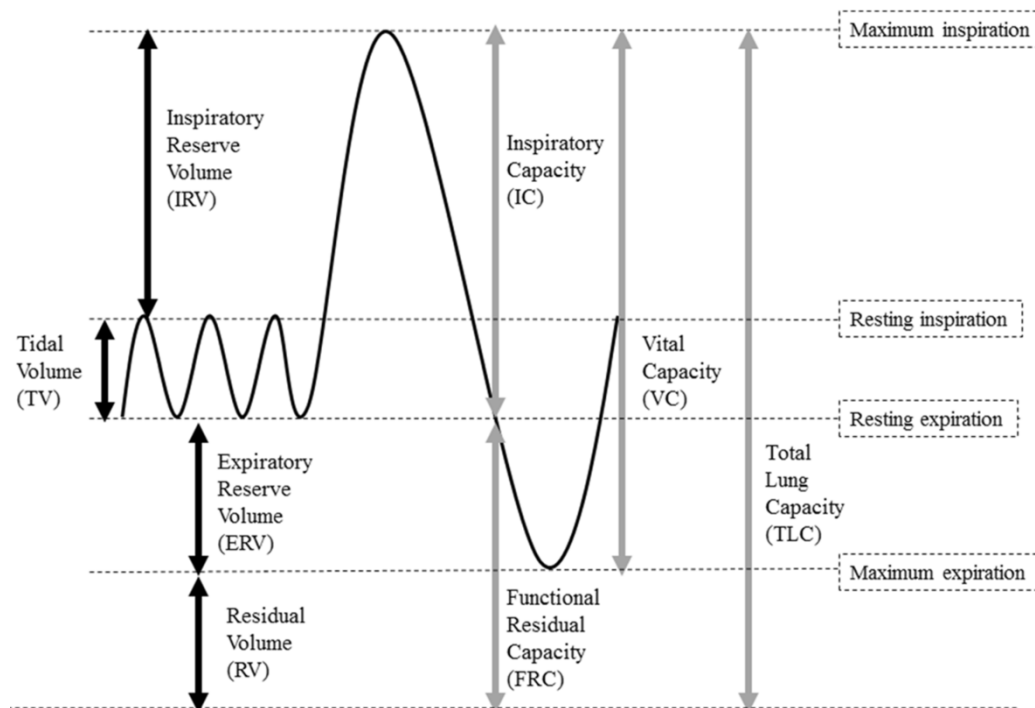

Figure 8. Interplay of lung volumes and capacities. The solid black and gray arrows indicate lung volumes and capacities respectively. TLC, Total Lung Capacity, total volume of the lungs representing the sum of all individual lung volumes ; FVC, Forced Vital Capacity, maximum volume of air that can be forcefully exhaled after a full inhalation ; RV, Residual Volume, amount of air remaining in the lungs after a full exhalation ; VT, Tidal Volume, volume of air inhaled or exhaled during regular breathing ; RV, Residual Volume, amount of air remaining in the lungs after a full exhalation ; FRC, Functional Residual Capacity, volume of air present in the lungs at the end of passive expiration ; IC, Inspiratory Capacity, maximum volume of air that can be inhaled after a normal exhalation ; IRV, Inspiratory Reserve Volume, amount of air that can be forcefully inhaled after a normal inhalation ; ERV, Expiratory Reserve Volume, amount of air that can be forcefully exhaled after a normal exhalation. *Figure from (Lutfi, 2017).*

Several complementary indices, although less commonly used, can be derived from lung function test measurements and have recently regained interest (Molgat-Seon et al., 2022). Individuals matched for lung volume do not necessarily have similar airway size and the mismatch of airway size to lung size is termed dysanapsis. This parameter can be non-invasively estimated using dysanapsis ratio (DR) (Mead, 1980). A lower dysanapsis ratio indicates smaller airways size relative to lung size. Dysanapsis ratio can be calculated as follow (Mead, 1980):

$$\text{Dysanapsis Ratio} = \frac{\text{FEF}_{50}}{(\text{FVC} \times \text{Pst}(1)_{50\%})} \quad (7)$$

where FVC corresponds to the forced vital capacity, FEF_{50} corresponds to the forced expiratory flow at 50% of FVC and $\text{Pst}(1)_{50\%}$ corresponds to static recoil pressure at 50% of FVC. $\text{Pst}(1)_{50\%}$ can be estimated with age using the following regression equation (Turner et al., 1968) :

$$\text{Pst}(1)_{50\%} = -0.056 \times \text{age} + 6.3038 \quad (8)$$

When using the DR, some methodological considerations must be acknowledged. For example, it is important to note that static recoil assessment is a challenging measure for subjects and requires the use of an invasive esophageal balloon. Previous work reported that direct measurements of $\text{Pst}(1)_{50\%}$ values showed a slight difference of ~ 1 cmH₂O with estimated values while both measured and predicted DR were found to be very similar (Dominelli et al., 2012), but others recommended that all data should be measured rather than estimated (Stickford et al., 2021). $\text{Pst}(1)_{50\%}$ values from equation (8) should therefore be used with caution. Nevertheless, although DR provides only a unitless index (usually between 0.1 and 0.6) of airway size relative to lung size, it can be easily derived from the MEFV curve and thus represents an accessible measure that can be used for further analysis of expiratory flow during exercise (Dominelli et al., 2011; Smith et al., 2014).

Further insight into airway characteristics can be obtained by quantifying the shape of the MEFV curve. The shape of the curve plays a crucial role because a more concave shape is indicative of smaller airways, while a more convex shape is indicative of larger airways. The curvilinearity of the MEFV curve can be calculated using the slope ratio (SR) according to previously detailed method (Dominelli et al., 2015a, 2016). To calculate the SR, a tangent line and a chord line must be drawn at 30 points of interest, calculated in 2% increments between 20% and 80% of FVC. This portion of the MEFV curve corresponds to the effort-independent portion of the MEFV curve and is not

influenced by increasing alveolar pressure (Mead, 1978). The tangent line must be drawn with a volume difference of 200 ml above and below the point of interest and the chord line corresponds to the line intersecting the point of interest and the end of the vital capacity (see Figure 9). The average SR value of each point of interest over the analyzed range of FVC and the global SR index can be reported. An SR value of 1 corresponds to a linear MEFV curve, while a value <1 indicates a smaller change in flow per volume unit resulting in a convex shape, and a value >1 indicates a larger change in flow per volume unit leading to a concave shape (Dominelli et al., 2015a, 2016; Klimenko et al., 2023).

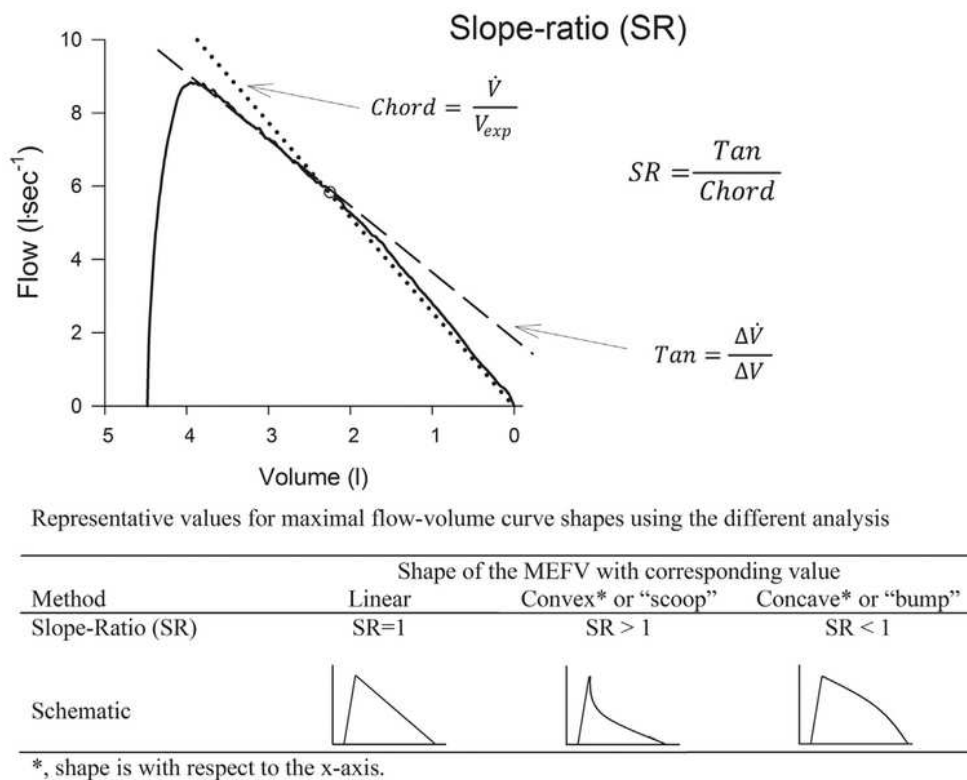

Figure 9. Details of the method to determine slope ratio (SR) from a maximal expiratory flow volume (MEFV) curve. The purpose of the SR is to quantify the MEFV curvilinearity. Data presented illustrate the calculation of SR in a young healthy subject. *Figure from (Dominelli et al., 2016).*

b) Pressure measurements

To further characterize the ventilatory system, it is possible to measure the pressure generated by respiratory muscles. Notably, the pressure generated by the diaphragm can be measured from transdiaphragmatic pressure (Pdi) which is calculated by subtracting the esophageal pressure (Pes) from the gastric pressure (Pga). Pes and Pga are measured by one double-lumen catheter that opens

into two latex balloons positioned in the esophagus and in the stomach, respectively (“ATS/ERS Statement on Respiratory Muscle Testing,” 2002). This method is considered the gold standard for evaluating diaphragm pressure, but it is not a very accessible technique, and it is invasive for the participant. However, another more accessible and non-invasive assessment of inspiratory muscle pressure is available. The simplest assessment is the sniff nasal inspiratory pressure (SNIP) which requires placing a nasal olive in one nostril while leaving the other nostril free and performing a short, sharp sniff with maximal effort. Other objective non-invasive methods to evaluate respiratory muscle strength include measuring maximal inspiratory pressure (MIP) and maximal expiratory pressure (MEP). These assessments require the subject to forcefully inhale or exhale against a closed valve with a small leak for at least three seconds from RV or TLC, respectively.

c) Mathematical modeling of the respiratory system

The complex and hierarchical architecture of the lung provides a rich but challenging area of research that requires a cross-scale understanding of lung mechanics and advanced computational tools to effectively model lung biomechanics. Computational modeling of the lung is an active field of study that integrates computational advances with lung biophysics, biomechanics, physiology, and medical imaging to promote individualized diagnosis (Bates and Lutchen, 2005). Computational modeling provides a unique platform for integrating imaging, respiratory mechanics, and structure-function data measured at different length scales to understand, simulate, and predict lung dynamics (Pozin et al., 2017). For example, understanding the distribution of ventilation in different regions of the lung requires understanding the mechanics of airflow through the airways (Bates, 2009). And this can be done using a mathematical fractal tree model developed by Weibel (Weibel, 1962). More recent advances in generating the airway tree structure obtained the lung and proximal airway morphology from MRI scans and "synthetically" generated the distal airway tree structure using a space-filling algorithm and lung morphology (Tawhai et al., 2004). Overall, mathematical modeling allows access to deeper areas of the lung that would be very difficult to image, and this offers the possibility of having access to new variables useful in the field of respiratory physiology.

3. The normal ventilatory system response during exercise

a) The ventilatory challenge during exercise

During a light or moderate exercise at a constant workload, minute ventilation ($\dot{V}E$) first increases rapidly from rest (phase I), then increases slowly in an exponential fashion (phase II), before reaching a steady state (phase III) within 3 minutes (Casaburi et al., 1989; Whipp et al., 1982). Oxygen uptake ($\dot{V}O_2$) and carbon dioxide production ($\dot{V}CO_2$) follow a similar pattern (Casaburi et al., 1989; Whipp et al., 1982). $\dot{V}E$ closely follows the increase in CO_2 production associated with exercise to maintain a stable ratio of alveolar ventilation to CO_2 production and arterial partial pressure of CO_2 ($PaCO_2$) (Dempsey et al., 2020). Therefore, from rest up to the second ventilatory threshold, $PaCO_2$ and arterial oxygen pressure (PaO_2), change minimally (Forster et al., 2012). As exercise intensity increases, hydrogen ions are produced with the increase of the role of the anaerobic metabolism which complements more and more aerobic metabolism. To maintain homeostasis, these ions are buffered by the bicarbonate system which produces CO_2 . The ensuing hyperventilatory response, results in an inflection point in the previously linear relation between ventilation and CO_2 production (Whipp, 1994) which means that the ventilatory equivalent of CO_2 ($\dot{V}E/\dot{V}CO_2$) increases until exhaustion (Casaburi et al., 1989). In addition, during heavy exercise pulmonary gas exchange becomes less efficient and the alveolar-arterial difference in partial pressure of oxygen (i.e., $PAO_2 - PaO_2$) increases (Asmussen and Nielsen, 1960; Whipp and Wasserman, 1969). The hyperventilatory response maintains PaO_2 , homeostasis, and prevents arterial hypoxemia in most cases, which illustrates that the lungs of most healthy individuals are well designed to meet the demands of heavy exercise (Asmussen et al., 1965; Asmussen and Nielsen, 1960; Forster et al., 2012). This is a remarkable achievement considering the impressive ventilatory response required to maintain $PaCO_2$ homeostasis during exercise (see Table 1). In fact, the level of minute ventilation must increase by ~ 20 -fold above resting values (e.g., from 6 to 115 $L \cdot min^{-1}$, see Table 1) to accomplish this when the typical untrained individual reaches $\dot{V}O_{2\ MAX}$. In endurance trained individuals, the magnitude of ventilation level that must be achieved is even greater and can rise to 30-fold the level of resting values (e.g., from 6 to 183 $L \cdot min^{-1}$, see Table 1).

	Untrained									Trained A	Trained B
	Relative Exercise Intensity (% Maximal Oxygen Uptake)										
	Rest	15	30	45	60	75	90	100			
\dot{V}_{O_2} (L/min)	0.24	0.45	0.9	1.35	1.8	2.25	2.7	3	5.25	5.25	
\dot{V}_{CO_2} (L/min)	0.19	0.4	0.77	1.21	1.71	2.31	3	3.3	6.04	6.04	
\dot{V}_E (L/min)	6	14	22	35	51	75	100	115	183	168	
\dot{V}_A (L/min)	4	9	18	28	41	60	81	94	150	138	
V_T (L)	0.6	0.9	1.2	1.6	2.2	2.5	2.6	2.6	3.1	2.9	
fR (breaths·min ⁻¹)	10	15	18	22	23	30	38	44	59	58	
V_D/V_T	0.35	0.28	0.21	0.2	0.19	0.18	0.18	0.18	0.18	0.18	
EELV (% TLC)	0.5	0.49	0.46	0.45	0.44	0.43	0.42	0.42	0.48	0.48	
Gas exchange											
PaO ₂ (mm Hg)	95	95	93	93	92	94	94	94	90	70	
PAO ₂ (mm Hg)	101	101	101	101	107	112	114	117	117	112	
PaCO ₂ (mm Hg)	41	41	41	41	39	35	33	31	31	38	
A-aDO ₂ (mm Hg)	6	6	8	8	15	18	20	23	27	42	
pH	7.40	7.40	7.38	7.36	7.34	7.30	7.29	7.28	7.25	7.25	
SaO ₂ (%)	97	97	97	97	96	96	95	95	93	86	
\dot{V}_A/\dot{Q}	0.8	1.3	2	2.5	2.9	3.5	4.1	4.5	4.7	4.3	
Pulmonary circulation											
\dot{Q} (L·min ⁻¹)	5	7	9	11	14	17	20	21	32	32	
PCBV (mL)	83	95	107	119	137	155	173	180	180	180	
Transit time (s)	1	0.81	0.71	0.65	0.59	0.55	0.52	0.51	0.33	0.33	
PAP (mm Hg)	13	15	17	20	23	27	29	32	30	35	
PAWP (mm Hg)	8	9	10	12	13	15	17	21	14	18	
PVR (mm Hg·min ⁻¹ ·s ⁻¹)	60	51.4	46.7	43.7	42.8	42.4	36	31.4	30	33	

Table 1. Mean values of healthy untrained and trained individuals cardiorespiratory response across work rates. \dot{V}_{O_2} , oxygen consumption; \dot{V}_{CO_2} , carbon dioxide output; \dot{V}_E , minute ventilation minute; \dot{V}_A , alveolar ventilation; V_T , tidal volume, fR, breathing frequency; V_D/V_T , dead space to tidal volume ratio; EELV, end expiratory lung volume as a percentage of total lung capacity; PaO₂, arterial PO₂; PAO₂, alveolar PO₂; PaCO₂, arterial PCO₂; A-aDO₂, alveolar to arterial oxygen partial pressure difference; SaO₂, arterial oxyhemoglobin saturation; \dot{V}_A/\dot{Q} , global ventilation to perfusion ratio; \dot{Q} , cardiac output; PCBV, pulmonary capillary blood volume; transit time, mean pulmonary capillary transit time; PAP, mean pulmonary artery pressure; PAWP, pulmonary artery wedge pressure; PVR, pulmonary vascular resistance. Group A experiences little arterial hypoxemia while Group B experiences substantial hypoxemia in heavy intensity exercise. *Table from Dempsey and Jacques (2015).*

The mechanical and metabolic cost of maintaining adequate alveolar ventilation during exercise can be substantial and increase exponentially as a function of \dot{V}_E (Dominelli et al., 2015). The work of breathing (WOB) is the product of pressure and volume for each breath and corresponds to the energy necessary to perform tidal ventilation over a set unit of time (Molgat-Seon et al., 2019). During incremental graded exercise, the WOB increases linearly and then exponentially as a function of \dot{V}_E (see Figure 10). The total WOB can be partitioned into viscoelastic and resistive components. Viscoelastic WOB represents the work required to overcome the viscous resistance offered by the lung tissues to deformation and by the respiratory tract to the laminar flow of air, whereas resistive WOB reflects the work required to overcome the resistance to turbulent air flow

(Otis et al., 1950). The increasing WOB requires an increasing use of different respiratory muscle to meet those demands. High levels of ventilation and WOB are also associated with an oxygen cost of breathing up to 15% of $\dot{V}O_{2\text{MAX}}$ and respiratory muscles must compete for available cardiac output with other working skeletal muscles (Aaron et al., 1992; Dempsey et al., 2006; Harms et al., 1997, p. 199; Vogiatzis et al., 2009). Specifically, both younger and older females have a higher cost to breathe than their male counterparts during moderate and high-intensity exercise and older individuals incur a higher cost to breathing than younger individuals for a given absolute $\dot{V}E$ (see Figure 10) (Molgaat-Seon et al., 2018). Despite the substantial metabolic and energetic cost of high levels of ventilation, the ventilatory system is able to meet the metabolic demand of high-intensity exercise and seems overbuilt, at least in untrained individuals.

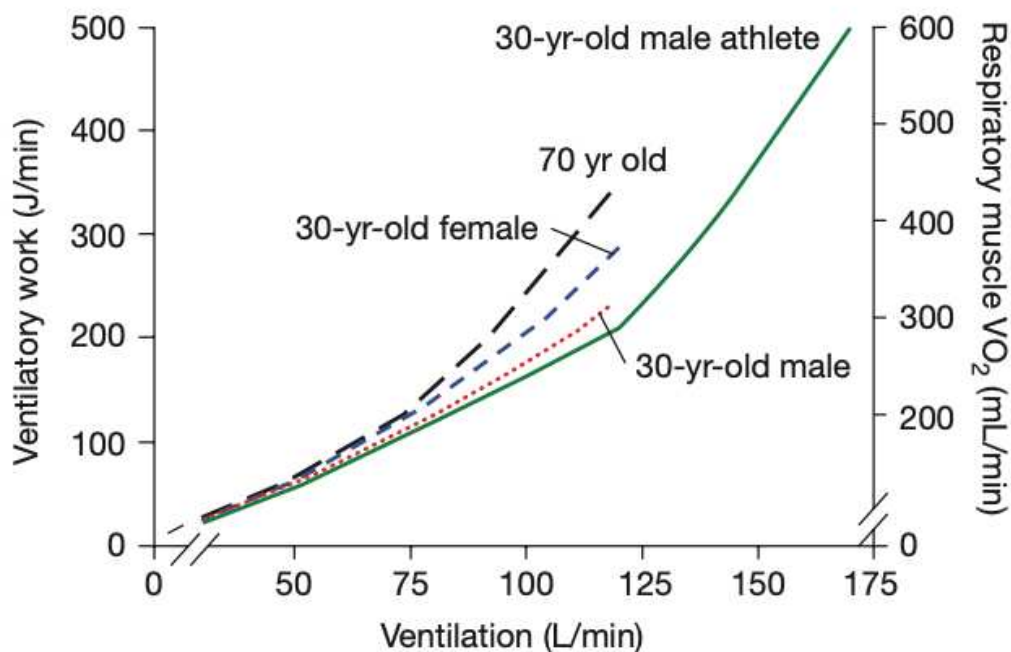

Figure 10. Ventilatory work and respiratory muscle $\dot{V}O_2$ during exercise of increasing intensity plotted as a function of $\dot{V}E$ for sedentary men, active young females, and trained young and older men. The increasing ventilation level required by high-intensity exercise requires substantial ventilatory work and respiratory muscle $\dot{V}O_2$. *Figure adapted from Johnson and Dempsey, 1991.*

b) The control of breathing

All the above-mentioned responses are carefully regulated. Preventing hypercapnia and hypoxemia when $\dot{V}E$ and increase up to 15-20 times resting values, represents a remarkable adaptation. This performance is made possible by feedforward and feedback regulatory mechanisms.

Neural feed forward is the signal generated in the brain that initiates exercise-induced hyperpnea and facilitates appropriate ventilation in anticipation of the increased oxygen demand and carbon dioxide production (Forster et al., 2012). Both animal and human studies have shown that descending drive from supraspinal areas increases cardiac and respiratory function with exercise intensity (Eldridge et al., 1981; Ryan and Waldrop, 1995; Waldrop and Iwamoto, 2006). In a rodent model, when the hypothalamus and midbrain were electrically or chemically stimulated, ventilation increased similarly to exercise, and this respiratory response persisted after paralysis, indicating that this response was not induced by muscle contraction (Dimitrijevic et al., 1998; Viala and Freton, 1983; Wagner and Eldridge, 1991). It has also been shown that activation of cell bodies in the hypothalamic locomotor region is sufficient to elicit a cardiorespiratory response (Waldrop and Iwamoto, 2006). In addition, some studies involving hypothalamic lesions have reported no or a blunted cardiorespiratory response to exercise (Ordway et al., 1989; Waldrop and Iwamoto, 2006). Investigating the contribution of feedforward central command to exercise hyperpnea is very challenging in humans. Therefore, only indirect evidence reported the involvement of midbrain and cortical sites in this command (Asmussen et al., 1965). During mild exercise, an increased activity in the mesencephalic structure (i.e., periaqueductal gray - PAG) was also found to be associated with small increases in ventilation when electrodes were implanted in patients with movement disorders (Paterson, 2014). This structure was presented as a key element of the subcortical neural circuitry of central command mechanisms regulating exercise hyperpnea (Paterson, 2014). Overall, neural feedforward plays a crucial role in efficiently adjusting oxygen supply and carbon dioxide removal and preventing a rapid decrease in pH levels during the initiation of exercise (Asmussen et al., 1965; Eldridge et al., 1981; Goodwin et al., 1972; Green and Paterson, 2008; Williamson et al., 2006). Central command is, at least in part, an anticipatory response, as demonstrated by cardiorespiratory responses occurring prior to, during, or shortly after the onset of exercise (Matsukawa, 2012; Secher, 2009).

While brain centers may be a critical factor driving hyperpnea during mild to moderate exercise, respiratory neural control also relies on feedback. The ventilatory response to exercise is closely

linked to the metabolic demand and aims to maintain PaO₂ and PaCO₂ levels within a narrow range (Forster et al., 2012). Neural feedback is the signal that reaches the brainstem respiratory neurons via spinal afferents (Forster et al., 2012). Chemical feedback of arterial gas content is provided by central and peripheral chemoreceptors located within the medulla oblongata (Loeschcke et al., 1963; Nattie and Li, 2009) and carotid body (Heymans et al., 1930), respectively. It should be noted that there is interaction between peripheral and central chemoreceptors as demonstrated in an unanesthetized, intact canine model (Blain et al., 2010). When the output of carotid body chemoreceptors was inhibited, the gain of the central chemoreceptor ventilatory response to CO₂ decreased significantly. However, when the carotid body chemoreceptors were stimulated, the gain of the response was significantly increased (Blain et al., 2010). Thus, there is a synergistic effect of inputs from peripheral chemoreceptors on the central chemoreceptor response to CO₂, which modulates the overall ventilatory response. Ventilation is controlled not only by the production of CO₂ but also by the level of O₂ in the arterial blood, as evidenced by changes in ventilatory response under conditions of hyperoxia (Ryan and Waldrop, 1995).

In addition, feedback from group III-IV muscle afferents significantly contribute to both exercise hyperpnea and to the hyperventilatory response during heavy intensity exercise (Amann et al., 2009; Haouzi et al., 1999). Group III-IV muscle afferents are nerve fibers activated by receptors located within the interstitial space and within muscle blood vessel walls which are sensible to mechanical strain and metabolite accumulation (Zhang et al., 2015). Their role was initially suggested while examining the ventilatory responses to hindlimb contraction in anesthetized cats (Coote et al., 1971; McCloskey and Mitchell, 1972). In the healthy human, the limb locomotor muscle group III-IV afferents can be studied by specifically attenuating (50-60 %, Hureau 2018) their tonic input with an intrathecal infusion of fentanyl, a μ -opioid receptor agonist. Fentanyl injection has no effect on resting ventilation, the ventilatory response to CO₂, or muscle strength (Amann et al., 2009). During moderate-intensity steady state exercise, partial blockade of group III-IV muscle afferents resulted in a reduction in breathing frequency and ventilation, resulting in an elevated end-tidal CO₂ pressure (P_{ET}CO₂) and a decreased arterial O₂ saturation (SaO₂). This reduced ventilatory response and significant CO₂ retention demonstrate the role of muscle afferents in regulating ventilation during exercise (Amann et al., 2006). It is important to note that other receptors located in the lung parenchyma can be stimulated by mechanical stimuli (i.e., stretch) and play a role in the control of breathing (Barlett et al., 1976).

Overall, when dealing with increased gas transport demands during exercise, ventilation is meticulously orchestrated by the feedback and feedforward components of the neural respiratory

control network which drive alveolar ventilation in proportion to CO₂ production while minimizing elastic and resistive loads on the respiratory muscles and ensuring optimal O₂ transport. Thus, hyperpnea precisely and efficiently adjusts to ventilatory demand. Therefore, in healthy humans, the ventilatory system is designed to successfully meet the demands placed on it during exercise, which is a remarkable achievement given the significant demands placed on it during prolonged, high-intensity exercise. As such, the ventilatory system is generally considered as “overbuilt” (Dempsey et al., 2006). However, previous work has identified several circumstances in which the ventilatory system may not be able to meet these demands like in athletes or master athletes for example.

c) Breathing pattern during exercise

The rise in \dot{V}_E during exercise occurs through increases in both breathing frequency (BF) and tidal volume (VT). At the onset of exercise VT expands in the inspiratory and expiratory reserve volumes while BF only increases slightly. The initial increase of VT instead of the increase of BF, reduces dead space ventilation and favors effective alveolar ventilation (V_A). With the increase in exercise intensity, VT reaches a plateau when it corresponds to ~50-60% of vital capacity. Increasing VT to a greater extent would not be advantageous for the ventilatory system because it would place substantial load on the respiratory muscles and increase the cost of breathing. Further increase in \dot{V}_E thus results from an increase in BF, itself achieved via reductions in both inspiratory and expiratory time (Ti and Te, respectively) (Sheel and Romer, 2012). During intense exercise, expiratory time (Te) decreases more than inspiratory time (Ti), leading to an increase in inspiratory duty cycle (Ti/T_{TOT}) from 0.4 at rest to 0.55 during maximal exercise (McParland et al., 1992). At the onset of exercise, VT increases due to expiratory muscle contraction, reducing end-expiratory lung volume (EELV) below functional residual capacity (FRC). Breathing at a lower EELV enables the diaphragm to work near its optimal length for force generation (Rahn et al., 1946). In addition, VT is heightened on the most compliant segment of the respiratory system pressure volume relationship (see Figure 6) where the least amount of pressure is needed to increase lung volume (Rahn et al., 1946). As exercise intensity increases, the increase in VT is attributed to the rise in end-inspiratory lung volume (EILV). During high-intensity exercise, EELV may increase towards, or at times exceed, resting values (i.e., dynamic hyperinflation, see Figure 10). Breathing at such high operating lung volumes enables to achieve greater expiratory flow rates and to compensates for expiratory flow limitation (EFL, further discussed later). However, breathing at higher

operating lung volume also increases the strain on the inspiratory muscles (Pellegrino et al., 1993). Indeed, dynamic hyperinflation is associated with a distortion of the thorax and puts the respiratory muscles in a non-optimal length to generate force. This increases the cost of their contraction and may result in a faster development of respiratory muscle fatigue (Aliverti, 2008; Guenette et al., 2010).

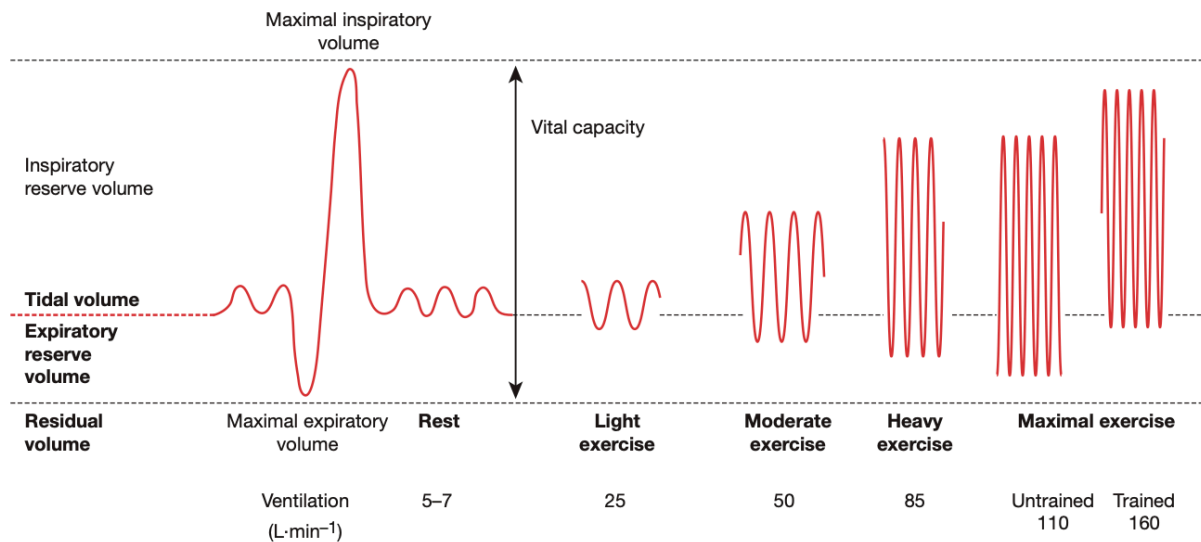

Figure 11. Typical changes in breathing pattern and dynamic hyperinflation during exercise in untrained and trained individuals. With light to heavy exercise the increase in ventilation is achieved by increasing breathing frequency and tidal volume. Tidal volume increases by encroaching on the expiratory and inspiratory reserve volumes. \dot{V}_E , V_T and BF are all higher and maximal exercise end-expiratory lung volume is increased to near resting values demonstrating dynamic hyperinflation. *Figure from Dempsey and Jacques, 2015.*

4. Expiratory flow limitation during exercise

a) Definition and mechanisms of EFL

Maximum expiratory flow is strongly influenced by the recoil force of the parenchyma, which pulls the airway wall outward. This maintains airway pressure above the thoracic pressures, keeping the airways open. Nevertheless, the airways are not entirely rigid, making them susceptible to collapse during vigorous expiration. Indeed, at its simplest level, flow limitation can be understood in terms of the viscous effects of gas flowing along a collapsible airway (Wilson et al., 1986) as illustrated by Figure 12. The expiratory muscles apply a positive pressure to increase the alveolar pressure (P_A) and the pressure outside of the airway (pleural pressure, P_{pl}).

The resulting pressure gradient from P_A to the airway opening (P_{ao}) drives flow down the airway. However, the compliant conduit tends to constrict with the increasing transmural pressure across its walls (Bates, 2009). As a result, the pressure within the conduit decreases from P_A at its distal end to P_{ao} at its proximal end, and the transmural pressure grows along the airway from $P_{pl} - P_A$ to $P_{pl} - P_{ao}$ (Bates and Lutchen, 2005). The increase in P_{pl} leads to higher upstream driving pressure, which in turn increases flow. Conversely, it also narrows the conduit, increasing its resistance and decreasing flow (see Figure 12). These effects are balanced but if the airway collapses, flow will not be able to increase despite further increase in P_{pl} and expiratory flow will become limited.

From a purely physical point of view, the fractal shape (i.e., exhibits the property of self-similarity at different length scales of evaluations) of the human lungs enables efficient airflow. Nevertheless, even a slight bronchial narrowing can have significant negative consequences (Mauroy et al., 2004). A constriction causes a significant increase in the overall resistance of the tree. For instance, a 4% reduction in the ratio of diameter to length between successive generations (i.e., the homothetic ratio) would increase the resistance of a simple airway tube by only 15%, while nearly doubling the resistance of the tree (Mauroy et al., 2004). This result implies that airway collapse with EFL could lead to a steep increase in the resistance of the bronchial tree.

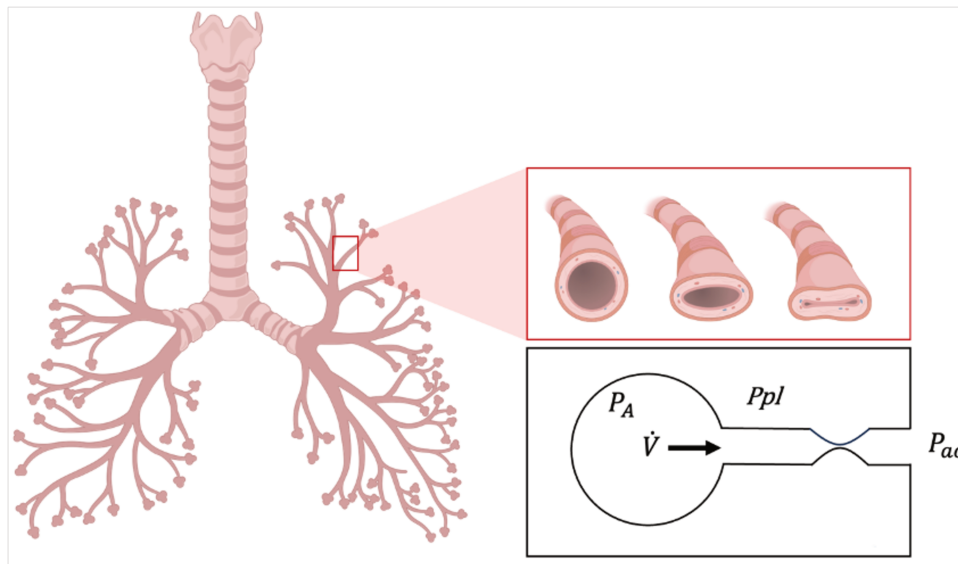

Figure 12. Stylized model of expiratory flow limitation according to “Mead model”. The respiratory system is represented as an elastic alveolar unit with flow \dot{V} going from an internal alveolar pressure P_A , through an airway to an outside airway opening pressure P_{ao} . Both the alveolar unit and airway are encased in a chest wall compartment that applies the pleural pressure P_{pl} along the airway.

c) Measurement of expiratory flow limitation

EFL has been studied in healthy humans of varying ages and fitness levels, as well as in individuals with chronic obstructive pulmonary diseases (Cox et al., 2020; Dominelli et al., 2011; Guenette et al., 2007; Johnson et al., 1999, 1991b; Koulouris et al., 1997; Molgat-Seon et al., 2022; Nourry et al., 2006; Smith et al., 2014; Wilkie et al., 2015). To date, the gold standard method to determine EFL is the use of a negative expiratory pressure (NEP). This technique, described by Valta et al. (1994), aims at enhancing spontaneous expiratory flow by manipulating the pressure at the mouth level. Specifically, a negative expiratory pressure of 5 to 10 hPa is applied using a Venturi system and EFL occurs when the negative pressure does not induce any increase in expiratory flow. This technique is better adapted for individuals who are reluctant or unable to perform acceptable forced expiratory maneuvers. However, the NEP technique could potentially induce a collapse of the upper airways in some individuals, thereby possibly impairing expiratory flows (Baydur, 2012). Moreover, this technique requires expensive equipment which limits its accessibility.

The most common method used to measure EFL involves placing the tidal flow–volume loops within the MEFV curve based on EELV (see Figure 13). The severity of EFL is determined by calculating the volume of the expiratory tidal breath that meets or exceeds the MEFV curve. This

measurement is then expressed relative to the tidal volume and determines the level of ventilatory constraint (Derchak et al., 2000; Guenette et al., 2010; Walls et al., 2002). While this approach offers multiple benefits, certain methodological errors may impact the extent of EFL typically observed in humans during exercise. Guenette et al., (2010) emphasize the significance of considering thoracic gas compression by directing participants to perform expirations from total lung capacity to residual volume at varying levels of exertion. Indeed, his study confirmed that maximal expiratory flows for a given lung volume can differ when considering thoracic gas compression (Guenette et al., 2010). In addition, Previous work has demonstrated increased MEFV curves after exercise (Guenette et al., 2010), indicating that bronchodilation continues post-exercise. Guenette et al., (2010) showed that post exercise bronchodilatation, combined with thoracic gas compression, significantly influence EFL and must be considered. Importantly, this method is critically dependent on an accurate measurement of inspiratory capacity (IC, i.e., maximal inspiration from FRC to TLC) to track changes in EELV (Guenette et al., 2013). Moreover, when TLC and static recoil were measured during progressive steady-state cycling exercise, they did not differ significantly from rest to maximal intensities confirming that the use of inspiratory capacity maneuvers is appropriate to estimate changes in operating lung volume during exercise (Babb and Rodarte, 1991; Younes and Kivinen, 1984).

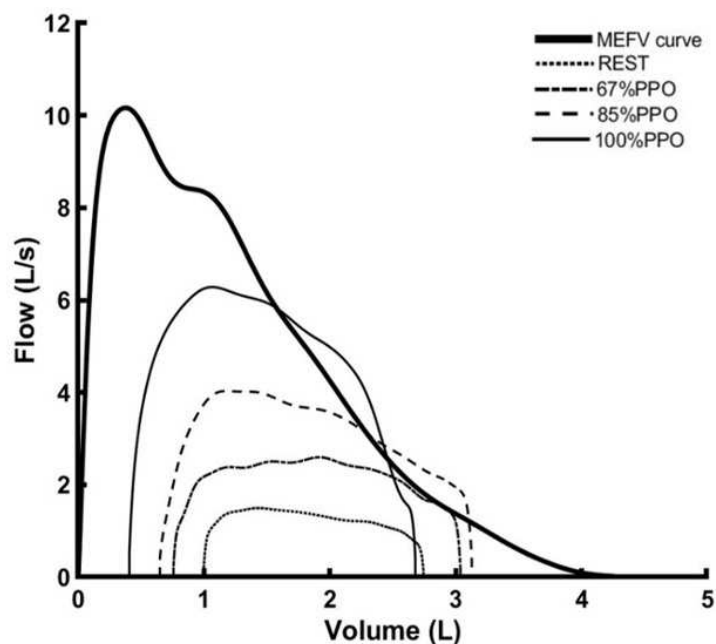

Figure 13. Expiratory flow limitation during exercise in a male master athlete. Maximal expiratory flow volume (MEFV, thick line) and expiratory tidal flow volume curves (thin lines) at rest and at different stages of a maximal and graded cycling exercise in a representative subject. Expiratory flow limitation (EFL) was first experienced at 85% of peak power output (PPO) and EFL severity increased from 27.5% to 43.7% at peak exercise in this example. Figure illustrates data recorded from our lab.

A better insight into the determinants of EFL can be derived from indices of the MEFV curves. The dysanapsis ratio (DR), depicted earlier, which is indicative of the mismatch between airway size and lung size, has been identified as a determinant of EFL in young women and men (Dominelli et al., 2015; Smith et al., 2014). Authors found that a lower DR (i.e., smaller airways relative to lung size) was associated with a greater propensity towards EFL. In addition, the slope ratio (SR) also appears as a predictor of EFL. In fact, Molgat-Seon et al., (2018) conducted a multiple logistic regression model on 126 healthy young men and women and found that exercise-induced EFL was primarily associated with indices of maximal expiratory flow such as FEF₂₅₇₅ and SR. Therefore, healthy individuals with a more concave MEFV curve may be more susceptible of experiencing EFL during exercise.

b) Functional consequences of EFL

EFL can lead to various secondary effects. Upon its onset, EELV may rise towards or surpass the resting levels, leading to dynamic hyperinflation (Johnson et al., 1992). Initially, this hyperinflation is beneficial as it allows an increase in expiratory flow (Pellegrino et al., 1993). However, this is also associated with an increased work of breathing because breathing at high lung volumes elevates the elastic strain on the inspiratory muscles, due to lower dynamic lung compliance (Agostoni and Rahn, 1960). Therefore, dynamic hyperinflation leads to a reduction in the length of the inspiratory muscles, which causes them to contract from a shorter length (i.e., non-optimal length). This can potentially increase the cost of breathing (Aaron et al., 1992). Additionally, the diaphragm has to contract while being too stretched which may cause relative ischemia and contribute to their fatigue (Bellemare and Bigland-Ritchie, 1984). It is worth noting that higher EELV has been observed in the absence of expiratory flow limitation (EFL) (Mota et al., 1999), suggesting that breathing at higher lung volumes may be initiated to prevent dynamic airway compression. EFL and dynamic hyperinflation have been found to exacerbate dyspnea, or breathing discomfort (Molgat-Seon et al., 2018), cause hypercapnia (Aliverti, 2008) and impair exercise performance (Wilkie et al., 2015). During typical exercise, \dot{V}_{O_2} is maintained within a narrow range despite the greater $PAO_2 - PaO_2$. However, with EFL, arterial blood gas homeostasis is not always maintained, and it can lead to exercise induced arterial hypoxemia (EIAH) (Prefaut et al., 1994). For example, the fall of pulse arterial O_2 saturation (SpO_2) below resting levels has been observed near maximum exercise in fit athletes and not in sedentary individuals (Prefaut et al., 2000). The precise cause of this fall in

arterial PO_2 or SpO_2 is unclear but available data suggest that it relates to relative alveolar hypoventilation, ventilation-perfusion inequality and diffusion limitation (Prefaut et al., 2000). EFL does not necessarily lead to dynamic hyperinflation and EIAH. Another potential important consequence of EFL is the additional load it imposes on the ventilatory system. As depicted in Figure 10, higher levels of ventilation are associated with an elevated WOB and cost of breathing. The combination of higher levels of ventilation, and EFL could amplify these demands by increasing resistance to airflow. Previous work using an idealized model of the lungs indicated that even a slight narrowing of the airways may cause a significant increase in the overall resistance of the lungs. For example, a 4% reduction in the ratio of diameter to length between successive generations would nearly double the resistance in the lungs (Mauroy et al., 2004). Therefore, airway narrowing associated with EFL may result in a steep increase in the resistance of the whole bronchial tree thereby putting additional demand on the respiratory muscles. As illustrated by figure 15, an increasing demand on the respiratory muscles may have systemic consequences and redirect blood flow towards the respiratory muscles at the expense of locomotor muscles (Harms et al., 2000). Therefore, EFL may amplify the competition for blood flow between respiratory and locomotor muscles, but further investigation is still required to confirm precisely this claim.

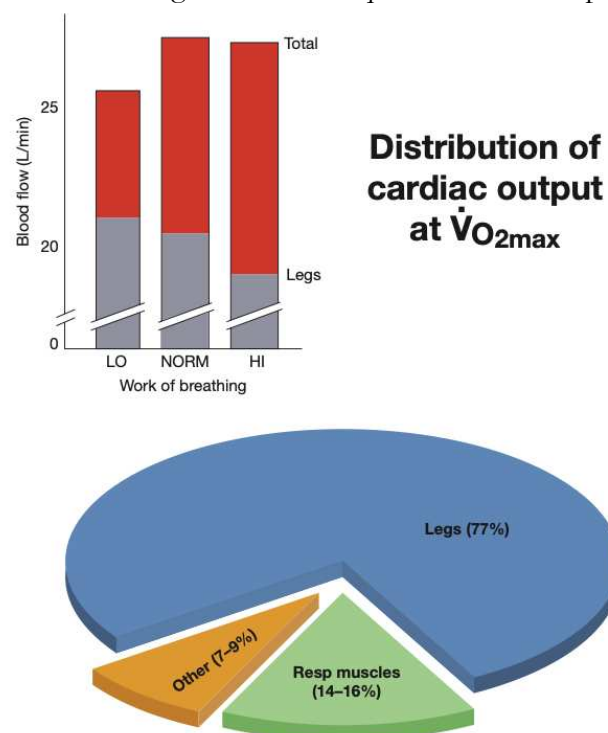

Figure 14. Effect of respiratory muscle work during exercise on cardiac output. LO, NORM, HI, refer to the relative levels of work of breathing during high intensity exercise under normal physiological conditions, with added resistive loads ("HI") and during unloading of the respiratory muscles with mechanical ventilation ("LO"). The top of each bar indicates total cardiac output, and each bar is divided into blood flow to the limbs and to the rest of the body. The estimated distribution of blood flow to the limb musculature and respiratory muscles is shown in the pie chart. *Figure from Dempsey and Jacques, 2015.*

Healthy and highly trained endurance athletes represent a special case. Among these individuals, the substantial hyperventilatory response to strenuous exercise leads to mechanical constraint, in such a way that the elevated ventilatory demand is not matched by the capacity of the airways for flow and volume (see Figure 15). Athletes demonstrate a heightened capacity to transport and utilize oxygen enabling them to reach higher exercising work rates and necessitating a greater maximal ventilatory response compared to untrained counterparts (Johnson et al., 1999). However, despite increased demand during exercise, lung capacity is similar between trained and untrained individuals (Dempsey et al., 2008b; Reuschlein et al., 1968). In fact, neither fitness level nor endurance training has been shown to affect lung function (Johnson et al., 1992; McClaran et al., 1995). In this context, the respiratory system may no longer be overbuilt to meet the demand associated with heavy exercise. The fact that endurance training does not have a positive effect on the pulmonary system in healthy humans is supported for example by the lack of modification in lung diffusion capacity and pulmonary capillary blood volume after 5 months of aerobic training (Reuschlein et al., 1968). Additionally, lung volumes and airway diameters do not adjust with training, and, as a result, the increased demand for flow rate often exceeds the airways flow capacity. Therefore, the high demands of intense physical activity may lead endurance athletes to reach the ceiling of their respiratory system, ultimately hindering their ability to further increase expiratory flow.

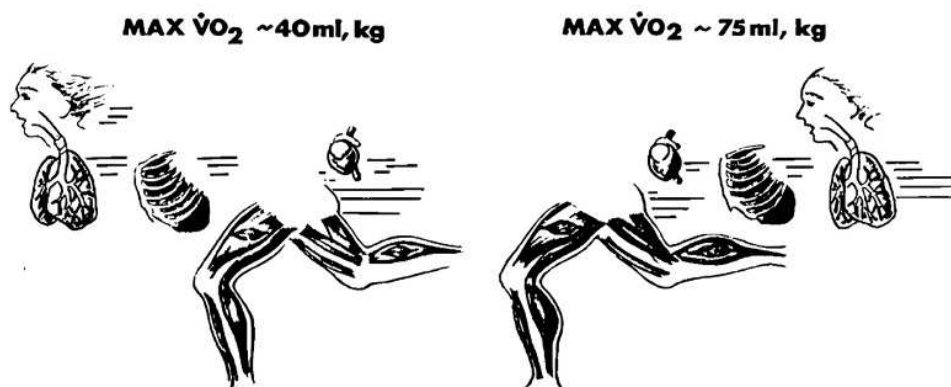

Figure 15. Limiting factor to exercise performance in untrained and trained individuals.

In untrained individuals with a $\dot{V}O_{2 \text{ MAX}}$ of $40 \text{ mL} \cdot \text{min}^{-1} \cdot \text{kg}^{-1}$, exercise performance is limited by the ability of the cardiac system to deliver O_2 to the exercising muscles and the respiratory system is overbuilt for the demand. However, athletes who have a $\dot{V}O_{2 \text{ MAX}}$ of $40 \text{ mL} \cdot \text{min}^{-1} \cdot \text{kg}^{-1}$ due to their increased maximal stroke volume, Hb mass, circulating blood volume, and locomotor muscle aerobic capacity, the respiratory system may become underbuilt. This change in limiting factors is notably due to the lack of plasticity of the lungs to endurance training.

Adapted from (Dempsey, 1986).

c) Influence of biological sex

Biological sex is important when considering the ventilatory response to exercise. For example, when matched for height, women have smaller lungs and lower maximum expiratory flows than men and even when matched for lung size, women have smaller large conducting airways (i.e., generations 0-5) than men (Sheel et al., 2009). Given these sex differences, healthy young women appear to be predisposed to greater mechanical ventilatory constraint during exercise compared with men. For a given $\dot{V}E$, women exhibited a higher WOB than men and it was suggested to be due to the differences in the resistive WOB, because the viscoelastic WOB is similar between men and women (Dominelli et al., 2015; Molgat-Seon et al., 2019). This indicated that biological sex differences in the WOB likely relate to sex differences in airway morphology (Mead, 1980; Sheel et al., 2009; Dominelli et al., 2018). In addition, women have been shown to exhibit a higher cost of breathing for a given ventilation level (Dominelli et al., 2018).

Studies conducted on female endurance athletes ($\geq 55 \text{ mL}\cdot\text{min}^{-1}\cdot\text{kg}^{-1}$) showed that they were more prone to experiencing EFL during exercise compared to their male counterparts (Guenette et al., 2007; McClaran et al., 1998). This suggests that sex may impact the ability to meet ventilatory demands when individuals use a substantial portion of their ventilatory capacity. Yet, these findings are not consistent with other results (Molgat-Seon et al., 2022), based on a larger sample size, where was reported a similar incidence of EFL between males and females, even among those with the highest levels of aerobic fitness. Research on young adults with different fitness characteristics demonstrated similar EFL levels regardless of biological sex during exercise (Dominelli et al., 2015b; Molgat-Seon et al., 2018; Smith et al., 2014). Additionally, in their recent multivariate analysis of 126 healthy males and females with varying fitness levels, Molgat-Seon and colleagues (Molgat-Seon et al., 2022) reported that 53% of healthy young men and 45% of women had a comparable incidence of EFL suggesting equal ability between males and females to meet the ventilatory demands during exercise.

5. The ventilatory limitation to exercise capacity in the master athlete

As shown in Figure 16, the lungs go through a period of growth and maturation during the first two decades of life, reaching peak lung function around the age of 20 years in women and 25 years in men, and then remain stable from age 20 to 35 before beginning to decline.

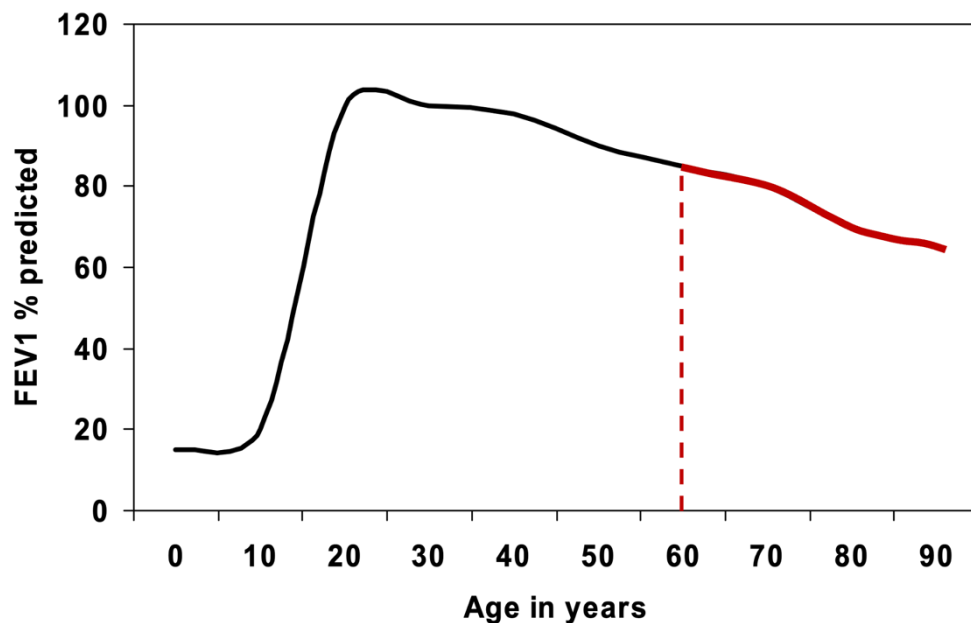

Figure 16. Evolution of the predicted FEV₁ across age. Red line represents the predicted FEV₁ for individuals who are >60 years of age, which is the age at which master athletes were recruited in this thesis. *Figure adapted from (Sharma and Goodwin, 2006).*

The decline in respiratory function with age is primarily due to changes in the properties of the lung and chest wall tissues. Specifically, the main alterations appear to be due to the loss of elastic recoil of the lung which is caused by alterations in the supporting connective tissue (Gibson et al., 1976; Pierce and Ebert, 1965; Turner et al., 1968). This may be caused by changes in elastin and collagen content, which are the predominant structural proteins in the lung (Krumpe, 1985). The loss of elastic recoil leads to a leftward shift of the pressure-volume curve and a dynamic narrowing or closure of the airways in a context of forced expiration, increasing resistance in the bronchial tree (Johnson et al., 1994; Molgat-Seon et al., 2019; Roman et al., 2016). In addition, the aging process affects the thoracic structure. There is a marked reduction in the intervertebral space and

increased stiffness of the thoracic cage with the calcification of the rib cage due to osteoporosis (Rizzato and Marazzini, 1970). This alteration of the costal cartilage distorts the thorax, reduces the mobility of the rib cage and limits its ability to expand during inspiration (Estenne et al., 1985; Janssens, 2005; Knudson et al., 1977). These age-related changes in the ventilatory system have significant consequences on operational lung volumes. They result in a decrease in vital capacity with concomitant increases in residual volume, physiological dead space and resting FRC. Changes in the intervertebral spaces result in decreased height and may account for some decrease in TLC reported in the elderly (Sharma and Goodwin, 2006). The combination of reduced connective tissue and a distorted thorax also affects the compliance of the chest wall. This affects the ability of the diaphragm to generate pressure, and leads to a reduction in maximal expiratory flow (Janssens, 2005). The structural and functional changes in the respiratory system associated with healthy aging alter the mechanics of breathing during exercise (Janssens et al., 1999; Roman et al., 2016). For example, healthy aging is known to result in an increase in WOB for a given ventilation level (Johnson and Dempsey, 1991). Molgat-Seon et al. (2019) applied a modeling approach to physiological data to address the question of whether aging may differentially affect WOB and found a significant effect of age on the resistive and viscoelastic components of WOB. However, in untrained individuals, the respiratory system is unlikely to be a major limitation to maximal exercise performance, because the 35-40% reduction in FEV₁ is accompanied by a 40% reduction in $\dot{V}O_{2\text{ MAX}}$.

On the other hand, master athletes are a special case among the elderly. Highly trained elderly subjects, whose trainable cardiovascular system and muscle metabolic capacity allow to reach a $\dot{V}O_{2\text{ MAX}}$ of 40-60mL.min⁻¹.kg⁻¹ range, require ventilation levels in the range of 100-130 L.min⁻¹ (Johnson et al., 1994, Trappe et al., 2013). This substantial demand on their aging ventilatory system may result in an imbalance between O₂ transport demand and respiratory system capacity. Some, but not all, cross-sectional comparisons between trained and untrained elderly subjects show superior lung function in the trained subjects (Babb, 1997; Hagberg et al., 1988; Johnson et al., 1991, 1994; McClaran et al., 1995). In addition, a 7-year longitudinal study showed that habitual exercise training did not provide a protective effect against age-related declines in lung function at rest and during exercise in the sixth and seventh decades (McClaran et al., 1995). Thus, the available evidence, although limited, suggests that the lungs of older athletes, like their younger counterparts, are not trainable, whereas the cardiovascular, hematological, and muscular systems remain highly trainable. Thus, a significant number of trained older adults experience respiratory limitations to high-intensity exercise. The major difference in the master athlete is that these limitations occur at much lower relative metabolic demands than in their younger counterparts.

EXERCISE INDUCED NEUROMUSCULAR FATIGUE

The higher ventilatory demand and the ventilatory constraints found in athletes places substantial load on respiratory muscles. This may increase respiratory muscle fatigue. In turn, evidence suggest that inspiratory or expiratory muscles fatigue accelerate the development of locomotor muscle fatigue during high-intensity exercise which may impair exercise performance (Romer et al., 2006).

1. Definition of neuromuscular fatigue

In everyday language, fatigue is a debilitating symptom that leads to a decline in task performance or an increase in the perception of the difficulty to execute this task owing to a state of weakness and/or exhaustion. Many studies on fatigue have divided this concept into distinct areas such as mental, psychological, cognitive, and perceived fatigue or physical, physiological, and muscle fatigue. In sport science research, fatigue mainly used to refer to the decrease of performance and was defined as the inability to maintain a given force level (Edwards, 1981) or to keep exercising at a given intensity (Booth and Thomason, 1991). Although uncomplete, these definitions already highlighted the close interplay between fatigue and exercise performance. More recently, Enoka & Duchateau (2016) proposed a classification adapted from (Kluger et al., 2013) that distinguishes the subjective sensation of fatigue (i.e., perceived fatigability) and the objective changes in performance (i.e., performance fatigability) with both indicators being tightly associated with each other (see Figure 17).

This thesis aims at studying limitation to exercise induced by high-intensity exercise ($> 85\% \dot{V}O_{2\text{MAX}}$), and we focused on the neuromuscular aspect of exercise-induced fatigue. Neuromuscular fatigue can be defined as “any exercise-induced reduction in the ability to exert muscle force or power, regardless of whether or not the task can be sustained” (Bigland-Ritchie and Woods, 1984). Fatigue is reversible by rest and should be distinguished from muscle weakness, which refers to an impaired capacity to generate force (NHLBI workshop, 1990). Neuromuscular fatigue is thus typically classified into two interdependent components: peripheral fatigue, which occurs downstream of the neuromuscular junction within the muscle itself, and central fatigue, which occurs upstream of the neuromuscular junction and involves the spinal and supraspinal

subdivisions of the central nervous system (CNS) (Bigland-Ritchie and Woods, 1984; Gandevia, 2001). Understanding the influence of neuromuscular fatigue on exercise performance is essential to improve training strategies, prevent injuries associated with fatigue, and develop effective fatigue management techniques.

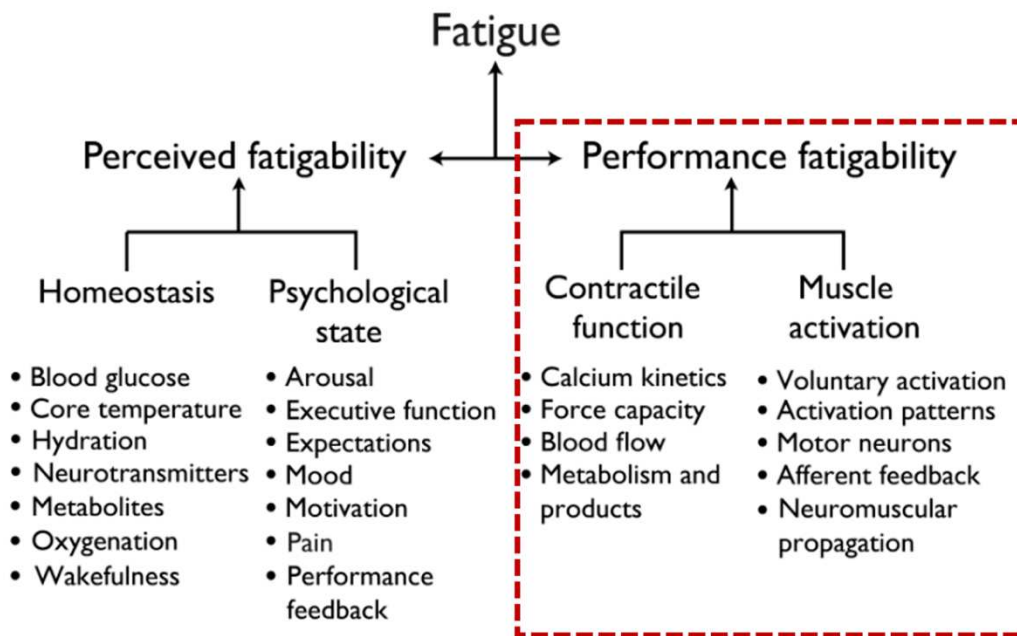

Figure 17. Taxonomy of fatigue from an integrative perspective. Fatigue is a debilitating symptom that can be divided into perceived fatigability and performance fatigability. Each attribute can further be subdivided into two parts which are influenced by various factors. In this thesis we will focus on the “performance fatigability” part of this taxonomy. *Adapted from (Enoka and Duchateau, 2016).*

2. Methodology of neuromuscular fatigue

Neuromuscular fatigue is associated with a decline in exercise performance and an impaired ability to generate force. The reduction in maximal force production is a standard measure to objectively assess the level of exercise-induced fatigue. Furthermore, analyzing the muscles' activation level also provides valuable insights into the changes caused by fatigue. Various methods exist to quantify those aspects and evaluate both the level of neuromuscular fatigue, and its corresponding mechanisms. A synthetic presentation is proposed below to illustrate the potential of these methods in distinguishing the peripheral component from the central component.

a) Maximal force production

The maximum voluntary force is typically measured through a maximum voluntary isometric contraction (MViC) using a calibrated load cell attached to an ergometer. The decrease in peak force from pre- to post-fatiguing effort is then calculated and serves as an objective measure of the overall neuromuscular fatigue (i.e., central and peripheral) instigated by exercise. When performed rigorously (i.e., familiarization, visual feedback, and vigorous encouragement) (Gandevia, 2001), MViC has been shown to vary only by 3.5% (Place et al., 2007) and 4.3% (Tofari et al., 2016) between sessions separated by 3 days and by 9.7% (Todd et al., 2004) when sessions were separated by a week. However, this measurement does not enable for further interpretation of the underlying physiological processes impacted by the strenuous activity (Allen et al., 2008; Bigland-Ritchie and Woods, 1984; Enoka and Duchateau, 2016; Gandevia, 2001). Therefore, additional measures are necessary to accurately quantify the implicated mechanisms.

b) Measurement of peripheral fatigue

Measuring peripheral fatigue enables to investigate the consequences of alterations occurring within the muscle (downstream of the neuromuscular junction). To evaluate the capacity of the muscle to generate force independently of voluntary activation (i.e., located upstream of the neuromuscular junction), the latter must be circumvented. Thus, muscle contraction can be elicited by percutaneous electrical stimulation of a motor nerve (Merton, 1954). This thesis specifically examines quadriceps fatigue and, therefore, stimulation of the femoral nerve is used. It is located on the femoral triangle a few centimeters below the inguinal ligament (Verges et al., 2009). To ensure complete spatial recruitment of motor units even with reduced motoneuron excitability, the stimulation intensity must exceed the intensity threshold that generates the highest peak force (i.e., supramaximal). This threshold is determined by gradually increasing the intensity of the stimulation during each evoked contraction, until reaching a plateau on the force signal and the amplitude of M-wave from the electromyography signal (EMG) (see Figure 19) (Lepers, 2010; Neyroud et al., 2014). Once this plateau is reached, the intensity of the stimulation should be increased to reach 120% to 150% of the threshold intensity (Lagerquist and Collins, 2010) The motor nerve can also be depolarized using magnetic stimulation which is less painful for the participants but have a lower maximal level of stimulation (Verges et al., 2009). In some participants, the intensity of the stimulation might not allow a complete spatial recruitment of motor units and in this case, the assessment cannot be rigorously performed. The magnetic field is also wider and less precise

compared to an electrode, which may lead to the stimulation of antagonist muscles (Wragg et al., 1994).

Whether magnetic or electrical, the single stimulation of the motor nerve on a relaxed muscle is the most common method employed to assess peripheral fatigue which corresponds to the reduction of the maximal twitch force or torque (Gandevia et al., 1996; Merton, 1954; Reid, 1928). Other secondary parameters including contraction time (CT), half-relaxation time (HRT), can also be determined to characterize exercise-induced alterations within the muscle (see Figure 18).

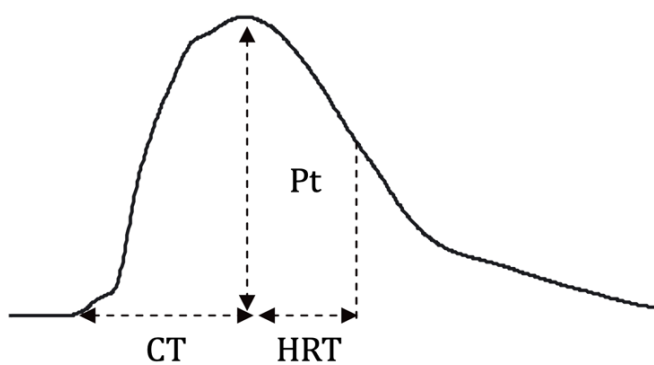

Figure 18. Characterization of the muscle twitch force in response to a single stimulation. The main feature of the signal is the maximal twitch force (Pt). Half relaxation time (HRT) and contraction time (CT) are secondary parameters. *Figure from (Lepers, 2010).*

Although single stimulation of the motor nerve is very useful to quantify peripheral fatigue, it does not provide insights in deeper underlying mechanisms (Bigland-Ritchie and Woods, 1984; Gandevia, 2001). Further information can be obtained through double stimulation of the motor nerve. Two electrical stimulations to the motor nerve, either at a high frequency (80-100 Hz) or a low frequency (10-20 Hz) enable to determine high frequency fatigue and low frequency fatigue, respectively (Martin et al., 2004; Verges et al., 2009). High frequency fatigue displays a rapid recovery and may indicate a change in membrane excitability (Fuglevand et al., 1993).

Low frequency fatigue is characterized by a prolonged recovery period ranging from few hours to several days (Edwards et al., 1977; Jones et al., 1989). Determining this fatigue can be performed through the calculation of the ratio between the peak force of a low-frequency doublet and that of a high-frequency doublet. Low frequency depression is primarily, but not exclusively, a result of excitation-contraction coupling failure caused by an increase in intramuscular metabolite concentration induced by exercise (Allen et al., 2008; Chin and Allen, 1996; Jones et al., 1989).

When evaluating peripheral fatigue measurement it is important to consider post-activation potentiation which refers to the temporary increase in force following a contraction (Manning and Stull, 1982; Moore and Stull, 1984; Sale, 2004). This phenomenon may be explained by the

phosphorylation of the light chains of myosin thereby increasing muscle fiber sensitivity to Ca^{2+} (Manning and Stull, 1982; Moore and Stull, 1984; Sale, 2004; Szczesna et al., 2002). An additional explanation for increased force production could be the greater recruitment of more motor units (Tillin and Bishop, 2009). Therefore, normalizing the level of post-activation potentiation is commonly achieved by maximizing it with a MViC of a few seconds (between 3 and 5 seconds) before stimulating the motor nerve. The twitch is then described as potentiated.

In addition to mechanical parameters, it is possible to record the electrical activity of the muscle during evoked contractions (Bigland-Ritchie et al., 1979; Fuglevand et al., 1993). The depolarization of the nerve during the stimulation generates a synchronized action potential of the recruited muscle fibers which can be recorded by surface EMG and forms a signal called an M-wave (Figure 19). Variations of the characteristics of the M-wave (e.g., amplitude or duration) during exercise may imply an alteration in the propagation of action potentials or membrane excitability of the fibers being stimulated (Allen et al., 2008; Fuglevand et al., 1993).

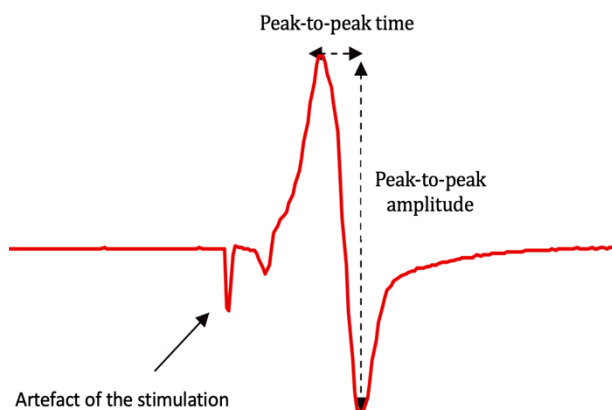

Figure 19. M-wave of the vastus lateralis in response to a single stimulation. Membrane excitability is commonly assessed through the study of the characteristics of the M-wave, particularly its amplitude. *Figure adapted from Lepers (2010).*

c) Measurement of central fatigue

Central fatigue is defined as a decrease in the subject's ability to voluntarily activate a muscle or muscle group (i.e., voluntary activation, VA). The most commonly used methods for measuring central fatigue is the superimposed twitch technique (Merton, 1954). Merton (1954) initially proposed that fluctuations in the amplitude of the muscle twitch superimposed on a MViC, would serve as an indicator of the extent of muscle activation. Today, it is well accepted that VA can be estimated by the ratio of the amplitude of the superimposed twitch on the muscle twitch evoked on a relaxed muscle (Bellemare and Bigland-Ritchie, 1984; Todd et al., 2004) :

$$VA(\%) = \left(1 - \frac{QT_{SUP}}{QT_{REST}}\right) \times 100 \quad (9)$$

With VA representing the percentage of voluntary activation (%), QT_{SUP} being the amplitude of the twitch superimposed on the MViC (N) and QT_{REST} being the amplitude of the muscle twitch measured on relaxed muscle (N). To ensure a rigorous assessment, it is necessary to superimpose the stimulation at the peak of force on the maximal contraction (Gandevia, 2001; Merton, 1954). Moreover, to ensure optimal recruitment of motor units, it is preferable to use high-frequency stimulus trains (Bigland-Ritchie et al., 1992; Strojnik and Komi, 1998). However, it is important to note that doublet stimulations can be perceived as very uncomfortable by some participants and in this case, the superimposed stimulation is a single stimulation. Although the evaluation of central fatigue through peripheral stimulation is frequently used, the reliability of this method as a surrogate of VA has been questioned (Taylor, 2009) and it does not elucidate the underlying mechanisms of central fatigue (Gandevia, 2001).

The decrease in VA may result from alterations in spinal or supraspinal processes. To differentiate the implication of each factor on muscle activation, it is possible to use transcranial stimulation techniques thereby targeting the motor cortex (i.e., transcranial magnetic stimulation, TMS) and the cervicomedullary region (Gandevia et al., 1996; Goodall et al., 2009; Ugawa et al., 1991). Increased force following stimulation suggests submaximal activation of the motor neuron pool that innervates the muscle (Gruet et al., 2013). To determine whether the reduction in VA results from supraspinal level processes, it is possible compare the results obtained through TMS with the results from peripheral nerve stimulation (Gandevia et al., 1996; Gruet et al., 2014; Sidhu et al., 2014; Thomas et al., 2015).

d) Surface EMG

The magnitude of the EMG signal serves as an indicator of the level of electric activity detected at an active muscle site. Fundamentally, this value is mainly impacted by the number of motor units recruited and their respective discharge frequencies (Moritani et al., 1986).

Various techniques have been developed to analyze EMG signal during exercise. To analyze the amplitude of the signal, it is possible to calculate the integral of the rectified signal or calculating the root mean square (De Luca and Van Dyk, 1975; González-Izal et al., 2012) :

$$iEMG = \frac{\sum_n |x_n|}{n} \quad (10)$$

$$RMS = \sqrt{\frac{\sum_n x_n^2}{n}} \quad (11)$$

With x_n being the EMG values and n being the number of values. Variations in the amplitude of the EMG signal can result from various factors, including the position of the electrodes or the impedance of the skin (Keen et al., 1994). Therefore, whether derived through integral or RMS calculation, the amplitude of the EMG signal should be normalized during exercise. Typically, data are normalized to the integral or RMS of the EMG signal recorded during MVIC.

3. Mechanisms of neuromuscular fatigue during exercise

a) Peripheral fatigue

Peripheral fatigue is defined as the change in the intrinsic ability of the muscle to produce force and is characterized by an alteration of the contraction processes located at or distal to the neuromuscular junction (Allen et al., 1992; Bellemare and Garzaniti, 1988). On the one hand, evidence suggest that the decline of muscle-fibers force production is strongly associated with intramuscular metabolic disturbances (Blain et al., 2016; Fitts, 1994; Westerblad and Allen, 1992). Indeed, during a fatiguing exercise, there is accumulation of metabolites within the muscle cell resulting from the breakdown of ATP or energetic substrates, such as inorganic phosphates (Pi), ADP, H⁺ protons, and reactive oxygen/nitrogen species (ROS/RNS). Previous studies used magnetic resonance spectroscopy to assess the intramuscular metabolic environment and have reported a coinciding occurrence between the accumulation these metabolites and voluntary exercise termination (Burnley et al., 2010; Chidnok et al., 2013). Therefore, the change in metabolic milieu is believed to determine peripheral fatigue by compromising excitation-contraction coupling within the active skeletal muscle (Allen et al., 2008). Specifically, metabolic disturbances can reduce

the number of activated troponin-C proteins, resulting in a reduction in the number of actin-myosin bridges (Allen et al., 2008; Gordon et al., 2000). Additionally, with the decrease of troponin-C sensitivity to Ca^{2+} , a greater amount of Ca^{2+} is required to generate a specific force while less Ca^{2+} is released by the sarcoplasmic reticulum. This together leads to a decreased intrinsic force capacity of each actin-myosin cross-bridge.

On the other hand, the reduction of force generated by muscle fibers can be caused by a decrease in sarcolemma excitability and subsequent action potential propagation (Allen et al., 2008; Bigland-Ritchie, 1981; Bigland-Ritchie and Woods, 1984). This phenomenon can be understood by analyzing the M-wave parameters, which serve as an indirect indicator for membrane excitability and neuromuscular transmission (Bigland-Ritchie et al., 1979; Fuglevand et al., 1993; Sejersted and Sjøgaard, 2000). One primary factor causing the reduction of sarcolemma excitability is an increase in the concentration of extracellular potassium [K^+] during exercise (Cairns et al., 2009, 1997; Hodgkin and Horowicz, 1959; Overgaard et al., 1999). The increase of potassium levels inhibits the activity of Na^+ channels and impairs the Na^+/K^+ pumps which are crucial for depolarization (when Na^+ ions move into the cell) and repolarization (when K^+ ions move out of the cell) and thus for cell homeostasis (Bouclin et al., 1995). The decrease in membrane excitability contributes to peripheral fatigue (Lepers et al., 2002; Millet, 2011). However, it is important to note that it may not be the principal cause of the peripheral fatigue during short (<10 minutes) high-intensity whole body exercise. In fact, after this type of exercise, the amplitude and shape of the M-wave usually did not decrease (Amann et al., 2006; Amann and Dempsey, 2008; Bigland-Ritchie et al., 1986; Edwards et al., 1977; Gandevia et al., 1996; Hureau et al., 2014).

b) Central fatigue

The decrease in force and/or power and the subsequent reduction in exercise performance can also be attributed to central fatigue. This type of fatigue involves processes that occur within the central nervous system (Gandevia, 2001; Taylor et al., 2016). It refers specifically to a change in the ability of an individual to voluntarily activate the muscles and is characterized by upstream changes from the neuromuscular junction (Bigland-Ritchie and Woods, 1984; Gandevia, 2001).

Muscle activation is determined by the integrity of the motor pathway linking the brain with the exercising skeletal muscles. This pathway, known as the corticospinal pathway, includes the motor cortex and spinal motoneurons. Central fatigue can thus be divided into two components: spinal fatigue and supraspinal fatigue. On the one hand, supraspinal fatigue is associated with a reduction

in neural drive caused by alterations in the premotor regions of the brain, resulting in a decline in the motor cortex's capacity to generate the requisite command for muscle contractions (Gandevia, 2001; Gruet et al., 2013). It can be functionally demonstrated through the increase in force response evoked by superimposed stimulation of the motor cortex which demonstrates an inability of the motor cortex to activate all the α -motoneurons (Gandevia et al., 1996). The decrease in neural drive may also result from spinal fatigue, which refers to muscle contraction impairment caused by mechanisms located in the spinal cord (Gandevia, 2001; Gruet et al., 2013). At this level, force production relies on the capability of the recruited α -motoneurons to transmit action potentials from supraspinal structures to the muscles. This mechanism termed as motoneuronal excitability, is dependent on the balance between inhibitory (e.g., afferent muscular nerve fibers) and facilitating (e.g., action of neuromodulators such as serotonin) processes (Gandevia, 2001; Taylor et al., 2016).

Although many studies have used a peripheral-central dichotomy to explain exercise-induced fatigue, evidence suggests that exercising muscles can modulate the central nervous system activity. In turn, the central nervous system can greatly impact exercise performance by inhibiting the output of motor neurons, which in turn limits muscle activation during exercise, ultimately restricting the development of peripheral fatigue (Amann et al., 2006). This limitation, mediated by the central nervous system, could prevent excessive and potentially harmful impairment of the contracting muscle due to severe intramuscular metabolic disturbance (Blain et al., 2016).

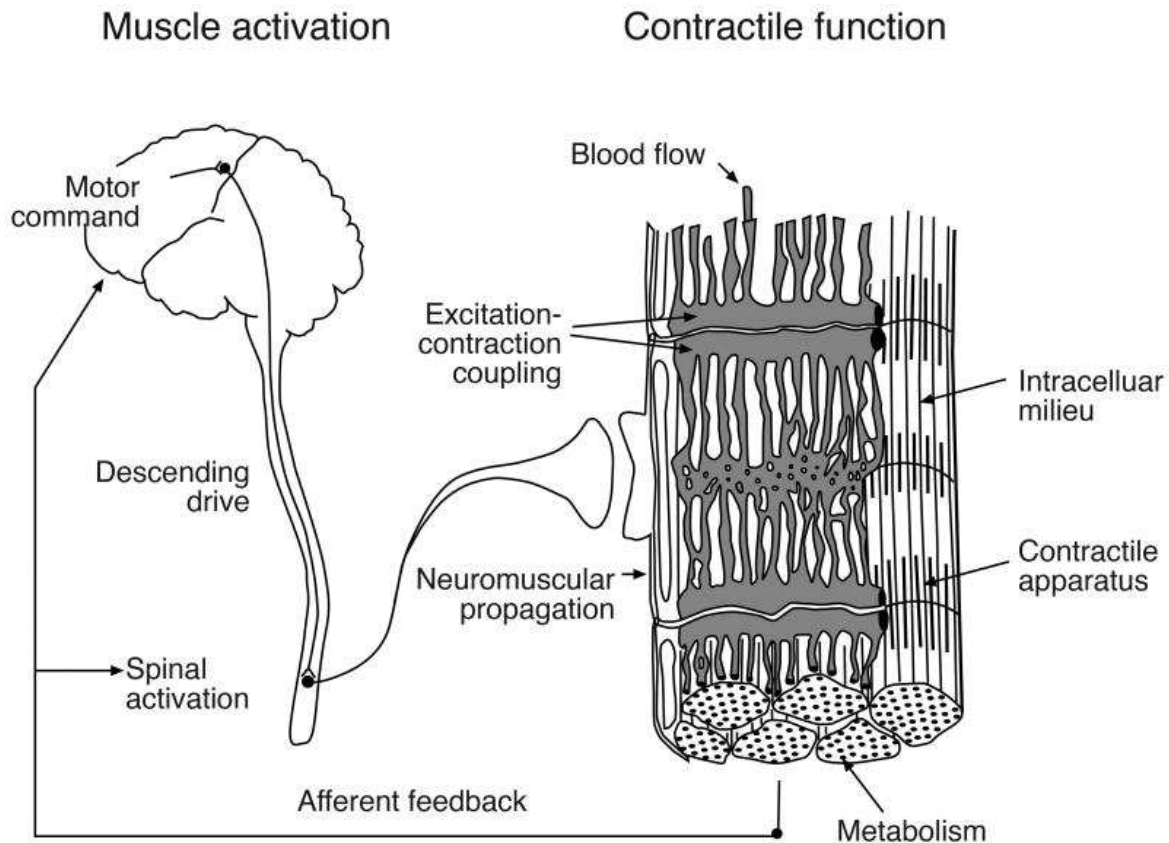

Figure 20. Sites which can contribute to neuromuscular fatigue. Fatigue may be due to alterations in activation of the primary motor cortex, propagation of the command from the central nervous system to the motoneurons, activation of the motor units and muscles, neuromuscular propagation, excitation-contraction coupling, availability of metabolic substrates, state of the intracellular medium, performance of the contractile apparatus, blood flow. *Figure from (Enoka and Duchateau, 2016) adapted from (Bigland-Ritchie, 1981).*

4. Peripheral and central fatigue interaction: the role of group III-IV muscle afferents

a) Group III-IV muscle afferents characteristics

As previously mentioned, fatigue mechanisms are commonly classified as either central or peripheral. However, this categorization appears to lack functional significance. Peripheral and central mechanisms constantly communicate through a rich network of muscle afferent nerve fibers that continuously provide the central nervous system with information regarding muscle activity. Different types of afferent nerves are present in the muscle with receptors responding to

distinct stimuli. Among them, group III and IV muscle afferent fibers play a crucial role in regulating neuromuscular fatigue.

Group III-IV muscle afferents are nerve fibers with a small diameter and are activated by receptors located within the interstitial space and within muscle blood vessel walls (Zhang et al., 2015). Specifically, these receptors are acid-sensing ion channels (ASIC), purinergic type 2X receptors (P2X), and transient receptor potential vanilloid 1 (TRPV1) (Delliaux et al., 2009; Hanna and Kaufman, 2004, 2003; Light et al., 2008). These nerve fibers concomitantly project via the dorsal horn of the spinal cord and convey information to both spinal and supraspinal levels of the central nervous system such as the premotor cortex (Craig, 1995), the thalamus and somatosensory cortex (Almeida et al., 2004), the ventral lateral medulla and/or the motor cortex (Liu et al., 2003, 2002). These receptors are, in a dose-dependent manner responsive to mechanical, metabolic, and pain stimuli.

Mechanical stimuli, which are related to muscular contraction, stretch, pressure, or strain, are mainly transmitted through group III afferents (Kaufman et al., 2002, 1983; Kumazawa and Mizumura, 1977; Mense and Meyer, 1985). These nerve fibers are myelinated, and their signal conduction velocity ranges between 2.5 and 30 m.s⁻¹. Biochemical changes associated with the buildup of Pi, bradykinine, potassium, ROS, lactate, ATP, histamine, prostaglandin E2, and serotonin mainly activate group IV afferents (Kaufman et al., 2002). These unmyelinated nerve fibers, have a conduction velocity of less than 2.5 m.s⁻¹ (Kaufman et al., 2002, 1983; Mense, 1977). The coordinated interaction between group III and group IV afferents enables a finely tuned regulatory mechanism called the metaboreflex (described below).

b) Role of group III-IV muscle afferents in modulating neuromuscular fatigue

Group III-IV muscle afferents are thought to restrain peripheral fatigue development or, more precisely, intramuscular metabolites accumulation by attenuating the motoneuronal output from the CNS (Amann et al., 2011, 2009; Sidhu et al., 2014). Therefore, their implication is crucial in determining whole-body exercise neuromuscular fatigue and thus exercise performance. Fentanyl administration can be used to evaluate the specific impact of type III-IV nerve fibers on the central nervous system and neuromuscular fatigue. The administration of this μ -opioid receptor agonist by lumbar intrathecal injection results in a 55-60% attenuation of the type III-IV nerve afferents, while leaving the motor efferent activity unaffected (Amann et al., 2009; Hureau et al., 2018). The inhibition of these afferences during a 5 km cycling time trial resulted in a significant increase in

EMG activity, measured by surface electromyography, compared to when a placebo was used (see Figure 21) (Amann et al., 2009). Similarly, during a constant workload cycling task performed at 80% of peak power output to exhaustion, a higher level of EMG activity was measured with fentanyl at exercise termination (Amann et al., 2011). Taken together, these findings suggest that during high-intensity whole body exercises, group III-IV afferents limit muscle activation.

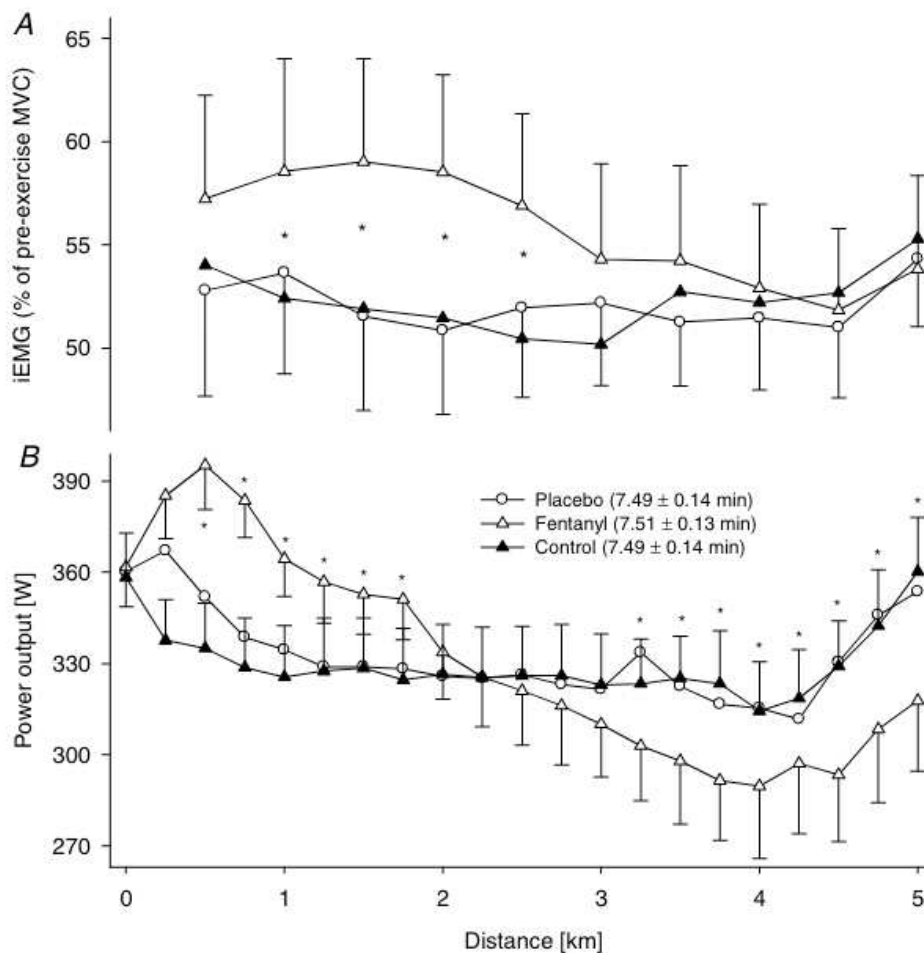

Figure 21. Effect of group III-IV afferents blockade with fentanyl on muscle activation and power output during a 5km time trial. A represents normalized mean integrated EMG (iEMG) during a 5km time trial with intrathecal injection of fentanyl, with a placebo (interspinous ligament injection of saline) or during a control condition. Time trial mean iEMG was significantly higher during the fentanyl condition. B represents mean power output during a 5km time trial under the same conditions. While different patterns were adopted with or without impaired afferent feedback, mean power output over the whole 5km time trial, were not different. These results highlight that type III-IV afferents limit muscle activation but do not impair or improve exercise performance. *Figure from (Amann et al., 2009)*

This attenuation of muscle activation may serve as a protective mechanism to limit intramuscular metabolites accumulation (Amann et al., 2011; Blain et al., 2016). Indeed, the motoneuronal output increase with fentanyl-blockade led to a significant pre- to post-exercise reduction in quadriceps twitch force (~40% greater than with a placebo) after strenuous whole-body exercise (Amann et

al., 2011, 2009). Concomitantly, fentanyl administration led to an increase in intramuscular PCr breakdown, and higher levels of intramuscular Pi and ADP along with a lower pH (Blain et al., 2016). In addition, these greater disruptions in the intramuscular environment were correlated with the more pronounced decline in quadriceps twitch forces (see Figure 22) (Blain et al., 2016). This strong association supports the concept that it is the actual disruption in the intramuscular metabolic milieu that is meant to be avoided through group III-IV afferents regulation to prevent a potentially detrimental and harmful impairment of muscle contractile function (Blain et al., 2016). This overall mechanism is called the metaboreflex and is known to protect the locomotor muscles from considerable functional deterioration (see Figure 22).

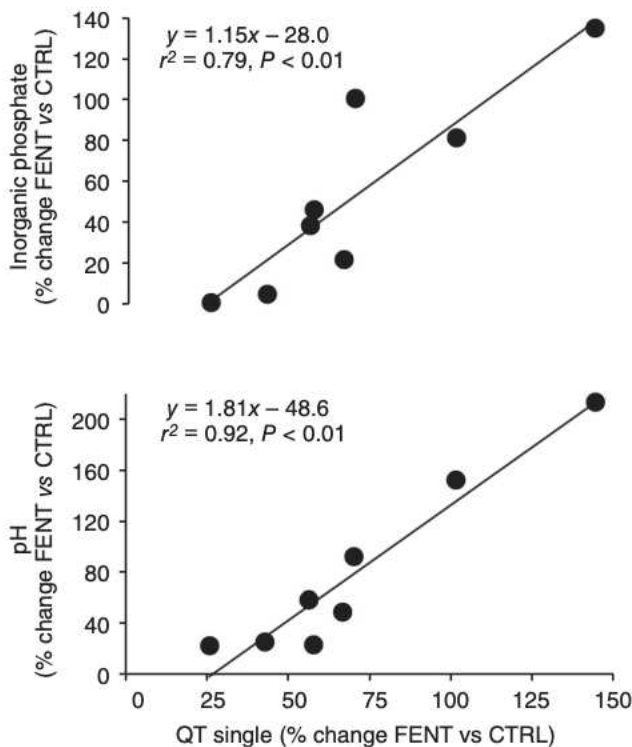

Figure 22. Relationship between quadriceps fatigue and intramuscular metabolites after a 5km time trial. Correlations were found between the level of peripheral fatigue and metabolic change after exercise. Greater peripheral fatigue was associated with greater pH change and greater inorganic phosphate accumulation in the muscle. These data highlight the regulatory role of group III-IV afferents in preventing metabolic disruption within the muscle, which can lead to potentially harmful impairments in muscle contractile function. *Figure from (Blain et al., 2016).*

On the other hand, group III-IV afferents influence cardiovascular and ventilatory responses to exercise (see Figure 23) (Kaufman and Forster, 1996). Indeed, during whole body exercise, these afferents are also known to attenuate the development of peripheral fatigue by enhancing cardiac output, ventilation and muscle perfusion pressure of the working muscles (Amann et al., 2011; Hureau et al., 2018). The increase of the cardiovascular and ventilatory response ensures appropriate O₂ delivery to the locomotor muscles and favors metabolites clearance thereby limiting peripheral fatigue (Amann et al., 2011). For example, when the central projection of group III-IV

afferents was blocked with fentanyl, pulmonary ventilation was compromised thereby leading to hypoventilation, CO₂ retention and exercise induced arterial hypoxemia which can particularly impair exercise performance (Amann et al., 2011). Furthermore, when hyperoxia was used to maintain arterial oxygenation and ensure similar locomotor muscle O₂ delivery compared to control, a higher power output and shorter time to completion of a 5km time trial was found with vs. without group III-IV afferents blockades (Hureau et al., 2019). Together, these findings highlight the pivotal role of group III-IV afferents in ensuring appropriate O₂ delivery to the working muscles.

Another important implication of these afferents is their role in increasing sympathetic nerve activity and vasoconstriction in non-exercising muscles, thereby redirecting blood flow towards the active fatiguing muscles (Harms, 2007). This may be particularly important during high-intensity exercise when locomotor muscle fatigue is coupled with respiratory muscle fatigue.

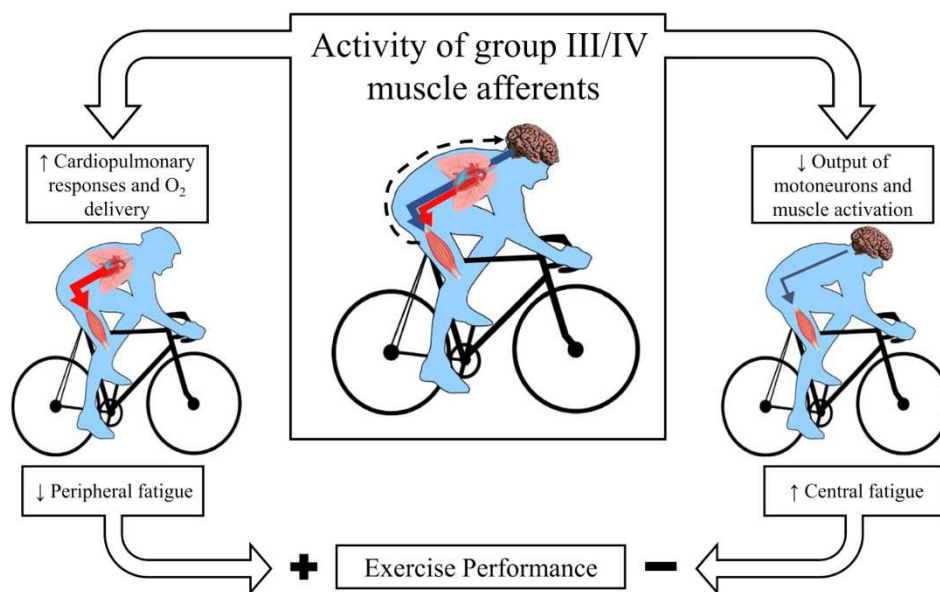

Figure 23. Double-edged sword role of group III-IV muscle afferents in the development of neuromuscular fatigue and exercise performance. On the one hand, the increase in group III-IV afferent feedback during exercise leads to an increase in cardiac output and ventilation thereby favoring adapted O₂ delivery to the working muscles and enhancing exercise performance. On the other hand, this afferent feedback can lead to a reduction in muscle activation thereby favoring central fatigue and impairing exercise performance. In this figure, the dashed black arrow represents the central projection of III-IV muscle afferents, the red arrow represents oxygen delivery, and the blue arrow represents the descending neural input to the locomotor muscles. *Figure from (Amann et al., 2020).*

5. Influence of intense, short-duration whole-body exercise on neuromuscular fatigue

The contribution of the above-mentioned mechanisms to exercise-induced neuromuscular fatigue depends on the undertaken exercise task: type of exercise (e.g., running vs. cycling), type of contraction (e.g., isometric vs. concentric), exercise characteristics (e.g., intensity and duration), and type of muscle used. In this thesis, we aim at investigating the limiting factors of whole-body exercise performance. Therefore, we will focus on neuromuscular fatigue levels following this type of exercise.

When subjects performed a high-intensity ($>80\% \dot{V}O_{2\text{ MAX}}$) whole-body exercise to exhaustion (<10 minutes), it was reported a decrease of $\sim 25\text{-}45\%$ in quadriceps twitch force and a decrease of $\sim 5\text{-}12\%$ in VA (Blain et al., 2016; Ross et al., 2010; Thomas et al., 2015; Weavil et al., 2018). Therefore, after a whole-body exercise of similar intensity and duration, the impact of central fatigue on an individual's ability to produce force seems less significant than peripheral fatigue even though it remains unclear which one is primarily responsible for exercise termination. For example, while no decrease in VA was observed after a 5km cycling time trial or a constant workload test performed at 80% of peak power output (Amann et al., 2009, 2006; Amann and Dempsey, 2008), other studies reported a reduction in voluntary activation levels of the quadriceps between 5% and 9% after a constant workload test performed at 80% of peak power output (Decorte et al., 2012; Sidhu et al., 2014) or between 6% and 7% after a 4 or 5 km cycling time trial (Blain et al., 2016; Thomas et al., 2015). These discrepancies could be attributed to the varying methodologies used (superimposed single stimulation vs. superimposed high-frequency doublet stimulation) but they highlight the apparent lower contribution of central fatigue in this type of exercise.

While relatively short and strenuous exercises may lead to a greater peripheral fatigue, on the other hand, central fatigue seems to have a greater contribution in the decrease in force generation after low-intensity exercise (Millet and Lepers, 2004). For instance, Lepers et al. (2002) investigated the time course of changes in the neural and contractile properties of the quadriceps muscle during a 5-hour cycling session performed at 55% of peak power output. Modifications in muscle functions, such as a decrease in maximal twitch torque and contraction time, were reported during the first hour of exercise while alterations in M-wave features of the vastus lateralis and VA were only found during the final stages of the exercise (Lepers et al., 2002). The weaker central command found

during prolonged exercise may be due to the decreased excitation supplied by the motor cortex (Gandevia, 1998; Taylor et al., 2006). Therefore, the contribution of peripheral or central fatigue in limiting whole body exercise performance seems to highly depend on exercise intensity and duration.

6. The effect of aging on neuromuscular fatigue

Aging is associated with cardiovascular limitations and increased ventilatory work (Ferrari et al., 2003; Molgat-Seon et al., 2019; Wray and Richardson, 2006) which have the potential to limit leg blood flow and oxygen delivery to the locomotor muscles during exercise, thereby exacerbating the development of neuromuscular fatigue (Dempsey et al., 2008a; Harms et al., 1997). From a cellular and tissue perspective, aging of the skeletal muscles primarily involves a decrease in overall mass due to atrophy and a decrease in the number of fibers (particularly type II, which are partly replaced by fat and connective tissue). This is coupled with a loss of elasticity, mitochondrial content, and capillary fiber ratio, and the disruption of coupling between excitation and contraction (Gea et al., 2020; Groen et al., 2014; Wang and Pessin, 2013).

When examining the effects of aging on neuromuscular fatigue, it is important to consider muscle typology. In humans, while the strength and speed levels increase progressively from type I muscle fibers to type IIx, resistance to fatigue gradually decreases from type IIx to type I. This is due to type I higher oxidative enzymatic activity and superior mitochondrial content. The level of peripheral fatigue during exercise, significantly depend on the type of muscle fibers within a single muscle (Hamada et al., 2003). This may partially explain the differences in fatigue levels seen between endurance-trained individuals and untrained individuals (Bachasson et al., 2016; Ducrocq et al., 2021) or in older individuals compared to younger individuals performing the same absolute exercise (Weavil et al., 2018). Indeed, older individuals exhibit a reduced proportion and size of type II (especially IIx) fibers and, conversely, a greater proportion of type I (Larsson et al., 2019).

Weavil et al., (2018) specifically compared the development of fatigue between physically active young and older individuals during a cycling and knee-extensor exercises to examine the development of fatigue in large and small muscle masses, respectively. Central and peripheral fatigue were significantly greater in older adults compared to their younger counterparts following exercise at a given absolute workload and duration (i.e., ISO-work, ISO-time). In contrast, when comparisons were made following an exercise performed at a normalized intensity, little difference

in fatigue resistance was found between young and older subjects. Furthermore, this study shows that the amount of active muscle mass influences the age-induced differences in neuromuscular fatigue after exercise. Specifically compromised fatigue resistance in the elderly is more pronounced after engaging in exercises that utilize large muscle mass (e.g., whole body exercise, cycling) as opposed to small muscle mass (e.g., knee extension). During this whole body cycling exercise, the exaggerated development of central and peripheral fatigue observed in older individuals may be attributed to an increase in the metabolic cost of muscle contractions (Layec et al., 2018, 2014), a decrease in cycling efficiency (Sacchetti et al., 2010), and a shift of the threshold for accelerated intramuscular perturbations to a lower absolute work rate (Chilibeck et al., 1998). The earlier disturbance of energetic homeostasis has indeed been shown in older individuals who exhibited a more rapid increase in Pi/PCr during a graded plantar flexion exercise in comparison to younger counterparts (Coggan et al., 1993). It is worth noting that Sundberg et al (2018) reported that the same concentration of H⁺ and Pi impaired skeletal muscle cross-bridge function similarly in young and older individuals. Therefore, the primary reason for accelerated peripheral fatigue appears to be the actual acceleration of metabolite accumulation at lower work rates. The larger exercise-induced intramuscular metabolic perturbation in the elderly may also contribute to greater central fatigue, by the influence of group III-IV muscle afferents (Sidhu et al., 2017).

7. Respiratory muscle fatigue and metaboreflex

a) Respiratory muscle fatigue during exercise

Respiratory muscles share certain properties with most skeletal muscles, but also possess distinct features. They seem built for fatigue resistance as evidenced by the relatively large number of fatigue-resistant slow-twitch and oxidative fast-twitch muscle fibers which account for ~75% of the muscle fiber type distribution in both the diaphragm and in expiratory abdominal muscles (Häggmark and Thorstensson, 1979; Lieberman et al., 1973; Mizuno and Secher, 1989; Polla, 2004). Moreover, during heavy exercise, the diaphragm exhibits an enhanced vasodilatory response (Supinski et al., 1993) and demonstrates reduced sensitivity to adrenergic vasoconstriction (Aaker and Laughlin, 2002) compared to locomotor muscles. These vascular characteristics potentially enhance oxygen delivery and metabolite removal during exercise, ultimately increasing fatigue resistance of the diaphragm.

Nonetheless, respiratory muscles can experience fatigue during high-intensity exercise despite these inherent properties. High levels of ventilation are associated with an oxygen cost of breathing up to 15% of $\dot{V}O_{2\text{MAX}}$ and respiratory muscles must compete for available cardiac output with other working skeletal muscles (Aaron et al., 1992; Dempsey et al., 2006; Harms et al., 1997, p. 199; Vogiatzis et al., 2009). Therefore, the substantial force development and high velocity of shortening required during high levels of ventilation, combined with the blood flow competition with locomotor muscles results in the occurrence of respiratory muscle fatigue (Romer et al., 2006). Fatigue of the respiratory muscles was specifically shown in several studies using electric or magnetic stimulations of the phrenic nerves or the thoracic nerve (Babcock et al., 2002; Dempsey and Babcock, 1995; Taylor and Romer, 2008; Verges et al., 2006; Wüthrich et al., 2013). Together, findings from these studies suggest that respiratory muscle fatigue occurs for exercises intensities eliciting oxygen uptake $>85\%$ of $\dot{V}O_{2\text{MAX}}$ (Archiza et al., 2018; Johnson et al., 1992). These levels of O_2 uptake and associated ventilatory demand should be maintained for $> 8-10$ minutes to result in respiratory muscles fatigue in healthy individuals. Indeed, neither low intensity exercise of long duration (Babcock et al., 1995; Johnson et al., 1993; Mador et al., 1993) nor incremental exercise of short duration, even when performed to exhaustion, have been shown to elicit diaphragm fatigue (Jeffery Mador et al., 2000; Johnson et al., 1993; Romer et al., 2007). Moreover, induction of respiratory muscle fatigue prior exercise, has been shown to impair subsequent exercise performance (ref). Although this fatigue may not compromise alveolar ventilation, it is believed to stimulate respiratory muscle III-IV afferents thereby initiating the respiratory muscle metaboreflex (Dempsey, 2006).

b) Respiratory muscles metaboreflex during exercise

Group III-IV muscle afferents nerves are also present within the diaphragm (Road, 1990). Neurovascular changes in response to various diaphragm stimuli were first evidenced in animal models. In anesthetized dogs, infusing lactic acid into the diaphragm via the phrenic artery (Rodman et al., 2003) or stimulating phrenic afferents with lactic acid (Hussain et al., 1991) led to a systemic and limb vasoconstriction, followed by a reduction in limb blood flow (Rodman et al., 2003). Furthermore, a study conducted in anesthetized rodents revealed that the onset of diaphragm fatigue resulted in an increase in the activity of the diaphragm metaboreceptors (Jammes and Balzamo, 1992). Additionally, the systemic cardiovascular effects of diaphragmatic acidosis

were prevented by adrenergic blockade indicating that the respiratory muscle metaboreflex contributes to an increased sympathetic tone and redistribution of blood flow during exercise.

In humans, accumulation of metabolites during fatiguing contractions of the diaphragm have been shown to trigger an increase in muscle sympathetic nerve activity (MSNA) in limb muscles (Croix et al., 2000; Dempsey et al., 2008b; Sheel et al., 2001). This activation depends on both the inspiratory duty cycle and contraction intensity. Indeed, to elicit the sympathetic response, a prolonged inspiratory duty cycle and moderately high inspiratory pressures are necessary (Croix et al., 2000; Sheel et al., 2001). Studies on animals have also shown that generating high inspiratory pressures resulted in increased intrathoracic pressure during inspiration, which, when sustained during prolonged duty cycles, can compromise diaphragmatic blood flow (Bellemare and Bigland-Ritchie, 1984). Yet, blood flow is a major determinant of diaphragmatic fatigue as evidenced by the substantial changes of fatigue when phrenic blood flow was modified (in canine model) (Supinski et al., 1988).

Prior studies have shown that inducing inspiratory (Mador and Acevedo, 1991; Welch et al., 2018a; Wüthrich et al., 2013) or expiratory (Romer and Polkey, 2008; Verges et al., 2007) muscle fatigue prior exercise results in a decrease in subsequent exercise performance, with a reduction of up to 30% in time to exhaustion (Romer and Polkey, 2008). Conversely, unloading the inspiratory work of breathing during exercise with an assisted ventilator by 50-70% in healthy and fit individuals decreases the WOB and increases performance by an average of 14% in normoxia (Harms et al., 2000).

One possible explanation is that the heightened sympathetic-mediated peripheral vasoconstriction led to reduced blood flow in the working locomotor muscles (See Figure 24) (Croix et al., 2000; Derchak et al., 2002; Harms et al., 2000, 1997; Katayama and Amann, 2012; Sheel et al., 2001). This ensuing reduction in muscle perfusion hinders oxygen delivery and metabolite clearance, thereby accelerating peripheral fatigue compared to exercise without respiratory muscle fatigue (Taylor and Romer, 2008; Wüthrich et al., 2013). Indeed, respiratory muscle unloading during exercise (compared to control conditions with the same power output and exercise duration) resulted in a 30-35% reduction in exercise-induced peripheral fatigue (evidenced by magnetic femoral nerve stimulation) in the locomotor muscles (Romer et al., 2006).

Based the above-mentioned changes in limb blood flow and their potential concomitant effects on limb fatigue with respiratory muscle loading and unloading, it can be suggested that blood flow is in priority redirected towards respiratory muscle over limb muscle during strenuous exercise

(Dempsey, 2006; Olson et al., 2010; Romer et al., 2006). This prioritization may be caused in part by the blunted vasoconstriction response to norepinephrine of the diaphragm which has a lower number of α_1 -adrenergic receptors in comparison to locomotor muscles (Aaker and Laughlin, 2002).

In humans, Dominelli et al., (2017) used near infrared spectroscopy (NIRS) in combination with indocyanine green (ICG) dye infusion to assess quadriceps and sternocleidomastoid (SCM) blood flow during constant workload exercises at 90% of peak work rate. They found that when respiratory muscles were unloaded, leg blood flow was increased and SCM blood flow was reduced (see Figure 25). Conversely, when the work of breathing was increased, they found a reduction in limb blood flow and an increase in SCM blood flow. These results suggest that respiratory muscle work significantly influences the distribution of blood flow to both respiratory and locomotor muscles (Dominelli et al., 2017). It can be noted that these findings are not consistent with previous work where blood flow of the intercostal muscles reached a plateau before returning towards resting values during heavy exercise (Vogiatzis et al., 2010, 2009). In the latter study, the optodes were placed over the intercostal muscle. However, this placement implies important limitations during heavy exercise because the chest distortion associated with high operating lung volumes may have altered the quality of the optode signal (Grimby et al., 1968).

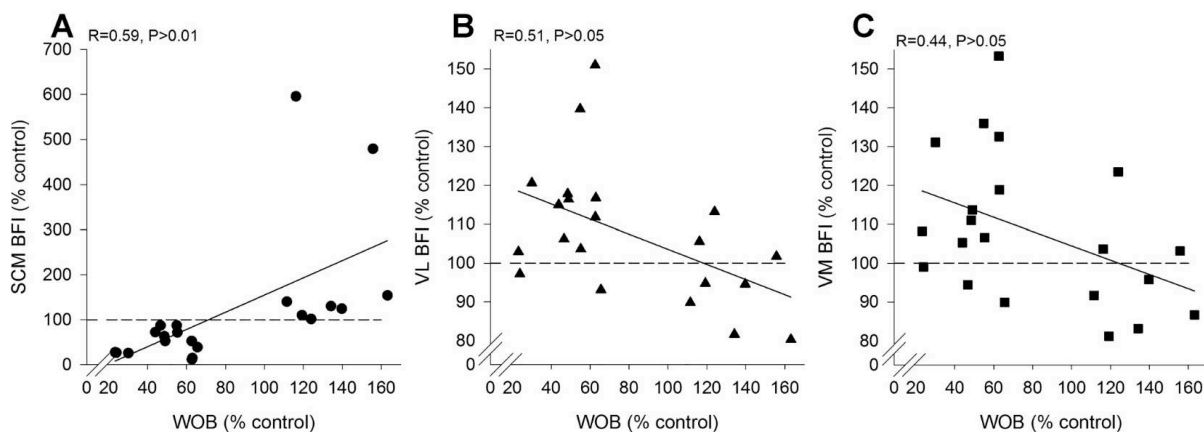

Figure 25. Sternocleidomastoid (SCM, A), vastus lateralis (VL, B) and vastus medialis (VM, C) blood flow during a high-intensity constant workload exercise with modulated work of breathing (WOB). The intensity of the workload was set at 85% of peak power output. While SCM blood flow increased with respiratory muscle loading, blood flow decreased in the locomotor muscles and vice versa. These results highlight the competition for blood flow between respiratory and locomotor muscles during high-intensity exercise *Figure from (Dominelli et al., 2017).*

Therefore, the available evidence from studies in both humans and animals supports the notion that high levels of sympathetic vasoconstrictor activity arising from the enhanced locomotor and respiratory muscles metaboreceptors during heavy-intensity exercise, impede blood flow and O₂ transport. This results in an accelerated fatigue in both diaphragm and, to a greater extent, limb muscles during high-intensity whole body exercise.

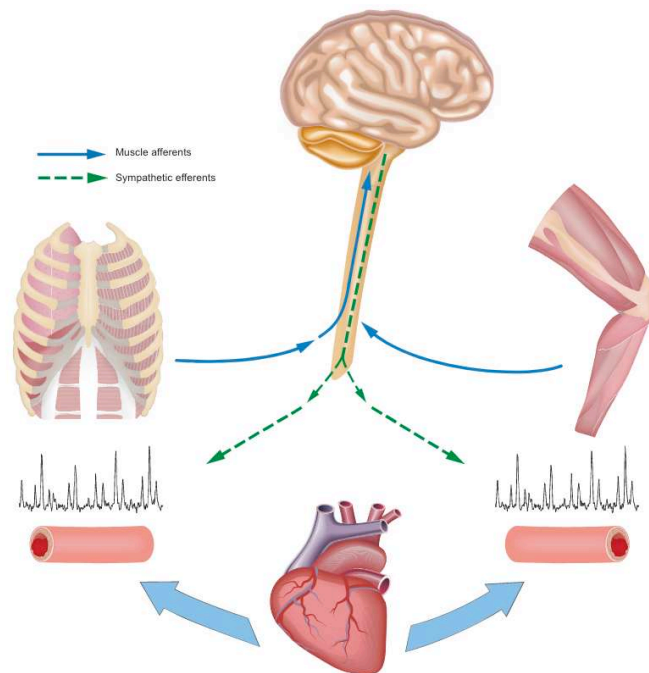

Figure 24. Blood flow competition between locomotor and respiratory muscles. Fatiguing contraction of locomotor and respiratory muscles trigger group III-IV afferents feedback resulting in a sympathetic efferent response that causes a vasoconstriction in both sets of muscles. This vasoconstriction compromises blood flow and accelerates fatigue. *Figure from (Sheel et al., 2018).*

c) The effect of age on the respiratory muscles metaboreflex

Age-related changes in the muscle have primarily been studied in human limb muscles or animal models. Based on rodent models, it has been demonstrated that the aged diaphragm does not experience excessive muscle mass loss. Instead, there is a type IIb and IIx fiber atrophy. Ultimately, this results in a decreased capacity for the diaphragm to generate force (Greising et al., 2015a, 2015b, 2013). Another factor involved in the decline of diaphragm function with aging is the reduction in the number of motoneurons, indicated by the decreased effects of neurotrophic factors such as neuregulin, which facilitate neuromuscular transmission (Elliott et al., 2016). Unlike

the limb muscles, there is no conclusive evidence of a significant change in the fiber to capillary ratio, or satellite cell dysfunction in respiratory muscles.

Functionally, aging of muscle tissue and can be associated with a potential, yet still unclear, loss of respiratory muscle strength. Studies conducted on age-related changes on diaphragm function in rodent reported a stable capillary density, no differences in myosin heavy chains, and light chain and no alterations of the diaphragm excitation - contraction coupling (Greising et al., 2013). Changes in the maximal pressure generated during inspiration in humans have mainly been evaluated in cross-sectional studies. Although some studies found no significant (Mcelvaney et al., 1989) or moderate (Black and Hyatt, 1969) decline in maximal inspiratory pressure generation, others (Enright et al., 1994) reported a pressure decrease of 0.8 to 2.7 cmH₂O per year between the ages of 65 and 85 years, with greater declines seen in men than women. A likely reason for the decline in diaphragm strength appears to be the muscle atrophy and the age-related reduction in fast twitch fibers, which are critical for generating higher peak tensions (Sharma and Goodwin, 2006).

The specific effects of age-induced changes on the respiratory muscle metaboreflex remain unclear, and only very limited data are available. Previous studies have reported greater (Choi et al. 2012; Milia et al. 2015), similar (Greaney et al. 2013), or reduced (Markel et al. 2003) cardiovascular responses to isometric and rhythmic forearm exercise in older adults compared to young adults. The differences found may be due to variations in exercise models, studied populations, and outcome variables. When focusing on the implication of respiratory metaboreflex, some evidence suggests a heightened cardiovascular response in the elderly. Indeed, (Leahy et al., 2023) found that when young and older men and women completed the same relative high intensity inspiratory loaded task, older individuals exhibited a more pronounced pressor response. From baseline to task failure, inspiratory resistive task evoked an increase in mean arterial pressure of 26 ± 11 , 27 ± 11 , 10 ± 6 and 19 ± 5 mmHg, in older women, older men, young women and young men, respectively. The heightened increase in blood pressure seen in older individuals was observed despite a higher time to exhaustion in younger individuals. (Smith et al., 2017b) previously reported a heightened blood pressure response to a similar inspiratory task in post-menopausal women (+ 16 mmHg) in comparison to young females (+ 7 mmHg). They also found that older males and females had comparable increases in mean arterial pressure indicating that there is no effect of sex with healthy ageing.

MATHEMATICAL MODELING TO UNDERSTAND PHYSIOLOGICAL LIMITATIONS

Understanding physical phenomena within the lung is important to better comprehend the respiratory system in health or disease, and at rest or during physical exercise. However, they cannot be directly measured but can be inferred by mathematical modeling. For example, when assuming a given airway length and cross-sectional area, airway resistance can be estimated and if the ratio of pressure drop between the proximal and distal ends of airway branches is also known, airflow can be calculated. Such relationships are used in mathematical models of the lung to make precise statements about the physical mechanisms of breathing and to explore the resulting consequences.

When studying human lungs, it is necessary to consider the underlying physical phenomena, such as branches geometry, fluid mechanics or tissue compliance to better understand breathing flow patterns. The complexity stems from the need to understand the interplay between these factors. Therefore, to better understand physiological responses and gain access to non-measurable information, we must examine the attributes of the human pulmonary structure and determine how the properties of the fluid favor or impair the flow within its branches.

1. Model of the human lung

The geometry and dimensions of the airways are important determinants of the efficiency of physiological processes. Modeling the human pulmonary system requires to acknowledge various features including lung branching patterns, airway shape and tissue elasticity. Depicting these characteristics as accurately as possible enables to build a reliable model that can be used for analytical purposes.

A) Lung geometry

The geometry of the lungs can be depicted as a bronchial "tree" that is branching in a nearly dichotomous way, thereby presenting a sequence of many levels of branches called generations. Estimations of airway dimensions are depicted in Table 2. The first generation is the trachea, it has a diameter of $\sim 2\text{cm}$, while the last generation, located at the 17th generation has a diameter of $\sim 0.5\text{mm}$ (Lambert et al., 1982). The number of branches in the bronchial tree can then be estimated to $\sim 2^{22-1}$ branches, (i.e., about 2 millions). It is worth noting that an acinus is a sub-tree within the lung of approximately six generations (from the 18th to the 23rd). At this level, the branches are covered by alveoli, resulting in significant modifications to the lung's geometric properties (Weibel, 1984). Therefore, the model of the lungs we used only takes into account the 17 first generations with the trachea being the generation of index 0.

The anatomical branching of the lungs is rarely symmetrical, particularly in the first generations that adjust to the chest geometry and to avoid the heart's location. Yet, identifying flow patterns between the trachea and the acinus within an asymmetrical structure is very challenging. Therefore, it may be more appropriate to first study a tree with symmetric branching and uniform and synchronous flow distribution (Pedley et al., 1970). In this context, the model utilized hypotheses that bifurcations are symmetrical, and all the branches of the same generation are identical. Furthermore, we hypothesize that the tree possesses an axis of symmetry that corresponds to the cylinder axis of its first generation.

In this symmetrical bronchial tree, the bronchi are modeled as smooth cylinders. Although they exhibit an annular structure causing undulations on their surface, the effect on flows remains negligible because the velocity is very low along the walls. The bronchi also exhibit a slightly conical shape, but the impact of this shape is neglected. The branches in a bifurcation are assumed on the same plane and two successive bifurcating planes are separated by angles close to 90 degrees. The angle between the consecutive branches is 60° and they have a length-to-diameter ratio of approximately three throughout the entire tree.

c) Compliant airway tree model

The walls of the bronchi and alveoli are flexible (West, 2012). Thus, if a force pushes the walls inwardly of the bronchi, they fold onto themselves, reducing the available section for air flow.

These variations of lumen cross-sectional areas depend on the transmural pressure which corresponds to the pressure difference between the inside and the outside of the branch. The relationship between the lumen area and the transmural pressure as well as the length of the branches are based on the model from Lambert (Lambert et al., 1982). We make the assumption that the internal volume of the branches remains cylindrical regardless of the transmural pressure. We also consider that flow in the generation n is determined by flow at the trachea Φ_0 and the pressure surrounding the bronchi P_{TISSUE} with pressure at the base of the acini being homogeneous. For expiration, we denote Ω as the set of these parameters:

$$W = \left(\begin{array}{c} \Phi_0 \\ P_{TISSUE} \\ n \\ A_{MAX} \end{array} \right) \left| \begin{array}{l} \Phi_0 \in \mathbb{R}_+ \\ P_{TISSUE} \in \mathbb{R} \\ n \in \llbracket 0,16 \rrbracket \\ A_{MAX} \in \mathbb{R}_+ \end{array} \right. \quad (12)$$

It is important to note that all these characteristics are typical observations. As a living tissue, the lung is inevitably subject to physiological variability that occurs between individuals, which may be due to geometric constraints, the environment, and other factors.

Generation (n)	L_{LAMBERT} (mm)	A_{MAX} (mm²)
0	120	237
1	47.6	119
2	19.0	70.0
3	7.6	43.8
4	12.7	28.1
5	10.7	16.6
6	9.0	10.2
7	7.6	6.25
8	6.4	3.98
9	5.4	2.48
10	4.7	1.56
11	3.9	1.01
12	3.3	0.70
13	2.7	0.54
14	2.3	0.42
15	2.0	0.35
16	1.7	0.28

Table 2. Airway dimensions from (Lambert et al., 1982) across the first 16 generations. L_{LAMBERT} and A_{MAX} are the length and the maximal cross-sectional area of the bronchi at the generation n , respectively. The trachea corresponds to the generation $n = 0$.

2. Expiratory flow in a compliant airway tree

We have seen the properties of the lungs and we assumed that the bronchial tree was dichotomic, symmetrical, compliant and that branches had the same length as depicted in previous work (Lambert et al., 1982). Complementary to this, in order to understand flow behavior in this complex structure, it is important to examine flow pattern and how the bronchi respond to it.

a) 0D model.

Due to the tree structure of the bronchial tree, the velocities change notably from the trachea inlet to the acinus and this differentiation enables the identification of different airflow patterns within the pulmonary tree, such as the Navier-Stokes inertial regime or the slow Stokes regime detailed after.

Fluid dynamics of each branch is described by a 0D model. To develop a reliable, yet accessible model, several assumptions were made. The assumed symmetrical branching implies that the number of branches in each generation n is 2^n . The pressure difference q between the inlet and outlet parts of the branch n is linked to the flow rate Φ within the branch and its hydrodynamic resistance R . Since each branch from a given generation share similar physical properties and the fluid within is incompressible, flow rate of a daughter airway at the generation n is determined by the flow at the trachea Φ_0 and at the mother airway $n-1$:

$$\Phi_n = 2^{-n}\Phi_0 \quad (13)$$

$$\Phi_n = \frac{\Phi_{n-1}}{2} \quad (14)$$

In this model, we neglected the influence of bifurcations on hydrodynamics, which allowed to assume that there are no pressure differences at the interface between two connected branches. We also assumed that air flow is steady, with velocity vectors oriented along the branch axis, and axisymmetric. This assumption allows to link the pressure gain, the branch length and section to the air flow in each branch. We also assumed that the pressure surrounding the branches P_{TISSUE} is known, uniform, with the reference pressure of the system being that of air at the trachea.

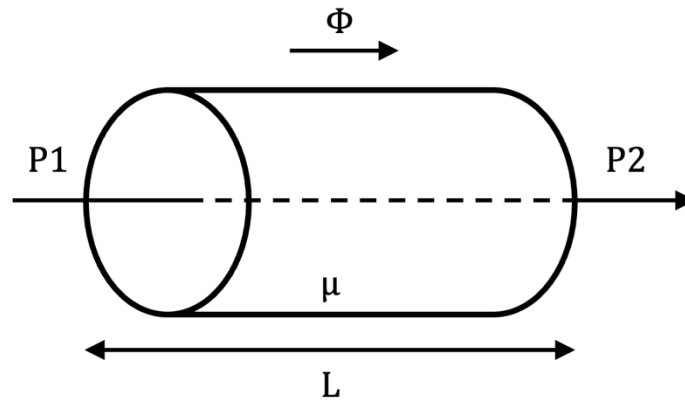

Figure 26. Scheme of a cylindrical conduit. The conduit has a length L , air has a viscosity μ . Air flows through the conduit with a flow rate Φ and has a pressure $P1$ at the conduit inlet and $P2$ at the conduit outlet $P2$.

b) Physics of airway resistance

The intricate geometry of the lungs can impede smooth airflow circulation, particularly during exercise where high flow rates can be reached. This raises questions about how the structure of the lungs modulates airflow and gives rise to particular levels of resistance? Characterizing the circulation of a fluid in a structure with bifurcations is a common challenge in physics and physiology. For the tree-like structure of the lungs in particular, the main purpose is to understand the mechanisms that govern the distribution of flows across the airways. Moreover, aging of the lung involves changes in lung mechanics. Being able to characterize the physical phenomena that explain these physiological changes is critical for a better understanding of how the respiratory system imposes constraints on the elderly.

Molecules circulation within a conduit tends to align with the overall flow direction. Yet, they don't all travel in an exact trajectory or at an identical speed. This variance causes them to collide, leading to an exchange of kinetic energy and momentum and introducing a rise in molecular random motion, or heat. This heat subsequently transfers to the conduit's walls and its surroundings. Thus, the kinetic energy of the flowing gas is constantly dissipated into heat. When the gas flow is fully developed (i.e., $\frac{\partial v}{\partial x} = 0$), it flows through the conduit in relatively parallel layers in the same direction. However, when adjacent layers move at different velocities, gas is experiencing shear and the layers slide past each other, causing friction. The coefficient that measures friction in a gas is the viscosity, which varies between gases depending on molecules interactions (see Figure 27). Some fluids known as "Newtonian" have a viscosity that is independent of shear rate. Laminar

flow occurs when layers of fluid flow parallel to each other in an orderly fashion, with each layer moving smoothly over the adjacent layers with a predictable shear stress due to the velocity gradient across the layers. As velocity increases, the flow pattern changes and streamlines start to merge. When flows reach a high enough velocity, each gas segment moves turbulently with strong lateral shifts.

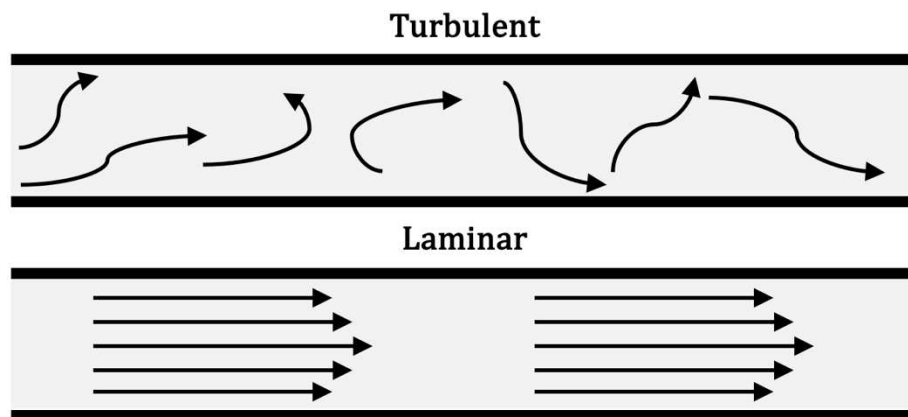

Figure 27. Illustration of Laminar and turbulent flow in a conduit. Stokes flow regimen is found when $Re \ll 1$, laminar flow regimen when $Re < 2000$ and turbulent flow regimen when $Re > 2000$.

c) Reynolds number

When v (velocity); density, viscosity, conduit diameter and L (conduit length) are known, and assuming steady state for flow, the mathematical description of a Newtonian and incompressible fluid on the bronchial branches is based on the non-dimensional form of the incompressible Navier-Stokes equations. These equations are derived from the 2nd Newton's law and describe the motion of the viscous fluids when fluid density does not change:

$$\nabla \cdot v = 0, \quad (15)$$

$$\rho \frac{Dv}{Dt} = -\nabla p + \mu \nabla^2 v + F, \quad (16)$$

With p being the local pressure, $\mu \nabla^2 v$ being viscous force or friction, and F being the external forces acting on the fluid. Gravity is often the only external forces acting on the fluid and its influence is neglected here ($F = 0$). The Reynolds Number Re is a crucial parameter to characterize the balance between viscous and inertial forces in a given situation. To derive the Reynolds Number, it is necessary to render the Navier-Stokes equations dimensionless which can be done

by multiplying the equation by the factor $\frac{L}{\rho V^2}$ where V is the mean velocity. This gives us the new variables $v' = \frac{v}{V}$, $p' = p \frac{1}{\rho V^2}$, $f' = f \frac{L}{V^2}$, $\frac{\partial}{\partial t'} = \frac{L}{V} \frac{\partial}{\partial t}$, $\nabla' = L \nabla$. Therefore, the dimensionless Navier-Stokes equations can be written:

$$\frac{Dv'}{Dt'} = -\nabla' p' + \frac{\mu}{\rho LV} \nabla'^2 v' \quad (17)$$

Where:

$$\frac{\mu}{\rho LV} = \frac{1}{Re} \quad (18)$$

$$\frac{Dv}{Dt} = -\nabla p + \frac{1}{Re} \nabla^2 v \quad (19)$$

Therefore, Re is a dimensionless quantity used in fluid mechanics to predict flow patterns and specifically the transition between laminar and turbulent flow. It describes the ratio of inertial forces to viscous forces and determines the behavior and appearance of flow structures. It is defined as follows:

$$Re = \frac{4\rho\Phi}{\mu\sqrt{\pi A}} \quad (20)$$

At high Reynolds numbers, the fluid transitions to the turbulent regime, while at medium and low Reynolds numbers it remains in the laminar regime. More specifically, experimental findings have established that flow in a conduit is laminar when the Reynolds number is significantly less than ~ 2000 , and turbulent when it is well above 2000 (Katz et al., 2011; Pedley, 1986). The Reynolds number decreases with each generation in such a way that it is possible to define a Reynolds number for each branch.

It can be illustrated if we consider resting ventilation in healthy individuals at rest. We can consider an expiratory flow rate of $1 \text{ L}\cdot\text{s}^{-1}$ at the trachea, which has a cross-sectional area of 237 mm^2 (cf Table 2 and (Lambert et al., 1982), and using air density $\rho_{\text{air}} = 1.25 \text{ kg}\cdot\text{m}^{-3}$ and air viscosity $\mu_{\text{air}} = 18.95 \times 10^{-6} \text{ n}\cdot\text{sec}\cdot\text{m}^{-2}$ at 37°C (Pozin et al., 2017). The resulting Re at rest is ~ 9300 with the trachea being considered as the generation 0. Flow pattern evolves throughout the airways and at the 5th generation for example, where the radius is $\sim 2.3 \text{ mm}$, the total flow of $1 \text{ L}\cdot\text{s}^{-1}$ is now divided between the $2^5 = 32$ parallel airways. At this level of the bronchial tree, Re becomes lower than 2000 which puts it in the laminar regime. During exercise, flow rates can increase up to $\sim 8 \text{ L}\cdot\text{s}^{-1}$ in

young athletes and $\sim 6 \text{ L}\cdot\text{s}^{-1}$ in master athletes, making flow at the trachea very turbulent. In this context, laminar regime is reached deeper in the lungs.

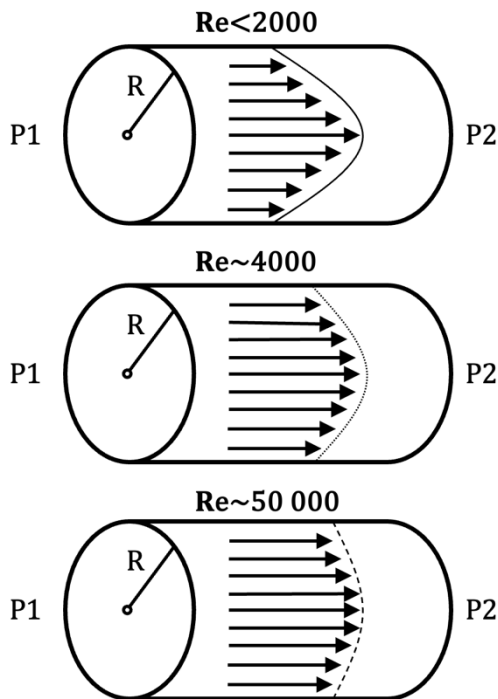

Figure 28. Flow regimen with various Reynolds numbers in a conduit. Hagen-Poiseuille flow can only be applied to Stokes regimen, i.e., for Reynolds number $\ll 1$. Therefore, when the Reynolds number becomes too large, Hagen-Poiseuille flow does not correctly represent the air flow in the conduit. In this case, the resistance of the conduit must be determined using a different set of hypotheses.

d) Poiseuille resistance (low Reynolds number)

Poiseuille's laws have long been considered adequate for describing the flow of fluids through tree-like structures. However, these laws only hold true for small Reynolds numbers ($\ll 1$), as the linear dependence between flow and pressure difference, $\Phi \propto \Delta P$, is not applicable for larger Reynolds numbers. One of the main challenges when modeling flow in a tree is inertia effects, which have been shown to be present in the bronchial tree (Newman et al., 1997). These effects cause Poiseuille's law to be inaccurate because inertia forces can become dominant over viscous forces.

Hagen-Poiseuille law applies to a slow flow of an incompressible and Newtonian fluid through a cylindrical pipe with a constant circular cross-section. It provides a relationship between the volumetric flow rate and the pressure drop across the length of the pipe. Within each branch of a generation n , considering Poiseuille law and the assumption that there is no fluid acceleration in the airways, a pressure drop q occurs, depending on both flow rate Φ and hydrodynamic resistance (or Poiseuille resistance) R_n of the branch:

$$q_n = \Phi R_n \quad (21)$$

Poiseuille resistance can be illustrated by considering gas flowing through a cylindrical tube under conditions that are stable, smooth, and fully developed. With symmetry of the conduit being assumed, the linear flow velocity v solely relies on the distance r from the inner surface of the tube to its center. The gas is then composed of layers of concentric circles that move at different speeds, and each velocity is not distributed randomly. The sliding friction between adjacent layers minimizes their velocity discrepancies, and thus the dissipation of energy. This principle similarly applies to the differences between the innermost layer and the tube wall. When the thickness of this innermost layer approaches zero, its velocity relative to the stationary wall also approaches zero. This implies that the layer of gas closest to the wall is almost stationary.

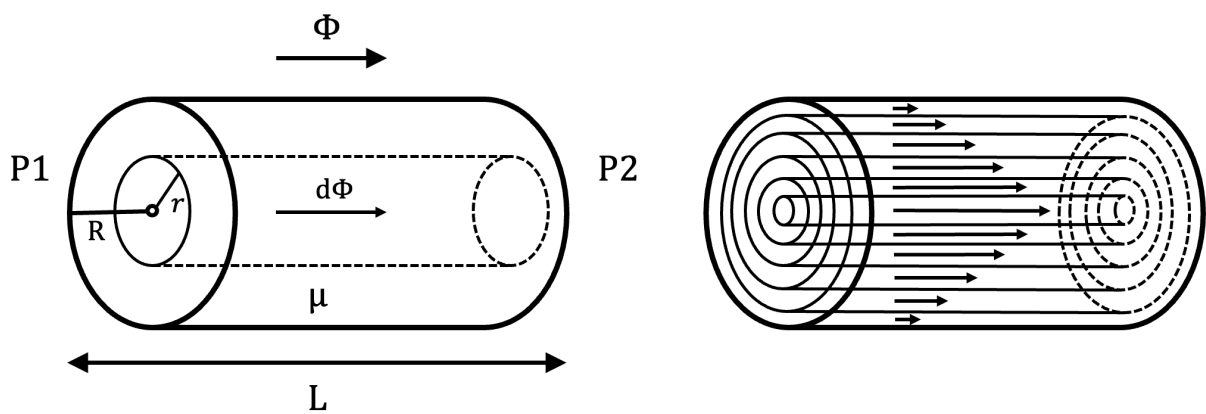

Figure 29. Gas flow through a cylindrical conduit. The conduit has a length L , a radius R and can be divided in multiple concentric layers of radius r . $d\Phi$ corresponds to the flow within each layer and Φ is the flow in the conduit. $P1$ and $P2$ are the pressure at the inlet and the outlet of the conduit, respectively and μ is the viscosity.

In a conduit illustrated in Figure 29 with a radius R , and a flow Φ we consider a cylindrical layer with a radius r and a thickness dx and a pressure drop between the inlet and the outlet of the layer $\Delta P = P1 - P2$. From the velocity profile principle, we know that (Atkinson et al., 1969):

$$\dot{v}(r) = \frac{\Delta P}{4\mu L} (R^2 - r^2) \quad (22)$$

The velocity profile in a conduit (see Figure 29) is based on this equation. We can also note that it illustrates the statement that the cylinders closest to the conduit ($r=R$) wall follows a stationary

regimen because when $(R^2 - r^2) = 0$, the corresponding velocity $v(R) = 0$. We need to determine the flow of each layer $d\Phi$ from its velocity v and its surface dS which gives us $d\Phi(r) = v(r) \times dS = v(r) \times 2\pi r dr$. The total flow in the conduit is calculated by considering the flow of each layer:

$$\Phi = \int_0^R d\Phi = \int_0^R v(r) 2\pi r dr$$

$$= \int_0^R \frac{\Delta P}{4\mu L} (R^2 - r^2) 2\pi r dr$$

$$= \frac{\Delta P 2\pi}{4\mu L} \int_0^R (R^2 - r^2) r dr$$

$$= \frac{\Delta P \pi}{2\mu L} \int_0^R (R^2 r - r^3) dr$$

$$= \frac{\Delta P \pi}{2\mu L} \left[R^2 \frac{r^2}{2} - \frac{r^4}{4} \right]_0^R$$

$$= \frac{\Delta P \pi}{2\mu L} \left(R^2 \frac{R^2}{2} - \frac{R^4}{4} \right)$$

$$= \frac{\Delta P \pi}{2\mu L} \left(\frac{R^4}{2} - \frac{R^4}{4} \right)$$

$$= \frac{\Delta P \pi}{2\mu L} \left(\frac{R^4}{2} - \frac{R^4}{4} \right)$$

$$= \frac{\Delta P \pi R^4}{2\mu L \cdot 4}$$

$$= \frac{\Delta P \pi}{8\mu L} R^4$$

Therefore, when pressure loss which corresponds to the resistance of the conduit, is isolated, we obtain:

$$\Delta P = \frac{8\mu L}{\pi R^4} \Phi \quad (23)$$

And considering equation (X) ($q_n = \Phi R_n$), we can deduce that the Poiseuille resistance is:

$$R_{Pois} = 8\pi\mu \frac{L}{A^2} \quad (24)$$

To summarize, Poiseuille's law provides a framework to understand how specific variables affect the slow laminar flow of a fluid within a cylindrical pipe. Flow rate is directly proportional to the pressure gradient across the length of the pipe and if the pressure difference increases from one end of the pipe to the other, the flow rate increases accordingly. The flow rate is significantly influenced by the radius of the pipe, as it is proportional to the fourth power of the radius. A minor change in the diameter can thus lead to substantial changes in the flow rate. This principle emphasizes the heightened sensitivity of fluid flow to the size the conduit which is particularly important when considering older narrower airways. The flow rate is inversely proportional to the fluid's viscosity. A more viscous fluid, being thicker, thus has a lower flow rate than a less viscous fluid under the same conditions. In addition, the flow rate is inversely proportional to the pipe's length. The longer the pipe, the greater is the resistance, leading to a reduced flow rate.

These principles fundamentally highlight how the interplay of pressure, physical properties of the fluid (like viscosity), and characteristics of the conduit (like length and radius) determine the behavior of slow laminar flow within a cylindrical conduit.

e) Inertia effects (high resistance number)

When higher flow rates are involved, (e.g., mainly in upstream airways), the flow profile is deformed by the inertial effects and the geometry. Thus, the hydrodynamic resistance of the fluid increases and becomes greater than Poiseuille resistance. In this context, we can use the resistance factor Z proposed by (Tawhai et al., 2004) to mimic the increase of hydrodynamic resistance with inertia effects:

$$R_n = Z_n R_{Pois,n} \quad \text{with : } Z \geq 1 \quad (25)$$

The resistance factor Z is superior to 1 for non-Poiseuille flow and depends on Reynolds number, $Re = \frac{4\rho\Phi}{\mu\sqrt{\pi A}}$, with ρ corresponding to gas density.

$$Z = \max\left(1, \frac{1}{2} + \frac{Re}{600}\right) \quad (26)$$

Here, we see that if the Reynolds number is inferior to 300, the flow is considered as a Poiseuille flow, and the factor Z is equal to 1.

The above-mentioned relationships are used in mathematical models of the lung to make precise statements about the physical mechanisms of breathing and to explore the resulting consequences. This gives access to non-observable information, and it is possible to modulate the physical properties of the inhaled gas such as density and viscosity to investigate the evolution of flow and pressures.

SUMMARY & RATIONALE

The respiratory system in most young healthy individuals is overbuilt and able to meet the ventilatory demand imposed during exercise with only rare alteration of arterial blood gas at maximal exercise. However, specific cases can be found in endurance-trained individuals who are capable of reaching higher exercise workloads and exercise at higher metabolic cost therefore putting substantial constraints on their respiratory system. In this context, the respiratory system may no longer be overbuilt, and athletes may reach their ventilatory limits. This translates into expiratory flow limitation during exercise which leads to a higher cost of breathing and more risks of experiencing respiratory muscle fatigue. In the elderly, the respiratory system is even more susceptible of being a limiting factor to exercise performance and tolerance because of the normal age-related alterations of lung mechanical properties and respiratory musculature to meet the demand during exercise.

More specifically, older individuals who have maintained a competitive training lifestyle through their lifespan, also called master athletes, can exercise at more elevated workloads putting higher work on their respiratory system despite its age induced alterations. This may significantly exacerbate the imbalance between respiratory demand and respiratory capacity, making the respiratory system even more susceptible to no longer be overbuilt. This can result in airflow limitation during maximal and even submaximal exercise which in turn, alters exercise performance with exercise induced arterial hypoxemia, altered operational lung volumes, and a higher cost of breathing. The resulting dynamic hyperinflation and higher work of breathing for a given ventilation may accelerate respiratory muscle fatigue during strenuous exercise. Respiratory muscle fatigue, in turn, triggers respiratory metaboreflex that may cause blood flow to redirect away from locomotor muscle and thus accelerate fatigue in those muscles therefore impairing exercise performance and tolerance. The mechanisms may be amplified with age-related changes in respiratory system structure and function. Biological sex differences can also be found in lung structure and fatigue tolerance which can result in a difference in ventilatory limitation and respiratory metaboreflex response between men and women. Therefore, a combined effect of age and sex may play a major role in modulating respiratory limitation to exercise.

The aim of this thesis was to study ventilatory limitation to exercise performance in master athletes combining a physiological approach with experimental measurements and mathematical approach with modeling of the human lung. The main purpose of this thesis was to determine: how does the ventilatory system represent a limitation to exercise performance in master athletes?

To answer this question, 3 main studies were conducted.

In the first study, we examined the susceptibility of endurance athletes to expiratory flow limitation (EFL) in light of age-induced declines in ventilatory capacity and anatomical sex differences. Yet, to our knowledge, the combined effect of age and sex on EFL has never been directly tested in trained individuals despite their higher likelihood to experience airflow limitation. Therefore, the purpose of the first study was to determine how does aging and biological sex influence EFL in endurance athletes? We hypothesized that EFL incidence and severity would be higher among master athletes as compared to young athletes and in women as compared to men.

From the new insights about airflow limitation in athletes and master athletes in the first study, we wanted to further comprehend how master athletes were more predisposed to EFL. Considering that breathing heliox (i.e., 21% O₂ - 79% He) alleviates EFL, and increases ventilation levels, we studied how gas density and viscosity influenced expiratory flow and resistance distribution in aging airways. We chose a mathematical modeling approach to evaluate the underlying mechanisms of expiratory flow and airway resistance. Therefore, the second study aimed at evaluating the effect of heliox on expiratory flow in master athletes. Principles from fluid mechanics were used and flow patterns were evaluated with a compliant airway tree model and experimental measurements. We hypothesized that heliox breathing would lead to a larger increase in expiratory flow in the first airway generation and that a simulated reduction in airway cross-sectional area would amplify the effect of heliox on expiratory flow. We also hypothesized that the effect of heliox on expiratory flow simulated in our compliant lung model would follow a similar pattern than experimental assessment of expiratory flow.

Airflow limitation may result in a steep increase in the resistance of the whole bronchial tree thereby putting additional demand on the respiratory muscles. Therefore, inspiratory muscle fatigue may be a common phenomenon in endurance athletes and particularly master athletes because of their greater susceptibility towards experiencing EFL. Respiratory muscle fatigue may in turn accelerate locomotor muscle fatigue during exercise. Therefore, the purpose of the third study was to determine how aging impacts the interplay between respiratory muscle fatigue and locomotor muscle fatigue. We hypothesized that inducing inspiratory muscle fatigue before a high-intensity exercise would accelerate locomotor muscle fatigue and reduce exercise performance. We also hypothesized that this response would be magnified in master athletes when compared to younger athletes.

CHAPTER 2

**PERSONAL
CONTRIBUTION**

Master athletes are a unique subpopulation among older adults. These individuals, who are highly trained and possess a cardiovascular system and muscle metabolic capacity that enable them to achieve a $\dot{V}O_{2\text{ MAX}}$ of 40-55 mL.min⁻¹.kg⁻¹ require increased levels of ventilation, typically within the range of 100-130 L.min⁻¹ (Johnson et al., 1994, Trappe et al., 2013). Given the natural decrease in lung function that occurs with aging and the heightened ventilatory demand of exercise, master athletes present a distinctive study population regarding airflow limitation. Only few studies investigated EFL in master athletes although they are believed to be the healthy population with the most chances to be limited by their ventilatory system (Johnson et al., 1991b). The primary aim of the first study presented in this thesis was to examine the prevalence of EFL in endurance athletes and the impact of age and biological sex on this limitation. The study participants were recruited from a variety of competitive events and included triathletes, runners, and trained cyclists.

**STUDY I. EXPIRATORY FLOW
LIMITATION DURING EXERCISE IN
MALE AND FEMALE, YOUNG AND
MASTER ATHLETES**

TITLE

Expiratory flow limitation during exercise in male and female, young and master athletes

AUTHORS & AFFILIATIONS

Mons, V.^{1,2,3}, Lavigne, C.¹, Meste O.⁴, Mauroy, B.^{2,3}, Blain, G.M.^{1,3}

¹Université Côte d'Azur, LAMHESS, Nice, France

²Université Côte d'Azur, CNRS, LJAD, Nice, France

³Université Côte d'Azur, Centre Vader, Nice, France

⁴Université Côte d'Azur Laboratoire I3S, UNSA-CNRS, Nice, France.

CORRESPONDANCE

Valentin Mons

Telephone: +33 7 86 43 30 23

E-mail: monsvalentin33@gmail.com

Campus STAPS, 261 Bd du Mercantour

06200, Nice

France

ABSTRACT (<250 words)

Introduction. Previous research has identified expiratory flow limitation (EFL) as a possible limit to exercise performance in young and older endurance athletes (i.e., master athletes). However, the effect of age and biological sex on EFL remain unclear in athletes. **Methods.** Thirty-eight healthy athletes participated in this study including 10 master athletes women (MW, age, 64.8 ± 3.8 years, $\dot{V}O_{2\text{ MAX}}$, 48.5 ± 8.4 mL.min⁻¹.kg⁻¹), 11 master athletes men (MM, age, 65.0 ± 5.1 years, $\dot{V}O_{2\text{ MAX}}$, 46.5 ± 2.7 mL.min⁻¹.kg⁻¹), 8 young athletes women (YW, age, 28.6 ± 4.4 years, $\dot{V}O_{2\text{ MAX}}$, 59.8 ± 2.0 mL.min⁻¹.kg⁻¹) and 10 young athletes men (YM, age, 27.4 ± 4.4 years, $\dot{V}O_{2\text{ MAX}}$, 65.9 ± 7.4 mL.min⁻¹.kg⁻¹). Participants performed a maximal and graded exercise test to exhaustion on a cycle ergometer. The maximal expiratory flow volume (MEFV) curve was assessed at rest and operational lung volumes were determined with participants performing inspiratory capacity (IC) maneuvers at each exercise workload. EFL severity was estimated as the percentage of the tidal expiratory volume that overlapped the MEFV curve. **Results.** At peak exercise, EFL was found in 61% of young athletes, 86% of master athletes, 78% of women and 71% of men. EFL_{SEVERITY} reached $27.9 \pm 10.2\%$ in YW, $42.9 \pm 21.6\%$ in YM, $46.0 \pm 28.5\%$ in MW and $52.1 \pm 20.4\%$ in MM.). EFL_{SEVERITY} of all participants was positively correlated with SR ($p = 0.012$, $r^2 = 0.16$). **Conclusion.** our findings indicate that age-related decline in pulmonary function increases the likelihood of EFL in master athletes, with women being particularly vulnerable.

KEY WORDS: aging, biological sex, exercise, expiratory flow limitation, master athlete

INTRODUCTION

In healthy individuals the respiratory system is designed to effectively meet the increased ventilatory demand encountered during exercise at sea level (Dempsey et al., 2020). However, during peak exercise, this demand can surpass ventilatory capacity, causing expiratory flow limitation (EFL) (Molgat-Seon et al., 2022). EFL is a physiological condition in which the dynamic compression of the airway limits airflow to such an extent that expiratory flow no longer increases with increasing expiratory effort or transpulmonary pressure (Aliverti, 2008). EFL leads to a series of secondary manifestations such as exercise-induced arterial hypoxemia (EIAH) (Prefaut et al., 1994; Derchak et al., 2000; Dominelli et al., 2013), increased dyspnea (Aliverti et al., 2002), altered operating lung volumes with dynamic lung hyperinflation (Pellegrino et al., 1993), an increase in respiratory muscle work and in the oxygen cost of breathing (Dominelli et al., 2015c; Guenette et al., 2007; Wilkie et al., 2015). Overall EFL adversely affects respiratory muscle dynamics, and alters exercise performance (Aliverti et al., 2002; Wilkie et al., 2015). The development of EFL during exercise may be foreseen by analyzing variables associated with respiratory capacity, such as lung volume, expiratory flow rates and slope ratio, as well as factors linked to the demand for ventilation, such as minute ventilation and breathing pattern (Molgat-Seon et al., 2022; Smith et al., 2014). Biological sex differences significantly affect these variables and therefore modulate ventilatory limitation. Over the past few decades, numerous studies have extensively documented structural differences in young males' and females' respiratory system and showed that females have smaller lung volumes and narrower airways compared to males of equivalent lung size, resulting in lower expiratory flow rates (Christou et al., 2021; Dominelli et al., 2018, 2018; Torres-Tamayo et al., 2018). It can therefore be assumed that females may be more susceptible to EFL during exercise than males at a given level of ventilatory demand (McClaran et al., 1998). However, research on young adults with different fitness characteristics demonstrated

similar EFL levels regardless of biological sex during exercise (Dominelli et al., 2015b; Molgat-Seon et al., 2018; Smith et al., 2014). Additionally, in a recent multivariate analysis of 126 healthy males and females with varying fitness levels, Molgat-Seon and colleagues (Molgat-Seon et al., 2022) identified key factors that influenced EFL during exercise. Healthy young men (53%) and women (45%) were found to have a comparable incidence of EFL suggesting equal ability between genders to meet the ventilatory demands during exercise. Nevertheless, other studies conducted on female endurance athletes ($\geq 55 \text{ mL}\cdot\text{min}^{-1}\cdot\text{kg}^{-1}$) showed that they were more prone to experiencing EFL during exercise compared to their male counterparts (Guenette et al., 2007; McClaran et al., 1998). This suggests that sex may impact the ability to meet ventilatory demands but only when individuals use a substantial portion of their ventilatory capacity. Yet, these findings are not consistent with the results of Molgat-Seon et al. (Molgat-Seon et al., 2022), based on a larger sample size, who reported a similar incidence of EFL among males and females, even among those with the highest levels of aerobic fitness. Regardless of the biological sex differences, ventilatory capacity does not adapt to endurance training (Dempsey et al., 2008b). Therefore, both males and females endurance athletes may face difficulties in meeting the increased metabolic demands placed on their respiratory system and are more likely to experience EFL during strenuous exercise (Guenette et al., 2007; Mota et al., 1999; Wilkie et al., 2015). This phenomenon may be particularly pronounced in older endurance-trained individuals or “master athletes” who still have elevated ventilation rates despite impaired lung function (Tanaka and Seals, 2003). Master athletes experience a natural decline in lung function due to a reduced lung elasticity and compliance (Turner et al., 1968) an increased airway resistance (Molgat-Seon et al., 2019), a decrease in lung surface area (Niewoehner and Kleinerman, 1974) and an increase in dead space ventilation (Johnson et al., 1991b). EFL was shown to be a common feature in physically active aging population (Johnson et al., 1991a) and in fit elderly individuals (McClaran et al., 1995) with EFL severity showing

a longitudinal increase from 63 to 73 years. However, these older active or fit groups were predominantly males as only a small number of women were included representing 4 out of 18 (McClaran et al., 1995) and 3 out of 29 subjects (Johnson et al., 1991a) with no further analysis conducted on sex differences.

Overall, endurance athletes may be more susceptible to EFL, which could be influenced by biological sex differences and exacerbated by age. Yet, to our knowledge, the combined effect of age and sex has never been directly tested in trained individuals. To address this gap, this study aims at determining the modulating effect of age and biological sex on EFL susceptibility and severity during maximal exercise in athletes. We hypothesized that EFL incidence and severity would be higher among master athletes as compared to young athletes and in women as compared to men.

METHODS

Subjects' characteristics

Thirty-eight healthy athletes ($\dot{V}O_{2\text{ MAX}} > 130\%$ predicted, (Myers et al., 2017) participated in this study including 10 master athletes women (MW, age, 64.8 ± 3.8 years, $\dot{V}O_{2\text{ MAX}}$, 48.5 ± 8.4 mL.min⁻¹.kg⁻¹), 11 master athletes men (MM, age, 65.0 ± 5.1 years, $\dot{V}O_{2\text{ MAX}}$, 46.5 ± 2.7 mL.min⁻¹.kg⁻¹), 8 young athletes women (YW, age, 28.6 ± 4.4 years, $\dot{V}O_{2\text{ MAX}}$, 59.8 ± 2.0 mL.min⁻¹.kg⁻¹) and 10 young athletes men (YM, age, 27.4 ± 4.4 years, $\dot{V}O_{2\text{ MAX}}$, 65.9 ± 7.4 mL.min⁻¹.kg⁻¹). All participants had normal pulmonary function (see Table 1), were healthy, free of any medication, had no history of smoking or current symptoms of cardiovascular or pulmonary disease, had no orthopedic injury, neuromuscular disorders, or any contraindications to exercise testing. Participants were instructed to avoid heavy training, consumption of caffeinated beverage and alcohol 24 hours before each experimental session. Written and verbal informed consent was obtained from each participant. The study was approved by the local

ethics committee and conducted according to the Helsinki Declaration for human experimentation.

Experimental protocol

Upon their arrival, participants underwent basic anthropometric measurements and were familiarised with pulmonary function testing. Then, participants performed a maximal and graded cycling test to exhaustion (see maximal exercise testing) with resting pulmonary function tests assessed at rest, both before and after the cycling exercise test.

Maximal exercise testing

The maximal and graded test to exhaustion was performed on an electromagnetically braked cycle ergometer (Velotron, RacerMate, Seattle, WA, USA). The incremental exercise test began at a workload of 80 W for MM and 160 W for YM with a 40 W increase every 3 min. The initial workload was 30 W for MW and 120 W for YW and increased by 30 W every 3 min. Participants were instructed to maintain a self-selected pedaling frequency until volitional exhaustion or until they could no longer maintain 60 rpm for more than ten seconds despite verbal encouragement. To ensure that $\dot{V}O_{2\text{MAX}}$ was reached during the maximal and graded exercise test, participants performed, after a twenty-minute recovery period, a constant work rate test until exhaustion at 110% of the peak power output (PPO) reached during the maximal and graded exercise test. PPO corresponded to the power which elicited $\dot{V}O_{2\text{MAX}}$.

Pulmonary function testing

Spirometry was conducted following standardized guidelines and requirements (Miller, 2005). Participants were seated on the ergocycle in the cycling position to avoid any posture effect. Data were expressed relative to predicted values (Quanjer et al., 2012). Maximal expiratory

flow volume (MEFV) curves were constructed by having subjects perform forced vital capacity (FVC) maneuvers with varying efforts prior to and after the incremental exercise test to consider the phenomenon of gas compression and potential exercise-induced bronchodilation (Guenette et al., 2010). The highest flow achieved at any given absolute lung volume was used to account for thoracic gas compression effect on maximal expiratory flows (Guenette et al., 2010). A monitor provided instantaneous visual feedback of the flow-volume loops during each attempt. The shape of the MEFV curves was evaluated using the slope ratio (SR) where a SR value of 1 indicated a linear MEFV curve while a value of $SR < 1$ indicated a convex shape with smaller change in flow per volume unit and a value of $SR > 1$ indicated a concave shape with greater change in flow per volume unit (Dominelli et al., 2015a, 2016; Klimenko et al., 2023). SR was calculated as follow (Dominelli et al., 2016, 2015a) : a tangency and a chord line were traced at 30 points which were calculated in 2% increments between 20% and 80% of maximal volume. The tangent line was drawn using a volume difference of 200 ml above and below the calculated point while the chord line corresponded to the line intersecting this point and the end of the vital capacity. The average SR value was calculated for each point within the VC range analyzed, and the resulting mean SR was reported.

Operational Lung volume

To determine operational lung volumes and accurately position tidal flow-volume loops within the maximal flow-volume loop, participants performed maximal inspiratory capacity (IC) maneuvers at rest and in the last 30 seconds of each exercise workload. Participants were prompted to perform the IC maneuver once the tidal breath and end-expiratory lung volume (EELV) were considered stable by experimenters from visual feedback for at least 10 breaths. Participants were verbally encouraged and the importance of reaching total lung capacity (TLC)

during every maneuver was emphasized. If participants thought they failed to perform a maximal IC, another attempt was made approximately 15 seconds later.

Perceptual responses

The perceived rate of breathlessness (dyspnea) and leg discomfort were measured independently at the end of each exercise workload using a Borg CR-100 numerical scale. Dyspnea was defined as the perception of breathing difficulty, and leg discomfort was defined as the perception of muscle fatigue in the legs. For each scale, "0" corresponded to no respiratory discomfort or no leg discomfort and "100" corresponded to the most severe respiratory discomfort or the most severe leg discomfort ever experienced, respectively.

Respiratory data collection and analysis

Inspiratory and expiratory airflows were assessed with a heated pneumotachograph (model 2730, Hans Rudolph, Kansas, USA). The pneumotachograph was calibrated using a 3L-syringe (model 5530, Hans Rudolph, Kansas, USA), at three different flow rates (<70L/min, 100-120L/min and >150L/min) to consider any non-linear relationship between flow and volume and six volumes ranging from 0.5 to 3 liters and gas exchange were measured using a respiratory gas analyzer (Metasys TR-M, Brainware, France). Volume was determined through numerical integration of the flow signal. During the entire session, flow and volume data were continuously recorded at a sampling rate of 2000Hz using a 16-channel analog-to-digital data acquisition system (Powerlab 16/35, AD Instrument, Australia). Data were saved and stored on a computer (LabChart v8.1.25, AD Instruments) and subsequent analysis was performed using MATLAB (R2023a, MathWorks Inc., USA).

To remove the flow signal drift from the pneumotachograph, we selected the volume of ten tidal cycles prior to each IC maneuvers. The drift trend on the selected cycles was determined

with a regression analysis and subtracted from the breathing cycles of interest. The resulting adjusted volume signal was used for subsequent analysis. Assuming that lung elastic recoil and TLC do not vary during exercise (Babb and Rodarte, 1991; Younes and Kivinen, 1984), EELV was calculated by subtracting the IC volume from FVC and end-inspiratory lung volume (EILV) was calculated as the sum of tidal volume and EELV. To obtain an accurate representation of the tidal flow volume loop, eight tidal breaths from the tenth to the second breath before the IC maneuver were selected and averaged. The averaged tidal flow volume loop was then inserted within the MEFV curve from EELV (see figure 1) for each workload. The severity of EFL was determined by the percentage of the expiratory tidal volume that encroached the MEFV curve (Johnson et al., 1999). Participants were considered to be experiencing EFL when the expiratory volume of the tidal breath exceeded the MEFV curve by more than 5% (Derchak et al., 2000). Greater percentages indicated more severe EFL. The relative workload (i.e., %PPO) at which EFL occurred (W_{EFL}) was determined.

Statistical analysis

Normality of the distribution was tested using the Shapiro-Wilk test and variance homogeneity was calculated with Levene's test. Descriptive characteristics, spirometry data and metabolic variables at peak exercise were compared for each group using a two-factor analysis of variance (ANOVA) for age (young or master) and sex (men or women). When a significant difference was found, a multiple comparisons analysis was performed using the Bonferroni test. Ventilatory and metabolic variables during exercise were compared via three-way repeated measure ANOVA with one within (time) and 2 between (age \times sex) main effects. SR values for each 30 datapoints of interest were compared within (from 20 to 80% of FVC) and among groups via two-way mixed-factorial ANOVA (group \times %FVC). Pearson correlation analysis was conducted to examine the association between $EFL_{SEVERITY}$ and participant characteristics.

All statistical analysis were completed with SPSS Statistics (v26.0, IBM Co., NY, USA). Data are presented as means \pm standard deviation (SD) unless stated otherwise and significance for all tests was set at $P < 0.05$.

RESULTS

Subject characteristics and pulmonary function

Participants characteristics and resting pulmonary function are displayed in Table 1. A significant main effect of age and sex was found for FVC ($p < 0.001$ in both groups) and FEV₁ ($p < 0.001$ in both groups) with men having higher values than women and young athletes having higher values than master athletes but with no age and sex interaction effect. A main effect of age was also found for FEF₂₅₋₇₅ with higher values for men ($p < 0.001$) and young athletes ($p = 0.009$). SR index was higher in master compared to young athletes ($p < 0.001$), with no effect of biological sex. When SR values from 20 to 80% of FVC were calculated, a main effect of age ($F = 25.14$, $p < 0.001$) was found with no effect of sex ($F = 0.02$, $p = 0.879$).

Ventilatory and metabolic response during exercise

Peak exercise data are shown in Table 2. At peak exercise, a main effect of both age and sex ($p < 0.02$) was found for PPO (W and W.kg⁻¹), $\dot{V}O_{2\text{ MAX}}$ (L.min⁻¹) and $\dot{V}CO_{2\text{ MAX}}$, with men having higher values than women and young athletes having higher values than master athletes. $\dot{V}O_{2\text{ MAX}}$ (mL.min⁻¹.kg⁻¹, $p < 0.001$), RER ($p = 0.004$), HR ($p < 0.001$) and [La]_b ($p = 0.001$) were higher in young athletes than master athletes. Women athletes, regardless of their age, experienced a slightly lower SpO₂ at peak exercise than men ($p = 0.001$). Ventilatory response across workloads is shown in Figure 2. At peak exercise, a main effect of age and sex was found for $\dot{V}E$ ($p < 0.001$), with men and young athletes achieving greater ventilation levels than women and master athletes, respectively. Women had also a lower VT than men ($p < 0.001$)

regardless of age, and master athletes had a lower BF than young athletes ($p = 0.010$) regardless of biological sex. A main age ($p = 0.005$), sex ($p = 0.016$) and age \times sex interaction effect ($p < 0.001$) was observed for $\dot{V}E / \dot{V}CO_2$, with higher values for men and master athletes.

Expiratory Flow limitation

The percentage of EFL occurrence for every participants' group and across workloads is shown in Figure 3. $EFL_{SEVERITY}$ was negatively correlated with W_{EFL} ($p < 0.001$, $r^2 = 0.47$), showing that participants who started to experience EFL at lower relative workloads had the most severe EFL. At peak exercise, EFL was thus found in 61% of young athletes, 86% of master athletes, 78% of women and 71% of men. When considering individuals who experienced EFL only, tidal breath overlapped the MEFV curve (i.e., $EFL_{SEVERITY}$) over $27.9 \pm 10.2\%$ in YW, $42.9 \pm 21.6\%$ in YM, $46.0 \pm 28.5\%$ in MW and $52.1 \pm 20.4\%$ in MM. When $EFL_{SEVERITY}$ of all participants was considered, it was positively correlated with SR ($p = 0.012$, $r^2 = 0.16$, see figure 4), showing that participants with the most concave MEFV curve had the most severe EFL.

Operating lung volumes

Operating lung volume are displayed in Figure 5. At the onset of exercise, EELV decreased below resting values ($p < 0.05$) in all groups and remained below resting values throughout exercise. At peak exercise, EELV increased towards resting values in all groups but, when the group mean data were considered, did not exceed them ($p > 0.05$). Using a qualitative approach, our results showed that EELV at peak exercise exceeded resting values (i.e., dynamic hyperinflation) in 25% ($n = 2/8$) of YW, in 40% ($n = 4/10$) of YM, in 50% ($n = 5/10$) in MW and in 27% ($n = 3/10$) of MM. EILV progressively and linearly increased during exercise for each group ($p < 0.05$), with no difference between groups.

DISCUSSION

Main findings

The purpose of this study was to determine the modulating effect of age and biological sex on EFL frequency and severity during a maximal graded cycling exercise in athletes. Our main findings were that i) master athletes were more susceptible at experiencing EFL compared to young athletes, ii) women and men were similarly likely to experience EFL when grouped by age, iii) master athletes who experienced flow limitation, had a greater EFL_{SEVERITY} than young athletes, iv) increased MEFV curvilinearity (i.e., increased slope ratio) was correlated with a greater EFL_{SEVERITY}. Our collective findings indicate that age-related changes, rather than biological sex differences, are primarily responsible for athletes reaching their ventilatory limits (i.e., unbalance between ventilatory capacity and demand). Thus, master athletes, appear to be more susceptible to EFL than their younger counterparts.

Ventilatory capacity at rest in young and master athletes

Ventilatory capacity is determined by lung volume and maximal expiratory flows which may be influenced by age and biological sex. Previous studies evidenced a decrease in lung function with healthy aging (i.e., FEV₁ decrease of 20-30 mL per year starting at age 35-40; (Johnson et al., 1991a, 1994; McClaran et al., 1995; Molgat-Seon et al., 2018; Molgat-Seon et al., 2019; Ofir et al., 2008; Smith et al., 2017b) and the differences in lung anatomy and function between men and women (Christou et al., 2021; Dominelli et al., 2018; Sheel et al., 2009; Torres-Tamayo et al., 2018). As expected, regardless of age, women displayed a lower FVC than men and regardless of biological sex, master athletes displayed a lower FVC than young athletes. While these data support the widely accepted notion that FVC is lower in women than men and in older than young individuals, it is, to our knowledge, the first time that it was directly

compared in young and master athletes of both sexes. Our data therefore support that the effects of age and biological sex in lung structure and function, are maintained in athletes.

When focusing on expiratory flow rates and particularly FEF₂₅, FEF₅₀ and FEF₂₅₋₇₅, women displayed lower values than men regardless of age and master athletes displayed lower values than young athletes regardless of biological sex. Lower expiratory flow rates in women may be attributed to differences in lung anatomy, with women having smaller airways than men even when matched for lung size (Christou et al., 2021; Dominelli et al., 2018, 2015b; Molgat-Seon et al., 2019). Age-related decline in expiratory flow rates stems from both a loss of lung elastic recoil and chest wall stiffening, which further exacerbate dynamic compression of the airways. This results in the observed reduction in maximal expiratory flow rates leading to the decline of maximum ventilatory capacity (Johnson et al., 1991b; Yernault et al., 1979). Collectively, our data support the notion that ventilatory capacity decreases with healthy aging in athletes.

The effect of endurance training conducted across the lifespan on curtailing the decline in pulmonary function associated with aging remains a widely debated topic and lacks a clear conclusion (Cheng, 2003; Hagberg et al., 1988; Jakes, 2002; Morris et al., 1971; Niinimaa and Shephard, 1978; Pelkonen et al., 2003). In our groups, FVC values were not different from predicted values, which supports existing evidence that lifelong endurance training does not counteract the age-related decline in FVC (Hagberg et al., 1988). Only FEF₂₅₋₇₅ in MM was higher than predicted values with values exceeding predicted ones by 147%. However, it was unclear whether this value resulted from endurance training. Only FEF₂₅₋₇₅ exceeded predicted values and this difference was only observed in older men, not women. These findings support the idea that endurance training does not mitigate the decline in lung function associated with aging. However, a more comprehensive longitudinal study with a larger sample size is necessary to verify this claim.

The effect of age and biological sex on EFL

Fitness level has been suggested to be an important determinant of EFL during exercise because while endurance training has little, if any, beneficial effects on lung function, it substantially increases metabolic and ventilation demand / levels (Cox et al., 2020; Guenette et al., 2007; McClaran et al., 1998). It is well accepted that elderly individuals are predisposed to EFL during exercise due to their decreased ventilatory capacity (DeLorey and Babb, 1999; Johnson and Dempsey, 1991). Our findings showed that master athletes had a greater propensity towards experiencing EFL with 25% more subjects experiencing EFL in the master athlete group (EFL occurrence of 86%, n = 18/21) than in the young athlete group (EFL occurrence of 61%, n = 11/18). The higher proportion of master athletes who experienced flow limitation during relative exercise intensities when compared to younger athletes, regardless of sex, extends findings conducted on untrained individuals (Molgat-Seon et al., 2018). The modulating effect of age was suggested to be attributed to age-related increase of ventilation over ventilatory capacity during exercise. Our results provide complementary information because when focusing on the effect of age in men only, EFL occurrence was similar between master men and young men (70% vs 73%, respectively) but greater in master women than in young women (100% vs 50%, respectively). This direct comparison underscores the pivotal effect of biological sex, especially among master athletes.

Biological sex differences in human pulmonary system have been well-documented (Christou et al., 2021; Dominelli et al., 2018; Sheel et al., 2009; Torres-Tamayo et al., 2018). In the context of high ventilatory demand, the relatively small sex differences in the structure of the lungs become important and is thought to predispose women to EFL for a given level of ventilation demand (McClaran et al., 1998; Molgat-Seon et al., 2018). We found that 78% of women and 71% of men experienced EFL. It should be noted that the slightly higher occurrence of EFL in women was mainly attributed to the subjects from the MW group who all displayed

flow limitation. Consequently, when grouped together regardless of age, our data indicate that, there was no greater likelihood of EFL in women. This observation was particularly prevalent among young athletes. On the one hand, our findings are not in agreement with, previous work conducted on young endurance-trained individuals who reported a higher propensity toward EFL at maximal exercise in women than in men using a negative expiratory pressure (NEP) device (Guenette et al., 2007) or using similar methodology to ours (Wilkie et al., 2015). On the other hand, other studies using similar methodology to ours and conducted on a larger sample size, found that within individuals with the highest fitness levels, the frequency of EFL was similar between the sexes (Molgat-Seon et al., 2022). Accordingly, these authors did not observe biological sex differences across a wide range of cardiorespiratory fitness (i.e., from 81% to 182% of predicted $\dot{V}O_{2\text{ MAX}}$) on 126 young healthy individuals. Other authors reported that sex did not affect the frequency of EFL when young recreationally active subjects were studied using similar methodology to ours (Dominelli et al., 2015b) or a NEP device (Molgat-Seon et al., 2018).

While there is a body of research on biological sex differences in young participants, there are only very few data available regarding direct comparisons between the sexes in older individuals. However, when examining the interplay between healthy aging and sex, MW in our study emerge as particularly interesting subjects due to their heightened susceptibility to developing EFL, with higher occurrence rates than MM. Previous work conducted on untrained older women, reported an EFL occurrence of 60% (5 subjects out of 8 in Wilkie et al., 2012) and 90% (11 subjects out of 12 in Molgat-Seon et al., 2018). It is important to acknowledge that while Wilkie et al., (2012) used similar methodology to ours, Molgat-Seon et al., (2018) used a NEP device to detect EFL (Molgat-Seon et al., 2018). Taken together, these results highlight the greater likelihood of experiencing EFL in older women. Furthermore, our data reveals new findings indicating that when these older women undergo endurance training, they

may be even more vulnerable to airflow limitation. These findings can be attributed to the interactive influences of healthy aging and biological sex on pulmonary structure and function (Molgat-Seon et al., 2018) which appear no longer overbuilt for the demand imposed by exercise.

Determinants of EFL.

The presence of EFL during exercise is caused by the unbalance between ventilatory capacity and ventilatory demand (Johnson and Dempsey, 1991). In healthy individuals our understanding of the determinants of EFL is mostly based on studies conducted on young male and, to a lesser extent, female participants. For example, the predictors of EFL has been well documented in a recent work involving a large sample of participants (Molgat-Seon et al., 2022). However, this study evaluated EFL in subjects of varying fitness levels and who were between the ages of 20 and 45 years (mean age ~26 years). Therefore, it did not provide insight into EFL determinants in older individuals or in athletes specifically. We found a positive relationship between EFL_{SEVERITY} and SR indicating that a more concave MEFV curve, and thus potentially smaller airways, was associated with a greater EFL_{SEVERITY}. It should be noted that this relationship was detected by including all participants, with non-EFL subjects, in the analysis (represented as “0%”). We included all participants to match with Molgat-Seon et al., (2022) methodology. Our results extend the findings of this study thereby suggesting that the SR may be an important determinant of EFL in trained individuals as well. Yet our findings are based on correlative evidence, and we cannot infer causation from our data.

Operating lung volume

During exercise, most young and master athletes reduced EELV below resting values. With the emergence of EFL, EELV can rise back to resting EELV to increase expiratory flow rates. In

some cases it can also continue to increase beyond EELV which leads to dynamic hyperinflation (Babb, 2013). We observed that 8 of 21 master athletes (n = 3 men, n = 5 women) and 6 of 18 young athletes (n = 4 men, n = 2 women) showed evidence of dynamic hyperinflation at maximal exercise. However, when data were gathered by group, EELV did not significantly increase above resting EELV. Therefore, our findings do not support evidence of a modulating effect of biological sex or age on dynamic hyperinflation in athletes. While the development of EFL has been shown to result in dynamic lung hyperinflation during exercise in older individuals in previous work (Johnson et al., 1991a; McClaran et al., 1999), other studies found EFL without dynamic hyperinflation suggesting that the net mechanical time constant for lung emptying was preserved (Faisal et al., 2015; Johnson et al., 1991b). Indeed, although EELV have been shown to increase during exercise with EFL (Pellegrino et al., 1993), it has been suggested more recently that it did not imply causality (Molgat-Seon et al., 2018). Some individuals confronted to EFL, may thus avoid high lung volumes to keep breathing on the steeper and most advantageous part of the pressure volume relationship of the respiratory system (Agostoni and Rahn, 1960; Molgat-Seon et al., 2018). This could be particularly useful in older men and women who have been shown to exhibit a higher work of breathing for a given \dot{V}_E than younger counterparts (Molgat-Seon et al., 2018). Overall, master athletes seem to regulate their operating lungs volumes during exercise similarly to young athletes. Although this similar lung volume pattern was also shown in untrained older individuals, our master athletes did not breathe at higher operating lung volumes than their younger counterparts as it was found in untrained individuals (Molgat-Seon et al., 2018). as previously shown in untrained individuals (Molgat-Seon et al., 2018). However, in contrast to this study, our master athletes did not breathe at higher operating lung volumes than their younger counterparts at similar relative work rates. This could be a strategic adaptation to mitigate exacerbated work of breathing due to their higher levels of ventilation. However, additional research utilizing direct

measurements of the work of breathing should be conducted to confirm this difference between older trained and untrained individuals.

Methodological considerations

Although we used validated methods to evaluate EFL, EELV, EILV and dysanapsis, these methods only provide indirect and approximate estimates of these indices. Specifically, we used volitional inspiratory capacity maneuvers during exercise to estimate operating lung volumes and, consequently, EFL. As we were unable to perform invasive esophageal pressure measurements, we could not determine peak esophageal pressure and confirm whether participants inspired maximally to total lung capacity during the maneuvers. To mitigate this limitation, each participant was thoroughly informed about the importance of producing a maximal effort during IC maneuver and was familiarized with the procedure. With comprehensive explanations and familiarization, IC measurements are considered reliable and reproducible (Guenette et al., 2013).

Moreover, in the absence of transpulmonary pressure measurement or negative expiratory pressure device to directly test for EFL, we estimated EFL by calculating the percentage of the tidal volume loop that overlapped the MEFV curve. To minimize potential false detection of EFL, expiratory flow was considered limited only when the tidal volume loop overlapped and exceeded the MEFV curve by $\geq 5\%$.

CONCLUSION

This study aimed at determining the modulating effect of age and biological sex on EFL susceptibility and severity during maximal exercise in athletes. Ventilatory capacity and demand were compared between young and master athletes of both sexes. Collectively, our findings indicate that age-related decline in pulmonary function increases the likelihood of EFL

in master athletes, with women being particularly susceptible. Further investigation is necessary to determine the extent to which EFL limits exercise and affects breathing for master athletes, particularly women.

ACKNOWLEDGEMENTS & GRANTS

We thank the participants for their time and effort dedicated to the participation in this study. Financial support was provided by Région Provence-Alpes-Côte d'Azur and the initiative of excellence (ANR-15-IDEX-01), joint, excellent, and dynamic initiative (JEDI) of the Université Côte d'Azur (UCA).

CONFLICT OF INTEREST

The authors declare having no conflicts of interest, financial or otherwise, no professional relationships with companies or manufacturers who may benefit from the results of the present study. The authors declare that the results of the study are presented clearly, honestly, and without fabrication, falsification, or inappropriate data manipulation and do not constitute endorsement by the American College of Sports Medicine.

Table 1. Subjects characteristics

Variable	YOUNG		MASTER		P value		
	Women	Men	Women	Men	Main effect of age	Main effect of sex	Effect of age × sex
n	8	10	10	11			
Age (yr)	28.6 ± 4.4	27.4 ± 4.4	64.8 ± 3.8	65.0 ± 5.1	< 0.001	0.744	0.644
Height (cm)	167.9 ± 4.2	178.1 ± 6.9	161.8 ± 5.9	176.5 ± 4.7	0.044	< 0.001	0.240
Weight (kg)	58.1 ± 7.2	71.6 ± 9.0	50.5 ± 6.8	67.9 ± 3.7	0.017	< 0.001	0.386
FVC (L)	4.5 ± 0.7	5.9 ± 0.8	3.2 ± 0.5	4.9 ± 0.9	< 0.001	< 0.001	0.478
FVC (% predicted)	102.8 ± 8.2	108.0 ± 9.7	106.7 ± 12.0	112.4 ± 17.3	0.325	0.194	0.961
FEV₁ (L)	3.2 ± 0.8	4.4 ± 0.6	2.0 ± 0.5	3.7 ± 0.8	< 0.001	< 0.001	0.296
FEV₁ (% predicted)	86.2 ± 15.3	98.2 ± 11.0	86.3 ± 20.4	110.5 ± 20.4	0.284	0.004	0.300
FEV₁/FVC (%)	70.7 ± 11.9	75.5 ± 7.3	63.7 ± 14.6	75.6 ± 6.4	0.322	0.020	0.303
FEV₁/FVC (%predicted)	83.6 ± 14.6	90.5 ± 9.0	81.0 ± 30.2	98.4 ± 8.4	0.695	0.006	0.093
PEF (L.s⁻¹)	8.7 ± 1.5	10.1 ± 0.8	6.6 ± 0.7	10.5 ± 1.9	0.066	< 0.001	0.007
FEF₂₅ (L.s⁻¹)	7.6 ± 1.7	8.4 ± 0.7	5.4 ± 1.1	8.8 ± 1.8	0.045	< 0.001	0.006
FEF₅₀ (L.s⁻¹)	5.0 ± 1.4	5.3 ± 1.1	2.8 ± 0.8	5.0 ± 1.4	0.002	0.004	0.014
FEF₇₅ (L.s⁻¹)	2.4 ± 0.7	2.3 ± 0.6	0.8 ± 0.4	1.6 ± 0.6	< 0.001	0.112	0.029
FEF₂₅₋₇₅ (L.s⁻¹)	4.5 ± 1.2	4.5 ± 0.8	2.1 ± 0.7	3.9 ± 1.0	< 0.001	0.009	0.006
FEF₂₅₋₇₅ (%predicted)	111.2 ± 19.1	95.9 ± 17.9	103.1 ± 31.5	147.1 ± 39.9	0.034	0.150	0.005
Slope ratio (AU)	1.1 ± 0.9	1.2 ± 0.3	1.7 ± 0.4	1.6 ± 0.3	< 0.001	0.885	0.172
PI_{MAX} (cmH₂O)	105.6 ± 4.0	113.5 ± 15.7	68.4 ± 13.1	105.0 ± 17.5	< 0.001	< 0.001	0.005
PI_{MAX} (% predicted)	131.1 ± 6.2	106.5 ± 14.7	101.7 ± 19.5	122.5 ± 20.4	0.184	0.137	< 0.001

All values are expressed as means ± SD. FVC: forced vital capacity; FEV₁: forced expiratory volume in 1 s; FEV₁/FVC: ratio of FEV₁ to FVC; PEF, peak expiratory flow; FEF₂₅, FEF₅₀, FEF₇₅: forced expiratory flow at respectively 25%, 50% and 75% of FVC; FEF₂₅₋₇₅: forced expiratory flow between 25% and 75% of FVC; PI_{MAX}, maximal inspiratory pressure.

Table 2. Peak metabolic and ventilatory response during maximal graded cycling test

Parameter	YOUNG		MASTER		<i>P</i> value		
	Women	Men	Women	Men	Main effect of age	Main effect of sex	Effect of age × sex
Metabolic							
PPO (W)	261 ± 48	348 ± 38	165 ± 32	258 ± 41	< 0.001	< 0.001	0.802
PPO/kg (W.kg ⁻¹)	3.8 ± 0.5	4.9 ± 0.5	3.3 ± 0.7	4.5 ± 0.4	< 0.001	0.021	0.827
$\dot{V}O_{2\text{MAX}}$ (L.min ⁻¹)	3.5 ± 0.4	4.7 ± 0.6	2.6 ± 0.2	3.1 ± 0.2	< 0.001	< 0.001	0.014
$\dot{V}O_{2\text{MAX}}$ (mL.min ⁻¹ .kg ⁻¹)	59.8 ± 2.0	65.9 ± 7.4	48.5 ± 8.4	46.5 ± 2.7	< 0.001	0.959	0.005
$\dot{V}CO_{2\text{MAX}}$ (L.min ⁻¹)	3.6 ± 0.5	4.9 ± 0.5	2.5 ± 0.2	3.0 ± 0.3	< 0.001	< 0.001	0.010
RER (AU)	1.02 ± 0.11	1.13 ± 0.14	1.01 ± 0.13	1.02 ± 0.13	0.004	0.743	0.857
HR (bpm)	183 ± 6	178 ± 9	155 ± 11	158 ± 16	< 0.001	0.792	0.329
SpO ₂ (%)	96.0 ± 1.0	97.0 ± 1.2	95.8 ± 1.4	97.9 ± 1.1	0.623	0.001	0.144
[La] _b (mmol.L ⁻¹)	11.6 ± 3.7	11.9 ± 3.5	7.0 ± 1.5	8.5 ± 2.5	0.001	0.432	0.604
Ventilation							
$\dot{V}E$ (L.min ⁻¹)	115.0 ± 24.0	144.4 ± 26.2	71.0 ± 17.7	118.8 ± 15.6	< 0.001	< 0.001	0.191
VT (L)	2.0 ± 0.3	2.5 ± 0.5	1.5 ± 0.3	2.5 ± 0.4	0.068	< 0.001	0.084
BF (breaths.min ⁻¹)	58.8 ± 8.9	66.4 ± 23.7	47.7 ± 8.4	50.3 ± 12.8	0.010	0.316	0.617
$\dot{V}E / \dot{V}O_2$	32.0 ± 4.3	29.9 ± 3.9	29.0 ± 5.1	37.6 ± 5.2	0.144	0.049	0.002
$\dot{V}E / \dot{V}CO_2$	30.8 ± 3.2	28.6 ± 4.0	29.3 ± 4.4	38.6 ± 4.6	0.005	0.016	< 0.001
Respiratory mechanics							
EFL (n)	4/8	7/10	10/10	8/11			
EFL _{SEVERITY} (%)	27.9 ± 10.2	42.9 ± 21.6	46.0 ± 28.6	52.1 ± 20.4	0.024	0.597	0.152
EILV (%CVF)	87.4 ± 3.9	90.7 ± 2.9	85.9 ± 5.0	92.9 ± 3.8	0.754	< 0.001	0.119
EELV (%CVF)	41.0 ± 6.5	45.4 ± 6.2	34.8 ± 7.4	36.3 ± 5.1	0.001	0.163	0.510

All values are expressed as means ± SD. PPO, peak power output; $\dot{V}O_2$, oxygen consumption; $\dot{V}CO_2$, carbon dioxide output; RER, respiratory exchange ratio; HR, heart rate; SpO₂, oxygen saturation; [La]_b, blood lactate concentration; $\dot{V}E$, minute ventilation; VT, tidal volume, BF, breathing frequency, EFL_{SEVERITY}, expiratory flow limitation severity; EILV : end inspiratory lung volume; EELV, end expiratory lung volume.

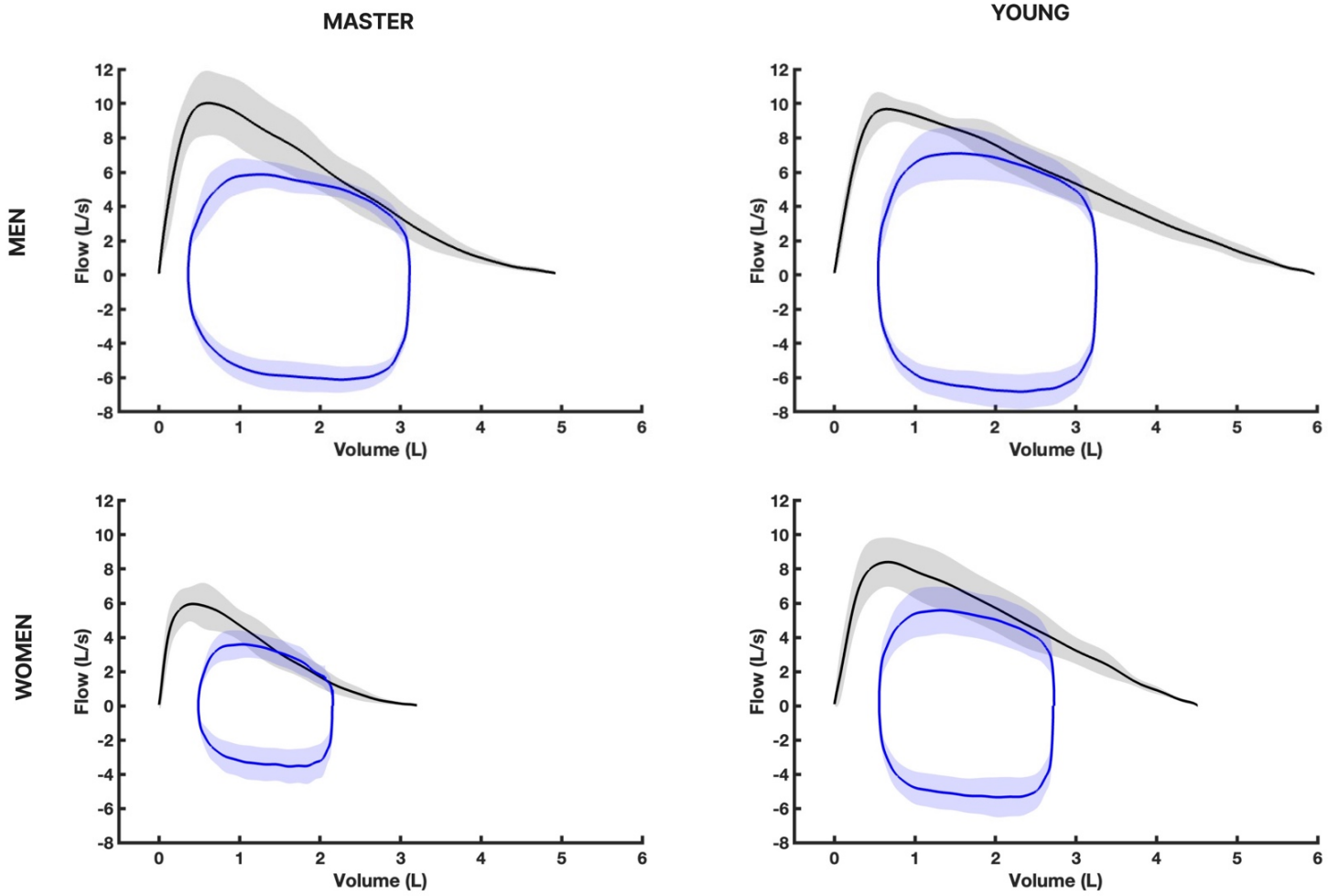

Figure 1. Maximal expiratory flow volume curves and tidal flow volume loop at peak exercise in YW, YM, MW and MM.

Values are means \pm SD.

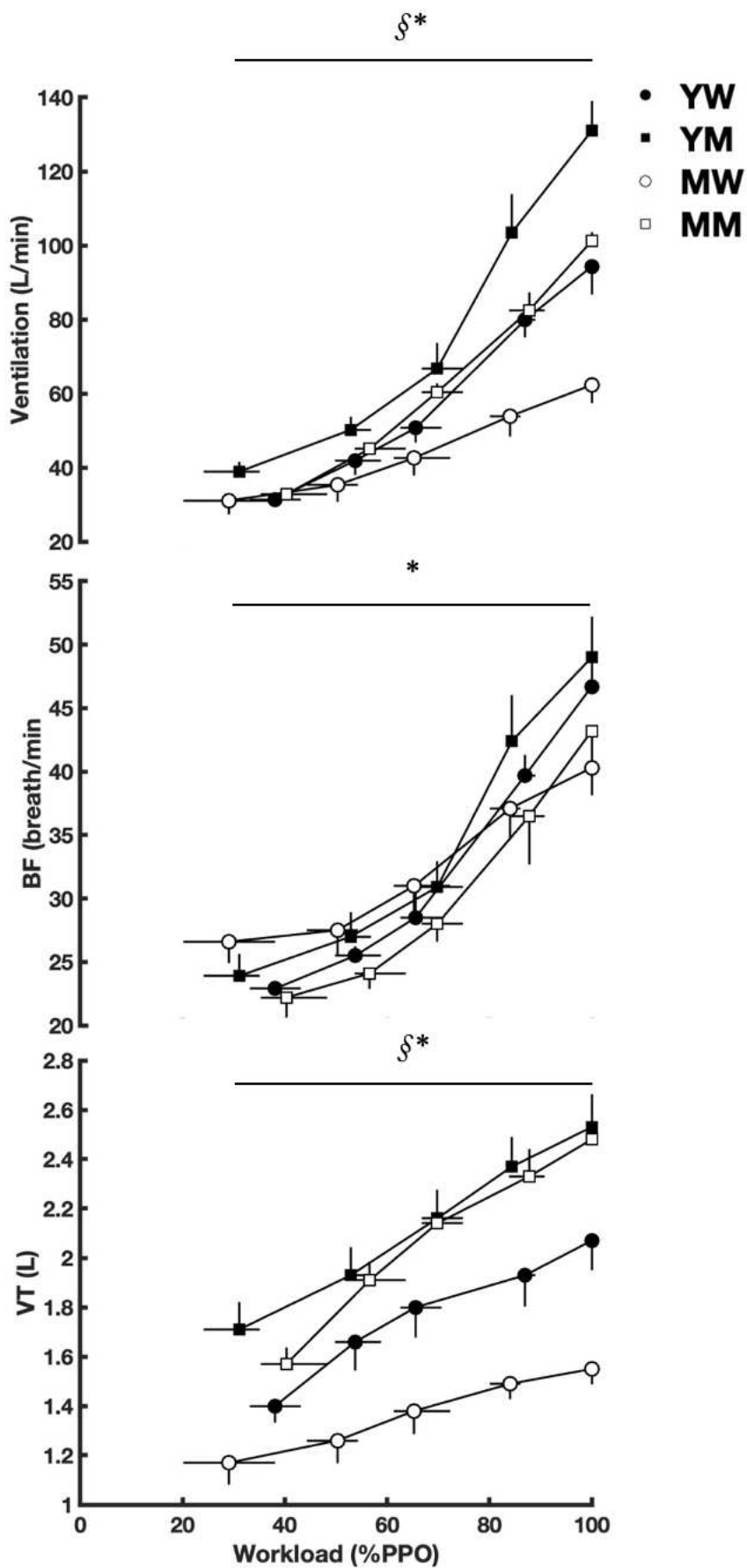

Figure 2. Ventilation, breathing frequency, and tidal volume across workloads in YW (●), YM (■), MW (○), and MM (■). §, significant main effect of biological sex
 *, significant main effect of age.
 Values are means ± SEM.

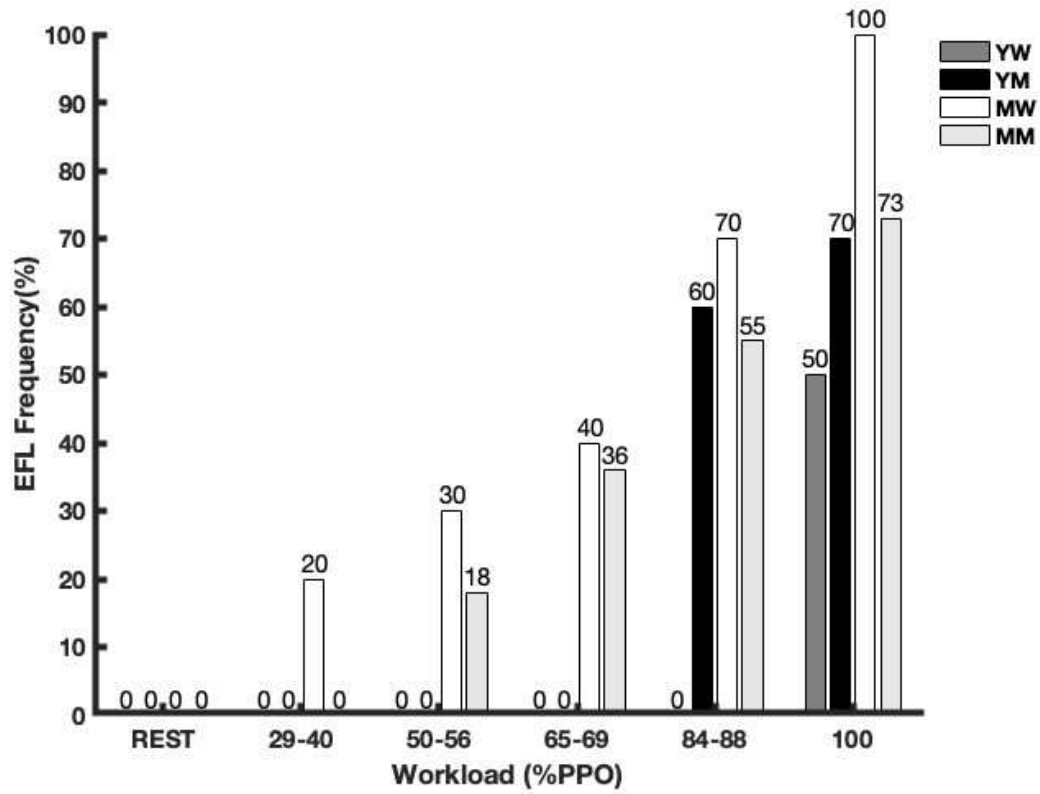

Figure 3. Expiratory flow limitation frequency at rest and across workloads in YW (●), YM (■), MW (○), and MM (■).

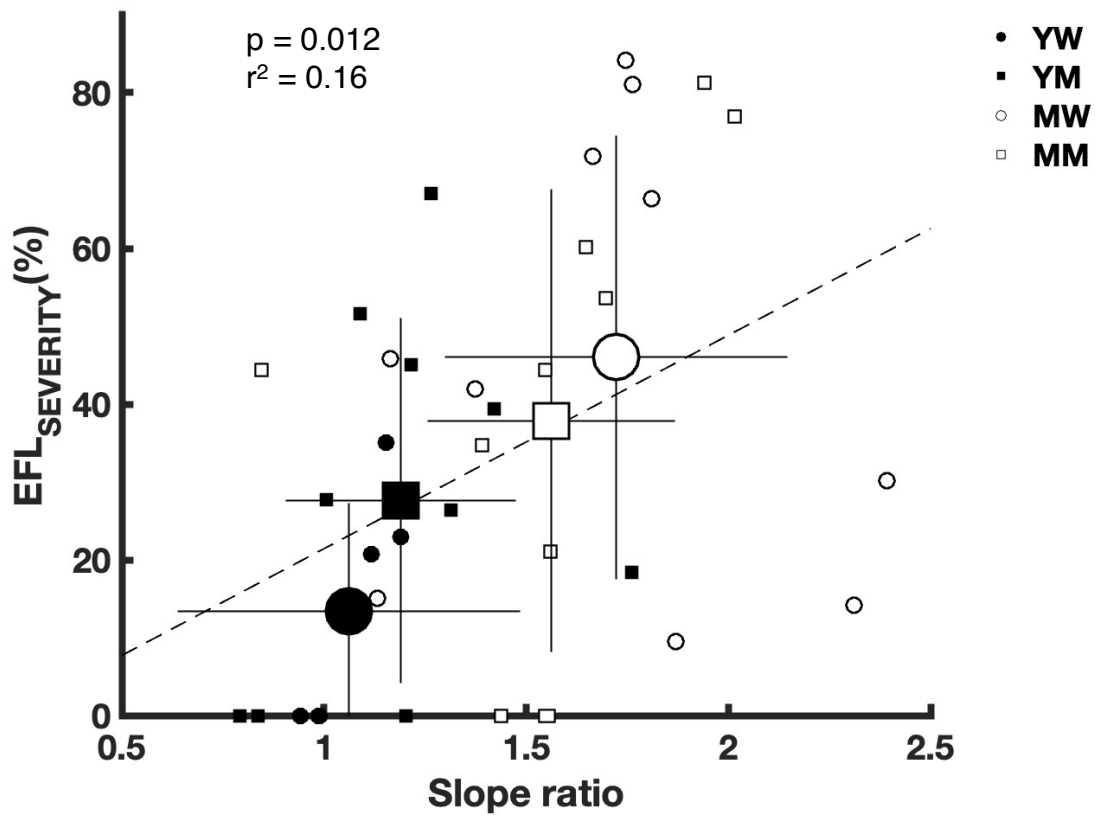

Figure 4 Relationship between slope ratio and expiratory flow limitation severity in YW (●), YM (■), MW (○), and MM (■).

Values are means \pm SD.

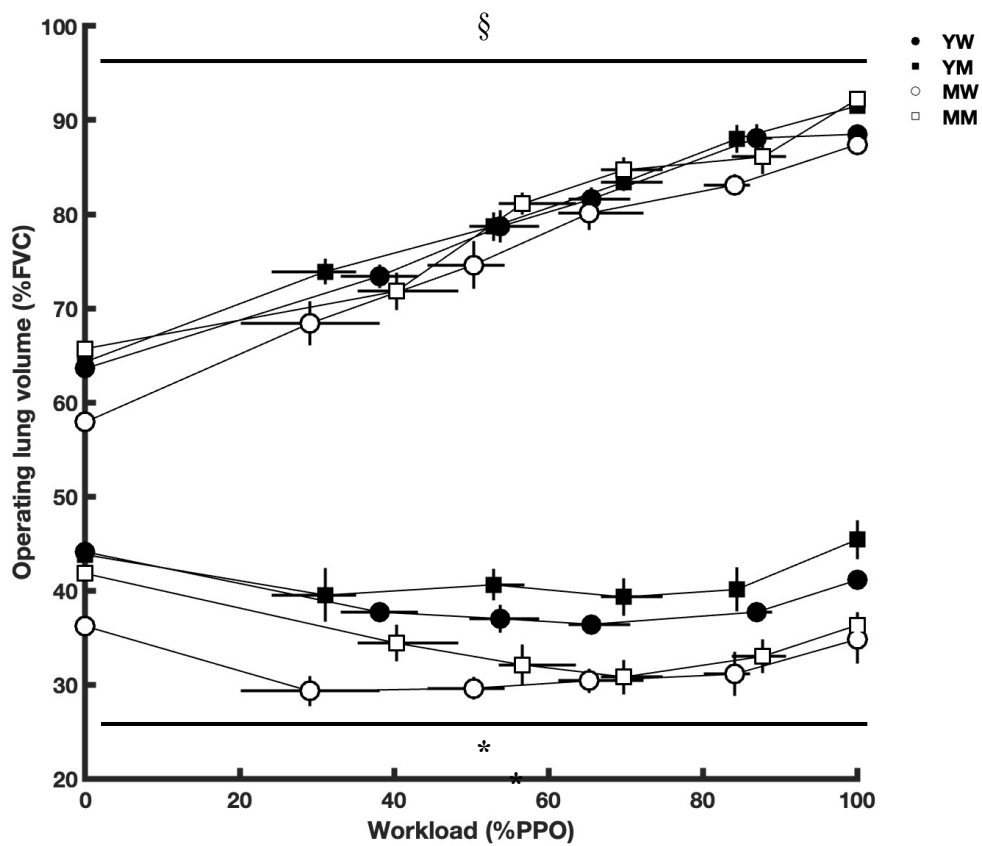

Figure 5. Operating lung volumes at rest and across workloads in YW (●), YM (■), MW (○), and MM (■).

Values are means \pm SEM.

§, significant main effect of biological sex

*, significant main effect of age.

REFERENCES

- Agostoni, E., Rahn, H., 1960. Abdominal and thoracic pressures at different lung volumes. *Journal of Applied Physiology* 15, 1087–1092. <https://doi.org/10.1152/jappl.1960.15.6.1087>
- Aliverti, A., 2008. Lung and chest wall mechanics during exercise: Effects of expiratory flow limitation. *Respiratory Physiology & Neurobiology* 163, 90–99. <https://doi.org/10.1016/j.resp.2008.07.025>
- Aliverti, A., Iandelli, I., Duranti, R., Cala, S.J., Kayser, B., Kelly, S., Misuri, G., Pedotti, A., Scano, G., Sliwinski, P., Yan, S., Macklem, P.T., 2002. Respiratory muscle dynamics and control during exercise with externally imposed expiratory flow limitation. *Journal of Applied Physiology* 92, 1953–1963. <https://doi.org/10.1152/japplphysiol.01222.2000>
- Babb, T.G., 2013. Exercise Ventilatory Limitation: The Role of Expiratory Flow Limitation 41.
- Babb, T.G., Rodarte, J.R., 1991. Lung volumes during low-intensity steady-state cycling. *Journal of Applied Physiology* 70, 934–937. <https://doi.org/10.1152/jappl.1991.70.2.934>
- Cheng, Y.J., 2003. Effects of physical activity on exercise tests and respiratory function. *British Journal of Sports Medicine* 37, 521–528. <https://doi.org/10.1136/bjism.37.6.521>
- Christou, S., Chatziathanasiou, T., Angeli, S., Koullapis, P., Stylianou, F., Sznitman, J., Guo, H.H., Kassinos, S.C., 2021. Anatomical variability in the upper tracheobronchial tree: sex-based differences and implications for personalized inhalation therapies. *Journal of Applied Physiology* 130, 678–707. <https://doi.org/10.1152/japplphysiol.00144.2020>
- Cox, K.R., Smith, J.R., Luden, N.D., Saunders, M.J., Kurti, S.P., 2020. The Prevalence of Expiratory Flow Limitation in Youth Elite Male Cyclists. *Medicine & Science in Sports & Exercise* 52, 1933–1939. <https://doi.org/10.1249/MSS.0000000000002325>
- DeLorey, D.S., Babb, T.G., 1999. Progressive Mechanical Ventilatory Constraints with Aging. *Am J Respir Crit Care Med* 160, 169–177. <https://doi.org/10.1164/ajrccm.160.1.9807045>
- Dempsey, J.A., La Gerche, A., Hull, J.H., 2020. Is the healthy respiratory system built just right, overbuilt, or underbuilt to meet the demands imposed by exercise? *Journal of Applied Physiology* 129, 1235–1256. <https://doi.org/10.1152/japplphysiol.00444.2020>
- Dempsey, J.A., McKenzie, D.C., Haverkamp, H.C., Eldridge, M.W., 2008. Update in the Understanding of Respiratory Limitations to Exercise Performance in Fit, Active Adults. *Chest* 134, 613–622. <https://doi.org/10.1378/chest.07-2730>
- Derchak, P.A., Stager, J.M., Tanner, D.A., Chapman, R.F., 2000. Expiratory flow limitation confounds ventilatory response during exercise in athletes: *Medicine & Science in Sports & Exercise* 32, 1873–1879. <https://doi.org/10.1097/00005768-200011000-00009>
- Dominelli, P.B., Foster, G.E., Dominelli, G.S., Henderson, W.R., Koehle, M.S., McKenzie, D.C., Sheel, A.W., 2013. Exercise-induced arterial hypoxaemia and the mechanics of breathing in healthy young women: Hypoxaemia and ventilatory mechanics in exercising women. *The Journal of Physiology* 591, 3017–3034. <https://doi.org/10.1113/jphysiol.2013.252767>
- Dominelli, P.B., Foster, G.E., Guenette, J.A., Haverkamp, H.C., Eves, N.D., Dominelli, G.S., Henderson, W.R., O'Donnell, D.E., Sheel, A.W., 2015a. Quantifying the shape of the maximal expiratory flow–volume curve in mild COPD. *Respiratory Physiology & Neurobiology* 219, 30–35. <https://doi.org/10.1016/j.resp.2015.08.002>

- Dominelli, P.B., Molgat-Seon, Y., Bingham, D., Swartz, P.M., Road, J.D., Foster, G.E., Sheel, A.W., 2015b. Dysanapsis and the resistive work of breathing during exercise in healthy men and women. *Journal of Applied Physiology* 119, 1105–1113.
- Dominelli, P.B., Molgat-Seon, Y., Foster, G.E., Dominelli, G.S., Haverkamp, H.C., Henderson, W.R., Sheel, A.W., 2016. Quantifying the shape of maximal expiratory flow-volume curves in healthy humans and asthmatic patients. *Respiratory Physiology & Neurobiology* 220, 46–53. <https://doi.org/10.1016/j.resp.2015.09.007>
- Dominelli, P.B., Render, J.N., Molgat-Seon, Y., Foster, G.E., Romer, L.M., Sheel, A.W., 2015c. Oxygen cost of exercise hyperpnoea is greater in women compared with men: Sex differences in the oxygen cost of breathing. *The Journal of Physiology* 593, 1965–1979. <https://doi.org/10.1113/jphysiol.2014.285965>
- Dominelli, P.B., Ripoll, J.G., Cross, T.J., Baker, S.E., Wiggins, C.C., Welch, B.T., Joyner, M.J., 2018. Sex differences in large conducting airway anatomy. *Journal of Applied Physiology* 125, 960–965. <https://doi.org/10.1152/jappphysiol.00440.2018>
- Faisal, A., Webb, K.A., Guenette, J.A., Jensen, D., Neder, J.A., O'Donnell, D.E., 2015. Effect of age-related ventilatory inefficiency on respiratory sensation during exercise. *Respiratory Physiology & Neurobiology* 205, 129–139. <https://doi.org/10.1016/j.resp.2014.10.017>
- Guenette, J.A., Chin, R.C., Cory, J.M., Webb, K.A., O'Donnell, D.E., 2013. Inspiratory Capacity during Exercise: Measurement, Analysis, and Interpretation. *Pulmonary Medicine* 2013, 1–13. <https://doi.org/10.1155/2013/956081>
- Guenette, J.A., Dominelli, P.B., Reeve, S.S., Durkin, C.M., Eves, N.D., Sheel, A.W., 2010. Effect of thoracic gas compression and bronchodilation on the assessment of expiratory flow limitation during exercise in healthy humans. *Respiratory Physiology & Neurobiology* 170, 279–286. <https://doi.org/10.1016/j.resp.2010.01.017>
- Guenette, J.A., Witt, J.D., McKenzie, D.C., Road, J.D., Sheel, A.W., 2007. Respiratory mechanics during exercise in endurance-trained men and women: Respiratory mechanics. *The Journal of Physiology* 581, 1309–1322. <https://doi.org/10.1113/jphysiol.2006.126466>
- Hagberg, J.M., Yerg, J.E., Seals, D.R., 1988. Pulmonary function in young and older athletes and untrained men. *Journal of Applied Physiology* 65, 101–105. <https://doi.org/10.1152/jappl.1988.65.1.101>
- Jakes, R.W., 2002. Physical Inactivity Is Associated with Lower Forced Expiratory Volume in 1 Second: European Prospective Investigation into Cancer-Norfolk Prospective Population Study. *American Journal of Epidemiology* 156, 139–147. <https://doi.org/10.1093/aje/kwf021>
- Johnson, B.D., Badr, M.S., Dempsey, J.A., 1994. IMPACT OF THE AGING PULMONARY SYSTEM ON THE RESPONSE TO EXERCISE. *Clinics in Chest Medicine* 15, 229–246. [https://doi.org/10.1016/S0272-5231\(21\)01070-4](https://doi.org/10.1016/S0272-5231(21)01070-4)
- Johnson, B.D., Dempsey, J.A., 1991. Demand vs. Capacity in the Aging Pulmonary System. *Exercise Sport Sci Rev* 19, 171–210. <https://doi.org/10.1249/00003677199101000-00005>
- Johnson, B.D., Reddan, W.G., Pegelow, D.F., Seow, K.C., Dempsey, J.A., 1991a. Flow Limitation and Regulation of Functional Residual Capacity during Exercise in a Physically Active Aging Population. *Am Rev Respir Dis* 143, 960–967. https://doi.org/10.1164/ajrccm/143.5_Pt_1.960
- Johnson, B.D., Reddan, W.G., Seow, K.C., Dempsey, J.A., 1991b. Mechanical Constraints on Exercise Hyperpnea in a Fit Aging Population. *Am Rev Respir Dis* 143, 968–977. https://doi.org/10.1164/ajrccm/143.5_Pt_1.968

- Johnson, B.D., Weisman, I.M., Zeballos, R.J., Beck, K.C., 1999. Emerging Concepts in the Evaluation of Ventilatory Limitation During Exercise. *Chest* 116, 488–503. <https://doi.org/10.1378/chest.116.2.488>
- Klimenko, O., Luu, P., Dominelli, P., Noggle, N., Petrics, G., Haverkamp, H.C., 2023. Effect of EXERCISE-INDUCED bronchoconstriction on the configuration of the maximal expiratory FLOW-VOLUME curve in adults with asthma. *Physiological Reports* 11. <https://doi.org/10.14814/phy2.15614>
- McClaran, S.R., Babcock, M.A., Pegelow, D.F., Reddan, W.G., Dempsey, J.A., 1995. Longitudinal effects of aging on lung function at rest and exercise in healthy active fit elderly adults. *Journal of Applied Physiology* 78, 1957–1968. <https://doi.org/10.1152/jappl.1995.78.5.1957>
- McClaran, S.R., Harms, C.A., Pegelow, D.F., Dempsey, J.A., 1998. Smaller lungs in women affect exercise hyperpnea. *Journal of Applied Physiology* 84, 1872–1881. <https://doi.org/10.1152/jappl.1998.84.6.1872>
- McClaran, S.R., Wetter, T.J., Pegelow, D.F., Dempsey, J.A., 1999. Role of expiratory flow limitation in determining lung volumes and ventilation during exercise. *Journal of Applied Physiology* 86, 1357–1366. <https://doi.org/10.1152/jappl.1999.86.4.1357>
- Miller, M.R., 2005. Standardisation of spirometry. *European Respiratory Journal* 26, 319–338. <https://doi.org/10.1183/09031936.05.00034805>
- Molgat-Seon, Y., Dominelli, P.B., Guenette, J.A., Sheel, A.W., 2019. Modelling the effects of age and sex on the resistive and viscoelastic components of the work of breathing during exercise. *Exp Physiol* 104, 1737–1745. <https://doi.org/10.1113/EP087956>
- Molgat-Seon, Y., Dominelli, P.B., Peters, C.M., Kipp, S., Welch, J.F., Parmar, H.R., Rabbani, T., Mann, L.M., Grift, G.O., Guenette, J.A., Sheel, A.W., 2022. Predictors of Expiratory Flow Limitation during Exercise in Healthy Males and Females. *Medicine & Science in Sports & Exercise* 54, 1428–1436. <https://doi.org/10.1249/MSS.0000000000002938>
- Molgat-Seon, Y., Dominelli, P.B., Ramsook, A.H., Schaeffer, M.R., Molgat Sereacki, S., Foster, G.E., Romer, L.M., Road, J.D., Guenette, J.A., Sheel, A.W., 2018. The effects of age and sex on mechanical ventilatory constraint and dyspnea during exercise in healthy humans. *Journal of Applied Physiology* 124, 1092–1106. <https://doi.org/10.1152/japplphysiol.00608.2017>
- Morris, J.F., Koski, A., Johnson, L.C., 1971. Spirometric Standards for Healthy Nonsmoking Adults: *Journal of Occupational and Environmental Medicine* 13, 360. <https://doi.org/10.1097/00043764-197107000-00021>
- Mota, S., Casan, P., Drobnic, F., Giner, J., Ruiz, O., Sanchis, J., Milic-Emili, J., 1999. Expiratory flow limitation during exercise in competition cyclists. *Journal of Applied Physiology* 86, 611–616. <https://doi.org/10.1152/jappl.1999.86.2.611>
- Myers, J., Kaminsky, L.A., Lima, R., Christle, J.W., Ashley, E., Arena, R., 2017. A Reference Equation for Normal Standards for VO₂ Max: Analysis from the Fitness Registry and the Importance of Exercise National Database (FRIEND Registry). *Progress in Cardiovascular Diseases* 60, 21–29. <https://doi.org/10.1016/j.pcad.2017.03.002>
- Niewoehner, D.E., Kleinerman, J., 1974. Morphologic basis of pulmonary resistance in the human lung and effects of aging. *Journal of Applied Physiology* 36, 412–418. <https://doi.org/10.1152/jappl.1974.36.4.412>
- Niinimaa, V., Shephard, R.J., 1978. Training and Oxygen Conductance in the Elderly I. The Respiratory System. *Journal of Gerontology* 33, 354–361. <https://doi.org/10.1093/geronj/33.3.354>
- Ofir, D., Laveneziana, P., Webb, K.A., Lam, Y.-M., O'Donnell, D.E., 2008. Sex differences in the perceived intensity of breathlessness during exercise with advancing age. *J Appl Physiol* 104.

- Pelkonen, M., Notkola, I.-L., Lakka, T., Tukiainen, H.O., Kivinen, P., Nissinen, A., 2003. Delaying Decline in Pulmonary Function with Physical Activity: A 25-Year Follow-up. *Am J Respir Crit Care Med* 168, 494–499. <https://doi.org/10.1164/rccm.200208-954OC>
- Pellegrino, R., Violante, B., Nava, S., Rampulla, C., Brusasco, V., Rodarte, J.R., 1993. Expiratory airflow limitation and hyperinflation during methacholine-induced bronchoconstriction. *Journal of Applied Physiology* 75, 1720–1727. <https://doi.org/10.1152/jappl.1993.75.4.1720>
- Prefaut, C., Anselme, F., Caillaud, C., Masse-Biron, J., 1994. Exercise-induced hypoxemia in older athletes. *Journal of Applied Physiology* 76, 120–126. <https://doi.org/10.1152/jappl.1994.76.1.120>
- Quanjer, P.H., Stanojevic, S., Cole, T.J., Baur, X., Hall, G.L., Culver, B.H., Enright, P.L., Hankinson, J.L., Ip, M.S.M., Zheng, J., Stocks, J., the ERS Global Lung Function Initiative, 2012. Multi-ethnic reference values for spirometry for the 3–95-yr age range: the global lung function 2012 equations. *Eur Respir J* 40, 1324–1343. <https://doi.org/10.1183/09031936.00080312>
- Sheel, A.W., Guenette, J.A., Yuan, R., Holy, L., Mayo, J.R., McWilliams, A.M., Lam, S., Coxson, H.O., 2009. Evidence for dysanapsis using computed tomographic imaging of the airways in older ex-smokers. *Journal of Applied Physiology* 107, 1622–1628. <https://doi.org/10.1152/japplphysiol.00562.2009>
- Smith, J.R., Kurti, S.P., Meskimen, K., Harms, C.A., 2017. Expiratory flow limitation and operating lung volumes during exercise in older and younger adults. *Respiratory Physiology & Neurobiology* 240, 26–31. <https://doi.org/10.1016/j.resp.2016.12.016>
- Smith, J.R., Rosenkranz, S.K., Harms, C.A., 2014. Dysanapsis ratio as a predictor for expiratory flow limitation. *Respiratory physiology & neurobiology* 198, 25–31.
- Tanaka, H., Seals, D.R., 2003. Invited Review: Dynamic exercise performance in Masters athletes: insight into the effects of primary human aging on physiological functional capacity. *Journal of Applied Physiology* 95, 2152–2162. <https://doi.org/10.1152/japplphysiol.00320.2003>
- Torres-Tamayo, N., García-Martínez, D., Lois Zloliniski, S., Torres-Sánchez, I., García-Río, F., Bastir, M., 2018. 3D analysis of sexual dimorphism in size, shape and breathing kinematics of human lungs. *J. Anat.* 232, 227–237. <https://doi.org/10.1111/joa.12743>
- Turner, J.M., Mead, J., Wohl, M.E., 1968. Elasticity of human lungs in relation to age. *Journal of Applied Physiology* 25, 664–671. <https://doi.org/10.1152/jappl.1968.25.6.664>
- Wilkie, S.S., Dominelli, P.B., Sporer, B.C., Koehle, M.S., Sheel, A.W., 2015. Heliox breathing equally influences respiratory mechanics and cycling performance in trained males and females. *Journal of Applied Physiology* 118, 255–264. <https://doi.org/10.1152/japplphysiol.00400.2014>
- Wilkie, S.S., Guenette, J.A., Dominelli, P.B., Sheel, A.W., 2012. Effects of an aging pulmonary system on expiratory flow limitation and dyspnoea during exercise in healthy women. *Eur J Appl Physiol* 112, 2195–2204. <https://doi.org/10.1007/s00421-011-2191-x>
- Yernault, J.C., De Troyer, A., Rodenstein, D., 1979. Sex and age differences in intrathoracic airways mechanics in normal man. *Journal of Applied Physiology* 46, 556–564. <https://doi.org/10.1152/jappl.1979.46.3.556>
- Younes, M., Kivinen, G., 1984. Respiratory mechanics and breathing pattern during and following maximal exercise. *Journal of Applied Physiology* 57, 1773–1782. <https://doi.org/10.1152/jappl.1984.57.6.1773>

**STUDY II. HELIOX EFFECT ON
EXPIRATORY FLOW IN MASTER
ATHLETES: A COMPREHENSIVE
ANALYSIS COUPLING EXPERIMENTAL
MEASURES AND COMPUTATIONAL
MODELING**

The results of the first study provide new insights about EFL in athletes and master athletes. Complementary information is needed if we want to further comprehend how and why master athletes are more predisposed to EFL. Heliox (i.e., 21% O₂ - 79% He) was found to alleviate EFL, decrease the work of breathing and increase ventilation levels in young trained (Wilkie et al., 2015; Dominelli et al., 2023; Mann et al., 2020; McClaran et al., 1999) and older untrained individuals (Babb, 1997; Molgat-Seon et al., 2019). A project conducted during this thesis, with the PhD candidate being the second main experimenter, aimed to assess the effects of heliox breathing on mechanical ventilatory constraints and exercise performance during a 5km cycling time-trial in male master athletes.

Fourteen endurance-trained older men (age = 67.9 ± 5.9 years, $\dot{V}O_{2\text{MAX}} = 50.8 \pm 5.8 \text{ ml}\cdot\text{min}^{-1}\cdot\text{kg}^{-1}$; 151% predicted) completed two cycling 5km time trials while breathing room air (i.e., 21% O₂ - 79% N₂) or heliox (i.e., 21% O₂ - 79% He). Exercise performance time improved (527.6 ± 38 vs 531.3 ± 36.9 sec; p = 0.017) and respiratory muscle force development decreased during inspiration (-22.8 ± 11.6%, p < 0.001) and expiration (-10.8 ± 11.4%, p = 0.003) with heliox compared to air breathing. EFL_{SEVERITY} tended to be lower with heliox (22 ± 23 vs 30 ± 23 %VT; p = 0.054).

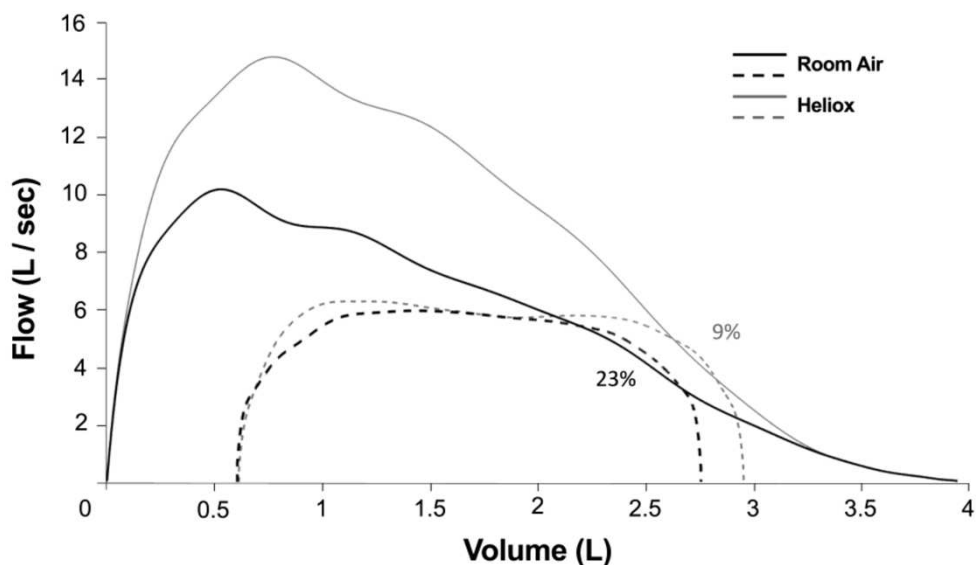

Figure 30. Maximal flow-volume loops (solid lines) and exercise tidal flow-volume loops (dashed lines) during 5km time-trial when inhaling room air or Heliox in a representative subject. Tidal flow-volume loops were obtained during the last 30-s of the time-trial. The severity of expiratory flow limitation is presented in %VT. *Figure from Haddad et al., (2023), accepted in Eur J Appl Physiol*

Therefore, considering these results, inhaling heliox appears to be a valuable method to further investigate EFL in master athletes. Better understanding how the physical mechanisms that govern

expiratory flow rates and thus EFL are influenced by heliox would be valuable to better comprehend this limitation.

Heliox is a gas mixture with a lower density and a slightly greater viscosity than air. However, the positive or negative influence of these gas properties on expiratory flow and thus the resistances in the airways are unclear especially in the context of healthy aging. We do not have access to physiological variables within the airways, but if we combine what we know about the geometry of the lungs with the physical properties of the gas, we may be able to investigate what happens within the lungs. Therefore, to investigate the interplay between flow mechanics, gas density/viscosity, and aging airways, we chose to simulate expiratory flow with a mathematical approach.

TITLE

Heliox effect on expiratory flow in master athletes: a comprehensive analysis coupling experimental measures and computational modeling.

AUTHORS & AFFILIATIONS

Valentin Mons^{1,2,3}, Jonathan Stephano^{2,3}, Toni Haddad^{1,3}, Olivier Meste^{3,4}, Grégory M.

Blain^{1,3}, Benjamin Mauroy^{2,3}

¹Université Côte d'Azur, LAMHESS, Nice, France

²Université Côte d'Azur, CNRS, LJAD, Nice, France

³Université Côte d'Azur, Centre Vader, Nice, France

⁴Université Côte d'Azur Laboratoire I3S, UNSA-CNRS, Nice, France.

CORRESPONDANCE

Valentin Mons

Telephone: +33 7 86 43 30 23

E-mail: monsvalentin33@gmail.com

Campus STAPS, 261 Bd du Mercantour

06200, Nice

France

ABSTRACT (< 250 words)

Introduction. Heliox breathing influences expiratory flow and resistance distribution in the airways but its effect on older lungs remains overlooked. The purpose of this study is to combine experimental measures with numerical modeling to better understand how heliox breathing modulates expiratory flow in older healthy individuals, whose airway size is reduced.

Methods. Fourteen master athletes, who represent a model of healthy aging, participated in this study (mean \pm SD; age, 69.3 ± 5.7 years). Mathematical model simulates maximal expiratory flow volume (MEFV) curve with heliox from MEFV curve directly measured with air using a compliant airway tree model of 17 symmetrical generations. Spirometry data, MEFV curvilinearity and airway resistances, were obtained with air (AIR), heliox breathing (HE) and heliox simulation with standard (SIMU) and a 15% decrease of airway lumen area (SIMU15).

Results. Maximal expiratory flow is higher for HE, SIMU and SIMU15 compared to AIR. MEFV curvilinearity between AIR, HE and SIMU is similar. When expiratory flow at the trachea is greater, the beneficial impact of heliox on airway resistance becomes more pronounced and goes deeper in the lungs. Reynolds number is lower with heliox, and flow is laminar up to 3.1 ± 0.3 generations further than with air.

Conclusion. Our results overall indicate that heliox breathing increases expiratory flow especially in branches where inertial effects are dominant and that the effects on expiratory flow may be enhanced in the elderly with age-induced smaller airways.

KEY WORDS: aging, heliox, lung, master athletes, modeling

INTRODUCTION

Flow in the lungs depends on airway mechanics and the physical properties of the inhaled gas. Expiratory flow measurements through lung function testing play a pivotal role in determining an individual's pulmonary function status, which is important for assessing general physical and respiratory health, particularly in the elderly. Pulmonary function testing, which is typically conducted with subjects breathing room air, requires forcefully inhaling and exhaling (Sylvester et al., 2020). Data generated from this test can be used to draw the maximal expiratory flow volume (MEFV).

Helium breathing has emerged as an advantageous technique for evaluating lung function because of its distinct physical properties, serving as a less dense and more viscous alternative to nitrogen. Inhaling heliox, a mixture containing 79% helium and 21% oxygen, enables the modulation of respiratory mechanics and gas convection in the alveoli which in turn provides complementary insights into expiratory flow patterns in the airways. Heliox notably finds widespread use in facilitating breathing, and achieving homogeneous ventilation in individuals with obstructed airways (Hashemian et al., 2014). Heliox is therefore advantageous in cases with smaller airways where increased gas velocity emphasizes turbulences and resistances (Otis et al., 1950).

Consequently, investigating the effect of heliox breathing should be particularly relevant for aging individuals, whose airway size is reduced due to the age-related loss of lung elastic recoil (Niewoehner and Kleinerman, 1974; Molgat-Seon et al., 2019). In turn, smaller airways modify the ability to generate flow which may alter the shape of the MEFV curve (Green et al., 1974; Niewoehner and Kleinerman, 1974; Johnson et al., 1995). The dimensionless slope-ratio (SR) index can be utilized to assess these alterations in airway function and quantify MEFV curvilinearity (Dominelli et al., 2016; Mead, 1978). However, most studies examining the effects of heliox on MEFV curvilinearity in the elderly, are conducted on individuals with

obstructive respiratory pathologies. This approach fails to specifically explore the effects of aging because the presence of respiratory conditions may exacerbate tissue alterations. To overcome this limitation, studying aging athletes, or master athletes, who represent a model of healthy aging, emerges as a preferred approach for isolating and examining the effects of heliox in association with age-related factors (Geard et al., 2017).

Nonetheless, clinical respiratory assessments in both master athletes and the general population offer only fragmentary insights into lung characteristics via the analysis of flow, volume, and pressure. Additional in-vivo measures that would provide further information can be very challenging to execute or interpret. Therefore, to gain a more comprehensive insight into physiological responses and related physical phenomena, it is valuable to combine numerical modeling with experimental measures. In the context of heliox breathing in master athletes, the combination of an experimental approach and mathematical modeling can offer complementary data to determine expiratory flow behavior in aging lungs. Several studies have utilized numerical modeling to compare the distribution of air versus helium-oxygen and evaluate the physical mechanisms involved in the reduction of the work breathing induced by heliox (Papamoschou, 1995; Brighenti et al., 2007; Katz et al., 2011; Pozin et al., 2017). In these models, the distribution of airflow within the lungs mainly depends on airway geometry. A widely used pulmonary tree model was introduced by Lambert and colleagues (Lambert et al., 1982), using the idealized lung geometry proposed by Weibel (Weibel, 1963). In this model, the airway tree is defined as a series of 17 cylindrical branches separated by symmetrical bifurcations, and flow distribution relies mainly on flow at the trachea, the pressure surrounding airway tissues, and hydrodynamic resistances. By modifying gas density and viscosity in such models, flow characteristics can be altered, along with resistance distribution throughout the airways. This, in turn, allows for the identification of possible constricted sites within the lungs. Lung responsiveness to heliox in healthy older lungs could help understanding the effect of gas

properties on expiratory flow and resistance distribution in aging airways but its effect in healthy older individuals has only been overlooked. Consequently, this study aims at evaluating the effect of heliox on expiratory flow in a healthy aged population. Principles from fluid mechanics are used and flow patterns are evaluated with a compliant airway tree model and experimental measurements. In summary, our findings from each approach yields that that heliox breathing enhances expiratory flow, particularly in upper generations and this effect may be further amplified in the elderly due to age-induced airway size reduction.

MODEL AND METHODS

Subjects' characteristics

Fourteen master athletes (n = 12 men, n = 2 women) participated in this study (mean \pm SD; age, 69.3 ± 5.7 years; height, 174.2 ± 6.7 cm; body mass, 69.0 ± 7.4 kg; $\dot{V}O_{2\text{ MAX}}$, 49.1 ± 6.9 mL.min⁻¹.kg⁻¹; peak power output, 3.5 ± 0.5 W.kg⁻¹). To be eligible as master athletes, participants needed to be 60 years or older and to have a $\dot{V}O_{2\text{ MAX}}$ exceeding 130% of age-matched predicted values (Myers et al., 2017). All participants were healthy, non-smokers, were not under any medication regimen, had no symptoms indicative of cardiovascular respiratory or neuromuscular disorders, did not have respiratory infection during the 6 weeks prior to participation and had normal pulmonary function (see Table 1). Written informed consent was obtained from each participant, and the study was conducted following the principles depicted in the Helsinki Declaration for human experimentation, with approval from the local ethics committee.

Model

Mathematical model in this study (see Figure. 1) simulates maximal expiratory flow volume (MEFV) curve with heliox from MEFV curve directly measured with air. Expiratory volume

was calculated by numerical integration of the flow signal. First, we use the model described in Stéphano and Mauroy (Stéphano and Mauroy, 2021) to estimate the hydrodynamic state of the flow and mechanical states of the bronchi.

Lung airflow model

This model relates the pressure distribution from the total flow rate and the tissue pressure in an airway network which mimics the human pulmonary tree. The airway tree model is depicted as a dichotomic tree of 17 symmetrical generations by Weibel (Weibel, 1963). The geometry of each branch of this tree is assumed cylindrical and defined by a length and a cross-sectional area. The length and the cross-sectional area are defined from the model proposed by Lambert and al. (Lambert et al., 1982). Lambert model characterizes the airway mechanics by the relationship between airway cross-sectional and transmural pressure P_T , i.e., the pressure difference between the inside and the outside of the branch.

Within each branch of a generation n , considering Hagen-Poiseuille law and the assumption that there is no fluid acceleration in the airways, a pressure drop q occurs, depending on both flow rate Φ and hydrodynamic resistance R_n of the branch:

$$q_n = \Phi R_n \quad (1)$$

For steady laminar flows, mainly in upstream airways, hydrodynamic resistance is determined using Poiseuille equation and depends on airway length L_n , airway surface area A_n and the viscosity of the fluid μ .

$$R_{Pois,n} = 8\pi\mu \frac{L_n}{A_n^2} \quad (2)$$

However, when higher flow rates are involved, (e.g., mainly in upstream airways), the flow profile is deformed by the inertial effects and the geometry. Thus, the hydrodynamic resistance of the fluid increases and becomes greater than Poiseuille resistance. In this context, we used

the resistance factor Z proposed by (Tawhai et al., 2004) to mimic the increase of hydrodynamic resistance with inertia effects :

$$R_n = Z_n R_{Pois,n} \quad \text{with : } Z \geq 1 \quad (3)$$

The resistance factor Z is superior to 1 for non-Poiseuille flow and depends on Reynolds number, $Re = \frac{4\rho\Phi}{\mu\sqrt{\pi A}}$, with ρ corresponding to gas density.

$$Z = \max\left(1, \frac{1}{2} + \frac{Re}{600}\right) \quad (4)$$

Here, we see that if the Reynolds number is inferior to 300, the flow is considered as a Poiseuille flow and the factor Z is equal to 1. Additionally, in our model, flow is always considered as laminar and turbulence effects ($Re > 2000$) are neglected (Katz et al., 2011).

As illustrated by Reynolds number, the viscosity of the gas and especially its density play a major role in modulating resistance factor when inertia effects are involved. In Stephano and Mauroy (Stéphano and Mauroy, 2021) study, the hydrodynamic resistance R_n is expressed in a sum of one term related to the gas viscosity μ and a second term related to the gas density ρ . Breathing a low-density gas like heliox therefore highly influences inertia effects and the hydrodynamic resistance during the high flow rate part of the ventilation.

These relationships are applicable to a single airway and can be expanded to the lungs by including flow variations in each subsequent generation. Considering that each branch from a given generation have similar physical properties and that air and heliox are incompressible, flow rate at the trachea Φ_0 corresponds to the sum of flows in each daughter airway generation, $\Phi_n = 2^{-n} \Phi_0$.

To resume, the model predicts alveolar pressure P_A from expiratory flow rates using gas density ρ and viscosity μ , Φ_0 and P_T . However, this model cannot estimate directly expiratory flow from the transmural pressure P_T and the alveolar pressure P_A , hence, an additional step is developed in this work to access the expiratory flow with heliox.

From experimental MEFV with air to simulated MEFV with heliox

We assume that P_T and P_A during MEFV maneuvers is dependent on respiratory muscle effort and independent from gas properties such that similar alveolar pressure should be found during a maximal forced expiration with both air and heliox. First, the transmural pressure P_T is estimated from lung volume using the respiratory system pressure-volume relationship of Rahn and al. (Rahn et al., 1946) and of (Agostoni and Hyatt, 1986) (A-box in figure 1). These relationships are determined in accordance with the physiologic measurements.

Next, the alveolar pressure P_A is estimated by running the Stephano and Mauroy model on the MEFV data with air (S-box with ρ_{air} and μ_{air} in figure 1).

Finally, to simulate expiratory flow with heliox, we test iteratively heliox flow rate to find an alveolar pressure which corresponds to the alveolar pressure P_A estimated with air (dotted-line box in figure 1). At each iteration i , we run the Stephano and Mauroy model with the tested Heliox flow rate Φ_0^i and the Heliox density and viscosity (S-box with ρ_{He} and μ_{He} in figure 1) to compute the corresponding alveolar pressure P_A^i ; The heliox flow rate Φ_0^i was adjusted to Φ_0^{i+1} until $P_A^i - P_A < 10^{-5} Pa$ using the secant method (Correction-box, in figure 1). The initial flow values at the trachea are the air flow rate taken previously to estimate P_A and the trivial no-flow value: $\Phi_0^0 = 0$ and $\Phi_0^1 = \Phi_{\text{AIR}}$.

Heliox and air gas properties

Helium is an inert gas with a lower density and a slightly higher viscosity than nitrogen ($\rho_{\text{He}} = 0.17$ vs. $\rho_{\text{N}_2} = 1.17 \text{ g.m}^{-3}$ and $\mu_{\text{He}} = 19.4 \times 10^{-6}$ vs. $\mu_{\text{N}_2} = 17.9 \times 10^{-6} \text{ n.sec.m}^{-2}$ at 20°C and 760 mmHg for helium and nitrogen, respectively) (Mann et al., 2020). Heliox and air therefore have different gas properties ($\rho_{\text{HeO}_2} = 0.40$ vs. $\rho_{\text{air}} = 1.20 \text{ g.m}^{-3}$ and $\mu_{\text{HeO}_2} = 19.5 \times 10^{-6}$ vs. $\mu_{\text{air}} = 18.3 \times 10^{-6} \text{ n.sec.m}^{-2}$ at 20°C and 760 mmHg for helium and nitrogen, respectively) (Papamoschou, 1995).

Experimental overview

Subjects came on 3 different occasions. During the first session, participants were familiarized with the experimental equipment and pulmonary function testing and performed a maximal and graded cycling test to exhaustion on a cycle ergometer (Velotron, RacerMate, Seattle, WA, USA). Subjects underwent routine pulmonary function assessment at rest, both before and after the cycling test, following the recommendations of the American Thoracic Society and European Respiratory (Miller, 2005). During the two other sessions, pulmonary function assessments were performed breathing either air (79% nitrogen - 21% O₂) or heliox (79% helium – 21% O₂) following a randomized single blinded cross-over design.

Maximal exercise testing

Peak power output (PPO) and maximal oxygen uptake ($\dot{V}O_{2\text{MAX}}$), were evaluated with participants performing a maximal and graded test to exhaustion on an electromagnetically braked cycle ergometer (Velotron, RacerMate, Seattle, WA, USA). Exercise started with an initial workload of 80 W, which was increased by 40 W every 2 minutes and 30 seconds. Participants were instructed to maintain a pedal rate between 80-90 revolutions per minute (rpm). The exercise terminated if participants either reached a state of volitional exhaustion or became unable to sustain a pedal rate of 60 rpm for more than ten seconds, even with verbal encouragement. After a recovery period of twenty minutes, the participants underwent a constant work rate test at 110% of the peak power output achieved during the preceding maximal and graded exercise test. The purpose of this additional test was to ensure that participants reached their $\dot{V}O_{2\text{MAX}}$ during the exercise.

Pulmonary function testing

After receiving a thorough explanation of the procedures for pulmonary function testing, the participants were asked to perform 6-8 spirometry maneuvers. These maneuvers aimed at measuring vital capacity (FVC), forced expiratory volume in 1 second (FEV₁), FEV₁/FVC ratio, peak expiratory flow (PEF), the volume of air breathed out at PEF (PEFvol), slope ratio (SR), and forced expiratory flow at 25-75% of vital capacity (FEF₂₅₋₇₅). Throughout each attempt, participants received immediate visual feedback of the flow-volume loops on a monitor. The best values from the technically acceptable maneuvers were selected for further analysis (Sylvester et al., 2020).

MEFV curvilinearity analysis

Slope ratio was calculated to quantify the shape of the MEFV curves. A tangency and a chord line were drawn at 30 points of interest calculated in 2% increments between 20% and 80% of maximal volume following previously detailed method (Dominelli et al., 2016, 2015a). This portion of the MEFV curve was chosen as it corresponds to the effort-independent portion of the MEFV curve and is not influenced by increasing alveolar pressure (Mead, 1978). Values close to peak expiratory flow and residual volume were not selected to avoid effort dependant values and the effect of the passive opposition of the chest-wall (Mead, 1978). The tangent line was drawn using a volume difference of 200 ml above and below the point of interest and the chord line corresponded to the line intersecting the point of interest and the end of the vital capacity. The average SR value of each point of interest over the analyzed range of VC and the global SR indexes were reported. A SR value of 1 corresponded to a linear MEFV curve while a <1 value indicated smaller change in flow per volume unit corresponding to a convex shape and a >1 value indicated greater change in flow per volume unit corresponding to a concave shape (Dominelli et al., 2015a, 2016; Klimenko et al., 2023).

Data collection and processing

Expiratory flows were measured with one calibrated heated pneumotachograph connected to a two-way nonrebreathing valve (model 2730, Hans Rudolph, Kansas, USA). The pneumotachograph was calibrated with air or heliox depending on the experimental condition. Calibration was performed with a 3L-syringe (model 5530, Hans Rudolph, Kansas, USA), using three different flow rates ($< 70 \text{ L}\cdot\text{min}^{-1}$, $100\text{-}120 \text{ L}\cdot\text{min}^{-1}$ and $> 150 \text{ L}\cdot\text{min}^{-1}$) and six different volumes (i.e., from 0,5 to 3 L) with the volume being calculated by numerical integration of the flow signal. During the whole session, raw flow and volume data were continuously recorded at a sample rate of 2000 Hz using a 16-channel analog-to-digital data acquisition system (Powerlab 16/35, AD Instrument, Australia). Data analysis was performed using MATLAB (MathWorks Inc., USA). Simulated data using the lung model detailed above are presented with data generated with similar methodology but with a lumen area decrease of 15%. AIR corresponds to air breathing condition, HE corresponds to heliox breathing condition, SIMU corresponds to the condition with heliox simulated data and SIMU15 corresponds to the condition with heliox simulated data with a decreased lumen area of 15%.

Statistical analysis

Measured and simulated data were compared using a one-way repeated measure analysis of variance (ANOVA) and when simulation did not allow to get a given data, air and heliox measures were compared using paired *t*-test. Normal distribution was evaluated using Shapiro-Wilk test and variance homogeneity was calculated using Levene test. A two-way repeated measure ANOVA was performed to evaluate SR differences between conditions and if significant effect was found, a Bonferroni post hoc test was applied. All statistical analysis were completed with SPSS Software (V26.0, IBM). Data are presented as means \pm standard deviation (SD) and significance for all tests was set at $P < 0.05$.

RESULTS

Master athletes' characteristics

Table 1 summarizes subjects' descriptive characteristics and pulmonary function data measured with air or heliox and simulated with and without a 15% reduction of airway lumen area. MEFV curves corresponding to these lung function data for each condition are illustrated in Figure 2. When breathing air, all participants had pulmonary function that was within the normal predictive values ("ATS/ERS Statement on Respiratory Muscle Testing," 2002). Exercise data at the end of the maximal and graded cycling test to exhaustion are presented in Table 2. Our participants had an average $\dot{V}O_{2\text{ MAX}}$ corresponding to $147 \pm 14\%$ of predicted $\dot{V}O_{2\text{ MAX}}$ (Myers et al., 2017).

Pulmonary function and MEFV characteristics

No effect of condition was observed for FVC ($p = 0.99$) and FEF_{75} ($p = 0.43$) while PEF ($p = 0.01$) and FEF_{25} ($p = 0.02$) were different between conditions. Post-hoc analysis revealed that, compared to AIR condition, PEF was $3.8 \pm 1.3 \text{ L}\cdot\text{s}^{-1}$ higher for HE ($p = 0.03$), $2.5 \pm 1.3 \text{ L}\cdot\text{s}^{-1}$ higher for SIMU ($p = 0.04$) and $2.9 \pm 1.3 \text{ L}\cdot\text{s}^{-1}$ higher for SIMU15 ($p = 0.03$) with no difference found for this variable between HE, SIMU and SIMU15 ($p = 0.99$). Similarly, FEF_{25} was $3.9 \pm 1.2 \text{ L}\cdot\text{s}^{-1}$ higher for HE ($p = 0.01$), when compared to AIR with no difference with SIMU nor SIMU15 ($p = 0.46$, $p = 0.65$, respectively). In comparison to AIR, HE values were higher for FEF_{25} ($+ 3.8 \pm 1.2 \text{ L}\cdot\text{s}^{-1}$, $p = 0.01$), FEV_1 ($+ 0.2 \pm 0.2 \text{ L}$, $p = 0.02$), FEV_1/FVC ($+ 5.3 \pm 4.6\%$, $p < 0.01$), FEF_{25-75} ($+ 1.1 \pm 0.6 \text{ L}\cdot\text{s}^{-1}$, $p < 0.01$), and PEF_{vol} ($+ 0.2 \pm 0.2 \text{ L}$, $p = 0.01$).

Figure 3 illustrates the average SR between 20% and 80% of FVC for AIR, HE, SIMU and SIMU15. We found a main effect of condition ($F = 5.6$, $p = 0.01$) with SR from AIR being different with SIMU and SIMU15 ($p = 0.01$). No significant effect of time was found ($p = 0.16$).

The effect of gas density and viscosity on airway resistance and flow laminarity

The use of heliox facilitates breathing by reducing inertia effects associated with hydrodynamic resistances. Inertia effects become noticeable when $Re > 300$ and they become dominant when $Re > 600$. Heliox enhances expiratory flow gain as the Reynolds number (Re) increases, which is particularly important when Re exceeds 2000 and turbulence plays a significant role. Re with air and heliox for flow rates of 5, 10 and 15 $L \cdot s^{-1}$ are depicted in Figure 4. Re is lower across the 17 generations when breathing heliox compared to air regardless of expiratory flow rate. When considering airway cross-sectional area from Lambert (Lambert et al., 1982) and a flow of 1 $L \cdot s^{-1}$ at the trachea, flow was laminar ($Re < 2000$) from the 5th generation breathing air and from the 2nd generation when breathing HeO_2 . For a 15 $L \cdot s^{-1}$ flow at the trachea, flow was laminar at the 12th generation breathing air and since the 9th generation breathing HeO_2 . On average, across the 17 generations studied, flow was laminar 3.1 ± 0.3 generation deeper with HeO_2 breathing. The ratio of airway resistance with air (RES_{Air}) to airway resistance with heliox (RES_{HeO_2}) along each generation for a flow rate ranging from 1 to 15 $L \cdot s^{-1}$ is depicted in Figure 5. A ratio $\frac{RES_{HeO_2}}{RES_{Air}} < 1$ indicates that RES_{HeO_2} is lower than RES_{Air} . For an expiratory flow rate of 1 $L \cdot s^{-1}$ at the trachea, RES_{HeO_2} becomes higher than RES_{Air} from the 10th generation. When flow rates increase, RES_{HeO_2} becomes higher than RES_{Air} deeper in the airways as it is the case for a flow rate of 14 $L \cdot s^{-1}$ where $\frac{RES_{HeO_2}}{RES_{Air}} < 1$ is found at from the 16th generation.

DISCUSSION

Resume & main findings.

Spirometry and maximal graded exercise results confirm that our participants were healthy older individuals with high athletic fitness levels and standard lung function. Expiratory flow rates were physiologically assessed and simulated considering the nonlinear interactions between lung geometry, airway compliance and gas physical properties. Our findings illustrate how and where the modulation of gas density and viscosity impacts expiratory flow rates in the airways. When analyzing the forced expiratory flow-volume curves from modeled airway mechanics scaled to standard lung geometry, expiratory flow rates with heliox, are lower than the flow rates obtained through physiological measurements in master athletes. It is important to note that the simulated data presented in this study aim at better understanding the trends of the effect of gas density and viscosity on modulating expiratory flow in older healthy lungs and are not meant to predict exact values that should be found experimentally.

Pulmonary function

No significant impact of heliox breathing on forced vital capacity was observed thereby supporting evidence that heliox does not affect lung volumes in healthy individuals (Mann et al., 2020). Breathing heliox results in a higher peak expiratory flow, with this difference remaining in computed values. The flow from the onset of the forced expiration until PEF, flow depends on lung geometry, gas properties and the force generated by the expiratory muscles. This force increases the driving pressure which ultimately overcomes the resistance of the chest wall tissues (Mead et al., 1967). Upon reaching PEF, the geometry of the lungs and expiratory muscle effort are assumed to be similar. Thus, the differences in PEF values should be attributed solely to the physical properties of the inhaled gas. The higher PEF values found while breathing heliox illustrate the noteworthy contribution of helium's lower density on expiratory

flow improvement particularly at high flow rates. PEF value is increased with heliox, but it is also delayed. Indeed, PEF was reached at a slightly, yet significantly, lower lung volume in HE than in AIR. Because mathematical simulation used expiratory flow volume data from AIR, this delay is maintained in SIMU and SIMU15. This shift is important to consider because it explains part of the differences in expiratory flow rates between simulated and experimentally measured values with heliox. Indeed, when matched for PEF volume, as shown in figure 6, measured and computed expiratory flow rates differences are reduced and data follow a more similar trend.

From 80 to 20% of total lung capacity, given that a maximal effort is performed, expiratory flow rates differences between maneuvers are primarily determined by air or heliox inertia and bronchial tree mechanics, rather than muscle effort per se (Mead, 1978). As well as with PEF, the higher values of FEV₁, FEF₂₅, and FEF₂₅₋₇₅ in the HE condition are thus primary due to the lower density of heliox in the airways compared to air. Yet, it should be noted that only expiratory flow rates at higher lung volumes are increased while expiratory flow rates at lower lung volumes, such as FEF₇₅, are not higher. Collectively, lung function analysis indicate that expiratory flow only increases in the proximal part of the bronchial tree within the wider airways. The underlying mechanisms of this result are discussed below (see Airway resistance & Reynolds number).

Airway resistance & Reynolds number

The mechanisms underlying the expiratory flow differences depicted above are based on variations in resistance within the airways. The ratio of the resistance of heliox to the resistance of air, i.e., $\frac{RES_{HeO_2}}{RES_{air}}$ in the 16 first generations is illustrated in Figure 5. When this ratio is below 1, the resistance to heliox is lower than the resistance to air. Conversely, when the ratio exceeds 1, resistance increases with heliox resulting in reduced benefits on expiratory flow. The increase

of $\frac{RES_{HeO_2}}{RES_{air}}$ is slight in the first generations. For higher expiratory flow rates at the trachea, this slight increase is shifted at deeper generations. This is illustrated by the rapid increase of $\frac{RES_{HeO_2}}{RES_{air}}$ since the 7th generation for a flow rate of 1 L.s⁻¹ when a similar rapid increase is only observed at the 13th generation for an expiratory flow of 15 L.s⁻¹ at the trachea. The slight increase in the first generation and with higher flow rates can be attributed to the difference in density between heliox and air resistance. Indeed, air density is 2.6 times greater than heliox density at 37°C and the density ratio of the gases ($\frac{\rho_{HeO_2}}{\rho_{air}} = 0.39$) significantly impacts resistance calculation particularly when inertia effects are involved. Viscosity has minimal impact on this region of the lungs even if the asymptote suggests its presence.

On the other hand, the rapid increase of $\frac{RES_{HeO_2}}{RES_{air}}$ when the ratio exceeds 1 and the observed plateau in the last generations corresponds to the viscosity ratio ($\frac{\mu_{HeO_2}}{\mu_{air}} = 1.19$). In the most distal part of the bronchial tree, the very small flow is a Poiseuille flow and resistance is exclusively impacted by viscosity with no effect of density. The higher viscosity of heliox leads to a reduced expiratory flow, as also observed by others (Mann et al., 2020). The modeling approach enables to understand the impact of heliox on expiratory flow in the deeper lung region. Indeed, when $\frac{RES_{HeO_2}}{RES_{air}}$ reaches the plateau at 1.19, flow becomes a Poiseuille flow ($Re < 600$) and no more linear effects are observables. Overall, these results indicate that resistance to air is greater than that of HeO₂ in most of the bronchial tree. Although improved ventilation of the distal airway region occurs when breathing HeO₂, the increase in expiratory flow rates is particularly amplified in the most proximal branches where higher flows prevail. This phenomenon shall explain pulmonary function differences discussed above. Moreover, our analysis provides an indication of the generations in which heliox benefits occur on resistance thereby improving expiratory flow.

Furthermore, Reynolds number changes in compliant airways may also play an important role. Regardless of gas physical properties, the Reynolds number decreases across airway generations and with lower flows at the trachea, as illustrated by figure 4. The most significant decrease occurring in the first generations is accentuated when applying the density and viscosity of heliox. Similarly, airway resistance decreases more in the upper branches of the bronchial tree during heliox breathing, resulting in a greater increase of heliox expiratory flow rates in the first generations. This finding is consistent with previous studies that reported lower pressure loss across bifurcations when breathing heliox (Katz et al., 2011; Pozin et al., 2017; Mann et al., 2020). Indeed, as mentioned earlier, in Poiseuille flow ($Re < 600$) hydrodynamic resistance is determined by viscous force while in turbulent flow, inertial forces dominate. Thus, there is a higher hydrodynamic resistance with heliox in $Re < 600$ compared to non-Poiseuille flow. However, while Poiseuille flows are present at more proximal generations with heliox, the benefits on expiratory flow observed when inertia effects are involved are not counterbalanced.

Overall, heliox breathing leads to a greater increase in expiratory flows in the first lung generations because there are more inertia effects in this part of the bronchial tree where gas density plays a major role in comparison with viscosity. Laminar flow is shifted deeper into the lungs with heliox resulting in improved flow efficiency throughout the bronchial tree. These findings may have important practical implications for fluid transport or efficient gas exchange.

Slope Ratio

Despite increased PEF, FEF₂₅₋₇₅ and FEF₂₅ values, the lack of differences in the average SR and in SR values ranging from 80% to 20% of FVC indicate that heliox did not modify MEFV curvature. While similar results were found in younger population with heliox (Dominelli et al., 2016), our finding suggest that SR, and hence MEFV convexity, is independent from

airways resistance in the elderly. Healthy aging is associated with a natural decrease in vital capacity, maximal expiratory flow rates with overall changes in the shape of MEFV curve (Mead, 1978). Investigating SR index in older population and characterizing shape variations therefore provides insight into the physiological mechanism and aging effect influencing MEFV curve convexities and airway resistance homogeneity (Spycher et al., 2012; Dominelli et al., 2015a; Klimenko et al., 2023). Following mathematical modeling predictions of Lambert, a more curvilinear MEFV curve is indicative of airway narrowing (Lambert, 1990). The more pronounced scooping of the MEFV curve illustrated by the higher SR for SIMU and SIMU15 therefore indicates that simulated data induce narrower upper airways. MEFV shape differences we observed between measured and simulated flows may be explained by a non-uniform narrowing of the airways in our master athletes. Yet, all subjects had an average SR < 2.5 indicating the absence of early airway closure or parenchymal damage (Mead, 1978). These differences may also be attributed to the volume delay of simulated data. Indeed, SR is calculated over 30 points of interest between 20 and 80% of FVC. The location of these points and therefore the corresponding shift in the simulated data because the volume under consideration is that of the air condition. Nevertheless, despite this delay, the concave and convex trends remain parallel in all conditions.

Aging effect & MEFV curve differences

Simulating the physical effects of age-related physiological changes in the respiratory system can provide insight into resistance and limitations in aging lungs. When we increased airway compliance in our model, we only noticed scarce changes in expiratory flow. We therefore believe that the differences in expiratory flow between physiological assessment and computational modeling can be primarily attributed to airway size changes with aging rather than airway elasticity.

While the original simulated curve was calculated using Lambert geometry, the subjects of our study were older subjects and should therefore have smaller airway cross sectional areas. We thus simulated a global 15% decrease of lumen area for all branches. Nevertheless, the lower simulated flow rates we found under this condition suggest that the actual size of the airways may be smaller than the computed size. Indeed, the extent of improvement in expiratory flow with heliox breathing in smaller airways may be more pronounced compared to larger airways because of their differences of resistance to airflow. From upper to lower branches, flow naturally decreases within the bronchial tree and as noted with Reynolds number, expiratory flow is more impacted by HeO₂ at higher flow rates. Consequently, depending on which branches are affected by the age-induced narrowing, responsiveness to HeO₂ on expiratory flows may be different.

Collectively, our data aim at enhancing our understanding of the physical mechanisms that drive aging of the lungs and their impact on expiratory flow, rather than predicting the exact expiratory flow rates in older individuals. When we decreased airway lumen area, the effect of heliox for a given alveolar pressure was increased, which underscores the magnified role of heliox breathing in individuals with smaller airways such as older individuals.

Therefore, our results provide insights on the direction of the age-related changes. It is important to note that aging involves multifactorial determinants and that the factors highlighted in this study represent only a few of them. Finally, our modeling analysis involved a unique lung geometry focused solely on a part of the lungs, hence differences between simulated and assessed data could also be attributed to inter-individual variability.

Conclusion

Low density gas like heliox increases expiratory flow especially in branches where inertial effects are dominant. This is achieved by decreasing flow inertia through the reduction of

Reynolds number and density-dependent resistance. Heliox effect on expiratory flow may be enhanced in the elderly with age-induced smaller airways. Overall, coupling computational modeling with clinical assessment help better understand expiratory flow behaviour in aging trachea-bronchial tree.

ACKNOWLEDGEMENTS & GRANTS

We thank the participants for their time and effort dedicated to the participation in this study. Financial support was provided by Région Provence-Alpes-Côte d'Azur and the initiative of excellence (ANR-15-IDEX-01), joint, excellent, and dynamic initiative (JEDI) of the Université Côte d'Azur (UCA).

CONFLICT OF INTEREST

The authors declare having no conflicts of interest, financial or otherwise, no professional relationships with companies or manufacturers who may benefit from the results of the present study. The authors declare that the results of the study are presented clearly, honestly, and without fabrication, falsification, or inappropriate data manipulation and do not constitute endorsement by the American College of Sports Medicine.

Table 1. General characteristics and pulmonary function test

Descriptive characteristics				
Variable	Measure			
Age (yr.)	69.3 ± 5.7			-
Height (cm)	174.2 ± 6.7			-
Mass (kg)	69.0 ± 7.4			-
BMI (kg.m ⁻²)	22.7 ± 1.3			-
Spirometry				
Variable	AIR	HE	SIMU	SIMU15
FVC (L)	4.4 ± 0.7	4.4 ± 0.7	4.4 ± 0.7	4.4 ± 0.7
FEV ₁ (L)	3.2 ± 0.5	3.5 ± 0.5*	-	-
FEV ₁ /FVC (%)	73.2 ± 8.2	79.1 ± 6.8**	-	-
PEF (L.s ⁻¹)	9.7 ± 2.4	13.5 ± 3.4*	11.2 ± 3.9*	11.6 ± 4.1*
PEFvol (L)	0.6 ± 0.2	0.8 ± 0.3**	0.6 ± 0.2	0.6 ± 0.2
FEF ₇₅	1.0 ± 0.5	1.3 ± 0.7	0.9 ± 0.5	0.9 ± 0.5
FEF ₂₅₋₇₅	2.9 ± 1.0	4.0 ± 1.5**	-	-
FEF ₂₅	7.9 ± 2.0	11.6 ± 3.4**	8.9 ± 3.0	9.2 ± 3.1
SR	1.9 ± 0.5	1.94 ± 0.5	2.1 ± 0.5	2.1 ± 0.5

All values are expressed as means ± SD. n: number of participants. BMI: Body Mass Index; BSA: Body Surface Area; FVC: Forced Vital Capacity; FEV₁: Forced Expiratory Volume in 1 s; FEV₁/FVC: ratio of FEV₁ to FVC; FEF₂₅, FEF₇₅: Forced Expiratory Flow at respectively 25%, 50% and 75% of FVC. The asterisks notify the values which are significantly different from AIR with the corresponding P-values: * $P < 0.05$, ** $P < 0.01$.

Table 2. Mechanical and physiological responses to maximal exercise

Variable	Measure
Peak Power Output (W)	232 ± 47
Peak Power Output (W/kg)	3.5 ± 0.5
$\dot{V}O_{2MAX}$ (L.min ⁻¹)	3.3 ± 0.6
$\dot{V}O_{2MAX}$ (mL.min ⁻¹ .kg ⁻¹)	49.1 ± 6.9
$\dot{V}CO_{2MAX}$ (L.min ⁻¹)	3.9 ± 0.3
RER	1.2 ± 0.1
$\dot{V}E$ (L.min ⁻¹)	113.3 ± 19.4
$\dot{V}E/\dot{V}O_2$	30.7 ± 3.3
$\dot{V}E/\dot{V}CO_2$	28.7 ± 3.0
VT (L)	2.4 ± 0.3
BF (breaths.min ⁻¹)	53.3 ± 8.7
SpO ₂ (%)	97.2 ± 1.0
Heart rate (bpm)	151 ± 6

All values are expressed as means ± SD. $\dot{V}O_2$: O₂ uptake; $\dot{V}CO_2$: CO₂ output; RER: respiratory exchange ratio $\dot{V}E$: minute ventilation; VT: tidal volume; BF, breathing frequency; SpO₂: saturated pulse in O₂.

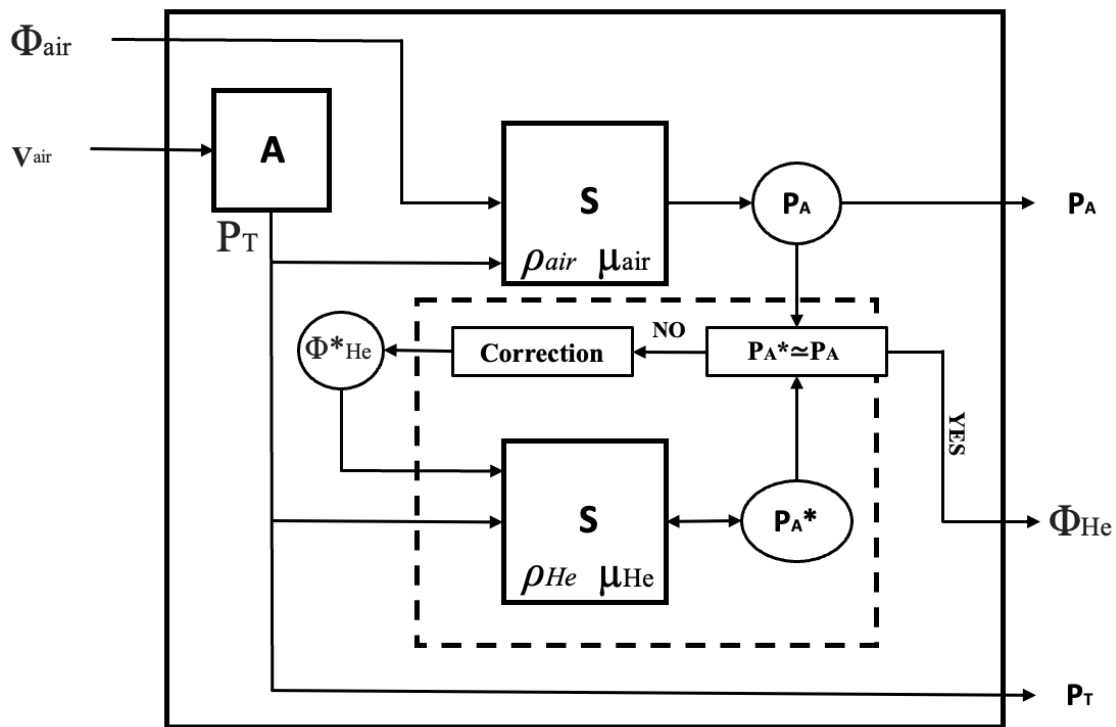

Φ_{air} : expiratory flow with air; Φ_{He} : expiratory flow with heliox; Φ_{He}^* : potential expiratory flow with heliox; V_{air} : volume with air; ρ_{air} : air density; ρ_{He} : heliox density; μ_{air} : air viscosity; μ_{He} : heliox viscosity; P_T : transmural pressure; P_A : alveolar pressure with air; P_{He}^* : alveolar pressure with heliox, A : Agostoni and Rahn model, S : Stephano model, circled elements: numerical variables, squared elements : numerical procedure.

Figure 1. Representation of the mathematical model used to determine MEFV curve with heliox from MEFV with air.

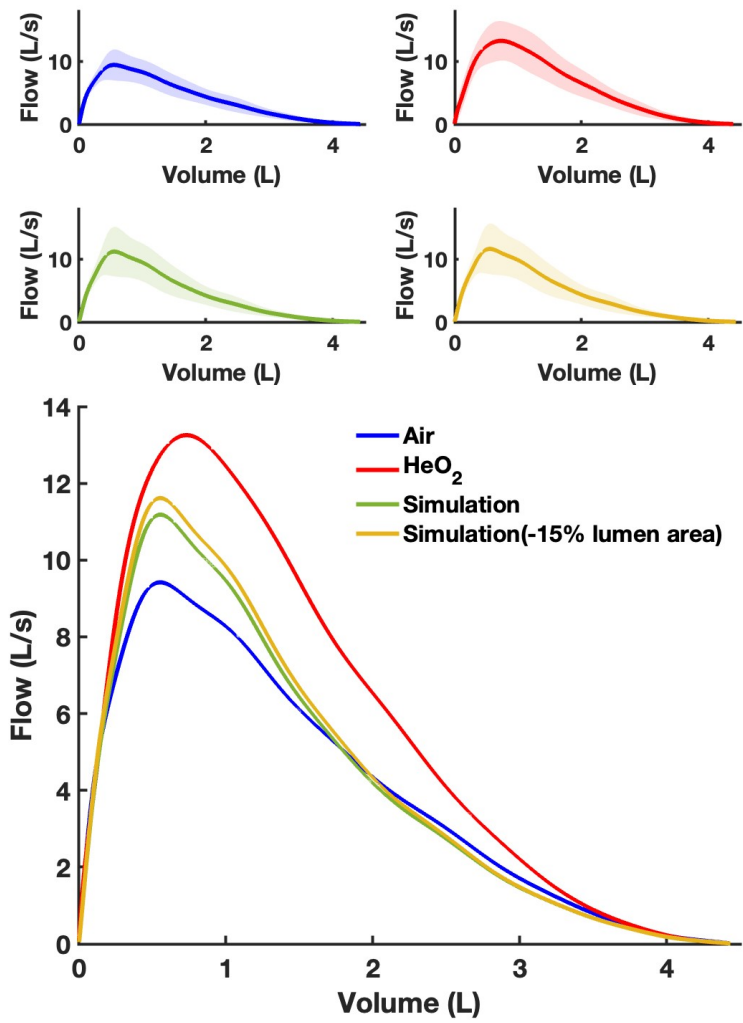

Figure 2. Mean values and standard deviation of maximal expiratory flow volume curve (MEFV) for Air, HeO₂, SIMU and SIMU15 conditions.

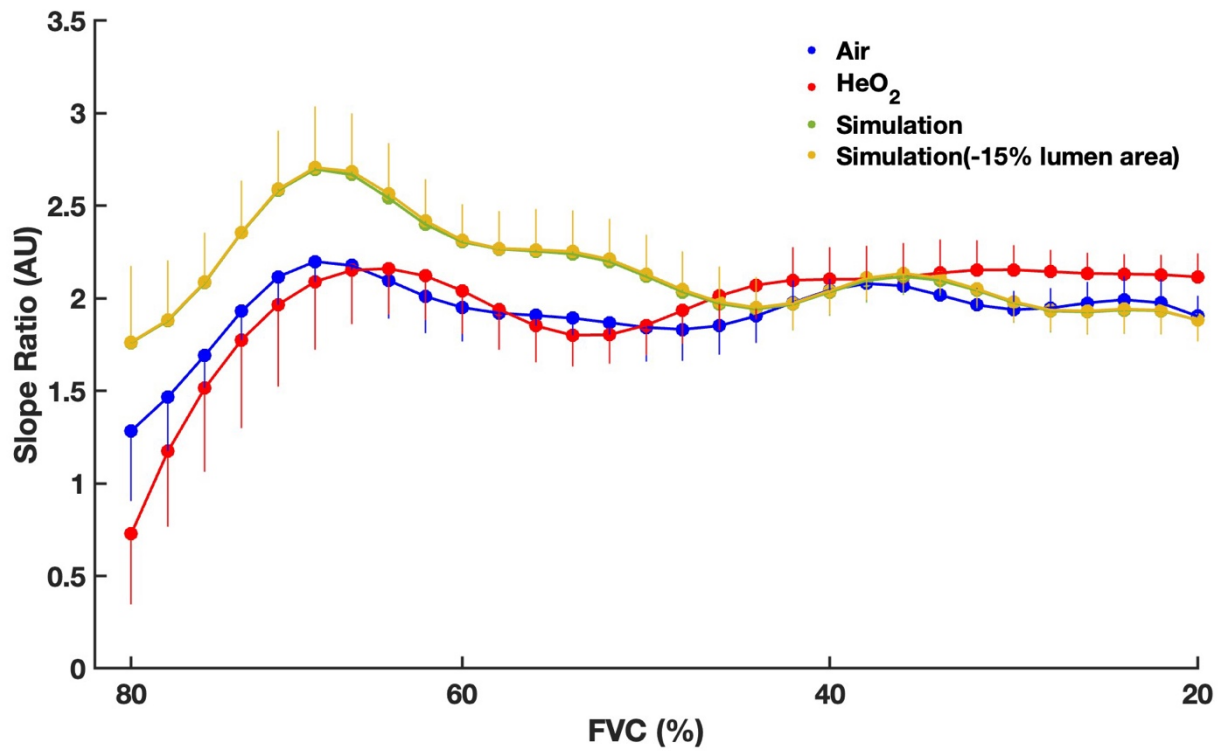

Figure 3. Slope Ratio index for air (●), HeO₂ (●), SIMU (●) and SIMU15 (●) conditions between 80% and 20% of forced vital capacity. Data are presented as mean ± SEM.

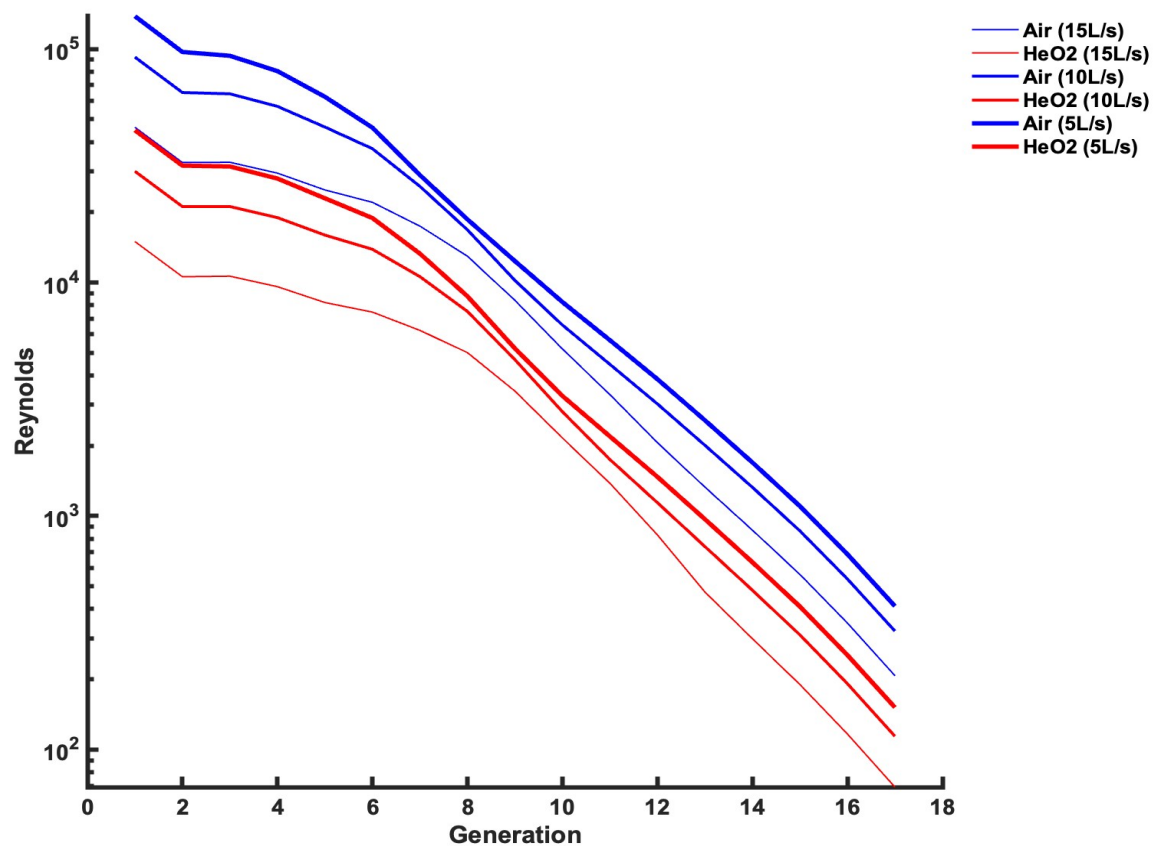

Figure 4. Reynolds number with Air and HeO₂ across lung generations for a flow rate at the trachea (generation 0) from 0.1 to 15 L.s⁻¹.

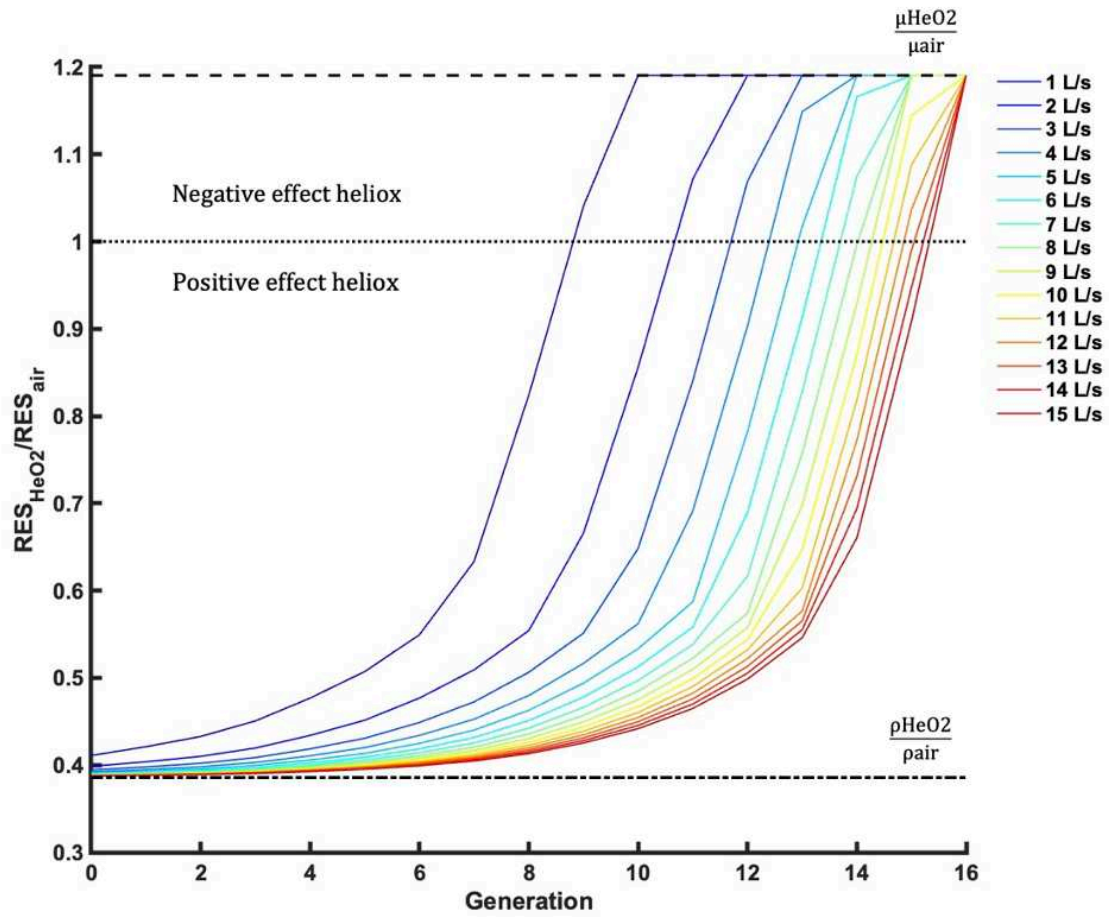

Figure 5. Ratio of air resistance by HeO₂ resistance across lung generations for a flow from 1 L.s⁻¹ to 10L.s⁻¹.

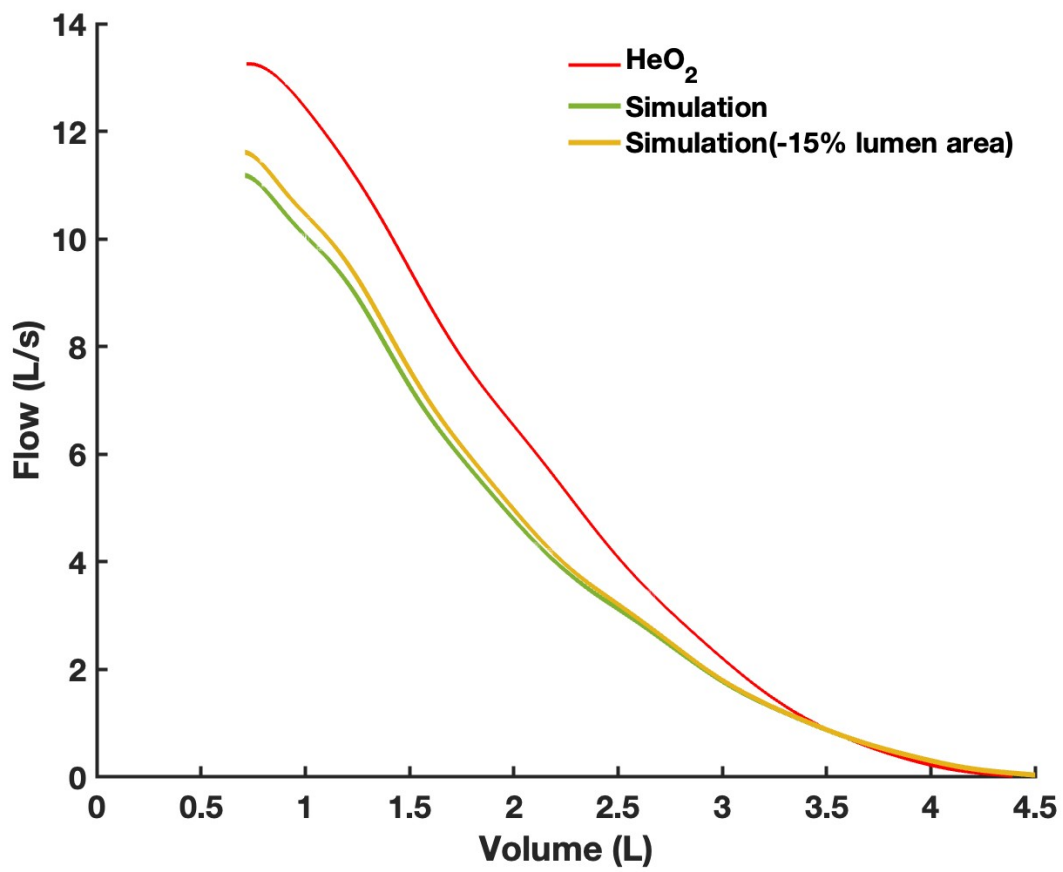

Figure 6. Maximal expiratory flow volume curve matched for PEFvol for, HE, SIMU and SIMU15 conditions.

REFERENCES

- Agostoni, E., Hyatt, R.E., 1986. Static Behavior of the Respiratory System, in: Terjung, R. (Ed.), *Comprehensive Physiology*. Wiley, pp. 113–130. <https://doi.org/10.1002/cphy.cp030309>
- ATS/ERS Statement on Respiratory Muscle Testing, 2002. *Am J Respir Crit Care Med* 166, 518–624. <https://doi.org/10.1164/rccm.166.4.518>
- Brighenti, C., Barbini, P., Gnudi, G., Cevenini, G., Pecchiari, M., D'Angelo, E., 2007. Helium–oxygen ventilation in the presence of expiratory flow-limitation: A model study. *Respiratory Physiology & Neurobiology* 157, 326–334. <https://doi.org/10.1016/j.resp.2006.12.012>
- Dominelli, P.B., Foster, G.E., Guenette, J.A., Haverkamp, H.C., Eves, N.D., Dominelli, G.S., Henderson, W.R., O'Donnell, D.E., Sheel, A.W., 2015. Quantifying the shape of the maximal expiratory flow–volume curve in mild COPD. *Respiratory Physiology & Neurobiology* 219, 30–35. <https://doi.org/10.1016/j.resp.2015.08.002>
- Dominelli, P.B., Molgat-Seon, Y., Foster, G.E., Dominelli, G.S., Haverkamp, H.C., Henderson, W.R., Sheel, A.W., 2016. Quantifying the shape of maximal expiratory flow-volume curves in healthy humans and asthmatic patients. *Respiratory Physiology & Neurobiology* 220, 46–53. <https://doi.org/10.1016/j.resp.2015.09.007>
- Geard, D., Reaburn, P.R.J., Rebar, A.L., Dionigi, R.A., 2017. Masters Athletes: Exemplars of Successful Aging? *Journal of Aging and Physical Activity* 25, 490–500. <https://doi.org/10.1123/japa.2016-0050>
- Green, M., Mead, J., Turner, J.M., 1974. Variability of maximum expiratory flow-volume curves. *J Appl Physiol* 37, 67–74. <https://doi.org/10.1152/jappl.1974.37.1.67>
- Hashemian, S., Fallahian, F., Hashemian, S., Fallahian, F., 2014. The use of heliox in critical care. *Int J Crit Illn Inj Sci* 4, 138. <https://doi.org/10.4103/2229-5151.134153>
- Johnson, B.D., Scanlon, P.D., Beck, K.C., 1995. Regulation of ventilatory capacity during exercise in asthmatics. *Journal of Applied Physiology* 79, 892–901. <https://doi.org/10.1152/jappl.1995.79.3.892>
- Katz, I.M., Martin, A.R., Muller, P.-A., Terzibachi, K., Feng, C.-H., Caillibotte, G., Sandeau, J., Texereau, J., 2011. The ventilation distribution of helium–oxygen mixtures and the role of inertial losses in the presence of heterogeneous airway obstructions. *Journal of Biomechanics* 44, 1137–1143. <https://doi.org/10.1016/j.jbiomech.2011.01.022>
- Klimenko, O., Luu, P., Dominelli, P., Noggle, N., Petrics, G., Haverkamp, H.C., 2023. Effect of EXERCISE-INDUCED bronchoconstriction on the configuration of the maximal expiratory FLOW-VOLUME curve in adults with asthma. *Physiological Reports* 11. <https://doi.org/10.14814/phy2.15614>
- Lambert, R.K., 1990. Simulation of the effects of mechanical nonhomogeneities on expiratory flow from human lungs. *Journal of Applied Physiology* 68, 2550–2563. <https://doi.org/10.1152/jappl.1990.68.6.2550>
- Lambert, R.K., Wilson, T.A., Hyatt, R.E., Rodarte, J.R., 1982. A computational model for expiratory flow. *Journal of Applied Physiology* 52, 44–56. <https://doi.org/10.1152/jappl.1982.52.1.44>
- Mann, L.M., Granger, E.A., Chan, J.S., Yu, A., Molgat-Seon, Y., Dominelli, P.B., 2020. Minimizing airflow turbulence in women lowers the work of breathing to levels similar to men. *Journal of Applied Physiology* 129, 410–418. <https://doi.org/10.1152/japplphysiol.00347.2020>

- Mead, J., 1978. Analysis of the configuration of maximum expiratory flow-volume curves. *Journal of Applied Physiology* 44, 156–165. <https://doi.org/10.1152/jappl.1978.44.2.156>
- Mead, J., Turner, J.M., Macklem, P.T., Little, J.B., 1967. Significance of the relationship between lung recoil and maximum expiratory flow. *Journal of Applied Physiology* 22, 95–108. <https://doi.org/10.1152/jappl.1967.22.1.95>
- Miller, M.R., 2005. Standardisation of spirometry. *European Respiratory Journal* 26, 319–338. <https://doi.org/10.1183/09031936.05.00034805>
- Molgaat-Seon, Y., Dominelli, P.B., Guenette, J.A., Sheel, A.W., 2019. Modelling the effects of age and sex on the resistive and viscoelastic components of the work of breathing during exercise. *Exp Physiol* 104, 1737–1745. <https://doi.org/10.1113/EP087956>
- Myers, J., Kaminsky, L.A., Lima, R., Christle, J.W., Ashley, E., Arena, R., 2017. A Reference Equation for Normal Standards for VO₂ Max: Analysis from the Fitness Registry and the Importance of Exercise National Database (FRIEND Registry). *Progress in Cardiovascular Diseases* 60, 21–29. <https://doi.org/10.1016/j.pcad.2017.03.002>
- Niewoehner, D.E., Kleinerman, J., 1974. Morphologic basis of pulmonary resistance in the human lung and effects of aging. *Journal of Applied Physiology* 36, 412–418. <https://doi.org/10.1152/jappl.1974.36.4.412>
- Otis, A.B., Fenn, W.O., Rahn, H., 1950. Mechanics of Breathing in Man. *Journal of Applied Physiology* 2, 592–607. <https://doi.org/10.1152/jappl.1950.2.11.592>
- Papamoschou, D., 1995. Theoretical validation of the respiratory benefits of helium-oxygen mixtures. *Respiration Physiology* 99, 183–190. [https://doi.org/10.1016/0034-5687\(94\)00071-7](https://doi.org/10.1016/0034-5687(94)00071-7)
- Pozin, N., Montesantos, S., Katz, I., Pichelin, M., Grandmont, C., Vignon-Clementel, I., 2017. Calculated ventilation and effort distribution as a measure of respiratory disease and Heliox effectiveness. *Journal of Biomechanics* 60, 100–109. <https://doi.org/10.1016/j.jbiomech.2017.06.009>
- Rahn, H., Otis, A.B., Chadwick, L.E., Fenn, W.O., 1946. THE PRESSURE-VOLUME DIAGRAM OF THE THORAX AND LUNG. *American Journal of Physiology-Legacy Content* 146, 161–178. <https://doi.org/10.1152/ajplegacy.1946.146.2.161>
- Spycher, B., Frey, U., Wildhaber, J.H., Sznitman, J., 2012. Mathematical Behavior of MEFV Curves in Childhood Asthma and the Role of Curvature in Quantifying Flow Obstruction. *ISRN Pulmonology* 2012, 1–13. <https://doi.org/10.5402/2012/305176>
- Stéphano, J., Mauroy, B., 2021. Wall shear stress distribution in a compliant airway tree. *Physics of Fluids* 33, 031907. <https://doi.org/10.1063/5.0038706>
- Sylvester, K.P., Clayton, N., Cliff, I., Hepple, M., Kendrick, A., Kirkby, J., Miller, M., Moore, A., Rafferty, G.F., O'Reilly, L., Shakespeare, J., Smith, L., Watts, T., Bucknall, M., Butterfield, K., 2020. ARTP statement on pulmonary function testing 2020. *BMJ Open Res* 7, e000575. <https://doi.org/10.1136/bmjresp-2020-000575>
- Tawhai, M.H., Hunter, P., Tschirren, J., Reinhardt, J., McLennan, G., Hoffman, E.A., 2004. CT-based geometry analysis and finite element models of the human and ovine bronchial tree. *Journal of Applied Physiology* 97, 2310–2321. <https://doi.org/10.1152/japplphysiol.00520.2004>
- Weibel, E.R., 1963. *Morphometry of the Human Lung*. Springer Berlin Heidelberg, Berlin, Heidelberg. <https://doi.org/10.1007/978-3-642-87553-3>

**STUDY III. EFFECTS OF INSPIRATORY
MUSCLES FATIGUE ON LOCOMOTOR
MUSCLE FATIGUE AND EXERCISE
PERFORMANCE IN YOUNG AND
MASTER ATHLETES**

When expiratory flow is limited, it may be due to airway collapse. Previous work using an idealized model of the lungs indicated that even a slight narrowing of the airways may cause a significant increase in the overall resistance of the lungs. For example, a 4% reduction in the ratio of diameter to length between successive generations would nearly double the resistance in the lungs (Mauroy et al., 2004). Therefore, airway collapse with EFL may result in a steep increase in the resistance of the whole bronchial tree thereby putting additional demand on the respiratory muscles. Additional demand on the respiratory muscles can also be caused by the various secondary effects of EFL. Upon the onset of exercise, EELV may rise towards or surpass the resting levels, leading to dynamic hyperinflation (Johnson et al., 1992). Initially, this hyperinflation is beneficial as it allows an increase in expiratory flow (Pellegrino et al., 1993). However, it is also associated with an increased work of breathing because high lung volumes elevate the elastic strain on the inspiratory muscles, due to lower dynamic lung compliance (Agostoni and Rahn, 1960). In turn, diaphragm needs to contract at a non-optimal length (stretched) which may cause an accelerated fatigue. Even for non-hyperinflators, hyperventilation occurs during high-intensity exercise and this ventilatory response requires a substantial use of inspiratory muscles, and if the exercise intensity exceeds 80% of peak power output, significant diaphragm fatigue occurs (Johnson et al., 1993). Accordingly, when a special mechanical ventilator was used to reduce the work of breathing of the inspiratory muscles by 40–60%, this prevented exercise-induced diaphragm fatigue (Babcock et al., 2002). Exercise performance time was increased with unloading by ~14% (Harms et al., 2000) and subsequent studies have shown that reducing the work of breathing during high intensity exercise prevented a significant portion of the exercise-induced quadriceps fatigue (Romer et al., 2006), an effect that is likely related to attenuating the consequences on limb blood flow of the respiratory muscle metaboreflex (Harms et al., 2000).

Inspiratory muscle fatigue may be a common phenomenon in endurance athletes and particularly master athletes because of age-induced decline on the ventilatory system and their higher ventilatory demand and likelihood of experiencing EFL. Although the effect of inspiratory muscles has been studied in young individuals, its effects on quadriceps muscle fatigue have never been explored in the elderly. Yet, the interplays between respiratory and locomotor muscles may be a key contributor to the decrease of exercise performance, particularly in master athletes.

TITLE

Effects of inspiratory muscles fatigue on locomotor muscle fatigue and exercise performance
in young and master athletes

AUTHORS & AFFILIATIONS

Mons, V.^{1,2,3}, Lavigne, C.¹, Meste O.⁴, Mauroy, B.^{2,3}, Blain, G.M.^{1,3}

¹Université Côte d'Azur, LAMHESS, Nice, France

²Université Côte d'Azur, CNRS, LJAD, Nice, France

³Université Côte d'Azur, Centre Vader, Nice, France

⁴Université Côte d'Azur Laboratoire I3S, UNSA-CNRS, Nice, France.

CORRESPONDANCE

Valentin Mons

Telephone: +33 7 86 43 30 23

E-mail: monsvalentin33@gmail.com

Campus STAPS, 261 Bd du Mercantour

06200, Nice

France

ABSTRACT (<250 words)

Introduction. Age-induced decline in ventilatory capacity associated with an elevated ventilatory demand may place substantial demand on respiratory muscles. The aim of this study was to evaluate the effect of inspiratory muscle fatigue and locomotor muscle fatigue and exercise performance in young and master athletes.

Methods. Ten young athletes (YA, 27.4 ± 4.4 years, $\dot{V}O_{2\text{MAX}} = 65.9 \pm 7.4$ mL.min⁻¹.kg⁻¹) and ten master athletes (MA, 65.0 ± 5.1 years, $\dot{V}O_{2\text{MAX}} = 46.5 \pm 2.7$ mL.min⁻¹.kg⁻¹) were recruited. Quadriceps neuromuscular fatigue was evaluated with maximal voluntary isometric contractions (MViC) and electrical stimulation of the femoral nerve before and after a constant workload test at 90% of peak power output (CWT₉₀). CWT₉₀ was performed to exhaustion without (ITL₂), or with (ILT₆₀) prior induction of inspiratory muscle fatigue or at iso-time to ILT₆₀ condition without prior induction of inspiratory muscle fatigue. Systemic and local cardiovascular responses were recorded during the inspiratory fatiguing task. **Results.** Inspiratory muscle fatigue was associated with a greater increase in mean arterial pressure and limb vascular resistance in master athletes ($p = 0.011$ and $p = 0.021$). Prior induction of inspiratory muscle fatigue induced a reduction in quadriceps muscle activation in both groups during CWT₉₀ and led to a greater decrease of exercise performance in master compared to young athletes ($\Delta\text{TTE}_{\text{YA}} = -12.4\%$ vs $\Delta\text{TTE}_{\text{MA}} = -39.7\%$, $p = 0.004$). Peripheral was attenuated during iso-time condition ($p = 0.001$).

Conclusion. Inspiratory muscle fatigue led to an increase in limb vascular resistance, a decrease in limb muscle activation, accelerates quadriceps fatigue during exercise and impairs exercise performance to a greater extent in master compared to young endurance athletes.

KEY WORDS: aging, cardiovascular, inspiratory muscle fatigue, neuromuscular evaluation, master athletes

INTRODUCTION

Exercise performance and the maximal oxygen uptake ($\dot{V}O_{2\text{ MAX}}$) invariably decrease with healthy aging particularly from 60 years of age. This decline is primarily attributed to the impairment of the cardiovascular and muscular systems (Cheitlin, 2003; Fleg and Lakatta, 1988). The elderly is also associated with a weakened respiratory system, caused by a decreased respiratory muscle strength (Harik-Khan et al., 1998), diminished lung elasticity (Knudson et al., 1977), and a stiffer chest wall (Johnson et al., 1994). Such alterations raise the work of breathing for a given ventilation, thereby imposing additional demands on respiratory muscles (Molgat-Seon et al., 2019). The constraints placed on aged respiratory muscles may be even more pronounced among older endurance athletes, commonly referred as master athletes. While their lifelong commitment to endurance training helps to counteract declines in cardiovascular and muscular function (Geard et al., 2017; Lepers and Stapley, 2016; Tanaka et al., 2019), allowing them to maintain higher exercise work rates and achieve elevated ventilation levels, it appears to have only a limited impact on mitigating age-related declines in pulmonary function (Hagberg et al., 1988; McClaran et al., 1995). Consequently, the respiratory muscles of master athletes may face exacerbated constraints during high-intensity exercise, making them particularly susceptible to fatigue. Fatigue is defined here as a reduction in the ability of the muscle to generate force reversible by rest (Gandevia, 2001).

The accumulation of metabolites and mechanical strain induced by fatiguing contractions of the diaphragm stimulate group III-IV muscles afferents and have been shown to increase muscle sympathetic nerve activity (MSNA) in limb muscles thereby increasing pressor reflex with an elevation of mean arterial pressure (MAP) and limb vascular resistance (LVR) (Croix et al., 2000; Dempsey et al., 2008b; Sheel et al., 2001). Recent evidence indicates that age-related alterations in the respiratory system led to an exacerbation of this response. This was shown by a greater increase in MAP in older individuals compared to their younger counterparts when

they performed a similar fatiguing inspiratory task (Smith et al., 2017a; Leahy et al., 2023). However, it remains unknown how this amplified response affects limb muscles fatigue and exercise tolerance in the elderly despite available evidence in young individuals. Previous studies have shown that induction of inspiratory (Mador and Acevedo, 1991; Welch et al., 2018a; Wüthrich et al., 2013) and expiratory (Romer and Polkey, 2008; Verges et al., 2007) muscle fatigue prior to exercise results in a reduction in subsequent exercise performance, with a reduction of up to ~30% in time to exhaustion during a high-intensity constant workload test (Romer and Polkey, 2008). Conversely, unloading the inspiratory work of breathing with an assisted ventilator by approximately 50% during exercise in healthy and fit individuals has been found to improve performance by an average of 14% (Harms et al., 2000) . One possible explanation is that the heightened activity of sympathetic-mediated vasoconstriction likely result in a reduction of blood flow to the working locomotor muscles (Croix et al., 2000; Derchak et al., 2002; Harms et al., 2000, 1997; Katayama and Amann, 2012; Sheel et al., 2001). The ensuing reduction in muscle perfusion hinders oxygen delivery and metabolite clearance, thereby accelerating locomotor muscle fatigue (Taylor and Romer, 2008; Wüthrich et al., 2013). However, we do not know how age modulates this response and whether exercise tolerance is impacted to a lower or a greater extent in master athletes.

Therefore, the aim of this study was to evaluate the influence of aging on the interplay between respiratory and locomotor muscle fatigue. We hypothesized that manipulating the level of inspiratory muscle fatigue prior to intense exercise would have a greater effect on locomotor muscle fatigue and, thus, exercise performance in master athletes compared to young athletes.

METHOD

Participants

Twenty athletes participated in this study including ten young athletes (YA, 27.4 ± 4.4 years, $\dot{V}O_{2\text{MAX}} = 65.9 \pm 7.4 \text{ mL}\cdot\text{min}^{-1}\cdot\text{kg}^{-1}$) and ten master athletes (MA, 65.0 ± 5.1 years, $\dot{V}O_{2\text{MAX}} = 46.5 \pm 2.7 \text{ mL}\cdot\text{min}^{-1}\cdot\text{kg}^{-1}$). All participants were healthy non-smokers, free of any medication, with normotensive levels ($<139/<89$ mmHg), standard pulmonary function (see Table 1), and no history of cardiovascular, neurological, or respiratory disease. Participants were instructed to refrain from strenuous physical exercise, alcohol, and caffeinated beverages for 24 hours prior to each experimental session while maintaining a consistent dietary intake and training commitments throughout the period of the study. Each participant provided written informed consent before participating in the study which was conducted according to Helsinki Declaration for human experimentation and approved by the national ethics committee.

Experimental design

The study was conducted over 6 experimental sessions. Each session was separated by at least 48 hours and took place at the same time of the day (~ 1 hour) to avoid confounding biological influence of the circadian rhythm. During the first session, subjects performed pulmonary function testing, including maximal inspiratory pressure (PI_{MAX}), and a graded cycling test until exhaustion to evaluate maximal oxygen consumption ($\dot{V}O_{2\text{MAX}}$) and peak power output (PPO). During the second experimental day, subjects were thoroughly familiarized with testing procedures. They performed pulmonary function assessment, baseline quadriceps neuromuscular evaluation, inspiratory loading task (ILT), cycling constant workload test to exhaustion with power set at 90% of their PPO (CWT_{90}) and quadriceps neuromuscular fatigue evaluation post exercise. The experimental design of the third and fourth sessions, was similar to the familiarisation session with participants either performing ILT at 2% (ILT_2) or 60%

(ILT₆₀) of their PI_{MAX} prior to CWT₉₀. Each condition was assigned following a single-blind, randomized crossover design. During the fifth experimental session, participants completed the inspiratory loading task set at 2% of PI_{MAX} followed by a CWT₉₀ performed for a time equal to that achieved during ILT₆₀ condition (ISO-time / ISO-work). On the last experimental visit participants underwent quadriceps neuromuscular evaluation and ILT₆₀ alone, for the same duration and modality as during previous session.

Pulmonary function testing

Lung function was evaluated on each experimental visit following standard procedures (“ATS/ERS Statement on Respiratory Muscle Testing,” 2002). Participants performed 6-8 maximal flow volume loops to determine vital capacity (FVC), forced expiratory volume in 1 second (FEV₁), FEV₁/FVC, peak expiratory flow (PEF), and forced expiratory flow at 25-75% of vital capacity (FEF₂₅₋₇₅). Spirometry manoeuvres were conducted with subjects seated in the cycling position and instantaneous visual feedback was provided for each maneuver. Greatest values selected for analysis and compared with predicted values (Quanjer et al., 2012; Sylvester et al., 2020). Maximal inspiratory pressure (PI_{MAX}) was determined on each experimental visit. Participants were seated in the upright position and prompted to maintain maximal inspiratory effort for 3 seconds from residual volume against an inspiratory resistance with a small leak to prevent glottis closure. Manoeuvres were performed with a nose clip and a mouthpiece connected to a pressure transducer (MLT844, AD Instruments, Colorado Springs, CO, USA) and repeated until PI_{MAX} values for both inter-session and intra-session were within a range of 5%.

Inspiratory loading task

Subjects inhaled against a custom-made flow-resistive device with no resistance during the exhalation phase. To isolate inspiratory muscles fatigue without the confounding effects of whole-body exercise, ILT₆₀ was conducted using intense muscular efforts throughout extended breath duty cycles (i.e., ratio of inspiratory time to total breathing cycle time; T_i/T_{TOT}). Participants were instructed to maintain a target inspiratory pressure corresponding to 60% of PI_{MAX} with a breathing frequency of 15 breaths per minute and a duty cycle of 0.7. Continuous visual feedback of the target mouth pressure was provided on a monitor, while an audio metronome with distinct inspiratory and expiratory tones was used to provide feedback on the breathing frequency. During each inspiratory effort, subjects were instructed to maintain a consistent mouth pressure waveform and to focus on isolating the diaphragm. When subjects failed to reach the target inspiratory pressure for three consecutive breaths despite verbal encouragement, they were prompted to perform a maximal inspiratory manoeuvre. If the mouth pressure reached was greater than 85% of PI_{MAX} , subjects were instructed to keep performing the breathing task until they failed again, otherwise it was terminated. ILT₂ served as the SHAM condition and was performed for 10 minutes with the same breathing frequency and duty cycle but with a target inspiratory pressure set at 2% of their PI_{MAX} . End-tidal carbon dioxide (PET_{CO_2}) was continuously monitored, and a rebreathing bag was added to prevent hypocapnia.

Maximal graded cycling test

To determine peak power output and maximal oxygen consumption participants underwent a graded test on an electromagnetically braked cycle ergometer (Velotron, RacerMate, Seattle, WA, USA) until exhaustion. The test began at an initial workload of 80W for master athletes and 160W for young athletes with an increase of 40W every 3 minutes. Participants were instructed to follow a self-selected pedalling frequency and exercise was stopped when they

could no longer sustain 60 rpm for more than five seconds despite verbal encouragement. To confirm participants reached $\dot{V}O_{2\text{MAX}}$, a constant workload exercise at an intensity of 110% of PPO was performed after a twenty-minute recovery period. $\dot{V}O_{2\text{MAX}}$ values were compared to predicted values based on age, sexes and weight (Myers et al., 2017).

Constant load test to exhaustion

Immediately after ILT₂ or ILT₆₀, participants performed a constant workload cycling test at 90% of PPO (CWT₉₀) with a prior standardized 2-minute warm-up set at 50% of PPO. Subjects were instructed to maintain a pedalling frequency of 85 rpm and exercise was terminated when cadence fell below >5 rpm for more than 10 seconds despite verbal encouragements. No feedback about exercise time was provided during the constant load cycling test. Participants exercised to exhaustion (TTE) during familiarisation and the third and fourth experimental sessions while they were stopped by experimenters on the fifth session when they reached an exercise time equal to that performed after ILT₆₀ (ISO-time / ISO-work).

Perceptual responses

During the constant load cycling exercise, dyspnea (i.e., perceived breathlessness) and leg discomfort levels were assessed separately by utilizing a Borg CR-100 every 1 min 30 sec. Dyspnea was defined as the “perception of difficulty in breathing”, while leg discomfort was defined as the individual’s “perception of fatigue in leg muscles”. For each scale, a rating of “0” indicated the absence of respiratory discomfort or leg discomfort, while a rating of “100” indicated the most intense respiratory discomfort or the highest level of leg discomfort ever experienced, respectively.

Contractile function and voluntary activation of the quadriceps.

Quadriceps muscle function was evaluated in response to electrical femoral nerve stimulation. Subjects were seated on a custom-made chair with the right knee joint set at a 90° angle. The ankle was fixed to a calibrated load cell (model LC101, Omega Engineering Inc, Norwalk, USA) by a non-elastic ankle strap positioned just above to the malleoli. The cathode, a self-adhesive electrode (30×30 mm, Ag-AgCl, Mini-KR; Contrôle Graphique, Brie-Comte-Robert, France) was placed on the femoral triangle and the anode, a carbon-impregnated electrode (70×50 mm) was placed on the gluteal fold. Both adhesive electrodes were positioned at the stimulation site leading to the highest force output and the greatest amplitude of the compound muscle action potential (M_{MAX}) of the vastus lateralis (VL), vastus medialis (VM) and rectus femoris (RF). A square wave stimulation of 1 ms was delivered by a constant current stimulator (DS7A; Digitimer, Hertfordshire, United Kingdom) at an intensity set to 130% of the stimulation intensity eliciting highest quadriceps twitch and M_{MAX} . Quadriceps neuromuscular function measurements were obtained before and after each CWT₉₀. Five maximal voluntary isometric contractions (MviC) were performed before the constant load cycling test with the best used as baseline. MviC were performed 15 sec, 1 min, 2 min, 4 min, 10 min and 15 min after exercise termination. Potentiated twitches force evoked by single electrical stimulation of the femoral nerve (QT_{SINGLE}), was measured after each MviC. Quadriceps peripheral fatigue was assessed by calculating the percentage change in QT_{SINGLE} evoked force from pre-exercise to post-exercise. To evaluate the voluntary activation of the quadriceps muscle, a single stimulation was superimposed during each MviC when force output was the highest. Voluntary activation was calculated as follow: $VA (\%) = [1 - (QT_{SINGLE, SUPERIMPOSED} / QT_{SINGLE}) \times 100$. For all quadriceps neuromuscular assessment, we determined peak force output, contraction time (CT), maximal rate of force development (MRFD) and half relaxation time (HRT).

Electromyography (EMG)

Electrical activity of the VL, the VM and the BF were recorded using wireless surface EMG sensors (Trigno Wireless EMG system, Delsys, Boston, USA) connected to a data acquisition system (PowerLab 16/35, ADInstrument, Australia). After preparing the skin through shaving, cleaning, and abrading, the sensors were positioned over the muscle belly according to the optimal M_{MAX} wave response to femoral nerve electrical stimulation. Raw EMG signals were amplified, filtered (bandwidth frequency, 0.03 – 1 kHz), and sampled at a rate of 2000 Hz to ensure accurate representation of muscle activity. The amplified signals were then digitized and stored for further analysis using commercially available software (Labchart v8.1.25, ADInstruments, Australia) with each EMG burst being delimited using a custom-made analysis with MATLAB software version R2023a (MathWorks Inc., Natick, MA, USA). The root mean square (RMS) of each EMG burst was calculated during the CWT_{90} . RMS values were then normalized to the highest RMS value of the pre-exercise M_{viC} ($RMS\%M_{viC}$) averaged over a 0.5 second interval.

Cardiovascular measurements

Blood pressure

Subjects were seated for >15 minutes for baseline cardiovascular measurements. Heart rate (HR) and beat-to-beat arterial blood pressure were recorded using finger pulse photoplethysmography (Finapres NOVA NC System, Finapres Medical Systems, Arnhem, Netherlands). HR, systolic blood pressure (SBP), diastolic blood pressure (DBP) and mean arterial blood pressure (MAP) were recorded at rest and continuously during ILT. Limb vascular resistance (LVR) was calculated as: $LVR = \frac{MAP}{\dot{Q}_L}$.

Blood flow

Doppler ultrasound (ArtUS, Teled, Lithuania) with a transducer probe (L12-5N40-A4, Teled, Lithuania) were used to measure femoral artery blood flow (\dot{Q}_L , L.min⁻¹) by simultaneous assessing femoral artery diameter (2D) and blood velocity. Measurements were performed ~3 cm distal to the bifurcation of the deep and superficial femoral artery for better accessibility of the artery and lower risk of turbulences. Doppler flow signals were corrected at an isonation angle of <60°. Cross sectional area (CSA) of the femoral artery was calculated as $CSA \text{ (mm}^2\text{)} = \pi \times r^2$, with r being artery radius. Mean blood velocity (V_{MEAN} , cm.s⁻¹) corresponded to the average blood velocity over each cardiac cycle. \dot{Q}_L corresponded to the product of V_{MEAN} and CSA and was calculated at baseline and every minute during ILT. Doppler data including artery 2D image and Doppler spectrum were recorded for subsequent analysis. Each video frame was digitized using a custom-made MATLAB analysis to determine V_{MEAN} and CSA.

Statistical analysis

For comparison of neuromuscular function, EMG, ventilatory and cardiovascular responses between different tests, a linear mixed-effect model was calculated, with condition (ILT₂, ILT₆₀ and ISO) and group (YA and MA) as main factors. For factors showing a significant main effect, planned pairwise comparisons were performed with a Boferroni post hoc analysis. Descriptive characteristics were compared using independent-samples t-tests. For all statistical tests, normality was assessed using the Shapiro–Wilk test and homogeneity of the variance of the distributions (equal variance) was evaluated with Levene test. All statistical analysis were completed with SPSS Statistics (v26.0, IBM Co., NY, USA). Data are presented as means ± standard deviation (SD) unless stated otherwise and significance for all tests was set at $P < 0.05$.

RESULTS

Subject characteristics

Subject characteristics with resting pulmonary function and peak metabolic and ventilatory data are presented in Table 1. MA were older than YA ($p < 0.001$), had significantly lower FVC ($p = 0.023$), FEV₁ ($p = 0.031$) and FEF₇₅ ($p = 0.008$) but not different PEF ($p = 0.525$), FEF₂₅ ($p = 0.550$), FEF₅₀ ($p = 0.627$), and FEF₂₅₋₇₅ ($p = 0.229$). Young athletes achieved PI_{MAX} that corresponded to 106% of predicted values ($p = 0.181$) and master athletes displayed PI_{MAX} values that corresponded to 123% of predicted values ($p < 0.001$). At peak exercise during the maximal graded cycling test, both absolute and relative PPO and $\dot{V}O_{2\text{ MAX}}$ were higher in YA ($p < 0.001$).

Cardiovascular measures during ILT

During ILT₆₀, the time to task failure was similar ($p = 0.378$) between YA (1025.3 ± 212.3 s) and MA (898.5 ± 373.3 s). During ILT₆₀, from baseline to task failure, PI_{MAX} values decreased by 18.02 ± 11.1 % in YA and 21.2 ± 11.3 % in MA with no difference between groups ($p = 0.456$).

Baseline HR ($p = 0.075$), SPB ($p = 0.568$), DBP ($p = 0.199$) and MAP ($p = 0.164$) were not different between YA and MA. Within subject cardiovascular measures at baseline were similar between conditions in YA and MA with no difference in HR ($p = 0.375$ and $p = 0.530$, respectively), SPB ($p = 0.468$ and $p = 0.330$, respectively), DBP ($p = 0.199$ and $p = 0.256$, respectively) and MAP ($p = 0.164$ and $p = 0.289$, respectively). Cardiovascular measures during ILT₂ and ILT₆₀ are depicted in Figure X. When inspiratory pressure was set at 2% of PI_{MAX}, no effect of condition or time was found for cardiovascular measures in both groups, but when inspiratory pressure was set at 60% of PI_{MAX}, time effect was found in both groups for MAP ($F = 9.77$, $p < 0.001$), SBP ($F = 4.80$, $p < 0.001$), DBP ($F = 2.84$, $p = 0.02$) and HR ($F = 8.49$, $p <$

0.01). During ILT₆₀, a group effect was found with MA having higher increase in MAP ($F = 8.28$, $p = 0.011$), SBP ($F = 7.47$, $p = 0.024$) and DBP ($F = 28.32$, $p < 0.001$) but not HR ($F = 1.450$, $p = 0.321$). In both groups a significant effect of time was found for blood flow values in the femoral artery ($p = 0.01$) but no effect of group was found. LVR values increased in both groups ($p < 0.001$) and were significantly higher in the MA compared to the YA ($p = 0.021$).

Exercise performances and surface electromyography

In both groups, CWT₉₀ time to exhaustion (see Table 2) was lower after the ILT₆₀ condition than after ILT₂ condition with a greater decrease of performance in the MA group ($\Delta TTE_{YA} = -12.4\%$ vs $\Delta TTE_{MA} = -39.7\%$, $p = 0.004$, Figure 1). These performance differences may be explained by the decrease in muscle activation after ILT₆₀. In YA, VL RMS was higher during the CWT₉₀ under ILT₂ condition than in the ILT₆₀ condition ($p = 0.007$) and, although not reaching significance, tended to be lower between ILT₆₀ and ISO conditions ($p = 0.084$), while higher values were found for under both ILT₂ and ISO conditions ($p < 0.001$) in the MA group. VM RMS was not different between conditions in YA ($F = 1.52$, $p = 0.220$) but differences between conditions were found in MA ($F = 8.85$, $p < 0.01$) with lower values in ILT₆₀ condition when compared to ILT₂ ($p = 0.007$) and ISO ($p < 0.001$) conditions. RF RMS was different between conditions for YA ($F = 23.43$, $p < 0.001$) and MA ($F = 8.58$, $p < 0.001$) with lower values found for ILT₆₀ condition compared to ILT₂ ($p < 0.001$ and $p = 0.003$, respectively) and ISO ($p < 0.001$ and $p = 0.007$, respectively). Within groups RMS values of VL, VM and RF were not different between ILT₂ and ISO conditions.

Neuromuscular evaluation

Lower muscle activation we generally observed after ILT₆₀ resulted in an acceleration of fatigue development under this condition. MVC decrease after CWT₉₀ was different between

conditions in YA and MA ($F = 5.54$, $p = 0.005$ and $F = 28.64$, $p < 0.01$, respectively) with a lower decrease observed in the ISO condition when compared to ILT_2 condition ($p = 0.03$ and $p < 0.01$ respectively). MVC decrease was lower in ISO condition than in ILT_{60} condition for the MA group ($p < 0.01$) but not for the YA group ($p = 0.380$). MVC decrease was similar between ILT_2 and ILT_{60} conditions in YA and MA groups ($p = 0.191$ and $p = 0.282$, respectively).

A condition effect was found for QT_{SINGLE} decrease after CWT_{90} in YA and MA ($F = 5.00$, $p = 0.008$ and $F = 25.27$, $p < 0.001$, respectively) with a lower decrease observed in ISO condition than in ILT_2 condition ($p = 0.010$ and $p < 0.001$, respectively) and ILT_{60} ($p = 0.038$ and $p < 0.001$, respectively) but no difference between ILT_2 and ILT_{60} conditions ($p = 1.00$ in both groups).

In MA group, VA was different between conditions ($F = 8.36$, $p < 0.001$) with a lower decrease found in ISO condition in comparison to ITL_2 ($p = 0.01$) and ITL_{60} ($p = 0.002$) conditions and no difference between ITL_2 and ITL_{60} conditions ($p = 1.000$). However, VA was not different between conditions in YA group ($F = 1.65$, $p = 0.196$). Ajouter les RMS des MVC pour renforcer ce résultat.

Ventilatory and metabolic data

$\dot{V}E$ values were similar between conditions for YA and MA ($F = 0.41$, $p = 0.665$ and $F = 1.51$, $p = 0.225$, respectively). However, in both YA and MA groups, a condition effect was found for VT ($F = 24.37$, $p < 0.001$ and $F = 21.87$, $p < 0.001$, respectively) and BF ($F = 4.52$, $p = 0.012$ and $F = 9.45$, $p < 0.001$, respectively) with a higher VT found in ISO when compared to ILT_{60} condition ($p < 0.001$ in both groups) and a lower BF ($p = 0.031$ and $p < 0.001$, respectively). $\dot{V}E / \dot{V}CO_2$ was different between conditions in YA ($F = 6.13$, $p = 0.003$) and MA ($F = 10.29$, $p < 0.001$) with lower values in ISO compared to ILT_2 ($p = 0.003$) and ILT_{60} ($p =$

0.021) conditions in YA group and lower values in ISO compared to ILT₆₀ in MA group ($p < 0.001$). No condition effect was found for $\dot{V}O_2$ in the YA group ($F = 0.74, p = 0.479$) and in the MA group ($F = 0.46, p = 0.630$). A between condition effect was found for $\dot{V}CO_2$ for the YA group ($F = 5.35, p = 0.006$) with $\dot{V}CO_2$ significantly lower during the ISO condition in comparison with the ILT₆₀ condition ($p = 0.021$)

DISCUSSION

Main findings

The aim of this study was to evaluate the influence of aging on the interplay between respiratory and locomotor muscle fatigue. Our results showed that the inspiratory muscle fatiguing task caused a significant reduction in limb muscle flow associated with an increase in mean arterial pressure and limb vascular resistance that were more pronounced in master compared to young athletes. These findings suggest an increased respiratory muscle metaboreflex and sympathetic nerve activity in master athletes. Following the inspiratory muscle fatiguing task, a decrease quadriceps muscle activation and in exercise performance was found in both groups, with the latter being much more pronounced in master athletes. Finally, for the same amount of work at exercise termination, exercise-induced locomotor muscle fatigue was more pronounced after the inspiratory muscle fatiguing vs non fatiguing task. The between task difference in peripheral fatigue was accentuated in master athlete. Taken together, our results suggest that inspiratory muscle fatigue accelerate fatigue development and impairs exercise performance to a greater extent in master compared to young athletes.

Cardiovascular response to inspiratory muscle fatigue

During ILT₆₀ but not during ILT₂, we found a time effect for LVR, MAP, HR and blood flow in both young and master athletes showing a decrease in femoral artery blood flow and an increase in LVR, MAP, and HR. Similar results were found in young and older untrained individuals (Leahy et al., 2023; Sheel et al., 2001; Smith et al., 2017; St Croix et al., 2000). In addition to our cardiovascular variables, Sheel et al., (2001) measured muscle sympathetic nerve activity (MSNA) in the limbs during a similar inspiratory loaded task and reported a concomitant decrease in blood flow with an increased MSNA. Therefore, we can speculate that similar mechanism occurred in our subjects and that our results have been caused by a sympathetically mediated peripheral vasoconstriction.

We found a heightened cardiovascular response in master compared to young athletes when the same relative inspiratory muscles loading task was performed. Specifically, from baseline to the respiratory task failure, MAP increased by 25 vs. 10 mmHg and LVR increased by 61 vs. 40 % in master vs. young athletes. Higher cardiovascular response to inspiratory muscle fatigue was also found in healthy older individuals when they were directly compared to their younger counterparts (Leahy et al., 2023; Smith et al., 2017a).

During a similar inspiratory loaded task, Peters et al., (2017) reported an increase in transdiaphragmatic pressure, which is indicative of a deformation and therefore high mechanical strain of the diaphragm. Coupled with the likely accumulation of intramuscular metabolic byproducts within the inspiratory muscles, we hypothesize that the group III-IV muscle afferents tonic input originating from these muscles was heightened during the respiratory muscle fatiguing task and led to a sympathetically mediated peripheral vasoconstriction (Dempsey et al., 2006, 2002). Consistent with this hypothesis are our results showing a time-dependent increase in MAP, HR and LVR and a decrease in limb blood flow during ILT₆₀ but in the ILT₆₀ (i.e., when the respiratory muscle task was not fatiguing). These

systemic and local cardiovascular responses are believed to be the consequence of an increased sympathetic nerve activity in response to the activation of the respiratory metaboreflex (Croix et al., 2000; Sheel et al., 2001).

Muscle activation and exercise performance

We found a main effect of condition resulting in a lower RMS EMG, indicating indirectly a lower activation of the quadriceps muscle, during the CWT₉₀ performed after ILT₆₀ in both groups. Consistent with our findings, a lower muscle activation of the vastus lateralis has been found during a cycling time trial with fatigued inspiratory muscles (Fulton et al., 2020). We interpret this reduction in EMG amplitude to the inhibitory effect of group III-IV muscle afferents on central motor drive (Amann et al., 2009). Indeed, pharmacological attenuation of these afferents via lumbar intrathecal injection of the μ -opioid receptor agonist fentanyl has been shown to increase motoneuronal output in the limbs (Amann et al., 2009; Blain et al., 2016).

Previous studies have examined the influence of the increase in inspiratory (Mador and Acevedo, 1991; Sliwinski et al., 1996; Welch et al., 2018a; Wüthrich et al., 2013), expiratory (Verges et al., 2007) or overall respiratory muscle work (Dodd et al., 1989; Martin et al., 1982; Spengler et al., 2000) on subsequent exercise performance. Mixed findings were reported with either a reduction (Mador and Acevedo, 1991; Martin et al., 1982; Verges et al., 2007; Welch et al., 2018a; Wüthrich et al., 2013) or no change (Dodd et al., 1989; Martin et al., 1982; Spengler et al., 2000) in exercise performance. The discrepancy between findings may be due to the heterogeneity in the respiratory muscle loading tasks and exercise protocols methodologies. The changes in exercise performance we found are consistent with other studies that induced inspiratory muscle fatigue before high-intensity constant load exercise and which found a reduction in time to exhaustion from 14% to 33% (Mador and Acevedo, 1991; Romer

and Polkey, 2008; Welch et al., 2018a; Wüthrich et al., 2013). However, all the above-mentioned studies were conducted exclusively on young healthy individuals. To our knowledge, it is the first time that whole-body exercise performance differences with prior induction of respiratory muscle fatigue are reported on older individuals or trained individuals. Our results therefore extend previous results and notably show that the impairment of exercise performance with prior induction of inspiratory muscle fatigue, is magnified in master athletes.

Locomotor muscle fatigue

In both young and master athletes, despite significant lower muscle activation and time to exhaustion in the ILT₆₀ compared to the ILT₂ condition, we observed similar exercise-induced reductions in MV_iC and QT_{SINGLE}. Moreover, when the very same exercise work was performed following the inspiratory muscle fatiguing vs. non fatiguing tasks (i.e., ILT₆₀ vs. ILT₂ ISO), a higher level of quadriceps fatigue was observed following inspiratory muscle pre fatigue (i.e., ILT₆₀). Taken together, these findings indicate that fatigue development was accelerated following the inspiratory muscle fatiguing task and that exhaustion was associated with a similar level of peripheral fatigue. Importantly, considering the decrease in QT_{SINGLE} and the lack or slight changes in VA, our results indicate that the changes in MV_iC were caused by peripheral fatigue and not by central fatigue. Our findings are consistent with priori results showing a greater severity of quadriceps muscle fatigue after a cycling exercise of the same intensity and duration with prior induction of inspiratory (Wüthrich et al., 2013) and expiratory (Taylor and Romer, 2008) muscles fatigue in young healthy subjects. The accelerated fatigue development following ILT₆₀ is consistent with the reduction in blood flow and O₂ delivery to the limb muscles associated with inspiratory muscle fatigue (Croix et al., 2000; Dempsey et al., 2006; Sheel et al., 2001).

As previously mentioned, similar relative differences of quadriceps fatigue were found after each CWT₉₀ in both groups. However, the difference in time to exhaustion with or without prior induction of inspiratory muscle fatigue, was greater in master athletes. This result could be explained by the slight difference of QT_{SINGLE} fall between conditions. Indeed, in MA, QT_{SINGLE} decrease between ILT₂ and ILT₆₀ varied by 1% while a 5% more severe decrease was found in YA.

Our results also showed differences in the ability of young and master athletes to generate force. For example, we found a 26% lower MV_{iC} and a 29% lower QT_{SINGLE} at baseline in master athletes. This result is consistent with the 15-35% reduction in maximal voluntary force production that was found in master athletes (Coggan et al., 1990; Porter et al., 1995, Macaluso et al., 2004). Although regular endurance training appears to preserve the number of functional motor units despite the advancing age (Power et al., 1990), aging and endurance training are associated with a conversion of type II toward type muscle I muscle fibers (Lexell, 1995; Coggan et al., 1990; Trappe et al., 1995) and with a reduced motor unit discharge rate (Grimby et al., 1979; Bellemare et al., 1983; Rice et al., 1993), both mechanisms being associated with a reduction in peak force.

Limitations & technical considerations

Several technical considerations must be acknowledged. We used PI_{MAX} measurements before and after each breathing task to assess inspiratory muscle fatigue. This approach may be influenced by subject motivation and ability to produce a maximal effort. To mitigate these potential limits, subjects were thoroughly familiarized with the maneuver and strong verbal encouragement along with visual feedback of pressure generation was provided during each measurement. In addition, during each experimental visit, baseline measurements consisted of a series of at least 6 maneuvers and were performed until at least 3 PI_{MAX} values presented an

intra and intersession coefficient of variation $< 5\%$. Although PI_{MAX} values do not provide objective data on inspiratory muscle fatigue, they are consistent with previous findings showing a reduction in transdiaphragmatic pressure indicative of diaphragmatic fatigue following a similar inspiratory muscles loading task (Peters et al., 2017; Welch et al., 2018b). Furthermore, we do not believe that substantial recovery from inspiratory muscle fatigue occurred from the end of the breathing task to the beginning of the constant workload exercise given that respiratory muscle fatigue after a similar breathing task has been shown to last for at least 30 min (Peters et al., 2017).

Conclusion

Taken together, our findings suggest that inspiratory muscle fatigue leads to an increase in limb vascular resistance and a reduction in limb blood flow, which accelerates exercise-induced peripheral fatigue and impairs time to exhaustion. This deleterious effect of inspiratory muscle fatigue on peripheral fatigue and exercise performance are accentuated in Master athletes, likely due to a heightened respiratory metaboreflex, as suggested by our cardiovascular data measured during the inspiratory muscles fatiguing task. Further studies are needed to confirm this hypothesis.

ACKNOWLEDGEMENTS & GRANTS

We thank the participants for their time and effort dedicated to the participation in this study. Financial support was provided by Région Provence-Alpes-Côte d'Azur and the initiative of excellence (ANR-15-IDEX-01), joint, excellent, and dynamic initiative (JEDI) of the Université Côte d'Azur (UCA).

CONFLICT OF INTEREST

The authors declare having no conflicts of interest, financial or otherwise, no professional relationships with companies or manufacturers who may benefit from the results of the present study. The authors declare that the results of the study are presented clearly, honestly, and without fabrication, falsification, or inappropriate data manipulation.

Table 1. Subject characteristics

Parameter	YOUNG	MASTER	P value
Age (yr)	27.4 ± 4.4	65.0 ± 5.1	<0.001
Height (cm)	178.1 ± 6.9	176.5 ± 4.7	0.527
Weight (kg)	71.8 ± 8.8	67.9 ± 3.7	0.196
SBP (mmHg)	121.6 ± 14.9	117.2 ± 18.0	0.568
DBP (mmHg)	60.6 ± 7.0	67.0 ± 13.3	0.199
MAP (mmHg)	77.1 ± 8.3	83.8 ± 11.5	0.164
HR (bpm)	61.2 ± 9.9	53.2 ± 8.3	0.075
FVC (L)	5.9 ± 0.8	4.9 ± 0.9	0.023
FVC (% predicted)	108.0 ± 8.7	112.4 ± 17.3	0.482
FEV₁ (L)	4.4 ± 0.6	3.7 ± 0.8	0.031
FEV₁ (% predicted)	98.2 ± 11.0	110.5 ± 20.5	0.106
FEV₁/FVC (%)	75.7 ± 6.5*	75.6 ± 6.5	0.977
PEF (L.s⁻¹)	10.1 ± 0.8	10.5 ± 1.9	0.525
FEF₂₅₋₇₅ (L.s⁻¹)	4.5 ± 0.8	3.9 ± 1.1	0.229
FEF₂₅₋₇₅ (%predicted)	95.9 ± 18.0	147.1 ± 39.9*	0.001
PI_{MAX} (cmH₂O)	113.5 ± 15.6	106.6 ± 15.3	0.319
PI_{MAX} (% predicted)	106.5 ± 14.7	122.5 ± 20.4*	0.056
PPO (W)	348.0 ± 37.9	258.2 ± 41.4	<0.001
PPO/kg (W.kg⁻¹)	4.9 ± 0.5	3.8 ± 0.5	<0.001
VO₂ MAX (L.min⁻¹)	4.7 ± 0.6	3.1 ± 0.2	<0.001

All values are expressed as means ± SD. SBP, systolic blood pressure ; DBP, diastolic blood pressure; MAP, mean arterial blood pressure; HR, heart rate; FVC: forced vital capacity; FEV₁: forced expiratory volume in 1 s; PEF, peak expiratory flow; FEF₂₅, FEF₅₀, FEF₇₅: forced expiratory flow at 25%, 50% and 75% of FVC, respectively; FEF₂₅₋₇₅: forced expiratory flow between 25% and 75% of FVC; PI_{MAX}, maximal inspiratory pressure; PPO, peak power output; VO₂, oxygen consumption. * Different from predicted values (p < 0.05).

Table 2. Peak metabolic and ventilatory response during constant workload test

Parameter	YOUNG			MASTER		
	ILT ₂	ILT ₆₀	ISO	ILT ₂	ILT ₆₀	ISO
Time (s)	502 ± 231	386 ± 119	386 ± 119	528 ± 222	308 ± 136	308 ± 136
Work rate (W)	313 ± 34			232 ± 37		
Work rate /kg (W.kg ⁻¹)	3.4 ± 0.4			4.4 ± 0.5		
Metabolic						
$\dot{V}O_2$ (L.min ⁻¹)	4.4 ± 0.6	4.4 ± 0.4	4.5 ± 0.6	3.4 ± 0.7	3.3 ± 0.6	3.4 ± 0.5
$\dot{V}CO_2$ (L.min ⁻¹)	4.4 ± 0.5	4.3 ± 0.3	4.5 ± 0.6	3.3 ± 0.7	3.2 ± 0.7	3.4 ± 0.6
RER (AU)	1.0 ± 0.1	1.0 ± 0.1	1.0 ± 0.1	1.0 ± 0.1	1.0 ± 0.1	1.0 ± 0.1
HR (bpm)	171 ± 13	167 ± 16	169 ± 10	145 ± 19	139 ± 14	141 ± 13
SpO ₂ (%)	98.0 ± 1.6	98.1 ± 1.2	98.5 ± 1.0	97.7 ± 2.4	97.7 ± 2.3	98.6 ± 1.2
[La] _b (mmol.L ⁻¹)	12.9 ± 3.7	14.1 ± 4.9	12.6 ± 3.4	8.0 ± 2.5	8.0 ± 2.3	7.5 ± 2.5
Ventilation						
$\dot{V}E$ (L.min ⁻¹)	144.6 ± 23.8	137.6 ± 22.5	136.8 ± 18.9	116.2 ± 20.6	112.5 ± 18.5	116.9
VT (L)	2.2 ± 0.4	2.3 ± 0.4*	2.6 ± 0.3 †	2.3 ± 0.5*	2.3 ± 0.4*	2.5 ± 0.5 #†
BF (breaths.min ⁻¹)	68.1 ± 22.0*	64.6 ± 24.9*	53.1 ± 5.8 #†	53.3 ± 16.4*	52.0 ± 16.7*	47.9 ± 14.4 #†
$\dot{V}E / \dot{V}O_2$	33.1 ± 4.5	31.4 ± 3.8	29.8 ± 3.3	35.5 ± 6.4	34.7 ± 6.2	34.5 ± 6.4
$\dot{V}E / \dot{V}CO_2$	32.5 ± 3.4*	31.9 ± 3.8*	29.9 ± 1.7 #†	36.4 ± 5.7	35.8 ± 5.5*	34.3 ± 5.0 †

Data are expressed as mean ± SD. $\dot{V}O_2$, oxygen consumption; $\dot{V}CO_2$, carbon dioxide output; RER, respiratory exchange ratio; P_{ET}O₂, end-tidal partial pressure for oxygen; P_{ET}CO₂, end-tidal partial pressure for carbon dioxide; HR, heart rate; SpO₂, peripheral capillary oxygen saturation; [La]_b, blood lactate concentration; $\dot{V}E$, minute ventilation; VT, tidal volume, BF, breathing frequency. #, significantly different from ITL₂ condition (p < 0.05); †, significantly different from ITL₆₀ condition (p < 0.05); *, significantly different from ISO condition (p < 0.05).

Table 3. Baseline and post-constant workload exercise neuromuscular function

Parameter	Group	ILT ₂			ILT ₆₀			ILT _{2 ISO}		
		PRE	15s	15min	PRE	15s	15min	PRE	15s	15min
MViC (N)	YA	609 ± 100	486 ± 118	558 ± 89	597 ± 114	497 ± 117	569 ± 122	621 ± 118	516 ± 144	589 ± 125
	MA	447 ± 73	378 ± 77	408 ± 80	441 ± 82	379 ± 86	413 ± 78	427 ± 95	385 ± 90	414 ± 95
QT _{SINGLE} (N)	YA	194 ± 30	120 ± 45	128 ± 29	197 ± 31	133 ± 36	135 ± 34	188 ± 17	133 ± 45	131 ± 24
	MA	140 ± 33	113 ± 41	104 ± 32	142 ± 38	113 ± 44	104 ± 32	136 ± 34	122 ± 41	110 ± 30
VA (%)	YA	93 ± 3	91 ± 5	87 ± 7	93 ± 3	90 ± 8	90 ± 6	94 ± 5	93 ± 5	91 ± 6
	MA	95 ± 3	91 ± 6	92 ± 5	95 ± 4	92 ± 6	94 ± 4	96 ± 3	96 ± 5	95 ± 3
CT (ms)	YA	53 ± 24	48 ± 16	43 ± 14	52 ± 21	48 ± 17	45 ± 11	59 ± 22	49 ± 18	41 ± 10
	MA	78 ± 7	59 ± 20	51 ± 18	77 ± 8	59 ± 19	46 ± 15	70 ± 16	53 ± 18	49 ± 18
MRFD (N.ms ⁻¹)	YA	6.7 ± 2.3	3.6 ± 2.5	4.0 ± 1.5	6.8 ± 3.2	4.4 ± 2.6	4.1 ± 2.0	6.5 ± 1.4	4.4 ± 2.8	4.0 ± 1.1
	MA	4.3 ± 1.5	3.2 ± 1.8	2.9 ± 1.8	4.5 ± 2.2	2.8 ± 1.4	3.0 ± 1.3	4.0 ± 1.4	3.0 ± 1.6	2.9 ± 1.2
HRT (ms)	YA	90 ± 15	77 ± 25	84 ± 11	90 ± 15	92 ± 32	67 ± 30	85 ± 16	91 ± 21	58 ± 11
	MA	117 ± 42	111 ± 35	78 ± 20	108 ± 33	130 ± 46	96 ± 45	112 ± 33	114 ± 51	82 ± 26
VL M _{MAX} (mV)	YA	8.0 ± 1.3	7.8 ± 1.4	7.8 ± 1.2	7.9 ± 2.0	8.0 ± 2.3	7.5 ± 2.2	7.5 ± 1.7	8.0 ± 2.0	7.1 ± 1.6
	MA	6.1 ± 2.6	6.2 ± 2.9	6.4 ± 1.9	6.3 ± 2.9	6.0 ± 3.0	6.4 ± 2.9	5.9 ± 3.0	6.3 ± 2.7	6.1 ± 2.4
VM M _{MAX} (mV)	YA	10.4 ± 1.2	10.9 ± 0.3	10.9 ± 0.2	11.0 ± 0.2	10.2 ± 1.5	10.2 ± 1.7	10.4 ± 0.7	10.5 ± 0.5	10.5 ± 0.6
	MA	9.1 ± 2.3	9.0 ± 2.6	9.2 ± 2.3	9.1 ± 2.5	9.6 ± 2.0	10.0 ± 1.7	9.1 ± 3.2	10.3 ± 1.6	9.6 ± 2.2
RF M _{MAX} (mV)	YA	3.8 ± 1.5	3.1 ± 1.0	3.6 ± 1.3	3.6 ± 1.3	3.2 ± 1.0	3.3 ± 0.8	3.2 ± 1.0	3.4 ± 1.4	3.4 ± 1.2
	MA	3.1 ± 1.0	3.9 ± 1.6	3.5 ± 0.8	3.7 ± 1.3	3.5 ± 1.0	3.4 ± 1.2	3.5 ± 1.0	3.3 ± 1.1	3.4 ± 1.0

Data are expressed as mean ± SD. YA, young athletes; MA, master athletes; MViC, maximal voluntary contraction; QT_{SINGLE}, potentiated quadriceps twitch evoked with a single supramaximal electrical stimulation; VA, voluntary activation of the quadriceps; CT, contraction time; MRFD, maximal rate of force development, HRT, half relaxation time; VL M_{MAX}, VM M_{MAX}, RF M_{MAX}, maximal amplitude of the compound muscle action potential for the vastus lateralis, the vastus medialis and the rectus femoris, respectively; ILT₂, 2% of PI_{MAX} non fatiguing inspiratory loading task condition; ILT₆₀, 60% of PI_{MAX} fatiguing inspiratory loading task condition; ILT_{2 ISO}, same as ILT₂ but exercise was stopped when the same amount of work than the ILT₆₀ condition was reached .

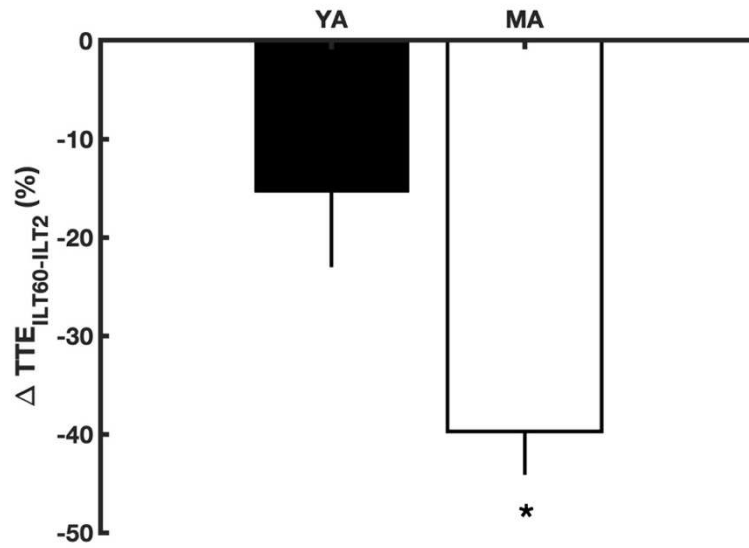

Figure 1. Time to exhaustion (TTE) decrease during CWT₉₀ after ILT₆₀ relative to ILT₂ in young athletes (YA, black) and master athletes (MA, white). Values are means \pm SD. *Significant effect of condition.

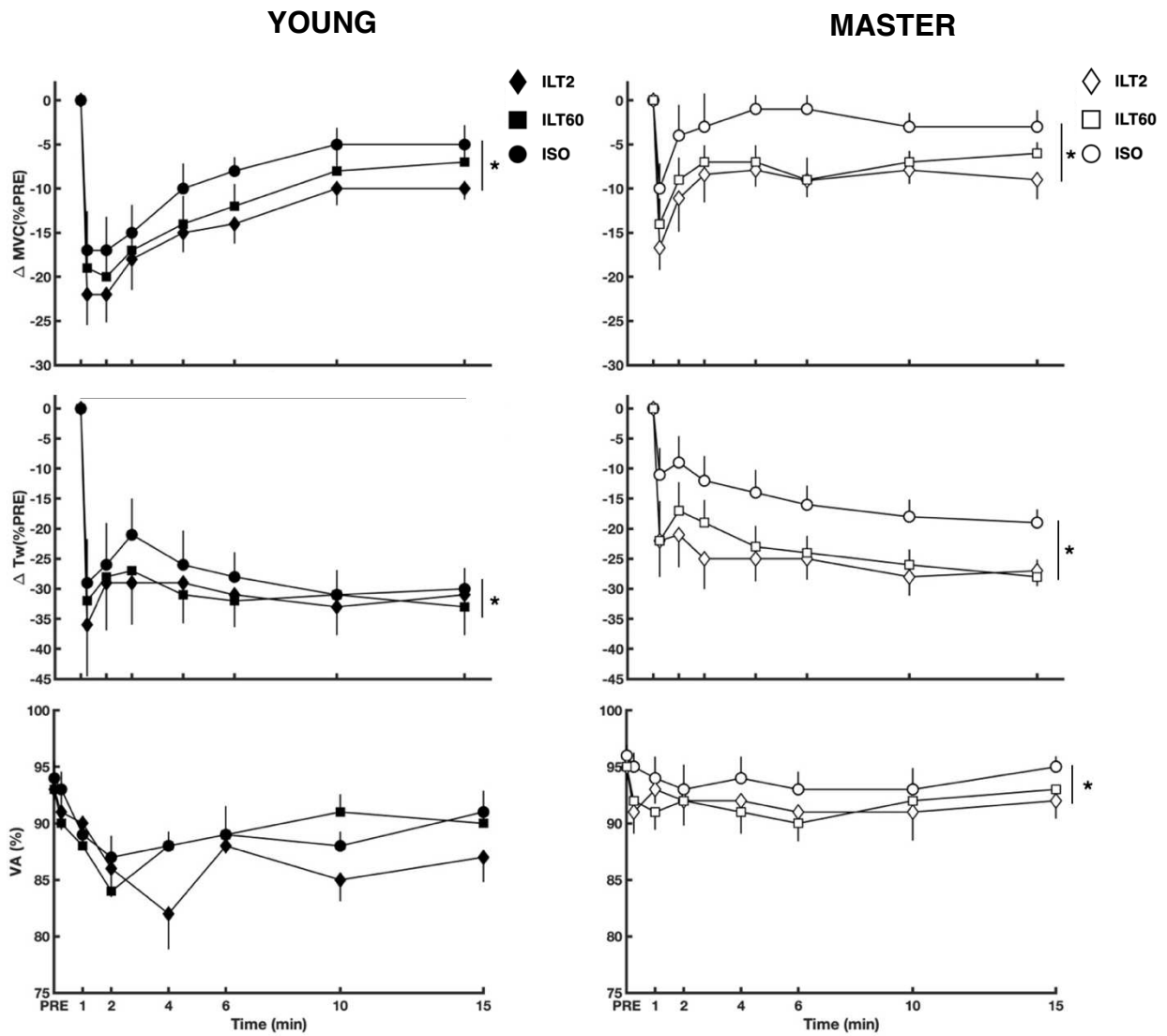

Figure 2. MVIC, QT_{SINGLE} and VA change from baseline in young athletes (YA, black) and master athletes (MA, white). Values are means \pm SEM. * Significant effect of condition.

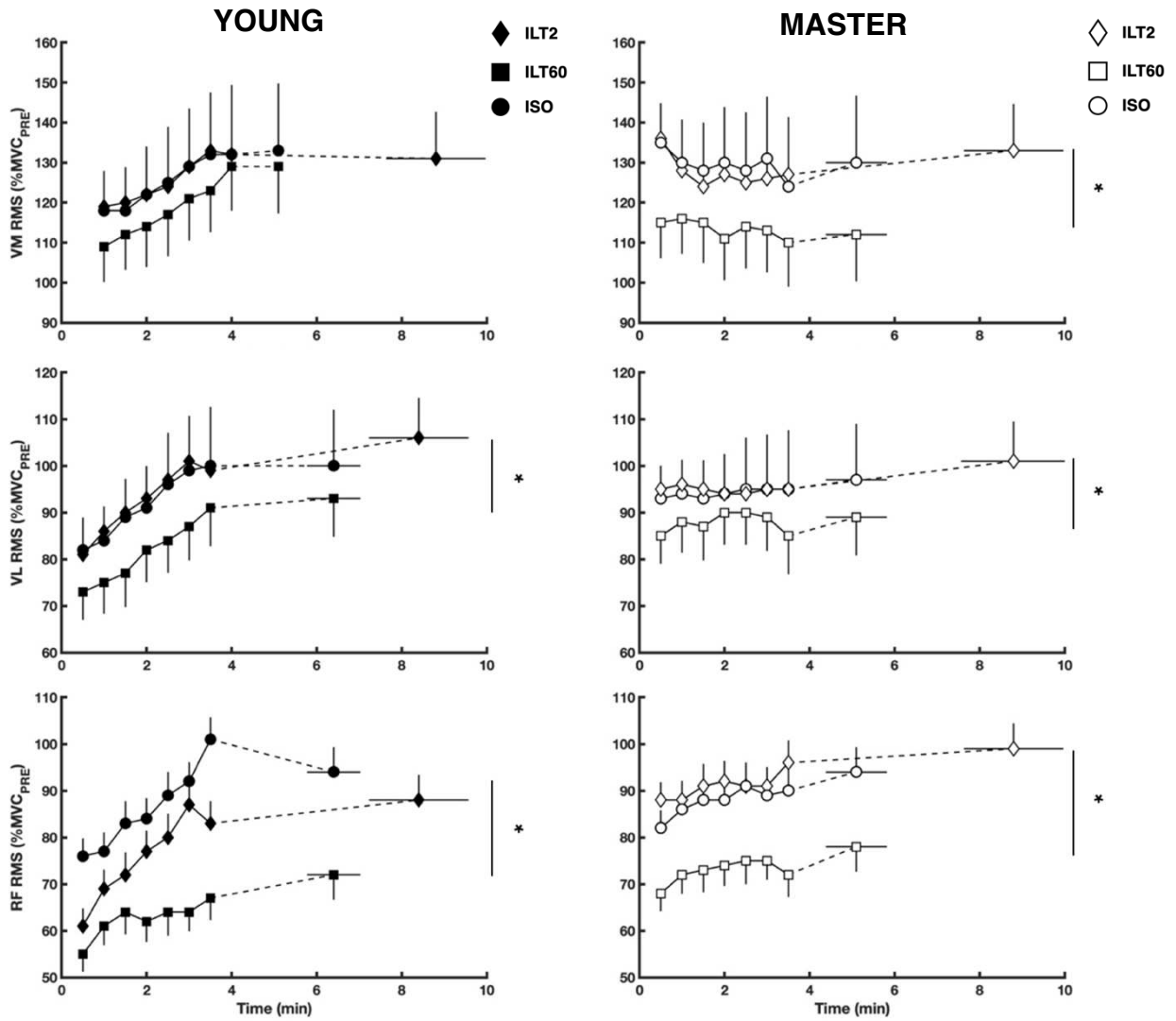

Figure 3. RMS of the vastus medialis, vastus lateralis and rectus femoris (%MVC) during CWT₉₀ in young athletes (YA, black) and master athletes (MA, white). Values are means \pm SEM. * Significant effect of condition.

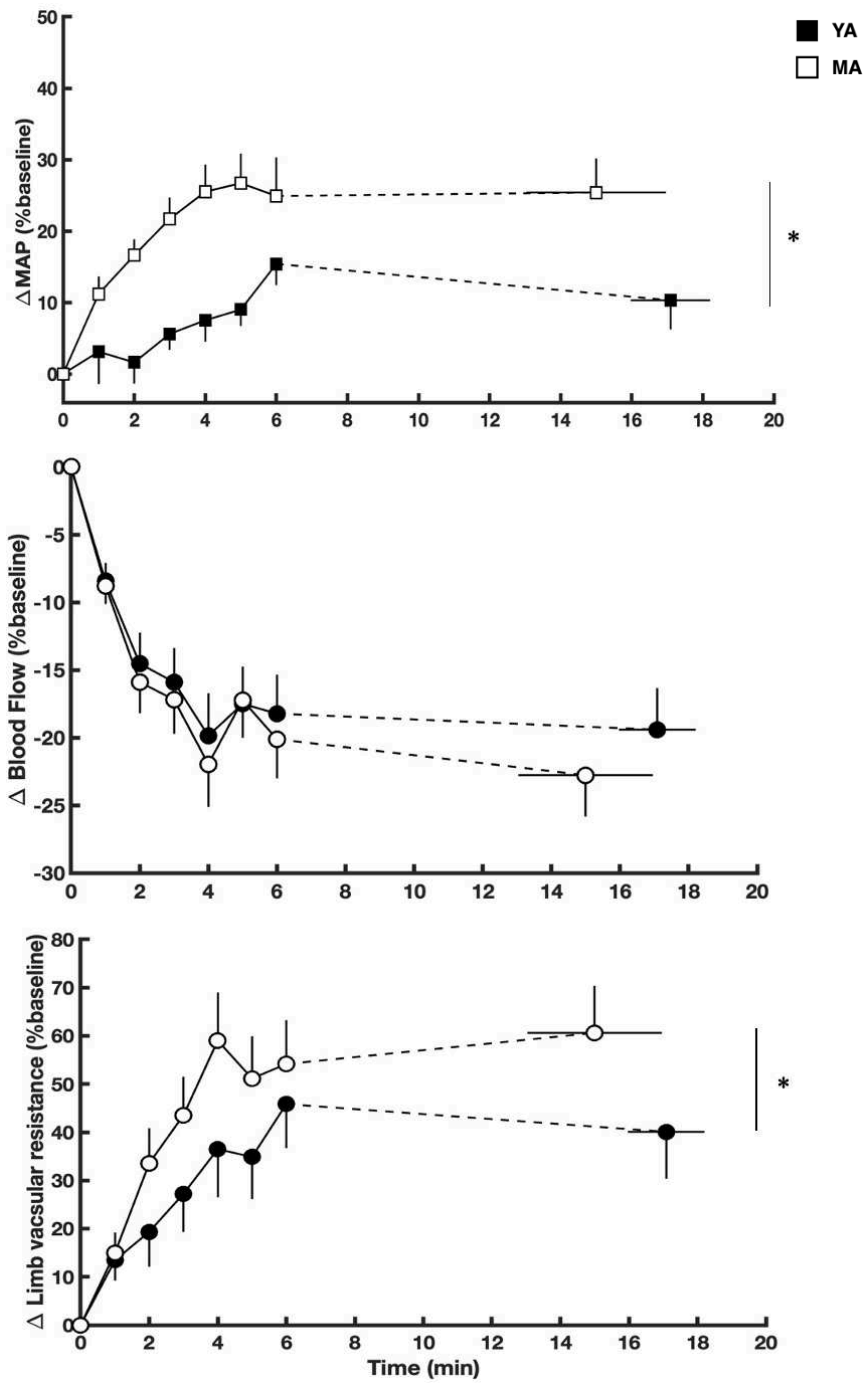

Figure 4. Cardiovascular system response to ILT_{60} in young athletes (YA, black) and master athletes (MA, white). Values are means \pm SEM. * Main effect of group.

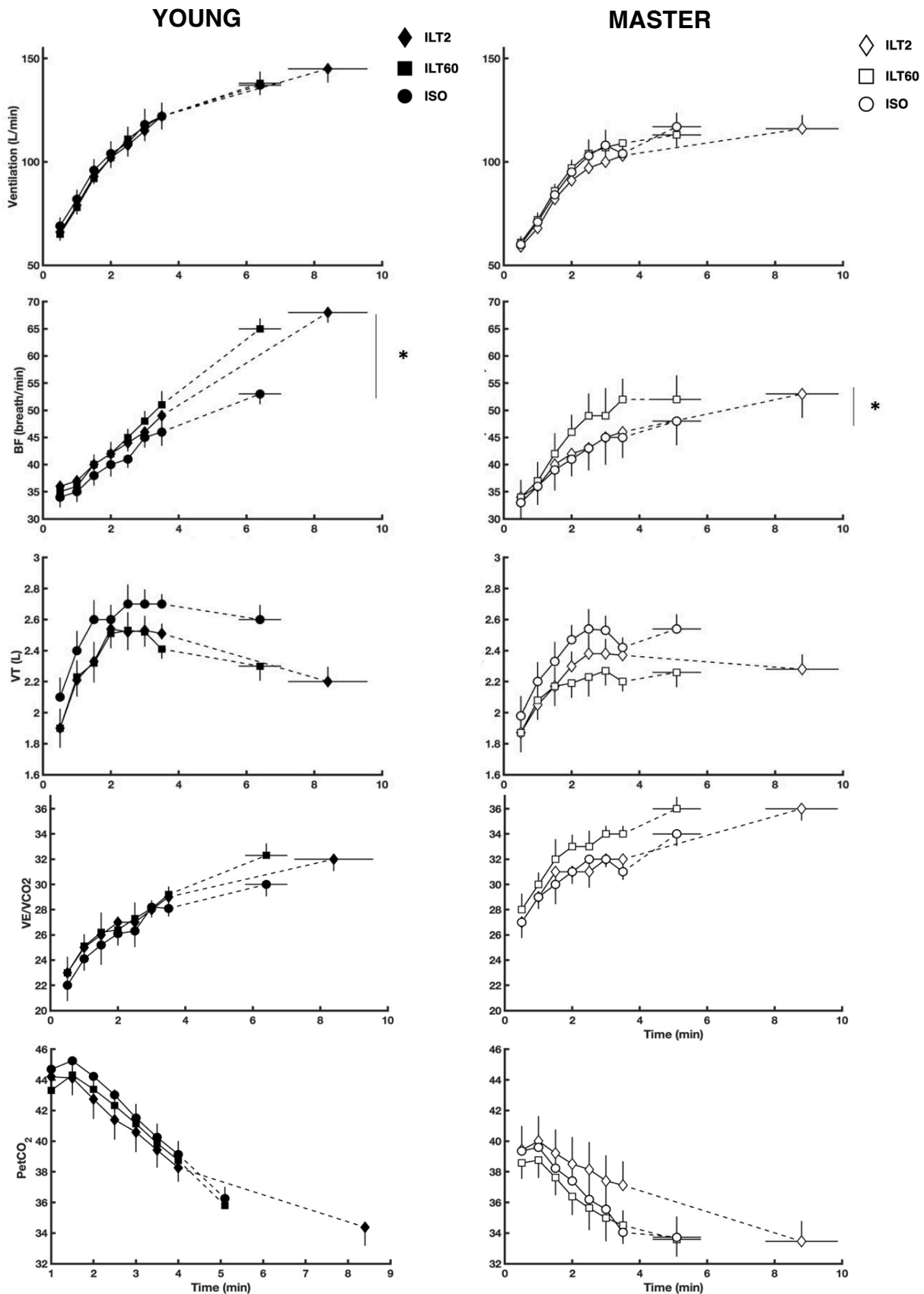

Figure 5. Ventilation, tidal volume (VT), breathing frequency (BF), ventilatory equivalent of carbon dioxide (VE/VCO₂) and P_{ET}CO₂ response during CWT₉₀ in young athletes (YA, black) and master athletes (MA, white). Values are means ± SEM. * Significant effect of condition.

REFERENCES

- Amann, M., Proctor, L.T., Sebranek, J.J., Pegelow, D.F., Dempsey, J.A., 2009. Opioid-mediated muscle afferents inhibit central motor drive and limit peripheral muscle fatigue development in humans: Intrathecal fentanyl and central motor drive. *The Journal of Physiology* 587, 271–283. <https://doi.org/10.1113/jphysiol.2008.163303>
- ATS/ERS Statement on Respiratory Muscle Testing, 2002. *Am J Respir Crit Care Med* 166, 518–624. <https://doi.org/10.1164/rccm.166.4.518>
- Babcock, M.C., DuBose, L.E., Witten, T.L., Brubaker, A., Stauffer, B.L., Hildreth, K.L., Moreau, K.L., 2021. Assessment of macrovascular and microvascular function in aging males. *Journal of Applied Physiology* 130, 96–103. <https://doi.org/10.1152/jappphysiol.00616.2020>
- Barclay, J.K., 1986. A delivery-independent blood flow effect on skeletal muscle fatigue. *Journal of Applied Physiology* 61, 1084–1090. <https://doi.org/10.1152/jappl.1986.61.3.1084>
- Blain, G.M., Mangum, T.S., Sidhu, S.K., Weavil, J.C., Hureau, T.J., Jessop, J.E., Bledsoe, A.D., Richardson, R.S., Amann, M., 2016. Group III/IV muscle afferents limit the intramuscular metabolic perturbation during whole body exercise in humans: Muscle afferents limit metabolic perturbation. *J Physiol* 594, 5303–5315. <https://doi.org/10.1113/JP272283>
- Cheitlin, M.D., 2003. Cardiovascular Physiology—Changes With Aging. *The American Journal of Geriatric Cardiology* 12, 9–13. <https://doi.org/10.1111/j.1076-7460.2003.01751.x>
- Croix, C.M., Morgan, B.J., Wetter, T.J., Dempsey, J.A., 2000. Fatiguing inspiratory muscle work causes reflex sympathetic activation in humans. *The Journal of Physiology* 529, 493–504. <https://doi.org/10.1111/j.1469-7793.2000.00493.x>
- Dempsey, J.A., McKenzie, D.C., Haverkamp, H.C., Eldridge, M.W., 2008. Update in the Understanding of Respiratory Limitations to Exercise Performance in Fit, Active Adults. *Chest* 134, 613–622. <https://doi.org/10.1378/chest.07-2730>
- Dempsey, J.A., Romer, L., Rodman, J., Miller, J., Smith, C., 2006. Consequences of exercise-induced respiratory muscle work. *Respiratory Physiology & Neurobiology* 151, 242–250. <https://doi.org/10.1016/j.resp.2005.12.015>
- Dempsey, J.A., Sheel, A.W., St. Croix, C.M., Morgan, B.J., 2002. Respiratory influences on sympathetic vasomotor outflow in humans. *Respiratory Physiology & Neurobiology* 130, 3–20. [https://doi.org/10.1016/S0034-5687\(01\)00327-9](https://doi.org/10.1016/S0034-5687(01)00327-9)
- Derchak, P.A., Sheel, A.W., Morgan, B.J., Dempsey, J.A., 2002. Effects of expiratory muscle work on muscle sympathetic nerve activity. *Journal of Applied Physiology* 92, 1539–1552. <https://doi.org/10.1152/jappphysiol.00790.2001>
- Dodd, S., Powers, S., Thompson, D., Landry, G., Lawler, J., 1989. Exercise Performance Following Intense, Short-Term Ventilatory Work. *Int J Sports Med* 10, 48–52. <https://doi.org/10.1055/s-2007-1024873>
- Fleg, J.L., Lakatta, E.G., 1988. Role of muscle loss in the age-associated reduction in VO₂ max. *Journal of Applied Physiology* 65, 1147–1151. <https://doi.org/10.1152/jappl.1988.65.3.1147>
- Fulton, T.J., Baranuskas, M.N., Paris, H.L., Kocejka, D.M., Mickleborough, T.D., Chapman, R.F., 2020. Respiratory Muscle Fatigue Alters Cycling Performance and Locomotor Muscle Fatigue. *Medicine & Science in Sports & Exercise* 52, 2380–2389. <https://doi.org/10.1249/MSS.0000000000002399>
- Gandevia, S.C., 2001. Spinal and Supraspinal Factors in Human Muscle Fatigue. *Physiological Reviews* 81, 1725–1789. <https://doi.org/10.1152/physrev.2001.81.4.1725>

- Geard, D., Reaburn, P.R.J., Rebar, A.L., Dionigi, R.A., 2017. Masters Athletes: Exemplars of Successful Aging? *Journal of Aging and Physical Activity* 25, 490–500. <https://doi.org/10.1123/japa.2016-0050>
- Hagberg, J.M., Yerg, J.E., Seals, D.R., 1988. Pulmonary function in young and older athletes and untrained men. *Journal of Applied Physiology* 65, 101–105. <https://doi.org/10.1152/jappl.1988.65.1.101>
- Harik-Khan, R.I., Wise, R.A., Fozard, J.L., 1998. Determinants of Maximal Inspiratory Pressure: The Baltimore Longitudinal Study of Aging. *Am J Respir Crit Care Med* 158, 1459–1464. <https://doi.org/10.1164/ajrccm.158.5.9712006>
- Harms, C.A., Babcock, M.A., McClaran, S.R., Pegelow, D.F., Nিকেle, G.A., Nelson, W.B., Dempsey, J.A., 1997. Respiratory muscle work compromises leg blood flow during maximal exercise. *Journal of Applied Physiology* 82, 1573–1583. <https://doi.org/10.1152/jappl.1997.82.5.1573>
- Harms, C.A., Wetter, T.J., St. Croix, C.M., Pegelow, D.F., Dempsey, J.A., 2000. Effects of respiratory muscle work on exercise performance. *Journal of Applied Physiology* 89, 131–138. <https://doi.org/10.1152/jappl.2000.89.1.131>
- Hogan, M.C., Gladden, L.B., Grassi, B., Stary, C.M., Samaja, M., 1998. Bioenergetics of contracting skeletal muscle after partial reduction of blood flow. *Journal of Applied Physiology* 84, 1882–1888. <https://doi.org/10.1152/jappl.1998.84.6.1882>
- Hureau, T.J., Weavil, J.C., Thurston, T.S., Wan, H.-Y., Gifford, J.R., Jessop, J.E., Buys, M.J., Richardson, R.S., Amann, M., 2019. Pharmacological attenuation of group III/IV muscle afferents improves endurance performance when oxygen delivery to locomotor muscles is preserved. *Journal of Applied Physiology* 127, 1257–1266. <https://doi.org/10.1152/japplphysiol.00490.2019>
- Johnson, B.D., Badr, M.S., Dempsey, J.A., 1994. IMPACT OF THE AGING PULMONARY SYSTEM ON THE RESPONSE TO EXERCISE. *Clinics in Chest Medicine* 15, 229–246. [https://doi.org/10.1016/S0272-5231\(21\)01070-4](https://doi.org/10.1016/S0272-5231(21)01070-4)
- Katayama, K., Amann, M., 2012. Respiratory muscle fatigue modulates the circulatory response to exercise. *JPFMS* 1, 523–530. <https://doi.org/10.7600/jpfs.1.523>
- Knudson, R.J., Clark, D.F., Kennedy, T.C., Knudson, D.E., 1977. Effect of aging alone on mechanical properties of the normal adult human lung. *Journal of Applied Physiology* 43, 1054–1062. <https://doi.org/10.1152/jappl.1977.43.6.1054>
- Leahy, M.G., Kipp, S., Benbaruj, J.M., Charkoudian, N., Foster, G.E., Koehle, M.S., Sheel, A.W., 2023. Effects of sex and ageing on the human respiratory muscle metaboreflex. *The Journal of Physiology* 601, 689–702. <https://doi.org/10.1113/JP283838>
- Lepers, R., Stapley, P.J., 2016. Master Athletes Are Extending the Limits of Human Endurance. *Front. Physiol.* 7. <https://doi.org/10.3389/fphys.2016.00613>
- Mador, M.J., Acevedo, F.A., 1991. Effect of respiratory muscle fatigue on subsequent exercise performance. *Journal of Applied Physiology* 70, 2059–2065. <https://doi.org/10.1152/jappl.1991.70.5.2059>
- Martin, B., Heintzelman, M., Chen, H.I., 1982. Exercise performance after ventilatory work. *Journal of Applied Physiology* 52, 1581–1585. <https://doi.org/10.1152/jappl.1982.52.6.1581>
- Mauroy, B., Filoche, M., Weibel, E.R., Sapoval, B., 2004. An optimal bronchial tree may be dangerous. *Nature* 427, 633–636. <https://doi.org/10.1038/nature02287>
- McClaran, S.R., Babcock, M.A., Pegelow, D.F., Reddan, W.G., Dempsey, J.A., 1995. Longitudinal effects of aging on lung function at rest and exercise in healthy active fit elderly adults. *Journal of Applied Physiology* 78, 1957–1968. <https://doi.org/10.1152/jappl.1995.78.5.1957>

- Molgat-Seon, Y., Dominelli, P.B., Guenette, J.A., Sheel, A.W., 2019. Modelling the effects of age and sex on the resistive and viscoelastic components of the work of breathing during exercise. *Exp Physiol* 104, 1737–1745. <https://doi.org/10.1113/EP087956>
- Myers, J., Kaminsky, L.A., Lima, R., Christle, J.W., Ashley, E., Arena, R., 2017. A Reference Equation for Normal Standards for VO₂ Max: Analysis from the Fitness Registry and the Importance of Exercise National Database (FRIEND Registry). *Progress in Cardiovascular Diseases* 60, 21–29. <https://doi.org/10.1016/j.pcad.2017.03.002>
- Peters, C.M., Welch, J.F., Dominelli, P.B., Molgat-Seon, Y., Romer, L.M., McKenzie, D.C., Sheel, A.W., 2017. Influence of inspiratory resistive loading on expiratory muscle fatigue in healthy humans. *Experimental Physiology* 102, 1221–1233. <https://doi.org/10.1113/EP086346>
- Quanjer, P.H., Stanojevic, S., Cole, T.J., Baur, X., Hall, G.L., Culver, B.H., Enright, P.L., Hankinson, J.L., Ip, M.S.M., Zheng, J., Stocks, J., the ERS Global Lung Function Initiative, 2012. Multi-ethnic reference values for spirometry for the 3–95-yr age range: the global lung function 2012 equations. *Eur Respir J* 40, 1324–1343. <https://doi.org/10.1183/09031936.00080312>
- Romer, L.M., Polkey, M.I., 2008. Exercise-induced respiratory muscle fatigue: implications for performance. *Journal of Applied Physiology* 104, 879–888. <https://doi.org/10.1152/jappphysiol.01157.2007>
- Sheel, A.W., Derchak, P.A., Morgan, B.J., Pegelow, D.F., Jacques, A.J., Dempsey, J.A., 2001. Fatiguing inspiratory muscle work causes reflex reduction in resting leg blood flow in humans. *The Journal of Physiology* 537, 277–289. <https://doi.org/10.1111/j.1469-7793.2001.0277k.x>
- Sliwinski, P., Yan, S., Gauthier, A.P., Macklem, P.T., 1996. Influence of global inspiratory muscle fatigue on breathing during exercise. *Journal of Applied Physiology* 80, 1270–1278. <https://doi.org/10.1152/jappl.1996.80.4.1270>
- Smith, J.R., Alexander, A.M., Hammer, S.M., Didier, K.D., Kurti, S.P., Broxterman, R.M., Barstow, T.J., Harms, C.A., 2017. Cardiovascular consequences of the inspiratory muscle metaboreflex: effects of age and sex. *American Journal of Physiology-Heart and Circulatory Physiology* 312, H1013–H1020. <https://doi.org/10.1152/ajpheart.00818.2016>
- Spengler, C.M., Knöpfli-Lenzin, C., Birchler, K., Trapletti, A., Boutellier, U., 2000. Breathing pattern and exercise endurance time after exhausting cycling or breathing. *European Journal of Applied Physiology* 81, 368–374. <https://doi.org/10.1007/s004210050056>
- Sylvester, K.P., Clayton, N., Cliff, I., Hepple, M., Kendrick, A., Kirkby, J., Miller, M., Moore, A., Rafferty, G.F., O'Reilly, L., Shakespeare, J., Smith, L., Watts, T., Bucknall, M., Butterfield, K., 2020. ARTP statement on pulmonary function testing 2020. *BMJ Open Resp Res* 7, e000575. <https://doi.org/10.1136/bmjresp-2020-000575>
- Tanaka, H., Tarumi, T., Rittweger, J., 2019. Aging and Physiological Lessons from Master Athletes, in: Terjung, R. (Ed.), *Comprehensive Physiology*. Wiley, pp. 261–296. <https://doi.org/10.1002/cphy.c180041>
- Taylor, B.J., Romer, L.M., 2008. Effect of expiratory muscle fatigue on exercise tolerance and locomotor muscle fatigue in healthy humans. *Journal of Applied Physiology* 104, 1442–1451. <https://doi.org/10.1152/jappphysiol.00428.2007>
- Verges, S., Sager, Y., Erni, C., Spengler, C.M., 2007. Expiratory muscle fatigue impairs exercise performance. *Eur J Appl Physiol* 101, 225–232. <https://doi.org/10.1007/s00421-007-0491-y>
- Welch, J.F., Archiza, B., Guenette, J.A., West, C.R., Sheel, A.W., 2018a. Effect of diaphragm fatigue on subsequent exercise tolerance in healthy men and women. *Journal of Applied Physiology* 125, 1987–1996. <https://doi.org/10.1152/jappphysiol.00630.2018>

- Welch, J.F., Archiza, B., Guenette, J.A., West, C.R., Sheel, A.W., 2018b. Sex differences in diaphragmatic fatigue: the cardiovascular response to inspiratory resistance: Sex differences in the inspiratory muscle metaboreflex. *J Physiol* 596, 4017–4032. <https://doi.org/10.1113/JP275794>
- Wüthrich, T.U., Notter, D.A., Spengler, C.M., 2013. Effect of inspiratory muscle fatigue on exercise performance taking into account the fatigue-induced excess respiratory drive: Prior-induced inspiratory muscle fatigue and performance. *Experimental Physiology* 98, 1705–1717. <https://doi.org/10.1113/expphysiol.2013.073635>

CHAPTER 3

GENERAL DISCUSSION

VENTILATORY SYSTEM LIMITATION IN MASTER ATHLETES

The healthy human ventilatory system is in many ways ideally structured and regulated to meet the demands imposed by physical exercise. However, there is now some evidence that it may not be so overbuilt. For example, for some individuals, an imbalance between ventilatory capacity and demand may occur and result in expiratory flow limitation (EFL) during exercise (Sheel and Romer, 2012). EFL may be particularly present during high-intensity exercise. This may concern more the elderly due to its reduced lung structure and respiratory muscle function. Among older individuals, it was suggested that master athletes, who combine very high O_2 and therefore ventilatory demand during exercise and reduced breathing capacity because of aging, were particularly susceptible to ventilatory limitations during exercise (Johnson et al., 1991b, 1991a).

The results of this PhD thesis support this idea and provide new evidence of the limiting role of the ventilatory system to exercise performance in master athletes. We mainly found that master athletes were more susceptible to EFL compared to young athletes, indicating that age, without the confounding effect of sedentary lifestyle, is an aggravating factor of breathing limitation during physical exercise. In addition, master athletes who experienced flow limitation had a greater $EFL_{SEVERITY}$ (i.e., greater expiratory tidal volume that reached or exceeded maximal expiratory flow volume) than young athletes. Similar results were found in a previous study comparing untrained young and older men with similar lung size, where $EFL_{SEVERITY}$ reached up to 82% in the elderly (Smith et al., 2017b). However, the authors acknowledged that they did not correct MEFV curves for gas compression which may explain such high levels of EFL. The contribution of aging to ventilatory limitation was also suggested when the effect of EFL was directly compared between young and older untrained women, with the latter experiencing a higher severity of flow limitation (Wilkie et al., 2012). Our findings of higher proportion of master athletes experiencing flow limitation across relative workloads when compared to younger athletes, extends these findings conducted on untrained individuals (Molgat-Seon et al., 2018). Indeed, because master athletes represent models of successful aging, we believe our results are mainly attributable to the effect of aging and not to other age-related confounding alteration of lifestyle, such as sedentarity. Nevertheless, it is important to acknowledge that the method we used to assess EFL, while widely used and validated, was not the gold-standard technique. The use of an invasive oesophageal balloon to measure transdiaphragmatic pressure and estimate the work of breathing would provide valuable complementary information on the mechanics of breathing in master athletes. While such

data have been obtained in untrained young and older men and women (Molgat-Seon et al., 2018; Molgat-Seon et al., 2019), the direct comparison with master athletes, who shall exhibit an exacerbated work due to their higher ventilation levels, would be very useful to further understand mechanical ventilatory constraints with aging. In the absence of such measurements, I can be kept in mind that mathematical modeling is a valuable tool to enhance our comprehension of the mechanisms to EFL. We did not find a greater likelihood for women or men to experience EFL when both young and old participants were grouped together, suggesting no direct effect of biological sex. Although our results are consistent with previous findings in untrained individuals (Molgat-Seon et al., 2022), anatomical and structural lung differences related to biological sex, such as smaller airways for a given lung size, were expected to significantly accentuate EFL in females athletes in the face of high ventilation flows during exercise (Guenette et al., 2007). However, the absence of biological sex effect on EFL was mainly due to the lower EFL occurrence and severity in young female athletes. With the natural reduction in the pulmonary function observed with age and the preserved O₂ and ventilation demands during exercise, we also expected master female athletes to be particularly vulnerable to EFL (Wilkie et al., 2012). We found that a 100% of our women master athletes experienced EFL with a substantial EFL_{SEVERITY} of 46%, thereby confirming this long-lasting hypothesis of increased propensity of EFL in this population. It is important to note that the higher fitness levels of our subjects must have played a significant role in these results because when untrained older women (~64 years) performed a maximal graded cycling exercise with similar method to ours, only 5 out of 8 participants (63%) experienced EFL and EFL_{SEVERITY} only reached 23% (Wilkie et al., 2012).

We also found a positive link between EFL_{SEVERITY} and the maximal expiratory flow volume curvilinearity (assessed with the slope ratio [SR] method). Using a linear regression analysis on 126 healthy participants, Molgat-Seon et al., (2022) showed that the SR was a determinant of EFL in healthy young individuals. Our findings extend these results by showing that reduced airway size, which is responsible for the concave shape of the MEFV curve, play a major role in expiratory flow limitation in endurance athletes and appears to be insensitive to long term endurance training. Moreover, smaller conducting airways show an increased resistance to airflow and tend to close under high transmural pressure (Junhasavasdikul et al., 2018). These phenomena are particularly significant in the active expiration phase of the respiratory cycle during physical exercise. Consequently, among individuals who demonstrate EFL during exercise, those with smaller airways tend to exhibit EFL at comparatively lower work rates than those with larger airways (Hopkins et al., 2004). Therefore, differences in airway size among individuals with similar lung volumes have been proposed as a determinant of EFL during exercise (Smith et al., 2014). The mismatch between

airway size and lung size is termed dysanapsis and can be non-invasively estimated using dysanapsis ratio (DR) (Mead, 1980) : $DR = \frac{FEF_{50}}{(FVC \times Pst(1)_{50\%})}$ where FVC corresponds to the forced vital capacity, FEF_{50} corresponds to the forced expiratory flow at 50% of FVC and $Pst(1)_{50\%}$ corresponds to static recoil pressure at 50% of FVC. $Pst(1)_{50\%}$ was estimated according to age and calculated using the following regression equation (Turner et al., 1968) : $Pst(1)_{50\%} = -0.056 \times \text{age} + 6.3038$. A low dysanapsis ratio, indicative of smaller airways size relative to lung size, is associated with an increase in the work of breathing (Dominelli et al., 2015) and a high incidence of EFL during exercise in healthy active young men and women (Dominelli et al., 2012; Smith et al., 2014). However, the impact of aging on dysanapsis is poorly documented. Considering that age induces a decline in lung elasticity and an increase in lung resistance to airflow (Janssens et al., 2005; Sheel et al., 2009), an older individual with a lower dysanapsis ratio might be more vulnerable to EFL. Understanding the influence of dysanapsis on EFL prevalence and severity during exercise in master athletes could thus provide valuable insights in understanding age-related ventilatory limitations during exercise.

In the first study, men master athletes showed the greater $EFL_{SEVERITY}$ (i.e., 52%) among all participants. We thus chose to investigate further the determinants of EFL in this group by determining the link between the DR and the severity of EFL. Our first sample was completed to achieve a sample of 20 male master athletes. To be able to interpret DR results, we had to compare individuals of similar FVC. Among the 20 male master athletes that were recruited, we found 11 subjects whose FVC was within a range of 0.8 L from 3.9 to 4.8 L. Further analysis of these 11 subjects revealed that their $EFL_{SEVERITY}$ was negatively correlated with DR (see Figure 1), indicating that participants with a lower DR exhibited a greater $EFL_{SEVERITY}$ ($r^2 = 0.38$, $p = 0.044$).

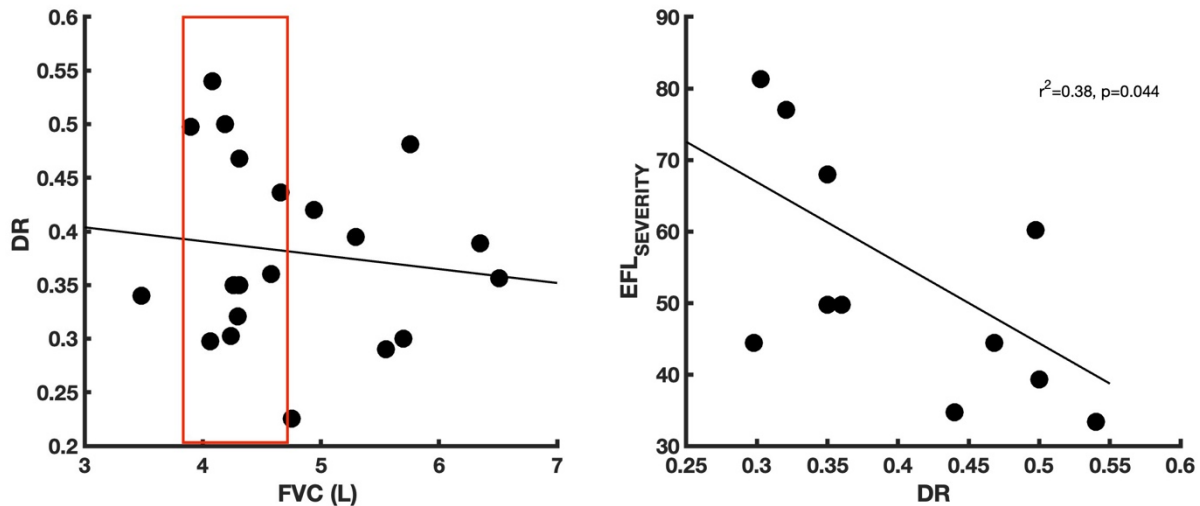

Figure 1. Correlation between dysanapsis ratio (DR) and forced vital capacity (FVC) for all male master athletes and between dysanapsis ratio (DR) and expiratory flow limitation (EFL) for subjects with similar FVC.

These findings suggest that individuals with disproportionately smaller airways relative to lung size (i.e., lower DR ratio) are more likely to experience a more severe EFL. Further investigation is needed to determine if DR is also related to EFL in young athletes and female master athletes who may have smaller airways relative to lung size than men (Sheel et al., 2016). An important methodological consideration of this study is that Pst(1)_{50%} values were estimated using the prediction equation developed by Turner et al. (Turner et al., 1968). We estimated Pst(1)_{50%} values because static recoil assessment is a challenging measure for subjects and requires the use of an invasive esophageal balloon.

Better understanding airflow resistance in the lungs of master athletes would contribute to elucidate the mechanisms of the accentuated exercise induced EFL with age. Indeed, Breathing a low-density gas mixture, such as helium (79 %) - oxygen (21%) (i.e., heliox, HeO₂), during intense exercise increases maximal expiratory airflow and thereby attenuates EFL (McClaran et al., 1999). An increase in minute ventilation can also be found with heliox but only in individuals who encountered EFL during exercise while breathing ambient air (McClaran et al., 1999). However, direct measurements of airways resistance across the bronchi generations cannot be assessed experimentally. Considering this limitation, we used a mathematical modeling approach, and we modified gas density and viscosity in a model of the lungs to determine how flow characteristics along with resistance distribution throughout the airways would be positively or negatively

impacted. While a modelling approach has been already used to understand the beneficial effects of heliox on the constricted airways of individuals with pathological conditions (Katz et al., 2011; Pozin et al., 2017) it is, to our knowledge, the first time that the estimated effect of heliox on expiratory flow from fluid mechanics in a compliant airway tree model were compared with experimental measurements in a healthy endurance trained aged population. Our approach enabled us to identify the physical mechanisms that explain expiratory flow pattern in the first 16 generations through an idealized lung. Heliox increased expiratory flow especially in the first airway generations and our modeling approach revealed that it corresponded to the area where the influence of inertial effects was dominant. The increase of expiratory flow was also achieved by decreasing flow turbulences through the reduction of Reynolds number and density-dependent resistance. Additionally, the simulation of varying reduction of airway size in our model show that heliox effect on expiratory flow may be enhanced in healthy older individuals because of their aging-induced smaller airways. Findings from our modeling approach help to better understand where the effect of density and viscosity are dominant in the lungs. The generation at which flow limitation occurs (i.e., site of airway collapse) could be deduced with further analysis if we know at which lung volume expiratory flow becomes limited. The latter information can be estimated by superimposing tidal flow volume curve on the MEFV curve as done in the first study. Therefore, comparing expiratory flow with air and heliox during exercise could aid to better understand the sites of constraints in the lungs across exercise work rates.

As mentioned above, EFL is associated with airway collapse. Previous modeling work (Mauroy et al., 2004) indicated that even a slight narrowing of the airways may cause a significant increase in the overall resistance of the lungs. For example, a 4% reduction in the ratio of diameter to length between successive bronchi generations would nearly double the resistance to airflow in the lungs (Mauroy et al., 2004). Therefore, airway collapse with EFL may result in a steep increase in the resistance of the whole bronchial tree thereby putting additional demand on the respiratory muscles. Considering that EFL occurs during high intensity exercise, the above-mentioned assumption coincides with the occurrence of respiratory muscle fatigue that was shown in endurance-trained men and women after a constant workload cycling test performed to exhaustion at an intensity of 90% of peak power output (Guenette et al., 2010). Therefore, EFL, which increases respiratory muscle work, may accentuate respiratory muscle fatigue. Considering our previous findings showing more prevalent and severe EFL in master athletes, we hypothesized that master athletes should be particularly susceptible to respiratory muscle fatigue during high-intensity exercise. Respiratory muscle fatigue is another phenomenon that would make the ventilatory

system a limiting factor to exercise performance in this population. However, very few data are available about respiratory muscles in the elderly and this matter required further investigation.

During our third study, we compared cardiovascular response to an inspiratory muscle fatiguing task in young vs. master and male vs. female athletes. Others (Smith et al., 2016; Welch et al., 2018) have demonstrated that young females have an attenuated increase in MAP and HR in response to high levels of inspiratory muscle work under resting conditions. The mechanisms to explain the different pressor response to respiratory muscle work seen in females vs. males has yet to be clearly identified but may be related, at least in part, to influences of female sex hormones that promote vasodilation. An increase in the sensitivity of vasodilatory β_2 -adrenergic receptors in young females has been attributed to the sympatho-inhibitory effects of oestrogen on the central nervous system and peripheral vasculature, thereby offsetting the activation of vasoconstricting α -adrenergic receptors (Joyner et al., 2016). The potential inhibitory effect is lost at menopause when circulating oestrogen levels decrease significantly (Hart et al., 2011; Barnes et al., 2014). The effects of oestrogen on the metaboreflex have been observed in humans performing isometric forearm exercise (Ettinger et al., 1998; Parmar et al., 2018) but its role with respect to the respiratory musculature is unknown. We aimed at investigating the effect of age and biological sex on the cardiovascular response to inspiratory muscle fatigue in athletes. 36 participants (8 YW, 10 YM, 8 OW and 10 MM) performed ILT_{60} following the same methodology as in the third study. Data are currently being analyzed but we already found a significant main effect of age ($p < 0.001$) for the increase in mean arterial pressure (see Figure 2).

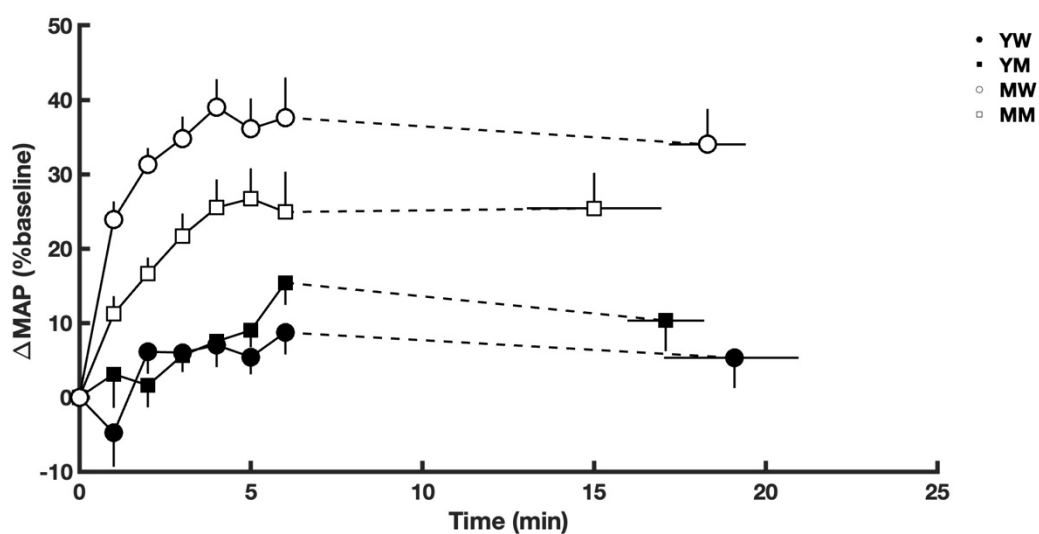

Figure 2. Mean arterial pressure (MAP) during ILT_{60} in young women (YW - ●), young men (YM - ■), master women (MW - ○), and master men (MM - ■).

Others previously reported a heightened blood pressure response to resistive, inspiratory muscle work in older men and post-menopausal as compared to young females (Leahy et al., 2023; Smith et al., 2017a). They also found that older males and females had comparable increases in MAP indicating that there is no effect of sex with healthy ageing. Our preliminary results of this study extend the results that were found in untrained individuals. The pressor response to high levels of respiratory muscle work seems augmented in master athletes compared to younger counterparts. From these observations it can be suggested that there are independent effects of chronological ageing and sex-hormones on the blood pressure response to respiratory muscles fatigue.

In men only, the third study of this thesis showed that inspiratory muscle fatigue caused a decrease in quadriceps muscle activation and accelerated the development of locomotor muscle fatigue which, ultimately, resulted in a lower exercise performance during the high-intensity exercise in both groups. Notably, the decrease of exercise performance was greater in master athletes. Taken together, these findings suggest that inspiratory muscle fatigue accelerated locomotor muscle fatigue to a greater extent in master athletes than in young athletes. We hypothesize that the higher level of quadriceps muscle fatigue we found after high intensity exercise with fatigued inspiratory muscles can be caused by the respiratory muscle metaboreflex summarized by Dempsey et al., (2006). Indeed, it was suggested that fatiguing inspiratory muscle contractions stimulate group III-IV muscle afferents and activate a sympathetically mediated vasoconstrictor activity in limb muscles, which causes an increase in vascular resistance (St Croix et al., 2000; Sheel et al., 2001). Limb muscle sympathetic nerve activity during concomitant cycling and resistive breathing was shown to be higher compared with control condition when no extra breathing work was imposed (Katayama et al., 2018; Katayama and Amann, 2012). Moreover, the greater muscle sympathetic nervous output remained present when the resistive respiratory muscle loading was stopped, which support the idea that induction of inspiratory muscle fatigue prior to exercise has the potential to substantially increase limb muscle sympathetic nervous output during exercise. In turn, the increase sympathetic nerve activity has been shown to reduce blood flow and O₂ delivery to limb muscles (Croix et al., 2000; Dempsey et al., 2006; Sheel et al., 2001). Although we did not measure blood flow or vascular resistance during exercise, they respectively decreased and increased during the inspiratory muscle fatiguing task at rest. Even small changes in blood flow to the contracting locomotor muscles substantially decrease their ability to generate muscle force (Barclay, 1986; Hureau et al., 2019) and these effects have been attributed to the reduction in O₂ delivery and in the washout of local metabolites (Barclay, 1986; Hureau et al., 2019). In the current study, although

we did not directly measure these variables, they may explain the faster development of fatigue we found following the inspiratory muscle fatiguing task.

FUTURE DIRECTIONS

This doctoral work opens new research perspectives related to healthy aging. Recent research has advanced our understanding of the effect of age and biological sex on the respiratory metaboreflex. Considering my keen interest in pursuing my training in respiratory physiology and my goal to become Maître de conférences in STAPS, I aim at pursuing a postdoctoral fellowship about the effect of respiratory metaboreflex on muscle sympathetic nerve activity in postmenopausal women. This project would be a logical continuation of my Ph.D. work and would be a valuable opportunity to extend my knowledge about on the neurovascular effects of the aging of the pulmonary system. Indeed, the decline of the cardiorespiratory system with age creates vulnerabilities and gives rise to new challenges in the pursuit of optimal health, especially in older women. As mentioned previously, the elevation of muscle sympathetic activity caused by inspiratory muscle fatigue leads to peripheral vasoconstriction and redirects blood flow towards the respiratory muscles, “stealing” flow from inactive territories and locomotor muscles, thereby accelerating fatigue development in the latter (Harms et al., 1997; Sheel et al., 2018). Additionally, the age-induced fall of estrogen levels in women affects vascular control and alters sympathetic nervous outflow, especially during exercise. As a result, postmenopausal women, are particularly vulnerable to exercise intolerance and cardiopulmonary diseases. However, it is not known how the combination of age-related decline of the respiratory function and changes to circulating hormones (i.e., menopause) impacts blood pressure regulation and the sympathetic response to exercise. Moreover, research that aimed at understanding the biology of aging suffers from a significant under-representation of female participants and is a major shortcoming of our understanding. Therefore, there is a great need to fully understand the impact of age-related changes to the respiratory system, how it influences blood pressure control and the sympathetic nervous system, and to identify the underlying mechanisms. During my PhD work we found that young women exhibited a smaller rise in arterial pressure than young men during a fatiguing inspiratory task. This difference may be attributed to the effects of estrogen on autonomic control (Joyner et al., 2014). However, this cardiovascular benefits in the young female athlete faded away in female master athletes. A privileged explanation lays in the influence of estrogen in mediating the cardiovascular response to the respiratory metaboreflex. Indeed, estrogen modulates the activity of β -adrenergic receptors, which induce vasodilatation and subsequent reduction in arterial pressure. Estrogen supplementation in postmenopausal females has been shown to lower the pressor response to isometric hand-grip

exercise (Fadel et al., 2004). Another method to lower this pressor response is to perform respiratory muscles training. This specific type of training has been shown to attenuate the increase of mean arterial pressure during an inspiratory loaded task (Witt et al., 2007). This intervention could be especially advantageous for elderly individuals, particularly older women who may no longer be protected by estrogen effects. Therefore, the aim of the proposed postdoctoral project would be to determine how circulating female hormones modulate sympathetic nerve activity and cardiovascular response during exercise and respiratory muscle fatigue in older women. Our overarching hypothesis are (i) postmenopausal women undergoing hormone replacement therapy would demonstrate a reduced sympathetic response to respiratory muscles fatigue compared to women with no hormone replacement therapy, (ii) respiratory muscle training would be more beneficial for postmenopausal women without than with hormone replacement therapy. Muscle sympathetic nerve activity would be measured via microneurography by inserting a tungsten microelectrode transcutaneously into the peroneal nerve. Transdiaphragmatic pressure would be measured by using cervical magnetic stimulation of the phrenic nerve and balloon- tipped catheters in the esophagus and the stomach. These techniques are commonly used in Canada and represent gold-standard measurements for muscle sympathetic neural activity and diaphragm fatigue. Therefore, a postdoctoral project about respiratory metaboreflex in postmenopausal women would provide a valuable chance to advance my training with very valuable skills.

CONCLUSION OF THE THESIS

The purpose of this PhD thesis was to determine if the ventilatory system was a limiting factor to exercise performance in master athletes.

Our findings indicate that age-related decline in lung function increases the likelihood of EFL in master athletes, with women being particularly vulnerable to such a limitation. Specifically, when comparing EFL between young and master athletes, men, and women, during a graded cycling exercise performed to exhaustion, we found that EFL in master athletes was both more frequent and more severe. This finding highlights the greater ventilatory constraint that master athletes must face during high-intensity exercise. These constraints and airflow limitation can be alleviated using heliox breathing which has recently been shown to increase exercise performance in male master athletes. Investigating the effect of this low-density gas on expiratory flow and airway resistance helped us better understand sites of constraints in the lungs of master athletes. This was performed by studying the effect of heliox on expiratory flow in an idealized modeled compliant airway tree. The model we used to investigate the physical mechanisms of heliox breathing, also indicated that the effect of this gas on expiratory flow may be enhanced in the elderly with age-induced smaller airways. These findings were obtained by combining experimental measurements with mathematical modeling and underscore the importance of considering the physical phenomena within the lung and conducting multidisciplinary research when investigating expiratory flow behavior in aging lungs.

Our research also suggests that fatigue of the inspiratory muscles has a significant impact on exercise performance in master athletes. We demonstrated that inspiratory muscle fatigue led to a substantial increase in limb vascular resistance, which was more prominent among master athletes as compared to young athletes. These findings led to an accelerated development of quadriceps fatigue during exercise and impaired exercise performance, which were also more pronounced for master athletes. Therefore, our findings provide evidence for an increased respiratory metaboreflex response to respiratory muscle fatigue in older adults.

Taken together, the findings of this PhD thesis showed that the ventilatory system can be a limiting factor during endurance exercise in master athletes. In a broader context, our data collected on master athletes, a model of successful aging, provide novel information regarding how aging impacts the respiratory response to exercise, as well as the underlying structural and functional mechanisms that mediate this response. A better comprehension of age-related alterations in the ventilatory system addresses a significant public health issue which is to distinguish the effects of healthy aging/senescence from those of disease or excess of sedentary behavior.

REFERENCES

- Aaker, A., Laughlin, M.H., 2002. Diaphragm arterioles are less responsive to $\alpha 1$ - adrenergic constriction than gastrocnemius arterioles. *Journal of Applied Physiology* 92, 1808–1816. <https://doi.org/10.1152/jappphysiol.01152.2001>
- Aaron, E.A., Seow, K.C., Johnson, B.D., Dempsey, J.A., 1992. Oxygen cost of exercise hyperpnea: implications for performance. *Journal of Applied Physiology* 72, 1818–1825. <https://doi.org/10.1152/jappl.1992.72.5.1818>
- Agostoni, E., Hyatt, R.E., 1986. Static Behavior of the Respiratory System, in: Terjung, R. (Ed.), *Comprehensive Physiology*. Wiley, pp. 113–130. <https://doi.org/10.1002/cphy.cp030309>
- Agostoni, E., Rahn, H., 1960. Abdominal and thoracic pressures at different lung volumes. *Journal of Applied Physiology* 15, 1087–1092. <https://doi.org/10.1152/jappl.1960.15.6.1087>
- Aliverti, A., 2008. Lung and chest wall mechanics during exercise: Effects of expiratory flow limitation. *Respiratory Physiology & Neurobiology* 163, 90–99. <https://doi.org/10.1016/j.resp.2008.07.025>
- Aliverti, A., Iandelli, I., Duranti, R., Cala, S.J., Kayser, B., Kelly, S., Misuri, G., Pedotti, A., Scano, G., Sliwinski, P., Yan, S., Macklem, P.T., 2002. Respiratory muscle dynamics and control during exercise with externally imposed expiratory flow limitation. *Journal of Applied Physiology* 92, 1953–1963. <https://doi.org/10.1152/jappphysiol.01222.2000>
- Allen, D.G., Lamb, G.D., Westerblad, H., 2008. Skeletal Muscle Fatigue: Cellular Mechanisms. *Physiological Reviews* 88, 287–332. <https://doi.org/10.1152/physrev.00015.2007>
- Allen, D.G., Westerblad, H., Lee, J.A., Lännergren, J., 1992. Role of Excitation-Contraction Coupling in Muscle Fatigue*. *Sports Medicine* 13, 116–126. <https://doi.org/10.2165/00007256-199213020-00007>
- Almeida, T.F., Roizenblatt, S., Tufik, S., 2004. Afferent pain pathways: a neuroanatomical review. *Brain Research* 1000, 40–56. <https://doi.org/10.1016/j.brainres.2003.10.073>
- Amann, M., Blain, G.M., Proctor, L.T., Sebranek, J.J., Pegelow, D.F., Dempsey, J.A., 2011. Implications of group III and IV muscle afferents for high-intensity endurance exercise performance in humans: Muscle afferents, peripheral fatigue and endurance exercise. *The Journal of Physiology* 589, 5299–5309. <https://doi.org/10.1113/jphysiol.2011.213769>
- Amann, M., Dempsey, J.A., 2008. Locomotor muscle fatigue modifies central motor drive in healthy humans and imposes a limitation to exercise performance: Locomotor muscle fatigue and exercise performance. *The Journal of Physiology* 586, 161–173. <https://doi.org/10.1113/jphysiol.2007.141838>
- Amann, M., Eldridge, M.W., Lovering, A.T., Stickland, M.K., Pegelow, D.F., Dempsey, J.A., 2006. Arterial oxygenation influences central motor output and exercise performance via effects on peripheral locomotor muscle fatigue in humans. *The Journal of Physiology* 575, 937–952. <https://doi.org/10.1113/jphysiol.2006.113936>
- Amann, M., Proctor, L.T., Sebranek, J.J., Pegelow, D.F., Dempsey, J.A., 2009. Opioid-mediated muscle afferents inhibit central motor drive and limit peripheral muscle fatigue development in humans: Intrathecal fentanyl and central motor drive. *The Journal of Physiology* 587, 271–283. <https://doi.org/10.1113/jphysiol.2008.163303>
- Amann, M., Wan, H.-Y., Thurston, T.S., Georgescu, V.P., Weavil, J.C., 2020. On the Influence of Group III/IV Muscle Afferent Feedback on Endurance Exercise Performance. *Exercise and Sport Sciences Reviews* 48, 209–216. <https://doi.org/10.1249/JES.0000000000000233>
- Archiza, B., Welch, J.F., Geary, C.M., Allen, G.P., Borghi-Silva, A., Sheel, A.W., 2018. Temporal characteristics of exercise-induced diaphragmatic fatigue. *Journal of Applied Physiology* 124, 906–914. <https://doi.org/10.1152/jappphysiol.00942.2017>
- Asmussen, E., Johansen, S.H., Jorgensen, M., Nielsen, M., 1965. ON THE NERVOUS FACTORS CONTROLLING RESPIRATION AND CIRCULATION DURING EXERCISE. EXPERIMENTS WITH CURARIZATION. *Acta Physiol Scand* 63, 343–350. <https://doi.org/10.1111/j.1748-1716.1965.tb04073.x>

Asmussen, E., Nielsen, M., 1960. Alveolo-Arterial Gas Exchange at Rest and During Work at Different O₂ Tensions. *Acta Physiologica Scandinavica* 50, 153–166.
<https://doi.org/10.1111/j.1748-1716.1960.tb02086.x>

Atkinson, B., Brocklebank, M.P., Card, C.C.H., Smith, J.M., 1969. Low Reynolds number developing flows. *AIChE J.* 15, 548–553.
<https://doi.org/10.1002/aic.690150414>

ATS/ERS Statement on Respiratory Muscle Testing, 2002. *Am J Respir Crit Care Med* 166, 518–624. <https://doi.org/10.1164/rccm.166.4.518>

Babb, T.G., 2013. Exercise Ventilatory Limitation: The Role of Expiratory Flow Limitation 41.

Babb, T.G., Rodarte, J.R., 1991. Lung volumes during low-intensity steady-state cycling. *Journal of Applied Physiology* 70, 934–937.
<https://doi.org/10.1152/jappl.1991.70.2.934>

Babcock, M.A., Pegelow, D.F., Harms, C.A., Dempsey, J.A., 2002. Effects of respiratory muscle unloading on exercise-induced diaphragm fatigue. *J Appl Physiol* 93.

Babcock, M.A., Pegelow, D.F., McClaran, S.R., Suman, O.E., Dempsey, J.A., 1995. Contribution of diaphragmatic power output to exercise-induced diaphragm fatigue. *Journal of Applied Physiology* 78, 1710–1719.
<https://doi.org/10.1152/jappl.1995.78.5.1710>

Bachasson, D., Decorte, N., Wuyam, B., Millet, G.Y., Verges, S., 2016. Original Research: Central and peripheral quadriceps fatigue in young and middle-aged untrained and endurance-trained men: A comparative study. *Exp Biol Med (Maywood)* 241, 1844–1852.
<https://doi.org/10.1177/1535370216654225>

Bachofen, H., Hobi, H.J., Scherrer, M., 1973. Alveolar-arterial N₂ gradients at rest and during exercise in healthy men of different ages. *Journal of Applied Physiology* 34, 137–142.
<https://doi.org/10.1152/jappl.1973.34.2.137>

Banker, B.Q., Kelly, S.S., Robbins, N., 1983. Neuromuscular transmission and correlative morphology in young and old mice. *The Journal of Physiology* 339, 355–377.
<https://doi.org/10.1113/jphysiol.1983.sp014721>

Barclay, J.K., 1986. A delivery-independent blood flow effect on skeletal muscle fatigue. *Journal*

of Applied Physiology 61, 1084–1090.
<https://doi.org/10.1152/jappl.1986.61.3.1084>

Bates, J.H.T., 2009. *Lung Mechanics, An Inverse Modeling Approach*, Cambridge University Press. ed.

Bates, J.H.T., Lutchen, K.R., 2005. The interface between measurement and modeling of peripheral lung mechanics. *Respiratory Physiology & Neurobiology* 148, 153–164.
<https://doi.org/10.1016/j.resp.2005.04.021>

Baydur, A., 2012. Expiratory Flow Limitation in Obstructive Sleep Apnea and COPD: A Quantitative Method to Detect Pattern Differences Using the Negative Expiratory Pressure Technique. *TORMJ* 6, 111–120.
<https://doi.org/10.2174/1874306401206010111>

Bellemare, F., Bigland-Ritchie, B., 1984. Assessment of human diaphragm strength and activation using phrenic nerve stimulation. *Respiration Physiology* 58, 263–277.
[https://doi.org/10.1016/0034-5687\(84\)90003-3](https://doi.org/10.1016/0034-5687(84)90003-3)

Bellemare, F., Garzaniti, N., 1988. Failure of neuromuscular propagation during human maximal voluntary contraction. *Journal of Applied Physiology* 64, 1084–1093.
<https://doi.org/10.1152/jappl.1988.64.3.1084>

Bellemare, F., Woods, J.J., Johansson, R., Bigland-Ritchie, B., 1983. Motor-unit discharge rates in maximal voluntary contractions of three human muscles. *Journal of Neurophysiology* 50, 1380–1392.
<https://doi.org/10.1152/jn.1983.50.6.1380>

Bigland-Ritchie, B., 1981. EMG and Fatigue of Human Voluntary and Stimulated Contractions, in: Porter, R., Whelan, J. (Eds.), *Novartis Foundation Symposia*. Wiley, pp. 130–156.
<https://doi.org/10.1002/9780470715420.ch9>

Bigland-Ritchie, B., Furbush, F., Woods, J.J., 1986. Fatigue of intermittent submaximal voluntary contractions: central and peripheral factors. *Journal of Applied Physiology* 61, 421–429.
<https://doi.org/10.1152/jappl.1986.61.2.421>

Bigland-Ritchie, B., Jones, D.A., Woods, J.J., 1979. Excitation frequency and muscle fatigue: Electrical responses during human voluntary and stimulated contractions. *Experimental Neurology* 64, 414–427. [https://doi.org/10.1016/0014-4886\(79\)90280-2](https://doi.org/10.1016/0014-4886(79)90280-2)

Bigland-Ritchie, B., Woods, J.J., 1984. Changes in muscle contractile properties and neural

control during human muscular fatigue. *Muscle and Nerve* 7, 691–699.
<https://doi.org/10.1002/mus.880070902>

Bigland-Ritchie, B.R., Furbush, F.H., Gandevia, S.C., Thomas, C.K., 1992. Voluntary discharge frequencies of human motoneurons at different muscle lengths. *Muscle and Nerve* 15, 130–137. <https://doi.org/10.1002/mus.880150203>

Black, L.F., Hyatt, R.E., 1969. Maximal respiratory pressures: normal values and relationship to age and sex 99, 696–702.
<https://doi.org/10.1164/arrd.1969.99.5.696>

Blain, G.M., Mangum, T.S., Sidhu, S.K., Weavil, J.C., Hureau, T.J., Jessop, J.E., Bledsoe, A.D., Richardson, R.S., Amann, M., 2016. Group III/IV muscle afferents limit the intramuscular metabolic perturbation during whole body exercise in humans: Muscle afferents limit metabolic perturbation. *J Physiol* 594, 5303–5315.
<https://doi.org/10.1113/JP272283>

Blain, G.M., Smith, C.A., Henderson, K.S., Dempsey, J.A., 2010. Peripheral chemoreceptors determine the respiratory sensitivity of central chemoreceptors to CO₂: Peripheral-central chemoreceptor interdependence. *The Journal of Physiology* 588, 2455–2471.
<https://doi.org/10.1113/jphysiol.2010.187211>

Booth, F.W., Thomason, D.B., 1991. Molecular and cellular adaptation of muscle in response to exercise: perspectives of various models 71, 541–585.
<https://doi.org/10.1152/physrev.1991.71.2.541>

Boucllin, R., Charbonneau, E., Renaud, J.M., 1995. Na⁺ and K⁺ effect on contractility of frog sartorius muscle: implication for the mechanism of fatigue. *American Journal of Physiology-Cell Physiology* 268, C1528–C1536.
<https://doi.org/10.1152/ajpcell.1995.268.6.C1528>

Brighenti, C., Barbini, P., Gnudi, G., Cevenini, G., Pecchiari, M., D'Angelo, E., 2007. Helium–oxygen ventilation in the presence of expiratory flow-limitation: A model study. *Respiratory Physiology & Neurobiology* 157, 326–334. <https://doi.org/10.1016/j.resp.2006.12.012>

Brisswalter, J., Nosaka, K., 2013. Neuromuscular Factors Associated with Decline in Long-Distance Running Performance in Master Athletes. *Sports Med* 43, 51–63.
<https://doi.org/10.1007/s40279-012-0006-9>

Burnley, M., Vanhatalo, A., Fulford, J., Jones, A.M., 2010. Similar metabolic perturbations during all-out and constant force exhaustive exercise in humans: a ³¹P magnetic resonance spectroscopy study: Muscle metabolism, maximal and exhaustive exercise. *Experimental Physiology* 95, 798–807.
<https://doi.org/10.1113/expphysiol.2010.052688>

Butler-Browne, G., Bigard, A.-X., 2006. Caractéristiques du vieillissement musculaire et effets préventifs de l'exercice régulier. *Science & Sports* 21, 184–193.
<https://doi.org/10.1016/j.scispo.2006.03.005>

Cairns, S.P., Hing, W.A., Slack, J.R., Mills, R.G., Loiselle, D.S., 1997. Different effects of raised [K⁺]_o on membrane potential and contraction in mouse fast- and slow-twitch muscle. *American Journal of Physiology-Cell Physiology* 273, C598–C611.
<https://doi.org/10.1152/ajpcell.1997.273.2.C598>

Cairns, S.P., Taberner, A.J., Loiselle, D.S., 2009. Changes of surface and t-tubular membrane excitability during fatigue with repeated tetani in isolated mouse fast- and slow-twitch muscle. *Journal of Applied Physiology* 106, 101–112.
<https://doi.org/10.1152/jappphysiol.90878.2008>

Campbell, M.J., McComas, A.J., Petito, F., 1973. Physiological changes in ageing muscles. *Journal of Neurology, Neurosurgery & Psychiatry* 36, 174–182. <https://doi.org/10.1136/jnnp.36.2.174>

Casaburi, R., Barstow, T.J., Robinson, T., Wasserman, K., 1989. Influence of work rate on ventilatory and gas exchange kinetics. *Journal of Applied Physiology* 67, 547–555.
<https://doi.org/10.1152/jappl.1989.67.2.547>

Cheitlin, M.D., 2003. Cardiovascular Physiology—Changes With Aging. *The American Journal of Geriatric Cardiology* 12, 9–13.
<https://doi.org/10.1111/j.1076-7460.2003.01751.x>

Cheng, Y.J., 2003. Effects of physical activity on exercise tests and respiratory function. *British Journal of Sports Medicine* 37, 521–528.
<https://doi.org/10.1136/bjism.37.6.521>

Chidnok, W., DiMenna, F.J., Fulford, J., Bailey, S.J., Skiba, P.F., Vanhatalo, A., Jones, A.M., 2013. Muscle metabolic responses during high-intensity intermittent exercise measured by ³¹P-MRS: relationship to the critical power concept. *American Journal of Physiology-Regulatory, Integrative and Comparative Physiology* 305, R1085–R1092. <https://doi.org/10.1152/ajpregu.00406.2013>

Chilibeck, P.D., McCreary, C.R., Marsh, G.D., Paterson, D.H., Noble, E.G., Taylor, A.W., Thompson, R.T., 1998. Evaluation of muscle oxidative potential by 31 P-MRS during incremental exercise in old and young humans. *European Journal of Applied Physiology* 78, 460–465. <https://doi.org/10.1007/s004210050446>

Chin, E.R., Allen, D.G., 1996. The role of elevations in intracellular [Ca²⁺] in the development of low frequency fatigue in mouse single muscle fibres. *The Journal of Physiology* 491, 813–824. <https://doi.org/10.1113/jphysiol.1996.sp021259>

Christensen, K., Doblhammer, G., Rau, R., Vaupel, J.W., 2009. Ageing populations: the challenges ahead 374.

Christou, S., Chatziathanasiou, T., Angeli, S., Koullapis, P., Stylianou, F., Sznitman, J., Guo, H.H., Kassinos, S.C., 2021. Anatomical variability in the upper tracheobronchial tree: sex-based differences and implications for personalized inhalation therapies. *Journal of Applied Physiology* 130, 678–707. <https://doi.org/10.1152/jappphysiol.00144.2020>

Coggan, A.R., Abduljalil, A.M., Swanson, S.C., Earle, M.S., Farris, J.W., Mendenhall, L.A., Robitaille, P.M., 1993. Muscle metabolism during exercise in young and older untrained and endurance-trained men. *Journal of Applied Physiology* 75, 2125–2133. <https://doi.org/10.1152/jappl.1993.75.5.2125>

Coggan, A.R., Spina, R.J., Rogers, M.A., King, D.S., Brown, M., Nemeth, P.M., Holloszy, J.O., 1990. Histochemical and enzymatic characteristics of skeletal muscle in master athletes. *Journal of Applied Physiology* 68, 1896–1901. <https://doi.org/10.1152/jappl.1990.68.5.1896>

Coote, J.H., Hilton, S.M., Perez-Gonzalez, J.F., 1971. The reflex nature of the pressor response to muscular exercise. *The Journal of Physiology* 215, 789–804. <https://doi.org/10.1113/jphysiol.1971.sp009498>

Cosco, T.D., Howse, K., Brayne, C., 2017. Healthy ageing, resilience and wellbeing. *Epidemiol Psychiatr Sci* 26, 579–583. <https://doi.org/10.1017/S2045796017000324>

Cox, K.R., Smith, J.R., Luden, N.D., Saunders, M.J., Kurti, S.P., 2020. The Prevalence of Expiratory Flow Limitation in Youth Elite Male Cyclists. *Medicine & Science in Sports & Exercise* 52, 1933–1939. <https://doi.org/10.1249/MSS.0000000000002325>

Craig, A.D. (Bud), 1995. Distribution of brainstem projections from spinal lamina I neurons in the cat and the monkey. *J. Comp. Neurol.* 361, 225–248. <https://doi.org/10.1002/cne.903610204>

Croix, C.M., Morgan, B.J., Wetter, T.J., Dempsey, J.A., 2000. Fatiguing inspiratory muscle work causes reflex sympathetic activation in humans. *The Journal of Physiology* 529, 493–504. <https://doi.org/10.1111/j.1469-7793.2000.00493.x>

D'Angelo, E., Santus, P., Civitillo, M.F., Centanni, S., Pecchiari, M., 2009. Expiratory flow-limitation and heliox breathing in resting and exercising COPD patients. *Respiratory Physiology & Neurobiology* 169, 291–296. <https://doi.org/10.1016/j.resp.2009.09.009>

De Luca, C.J., Van Dyk, E.J., 1975. Derivation of some parameters of myoelectric signals recorded during sustained constant force isometric contractions. *Biophysical Journal* 15, 1167–1180. [https://doi.org/10.1016/S0006-3495\(75\)85893-0](https://doi.org/10.1016/S0006-3495(75)85893-0)

Decorte, N., Lafaix, P.A., Millet, G.Y., Wuyam, B., Verges, S., 2012. Central and peripheral fatigue kinetics during exhaustive constant-load cycling: Kinetics of neuromuscular fatigue development. *Scandinavian Journal of Medicine & Science in Sports* 22, 381–391. <https://doi.org/10.1111/j.1600-0838.2010.01167.x>

Delliaux, S., Brerro-Saby, C., Steinberg, J.G., Jammes, Y., 2009. Reactive oxygen species activate the group IV muscle afferents in resting and exercising muscle in rats. *Pflugers Arch - Eur J Physiol* 459, 143–150. <https://doi.org/10.1007/s00424-009-0713-8>

DeLorey, D.S., Babb, T.G., 1999. Progressive Mechanical Ventilatory Constraints with Aging. *Am J Respir Crit Care Med* 160, 169–177. <https://doi.org/10.1164/ajrccm.160.1.9807045>

Dempsey, J.A., 2006. Challenges for Future Research in Exercise Physiology as Applied to the Respiratory System: Exercise and Sport Sciences Reviews 34, 92–98. <https://doi.org/10.1249/00003677-200607000-00002>

Dempsey, J.A., 1986. J.B. Wolffe Memorial Lecture. Is the lung built for exercise? *MSSE* 18, 143–155.

Dempsey, J.A., Amann, M., Romer, L.M., Miller, J.D., 2008a. Respiratory System Determinants of Peripheral Fatigue and Endurance Performance. *Medicine & Science in Sports & Exercise* 40, 457–

461.

<https://doi.org/10.1249/MSS.0b013e31815f8957>

Dempsey, J.A., Babcock, M.A., 1995. An Integrative View of Limitations to Muscular Performance, in: Gandevia, S.C., Enoka, R.M., McComas, A.J., Stuart, D.G., Thomas, C.K., Pierce, P.A. (Eds.), *Fatigue, Advances in Experimental Medicine and Biology*. Springer US, Boston, MA, pp. 393–399. https://doi.org/10.1007/978-1-4899-1016-5_31

Dempsey, J.A., Jacques, A.J., 2015. Respiratory System Response to Exercise in Health, in: *Fishman's Pulmonary Diseases and Disorders*, McGraw Hill.

Dempsey, J.A., La Gerche, A., Hull, J.H., 2020. Is the healthy respiratory system built just right, overbuilt, or underbuilt to meet the demands imposed by exercise? *Journal of Applied Physiology* 129, 1235–1256. <https://doi.org/10.1152/jappphysiol.00444.2020>

Dempsey, J.A., McKenzie, D.C., Haverkamp, H.C., Eldridge, M.W., 2008b. Update in the Understanding of Respiratory Limitations to Exercise Performance in Fit, Active Adults. *Chest* 134, 613–622. <https://doi.org/10.1378/chest.07-2730>

Dempsey, J.A., Romer, L., Rodman, J., Miller, J., Smith, C., 2006. Consequences of exercise-induced respiratory muscle work. *Respiratory Physiology & Neurobiology* 151, 242–250. <https://doi.org/10.1016/j.resp.2005.12.015>

Dempsey, J.A., Sheel, A.W., St. Croix, C.M., Morgan, B.J., 2002. Respiratory influences on sympathetic vasomotor outflow in humans. *Respiratory Physiology & Neurobiology* 130, 3–20. [https://doi.org/10.1016/S0034-5687\(01\)00327-9](https://doi.org/10.1016/S0034-5687(01)00327-9)

Derchak, P.A., Sheel, A.W., Morgan, B.J., Dempsey, J.A., 2002. Effects of expiratory muscle work on muscle sympathetic nerve activity. *Journal of Applied Physiology* 92, 1539–1552. <https://doi.org/10.1152/jappphysiol.00790.2001>

Derchak, P.A., Stager, J.M., Tanner, D.A., Chapman, R.F., 2000. Expiratory flow limitation confounds ventilatory response during exercise in athletes: *Medicine & Science in Sports & Exercise* 32, 1873–1879. <https://doi.org/10.1097/00005768-200011000-00009>

Desaphy, J., Dipalma, A., Costanza, T., Bruno, C., Lentini, G., Franchini, C., George, A., Conte Camerino, D., 2010. Molecular determinants

of state-dependent block of voltage-gated sodium channels by pilsicainide. *British J Pharmacology* 160, 1521–1533. <https://doi.org/10.1111/j.1476-5381.2010.00816.x>

Dimitrijevic, M.R., Gerasimenko, Y., Pinter, M.M., 1998. Evidence for a Spinal Central Pattern Generator in Humans a. *Annals of the New York Academy of Sciences* 860, 360–376. <https://doi.org/10.1111/j.1749-6632.1998.tb09062.x>

Dodd, S., Powers, S., Thompson, D., Landry, G., Lawler, J., 1989. Exercise Performance Following Intense, Short-Term Ventilatory Work. *Int J Sports Med* 10, 48–52. <https://doi.org/10.1055/s-2007-1024873>

Dominelli, P.B., Archiza, B., Ramsook, A.H., Mitchell, R.A., Peters, C.M., Molgat-Seon, Y., Henderson, W.R., Koehle, M.S., Boushel, R., Sheel, A.W., 2017. Effects of respiratory muscle work on respiratory and locomotor blood flow during exercise: Work of breathing and blood flow. *Exp Physiol* 102, 1535–1547. <https://doi.org/10.1113/EP086566>

Dominelli, P.B., Foster, G.E., Dominelli, G.S., Henderson, W.R., Koehle, M.S., McKenzie, D.C., Sheel, A.W., 2013. Exercise-induced arterial hypoxaemia and the mechanics of breathing in healthy young women: Hypoxaemia and ventilatory mechanics in exercising women. *The Journal of Physiology* 591, 3017–3034. <https://doi.org/10.1113/jphysiol.2013.252767>

Dominelli, P.B., Foster, G.E., Guenette, J.A., Haverkamp, H.C., Eves, N.D., Dominelli, G.S., Henderson, W.R., O'Donnell, D.E., Sheel, A.W., 2015a. Quantifying the shape of the maximal expiratory flow–volume curve in mild COPD. *Respiratory Physiology & Neurobiology* 219, 30–35. <https://doi.org/10.1016/j.resp.2015.08.002>

Dominelli, P.B., Guenette, J.A., Wilkie, S.S., Foster, G.E., Sheel, A.W., 2012. Dysanapsis: importance of measured lung and static recoil pressure response. *Medicine & Science in Sports & Exercise* 44, 1195. <https://doi.org/10.1249/MSS.0b013e3182508525>

Dominelli, P.B., Guenette, J.A., Wilkie, S.S., Foster, G.E., Sheel, A.W., 2011. Determinants of expiratory flow limitation in healthy women during exercise. *Medicine & Science in Sports & Exercise* 43, 1666–1674.

Dominelli, P.B., Molgat-Seon, Y., Bingham, D., Swartz, P.M., Road, J.D., Foster, G.E., Sheel, A.W., 2015b. Dysanapsis and the resistive work of

breathing during exercise in healthy men and women. *Journal of Applied Physiology* 119, 1105–1113.

Dominelli, P.B., Molgat-Seon, Y., Foster, G.E., Dominelli, G.S., Haverkamp, H.C., Henderson, W.R., Sheel, A.W., 2016. Quantifying the shape of maximal expiratory flow-volume curves in healthy humans and asthmatic patients. *Respiratory Physiology & Neurobiology* 220, 46–53. <https://doi.org/10.1016/j.resp.2015.09.007>

Dominelli, P.B., Render, J.N., Molgat-Seon, Y., Foster, G.E., Romer, L.M., Sheel, A.W., 2015c. Oxygen cost of exercise hyperpnoea is greater in women compared with men: Sex differences in the oxygen cost of breathing. *The Journal of Physiology* 593, 1965–1979. <https://doi.org/10.1113/jphysiol.2014.285965>

Dominelli, P.B., Ripoll, J.G., Cross, T.J., Baker, S.E., Wiggins, C.C., Welch, B.T., Joyner, M.J., 2018. Sex differences in large conducting airway anatomy. *Journal of Applied Physiology* 125, 960–965. <https://doi.org/10.1152/jappphysiol.00440.2018>

Ducrocq, G.P., Hureau, T.J., Bøgseth, T., Meste, O., Blain, G.M., 2021. Recovery from Fatigue after Cycling Time Trials in Elite Endurance Athletes. *Medicine & Science in Sports & Exercise* 53, 904–917. <https://doi.org/10.1249/MSS.0000000000002557>

Edwards, R.H., Hill, D.K., Jones, D.A., Merton, P.A., 1977. Fatigue of long duration in human skeletal muscle after exercise. *The Journal of Physiology* 272, 769–778. <https://doi.org/10.1113/jphysiol.1977.sp012072>

Edwards, R.H.T., 1981. Human Muscle Function and Fatigue, in: Porter, R., Whelan, J. (Eds.), *Novartis Foundation Symposia*. Wiley, pp. 1–18. <https://doi.org/10.1002/9780470715420.ch1>

Eldridge, F.L., Millhorn, D.E., Waldrop, T.G., 1981. Exercise Hyperpnea and Locomotion: Parallel Activation from the Hypothalamus. *Science* 211, 844–846. <https://doi.org/10.1126/science.7466362>

Elliott, J.E., Greising, S.M., Mantilla, C.B., Sieck, G.C., 2016. Functional impact of sarcopenia in respiratory muscles. *Respiratory Physiology & Neurobiology* 226, 137–146. <https://doi.org/10.1016/j.resp.2015.10.001>

Enoka, R.M., Duchateau, J., 2016. Translating Fatigue to Human Performance. *Medicine & Science in Sports & Exercise* 48, 2228–

2238. <https://doi.org/10.1249/MSS.0000000000000929>

Enright, P.L., Kronmal, R.A., Manolio, T.A., Schenker, M.B., Hyatt, R.E., 1994. Respiratory muscle strength in the elderly. Correlates and reference values. *Cardiovascular Health Study Research Group. Am J Respir Crit Care Med* 149, 430–438. <https://doi.org/10.1164/ajrccm.149.2.8306041>

Estenne, M., Yernault, J.C., De Troyer, A., 1985. Rib cage and diaphragm-abdomen compliance in humans: effects of age and posture. *Journal of Applied Physiology* 59, 1842–1848. <https://doi.org/10.1152/jappl.1985.59.6.1842>

Faisal, A., Webb, K.A., Guenette, J.A., Jensen, D., Neder, J.A., O'Donnell, D.E., 2015. Effect of age-related ventilatory inefficiency on respiratory sensation during exercise. *Respiratory Physiology & Neurobiology* 205, 129–139. <https://doi.org/10.1016/j.resp.2014.10.017>

Ferrari, A.U., Radaelli, A., Centola, M., 2003. Invited Review: Aging and the cardiovascular system. *Journal of Applied Physiology* 95, 2591–2597. <https://doi.org/10.1152/jappphysiol.00601.2003>

Fitts, R.H., 1994. Cellular mechanisms of muscle fatigue. *Physiological Reviews* 74, 49–94. <https://doi.org/10.1152/physrev.1994.74.1.49>

Fleg, J.L., Lakatta, E.G., 1988. Role of muscle loss in the age-associated reduction in VO₂ max. *Journal of Applied Physiology* 65, 1147–1151. <https://doi.org/10.1152/jappl.1988.65.3.1147>

Forster, H.V., Haouzi, P., Dempsey, J.A., 2012. Control of Breathing During Exercise, in: Prakash, Y.S. (Ed.), *Comprehensive Physiology*. Wiley, pp. 743–777. <https://doi.org/10.1002/cphy.c100045>

Fuglevand, A.J., Zackowski, K.M., Huey, K.A., Enoka, R.M., 1993. Impairment of neuromuscular propagation during human fatiguing contractions at submaximal forces. *The Journal of Physiology* 460, 549–572. <https://doi.org/10.1113/jphysiol.1993.sp019486>

Fulton, T.J., Baranaukas, M.N., Paris, H.L., Kocaja, D.M., Mickleborough, T.D., Chapman, R.F., 2020. Respiratory Muscle Fatigue Alters Cycling Performance and Locomotor Muscle Fatigue. *Medicine & Science in Sports & Exercise* 52, 2380–2389. <https://doi.org/10.1249/MSS.0000000000002399>

- Gandevia, S.C., 2001. Spinal and Supraspinal Factors in Human Muscle Fatigue. *Physiological Reviews* 81, 1725–1789. <https://doi.org/10.1152/physrev.2001.81.4.1725>
- Gandevia, S.C., 1998. Neural control in human muscle fatigue: changes in muscle afferents, moto neurones and moto cortical drive. *Acta Physiologica Scandinavica* 162, 275–283. <https://doi.org/10.1046/j.1365-201X.1998.0299f.x>
- Gandevia, S.C., Allen, G.M., Butler, J.E., Taylor, J.L., 1996. Supraspinal factors in human muscle fatigue: evidence for suboptimal output from the motor cortex. *The Journal of Physiology* 490, 529–536. <https://doi.org/10.1113/jphysiol.1996.sp021164>
- Gea, J., Ausín, P., Martínez-Llorens, J.M., Barreiro, E., 2020. Respiratory muscle senescence in ageing and chronic lung diseases. *Eur Respir Rev* 29, 200087. <https://doi.org/10.1183/16000617.0087-2020>
- Geard, D., Reaburn, P.R.J., Rebar, A.L., Dionigi, R.A., 2017. Masters Athletes: Exemplars of Successful Aging? *Journal of Aging and Physical Activity* 25, 490–500. <https://doi.org/10.1123/japa.2016-0050>
- Gibson, G.J., Pride, N.B., O'cain, C., Quagliato, R., 1976. Sex and age differences in pulmonary mechanics in normal nonsmoking subjects. *Journal of Applied Physiology* 41, 20–25. <https://doi.org/10.1152/jappl.1976.41.1.20>
- González-Izal, M., Malanda, A., Gorostiaga, E., Izquierdo, M., 2012. Electromyographic models to assess muscle fatigue. *Journal of Electromyography and Kinesiology* 22, 501–512. <https://doi.org/10.1016/j.jelekin.2012.02.019>
- Goodall, S., Romer, L.M., Ross, E.Z., 2009. Voluntary activation of human knee extensors measured using transcranial magnetic stimulation. *Experimental Physiology* 94, 995–1004. <https://doi.org/10.1113/expphysiol.2009.047902>
- Goodwin, G.M., McCLOSKEY, D.I., Matthews, P.B.C., 1972. THE CONTRIBUTION OF MUSCLE AFFERENTS TO KESLESTHESIA SHOWN BY VIBRATION INDUCED ILLUSIONSOF MOVEMENT AND BY THE EFFECTS OF PARALYSING JOINT AFFERENTS. *Brain* 95, 705–748. <https://doi.org/10.1093/brain/95.4.705>
- Gordon, A.M., Homsher, E., Regnier, M., 2000. Regulation of Contraction in Striated Muscle. *Physiological Reviews* 80, 853–924. <https://doi.org/10.1152/physrev.2000.80.2.853>
- Green, A.L., Paterson, D.J., 2008. Identification of neurocircuitry controlling cardiovascular function in humans using functional neurosurgery: implications for exercise control. *Experimental Physiology* 93, 1022–1028. <https://doi.org/10.1113/expphysiol.2007.039461>
- Green, M., Mead, J., Turner, J.M., 1974. Variability of maximum expiratory flow-volume curves. *J Appl Physiol* 37, 67–74. <https://doi.org/10.1152/jappl.1974.37.1.67>
- Greising, S.M., Ermilov, L.G., Sieck, G.C., Mantilla, C.B., 2015a. Ageing and neurotrophic signalling effects on diaphragm neuromuscular function. *The Journal of Physiology* 593, 431–440. <https://doi.org/10.1113/jphysiol.2014.282244>
- Greising, S.M., Mantilla, C.B., Gorman, B.A., Ermilov, L.G., Sieck, G.C., 2013. Diaphragm muscle sarcopenia in aging mice. *Experimental Gerontology* 48, 881–887. <https://doi.org/10.1016/j.exger.2013.06.001>
- Greising, S.M., Medina-Martínez, J.S., Vasdev, A.K., Sieck, G.C., Mantilla, C.B., 2015b. Analysis of muscle fiber clustering in the diaphragm muscle of sarcopenic mice: Fiber Type Clustering in Sarcopenia. *Muscle Nerve* 52, 76–82. <https://doi.org/10.1002/mus.24641>
- Grimby, G., Bunn, J., Mead, J., 1968. Relative contribution of rib cage and abdomen to ventilation during exercise. *Journal of Applied Physiology* 24, 159–166. <https://doi.org/10.1152/jappl.1968.24.2.159>
- Groen, B.B.L., Hamer, H.M., Snijders, T., Van Kranenburg, J., Frijns, D., Vink, H., Van Loon, L.J.C., 2014. Skeletal muscle capillary density and microvascular function are compromised with aging and type 2 diabetes. *Journal of Applied Physiology* 116, 998–1005. <https://doi.org/10.1152/jappphysiol.00919.2013>
- Gruet, M., Temesi, J., Rupp, T., Levy, P., Millet, G.Y., Verges, S., 2013. Stimulation of the motor cortex and corticospinal tract to assess human muscle fatigue. *Neuroscience* 231, 384–399. <https://doi.org/10.1016/j.neuroscience.2012.10.058>
- Gruet, M., Temesi, J., Rupp, T., Levy, P., Verges, S., Millet, G.Y., 2014. Dynamics of corticospinal changes during and after high-intensity quadriceps exercise. *Experimental Physiology* 99,

1053–1064.
<https://doi.org/10.1113/expphysiol.2014.078840>

Guenette, J.A., Chin, R.C., Cory, J.M., Webb, K.A., O'Donnell, D.E., 2013. Inspiratory Capacity during Exercise: Measurement, Analysis, and Interpretation. *Pulmonary Medicine* 2013, 1–13. <https://doi.org/10.1155/2013/956081>

Guenette, Jordan A., Dominelli, P.B., Reeve, S.S., Durkin, C.M., Eves, N.D., Sheel, A.W., 2010. Effect of thoracic gas compression and bronchodilation on the assessment of expiratory flow limitation during exercise in healthy humans. *Respiratory Physiology & Neurobiology* 170, 279–286. <https://doi.org/10.1016/j.resp.2010.01.017>

Guenette, Jordan A., Romer, L.M., Querido, J.S., Chua, R., Eves, N.D., Road, J.D., McKenzie, D.C., Sheel, A.W., 2010. Sex differences in exercise-induced diaphragmatic fatigue in endurance-trained athletes. *J Appl Physiol* 109.

Guenette, J.A., Witt, J.D., McKenzie, D.C., Road, J.D., Sheel, A.W., 2007. Respiratory mechanics during exercise in endurance-trained men and women: Respiratory mechanics. *The Journal of Physiology* 581, 1309–1322. <https://doi.org/10.1113/jphysiol.2006.126466>

Hagberg, J.M., Yerg, J.E., Seals, D.R., 1988. Pulmonary function in young and older athletes and untrained men. *Journal of Applied Physiology* 65, 101–105. <https://doi.org/10.1152/jappl.1988.65.1.101>

Häggmark, T., Thorstensson, A., 1979. Fibre types in human abdominal muscles. *Acta Physiologica Scandinavica* 107, 319–325. <https://doi.org/10.1111/j.1748-1716.1979.tb06482.x>

Hamada, T., Sale, D.G., MacDougall, J.D., Tarnopolsky, M.A., 2003. Interaction of fibre type, potentiation and fatigue in human knee extensor muscles: Post-activation potentiation, fatigue and fibre type. *Acta Physiologica Scandinavica* 178, 165–173. <https://doi.org/10.1046/j.1365-201X.2003.01121.x>

Hanna, R.L., Kaufman, M.P., 2004. Activation of thin-fiber muscle afferents by a P2X agonist in cats. *Journal of Applied Physiology* 96, 1166–1169. <https://doi.org/10.1152/japplphysiol.01020.2003>

Hanna, R.L., Kaufman, M.P., 2003. Role played by purinergic receptors on muscle afferents in evoking the exercise pressor reflex. *Journal of*

Applied Physiology 94, 1437–1445. <https://doi.org/10.1152/japplphysiol.01011.2002>

Haouzi, P., Hill, J.M., Lewis, B.K., Kaufman, M.P., 1999. Responses of group III and IV muscle afferents to distension of the peripheral vascular bed. *Journal of Applied Physiology* 87, 545–553. <https://doi.org/10.1152/jappl.1999.87.2.545>

Harik-Khan, R.I., Wise, R.A., Fozard, J.L., 1998. Determinants of Maximal Inspiratory Pressure: The Baltimore Longitudinal Study of Aging. *Am J Respir Crit Care Med* 158, 1459–1464. <https://doi.org/10.1164/ajrccm.158.5.9712006>

Harms, C.A., 2007. Insights into the role of the respiratory muscle metaboreflex. *The Journal of Physiology* 584, 711–711. <https://doi.org/10.1113/jphysiol.2007.145540>

Harms, C.A., Babcock, M.A., McClaran, S.R., Pegelow, D.F., Nickle, G.A., Nelson, W.B., Dempsey, J.A., 1997. Respiratory muscle work compromises leg blood flow during maximal exercise. *Journal of Applied Physiology* 82, 1573–1583. <https://doi.org/10.1152/jappl.1997.82.5.1573>

Harms, C.A., Wetter, T.J., St. Croix, C.M., Pegelow, D.F., Dempsey, J.A., 2000. Effects of respiratory muscle work on exercise performance. *Journal of Applied Physiology* 89, 131–138. <https://doi.org/10.1152/jappl.2000.89.1.131>

Hashemian, S., Fallahian, F., Hashemian, S., Fallahian, F., 2014. The use of heliox in critical care. *Int J Crit Illn Inj Sci* 4, 138. <https://doi.org/10.4103/2229-5151.134153>

Havighurst, R.J., 1965. Robert J. Havighurst. *The bulletin of the National Association of Secondary School Principals* 49, 61–66. <https://doi.org/10.1177/019263656504929805>

Heymans, C., Bouckaert, J., Dautrebande, L., 1930. Sinus carotidien et reflexes respiratoires. II. Influences respiratoires reflexes de l'acidose, de l'alcalose, de l'anhydride carbonique, de l'ion hydrogene et de l'anoxemie. Sinus carotidien et echanges respiratoires dans les poumons et au dela des poumons. *Arch Intern Pharmacodyn* 39, 400–450.

Hodgkin, A.L., Horowicz, P., 1959. The influence of potassium and chloride ions on the membrane potential of single muscle fibres. *The Journal of Physiology* 148, 127–160. <https://doi.org/10.1113/jphysiol.1959.sp006278>

- Hogan, M.C., Gladden, L.B., Grassi, B., Stry, C.M., Samaja, M., 1998. Bioenergetics of contracting skeletal muscle after partial reduction of blood flow. *Journal of Applied Physiology* 84, 1882–1888. <https://doi.org/10.1152/jappl.1998.84.6.1882>
- Hureau, T.J., Olivier, N., Millet, G.Y., Meste, O., Blain, G.M., 2014. Exercise performance is regulated during repeated sprints to limit the development of peripheral fatigue beyond a critical threshold. *Experimental Physiology* 99, 951–963. <https://doi.org/10.1113/expphysiol.2014.077974>
- Hureau, T.J., Weavil, J.C., Thurston, T.S., Broxterman, R.M., Nelson, A.D., Bledsoe, A.D., Jessop, J.E., Richardson, R.S., Wray, D.W., Amann, M., 2018. Identifying the role of group III/IV muscle afferents in the carotid baroreflex control of mean arterial pressure and heart rate during exercise. *The Journal of Physiology* 596, 1373–1384. <https://doi.org/10.1113/JP275465>
- Hureau, T.J., Weavil, J.C., Thurston, T.S., Wan, H.-Y., Gifford, J.R., Jessop, J.E., Buys, M.J., Richardson, R.S., Amann, M., 2019. Pharmacological attenuation of group III/IV muscle afferents improves endurance performance when oxygen delivery to locomotor muscles is preserved. *Journal of Applied Physiology* 127, 1257–1266. <https://doi.org/10.1152/japplphysiol.00490.2019>
- Hussain, S.N., Chatillon, A., Comtois, A., Roussos, C., Magder, S., 1991. Chemical activation of thin-fiber phrenic afferents. 2. Cardiovascular responses. *Journal of Applied Physiology* 70, 77–86. <https://doi.org/10.1152/jappl.1991.70.1.77>
- Jakes, R.W., 2002. Physical Inactivity Is Associated with Lower Forced Expiratory Volume in 1 Second: European Prospective Investigation into Cancer-Norfolk Prospective Population Study. *American Journal of Epidemiology* 156, 139–147. <https://doi.org/10.1093/aje/kwf021>
- Jammes, Y., Balzamo, E., 1992. Changes in afferent and efferent phrenic activities with electrically induced diaphragmatic fatigue. *Journal of Applied Physiology* 73, 894–902. <https://doi.org/10.1152/jappl.1992.73.3.894>
- Janssens, J.-P., 2005. Aging of the Respiratory System: Impact on Pulmonary Function Tests and Adaptation to Exertion. *Clinics in Chest Medicine* 26, 469–484. <https://doi.org/10.1016/j.ccm.2005.05.004>
- Jeffery Mador, M., Kufel, T.J., Pineda, L.A., 2000. Quadriceps and Diaphragmatic Function after Exhaustive Cycle Exercise in the Healthy Elderly. *Am J Respir Crit Care Med* 162, 1760–1766. <https://doi.org/10.1164/ajrccm.162.5.2001005>
- Johnson, B.D., Babcock, M.A., Suman, O.E., Dempsey, J.A., 1993. Exercise-induced diaphragmatic fatigue in healthy humans. *The Journal of Physiology* 460, 385–405. <https://doi.org/10.1113/jphysiol.1993.sp019477>
- Johnson, B.D., Badr, M.S., Dempsey, J.A., 1994. IMPACT OF THE AGING PULMONARY SYSTEM ON THE RESPONSE TO EXERCISE. *Clinics in Chest Medicine* 15, 229–246. [https://doi.org/10.1016/S0272-5231\(21\)01070-4](https://doi.org/10.1016/S0272-5231(21)01070-4)
- Johnson, B.D., Dempsey, J.A., 1991. Demand vs. Capacity in the Aging Pulmonary System. *Exercise Sport Sci Rev* 19, 171–210. <https://doi.org/10.1249/00003677199101000-00005>
- Johnson, B.D., Reddan, W.G., Pegelow, D.F., Seow, K.C., Dempsey, J.A., 1991a. Flow Limitation and Regulation of Functional Residual Capacity during Exercise in a Physically Active Aging Population. *Am Rev Respir Dis* 143, 960–967. https://doi.org/10.1164/ajrccm/143.5_Pt_1.960
- Johnson, B.D., Reddan, W.G., Seow, K.C., Dempsey, J.A., 1991b. Mechanical Constraints on Exercise Hyperpnea in a Fit Aging Population. *Am Rev Respir Dis* 143, 968–977. https://doi.org/10.1164/ajrccm/143.5_Pt_1.968
- Johnson, B.D., Saupe, K.W., Dempsey, J.A., 1992. Mechanical constraints on exercise hyperpnea in endurance athletes. *Journal of Applied Physiology* 73, 874–886. <https://doi.org/10.1152/jappl.1992.73.3.874>
- Johnson, B.D., Scanlon, P.D., Beck, K.C., 1995. Regulation of ventilatory capacity during exercise in asthmatics. *Journal of Applied Physiology* 79, 892–901. <https://doi.org/10.1152/jappl.1995.79.3.892>
- Johnson, B.D., Weisman, I.M., Zeballos, R.J., Beck, K.C., 1999. Emerging Concepts in the Evaluation of Ventilatory Limitation During Exercise. *Chest* 116, 488–503. <https://doi.org/10.1378/chest.116.2.488>
- Jones, D.A., Newham, D.J., Torgan, C., 1989. Mechanical influences on long-lasting human muscle fatigue and delayed-onset pain. *The Journal of Physiology* 412, 415–427. <https://doi.org/10.1113/jphysiol.1989.sp017624>
- Joyner, M.J., Barnes, J.N., Hart, E.C., Wallin, B.G., Charkoudian, N., 2014. Neural Control of the

Circulation: How Sex and Age Differences Interact in Humans, in: Terjung, R. (Ed.), *Comprehensive Physiology*. Wiley, pp. 193–215.
<https://doi.org/10.1002/cphy.c140005>

Junhasavasdikul, D., Telias, I., Grieco, D.L., Chen, L., Gutierrez, C.M., Piraino, T., Brochard, L., 2018. Expiratory Flow Limitation During Mechanical Ventilation. *Chest* 154, 948–962.
<https://doi.org/10.1016/j.chest.2018.01.046>

Katayama, K., Amann, M., 2012. Respiratory muscle fatigue modulates the circulatory response to exercise. *JPFMSM* 1, 523–530.
<https://doi.org/10.7600/jpfs.1.523>

Katayama, K., Smith, J.R., Goto, K., Shimizu, K., Saito, M., Ishida, K., Koike, T., Iwase, S., Harms, C.A., 2018. Elevated sympathetic vasomotor outflow in response to increased inspiratory muscle activity during exercise is less in young women compared with men. *Exp Physiol* 103, 570–580. <https://doi.org/10.1113/EP086817>

Katz, I.M., Martin, A.R., Muller, P.-A., Terzibachi, K., Feng, C.-H., Caillibotte, G., Sandeau, J., Texereau, J., 2011. The ventilation distribution of helium–oxygen mixtures and the role of inertial losses in the presence of heterogeneous airway obstructions. *Journal of Biomechanics* 44, 1137–1143.
<https://doi.org/10.1016/j.jbiomech.2011.01.022>

Kaufman, M.P., Forster, H.V., 1996. Reflexes Controlling Circulatory, Ventilatory and Airway Responses to Exercise, in: Prakash, Y.S. (Ed.), *Comprehensive Physiology*. Wiley, pp. 381–447.
<https://doi.org/10.1002/cphy.cp120110>

Kaufman, M.P., Hayes, S.G., Adreani, C.M., Pickar, J.G., 2002. Discharge Properties of Group III and IV Muscle Afferents, in: Gandevia, S.C., Proske, U., Stuart, D.G. (Eds.), *Sensorimotor Control of Movement and Posture, Advances in Experimental Medicine and Biology*. Springer US, Boston, MA, pp. 25–32. https://doi.org/10.1007/978-1-4615-0713-0_4

Kaufman, M.P., Longhurst, J.C., Rybicki, K.J., Wallach, J.H., Mitchell, J.H., 1983. Effects of static muscular contraction on impulse activity of groups III and IV afferents in cats. *Journal of Applied Physiology* 55, 105–112.
<https://doi.org/10.1152/jappl.1983.55.1.105>

Keen, D.A., Yue, G.H., Enoka, R.M., 1994. Training-related enhancement in the control of motor output in elderly humans. *Journal of Applied Physiology* 77, 2648–2658.
<https://doi.org/10.1152/jappl.1994.77.6.2648>

Klimenko, O., Luu, P., Dominelli, P., Noggle, N., Petrics, G., Haverkamp, H.C., 2023. Effect of EXERCISE-INDUCED bronchoconstriction on the configuration of the maximal expiratory FLOW-VOLUME curve in adults with asthma. *Physiological Reports* 11.
<https://doi.org/10.14814/phy2.15614>

Kluger, B.M., Krupp, L.B., Enoka, R.M., 2013. Fatigue and fatigability in neurologic illnesses: Proposal for a unified taxonomy. *Neurology* 80, 409–416.
<https://doi.org/10.1212/WNL.0b013e31827f07be>

Knudson, R.J., Clark, D.F., Kennedy, T.C., Knudson, D.E., 1977. Effect of aging alone on mechanical properties of the normal adult human lung. *Journal of Applied Physiology* 43, 1054–1062.
<https://doi.org/10.1152/jappl.1977.43.6.1054>

Koulouris, N.G., Dimopoulou, I., Valta, P., Finkelstein, R., Cosio, M.G., Milic-Emili, J., 1997. Detection of expiratory flow limitation during exercise in COPD patients. *Journal of Applied Physiology* 82, 723–731.
<https://doi.org/10.1152/jappl.1997.82.3.723>

Krumpe, P.E., 1985. The aging respiratory system. *Clinics in Geriatric Medicine* 1, 143–155.

Kumazawa, T., Mizumura, K., 1977. Thin-fibre receptors responding to mechanical, chemical, and thermal stimulation in the skeletal muscle of the dog. *The Journal of Physiology* 273, 179–194.
<https://doi.org/10.1113/jphysiol.1977.sp012088>

Lagerquist, O., Collins, D.F., 2010. Influence of stimulus pulse width on M-waves, H-reflexes, and torque during tetanic low-intensity neuromuscular stimulation. *Muscle Nerve* 42, 886–893. <https://doi.org/10.1002/mus.21762>

Lambert, R.K., 1990. Simulation of the effects of mechanical nonhomogeneities on expiratory flow from human lungs. *Journal of Applied Physiology* 68, 2550–2563.
<https://doi.org/10.1152/jappl.1990.68.6.2550>

Lambert, R.K., Wilson, T.A., Hyatt, R.E., Rodarte, J.R., 1982. A computational model for expiratory flow. *Journal of Applied Physiology* 52, 44–56. <https://doi.org/10.1152/jappl.1982.52.1.44>

Larsson, L., Degens, H., Li, M., Salviati, L., Lee, Y.I., Thompson, W., Kirkland, J.L., Sandri, M., 2019. Sarcopenia: Aging-Related Loss of Muscle Mass and Function. *Physiological Reviews* 99, 427–511.
<https://doi.org/10.1152/physrev.00061.2017>

- Layec, G., Trinity, J.D., Hart, C.R., Kim, S.-E., Groot, H.J., Le Fur, Y., Sorensen, J.R., Jeong, E.-K., Richardson, R.S., 2014. In vivo evidence of an age-related increase in ATP cost of contraction in the plantar flexor muscles. *Clinical Science* 126, 581–592. <https://doi.org/10.1042/CS20130442>
- Layec, G., Trinity, J.D., Hart, C.R., Le Fur, Y., Zhao, J., Reese, V., Jeong, E.-K., Richardson, R.S., 2018. Impaired Muscle Efficiency but Preserved Peripheral Hemodynamics and Mitochondrial Function With Advancing Age: Evidence From Exercise in the Young, Old, and Oldest-Old. *The Journals of Gerontology: Series A* 73, 1303–1312. <https://doi.org/10.1093/gerona/gly050>
- Leahy, M.G., Kipp, S., Benbaruj, J.M., Charkoudian, N., Foster, G.E., Koehle, M.S., Sheel, A.W., 2023. Effects of sex and ageing on the human respiratory muscle metaboreflex. *The Journal of Physiology* 601, 689–702. <https://doi.org/10.1113/JP283838>
- Lepers, R., 2010. Intérêts et limites de la neurostimulation percutanée dans l'évaluation de la fatigue musculaire. *Movement & Sport Sciences n° 70*, 31. <https://doi.org/10.3917/sm.070.0031>
- Lepers, R., Maffiuletti, N.A., Rochette, L., Brugniaux, J., Millet, G.Y., 2002. Neuromuscular fatigue during a long-duration cycling exercise. *Journal of Applied Physiology* 92, 1487–1493. <https://doi.org/10.1152/jappphysiol.00880.2001>
- Lepers, R., Stapley, P.J., 2016. Master Athletes Are Extending the Limits of Human Endurance. *Front. Physiol.* 7. <https://doi.org/10.3389/fphys.2016.00613>
- Lexell, J., Taylor, C.C., Sj, M., 1995. What is the cause of the ageing atrophy? Total number, size and proportion of different fiber types studied in whole vastus lateralis muscle from 15- to 83-year-old men.
- Lieberman, D.A., Faulkner, J.A., Craig, A.B., Maxwell, L.C., 1973. Performance and histochemical composition of guinea pig and human diaphragm. *Journal of Applied Physiology* 34, 233–237. <https://doi.org/10.1152/jappl.1973.34.2.233>
- Light, A.R., Huguen, R.W., Zhang, J., Rainier, J., Liu, Z., Lee, J., 2008. Dorsal Root Ganglion Neurons Innervating Skeletal Muscle Respond to Physiological Combinations of Protons, ATP, and Lactate Mediated by ASIC, P2X, and TRPV1. *Journal of Neurophysiology* 100, 1184–1201. <https://doi.org/10.1152/jn.01344.2007>
- Liu, J.Z., Dai, T.H., Sahgal, V., Brown, R.W., Yue, G.H., 2002. Nonlinear cortical modulation of muscle fatigue: a functional MRI study. *Brain Research* 957, 320–329. [https://doi.org/10.1016/S0006-8993\(02\)03665-X](https://doi.org/10.1016/S0006-8993(02)03665-X)
- Liu, J.Z., Shan, Z.Y., Zhang, L.D., Sahgal, V., Brown, R.W., Yue, G.H., 2003. Human Brain Activation During Sustained and Intermittent Submaximal Fatigue Muscle Contractions: An fMRI Study. *Journal of Neurophysiology* 90, 300–312. <https://doi.org/10.1152/jn.00821.2002>
- Loeschcke, H.H., Mitchell, R.A., Katsaros, B., Perkins, J.F., Konig, A., 1963. INTERACTION OF INTRACRANIAL CHEMOSENSITIVITY WITH PERIPHERAL AFFERENTS TO THE RESPIRATORY CENTERS. *Annals of the New York Academy of Sciences* 109, 651–660. <https://doi.org/10.1111/j.1749-6632.1963.tb13495.x>
- López-Otín, C., Blasco, M.A., Partridge, L., Serrano, M., Kroemer, G., 2013. The Hallmarks of Aging. *Cell* 153, 1194–1217. <https://doi.org/10.1016/j.cell.2013.05.039>
- Lutfi, M.F., 2017. The physiological basis and clinical significance of lung volume measurements. *Multidiscip Respir Med* 12, 3. <https://doi.org/10.1186/s40248-017-0084-5>
- Macaluso, A., De Vito, G., 2004. Muscle strength, power and adaptations to resistance training in older people. *Eur J Appl Physiol* 91, 450–472. <https://doi.org/10.1007/s00421-003-0991-3>
- Mador, M.J., Acevedo, F.A., 1991. Effect of respiratory muscle fatigue on subsequent exercise performance. *Journal of Applied Physiology* 70, 2059–2065. <https://doi.org/10.1152/jappl.1991.70.5.2059>
- Mador, M.J., Magalang, U.J., Rodis, A., Kufel, T.J., 1993. Diaphragmatic Fatigue after Exercise in Healthy Human Subjects. *Am Rev Respir Dis* 148, 1571–1575. https://doi.org/10.1164/ajrccm/148.6_Pt_1.1571
- Maharam, L.G., Bauman, P.A., Kalman, D., Skolnik, H., Perle, S.M., 1999. Masters Athletes: Factors Affecting Performance. *Sports Medicine* 28, 273–285. <https://doi.org/10.2165/00007256-199928040-00005>
- Mann, L.M., Granger, E.A., Chan, J.S., Yu, A., Molgat-Seon, Y., Dominelli, P.B., 2020. Minimizing airflow turbulence in women lowers the work of breathing to levels similar to men. *Journal of*

Applied Physiology 129, 410–418.
<https://doi.org/10.1152/jappphysiol.00347.2020>

Manning, D.R., Stull, J.T., 1982. Myosin light chain phosphorylation-dephosphorylation in mammalian skeletal muscle. *American Journal of Physiology-Cell Physiology* 242, C234–C241.
<https://doi.org/10.1152/ajpcell.1982.242.3.C234>

Martin, B., Heintzelman, M., Chen, H.I., 1982. Exercise performance after ventilatory work. *Journal of Applied Physiology* 52, 1581–1585.
<https://doi.org/10.1152/jappl.1982.52.6.1581>

Martin, V., Millet, G.Y., Martin, A., Deley, G., Lattier, G., 2004. Assessment of low-frequency fatigue with two methods of electrical stimulation. *Journal of Applied Physiology* 97, 1923–1929.
<https://doi.org/10.1152/jappphysiol.00376.2004>

Matsukawa, K., 2012. Central command: control of cardiac sympathetic and vagal efferent nerve activity and the arterial baroreflex during spontaneous motor behaviour in animals: Cardiac autonomic control during spontaneous motor behaviour. *Experimental Physiology* 97, 20–28.
<https://doi.org/10.1113/expphysiol.2011.057661>

Mauroy, B., Filoche, M., Weibel, E.R., Sapoval, B., 2004. An optimal bronchial tree may be dangerous. *Nature* 427, 633–636.
<https://doi.org/10.1038/nature02287>

McClaran, S.R., Babcock, M.A., Pegelow, D.F., Reddan, W.G., Dempsey, J.A., 1995. Longitudinal effects of aging on lung function at rest and exercise in healthy active fit elderly adults. *Journal of Applied Physiology* 78, 1957–1968.
<https://doi.org/10.1152/jappl.1995.78.5.1957>

McClaran, S.R., Harms, C.A., Pegelow, D.F., Dempsey, J.A., 1998. Smaller lungs in women affect exercise hyperpnea. *Journal of Applied Physiology* 84, 1872–1881.
<https://doi.org/10.1152/jappl.1998.84.6.1872>

McClaran, S.R., Wetter, T.J., Pegelow, D.F., Dempsey, J.A., 1999. Role of expiratory flow limitation in determining lung volumes and ventilation during exercise. *Journal of Applied Physiology* 86, 1357–1366.
<https://doi.org/10.1152/jappl.1999.86.4.1357>

McCloskey, D.I., Mitchell, J.H., 1972. Reflex cardiovascular and respiratory responses originating in exercising muscle. *The Journal of Physiology* 224, 173–186.
<https://doi.org/10.1113/jphysiol.1972.sp009887>

Mcelvaney, G., Blackie, S., Morrison, N.J., Wilcox, P.G., Fairbairn, M.S., Pardy, R.I., 1989. Maximal Static Respiratory Pressures in the Normal Elderly. *Am Rev Respir Dis* 139, 277–281.
<https://doi.org/10.1164/ajrccm/139.1.277>

McParland, C., Krishnan, B., Lobo, J., Gallagher, C.G., 1992. Effect of physical training on breathing pattern during progressive exercise. *Respiration Physiology* 90, 311–323.
[https://doi.org/10.1016/0034-5687\(92\)90111-9](https://doi.org/10.1016/0034-5687(92)90111-9)

Mead, J., 1980. Dyanapsis in Normal Lungs Assessed by the Relationship between Maximal Flow, Static Recoil, and Vital Capacity. *Am Rev Respir Dis* 121, 339–42.
<https://doi.org/10.1164/arrd.1980.121.2.339>

Mead, J., 1978. Analysis of the configuration of maximum expiratory flow-volume curves. *Journal of Applied Physiology* 44, 156–165.
<https://doi.org/10.1152/jappl.1978.44.2.156>

Mead, J., Turner, J.M., Macklem, P.T., Little, J.B., 1967. Significance of the relationship between lung recoil and maximum expiratory flow. *Journal of Applied Physiology* 22, 95–108.
<https://doi.org/10.1152/jappl.1967.22.1.95>

Mense, S., 1977. Nervous outflow from skeletal muscle following chemical noxious stimulation. *The Journal of Physiology* 267, 75–88.
<https://doi.org/10.1113/jphysiol.1977.sp011802>

Mense, S., Meyer, H., 1985. Different types of slowly conducting afferent units in cat skeletal muscle and tendon. *The Journal of Physiology* 363, 403–417.
<https://doi.org/10.1113/jphysiol.1985.sp015718>

Merton, P.A., 1954. Voluntary strength and fatigue. *The Journal of Physiology* 123, 553–564.
<https://doi.org/10.1113/jphysiol.1954.sp005070>

Miller, M.R., 2005. Standardisation of spirometry. *European Respiratory Journal* 26, 319–338. <https://doi.org/10.1183/09031936.05.00034805>

Millet, G.Y., 2011. Can Neuromuscular Fatigue Explain Running Strategies and Performance in Ultra-Marathons?: The Flush Model. *Sports Medicine* 41, 489–506.
<https://doi.org/10.2165/11588760-000000000-00000>

Millet, G.Y., Lepers, R., 2004. Alterations of Neuromuscular Function After Prolonged Running, Cycling and Skiing Exercises: *Sports Medicine* 34, 105–116. <https://doi.org/10.2165/00007256-200434020-00004>

- Mizuno, M., Secher, N.H., 1989. Histochemical characteristics of human expiratory and inspiratory intercostal muscles. *Journal of Applied Physiology* 67, 592–598. <https://doi.org/10.1152/jappl.1989.67.2.592>
- Molgat-Seon, Y., Dominelli, P.B., Guenette, J.A., Sheel, A.W., 2019. Modelling the effects of age and sex on the resistive and viscoelastic components of the work of breathing during exercise. *Exp Physiol* 104, 1737–1745. <https://doi.org/10.1113/EP087956>
- Molgat-Seon, Y., Dominelli, P.B., Peters, C.M., Kipp, S., Welch, J.F., Parmar, H.R., Rabbani, T., Mann, L.M., Grift, G.O., Guenette, J.A., Sheel, A.W., 2022. Predictors of Expiratory Flow Limitation during Exercise in Healthy Males and Females. *Medicine & Science in Sports & Exercise* 54, 1428–1436. <https://doi.org/10.1249/MSS.0000000000002938>
- Molgat-Seon, Y., Dominelli, P.B., Ramsook, A.H., Schaeffer, M.R., Molgat Sereacki, S., Foster, G.E., Romer, L.M., Road, J.D., Guenette, J.A., Sheel, A.W., 2018. The effects of age and sex on mechanical ventilatory constraint and dyspnea during exercise in healthy humans. *Journal of Applied Physiology* 124, 1092–1106. <https://doi.org/10.1152/japplphysiol.00608.2017>
- Moore, R.L., Stull, J.T., 1984. Myosin light chain phosphorylation in fast and slow skeletal muscles in situ. *American Journal of Physiology-Cell Physiology* 247, C462–C471. <https://doi.org/10.1152/ajpcell.1984.247.5.C462>
- Moritani, T., Muro, M., Nagata, A., 1986. Intramuscular and surface electromyogram changes during muscle fatigue. *Journal of Applied Physiology* 60, 1179–1185. <https://doi.org/10.1152/jappl.1986.60.4.1179>
- Morris, J.F., Koski, A., Johnson, L.C., 1971. Spirometric Standards for Healthy Nonsmoking Adults: *Journal of Occupational and Environmental Medicine* 13, 360. <https://doi.org/10.1097/00043764-197107000-00021>
- Mota, S., Casan, P., Drobnic, F., Giner, J., Ruiz, O., Sanchis, J., Milic-Emili, J., 1999. Expiratory flow limitation during exercise in competition cyclists. *Journal of Applied Physiology* 86, 611–616. <https://doi.org/10.1152/jappl.1999.86.2.611>
- Myers, J., Kaminsky, L.A., Lima, R., Christle, J.W., Ashley, E., Arena, R., 2017. A Reference Equation for Normal Standards for VO₂ Max: Analysis from the Fitness Registry and the Importance of Exercise National Database (FRIEND Registry). *Progress in Cardiovascular Diseases* 60, 21–29. <https://doi.org/10.1016/j.pcad.2017.03.002>
- Nattie, E., Li, A., 2009. Central chemoreception is a complex system function that involves multiple brain stem sites. *Journal of Applied Physiology* 106, 1464–1466. <https://doi.org/10.1152/japplphysiol.00112.2008>
- Newman, W.I., Turcotte, D.L., Gabrielov, A.M., 1997. Fractal Trees with Side Branching. *Fractals* 05, 603–614. <https://doi.org/10.1142/S0218348X97000486>
- Neyroud, D., Vallotton, A., Millet, G.Y., Kayser, B., Place, N., 2014. The effect of muscle fatigue on stimulus intensity requirements for central and peripheral fatigue quantification. *Eur J Appl Physiol* 114, 205–215. <https://doi.org/10.1007/s00421-013-2760-2>
- Niewoehner, D.E., Kleinerman, J., 1974. Morphologic basis of pulmonary resistance in the human lung and effects of aging. *Journal of Applied Physiology* 36, 412–418. <https://doi.org/10.1152/jappl.1974.36.4.412>
- Niinimaa, V., Shephard, R.J., 1978. Training and Oxygen Conductance in the Elderly I. The Respiratory System. *Journal of Gerontology* 33, 354–361. <https://doi.org/10.1093/geronj/33.3.354>
- Nourry, C., Deruelle, F., Fabre, C., Baquet, G., Bart, F., Grosbois, J.-M., Berthoin, S., Mucci, P., 2006. Evidence of Ventilatory Constraints in Healthy Exercising Prepubescent Children. *Pediatr. Pulmonol.* 41, 133–140. <https://doi.org/10.1002/ppul.20332>
- Ofir, D., Laveneziana, P., Webb, K.A., Lam, Y.-M., O'Donnell, D.E., 2008. Sex differences in the perceived intensity of breathlessness during exercise with advancing age. *J Appl Physiol* 104.
- Ogawa, T., Spina, R.J., Martin, W.H., Kohrt, W.M., Schechtman, K.B., Holloszy, J.O., Ehsani, A.A., 1992. Effects of aging, sex, and physical training on cardiovascular responses to exercise. *Circulation* 86, 494–503. <https://doi.org/10.1161/01.CIR.86.2.494>
- Olson, T.P., Joyner, M.J., Dietz, N.M., Eisenach, J.H., Curry, T.B., Johnson, B.D., 2010. Effects of respiratory muscle work on blood flow distribution during exercise in heart failure. *The*

Journal of Physiology 588, 2487–2501.
<https://doi.org/10.1113/jphysiol.2009.186056>

Ordway, G.A., Waldrop, T.G., Iwamoto, G.A., Gentile, B.J., 1989. Hypothalamic influences on cardiovascular response of beagles to dynamic exercise. *American Journal of Physiology-Heart and Circulatory Physiology* 257, H1247–H1253.
<https://doi.org/10.1152/ajpheart.1989.257.4.H1247>

Otis, A.B., Fenn, W.O., Rahn, H., 1950. Mechanics of Breathing in Man. *Journal of Applied Physiology* 2, 592–607.
<https://doi.org/10.1152/jappl.1950.2.11.592>

Overgaard, K., Nielsen, O.B., Flatman, J.A., Clausen, T., 1999. Relations between excitability and contractility in rat soleus muscle: role of the Na⁺ + -K⁺ + pump and Na⁺ + /K⁺ + gradients. *The Journal of Physiology* 518, 215–225.
<https://doi.org/10.1111/j.1469-7793.1999.0215r.x>

Papamoschou, D., 1995. Theoretical validation of the respiratory benefits of helium-oxygen mixtures. *Respiration Physiology* 99, 183–190.
[https://doi.org/10.1016/0034-5687\(94\)00071-7](https://doi.org/10.1016/0034-5687(94)00071-7)

Paterson, D.J., 2014. Defining the neurocircuitry of exercise hyperpnoea. *J Physiol* 592, 433–444.
<https://doi.org/10.1113/jphysiol.2013.261586>

Pedley, T., 1986. Aerodynamic theory, in: *Handbook of Physiology, The Respiratory System*. pp. 41–54.

Pedley, T.J., Schroter, R.C., Sudlow, M.F., 1970. The prediction of pressure drop and variation of resistance within the human bronchial airways. *Respiration Physiology* 9, 387–405.
[https://doi.org/10.1016/0034-5687\(70\)90094-0](https://doi.org/10.1016/0034-5687(70)90094-0)

Pelkonen, M., Notkola, I.-L., Lakka, T., Tukiainen, H.O., Kivinen, P., Nissinen, A., 2003. Delaying Decline in Pulmonary Function with Physical Activity: A 25-Year Follow-up. *Am J Respir Crit Care Med* 168, 494–499.
<https://doi.org/10.1164/rccm.200208-954OC>

Pellegrino, R., Violante, B., Nava, S., Rampulla, C., Brusasco, V., Rodarte, J.R., 1993. Expiratory airflow limitation and hyperinflation during methacholine-induced bronchoconstriction. *Journal of Applied Physiology* 75, 1720–1727.
<https://doi.org/10.1152/jappl.1993.75.4.1720>

Peters, C.M., Welch, J.F., Dominelli, P.B., Molgat-Seon, Y., Romer, L.M., McKenzie, D.C., Sheel, A.W., 2017. Influence of inspiratory resistive

loading on expiratory muscle fatigue in healthy humans. *Experimental Physiology* 102, 1221–1233.
<https://doi.org/10.1113/EP086346>

Pierce, J.A., Ebert, R.V., 1965. Fibrous Network of the Lung and its Change with Age. *Thorax* 20, 469–476.
<https://doi.org/10.1136/thx.20.5.469>

Pimentel, A.E., Gentile, C.L., Tanaka, H., Seals, D.R., Gates, P.E., 2003. Greater rate of decline in maximal aerobic capacity with age in endurance-trained than in sedentary men. *Journal of Applied Physiology* 94, 2406–2413.
<https://doi.org/10.1152/jappphysiol.00774.2002>

Place, N., Maffiuletti, N.A., Martin, A., Lepers, R., 2007. Assessment of the reliability of central and peripheral fatigue after sustained maximal voluntary contraction of the quadriceps muscle. *Muscle and Nerve* 35, 486–495.
<https://doi.org/10.1002/mus.20714>

Polla, B., 2004. Respiratory muscle fibres: specialisation and plasticity. *Thorax* 59, 808–817.
<https://doi.org/10.1136/thx.2003.009894>

Porter, M.M., Vandervoort, A.A., Lexell, J., 1995. Aging of human muscle: structure, function and adaptability. *Scandinavian Med Sci Sports* 5, 129–142. <https://doi.org/10.1111/j.1600-0838.1995.tb00026.x>

Power, G.A., Allen, M.D., Gilmore, K.J., Stashuk, D.W., Doherty, T.J., Hepple, R.T., Taivassalo, T., Rice, C.L., 2016. Motor unit number and transmission stability in octogenarian world class athletes: Can age-related deficits be outrun? *Journal of Applied Physiology* 121, 1013–1020.
<https://doi.org/10.1152/jappphysiol.00149.2016>

Pozin, N., Montesantos, S., Katz, I., Pichelin, M., Grandmont, C., Vignon-Clementel, I., 2017. Calculated ventilation and effort distribution as a measure of respiratory disease and Heliox effectiveness. *Journal of Biomechanics* 60, 100–109.
<https://doi.org/10.1016/j.jbiomech.2017.06.009>

Prefaut, C., Anselme, F., Caillaud, C., Masse-Biron, J., 1994. Exercise-induced hypoxemia in older athletes. *Journal of Applied Physiology* 76, 120–126.
<https://doi.org/10.1152/jappl.1994.76.1.120>

Prefaut, C., Durand, F., Mucci, P., Caillaud, C., 2000. Exercise-Induced Arterial Hypoxaemia in Athletes: A Review. *Sports Medicine* 30, 47–61.
<https://doi.org/10.2165/00007256-200030010-00005>

Quanjer, P.H., Stanojevic, S., Cole, T.J., Baur, X., Hall, G.L., Culver, B.H., Enright, P.L., Hankinson, J.L., Ip, M.S.M., Zheng, J., Stocks, J., the ERS Global Lung Function Initiative, 2012. Multi-ethnic reference values for spirometry for the 3–95-yr age range: the global lung function 2012 equations. *Eur Respir J* 40, 1324–1343. <https://doi.org/10.1183/09031936.00080312>

Rahn, H., Otis, A.B., Chadwick, L.E., Fenn, W.O., 1946. THE PRESSURE-VOLUME DIAGRAM OF THE THORAX AND LUNG. *American Journal of Physiology-Legacy Content* 146, 161–178. <https://doi.org/10.1152/ajplegacy.1946.146.2.161>

Ransdell, L.B., Vener, J., Huberty, J., 2009. Masters Athletes: An Analysis of Running, Swimming and Cycling Performance by Age and Gender. *Journal of Exercise Science & Fitness* 7, S61–S73. [https://doi.org/10.1016/S1728-869X\(09\)60024-1](https://doi.org/10.1016/S1728-869X(09)60024-1)

Reid, C., 1928. THE MECHANISM OF VOLUNTARY MUSCULAR FATIGUE. *Exp Physiol* 19, 17–42. <https://doi.org/10.1113/expphysiol.1928.sp000451>

Reuschlein, P.S., Reddan, W.G., Burpee, J., Gee, J.B., Rankin, J., 1968. Effect of physical training on the pulmonary diffusing capacity during submaximal work. *Journal of Applied Physiology* 24, 152–158. <https://doi.org/10.1152/jappl.1968.24.2.152>

Rizzato, G., Marazzini, L., 1970. Thoracoabdominal mechanics in elderly men. *Journal of Applied Physiology* 28, 457–460. <https://doi.org/10.1152/jappl.1970.28.4.457>

Road, J.D., 1990. Phrenic afferents and ventilatory control. *Lung* 168, 137–149. <https://doi.org/10.1007/BF02719685>

Rodman, J.R., Henderson, K.S., Smith, C.A., Dempsey, J.A., 2003. Cardiovascular effects of the respiratory muscle metaboreflexes in dogs: rest and exercise. *Journal of Applied Physiology* 95, 1159–1169. <https://doi.org/10.1152/jappphysiol.00258.2003>

Roman, M.A., Rossiter, H.B., Casaburi, R., 2016. Exercise, ageing and the lung. *Eur Respir J* 48, 1471–1486. <https://doi.org/10.1183/13993003.00347-2016>

Romer, L.M., Lovering, A.T., Haverkamp, H.C., Pegelow, D.F., Dempsey, J.A., 2006. Effect of inspiratory muscle work on peripheral fatigue of locomotor muscles in healthy humans: Inspiratory

muscle work and locomotor muscle fatigue. *The Journal of Physiology* 571, 425–439. <https://doi.org/10.1113/jphysiol.2005.099697>

Romer, L.M., Miller, J.D., Haverkamp, H.C., Pegelow, D.F., Dempsey, J.A., 2007. Inspiratory muscles do not limit maximal incremental exercise performance in healthy subjects. *Respiratory Physiology & Neurobiology* 156, 353–361. <https://doi.org/10.1016/j.resp.2006.10.008>

Romer, L.M., Polkey, M.I., 2008. Exercise-induced respiratory muscle fatigue: implications for performance. *Journal of Applied Physiology* 104, 879–888. <https://doi.org/10.1152/jappphysiol.01157.2007>

Ross, E.Z., Gregson, W., Williams, K., Robertson, C., George, K., 2010. Muscle Contractile Function and Neural Control after Repetitive Endurance Cycling. *Medicine & Science in Sports & Exercise* 42, 206–212. <https://doi.org/10.1249/MSS.0b013e3181b07a18>

Rossi, A., Ganassini, A., Tantucci, C., Grassi, V., 1978 Aging and the respiratory system.

Rowell, L.B., Saltin, B., Kiens, B., Christensen, N.J., 1986. Is peak quadriceps blood flow in humans even higher during exercise with hypoxemia? *American Journal of Physiology-Heart and Circulatory Physiology* 251, H1038–H1044. <https://doi.org/10.1152/ajpheart.1986.251.5.H1038>

Ryan, J.W., Waldrop, T.G., 1995. Hypoxia sensitive neurons in the caudal hypothalamus project to the periaqueductal gray. *Respiration Physiology* 100, 185–194. [https://doi.org/10.1016/0034-5687\(95\)00010-B](https://doi.org/10.1016/0034-5687(95)00010-B)

Sacchetti, M., Lenti, M., Di Palumbo, A.S., De Vito, G., 2010. Different Effect of Cadence on Cycling Efficiency between Young and Older Cyclists. *Medicine & Science in Sports & Exercise* 42, 2128–2133. <https://doi.org/10.1249/MSS.0b013e3181e05526>

Sale, D., 2004. Postactivation potentiation: role in performance. *Br J Sports Med* 38, 386–387. <https://doi.org/10.1136/bjsm.2002.003392>

Secher, N.H., 2009. Central command and cerebral blood flow during exercise. *Experimental Physiology* 94, 1101–1102. <https://doi.org/10.1113/expphysiol.2009.050195>

Sejersted, O.M., Sjøgaard, G., 2000. Dynamics and Consequences of Potassium Shifts in Skeletal Muscle and Heart During Exercise.

Physiological Reviews 80, 1411–1481.
<https://doi.org/10.1152/physrev.2000.80.4.1411>

Sharma, G., Goodwin, J., 2006. Effect of aging on respiratory system physiology and immunology. *Clinical Interventions in Aging* 1, 253–260. <https://doi.org/10.2147/cia.2006.1.3.253>

Sheel, A.W., Boushel, R., Dempsey, J.A., 2018. Competition for blood flow distribution between respiratory and locomotor muscles: implications for muscle fatigue. *Journal of Applied Physiology* 125, 820–831. <https://doi.org/10.1152/jappphysiol.00189.2018>

Sheel, A.W., Derchak, P.A., Morgan, B.J., Pegelow, D.F., Jacques, A.J., Dempsey, J.A., 2001. Fatiguing inspiratory muscle work causes reflex reduction in resting leg blood flow in humans. *The Journal of Physiology* 537, 277–289. <https://doi.org/10.1111/j.1469-7793.2001.0277k.x>

Sheel, A.W., Guenette, J.A., Yuan, R., Holy, L., Mayo, J.R., McWilliams, A.M., Lam, S., Coxson, H.O., 2009. Evidence for dysanapsis using computed tomographic imaging of the airways in older ex-smokers. *Journal of Applied Physiology* 107, 1622–1628. <https://doi.org/10.1152/jappphysiol.00562.2009>

Sheel, A.W., Romer, L.M., 2012. Ventilation and Respiratory Mechanics, in: Terjung, R. (Ed.), *Comprehensive Physiology*. Wiley, pp. 1093–1142. <https://doi.org/10.1002/cphy.c100046>

Sidhu, S.K., Weavil, J.C., Mangum, T.S., Jessop, J.E., Richardson, R.S., Morgan, D.E., Amann, M., 2017. Group III/IV locomotor muscle afferents alter motor cortical and corticospinal excitability and promote central fatigue during cycling exercise. *Clinical Neurophysiology* 128, 44–55. <https://doi.org/10.1016/j.clinph.2016.10.008>

Sidhu, S.K., Weavil, J.C., Venturelli, M., Garten, R.S., Rossman, M.J., Richardson, R.S., Gmelch, B.S., Morgan, D.E., Amann, M., 2014. Spinal μ -opioid receptor-sensitive lower limb muscle afferents determine corticospinal responsiveness and promote central fatigue in upper limb muscle. *The Journal of Physiology* 592, 5011–5024. <https://doi.org/10.1113/jphysiol.2014.275438>

Sliwinski, P., Yan, S., Gauthier, A.P., Macklem, P.T., 1996. Influence of global inspiratory muscle fatigue on breathing during exercise. *Journal of Applied Physiology* 80, 1270–1278. <https://doi.org/10.1152/jappl.1996.80.4.1270>

Smith, D.O., Chapman, M.R., 1987. Acetylcholine Receptor Binding Properties at the Rat Neuromuscular Junction During Aging. *Journal of Neurochemistry* 48, 1834–1841. <https://doi.org/10.1111/j.1471-4159.1987.tb05744.x>

Smith, J.R., Alexander, A.M., Hammer, S.M., Didier, K.D., Kurti, S.P., Broxterman, R.M., Barstow, T.J., Harms, C.A., 2017a. Cardiovascular consequences of the inspiratory muscle metaboreflex: effects of age and sex. *American Journal of Physiology-Heart and Circulatory Physiology* 312, H1013–H1020. <https://doi.org/10.1152/ajpheart.00818.2016>

Smith, J.R., Kurti, S.P., Meskimen, K., Harms, C.A., 2017b. Expiratory flow limitation and operating lung volumes during exercise in older and younger adults. *Respiratory Physiology & Neurobiology* 240, 26–31. <https://doi.org/10.1016/j.resp.2016.12.016>

Smith, J.R., Rosenkranz, S.K., Harms, C.A., 2014. Dysanapsis ratio as a predictor for expiratory flow limitation. *Respiratory physiology & neurobiology* 198, 25–31.

Spengler, C.M., Knöpfli-Lenzin, C., Birchler, K., Trapletti, A., Boutellier, U., 2000. Breathing pattern and exercise endurance time after exhausting cycling or breathing. *European Journal of Applied Physiology* 81, 368–374. <https://doi.org/10.1007/s004210050056>

Spycher, B., Frey, U., Wildhaber, J.H., Sznitman, J., 2012. Mathematical Behavior of MEFV Curves in Childhood Asthma and the Role of Curvature in Quantifying Flow Obstruction. *ISRN Pulmonology* 2012, 1–13. <https://doi.org/10.5402/2012/305176>

Stéphano, J., Mauroy, B., 2021. Wall shear stress distribution in a compliant airway tree. *Physics of Fluids* 33, 031907. <https://doi.org/10.1063/5.0038706>

Stickford, J.L., Wilhite, D.P., Bhammar, D.M., Balmain, B.N., Babb, T.G., 2021. Dysanapsis in men and women with obesity. *Journal of Applied Physiology* 131, 496–503. <https://doi.org/10.1152/jappphysiol.00133.2021>

Strojnik, V., Komi, P.V., 1998. Neuromuscular fatigue after maximal stretch-shortening cycle exercise. *Journal of Applied Physiology* 84, 344–350. <https://doi.org/10.1152/jappl.1998.84.1.344>

Supinski, G., Dimarco, A., Ketai, L., Hussein, F., Altose, M., 1988. Reversibility of Diaphragm Fatigue by Mechanical Hyperperfusion. *Am Rev Respir Dis* 138, 604–609. <https://doi.org/10.1164/ajrccm/138.3.604>

Supinski, G., Stofan, D., DiMarco, A., 1993. Effect of ischemia-reperfusion on diaphragm strength and fatigability. *Journal of Applied Physiology* 75, 2180–2187. <https://doi.org/10.1152/jappl.1993.75.5.2180>

Sylvester, K.P., Clayton, N., Cliff, I., Hepple, M., Kendrick, A., Kirkby, J., Miller, M., Moore, A., Rafferty, G.F., O'Reilly, L., Shakespeare, J., Smith, L., Watts, T., Bucknall, M., Butterfield, K., 2020. ARTP statement on pulmonary function testing 2020. *BMJ Open Res* 7, e000575. <https://doi.org/10.1136/bmjresp-2020-000575>

Szczesna, D., Zhao, J., Jones, M., Zhi, G., Stull, J., Potter, J.D., 2002. Phosphorylation of the regulatory light chains of myosin affects Ca²⁺ sensitivity of skeletal muscle contraction. *Journal of Applied Physiology* 92, 1661–1670. <https://doi.org/10.1152/japplphysiol.00858.2001>

Tanaka, H., Seals, D.R., 2003. Invited Review: Dynamic exercise performance in Masters athletes: insight into the effects of primary human aging on physiological functional capacity. *Journal of Applied Physiology* 95, 2152–2162. <https://doi.org/10.1152/japplphysiol.00320.2003>

Tanaka, H., Tarumi, T., Rittweger, J., 2019. Aging and Physiological Lessons from Master Athletes, in: Terjung, R. (Ed.), *Comprehensive Physiology*. Wiley, pp. 261–296. <https://doi.org/10.1002/cphy.c180041>

Tawhai, M.H., Hunter, P., Tschirren, J., Reinhardt, J., McLennan, G., Hoffman, E.A., 2004. CT-based geometry analysis and finite element models of the human and ovine bronchial tree. *Journal of Applied Physiology* 97, 2310–2321. <https://doi.org/10.1152/japplphysiol.00520.2004>

Taylor, B.J., Romer, L.M., 2008. Effect of expiratory muscle fatigue on exercise tolerance and locomotor muscle fatigue in healthy humans. *Journal of Applied Physiology* 104, 1442–1451. <https://doi.org/10.1152/japplphysiol.00428.2007>

Taylor, J.L., 2009. Point:Counterpoint: The interpolated twitch does/does not provide a valid measure of the voluntary activation of muscle. *Journal of Applied Physiology* 107, 354–355. <https://doi.org/10.1152/japplphysiol.91220.2008>

Taylor, J.L., Amann, M., Duchateau, J., Meeusen, R., Rice, C.L., 2016. Neural Contributions to Muscle Fatigue: From the Brain to the Muscle and Back Again. *Medicine & Science in Sports & Exercise* 48, 2294–2306. <https://doi.org/10.1249/MSS.0000000000000923>

Taylor, J.L., Todd, G., Gandevia, S.C., 2006. EVIDENCE FOR A SUPRASPINAL CONTRIBUTION TO HUMAN MUSCLE FATIGUE. *Clin Exp Pharma Physio* 33, 400–405. <https://doi.org/10.1111/j.1440-1681.2006.04363.x>

Thomas, K., Goodall, S., Stone, M., Howatson, G., Gibson, A.S.C., Ansley, L., 2015. Central and Peripheral Fatigue in Male Cyclists after 4-, 20-, and 40-km Time Trials. *Medicine & Science in Sports & Exercise* 47, 537–546. <https://doi.org/10.1249/MSS.0000000000000448>

Tillin, N.A., Bishop, D., 2009. Factors Modulating Post-Activation Potentiation and its Effect on Performance of Subsequent Explosive Activities: *Sports Medicine* 39, 147–166. <https://doi.org/10.2165/00007256-200939020-00004>

Todd, G., Gorman, R.B., Gandevia, S.C., 2004. Measurement and reproducibility of strength and voluntary activation of lower-limb muscles. *Muscle and Nerve* 29, 834–842. <https://doi.org/10.1002/mus.20027>

Tofari, P.J., Opar, D.A., Kemp, J.G., Billaut, F., Cormack, S., 2016. Reliability of measures of quadriceps muscle function using magnetic stimulation. *Muscle and Nerve* 53, 770–778. <https://doi.org/10.1002/mus.24926>

Torres-Tamayo, N., García-Martínez, D., Lois Zolniski, S., Torres-Sánchez, I., García-Río, F., Bastir, M., 2018. 3D analysis of sexual dimorphism in size, shape and breathing kinematics of human lungs. *J. Anat.* 232, 227–237. <https://doi.org/10.1111/joa.12743>

Trappe, S., Hayes, E., Galpin, A., Kaminsky, L., Jemiolo, B., Fink, W., Trappe, T., Jansson, A., Gustafsson, T., Tesch, P., 2013. New records in aerobic power among octogenarian lifelong endurance athletes. *Journal of Applied Physiology* 114, 3–10. <https://doi.org/10.1152/japplphysiol.01107.2012>

Turner, J.M., Mead, J., Wohl, M.E., 1968. Elasticity of human lungs in relation to age. *Journal of Applied Physiology* 25, 664–671. <https://doi.org/10.1152/jappl.1968.25.6.664>

- Tzankoff, S.P., Norris, A.H., 1977. Effect of muscle mass decrease on age-related BMR changes. *Journal of Applied Physiology* 43, 1001–1006. <https://doi.org/10.1152/jappl.1977.43.6.1001>
- Ugawa, Y., Rothwell, J.C., Day, B.L., Thompson, P.D., Marsden, C.D., 1991. Percutaneous electrical stimulation of corticospinal pathways at the level of the pyramidal decussation in humans. *Annals of Neurology* 29, 418–427. <https://doi.org/10.1002/ana.410290413>
- Verges, S., Maffiuletti, N.A., Kerherve, H., Decorte, N., Wuyam, B., Millet, G.Y., 2009. Comparison of electrical and magnetic stimulations to assess quadriceps muscle function. *Journal of Applied Physiology* 106, 701–710. <https://doi.org/10.1152/japplphysiol.01051.2007>
- Verges, S., Notter, D., Spengler, C.M., 2006. Influence of diaphragm and rib cage muscle fatigue on breathing during endurance exercise. *Respiratory Physiology & Neurobiology* 154, 431–442. <https://doi.org/10.1016/j.resp.2005.12.007>
- Verges, S., Sager, Y., Erni, C., Spengler, C.M., 2007. Expiratory muscle fatigue impairs exercise performance. *Eur J Appl Physiol* 101, 225–232. <https://doi.org/10.1007/s00421-007-0491-y>
- Viala, D., Freton, E., 1983. Evidence for respiratory and locomotor pattern generators in the rabbit cervico-thoracic cord and for their interactions. *Exp Brain Res* 49. <https://doi.org/10.1007/BF00238584>
- Vogiatis, I., Athanasopoulos, D., Habazettl, H., Aliverti, A., Louvaris, Z., Cherouveim, E., Wagner, H., Roussos, C., Wagner, P.D., Zakynthinos, S., 2010. Intercostal Muscle Blood Flow Limitation during Exercise in Chronic Obstructive Pulmonary Disease. *Am J Respir Crit Care Med* 182, 1105–1113. <https://doi.org/10.1164/rccm.201002-0172OC>
- Vogiatis, I., Athanasopoulos, D., Habazettl, H., Kuebler, W.M., Wagner, H., Roussos, C., Wagner, P.D., Zakynthinos, S., 2009. Intercostal muscle blood flow limitation in athletes during maximal exercise. *The Journal of Physiology* 587, 3665–3677. <https://doi.org/10.1113/jphysiol.2009.171694>
- Wagner, P.G., Eldridge, F.L., 1991. Development of short-term potentiation of respiration. *Respiration Physiology* 83, 129–139. [https://doi.org/10.1016/0034-5687\(91\)90098-4](https://doi.org/10.1016/0034-5687(91)90098-4)
- Waldrop, T.G., Iwamoto, G.A., 2006. Point:Counterpoint: Supraspinal locomotor centers do/do not contribute significantly to the hyperpnea of dynamic exercise. *Journal of Applied Physiology* 100, 1077–1083. <https://doi.org/10.1152/japplphysiol.01528.2005>
- Walls, J., Maskrey, M., Wood-Baker, R., Stedman, W., 2002. Exercise-induced oxyhaemoglobin desaturation, ventilatory limitation and lung diffusing capacity in women during and after exercise. *European Journal of Applied Physiology* 87, 145–152. <https://doi.org/10.1007/s00421-002-0600-x>
- Wang, Y., Pessin, J.E., 2013. Mechanisms for fiber-type specificity of skeletal muscle atrophy: Current Opinion in Clinical Nutrition and Metabolic Care 16, 243–250. <https://doi.org/10.1097/MCO.0b013e328360272d>
- Weavil, J.C., Hureau, T.J., Thurston, T.S., Sidhu, S.K., Garten, R.S., Nelson, A.D., McNeil, C.J., Richardson, R.S., Amann, M., 2018. Impact of age on the development of fatigue during large and small muscle mass exercise. *American Journal of Physiology-Regulatory, Integrative and Comparative Physiology* 315, R741–R750. <https://doi.org/10.1152/ajpregu.00156.2018>
- Weibel, E.R., 1963. Morphometry of the Human Lung. Springer Berlin Heidelberg, Berlin, Heidelberg. <https://doi.org/10.1007/978-3-642-87553-3>
- Weibel, E.R.W., 1984. The Pathway for Oxygen: Structure and Function in the Mammalian Respiratory. Cambridge, MA: Harvard University Press.
- Welch, J.F., Archiza, B., Guenette, J.A., West, C.R., Sheel, A.W., 2018a. Effect of diaphragm fatigue on subsequent exercise tolerance in healthy men and women. *Journal of Applied Physiology* 125, 1987–1996. <https://doi.org/10.1152/japplphysiol.00630.2018>
- Welch, J.F., Archiza, B., Guenette, J.A., West, C.R., Sheel, A.W., 2018b. Sex differences in diaphragmatic fatigue: the cardiovascular response to inspiratory resistance: Sex differences in the inspiratory muscle metaboreflex. *J Physiol* 596, 4017–4032. <https://doi.org/10.1113/JP275794>
- West, J.B., 2012. Respiratory physiology: the essentials, 9. Aufl. ed. Wolters Kluwer Health/Lippincott Williams & Wilkins, Philadelphia.
- Westerblad, H., Allen, D.G., 1992. Changes of intracellular pH due to repetitive stimulation of single fibres from mouse skeletal muscle. *The Journal*

of Physiology 449, 49–71.
<https://doi.org/10.1113/jphysiol.1992.sp019074>

Whipp, B.J., 1994. Peripheral chemoreceptor control of exercise hyperpnea in humans. *MSSE* 26, 337–347.

Whipp, B.J., Ward, S.A., Lamarra, N., Davis, J.A., Wasserman, K., 1982. Parameters of ventilatory and gas exchange dynamics during exercise. *Journal of Applied Physiology* 52, 1506–1513.
<https://doi.org/10.1152/jappl.1982.52.6.1506>

Whipp, B.J., Wasserman, K., 1969. Alveolar-arterial gas tension differences during graded exercise. *Journal of Applied Physiology* 27, 361–365.
<https://doi.org/10.1152/jappl.1969.27.3.361>

Wilkie, S.S., Dominelli, P.B., Sporer, B.C., Koehle, M.S., Sheel, A.W., 2015. Heliox breathing equally influences respiratory mechanics and cycling performance in trained males and females. *Journal of Applied Physiology* 118, 255–264.
<https://doi.org/10.1152/japplphysiol.00400.2014>

Wilkie, S.S., Guenette, J.A., Dominelli, P.B., Sheel, A.W., 2012. Effects of an aging pulmonary system on expiratory flow limitation and dyspnoea during exercise in healthy women. *Eur J Appl Physiol* 112, 2195–2204. <https://doi.org/10.1007/s00421-011-2191-x>

Williamson, J.W., Fadel, P.J., Mitchell, J.H., 2006. New insights into central cardiovascular control during exercise in humans: a central command update. *Experimental Physiology* 91, 51–58.
<https://doi.org/10.1113/expphysiol.2005.032037>

Wilson, T.M., Tanaka, H., 2000. Meta-analysis of the age-associated decline in maximal aerobic capacity in men: relation to training status. *American Journal of Physiology-Heart and Circulatory Physiology* 278, H829–H834.
<https://doi.org/10.1152/ajpheart.2000.278.3.H829>

Witt, J.D., Guenette, J.A., Rupert, J.L., McKenzie, D.C., Sheel, A.W., 2007. Inspiratory

muscle training attenuates the human respiratory muscle metaboreflex: Cardiovascular effects of training respiratory muscle. *The Journal of Physiology* 584, 1019–1028.
<https://doi.org/10.1113/jphysiol.2007.140855>

Wragg, S., Aquilina, R., Moran, J., Ridding, M., Hamnegard, C., Fearn, T., Green, M., Moxham, J., 1994. Comparison of cervical magnetic stimulation and bilateral percutaneous electrical stimulation of the phrenic nerves in normal subjects. *Eur Respir J* 7, 1788–1792.
<https://doi.org/10.1183/09031936.94.07101788>

Wray, D.W., Richardson, R.S., 2006. Aging, Exercise, and Limb Vascular Heterogeneity in Humans. *Medicine & Science in Sports & Exercise* 38, 1804–1810.
<https://doi.org/10.1249/01.mss.0000230342.86870.94>

Wüthrich, T.U., Notter, D.A., Spengler, C.M., 2013. Effect of inspiratory muscle fatigue on exercise performance taking into account the fatigue-induced excess respiratory drive: Prior-induced inspiratory muscle fatigue and performance. *Experimental Physiology* 98, 1705–1717.
<https://doi.org/10.1113/expphysiol.2013.073635>

Yernault, J.C., De Troyer, A., Rodenstein, D., 1979. Sex and age differences in intrathoracic airways mechanics in normal man. *Journal of Applied Physiology* 46, 556–564.
<https://doi.org/10.1152/jappl.1979.46.3.556>

Younes, M., Kivinen, G., 1984. Respiratory mechanics and breathing pattern during and following maximal exercise. *Journal of Applied Physiology* 57, 1773–1782.
<https://doi.org/10.1152/jappl.1984.57.6.1773>

Zhang, J., Huang, W., Hughen, R., Kang, S., Light, A., 2015. (322) Sensory and sympathetic innervation of mouse skeletal muscle blood and lymphatic vasculature. *The Journal of Pain* 16, S56.
<https://doi.org/10.1016/j.jpain.2015.01.240>

Conséquences physiologiques de la limitation du système respiratoire chez le master athlète, approches par expériences et modèles

Résumé. Le système respiratoire sain est généralement surdimensionné par rapport à la demande imposée lors d'un exercice physique. Toutefois, les poumons s'adaptent peu à l'entraînement en endurance. Lors d'exercices réalisés à haute intensité, le système respiratoire des athlètes pourrait donc ne plus être surdimensionné face à une demande ventilatoire aussi élevée. Cela pourrait être accentué avec les altérations de la structure des poumons et de la fonction des muscles respiratoires liées à l'âge. Les personnes âgées entraînées en endurance, appelées master athlètes (> 60 ans), pourraient donc être particulièrement vulnérables aux limitations respiratoires pendant l'exercice. Cela nous amène à la question centrale : comment le système respiratoire limite-t-il l'exercice chez le master athlète ? Pour y répondre, une approche multidisciplinaire a été mise en œuvre combinant des mesures physiologiques avec une modélisation mathématique.

Nous avons d'abord étudié la limitation de débit expiratoire chez les athlètes jeunes et âgés, hommes et femmes. La limitation de débit expiratoire a été mesurée lors d'un test incrémental sur ergocycle en positionnant la boucle débit volume courant dans la courbe débit volume expiratoire maximale. Nous avons constaté que les master athlètes étaient davantage sujets à la limitation de débit et que cela était associé à la convexité de la courbe débit volume expiratoire maximale. Chez un plus grand groupe de master athlètes hommes, la forme de cette courbe était un indice majeur de la sévérité de la limitation de débit expiratoire. Ces résultats mettent en avant l'importance de prendre en compte le débit expiratoire et les caractéristiques des voies aériennes pour mieux comprendre les contraintes ventilatoires du master athlète.

L'objectif suivant était donc d'étudier les mécanismes physiques sous-jacents. Pour cela, nous avons analysé l'effet de la densité et de la viscosité du gaz avec l'utilisation d'héliox. Des principes de mécanique des fluides et des simulations de débits expiratoires dans un modèle d'arbre bronchique compliant ont été combinés avec des mesures expérimentales. Nos résultats détaillent le pattern du débit à travers les générations bronchiques avec de l'air et de l'héliox et indiquent où la laminarité et les turbulences apparaissent. L'héliox augmente le débit expiratoire, surtout quand les effets d'inertie sont dominants, et l'effet de l'héliox pourrait être amplifié chez les master athlètes en raison de leurs bronches âgées et donc plus étroites.

Les contraintes ventilatoires accroissent également la demande sur les muscles respiratoires. Dans une troisième étape, nous avons étudié l'effet du vieillissement sur l'interaction entre la fatigue musculaire respiratoire et locomotrice. Lors d'une tâche inspiratoire fatigante, la pression artérielle moyenne et les résistances vasculaires périphériques des master athlètes ont augmenté davantage

que chez les jeunes athlètes. Durant l'exercice sur ergocycle qui a suivi l'activation musculaire des quadriceps était réduite, entraînant une diminution du temps réalisé par rapport au même exercice effectué sans fatigue inspiratoire préalable. Cette chute de performance était amplifiée chez les master athlètes. Lorsque le même exercice a été effectué à temps égal, mais sans fatigue inspiratoire préalable, moins de fatigue a été observée au niveau des quadriceps, suggérant que la fatigue inspiratoire accélère la fatigue des quadriceps et ce, de manière amplifiée chez les master athlètes. En étudiant les différences liées au sexe entre les athlètes jeunes et master, l'augmentation plus prononcée liée à l'âge de la réponse cardiovasculaire à la fatigue inspiratoire était maintenue.

Pour conclure, les principaux résultats de cette thèse mettent en évidence le rôle crucial du système respiratoire dans la limitation de la performance à l'exercice chez les master athlètes.

Mots clés. Fatigue neuromusculaire, limitation de débit expiratoire, master athlètes, modélisation mathématique, système respiratoire

Physiological Consequences of Respiratory System Limitation in the Master Athlete, Approaches through Experiments and Models

Abstract. The healthy respiratory system is generally overbuilt for the demand imposed by physical exercise. Yet, lung adaptations to endurance training are limited. Therefore, during high-intensity exercise, the respiratory system of athletes may no longer be overbuilt to meet the unusually high ventilatory demand. This statement may be amplified in the elderly due to age-induced alterations of lungs structure and respiratory muscle function. Older endurance-trained individuals, called master athletes (>60 years old), thus emerge as particularly susceptible to respiratory limitations during exercise. Taken together, it brings us to the central question: how does the respiratory system limits exercise in master athletes? To answer this question, a multidisciplinary approach was implemented combining physiological measurements with mathematical modeling.

We first examined the phenomenon of expiratory flow limitation among young and master female and male athletes. Airflow limitation was measured during a graded cycling test to exhaustion by positioning the averaged tidal flow volume loop within the maximal expiratory flow volume curve. We mainly found that master athletes were more likely to experience flow limitation and that it was associated with maximal expiratory flow volume curvilinearity. For a larger group of male master athletes, the shape of this curve was a major index of the severity of expiratory flow limitation. These results highlight the importance of examining expiratory flow pattern and airway characteristics to understand ventilatory constraints in master athletes.

Therefore, in a second time, our aim was to investigate the physical mechanisms underlying expiratory flow in the lungs. We analyzed the effect of gas density and viscosity through heliox breathing in aging airways. Principles from fluid mechanics and simulations of expiratory flow in a compliant airway tree model were combined with experimental measurements. Our findings depicted flow pattern across airway generations with both air and heliox and provided insight of where laminarity and turbulences should be found. Heliox increases expiratory flow especially in branches where inertial effects are dominant and its effect may be enhanced in the master athletes because of their age-induced smaller airways.

Expiratory flow constraints in the lungs increases the demand upon respiratory muscles. Consequently, in a third step we aimed at evaluating the influence of aging on the interplay between respiratory and locomotor muscle fatigue. During a fatiguing inspiratory loaded task, male master athletes exhibited a greater elevation of mean arterial pressure and limb vascular resistance compared to young athletes. On a subsequent strenuous cycling exercise, the activation of the quadriceps muscle was reduced. It resulted in a decrease in time to exhaustion in comparison to a

cycling exercise performed with no prior induction of inspiratory muscle fatigue. Moreover, the reduction of exercise performance was greater in master athletes. When the cycling exercise was performed for the same duration without prior induction of inspiratory muscle fatigue, we found less neuromuscular fatigue in limb muscles, implying that inspiratory muscle fatigue accelerated limb muscle fatigue to a greater extent in master athletes.

Furthermore, when examining biological sex differences between young and master athletes, the greater age-related elevation of cardiovascular response to inspiratory muscle fatigue, was maintained.

In summary, the main findings of this thesis highlight the pivotal role of the respiratory system in limiting exercise performance in master athletes.

Key words. Expiratory flow limitation, master athletes, mathematical modeling, neuromuscular fatigue, respiratory system