



**HAL**  
open science

# A multi-viewed semantic for cyber-physical production system to support its life cycle-using system Engineering approach

Puviyarasu Subramaniam Anbuezhian

## ► To cite this version:

Puviyarasu Subramaniam Anbuezhian. A multi-viewed semantic for cyber-physical production system to support its life cycle-using system Engineering approach. Chemical and Process Engineering. École centrale de Nantes, 2023. English. NNT : 2023ECDN0010 . tel-04520752

**HAL Id: tel-04520752**

**<https://theses.hal.science/tel-04520752v1>**

Submitted on 25 Mar 2024

**HAL** is a multi-disciplinary open access archive for the deposit and dissemination of scientific research documents, whether they are published or not. The documents may come from teaching and research institutions in France or abroad, or from public or private research centers.

L'archive ouverte pluridisciplinaire **HAL**, est destinée au dépôt et à la diffusion de documents scientifiques de niveau recherche, publiés ou non, émanant des établissements d'enseignement et de recherche français ou étrangers, des laboratoires publics ou privés.

# MÉMOIRE DE DOCTORAT DE

L'ECOLE CENTRALE DE NANTES

ECOLE DOCTORALE N° 602  
*Sciences de l'Ingénierie et des Systèmes*  
Spécialité : Génie industriel

Par

**Puviyarasu SUBRAMANIAM ANBUCHEZHIAN**

**A Multi-viewed semantic for “Cyber-Physical Production System” to support its life cycle- using System Engineering (SE) approach**

Projet de recherche doctoral présenté et soutenu à Nantes, le 29/03/2023

Unité de recherche : UMR 6004, Laboratoire des sciences du Numérique de Nantes (LS2N)

## Rapporteurs avant soutenance :

Mario LEZOCHÉ Maitre de Conférences, HDR, Université de Lorraine, Nancy, France

Christophe MERLO Professeur, HDR, École supérieure des technologies industrielles avancées, Bidart, France

## Composition du Jury :

Président : Nasser MEBARKI Professeur des universités, Nantes Université, Nantes, France

Examineurs : Mario LEZOCHÉ Maitre de Conférences, HDR, Université de Lorraine, Nancy, France

Christophe MERLO Professeur, HDR, École supérieure des technologies industrielles avancées, Bidart, France

Directrice de  
Recherches  
doctorales :

Catherine DA CUNHA Professeure des universités, École Centrale de Nantes, France

Invité: Surenthar KANNADHASAN Business process Expert, Dassault system, Paris, France





# Abstract

---

THE Cyber-physical systems are currently proposed as an answer to this industrial 4.0 revolution. Over the years, different researchers used to refer the integration of the production aspect in the CPS, projecting as Cyber-Physical Production System (CPPS). The notion of CPPS has been gained increasing attention over the past few years in production topics. Although the notion of CPPS has been adopted by many researchers, there is a lack of unified definition and common understanding of the concept. Despite the CPPS notion still in its infancy, the complex heterogeneity, crosslinking entities, dependency relation between product and production system, involved intertwined entities, are rapid increasing. It is hindered by a lack of common understanding of CPPS concept (i.e) what are the involved entities, life cycle, what is the human-CPPS (HCPPS) interactions phenomenon are. how humans perceive and respond to machine' interaction responses (emotional and cognitive aspects). As a result of such limitation and missing standard leads to major challenge in its evolution and reusability across the domain. There is a need for a standard organising for these challenges. This thesis aims to provide a semantic foundation for the CPPS notion by proposing an organizing the concept, and multi-viewed semantic framework. It is meant to be the semantic basis of future classification of CPPS notion for researchers, and practitioners in the field. It supports in CPPS evolution and tailoring to multiple purposes, which includes CPPS-SE process, stakeholders, actor network and other aspects of paradigm. The thesis work is supported by the laboratory of digital science of Nantes (LS2N)- CPPS platform project.

**Key-words:** Cyber-Physical Production System (CPPS), Human-CPPS integrations (HCPPS), Ontology, Semantics, System Engineering approach, LS2N-Platform project.

*Dedicated to my loveable Mom, Dad, Suba, and  
Grandma*

Memory of my grandpa.....

# Acknowledgement

---

First, I would acknowledge myself for being patience in a long journey.....

Then, I would like to thank my director, who got the funding and gave me the full freedom to work completely on my own and be there whenever I need support

Special thanks to all my collaborators for the interesting collaboration.

Special thanks to all my CSI members, for agreeing to review my work each year.

Special thanks to all my jury members for agreeing to examine the work and having an interesting scientific discussion.

Special thanks to my Professor brother. It was always cherishable in our research conversations.

Special thanks all my Professors who had fruitful and cross-cutting research collaborations in my past. Special thanks to my friend, KPS for helping me in a valuable time.

Furthermore, I would like to acknowledge the Ecole centrale de Nantes(ECN) and Laboratory of digital Science of Nantes (LS2N) research unit gave me good environment of S-Building; Room no: 211 to conduct my PhD research work in a successful manner.

In addition, I would like to express my gratitude to my family for all the unwavering support; giving me full freedom to do what I like.

Finally, the PhD life wouldn't have been so much fun without my family in India and friends around the World for sharing the happy moments. I am also grateful for interesting discussions and beautiful memories that I cherish.....

**Puviyarasu S.A**

**2023, Nantes, France**

# Contents

Abstract	1
Acknowledgements	2
General Introduction	3
Nomenclature	4
<hr/>	
= ° = ° = °	
Chapter 1	
Research context and Problematic	
<hr/>	
1.1 Global context and Motivation . . . . .	9
1.1.1 Global issue and Industry 4.0 production paradigm challenges . . . . .	9
1.1.2 Motivation of thesis . . . . .	12
1.2 Research area and background . . . . .	13
1.2.1 CPPS fundamentals and definitions . . . . .	13
1.2.2 CPPS terminology, taxonomy, and typology . . . . .	14
1.2.3 CPPS system theory . . . . .	15
1.2.4 CPPS life cycle aspects . . . . .	16
1.3 Application context-Laboratory of digital science of Nantes (LS2N)-CPPS . . . . .	17
1.3.1 LS2N Platform Project description . . . . .	19
1.3.2 LS2N CPPS Platform Project and Knowledge Sources Needs . . . . .	21
1.4 Thesis Scientific Problematics . . . . .	22
1.4.1 Challenges on CPPS Understanding . . . . .	22
1.4.2 Challenges on CPPS Informatics . . . . .	22
1.4.3 Challenges on CPPS Collaboration . . . . .	23
1.4.4 Challenges on CPPS Knowledge reuse and sharing . . . . .	24
1.4.5 Thesis Problem statement . . . . .	25
1.5 Research Question, Methods, and Process . . . . .	26
1.6 Thesis structure . . . . .	31
<hr/>	
Chapter 2	
Related works and Scientific background	
<hr/>	
2.1 Introduction . . . . .	36
2.2 Systematic Literature review on CPPS concept . . . . .	36
2.3 Normalization, mapping, and clustering of SLR . . . . .	41
<hr/>	

2.4	Bibliometric network and fractional counting . . . . .	44
2.5	Backward Snowfall sampling -Reference tracking . . . . .	45
2.6	Quality assessment on inclusive papers . . . . .	47
2.7	Synthesis: SLR results . . . . .	58
2.8	Knowledge representation techniques . . . . .	58
2.8.1	Ontology for knowledge classification . . . . .	59
2.8.2	Semantic concept and representation . . . . .	61
2.8.3	Multi-viewed modeling mechanism . . . . .	68
2.8.4	Modeling language and tools . . . . .	68
2.8.5	Synthesis . . . . .	71
2.9	System and Systems Engineering approach . . . . .	72
2.9.1	General system theory . . . . .	72
2.9.2	Systems Engineering approach . . . . .	73
2.9.3	Reusability and modularity practices/concepts . . . . .	75
2.9.4	Synthesis . . . . .	76
2.10	PhD Contribution positioning . . . . .	77

### Chapter 3

#### Organizing Cyber-physical production system notion

---

3.1	Introduction . . . . .	83
3.2	Production system paradigms . . . . .	83
3.3	CPPS notion organizing . . . . .	85
3.3.1	CPPS notion- Understanding . . . . .	85
3.3.2	CPPS notion- fundamental theory . . . . .	88
3.3.3	CPPS notion-System of interest and Enabling system . . . . .	90
3.4	Metamodel for CPPS notion . . . . .	93
3.5	Synthesis . . . . .	97

### Chapter 4

#### Multi-viewed Semantic framework for CPPS Notion

---

4.1	<b>Introduction</b> . . . . .	100
4.1.1	Multi-viewed modeling mechanism . . . . .	104
4.1.2	Semantic framework for CPPS notion . . . . .	107
4.1.3	Modular and Resuable architecture for CPPS notion . . . . .	108
4.2	<b>Multi-viewed Semantic for CPPS notion</b> . . . . .	113
4.2.1	CPPS- Terminology classified exploitation . . . . .	114
4.2.2	CPPS-Typology classifications and its entities . . . . .	117
4.2.3	<b>Overview of multi-viewed mechanism and specification</b> . . . . .	123
4.2.4	CPPS domain production and product aspects model . . . . .	125
4.2.5	CPPS Business process model . . . . .	128
4.2.6	CPPS Life cycle artifact model . . . . .	130
4.2.7	CPPS Value creation models . . . . .	135
4.2.8	Synthesis . . . . .	136
4.3	<b>Formal specifications of models operation/algorithm</b> . . . . .	137
4.4	<b>Model Verification and Validation- algorithm</b> . . . . .	141
4.4.1	Case-1 CPPS-Discrete event Scenario . . . . .	145

4.4.2	Case-2 CPPS- Retrofitted event Scenario . . . . .	148
4.5	<b>Conclusion and synthesis</b> . . . . .	151

## Chapter 5

### Application context

---

5.1	Introduction . . . . .	154
5.2	LS2N CPPS Platform project . . . . .	155
5.3	App-1- Semantic Knowledge Repository application . . . . .	155
5.3.1	Introduction and Problem context . . . . .	155
5.3.2	Schematic overview of reuse and instantiation . . . . .	155
5.3.3	Collaborative semantic knowledge repository for platform . . . . .	156
5.3.4	Analysis of CPPS performance evaluation . . . . .	161
5.3.5	Identifying influence factors on CPPS operation . . . . .	165
5.3.6	Analysis of Operational satisfaction . . . . .	168
5.3.7	Conclusion . . . . .	171
5.4	App-2 Collaborative management application . . . . .	173
5.4.1	Introduction and problem statement . . . . .	173
5.4.2	Schematic overview of reuse and instantiation . . . . .	173
5.4.3	Overview of Collaborative management application . . . . .	174
5.4.4	Feasibility analysis on alternatives . . . . .	175
5.4.5	Prototype of the collaborative application . . . . .	179
5.4.6	Collaborative management application . . . . .	181
5.4.7	Collaborative management space . . . . .	184
5.4.8	Synthesis . . . . .	186
5.5	<b>Conclusion</b> . . . . .	187

## Chapter 6

### Multi-viewed Semantic for Human-CPPS notion integration

---

6.1	Introduction . . . . .	190
6.2	Terminology and typology of Human-CPPS notion integration . . . . .	192
6.3	Multi-viewed Semantic for Human-CPPS notion integration . . . . .	194
6.3.1	Related works before developing HCPPS . . . . .	194
6.3.2	Mechanism before developing HCPPS Semantics . . . . .	196
6.3.3	Fragment top domain model of HCPPS . . . . .	199
6.3.4	Interaction Human modality aspects . . . . .	200
6.3.5	Interaction CPPS modality aspects . . . . .	203
6.3.6	Human-CPPS interaction phenomenon . . . . .	205
6.3.7	Collaborative HCPPS integration semantics web page . . . . .	207
6.3.8	Synthesis . . . . .	210
6.4	Model Verification and Validation-algorithms . . . . .	211
6.5	Application context . . . . .	219
6.5.1	Introduction and problem statement . . . . .	219
6.5.2	Schematic overview of reuse and instantiation . . . . .	219
6.5.3	Configurator for human learning process . . . . .	220
6.5.4	Knowledge Tool for Interaction - HCPPS . . . . .	224
6.5.5	Inventor Solution Query and dialog box . . . . .	227

6.5.6	Synthesis	230
6.6	<b>Conclusion</b>	231

## Chapter 7

### Conclusion and perspective

---

7.1	Summary	232
7.2	CPPS notion Semantic framework Contributions	234
7.2.1	Scientific implication to CPPS notion- Generic view	234
7.2.2	Practical implication to CPPS notion-Generic view	235
7.2.3	Research gap and contributions	236
7.2.4	Contribution to INCOSE Community vision	237
7.3	Framework limitations and discussion	237
7.4	Future directions and perspective	238

## Chapter 8

### Appendix

---

8.1	Appendix-A Chapter-1 Research process and artifact	241
8.2	Appendix-B Chapter-2-System theory	242
8.3	Appendix-C Chapter-2-Terminology and definitions	243
8.4	Appendix-D- Chapter-2-Snowballing analysis	246
8.5	Appendix-E-Semantic Supplementary Models	247
8.6	Appendix-E-Chapter-5 Application context(1)	251
8.7	Appendix-F-Chapter-5 Application context (1)	252
8.8	Appendix-G-Chapter-6- Application context (3)	264
8.9	Appendix-H-Human-CPPS Semantic integration	266
8.10	Appendix-I-Human-CPPS Configurator app	267

## Index

---

## Bibliography

---



# List of Figures

<b>Figure 1:</b>	Thesis structure . . . . .	3
<b>Figure 2:</b>	Thesis structure . . . . .	6
<b>Figure 1.1:</b>	Future production system criteria . . . . .	9
<b>Figure 1.2:</b>	Survey of human interaction with machine . . . . .	10
<b>Figure 1.3:</b>	Challenges of industry 4.0 production paradigm . . . . .	11
<b>Figure 1.4:</b>	CPPS Notion (figure enhanced from . . . . .	12
<b>Figure 1.5:</b>	CPS-based automation . . . . .	13
<b>Figure 1.6:</b>	CPS analog to CPPS . . . . .	15
<b>Figure 1.7:</b>	CPS-System theory . . . . .	16
<b>Figure 1.8:</b>	Production system life cycle . . . . .	17
<b>Figure 1.9:</b>	LS2N-CPPS Concept demonstrator . . . . .	18
<b>Figure 1.10:</b>	LS2N- CPPS schematic view . . . . .	19
<b>Figure 1.11:</b>	LS2N- CPPS platform project . . . . .	20
<b>Figure 1.12:</b>	CPPS system theory . . . . .	22
<b>Figure 1.13:</b>	CPPS informatics . . . . .	23
<b>Figure 1.14:</b>	CPPS Collaboration . . . . .	23
<b>Figure 1.15:</b>	Knowledge reuse and sharing . . . . .	24
<b>Figure 1.16:</b>	Stages of Research process for the framework . . . . .	30
<b>Figure 1.17:</b>	Thesis structure . . . . .	31
<b>Figure 2.1:</b>	Systematic Literature review (Until 2019) . . . . .	38
<b>Figure 2.2:</b>	Publication each year until 2019 . . . . .	39
<b>Figure 2.3:</b>	Cluster-1 Keywords on overall CPPS exploration . . . . .	40
<b>Figure 2.4:</b>	Cluster-2 Cluster node analysis on CPPS concept . . . . .	41
<b>Figure 2.5:</b>	Cluster-3 Cluster on Human-CPPS integration . . . . .	41
<b>Figure 2.6:</b>	Cluster-4 Cluster node analysis for CPPS concept . . . . .	42
<b>Figure 2.7:</b>	Cluster-5 Cluster node analysis for CPPS referencing . . . . .	42
<b>Figure 2.8:</b>	Cluster-6 Cluster node analysis for CPPS architecture . . . . .	42
<b>Figure 2.9:</b>	Cluster-7 Cluster node analysis for human-centered CPPS architecture . . . . .	42
<b>Figure 2.10:</b>	Cluster-8 Cluster node analysis for life cycle concept . . . . .	42
<b>Figure 2.11:</b>	Cluster-9 Cluster node analysis for Business aspects . . . . .	42
<b>Figure 2.12:</b>	Cluster-10 Density visualisation for CPPS concept . . . . .	43
<b>Figure 2.13:</b>	Cluster-11 Density visualisation for CPPS referencing . . . . .	43
<b>Figure 2.14:</b>	Cluster-12 Density visualisation for CPPS architecture . . . . .	43
<b>Figure 2.15:</b>	Cluster-13 Density visualisation for human-centered CPPS architecture . . . . .	43

<b>Figure 2.16:</b>	Cluster-14 Density visualisation for CPPS business aspects . . . . .	43
<b>Figure 2.17:</b>	Cluster-15 Density visualisation for CPPS life cycle aspects . . . . .	43
<b>Figure 2.18:</b>	Overall Co-occurrence CPPS density exploration . . . . .	44
<b>Figure 2.19:</b>	Overview of snowball procedure . . . . .	45
<b>Figure 2.20:</b>	Overview of snowball procedure . . . . .	46
<b>Figure 2.21:</b>	Publication inclusion after eligibility . . . . .	49
<b>Figure 2.22:</b>	Publication inclusion density . . . . .	50
<b>Figure 2.23:</b>	Publication inclusion after eligibility . . . . .	51
<b>Figure 2.24:</b>	Acronym-Production system concepts . . . . .	52
<b>Figure 2.25:</b>	Sample of production terms in reviewed papers . . . . .	52
<b>Figure 2.26:</b>	CPPS architecture . . . . .	55
<b>Figure 2.27:</b>	CPS Design pattern . . . . .	56
<b>Figure 2.28:</b>	CPPS architecture . . . . .	56
<b>Figure 2.29:</b>	CPPS adaptive component . . . . .	57
<b>Figure 2.30:</b>	Security CPPS architecture . . . . .	57
<b>Figure 2.31:</b>	Domain ontology . . . . .	59
<b>Figure 2.32:</b>	Semantics and pragmatic view . . . . .	60
<b>Figure 2.33:</b>	Semantics representation . . . . .	61
<b>Figure 2.34:</b>	Abstract semantics . . . . .	62
<b>Figure 2.35:</b>	Standard model to support life cycle . . . . .	64
<b>Figure 2.36:</b>	Product service system (PSS) . . . . .	65
<b>Figure 2.37:</b>	Product service system (PSS) . . . . .	65
<b>Figure 2.38:</b>	Human-System integration . . . . .	65
<b>Figure 2.39:</b>	Human-machine ontology . . . . .	65
<b>Figure 2.40:</b>	Examples of Standard modeling framework . . . . .	65
<b>Figure 2.41:</b>	Flexible manufacturing system (FMS) [[Guarino [1998]]] . . . . .	66
<b>Figure 2.42:</b>	holonic manufacturing system [[Valckenaers et al. [1997]]] . . . . .	66
<b>Figure 2.43:</b>	Reconfigurable manufacturing system [[Bortolini et al. [2018]]] . . . . .	66
<b>Figure 2.44:</b>	dedicated manufacturing system [[Azangoo et al. [2020]]] . . . . .	66
<b>Figure 2.45:</b>	Examples of Standard modeling framework . . . . .	66
<b>Figure 2.46:</b>	Manufacturing system ontology . . . . .	67
<b>Figure 2.47:</b>	Manufacturing system ontology . . . . .	67
<b>Figure 2.48:</b>	Multi-view point modeling . . . . .	69
<b>Figure 2.49:</b>	Referential schema-multi-viewpoint . . . . .	69
<b>Figure 2.50:</b>	multi-viewpoint modeling for DMU(S) . . . . .	70
<b>Figure 2.51:</b>	Multi-viewpoint modeling for multiple aspects . . . . .	70
<b>Figure 2.52:</b>	Modeling language and tools . . . . .	71
<b>Figure 2.53:</b>	General system representation . . . . .	72
<b>Figure 2.54:</b>	System Engineering approach . . . . .	73
<b>Figure 2.55:</b>	System of interest and Enabling system . . . . .	74
<b>Figure 2.56:</b>	Top-level system model . . . . .	75

<b>Figure 2.57:</b>	Explicit conceptualization of a CPPS domain . . . . .	79
<b>Figure 2.58:</b>	Contribution of thesis work . . . . .	80
<b>Figure 3.1:</b>	Different production system paradigms . . . . .	84
<b>Figure 3.2:</b>	Production system . . . . .	86
<b>Figure 3.3:</b>	CPPS- Product and production collaboration . . . . .	87
<b>Figure 3.4:</b>	CPPS-Input and Output . . . . .	90
<b>Figure 3.5:</b>	CPPS- Separability property (enhanced from . . . . .	91
<b>Figure 3.6:</b>	System of interest and Enabling system . . . . .	91
<b>Figure 3.7:</b>	CPPS understanding-(figure enhanced from . . . . .	93
<b>Figure 3.8:</b>	CPPS metamodel is based on the above formal system classification-System of Interest and Enabling System; dark gray represents- SOI and Blue represent-ES) . . . . .	94
<b>Figure 3.9:</b>	CPPS Notion . . . . .	97
<b>Figure 4.1:</b>	CPPS notion domain framework . . . . .	102
<b>Figure 4.2:</b>	Instance level and relations concepts . . . . .	104
<b>Figure 4.3:</b>	Content relationships between view . . . . .	105
<b>Figure 4.4:</b>	Different kinds of process relation . . . . .	106
<b>Figure 4.5:</b>	Different types of operations . . . . .	106
<b>Figure 4.6:</b>	CPPS framework for SE process . . . . .	109
<b>Figure 4.7:</b>	Framework structure . . . . .	110
<b>Figure 4.8:</b>	CPPS Typology core classifications . . . . .	117
<b>Figure 4.9:</b>	human-cpps integration . . . . .	121
<b>Figure 4.10:</b>	Cyber and physical infrastructure . . . . .	122
<b>Figure 4.11:</b>	CPPS domain property aspects . . . . .	126
<b>Figure 4.12:</b>	CPPS property interrelations views . . . . .	127
<b>Figure 4.13:</b>	CPPS business process . . . . .	129
<b>Figure 4.14:</b>	CPPS Life-cycle(figure enhanced from . . . . .	130
<b>Figure 4.15:</b>	CPPS Life-cycle(figure enhanced from . . . . .	131
<b>Figure 4.16:</b>	CPPS Life-cycle(figure enhanced from . . . . .	132
<b>Figure 4.17:</b>	CPPS life cycle (figure enhanced from . . . . .	133
<b>Figure 4.18:</b>	CPPS value creation elemental synthesis . . . . .	135
<b>Figure 4.19:</b>	CPPS verification and validation . . . . .	141
<b>Figure 4.20:</b>	CPPS validation . . . . .	143
<b>Figure 4.21:</b>	UC structure model . . . . .	147
<b>Figure 4.22:</b>	UC property, business process model . . . . .	147
<b>Figure 4.23:</b>	UC-Assembly operation . . . . .	147
<b>Figure 4.24:</b>	UC integrated structure . . . . .	149
<b>Figure 4.25:</b>	UC description . . . . .	149
<b>Figure 4.26:</b>	Retrofit operation . . . . .	149
<b>Figure 5.1:</b>	Collaborative LS2N- CPPS knowledge repository . . . . .	156
<b>Figure 5.2:</b>	CPPS knowledge repository . . . . .	158
<b>Figure 5.3:</b>	LS2N- CPPS-Application magazine module . . . . .	160
<b>Figure 5.4:</b>	LS2N CPPS- Personalized category model explorer . . . . .	160
<b>Figure 5.5:</b>	Scenario-1 time-line . . . . .	164

<b>Figure 5.6:</b>	Scenario-1 OEE . . . . .	164
<b>Figure 5.7:</b>	Scenario-2 time-line . . . . .	164
<b>Figure 5.8:</b>	Scenario-2 OEE . . . . .	164
<b>Figure 5.9:</b>	Scenario-3 production time-line . . . . .	164
<b>Figure 5.10:</b>	Scenario-3 OEE . . . . .	164
<b>Figure 5.11:</b>	Individual plot of OEE . . . . .	165
<b>Figure 5.12:</b>	Box plot of OEE . . . . .	165
<b>Figure 5.13:</b>	Interval plot b/w S1, S2, S3 . . . . .	165
<b>Figure 5.14:</b>	Residual plot for OEE . . . . .	165
<b>Figure 5.15:</b>	ANOVA analysis . . . . .	165
<b>Figure 5.16:</b>	Residual plot for OEE . . . . .	166
<b>Figure 5.17:</b>	Response contour plot 1 . . . . .	167
<b>Figure 5.18:</b>	Response contour plot 2 . . . . .	167
<b>Figure 5.19:</b>	Response contour plot . . . . .	168
<b>Figure 5.20:</b>	Response contour plot . . . . .	168
<b>Figure 5.21:</b>	Summary of fit (OEE) . . . . .	168
<b>Figure 5.22:</b>	Summary of fit (OEE) . . . . .	168
<b>Figure 5.23:</b>	System description . . . . .	169
<b>Figure 5.24:</b>	System Workforce . . . . .	170
<b>Figure 5.25:</b>	Transition comparision . . . . .	170
<b>Figure 5.26:</b>	Overview of collaborative management application . . . . .	174
<b>Figure 5.27:</b>	PROMETHEE I—Partial Ranking . . . . .	176
<b>Figure 5.28:</b>	PROMETHEE II—Partial Ranking . . . . .	176
<b>Figure 5.29:</b>	PROMETHEE III—Partial Ranking . . . . .	177
<b>Figure 5.30:</b>	Network display on alternatives . . . . .	177
<b>Figure 5.31:</b>	PROMETHEE III—Partial Ranking . . . . .	177
<b>Figure 5.32:</b>	Network display on alternatives . . . . .	177
<b>Figure 5.33:</b>	PROMETHEE III—Partial Ranking . . . . .	177
<b>Figure 5.34:</b>	Network display on alternatives . . . . .	177
<b>Figure 5.35:</b>	PROMETHEE III—Partial Ranking . . . . .	178
<b>Figure 5.36:</b>	Network display on alternatives . . . . .	178
<b>Figure 5.37:</b>	Concept of operation(CONOPS)(S1),(S2,(S3) . . . . .	179
<b>Figure 5.38:</b>	Prototype of Collaborative Graphical interface . . . . .	180
<b>Figure 5.39:</b>	Logical interfacing solution . . . . .	181
<b>Figure 5.40:</b>	Smart soft component of application . . . . .	182
<b>Figure 5.41:</b>	Collaborative Interface management application . . . . .	183
<b>Figure 5.42:</b>	Collaborative fleet management view . . . . .	184
<b>Figure 5.43:</b>	Collaborative fleet manager . . . . .	184
<b>Figure 5.44:</b>	Design structure matrix for Interface matrix) . . . . .	185
<b>Figure 6.1:</b>	Human-CPPS core entities . . . . .	193
<b>Figure 6.2:</b>	Human-CPPS Network . . . . .	196
<b>Figure 6.3:</b>	Fragment Human-CPPS Network . . . . .	198
<b>Figure 6.4:</b>	Fragment human-CPPS concept model . . . . .	199
<b>Figure 6.5:</b>	Human-CPPS interaction . . . . .	200
<b>Figure 6.6:</b>	Human Property . . . . .	201
<b>Figure 6.7:</b>	Human-modality semantics . . . . .	202

<b>Figure 6.8:</b>	CPPS modalities aspects . . . . .	203
<b>Figure 6.9:</b>	CPPS modality semantics . . . . .	204
<b>Figure 6.10:</b>	Human-CPPS interaction semantics . . . . .	206
<b>Figure 6.11:</b>	Collaborative Human-CPPS matrix model . . . . .	207
<b>Figure 6.12:</b>	Collaborative HCPPS integration webpage . . . . .	208
<b>Figure 6.13:</b>	CPPS validation . . . . .	213
<b>Figure 6.14:</b>	Storyboard (intangible interaction) . . . . .	215
<b>Figure 6.15:</b>	Story board (tangible and intangible interaction) . . . . .	215
<b>Figure 6.16:</b>	Configurator for human learning process . . . . .	221
<b>Figure 6.17:</b>	Learning operation scenario . . . . .	221
<b>Figure 6.18:</b>	Learning operation scenario . . . . .	221
<b>Figure 6.19:</b>	UE-1 H-CPPS Integration . . . . .	222
<b>Figure 6.20:</b>	UE-2 Didactic concepts . . . . .	222
<b>Figure 6.21:</b>	UE-3 Cyber entities impacts . . . . .	222
<b>Figure 6.22:</b>	UE-4 Human integration . . . . .	222
<b>Figure 6.23:</b>	UE-5 Physical impacts . . . . .	222
<b>Figure 6.24:</b>	UE-6 Cyber impacts . . . . .	222
<b>Figure 6.25:</b>	UE-7 Application module machine . . . . .	222
<b>Figure 6.26:</b>	UE-8 Overall AS/IS-TO/BE impacts . . . . .	222
<b>Figure 6.27:</b>	HCPPS model reused in application . . . . .	224
<b>Figure 6.28:</b>	App inventor Overview . . . . .	224
<b>Figure 6.29:</b>	Learning operation scenario . . . . .	225
<b>Figure 6.30:</b>	Learning operation scenario . . . . .	225
<b>Figure 6.31:</b>	Measurement, User and User Participation . . . . .	226
<b>Figure 6.32:</b>	Object Property: is measured by . . . . .	226
<b>Figure 6.33:</b>	App inventor (industrial project) . . . . .	227
<b>Figure 6.34:</b>	Configurator- Inspect operation(from industry) . . . . .	228
<b>Figure 6.35:</b>	Configurator- review report (from industry) . . . . .	228
<b>Figure 8.1:</b>	Stages of Research process for the framework . . . . .	241
<b>Figure 8.2:</b>	Example of system theory . . . . .	242
<b>Figure 8.3:</b>	Cluster-2 Cluster node analysis on CPPS concept . . . . .	246
<b>Figure 8.4:</b>	Cluster-3 Cluster on Human-CPPS integration . . . . .	246
<b>Figure 8.5:</b>	Cluster-2 Cluster on CPPS concept . . . . .	246
<b>Figure 8.6:</b>	Cluster-3 Cluster on Human-CPPS integration . . . . .	246
<b>Figure 8.7:</b>	CPPS structure . . . . .	247
<b>Figure 8.8:</b>	CPPS function . . . . .	247
<b>Figure 8.9:</b>	CPPS other properties . . . . .	248
<b>Figure 8.10:</b>	CPPS Product and production view . . . . .	248
<b>Figure 8.11:</b>	CPPS interface model . . . . .	249
<b>Figure 8.12:</b>	CPPS life cycle (enhanced from . . . . .	249
<b>Figure 8.13:</b>	CPPS life cycles (enhanced from . . . . .	250
<b>Figure 8.14:</b>	HCPPS integration matrix . . . . .	250
<b>Figure 8.15:</b>	Scenario-1 production time-line . . . . .	251
<b>Figure 8.16:</b>	Scenario-1 OEE . . . . .	251
<b>Figure 8.17:</b>	Scenario-2 production time-line . . . . .	251
<b>Figure 8.18:</b>	Scenario-2 OEE . . . . .	251

<b>Figure 8.19:</b>	Utilization time on CS part-1 . . . . .	251
<b>Figure 8.20:</b>	Utilisation time on CS part-2 . . . . .	251
<b>Figure 8.21:</b>	ANOVA analysis-(P value and F value) . . . . .	252
<b>Figure 8.22:</b>	ANOVA analysis (OEE) . . . . .	252
<b>Figure 8.23:</b>	ANOVA analysis (OEE-Interval plot) . . . . .	252
<b>Figure 8.24:</b>	ANOVA (OEE-Box plot) . . . . .	252
<b>Figure 8.25:</b>	ANOVA-Influence factor 1 . . . . .	252
<b>Figure 8.26:</b>	ANOVA-Influence factor 2 . . . . .	252
<b>Figure 8.27:</b>	Scenario-1 on alternatives . . . . .	253
<b>Figure 8.28:</b>	Scenario-2 on alternatives . . . . .	253
<b>Figure 8.29:</b>	Scenario-4 on alternatives . . . . .	253
<b>Figure 8.30:</b>	Scenario-5 on alternatives . . . . .	253
<b>Figure 8.31:</b>	Stakeholders-on preferences . . . . .	253
<b>Figure 8.32:</b>	Stakeholders-on preferences . . . . .	253
<b>Figure 8.33:</b>	Visual stability analysis . . . . .	254
<b>Figure 8.34:</b>	Scenario-3 on alternatives . . . . .	254
<b>Figure 8.35:</b>	Stakeholders-on preferences . . . . .	254
<b>Figure 8.36:</b>	Stakeholders-on preferences . . . . .	254
<b>Figure 8.37:</b>	Walking weights . . . . .	254
<b>Figure 8.38:</b>	Walking weights . . . . .	254
<b>Figure 8.39:</b>	Response contour plot 1 . . . . .	255
<b>Figure 8.40:</b>	Response contour plot 2 . . . . .	255
<b>Figure 8.41:</b>	Response contour plot . . . . .	255
<b>Figure 8.42:</b>	Response contour plot . . . . .	255
<b>Figure 8.43:</b>	Summary of fit (OEE) . . . . .	255
<b>Figure 8.44:</b>	Summary of fit (OEE) . . . . .	255
<b>Figure 8.45:</b>	RCP- OEE dehydration . . . . .	256
<b>Figure 8.46:</b>	RCP- OEE dehydration . . . . .	256
<b>Figure 8.47:</b>	RCP- OEE ratio . . . . .	256
<b>Figure 8.48:</b>	RCP-OEE ratio . . . . .	256
<b>Figure 8.49:</b>	Summary of fit (Quality) . . . . .	256
<b>Figure 8.50:</b>	Summary of fit (Quality) . . . . .	256
<b>Figure 8.51:</b>	S-1 Req observation . . . . .	257
<b>Figure 8.52:</b>	S-2 Req observation . . . . .	257
<b>Figure 8.53:</b>	S-3 Req observation . . . . .	257
<b>Figure 8.54:</b>	S-4 Req observation . . . . .	257
<b>Figure 8.55:</b>	S-5 Req observation . . . . .	257
<b>Figure 8.56:</b>	S-6 Req observation . . . . .	257
<b>Figure 8.57:</b>	S-7 Req observation . . . . .	258
<b>Figure 8.58:</b>	S-8 Req observation . . . . .	258
<b>Figure 8.59:</b>	S-9 Req observation . . . . .	258
<b>Figure 8.60:</b>	S-10 Req observation . . . . .	258
<b>Figure 8.61:</b>	S-11 Req observation . . . . .	258
<b>Figure 8.62:</b>	S-12 Req observation . . . . .	258
<b>Figure 8.63:</b>	S-13 Req observation . . . . .	259
<b>Figure 8.64:</b>	S-14 Req observation . . . . .	259
<b>Figure 8.65:</b>	S-15 Req observation . . . . .	259



<b>Figure 8.66:</b>	S-16 Req observation . . . . .	259
<b>Figure 8.67:</b>	S-17 Req observation . . . . .	259
<b>Figure 8.68:</b>	S-18 Req observation . . . . .	259
<b>Figure 8.69:</b>	Requirement flow chart . . . . .	260
<b>Figure 8.70:</b>	Requirement flow chart . . . . .	260
<b>Figure 8.71:</b>	Requirement Observer box . . . . .	260
<b>Figure 8.72:</b>	Requirement Observer box . . . . .	260
<b>Figure 8.73:</b>	Scenario-1-Requirement Obr . . . . .	260
<b>Figure 8.74:</b>	Scenario-2-Requirement Obr . . . . .	260
<b>Figure 8.75:</b>	Scenario-3-Requirement Obr . . . . .	261
<b>Figure 8.76:</b>	Scenario-4-Requirement Obr . . . . .	261
<b>Figure 8.77:</b>	Scenario-5-Requirement Obr . . . . .	261
<b>Figure 8.78:</b>	Scenario-6 Requirement Obr . . . . .	261
<b>Figure 8.79:</b>	Scenario-7 Requirement Obr . . . . .	261
<b>Figure 8.80:</b>	Scenario-8 Requirement Obr . . . . .	261
<b>Figure 8.81:</b>	Logical Architecture . . . . .	262
<b>Figure 8.82:</b>	Robt fuse assembly module . . . . .	262
<b>Figure 8.83:</b>	Application magazine module . . . . .	262
<b>Figure 8.84:</b>	Mobile robot architecture . . . . .	262
<b>Figure 8.85:</b>	Robot architecture . . . . .	262
<b>Figure 8.86:</b>	AS/RS warehouse architecture . . . . .	262
<b>Figure 8.87:</b>	Traceability matrix . . . . .	263
<b>Figure 8.88:</b>	LS2N- Learning activity with students . . . . .	264
<b>Figure 8.89:</b>	LS2N-Resource integrator activity with students . . . . .	264
<b>Figure 8.90:</b>	LS2N- Learning activity with students . . . . .	264
<b>Figure 8.91:</b>	LS2N-Resource integrator activity with students . . . . .	264
<b>Figure 8.92:</b>	LS2N- Learning activity with students . . . . .	264
<b>Figure 8.93:</b>	LS2N-Resource integrator activity with students . . . . .	264
<b>Figure 8.94:</b>	LS2N- Smart CPPS . . . . .	265
<b>Figure 8.95:</b>	LS2N-Cyber world CPPS . . . . .	265
<b>Figure 8.96:</b>	LS2N-Software design CPPS . . . . .	265
<b>Figure 8.97:</b>	LS2N-5C in CPS . . . . .	265
<b>Figure 8.98:</b>	LS2N- manufacturing architecture layer . . . . .	265
<b>Figure 8.99:</b>	LS2N-various functionalities of CPPS . . . . .	265
<b>Figure 8.100:</b>	LS2N- core capabilities of CPPS . . . . .	265
<b>Figure 8.101:</b>	LS2N-Role of humans . . . . .	265
<b>Figure 8.102:</b>	Collaborative HCPPS integration webpage . . . . .	266
<b>Figure 8.103:</b>	Measurement, User and User Participation . . . . .	267
<b>Figure 8.104:</b>	Object Property: <i>is<sub>m</sub> easured<sub>by</sub></i> . . . . .	267
<b>Figure 8.105:</b>	App invetor codes . . . . .	268
<b>Figure 8.106:</b>	App inventor codes . . . . .	268
<b>Figure 8.107:</b>	App inventor code . . . . .	268
<b>Figure 8.108:</b>	App inventor code . . . . .	268

# List of Tables

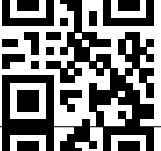
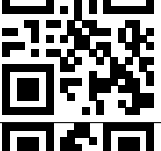
<b>Table 1:</b>	Application context-Human-CPPS integration . . . . .	xiii
<b>Table 1.1:</b>	Details of expert group focus gathering . . . . .	28
<b>Table 2.1:</b>	Number of papers retrieved per search string . . . . .	39
<b>Table 2.2:</b>	Exclusion criteria . . . . .	47
<b>Table 2.3:</b>	The quality criteria applied on inclusion paper . . . . .	48
<b>Table 2.4:</b>	Quality criteria . . . . .	48
<b>Table 4.1:</b>	Description of CPPS viewpoint relationships . . . . .	124
<b>Table 4.2:</b>	Comparison of Existing and Our Proposed models . . . . .	136
<b>Table 4.3:</b>	Description of multi view modeling (MVM) operations . . . . .	138
<b>Table 4.4:</b>	CPPS and its description . . . . .	145
<b>Table 5.1:</b>	Reuse of repository application context . . . . .	155
<b>Table 5.2:</b>	Experimental testing . . . . .	162
<b>Table 5.3:</b>	ANOVA results . . . . .	167
<b>Table 5.4:</b>	Response table for OEE . . . . .	167
<b>Table 5.5:</b>	Comparison of analysis on satisfaction . . . . .	171
<b>Table 5.6:</b>	Reuse for interface management application context . . . . .	173
<b>Table 5.7:</b>	The flows of the alternatives . . . . .	178
<b>Table 6.1:</b>	Research focus competences questions . . . . .	190
<b>Table 6.2:</b>	Analysis of HCPPS- related Semantics criteria . . . . .	194
<b>Table 6.3:</b>	HCPPS semantics found in the literature . . . . .	195
<b>Table 6.4:</b>	Semantics relationships between concepts . . . . .	197
<b>Table 6.5:</b>	Comparison of Existing and Our Proposed models . . . . .	210
<b>Table 6.6:</b>	H-CPPS(Operator) A and B- instantiation use case . . . . .	216
<b>Table 6.7:</b>	Reuse of architecture for interface application . . . . .	219
<b>Table 6.8:</b>	Learning scenario and evaluation result . . . . .	223
<b>Table 6.9:</b>	Learning case initiation . . . . .	225
<b>Table 7.1:</b>	Research question and answer of thesis work . . . . .	233



# List of media

---

**Table 1:** Application context-Human-CPPS integration

Chapter	Description and Link	QR Code
Chapter-6	<b>Application context-</b> Image target Application	
Chapter-6	<b>Application context-</b> Upload/managing image targets	
Chapter-6	<b>Application context-</b> Human operator-Assembly lines	
Chapter-6	<b>Application context-</b> Design concept, features	
Chapter-6	<b>Application context-</b> Uploading, managing image targets	
Chapter-6	<b>Application context-</b> Unique Image target of our product with code	
Chapter-6	<b>Application context-</b> Unique Image target	
Chapter-6	<b>Application context-</b> Vuforia engine target images	

# Acronyms

---

<b>CPS</b>	Cyber-Physical system
<b>CPPS</b>	Cyber-physical production system
<b>H-CPPS</b>	Human-Cyber-physical production system
<b>INCOSE</b>	International council of system engineering (INCOSE)
<b>AFIS</b>	L'Association Française d'ingénierie Système (AFIS)
<b>SE</b>	System Engineering approach
<b>ST</b>	Systems Theory
<b>GST</b>	General system theory
<b>LCS</b>	Loosely Coupled Systems
<b>KM</b>	Knowledge Modelling
<b>SM</b>	Semantics Models
<b>RA</b>	Reference architecture
<b>LC</b>	Life cycle
<b>MVM</b>	Multi-view point modeling
<b>OEE</b>	Original equipment efficiency
<b>CONOPS</b>	Concept of operation
<b>DSM</b>	Design structured matrix
<b>DSL</b>	Domain-Specific Languages
<b>RE</b>	Requirement Engineering
<b>V and V</b>	Verification and Validation
<b>MBSE</b>	Model-Based Systems Engineering
<b>UML</b>	Unified modeling language
<b>SySML</b>	System modeling language

# Glossary

---

In accordance with the **International Council of System Engineering (INCOSE)**, the following terminologies are repeatedly used in this doctoral thesis.

**Definition 1=General system theory-** A “system is defined very generically as a complex set of interacting elements, with properties richer than the sum of its parts [Von Bertalanffy [1973]][Blanchard et al. [1990]]

**Definition 2=System of interest (SOI) (EIA632 standard)-** is a “the top system in the system structure is called a System of Interest (SOI)” . It is the final result of the end-product. [Blanchard [2004]]

**Definition 3=Enabling system (ES) (EIA632 standard)-** is a system which makes possible the creation, or ongoing availability for use, of the System of Interest during some part of its life cycle”. [Spellini et al. [2021]]

**Definition 4=Engineered system-** "An engineered system is a system designed or adapted to interact with an anticipated operational environment to achieve one or more intended purposes while complying with applicable constraints" [Spellini et al. [2021]].

**Definition 5=Conceptual systems-** Conceptual systems are abstract systems of pure information, and do not directly exhibit behaviour, but exhibit “meaning”. In both cases, the system’s properties (as a whole)" [Spellini et al. [2021]].

**Definition 6= Complex systems-** A complex system is a system in which there are non-trivial relationships between cause and effect: each effect may be due to multiple causes; each cause may contribute to multiple effects; causes and effects may be related as feedback loops, both positive and negative; and cause-effect chains are cyclic and highly entangled rather than linear and separable.[Spellini et al. [2021]]

**Definition 7= Physcial systems-** A physical system is an arrangement of parts or elements that together exhibit behaviour that the individual constituents do not. This definition includes biological systems and living systems.[Spellini et al. [2021]]

**Definition 8 = Open system-** An open system is a system that has flows of information, energy, and/or matter between the system and its environment, and which adapts to the exchange.[Von Bertalanffy [1950]]

**Definition 9= Closed system-** A closed system is a system that is completely isolated from its environment. It allows a vendor-independent, non-proprietary, computer system or device design based on official and/or popular standards.[Von Bertalanffy [1950]]

# Nomenclature

---

## Operators

$\forall$	For all
$\cup$	Union
$\cap$	Intersection
$\subset$	Subset
$\Delta$	Abstract set
$\lambda$	In/OP process

## Relations

$\exists$	Exists
$\in$	Owns
$\subseteq$	Subset
$V_i$	Viewpoint

## General Notation

<b>X</b>	Input
<b>Y</b>	Output
<b>R</b>	Real function
<b>E</b>	Set of events
<b>S</b>	Semantics
<b>SOI</b>	System of interest
<b>ES</b>	Enabling System
<b>HL</b>	Hierarchy layer
<b>C</b>	Cyber elements
<b>P</b>	Physical elements
<b>L</b>	Link elements
<b>PR</b>	Product elements
<b>PD</b>	Production elements
<b>H</b>	Human elements
<b>CPI</b>	Cyber-physical infrastructure
<b>CPPS</b>	Cyber-physical production system
<b>HCPPS</b>	Human-Cyber-physical production system
<b>CPI-CPPS</b>	Infrastructure-Cyber-physical production system

---

## Symbols

This section contains a list of symbols used in the thesis. We use the convention:

- Lower case symbols "**x**" indicates a Countable set of states.
- Bold upper case symbols "**X**" represents a Cartesian product.
- Bold upper case symbols "**R**" represents a arbitrary function.
- Lower case symbols "**s**" represents a Semantics.
- Bold upper case symbols "**S**" represents a System.

## Formal modeling notation

$V_P$	Property viewpoint
$V_B$	Behaviour viewpoint
$V_f$	Function viewpoint
$M_PCPPS$	Property viewpoint
$M_SCPPS$	Structure viewpoint
$M_BCPPS$	Behavioral viewpoint
$M_FCPPS$	Function viewpoint
$M_ICPPS$	Interface viewpoint
$M_LFCPPS$	Life cycle viewpoint
$M_BPCPPS$	Business process viewpoint
$M_TCPPS$	Terminology and typology
$M_HCPPS$	Human interaction modality
$M_MCPPS$	CPPS interaction modality
$M_PPCPPS$	Production system viewpoint
$M_MCPPS$	Human-CPPS interaction modality

## Formula Notation

<b>ANOVA</b>	Analysis of variance
<b>CONOPS</b>	Concept of operation
<b>OEE(A)</b>	OEE- Availability
<b>OEE(P)</b>	OEE- Performance
<b>OEE(Q)</b>	OEE- Quality
<b>PROMETHEE</b>	Preference ranking method
<b>OEE</b>	Original Equipment Efficiency

---

## Algorithm and MVM Description

<b>Decomposition</b>	The set of state variables into several subsets.
<b>Extension</b>	The Part that is added to something to enlarge.
<b>Reuse</b>	Reuse is the action or practice of using an item.
<b>Merging</b>	Combine or cause to combine to form a single entity.
<b>Synthesis</b>	The combination of components or elements.
<b>Synchronization</b>	The operation of two or more things at the same time.
<b>Syntactic</b>	The Theories of syntax assume.
<b>Independent</b>	Not determined or influenced by someone or something else.
<b>Refinement</b>	The process of removing unwanted elements

## Multi-Viewed Model Description

<b>Orthogonal</b>	Not determined or influenced by someone or something else.
<b>Association</b>	The connection or cooperative for a joint purpose.
<b>Operations</b>	To view the MV system in terms of operations.
<b>Process</b>	Relations over time and causality.
<b>Content</b>	Syntactic and semantic relations.

# General Introduction

---

**Title:** A Multi-viewed semantic for "Cyber physical production system" (CPPS) to support its life cycle: using System Engineering approach

**Context-** The traditional production system paradigm has several flagships in the past decades, which includes the Dedicated(DMS), flexible(FMS), Holonic (HMS), biological(BMS), Intelligent(IMS), reconfigurable(RMS) production system. It is widely accepted and recognized by production communities.

However, the cyber physical system is currently proposed as an answer to the industry 4.0 revolution. Over the few years, the integration of product and production systems into CPS and projecting as new paradigm of cyber-physical production system(CPPS). The concept of Cyber-Physical Production System (CPPS) notion has gained increasing attention over the few years. Many researchers are using the notion for the use case and application-oriented context without having lack of unified definition and common understanding of the concept. The exact meaning and scope of the human part differs among current works and application domains [[Monostori et al. \[2016\]](#)]. Despite the CPPS notion still being in its infancy, the environments are often considered as cyber and physical production spaces, which interact with each other and able to operate on different scales when a change, in context.

**Scientific Problems-** Due to the CPPS notion is still in its infancy, the involved cross-linking entities, rapid technological advances, multi-functionality, the complex heterogeneity, dependency relation between product and production system, structural ambiguity of CPPS are rapidly increasing. It is hindered by a lack of formalism and common understanding of the CPPS notion (i.e) what are involved CPPS entities along its life cycle, what are human-CPPS interactions phenomenon are, how humans perceive and respond to machine' responses (emotional and cognitive aspect). As a result of such limitation and missing standard leads to major challenge in its evolution of CPPS concept and reusability across the domain [[Lüder et al. \[2017c\]](#)] [[Wu et al. \[2020\]](#)]. There is a need of common understanding of the CPPS concept and vice versa, gradually paving a way and providing a basis for the CPPS concept.

**Genesis of thesis-** In addition, the genesis of this PhD thesis work is the Laboratory of digital science of Nantes-CPPS Platform project. The platform project aims to capitalize knowledge and sharing between multidisciplinary research during the creation, operation

---

of CPPS. It helps to support the multidisciplinary research to be validated before the industry deployment [SA and Da Cunha [2021]]. Our role is to develop the semantic as an implementable ontology structuring the common repository, collaborative management application and human-CPPS configurator. It is required as a scientific foundation at the meta-level.

**Approach used-** The above scientific problems and besides our LS2N platform project make us to choose **Conceptual and analytical research methods adapted in this thesis.** [Meredith [1993]] Then, the knowledge modelling approach is used to explicit conceptual research method [Meredith [1993]]. The set of interlinked set of domain concepts on involved entities and support in common understanding. It can formally represent the abstract domain-conceptualization. Especially, the CPPS notion is an interdisciplinary system with “homogeneous tangible and intangible components [Frank [2007]] [Fettke and Loos [2003]]. However, System and Systems engineering principles are used as methodological foundation to identify the boundaries to obtain an accurate representation of CPPS and interconnections along its life cycle [Lee and Miller [2007]]. It is used as a methodological foundation to build the model consistently.

## **Contribution-**

- **1) First, Systematic literature review(SLR) is carried out on cyber-physical production system concept (CPPS).** We illustrate that the current lack of consensus regarding the CPPS notion and its existing works. It is required to develop a new standard framework for the CPPS concept.
- **2) Second, We proposed the organising for CPPS notion.** It is from our current understanding of the concept. It is composed of definition, system theory and metamodel. It details the main elements and an axiom of domain independent view. It illustrates the systemic core and boundary of the CPPS notion.
- **3) Based on our organizing, We proposed the generic modular semantic framework for CPPS notion.** It is a conceptual framework in which the defined domain concept and illustrate the relation aspects.(i.e) defining, classifying CPPS entities, Human-CPPS interactions etc. The involved modular models can be reused and extendable in future cases from identified entities.
- **4) Application context-** It is reused and instantiated in a real application context in



LS2N CPPS platform project which includes 1) **knowledge repository application**, 2) **Collaborative interface management application** and 3) **Human-CPPS Configurator application**. From this, we illustrate that, the modular models are re-used across the domain and unambiguously across different application context.

## Scope-

This thesis has a mutual contribution to CPPS domain of interest and INCOSE Community new vision. First, the semantic foundation for the CPPS notion is established in this thesis. The proposed organizing and multi-viewed semantics framework is reusable and extendable for multiple purposes. It supports in CPPS notion evolution and tailoring to CPPS actors network, whole life cycle aspects, System Engineering process, literature, refined applications, and other aspects of the paradigm.

**This thesis work is meant to be the semantic basis of future classification of CPPS notion for researchers, and practitioners in the field.** We encourage future research can consider our identified domain concepts and endeavors toward the quest for new production concepts.

Parallely, It also contributes to INCOSE Community vision, 1) Realizing the system's (CPS) theoretical foundation vision 2) Realizing the Ontology-based modeling practices (cyber-physical-based systems) vision.

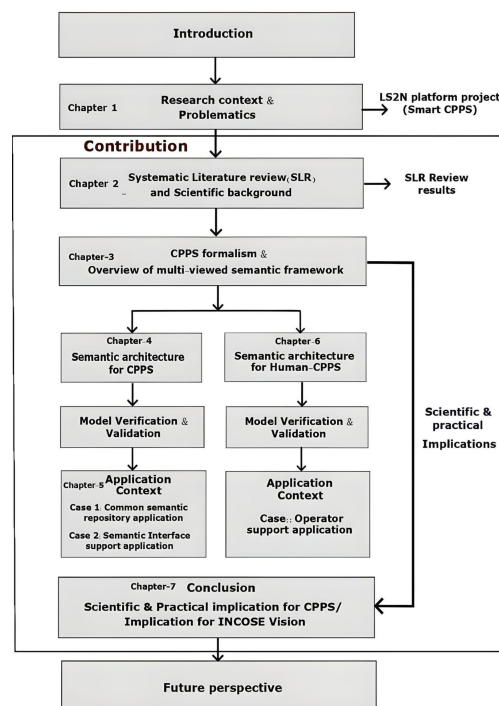


Figure 1: Thesis structure

# Introduction générale

---

**Titre français:** Un cadre sémantique multi-vues pour le "Système de production cyber-physique" pour soutenir le cycle de vie en utilisant l'approche d'ingénierie système.

**Contexte:** Le paradigme du système de production traditionnel a plusieurs produits phares au cours des dernières décennies, notamment le système de production dédié (DMS), flexible (FMS), holonique (HMS), biologique (BMS), intelligent (IMS), reconfigurable (RMS). Il est largement accepté et reconnu par les communautés de production.

Cependant, le système cyber physique est actuellement proposé comme une réponse à la révolution de l'industrie 4.0. Au cours des quelques années, l'intégration des systèmes de produits et de production dans le CPS et la projection en tant que nouveau paradigme du système de production cyber-physique (CPPS). Le concept de système de production cyber-physique (CPPS) a fait l'objet d'une attention croissante au cours des dernières années. De nombreux chercheurs utilisent la notion pour le cas d'utilisation et le contexte orienté application sans manquer de définition unifiée et de compréhension commune du concept. La signification exacte et la portée de la partie humaine diffèrent selon les travaux actuels et les domaines d'application [Monostori et al. [2016]]. Bien que la notion de CPPS soit encore balbutiante, les environnements sont souvent considérés comme des espaces de production cyber et physiques, qui interagissent entre eux et capables d'opérer à différentes échelles lors d'un changement, de contexte.

**Problèmes scientifiques:** En raison de la notion de CPPS qui en est encore à ses balbutiements, les entités de réticulation impliquées, les avancées technologiques rapides, la multifonctionnalité, la complexité, la relation de dépendance entre le produit et le système de production, l'ambiguïté structurelle du CPPS augmentent rapidement. Elle est entravée par un manque de formalisme et de compréhension commune de la notion de CPPS (c'est-à-dire quelles sont les entités CPPS tout au long de son cycle de vie, quels sont les phénomènes d'interactions homme-CPPS, comment les humains perçoivent et réagissent aux réponses de la machine (aspect émotionnel et cognitif). ). En raison d'une telle limitation et d'une norme manquante, cela pose un défi majeur dans son évolution du concept CPPS et sa réutilisabilité dans le domaine [Lüder et al. [2017c]] [Wu et al. [2020]]. Il est nécessaire de comprendre le concept CPPS, ses intégrations humaines et vice versa ont progressivement ouvert la voie et fourni une base au concept CPPS.

---

**Genèse de la thèse** Par ailleurs, la genèse de ce travail de thèse est le projet Laboratoire des sciences du numérique de Nantes-CPPS Platform. Le projet de plateforme a pour objectif de capitaliser les connaissances et le partage entre la recherche pluridisciplinaire lors de la création, du fonctionnement du CPPS. Il permet de soutenir la recherche pluridisciplinaire à valider avant le déploiement industriel [SA and Da Cunha [2021]]. Notre rôle est de développer la sémantique comme une ontologie implémentable structurant le référentiel commun, l'application de gestion collaborative et le configurateur homme-CPPS. Il est requis en tant que fondement scientifique au niveau méta.

**Approche utilisée:** Les problèmes scientifiques ci-dessus et en plus de notre projet de plateforme LS2N nous font choisir **Méthodes de recherche conceptuelles et analytiques adaptées dans cette thèse.** [Meredith [1993]] Ensuite, l'approche de modélisation des connaissances est utilisée pour expliciter la méthode de recherche conceptuelle [Meredith [1993]]. L'ensemble des ensembles de concepts de domaine interconnectés sur les entités impliquées et le soutien à la compréhension commune. Il peut formellement représenter la conceptualisation abstraite du domaine. En particulier, la notion de CPPS est un système interdisciplinaire avec « des composants matériels et immatériels homogènes [Frank [2007]] [Fettke and Loos [2003]]. Cependant, les principes d'ingénierie des systèmes et des systèmes sont utilisés comme base méthodologique pour identifier les limites afin d'obtenir une représentation précise du CPPS et des interconnexions tout au long de son cycle de vie [Lee and Miller [2007]]. Il est utilisé comme base méthodologique pour construire le modèle de manière cohérente.

## **Contribution:**

- **1) Tout d'abord, Une revue systématique de la littérature (SLR) est effectuée sur le concept de système de production cyber-physique (CPPS).** Nous illustrons que l'absence actuelle de consensus concernant la notion de CPPS et ses travaux existants. Il est nécessaire de développer un nouveau cadre standard pour le concept CPPS. 0.2cm
- **2) Deuxièmement, Nous avons proposé la organiser de la notion de CPPS.** C'est à partir de notre compréhension actuelle du concept. Il est composé d'un énoncé générique, d'une théorie et d'un métamodèle. Il détaille les principaux éléments et un axiome de vue indépendante du domaine. Il illustre le noyau systémique et les limites de la notion de CPPS.

- 3) Sur la base de notre organiser, nous avons proposé le cadre sémantique modulaire générique pour la notion CPPS. Il s'agit d'un cadre conceptuel dans lequel le concept de domaine défini et illustrent les aspects de la relation.(i.e) définir, classer les entités CPPS, les interactions homme-CPPS, etc. Les modèles modulaires impliqués peuvent être réutilisés et extensibles dans des cas futurs à partir d'entités identifiées.
- 4) Contexte d'application- Il est réutilisé et instancié dans un contexte d'application réel dans le projet de plate-forme CPPS LS2N qui comprend 1) une application de référentiel de connaissances, 2) une gestion d'interface collaborative application et 3) Application Configurateur Human-CPPS. À partir de là, nous illustrons que les modèles modulaires sont réutilisés dans le domaine et sans ambiguïté dans différents contextes d'application.

**Portée:** Cette thèse a une contribution mutuelle au domaine d'intérêt du CPPS et à la nouvelle vision de l'INCOSE communauté. Tout d'abord, les prémisses et l'exploration du concept CPPS établi dans cette thèse. Le cadre de organiser et de sémantique modulaire proposé est réutilisable et extensible à des fins multiples. Il prend en charge l'évolution de la notion CPPS et l'adaptation au processus d'ingénierie système CPPS, dans la littérature, le réseau d'acteurs, les aspects du cycle de vie complet, les applications raffinées et d'autres aspects du paradigme. **Ce travail de thèse est censé être la base sémantique de la future classification de la notion de CPPS pour les chercheurs et les praticiens sur le terrain.**

En Parallèle, Il contribue également à INCOSE communauté et à sa vision, 1) Réaliser la vision fondamentale théorique (ontologies formelles) du système (CPPS) — En présentant la compréhension systémique, la sémantique et la théorie dérivée du système CPPS. 2) Réaliser la vision des pratiques de modélisation basées sur les ontologies (systèmes cyberphysiques)

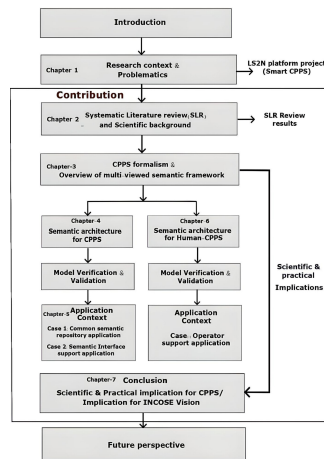


Figure 2: Thesis structure



# Research context and Problematic

*This chapter presents the motivation, scope and overview of the doctoral thesis. First, it describes a research context and background of the thesis work. Then, the thesis problematic, derived research questions, and methodology used is illustrated. Then, the application context of thesis work CPPS in laboratory of digital science of Nantes (LS2N) is described. Finally, the overall thesis structure is shown.*

1.1	Global context and Motivation . . . . .	<b>9</b>
1.1.1	Global issue and Industry 4.0 production paradigm challenges . .	9
1.1.2	Motivation of thesis . . . . .	12
1.2	Research area and background . . . . .	<b>13</b>
1.2.1	CPPS fundamentals and definitions . . . . .	13
1.2.2	CPPS terminology, taxonomy, and typology . . . . .	14
1.2.3	CPPS system theory . . . . .	15
1.2.4	CPPS life cycle aspects . . . . .	16
1.3	Application context-Laboratory of digital science of Nantes (LS2N)-CPPS	<b>17</b>
1.3.1	LS2N Platform Project description . . . . .	19
1.3.2	LS2N CPPS Platform Project and Knowledge Sources Needs . . .	21
1.4	Thesis Scientific Problematics . . . . .	<b>22</b>
1.4.1	Challenges on CPPS Understanding . . . . .	22
1.4.2	Challenges on CPPS Informatics . . . . .	22
1.4.3	Challenges on CPPS Collaboration . . . . .	23
1.4.4	Challenges on CPPS Knowledge reuse and sharing . . . . .	24
1.4.5	Thesis Problem statement . . . . .	25
1.5	Research Question, Methods, and Process . . . . .	<b>26</b>
1.6	Thesis structure . . . . .	<b>31</b>

## 1.1 Global context and Motivation

This section describes the global issue and motivation for the thesis research work.

### 1.1.1 Global issue and Industry 4.0 production paradigm challenges

FROM the survey of the United nation industrial development organization (UNIDO) and World economic forum (WEF), <sup>1, 2</sup> report says that:

- More than half (**59 %**) of industries in the world has already begun using smarter manufacturing systems or technologies on their shop floor. Almost the same number (58 %) said the complexity of systems integration is the main issue [Vopson [2021]].
- However, (**63%**) are in pilot purgatory in that implementation (initial study) because of lack of value and return on investment. Many industries have started to implement new technologies in production to meet the new market dynamics.[Fraumeni and Liu [2021]]
- More than (**65%**) of human workers is expect to foster significant changes in their tasks in production due to technology-centric human-machine integration [Moavenzadeh [2015]].

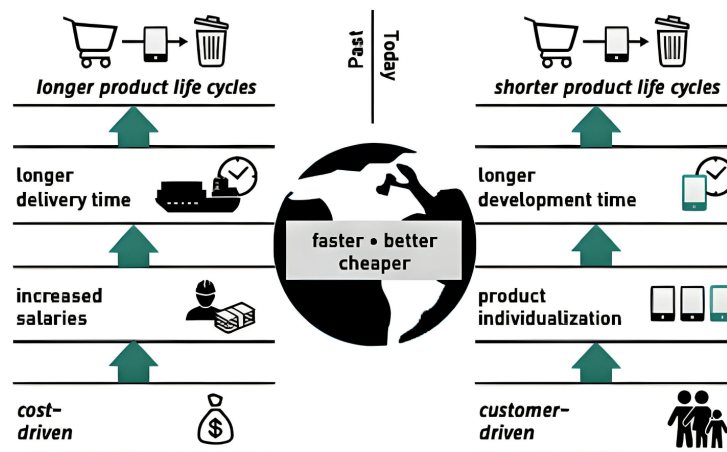
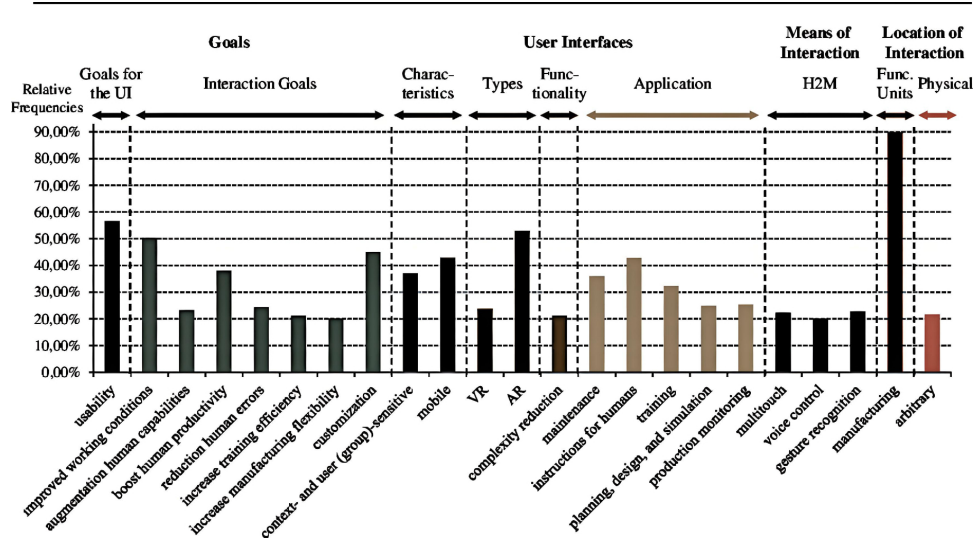


Figure 1.1: Future production system criteria [Hodek and Floerchinger [2009]]

It is because industries are moving towards the up-gradation or engineering of a to meet new market needs and customer-centric manufacturing from (i.e.) mass production to “lot-size-one”

<sup>1</sup><https://www.weforum.org/reports/>

<sup>2</sup><https://www.unido.org/>



**Figure 1.2:** Survey of human interaction with machine  
[Krupitzer et al. [2020]]

production [Zuehlke [2008]].

It leads the system has to be 1) It involves a modular, Agile system, , and Greater product network transparency (see figure 1.5 [Weyrich et al. [2017]]). 2) On the other side, the enormous deposit of technology and advanced characteristics push. [Lins and Oliveira [2020]] [Monostori [2015]]. 3) On the other hand, the technology-centric human-machine integration. The human elements are interconnected with the production system in different modules, which are controlled and coordinated (rather passively) by the whole system [Ansari et al. [2018]]. To overcome this issue, the Industry 4.0 revolution accelerates the transformation and introduces new paradigm concepts [Vogel-Heuser et al. [2014]]. The transformation and integration of physical production and traditional computing systems into Smart objects and their connectivity, forming the Internet of Things. In manufacturing, the cross-linking of Embedded systems creates adaptive and self-organizing. Due to ever-increasing cross-linking, rapid technological advances, and multi-functionality, the complexity and structural opacity are rapidly increasing. Deploying and developing the new production paradigm raises semantics challenges. These semantic challenges become even harder since participants in a networked manufacturing apply different policies [Saldivar et al. [2015]] [Drath and Horch [2014]].It includes as follows:

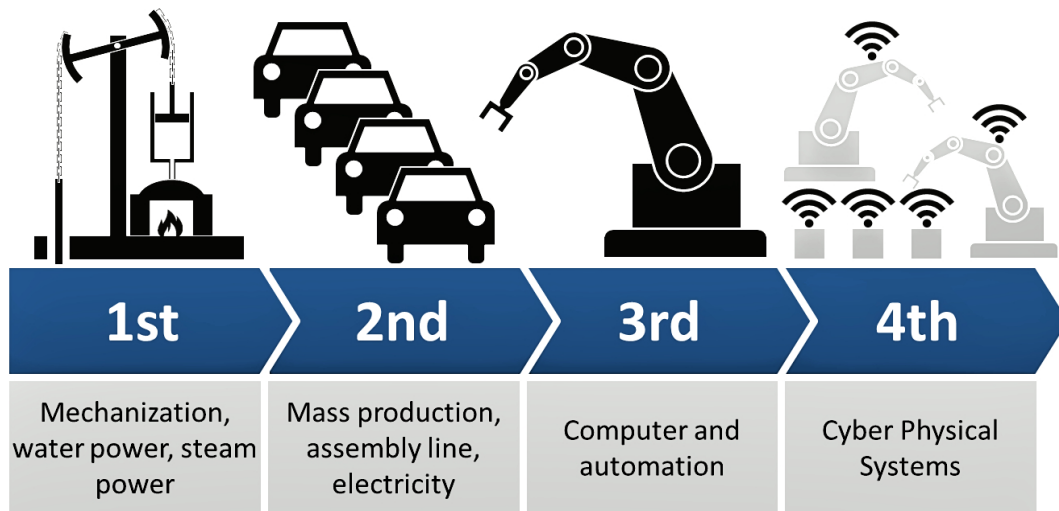
### 1.1.1 Industry 4.0 production paradigm challenges<sup>3</sup>,

- **Global unique identification (Ch1):** Identification of each entity and component is disambiguation and non-retrievable.[Bandyopadhyay and Sen [2011]]. It is difficult with

<sup>3</sup>[https://www.plattform-i40.de/IP/Redaktion/DE/Downloads/Publikation/Whitepaper\\_Plattform-Eclass.html](https://www.plattform-i40.de/IP/Redaktion/DE/Downloads/Publikation/Whitepaper_Plattform-Eclass.html)



cross-linking entities. There is a need for a linking mechanism between the components and the generated information [Vermesan et al. [2022]].



**Figure 1.3:** Challenges of industry 4.0 production paradigm [Kagermann et al. [2013]]

- **Standardization compliance (Ch2):** Identifying Standard compliance is an important step toward the realization of a new concept. It is challenging for several standards to deal with different layers in the paradigms. There is a need of standard concept of paradigm.[Grangel-González et al. [2016]] [Mikusz [2014]] [Vermesan et al. [2022]]
- **Multilingualism (Ch3):** There is a lot of multilingualism across the entity. It is becoming a challenge even for the newly introduced concepts. To achieve a wide range of applicability to different concepts [Hillier [2003]]. It is important to support that they will receive terms in their language.
- **Interoperability (Ch4):** The interoperability of managing data, machines, and components is in different formats (e.g. plain text, DBMS, XML, etc.).[Burns et al. [2019]] [Lelli [2019]]. Commonly, the new data and new formats have to coexist with the old ones. It is to become challenging for emerging production concepts.
- **Data availability (Ch5):** Enabling intercommunication among I4.0 components and the environment over the Internet is a big challenge. In addition to this, there should be a linking mechanism between the I4.0 components and the generated information.[Abu-Elkheir et al. [2013]][Hillier [2003]]
- **Integration (Ch6):** The complexity of horizontal and vertical integration integration of the components is drastically increased with the fluctuating number of the entities in the paradigm.[Hillier [2003]].

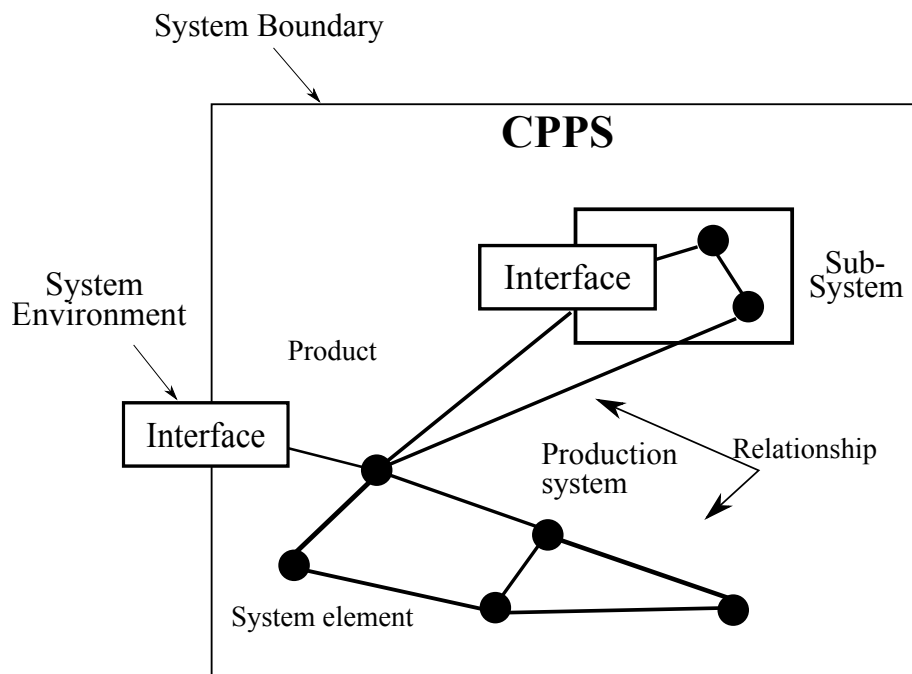
### 1.1.2 Motivation of thesis

As a part of global issue on semantic challenges within industry 4.0 production paradigms. This thesis work motivates and addresses for new CPPS production concept.

Organizing a concept with an idea or real domain that corresponds to some distinct entity or class of entities, or to its essential features, or determines the application of a term (especially a predicate), and thus plays a part in the use of reason or language” ( Oxford Dictionary). It can support and serve for **"whole life cycle"**, **"whole stakeholder community"** and **"reusability across domain"**.

In this context, CPPS notion and flagship evolved in the past few years. The Explicit conceptualization of the CPPS domain, with a set of terms naming concepts (classes), common vocabulary, which is vital for the domain. The philosophical foundation that distinguishes the production system terminology, and semantic for CPPS notion.

It allows the **"whole life cycle"** , **"whole stakeholder community"** and **"reusability across domain"**. It can visualize the system entities and identify their objectives, relationships, and interdependencies. The model-driven approaches are supported to exploit the domain models though-out the life cycle in a multi-user environment, where parts of the system and their interactions can be identified, defined, and managed.



**Figure 1.4:** CPPS Notion (figure enhanced from [Matook and Brown [2008]])

This doctoral thesis focuses on the studied the Cyber-physical production system notion from a systemic perspective, covering the life cycle phases.

## 1.2 Research area and background

This section describes the research area and background of the thesis. First, it introduces the Cyber-physical production system (CPPS), its fundamentals, typology, and life-cycle aspects. Then, the thesis problem is derived and described in the coming sections from this research context.

### 1.2.1 CPPS fundamentals and definitions

4

The Cyber-Physical System (CPS) was originally derived from an engineering perspective with the support of the US National Science Foundation (NSF) [Koubâa and Andersson [2009]], [Gharib et al. [2017]]. The extension of cybernetic systems towards CPS is therefore explicitly dealt with in literature since 2006-2007 and is constantly growing in popularity [Krugh and Mears [2018]].

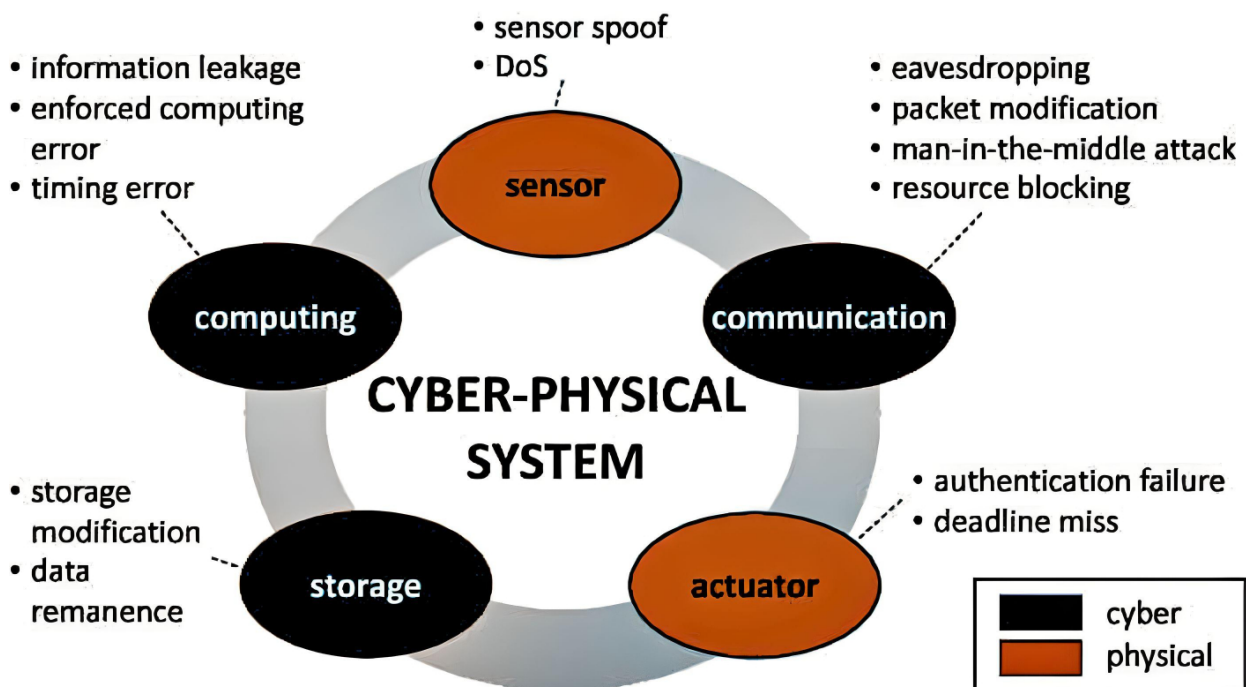


Figure 1.5: CPS-based automation [Onik et al. [2019]]

Subsequent research studies have then started to incorporate production in CPS research. Over the few years, different researchers used different terminologies to refer to the integration of the production aspect in the CPS, projecting different conceptualizations. The impact of

<sup>4</sup><https://www.nsf.gov/>

CPS on smart production and vice versa gradually paved a way for the foundation of a new paradigm: Cyber-Physical-production system [Monostori et al. [2016]].

Although the notion of CPPS has been adopted by many researchers, there is no unified definition and common understanding of the concept. Particularly, the rationale behind the paradigm shift from CPS to CPPS can be seen as a means to make interactions with CPS devices with production concepts. Some of famous statements in literature -Monostori describes the term "Cyber-Physical production system" (CPPS) in 2014. [Monostori]

***"Cyber-Physical Production Systems (CPPS) consist of autonomous and cooperate elements and subsystems that are connected based on the context within and across all levels of production, from processes through machines up to production and logistics networks."*** [Monostori]

Figure 1.4 shows the CPS-based automation. It shows the hardware and software components interconnected via a common network infrastructure. The basic functionalities of CPPS are Connectedness, Responsiveness, and Intelligence [Cardin [2019]].

The CPPS possesses many advanced characteristics, capabilities, and properties with human collaboration across all production levels of production [Zühlke [2009]]. The system's main objective is to produce high variability of products with transparent and digitized production processes by producing customer-oriented production of small batch size one [Schuhmacher and Hummel [2016]]. [Rudtsch et al. [2014]].

### 1.2.2 CPPS terminology, taxonomy, and typology

The study of CPPS taxonomy and typology helps to understand how the general concept of the system groups together based on similarities. It is a scheme of classification in which things are fundamental entities and are organized into groups or types [Herterich et al. [2015]]. It classifies an act of forming, a distribution into groups, families, etc. It is the systematic classification of the types of something according to their common characteristics [Fu et al. [2016]]. It helps to better understand certain conditions or factors by grouping things with similar characteristics. It provides a practical framework for processing, organizing, and understanding information.

Many researchers in literature are using used different terminologies to refer to the integration of the production aspect in the CPS, projecting different conceptualizations. Exact meaning and scope is differing on current conceptualizations fail to capture such characteristics. Considering all the above, various concepts and fundamentals of CPPS in the literature and main points about CPPS are of interest:

- CPPS has a tangible and intangible components [Griffor et al. [2017]].

- CPPS has a cyber and physical world that provides the integrated service [SA and da Cunha [2021]].
- CPPS is a networked production system that enable the communication between the human, machine, and products [Weyrich et al. [2017]].
- CPPS interact with a human, support system network and infrastructure [Cardin [2019]].

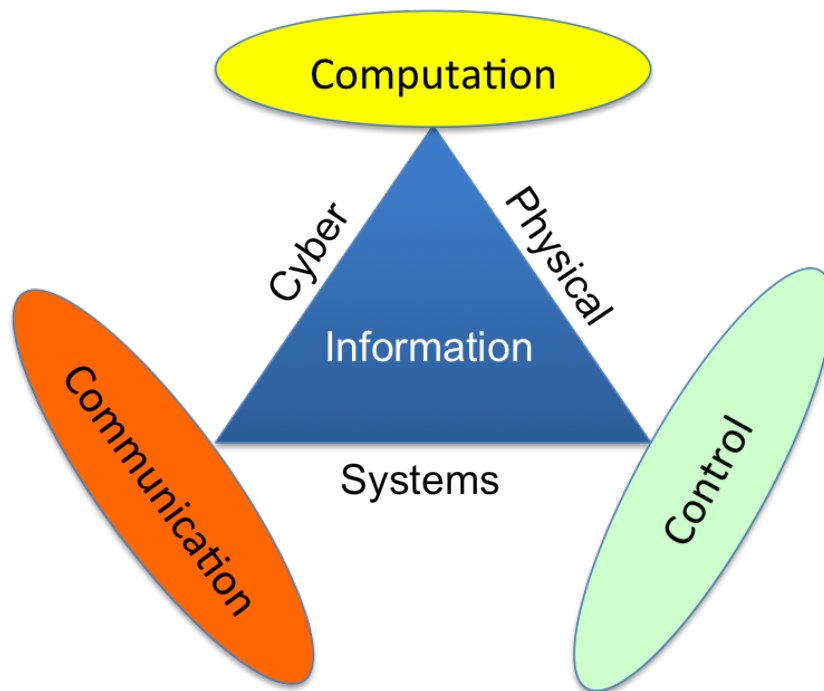


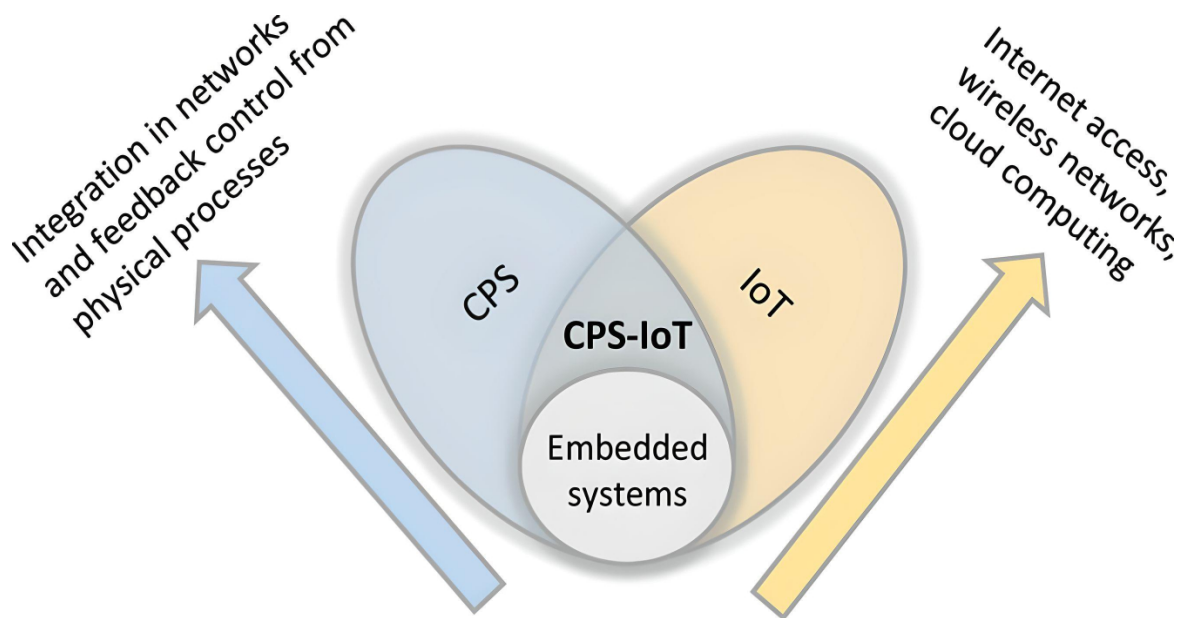
Figure 1.6: CPS analog to CPPS  
[Okolie et al. [2018]]

### 1.2.3 CPPS system theory

The study of CPPS system theory can develop logical and frameworks in which physical and technological can be studied and modeled. Based on the current development of Cyber-physical production system (CPPS) applications [Cardin [2019]]. It includes 1) a Cyber-Physical production (Learning) system, 2) Lab XP CPPS, and 3) an Industrial retrofitted CPPS system. It is described as follows:

- **CPPS-Learning system-** The cyber-physical production (learning) system concept has been developed in recent years. It replicates the Smart production paradigm and thereby redefines the entire value chain in production [Abele et al. [2019]]. The system is net-workable and modular, communicating between the ecosystem's machines, people, and products.

- **CPSS- Lab XP and Proof of concept(POF)-** Some of the other types of developments in CPSS are the Lab XP (Laboratory experiments). It deals with the technologies that are developed and evaluated. It incorporates the technologies to test and evaluate at a single level. [Cardin [2019]].



**Figure 1.7:** CPS-System theory  
[Carreras Guzman et al. [2020]]

- **CPSS-Retrofitted system-** The retrofitted CPSS system is a level where the actual developments are made on a running production system. The existing production system is upgraded to new production levels, and the system's future growth [Lins and Oliveira [2020]]. At this level, the addition of new technologies to upgrade the production system.

#### 1.2.4 CPSS life cycle aspects

Within the CPSS life cycle, several entities are created and applied. It is common sense that these information sets shall be represented by models and other means for description that are the best applicable for the involved engineers and technical systems (hard- and software).

- **Engineering phase-** It covers all activities related to the production system before its complete physical existence. It ends with a completely built-up/installed, commissioned, and ramped-up production system[Biffi et al. [2017]].
- **Operation and maintenance phase-** It covers the entire period of the use of the production system to manufacture products. During this phase, the production system is controlled, monitored, repaired if necessary, and partially sets of products, production

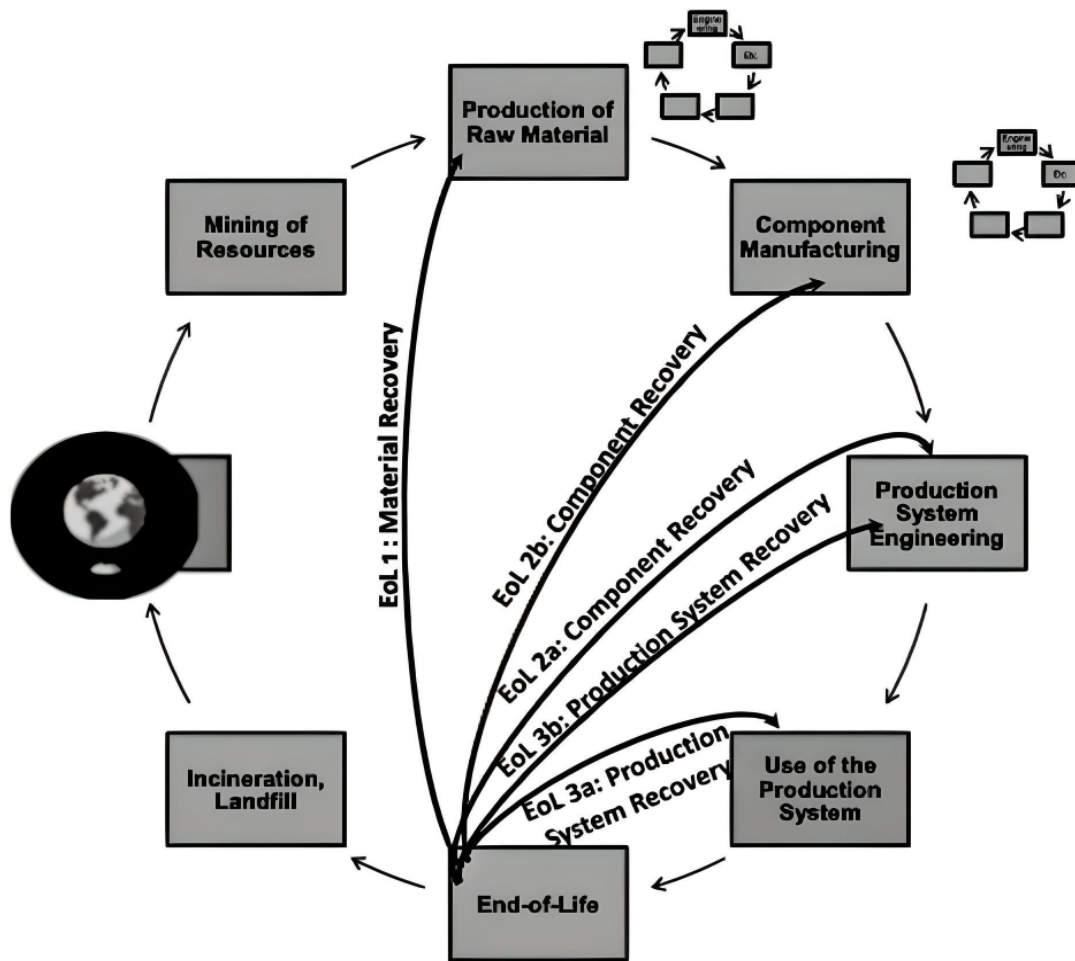


Figure 1.8: Production system life cycle  
[Lüder et al. [2017a]]

technologies, etc[Lindahl et al. [2006]].

- **End-of-Life phase**- It covers the period of the production system between the end of the production of the final product; It is the complete removal of the production system[Schmidt and Lüder [2017]].

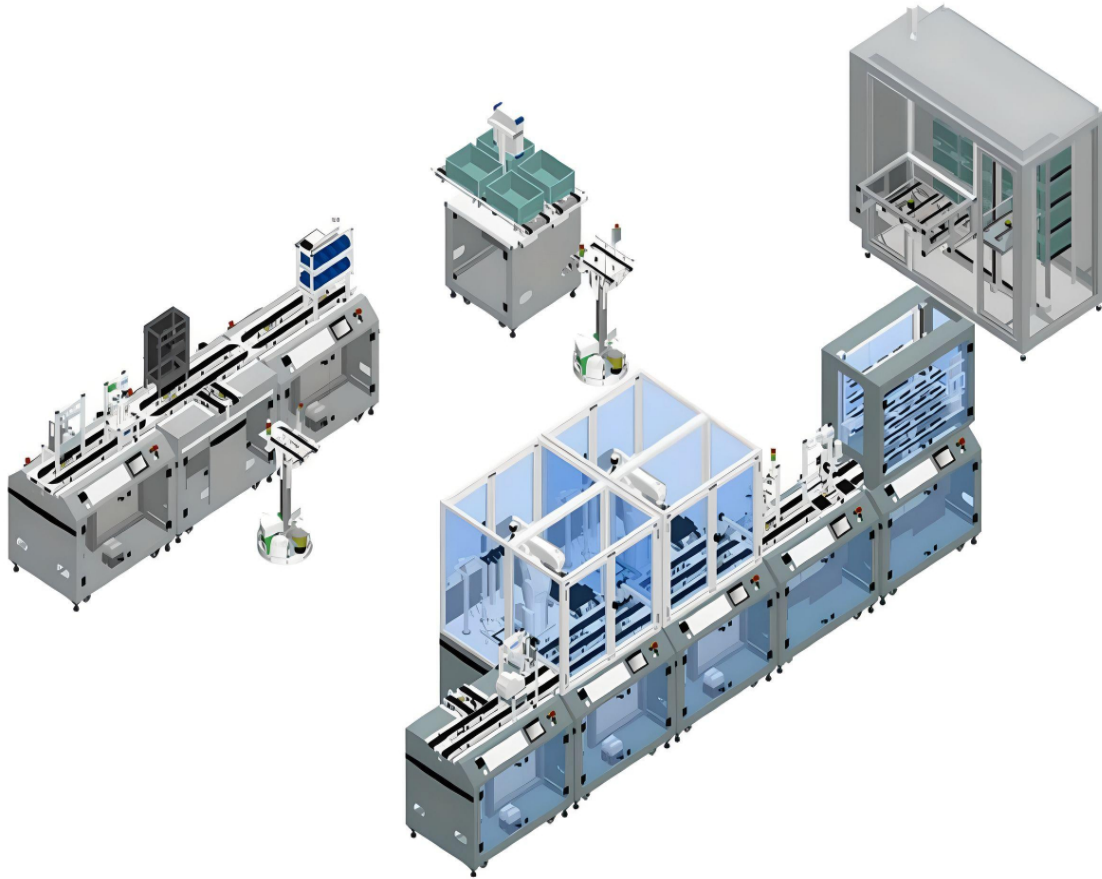
From this section, we point out the multidisciplinary aspect of CPPS and the need to develop specific collaborative supports to manage the whole life cycle, including its relationship and the management of all knowledge of the CPPS notion.

### 1.3 Application context-Laboratory of digital science of Nantes (LS2N)-CPPS

In this section, the genesis of this Ph.D. work is the laboratory of digital science of Nantes (LS2N)-CPPS and its platform Project. The platform is a new initiation in the LS2N



laboratory <sup>5</sup>. In the LS2N, the didactical concept of smart Cyber-Physical production system (CPPS) which illustrates the practical implementation of a networked system.



**Figure 1.9:** LS2N-CPPS Concept demonstrator

It is a comprehensive, modular and expandable Industry 4.0 real demonstrator that represents the entire value chain. It assembles the mobile phone product in a standard or customized way. It is equipped with a support system for the management of processes, functions for traceability, and quality monitoring, where humans have an essential role. This CPPS is a demonstrator for training (initial and executive) and research purposes. The platform also serves as a place of mediation because it illustrates the practical use of 4.0 technologies.

For educational objectives, the students can take on different roles within the same experiment; they must define and set up multiple scenarios. This integrated design/production and management allows them to implement and acquire different knowledge and skills. Some overviews of the CPPS system modules are described and summarized below. The Station modules, AS/RS Warehouse modules, and Robot assembly modules. The application module is the sub-core part of the factory; it is the tiny module fitted in Basic linear and branch

---

<sup>5</sup><https://www.ecnantes.fr/recherche/plateformes-dexperimentation/plateforme-smart-factory>



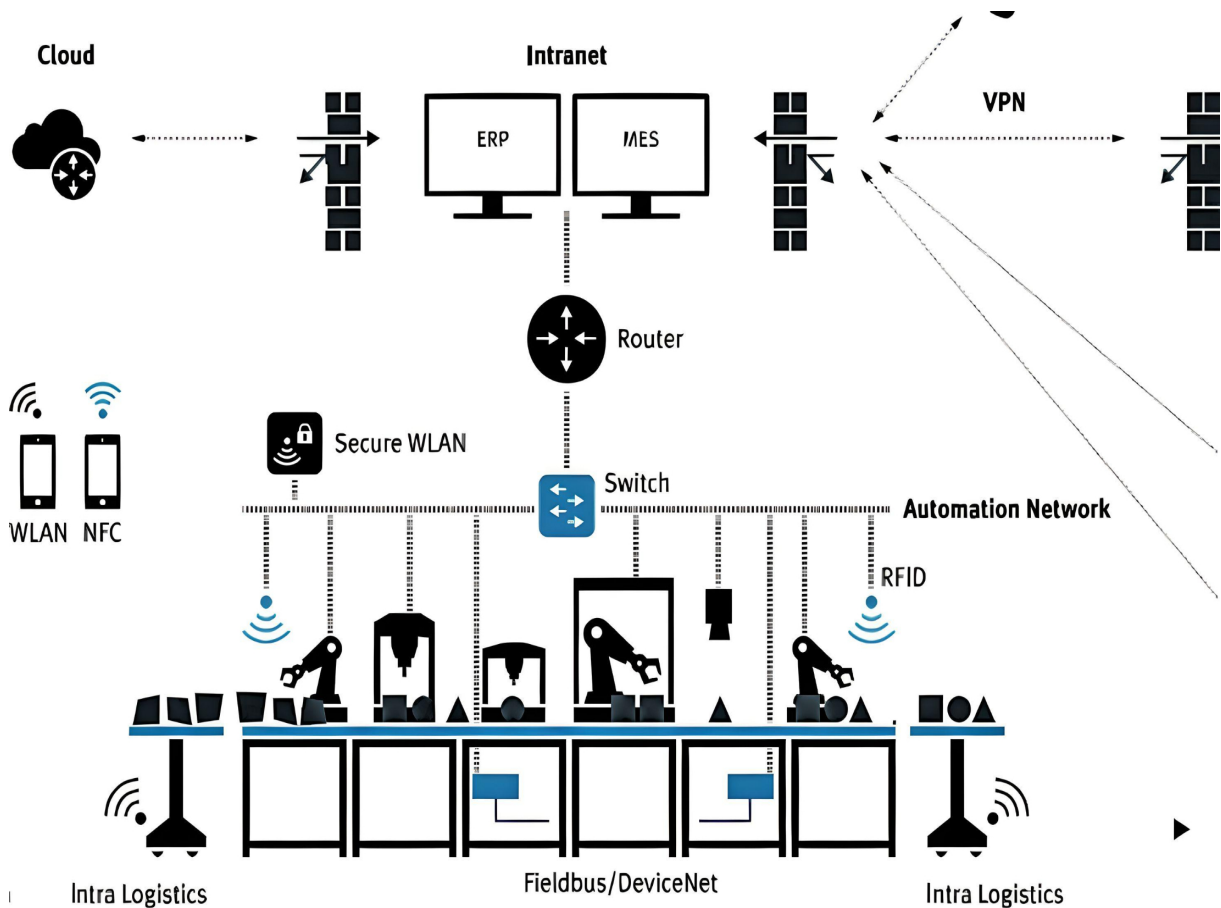


Figure 1.10: LS2N- CPPS schematic view

linear modules, depending upon the assembly scenario. This module can easily be convertible with the standard interface with the station modules.

There are six application modules currently in function in the factory. It includes the 1) Application module Camera inspection, 2) Application module labeling, 3) Application module manual work, 4) Application module magazine, 5) Application printing module, and 6) Application pressing modules. Next section illustrates the platform project description.

### 1.3.1 LS2N Platform Project description

<sup>6</sup>The aim of LS2N Platform project is to capitalize knowledge and sharing between heterogeneous actors during the multidisciplinary research, creation, or operation of CPPS. Figure 1.11 present the LS2N- CPPS platform project has the experimental loop, which illustrates

<sup>6</sup><https://www.ecnantes.fr/recherche/plateformes-dexperimentation/plateforme-smart-factory>

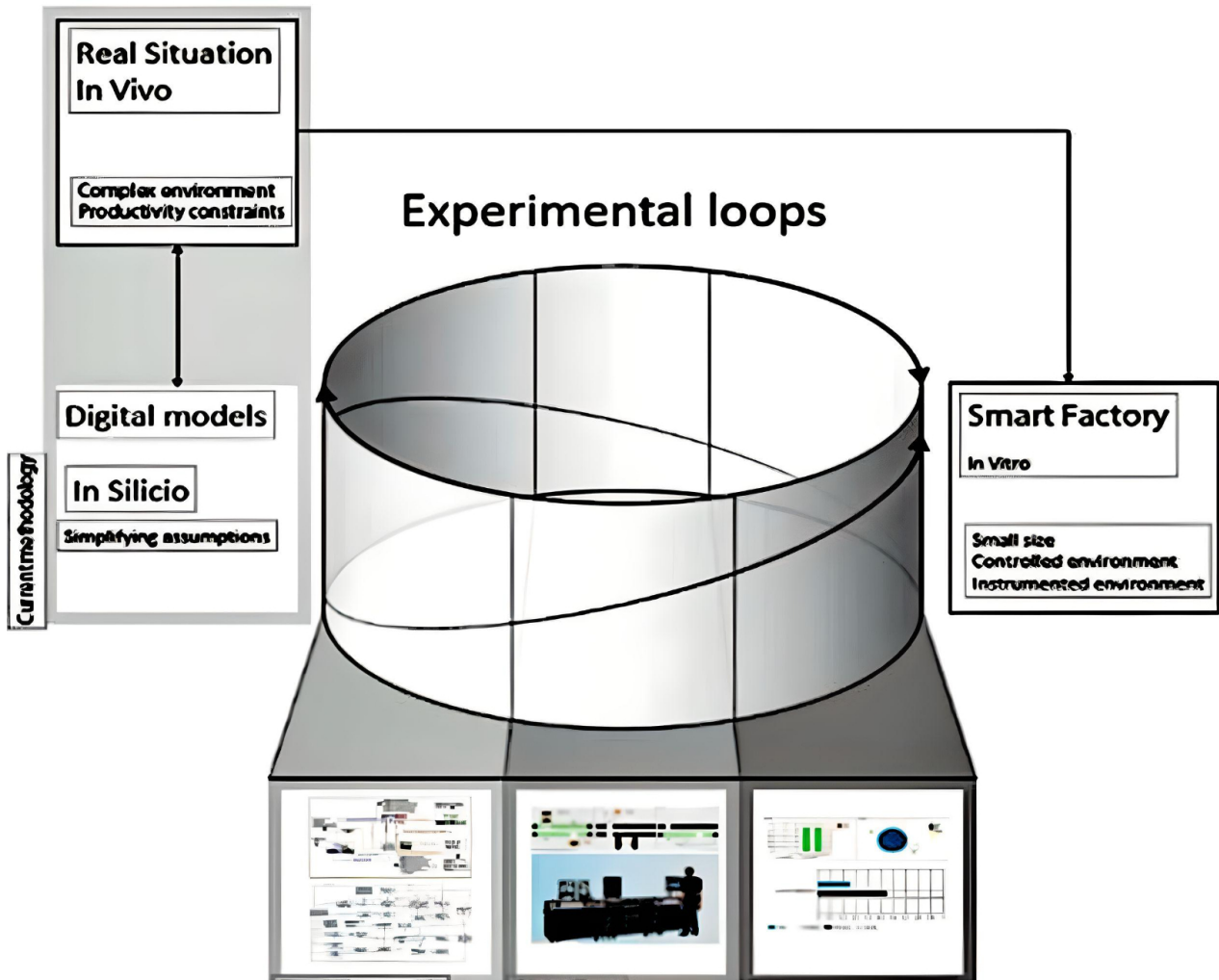


Figure 1.11: LS2N- CPPS platform project

- **"Real situation in vivo"**. where the real-world system has the productivity constraint. It has the complex environment productivity constraint.
- **"Demo situation in vivo"** where the demonstrator (our demonstrator) is a Small size, controlled and instrumental environment. It can test used whether the data at hand sufficiently support a particular hypothesis.
- **"Assumptions in silicon"**, refers to intermediate where the digital model can relate based on simplifying assumptions to validate the real situation.

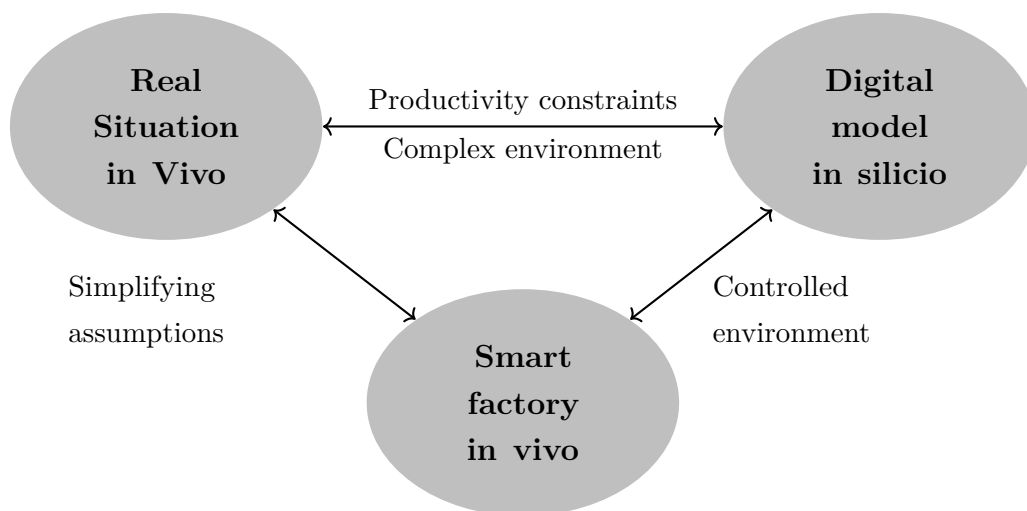
This Experimental loop allows the theoretical results to be tested in the platform and simplifies the assumption and helps to support the real situation. It will play an important role to validating the test before industry deployment. To achieve that, there is a need to capitalize knowledge and sharing between heterogeneous actors during the multidisciplinary

research, creation, or operation of CPPS. It aims to provide a neutral, easy-to- interface system featuring a more efficient collaboration strategy and an effective knowledge-sharing environment. Our role is to develop the semantic models as an implementable ontology structuring the repository. A conceptual modeling framework is required as a scientific foundation at the meta-level. As a result, it can be used unambiguously across different implementation's context. At the same time, it lays the foundations for future applications in this research area

### 1.3.2 LS2N CPPS Platform Project and Knowledge Sources Needs

7

From the platform project description, there is a need for a common repository and collaborative management application. This is because the unified model can bring a robust foundation of well-defined, classified, and related terms which provide information about the boundaries, abilities, and inner workings of such a system. It manages information and knowledge to support the decision-making and communication process during the CPPS development and operation. It is bounded with the product configuration and production-related knowledge, as well as quality assurance knowledge.



It manages information and knowledge (semantic model, ontology in the knowledge repository) to support the decision-making and used unambiguously across different implementations. This knowledge is extracted by the semantic case-based reasoning (CBS) method. The LS2N-platform is a supportive element in the whole CPPS network. It manages information and knowledge (semantic model, ontology in the knowledge repository) to support the decision-making and communication process during the CPPS development and operation.

---

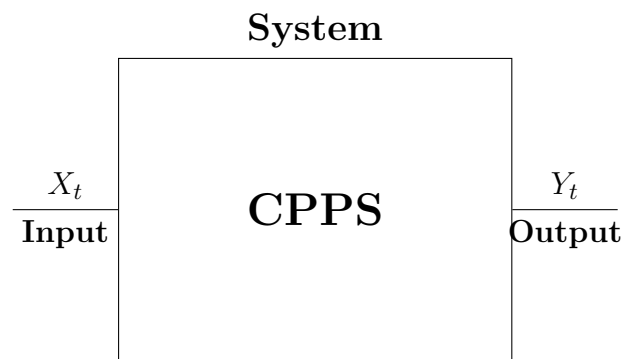
<sup>7</sup><https://www.ecnantes.fr/recherche/plateformes-d experimentation/plateforme-smart-factory>

## 1.4 Thesis Scientific Problematics

The research context and the LS2N-CPPS platform project point out scientific challenges that should be resolved as part of a global framework. The following challenges are at the origin of the scientific problematic of this thesis work. It is described as follows:

### 1.4.1 Challenges on CPPS Understanding

Owing to ever-increasing cross-linking, rapid technological advances, cross-linking of embedded systems, creates adaptive and multi-functionality [Chen [2017]], the complexity and structural ambiguity of CPPS are rapidly increasing[Müller et al. [2021b]]. Although the notion of CPPS has been adopted by many researchers, there is no unified definition and common understanding of the concept.

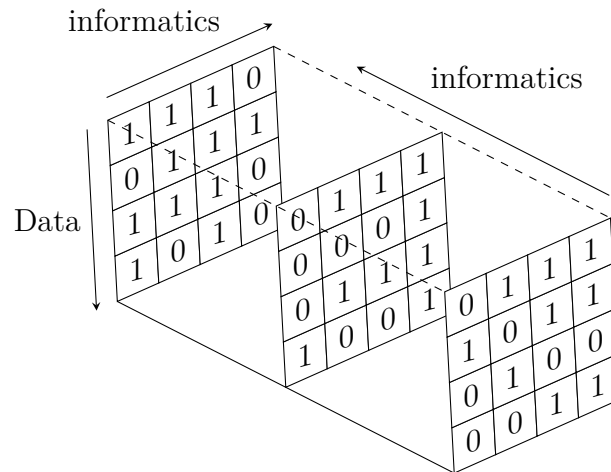


**Figure 1.12:** CPPS system theory

Due to the complex dependencies of entities, the sum of elementary parts, involved entities, and interrelationships of product and production system, their phenomenon as a whole is complex to understand[Baheti and Gill [2011]]. Identifying core entities, the connection between these entities, and distinguishing the borders is challenging. The development of urgently needed modeling approaches for managing such complexity and structural opacity, however, is impeded by a lack of common understanding of CPPS.

### 1.4.2 Challenges on CPPS Informatics

The CPPS has a tremendous increase in available information that has accompanied the onset of the CPPS. With continuing developments in technology, including broadband expansion, improved data processing, and storage performance, the digital revolution has gathered further momentum[Biffi et al. [2017]].

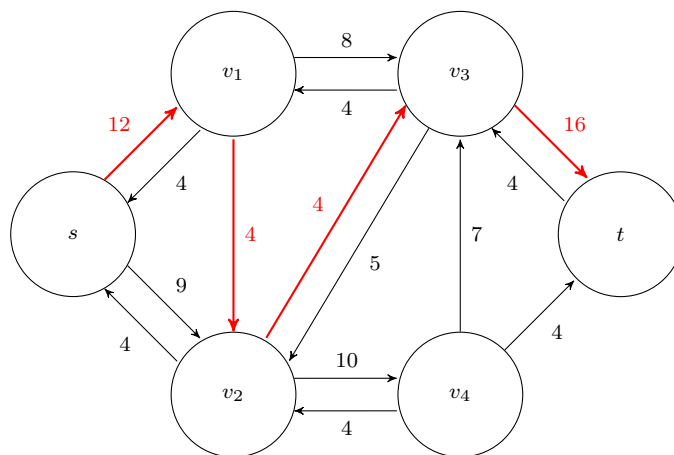


**Figure 1.13:** CPPS informatics

Although the notion of CPPS has been adopted by many researchers, the exact meaning and scope is differing among the current works and application domains. Accessing the standard frame of an interlinked set of clearly defined concepts and their relationship (i.e.) Property, along the life cycle of artifacts, considering the hierarchical CPPS is challenging. There is a need for common terminology, especially as CPPS are an interdisciplinary concept which combines elements of automation, informatics, and (production) engineering [Kagermann et al. [2013]] [Hellinger [2011]] [Karnouskos and Colombo [2011]]. Yet, to date, heterogeneity and isolated [CPPS] solutions prevail [Hellinger and Seeger [2011]] [Monostori et al. [2016]] Supporting informed informatics when needed at the right time and quantity is a good source of knowledge in the life cycles of Cyber-physical production systems is needed [Lüder et al. [2017c]].

### 1.4.3 Challenges on CPPS Collaboration

The CPPS has wide integration and collaboration with its parts and the environment.

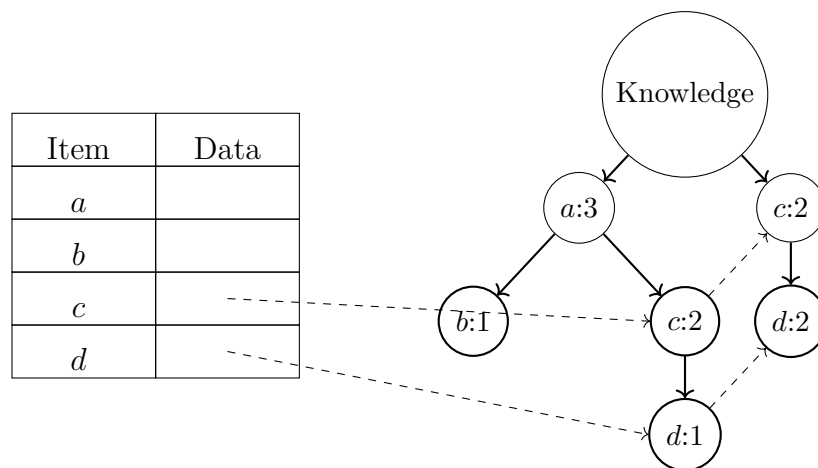


**Figure 1.14:** CPPS Collaboration

It includes: (a) the entities which interact in the different layers of the system [Biffi and Sabou [2016]], (b) the horizontal and vertical integration within production systems and production value chains [Mazak and Huemer [2015]], and (c) The dependencies' relation between product, production system, and production system technologies.[Lucke et al. [2008]]. d) the interaction links between the CPPS and humans. With their cognition and decision-making abilities, humans integrate with CPPS to do their tasks [Liu and Wang [2020]]. e) the CPPS interaction with the organization performed for a particular customer/organization needs. The huge collaboration within the hierarchy layer, with many parts where those parts interact with each other in multiple ways, culminating in a higher order at various scales, is challenging.

#### 1.4.4 Challenges on CPPS Knowledge reuse and sharing

The CPPS notion production concept domain knowledge. The Knowledge Capitalization is an active process of capturing your knowledge assets and making them actionable to support workers at the time of need – when they are performing a task[Bertschi et al. [2013]]. The Knowledge sharing and reuse influence the system. This earned knowledge and experience are used to reduce the risk of the system fails to guarantee the success of future projects[Ode and Ayavoo [2020]][Bertschi et al. [2013]].



**Figure 1.15:** Knowledge reuse and sharing

It encourages clear communication among the members. In this context, the knowledge representation is crucial for successful knowledge sharing and reuse by means of unveiling the knowledge hidden behind the set of data and information [Bertschi et al. [2013]]. The Capturing the CPPS concept paradigm knowledge is challenging.[Chandrasegaran et al. [2013]]. Considering all the above challenges of CPPS, the thesis problem statement is described as follows.

### 1.4.5 Thesis Problem statement

The literature survey and the topic of the LS2N-platform project point out several scientific challenges that should be resolved of the CPPS development project. The following challenges are at the origin of the scientific problematic of this research work.

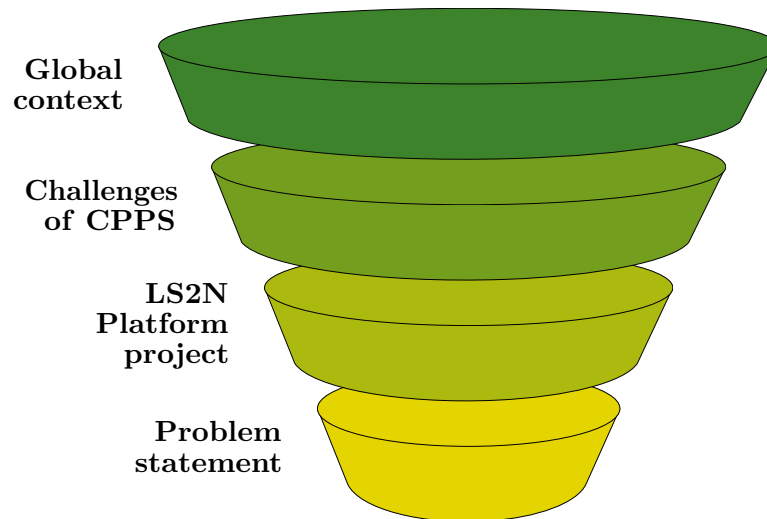


Figure 1.11(b) Scientific Problem statement funnel

- **Problem-1 Lack of proper organizing of the CPPS notion.**

There is no unified common understanding of the concept. The existing work of CPPS have always been inconsistent.

- **Problem-2 Lack of CPPS entity from terminology, typology, properties, different life cycle phases.**

Most of these terms are neither clearly defined nor classified, nor are the relations between the terms examined. Up to now, i.e., there is lack of entity of a production system can be regarded within the hierarchy layer.

- **Problem-3 Lack of Comprehensive human-CPPS interaction phenomenon.**

The human part largely resides in how machines perceive and respond to human interaction responses. What interactive human-CPPS are?, remains lagging.

As a result of this limitation and missing standard leads to major challenge in its evolution and tailoring to other aspects. To tackle these problems and research gap in common solution, there is a need for CPPS domain formalism to manage complexities, and provide a common understanding of CPPS concept.

## 1.5 Research Question, Methods, and Process

From the above problem statement, the research questions and method is described as follows. To answer this problem statement, there is a need of dedicated framework for CPPS. For that, the two main research questions is formed as follows:

### Research Question 1

**RQ-1 How to define Cyber-physical production system (CPPS) notion formally?**

*SQ-1-What is the fundamental theory for CPPS notion?*

*SQ-2: What is the current level maturity of CPPS notion?*

To address this research question, there is a need of organize of CPPS notion. To achieve this goal, we organize and present the cyber physical production system(CPPS) using SE principle. It mainly constitutes our understanding CPPS and a metamodel is proposed. The core entities and boundary of the CPPS is illustrated. It contributes to a common understanding of CPPS by classifying entities and illustrating their relations. To demonstrate the general applicability of our artifacts, we applied into three static scenarios of CPPS with differing levels of distributed intelligence.

### Research Question 2

**RQ-2-How can cyber-physical production system (CPPS) entities be defined in unified semantics considering its life cycle?**

*SQ-1-How can cyber-physical production system (CPPS) entities be defined in unified semantics?*

*SQ-2:How can human-CPPS integration be defined in unified semantics?*

Based on the CPPS Organising, we propose a conceptual modular semantic framework for CPPS notion.(i.e. terminology, typology, life cycle, human-CPPS interaction aspects, etc). It is an abstract domain-conceptualization. It involves a set of terms naming concepts (classes) and relations. It is based on the immediate influence on the structure and functionality of CPPS notion. It ensures the level of abstraction to guarantee was clear and comprehensive by including all core entities of interest.



### 1.5.1 Mutual contribution to CPPS domain and INCOSE New vision

This framework serves as a value creation for CPPS notion. It lays a semantic basis, helping to understand and support in evolution of CPPS paradigm. Figure ?? shows the multi-viewed modular semantic framework for CPPS notion which supports multiple aspects as follows:

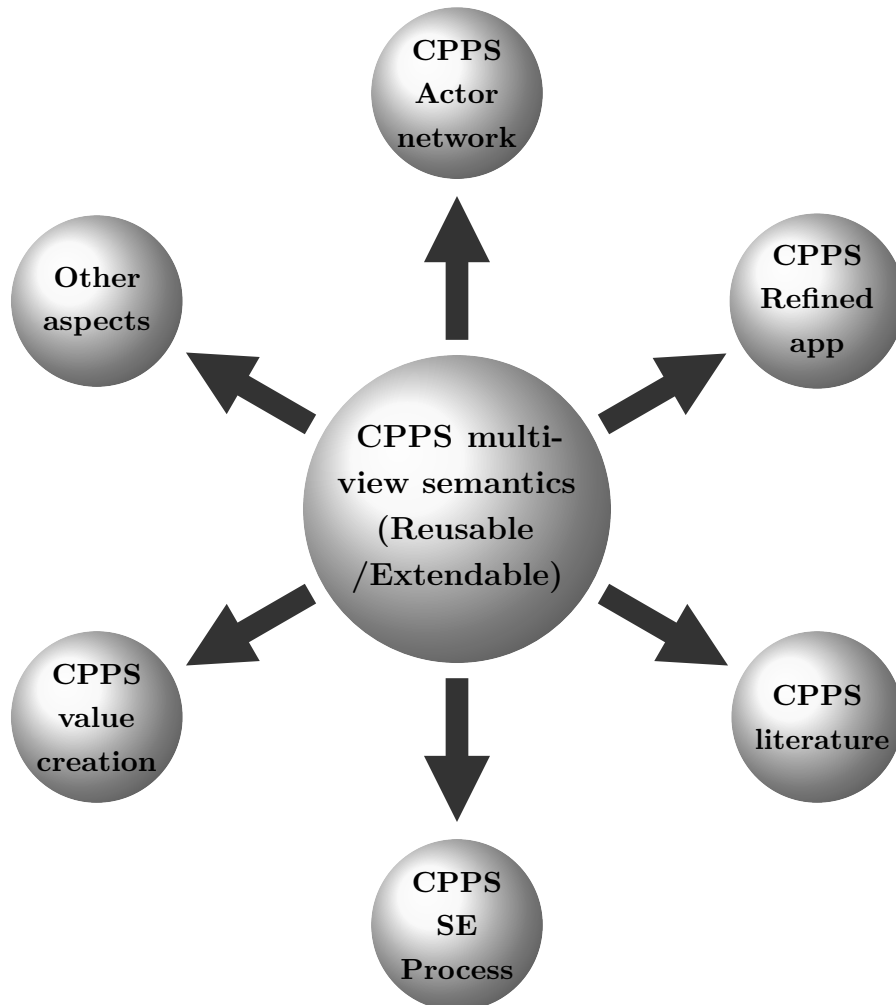


Figure CPPS notion multi-viewed modular semantic framework

- **CPPS Value creation-** It serves as a value creation and semantic basis for CPPS notion.
- **CPPS SE process-** It supports for system thinking and System Engineering process.
- **CPPS Literature advances-** It provides a valid source of knowledge to raise the system theory for practitioners and researchers in the field.

- **CPPS refined applications-** It supports and used unambiguously across different implementations.
- **Actor’s network-** It supports the whole actors’ network and encourages communication and sharing among the CPPS members.
- **Other aspects-** It supports the other aspects, which include external sources and simulating other paradigms.

### 1.5.2 Research Methods

To address the research questions, the thesis work globally adapted the **Conceptual and explanatory research methodology** [Meredith [1993]]. This method is a mixed research method of top-down from an academic point of view and bottom-up from a pragmatic point of view. This method helps to observe and analyze the present information on a CPPS.

Category	Domain	Employee	Expertise	Expert	Role
EG 1	Production system	>2750	IT	Production system	Production Researchers
EG 2	Cyber physical system	>3000	Hardware and software	CPS	CPS Expert and researchers
EG 3	HMI integration	>4750	Human skill	HMI integration	HMI specialist
EG 4	System Engineering	> 8760	MBSE consultant	MBSE	System thinking

EG- Expert group, I and A- Industry and Academia, IT- Information technology, MBSE- Model-based system engineering (MBSE)

**Table 1.1:** Details of expert group focus gathering

It conceptualizes the entity, and phenomenon, uses expressions and organizes the derived theory of the system knowledge in a model based -context. Also, it helps construct the domain system architecture framework that depicts the structural elements and their conceptual constraints [Meredith [1993]] [Wu et al. [2020]].

The above research question leads us to an auxiliary but important question concerning the selection of suitable methodological foundation and modeling languages that allow constructing a robust CPPS modeling framework able to support the representation of all CPPS related knowledge at the conceptual level and to provide detailed model ready to implement and use in the LS2N-Platform project.

Following this characteristic, the kernel hypothesis of this research work is that Systems Engineering (SE) provides suitable methodological foundations to support the building of the CPPS modeling framework. [Maier [1996]] Indeed, SE proved its applicability to support the definition and integration of multi-domains systems along with their life cycles.

### 1.5.3 Research process

The different stages of research process is used in this thesis work for constructing semantic architecture. Figure 8.1 shows the stages of research process. It includes:

- **Domain knowledge analysis-** The domain knowledge extraction is conducted in the SLR literature on cyber-physical production system-related works [Lynch et al. [2006]]. We examine the research papers, public working group projects, and related studies with little information on real-world CPPS applications. Based on the identified axioms, we began to conceptualize the involved entities and their dimensions of CPPS. It served as a first draft and base for the following research process.
- **Real system analysis-** Then, We examine how the real objects (real system) fit with this conceptualization. We analyzed the different types of real CPPS. From the current development of Cyber-physical production system (CPPS) classification, [Cardin [2019]]. The commonalities among different CPPS and its logical relationships are captured.
- **SEBOK Guidance and recommendations-** Then, the SEBOK (System engineering body of knowledge) guidance is followed to understand the system concepts model and principles [Olwell et al. [2013]]. Then, the recommendation from the INCOSE community on system semantic concepts and standard modeling techniques are followed [Dickerson et al. [2004]].
- **Semantic coding process-** Then, the identified entities of CPPS in literature and captured abstractions from the real CPPS system. We underwent an inductive qualitative coding process to define the meaning of the entities in the system. The inductive qualitative approach is when "there is not enough former knowledge about the phenomenon or if this knowledge is fragmented." The object category is derived

from the material under examination itself. [Elo and Kyngäs [2008]]

- **Model construction:** Then, the generic conceptual unified semantic architecture builds for CPPS notion using a system. It constructs based on the "logical relationship and theoretical assumptions," which integrates academic and industrial points of view to represent the integrated generic CPPS architecture [Tremblay et al. [2010]] [Krueger [2014]]. It involves commonality and a reusable and extendable abstract in future cases.

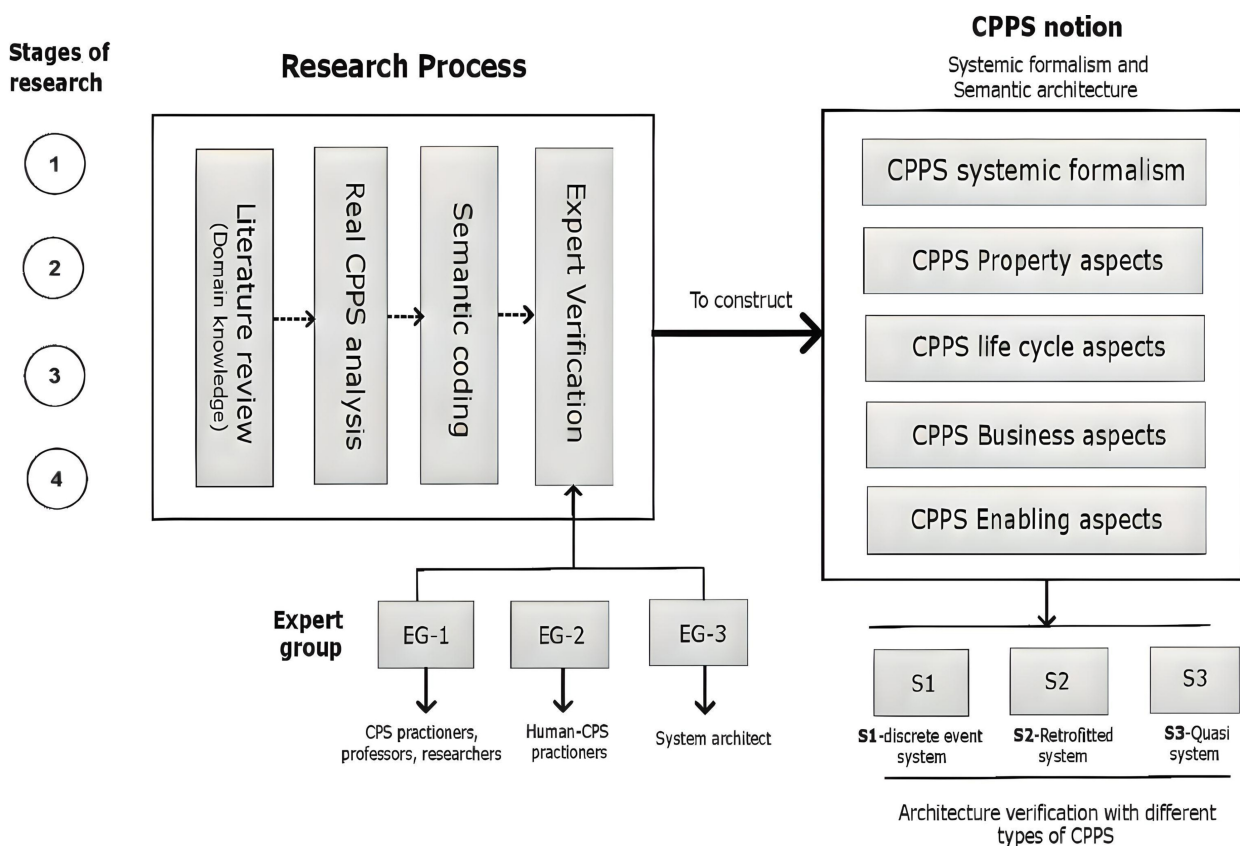


Figure 1.16: Stages of Research process for the framework

- **Verification and Validation(V and V)-** Finally, expert verification and validation by instantiating operation scenario is carried out. It checks “whether theories and assumptions underlying the semantic models are consistent, completeness, and causal relationships are “reasonable” for the intended purpose of the model”[Unhelkar [2005]] [Panasiuk et al. [2019]].
- **Application context-** It is reused and instantiated in the three independent application context of LS2N-platform project. It includes the 1) common repository application 2) Collaborative interface management application 3) Human-CPPS configurator application. It illustrates that, it can be used unambiguously across different implementations.

## 1.6 Thesis structure

As shown in the figure, the thesis mainly consists of seven chapters. Chapter 1 is an introduction to the main research concept including the motivation, objectives of the research, scope of the thesis and thesis structure.

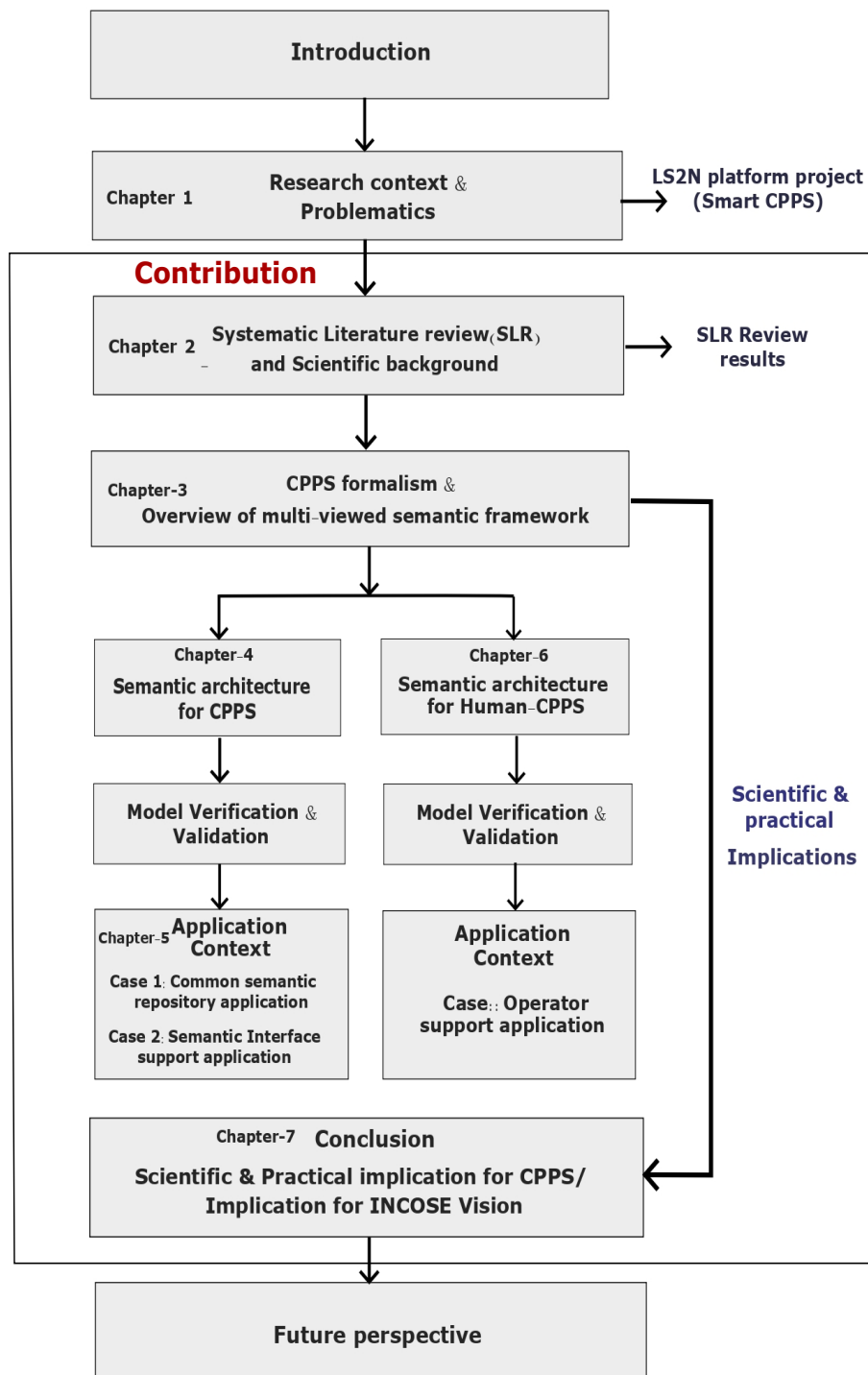


Figure 1.17: Thesis structure

**Chapter-1-**This chapter presents the motivation, Scope and overview of the doctoral thesis. First, it describes a research context and the background of the thesis work is researching. Then, the thesis problematic, derived research question, methods, and application context of LS2N-CPPS is presented.

**Chapter 2-** This chapter presents a systematic literature review and scientific background. First, the chapter highlights the systematic literature review of CPPS. The second half of this chapter discuss the scientific background of knowledge modeling and system engineering approach, that were deployed to construct the CPPS domain standard modular framework.

**Chapter 3-** This chapter proposed the formalization of cyber physical production system notion using system and SE principle. It consists of definition, system theory and the metamodel.

**Chapter 4-** This chapter proposed a multi-viewed modular semantic models for Cyber-physical production system (CPPS) which includes the system property, system life cycle and system business process. Then, we underwent a scenario-based verification that determines the theories and assumptions underlying the conceptual models are correct by representing different CPPS.

**Chapter 5-** It is realized in the LS2N-Platform project. The chapter instantiated and reused in two independent application context. **Semantic repository application**, 2) **Collaborative management application**, 3) **HCPPS configurator** It illustrates that, it can be used unambiguously across different implementations.

**Chapter 6-** This chapter presents the second part of the framework. It proposed the semantic for Human-Cyber-physical production system integration (CPPS). Then, the models are instantiated and reused for a specific application context of human-CPPS configurator application (industrial work).

**Chapter 7-** The overall conclusion of thesis work is presented by summarizing scientific and practical implication to CPPS. Then, the framework how it contributes to INCOSE community and its vision is described. Finally, the main limitations, discussion and future work is summarized.

## Synthesis and conclusion

This chapter explored the primary review on CPPS characteristics (definition, typology, life cycle, development lead us to the conclusion that adopting a system-based approach for CPPS development is a promising method to manage the complexity of such projects. The main characteristics of Cyber physical production system and the general challenges of providing a robust modeling framework for the representation of the related CPPS complexity.

To make the basis to represent the CPPS models, the next chapter explores the standard modeling frameworks and tools for knowledge classification as well as CPPS-dedicated ones. To shed light on the primary idea of adopting a system-based approach in CPPS development and modeling is investigated. Finally, the hypothesis is illustrated with different points of view in CPPS.





## Related works and Scientific background

---

*This chapter describes the Systematic literature review of the thesis. More precisely, the first half of the chapter highlight the systematic literature review. It illustrates the current lack of consensus regarding CPPS concept and existing work, which would be required to develop a new CPPS standard modeling framework. The second half of this chapter discuss the knowledge classification techniques. Then, the system and system engineering approach is described that were deployed to construct the framework.*

---

2.1	Introduction . . . . .	36
2.2	Systematic Literature review on CPPS concept . . . . .	36
2.3	Normalization, mapping, and clustering of SLR . . . . .	41
2.4	Bibliometric network and fractional counting . . . . .	44
2.5	Backward Snowfall sampling -Reference tracking . . . . .	45
2.6	Quality assessment on inclusive papers . . . . .	47
2.7	Synthesis: SLR results . . . . .	58
2.8	Knowledge representation techniques . . . . .	58
2.8.1	Ontology for knowledge classification . . . . .	59
2.8.2	Semantic concept and representation . . . . .	61
2.8.3	Multi-viewed modeling mechanism . . . . .	68
2.8.4	Modeling language and tools . . . . .	68
2.8.5	Synthesis . . . . .	71
2.9	System and Systems Engineering approach . . . . .	72
2.9.1	General system theory . . . . .	72
2.9.2	Systems Engineering approach . . . . .	73
2.9.3	Reusability and modularity practices/concepts . . . . .	75
2.9.4	Synthesis . . . . .	76
2.10	PhD Contribution positioning . . . . .	77

---

## 2.1 Introduction

As explained in the research context, the Cyber-Physical-Production System (CPPS) is an emerging research topic [Ganti et al. [2008]]. The paradigm shift from CPS to CPPS was mainly attributed to the increasing use of CPS enabled smart production devices.[Monostori]. The concept of CPS has been around for over a decade now, but the CPPS concept has gained an increasing attention over the past few years.

In this chapter, we begin with a detailed overview of Cyber-Physical-Production System (CPPS) through a Systematic Literature Review (SLR). The SLR explores the different definitions of CPPS, its application areas and how the social aspect is conceptualized in literature. The literature search is up to 2019, since this literature review has been performed in the first year of the thesis to know the CPPS concept and identify the modeling works. The SLR explores the different definitions of CPPS, and what are the existing modeling works are conceptualized in literature. It also illustrates that the current lack of consensus regarding CPPS entities and existing modeling works.

It illustrates the current lack of consensus of CPPS concept and existing work. It requires the CPPS formalization and development of modeling approaches, which are urgently needed in order to make the complexity and structural opacity of CPPS more manageable and support the life cycle phases. Then, we describe the Knowledge classification techniques and their foundations. It illustrates the overview of standard modeling approaches and framework. Some examples of the standard modeling framework of different domain are shown.

Fourth, the methodological foundation is deployed to represent the CPPS (i.e.,) system and system engineering approach, that were used to construct the modeling framework is described [Nadoveza and Kiritsis [2014]]. Finally, We position the contribution of the thesis based on these findings and describe the thesis hypothesis of the contribution.

This chapter organized as follows: section 2.2-systematic literature review on CPPS; Section 2.6 shows the background of knowledge classifications and some examples of standard modeling framework; section 2.9 describes the system and system engineering approach; It serves as a methodological foundation to represent the CPPS; section 2.10 presents the PhD contribution positioning.

## 2.2 Systematic Literature review on CPPS concept

In this section, the systematic literature reviews(SLR) are described. It is an explicit and rigorous approach to identify, evaluate, synthesize all the literature on a particular topic, where data extraction can be largely reduced [Cronin et al. [2008]]. It helps to analyze the

existing works and identify the research gap in the literature. The systematic literature review, [Kitchenham et al. [2010]], explores the broad spectrum of CPPS from its evolution and existing works in state-of-the-art perspectives. In particular, the SLR tries to answer the following questions:

- **SLR Q-1** How is the CPPS notion formally defined?
- **SLR Q-2** What are involved terminology, typology, taxonomy?
- **SLR Q-3** What are the existing modeling works?
- **SLR Q-3** What are the limitations and gap in existing works?

The literature review were made and searched until the year 2019 (starting of thesis work). The step by step literature review process is described as follows, and figure 2.1 shows the systematic literature review process chart.

### 2.2.1 Database selection

First, to cover all relevant studies that could potentially answer the above-mentioned key research questions. We searched for reports, papers, and conference proceedings by using the digital library as follows: Scopus, Wiley, IEEE, Springer. We restricted to search on selected four databases, considering that is sufficient to perform a robust and comprehensive literature search.

It is expected that, it will provide more robustness to the search.(We didn't analysis other databases). The Scopus is known to be an extensive abstract and citation database that gather papers from several peer-reviewed journals [Baška et al. [2019]]. The paper retrieving from the database coming from publishers such as Elsevier, Springer, Wiley, and IEEE. Hence, the search strings and keyword described are slightly modified for each database to obtain the expected output.

### 2.2.2 Keywords and search strings <sup>1</sup>

The keywords used in this literature review were defined based on a [stages of research process](#), which is described as follows. This step defines the keywords used for searching articles.[Hoffart et al. [2014]]. First, we queried the digital libraries that specified below with the search string (S1), (S2)(S3) as follows:

---

<sup>1</sup><https://www.vosviewer.com/>

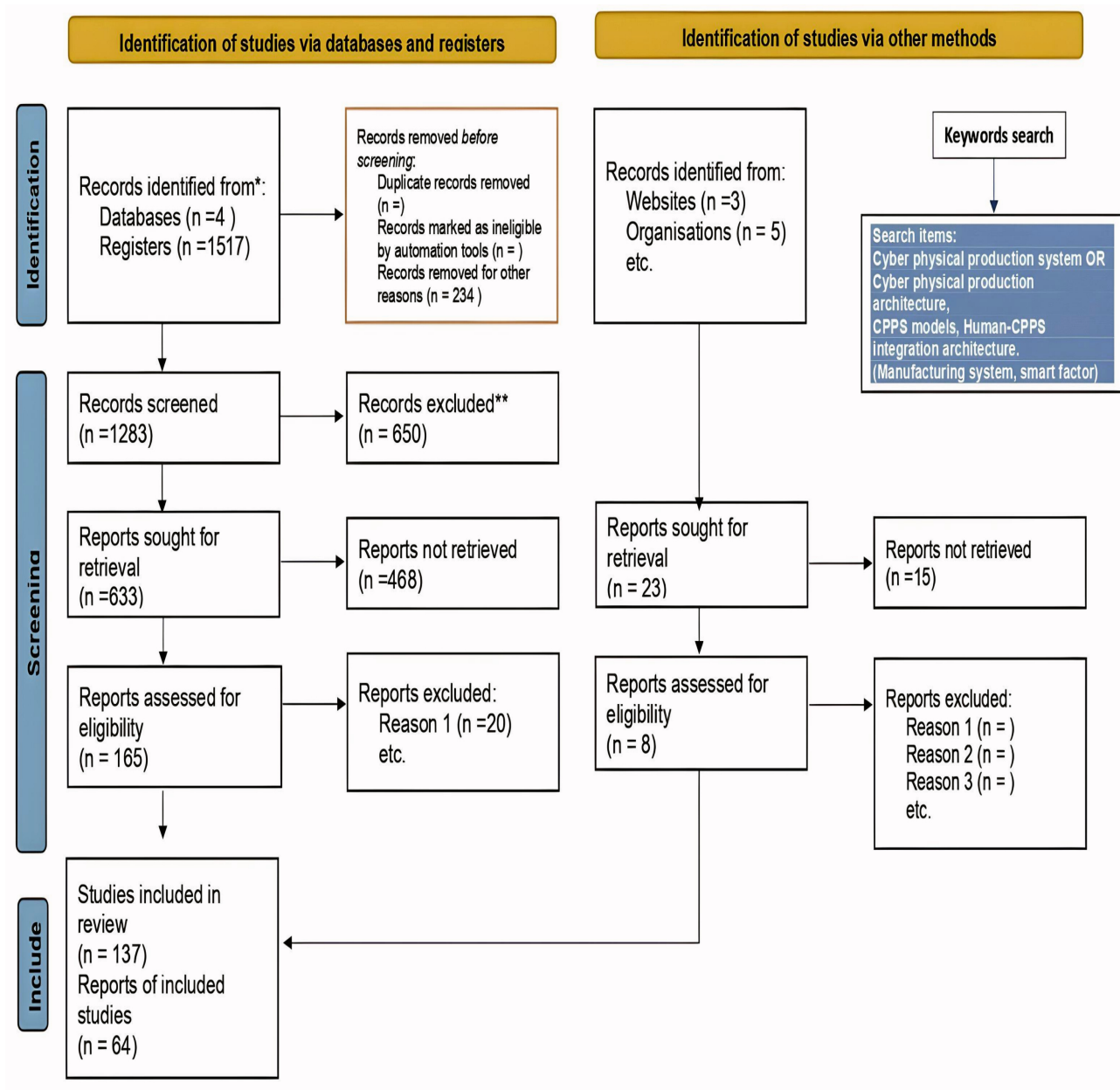


Figure 2.1: Systematic Literature review (Until 2019)

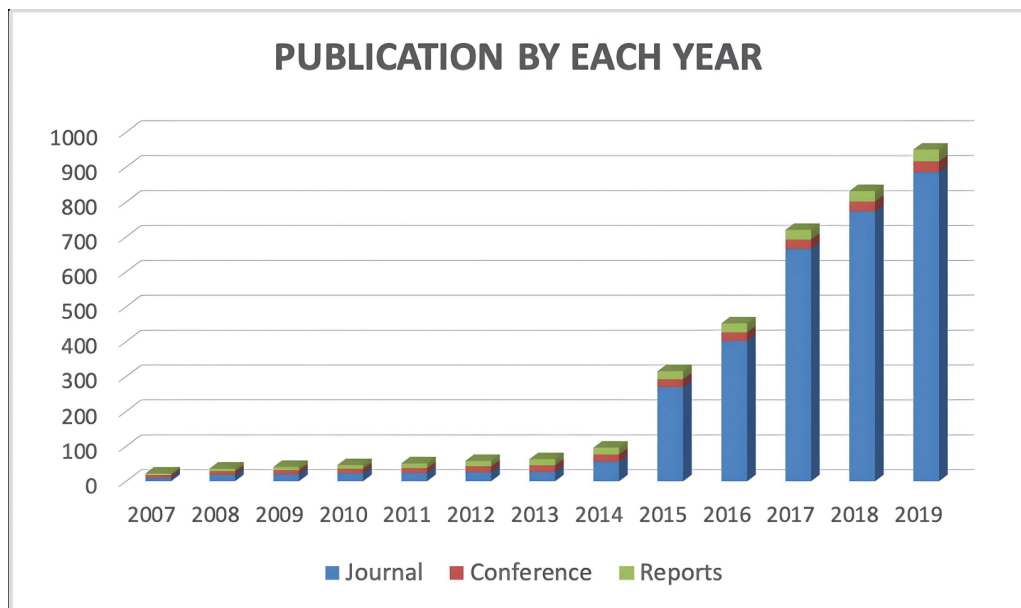
- *S1: Cyber Physical production System*
- *S2 Cyber Physical production system, Human-Cyber Physical production System, CPS enabled production, CPS product and production system*
- *S3 Cyber Physical production system reference modeling, CPPS architecture Human-Cyber Physical production System architecture, CPPS Semantics*

Table 2.1 summarizes the total number of papers obtained from each database per search string. A total of 1517 papers were retrieved.

**Table 2.1:** Number of papers retrieved per search string

Publisher database	Query 1	Query 2	Query 3
Scopus	670	160	124
Wiley	68	49	45
Springer plus journal	78	44	90
IEEE	66	51	72
Total	882	304	331

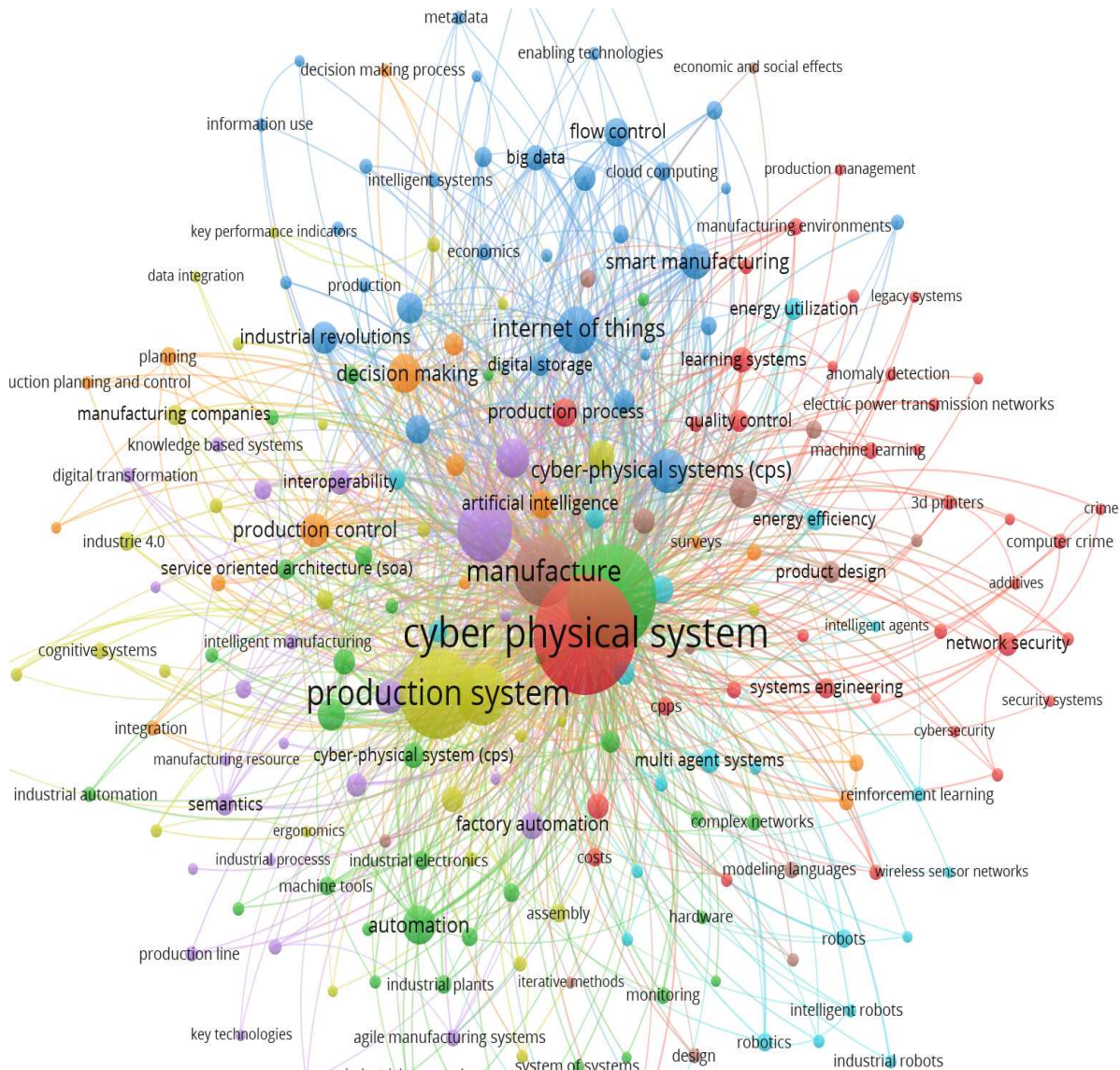
Figure 2.2 shows the time distribution of the papers published between the years 2007 to 2019 in the number of papers.



**Figure 2.2:** Publication each year until 2019

In 2015, a steady growth appeared followed by a sharp increase in 2016 with gradual changes in 2017 and 2018. In the year 2019, the rate of publication only within the first has almost doubled the previous year. This evolution rationalizes the increasing attention the CPPS research gained over the years. From these papers, we extract the most used keywords (i.e., repeated more than five times) and the most repeated terms (i.e., repeated more than twenty times) in their titles and abstract. This was done by downloading the paper's metadata (i.e. title, year of publication, authors, abstract and keywords). The 234 paper were removed from this metadata sources.



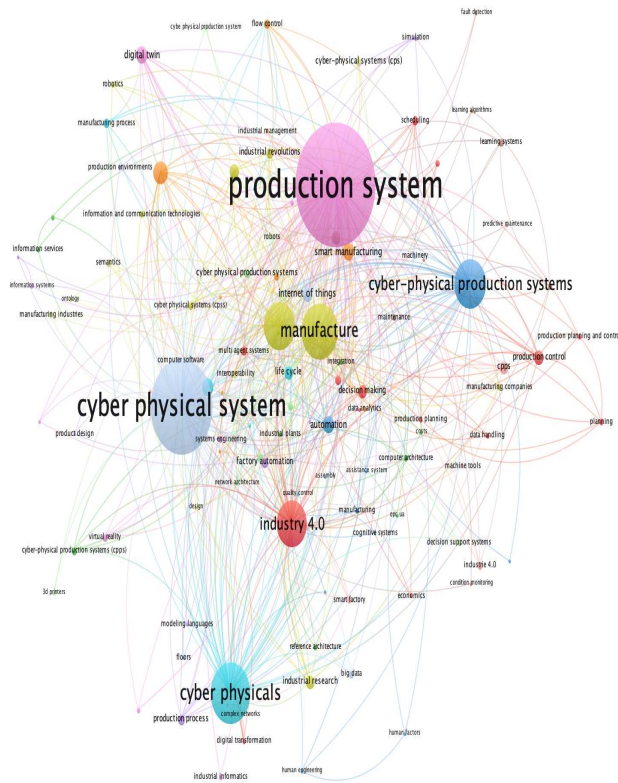


**Figure 2.3:** Cluster-1 Keywords on overall CPPS exploration

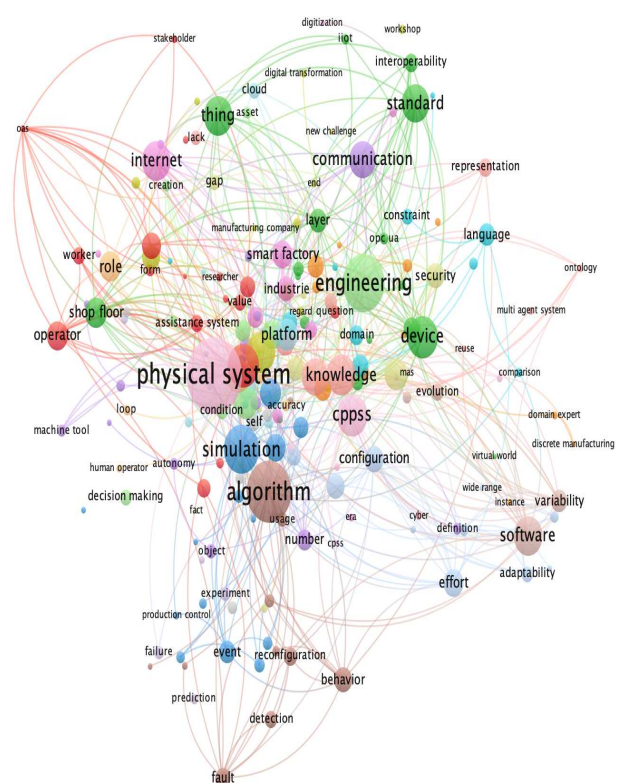
Next, we perform a data mining on the extracted metadata in order to identify the relevant keywords using VOS viewer software [Van Eck and Waltman [2010]]. Total of 1283 papers were screened. Figure 2.18, 2.17, 8.5, 8.6 shows the keywords co-occurrence network visualization. It provides the co-occurrence networks of important terms from a body of scientific literature.

From the identification results, it is known that there are 5 main clusters in the network, with a total link strength of 1283 and 423 items with the main node "cyber-physical production system" in Cluster 1. Figure 2.18 shows that, it can be seen that the dominant topics or keywords were scientific literacy. This means that these topics in the 2014-2019 period were the most discussed by researchers. Also, nodes or keywords, have the potential to become new research topics in the future.

After being analyzed in the VOS viewer software, 15 clusters had been obtained in the mapping of all topics (red, dark green, blue, dark yellow, dark purple, Tosca, orange, brown, light purple, pink, green, light grey, cream, violet, and light Tosca). The thickness of the connecting line showed the strength of pairs of topic areas or keywords.



**Figure 2.4:** Cluster-2 Cluster node analysis on CPPS concept



**Figure 2.5:** Cluster-3 Cluster on Human-CPPS integration

## 2.3 Normalization, mapping, and clustering of SLR

In a bibliometric network, there are often large differences between nodes in the number of edges they have to other nodes. Popular nodes, for instance representing highly cited publications or highly prolific researchers, may have several orders of magnitude more connections than their less popular counterparts. In the analysis of bibliometric networks, one usually performs a normalization for these differences between nodes. VOSviewer by default applies the association strength Normalization. This normalization is discussed in detail by [Van Eck and Waltman [2010]].



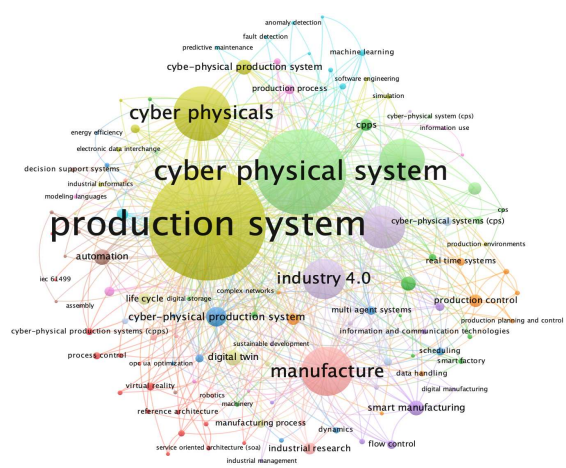


Figure 2.6: Cluster-4 Cluster node analysis for CPPS concept

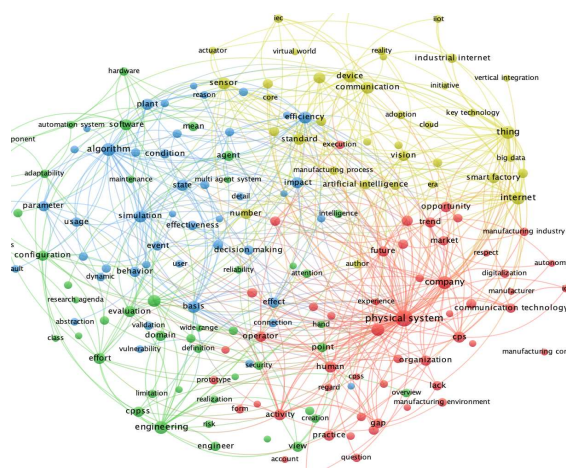


Figure 2.7: Cluster-5 Cluster node analysis for CPPS referencing

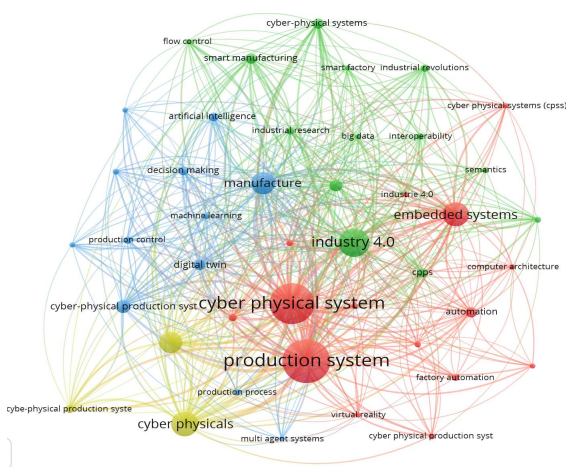


Figure 2.8: Cluster-6 Cluster node analysis for CPPS architecture

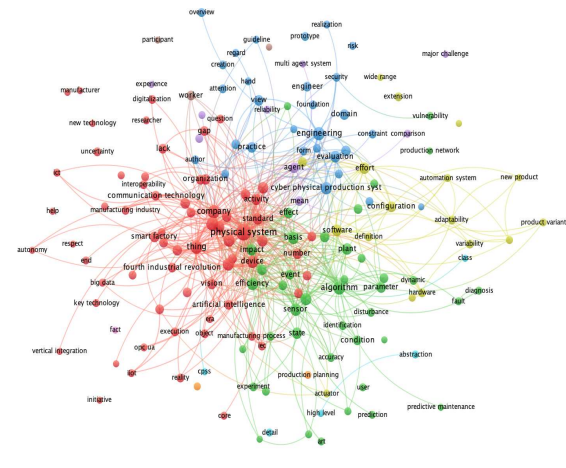


Figure 2.9: Cluster-7 Cluster node analysis for human-centered CPPS architecture

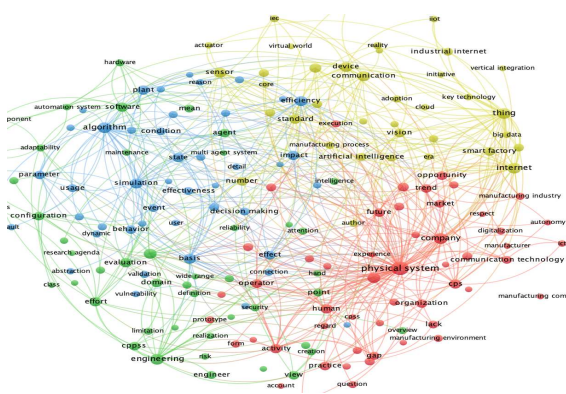


Figure 2.10: Cluster-8 Cluster node analysis for life cycle concept

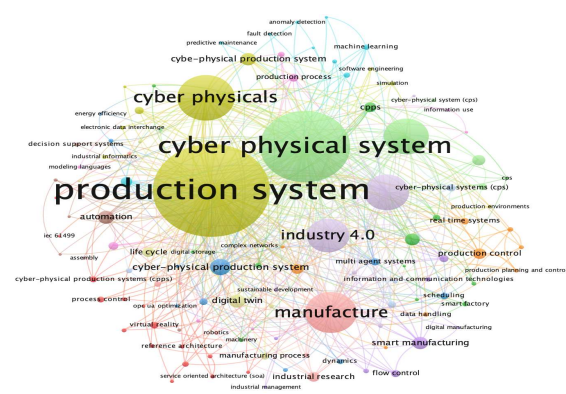
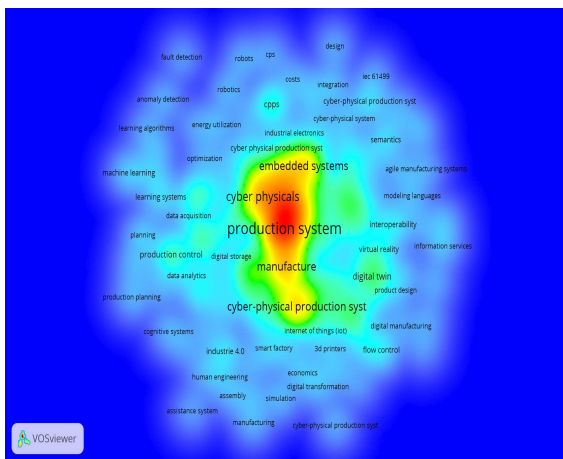
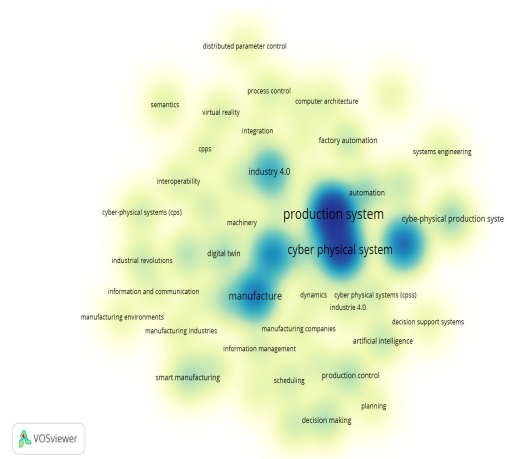


Figure 2.11: Cluster-9 Cluster node analysis for Business aspects

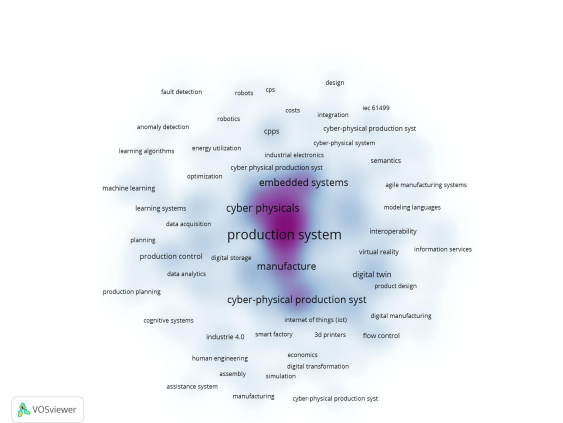




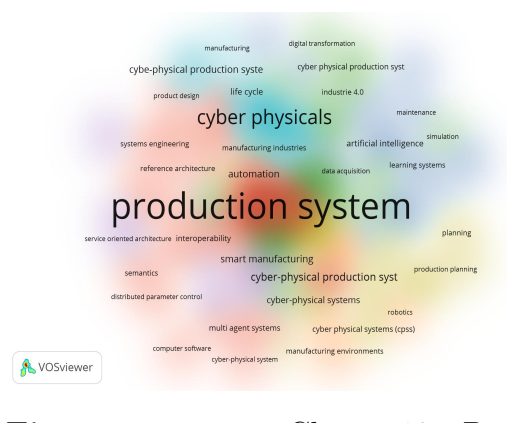
**Figure 2.12:** Cluster-10 Density visualisation for CPPS concept



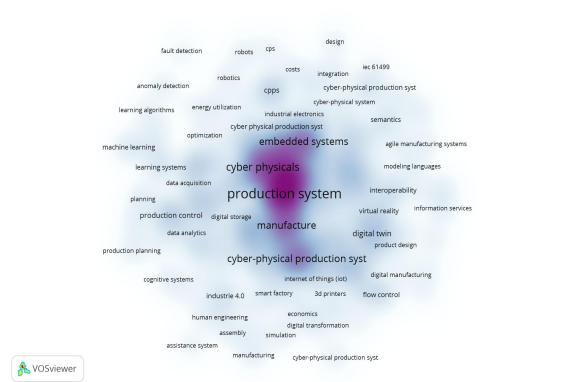
**Figure 2.13:** Cluster-11 Density visualisation for CPPS referencing



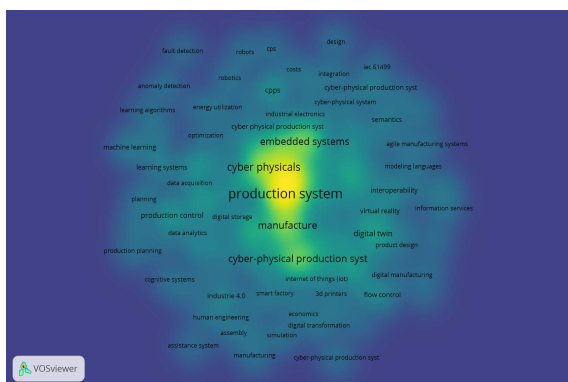
**Figure 2.14:** Cluster-12 Density visualisation for CPPS architecture



**Figure 2.15:** Cluster-13 Density visualisation for human-centered CPPS architecture



**Figure 2.16:** Cluster-14 Density visualisation for CPPS business aspects



**Figure 2.17:** Cluster-15 Density visualisation for CPPS life cycle aspects

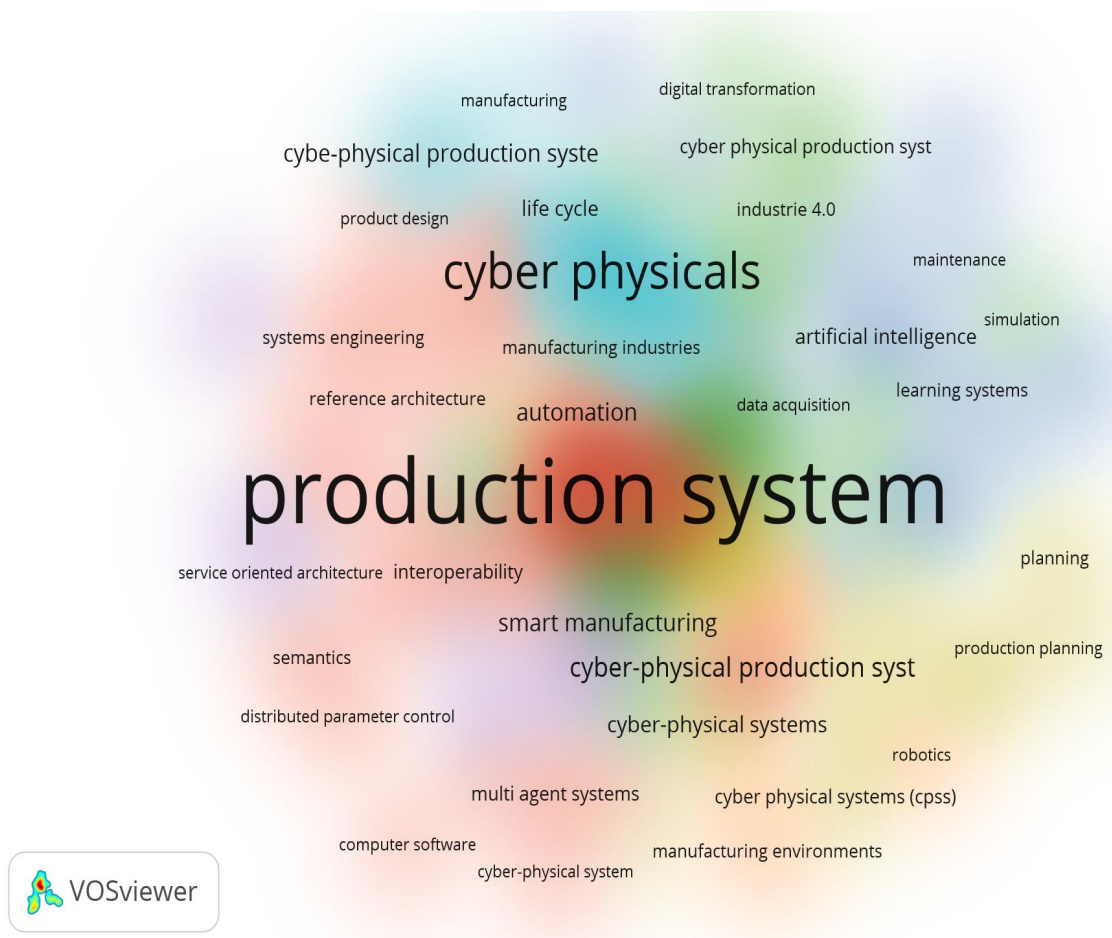
## 2.4 Bibliometric network and fractional counting

After the nodes in a bibliometric network have been positioned in a two-dimensional space and have been assigned to clusters, the network can be displayed.

VOS viewer uses various techniques to optimize the way in which networks are displayed. In order to ensure that labels of nodes do not overlap each other, labels are displayed only for a selection of all nodes. This selection is determined in such a way that as many labels as possible are displayed while labels of more important nodes (i.e., nodes that have more edges) are given priority over labels of less important nodes.

### 2.3.1 Fractional counting methodology

Based on these files, VOS viewer can construct co-citation and bibliographic coupling networks. A special feature of VOS viewer is the possibility to construct Co-citation and bibliographic coupling networks.



**Figure 2.18:** Overall Co-occurrence CPPS density exploration

From the analysis, we categorize the sub cluster of each category to identify the metadata in category. The "cyber-physical production system architecture" of Cluster 2; "Human-CPPS integration" in Cluster 3. Figure 6.4 shows the cluster on Co-occurrence of keywords of the selected documents published on CPPS modeling. It illustrates that the co-occurrence existing modeling practices which has high value in the first co-occurrence time of the two. The thicker the line is, the greater the intensity, and the greater the number of co-occurrence between the keywords. Figure 2.17 presented the cluster on human-CPPS integration co-occurrence of keywords of the selected documents published on human-CPPS integration. It can be seen from time that before human-CPPS integration, clusters have been showing a different degree of connection, which indicates that researchers on a certain basis for human-CPPS integration.

Overall, the cluster analysis specified that, the density of the node will change with the change of the surrounding keyword values. In the center of the node density is higher, the deeper the color, the more bright, as the research focus areas. The lower the density of the nodes at the edges, the closer their colors are to blue, indicating that the research topic is hot. Based on that, the title and abstract screening for systematic reviews is carried out. Let  $N$  be the total number of papers and  $R$  the number of relevant papers. In general,  $R$  is not known. To estimate  $R$  we can evaluate papers until we have marked  $r$  papers as relevant. A potential stopping criterion is then to stop once a predefined percentage  $p$  of the estimated number of relevant papers  $R$  has been marked relevant. Next section shows the backward snowfall analysis.

## 2.5 Backward Snowfall sampling -Reference tracking

2

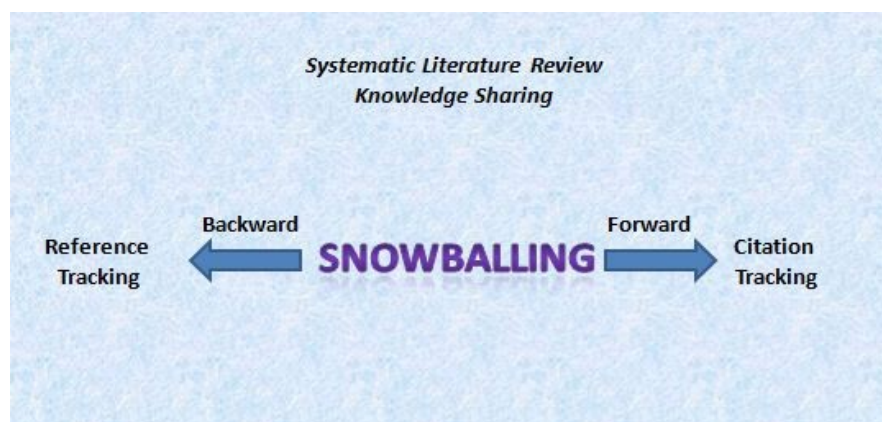
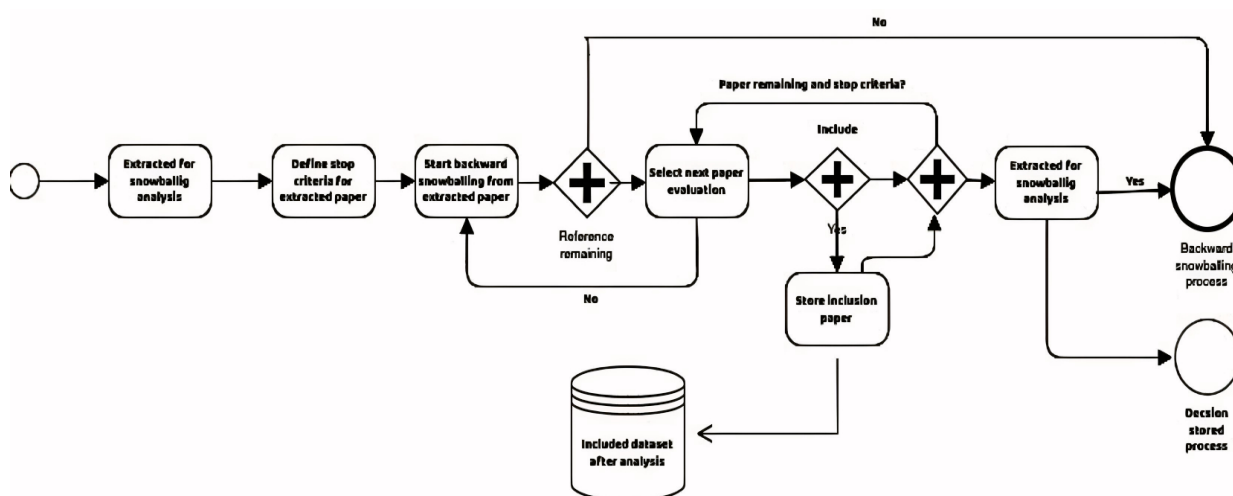


Figure 2.19: Overview of snowball procedure

<sup>2</sup><https://www.rayyan.ai/>

We choose to blend active learning and backward snowballing. This allows to complement their set of relevant papers with additional sources [Yu and Menzies [2019]]. There are three main classes of relevant papers that may not be included at this stage. The first is the group of relevant papers included in the set that was automatically excluded in the active learning phase. An appropriately defined stopping criterion should keep this set relatively small. Additionally, there are relevant papers that do not satisfy the search query used. Last, and certainly not least, is the group of relevant papers that are not present in the databases considered. This will mostly be grey literature and, from our experience, relatively old research.



**Figure 2.20:** Overview of snowball procedure

Figure 2.23 depicts the backward snowballing procedure in our setting. The second filtering step involves reading the full text of the remaining papers. To select which papers are to be considered in this study an additional set of inclusion and exclusion criteria were applied represented by F2 which is based on analysing the full text of the papers is described in table 2.2. The procedure differs from the traditional backward snowballing procedure [Wohlin [2014]] due to the large set of inclusions that already exist in our process from the active learning phase.

Terminological saturation of ordered publications set is defined with the following condition: adding publication into the end of the list leaves the term list almost unchanged. This also implies the stopping criterion for backward snowballing has to differ from traditional stopping criteria [Wohlin [2014]]. One could consider stopping after evaluating  $n$  irrelevant references or papers in a row. Table 2.4 shows the averaged results, where the scoring for the 20 duplicate papers.

We recommend stopping when in the last  $N_r$  references, the number of new relevant additions

**Table 2.2:** Exclusion criteria

Exclusion criteria	Criteria explanation
<b>Without Full Text</b>	No access to full text.
<b>Editorial Material (EM)</b>	Exclude editorial material.
<b>Language</b>	Papers not in English.
<b>Un-Related</b>	The term CPPS is only used as the background or future research direction. review articles Without the CPPS modeling works.
<b>Similar Articles (SA)</b>	The several articles discussing the same topic, only the article with the highest citations is included.
<b>Generic view</b>	The CPPS generic concepts without systemic aspects.
<b>Year of publication</b>	2007-2019

rr is less than some constant  $C$ , given that the number of snowballed papers  $s$  is at least  $S$ . For example, if our set of inclusions contains 100 papers, we may set the minimum number of papers to snowball to  $S = 10$ . Once 10 papers have been snowballed, we stop when the last  $N_r = 100$  references contained less than  $C = 5$  additions to our inclusions. Next, the descriptive analysis is shown. Next section, we assess the Quality of the included paper.

The paper filtering process is made out of 1283 publications. The exclusion criteria for the filtering process is shown in Table 2.2. The Rayyan software is used to expedite the screening work. It is used for labeling papers, making exclude decisions and sharing results. The abstract/title screening is performed automatically by Rayyan. The 633 papers were sought and extracted to retrieval on labeling paper process. The full-text-screening has been done manually based on the criteria and in the subjective way. Then, we have undergone the quality assessment in the next section.

## 2.6 Quality assessment on inclusive papers

Given the large number of included papers at this stage, the logical choice was to apply a quality assessment step. We adapted the most relevant commonly used quality criteria [Zhou et al. [2016]], to be suitable for use in combination with a Likert scale. Table 5.1 illustrate the Quality assessment of SLR.

**Table 2.3:** The quality criteria applied on inclusion paper

	<b>Criterion</b>	<b>SD</b>	<b>D</b>	<b>N</b>	<b>A</b>	<b>SA</b>
<b>Reporting</b>	There are clear statement of the research aims	0	17	22	23	30
<b>Reporting</b>	There is an adequate description of research context	0	6	11	17	30
Vigour	Metrics used in study are clearly defined	0	6	19	22	38
<b>Rigour</b>	Metrics used in study are clearly defined	0	3	19	21	30
<b>Rigour</b>	Metrics used in study are clearly defined	0	3	16	17	19
<b>Credibility</b>	Finding are clearly stated to research aims	1	24	22	18	24
<b>Credibility</b>	The study is of value to research or practice	13	18	12	18	24
<b>Credibility</b>	The study is of value to research or practice	0	9	12	28	30

**Table 2.4:** Quality criteria

**Strongly disagree (SD), disagree (D), neutral (N), agree (A), or strongly agree (SA).**

The response to each quality criterion was scored with 0, 0.25, 0.5, 0.75 or 1, corresponding to the five possible evaluations. With the sheer size of the set of inclusions, it was not possible to assess the quality of all papers. One possible solution to this problem is the following. We split the 60 evaluated papers into a training set (48 papers) and a test set (12 papers).

Each paper was labelled as having sufficient quality if it obtained a score of at least 6 out of 9. In the 20 papers that, there were five edge cases where a disagreement occurred. On average, the quality scores differed by roughly 0.7 points. It is almost equally strict in the evaluation of the papers, with the total sum of all quality scores differing by just 0.25. We extended our quality scores with three explanatory features: years since publication, citation count, and the number of pages. A binary decision tree was trained on the explanatory features for the 48 training papers and evaluated on the 12 test papers.

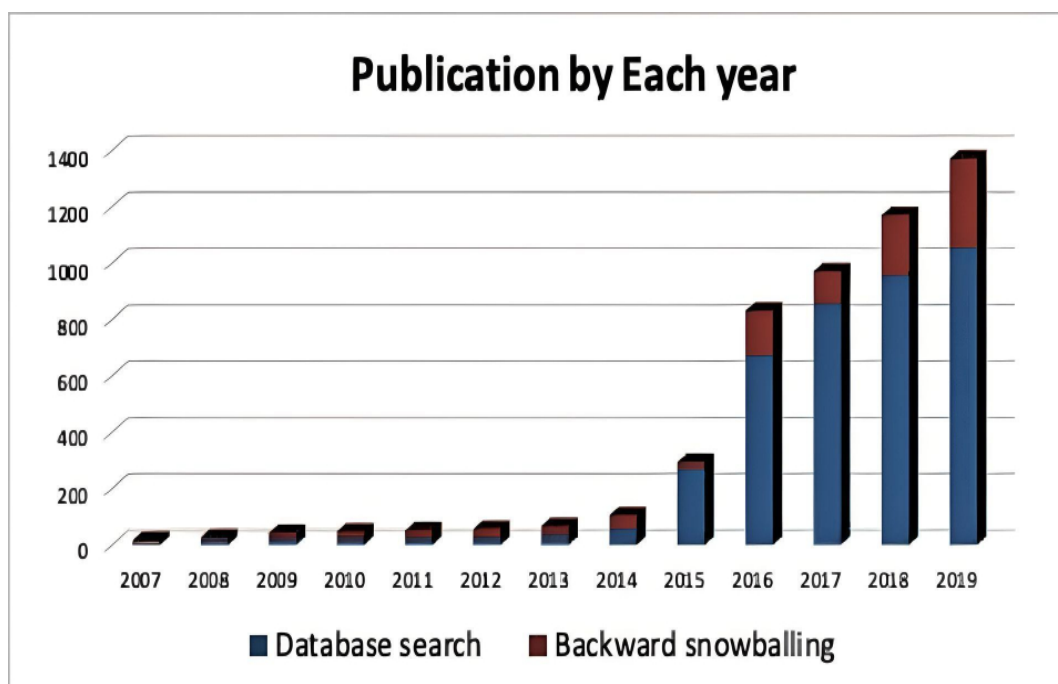
The model predicted 11 of the 12 papers correctly, incorrectly predicting one edge case with a



quality score of 6 as having insufficient quality. This short demonstration shows that training decision trees on assessed papers is a viable alternative to other strategies to filter a large set of inclusions.

Commonly used alternatives are to only consider articles or to limit the time frame of the search. After the full-text screening, a total number of 165 papers were selected for the eligibility and it is relevant for our study. Based on that, the full text, extraction is carried out.

### 2.5.1 Data Extraction and Synthesis



**Figure 2.21:** Publication inclusion after eligibility

The absolute number of CPPS metric papers per year in the final inclusion set. We distinguish papers resulting from database search (light blue) from those resulting from backward snowballing (light red).

The set of excluded papers comprised both research that did not pass the decision tree assessment and research that had insufficient data for assessment. Figure 2.23 illustrates the importance of the backward snowballing phase. Of our inclusions, 17% originated from backward snowballing. Considering only papers from before 2011, this figure jumps to 45%, highlighting the potential weakness of using only a database search step. Figure 2.23 therefore demonstrates the ability to ensure broad coverage over time. After an initial analysis of our inclusions, we formulated our data extraction form and used this as a guide to extract the necessary data. We then used quantitative data synthesis to produce more detailed

and insightful results, aided by the homogeneity of our extracted data. Given that this is a demonstration of our methodology, rather than a complete systematic review study, we leave further analysis and presentation of our detailed results for future work.

### 2.5.2 Analysis of inclusion papers

After the paper filtering and screening process, the papers dropped to 137. Furthermore, after reading and analyzing the full text of the remaining papers according to exclusion criteria, we selected 64 of them related to our relevant category of research on modeling works.



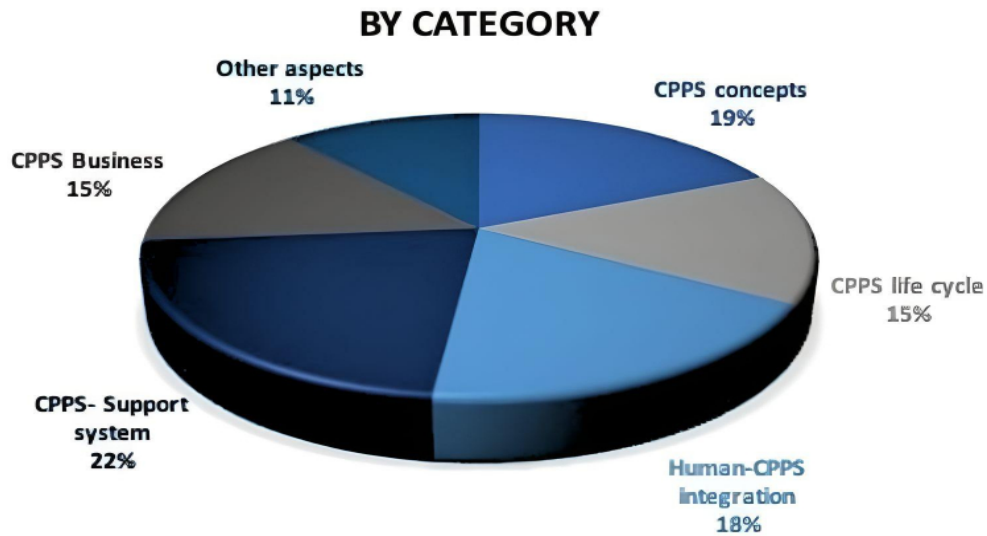
**Figure 2.22:** Publication inclusion density

Since the goal of this SLR is also to identify the application areas of CPPS, we did not restrict the search to specific domains. Consequently, the analysis revealed that the selected papers referring to CPPS, address different issues in various application domains. In Figure 2.23 we summarized a list of application areas where the concept of CPPS has been adopted according to the selected papers for this study. Figure ?? shows the publication type selected after eligibility.

Once the papers are selected, we classify them by the types of categories of study, year of publication. It is described as follows: in the system life cycle model papers, the concept development stage can be further divided into three phases.

Therefore, 12 articles were further categorized into three sub-categories (Models analysis: 3





**Figure 2.23:** Publication inclusion after eligibility

articles, concept exploration: 6 articles, concept definition: 3 articles). The CPPS system architecture- 34 articles were further categorized: model exploration: 24 articles, concept definition: 8 articles). The Human-CPPS architecture, therefore, 18 articles were further categorized: model exploration: 8 articles, concept definition: 5 articles). The next section describes the identified existing research works.

### 2.5.3 Synthesis: SLR results

From the systematic literature review, the authors have different insight about the CPPS. Although, We selected four databases, considering that is sufficient to perform a robust and comprehensive literature search. It is expected that, it will provide more robustness to the search.(We didn't analysis other databases). We have identified less than 25 axioms (until 2019- start of the thesis) of the core concept and modeling works. The characteristics vary significantly in their level of abstraction and context. They address the specific characteristics of the system without an under-pining systemic ground and commonalities. Next section illustrates the existing identified interesting work of inclusion paper.

### 2.5.4 Existing works

In the following, we present the existing works on CPPS by first exploring concepts.The corresponding definitions, followed by a modeling work's of different researchers identified works as follows 8.3: While studying the selected papers we observed that a number of alternative terminologies to CPPS has been used by different researchers.

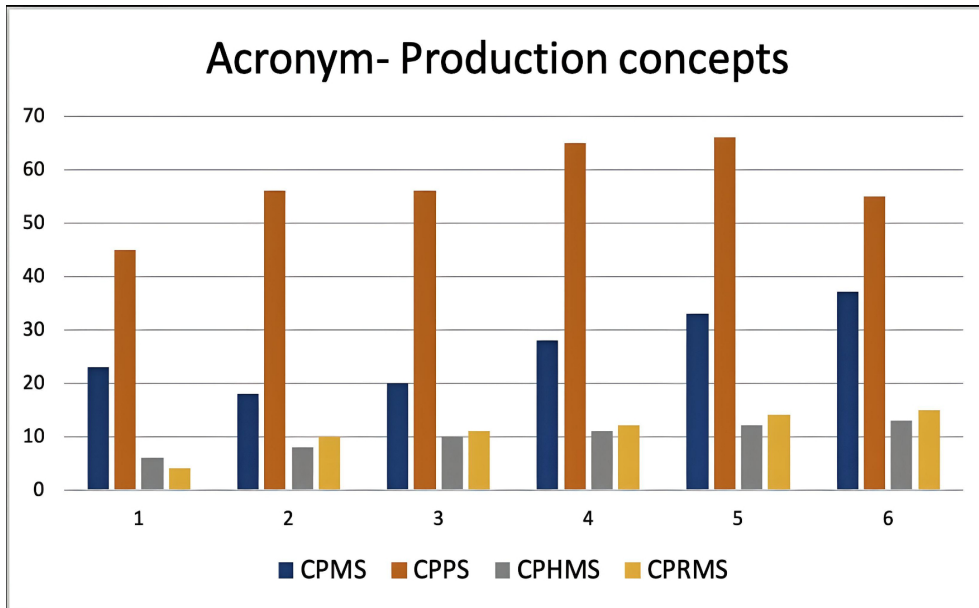


Figure 2.24: Acronym-Production system concepts

Figure 2.24 illustrates the sample of acronyms used for production concepts (Cyber physical production system has the majority of use). Thus, we identified eleven terminologies for which a seemingly coherent definitions could be extracted, which are shown in table 8.3.

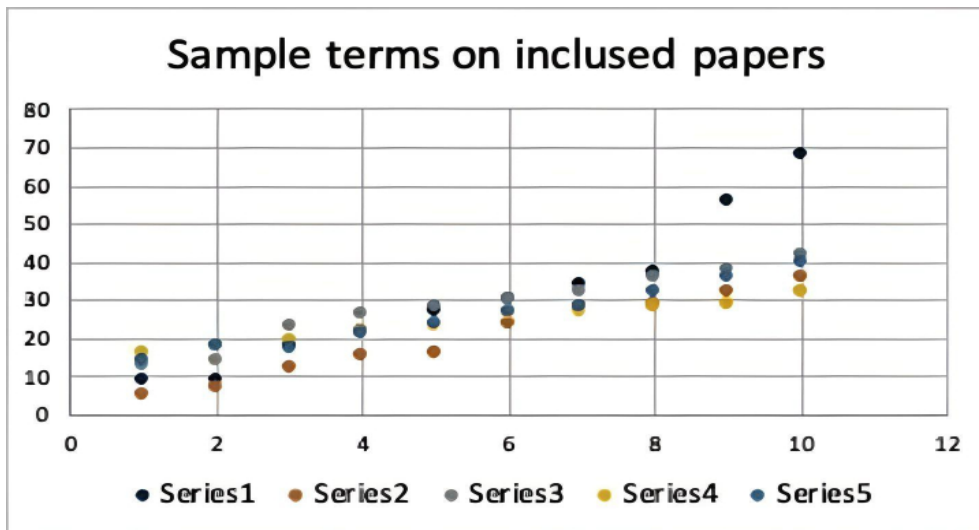


Figure 2.25: Sample of production terms in reviewed papers

A summary of the terminologies and their extracted definitions is presented. Despite the alternative concepts used, and their different conceptualizations discussed in the common understanding of CPPS shared among all works can be summarized by the following definition. The next section takes a closer look at how human aspects.

## 2.5.5 Terminology, typology, taxonomy

Reference	Type	Definition
M Monostori [Monostori [2015]]	CPPS concept exploration	Cyber-Physical Production Systems (CPPS) consist of autonomous and cooperative elements and subsystems that are connected based on the context within and across all levels of production, from processes through machines up to production and logistics networks".[Monostori [2015]]
Monostori [Monostori [2015]][Monostori et al. [2016]]	CPPS	Review of CPSs in manufacturing from the viewpoint of Manufacturing Science and Technology (MST), including the concept, characteristics, expectations, challenges, and case studies.[Monostori et al. [2016]]
Liu [Liu and Wang [2020]]	Concept (HCPS)	Cyber-Physical-Human System (CPHS) or Human-Cyber-Physical System(HCPS) is a system of interconnected systems that interact in real-time.[Monostori [2015]]
Jiang et al., [Jiang et al. [2018]]	Concept (Review)	Review of the recent advancements of Industrial Cyber Physical Systems (ICPSs) in monitoring, fault diagnosis and control approaches by data-driven realization.[Jiang et al. [2018]]
NIST [Lemmon et al. [2018]]	Concept	CPS consists of two main functional components: the advanced connectivity that ensures real-time data acquisition from the physical world and the cyberspace[Griffor et al. [2017]] [Mell et al. [2011]] [Lemmon et al. [2018]]
Industry 4.0 [Jazdi [2014]]	Smart interactions	CPS is a paradigm originates from the technology development of the cyber-physical systems (CPS) to enable smart interaction between cyber, physical and production spaces etc.[Jazdi [2014]]
Tilbury [Tilbury [2019]]	Production network	CPMS, in which computation and networking technologies interact with physical systems, have made great strides into manufacturing systems.[Tilbury [2019]]
Pinzone et al [Romero et al. [2020]]	Industry 4.0	Human Cyber-Physical Production System (HCPPS) is a generic architecture with the control loop, adaptive automation control systems, to support humans and machines. [Romero et al. [2020]]

References	Type	Terminology, Taxonomy, Typology
[ <a href="#">Francalanza et al. [2017]</a> ] [ <a href="#">Niggemann and Lohweg [2015]</a> ] [ <a href="#">Ansari [2019]</a> ]	Terminology, Taxonomy	The Cyber and physical Components refers to an umbrella term referring to all hardware and software (IS) components which serve the purpose of collecting, storing, analyzing, processing, or securing data within a CPPS., etc.[ <a href="#">Barnard Feeney et al. [2017]</a> ] [ <a href="#">Engel et al. [2018]</a> ] [ <a href="#">Thiede [2021]</a> ] [ <a href="#">Andronie et al. [2021b]</a> ]
[ <a href="#">Romero et al. [2016b]</a> ] [ <a href="#">Rúbio et al. [2019]</a> ]	Typologies	The tangible and intangible assets that actively or passively participate in the production process in order to add value. [ <a href="#">Rúbio et al. [2019]</a> ] [ <a href="#">Lăzăroiu et al. [2021]</a> ] [ <a href="#">Rojas et al. [2017]</a> ] [ <a href="#">Monostori [2015]</a> ]
[ <a href="#">Andronie et al. [2021a]</a> ] [ <a href="#">Babiceanu and Seker [2016]</a> ] [ <a href="#">Suvarna et al. [2021]</a> ]	Production Networking	CPPS Network Infrastructure as the entirety of hardware and software components that enables object-to- object interactions within the inner system of a CPPS. This explicitly excludes interactions between human beings and the inner system [ <a href="#">Rajkumar et al. [2010]</a> ] [ <a href="#">Rosen et al. [2015]</a> ] [ <a href="#">Rojas et al. [2017]</a> ] [ <a href="#">Silva et al. [2017]</a> ] [ <a href="#">Lăzăroiu et al. [2021]</a> ] [ <a href="#">Szabó et al. [2019]</a> ]
[ <a href="#">Valaskova et al. [2021]</a> ] [ <a href="#">Große et al. [2020]</a> ]	Self-organisation	The Self-organization can be described as the unplanned changes in the behavior of the components that are part of a system. [ <a href="#">Kagermann and Wahlster [2022]</a> ][ <a href="#">Lee et al. [2015]</a> ] [ <a href="#">Estrada-Jimenez et al. [2021]</a> ] [ <a href="#">Rocha and Barata [2021]</a> ] [ <a href="#">Lu and Xu [2018]</a> ]
[ <a href="#">Rúbio et al. [2019]</a> ] [ <a href="#">Mordinyi and Biffi [2015]</a> ] [ <a href="#">Mahmood et al. [2019]</a> ]	Big Data, IOT	a Cyber-Physical Production System (CPPS) using data analytics is proposed to enable production visibility. It uses data stream processing approaches to clean redundant data efficiently. [ <a href="#">Wu et al. [2020]</a> ] [ <a href="#">Cardin [2019]</a> ] [ <a href="#">Salunkhe et al. [2018]</a> ]
[ <a href="#">Gronau et al. [2016]</a> ] [ <a href="#">Andronie et al. [2021b]</a> ]	Autonomy	The next generation of systems, that are able to raise the level of autonomy of its production components. This CPPS has the ability to evolve and adapt has been anticipated in the works on self-x production ( Self-evolvable, Self-reconfigurable, Self-diagnosing.[ <a href="#">Zolotová et al. [2020]</a> ]

### 2.5.6 Existing modeling works

The few existing literature on CPPS modeling approaches that address system aspects, which includes: The Concept Map of cyber physical systems (2018) presents CP(P)S characteristics, it falls short of describing and classifying CP(P)S entities and their relations [Kamaludin and Mulyanti [2020]]. Constantin Zamfirescu, 2013 [Zamfirescu et al. [2013]] presented an anthropocentric cyber-physical reference architecture for CPPS (ACPA4SF).

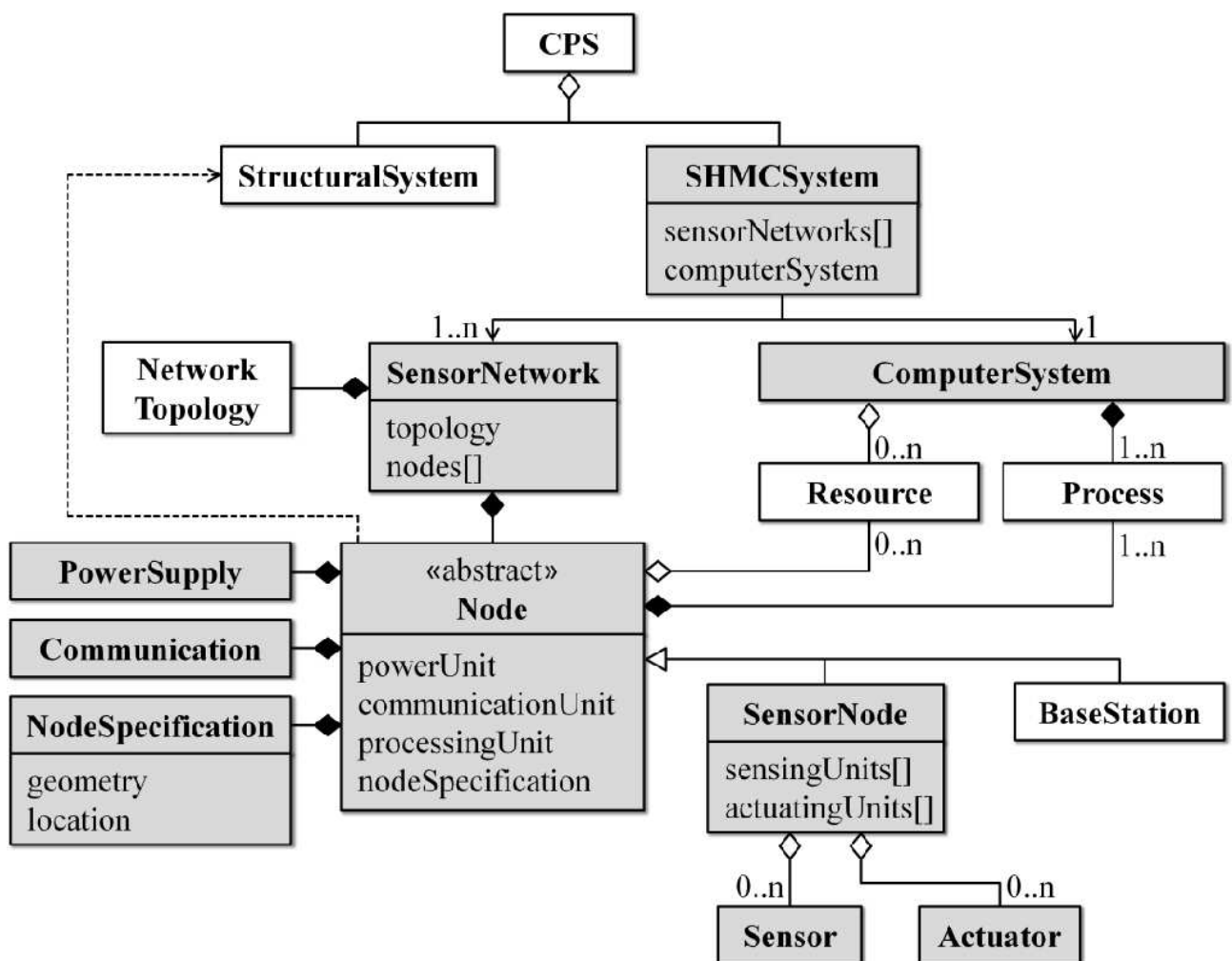


Figure 2.26: CPPS architecture

[Guarino [1998]]

The reference model specifies the basic abstraction building block (i.e) product design, production system, infrastructure, and planning and control. The model does not illustrate the involved entities, unified description and comprehensive view of the system.

Tomiyaama et Moyen, 2018 [Tomiyaama and Moyen [2018]] presents a CPPS resilient architecture

to handle the event-driven process. The architecture concerns only event-driven aspects, leaving the involved entities, support systems, and their relationships. Sanchez et al., 2016 [Bordel Sánchez et al. [2016]] presented an underlying architecture for a CPS-based manufacturing system. The model stresses only the Service-oriented application aspects of the system.

Ani Bicaku, 2017 [Bicaku et al. [2017]] present a CPPS meta-model composed of five main levels and the corresponding objects, used to describe an use case for an Industry 4.0 application scenario. The model stresses based on the industry 4.0 application.

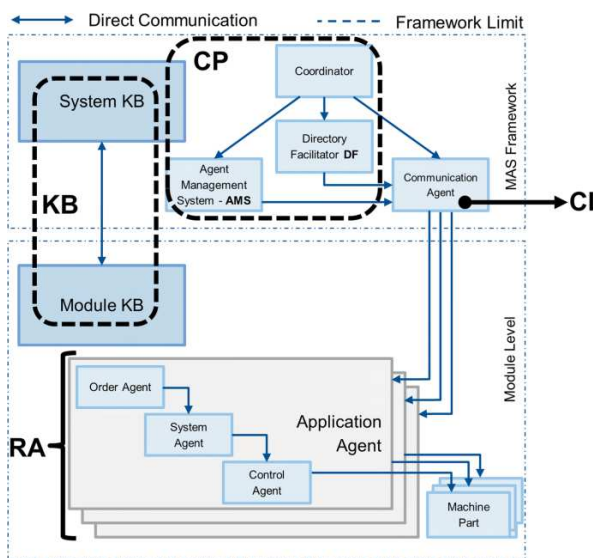


Figure 2.27: CPS Design pattern [Guarino [1998]]

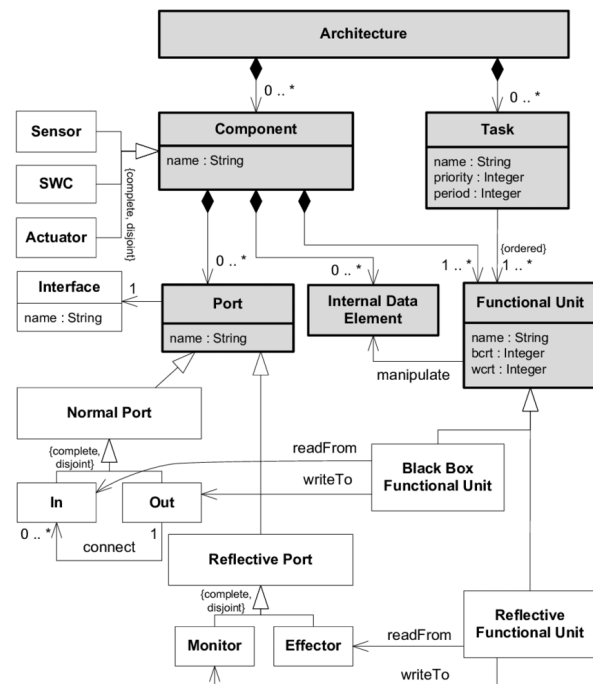
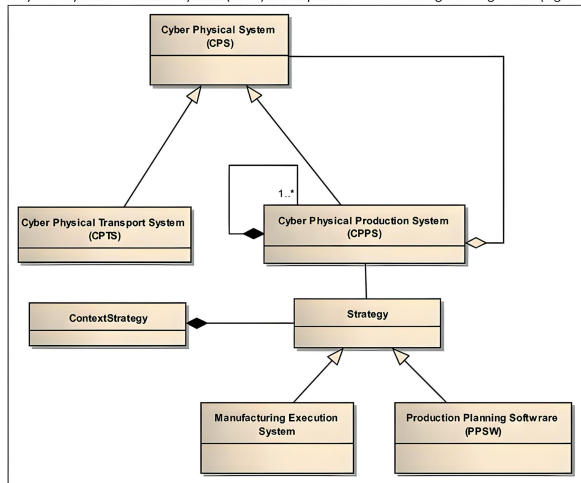


Figure 2.28: CPPS architecture [Guarino [1998]]

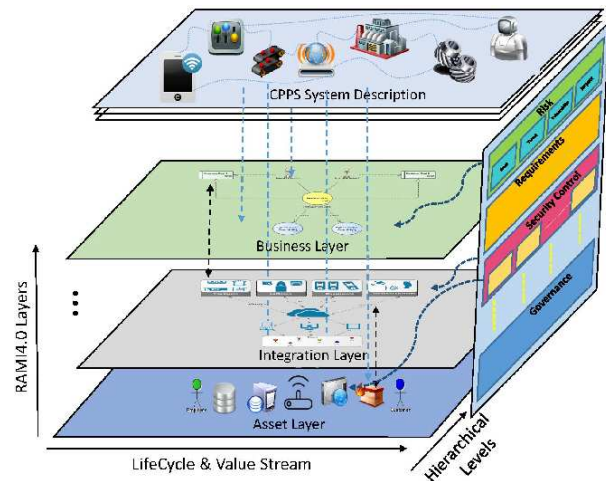
Agostino et al., 2018 [Agostinho et al. [2018]] develops CPPS architectures, which assist in integrating data collection and feedback systems. The architecture focuses only on sensors and data processing elements, leaving out the other facet entities. Gronau et Theuer, 2016 [Gronau and Theuer [2016]] proposed a hybrid architecture approach to stimulate the various degree of autonomy of CPPS. The architecture focused only on the system's optimal degree of autonomy aspects. Stephen Berger et al., 2019, [Berger et al. [2021]] presents the reference model for CPPS by defining taxonomy, terminology, and classifying CPPS entities. The referenced model failed to stress all other property aspects involved in the CPPS which includes the behavior, function, system of interest, enabling system, and organization process aspects.



A Cyber Physical Production System (CPPS) is composed of the following building blocks (Fig. 11):



**Figure 2.29:** CPPS adaptive component [Guarino [1998]]



**Figure 2.30:** Security CPPS architecture [Guarino [1998]]

Arndt Lüder et al., 2017, [Lüder et al. [2017a]], presented the artifact life-cycle phases model for CPPS. The lifecycle artifacts model involves the representation of the components, and their description in the different life cycle phases of a production system. The model doesn't stress the unified description and a common meaning.

Luca Bernardelli [Berardinelli et al. [2017]] presented the challenges towards the adoption of model-driven approaches in the cyber-physical production system. They discussed the modeling standards, languages, and approaches to support the adoption. Stefan Biffi et al., 2017, [Biffi et al. [2017]] presented the guidance and support for researchers and practitioners to adopt modelling approaches in the CPPS domain.

Iris grabler, et al, 2021 [Simola [2021]], presents an approach of human factors integration into procedure of model based system engineering for cyber-physical production systems. It depicts the individual workers with the help of the developed concepts and systematically integrate them into the development process of a CPPS. Fazel Ansari, et al, 2018 [Ansari et al. [2018]] presents an holistic ontological framework for human-CPPS task(Problem, Solution, Problem-Solver Ontology), which represents the logical relations between the three super-concepts of "Problem Profile", "Problem-Solver Profile", and "Solution Profile". It doesn't stress any life cycle aspects.

Agostinho et al. [Agostinho et al. [2018]] develop a CPPS architecture that uses modeling and simulation technologies to integrate data collection and feedback systems into the physical production environment. With a strong focus on sensors and data processing, details on general CPPS entities and their interrelations are missing. Ding et al. [Ding et al. [2019]] propose a framework reference model for CPPS based on digital twin technology. In addition to an input and output layer for product specifications, the framework describes the

autonomous behavior of smart parts, shop floor, and manufacturing operations, yet it does not define, or show the interrelations between, entities.

## 2.7 Synthesis: SLR results

From the systematic literature review on CPPS concepts and the different existing modelling works. The authors have different insight about the CPPS. There is a lack of under-pining systemic ground and representation of the life cycle aspects of the system. More importantly, there is a lack of concept models in order to have structure information and define information types. We have identified less than 25 axioms (until 2019- start of the thesis) of the core concept and modeling works. The characteristics vary significantly in their level of abstraction and context. They address the specific characteristics of the system without an under-pining systemic ground and commonalities.

To the best of our knowledge, there is lack of systemic models that has domain independent view and address the sum of elementary parts, commonalities. It urgently needed a modeling approaches for managing such complexity and structural opacity, systemic understanding of CPPS. To support the life cycle and fill this research gap, there is a need of an appropriate framework with the unified semantic description. The new domain of interest urgently requires a semantic framework for defining and classifying CPPS entities and illustrating their relations. The next section describes the knowledge and information modeling foundation.

## 2.8 Knowledge representation techniques

Knowledge modeling is a process of creating a computer interpret-able model about a kind of process and/or facility or product [Coffey et al. [2002]].

It is a representation of one or more knowledge category and core content of the domain. It provides a set of relations between the concepts which contribute to the understanding of the whole problem of interest [Belkadi et al. [2012]].

It is a sharable, stable, organized structure of information requirements or knowledge for the domain context. It is a standard way of visualizing an object and information contained in descriptions and built from a combination of data to which meaning is attributed with an appropriate semantic [Tergan and Keller [2005]]. Unlike, it is more difficult to define since it is associated with cognitive resources and expert activity [Grundstein [2000]]. The most known definitions is a acquisition of information and its interpretation in a given operational context [Chergui et al. [2020]]. The modeling approaches focus on three different aspects, as [Mentink [2004]].



- “**Communication-Based modeling**”- It defines processes in terms of communication acts between costumers and performers. [Narula [2006]]
- “**Artefacts-Based modeling**”- It focuses on the objects (e.g., data or information) that are created, modified, and used within a process along with their paths through a series of activities”.
- “**Activity-Based modeling**”- It focuses on the activities that are to be performed within a process, along with dependencies and constraints among them”.

### 2.8.1 Ontology for knowledge classification

The commonly accepted approach for structuring the domain knowledge is constructing domain ontologies [Medina-Oliva et al. [2014]]. Ontology is defined as “a set of concepts and relationships used to describe a particular domain of knowledge” [Nadoveza and Kiritsis [2014]]. In other words, it provides the vocabulary for a domain and uses formal language to explicitly represent and manipulate complex models [Nadoveza and Kiritsis [2014]]. They are used to formalize the knowledge of a domain and thus add a semantic layer to computer systems and applications.

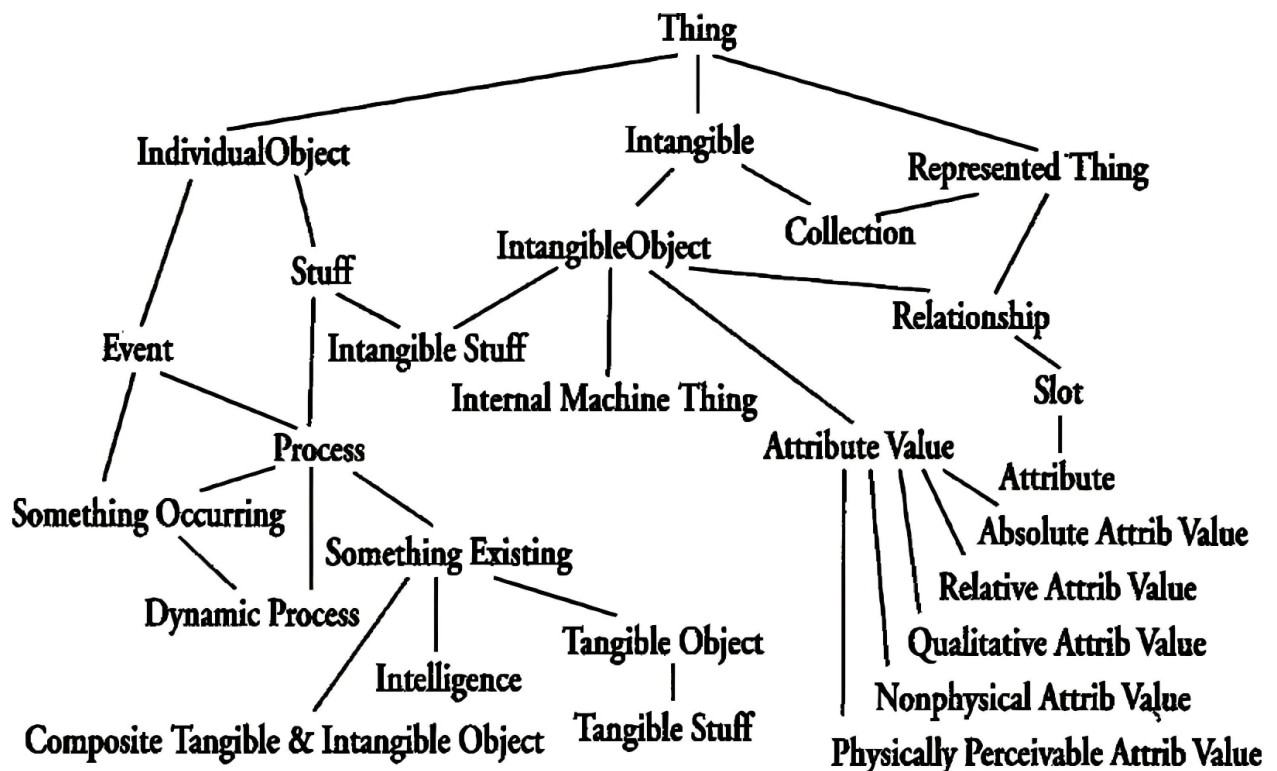
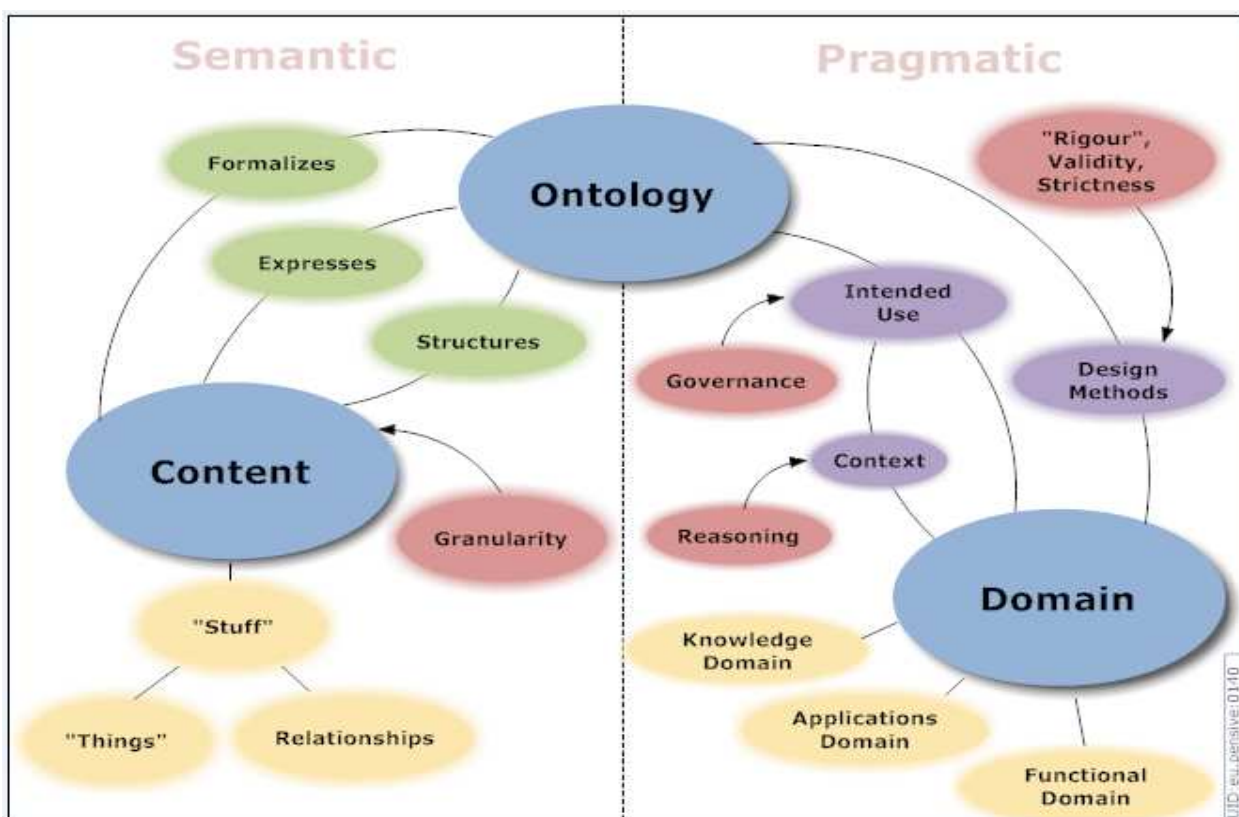


Figure 2.31: Domain ontology  
[Tazin [2022]]

Ontology-based modeling is a well-known approach to support knowledge integration and interoperability between IT systems [Barbau et al. [2012]] to facilitate data exchange between engineering activities during the collaborative business process [Zhou and El-Gohary [2017]]. In this context, its main purpose is to produce a set of information elements to be shared and reused by human and computer systems [Fitzpatrick et al. [2012]] by means of data integration, knowledge management, and decision support [Sahoo et al. [2008]]. Ontologies are developed as an OWL file with the Protégé software. Protégé is a “graphical tool for ontology editing and knowledge acquisition that we can adapt to enable conceptual modeling with new and evolving Semantic Web languages [Fluit et al. [2003]]



**Figure 2.32:** Semantics and pragmatic view  
[Wiese [2012]]

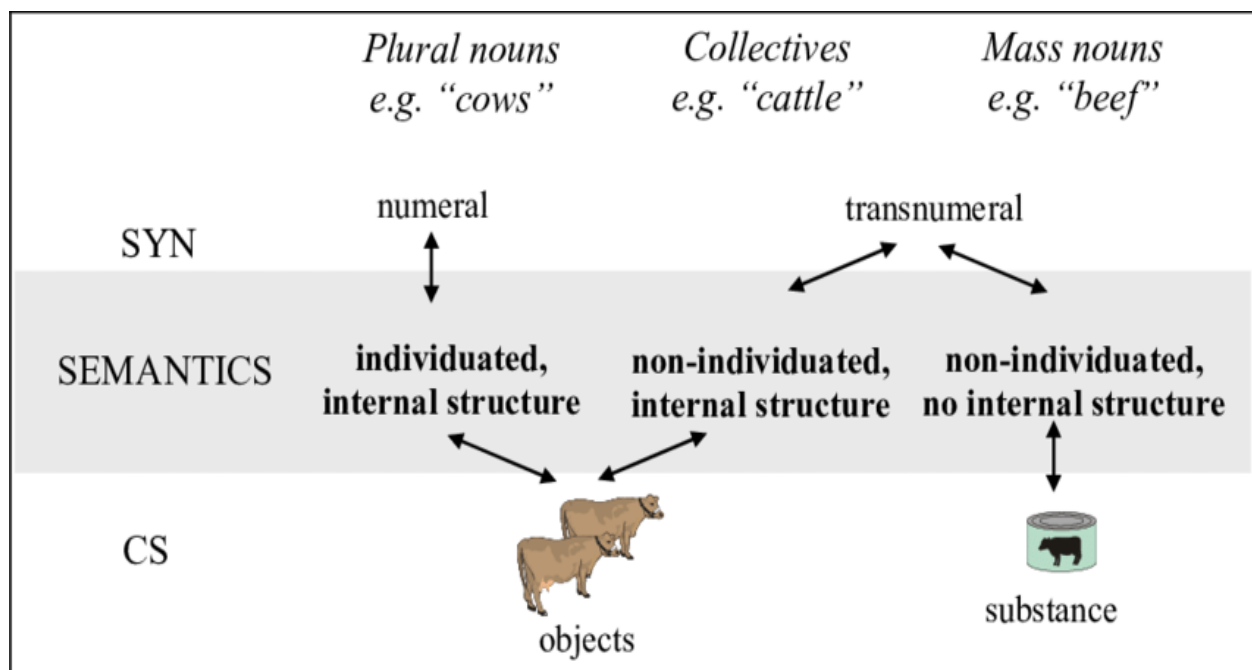
As shown in Figure 2.31, three types of ontology are distinguished as global ontologies, domain ontologies and application ontologies [Guarino and Musen [2015]]. Global ontologies (Top-Level Ontology) propose a formal representation of general concepts which are “independent of a particular problem or domain”. They are the result of a systematic, consensual and rigorous development that allow sharing knowledge and transferring one context to another. Domain ontologies define the vocabulary of general domains or tasks or activities, by “specializing the terms introduced in the top-level ontology”. Application ontologies describe concepts in a particular domain or task, which are often “specializations of both the related ontologies”

[Guarino and Musen [2015]].

The domain knowledge classification is “a set of structuring and relationships used to describe a particular domain [Nadoveza and Kiritsis [2014]] [Medina-Oliva et al. [2014]]. Figure ?? shows the concept model.

### 2.8.2 Semantic concept and representation

The Semantic is a study of meaning which envisions to unambiguously capture, catalog, communicate, preserve, and interoperably exchange semantics of their architectures, thus making architecture descriptions true assets [Laclavik et al. [2006]]. It defines a formal semantic way of representing architecture intended to use both human and machine-readable. It can represent the components of any consistent idea, from business functions to system components, as long as it represents a complete set [Parsons and Cole [2005]].

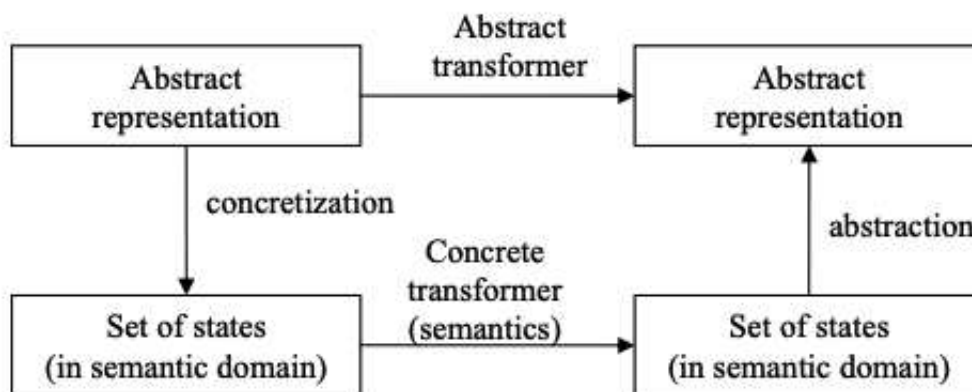


**Figure 2.33:** Semantics representation  
[Wiese [2012]]

It consists of concepts used to help people know, understand, or simulate a subject the model represents. In contrast, physical models are physical objects, such as a toy model that may be assembled and made to work like the object it represents [Papadimitriou [2010]]. The primary objective is to convey the fundamental principles and basic functionality of the system which it represents. Also, a conceptual model must be developed in such a way as to provide an easily understood system interpretation for the model’s users [Papadimitriou [2010]]. It ensures information is captured, combined, processed and shared correctly and consistently requires

more than just names and structures — it is vital to understand its meaning in a formal way — that’s semantics [Jackendoff [1983]]. It enables its users to leverage existing information and models to create semantic content for people and for automated understanding, interchange, and reasoning.

It represents the domain concepts, provide the basic structure or armature around which a knowledge foundation can be built [Reinhartz-Berger and Sturm [2009]]. It gives the explicit specification of some topic or a formal and declarative representation of some subject area [Kaiya and Saeki [2006]]. It has a core content of the domain and a set of relations between these concepts which contribute to the understanding of the whole problem of interest. This knowledge encompasses types of entities, properties, relations and functions, as well as various constraints. The most used concept is a domain ontology provides vocabulary (or names) for referring to the terms in that subject area, and the logical statements that describe what the terms are, how they are related to each other, and how they can or cannot be related to each other [El-Diraby [2013]]. It also has a rules for combining terms and relations to define extensions to the vocabulary, as well as the problem semantics independent of reader and context.



**Figure 2.34:** Abstract semantics  
[Mkrtychian et al. [2019]]

It is abstract and provides information about environments of a certain kind. A reference model describes the type or kind of entities that may occur in such an environment, not the particular entities that actually do occur in a specific environment [Thalheim [2010]]. For example, when describing the architecture of a particular house (which is a specific environment of a certain kind), an actual exterior wall may have dimensions and materials, but the concept of a wall (type of entity) is part of the reference model [Gemino and Wand [2004]].

Entities and relationships: A reference model describes both types of entities (things that exist) and their relationships (how they connect, interact with one another, and exhibit

joint properties) [Thalheim [2010]]. A list of entity types, by itself, doesn't provide enough information to serve as a reference model [Kotiadis and Robinson [2008]] [Faber [1994]].

A third use of a reference model is to improve communication between people. A reference model breaks up a problem into entities, or "things that exist all by themselves." This is often an explicit recognition of concepts that many people already share, but when created in an explicit manner, a reference model is useful by defining how these concepts differ from, and relate to, one another. This improves communication between individuals involved in using these concepts[Copel [1988]].

A fifth use of a reference model is to allow the comparison of different things. By breaking up a problem space into basic concepts, a reference model can be used to examine two different solutions to that problem. In doing so, the component parts of a solution can be discussed in relation to one another[Robinson [2010]].

The tooling or toolkits for semantic architecture should be suitable for communicating an architecture to all stakeholders supports architecture creation, refinement, evaluation, and validation of quality attributes provides a basis for further implementation allows the architecture community to exchange semantics of architecture styles and patterns in an interoperable fashion.

In other words, it provides the vocabulary for a domain and uses formal language to explicitly represent and manipulate complex models [Nadoveza and Kiritsis [2014]]. It formalizes the knowledge of a domain and thus adds a semantic layer to computer systems and applications. It supports knowledge integration and interoperability between IT systems [Barbau et al. [2012]] to facilitate data exchange between engineering activities during the collaborative business process [Zhang et al. [2017]]. In this context, its main purpose is to produce a set of information elements to be shared and reused by human and computer systems [Fitzpatrick et al. [2012]] by means of data integration, knowledge management, and decision support [Sahoo et al. [2008]]. The next section describes the domain standard modeling framework.

### **Standard modeling framework**

The Standard model is usually created to structure domain concepts and define information types. The standard way of visualizing an object and information contained in descriptions and built from a combination of data to which meaning is attributed with an appropriate semantic[Tariq et al. [2014]].

The standard modeling framework which categorizes the essential knowledge and delivers the core content and contributes to the understanding of the whole problem of interest. It brings the domain concepts, provide the basic structure or armature of any objects [Collins et al. [2005]]. It is generally distinguished: the Product knowledge, Manufacturing knowledge, and Organizational knowledg . It conveys the informational content of the elements consisting of



a system, the relationships among those elements, and the rules governing those relationships [Adcock et al. [2016]]. It provides a useful description considering the stakeholder concerns, system viewpoints and architecting throughout the life cycle [Clements [2005]].

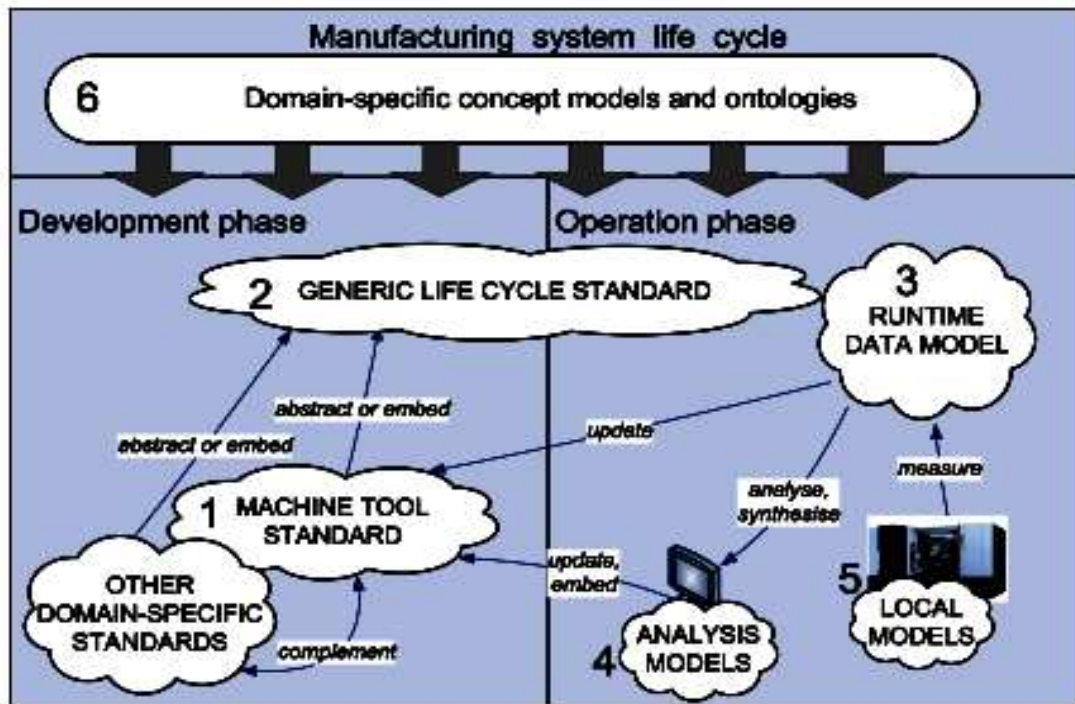


Figure 2.35: Standard model to support life cycle  
[von Euler-Chelpin [2008]]

The domain standard is a Conceptual model. It has a glossary of terms called the unified semantic dictionary. It contributes to understanding the whole problem of interest. It provides a common way to talk about the system, which is underlying in common architecture for various purposes [Mori et al. [2018]]. Some root Concepts of standard modeling framework which consist of “Requirement, Stakeholder, Business Model, Life Cycle, Design, Support System and Outcome” [Tan et al. [2009]].

It distinguishes the external things in the environment, stakeholders, enabling things that may cause failure, and all other things of interests. The most known modeling framework are FBS (Function-Behavior-Structure) which focusing on the vital knowledge for designing expert systems [Kannengiesser and Gero [2002]][Christophe et al. [2010]]. Some of the examples of standard modeling framework of the system as follows:

#### 2.7.4 Example of standard modeling framework

The different domain standard modeling framework examples are shown as follows: For eg: Product-service system (see Figure 5.27) 2) Human-machine interaction, etc.(see Figure 5.28),

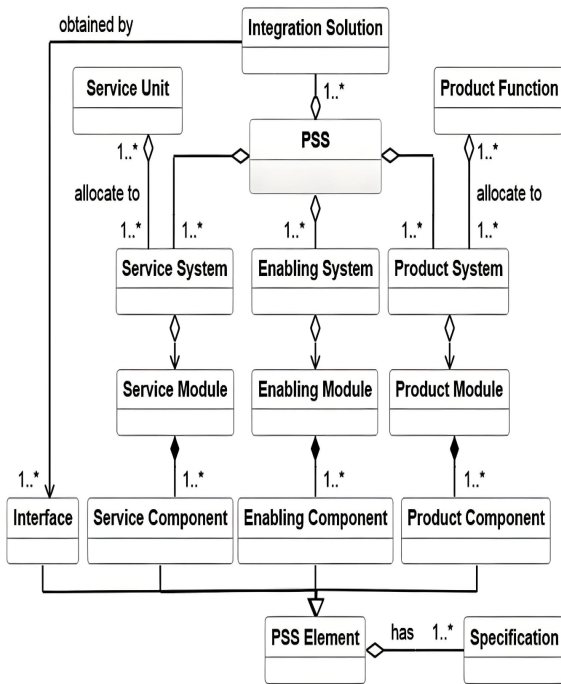


Figure 2.36: Product service system (PSS)

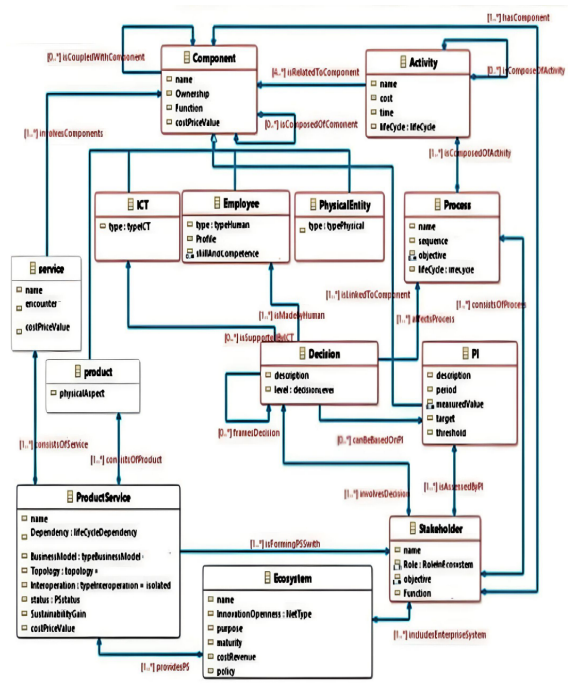


Figure 2.37: Product service system (PSS)

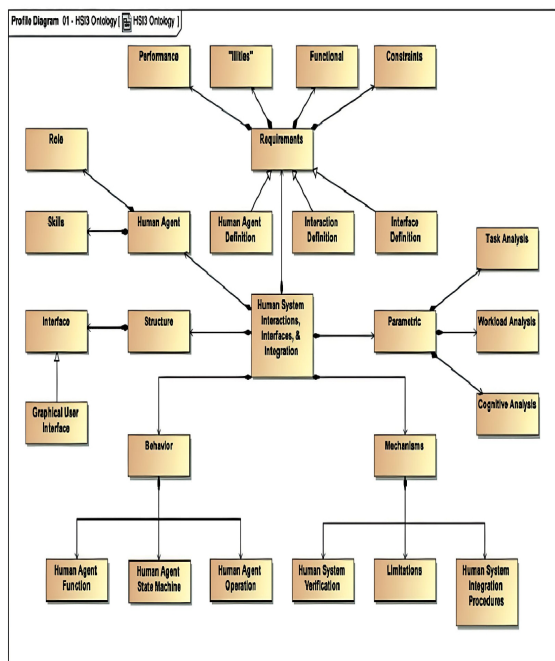


Figure 2.38: Human-System integration

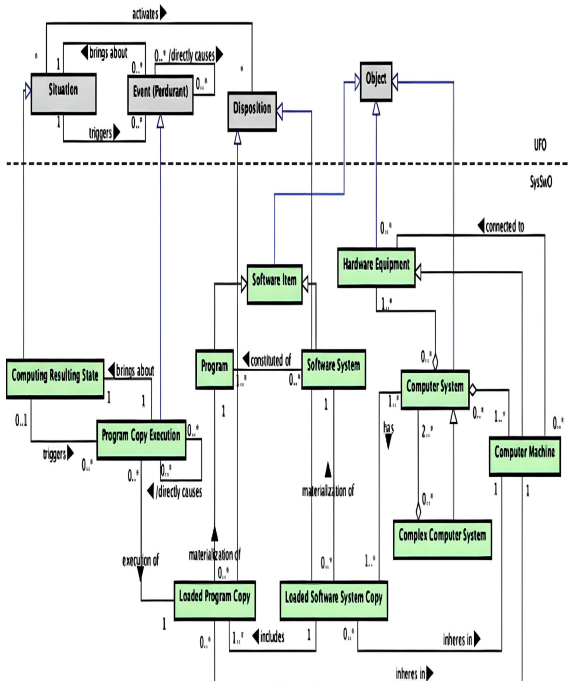
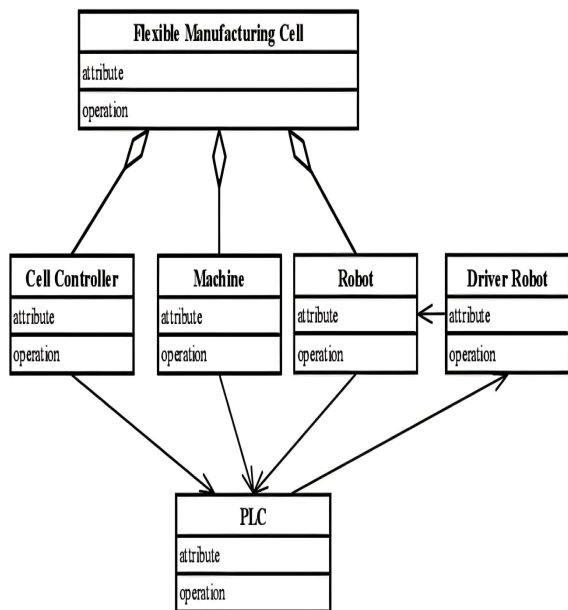
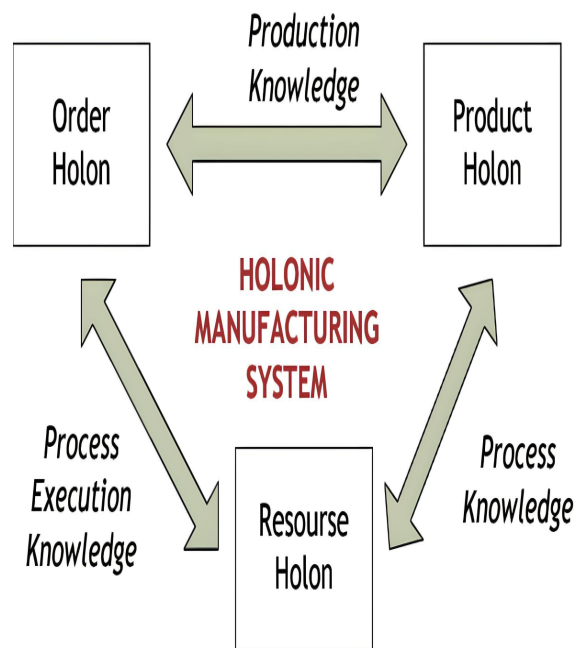


Figure 2.39: Human-machine ontology

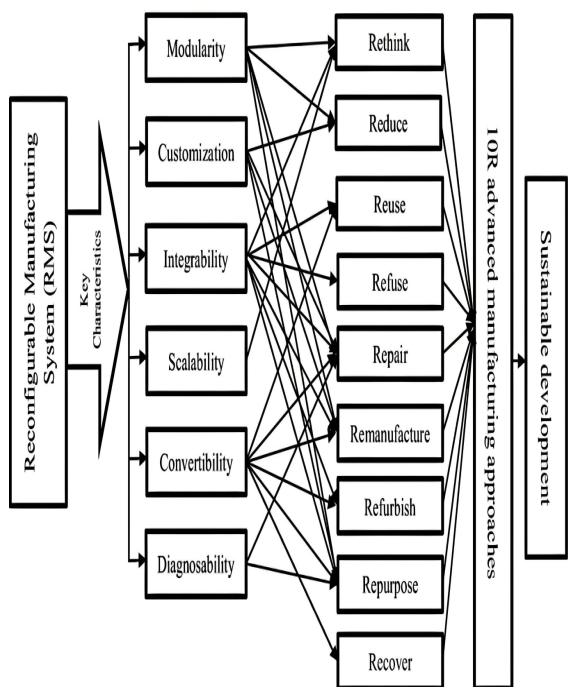
Figure 2.40: Examples of Standard modeling framework



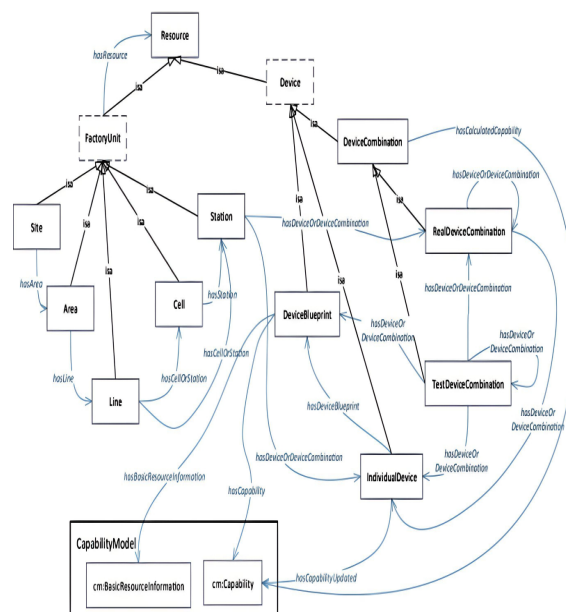
**Figure 2.41:** Flexible manufacturing system (FMS) [Guarino [1998]]



**Figure 2.42:** holonic manufacturing system [Valckenaers et al. [1997]]



**Figure 2.43:** Reconfigurable manufacturing system [Bortolini et al. [2018]]



**Figure 2.44:** dedicated manufacturing system [Azangoo et al. [2020]]

**Figure 2.45:** Examples of Standard modeling framework



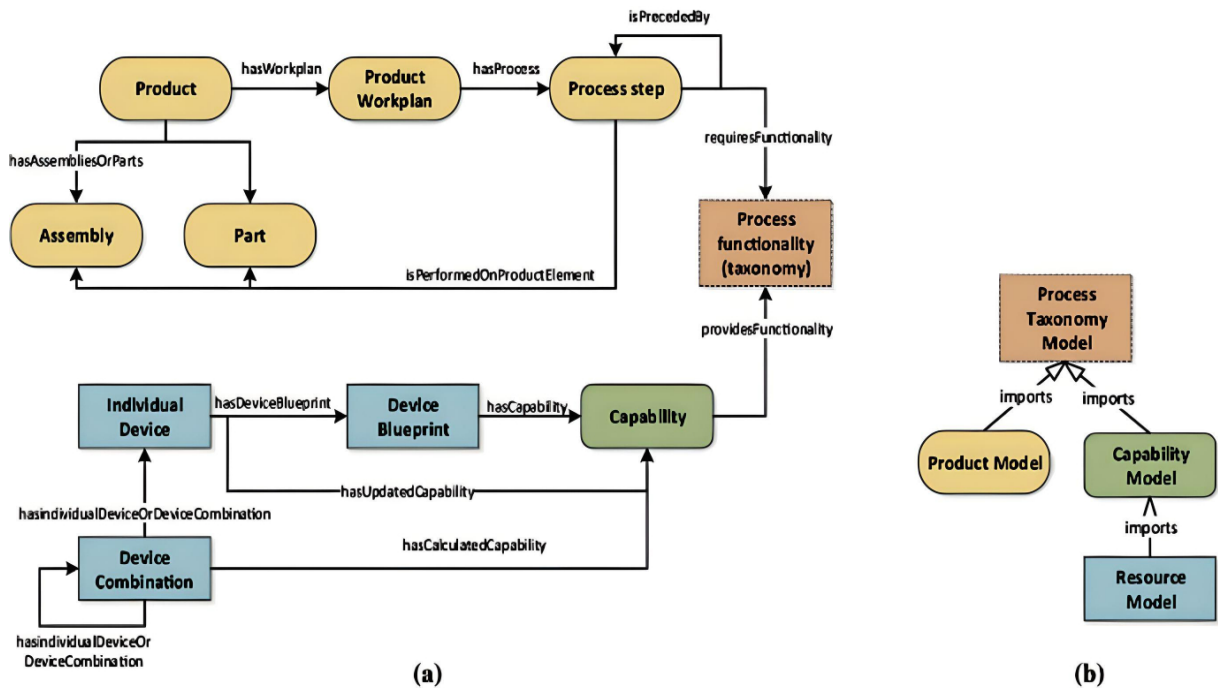


Figure 2.46: Manufacturing system ontology  
[von Euler-Chelpin [2008]]

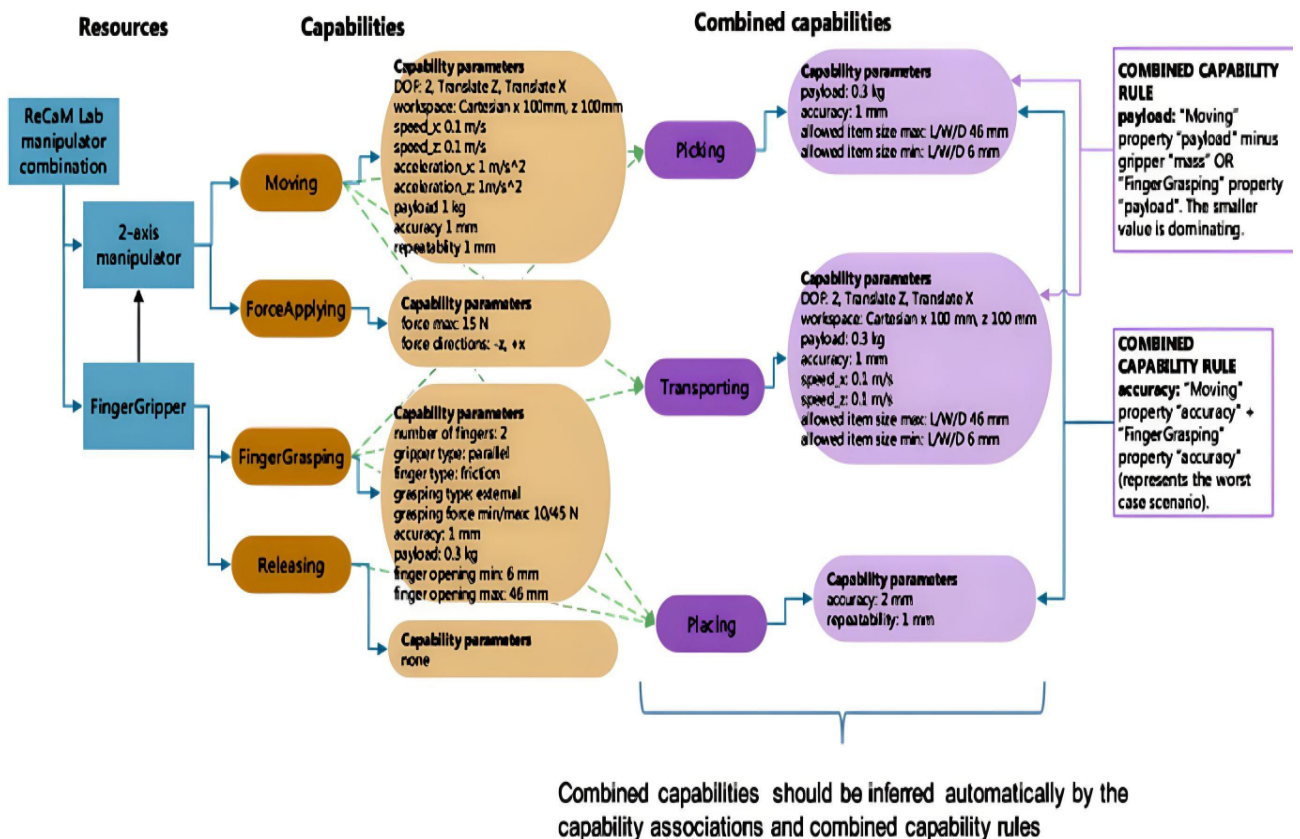


Figure 2.47: Manufacturing system ontology  
[Järvenpää et al. [2019]]

3) Holonic manufacturing system , 4) Product information modeling framework, Figure 2.47 shows the reconfigurable modeling framework. Figure 2.47 dedicated modeling framework. It addresses the system concepts, properties, and characteristics of the system-of-interest. It may also be applied to more than one system, in some cases forming the common structure, pattern, and set of requirements for classes or families of similar or related systems. It also focuses on high-level structure in systems and system elements.

### 2.8.3 Multi-viewed modeling mechanism

The “Multi-view modeling is a mechanism which enables humans and machines to interact from multiple semantically or syntactically dependent perspectives with different views of a modeled artifact”[Bork [2015]].

The multi-view point model is decomposed into smaller models, representing views, that focus only on certain aspects and ignores everything else. It is used to model complex systems of interest (SoI) by promoting multi-viewpoints, multi-paradigms, modelling patterns [Pfister et al. [2012]], reference models and tools but preserving autonomy, simplicity and habits of enterprise staff members;[Golra et al. [2016]].

Figure 2.49, 2.51 shows the multi view point concept. It is characterized as being consistent, if all views are syntactically and semantically consistent with each other. Keeping the multiple views consistent and providing suitable visualization means is crucial for the utility and the applicability of a multi-view modelling method.[Bork [2015]].

It is abstract, which concerns hiding unimportant details in order to focus on essential characteristics [Gerstlauer and Gajski [2002]]. It’s taking away characteristics to reduce it to a set of base characteristics [Clements [2005]]. It support multiple aspects from stakeholders to SE processes to refined applications. Next section describes the modularity in architecture.

### 2.8.4 Modeling language and tools

The Knowledge can be represented by symbols combined in various ways, the most familiar of which is Natural language: ‘cats eat fish’ is a sentence that represents a meaningful combination of symbols for three concepts [Wang et al. [2021]]. The expression ‘symbol structures’ relates to the patterns and rules used to control both the structure of individual symbols (e.g. the rules for plurals) and the structure of symbol combinations (e.g. natural language syntax) [Specification [2006]]. It is named with symbols that represent concepts and lines that connect the symbols and represent relationships. OMG (Object Management Group) as an international technology standards consortium developed several standardization languages to support knowledge representation [Specification [2006]].

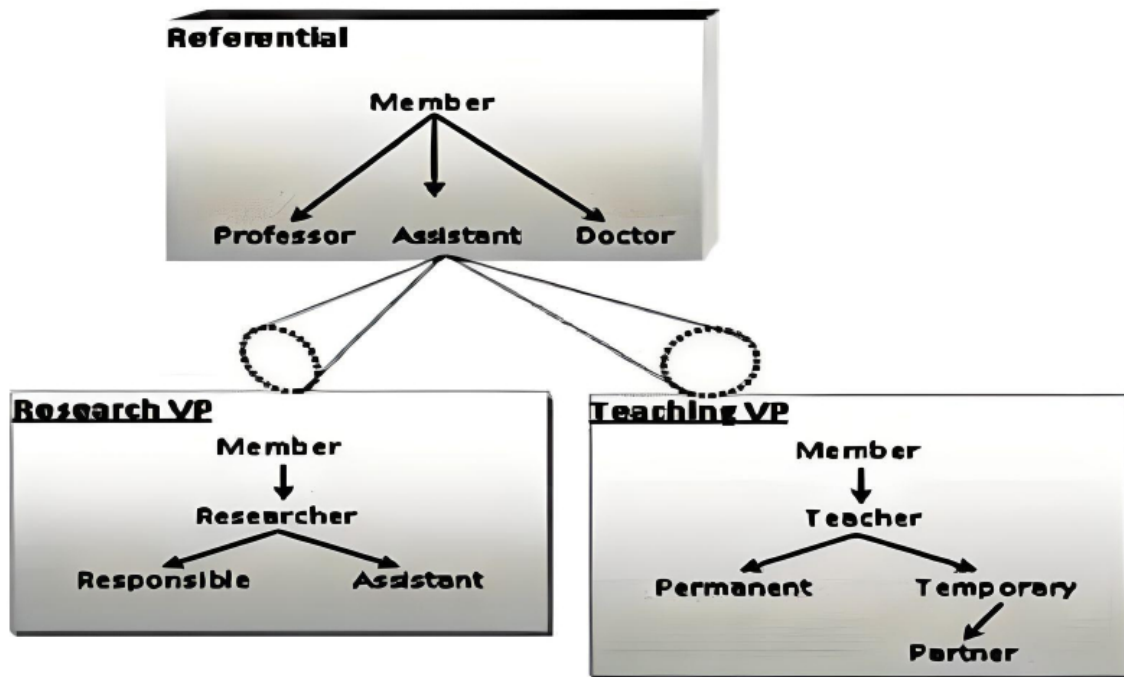


Figure 2.48: Multi-view point modeling  
[Muşan et al. [2008]]

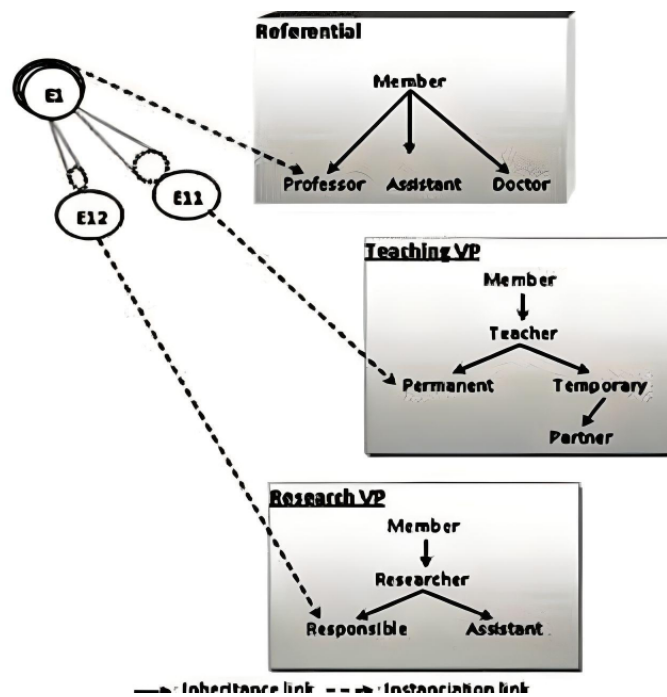


Figure 2.49: Referential schema-multi-viewpoint  
[Muşan et al. [2008]]

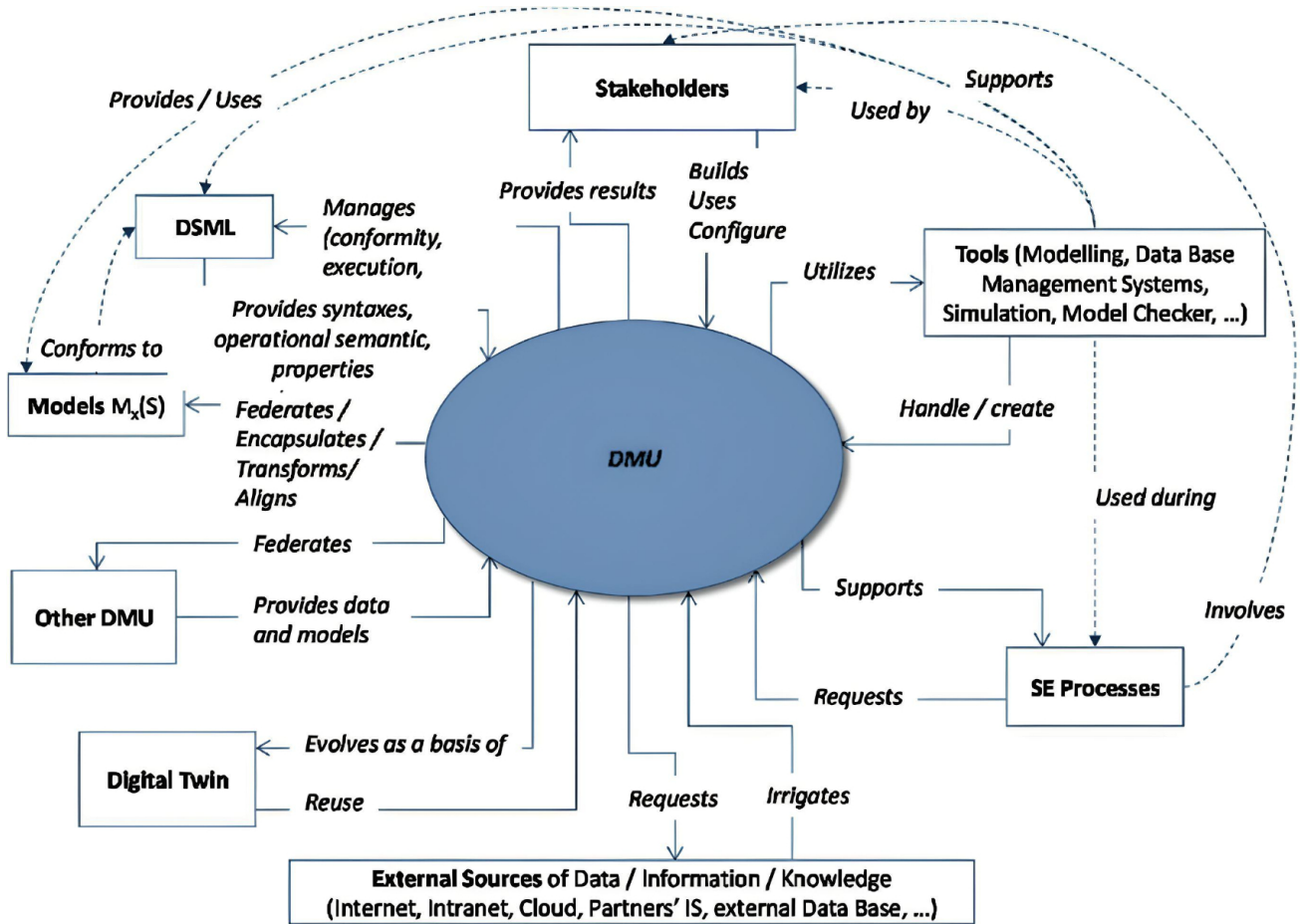


Figure 2.50: multi-viewpoint modeling for DMU(S) [Chapurlat and Nastov [2020]]

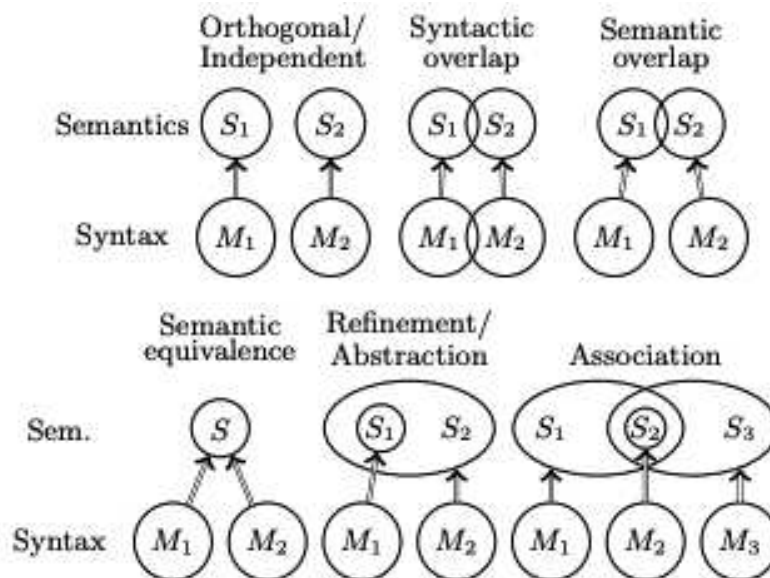


Figure 2.51: Multi-viewpoint modeling for multiple aspects [Thabet et al. [2021]]

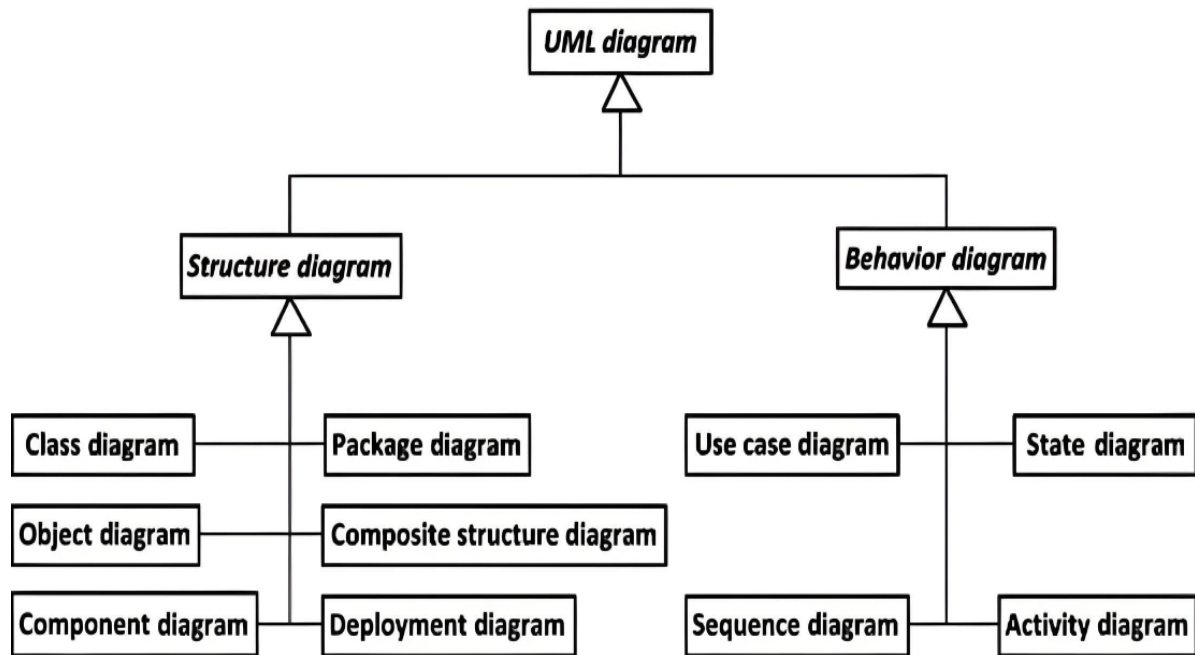


Figure 2.52: Modeling language and tools  
[Von Bertalanffy [1950]]

The tools include, Unified Modeling Language (UML) is a general-purpose, developmental, modeling language that is intended to provide a standard way to visualize an object [Booch et al. [1996]]. The System modelling language (SySML) is a general-purpose modeling language for systems and system engineering applications. It supports the specification, analysis, design, verification of a broad range of systems and systems-of-systems [Friedenthal et al. [2014]]. Other miscellaneous analysis and simulation tool also used in the application aspects of the work. This modeling language is used in this work to create a domain dedicated generic representation through a set of standard concepts.

### 2.8.5 Synthesis

The standard modeling framework is evolved to support the different domain aspects. It brings the domain concepts, basic structure or armature of any objects. It is to confirm that, some previous works on standards modeling framework has proved its applicability to support various applications and integration across the systems.

To build the model consistently, there is a need of methodological foundation as a support to build such a framework. It has to be organized, abstract, and multi-viewpoint. It also can be sharable, reusable and extendable.

The next section describes the system and Systems Engineering approach as an answer to such problematic.

## 2.9 System and Systems Engineering approach

### 2.9.1 General system theory

The General Systems Theory is the interdisciplinary study of complex systems. In this context, the term systems refer to self-regulating systems that are self-correcting through feedback. Figure 2.53 shows the general system representation.

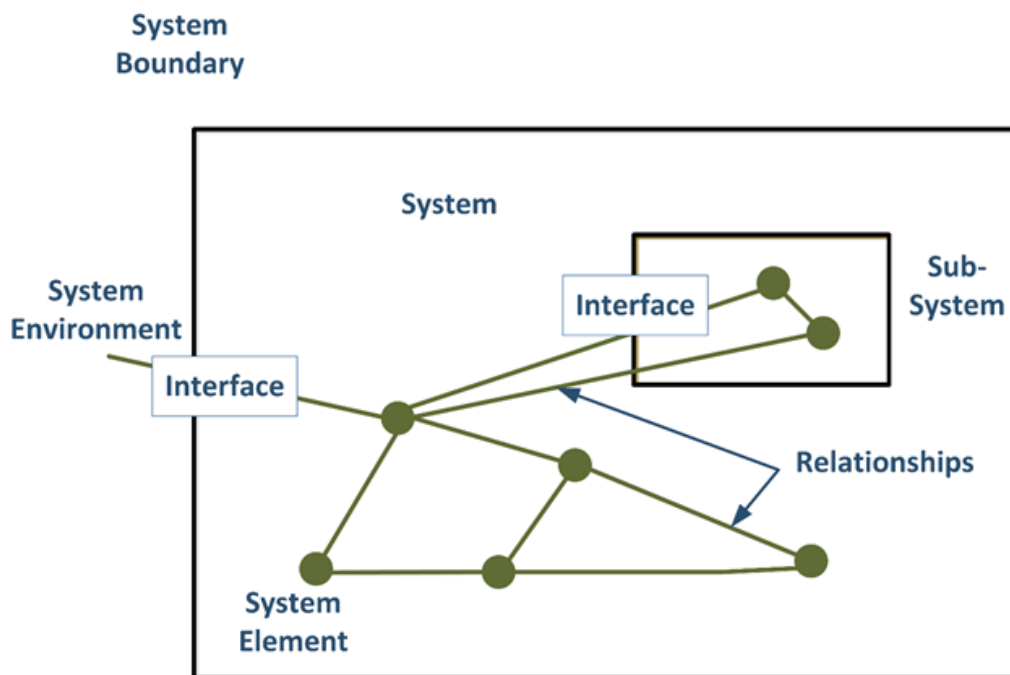


Figure 2.53: General system representation  
[Von Bertalanffy [1950]]

"A System is a bounded set of interconnected elements forming a whole that functions for a specific finality (objective) in an environment, from which it is dis-sociable, and it exchanges through interfaces" [Von Bertalanffy [1950]][Von Bertalanffy [1973]].

The system is a group of interacting or interrelated elements that act according to a set of rules to form a unified whole [Rapoport [1986]]. It is surrounded and influenced by its environment, boundaries, structure and purpose expressed in its functioning. There are two fundamental perspectives to view a system [Klir and Karnopp [1972]]: from the teleological aspect and from the ontological aspect. The teleological aspect is focused on the behavior and functioning of the system, whilst in the ontological view, the system is analyzed from a structural perspective. The emphasis of a system as an "organized whole" incorporates the concept of holism developed by Aristotle and commonly expressed as "the whole is more than the sum of its parts" [Klir and Karnopp [1972]].

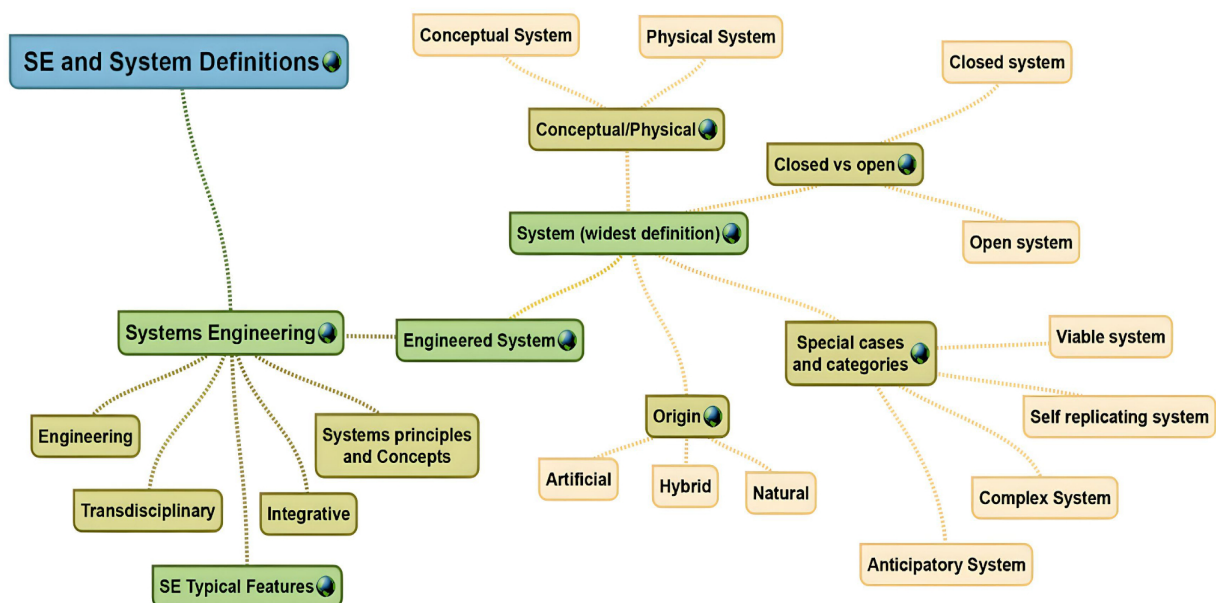


## 2.9.2 Systems Engineering approach

Systems Engineering (SE) is a "trans-disciplinary and integrative approach for the successful realization, use, and retirement of engineered systems, using its principle, concepts and methods [Blanchard [2004]]. Figure 2.54 shows the classifications of system from International council of system Engineering (INCOSE) community.

The system Engineering (SE) approach enable “to deliver the successful projects (systems) in complex environments” [Sillitto et al. [2019]]. It can applied to Engineered Systems to create or change a specific engineered system-of-interest, and to understand and deal with the consequences of these changes in appropriate wider systems [Watson et al. [2019]].

The systems engineering principles helps to organize the system body of knowledge. It address all kinds of systems,its phenomenon on the scientific basis and characterizing them via cohesive groups of interrelated, interdependent components that can be natural or human-made [Thomé [1993]].



**Figure 2.54:** System Engineering approach  
[Walden et al. [2015]]

It supports a wide range of activities from “characterizing the existing system” to the “concept formulation, system formalization, design synthesis, and integration” of the system [Schlager [1956]]. It also helps in system formalism, common understanding, interpreting, and leveraging the system theoretical foundations, which provides the systems engineer, a derived theory about the system. [Sillitto et al. [2018]]. Some fundamental SE principle that were used in thesis which is described as follows:



- **System-** It is a bounded set of interconnected elements forming a whole that functions for a specific finality (objective) in an environment, from which it is dissociable and with which it exchanges through interfaces" [Rapoport [1986]].
- **System-of-Systems(SOS)-** It is an assemblage of components which individually may be regarded as systems, and which possesses two additional properties: operational and managerial independence of the components" [Ackoff [1971]].
- **System of interest (SOI)-** is a “the top system in the system structure is called a System of Interest (SOI)” [Blanchard [2004]]. It can be considered as the final result of the development process.

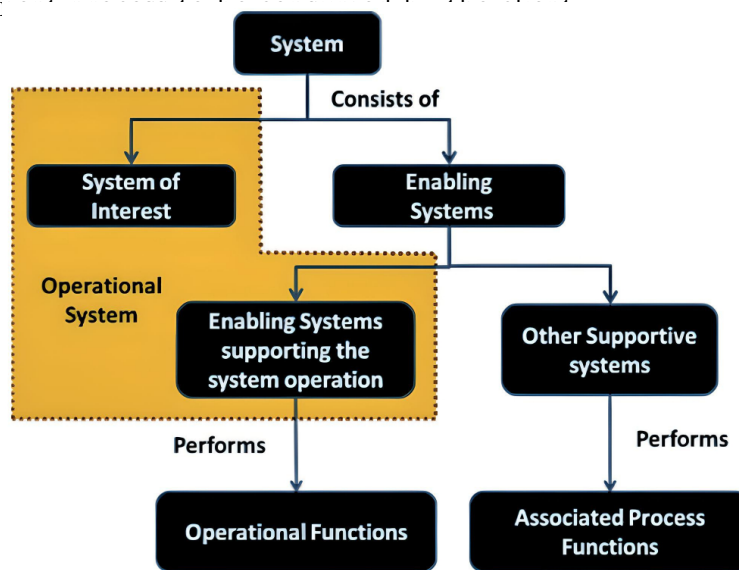
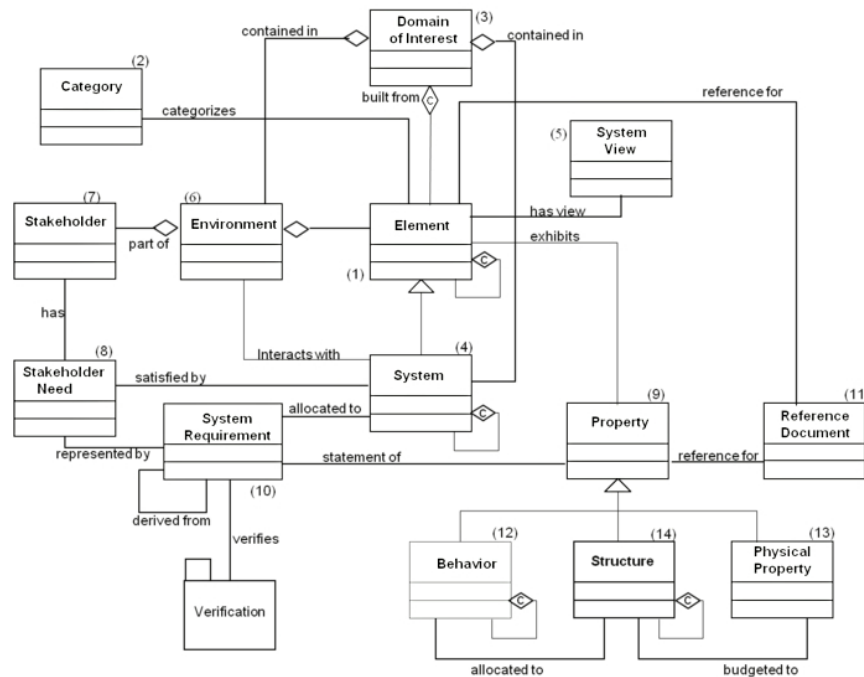


Figure 2.55: System of interest and Enabling system [Walden et al. [2015]]

- **Enabling system (ES)** is a system which makes possible the creation, or ongoing availability for use, of the System of Interest during some part of its life cycle” [Blanchard [2004]]. They can be systems such as development, training, and production. Enabling Systems facilitate the progression of a System of Interest (creation, production, exploitation, and dismantling) through its life cycle stages.

Currently, System Engineering it has been evolved to deal with new system’s complexity in “representing system architectures or modeling specific system properties” [Lee and Miller [2007]](SEBOK1.8 2007). The new modeling practice, which is a formalized methodology that is used to support the design, analysis, verification, and validation associated with the development and analysis of complex systems [Kopeika [1998]]. The new transformed approach in System Engineering is “relevant to a broad range of application domains, well beyond its traditional roots in aerospace and defense, to meet society’s growing quest for sustainable system solutions” [Ramos et al. [2011]] (SEBOK1.8 2017).



**Figure 2.56:** Top-level system model  
 [Dickerson et al. [2004]]

## 2.8.2 Abstraction

The most fundamental concept in systems architecture is abstraction, which concerns hiding unimportant details to focus on essential characteristics [Gerstlauer and Gajski [2002]]. Systems that are worth architects have too many details for all of them to reasonably be architecture. The abstraction is the process of taking away characteristics from something to reduce it to a set of base characteristics [Clements [2005]]. In attempting to understand complex situations, it is easier to focus on bounded problems, whose solutions remain agnostic to the greater problem. There are two key concepts that are applied regarding modeling different levels of abstraction, which are: view and viewpoint, and black-box and white-box modeling, which are described below. Although these two modeling methods are the most widely recognized, different modeling languages and tools employ other techniques as well. IEEE 1471, a standard for architecture modeling, defines “view” and “viewpoint” as follows [Woods and Rozanski [2009]]:

## 2.9.3 Reusability and modularity practices/concepts

The modular architecture refers to the interpretations of separate repetitive system element that are connected. The beauty of modular architecture is that you can replace or add any one component (module) without affecting the rest of the system [Coronado Mondragon et al. [2006]]. These can be linked up to each other, be replaced or added. It has the ability to integrate, to add, or to replace models [Fujita [2002]]. The modular architecture is a separate repetitive elements (standard units), which are similar in size, shape and functional nature.

It can detail the various layers of the system into its sub-systems, modules and their relations. The modular architecture is a separate repetitive elements (standard units), which are similar in size, shape and functional nature. It can be used independently or together that fit with any system. It is a tremendously versatile architecture and allows personalization [Voss and Hsuan [2009]]. Versatile in the sense that it can be used in permanent and temporary installations. It allows personalization because its constructive system admits adding, replacing and removing the standard units, and it accepts every kind of finishing.

It can integrate, to add, or to replace models. The modular architecture is a separate repetitive elements (standard units), which are similar in size, shape and functional nature. These can be linked up to each other, be replaced or added. It can be modified, replaced the standard units, exchanged with other modules or between different systems. It can be reused by selecting those features required in a target system. The right reuse process consists of defining reusable system elements in every context of use (SEBOK 1.7) [Gamma et al. [1993]][Brodsky et al. [2016]]. It can be extendable in future cases from our identified entities and artifacts. It provides the openness to accommodate the changes in representation on inclusion and exclusion part of the system [Frakes et al. [1998]]. It can be easily fetched and refined in CPPS applications context. It can be used and instantiated in real application on various context. It provides the intended level of abstraction, defining each view independently to completely define the system. Figure shows the example of modular models with standard units (Product and service).

### 2.9.4 Synthesis

From the description of system and SE approach, it is entirely convincing to lead us to use the system and System Engineering approach as a methodological foundation. Some Previous works was the systems engineering approach as a foundation to construct the semantic architecture. For example, Dickerson et al. 2004 [Dickerson et al. [2004]] presents a semantic dictionary in system concepts model. Maleki, et al., 2018 [Maleki et al. [2018]] constructed the semantic models for product-service systems using system Engineering approach. Meixner et al., 2019 [Meixner et al. [2019]] used the approach to identify production system elements and relationships of the system. Christian Neureiter et al., [Neureiter et al. [2016]], a standards-based Approach for Domain-Specific Modelling of Smart Grid System Architectures. Following these backgrounds, We have adapted the systems engineering approach as a foundation to represent a CPPS. It is more likely to cover all requirements of the multidisciplinary character of the CPPS related to products and production systems. It is already considered as an accepted practice in CPPS projects. It is entirely convincing to lead us to use the system and System Engineering approach as a methodological foundation to build the CPPS semantic framework consistently.

## 2.10 PhD Contribution positioning

**SLR Q-1** When the CPPS notion evolve and its existing statement?

**SLR Q-2** What are the existing modeling works?

**SLR Q-3** What are the existing modeling works?

**Systematic Literature review results:** From the systematic literature review (SLR) on CPPS concepts and existing modelling work, we have identified less than 30 axioms (until 2019- start of the thesis) of the general CPPS concept and modeling works. The identified limitations and research gap is illustrated below:

### 1) Limitation and Research gap-1- Lack of proper organizing of the CPPS notion

The systematic literature analysis (SLR) reveals that, exploration of CPPS has gained increasing attention over the past few years. Many researchers exploring the concept, with different terminology and projecting different conceptualizations addressed in few scientific literatures. Mainly, they illustrate CPPS is a composite from the cyber physical system.

But the exact meaning and scope differ among current works. The understanding of CPPS has always been inconsistent. Researchers often adopt their exploration to conceptualize the notion of CPPS. Due to lack of a proper organising of the CPPS concept. It hinders the re-usability and domain adaptability of research works. There is a need for a organizing of CPPS notion. Therefore, to support the evolution, development, and adaptability of CPPS across different application areas.

### 2) Limitation and Research gap-2 Lack of comprehensive framework of CPPS notion from terminology to typology to spanning the whole life cycle

From the SLR reveals that, clearly illustrate that researchers use different terminology to describe CPPS entities and characteristics, but they employ various levels of abstraction. Most of these terms are neither clearly defined nor classified, nor are the relations between the terms examined. This terminological heterogeneity in the literature and, therefore, missing standards – in practice.

Up to now, there is lack of entity can constitute in hierarchy layer of different life cycle phases. i.e., which entity of a production system can be regarded within the hierarchy layer. It fails to provide a comprehensive representation of CPPS notion. There is need of information artifacts to be assigned from terminology to typology to different layer's of life cycle phases of a production system.

### 3) Limitation and Research gap-3 Lack of human-CPPS interaction phenomenon.

From the SLR reveals that, the conceptualization of the human aspect over the various definitions of CPPS. It is tightly integrated with the presence of a human at the vicinity of the production ecosystem. either serving as a source of information or consuming a service. Despite its importance, none of the existing works provide a comprehensive representation of such aspects.

There is still a lack of understanding of what the Human-CPPS phenomenon is. How the human part perceive and respond with anthropocentric machines. There is a need to clarify the Human-CPPS phenomenon, by establishing an explicit formal understanding of what interactive human-CPPS are, which types of actions humans perform when interacting with an interactive CPPS, and finally, what human-CPPS itself is.

To fill the limitation and research gap, the development of urgently needed modeling approaches to managing the complexity and structural opacity of CPPS. This is because the modeling of CPPSs requires a robust foundation of well-defined, classified, and related terms which provide information about the boundaries, abilities, and inner workings of such a system.

**Some Previous PhD thesis outcome on dedicated standard semantic modeling framework has proved its applicability. It includes:**

- **Elaheh Maleki-** in her Phd thesis, proposed a Standard Semantic modelling framework for product-service systems (PSS) to support life cycle [Maleki [2018]].The Standard modeling framework for the PSS using a system engineering approach.
- **Astrid von euler-chelpin-** in his Phd thesis, the Information modelling for the manufacturing system to support life cycle [von Euler-Chelpin [2008]]. In his work, the Standard and concept modeling framework for manufacturing system, its commonality and core entities which support the life cycle phases.
- **INCOSE (Semantic dictionary and concept model)-** recommendation on system semantic and concept models [Dickerson et al. [2004]]. The engineered systems semantics to examine the "whole system, whole life-cycle, and whole stakeholder community".

Following these perspectives, it is confirming that the standard semantic modeling framework are existing scientific frameworks for each domain. It is proved its applicability. It categorizes the essential knowledge of the domain as shown in section 2.8.2.

The previous sections provided a global context for CPPS modeling by characterizing the

already existing frameworks. The findings of this literature survey are entirely convincing to lead us to support the hypothesis that extending the capacities of System and SE is a promising method.

The system and system engineering approach help in methodological foundation to organize the model building process consistently (with abstraction) as shown in section 2.9; and finally, a modeling language section 2.8.4 to support the representation of identified concepts and relationships.

### 2.9.1 Thesis outcome hypothesis:

3

The expected outcome of the thesis work is mutual contribution between the Cyber-physical production System (CPPS) domain of interest and INCOSE community vision, as shown in figure 2.58.

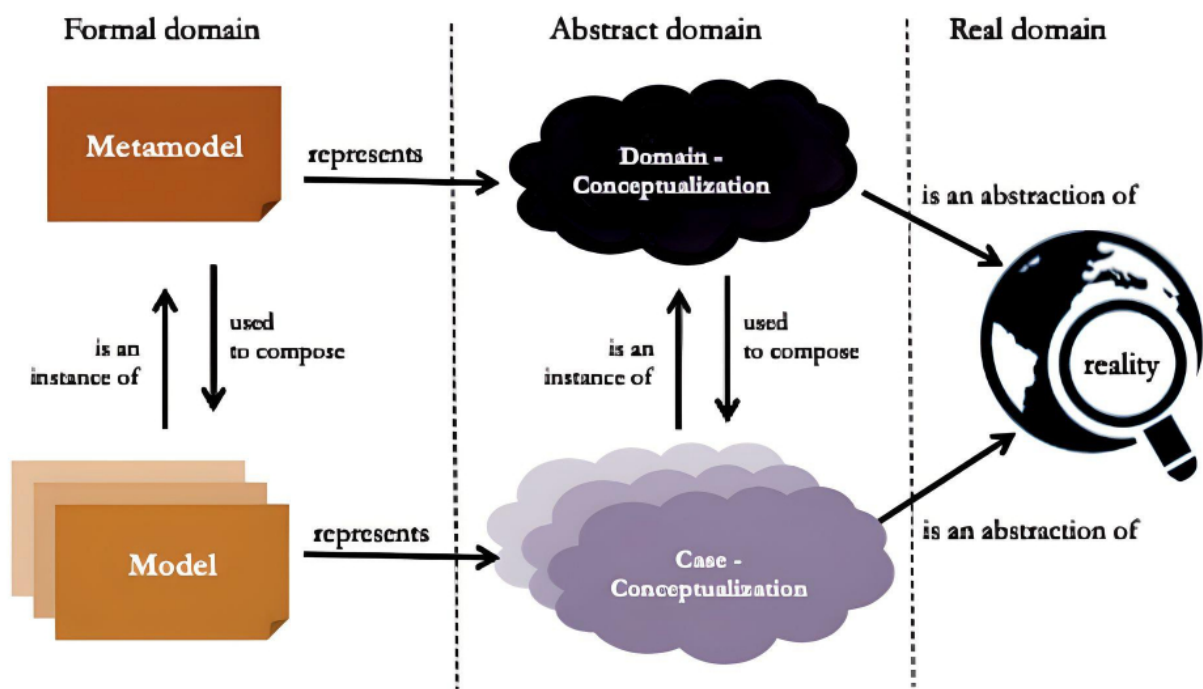


Figure 2.57: Explicit conceptualization of a CPPS domain  
[Guizzardi and Halpin [2008]]

The research work aims to organise the CPPS notion from the current understanding. The center of this contribution is to specify an abstract domain-conceptualization. It involves a set of terms naming concepts (classes) and relations. Figure 2.57 shows the explicit conceptualization approach. We consider a “information” as an understanding of the

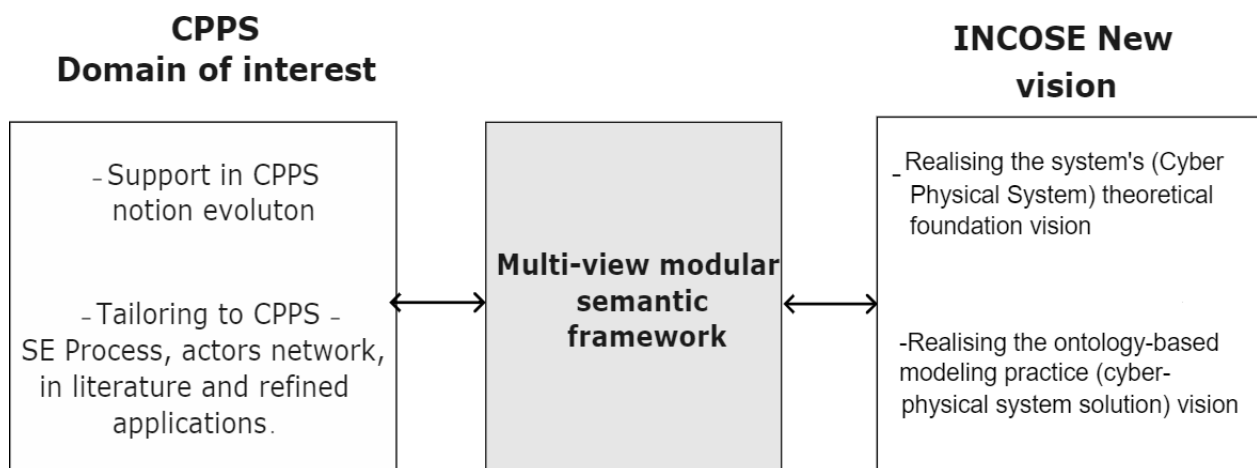
<sup>3</sup><https://www.incose.org/about-systems-engineering/se-vision-2035>

relationships among the domain (CPPS in this concrete case), and “knowledge” as the use of information. [Guizzardi et al. [2007]]

The premises of CPPS concept established in this thesis work. The proposed formalization and modular semantics is re-usable and extendable for multiple purposes. It supports in evolution and tailoring to CPPS System Engineering process, actors network, in Literature knowledge, refined application and other aspects. It serves as a view of reference, support the evolution and future developments of the CPPS paradigm.

**2.9.2 Parallely, it contributes to realizing the INCOSE (International council of system engineering Community) Vision 35**<sup>4</sup>. It includes:

- **Vision-1)** Realizing the Systems (CPS) theoretical foundation (formal ontologies and observable phenomenon) vision — The thesis presents the CPPS systemic understanding, semantics, and the derived theory of the CPPS system. It supports the systems engineer with the domain concepts, derived meaning, and different applications.
- **Vision-2)** Realizing the ontology-based modeling practices (cyber-physical systems solutions) vision— The thesis presents the CPPS and HCPPS knowledge representation that provides a seamless exchange of information that integrates across the domains, and life cycle phases of a single, consistent, unambiguous, system representation. It supports across the CPPS domains and shares the value for different applications.



**Figure 2.58:** Contribution of thesis work

<sup>4</sup><https://www.incose.org/about-systems-engineering/se-vision-2035>



daleifmodif

# Organizing Cyber-physical production system notion

*In this chapter, based on current understanding and our perspective, we propose the organisation of the cyber physical production system(CPPS) notion using SE principle. It consists of the proposed CPPS fundamental theory and the metamodel.*

3.1	Introduction . . . . .	83
3.2	Production system paradigms . . . . .	83
3.3	CPPS notion organizing . . . . .	85
3.3.1	CPPS notion- Understanding . . . . .	85
3.3.2	CPPS notion- fundamental theory . . . . .	88
3.3.3	CPPS notion-System of interest and Enabling system . . . . .	90
3.4	Metamodel for CPPS notion . . . . .	93
3.5	Synthesis . . . . .	97

This work published as:

**Puviyarasu SA**, Catherine da Cunha, *A Semantic Model Framework for the Cyber-Physical Production System in the Systems Engineering Perspective*, **INSIGHT Journal of International council of system engineering (INCOSE)**, pp. 2022, [Doi.org/10.1002/inst.12355](https://doi.org/10.1002/inst.12355).

**Puviyarasu SA**, Catherine da Cunha, *A standard Modeling Framework for the Cyber-Physical Production System to support life cycle using Systems Engineering approach*, **Rencontres Académie -Industrie - Association Français ingenierie Systeme (AFIS)(INCOSE)**, **Doctoral symposium 2020**.

## 3.1 Introduction

**RQ-1- How to define the Cyber-physical production system (CPPS) notion formally?**

**SQ-1 What is the fundamental theory of CPPS notion?**

**SQ-2 What is the current level of maturity of CPPS notion?**

To address the research question,

**F**ROM our current understanding and our perspective, we propose the organizing of the CPPS notion. It establishes a proper organization of the CPPS concept using the SE principle.

To accomplish that, first we illustrate the past production system paradigm flagships and its objective. It illustrates the paradigms and its associated characteristics. It helps to embrace the CPPS notion and its characterization more visible compare to other paradigms.

Second, we understand the CPPS. we illustrate the most fundamental aspects and provide the underlying phenomenon of CPPS. It is grounded by the idea of SE principles.

Third, the organization contains a CPPS fundamental theory and a metamodel for the CPPS proposal. It details the main elements, core entities, hypothesis, and boundary of the CPPS is illustrated. The metamodel is believed to facilitate the sharing and re-usability across various application and domain areas of CPPS notion. It projects a view of reference, support in CPPS evolution, and future development of paradigm.

This chapter is structured as follows: Section 3.3 CPPS notion understanding; Section 3.3.2 shows the CPPS fundamental theory; Section 3.3.3 shows the CPPS perspective; Section 3.4 presents the proposed metal model; Section 3.5 Synthesis.

## 3.2 Production system paradigms

In this section, the production system paradigm flagships are illustrated, which is shown in figure 3.2. The development of paradigms over time is associated with changing customer requirements and needs. In general, according to [Suri and Burke [2020]], four basic approaches to production can be identified:

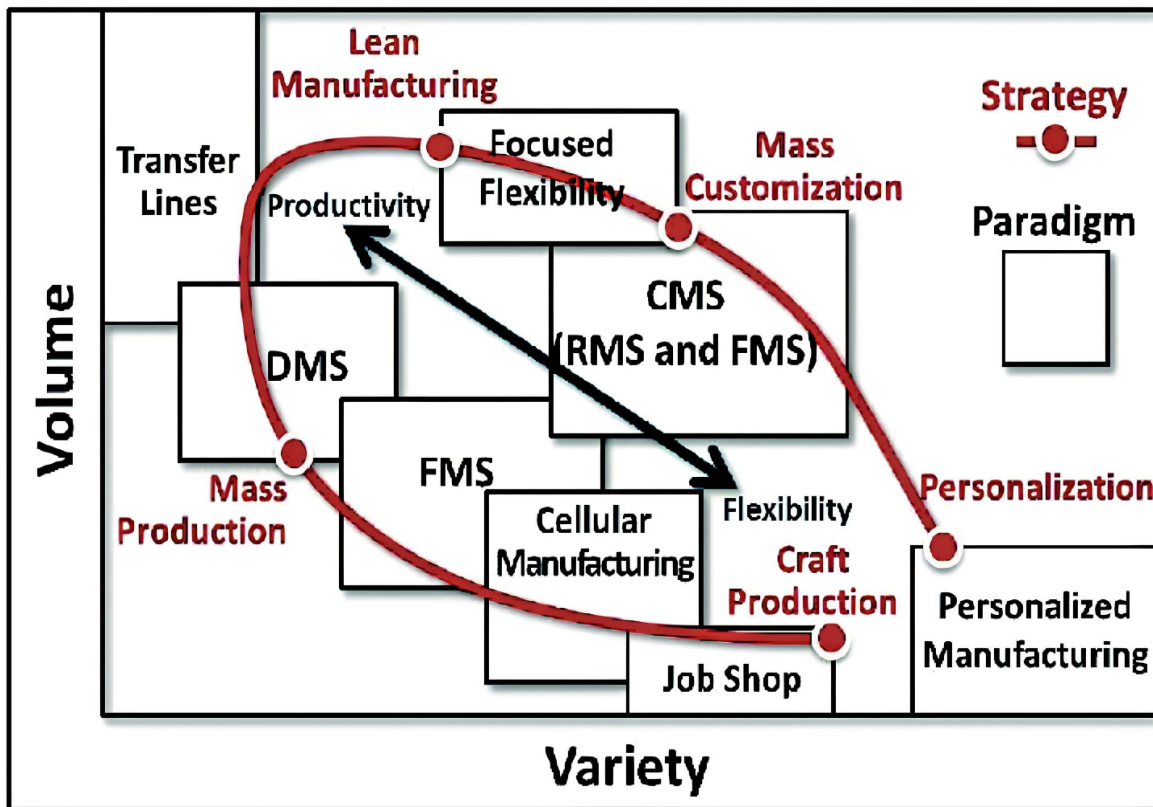


Figure 3.1: Different production system paradigms  
[Suri and Burke [2020]]

- **Craft production**– the manufactured product is intended for a particular customer and can therefore be described as a 'one customer's market.' It is a pull business model.
- **Mass production** – produced is a narrow range of products; a constant demand is assumed. This is a press business model.
- **Mass customization** – customer chooses from a wide range of options before production. The repetitive flow production, series production or serial production, is a manufacturing process and assembly line techniques.
- **Personalized production**–this is produced according to the customer's configuration. The customer-centric production paradigm, where individual needs and preferences are transformed into personalized products and services at an affordable cost.

Several flagship notions in the past decades were already addressing the same objectives with globally the same ideas of solutions, among which

**Intelligent Manufacturing Systems [Hatvany and Nemes [1978]], Biological Manufacturing Systems(BMS) [Ueda [1992]], Reconfigurable Manufacturing Systems RMS) [Chalfoun et al. [2014]], [Viharos et al. [2003]], Dedicated Manufacturing Systems(DMS) holonic Manufacturing Systems(HMS) [Valckenaers et al. [1998]], Industrial Agents [Leitão et al. [2013]]. It is widely accepted and recognized by production communities**

However, the cyber physical system is currently proposed as an answer to the industry 4.0 revolution. Over the few years, the integration of product and production systems into CPS and projecting as new paradigm of cyber-physical production system(CPPS). The concept of Cyber-Physical Production System (CPPS) notion has gained increasing attention over the few years.

**Many researchers are using the CPPS notion for the use case and application-oriented context without having lack of common understanding of the concept. The exact meaning and scope of the human and other infrastructure part differs among current works and application domains [Monostori et al. [2016]].**

Despite the CPPS notion still being in its infancy, the environments are often considered as cyber and physical production spaces, which interact with each other and able to operate on different scales when a change, in context.

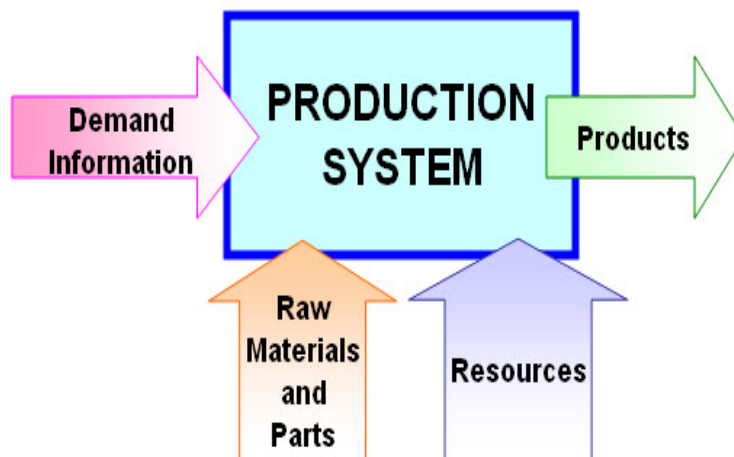
Likewise, the CPPS notion flagships recently evolved in production paradigms. The notion of CPPS is new and brings many fields together with high-level objectives; the fundamentals considered one by one are familiar. The CPS application for production management, termed as Cyber-Physical Production Systems (CPPS) [Monostori et al. [2016]] [Zezulka et al. [Monostori et al. [2016]]. Next section illustrates our understanding of the CPPS concept

## 3.3 CPPS notion organizing

### 3.3.1 CPPS notion- Understanding

The state-of-the-art and stages of research process (see chapter-1,2) illustrate that, CPPS notion is an emerging new formal paradigm. It is a type from cyber-Physical systems [SA and da Cunha [2021]]. It involves tangible (physical) and intangible (cyber) elements) that deliver

integrated service. The production systems, which include the products, customers, raw materials, transformation processes, direct and indirect that organize and control the entire process. These elements lead to take decisions that must be addressed for the production system to operate properly. The other infrastructure aspects need to be clearly expressed [Bar-Yam et al. [2004]]. They remain partially specified in different CPPS notion, which include the support system, logistics, warehouses, etc. but the other infrastructure remains unclear [Weyrich et al. [2017]].



**Figure 3.2:** Production system  
[Davis and King [1975]]

Even the systems Community specifies that the newly formed intelligent systems is characterized as interconnected with other systems, which made as a system of systems [Sillitto et al. [2018]] [Agostinho et al. [2018]] [Gronau and Theuer [2016]]. The typical examples of so-called Smart systems such as intelligent enterprises, smart buildings, smart homes, smart cities, etc. [Popper et al. [2004]] [Lewe et al. [2004]].

Even in the CPPS notion development classification [Cardin [2019]], which includes a) learning system b) a quasi-level system c) a retrofitted system. The CPPS interacts with humans and other enabling systems to produce the product. It is a central and federative system comprising more complex relationships and provides the general concept and specific instances [Weyrich et al. [2017]].

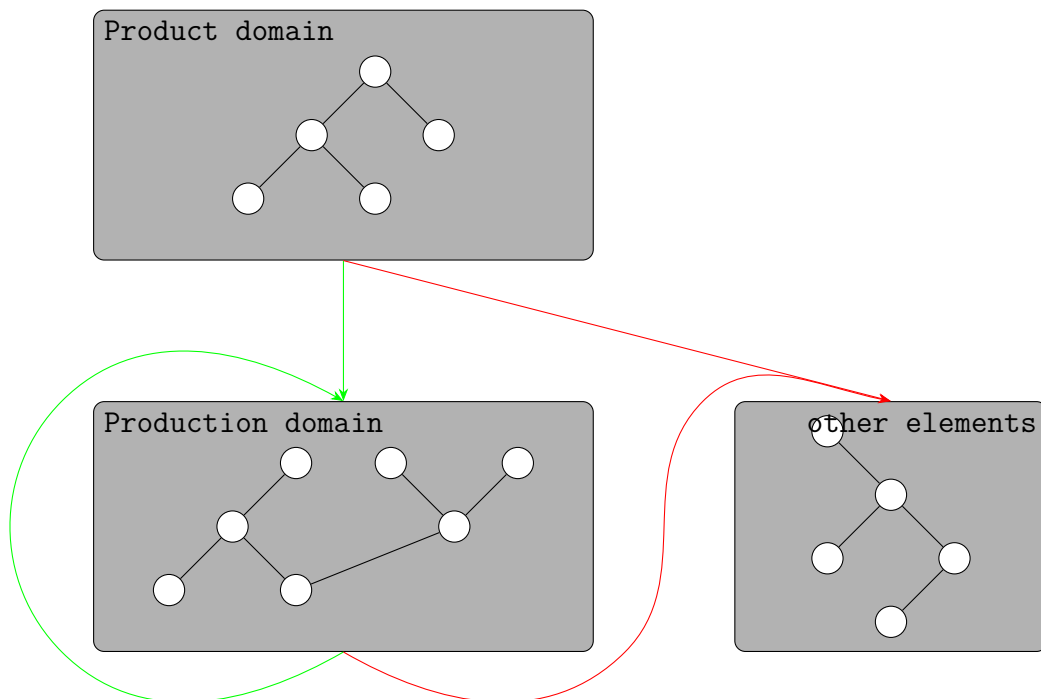
The CPPS depicts the projection of the CPS concept to the production domain. Nonetheless, CPPS notion, with emphasis on intelligent products, smart production, and product service systems, has several links to CPS concepts focusing on other domains, e.g., “smart grid” in the energy domain and “smart mobility” in the mobility domain.

Furthermore, our stages of research process (see chapter-1) and topology classification shows that the CPPS environment formed, with smart product and production system as follows:

**Product domain-** The Product elements, which comprises raw materials and finished products. Raw materials are the unprocessed substances which form an integral part of every tangible asset. Semifinished products are partially processed raw materials which have not yet been assembled to form a finished product.)

**Production system domain-** The Production system is used to refer the production machines (e.g., machines to transform or assemble raw material and semi-finished product, auxiliary machines. It comprises raw materials and machines of, physical object that form an integral part to producing a tangible asset.)

The production system has the nature of interrelations are created by leading the events in themselves and supporting other systems. It can produce and takes specific inputs, adds value and transforms the outputs of useful products and services. [Röpke et al. [2016]].



**Figure 3.3:** CPPS- Product and production collaboration

This essentially means a CPPS notion is primarily an independent system, but can also emerge as an when the smart devices are engaged in a human and other infrastructure interaction.



Furthermore, we noted that the formation of an System of System is not necessarily a permanent phenomenon but rather a necessity for integrating and networking systems in a coordinated way for specific goals, etc. [Boardman and Sauser [2006]]. Hence, our predicate is that a CPPS devices as an independent system with the addition of a human and other infrastructure. Thus, making it possible for a new kind of CPPS to emerge as SoS from the interaction of these human capable CPPS devices with humans as well as other non-human entities possessing a interaction facets. E.g. logistics, warehouse, material transportation, etc. Nonetheless, the scope of our research remains limited to interactions with a human. This essentially means a CPPS is primarily an independent system in the form of a Smart device but can also emerge as an System of System when the smart devices are engaged in a human and other infrastructure interaction.

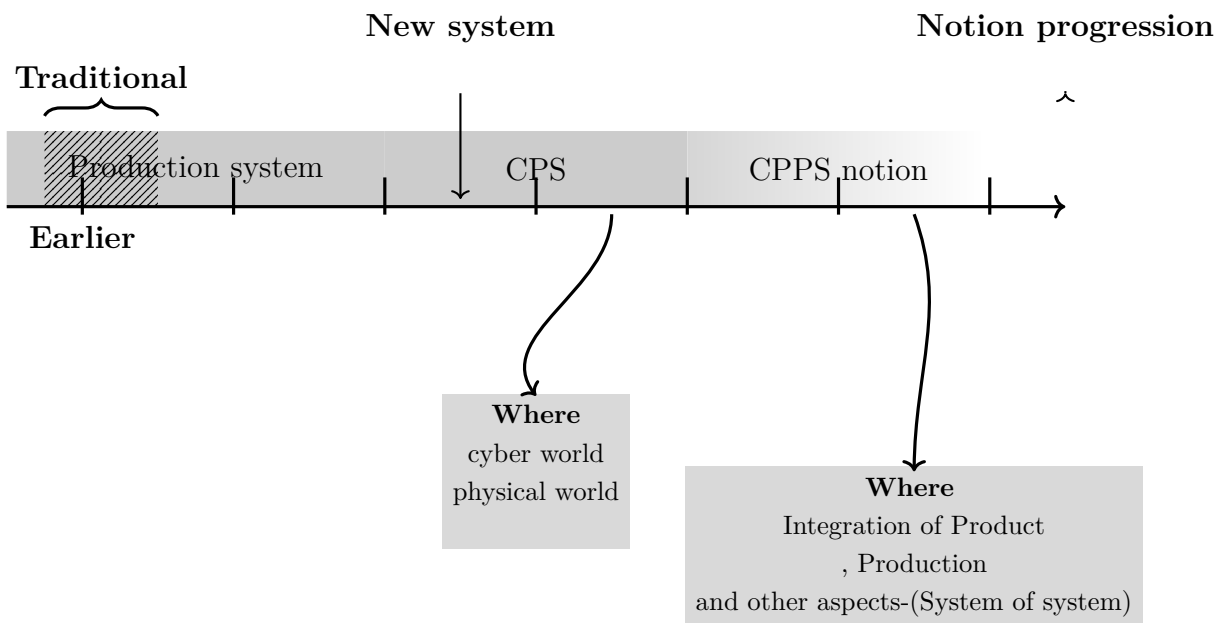


Figure- CPPS Notion

However, we summarize the evolution of CPPS notion encapsulating our perspective. Our predicate for CPPS notion has two primary system, which is materialized through the product and production system. Next section, we described the fundamental theory for CPPS notion.

### 3.3.2 CPPS notion- fundamental theory

Based on our system understanding, we summarize the fundamental theory for CPPS notion. The system is defined in terms of observed features. It describes the fundamental aspects and provides the underlying phenomenon, principles that can specify universally of different CPPS notion. It is about **"seeing things whole"** and **"seeing the world as an interconnected,**

interdependent field continuous with itself [Von Bertalanffy [1973]] [Blanchard et al. [1990]]. It constitutes the basic elements, namely system theory, System technology and System philosophy, which served to reconcile competing traditions of theory. and provide a fully articulated world view.

Based on the observed features or more preciously the relationship between those features what they actually are (physical, biological or other phenomenon). The starting point for any system is the concept of system defined on set of theoretic level and most naturally, a system defines on theoretic set.

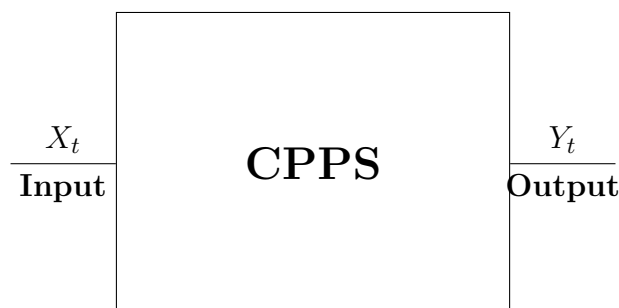
Based on the above formalization concept from General System theory(GST), the CPPS notion theory is described (figure 3.4). Figure 3.4 and 3.8 shows the Synthetic view of the system representation. The CPPS notion is with discrete events. It has a **loosely coupled system** in which components are weakly associated with each other, and thus changes in one component least affect the existence or performance of another component within the hierarchy layer. These hierarchies layer is categorized and classifies from production network layer to component layer[Lee et al. [2015]].

**Definition** -Given a discrete event system (DES), the event set which consists of arrivals and departures at the various servers.(E, X, f, x0), where :[Cassandras and Lafortune [2008]]. Formally, a DEVS model is defined by the following structure:

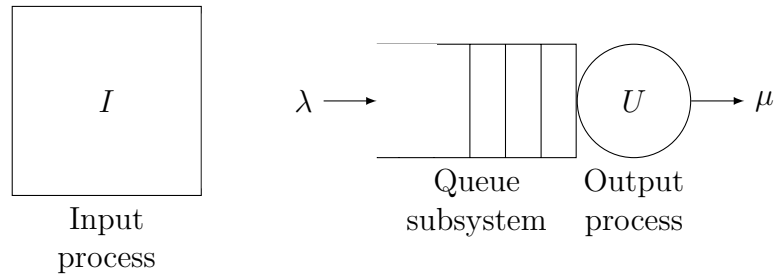
$$M = X, Y, S, int, ext, , ta \tag{3.1}$$

E is a countable set of events; X is a countable set of states; Eis the active event function, is the set of all events that are possible in state of transition function.

$$M = m_x: e_i, p_j \langle e_i \rangle \epsilon (\in x p_j \epsilon P(\circ)) \text{ and}$$



The CPPS interrelations that are created as a result of leading the events in itself and support other systems [Lee [2008]]. Each interrelation has a component that are serving for production



**Figure 3.4:** CPPS-Input and Output

system. This set of interrelation takes specific inputs, adds value and transforms the outputs to the customer.

It leads the events in itself and supports other systems. Whereas it takes specific inputs are those variables that can be varied independently of the system, that are fed to the system to modify its behavior. It takes specific inputs, adds value and transforms the outputs of useful products and services. Based on the understanding, we align it with the CPPS notion with systems of interest and enabling system perspective, which helps to visualize the CPPS core elements and their boundaries.

The CPPS notion fundamental theory provides a fully articulated world view as figure 3.8. The further research can go beyond to analyzing system technology and System philosophy, which served to reconcile, capable of unifying the various domains of empirical understanding. The next section illustrates the CPPS notion concept.

### 3.3.3 CPPS notion-System of interest and Enabling system

<sup>1</sup>

Based on CPPS fundamental theory, we propose the CPPS domain-independent common understanding. For that, the system and SE principle is taken into consideration.

- **Definition 1-General System Theory:-** A “system is defined very generically as a complex set of interacting elements, with properties richer than the sum of its parts” [Von Bertalanffy [1973]] [Blanchard et al. [1990]].
- **Definition 2- Engineered system-** An Engineered system is a system designed or adapted to interact with an anticipated operational environment to achieve one or more intended purposes while complying with applicable constraints [Walden et al. [2015]].

<sup>1</sup><https://sebokwiki.org>

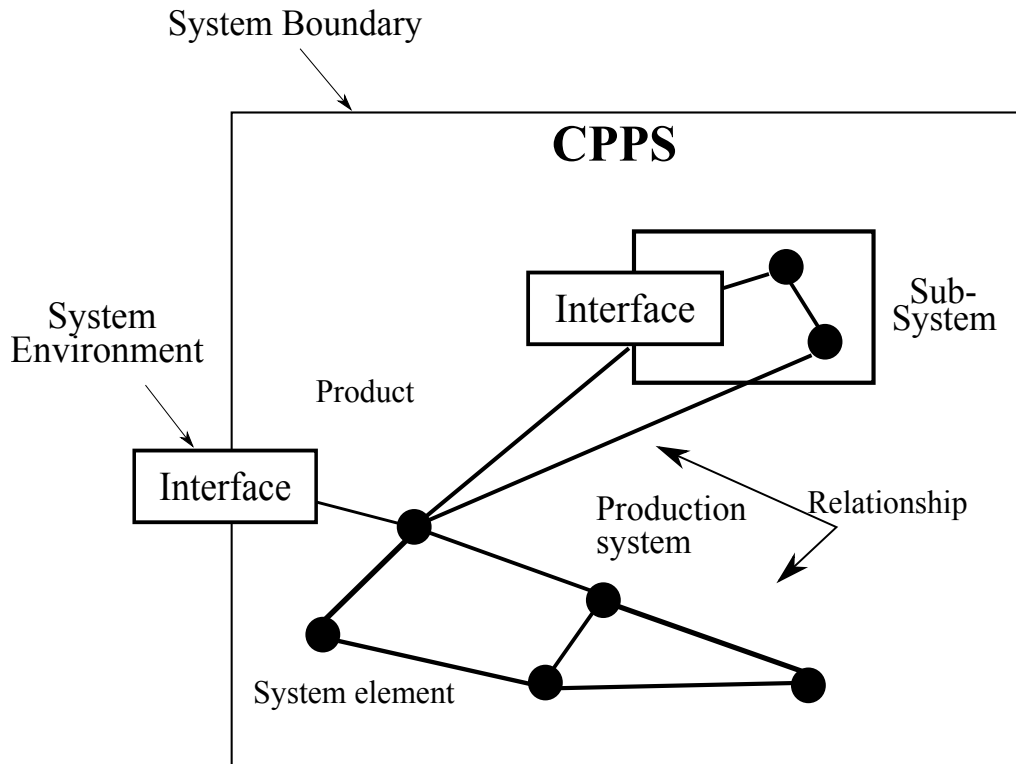


Figure 3.5: CPPS- Separability property (enhanced from [Matook and Brown [2008]])

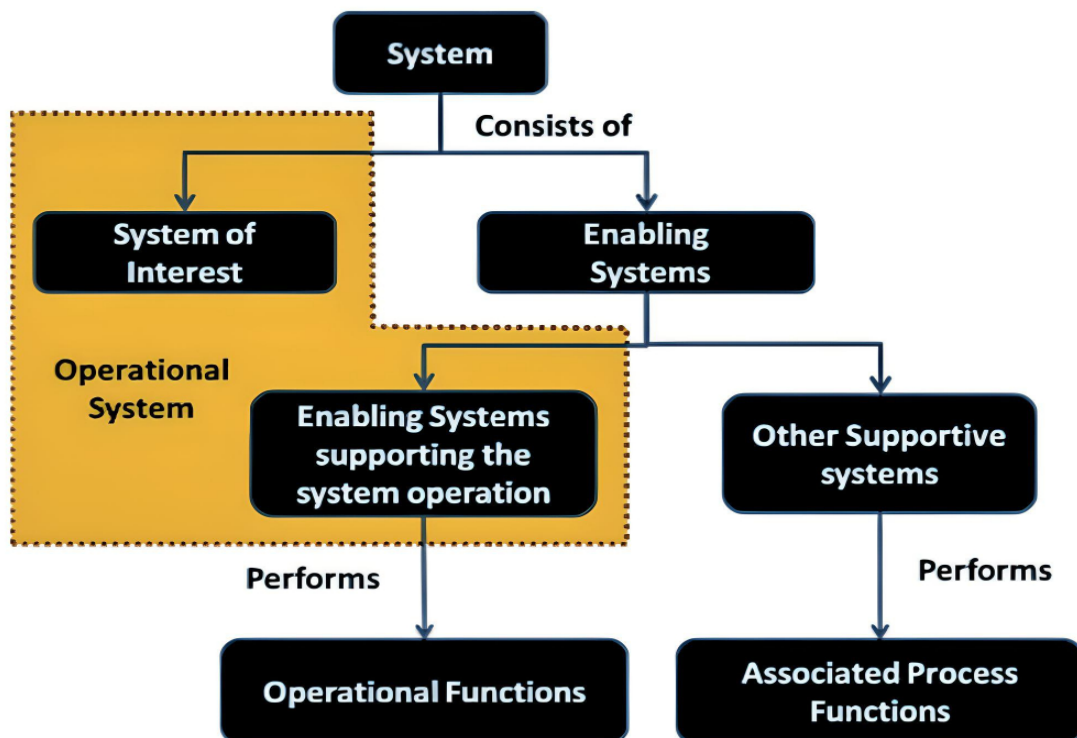


Figure 3.6: System of interest and Enabling system [Walden et al. [2015]]

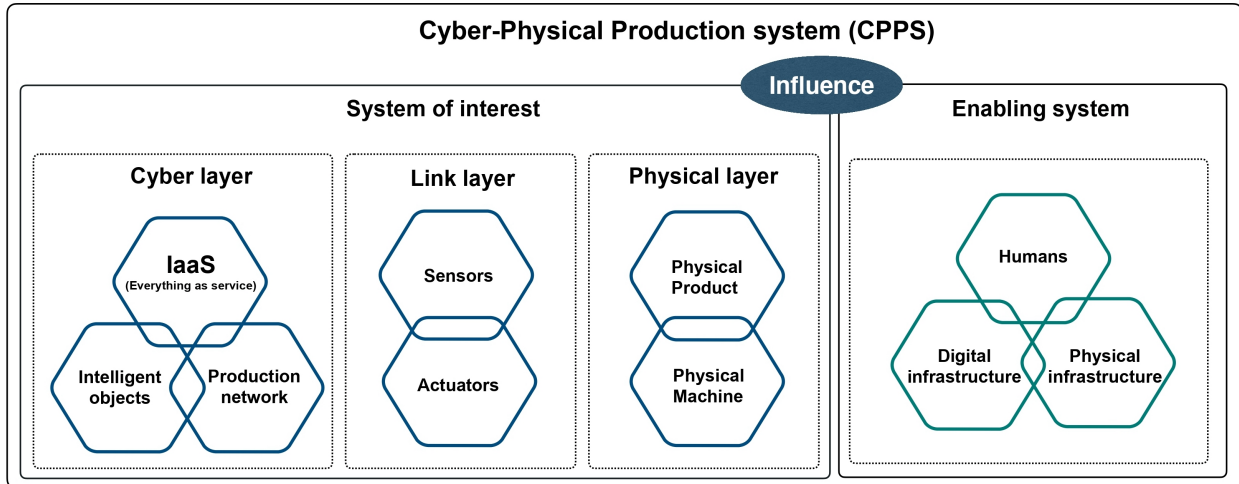
- **Definition 3-Conceptual systems-** Conceptual systems are abstract systems of pure information, and do not directly exhibit behaviour, but exhibit “meaning”. In both cases, the system’s properties (as a whole).[Sillitto et al. [2019]]
- **Definition 4-System of interest (SOI) (EIA632 standard)-** is a “the top system in the system structure is called a System of Interest (SOI)” [Blanchard [2004]]. It is the final result of the end-product.
- **Definition 5-Enabling system (ES)(EIA632 standard)-** is a system which makes possible the creation, or ongoing availability for use, of the System of Interest during some part of its life cycle” [Spellini et al. [2021]]. The enabling system is a system which makes possible the creation, or ongoing availability for use.

Based on this principle, we take the principle of them, their connections to present the CPPS notion. It stipulates the fundamental understanding of CPPS, which involves the basic elements (Cyber, link, Physical). It describes that CPPS can be independent systems or, recursively, a CPPS in a human and other enabling interaction. The statement can help in current effort and guide the newer ones on the CPPS. Thus, making it suitable to adapt across different CPPS notions.

**Our Understanding-** The “Cyber-physical production system (CPPS) which has cyber, link, physical element (system of interest (SOI)) connected with the production network. These elements interact together with other Enabling systems (ES) to transform the smart product into useful products or services. It enhances the decision-making process and communication between machine, product, and human in real-time”.

Based on the proposed CPPS understanding, we aligning it with the CPPS notion systems of interest and enabling system perspective helps to visualize the CPPS core elements and their boundaries. Figure 3.7 shows the core elements and boundaries of CPPS. The CPPS is a wholeness, expresses both the interdependence of elements of the system and the coherence of the whole. It can be specified as two primary systems (see Figure 3.7). It described as follows:

- **System of Interest (SOI)-** It is the set of elements of the system to produce a product. It is composed of: Cyber element, and physical element. It has a collective set of all the elements of system considered by its life-cycle. (According to ISO/IEC 15288



**Figure 3.7:** CPPS understanding-(figure enhanced from [Maleki et al. [2019]])

[ISO [2008]]- “the top system in the system structure is called a system-of-interest and consists of lower level systems).

- **Enabling system (ES)**-It is a collection of any system that may support CPPS (SOI). It is composed of: humans, digital and physical infrastructure. The enabling system is a system that may support CPPS (SOI) or indirectly influenced during its operational life cycle”.(According to ISO/IEC 15288 [ISO [2008]])

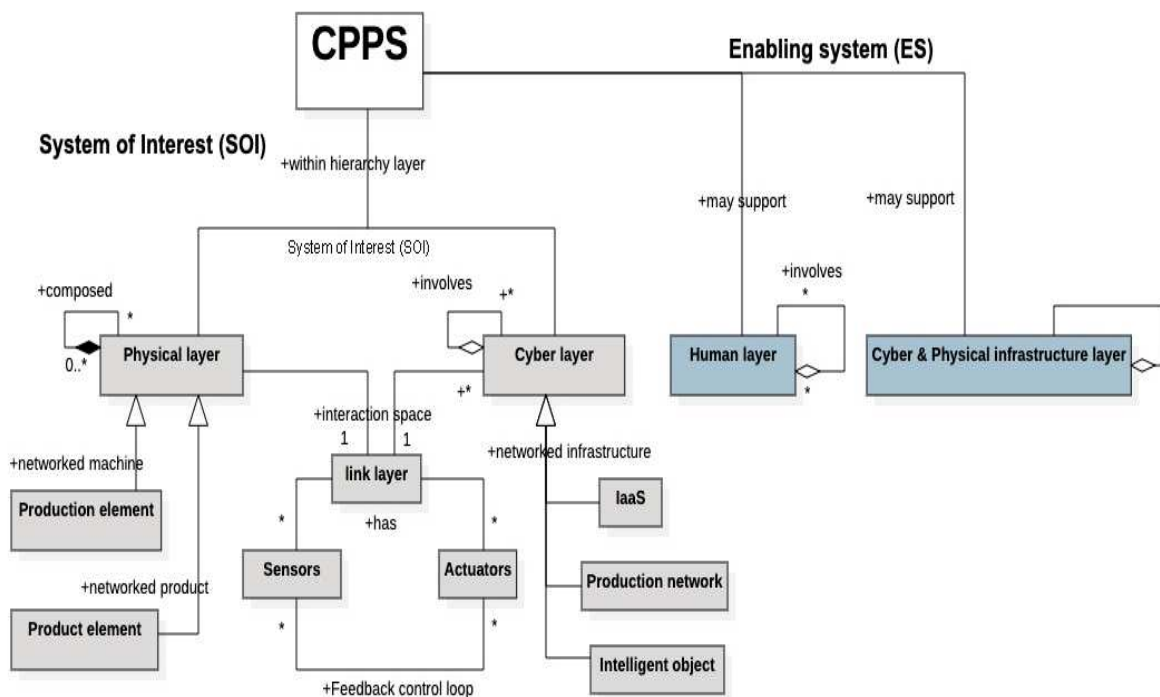
From this, the core elements, and boundaries of the CPPS are seen from this classification. It helps to identify their relationships, interdependencies. It brings together the system and poses the borders, relationships, structures. It helps in understanding the anticipated operational environment to achieve one or more intended purposes. It brings together the system in a reductionist way, and helps in current effort and guides the newer ones on the CPPS. Thus, the system of interest(SOI) and enabling system(ES) perspective model as a basis, we proposed a metamodel for CPPS in the next section.

### 3.4 Metamodel for CPPS notion

In this section, based on the above classification of CPPS notion. We propose a Metamodel for the CPPS notion using formal classification of **system of interest and enabling system**. The standard concept is followed. The environment, embodied in its elements and relationships. For simplicity, we structure the metamodel. The ambition of metamodel is applicable to all types of CPPS. The metamodel is constructed to adapt and support all types of CPPS. Figure 3.8 shows the metamodel. It constitutes the main elements of a CPPS as combinations of fundamental elements, as well as the relation between them. It involves

core entities structured to form a CPPS.[Kang et al. [2016]].

We specify them to illustrate any elements in the production system can be passed by in layers[Röpke et al. [2016]]. It can also help to structure the system in a structural view. These layers have interrelations that are created as a result of leading the events in itself[Morgan et al. [2021]]. These aspects are taken into consideration, We presented the metamodel as (we detail below in our discussion) follows:



**Figure 3.8:** CPPS metamodel is based on the above formal system classification-System of Interest and Enabling System; dark gray represents- SOI and Blue represent-ES)

- **Cyber layer-** It refers to all the Cyber elements. It encompasses the intangible elements that help store data, analyze, process, collect, control, and actuate the information within the CPPS ecosystem.
- **Link layer-** It refers to the link layer space. In production system, it encompasses the sensors and actuators of the elements connecting or intersecting two things, in particular to combine the cyber and physical world of production. It is an enabler and feedback control space in the production system.
- **Physical layer-**It refers to all the Physical elements. It encompasses the tangible elements. It is to actively or passively participate in the production process to add value. It includes all the physical machine elements and product elements are referred in the physical layer.



- **Human layer-** It refers to all human elements . It enables humans to manage industrial and process control machinery via a Human-CPPS interface. It encompass the human in the loop with production entities. There are three different modes of operation where the interaction between humans and the inner system (CPPS) occurs. An operator is an individual who operates the equipment or machine in the factory in order to perform a global task.
- **Infrastructure layers-** It refers to all the Cyber and Physical infrastructure . It is to actively or passively participate in the production process to add value. It specifies the external elements that interact with the Cyber-physical production system.
- **Combined CPPS elements-** The integrated relation between the classes together, leading to the emergence of a CPPS as an independent system with the hierarchy layer.

The integrated relation between the classes together, leading to the emergence of a CPPS. Let it formally be described as follows:

$$H, \text{CPPS} = \text{Human and CPPS combined elements (SOI and ES layer)} \quad (3.2)$$

- **Human and CPPS-** the integrated relation between the Human and CPPS elements classes has the relation of together, leading to the emergence of a Human-CPPS as an integrated system. It enhances the integration of Sensing, Actuation, Computation and human processes.

The relation of together, leading to the emergence of a Human-CPPS as an integrated system. Let it formally be described as follows:

$$H, \text{CPPS} = \text{Human and CPPS combined elements (SOI and ES layer)} \quad (3.3)$$

- **CPPS-CPI infrastructure-** the integrated relation between the CPPS and Cyber/physical infrastructure elements classes has the relation of together, leading to the emergence of a CPI-CPPS as an integrated system. We denoted it as: **CPI, CPPS**

The integrated relation between the CPPS and Cyber/ physical infrastructure elements classes has the relation of together. Let it formally be described as follows:

$$\text{CPI, CPPS} = \text{CPPS and CPI combined layer elements (SOI and ES layer)} \quad (3.4)$$

The axioms **Cyber**, **Link** and **Physical** define the principle system (**System of interest**) that can be formed as a result of leading the production events. The axioms **CPI** and **H** define the result of the interaction between them (Enabling system). It illustrates the Loosely coupled systems in which elements are weakly associated (have breakable relationships) with each other, and thus changes in one element the least affect the existence or performance of other elements.

Each of these classes of system exists on their own, as the result of the interaction between them (see Fig. 3.8). But when combined, they form a System of system (SOS). Formally, all element classes are subclasses of System elements, by inheritance. As systems, the latter inherits from all the properties detailed. The constraint and is used to represent the mandatory requirement of at least one element from each part in relation in order to form a complete set.

The CPPS metamodel is completed by axioms (as shown above) that formed a CPPS. These elements collaborate for the result of leading the events in itself. (i.e) It takes specific inputs, adds value and transforms the outputs of useful product and services to the customer. These layers have interrelations that are created as a result of leading the events in itself and support other systems. From this domain view, its relation of CPPS notion is presented.

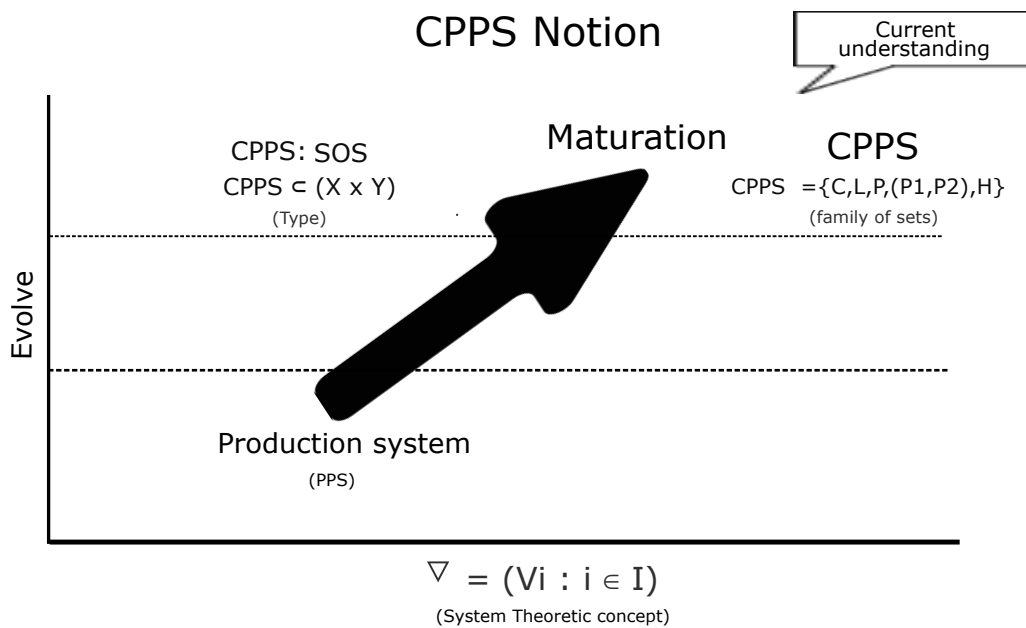
**Summary:** To conclude that, the metamodel is believed to facilitate in sharing and re-usability across the domains and application areas of CPPS. Thus, it opens the opportunities for multidisciplinary research in CPPS.

## 3.5 Synthesis

From this chapter, it's answer our first research question

- (RQ1) how to define the Cyber-physical production system (CPPS) notion formally?.

From this chapter, based on **our current understanding and our perspective**, we proposed an organizing for CPPS notion. The proposed organizing of the CPPS notion from our current understanding of a notion.



**Figure 3.9:** CPPS Notion

It mainly constituent a fundamental theory and metamodel. Figure3.9 shows the CPPS notion evolution. It reveals the current understanding and the maturation in system view point. It illustrates that CPPS, which has human and other enabling system infrastructure interaction. The organization are believed to facilitate the sharing and re-usability across application areas and various domains of CPPS. It serves as a view of reference, support in CPPS evolution and future development. Thus, it opens opportunities for a collaborative and multidisciplinary research space.

This contributes to address the identified research challenges in **Limitation and research gap-1**, while answering our first research question (RQ1) on how to define the CPPS notion formally?

Based on our proposed CPPS organizing, the multi-viewed modular semantic framework for CPPS notion is proposed, which is described in the next chapter.



# Multi-viewed Semantic framework for CPPS Notion

*Based on our CPPS notion organising, the multi-viewed modular semantic framework for CPPS notion is proposed. The first part of this chapter is dedicated to set up the main methodological foundations adopted to realize the semantic model. Based on this, the second part of this chapter is to detail semantic models and provide a unique description. Then, the scenario-based verification and validation is carried out*

<b>4.1</b>	<b>Introduction</b>	<b>100</b>
4.1.1	Multi-viewed modeling mechanism	104
4.1.2	Semantic framework for CPPS notion	107
4.1.3	Modular and Resuable architecture for CPPS notion	108
<b>4.2</b>	<b>Multi-viewed Semantic for CPPS notion</b>	<b>113</b>
4.2.1	CPPS- Terminology classified exploitation	114
4.2.2	CPPS-Typology classifications and its entities	117
4.2.3	<b>Overview of multi-viewed mechanism and specification</b>	<b>123</b>
4.2.4	CPPS domain production and product aspects model	125
4.2.5	CPPS Business process model	128
4.2.6	CPPS Life cycle artifact model	130
4.2.7	CPPS Value creation models	135
4.2.8	Synthesis	136
<b>4.3</b>	<b>Formal specifications of models operation/algorithm</b>	<b>137</b>
<b>4.4</b>	<b>Model Verification and Validation- algorithm</b>	<b>141</b>
4.4.1	Case-1 CPPS-Discrete event Scenario	145
4.4.2	Case-2 CPPS- Retrofitted event Scenario	148
<b>4.5</b>	<b>Conclusion and synthesis</b>	<b>151</b>

This work is published as:

- **Puviyarasu SA**, Catherine da Cunha, *A Semantic Model for Cyber-physical production system inspired from Current developments-A Typology*, **CIGI, QUALITA 2021-Conférence Internationale de Génie Industriel**, [hal.archives-ouvertes.fr/hal-03250874](https://hal.archives-ouvertes.fr/hal-03250874).
- **Puviyarasu SA**, Catherine da Cunha, *Smart factory:from concepts to operational sustainable outcomes using test-beds* , **Scientific journal of logistics**, 2021, 17 (1), 7-23, [Doi.org/10.17270/J.LOG.2021.545](https://doi.org/10.17270/J.LOG.2021.545).
- **Puviyarasu SA**, Farouk belkadi, Catherine da cunha, Alain bernard, Abdelhamid Chriette. Model-based system engineering for the conception of flexible production system, **Systems Engineering: Product, Process, Performance France**, [hal.archives-ouvertes.fr/hal-03263104](https://hal.archives-ouvertes.fr/hal-03263104).

## 4.1 Introduction

1

**F**ROM our CPPS notion formalization (previous chapter) and [stages of research process in chapter-1](#), the modular semantic framework for CPPS notion is proposed. It is a domain-specific framework which involves a well-defined glossary of terms for CPPS notion. It is a comprehensive framework by defining, classifying the entities and illustrating their relations.

It represents the relationships between a thing in reality, its conceptualizations and a symbolic representation of this conceptualization. It is based on the immediate influence on the structure and functionality of CPPS notion. It defines a concept with indication of given a meaning to the elements [[Saif et al. \[2018\]](#)].

It highlights the role of understanding the concept of a thing and the thing as a CPPS notion. It is detailed by individual concept model to have interconnected semantic description of the whole system. For that, we consider the structural ontological as the fundamental level of parts and relationships, which allows us to model the conceptual system of CPPS notion [[Gero and Kannengiesser \[2007\]](#)]. It organises the knowledge by identifying the different concepts

---

<sup>1</sup>[https://www.sebokwiki.org/wiki/System\\_Modeling\\_Concepts](https://www.sebokwiki.org/wiki/System_Modeling_Concepts)

(which we refer as different views of information) and mapping the relevant relationships between them. [Ciobanu [1997]].

It is explicit to construct any rules needed to build specific models within a domain of interest [Ciobanu [1997]] [Nag and Gioia [2012]]. Some standard descriptions of the concept model are followed (INCOSE), which is illustrated below

- **ISO 9000:2015:** System: set or combination of interrelated or interacting elements organized to achieve one or more stated purposes.
- **ISO 42010:2011:** System fundamental concepts or properties of a system in its environment embodied in its elements, relationships, and in the principles of its design and evolution.
- **ISO 42010: 2011 and ISO 15288:2015:** Environment: (system) context, determining the setting and circumstances of all influences upon a system.
- **ISO 42010:2022** identifies the following new concepts:, Structuring Formalism. It provides more flexibility in identifying and developing the descriptions across a full range.

From our CPPS organising (previous chapter 3.3), which has human and other enabling system infrastructure interaction in the production network 3.5. This production system has the nature of hierarchy layers. These layers' interrelations are created by leading the events in themselves and supporting other systems. It can produce and takes specific inputs, adds value and transforms the outputs of useful products and services. Further, it interacts with humans and various enabling systems within the production system hierarchy layer (from the production system network to the component element). The following categories of knowledge are at the heart of the semantic framework, as listed below:

- **The Terminology exploitation, and typology classification entities for CPPS** is carried out.
- Then, **the CPPS notion property aspects** highlights the ontological consideration of the system (**System property ISO 42010:2011**).
- The CPPS Product and production system view value oriented architecture. (**ISO 42010:2011**)



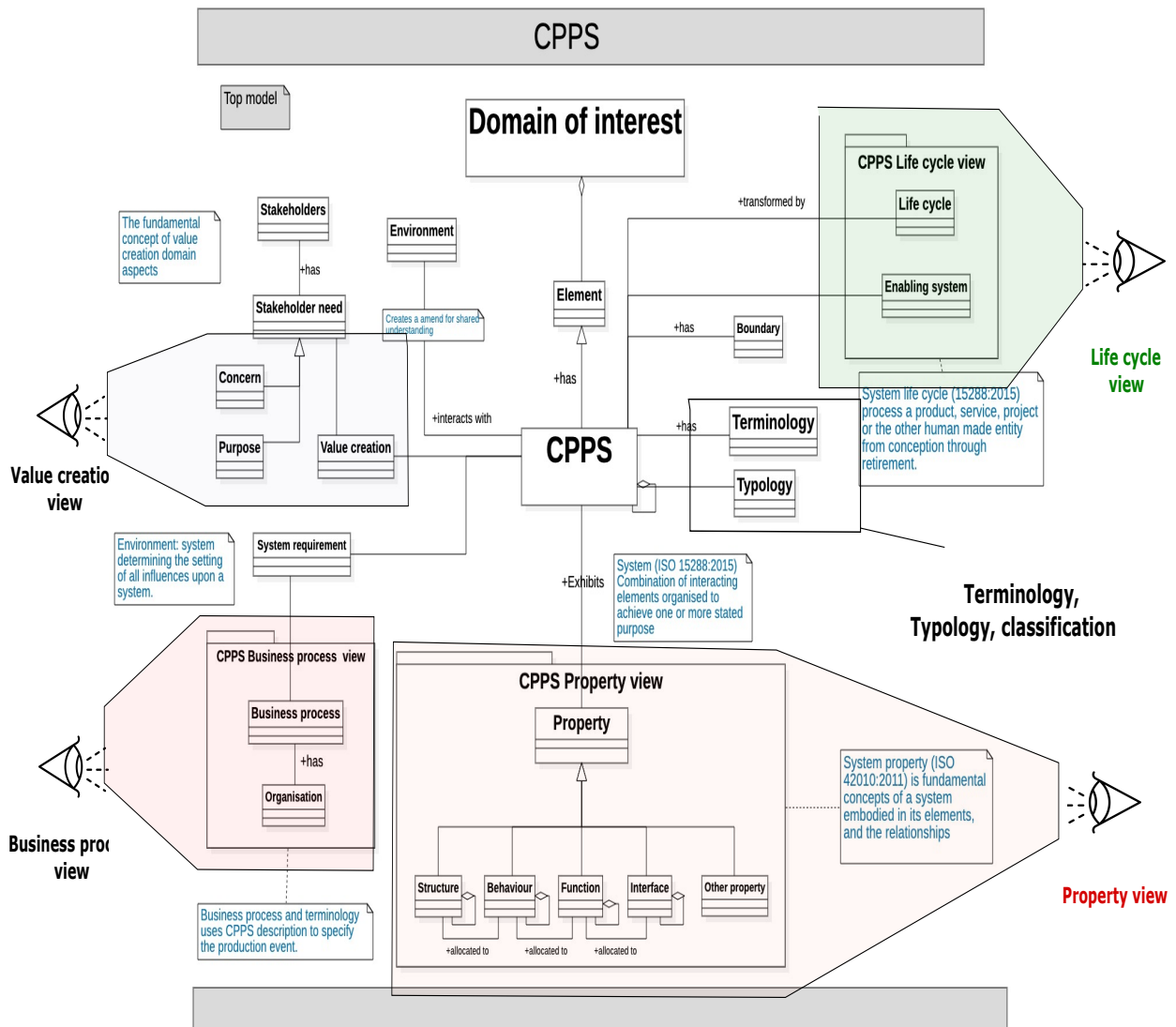


Figure 4.1: CPPS notion domain framework

[Dickerson et al. [2004]]

- The **Business process of CPPS** highlights the business aspects. (ISO/IEC 19510:2013)
- The **CPPS life cycle artifact phases and the related processes**. (System life cycle ISO 15288:2015 processes)
- The **human-CPPS integration** considers all the interactions between them.

To integrate all the above aspects in a unified model, a conceptual framework is needed. This is because a robust foundation of well-defined, classified, and related terms which provide information about the boundaries, abilities, and inner workings of such a system. It has

inclusion, and exclusion entities of the system.

Figure 4.1 shows the semantic framework top model (figure enhance from semantic concept model [Dickerson et al. [2004]]). The top-model is presented by a schema of the framework, which is the start point. It encompasses: the class “*domain of interest*” refers to all the elements involved in the “*CPPS*”.

It includes the system property, environment, boundary, external systems, stakeholders, enabling things and all other things of interests. The associated relationship with the set of elements includes: The class “*CPPS*” is a system of interest which interact with the “*Environment*” (Class “*Environment*”) is being utilized. It has its own “*boundary*” (class “*boundary*”) in a given environment to provide the desired service.

The “*CPPS*” is directly or indirectly influence with the “*enabling system*” (class “*enabling system*”) during its operational life-cycle. Each class in the top-model is detailed by an individual semantic model in the proposed framework to have interconnected semantic description of the whole system. In modeling, the axiom classes and object relations are presented. The classes and object relations are expressed as follows:[France et al. [1998]] [Szlenk [2006]] [Varró and Pataricza [2003]]:

- **Object classification:** Every object must be an instance of a class.
- **Attribute declaration:** Every attribute declared in a class is a property of the class.
- **Operations declaration:** Every operation declared in a class is an operation of the class.
- **Enumerations:** The different literals in an enumeration class are different values.
- **Literal constants:** An enumeration class only has its literals as instances.
- **Abstract class:** If class A is abstract, for every object x, if x is an instance of class A, then, there must be a subclass B of A such that x is an instance of B.

For constructing the semantics model, the multi-view modular mechanism is used for constructing each model in the framework, which is illustrated below:

### 4.1.1 Multi-viewed modeling mechanism

When the complexity of a system to be modelled exceeds a certain threshold, it is common to refer to multi-view modeling [Bork et al. [2020]]. By doing so, the overarching model is decomposed into smaller models, representing views, that focus only on certain aspects while ignoring everything else. i.e., a viewpoint, which naturally only comprises a subset of the concepts necessary for the overarching model. The “Multi-view modeling is a mechanism which interacts from multiple semantically or syntactically dependent perspectives with different views of a modeled artifact” [Guo et al. [2019]].

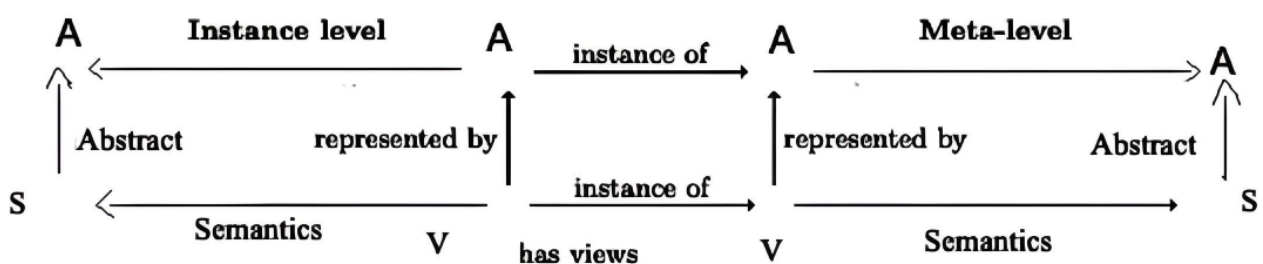


Figure 4.2: Instance level and relations concepts

[Thabet et al. [2021]]

In this context, the multi-view modular modeling techniques that are adapted to represent the system, which focus on abstract and essential characteristics. The modular models is a separate repetitive element composed of standardized units (standard unit). It has the ability to integrate, to add, or to replace models, modified, exchanged with other modules or between different systems [Guo et al. [2019]] [Friedenthal et al. [2007]]. It provides the openness to accommodate the changes in representation on inclusion and exclusion part of the system. It is a tremendously versatile, which allows personalization. It is because its constructive system admits adding, replacing and removing the standard units, and it accepts every kind of finishing [Friedenthal et al. [2007]].

Figure 4.2 shows the multi-viewed mechanism and its relationships. Figure 4.1 shows the different types of operation in multi view point models. It includes the Orthogonal/Independent, Semantic, Refinement/ Abstraction and association relations as follows:

- **Orthogonal/Independent:** It is known that the views  $V_1, V_2$  have no direct semantic relationship, i.e.  $SV_1 \cap SV_2$ . It has an independent relation. Indirect relationships,

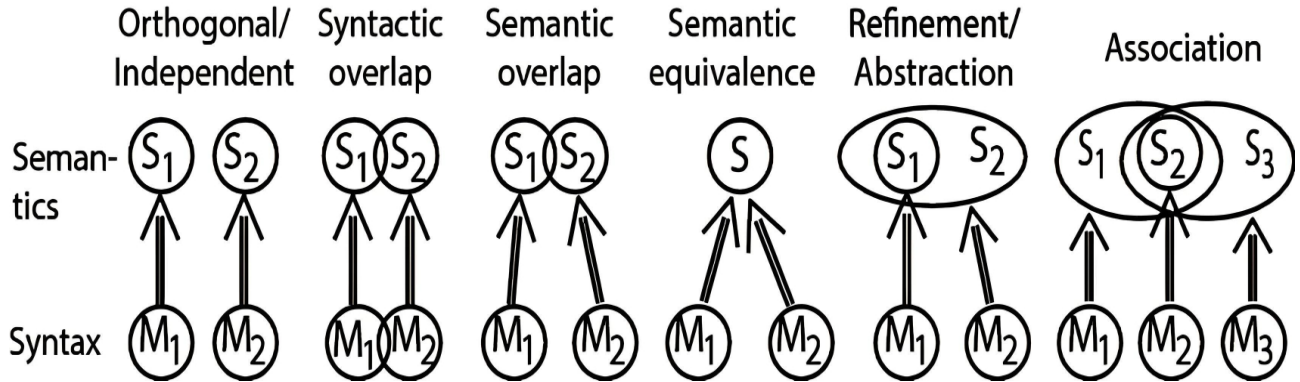


Figure 4.3: Content relationships between view

[Thabet et al. [2021]]

going through a third view, may be possible but no direct ones [Persson et al. [2013]].

- **Semantic equivalence:** Two views are semantically equivalent if they have the same semantics, i.e.  $S(V1) = S(V2)$  [Persson et al. [2013]].
- **Semantic overlap:** It is known (or possibly only assumed) that there is a semantic relation between two views  $V1, V2$ , i.e.  $S(V1) \cap S(V2)$ . E.g. through a suitable operation or by explicitly modeling the semantic mapping for both involved viewpoints. We distinguish one special case: Two views are semantically equivalent if they have the same semantics. This conceptually means that  $S(V12) \supseteq S(V1 \cup V2) \supseteq S(V21)$ , and that a syntactic overlap  $M1 \cup M2$  can be identified [Persson2013characterization].
- **Abstraction:** It is an abstract. Formally, we say that view  $V1$  is an abstraction of another view  $V2$ , i.e.  $S(V1) \supseteq S(V2)$ . We distinguish one case especially: filter/subset, as a relation where the more abstract view  $V1$  is a strict syntactical subset of the refined view  $V2$ . [Persson et al. [2013]].
- **Syntactic:** The mapping of viewpoints ( $V$ ) to a semantic ( $S$ ), where  $V \in V, M \in M$  and  $V \subseteq S$  and where  $V \subseteq M$ . Formally:  $V1 \in V1$  and  $V2 \in V2$  are views of the same system. A view  $V1$  is an abstraction of another view  $V2$  if its semantics is a superset of the other, i.e.  $S(V1) \supseteq S(V2)$ . [Persson et al. [2013]]

#### 4.1.1.1 Operations

Another way to study MV systems is to study operations on views, e.g. analysis, consistency checking, view composition, projection, as illustrated in Figure [Persson et al. [2013]]. Here,

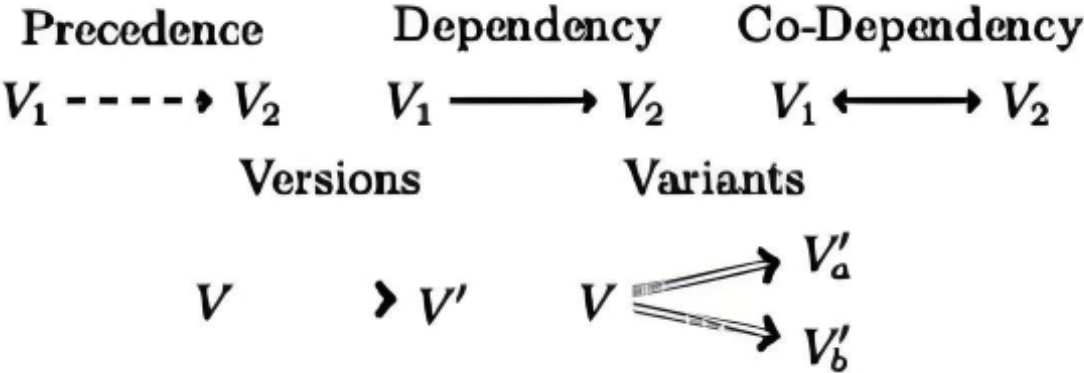


Figure 4.4: Different kinds of process relation [Thabet et al. [2021]]

we categorize such operations and how they may be implemented. Operations on views may take one or several inputs.

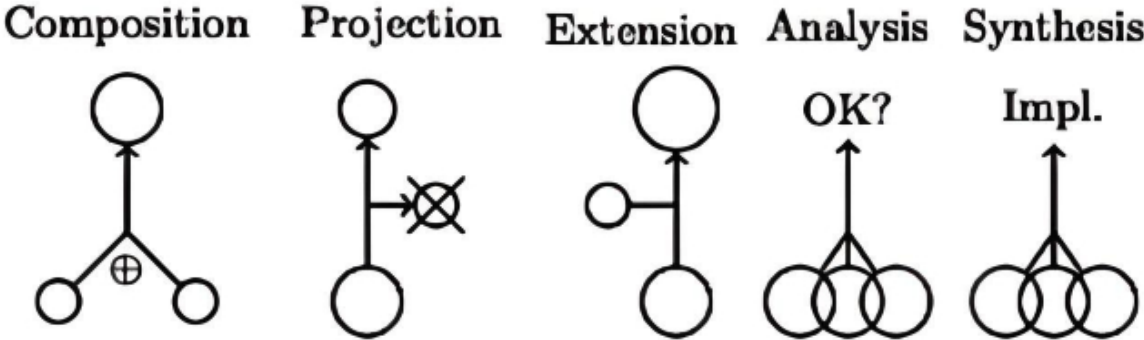


Figure 4.5: Different types of operations [Persson et al. [2013]]

The perspective of viewing MV environments focused on the operations between the different views places the emphasis on the mechanisms, rather than on the content. Composition,, involves defining an operation creating a common view encompassing the semantics of two or more incoming views, i.e.  $V_A \oplus B = V_A \oplus V_B$ .

4.1.1.2 Characteristics of multi-view models

The characteristics of multi-view models is illustrated as follows:

- **Use and reusable:** The model can be easily fetched and refined in CPPS applications context. It can be reused and instantiated in real application on various context. It

can be reused in future cases from our identified entities and artifacts. It provides the openness to accommodate the changes in representation on inclusion and exclusion part of the system.

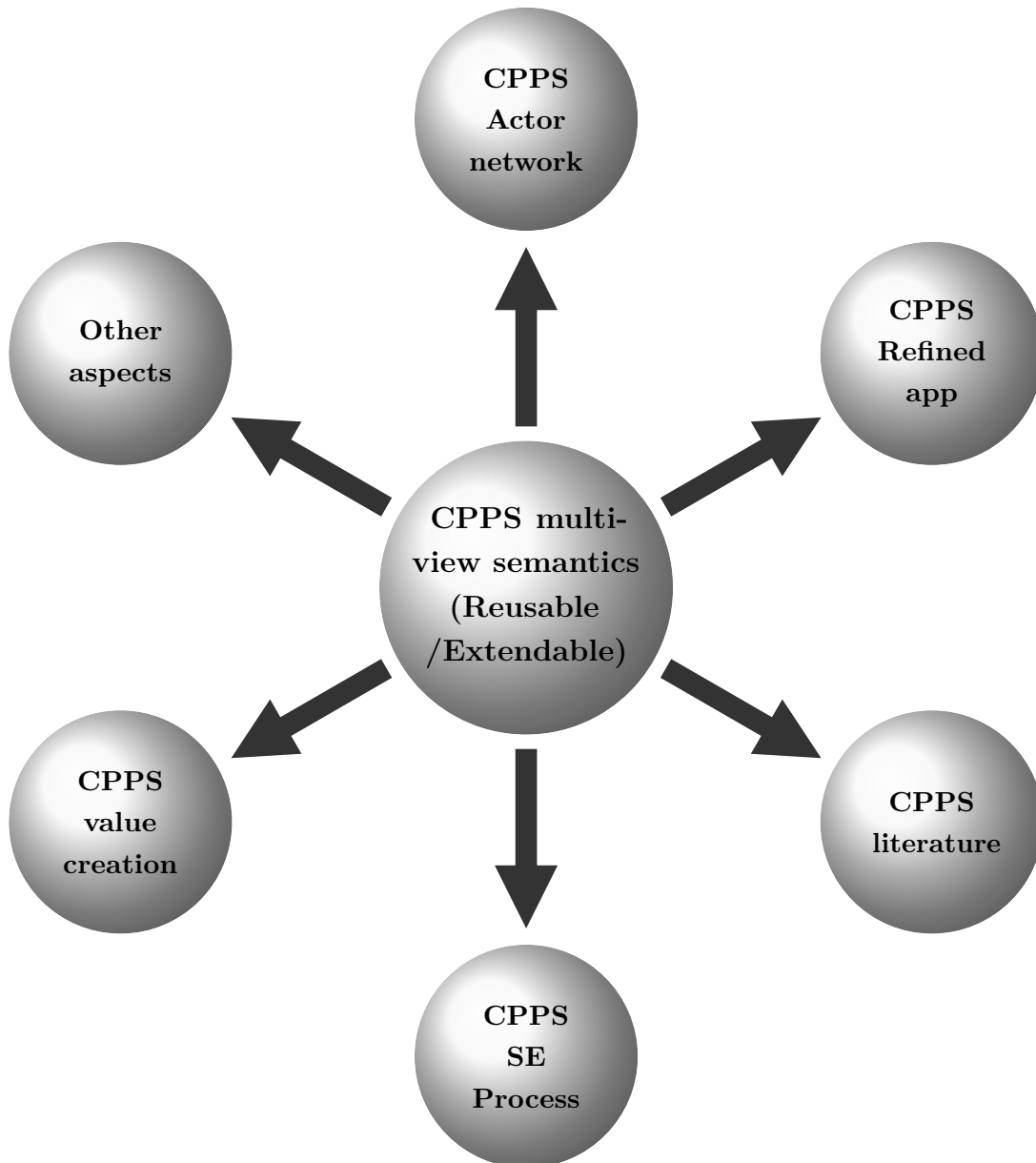
- **Semantic overlap:** It is known (or possibly only assumed) that there is a semantic relation between two views  $V1, V2$ , i.e.  $S(V1) \cap S(V2)$ . E.g. through a suitable operation or by explicitly the semantic mapping for both viewpoints. [Persson et al. [2013]].
- **Extendable:** It can be extendable in future cases from our identified entities and artifacts. It provides the openness to accommodate the changes in representation on the inclusion and exclusion part of the system.
- **Consistency.** Given a set of internally consistent views  $V1, V2, \dots, Vn$ , does there exist any system(S). It involves limited number of terms, classification, and relations, for reasons of comprehensibility, robust and simplicity.
- **Completeness,** Given an intended level of abstraction, defining each view independently to completely define the system. Such abstraction is a complete to a semantic domain  $S(V)$ .

The multi-viewed modular semantic framework can support multiple aspects(figure??), which is illustrated below:

#### 4.1.2 Semantic framework for CPPS notion

The figure below shows the multi-view modular semantics framework is considered to support the multiple aspects. The framework will serve as a value creation for CPPS paradigm. It serves as a foundation to contribute to a systemic understanding of CPPS by defining and classifying the terminology, typology of involves entities and illustrating their relations. It has a glossary of terms called the unified semantic dictionary.

It contributes to understanding the whole problem of interest. It provides a common way to talk about the system, which is underlying in common architecture for various purposes. It represents the domain concepts, providing the basic structure or armature around which a knowledge foundation can be built. It has a core content of the domain and a set of relations between these concepts which contribute to the understanding of the whole problem of interest. It can be used independently or together that fit with any system. Thereby, it lays a semantic foundation helping to understand and support in evolution of CPPS paradigm.



**Figure-** CPPS notion multi-viewed modular semantic framework

### 4.1.3 Modular and Resuable architecture for CPPS notion

The framework involves the Modular architecture for CPPS. It is reusable, that can be easily fetched and refined in any CPPS applications context. It can detail the various layers of the system into its sub-systems, modules and their relations. It allows personalization because its constructive system admits adding, replacing and removing the standard units. It provides the openness to accommodate the changes in representation on inclusion and exclusion part of the system. It will support the concrete implementation details, that can be used unambiguously across and between different implementations. The multi-view modular architecture support multiple aspects, which includes System Engineering process, refined applications and actors network etc. It is detailed as follows:



## 4.1.4 Framework for CPPS SE process

The framework can serve as reference which can integrate as a first class citizen in CPPS SE process. It is theoretically analyzed from system definition to the structural architecture to provide an integrated information model spanning the whole life cycle of CPPS.

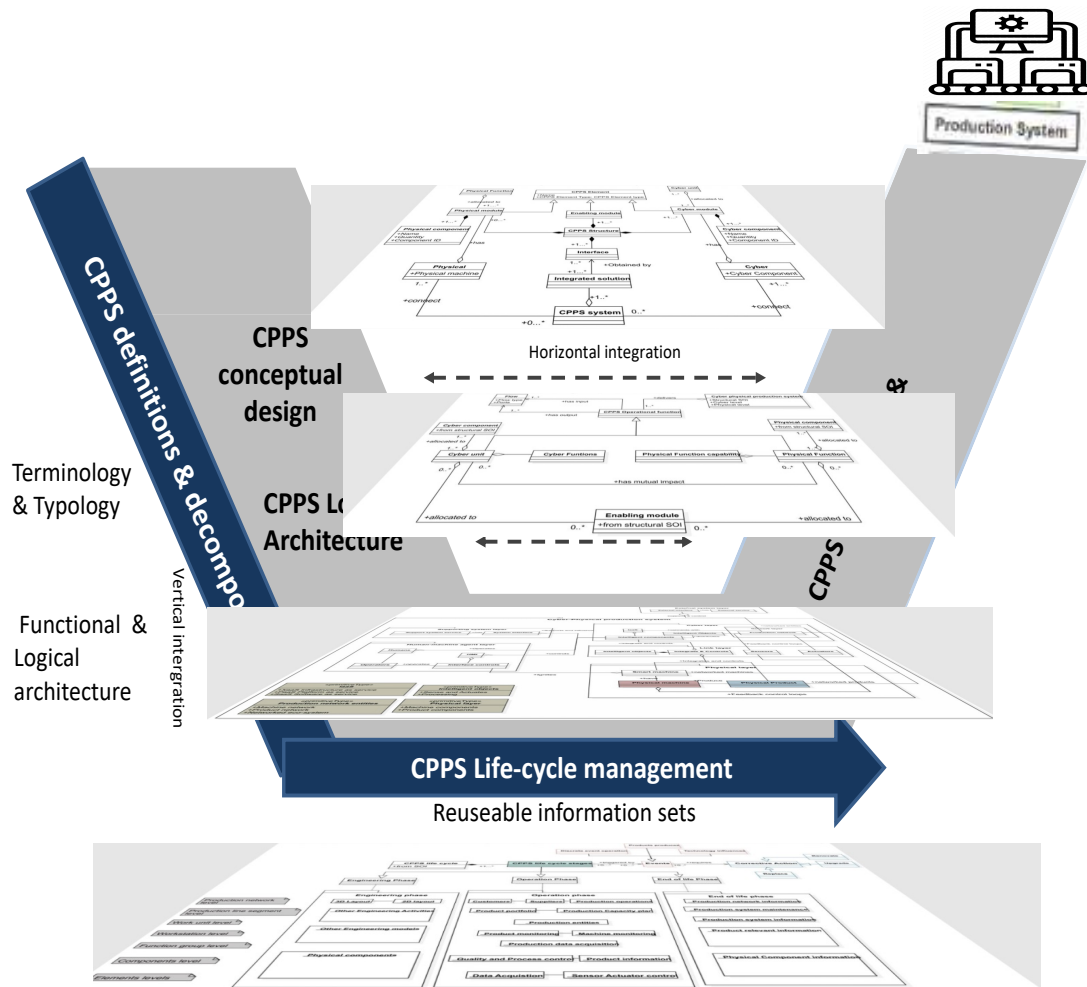


Figure 4.6: CPPS framework for SE process

It involves the basic building block of CPPS phenomenon and theory. It can be detailed to various layers of the system into its sub-systems, modules and their relations. The integrated solution's of life cycle can be detailed as “strategic engagement (system requirements), value proposition (system function), system integration (system logical & physical structure) and operational services phase”. Figure 4.6 architecture integration in SE process. It can detail to various layers of sub-systems to one as System of Interest, Enabling Systems and adds a transverse model describing the integration infrastructure. It can tailor to design and whole life cycle of CPPS.

## 4.1.5 Framework structure

Figure 4.10 shows the structure of the framework in the coming section.

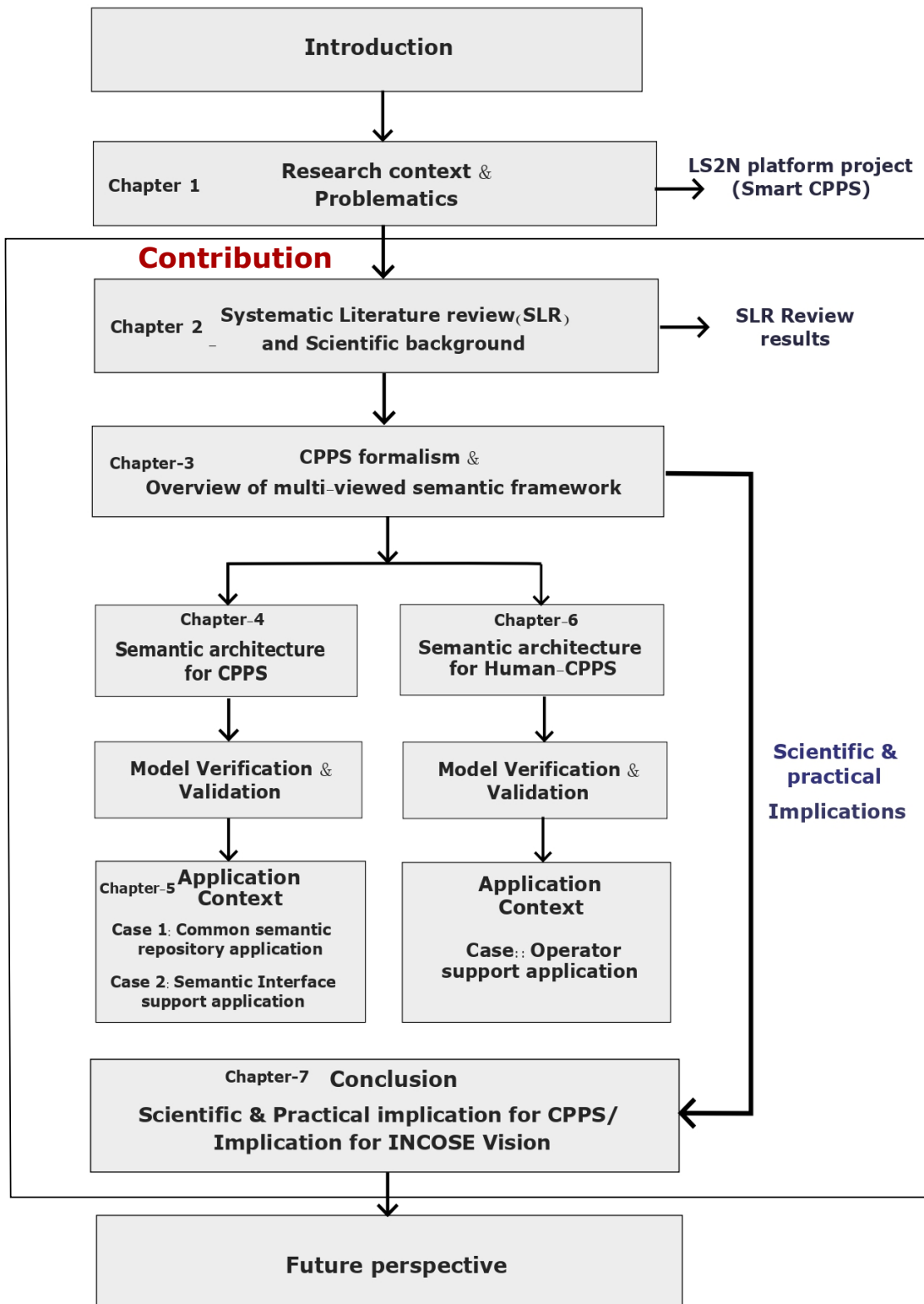


Figure 4.7: Framework structure

**Chapter 4** The semantic models for Cyber-physical production system (CPPS). Then, we underwent a scenario-based verification that determines the theories and assumptions underlying the conceptual architecture are consistent by representing different CPPS.

**Chapter 5** The proposed modular semantics is reused and instantiated to support two different independent application context. It presents two independent case study application to illustrate the adaptability of the proposed approach across different domains. 1) Design of repository construction. 2) Design of integrated interface.

**Chapter 6-** The semantic for human-Cyber-physical production system integration (CPPS) is constructed. It illustrates Human-CPPS interaction phenomenon. It establishes an explicit and formal representation of what the interactive human-CPPS are, which types of actions and finally, what human-CPPS itself is. Then, it is instantiated and used for an specific application context to design a human-operator configurator.

**Chapter 7-** The overall conclusion of thesis work is summarized. It describes the scientific and practical implication for CPPS. Then, the limitation and future perspective of the framework is summarized. It also describes the research outcome contributed to INCOSE (System engineering) community and leverage towards its vision.



## 4.2 Multi-viewed Semantic for CPPS notion

The first part of the framework is described in this section and answers the following research questions:

- **RQ-2 How can cyber-physical production system (CPPS) defined in a unified semantics through its life cycle?**
- **SQ-1 How can the cyber-physical production system (CPPS) entities defined in a unified semantics?**

To address the above research questions, first, we identify and classify the typology of CPPS notion. Then, the modular semantic is proposed which focus on the essential characteristics and provide a unique description. The first part of this section is dedicated in presenting the identified CPPS terminology and typology according to the system abstraction. Then, the semantic architecture is constructed for CPPS. It represents an abstraction of the system, focusing on the system commonality, essential characteristics and its relationships. It provides the semantics meaning, for CPPS. For describing the semantics, the “special words and condition”, expressions relating to a CPPS is used. The unified modeling language (UML) is used to construct the architecture. The following categories of knowledge are at the heart of the semantic architecture framework:

- First, we identified **CPPS terminology, typology**, which is comprehensive by including all the entities of interest.
- Then, classification of **CPPS domain property** which involves tangible, intangible element and its relation which highlights the ontological consideration of the system.
- The **CPPS business aspects** consider the business-oriented aspects.
- The **CPPS life cycle (Engineering phase, Operation phase and end of life phase)** considers the system in its lifecycle oriented context.
- The CPPS value creation product or production system consider its temporal view.

**Application context**-It is reused in 1) Common repository and 2) Collaborative interface management application.

The chapter describes as follows: Section 4.1 proposed semantic architecture for CPPS; Section 4.4 model Verification; Section 4.5 Conclusion and Synthesis.

### 4.2.1 CPPS- Terminology classified exploitation

In this section, we identified the Terminology and typology of the CPPS notion. It is a group of specialized words and respective meanings in a particular field, and also the study of such terms and their use. [Sager et al. [1997]]. It "labels or designating the concepts" particular to one or more subject fields or domains [Kockaert and Steurs [2015]]. In accordance with [Nickerson et al. [2009]], we chose to forgo the structure terminology by level of abstraction to guarantee that our output was clear and comprehensive by including all core entities of interest. [Sageder [2010]] [Wright and Budin [2001]] i.e., all terminology that have an immediate influence on the structure and functionality of CPPS. Thereby, we define this terminology dimension as a generic category that contains one or several entities

Based on our CPPS formalism, We categorize CPPS terminology in six basic dimensions. We categorize entities in **six basic entity dimensions**, which we formed during our CPPS formalism in the last chapter. We distinguish dimensions for cyber, link and physical entities. To account for interactions between these dimensions, additional dimensions are required. Hence, we identify the two interconnecting dimensions of Human-CPPS integration and cyber, physical infrastructure. In the following, we define the CPPS terms which used to establish the meaning to illustrate relations, which are the subject of our semantic models below.

#### 4.2.1.1 CPPS-Terminology exploitation

1) **Cyber layer-** The cyber layer refers to all the intangible elements. It encompasses the software that helps store data, analyze, process, collect, control, and actuate the information within the CPPS ecosystem. The Cyber layer acts as a central medium in the system that pushes each connected entity to enable the task. It connects people, product, and the production system.[Imkamp et al. [2016]] [Horváth and Gerritsen [2013]]

*Other authors may use-* “Cyber world”, “cyber stack”, “network world”, “Cyber technologies”, “Cyber components”, “Virtual world”, “Network world”, “Cyber world”, “Networked production”, “Cybersecurity”, etc [Kim et al. [2018]], [Akanmu et al. [2012]] [Holtewert et al. [2013]]

2) **Physical layer-** The Physical layer refers to all tangible elements that actively or passively participate in the production process to add value. The Physical Parts/layer that actively or passively participate in the production process to add value. In CPPS, the machine elements and physical product components are referred in the physical layer. It comprises

raw materials and machines, physical object that forms an integral part to produce a tangible asset. [Zhu et al. [2011]]

**Other authors may use** “Physical level”, “Physical layer”, “Physical Stack”, “Physical components”, “Real-world”, “Physical part”, “Physical product”, “Physical process”, “Physical control”, “Product components etc. [Weyrich et al. [2017]] [Akanmu et al. [2012]] [Imkamp et al. [2016]].

**3) Link space-** The link layer refers to all the elements connecting or intersecting two things, in particular to combine the cyber and physical world of production. It is an enabler and feedback control space in production system. It is a relaying of information between Physical Production and Cyber Components, interaction through cyber events [Hao and Xie [2009]] [Yao et al. [2019]] [Thiede et al. [2016]] [Akanmu et al. [2012]].

**Other authors may use-** it as “Feedback control space”, “Enabler”, “Linking components”, “Interfacing components”, “combined level”, “feedback control”, “sensing and actuating”, “Link level”, etc. [Kuehnle [2014]] [Liu et al. [2018]]

**4) Human-CPPS integration layer-** The Human-CPPS integration layer refers to the layer refers to the elements that enable operators to manage industrial and process control machinery via a computer-based user interface. From the current developments, the human-machine agents feature a component of a certain device, or software application that enables humans to engage and interact with machines. [Darwish and Hassanien [2018]] [Becker and Stern [2016]].

In currently developed systems, there is a need for human intervention to make decisions. We define this layer to encompass the human in the loop with production entities. [Wang et al. [2008]] There are three different modes of operation where the interaction between humans and the inner system (CPPS) occurs. An operator is an individual who operates the equipment or machine in the factory in order to perform a global task [Kagermann et al. [2013]].

**Other authors may use-** “Man-machine interaction (MMI)”, “CPPS-human interaction (CHI)” and “User- CPPS interface”. etc where the humans intervene to make informed decisions and perform production tasks” etc. [Weyrich et al. [2017]] [Becker and Stern [2016]] [Wang et al. [2008]]



5) **Cyber and physical infrastructure layer-** The Cyber and physical infrastructure layer refers to the layer with tangible and intangible parts that influenced directly or indirectly by CPPS like transportation, logistics, miscellaneous system, organization etc. directly or indirectly influencing the CPPS.[Yang et al. [2020]] [Möller and Vakilzadian [2016]]

It specifies the external elements that interact with the Cyber-physical production system. It connects with external systems such as other partner facility, ERP, transportation system and other enabling system directly or indirectly influencing the CPPS[Zamfirescu et al. [2014]] [Karnouskos and Colombo [2011]].

*Other authors may use-* transportation system, organization aspects, miscellaneous system etc. The CPPS is influenced directly or indirectly by other types of systems. [Yang et al. [2020]] [Möller and Vakilzadian [2016]]

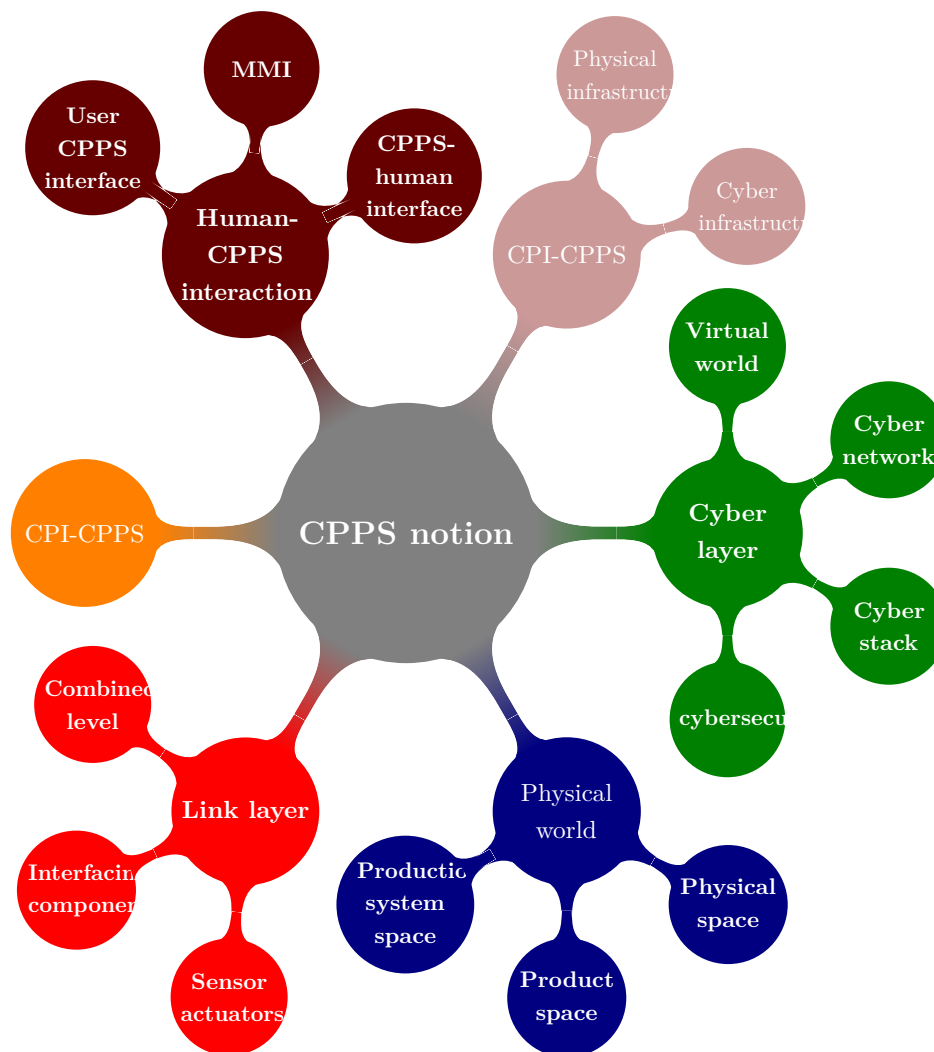


Figure. Basic CPPS Terminology

## 4.2.2 CPPS-Typology classifications and its entities

In this context, the CPPS Typology is carried out, It is the study of the systematic classification of the types of something according to their common characteristics [Nichols [2007]] [Thomas [2011]]. Table 4.8 shows the typology classification. Based on our CPPS formalism, We categorize CPPS terminology into six basic dimensions.

We categorize entities in **six basic entity dimensions**, which we formed during our CPPS formalism in the last chapter. It illustrates the two different lanes of granularity, i.e., levels of abstraction 4.8. It classifies based on the immediate influence on the structure and functionality of CPPS. These abstraction levels are conceptualized as generic categories, which helps to identify the entities of CPPS involved in each level [Garcia and Calantone [2002]]. The first lanes specify the abstract dimensions of CPPS.

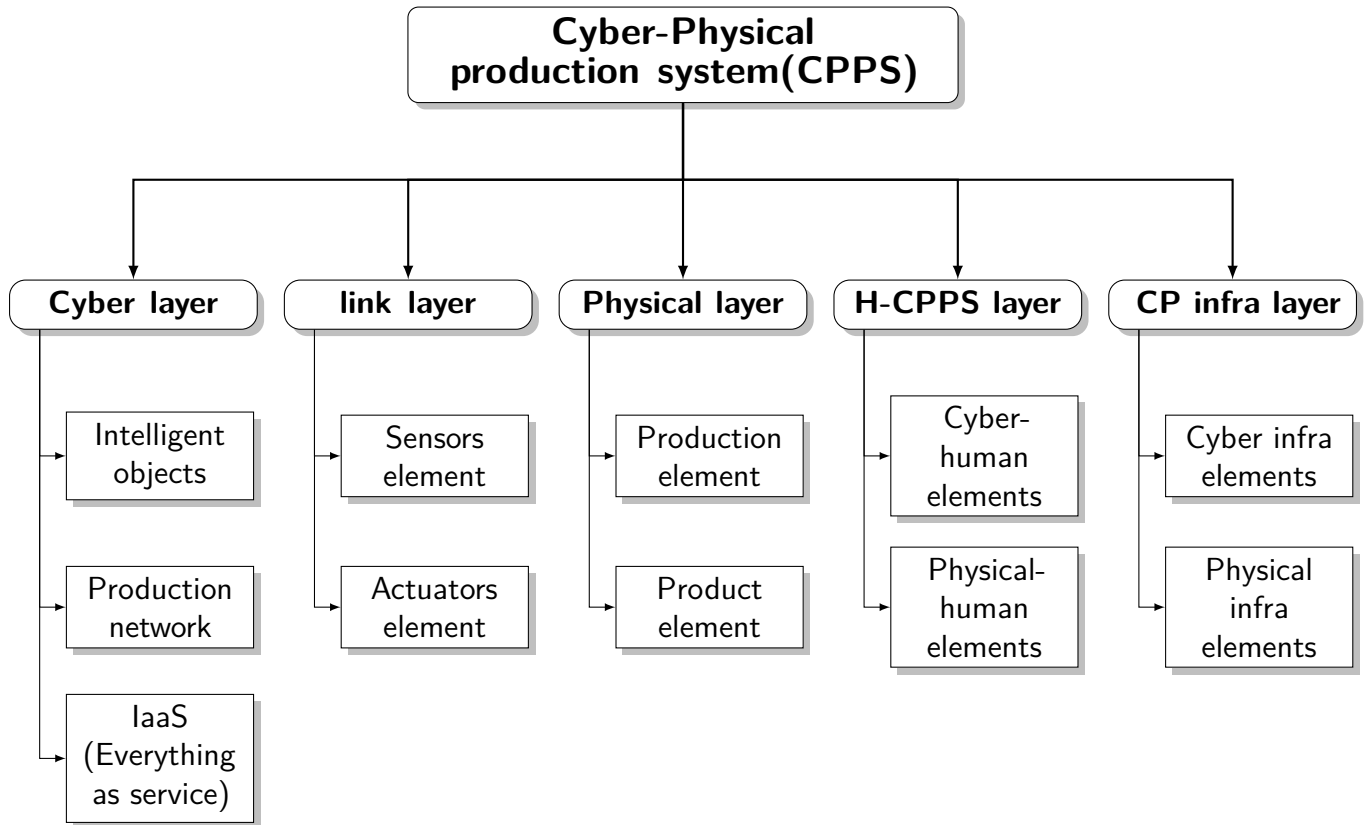


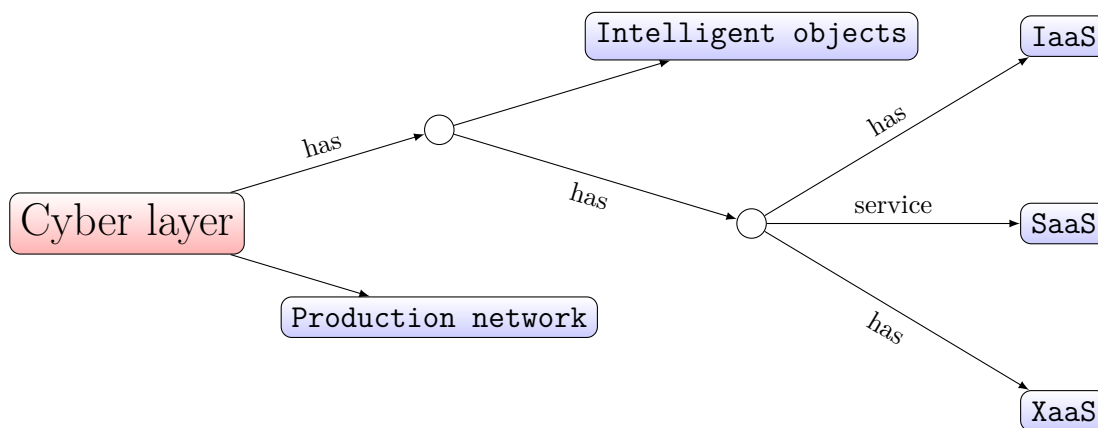
Figure 4.8: CPPS Typology core classifications

The second lane presents relevant entities for each dimension. Entities in different lanes are connected within a relationship, moving from specific to general terms. Thereby, we define an entity dimension as a generic category that contains one or several entities. It is a systematic classification of the core entities in each abstraction.[SA and da Cunha [2021]]

## 1) Cyber layer

*It refers to all the intangible elements. It encompasses the software that helps store data, analyze, process, collect, control, and actuate the information within the CPPS ecosystem.* [Imkamp et al. [2016]] [Horváth and Gerritsen [2013]]

The following definition formally defines a semantic annotation. Formally, the set of relationships between an element of the set of electronic resources and an element of the ontology. The semantic annotations of the **Cyber layer: C** as follows. The set of ontology that brings some meaning to any annotated element.



**Intelligent object-** We define “**intelligent object**” refers to all software system that makes its pre-cause in its capabilities. It controls, and adapts its environments concerning the operator’s need. It acts autonomously with humans [Ribeiro [2017]] [Shi et al. [2011]].

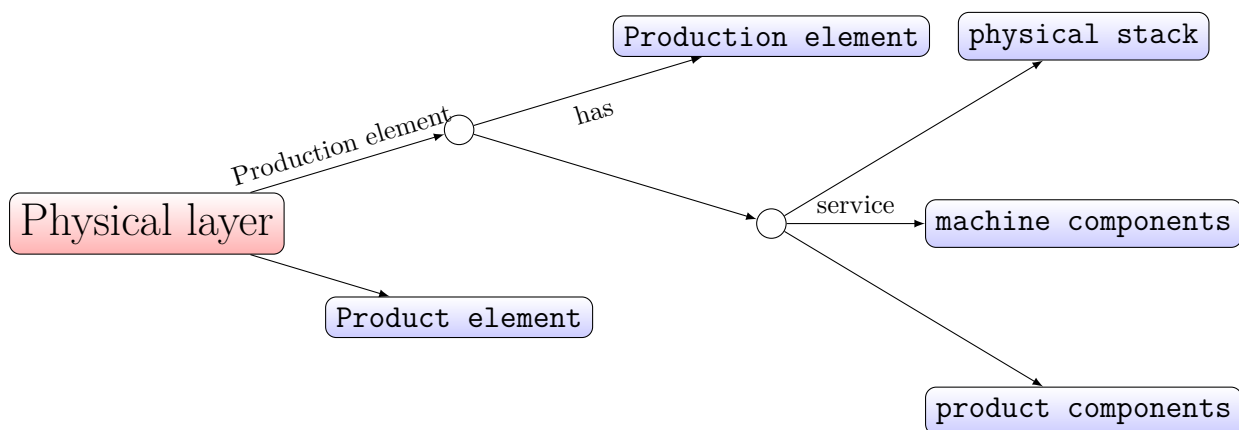
**Production Network-** We define “**Production Network**” defines the networking of hardware and software components of the system. It communicates between the product, production and people in the eco-system. [Imkamp et al. [2016]] [Gaham et al. [2015]].

**IaaS-** We define “**IaaS**” (**Infrastructure as a service**) provides services, stores, access and controls through the internet to the system. The main services offered are SaaS, PaaS, XaaS in the Sharing services in the ecosystem. [Darwish and Hassanien [2018]].

## 2) Physical layer

*It refers to all tangible elements that actively or passively participate in the production process to add value. The Physical Parts/layer refers to all tangible components that actively or passively participate in the production process to add value. [Zhu et al. [2011]]*

The following definition formally defines a semantic annotation. Formally, the set of relationships between an element of the set of electronic resources and an element of the ontology set. The semantic annotations of the **Physical layer: P** as described as follows.



**Production element-** We define a “**Production element**” refers to tangible elements that actively or passively participate in the production process to add value. In CPPS, the **machine elements** are referred to as the production element. [Dictionary [2018]]

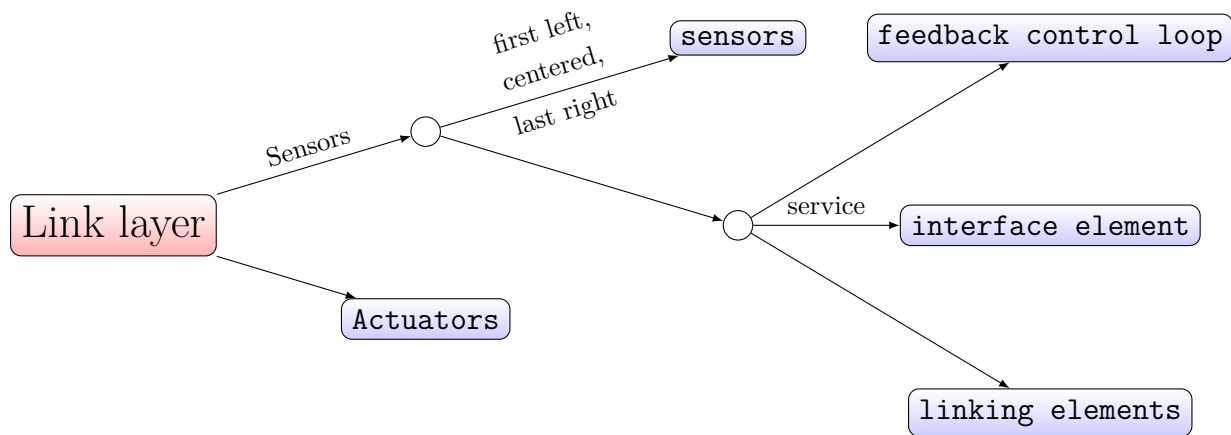
**Product element** - We define a “**Product element**” refers to raw materials, finished products in CPPS ecosystem. It is processed or unprocessed substances which form an the integral part of every tangible asset. [Glatt and Aurich [2019]] [Gronau et al. [2016]].

The terms used in place of Machine elements are machine, machinery, and physical equipment. It is used to refer to production machines(e.g., machines to transform or assemble raw material into finished products). The production elements represent the overall production system tangible asset [Wang et al. [2008]] [Darwish and Hassanien [2018]]. It actively or passively participate in the production process to add value. Similar terms used in place of Product elements are product and manufactured product [Gaham et al. [2015]].

### 3) Link layer

*It refers to all the elements connecting or intersecting two things, in particular to combine the cyber and physical world of production. It is an enabler and feedback control space in production system.* [Hao and Xie [2009]] [Yao et al. [2019]]

The following definition formally defines a semantic annotation. The semantic annotations of the **Link layer**: **L**. The set of ontology that bring some meaning to any annotated element in the layer.



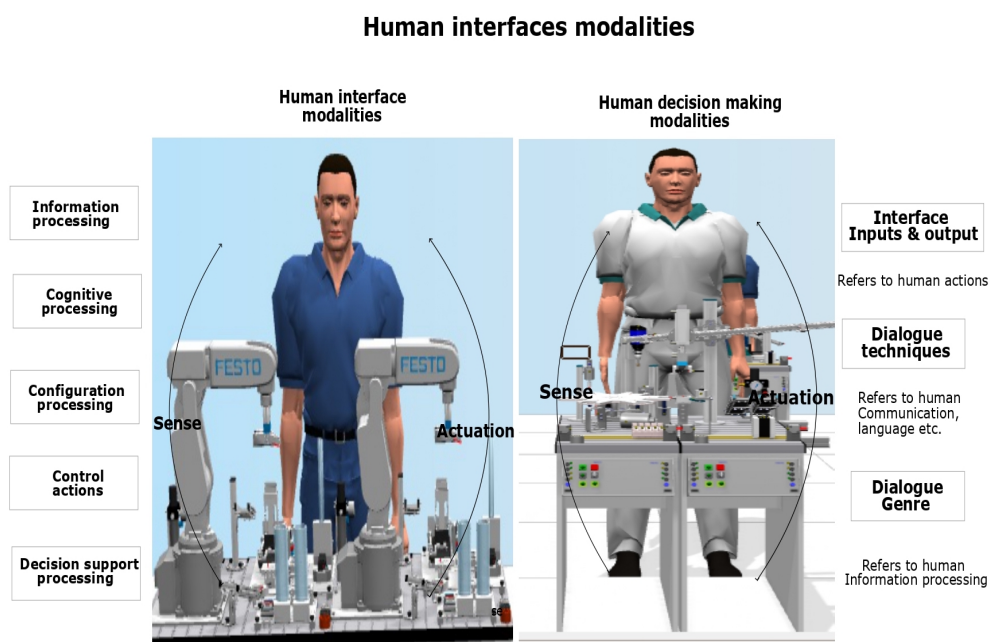
**Sensor and Actuators-** We define a **Sensor** and **Actuators** as an entity that observes system states and changes in the physical environment, and transforms the gathered within the physical production environment [Vogel-Heuser et al. [2014]]

The feedback loop is a common and powerful to take the system output into consideration, which enables the system to adjust its performance to meet a desired output response. It is a feedback control loop of cyber and physical layer has the networking communication through sensors and actuators [Hao and Xie [2009]]. The elements connecting or intersecting two things, in particular to combine the real and virtual world of production. It can integrate Sensors and Actuator using its Production Component and networking capabilities through a connection of the Production elements to the CPPS Infrastructure [Akyildiz and Kasimoglu [2004]] [Zhang et al. [2018]]. It is information relation between Physical Production and Cyber elements. [Akanmu et al. [2012]].

#### 4) Human-CPPS integration layer

*It refers to the layer that enables humans to manage industrial and process control machinery via a Human-CPPS interface. Such interaction comprises collaborative factory work and the application of smart assistance systems with multimodal interfaces. [Darwish and Hassanién [2018]]*

The semantic annotations that illustrate the link layer: **HCPPS**. Formally, it represents the set of relationships between an HCPPS element of the ontology set as follows:



**Figure 4.9:** human-cpps integration

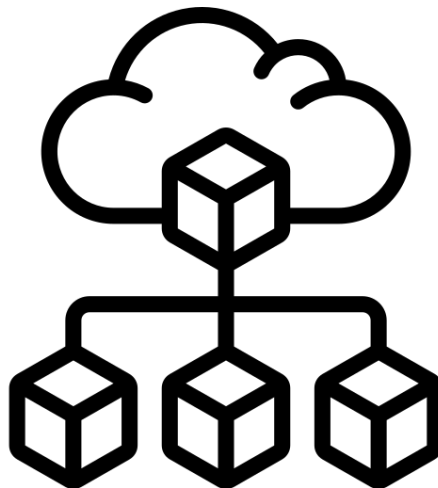
**Human-Cyber elements-** We define interact with the CPPS's inner system. It translate either human input information into signals for the CPPS inner system. It interact with the individuals. [Dworschak and Zaiser [2014]] [Bitsch [2022]]

**Human-Physical elements-** We define the CPPS's inner system. It translates either human input information into signals for the CPPS inner system. It comprises factory workers on a specific task and their applications with machine agents [Dworschak and Zaiser [2014]] [Bitsch [2022]] [Pinzone et al. [2018]].

## 5) Cyber and physical infrastructure

*It refers to the layer with tangible and intangible parts that influenced directly or indirectly by CPPS like transportation, logistics, miscellaneous system, organization etc. It specifies the external elements that interact with the Cyber-physical production system. It connects with external system such as other partner facilities, ERP, transportation system and other Enabling system. [Yang et al. [2020]] [Möller and Vakilzadian [2016]]*

The following definition formally defines a semantic annotation: The semantic annotations of the **Cyber and Physical infrastructure layer: CPI**. The semantic annotation model for the cyber and physical infrastructure is a tuple  $SA := (RA, CA, PA)$  where: **RA**: set of resources; **CA**: set of concept names defined in ontology ( $CA \subseteq RA$ ); **PA**: set of property names defined in ontology.



**Figure 4.10:** Cyber and physical infrastructure

**Cyber infra elements:** We define a “cyber infra elements” who we consider to be an integral part of CPPS, observe and control the production’s operating systems in order to guarantee objectives. [Zamfirescu et al. [2014]] [Karnouskos and Colombo [2011]]

**Physical infra elements:** We define a **Physical infra elements** the transportation, miscellaneous system etc. which influences directly or indirectly the CPPS. The abstract level is the supplement from the current development inside the CPPS ecosystem [Alur [2015]] [Mordinyi and Biffi [2015]].



### 4.2.3 Overview of multi-viewed mechanism and specification

From the identified topology and their classification of involved entities in CPPS. The semantic model for CPPS notion is constructed. In this section, the overview of multi-viewed mechanism and specification is illustrated [Kiewkanya and Muenchaisri [2011]]. The abstract schema which is composed of the tangible and intangible elements, the property, life cycle aspects, business aspects, enabling things, and all other things of interest. [Gero and Kannengiesser [2007]]. In this context, We contextualize the multi-viewed model description. First, We specify the mechanism of the modeling procedure. [Karagiannis [2015]]. Then, the table ?? illustrate the overview of CPPS landscape environment. It illustrates the greater understanding of the “CPPS Landscape” by illustrating the multiple interdependent viewpoints that, all together, represent a system.

It shows the aim of study in the model, Object type and relationship cardinalities of the different viewpoint models. It provides a detailed description of each CPPS viewpoint relationship. Then, we specify the defined different CPPS viewpoint relationships on a static basis. Each viewpoint only covers those concepts that are necessary to separate the different concerns. Identifying and specifying a viewpoint relationships are a prerequisite to the design and implementation of consistency mechanisms. Therefore, in the following, we will specify the different CPPS viewpoint relationships in detail by applying the characterization introduced in [Peffer et al. [2007]]

- **Syntactic overlaps:** describe a model concept is represented in two different viewpoints by the same syntactic element. [Persson et al. [2013]] For CPPS, we identified syntactic overlaps in Fig. 4.11).
- **Orthogonal/Independent:** It is known that the views V1, V2 have no direct semantic relationship, i.e.  $S(V1) \perp S(V2)$ . It has an independent relation. For CPPS, we identified syntactic overlaps in Fig. 4.11).
- **Semantic overlaps:** describe a model concept represented in two different viewpoints and syntactic elements but the semantics of the two concepts overlap. [Persson et al. [2013]] In CPPS, we identified four semantic overlaps in Fig.4.11).
- **Refinement/Abstraction:** indicated as red dotted arrows describe a relationship between viewpoints where one viewpoint is a more abstract representation of the other. In CPPS, we identified two such overlaps in Fig.4.11).

Therefore, in the following, table 4.1 provides a detailed description of each CPPS

viewpoint relationship in Fig. 6. The description uses the notion of an overlapping concept. An OC refers to model elements that form part of two or more different viewpoints by either a syntactic or a semantic overlap. Then, the following description extends the multi-view modeling operations as introduced. It provides a comprehensive overview of the main multi-view modeling consistency operations designed in CPPS.

**Table 4.1:** Description of CPPS viewpoint relationships

Viewpoint relationship	Description
<b>Context</b>	It is a scheme of overall case under study for CPPS notion $V_c$
<b>Terminology</b>	It is a comprehensive by including all entities of interest, i.e., all terminology of CPPS $V_T$
<b>Property</b>	It defines an entity, components involved together and interact in a set of rules to form a unified whole system $V_p$
<b>Business Process</b>	It describes a set of related and collaborative activities that produce a specific service or product $V_{BP}$
<b>Life cycle</b>	The CPPS life cycle is composed of different phases which includes system development phase, Operation phase and End of life phases artifacts $V_{LF}$
<b>Value creation</b>	The value creation involves the immediate influence on the structure and functionality of CPPS Artifact information $V_c$

- **Decomposition(Op1)** All models are a detailed decomposition of each CPPS  $M_{CPPS}$  property. It provides a more detailed description of subsystem and component level in Fig. 4.12, 4.13, 4.14
- **Extension(Op2):** All models are detailed to some syntactic overlap relationships in Fig. 4.12, 4.13, 4.14. With this operation, a new view is created by extending an existing view with additional syntactic concepts.
- **Reuse (Op3):** All models refer to some syntactic and/or semantic overlap relationships in Fig. 4.12, 4.13, 4.14. With this operation, a new view is created by reusing one or several syntactic and/or semantic concepts from one or more existing views.
- **Merging (Op4):** All models are referred to some syntactic overlap in Fig. 4.12, 4.13, 4.14.

#### 4.2.4 CPPS domain production and product aspects model

According to ISO/IEC/IEEE15288, a system element is “a discrete part of a system that can be implemented to fulfill design properties.[Heras-Saizarbitoria and Boiral [2013]](e.g., operator instructions), that facilities, materials, and naturally occurring entities (e.g., water, organisms, and minerals), or any combination of these” (SEBOK1.8 2017)[Henshaw].

In this context, the CPPS domain property is defined, which involves together and interact in a set of rules to form a unified whole system[Walden et al. [2015]]. It encompasses measurable characteristics that require additional instrumentation to measure them. [Dickerson et al. [2004]]. Figure 4.11 shows the identified domain property of CPPS. It illustrates the CPPS property abstract concept. It characterizes the domain contents (including the rationale) of inclusion or exclusion of a system view. It consists of modular standard unit (cyber and physical unit) properties  $M_x(\text{CPPS})$ . Let the properties  $M_x(\text{CPPS}) = \text{set of models of the system of interest as it is modeled (system properties)}$ . The different viewpoints are composed as follows: It is expressed as: 4.3 and 5.1.

$$M_x\text{CPPS} = \text{Domain Production system elements} \quad (4.1)$$

$$\mathbf{M}(\text{CPPS}) = \mathbf{MS}(\text{cpps}) \cup \mathbf{MB}(\text{cpps}) \cup \mathbf{MF}(\text{cpps}) \cup \mathbf{MP}(\text{cpps}) \cup \mathbf{MOV}(\text{cpps}) \quad (4.2)$$

- $M_S\text{CPPS}$  = where the System of Interest definition as a whole in System viewpoint.  
It highlights the ontological consideration of the system.
- $M_S\text{CPPS}$  = where system view.
- $M_R\text{CPPS}$  = where the Requirements, usages, Values, and Properties viewpoint
- $M_B\text{CPPS}$  = where the Behavioral viewpoint in its temporal behavior
- $M_F\text{CPPS}$  = where the Functional architectures' viewpoint
- $M_I\text{CPPS}$  = where the interface viewpoint in its temporal interface.
- $M_P\text{PCPPS}$  = where the Product and production system viewpoint.

The viewpoints are described of both production and product domain. These properties are grouped together to fulfill the system objective". As a result of unified CPPS model, the involved categories and their relationship is identified and exploited.

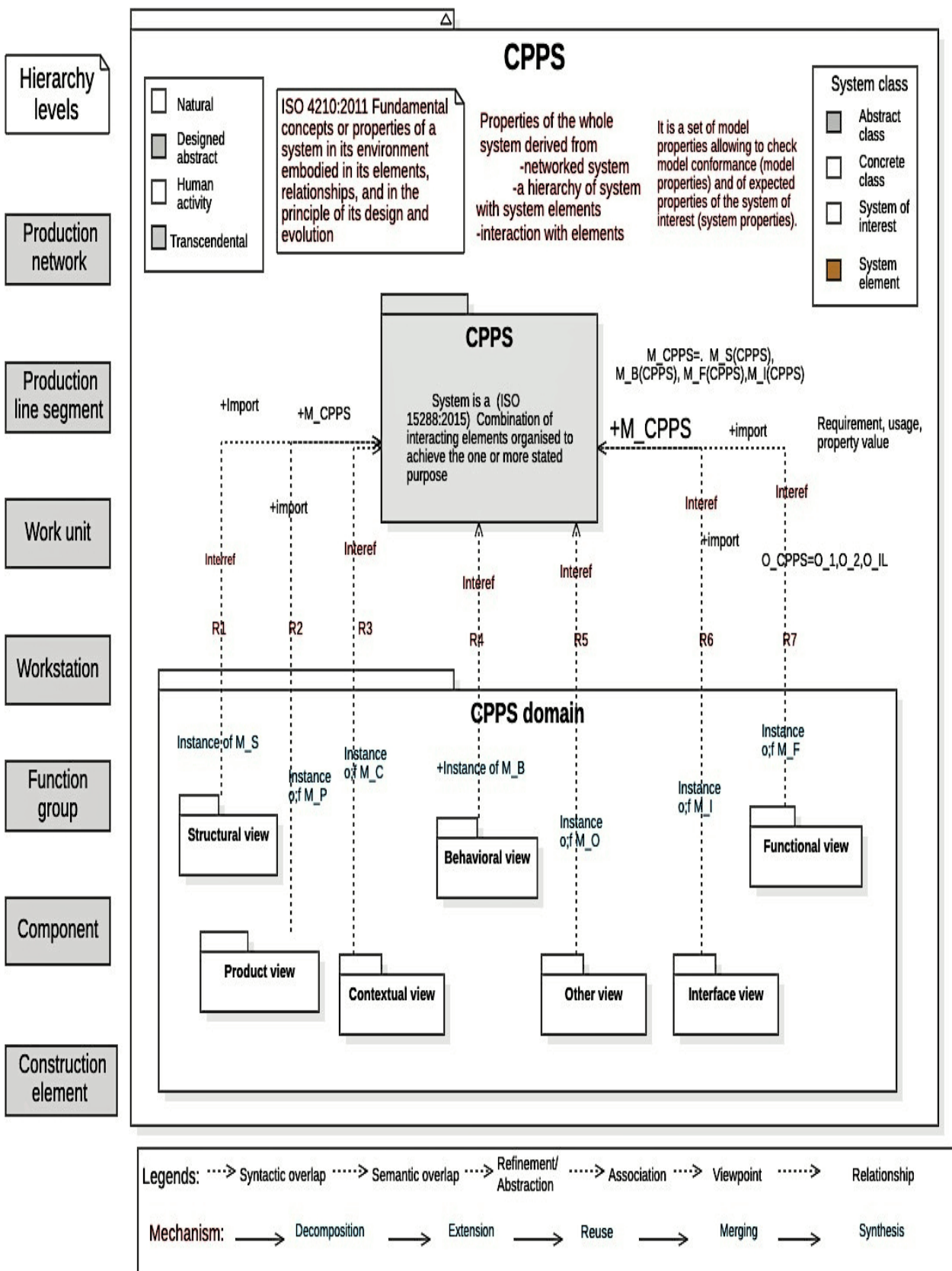


Figure 4.11: CPPS domain property aspects

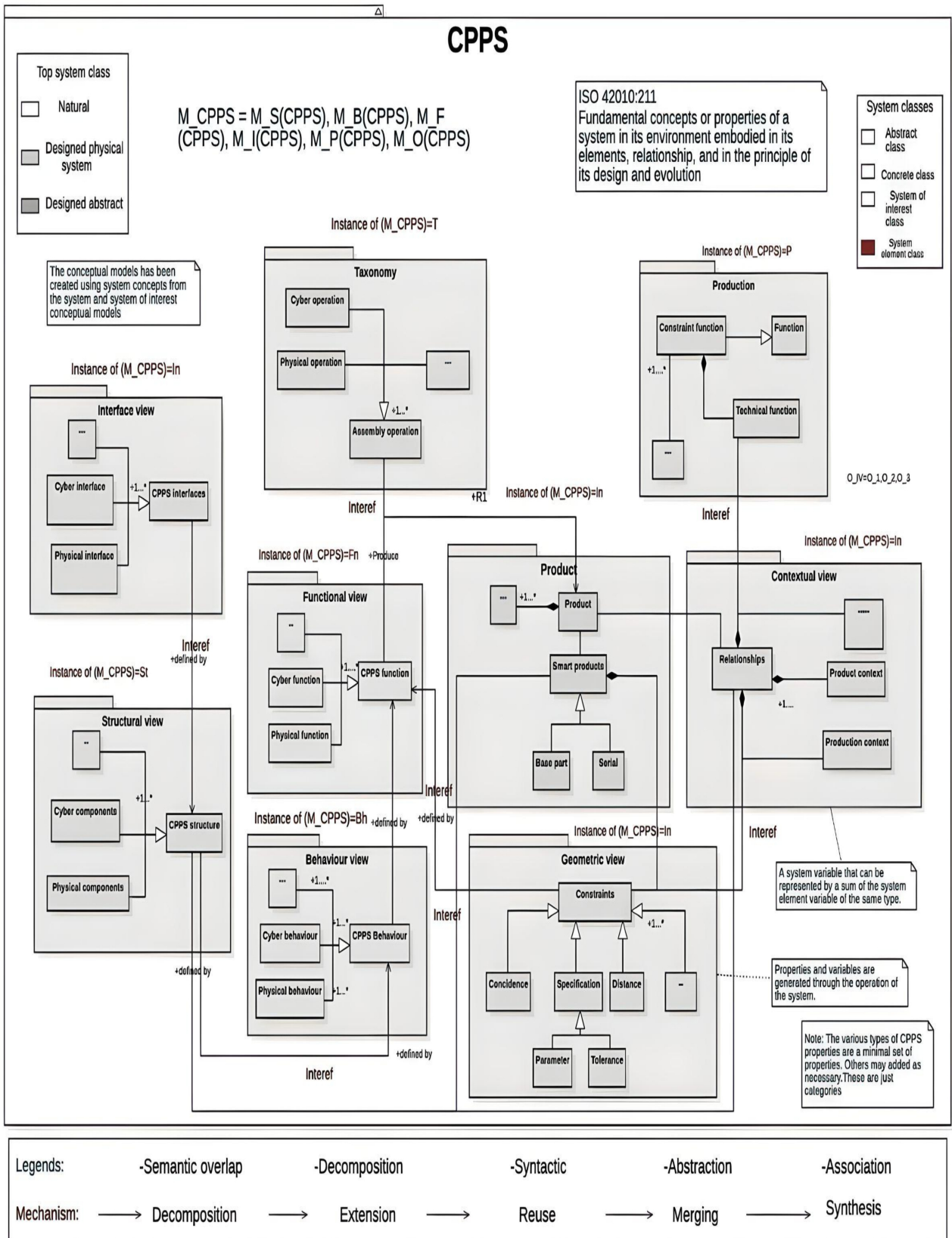


Figure 4.12: CPPS property interrelations views

4.2.5 CPPS Business process model

The **CPPS business process (ISO/IEC 19510:2013)** is a collection of structured activities or tasks in a specific sequence to produce a product (serves a particular business goal) for a customer [Rudtsch et al. [2014]]. It begins with a mission objective and ends with achievement of the business objective, providing a result of customer product.[Von Rosing et al. [2014]]. In this context, alignment or realignment of resources (financial, technological and physical) is vital to emerging the dynamic capabilities [Huikkola et al. [2016]] and increasing the competitive advantage of the firm [Sirmon et al. [2007]].

Processes in CPPS are knowledge-intensive which means they would be useful to improve the strategic capabilities if the company uses the important resources for the key stakeholders [Kohtamäki and Partanen [2016]]-which is to say they have interconnection. To proceed toward the system life cycle stages, the business process is performed. The business process is expressed as follows:

$$M_{BPCPPS} = \text{Business process } MxCPPS, \tag{4.3}$$

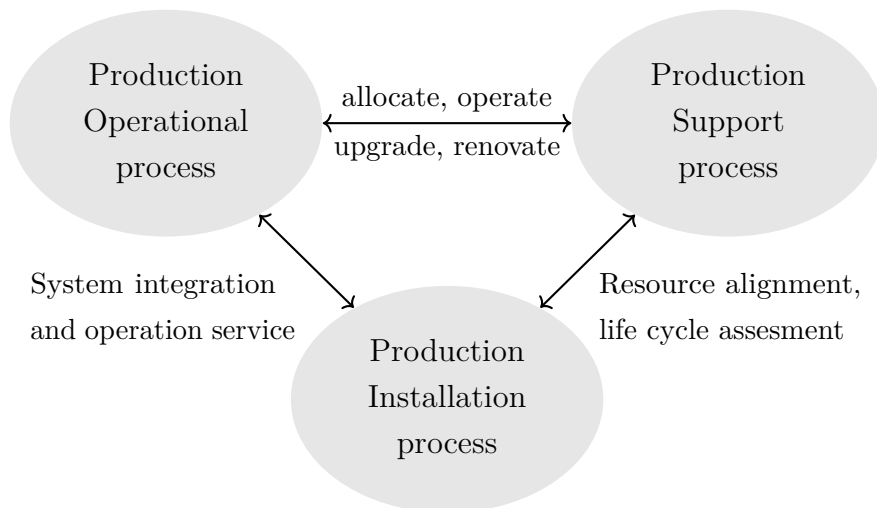


Figure 4.13 shows the unified CPPS business process model. In CPPS, business processes are considered as Enabling Systems. In the organization view, the class “business process” has different types of process which is defined as attributes such as “production installation process”, production “operational process” and “production support process” [Rudtsch et al. [2014]]. In CPPS, all business processes are considered as Enabling Systems. Four main categories of processes during the CPPS life cycle are distinguished as follows: 1.) CPPS creation process 2.) CPPS associated process 3.) CPPS operation process 4.) CPPS operation control process.



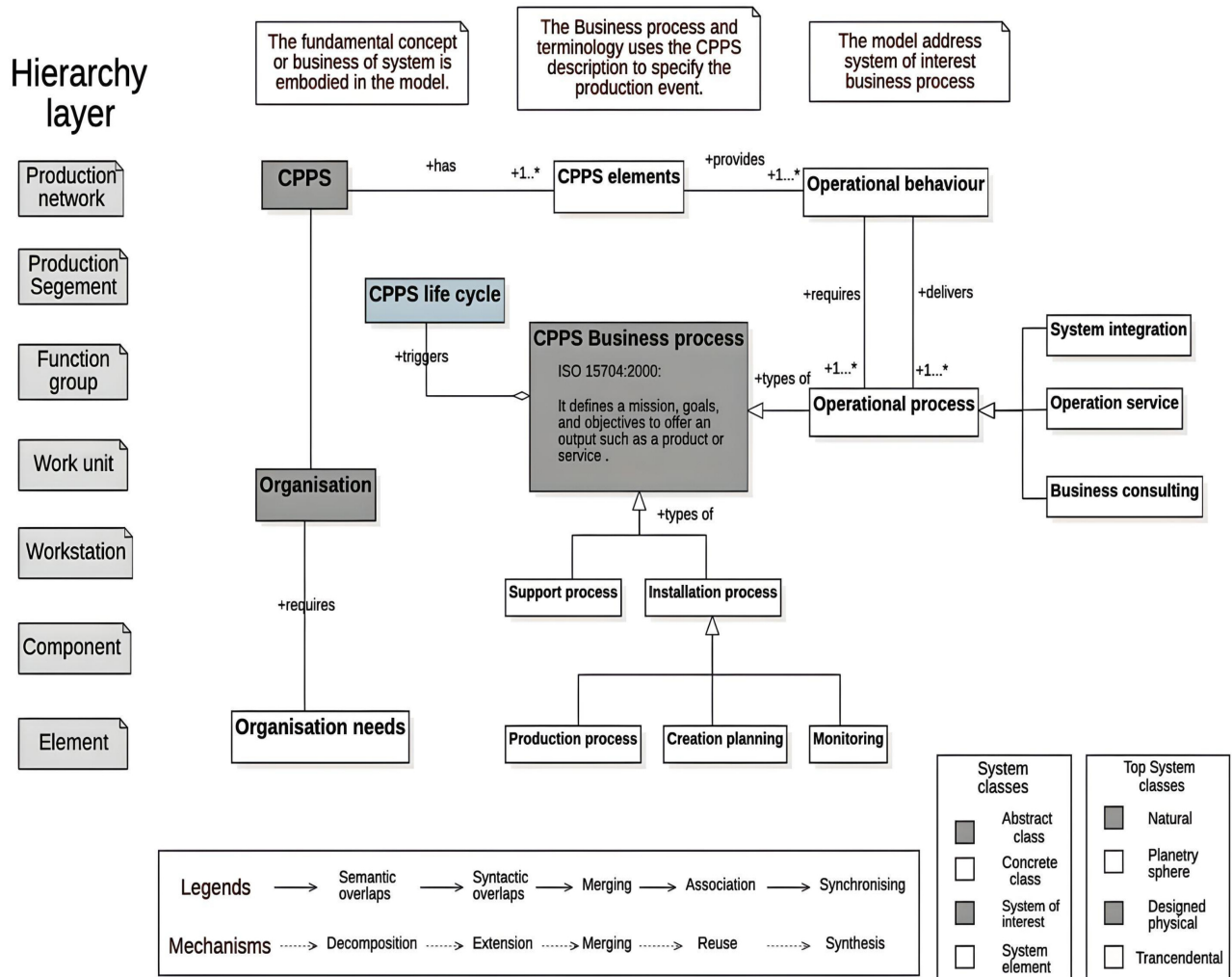


Figure 4.13: CPPS business process

Figure 4.13 shows the unified CPPS business process model. In CPPS, business processes are considered as Enabling Systems. The view of CPPS and business process model encompass as follows: In the CPPS view, the class “CPPS component” is a entity which has a configuration (class “CPPS Configuration”) that provides the CPPS behavior (class "CPPS behavior"). This one or more elemental behavior forms a CPPS function (class "CPPS function") to deliver the system needs. The operational processes are the necessary process (installation process, operate, renovate, support etc) to set the CPPS in motion[[Huikkola et al. \[2016\]](#)].

The integrated match-making relation between the CPPS (class “configuration”, class “function”) and organization (class “operational process”) supports the repartition of structured tasks that are performed by the systems. As a result of the unified relationship model of organization and CPPS enriches, the possible integration flows at unified meta-level is identified and exploited.

#### 4.2.6 CPPS Life cycle artifact model

The **System life cycle stages** processes are defined based on **ISO/IEC 2001 (ISO/IEC 2001)**. [Sebok and Walters [2016]]. The **CPPS life cycle** is composed of different phases which includes **system development phase, Operation phase and End of life phases**. [Wu et al. [2020]][Harrison et al. [2021]]. It is essential to understand completely the life cycle of a production system, with its different phases and the dependencies among them.

Figure 4.2.6 shows the CPPS life cycle model. All other reusable life cycle artifact are shown, in the appendix section, to minimize the page size. For capturing the CPPS life cycle, we have followed the technique [Lüder et al. [2017b]] and enhanced and reuse the figures from [Lüder et al. [2017b]]. Based on the author's recommendation, to identify the other levels of entity. We followed their recommendation and identified other artifacts. [Lüder et al. [2017c]]. We advanced their research and went ahead on identifying other information sets around life cycle from requirement information sets to technical sets to management and planning sets etc.

Based on stages of research process, the object-oriented information sets along the different CPPS life cycle phase are identified. It includes the design and development phase, operation, phase and the end-of-life phase which is described as follows:

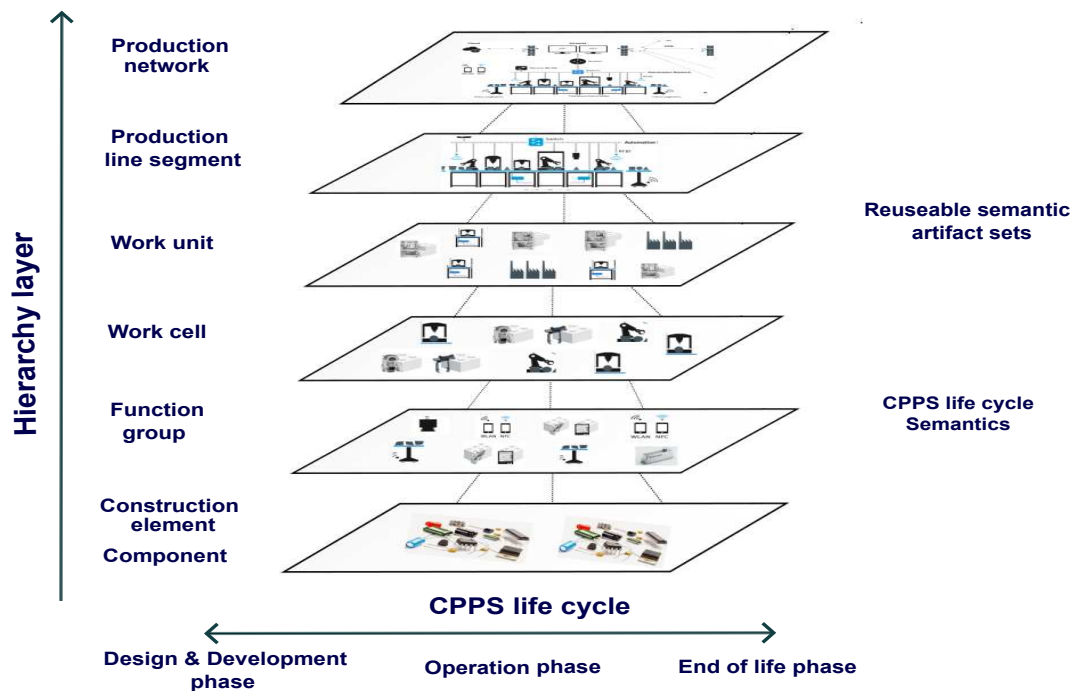


Figure 4.14: CPPS Life-cycle (figure enhanced from [Lüder et al. [2017b]])







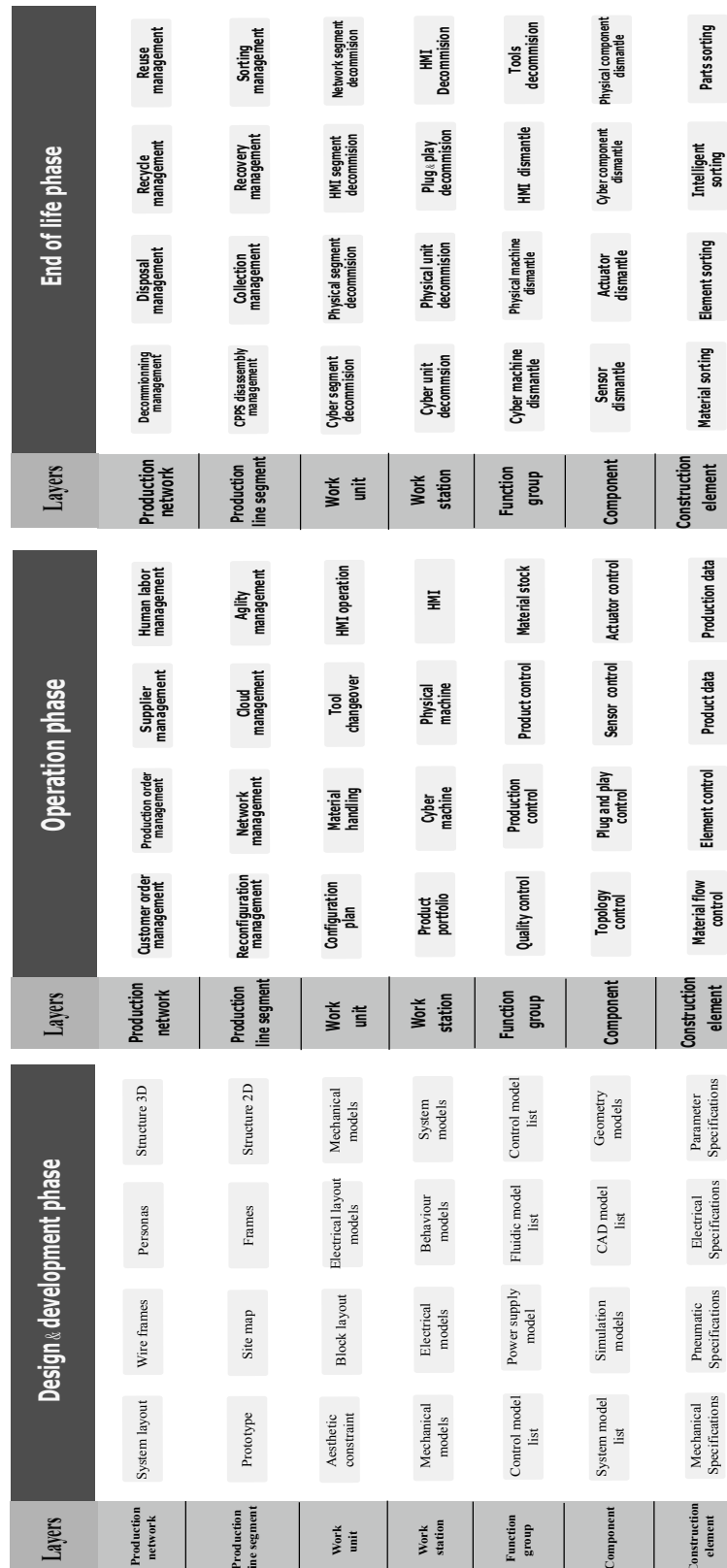


Figure 4.17: CPPS life cycle (figure enhanced from [Lüder et al. [2017b]])

### 4.2.7.2 CPPS Operation Phase -

The **CPPS Operation phase** covers the complete period of the use of the production system to produce the products. Within this phase, CPPS operation artifact in the hierarchy level is identified. The identified process, determines the interrelated series of actions that is done for a particular purpose. It is controlled, monitored, and configured.

First, on one side of the spectrum, sensors and actuators need to be controlled in order to perform physical processes on field level. Examples of the production operation information set like client order management, production operation management and data management. Figure 4.2.6 (enhanced figure from [Lüder et al. [2017a]]) shows the artifact information set of operation phase. The Operation phase is identified and mapped to each hierarchy layers.

The information set activities include part numbers or primary properties of each part, that allow or prohibit certain configurations. The different tasks to be performed on each layer, the input, throughput and output information varies greatly. As a result, the artifacts used during production can also be a valuable input during the Operation and Maintenance Phase on reusable. It demonstrates that a single control decision may require information on numerous level, and artifacts can be used within and between different life cycle phases.

### 4.2.7.3 CPPS End of life Phase -

The **CPPS End of life phase covers** the period of complete removal or reuse of the production system. During this phase, it covers the period of the production system between the end of the production of the last product and the restoration of the so-called greenfield; It is the complete removal of the production system. It includes the dis-assembly, possibly completely or partially reused, and recycled.

During this phase, the production system is disassembled, possibly completely or partially reused, and/or recycled. The phase is identified as relevant and mapped to each hierarchy layer, which will result in a characterization of each layer of the hierarchical production system structure point of view.

Figure 4.2.6 (enhanced figure from [Lüder et al. [2017a]]) shows the main artifact information of end of life phase. It involves decommissioned, disassembled, removed, reused, recycled, and disposed to make for another production system, then, it is engineered to meet the changed requirements which come along with the demand of producing new products or a new product mix for the customers. As a result of unified life cycle artifact models, the main information required at layers and their description is identified and exploited in the different life cycle phases of a production system.

4.2.7.4 Summary

The information sets of different life cycle phase of CPPS is identified and exploited. It includes the mapping of information sets in hierarchy layers covers the information in the different life cycle phase of CPPS. As a result, the mapping of information sets of hierarchy layers are presented. This information sets can be used or reused both within and between different life cycle phases. Next section shows elemental value creation models of CPPS.

4.2.7 CPPS Value creation models

The CPPS Value creation models involve the other views of main interest, which have immediate influence on the structure and functionality of CPPS. It is comprehensive by including all the views of interest. We categorized to ensure the results are comprehensive by including all core entities of interest. It includes the triangle of (1) the product to be produced by (2) a production process executed on (3) a production system resource. etc. Figure 6.13 shows the value creation model of elemental synthesis of CPPS. All the individual artifact in appendix section. It is an elemental synthesis of main interest. Only the elemental synthesis is specified. It is formally specified as:

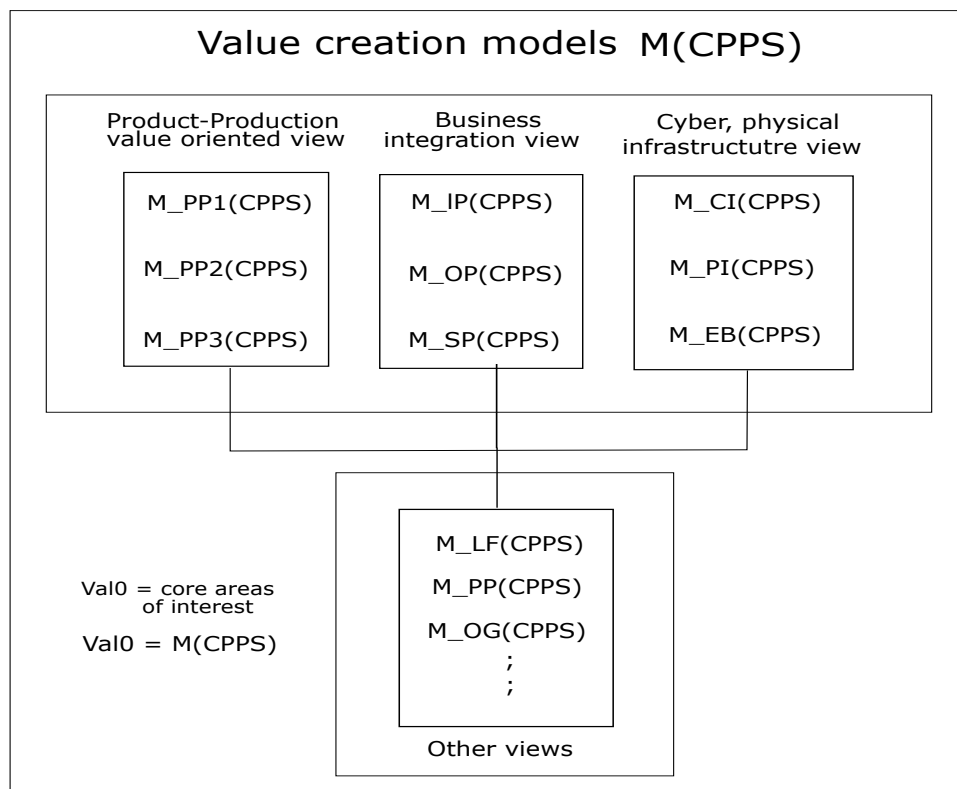


Figure 4.18: CPPS value creation elemental synthesis

### 4.2.8 Synthesis

From this work, the generic modular semantic model for CPPS is proposed. It is described as follows:

- First, We identified and classify the terminology, typology of CPPS. It is a systematic classification of the core entities in each abstraction level.
- Then, the modular semantic models is constructed which includes the CPPS system property: the business aspects; environment and boundary;
- The CPPS life cycle artifact, which includes the design, development, operation, and end of life phases. The artifacts' information are assigned on the different layers.

**Table 4.2:** Comparison of Existing and Our Proposed models

Criteria	# 12 [Sutcliffe [2014]]	# 15 [Sun et al. [2020]]	# 18 [Ansari et al. [2018]]	# 19 [Şahinel et al. [2021]]	Our CPPS models
Comprehensive Domain coverage	✓	✓		✓	✓
Addressing CPPS phenomenon	✓		✓		✓
Modular	✓		✓		
Formally rigorous		✓			✓
Taxonomic relations		✓			✓
Reusing unified semantics		✓			✓

Table 6.5 presents an overview of the semantics considering the criteria used in the study. In the table, we marked all semantics in the sense that each of them covers the domain portion it is intended to. As for being formally rigorous, we marked the ones that are represented in some degree of formalism, even if not very rigorous. It ensures the results are comprehensive by including all core entities of interest. It is based on the immediate influence on the structure and functionality of CPPS. Next section, we illustrate verification and validation of model. Next section, we illustrate the specification of model operation and algorithms.

### 4.3 Formal specifications of models operation/algorithm

To illustrate the above proposed models, comprehensively and unambiguously. We introduce a formal specification for the model. Some assumptions are inspired from the FDMM formalism (Formalism for Describing Models) [Fill [2012]] [Fill et al. [2013]]. Similarly, as outlined in Sect. 4.1.1, the CPPS is composed of many viewpoints that are all tightly interconnected. The formal specification presented in the following covers only certain aspects of CPPS to show the expressive power of the formalism on the one hand while respecting the limited added value. The formal specifications involve the object and data types, together with their respective attributes, which are realized very efficiently. We describe the models in a mathematical way. In this way, the resulting formal descriptions can serve as input for the implementation of the models in an environment. In CPPS, a model has following parts:

$$M_{CPPS} = MT, domain \quad (4.4)$$

Thereby, the set comprises the model types which are specified:

$$M_{CPPS} = MT_1, MT_2, ..MT_m \quad (4.5)$$

All object types, data types, and attributes of the model types are parts of the sets OT, DT and A whereby object types may also exist independently of model types:

$$O^T = O_i^t, D_i^t, A_i^t \quad (4.6)$$

Similarly, the available objects of the CPPS viewpoint can be expressed in Equation 4.7:

$$O_{CPPS} = O, O, ..., O \quad (4.7)$$

Let  $OI_iV$  be the objects instances set of a view  $V_i$  which can be expressed by:4.8

$$O_{CPPS_iV} = OI1, OI2, ..., OIL \quad (4.8)$$

As outlined, CPPS is composed of a large number of viewpoints that are all tightly interconnected. The formal specification presented in the following covers only certain aspects of CPPS to show the expressive power of the formalism on the one hand while respecting the limited added value or showing the complete formal specification. We selected four core viewpoints of the CPPS model: Business Process, Property  $VP_{CPPS}$ . To conclude that, the



formal specification in these domains is illustrated. It can comprehensively make explicit the complete formal specification

### 4.3.1 Model formal specifications for operation

**Table 4.3:** Description of multi view modeling (MVM) operations

Operation	Description	OC	Relationship
<b>Decomposition</b>	It provides a more detailed description of the $M_{CPPS}$ concept	All $M_{CPPS}$ concept	R1-R7
<b>Extension</b>	It extends the Value concepts and provides more detailed description of the $M_{CPPS}$ concept	All $M_{CPPS}$ concept	R1-R7
<b>Reuse</b>	The model can reuses all $M_{CPPS}$ concepts in different modules from the existing concepts,	All $M_{CPPS}$ concept	R1-R7
<b>Merging</b>	The model has a merged operation between any property	All $M_{CPPS}$ concept	R1-R7
<b>Synthesis</b>	The model provides a synthesis view of the information about the Synchronization of $M_{CPPS}$ concept	All $M_{CPPS}$ concept	R1-R7
<b>Synchronization</b>	All $M_{CPPS}$ views keep consistent after any modification (i.e. create, edit or delete) on any overlapping concept	All $M_{CPPS}$ concept	R1-R7

In order to use the proposed models, in this section, we start with introducing the assumptions to present a formal description of proposed modeling operations. As outlined previously, each viewpoint can be represented by a set of objects which is expressed. Based on these assumptions, we will constrain our focus by exemplifying the formal specification of selected CPPS operations on views that play a central role in enabling consistency.

Based on the defined viewpoint relationships and the CPPS model, operations emphasize the CPPS mechanisms and algorithms. Table 4.3 provides a comprehensive overview of the main multi-view model operations designed for CPPS. It will show how these operations ensure consistency in the event. As outlined previously, We will show how these standard units can be reused by selecting those features required in a target system. Each viewpoint can be represented by views, then each view can also specify by a set of objects:

We will describe the instantiation of a metamodel. The instantiation of a metamodel essentially describes the mapping of the model types, object types, and data types to model instances, objects, and data values together with a set of triples. One-to One mapping from model types to the power set of model instances:

$$\mathfrak{t}mt, \mathfrak{t}O, \mathfrak{t}D, T, \tag{4.9}$$

Based on these assumptions, we will constrain our focus by exemplifying the formal specification of selected CPPS operations on views that play a central role in enabling consistency. We will show how these modeling operations can ensure consistency in the event of: i) generation of a "event" (**Algorithm 1**); ii) an attribute value change (**Algorithm 2**); and iii) an instance deletion (**Algorithm 3**); We will show how these operations ensure consistency in the event in table 4.3

**Algorithm 1** represents the formal specification of the  $V_{CPPS}$  using the Reuse operation (Op3). First, the algorithm creates an empty  $V_{CPPS}$  view and then retrieves all objects of the corresponding  $V_{CPPS}$ . Then, for each object, a new instance of the same type. The algorithm can assign them in a final step to the corresponding objects in the  $V_{CPPS}$ .

**Algorithm 2** describes how consistency is ensured in the event of an attribute value change of an overlapping concept. More particularly, the algorithm shows, how changing the value of an instance in one view triggers change propagation in other affected CPPS. The deletion provides a instance of the overall consistency of the CPPS views.

---

**Algorithm 1 All MVM  $V_{CPPS} \leftarrow O_{P6}V_{CPPS}$  for use case**

---

- 1: **Input**
  - 2: Instated model
  - 3: Model instance ID
  - 4: /Synchronization list of selected model/  
Detailed description in model
  - 5: Synchro in all selected CPPS views
  - 6: **Output**
  - 7: Corresponding instance
  - 8: **Begin**
  - 9: For each view in  $V_{CPPS}$
  - 10: Instance(instance value)
  - 11:
  - 12: Prerequisite overarching model
  - 13: Types of operation in overarching model
  - 14: Decompose, reuse, merge, synthesis, sync
  - 15: update synchro list
  - 16: Instiate content relation
  - 17: Finish overarching model for use-case  
or application context
  - 18: **End**
- 

---

**Algorithm 2 All MVM  $V_{CPPS} \leftarrow O_{P6}V_{CPPS}$  for app context**

---

- 1: **Input**
  - 2: Model instance id
  - 3: Synchronization list of selected model
  - 4: Detailed description in model
  - 5: **Output**
  - 6: Corresponding instance
  - 7: **Begin**
  - 8: **Each view in  $V_{CPPS}$**
  - 9:
  - 10: Instance(instance value)
  - 11: Prerequisite overarching model
  - 12: Types of operation in overarching
  - 13: Decompose, reuse, merge, synthesis  
**Else**
  - 14: Extension, projection, composition
  - 15: update synchro list
  - 16: Instiate content relation
  - 17: Finish overarching model for use-case  
or application context
  - 18: **End**
- 

---

**Algorithm 3 Automated new instance value generation  $V_{CPPS}$**

---

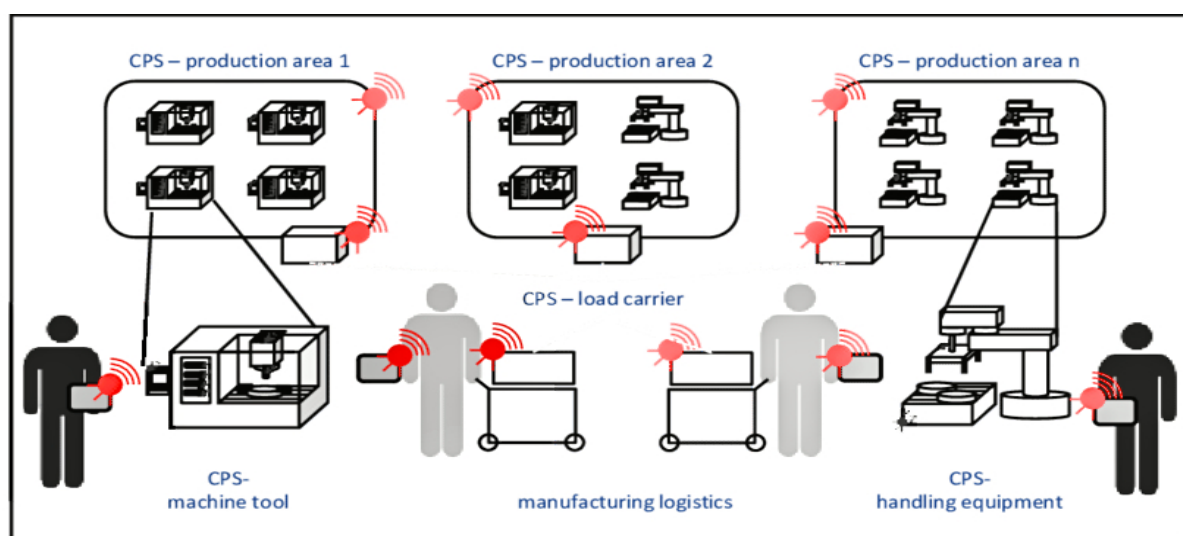
- 1: **Inputs:**
  - 2: Instantiation on scenarios
  - 3: **Output:**
  - 4: **Begin**
  - 5: Prerequisite overarching model.
  - 6: Types of operation in overarching model.
  - 7: Decompose, reuse, merge, synthesis, sync.
  - 8: **Else**
  - 9: Extension, projection, composition, extension
  - 10: update synchro list
  - 11: Instiate content relation
  - 12: Finish overarching model for use-case or application context
  - 13: **End**
-

## 4.4 Model Verification and Validation- algorithm

In this section, the Verification and Validation activities were performed, considering the proposed semantic models. The model was evaluated by using two evaluation approaches: assessment by human approach and data-driven approach, [Brank et al. [2005]]. First, we performed a verification activity by means of expert judgment and real-world situations, in which we checked if the concepts, relations and axioms defined in the model can answer the questions.

In the second, a semantic model is validated by instantiating the two different types of CPPS, in which the concepts and relations are extracted from real cases. It checks “whether theories and assumptions underlying the semantic models are consistent, completeness, and causal relationships are “reasonable” for the intended purpose of the model” [Panasiuk et al. [2019]] [Sun et al. [2005]]. It also enhances the represented model have structure, logic, and causal relationships that are “reasonable” for the intended purpose of the model. [Sargent [2010]] [Engels et al. [2003]].

As we explained in our methodological approach, to achieve the CPPS current version. We performed two cycles involving development and evaluation [Brank et al. [2005]]. Each cycle resulted in a version of the model, which improved the previous one. After producing each version of the model, we evaluated it by performing V and V activities and submitting the semantics specification and the V and V results to the evaluation by domain experts. Based on the evaluation results, we improved the semantics and evaluated it again until we reached the current version.



**Figure 4.19:** CPPS verification and validation  
[Thoben et al. [2017]]

### 4.4.1 Verification by experts

For verifying CPPS, we started by manually checking the concepts, relations and axioms defined in CPPS are able to answer its competency questions (CQs). Table 6.4 shows the verification process for CPPS against its competency question. It enabled us to check the CQs were answered, but also there were irrelevant elements in the semantics, i.e., elements that do not contribute to answering any of the questions.

ID	Defined semantic concept and description	Axioms
01	<b>What is an CPPS concept?</b> The CPPS notion flagship is evolve recently, and formation of new production paradigm	<b>A1</b>
02	<b>What is a core CPPS terminology?</b> It consists of the terminology by level of abstraction by including all core entities of interest	<b>A1, A2</b>
03	<b>What does core CPPS typology entities?</b> It is the systematic classification according to their common characteristics.	<b>A1,A2</b>
04	<b>How can a hierarchy layer in the production nature?</b> These layers have interrelations that are created leading the events in itself.	<b>A5</b>
05	<b>What can a CPPS Boundary and environment?</b> It can be a conceptual line that affects the system or be affected in a given environment.	<b>A6</b>
06	<b>What does make up of CPPS domain axis Property?</b> model The CPPS property, which involves together and interacting in a set of rules to form a unified whole system.	<b>A7</b>
08	<b>What does make of CPPS business process?</b> The CPPS business process, is a collection of structured activities or tasks in a specific sequence to produce a product.	<b>A8</b>
09	<b>What is a CPPS life cycle artifacts?</b> The CPPS life cycle design, operation and end of life phases.	<b>A8</b>
10	<b>What can a CPPS domain value creation process?</b> The CPPS domain value creation process includes entities, their attributes, and relationships	<b>A9</b>

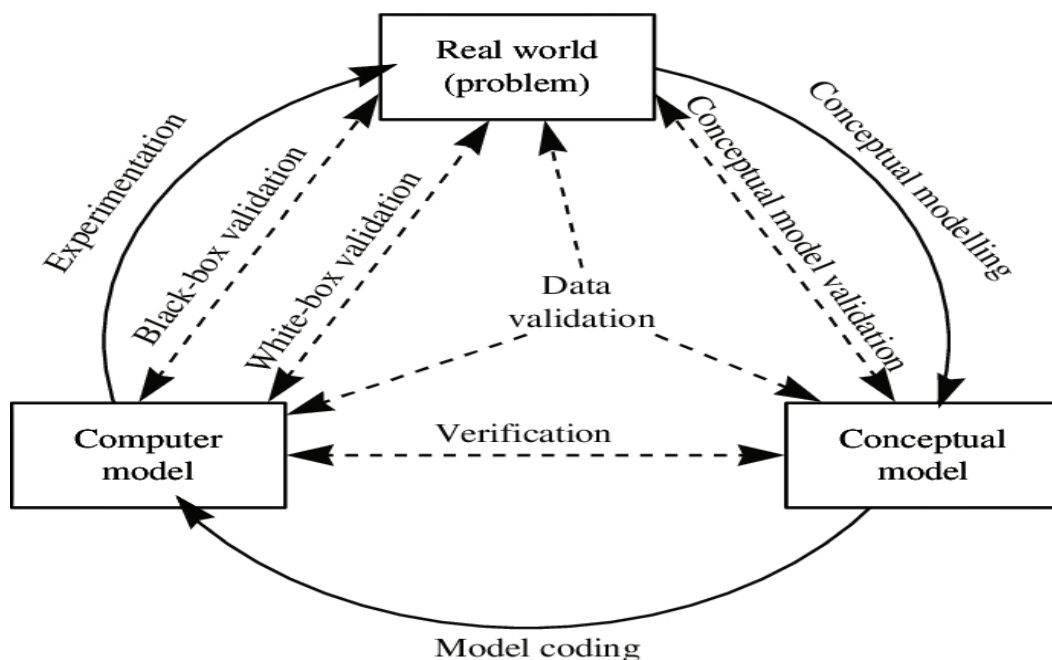
Some situations the domain experts pointed out that, it is not properly covered by previous versions of CPPS with a production goal in mind (e.g., it can move his/her arm in a smart home and turn on the light without intending to do so). We checked the defined semantic concepts, relations and axioms in CPPS, which are able to answer the competency questions

The table 6.4 can also be used as a traceability tool, supporting semantic change management. The Verification results shows that CPPS is able to answer the competency questions (i.e., the semantic addresses the established scope) and that it contains the sufficient and necessary elements to do so.

The standard units in the model are significant and empirically verified our artifacts, which we created and evaluated. It illustrates the constraints of CPPS Business process, property and other aspects). The consistency between use case, related constraints and related semantic model is analyzed. It is the consistency, completeness, and causal relationships. Next section, we illustrate the reference semantic model is validated by instantiating the three real-world situations.

#### 4.4.2 Validation by instantiation

In this section, the semantics validation is carried out by representing the real-world situations of CPPS. Figure 6.13 shows the CPPS validation process.



**Figure 4.20:** CPPS validation  
 [Thacker et al. [2004]]

We instantiate CPPS considering only the two cases described in Section 5, during validation we also considered several other cases (e.g., quasi scenarios) to ensure that CPPS is able to represent them. The validation checks whether the constructed modular models are well-defined, consistency and completeness among different CPPS in real situations.

---

**Algorithm 4 Validation by instantiation of model on scenarios**

---

```
1: Input
2: Model instance id
3: Synchronization list of selected model
4: Detailed description in model
5: Output
6: Corresponding scenario
7: Begin if connect then
8: ListIdsObjets  $\leftarrow$  IdsObjetsModel (IdModel)
9: connexion  $\leftarrow$  VerifierConnexionObjets (Liste ID objects)
10: Verifier connection of objets of model active()
11: Check connection of model objects instantiation()
12: ListIdsEvents  $\leftarrow$  GetIdsEvents (ListIdsObjets())
13:
14: Each view in  $V_{CPPS}$ 
15:
16: connexion  $\leftarrow$  VerifierConnexionObjets (Liste ID objects)
17: Verifier connection of objets of model active()
18: Check connection of model objects instantiation()
19: ListIdsEvents  $\leftarrow$  GetIdsEvents (ListIdsObjets())
20: if
21: Uniqueness  $\leftarrow$  VerifierUnicity (ListIdsEvents)
22: Then
23: Check the validity of incoming relationship types at each object ()
24: Else
25: RelationsIn  $\leftarrow$  VerifierRelationsIn (ListIdsObjets)
26: Check the validity of incoming relationship types at each object
27: Then
28:
29: Decompose, reuse, merge, synthesis, sync
30: RelationsOut  $\leftarrow$  VerifierRelationsOut (ListeIdsObjets)
31: Check the validity of the outgoing relationship types of each object
32: ConfirmerValiditeModel(Confirme)
33: Else if
34: ErrorRelationOut()
35: Any Error in définition of relations()
36: End
```

---

It enhances that the proposed model has structure, logic, and causal relationships that are “reasonable” for the intended purpose of the model [Oulasvirta [2017]][Zarour and Alharbi [2017]]. Although in this, we instantiate CPPS considering only the two cases described. We also considered several other cases (e.g., quasi, discrete.) during validation to ensure that CPPS is able to represent them. The successful instantiation of CPPS notion with data



coming from real cases gave us indications of the appropriateness of the proposed semantic as a reference model.

### 4.4.3 Different distribution level of CPPS

To do so, the current CPPS development classification is taken into consideration. It is three different levels of classification [Cardin [2019]]. It specified as follows.

**Table 4.4:** CPPS and its description

	Machine 1	Machine 2	Machine 3
<b>System of interest (SOI)</b>	Assembly machine	Magazine machine	Printer machine
Product	PCB fuse part	Top cover part	Labels
Machine	Robots assembly	Magazine assembly	Printer components
Service	PCB fuse part	Top cover part	Labels
<b>Enabling system</b>	Support	Support	
Cyber infrastructure	Robotino	Fleet manager	Zebra software
Physical infrastructure	Box warehouse	Pressing module	Output module

- **CPPS-Discrete Scenario-** The CPPS- discrete system with discrete states of transitions which are triggered by events. It enables great flexibility by combining modules in different configurations for a variety of applications.
- **CPPS-Retrofitted Scenario -** The retrofitted CPPS is a level where the actual developments made on a running production system.

The algorithm 7 illustrates the validation by instantiation the scenarios of model on each object. Before starting any manipulation, the validity of the designed model is checked in all CPPS models. By way of example, algorithm 1 (see algorithm.1) makes it possible to check that the risk analysis model (by bijection the view) designed complies with the proposed model. Indeed, such a model is said to be “valid” if it satisfies the following conditions:

#### 4.4.1 Case-1 CPPS-Discrete event Scenario

In this section, the consistency and completeness of modular semantic model is validated with CPPS discrete machines (M1)(M2)(M3). The proposed semantic model is replacing

with the CPPS (M1) (M2)(M3). Table 4.4 shows the CPPS and use case description.

#### 4.4.4.1 Use case scenario

In this context, the CPPS operational scenario is to assembly a product and satisfy the customer/organization needs according to the given strategy. The use case task fulfilled by the system and delivered the desired product using its property (M1)(M2)(M3) which the human executes the customer order in the assembly machine to inspect and assembly the PCB part and 40 quantities of fuse part of the mobile phone product to fulfill the customer/organization's need.

#### 4.4.4.2 Instance case

Based on the assembly operation use case, the CPPS interacts with the cyber and physical space of indoor shop-floor environment. Figure shows the use case models. It illustrate Business process- Detailed based on generic business process model- figure 4.26); System Functions- Detailed based on generic function model ); System Behavior- Detailed based on generic behavior model); System Interfaces- After defining the logical components, the interaction between each pair of components is analyzed based on generic interface model; System boundary and environment-According to the use, the system environment and boundary is cyber and physical space in CPPS industrial system which has the local I/O interactions. As an example, the interactions are analyzed based on Figure 4.26.(Figure 4.26). From the use case, the classes, and associations can be extracted from analyzing use case one by one. Figure 4.26 shows the scenario-based CPPS discrete consistency and completeness checking. It illustrates the constraints of CPPS Business process, property and other aspects). The consistency between use case, related constraints and related semantic model is analyzed one by one. From our discrete use case scenario analysis, the consistency, completeness, and causal relationships which is illustrated from the use case is described below:

$$\forall case - 1, c \bullet LendCopyproperty, Businessprocess, otherentity; ReturnCopy \quad (4.10)$$

$$Property, businessprocess, otherentity$$

$$\forall case - 1, c \bullet LendCopyBoundary, Environment; ReturnCopy \quad (4.11)$$

$$Boundary, Environment$$

- **Check with Properties-** From the above use case scenarios instantiation, we can be guaranteed.

## 4.4. Model Verification and Validation- algorithm

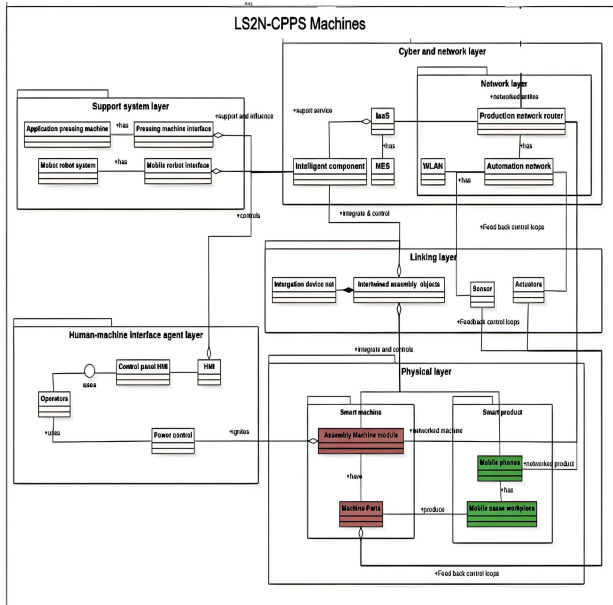


Figure 4.21: UC structure model

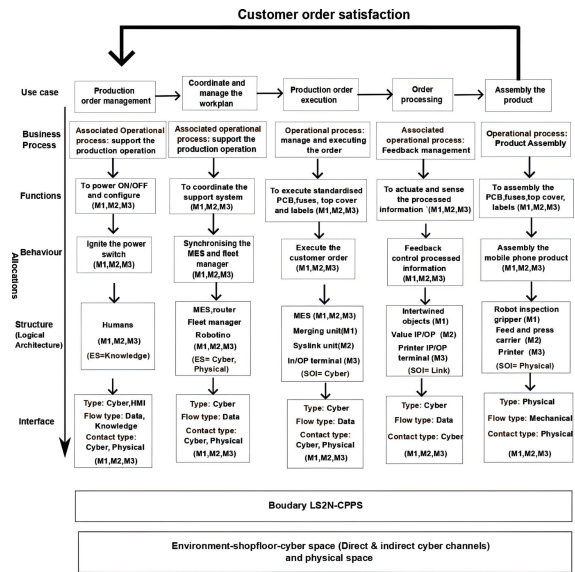


Figure 4.22: UC property, business process model

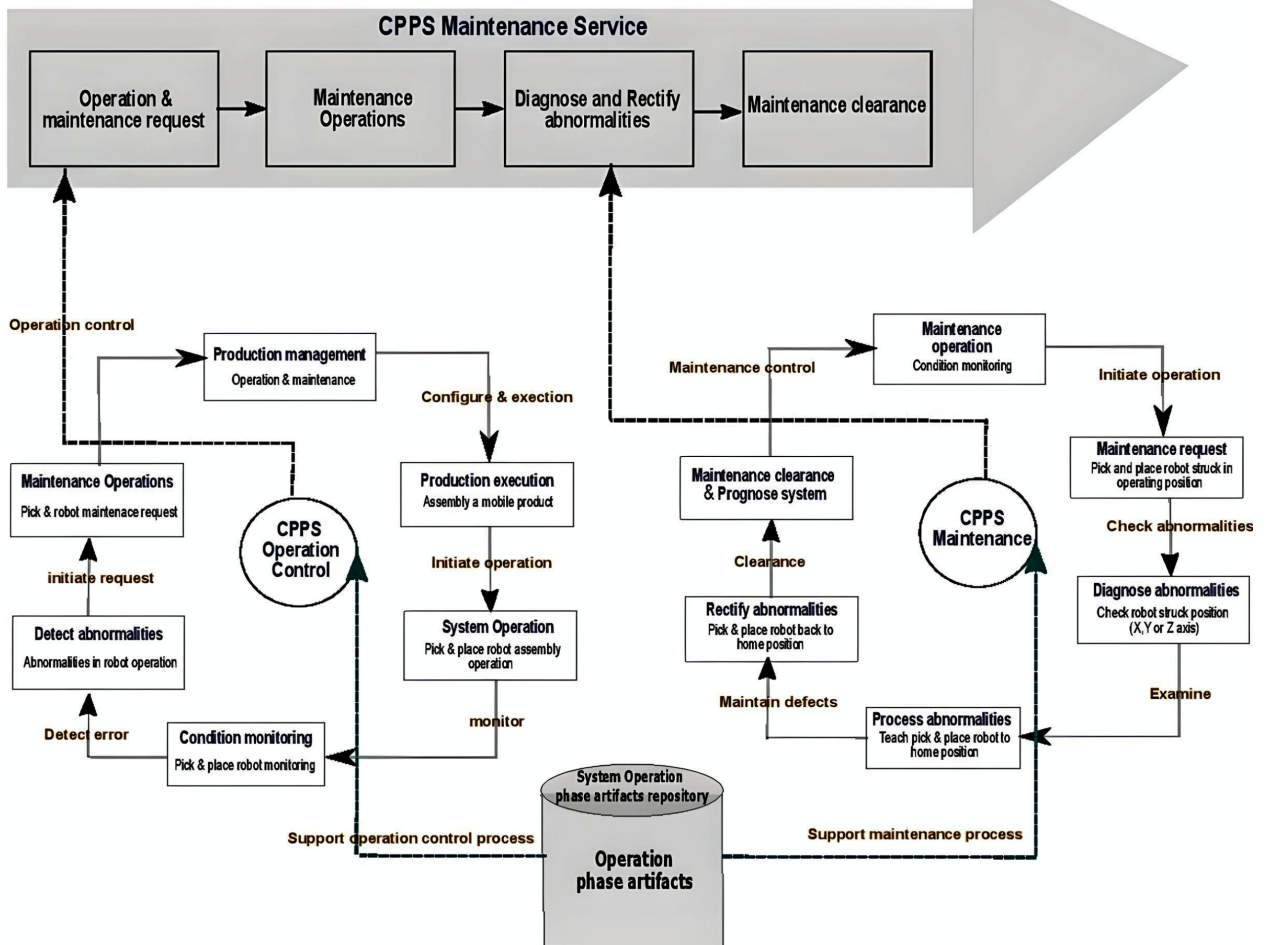


Figure 4.23: UC-Assembly operation

- **Check with Business Process-** The business process are available. Therefore, it (operational, support process) is still consistent at the post state.
- **Check with other model aspects-** From the precondition of Lendcopy, the discrete event states of transitions which are triggered by events. It is guaranteed on a joint action on post-conditions. The association is realized and define on the effect of the use cases.

#### 4.4.2 Case-2 CPPS- Retrofitted event Scenario

In this case, we verify the proposed generic CPPS life cycle model (design and development phase) in the industrial CPPS. Figure 5.3 shows the schematic representation of CPPS-Industrial system. Table describes the system and its use case description.

##### 4.4.2.1 Use case scenario

The objective of the use case scenario is to show the retrofiting of the system. The purpose of retrofiting is to preserve the functionality of existing equipment and adapt it to current requirements and extend its service life. In this context, it is a laser cutting machine where the actual development and retrofiting of a new visual inspection device. It is made on a running production system.

##### 4.4.2.2 Instance case

The retrofiting is made on transforming the manual inspection into monitored visual inspection in CPPS. The retrofiting process is structured in three parts: infrastructure, communication, and application. The process structuring is the basis for defining the requirements, functional components, and other features of CPPS Retrofitting. Figure 4.26 shows, the retrofitted process from manual inspection into monitored visual inspection in CPPS (detailed based on generic artifact process).

This retrofitted system use case model is summarized below: Business process-Detailed based on generic business process model; System Functions-Detailed based on generic function model); System Behavior-Detailed based on generic behavior model; System Interfaces-After defining the logical components, the interaction between each pair of components is analyzed based on generic interface model; System boundary and environment. According to the use, the system environment and boundary (detailed based on generic boundary and environment model is cyber and physical space in CPPS industrial system which has the local I/O interactions.

#### 4.4. Model Verification and Validation- algorithm

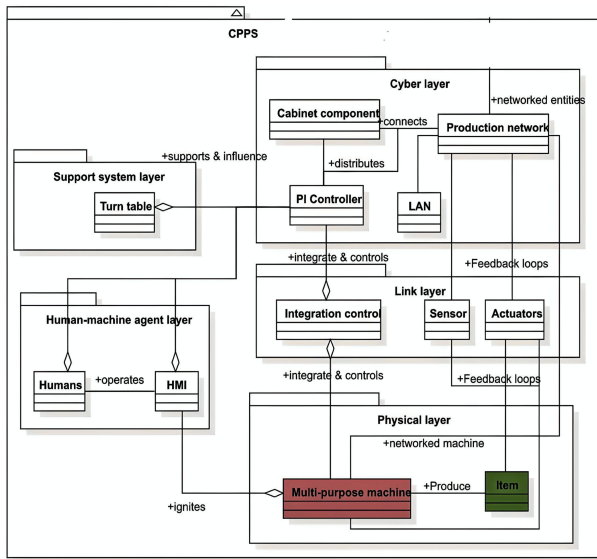


Figure 4.24: UC integrated structure

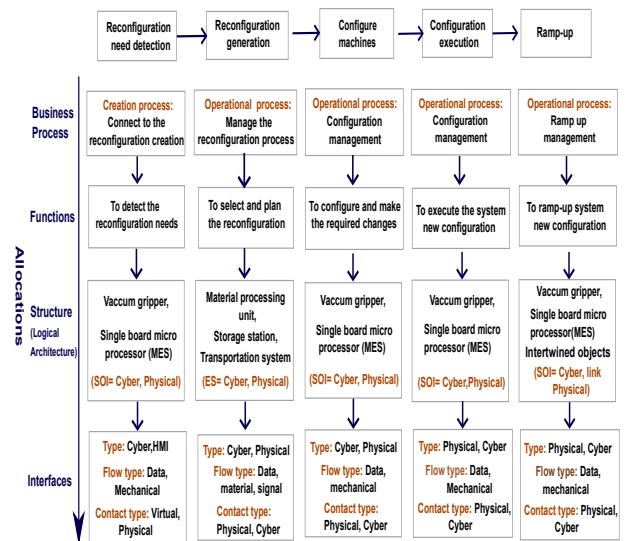


Figure 4.25: UC description

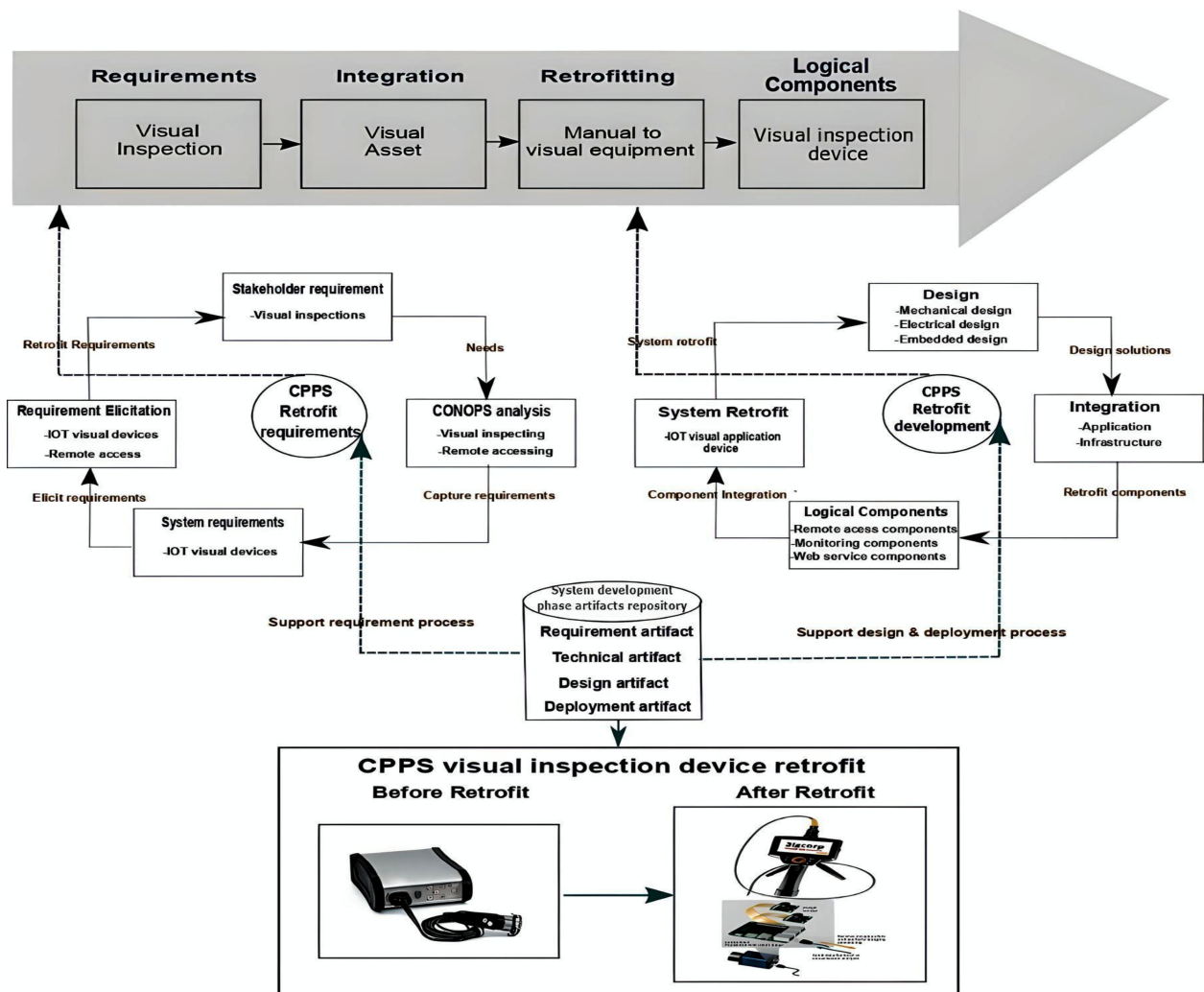


Figure 4.26: Retrofit operation

### 4.4.2.3 Consistency and completeness in use cases

From the use case, the classes, and associations can be extracted from analyzing use case one by one. The scenario-based CPPS discrete consistency and completeness checking. It illustrates the constraints of CPPS Business process, property and other aspects). The consistency between use case, related constraints and related semantic model is analyzed one by one. From our retrofit use case scenario analysis, the consistency, completeness, and causal relationships which is illustrated from the use case is described below:

- **Check with Property-** From the above use case scenarios instantiation, we can be guaranteed.
- **Check with Business Process-** The business process are available. Therefore, it (operational, support process) is still consistent at the post state.
- **Check with other aspects-** The life cycle artifact are consistent. The retrofitting is made on transforming the manual inspection into monitored visual inspection in CPPS. The process structuring the life cycle artifact is guaranteed on a joint action on post-conditions. The association is realized and define on the effect of the use cases.

### 4.4.5 Synthesis

From this chapter, the scenario-based check of the model is illustrated. As a result of checking the consistency of proposed model in different CPPS types. To the best of our knowledge, all identified (relevant) entities fall within the scope of our standard units. Our fictional applying scenarios illustrate the wide range of possible instantiations of our standard unit Semantic model, which reused a broad variety of different CPPS (quasi, discrete etc). On the other hand, our real-world example demonstrates the artifact's practical relevance and applicability. It is confirmed that the model is global and re-useable in different CPPS. It is theoretically significant and empirically verified our artifacts, which we created and evaluated using the stages of research process and applicability in different CPPS.

## 4.5 Conclusion and synthesis

From this chapter, It answers the second research question

- **RQ-2 How can cyber-physical production system (CPPS) are represented in a unified semantics through its life cycle?**
- **SQ-1 How can the cyber-physical production system (CPPS) entities defined in a unified semantics?**

From this chapter, the terminology, a typology, and a semantic model for CPPS considering its life cycle is proposed. The modular semantic models which classifies entities and illustrating their relations. i.e., which entity of a production system can be regarded within the hierarchy layer. It is a comprehensive classification of CPPS by defining, classifying the entities and illustrating their relations. It is based on the immediate influence on the structure and functionality of CPPS. It lays a foundation for managing system complexity and understanding the structural ambiguity. To demonstrate the efficacy and general applicability of our artifacts, we applied to three fictional application scenarios of CPPS with differing levels of distributed intelligence.

From this work, we claim that our modular semantics models is **well-structured and comprehensive** (i.e., limited number of terms, classifications, and relations, for reasons of comprehensibility and simplicity), **standard units (modular)** (i.e., enough terms, classifications, and applicable to different kinds of CPPS), **completeness** (i.e., include all relevant terms and relations), **reusable** (i.e., reusable on future cases of our artifacts), and **explanatory**(i.e., allowing for a suitable instantiation of real-world examples with our terminology, typology and semantic models)

This contributes to address the identified research challenges, **Limitation, and research gap-2** and answering our second research question (RQ-2). Next chapter shows the reused in an application context.





# Application context

---

*This chapter describes the application context. The modular semantics is reused and instantiated to support two different independent application context. It is fetched, openness to accommodate the changes in representation on inclusion and exclusion is part of the system. It illustrates that it can be used unambiguously across different application context.*

---

5.1	Introduction . . . . .	154
5.2	LS2N CPPS Platform project . . . . .	155
5.3	App-1- Semantic Knowledge Repository application . . . . .	155
5.3.1	Introduction and Problem context . . . . .	155
5.3.2	Schematic overview of reuse and instantiation . . . . .	155
5.3.3	Collaborative semantic knowledge repository for platform . . . . .	156
5.3.4	Analysis of CPPS performance evaluation . . . . .	161
5.3.5	Identifying influence factors on CPPS operation . . . . .	165
5.3.6	Analysis of Operational satisfaction . . . . .	168
5.3.7	Conclusion . . . . .	171
5.4	App-2 Collaborative management application . . . . .	173
5.4.1	Introduction and problem statement . . . . .	173
5.4.2	Schematic overview of reuse and instantiation . . . . .	173
5.4.3	Overview of Collaborative management application . . . . .	174
5.4.4	Feasibility analysis on alternatives . . . . .	175
5.4.5	Prototype of the collaborative application . . . . .	179
5.4.6	Collaborative management application . . . . .	181
5.4.7	Collaborative management space . . . . .	184
5.4.8	Synthesis . . . . .	186
5.5	Conclusion . . . . .	187

---

This work published and under publishing as:

- **Puviyarasu SA**, Catherine da Cunha, et al, *Semantic Knowledge management for cyber-physical production system*, **GDR macs conference, France**, 2020, Nantes, France.
- **Puviyarasu SA**, Farouk Belkadi, Catherine da Cunha, Alain Bernard, Abdelhamid Chriette *A semantic interface model to support the integration of drones in a cyber-physical factory*, **Enterprise interoperability IX, Springer-Book chapter**, DOI-hal.archives-ouvertes.fr/hal-03011568, 2019.
- **Puviyarasu SA**, Farouk Belkadi, Catherine da Cunha, Abdelhamid Chriette, *A Requirement Engineering Framework for Smart Cyber-Physical Production System*, **Lecture Notes in Mechanical Engineering, Springer-Book chapter**, DOI - 10.1007/978-3-030-90700-643, pp.381-388, 2022.

## 5.1 Introduction

**I**N this chapter, we present two independent application's context, which are reuse and instantiated from the proposed CPPS models. It is realized in LS2N-Platform project. The first application context concerns the semantic repository application, and the second one is about semantic interface management application. Framing their respective needs, implement to fulfil their objective and fitting to their specific context.

### Application context

**Case-1 Common repository application.**

**Case-2 Collaborative management application.(Demonstrator)**

Finally, we close the chapter by summarizing the takeaways of the two real application context is instantiated from the proposed modular models. It illustrates that can be used across different application context. This chapter is structured as follows: Section 5.3 Semantic repository application; Section 5.4 semantic interface application; Section 5.5 Synthesis

## 5.2 LS2N CPPS Platform project

The LS2N-CPPS Platform project aims is to capitalize knowledge and sharing between heterogeneous actors during the creation or operation of CPPS. It provides a neutral, easy-to-interface system featuring a more efficient collaboration strategy and an effective knowledge-sharing environment. In this context, the proposed model is reused in two independent application context. It allows theoretical results to be validated before industry deployment. It has major benefit of time and cost savings for manufacturing companies.

## 5.3 App-1- Semantic Knowledge Repository application

### 5.3.1<sup>1</sup> Introduction and Problem context

In this section, we reuse and instantiate the generic modular semantics in an knowledge management application context. The LS2N-CPPS are deeply intertwined and able to operate in situation-dependent ways across all production levels. It leads to challenges in managing the engineering workflow of product development, allocating the manufacturing process and setting up the production system of the involved actors. To face this challenges, the semantic model is reuse and instantiated to build a data model. The information model of the CPPS is created and stored in the repository. It allows the involved stakeholders to have the proper information to facilitate, **1) New products' development, 2) Management of the complex manufacturing process, 3) Set-up of the production system (reconfiguration), 4) Assist in system analysis.**

### 5.3.2 Schematic overview of reuse and instantiation

**Table 5.1:** Reuse of repository application context

Viewpoints	Operation	Description
$V_P V_{BP}$	<b>Decomposition</b>	Provided a more detailed description in all views
$V_P V_{BP}$	<b>Extension</b>	Added a syntactic concept to a given view
$V_P V_{BP}$	<b>Reuse</b>	Reused the 'Operational concept' from the existing viewpoint.

<sup>1</sup><https://www.ecnantes.fr/recherche/plateformes-dexperimentation/plateforme-smart-factory>

Table shows 5.1 schematic overview of generic modular semantic is reuse and instantiated. It illustrates the viewpoint operation, relationships, and their description for application context is described. It admits adding, replacing and removing the standard units. The next section illustrates the developed data model repository.

### 5.3.3 Collaborative semantic knowledge repository for platform

In this section, figure 5.2 shows the developed common repository. The model repository (library) is constructed (specialized) directly from the abstractions with the stereotypes class.

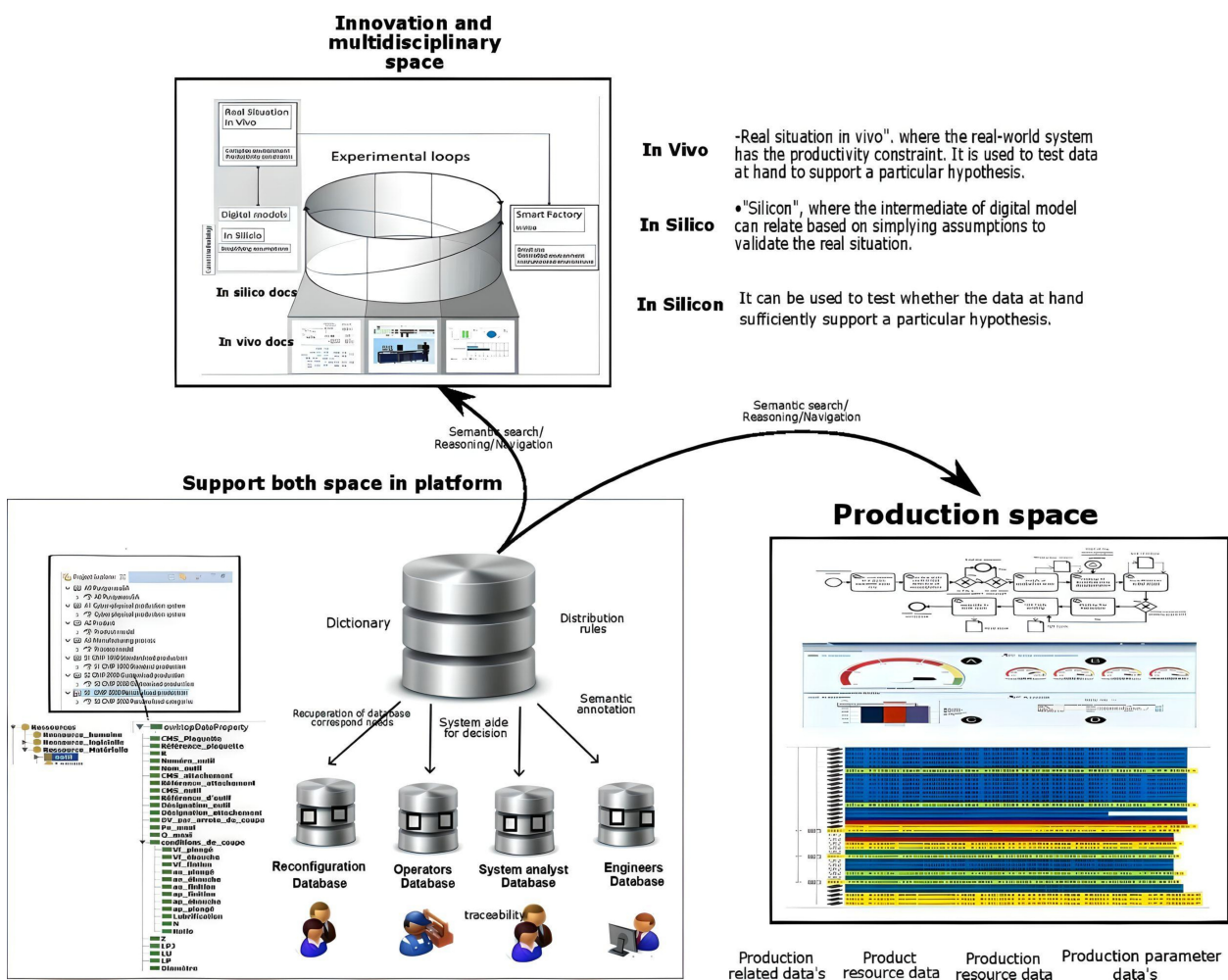


Figure 5.1: Collaborative LS2N- CPSS knowledge repository

It allows observers to analyze and understand the different properties of a given system according to a specific perspective which is connected to their problem of interest. It significantly enhances the quality and timeliness traceability of the information that serves as a supporting tool for involved actors. The common repository provides the semantic

information on the allocated system for the personalized strategies.

Figure 5.3 shows the common repository explorer. The listed information requirements set for this personalized production strategies. It provides the right fit between the production system set-up, and the product portfolio offered to the market. It means that any actors involved with the system can use the repository according to their interest. It consists of top and bottom layers, which described as follows:

### Modeling layers

- **The Top layer (M1)**- It contains the abstraction and combined systems model relations (For, e.g., the product model, processes model, and resource model relations). It provides the discrete events and match-making resource information. For example, an Assembly machine has the capability to do an assembly process to produce a phone.
- **The Bottom layer (M0)**- It contains the detailed specific system models. These detailed system models include the complete information on the single system, (i.e) System decomposition- System abstraction to system element level, e.g., Assembly machine.

The information models of CPPS are created and stored in the repository. It allows observers to analyze and understand the different properties according to a specific perspective which is connected to their problem of interest.

- `<!-- http://www.ls2ncpps.com/semantic channel/Channel -->`  
`<owl:Class rdf:about="http://www.ls2ncpps.com/smemantics/Channel">`  
`<rdf:resource="http://www.ls2ncpps.com/semantics/Function"/>`  
`</ppl:Class><!-- http://www.ls2ncpps.com/semantic/Connect -->`  
`< rdf:resource="http://www.ls2ncpps.com/semantics/Function"/>`  
`</ppl:Class>`
- `<!-- http://www.ls2ncpps.com/semantic channel/Channel -->`  
`<owl:Class rdf:about="http://www.ls2ncpps.com/smemantics/Channel">`  
`<rdf:resource="http://www.ls2ncpps.com/semantics/Function"/>`  
`</ppl:Class><!-- http://www.ls2ncpps.com/semantic/Connect -->`  
`</ppl:Class>`

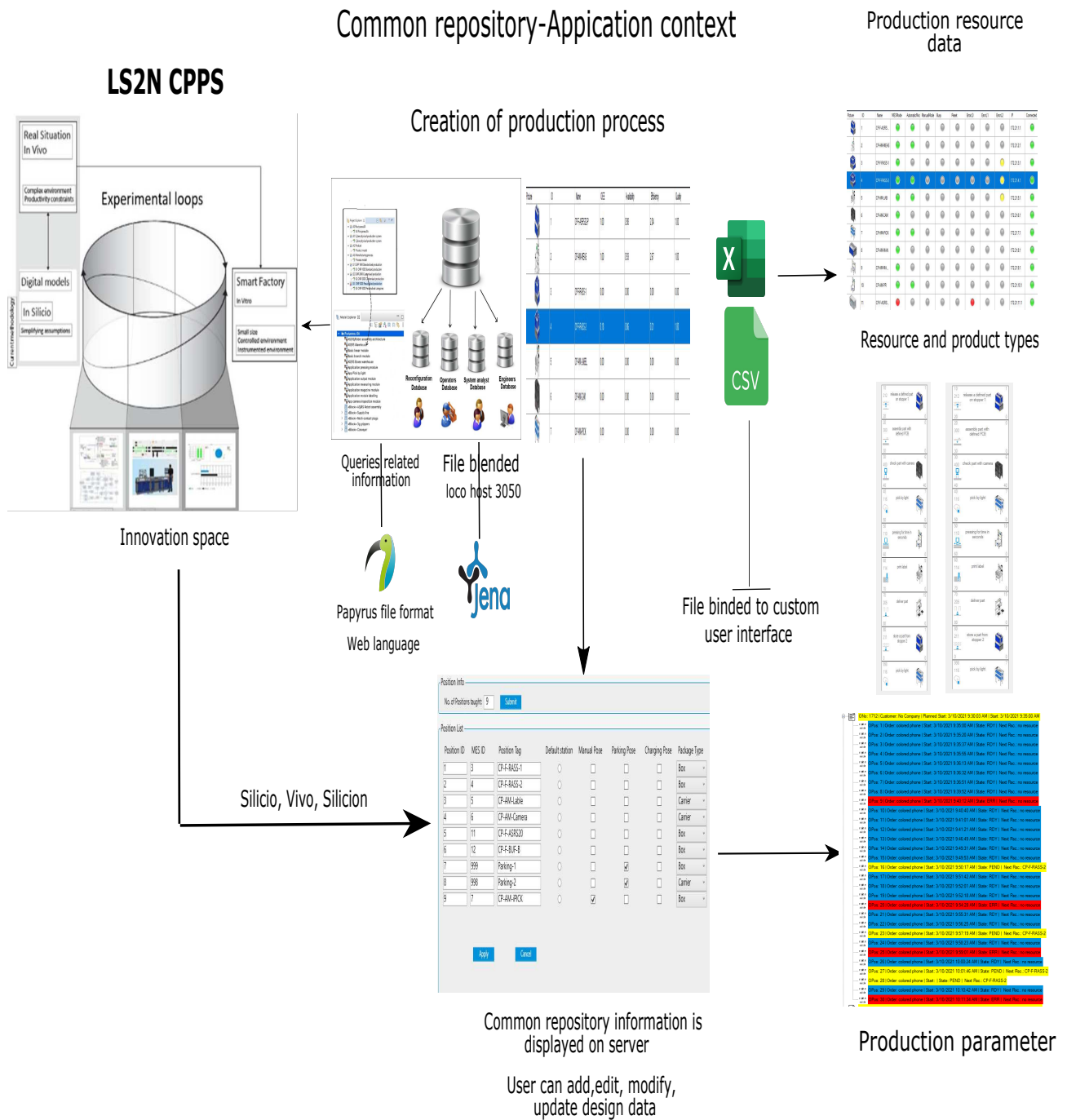


Figure 5.2: CPPS knowledge repository



The repository provides the ten types of semantic information to the stakeholders. The types of semantic information and their description are shown below with stakeholder competency questions as follows;

### Competency Questions

- **CQ-1** What is the description of the Production system? (**Resource class property**)
- **CQ-2** What is the structure of each machine in Production system? (**Individual Machine class property**)
- **CQ-3** What is the capability of each machine in production system? (**Machine capability class property**)
- **CQ-4** Which combined set of machines has the combined capability to achieve X? (**Machine combination capability class property**)
- **CQ-5** Which machine has re-configuration features? (**Machine Parameter class property**)
- **CQ-6** Which individual or combined machines have a certain configuration parameters to achieve X? (**Machine Parameter class property**)
- **CQ-7** Which individual or combined machine capability can satisfy certain manufacturing processes? (**Machine capability relation class property**)
- **CQ-8** Which machine and their configuration parameters is allocated to each production strategies of manufacturing system?(**Machine Allocation class property**)
- **CQ-9** Which machine and their resource combinations are allocated to each production strategies of manufacturing system? (**Resource and product class property**)

#### 5.3.3.1 Usage of system Repository

In this section, the usage of system Common Repository is summarized. Figure 5.3 shows the CPPS Application magazine module. The listed model satisfies all the information requirements set for this personalized production category. It provides the right fit between the production system set up, and the product portfolio offered to the market. It supports

the setting-up of the production system and answers to the competency questions of the stakeholders, “Which system and their resource combinations is allocated to personalized production categories?”.(7th type of information 3.2.1 section)

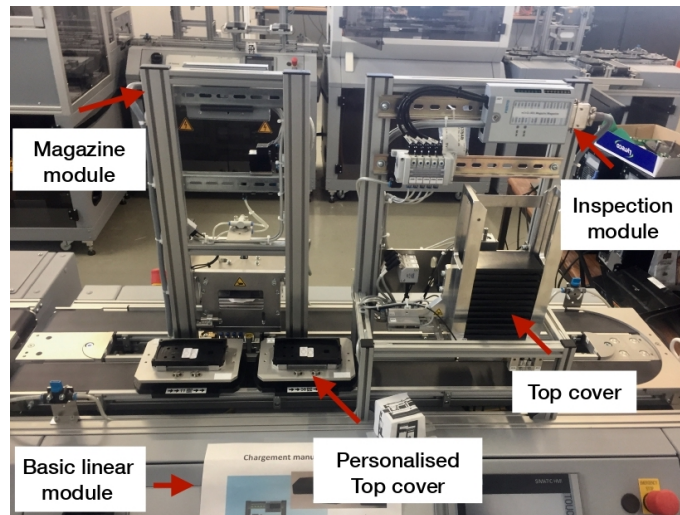


Figure 5.3: LS2N- CPPS-Application magazine module

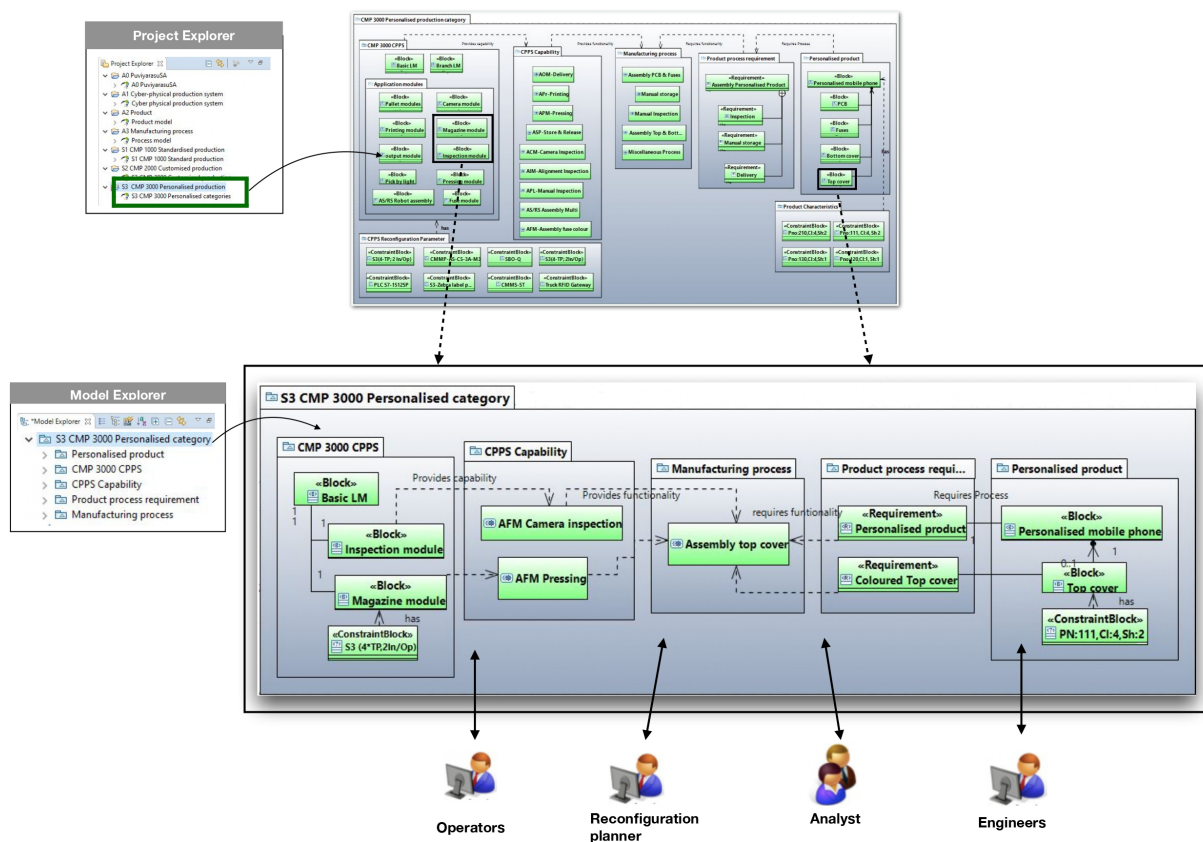


Figure 5.4: LS2N CPPS- Personalized category model explorer

### 5.3.3.2 Analysis of CPPS performance and stakeholders evaluation

To analysis the benefit of the repository, we have assessed the influence factors and gains of the practice implementation. It helps in demonstrating how the system effectively achieving its mission with practice. The assessment is made in two stages:

#### Analysis phase

- 1) Analysis of CPPS system operational performances.
- 2) Analysis of Operational Satisfaction.

### 5.3.4 Analysis of CPPS performance evaluation

To analysis the system operational performance, a case study is carried out. The case study considers three assembly operation scenarios: **document-centric (Scenario 1)** and **model-centric (Scenario 2)** and **mixed practice (S3)** assembly operation scenarios in the CPPS. The document-centric (S1) operation scenario is taken as a reference that helps to analyze the other assembly operation scenario. For each of the three scenarios, 30 customer orders are launched. The system recuperation impacts and performances are analyzed. Table 5.2 shows the experimental testing of operation performance. The Key Performance Indicators (KPI) helps to evaluate the CPPS operational performances.

#### 5.3.4.1 Key performance indicator

Overall Equipment Efficiency (OEE): It is a measure of how well a production operation (facilities, time and material) is utilized compared to its full potential, during the periods when it is scheduled to run. OEE is evaluated based on three factors:

#### OEE description

- **Availability:** Machine being available for production. (percentage of scheduled time that the system is available to operate (uptime))
- **Efficiency:** how much waste is producing on each cycle times.
- **Quality** time wasted on producing product, comparing product to reject parts.

They are calculated as follows:

### OEE formula

- **Availability** =  $\frac{\text{Operating time}}{\text{Scheduled time}} = \frac{\text{Scheduled time} - \text{unscheduled downtime}}{\text{Schedule time}}$
  - **Efficiency** =  $\frac{\text{Standard routing time} \times \text{Total count}}{\text{Real operation time}}$
  - **Quality** =  $\frac{\text{Compliant products}}{\text{Total products}}$
- OEE** =  $\text{Availability}A \times \text{Efficiency}E \times \text{Quality}Q$
- **Utilization rate:**  $\frac{\text{Actual Output}}{\text{Potential Output}} * 100$
  - **Customer order:**  $(\text{Complete Orders Delivered On-Time} / \text{Total Orders Delivered}) * 100$

**Table 5.2:** Experimental testing

		Experimental testing					
	CPPS-machine	A	P	Q	OEE	UR	CS
<b>Scenario-1</b>	1	0.82	0.52	0.57	0.42	0.42	28/30
"	2	0.78	0.76	1	0.79	0.50	28/30
"	3	0.68	0.65	0.8	0.65	0.45	27/30
"	4	0.68	0.65	0.8	0.65	0.45	26/30
"	5	0.68	0.65	0.8	0.65	0.45	28/30
"	6	0.68	0.65	0.8	0.65	0.45	27/30
<b>Scenario-2</b>	1	0.89	0.79	1	0.70	0.50	28/30
"	2	0.74	0.64	0.7	0.70	0.50	27/30
"	3	0.68	0.72	1	0.78	0.48	28/30
"	4	0.68	0.72	1	0.78	0.48	29/30
"	5	0.68	0.72	1	0.78	0.48	27/30
"	6	0.68	0.72	1	0.78	0.48	28/30
<b>Scenario-3</b>	1	0.89	0.79	1	0.70	0.45	28/30
"	2	0.89	0.79	1	0.70	0.42	27/30
"	3	0.68	0.72	1	0.78	0.32	26/30
"	4	0.68	0.72	1	0.78	0.32	28/30
"	5	0.68	0.72	1	0.78	0.36	29/30
"	6	0.68	0.72	1	0.78	0.38	28/30

Availability (A), Performance(P), Quality(Q), Utilization rate(UR) and Customer satisfaction(CS), Scenario-1(S1), Scenario-2(S2), Scenario-3(S3)

#### 5.3.4.2 Results

The production timeline indicates the progression of the tasks. It compares the real state of the system and the manufactured products with the planned operations. The legend of the production time-line as follows. From the experimental testing, the monitored result of production timeline and OEE indicate as follows in figures 5.28, 5.27.

- **Green**-The system worked on track: it completed the task according to the schedule.
- **Yellow**-The system worked according to the schedule, but the manufactured product was not compliant with the working order requirements.
- **Red**—The system did not respect the schedule. But the manufactured product was not compliant with the working order requirements.

#### 5.3.4.3 Results Comparison

From the testing, the result comparison of each scenario is illustrated. The monitored results indicate that,

- **Availability** - The mixed practice offers (S3) a higher availability. The commission and decommission of the machine took more time than scheduled in (S1)(S2). The Machine being available for production are maximum in S2 than S1, where commission and decommission of the machine is Efficient in model-centric practice.
- **Efficiency**-The S1, S2 and S3 have similar level of performances on both the practices. The efficiency of the CPPS is lower in the document-centric practice(S1). The system decoupling causes no change with the practices.
- **Quality**- The quality is identical for all the scenarios, corrective operations taking place before the final inspection. Quality- S1 and S2 have producing equal quality products.
- **Overall equipment efficiency (OEE)**- The OEE of the system with model centric practice is 34% more than with the traditional practice. It has low lead time of new product development of the system. The result shows that the system produces a quality product that is identical in both assembly operations (S2 and S3). It improves the system in static operations.

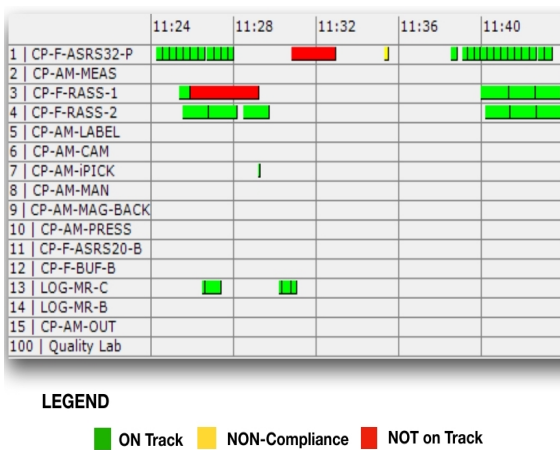


Figure 5.5: Scenario-1 time-line

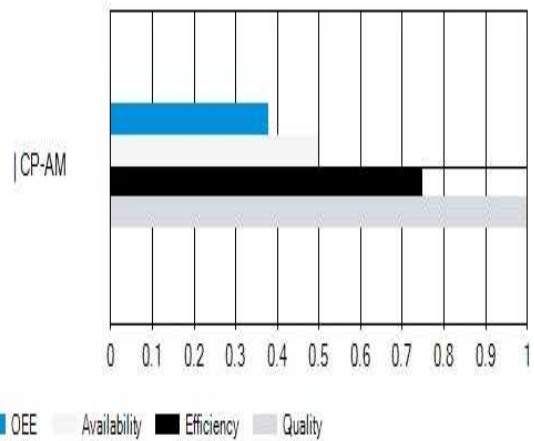


Figure 5.6: Scenario-1 OEE

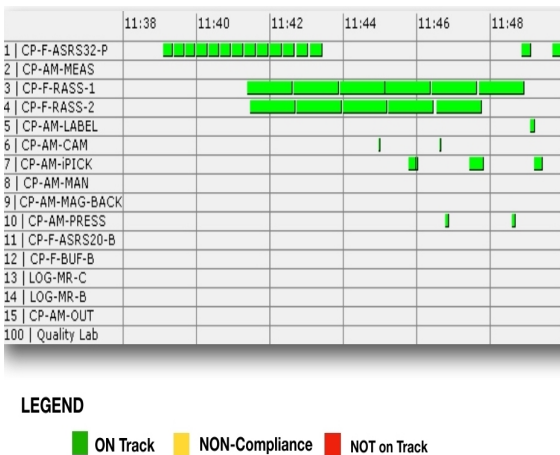


Figure 5.7: Scenario-2 time-line

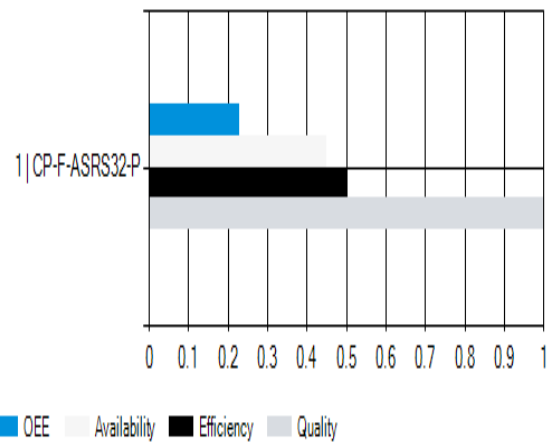


Figure 5.8: Scenario-2 OEE

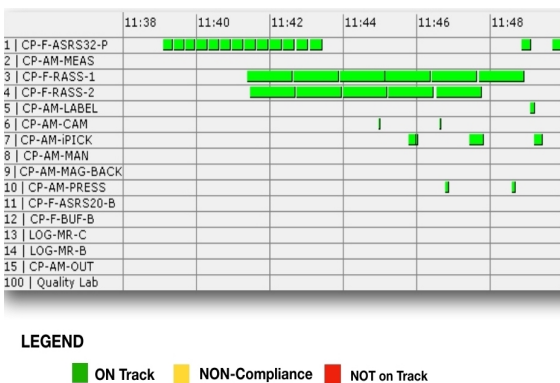


Figure 5.9: Scenario-3 production time-line

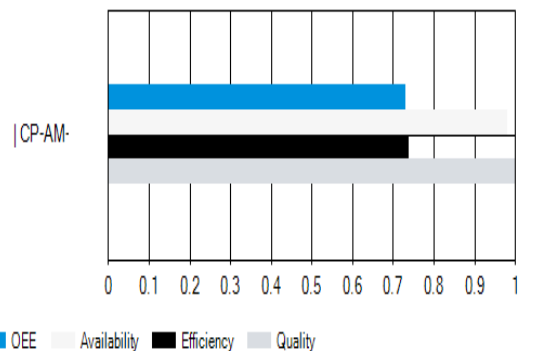


Figure 5.10: Scenario-3 OEE

### 5.3.5 Identifying influence factors on CPPS operation

From the OEE experimental results, the overall performance of the system is identified. To identify the influence factors of each scenario that affect overall system operations. The two-way ANOVA analysis is carried out. The formula for Analysis of Variance. The ANOVA coefficient,  $F = \text{Mean sum of squares between the groups (MSB)} / \text{Mean squares of errors (MSE)}$ . [Cuevas et al. [2004]]

$$F = \text{MSB} / \text{MSE} \tag{5.1}$$

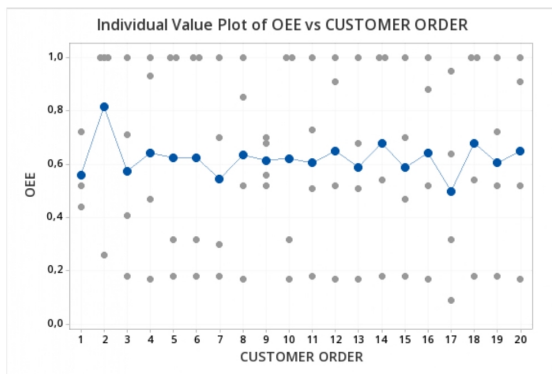


Figure 5.11: Individual plot of OEE

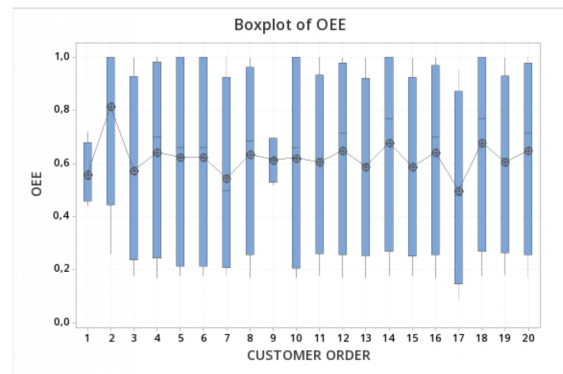


Figure 5.12: Box plot of OEE

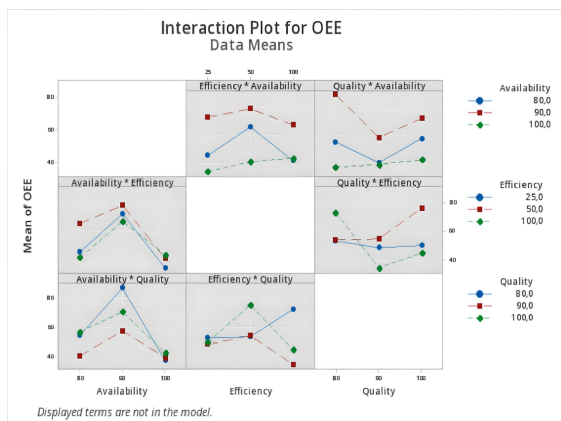


Figure 5.13: Interval plot b/w S1, S2, S3

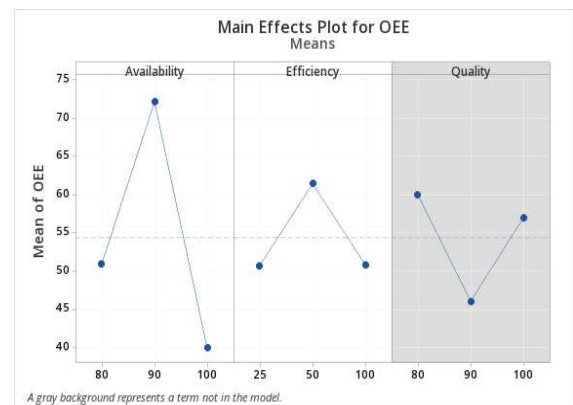


Figure 5.14: Residual plot for OEE

### Figure 5.15: ANOVA analysis

The F-test is used for comparing the factors of the total deviation. For example, in one-way, or single-factor ANOVA, statistical significance is tested for by comparing the F test statistic.

$$F = \frac{\text{variance between treatments}}{\text{variance within treatments}} \tag{5.2}$$



$$F = \frac{MS_{\text{Treatments}}}{MS_{\text{Error}}} = \frac{SS_{\text{Treatments}}I - 1}{SS_{\text{Error}}n_T - I} \quad (5.3)$$

The calculations for all the values needed for the hypothesis test. For that, we set a hypothesis for analyzing the variance. The hypotheses is a state that were the (or are not) differences among the factor group means but does not indicate where the differences are, just if there are some. We set the hypothesis as follows:

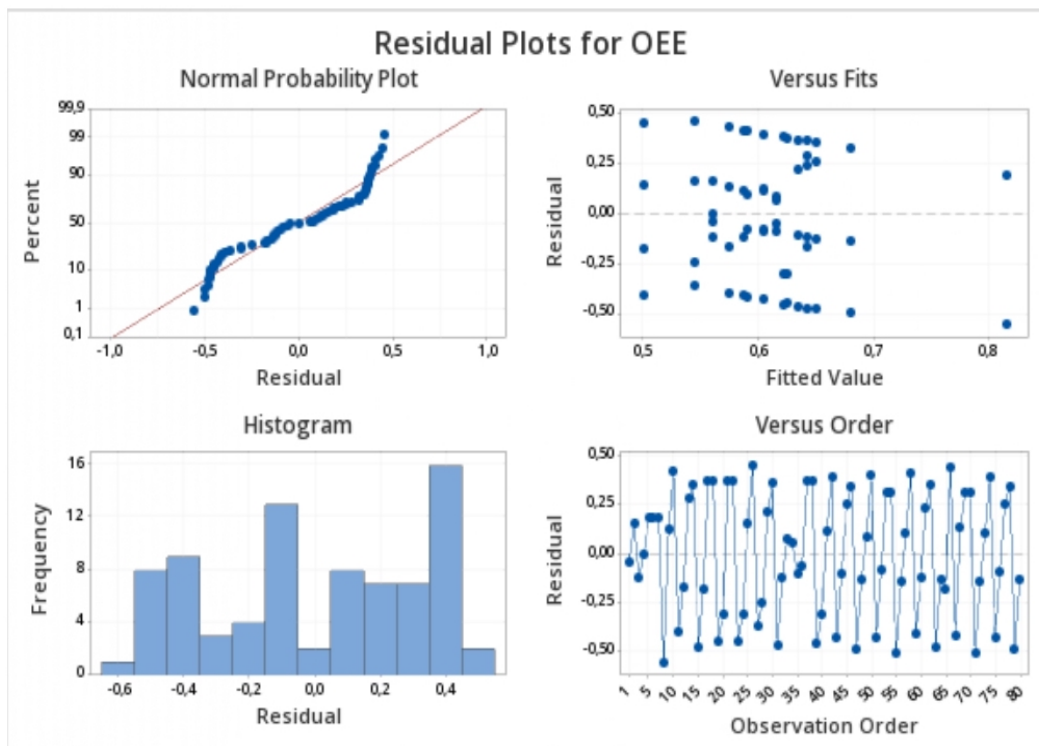


Figure 5.16: Residual plot for OEE

- **H0:** The means of all the groups are equal;  $\mu_1 = \mu_2 = \mu_3 = \mu_4 = \mu_k$
- **H1:** Not all the means are equal

All the factors were considered statistically significant at a 95% confidence level, which is a probability value (p-value)  $< 0.05$ . It shows the input parameters and how they contribute or Influence the OEE. Among the three parameters which includes the availability, performance, and quality. Table 5.3, figure ??, 5.27 shows the analysis of variance results. It shows the graphs of normal probability plot, constant variance and histogram plot.

The analysis result indicates that: The value of **Dof = 1**, **F= 4.45** and **P= 0**. Since, the null hypothesis (H0) is rejected and the alternative hypothesis (H1) is accepted: these are significant differences between the data series of corresponding to analyze.

	Dof	Sum Sq	Mean Sq	F value	Pr(>F)
Scenario-1	1	21.34	68.66	4.45	0
Scenario-2	1	24.28	59.28	12.26	
Scenario-3	1	27.18	28.40	0.54	
Scenario-1,2	1	19.20	95.20	6.17	
Scenario-2,3	1	21.28	21.28	1.38	
Scenario-1,3	1	33.13	33.13	2.15	
Scenario 1,2,3	1	21.48	0.48	0.03	
Error	1	18.48	0.48	0.03	

**Table 5.3:** ANOVA results

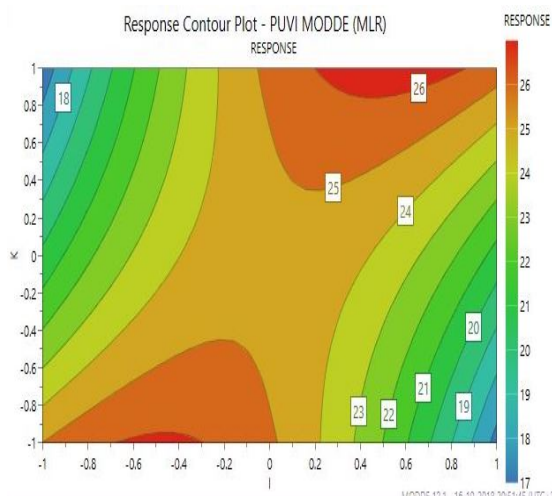
Source	S-1,2	S-1	S-2
1	95.2%	68.6%	58.2%
Rank	1	2	3

**Table 5.4:** Response table for OEE

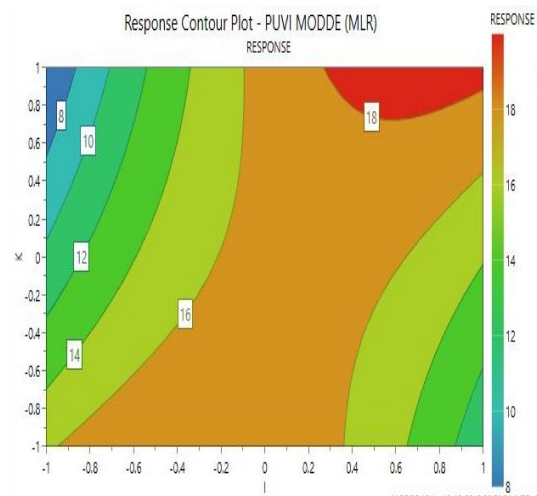
Hence, the depicts data is normally, evenly distributed and validates that this model has a satisfactory goodness of fit. Hence, we conclude that the document-centric practice significantly differ. Next section, illustrates the stakeholder satisfaction analysis.

### RSM analysis for OEE

The moodle method illustrates the RSM-3D contour graphs plotted for two participating factors at one time, on x- and y-axis, against the obtained responses for COD recovery plotted on the z-axis, with different levels indicated by the color/height/contours of the obtained curve; Figures shows the 8.39, 8.40, 8.41, 8.42,8.43 , 8.44.



**Figure 5.17:** Response contour plot 1



**Figure 5.18:** Response contour plot 2

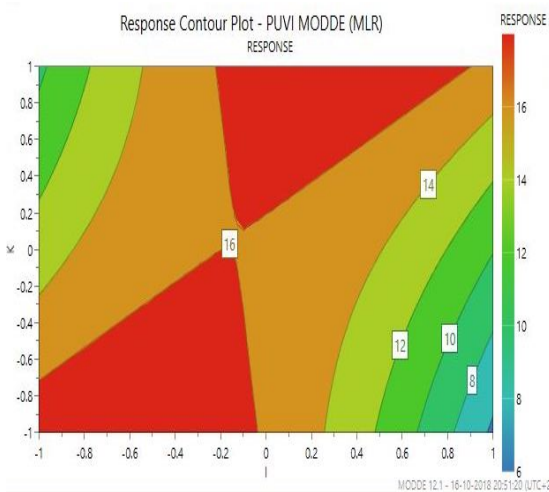


Figure 5.19: Response contour plot

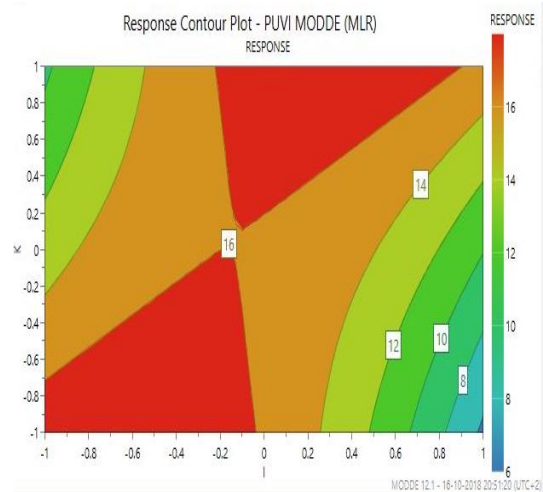


Figure 5.20: Response contour plot

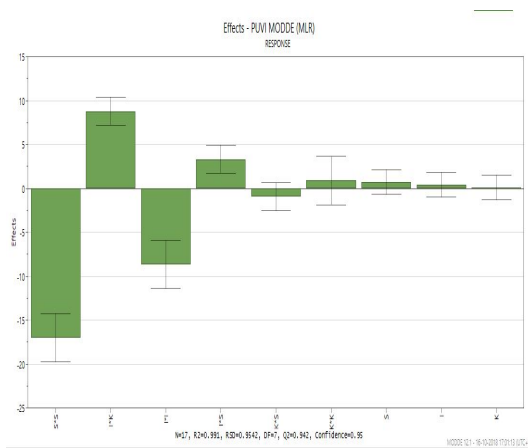


Figure 5.21: Summary of fit (OEE)

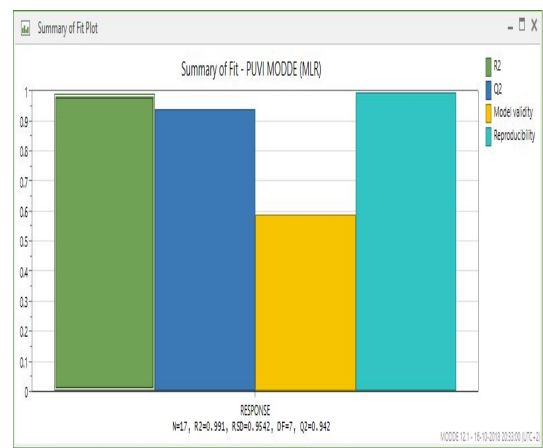


Figure 5.22: Summary of fit (OEE)

### 5.3.6 Analysis of Operational satisfaction

## Operational satisfaction analysis

- Phase-1 System description phase
- Phase-2 System Operation phase
- Phase-3 System Document to model practice Transition phase

In this section, stakeholder satisfaction is measured on perceptions of a transition of model-centric practice. It is calculated by asking the stakeholders to rate their satisfaction on a numerical scale. We have conducted subjective research to assess and identify satisfaction. For that, We have prepared the multi-choice questions in three Phases. Each phase has a different level of questions. It includes:

A total of 34 participants participated in the survey on three levels of the questionnaire. After the survey, we have collected the data and analyzed its outcomes. The following section shows the results of each phase of the questionnaire.

### 5.3.6.1 System awareness

In this section, the respondents were asked to choose the practice that help them to understand the system and its descriptions. 4 levels of questionnaire addressed this aspect. Figure 5.23 shows the survey outcome related to the awareness.

The results show that the majority of the respondents agree that they understand the individual or combined system description (Q1.1, Q1.2, Q1.3, Q1.4). However, at the same time, 7% that they have less confidence in understanding the system configuration parameters. In addition, the respondents commented the existing technical documentation of the CPPS system does not describe the system context well. The model-centric practice offers better visualization and increases the ability to manage system complexity on the static nature of the system.

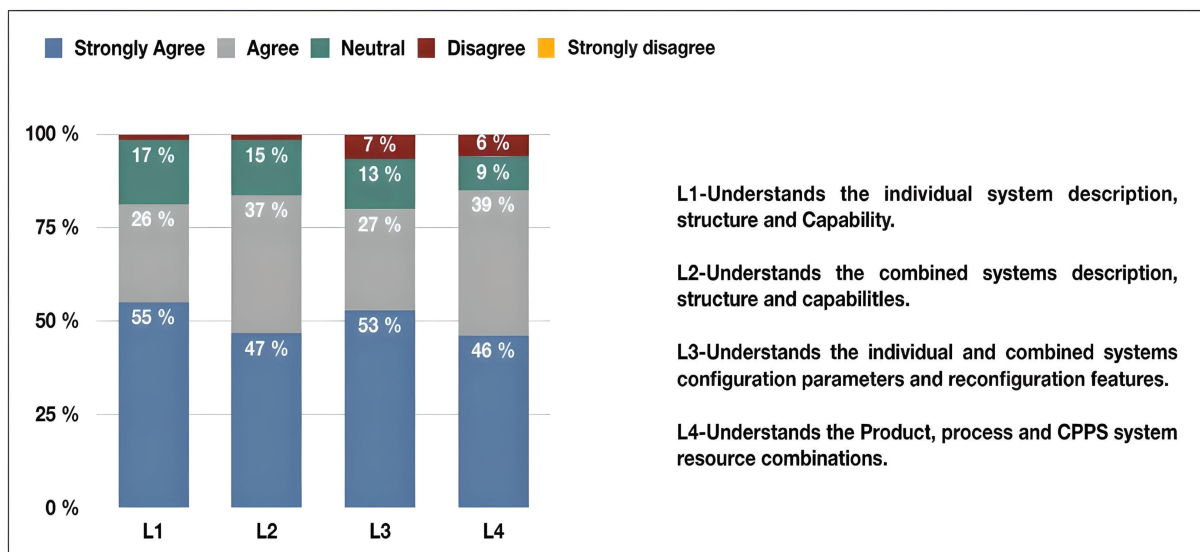


Figure 5.23: System description

### 5.3.6.2 Workforce

The stakeholders' satisfaction on workforce is evaluated based on the perception of the overall cognitive work-load. The survey result, Figure 5.24, shows that respondents strongly feel that model-based practices are more adapted. The results indicate that the stakeholders strongly agree on static operations like commission and decommission, execute/monitor and

maintain/repair (Q1, Q2, Q5).

The stakeholders strongly disagree with model-centric practice in dynamic operations (Q3, Q4). It shows that, 75% can't able make to decision during its dynamic system operations. The system is discretely changing its entities on each production orders, it is difficult to manage these operations. Also, 63% can't be able to make dynamic decouple of the system.

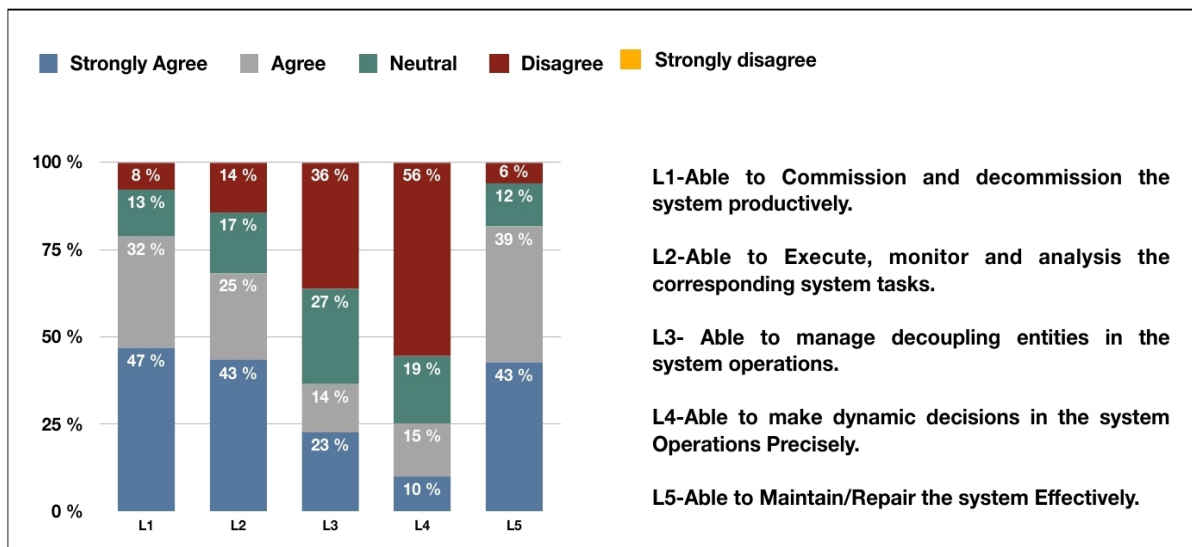


Figure 5.24: System Workforce

### 5.3.6.3 Transition comparison

In this section, the overall transition of document-centric to model-centric practice in CPPS is evaluated.

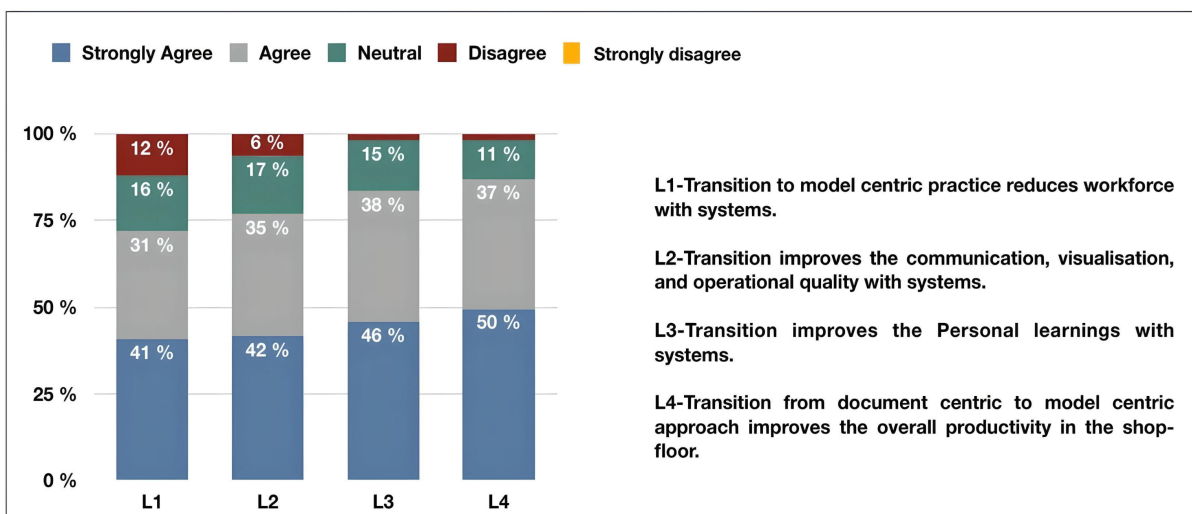


Figure 5.25: Transition comparison

We asked the respondents to assess their learning, overall workforce experiences with systems. The questionnaire is split into different levels based on their overall transition experience (**Q1, Q2, Q3, Q4**).

**Table 5.5:** Comparison of analysis on satisfaction

Scenario	lLegends	L11	L-2	L-3	L-4
<b>S1</b>	lStrongly agree	55%	47%	53%	46%
	lAgree	26%	37%	27%	39%
	lNeutral	17%	15%	13%	9%
	lDisagree	2%	2%	7%	6%
<b>S2</b>	lStrongly agree	41%	42%	46%	50%
	lAgree	31%	35%	38%	37%
	lNeutral	16%	17%	15%	11%
	lDisagree	12%	6%	3%	4%
<b>S3</b>	lStrongly agree	47%	43%	10%	43%
	lAgree	32%	25%	14%	15%
	lNeutral	13%	17%	27%	19%
	lDisagree	8%	14%	36%	56%

The survey result Figure 5.25 shows that respondents strongly agree that the transition to model-centric practice reduces the workforce, improves personal learning and overall productivity on the shop floor. The results also show that Level 2 disagrees with 6%; it replicates operational quality does not improve with the practice. The transition of model-centric practice brings the overall workforce productivity with the system.

### 5.3.7 Conclusion

To conclude that, the semantic repository application provides the standard semantic information of the system, their capabilities, and resource combinations.

- **Production operation performance** : It brings the benefits of improved productivity and dramatically reduce the time and cost of the production system.
- **Stakeholder satisfaction**: The stakeholder's satisfaction analysis is performed out to measure and assess the system awareness and workforce of those stakeholders.

The database offers different properties of a system, which is available in a model-based

semantics. Then, the benefits are carried out.

The presented repository was tested with real experimental scenarios in the system. The assessment results of system performance and survey outcomes that model-supported practice improve the productivity compared to document-centric practices. It brings the benefits of improved productivity and dramatically reduces the time and cost of the production system.



## 5.4 App-2 Collaborative management application

### 5.4.1 Introduction and problem statement

In this section, we reuse a modular semantics in an collaborative management application. The incorporation of new device is carried out. However, adopting of technologies with the existing complex system raises interface issues. there is a need of development of integrated interfaces to solve interoperability issues between the different components of the global production system.

For that, it is necessary to identify the interfaces representing the exchanged data flows between the given CPPS. It aims to support communication between the related logical and software components. Therefore, it considers all collaboration scenarios between the system to realize the requirements, identify the exchanged flows and interfaces flows between them. Finally, the application brings the interface management to support the MES and fleet manager. Finally, the initial stages of the demonstrator tool of collaborative management application are illustrated..

### 5.4.2 Schematic overview of reuse and instantiation

In this context, the Schematic overview of reuse and instantiation is illustrated. Table shows 5.6 schematic overview of generic modular architecture instantiation is described. It illustrates the viewpoint operation, relationships, and their description for application context is described.

**Table 5.6:** Reuse for interface management application context

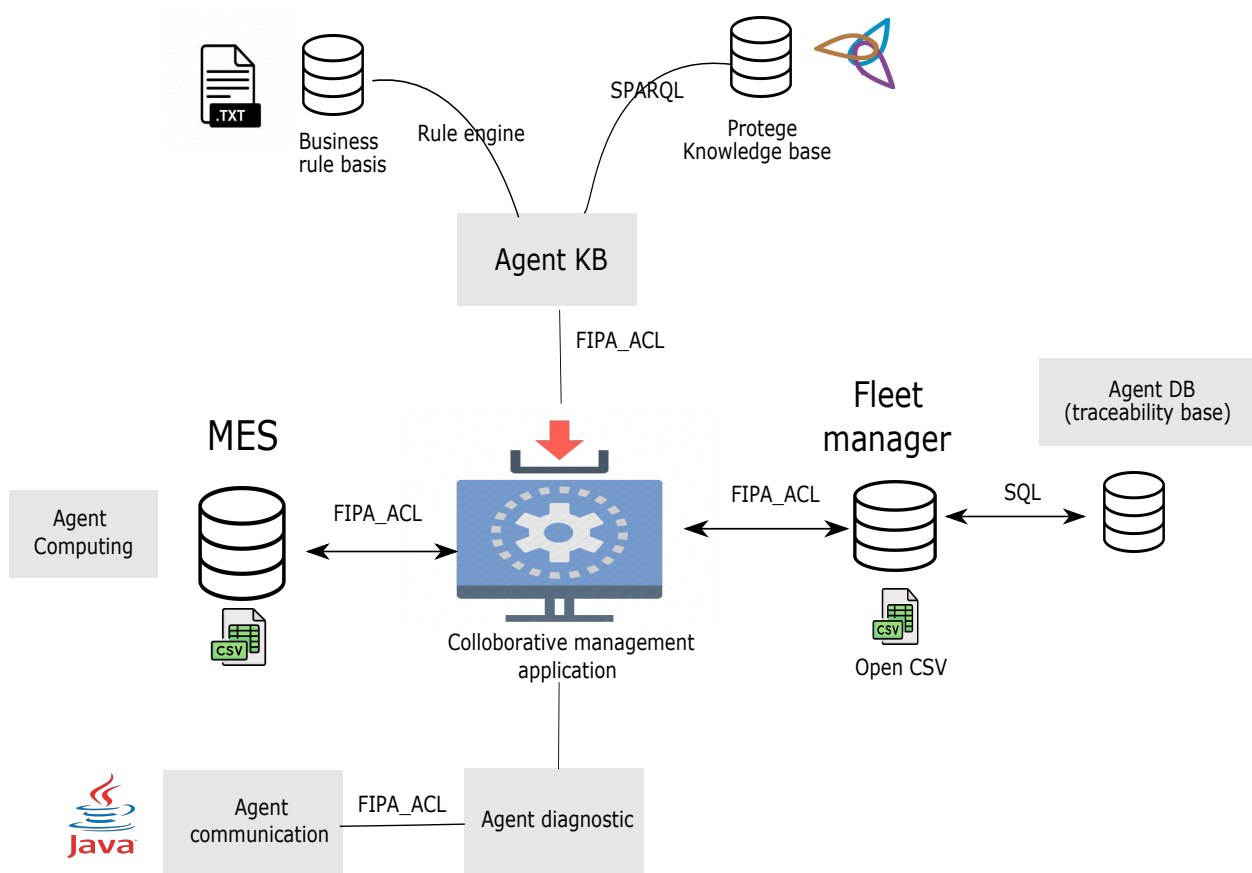
Viewpoints	Operation	Description
$V_I$	<b>Decomposition</b>	Provided a more detailed description in all views
$V_I$	<b>Extension</b>	Added a syntactic concept to a given view
$V_I$	<b>Reuse</b>	Reused the 'Operational concept' from the existing viewpoint

**The step-by-step application process is described in this chapter. Only the abstract results of each phase is illustrated in this application in context to reduce the pages.** It includes as follows. Next section, we illustrate the feasibility analysis on alternatives.

- 1) Feasibility analysis on alternatives (**Promethee decision-making analysis**)
- 2) Concept of operation (**CONOPS**) analysis
- 3) Collaborative space on-Software level (**Prototype**)
- 4) Collaborative space on-Physical level (**Prototype**)

### 5.4.3 Overview of Collaborative management application

In this section, the overview of collaborative management application is described. Figure 5.26 illustrates the schematic overview of Collaborative management application. It illustrates the development of the Collaborative management application, several technologies and programming languages were used.



**Figure 5.26:** Overview of collaborative management application

To achieve the global aim, there is a need of the development of integrated interfaces to solve interoperability issues between the different components of the global production system. The preliminary work on analyzing identification and analyzing the different alternatives. Then, the realization of communication between the related logical and software element is described. This work is a first step in order to later address the interoperability issues as a future work of the Collaborative management application.

#### 5.4.4 Feasibility analysis on alternatives

First, the feasibility analysis on alternatives is carried out. For that, the multi-criteria decision-making analysis is carried out. It is computed to each criterion by the decision maker and comparisons between all pairs of actions that can be done for all the criteria [Brans and Vincke [1985]].

### Promethee- decision making formula

$$\pi a, b = \sum_{k=1}^q P_k a, b \cdot w_k \quad \pi a, b = \sum_{k=1}^q P_k a, b \cdot w_k \quad (5.4)$$

$$\pi a_i, a_j \geq 0 \quad \pi a_i, a_j \geq 0 \quad (5.5)$$

$$\pi a_i, a_j \quad \pi a_j, a_i \leq 1 \quad \pi a_i, a_j \quad \pi a_j, a_i \leq 1 \quad (5.6)$$

$$d_k a_i, a_j = f_k a_i - f_k a_j \quad d_k a_i, a_j = f_k a_i - f_k a_j \quad (5.7)$$

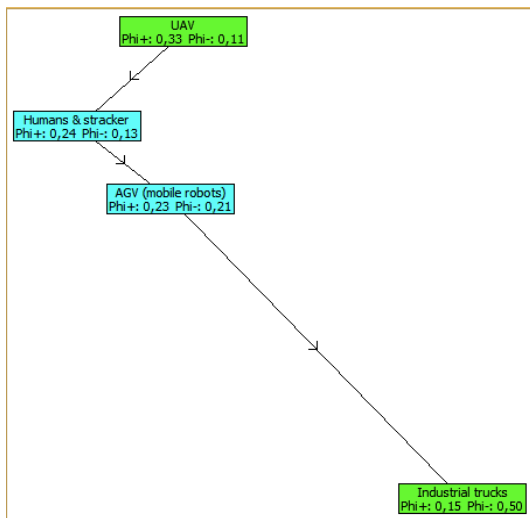
In order to analysis, it is necessary to find all the possible stakeholders of the system. The next section shows the all possible (SC) and categorized alternatives. It is expressed as follows:

- AS/RS Warehouse, Robot assembly, material handling modules transfer unit provider, Boxes, Shop floor Environment, Execution information provider,. **(SC1)**
- T-branch moduler-1, T-branch moduler- 2, Pallet semi-finished carriers, Shop floor environment, MES. **(SC2)**
- Finished product transportation process- AS/RS Warehouse, App O/P module transfer unit. **(SC3)**

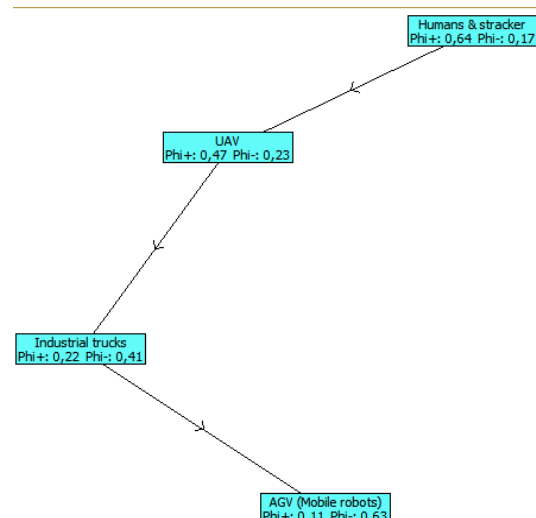
- Pick by light transportation process-AS/RS Warehouse, App pick by light, Shop floor environment, shop floor operator. **(SC4)**
- Fuse transportation- AS/RS Warehouse process, App robot fuse transfer unit, Fuses, CP environment, **(SC5)**
- AS/RS Warehouse, App magazine module, Top cover, CP Environment, **(SC6)**

$$\begin{bmatrix} SC1 \\ SC2 \\ SC3 \\ SC4 \\ SC5 \\ SC6 \end{bmatrix} = \begin{bmatrix} S_{h1} & S_{h12} & \dots & S_{h1n} \\ S_{h2} & S_{h13} & \dots & S_{h2n} \\ S_{h3} & S_{h13} & \dots & S_{h3n} \\ S_{h4} & S_{h14} & \dots & S_{h4n} \\ S_{h5} & S_{h15} & \dots & S_{h5n} \\ S_{h6} & S_{h16} & \dots & S_{h6n} \end{bmatrix}$$

Figure 5.27 shows the Gaia visual analysis. The result indicates that different categories of alternatives on scenario has different perspective and concern. The figure shown is red thick angle which is a decision angle and it indicates the AGV's for stakeholder criteria. The loading transportation process (**Scenario-2**), the stakeholder group  $SCT_4, SCT_6$  is preferred more on UAV's attribute because of more flexibility tiny load and adaptation of their concern.



**Figure 5.27:** PROMETHEE I—Partial Ranking



**Figure 5.28:** PROMETHEE II—Partial Ranking

The Unloading transportation process (**Scenario-3**), the stakeholder group  $SCT_3, SCT_4$  is preferred more in human stacker because of feasibility on their concern. Next section shows the Concept of operation(CONOPS) analysis.

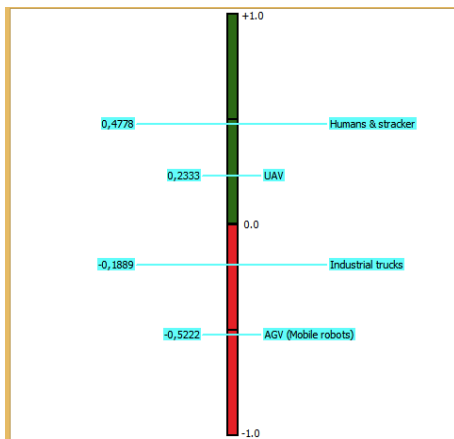


Figure 5.29: PROMETHEE III—Partial Ranking

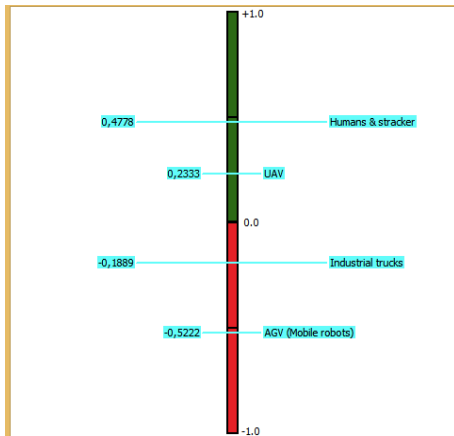


Figure 5.31: PROMETHEE III—Partial Ranking

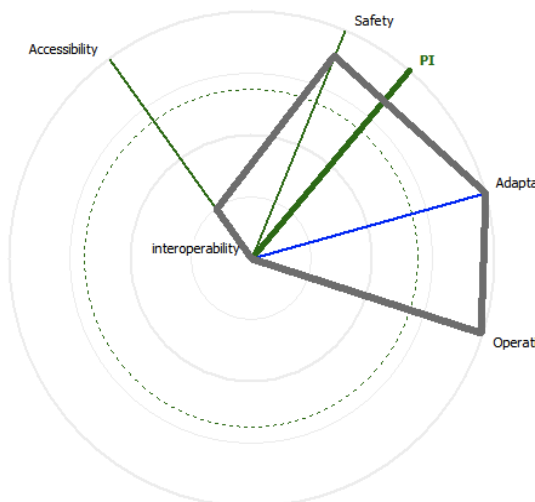


Figure 5.33: PROMETHEE III—Partial Ranking

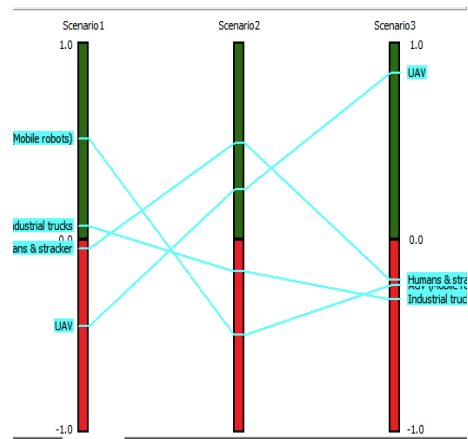


Figure 5.30: Network display on alternatives

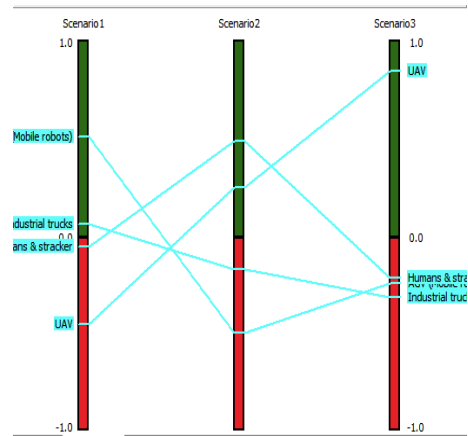


Figure 5.32: Network display on alternatives

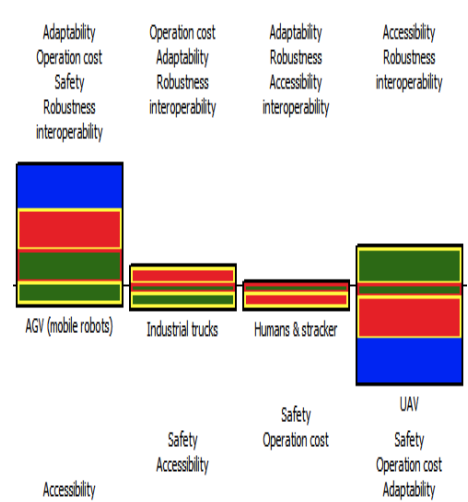
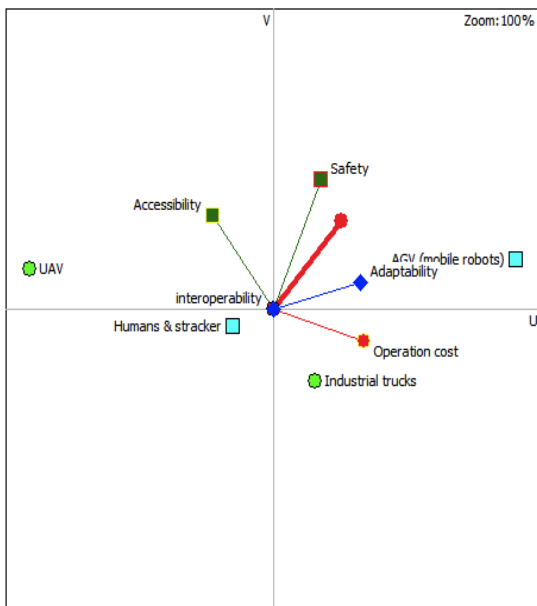
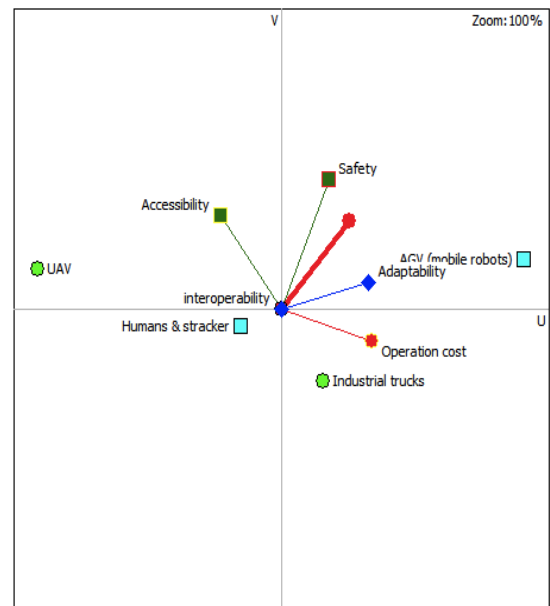


Figure 5.34: Network display on alternatives

**Table 5.7:** The flows of the alternatives

Rank	Actions on alternatives	Netflow( $\Phi$ )	Positive Flow ( $\Phi+$ )	Negative Flow ( $\Phi$ )
1	$SCT_1, SCT_2$	0.2042	0.3464	0.1423
2	$SCT_3, SCT_4$	0.0784	0.2295	0.1512
3	$SCT_4, SCT_6$	0.0772	0.2572	0.1800

**Figure 5.35:** PROMETHEE III—Partial Ranking**Figure 5.36:** Network display on alternatives

Based on the above stakeholder preference and conflict on each alternatives, we can find that what is possible transportation process for proposed system. From the above result, the drone attribute can transport the fuses and top cover assembly parts. The stations have to interface with AS/RS Warehouse, Application magazine module and Application robot fuse assembly.

#### 5.4.5 Concept of operation(CONOPS) analysis

Based on alternative analysis, the Concept of operation (CONOPS) is carried out. It operates on user perspectives and in real-time operation[Mahboob et al. [2017]]. The concept of operation helps the system to be developed based on the operations on different scenarios. Fig 6.33. Secondly, we analyzed how the concept system integrates with another system in the physical and cyber component level according to the assembly operations.

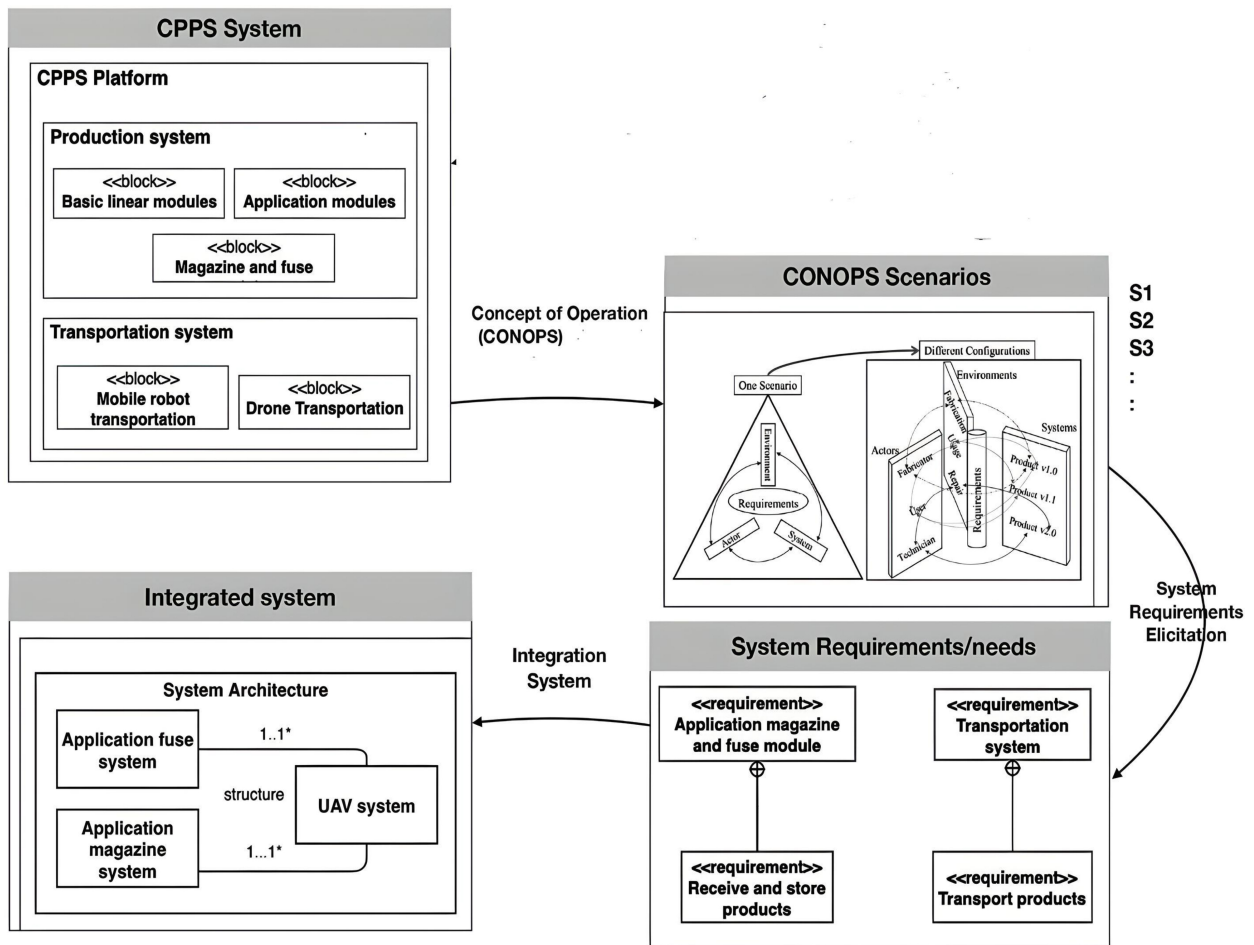


Figure 5.37: Concept of operation (CONOPS) (S1), (S2), (S3)

Based on the concept of operation of each assembly scenario, the identification of collaborative logical and software level is described. Next section, we illustrate the prototype of the Collaborative management application.

### 5.4.5 Prototype of the collaborative application

In this context, we illustrate the Prototype of the application is described. It identifies the exchanged flows and interfaces flows between them. It is at two levels: logical and software solution. Figure 5.38 shows the prototype of the application. It is based on Interface Design and Control Methodology for collaborative development. The Port is bonded to the Graphical user interface. In that, two main classes are: Subsystems and Ports Subsystem attributes can be: Subsystem ID, Subsystem Name, Subsystem Type, Number of ports etc. Ports Attributes can be: Port ID, Port Form, Port Function, Port Behaviour etc. When two ports are mated an interface is formed.

This Dataset will be imported into the Protégé tool. It will be visible as Individuals in the



entities tab. Some samples are illustrated. To query and manipulate RDF data, a query language is required. For that purpose, W3C standard recommended SPARQL, a recent addition to the Semantic Web stack of languages which is illustrated as follows:

```

<owl:ObjectProperty rdf:about="http://www.colloborative ls2n.com//hasA">
<rdfs:domain rdf:resource="http://www.colloborative ls2n.com/ontology/Function"/>
<rdfs:domain rdf:resource="http://www.colloborative ls2n.com//Subsystems"/>
<rdfs:range rdf:resource="http://www.colloborative ls2n.com//Flow"/>
<rdfs:range rdf:resource="http://www.colloborative ls2n.com//Function"/>
<rdfs:range rdf:resource="http://www.colloborative ls2n.com//Ports"/>
</owl:ObjectProperty
    
```

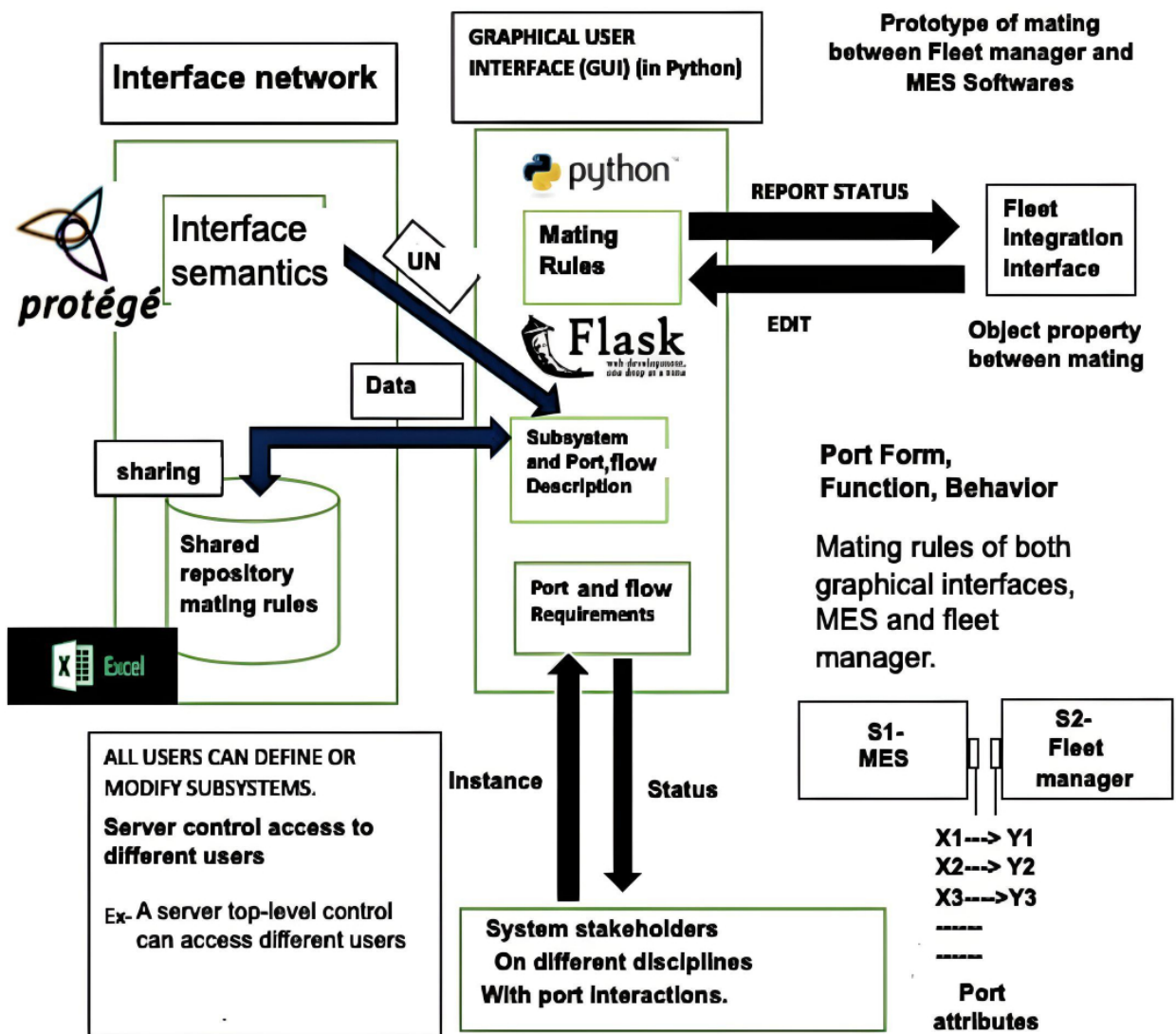


Figure 5.38: Prototype of Collaborative Graphical interface

### 5.4.6 Collaborative management application

In this section, the Collaborative management application is described. Figure 5.40 shows the Semantic smart soft component interface model. Figures 8.53 and 8.54 show the logical component interface of collaborative system. figure 5.40 5.44

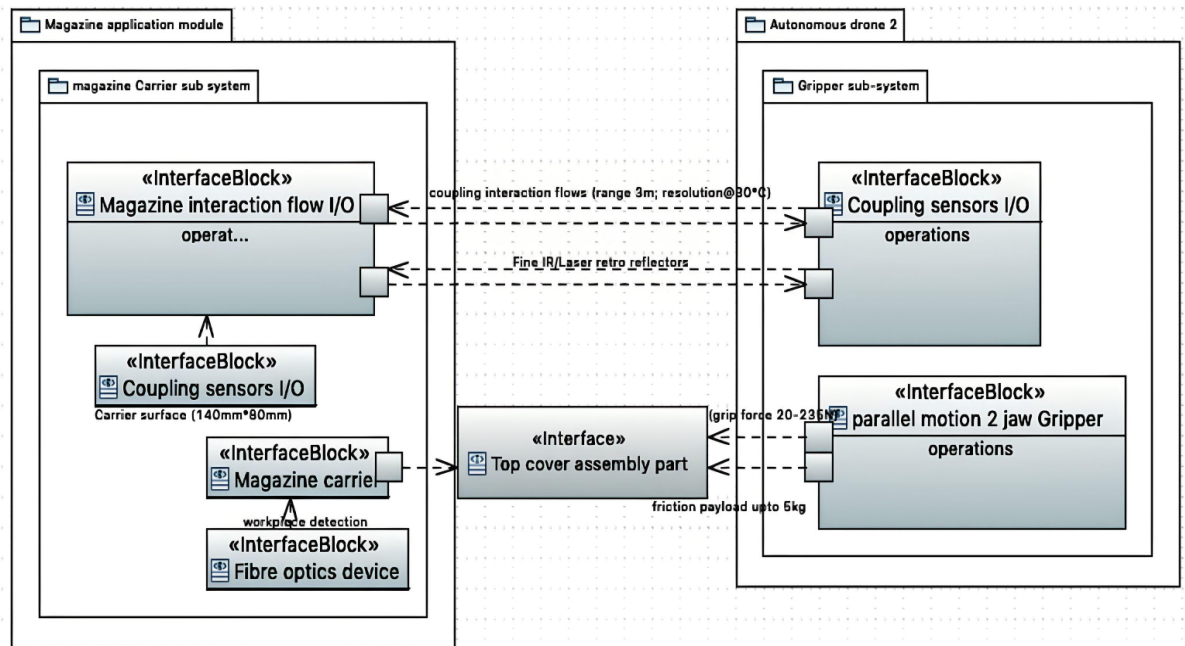


Figure 5.39: Logical interfacing solution

- **I-1** The fleet manager performs the coordinate functionality of data processing, mapping, environment positioning, configuration of the system (drone deploys, other fleets, MES). For example, the drone deploys sends the drone initialized command to the fleet manager. The command helps the fleet manager position the drone for transportation.
- **I-2** The smart soft components of mobile robots and drones are deeply intertwined with fleet coordination. For example, the task library of the fleet manager receives and synchronize the predefined intelligence of drone for docking and undocking the materials.
- **I-3** To perform a global task of the production process, the interoperable information exchanges of (1), (2) shares the configuration information, predefined intelligence of the system. For example, synchronization of production tasks with drone tasks. These three collaborative communication exchanges at the software level to perform collaborative management support.

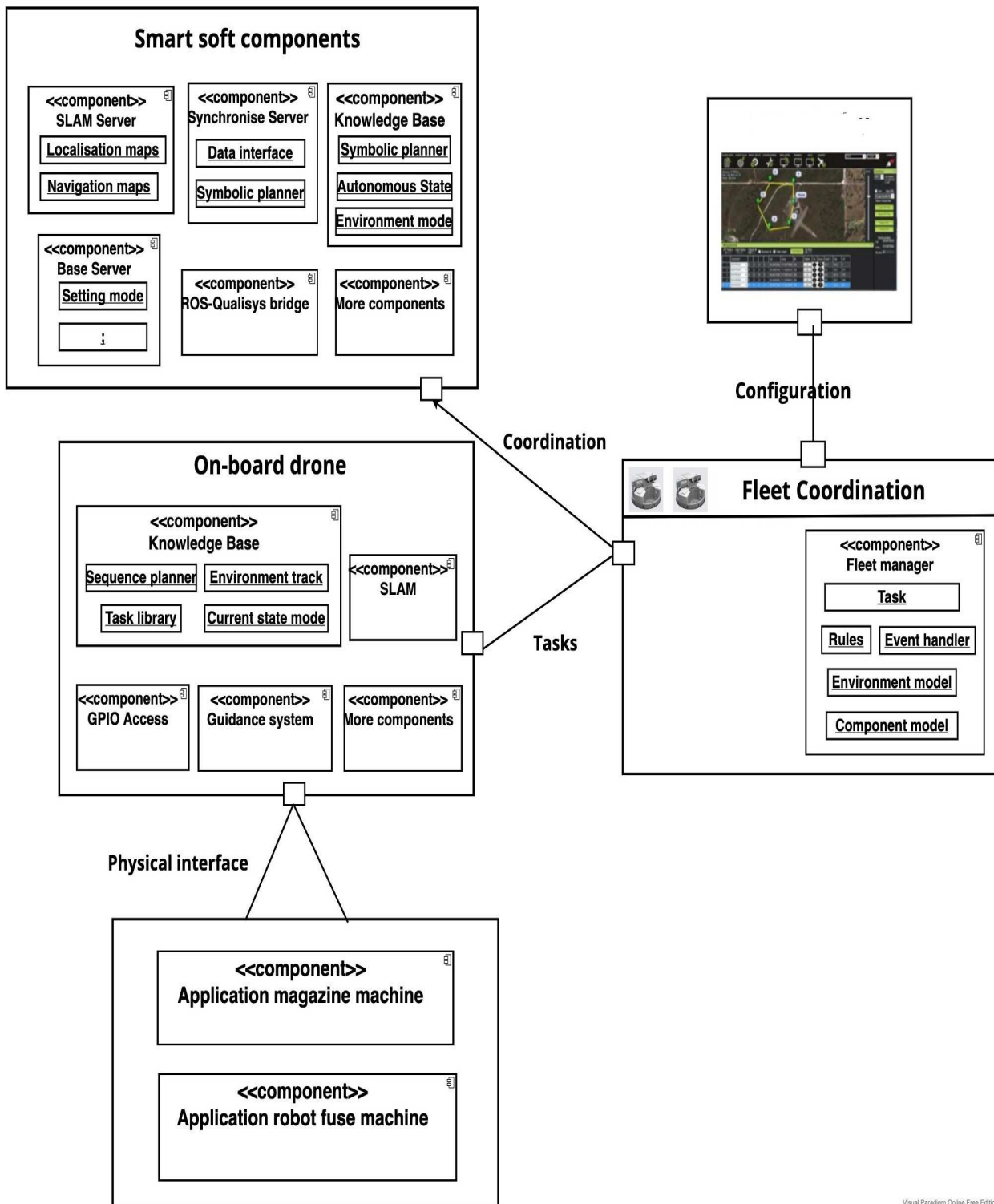


Figure 5.40: Smart soft component of application

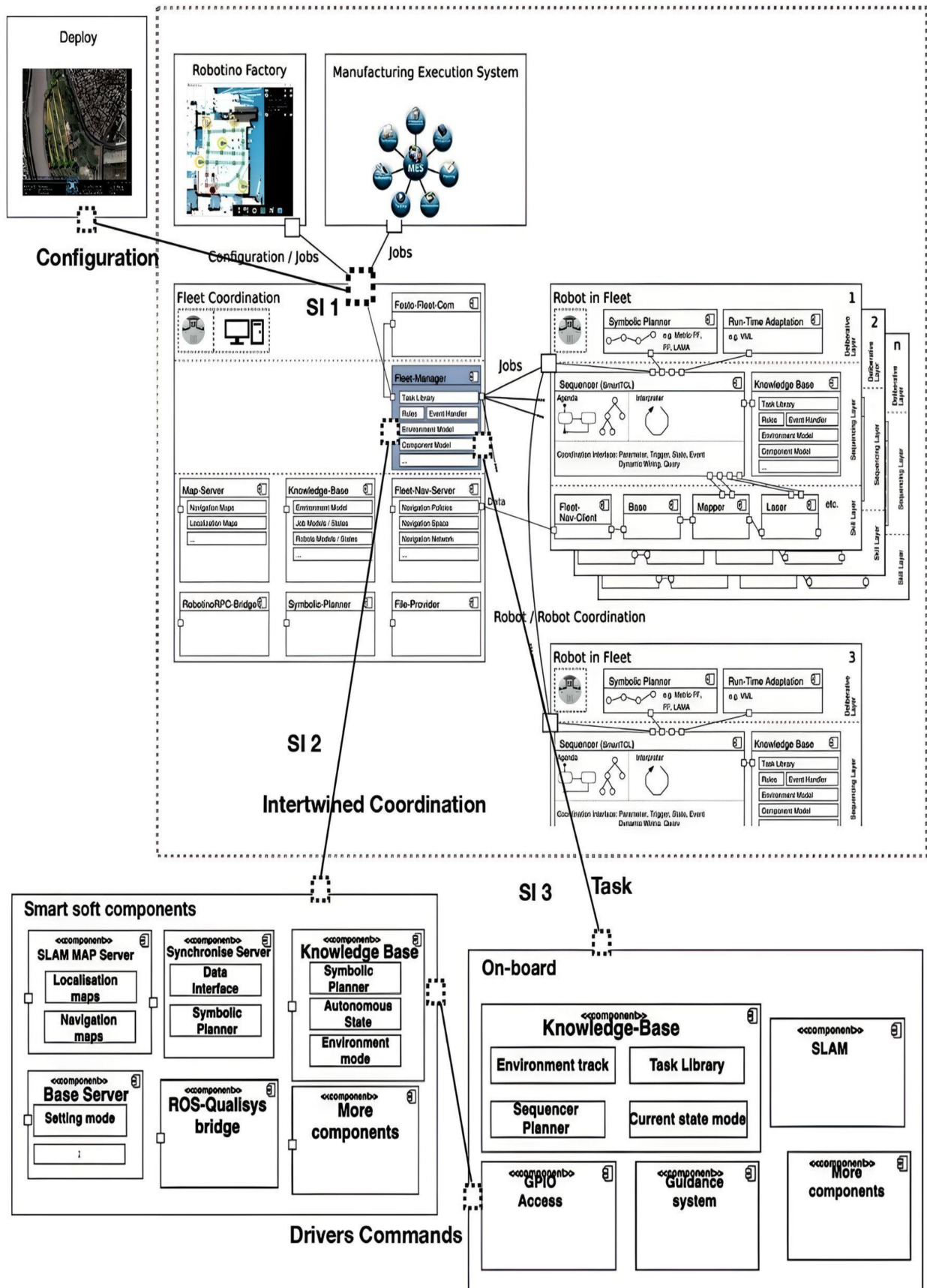


Figure 5.41: Collaborative Interface management application

### 5.4.7 Collaborative management space

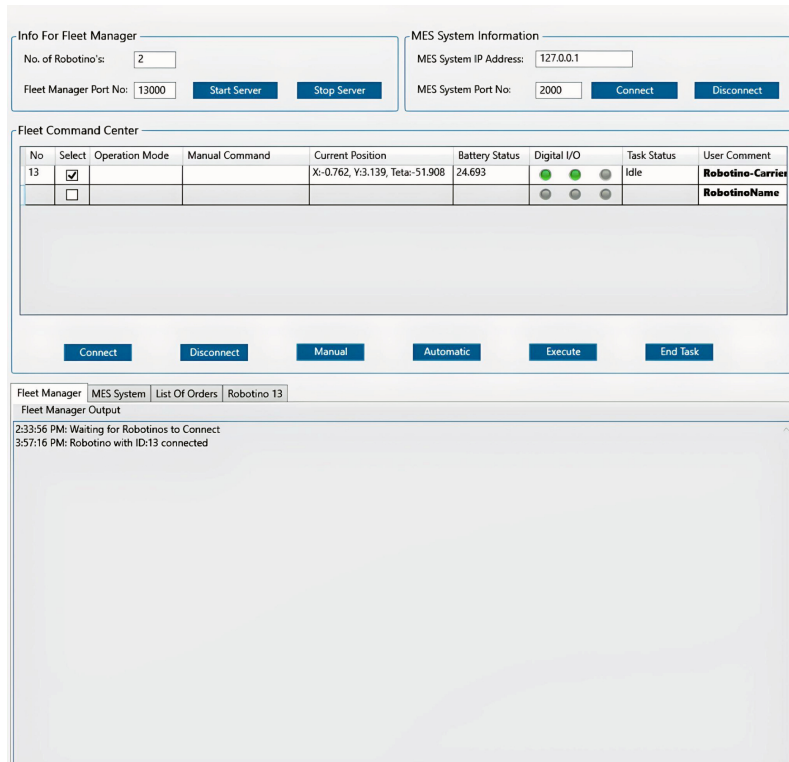


Figure 5.42: Collaborative fleet management view

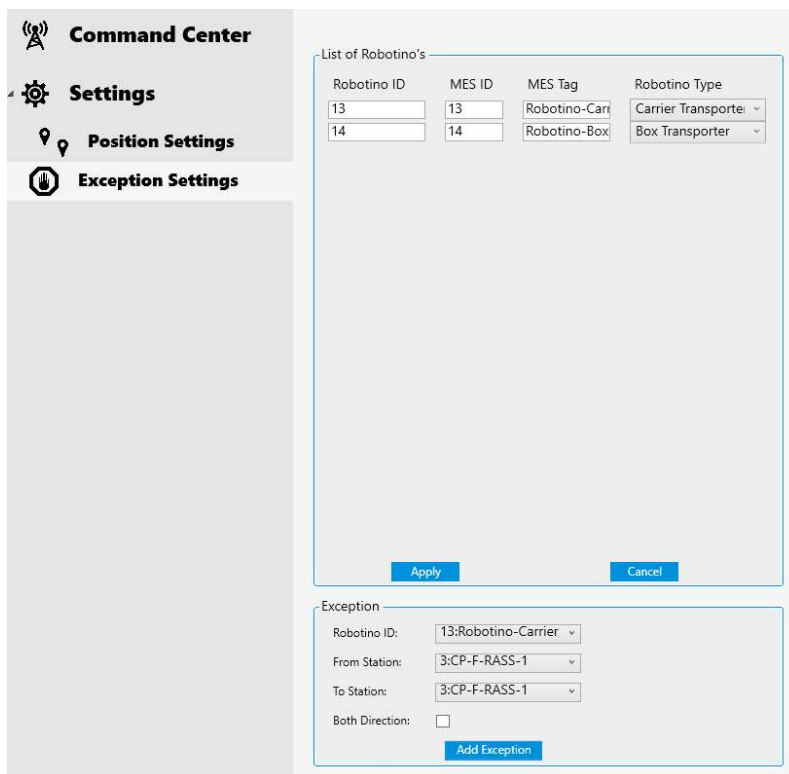


Figure 5.43: Collaborative fleet manager



The figure 5.42 shows the CPPS resources and Manufacturing Execution System (MES) applications. As discussed in the system architecture section, the MES, which executes the assembly operation and has global control of the production system. Fig ?? shows the drone applications available to process the planning of flight, 3D Mapping, localization and mapping.

It is the initial level of demonstrator which is created for software components to communicate with each other. It may include specifications for routines, data structures, object classes, and variables. It transmits and communicate with each other for the operations.

		LOGICAL COMPONENTS																				
		MCCPSP	Ground control station	self-module	RC Controller	RC Receiver	Battery	SLAM	Proteack	Realtime PC (Nucleo-)	IFT Marker	Brushless motor	Guid-Proxalle	Frame	Proximity sensor		Vision board camera	Shurclon Gripper	Parallel motion jaw gripper	Drone platform		
REQUIREMENTS	R1.001-System shall transport the standardised and customised fuse		X	X				X	X	X	X							X		SATISFY		
	R1.002-System shall transport the standardised and customised top cover assembly part from AS/RS Warehouse to application magazine module from fleet manager		X	X				X	X	X	X								X			
	R1.004-The system shall autonomously take off and land from a visually marked drone platform in indoor Environment known or unknown stations in CP Factory on scenario basis		X	X	X				X												X	
	R1.005-The system shall pick and drop products in target area with stations (RFID tags) products in aerodrome flying space														X		X	X	X			
	R1.008- The system shall carry a product weight upto max 5 Kg on each scenario cruise task aerodrome flying space depends on the scenario may changes		X	X				X		X				X				X	X			
	R1.011-The system shall communicates with fleet manager continuously to process for cruise task		X	X				X		X											X	
	R1.012-The system shall autonomously charge the battery whenever it is necessary in the Environment		X	X				X														
	R1.013-The system shall be stable positioning while transferring the product to stations		X	X				X					X									
	R1.014-The system shall be safe without harming anything while on operations and should impose flight clearance safety before flying		X	X						X												
	FUNCTIONS ANALYSIS	FA.001-The system will process based on the command received from Fleet manager		X						X												ALLOCATIONS
		FA.002- Autonomous takeoff from drone platform						X		X		X	X	X								
		FA.003-The system Load the assembly part from AS/RS Warehouse																X	X			
FA.004-The system will position stable when interface with any stations or any scenarios			X	X				X														
FA.005-Transport the assembly part to the required stations			X	X				X								X						
FA.006-Detect and Avoid collision when transporting the assembly part															X							
FA.007-Unloading the fuse assembly part in app robot fuse module								X	X	X		X	X					X				
FA.008-unloading the top cover assembly part in application magazine module								X	X	X		X	X					X				
FA.009-Returning to original drone platform position																			X			
FA.010-If any failure occurs during operation.The drone calls another to do the operation			X	X	X	X																
FA.011-The system carry a weight upto max 5kgs during cruise trajectory path when production system changes based on scenarios			X					X														
FA.013-The system transport a product with a maximum speed of upto 25km/hr									X	X		X	X									
FA.014-The system will fly a maximum altitude of upto 7ft									X	X	X	X	X									
FA.015-The system will function after the flight clearance safety imposed by the fleet manager			X					X														
FA.016-The operator will access the drone if any emergency case					X	X																
FA.017-The system automatically charge the battery in indoor environment . if power is low							X												X			

Figure 5.44: Design structure matrix for Interface matrix)

#### 5.4.8 Synthesis

To conclude that, the first step on the collaborative management application context is achieved for this application in LS2N platform project. Firstly, the feasibility analysis, Concept of operation (CONOPS) scenario analysis is carried out. Then, the elicitation of requirement scenario of transportation device and application modules is analyzed. Then, the collaborative interface application. It is the required step to analyze and address the interoperability problems further in future work. Finally, the design and realization of the interoperability between the different components at physical (for eg, coupling sensors) and software (for eg, synchronization, drone task planning) level of the system will be achieved. In the end, the realization of the interoperability between the different components at physical (for eg, coupling sensors) and software (for eg, synchronization, task planning) level of the system is achieved in that application context as future work.

## 5.5 Conclusion

In this chapter, the modular semantic is re-used and instantiated in two independent application context. It is realized from the LS2N-Platform project. It demonstrated through the case application context in CPPS environments.

- **Case-1 Application context** It presents the repository application. It provides the standard semantic information of the system, their capabilities, and resource combinations. It manages the engineering workflow of product development, allocating the manufacturing process and setting up the production system of the involved actors.
- **Case-2 Application context** It presents the collaborative interface application management. From this work, the first solution is achieved. It shows the collaborative design solution is realized for problem is achieved. The realization of the cyber and physical elements of the (for eg, coupling sensors) and software (for eg, synchronization, task planning) system is achieved.

From this chapter, it illustrates that the modular semantic architecture can be re-used unambiguously across different independent application context of CPPS. It shows that, the standard unit openness to accommodate the changes in representation on inclusion and exclusion part of the system. It answers the **second research question (RQ2)** by opening new perspectives and demonstrated through the application context. Finally, we close the chapter by summarizing the takeaways of the two real case application is instantiated from the proposed model.



.

# Multi-viewed Semantic for Human-CPPS notion integration

*This chapter describes the second part of the framework. The semantic for Human-CPPS interaction phenomenon is presented. It establishes an explicit and formal phenomenon of what the interactive human-CPPS are (limitation and research gap-3.) Finally, it is reused in application context of HCPPS configurator.*

6.1	Introduction . . . . .	190
6.2	Terminology and typology of Human-CPPS notion integration . . . . .	192
6.3	Multi-viewed Semantic for Human-CPPS notion integration . . . . .	194
6.3.1	Related works before developing HCPPS . . . . .	194
6.3.2	Mechanism before developing HCPPS Semantics . . . . .	196
6.3.3	Fragment top domain model of HCPPS . . . . .	199
6.3.4	Interaction Human modality aspects . . . . .	200
6.3.5	Interaction CPPS modality aspects . . . . .	203
6.3.6	Human-CPPS interaction phenomenon . . . . .	205
6.3.7	Collaborative HCPPS integration semantics web page . . . . .	207
6.3.8	Synthesis . . . . .	210
6.4	Model Verification and Validation-algorithms . . . . .	211
6.5	Application context . . . . .	219
6.5.1	Introduction and problem statement . . . . .	219
6.5.2	Schematic overview of reuse and instantiation . . . . .	219
6.5.3	Configurator for human learning process . . . . .	220
6.5.4	Knowledge Tool for Interaction - HCPPS . . . . .	224
6.5.5	Inventor Solution Query and dialog box . . . . .	227
6.5.6	Synthesis . . . . .	230
6.6	Conclusion . . . . .	231

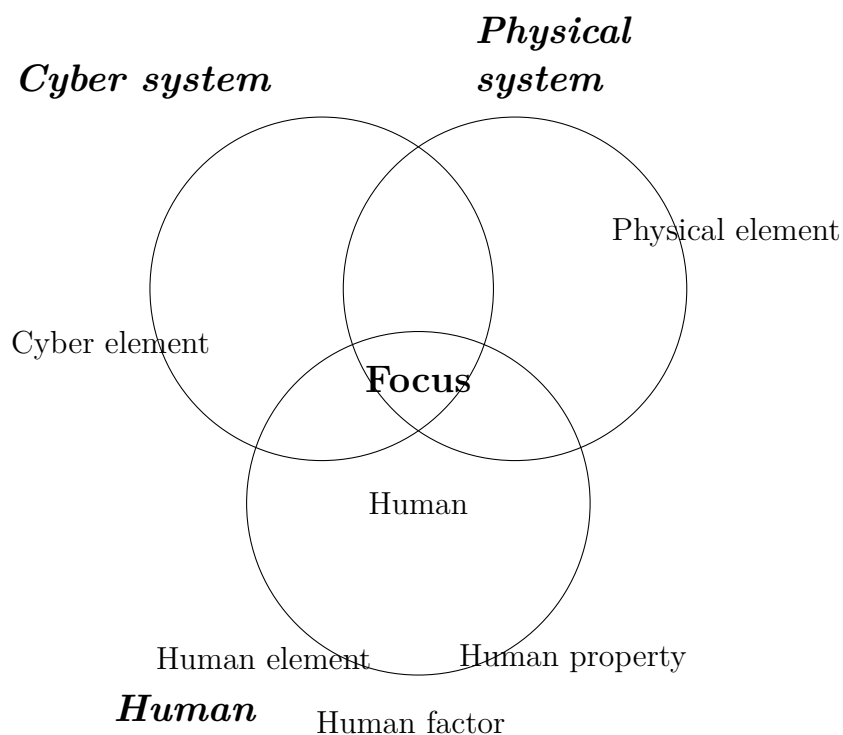
## 6.1 Introduction

To address the answer to the third research question,

### SQ-2 How can human-CPPS integration are defined in a unified semantics?

It is answered using the competence question that formed between the human and CPPS-configure and configuration level as shown below.

**Puviyarasu SA** et al, *Anthoroporhic of cognition and configuration level of human and machine*, human-computer interaction journal, 2021, France. (in preparation)



SNo	Research Competence questions
CQ-1	What is human interaction?
CQ-2	What is CPPS interaction?
CQ-3	What is the human-CPPS theoretical phenomenon?
CQ-4	What are the axioms of human-CPPS interfaces?
CQ-5	What is the level of human-CPPS integration?
CQ-6	What is a human-CPPS interaction?
CQ-7	How is a human input processed by an interactive CPPS?
CQ-8	How is a CPPS input processed by a human?

**Table 6.1:** Research focus competences questions

**I**N this chapter, we have explicit the involved HCPPS integration phenomenon, by establishing a conceptualization of it. It is an abstract, formal representation of HCPPS, which is grounded on ontological consideration of the system. The Human-CPPS Integration (HCPPS) is a complex phenomenon involving human beings and CPPS. It is an advent of new types of interactive systems (mobile applications, smart cities, smart homes, ubiquitous systems and so on). Despite its importance, there is still a lack of formal and explicit understanding of what the HCPPS phenomenon is (Limitation and research gap-3). Table 6.1 shows the research focus competency question as above. It focuses on the human-CPPS standard axioms which include the interface, integration, interactions. The following categories of knowledge are at the heart of the proposed human-CPPS phenomenon:

- First, we identify and classify the **terminology and typology of HCPPS**.
- Second, the interactive human property and their possible actions when interacting with an CPPS is described. It answers the **CQ-01-** by understanding the interactive human.
- Third, the interactive CPPS property and their possible actions when interacting with a human is described. It answers the **CQ02-** by understanding the interactive CPPS.
- Fourth, the human-CPPS interaction is described. It addresses the **CQ03-CQ-08** human inputs, system outputs, actions, and their interpretations.
- Finally, categorizing the interaction of Human-CPPS notion and define the possible flows between each pair of elements to achieve a certain goal **CQ03-CQ-08**.

**Application context-** It is reused and initiated in an application context to support the specific human-CPPS context. It is reused to design the configurator. It enhances the human to take actions, synthesizes the information and assists the decision-making process in human-CPPS related activities. **(The application work is done by united industry context)**

From this chapter, we established a consistent and more comprehensive conceptualization of the HCPPS phenomenon. It will serve as a foundation, in particularly, to understand the Human-CPPS body of knowledge.

The chapter describes as follows: Section 6.3 proposed semantic model for human-CPPS; Section shows the 6.4 model verification; Section shows the 6.5 case application; Section 6.6 Conclusion and Synthesis.

## 6.2 Terminology and typology of Human-CPPS notion integration

In this section, we have identified and classified the terminology of Human-CPPS. It is a systematic classification of the core terminology of inclusion and exclusion (including the rationale), part of the human-CPPS. It is an open and closely coupled system. It is a system of system(SOS) integration. The cyber, physical, human which interact together to fulfill the objective [Cardin [2019]] [Nichols [2007]].

The humans intervene to make informed decisions and perform production tasks. Based on this category, we categorized the H-CPPS terminology, i.e., in terms of levels of abstraction, to ensure the results are comprehensive by including all core entities of interest. Thereby, we define this terminology dimension as a generic category that contains one or several entities. In the following, we define the CPPS terms and used to establish the meaning to illustrate relations, which are the subject of our semantic models below.

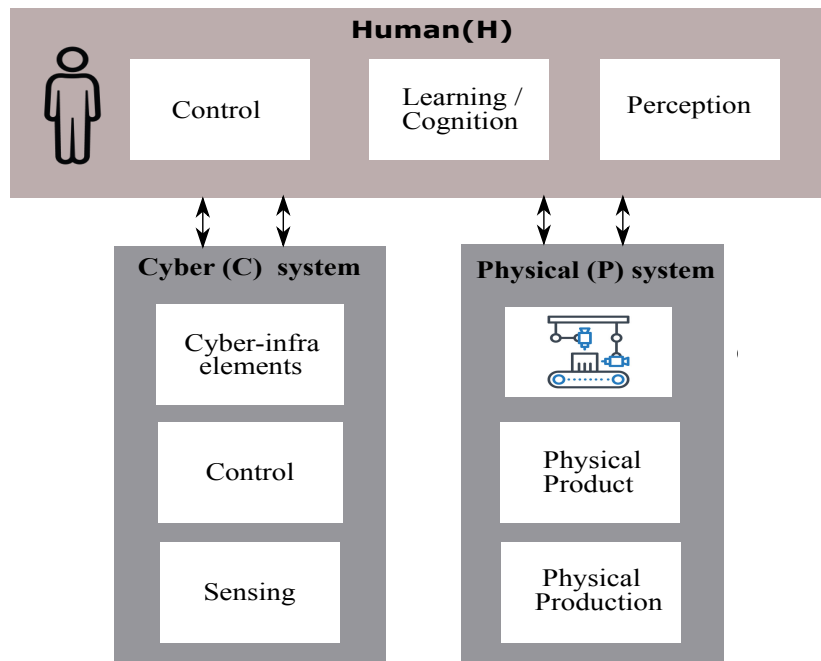
### Human-CPPS integration layers

*It refers all the entities which enable (authorized) human beings to interact with the CPPS's inner system. It involves both the tangible and intangible elements. It manages industrial and process control machinery via a CPPS-based human interface [Ansari et al. [2020]] [Bednar and Welch [2020]] [Kagermann et al. [2013]]*

### Human beings

*The "human-beings" which refers to an integral part of CPPS, observe and control the production's operating systems to guarantee congruence between human objectives and constraints. It can be essential to the technical operation to guarantee congruence between human objectives and constraints. [Zamfirescu et al. [2014]] [Pinzone et al. [2018]][Romero et al. [2016a]]*

**Other author may use-** *"Man-machine interaction (MMI)", "CPPS-human interaction (CHI)", "human-cyber interaction", "human-physical interaction" and "human- CPPS interface". where the humans intervene to make informed decisions and perform production tasks" etc. [Weyrich et al. [2017]] [Becker and Stern [2016]], [Darwish and Hassanien [2018]]*



**Figure 6.1:** Human-CPPS core entities

Figure 6.4 shows the core entities of HCPPS from. The semantic annotations of Human-CPPS layer: **HCPPS**. It is the set of HCPPS semantics that brings some meaning to any annotated element. The semantic annotation is a tuple  $SA := (R_A, C_A)$ . Where **RA** : set of resources; **CA** : set of concept names defined in semantics ( $CA \subseteq RA$ );

- **In the cyber-human level-** We define a “**cyber-human element**”, refers to translates either human input information into electronic signals for the CPPS’s inner system and AS, or system output information vice versa. Human input information may be provided by, among other things. [Kassner and Mitschang [2015]], [Kuhnle and Lanza [2019]] [Niggemann and Lohweg [2015]] [Oberc et al. [2018]]

- **In the physical-human level -** We define an “**cyber-human element**” refers as hardware that acting/perceiving to/from the physical world-of-interest. The Physical behavior is under the control of Conscious or Unconscious processes. [Weyrich et al. [2017]] [Akanmu et al. [2012]] [Imkamp et al. [2016]] [Karnouskos et al. [2012]].

The core entities are identified as inclusion and exclusion (including the rationale), part of the CPPS. Next section, we illustrate the existing related work and mechanism before developing HCPPS.

## 6.3 Multi-viewed Semantic for Human-CPPS notion integration

### 6.3.1 Related works before developing HCPPS

**Table 6.2:** Analysis of HCPPS- related Semantics criteria

Semantics	# Domain coverage [Sutcliffe [2014]]	# Modular [Sun et al. [2020]]	# Formally rigorous [Ansari et al. [2018]]	# Reusing foundation semantics [Şahinel et al. [2021]]	Taxonomy relation [Ansari et al. [2018]]	# H-CPPS
1	✓	✓		✓		✓
2	✓	✓		✓		✓
2	✓		✓			✓
3		✓			✓	✓
4		✓			✓	✓
5		✓			✓	✓
6		✓		✓		✓
7	✓		✓			✓
8	✓		✓			✓
9	✓		✓			✓
10	✓		✓			✓

Before developing HCPPS, We followed the process defined in [Kitchenham et al. [2007]] to identify the existing HCPPS semantics. Understanding how they have been developed and used to solve HCPPS problems. The rigorous study used to gather and synthesize the evidence. As a result, we identified semantics identified less than 15 axioms of the concept, which are listed in Table 6.4.

We analyzed the above work and taking the following characteristics of “semantics” into account [Ansari et al. [2018]]. Table 6.5 presents an overview of the semantics considering the



criteria used in the study. (i) **Domain coverage**; (ii) **being modular**; (iii) **formally rigorous**; (iv) **comprehensive** ; (v) **reusing foundational semantics**.

**Table 6.3:** HCPPS semantics found in the literature

ID	Description	Reference
01	It presents a conceptual model, based in the form of a textual description, which addresses HCPPS phenomenon and the involved parts	[Reis et al. [2017]]
02	It presents a conceptual model on task modeling and interaction with focus on UI design	[Reis et al. [2017]]
03	It presents a conceptual model on UI design addressing concepts such as Target User	[Shahzad et al. [2011]]
04	It presents a small extract of an operational semantics implemented that addresses interaction patterns and web interfaces aspects	[Ansari et al. [2018]]
05	It presents an semantics for interactive adaptive systems, addressing concepts such as Dialog System, Dialog Domain	[Yao et al. [2018]]
06	It presents an abstract widget, by a conceptual model, addressing concepts related to UI objects.	[Ansari et al. [2020]]
07	It presents a conceptual model that addresses ergonomics, UI design and evaluation.	[Müller et al. [2021a]]
08	It presents a user feedback semantics a conceptual model that addresses characterization of user feedback on UI adaptation.	[Graessler and Pöhler [2017]]
09	It presents a graphical web design ontology that addresses web UI structure and elements and web design property	[Müller et al. [2021a]]

It shows the marked all semantics, in the sense that each of them covers the domain portion it is intended to. As for being formally rigorous, we marked the ones that are represented in some degree of formalism, even if not very rigorous. The HCPPS phenomenon we analyze the semantics # 1, # 2, # 3, # 4, #05, #06, #07, #09 [Pinzone et al. [2020]][Müller et al. [2021a]][Graessler and Pöhler [2017]] is on the HCPPS phenomenon.

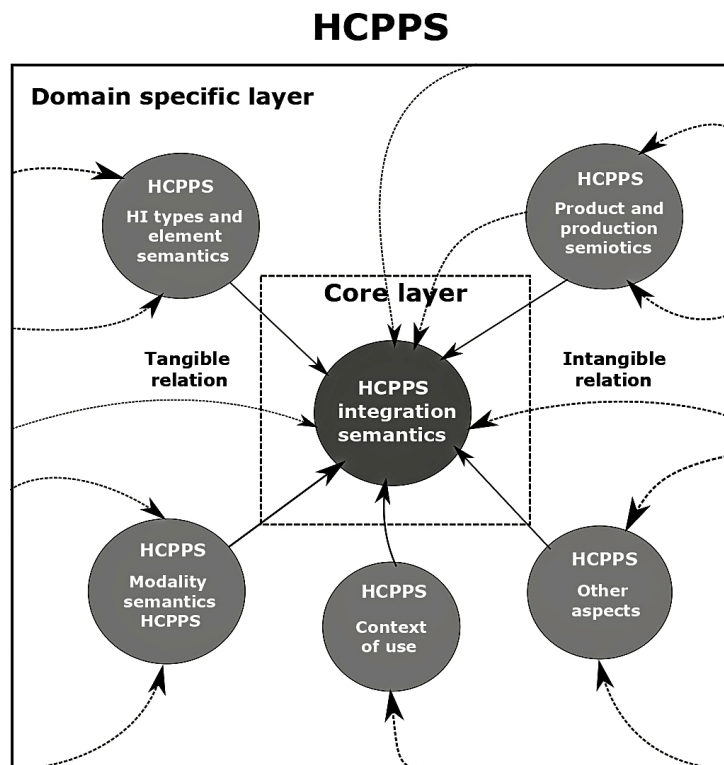
To summarize, the analyzed semantics cover different but related HCPPS aspects and most of the analyzed semantics did not satisfy at least one of the considered characteristics of

beautiful semantics [Gaham et al. [2015]] [d'Aquin and Gangemi [2011]].

In summary: (i) HCPPS covers core aspects regarding the interaction phenomenon, providing explanation about the interaction itself and the involved parts; (ii) HCPPS is a modular semantics, which favors understanding and reuse; (iii) HCPPS is represented in a good level of formalism by means of conceptual models and axioms; (iv) HCPPS is a well-founded unified semantic; and, finally, (v) HCPPS, a well-established method used in several semantics development efforts [Ruy et al. [2017]] [Sutcliffe [2014]] [Şahinel et al. [2021]] [Sun et al. [2020]].

### 6.3.2 Mechanism before developing HCPPS Semantics

In this section, the mechanism is used to construct the model is illustrated.



**Figure 6.2:** Human-CPPS Network

Table 6.4, shows the mechanisms to evolve the HCPPS. It structure and extend the SEON's integration mechanisms [Ruy et al. [2017]] by considering the semantics that can be aligned or merged to the network.

Before explaining the mechanisms, it is necessary to clarify the meaning of some terms integrate is the act of joining two (or more) semantics (which deal with different subjects) using dependency relationships [Salamon et al. [2018]]; merge is the act of joining two (or more)

semantics (which deal with the same subject) also using dependency relationships [Suárez-Figueroa et al. [2012]]; align consists in putting two (or more) semantics in correspondence using alignment relationships [Suárez-Figueroa et al. [2012]]; and consists in changing, restructuring and improving existing semantics [Suárez-Figueroa et al. [2012]].

The mechanisms are not intended to restrict the use of one integration (or alignment) approach or another. Thus, the semantics can choose the integration (or alignment) approach to be used (e.g., the one he/she is most familiar with)[Jetter et al. [2014]]. Table [Salamon et al. [2018]] shows the Semantics relationships between concepts.

**Table 6.4:** Semantics relationships between concepts

Correspondence	Symbol	Meaning	Example
Equivalence	A [E] B1	A is <b>equivalent</b> to B. Element A represents a concept equivalent to the Concept B	Student [E]
Part of	A [P] B	A Element A <b>covers part</b> of the concept represented by Concept B	Heart [P] Person
Part whole	A [P] B	Element A <b>covers part</b> of the concept represented by Concept B	Heart [P] Person
Intersection	A [I] B	Element A and Element B <b>intersects</b> that are either of A or of B	Man [I] Woman
Specialization	A [Es] B	A is the <b>specialization</b> of B	School
Acts	A [Dp] B	Element A represents a concept that can act as Concept B	System analyst [A]
Performed by	A [Dp] B	Element A represents the <b>concept</b> of a role that Concept B can play	Proof of address
Inverse of	R1 [Inv] R2	The relation R1 has the <b>inverse meaning</b> of the relation R2	Professor teaches.

If it is not possible to adopt some existing approach, we strongly recommend that the semantics performs at least mapping activities. It summarizes a set of types of semantic relationships between concepts (Table 6.1) and between relationships that can help in mapping activities.[Ruy et al. [2017]][Salamon et al. [2018]]

The mapping (or correspondence) between them aims to establish semantic relationships among elements (e.g., concepts, relationships) from different ontologies so that it is possible

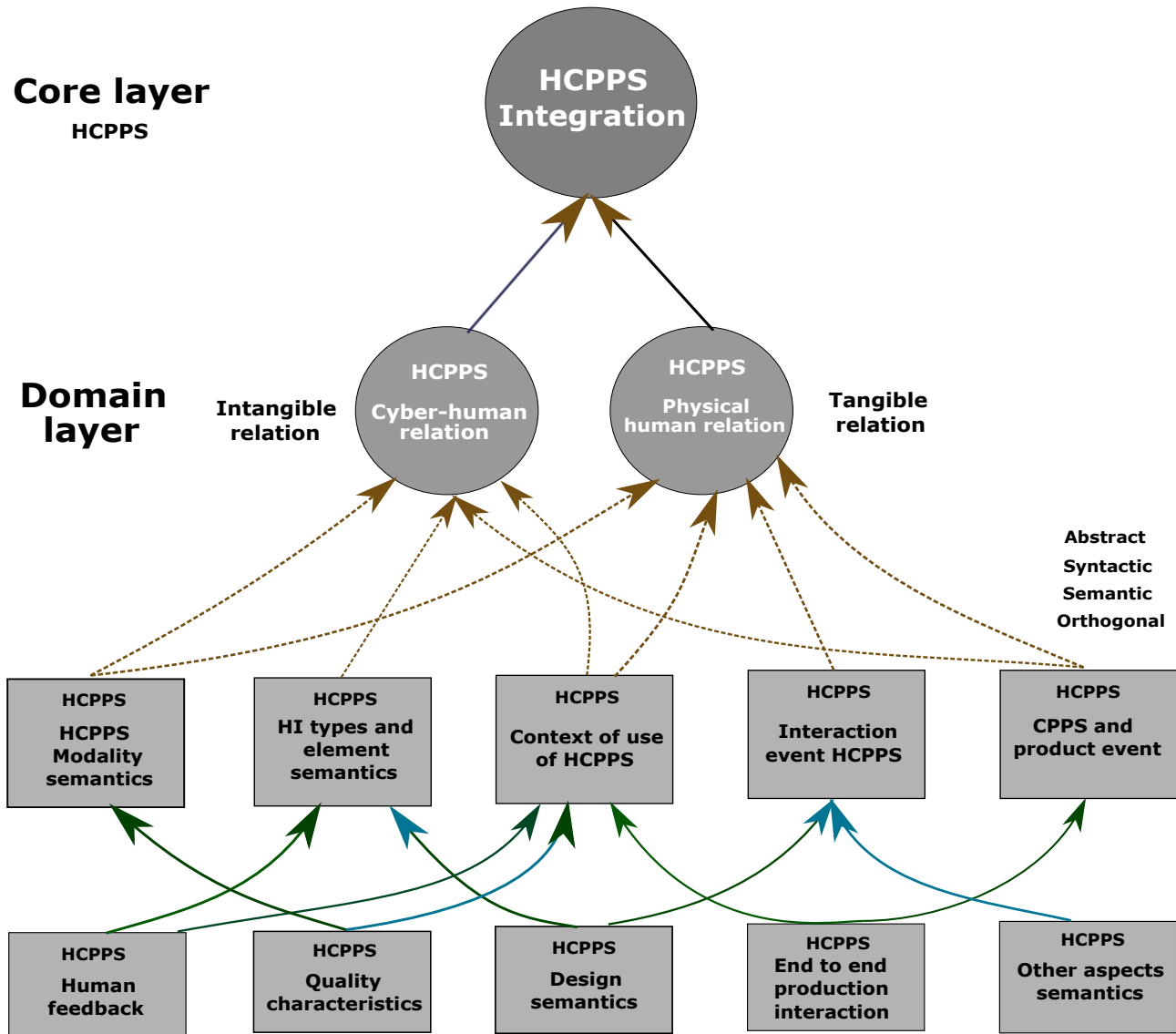


Figure 6.3: Fragment Human-CPPS Network

to carry out an adequate semantics integration (or alignment).

Then, We illustrate the domain network. Each circle (network node) represents a core or a domain of semantics. Obfuscated circles represent semantics under development. Arrows represent dependency relationships, indicating that concepts from the target semantics by the source semantics (in red from HCPPS).

Circle size varies according to the number of concepts. For example, the terms People [Negru and Buraga [2013]] [Storrs [1994]], Person and Person ([Salma et al. [2016]]) have the same meaning as HCPPS's Person concept. Next section, we illustrate the fragment top domain model of HCPPS.

### 6.3.3 Fragment top domain model of HCPPS

In this section, the human-CPPS top model is presented (see Figure 6.4) which is a well-defined glossary of terms in the human-CPPS integration.

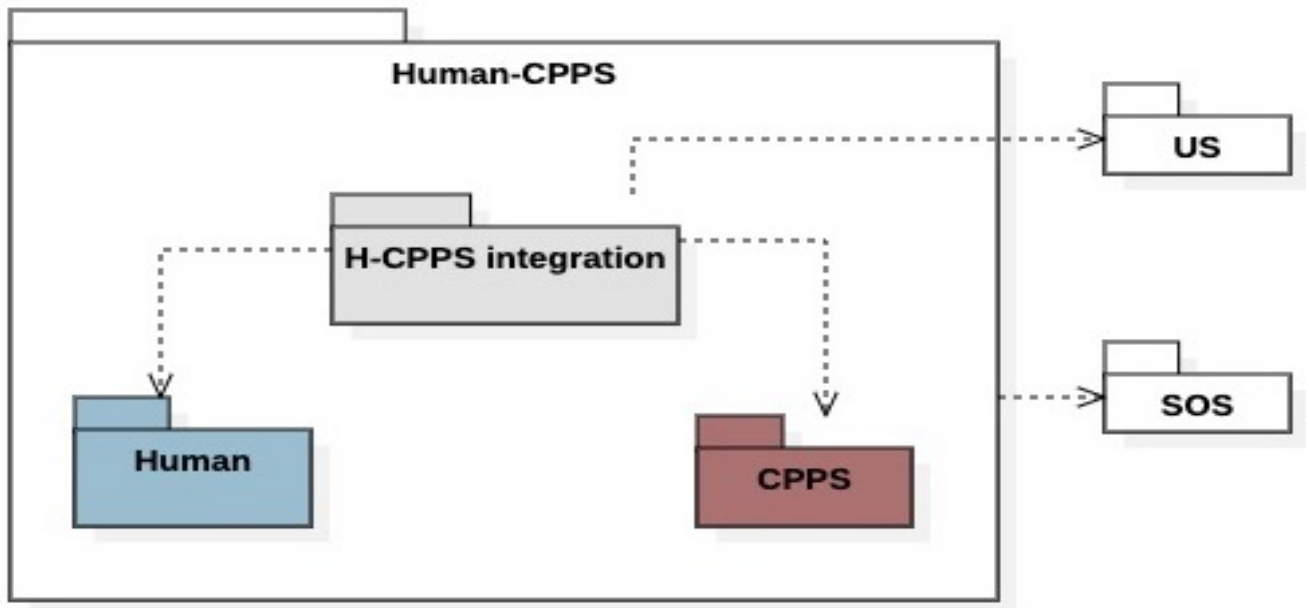


Figure 6.4: Fragment human-CPPS concept model

It is the abstract and top-level schema of the system. It is defined by means of competency questions, which are used as a basis to create a top model. It includes the **CQ01** -understanding what an interactive CPPS, its cyber and physical elements. **CQ02**-understanding human, the actions he/she performs when interacting with interactive CPPS and what causes user to interact with the system.

The **CQ03 to CQ07** referring to human-CPPS interaction itself, addressing human inputs, system outputs, and interpretations involved in the interaction. **CQ08**- goal, which is relevant when the human interacts with the system aiming to achieve a certain goal.

Figure 6.5 shows the human-CPPS interactions. Based on this, the top-model of human-CPPS encompass as follows: The class "*CPPS system*" refers to all the elements involved in the system. It includes "**CPPS property**", "**Environment**", "**boundary**", and all other things of interests. The class "*Human*" system refers to all the elements involved in the human. The class "**Human-CPPS Interaction**" refers to all the integration elements of the system. It includes the interface, integration's and interactions. This property are grouped together to fulfill the humans objective.

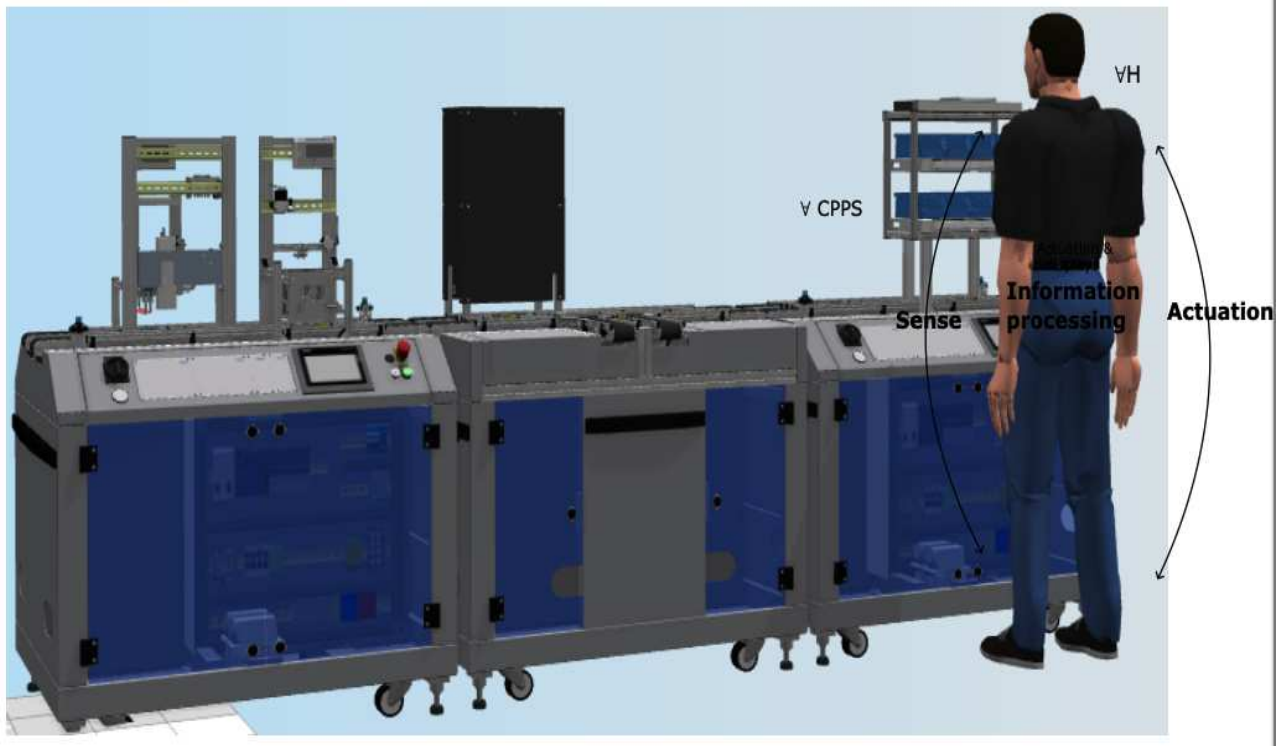


Figure 6.5: Human-CPPS interaction

**Human-CPPS Interaction fragment concept:** (a) Human goal triggering the interaction, (b) Human action, explicit human input, (c) CPPS output and human interpretation, (d) human action; implicit human input

#### 6.3.4 Interaction Human modality aspects

In this section, the human modality aspects is described. It is the actions human perform in the context of a human-CPPS interaction and aims to answer **the competence questions CQ01**. Figure 6.6 shows the human property aspects. The human property includes the characteristics of human. It is the physical part of the body[DeScioli and Wilson [2011]].

It has the characteristics of human component (i.e physical part of the body), human factor (i.e tactile, inotation , perspective etc), human ergonomics (i.e Anthromorphic Physiological characteristics etc)[Tortora and Derrickson [2017]]. Based on that, the human sense, actuate (e.g., Cognition and Processing ), (e.g., motivation) with the CPPS[Lohman et al. [2005]].

Figure 6.7 shows the human modality. It includes the human interface modalities and decision-making modality[Alexander [1992]]. We adopted the terms tangibly and intangibly, referring respectively to the cyber and physical interaction.

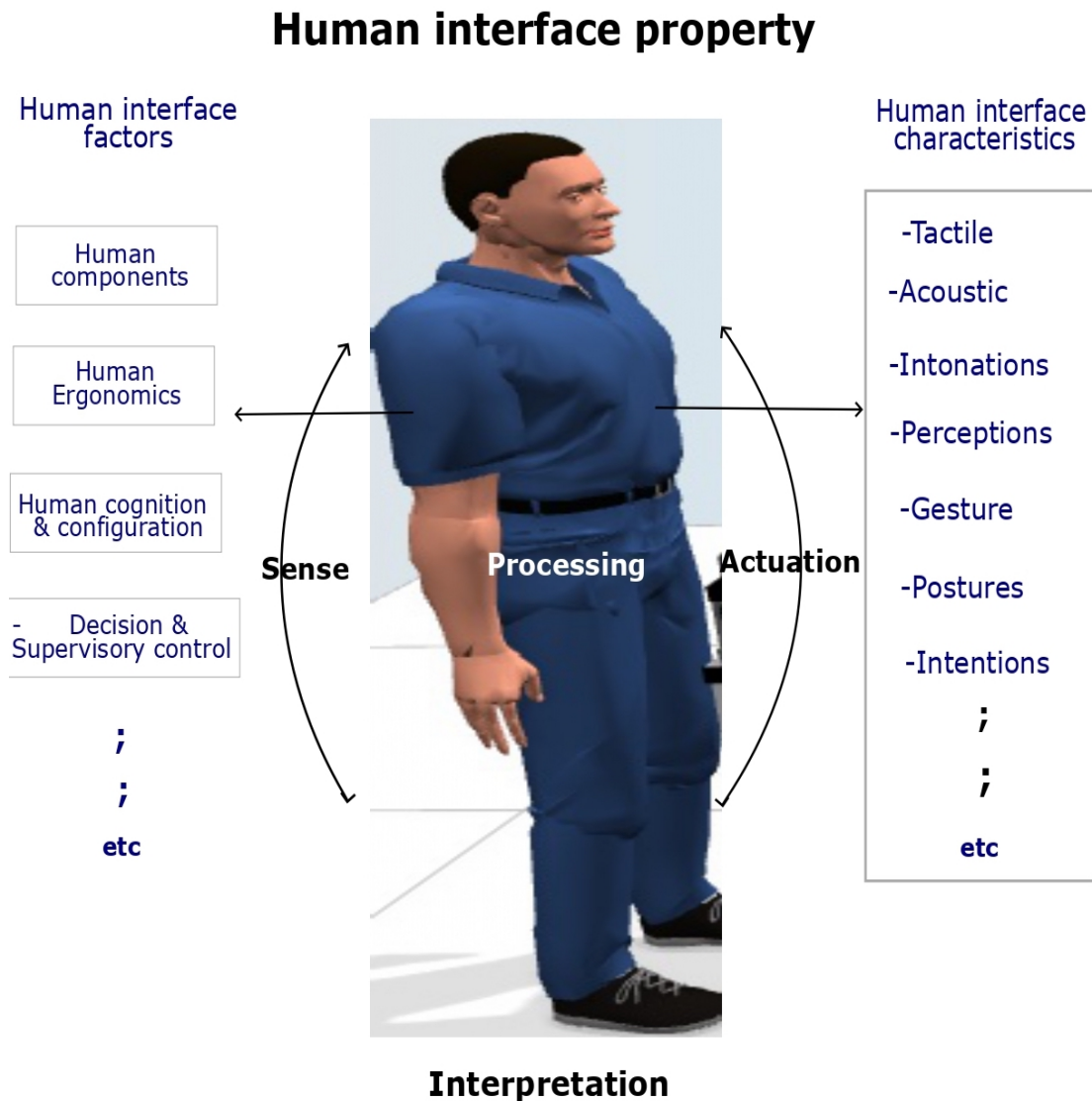


Figure 6.6: Human Property

Human-modalities (a) Human goal triggering the interaction (Sense) (b) Explicit human input and interpretation (cognition), (c) human action (actuation)

- **Tangibly human engagement** is a(**human action**) Contribution, likewise, the **tangibly engagement** is a human action. The human action has a (**human Goal**) as its propositional content, which is performed by the human in order to achieve a human Goal.
- **Intangible human engagement** is a(**human action**) Contribution, likewise, the **intangibly engagement** is a human action. The human action has a (**human Goal**). Next section, we present the modalities aspects of CPPS. It aims to answer the CQ-2



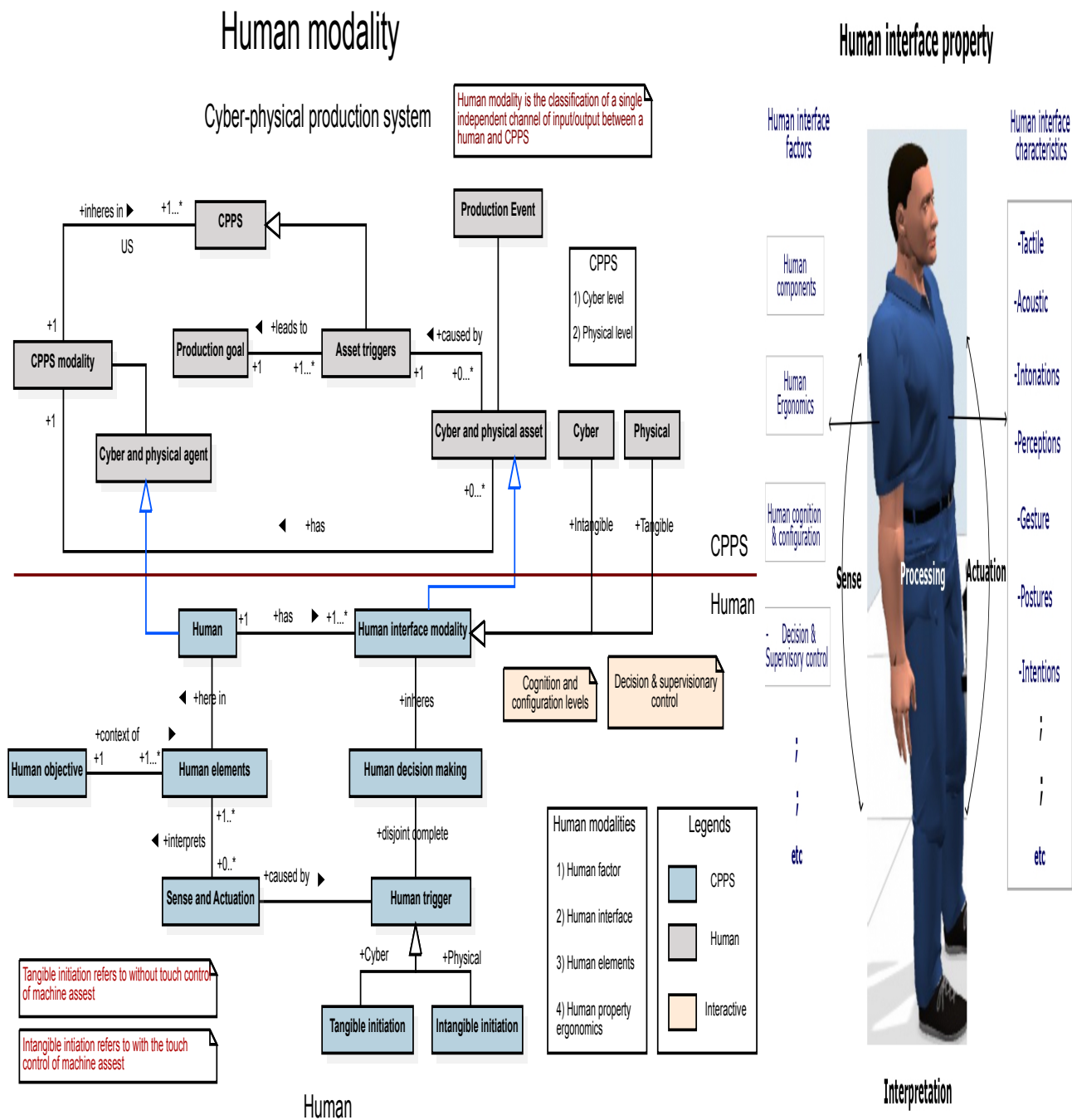


Figure 6.7: Human-modality semantics



### 6.3.5 Interaction CPPS modality aspects

In this section, the CPPS modality are described. It aims to answer **the competence question CQ-02**. The interactive CPPS involves cyber and physical system aspects. Figure 6.9 shows the Interactive CPPS. It illustrates the dotted lines separate into the layers. At the top, the general foundation. At the center, the core concepts related to CPPS. These interconnected equipments are grouped together to fulfill the CPPS Objective. At the bottom, there are CPPS concepts, grounded or specialized are shown in blue.

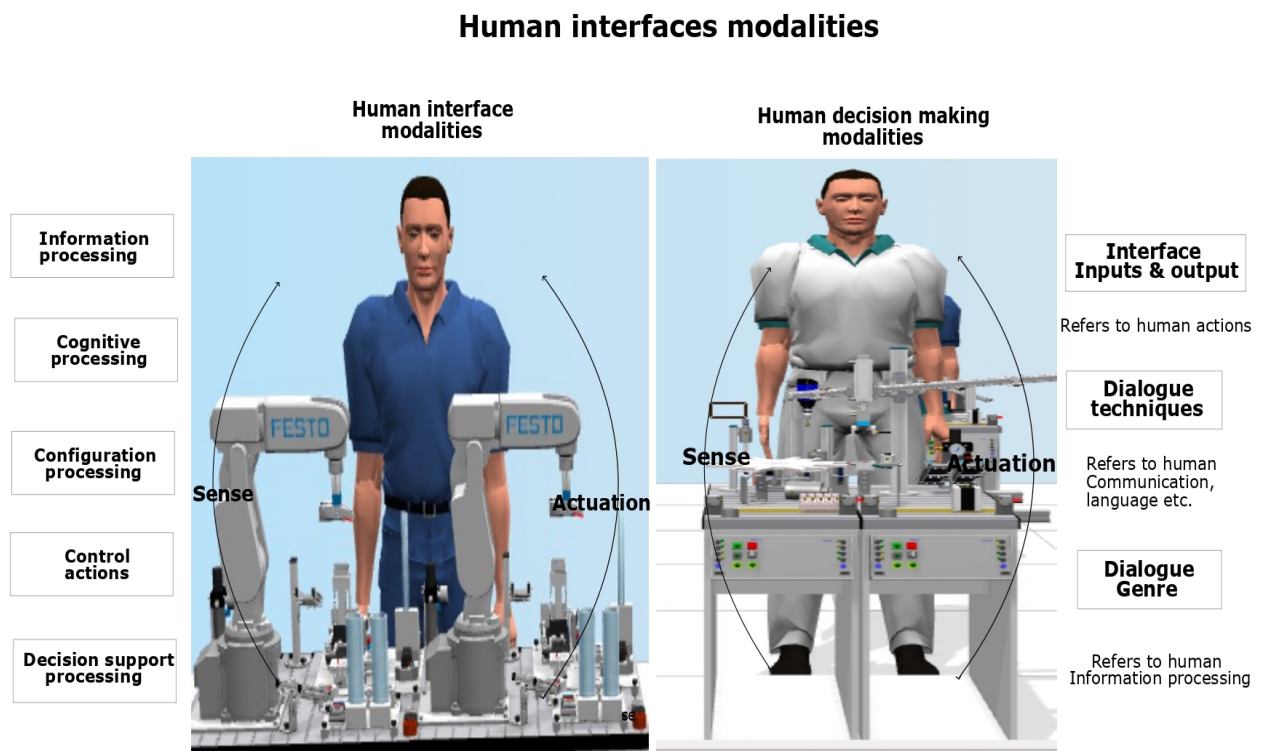


Figure 6.8: CPPS modalities aspects

Human-CPPS modalities (a) CPPS goal triggering the interaction (Sense) (b) Explicit CPPS input and interpretation (cognition), (c) CPPS action (actuation)

- **Cyber modality-** The interactive CPPS has a set of cyber system (Interactive cyber System) loaded in its CPPS Machines (Loaded Interactive cyber System)[Monostori et al. [2016]]. It has copies of the programs that interacts with humans intangibly.
- **Physical modality-** The Interactive CPPS has a set of physical System (Interactive physical System) loaded in its CPPS Machines (Loaded Interactive physical System) [Monostori et al. [2016]]. It has copies that interacts with humans tangibly.

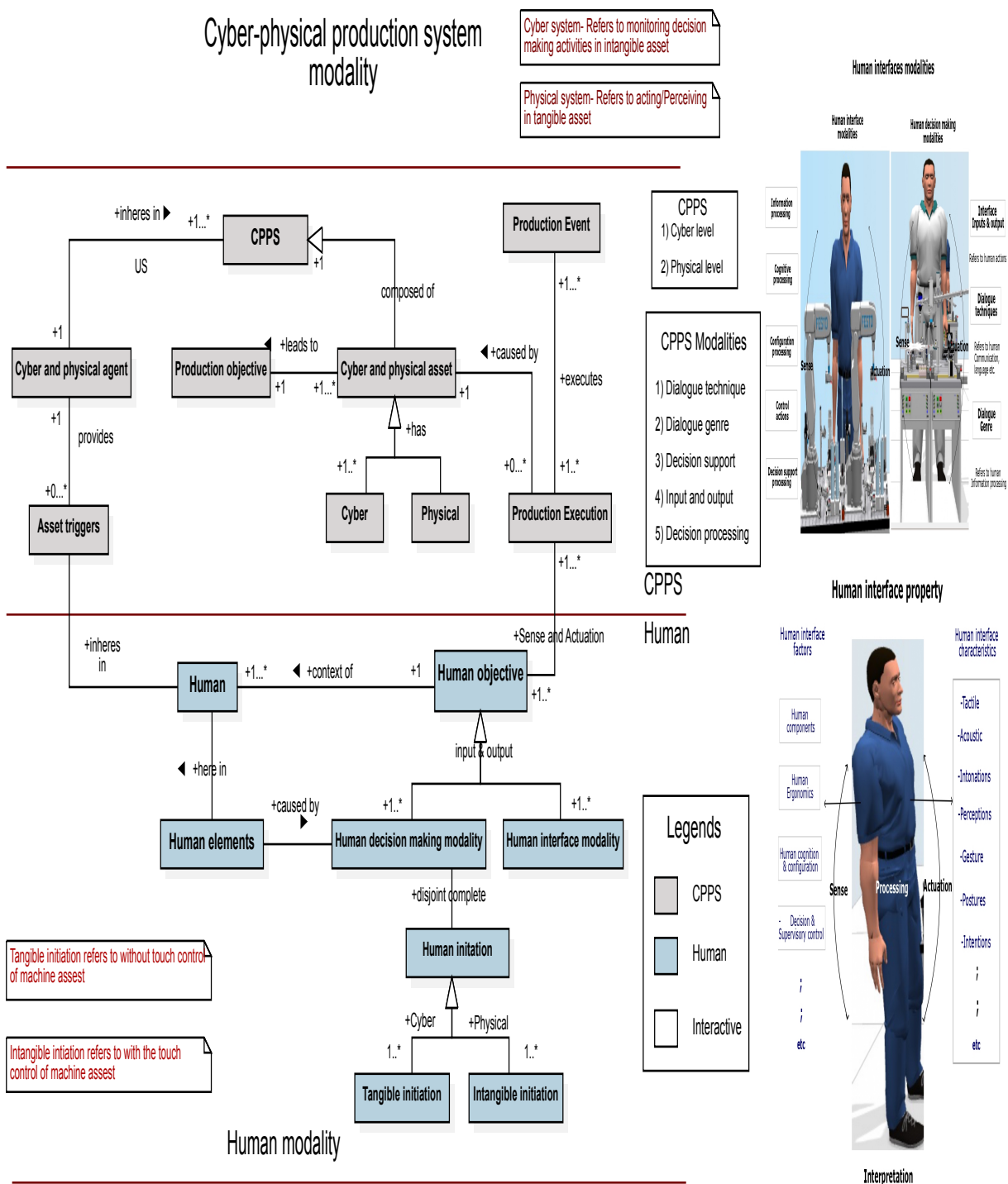


Figure 6.9: CPPS modality semantics

### 6.3.6 Human-CPPS interaction phenomenon

In this section, the human-CPPS phenomenon is described. This section aims to answer **the competence questions CQ06 to CQ08**. It is described based on the logical relationships integrating the system elements from the abstraction levels [Paelke et al. [2015]]. We illustrate all kinds of relationships which occur between human and CPPS (cyber, physical, human).

- “**Cyber element**”- (**C**) refers to all the cyber element. For eg. software element in CPPS machine. [Jirkovský et al. [2018]]
- “**Physical element**”- (**P**) :- refers to all the physical components. For eg. mechanical parts in a CPPS machine. [Lee [2008]] .
- “**Human element**”- (**H**) refers to all the human element. For e.g., human body part etc.  $\forall H$  [DeScioli and Wilson [2011]][Lohman et al. [2005]]

#### The Human-CPPS interactions(I/P and O/P processed)

In this context, the Human-CPPS interactions (I/P and O/P) processed is described. The “**CPPS and human interactions**” refers to combination of interaction between the system [Baheti and Gill [2011]]. It is composed by a **human engagement** and an **Interactive CPPS** , indicating the events performed by both parties in a specific interaction.

The **H-CPPS** as a set = **CS, PS, HS, P, C, H**. It has the sets containing Cyber element, Physical element and Human element respectively.

- “**Cyber interaction**”- It refers to all the monitoring and decision-making activities. It synthesizes knowledge from lower levels of information [Kim et al. [2018]], [Akanmu et al. [2012]][Monostori [2014]].
- “**Physical interaction**”- It refers to all the physical interactions acting/perceiving to/from the physical world-of-interest. The Physical behavior is under the control of conscious or unconscious processes. [Monostori et al. [2016]] [Weyrich et al. [2017]]

## H-CPPS Interaction phenomenon

The 'CPPS and human interactions refers to combination of interaction between the system. It is composed by a human engagement and an Interactive CPPS, indicating the events performed by both parties in a specific interaction.

Phenomenon

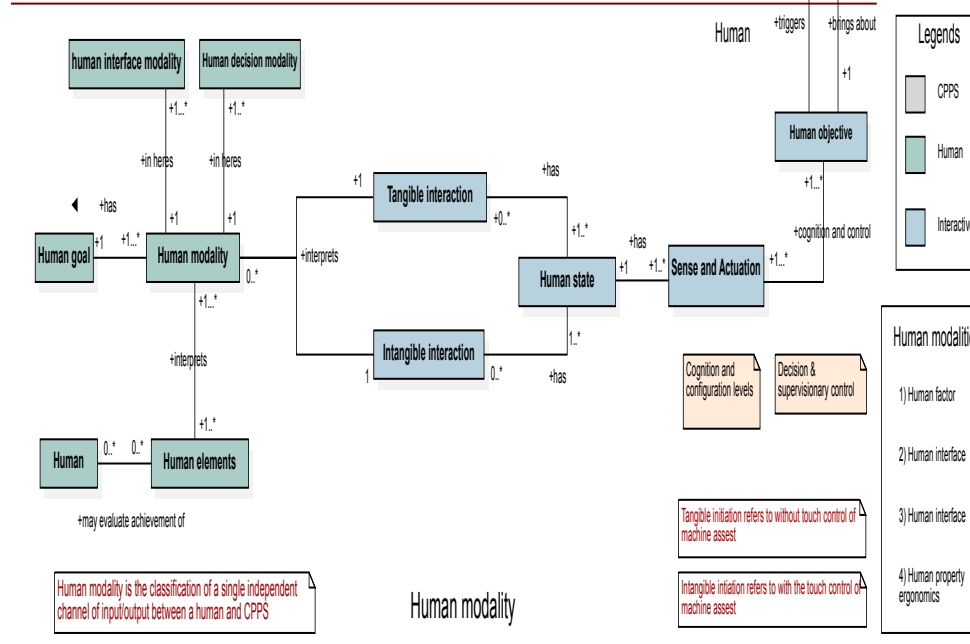
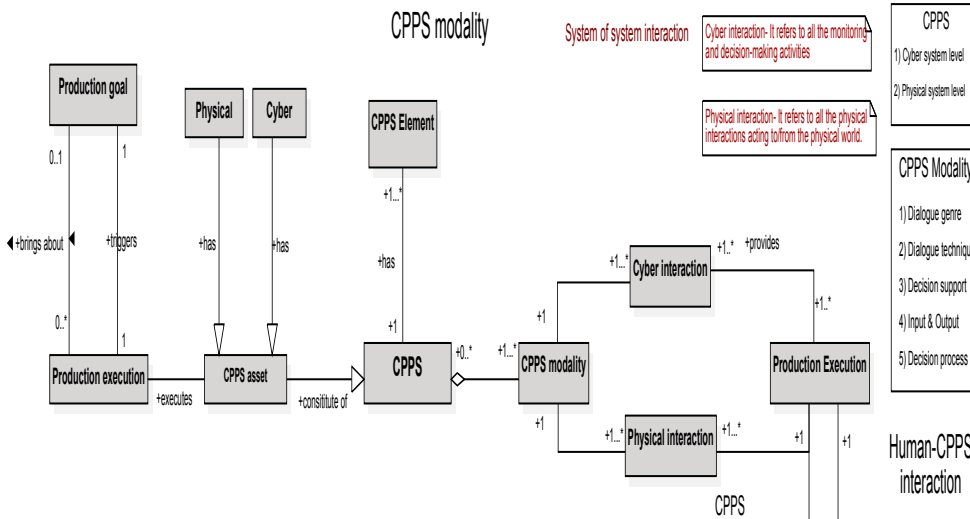
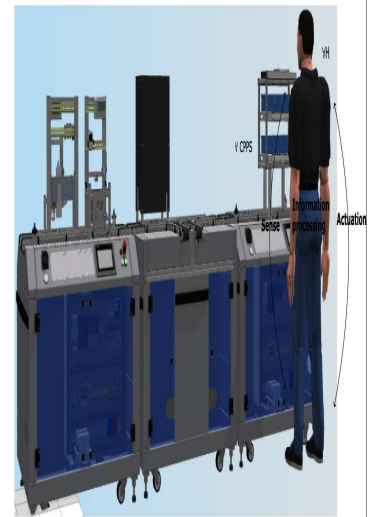


Figure 6.10: Human-CPPS interaction semantics

### 6.3.7 Collaborative HCPPS integration semantics web page

1

For that, building a semantics network which involves various aspects regarding the creation, integration, and evolution of the networked semantics. Thus, we reused and adapted the transformation tool, which is able to collect data from semantic models built and transform it into an HTML specification. This Human-CPPS Semantic interaction matrix model which categorizes all the interfaces, integration, and interaction between the human-CPPS concept as shown in table 6.11 and figure H-CPPS concept. The semantic integration matrix model is described as follows:




Human-CPPS Interface Components (VH, VCPPS)	Human-CPPS Integrations Vaeq : HCPPS integration level, HI : Human Interface, ICPPS : Interactive CPPS part Of(aeq, HI)	VH-CPPS (SOS) Human-CPPS concepts									
		Cyber, Physical & human Interaction relation VH-CPPS : Complex human Participation, human: User, : User Participation participationOf CPPS, Human A partOf (sp, cup) → participationOf(sp, human)									
CPPS view:	Human-CPPS integration level	Human (VH)	Human Interface	Interactive cyber system (VC)	Interactive Physical system (VP)	Input Equipment (IP)	Output Equipment (OP)	Input resulting state	Observable state	Output resulting state state	HCPPS Phenomenon (VH-CPPS)
<p>CPPS (VCPPS)</p> <p>1) Cyber element,</p> <p>2) Physical element</p>	<p>Centralised level</p>  <p>Decentralised level</p> 										
Human view:	Equipment level										
3) Human component (VH) Hand/ naked eye (CA) (Sense, Actuation, Cognition)	Portable level										
											
<p>Legends:</p> <p>Interface Elements (C1)(C2)(C3):</p> <p>Integration level (IT):</p> <p>System interaction (SI):</p>											

Figure 6.11: Collaborative Human-CPPS matrix model

Figure 8.102 shows the page that present detailed information of the networked semantics, such as their description, related semantics, models/diagrams, concepts definition, detailing of concepts. It has the features, such as: Searcher: a search engine for finding concepts by name and definition (Figure 8.102); Graph: the network visualization as a graph; Stats: some network statistics (Figure 8.102b);It also allows a faster and reliable way to publish HCPPS new versions.

<sup>1</sup><https://www.ecnantes.fr/recherche/plateformes-dexperimentation/plateforme-smart-factory>

HCPPS
Domain concepts +
HCPPS Semantics +
Home About Contact Page 1

⚙

### Semantic description

- ✓ The HCPPS semantic that aims to provide a common conceptualisation of domain
- ✓ The HCPPS Covers relevant aspects of involved entities
- ✓ It covers a tangible and intangible relation

Core integration layer
  Domain layer

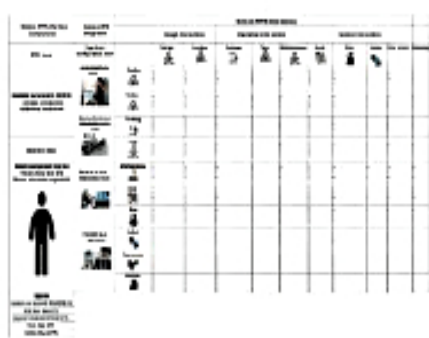
### Semantic models

It presents the modular models

Core integration layer
  Domain layer
  HCPPS

### Concept definition

- ✓ The definitors of HCPPS Concept
- ✓ The artifact information set of HCPPS domain
- ✓ It specify the evaluation in the context of HCPPS



**Graph page**

ⓘ Scroll

HCPPS
Domain concepts +
HCPPS Semantics +
Relations +

SHOW MORE ⌵

⚙

### Related semantics

Integration	Relation	Integration level
US		
HC	Human-cyber system	High
HP	Human-physical system	High
HCPPS	Most HCPPS extends concept	High

### Detailed concepts

Intentional event caused by HCPPS Evaluator and consist of systematic determination of extent an interactive CPPS

- ✓ The HCPPS modality aspects
- ✓ HI Types and element semantics
- ✓ interaction event HCPPS
- ✓ Design semantics
- ✓ End to end production
- ✓ Quality characteristics
- ✓ Other semantic aspects
- ✓ Context of use of HCPPS

### Relations

- ✓ HCPPS Concept (0...\*) creates (1...\*) interactive human
- ✓ The HCPPS concept (a...\*) creates (1...\*) interactive CPPS
- ✓ The HCPPS concept (a...\*) creates (1...\*) interaction
- ✓ The HCPPS concept (0...\*) creates (1...\*) input and output processed.
- ✓ (ISO:IEC.25066,2016; ISO 9241: 2202019)

ⓘ Scroll

Figure 6.12: Collaborative HCPPS integration webpage

Phd Thesis- Puviyarasu SA

Page | 208

### 6.3.7.1 Model operation and Algorithm

It performs network consistency checks on networked semantic' concepts (i.e., definition; ground; relationships; and semantics source) and produces a preliminary operational version of HCPPS. The HCPPS page aims to provide useful information about the network and its networked semantics.

**Algorithm 1** represents the formal specification of the  $V_{CPPS}$  using the Reuse operation (Op3). First, the algorithm creates an empty  $V_{CPPS}$  view and all objects corresponds  $V_{CPPS}$ . The algorithm can assign to corresponding objects in the  $V_{CPPS}$ .

**Algorithm 2** describes how consistency is ensured in the event of an attribute value change of an overlapping concept. More particularly, the algorithm shows, how changing the value of an instance in one view triggers change propagation in CPPS. The deletion provides a instance in one view might parodize the overall consistency of the CPPS views.

---

**Algorithm 5** All MVM  $V_{CPPS} \leftarrow OP_6 V_{CPPS}$ ) for use case

---

- 1: **Input**
- 2: Instated model
- 3: Model instance ID
- 4: /Synchronization list of selected model/  
Detailed description in model
- 5: Synchro in all selected CPPS views
- 6: **Output**
- 7: Corresponding instance
- 8: **Begin**
- 9: For each view in  $V_{CPPS}$
- 10: Instance(instance value)
- 11:
- 12: Prerequisite overarching model
- 13: Types of operation in overarching model
- 14: Decompose, reuse, merge, synthesis, sync
- 15: update synchro list
- 16: Instiate content relation
- 17: Finish overarching model for use-case  
or application context
- 18: **End**

---



---

**Algorithm 6** All MVM  $V_{CPPS} \leftarrow OP_6 V_{CPPS}$ ) for app context

---

- 1: **Input**
- 2: Model instance id
- 3: Synchronization list of selected model
- 4: Detailed description in model
- 5: **Output**
- 6: Corresponding instance
- 7: **Begin**
- 8: **Each view in  $V_{CPPS}$**
- 9:
- 10: Instance(instance value)
- 11: Prerequisite overarching model
- 12: Types of operation in overarching model
- 13: Decompose, reuse, merge, synthesis, sync
- Else**
- 14: Extension, projection, composition
- 15: update synchro list
- 16: Instiate content relation
- 17: Finish overarching model for use-case  
or application context
- 18: **End**

---



### 6.3.8 Synthesis

The synthesis, a human-CPPS phenomenon. We proposed and establish a human-CPPS phenomenon. It is formal and explicit representations of what the Human-CPPS phenomenon is. Table 6.5 shows the comparison of Existing and proposed models. It is summarized as follows:

- We identified and classify the terminology, typology of human-CPPS. It is a systematic classification of the core entities in each abstraction level.
- Secondly, the modular semantic models is constructed which includes the Human-CPPS system property: with the system.
- It categorizes all the phenomenon; which includes the namely, **(i) what an interactive CPPS and human is, (ii) its components, interface, and their integration; (iii) What human inputs, CPPS outputs, actions and interpretations involved in the interaction.**

**Table 6.5:** Comparison of Existing and Our Proposed models

	# 12 [Sutcliffe [2014]]	# 15 [Sun et al. [2020]]	# 18 [Ansari et al. [2018]]	# 19 [Şahinel et al. [2021]]	H- CPPS
<b>Good domain coverage</b>	✓	✓		✓	✓
<b>H-CPPS phenomenon</b>	✓	✓		✓	✓
<b>Being modular</b>	✓		✓		
<b>Being formally rigorous</b>		✓			✓
<b>Non-taxonomic relations</b>		✓			✓
<b>Reusing foundational semantic</b>		✓		✓	✓
<b>Based on competency questions</b>	✓		✓	✓	

From the work, it provides a comprehensive and consistent conceptualization of HCPPS body of knowledge. It brings all the knowledge of the specific views in an explicit phenomenon. Next section, we verified and validate by initiating the two fictional scenarios of human-CPPS to check the consistency and completeness



## 6.4 Model Verification and Validation-algorithms

In this section, the Verification and Validation activities were performed, considering the proposed semantic models. The HCPPS was evaluated by using two evaluation approaches: assessment by human approach and data-driven approach, [Brank et al. [2005]]. First, we performed a verification activity by means of expert judgment and real-world situations, in which we checked if the concepts, relations and axioms defined in HCPPS can answer the competency questions. In the second, a reference semantic is validated by instantiating the two real-world situations from real cases. It checks “whether theories and assumptions underlying the semantic models are consistent, completeness, and causal relationships [Panasiuk et al. [2019]] [Sun et al. [2005]]. It also enhances the represented model have structure, logic, and causal relationships that are “reasonable”. [Sargent [2010]] [Engels et al. [2003]].

As we explained in our methodological approach, to achieve the HCPPS version. We performed three cycles involving development and evaluation [Brank et al. [2005]]. Each cycle resulted in a version of HCPPS, which improved the previous one. After producing each version of HCPPS, we evaluated it by performing V and V activities and submitting the semantics specification and the V and V results to the evaluation by domain experts. Based on the evaluation results, we improved the semantics and evaluated it again until we reached the current version.

### 6.4.1 Verification

For verifying HCPPS, we started by manually checking the concepts, relations and axioms defined in HCPPS are able to answer its Competency questions (CQs). Table 6.4 shows the verification process for HCPPS against its competency question. It enabled us to check the CQs were answered, but also there were irrelevant elements in the semantics, i.e., elements that do not contribute to answering any of the questions.

Some situations the domain experts pointed out as not properly covered by previous versions of HCPPS include: the human can interact with the CPPS without a production goal in mind (e.g., the human can move his/her arm in a smart home and turn on the light without intending to do so); the same production equipment can be used as input and output equipment at the same time (e.g., MES touch screens); more than one user can interact with the CPPS at the same time (e.g., production event). We checked the defined semantic concepts, relations and axioms in HCPPS, which are able to answer the competency questions.

---

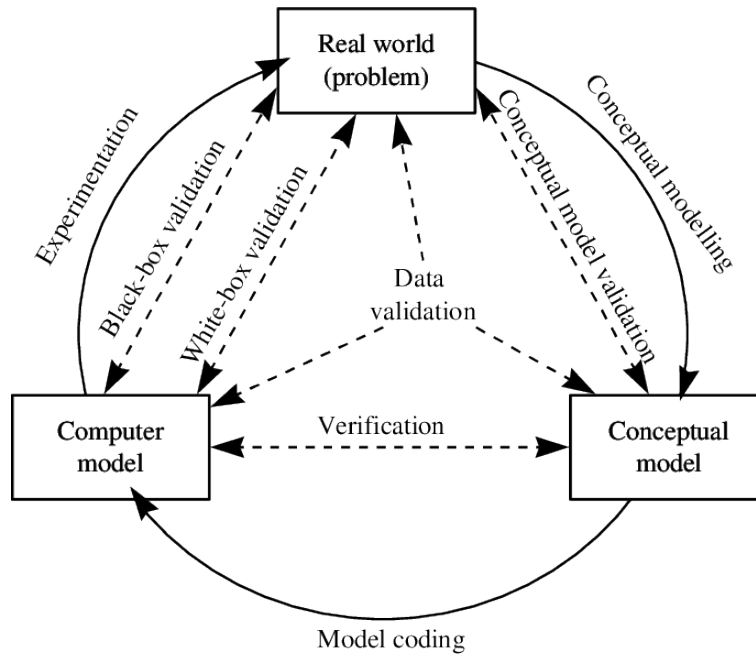
ID	Defined semantic concept and description
01	<b>What is an CPPS?</b> Interactive CPPS is subtype of Cyber and physical system that has Human Interface.
02	<b>What is an Interactive Cyber system?</b> Interactive Cyber System is a subtype of CPPS that is constituted that handles by materialization of human Interface Program.
03	<b>What is an Interactive physical System?</b> Interactive physical System is a subtype of CPPS- human interface that handles by materialization of human Interface Program.
04	<b>What can a CPPS tangible and intangible interaction?</b> The human involvement is subtypes composed of Participation with cyber and physical system of CPPS
05	<b>How is a CPPS input processed by an human?</b> Human Involvement brings about human Input, Resulting State that triggers task Execution
06	<b>How is a CPPS input processed by an human?</b> Human Involvement brings about human Input, Resulting State that triggers task Execution
07	<b>What is a Human?</b> Human is a subtype of operator who performs the production operation
08	<b>What make up a human engagement?</b> The human involvement is subtypes composed of other human Participation with CPPS
09	<b>What can a human tangible and intangible interaction?</b> The human involvement is subtypes composed of Participation with cyber and physical system of CPPS
10	<b>How can a human interact in human–CPPS interactions?</b> Human involvement and CPPS interpretation are subtypes of human-CPPS interactions
11	<b>How is a human input processed by an CPPS?</b> Human Involvement brings about human Input, Resulting State that triggers task Execution
12	<b>How is a human output processed by an interactive CPPS?</b> Human Involvement brings about human output, Resulting State that triggers task Execution

---

The Verification results show that HCPPS is able to answer the competency questions (i.e., the semantic addresses the established scope) and that it contains the sufficient and necessary elements to do so. It is theoretically significant and empirically verified our artifacts, which we created and evaluated using the stages of research process. Next section shows the validation by instantiating two real-world situations.

### 6.4.2 Validation by instantiation

In this section, the semantics validation is carried out by representing the real-world situations of H-CPPS. The validation checks whether the constructed modular models are well-defined, consistency and completeness among different H-CPPS real work situation. [Oulasvirta [2017]][Zarour and Alharbi [2017]].



**Figure 6.13:** CPPS validation  
[Thacker et al. [2004]]

We instantiated the semantics of the human-CPPS real case scenario. We describe two scenarios of use of human-CPPS interaction, which are used to exemplify (i.e., instantiate) the proposed HCPPS semantic models in figure 6.11. The involved scenario is illustrated as follows:

**Scenario-1** - Figure 6.4 shows the first case, a human (operator)-CPPS interaction which is illustrated. The Cyber storyboard illustrate (figure 6.4) that the desktop (cyber-level) to execute a production event. The Operator touches the widget [+] until it reaches 30 customer order. The operator notified the production event is executed.

**Scenario-2** Figure 6.4 shows the second cases. The Cyber and physical storyboard which is illustrate a human (operator) interacts with both cyber and physical to the arrange the system. The fundamental interactions between the human and CPPS is defined. They are CPPS operator executes the production order, he interacts with cyber and physical level.

**Algorithm 7 Validation by instantiation of model on scenarios**


---

```

1: Input
2: Model instance id
3: Synchronization list of selected model
4: Detailed description in model
5: Output
6: Corresponding scenario
7: Begin if connect then
8: ListIdsObjets  $\leftarrow$  IdsObjetsModel (IdModel)
9: connexion  $\leftarrow$  VerifierConnexionObjets (Liste ID objects)
10: Verifier connection of objets of model active()
11: Check connection of model objects instantiation()
12: ListIdsEvents  $\leftarrow$  GetIdsEvents (ListIdsObjets())
13:
14: Each view in  $V_{CPPS}$ 
15:
16: connexion  $\leftarrow$  VerifierConnexionObjets (Liste ID objects)
17: Verifier connection of objets of model active()
18: Check connection of model objects instantiation()
19: ListIdsEvents  $\leftarrow$  GetIdsEvents (ListIdsObjets())
20: if
21: Uniqueness  $\leftarrow$  VerifierUnicity (ListIdsEvents)
22: Then
23: Check completeness, non redundancy,()
24: Check the validity of incoming relationship types at each object ()
25: Else
26: RelationsIn  $\leftarrow$  VerifierRelationsIn (ListIdsObjects)
27: Check the validity of incoming relationship types at each object
28: Then
29:
30: Decompose, reuse, merge, synthesis, sync
31: RelationsOut  $\leftarrow$  VerifierRelationsOut (ListeIdsObjets)
32: Check the validity of the outgoing relationship types of each object
33: ConfirmerValiditeModel(Confirme)
34: Else if
35: ErrorRelationOut()
36: Any Error in définition of relations()
37: End

```

---

The algorithms illustrate the validation by instantiation the scenarios of model on each object. Before starting any manipulation, the validity of the designed model is checked in all CPPS models. By way of example, algorithm 1 (see algorithm.1) makes it possible to check that the risk analysis model (by bijection the view) designed complies with the proposed model. Indeed, such a model is said to be “valid” if it satisfies the following conditions:

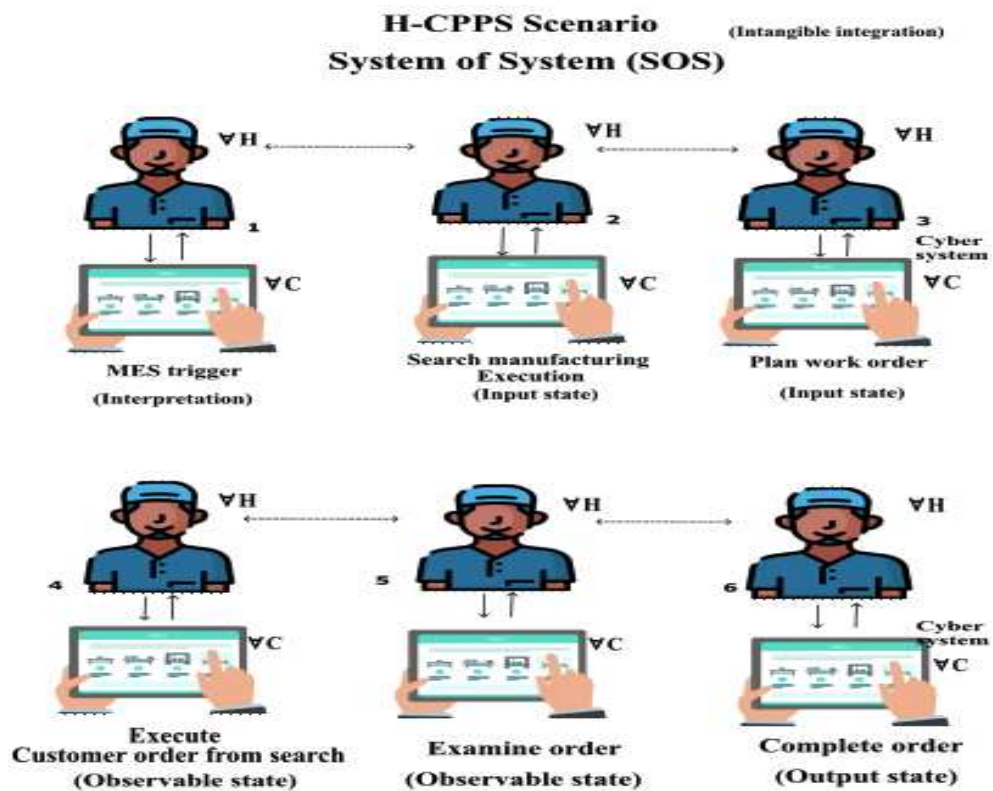


Figure 6.14: Storyboard (intangible interaction)

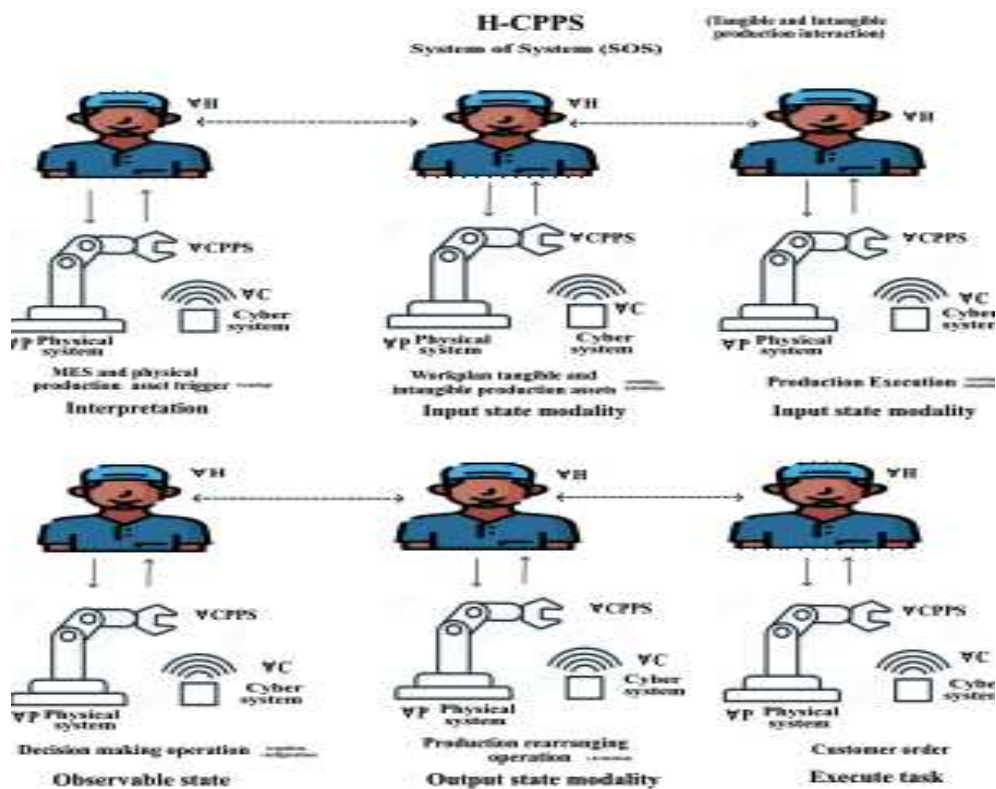


Figure 6.15: Story board (tangible and intangible interaction)

**Table 6.6:** H-CPPS(Operator) A and B- instantiation use case

Human	
<b>Human</b>	Operator A and B
<b>Human objective</b>	Production event ( <b>case-1, case-2</b> )
<b>Interface Program</b>	MES ( <b>Case 1</b> ) and physical workstation ( <b>Case 2</b> )
<b>Human Engagement</b>	Cyber and physical level( <b>Case 2</b> )
CPPS	
<b>CPPS</b>	Assembly machine ( <b>Case-1,2</b> )
<b>Input equipment</b>	MES ( <b>Case-1,2</b> ), Physical workstation ( <b>Case-2</b> )
<b>Output equipment</b>	Cyber workstation ( <b>Case-1,2</b> )
<b>Cyber system</b>	Cyber workstation ( <b>Case-1,2</b> )
<b>Physical system</b>	Physical workstation ( <b>Case-2</b> )
Human-CPPS Integration	
<b>H-CPPS interfaces</b>	MES (cyber component), Equipment (Physical components) ( <b>Case-1,2</b> )
<b>H-CPPS integration</b>	Automation chain network ( <b>Case-1,2</b> )
<b>H-CPPS interactions</b>	They interact to complete the work order of production event
<b>Input State</b>	The situation observable on sensing the CPPS on cognition level ( <b>Case-1,2</b> )
<b>Observable State</b>	The situation observable on sensing and processing ( <b>Case-1,2</b> )
<b>Output State</b>	The situation observable as a result of actuating the CPPS ( <b>Case-1,2</b> )
<b>Executed programs</b>	The customer order is executed and satisfy the needs

Table 6.9, present a summary containing some instances extracted from operator case. The cases were performed following reality, and here they are presented by means of storyboards using fictitious names. Then, the validation illustrates that the real-world situations, its concepts, relations instantiated from real cases of Operator A and Operator B cases (shown in figure 6.11). When describing HCPPS conceptual models, we included some instances from these cases as examples.

The Validation results shows that HCPPS is able to answer the competency questions (i.e., the semantic addresses the established scope) and that it contains the sufficient and necessary elements to do so. It can properly represent real-world situations. During validation, we considered several other cases (e.g., gesture and haptic interaction, interaction with a smart house, Physiological interaction, interaction with a collaborative system) to ensure that

HCPPS is able to represent them. It is confirmed that the model is global and re-useable in different H-CPPS. It is theoretically significant and empirically verified our artifacts, which we created and evaluated using the stages of research process and applicability in different H-CPPS.

### 6.4.3 Evaluation of HCPPS

After the instantiation of models, the evaluation is performed from the method that we specified above. It includes as follows: In the cyber only case(Figure 6.4), the Operator A (HCPPS Evaluator) uses the Heuristic Evaluation (HCPPS Evaluation Method) to perform the evaluation (HCPPS Evaluation). Her goal in the evaluation (HCPPS Evaluator Goal) influenced her choice for that method (i.e., as her goal was to improve the usability (HCPPS Quality Characteristic) of the login UI (User Interface ).

He/She should use a method suitable for that purpose). Operator A followed the Heuristic Evaluation method, which determines the 10 usability heuristics (HCPPS Evaluation Criteria) to be applied in the evaluation and requires the use of a checklist (HCPPS Evaluation Artifact Type). During the evaluation, Operator A used a particular checklist (HCPPS Evaluation Artifact) that specifies each one of the usability heuristics.

ID	Description
CQ01	What leads to an HCPPS evaluation?
CQ02	What does an HCPPS evaluate?
CQ03	What criteria are applied in an HCPPS evaluation?
CQ04	What quality characteristics are evaluated in an HCPPS evaluation?
CQ05	What criteria are applied in an HCPPS evaluation?
CQ06	What artifacts are used to perform an HCPPS evaluation?
CQ07	What is the result of an HCPPS evaluation?

Table 6.4 shows HCPPS competency questions (CQ). CQ01 to CQ03 help understand the motivation behind an HCPPS evaluation and what it evaluates. CQ04 and CQ05 are to know the criteria and artifacts used to conduct an evaluation. CQ06 and CQ07 refer to the evaluation results. CQ08 and CQ09 concern the stakeholders involved in an evaluation. CQ10 concerns the evaluation method. Finally, CQ11 and CQ12 are to understand how quality characteristics are quantified in an evaluation.

## 6.4.4 Synthesis

From this chapter, the consistency, and completeness check is done with H-CPPS. During the scenario-based check of the model, the model has been revised based on the lacks we faced on applying the model. These improvements are mostly in the boundaries and interlinking connections. The table shows the operator case. As a result of checking the consistency of proposed model in different CPPS types. To the best of our knowledge, all identified (relevant) entities fall within the scope of our HCPPS. If terms are not at the same level of abstraction as our dimensions and entities, they are either more fine-grained than our HCPPS. It matches the different Human-CPPS specifications and assumptions deemed acceptable for the given purpose of application. It is confirmed that the model is global and re-useable in different Human-CPPS. It is theoretically significant and empirically verified our artifacts, which we created and evaluated using the stages of research process and applicability in different Human-CPPS.

2

---

<sup>2</sup><https://www.ecnantes.fr/recherche/plateformes-dexperimentation/plateforme-smart-factory>



## 6.5 Application context

### 6.5.1 Introduction and problem statement

In this section, we reused the modular semantics in an application context. First, we describe how HCPPS has been used as core semantics in an HCPPS Network of LS2N-CPPS. Then, we illustrate the immersive application and aid knowledge sharing in a HCPPS design. Finally, we discuss envisioned applications of HCPPS. **The learning scenario analysis is done by us. (The application configurator is done by Ls2n-united context)**

The configurator is to enhance the human to take actions, synthesizes the information and assist the decision-making process. The use of HCPPS in these practical applications meets the requirement (support interoperability and knowledge-related solutions in the HCPPS domain) and satisfies the evaluation criteria of knowledge framework must be able to represent real-world situations). It assists in collection of storage, and analysis of the data about human experience, when using application context. It manages all the required inspection operation of the assembly machine productively. It is done by the industry on design the configurator.

It is due to manual inspection of the product. The humans are facing the difficulty in identifying the defected products on each cycle of production operation. Section 6.5.2 schematic overview of reuse. Section 6.5.3 illustrate the learning scenario. Section 6.5.3 shows the configurator inventor. Section 6.5.4 shows the Knowledge Supporting Tool For Human-CPPS Interaction Design. Section 6.5.5 shows the inventor solution query.

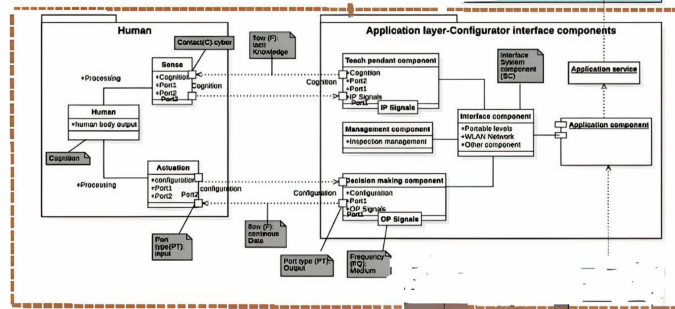
### 6.5.2 Schematic overview of reuse and instantiation

In this section, the schematic overview of reuse and instantiation is described. It admits adding, replacing and removing the standard units as follows. The table 6.9, 8.108 6.33.

**Table 6.7:** Reuse of architecture for interface application

Viewpoints	Operation	Description
$V_I$	<b>Decomposition</b>	Provided a more detailed description in all views
$V_I$	<b>Extension</b>	Added a syntactic concept to a given view
$V_I$	<b>Reuse</b>	Reused the 'Operational concept' from the existing viewpoint

Human-CPPS Interface Components (VC, VP, VHR ⇌ 3CPPS)	Human-CPPS Integrations	Human-CPPS Interactions											
		Interactions	Initiation Interactions			Operation Interactions				Service Interactions			
			Setting-up	TEST	Training/ Learning	Task	Maintenance	Quality control	Stack	Risk & Safety	Clean	End of life	
<b>CPPS view:</b>  <b>Intelligent components (HCPPS)</b> 1) Cyber component, (VC, VH, 3R ⇌ 3CH) 2) Physical component (VP, VH, 3R ⇌ 3PPS)	Cognition, Configuration level/ Network integration  Centralised level/WAN network  Decentralised level/WAN or LAN network	Setting-up	TEST	Training/ Learning	Task	Maintenance	Quality control	Stack	Risk & Safety	Clean	End of life		
<b>Operator view:</b>  <b>Human component (HCPPS)</b> (Hand, body part etc (vH)) (Sense, Actuation, Cognition)	Equipment level- LAN network  Portable level- PAN network	Setting-up	TEST	Training/ Learning	Task	Maintenance	Quality control	Stack	Risk & Safety	Clean	End of life		



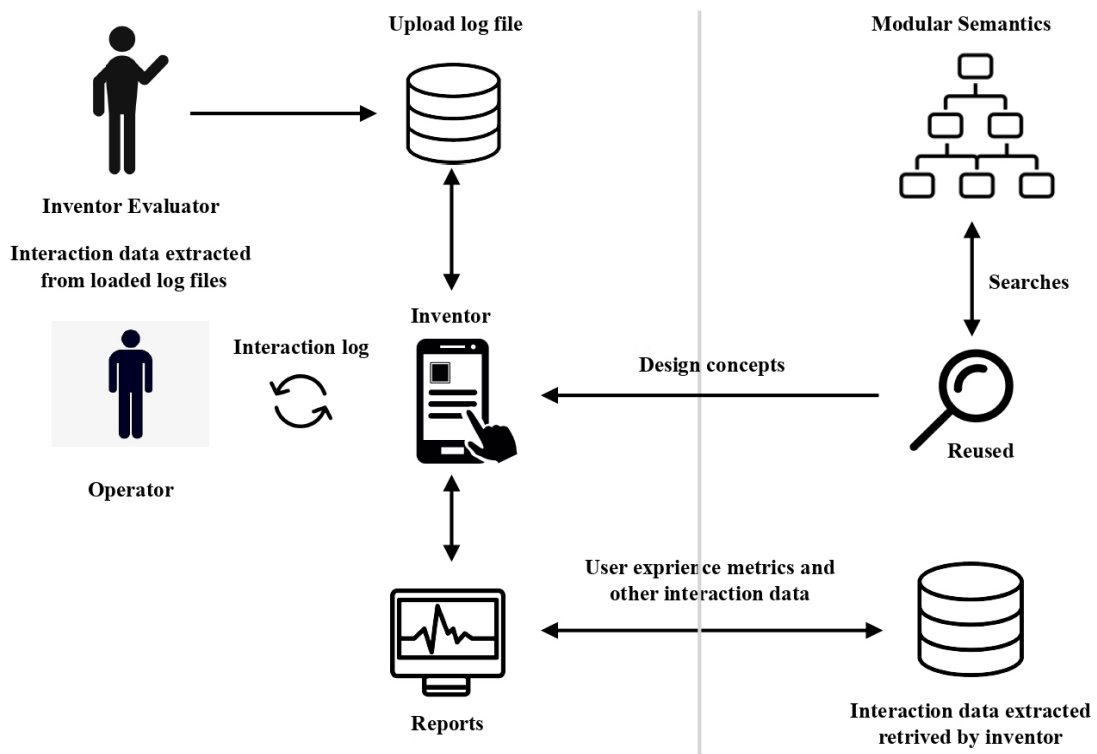
LS2N- Learning activity with students

### 6.5.3 Configurator for human learning process

First, the feasibility analysis is carried out. The usage scenario of human-CPPS phenomenon learning case is described (i.e) what interactive human-CPPS are, which types of actions human perform when interacting with an interactive CPPS, and finally, what human-CPPS itself for the case is described. Figure 8.108 shows the learning scenario of human-CPPS interaction.

It analysis the circumstance of , experience, human acceptance and foreseen impacts of the technology solutions. Table below shows the aligning HCPPS phenomenon on usage scenarios. Table 6.9 presents a summary containing the instances extracted from H-CPPS model dictionary of terms. The complete instantiation of HCPPS coming from real cases which gave us indications of the appropriate proposed reference model.

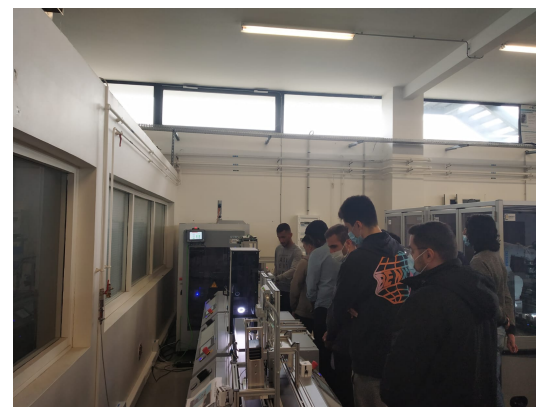
The portion of the HCPPS domain involved in this scenario includes aspects related to HCPPS phenomenon (e.g., User, Human-CPPS Interaction, User Interface, Human Action, Human Participation), user characterization (e.g., Human Profile) and HCPPS evaluation (e.g., HCPPS Evaluation, HCPPS Quality Characteristic). Therefore, we extracted the ON fragment composed of HCPPS, and used it in our semantic-based solution.



**Figure 6.16:** Configurator for human learning process

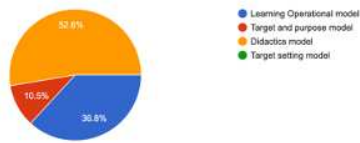


**Figure 6.17:** Learning operation scenario



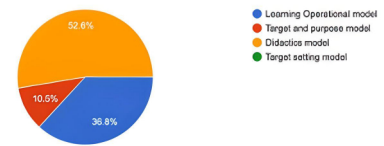
**Figure 6.18:** Learning operation scenario

9. What type of smart CPPS in the LS2N Laboratory?  
19 responses



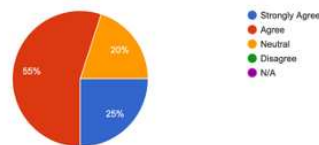
**Figure 6.19:** UE-1 H-CPPS Integration

9. What type of smart CPPS in the LS2N Laboratory?  
19 responses



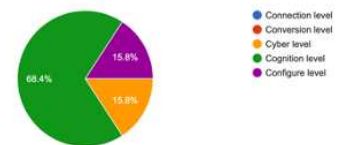
**Figure 6.20:** UE-2 Didactic concepts

38. Do you think, the observed Cyber abilities - (Information systems, IT integration, virtual interactive physical assets and Human-machine in...as productive impact on shop-floor productivity?  
20 responses



**Figure 6.21:** UE-3 Cyber entities impacts

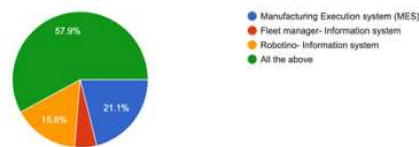
16. Which level of 5C architecture in CPS, the humans will integrate?  
19 responses



**Figure 6.22:** UE-4 Human integration

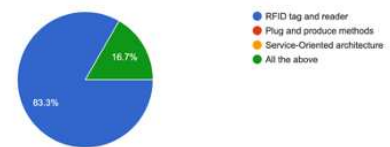
» » »

13. What is the cyber world in LS2N-CPPS system that you experienced during the visit?  
19 responses



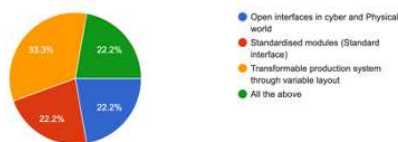
**Figure 6.23:** UE-5 Physical impacts

17. How the application module machine can retrieve and execute processing jobs individually? How it provides the identification of digital prod...k-piece? Which technology behind these functions?  
18 responses



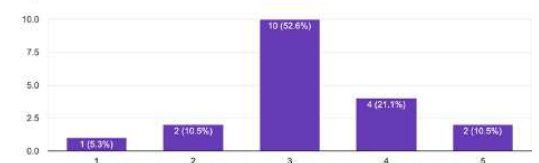
**Figure 6.24:** UE-6 Cyber impacts

18. What makes the application module machine allows to be interchanged in just a few minutes?  
18 responses



**Figure 6.25:** UE-7 Application module machine

46. How could you rate your overall first learning experience with the CPPS platform? (AS-IS/TO-BE)  
19 responses



**Figure 6.26:** UE-8 Overall AS/IS-TO-BE impacts

To address the need of user experience metrics, we added some concepts to HCPPS. In this section, the different interaction types are described. Figure 6.26 shows the analyzed

**Table 6.8:** Learning scenario and evaluation result

User Experience	Strongly agree	Agree	Neutral	Disagree
UE-1	115.8%	52.8%	28.3%	3%
UE-2	152.6%	10.5%	36.8%	2%
UE-3	125%	55%	20%	2%
UE-4	168.2%	15.8%	10%	1%
UE-5	130%	50%	42%	46%
UE-6	130%	31%	35%	38%
UE-7	122.2%	22.2%	22%	33.3%
UE-8	15.3%	10.5%	52.6%	21.1%

scenario. The HCPPS is able to represent both explicit and implicit interaction (what we call respectively as intentional and unintentional). Overall, it indicates that- TO-BE (scenario) situation brings the productivity when compared to AS/IS scenario. It has higher work productivity and efficiency with the smart application to attain higher work productivity and efficiency. It has the foster significant job changes. But it lacks in the skill gap of the operator in current circumstances. For example, in learning case, when it performs the intentional actions driven by his goal. For that, the human handles the various scenarios which arise for skills and the knowledge is needed to do the task. Based on these circumstances, we have analyzed the human-CPPS phenomenon, experience, human acceptance and foreseen impacts of the technology solutions.

### Configurator inventor design

3

In this section, the operator-inspection configurator is described. It is a project work. Figure 6.33 shows the operator inspection configurator. The configurator enhances the human to take actions, synthesizes the information and establishes collaboration between the CPPS and human for decision process. It assists in automatized collection, storage, and analysis of the data about human experience, when using an application. It manages all the required inspection operation of the assembly machine productively. It reduces the stress on the workers and to ease the production flow, which could have possibility to reduce the errors and mental load.

<sup>3</sup><https://www.ecnantes.fr/recherche/plateformes-dexperimentation/plateforme-smart-factory>

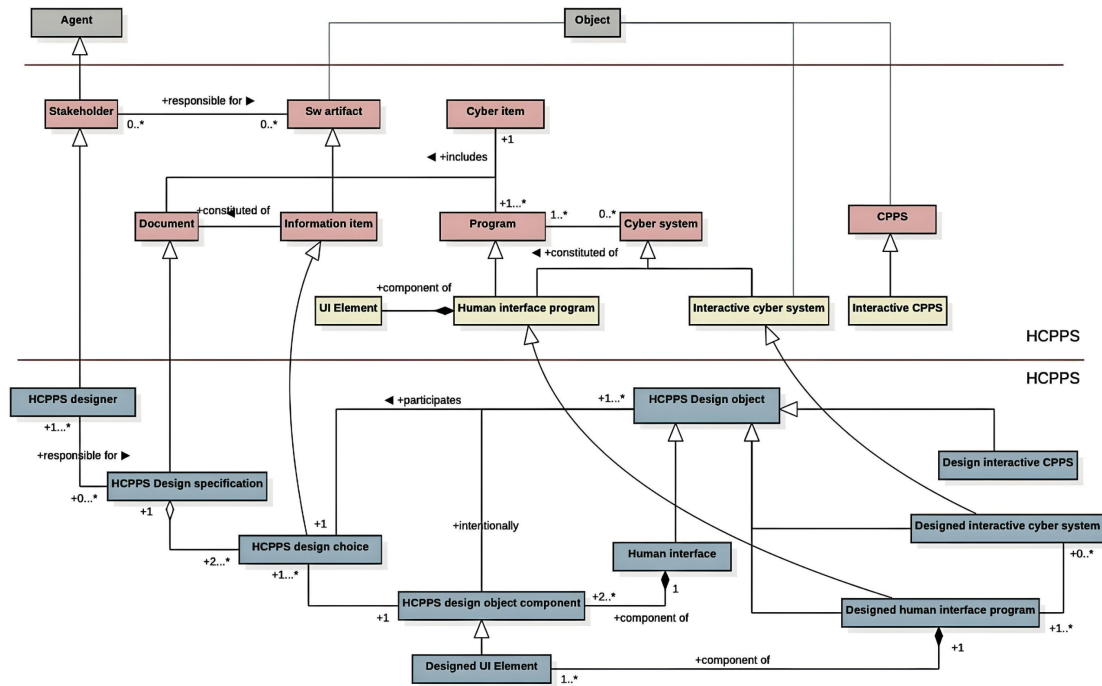


Figure 6.27: HCPPS model reused in application

### 6.5.4 Knowledge Tool for Interaction - HCPPS

It is then installed in a tablet or mobile phone connected with an interface to carry out the functions, ease the operation and reduce the stress on the operator. The design solution of the configurator include as follows:

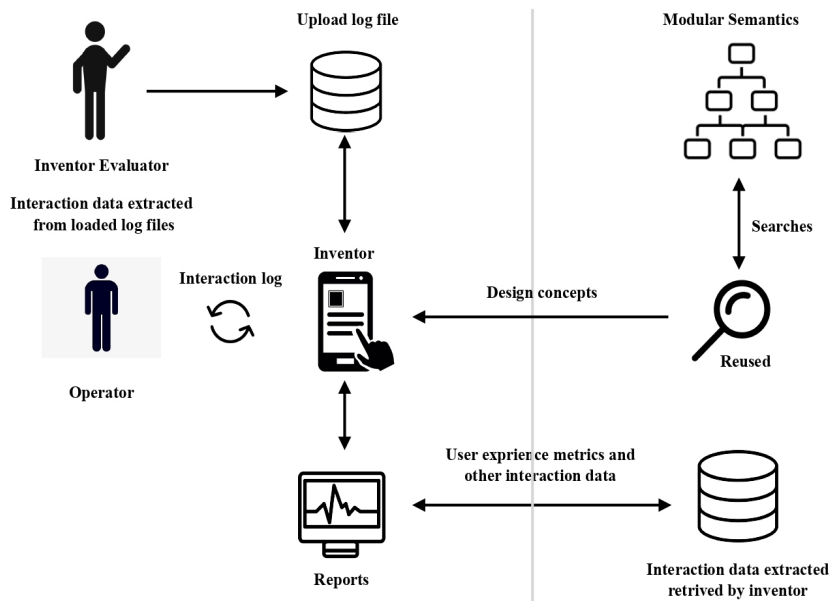


Figure 6.28: App inventor Overview



**Table 6.9:** Learning case initiation

Human	
Human	Operator
Human Interface	Learning activity
Program	
Human Engagement	Knowledge and skill assessment
CPPS	
CPPS	Assembly machine
Interactive CPPS	Assembly machine MES
Input equipment	MES, Physical workstation
Output equipment	Cyber workstation
Cyber system	Cyber workstation
Physical system	Physical workstation
Human-CPPS Integration	
H-CPPS interfaces	MES (cyber component), Equipment (Physical components)
H-CPPS integration	Automation chain network
	The interaction constituted of the Human and Interactive CPPS Participation.
H-CPPS interactions	AC-1 Operator presses the MES crown AC-2 = Operator sees a message from Execution application of screen
Input State	AC-4 Operator sees a new screen from the execution
Observable State	The situation observable on sensing the CPPS on cognition level
Output State	The situation observable on sensing and processing
Executed programs	The situation observable as a result of actuating the CPPS
	The set of executions of program copies constituting.

```

C:\Extensions\extension-template-master>ant extensions
Buildfile: C:\Extensions\extension-template-master\build.xml

javac:
  [javac] Compiling 1 source file to C:\Extensions\extension-template-master\build\classes
  [javac] warning: [options] bootstrap class path not set in conjunction with -source 1.7
  [javac] error: cannot access Pair
  [javac]   class file for gnu.lists.Pair not found
  [javac]   Consult the following stack trace for details.
  [javac]   com.sun.tools.javac.code.Symbol$CompletionFailure: class file for gnu.lists.Pair not found
  [javac] Note: Wrote file file:/C:/Extensions/extension-template-master/build/classes/simple_components.txt
  [javac] Note: Wrote file file:/C:/Extensions/extension-template-master/build/classes/simple_components_build_info.json
  [javac] Note: Wrote file file:/C:/Extensions/extension-template-master/build/classes/AutogeneratedOdeMessages.java
  [javac] Note: Wrote file file:/C:/Extensions/extension-template-master/build/classes/ComponentsTranslation.java
  [javac] 1 error

BUILD FAILED
C:\Extensions\extension-template-master\build.xml:29: Compile failed; see the compiler error output for details.

Total time: 0 seconds

```

**Figure 6.29:** Learning operation scenario

```

<html>
<head>
<script type="text/javascript" src="https://www.gstatic.com/charts/loader.js"></script>
<script type="text/javascript">
google.charts.load('current', {'packages':['gauge']});
google.charts.setOnLoadCallback(drawChart);

function drawChart() {
  var data = google.visualization.arrayToDataTable([
    [ 'Label', 'Value' ],
    [ 'Memory', 80 ],
    [ 'CPU', 65 ],
    [ 'Network', 50 ]
  ]);

  var options = {
    width: 400, height: 120,
    redFrom: 90, redTo: 100,
    yellowFrom: 75, yellowTo: 90,
    minorTicks: 5
  };

  var chart = new google.visualization.Gauge(document.getElementById('chart_div'));
  chart.draw(data, options);

  setInterval(function() {
    data.setValue(0, 1, 40 + Math.round(60 * Math.random()));
    chart.draw(data, options);
  }, 1000);
  setInterval(function() {
    data.setValue(1, 1, 40 + Math.round(60 * Math.random()));
    chart.draw(data, options);
  }, 500);
  setInterval(function() {
    data.setValue(2, 1, 60 + Math.round(20 * Math.random()));
    chart.draw(data, options);
  }, 2000);
}
</script>
</head>
<body>
<div id="chart_div" style="width: 400px; height: 120px;"></div>
</body>
</html>

```

**Figure 6.30:** Learning operation scenario

```

#include <DHT.h>
#include <ESP8266WiFi.h>
String apiKey = "1YMSRK1TDFI058HA"; // Enter your Write API key here
const char *ssid = "MengiJio fiber op"; // Enter your WiFi Name
const char *pass = "xxxxxxxxxxx"; // Enter your WiFi Password
const char* server = "api.thingspeak.com";
#define DHTPIN 4 // GPIO Pin where the dht11 is connected
DHT dht(DHTPIN, DHT11);
WiFiClient client;
void setup()
{
    Serial.begin(115200);
    delay(10);
    dht.begin();
    Serial.println("Connecting to ");
    Serial.println(ssid);
    WiFi.begin(ssid, pass);
    while (WiFi.status() != WL_CONNECTED)
    {
        delay(550);
        Serial.print(".");
    }
    Serial.println("");
    Serial.println("WiFi connected");
}
void loop()
{
    float h = dht.readHumidity();
    float t = dht.readTemperature();

    if (isnan(h) || isnan(t))

```

Figure 6.31: Measurement, User and User Participation

```

import java.util.Scanner;
import java.util.Random;

public class GuessingGame {
    public static void main (String [] args) {
        // set up variables
        Scanner scan = new Scanner(System.in);
        Random rand = new Random();
        int random;
        int guess;

        // generate random number
        random = rand.nextInt(20) + 1;
        //System.out.println(random); // testing (comment out later)

        // get user input
        System.out.println("Please guess a number from 1 to 20 (inclusive):");
        guess = scan.nextInt();

        // output
        if (guess == random) {
            System.out.println("Congratuations! You got it!");
        }
        else {
            int diff = guess - random;
            System.out.printf("Sorry, you were off by %d.%n", Math.abs(diff));
        }
    }
}

```

Figure 6.32: Object Property: is measured by



### 6.5.5 Inventor Solution Query and dialog box

In this section, the overview of configuration is presented. Figure 6.34 and 6.35 shows the dialog box from the log. It illustrates a graph showing data regarding interactivity. It provides the information made by the human during the task. These are some defined queries (e.g., the evaluator can search for human interactions that involved or for how many times a sound was chosen by the users) and he/she can also create new queries.

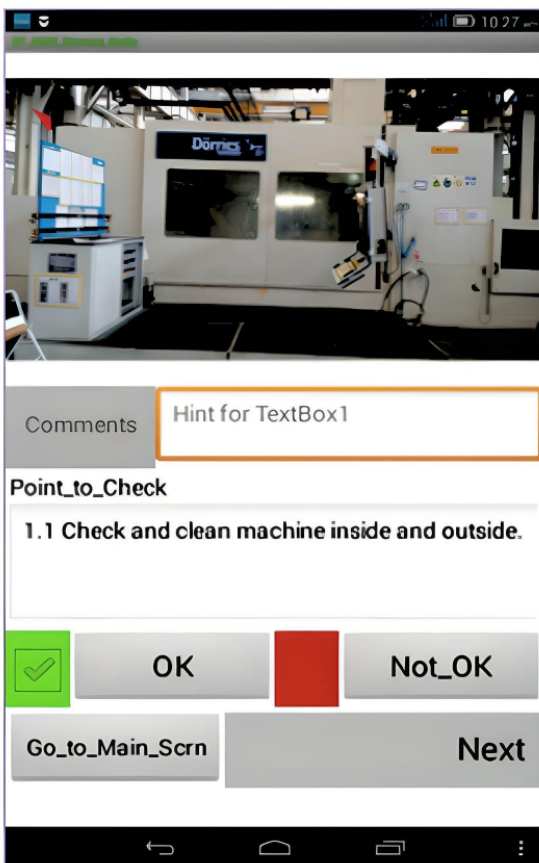


Figure 6.33: App inventor (industrial project)

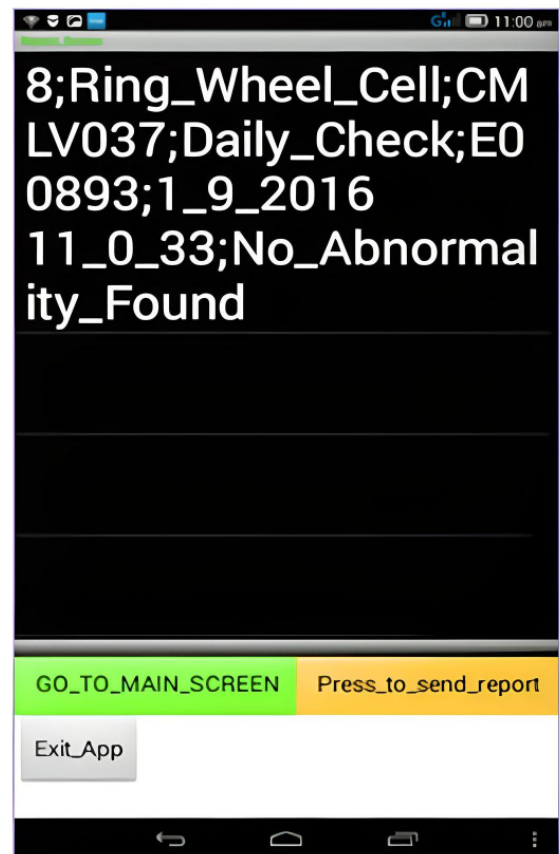
Regarding the main advantages of using App inventor , the participants listed: support in the analysis process; visual analysis of data; analysis by participant and overall experience; individual analysis of Inventor metrics for the immersive experience, allowing conclusions regarding the experience; practicality; ease of use; simplicity in the process of loading log files;

graphical presentations that make it possible to have an overview of the interaction; diversity of forms of data organization (different graphics); and possibility of performing new queries.

As for the main disadvantages of using app inventor, the participants cited: data processing time; graphic quality of the evaluation report; prepare log file as input without knowing the data format of the database expected by the system; and only works for inventor. Finally, when asked about suggestions to inventor improvement, the participants answered: improve data processing time; make some graphs more explanatory; improve the layout of the data/graphics presentation; provide a documentation that informs which fields are required and expected by the system for the evaluator to prepare its log file; and, offer help in creating new queries. In this inventor we can connect the program to our android phone by USB, WIFI, scanning the QR code of the program, etc. Each component can have events, and properties. Most properties can be changed by apps – these properties have blocks you can use to get and set the values. These components can add in our app by drag and drop method. It is described as follows:



**Figure 6.34:** Configurator- Inspect operation(from industry)



**Figure 6.35:** Configurator- review report (from industry)

- **Teach Pendant-** It displays the information of the machine. It provides the information of the machine and the current status of the assembly products.
- **Status provider-** The application notify and provide the status of the machine to the operator.
- **Decision-making component-** The decision-making process of making choices by identifying a decision, gathering information, and assessing alternative resolutions. It helps to make more deliberate, thoughtful decisions by organizing relevant information and defining alternatives. The next section shows the initial stages of the operator configurator. Operator configurator (Industrial work)

During the inspection operation, the operator scans the bar code of the machine. It informs the operator with a signal stating the machine and their conditions. It notifies the operator with the respective images and its appropriate level. In that case, the operator can confirm and inspect the condition without any errors. As a case of simple working of the configurator for machine inspection, which is explained below:

- **Step-1,2,3** Open the configurator and select the login employee id. Select the shift operation of the machine and the information is displayed on the interface screen.
- **Step-4,5** When the operator scans the code on the machine and as per the design it informs the operator with a signal stating the machine condition. When there are a abnormalities, it sends a sound signal along with displaying the status.
- **Step-6,7** When the final output is fine, it displays the information review report. If the output is not fine, it displays the abnormality information message. This information dispatch to all the employees in the next shift of the same operation. It transmits report of the current status and the conditions.
- **Step-8** Finally, the operator review the report and rectify the abnormalities.

### 6.5.6 Synthesis

To conclude that, the implementable H-CPPS semantic model is reused in an application context. It is the central aspects (e.g., for communication and learning purposes), to support in structuring the knowledge and to develop (e.g., through specialization) the configurator. The configurator enhances the human to take actions, synthesizes the information and establish collaboration between the CPPS and human for decision process. It assists in automatized collection, storage, and analysis of the data about human experience, when using an application. It manages all the required inspection operation of the assembly machine productively. It reduces the stress on the workers and to ease the production flow, which could have possibility to reduce the errors and mental load. The application context illustrates that the modular semantic can be re-used unambiguously across different independent context.

## 6.6 Conclusion

**SQ-2 How can human-CPPS integration entities are defined in a unified semantics?**

From this chapter, we propose and establish a human-CPPS phenomenon. It is formal and explicit of what the Human-CPPS phenomenon is. From the work, it provides a comprehensive and consistent conceptualization of HCPPS body of knowledge. It includes entities of interest which has immediate influence on the structure and functionality of human-CPPS. It enriches by defining possible flows and their characteristics between Human-CPPS is identified and exploited. It brings all the knowledge of the specific views in an explicit phenomenon.

Then, it is instantiated and reused on real application to design configurator that support HCPPS- related activities. It enhances the human to take actions, synthesizes the information and defines a decision process, establishing collaboration between the CPPS and the human user. It manages all the required inspection operation of the assembly machine productively.

From this, we have experienced the benefits of reusing HCPPS. It gave us indications of the appropriateness and robustness of the proposed semantic models. From this chapter, it establishes a consistent and comprehensive conceptualization of the HCPPS. It will serve as a foundation, in particularly, to understand the Human-CPPS body of knowledge.

It contributes to addressing the identified research challenges, **Limitation, and research gap-3** and answering our third research question (SQ-3) on how can human-CPPS integration be defined in unified semantics?

# Conclusion and perspective

---

*This chapter presented the overall outcome of the thesis. It describes the scientific and practical implications for CPPS notion. Then, the limitations and future perspective of the framework is summarized. It also describes the research outcome contributed to INCOSE (System engineering) community and leverage towards its vision.*

---



---

7.1	Summary . . . . .	232
7.2	CPPS notion Semantic framework Contributions . . . . .	234
7.2.1	Scientific implication to CPPS notion- Generic view . . . . .	234
7.2.2	Practical implication to CPPS notion-Generic view . . . . .	235
7.2.3	Research gap and contributions . . . . .	236
7.2.4	Contribution to INCOSE Community vision . . . . .	237
7.3	Framework limitations and discussion . . . . .	237
7.4	Future directions and perspective . . . . .	238

---

## 7.1 Summary

**F**ROM the doctoral thesis, we proposed the organising and generic modular and reusable semantic framework for Cyber-Physical-production System (CPPS) notion is proposed. It is reused in different real application context. **This thesis work is meant to be the semantic basis of future classification of CPPS notion for researchers, and practitioners in the field.** In this chapter, we revisit the research problems, the state-of-the-art limitations as well as an overview of our contributions. Finally, we conclude with a discussion on perspectives and future research directions.

First, the systematic literature review (SLR) revealed that the way of defining a CPPS has always been inconsistent and often use-case dependent.

Table 7.1 shows the thesis research question and answers with the contribution. It shows the chapter wise(3,4,5) main contribution of the framework.

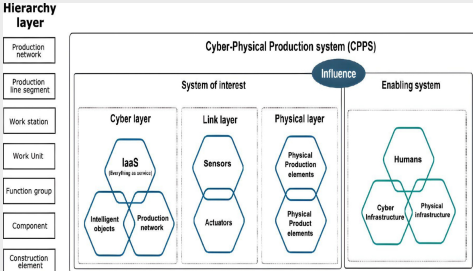
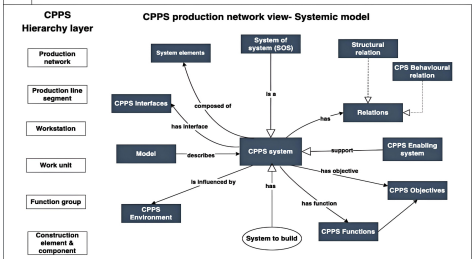
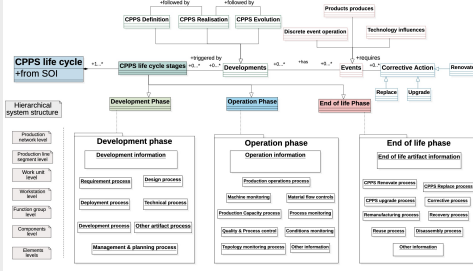
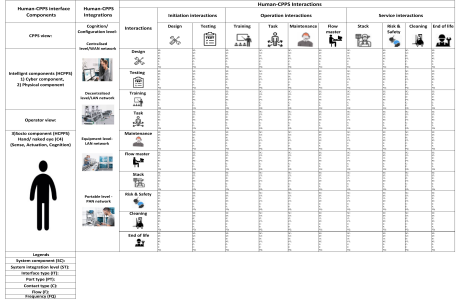
Research Question	Answers	Contribution
<p>RQ-1 How to define the cyber-physical production system (CPPS) notion formally?</p>	<p>The CPPS notion is formally organized and presented.</p>	 <p>The diagram illustrates the Cyber-Physical Production system (CPPS) structure. On the left, a 'Hierarchy layer' lists levels from 'Production network' down to 'Construction element'. The main part shows a 'System of Interest' (Cyber layer with IaaS and Production objects, Link layer with Sensors and Actuators, Physical layer with Physical Production elements and Physical Product elements) and an 'Enabling system' (Humans, Cyber infrastructure, Physical infrastructure). An 'Influence' bubble connects the two.</p>
<p>RQ-2 How can CPPS notion are represented in a unified semantics through its life cycle?</p>	<p>The CPPS terminology, typology, and fundamental systemic classification is presented.</p>	 <p>This diagram shows the 'CPPS production network view- Systemic model'. It features a 'Hierarchy layer' on the left and a central 'CPPS system' node. Relationships include 'composed of' (System elements, Systems of system (SOS), Structural relation), 'describes' (Model), 'is influenced by' (CPPS Environment), 'has function' (System to build, CPPS Functions), 'has objective' (CPPS Objectives), and 'support' (CPPS Enabling system, Relations, CPPS Behavioural relation).</p>
<p>SQ-1 How can CPPS notion entities be defined in unified semantics?</p>	<p>The different life cycle phases of a production system are identified and exploited.</p>	 <p>The diagram details the 'CPPS life cycle -from SOI'. It shows 'CPPS life cycle stages' (Development, Operation, End of life phase) and 'CPPS life cycle phases' (Development phase, Operation phase, End of life phase). Each phase includes specific processes like 'Requirement process', 'Production operators process', and 'Maintenance process'.</p>
<p>SQ-2 How can the human-CPPS notion be defined in unified semantics?</p>	<p>The H-CPPS integration formal and explicit phenomenon is presented.</p>	 <p>A matrix table showing 'Human-CPPS interaction'. The columns are 'Human-CPPS interaction' (Design, Training, Maintenance, Repair, Upgrade) and 'Human-CPPS interaction' (Design, Training, Maintenance, Repair, Upgrade). The rows list various components like 'Human-CPPS interface components', 'Intelligent components (ICPPS)', 'Operator view', and 'Human-CPPS interaction'.</p>

Table 7.1: Research question and answer of thesis work



## 7.2 CPPS notion Semantic framework Contributions

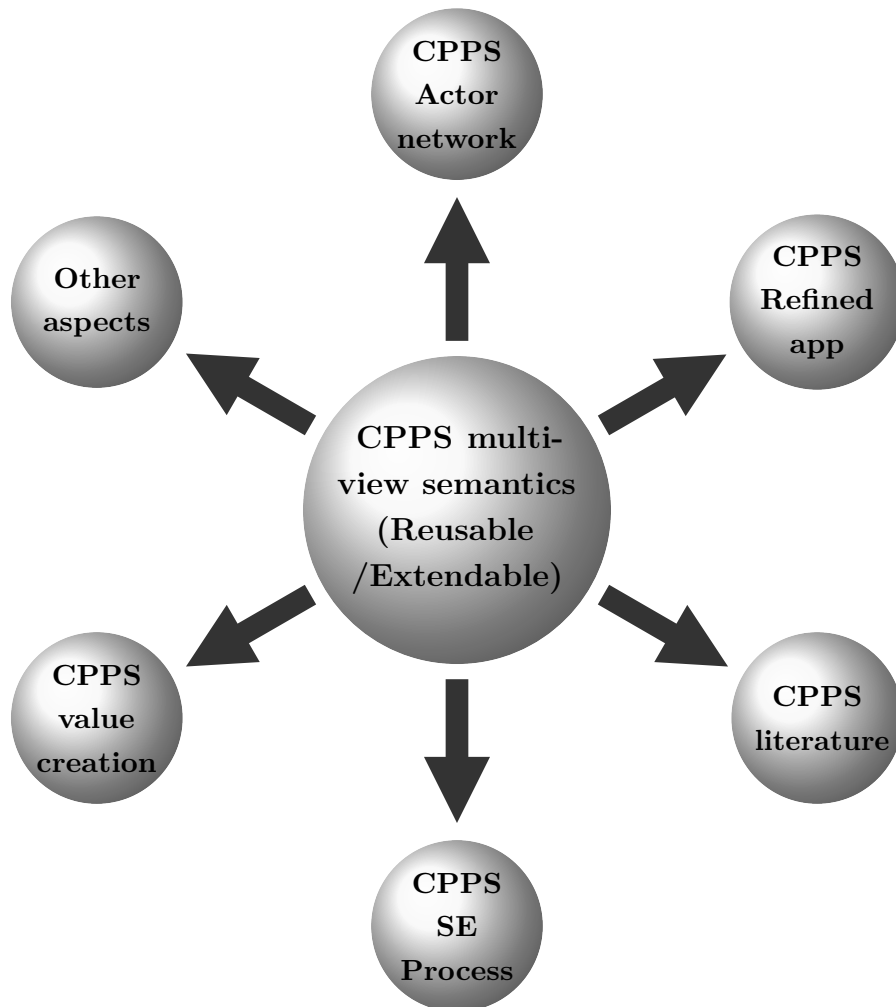
### 7.2.1 Scientific implication to CPPS notion- Generic view

In global view, the main scientific implication to CPPS as follows and illustrated in figure 7.2.1.

- **CPPS notion:** Based on our classification SOI and ES- *"Cyber-physical production system (CPPS) which has cyber, link, physical elements (System of interest) connected with the production network. These elements interact together with other enabling system (ES) to transform the raw material into useful product and services. It enhances the decision-making process and communication between machine, product, and human in real-time."*
- **CPPS notion metamodel:** The systemic metamodel is proposed. It provides the independent systemic formal view of CPPS. It helps to understand the structural ambiguity, abstraction and constituent system. It supports in evolution and further development of CPPS paradigm.
- **CPPS notion terminology and typology classifications-** The CPPS terminology and typology is classified based on the abstraction of the system. It brings the large group of involved entities into smaller groups based on similarities and commonality. It classifies based on the immediate influence on the structure and functionality of CPPS.
- **CPPS notion-Semantic meaning in a common architecture:** The framework provides a unique meaning and brings all the abstract knowledge of the specific views in a unique common architecture.
- **CPPS notion system theory-** The framework brings an attempt on developing a logical, philosophical theory for CPPS. It characterizes a set of domain concepts and the relationships among those concepts of the paradigm.
- **Support in CPPS notion design-** The framework support in CPPS design (Structure, Behavior, Function, interface, environment, and system component, Human-CPPS integration etc) which helps to ease the collaborative design by allowing clearly to visualize the system components, identify their individual objectives, relationships, and interdependencies.
- **Support in CPPS notion life cycle phases:** The framework support in life cycle

phases (i.e) the identified information in different hierarchy layers artifact of the production system serves as reference. It can be reused within the life cycle of production systems; according to their interest.

- **Support CPPS notion literature-** The framework creates value in literature. The framework provides the valid source of knowledge for all readers. It advances the current literature and put a step forward on current understanding of new notion CPPS.



**Figure-** CPPS notion multi-viewed modular semantic framework

### 7.2.2 Practical implication to CPPS notion-Generic view

The main contribution of architecture framework in practical use as follows:

- **Framework for design and development projects:** The multi-viewed framework supports in design and development projects. The basic building block of CPPS theory and semantics can foster the development project. It can integrate into the SE process

and adding to the detail in corresponding architecture can foster the CPPS system engineering process (agile or V-model).

- **CPPS notion framework-reuse or extend:-** The multi-viewed semantic framework involves the abstract concept of the CPPS paradigm that can be reuse unambiguously across any CPPS applications context. It can be extendable from our identified entities and artifacts. It provides the openness to accommodate the changes in representation on inclusion and exclusion part.
- **CPPS notion framework for actor network:-** The multi-view framework offers a first support for actors network of CPPS notion. The domain concepts, basic structure or armature which contribute to the understanding of the whole problem of interest.

### 7.2.3 Research gap and contributions

The thesis work fills the limitation and research gap that we identified in systematic literature review (SLR) perspective

- **Research gap:1 Lack of a common understanding of the CPPS notion.**

The research fills the gap by encapsulating current systemic understanding of cyber physical production system(CPPS) formally. It mainly constitutes a generic statement and a metamodel proposition using theory of system and SE principle.

- **Research gap:2 Lack of semantic on spanning the whole CPPS life cycle.**

The research fills the gap by proposing the semantic framework, which involves an abstract formal concept covering the life cycle phases. The information artifacts to be assigned from terminology to typology to different layer's of life cycle phases of a production system.

- **Research gap 3 Lack of semantic for human-CPPS notion interaction phenomenon.**

The research fills the gap by establishes a common ground for anthropomorphizing CPPS machines and humans. We're contributing to understand the novel ways of what interactive human-CPPS is. We clarify the involved Human-CPPS phenomenon, by establishing an explicit conceptualization of it.

#### 7.2.4 Contribution to INCOSE Community vision

The Thesis research outcome is mutually contributed to the **INCOSE community and its vision 2035**. It is described as follows<sup>1 2</sup>

- **Vision-1) Realizing the Systems (CPS) theoretical foundation vision** — The thesis presents the CPPS systemic understanding, semantics, and the derived theory of the CPPS system. It supports the systems engineer with the domain concepts, derived meaning, and different applications.
- **Vision-2) Realizing the ontology-based modeling practices (cyber-physical systems solutions) vision**— The thesis presents the CPPS and HCPPS knowledge representation that provides a seamless exchange of information that integrates across the domains, and life cycle phases of a system. It supports across the CPPS domains and shares the value for different applications.

### 7.3 Framework limitations and discussion

#### 7.3.1 Some limitation of framework

- We did not take a whole state-of-the-art approach. We restricted from our SLR. we claim that our artifacts are comprehensive, reusable and extendable
- The framework aims to present a vast group of abstract concepts of CPPS notion. Though, the ambition is to provide a generic standard unit that has fit any types of CPPS. It makes additional adaption process is required for each use case and application context.
- The framework is generic and tries to cover a abstract concept and schema of notion. As a result, sub system level, element level and other system decomposition level are not discussed. The specificity of different decomposition view should be better considered on future cases.
- The framework has domain concepts and relations. It serves as a first class citizen from a practical viewpoint. We are convinced that, it solves the fundamental problem, but it is extendable and explanatory allowing to reuse and instantiate in suitable application.
- Despite these limitations, our artifacts represent an important step towards the establishment of a common understanding of application area of CPPS notion. In

---

<sup>1</sup><https://www.incose.org/>

<sup>2</sup><https://www.incose.org/about-systems-engineering/se-vision-2035>

particular, we encourage other researchers and practitioners to join our interdisciplinary endeavor to enable future CPPS notion applications and modeling approaches which make the complexity and structural opacity of CPPS notion more manageable.

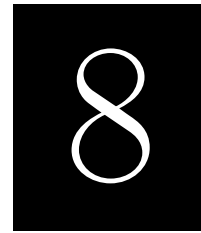
### 7.3.2 Other research connection view

- The framework provides the systemic ground by classifying the System of interest (SOI) and enabling system (ES). It supports in evolution for CPPS paradigm. It opens the new opportunities and gradually introduce the multidisciplinary research in CPPS paradigm.
- The framework is advantageous in Multidisciplinary engineering of product and production system. It supports to built an strong information management system to assist the high-quality information generation, processing, and use.
- The framework is advantageous in CPPS life cycle aspects of a product and/or a production system. The further research can explore to built strong information management system to assist the high-quality information generation, processing, and use.
- **Laboratory of digital science of Nantes (LS2N)-CPPS-** The architecture is advantageous for the students in the Ecole centrale de nantes for their course and research work in the platform. It enables a step forth on doing the multidisciplinary research in the LS2N-CPPS platform.

## 7.4 Future directions and perspective

- The premises and exploration of CPPS concept established in this work, it provides the open opportunities to gradually introduce, the collaborative and multidisciplinary research in future cases.
- Going forward, the organisation and the metamodel are believed to facilitate the sharing and re-usability of the application areas of CPPS as a future work.
- From the identified semantics and artifact, the future work can extend and reuse in application areas. It provides the openness to accommodate the changes in representation on the inclusion and exclusion part of the system.

- We encourage future research direction should consider our identified domain concepts and artifacts. To go further on other categories of resources to achieve the endeavors toward the new CPPS production concept.
- To go further on other categories of human integration and its typology to achieve the endeavors toward the human-CPPS production concept.



# Appendix

---

*This chapter presented is a section at the end of your main document that contains supplementary information such as figures, tables, raw data, code, etc. The appendix can also be structured in chapters (which are often considered to be multiple appendices).*

8.1	Appendix-A Chapter-1 Research process and artifact . . . . .	241
8.2	Appendix-B Chapter-2-System theory . . . . .	242
8.3	Appendix-C Chapter-2-Terminology and definitions . . . . .	243
8.4	Appendix-D- Chapter-2-Snowballing analysis . . . . .	246
8.5	Appendix-E-Semantic Supplementary Models . . . . .	247
8.6	Appendix-E-Chapter-5 Application context(1) . . . . .	251
8.7	Appendix-F-Chapter-5 Application context (1) . . . . .	252
8.8	Appendix-G-Chapter-6- Application context (3) . . . . .	264
8.9	Appendix-H-Human-CPPS Semantic integration . . . . .	266
8.10	Appendix-I-Human-CPPS Configurator app . . . . .	267

---

**T**HE appendix is a supplementary material that is not an essential part of the text itself but which may be helpful in providing a more comprehensive understanding of the research problem or it is information that is too cumbersome to be included in the body of the thesis work.

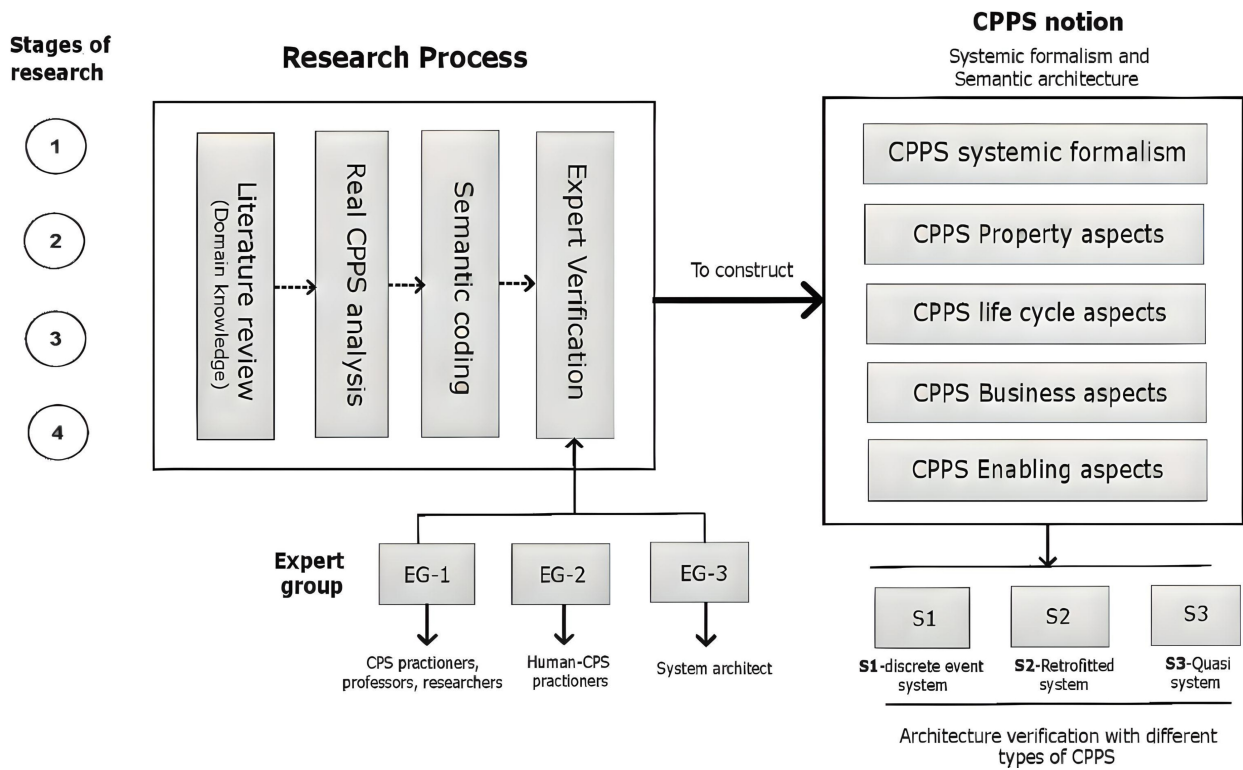
It is used to expand the knowledge of the main text by furthering the information provided in the main documents. Hence, the information is much relevant to your finding; however, it backs the analysis, validates generalizations and strengthens the point, is covered in the appendix.

It contains supplementary information such as figures, tables, raw data, code, etc. The appendix can also be structured in chapters (which are often considered).



## 8.1 Appendix-A Chapter-1 Research process and artifact

To address this research process, there is a need of systemic organize of CPPS notion. To achieve this goal, we organize and present the cyber physical production.



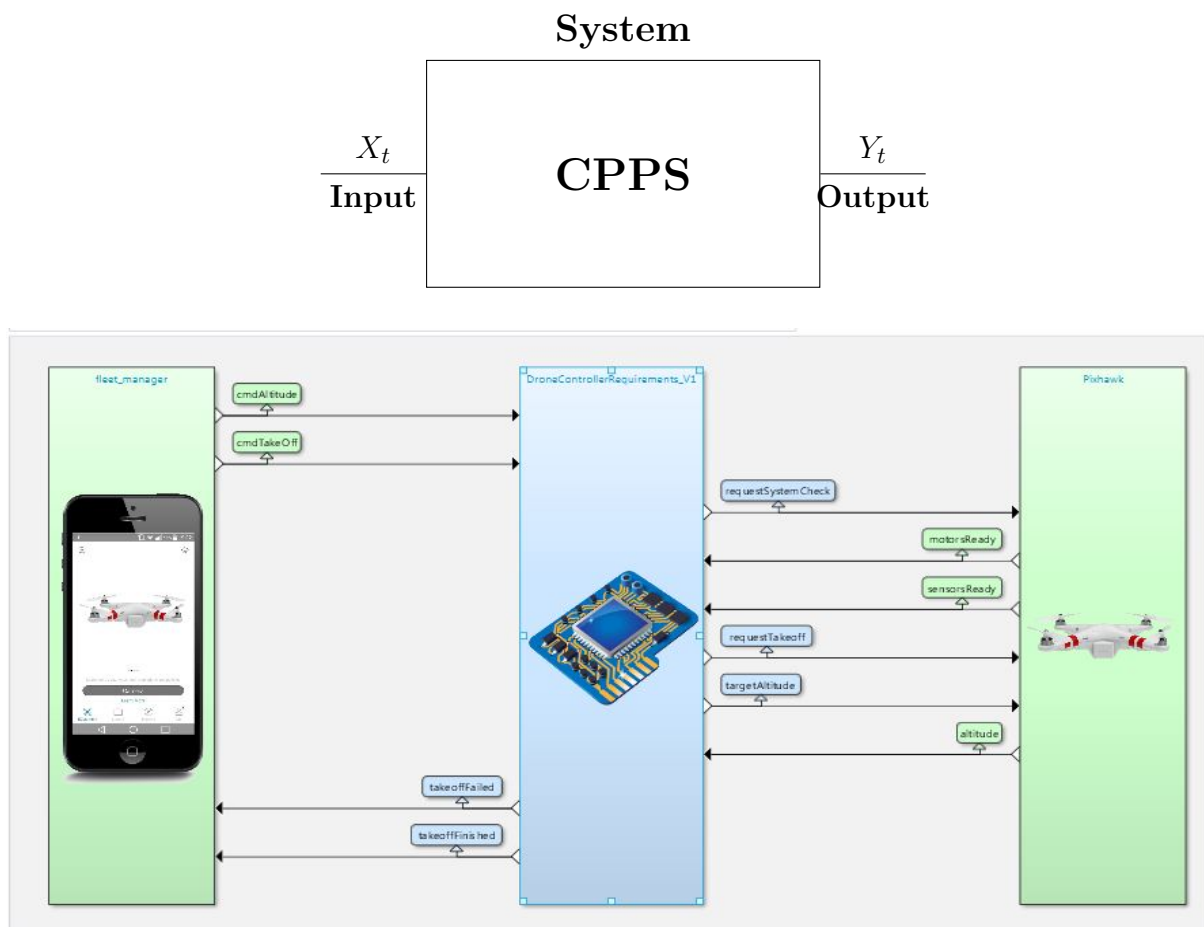
**Figure 8.1:** Stages of Research process for the framework

- Firstly, the domain knowledge extraction is conducted in literature on cyber physical production system related works. we examine the research papers, public working group projects and related studies. With the little information in real world CPPS applications.
- We have identified less than 25 axioms of core concept and modeling works. Based on the axioms, we began to conceptualize the involved entities and their dimensions of CPPS. It served as a first draft and base for the following research process.
- Secondly, we examine how the real objects (real system) fit with this conceptualization. We analyzed the different types of real CPPS. The inductive and deductive scientific reasoning of real CPPS is carried out.
- Then, the generic conceptual unified semantic model is constructed for CPPS. It is built on the “logical relationship and theoretical assumptions,” which integrates academic and industrial points of view to represent the integrated generic CPPS model.

- Finally, the model is instantiated and applied in a different CPPS machines by a scenario (use cases) to “describe the properties, involved entities of the system from a user-centered perspective” to show the ease and applicability of the models.

## 8.2 Appendix-B Chapter-2-System theory

The System theory emerged as a result of several decades of work by scientists, philosophers, and mathematicians in an effort to come up with an exact theory that unifies the many branches of the scientific enterprise.



**Figure 8.2:** Example of system theory

The concept of system theory finds its origin from Aristotle’s descriptive-metaphysical approach to characterizing the world. He expressed the basic tenet of system theory as "The whole is more than the sum of the parts". This was later replaced by Galileo’s mathematical conception of the world, paving the way for modern scientific methods, analyzing complex phenomena into elementary particles and processes.

## 8.3 Appendix-C Chapter-2-Terminology and definitions

Reference	Type	Concept/definition
M Monostori	<b>Concept exploration</b>	Cyber-Physical Production Systems (CPPS) consist of autonomous and cooperative elements and subsystems that are connected based on the context within and across all levels of production, from processes through machines up to production and logistics networks".[Monostori [2015]]
Monostori et al.,	<b>CPS- Manufacturing</b>	Review of CPSs in manufacturing from the viewpoint of Manufacturing Science and Technology (MST), including the concept, characteristics, expectations, challenges and case studies.[Monostori et al. [2016]]
Jiang et al.,	<b>Concept exploration</b>	Review of the recent advancements of Industrial Cyber Physical Systems (ICPSs) in monitoring, fault diagnosis and control approaches by data-driven realization.[Jiang et al. [2018]]
NIST	<b>Concept exploration</b>	CPS consists of two main functional components: (1) the advanced connectivity that ensures real-time data acquisition from the physical world and information feedback from the cyberspace.[Griffor et al. [2017]]
Industry 4.0	<b>Smart interactions</b>	CPS is a paradigm originates from the technology development of the cyber-physical systems (CPS) to enable smart interaction between cyber, physical and production spaces etc.
Pinzone et al [Pinzone et al. [2018]]	<b>Industry 4.0</b>	Human Cyber-Physical Production System (HCPPS) is a generic architecture with the control loop, adaptive automation control systems, to support humans and machines.
Tilbury	<b>Production network</b>	CPMS, in which computation and networking technologies interact with physical systems, have made great strides into manufacturing systems.[Tilbury [2019]]

References	Type	Concept exploration
Industry 4.0	<b>RAMI 4.0</b>	CPPS is a paradigm originates from the technology development of the cyber-physical systems (CPS) to enable smart interaction between cyber, physical and production spaces etc.[Jazdi [2014]]
A. Sheth	<b>Networking</b>	CPPS is a paradigm originates from the technology development of the cyber-physical systems (CPS) to enable smart interaction between cyber, physical and social spaces etc.[Monostori [2015]]
Barnard Feeney et al	<b>CPPS</b>	Cyber-physical systems are an inevitable consequence of the information revolution. Embedded computing, internet communication, and digital control have now become integral parts of modern engineered products and their manufacturing processes.[Barnard Feeney et al. [2017]]
Zuehkle	<b>Smart system</b>	possess a number of properties that are common to ubiquitous context aware systems, and recognise that the human machine-process-logistics connectivity across all levels of production can lead to a variety of key applications.[Rajkumar et al. [2010]][Rosen et al. [2015]]
S. Wang,	<b>Self-organisation</b>	CPPS is a system comprising three intertwining subsystems (i) The human-based system which refers to the social system containing human actors and their interconnected devices/agents and/or social platforms providing human-based services.[Kagermann and Wahlster [2022]][Lee et al. [2015]]
J. Wang	<b>Big Data</b>	CPPS is an extension of CPS/IoT formed by introducing human's social behaviour fostering a synergetic interaction between computing and human experience.
Lab- HCPPS	<b>HCPPS</b>	Human Cyber-Physical Production System (HCPPS) is a generic architecture with the control loop, adaptive automation control systems, and human-machine interaction to create a human-centric production system.[Zolotová et al. [2020]] [Romero et al. [2020]]

References	Type	Terminology, Taxonomy, Typology
[Francalanza et al. [2017]] [Niggemann and Lohweg [2015]] [Ansari [2019]]	<b>Terminology, Taxonomy</b>	The Cyber and physical Components refers to an umbrella term referring to all hardware and software (IS) components which serve the purpose of collecting, storing, analyzing, processing, or securing data within a CPPS., etc.[Barnard Feeney et al. [2017]]
[Romero et al. [2016b]] [Rúbio et al. [2019]]	<b>Typologies</b>	The tangible and intangible assets that actively or passively participate in the production process in order to add value.[Monostori [2015]]
[Andronie et al. [2021a]] [Babiceanu and Seker [2016]] [Suvarna et al. [2021]]	<b>Production Networking</b>	CPPS Network Infrastructure as the entirety of hardware and software components that enables object-to- object interactions within the inner system of a CPPS. This explicitly excludes interactions between human beings and the inner system[Rajkumar et al. [2010]][Rosen et al. [2015]]
[Valaskova et al. [2021]] [Große et al. [2020]]	<b>Self organisation</b>	The Self-organization can be described as the unplanned changes in the behavior of the components that are part of a system. These changes lead to a modification of its structure and to a collective and adaptive response. An essential part of self-organizing systems includes the non-inclusion of external control.[Kagermann and Wahlster [2022]]
[Rúbio et al. [2019]] [Mordinyi and Biffi [2015]]	<b>Big Data, IOT</b>	a Cyber-Physical Production System (CPPS) using data analytics is proposed to enable production visibility. It uses data stream processing approaches to clean redundant data efficiently. It is trained by mining the historical data offline, is employed to identify the accuracy of an RFID-captured event online.
[Gronau et al. [2016]]	<b>Autonomy</b>	The next generation of systems, that are able to raise the level of autonomy of its production components. This CPPS has the ability to evolve and adapt has been anticipated in the works on self-x production. [Romero et al. [2020]]



## 8.4 Appendix-D- Chapter-2-Snowballing analysis

In this section, the systematic literature reviews(SLR) are described. It is an explicit and rigorous approach to identify, evaluate, synthesize all the literature on a particular topic, where data extraction can be largely reduced.

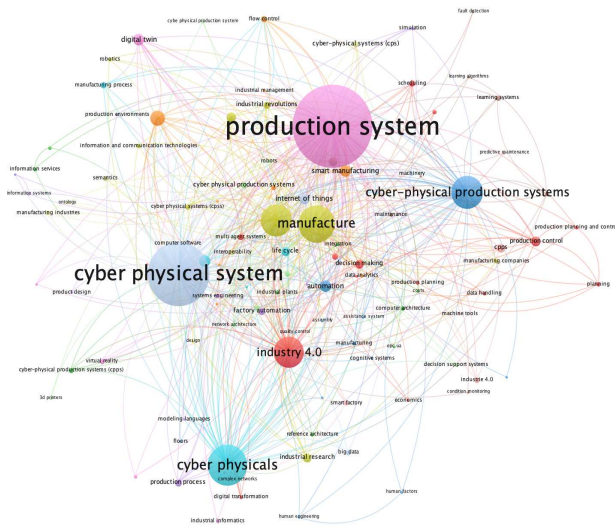


Figure 8.3: Cluster-2 Cluster node analysis on CPPS concept

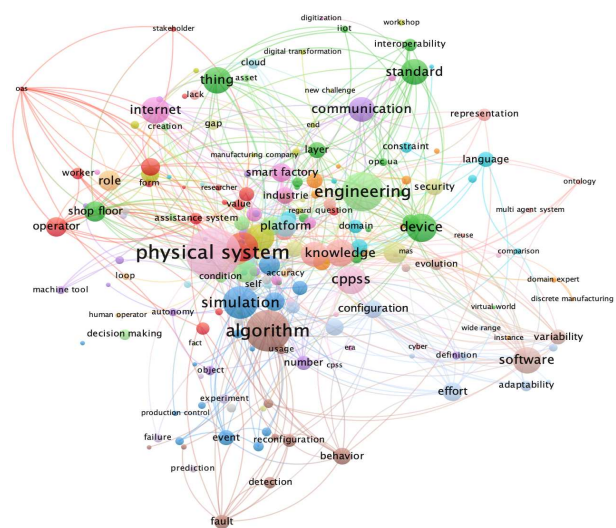


Figure 8.4: Cluster-3 Cluster on Human-CPPS integration

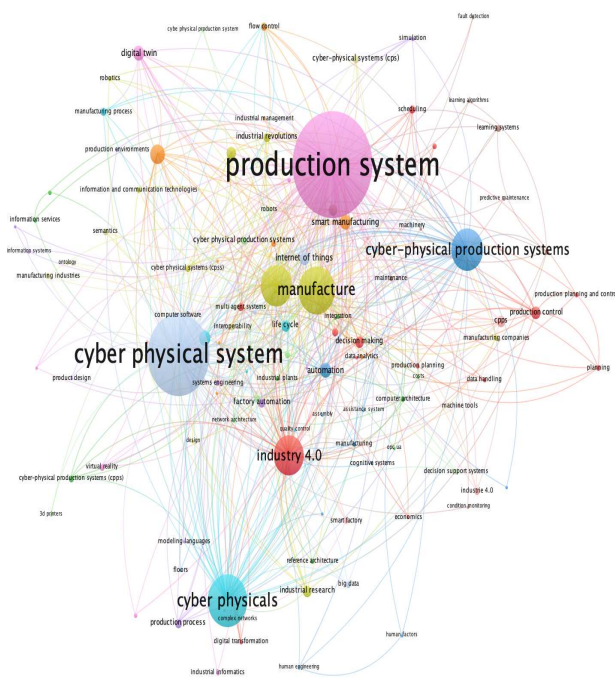


Figure 8.5: Cluster-2 Cluster on CPPS concept

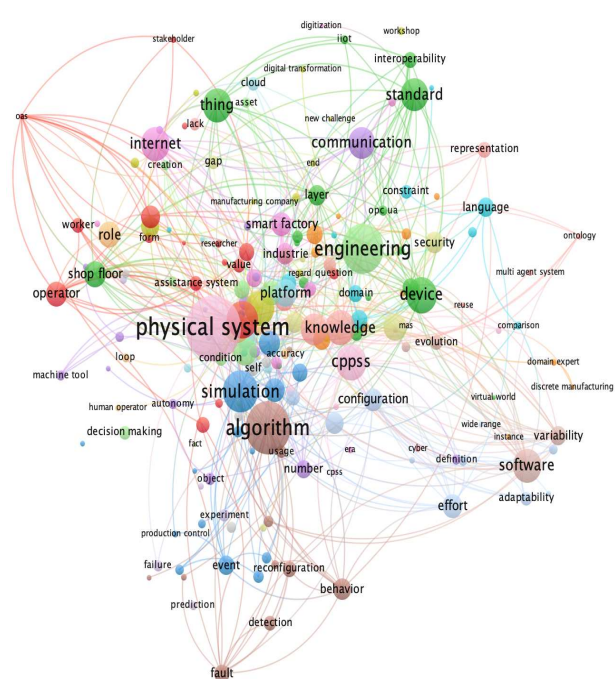


Figure 8.6: Cluster-3 Cluster on Human-CPPS integration

## 8.5 Appendix-E-Semantic Supplementary Models

The supplementary models of the constructed semantic models, which is illustrated below:

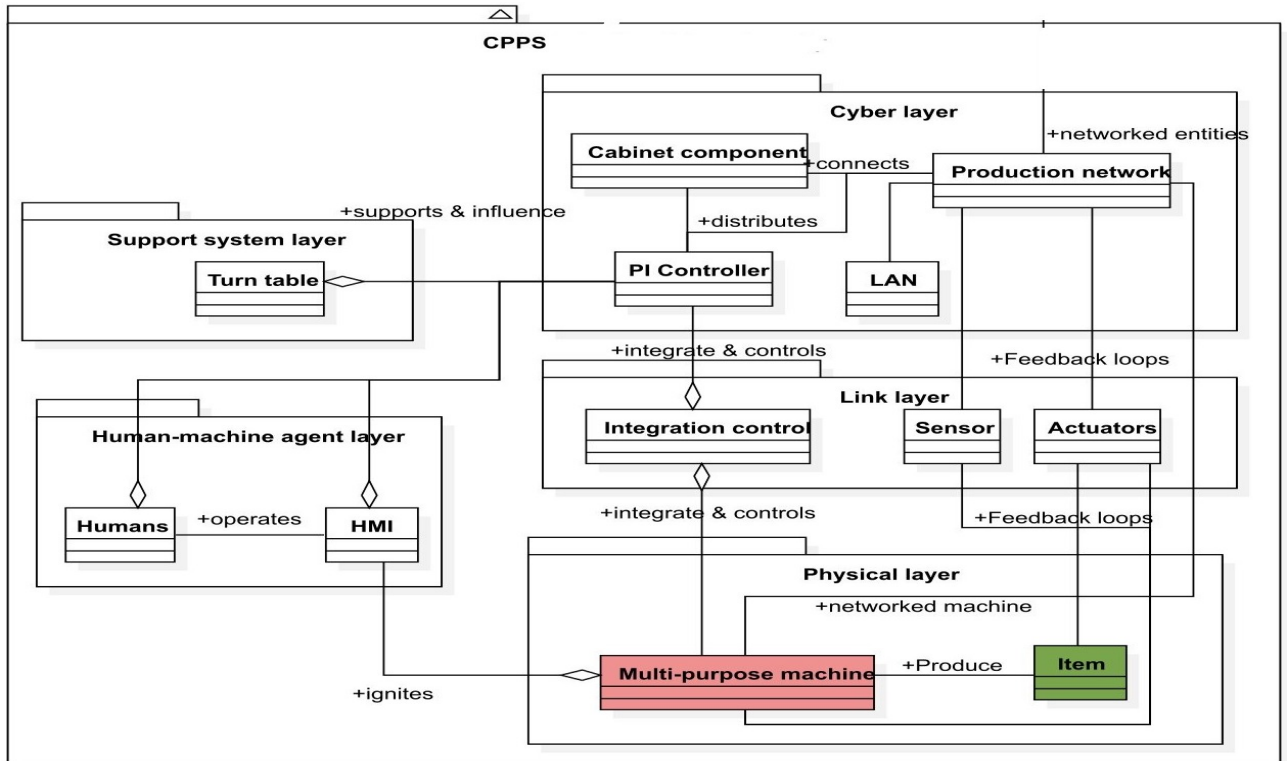


Figure 8.7: CPPS structure

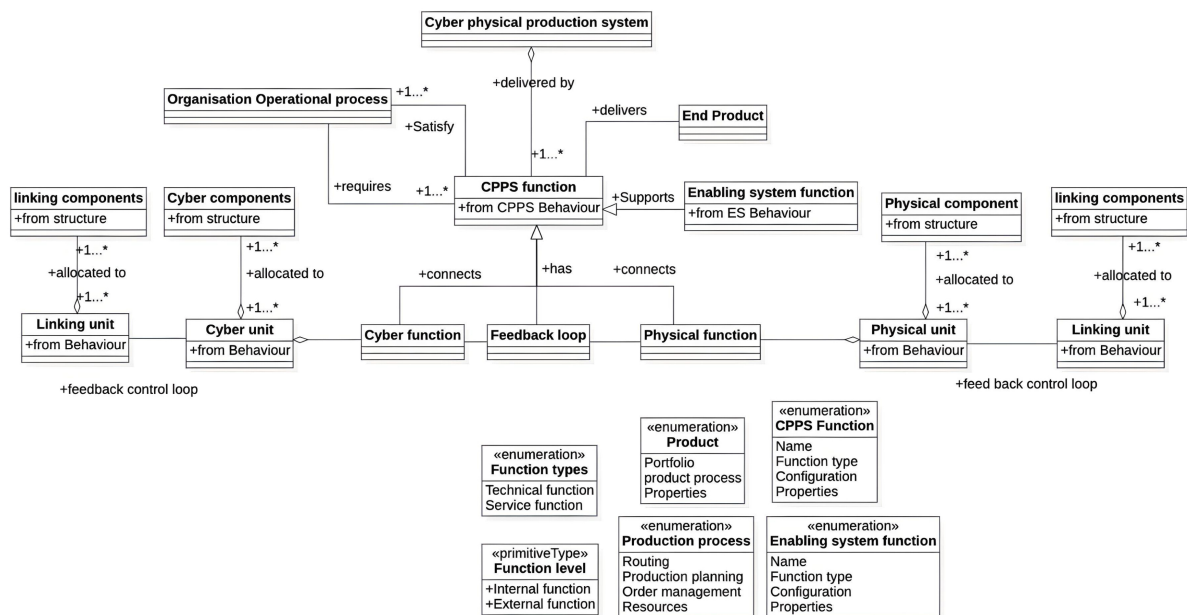


Figure 8.8: CPPS function

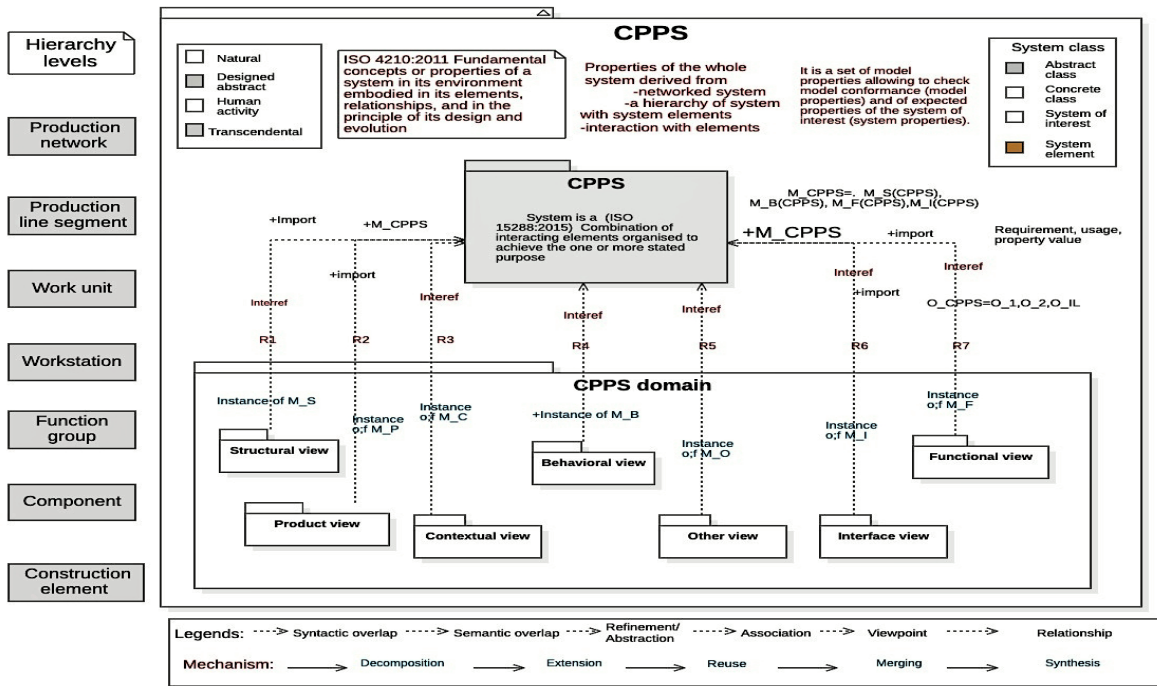


Figure 8.9: CPPS other properties

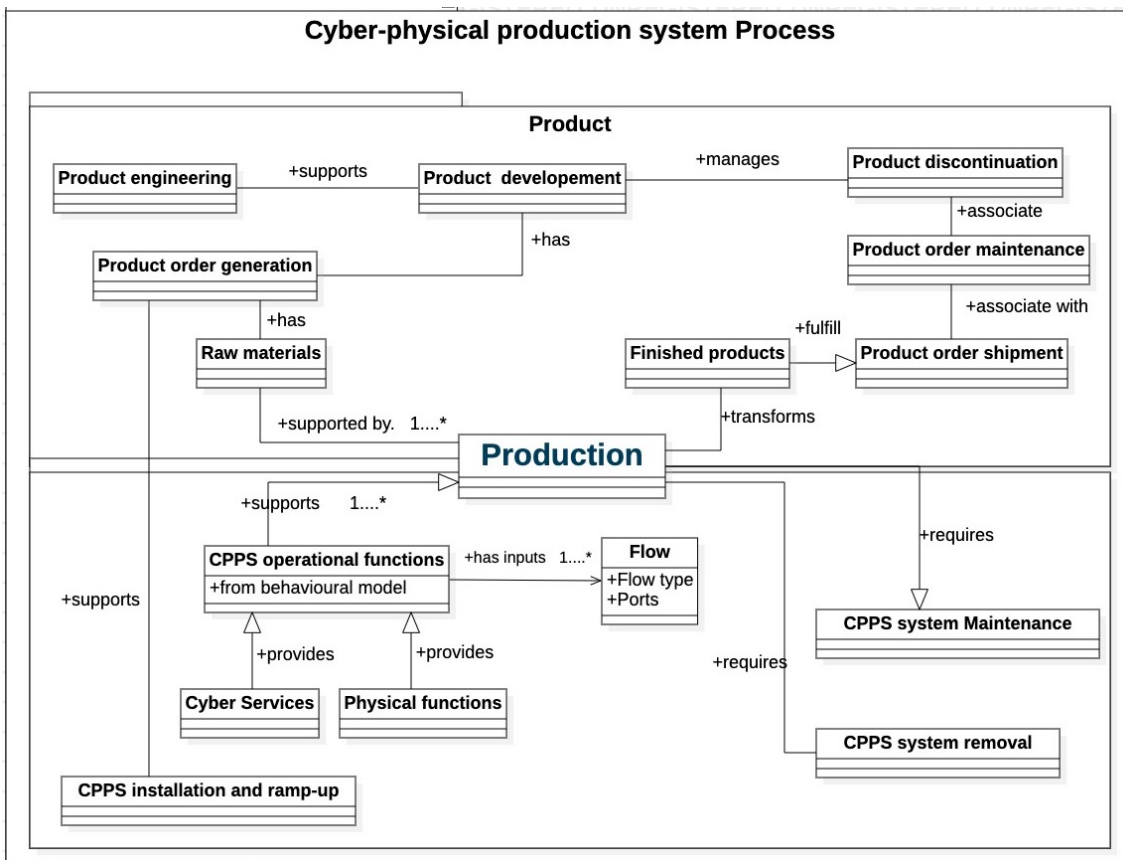


Figure 8.10: CPPS Product and production view



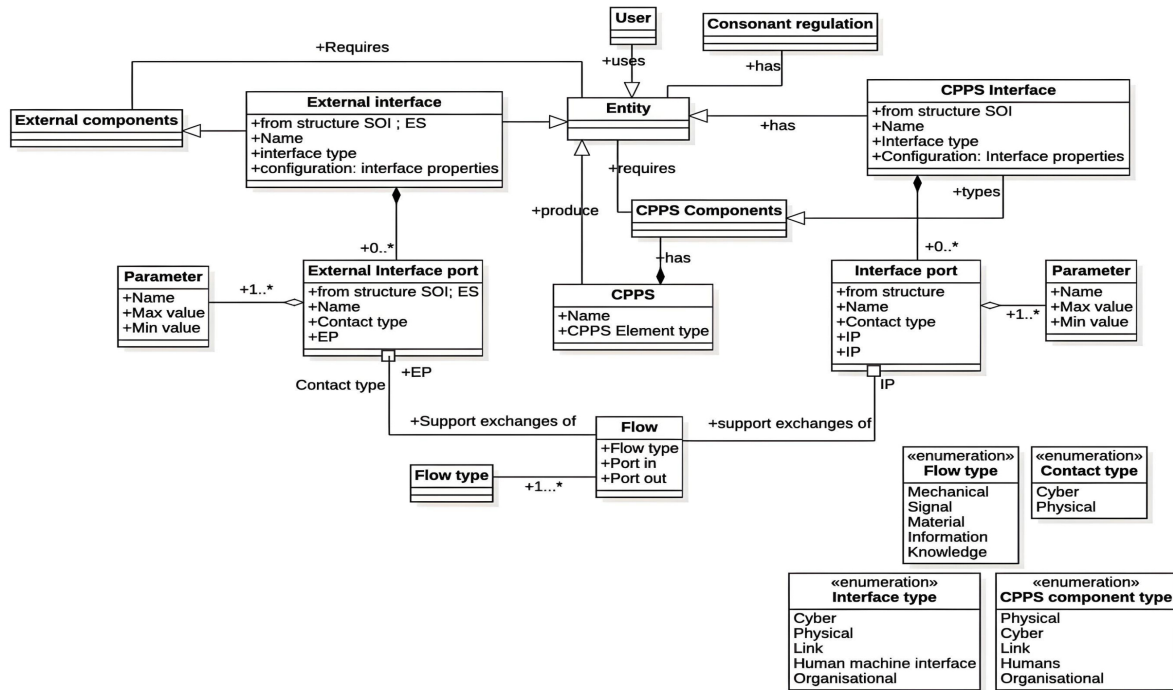


Figure 8.11: CPPS interface model

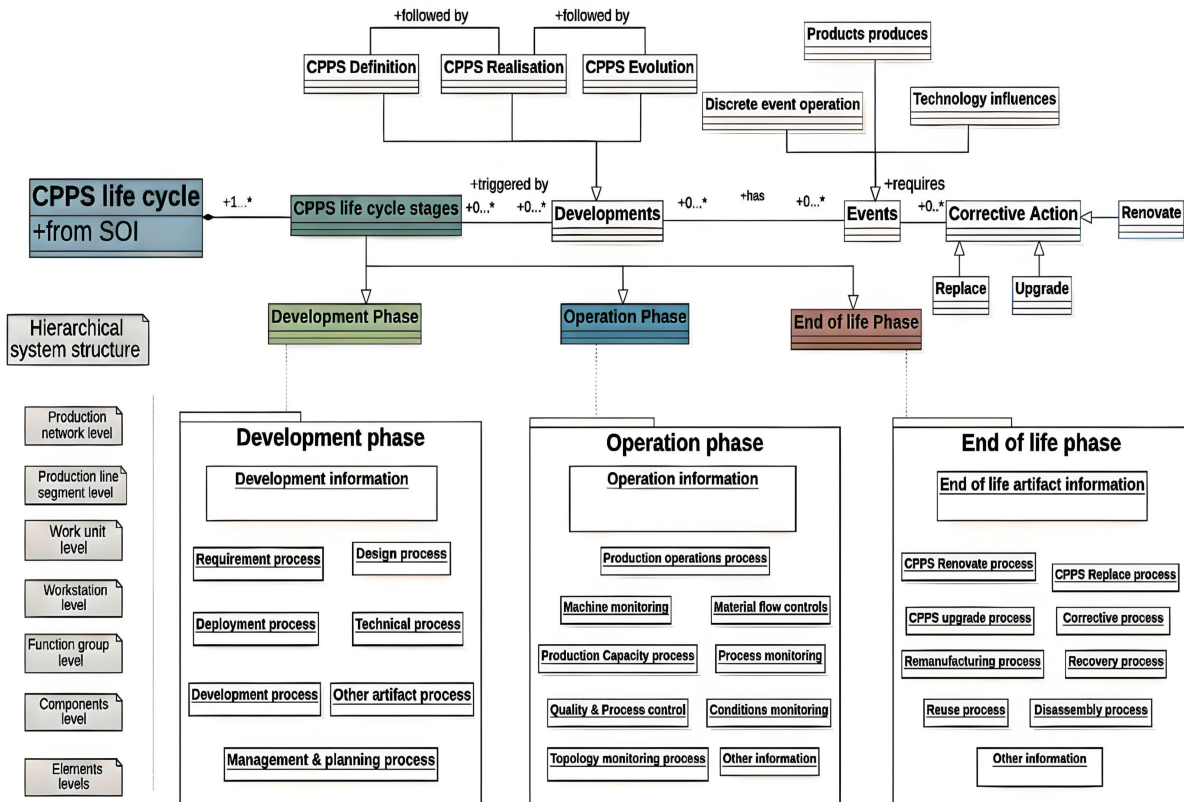


Figure 8.12: CPPS life cycle (enhanced from

[Lüder et al. [2017b]])

Layers	Design & development phase				Layers	Operation phase				Layers	End of life phase			
Production network	System layout	Wire frames	Personas	Structure 3D	Production network	Customer order management	Production order management	Supplier management	Human labor management	Production network	Decommissioning management	Disposal management	Recycle management	Reuse management
Production line segment	Prototype	Site map	Frames	Structure 2D	Production line segment	Reconfiguration management	Network management	Cloud management	Agility management	Production line segment	CPSS disassembly management	Collection management	Recovery management	Sorting management
Work unit	Aesthetic constraint	Block layout	Electrical layout	Mechanical models	Work unit	Configuration plan	Material handling	Tool changeover	HMI operation	Work unit	Cyber segment decommission	Physical segment decommission	HMI segment decommission	Network segment decommission
Work station	Mechanical models	Electrical models	Behaviour models	System models	Work station	Product portfolio	Cyber machine	Physical machine	HMI	Work station	Cyber unit decommission	Physical unit decommission	Plug & play decommission	HMI Decommission
Function group	Control model list	Power supply model	Fluidic model list	Control models list	Function group	Quality control	Production control	Product control	Material stock	Function group	Cyber machine dismantle	Physical machine dismantle	HMI dismantle	Tools decommission
Component	System model list	Simulation models	CAD model list	Geometry models	Component	Topology control	Plug and play control	Sensor control	Actuator control	Component	Sensor dismantle	Actuator dismantle	Cyber component dismantle	Physical component dismantle
Construction element	Mechanical specifications	Pneumatic specifications	Electrical specifications	Parameter specifications	Construction element	Material flow control	Element control	Product data	Production data	Construction element	Material sorting	Element sorting	Intelligent sorting	Parts sorting

Figure 8.13: CPSS life cycles (enhanced from

[Lüder et al. [2017b]])

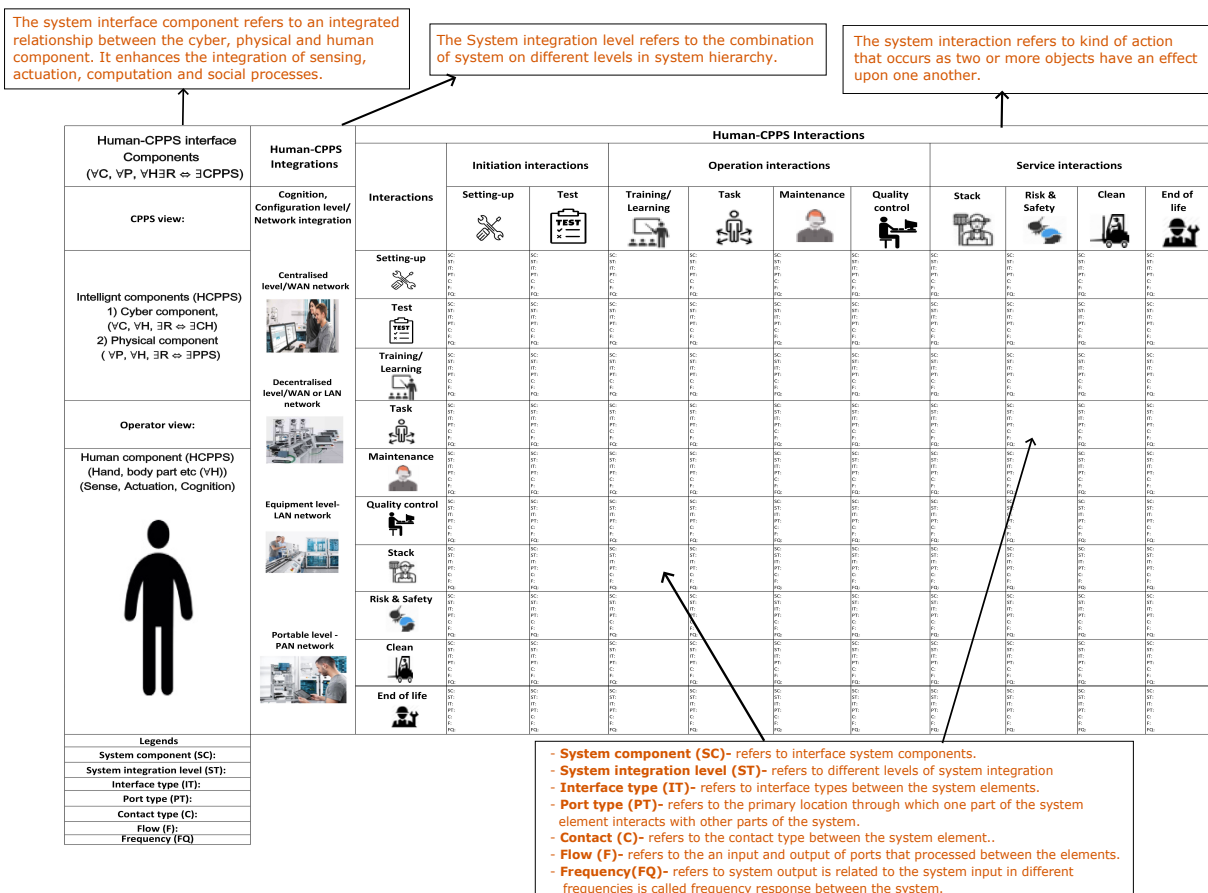


Figure 8.14: HCPSS integration matrix

[Lüder et al. [2017b]])

## 8.6 Appendix-E-Chapter-5 Application context(1)

In this section, the supplementary analysis for the application context is presented.

Case-1) The performance assessment is illustrated. It has influence factors of the repository is illustrated which is shown below in figure 8.33 8.34 8.37 8.48.

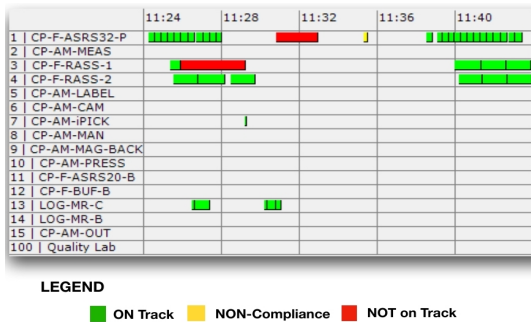


Figure 8.15: Scenario-1 production time-line

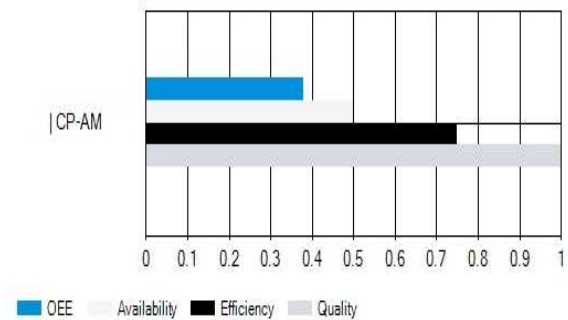


Figure 8.16: Scenario-1 OEE

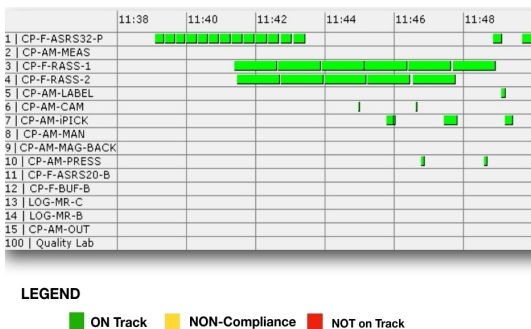


Figure 8.17: Scenario-2 production time-line

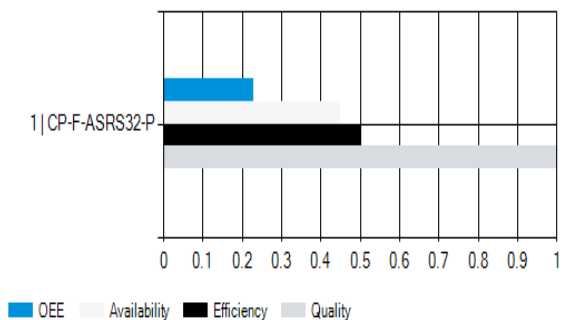


Figure 8.18: Scenario-2 OEE

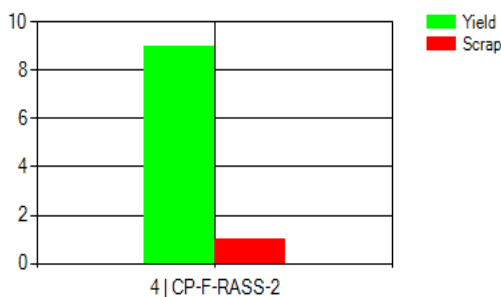


Figure 8.19: Utilization time on CS part-1

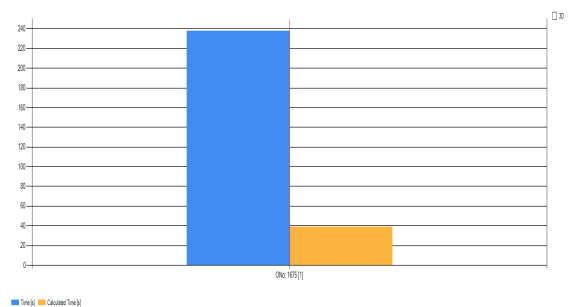


Figure 8.20: Utilisation time on CS part-2

## 8.7 Appendix-F-Chapter-5 Application context (1)

In this section, the supplementary analysis for the application context is presented.

Case-1) The performance assessment is illustrated. It has influence factors of the repository is illustrated which is shown below in figure 8.33 8.34 8.37 8.48.

### Analysis of Variance

Source	DF	Adj SS	Adj MS	F-Value	P-Value
Sceanrio	1	6,0	6,000	0,01	0,917
Error	22	12015,3	546,152		
Total	23	12021,3			

Figure 8.21: ANOVA analysis-(P value and F value)

### Regression Equation

$$OEE = 54,37 - 3,37 \text{ Availability}_{80} + 17,74 \text{ Availability}_{90} - 14,37 \text{ Availability}_{100} - 3,59 \text{ Efficiency}_{25} + 7,07 \text{ Efficiency}_{50} - 3,48 \text{ Efficiency}_{100} + 5,63 \text{ Quality}_{80} - 8,26 \text{ Quality}_{90} + 2,63 \text{ Quality}_{100}$$

### Coefficients

Term	Coef	SE Coef	T-Value	P-Value	VIF
Constant	54,37	3,94	13,79	0,000	
Availability					
80	-3,37	5,58	-0,60	0,552	1,33
90	17,74	5,58	3,18	0,005	1,33
Efficiency					
25	-3,59	5,58	-0,64	0,527	1,33
50	7,07	5,58	1,27	0,219	1,33
Quality					
80	5,63	5,58	1,01	0,325	1,33
90	-8,26	5,58	-1,48	0,154	1,33

Figure 8.22: ANOVA analysis (OEE)

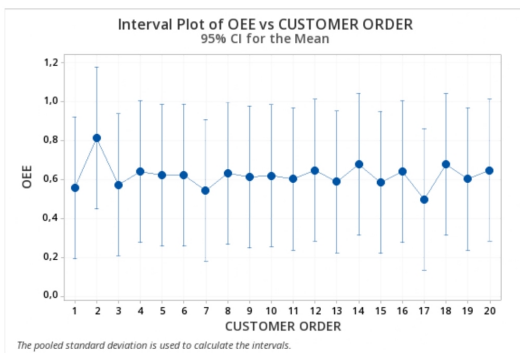


Figure 8.23: ANOVA analysis (OEE-Interval plot)

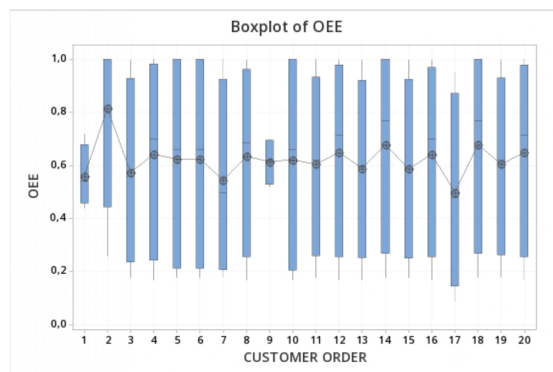


Figure 8.24: ANOVA (OEE-Box plot)

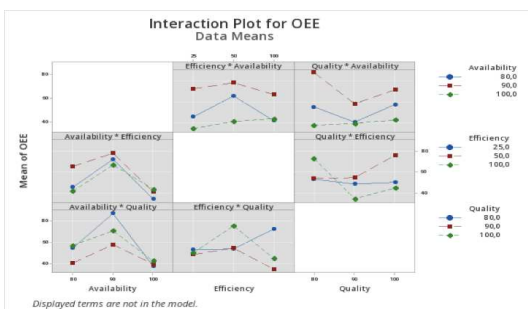


Figure 8.25: ANOVA-Influence factor 1

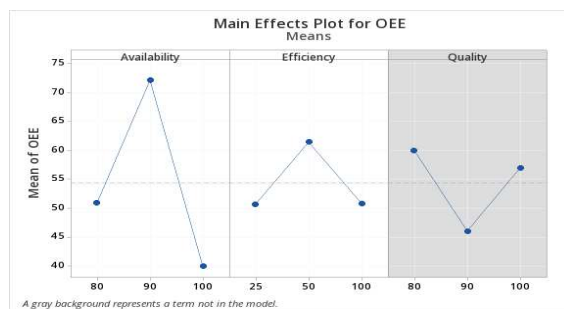


Figure 8.26: ANOVA-Influence factor 2

## Appendix-G-Chapter-5 Application context(2)

In this section, the Promethee decision-making analysis is illustrated. The supplementary of the analysis is presented in figure 8.33, 8.34 8.37. The Preference Ranking Organization Method for Enrichment of Evaluations and its descriptive for interactive known as the Promethee and Gaia methods.

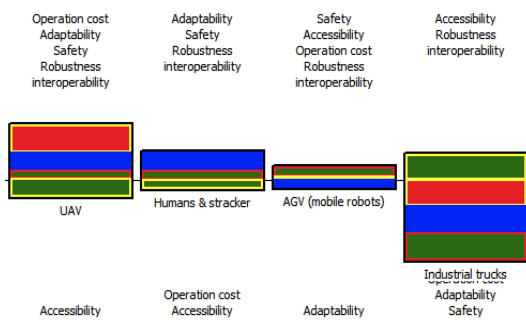


Figure 8.27: Scenario-1 on alternatives

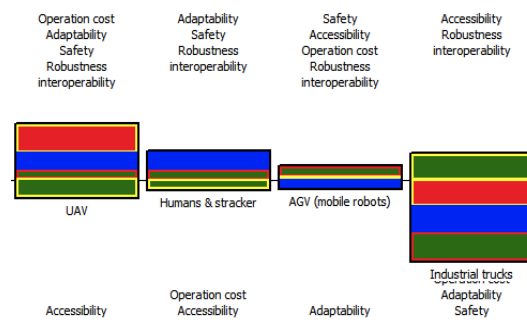


Figure 8.28: Scenario-2 on alternatives

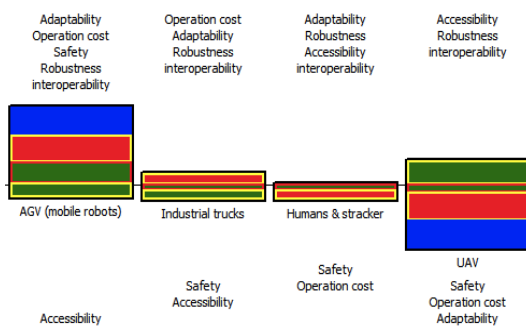


Figure 8.29: Scenario-4 on alternatives

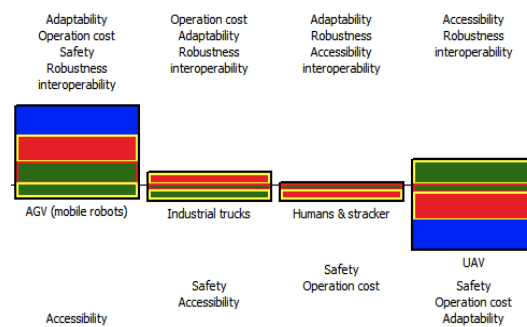


Figure 8.30: Scenario-5 on alternatives

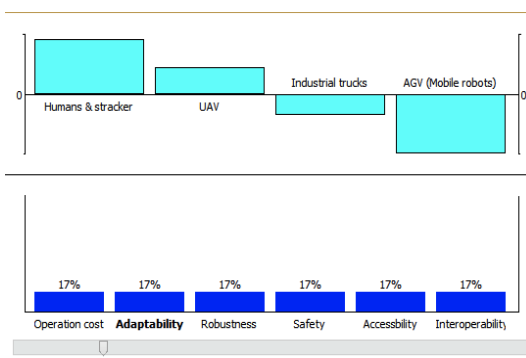


Figure 8.31: Stakeholders-on preferences

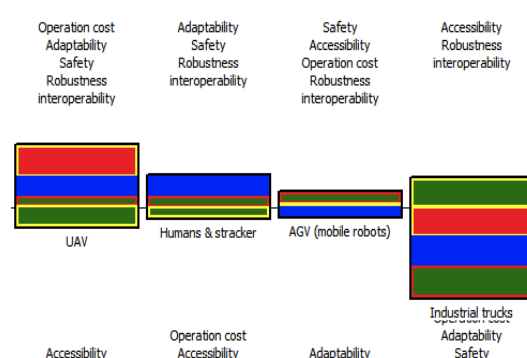


Figure 8.32: Stakeholders-on preferences

## Appendix-H-Chapter-5 Application context (2)

The Promethee decision-making analysis is illustrated. The preference ranking organization method for enrichment, and it's descriptive. The figure shows the 8.33, 8.34, 8.37, 8.48. It provides the decision-maker with both complete and partial rankings of the actions. It consists of a preference function associated to each criterion as well as weights describing their relative importance.

Scenario2	Operation cost	Adaptability	Robustness	Safety	Accessability	Interoperability	crit
Unit	unit	unit	unit	unit	unit	unit	unit
Cluster Group							
<b>Preferences</b>							
Min/Max	max	max	max	max	max	max	max
Weight	1,00	1,00	1,00	1,00	1,00	1,00	1,00
Preference Fm.	U-shape	Level	Linear	Linear	Linear	Linear	Linear
Thresholds	absolute	absolute	absolute	absolute	absolute	absolute	absolute
-Q: Indifference	1,00	1,00	1,00	1,00	1,00	1,00	1,00
-P: Preference	n/a	2,00	2,00	2,00	2,00	2,00	2,00
-S: Gaussian	n/a	n/a	n/a	n/a	n/a	n/a	n/a
<b>Statistics</b>							
Minimum	6000,00	40,00	4,50	5,00	5,00	7,00	
Maximum	25000,00	90,00	8,50	9,00	9,10	9,40	
Average	15200,00	65,00	6,50	6,75	7,00	8,22	
Standard Dev.	7630,20	20,62	1,58	1,48	1,60	0,87	
<b>Evaluations</b>							
AGV (Mobile robots)	20000,00	40,00	4,50	5,00	6,00	7,00	
UAV	9800,00	80,00	7,50	7,00	7,90	8,50	
Humans & stracker	6000,00	90,00	8,50	9,00	9,10	9,40	
Industrial trucks	25000,00	50,00	5,50	6,00	5,00	8,00	

Figure 8.33: Visual stability analysis

Scenario2	Operation cost	Adaptability	Robustness	Safety	Accessability	Interoperability	crit
Unit	unit	unit	unit	unit	unit	unit	unit
Cluster Group							
<b>Preferences</b>							
Min/Max	max	max	max	max	max	max	max
Weight	1,00	1,00	1,00	1,00	1,00	1,00	1,00
Preference Fm.	U-shape	Level	Linear	Linear	Linear	Linear	Linear
Thresholds	absolute	absolute	absolute	absolute	absolute	absolute	absolute
-Q: Indifference	1,00	1,00	1,00	1,00	1,00	1,00	1,00
-P: Preference	n/a	2,00	2,00	2,00	2,00	2,00	2,00
-S: Gaussian	n/a	n/a	n/a	n/a	n/a	n/a	n/a
<b>Statistics</b>							
Minimum	6000,00	40,00	4,50	5,00	5,00	7,00	
Maximum	25000,00	90,00	8,50	9,00	9,10	9,40	
Average	15200,00	65,00	6,50	6,75	7,00	8,22	
Standard Dev.	7630,20	20,62	1,58	1,48	1,60	0,87	
<b>Evaluations</b>							
AGV (Mobile robots)	20000,00	40,00	4,50	5,00	6,00	7,00	
UAV	9800,00	80,00	7,50	7,00	7,90	8,50	
Humans & stracker	6000,00	90,00	8,50	9,00	9,10	9,40	
Industrial trucks	25000,00	50,00	5,50	6,00	5,00	8,00	

Figure 8.34: Scenario-3 on alternatives

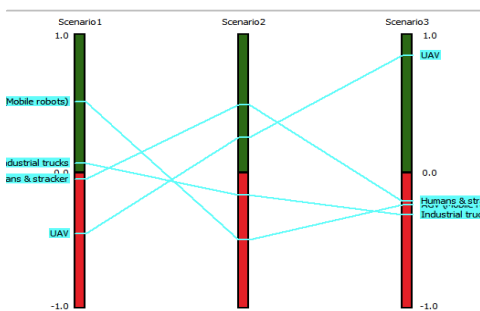


Figure 8.35: Stakeholders-on preferences

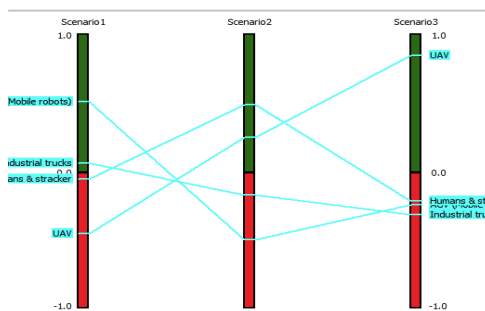


Figure 8.36: Stakeholders-on preferences

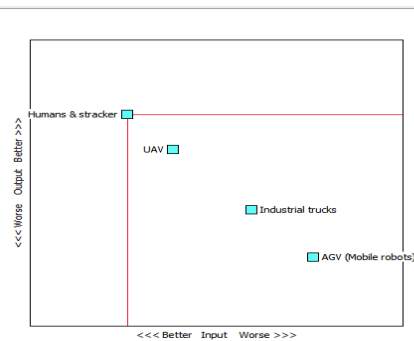


Figure 8.37: Walking weights

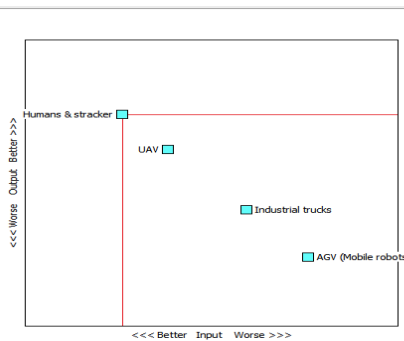


Figure 8.38: Walking weights

## Appendix-H-Chapter-5 Application context (2)

The moodle method illustrates the RSM-3D contour graphs plotted for two participating factors at one time, on x- and y-axis, against the obtained responses for COD recovery plotted on the z-axis, with different levels indicated by the color/height/contours of the obtained curve; Figures shows the 8.39, 8.40, 8.41, 8.42,8.43 , 8.44.

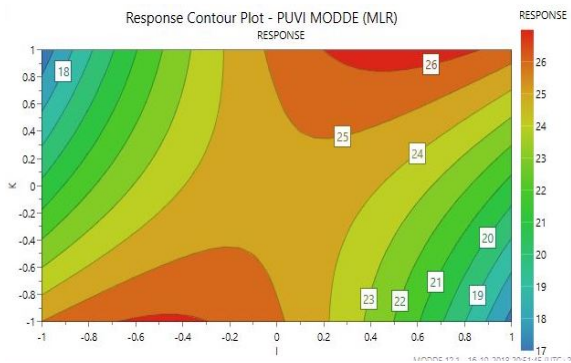


Figure 8.39: Response contour plot 1

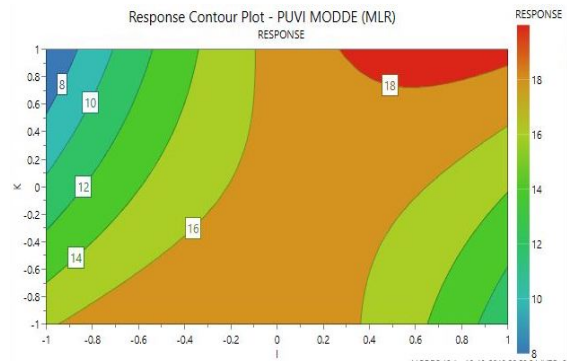


Figure 8.40: Response contour plot 2

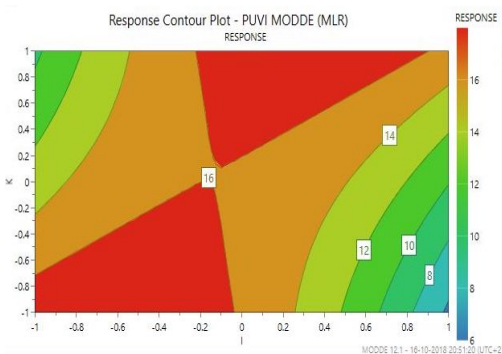


Figure 8.41: Response contour plot

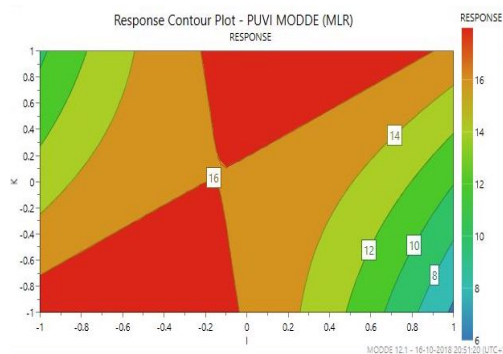


Figure 8.42: Response contour plot

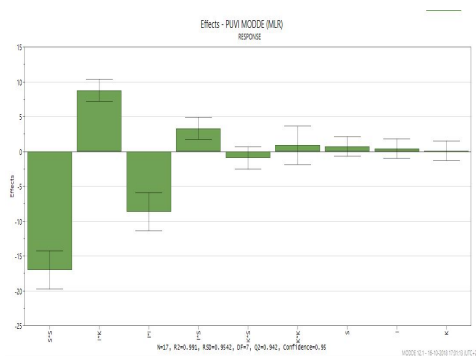


Figure 8.43: Summary of fit (OEE)

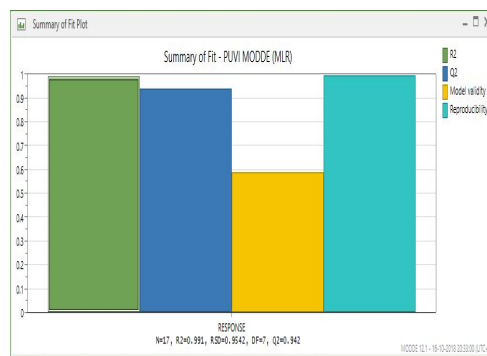


Figure 8.44: Summary of fit (OEE)





## Appendix-I-Chapter-5 Application context(2)

System requirement (SRS) for each scenario is different where only drone system is simulated not application module (because of interface requirements). This simulation helps to compare, conflict, or analysis the requirement for each scenario and gives us the better choice to select logical solution. But also helps to debug the requirements in larger scale without missing any requirements of the system.

The functional requirement of drone system is simulated for each scenario with the step scale of 10 period and observing the port of each scenario of autonomous drone. The case result of requirement elicitation simulation using Argosim tool, which is illustrated in figure 8.69 8.70 8.53, 8.54

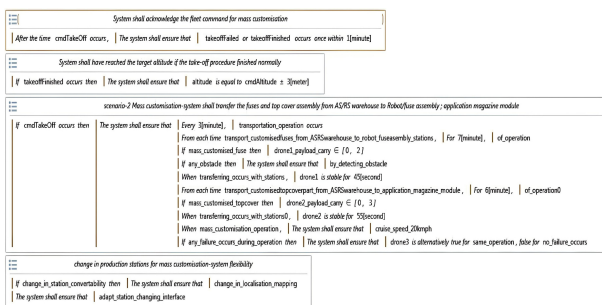


Figure 8.51: S-1 Req observation



Figure 8.52: S-2 Req observation

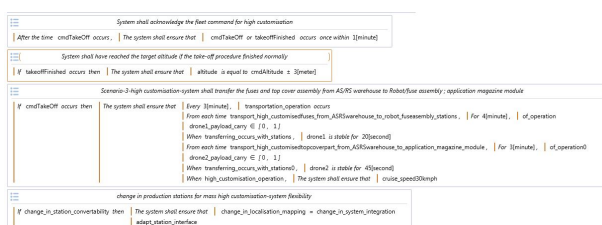


Figure 8.53: S-3 Req observation

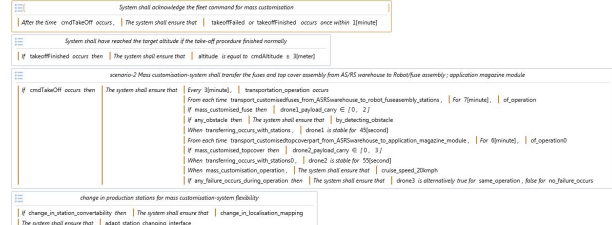


Figure 8.54: S-4 Req observation

/;

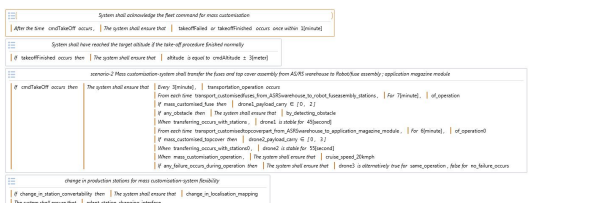


Figure 8.55: S-5 Req observation

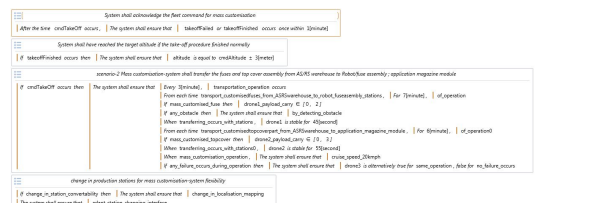


Figure 8.56: S-6 Req observation

## Appendix-I-Chapter-5 Application context(2)

**System requirement (SRS)** for each scenario is different where only drone system is simulated not application module (because of interface requirements). This simulation helps to compare, conflict, or analysis the requirement for each scenario and gives us the better choice to select logical solution.

The functional requirement of drone system is simulated for each scenario with the step scale of 10 period and observing the port of each scenario of autonomous drone. The case result of requirement elicitation simulation using Argosim tool, which is illustrated in figure 8.69 8.70 8.53, 8.54

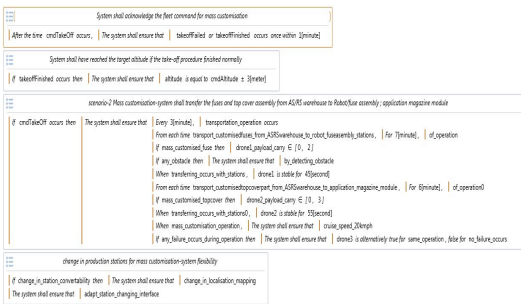


Figure 8.57: S-7 Req observation

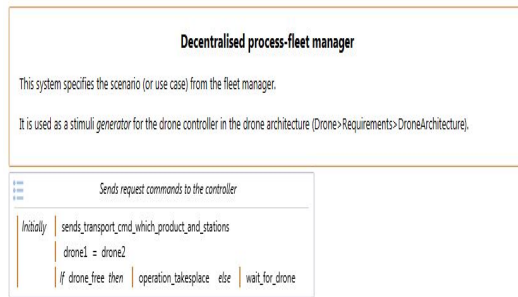


Figure 8.58: S-8 Req observation

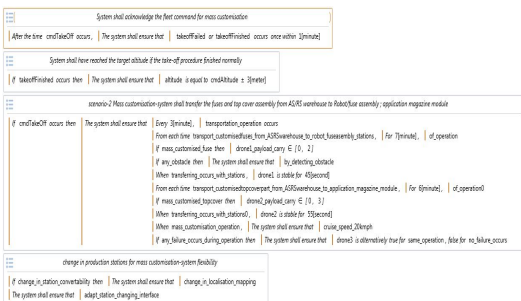


Figure 8.59: S-9 Req observation

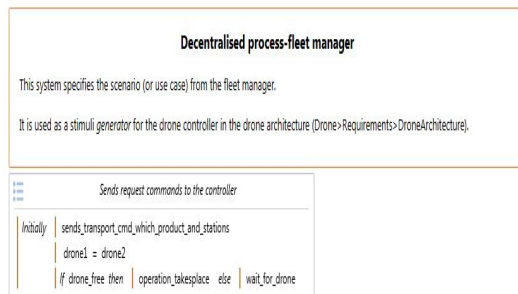


Figure 8.60: S-10 Req observation

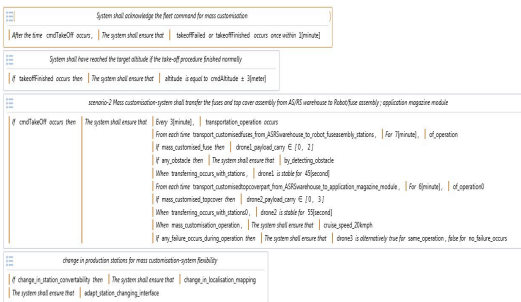


Figure 8.61: S-11 Req observation

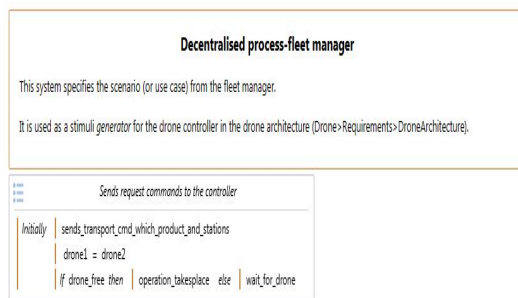


Figure 8.62: S-12 Req observation

## Appendix-I-Chapter-5 Application context(2)

System requirement (SRS) for each scenario is different where only drone system is simulated, not the application module (because of interface requirements).

The functional requirement of drone system is simulated for each scenario with the step scale of 10 period and observing the port of each scenario of autonomous drone. The case result of requirement elicitation simulation using Argosim tool, which is illustrated in figure 8.69 8.70 8.53, 8.54

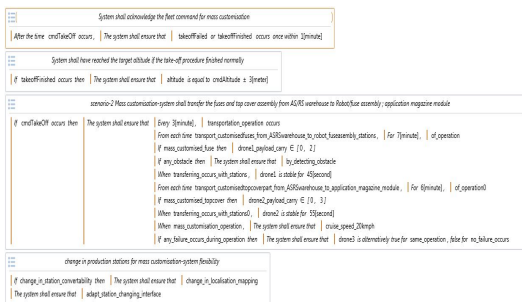


Figure 8.63: S-13 Req observation

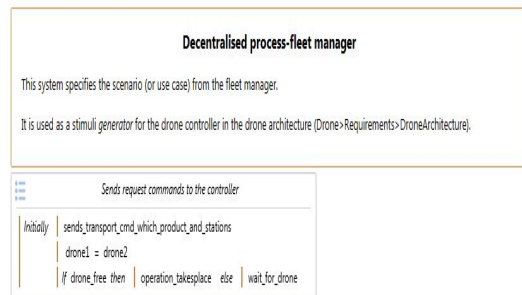


Figure 8.64: S-14 Req observation

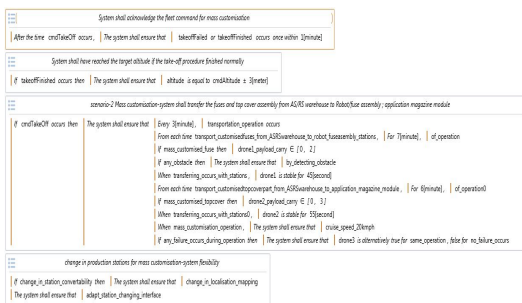


Figure 8.65: S-15 Req observation

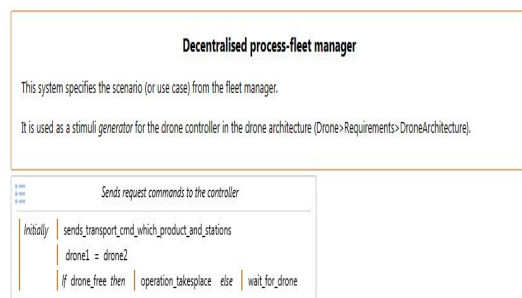


Figure 8.66: S-16 Req observation

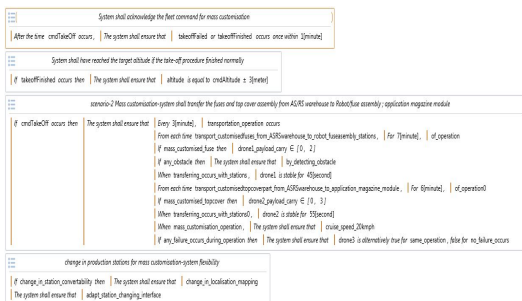


Figure 8.67: S-17 Req observation

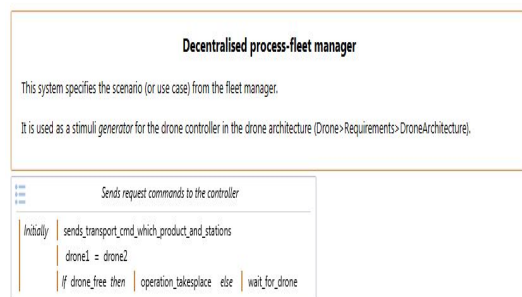


Figure 8.68: S-18 Req observation

## Appendix-J-Chapter-5 Application context(2)

System requirement (SRS) for each scenario. The case result of requirement elicitation simulation using Argosim tool, which is illustrated in figure 8.69 8.70 8.53, 8.54

The functional and non-functional requirements of drone system is simulated for each scenario with the step scale of 10 period and observing the port of each scenario of autonomous drone.

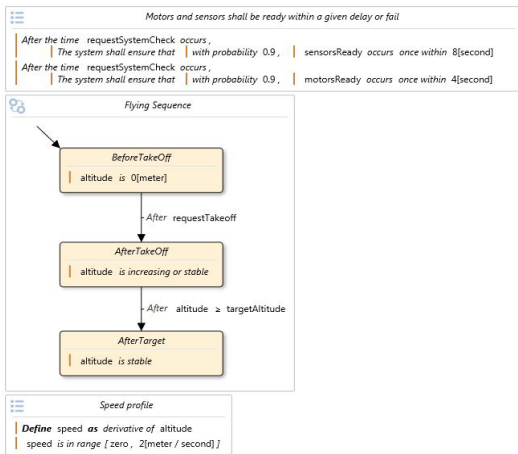


Figure 8.69: Requirement flow chart

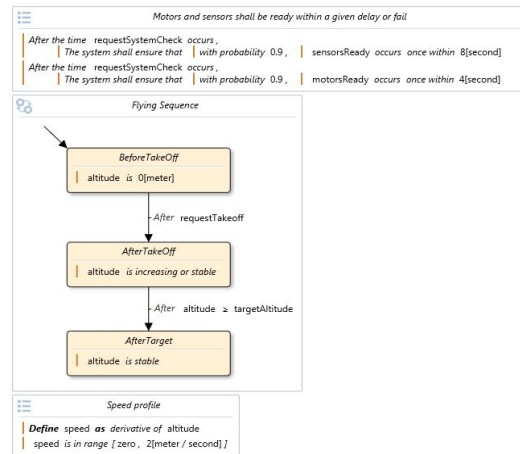


Figure 8.70: Requirement flow chart

Name	Value	Observers
DroneRequirements		
Ports		
After the time cmdTakeOff occurs, .....		
If takeoffFinished occurs then ...		
If takeoffFailed occurs then ...		
If cmdTakeOff then ...		
After the time cmdTakeOff occurs, .....		
If takeoffFinished occurs then ...		
If takeoffFailed occurs then ...		
If takeoffFinished occurs then ...		
After the time cmdTakeOff occurs, .....		
If takeoffFinished occurs then ...		
If takeoffFailed occurs then ...		
If takeoffFinished occurs then ...		

Figure 8.71: Requirement Observer box

Name	Value	Observers
DroneRequirements		
Ports		
After the time cmdTakeOff occurs, .....		
If takeoffFinished occurs then ...		
If takeoffFailed occurs then ...		
If cmdTakeOff then ...		
After the time cmdTakeOff occurs, .....		
If takeoffFinished occurs then ...		
If takeoffFailed occurs then ...		
If takeoffFinished occurs then ...		
After the time cmdTakeOff occurs, .....		
If takeoffFinished occurs then ...		
If takeoffFailed occurs then ...		
If takeoffFinished occurs then ...		

Figure 8.72: Requirement Observer box

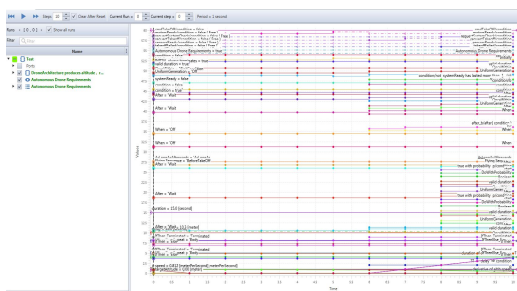


Figure 8.73: Scenario-1-Requirement Obr

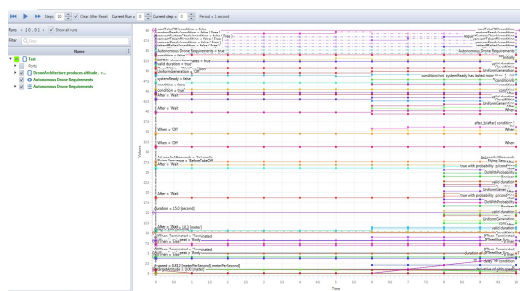


Figure 8.74: Scenario-2-Requirement Obr



## Appendix-K-Chapter-5 Application context(2)

**Requirements analysis(RT)-** When the elicitation of requirements is completed, the next traditional phase is to analysis the collected requirements. In this research, the requirement analysis phase is carried out by analyzing the different view points of stakeholders and system-level functional and non-functional requirements. Figure shows the 8.81, 8.82, 8.83, 8.85, 8.86. The below shown pre- requirement trace-ability is from the stakeholder requirement to system requirement to system use case which is traced and template below in order to trace between user needs to system use-case.

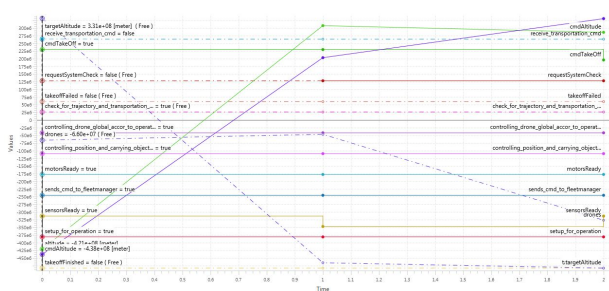


Figure 8.75: Scenario-3-Requirement Obr

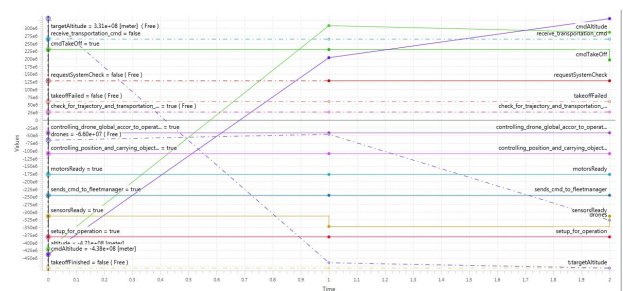


Figure 8.76: Scenario-4-Requirement Obr

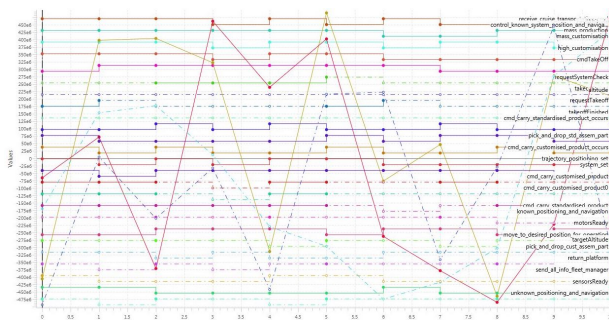


Figure 8.77: Scenario-5-Requirement Obr

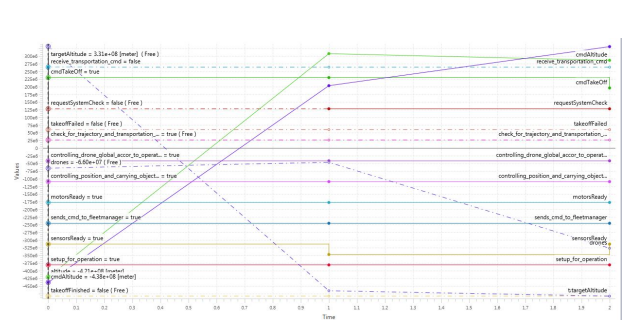


Figure 8.78: Scenario-6 Requirement Obr

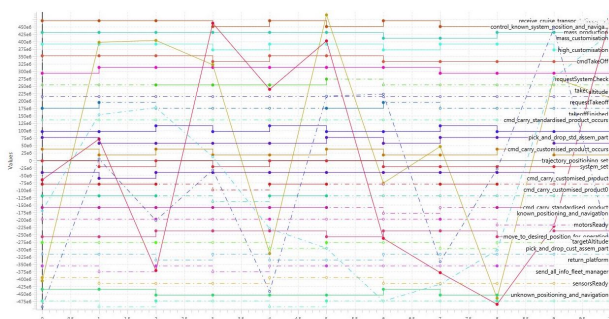


Figure 8.79: Scenario-7 Requirement Obr

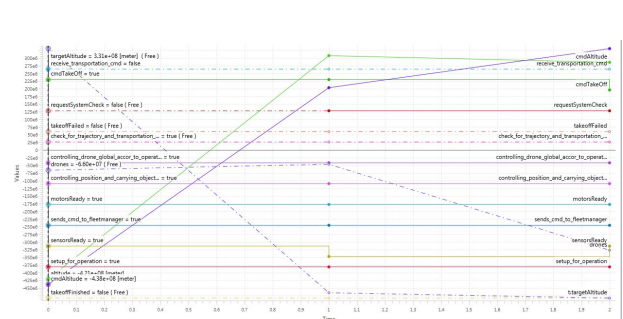


Figure 8.80: Scenario-8 Requirement Obr

## Appendix-J-Chapter-5 Application context (2)

Figure shows the 8.81, 8.82, 8.83, 8.84, 8.85, 8.86 the logical and physical architecture.

- **Logical architecture** - This part of the system architecture design that includes decomposing of system.
- **Physical architecture**- It is an arrangement of physical elements (system elements and physical interfaces) which provides the design solution.

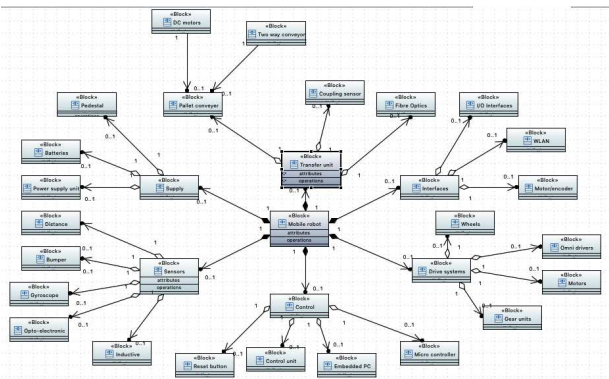


Figure 8.81: Logical Architecture

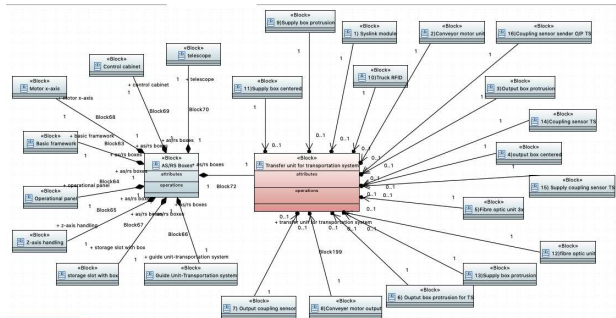


Figure 8.82: Robt fuse assembly module

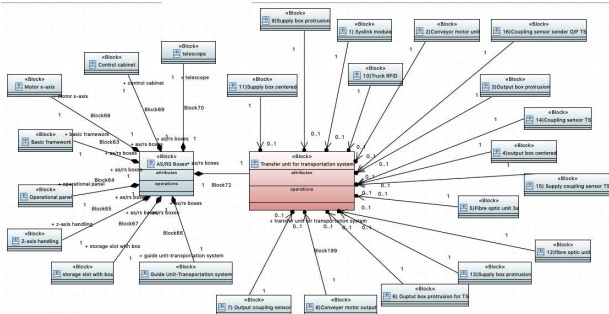


Figure 8.83: Application magazine module

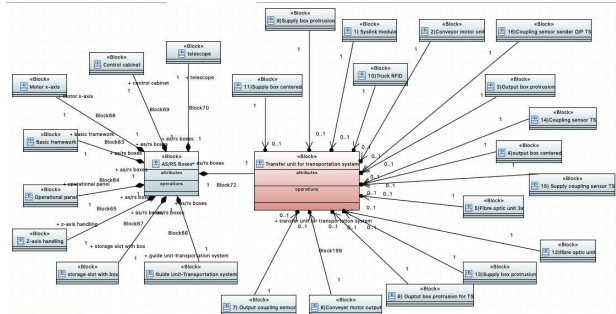


Figure 8.84: Mobile robot architecture

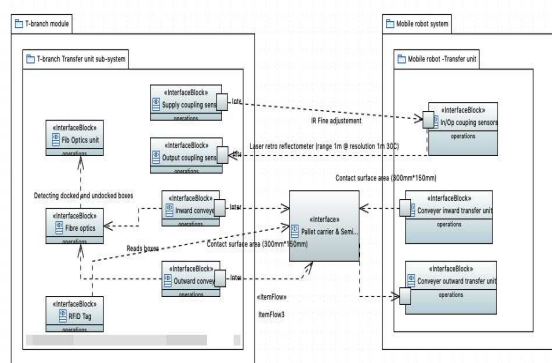


Figure 8.85: Robot architecture

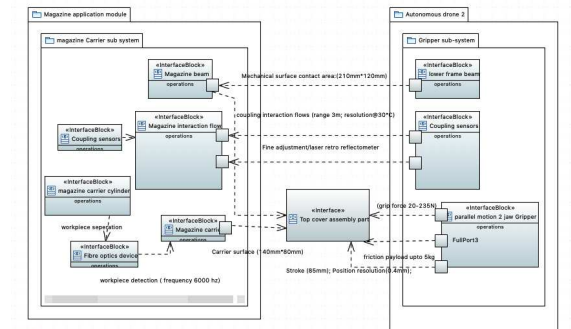


Figure 8.86: AS/RS warehouse architecture



## Appendix-K-Chapter-5 Application context (2)

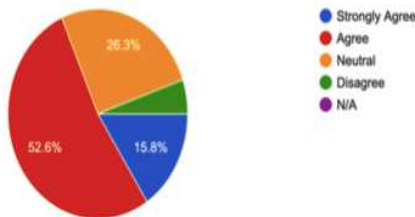
**Requirements trace-ability (RT)**- It refers to the ability to describe and follow the life of a requirement, in both forwards and backwards direction. Figure 8.87 shows the requirement of traceability. The below shown pre- requirement trace-ability is from the stakeholder requirement to system requirement to system use case which is traced and template below in order to trace between user needs to system use-case.

		Autonomous drive Use-Subsystems needs										
		SR1.1.1.1	SR1.1.1.2	SR1.1.1.3	SR1.1.1.4	SR1.1.1.5	SR1.1.1.6	SR1.1.1.7	SR1.1.1.8	SR1.1.1.9		
Driver REQUIREMENTS	FR101 The system shall transport the standardized and customized base load A.2.F.2.1. Warehouse to retail base module	■		■								UC101 The driver load the standardized/customized base load A.2.F.2.1. Warehouse and collect base to retail base module
	FR102 The system shall transport the standardized and customized base load security guard from A.2.F.2.2. Warehouse to application magazine module		■	■								UC102 The driver load the standardized/customized base load security guard from A.2.F.2.2. Warehouse to collect base application magazine module
	FR103 The system shall processed based on the signal received from fleet manager					■						UC103 The driver to processed (which driver what specialized) on the signal received from fleet manager
	FR104 The system shall automatically take off and land from a runway without driver platform to collect B.2.2.2.2										■	UC104 The driver system automatically take off and land according to signal received from the fleet manager
	FR105 The system shall detect and navigate automatically to house or warehouse (static or CP Facility) on concrete base	■	■									UC105 If any flexibility (adaptability) to handle the driver automatically detect and navigate the entrance path automatically
	FR106 The system shall pick and drop products in target area with vehicle (PFC) load											UC106 The driver pick and drop assembly product in a targeted station assembly
	FR107 The system shall avoid obstacles while transporting the products in warehouse flying space											UC107 The driver can avoid and detect the obstacle before it facing with other station or vehicle
	FR108 The system shall carry a product weight upto max 7.5 kg for each concrete vehicle load											UC108 The changed driver can carry a product weight upto max 7.5 kg for each concrete vehicle load
	FR109 The system shall transport only in indoor environment and warehouse flying space											UC109 The driver transport only in indoor environment and warehouse flying space
	FR110 The system shall fly a maximum altitude of 70 which depends on the concrete use case											UC110 The driver control with fly a maximum altitude of 70 which depends on the concrete use case
	FR111 The system shall communicate with fleet manager continuously to process for error load											UC111 The driver continuously handling their information to ground control stations based on information, not only nearby nearby situations
	FR112 The system shall automatically charge the battery whenever it is necessary in the environment											UC112 The driver can automatically charge the battery whenever it is necessary in the environment
FR113 The system shall be stable positioning while handling the product line station	■	■	■								UC113 The driver will be in stable positioning while handling the product line station	
FR114 The system shall be safe without handling anything while on operation and critical rescue flight clearance safety before flying											UC114 The driver will operate in safe without handling anything while on operation and should respect flight clearance safety before flying	
App robot Use module Requirements	FR120 The system shall store the standardized or customized security fence											UC120 The module to store the standardized or customized security fence
	FR121 The system shall interface with the driver system in order to solve the fence											UC121 The module interfacing with the driver system in order to solve the fence
	FR122 The system shall be customizable on different scenario circumstances											UC122 The module to adjust the customizable on different scenario circumstances
	FR123 The system shall be reliable and flexible for any transportation system interface											UC123 The module will be reliable and flexible for any transportation system interface. The flexible is control adjust for use interface
	FR124 The system shall be safe and secure while transportation operation											UC124 The module shall be safe and secure while transportation operation
	FR125 The system shall adopt new installation of fleet manager in order to communicate with the driver system											UC125 The module level sensor install the fleet manager in order to communicate with the driver for secure operation
Application magazine module Requirements	FR130 The system shall store the standardized or customized base load assembly part	■	■									UC130 The module handling the standardized or customized base load assembly part
	FR131 The system shall be customizable on different scenario circumstances											UC131 The module will be customizable on different scenario circumstances in operate with body of MFC system
	FR132 The system shall be reliable and flexible for any transportation system interface											UC132 The module will be reliable and flexible for any transportation system interface
	FR133 The system shall interface with the driver system in order to store the base load assembly part	■										UC133 The module is interfacing with the driver system in order to store the base load assembly part
	FR134 The system shall adopt new installation of fleet manager in order to communicate with the driver system											UC134 The module level sensor install the fleet manager in order to communicate with the driver for secure operation
	FR135 The system shall be safe and secure while transportation operation	■	■									UC135 The module will be safe and secure while transportation operation

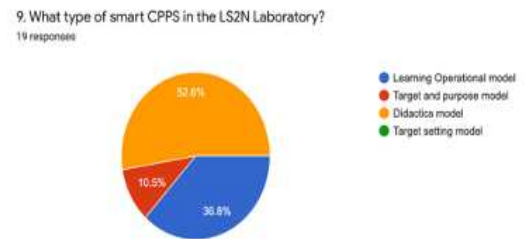
Figure 8.87: Traceability matrix

## 8.8 Appendix-G-Chapter-6- Application context (3)

In this section, the supplementary of evaluation of human-CPPS integration is illustrated. It establishes an explicit and formal phenomenon of human-CPPS evaluation. Figure 8.101 and 8.97 shows the explicit of involved HCPPS integration phenomenon, by establishing it.

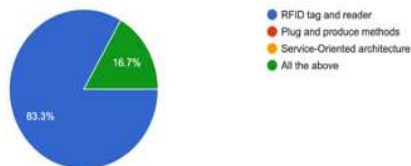


**Figure 8.88:** LS2N- Learning activity with students



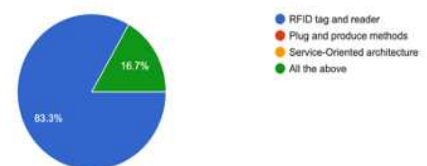
**Figure 8.89:** LS2N-Resource integrator activity with students

17. How the application module machine can retrieve and execute processing jobs individually? How it provides the identification of digital prod...k-piece? Which technology behind these functions? 18 responses



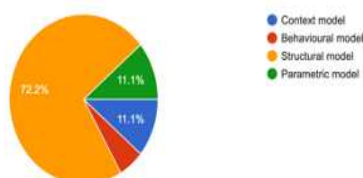
**Figure 8.90:** LS2N- Learning activity with students

17. How the application module machine can retrieve and execute processing jobs individually? How it provides the identification of digital prod...k-piece? Which technology behind these functions? 18 responses



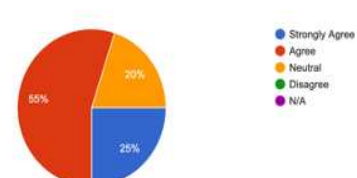
**Figure 8.91:** LS2N-Resource integrator activity with students

28. Which system model (SysML) depicts the static nature of the system? 18 responses



**Figure 8.92:** LS2N- Learning activity with students

38. Do you think, the observed Cyber abilities - (Information systems, IT integration, virtual interactive physical assets and Human-machine in...as productive impact on shop-floor productivity? 20 responses



**Figure 8.93:** LS2N-Resource integrator activity with students

## Appendix-G-Chapter-6- Application context (3)

In this section, the evaluation of human-CPPS integration. Figure 8.101, 8.97, 8.101.

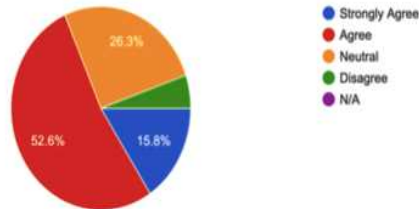


Figure 8.94: LS2N- Smart CPPS

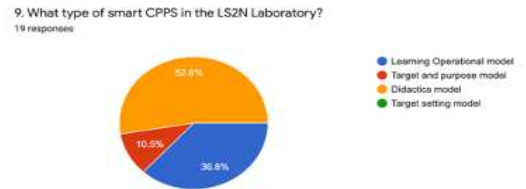


Figure 8.95: LS2N-Cyber world CPPS

17. How the application module machine can retrieve and execute processing jobs individually? How it provides the identification of digital prod...k-piece? Which technology behind these functions? 18 responses

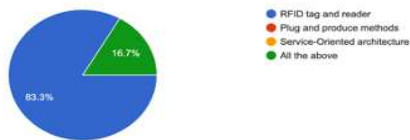


Figure 8.96: LS2N-Software design CPPS

17. How the application module machine can retrieve and execute processing jobs individually? How it provides the identification of digital prod...k-piece? Which technology behind these functions? 18 responses

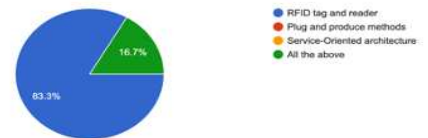


Figure 8.97: LS2N-5C in CPS

28. Which system model (SysML) depicts the static nature of the system? 18 responses

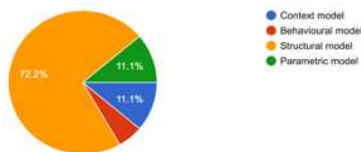


Figure 8.98: LS2N- manufacturing architecture layer

38. Do you think, the observed Cyber abilities - (Information systems, IT integration, virtual interactive physical assets and Human-machine in...as productive impact on shop-floor productivity? 20 responses

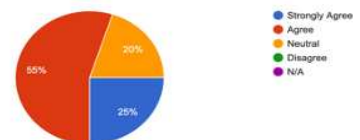


Figure 8.99: LS2N-various functionalities of CPPS

28. Which system model (SysML) depicts the static nature of the system? 18 responses

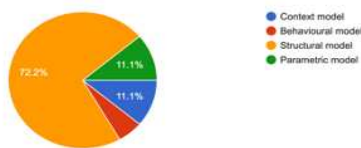


Figure 8.100: LS2N- core capabilities of CPPS

38. Do you think, the observed Cyber abilities - (Information systems, IT integration, virtual interactive physical assets and Human-machine in...as productive impact on shop-floor productivity? 20 responses

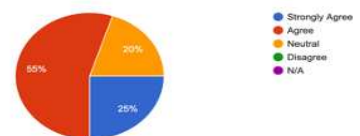


Figure 8.101: LS2N-Role of humans

## 8.9 Appendix-H-Human-CPPS Semantic integration

The semantic for Human-CPPS interaction phenomenon is presented. It establishes an explicit and formal phenomenon of human-CPPS evaluation. Figure 8.102 and 8.103 shows the explicit of involved HCPPS integration phenomenon, by establishing it.

The screenshot displays a web interface for HCPPS semantic integration. The top navigation bar includes 'HCPPS', 'Domain concepts', 'HCPPS Semantics', and a search bar. The main content is divided into two sections: 'Semantic description' and 'Semantic models'.

**Semantic description:**

- ✓ The HCPPS semantic that aims to provide a common conceptualisation of domain
- ✓ The HCPPS Covers relevant aspects of involved entities
- ✓ It covers a tangible and intangible relation

**Concept definition:**

- ✓ The definitors of HCPPS Concept
- ✓ The artifact information set of HCPPS domain
- ✓ It specify the evaluation in the context of HCPPS

**Semantic models:** It presents the modular models. A legend indicates three layers: Core integration layer, Domain layer, and HCPPS. Below is a 'Graph page' showing a complex network diagram.

**Related semantics:**

Integration	Relation	Integration level
US		
HC	Human-cyber system	High
HP	Human-physical system	High
HCPPS	Most HCPPS extends concept	High

**Detailed concepts:** Intentional event caused by HCPPS Evaluator and consist of systematic determination of extent an interactive CPPS

**Relations:**

- ✓ HCPPS Concept (0..\*) creates (1..\*) interactive human
- ✓ The HCPPS concept (a..\*) creates (1..\*) interactive CPPS
- ✓ The HCPPS concept (a..\*) creates (1..\*) interaction
- ✓ The HCPPS concept (0..\*) creates (1..\*) input and output processed.
- ✓ (ISO:IEC.25066,2016; ISO 9241: 2202019)

Figure 8.102: Collaborative HCPPS integration webpage

## 8.10 Appendix-I-Human-CPPS Configurator app

Figure 8.104 and 8.103 shows the explicit of involved HCPPS integration java codes.

```
#include <DHT.h>
#include <ESP8266WiFi.h>
String apiKey = "1YMSRK1TDFI058HA"; // Enter your Write API key here
const char *ssid = "MengiJio fiber op"; // Enter your WiFi Name
const char *pass = "xxxxxxxxxxx"; // Enter your WiFi Password
const char* server = "api.thingspeak.com";
#define DHTPIN 4 // GPIO Pin where the dht11 is connected
DHT dht(DHTPIN, DHT11);
WiFiClient client;
void setup()
{
    Serial.begin(115200);
    delay(10);
    dht.begin();
    Serial.println("Connecting to ");
    Serial.println(ssid);
    WiFi.begin(ssid, pass);
    while (WiFi.status() != WL_CONNECTED)
    {
        delay(550);
        Serial.print(".");
    }
    Serial.println("");
    Serial.println("WiFi connected");
}
void loop()
{
    float h = dht.readHumidity();
    float t = dht.readTemperature();

    if (isnan(h) || isnan(t))
```

Figure 8.103: Measurement, User and User Participation

```
import java.util.Scanner;
import java.util.Random;

public class GuessingGame {
    public static void main (String [] args) {
        // set up variables
        Scanner scan = new Scanner(System.in);
        Random rand = new Random();
        int random;
        int guess;

        // generate random number
        random = rand.nextInt(20) + 1;
        //System.out.println(random); // testing (comment out later)

        // get user input
        System.out.println("Please guess a number from 1 to 20 (inclusive):");
        guess = scan.nextInt();

        // output
        if (guess == random) {
            System.out.println("Congratuations! You got it!");
        }
        else {
            int diff = guess - random;
            System.out.printf("Sorry, you were off by %d.%n", Math.abs(diff));
        }
    }
}
```

Figure 8.104: Object Property: *is<sub>m</sub>measured<sub>y</sub>*



```

C:\Extensions\extension-template-master>ant extensions
Buildfile: C:\Extensions\extension-template-master\build.xml

javac:
[javac] Compiling 1 source file to C:\Extensions\extension-template-master\build\classes
[javac] warning: [options] bootstrap class path not set in conjunction with -source 1.7
[javac] error: cannot access Pair
[javac]   class file for gnu.lists.Pair not found
[javac]   Consult the following stack trace for details.
[javac]   com.sun.tools.javac.code.Symbol$CompletionFailure: class file for gnu.lists.Pair not found
[javac] Note: Wrote file file:/C:/Extensions/extension-template-master/build/classes/simple_components.txt
[javac] Note: Wrote file file:/C:/Extensions/extension-template-master/build/classes/simple_components_build_info.json
[javac] Note: Wrote file file:/C:/Extensions/extension-template-master/build/classes/AutogeneratedOdeMessages.java
[javac] Note: Wrote file file:/C:/Extensions/extension-template-master/build/classes/ComponentsTranslation.java
[javac] 1 error

BUILD FAILED
C:\Extensions\extension-template-master\build.xml:29: Compile failed; see the compiler error output for details.

Total time: 0 seconds

```

Figure 8.107: App inventor code

```

<html>
<head>
<script type="text/javascript" src="https://www.gstatic.com/charts/loader.js"></script>
<script type="text/javascript">
google.charts.load({current: {'packages': ['gauge']}});
google.charts.setOnLoadCallback(drawChart);

function drawChart() {

var data = google.visualization.arrayToDataTable([
[ 'Label', 'Value' ],
[ 'Memory', 88 ],
[ 'CPU', 55 ],
[ 'Network', 68 ]
]);

var options = {
width: 480, height: 120,
redFrom: 90, redTo: 100,
yellowFrom: 75, yellowTo: 90,
minorTicks: 5
};

var chart = new google.visualization.Gauge(document.getElementById('chart_div'));
chart.draw(data, options);

setInterval(function() {
data.setValue(0, 1, 40 + Math.round(60 * Math.random()));
chart.draw(data, options);
}, 13000);
setInterval(function() {
data.setValue(1, 1, 40 + Math.round(60 * Math.random()));
chart.draw(data, options);
}, 5000);
setInterval(function() {
data.setValue(2, 1, 60 + Math.round(20 * Math.random()));
chart.draw(data, options);
}, 26000);
}
</script>
</head>
<body>
<div id="chart_div" style="width: 480px; height: 120px;"></div>
</body>
</html>

```

Figure 8.108: App inventor code

# Bibliography

1. Eberhard Abele, Joachim Metternich, and Michael Tisch. Learning factories. In *Concepts, Guidelines, Best-Practice Examples*. Springer, 2019.
2. Mervat Abu-Elkheir, Mohammad Hayajneh, and Najah Abu Ali. Data management for the internet of things: Design primitives and solution. *Sensors*, 13(11):15582–15612, 2013.
3. Russell L Ackoff. Towards a system of systems concepts. *Management science*, 17(11):661–671, 1971.
4. Rick Adcock, Nicole Hutchison, and Claus Nielsen. Defining an architecture for the systems engineering body of knowledge. In *2016 Annual IEEE Systems Conference (SysCon)*, pages 1–7. IEEE, 2016.
5. Carlos Agostinho, José Ferreira, Sudeep Ghimire, Gregory Zacharewicz, Amir Pirayesh, and Guy Doumeingts. A comprehensive architecture to integrate modeling and simulation solutions in cpps. *Enterprise Interoperability: Smart Services and Business Impact of Enterprise Interoperability*, pages 349–355, 2018.
6. Abiola A Akanmu, Chimay J Anumba, and John I Messner. An rtls-based approach to cyber-physical systems integration in design and construction. *International Journal of Distributed Sensor Networks*, 8(12):596845, 2012.
7. Ian F Akyildiz and Ismail H Kasimoglu. Wireless sensor and actor networks: research challenges. *Ad hoc networks*, 2(4):351–367, 2004.
8. R McNeill Alexander. *The human machine: How the body works*. Columbia University Press, 1992.
9. Rajeev Alur. *Principles of cyber-physical systems*. MIT press, 2015.
10. Mihai Andronie, George Lăzăroiu, Mariana Iatagan, Cristian Uță, Roxana Ștefănescu, and Mădălina Cocoșatu. Artificial intelligence-based decision-making algorithms, internet of things sensing networks, and deep learning-assisted smart process management in cyber-physical production systems. *Electronics*, 10(20):2497, 2021a.
11. Mihai Andronie, George Lăzăroiu, Roxana Ștefănescu, Cristian Uță, and Irina Dijmărescu. Sustainable, smart, and sensing technologies for cyber-physical manufacturing systems: A systematic literature review. *Sustainability*, 13(10):5495, 2021b.
12. Fazel Ansari. Knowledge management 4.0: theoretical and practical considerations in cyber physical production systems. *IFAC-PapersOnLine*, 52(13):1597–1602, 2019.



13. Fazel Ansari, Marjan Khobreh, Ulrich Seidenberg, and Wilfried Sihn. A problem-solving ontology for human-centered cyber physical production systems. *CIRP Journal of Manufacturing Science and Technology*, 22:91–106, 2018.
14. Fazel Ansari, Philipp Hold, and Marjan Khobreh. A knowledge-based approach for representing jobholder profile toward optimal human–machine collaboration in cyber physical production systems. *CIRP Journal of manufacturing science and technology*, 28:87–106, 2020.
15. Mohammad Azangoo, Amir Taherkordi, and Jan Olaf Blech. Digital twins for manufacturing using uml and behavioral specifications. In *2020 25th IEEE International Conference on Emerging Technologies and Factory Automation (ETFA)*, volume 1, pages 1035–1038. IEEE, 2020.
16. Radu F Babiceanu and Remzi Seker. Big data and virtualization for manufacturing cyber-physical systems: A survey of the current status and future outlook. *Computers in industry*, 81:128–137, 2016.
17. Radhakisan Baheti and Helen Gill. Cyber-physical systems. *The impact of control technology*, 12(1):161–166, 2011.
18. Debasis Bandyopadhyay and Jaydip Sen. Internet of things: Applications and challenges in technology and standardization. *Wireless personal communications*, 58:49–69, 2011.
19. Y Bar-Yam, MA Allison, R Batdorf, H Chen, H Generazio, H Singh, and S Tucker. The characteristics and emerging behaviors of system of systems, necsi: Complex physical, biological and social systems project, 2004.
20. Raphael Barbau, Sylvere Krime, Sudarsan Rachuri, Anantha Narayanan, Xenia Fiorentini, Sebti Foufou, and Ram D Sriram. Ontostep: Enriching product model data using ontologies. *Computer-Aided Design*, 44(6):575–590, 2012.
21. Allison Barnard Feeney, Simon Frechette, and Vijay Srinivasan. Cyber-physical systems engineering for manufacturing. In *Industrial internet of things*, pages 81–110. Springer, 2017.
22. Mateusz Bařka, Helena Dudycz, and Maciej Pondel. Identification of advanced data analysis in marketing: A systematic literature review. *journal of economics and management*, 35(1): 18–39, 2019.
23. Till Becker and Hendrik Stern. Future trends in human work area design for cyber-physical production systems. *Procedia Cirp*, 57:404–409, 2016.
24. Peter M Bednar and Christine Welch. Socio-technical perspectives on smart working: Creating meaningful and sustainable systems. *Information Systems Frontiers*, 22(2):281–298, 2020.
25. Farouk Belkadi, Nicolas Dremont, Alban Notin, Nadege Troussier, and Mourad Messadia. A

- meta-modelling framework for knowledge consistency in collaborative design. *Annual Reviews in Control*, 36(2):346–358, 2012.
26. Luca Berardinelli, Alexandra Mazak, Oliver Alt, Manuel Wimmer, and Gerti Kappel. Model-driven systems engineering: Principles and application in the cpps domain. In *Multi-disciplinary engineering for cyber-physical production systems*, pages 261–299. Springer, 2017.
27. Stephan Berger, Björn Häckel, and Lukas Häfner. Organizing self-organizing systems: A terminology, taxonomy, and reference model for entities in cyber-physical production systems. *Information Systems Frontiers*, 23:391–414, 2021.
28. Stefan Bertschi, Sabrina Bresciani, Tom Crawford, Randy Goebel, Wolfgang Kienreich, Martin Lindner, Vedran Sabol, and Andrew Vande Moere. What is knowledge visualization? eight reflections on an evolving discipline. *Knowledge Visualization Currents: From Text to Art to Culture*, pages 13–32, 2013.
29. Ani Bicaku, Silia Maksuti, Silke Palkovits-Rauter, Markus Tauber, Rainer Matischek, Christoph Schmittner, Georgios Mantas, Mario Thron, and Jerker Delsing. Towards trustworthy end-to-end communication in industry 4.0. In *2017 IEEE 15th International Conference on Industrial Informatics (INDIN)*, pages 889–896. IEEE, 2017.
30. Stefan Biffel and Marta Sabou. *Semantic web technologies for intelligent engineering applications*. Springer, 2016.
31. Stefan Biffel, Detlef Gerhard, and Arndt Lüder. Conclusions and outlook on research for multi-disciplinary engineering for cyber-physical production systems. In *Multi-Disciplinary Engineering for Cyber-Physical Production Systems*, pages 459–468. Springer, 2017.
32. Günter Bitsch. Conceptions of man in human-centric cyber-physical production systems. *Procedia CIRP*, 107:1439–1443, 2022.
33. Benjamin S Blanchard. *System engineering management*. John Wiley & Sons, 2004.
34. Benjamin S Blanchard, Wolter J Fabrycky, and Walter J Fabrycky. *Systems engineering and analysis*, volume 4. Prentice hall Englewood Cliffs, NJ, 1990.
35. John Boardman and Brian Sauser. System of systems-the meaning of of. In *2006 IEEE/SMC International Conference on System of Systems Engineering*, pages 6–pp. IEEE, 2006.
36. Grady Booch, Ivar Jacobson, James Rumbaugh, et al. The unified modeling language. *Unix Review*, 14(13):5, 1996.
37. Borja Bordel Sánchez, Ramón Pablo Alcarria Garrido, Diego Sánchez de Rivera, and Álvaro Sánchez Picot. Enhancing process control in industry 4.0 scenarios using cyber-physical systems. *Journal of Wireless Mobile Networks, Ubiquitous Computing, and Dependable*

- Applications*, 7:41–64, 2016.
38. Dominik Bork. *A development method for the conceptual design of multi-view modeling tools with an emphasis on consistency requirements*. PhD thesis, Otto-Friedrich-Universität Bamberg, Fakultät Wirtschaftsinformatik und . . . , 2015.
  39. Dominik Bork, Dimitris Karagiannis, and Benedikt Pittl. A survey of modeling language specification techniques. *Information Systems*, 87:101425, 2020.
  40. Marco Bortolini, Francesco Gabriele Galizia, and Cristina Mora. Reconfigurable manufacturing systems: Literature review and research trend. *Journal of manufacturing systems*, 49:93–106, 2018.
  41. Janez Brank, Marko Grobelnik, and Dunja Mladenic. A survey of ontology evaluation techniques. In *Proceedings of the conference on data mining and data warehouses (SiKDD 2005)*, pages 166–170. Citeseer Ljubljana Slovenia, 2005.
  42. Jean-Pierre Brans and Ph Vincke. Note—a preference ranking organisation method: (the promethee method for multiple criteria decision-making). *Management science*, 31(6):647–656, 1985.
  43. Alexander Brodsky, Mohan Krishnamoorthy, William Z Bernstein, and M Omar Nachawati. A system and architecture for reusable abstractions of manufacturing processes. In *2016 IEEE International Conference on Big Data (Big Data)*, pages 2004–2013. IEEE, 2016.
  44. Thomas Burns, John Cosgrove, and Frank Doyle. A review of interoperability standards for industry 4.0. *Procedia Manufacturing*, 38:646–653, 2019.
  45. Olivier Cardin. Classification of cyber-physical production systems applications: Proposition of an analysis framework. *Computers in Industry*, 104:11–21, 2019.
  46. Nelson H Carreras Guzman, Morten Wied, Igor Kozine, and Mary Ann Lundteigen. Conceptualizing the key features of cyber-physical systems in a multi-layered representation for safety and security analysis. *Systems Engineering*, 23(2):189–210, 2020.
  47. Christos G Cassandras and Stéphane Lafortune. *Introduction to discrete event systems*. Springer, 2008.
  48. I Chalfoun, K Kouiss, N Bouton, and P Ray. Specification of a reconfigurable and agile manufacturing system (rams). *Int. J. Mech. Eng. Autom*, 1(6):387–394, 2014.
  49. Senthil K Chandrasegaran, Karthik Ramani, Ram D Sriram, Imré Horváth, Alain Bernard, Ramy F Harik, and Wei Gao. The evolution, challenges, and future of knowledge representation in product design systems. *Computer-aided design*, 45(2):204–228, 2013.

50. Vincent Chapurlat and Blazo Nastov. Deploying mbse in sme context: revisiting and equipping digital mock-up. In *2020 IEEE International Symposium on Systems Engineering (ISSE)*, pages 1–8. IEEE, 2020.
51. Hong Chen. Theoretical foundations for cyber-physical systems: a literature review. *Journal of Industrial Integration and Management*, 2(03):1750013, 2017.
52. Wahid Chergui, Samir Zidat, and Farhi Marir. An approach to the acquisition of tacit knowledge based on an ontological model. *Journal of King Saud University-computer and information sciences*, 32(7):818–828, 2020.
53. François Christophe, Alain Bernard, and Éric Coatanéa. Rfbs: A model for knowledge representation of conceptual design. *CIRP annals*, 59(1):155–158, 2010.
54. Georgeta Ciobanu. *Introduction to terminology*. Timișoara: Centrul de Multiplicare al Institutului Politehnic" Traian Vuia . . . , 1997.
55. Paul Clements. Comparing the sei’s views and beyond approach for documenting software architecture with ansi-ieee 1471-2000. Technical report, Carnegie-Mellon Univ. Pittsburgh PA software engineering inst., 2005.
56. John W Coffey, Robert R Hoffman, Alberto J Cañas, and Kenneth M Ford. A concept map-based knowledge modeling approach to expert knowledge sharing. *Proceedings of IKS*, pages 212–217, 2002.
57. Nancy Collins, Gerhard Theurich, Cecelia DeLuca, Max Suarez, Atanas Trayanov, Venkatramani Balaji, Peggy Li, Weiyu Yang, Chris Hill, and Arlindo Da Silva. Design and implementation of components in the earth system modeling framework. *The International Journal of High Performance Computing Applications*, 19(3):341–350, 2005.
58. Linda Carman Copel. A conceptual model, 1988.
59. Christian E Coronado Mondragon, Adrian E Coronado Mondragon, and Roger Miller. Modularity, open architecture and innovation: an automotive perspective. *International journal of automotive technology and management*, 6(3):346–363, 2006.
60. Patricia Cronin, Frances Ryan, and Michael Coughlan. Undertaking a literature review: a step-by-step approach. *British journal of nursing*, 17(1):38–43, 2008.
61. Antonio Cuevas, Manuel Febrero, and Ricardo Fraiman. An anova test for functional data. *Computational statistics & data analysis*, 47(1):111–122, 2004.
62. Mathieu d’Aquin and Aldo Gangemi. Is there beauty in ontologies? *Applied Ontology*, 6(3):165–175, 2011.

63. Ashraf Darwish and Aboul Ella Hassanien. Cyber physical systems design, methodology, and integration: the current status and future outlook. *Journal of Ambient Intelligence and Humanized Computing*, 9:1541–1556, 2018.
64. Randall Davis and Jonathan King. *An overview of production systems*. Stanford University, 1975.
65. Peter DeScioli and Bart J Wilson. The territorial foundations of human property. *Evolution and Human Behavior*, 32(5):297–304, 2011.
66. Michael Dickerson, David Oliver, and Joseph Skipper. Semantic dictionary and concept model. *INSIGHT*, 7(2):21–28, 2004.
67. Cambridge Dictionary. English dictionary. *Cambridge University Press*. Retrieved June, 14: 2018, 2018.
68. Kai Ding, Felix TS Chan, Xudong Zhang, Guanghui Zhou, and Fuqiang Zhang. Defining a digital twin-based cyber-physical production system for autonomous manufacturing in smart shop floors. *International Journal of Production Research*, 57(20):6315–6334, 2019.
69. Rainer Drath and Alexander Horch. Industrie 4.0: Hit or hype?[industry forum]. *IEEE industrial electronics magazine*, 8(2):56–58, 2014.
70. Bernd Dworschak and Helmut Zaiser. Competences for cyber-physical systems in manufacturing—first findings and scenarios. *Procedia Cirp*, 25:345–350, 2014.
71. Tamer E El-Diraby. Domain ontology for construction knowledge. *Journal of Construction Engineering and Management*, 139(7):768–784, 2013.
72. Satu Elo and Helvi Kyngäs. The qualitative content analysis process. *Journal of advanced nursing*, 62(1):107–115, 2008.
73. Grischan Engel, Thomas Greiner, and Sascha Seifert. Ontology-assisted engineering of cyber-physical production systems in the field of process technology. *IEEE Transactions on Industrial Informatics*, 14(6):2792–2802, 2018.
74. Gregor Engels, Jochen M Küster, Reiko Heckel, and Marc Lohmann. Model-based verification and validation of properties. *Electronic Notes in Theoretical Computer Science*, 82(7):133–150, 2003.
75. Luis Alberto Estrada-Jimenez, Terrin Pulikottil, Ricardo Silva Peres, Sanaz Nikghadam-Hojjati, and Jose Barata. Complexity theory and self-organization in cyber-physical production systems. *Procedia CIRP*, 104:1831–1836, 2021.
76. Pamela Faber. The semantic architecture of the lexicon. *Lexicographica. Series Maior*, 57:

- 37–50, 1994.
77. Peter Fettke and Peter Loos. Classification of reference models: a methodology and its application. *Information systems and e-business management*, 1(1):35–53, 2003.
  78. Hans-Georg Fill. An approach for analyzing the effects of risks on business processes using semantic annotations. 2012.
  79. Hans-Georg Fill, Susan Hickl, Dimitris Karagiannis, Andreas Oberweis, and Andreas Schoknecht. A formal specification of the horus modeling language using fdmm. 2013.
  80. Daniel Fitzpatrick, François Coallier, and Sylvie Ratté. A holistic approach for the architecture and design of an ontology-based data integration capability in product master data management. In *IFIP International Conference on Product Lifecycle Management*, pages 559–568. Springer, 2012.
  81. Christiaan Fluit, Marta Sabou, and Frank Van Harmelen. Ontology-based information visualization. In *Visualizing the Semantic Web*, pages 36–48. Springer, 2003.
  82. William Frakes, Ruben Diaz, Christopher Fox, et al. Dare: Domain analysis and reuse environment. *Annals of software engineering*, 5(1):125–141, 1998.
  83. Emmanuel Francalanza, Jonathan Borg, and Carmen Constantinescu. A knowledge-based tool for designing cyber physical production systems. *Computers in Industry*, 84:39–58, 2017.
  84. Robert France, Andy Evans, Kevin Lano, and Bernhard Rumpe. The uml as a formal modeling notation. *Computer Standards & Interfaces*, 19(7):325–334, 1998.
  85. Ulrich Frank. Evaluation of reference models. In *Reference modeling for business systems analysis*, pages 118–140. IGI Global, 2007.
  86. Barbara M Fraumeni and Gang Liu. Summary of world economic forum, “the global human capital report 2017—preparing people for the future of work”. In *Measuring Human Capital*, pages 125–138. Elsevier, 2021.
  87. Sanford Friedenthal, Regina Griego, and Mark Sampson. Incose model based systems engineering (mbse) initiative. In *INCOSE 2007 symposium*, volume 11. sn, 2007.
  88. Sanford Friedenthal, Alan Moore, and Rick Steiner. *A practical guide to SysML: the systems modeling language*. Morgan Kaufmann, 2014.
  89. Xiaoming Fu, Andrea Passarella, Daniele Quercia, Alessandra Sala, and Thorsten Strufe. Online social networks. *Comput. Commun.*, 73:163–166, 2016.
  90. Kikuo Fujita. Product variety optimization under modular architecture. *Computer-aided design*, 34(12):953–965, 2002.

91. Mehdi Gaham, Brahim Bouzouia, and Noura Achour. Human-in-the-loop cyber-physical production systems control (hilcp 2 sc): A multi-objective interactive framework proposal. *Service orientation in holonic and multi-agent manufacturing*, pages 315–325, 2015.
92. Erich Gamma, Richard Helm, Ralph Johnson, and John Vlissides. Design patterns: Abstraction and reuse of object-oriented design. In *European Conference on Object-Oriented Programming*, pages 406–431. Springer, 1993.
93. Raghu K Ganti, Yu-En Tsai, and Tarek F Abdelzaher. Senseworld: Towards cyber-physical social networks. In *2008 International Conference on Information Processing in Sensor Networks (ipsn 2008)*, pages 563–564. IEEE, 2008.
94. Rosanna Garcia and Roger Calantone. A critical look at technological innovation typology and innovativeness terminology: a literature review. *Journal of Product Innovation Management: An international publication of the product development & management association*, 19(2): 110–132, 2002.
95. Andrew Gemino and Yair Wand. A framework for empirical evaluation of conceptual modeling techniques. *Requirements Engineering*, 9(4):248–260, 2004.
96. John S Gero and Udo Kannengiesser. A function–behavior–structure ontology of processes. *Ai Edam*, 21(4):379–391, 2007.
97. Andreas Gerstlauer and Daniel D Gajski. System-level abstraction semantics. In *Proceedings of the 15th international symposium on System Synthesis*, pages 231–236, 2002.
98. Mohamad Gharib, Paolo Lollini, and Andrea Bondavalli. Towards an approach for analyzing trust in cyber-physical-social systems. In *2017 12th System of Systems Engineering Conference (SoSE)*, pages 1–6. IEEE, 2017.
99. Moritz Glatt and Jan C Aurich. Physical modeling of material flows in cyber-physical production systems. *Procedia manufacturing*, 28:10–17, 2019.
100. Fahad R Golra, Antoine Beugnard, Fabien Dagnat, Sylvain Guerin, and Christophe Guychard. Continuous requirements engineering using model federation. In *2016 IEEE 24th International Requirements Engineering Conference (RE)*, pages 347–352. IEEE, 2016.
101. Iris Graessler and Alexander Pöhler. Integration of a digital twin as human representation in a scheduling procedure of a cyber-physical production system. In *2017 IEEE international conference on industrial engineering and engineering management (IEEM)*, pages 289–293. IEEE, 2017.
102. Irlán Grangel-González, Lavdim Halilaj, Gökhan Coskun, Sören Auer, Diego Collarana, and Michael Hoffmeister. Towards a semantic administrative shell for industry 4.0 components. In



- 
- 2016 IEEE Tenth International Conference on Semantic Computing (ICSC), pages 230–237. IEEE, 2016.
103. Edward R Griffor, Christopher Greer, David A Wollman, Martin J Burns, et al. Framework for cyber-physical systems: Volume 1, overview. *Cirp Annals*, 2017.
104. Norbert Gronau and Hanna Theuer. Determination of the optimal degree of autonomy in a cyber-physical production system. *Procedia CIRP*, 57:110–115, 2016.
105. Norbert Gronau, Marcus Grum, and Benedict Bender. Determining the optimal level of autonomy in cyber-physical production systems. In *2016 IEEE 14th International Conference on Industrial Informatics (INDIN)*, pages 1293–1299. IEEE, 2016.
106. Nick Große, David Leisen, Tan Gürpınar, Robert Schulze Forsthövel, Michael Henke, and Michael ten Hompel. Evaluation of (de-) centralized it technologies in the fields of cyber-physical production systems. In *Proceedings of the Conference on Production Systems and Logistics: CPSL 2020*. Hannover: publish-Ing., 2020.
107. Michel Grundstein. From capitalizing on company knowledge to knowledge management. *Knowledge management, classic and contemporary works*, 12:261–287, 2000.
108. Nicola Guarino. *Formal ontology in information systems: Proceedings of the first international conference (FOIS'98), June 6-8, Trento, Italy*, volume 46. IOS press, 1998.
109. Nicola Guarino and Mark Musen. Applied ontology: The next decade begins. *Applied ontology*, 10(1), 2015.
110. Giancarlo Guizzardi and Terry Halpin. Ontological foundations for conceptual modelling. *Applied Ontology*, 3(1-2):1–12, 2008.
111. Giancarlo Guizzardi et al. On ontology, ontologies, conceptualizations, modeling languages, and (meta) models. *Frontiers in artificial intelligence and applications*, 155:18, 2007.
112. Jiapeng Guo, Ning Zhao, Lin Sun, and Saipeng Zhang. Modular based flexible digital twin for factory design. *Journal of Ambient Intelligence and Humanized Computing*, 10(3):1189–1200, 2019.
113. Kecheng Hao and Fei Xie. Componentizing hardware/software interface design. In *2009 Design, Automation & Test in Europe Conference & Exhibition*, pages 232–237. IEEE, 2009.
114. Robert Harrison, Daniel A Vera, and Bilal Ahmad. A connective framework to support the lifecycle of cyber-physical production systems. *Proceedings of the IEEE*, 109(4):568–581, 2021.
115. J Hatvany and L Nemes. Intelligent manufacturing systems—a tentative forecast. *IFAC*

- Proceedings Volumes*, 11(1):895–899, 1978.
116. Ariane Hellinger. Ariane hellinger, heinrich seeger. cyber-physical systems. driving force for innovation in mobility, health, energy and production. acatech. *National Academy of Science and Engineering*, 2011.
117. Ariane Hellinger and Heinrich Seeger. Cyber-physical systems. driving force for innovation in mobility, health, energy and production. *Acatech Position Paper, National Academy of Science and Engineering*, 1(2), 2011.
118. Mike Henshaw. Systems of systems (sos)-sebok (2023).
119. Iñaki Heras-Saizarbitoria and Olivier Boiral. Iso 9001 and iso 14001: towards a research agenda on management system standards. *International Journal of Management Reviews*, 15(1):47–65, 2013.
120. Matthias M Herterich, Manuel Holler, Falk Uebernickel, and Walter Brenner. Understanding the business value: towards a taxonomy of industrial use scenarios enabled by cyber-physical systems in the equipment manufacturing industry. *Procedia CIRP*, 2015.
121. Mathew Hillier. The role of cultural context in multilingual website usability. *Electronic Commerce Research and Applications*, 2(1):2–14, 2003.
122. Stefan Hodek and Florian Floerchinger. An approach for modular production from mechanics to decentralized control, realized in the smartfactory kl. In *2009 IEEE Conference on Emerging Technologies & Factory Automation*, pages 1–7. IEEE, 2009.
123. Johannes Hoffart, Dragan Milchevski, and Gerhard Weikum. Stics: searching with strings, things, and cats. In *Proceedings of the 37th international ACM SIGIR conference on Research & development in information retrieval*, pages 1247–1248, 2014.
124. Philipp Holtewert, Rolf Wutzke, Joachim Seidelmann, and Thomas Bauernhansl. Virtual fort knox federative, secure and cloud-based platform for manufacturing. *Procedia CIRP*, 7: 527–532, 2013.
125. Imre Horváth and Bart HM Gerritsen. Outlining nine major design challenges of open, decentralized, adaptive cyber-physical systems. In *International Design Engineering Technical Conferences and Computers and Information in Engineering Conference*, volume 55867, page V02BT02A001. American Society of Mechanical Engineers, 2013.
126. Tuomas Huikkola, Marko Kohtamäki, and Rodrigo Rabetino. Resource realignment in servitization: A study of successful service providers explores how manufacturers modify their resource bases in transitioning to service-oriented offerings. *Research-Technology Management*, 59(4):30–39, 2016.

127. Dietrich Imkamp, Jürgen Berthold, Michael Heizmann, Karin Kniel, Eberhard Manske, Martin Peterek, Robert Schmitt, Jochen Seidler, and Klaus-Dieter Sommer. Challenges and trends in manufacturing measurement technology—the “industrie 4.0” concept. *Journal of sensors and sensor systems*, 5(2):325–335, 2016.
128. ISO ISO. Iec 12207 systems and software engineering-software life cycle processes. *International Organization for Standardization: Geneva*, 2008.
129. Ray Jackendoff. Semantics and cognition mit press. *Cambridge, MA*, 1983.
130. Eeva Järvenpää, Niko Siltala, Otto Hylli, and Minna Lanz. The development of an ontology for describing the capabilities of manufacturing resources. *Journal of Intelligent Manufacturing*, 30(2):959–978, 2019.
131. Nasser Jazdi. Cyber physical systems in the context of industry 4.0. In *2014 IEEE international conference on automation, quality and testing, robotics*, pages 1–4. IEEE, 2014.
132. Hans-Christian Jetter, Harald Reiterer, and Florian Geyer. Blended interaction: understanding natural human–computer interaction in post-wimp interactive spaces. *Personal and Ubiquitous Computing*, 18:1139–1158, 2014.
133. Yuchen Jiang, Shen Yin, and Okyay Kaynak. Data-driven monitoring and safety control of industrial cyber-physical systems: Basics and beyond. *IEEE Access*, 6:47374–47384, 2018.
134. Václav Jirkovský, Marek Obitko, Petr Kadera, and Vladimír Mařík. Toward plug&play cyber-physical system components. *IEEE Transactions on Industrial Informatics*, 14(6): 2803–2811, 2018.
135. Henning Kagermann and Wolfgang Wahlster. Ten years of industrie 4.0. *Sci*, 4(3):26, 2022.
136. Henning Kagermann, Johannes Helbig, Ariane Hellinger, and Wolfgang Wahlster. *Recommendations for implementing the strategic initiative INDUSTRIE 4.0: Securing the future of German manufacturing industry; final report of the Industrie 4.0 Working Group*. Forschungsunion, 2013.
137. Haruhiko Kaiya and Motoshi Saeki. Using domain ontology as domain knowledge for requirements elicitation. In *14th IEEE International Requirements Engineering Conference (RE’06)*, pages 189–198. IEEE, 2006.
138. N Kamaludin and B Mulyanti. Cyber physical system in the industry. In *IOP Conference Series: Materials Science and Engineering*, volume 830, page 032062. IOP Publishing, 2020.
139. Ningxuan Kang, Cong Zhao, Jingshan Li, and John A Horst. A hierarchical structure of key performance indicators for operation management and continuous improvement in production

- systems. *International journal of production research*, 54(21):6333–6350, 2016.
140. Udo Kannengiesser and John S Gero. Situated agent communication for design. *CIRP annals*, 2002.
141. Dimitris Karagiannis. Agile modeling method engineering. In *Proceedings of the 19th panhellenic conference on informatics*, pages 5–10, 2015.
142. Stamatis Karnouskos and Armando Walter Colombo. Architecting the next generation of service-based scada/dcs system of systems. In *IECON 2011-37th Annual Conference of the IEEE Industrial Electronics Society*, pages 359–364. IEEE, 2011.
143. Stamatis Karnouskos, Armando Walter Colombo, Thomas Bangemann, Keijo Manninen, Roberto Camp, Marcel Tilly, Petr Stluka, François Jammes, Jerker Delsing, and Jens Eliasson. A soa-based architecture for empowering future collaborative cloud-based industrial automation. In *IECON 2012-38th Annual Conference on IEEE Industrial Electronics Society*, pages 5766–5772. IEEE, 2012.
144. Laura Bernadette Kassner and Bernhard Mitschang. Maxcept–decision support in exception handling through unstructured data integration in the production context: An integral part of the smart factory. In *2015 48th Hawaii International Conference on System Sciences*, pages 1007–1016. IEEE, 2015.
145. Matinee Kiewkanya and Pornsiri Muenchaisri. Constructing modifiability metrics by considering different relationships. *Chiang Mai Journal of Science*, 28:82–98, 2011.
146. Nam Yong Kim, Shailendra Rathore, Jung Hyun Ryu, Jin Ho Park, and Jong Hyuk Park. A survey on cyber physical system security for iot: issues, challenges, threats, solutions. *Journal of Information Processing Systems*, 14(6):1361–1384, 2018.
147. Barbara Kitchenham, Rialette Pretorius, David Budgen, O Pearl Brereton, Mark Turner, Mahmood Niazi, and Stephen Linkman. Systematic literature reviews in software engineering—a tertiary study. *Information and software technology*, 52(8):792–805, 2010.
148. Barbara A Kitchenham, Emilia Mendes, and Guilherme H Travassos. Cross versus within-company cost estimation studies: A systematic review. *IEEE Transactions on Software Engineering*, 33(5):316–329, 2007.
149. George J Klir and Dean Karnopp. Trends in general system theory. *General system theory: Foundations, development, applications*, 1972.
150. Hendrik J Kockaert and Frieda Steurs. *Handbook of terminology*, volume 1. John Benjamins Publishing Company, 2015.
151. Marko Kohtamäki and Jukka Partanen. Co-creating value from knowledge-intensive business

- services in manufacturing firms: The moderating role of relationship learning in supplier–customer interactions. *Journal of Business Research*, 69(7):2498–2506, 2016.
152. Norman S Kopeika. *A system engineering approach to imaging*, volume 38. SPIE press, 1998.
153. Kathy Kotiadis and Stewart Robinson. Conceptual modelling: knowledge acquisition and model abstraction. In *2008 Winter Simulation Conference*, pages 951–958. IEEE, 2008.
154. Anis Koubâa and Björn Andersson. A vision of cyber-physical internet. In *8th International Workshop on Real-Time Networks*, 2009.
155. Richard A Krueger. *Focus groups: A practical guide for applied research*. Sage publications, 2014.
156. Matthew Krugh and Laine Mears. A complementary cyber-human systems framework for industry 4.0 cyber-physical systems. *Manufacturing letters*, 15:89–92, 2018.
157. Christian Krupitzer, Sebastian Müller, Veronika Lesch, Marwin Züfle, Janick Edinger, Alexander Lemken, Dominik Schäfer, Samuel Kounev, and Christian Becker. A survey on human machine interaction in industry 4.0. *arXiv preprint arXiv:2002.01025*, 2020.
158. Hermann Kuehnle. Smart units in distributed manufacturing (dm)–key properties and upcoming abilities. In *18th Annual Cambridge International Manufacturing Symposium*, 2014.
159. Andreas Kuhnle and Gisela Lanza. Application of reinforcement learning in production planning and control of cyber physical production systems. In *Machine Learning for Cyber Physical Systems: Selected papers from the International Conference ML4CPS 2018*, pages 123–132. Springer, 2019.
160. Michal Laclavík, Zoltan Balogh, Marián Babík, and Ladislav Hluchý. Agentowl: Semantic knowledge model and agent architecture. *Computing and Informatics*, 25(5):419–437, 2006.
161. George Lăzăroiu, Tomas Kliestik, and Andrej Novak. Internet of things smart devices, industrial artificial intelligence, and real-time sensor networks in sustainable cyber-physical production systems. *Journal of Self-Governance and Management Economics*, 9(1):20–30, 2021.
162. Edward A Lee. Cyber physical systems: Design challenges. In *2008 11th IEEE international symposium on object and component-oriented real-time distributed computing (ISORC)*, pages 363–369. IEEE, 2008.
163. Jay Lee, Behrad Bagheri, and Hung-An Kao. A cyber-physical systems architecture for industry 4.0-based manufacturing systems. *Manufacturing letters*, 3:18–23, 2015.

164. JS Lee and LE Miller. Incose-systems engineering handbook. *Syst. Eng*, 304, 2007.
165. Paulo Leitão, José Barbosa, Pavel Vrba, Petr Skobelev, Alexander Tsarev, and Daria Kazanskaia. Multi-agent system approach for the strategic planning in ramp-up production of small lots. In *2013 IEEE International Conference on Systems, Man, and Cybernetics*, pages 4743–4748. IEEE, 2013.
166. Francesco Lelli. Interoperability of the time of industry 4.0 and the internet of things. *Future Internet*, 11(2):36, 2019.
167. Eric W Lemmon, Ian H Bell, ML Huber, and MO McLinden. Nist standard reference database 23: reference fluid thermodynamic and transport properties-refprop, version 10.0, national institute of standards and technology. *Standard Reference Data Program, Gaithersburg*, 2018.
168. JH Lewe, Daniel A DeLaurentis, and Dimitri N Mavris. Foundation for study of future transportation systems through agent-based simulation. In *24th international congress of the aeronautical sciences*, pages 1–10, 2004.
169. Mattias Lindahl, Erik Sundin, Johan Östlin, and Mats Björkman. Concepts and definitions for product recovery analysis and clarification of the terminology used in academia and industry. In *Innovation in life cycle engineering and sustainable development*, pages 123–138. Springer, 2006.
170. Theo Lins and Ricardo Augusto Rabelo Oliveira. Cyber-physical production systems retrofitting in context of industry 4.0. *Computers & Industrial Engineering*, 139:106193, 2020.
171. Chao Liu, Hrishikesh Vengayil, Ray Y Zhong, and Xun Xu. A systematic development method for cyber-physical machine tools. *Journal of manufacturing systems*, 48:13–24, 2018.
172. Zhiming Liu and Ji Wang. Human-cyber-physical systems: concepts, challenges, and research opportunities. *Frontiers of Information Technology & Electronic Engineering*, 21(11):1535–1553, 2020.
173. Timothy Lohman, ZiMian Wang, and Scott B Going. *Human body composition*, volume 918. Human Kinetics, 2005.
174. Yuqian Lu and Xun Xu. Resource virtualization: A core technology for developing cyber-physical production systems. *Journal of manufacturing systems*, 47:128–140, 2018.
175. Dominik Lucke, Carmen Constantinescu, and Engelbert Westkämper. Smart factory-a step towards the next generation of manufacturing. In *Manufacturing systems and technologies for the new frontier*, pages 115–118. Springer, 2008.
176. Arndt Lüder, Nicole Schmidt, Kristofer Hell, Hannes Röpke, and Jacek Zawisza. Description means for information artifacts throughout the life cycle of cpps. *Multi-disciplinary engineering*

- for cyber-physical production systems: data models and software solutions for handling complex engineering projects*, pages 169–183, 2017a.
177. Arndt Lüder, Nicole Schmidt, Kristofer Hell, Hannes Röpke, and Jacek Zawisza. Fundamentals of artifact reuse in cpps. *Multi-disciplinary engineering for cyber-physical production systems: Data models and software solutions for handling complex engineering projects*, pages 113–138, 2017b.
178. Arndt Lüder, Nicole Schmidt, Kristofer Hell, Hannes Röpke, and Jacek Zawisza. Identification of artifacts in life cycle phases of cpps. In *Multi-Disciplinary Engineering for Cyber-Physical Production Systems*, pages 139–167. Springer, 2017c.
179. Collin F Lynch, Kevin D Ashley, Vincent Alevan, and Niels Pinkwart. Defining ill-defined domains; a literature survey. In *Intelligent Tutoring Systems (ITS 2006): Workshop on Intelligent Tutoring Systems for Ill-Defined Domains*, 2006.
180. Atif Mahboob, Christian Weber, Stephan Husung, Andreas Liebal, Heidi Krömker, et al. Model based systems engineering (mbse) approach for configurable product use-case scenarios in virtual environments. In *DS 87-3 Proceedings of the 21st International Conference on Engineering Design (ICED 17) Vol 3: Product, Services and Systems Design, Vancouver, Canada, 21-25.08. 2017*, pages 281–290, 2017.
181. Kashif Mahmood, Tatjana Karaulova, Tauno Otto, and Eduard Shevtshenko. Development of cyber-physical production systems based on modelling technologies. *Proceedings of the Estonian Academy of Sciences*, 68(4), 2019.
182. Mark W Maier. Integrated modeling: A unified approach to system engineering. *Journal of Systems and Software*, 32(2):101–119, 1996.
183. Elaheh Maleki. *A Systems Engineering-based semantic model to support “Product-Service System” life cycle*. PhD thesis, École centrale de Nantes, 2018.
184. Elaheh Maleki, Farouk Belkadi, and Alain Bernard. A meta-model for product-service system based on systems engineering approach. *Procedia CIRP*, 73:39–44, 2018.
185. Elaheh Maleki, Farouk Belkadi, Eric Bonjour, Ali Slayman, and Alain Bernard. Interface modeling for product-service system integration. *Systems Engineering*, 22(6):471–484, 2019.
186. Sabine Matook and Susan A Brown. Conceptualizing the it artifact for mis research. 2008.
187. Alexandra Mazak and Christian Huemer. Hover: A modeling framework for horizontal and vertical integration. In *2015 IEEE 13th International Conference on Industrial Informatics (INDIN)*, pages 1642–1647. IEEE, 2015.
188. Gabriela Medina-Oliva, Alexandre Voisin, Maxime Monnin, and Jean-Baptiste Leger.



- Predictive diagnosis based on a fleet-wide ontology approach. *Knowledge-Based Systems*, 68: 40–57, 2014.
189. Kristof Meixner, Rick Rabiser, and Stefan Biffl. Towards modeling variability of products, processes and resources in cyber-physical production systems engineering. In *Proceedings of the 23rd International Systems and Software Product Line Conference-Volume B*, pages 49–56, 2019.
190. Peter Mell, Tim Grance, et al. The nist definition of cloud computing. 2011.
191. RJ Mentink. Process management in design & engineering applying dynamic process modeling based on evolving information content. *Annual Reviews in Control*, 2004.
192. Jack Meredith. Theory building through conceptual methods. *International Journal of Operations & Production Management*, 13(5):3–11, 1993.
193. Martin Mikusz. Towards an understanding of cyber-physical systems as industrial software-product-service systems. *Procedia Cirp*, 16:385–389, 2014.
194. Nadezhda Mkrtychian, Evgeny Blagovechtchenski, Diana Kurmakaeva, Daria Gnedykh, Svetlana Kostromina, and Yury Shtyrov. Concrete vs. abstract semantics: from mental representations to functional brain mapping. *Frontiers in human neuroscience*, 13:267, 2019.
195. John Moavenzadeh. The 4th industrial revolution: Reshaping the future of production. In *World Economic Forum*, page 57. DHL Global Engineering & Manufacturing Summit Amsterdam, 2015.
196. Dietmar PF Möller and Hamid Vakilzadian. Cyber-physical systems in smart transportation. In *2016 IEEE international conference on electro information technology (EIT)*, pages 0776–0781. IEEE, 2016.
197. L Monostori. Cyber-physical production systems: roots, expectations and r&d challenges. *procedia cirp* 17, 9–13 (2014).
198. László Monostori. Cyber-physical production systems: Roots, expectations and r&d challenges. *Procedia Cirp*, 17:9–13, 2014.
199. László Monostori. Cyber-physical production systems: roots from manufacturing science and technology. *at-Automatisierungstechnik*, 63(10):766–776, 2015.
200. László Monostori, Botond Kádár, Thomas Bauernhansl, Shinsuke Kondoh, Soundar Kumara, Gunther Reinhart, Olaf Sauer, Gunther Schuh, Wilfried Sihn, and Kenichi Ueda. Cyber-physical systems in manufacturing. *Cirp Annals*, 65(2):621–641, 2016.
201. Richard Mordinyi and Stefan Biffl. Versioning in cyber-physical production system engineering–

- best-practice and research agenda. In *2015 IEEE/ACM 1st International Workshop on Software Engineering for Smart Cyber-Physical Systems*, pages 44–47. IEEE, 2015.
202. Jeff Morgan, Mark Halton, Yuansong Qiao, and John G Breslin. Industry 4.0 smart reconfigurable manufacturing machines. *Journal of Manufacturing Systems*, 59:481–506, 2021.
203. Marco Mori, Andrea Ceccarelli, Paolo Lollini, Bernhard Frömel, Francesco Brancati, and Andrea Bondavalli. Systems-of-systems modeling using a comprehensive viewpoint-based sysml profile. *Journal of Software: Evolution and Process*, 30(3):e1878, 2018.
204. Romy Müller, Franziska Kessler, David W Humphrey, and Julian Rahm. Data in context: How digital transformation can support human reasoning in cyber-physical production systems. *Future Internet*, 13(6):156, 2021a.
205. Timo Müller, Nasser Jazdi, Jan-Philipp Schmidt, and Michael Weyrich. Cyber-physical production systems: enhancement with a self-organized reconfiguration management. *Procedia CIRP*, 99:549–554, 2021b.
206. Mircea A Muşan, Marian P Cristescu, and Daniel I Hunyadi. Distribution of the object oriented databases. a viewpoint of the mvdb model’s methodology and architecture. *Revista Informatica Economică nr*, 1(45):56, 2008.
207. Dražen Nadoveza and Dimitris Kiritsis. Ontology-based approach for context modeling in enterprise applications. *Computers in Industry*, 65(9):1218–1231, 2014.
208. Rajiv Nag and Dennis A Gioia. From common to uncommon knowledge: Foundations of firm-specific use of knowledge as a resource. *Academy of Management journal*, 55(2):421–457, 2012.
209. Uma Narula. *Communication models*. Atlantic Publishers & Dist, 2006.
210. Stefan Negru and Sabin Buraga. A knowledge-based approach to the user-centered design process. In *Knowledge Discovery, Knowledge Engineering and Knowledge Management: 4th International Joint Conference, IC3K 2012, Barcelona, Spain, October 4-7, 2012, Revised Selected Papers 4*, pages 165–178. Springer, 2013.
211. Christian Neureiter, Mathias Uslar, Dominik Engel, and Goran Lastro. A standards-based approach for domain specific modelling of smart grid system architectures. In *2016 11th System of Systems Engineering Conference (SoSE)*, pages 1–6. IEEE, 2016.
212. Johanna Nichols. What, if anything, is typology? 2007.
213. Robert Nickerson, Jan Muntermann, Upkar Varshney, and Henri Isaac. Taxonomy development in information systems: Developing a taxonomy of mobile applications. In

- European conference in information systems*, pages xxx–xxx, 2009.
214. Oliver Niggemann and Volker Lohweg. On the diagnosis of cyber-physical production systems. In *Proceedings of the AAAI Conference on Artificial Intelligence*, volume 29, 2015.
215. Henning Oberc, Melissa Reuter, Manfred Wannöffel, and Bernd Kuhlenkötter. Development of a learning factory concept to train participants regarding digital and human centered decision support. *Procedia Manufacturing*, 23:165–170, 2018.
216. Egena Ode and Rajenthyan Ayavoo. The mediating role of knowledge application in the relationship between knowledge management practices and firm innovation. *Journal of Innovation & Knowledge*, 5(3):210–218, 2020.
217. SO Okolie, SO Kuyoro, and OB Ohwo. Emerging cyber-physical systems: An overview. *International Journal of Scientific Research in Computer Science, Engineering and Information Technologym*, 3(8):306–316, 2018.
218. David H Olwell, Devanandham Henry, Art Pyster, Nicole Hutchison, Stephanie Enck, and James F Anthony Jr. Analysis of the references from the guide to the systems engineering body of knowledge (sebok). *Procedia Computer Science*, 16:1000–1006, 2013.
219. Md Mehedi Hassan Onik, KIM Chul-Soo, and YANG Jinhong. Personal data privacy challenges of the fourth industrial revolution. In *2019 21st International Conference on Advanced Communication Technology (ICACT)*, pages 635–638. IEEE, 2019.
220. Kasper Hornbæk Antti Oulasvirta. What is interaction. *Proceedings of ACM Press*, 5040:5052, 2017.
221. Volker Paelke, Carsten Röcker, Nils Koch, Holger Flatt, and Sebastian Büttner. User interfaces for cyber-physical systems. *at-Automatisierungstechnik*, 63(10):833–843, 2015.
222. Oleksandra Panasiuk, Omar Holzknicht, Umutcan Şimşek, Elias Kärle, and Dieter Fensel. Verification and validation of semantic annotations. In *International Andrei Ershov Memorial Conference on Perspectives of System Informatics*, pages 223–231. Springer, 2019.
223. Fivos Papadimitriou. Conceptual modelling of landscape complexity. *Landscape Research*, 35(5):563–570, 2010.
224. Jeffrey Parsons and Linda Cole. What do the pictures mean? guidelines for experimental evaluation of representation fidelity in diagrammatical conceptual modeling techniques. *Data & Knowledge Engineering*, 55(3):327–342, 2005.
225. Ken Peppers, Tuure Tuunanen, Marcus A Rothenberger, and Samir Chatterjee. A design science research methodology for information systems research. *Journal of management information systems*, 24(3):45–77, 2007.

226. Magnus Persson, Martin Törngren, Ahsan Qamar, Jonas Westman, Matthias Biehl, Stavros Tripakis, Hans Vangheluwe, and Joachim Denil. A characterization of integrated multi-view modeling in the context of embedded and cyber-physical systems. In *2013 Proceedings of the international conference on embedded software (EMSOFT)*, pages 1–10. IEEE, 2013.
227. François Pfister, Vincent Chapurlat, Marianne Huchard, Clémentine Nebut, and J-L Wippler. A proposed meta-model for formalizing systems engineering knowledge, based on functional architectural patterns. *Systems Engineering*, 15(3):321–332, 2012.
228. Marta Pinzone, Federico Albè, Davide Orlandelli, Ilaria Barletta, Cecilia Berlin, Björn Johansson, and Marco Taisch. A framework for operative and social sustainability functionalities in human-centric cyber-physical production systems. *Computers & Industrial Engineering*, page 105132, 2018.
229. Marta Pinzone, Federico Albè, Davide Orlandelli, Ilaria Barletta, Cecilia Berlin, Björn Johansson, and Marco Taisch. A framework for operative and social sustainability functionalities in human-centric cyber-physical production systems. *Computers & industrial engineering*, 139:105132, 2020.
230. Steven W Popper, Steven C Bankes, Robert Callaway, and Daniel DeLaurentis. System of systems symposium: Report on a summer conversation. *Potomac Institute for Policy Studies, Arlington, VA*, 320, 2004.
231. Rangunathan Rajkumar, Insup Lee, Lui Sha, and John Stankovic. Cyber-physical systems: the next computing revolution. In *Design automation conference*, pages 731–736. IEEE, 2010.
232. Ana Luísa Ramos, José Vasconcelos Ferreira, and Jaume Barceló. Model-based systems engineering: An emerging approach for modern systems. *IEEE Transactions on Systems, Man, and Cybernetics, Part C (Applications and Reviews)*, 42(1):101–111, 2011.
233. Anatol Rapoport. *General system theory: Essential concepts & applications*, volume 10. CRC Press, 1986.
234. Iris Reinhartz-Berger and Arnon Sturm. Utilizing domain models for application design and validation. *Information and Software Technology*, 51(8):1275–1289, 2009.
235. João Reis, Rui Pinto, and Gil Gonçalves. Human-centered application using cyber-physical production system. In *IECON 2017-43rd Annual Conference of the IEEE Industrial Electronics Society*, pages 8634–8639. IEEE, 2017.
236. Luis Ribeiro. Cyber-physical production systems’ design challenges. In *2017 IEEE 26th international symposium on industrial electronics (isie)*, pages 1189–1194. IEEE, 2017.
237. Stewart Robinson. Conceptual modelling: Who needs it. *SCS M&S Magazine*, 2(7), 2010.

238. Andre Dionisio Rocha and Jose Barata. Digital twin-based optimiser for self-organised collaborative cyber-physical production systems. *Manufacturing Letters*, 29:79–83, 2021.
239. Rafael A Rojas, Erwin Rauch, Renato Vidoni, and Dominik T Matt. Enabling connectivity of cyber-physical production systems: a conceptual framework. *Procedia Manufacturing*, 11: 822–829, 2017.
240. David Romero, Peter Bernus, Ovidiu Noran, Johan Stahre, and Åsa Fast-Berglund. The operator 4.0: Human cyber-physical systems & adaptive automation towards human-automation symbiosis work systems. In *Advances in Production Management Systems. Initiatives for a Sustainable World: IFIP WG 5.7 International Conference, APMS 2016, Iguassu Falls, Brazil, September 3-7, 2016, Revised Selected Papers*, pages 677–686. Springer, 2016a.
241. David Romero, Johan Stahre, Thorsten Wuest, Ovidiu Noran, Peter Bernus, Åsa Fast-Berglund, and Dominic Gorecky. Towards an operator 4.0 typology: a human-centric perspective on the fourth industrial revolution technologies. In *proceedings of the international conference on computers and industrial engineering (CIE46), Tianjin, China*, pages 29–31, 2016b.
242. David Romero, Johan Stahre, and Marco Taisch. The operator 4.0: Towards socially sustainable factories of the future, 2020.
243. Hannes Röpke, Kristofer Hell, Jacek Zawisza, Arndt Lüder, and Nicole Schmidt. Identification of “industrie 4.0” component hierarchy layers. In *2016 IEEE 21st International Conference on Emerging Technologies and Factory Automation (ETFA)*, pages 1–8. IEEE, 2016.
244. Roland Rosen, Georg Von Wichert, George Lo, and Kurt D Bettenhausen. About the importance of autonomy and digital twins for the future of manufacturing. *Ifac-papersonline*, 48(3):567–572, 2015.
245. Eva Masero Rúbio, Rogério Pais Dionísio, and Pedro Miguel Baptista Torres. Industrial iot devices and cyber-physical production systems: Review and use case. *Innovation, Engineering and Entrepreneurship*, pages 292–298, 2019.
246. Vinzent Rudtsch, Jürgen Gausemeier, Judith Gesing, Tobias Mittag, and Stefan Peter. Pattern-based business model development for cyber-physical production systems. *Procedia CIRP*, 25:313–319, 2014.
247. Fabiano B Ruy, Giancarlo Guizzardi, Ricardo A Falbo, Cássio C Reginato, and Victor A Santos. From reference ontologies to ontology patterns and back. *Data & Knowledge Engineering*, 109:41–69, 2017.
248. Puviyarasu SA and Catherine da Cunha. A semantic model for cyber-physical production

- system inspired from current developments-a taxonomy. In *CIGI-QUALITA 2021-Conférence Internationale de Génie Industriel*, volume 17, pages 7–23, 2021.
249. Puviyarasu SA and Catherine Da Cunha. Smart factory: From concepts to operational sustainable outcomes using test-beds. In *Log forum-Scientific journal of logistics*, volume 1, pages 7–23, 2021.
250. Dagmar Sageder. Terminology today: a science, an art or a practice?: Some aspects on terminology and its development. 2010.
251. Juan C Sager, Sue Ellen Wright, and Gerhard Budin. Handbook of terminology management, 1997.
252. Doruk Şahinel, Cem Akpolat, O Can Görür, Fikret Sivrikaya, and Sahin Albayrak. Human modeling and interaction in cyber-physical systems: A reference framework. *Journal of Manufacturing Systems*, 59:367–385, 2021.
253. Satya S Sahoo, Olivier Bodenreider, Joni L Rutter, Karen J Skinner, and Amit P Sheth. An ontology-driven semantic mashup of gene and biological pathway information: Application to the domain of nicotine dependence. *Journal of biomedical informatics*, 41(5):752–765, 2008.
254. Abdulgabbbar Saif, Nazlia Omar, Mohd Juzaidin Ab Aziz, Umami Zakiah Zainodin, and Naomie Salim. Semantic concept model using wikipedia semantic features. *Journal of Information Science*, 44(4):526–551, 2018.
255. Jordana Sarmenghi Salamon, Cássio Chaves Reginato, and Monalessa Perini Barcellos. Ontology integration approaches: A systematic mapping. In *ONTOBRAS*, pages 161–172, 2018.
256. Alfredo Alan Flores Saldivar, Yun Li, Wei-neng Chen, Zhi-hui Zhan, Jun Zhang, and Leo Yi Chen. Industry 4.0 with cyber-physical integration: A design and manufacture perspective. In *2015 21st international conference on automation and computing (ICAC)*, pages 1–6. IEEE, 2015.
257. Gaou Salma et al. Operating an application for modeling persona by using ontologies. *Journal of Theoretical and Applied Information Technology*, 88(1):57, 2016.
258. Omkar Salunkhe, Maheshwaran Gopalakrishnan, Anders Skoogh, and Åsa Fasth-Berglund. Cyber-physical production testbed: literature review and concept development. *Procedia manufacturing*, 25:2–9, 2018.
259. Robert G Sargent. Verification and validation of simulation models. In *Proceedings of the 2010 winter simulation conference*, pages 166–183. IEEE, 2010.
260. Kenneth J Schlager. Systems engineering-key to modern development. *IRE transactions on*

- engineering management*, 3:64–66, 1956.
261. Nicole Schmidt and Arndt Lüder. Development of a generic model for end-of-life scenarios of production systems. *Procedia Manufacturing*, 8:385–392, 2017.
262. Jan Schuhmacher and Vera Hummel. Decentralized control of logistic processes in cyber-physical production systems at the example of esb logistics learning factory. *Procedia Cirp*, 54:19–24, 2016.
263. Angelia Sebok and Brett Walters. The identification and application of human system integration software tools to support the systems engineering lifecycle and the acquisition process. In *Proceedings of the Human Factors and Ergonomics Society Annual Meeting*, volume 60, pages 1731–1735. SAGE Publications Sage CA: Los Angeles, CA, 2016.
264. Syed K Shahzad, Michael Granitzer, and Denis Helic. Ontological model driven gui development: User interface ontology approach. In *2011 6th International Conference on Computer Sciences and Convergence Information Technology (ICCIT)*, pages 214–218. IEEE, 2011.
265. Jianhua Shi, Jiafu Wan, Hehua Yan, and Hui Suo. A survey of cyber-physical systems. In *2011 international conference on wireless communications and signal processing (WCSP)*, pages 1–6. IEEE, 2011.
266. Hillary Sillitto, Regina Griego, Eileen Arnold, Dov Dori, James Martin, Dorothy McKinney, Patrick Godfrey, Daniel Krob, and Scott Jackson. What do we mean by “system”?—system beliefs and worldviews in the incose community. In *INCOSE International Symposium*, volume 28, pages 1190–1206. Wiley Online Library, 2018.
267. Hillary Sillitto, James Martin, Dorothy McKinney, Regina Griego, Dov Dori, Daniel Krob, Patrick Godfrey, Eileen Arnold, and Scott Jackson. Systems engineering and system definitions. *INCOSE, USA*, 2019.
268. Ricardo Silva, João Reis, Luís Neto, and Gil Gonçalves. Universal parser for wireless sensor networks in industrial cyber physical production systems. In *2017 IEEE 15th International Conference on Industrial Informatics (INDIN)*, pages 633–638. IEEE, 2017.
269. J Simola. Literature review of scientific articles about cyber information sharing. *Journal of Information Warfare*, 20(3):44–59, 2021.
270. David G Sirmon, Michael A Hitt, and R Duane Ireland. Managing firm resources in dynamic environments to create value: Looking inside the black box. *Academy of management review*, 32(1):273–292, 2007.
271. OMG Business Process Modeling Notation Specification. Object management group. *Needham*,



- MA, USA, 2(2), 2006.
272. Stefano Spellini, Sebastiano Gaiardelli, Michele Lora, and Franco Fummi. Enabling component reuse in model-based system engineering of cyber-physical production systems. In *2021 26th IEEE International Conference on Emerging Technologies and Factory Automation (ETFA)*, pages 1–8. IEEE, 2021.
273. Graham Storrs. A conceptualisation of multiparty interaction. *Interacting with Computers*, 6(2):173–189, 1994.
274. Mari Carmen Suárez-Figueroa, Asunción Gómez-Pérez, Enrico Motta, and Aldo Gangemi. *Introduction: Ontology engineering in a networked world*. Springer, 2012.
275. Jing Sun, Hongyu Zhang, Yuan Fang, and Li Hai Wang. Formal semantics and verification for feature modeling. In *10th IEEE International Conference on Engineering of Complex Computer Systems (ICECCS'05)*, pages 303–312. IEEE, 2005.
276. Shengjing Sun, Xiaochen Zheng, Bing Gong, Jorge Garcia Paredes, and Joaquín Ordieres-Meré. Healthy operator 4.0: A human cyber-physical system architecture for smart workplaces. *Sensors*, 20(7):2011, 2020.
277. Rajan Suri and John Burke. *Quick response manufacturing: a companywide approach to reducing lead times*. Productivity Press, 2020.
278. Alistair G Sutcliffe. Requirements engineering from an hci perspective. *The Encyclopedia of Human-Computer Interaction*, 2:707–760, 2014.
279. Manu Suvarna, Ken Shaun Yap, Wentao Yang, Jun Li, Yen Ting Ng, and Xiaonan Wang. Cyber-physical production systems for data-driven, decentralized, and secure manufacturing—a perspective. *Engineering*, 7(9):1212–1223, 2021.
280. Géza Szabó, Sándor Rácz, Norbert Reider, Hubertus A Munz, and József Petó. Digital twin: Network provisioning of mission critical communication in cyber physical production systems. In *2019 IEEE International Conference on Industry 4.0, Artificial Intelligence, and Communications Technology (IAICT)*, pages 37–43. IEEE, 2019.
281. Marcin Szlenk. Formal semantics and reasoning about uml class diagram. In *2006 International Conference on Dependability of Computer Systems*, pages 51–59. IEEE, 2006.
282. Guoxin Tan, Tinglei Hao, and Zheng Zhong. A knowledge modeling framework for intangible cultural heritage based on ontology. In *2009 Second International Symposium on Knowledge Acquisition and Modeling*, volume 1, pages 304–307. IEEE, 2009.
283. Muhammad Umer Tariq, Jacques Florence, and Marilyn Wolf. Design specification of cyber-physical systems: Towards a domain-specific modeling language based on simulink, eclipse

- modeling framework, and giotto. In *ACES-MB@ MoDELS*, pages 6–15, 2014.
284. Alexey Tazin. *Composition of UML Class Diagrams Using Category Theory and External Constraints*. PhD thesis, Northeastern University, 2022.
285. Sigmar-Olaf Tergan and Tanja Keller. *Knowledge and information visualization: Searching for synergies*, volume 3426. Springer, 2005.
286. Rafika Thabet, Dominik Bork, Amine Boufaied, Elyes Lamine, Ouajdi Korbaa, and Hervé Pingaud. Risk-aware business process management using multi-view modeling: method and tool. *Requirements Engineering*, 26:371–397, 2021.
287. Ben H Thacker, Scott W Doebbling, Francois M Hemez, Mark C Anderson, Jason E Pepin, and Edward A Rodriguez. Concepts of model verification and validation. 2004.
288. Bernhard Thalheim. Towards a theory of conceptual modelling. *J. Univers. Comput. Sci.*, 16(20):3102–3137, 2010.
289. Sebastian Thiede. Cyber-physical production systems (cpps): introduction, 2021.
290. Sebastian Thiede, Max Juraschek, and Christoph Herrmann. Implementing cyber-physical production systems in learning factories. *Procedia Cirp*, 54:7–12, 2016.
291. Klaus-Dieter Thoben, Stefan Wiesner, and Thorsten Wuest. “industrie 4.0” and smart manufacturing—a review of research issues and application examples. *International journal of automation technology*, 11(1):4–16, 2017.
292. Gary Thomas. A typology for the case study in social science following a review of definition, discourse, and structure. *Qualitative inquiry*, 17(6):511–521, 2011.
293. Bernhard Thomé. *Systems engineering: principles and practice of computer-based systems engineering*. John Wiley and Sons Ltd., 1993.
294. Dawn M Tilbury. Cyber-physical manufacturing systems. *Annual Review of Control, Robotics, and Autonomous Systems*, 2:427–443, 2019.
295. Tetsuo Tomiyama and Florian Moyen. Resilient architecture for cyber-physical production systems. *CIRP Annals*, 67(1):161–164, 2018.
296. Gerard J Tortora and Bryan H Derrickson. *Introduction to the human body*. John Wiley & Sons, 2017.
297. Monica Chiarini Tremblay, Alan R Hevner, and Donald J Berndt. Focus groups for artifact refinement and evaluation in design research. *Communications of the association for information systems*, 26(1):27, 2010.

298. Kanji Ueda. A concept for bionic manufacturing systems based on dna-type information. In *Human Aspects in Computer Integrated Manufacturing*, pages 853–863. Elsevier, 1992.
299. Bhuvan Unhelkar. *Verification and validation for quality of UML 2.0 models*. John Wiley & Sons, 2005.
300. Katarina Valaskova, Peter Ward, and Lucia Svabova. Deep learning-assisted smart process planning, cognitive automation, and industrial big data analytics in sustainable cyber-physical production systems. *Journal of Self-Governance and Management Economics*, 9(2):9–20, 2021.
301. PAUL Valckenaers, Hendrik Van Brussel, Luc Bongaerts, and Jozef Wyns. Holonic manufacturing systems. *Integrated Computer-Aided Engineering*, 4(3):191–201, 1997.
302. Paul Valckenaers, Hendrik Van Brussel, Jo Wyns, Luc Bongaerts, and Patrick Peeters. Designing holonic manufacturing systems. *Robotics and Computer-Integrated Manufacturing*, 14(5-6):455–464, 1998.
303. Nees Van Eck and Ludo Waltman. Software survey: Vosviewer, a computer program for bibliometric mapping. *scientometrics*, 84(2):523–538, 2010.
304. Dániel Varró and András Pataricza. Vpm: A visual, precise and multilevel metamodeling framework for describing mathematical domains and uml (the mathematics of metamodeling is metamodeling mathematics). *Software & Systems Modeling*, 2(3), 2003.
305. Ovidiu Vermesan, Peter Friess, Patrick Guillemin, Sergio Gusmeroli, Harald Sundmaeker, Alessandro Bassi, Ignacio Soler Jubert, Margaretha Mazura, Mark Harrison, Markus Eisenhauer, et al. Internet of things strategic research roadmap. In *Internet of things-global technological and societal trends from smart environments and spaces to green ICT*, pages 9–52. River Publishers, 2022.
306. Zs J Viharos, László Monostori, and Z Csongrádi. Realizing the digital factory: monitoring of complex production systems. *IFAC Proceedings Volumes*, 36(3):31–36, 2003.
307. Birgit Vogel-Heuser, Christian Diedrich, Dorothea Pantförder, and Peter Göhner. Coupling heterogeneous production systems by a multi-agent based cyber-physical production system. In *2014 12th IEEE international conference on industrial informatics (INDIN)*, pages 713–719. IEEE, 2014.
308. Ludwig Von Bertalanffy. An outline of general system theory. *British Journal for the Philosophy of science*, 1950.
309. Ludwig Von Bertalanffy. The meaning of general system theory. *General system theory: Foundations, development, applications*, 30:53, 1973.

310. Astrid von Euler-Chelpin. *Information modelling for the manufacturing system life cycle*. PhD thesis, KTH, 2008.
311. Mark Von Rosing, Henrik Von Scheel, and August-Wilhelm Scheer. *The Complete Business Process Handbook: Body of Knowledge from Process Modeling to BPM, Volume 1*, volume 1. Morgan Kaufmann, 2014.
312. Melvin M Vopson. The world's data explained: How much we're producing and where it's all stored. In *World Economic Forum, May*, 2021.
313. Christopher A Voss and Juliana Hsuan. Service architecture and modularity. *Decision Sciences*, 40(3):541–569, 2009.
314. David D Walden, Garry J Roedler, and Kevin Forsberg. Incose systems engineering handbook version 4: updating the reference for practitioners. In *INCOSE International Symposium*, volume 25, pages 678–686. Wiley Online Library, 2015.
315. Xiaozhi Wang, Tianyu Gao, Zhaocheng Zhu, Zhengyan Zhang, Zhiyuan Liu, Juanzi Li, and Jian Tang. Kepler: A unified model for knowledge embedding and pre-trained language representation. *Transactions of the Association for Computational Linguistics*, 9:176–194, 2021.
316. Yunbo Wang, Mehmet C Vuran, and Steve Goddard. Cyber-physical systems in industrial process control. *ACM Sigbed Review*, 5(1):1–2, 2008.
317. Michael D Watson, Bryan Mesmer, and Phillip Farrington. Engineering elegant systems: Postulates, principles, and hypotheses of systems engineering. In *Systems Engineering in Context*, pages 495–513. Springer, 2019.
318. Michael Weyrich, Matthias Klein, Jan-Philipp Schmidt, Nasser Jazdi, Kurt D Bettenhausen, Frank Buschmann, Carolin Rubner, Michael Pirker, and Kai Wurm. Evaluation model for assessment of cyber-physical production systems. *Industrial Internet of Things: Cybermanufacturing Systems*, pages 169–199, 2017.
319. Heike Wiese. Collectives in the intersection of mass and count nouns: A cross-linguistic account. *Count and mass across languages*, pages 54–74, 2012.
320. Claes Wohlin. Guidelines for snowballing in systematic literature studies and a replication in software engineering. In *Proceedings of the 18th international conference on evaluation and assessment in software engineering*, pages 1–10, 2014.
321. Eoin Woods and Nick Rozanski. The system context architectural viewpoint. In *2009 Joint Working IEEE/IFIP Conference on Software Architecture & European Conference on Software Architecture*, pages 333–336. IEEE, 2009.

322. Sue Ellen Wright and Gerhard Budin. *Handbook of terminology management: application-oriented terminology management*, volume 2. John Benjamins Publishing, 2001.
323. Xuan Wu, Virginie Goepp, and Ali Siadat. Concept and engineering development of cyber physical production systems: a systematic literature review. *The International Journal of Advanced Manufacturing Technology*, 111:243–261, 2020.
324. Jiakang Yang, Yong Li, Yijia Cao, Yi Tan, and Christian Rehtanz. Transactive energy system: a review of cyber-physical infrastructure and optimal scheduling. *IET Generation, Transmission & Distribution*, 14(2):173–179, 2020.
325. Bitao Yao, Zude Zhou, Lihui Wang, Wenjun Xu, Junwei Yan, and Quan Liu. A function block based cyber-physical production system for physical human–robot interaction. *Journal of manufacturing systems*, 48:12–23, 2018.
326. Xifan Yao, Jiajun Zhou, Yingzi Lin, Yun Li, Hongnian Yu, and Ying Liu. Smart manufacturing based on cyber-physical systems and beyond. *Journal of Intelligent Manufacturing*, 30(8): 2805–2817, 2019.
327. Zhe Yu and Tim Menzies. Fast2: An intelligent assistant for finding relevant papers. *Expert Systems with Applications*, 120:57–71, 2019.
328. Constantin-Bala Zamfirescu, Bogdan-Constantin Pirvu, Jochen Schlick, and Detlef Zuehlke. Preliminary insides for an anthropocentric cyber-physical reference architecture of the smart factory. *Studies in Informatics and Control*, 22(3):269–278, 2013.
329. Constantin-Bala Zamfirescu, Bogdan-Constantin Pirvu, Dominic Gorecky, and Harish Chakravarthy. Human-centred assembly: a case study for an anthropocentric cyber-physical system. *Procedia Technology*, 15:90–98, 2014.
330. Mohammad Zarour and Mubarak Alharbi. User experience framework that combines aspects, dimensions, and measurement methods. *Cogent Engineering*, 4(1):1421006, 2017.
331. F Zezulka, P Marcon, I Vesely, and O Sajdl. Industry 4.0—an introduction in the phenomenon, ifac-papersonline, volume 49, issue 25, 2016.
332. Chuan Zhang, Alessandro Romagnoli, Li Zhou, and Markus Kraft. Knowledge management of eco-industrial park for efficient energy utilization through ontology-based approach. *Applied energy*, 204:1412–1421, 2017.
333. Yingfeng Zhang, Zhengang Guo, Jingxiang Lv, and Ying Liu. A framework for smart production-logistics systems based on cps and industrial iot. *IEEE Transactions on Industrial Informatics*, 14(9):4019–4032, 2018.
334. Peng Zhou and Nora El-Gohary. Ontology-based automated information extraction from

- building energy conservation codes. *Automation in Construction*, 74:103–117, 2017.
335. Xin Zhou, Yuqin Jin, He Zhang, Shanshan Li, and Xin Huang. A map of threats to validity of systematic literature reviews in software engineering. In *2016 23rd Asia-Pacific Software Engineering Conference (APSEC)*, pages 153–160. IEEE, 2016.
336. Quanyan Zhu, Craig Rieger, and Tamer Başar. A hierarchical security architecture for cyber-physical systems. In *2011 4th international symposium on resilient control systems*, pages 15–20. IEEE, 2011.
337. Iveta Zolotová, Peter Papcun, Erik Kajáti, Martin Miškuf, and Jozef Mocnej. Smart and cognitive solutions for operator 4.0: Laboratory h-cpps case studies. *Computers & Industrial Engineering*, 139:105471, 2020.
338. Detlef Zuehlke. Smartfactory—from vision to reality in factory technologies. *IFAC Proceedings Volumes*, 41(2):14101–14108, 2008.
339. Detlef Zühlke. Smartfactory—a vision becomes reality. *IFAC Proceedings Volumes*, 42(4): 31–39, 2009.







# Index

- Abstraction, 108
- Activity-Based modeling, 59
- Actuation, 98
- Agile system, 9
- Algorithm, 212
- Annotations, 121–123, 125
- Anthromorphic, 203
- App inventor, 230
- Artefacts-Based modeling, 59
  
- Backward snowballing, 47
- Bibliometric networks, 42
- boundary, 202
- Business Model, 64
  
- Cluster, 42
- Co-citation, 45
- Co-occurrence, 46
- Cognition and Processing, 203
- Communication-Based modeling, 59
- Competency questions, 214
- Computation, 98
- Concept exploration, 51
- Concept of operation, 182
- Conceptual model, 64
- Conscious, 197
- Convertible production lines, 9
- CPPS definition, 84
- CPPS design and development, 137
- CPPS End of life, 140
- CPPS formalization, 27, 104
- CPPS life cycle, 16
- CPPS modality, 206
- CPPS notion, 89
- CPPS operation artifact, 140
- CPPS property, 104
- Cyber and Physical infrastructure, 98
- Cyber elements, 96
- Cyber-Physical System, 13
  
- Cyber-Physical-production system, 13
  
- Data mining, 41
- Dedicated Manufacturing Systems, 87
- Domain knowledge extraction, 29
- Domain ontologies, 60
  
- Embedded systems, 10
- Empirical evidence, 240
- Enabling intercommunication, 11
- Enabling systems, 95
- End-to-End communication, 57
- Engineered system, 94
- Environment, 202
- Experimental loop, 20
- Explicit conceptualization, 12
  
- Feedback systems, 57
  
- General Systems Theory, 71
- Global unique identification, 10
  
- Haptic interaction, 219
- HCPPS Evaluation, 224
- Heuristic Evaluation method, 220
- Hierarchy layer, 127
- Holonic manufacturing system, 69
- Human elements, 97
- Human modality, 203
- Human-beings, 195
- Human-CPPS integration, 106
- Human-CPPS Interaction, 222
- Human-CPPS phenomenon, 223
- Human-machine interaction, 66
  
- INCOSE, 82
- Independent, 108
- Industrial Agents, 87
- Industry 4.0 revolution, 10
- Information artifacts, 239
- Integration, 11

- 
- Intelligent Manufacturing Systems, 87
  - Interactive cyber System, 206
  - Interactive physical System, 206
  - Internet of Things, 10
  - Interoperability, 11
  - Knowledge modeling, 59
  - Link layer space, 97
  - Loosely coupled systems, 99
  - Manufacturing knowledge, 64
  - MBSE, 240
  - Metamodel, 96
  - Model-driven approaches, 12
  - Modular architecture, 111
  - Multi-view modeling, 107
  - Multidisciplinary engineering, 241
  - Multilingualism, 11
  - Natural language, 70
  - Normalization, 42
  - Ontology-based modeling, 60
  - Organizational knowledge, 64
  - Orthogonal, 108
  - Overall Equipment Efficiency, 167
  - Oxford Dictionary, 12
  - Physical elements, 97
  - Physiological, 203
  - Physiological interaction, 219
  - Platform project, 19
  - Product domain, 89
  - Product knowledge, 64
  - Production system domain, 89
  - Reconfigurable Manufacturing Systems, 87
  - Reference model, 56
  - Refinement, 108
  - Self-diagnosing, 55
  - Self-evolvable, 55
  - Self-reconfigurable, 55
  - Semantic, 61
  - Sensing, 98
  - Service-oriented application, 56
  - Smart device, 90
  - Smart objects, 10
  - Smart production system, 9
  - Standard compliance, 11
  - Standard model, 64
  - System, 71
  - System modelling language, 70
  - System of Interest, 94
  - System of Systems, 95
  - System philosophy, 92
  - System theory, 92
  - Systematic Literature Review, 37
  - Systems Engineering, 28
  - tactile, 203
  - Terminology, Typology, 117
  - Unconscious, 197
  - Unified Modeling Language, 70
  - US National Science Foundation, 13
  - Value creation models, 141
  - Verification and Validation, 30
  - Viewpoints, 131
  - VOS viewer, 45
  - Whole life cycle, 12
  - Whole stakeholder community, 12



---

**Titre : Un cadre sémantique multi-vues pour le "Système de production cyber-physique" pour soutenir le cycle de vie en utilisant l'approche d'ingénierie système**

**Mots clés :** Système de production cyber-physique (CPPS), Intégration humain-CPPS, l'approche d'ingénierie système, sémantique, LS2N- Projet de Plateforme

**Résumé :** Les systèmes cyber-physiques sont actuellement proposés comme une réponse à cette révolution industrielle 4.0. Au fil des ans, différents chercheurs ont utilisé pour désigner l'intégration de l'aspect de la production dans le CPS, se projetant comme système de production cyber-physique (CPPS). La notion de CPPS a fait l'objet d'une attention croissante au cours des dernières années dans les domaines de la production. Bien que la notion de CPPS ait été adoptée par de nombreux chercheurs, il y a un manque de définition unifiée et de compréhension commune du concept. Malgré la notion de CPPS encore balbutiante, l'hétérogénéité complexe, les entités réticulantes, la relation de dépendance entre le produit et le système de production, les entités imbriquées impliquées, augmentent rapidement. Il est entravé par un manque de compréhension commune du concept CPPS (c'est-à-dire quelles sont les entités impliquées dans le cycle de vie, quel est le phénomène d'interactions homme-CPPS (HCPPS).

comment les humains perçoivent et réagissent aux réponses d'interaction de la machine (aspects émotionnels et cognitifs). En raison d'une telle limitation et d'une norme manquante, son évolution et sa réutilisabilité dans le domaine constituent un défi majeur. Il faut un cadre pour relever ces défis. Cette thèse vise à fournir une prémisse à la notion de CPPS en proposant un formalisme indépendant du domaine, suivi d'un cadre sémantique modulaire. Le framework proposé est réutilisé dans un contexte applicatif réel et différent dans le projet LS2N Platform. Le travail de thèse sert de base sémantique à la notion de CPPS. Il prend en charge l'évolution du CPPS et l'adaptation à de multiples objectifs, notamment le processus SE, la littérature, le réseau d'acteurs et d'autres aspects du paradigme. Le travail de thèse est soutenu par le projet de plateforme du laboratoire des sciences du numérique de Nantes (LS2N)-CPPS.

---

**Title : A Multi-viewed semantic for "Cyber physical production system" (CPPS) to support life cycle: using System Engineering approach**

**Keywords :** Cyber-physical Production system (CPPS), Human-CPPS integrations (HCPPS), System Engineering approach, Semantics, LS2N-Platform project.

**Abstract :** The Cyber-physical systems are currently proposed as an answer to this industrial 4.0 revolution. Over the years, different researchers used to refer the integration of the production aspect in the CPS, projecting as Cyber-Physical Production System (CPPS). The notion of CPPS has been gained increasing attention over the past few years in production topics. Although the notion of CPPS has been adopted by many researchers, there is a lack of unified definition and common understanding of the concept. Despite the CPPS notion still in its infancy, the complex heterogeneity, crosslinking entities, dependency relation between product and production system, involved intertwined entities, are rapid increasing. It is hindered by a lack of common understanding of CPPS concept (i.e) what are the involved entities of the life cycle, what is the human-CPPS (HCPPS) interactions phenomenon are.

how humans perceive and respond to machine' interaction responses (emotional and cognitive aspects). As a result of such limitation and missing standard leads to major challenge in its evolution and reusability across the domain. There is a need for a framework for these challenges. This thesis aims to provide a premise for CPPS notion by proposing a domain-independent formalism, followed by, modular semantic framework is proposed. The proposed framework is reused in a real, different application context in the LS2N Platform project. The thesis work serves as the semantic basis for the CPPS notion. It supports in CPPS evolution and tailoring to multiple purposes which includes SE process, literature, actor network and other aspects of paradigm. The thesis work is supported by the laboratory of digital science of Nantes (LS2N)- CPPS platform project.