



HAL
open science

Essays on Access to Electricity in Sub-Saharan Africa

Mamadou Saliou Barry

► **To cite this version:**

Mamadou Saliou Barry. Essays on Access to Electricity in Sub-Saharan Africa. Economics and Finance. Université Paris sciences et lettres, 2022. English. NNT : 2022UPSLD065 . tel-04542896

HAL Id: tel-04542896

<https://theses.hal.science/tel-04542896>

Submitted on 11 Apr 2024

HAL is a multi-disciplinary open access archive for the deposit and dissemination of scientific research documents, whether they are published or not. The documents may come from teaching and research institutions in France or abroad, or from public or private research centers.

L'archive ouverte pluridisciplinaire **HAL**, est destinée au dépôt et à la diffusion de documents scientifiques de niveau recherche, publiés ou non, émanant des établissements d'enseignement et de recherche français ou étrangers, des laboratoires publics ou privés.



THÈSE DE DOCTORAT
DE L'UNIVERSITÉ PSL

Préparée à l'Université Paris-Dauphine

Essays on Access to Electricity in Sub-Saharan Africa

Soutenue par

Mamadou Saliou BARRY

Le 5 Juillet 2022

École doctorale n°543

SDOSE

Spécialité

Économie

Composition du jury :

Patrice GEOFFRON

Professeur, Université Paris-Dauphine *Président*

Lisa CHAUVET

Professeure, Université Paris 1 Panthéon Sorbonne *Rapporteuse*

Jörg PETERS

Professeur, Université de Passau *Rapporteur*

Pascale MOTEL-COMBES

Professeure, Université Clermont Auvergne *Examinatrice*

Johanna CHOUMERT-NKOLO

Maître de Conférences, EDI-Global *Examinatrice*

Ahmed TRITAH

Professeur, Université de Poitiers *Examineur*

Anna CRETl

Professeure, Université Paris-Dauphine *Directrice de thèse*

L'Université Paris-Dauphine n'entend donner aucune approbation ni improbation aux opinions émises dans les thèses; ces opinions doivent être considérées comme propres à leurs auteurs.

Remerciements

Au moment où j'achève ces trois années de recherche, je saisi cette opportunité pour remercier toutes ces personnes qui m'ont soutenues et accompagner tout au long cette aventure.

J'exprime tout d'abord ma profonde gratitude à ma directrice de thèse Anna Creti pour la confiance portée en ma modeste personne et d'avoir accepté de m'encadrer, dans un premier temps, dans le cadre d'un stage de recherche qui nourrira ce projet de recherche. Je te remercie pour ta bienveillance et ta promptitude malgré ton agenda très chargé. Les nombreux échanges et séances de travail qu'on a eu ensemble m'auront tant fait grandir et je serais sans doute très nostalgique de ces moments.

Mes remerciements vont également à l'endroit de Ahmed TRITAH et Philippe DELACOTE qui ont bien accepté de faire partie de mon comité de suivi de thèse. Les nombreux échanges que j'ai eus avec vous, vos précieux conseils et votre regard extérieur m'ont été d'une importance capitale.

J'adresse mes sincères remerciements à Lisa CHAUVET, Professeure à l'Université Paris 1 Panthéon Sorbonne, Pascale MOTEL-COMBES, Professeure à l'Université Clermont Auvergne, Patrice GEOFFRON, Professeur à l'Université Paris-Dauphine, Johanna CHOUMERT-NKOLO, Maître de Conférences et Directrice de Recherche à EDI-Global, Ahmed TRITAH, Professeur à l'Université de Poitiers ainsi qu'à Jörg PETERS, Professeur à l'Université de Passau de l'honneur

qu'ils m'ont fait d'avoir accepté de participer à mon jury de thèse.

Mes remerciements vont également à l'endroit de la Chaire Économie du Climat qui a financé cette thèse. Cette thèse a également bénéficié du soutien financier de l'Institut Louis Bachelier et du Centre de Géopolitique de l'Energie et des Matières Premières (CGEMP) de l'Université Paris-Dauphine dans le cadre d'un séjour de recherche au Sénégal. Un grand merci pour avoir soutenu ce projet de mobilité. Je tiens également à exprimer ma profonde gratitude à Awa Diouf et à Laure Tall, Directrice de recherche de l'Initiative Prospective Agricole et Rural (IPAR) pour l'invitation et la possibilité qui m'a été offerte d'inclure une section sur l'inclusion financière dans le cadre d'une récente enquête représentative des ménages sénégalais. Mes pensées vont également à l'endroit de toute l'équipe de la Chaire Économie du Climat notamment, mes collègues doctorants et les seniors avec lesquels j'ai eu d'enrichissantes discussions.

Je suis très reconnaissant à l'égard de Ababacar Sedikh Gueye et Oulimata Ndiaye pour avoir facilité mon intégration à Clermont-Ferrand et pour vos précieux conseils tout au long du magistère au CERDI.

On dit souvent en Afrique « qu'il faut tout un village pour élever un enfant », je saisi cette opportunité remercier toutes ces personnes qui ont contribué à ma formation du primaire au supérieur.

A Binta, Haby, Anaïs, Fatou, Kabinet, Fatimata, Abdoukarim, Abdoulaye, Bocar, Salam, Alpha, Moustapha, Hamidou, Sita, Souleymane, Yoro je suis profondément marqué par votre amitié et votre soutien moral sans faille tout au long de cette aventure.

Je profite également de cette opportunité pour remercier mes amis avec lesquels j'ai pu me lancer dans une aventure entrepreneuriale notamment, par la création d'une entreprise de collecte de déchets en Guinée.

Mes remerciements vont également à l'endroit de ma famille:

A vous papa et maman merci pour vos encouragements et votre patience pendant ces longues années d'absence.

A mes oncles Ibrahima Barry et Elhadj Mamadou Saliou Barry pour avoir financé mes études en France et m'avoir toujours encouragé à poursuivre des études doctorales. J'espère vous rendre

fier à travers cette thèse.

A mes oncles, tantes, grands frères et soeurs, je vous remercie pour vos encouragements.

A toi Aissatou merci pour tes encouragements et d'avoir toujours pris de mes nouvelles, je t'en suis très reconnaissant.

A toi Khadija merci pour ta patience et pour ta compréhension. Les mots me manquent pour t'exprimer ma profonde gratitude.

Summary

There is widespread recognition that access to affordable and reliable sources of electricity is a major determinant of economic development. Electricity is, for example, essential to the development of human capital, industrial activities, the enhancement of living conditions and the adoption of disruptive technologies in key sectors of the economy. Nevertheless, over 820 million people, worldwide, still live without electricity. More than 80% of these people are located in Sub-Saharan Africa (SSA), particularly in rural areas. Energy poverty has detrimental economic and welfare effects. It constitutes a major impediment to economic growth and poverty reduction. The dissertation studies the drivers of modern energy services adoption in developing countries and is organized into four chapters. Chapter 1 studies the regulatory framework, the tariff structure, and the subsidy schemes for mini-grids development in Tanzania. It therefore assesses the profitability of a mini-grid electrification project in Tanzania from a private investment perspective. Using an optimization technique we find that the approved standardized small power producers' tariffs and subsidy schemes in Tanzania still do not allow mini-grid for rural electrification projects to be profitable. Chapter 2 studies the effect of mobile money adoption on households' decision to buy solar panels for electricity access in Tanzania. Using household data from Tanzania, we reveal that mobile money adoption, holding all other variables constant, leads to a 19% increase in the probability of adopting solar panels. Furthermore, we find the effect of mobile money to be positive and statistically significant for only poor households. Finally, receipt of remittances, access to credit

and participation in off-farm revenue generating activities are the mediating channels through which mobile money affects the probability of adopting solar panels. Chapter 3 expands on the analysis of Chapter 2 by looking at the impact of mobile money on Senegalese households' cooking fuel choices. Drawing on a novel representative household survey and applying a probit and an instrumental variable technique, we show that mobile money leads to 24.5% and 44% increase in the probability of using clean and charcoal cooking fuels, respectively. Conversely, mobile money leads to a 68.2% decrease in the probability of using dirty cooking fuels, supporting the view that financial inclusion plays a pivotal role in promoting energy transition in developing countries. We show that receipt of remittances is the mediating channel through which mobile money affects households' cooking fuel choices. Finally, Chapter 4 is a case study that analyzes pay-as-you-go (PAYG) contracts subscribed by 10,120 consumers living in Benin (Sub-Saharan Africa) to purchase solar kits or panels for lighting and charging services. PAYG are flexible loans that allow fees payment through mobile banking. Most of the PAYG consumers live in well electrified areas (Cotonou, Porto Novo, Abomey Calavi, in the coastal zone). By estimating a very simple multinomial logit model, we find that these customers have a high probability to enroll in PAYG contracts. Living in urban and peri-urban areas, they use solar devices to substitute expensive and often unreliable grid electricity services. Consumers located in more periferic and less electrified areas (Savalou) have a low probability to default, as the substitution effect is weaker. Overall, in our case study, PAYG targets credit worthy consumers, in order to decrease the investment risk of the company providing solar devices. These results cast some doubts as to whether PAYG bridges the "last mile" electrification gap.

Résumé

L'accès à une source d'électricité abordable et fiable est un facteur déterminant pour le développement économique. L'électricité est, par exemple, essentielle au développement du capital humain, des activités industrielles, à l'amélioration des conditions de vie et à l'adoption de technologies de pointe dans des secteurs clés de l'économie. Néanmoins, plus de 820 millions de personnes, dans le monde entier, vivent toujours sans électricité. Plus de 80% de ces personnes se trouvent en Afrique subsaharienne (ASS), notamment dans les zones rurales. Cette thèse étudie les déterminants de l'adoption des services énergétiques modernes dans les pays en développement et s'articule autour de quatre chapitres. Le Chapitre 1 étudie le cadre réglementaire, la structure tarifaire et les régimes de subvention pour le développement des mini-réseaux en Tanzanie. Il évalue donc la rentabilité d'un projet d'électrification par mini-réseau en Tanzanie du point de vue de l'investissement privé. À l'aide d'une technique d'optimisation, nous constatons que les tarifs harmonisés applicables aux petits producteurs d'électricité et les régimes de subvention en vigueur en Tanzanie ne permettent toujours pas de rentabiliser les projets d'électrification rurale par mini-réseau. Le Chapitre 2 étudie l'effet de l'adoption de l'argent mobile sur la décision des ménages d'acheter des panneaux solaires pour accéder à l'électricité en Tanzanie. En utilisant des données sur les ménages de Tanzanie, nous révélons que l'adoption de l'argent mobile entraîne une augmentation de 19% de la probabilité d'adopter des panneaux solaires. En outre, nous montrons que la réception de transferts de fonds, l'accès au crédit et la participation à des activ-

ités génératrices de revenus non agricoles sont les canaux par lesquels l'argent mobile affecte la probabilité d'adopter des panneaux solaires. Le Chapitre 3 approfondit l'analyse du Chapitre 2 en examinant l'impact de l'argent mobile sur les choix de combustibles de cuisson des ménages sénégalais. Nos résultats révèlent que l'argent mobile entraîne une augmentation de 24,5% et de 44% de la probabilité d'utiliser des combustibles de cuisson propres et du charbon de bois, respectivement. À l'inverse, l'argent mobile entraîne une diminution de 68,2% la probabilité d'utiliser des combustibles de cuisson polluants, ce qui confirme l'idée que l'inclusion financière joue un rôle central dans le processus de transition énergétique dans les pays en développement. Nous identifions la réception de transferts de fonds comme le canal par lequel l'argent mobile affecte les choix de combustibles de cuisson des ménages. Enfin, le Chapitre 4 est une étude de cas qui analyse les contrats de paiement à la consommation (PAYG) souscrits par 10 120 consommateurs vivant au Bénin (Afrique subsaharienne) pour acheter des kits ou des panneaux solaires pour l'éclairage et les services de charge. En estimant un modèle logit multinomial très simple, nous constatons que ces clients ont une forte probabilité d'adhérer à des contrats PAYG. Vivant dans des zones urbaines et périurbaines, ils utilisent des dispositifs solaires pour remplacer les services d'électricité du réseau, coûteux et souvent peu fiables. Les consommateurs situés dans des zones plus périphériques et moins électrifiées (Savalou) ont une faible probabilité de défaillance, car l'effet de substitution est plus faible. Globalement, dans notre étude de cas, le système PAYG cible les consommateurs solvables, afin de réduire le risque d'investissement de l'entreprise qui fournit les panneaux solaires. Ces résultats mettent en doute la capacité des systèmes PAYG à combler le gap d'électrification du " dernier kilomètre".

Contents

Summary	6
1 General introduction	17
2 Are Mini-grid Projects in Tanzania Financially Sustainable?	35
2.1 Introduction	35
2.2 History of mini-grid projects in Tanzania	37
2.3 Regulatory Framework	39
2.3.1 Financing mini-grid systems in Tanzania	39
2.3.2 Tariff Regulatory Policy in Tanzania	40
2.4 Results: Methods and Data	42
2.4.1 Description of Project Site – Mafinga Tow	42
2.4.2 Solar Resource	42
2.4.3 Levelized Cost of Energy	43
2.4.4 Modelling the energy flow and the LCOE of the project.	45
2.4.5 Electricity Demand Estimation	49
2.5 Results	51
2.5.1 The Profitability of the Proposed Mini-grid System	52
2.5.2 Sensitivity Analysis	53
2.6 Conclusion	54
3 Does Financial Inclusion Facilitate Solar Panels’ Adoption? Evidence from Tanzania	63
3.1 Introduction	63
3.2 Literature review	66
3.3 Background on Tanzania	69
3.4 Data and summary statistics	71

3.4.1	Data	71
3.4.2	Summary statistics	71
3.5	Empirical strategy	72
3.5.1	Modelling solar adoption	72
3.5.2	Endogeneity	73
3.5.3	Modelling the Economic Drivers	75
3.6	Results	76
3.7	Heterogeneity	77
3.8	Economic Drivers	79
3.9	Robustness check	83
3.10	Conclusion	85
4	The Impact of Mobile Money on Households Cooking Fuel Choices : Evidence from Senegal	91
4.1	Introduction	91
4.2	Background on Senegal	95
4.3	Theoretical framework: financial inclusion and cooking fuel choices	96
4.3.1	Mobile money, savings and investment	97
4.3.2	Mobile money and remittances	98
4.4	Data and summary statistics	99
4.5	Empirical strategy	103
4.6	Main results	105
4.7	Heterogeneous effects of mobile money	108
4.7.1	Rural vs urban	108
4.7.2	Poverty status	109
4.7.3	Household head's gender	110
4.8	Mechanisms at play	113
4.9	Robustness check	115
4.10	Conclusion	117
5	Pay-as-you-go contracts for electricity access: bridging the "last mile" gap? A case study in Benin	129

5.1	Introduction	129
5.2	Pay-as-you-go services: literature review	133
5.3	Benin: country profile	137
5.4	PAYG case study	140
5.5	A simple empirical model	145
5.6	Results	146
5.6.1	Summary statistics	146
5.6.2	Key findings	146
5.7	Conclusion	149
6	General conclusion	157

List of Figures

1.1	Share of population with electricity access	19
1.2	Share of rural population with electricity access	20
1.3	Share of urban population with electricity access	21
1.4	Share of urban population with using clean cooking fuels	22
2.1	Mini-grid Projects in Tanzania	38
2.2	Satellite image of Mafinga Town	43
2.3	Photovoltaic Power Potential of Tanzania	44
2.4	Solar Global Horizontal Irradiance (GHI) for Mafinga Town- Iringa Region	44
2.5	Proposed mini-grid system design	45
2.6	Fuel Consumption Curve	48
2.7	Estimated Load Profile of Mafinga Town	51
2.8	LCOE Breakdown	53
2.9	Parameters	54
.0.10	A Two-tank Kinetic Battery Model Concept	61

4.4.1 The share of households using solid biomass as their main cooking fuel	101
4.4.2 The share of households using charcoal as their main cooking fuel	102
4.4.3 The share of households using LPG/electricity as their main cooking fuel	102
5.3.1 Access to electricity by municipality	139
5.4.1 Solar status by gender	142
5.4.2 Early PAYG users by department	143
5.4.3 New PAYG users by department	144
5.4.4 Default rate by department	144

List of Tables

2.1 Approved Standardised Small Power Producers Tariffs (Selling to the Grid)	41
2.2 Cost assumptions of the input parameters	50
2.3 Load Profile Output Table	50
2.4 LCOE Result Summary	52
2.5 LCOE Result Summary - Future Case	54
.0.6 Cost Summary - Hybrid System	59
.0.7 Cost Summary - PV+Battery	59
.0.8 Diesel Genset	59
.0.9 Hybrid System	60
.0.10 PV+BATTERY	60
.0.11 Diesel Genset	60
3.4.1 Summary statistics	72
3.6.1 Impact of mobile money on solar panel adoption	78
3.7.1 Solar adoption by poverty status	80
3.7.2 Solar adoption depending on whether household has a migrant or not	80
3.7.3 Solar adoption depending on house ownership status	81

3.8.1 Mechanisms at play	83
3.9.1 Impact of financial inclusion on solar panel adoption	84
4.6.1 The impact of mobile money on cooking fuel choices	107
4.7.1 The impact of mobile money on cooking fuel choices in urban and rural areas (IV)	111
4.7.2 The impact of mobile money on cooking fuel choices for non-poor and poor house-	
holds (IV)	112
4.7.3 The impact of mobile money on cooking fuel choices for female and male heads	
(IV)	113
4.8.1 The mechanisms at play	115
4.9.1 The impact of mobile money on cooking fuel expenditure	117
.01 Financial inclusion in Senegal by urban and rural areas in 2021	123
.02 Descriptive statistics of the main variables by mobile money usage status	124
.03 Descriptive statistics of the main variables by mobile money usage status in rural	
area	125
.04 Descriptive statistics of the main variables by mobile money usage status in urban	
area	126
.05 The first stage equation	127
5.6.1 Summary statistics	147
5.6.2 Odds Ratios Results	148
5.7.1 Marginal Effects	156

CHAPTER 1

General introduction

Access to affordable, reliable and sustainable source of energy is crucial for economic growth, human capital development, poverty reduction and improved living standards. For instance, access to electricity promotes off-farm revenue generating activities ([Rao 2013](#), [Kumar & Rauniyar 2018](#)), women participation in the labor market ([Dinkelman 2011](#), [Grogan & Sadanand 2013](#), [Salmon & Tanguy 2016](#)), industrial activities ([Rud 2012](#)) and also the adoption of disruptive technology in the key sectors of the economy. Moreover, reliable power supply is critical for the provision of quality health services and the COVID-19 pandemic has stressed the urgency of accelerating universal access to electricity in developing countries. Over the last decade, significant efforts have been made to expand access to electricity globally. The share of the world population with access to electricity went up from 83% in 2010 to 90% in 2019, bringing electricity to more than 1.1 billion people worldwide. This tremendous drop in access deficit is largely driven by progress achieved in Central and Southern Asian region. For instance, China achieved universal access to electricity in 2015, while India alone brought electricity to about 500 million people making it one of the largest electrification success stories in history.

Notwithstanding this global drop in access deficit, Sub-Saharan Africa (SSA) region still con-

concentrates the majority of the population without access to electricity and clean cooking technology. More than 80% of the world population without access to electricity live in the region, with huge spatial disparities between urban and rural areas. Less than 50% of the Sub-Saharan Africa's population have access to electricity (see Figure 1.1). While access in urban areas is nearly universal, the access rate in rural areas is very low. Rural areas are home to the overwhelming majority of the population without access to electricity. According to the statistics of the World Bank, less than 30% of the region's rural population have access to electricity (see Figure 1.4).

The traditional approach to electrification in Sub-Saharan Africa has long been through grid extension. While grid extension in economic buoyant and densely populated areas is economically viable, in remote rural settings it is generally not cost effective. In these areas, off-grid solutions are seen as a viable and least cost solution to expanding access to electricity. Furthermore, the declining cost of renewable energy technologies combined with innovative business models such as pay-as-you-go (PAYG), are addressing longstanding issues of affordability in rural areas. PAYG is a technology-driven method that allows consumers to get a stand-alone electricity system by paying loan fees through a mobile banking service. More precisely, the installed devices (solar kits or panels) use information technology to enable remote activation with payment receipt or disconnection in case of failure. According to estimates from the World Bank, more than 130 million off-grid solar devices were sold between 2010 and 2018. Sales are even projected to grow in the coming years as geospatial modeling by the International Energy Agency (IEA) reveals that off-grid solutions would provide electricity access to more than 60% of rural population in SSA.

Meeting Sustainable Development Goal 7, which ensure universal access to modern energy services by 2030 will require mobilizing important financial resources over the coming decades. The Sustainable Energy For All (SE4All) initiative in its 2019 report estimates that achieving universal access to electricity will require investing nearly \$50 billion per year, with \$4 billion allocated to the expansion of clean cooking solutions. Half of this amount would be invested to increase the share of renewable energy in total final energy consumption, which is projected to reach 22% of total final energy consumption. Around \$140 billion per year is also expected to go to end-use energy efficiency, which is seen as a key element to achieving rapidly the Sustainable Development Goal 7 at a least cost.

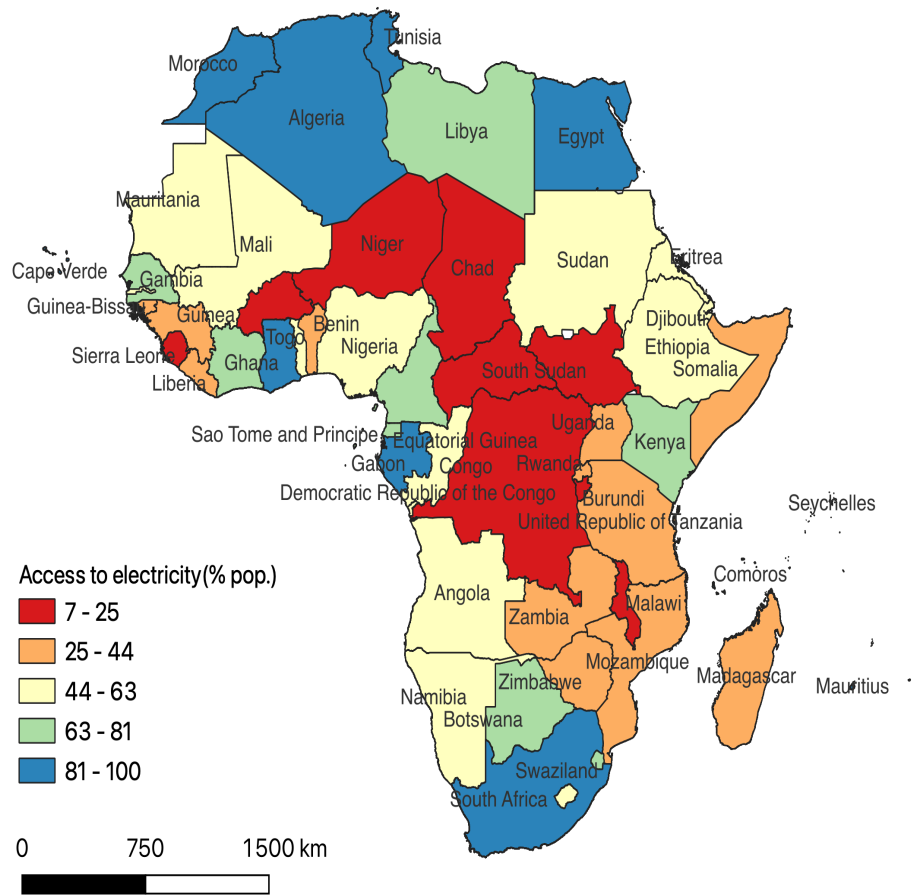

Figure 1.1: Share of population with electricity access
 Source : author's elaboration using data from WDI

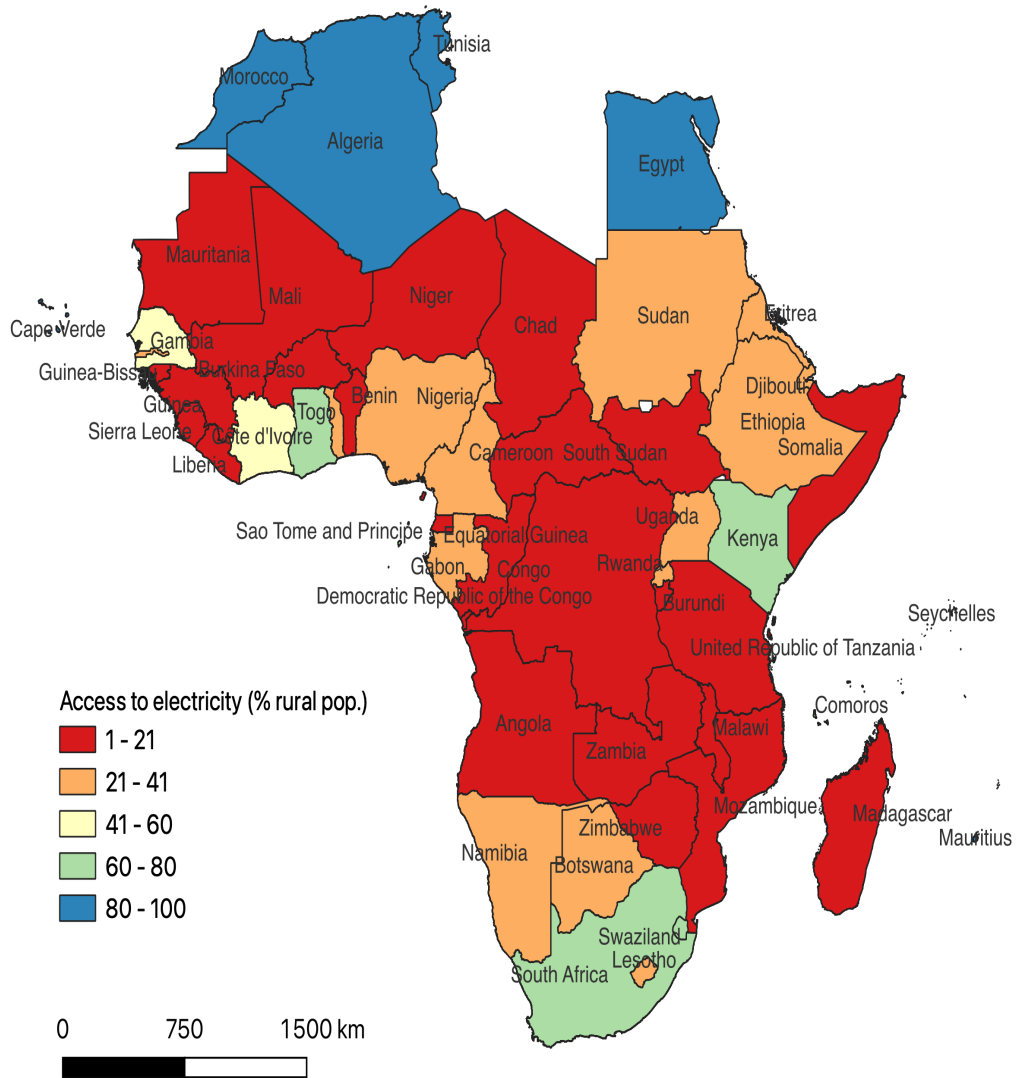

Figure 1.2: Share of rural population with electricity access
Source : author's elaboration using data from WDI

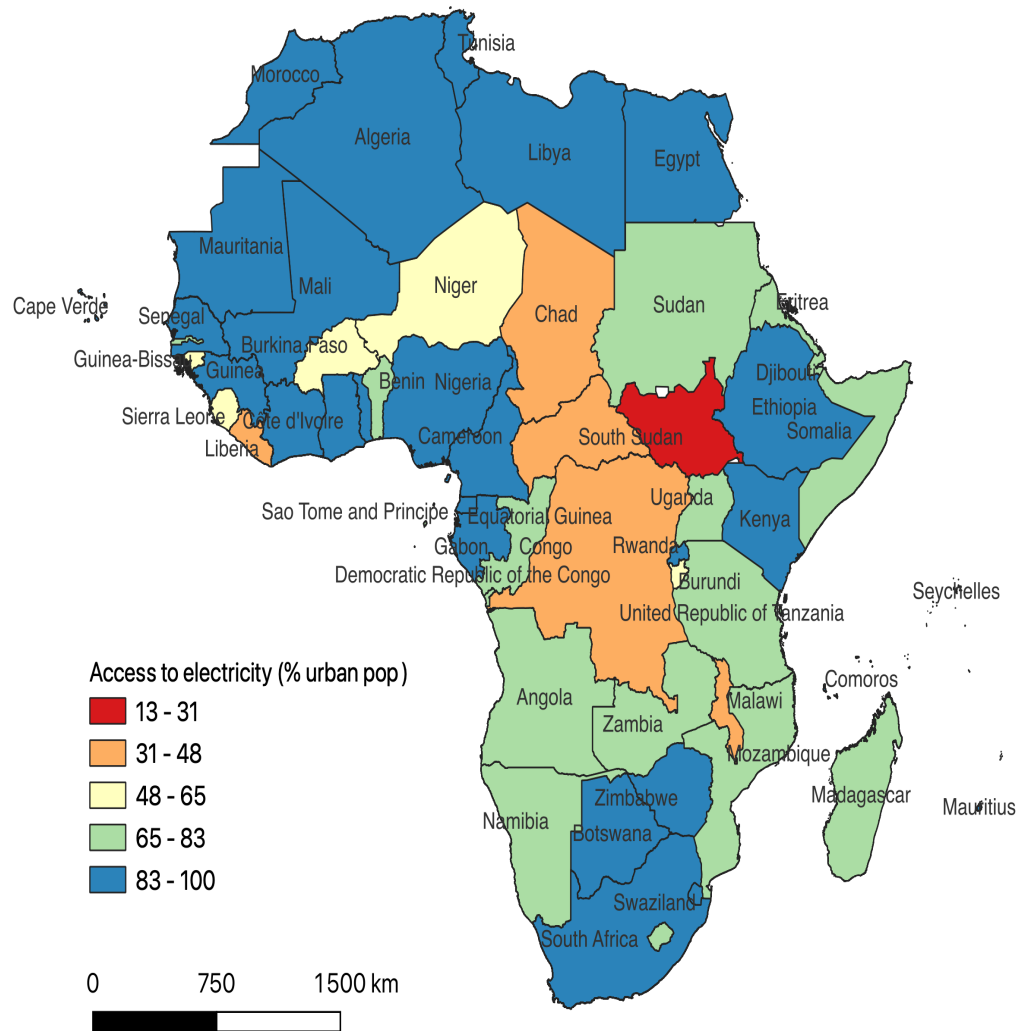

Figure 1.3: Share of urban population with electricity access
 Source : author's elaboration using data from WDI

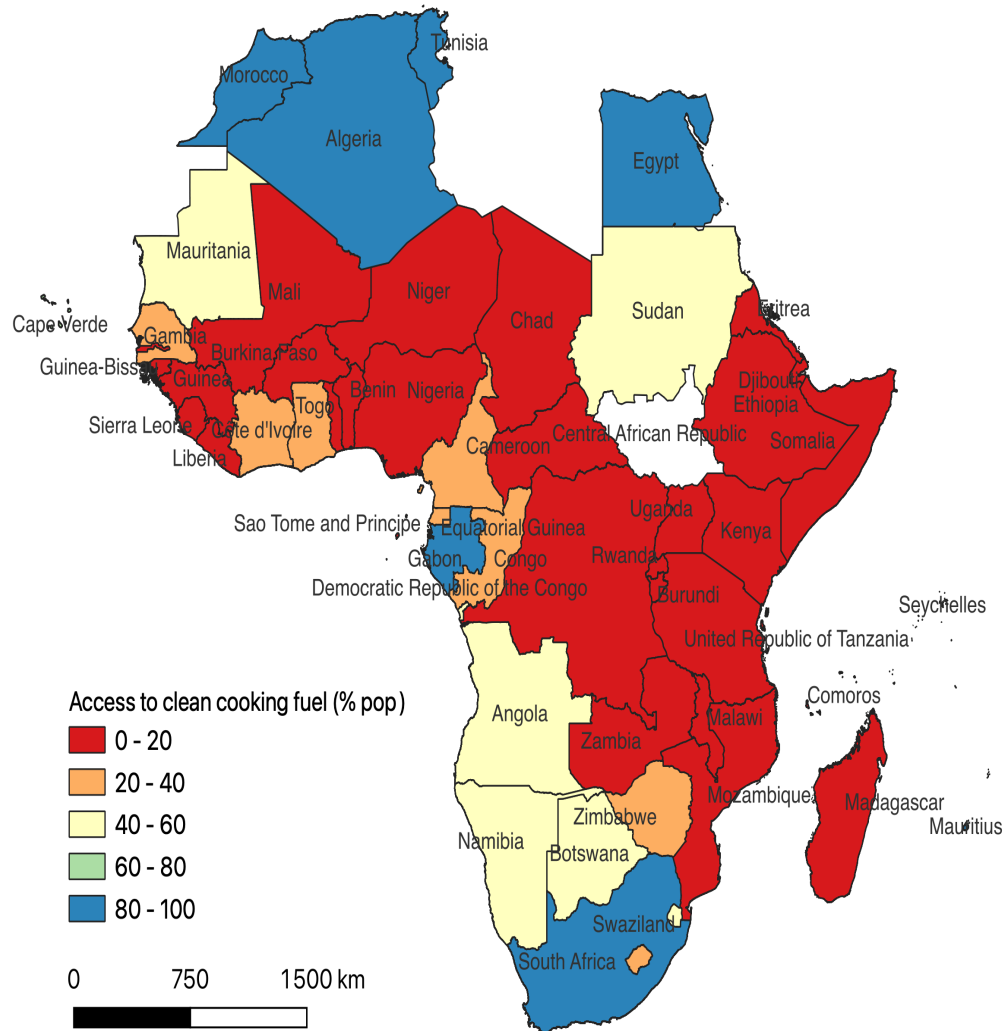

Figure 1.4: Share of urban population with using clean cooking fuels
 Source : author's elaboration using data from WDI

The economic costs of disruptive power supply in sub-Saharan Africa is enormous and it is estimated to be as much as 2.1% of GDP (Eberhard et al. 2011). In addition to this, power shortages are also associated with important tax revenue losses and shortfall in job creation (Mensah 2018). The overall tax revenue losses associated with unreliable power supply in sub-Saharan Africa is

colossal and it is estimated to be as much as \$9.5 billion (Blimpo et al. 2018). Moreover, the heavy reliance on solid polluting sources of energy for cooking has detrimental environmental and health effects. The economic cost of solid biomass cooking fuels is enormous, and it is estimated to cost the world more than 2.4 trillion dollars each year, with \$0.8 trillion from lost productivity for women, \$0.2 trillion for climate change and \$1.4 trillion for adverse impacts on health (ESMAP 2020). This is naturally the reason why electricity and clean cooking fuel provision are among the top priorities of several international organizations, development agencies and governments as well.

Sub-Saharan Africa is an interesting case study. On the one hand, this region is experiencing rapid economic growth and is making significant efforts to reduce poverty. On the other hand, there is still a long way to go because the vast majority of the population remains extremely poor. As a result, the continent must maintain not only a sustainable economic growth, but also make significant structural changes to address its development challenges while also addressing the growing concern of climate change. Indeed, over the last decade, the region has witnessed increased weather shocks and climate variability, which is causing disasters and disrupting economic, ecological, and social systems. By 2030, unless appropriate adaptation strategies are put in place, it is estimated that 118 millions people living in extreme poverty will be exposed to extreme weather events such as drought, heatwaves and floods. Additionally, according to the World Meteorological Organization (WMO), climate change is expected to lower the region's gross domestic product by up to 3% by 2050, posing serious climate mitigation, adaptation and resilience challenges. It is, therefore, important that the region integrates climate change in its long term development strategies and also accelerates the transition of its energy system, which heavily depends on fossil fuels. In line with a low carbon transition economy and given the huge renewable energy potential of the region, electrification projects should be carbon free.

Over the recent years, there has been a growing interest among scholars on energy access in developing countries. To date, the literature has focused on establishing a causal relationship between access to electricity and certain socioeconomic outcome variables at the household or firm level. Overall, access to electricity has been shown to increase women participation in labor market (Dinkelman 2011, Grogan & Sadanand 2013, Salmon & Tanguy 2016), reduce women fertility (Peters & Vance 2011) and domestic violence (Sievert 2015), increase job creation (Rud

2012), improve human capital development (Lipscomb et al. 2013) and educational outcomes (Kumar & Rauniyar 2018, Khandker et al. 2013, Aguirre 2017), increase consumption (Khandker et al. 2012). Other studies have focused on investigating the nexus between electrification and industrial development and reveal that access to electricity promotes industrial activities (Rud 2012), the shift away from agricultural activities towards non-farm revenue generating activities (Rao 2013, Kumar & Rauniyar 2018). The studies presented thus far provide evidence that access to electricity not only improves households' welfare but also promote industrial development. While access to electricity undeniably promotes economic and human capital development, its unreliable provision can negatively affect economic growth. Recently, a strand of the economic literature has started examining the economic consequences of unreliable energy infrastructures. In brief, power outages are found to have distributional effect on firms' size (Alby et al. 2012), reduce firms' productivity (Grainger & Zhang 2017, Fisher-Vanden et al. 2015) and firms' profit (Cole et al. 2018). Last but not least, it is important to note that the common denominator of the studies reviewed thus far is that they focus on access to electricity through grid.

However, with the declining cost of solar technology over the last two decades and given its pivotal role in bridging the access gap in remote rural areas, there has been a growing interest among scholars in solar panels diffusion in developing and emerging countries. A strand of this literature has focused on examining the socioeconomic impacts of solar home systems (SHS). Overall, SHS have been shown to increase children study time (Furukawa 2014, Kudo et al. 2017, Grimm, Munyehirwe, Peters & Sievert 2017), improve social inclusion and communication (Komatsu, Kaneko & Ghosh 2011), reduce kerosene expenditure (Komatsu, Kaneko & Ghosh 2011, Arraiz & Calero 2015, Grimm, Munyehirwe, Peters & Sievert 2017, Yuya et al. 2015, Khandker et al. 2014, Buragohain 2012, Chen et al. 2017), but little evidence on income generating activities and productivity.¹ Another strand of this literature has focused on demand side, more specifically investigating the drivers of solar panels adoption. In this regard, several lines of evidence suggest that demographic and socioeconomic factors such as age, gender, household education attainment, household income, size, assets, and housing condition, among others, play a key role in enabling residential solar adoption in African countries (Smith & Urpelainen 2014, Komatsu, Kaneko, Shrestha & Ghosh 2011, Klasen & Mbegalo 2016, Guta 2018). Other studies have un-

¹For a comprehensive literature review on the impact of SHS see Lemaire (2018).

derlined the key role of social interactions or peer effects (Bollinger & Gillingham 2012, Richter 2013). Households' willingness to purchase off-grid solutions for electricity access has also been investigated. Grimm, Lenz, Peters & Sievert (2017) reveal that while households are willing to allocate a substantial part of their budget to electricity expenditure, this is unfortunately not enough to reach cost-covering prices, suggesting the need for subsidization to boost adoption. In the same vein, Yoon et al. (2016) in the Unnao district of Uttar Pradesh (India) study the impact of trial period on willingness to pay for solar lanterns and find no significant impact of trial period on bid price for solar lanterns. Contrary to the results of Grimm, Lenz, Peters & Sievert (2017) in Rwanda, which suggest government intervention, Yoon et al. (2016) results do not suggest any market failure that ought to be corrected to promote solar lanterns sales in rural India. Moreover, the authors find no clear evidence for concerns about the uncertainty related to the quality of the product or liquidity constraints. Furthermore, as uncertainty on the quality of the technology might be an impediment to adoption, scholars have also investigated the role of quality in technology adoption and reveal that for the case of Burkina Faso, for example, that promotion is not needed to promote solar uptake (Bensch et al. 2017).

This dissertation adds to the existing literature on the factors influencing the adoption of modern energy services in Sub-Saharan Africa by focusing on the role of financial inclusion. More specifically, the thesis investigates on one hand the diffusion of off-grid solutions for electrification and on the other hand, it analyses the enabling role of financial inclusion for cooking fuels transition in developing countries. By addressing these research questions, we contribute to the growing literature on the provision of energy services in developing countries. We depart from the traditional approach to rural electrification, which has so far focused on grid extension and leverage the potential of off-grid solutions for bridging the access deficit in remote rural areas of Sub-Saharan Africa.

The dissertation is organized into four chapters. Each chapter makes a contribution to the existing literature by utilizing both geospatial and household survey data from Sub-Saharan Africa. Chapter 1² studies the regulatory framework, the tariff structure, and the subsidy schemes for mini-grids development in Tanzania. Indeed, understanding mini-grid projects' profitability from an investment perspective is particularly crucial for designing optimal regulations and cost-reflective

²A version of this chapter has been accepted as a book chapter in *Electricity Access, Decarbonization, and Integration of Renewables* (Springer).

tariff schemes to attract adequate private sector investments in the power sector. However, this is a less explored area in the literature. Comparably, only a few quantitative studies have critically assessed how existing regulations and tariff policies in SSA affect mini-grid projects' potential to attract the number of private investments required to scale-up deployments (Williams et al. 2018). From another perspective, there is no consensus in the literature about whether mini-grid projects in SSA are profitable enough to crowd in private financing of mini-grid projects. On the one hand, some researchers argue that mini-grid projects powered by renewable energy are economically viable and capable of paying-off their financing cost and earning adequate returns for investors (Okoye & Oranekwu-Okoye 2018, Arowolo et al. 2019). On the other hand, other studies also argue that mini-grid projects in SSA are not economically feasible; thus, it requires subsidies to enable investors to recover their production cost (Azimoh et al. 2016, Nizami et al. 2017, Adaramola et al. 2017). This controversy about the profitability of mini-grid projects in SSA further strengthens the motivation of this paper. This Chapter therefore assesses the profitability of a mini-grid electrification project in Tanzania from a private investment perspective. Using an optimization technique we find that the approved standardized small power producers' tariffs and subsidy scheme in Tanzania still do not allow mini-grid for rural electrification projects to be profitable.

Drawing on the results from Chapter 1, which support the view that most households in developing countries are unable to pay cost-reflective electricity tariffs due to their low level of revenue, we posit that standalone solar home system can be an interesting alternative to providing electricity access to the poor. In spite of this, the uptake of solar panels is still very low. Credit constraints and lack of access to financial services, which could allow households, for instance, to gradually save up small amounts of money and overcome the high up-front investment costs, are often identified as the main barriers to technology adoption in developing countries (Dupas & Robinson 2013, Tarozzi et al. 2014, Batista & Vicente 2020). However, while it is well documented that relieving credit constraints and introducing flexible payment mechanism increase the uptake of welfare improving technologies (e.g. bed nets and solar panels) in developing countries (Tarozzi et al. 2014, Barry & Creti 2020), little is known on the impact of financial services more specifically, on the use of mobile money services on technology adoption. Chapter 2 fills this gap by examining the drivers of standalone solar panels adoption in Tanzania. More specifically, Chapter

2³ examines the effect of mobile money adoption on households' decision to buy solar panels for electricity access in Tanzania. Using a logit model and an instrumental variable (IV) approach to account for the potential endogeneity issue arising from mobile money adoption, we find positive effect of mobile money services on solar panels' acquisition. Results from the logit model reveal that the odds of adopting solar panel is 2.6 times higher for households that use mobile money services than non-using households. Additionally, our IV results show that mobile money adoption, holding all other variables constant, leads to a 19% increase in the probability of adopting solar panels. Furthermore, examining the heterogeneous effect of mobile money adoption by poverty status of households, we find that the effect of mobile money on solar panels' adoption is positive and statistically significant for poorer households only. Finally, we show that reception of remittances, access to credit and participation in off-farm income generating activities are the mediating channels through which mobile money affects solar adoption.

Chapter 3 expands on the analysis of Chapter 2 by looking at the impact of mobile money on Senegalese households' cooking fuel choices. The aim of this Chapter, therefore, is to assess the role of financial inclusion, more specifically the enabling role of mobile money on households' decision to use clean cooking fuels in Senegal. Specifically, we would like to know if households that use mobile money services are more likely to switch from pollutant sources of cooking fuels towards clean and efficient cooking fuels. By addressing this research question, we contribute to the growing literature on the drivers of cooking fuel transition in developing countries. More specifically, understanding the factors that influence clean cooking fuel choices and particularly how financial inclusion facilitates the transition away from dirty cooking fuels towards clean and efficient cooking fuels is of utmost importance for policymakers. Drawing on a novel representative household survey and applying a probit and an instrumental variable technique, we show that mobile money eases the transition away from dirty cooking fuels towards clean and efficient cooking fuels. More specifically, we find that mobile money leads to 24.5% and 44% increase in the probability of using clean and charcoal cooking fuels, respectively. Conversely, mobile money leads to a 68.2% decrease in the probability of using dirty cooking fuels, supporting the view that financial inclusion plays a pivotal role in promoting energy transition in developing countries. Furthermore, we examine the heterogeneous effects of mobile money on cooking fuel choices

³Chapter 2 benefited from a grant of 10,000 EUR from the Financial Inclusion Initiative, Toulouse School of Economics

with respect to household's head gender, poverty status and geographic location. While we find no differentiated effect of mobile money on cooking fuel choices with regard to household head's gender and poverty status, we find different results regarding household's location. Mobile money is positive and statistically significant for only rural households, supporting the view that financial inclusion reduces energy poverty in rural areas. Finally, we show that receipt of remittances is the mediating channel through which mobile money affects households' cooking fuel choices.

Finally, Chapter 4⁴ is a case study that analyzes pay-as-you-go (PAYG) contracts subscribed by 10,120 consumers living in Benin (Sub-Saharan Africa) to purchase solar kits or panels for lighting and charging services. PAYG are flexible loans that allow fees payment through mobile banking. Most of the PAYG consumers live in well electrified areas (Cotonou, Porto Novo, Abomey Calavi, in the coastal zone). By estimating a very simple multinomial logit model, we find that these customers have a high probability to enroll in PAYG contracts. Living in urban and peri-urban areas, they use solar devices to substitute expensive and often unreliable grid electricity services. Consumers located in more periferic and less electrified areas (Savalou) have a low probability to default, as the substitution effect is weaker. Overall, in our case study, PAYG targets credit worthy consumers, in order to decrease the investment risk of the company providing solar devices. These results cast some doubts as to whether PAYG bridges the "last mile" electrification gap.

⁴A version of this paper is published in *Energy Economics* under the reference: Barry, M. S., Creti, A. (2020). Pay-as-you-go contracts for electricity access: Bridging the "last mile" gap? A case study in Benin. *Energy Economics*, 90, 104843.

Bibliography

- Adaramola, M. S., Quansah, D. A., Agelin-Chaab, M. & Paul, S. S. (2017), 'Multipurpose renewable energy resources based hybrid energy system for remote community in northern ghana', *Sustainable Energy Technologies and Assessments* **22**, 161–170.
- Aguirre, J. (2017), 'The impact of rural electrification on education: A case study from peru'.
- Alby, P., Dethier, J.-J. & Straub, S. (2012), 'Firms operating under electricity constraints in developing countries', *The World Bank Economic Review* **27**(1), 109–132.
- Arowolo, W., Blechinger, P., Cader, C. & Perez, Y. (2019), 'Seeking workable solutions to the electrification challenge in nigeria: Minigrid, reverse auctions and institutional adaptation', *Energy Strategy Reviews* **23**, 114–141.
- Arraiz, I. & Calero, C. (2015), *From Candles to Light: The Impact of Rural Electrification*, Technical report.
- URL:** <http://www.iadb.org>
- Azimoh, C. L., Klintonberg, P., Wallin, F., Karlsson, B. & Mbohwa, C. (2016), 'Electricity for development: Mini-grid solution for rural electrification in south africa', *Energy Conversion and Management* **110**, 268–277.
- Barry, M. S. & Creti, A. (2020), 'Pay-as-you-go contracts for electricity access: Bridging the “last mile” gap? a case study in benin', *Energy Economics* **90**, 104843.

- Batista, C. & Vicente, P. C. (2020), 'Improving access to savings through mobile money: Experimental evidence from African smallholder farmers', *World Development* **129**, 104905.
- Bensch, G., Grimm, M., Huppertz, M., Langbein, J. & Peters, J. (2017), 'Are promotion programs needed to establish off-grid solar energy markets? evidence from rural burkina faso', *Renewable and Sustainable Energy Reviews* .
- Blimpo, M., Mensah, J. T., Opalo, K. O. & Shi, R. (2018), 'Electricity provision and tax mobilization in africa'.
- Bollinger, B. & Gillingham, K. (2012), 'Peer effects in the diffusion of solar photovoltaic panels', *Marketing Science* **31**(6), 900–912.
- Buragohain, T. (2012), 'Impact of solar energy in rural development in india', *International journal of environmental science and development* **3**(4), 334.
- Chen, A. Z., Fischer, J., Fraker, A., Shah, N. B., Shirrell, S. & Stein, D. (2017), 'Welfare impacts of an entry-level solar home system in Uganda', *Journal of Development Effectiveness* **9**(2), 277–294.
- Cole, M. A., Elliott, R. J., Occhiali, G. & Strobl, E. (2018), 'Power outages and firm performance in sub-saharan africa', *Journal of Development Economics* **134**, 150–159.
- Dinkelman, T. (2011), 'The effects of rural electrification on employment: New evidence from south africa', *American Economic Review* **101**(7), 3078–3108.
- Dupas, P. & Robinson, J. (2013), 'Why don't the poor save more? evidence from health savings experiments', *American Economic Review* **103**(4), 1138–71.
- Eberhard, A., Rosnes, O., Shkaratan, M. & Vennemo, H. (2011), *Africa's power infrastructure: investment, integration, efficiency*, The World Bank.
- ESMAP (2020), 'The state of access to modern energy cooking services'.
- Fisher-Vanden, K., Mansur, E. T. & Wang, Q. J. (2015), 'Electricity shortages and firm productivity: evidence from china's industrial firms', *Journal of Development Economics* **114**, 172–188.
- Furukawa, C. (2014), 'Do solar lamps help children study? contrary evidence from a pilot study in uganda', *Journal of Development Studies* **50**(2), 319–341.

- Grainger, C. A. & Zhang, F. (2017), *The impact of electricity shortages on firm productivity: evidence from Pakistan*, The World Bank.
- Grimm, M., Lenz, L., Peters, J. & Sievert, M. (2017), 'Demand for off-grid solar electricity—experimental evidence from Rwanda'.
- Grimm, M., Munyehirwe, A., Peters, J. & Sievert, M. (2017), 'A first step up the energy ladder? Low cost solar kits and household's welfare in rural Rwanda', *World Bank Economic Review* **31**(3), 631–649.
- Grogan, L. & Sadanand, A. (2013), 'Rural electrification and employment in poor countries: Evidence from Nicaragua', *World Development* **43**, 252–265.
- Guta, D. D. (2018), 'Determinants of household adoption of solar energy technology in rural Ethiopia', *Journal of Cleaner Production* **204**, 193–204.
- Khandker, S. R., Barnes, D. F. & Samad, H. A. (2012), 'The welfare impacts of rural electrification in Bangladesh', *The Energy Journal* pp. 187–206.
- Khandker, S. R., Barnes, D. F. & Samad, H. A. (2013), 'Welfare impacts of rural electrification: A panel data analysis from Vietnam', *Economic Development and Cultural Change* **61**(3), 659–692.
- Khandker, S. R., Samad, H. A., Sadeque, Z. K., Asaduzzaman, M., Yunus, M. & Haque, A. E. (2014), *Surge in solar-powered homes: Experience in off-grid rural Bangladesh*, The World Bank.
- Klasen, S. & Mbegalo, T. (2016), The impact of livestock ownership on solar home system adoption in the northern and western regions of rural Tanzania, Technical report, Courant Research Centre: Poverty, Equity and Growth-Discussion Papers.
- Komatsu, S., Kaneko, S. & Ghosh, P. P. (2011), 'Are micro-benefits negligible? The implications of the rapid expansion of Solar Home Systems (SHS) in rural Bangladesh for sustainable development', *Energy Policy* **39**(7), 4022–4031.
- Komatsu, S., Kaneko, S., Shrestha, R. M. & Ghosh, P. P. (2011), 'Nonincome factors behind the purchase decisions of solar home systems in rural Bangladesh', *Energy for Sustainable Development* **15**(3), 284–292.

- Kudo, Y., Shonchoy, A. S. & Takahashi, K. (2017), 'Can Solar Lanterns Improve Youth Academic Performance? Experimental Evidence from Bangladesh', *The World Bank Economic Review* (January).
- URL:** <https://academic.oup.com/wber/article-lookup/doi/10.1093/wber/lhw073>
- Kumar, S. & Rauniyar, G. (2018), 'The impact of rural electrification on income and education: Evidence from bhutan', *Review of Development Economics* .
- Lemaire, X. (2018), 'Solar home systems and solar lanterns in rural areas of the global south: What impact?', *Wiley Interdisciplinary Reviews: Energy and Environment* **7**(5), e301.
- Lipscomb, M., Mobarak, A. M. & Barham, T. (2013), 'Development effects of electrification: Evidence from the topographic placement of hydropower plants in brazil', *American Economic Journal: Applied Economics* **5**(2), 200–231.
- Mensah, J. T. (2018), 'Jobs! electricity shortages and unemployment in africa'.
- Nizami, A.-S., Rehan, M., Waqas, M., Naqvi, M., Ouda, O. K., Shahzad, K., Miandad, R., Khan, M. Z., Syamsiro, M., Ismail, I. M. et al. (2017), 'Waste biorefineries: enabling circular economies in developing countries', *Bioresource technology* **241**, 1101–1117.
- Okoye, C. O. & Oranekwu-Okoye, B. C. (2018), 'Economic feasibility of solar pv system for rural electrification in sub-sahara africa', *Renewable and Sustainable Energy Reviews* **82**, 2537–2547.
- Peters, J. & Vance, C. (2011), 'Rural electrification and fertility–evidence from côte d'ivoire', *The Journal of Development Studies* **47**(5), 753–766.
- Rao, N. D. (2013), 'Does (better) electricity supply increase household enterprise income in india?', *Energy policy* **57**, 532–541.
- Richter, L.-L. (2013), 'Social effects in the diffusion of solar photovoltaic technology in the uk'.
- Rud, J. P. (2012), 'Electricity provision and industrial development: Evidence from india', *Journal of development Economics* **97**(2), 352–367.
- Salmon, C. & Tanguy, J. (2016), 'Rural electrification and household labor supply: Evidence from nigeria', *World Development* **82**, 48–68.
- Sievert, M. (2015), 'Rural electrification and domestic violence in sub-saharan africa'.

- Smith, M. G. & Urpelainen, J. (2014), 'Early adopters of solar panels in developing countries: Evidence from Tanzania', *Review of Policy Research* **31**(1), 17–37.
- Tarozzi, A., Mahajan, A., Blackburn, B., Kopf, D., Krishnan, L. & Yoong, J. (2014), 'Micro-loans, insecticide-treated bednets, and malaria: Evidence from a randomized controlled trial in Orissa, India', *American Economic Review* **104**(7), 1909–1941.
- Williams, N. J., Jaramillo, P. & Taneja, J. (2018), 'An investment risk assessment of microgrid utilities for rural electrification using the stochastic techno-economic microgrid model: A case study in Rwanda', *Energy for Sustainable Development* **42**, 87–96.
- Yoon, S., Urpelainen, J. & Kandlikar, M. (2016), 'Willingness to pay for solar lanterns: Does the trial period play a role?', *Review of Policy Research* **33**(3), 291–315.
- Yuya, K., Shonchoy Abu, S. & Kazushi, T. (2015), 'Impacts of solar lanterns in geographically challenged locations: experimental evidence from Bangladesh'.

Are Mini-grid Projects in Tanzania Financially Sustainable?

This chapter is a joint work with Anna Creti and Elias Zigah. A version of this chapter has been accepted as a book chapter in *Electricity Access, Decarbonization, and Integration of Renewables* (Springer).

2.1 Introduction

Mini-grids are becoming the mainstream solution to electrification problems in high electricity access deficit countries, especially in Sub-Saharan Africa (SSA), where there is evidence of a significant gap between urban and rural population (SDG 2019). Given the enormous solar energy potential (about 300,000 Giga Watts) of SSA and the declining cost of renewable energy technologies, it is expected that by 2030, solar mini-grid solutions would provide more than 60% of rural electricity access in SSA (WEO 2017). Large-scale commercial deployments of mini-grids require a degree of profitability to ensure their financial sustainability (Peters et al. 2019). For this to happen, new regulations and cost-reflective electricity tariffs for small power producers are needed to incentivize private sector participation in the power sector. Private investors' participation is particularly crucial to meet the annual electrification investment needs of \$120 billions in

the region (IEA 2019). However, in most SSA countries, non-cost-reflective electricity tariffs as a result of institutional and political pressure to keep tariffs low and high commercial risk of mini-grid projects are significant barriers that disincentivize private mini-grid developers from investing in the power sector (Eberhard & Shkaratan 2012, Peters et al. 2019, SDG 2019).

Amidst these challenges, Tanzania policymakers have implemented innovative policies and regulatory frameworks that have seen increased investments in small power projects. According to the World Bank (2019), Tanzania's comprehensive approach to mini-grid developments has achieved one of the fastest results in electricity access (56% and 73% increase in national and rural access rates respectively over the past decade) in SSA. The Tanzanian mini-grid model is anchored on public-private partnerships, where the government introduced a regulatory framework and legal and financial support to attract private mini-grid developers (Peters et al. 2019). This remarkable performance makes Tanzania a unique case of interest in Sub-Saharan Africa (Odarno et al. 2017). Therefore, this study is interested in understanding the factors that account for the proliferation of small power projects in Tanzania. Besides, given the need for increased private sector investments in mini-grid deployments to meet Tanzania's electrification needs, we further investigate whether the current tariff structure in Tanzania is cost-reflective for private commercial mini-grid developers.

Understanding mini-grid projects' profitability from an investment perspective is particularly crucial for designing optimal regulations and cost-reflective tariff schemes to attract adequate private sector investments in the power sector. However, this is a less explored area in the literature. Comparably, only a few quantitative studies have critically assessed how existing regulations and tariff policies in SSA affect mini-grid projects' potential to attract the number of private investments required to scale-up deployments (Williams et al. 2018). From another perspective, there is no consensus in the literature about whether mini-grid projects in SSA are profitable enough to crowd in private financing of mini-grid projects. On the one hand, some researchers argue that mini-grid projects powered by renewable energy are economically viable and capable of paying-off their financing cost and earning adequate returns for investors (Okoye & Oranekwu-Okoye 2018, Arowolo et al. 2019). On the other hand, other studies also argue that mini-grid projects in SSA are not economically feasible; thus, it requires subsidies to enable investors to recover their production cost (Azimoh et al. 2016, Nizami et al. 2017, Adaramola et al. 2017). This controversy

about the profitability of mini-grid projects in SSA further strengthens the motivation of this paper.

Firstly, we review the regulatory policies and the operation of mini-grid systems in Tanzania to draw useful lessons for other SSA countries. Secondly, we use an optimization model to estimate the Levelized cost of energy (LCOE) for three mini-grid project designs: Thermal, PV+Battery and Hybrid systems in Mafinga Town. The model uses a derivative-free optimization to search for the least costly system. The LCOE for the least costly system is then compared with the regulated mini-grid tariff and the available subsidy schemes in Tanzania to assess the mini-grid project's profitability.

Mafinga Town, the study's specific location, is based on recommendations by the Electricity and Water Regulatory Authority (EWURA) and the World Resource Institute (WRI). It is one of the preferred locations for private mini-grid investments in Tanzania. Additionally, this choice is also motivated by other factors, including high electricity need (92% unconnected households) and the presence of a high solar resource of 6.24 kWh/m².

We organize the rest of the paper as follows. Section 2 presents a background of mini-grid development, regulation, financing, and operation in Tanzania. In Section 3, we describe both the methodology and the study area chosen for this paper. Section 4 discusses the results from our LCOE model vis-à-vis the current tariff structure in Tanzania. Section 5 concludes with some policy recommendations.

2.2 History of mini-grid projects in Tanzania

Tanzania has rich experience in terms of mini-grid developments and regulations. The development and operation of mini-grid systems in Tanzania is dated as far back as 1908 during the colonial era, where the colonial masters develop mini-grid systems to power railway workshops, mining and agricultural industries (Odarno et al. 2017). During the same period, faith-based organizations also develop mini-grid systems to provide social services in a particular part of Tanzania. After independence in 1964, Tanzania continued to develop mini-grid systems to provide electricity access to decentralized communities in the country. Despite Tanzania's long history with mini-grid systems development, electricity access in the country is still low. According to the World Bank (2016b) household electrification survey, only 32.8% of Tanzanians have access

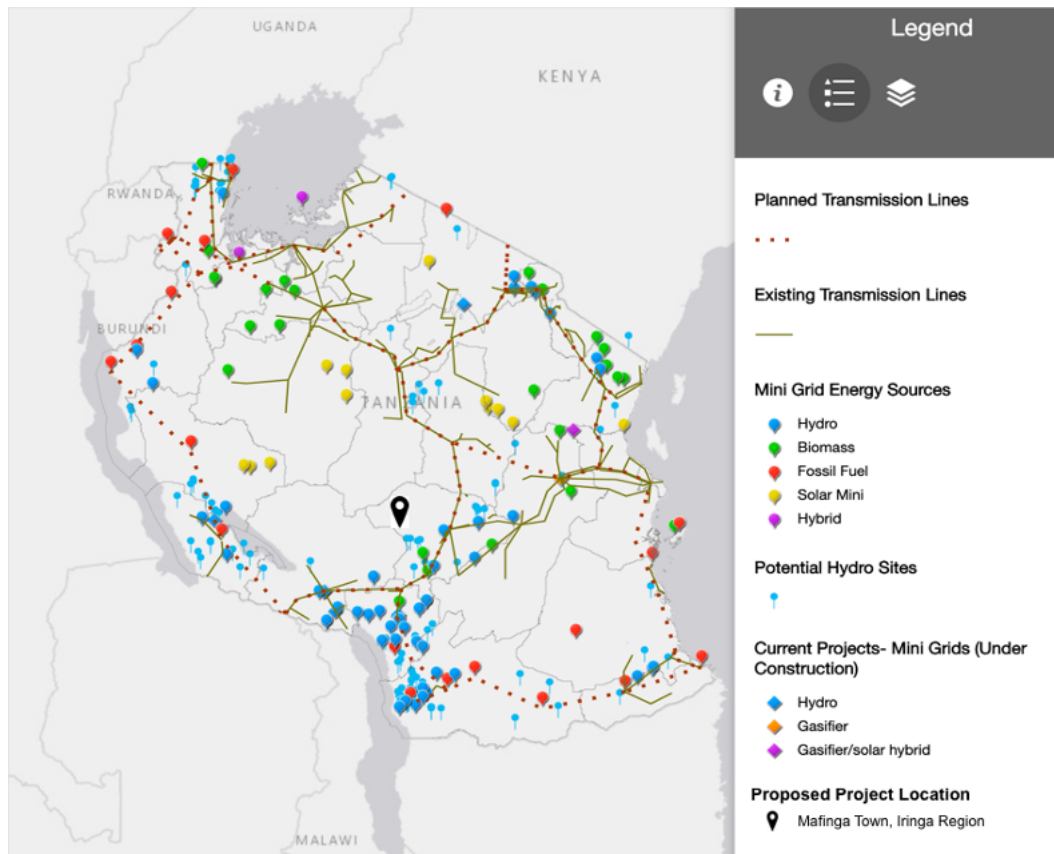

Figure 2.1: Mini-grid Projects in Tanzania

Source : Authors' elaboration from the WRI energy access map

to electricity. About 6.2 million rural households in Tanzania lack access to electricity (World Bank, 2016b). Given the dispersed type of settlement in rural Tanzania, grid extension is not a cost-effective option for extending electricity access to rural consumers. Therefore, TANESCO, the national utility company, uses standalone mini-grid systems powered by diesel and natural gas to extend electricity access to isolated communities. Tanzania currently has about 109 mini-grid systems in 21 regions operated by the national utility company, faith-based organizations, local communities, and private developers. Figure 2.1 shows the various types of mini-grid systems in Tanzania as of 2014. It highlights areas suitable for various mini-grid technologies based on the energy resources available in those areas. The black location indication on the map represents the specific area of interest for our study.

2.3 Regulatory Framework

After several years of operations, Mini-grid developers in Tanzania still face some challenges, including a lack of regulatory framework and a specific tariff policy for mini-grid systems. The Electricity and Water Utilities Regulatory Authority (EWURA), which oversees Tanzania's power sector regulation, introduces a specific regulatory framework for small power producers (SPPs). The regulatory intervention saw the implementation of standardized power purchase agreements (SPPA) and standardized power purchase tariffs (SPPT), popularly known as feed-in-tariffs (FiT) for SPPs. However, the first generation of feed-in-tariffs EWURA introduced was technology-neutral, which means that the FiT favors some technologies. The regulator also quotes the FiTs in the local currency, which exposes developers to high currency risks.

In response to the above challenges, in 2008, the regulator developed attractive mini-grid policies and regulatory frameworks that address the power sector's challenges and encourage further investments in renewable energy-based mini-grid systems in the country (Odarno et al. 2017). EWURA revised the SPP regulatory policies to provide clear policy guidance for SPPs connected to the national grid and mini-grid systems that serve isolated communities. The regulations require developers of mini-grid systems with capacities of 1 MW and above to obtain a license from the regulator before commencing operations. Mini-grid systems between 1 MW and 100 kW are required to register with the regulator, whereas projects below 100 kW require neither a license nor the regulator's tariff approval. Additionally, EWURA implemented the technologic-specific and size-specific feed-in-tariffs for various mini-grid technologies. Feed-in-tariffs for mini-grid systems connected to the national grid were denominated in the US dollar to reduce the currency risks. Also, EWURA removed taxes and import duties on renewable energy technologies to make them more competitive. Additionally, the EWURA introduced a mini-grid information portal and geospatial portfolio planning tools, which provide comprehensive information on mini-grid developments in Tanzania and reduce pre-site preparation costs significantly.

2.3.1 Financing mini-grid systems in Tanzania

Furthermore, from 2008 to 2014, the Tanzanian government, with support from the World Bank, establish some financial support schemes to encourage local mini-grid developers to invest in the rural electrification program. The financial support scheme includes Smart Subsidies and Credit

Line Facility. Under the Smart Subsidies, policymakers assist local developers with a matching grant of \$100,000 for environmental impact assessment and business plan development. Also, as part of the Smart Subsidies, developers benefit from a performance grant of \$500 for each household connected. However, renewable energy-based mini-grid systems require high initial capital investments that are often difficult for local developers to access from financial institutions due to doubts about mini-grid projects' economic viability (Ahlborg & Hammar 2014). Therefore, the government introduced the US \$23 million credit line facility to provide commercial loan to small power producers. The loan facility is accessible through the Tanzania Investment Bank with 15 years payback period. Additionally, the World Bank has also made available \$75 million under the Renewable Energy Rural Electrification Program to support the development of mini-grid projects between 2015 and 2019 (Odarno et al. 2017).

Despite the above regulatory interventions, there is still uncertainty among private developers about the fate of their investments in the arrival of the national grid. Up to date, there is no clear regulatory directive in that regard. However, the regulator envisages the following possible options. Firstly, the mini-grid operator can continue its operations as a small power producer and sell excess electricity to TANESCO. Secondly, in the event where the mini-grid operator is unable to compete with the national utility, the operator has the option to decommission its generation asset and buys electricity from TANESCO as a small power distributor. Lastly, the operator has the option to decommission its generation asset and sell-off its distribution asset to TANESCO.

2.3.2 Tariff Regulatory Policy in Tanzania

Electricity regulators in SSA face the choice of applying the uniform national tariff or the cost-reflective tariffs for mini-grid systems operators. The uniform national tariff is a fixed regulated rate that the regulator charges all customers irrespective of whether they are served by the national grid or by mini-grid systems. The idea behind this tariff scheme is to ensure equality and fairness across all consumer types. Mostly, utility regulators fix the electricity tariff for commercial mini-grid operators at the same rate as the state-owned utility service, which the government often subsidizes below the cost of supply (Reber et al. 2018). Usually, the main drivers of the tariff scheme are political and social considerations. Mini-grid systems operators struggle to be competitive under the national uniform tariff scheme as their production costs are often significantly higher

than the uniform national tariffs.

Under the cost-reflective tariff scheme, the regulator deregulates the electricity rates, and operators are allowed to charge rates that will enable them to recover the power supply costs and earn favorable returns on their investments. With the cost-reflective tariff scheme, economic considerations are the main determinants of the electricity rates underpinned by "*willing buyer – willing seller agreements*". Therefore, it is perceived as a more effective scheme for attracting private mini-grid developers and encouraging efficient electricity use (ECA, 2017). However, it does not consider the consumer ability to pay for power.

According to the Economic Consulting Associates (ECA), there is a mid-way approach that serves as a third option for regulators. Under the mid-way approach, operators are allowed to charge regulated cost-reflective tariffs. However, the regulator and the operator must agree on the rate of financial returns and the payback periods (ECA, 2017). In the case of Tanzania, the regulator is more inclined towards the mid-way approach. EWURA sets the mini-grid tariffs relatively higher than the grid rate (TZS 203.11/kWh or \$0.08/kWh). However, EWURA determines the rate of financial returns and the payback periods for the mini-grid operators. EWURA uses the "*avoided cost*" methodology to determine the electricity tariffs for small power producers in Tanzania. Moner-Girona et al. (2016) define avoided cost as "*the price that the utility would have paid if it had to produce the power by itself or bought it.*" In other words, it is the best-forgone alternative for a set of consumer groups at a particular location. Therefore, "the avoided cost, therefore, serves as the 'floor' price (a price specified in a market-price contract as the lowest purchase price of electricity, even if the market price falls below the specified floor price)" (Moner-Girona et al. 2016). Once the floor price is determined, a capacity band is applied to balance the tariff option for the various mini-grid technologies effectively. The approved standardized small power producers' tariffs are then subject to review once every three years. Table 2.1 presents the recently updated approved tariffs for various mini-grid system operators in Tanzania.

Table 2.1: Approved Standardised Small Power Producers Tariffs (Selling to the Grid)

Capacity (MW)	Minihydro (USc/kWh)	Wind (USc/kWh)	Solar (USc/kWh)	Biomass	Bagasse (USc/kWh)
0.1 – 0.5 MW	10.65	10.82	10.54	10.15	9.71
0.51 – 1 MW	9.90	9.95	9.84	9.34	9.09
1.01 – 5 MW	8.95	9.42	9.24	8.64	8.56
5.01 – 10 MW	7.83	8.88	8.34	7.60	7.55

Source : EWURA, 2019a.

2.4 Results: Methods and Data

This section describes the methodology adopted by this study. We provide an overview of the selected community for the study, followed by explaining the two indicators used to assess the proposed project's profitability: the economic buoyancy vector and the LCOE. Later, we describe the data used for this project.

2.4.1 Description of Project Site – Mafinga Tow

Our study's area comprises five villages in Mafinga Town, located in the Mufindi district of central Tanzania (Iringa Region). The villages are Ivambinungu, Mkombwe, Pipeline, Malingumu, and Mjimwema. According to the 2012 Tanzania national census, Mafinga Town has a total population of 51,902 and a total household of 12,532 (*The United Republic of Tanzania, 2013*). We choose Mafinga Town for our study because both EWURA and the World Resource Institute (WRI) identify the Mufindi district as a preferred location for mini-grid enterprise investment. Both in terms of the rich solar energy resource potential and the economic buoyancy of the district. However, the district has one of the lowest electrification rates in the region. Out of the total households in Mafinga Town, 11,629 households with about 92.8% do not have access to electricity. Kerosene remains the primary energy source of light in the entire Mafinga Township to the extent that its usage has decreased by only 3.8% between 2012 and 2016 (*The United Republic of Tanzania, 2017*). The five villages considered in this study have a total unconnected population of 18,140 people and 4,424 unconnected households. Figure 2.2 shows a satellite image of Mafinga Town with the five villages earmarked for mini-grid electrification.

2.4.2 Solar Resource

The Iringa region is considered to have one of the highest solar energy resources in Tanzania, as presented in Figure 2.3 (*ESMAP 2015*). The Global Horizontal Irradiance (GHI) of the region located at latitude 7.67 south and longitude 35.75 east is estimated at 6.24 kWh/m² (*ESMAP 2015*). We use the HOMER software, linked to NASA's Surface Meteorology and Solar Energy (SSE) dataset, to estimate the region's average daily radiations. The SSE has proved to be an accurate and reliable source for providing solar and meteorological data for regions with sparse or no surface measurement data (*Pavlović et al. 2013*). Additionally, the SSE dataset is explicitly



Figure 2.2: Satellite image of Mafinga Town
Source : Tanzania Mini-grid Portal GIS

formatted to support PV power system designs.

The graph in Figure 2.4 illustrates the average daily variations in the solar resource data for the Iringa region downloaded from NASA's SSE dataset.

2.4.3 Levelized Cost of Energy

The LCOE is the cost of producing a kilowatt unit of electricity. To compute the LCOE, we use the Hybrid Optimisation of Multiple Electric Renewables (HOMER), a computational software developed by the Alliance for Sustainable Energy System (ASES). For the proposed project, we consider three system design options: Thermal generation with a diesel generator, renewable energy generation with PV + Battery and a Hybrid System with a combination of thermal and renewable generation sources. The objective is to evaluate the economic and technical feasibility of these technology options. We use the HOMER software to model the project's power system's physical behaviour by performing energy balance calculations and simulating all feasible system configurations such as sizing system components (PV array, Battery, system convertor and generator). The software calculates the energy flow to and from each component to determine the best

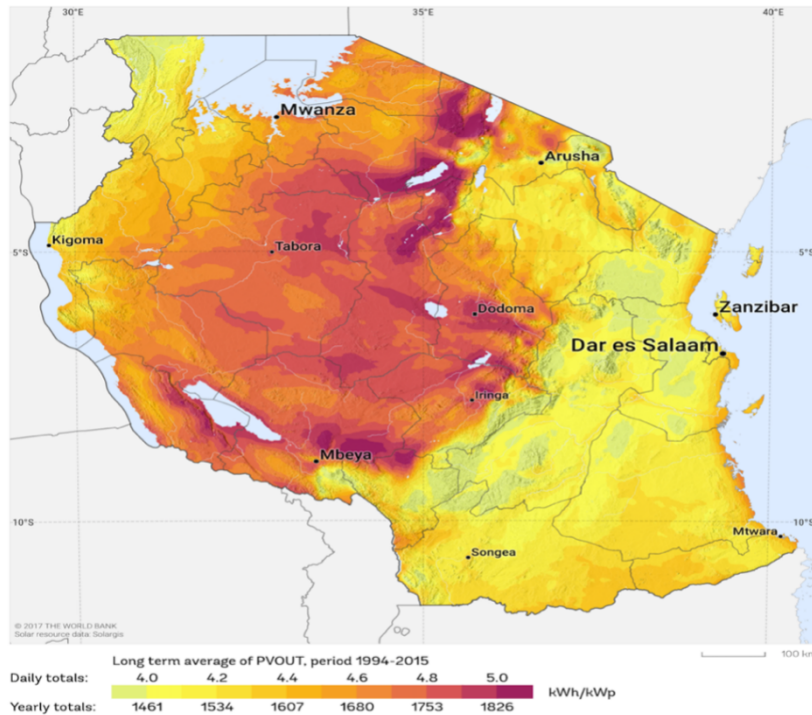

Figure 2.3: Photovoltaic Power Potential of Tanzania
 Source : World Bank Group, 2015

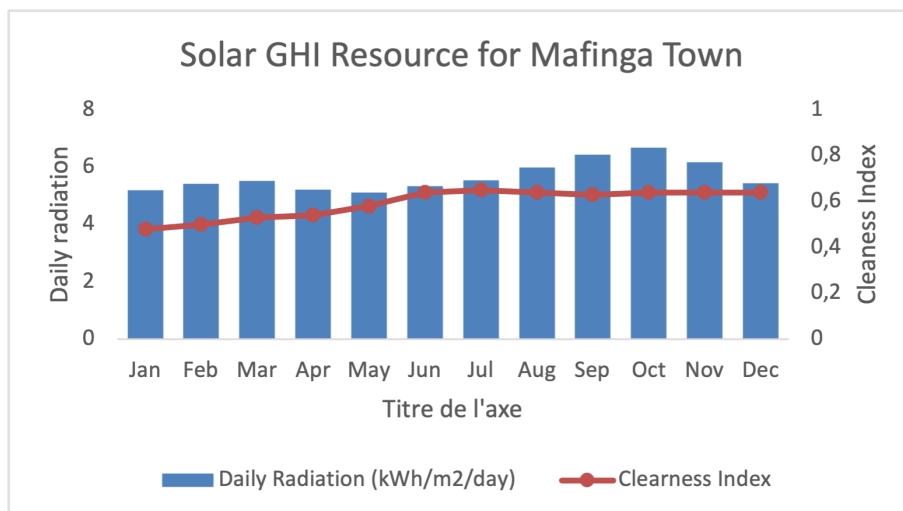

Figure 2.4: Solar Global Horizontal Irradiance (GHI) for Mafinga Town- Iringa Region
 Source : Authors' elaboration with data obtained from the SSE database, 2019

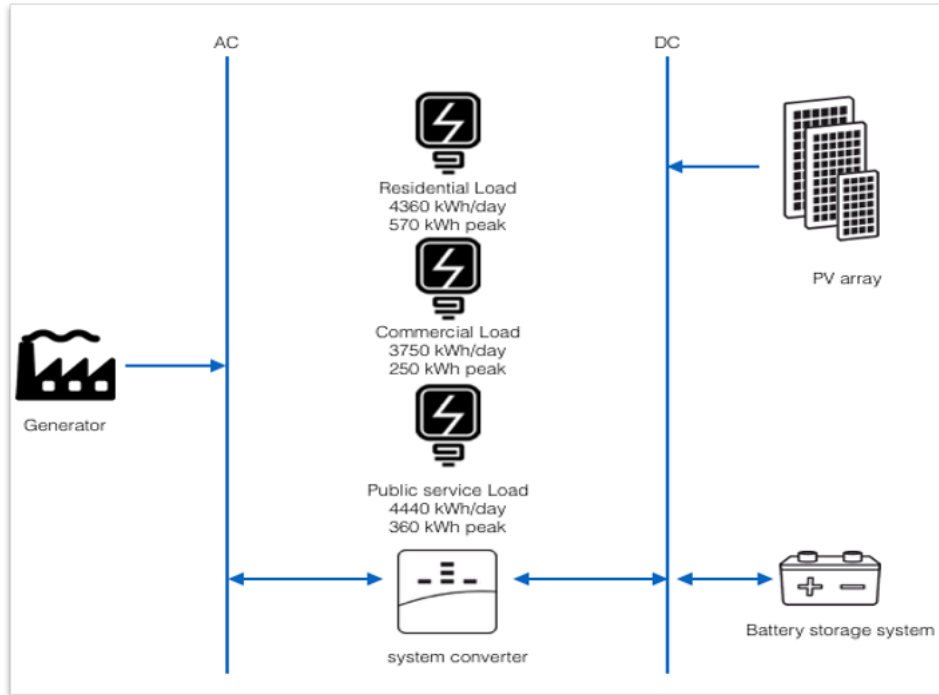

Figure 2.5: Proposed mini-grid system design
 Source : Authors' elaboration

system configurations required to meet the load demand and estimate the system's minimum capital and operating and maintenance costs over the project's lifetime. HOMER uses a derivative-free optimization to search for the least costly system ranked by the LCOE, which is then compared with the approved mini-grid tariff to determine the mini-grid project's profitability. Figure 2.5 illustrates the System Design.

2.4.4 Modelling the energy flow and the LCOE of the project.

We discuss the calculation of the energy flow and the simulation of the feasible system configuration components that feed into the financial model.

The PV+Battery system Model

The PV+Battery system consists of a PV array, a battery storage system, and a converter as illustrated in Figure 2.5. The model uses Equation 2.1 to simulate the PV array power output from a series of parameters, including the solar irradiance of Mafinga Town, temperature, degradation factor, PV module installation and system component specifications. We present the PV module's

system optimized capacity in the LCOE result summary in Table 4 and the total net present cost and the annualized cost of the PV module in Table .0.7 in Appendix.

2.1: Equation: PV array power output

$$P_{pv} = Y_{pv} f_{pv} \left(\frac{\bar{G}_T}{\bar{G}_{T,STC}} \right) [1 + \alpha_P (T_c - T_{c,STC})] \quad (2.1)$$

Where: Y_{pv} is the predicted average power output of the PV array under standard test conditions in kW, f_{pv} denote the derating factor of the PV array, \bar{G}_T is the solar radiation incident on the PV array in the current time step expressed in (kW/m²), $\bar{G}_{T,STC}$ represents the incident radiation at the standard test condition given as (1kW/m²), α_P is the temperature coefficient of power expressed as (%/°C), T_c equals to the ambient temperature of PV cell, average throughout the test (°C), and $T_{c,STC}$ equals to the PV cell temperature of 25°C under standard test condition.

Battery Storage System

“The variability and intermittency of solar generation require a flexible storage system” (Hoarau & Perez 2019). Therefore, to ensure the system’s higher reliability, we consider a battery storage system consisting of several Lithium-Ion (Li-ion) batteries. Li-ion batteries have higher round-trip efficiency (97.5%) and a higher life span than lead-acid batteries. The temperature at which a battery is kept has a strong bearing on the storage system’s life span. According to (Smith et al. 2017), batteries exposed to higher temperature often have a shorter life-span. Therefore, we consider a battery maintenance system consisting of air conditioning, active air circulation, and direct evaporative cooling to control the batteries’ temperature and improve the storage system’s useful life for the proposed project. Lockhart et al. (2019) referred to this maintenance system as the heating, ventilation, and air-conditioning (HVAC) configuration, which the authors found to be very useful in prolonging a battery’s life-span in SSA. However, it costs relatively more to implement the battery maintenance system’s HVAC configuration; therefore, we consider \$20 per kWh as the battery maintenance cost, consistent with Lockhart et al. (2019).

The battery storage system (BSS) model requires the following values to calculate the total cost of the BSS: The Battery initial and replacement cost (\$/kW), maintenance cost (\$/kW), the life-span of BSS (years) and BSS total capacity. HOMER uses a simulation optimization technique to determines the optimal BSS capacity. We present the storage systems’ capacity in the LCOE

result summary in table 2.4. Table 2.4 shows the BSS initial cost, and Table .0.7 in Appendix shows the replacement cost and maintenance cost. The life-span of the BSS is determined using the following Equation.

Equation: Life-Span of the Storage Bank

$$R_{batt} = MIN \left(\frac{N_{batt} \cdot Q_{lifetime}}{Q_{thrpt}}, R_{batt,f} \right) \quad (2.2)$$

Where R_{batt} is the BSS' life (yr.), N_{batt} is the number of batteries in the BSS, $Q_{lifetime}$ is the lifetime throughput of a single battery (kWh), Q_{thrpt} and $R_{batt,f}$ represent the annual storage throughput (kWh/yr.) and storage float life (yr.) respectively.

Generator Model

Following values are needed to model the LCOE for the diesel generator system design: the generator capacity, fuel consumption rate, generator efficiency rate, diesel cost (\$/litre), generator life-span and operation and maintenance cost. The fuel cost is a significant cost parameter of the generator model, depending on the generator's fuel consumption curve. The fuel consumption curve is defined as the amount of fuel the generator consumes to produce a kilowatt-hour of electricity; thus, it is linearly related to the electrical output as expressed in Equation 3 and illustrated in Figure 2.6.

Equation: Fuel consumption curve

$$F = F_0 \cdot Y_{gen} + F_1 \cdot P_{gen} \quad (2.3)$$

Where F denotes the total fuel consumption for each timestep, F_0 represents the non-load fuel consumption per kW by the generator (fuel curve intercept coefficient expressed in (units /hr/kW)), and Y_{gen} represents the rated capacity of the diesel generator (kW). F_1 is the marginal fuel consumption per kW of the generator output in each timestep (the fuel curve slope also expressed in (units /hr/kW)), and P_{gen} represents the electrical output of the diesel generator. For our proposed project, we use the system optimized $F_0 = 32.4$ L/hr and $F_1 = 0.236$, which give the fuel consumption curve illustrated in Figure 2.6.

The life-span of the generator represents the generator's actual operational life (R_{gen}), after which a replacement is required. It is defined in Equation 2.4 as the lifetime hours of the generator

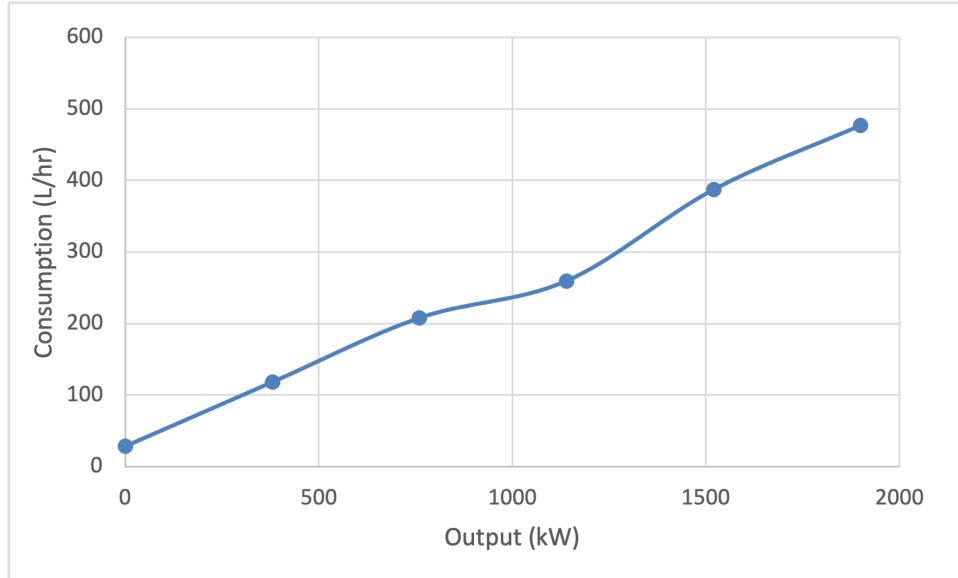

Figure 2.6: Fuel Consumption Curve
 Source : Authors' elaboration

$(R_{gen,hr})$ divided by the number of hours the generator operates during the year (N_{gen}).

Equation: Operational life-span of the generator

$$R_{gen} = \frac{R_{gen,hr}}{N_{gen}} \quad (2.4)$$

The summation of the annualized fuel cost, generator initial and replacement costs, and OPEX divided by the total electrical load served gives the LCOE for the generator model. We present the individual cost components in Table .0.8 of Appendix and the generator's auto-sized capacity in Table 2.4 (LCOE result summary).

Modelling the LCOE

The LCOE is the total annual cost of installing, operating, and maintaining the mini-grid system divided by the total electricity served to consumers. We use Equation 5 to calculate the LCOE.

Equation: Levelized Cost of Energy

$$LCOE = \frac{C_{ann,tot}}{E_{served}} \quad (2.5)$$

Where $C_{ann,tot}$ is the total annualised system cost per year expressed in (\$/yr.). The E_{served} is the total electrical load served respectively for our proposed system.

The Annualized Cost

As mentioned, the proposed mini-grid system has a life-cycle of 25 years, which implies that system components such as the battery storage system, converter and Genset will require replacements at particular times. Therefore, we assume a discount rate of 10% to translate all future cash flows of the project to present costs to estimate the proposed project's net present cost. This assumption is consistent with (Hittinger et al. 2015). The total NPC and annualized cost of each system components are presented in Appendix.

Equation: Annualized Cost

$$C_{ann,tot} = CRF \cdot C_{NPC,tot} \quad (2.6)$$

Where $C_{ann,tot}$ represents the total annualised cost, $C_{NPC,tot}$ is the total net present cost (\$), CRF is the capital recovery factor (the present value of an annuity), and it is defined in Equation 2.7 as:

Equation: Capital Recovery Factor

$$CRF = \frac{i(1+i)^N}{i(1+i)^N - 1} \quad (2.7)$$

Where: i and N represent the real discount rate and the number of years, respectively.

Data and Load estimation.

We obtain the local economic and techno-economic data from the Tanzania 2012 National Population Census, Tanzania mini-grid portal, World Bank Group and the National Renewable Energy Laboratory (NREL) publications. We obtain about two-thirds of the cost assumptions from the World Bank Group's publication on mini-grids market outlook (ESMP 2019). Table 2.2 shows the cost assumptions used in this study.

2.4.5 Electricity Demand Estimation

We rely on data from the following two sources to estimate the potential electricity demand from the five villages in Mafinga Town (Banerjee et al. 2017, Williams et al. 2017). Banerjee et al. (2017) include case-studies of two mini-grids systems in Tanzania, of which the Mwenga mini-grid project is of comparable size as the proposed project, in terms of similar household types,

commercial, community and agricultural activities. Likewise, the study by Williams et al. (2017) is based on case-studies of mini-grid projects in four different Tanzania communities, which exhibit similar daily load consumption reported by the World Bank report. The Rural African load profile tool simulates the hourly electrical load profile for various households and commercial entities commonly found in rural Sub-Saharan Africa. Thus, based on the data obtained from the world bank publication and validated with Williams et al. (2017), we used the Load profile tool to simulate the potential electricity demand for Mafinga Town. Table 2.3 presents the total estimated daily, yearly loads and the peak demand for the various consumer types in the five villages in Mafinga Town. The projected load profile for Mafinga Town is exhibited in Figure 2.7.

Table 2.2: Cost assumptions of the input parameters

Assumptions	Base Case	Future Projections	References
Solar generation			
Installed PV cost [\$/kW]	\$230	\$140	Estimated 39% cost reduction by 2030 (ESMAP, 2019)
PV OM \$/kW	\$10	\$6.1	
Useful life	25 years	25 years	
Battery storage cost [\$/kWh]	\$263	\$95	Estimated 64% cost reduction by 2030 (ESMAP, 2019)
Battery useful life	15 years	15 years	
Battery O&M [\$/kWh-installed]	\$20	\$10	
Converter costs [\$/kW]	\$115	\$58	Estimated 50% cost reduction by 2030 (ESMAP, 2019)
Converter replacement cost [\$/kW]	\$58	\$58	
Converter useful life	15 years	15 years	
Thermal generation			
Diesel genset cost [\$/kW]	\$500	\$400	NREL and ASES
Useful life	10 years	10 years	(https://www.nrel.gov/)
Fuel cost [\$/L]	\$0.95/L	\$0.95/	(EWURA, 2019b)
Fuel escalation rate	3%	3%	NREL and ASES
System fixed and operational cost			
Total distribution system costs	\$160/client	\$160/client	(ESMAP, 2019)
Smart Meters	\$40/client	\$30/client	
Pre-operating soft costs [\$/kW]	\$2'300	\$2'300	(Reber et al., 2018) and NREL, (ESMAP, 2019)
Annual labor costs [\$/year]	\$38'000	\$38'000	
Annual land lease costs [\$/year]	\$800	\$800	

Table 2.3: Load Profile Output Table

	Household Load	Commercial Load	Public Service Load	Total Community Load
Total MWh/day	4.36	3.75	4.44	12.55
Total MWh/year	1'591.40	1'368.75	1'620.60	4'580
Peak MW/day	0.57	0.25	0.36	0.77
Reserve Margin	10%	10%	10%	10%
Timestep variability	16%	16%	16%	16%
Daily Variations	20%	20%	20%	20%
Load Factor %	22%	27%	27%	31%

Source : Author's estimation

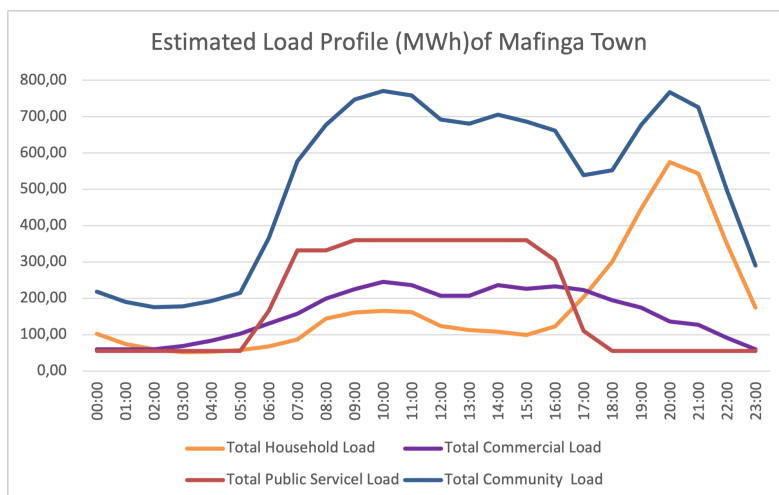

Figure 2.7: Estimated Load Profile of Mafinga Town
 Source : Authors' estimation

2.5 Results

This section discusses the results of the HOMER model. Table 2.4 shows the possible system configuration, such as the system components' capacity, the system cost summary, and the LCOE for the three system designs. In Table 2.5, we present the sensitivity analysis using 2030 cost estimates. Figure 2.8 demonstrates the breakdown of the LCOE by system cost components.

The LCOE vary significantly from one technology option to another. The Hybrid System emerges as the most cost-effective solution with approximately 89% penetration of renewable energy generation (PV+ Battery) throughout the year. Its optimal system configuration is expected to generate 16.75 MW of electricity per day, approximately 22% more than the estimated load demand of 12.55 MW per day. It has a total life-cycle cost (net present cost) of \$18.20 million and requires an electricity tariff of 32 cents to breakeven. The PV+ Battery System appears to be the second cost-effective solution and compared to the Hybrid System; it will cost consumers extra 14 cents per kWh of electricity consumed. The PV+Battery system generates almost twice the projected electricity demand (23.17 MWh per day) to ensure high system reliability, indicating that the feasible system configuration is over-sized to make-up for the PV's intermittent generation. The Diesel Genset option is the least cost-effective solution. Besides, it has a higher impact on the environment and produces about 4,067 tonnes of greenhouse gas emission per year. It also produces about 16% excess electricity to ensure high system reliability. The cost of fuel accounts for about half (\$0.36/kWh) of the LCOE. However, under the PV + Battery and the

Hybrid Systems, capital expenditure (CAPEX) accounts for more than half of the LCOE (see Figure 2.8).

2.5.1 The Profitability of the Proposed Mini-grid System

The approved tariff for the proposed mini-grid project is approximately 10 cents per kWh, below the LCOE of the most cost-effective solution for the proposed project – the Hybrid System. The Hybrid system requires a minimum of 31 cents per kWh to recover its cost of investments. Thus, selling electricity at the current rate of 10 cents per kWh for the proposed mini-grid system will result in a loss of 21 cents on every kWh of electricity produced, which amounts to a total gross loss of \$998,145 per year. Besides, EWURA approves an 18.5% return on equity for SPPs. Therefore, for the proposed mini-grid project to be financially sustainable, it must retail its electricity at a minimum rate of 38 cents per kWh, which implies that the project will require a subsidy of approximately \$1 million per year to be financially feasible.

However, most of the subsidies for mini-grid projects in Tanzania were implemented between 2008 and 2014 (Odarno et al. 2017). Even if we apply the subsidies that used to be in place (Marching Grant and Performance Grant), they will not be enough to make the project profitable. Therefore, we argue that under the current tariff scheme in Tanzania, mini-grid projects are not financially viable from an investment perspective.

Table 2.4: LCOE Result Summary

	Diesel Genset	PV + Battery	Hybrid System
PV capacity	-	5,095 kW	2,849 kW
Battery (LA) capacity	-	24,122 kWh	10,625 kWh
Converter capacity	-	2,276 kW	1,460 kW
Diesel generator capacity	1,900 kW	-	1,900 kW
NP life-cycle cost	\$33'495'760	\$26'713'380	\$18'186'120
Initial Capital cost	\$1'837'100	\$20'231'101	\$11'922'078
Operating Cost	\$2'518'502	\$515'677	\$498'315
LCOE	\$0.58	\$0.46	\$0.32
Total emission/yr.	4,067,580 kg	0.00 kg	451,083.50 kg
SSP Tariff \$/kwh	\$0.10	\$0.10	\$0.10
Difference \$/kwh	-\$0.48	-\$0.37	-\$0.22
Annual Loss	-\$2'213'876	-\$1'675'193	-\$995'855

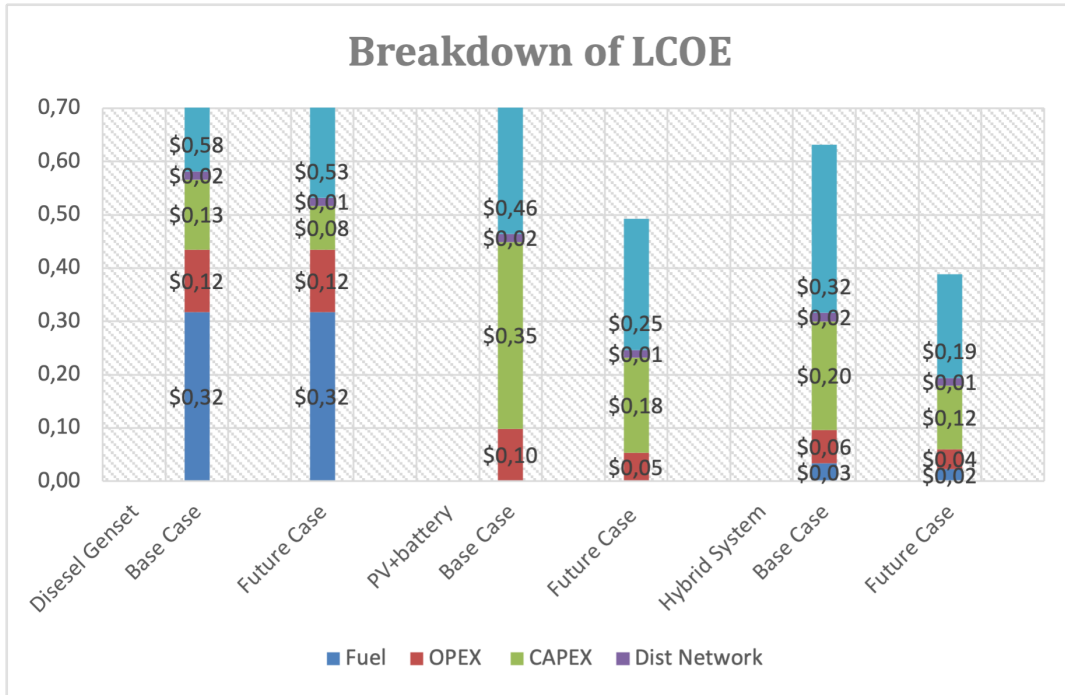

Figure 2.8: LCOE Breakdown
 Source : Authors' estimation

2.5.2 Sensitivity Analysis

Although the Hybrid System emerges as the most cost-effective solution, the competitiveness of the PV+Battery system is highly influenced by parameters such as cost of capital, system reliability and capital investment cost. Therefore, given the rapidly declining cost of renewable energy technologies, we performed a sensitivity analysis on the LCOE for the three system designs using the 2030 cost estimates by (ESMP 2019), different discount rates from 3% to 15% and annual capacity shortages from 5% to 30%. We assess the effect of all the variables on the LCOE and find that combining the three factors will deliver the lowest LCOE between 10 cents per kWh and 7 cents per kWh.

However, this is an extreme case, which in the context of Tanzania, it is neither feasible now nor by 2030. This is based on the assumption that given the high investment risks associated with mini-grid projects in SSA, most private investors prefer to discount their future cash flows at the interest rates they anticipate receiving over the life of their investments (Williams et al. 2018, Thornton 2018). Thus, it is less likely for solar mini-grid projects to be discounted at the rate of 3% in SSA from an investment perspective. Therefore, this reinforces our argument that private commercial mini-grid projects in Tanzania purposely for rural electrification are not profitable

even by 2030. Figure 2.9 illustrates the sensitivity of the LCOE to all three variables.

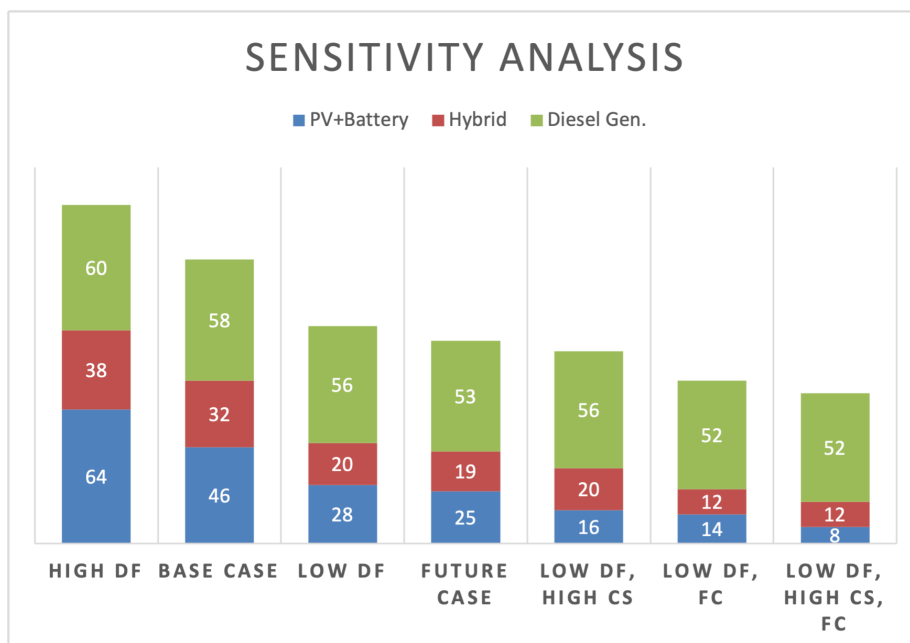

Figure 2.9: Sensitivity analysis using Discount Factor (DF), Capacity Shortage (CS) and Future Cost (FC)¹

Table 2.5: LCOE Result Summary - Future Case

	Diesel Genset	PV + Battery	Hybrid System
PV capacity	-	4,344 kW	3,004 kW
Battery (LA) capacity	-	32,707 kWh	12,972 kWh
Converter capacity	-	2,349 kW	1,702 kW
Diesel generator capacity	1,900 kW	-	1,900 kW
NP life-cycle cost	\$30'615'800	\$14'191'200	\$11'185'560
Initial Capital cost	\$1'602'860	\$10'711'328	\$7'514'684
Operating Cost	\$2'308'030	\$276'830	\$292'025
LCOE	\$0.53	\$0.25	\$0.19
Total emission/yr.	4,067,580 kg	0.00 kg	649,684.50 kg
Avg. Nat. Tariff \$/kwh	\$0.10	\$0.10	\$0.10
Difference \$/kwh	-\$0.43	-\$0.15	-\$0.10
Annual Loss	-\$1'984'839	-\$678'522	-\$439'294
LCOE @ 8%	\$0.53	\$0.21	\$0.17
LCOE @ 15%	\$0.55	\$0.34	\$0.26

2.6 Conclusion

Our analysis shows that despite a well-structured mini-grid tariff system and subsidies initiatives in Tanzania, operating privately-owned mini-grid systems in rural communities is not financially

¹High DF = 15% and Low DF = 3%, CS: 25% (about 18 hours of power supply per day), FC: 2030 cost estimates.

feasible. Further, we describe some of the challenges with the effective deployment of mini-grid systems in Tanzania. Specifically, we highlight non-cost-reflective tariff for mini-grid projects and the commercial risk of mini-grid projects as significant challenges facing the commercial deployment of mini-grid systems in Tanzania. Therefore, the government may consider the following:

Firstly, EWURA may want to review its tariff scheme for mini-grid developers to reflect the electricity supply cost from an off-grid system to serve isolated rural communities. This is particularly important because it appears the current tariff scheme is based on mini-grids systems connected to the grid. Meanwhile, the grid-connected mini-grids enjoys significant trade-offs between buying unmet load from the grid and selling excess load to the grid and oversizing the system to ensure system reliability. This option is rarely available to off-grid developers except for the latter, which is considerably more expensive.

Secondly, given the Hybrid and PV+Battery systems' high initial capital requirement, the government may consider expanding its loan facilities to enable private developers to access adequate funding for their projects at a considerably low rate.

Lastly, as pointed out earlier, with an annual capacity shortage of 15%, the PV+Battery system emerges as the most cost-effective solution for providing electricity at the rate of 28 cents per kWh (approximately 40 percent decrease in LCOE). In this regard, we recommend that private developers consider complementary solutions such as Solar Home Systems to make-up for the capacity shortage if necessary.

Bibliography

- Adaramola, M. S., Quansah, D. A., Agelin-Chaab, M. & Paul, S. S. (2017), 'Multipurpose renewable energy resources based hybrid energy system for remote community in northern ghana', *Sustainable Energy Technologies and Assessments* **22**, 161–170.
- Ahlborg, H. & Hammar, L. (2014), 'Drivers and barriers to rural electrification in tanzania and mozambique–grid-extension, off-grid, and renewable energy technologies', *Renewable Energy* **61**, 117–124.
- Arowolo, W., Blechinger, P., Cader, C. & Perez, Y. (2019), 'Seeking workable solutions to the electrification challenge in nigeria: Minigrid, reverse auctions and institutional adaptation', *Energy Strategy Reviews* **23**, 114–141.
- Azimoh, C. L., Klintonberg, P., Wallin, F., Karlsson, B. & Mbohwa, C. (2016), 'Electricity for development: Mini-grid solution for rural electrification in south africa', *Energy Conversion and Management* **110**, 268–277.
- Banerjee, S., Malik, K., Tipping, A., Besnard, J. & Nash, J. (2017), 'Double dividend: Power and agriculture nexus in sub-saharan africa. 250'.
- Eberhard, A. & Shkaratan, M. (2012), 'Powering africa: Meeting the financing and reform challenges', *Energy Policy* **42**, 9–18.
- ECA, (2017), 'Economic Consulting Associates Viewpoint Mini-grids: Are cost-reflective tariffs

necessary? What are the options? Economic drivers of tariff policy’. Retrieved from www.eca-uk.com.

ESMAP (2015), ‘Solar resource mapping in tanzania’. Retrieved from.

URL: <http://documents.worldbank.org/curated/en/651091467986286838/pdf/96827-ESM-P145287-PUBLIC-Box391467B-WBG-ESMAP-Tanzania-Solar-Modeling-Report-2015-02.pdf>

ESMP (2019), ‘Mini grids for half a billion people market outlook and handbook for decision makers’. Retrieved from.

URL: <https://openknowledge.worldbank.org/bitstream/handle/10986/31926/Mini-Grids-for-Half-a-Billion-People-Market-Outlook-and-Handbook-for-Decision-Makers-Executive-Summary.pdf?sequence=1&isAllowed=y>

Hittinger, E., Wiley, T., Kluza, J. & Whitacre, J. (2015), ‘Evaluating the value of batteries in microgrid electricity systems using an improved energy systems model’, *Energy Conversion and Management* **89**, 458–472.

Hoarau, Q. & Perez, Y. (2019), ‘Network tariff design with prosumers and electromobility: Who wins, who loses?’, *Energy Economics* **83**, 26–39.

IEA (2019), ‘Africa energy outlook 2019’, *World Energy Outlook Special Report* .

Lockhart, E., Li, X., Booth, S. S., Olis, D. R., Salasovich, J. A., Elsworth, J. & Lisell, L. (2019), Comparative study of techno-economics of lithium-ion and lead-acid batteries in micro-grids in sub-saharan africa, Technical report, National Renewable Energy Lab.(NREL), Golden, CO (United States).

Moner-Girona, M., Ghanadan, R., Solano-Peralta, M., Kougias, I., Bódis, K., Huld, T. & Szabó, S. (2016), ‘Adaptation of feed-in tariff for remote mini-grids: Tanzania as an illustrative case’, *Renewable and Sustainable Energy Reviews* **53**, 306–318.

Nizami, A.-S., Rehan, M., Waqas, M., Naqvi, M., Ouda, O. K., Shahzad, K., Miandad, R., Khan, M. Z., Syamsiro, M., Ismail, I. M. et al. (2017), ‘Waste biorefineries: enabling circular economies in developing countries’, *Bioresource technology* **241**, 1101–1117.

Odarno, L., Sawe, E., Swai, M., Katyega, M. J. & Lee, A. (2017), ‘Accelerating mini-grid deployment in sub-saharan africa: Lessons from tanzania’.

- Okoye, C. O. & Oranekwu-Okoye, B. C. (2018), 'Economic feasibility of solar pv system for rural electrification in sub-sahara africa', *Renewable and Sustainable Energy Reviews* **82**, 2537–2547.
- Pavlović, T. M., Milosavljević, D. D. & Pirsl, D. S. (2013), 'Simulation of photovoltaic systems electricity generation using homer software in specific locations in serbia', *Thermal Science* **17**(2), 333–347.
- Peters, J., Sievert, M. & Toman, M. A. (2019), 'Rural electrification through mini-grids: Challenges ahead', *Energy Policy* **132**, 27–31.
- Reber, T. J., Booth, S. S., Cutler, D. S., Li, X. & Salasovich, J. A. (2018), Tariff considerations for micro-grids in sub-saharan africa, Technical report, National Renewable Energy Lab.(NREL), Golden, CO (United States).
- SDG, U. (2019), 'Sustainable development goals', *The energy progress report. Tracking SDG 7*.
- Smith, K., Saxon, A., Keyser, M., Lundstrom, B., Cao, Z. & Roc, A. (2017), Life prediction model for grid-connected li-ion battery energy storage system, in '2017 American Control Conference (ACC)', IEEE, pp. 4062–4068.
- The United Republic of Tanzania*, (2013). Retrieved from.
URL: http://www.tzdp.gov.tz/fileadmin/documents/dpg_internal/dpg_working_groups_clusters/cluster_2/water/WSDP/Background_information/2012_Census_General_Report.pdf
- The United Republic of Tanzania*, (2017). 2(February), 2017.
URL: [https://doi.org/10.1016/S1052-3057\(16\)30617-6](https://doi.org/10.1016/S1052-3057(16)30617-6)
- Thornton, G. (2018), 'Africa renewable energy discount rate survey–2018', *no. October* .
- WEO, I. (2017), 'Special report: Energy access outlook', *IEA WEO: Paris, France* .
- Williams, N. J., Jaramillo, P., Cornell, B., Lyons-Galante, I. & Wynn, E. (2017), Load characteristics of east african microgrids, in '2017 IEEE PES PowerAfrica', IEEE, pp. 236–241.
- Williams, N. J., Jaramillo, P. & Taneja, J. (2018), 'An investment risk assessment of microgrid utilities for rural electrification using the stochastic techno-economic microgrid model: A case study in rwanda', *Energy for Sustainable Development* **42**, 87–96.

Base Case Cost Summary

Table .0.6: Cost Summary - Hybrid System

Net Present Cost						
Name	CAPEX	OPEX	Replacement	Salvage	Fuel	Total
Genset	\$950'000	\$741'593	\$398'506	-\$58'376	\$1'930'000	\$3'961'723
Li-Ion Battery	\$2'790'000	\$2'000'000	\$430'367	-\$54'588	\$0	\$5'165'779
PV Array	\$7'120'000	\$358'140	\$0	\$0	\$0	\$7'478'140
Converter	\$167'938	\$0	\$34'466	-\$6'309	\$0	\$196'095
System FC VC	\$887'100	\$487'733	\$0	\$0	\$0	\$1'374'833
Annualized Cost						
Name	CAPEX	OPEX	Replacement	Salvage	Fuel	Total
Genset	\$75'574	\$58'995	\$31'702	-\$4'644	\$153'463	\$315'090
Li-Ion Battery	\$222'297	\$159'375	\$34'236	-\$4'343	\$0	\$411'565
PV Array	\$566'620	\$28'491	\$0	\$0	\$0	\$595'111
Converter	\$13'360	\$0	\$2'742	-\$502	\$0	\$15'600
System FC VC	\$70'570	\$38'800	\$0	\$0	\$0	\$109'370

Table .0.7: Cost Summary - PV+Battery

Net Present Cost					
Name	CAPEX	OPEX	Replacement Cost	Salvage	Total
Li-Ion Battery	\$6'340'000	\$4'550'000	\$932'487	-\$170'684	\$11'651'803
PV Array	\$12'700'000	\$640'495	\$0	\$0	\$13'340'495
System Converter	\$261'785	\$0	\$53'726	-\$9'834	\$305'677
System FC VC	\$887'100	\$487'733	\$0	\$0	\$1'374'833
Annualized Cost					
Name	CAPEX	OPEX	Replacement	Salvage	Total
Li-Ion Battery	\$504'683	\$361'830	\$74'181	-\$13'578	\$927'116
PV Array	\$1'010'000	\$50'953	\$0	\$0	\$1'060'953
System Converter	\$20'825	\$0	\$4'274	-\$782	\$24'317
System FC VC	\$70'570	\$38'800	\$0	\$0	\$109'370

Table .0.8: Diesel Genset

Net Present Cost						
Name	CAPEX	OPEX	Replacement	Salvage	Fuel	Total
Genset	\$950'000	\$6'280'000	\$6'700'000	-\$85'264	\$18'300'000	\$32'144'736
System FC VC	\$70'570	\$38'800	\$0	\$0	\$0	\$109'370
Annualized Cost						
Name	CAPEX	OPEX	Replacement	Salvage	Fuel	Total
Genset	\$75'574	\$499'263	\$532'964	-\$6'783	\$1'450'000	\$2'551'018
System FC VC	\$70'570	\$38'800	\$0	\$0	\$0	\$109'370

Future Case Cost Summary

Table .0.9: Hybrid System

Net Present Cost						
Name	CAPEX	OPEX	Replacement	Salvage	Fuel	Total
Genset	\$760'000	\$504'426	\$158'926	-\$105'289	\$1'330'000	\$2'648'063
Li-Ion Battery	\$1'230'000	\$897'058	\$184'791	-\$33'824	\$0	\$2'278'025
PV Array	\$4'580'000	\$226'539	\$0	\$0	\$0	\$4'806'539
Converter	\$98'706	\$0	\$20'083	-\$3'676	\$0	\$115'113
System FC VC	\$842'860	\$487'733	\$0	\$0	\$0	\$1'330'593
Annualized Cost						
Name	CAPEX	OPEX	Replacement	Salvage	Fuel	Total
Genset	\$60'459	\$40'128	\$12'643	-\$8'376	\$106'131	\$210'985
Li-Ion Battery	\$98'057	\$71'362	\$14'700	-\$2'691	\$0	\$181'428
PV Array	\$364'386	\$18'022	\$0	\$0	\$0	\$382'408
Converter	\$7'852	\$0	\$1'598	-\$292	\$0	\$9'158
System FC VC	\$67'051	\$38'800	\$0	\$0	\$0	\$105'851

Table .0.10: PV+BATTERY

Net Present Cost					
Name	CAPEX	OPEX	Replacement Cost	Salvage	Total
Li-Ion Battery	\$3'107'165	\$465'816	\$2'261'276	-\$85'264	\$5'748'993
PV Array	\$6'625'056	\$0	\$327'658	\$0	\$6'952'714
System Converter	\$136'247	\$27'721	\$0	-\$5'074	\$158'894
System FC VC	\$842'860	\$487'733	\$0	\$0	\$1'330'593
Annualized Cost					
Name	CAPEX	OPEX	Replacement	Salvage	Total
Li-Ion Battery	\$247'180	\$37'057	\$179'889	-\$6'783	\$457'343
PV Array	\$527'035	\$0	\$26'066	\$0	\$553'101
System Converter	\$10'839	\$2'205	\$0	-\$404	\$12'640
System FC VC	\$67'051	\$38'800	\$0	\$0	\$105'851

Table .0.11: Diesel Genset

Net Present Cost						
Name	CAPEX	OPEX	Replacement	Salvage	Fuel	Total
Genset	\$760'000	\$6'280'000	\$4'020'000	-\$51'158	\$18'300'000	\$29'308'842
System FC VC	\$842'860	\$487'733	\$0	\$0	\$0	\$1'330'593
Annualized Cost						
Name	CAPEX	OPEX	Replacement	Salvage	Fuel	Total
Genset	\$60'459	\$499'263	\$319'778	-\$4'070	\$1'450'000	\$2'325'430
System FC VC	\$67'051	\$38'800	\$0	\$0	\$0	\$105'851

Modelling Storage Bank's maximum power absorption and discharge

Using the Kinetic Battery Model, the system calculates the battery's maximum power storage and maximum power discharge is as follows.

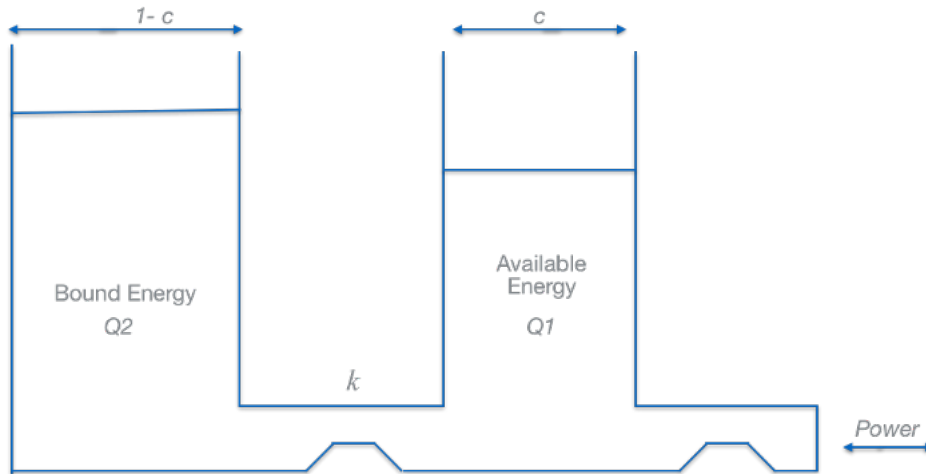

Figure .0.10: A Two-tank Kinetic Battery Model Concept

In Figure .0.10, (c) is a fraction of the total capacity of the storage bank in the available energy tank and $(1 - c)$ is the fraction of the total capacity of the storage bank in the bound energy tank. To determine the battery's maximum power storage and maximum power discharge, the following three parameters are considered.

- *Maximum storage capacity (Q_{max})*: the sum of the available energy (electrical energy) and bound energy (chemical energy).
- *The Capacity ratio (c)*: this parameter denotes the rate at which the charge energy flows between the available energy tank and the bound energy tank. It is therefore, represented as the ratio of the available energy tank to the combine size of both tanks.
- *The fixed Conductance (k)*: This parameter has a dimension of 1/time, which is a measure of the rate at which as bounded energy is converted to available energy and vice versa. The storage bank's maximum power absorption over a given period of time ($P_{batt,Cmax,kbm}$) is determined using Equation 0.8.

$$P_{batt,Cmax,kbm} = \frac{kQ_1e^{-k\Delta t} + Qkc(1 - e^{-k\Delta t})}{1 - e^{-k\Delta t} + c(k\Delta t - 1 + e^{-k\Delta t})} \quad (.0.8)$$

	Diesel Genset	PV + Battery	Hybrid System
PV capacity	-	5,095 kW	2,849 kW
Battery (LA) capacity	-	24,122 kWh	10,625 kWh
Converter capacity	-	2,276 kW	1,460 kW
Diesel generator capacity	1,900 kW	-	1,900 kW
NP life-cycle cost	\$33'495'760	\$26'713'380	\$18'186'120
Initial Capital cost	\$1'837'100	\$20'231'101	\$11'922'078
Operating Cost	\$2'518'502	\$515'677	\$498'315
LCOE	\$0.58	\$0.46	\$0.32
Total emission/yr.	4,067,580 kg	0.00 kg	451,083.50 kg
SSP Tariff \$/kwh	\$0.10	\$0.10	\$0.10
Difference \$/kwh	-\$0.48	-\$0.37	-\$0.22
Annual Loss	-\$2'213'876	-\$1'675'193	-\$995'855

Similarly, the storage bank's maximum power discharge over a given period of time ($P_{batt,dmax,kbm}$) is determined using Equation 0.9.

$$P_{batt,dmax,kbm} = \frac{-kcQ_{max} + kQ_1e^{-k\Delta t} + Qkc(1 - e^{-k\Delta t})}{1 - e^{-k\Delta t} + c(k\Delta t - 1 + e^{-k\Delta t})} \quad (.0.9)$$

Does Financial Inclusion Facilitate Solar Panels' Adoption? Evidence from
Tanzania

This chapter is a joint work with Anna Creti.

3.1 Introduction

Access to electricity is widely acknowledged as an important determinant of economic development. For instance, electricity is essential to development of human capital (Lipscomb et al. 2013), industrial activities (Rud 2012, Allcott et al. 2016, Fisher-Vanden et al. 2015) and enhancement of living conditions (Lee et al. 2020). Moreover, access to electricity facilitates the diffusion and adoption of innovative technologies in key sectors of the economy (i.e. telecommunication, banking, education and healthcare). Nevertheless, over 820 million people, worldwide, still live without electricity. More than 80% of these people are located in Sub-Saharan Africa (SSA), particularly in rural areas. In urban areas, due to prohibitive connection fees, there is still an important share of the population living under the grid without access to electricity. Energy poverty¹ has detrimental economic and welfare effects. It constitutes a major impediment to economic growth and poverty

¹It is defined by the International Energy Agency (IEA) as a lack of access to modern energy services

reduction.

The traditional approach to electrification in SSA has long been through grid extension. While grid extension in densely populated areas can be cost effective, in rural settings, the dispersed nature of settlements makes grid extension expensive and financially unviable. However, with the declining cost of solar panels, improvement in storage capacity and energy efficiency, off-grid solutions (standalone solar panels or mini-grids) play a key role in bridging the access gap in rural areas. Although this is true, the uptake rate of solar panels is still very low. This technology, due to its high up-front investment costs, remains unaffordable to many households in developing countries.

Credit constraints and lack of access to financial services, which could allow households, for instance, to gradually save up small amounts of money and overcome the up-front investment costs, are often identified as the main barriers to technology adoption in developing countries (Dupas & Robinson 2013, Tarozzi et al. 2014, Batista & Vicente 2020). However, while it is documented that relieving credit constraints and introducing flexible payment mechanism increase the uptake of welfare improving technologies (e.g. bed nets and solar panels) in developing countries (Tarozzi et al. 2014, Barry & Creti 2020), little is known on the impact of financial services more specifically, on the use of mobile money services on technology adoption. Mobile money is an innovative mobile banking service that relies on Global System for Mobile (GSM) technology. It allows its users to make basic banking operations such as payment, reception of remittances and saving solution. Understanding how financial inclusion and specifically, the use of mobile money services enables poor households to adopt welfare improving technologies is of utmost importance to policy makers. Clearly, extending financial services to the unbanked, living mostly in rural areas, might reduce high transaction costs and affordability solar products distributors face in serving the last mile, and hence spur energy access.

The purpose of this paper, therefore, is to estimate the impact of mobile money adoption on households' decision to buy solar panels in Tanzania. Specifically, we would like to know if households that use mobile money services are more likely to adopt solar panels than non-using households. Tanzania offers an interesting setting for this study. The country not only has the lowest electrification rate of the East African region, but also a widespread use of mobile money services. On top of this, Tanzania's off-grid solar energy market is among the most dynamic

of the East African region. By addressing this research question, we contribute to the growing literature on the role of financial inclusion, more specifically the nexus between mobile money services and technology adoption in developing countries. Previous studies on mobile money in developing countries have so far focused on assessing the welfare effects (Tadesse & Bahiigwa 2015, Sekabira & Qaim 2017) and mainly on risk sharing mechanisms (Jack & Suri 2014a, Riley 2018). To the best of our knowledge, this is the first paper to examine the impact of mobile money on technology adoption in developing countries. We present new insights of the development effects of mobile money services in a poor developing country.

To shed light on the effect of mobile money services on households' decision to adopt solar panels, we use the first wave of the refreshed sample of Tanzania's National Panel Survey conducted between 2014-2015. We find strong evidence of mobile money adoption on households' decision to adopt solar panels. Specifically, we find that the odds of buying solar panels is twice higher for mobile money using households than non-using ones. We address the potential endogeneity issue of mobile money adoption by setting an instrumental variable (IV) approach. This allows us to establish a causal relationship between mobile money and solar panels' adoption. Our IV results reveal that mobile money leads to a 19% increase in the probability of adopting solar panels. Furthermore, examining the heterogeneous effect of mobile money adoption by poverty status of households, we find that the effect of mobile money on solar panels' adoption is positive and statistically significant for poorer households only. Finally, we show that reception of remittances, access to credit and participation in off-farm income generating activities are the mediating channels through which mobile money affects the probability of adopting solar panels.

The remainder of the paper is organized as follows: Section 2 reviews the relevant literature. Tanzanian economic situation is summarized in Section 3, together with the specificity of its electricity sector. Section 4 describes the data and summary statistics of the main variables used in this study. The empirical strategy and results are presented respectively in Section 5 and 6. While Section 7 covers heterogeneous effects, Section 8 presents the economic drivers at stake. Section 9 presents robustness checks. Concluding remarks are developed in section 10.

3.2 Literature review

Over recent years, there has been a growing interest among scholars in solar panels diffusion in emerging countries. Up to now, the literature has focused on estimating socioeconomic impacts of solar home systems (SHS). Overall, SHS have been shown to increase children study time (Furukawa 2014, Kudo et al. 2017, Grimm et al. 2017), improve social inclusion and communication (Komatsu, Kaneko & Ghosh 2011), reduce kerosene expenditure (Komatsu, Kaneko & Ghosh 2011, Arraiz & Calero 2015, Grimm et al. 2017, Yuya et al. 2015, Khandker et al. 2014, Buragohain 2012, Chen et al. 2017), but little evidence on income generating activities and productivity.² Although assessing socioeconomic impacts of solar technology remains an interesting avenue of research, it is not the scope of this paper.

We take a different perspective by focusing on energy demand. Surprisingly, only a handful of papers investigate this question in developing countries. For instance, Smith & Urpelainen (2014) using data from a nationally representative household survey in Tanzania, study the determinants of solar panels adoption. They find that poorer households are less likely to purchase solar panels while large households with grid connection are more likely to adopt solar panels. Similar results were also found by Guta (2018) in rural areas of Ethiopia. In the same vein, Komatsu, Kaneko, Shrestha & Ghosh (2011) study non income factors behind solar panels adoption in rural Bangladesh. They reveal that beyond household income, there are other factors positively affecting solar adoption. These factors include ownership of rechargeable batteries, kerosene consumption, and the number of mobile phones. Again in four districts of the Kagera and Rukwa regions in Tanzania, Klasen & Mbegalo (2016) study the effect of livestock ownership on households' decision to adopt solar panels. They find that livestock ownership is positively correlated with solar panels adoption. Put differently, the probability of adopting solar panels is higher for households with livestock ownership than households without. Such findings underline the important role of assets in developing countries, where the vast majority of the population lack access to financial services. Hence, investment in assets (i.e. durable goods or livestock) remains the only saving alternative.

While many studies on solar panels adoption have so far focused on socioeconomic determinants, several other studies have underlined the key role of social interactions or peer effects. For

²For a comprehensive literature review on the impact of SHS see Lemaire (2018).

example, [Bollinger & Gillingham \(2012\)](#) using a large dataset of photovoltaic (PV) system adoptions in California examine the effect of previous nearby adoptions on actual PV system adoption. They show that an additional previous installation in a zip code increases the probability of a new adoption in that zip code by 0.78%. Although the effects are small, [Richter \(2013\)](#) finds positive and statistically significant social effects on solar panels adoption in the United Kingdom. The evidence reviewed here seems to suggest a pertinent role for education, income and peer effects in influencing the decision to adopt solar panels.

The use of telecommunication services, more specifically mobile money services is another strand of the literature our paper is related to. Over the last decade, developing countries have experienced an unprecedented penetration rate of mobile phones. Mobile phones have become an essential part of the daily life of millions of people in the developing world. Today, the widespread use of mobile money perfectly illustrates this trend. Moreover, mobile money is not only revamping the way basic services are delivered, but it is also enabling adoption of welfare improving technologies by the poorest. In this regard, there has been growing recognition of the development effects of improved telecommunication services ([Aker & Mbiti 2010](#)).

It is now well established from a variety of studies that the use of mobile phones, for instance, reduces price dispersion and increases market participation of rural farmers. [Jensen \(2007\)](#) is among the first papers to rigorously examine the effect of the introduction of mobile phone network on market performance and welfare. Using micro-level data of the South Indian fisheries sector, he finds that the introduction of mobile phones induced a reduction in price dispersion from 60-70% to 15%. Overall, the introduction of mobile phone was welfare improving as it not only eliminated waste, but also decreased consumer's price by 4% while fishermen's profit increased on average by 8%. In the same vein, [Aker \(2010\)](#) studies the impact of mobile coverage on market performance in Niger. She finds that the introduction of mobile phones was associated with a 10 to 16% reduction in price dispersion across markets, with a larger impact for market pairs with higher transport costs. Unlike [Aker \(2010\)](#) and [Jensen \(2007\)](#) who focus on price dispersion, [Muto & Yamano \(2009\)](#) examine the effect of mobile phone network coverage expansion on market participation of farmers producing perishable crops in Uganda. Their results reveal that network expansion has a positive impact on market participation for farmers of perishable crops. However, while the impact is larger for areas farther away from district centers, they did not find any impact of network

expansion on marketing for less perishable crops like maize. If the study mentioned above focuses on the use of mobile phone, more recently, interest has shifted toward mobile banking or mobile money services.

Several studies have demonstrated that the use of mobile money, by reducing transaction cost, facilitates informal risk sharing. [Jack & Suri \(2014a\)](#) are the first to provide an empirical evidence of the attenuating effect of mobile money in the advent of negative shocks. Using a large panel data of Kenyan households, they reveal that while the consumption of households that use mobile money is unaffected in the advent of shocks, the consumption of nonusers declines by 7%. Increases in remittances received and the diversity of senders are the underlying mechanisms of these consumption effects. [Riley \(2018\)](#) examines the impact of mobile money services on Tanzanian households' consumption after a rainfall shock (i.e. flood or drought). Contrary to [Jack & Suri \(2014a\)](#), she examines the spillover effects of mobile money services at the village level. Her objective is to verify if remittances received by households that use mobile money services are shared with non-using households within the same village. She finds that after a village-level rainfall-shock, only mobile money using households that do not experience a drop in their consumption. In other words, she finds no spillover effects at the village level.

More recently, several studies have also confirmed that the use of mobile money not only allows farmer to adopt best practices, but also to have access to high value markets. [Tadesse & Bahiigwa \(2015\)](#) examine the impact of mobile money on agricultural income, input use and commercialization of rural farmers in Kenya. They find that commercialization increased by 37% for mobile money using households, while also users of mobile money experienced an increase in their agricultural income and input use by US\$ 224 and US\$ 42, respectively. Similarly, [Sekabira & Qaim \(2017\)](#) examine the nexus between mobile money usage and access to higher-value markets by rural farmers in Uganda. Using a panel data of smallholder coffee farmers, the authors find that the use of mobile money increased the share of shelled beans sold by 12%. The underlying mechanism is that mobile money facilitates transactions with buyers outside the local regions.

Together, these studies indicate that telecommunication services and more particularly, mobile money may considerably impact economic development. Recognizing the key role of financial inclusion in reducing poverty ([Burgess & Pande 2005](#)), mobile money could not only help in bridging the financial services access gap, but also improve the welfare of the financially excluded

population. However, little is known on the effect of improved access to financial services on technology adoption. The aim of this paper is, therefore, to fill this gap by examining the role of mobile money services on solar panel adoption.

3.3 Background on Tanzania

Tanzania is located in East Africa. In 2017, it had an estimated population of 57.31 million people. Despite Tanzania's growing urbanization rate, still 66% of Tanzanians live in rural areas (World Bank)³. Agriculture is the mainstay of 70% of Tanzanian households. The sector employs nearly 80% of the active labor force. The share of agricultural sector in the country's economy is still very important. In 2017, the sector's contribution to Tanzania's GDP stood at 28.7% (WB). Over the last decade, Tanzania has experienced rapid economic growth, averaging 6-7% per year. However, after more than a decade of buoyant economic growth, poverty is still prevalent. Rural areas are home to the country's poorest people. The government's efforts to extirpate millions of Tanzanians out of poverty is, however, undermined by its rapid population growth.

Electrification rate in Tanzania is among the lowest of the East-African region. According to the World Bank statistics, only 32.8% of Tanzanians had access to electricity in 2017. This figure hides huge heterogeneity between urban and rural areas. While 65.3% of urban population had access to electricity in 2017, the proportion in rural areas was 16.8%. The low electrification rate is indicative of the country's low level of economic development. Tanzania is not only ranked among the countries with the lowest electrification rate in Sub-Saharan Africa but also with the lowest per capita energy consumption. In 2014, its per capita energy consumption stood at 104 KWh (WB). Although significant efforts have been done over recent years in promoting the use of modern and efficient energy technology, still a bulk of Tanzanians rely on pollutant sources of energy. Traditional biomass remains their primary source of energy. This source of energy is not only expensive and inefficient, but it also has huge detrimental health and environmental impacts. Besides the low electrification rate, the unreliable nature of electricity provision in Tanzania is another major problem. Recurrent power outages are detrimental to industrial development and leads to huge economic losses. Recognizing the key role of access to electricity in unlocking the country's economic potential, Tanzania's government, over recent years, has been at the forefront

³<https://data.worldbank.org/indicator/sp.urb.totl.in.zs>

of institutional reforms. These reforms have the dual aim of addressing both the pending issue of access to electricity in rural areas and the low participation of the private sector in the energy sector.

Providing electricity to rural areas of mainland Tanzania is challenging. Communities are not only sparsely dispersed in a hilly landscape, but also with low electricity consumption. Obviously, rural electrification through grid extension does not seem to be a cost effective solution. However, with declining costs of solar panels and the ongoing development of high capacity battery, solar technology has emerged, among energy specialists, as a cost effective solution to providing electricity to rural areas of developing countries.

Furthermore, under the supervision of the Ministry of Energy and Mineral, the vertically integrated national utility, TANESCO, is undergoing huge structural changes. The government's goal is to totally unbundle the generation, transmission and distribution activities of TANESCO with a sole objective of giving more room to the private sector. Public-private partnership is, indeed, a rapid way of filling the huge investment deficit in the energy sector of developing countries. Nowadays, many energy projects in SSA are developed or expected to be developed under the public-private partnership scheme.

In Tanzania, the development of decentralized mini-grids is at the heart of the government's energy access program in rural areas. In this regard, over the recent years, the country has taken proactive actions in not only regulating the sector but also by providing financial support to developers.⁴ More, to better address the energy access issue in rural areas, the government has established a Rural Electrification Agency (REA) to pilot rural electrification programs. Its primary goal is to oversee the implementation of the electrification projects in rural areas, using the Rural Energy Fund as provided in the REA. These projects include mini-grids development in villages with economic potential (i.e. productive use of electricity) and support the adoption of standalone solar panels in remote rural areas to leave no one behind.

⁴Developers are small power producers with generation capacity below 1 megawatt.

3.4 Data and summary statistics

3.4.1 Data

The data used in this study come from two different sources. The first set of data comes from the Tanzania National Panel Survey (TNPS). Recently, due to rapid demographic shifts and new administrative boundaries, the National Bureau of Statistics (NBS) renewed its original sample to ensure a proper representativeness of Tanzanian population. Therefore, in this study we use the first wave of the refreshed sample of the TNPS conducted between 2014-2015.

The Tanzania National Panel Survey is a nationally representative survey that collects a range of information both at the community, household and individual level. As we are interested on the determinants of solar panel adoption in Tanzania, the unit of observation is the household. The main household level data retrieved from the National Panel Survey includes socioeconomic characteristics such as the household's head gender, age, level of education, female ratio, dependence ratio, use of financial and telecommunication services such as mobile money services and mobile phone, respectively.

In addition to these variables, we also use several other variables to complete our approach. These include district level variables such as the existence of mobile money agents within the ward. Finally, regional differences in photovoltaic potential is controlled for by adding irradiation data. The irradiation data is retrieved from GeoQuery, a public web-based geospatial data tools.

3.4.2 Summary statistics

Table 3.4.1 exhibits the summary statistics and definition of the main variables used in this study. As it can be noticed, solar technology is paving its way with 9% of households in the survey declare using solar panels for electricity access. However, access to electricity remains very low. Only, 29% of households are connected to the electric grid. Most of the households in our survey reside in remote rural areas. Although Tanzania has witnessed rapid urbanization over the last decades, yet nearly 60% of households live in rural areas.

Looking at the household composition, we notice that the average size of a Tanzanian household is approximately 5 persons with a female ratio of 3 women per household. More than 70% of the households are male headed with an average age of nearly 45 years. With regard to human

capital development, household heads seem to have a fairly good level of education. On average, 76% of household heads can read and write in Swahili or in English. However, the proportion of household heads engaged in off-farm revenue generating activities is 27%.

Furthermore, examining the use of telecommunication services, we notice an ubiquitous presence of mobile phone in nearly each Tanzanian household. If mobile phones are present in almost each Tanzanian household nowadays, the use of mobile money services is yet to be the case. In our sample, only 53% of households use the service. In addition to this, 68% of households live within a ward where mobile money service is available. While access to credit in Tanzania is very low, with only 11% of households declaring having contracted a formal or informal credit, the proportion of households receiving remittances is 33%.

Finally, the mean solar irradiation of Tanzanian regions is 4.38 kWh/m², suggesting a huge photovoltaic potential.

Table 3.4.1: Summary statistics

Variables	Definition	Mean	SD
Mobile phone	Household has a mobile phone (1=Yes, 0=No)	0.80	0.40
Mobile money (MM)	Household uses mobile money(1=Yes, 0=No)	0.53	0.50
MM ser. availability	MM service available within the ward (1=Yes, 0=No)	0.68	0.46
Remittance	Household received remittances (1=Yes, 0=No)	0.33	0.47
Credit	Household contracted formal/informal credit (1=Yes, 0=No)	0.11	0.31
Off farm activities	Household exercises off farm activities (1=Yes, 0=No)	0.27	0.45
Solar	Household has a solar panel (1=Yes, 0=No)	0.09	0.29
Electricity	Household has access to electricity (1=Yes, 0=No)	0.29	0.45
Migrant	One member of the household migrated (1=Yes, 0=No)	0.32	0.47
Head age	Household head age	44.43	14.99
Literacy	Head can read and write (1=Yes, 0=No)	0.76	0.43
Household size	Household size	4.86	2.84
Head gender	Household head gender (1=Male, 0=Female)	0.71	0.45
Female ratio	Number of females in the household	2.50	1.70
Rural	Household lives in rural area (1=Yes, 0=No)	0.59	0.49
Irradiation	Regional photovoltaic potentials in (kWh/m ²)	4.38	0.23
<i>N</i>		3320	

3.5 Empirical strategy

3.5.1 Modelling solar adoption

In order to identify the effect of mobile money on households' decision to adopt solar panels, we use a logit model. We estimate the following specification :

$$Solar_i = \alpha + \beta MM_i + \gamma X_i + \varepsilon_i$$

Where $Solar_i$ is a binary variable that indicates whether household i uses solar panels. It is equal to one if household i uses solar panels and zero otherwise. MM_i is a dummy variable that is equal to one if household i uses mobile money services and zero otherwise. X_i is a set of socioeconomic control variables. ε_i is the random error term that follows a logistic distribution. The parameters α , β and γ are estimated using the Maximum Likelihood Estimator (MLE). MM_i is the variable of interest. If β is positive and statistically different from zero, then the odds ratio of adopting solar panels is higher for mobile money users than non users. In some specifications, district fixed-effects are added to control for unobserved district characteristics that might both influence mobile money and solar panels adoption. Not controlling for the correlated effects might potentially bias the estimated parameters. Having presented our solar panel adoption model, we will now move on to discuss some identification issues.

3.5.2 Endogeneity

The main threat to our identification strategy stem from the variable MM_i , which is potentially endogenous. For instance, mobile money users are more likely to be better off, well educated and also better informed of the benefits of mobile money and solar panels than non-users. There are thus both observable and unobservable household characteristics that affect the household's decision to use mobile money. While observed household heterogeneity (difference in education and wealth) can be controlled for, unobserved heterogeneity (aversion to risk and preferences) is difficult to rule out. In the presence of unobserved heterogeneity in mobile money adoption, the estimated parameter β will be biased since mobile money adoption will be correlated with the error term.

Similarly, reverse causality stemming from the fact that solar adoption is likely to lead to mobile money adoption is another source of endogeneity. This is possible since Tanzania's current standalone solar panels market, mainly led by international private enterprises, relies on mobile money, an innovative way of financing access to modern energy services. Also known as the pay-as-you-go (PAYG) energy service, it allows budget-constrained households that cannot

make a lump sum payment of the solar panel to use its electricity while paying it through, small, weekly installment payments. The repayment period depends on the price of the solar panel, which depends on its capacity. The market's cheapest solar home system is sold at US\$305.25, with 36 months of installments of US\$8.25 per month, while the highest solar capacity is sold at US\$1,794, with US\$46 per month for a repayment period of 36 months (Sanyal et al. 2016).

Generally, an upfront payment has to be done before starting the weekly installments. The upfront payment depends on the solar panel's capacity. It is estimated to be as much as 15% to 20% of the cost of the solar panel. However, while nearly 70% of Tanzanians leave with less than US\$2 per day (World Bank),⁵ it is more likely that households that decide to buy solar panels do it through weekly installment payments. And, since the payments have to be made through mobile money, the adoption of solar panel is likely to lead to the adoption of mobile money, hence, introducing a simultaneity bias between solar panel and mobile money adoption.⁶

To address the endogeneity issue, we use a Linear Probability Model (LPM) with an Instrumental Variable (IV) approach. The most common instrument used in the economic literature on mobile banking is generally the distance separating a household to its nearest mobile money agent (Jack & Suri 2014a, Riley 2018, Munyegera & Matsumoto 2016). The idea behind the use of this instrument is that the farther a household is to the nearest mobile money agent, the less likely the household is to use mobile money services. However, we believe that the use of this instrument is not appropriate in many settings. The distance separating a household to its nearest mobile money agent might be, indeed, correlated with the outcome variable and consequently violate the exclusion restriction.

In this paper we use two different instruments: ownership of a mobile phone and mobile money services availability within the ward of each household. These are dummy variables. They indicate whether a household has a mobile phone and lives within a ward where mobile money service is available, respectively. Since mobile money relies on GSM technology, the likelihood of using this services is higher for households with mobile phone ownership than those without. Another important condition is the availability of the services closer to its users. Hence, a household

⁵<https://www.worldbank.org/en/country/tanzania/publication/tanzania-mainland-poverty-assessment-a-new-picture-of-growth-for-tanzania-emerges>

⁶It is possible to have households that buy solar panels in a one lump sum payment. However, given the level of poverty in Tanzania, the number is likely to be very limited.

living within a ward where the mobile money service is available is more likely to use this service than a household living in an area without the service. We expect this variable to be positively correlated with mobile money adoption.

3.5.3 Modelling the Economic Drivers

In this section, we examine the channels through which mobile money adoption might affect the uptake of solar panels. The impact of mobile money on solar panel adoption might be direct, for example, if a household decides to purchase a solar panel through the PAYG scheme. While this direct effect might be at play, we unfortunately cannot test this hypothesis. The data we have do not provide any information on how the solar panel was bought. Put differently, if the solar panel was bought through the PAYG scheme via weekly installments or in a lump sum payment. Apart this direct effect, there are also other mechanisms through which mobile money could enable households to adopt solar panels. These include the remittances, credit and income generating activities channels. Since mobile money not only reduces transaction costs but also allows access to basic financial services, naturally, mobile money users are more likely to receive remittances, to contract a credit and also, to engage in off farm revenue generating activities. To test these channels, we estimate the specification below:

$$y_i = \alpha + \mu MM_i + \delta X_i + \varepsilon_i,$$

where y_i stands respectively for reception of remittances, access to credit and participation in off-farm income generating activities. The variable y_i is equal to one if household i receives remittances, contracts a credit and participates in off-farm income generating activities, respectively and zero otherwise. MM_i is a dummy variable indicating whether household i uses mobile money services. It takes one if household i uses mobile money services and zero otherwise. X_i represents a set of socioeconomic control variables and ε_i the random error term. If μ is positive and statistically different from zero, it means that mobile money using households are more likely to receive remittances, to have access to credit and also, to engage in revenue generating activities. These elements, combined together, are welfare improving as they increase the household's revenue. This in turn, relaxes the household's liquidity-constraints, which enables investment in durable assets such as solar panels. The parameters are estimated using a 2SLS Linear Probability

Model (LPM). MM_i is instrumented with two dummy variables indicating whether household i owns a mobile phone and lives within a ward where mobile money service available.

3.6 Results

Table 3.6.1 reports the determinants of solar panels adoption and in particular, the impact of mobile money on households' decision to adopt solar panels. In columns (1)-(2) we report the odds ratio or exponentiated coefficients. The odds ratio can be interpreted as the estimated odds of change in solar panel adoption as a unit change in the independent variable (Murendo et al. 2018). In column (1) we present the results of the logit model without controlling for the district fixed effects while in column (2), we control for the district fixed effects. In all specifications, mobile money is positive and statistically significant at 1% level indicating that the use of mobile money is positively associated with the adoption of solar panels.

Since the specifications in column (1) and (2) are quantitatively quite similar, in what follows we interpret only the results in column (2), which is the most convincing specification. In column (2), mobile money which is our variable of interest has an odds ratio of 2.65. This odds ratio implies that the probability of adopting solar panel is 2.65 times higher for mobile money users than non users. This result highlights the important role of financial inclusion in facilitating investment by households in welfare improving assets. Indeed, access to financial services as rudimentary as mobile money can have huge positive impacts on people's welfare. In the context of Tanzania, mobile money not only allows its users to save small amounts of money which could not have been possible in the traditional banking system, but also to receive internal remittances safely and at a lower price.

Besides our variable of interest mobile money, there are others control variables that affect solar panel adoption. Specifically, our results indicate that living in rural area, household size and literacy are statistically significant and positively correlated with solar panels adoption.

The odds ratio of adopting solar panel for households living in rural areas is 4 times higher than those living in urban areas. This result is not surprising as those lacking access to electricity in Tanzania live in remote rural areas where the grid is quasi-inexistent. While the odds of adopting solar panel is 1.07 times higher with an extra person in the household, the odds off adopting solar

panel is 1.62 times for households with an educated head.

In columns (3)-(4), we report the results from the linear probability model. Again, mobile money is positive and statistically significant at the 1% level. Column (4) reveals that mobile money adoption is associated with an increase of 8% in the probability of adopting solar panel. However, since mobile money is endogenous, the estimated parameters are potentially biased.

Finally, in columns (5)-(6), we account for the potential endogeneity of mobile money adoption by using a 2SLS linear probability model. This allows us to establish a causal relationship between mobile money usage and solar panel adoption. Columns (5)-(6) report respectively, the first and second stage estimations. In columns (6) mobile money is positive and statistically significant at the 1% level indicating that mobile money usage increases the probability of solar panel adoption. Specifically, we find that mobile money adoption leads to a 19% increase in the probability of adopting solar panels. Furthermore, the results from the first stage estimations reveal that mobile phone ownership and mobile money service availability are strong determinants of mobile money adoption. This implies its power to establish a causal link between mobile money and solar panel adoption.

In addition to the positive impact of mobile money usage on solar panels adoption, household size, living in rural areas and irradiation are positive and statistically significant. However, we find no effect of household head's age and gender on solar panel adoption. Taken together, our results suggest that there is a strong and positive association between mobile money and solar panel adoption.

3.7 Heterogeneity

In this section we examine the heterogeneous effect of mobile money adoption on households' decision to adopt solar panel. We begin with households' poverty status. Clearly, in many developing countries, poor households are, generally, the ones lacking access to financial services. Therefore, the effect of mobile money adoption on household's decision to purchase a solar panel is likely to differ depending whether or not the household is poor. To test this hypothesis, we split the sample into two categories: poor households and non-poor households. A household is considered poor if its per capita consumption is below the median consumption.

Table 3.6.1: Impact of mobile money on solar panel adoption

	Logit		Linear Probability (LP)		2SLS-LP	
	(1) Odds ratio (0.364)	(2) Odds ratio (0.369)	(3) Coef./se (0.011)	(4) Coef./se (0.011)	(5) 1 st stage	(6) 2 nd stage (0.032)
Mobile money	2.653***	2.647***	0.081***	0.080***		0.186***
Mobile phone					0.442*** (0.022)	
MM ser. availability					0.045* (0.026)	
Migrant	1.030 (0.148)	1.035 (0.150)	0.001 (0.011)	0.001 (0.012)	0.177*** (0.020)	-0.017 (0.013)
Head age	0.996 (0.005)	0.996 (0.005)	-0.000 (0.000)	-0.000 (0.000)	-0.003*** (0.001)	0.000 (0.000)
Literacy	1.623*** (0.281)	1.598*** (0.277)	0.038** (0.015)	0.037** (0.015)	0.141*** (0.018)	0.013 (0.019)
Household size	1.069* (0.040)	1.066* (0.040)	0.007** (0.003)	0.007** (0.003)	-0.006 (0.005)	0.006** (0.003)
Head gender	0.995 (0.159)	1.005 (0.160)	-0.002 (0.012)	-0.001 (0.012)	0.012 (0.017)	-0.005 (0.012)
Female ratio	0.979 (0.060)	0.985 (0.060)	-0.002 (0.006)	-0.002 (0.006)	0.003 (0.009)	-0.003 (0.006)
Rural	3.674*** (0.595)	3.715*** (0.627)	0.096*** (0.012)	0.097*** (0.012)	-0.199*** (0.030)	0.128*** (0.016)
Irradiation	4.810*** (1.273)	4.597*** (1.245)	0.137*** (0.027)	0.136*** (0.025)	0.017 (0.042)	0.138*** (0.029)
Constant	0.000*** (0.000)	0.000*** (0.000)	-0.655*** (0.123)	-0.665*** (0.125)	0.149 (0.179)	-0.719*** (0.131)
District fixed effects	No	Yes	No	Yes	No	No
Observation	3320	3320	3320	3320	3320	3320
Log likelihood	-913.065	-909.389				
LR χ^2	181.206	189.415				
Pseudo R ²	0.093	0.097				
R-Square			0.057	0.059	0.310	0.031
Kleibergen-Paap underidentification test						38.658
Underidentification test χ^2 p-val						0.000
Hansen J statistic						0.859
Hansen test χ^2 p-val						0.354

Note: Robust standard errors in parenthesis clustered by wards, *** p<0.01, ** p<0.05, * p<0.1.

Table 3.7.1 presents the estimation results by poverty status. For each category, we present both the logit and 2SLS estimates. However, since mobile money adoption is endogenous we will only interpret the 2SLS results. Our results reveal that, for poor households, mobile money adoption has a positive and significant effect on solar panels adoption. Specifically, for poor households, mobile money adoption is associated with a 20% increase in the probability of adopting solar panels. This result underlines the important role of financial inclusion in facilitating the adoption of welfare improving technologies by poor households. For non-poor households, although mobile money adoption is positive, it is not statistically significant suggesting that for wealthy households, mobile money does not affect solar panels adoption. A possible explanation

to this might be that non-poor households already have access to an array of financial services rendering the effect of an additional service less pronounced.

Additionally, we investigate the heterogeneous effect of mobile money on solar panel adoption depending on whether the household has a migrant or not. Indeed, a household's probability of receiving remittances, generally, hinges on it possessing a migrant. To test this heterogeneous effect, we split the sample in two subcategories: households with a migrant and households without. The results are presented in table 3.7.2. Table 3.7.2, show no difference in the effect of mobile money on solar panel adoption between households with a migrant and households without. The effect of mobile money is positive and statistically significant for both households with a migrant and households without.

Finally, we examine the heterogeneous effect of mobile money on solar panel adoption with regard to house ownership status. Indeed, the decision to invest in solar technology might be affected depending whether or not one lives in its own house. To test this possibility, we split the sample in two subcategories: house ownership and no ownership. The results are presented in table 3.7.3. We find no difference in the effect of mobile money on solar panel adoption with regard to house ownership status. Mobile money is positive and statistically significant for both household heads with house ownership status and those without.'

Overall, the main lesson we can draw from this analysis is that the effect of mobile money on household's decision to buy solar panels is positive and statistically significant for only poor households. All together, these findings support the welfare effect of financial inclusion and calls for expansion of financial services to the poor, in particular, to improve access to electricity. In the next section, we examine the mechanisms at play.

3.8 Economic Drivers

In this section, we examine the mechanism through which mobile money usage might affect the uptake of solar panels by households. Since mobile money reduces transaction cost and also provides access to basic financial services to the unbanked, we hypothesize that households that use mobile money are more likely to receive remittances, contract a credit and engage in off-farm revenue generating activities.

Table 3.7.1: Solar adoption by poverty status

	Poor			Wealthy		
	Logit	2SLS		Logit	2SLS	
	(1) Odds ratio	(2) 1 st stage	(3) 2 nd stage	(4) Odds ratio	(5) 1 st stage	(6) 2 nd stage
Mobile money	2.435*** (0.464)		0.202*** (0.052)	2.244*** (0.478)		0.083 (0.069)
Mobile phone		0.385*** (0.022)			0.438*** (0.042)	
MM ser. availability		0.053* (0.030)			0.005 (0.035)	
Controls	Yes	Yes	Yes	Yes	Yes	Yes
District fixed effects	Yes	No	No	Yes	No	No
Constant	0.000*** (0.000)	-0.216 (0.213)	-0.459*** (0.152)	0.000*** (0.000)	0.123 (0.236)	-0.924*** (0.237)
Observation	1654	1658	1658	1662	1662	1662
Log likelihood	-442.934			-441.669		
LR χ^2	65.532			160.324		
Pseudo R ²	0.072			0.165		
R-Square		0.488	0.081		0.787	0.189
Kleibergen-Paap underidentification test			34.541			28.456
Underidentification test χ^2 p-val			0.000			0.000
Hansen J statistic			1.055			0.287
Hansen test χ^2 p-val			0.304			0.592

Note: Robust standard errors in parenthesis clustered by wards, *** p<0.01, ** p<0.05, * p<0.1.

Table 3.7.2: Solar adoption depending on whether household has a migrant or not

	Has migrant			No migrant		
	Logit	2SLS		Logit	2SLS	
	(1) Odds ratio	(2) 1 st stage	(3) 2 nd stage	(4) Odds ratio	(5) 1 st stage	(6) 2 nd stage
Mobile money	2.499*** (0.670)		0.129*** (0.041)	2.659*** (0.436)		0.230*** (0.037)
Mobile phone		0.521*** (0.038)			0.394*** (0.025)	
MM ser. availability		0.046 (0.030)			0.041 (0.031)	
Controls	Yes	Yes	Yes	Yes	Yes	Yes
District fixed effects	Yes	No	No	Yes	No	No
Constant	0.000*** (0.000)	0.318 (0.202)	-0.931*** (0.176)	0.000*** (0.000)	0.096 (0.223)	-0.609*** (0.175)
Observation	1060	1063	1063	2257	2257	2257
Log likelihood	-283.437	-450.897	-139.917	-620.191	-1308.227	-388.119
LR Chi2	66.775			136.211		
Pseudo R ²	0.107			0.100		
R-Square		0.777	0.138		0.615	0.095
Kleibergen-Paap underidentification test			30.265			38.917
Underidentification test 2 p-val			0.000			0.000
Hansen J statistic		0.000	1.477		0.000	0.271
Hansen test 2 p-val			0.224			0.603

Note: Robust standard errors in parenthesis clustered by wards, *** p<0.01, ** p<0.05, * p<0.1.

Table 3.8.1 reports the results of the underlying mechanisms. All models are estimated using a 2SLS linear probability model to account for endogeneity issues. For each specification, the first

Table 3.7.3: Solar adoption depending on house ownership status

	House ownership			No ownership		
	Logit	2SLS		Logit	2SLS	
	(1)	(2)	(3)	(4)	(5)	(6)
	Odds ratio	1 st stage	2 nd stage	Odds ratio	1 st stage	2 nd stage
Mobile money	2.372*** (0.353)		0.191*** (0.039)	7.591*** (4.136)		0.172*** (0.057)
Mobile phone		0.424*** (0.025)			0.485*** (0.043)	
MM ser. availability		0.040 (0.030)			0.025 (0.044)	
Controls	Yes	Yes	Yes	Yes	Yes	Yes
District fixed effects	Yes	No	No	Yes	No	No
Constant	0.000*** (0.000)	-0.066 (0.212)	-0.698*** (0.148)	0.000*** (0.000)	0.404 (0.272)	-0.584** (0.268)
Observation	2234	2234	2234	1077	1086	1086
Log likelihood	-707.548	-1275.048	-535.895	-185.628	-463.067	110.845
LR Chi2	123.587			85.824		
Pseudo R2	0.079			0.168		
R-Square		0.575	0.130		0.809	0.090
Kleibergen-Paap underidentification test			33.753			34.914
Underidentification test 2 p-val			0.000			0.000
Hansen J statistic		0.000	0.139		0.000	1.862
Hansen test 2 p-val			0.709			0.172

Note: Robust standard errors in parenthesis clustered by wards, *** p<0.01, ** p<0.05, * p<0.1.

and second stage estimations are presented. As it can also be noticed, in all specifications, our instruments are positive and statistically different from zero. In addition, the Kleibergen-Paap F-statistic is very large suggesting that our instruments are strongly correlated with our endogenous variable, mobile money. Consequently, this allows us to be confident on the causal relationship between mobile money adoption and reception of remittances, access to credit and participation in off-farm revenue generating activities, respectively.

Focusing on the remittances channel, our estimations reveal that mobile money is positive and statistically different from zero at the 1% level, implying that the probability of receiving remittances being higher for households that use mobile money than households that do not use the service. More precisely, the use of mobile money is associated with an increase of 2.1% in the probability of receiving remittances. This result is at odds with previous studies that found that the use of mobile money increases the likelihood of receiving remittances (Jack & Suri 2014b, Sekabira & Qaim 2017, Riley 2018). If remittances are, often, seen as an informal mechanism of insurance against negative shocks, they can also serve as an additional source of revenue to a household. Indeed, the reception of remittances might relax the household's budget constraint and so, facilitate investment in welfare improving assets like solar panels.

Looking at the off-farm revenue generating activity channel, we find that mobile money usage is positive and statistically different from zero, suggesting that mobile money users are more likely to run an off-farm revenue generating activities. The second stage coefficient of 0.294 implies that mobile money adoption leads to a 29.4% increase in the probability of operating an off-farm revenue generating activities. This might be explained by the reduction in transaction costs associated with the usage of mobile money services, which allows households, located in rural areas not only to have access to high value markets (Tadesse & Bahiigwa 2015) (Tadesse & Bahiigwa 2015) but also to develop their business. In short, this is also likely to increase the household's revenue and, therefore, facilitate investment in welfare improving assets.

Turning now to the credit channel, we find a positive effect of mobile money adoption on access to credit. Specifically, mobile money adoption induces a 10% increase in the probability of contracting a credit. Indeed, the reduction in transaction costs associated with the use of mobile money might facilitate the access to a wider network money lenders nationwide. Similarly, by providing basic financial services, mobile money might also facilitate the transition toward the traditional banking system and hence, ease the access to formal credit. Overall, our result suggests that providing financial services as basic as mobile money can be a catalyst for technology adoption in developing by relaxing credit constraints.

Last but not least, since investment in solar panels requires huge amount of money, which most Tanzanian households lack, the use of mobile money could help households in building up savings to undertake such investment. Unfortunately, due to data limitation we cannot test this hypothesis. The Tanzania National Panel Survey (TNPS) do not provide any information on households' savings behavior. However, there is evidence in the economic literature that mobile money increases the likelihood of saving money (Ky et al. 2018).

Finally, the impact of mobile money on solar panel adoption might be direct. This is particularly possible if a household decides to purchase a solar panel via the pay-as-you-go mechanism. Again, we cannot test this hypothesis. The Tanzania National Panel Survey (TNPS) does not provide any information on how the solar panel was bought. In other words, if the solar panel was bought in a lump sum payment or through the pay-as-you go mechanism. Clearly, over the recent years, Tanzania has witnessed a rapid expansion of pay-as-you-go energy services providers. Therefore, we argue that the surge in solar panels adoption might, in part, be imputed to the pres-

ence of pay-as-you-go energy services providers.

Table 3.8.1: Mechanisms at play

	Two Stage Least Squares (2SLS)					
	Remittance		Off farm activity		Credit	
	1 st stage	2 nd stage	1 st stage	2 nd stage	1 st stage	2 nd stage
Mobile money		0.021** (0.008)		0.294*** (0.041)		0.095*** (0.021)
Mobile phone	0.446*** (0.023)		0.446*** (0.023)		0.446*** (0.023)	
MM service availability	0.051** (0.025)		0.051** (0.025)		0.051** (0.025)	
Migrant	0.166*** (0.019)	0.980*** (0.005)	0.166*** (0.019)	-0.086*** (0.018)	0.166*** (0.019)	0.004 (0.011)
Head age	-0.003*** (0.001)	0.000*** (0.000)	-0.003*** (0.001)	-0.002*** (0.001)	-0.003*** (0.001)	-0.001** (0.000)
Literacy	0.144*** (0.017)	0.005* (0.003)	0.144*** (0.017)	-0.012 (0.018)	0.144*** (0.017)	0.024* (0.014)
Household size	-0.006 (0.005)	0.001 (0.001)	-0.006 (0.005)	-0.002 (0.005)	-0.006 (0.005)	0.002 (0.003)
Head gender	0.008 (0.016)	-0.012*** (0.005)	0.008 (0.016)	-0.055*** (0.020)	0.008 (0.016)	-0.008 (0.015)
Female ratio	0.004 (0.009)	-0.002 (0.002)	0.004 (0.009)	0.002 (0.007)	0.004 (0.009)	0.003 (0.007)
Rural	-0.217*** (0.030)	0.008 (0.006)	-0.217*** (0.030)	-0.097*** (0.024)	-0.217*** (0.030)	0.017 (0.016)
Observation	3320	3320	3320	3320	3320	3320
R-Square	0.319	0.962	0.319	0.057	0.319	0.021
Kleibergen-Paap underidentification test		38.363		38.363		38.363
Underidentification test χ^2 p-val		0.000		0.000		0.000
Hansen J statistic		4.678		3.046		1.483
Hansen test χ^2 p-val		0.031		0.081		0.223

Note: Robust standard errors in parenthesis clustered by wards, *** p<0.01, ** p<0.05, * p<0.1.

3.9 Robustness check

In this section we would like to ascertain if we are estimating the effect of financial inclusion through mobile money. Indeed, it is possible that mobile money is not measuring financial inclusion, but rather the flow of information. If mobile money is indeed measuring financial inclusion, replacing this variable with another proxy of financial inclusion should yield the same results. To test this possibility, we use an alternative definition of financial inclusion: ownership of a bank account. Table 3.9.1 shows the results from the logit and linear probability model. In columns (1) and (2) we presents the odds ratio while in columns (3) and (4) we present the estimates from the linear probability model. As it can be noticed, ownership of a bank account is positive and statistically significant in all specifications suggesting that financial inclusion is positively correlated with solar panel adoption. Results from the logit model show that the probability of adopting

solar panels is 2.37 times higher for household heads with a formal bank account than those without. The magnitude of the odds ratio for bank account ownership is quite similar to what we find for mobile money. On the other hand, the linear probability model indicates that having a bank account increase the probability of solar panels by 6.2%.

In a nutshell, the results from our robustness check suggest that financial inclusion is positively associated with solar panel adoption. We can, therefore, be confident that mobile money is effectively measuring financial inclusion and not the information flow.

Table 3.9.1: Impact of financial inclusion on solar panel adoption

	Logit		Linear Probability (LP)	
	Odds ratio (1)	Odds ratio (2)	Coef./se (3)	Coef./se (4)
Bank account	2.378*** (0.406)	2.365*** (0.409)	0.062*** (0.016)	0.062*** (0.016)
Migrant	1.241 (0.175)	1.237 (0.176)	0.016 (0.011)	0.015 (0.012)
Head age	0.993* (0.004)	0.993 (0.005)	-0.001* (0.000)	-0.001* (0.000)
Literacy	1.793*** (0.308)	1.766*** (0.303)	0.047*** (0.015)	0.046*** (0.015)
Household size	1.081** (0.040)	1.079** (0.040)	0.007** (0.003)	0.007** (0.003)
Head gender	0.988 (0.157)	0.997 (0.158)	-0.004 (0.012)	-0.003 (0.012)
Female ratio	0.974 (0.059)	0.979 (0.060)	-0.003 (0.006)	-0.002 (0.006)
Rural	3.661*** (0.676)	3.617*** (0.692)	0.088*** (0.014)	0.088*** (0.014)
Irradiation	5.312*** (1.424)	4.970*** (1.360)	0.143*** (0.027)	0.138*** (0.026)
Constant	0.000*** (0.000)	0.000*** (0.000)	-0.643*** (0.122)	-0.616*** (0.127)
District fixed effects	No	Yes	No	Yes
Observation	3319	3319	3319	3319
Log likelihood	-924.783	-920.823		
LR Chi2	130.661	139.749		
Pseudo R2	0.082	0.086		
R-Square			0.048	0.051

Note: Robust standard errors in parenthesis clustered by wards, *** p<0.01, ** p<0.05, * p<0.1.

3.10 Conclusion

This paper examines the effect of mobile money adoption on solar panels' adoption and the underlying mechanisms through which mobile money adoption affects the uptake of solar panels in Tanzania. Mobile money is a basic banking solution that relies on Global System for Mobile (GSM) technology. It allows its users, via secured text messages, to make basic banking operations such as payment, reception of remittances. Although savings are not remunerated, yet mobile money remains an attractive saving solution for the unbanked.

Using the first wave of the refreshed sample of the Tanzania National Panel Survey, we find that households that use mobile money services are more likely to adopt solar panels than households that do not use. Specifically, we find the odds of adopting solar panels to be 2.65 times higher for mobile money using households than non-using ones. More, using an instrumental variable approach to account for potential endogeneity issues arising from mobile money adoption, we find mobile money adoption to lead to a 19% increase in the probability of adopting solar panels. Furthermore, we examine the heterogeneous effects of mobile money adoption with respect to households' poverty status, house ownership status and having a migrant. We find the effect of mobile money adoption to be positive and statistically significant for only poor households. Finally, we investigate the potential mechanisms at play. We show that reception of remittances, access to credit and participation in off-farm income generating activities are the mediating channels through which mobile money affect the probability of adopting solar panels.

Our paper shows that promoting the use of mobile money can enable the adoption of welfare improving technology. Hence, efforts should be concentrated in reaching those at the bottom of the pyramid mainly living in remote rural areas. Energy services providers should systematically offer mobile money payment solutions in their business model to allow, for example, flexible payment of costly electricity connection fees. This might, for instance, help households in overcoming the high upfront grid connection fees.

Bibliography

Aker, J. C. (2010), 'Information from markets near and far: Mobile phones and agricultural markets in niger', *American Economic Journal: Applied Economics* **2**(3), 46–59.

URL: <http://pubs.aeaweb.org/doi/10.1257/app.2.3.46>

Aker, J. C. & Mbiti, I. M. (2010), 'Mobile phones and economic development in Africa', *Journal of Economic Perspectives* **24**(3), 207–232.

Allcott, H., Collard-Wexler, A. & O'Connell, S. D. (2016), 'How do electricity shortages affect industry? evidence from india', *American Economic Review* **106**(3), 587–624.

Arraiz, I. & Calero, C. (2015), From Candles to Light: The Impact of Rural Electrification, Technical report.

URL: <http://www.iadb.org>

Barry, M. S. & Creti, A. (2020), 'Pay-as-you-go contracts for electricity access: Bridging the "last mile" gap? a case study in benin', *Energy Economics* **90**, 104843.

Batista, C. & Vicente, P. C. (2020), 'Improving access to savings through mobile money: Experimental evidence from African smallholder farmers', *World Development* **129**, 104905.

Bollinger, B. & Gillingham, K. (2012), 'Peer effects in the diffusion of solar photovoltaic panels', *Marketing Science* **31**(6), 900–912.

- Buragohain, T. (2012), 'Impact of solar energy in rural development in india', *International journal of environmental science and development* **3**(4), 334.
- Burgess, R. & Pande, R. (2005), 'Do rural banks matter? evidence from the indian social banking experiment', *American Economic Review* **95**(3), 780–795.
- Chen, A. Z., Fischer, J., Fraker, A., Shah, N. B., Shirrell, S. & Stein, D. (2017), 'Welfare impacts of an entry-level solar home system in Uganda', *Journal of Development Effectiveness* **9**(2), 277–294.
- Dupas, P. & Robinson, J. (2013), 'Why don't the poor save more? evidence from health savings experiments', *American Economic Review* **103**(4), 1138–71.
- EconStor: From Candles to Light: The Impact of Rural Electrification* (n.d.).
URL: <https://www.econstor.eu/handle/10419/115541>
- Fisher-Vanden, K., Mansur, E. T. & Wang, Q. J. (2015), 'Electricity shortages and firm productivity: evidence from china's industrial firms', *Journal of Development Economics* **114**, 172–188.
- Furukawa, C. (2014), 'Do solar lamps help children study? Contrary evidence from a pilot study in Uganda', *Journal of Development Studies* **50**(2), 319–341.
- Grimm, M., Munyehirwe, A., Peters, J. & Sievert, M. (2017), 'A first step up the energy ladder? Low cost solar kits and household's welfare in rural Rwanda', *World Bank Economic Review* **31**(3), 631–649.
- Guta, D. D. (2018), 'Determinants of household adoption of solar energy technology in rural ethiopia', *Journal of Cleaner Production* **204**, 193–204.
- Jack, W. & Suri, T. (2014a), 'Risk sharing and transactions costs: Evidence from Kenya's mobile money revolution', *American Economic Review* **104**(1), 183–223.
- Jack, W. & Suri, T. (2014b), 'Risk sharing and transactions costs: Evidence from Kenya's mobile money revolution', *American Economic Review* **104**(1), 183–223.
- Jensen, R. (2007), 'The digital divide: Information (technology), market performance, and welfare in the south indian fisheries sector', *The quarterly journal of economics* **122**(3), 879–924.
- Khandker, S. R., Samad, H. A., Sadeque, Z. K., Asaduzzaman, M., Yunus, M. & Haque, A. E.

- (2014), *Surge in solar-powered homes: Experience in off-grid rural Bangladesh*, The World Bank.
- Klasen, S. & Mbegalo, T. (2016), The impact of livestock ownership on solar home system adoption in the northern and western regions of rural tanzania, Technical report, Courant Research Centre: Poverty, Equity and Growth-Discussion Papers.
- Komatsu, S., Kaneko, S. & Ghosh, P. P. (2011), 'Are micro-benefits negligible? The implications of the rapid expansion of Solar Home Systems (SHS) in rural Bangladesh for sustainable development', *Energy Policy* **39**(7), 4022–4031.
- Komatsu, S., Kaneko, S., Shrestha, R. M. & Ghosh, P. P. (2011), 'Nonincome factors behind the purchase decisions of solar home systems in rural bangladesh', *Energy for Sustainable Development* **15**(3), 284–292.
- Kudo, Y., Shonchoy, A. S. & Takahashi, K. (2017), 'Can Solar Lanterns Improve Youth Academic Performance? Experimental Evidence from Bangladesh', *The World Bank Economic Review* (January).
URL: <https://academic.oup.com/wber/article-lookup/doi/10.1093/wber/lhw073>
- Ky, S., Rugemintwari, C. & Sauviat, A. (2018), 'Does mobile money affect saving behaviour? evidence from a developing country', *Journal of African Economies* **27**(3), 285–320.
- Lee, K., Miguel, E. & Wolfram, C. (2020), 'Does household electrification supercharge economic development?', *Journal of Economic Perspectives* **34**(1), 122–44.
- Lemaire, X. (2018), 'Solar home systems and solar lanterns in rural areas of the global south: What impact?', *Wiley Interdisciplinary Reviews: Energy and Environment* **7**(5), e301.
- Lipscomb, M., Mobarak, A. M. & Barham, T. (2013), 'Development effects of electrification: Evidence from the topographic placement of hydropower plants in brazil', *American Economic Journal: Applied Economics* **5**(2), 200–231.
- Munyegera, G. K. & Matsumoto, T. (2016), 'Mobile Money, Remittances, and Household Welfare: Panel Evidence from Rural Uganda', *World Development* **79**(25101002), 127–137.
URL: <http://dx.doi.org/10.1016/j.worlddev.2015.11.006>
- Murendo, C., Wollni, M., Brauw, A. D. & Mugabi, N. (2018), 'Social Network Effects on Mobile

- Money Adoption in Uganda Social Network Effects on Mobile Money Adoption in Uganda', *The Journal of Development Studies* **54**(2), 327–342.
URL: <https://doi.org/10.1080/00220388.2017.1296569>
- Muto, M. & Yamano, T. (2009), 'The Impact of Mobile Phone Coverage Expansion on Market Participation: Panel Data Evidence from Uganda', *World Development* .
- Richter, L.-L. (2013), 'Social effects in the diffusion of solar photovoltaic technology in the uk'.
- Riley, E. (2018), 'Mobile money and risk sharing against village shocks', *Journal of Development Economics* **135**, 43–58.
URL: <https://doi.org/10.1016/j.jdeveco.2018.06.015>
- Rud, J. P. (2012), 'Electricity provision and industrial development: Evidence from india', *Journal of Development Economics* **97**(2), 352–367.
- Sanyal, S., Prins, J., Visco, F. & Pinchot, A. (2016), 'Stimulating pay-as-you-go energy access in kenya and tanzania: the role of development finance', *World Resources Institute* .
- Sekabira, H. & Qaim, M. (2017), 'Mobile money, agricultural marketing, and off-farm income in uganda', *Agricultural Economics* **48**(5), 597–611.
- Smith, M. G. & Urpelainen, J. (2014), 'Early adopters of solar panels in developing countries: Evidence from tanzania', *Review of Policy Research* **31**(1), 17–37.
- Tadesse, G. & Bahiigwa, G. (2015), 'Mobile Phones and Farmers' Marketing Decisions in Ethiopia', *World Development* .
- Tarozzi, A., Mahajan, A., Blackburn, B., Kopf, D., Krishnan, L. & Yoong, J. (2014), 'Micro-loans, insecticide-treated bednets, and malaria: Evidence from a randomized controlled trial in Orissa, India', *American Economic Review* **104**(7), 1909–1941.
- Yuya, K., Shonchoy Abu, S. & Kazushi, T. (2015), 'Impacts of solar lanterns in geographically challenged locations: experimental evidence from bangladesh'.

The Impact of Mobile Money on Households Cooking Fuel Choices :
Evidence from Senegal

4.1 Introduction

Access to financial services is widely recognized as a key determinant of economic development and poverty reduction (Burgess & Pande 2005). For instance, access to financial services, enables households to accumulate small amounts of money into large sums (Prina 2015), which allows them to invest in human capital, and also to better cope with adverse shocks (Demirgüç-Kunt et al. 2020). Furthermore, access to financial services facilitates access to formal credit, allowing households to invest in income-generating activities or welfare-improving technologies (Barry & Creti 2020, Devoto et al. 2012, Dupas & Robinson 2013, Tarozzi et al. 2014). Moreover, access to financial services makes it easier to allocate resources in an economy and thereby reinforcing economic growth. Nonetheless, a sizable proportion of the global population, particularly, the world's poorest, lacks access to basic financial services. According to the Global Findex, there were 1.7 billion adults in 2017 without access to financial services. In this regard, Sub-Saharan Africa (SSA) has made significant strides in providing financial services to the unbanked. The proportion of adults who have a bank account increased from 34% in 2014 to 43% in 2017 (Demirgüç-Kunt et al.

2020). The rapid expansion of financial services in SSA has been fostered by the development of innovative digital financial services such as mobile money services.

Mobile money services is a cutting-edge financial service that uses GSM technology. It enables its users to perform basic financial transactions such as payment, withdrawal of funds, and receipt of remittances. Although there is no interest on a mobile money account, it remains an appealing savings option for those who do not have access to the traditional banking system. Furthermore, because of its ease of use, mobile money is revolutionizing the delivery of basic services in developing countries. Mobile money is more and more used by governments, in developing countries, for payments in cash transfer programs. Also, by lowering transaction costs and securing payments, mobile money is expected to play a key role in bridging the access gap to modern energy services in developing countries. In this regard, the service is currently used by many utilities to sell electricity on a pay-as-you-go scheme or for bill payments. However, while mobile money services are making impressive strides in developing countries, the provision of other essential services such as electricity is still problematic.

Indeed, given the pivotal role of access to electricity and clean cooking fuel for human capital development and economic growth, the United Nations Sustainable Energy for All (SE4All) initiative, has embarked on an ambitious goal of providing modern energy services to all by 2030. This ambitious goal is enshrined in the Sustainable Development Goals, which aims to ensure prosperity for all, end poverty, and, most importantly, address climate change through universal access to modern energy services. However, despite decades of significant progress in expanding access to modern energy services, a sizable portion of the world's population continues to rely on traditional polluting cooking fuels. According to estimates from the World Bank, more than 2.6 billion people globally lack access to clean cooking fuels. Sub-Saharan Africa region concentrate the bulk of the population lacking access to clean cooking fuels, with an access deficit of 910 million people. Only 10% of the region's population have access to modern energy sources for cooking fuels. The heavy reliance on solid polluting cooking fuels has detrimental environmental and health effects. The economic cost of solid biomass cooking fuels is enormous. It is estimated to cost the world more than 2.4 trillion dollars each year, with \$0.8 trillion from lost productivity for women, \$0.2 trillion for climate change and \$1.4 trillion for adverse impacts on health (ESMAP 2020).

The aim of this paper, therefore, is to assess the role of financial inclusion, more specifically

the enabling role of mobile money on households' decision to use clean cooking fuels in Senegal. Specifically, I would like to examine whether households that use mobile money services are more likely to switch from pollutant sources of cooking fuels towards clean and efficient cooking fuels. Firstly, I begin by estimating the causal impact of mobile money on Senegalese households' cooking fuel choices. Secondly, I investigate the heterogeneous effects of mobile money adoption on households' cooking fuel choices with regard to their geographic location, poverty status, and head's gender. Finally, I examine the mediating channels through which mobile money affects households' decision to purchase clean cooking fuels. By addressing this research question, we contribute to the growing literature on the drivers of cooking fuel transition in developing countries. More specifically, understanding the factors that influence clean cooking fuel choices, particularly how financial inclusion facilitates the transition from dirty cooking fuels towards clean and efficient cooking fuels is of utmost importance for policymakers.

To shed light on the impact of mobile money on cooking fuel choices, I rely on a novel representative survey of Senegalese households, which provides detailed information on households' use of financial services. I begin by applying a probit model, where I compare cooking fuel choices among mobile money users and non-users. However, the results from the Probit model are likely to be biased due to endogeneity of mobile money. Indeed, there might be omitted unobserved factors that can explain both mobile money adoption and cooking fuel choices. I address the endogeneity issue by using an instrumental variable technique. I follow [Riley \(2018\)](#) and instrument mobile money adoption with a dummy variable that indicates whether a household lives within a ward that has a mobile money agent.

My results reveal that mobile money is positively associated with clean and charcoal cooking fuels while it is negatively associated with biomass cooking fuel. Specifically, the results from the instrumental variable reveal that mobile money leads to a 24.5% and 44% increase in the probability of adopting clean and charcoal cooking fuels, respectively. However, mobile money leads to a 68.2% decrease in the probability of using solid biomass cooking fuels. These results support the view that financial inclusion impacts energy transition by enabling households to switch from dirty cooking fuels towards clean cooking fuels. Furthermore, I examine the heterogeneous effects of mobile money on cooking fuel choices with respect to head's gender, poverty status and geographic location. While I find no differentiated effect of mobile money with regard to house-

hold head's gender and poverty status, the result is different with regard to household's geographic location. More specifically, I find the effect of mobile money to be positive and statistically significant with clean cooking fuels adoption for rural dwellers only, whereas mobile money has a negative and significant impact on biomass cooking fuels in both urban and rural areas. Overall, my results support the view that financial inclusion can accelerate energy transition in developing countries.

My paper contributes to the scant, but rapidly growing literature examining the development effects of mobile money services in developing countries. For example, it is now well established from a variety of studies that households using mobile money services are better able to cope with unforeseen adverse shocks than non-using households (Jack & Suri 2014, Riley 2018). However, the nexus between mobile money and access to modern energy services has received less attention. Hence, in this paper, I take a different perspective and explore the relationship between mobile money adoption and households cooking fuel choices. To my knowledge, this is the first paper to explore the impact of mobile money on cooking fuel choices. I provide new insights on the key role of financial inclusion in bridging the access gap to clean cooking fuels. By addressing this research question, I also provide evidence of the pivotal role the financial sector could play in accelerating the transition away from dirty cooking fuels towards clean cooking fuels for poor households. My paper is close to that of (Koomson & Danquah 2021) and (Boutabba et al. 2020) who study the impact of financial inclusion and access to micro-finance on energy poverty in Ghana and Togo, respectively. Contrary to Koomson & Danquah (2021), who construct an index of access to financial services and energy poverty, I focus on mobile money services and households' main cooking fuels.

The remainder of the paper is organized as follows: Section 2 provides a background on Senegal. Section 3 describes the data and summary statistics of the main variables used in this study. The empirical strategy and results are presented respectively in Section 4 and 5. Section 6 and 7 covers heterogeneous effects and the underlying mechanism at play, respectively. Section 8 presents robustness checks. Concluding remarks are developed in section 8.

4.2 Background on Senegal

Located in West Africa, Senegal is one of the most politically stable country of the region. In 2020, its population was estimated at 16,7 million. Its per capita Gross National Income (GNI) of \$1,430 places it in the lower middle-income countries category. Over the past five years, Senegal has achieved outstanding economic performance. According to the statistics of the World Bank, the country's Gross Domestic Product (GDP) has grown at an average annual rate of 6% per year. Senegal's economy is essentially driven by a very dynamic service sector. The services sector accounts for nearly 52% of Senegal's GDP, while the share of the secondary and primary sectors in GDP stands at 15% and 23%, respectively. Nevertheless, despite Senegal's economic performance, the overwhelming majority of the Senegalese population still live in extreme poverty. According to the National Statistics and Demography Agency (ANSD), nearly 37.8% of the population live below the poverty line. Rural areas concentrate the bulk of the country's poorest people. Recognizing that extreme poverty could undermine its economic development, the Senegalese government has made the fight against poverty a central concern. In this regard, several initiatives have been developed by the government. The flagship initiative is the National Family Allowance Program. It is a nationwide, conditional cash transfer, program that provides quarterly cash transfers of about \$40, to the country's most vulnerable households. The receipt of the allowance is conditional on households participation in outreach sessions aimed at effecting behavior change in the areas of education, health, and civil registration. The ultimate goal of the program in one hand is to restore human dignity by enabling the poorest to cover essential expenses, and on the other hand to break the intergenerational transmission chain of poverty. Since its inception in 2014, more than 250,000 households living in extreme poverty have benefited from the program.

Over the past two decades, Senegal has made tremendous progress in terms of access to electricity. The share of the population with access to electricity increased from 37.74% to 70.4% between 2000 and 2019. While significant progress has been made in terms of access to electricity, the situation regarding access to clean cooking fuels is not encouraging. Only 32% of the Senegalese population uses modern cooking fuels. The majority of the Senegalese population, especially those living in rural areas, use biomass sources of energy to meet their daily energy needs. The heavy dependence on biomass sources has detrimental environmental and health effects. For

Senegal to undertake low-carbon transition and resilient development, it is vital to accelerate universal access to electricity and clean cooking fuels. However, despite the progress that has been made so far, the path to universal access by 2025 is still a long way off.

Furthermore, access to financial services in Senegal remains very low. According to the Central Bank of West African States (BCEAO), only 33% of the Senegalese population, in 2019, had a bank account in a financial institution. However, the high penetration rate of cell phones observed over the last decade is reinventing the provision of basic financial services. Mobile money is a major innovation that is accelerating the delivery of basic financial services to millions of people, in developing countries, at low cost. Mobile money is based on GSM technology and allows users to perform basic financial services such as paying for goods and services, transferring money, and also saving up money. Users can deposit and withdraw money at mobile money agents. While the deposit is free of charge, withdrawals and transfers are subject to fees.

The mobile money market, in Senegal, has long been dominated by the incumbent telephone operator, Orange. The latter has abused its market power by charging very high transfer and withdrawal fees, sometimes angering users. However, Orange's leadership position is currently being challenged with the entry of the American startup Wave into the mobile banking market. Wave's business model is based on free bill payment and a 1% withdrawal fee regardless of the amount. Since its entry into the Senegalese market, in 2019, Wave has grown considerably, with an average monthly growth of 15%. Noting the breakthrough of its competitor, Orange was forced to provide a concrete response to limit the financial bleeding. In concrete terms, Orange has, recently, lowered its withdrawal fees to 0.8% and has also proposed to remunerate users' savings.

Altogether, in order for mobile money to potentially contribute to the improvement of households' living conditions, it is important that the fees applied decrease and that interoperability of transfers between mobile money service operators becomes a reality.

4.3 Theoretical framework: financial inclusion and cooking fuel choices

There are very few empirical papers that explore the effect of financial inclusion, more specifically the use of mobile money services on households' use of modern energy services. Much of the current literature on mobile money services, in developing countries, pays particular attention

to its welfare effects. Overall, there seems to be some evidence to indicate that mobile money facilitates risk coping strategies (Jack & Suri 2014, Riley 2018). For example, a study by Jack & Suri (2014) in Kenya reveals that while households without mobile money accounts experienced a 7% decline in their consumption in the advent of a negative shock, those with mobile money accounts maintained the same level of consumption. Similar results were found by Tabetando & Matsumoto (2020) and Abiona & Koppensteiner (2020), who investigate the impact of mobile money on households' ability to smooth investment in human capital after a negative shock, respectively in rural Uganda and Tanzania. Riley (2018) studies the impact of mobile money services on Tanzanian households' consumption after a rainfall shock (i.e. flood or drought). Concretely, she seeks to understand whether, within a village, remittances received by mobile money using households are shared with non-using households. She finds no spillover effects at the village level. Put differently, only households with mobile money accounts maintained the same level of consumption after a village-level rainfall-shock. Receipt of remittances is identified as the underlying mechanism through which mobile money enables households to better cope with negative shocks. Indeed, by reducing transaction cost, mobile money services, enables households participation in informal risk sharing networks.

Other studies have focused on the revenue generating effects of mobile money services and reveal that mobile money facilitates the access to high value markets (Sekabira & Qaim 2017). More recently, several studies have confirmed that mobile money reduces poverty (Suri & Jack 2016), increases households consumption (Munyegera & Matsumoto 2016), improves well-being (Sakyi-Nyarko et al. 2021), improves diet diversity (Aker et al. 2016), ameliorates food security (Wieser et al. 2019) and facilitates migration from rural to urban areas (Batista et al. 2021). Having summarized the main papers on the development effect of mobile money services, next I present the theoretical channels through which mobile money might affect households fuel use.

4.3.1 Mobile money, savings and investment

Limited access to financial services are often identified in the economic literature as the main barrier to investment in welfare improving technologies in developing countries (Dupas & Robinson 2013, Tarozzi et al. 2014). Hence, providing basic financial services such as mobile money, which allows people to save small amounts of money can have significant welfare improving effects.

In this regard, several lines of evidence suggest that mobile money adoption promotes the use of financial services such as savings (Mbiti & Weil 2016, Demombynes & Thegeya 2012) and access to formal credit (Munyegera & Matsumoto 2018). For example, a study by Ky et al. (2018) in Burkina Faso examines the effect mobile money on individuals savings behaviour. They reveal that mobile money increases the likelihood of individuals to save for unseen health emergencies. Similar results were found in Kenya by Dupas & Robinson (2013) who find that providing simple savings technologies can substantially increase investment in preventative health and reduce vulnerability to health shocks. Besides mobilizing savings, mobile money is also believed to release financial constraints and enable investment. Investigating the impact of mobile money on smallholder farmers investment in rural Mozambique, Batista & Vicente (2020) find that mobile money leads to an increased investment in agricultural inputs such as fertilizer. Similar results were found by Islam et al. (2018) who focus on the nexus between mobile money adoption and firms' investment. Together, the studies support the view that mobile money helps in building up savings, and thereby enabling investment. However, while the saving channel might be at work, unfortunately, due to data limitation I cannot examine this channel. The next subsection examines the remittances channel.

4.3.2 Mobile money and remittances

Beyond providing savings solution to the unbanked, mobile money also enables its users to send or receive remittances instantly and securely at a lower cost. Indeed, in many developing countries the use of mobile money increase the likelihood of receiving remittances. Hence, remittances as an additional revenue to households have the potential to relax the tight budget constraints and enable investment in welfare improving technologies (e.g. clean cooking fuels, fertilizer, etc.). In this regard, several lines of evidence suggest that remittances can facilitate the adoption of new technologies (Quinn (2009)). For example, Veljanoska (2021) investigates whether remittances have the potential to alleviate credit and liquidity constraints by enabling Ugandan farmers to use more fertilizer. She finds that farmers who receive remittances are more likely to use both types (organic and inorganic) of fertilizer. However, the effect is higher and statistically significant for organic fertilizer, suggesting that farmer who receive remittances are more likely to invest in live-stock, which in turn provides organic fertilizer to the farmer. However, while remittances can ease the adoption of clean cooking fuels by relaxing the liquidity constraints, the credit channels might

also be at work. Indeed, remittances can facilitate the participation of a household to the credit market and hence, facilitate the adoption of welfare improving technologies. In this regard, [Mbaye \(2021\)](#) examines the nexus between receipt of remittances and households' access to rural credit markets in Senegal. She finds that the receipt of remittances increases the likelihood of having a loan in a household, suggesting that remittances and credit markets are complements. Together, these studies indicate that remittances have positive development effects. I therefore posit that the channel through which mobile money impacts clean cooking fuels adoption is via the receipt of remittances. I investigate this hypothesis at the mechanism section.

4.4 Data and summary statistics

Studying the impact of mobile money on Senegalese households' cooking fuel choices requires detailed information on households use of financial services and main sources of energy for cooking. Data with such granularity is difficult to have in many developing countries. I rely on data collected by the Initiative Prospective Agricole et Rural (IPAR) which is well suited for this study. Indeed, the survey provides detailed information on households main cooking fuels and use of mobile money services. The survey consists of a sample of 4,803 households deemed representative of Senegalese population, and was conducted between April and July 2021. A range of information were collected at the household level. The survey, for example, includes detailed information on household socioeconomic characteristics, household's assets, access to financial services and basic services such as clean water, sanitation etc. To assess the effect of mobile money on a household's cooking fuel choice, I construct three main cooking fuel variables based on their level of pollution. The first one is the clean cooking fuel variable. It is a dummy variable taking 1 if a household uses electricity or gas as its main cooking fuel and 0 otherwise. Charcoal is the second cooking fuel variable, and it takes 1 if a household uses charcoal as its main cooking fuel, 0 otherwise. Third, biomass takes 1 if the household main cooking fuel is crop residue, firewood or animal dung, 0 otherwise. In addition to this, I also compute households total annual energy expenditure. My variable of interest is the use of mobile money services by households. It is a dummy variable that takes 1 if a household uses mobile money services, 0 otherwise. In addition to these variables, I also include geographic variables. These include regional dummies to control for the specificity of each region and district level variables such as the existence of mobile money

agents within the ward.

Table 1 exhibits summary statistics for the main variables used in this study. Column 1 presents the statistics for all households. Column 2 shows the statistics for mobile money using households, while column 3 presents the statistics for non-using households. It can be noticed that the bulk of Senegalese households relies on pollutant sources of energy for cooking (see figure 4.4.1). More precisely, 62% of households use biomass sources of energy for cooking. Rural area is home to the country's energy-poor households. The share of households using charcoal as their main cooking fuel stands at 16% (see figure 4.4.2), while the share of households using clean cooking fuel is 22% (see figure 4.4.3). Surprisingly, despite government subsidies of liquefied petroleum gas (LPG), its adoption rate is still very low. This could be attributed to the low level of income of Senegalese households. On the other hand, electrification rate in Senegal is among the highest of the region. Nearly 60% of Senegalese households have access to electricity. This figure, however, hides huge geographic disparities. While, nearly 90% of households in urban areas have access to electricity, only 32% of households in rural areas have access to electricity. Similar trend is found for access to clean water, with approximately 60% of households having access to clean water. Although Senegal has witnessed rapid urbanization rate over the last decades, still an important share of its population live in rural areas. More than 50% of households in our survey live in rural areas.

One can notice that Senegalese households are, generally, very large. The average size of a Senegalese household is approximately, 12 persons, with an average dependency ratio of 3 children per household. With an average age of household heads of 54, Senegalese households are predominantly male headed. Only, 33% of households are female headed. However, regarding the socio-professional category of household heads, I find that agriculture is still the mainstay, with approximately 38% of households engaged in agricultural activities. Furthermore, examining the use of telecommunication services, one can notice the rapid penetration of mobile phones in Senegal, over the last years. On average, Senegalese households, approximately, own 4 mobile phones. Similarly to mobile phone penetration, mobile money adoption has grown at an exponential rate. Currently, more than 75% of the households in my sample use mobile money. The service is predominantly used for receiving remittances, saving up money and for buying good and services.

Finally breaking down the analysis with regard to household use of mobile money, I find

significant differences. Overall, mobile money using households are more likely to be better off, more educated, to have access to basics services, to own their house, to have larger family, and also more likely to use clean cooking fuels than non-using households. The next section presents my empirical strategy.

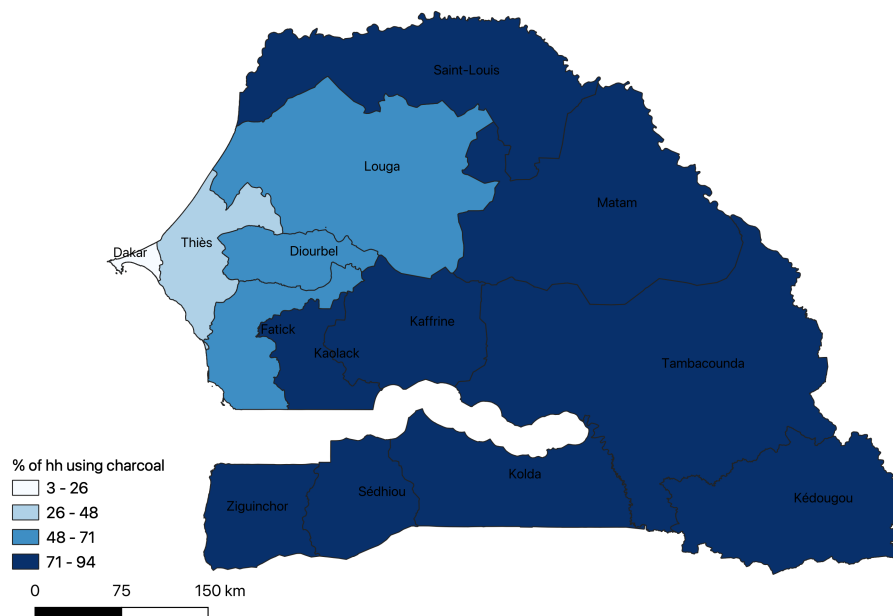

Figure 4.4.1: The share of households using solid biomass as their main cooking fuel
Source : author's elaboration from survey data

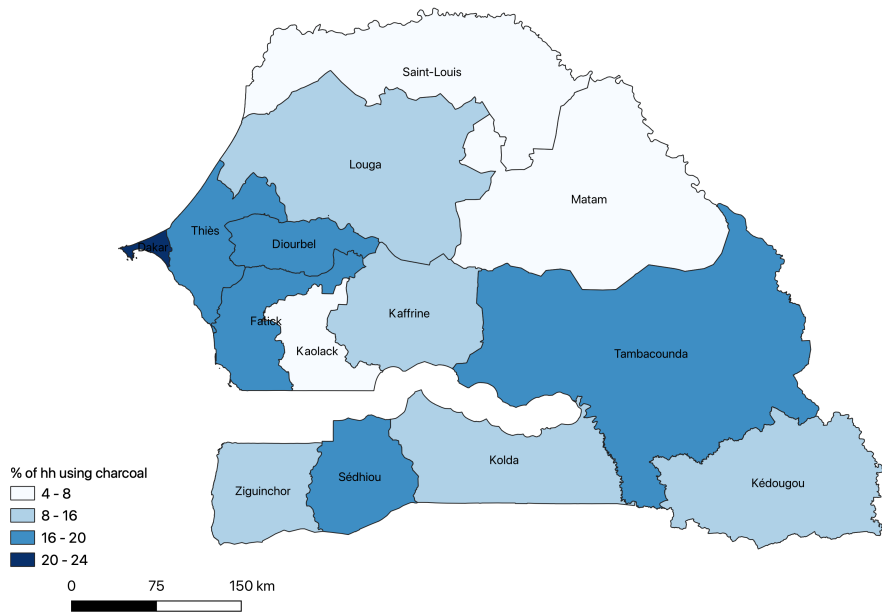

Figure 4.4.2: The share of households using charcoal as their main cooking fuel
Source : author's elaboration from survey data

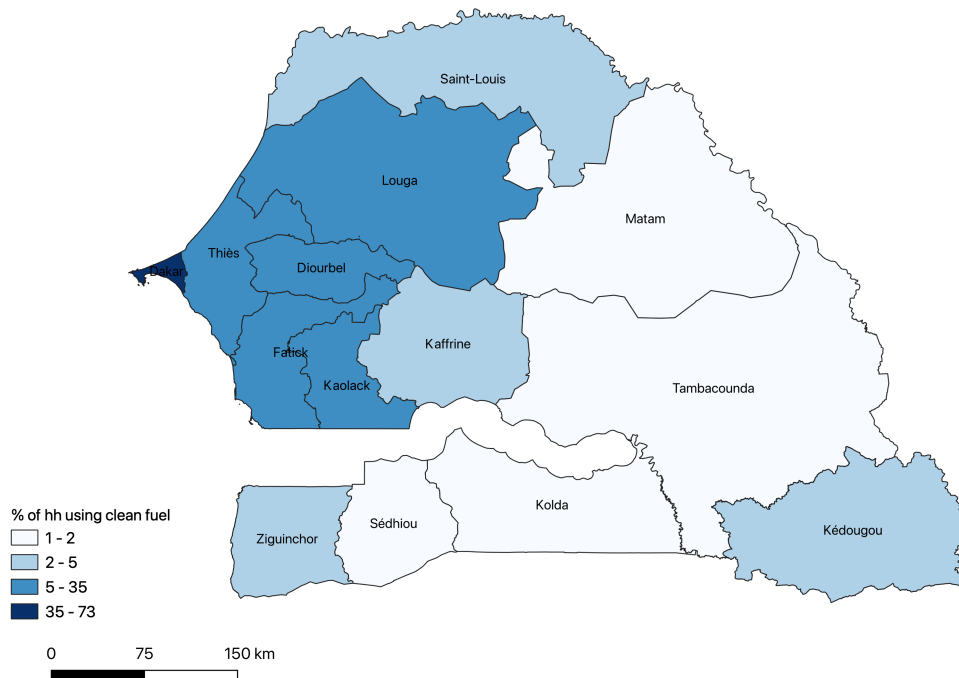

Figure 4.4.3: The share of households using LPG/electricity as their main cooking fuel
Source : author's elaboration from survey data

4.5 Empirical strategy

To examine the impact of mobile money services on Senegalese households' cooking fuel choices, I estimate the specification below:

$$y_i = \alpha + \beta MM_i + \gamma X_i + \varepsilon_i \quad (4.5.1)$$

where y_i is a dummy variable equals to 1 if the household uses cooking fuel i (*clean fuel, charcoal and biomass*) and 0 otherwise. MM_i is also a dummy variable that takes 1 if the household uses mobile money services and 0 otherwise. X_i represents a set of household socioeconomic characteristics. The error term, ε_i is assumed to follow a normal distribution and clustered at the ward level to control for unobserved heterogeneity at the ward level. I first estimate a Probit model, in which I compare cooking fuel adoption among mobile money using households and non-using households. However, the use of a Probit model might lead to a biased estimate of the parameter of interest β . Indeed, mobile money is likely to be endogenous. I identify two main sources of endogeneity. The first source of endogeneity might stem from omitted unobservable factors that can both influence the adoption of mobile money services and cooking fuels. Reverse causality is the second source of endogeneity. This is possible for the case of Senegal if, for example, a household uses electricity as its main cooking fuel. Hence, it might be possible that a household adopts mobile money simply because it has to use it to buy electricity. Recently, Senegal has begun to replace all traditional electric meters with intelligent pay-as-you-go electric meters, which allows households not only to monitor their electricity consumption, but also to purchase electricity through their mobile money account. The introduction of these intelligent meters might, therefore, lead late adopters of mobile money services to adopt the technology.

To address the endogeneity issue, I use a Linear Probability Model (LPM) with an Instrumental Variable (IV) approach. Previous paper examining the development effect of mobile money have address the endogeneity concerns of mobile money adoption by using, for example, the distance separating a household to its nearest mobile money agent (Jack & Suri 2014, Riley 2018, Munyegera & Matsumoto 2016, Gurbuz 2017) and the proportion of households owning a mobile phone in the ward (Kikulwe et al. 2014). The underpinning idea behind the use of these instruments is that the closer is a household to a mobile money agent, the more likely the household

is to use the service. Likewise, since mobile money relies on GSM technology, the lower the proportion of households owning a mobile phone in a ward is, the less likely the households are to adopt the services. While the ownership of mobile phone is a clear predictor of mobile money adoption in Kenya (Kikulwe et al. 2014), in the Senegalese context, Ndiaye & Weibigu (2020) find that the availability and proximity to mobile money agents are key determinants of mobile money adoption. Indeed, mobile money agents are at the heart of the business model of mobile money services. More specifically, it is at the mobile money agents that one can, for instance, subscribe for the service, cash in or cash out money. Therefore, in this paper, I follow Riley (2018) and use the availability of mobile money agent within the ward of each household as an instrument of mobile money adoption. To be qualified as a good instrument, the variable must satisfy two criteria. Firstly, the availability of mobile money services within the ward should be correlated with mobile money use. I expect the availability of mobile money agents within the ward to be positively correlated with households' use mobile money services. My first stage equation is specified as follow:

$$MM_i = \alpha + \beta MM_{Ser_availability} + \gamma X_i + \varepsilon_i \quad (4.5.2)$$

where $MM_availability$ is a dummy variable that is equal to 1 if a household lives within a ward that has, at least, one mobile money agent and 0 otherwise. X_i is a set of control variables and ε the error term, which is assumed to follow a normal distribution and clustered at the ward level. Secondly, there should be no self-selection of mobile money agents into wards. Put differently, the choice of location of mobile money agents should be random and not correlated, for instance, with the level of development of the ward. In this regard, for the Senegalese context, it is less likely that the level of development of wards has had an impact on the location choice of mobile money agents. Indeed, before the introduction of mobile money in 2011, the historical incumbent telephone operator had a very dense territorial network of wholesalers, who retail to thousands of airtime resellers. First of all, it is important to note that in Senegal, it is the pay-as-you-go system that prevails in the telephony sector. Thus, to make a phone call or browse on internet, the user must have credit in his cellphone. And, given the low level of income of the majority of the Senegalese population, very early, Orange developed an airtime selling system, which could transfer airtime from a minimum amount of 100 FCFA, while the lowest refill scratch card credit

is 500 FCFA. Although mobile operators do sell airtime, the overwhelming share of airtime sold in Senegal is performed by retailers, through this system. These include businesses, grocery stores, hair salons, gas stations and multi-service stores, which are spread nationwide.

Clearly, before the introduction of mobile money services in Senegal, in 2011, Orange already had a dense network of distributors and retailers all over the country. Hence, when Orange launched its mobile money service, the operator relied on its dense network of distributors to rapidly develop its network of mobile money agents. This was, in part, facilitated by the fact that, becoming a mobile money agent does not involve high fixed costs. All that matters is to have a business that can generate cash to guarantee payments to mobile money users. However, while it is clear that the location choice of mobile money agents is completely random, the density of mobile money agents on the other hand is likely to be correlated with the level of development the district. Mobile money agents are, generally, concentrated in highly populated areas with high economic potential. Having presented the empirical strategy, in the next section, I present the main results.

4.6 Main results

Table 4.6.1 reports the results of the effect of mobile money on Senegalese households' cooking fuel choices. In columns (1)-(3), I report the marginal effects. The marginal effects can be interpreted as the change in probability when the predictor or independent variable increases by one unit. In all specifications, I include regional dummies to control for regional fixed effects and the error terms are clustered at the ward level. The results from the Probit model reveal that mobile money promotes the transition away from biomass sources of cooking fuels towards cleaner cooking fuels. More specifically, the use of mobile money is negatively associated with biomass sources of cooking fuels, while it is positively associated with the use of clean cooking fuels and charcoal. However, results from the Probit model are likely to be biased due to the endogeneity of mobile money adoption.

Turning to the instrumental variable approach, table.0.5 reports the first stage equation. I find that the availability of mobile money agent within a ward is positive and statistically significant, suggesting that my instrument is a good predictor of mobile money adoption. Besides this, my instrument passes the tests for weak identification and under-identification. The Kleibergen-Paap

F-statistic for weak identification and the Kleibergen-Paap LM rk-statistic for under-identification are both above the standard threshold of 10 used in the literature. The second stage results are presented in columns (4)-(6).

The results from the instrumental variable approach reveal that mobile money is positively associated with charcoal and clean cooking fuel use, while it is negatively associated with biomass cooking fuels. More specifically, I find that using mobile money leads to a 24,5% and 44% increase the probability of using clean cooking fuel and charcoal, respectively. In contrast, mobile money leads to a 68% decrease in the probability of using biomass sources of cooking fuels. This result highlights the important role of financial inclusion in facilitating households' transition away pollutant sources of cooking fuels towards cleaner and more efficient cooking fuels.

Besides the variable of interest mobile money, there are other control variables that also affect cooking fuel use. Household size, receipt of government assistance and working in the agriculture sector and as a public servant is significant and negatively correlated with the use of clean and charcoal cooking fuels. Specifically, an additional person in the household induces a decrease of 5% and 3% in the probability of the household using clean and charcoal cooking fuels, respectively. Conversely, larger households that evolve in the agricultural sector and also receiving government assistance are more likely to rely on biomass sources to meet their energy needs for cooking. Furthermore, a differentiated gender effect with regard to cooking fuels use is at stake. I find that female-headed households are more likely to use clean cooking fuels than male-headed households. This result highlights strong preference of women for cleaner cooking fuels. Finally, I find that having access to clean water, house ownership and the number of mobile phones owned by a household to be statistically significant and positively associated with clean cooking fuels use. This result underlines the pivotal role of revenue in promoting energy transition in developing countries.

The results presented in this section indicate that mobile money promotes the transition away from dirty cooking fuels towards cleaner cooking fuels such as liquefied petroleum gas or electricity. The next section, therefore, moves on to discuss the heterogeneous effect of mobile money on Senegalese cooking fuels use.

Table 4.6.1: The impact of mobile money on cooking fuel choices

	Probit			IV		
	(1)	(2)	(3)	(4)	(5)	(6)
	Clean Coef./se	Charcoal Coef./se	Biomass Coef./se	Clean Coef./se	Charcoal Coef./se	Biomass Coef./se
Mobile money	0.080*** (0.015)	0.067*** (0.016)	-0.101*** (0.014)	0.245*** (0.076)	0.437*** (0.089)	-0.682*** (0.126)
Gender of hoh(=1 if female)	0.028*** (0.010)	0.026** (0.013)	-0.055*** (0.012)	0.025** (0.012)	0.013 (0.015)	-0.038** (0.017)
Household owner	0.054*** (0.009)	0.019 (0.012)	-0.075*** (0.011)	0.065*** (0.016)	0.009 (0.016)	-0.074*** (0.018)
Running water in the house	0.046*** (0.012)	0.059*** (0.015)	-0.087*** (0.013)	0.011 (0.019)	0.002 (0.021)	-0.013 (0.028)
Number of mobile phone	0.013*** (0.002)	0.004 (0.002)	-0.017*** (0.003)	0.009*** (0.004)	-0.005 (0.004)	-0.004 (0.005)
Household size	-0.005*** (0.001)	-0.001 (0.001)	0.005*** (0.001)	-0.005*** (0.001)	-0.003* (0.001)	0.008*** (0.002)
Age of hoh (years)	0.001** (0.000)	0.000 (0.000)	-0.001 (0.000)	0.001 (0.000)	-0.000 (0.001)	-0.001 (0.001)
Number of children aged 6-14	-0.003 (0.003)	-0.002 (0.003)	0.005 (0.003)	-0.002 (0.003)	-0.001 (0.003)	0.003 (0.004)
Number of people over 65 years old	-0.010 (0.007)	-0.003 (0.008)	0.011 (0.008)	-0.011 (0.007)	-0.006 (0.008)	0.017* (0.009)
Educated household head	0.036*** (0.010)	0.027** (0.013)	-0.060*** (0.012)	0.022 (0.014)	-0.014 (0.016)	-0.008 (0.021)
Socio-professional category : agriculture	-0.104*** (0.015)	-0.085*** (0.018)	0.132*** (0.016)	-0.058*** (0.021)	-0.021 (0.024)	0.079*** (0.028)
Socio-professional category : Retailer	-0.007 (0.012)	0.028* (0.016)	-0.005 (0.015)	-0.024 (0.019)	0.025 (0.021)	-0.001 (0.019)
Socio-professional category : Executives/Public Servants	-0.028 (0.019)	0.037 (0.024)	0.021 (0.023)	-0.067** (0.028)	0.034 (0.030)	0.033 (0.032)
Socio-professional category : Worker	0.047*** (0.018)	0.008 (0.023)	-0.053** (0.022)	0.045 (0.029)	-0.017 (0.031)	-0.028 (0.028)
Household receives government assistance	-0.060*** (0.011)	-0.018 (0.012)	0.070*** (0.012)	-0.070*** (0.012)	-0.037** (0.015)	0.107*** (0.018)
Regional controls	Yes	Yes	Yes	Yes	Yes	Yes
Observation	4719	4719	4719	4719	4719	4719
F-stats				37.667	6.974	118.000
R ²				0.399	-0.089	0.280
Weak identification(F-IV)				65.365	65.365	65.365
LM test statistic for underidentification				46.308	46.308	46.308
Underidentification LM (p-value)				0.000	0.000	0.000

Standard errors in parentheses are obtained clustering observations at the district level. *** p < 0.01, ** p < 0.05, * p < 0.1.

4.7 Heterogeneous effects of mobile money

In this section, I analyze the heterogeneous effect of mobile money on Senegalese households' cooking fuels choices. Put differently, I examine whether the results found previously differ with respect to the head's gender, place of location and poverty status of the household. To do so, I split the sample in two subcategories with respect to the household's location (urban vs rural), poverty status (poor vs non-poor) and head's gender (female vs male). In the next subsection, I begin by examining the heterogeneous effect of mobile money on households' cooking fuel choices with respect their location.

4.7.1 Rural vs urban

The effect of mobile money on households' cooking fuel choices is likely to differ depending on the geographic location of households. In Senegal, there are geographic disparities in access to financial services and modern energy services. Indeed, rural areas concentrate the bulk of the population lacking access to basic financial services. Besides this, the provision of modern energy services in rural areas is challenging due to the dispersed nature of settlements. Furthermore, the low level of income in rural areas renders clean cooking fuels adoption unaffordable for the vast majority of the population. Therefore, providing financial solution such as mobile money, which allows households not only to receive remittances at a low cost and also enables households to save small amounts of money can have significant welfare improving effect.

To test the heterogeneous effect of mobile money on households' use of cooking fuels with regard to their geographic location, I split the sample in two subcategories : urban and rural. Table ?? exhibits the results of the impact of mobile money on households cooking fuels choices by household's place of location. All specification are estimated using a linear probability model, with an instrumental variable approach. Columns (1)-(3) present the results for urban area, while columns (4)-(6) display the results for rural area.

For urban area, the results reveal that mobile money has no effect on clean cooking fuels, but a positive and significant effect on charcoal use. In contrast, I find that mobile money is significant and positively associated with clean cooking fuel use in rural areas. Specifically, for rural households, mobile money leads to a 22% increase in the probability of adopting clean

cooking fuels. While mobile money is negatively associated with biomass cooking fuel in both urban and rural areas, mobile money is positively associated with charcoal use in urban areas. Overall, the results reveal a differentiated effect of mobile money on households cooking fuels use with regard to their geographic location. Mobile money promotes households use of clean cooking fuel in rural areas, while it has no effect in urban areas. The results herein support the idea that financial inclusion, in rural areas, has the potential to ease the transition away from dirty cooking fuels towards clean and efficient cooking fuels.

4.7.2 Poverty status

In this subsection, I examine the heterogeneous effect of mobile money on households' cooking fuels with respect to the household's poverty status. Indeed, the poverty status of a household is likely to affect cooking fuel and use of financial services. To test this hypothesis, I split the sample in two subcategories : poor and non-poor household. A household is considered as poor if it benefits from the government national family allowance. The national family allowance is a conditional cash transfer designed to provide assistance to the most vulnerable households of the country. The goal of this conditional cash transfer program is to restore human dignity by helping the poorest households to satisfy their basic needs, and also to break the intergenerational transmission of poverty through, mandatory, outreach participation of recipients.

Table 4.7.2 presents the results of the impact of mobile money on households' cooking fuel with respect to the poverty status of household. The parameters are estimated using a linear probability model with an instrumental variable approach. In all specifications, I control for regional heterogeneity by including regional dummies. Columns (1)-(3) show the results for non-poor households, while columns (4)-(6) display the results for poor households. The results reveal no differentiated impact of mobile money on households' cooking fuels use with respect to their poverty status. I find that, while mobile money is statistically significant and positively associated with clean and charcoal fuels for both poor and non-poor households, it is negatively associated with biomass sources of cooking fuels. Altogether, the results support the view that financial inclusion promotes cooking fuels transition for both poor and non-poor households.

4.7.3 Household head's gender

In this subsection, I investigate the heterogeneous effect of mobile money on households' cooking fuel choices with respect to the household's head gender. Indeed, women and children are generally the segment of the population that bears the burden of energy poverty in developing countries. Women in developing countries allocate an important share of their time to firewood collection and cooking activities, which significantly reduces their participation in income generating activities. Hence understanding how gender affects cooking fuel choices might help in designing tailored measure aimed at increasing the uptake of modern cooking technologies.

To test the heterogeneous effect of household's gender on cooking fuel choices, I split the sample two subcategories : female and male headed households. The results are summarized in table 4.7.3 . The parameters are estimated using a linear probability model with an instrumental variable technique. Columns (1)-(3) display the results for female-headed households while columns (4)-(7) show the results for male-headed households. My results reveal no differentiated effect of mobile money on households cooking fuel choices with regard to head's gender. More specifically, I find that mobile money promotes cooking fuel transition for both female and male headed households. However, the effect of mobile money on cooking fuel choices seems to be much more stronger for female-headed households. Next, I analyze the mechanism through which mobile money facilitates cooking fuel choices.

Table 4.7.1: The impact of mobile money on cooking fuel choices in urban and rural areas (IV)

	Urban			Rural		
	(1)	(2)	(3)	(4)	(5)	(6)
	Clean Coef./se	Charcoal Coef./se	Biomass Coef./se	Clean Coef./se	Charcoal Coef./se	Biomass Coef./se
Mobile money	-0.029 (0.098)	0.570*** (0.143)	-0.542*** (0.133)	0.221*** (0.079)	0.125 (0.091)	-0.346*** (0.124)
Gender of hoh(=1 if female)	0.023 (0.017)	0.006 (0.025)	-0.029 (0.021)	-0.001 (0.013)	0.006 (0.013)	-0.005 (0.020)
Household owner	0.035* (0.020)	-0.010 (0.023)	-0.025 (0.019)	0.071*** (0.021)	-0.008 (0.017)	-0.064*** (0.023)
Running water in the house	0.104*** (0.030)	-0.013 (0.036)	-0.091** (0.036)	-0.007 (0.020)	-0.008 (0.018)	0.014 (0.029)
Number of mobile phone	0.025*** (0.005)	-0.010* (0.006)	-0.015*** (0.005)	-0.004 (0.003)	0.004 (0.004)	-0.000 (0.006)
Household size	-0.007*** (0.002)	-0.002 (0.003)	0.009*** (0.002)	-0.003*** (0.001)	-0.001 (0.001)	0.003* (0.002)
Age of hoh (years)	0.001 (0.001)	-0.001 (0.001)	0.001 (0.001)	0.001 (0.000)	0.000 (0.000)	-0.001 (0.001)
Number of children aged 6-14	-0.005 (0.005)	0.003 (0.006)	0.002 (0.005)	-0.000 (0.002)	-0.002 (0.003)	0.002 (0.003)
Number of people over 65 years old	-0.017 (0.011)	0.006 (0.014)	0.011 (0.012)	0.001 (0.007)	-0.008 (0.008)	0.007 (0.010)
Educated household head	0.065*** (0.023)	-0.031 (0.027)	-0.033 (0.023)	-0.009 (0.013)	0.027* (0.015)	-0.019 (0.021)
Socio-professional category : agriculture	-0.123*** (0.040)	0.049 (0.042)	0.074* (0.038)	-0.005 (0.018)	-0.032 (0.023)	0.036 (0.028)
Socio-professional category : Retailer	-0.040 (0.025)	0.037 (0.031)	0.004 (0.022)	0.028 (0.022)	-0.029 (0.022)	0.001 (0.028)
Socio-professional category : Executives/Public Servants	-0.068** (0.034)	0.051 (0.042)	0.016 (0.035)	-0.026 (0.031)	-0.023 (0.033)	0.049 (0.045)
Socio-professional category : Worker	0.045 (0.034)	-0.057 (0.039)	0.013 (0.028)	0.058 (0.042)	0.044 (0.057)	-0.102* (0.052)
Household receives government assistance	-0.068*** (0.020)	-0.024 (0.028)	0.092*** (0.024)	-0.041*** (0.012)	-0.033** (0.013)	0.074*** (0.018)
Regional controls	Yes	Yes	Yes	Yes	Yes	Yes
Observation	2196	2196	2196	2523	2523	2523
F-stats	49.541	13.332	94.728	11.265	4.822	12.246
R ²	0.414	-0.063	0.409	0.181	0.010	0.098
Weak identification(F-IV)	37.436	37.436	37.436	27.197	27.197	27.197
LM test statistic for underidentification	12.523	12.523	12.523	22.453	22.453	22.453
Underidentification LM (p-value)	0.000	0.000	0.000	0.000	0.000	0.000

Standard errors in parentheses are obtained clustering observations at the district level. *** p < 0.01, ** p < 0.05, * p < 0.1.

Table 4.7.2: The impact of mobile money on cooking fuel choices for non-poor and poor households (IV)

	Non-poor			Poor		
	(1)	(2)	(3)	(4)	(5)	(6)
	Clean Coef./se	Charcoal Coef./se	Biomass Coef./se	Clean Coef./se	Charcoal Coef./se	Biomass Coef./se
Mobile money	0.323*** (0.108)	0.598*** (0.138)	-0.921*** (0.192)	0.125** (0.063)	0.225*** (0.083)	-0.350*** (0.106)
Gender of hoh(=1 if female)	0.028* (0.015)	0.006 (0.018)	-0.034* (0.020)	0.019 (0.019)	0.031 (0.024)	-0.051** (0.026)
Household owner	0.056*** (0.018)	-0.000 (0.018)	-0.056*** (0.021)	0.081*** (0.022)	0.021 (0.026)	-0.102*** (0.030)
Running water in the house	-0.007 (0.026)	-0.018 (0.030)	0.025 (0.040)	0.035* (0.021)	0.028 (0.030)	-0.063* (0.034)
Number of mobile phone	0.010** (0.005)	-0.009** (0.005)	-0.000 (0.006)	0.009** (0.004)	0.000 (0.005)	-0.009* (0.005)
Household size	-0.007*** (0.002)	-0.003 (0.002)	0.010*** (0.002)	-0.001 (0.002)	-0.002 (0.002)	0.004* (0.002)
Age of hoh (years)	0.001* (0.001)	-0.001 (0.001)	-0.000 (0.001)	-0.000 (0.001)	0.001 (0.001)	-0.001 (0.001)
Number of children aged 6-14	0.001 (0.004)	0.002 (0.004)	-0.003 (0.005)	-0.008* (0.004)	-0.003 (0.005)	0.010** (0.005)
Number of people over 65 years old	-0.023** (0.009)	0.006 (0.011)	0.017 (0.013)	0.016 (0.010)	-0.025** (0.011)	0.010 (0.014)
Educated household head	0.021 (0.021)	-0.045* (0.023)	0.023 (0.032)	0.006 (0.016)	0.024 (0.023)	-0.030 (0.022)
Socio-professional category : agriculture	-0.067** (0.029)	0.017 (0.036)	0.050 (0.043)	-0.020 (0.022)	-0.063** (0.030)	0.083** (0.032)
Socio-professional category : Retailer	-0.031 (0.023)	0.029 (0.025)	0.002 (0.023)	-0.010 (0.028)	0.010 (0.033)	0.001 (0.031)
Socio-professional category : Executives/Public Servants	-0.075** (0.032)	0.032 (0.037)	0.043 (0.042)	-0.034 (0.057)	0.047 (0.077)	-0.013 (0.062)
Socio-professional category : Worker	0.025 (0.034)	-0.022 (0.035)	-0.004 (0.033)	0.090 (0.056)	0.005 (0.058)	-0.094* (0.054)
Regional controls	Yes	Yes	Yes	Yes	Yes	Yes
Observation	3379	3379	3379	1340	1340	1340
F-stats	43.829	4.422	77.826	9.738	4.632	49.692
R ²	0.393	-0.203	0.145	0.316	0.044	0.337
Weak identification(F-IV)	37.989	37.989	37.989	50.078	50.078	50.078
LM test statistic for underidentification	29.809	29.809	29.809	37.257	37.257	37.257
Underidentification LM (p-value)	0.000	0.000	0.000	0.000	0.000	0.000

Standard errors in parentheses are obtained clustering observations at the district level. *** p < 0.01, ** p < 0.05, * p < 0.1.

Table 4.7.3: The impact of mobile money on cooking fuel choices for female and male heads (IV)

	Female head			Male head		
	(1)	(2)	(3)	(4)	(5)	(6)
	Clean Coef./se	Charcoal Coef./se	Biomass Coef./se	Clean Coef./se	Charcoal Coef./se	Biomass Coef./se
Mobile money	0.286*** (0.085)	0.521*** (0.102)	-0.807*** (0.137)	0.205** (0.086)	0.377*** (0.124)	-0.581*** (0.157)
Household owner	0.055** (0.028)	0.024 (0.029)	-0.080*** (0.028)	0.061*** (0.017)	0.005 (0.018)	-0.066*** (0.021)
Running water in the house	0.032 (0.028)	-0.021 (0.034)	-0.012 (0.041)	0.006 (0.022)	0.019 (0.029)	-0.025 (0.034)
Number of mobile phone	0.017*** (0.006)	-0.016** (0.006)	-0.001 (0.007)	0.007** (0.004)	-0.000 (0.004)	-0.007 (0.005)
Household size	-0.008*** (0.003)	-0.001 (0.003)	0.010*** (0.003)	-0.004*** (0.001)	-0.003* (0.002)	0.007*** (0.002)
Age of hoh (years)	0.001 (0.001)	-0.002* (0.001)	0.000 (0.001)	0.000 (0.000)	0.001 (0.001)	-0.001 (0.001)
Number of children aged 6-14	-0.002 (0.006)	0.000 (0.006)	0.002 (0.007)	-0.003 (0.003)	-0.000 (0.003)	0.003 (0.004)
Number of people over 65 years old	0.014 (0.015)	-0.009 (0.015)	-0.005 (0.019)	-0.019** (0.008)	-0.005 (0.010)	0.025** (0.011)
Educated household head	0.047** (0.024)	0.003 (0.028)	-0.050* (0.028)	0.008 (0.015)	-0.018 (0.020)	0.010 (0.026)
Socio-professional category : agriculture	-0.016 (0.034)	-0.045 (0.039)	0.061 (0.045)	-0.083*** (0.027)	-0.011 (0.033)	0.095*** (0.036)
Socio-professional category : Retailer	-0.003 (0.026)	0.002 (0.029)	0.001 (0.025)	-0.047* (0.027)	0.045 (0.030)	0.002 (0.027)
Socio-professional category : Executives/Public Servants	-0.124* (0.074)	0.150 (0.099)	-0.026 (0.060)	-0.064* (0.035)	0.020 (0.037)	0.044 (0.038)
Socio-professional category : Worker	-0.023 (0.044)	0.007 (0.053)	0.016 (0.043)	0.066* (0.036)	-0.022 (0.039)	-0.044 (0.037)
Household receives government assistance	-0.093*** (0.019)	-0.030 (0.024)	0.124*** (0.029)	-0.054*** (0.014)	-0.043** (0.018)	0.097*** (0.021)
Regional controls	Yes	Yes	Yes	Yes	Yes	Yes
Observation	1544	1544	1544	3175	3175	3175
F-stats	37.451	5.070	51.525	37.787	4.688	102.865
R ²	0.382	-0.110	0.256	0.410	-0.064	0.302
Weak identification(F-IV)	51.263	51.263	51.263	35.475	35.475	35.475
LM test statistic for underidentification	33.659	33.659	33.659	29.305	29.305	29.305
Underidentification LM (p-value)	0.000	0.000	0.000	0.000	0.000	0.000

Standard errors in parentheses are obtained clustering observations at the district level. *** p < 0.01, ** p < 0.05, * p < 0.1.

4.8 Mechanisms at play

In this section, I analyze the mediating channels through which mobile money adoption affects households cooking fuel choices. Indeed, in developing countries and specially in Senegal, mobile money is mainly used by households to send and receive remittances, from relatives or social network. Besides, mobile money enables households to have access to a wider network, geographically dispersed. Therefore, I assume that households that use mobile money services are

more likely to receive remittances, and these households are more likely to invest in clean cooking fuels. I focus on two categories of remittances: internal remittances and international remittances. I rely on a probit model to estimate the parameters. The results are presented in Table 4.8.1. My results reveal that mobile money is significant and positively correlated with internal remittances, supporting the view that mobile money promotes internal remittances. However, I find no effect of mobile money on international remittances. This result is at odds with previous studies that found that the use of mobile money increases the probability of receiving remittances (Jack & Suri 2014, Sekabira & Qaim 2017, Riley 2018). Having examined the mechanism at play, next I focus on the robustness check.

Table 4.8.1: The mechanisms at play

	Probit	
	(1)	(2)
	Local remittance Coef./se	Int. remittance Coef./se
Mobile money	0.014*	0.003
	(0.009)	(0.008)
Gender of hoh(=1 if female)	0.031***	0.022***
	(0.007)	(0.007)
Household owner	-0.025***	-0.001
	(0.008)	(0.007)
Running water in the house	0.014*	0.015*
	(0.008)	(0.008)
Number of mobile phone	0.003*	0.006***
	(0.002)	(0.001)
Household size	-0.001	-0.001
	(0.001)	(0.001)
Age of hoh (years)	0.001***	0.000*
	(0.000)	(0.000)
Number of children aged 6-14	-0.000	0.004**
	(0.002)	(0.002)
Number of people over 65 years old	0.004	0.007
	(0.005)	(0.004)
Educated household head	0.010	0.012*
	(0.007)	(0.007)
Socio-professional category : agriculture	-0.020**	-0.031***
	(0.010)	(0.010)
Socio-professional category : Retailer	-0.033***	-0.036***
	(0.010)	(0.009)
Socio-professional category : Executives/Public Servants	-0.034*	-0.027*
	(0.019)	(0.015)
Socio-professional category : Worker	-0.058***	-0.046***
	(0.019)	(0.014)
Household receives government assistance	0.005	-0.016**
	(0.007)	(0.007)
Rural	0.019**	0.013
	(0.008)	(0.008)
Regional controls	Yes	Yes
Observation	4719	4719

Standard errors in parentheses are obtained clustering observations at the district level.
 *** p < 0.01, ** p < 0.05, * p < 0.1.

4.9 Robustness check

In this section, I perform a robustness analysis to examine if the positive effect of mobile money on the uptake of clean cooking fuels is altered by how cooking fuel is proxied. Specifically, rather than focusing on households' use of cooking fuels, I examine households' cooking fuel

expenditures. If mobile money adoption promotes cooking fuel transition, I assume that mobile money will, indeed, be negatively associated with biomass cooking fuel expenditure and positively associated with clean and charcoal cooking fuel expenditures. To test this hypothesis, I estimate the specification below:

$$\log(y_i) = \alpha + \beta MM_i + \gamma X_i + \varepsilon_i \quad (4.9.1)$$

where $\log(y_i)$ stands for clean cooking fuel expenditure, charcoal fuel expenditure and solid biomass cooking fuel expenditure, respectively. MM_i is a dummy variable that is equal to 1 if a household uses mobile money, 0 otherwise. X_i is a set of socioeconomic control variables. ε is the error term, which is assumed to follow a normal distribution and clustered at the ward level. In all specifications, I include regional dummies to control for regional fixed-effects. To estimate the parameters, I use an ordinary least squares (OLS) estimator and an instrumental variable approach, comparing cooking fuel expenditure between mobile money users and non-users. My main interest is in the parameter β . It assesses the impact of mobile money on cooking fuel expenditures. The results of the impact of mobile money on households cooking fuel expenditure are shown in table [4.9.1](#).

The results reveal that mobile money is statistically significant and positively associated with charcoal and clean cooking fuel expenditures. However, mobile money is negatively associated with biomass sources of cooking fuels. Altogether, the results found herein are in line with that found previously, and support the pivotal role of financial inclusion in enabling transition away from dirty cooking fuels towards clean cooking fuels in developing countries.

Table 4.9.1: The impact of mobile money on cooking fuel expenditure

	OLS			IV		
	(1)	(2)	(3)	(4)	(5)	(6)
	Clean Coef./se	Charcoal Coef./se	Biomass Coef./se	Clean Coef./se	Charcoal Coef./se	Biomass Coef./se
Mobile money	1.583*** (0.155)	0.892*** (0.167)	-0.395*** (0.128)	12.548*** (1.763)	9.734*** (1.593)	-1.538 (0.937)
Gender of hoh(=1 if female)	0.554*** (0.143)	0.536*** (0.136)	-0.385*** (0.135)	0.120 (0.223)	0.186 (0.182)	-0.339** (0.135)
Household owner	0.627*** (0.171)	0.344** (0.162)	-0.628*** (0.153)	0.249 (0.242)	0.039 (0.203)	-0.589*** (0.155)
Running water in the house	1.595*** (0.226)	0.616*** (0.206)	-0.640*** (0.187)	-0.110 (0.393)	-0.760** (0.345)	-0.462* (0.255)
Number of mobile phone	0.205*** (0.027)	0.154*** (0.032)	-0.038 (0.024)	-0.055 (0.058)	-0.056 (0.051)	-0.010 (0.033)
Household size	0.014 (0.017)	-0.006 (0.015)	0.046*** (0.013)	-0.034 (0.021)	-0.045** (0.020)	0.051*** (0.013)
Age of hoh (years)	0.024*** (0.006)	0.011** (0.005)	0.001 (0.004)	0.022*** (0.008)	0.009 (0.007)	0.002 (0.004)
Number of children aged 6-14	-0.065* (0.034)	-0.025 (0.031)	0.053* (0.028)	-0.022 (0.049)	0.009 (0.043)	0.049* (0.028)
Number of people over 65 years old	-0.188** (0.088)	-0.071 (0.076)	0.108* (0.064)	-0.260** (0.123)	-0.129 (0.102)	0.115* (0.064)
Educated household head	1.085*** (0.160)	0.491*** (0.145)	-0.569*** (0.122)	-0.057 (0.295)	-0.430* (0.249)	-0.450*** (0.147)
Socio-professional category : agriculture	-1.356*** (0.210)	-1.242*** (0.222)	1.055*** (0.189)	0.226 (0.356)	0.034 (0.336)	0.890*** (0.214)
Socio-professional category : Retailer	0.406** (0.164)	0.371** (0.184)	0.323** (0.160)	0.150 (0.236)	0.165 (0.232)	0.350** (0.163)
Socio-professional category : Executives/Public Servants	-0.093 (0.284)	0.247 (0.296)	0.250 (0.236)	-0.450 (0.420)	-0.040 (0.374)	0.287 (0.233)
Socio-professional category : Worker	0.511** (0.258)	0.406 (0.257)	0.204 (0.233)	-0.377 (0.390)	-0.310 (0.327)	0.297 (0.245)
Household receives government assistance	-0.553*** (0.146)	-0.071 (0.134)	0.378*** (0.101)	-1.144*** (0.239)	-0.548*** (0.210)	0.440*** (0.114)
Regional controls	Yes	Yes	Yes	Yes	Yes	Yes
Observation	4719	4719	4719	4719	4719	4719
F-stats	101.753	31.017	120.508	38.057	20.741	112.738
R ²	0.401	0.251	0.435	-0.390	-0.371	0.423
Weak identification(F-IV)				65.365	65.365	65.365
LM test statistic for underidentification				46.308	46.308	46.308
Underidentification LM (p-value)				0.000	0.000	0.000

Standard errors in parentheses are obtained clustering observations at the district level. *** p < 0.01, ** p < 0.05, * p < 0.1.

4.10 Conclusion

The aim of the paper was to examine the impact of mobile money on Senegalese households cooking fuel choices. Using a novel representative household survey and applying a probit model, I show that mobile money is positively associated with clean and charcoal cooking fuels while it

is negatively associated with biomass cooking fuel. However, given the potential endogeneity of mobile money adoption, the results from the probit model are likely to be biased. I address the endogeneity concern, by using an instrumental variable approach. My results from the instrumental variable reveal that mobile money leads to a 24.5% and 44% increase in the probability of adopting clean and charcoal cooking fuels, respectively. However, mobile money leads to a 68.2% decrease in the probability of using solid biomass cooking fuels. The results support the view that financial inclusion support energy transition by enabling households to switch from dirty cooking fuels towards clean cooking fuels.

Furthermore, I examine the heterogeneous effects of mobile money on cooking fuel choices with respect to head's gender, poverty status and geographic location. While I find no differentiated effect of mobile money with regard to household head's gender and poverty status, the result is different with regard to household's geographic location. More specifically, I find the effect of mobile money to be positive and statistically significant with clean cooking fuels adoption in rural areas. Although mobile mobile money is significant and positively associated with charcoal fuel use in urban areas, it is not statistically significant for clean cooking fuels. However, in both areas, mobile money is significant and negatively associated with biomass cooking fuel. Finally, I examine the potential mechanisms at play, and show that reception of remittances is the mediating channels through which mobile money affects households' use of clean cooking fuels.

My results have several policy implications. Indeed, my paper suggests that providing financial services to the unbanked might improve their access to modern energy services. Hence, efforts should be concentrated in expanding financial services and a greater integration of mobile money services in the business model of energy services providers. In addition to this, the regulatory body should work towards the interoperability of transfers between mobile money service providers.

Bibliography

- Abiona, O. & Koppensteiner, M. F. (2020), 'Financial inclusion, shocks, and poverty: Evidence from the expansion of mobile money in tanzania', *Journal of Human Resources* pp. 1018–9796R1.
- Aker, J. C., Boumnijel, R., McClelland, A. & Tierney, N. (2016), 'Payment mechanisms and antipoverty programs: Evidence from a mobile money cash transfer experiment in niger', *Economic Development and Cultural Change* **65**(1), 1–37.
- Barry, M. S. & Creti, A. (2020), 'Pay-as-you-go contracts for electricity access: Bridging the “last mile” gap? a case study in benin', *Energy Economics* **90**, 104843.
- Batista, C. & Vicente, P. C. (2020), 'Improving access to savings through mobile money: Experimental evidence from african smallholder farmers', *World Development* **129**, 104905.
- Batista, C., Vicente, P. C. et al. (2021), *Is Mobile Money Changing Rural Africa?: Evidence from a Field Experiment*, Centre for Research and Analysis of Migration, Department of Economics
- Boutabba, M. A., Diaw, D., Laré, A. & Lessoua, A. (2020), 'The impact of microfinance on energy access: a case study from peripheral districts of lomé, togo', *Applied Economics* **52**(45), 4927–4951.

- Burgess, R. & Pande, R. (2005), 'Do rural banks matter? evidence from the indian social banking experiment', *American Economic Review* **95**(3), 780–795.
- Demirgüç-Kunt, A., Klapper, L., Singer, D., Ansar, S. & Hess, J. (2020), 'The global index database 2017: measuring financial inclusion and opportunities to expand access to and use of financial services', *The World Bank Economic Review* **34**(Supplement_1), S2–S8.
- Demombynes, G. & Thegeya, A. (2012), 'Kenya's mobile revolution and the promise of mobile savings', *World Bank policy research working paper* (5988).
- Devoto, F., Duflo, E., Dupas, P., Parienté, W. & Pons, V. (2012), 'Happiness on tap: Piped water adoption in urban morocco', *American Economic Journal: Economic Policy* **4**(4), 68–99.
- Dupas, P. & Robinson, J. (2013), 'Why don't the poor save more? evidence from health savings experiments', *American Economic Review* **103**(4), 1138–71.
- ESMAP (2020), 'The state of access to modern energy cooking services'.
- Gurbuz, A. (2017), 'Mobile money and savings in rural kenya', *unpublished*, <https://blogs.worldbank.org/impactevaluations/does-mobile-money-mobilize-savings-yes-guest-post-alev-gurbuz>.
- Islam, A., Muzi, S. & Rodriguez Meza, J. L. (2018), 'Does mobile money use increase firms' investment? Evidence from Enterprise Surveys in Kenya, Uganda, and Tanzania', *Small Business Economics* .
- Jack, W. & Suri, T. (2014), 'Risk sharing and transactions costs: Evidence from Kenya's mobile money revolution', *American Economic Review* **104**(1), 183–223.
- Kikulwe, E. M., Fischer, E. & Qaim, M. (2014), 'Mobile money, smallholder farmers, and household welfare in kenya', *PloS one* **9**(10), e109804.
- Koomson, I. & Danquah, M. (2021), 'Financial inclusion and energy poverty: Empirical evidence from ghana', *Energy Economics* **94**, 105085.
- Ky, S., Rugemintwari, C. & Sauviat, A. (2018), 'Does mobile money affect saving behaviour? evidence from a developing country', *Journal of African Economies* **27**(3), 285–320.

- Mbaye, L. M. (2021), 'Remittances and rural credit markets: Evidence from senegal', *Review of Development Economics* **25**(1), 183–199.
- Mbiti, I. & Weil, D. N. (2016), *7. Mobile Banking: The Impact of M-Pesa in Kenya*, University of Chicago Press.
- Munyegera, G. K. & Matsumoto, T. (2016), 'Mobile money, remittances, and household welfare: Panel evidence from rural uganda', *World Development* **79**, 127–137.
- Munyegera, G. K. & Matsumoto, T. (2018), 'Ict for financial access: Mobile money and the financial behavior of rural households in uganda', *Review of Development Economics* **22**(1), 45–66.
- Ndiaye, A. & Weibigu, A. (2020), 'Mobile-banking, un potentiel d'inclusion financière au sénégal: le rôle de la proximité géographique des points de services de transfert d'argent sur l'adoption'.
- Prina, S. (2015), 'Banking the poor via savings accounts: Evidence from a field experiment', *Journal of development economics* **115**, 16–31.
- Quinn, M. A. (2009), 'Estimating the impact of migration and remittances on agricultural technology', *The Journal of Developing Areas* pp. 199–216.
- Riley, E. (2018), 'Mobile money and risk sharing against village shocks', *Journal of Development Economics* **135**, 43–58.
- Sakyi-Nyarko, C., Ahmad, A. H. & Green, C. J. (2021), 'Investigating the well-being implications of mobile money access and usage from a multidimensional perspective', *Review of Development Economics* .
- Sekabira, H. & Qaim, M. (2017), 'Mobile money, agricultural marketing, and off-farm income in uganda', *Agricultural Economics* **48**(5), 597–611.
- Suri, T. & Jack, W. (2016), 'The long-run poverty and gender impacts of mobile money', *Science* **354**(6317), 1288–1292.
- Tabetando, R. & Matsumoto, T. (2020), 'Mobile money, risk sharing, and educational investment: Panel evidence from rural uganda', *Review of Development Economics* **24**(1), 84–105.
- Tarozzi, A., Mahajan, A., Blackburn, B., Kopf, D., Krishnan, L. & Yoong, J. (2014), 'Micro-loans,

insecticide-treated bednets, and malaria: evidence from a randomized controlled trial in orissa, india', *American Economic Review* **104**(7), 1909–41.

Veljanoska, S. (2021), 'Do remittances promote fertilizer use? the case of ugandan farmers', *American Journal of Agricultural Economics* .

Wieser, C., Bruhn, M., Kinzinger, J. P., Ruckteschler, C. S. & Heitmann, S. (2019), 'The impact of mobile money on poor rural households: Experimental evidence from uganda', *World Bank Policy Research Working Paper* (8913).

Table .0.1: Financial inclusion in Senegal by urban and rural areas in 2021

	(1)		(2)		(3)	
	All		Urban		Rural	
	Mean.	sd	Mean.	sd	Mean.	sd
% of households using mobile money (MM) services	0.74	(0.44)	0.87	(0.33)	0.62	(0.49)
% of households holding a bank account	0.02	(0.15)	0.02	(0.15)	0.02	(0.15)
% of households using Expresso MM	0.01	(0.10)	0.01	(0.11)	0.01	(0.09)
% of households using Free MM	0.02	(0.14)	0.03	(0.17)	0.01	(0.08)
% of households using Orange MM	0.86	(0.35)	0.88	(0.33)	0.84	(0.37)
% of households using Wave MM	0.67	(0.47)	0.79	(0.41)	0.53	(0.50)
Buy credit	0.58	(0.49)	0.64	(0.48)	0.52	(0.50)
Save money	0.20	(0.40)	0.22	(0.41)	0.17	(0.38)
Payment of bills	0.24	(0.43)	0.32	(0.47)	0.15	(0.36)
Reception of remittances	0.92	(0.28)	0.92	(0.27)	0.91	(0.29)
Transfer of money	0.68	(0.47)	0.73	(0.45)	0.62	(0.48)
<i>N</i>	4803		2252		2551	

Table .0.2: Descriptive statistics of the main variables by mobile money usage status

	(1)		(2)		(3)	
	All		MM user		Non-user	
	Mean.	sd	Mean.	sd	Mean.	sd
Gender of hoh(=1 if female)	0.33	(0.47)	0.35	(0.48)	0.25	(0.44)
Household owner	0.32	(0.47)	0.37	(0.48)	0.20	(0.40)
Access to electricity (=1 if yes)	0.59	(0.49)	0.71	(0.45)	0.24	(0.43)
Rural area location (=1 if yes)	0.53	(0.50)	0.45	(0.50)	0.77	(0.42)
Running water in the house	0.59	(0.49)	0.69	(0.46)	0.30	(0.46)
Number of mobile phone	3.59	(2.75)	4.06	(2.84)	2.26	(1.95)
Household size	12.32	(7.67)	13.03	(8.05)	10.31	(6.01)
Age of hoh (years)	53.89	(13.28)	54.77	(13.16)	51.42	(13.30)
Number of children aged 6-14	3.25	(2.75)	3.34	(2.87)	2.99	(2.40)
Number of people over 65 years old	0.60	(0.77)	0.65	(0.79)	0.46	(0.71)
Educated household head	0.65	(0.48)	0.69	(0.46)	0.53	(0.50)
Socio-professional category : Agriculture	0.38	(0.49)	0.29	(0.45)	0.65	(0.48)
Socio-professional category : Retailer	0.30	(0.46)	0.34	(0.47)	0.19	(0.39)
Socio-professional category : Executives/Public Servants	0.06	(0.23)	0.06	(0.24)	0.04	(0.20)
Socio-professional category : Worker	0.07	(0.26)	0.09	(0.29)	0.02	(0.13)
Socio-professional category : Inactive/unemployed	0.19	(0.39)	0.21	(0.41)	0.10	(0.31)
Household receives government assistance	0.28	(0.45)	0.28	(0.45)	0.29	(0.45)
Total cooking fuel expenditure (log)	8.96	(1.81)	9.25	(1.61)	8.13	(2.09)
Household uses gas or electricity as cooking fuel	0.22	(0.41)	0.28	(0.45)	0.05	(0.21)
Household uses charcoal as cooking fuel	0.16	(0.37)	0.19	(0.39)	0.08	(0.28)
Household uses biomass as cooking fuel	0.62	(0.49)	0.53	(0.50)	0.87	(0.34)
<i>N</i>	4803		3550		1253	

Table .0.3: Descriptive statistics of the main variables by mobile money usage status in rural area

	(1)		(2)		(3)	
	Rural		MM user (1=Yes)		Non-user(0=No)	
	Mean.	sd	Mean.	sd	Mean.	sd
Gender of hoh(=1 if female)	0.23	(0.42)	0.24	(0.43)	0.21	(0.41)
Household owner	0.20	(0.40)	0.23	(0.42)	0.16	(0.37)
Access to electricity (=1 if yes)	0.32	(0.47)	0.44	(0.50)	0.13	(0.34)
Running water in the house	0.45	(0.50)	0.56	(0.50)	0.27	(0.44)
Number of mobile phone	3.22	(2.53)	3.80	(2.65)	2.28	(1.97)
Household size	13.17	(8.14)	14.65	(8.88)	10.74	(6.01)
Age of hoh (years)	52.87	(13.66)	54.03	(13.77)	50.97	(13.26)
Number of children aged 6-14	3.70	(2.95)	4.04	(3.19)	3.14	(2.41)
Number of people over 65 years old	0.60	(0.77)	0.68	(0.80)	0.46	(0.69)
Educated household head	0.60	(0.49)	0.66	(0.48)	0.52	(0.50)
Socio-professional category : Agriculture	0.61	(0.49)	0.52	(0.50)	0.75	(0.43)
Socio-professional category : Retailer	0.19	(0.40)	0.23	(0.42)	0.13	(0.33)
Socio-professional category : Executives/Public Servants	0.03	(0.18)	0.04	(0.20)	0.02	(0.14)
Socio-professional category : Worker	0.04	(0.18)	0.05	(0.22)	0.01	(0.10)
Socio-professional category : Inactive/unemployed	0.13	(0.34)	0.15	(0.36)	0.09	(0.29)
Household receives government assistance	0.33	(0.47)	0.34	(0.47)	0.31	(0.46)
Total cooking fuel expenditure (log)	8.39	(2.06)	8.69	(1.98)	7.90	(2.11)
Household uses gas or electricity as cooking fuel	0.06	(0.25)	0.09	(0.29)	0.02	(0.15)
Household uses charcoal as cooking fuel	0.08	(0.27)	0.09	(0.29)	0.05	(0.22)
Household uses biomass as cooking fuel	0.86	(0.35)	0.82	(0.39)	0.93	(0.26)
<i>N</i>	2551		1584		967	

Table .0.4: Descriptive statistics of the main variables by mobile money usage status in urban area

	(1)		(2)		(3)	
	Urban		MM user (1=Yes)		Non-user(0=No)	
	Mean.	sd	Mean.	sd	Mean.	sd
Gender of hoh(=1 if female)	0.44	(0.50)	0.44	(0.50)	0.40	(0.49)
Household owner	0.46	(0.50)	0.48	(0.50)	0.36	(0.48)
Access to electricity (=1 if yes)	0.89	(0.31)	0.93	(0.26)	0.63	(0.48)
Running water in the house	0.76	(0.43)	0.80	(0.40)	0.43	(0.50)
Number of mobile phone	4.01	(2.94)	4.27	(2.98)	2.23	(1.86)
Household size	11.37	(6.97)	11.73	(7.06)	8.86	(5.79)
Age of hoh (years)	55.05	(12.74)	55.36	(12.62)	52.94	(13.33)
Number of children aged 6-14	2.74	(2.41)	2.78	(2.43)	2.50	(2.29)
Number of people over 65 years old	0.61	(0.78)	0.63	(0.78)	0.44	(0.76)
Educated household head	0.70	(0.46)	0.72	(0.45)	0.56	(0.50)
Socio-professional category : Agriculture	0.12	(0.33)	0.10	(0.30)	0.30	(0.46)
Socio-professional category : Retailer	0.43	(0.49)	0.43	(0.50)	0.40	(0.49)
Socio-professional category : Executives/Public Servants	0.09	(0.28)	0.08	(0.27)	0.12	(0.32)
Socio-professional category : Worker	0.11	(0.32)	0.12	(0.33)	0.04	(0.19)
Socio-professional category : Inactive/unemployed	0.25	(0.43)	0.27	(0.44)	0.14	(0.35)
Household receives government assistance	0.24	(0.43)	0.23	(0.42)	0.25	(0.43)
Total cooking fuel expenditure (log)	9.60	(1.19)	9.71	(1.03)	8.89	(1.82)
Household uses gas or electricity as cooking fuel	0.40	(0.49)	0.43	(0.50)	0.13	(0.34)
Household uses charcoal as cooking fuel	0.26	(0.44)	0.27	(0.45)	0.20	(0.40)
Household uses biomass as cooking fuel	0.34	(0.47)	0.29	(0.46)	0.66	(0.47)
<i>N</i>	2252		1966		286	

Table .0.5: The first stage equation

	OLS
	(1)
	Mobile money adoption
	Coef./se
Mobile money agent within the ward (1=yes, 0=No)	0.184*** (0.023)
Gender of hoh(=1 if female)	0.040*** (0.014)
Household owner	0.013 (0.015)
Running water in the house	0.137*** (0.019)
Number of mobile phone	0.022*** (0.003)
Household size	0.004*** (0.001)
Age of hoh (years)	-0.000 (0.001)
Number of children aged 6-14	-0.003 (0.003)
Number of people over 65 years old	0.013* (0.008)
Educated household head	0.090*** (0.015)
Socio-professional category : agriculture	-0.117*** (0.019)
Socio-professional category : Retailer	0.015 (0.015)
Socio-professional category : Executives/Public Servants	0.018 (0.028)
Socio-professional category : Worker	0.078*** (0.021)
Household receives government assistance	0.056*** (0.014)
Regional controls	Yes
Observation	4719
F-stats	55.368
R ²	0.287

Standard errors in parentheses are obtained clustering observations at the district level. *** p < 0.01, ** p < 0.05, * p < 0.1.

Pay-as-you-go contracts for electricity access: bridging the "last mile" gap? A case study in Benin

This chapter is a joint work with Anna Creti. A version of paper is published in under the reference: Barry, M. S., Creti, A. (2020). Pay-as-you-go contracts for electricity access: Bridging the “last mile” gap? A case study in Benin. *Energy Economics*, 90, 104843.

5.1 Introduction

Access to a reliable and affordable energy is a prerequisite for any industrial development (Eberhard et al. 2011) and economic growth (Louw et al. 2008). Yet, approximately 1.06 billion people (about 14% of the global population) live without electricity and an additional one billion are under-electrified, a status characterized by unstable grid connection with regular power outages.¹

The Africa Energy Outlook (IAE 2019) points out that Africa is the continent most in need of a significant scale-up in electricity generation and grid investment, for which it currently ranks among the lowest in the world. Despite being home to 17% of the world’s population, Africa

¹A.T. Kearney, and GOGLA (Global Off-Grid Lighting Association). 2014. Investment and Finance Study for Off-Grid Lighting. Retrieved from GOGLA website: <http://global-off-grid-lighting-association.org/wp-content/uploads/2013/09/A-T-Kearney-GOGLA.pdf>.

currently accounts for just 4% of global power supply investment. Achieving reliable electricity supply for all would require an almost fourfold increase, to around USD 120 billion a year through 2040.

According to the World Bank's Energy Sector Management Assistance Program (ESMAP), access to electricity is not a binary variable, but it rather refers to the ability to obtain electricity that is characterized by the following attributes: "adequate, available when needed, reliable, of good quality, affordable, legal, convenient, healthy and safe for all required applications across households, productive enterprises and community institutions "(Bhatia & Angelou 2015).

The ESMAP framework measures electricity access across five Tiers ranked by increasing availability of electricity usages, spanning from basic lighting to 23 hours of uninterrupted electricity services. In this paper we focus on accessing Tier 1 and Tier 2 electricity capacity levels. At Tier 1 level (3W), electricity access is defined as providing lighting and mobile charging for a minimum of four hours per day. At Tier 2 level (50W), access additionally includes the ability to power a fan and/or television for four hours. Distributed renewables for energy access (DREA) systems are increasingly being considered as a solution to electrification through the deployment of renewable-based mini-grids and off-grid solar systems. DREA are so far the most significant technology in the sector, providing electricity access to more than 360 million people worldwide (Sawin et al. 2018).

We study the case of Benin, located in Sub-Saharan Africa. The country has a 121-kilometer-long coastline on the Gulf of Guinea and a population of 11.2 million.² Benin has recently been carrying out key economic and structural reforms, among which ambitious programs for expanding electricity access. To overcome a situation where around 30% of the population is electrified, the Government has launched several initiatives, including intensive deployment of renewable energy. Therefore, Benin provides an interesting case study to analyze DREA deployment.

Our study provides evidence on a specific financial service easing electricity access, namely the pay-as-you-go (PAYG) contract. PAYG is a technology-driven method that allows consumers to get a stand-alone electricity system by paying loan fees and using mobile banking. More precisely, the installed devices (solar kits or panels) use information technology to enable remote activation with payment receipt or disconnection in case of failure. The PAYG service is more flexible than a standard microcredit as no guarantees are demanded. Combining PAYG financing

²<https://www.worldbank.org/en/country/benin>, accessed March 2019.

with digital payments has been a boon for the sector: a mobile banking account and an ID card and a pre-payment of the 10-20% of the total equipment price suffice to subscribe a contract. The insurance comes from the machine-to-machine technology. The key success factor of PAYG is then the financial inclusion of consumers, through flexible payment methods, which ensures electricity providers to repay kits or solar home systems (SHS)³ investments at low transaction costs.

Investment in PAYG in Africa and Asia has been estimated at USD 263 million in 2017 with a 1,400% increase over the period 2013-2017 (REN21, 2018). According to [Gogla \(2019\)](#), in 2018 PAYG has reached its greatest volumes ever recorded, at 1 million units with a value of USD 216.85 million. PAYG-based plug-and-play solar solutions spread at an average annual growth rate of 140% between 2013 and 2016. The sector is estimated to exceed USD 20 million in annual sales and to generate USD 6-7 billion in annual revenue by 2022.

East African countries like Rwanda and Tanzania have implemented PAYG schemes at a very fast pace, and many other countries are following the same path. The growth of these payment systems is based on a complex business model: strong field presence, marketing close to people, technical assistance, high investment from the providers to buy in advance the equipment ([Advisors & Global 2018](#)). Mobisol and M-Kopa have introduced this electricity services as from 2009 ([Rolffs et al. \(2014\)](#)). PAYG companies have also attracted international private sector investors and have been successful in raising grants, equity capital, and debt. East Africa has been leader in the expansion of these services, whereas West Africa represented only 12% of total PAYG sales in Africa over the period 2013-17. This slow diffusion effect is explained by slower penetration rate of mobile money.

Research on PAYG as financial instrument to provide electricity access is scarce and generally based on surveys or field experiments. As [Alstone et al. \(2015\)](#) point out: "If customers do continue to sign up and make regular payments, however, energy service providers will be able to demonstrate their viability. What is now required, in order to secure long-term financing *at* competitive rates, is clear evidence of regular payments on a larger scale. This is a rich topic for future investigation." To the best of our knowledge, this work is the first paper providing such an

³SHS are stand-alone photovoltaic systems that can be used to meet a household's energy demand fulfilling basic electric needs. They usually operate at a rated voltage of 12 V direct current (DC) and provide power for low power DC appliances such as lights, radios and small TVs for about three to five hours a day. A SHS typically includes one or more PV modules consisting of solar cells, a charge controller which distributes power and protects the batteries and appliances from damage and at least one battery to store energy for use when the sun is not shining.

evidence.

We exploit a unique and original database of a leading private company, selling solar kits and panel as from 2012 in Benin. We analyze contracts of 10,120 consumers having subscribed PAYG. We aim to unveil the determinants of successfully conducting PAYG credit that allows, with a minimum of 6 months loan, to access Tier 1 and 2 devices. Our purpose is to understand whether consumers in our sample are able to commit to long-term payments in order to get solar kits/panels. After a thorough description of our database, by means of detailed maps, we test whether the localization of consumers, which proxies their access to grid electricity, leads to significant differences in payment behavior for off-grid electricity and thus PAYG services. We thus estimate a simple multinomial logit model (Ben-Akiva et al. 1985). We calculate the relative probability of regular payments, failures, enrolment in PAYG services with respect to the base case of cash payment for small SHS, considering these latter as "early adopters" of solar electricity devices. In order to understand the impact of some simple structural factors, we control for the available information in the database that is consumers' gender and location. We take into account four possible urban areas, three of which (Cotonou, Abomey-Calavi, Porto Novo) being the biggest cities in Benin, near the coastal area, and displaying almost 100% access rate; and a fourth locality, Savalou, in the center region, by only 9% access rate to the electricity grid.

Addressing an area neglected within the field of energy access, the "last mile" scaling challenge, we show that PAYG flexibility has a clear value for consumers, as few of them default. However, important geographical differences exist. Given that households with PAYG electricity access services are mainly located in electrified zones, our results point out a substitution effect from expensive and unreliable on-grid electricity service to off-grid devices allowing lighting, radios, mobile charging. This effect is smoothed in the case of Savalou, where the electricity access rate is lower and the value of solar kits to consumers is perhaps higher. This result is confirmed by marginal effects estimation in the multinomial logit. We show that people living in Savalou have a lower probability to default compared to other locations. Overall, given the global small failure rate in our sample (only 10% of consumers are disabled due to a discontinued payment), we argue that in our case study, PAYG services mainly targets credit worthy consumers. At an early development stage, PAYG improves energy affordability or vulnerability, instead of really bridging the electricity gap of households not connected to the grid. This cream-skimming effect decreases the default risk in the business model of the PAYG provider and ensures the bulk of its

development, an issue also raised at a broader scale in Africa by [Fondem \(2019\)](#)⁴. Therefore this seems to be the first step toward a broader adoption of PAYG services, possibly in rural areas, but further efforts are needed to meet the last mile electricity challenge.

The paper is organized as follows. Section 2 explains the details of PAYG services and reviews the relevant literature. Beninese economic situation is summarized in Section 3, together with the specificity of its electricity sector. Section 4 describes our case study. The estimation method and results are presented respectively in Section 5 and 6. Section 7 briefly concludes. The Appendix provides a few details on the model estimation.

5.2 Pay-as-you-go services: literature review

So far, the literature on solar lighting and SHS has focused on the impact assessment of electrification. Different surveys have recently been written, highlighting crucial points to be addressed when assessing the ex-post impact of electrification, such as for instance geographical bias for decentralized projects ([Jean-Claude & Arnaud 2018](#), [Hamburger et al. 2019](#)), or links with specific usages, like substitution with kerosene lighting or socio-economic constraints ([Rom et al. 2017](#), [Lemaire 2018](#)), child health and study time ([Furukawa 2014](#), [Kudo et al. 2019](#), [Stojanovski et al. 2018](#), [Grimm et al. 2016](#)). Nevertheless, the existing evidence on household light use, expenditure, wellbeing, and productivity is not conclusive and calls for further analysis to clarify the advantages of electrification ([Hamburger et al. 2019](#)).

We take a different perspective, considering incentives to buy off-grids devices allowing electricity access through PAYG, which is a specific micro-credit contract. Relying on the wide-spread diffusion of mobile phones, PAYG energy services offer a flexible service. Users make a small up-front payment for the installation and commit to topping up their units by buying scratch cards or using mobile payment platforms. If scratch cards are used, the number in the card is validated by sending a text message to the server of the electricity service company (ESCO) and then a pass code is introduced in the household energy system, which allows it to operate for a period of time. The consumer must usually pay upfront a fraction of the total cost of the solar kit or photovoltaic (PV) panels with batteries, but the rest is paid through small installments that give credit to consume the electricity generated by the system for a period of time. Usually, after several payments

⁴Fondem is a Non Governmental Organisation working on issues related to access to electricity in rural areas of developing countries.

for the energy service provided, once the cost of the system has been covered, the device is permanently unlocked and ownership is granted to the consumer. A machine-to-machine system allows the monitoring of the payments. The initial commitment specifies the period during which they must buy scratch cards or pay the credit fee directly by using mobile banking, at the end of which their system can be either unlocked or upgraded to a larger system. If the payment is not made, the system automatically disconnects the customer. This contract reduces the transaction costs for providing and enforcing small loans, given that the periodic fee for PAYG off-grid power is similar to the typical expenditures for traditional fossil or biomass fuels being replaced by electricity. Customers thus do not need to set aside additional funds to purchase the new service. This approach to financing fits people's ability and willingness to pay in the context of uncertainty and careful budgeting of scarce cash. Notably, the PAYG has the advantage of giving the opportunity to the liquidity-constrained people, who cannot contract credit from traditional banking system, to switch to a modern and less pollutant source of energy. Small payments and some flexibility to account for unforeseen circumstances may be sufficient to attract consumers' interest ([Moreno & Bareisaite 2015](#)).

Some systems include remote monitoring features, enabling better knowledge about user behavior and the performance of decentralized devices ([Alstone et al. 2015](#)). Therefore PAYG represents an interesting alternative to microfinance programs, whose success in terms of electricity access has been questioned by several studies ([Karplus & von Hirschhausen 2019](#)). Moreover, prepayment systems have often presented fraud and metering problems ([Tewari & Shah 2003](#)).

[Jack & Smith \(2015, 2017\)](#) have done pioneering studies on the willingness to pay, electricity usage and expenditures in South Africa when different billing services are proposed. In particular, they study prepaid metering that helps the poorest in paying bills, both by using data of consumers in Cape Town and making a field experiment. They find that flexibility of prepaid meters allows customers to smooth expenditures to income and potentially improves customer welfare. Nevertheless, when customers on monthly billing are involuntarily assigned to receive a prepaid electricity meter, with exogenous variation in the timing of the meter replacement, electricity use falls by about 13 percent as a result of the change in meter type. Although we share with this paper the use of real consumer data, we differ in the typology of the service used. Jack and Smith analyze on-grid electricity services subscription, whereas we look at off-grid electricity, also providing the ownership of the device generating electricity. Grid connections and electricity demand

is also what [Lee et al. \(2020\)](#) study. Using a randomized control trial experiment, they find that demand for connections falls sharply with price, and is far lower than anticipated by policymakers. Among newly connected households, average electricity consumption is very low, implying low consumer surplus. The methodology of randomized control trials is also used by [Grimm et al. \(2020\)](#) for off-grid services. The authors elicit the revealed willingness-to-pay for different off-grid solar technologies in a field experiment in rural Rwanda and show that households are willing to dedicate substantial parts of their budget to electricity, but not enough to reach cost-covering prices. This result questions the viability of business models used by off-grid electricity providers, an issue we are also interested in.

Although PAYG is often advocated as an interesting research avenue ([Lee et al. 2016, 2017](#)), a few studies have analyzed it. [Rolffs et al. \(2015\)](#) focus on a case-study of PAYG services in Kenya, showing that the success of this kind of micro-finance is crucially linked to socio-economic factors that make the contract successful. The data collected are qualitative, with 20 quasi-directed interviews. On a similar vein, crossing the results of interviews and best practices of PAYG providers in East Africa, [Yadav et al. \(2019\)](#) present the advantages of eventual PAYG diffusion in India. While the scope of these latter paper is similar to ours, the focus, data and methodology differ.

We use data from consumers actually involved in PAYG electricity provision, and investigate their behavior in terms of fees payment along the contract duration. To this extent, the objective of our paper is more similar to [Stojanovski et al. \(2017\)](#) who studied how 500 early adopters use solar kits, finding that they replace kerosene lighting and phone charging. [Collings & Munyehirwe \(2016\)](#) conducted a survey evaluation of PAYG systems for the solar kit Indigo (a battery charger and 2 led lights) in Rwanda, provided by the company Azuri to 480 customers. Households that adopted Indigo as their sole source of lighting or in combination with others had respectively 1.75 and 2.5 times more lighting time per day than the control group with no kit. This allowed Indigo users to find extra time for family gathering, education of children and reading for adults. In the majority of cases it did not fully replace other devices, but rather allowed for additional lighting or phone charging. More importantly, seventy-six percent of Indigo customers said that the monthly payment was too high. In fact, thirty-two percent of customers had been out of credit at least once because they do not have money to pay for the top up. This result questions the affordability of the service offered. Issues related to credit fees are also analyzed by [Barrie & Cruickshank \(2017\)](#)

who explain the main drivers of PAYG diffusion according to the theory of social innovation. By conducting 118 semi-directed interview, the authors focus on default consumers and find that the last mile challenges associated with PAYG are far greater than traditional retail models. Indeed the SHS distributor is required to retain a long-term relationship with each customer as well as provide support services, such as system maintenance, to ensure regular payments. In a similar vein, [Sanyal et al. \(2016\)](#) analyzed several business model that can make profitable the supply of PAYG services.

Even if we do not focus on mobile banking adoption, our paper supports general evidence on the link between economic development and mobile phone/banking use. There are few studies that analyze specifically these telecommunication services in Africa. [Aker & Mbiti \(2010\)](#) offer a very complete review of the factors that explain mobile phones adoption and its potential for African economic development, since the pioneering experience of "banking the unbanked" done by the leader company M-Pesa in Kenya (also studied by [Mbiti & Weil \(2013\)](#)). Reducing searching costs and risks, improving coordination among firms and introducing new markets are key factors. Nevertheless, the authors affirm: "Yet even if mobile phones can enhance access to resources and information, they cannot replace investments in public goods such as roads, power, and water. In fact, they are less effective without them [...] Without power, a firm could receive more customer orders via mobile services but would still have work hours limited by the available sunlight [...] For economic development to occur, complementarity between mobile adoption and investment in these other forms of capital is needed". This view is shared by [Mothobi & Grzybowski \(2017\)](#), who find that adoption of mobile phones is higher where there are infrastructures, but mobile transactions are more frequent in areas with less infrastructures. More recently, [Asongu \(2018\)](#) studies the motives for mobile banking adoption in 49 Sub-Saharan African countries and finds that using mobile banking is also positively correlated with trade openness, remittances volume and human development indexes, which can amplify the welfare impact of physical infrastructure.

Our study is the first one to investigate PAYG services on a very large sample of actual users. The aim of this paper is thus to provide insights on PAYG users' behavior in repaying PAYG loan fees, all along the contract duration. More specifically, we look at customers payment behavior during the contract lifetime, controlling for customers' location and gender, type of contract, number and amount of payments. Our results shed light on the determinants and reliability of PAYG contracts. Unfortunately, we do not have any information on customers' level of education and

income, household composition, dwelling characteristics, which, of course, would be relevant to study technology adoption. However, despite these limitations, we believe that insightful conclusions can be drawn from this study, in particular on the feasibility of large scale PAYG services, both in rural and urban areas.

5.3 Benin: country profile

Benin is a small country located in West Africa, bordered by Togo on the West, Nigeria on the East, Burkina Faso and Niger on the North and the Atlantic Ocean on the South. The population, predominantly young, is concentrated in the Southern region. The urbanization rate has kept growing since the last two decades. In recent years, Benin's economy has experienced positive economic growth. Its Gross Domestic Product (GDP) growth averaged 6% between 2012 and 2015, and amounted to 5.6% in 2017. According to the initiative Power for All (US Government), the GDP per capita in PPP is \$2,266.⁵ Despite a recent downward trend, the poverty rate remains high, at 46.4% in 2018, with a poverty line of \$1.90 a day in purchasing power parity (WB 2019). Benin growth is driven by two sectors: agriculture and services that account respectively for 23% and 56% of GDP. Cotton and pineapple are the main export products of the agricultural sector. Likewise, the services sector core activity is formal or informal import/export of goods to Nigeria. As a consequence, Benin economy is heavily dependent on Nigerian economic cycles. The industrial sector is not very well developed. This is probably due to barriers in obtaining financial credit and accessing energy. Benin is ranked 153 among 190 economies in the ease of doing business, according to the latest World Bank annual ratings. The index averaged 165 from 2008 until 2018, reaching an all time high of 175 in 2011 and a record low of 151 in 2017. Noteworthy for this study, with 9,3 millions of subscribers, the mobile penetration rate is 81%(ARCEP 2019). The bankarisation rate has been estimated at 27% in 2017, the largest in the countries belonging to the Franc CFA monetary Union.⁶ According to the G20 financial inclusion indicators (World Bank, 2018), with a population of age 15+ of 8 millions, 38,5% of the population has a financial account (against 10.5 in 2011) and 60% a mobile phone. The mobile bank account has made a substantial jump, counting today 18% of the adult population, against only 2% in 2011 (WB 2018). Similarly,

⁵<https://www.powerforall.org/> (accessed November-2019)

⁶The CFA Monetary Union (UEMOA) is composed of Benin, Burkina Faso, Côte d'Ivoire, Guinea-Bissau, Mali, Niger, Senegal and Togo.

digital payments by phone are made by 28.5% of the adult population. Among adults having a mobile banking, 41% of the poorest have an account, probably to receive remittances, and 25% are in rural areas.

The country nationwide access to electricity in 2016 was 32% of the population. There is a huge gap between access to electricity in rural and urban areas. In 2015, only 5.5% of the rural population was connected to the electric grid, whilst in urban areas it is estimated that 56.4% of the population access electricity. The actual installed capacity amounts to 349 MW, of which diesel and fuel oil is 249 MW and the remaining capacity is hydro. Benin is characterized by a relatively low energy consumption and a predominance of biomass energy with high carbon emissions. Energy consumption was 3344 ktoe in 2010, or about 0.4 toe/ capita. This figure is well below average worldwide, which is 1.7 toe/inhabitant. The consumption of firewood and charcoal represents approximately 59.5% of the total final energy consumed in 2010, 38.3% oil and 2.2% electricity. In 2012, the consumption of fuelwood and charcoal accounted for approximately 48.8% of the total final energy consumed; petroleum products 49.1% and electricity 2.1%.⁷ This latter has been increasing over time, reaching 100 kWh/hab in 2014 compared to 33kWh/hab in 1984.⁸

According to ARE (2018)⁹ in 2016, total residential electricity consumption amounted to 411 GWh in Benin. Around 41% of Beninese currently have access to electricity, with a sharp divide between urban (70%) and rural areas (18%). The average consumption per capita with electricity access was 138 kWh. Electricity consumption is below the average for Africa's low income countries. Accounting for an average tariff of 100 FCFA per Kwh and a monthly subscription rate of 500 FCA per month (ARE 2010), the total annual average electricity expenditure amounts at 149 000 FCFA, that is 240\$ or 20\$ per month. Rom et al. (2017) estimate at \$2.99 per month on kerosene expenditure for lighting.

Irregular connections as well as disruptions are quite frequent. Above all, electricity bills are extremely expensive. As reported by Sinsin (2017) the average monthly bill is 11 110 FCFA (19 dollars) compared to an average income of 38 500 FCFA (66 dollars). Beninese households thus spend about 28.9% of their monthly income to pay the electricity bill, which means that there is a

⁷Source: <https://www.benin-energie.org/>.

⁸Source: <https://donnees.banquemondiale.org/indicateur/EG.USE.ELEC.KH.PC?locations=BJ&view=map>

⁹ARE is Benin's Electricity Sector Regulator

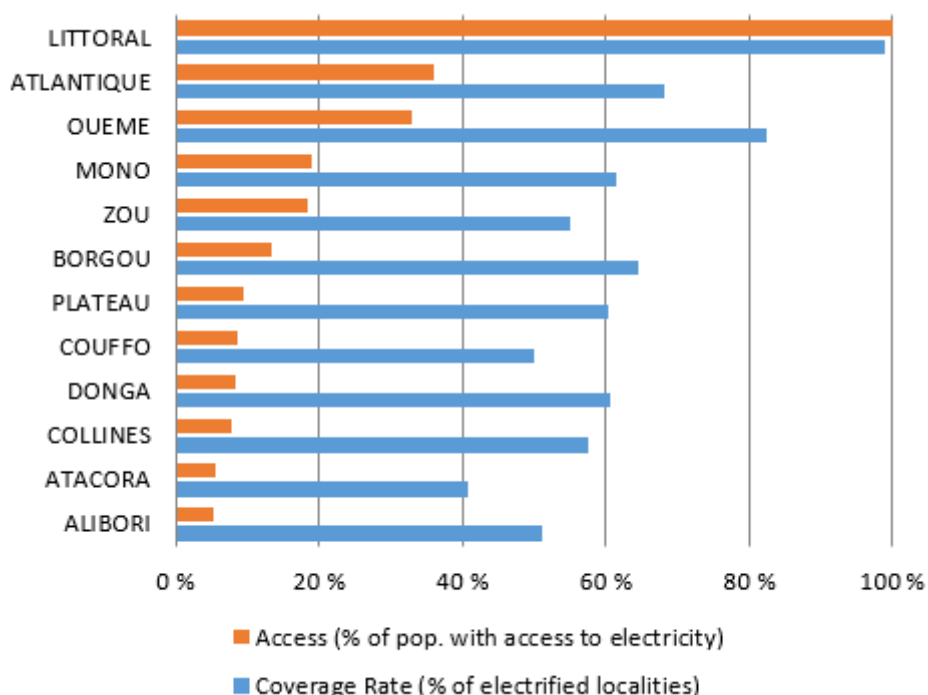

Figure 5.3.1: Access to electricity by municipality
 Source: www.benin-energie.com

serious issue of energy poverty even for electrified people.

Territorial diversity in accessing electricity is one of the difficulties in reaching universal access by 2030, together with full coverage of public lighting. The departments with the lowest service rates are Atacora, Alibori and Couffo, with less than 53% and a number of electrified localities of less than 40%. At the top ranking, the departments which have the highest electrification rate are Littoral, Ouéme and Atlantique (see Figure 5.3.1).

In order to overcome energy import dependence and inability to develop adequate electricity infrastructure, the Government has traditionally reacted to this unsatisfactory situation by installing large-scale diesel-powered generators, but at a substantially higher cost and strong environmental impact. Although in 2016 Benin's share of DREA amounted to 8.6%, below the endowment of developing economies (9.6%), off-grid photovoltaics units have been growing during the latest years. In fact, as from 2017, the Government of Benin has changed and adopted a far-reaching policy reform agenda in partnership with the Millennium Challenge Corporation (MCC) to establish an independent electrification regulator with the authority to set tariffs, pass a new law encouraging public-private consortia, and approve a performance plan with mea-

surable targets for electrification. ¹⁰

Even if it is difficult to get precise information on off-grid initiatives, the "Benin Energie MCC Initiative" reports that 72,500 pico systems and 1,640 solar kits were registered in 2017. As of June 2018, 3804 cities and villages were electrified (Benin-Energie 2019).¹¹ This new path toward electrification has eased the entry of new investors offering innovative services like PAYG.

Gogla (2019) reports that private investment in the off-grid solar sector in Benin has been limited. By creating a long-term electrification policy and benefiting from international donors funds, the government is now aiming to attract private investors. Targeting universal access to electricity by 2030, OnSSET (2018) calculates a total investment costs ranging from 1.2 to 5.9 billion USD, depending on the level of service provided, mixing on-grid and off-grid services, and technology cost development.

5.4 PAYG case study

We analyze 10,120 PAYG contracts, subscribed over the period of September 2016 to January 2019. We gathered our data from commercial sales of African Renewable Energy System and Solution (ARESS), one of the ninth biggest ESCOs selling PV panels and kits in Benin. ARESS, located in Cotonou, specializes in the installation and distribution of certified electricity products and services. Her activities are divided into four areas: distribution of existing solutions (pico and solar home systems); management of solar stores throughout the country in order to bring electrification solutions closer to end users and local communities, training and development and monitoring public private partnerships. Since 2015, ARESS imports lighting products from the Asian manufacturer Sun King and has organized PAYG services, allying with the largest Benin mobile telephone provider, MTN.

ARESS sales different solar products, ranging from the pico solar system to the solar home

¹⁰To reach these goals, the Communauté Electrique du Bénin (CEB), the joint generation and transmission utility of both Benin and Togo, and the national utility, SBEE (Société Béninoise d'Énergie Electrique), heavily indebted, are undertaking institutional reforms to ensure a viable energy sector. This would arguably reduce the country's energy dependence from its neighbors, underpin its economic development, and achieve universal access by 2030. The Off-Grid Clean Energy Facility is providing grant funding to proven, sustainable off-grid clean energy solutions within four windows nationwide in Benin: essential public infrastructure; decentralized community-level generation and distribution (minigrids); household energy systems and products (solar home kits and panels); and energy efficiency measures.

¹¹There are no doubts that PV systems will have a widespread diffusion, representing interesting business opportunities for private investors. According to the SE4All initiative, given the solar irradiation potential of the country, the estimated PV production between 2020 et 2030 will be of 1098 GWh and 2412 GWh respectively, with an installed capacity of 427 MW increasing to 843 MW in the best scenario of Benin economic growth.

system. The company's flagship product is the pico solar system. It consists of the Sun King Pro and the Sun King Boom costing 42 Euros and 56 Euros, respectively. Sun King Home 60 is the most expensive product ARESS sells and its price is approximately 96 Euros, nearly twice the legal minimum wage (40,000 FCFA approximately 61 Euros) in Benin. The main difference between these products, is their respective electricity production capacity. While the pico solar can, for instance, provide sufficient electricity to charge low power gadgets such as mp3 players, mobile phones and radios, the solar home system on the other hand, is capable of running high energy-consuming appliances (i.e. fan or television).

ARESS offers two payment options to acquire its products : the cash payment or the pay-as-you-go option. If the consumer chooses the cash payment option, he must purchase the solar panel in a one lump-sum payment. However, if he opts for the PAYG scheme, the consumer must make a prepayment of 10% or 15% of the price of the solar device and the rest has to be paid through weekly installments. While under normal condition (without experiencing payment default) ownership of the device is granted under 24 weekly instalments, it is possible to anticipate the ownership date. Put differently, the customer can own the solar panel earlier than 24 weeks if he pays the remaining balance. Hence, based on this information, PAYG users are either classified in the group of "anticipated payment" or "normal payment".

As the data used in this study comes from commercial sales of ARESS, we only have PAYG users. In addition to this, the dataset provides limited socio-economics information on PAYG users. For instance, we do not have any information on customers' level of education, age, electric appliances ownership, past electricity consumption or level of income. However, the dataset provides some basic information such as the customer's gender, type of product under the PAYG contract, geographic location and solar panel status. The status of each solar panel is either enabled, disabled or unlocked. When the status of the solar panel is unlocked, it means that the consumer has completely finished paying off the solar panel. The disabled status is attached to clients under payment default. Contrary to the unlocked status, the enabled status is associated to new PAYG clients who are still paying off the solar panel.¹²

Figure 5.4.1 depicts solar panel status by gender. As it can be noticed, there is no gender dif-

¹²Also, while the mobile phone number of the customer is available, unfortunately, we do not have any information on his historical credit refill. This information, if available, would have been a good proxy for income.

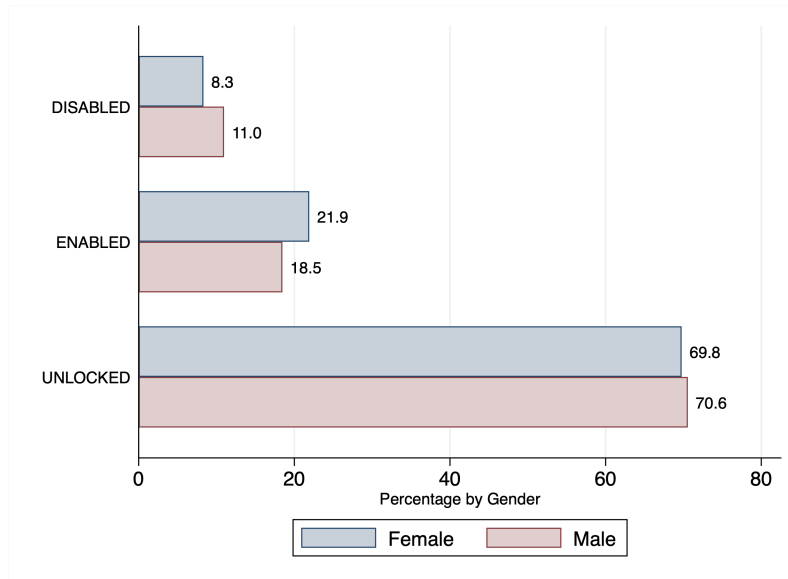

Figure 5.4.1: Solar status by gender

Source: Authors' elaboration from ARESS sales database.

ferences with regard to successfully going through the program. The percentage of unlocked solar panels for both female and male PAYG users is quite similar, nearly 70%. However, examining the enabled status, we notice some discrepancies. Indeed, new purchases of PAYG solutions in Benin are more likely to be undertaken by women than men. Finally, breaking down the disabled status by gender, one can notice that the percentage of male PAYG users in a default payment is greater than that of female. Hence, this suggest that male PAYG users are more likely to default than female ones.

Figure 5.4.2 displays the geographical location of early PAYG users, that is consumers who have entirely repaid their credit. As it can be noticed, the vast majority of early PAYG users are located in already electrified departments. In these departments, despite the existence of the grid and a relatively high access rate to electricity, still, a growing number of people rely on PAYG solutions to have to electricity. Littoral, Ouémé and Zou are the departments that concentrate the highest rate of PAYG adoption. This figure is indicative of an unreliable supply of electricity, characterized by frequent power outages. In such settings, solar home systems can, therefore, be considered as a complementary solution to the unreliable grid in providing continuous electricity services to households. Likewise, in many low electrified departments such as Alibori, Atakora, Borgou and Donga, PAYG services are penetrating, albeit, at a very slow pace. In these localities, PAYG services are rather used to access basic electricity services as the grid is almost nonexistent.

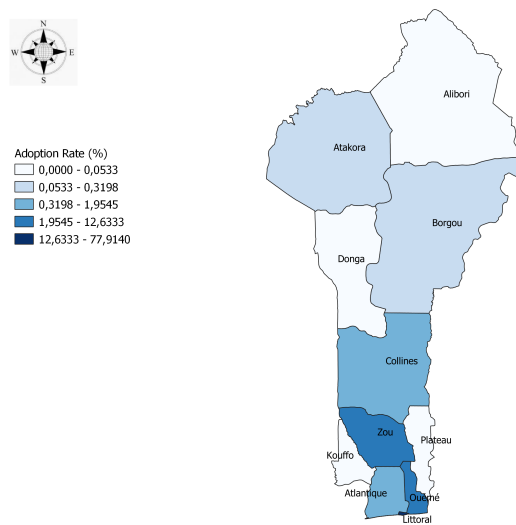

Figure 5.4.2: Early PAYG users by department
Source: Authors' elaboration from ARESS sales database.

Figure 5.4.3 on the other hand shows the location of new PAYG users by departments. Again, Littoral, Oumé and Zou are the departments that registered a strong growth of new PAYG users. Oumé and Zou account for 2.7% to 19.57% of new PAYG users followed by remote departments like Borgou and Atlantique which account for 1.1% to 2.7% of new solar kit purchases. Surprisingly, in the north of Benin where the electric grid is almost nonexistent, the adoption rate of PAYG solutions remains very low. This is mainly due to high operation costs PAYG services provider faces in reaching these locations. Clearly, the main insight one can draw from these statistics is that PAYG services providers are not serving the "last mile". Nearly all PAYG users in Benin have access to the grid.

Finally, Figure 5.4.4 depicts default rate statistics by department. First of all, it is important to note that ARESS has a relatively low default rate (i.e. less than 11%). Littoral is the department that concentrates the bulk of defaulters (14% to 68%). It is followed by Ouémé and Zou that account for 2% to 14% of the defaulters. The geographical patterns displayed in the previous figures suggest that there is a link between access to grid electricity and PAYG enrollement, as well as regularity and frequency of the payments. Is PAYG targeted to reliable clients, perhaps located in richer regions, where access to electricity is rather satisfactory? To test this hypothesis, we estimate in Section 5 a simple model that takes into account enabled, disabled or unlocked status

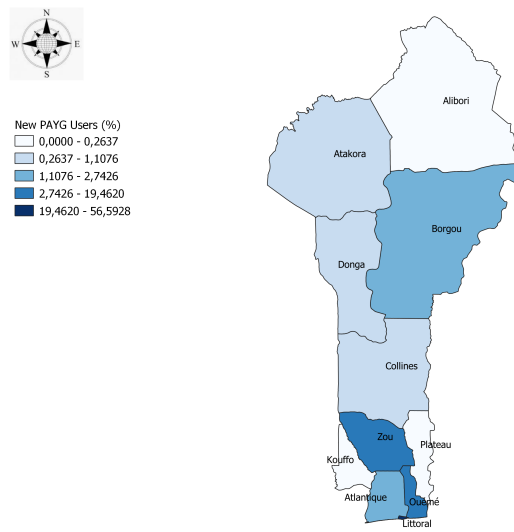

Figure 5.4.3: New PAYG users by department
Source: Authors' elaboration from ARESS sales database.

and the payment behavior of PAYG consumers.

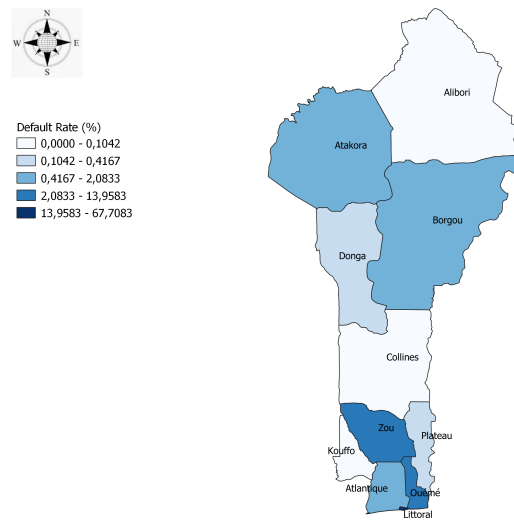

Figure 5.4.4: Default rate by department
Source: Authors' elaboration from ARESS sales database.

5.5 A simple empirical model

Based on the solar panel status (enabled, disabled or unlocked) and the payment patterns (cash payment or PAYG payment plan), 5 groups were defined: anticipated payment, cash payment, failure, normal payment and ongoing payment).

We resort to a minimalist Multinomial Logit Model to estimate the probability of falling into a group of payment given a set of control variables. For instance, the same modelling approach has been used to model alternative fuel choices in emerging countries (see for instance [Alem et al. 2016](#)). The Logit model is often used to predict categorical placement in or the probability of category membership on a dependent variable based on multiple independent variables. The independent variables can be either dichotomous (i.e., binary) or continuous (i.e., interval or ratio in scale). Multinomial logistic regression is a simple extension of binary logistic regression that allows for more than two categories of the dependent or outcome variable.¹³ Like binary logistic regression, multinomial logistic regression uses maximum likelihood estimation to evaluate the probability of categorical membership. Multinomial logistic regression does necessitate careful consideration of the sample size and examination for outlying cases. Data normality, linearity, or homoscedasticity, instead, are not needed to perform the estimate. The multinomial logit model relies on a very restrictive assumption: the independence of irrelevant alternatives (IIA). It supports the idea that the probability of choosing an alternative is not affected by the existence of other alternatives. In our model, the independence of irrelevant alternative holds as the probability of choosing is independent from other alternatives. Additionally, in our sample there are no consumer subscribing to more than one contract.

Formally, the conditional probability of a PAYG customer i falling into a category of payment $j = (1, 2, 3, 4, 5)$ is defined as follow:

$$Prob(y_i = j) = \frac{\exp(\beta_j X_i)}{\sum_{k=1}^J \exp(\beta_k X_i)} \quad (5.5.1)$$

where X_i represents a vector of control variables such as geographic location, gender and type of payment contract. A reference outcome in order to fit the model must be defined. We choose the cash payment as the base category. The model is estimated using the Maximum Likelihood

¹³A comprehensive analysis of multinomial logit models can be found in [Ben-Akiva et al. \(1985\)](#).

Estimator. Notice that we tried to retrace the history of payment of the customers in order to shed light on the payments dynamic with a panel model. However, due to persistence and low variability in the data, the panel multinomial logit model could not converge. Hence, we used a multinomial logit model on cross-sectional data.¹⁴

5.6 Results

5.6.1 Summary statistics

Table 5.6.1 summarizes the definitions and statistics of the main variables used in our empirical analysis. Our statistics indicate an unequal spatial distribution of PAYG users between cities. Cotonou, Porto Novo and Abomey Calavi concentrate the most important share of PAYG users, with respectively 59.43%, 9.39 % and 8.13% of the sample size.

The mean number of payment by PAYG users is 10.17, which is twice below the normal 24 weekly installment payments. The anticipation of installment payments might also reflect customers' uncertainty about their future revenues. We argue that customers falling into this category of payment could be risk averse. The proportion of customers in this category is 50.18% while cash payment, normal payment and ongoing payment represent respectively 18.7%, 10.4%, 4.4% and 16.3% of our sample.

Another important characteristic worth mentioning is the proportion of customers' in default payment situation, which we believe is relatively low (10.4%). People joining this program are less likely to be in the lowest distribution of income. Examining the ongoing payment category, one can notice that despite the low proportion of enrolment into the program, there is a positive dynamic in adoption of solar panels.

5.6.2 Key findings

The results of the determinants of group membership are presented in Tables 2.¹⁵ It is important to note that the estimated parameters from the multinomial logit cannot be interpreted directly.

¹⁴More precisely 87.4% of our sample size consists of Sun king Pro and Sun king Boom, which are quite similar products. In our main results we do not control for the type of products. However, to be sure that our results hold when the type of product is controlled for, we estimate a model including dummy variables to control for product type. We find that the results were not altered. The results can be provided upon request.

¹⁵Marginal effects results are presented in the Appendix (see Table 5.7.1).

Table 5.6.1: Summary statistics

Variables	Mean	Std. Dev.
Nb. of payments	10.169	7.685
Anticipated payment	.502	.5
Cash payment	.187	.39
Failure	.104	.305
Normal payment	.044	.205
Ongoing payment	.163	.369
Gender (dummy=1 if male, 0 otherwise)	1.828	.378
Cotonou (dummy=1 if lives in Cotonou, 0 otherwise)	.594	.491
Porto Novo (dummy=1 if lives in Porto Novo, 0 otherwise)	.094	.292
Abomey (dummy=1 if lives in Abomey, 0 otherwise)	.081	.273
Savalou (dummy=1 if lives in Savalou, 0 otherwise)	.011	.103
Contract (dummy=1 if PAYG, 0 otherwise)	.644	.479

N: 10,120

Scholars often resort to the relative risk ratio or the marginal effects. As we are interested in studying the factors influencing group membership, we begin by looking at how variables influence the choice of one outcome compared the base category (cash payment). To this end, odds ratios, which are also known as relative-risk ratios are calculated, even if we are aware that the relative-risk ratios does not convey a clear picture of the impacts of variables on outcomes.

Columns 2 to 5 of Table 5.6.2 present the odds ratios of falling into an alternative j compared to our base outcome (cash payment). Geographic location, PAYG payment contract and the number of payment are key determinant of group membership. For a PAYG customer living in Savalou for example, the odds of falling into the anticipated group of payment versus cash payment are expected to increase by a factor of 8.5, holding all others covariates constant. For a unit increase in the number of payment, holding all other variables constant the odds of falling into the anticipated group are multiplied by a factor of 129. Contrarily to Savalou, living in Abomey Calavi reduces the odds of anticipating the payment versus cash payment by 72%.

For the failure group outcome, we find that customers using the PAYG payment contract and living in Cotonou are more likely to experience default payment than cash payment. An explanation for this result could be that customers living in Cotonou are using kits to backup unreliable and expensive electricity services and they can somehow decide to give up paying for solar devices. Lack of detailed screening to calculate future financial ability to make regular payments might also explain why some customers experience payment default. Moreover, we also find that

Table 5.6.2: Odds Ratios Results

Variables	Ant. Payment	Failure	Norm Payment	Ong Payment
	vs Cash. Payment	vs Cash. Payment	vs Cash. Payment	vs Cash. Payment
Male	0.682* (0.145)	1.052 (0.237)	0.489 (0.216)	0.664** (0.128)
PAYG contract	33.37*** (7.011)	10.86*** (2.346)	39.46*** (27.94)	4.136*** (0.820)
Nb of payment	128.8*** (39.77)	111.6*** (34.44)	103,923*** (132,067)	109.3*** (33.59)
Cotonou	0.891 (0.170)	1.542** (0.329)	0.579 (0.229)	1.536** (0.277)
Porto Novo	0.757 (0.251)	1.383 (0.493)	0.496 (0.348)	1.277 (0.408)
Abomey Calavi	0.282*** (0.0794)	1.214 (0.364)	0.198* (0.166)	1.994*** (0.514)
Savalou	8.506*** (5.396)	2.74e-07*** (8.63e-08)	265,722** (1.325e+06)	1.690 (0.739)
Constant	0.000101*** (6.42e-05)	6.89e-05*** (4.47e-05)	0*** (0)	0.000495*** (0.000291)
Observations	10,120			
Log likelihood	-6087			

Robust standard errors of exponentiated coefficients in parentheses

*** p<0.01, ** p<0.05, * p<0.1

for a unit increase in the number of payment, the odds of falling into failure group versus cash payment are expected to rise by a factor of 111 holding all other variables constant. We interpret this effect as a possible time inconsistency issue. Clearly, beyond a certain number of payments, people with low and unpredictable revenue may give up regular weekly instalments fees. Indeed, when implementing this kind of services in developing countries, it is important to think about the optimal number of payments that reduces the risk of failure.

Positive and significant odds for PAYG payment contract and number of payment for the group of consumers in the normal payment and ongoing payment groups highlights the positive value of flexibility in contract which only requires weekly payments. The PAYG contract relaxes the budget constraint of its users.

Geography also matters for both ongoing payment and normal payment groups. For instance, the odds of falling into the normal payment versus cash payment, holding all other variables constant are higher for those living in Savalou than elsewhere. For the ongoing payment outcome, the odds are statistically significant for only those living in Abomey Calavi. The chance of being in the ongoing payment category rather than in the cash payment category is twice as important

for those living in Abomey, holding all other covariates constant. These geographical differences in group membership might be attributed to disparities in economic development of the different regions. It might also reflect disparities in access to electricity or reliability of the electric grid. We believe that solar kits are more likely to be used by customers as they are more affordable and reliable than on grid electricity, since the bulk of PAYG users are located in highly electrified cities.

Except for the ongoing payment category, gender in general, does not seem to be a key determinant of group membership.

5.7 Conclusion

PAYG aims at providing clean and reliable energy services to those without access to electricity or as a backup solution to those connected to the electric grid. Its business model relies on mobile money technology which reduces transaction costs. Beyond the transaction costs, PAYG service providers in developing countries operate under high costs, as they buy in advance the SHS devices, find consumers and offer post-sales services. However, they get uncertain revenues, due to eventual irregular payments or default. These are major impediments to PAYG services expansion at a larger scale.

We study the behavior of a large sample of PAYG consumers for electricity access, by using commercial data on PAYG users provided by a leading PAYG electricity operator in Benin. The main results of the model show that consumers in electrified areas still find interesting to get lighting and domestic electricity services by embarking on a flexible SHS loan. However, in a country where nearly half of the population live below the international poverty line of US\$ 1.90 per day, PAYG services might still be very expensive for the ultra-poor more specifically, those living in rural areas ([Bensch et al. 2018](#)). Matching our data with socioeconomic and dwelling information would be a valuable extension of our work.

In the years to come, flexible credit services could help addressing rural electricity access in Sub-Saharan Africa, but this will require Government intervention and adequate financial guarantees for electricity service companies. International donors or private sector funds will play a significant role toward this direction.

Acknowledgements. The authors thank the Climate Economics Chair for financial support as well as the ARESS Group for kindly providing data and support all along the study. Usual disclaimers apply.

Bibliography

- Advisors & Global (2018), ‘ Off-grid solar market trends report 2018’, <https://www.lightingglobal.org/2018-global-off-grid-solar-market-trends-report/>. [Online; accessed November-2019].
- Aker, J. C. & Mbiti, I. M. (2010), ‘Mobile phones and economic development in africa’, *Journal of economic Perspectives* **24**(3), 207–32.
- Alem, Y., Beyene, A. D., Köhlin, G. & Mekonnen, A. (2016), ‘Modeling household cooking fuel choice: A panel multinomial logit approach’, *Energy Economics* **59**, 129–137.
- Alstone, P., Gershenson, D. & Kammen, D. M. (2015), ‘Decentralized energy systems for clean electricity access’, *Nature Climate Change* **5**(4), 305.
- ARCEP (2019), ‘Rapport Annuel d’Activité’, https://arcep.bj/wp-content/uploads/2019/12/Rapport-Annuel-2018_Final.pdf. [Online; accessed November-2019].
- ARE (2010), ‘Nouveaux Tarifs de l’Electricité au Benin’, <https://are.bj/les-nouveaux-prix-de-la-sbee/>, Accessed November 2019. [Online; accessed November-2019].
- ARE (2018), ‘Scenario Demande’, http://are.bj/first_shortcode/uploads/2018/06/Tome-1-Scenario-demande-Final.pdf. [Online; accessed November-2019].

- Asongu, S. A. (2018), 'Conditional determinants of mobile phones penetration and mobile banking in sub-saharan africa', *Journal of the Knowledge Economy* **9**(1), 81–135.
- Barrie, J. & Cruickshank, H. J. (2017), 'Shedding light on the last mile: A study on the diffusion of pay as you go solar home systems in central east africa', *Energy Policy* **107**, 425–436.
- Ben-Akiva, M. E., Lerman, S. R. & Lerman, S. R. (1985), *Discrete choice analysis: theory and application to travel demand*, Vol. 9, MIT press.
- Benin-Energie (2019), 'Cartographie', <https://www.benin-energie.org/cartographie-new.html>. [Online; accessed November-2019].
- Bensch, G., Grimm, M., Huppertz, M., Langbein, J. & Peters, J. (2018), 'Are promotion programs needed to establish off-grid solar energy markets? evidence from rural burkina faso', *Renewable and Sustainable Energy Reviews* **90**, 1060–1068.
- Bhatia, M. & Angelou, N. (2015), *Beyond connections: energy access redefined*, World Bank.
- Collings, S. & Munyehirwe, A. (2016), 'Pay-as-you-go solar pv in rwanda: evidence of benefits to users and issues of affordability', *Field Actions Science Reports. The journal of field actions* (Special Issue 15), 94–103.
- Eberhard, A., Rosnes, O., Shkaratan, M. & Vennemo, H. (2011), *Africa's power infrastructure: investment, integration, efficiency*, The World Bank.
- Fondem (2019), 'Electrifier l'Afrique Rurale', <http://www.fondem.org/electrifier-lafrique-rurale/>. [Online; accessed November-2019].
- Furukawa, C. (2014), 'Do solar lamps help children study? contrary evidence from a pilot study in uganda', *Journal of Development Studies* **50**(2), 319–341.
- Gogla (2019), 'Global Off-Grid Solar Market Report', <http://www.gogla.org/global-off-grid-solar-market-report/>. [Online; accessed November-2019].
- Grimm, M., Lenz, L., Peters, J. & Sievert, M. (2020), 'Demand for off-grid solar electricity: Experimental evidence from rwanda', *Journal of the Association of Environmental and Resource Economists* **7**(3), 417–454.
- Grimm, M., Munyehirwe, A., Peters, J. & Sievert, M. (2016), 'A first step up the energy ladder?

- low cost solar kits and household's welfare in rural rwanda', *The World Bank Economic Review* **31**(3), 631–649.
- Hamburger, D., Jaeger, J., Bayer, P., Kennedy, R., Yang, J. & Urpelainen, J. (2019), 'Shades of darkness or light? a systematic review of geographic bias in impact evaluations of electricity access', *Energy Research & Social Science* **58**, 101236.
- IAE (2019), 'Africa energy outlook', *Paris: International Energy Agency* .
- Jack, B. K. & Smith, G. (2015), 'Pay as you go: Prepaid metering and electricity expenditures in south africa', *American Economic Review* **105**(5), 237–41.
- Jack, B. K. & Smith, G. (2017), 'Charging ahead: Prepaid metering, electricity use and utility revenue', *American Economic Journal: Applied Economics* .
- Jean-Claude, B. & Arnaud, M. (2018), Impact of decentralized electrification projects on sustainable development: A meta-analysis, Technical report, FERDI.
- Karplus, V. J. & von Hirschhausen, C. (2019), 'Electricity access: An introduction', *Economics of Energy Environmental Policy* **Volume 8**(1), 1–18.
- Kudo, Y., Shonchoy, A. S. & Takahashi, K. (2019), 'Short-term impacts of solar lanterns on child health: experimental evidence from bangladesh', *The Journal of Development Studies* **55**(11), 2329–2346.
- Lee, K., Miguel, E. & Wolfram, C. (2016), Experimental evidence on the demand for and costs of rural electrification, Technical report, National Bureau of Economic Research.
- Lee, K., Miguel, E. & Wolfram, C. (2017), 'Electrification and economic development: A microeconomic perspective'.
- Lee, K., Miguel, E. & Wolfram, C. (2020), 'Experimental evidence on the economics of rural electrification', *Journal of Political Economy* **128**(4), 1523–1565.
- Lemaire, X. (2018), 'Solar home systems and solar lanterns in rural areas of the global south: What impact?', *Wiley Interdisciplinary Reviews: Energy and Environment* **7**(5), e301.
- Louw, K., Conradie, B., Howells, M. & Dekenah, M. (2008), 'Determinants of electricity demand for newly electrified low-income african households', *Energy policy* **36**(8), 2812–2818.

- Mbiti, I. & Weil, D. N. (2013), 'The home economics of e-money: velocity, cash management, and discount rates of m-pesa users', *American Economic Review* **103**(3), 369–74.
- Moreno, A. & Bareisaite, A. (2015), 'Scaling up access to electricity: pay-as-you-go plans in off-grid energy services'.
- Mothobi, O. & Grzybowski, L. (2017), 'Infrastructure deficiencies and adoption of mobile money in sub-saharan africa', *Information Economics and Policy* **40**, 71–79.
- OnSSET (2018), 'Electrification Pathways for Benin', <http://www.onsset.org/electrification-pathways-for-benin.html>. [Online; accessed November-2019].
- Rolffs, P., Byrne, R. & Ockwell, D. (2014), 'Financing sustainable energy for all: Pay-as-you-go vs. traditional solar finance approaches in kenya'.
- Rolffs, P., Ockwell, D. & Byrne, R. (2015), 'Beyond technology and finance: pay-as-you-go sustainable energy access and theories of social change', *Environment and Planning a* **47**(12), 2609–2627.
- Rom, A., Günther, I. & Harrison, K. (2017), The economic impact of solar lighting: Results from a randomised field experiment in rural kenya, Technical report, ETH Zurich.
- Sanyal, S., Prins, J., Visco, F. & Pinchot, A. (2016), 'Stimulating pay-as-you-go energy access in kenya and tanzania: the role of development finance', *World Resources Institute*. www.gogla.org/sites/default/files/recourse_docs/stimulating_pay-as-yougo_energy_access_in_kenya_and_tanzania_the_role_of_development_finance.pdf.
- Sawin, J. L., Sverrisson, F., Chawla, K., Lins, C., Adib, R., Hullin, M., Leitner, S., Mazzaccaro, S., Murdock, H., Williamson, L. E. et al. (2018), 'Renewables 2018. global status report 2018'.
- Sinsin, L. M. (2017), *Économie de l'énergie et accès à l'électricité : trois essais sur le Bénin*, PhD thesis, Université Paris Dauphine.
- Stojanovski, O., Thurber, M. C., Wolak, F., Muwowo, G. & Harrison, K. (2018), 'Assessing opportunities for solar lanterns to improve educational outcomes in rural off-grid regions: Challenges and lessons from a randomized controlled trial', *Available at SSRN 3289855*.
- Stojanovski, O., Thurber, M. & Wolak, F. (2017), 'Rural energy access through solar home sys-

tems: Use patterns and opportunities for improvement’, *Energy for Sustainable Development* **37**, 33–50.

Tewari, D. D. & Shah, T. (2003), ‘An assessment of south african prepaid electricity experiment, lessons learned, and their policy implications for developing countries’, *Energy Policy* **31**(9), 911–927.

WB (2018), ‘Benin Financial Inclusion Indicators’, https://databank.worldbank.org/views/reports/reportwidget.aspx?Report_Name=CountryProfile&Id=b450fd57&tbar=y&dd=y&inf=n&zm=n&country=BEN. [Online; accessed November-2019].

WB (2019), ‘Benin Country Profile’, https://databank.worldbank.org/views/reports/reportwidget.aspx?Report_Name=CountryProfile&Id=b450fd57&tbar=y&dd=y&inf=n&zm=n&country=BEN. [Online; accessed November-2019].

Yadav, P., Heynen, A. P. & Palit, D. (2019), ‘Pay-as-you-go financing: a model for viable and widespread deployment of solar home systems in rural india’, *Energy for sustainable development* **48**, 139–153.

I. Appendix: marginal effects

Marginal effects inform about the change of the probabilities estimated in the multinomial logit in response to an instantaneous change of a continuous variable or a discrete change for a categorical variable. For instance, understanding how the probability of falling into the failure category changes in response to a unit increase in the number of payment is relevant to the PAYG service provider. For example, it could help the PAYG service provider to define an optimal number of payment that reduces the risk of failure.

Column (1), (2), (3), (4) and (5) gives the predicted probability of the anticipated payment, failure, normal payment and ongoing payment respectively in response to a discrete or marginal change of an explanatory variable. Looking at the anticipated payment category, we find that for two average PAYG customers, the predicted probability of making an anticipated payment is higher for female customers than for male. Being a male PAYG customer reduces the probability of making an anticipated payment roughly by 4%. An increase in the number of payment made by a PAYG customer is positive and significant for all groups of payments, the marginal effects

Table 5.7.1: Marginal Effects

VARIABLES	(1) Ant. Payment	(3) Failure	(4) Norm Payment	(5) Ong Payment
Male	-0.382* (0.213)	0.0509 (0.225)	-0.716 (0.442)	-0.410** (0.193)
PAYG contract	3.508*** (0.210)	2.385*** (0.216)	3.675*** (0.708)	1.420*** (0.198)
Nb of Payment	4.858*** (0.309)	4.715*** (0.309)	11.55*** (1.271)	4.694*** (0.307)
Cotonou	-0.116 (0.191)	0.433** (0.214)	-0.546 (0.395)	0.429** (0.181)
Porto Novo	-0.278 (0.332)	0.324 (0.356)	-0.701 (0.702)	0.245 (0.319)
Abomey Calavi	-1.266*** (0.282)	0.194 (0.300)	-1.620* (0.840)	0.690*** (0.258)
Savalou	2.141*** (0.634)	-15.11*** (0.315)	12.49** (4.985)	0.525 (0.438)
Constant	-9.203*** (0.638)	-9.583*** (0.649)	-166.4*** (29.53)	-7.612*** (0.589)
Observations	10,120			

Robust standard errors in parentheses

*** p<0.01, ** p<0.05, * p<0.1

are however different. We found the highest marginal effect for the normal payment group. For instance, a unit increase in the number of payment made by PAYG client increases the probability of making a normal payment by 11.5%.

We also observe geographical patterns in group membership. People living in Cotonou are more likely to fall into the failure and ongoing payment category. For example, for two hypothetical customers with mean characteristics, the one living in Cotonou has a 4.33% probability to experience failure than the one living elsewhere. Regarding the ongoing payment, the probability of entering the program is 4.3% for a person living in Cotonou than in another city. This might be due to the fact that there is still people living in the capital, who do not have access to a reliable electricity supply.

For these customers, the PAYG service could reflect a substitution effect (i.e. buying a solar panel to replace costly bills and unreliable electricity supply). Finally, we find some interesting related to Savalou. Living in that city reduces the probability of experiencing failure by 15.11% than being in other locations. People in Savalou are not only more likely to make normal payments, but also anticipated payment. The marginal effect of living in Savalou on the probability of making normal and anticipated payment are 2.14% and 12.5% respectively.

CHAPTER 6

General conclusion

The objective of this dissertation is to contribute to the existing literature on the factors influencing the adoption of modern energy services in Sub-Saharan Africa, with a particular focus on the role of financial inclusion. By utilizing both geospatial and household survey data from Tanzania, Senegal and Benin, each chapter makes an empirical contribution to the existing literature. Chapter 1 examine the profitability of mini-grid projects from an investment perspective. Chapter 2 and Chapter investigate the enabling role of mobile money services on households' adoption of solar panels and clean cooking fuels in Tanzania and Senegal, respectively. Chapter 4 is case study on how telecommunication services could be leveraged to bring electricity services to people living in remote rural areas.

Chapter 1 studies the regulatory framework, the tariff structure, and the subsidy schemes for mini-grids development in Tanzania. Indeed, understanding mini-grid projects' profitability from an investment perspective is particularly crucial for designing optimal regulations and cost-reflective tariff schemes to attract adequate private sector investments in the power sector. However, this is a less explored area in the literature. Comparably, only a few quantitative studies have critically assessed how existing regulations and tariff policies in SSA affect mini-grid projects'

potential to attract the number of private investments required to scale-up deployments (Williams et al. 2018). From another perspective, there is no consensus in the literature about whether mini-grid projects in SSA are profitable enough to crowd in private financing of mini-grid projects. On the one hand, some researchers argue that mini-grid projects powered by renewable energy are economically viable and capable of paying-off their financing cost and earning adequate returns for investors (Okoye & Oranekwu-Okoye 2018, Arowolo et al. 2019). On the other hand, other studies also argue that mini-grid projects in SSA are not economically feasible; thus, it requires subsidies to enable investors to recover their production cost (Azimoh et al. 2016, Nizami et al. 2017, Adaramola et al. 2017). This controversy about the profitability of mini-grid projects in SSA further strengthens the motivation of this paper. This Chapter therefore assesses the profitability of a mini-grid electrification project in Tanzania from a private investment perspective. Using an optimization technique we find that the approved standardized small power producers' tariffs and subsidy scheme in Tanzania still do not allow mini-grid for rural electrification projects to be profitable.

Drawing on the results from Chapter 1, which support the view that most households in developing countries are unable to pay cost-reflective electricity tariffs due to their low level of revenue, standalone solar home system is seen as interesting alternative to providing electricity access to the poor. In spite of this, the uptake of solar panels is still very low. Credit constraints and lack of access to financial services, which could allow households, for instance, to gradually save up small amounts of money and overcome the up-front investment costs, are often identified as the main barriers to technology adoption in developing countries (Dupas & Robinson 2013, Tarozzi et al. 2014, Batista & Vicente 2020). However, while it well documented that relieving credit constraints and introducing flexible payment mechanism increase the uptake of welfare improving technologies (e.g. bed nets and solar panels) in developing countries (Tarozzi et al. 2014, Barry & Creti 2020), little is known on the impact of financial services more specifically, on the use of mobile money services on technology adoption. Chapter 2 fills this gap by examining the drivers of standalone solar panels adoption in Tanzania. More specifically, Chapter 2 examines the effect of mobile money adoption on households' decision to buy solar panels for electricity access in Tanzania. Using a logit model and an instrumental variable (IV) approach to account for the potential endogeneity issue arising from mobile money adoption, we find positive effect of mobile

money services on solar panels' acquisition. Results from the logit model reveal that the odds of adopting solar panel is 2.6 times higher for households that use mobile money services than non-using households. Additionally, our IV results show that mobile money adoption, holding all other variables constant, leads to a 19% increase in the probability of adopting a solar panels. Furthermore, we find the effect of mobile money to be positive and statistically significant for only poor households. Finally, reception of remittances, access to credit and participation in off-farm revenue generating activities are the mediating channels through which mobile money affects the probability of adopting solar panels.

Chapter 3 expands on the analysis of Chapter 2 by investigating the impact of mobile money on Senegalese households' cooking fuel choices. The aim of this Chapter, therefore, is to assess the role of financial inclusion, more specifically the enabling role of mobile money on households' decision to use clean cooking fuels in Senegal. Specifically, we would like to know if households that use mobile money services are more likely to switch from pollutant sources of cooking fuels towards clean and efficient cooking fuels. By addressing this research question, we contribute to the growing literature on the drivers of cooking fuel transition in developing countries. More specifically, understanding the factors that influence clean cooking fuel choices and particularly how financial inclusion facilitates the transition from dirty cooking fuels towards clean and efficient cooking fuels is of utmost importance for policymakers. Drawing on a novel representative household survey and applying a probit and an instrumental variable technique, we show that mobile money eases the transition away from dirty cooking fuels towards clean and efficient cooking fuels. More specifically, we find that mobile money leads to 24.5% and 44% increase in the probability of using clean and charcoal cooking fuels, respectively. Conversely, mobile money leads to a 68.2% decrease in the probability of using dirty cooking fuels, supporting the view that financial inclusion plays a pivotal role in promoting energy transition in developing countries. Furthermore, we examine the heterogeneous effects of mobile money on cooking fuel choices with respect to household's head gender, poverty status and geographic location. While we find no differentiated effect of mobile money on cooking fuel choices with regard to household head's gender and poverty status, we find different results regarding household's location. Mobile money is positive and statistically significant for only rural households, supporting the view that financial inclusion reduces energy poverty. Finally, I show that receipt of remittances is the mediating channel

through which mobile money affects households' cooking fuel choices.

Finally, Chapter 4 is a case study that analyzes pay-as-you-go (PAYG) contracts subscribed by 10,120 consumers living in Benin (Sub-Saharan Africa) to purchase solar kits or panels for lighting and charging services. PAYG are flexible loans that allow fees payment through mobile banking. Most of the PAYG consumers live in well electrified areas (Cotonou, Porto Novo, Abomey Calavi, in the coastal zone). By estimating a very simple multinomial logit model, we find that these customers have a high probability to enroll in PAYG contracts. Living in urban and peri-urban areas, they use solar devices to substitute expensive and often unreliable grid electricity services. Consumers located in more periferic and less electrified areas (Savalou) have a low probability to default, as the substitution effect is weaker. Overall, in our case study, PAYG targets credit worthy consumers, in order to decrease the investment risk of the company providing solar devices. These results cast some doubts as to whether PAYG bridges the "last mile" electrification gap.

Before turning to the policy implications of this dissertation, it is important to discuss some limitations of this thesis. The data in Chapters 2 and 3 are cross-sectional and provide a snapshot of the impact of mobile money in Tanzania and Senegal on the adoption of solar and cooking fuel, respectively. A panel data, could for instance, not only enable us to capture the adoption dynamic but also to get more precise estimation of our parameters of interest by controlling for household fixed-effects. The second limitation worth mentioning stem from the endogeneity issue. Indeed, although we have tried to address this concern, its is generally difficult to find good instruments that meet the exclusion restriction. Hence, a panel data combined with good instruments can help in attenuating the endogeneity concerns. Finally, in Chapter 4, we rely on commercial sales from a pay-as-you-go service provider in Benin to analyze the adoption of pay-as-you-go solar panels for electricity access. The data had few socioeconomic characteristics of the individuals who buy this solution. Hence, a large scale survey on households use of financial inclusion and main energy sources could better help in understanding the drivers of pay-as-you-go adoption in developing countries. Having mentioned the limitations of the different chapters, we will now move on to the policy implications this dissertation.

First of all, Chapter 1 identifies some valuable lessons from the mini-grid regulatory and policy regime in Tanzania that may be worth emulating by other SSA countries of similar context. First, the establishment of a specific policy to regulate the development and operations of

SPPs. This includes the implementation of the technology-specific and size-specific Standardized Power Purchase Agreements (SPPA) and Standardized Power Purchase Tariffs (SPPT). However, the Standardized Power Purchase Agreements (SPPA) and Standardized Power Purchase Tariffs (SPPT) must be cost-reflective to enable private mini-grid systems and developers to recover their cost and earn adequate investments. Second, the establishment of a financial support scheme for rural mini-grid developers. However, we suggest the government expand its loan facility to enable local and other private developers access funding at an affordable rate for their project. We also recommend that the government consider investing subsidies in developing economic activities in rural communities to empower consumers financially to pay cost-reflective tariffs. Third, establishing a comprehensive mini-grid information portal and a geospatial portfolio planning tool is particularly important in reducing pre-site costs. The above critical lessons from Tanzania demonstrates the government's commitments to establishing an enabling business environment which are critical success factors in leveraging development partner funding and a few private sector developers. Fourth, government could for instance couple mini-grid projects with development projects aimed at stimulating productive (use of electricity for irrigation in areas with huge agricultural potential) use of electricity to attenuate the demand risk and enhance the financial viability of mini-grid projects in rural areas. Finally, given the enabling role of financial inclusion we recommend that governments in SSA put into place policies that widen vulnerable people's access to financial services.

Bibliography

- Adaramola, M. S., Quansah, D. A., Agelin-Chaab, M. & Paul, S. S. (2017), 'Multipurpose renewable energy resources based hybrid energy system for remote community in northern ghana', *Sustainable Energy Technologies and Assessments* **22**, 161–170.
- Arowolo, W., Blechinger, P., Cader, C. & Perez, Y. (2019), 'Seeking workable solutions to the electrification challenge in nigeria: Minigrid, reverse auctions and institutional adaptation', *Energy Strategy Reviews* **23**, 114–141.
- Azimoh, C. L., Klintenberg, P., Wallin, F., Karlsson, B. & Mbohwa, C. (2016), 'Electricity for development: Mini-grid solution for rural electrification in south africa', *Energy Conversion and Management* **110**, 268–277.
- Barry, M. S. & Creti, A. (2020), 'Pay-as-you-go contracts for electricity access: Bridging the “last mile” gap? a case study in benin', *Energy Economics* **90**, 104843.
- Batista, C. & Vicente, P. C. (2020), 'Improving access to savings through mobile money: Experimental evidence from african smallholder farmers', *World Development* **129**, 104905.
- Dupas, P. & Robinson, J. (2013), 'Why don't the poor save more? evidence from health savings experiments', *American Economic Review* **103**(4), 1138–71.
- Nizami, A.-S., Rehan, M., Waqas, M., Naqvi, M., Ouda, O. K., Shahzad, K., Miandad, R.,

- Khan, M. Z., Syamsiro, M., Ismail, I. M. et al. (2017), 'Waste biorefineries: enabling circular economies in developing countries', *Bioresource technology* **241**, 1101–1117.
- Okoye, C. O. & Oranekwu-Okoye, B. C. (2018), 'Economic feasibility of solar pv system for rural electrification in sub-sahara africa', *Renewable and Sustainable Energy Reviews* **82**, 2537–2547.
- Tarozzi, A., Mahajan, A., Blackburn, B., Kopf, D., Krishnan, L. & Yoong, J. (2014), 'Micro-loans, insecticide-treated bednets, and malaria: Evidence from a randomized controlled trial in Orissa, India', *American Economic Review* **104**(7), 1909–1941.
- Williams, N. J., Jaramillo, P. & Taneja, J. (2018), 'An investment risk assessment of microgrid utilities for rural electrification using the stochastic techno-economic microgrid model: A case study in rwanda', *Energy for Sustainable Development* **42**, 87–96.

RÉSUMÉ

L'accès à une source d'électricité abordable et fiable est un facteur déterminant du développement économique. L'électricité est, par exemple, essentielle au développement du capital humain, des activités industrielles, à l'amélioration des conditions de vie et à l'adoption de technologies de pointe dans des secteurs clés de l'économie. Pourtant, plus de 820 millions de personnes dans le monde vivent encore sans électricité. Plus de 80% de ces personnes se trouvent en Afrique subsaharienne (ASS), notamment dans les zones rurales. Cette thèse contribue à la littérature existante sur les facteurs influençant l'adoption de services énergétiques modernes en Afrique subsaharienne en se focalisant sur le rôle de l'inclusion financière et est organisée en quatre Chapitres. Le Chapitre 1 étudie le cadre réglementaire, la structure tarifaire et les programmes de subvention pour le développement des mini-réseaux en Tanzanie. Les Chapitres 2 et 3 étudient l'impact de l'inclusion financière à travers les services de mobile money sur l'adoption de panneaux solaires et de combustibles de cuisson propres par les ménages tanzaniens et sénégalais, respectivement. Enfin, le Chapitre 4 est une étude de cas qui analyse les contrats de paiement à la carte (PAYG) souscrits par 10,120 consommateurs vivant au Bénin (Afrique sub-saharienne) pour acheter des kits ou des panneaux solaires pour l'éclairage et les services de charge.

MOTS CLÉS

Électricité, Mini-réseaux, Mobile Money, Afrique Sub-Saharienne, Solaire, Technologie.

ABSTRACT

There is widespread recognition that access to affordable and reliable sources of electricity is a major determinant of economic development. Electricity is, for example, essential to development of human capital, industrial activities, the enhancement of living conditions and the adoption of disruptive technologies in key sectors of the economy. Nevertheless, over 820 million people, worldwide, still live without electricity. More than 80% of these people are located in Sub-Saharan Africa (SSA), particularly in rural areas. This dissertation adds to the existing literature on the factors influencing the adoption of modern energy services in Sub-Saharan Africa by focusing on the role of financial inclusion and is organized into four Chapters. Chapter 1 studies the regulatory framework, the tariff structure, and the subsidy schemes for mini-grids development in Tanzania. Chapter 2 and 3 study the impact of mobile money services on the uptake of solar panels and clean cooking fuels by Tanzanian and Senegalese households, respectively. Finally, Chapter 4 is a case study that analyzes pay-as-you-go (PAYG) contracts subscribed by 10,120 consumers living in Benin (Sub-Saharan Africa) to purchase solar kits or panels for lighting and charging services.

KEYWORDS

Electricity, Mini-grid, Mobile Money, Sub-Saharan Africa, Solar, Technology.

