



**HAL**  
open science

# Light fluoros-tag-assisted synthesis of oligosaccharides and peptidoglycan partial structures for the preparation of defined carbohydrate vaccine antigens and adjuvants

Idris Habibu Mahmud

## ► To cite this version:

Idris Habibu Mahmud. Light fluoros-tag-assisted synthesis of oligosaccharides and peptidoglycan partial structures for the preparation of defined carbohydrate vaccine antigens and adjuvants. Organic chemistry. Université de Lyon, 2021. English. NNT : 2021LYSE1309 . tel-04544722

**HAL Id: tel-04544722**

**<https://theses.hal.science/tel-04544722>**

Submitted on 13 Apr 2024

**HAL** is a multi-disciplinary open access archive for the deposit and dissemination of scientific research documents, whether they are published or not. The documents may come from teaching and research institutions in France or abroad, or from public or private research centers.

L'archive ouverte pluridisciplinaire **HAL**, est destinée au dépôt et à la diffusion de documents scientifiques de niveau recherche, publiés ou non, émanant des établissements d'enseignement et de recherche français ou étrangers, des laboratoires publics ou privés.



N°d'ordre NNT : 2021LYSE1309

## **THESE de DOCTORAT DE L'UNIVERSITE DE LYON**

opérée au sein de  
**l'Université Claude Bernard Lyon 1**

**Ecole Doctorale N°206**  
**Chimie, Procédés, Environnement**

**Spécialité de doctorat** : Chimie

**Discipline** : Chimie Organique

Soutenue publiquement le 09/12/2021, par :

**Idris Habibu MAHMUD**

---

# Light fluororous-tag-assisted synthesis of oligosaccharides and peptidoglycan partial structures for the preparation of defined carbohydrate vaccine antigens and adjuvants

---

Devant le jury composé de :

ANDRIOLETTI, Bruno	Professeur, Université de Lyon	Président du jury
NORSIKIAN, Stéphanie	Chargée de Recherche CNRS, Institut de Chimie des Substances Naturelles	Rapportrice
POHL, Nicola	Professeur, Indiana University Bloomington	Rapportrice
CHAMBERT, Stéphane	Maître de conférences, Université de Lyon	Examinateur
NGWULUKA, Ndidi	Professeur, University of Jos	Examinatrice
GOEKJIAN, Peter	Professeur, Université de Lyon	Directeur de thèse



## Université Claude Bernard – LYON 1

Président de l'Université	M. Frédéric FLEURY
Président du Conseil Académique	M. Hamda BEN HADID
Vice-Président du Conseil d'Administration	M. Didier REVEL
Vice-Président du Conseil des Etudes et de la Vie Universitaire	M. Philippe CHEVALLIER
Vice-Président de la Commission de Recherche	M. Jean-François MORNEX
Directeur Général des Services	M. Damien VERHAEGHE

### **COMPOSANTES SANTE**

Faculté de Médecine Lyon-Est – Claude Bernard	Doyen : M. Gilles RODE
Faculté de Médecine et Maïeutique Lyon Sud Charles. Mérieux	Doyenne : Mme Carole BURILLON
UFR d'Odontologie	Doyenne : Mme Dominique SEUX
Institut des Sciences Pharmaceutiques et Biologiques	Directrice : Mme Christine VINCIGUERRA
Institut des Sciences et Techniques de la Réadaptation	Directeur : M. Xavier PERROT
Département de Formation et Centre de Recherche en Biologie Humaine	Directrice : Mme Anne-Marie SCHOTT

### **COMPOSANTES & DEPARTEMENTS DE SCIENCES & TECHNOLOGIE**

UFR Biosciences	Directrice : Mme Kathrin GIESELER
Département Génie Electrique et des Procédés (GEP)	Directrice : Mme Rosaria FERRIGNO
Département Informatique	Directeur : M. Behzad SHARIAT
Département Mécanique	Directeur M. Marc BUFFAT
UFR - Faculté des Sciences	Directeur : M. Bruno ANDRIOLETTI
UFR (STAPS)	Directeur : M. Yannick VANPOULLE
Observatoire de Lyon	Directrice : Mme Isabelle DANIEL
Ecole Polytechnique Universitaire Lyon 1	Directeur : Emmanuel PERRIN
Ecole Supérieure de Chimie, Physique, Electronique (CPE Lyon)	Directeur : Gérard PIGNAULT
Institut Universitaire de Technologie de Lyon 1	Directeur : M. Christophe VITON
Institut de Science Financière et d'Assurances	Directeur : M. Nicolas LEBOISNE
ESPE	Directeur : M. Pierre CHAREYRON



For my family



## Acknowledgement:

I want to convey my heartfelt gratitude, appreciation, and thanks to my supervisor, Pr. Peter GOEKJIAN, a unique definition of mentor, Université de Lyon, Laboratoire Chimie Organique 2 – Glycochimie, Institut de Chimie et Biochimie Moleculaires et Supramoleculaire (ICBMS) who guides and inspires my scientific journey, and of course takes majority of the credit for actualizing this piece of work. His humble attitude, friendly relationship, and steadfast commitment to science lay the foundation for our success. Several personal and collaborative efforts have been fully invested purposely to improve my scientific training to standard-setting. Despite continued challenge, I am able to come out of it strongly. I recognize and appreciate your invaluable suggestions, tolerance, and broad heart by which you host my family at the beginning of this study. I am therefore sincerely indebted to you for this opportunity from masters to Ph.D. studies. I am also humbly extending vote of thanks to my jury members; Prof. Nicola POHL, Dr. Stéphanie NORSIKIAN, Prof. Ndidi NGWULUKA, Prof. Bruno ANDRIOLETTI and Dr. Stéphane CHAMBERT, for inspiring my scientific journey, accepting this task, and for judiciously reviewing the manuscript. I will not end this also without sincere appreciation to Dr. Anis TLILI.

The entire project would not have been possible without the joint scholarship between the Kano State Ministry of Higher Education and the French Governments; they have invested hugely and thank you. We have partnered with Dr. Hervé Casabianca of Institutes des Sciences Analytiques (ISA) Lyon and his intern student for LC-MS analysis; we are grateful. I'll also express my warm regards to innovative mind drivers of the LCO2 team; Dr. David Gueyrard, Pr. Pierre Strazewski, Dr. Sebastian Vidal, Dr. Michele Fiore and Dr. Thierry GRANJON for their helpful contributions.

Some of our past and current colleagues, such as Dr. Nicolas Dussart, Bastien Raison, Coline Vinay, Dr. Baptiste Thomas, Dr. Yoann Pascal, Dr. Lei Dong, Dr. Maxime Pommier, Fanny Demontrond, Yann Berthelo, Dr. Dimitri Fayolle, Augustin Lopez, Carolina Chieffo, Anastasiia Shvetsova, and other friends have rendered so much help in particular, with the laboratory etiquette and instrumental usage. Their experimental and intellectual mind towards science has been thankfully articulated in my research endeavor. The broadmindedness of every group member in the perspective of our diversity firmly holds the maturity of our strength.

In a general sense, every team in the ICBMS has been fully appreciated for collaborative assistance and support, particularly the NMR and Mass spec service team who analyze majority of our compounds during my master's and Ph.D. studies. Well-wishes and prayers from a group of family and friends, the university senior colleagues, the Nigerian community of friends and colleagues in Lyon, have been all delightfully acknowledged.

Most and foremost, my father and mother deserve special acknowledgments for nursing and providing me with everything to date. Words cannot express my deep gratitude for many expressions of motivation, guidance, love, and prayers. Indeed, that is what keeps me strong and going. Hmmm.....my wife has suffered from my short attention and denial of my presence for many months. I, therefore, thank you for your generosity and understanding. Finally, to my son, your father loves and misses you now and then. My absence is an exceptional vow to better your life and a legacy to accept life's most challenging moments.





## List of Abbreviations:

Ac	acetyl
Ac <sub>2</sub> O	acetic anhydride
APCs	antigen-presenting cells
aq.	Aqueous
BDMS	bromodimethylsulfonium bromide
Bn	benzyl
BnBr	benzyl bromide
BSP	benzenesulfinyl piperidine
Bz	benzoyl
DAP	<i>meso</i> -diaminopimelate
DAST	<i>N,N</i> -dimethylaminosulfur trifluoride
DC	dendritic cells
DCE	dichloroethane
DCM	dichloromethane
DDQ	2,3-dichloro-5,6-dicyano- <i>p</i> -benzoquinone
DEM	diethylmalonate
DMAP	4-dimethylaminopyridine
DMF	<i>N, N</i> -dimethylformamide
DMSO	dimethyl sulfoxide
DMTPSB	<i>O,O</i> -dimethylthiophosphonosulfonyl bromide
DMTST	dimethyl(methylthio)sulfonium ion
eq.	equivalent
FBS	fluorous biphasic reaction system
FC-72	perfluorohexane
FLE	fluorous liquid-liquid extraction
Fmoc	fluorenylmethoxycarbonyl
HBr	hydrogen bromide
HPLC	high performance liquid chromatography
LC	liquid chromatography
LPS	lipopolysaccharide
MDP	muramyl dipeptide
MeCN	acetonitrile
MeOH	methanol
MHC	major histocompatibility complex
Mp	methoxyphenyl
MS	mass spectrometry
Mol. Sieves	molecular sieves
NAP	2-naphthylmethyl
NBS	<i>N</i> -bromosuccinimide
NIS	<i>N</i> -iodosuccinimide
NMR	nuclear magnetic resonance
NOD	Nucleotide-binding oligomerization domain

NLR	Nucleotide-binding oligomerization domain-like receptors/nucleotide-binding domain and leucine-rich repeat containing gene family
PAMP	pathogen-associated molecular patterns
<i>p</i> -BrBn	<i>p</i> -bromobenzyl
PBMC	human peripheral blood mononuclear cells
PFD	perfluorodecalin
PFP	perfluorophenyl
PGN	peptidoglycan
Ph	phenyl
PhMe	toluene
PMB	<i>p</i> -methoxybenzyl
PRR	pattern recognition receptors
RP	reverse phase
rt	room temperature
TBAF	tetrabutylammonium fluoride
TBDPS	<i>tert</i> -butyldiphenylsilyl
TCBOC	2,2,2-Trichloro-1,1-dimethylethyloxycarbonyl
TCR	T-cell receptor
TCT	tracheal cytotoxin
TDS	texyldimethylsilyl
TEA	triethylamine
Troc	2,2,2-trichloroethoxycarbonyl
TFA	trifluoroacetic acid
THF	tetrahydrofuran
TLC	thin layer chromatography
TLR	Toll-like receptors
TMU	tetramethylurea
UV	ultraviolet

## General Introduction:

Carbohydrate chemistry has greatly evolved in an effort to supply ever more complex natural cellular components needed for the study, treatment, and prevention of various diseases and disease mechanisms. Bacterial, fungal and viral glycans are inevitably heterogeneous substances, for which absolute purity is extremely difficult to attain within a reasonable period of time. The necessity to make life better for the population has led chemists to espouse this undertaking and carry it in the right direction. The in-depth knowledge of the structure of microbial antigens and related components that participate in the host immune recognition response has laid down a rich context for chemists' research interests in this field.

Construction of many biomolecules has been undertaken in a chemical strategy to provide them in a fully defined state. The quality of each synthetic molecule can be quickly assessed by established analytical methods anywhere around the world. It is in particular free of other immuno-active substances. Over the years, many protocols have been developed to effectively build complex oligosaccharides. Yet, there are still gaps to fill in an effort to create ever more powerful and convenient methodologies, in order to construct these types of molecules in a few months if not days.

The most effective technology for containing infectious diseases has been the immunization/vaccination strategy. Its acceptability predates the elimination of such infections such as smallpox and the curtailing of other diseases, including polio and measles, that the world has witnessed a number of decades ago. Vaccine design aims toward an agent that triggers the immune system to activate the entire mechanism for recognition, destruction, and future defense against all active pathogenic components. We have seen one of the worst scenarios the world has faced in our lifetime with the Covid-19 epidemic. The same approach has made it possible to arrest the devastating effect of this infection with a variety of vaccine technologies.

The scope of this thesis entails the synthesis of glucosamine oligosaccharides related to a bacterial antigen and a bacterial pathogen-associated molecular pattern, which could be used as vaccine-related antigens and adjuvants, respectively. Chapter one discusses the biological role of pathogenic glycans on the host immune system, including the different signaling cascades, as well as general considerations for carbohydrate synthesis.

Chapter two focuses on a comprehensive literature review of fluorine-tagged-assisted synthesis of oligosaccharides, and on the preparation of fluorine tagged glycosyl donors and glycosyl acceptors of varying fluorine chain length. A variety of innovations starting from traditional heavy fluorine tags and liquid-liquid extraction to fluorine solid phase extraction and light fluorine tag technology, is discussed. New fluorine tagged donors and acceptors were designed and synthesized for a differential-doubly-tag glycoside coupling strategy, as well as for single-fluorine -tag glycosylation.

The following chapter (chapter-three) provides detailed glycosylation protocols for preparing partial *E. coli* O-antigen trisaccharides. Preliminary studies with the differential fluorine tag strategy confirmed that the various fluorine tag glycosyl donors are fully soluble in common reaction solvents whereas the solubility of the fluorine glucosamine acceptors was problematic and decreases as the length of the fluorine chain increases. The coupling reactions gave only traces of product in most instances, which is attributed to the strong hydrogen bond by the fluorine amide deactivating the nucleophilic hydroxyl group. Designing new acceptors bearing a 2-azido functionality instead of a fluorine amide improved both the solubility and reactivity of precursors. Studying the traditional

single fluororous tag coupling with different non-fluororous 2-azido acceptors overcame these limitations and proceeded in high yield. A strategy introducing the differential fluororous tag after the coupling was elaborated. Another issue encountered was the purification of the coupling reaction mixture. Exhaustive silica gel chromatography was low-yielding and offered no clean product. Analytical HPLC data on the analytical perfluorophenyl (PFP) column opened a window of hope for effective isolation of compound of interest from the recovered reaction substrates. A combined hydrophobic and fluorophilic approach appears to deliver an optimum solution to this problem. Furthermore, we tested preparative reverse phase purification of the coupling reaction mixtures, which appears to provide an effective compromise for synthetic purposes. This progress allows us to further the synthesis of target trisaccharide structures by a fluororous-hydrophobic tag approach.

The fluororous tag glucosamine donor was used to prepare a disaccharide analog of the peptidoglycan partial structure in chapter four. In both chapter three and four the fluororous amide on the glucosamine participated efficiently in the control of the newly created stereocenter. Unfortunately, coupling to the peptide moiety proved ineffective. These compounds may lead to novel PPR agonists for use as vaccine adjuvants, or antagonists for the study and treatment of septic shock.

Finally, chapter five presents the experimental conditions and data in all the syntheses conducted. The conclusions and perspectives of this work are provided in a final chapter.

## Resume

Dans un but de recherches de molécules immunologiquement actives, nous avons visé la construction de saccharides antigéniques partiels et d'analogues de disaccharides peptidoglycanes riches en glycosamines, en utilisant de nouvelles étiquettes fluorées amides en C2 de longueur de chaînes variable. L'amide fluoré a contrôlé avec succès la stéréochimie anomérique par une participation anchimérique en C2 au cours de la synthèse de disaccharides, de trisaccharides et d'autres composés modèles.

Dans notre effort initial d'employer une stratégie de double-marquage fluoré pour la préparation de disaccharides  $\beta(1\rightarrow3)$  de glucosamine modèles, un panel d'accepteurs et de donneurs de glycosides fluorés ont été préparés et purifiés par chromatographie traditionnelle sur colonne de gel de silice. La glycosylation avec double marquage a été entravée par des accepteurs de glycosides fluorés peu solubles et peu réactifs. La CCM fluorée s'est avérée à la fois efficace et nécessaire pour récupérer le donneur de glycoside, l'accepteur de glycoside et le disaccharide couplé dans ces réactions à faible rendement.

Dans une approche alternative, la glycosylation traditionnelle à simple marqueur fluoré a été testée avec des accepteurs de glycoside non-fluorés préalablement préparés, et a ainsi révélé la tendance de désactivation de l'amide fluoré  $\gg$  NH-amide  $>$  phtalimide, tel le confirment les rendements isolés relatifs, suggérant la désactivation de l'hydroxyle nucléophile par la liaison hydrogène de l'amide comme facteur significatif dans leur faible réactivité en tant qu'accepteurs de glycoside. Dans cette stratégie, des accepteurs 2-azido ont été préparés et ont fourni avec succès les disaccharides de glucosamine  $\beta(1\rightarrow3)$  visés. Les dérivés de glucosamine marqués par un amide fluoré se sont révélés être des donneurs de glycoside très efficaces. De plus, ces progrès nous ont inspirés à étendre davantage la synthèse à une structure partielle trisaccharidique de l'antigène de *E. coli* O142 et à un peptidoglycane disaccharide de la cytotoxine trachéale (TCT). La synthèse des trisaccharides nous a permis d'effectuer une stratégie de marquage fluoré différentiel pour le contrôle du deuxième stéréocentre formé et pour la synthèse itérative d'oligosaccharides.

La fonction principale de la chimie du fluor ici, cependant, était également de permettre une purification rapide des intermédiaires synthétiques et des composés cibles. Les monosaccharides marqués au fluor ont été efficacement purifiés par chromatographie sur colonne de gel de silice standard, mais d'autres intermédiaires et molécules cibles n'ont pas pu être purifiés par cette méthode. En raison de l'indisponibilité du gel de silice fluoré et des colonnes fluorées, nous avons testé les colonnes perfluorophényle. Nos données expérimentales ont révélé que les interactions fluorophiles et hydrophobes entre les composés synthétiques et la colonne PFP a fourni une bonne résolution. D'autres études sur l'utilisation de la colonne de phase inverse ont donné des résultats HPLC généralement similaires. Ainsi la chromatographie préparative en phase inverse s'est avérée très efficace pour la purification des mélanges réactionnelles. De plus, le gel de silice fluoré préparé dans notre groupe a démontré un pouvoir de résolution considérablement amélioré afin de purifier rapidement les intermédiaires synthétiques par rapport au gel de silice traditionnel.

## Abstract

In the quest for immunologically active molecules, we aimed towards the construction of glycosamine-rich partial antigen saccharides and peptidoglycan disaccharide analogs using novel C2 fluorous amide tags of varying chains length. The fluorous amide successfully controlled the anomeric stereochemistry by anchimeric C2-participation in the synthesis of disaccharides, trisaccharide and other model compounds.

In our initial effort to employ this method for the preparation of model glucosamine  $\beta(1\rightarrow3)$  disaccharides, a panel of fluorous tag glycoside acceptors and donors were prepared and purified by traditional silica gel column chromatography. Double-fluorous tag glycosylation was hampered by poorly soluble and poorly reactive fluorous glycoside acceptors. Fluorous TLC was found to be both effective and essential in order to recover the fluorous glycoside donor, fluorous acceptor and doubly fluorous coupled disaccharide in these low-yielding reactions.

In an alternative approach, traditional single-fluorous tag glycosylation was tested with previously prepared non-fluorous glycoside acceptors, and thus revealed the deactivation trend effect from fluorous amide  $\gg$  NH-amide  $>$  phthalimide, as confirmed by the relative recovered yields, suggesting the deactivation of the nucleophilic hydroxyl by the amide hydrogen bond as a significant factor in their poor reactivity as glycoside acceptors. In this strategy, 2-azido acceptors were prepared and successfully furnished the desired glucosamine  $\beta(1\rightarrow3)$  disaccharides. The fluorous amide-tagged glucosamine derivatives were shown to be very effective glycoside donors. Additionally, this progress inspired us to further extend the synthesis to a trisaccharide partial *E. coli* O142 O antigen structure and a tracheal cytotoxin (TCT) peptidoglycan disaccharide. The trisaccharide synthesis allowed us to perform a "differential fluorous tagging afterwards" strategy for the control of a newly formed stereocenter for iterative oligosaccharide synthesis.

The primary function of fluorous chemistry here, however, was also to allow for facile purification of synthetic intermediates and the target compounds. All fluorous-tagged monosaccharides were efficiently purified by standard silica gel column chromatography, but purification of further intermediates and target molecules by this method failed. Due to the unavailability of fluorous silica gel and fluorous columns, we tested the perfluorophenyl columns. The experimental data revealed the fluorophilic and hydrophobic interaction between the synthetic compounds and the PFP column provided good resolution. Further studies on the use of RP column yielded generally similar HPLC results, and preparative reverse phase chromatography provided an effective solution for the purification of coupling reaction mixtures. Furthermore, fluorous silica gel prepared in our group has demonstrated a vastly improved resolving power for rapidly purifying synthetic intermediates compared to traditional silica gel.

## TABLE OF CONTENTS

<b>ACKNOWLEDGEMENT:</b> .....	<b>7</b>
<b>LIST OF ABBREVIATIONS:</b> .....	<b>9</b>
<b>GENERAL INTRODUCTION:</b> .....	<b>11</b>
<b>RESUME</b> .....	<b>13</b>
<b>ABSTRACT</b> .....	<b>14</b>
<b>CHAPTER ONE: INTRODUCTION</b> .....	<b>17</b>
BIOLOGICAL ROLES OF CARBOHYDRATES.....	17
HOST PATHOGEN RECOGNITION AND THE IMMUNE SYSTEM.....	17
<i>Innate immunity</i> .....	18
<i>Adaptive immunity</i> .....	18
<i>PRRs and PAMPs; Partners for innate host defense</i> .....	18
<i>Recognition by B-cells</i> .....	21
<i>Recognition by T-cells</i> .....	23
<i>Vaccine and Vaccine design</i> .....	25
SYNTHETIC CARBOHYDRATES .....	26
<i>General aspects</i> .....	26
<i>Objectives</i> .....	26
<i>Stereochemistry</i> .....	27
<i>Factors affecting efficient oligosaccharide assembly</i> .....	30
<i>Automated and accelerated carbohydrate synthesis</i> .....	40
<b>CHAPTER TWO: SYNTHESIS OF NOVEL F-TAG GLYCOSYL BUILDING BLOCKS</b> .....	<b>43</b>
INTRODUCTION .....	43
APPLICATIONS OF FLUOROUS TAG METHODOLOGY IN CARBOHYDRATE SYNTHESIS .....	43
<i>F-tags in carbohydrate synthesis</i> .....	46
<i>Anomeric fluororous tags</i> .....	47
<i>Terminal fluororous tag protecting groups</i> .....	54
<i>Late-stage fluororous tag protecting groups</i> .....	55
<i>Iterative protecting group fluororous tags</i> .....	59
<i>Fluororous thioglycosides as activatable group</i> .....	60
<i>Fluororous N-protecting groups</i> .....	61
<i>Fluororous phosphate protecting groups</i> .....	62
RESULTS AND DISCUSSION .....	63
<i>Synthesis of F-tag donors</i> .....	64
<i>Synthesis of F-tag acceptors</i> .....	66
<i>Synthesis of non-fluororous glycosyl acceptors</i> .....	67
<i>Conclusion</i> .....	72
<b>CHAPTER THREE: SYNTHESIS OF TRISACCHARIDES CORRESPONDING TO A PARTIAL E COLI O412 O-ANTIGEN OLIGOSACCHARIDE</b> .....	<b>73</b>
INTRODUCTION .....	73
RESULTS AND DISCUSSION .....	78
<i>Double F-tag glycosylation</i> .....	78
<i>Traditional single F-tag glycosylation</i> .....	83



<i>Modified F-tag glycosylation strategy</i> .....	85
<i>Synthesis of O-antigen trisaccharides</i> .....	91
<i>Conclusion</i> .....	97
<b>CHAPTER FOUR: STUDIES TOWARD THE SYNTHESIS OF PARTIAL PEPTIDOGLYCAN STRUCTURES</b> .....	<b>100</b>
INTRODUCTION .....	100
RESULTS AND DISCUSSION .....	103
<i>Synthesis of acceptor for 1,4-peptidoglycan disaccharide</i> .....	103
<i>Synthesis of peptidoglycan disaccharide</i> .....	104
CONCLUSION .....	107
<b>CHAPTER FIVE: EXPERIMENTAL SECTION</b> .....	<b>108</b>
GENERAL INFORMATION .....	108
<i>Reagents and solvents</i> .....	108
<i>Nuclear Magnetic Resonance</i> .....	108
<i>Mass Spectrometry</i> .....	108
HPLC	108
<i>Reverse Phase C18 Chromatography</i> .....	108
EXPERIMENTAL SECTION .....	109
EXPERIMENTAL FOR CHAPTER THREE .....	168
<i>General optimized procedure for glycosylation with trichloroacetimidate donors</i> .....	168
EXPERIMENTAL FOR CHAPTER FOUR.....	210
<b>CONCLUSION AND FUTURE PERSPECTIVES</b> .....	<b>225</b>
<b>REFERENCES</b> .....	<b>227</b>

# CHAPTER ONE: Introduction

## BIOLOGICAL ROLES OF CARBOHYDRATES

The chemical synthesis of biopolymers such as carbohydrates and functionalized structures thereof is crucial for advancement in the life sciences, and the development of more reliable synthetic techniques for their assembly continues to be an active realm of research.<sup>1,2</sup> Carbohydrates are undoubtedly the most diverse biomolecules available on Earth when compared to lipids, proteins and nucleic acids. The structural complexity, heterogeneity, and difficulty entailed in purifying them has hampered our understanding of their detailed biological functions and possible applications in medicine and pharmaceuticals.<sup>3</sup> The recent advances in carbohydrate synthesis, identification and purification have considerably improved the opportunities in this field. A ray of hope arises as we gain insight into the numerous roles of carbohydrates in the host's cellular events and disruption thereof, such as during bacterial and viral infections, development and growth of tumors, metastasis, and septic shock, and in the context of deadly diseases such as AIDS, cancer, meningitis, and septicemia. For example, synthetic carbohydrate vaccines and therapeutics continue to present considerable medicinal potential for the protection, prevention, and containment of many of the world's diseases. Our understanding of the detailed mechanism of the pathogenic processes and their relationship to disease will be enhanced as the structure, conformation, and activity of carbohydrates continue to be given in-depth study. The many critical innovations in the development of effective methodologies and isolation approaches have yet to provide a reliable and general technique for the preparation of carbohydrates. Although considerable advances in glycoside and oligosaccharide synthesis have already been achieved, a variety of synthetic targets containing challenging glycosidic linkages, as well as the development of new strategies and methods, remain interesting areas of research.

## HOST PATHOGEN RECOGNITION AND THE IMMUNE SYSTEM

Microorganisms such as bacteria, virus, and parasites that invade a host are characterized by signature molecules which are recognized by the immune system to initiate a complex chain of responses. The immune system consists of a coordinated network of biological processes that responds to foreign molecules.

-Pathogen recognition receptors (PRR) on dendritic cells (DC), macrophages, epithelial cells, etc. mediate the innate immune response, recognize microbial components known as pathogen-associated molecular patterns (PAMPs) that are essential for the survival of the microorganism and are therefore difficult for the microorganism to alter. Activation of the PRRs induce the production of cytokines to activate all components of the immune system.

-B cells are antibody-producing cells and an important part of acquired immunity which recognize the pathogen itself based on surface antigens. Their action leads to the pathogen being tagged for destruction (opsonization). Ultimately, upon activation of the helper T cells, B-cells ensure immunological memory.

-Helper T-cells (Th1 and Th2) recognize intracellular components of the pathogen, displayed on major histocompatibility complex (MHC II) after phagocytosis of the pathogen. In response to the presence of pathogen-derived molecules on MHC II, the helper T-cells strongly activate the adaptive immunity system. A subset of long-lived activated helper T-cells persist as memory T cells.

-Killer T-cells, macrophages, and neutrophils carry out the destruction of unwanted materials and pathogens from the body. Killer T cells are activated as part of adaptive immunity by binding to pathogen-derived antigens on the MHC I receptor of another cell. Macrophages and neutrophils mediate both innate and acquired immunity.

### **Innate immunity**

The body's first, rapid and usually non-specific line of defense is achieved by the innate immune system within cells such as dendritic cells, macrophages, monocytes, neutrophils and epithelial cells. They are coordinated at the first stage of the defense to quickly respond to conserved microbial cellular components known as pathogen associated molecular patterns (PAMPs) as an inherent defense against infection. In essence, invading pathogens are attacked because innate cell receptors discriminate between self and a variety of pathogen-produced materials. This response is elicited by conserved components of invading microbes that are sensed by pattern recognition receptors (PRR). Several classes of PRRs, including Toll like receptors (TLR) and cytoplasmic receptors, recognize distinct microbial components and directly activate immune cells.<sup>4, 5,6</sup> Three major classes of cytosolic PRR receptors are comprised of NOD-like receptors, RIG (retinoic acid inducible gene)-like receptors, and cytosolic DNA sensors.<sup>7</sup> Together, the different families of PRR play a significant function for inducing the synthesis and secretion of cytokines and the activation of other host defense processes that are paramount for both innate and acquired immune responses.

### **Adaptive immunity**

As a subset of the immune system, the adaptive or acquired immune system is composed of a coordinated group of cells and processes aimed at removing a specific invading pathogen once the organism has been exposed to it, and at protecting against future occurrence. Both an antibody response and a cell-mediated response participate in a coordinated way to recognize specific molecular structures of the pathogen, in order to eliminate it and to prime the immune system against future infections. Acquired (adaptive) immunity is therefore defined by specificity and develops by clonal selection from a vast collection of T-cells and B-cells bearing antigen-specific receptors. This route also has the ability to set up a sort of immunological memory that can retrieve past pathogens binding pattern as a basis for specific recognition and elimination of foreign threats upon re-emergence. While innate immunity is rapid, adaptive cells take longer to develop, because it creates a memory signature (immunological memory) and delivers long-lasting protection. This sets the basis for vaccine development for conferring host immunity by presenting various extracellular antigens characteristic of specific bacterial and viral infections.

### **PRRs and PAMPs; Partners for innate host defense**

Protection by the innate immune system against invasive pathogens are initiated when PAMPs are identified by the PRRs of the host. In mammals, these PAMPs are recognized specifically by their respective extracellular toll-like receptors (TLRs) or intracellular NOD-like receptors (NLRs): peptidoglycans and lipopeptides mainly by TLR2, double-stranded RNA by TLR3, lipopolysaccharide (LPS) by TLR4, single-stranded RNA by TLR7, and bacterial CpG DNA by TLR9.<sup>6</sup> Nucleotide-binding oligomerization domain (NOD) -like receptors or NOD-like receptors/nucleotide-binding domain and leucine-rich repeat containing gene family (NLRs) belong to the large family of cytosolic PRRs,<sup>8</sup> the most widely described forms are classified into NOD1 and NOD2 receptors. Both NOD1 and NOD2 sense monomeric fragments of bacterial peptidoglycan (PGN) known as muropeptides. NOD1

recognizes specific muropeptides from Gram-negative bacteria, bearing a *meso*-diaminopimelate (DAP) on natural and synthetic residues.<sup>9,10</sup> Muramyl dipeptide (MDP), a structural scaffold present in both Gram-negative and Gram-positive peptidoglycans, is reported as the best-known agonist for NOD2.<sup>11</sup> Similar to TLRs, NOD1 and NOD2 directly elicit transcription of innate immune response genes.<sup>12</sup> The synergistic response between these receptors (NLRs and TLRs) to a number of agonists (ligands/PAMPs) lie in the early stages of developing potential adaptive and hard immunity. The combined effect between Toll-like receptors (TLRs) and nucleotide binding oligomerization domain receptors (i.e., NOD1 and NOD2), the two major groups of PRRs involved in innate recognition, has shown both significant agonistic and antagonistic effects.<sup>13</sup>

#### *TLR-NLR Synergistic response*

Both in vitro and in vivo experimental data imply that NODs and TLRs, as key drivers for innate host defense, synergize with each other in inducing the production of cytokines and antimicrobial peptides. There are possible useful consequences of NOD-TLR synergy: In sepsis, where synergistic effects contribute to unwarranted proinflammatory cytokine production, suppression of NOD1, and/or NOD2 in addition to TLR4 blockade may be essential to achieve therapeutic benefit. Conversely, controlled synergistic combined doses of NOD and TLR agonists administered before infection or vaccination could serve as a principle for boosting innate resistance against bacterial pathogens and for improving vaccine effectiveness.

The production of cytokines including TNF, IL-1 $\beta$ , IL-6, IL-8 and IL-10 has been shown to be synergistically increased upon stimulation of human peripheral blood mononuclear cells (PBMC) with NOD1 agonist (M-triDAP) or a NOD2 agonist (MDP or M-triLYS) in combination with a TLR1,2 (Pam2CSK4) or TLR4 (LPS) agonist.<sup>14–18</sup> Similarly, synergistic interactions between NOD1 and TLR5,7,8 and between NOD2 and TLR3, but not TLR5, agonists have revealed interesting features of the interplay between the extracellular and intracellular PRRs. Furthermore, cytokine production by human and mouse DCs<sup>15,19,20</sup> and by mouse macrophages<sup>21</sup> is associated with a synergistic combination of synthetic NOD1 or NOD2 agonists with TLR2 or TLR4 agonists. The synergy between NOD1 or NOD2 agonists and some specific TLRs triggers is illustrated by the fact that these induced responses in DCs only in combined action:<sup>19,20,22,23</sup> For instance, muramyl dipeptide and FK-156 (a NOD1 agonist) alone do not induce IL-12p70 production by DCs, but only do so when combined with LPS or lipid A (a TLR4 agonist).

A combination of NOD2 and TLR2 agonists in human monocyte-derived DCs was reported to synergistically induce the production of CD80, CD83, CD86 and MHC class II.<sup>24</sup> Synergy in the production and expression of IL-8 was also observed with NOD1 or NOD2 agonists combined with TLR2, TLR4 or TLR9 agonists.<sup>25</sup> Another report established a simple additive effect rather than synergy between NOD2 agonist MDP and monophosphorylated lipid A (a TLR4 agonist) in mouse bone marrow-derived DC that produce CD80, CD86 and MHC class II,<sup>20</sup> whereas the expression of CD40, CD80 and CD86 in human DCs was affected infra-additively by the presence of NOD1 or NOD2 agonist with different TLR agonists.<sup>19</sup>

In another report, neither NOD1/NOD2 nor TLR agonists alone or in combination induce cytokine or chemokine production in oral epithelial cells. Nevertheless, different TLR agonists synergize with both FK-156 (NOD1 agonist) and MDP (NOD2 agonist) to induce the production of peptides and proteins with antimicrobial functions, such as hBD2 and PGRP-1 $\alpha$ .<sup>26</sup>

The potential application of innate immune cell activation with appropriate agonist combinations is a key strategy for a form of broad vaccination to protect the population from a range of deadly diseases that claim hundreds of thousands of lives worldwide.<sup>27</sup> In vitro experimental data established the prolongation of survival in animal models by NOD or TLR agonist before inoculation with lethal doses of bacterial pathogens, an effect of enhanced bactericidal activities of innate immune cells and the prevention of excessive cytokine release upon bacterial challenge.<sup>28–32</sup> However, improved protection by a synergistic combination NOD/TLR agonists gave better results and at lower concentrations than individual agonists.<sup>33</sup> Henceforth, a more robust model for the prevention of highly infectious disease by this method will undoubtedly lead to more efficacious and general vaccines that are urgently needed. The study of synergistic agonists in other response pathways (such as reprogramming innate immune cells) could improve several immune impairments as evidenced from Bacillus Calmette–Guérin (BCG) vaccine,<sup>34</sup> to enhance early intervention, extending survival and reducing complicating health incidents such as sepsis.<sup>35–38</sup>

In the context of septic shock, simultaneous obstruction of the synergistic receptors' response in order to prevent excessive inflammatory response could be a promising strategy for treatment. Controlled suppression of PRR activation can limit cytokine production, thereby arresting the inflammation. Extensive research for neutralizing the effect of LPS (endotoxin) as a proinflammatory pathogenic compound has been an enthusiastic field of clinical research. The interaction of LPS with TLR4 is blocked by Eritoran, an antagonist for MD2-TLR4.<sup>39</sup> However, the anti-LPS treatment could still not completely block the synergistic response with NOD1/NOD2 due to the abnormally high concentration of peptidoglycan fragments in the plasma of septic patients.<sup>40</sup> The efficacy of this Eritoran as a single agent thus remains unreliable.<sup>39,41</sup> The use of synthetic heterocyclic NOD1/NOD2 response antagonist molecules, such as benzimidazole, indole, or purine derivatives, are among the ongoing endeavors to deliver the therapeutic need for sepsis and septic shock.<sup>42–44</sup> Supporting the lethal role of NOD receptors in sepsis, NOD2<sup>-/-</sup> mice with polymicrobial sepsis and in the Enterococcus *faecalis* sepsis model have shown better survival.<sup>45,46</sup> Similarly, targeting the process further downstream, a potent receptor interacting protein 2 (RIP2) inhibitor (SB203580) blocks NOD1 and NOD2 signaling in mice with polymicrobial sepsis, thereby raising survival chances. IκB kinase (IKK) inhibitors have demonstrated improved survival function or alleviated the deterioration of vital functions seen in animals with polymicrobial sepsis.<sup>47–50</sup> It is thus another therapeutic target because both NOD1/2 and TLRs signal through IKK/NF-κB. Therefore, utilizing these established results, a synergistic combination of NOD and TLR antagonists in a clinical setting for the treatment of sepsis may pave a way for more enhanced drug regimens.

#### *TLR-NLR antagonistic effect*

These combined interactive studies also revealed a number of antagonistic NOD-TLR mechanisms. Inhibitory characteristics of NOD agonists on TLR-induced response could be exploited to understand, describe and arrest abnormal cellular responses in a variety of diseases. To demonstrate this, an investigation on bone marrow-derived macrophages and DCs from NOD2<sup>-/-</sup> mice showed enhanced NF-κB and MAPK activation along with higher IL-1β, IL-6, and TNF mRNA presentation upon LPS and poly-I:C induction in vitro.<sup>51</sup> However, a majority of the established reports in Crohn's disease patients homozygous for NOD2 null mutations depicted unchanged responses to TLR agonists in PBMCs.<sup>14,17,52,53</sup> Likewise, splenocytes from NOD2<sup>-/-</sup> mice, as compared to wild-type splenocytes, generated additional IL-12 and IL-18 in response to agonists of TLR2 (but not of several other TLRs,

and TLR-induced TNF and IL-10 production remained undisturbed).<sup>54</sup> Furthermore, a concentration of 10  $\mu\text{g/ml}$  of MDP NOD2 agonist has been described to down-regulate IL-1 $\beta$  expression induced by a TLR2/1 agonist (peptidoglycan) in murine peritoneal macrophages in vitro. However, MDP did not affect IL-1 $\beta$  production induced by LPS (injected at a high concentration of 1  $\mu\text{g/ml}$ ) and up-regulated TLR2-induced IL-10 and TNF production.<sup>55</sup> An analogous report established that in murine splenic macrophages in vitro, MDP at 10–100  $\mu\text{g/ml}$  specifically down-regulated IL-12 production induced through TLR2 exclusively.<sup>54</sup> An explicit answer to the opposing data about positive and negative regulation of MDP on TLR-mediated activation made it clear that MDP at low concentrations (1–25  $\mu\text{g/ml}$ ) activates TLR2-induced TNF production by monocytes, whereas at a high concentration (100  $\mu\text{g/ml}$ ) suppresses it.<sup>56</sup>

Further insight was obtained from sequential stimulus application; TNF, IL-1 $\beta$ , and IL-8 secretion in response to TLR4 and TLR2 agonists was sharply inhibited after 24–48 h pretreatment of human monocyte-derived macrophages with MDP (at 100  $\mu\text{g/ml}$ ).<sup>57</sup> However, a 24 h pretreatment of human monocytes with 0.1–10  $\mu\text{g/ml}$  MDP by Kullberg et al., down-regulated TNF production induced through TLR4 but not through TLR2, and did not affect IL-6 or IL-10 production induced through either receptor in a study of mutated NOD2 in Crohn's disease.<sup>58</sup> In another research report by Watanabe et al., MDP had no effect on TLR-induced TNF after 24 h pretreatment of human monocyte-derived DCs, but suppressed IL-6 and IL-12p40 production induced by diverse TLR agonists. Additionally, MDP administration to mice (100  $\mu\text{g}$  for 3 consecutive days) deactivated IL-6, IL-12, and TNF production by mesenteric lymph node and lamina propria mononuclear cells restimulated in vitro with diverse TLR agonists.<sup>59</sup> These results will continue to reshape our understanding of the complex inhibitory effects of NOD receptor agonists on the TLR-induced responses; an important principle for receptor antagonist discovery and for our understanding of pathological and non-pathological receptor function.

Pathogens have evolved multiple strategies to evade and attack the host immune system. Several viral proteins inhibit host immune responses, block viral antigen presentation, or interfere with the induction of cell death. It is not surprising that many immune system signaling cascades are antagonized in a number of infection models.<sup>60–67</sup> Bacteria and fungi thus escape the TLR system, as certain pathogens have altered forms of the typical TLR ligands, such as the LPSs from *H. pylori*, *P. gingivalis*, and *L. pneumophila* and flagellin of *H. pylori* and *C. jejuni*.<sup>68</sup> Conversely, some pathogens mediate TLR2 activation to their advantage for long-term infection through TLR2's antagonistic effect on other immune processes.<sup>69–71</sup>

## Recognition by B-cells

B-cell recognition of pathogens initiates an antibody response where the cells are activated to secrete immunoglobulins (Ig, antibodies). Antigens (short for antibody generators) are defined as the class of non-self-molecules which bind to specific B-cell receptors and trigger the production of the corresponding antibodies. These are proteins that circulate in the bloodstream and lymph (hence the term humoral immunity) which bind to foreign molecules of the pathogen thus protecting against interaction with the host, a process called opsonization. Antibodies are Y-shaped globular proteins produced by B-cells that are tailored to identify specific pathogenic antigens to neutralize the pathogen's harmful effect and to mark it for removal by macrophages.

Mammalian antibodies comprise of IgA, IgD, IgE, IgG and IgM and differ in their biological characteristics and kind of antigen targeted. A specific B cell receptor that resembles a membrane-bound antibody are expressed by B cells and binds to particular antigen that is not normally present in the host. This encounter is usually in the native form of the pathogen by the B cells which then receives additional signals from helper T cells (predominantly Th2), and differentiates into effector cells, also called plasma cells. The plasma cells are short-lived and secrete the corresponding antibodies that bind to the antigens, and thus target it for phagocytosis and initiate the complement cascade. In response to further T-cell signaling, about 10% of cells survive to become long-lived antigen-specific memory B cells programmed with antigen-specific antibodies, which can be recruited in a future event if the host re-encounters the same pathogen, and thus limit the effect to very mild symptoms.

### *Structure of bacterial cell walls*

As the initial recognition by the B-cells will likely take place with the intact form of the pathogen, B-cell mediated antibody response will typically target molecules on the surface of the bacteria. Furthermore, we have seen that the innate immune response is also in large part driven by recognition of bacterial cell wall components by the PRRs. A schematic view of the bacterial cell wall structure of Gram negative and Gram-positive bacteria are shown in Figure 1.

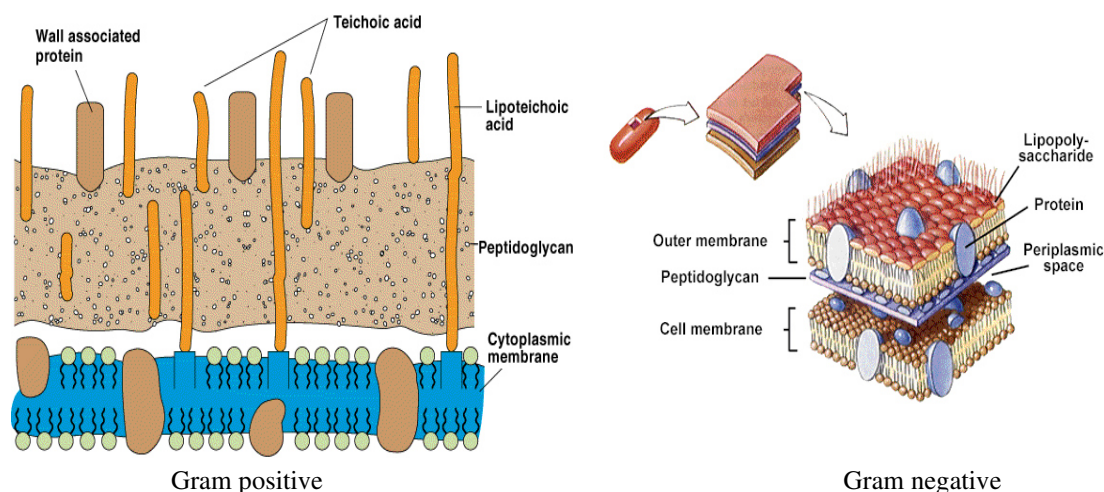

**Figure 1:** Schematic representation of bacterial cell walls. Reproduced from J. G. Black 1999

### *LPS and O-antigen*

Lipopolysaccharide refers to the large molecules and principal components of the outer membrane of gram-negative bacterial cell walls. LPS is comprised of a covalently joined hydrophobic domain, lipid A, and a polysaccharide which is composed of the inner core, the outer core, and the O-antigen (Figure 2). It stabilizes the structural integrity of the cell wall and shields the bacteria from certain external chemical and biological attacks. LPS is released as part of physiological processes of membrane vesicle trafficking in the form of outer membrane vesicles (OMVs)<sup>72</sup>. It is a potent endotoxin, as its presence in the mammalian blood system triggers a strong immune response by activation of the TLR4 PRR, and the release of cytokines such as TNF- $\alpha$ .

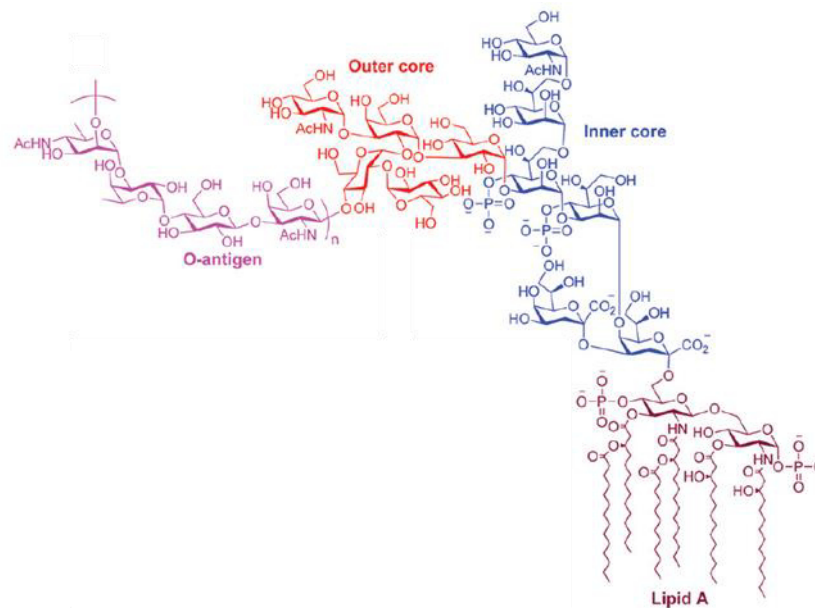

**Figure 2:** Chemical structure of a bacterial LPS and O-antigen. Reproduced from Shang 2015

The repetitive polymeric glycan chain bound to the core oligosaccharide of LPS is termed the O-antigen, O-polysaccharide, or O-side chain. The composition of the O-side chain varies from one strain to another, for instance different *E. coli* bacterial strain produce nearly about 170 serotypes<sup>73</sup>. The structural diversity arises from the sugar composition and the position and stereochemistry of the glycoside linkages, but also from the presence or absence of non-carbohydrate substituents. The repeating unit pattern and in some instances nonstoichiometric modification thus play a significant role in shaping O-antigen structural variation, and hence recognition by the immune system. O-antigen is found in the outer surface of bacterial cell wall and is therefore the potential target for the initial B-cell mediated host immune response.

### Recognition by T-cells

T-cells strongly participate in cell-mediated immune response by recognizing a variety of foreign structures from pathogens, which are displayed on the surface of the host's cells. T-cells sense the presence of either intracellular or extracellular pathogens from the peptide, glycolipid, or other fragments derived from the digestion of the pathogen's biomolecules, displayed on specific surface receptors of the cells. Transporting these foreign peptides to the cell surface is mediated by specialized host-cell glycoproteins encoded in a large cluster of genes. This gene complex is known as the major histocompatibility complex (MHC).

#### *MHC I and II*

The major histocompatibility complex primarily code for cell surface proteins which play a fundamental role in the adaptive immune system. They are divided into two classes, MHC I and MHC II (Figure 3). Class II MHC may be present on all type of cells but are most commonly found on professional antigen-presenting cells (APCs), such as macrophages, B-cells, and in particular dendritic cells. Following antigenic protein uptake and degradation within endocytic vesicles various fragments are returned and displayed as epitopes on the MHC II at the surface of antigen presenting cells. Epitope recognition by immunologic structures, in particular T-cells, is only possible on the cell surface in presence of the MHC complex. The MHC class I differs in that it displays fragments from the proteasome and is therefore able to report on the presence of intracellular antigens.



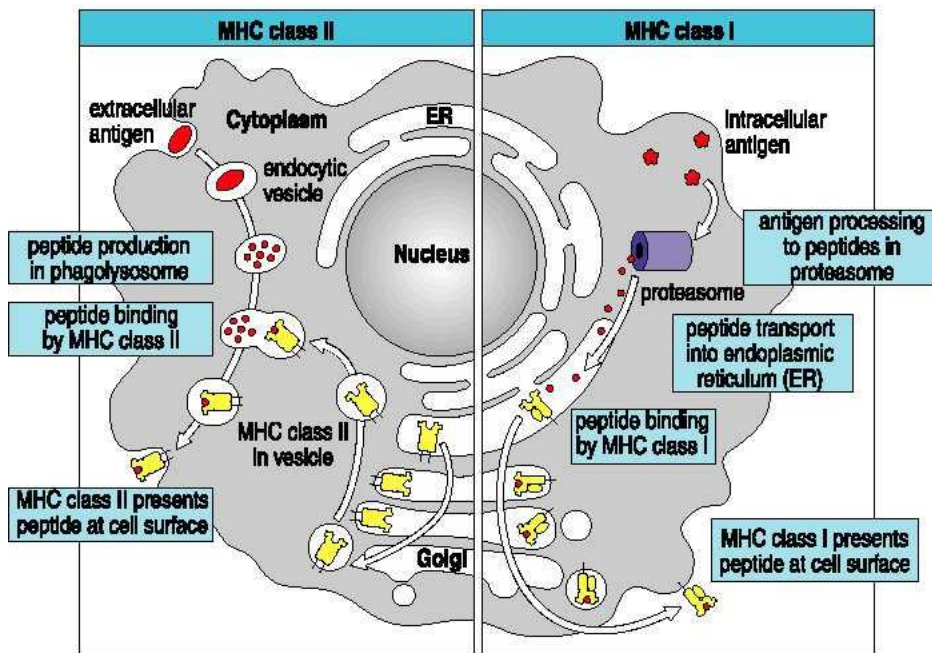

**Figure 3:** Schematic representation of major class of major histocompatibility complexes (MHC). Reproduced from Janeway 2001

### *T cell receptors*

A protein complex found on the surface of T-cells responsible for recognizing fragments of antigen bound to the MHC is known as the T-cell receptor (TCR). The binding affinity between TCR and antigen peptide is relatively low and non-specific, as many TCRs recognize the same antigen peptide and vice versa. TCR is hetero dimer composed of two different protein chains that bears some analogy to the short arm of an antibody. In 95% of human T-cells, the TCR consist of an alpha ( $\alpha$ ) chain and beta ( $\beta$ ) chain (encoded by TRA and TRB, respectively), whereas in 5% of T-cells, the TCR consist of gamma and delta ( $\gamma/\delta$ ) chains (encoded by TRG and TRD, respectively). The engagement between the TCR and antigenic peptide/MHC results in the activation of the T-lymphocyte through activation or release of a variety of transcription factors, including those for the relevant cytokines.

### *TH I and TH II and the killer T cells*

The helper T cells Th1 and Th2 are two type of effector T cells that can be induced by recognition of antigens on the MHC II of APCs. They bear a CD4 protein that recognizes the MHC II complex. They primarily serve as immune response mediators for initiating and amplifying the adaptive immune response. They direct other cells to perform cytotoxic or phagocytic functions and therefore cannot kill infected cells or clear pathogens by themselves. The Th1 responses are more effective against intracellular pathogens (viruses and bacteria that are inside host cells). Th1 produces Interferon-gamma, which activates the bactericidal activities of macrophages, induces B cells to accelerate the production of antibodies and activates cell-mediated immunity via killer T-cells, macrophages and neutrophils. Th2 response on another hand is characterized by the release of Interleukin 5, which induces eosinophils in the clearance of parasites and Interleukin 4 and 13, which facilitate B cell isotype switching and B-cell proliferation.

Conversely, killer T cells attack cells infected with pathogens.<sup>74</sup> Killer T cells are activated when their T-cell receptor binds its antigen in a complex with the MHC I receptor of another cell. Recognition of

this complex is aided by a coreceptor on the T cell, known as CD8. When an activated killer T cell recognizes an antigen, it releases cytotoxins, such as perforin, which form pores in the target cell's plasma membrane, allowing ions, water and toxins to enter. The production of other messengers such as granulysin (a protease) induces the target cell to undergo apoptosis, a programmed cell death.<sup>75</sup>

### Vaccine and Vaccine design

Vaccination is a very effective strategy for preventing and eradicating a wide range of deadly diseases, including devastating infections of virus (such as, covid-19, polio, measles, smallpox, etc.) and bacterial (such as, tetanus, diphtheria) origin. Over the last century, vaccine development has undoubtedly saved many lives in both emerging and developed countries. The potential displayed by carbohydrate antigens as important targets for developing efficacious vaccines is clear from the wide range of carbohydrate-based vaccines currently in use. However, the use of heterogeneous carbohydrate mixtures from bacterial sources has its problems. Unlike proteins, oligosaccharide synthesis requires an entire series of genes, and therefore cannot be conveniently introduced by the gene insertion or mRNA strategies that were so successful with the Covid-19. Chemical modification of the antigenic motifs has also proven to be a productive tool to advance carbohydrate-based vaccines and diagnostics. However, the production of vaccines based on fully defined, chemically homogeneous synthetic carbohydrate antigens has recently seen the day, and the trend will necessarily continue in that direction. Recent technological advancement in tools for glycan synthesis and modification, high-throughput screening of biological samples, and 3D structural analysis may further drive this process in innovative directions.<sup>76</sup>

The binding sites of B cell membrane immunoglobulins (B cell receptor, BCR) recognize cell-surface glycans or glycan epitopes (fragments of antigenic polysaccharides). However, polysaccharides induce only short term, IgM-dependent immune response because they are T cell-independent antigens that fail to efficiently trigger immunological memory.<sup>77</sup> Long lasting memory response is achieved through conjugation of these glycans to a carrier proteins forming a T-cell dependent antigen. This response is followed by the differentiation of polysaccharide-specific B cells to plasma cells. Proliferation of plasma cells and affinity maturation of secreted antibodies as a result of pathogen reinfection or vaccine booster shot in the case of vaccine.<sup>78</sup> The success of glycoconjugate vaccines has been demonstrated in preventing infectious diseases caused by *Neisseria meningitidis*, *Haemophilus influenzae*, and *Streptococcus pneumoniae*.<sup>79</sup> Some disadvantages of purified CPS-based vaccines, including method of isolation and purification, structural instability and cellular contaminants is extremely difficult to be excluded. These are important factors for high cost per dose of the final vaccine.

An alternative option for producing carbohydrate B-cell epitopes is a chemical synthetic strategy that is attractive for its reproducibility, cost effectiveness, and its ability to provide fully defined carbohydrate structures. These opportunities are demonstrated by the potency and protective effect of a *Haemophilus influenzae* type b (Hib) vaccine based on a synthetic oligosaccharide, developed in Cuba and marketed around the world,<sup>80</sup> as well as by the studies of Globo H and SSEA-4, among a number of interesting targets in the development of antitumor vaccines, based on chemical<sup>81</sup> and chemoenzymatic<sup>82,83</sup> methods.

## SYNTHETIC CARBOHYDRATES

### General aspects

Oligosaccharides associated with pathogens are extremely complex and their study is quite a challenging and interesting one. The diversity in carbohydrate composition, branching, and stereochemistry allows for the existence of a multitude of pathogenic serotypes in nature, which is a potential strategy for the microorganism to evade immune recognition. In the medical sciences, the understanding of the basis of carbohydrate structural diversity is a valuable field of investigation for studying the mechanism and function of pathogen serotype generation, as well as for developing effective vaccines. Convenient methods to deliver  $\alpha$  and or  $\beta$  glycoside bonds in an efficient and stereo- and regio-controlled way has been a challenging and a continuing area of endeavor for carbohydrate chemists.

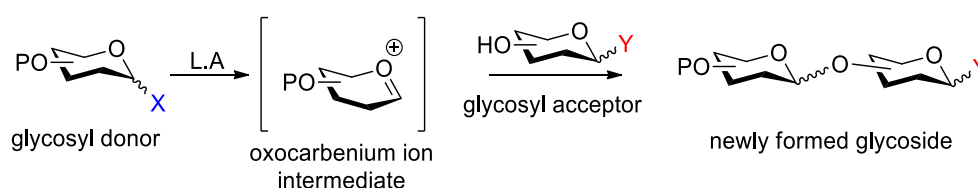

**Figure 4:** Basic requirements for glycoside bond formation. X = leaving group; Y = orthogonal leaving group for iteration.

In this context, several strategies for glycoside bond formation have been established and documented, and in laboratory practice there is still need for the development of effective methodologies for the synthesis and purification of complex glycostructures. Glycostructures are polymeric in nature built by assembly of monomers through the formation of glycosidic bonds between the hemiacetal anomeric group of one sugar, called the glycosyl donor, and one of the alcohol or hemiacetal groups of another sugar, called the glycosyl acceptor (Figure 4). This reaction creates a new stereochemistry, that must be controlled. Due to the similarity in the reactivity of different hydroxyls on the monosaccharides, a strategy is also necessary to install this bond at the right position. Nature uses a very large family of enzymes, the glycosyl transferases, to achieve this, and a different enzyme is needed for each glycoside coupling. Well over a dozen genes are thus involved in the production of a single O-antigen.<sup>84</sup> For chemists, protecting group manipulation allows for differential protection of monosaccharide polyols: a leaving group is introduced at the anomeric position of the glycosyl donor; on the glycosyl acceptor, one of the hydroxyls is left free while others are fully blocked with appropriate protecting groups installed regioselectively, and in many cases, these groups are discriminated chemoselectively to allow for iterative complex carbohydrate synthesis. Likewise, the choice of protecting groups is of utmost importance for steric and electronic factors that govern glycoside reactivity and successful glycosylation. In the presence of the right reagents (a promoter system) and conditions, the nucleophile on the glycosyl acceptor will displace the leaving group from the donor in a stereoselective manner, thus establishing a glycoside bond. The many factors that influence this reaction will be pointed out below.

### Objectives

Amino sugars are an abundant class of carbohydrates found in nature and which play a role in a multitude of biological processes. Among them, it is a core structural unit of many bacterial polysaccharides. Notably, repeating glycosamine units are found in a variety of bacterial structures, while they are rarely found in mammalian systems (Figure 5).<sup>84</sup> For instance, a variety of bacterial O-

antigens and capsular polysaccharides, as well as the bacterial cell wall peptidoglycan contain oligoglycosamine backbones. Chemical synthesis of these structures is an interesting endeavor because they are important virulence factors that are targets of both the innate and adaptive immune systems and play a major role in host-pathogen interactions. GlcpNAc- $\beta$ -D-(1 $\rightarrow$ 3)-GalpNAc- $\alpha$ -D-(1 $\rightarrow$ 3)-GalpNAc trisaccharide fragment from the *E. coli* and the peptidoglycan GlcpNAc- $\beta$ -D-(1 $\rightarrow$ 4)-Glc pNAc-peptide disaccharide chain will be our target molecules.

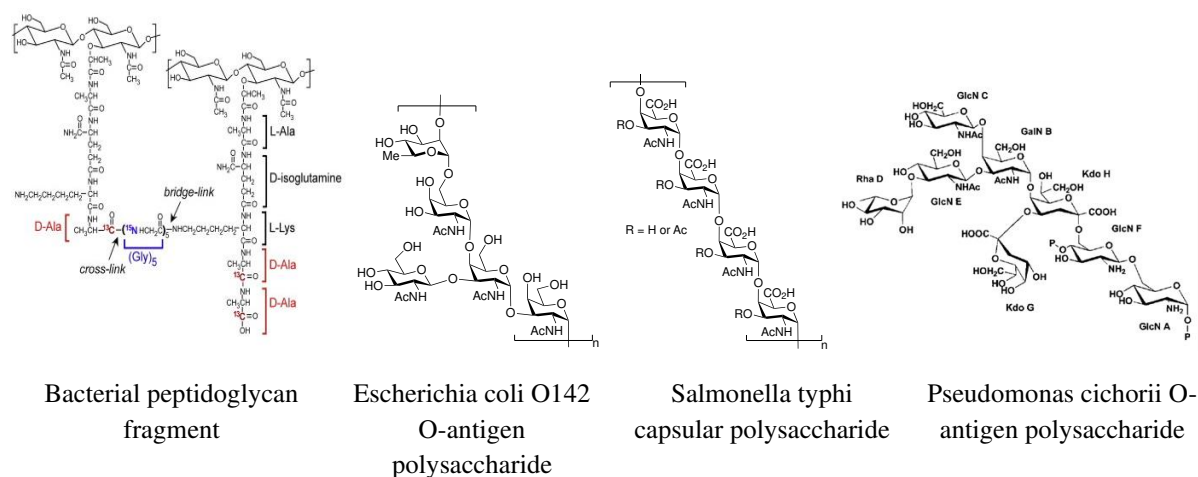

**Figure 5:** Structure of bacterial antigens and peptidoglycan.

## Stereochemistry

### *Stereoselective 1,2-trans- $\beta$ -D-glycosylation*

Building 1,2-trans-glycosidic bonds for glucosamine and galactosamine requires a C2 participating group that will direct the incoming nucleophile acceptor selectively to the opposing face to provide the equatorial glycoside. After departure of the leaving group by the action of promoter in an  $S_N1$ -type mechanism, Lewis basic nitrogen protecting groups such as acetamides and aminocarbonyls form an oxazocarbenium ion intermediate. The glycosyl acceptor then approaches this intermediate from the top face due to the steric hinderance exerted by the newly formed five membered ring ion which blocks the bottom face, thereby yielding preferentially a 1,2-trans glycoside bond (Figure 6A). The stereochemistry of the product does not depend on the initial configuration of the anomeric leaving group of the donor. In the mannosamine and stereochemically related cases (*rhamno-*, *altro-*, *talo-*, *ido-*, etc.), one will obtain the axial  $\alpha$ -anomer. However, in the case of carbonyl-protected aminosugars, in particular natural *N*-acetyl glycosamines, there is also the possibility of forming a stable oxazoline by deprotonation, a route which is not available in non-aminosugars. Stereoselective C2 directed 1,2-trans glycosylation remains the most reliable stereocontrol element in oligosaccharide synthesis.

### *Stereospecific glycosylation*

Controlling the glycoside formation in favor of the 1,2-*cis* stereoisomer in the *gluco-* or *galacto-* series is necessary for the preparation of many oligosaccharides and remains a more challenging task. A C2 participating group is unnecessary on the donor and should be avoided. The formation of the  $\alpha$ -glycoside is achievable by a stereospecific  $S_N2$ -like glycosylation to afford the glycoside with inversion of stereochemistry upon displacement of the leaving group by the nucleophilic acceptor (Figure 6B). Stereospecific inversion is possible using various anomeric leaving groups with a careful choice of

reagents and conditions but is rather difficult to control. The reaction can proceed by a mechanism ranging from a pure  $S_N2$  with little or no positive charge on the carbon, through intermediate mechanisms in which the length of the bond between the anomeric carbon and leaving group and the amount of positive charge on the sugar ring increases, all the way to an  $S_N1$  mechanism *via* a tight ion pair. The stereochemistry of the product in each of these cases depends on the anomeric configuration of glycoside donor, which in this case requires the thermodynamically less favorable, but more reactive  $\beta$ -anomer of the anomeric leaving group. Starting from the axial glycoside donor by this mechanism gives access to the equatorial  $\beta$ -glycoside. In another strategy, in-situ rapid equilibrium anomerization of the stable  $\alpha$ -glycosyl bromide to the kinetically more reactive  $\beta$ -anomer by the action of tetraethylammonium bromide, reacts preferentially with glycosyl acceptor.<sup>85</sup> This accesses the desired stereochemistry of the reactive precursor, and delivers high yielding reactions.

### Stereoselective 1,2-cis- $\alpha$ -D-glycosylation

Performing an  $S_N2$ -type reaction on the anomeric carbon is difficult, and an  $S_N1$ -type mechanism in the reaction of a glycosyl donor with a non-C2-participating group and a weak nucleophile is more reliable. The glycosylation reaction involves the formation of an oxocarbenium ion on the anomeric carbon of the glycosyl donor, stabilized by the O-5 resonance form. The addition of the nucleophilic glycosyl donor occurs stereoselectively from the axial position. The Fürst-Plattner is the most widely used transition state model to explain this stereoselectivity (Figure 6C). The substituents on the pyranose ring prefer an equatorial position in the transition state. Rehybridization of the anomeric carbon during addition from the  $\beta$ -face leads to a boat conformation, whereas addition from the  $\alpha$ -face proceeds via a more favorable chair transition state. This transition state applies to a solvent-separated ion pair, so the difference in conditions with a stereospecific substitution via a tight-ion pair may be a subtle one. In addition, the presence of a solvent or additive molecule on the opposite face from the attacking nucleophile in the transition state cannot be neglected and is discussed below.

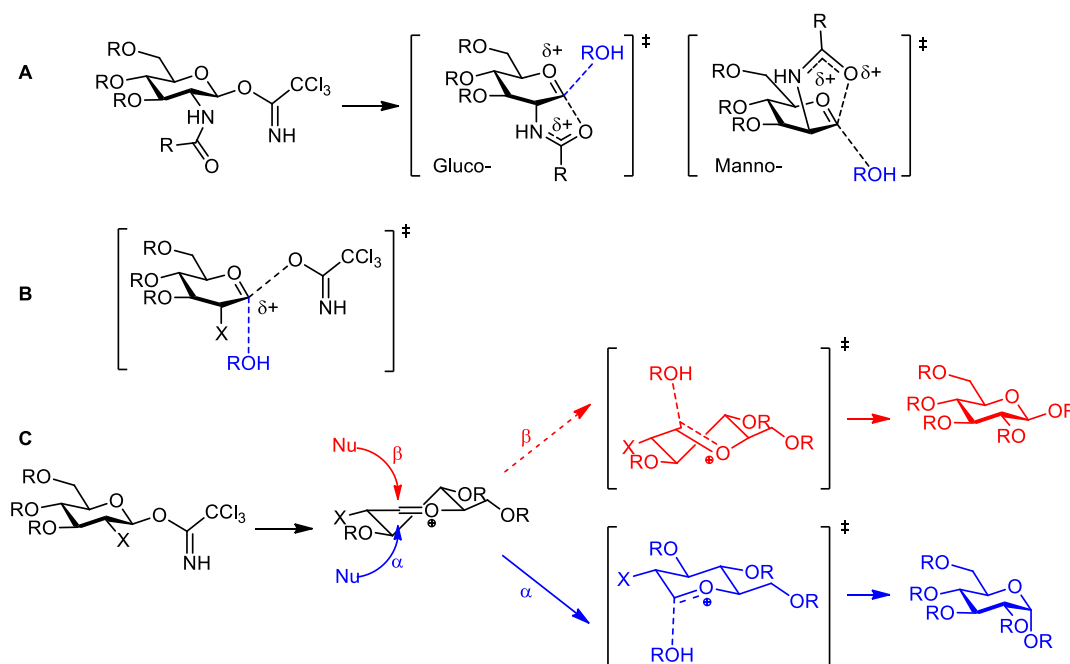

**Figure 6:** Transition state models for glycosylation. A. anchimeric C2-participation; B. stereospecific inversion; C. Fürst-Plattner model for axial glycosylation in the absence of C2-participation.

Other models, such as a Giese-like model via addition to the convex face of a boat transition state can also be used. The preference for the formation of the axial *O*-glycoside in the absence of a C2-participating group is often termed the kinetic anomeric effect but should not be confused with the thermodynamic anomeric effect, below, which only applies when the *O*-glycoside is formed under equilibrium conditions, such as a Fischer glycosylation. Several additional factors such as intramolecular delivery, protecting groups, promoters, additives, solvents, temperature, concentration, and addition sequence continue to show promising effects for improving stereoselectivity. Many advances are thus ongoing in developing suitable reagents with a number of anomeric leaving groups (described below) for achieving stereocontrol of the anomeric center, and have been well-reviewed.<sup>86</sup>

### *The thermodynamic anomeric effect*

The anomeric effect is the observed thermodynamic preference of polar substituents for the axial position at the anomeric position of a sugar. In the initial observation, the substituents in cyclohexanes, such as cyclohexanol or its methyl ether, preferably assume the equatorial position over the axial one, due to fewer nonbonded interactions with other substituents (C3 and the C5 hydrogen atoms in this case) on the ring.<sup>87</sup> Therefore, the conformational mixture of this substituted molecule, at equilibrium, contains 89% of the equatorially oriented hydroxyl and 11% of the conformer with axially oriented hydroxyl or methoxy group. In contrast, the equilibrium mixture of two D-glucopyranose anomers contains 63% of equatorial ( $\beta$ ) and 36% of axial ( $\alpha$ ) anomer. Similarly, conformational equilibria studies of other glycopyranose anomers revealed a significant increase in the percentage of axially oriented anomers. The preference for axial orientation of the C1 substituent in D-glucopyranose was found to increase with the increase of electronegativity of the C1 substituent.<sup>88</sup> The work of Pacsu showed that  $\beta$ -anomers of acetylated alkyl glycopyranosides anomerize in the presence of stannic chloride or titanium tetrachloride in chloroform to their  $\alpha$ -anomers, indicating the greater thermodynamic stability of anomeric alkoxy group in the axial orientation.<sup>89</sup> Extensive study on the  $\beta$ - to  $\alpha$ -anomerization of several acetylated methyl glycopyranosides during sulfuric acid catalyzed acetolysis ruled out the complexing effect of Lewis acid catalysts<sup>90,91,92</sup>. Later studies with a variety of electronegative anomeric substituents confirmed a force responsible for favoring the axial anomer, defined as the anomeric effect, estimated to be greater than 1.5 kcal/mol.

The anomeric effect can be explained in terms of molecular orbital interactions involving the pair of nonbonding electrons on the ring oxygen that destabilize equatorially oriented C1 electronegative substituents and stabilize axially oriented ones. The anomeric effect was originally considered to be an electrostatic effect that destabilizes the equatorially oriented C1 electronegative substituent through dipolar interaction with the two pairs of nonbonding electrons on the ring oxygen. The analogy put down by Edward<sup>93</sup> from a study on the stereochemistry of some  $\alpha$ -halocyclohexanones by Corey<sup>94</sup> proposed that the equatorially oriented electronegative aglycon group such as *O*-alkyl, halogen, etc., is subjected to energetically unfavorable dipolar interactions with the resultant dipole between two unshared electron pairs of the ring oxygen atom since these two dipoles are coplanar and parallel. This destabilization was considered to be larger than the two *syn*-axial interactions between the axially oriented aglycone and the C3 and C5 hydrogen atoms in the  $\alpha$ -D-anomer, and as a result the heteroatom substituents such as Cl, OH, and OR at C1 of pyranosides preferred an axial orientation. More recently, the anomeric effect has been explained by a stabilizing  $n-\sigma^*$  interaction

that is possible only when the substituent is axially oriented. Thus, both orbital bonding and electrostatic interactions of the O5 lone-pair electrons can contribute to the anomeric effect. The nonbonding electrostatic interaction with the equatorial oxygen can also be regarded as a thermodynamically unfavorable n-n nonbonding pi interaction. This would lead to a thermodynamic destabilization of the  $\beta$ -anomer but would also explain the much greater nucleophilicity of the  $\beta$ -alkoxy group in the formation of the  $\beta$ -trichloroacetimidate under kinetic control, as the nucleophilic electron pair is in the higher energy antibonding  $\Pi^*$  orbital. Additional factors may also come into play, and there is a balance between the stabilizing anomeric effect which favors the  $\alpha$ -anomer and other factors such as solvent effects and sterics which can favor the  $\beta$ -anomer, that contribute to the anomeric preference of a particular sugar.<sup>95</sup>

## Factors affecting efficient oligosaccharide assembly

### *Protecting groups*

Protecting groups are indispensable tools in organic chemistry to allow for a sequential and selective activation of reactive functionalities.<sup>96,97</sup> This is a way to silence/mask other protected groups until it is necessary to unveil them for a subsequent reaction. Of interest, is the ability to transform the protected group back to its initial functional group without affecting other functionalities within the molecule. Chemical carbohydrate synthesis poses a daunting challenge among biomolecules, because of the 4-5 exposed hydroxyl groups that must be protected at some point in order to develop complex oligosaccharide molecules. Regioselective synthesis of protected monosaccharide unit is sometimes complicated and requires special consideration for careful protecting group selection.<sup>97</sup> The slight differences in reactivity between the hydroxyls, defined by steric, electronic, and stereochemical effects, helps to navigate among them. The characteristic structural diversity of carbohydrates in their linkage, branching, stereochemistry, and functionalization translate into a requirement in carbohydrate synthesis to strategically apply the diverse protecting groups at our disposal and to further develop novel ones.<sup>98-100</sup>

The different protecting groups for hydroxyls and amino sugars provide a pool of choices for carbohydrate chemists to allow for many alternative strategies. The protecting groups need to be both inserted and cleaved in a carefully planned sequence to allow for iterative carbohydrate synthesis. Orthogonality of the protecting groups is needed to tolerate the frequent coupling, protection and deprotection steps encountered in carbohydrate synthesis. In addition, the choice of protecting group closely fine tunes the substrates' reactivity and solubility due to inductive effects, steric hindrance and stereoelectronic effects. Henceforth, their discovery will continue to serve and open windows for easy access to a well-defined homogeneous biological structures in oligosaccharide synthesis.<sup>101-103</sup>

In carbohydrate synthesis, protecting groups can be categorized into terminal, late stage, iterative, and stereo-directing based on a combination of orthogonality and structural and electronic effects they may provide during later chemical steps. Terminal protecting groups will be removed last to reveal the free hydroxyl or amino groups, and must be stable to all of the reaction conditions during the synthesis; late-stage protecting groups will be removed late in the synthesis, in order to introduce a repeating sugar or modification (sulfate, phosphate) or to introduce a branching point; iterative protecting groups are required for reducing-to non-reducing synthesis in order to introduce the next sugar; and activatable protecting groups for the anomeric position are needed for non-reducing-to-reducing and bi-directional oligosaccharide synthesis. The nature of the protecting group, particularly

at the C2 position, also plays a major role in the stereoselectivity of the glycosylation reaction. The protection conditions, deprotection conditions, and regioselectivity during the protection steps all need to be taken into account in the choice of protecting groups. Through their inductive and steric influence, protecting groups can render the glycosyl donor either more or less reactive, a key property for efficient and effective oligosaccharide synthesis; we then refer to the glycosyl donors as being “armed” or “disarmed”. All of these considerations must be taken into account in order to plan the synthesis of a complex oligosaccharide.

### Benzyl ethers

Benzyl ethers are typically the most widely used terminal protecting groups and are considered as non-stereo-directing and electron donating, which can enhance the reactivity of the glycosyl donor (armed). Classically installed by Williamson ether synthesis with an arylmethyl halide and a strong base, such as NaH,<sup>96</sup> or with Ag<sub>2</sub>O<sup>104</sup> to allow base labile functionalities to withstand the reaction. Benzyl group formation typically suffers from poor functional group compatibility and limited regioselectivity, and developing new procedures remains an unrelenting undertaking by chemists. Among the many novel conditions available, the use of benzyl imidates<sup>105,106</sup> and reductive etherification of benzaldehyde<sup>107</sup> offer alternative routes to form benzyl ethers under acidic conditions. Benzyl ethers are excellent terminal protecting groups, however, as they withstand most strong acidic and basic conditions and can be removed cleanly, usually after a long synthetic sequence, by birch reduction or hydrogenolysis without affecting the carbohydrate product.<sup>97</sup> Substituted benzyl ethers, on the other hand, can be cleaved at an intermediate stage in the synthesis, orthogonally to other groups, making them very useful benzyl type late-stage or iterative protecting groups. *P*-Methoxybenzyl (PMB), 2-naphthylmethyl (NAP), 3,4-dimethoxybenzyl, *o*-nitrobenzyl, *p*-cyanobenzyl, *p*-phenylbenzyl, 4-azido-3-chlorobenzyl, *p*-azidobenzyl and halogen-substituted benzyl groups present the various options that can each be removed with specific reagents in the presence of many other functionalities and protecting groups. Their utility is demonstrated by their numerous applications in carbohydrate synthesis.<sup>96,108,109</sup>

### Allyl ethers

Allyl ethers are another valuable class of ether protecting groups that are quite simple to prepare and possess moderate stability. Just like the benzyls, various substituted allyl protecting groups allow alternative deprotection modes that enhance their orthogonality. Different design of allyl ethers such as prenyl and cinnamyl not only offer structural diversity but also are supported by alternative removal schemes.<sup>110–113</sup> As a rule, Williamson etherification with allyl bromide and NaH<sup>114</sup> easily furnishes the allyl protecting group, otherwise BaO allows base sensitive functionalities to withstand the alkylation process.<sup>115</sup> In the event of base-labile functional groups, allylation is achieved by allyl imidates or allyl aldehyde and a reducing agent, catalyzed by an acid.<sup>116,117</sup> Allyl carbonates provide a further alternative system for fast allylation when treated with Pd(PPh)<sub>4</sub> or Pd(OAc)<sub>2</sub> and PPh<sub>3</sub> under neutral conditions.<sup>118</sup> Several systems for deallylation with palladium or Nickel complexes in the presence of chosen additives to improve selectivity, have been reported.<sup>119,120</sup> More classically, Gent and Gigg developed the isomerization of allyl to vinyl group in the presence of potassium *tert*-butoxide (*t*BuOK) in dimethyl sulfoxide (DMSO) or Wilkinson’s catalyst [Rh(PPh)<sub>3</sub>Cl] and 1,4-diazabicyclo[2.2.2]octane (DABCO)<sup>121,122</sup> that may either be accompanied by acid hydrolysis<sup>117,123</sup> or oxidation<sup>124–126</sup> in a two-step manner, to eventually expose the free alcohol.



### Silyl ethers

The third category of ether is the variety of modified silicon groups that constitutes trimethylsilyl (TMS), triethylsilyl (TES), triisopropylsilyl (TIPS), *tert*-butyldimethylsilyl (TBDMS) and *tert*-butyldiphenylsilyl (TBDPS). These are widely applied in oligosaccharide synthesis because of their specific reactivity and steric hinderance, and are non-C2-participating.<sup>96,97</sup> Their introduction is based on the use of silyl halide and or triflate in combination with a base/nucleophilic catalyst such as imidazole, pyridine, triethylamine (TEA), or 2,6-lutidine.

The electronic and steric effects of the substituents on the silicon atom stabilize the silyl group. Steric hindrance generally stabilizes the silyl protecting group by raising the energy of the pentavalent intermediate during substitution. Electron-withdrawing substituents on the silicon increases its stability towards acidic conditions, while the reverse is the case in basic medium. Hence, the stability hierarchy towards acidic media follows: TMS < TES < TBDMS < TIPS < TBDPS while in the basic media the trend is: TMS < TES < TBDMS - TBDPS < TIPS. Silyl deprotection can be achieved with a fluoride ion source such as tetrabutylammonium fluoride (TBAF), HF.Pyridine complex, or with acidic conditions, including strong acids for mild acid-resistant silyls.<sup>127,128</sup> These lists provide important choices for both late-stage or iterative protecting groups in the design of oligosaccharide synthesis, as well as in the synthesis of the precursors. The steric bulkiness of the group allows them to selectively protect the primary hydroxyl in the presence of secondary hydroxyls, although silyl migration can provide some additional complexity during protecting group manipulation.

### Esters

The chemistry of protecting groups in carbohydrate synthesis cannot be complete without mentioning esters because of the crucial role they play as typical temporary protecting groups, coupled with their ease of installation and removal in high yield. Most importantly, *O*-esters are the C2-participating groups of choice in the case of non-amino sugars. They are stable to the acidic conditions during glycosylation, which makes them suitable protecting groups in many oligosaccharides' retrosynthetic plans, but do not survive basic reagents. Typically, esterification is ensured with acid chlorides or anhydrides in combination with pyridine or triethylamine and 4-dimethylaminopyridine (DMAP) as catalyst. Alternatively, a mild Steglich esterification with *N,N'*-dicyclohexylcarbodiimide (DCC) and DMAP catalyst permits the direct coupling of carboxylic acid and an alcohol reagent with satisfactory outcomes, in particular in the case of more complex carboxylic acids.<sup>129</sup> Procopiou et al. reported an alternative clean and very rapid acylation of different kinds of alcohols by TMSOTf catalysis in the presence of an acid anhydride.<sup>130,131</sup>

Frequently employed esters in oligosaccharide synthesis include acetate, chloroacetate, dichloroacetate, trichloroacetate, benzoate, levulinate and pivaloate.<sup>97</sup> As previously noted, esters are base labile, a significant point for their cleavage. Commonly, the Zemplén conditions with sodium methoxide in MeOH is one of the best-known esters deprotection method. Furthermore, NaOH or ammonia are other choices for ester removal. Moreover, selective nucleophilic cleavage of the anomeric ester is routinely used to expose anomeric hydroxyl for further conversion and activation.<sup>132</sup> The increasing base sensitivity of acetate is related to the number of electron-withdrawing chlorine atoms that follow the order; chloroacetate, dichloroacetate and trichloroacetate.<sup>133</sup> Benzoates and pivalate are less sensitive to acid or base and less prone to acyl migration, and take longer reaction time or harsher conditions to be deprotected.<sup>97,134,135</sup> However, their greater stability during the various synthetic steps during oligosaccharide synthesis make them attractive late-stage or iterative

protecting groups, and their greater steric hindrance is a useful property for their regioselective installation. Ester groups such as levulinates, chloroacetates, and a number of other substituted esters can be deprotected in an orthogonal fashion by nucleophilic substitution at the remote functional group.

#### Cyclic acetals

It is clear how acetals and ketals anchor diols to generate 1,3-dioxane or 1,3-dioxalane rings, therefore, ideal for diol control at a go. Typical scaffold employed in this group include acetonide or isopropylidene and benzylidene group that may be varied by phenyl, *p*-methoxybenzyl and 2-naphthyl moieties. A combination of 2,2-dimethoxy propane under acidic condition delivers five 1,2-*O*-isopropylidene membered ring<sup>136</sup> as thermodynamically favored major product. On the other end, 2-methoxy propene favors the kinetically controlled mechanism for 1,3-*O*-isopropylidene six membered ring product.<sup>137,138</sup> Additionally, benzylidene analogue favors the formation of six-membered ring adduct. Acetal and ketals are upon removed by acid and their manipulation, however, provides a significant approach for exposing either 4-*O* or 6-*O* hydroxyls for iterative synthesis.

#### Amino *N*-protecting groups

2-amino-2-deoxy sugars are an integral component of microbial-associated molecular patterns and *O*-antigens, as well as a wide range of other key structures, such as ABO blood group antigens, chitin and chitosan, glycosaminoglycans, and peptidoglycans. The strong nucleophilicity of amine allows their protection in the presence of hydroxyls, with less complexity than in the case of oxygen protecting groups. The majority of natural amino groups are positioned at C2; therefore, amino protecting groups are effective targets for controlling the stereochemistry of glycosylation reactions involving amino sugar units.

Amides, imides, sulfonamides, and carbamates represent C2 stereodirecting amino protecting groups that favor the 1,2-*trans* glycoside bond formation, whereas inactivating the amine by replacing it with an azido functionality remains the best non-participatory amine equivalent in order to establish the 1,2-*cis* stereochemistry. Azides can be installed by diaxial ring opening of an 2,3-anhydro epoxide with  $\text{NaN}_3$  in aqueous DMF or more frequently, diazo transfer from triflic azide ( $\text{TfN}_3$ ) generated by a combination of  $\text{NaN}_3$ , triflic anhydride ( $\text{Tf}_2\text{O}$ ) and  $\text{CuSO}_4$  as a catalyst with the native free amino sugar could be another choice.<sup>139</sup> The use of acid chlorides/acid anhydrides or chloroformates broadly address amine protection to the corresponding amide and carbamate respectively on the saccharide units.<sup>96,97,140</sup> The phthalimide protecting group is introduced by amide formation upon phthalic anhydride opening, followed by cyclization with  $\text{Ac}_2\text{O}$  and pyridine.<sup>140,141</sup> Modified phthalimides such as dichlorophthaloyl (DCPhth)<sup>142</sup> and tetrachlorophthaloyl (TCP)<sup>140</sup> have been explored and offer excellent C2 participation for 1,2-*trans* glycosylation.<sup>140,141</sup>

Similarly, azide group can be reduced to an amine by hydrogenolysis<sup>96,97</sup> or Staudinger reaction.<sup>143</sup> Amide bonds such as trichloroacetimide (TCA) and trifluoroacetamide (TFA) are conveniently removed by treatment with  $\text{Cs}_2\text{CO}_3$ <sup>144</sup> or  $\text{K}_2\text{CO}_3$ .<sup>145,146</sup> Alternatively, direct conversion of TCA to acetimidate (Ac) is carried out by  $\text{Bu}_3\text{SnH}$  or Zn reduction to afford the biologically common *N*-acetyl aminosugars.<sup>147,148</sup> Phthaloyl-type protecting groups can be deprotected with hydrazine. Chemoselective cleavage of DCPhth or TCPPhth in the presence Phth group is possible based on the increasing number of chlorine atoms.<sup>140,142</sup> The collection of *N*-amino protecting group is extended with a variety of carbamate protecting groups with selective deprotection methods. The alloxycarbonyl (Alloc) group can be hydrolyzed by iodine with water or with  $\text{Pd}(0)$ .<sup>149,150</sup> The *t*-butoxycarbonyl (Boc) group can be cleaved

with different acids, but may not survive many glycosylation conditions.<sup>97</sup> The carboxybenzyl (Cbz) is removed by hydrogenolysis, and may serve as a terminal protecting group in conjunction with benzyl *O*-protecting groups.<sup>151</sup> The fluorenylmethoxycarbonyl (Fmoc) group tolerates acidic conditions while its susceptibility to base makes it cleavable with piperidine. The trichloroethoxycarbonyl (Troc) on another hand is reduced with Zn under acidic conditions.<sup>152</sup> Finally, methyl carbamate is deprotected with TMSCl and TEA.<sup>153</sup>

### C2 participating groups

The presence of C2 participating group serves to ensure 1,2-*trans* glycoside bond formation. In the case of non-amino sugars, esters are the overwhelming choice as C2-participating groups. They generate an oxocarbenium ion intermediate that control the attack by the nucleophile preferentially from the top face selectively. However, the attacking nucleophile may also react with the C2 carbonyl group, thus forming an orthoester, an unwanted product that can be rearranged to the *O*-glycoside compound at higher reaction temperature and longer reaction time. Isolating the orthoester instead of the *O*-glycoside is a common trap in glycosylation reactions. A small number of other Lewis basic protecting groups for anchimeric participation have been developed, in particular for 1,2-*cis* glycosylation.

In the case of 2-deoxy-2-amino sugars, carbamates, amides and phthalimides represent the usual groups deploy in this regard. Unfortunately, relatively few are effective C2 participating groups in practice, because of the formation of stable oxazoline byproduct. Only electron-deficient esters and carbamates, such as TCA, TFA, and Troc, and sulfonamides are reliable C-2 directing groups. Phthalimides are the C2-directing groups of choice, as they cannot form a stable oxazoline.

Very recently, Gosh and Kulkarni among others, published excellent reviews of the most recent developments in protecting groups for carbohydrate synthesis.<sup>154-157</sup> It highlights the progress in orthogonality achieved through structural modification in order to provide an arsenal of fully orthogonal protecting groups for oligosaccharide synthesis. In addition, with slight modifications, one class of protecting group can be transformed from non-stereodirecting to directing or vice versa, and by extension, provide an alternative discrimination tool with a variety of novel reagent combinations even within the same group.

### Anomeric leaving groups

The development of chemical methods for glycosidic bond formation is a critical and challenging issue, in particular, for obtaining the 1,2-*cis* stereochemistry. For over a century, the development of glycosyl halides and other activated hemiacetals has undoubtedly led to progress, away from toxic reagents to more benign and safe chemicals, and towards methods that not only ensure expeditious synthesis but navigate the transformation in a controlled fashion.<sup>158</sup> Many research efforts have been aimed at exploring alternative anomeric groups with specific applications to allow for facile access and improved results compared to existing methods. Nevertheless, the continued application and reliability of certain classical anomeric activated groups has confirmed their wide utility among carbohydrate chemists.

There are many versatile anomeric leaving groups for efficient glycoside bond formation, these include the glycoside halides, *O*-imidates, thioglycosides, carbamate,<sup>159,160</sup> carbonates,<sup>161,162</sup> selenosides,<sup>163,164</sup> phthalates,<sup>165</sup> phosphates/phosphites,<sup>166,167</sup> disulfides,<sup>168,169</sup> carboxybenzyls,<sup>170</sup>

alkynyls<sup>171–173</sup> and n-pentenyls<sup>174,175</sup> among others. We will highlight the progress developed over the years for the most widely employed groups below.

#### Anomeric halide leaving groups.

Typical glycosyl halides such as chlorides and bromides (Koenig's donors) present the most widely employed halide donors and are prepared in a straightforward manner.<sup>176</sup>  $\alpha$ -Glycosyl bromide donors are prepared from peracetylated sugars by HBr in acetic acid and can be activated with silver salts such as Ag<sub>2</sub>O, Ag<sub>2</sub>CO<sub>3</sub>, AgOTf, AgCl<sub>4</sub>, or other metal salts such as HgBr<sub>2</sub>, or Hg(CN)<sub>2</sub>.<sup>177</sup> Glycosyl chlorides on the other hand are prepared with chlorinating agents including SnCl<sub>4</sub>, TiCl<sub>4</sub>, AlCl<sub>3</sub>. The peracetylated  $\beta$ -glycosyl chloride can be obtained under kinetic control, and the  $\alpha$ -glycosyl chloride under thermodynamic control. Glycosylation of glycosyl halides with stereodirecting groups afforded 1,2-trans glycosides.<sup>178</sup> The presence of tetraalkylammonium halides favors the formation of the 1,2-cis stereochemistry by rapid equilibration of the halide and rate-determining substitution of the  $\beta$ -glycosyl halide, as described above. The application of these donors is to some extent limited by their poor stability, the undesirable use of excess toxic heavy metals, and need for desiccants and acid scavengers for reliable results.

Later studies aimed at improved glycosyl halide donors for selective glycosidic bond formation led to the use of glycosyl fluorides,<sup>179</sup> which can be prepared by the action of *N,N*-dimethylaminosulfur trifluoride (DAST)<sup>180,181</sup> on the free hemiacetal sugar or HF-pyridine complex<sup>182</sup> on the peracetylated saccharide. Many other fluorinating reagents are routinely employed on a variety of precursors to give better chemoselectivity<sup>183</sup> to prepare glycosyl donors useful for the synthesis of highly challenging natural oligosaccharides. Activation is achieved with SnCl<sub>2</sub>-AgClO<sub>4</sub><sup>184</sup> in the absence of a C2-participating group for a difficult 1,2-cis glycosylation, or with a mild Lewis acid such as BF<sub>3</sub>·Et<sub>2</sub>O<sup>185</sup> for an orthogonal glycosylation strategy. Fluoride sugar donors proved to be more stable, even under silica gel chromatography, easy to prepare, and can be activate by several choices of available reagents with significant benefits for orthogonal and convergent synthesis.

The third class of glycosyl halides is the iodide, which despite its high reactivity has been developed for its synthetic advantages in certain glycosylation reactions. Generally the iodide is formed from TMSI<sup>186</sup> and activated under mild basic conditions to give the glycosides of interest with good selectivity.

Despite the stability issues and heavy metal risk, chemists continue to explore and harness alternative combinations for glycosyl halides because of their efficacy, reactivity and stereochemical selectivity.<sup>187–189</sup>

#### Thioglycosides

Thioglycosides, first introduced half a century ago,<sup>190</sup> have a number of benefits over other glycosyl donors, in particular orthogonal activation, chemoselectivity between similar functionalities with varying alkyl or aryl substituents, and a large number of options of thiolation agents available. Thioglycoside protecting groups in particular open opportunities for non-reducing-to-reducing and bidirectional iterative synthesis. The most frequently used method for their preparation involves selective transacetylation of anomeric acetates with thiols and BF<sub>3</sub>·OEt<sub>2</sub> Lewis acid as catalyst, with good to excellent yields. The recent work of Escopy, Singh and Demchenko demonstrated that triflic acid also catalyzes thioglycoside transacetalization with high reaction rates and product yields.<sup>191</sup>

Thioglycosides can be activated with a broad range of thiophilic promoters. A mixture of NIS and triflic acid<sup>192</sup> or AgOTf<sup>193</sup> is a well-known promoter system for glycosylation. Furthermore, triflic anhydride with different organosulfur compounds such as diphenylsulfoxide (Ph<sub>2</sub>SO),<sup>194</sup> 1-benzenesulfinylpiperidine (BSP),<sup>195</sup> benzenesulfinylmorpholine,<sup>196</sup> or dimethyl(methylthio)sulfonium ion (DMTST)<sup>197</sup> are currently in use. Heavy metals salts e.g. Hg<sup>2+</sup>, Cu<sup>2+</sup>, Ag<sup>+</sup> are no longer recommended thiophilic promoters in practice because of the threat to both health and the environment, and have been largely replaced by halonium and sulfonium ions.<sup>190,198</sup> Mild halonium promoters such as NBS,<sup>199</sup> nitrosyl tetrafluoroborate (NOBF<sub>4</sub>),<sup>200</sup> Br<sub>2</sub>/AgOTf,<sup>201</sup> iodonium dicollidine perchlorate (IDCP),<sup>202</sup> NBS/TfOH,<sup>203</sup> iodosobenzene-PhIO/Tf<sub>2</sub>O,<sup>204</sup> I<sub>2</sub><sup>205</sup> and bis(pyridine)iodonium tetrafluoroborate (IPy<sub>2</sub>BF<sub>4</sub>)<sup>206</sup> were thoroughly evaluated. Their compatibility for various protecting groups related to armed or disarmed precursors, reactivity with hindered acceptors, stereochemical control, orthogonality and interesting yield have all favored their practical application. A promoter system based on catalytic amounts of trityl tetrakis(pentafluorophenyl)borate TrB(C<sub>6</sub>F<sub>5</sub>)<sub>4</sub> with a variety of co-promoters such as: NIS/NBS,<sup>207</sup> iodine (I<sub>2</sub>), 2,3-dichloro-5,6-dicyano-*p*-benzoquinone (DDQ),<sup>208</sup> or *N*-(ethylthio)phthalimide (PhthNSET)<sup>209</sup> can activate thioglycosides bearing different protecting groups, and their use has been well documented in oligosaccharide synthesis.

In 2008 and 2011, Ye Xin-Shan and co-workers developed the novel bromodimethylsulfonium bromide (BDMS)<sup>210</sup> and *O,O*-dimethylthiophosphonosulfonyl bromide (DMTPSB)<sup>211</sup> in combination with silver triflate for the convenient activation of poorly reactive thioglycosides. Furthermore, Kaeothip, S., Yasomanee J. P., and Demchenko A. V. demonstrated the formation of disarmed β-bromide intermediate from thioglycoside using Br<sub>2</sub>, which exclusively results in α-glycoside disaccharide in the glycosylation reaction, although in low yield.<sup>212</sup> The very recent effort by Escopy et al. reported the activation of different thioglycosides by palladium (II) bromide in the presence of propargyl bromide as an additive that provides high yielding and clean glycosylation reactions.<sup>213</sup> This is supported by mechanistic study that propargyl bromide assists the reaction by creating an ionizing complex intermediate, which expedites departure of the leaving group. Interestingly, the same group and others have independently demonstrated new activator protocols and or truncated donors in an effort to improve important features such as chemoselectivity, stereoselectivity, orthogonality, environmental safety and yield.<sup>214–217</sup>

To replace most acid promoter combinations, Basu N. et al. reported that trichloroisocyanuric acid (TCCA), a readily available, inexpensive, and shelf-stable reagent, with a catalytic amount of TMSOTf successfully displaces thioglycoside leaving groups (SEt, SPh and S-*p*Tol) to generate a glycosidic bond.<sup>218</sup> A similar example employed *N*-(*p*-Methylphenylthio)-ε-caprolactam in combination with trimethylsilyl trifluoromethanesulfonate (TMSOTf) as a competent thiophilic promoter system, to activate different thioglycosides.<sup>219</sup> In a recent publication by Carthy and Zhu, a promoter system *N*-trifluoromethylthiosaccharin/TMSOTf was effective at chemoselectively activating ethyl thioglycoside donors over phenyl glycoside acceptors in the glycosylation reaction even with armed or disarmed systems. The new promoter system is thus a promising candidate for iterative one-pot oligosaccharide synthesis.<sup>220</sup>

A lanthanide metal salt such as La(OTf)<sub>3</sub> in the presence of NIS was found to serve as efficient promoters for disarmed thioglycosides in glycosylation reactions.<sup>221</sup> The solid and moisture-tolerant salt is simple to handle and surpassed the traditional catalyst systems such as TfOH and TMSOTf. HClO<sub>4</sub>-silica as supported acid catalyst was also reported as an alternative to traditional Lewis acid

promoters for the activation of 'disarmed' thioglycosides in conjunction with NIS.<sup>222</sup> This was used as milder and safer protic acid source. The practical effectiveness of a related H<sub>2</sub>SO<sub>4</sub>-silica system was demonstrated in the synthesis of an O-antigen related oligosaccharide.<sup>223</sup>

Pohl and co-workers introduced a novel promoter-free glycosylation technique, that used sub-stoichiometric amounts of triphenyl bismuth ditriflate [Ph<sub>3</sub>Bi(OTf)<sub>2</sub>] to activate various thiopropyl glycosides.<sup>224</sup> The strength and solubility of bismuth(V) salts made it a superior catalyst for glycosylation, which obviates the need for additives or co-promoters. The method by Vibhute et al. employing 3mol% of AuCl<sub>3</sub> catalyst to activate thioglycoside in a versatile and high-yielding methodology represents further progress in this direction.<sup>225</sup> The air- and water stable iodonium salt phenyl(trifluoroethyl)-iodoniumtriflimide was reported to activate a diversity of armed/disarmed thioglycosides based for glycosylation at ambient temperature.<sup>226</sup> In another perspective, efficient light-induced glycosylation by activation of thioglycosides with Umemoto's reagent (a photoinduced CF<sub>3</sub> radical source) in the presence of Cu(OTf)<sub>2</sub> was reported by Moa et al.<sup>227</sup> Additionally, electrochemical *O*-glycosylation of primary alcohol acceptors with thioglycoside donors using sodium trifluoromethanesulfonate as a supporting electrolyte has been reported.<sup>228</sup>

### *O*-imidates

*O*-imidates represent the most common glycosyl donors among carbohydrate chemists for the assembly of oligosaccharides. Their preparation is quite simple, and their stability, stereocontrol, cost effectiveness, high yields and versatility makes them the most accessible to less experienced chemists. Trichloroacetimidates are foremost in this category, dating back the first *o*-imidates developed by Schmidt in 1980.<sup>229</sup> It has gained broad application due to its outstanding properties and generality. The *N*-methyl acetimidate<sup>230</sup> reported by Sinay could be regarded as the first *O*-imide to be developed, but sadly exhibited low reactivity and lengthy preparation. Other investigated *O*-imidates include trifluoroacetimidate<sup>231</sup> and *N*-phenyl trifluoroacetimidates,<sup>232</sup> which have shown some utility in certain cases. Schmidt's trichloroacetimidates can be prepared in a straightforward addition of trichloroacetonitrile (Cl<sub>3</sub>CCN) to the anomeric hydroxyl group catalysed by either organic or inorganic base. The stereochemical outcome of this transformation is upon guided by the type of base used. Strong bases such as NaH, Cs<sub>2</sub>CO<sub>3</sub> or 1,8-diazabicyclo[5.4.0]undec-7-ene (DBU) leads to  $\alpha$  anomer under thermodynamic control, whereas the use of mild base like K<sub>2</sub>CO<sub>3</sub> favors formation of the  $\beta$  anomer under kinetic control.

The activation is attained with a catalytic amount of Lewis acids such as BF<sub>3</sub>.OEt<sub>2</sub><sup>233</sup> or TMSOTf<sup>234</sup>, TBDMSOTf,<sup>235</sup> Tf<sub>2</sub>O,<sup>236</sup> ZnBr,<sup>237</sup> or AgOTf.<sup>238</sup> Stereocontrol of the glycosylation can be achieved by C2-anchimeric participation, axial addition to solvent-separated ion pairs (kinetic anomeric effect), or stereospecific substitution. The glycosylation of trichloroacetimidates bearing C2-participating groups to give the 1,2-*trans* glycoside is extremely reliable. In the absence of C2 participating group, trichloroacetimidate donors with stronger Lewis acid such as TMSOTf usually afford the  $\alpha$ -glycosides, while milder acids like BF<sub>3</sub>.OEt<sub>2</sub> at a very low temperature yields the product resulting from an inversion of stereochemistry of the trichloroacetimidate via a stereospecific S<sub>N</sub>2-like mechanism. As discussed above, Lewis basic solvents and additives can play a strong role in improving the stereoselectivity. The effect of BF<sub>3</sub>.Et<sub>2</sub>O and TMSOTf for the activation of trichloro- or (*N*-phenyl)trifluoro-acetimidate donors of various sugars at different temperature for the selective formation of glycosides in high yields, has been extensively explored.<sup>239</sup> Later studies established that In(III) salts works even better than BF<sub>3</sub>.Et<sub>2</sub>O with trichloroacetimidates.<sup>240</sup> Nonetheless, the border

between the  $S_N1$  and  $S_N2$  mechanisms (and no reaction at all) is a subtle one in acetal systems, and only experiment can validate the optimal reaction condition for a specific oligosaccharide synthesis.

Adinolfi et al recently reported a mixture of iodine and triethylsilane for the convenient activation of disarmed glycosyl trichloro- and *N*-phenyl-trifluoroacetimidates.<sup>241</sup> Similarly, glycosylation reaction of armed trichloroacetimidates was conducted with catalytic amount of lanthanide salts like  $\text{Sm}(\text{OTf})_3$  under mild conditions.<sup>242</sup> The stereochemical outcome has been shown to be fine-tuned with suitable choice of solvent and temperature. Encouraged by this result, the same group successfully extended their findings to  $\text{Sc}(\text{OTf})_3$ ,  $\text{Tb}(\text{OTf})_3$  and  $\text{Yb}(\text{OTf})_3$ , particularly toward 1,2-*trans* glycosylation of disarmed donors.<sup>243</sup> Furthermore, with a catalytic amount of  $\text{Yb}(\text{OTf})_3$ , glycosylation with glycosyl *N*-phenyl-trifluoroacetimidate was accomplished at room temperature with a variety of donors.<sup>244</sup> Following on these results, a more efficient and fast glycosylation with a novel powerful promoter  $\text{Bi}(\text{OTf})_3$  for perbenzylated trichloro/*N*-phenyl-trifluoroacetimidate donors can provide a more practical and less toxic solution along this path.<sup>245</sup>

Linhardt and co-workers also showed how silica supported perchloric acid ( $\text{HClO}_4\text{-SiO}_2$ ), optimized to a 100:3 molar ratio, could perform the glycosylation with trichloroacetimidates in excellent yields.<sup>246</sup> Apart from its convenience (moisture stable and easily accessible) and safety level, it was also demonstrated to enhanced  $\alpha$ -selectivity in glycosylation.<sup>247</sup> The use of acid-washed molecular sieves (4Å, AW 300 MS)<sup>248</sup> and Amberlyst 15H<sup>+</sup> acidic resin<sup>249</sup> were independently reported to strongly activate trichloroacetimidates. These recyclable promoters offer interesting opportunities to replace the traditional Lewis acids such as  $\text{TMSOTf}$  and  $\text{BF}_3\cdot\text{Et}_2\text{O}$ .

A highly  $\beta$ -selective mannosylation with the mannopyranosyl trichloro- and *N*-phenyltrifluoroacetimidates using  $\text{TMSB}(\text{C}_6\text{F}_5)_4$  as a catalyst that served dual purpose as Lewis acid and cation trap was demonstrated in good yields by Tanaka et al.<sup>250</sup> The formation of a tight ion pair between the oxonium ion intermediate and the tetraarylborate anion leads to the particularly challenging  $\beta$ -mannose stereochemistry. Gotze, Pizner and Kunz validated the potential of  $\text{AuCl}$  (5-10 mol%) catalyzed glycosylation for precursors bearing highly acid-sensitive groups with good stereoselectivity.<sup>251,252</sup> Glycosylation with  $\text{AuCl}_3$  and or an  $\text{AuCl}_3$ -phenylacetylene combination was studied for various trichloroacetimidate glycosyl donors at room temperature with excellent  $\beta$ -selectivity. The yield with  $\text{AuCl}_3$ -phenylacetylene catalyst was superior to the single catalyst and acid sensitive groups remained unaffected by the transformation. A later contribution by Peng and Schmidt revealed a new conceptual strategy with  $\text{AuCl}_3$  as initiator for the formation of a catalyst-acceptor adduct through an intramolecular dual catalysis pathway for stereospecific glycosylation with trichloroacetimidates.<sup>253</sup>

The development of a moisture-tolerant cationic palladium (II) complex, with commercial  $\text{Pd}(\text{CH}_3\text{CN})_4(\text{BF}_4)_2$  as an efficient activator for glycosylation with glycosyl trichloroacetimidate donors exerts an unusual stereoselective directing effect towards 1,2-*trans* glycosides in the absence of C2 participating group.<sup>254</sup> The strategy employed 5 mole % of the catalyst and formed excellent yields for a variety disaccharides and glycopeptides under mild conditions. The authors invoke a complexation of the palladium catalyst with the C2 oxygen as a rationale for the stereoselectivity in the glucose series. Zandanel expanded the panel of chemical reagents for construction of 1,2-*trans*-glycosides with permethacrylated Schmidt reagents promoted by  $\text{TMSNTf}_2$  in moderate yield.<sup>255</sup> Just recently, a practical application of benzoylglycine/thiourea cooperative catalysis for stereospecific glycosylation via activation of *O*-glycosyl trichloroacetimidate donors has been demonstrated by Dubey et al with

strong effect on the reaction rate, yield, and the stereospecificity.<sup>256</sup> The amino acid-derived *N* benzoylglycine in the presence of Schreiner's thiourea is used as a protic acid catalyst for *O*-glycosylation under mild reaction conditions at ambient temperature.

The issue of recyclability, environmental impact, and cost effectiveness of so many of the reagents used in carbohydrate synthesis is addressed by photo-induced glycosylation, which has enticed attention for applications in chemical glycobiology in recent years. Though in its infancy, Iwata et al have shown that activation by naphthol photoacids under photoirradiation of glycosyl trichloroacetimidates donors can be a powerful and efficient tool to further advance carbohydrate synthesis.<sup>257</sup> The related work by Liu et al in 2020 further showcases visible light activation of glycosyl trichloroacetimidates donors with eosin Y as an organophotoacid.<sup>258</sup> Photocatalysis has yielded positive results and will hopefully be extended to future oligosaccharide synthesis.

### *Solvent effects*

Solvent is inherently a factor that drives many chemical reactions. Effective solvolysis is rather critical for a molecule to interact at the reaction interface that will eventually deliver the product of the system in many organic syntheses. The choice of solvent plays an important role in achieving stereocontrolled glycosylation. In a general solvation sense, polar reaction solvents will increase the rate of glycosylation via a stereoselective  $S_N1$  type mechanism by stabilizing the charge separation between O-5 and  $\beta$ -O-1 while a stereospecific  $S_N2$  type mechanism is favored by nonpolar solvents. The solvent will in particular play a key role in differentiating between a glycosylation via a tight ion pair and a solvent-separated ion pair. Less polar solvents may also favor anchimeric C2 participation in 1,2-tans glycosylation.

An unusually strong solvent effect is observed on the stereochemical outcome of many glycosylation reactions and the solvent is a major parameter in improving stereocontrol.<sup>259</sup> This effect is of particular importance in the absence of C2 participation, to control the more challenging 1,2-cis glycoside formation. Ordinarily, non-polar solvent such as DCM, dichloroethane or toluene favor the  $\alpha$ -glycosylation product through stereospecific substitution, while more polar solvents such as acetonitrile and diethyl ether<sup>260</sup> show opposing effects, with the former favoring the equatorial *O*-glycoside, and the latter the axial product. With more sterically demanding ether solvents including diethyl ether, tetrahydrofuran<sup>261</sup> or dioxane,<sup>262</sup> the presence of a solvent molecule preferentially at the equatorial position in the transition state directs the nucleophilic attack by the acceptor towards the axial position.<sup>263</sup> This is the basis for 1,2-cis glycosylation bond formation with solvent participation. Conversely, the sterically undemanding linear acetonitrile generates an axial nitrilium intermediate hindering the axial approach by the acceptor and leads to  $\beta$ - glycosides. Other solvent system, for instance nitromethane, afforded similarly strong effects.<sup>264</sup>

### *Additives*

Other chemical additives are sometimes introduced in addition to promoters and catalysts to take part in the reaction and provide an assistance for controlling the mechanism and in particular the stereoselectivity of the glycosylation reaction. Several probes have been explored over the years to fine-tune the reactivity of one of the substrates for an expeditious and controlled synthesis, such as amides and formamides,<sup>265–267</sup> iodide derivatives,<sup>268–270</sup> phosphine oxides,<sup>271,272</sup> sulfides<sup>273,274</sup> and sulfoxide/sulfinamides.<sup>275,276</sup> In a very recent application, Wang L. et al 2018 demonstrated the use of a combination of trimethylsilyltriflate and DMF, which acts as an exogenous nucleophile for the



stereoselective construction of an  $\alpha$ -glucosyl linkages to a secondary alcohol with a per-benzylated glucosyl trichloroacetimidate donor. Activation of the same imidate donor with trimethylsilyl iodide in the presence of triphenylphosphine oxide allows for the stereoselective 1,2-cis-glycosylation of primary alcohols.<sup>277</sup> The pioneering effort of Park J. et al. group disclosed the efficient formation of stereoselective glycosylation of 2-azido-2-deoxy-glucoside by sulfonium ion intermediates: Glycosylation of 2-azido-2-deoxy-glycosyl trichloroacetimidate activated by TMSOTf afforded excellent  $\alpha$ -anomeric selectivity at higher temperatures in the presence of thiophene as an additive.<sup>273</sup> Mechanistic and computational studies provided strong evidence that the  $\beta$ -sulfonium ion is displaced by the attacking nucleophile from the acceptor when the trichloroacetimidate is activated in the presence of PhSEt, favoring predominantly the  $\alpha$ -glycoside.

### *Temperature*

Temperature plays a particularly critical role in glycosylation reactions. Its primary influence is in determining the selectivity based on the difference in enthalpy between the transition state for the favorable or unfavorable product. Another argument is that an intermolecular hydrogen bond between the two substrates at low temperature may be a contributing factor affecting the kinetics and stereochemical outcome of glycosylation.<sup>278</sup> In addition, temperature will play a key role in switching between  $S_N2$ , tight-ion pair, and solvent-separated ion pair mechanisms. Either the 1,2-trans or 1,2-cis product may be favored by lower temperatures.<sup>279–282,283,284</sup> It is generally necessary to investigate the optimal temperature for each sugar condensations, a hurdle that needs careful screening to minimize time, resources and effort.

### *Purification*

Purification is the most time-consuming part of oligosaccharide synthesis. The desired coupled product needs to be separated from the unreacted glycosyl acceptor, the hydrolyzed glycosyl donor (usually as a mixture of anomers), the by-product of the activating group (e.g., trichloroacetamide, disulfide compounds, etc.), degradation products, and other reaction components, with no large difference in polarity between them. The stereocontrol of the glycosylation step is not always perfect, in which case the product must also be separated from its anomer, which tends to be difficult. It is often necessary to perform multiple purifications to isolate the product in acceptable purity. In addition, there are typically a large number of regioselective protection steps to make the precursors, which adds considerably to the number of purifications.

### **Automated and accelerated carbohydrate synthesis**

The considerable progress in oligosaccharide synthesis over the last thirty years has made the synthesis of complex, biologically relevant oligosaccharides accessible to organic chemists by chemical and enzymatic routes,<sup>285,286</sup> including the industrial syntheses of complex, chemically defined carbohydrate drugs that are currently on the market as anticoagulants<sup>287</sup> and vaccines.<sup>80</sup> The carbohydrate community has convincingly demonstrated that it can make oligosaccharides. While many opportunities remain in developing ever more efficient and stereoselective reaction conditions, much of the progress to be made is in accelerating the process, so that new complex defined carbohydrates can be prepared in months rather than 5-10 years. The work of Seeberger et al. and others in developing solid-phase oligosaccharide synthesis is a key step in that direction,<sup>288</sup> but, despite the strong results shown by solid-state oligosaccharide synthesis, this methodology is not yet accessible to the average non-carbohydrate research group, unlike solid-phase peptide or

oligonucleotide synthesis. There are several aspects of carbohydrate synthesis that make automation on solid-state particularly challenging:

Reaction conditions for the key glycosylation step are highly variable, are typically run at low temperatures in the presence of highly reactive Lewis acids and are rather temperamental. Unlike peptide and nucleotide synthesis, where there are a few broadly applicable reaction conditions, there are many glycosylation conditions, and more are constantly being developed. Functional group chemistry is a first approximation, and the idea that the activated acetal group of the glycosyl donor and the alcohol of the glycosyl acceptor will react in the same way regardless of the rest of the carbohydrate molecule is not always supported by experimental results.

There are complex issues of regiochemistry and stereochemistry that do not exist in peptide and nucleotide chemistry. The mantra of carbohydrate chemists is that there is one peptide sequence Ala-Ala-Ala; there is one nucleotide sequence AAA; there are 832 different trisaccharides Gal-Gal-Gal. Unlike phosphodiester and amide-forming reactions, the glycosylation reaction creates a new stereocenter, the control of which is of central concern in oligosaccharide synthesis.

Protecting groups play a highly strategic role in carbohydrate synthesis, far beyond the typical temporary capping of a functional group.<sup>97</sup> In chemical oligosaccharide synthesis, the issue of regiochemistry is ultimately solved through protecting groups, and it is, therefore, necessary to control the regioselectivity of the protection steps. The structural variety of oligosaccharides requires a panel of varyingly orthogonal protecting groups: terminal, late-stage, and iterative protecting groups, as well as activatable protecting groups for the anomeric position. The nature of the protecting group, in particular at the C2 position, plays a key role in the stereoselectivity of the glycosylation reaction. The protection conditions, deprotection conditions, and regioselectivity in the protection steps all need to be taken into account in the choice of protecting groups. There is, therefore, no single universal set of protecting groups that are used for carbohydrate synthesis.

While progress in the field of solid-state carbohydrate synthesis will require, and therefore will drive considerable progress in our understanding of carbohydrate chemistry and heterogeneous phase reactions, fluororous tag methodology offers another powerful tool for automated oligosaccharide synthesis. By using fluororous tagged protecting groups, this methodology can be adapted in a straightforward manner to existing synthetic approaches. Fluororous analogs of many protecting groups used in carbohydrate synthesis are available for the synthesis of fluororous monosaccharide precursors, with relatively similar stabilities, protection and deprotection conditions, and regiochemical behavior to the traditional protecting groups. In short, while automated solid-state and F-tag carbohydrate synthesis will soon bring oligosaccharide synthesis to non-carbohydrate groups, in a more immediate sense, F-Tag synthesis can also bring accelerated synthesis to carbohydrate groups.

Oligosaccharide synthesis is therefore a particularly opportune application for fluororous tag assisted synthesis. An overview of F-tagged carbohydrate synthesis is provided in the next chapter to show both the progress and the opportunities in this field. In this thesis, we will apply fluororous tag methodology towards the synthesis of two vaccine-related targets, the *E. coli* 0142 antigens and the peptidoglycan fragment tracheal cytotoxin (TCT), which can be classified as an adjuvant because of its stimulating effects on the immune system (Figure 7). More specifically, we will investigate fluororous-tagged non-reducing to reducing iterative synthesis of oligomers of glucosamine and galactosamine.

Amino sugars are a particular challenge in oligosaccharide synthesis due to their poor solubility and reactivity.

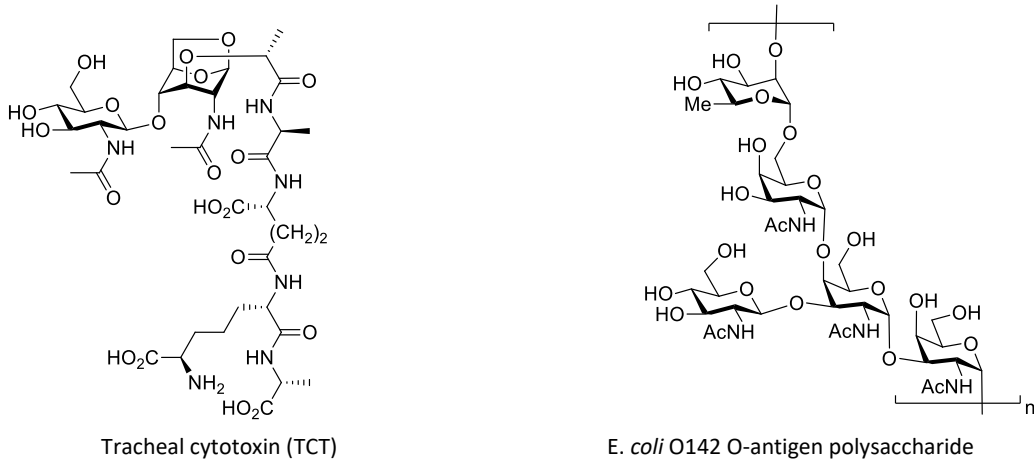

**Figure 7:** Structure of TCT and O142 O-antigen.

## CHAPTER TWO: Synthesis of Novel F-tag Glycosyl Building Blocks

### INTRODUCTION

Many factors contribute to the relative difficulty in making oligosaccharides compared to producing other biopolymers. Unlike an amide or phosphate diester bond formation, the synthesis of a glycosidic bond results in a new stereocenter that is often difficult to control. The syntheses of glycosyl building blocks require many reaction steps—far more than are required for protecting amino acid building blocks for instance. It is often necessary to synthesize large numbers and quantities of precursors to allow for optimization studies in order to develop an efficient synthetic route to complex oligosaccharides for biological applications.

Fluorous tag synthesis offers a simplified purification protocol to reduce synthetic manipulations and improve yields, originally by liquid-liquid extraction for heavy fluorous-tagged scaffolds and more recently by solid phase extraction on stationary fluorous silica gel for fast and effective isolation of less heavily fluorinated molecules. An overview of F-tagged carbohydrate synthesis is provided here to show both the progress and the opportunities in this field.

### APPLICATIONS OF FLUOROUS TAG METHODOLOGY IN CARBOHYDRATE SYNTHESIS

Fluorous-assisted synthesis is a strategy for performing stoichiometric or catalytic chemical conversions based on the limited miscibility of partially or fully fluorinated compounds in nonfluorinated media.<sup>289</sup> It permits easy isolation of the fluorous compound from complex reaction mixtures and combines the advantages of solid- and liquid-phase synthesis.<sup>290–292</sup> In practice, several parameters need to be adjusted to apply fluorous synthesis effectively. These include the availability of fluorous tagging groups, the number of fluorines required to render organic molecules "fluorous," and the overall efficacy with which fluorous substrates react in organic transformations. Over the years, many different incarnations of fluorous technology have appeared, each presenting advantages in particular contexts.

Horváth and Rábai, in the early 90s', developed a fluorous biphasic reaction system (FBS) consisting of a fluorous phase containing a dissolved reagent or catalyst and another phase, which could be any common organic or aqueous solvent with limited solubility in the fluorous phase.<sup>293</sup> Under vigorous stirring and or at higher temperatures, the fluorous and non-fluorous components become sufficiently miscible for the reaction to proceed efficiently. Upon cooling, there is complete separation of the fluorous and non-fluorous partners. In the case of a fluorous catalyst, the organic product can be decanted off, and the catalyst can be efficiently recycled. A variety of fluorous solvents with different miscibility, physical properties, and solvent properties are available. The ability to completely separate a catalyst or a reagent from the products under mild conditions can lead to industrial applications in homogeneous catalysis and the development of more environmentally benign processes. A significant number of fluorous chains are needed to entice otherwise organic molecules or transition metal complexes to partition into a fluorous phase to the extent necessary to avoid leaching of the catalyst. Still, the high molecular weights associated with heavy fluorous molecules are not detrimental, provided that the fluorous catalysts are efficient and can therefore be used in low molar ratios.<sup>294</sup>

Dennis P. Curran and co-workers in another incarnation demonstrated in the late 1990s that the starting material of a multistep synthesis could be labeled with a fluorous "tag," the reaction sequence could be run under standard conditions in organic solvents, and the final products could be extracted

into a fluororous layer by liquid-liquid extraction (Fig 8). The use of this approach for conducting and purifying multicomponent reactions illustrated the power of the fluororous approach.<sup>295</sup> Thus, successfully combining the experimental conditions of traditional organic synthesis in solution with the ease of purification of solid-phase synthesis provided a broadly applicable method for synthesizing small molecules.

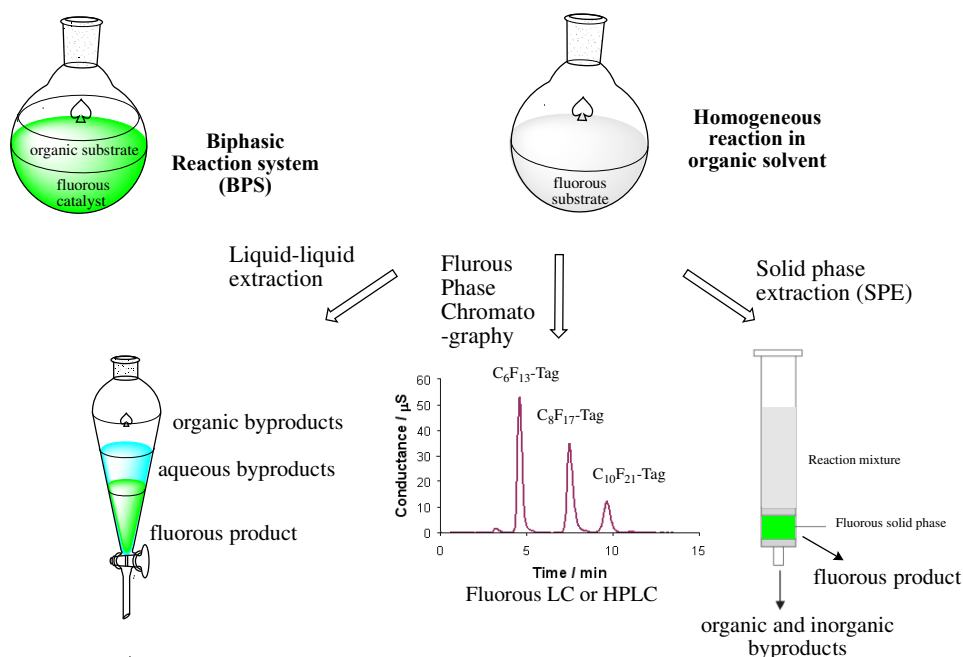

**Figure 8:** Different variations of fluororous synthesis

Fluorous biphasic synthesis (FBS) and fluororous liquid-liquid extraction (FLE) require "heavy fluororous chain" tags leading to compounds with about 60% fluorine by molecular weight to ensure complete partitioning into the fluororous layer and efficient liquid extraction in organic/fluorous biphasic or aqueous/organic/fluorous triphasic systems. On the other hand, many methods have been developed based on "light fluororous tagged" protecting groups, with 40% fluorine or less by molecular weight relying on a fluororous stationary phase rather than liquid-liquid extraction.

Compounds labeled with light fluororous could be recovered with excellent purity by solid/liquid separation, first evolved as fluororous solid-phase extraction (FSPE),<sup>296</sup> as an alternative to the liquid/liquid approach. FSPE in combination with light fluororous molecules ( $C_3F_7$  to  $C_{10}F_{21}$ ) has become the most widely used isolation technique. FSPE of heavy fluororous compounds can also be an attractive tool for its more robust separation and because water-free fluorophobic solvents can be used to elute the organic fraction. Although SPE has long been popular in chemical analysis, solid-phase extraction is increasingly used in chemical synthesis due to its relative simplicity and separation power. In FSPE, a crude mixture of fluororous, organic, and inorganic compounds is loaded onto fluororous silica gel and eluted in a first-pass with a "fluorophobic" solvent. The fluororous material adsorbs onto the column while the organic and inorganic materials elute with or near the solvent front. A second-pass elution with a "fluorophilic" solvent then elutes the fluororous compound in a single fraction or in several fractions. Apart from its simplicity, the FSPE procedure is attractive because no fluororous solvent is needed for either the reaction or the separation, and because the fluororous silica is robust and reusable. FSPE features high loading levels (sometimes 10% or more), and generally, only two fractions—organic and fluororous—are collected.

At the other extreme of chromatographic resolution, fluororous HPLC has been used to separate mixtures of fluororous-tagged compounds on a stationary phase bearing fluorocarbon chains in a high pressure/performance liquid chromatography mode. Several trademarks for these columns, such as Fluofix<sup>®</sup>, Fluoroflash<sup>™</sup> among others, are available, many of which show broad utility for the chemical analysis of organic or biological molecules beyond fluororous synthesis.<sup>291,297–302</sup> Fluororous columns present a significantly superior power for purifying mixtures of fluororous compounds (heavy and light fluororous, organic..) relative to standard reverse-phase columns. The more common pentafluorophenyl (PFP) columns can provide an intermediate compromise that combines fluororous and hydrophobic affinities.<sup>303</sup> The significant retention affinity of fluororous motifs allows the efficient separation of multiple or differentially fluororous tagged compounds. For example, Curran and co-workers reported the separation of differentially F-tagged mappicine libraries prepared by a "split and pool" approach.<sup>304</sup> Fluororous HPLC cleanly separated the different components based on fluorine content.

Fluororous flash chromatography bridges the gap between fluororous SPE and fluororous HPLC.<sup>294,305</sup> Fluororous phase silica gel is prepared by silylation of standard silica gel with ClSi(Me)<sub>2</sub>CH<sub>2</sub>CH<sub>2</sub>C<sub>6</sub>F<sub>13</sub>.<sup>306</sup> It has a far higher affinity for fluororous compounds relative to organic compounds. Fluororous chromatography may be conducted on SPE cartridges with lower loading by collecting and analyzing several fractions,<sup>294</sup> or preparatively by column chromatography. The successful purification of fluorinated compounds by column chromatography on fluororous reverse-phase silica gel predates Dennis P. Curran's report,<sup>306,307</sup> but it can be particularly beneficial in the context of F-tag-assisted synthesis.

These innovations have led to the development over the years of readily accessible and versatile tagging reagents containing perfluoroalkyl chains. In particular, fluororous protecting groups such as fluororous benzyloxycarbonyl (F-Cbz),<sup>308,309</sup> F-*t*-butyloxycarbonyl (F-Boc),<sup>310</sup> F-methylsulfonylethoxycarbonyl (F-Msc),<sup>311</sup> F-benzyl,<sup>312</sup> F-silyl,<sup>313</sup> F-alkoxy ethyl ether,<sup>314</sup> F-*t*-butyl,<sup>315,316</sup> F-*p*-methoxybenzyl (F-PMB),<sup>316</sup> F-trialkoxymethyl (F-Rink-type),<sup>316,317</sup> F-propionate (Bpf),<sup>318,319</sup> among others,<sup>320</sup> were reported in the literature to provide convenient F-Tags for fluororous synthesis. The fluororous chain is typically isolated from the reacting functional group by two or three methylene groups to maintain the reactivity of the corresponding non-fluororous protecting groups.

The attractive qualities of light tag fluororous synthesis were outlined by W. Zhang:<sup>321</sup>

- 1 Fluororous tag is inert to chemical reactions and has minimal effect on the attached molecules' reactivity.
- 2 The solubility of the fluororous molecules in organic solvents may be equal or better than the untagged molecules because of the perfluoroalkyl chain's lipophilicity.
- 3 Homogeneous reactions in organic solvents are faster than polymer-bound heterogeneous reactions.
- 4 Literature reaction conditions can be applied with little or no modification.
- 5 A large excess of fluororous reagent is not required in most cases.
- 6 The measure of the stoichiometry of fluororous compounds is easier to determine accurately compared to immobilized compounds.

7 The reaction progress can be monitored by conventional analytical methods such as TLC, HPLC, MS, IR, and NMR.

8 Both intermediates and final products can be purified either by fluororous methods or by normal and reverse-phase chromatography.

9 Scale-up and automation are possible.

### F-tags in carbohydrate synthesis

Over the last thirty years, the remarkable progress in oligosaccharide synthesis has made the synthesis of complex, biologically relevant oligosaccharides accessible to organic chemists by chemical and enzymatic routes,<sup>285,286</sup> including the industrial syntheses of complex, chemically defined carbohydrate drugs that are currently on the market as anticoagulants<sup>287</sup> and vaccines.<sup>80</sup> The carbohydrate community has convincingly demonstrated its ability to produce complex oligosaccharides. Much of the progress is thus accelerating the process, so that newly defined carbohydrates can be prepared in 6-12 months rather than 5-10 years. Developing solid-phase oligosaccharide synthesis is a crucial step in this direction,<sup>288</sup> but, despite the strong results shown by solid-state oligosaccharide synthesis, this methodology requires considerable expertise and optimization, and is therefore not yet accessible to the average non-carbohydrate research group, unlike solid-phase peptide or oligonucleotide synthesis. In addition, there are several aspects of carbohydrate synthesis that make it particularly challenging:

Finding optimal reaction conditions for the glycosylation step requires exhaustive experimentation. Reactions are typically run at low temperatures in the presence of highly reactive Lewis acids and are somewhat temperamental. Unlike peptide and nucleotide synthesis, where there are a few broadly applicable reaction conditions, there are a wide variety of glycosylation conditions, and many more need to be developed for general application. Functional group chemistry is a first approximation. The idea that the glycosyl donor's activated acetal group and the glycosyl acceptor's alcohol will react in the same way regardless of the rest of the carbohydrate molecule is not supported by the experimental results.

The central role of protecting groups in carbohydrate synthesis cannot be overemphasized, far beyond the typical temporary capping of a functional group.<sup>97</sup> The issue of regiochemistry is ultimately solved through protecting groups in chemical oligosaccharide synthesis, and a full panoply of orthogonal terminal, late stage, iterative and C2-directing groups are required. A detailed knowledge of each protecting group is also necessary to control the regioselectivity of the protection steps. There is, therefore, no single set of protecting groups that are universally used for carbohydrate synthesis.

Purification is the most time-consuming part of oligosaccharide synthesis. It is necessary to separate the desired coupled product from the unreacted glycosyl acceptor, the hydrolyzed glycosyl donor (usually as a mixture of anomers), the by-product of the activating group (e.g., trichloroacetamide, disulfide compounds, etc.), degradation products, and other reaction components, with no large difference in polarity between them. Controlling the stereochemistry of the glycosylation step is not always perfect, in which case the product must also be separated from its anomer, which tends to be particularly challenging. It is often necessary to perform multiple purifications to isolate the product in acceptable purity. In addition, there are typically many

regioselective protection steps to make the precursors, which adds considerably to the number of purifications to be performed.

Fluorous tag methodology using fluorous tag protecting groups is a robust tool for oligosaccharide synthesis. It can be applied in a straightforward way to existing synthetic approaches. Fluorous analogs of many protecting groups used in carbohydrate synthesis are available to synthesize fluorous monosaccharide precursors, with relatively similar stabilities, protection and deprotection conditions, and regiochemical behavior to the traditional protecting groups. In short, while automated solid-state and F-tag carbohydrate synthesis will eventually bring oligosaccharide synthesis to non-carbohydrate groups, in a more immediate sense, F-Tag synthesis can also bring accelerated synthesis to carbohydrate groups.

Oligosaccharide synthesis is, therefore, a particularly suitable application for fluorous-tag-assisted synthesis. An overview of F-tagged carbohydrate synthesis is provided below with a focus on the aspects related to carbohydrate synthesis rather than on the preparation of the F-tags, which generally involve relatively accessible chemistry and has been discussed elsewhere.<sup>97</sup> The choice of fluorous tag and synthetic strategy will be the principal subject, and although some experimental details are provided in the discussion to emphasize their similarity to traditional carbohydrate chemistry, complete synthetic schemes are not provided here, but can be found in the published review provided in the appendix.<sup>322</sup>

### Anomeric fluorous tags

Installing a fluorous tag at the anomeric position of the reducing sugar is a strategy for reducing-to-non-reducing iterative oligosaccharide synthesis with a single fluorous tag to efficiently separate the fluorous tagged oligosaccharide from the residual glycosyl donor and reaction by-products at each step. The fluorous tag methodology will generally not separate the coupled product from the uncoupled glycosyl acceptor. Hence, as in solid-phase synthesis, it is necessary to push the coupling reaction to completion; however, in contrast to solid-phase synthesis, this is usually possible with a few equivalents of the glycosyl donor and recycling through the reaction conditions once or twice. The reducing sugar anomeric tag has been the most widely used option, by analogy to solid-phase synthesis, as this position will not be involved in glycosylation reactions, by definition. The anomeric tag can be removed at the end of the synthesis or may serve as a linker for immobilization.

#### *Cleavable anomeric fluorous tags*

Mizuno and co-workers developed the "tag and sacrificial linker" concept to develop recyclable heavy fluorous tags for oligosaccharide and peptide synthesis using liquid-liquid fluorous extraction (Fig 9). The first example used a benzyl-type linker to efficiently introduce a hexakis(fluorous chain) alcohol and perform reducing-to-non-reducing synthesis.<sup>323</sup> Glycosylation of the linker with a 2.0-fold excess of the phenyl tri-*O*-benzyl-6-*O*-Fmoc-thioglycoside donor, in the presence of *N*-iodosuccinimide (NIS) and triflic acid (TfOH) in dichloromethane - ethyl perfluorobutyl ether mixture, followed by deprotection of the Fmoc iterative protecting group gave the heavy F-tagged glycosyl acceptor. The reaction with a 2.0-fold excess of thioglycoside donor under the same conditions afforded the fluorous disaccharide **1**, thus setting the basis for iterative reducing-to-non-reducing oligosaccharide synthesis. Each fluorous intermediate was isolated directly by a simple partitioning between FC72/MeOH or MeCN mixtures. The fluorous tag was cleaved by treatment with NaOMe and the heavy fluorous tag could be recovered in 91% yield with an FC72/MeOH partition system. After silica-gel column



chromatographic purification of the crude MeOH extract, the disaccharide was obtained at 56% overall yield.

The same group came up with a nearly related glutarate-linked anomeric ester heavy fluororous tag, hexakisfluororous chain-type butanoyl (Hfb) for the efficient iterative oligosaccharide assembly and recycling of the F-Tag, as demonstrated by the synthesis of the trisaccharide **2** using the 6-*O*-TBDPS group as the iterative protecting group, under similar conditions to those used above.<sup>324</sup>  $\alpha$ -selectivity was enhanced using the tribenzyl 6-*O*-Fmoc iterative group and each synthetic intermediate could be monitored by TLC, NMR, and mass spectrometry. In addition, the use of the Hfb allows rapid purification of synthetic intermediates by partitioning between fluororous and organic solvents.

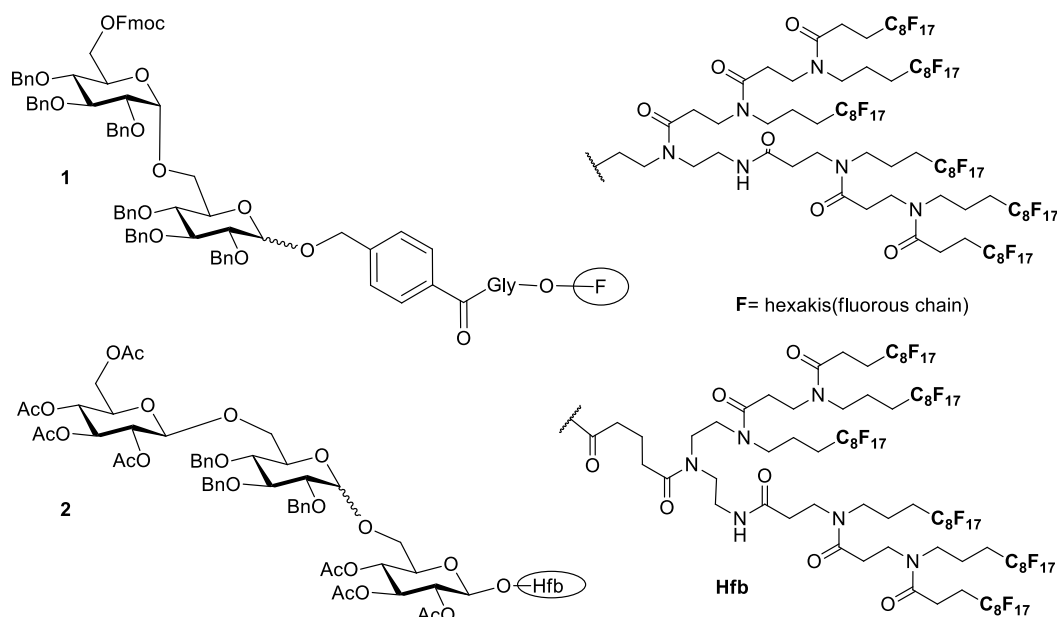

**Figure 9:** Anomeric heavy-fluororous tagged glycosyl acceptors for reducing-to-non-reducing oligosaccharide synthesis.

Goto and Mizuno developed a dihydroquinone linker, a heavy fluororous tag derived from meso-erythritol linked at the anomeric center to prepare a disaccharide unit **3**<sup>325</sup> (Fig 10). Fluororous–organic solvent partition efficiently isolated the fluororous synthetic intermediates. Unfortunately, the proton NMR signals from the tag’s meso-erythritol scaffold interfered with those of the sugar ring, complicating structure elucidation. In the same vein from the Mizuno group, chemical modification of an acid-resistant all-carbon-linked heavy fluororous tag via a bis-allylic alcohol was reported by Fukuda et al for the synthesis of disaccharide **4**.<sup>326</sup> Fluororous liquid-liquid extraction simplified the synthetic schemes by allowing fast purification and high isolated yields. The anomeric fluororous tag was removed by Pd(PPh<sub>3</sub>)<sub>4</sub>, and the initial heavy fluororous tag was efficiently recovered (>90% yield) along with free anomeric sugar. Many additional fluororous tags were inspired by these precedents.<sup>327,328</sup> These results collectively establish the basis for efficient reducing-to-non-reducing iterative oligosaccharide synthesis by liquid-liquid extraction using heavy F-tags, which may find optimal applications in an industrial context, where the fluororous solvents can be handled and recycled efficiently.<sup>329</sup>

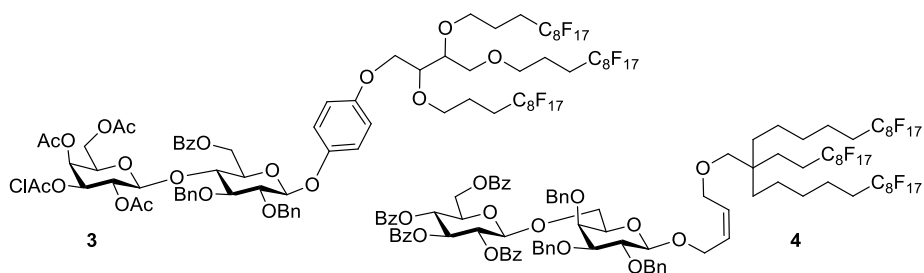

**Figure 10:** Dihydroquinone and allyl-linked anomeric heavy-fluor tagged glycosyl acceptors for reducing-to-non-reducing oligosaccharide synthesis.

An acid and base-stable light fluoros silyl ether tag developed by Rover and Wipf<sup>313</sup> has found application in the fluoros oligosaccharide synthesis reported by Manzoni *et al.*<sup>330,331</sup>(Fig 11). The fluoros silyl group was installed at the anomeric position of a glucosamine building block to synthesize disaccharide **5** and the Lewis a trisaccharide **6**. Convenient TLC and MALDI MS reaction monitoring allowed the protection and coupling reactions to be driven to completion by multiple cycles. Coupling the  $\beta$ -trichloroacetimidate of galactose tetracetate with 0.1 eq TMSOTf at -30 °C on the F-tagged glycosyl acceptor gave the  $\beta$ -disaccharide **5** in 78% yield after two cycles. After a similar coupling using the related Troc-protected glucosamine, regioselective reductive opening of the benzylidene group with triethylsilane, trifluoroacetic acid and trifluoroacetic anhydride and coupling with the 2-*O*-benzyl-3,4-*O*-acetylfucose trichloroacetimidate under similar conditions gave the trisaccharide **6**. The F-Tag was removed with TBAF to afford the Lewis a trisaccharide. The fluoros tag dramatically accelerated the synthesis of the trisaccharide by reducing the purification procedures to a simple fluoros solid-phase extraction, providing the trisaccharide in seven steps and 23% overall yield, average 81% per step, in only 3 days.

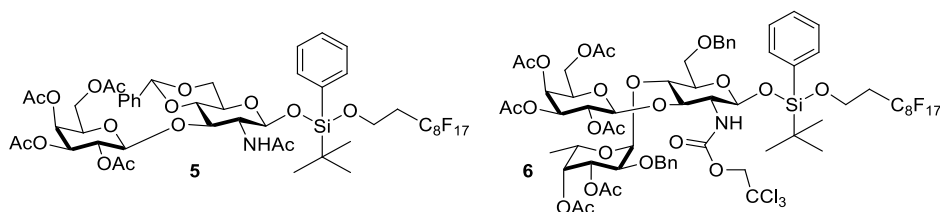

**Figure 11:** Reducing-to-non-reducing oligosaccharide synthesis of the Lewis a trisaccharide using light-fluoros tagged anomeric *O*-silyl glycosyl acceptor.

Pohl and co-workers reported the automated iterative reducing to the non-reducing fluoros synthesis of polymannoside and polyrhamnoside oligosaccharides using a light fluoros allyl anomeric protecting group tag.<sup>332–334</sup> Synthesis of linear **7** and branched mannose **8** oligosaccharides employing allyl anomeric fluoros-tag along with reaction conditions and FSPE protocols amenable to automation was demonstrated by Jaipuri and Pohl<sup>335</sup> (Fig 12). The tag permitted fluoros SPE purification of all intermediates and was cleaved under standard palladium-mediated deallylation conditions. Multiple glycosylations with the 2-*O*-acetyl-tri-*O*-benzylmannose trichloroacetimidate in the presence of TMSOTf in dichloromethane at 5 °C and methanolysis of the iterative C-2 acetyl group in the crude SPE methanol extract delivered the tetra- $\alpha$ -mannoside oligosaccharide **7** in 79% overall yield using only a total of 7 equivalents of the trichloroacetimidate donor. A more complex branched oligomannoside **8** was synthesized using an orthogonally protected 2-*O*-pivaloyl-3-*O*-levulonoyle-4-*O*-benzyl-6-*O*-TBDPS glycosyl donor (Fig 12). The linker design improved the solubility in the reaction solvent and aqueous-organic solvent for purification protocol as a simple handle to facilitates scale-up. Kohout and Pohl recently reported the automated synthesis of  $\alpha$ (1 $\rightarrow$ 2),(1 $\rightarrow$ 3) L-rhamnan, and L-rhamnan sulfate fragments, e.g., **9**.<sup>334</sup> As solution-phase fluoros-tag-assisted chemistry evolves,

automation for robust and rapid oligosaccharide assembly will provide a solution to the demand for biologically relevant oligosaccharides.

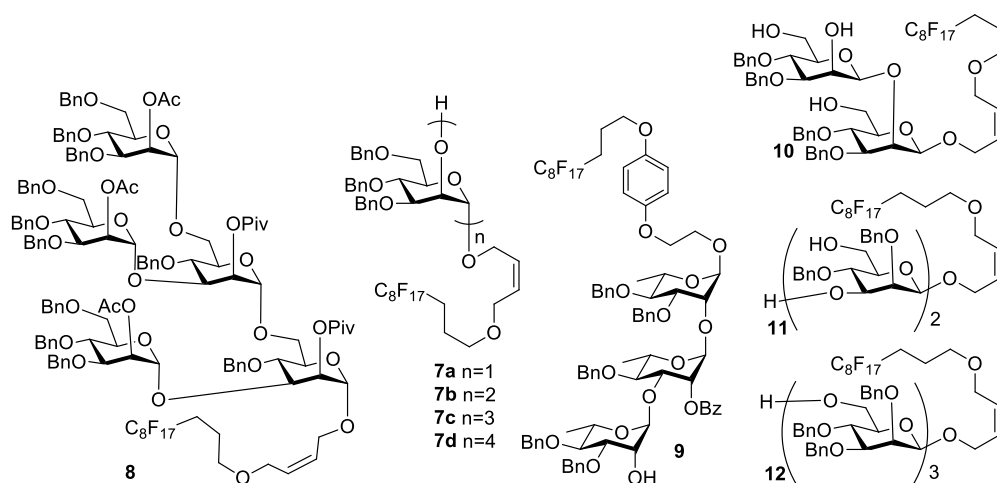

**Figure 12:** Anomeric light-fluorous tagged glycosyl acceptors for automated reducing-to-non-reducing oligosaccharide synthesis of oligomannans and rhamnans.

Using a  $\beta$ -directing C-5 carboxylate manuronate strategy, a fully automated solution-phase synthesis of the challenging  $\beta$ -(1 $\rightarrow$ 2); **10**,  $\beta$ -(1 $\rightarrow$ 3); **11**, and  $\beta$ -(1 $\rightarrow$ 6); **12**-mannan oligomers was achieved by Tang and Pohl<sup>336</sup> (Fig 12). The conjugation of the F-tag allyl alcohol with the trichloroacetimidate of methyl di-*O*-benzylmanuronate bearing a *p*-methoxybenzyl group at either the 2-*O*- or 3-*O*- position was the starting point, catalyzed by TMSOTf at  $-20$  °C. After 30 min, the solvent was removed and a ceric ammonium nitrate (CAN) solution in MeCN/H<sub>2</sub>O (1/9) was added to the mixture and vortexed for 1h to remove the iterative *p*-methoxybenzyl group. TLC confirmed the complete reaction, and the mixture was robotically transferred to the SPE station for FSPE purification. After the FSPE, the purified product underwent another glycosylation–deprotection–FSPE cycle, and the crude product was transferred from the synthesis platform and purified manually to afford the desired  $\beta$ (1 $\rightarrow$ 2) or  $\beta$ (1 $\rightarrow$ 3)-linked mannose oligosaccharides **10** and **11**. The  $\beta$ (1 $\rightarrow$ 6)-oligomannoside **12** was obtained similarly by reducing the ester group in place of CAN deprotection. The tags were removed by hydrogenation on palladium/C along with the terminal benzyl protecting groups. The methodology significantly improved the glycosylation reactions and thus limited the number of equivalents of glycosyl donor needed compared to solid-state synthesis, thereby considerably reducing the cost of oligosaccharide synthesis.

In a recent methodology paper, Kabotso and Pohl reported using a pentavalent bismuth complex to activate thioglycosides, which they exemplified utilizing a variety of anomeric fluorous tags.<sup>337</sup> For example, a sialic acid thiophenyl glycoside was coupled to a dihydroquinone-linked fluorous tag in the presence of Ph<sub>3</sub>Bi(OTf)<sub>2</sub> and isopropylthiol at room temperature to provide the fluorous sialic acid derivative **13**. Although the reaction was somewhat sluggish, the stereoselectivity was high. Similarly, coupling adamantyl tetra-*O*-acetylthioglucoside under the same conditions provided the anomeric fluorous benzyl glucoside; deacetylation, tritylation, benzylation, and removal of the trityl group provided the fluorous glycosyl acceptor, which was coupled with a tri-*O*-benzoyl galacturonic acid thiopropyl glycoside donor under the same conditions to give the disaccharide **14**. FSPE and MPLC efficiently purified all intermediates. The preparation of the disaccharide **15** using the bis-allyl linked fluorous tag bearing an iterative levulinate protecting group clearly shows the potential for iterative reducing-to-non-reducing oligosaccharide synthesis (Fig 13).

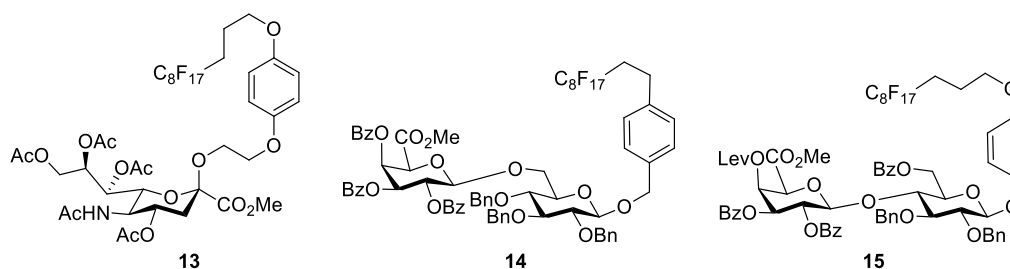
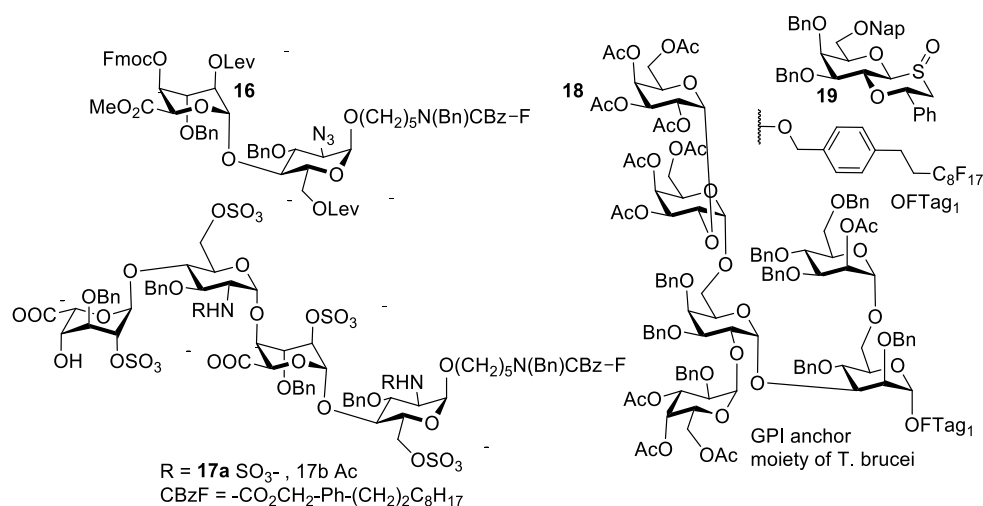

**Figure 13:** Anomeric F-tags for the synthesis of sialic acid and lacturonic acid derivatives

The Boons group has developed several efficient fluorous-tag-assisted syntheses of complex oligosaccharides. Zong *et al.* reported the modular, convergent synthesis of defined heparan sulfate fragments **17a,b** (Fig 14) using an anomeric aminopentyl linker protected by a perfluorodecyl-tagged benzyloxycarbonyl group.<sup>338</sup> Coupling the F-tagged aminopentyl alcohol to the trifluoro-*N*-phenylacetamide of the L-iduronic acid – D-azidoglucose disaccharide gave the F-tagged disaccharide **16** bearing late-stage levulinyl groups for installation of the sulfate groups and an Fmoc iterative protecting group. Deprotection of the iterative Fmoc and coupling to the same disaccharide donor in the presence of triflic acid in dichloromethane at -20 °C gives the suitably protected tetrasaccharide in 72% yield after one recycle, with excellent  $\alpha$ -stereoselectivity. Deprotection of the levulinate groups, sulfation with SO<sub>3</sub>-pyridine, saponification of the ester groups and the Fmoc group, Staudinger reduction of the azido groups to the amines, and either sulfation or acetylation provides the heparan sulfate tetrasaccharides **17a** and **17b**, which were subsequently debenzylated by hydrogenolysis. The F-tag allowed the authors to drive reactions to completion by recycling and simplified the notoriously difficult purification of these compounds, particularly the late stages of installing the sulfate and carboxylate groups. The use of trifluoroethanol to avoid the formation of micelles is noteworthy. This approach greatly simplified the synthesis due to improved selectivity, lower reagent use, facile purification, and the final steps of modifying the target molecule and set the basis for fluorous-tag assisted synthesis of defined heparan sulfate oligosaccharides.

In another important advance, Huang, Gao and Boons reported the synthesis of the highly complex, biologically relevant branched hexasaccharide moiety **18** of the GPI anchor of *Trypanosoma brucei* using a benzyl fluorous-tag at the anomeric position of the reducing sugar.<sup>339</sup> The other anomeric configurations were controlled using complementary anchimeric C2-participations, with C-2 pyrano[1,4]oxathiane glycosyl donors such as **19** to introduce 1,2-*cis*-glycosides and C-2 acetyl groups for 1,2-*trans*-glycosides. The light fluorous benzyl alcohol tag was glycosylated with the reducing mannose thioglycoside donor bearing a C2-directing acetyl group and orthogonal naphthylmethyl ether and levulinate iterative protecting groups. DDQ deprotection of the naphthylmethyl group and glycosylation with the oxidized oxathiane donor **19**, a stoichiometric amount of triflic anhydride and 1,3,5-trimethoxybenzene in the presence of 2,6-di-*tert*-butyl-4-methylpyridine in DCM at -40 °C gave the Gal- $\alpha$ (1 $\rightarrow$ 3)Man disaccharide, thanks to the anchimeric participation of the C2 group. Acid-mediated removal of the C-2 auxiliary and glycosylation with the trifluoro-*N*-phenylacetimidate of 3,4,6-tri-*O*-acetyl-2-*O*-benzyl-D-galactose with TfOH in DCM at -25 °C gave the linear trisaccharide. Deprotection of the galactose 6-*O*-Nap group and iterative galactosylation using the triacetylated pyrano[1,4]oxathiane affords the branched pentasaccharide. Subsequently, acetylation of the free C2 group on the non-reducing galactose and deprotection of the levulinate group on the reducing mannose allowed coupling with the tri-*O*-benzyl-2-acetyl mannose trifluoro-*N*-phenylacetimidate donor to provide the protected hexasaccharide **18**. The synthesis of this

compound was performed using a purification protocol based on fluororous solid-phase extraction at each step and recycling of the glycosylation steps to push the reactions to completion. Global deprotection by hydrogenation over Pd/C, followed by removal of the acetyl esters using sodium methoxide in methanol, furnished the target GPI anchor hexasaccharide. This is perhaps the most general demonstration of fluororous tag-assisted oligosaccharide synthesis to date and can be adapted to a wide variety of target structures.



**Figure 14:** Fluororous tag-assisted synthesis of complex oligosaccharides by the Boons group

One-pot multienzyme (OPME) glycan assembly is another innovation using fluororous mixture synthesis to efficiently prepare complex oligosaccharides, as reported by Hwang et al.<sup>340</sup> The light fluororous tag was extremely useful in overcoming the severe purification challenges and time constraints inherent in enzyme-based methodology. Light fluororous tagged glycosyltransferase acceptors with different lengths of perfluoroalkanes and oligoethylene glycol linkers were synthesized and tested to find optimal fluororous tags which were well tolerated by the glycosyltransferases used in OPME reactions, while allowing for facile purification of the products by FSPE. They found that lactosides bearing a triethylene glycol (TEG) or hexaethylene glycol (HEG) spacer, with a perfluorohexyl or perfluorooctyl tag, provided sufficiently good yields for practical preparation of glycosylated products. Glycosylation of the TEG- $\text{C}_6\text{F}_{13}$  tagged lactoside with the sugar nucleotide synthase/glycosyl transferase system PmST1 E271F/R313Y/NmCSS, Pd2,6ST/NmCSS, or EcGalK/BLUSP/PmPpA/a1-3GalT gave the trisaccharides **20-22** (Fig 15). Isolation of the products was achieved with excellent purity by centrifugation and FSPE, washing with water, and eluting the tagged trisaccharides with methanol, in 86%, quantitative, and 89% yield, respectively. The TEG/HEG- $\text{C}_8\text{F}_{17}$ / $\text{C}_6\text{F}_{13}$ -tagged lactosides improved the substrates' solubility and increased the OPME glycosylation yields without compromising the FSPE purification process. In related work, Hatanaka showed that lactose and *N*-acetyl glucosamine bearing anomeric fluororous tags could be incorporated into cell membranes and be glycosylated by cellular enzymes.<sup>341</sup>



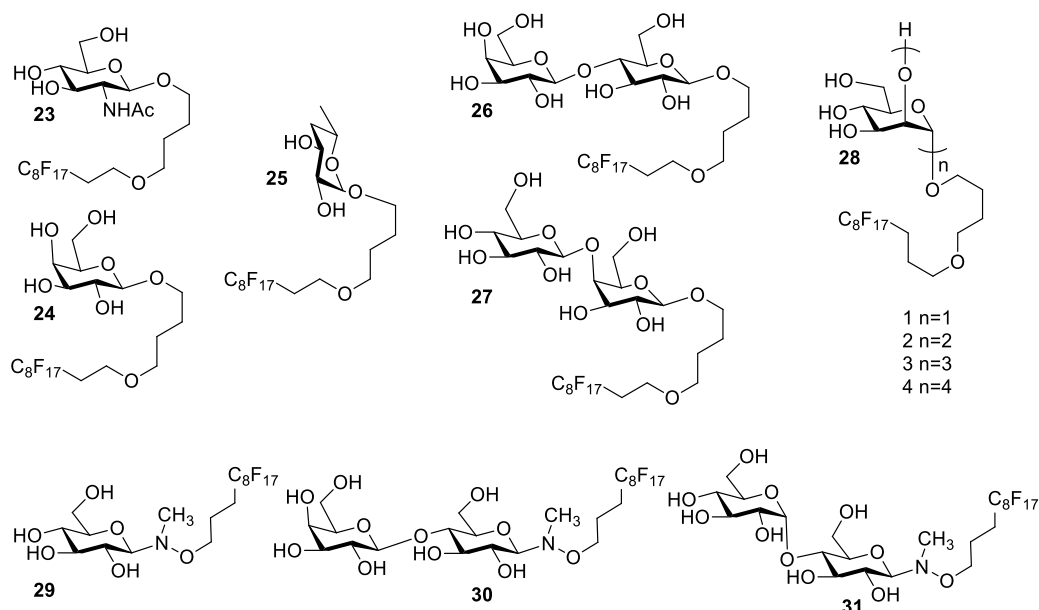
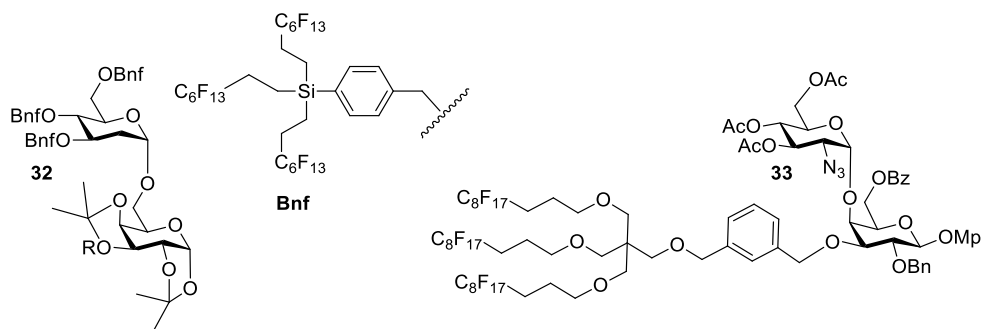

**Figure 16:** Anomeric fluoros tags for glycoarray production

### Terminal fluoros tag protecting groups

Shifting the point of fluoros tag attachment beyond the anomeric position to other carbohydrate hydroxyls allows one to adjust the number of fluorines by the number of protecting groups and the length of the fluorine chain on each group. The methodology also permits for reducing-to-non-reducing, non-reducing-to-reducing, and bidirectional oligosaccharide synthesis. These protecting groups will be cleaved in the final synthetic steps to unmask the sugar's free hydroxyl groups. It must therefore be stable to all of the prior coupling, functionalization, and deprotection conditions. Benzyl and acetyl groups are the most popular terminal protecting groups in oligosaccharide synthesis. They are converted to volatile by-products so that the oligosaccharide does not require further purification. In the fluoros case, the protecting group will be retained by fluoros liquid- or solid-phase extraction, so the main issue concerns any residues from the reagents. Although many fluoros protecting groups can be used as a terminal protecting group, providing they are stable to the previous coupling and deprotection steps, we will focus on fluoros benzyl groups in this section.

The application of a heavy-fluorous-tagged glucal to the synthesis of a disaccharide bearing multiple benzyl fluoros tags was perhaps the earliest known demonstration of fluoros-tagged carbohydrate synthesis by the Curran group. A silicon bridge was used to attach three fluoros chains to a benzyl group, to afford a novel protecting group for liquid-liquid extraction.<sup>312</sup> Glucal protected with three tris(perfluoroalkylsilane)-substituted benzyl groups (Bnf) was coupled with diacetone galactose in the presence of toluenesulfonic acid in trifluorotoluene to furnish fluoros disaccharide **32**, which was extracted by three-phase extraction in 85% yield (Fig 17). Although limited in scope, this result demonstrates the possibility of placing the fluoros tag on the non-reducing sugar for non-reducing-to-reducing iterative oligosaccharide synthesis. Unfortunately, the need for multiple fluorocarbon tails for effective liquid-liquid extraction also hinders the solubility of the compounds in nonfluorocarbon reaction solvents. Still, this result set the basis for further development of liquid-liquid fluoros assisted carbohydrate synthesis.



**Figure 17:** Benzyl heavy fluororous tags for non-reducing-to-reducing and reducing-to-non-reducing oligosaccharide synthesis

Goto applied a benzyl heavy fluororous tag to synthesize the terminal disaccharide structure of class III mucin **33**<sup>348</sup> (Fig 17). The chain was attached to the galactose glycosyl acceptor by a regioselective *n*-Bu<sub>2</sub>SnO-directed Williamson ether synthesis. Glycosylation with the trichloroacetimidate of tri-*O*-acetylazidoglucose in the presence of TMSOTf in DCM-diethyl ether provided the disaccharide **33**. Isolation of fluororous intermediates was by liquid-liquid extraction without further purification, and the desired compound was obtained not only in high yield but in pure form. Due to the symmetrical nature of the fluororous moiety, the spectrum was sufficiently simple that the signals from the protecting group did not interfere with the analysis of the sugar ring protons. After hydrogenolysis, the fluororous alcohol was recovered from the fluororous layer in 94% yield and was recycled.

Kojima, Nakamura, Takeuchi reported a light fluororous benzyl protecting group version for fluororous tag-assisted carbohydrate synthesis.<sup>349</sup> Reductive cleavage of the 4,6-*O*-<sup>F17</sup>benzylidene acetal with Et<sub>3</sub>SiH-TFAA affords the corresponding 6-*O*-<sup>F17</sup>benzyl-4-*O*-hydroxyl derivative in 98% yield. On the other hand, utilizing PhBCl<sub>2</sub> as a Lewis acid provided the related 4-*O*-<sup>F17</sup>benzyl-6-*O*-hydroxyl compound in (96%) yield, making it possible to synthesize representative α(1→4), β(1→4), α(1→6), and β(1→6), disaccharides **34-37** (Fig 18). The separation of the fluororous intermediates by FSPE was straightforward. The fluorine atom content was around 21% at the final stage, and the fluororous compounds could also be purified by standard silica gel column chromatography. The <sup>F17</sup>Bn-group deprotection was achieved by hydrogenation with 10% Pd-C and the fluororous toluene was efficiently removed in EtOAc and MeOH by FSPE.

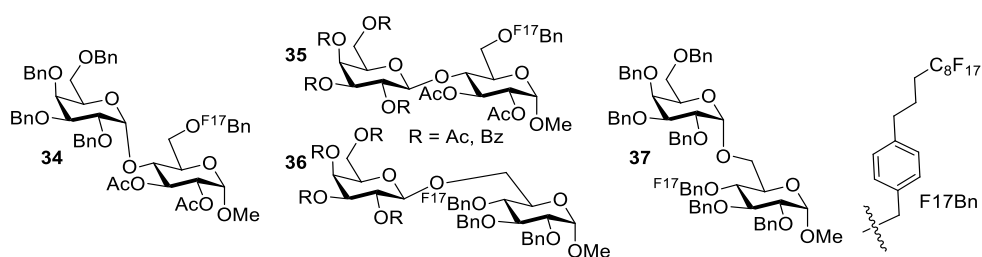

**Figure 18:** Light fluororous benzyl protecting group derived from <sup>F17</sup>benzylidene acetal compounds

### Late-stage fluororous tag protecting groups

The protecting groups deprotected in the penultimate steps of oligosaccharide synthesis, either to install multiple copies of a functionality (sugar, sulfate, phosphate, etc.) or simply before the deprotection of the terminal groups in the deprotection sequence are termed late-stage, and they include the following:



### Fluorous ester groups

Ester groups are often late-stage protecting groups of choice, providing they are not used as iterative groups and are compatible with the overall synthetic design. Miura and co-workers developed a novel ester-type heavy tag Bfp (bisfluorous chain propanoyl) group, prepared by alkylation then acylation of  $\beta$ -alanine.<sup>318,350</sup> Three Bfp groups were introduced onto the reducing sugar glycoside acceptor for iterative oligosaccharide synthesis, using *N,N*-dicyclohexylcarbodiimide (DCC), and 4-(dimethylamino)pyridine (DMAP). The synthesis of the  $\beta$ -1,6-linked gentiotetraose pentasaccharide **38** by glycosylation sequences with the trichloroacetimidate of 6-*O*-TBDPS triacetyl-D-glucose in the presence of TMSOTf in Et<sub>2</sub>O at 0 °C followed by desilylation, was achieved using minimal column chromatography purification of the target oligosaccharide. Each synthetic intermediate was purified by simple FC-72-toluene fluoruous-organic solvent extraction. Only three Bfp groups made it possible to extract the derivative of the pentasaccharide synthesized with the FC-72-organic solvent extraction and monitored by TLC, NMR, and MS.

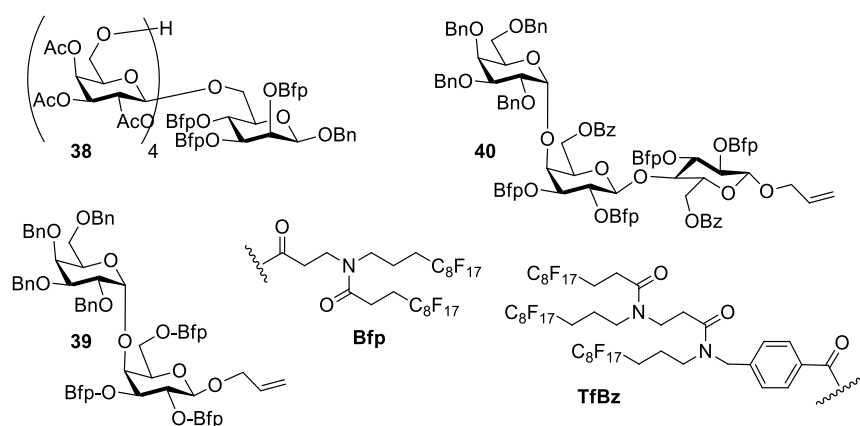

Figure 19: Late-stage fluoruous ester protecting groups

The same group extended the strategy to the rapid synthesis of galabiose Gb2 **39** and the Gb3 **40** oligosaccharide derivatives using fluoruous–organic extraction purification<sup>319,351</sup> (Fig 19). Miura et al. introduced the Bfp groups onto the two hydroxyl functions of allyl 4,6-*O*-benzylidene galactoside with DCC/DMAP. After benzylidene deprotection, the same group was again selectively introduced to the primary hydroxyl function to give the fluoruous glycosyl acceptor, which was successfully glycosylated with an excess of the glycosyl donor (6 equiv.) promoted by TMS-OTf in ether–EtOC<sub>4</sub>F<sub>9</sub> afforded selectively the  $\alpha$ -linked fluoruous disaccharide **39** (No  $\beta$ -isomer could be detected). The trisaccharide derivative of this molecule was synthesized efficiently using the galactosyl donor with two Bfp groups. Miura et al. also reported the novel heavy fluoruous benzoyl protecting group TfBz (tris-fluorous chain-type benzoyl, Fig 19) and its application to synthesizing oligosaccharides, particularly for cases where the Bfp group was insufficient to draw the oligosaccharide into the fluoruous layer.<sup>352</sup>

Maza, de Paz, and Nieto, in a recent application synthesis of a sulfated, fully protected hexasaccharide as a glycosaminoglycan **41** mimetic, studied its interactions with different growth factors: midkine, basic fibroblast growth factor (FGF-2), and nerve growth factor (NGF) by a light ester-fluorous tag approach.<sup>353</sup> The fluoruous tag was introduced by selective acylation at the reducing end of 4-*O*- and 6-*O*- diol using standard recipes; heptadecafluoroundecanoyl chloride, triethylamine, DMAP in CH<sub>2</sub>Cl<sub>2</sub> at 0 °C formed glycosyl acceptor.<sup>354</sup> Condensation of the established fluoruous tagged acceptor with trichloroacetimidate bound donor (2 equiv.) as a leaving group was catalyzed by TBSOTf at 0 °C. F-SPE

plus standard silica gel column chromatography purification yielded a clean disaccharide product. Treatment of the disaccharide with hydrazine monohydrate in pyridine/acetic acid buffer removed the levulinoyl tag that opened a way for chain elongation to trisaccharide. Subsequent isolation of the synthetic intermediate by F-SPE and a silica gel column purification when needed is followed by delevulination as pointed out to make available tri, tetra, pentasaccharide acceptors. Several glycosylation cycles require (2.5-3 equiv.) donor to establish the hexamer with an average of 90% yield per step. Selective removal of silylidine with (HF).py complex in THF at 0 °C resulted in hexaol, and sulfation with SO<sub>3</sub>.NMe at 100 °C by microwave heating to deliver the target molecule **41** (Fig 20).

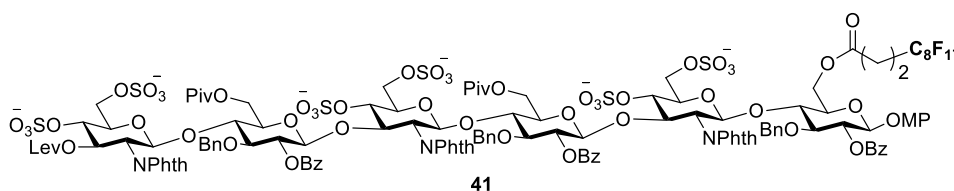

Figure 20: Light fluororous tag ester employed for the synthesis of hexamer derivative

### Fluorous O-carbamates

The first total synthesis of the natural product cucurbitoside A **42** was accomplished by Kojima et al. using a novel fluororous *N*-phenylcarbamoyl (<sup>F</sup>Car) protecting group (Fig 21).<sup>355</sup> The <sup>F</sup>Car group was introduced onto glucose diacetonide in high yield by in situ Curtius rearrangement of the fluororous benzoic acid with diphenylphosphoryl azide, and after conversion to the triacetylated pyranose trichloroacetimidate, was glycosylated with the phenolic acceptor in the presence of BF<sub>3</sub>.Et<sub>2</sub>O in DCM at -20 °C. Deacetylation and formation of the benzylidene provided the glycosyl acceptor in 8 steps using FSPE with single column chromatography. Coupling the trichloroacetimidate of the benzoyl D-apiose donor with TMSOTf in DCM at -20 °C gave the protected cucurbitoside A **42**, and the <sup>F</sup>Car group was selectively removed with Bu<sub>4</sub>NNO<sub>2</sub>. Its stability to most reaction conditions and orthogonal deprotection conditions make it an excellent late-stage protecting group. This example represents one of the few cases of fluororous tag-assisted bidirectional synthesis.

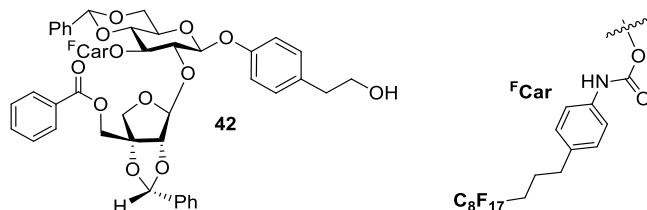
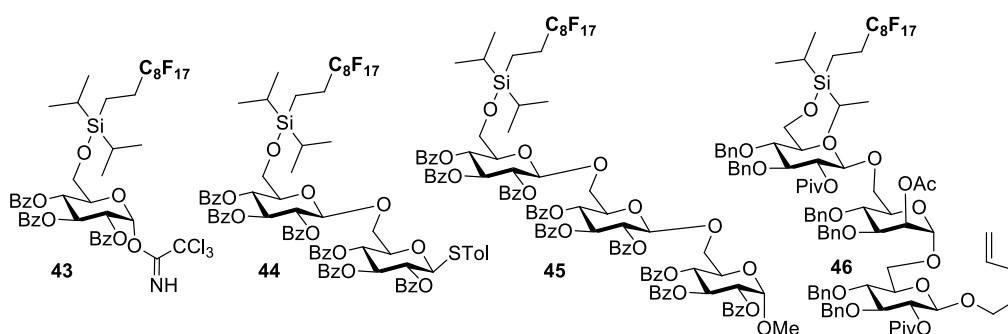

Figure 21: Light fluororous *N*-phenylcarbamoyl (<sup>F</sup>Car) protecting group

### Fluorous silyl groups

Zhang et al. from the Liu group reported one of the few clearcut examples of iterative non-reducing-to-reducing oligosaccharide synthesis, using a single silyl fluororous tag on the trichloroacetimidate acceptor<sup>356</sup> (Fig 22). The approach uses an excess glycosyl acceptor to ensure a high yield with respect to the F-tagged donor. The product formed after each glycosylation cycle is purified by simple fluororous solid-phase extraction (FSPE). The excess glycosyl acceptor is recovered and reused. A fluororous silyl group was attached to the primary hydroxyl group of the trichloroacetimidate glycosyl donor **43**. Three equivalents of the toluyl thioglycoside acceptor were coupled with the tagged donor in anhydrous DCM at -40 °C in the presence of a catalytic amount of TMSOTf. The anticipated disaccharide **44** was isolated in 92.5% yield by FSPE. Thus, 95% of the excess glycosyl acceptor was recovered in pure form and could be recycled. The disaccharide was subsequently converted into the

trichloroacetimidate and purified by silica gel chromatography. After another cycle of glycosylation and F-SPE, the protected trisaccharide **45** was obtained in 93.7% yield (Fig 22) along with the excess glycosyl acceptor in 98% recovery.



**Figure 22:** Non-reducing-to-reducing synthesis using a fluorous silyl protecting group

### *Cap and Tag solid-state oligosaccharide synthesis*

The Seeberger group used the same fluorous silyl tag in a novel capping-and-tagging (cap-tag) strategy to facilitate the purification of oligosaccharides prepared by automated solid-phase synthesis. Cap-tags render deletion sequences silent in subsequent coupling reactions. A first incarnation also separates unwanted, capped, and tagged products from the desired, untagged ones. Palmacci et al. reported that introducing fluorous silyl ether caps (F-Cap-tags) during automated solid-phase synthesis of oligosaccharides greatly simplifies post-synthetic workup and purification, as demonstrated for the syntheses of several trisaccharides.<sup>357</sup> The F-cap-tagged deletion sequences were easily separated from the desired untagged product by FSPE. In a second incarnation, Carrel and Seeberger used pivaloyl caps during the automated solid-phase synthesis and the silyl fluorous F-Tag to cap the final desired oligosaccharide, which could be easily purified by gradient fluorous solid-phase extraction (FSPE), as illustrated by the synthesis of a model trisaccharide **46** (Fig 22).<sup>358</sup> Liu et al. carried the concept further by combining solid-state and fluorous tag-assisted oligosaccharide synthesis. They performed the final glycosylation with a fluorous ester-tagged trichloroacetimidate glycoside donor to synthesize a complex glycopeptide fragment.<sup>359</sup>

### *Fluorous mixture synthesis of oligosaccharides*

Tojino and Mizuno demonstrated solution-phase chemistry with fluorous tags for carbohydrate mixture synthesis and deconvolution.<sup>360</sup> Fluorous oligosaccharide libraries were formed by fluorous mixture synthesis (FMS) using 4-alkoxyphenyl fluorous labels of different lengths at the anomeric position of the glycosyl acceptor, and either a fluorous ester tagged or an untagged glycosyl donor (Fig 23). Glycosylation of a mixture of three galactose acceptors bearing C<sub>4</sub>F<sub>9</sub>, C<sub>6</sub>F<sub>13</sub>, or C<sub>8</sub>F<sub>17</sub> alkoxyphenyl tags with a mixture of the trichloroacetimidate of galactose taking a C<sub>3</sub>F<sub>7</sub>-tagged ester group and the trichloroacetimidate of peracetyl 2-azidoglucose under standard conditions provided a combination of six disaccharides **47-52**. Preparative fluorous silica gel HPLC resolved all six products, eluted in the order of total fluorine content of the tags. This method has the advantage of a single reaction mixture and separation for synthesizing six products and could be applied to oligosaccharide libraries consisting of two sets of structural units.

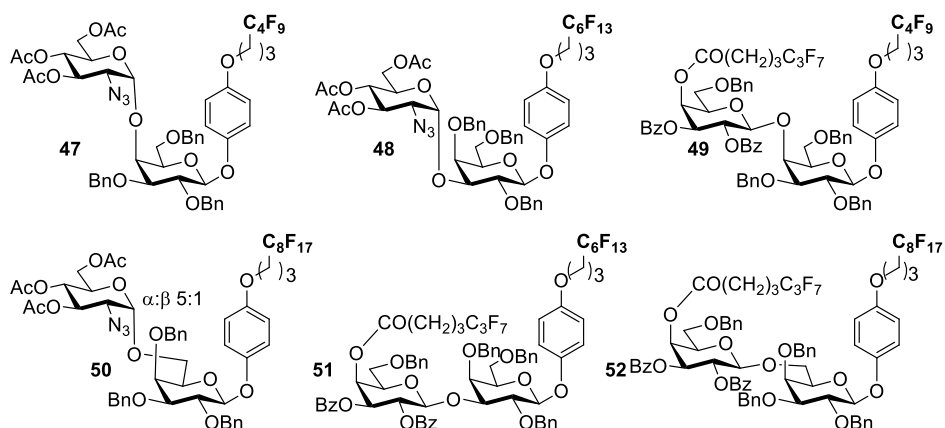
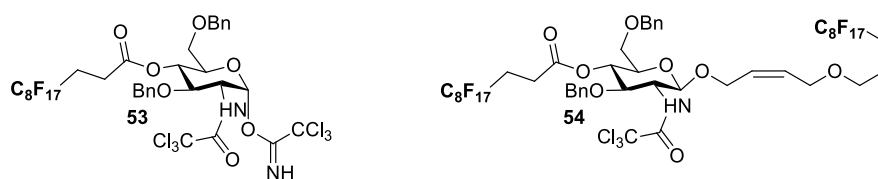

**Figure 23:** Fluorous mixture synthesis of a disaccharide library, in order of elution by F-HPLC

## Iterative protecting group fluorous tags

### *Double fluorous tag for reducing-to-non-reducing iterative oligosaccharide synthesis*

In the iterative reducing-to-non-reducing oligosaccharide synthesis requires a glycosyl donor with an "iterative" protecting group, which can be deprotected in the presence of all other protecting groups for the free hydroxyl to react with the next glycosyl donor. However, any of the fluorous late-stage protecting groups above can, in principle, be used as an iterative protecting group. Only the Pohl group has explicitly reported an oligosaccharide synthesis with an iterative fluorous group, using a double fluorous label strategy for the synthesis of *N*-acetyl glucosamine oligomers. Park et al. selected an ester-fluorous protecting group among the different functionalities of fluorinated-protecting groups for its simple and readily automated deprotection conditions. The protected glucosamine trichloroacetamide donor **53** was coupled to the anomeric bis-allylic fluorous tag with TMSOTf in toluene at 0 °C to provide the doubly-tagged compound **54**. (Fig 24). Clear cut separation was achieved by FSPE, eluting with increasing proportions of methanol in water. The excess donor eluted first, followed by unreacted/excess reagents. The desired doubly-tagged product was retained on the fluorous cartridge and thus eluted last from the cartridge using 100% methanol as eluent.<sup>361</sup> Deprotection of the ester fluorous tag and isolation of the glycosyl donor by extraction in toluene gave the glycosyl acceptor for iterative reducing to the non-reducing synthesis of oligomers of *N*-acetylglucosamine with the glycosyl donor **53**.



**Figure 24:** Iterative acyl fluorous tag for reducing-to-non-reducing oligosaccharide synthesis

The first chemical synthesis of the conserved oligosaccharide unit corresponding to the dengue virus set out further progress by the Liu group.<sup>362</sup> Zhang, Liu, and Liu reported that coupling a light-fluorous-tagged glycosyl donor to the untagged acceptor **55** gave the tetrasaccharide **56**. The fluorous benzoyl group was designed and synthesized to withstand the acidic coupling conditions and yet be removable with a catalytic amount of base. The di-fluorous tagged strategy allowed the authors to efficiently separate the desired tetrasaccharide from the mono-fluorous-tagged donor and mono-adduct trisaccharides and the untagged glycosyl acceptor by FSPE using a water-methanol-

dichloromethane eluent (Fig 25). The convergent synthetic strategy offers high synthetic efficiency and significant savings in both time and solvents.

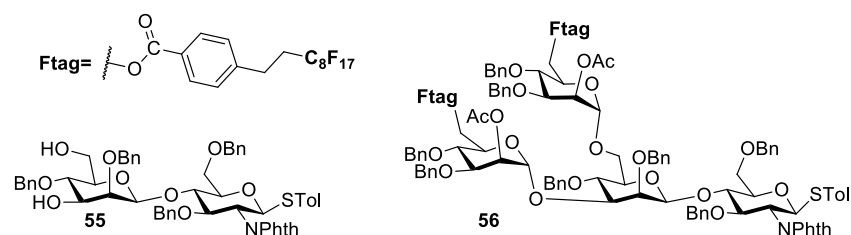

**Figure 25:** Double light fluororous tag strategy for oligosaccharide synthesis

Kojima, Nakamura, and Takeuchi reported a light fluororous 4,6-*O*-<sup>F17</sup>benzylidene protecting group for fluororous tag-assisted carbohydrate synthesis.<sup>349</sup> Although the authors did not explicitly show its use as an iterative protecting group, their results do indicate that if the benzylidene were placed on the glycosyl donor, either hydrolysis or reductive cleavage of the 4,6-*O*-<sup>F17</sup>benzylidene acetal with Et<sub>3</sub>SiH-TFA or PhBCl<sub>2</sub> would enable reducing to the non-reducing iterative synthesis of 1,4- or 1,6-linked oligosaccharides.

### Fluororous thioglycosides as activatable group

Non-reducing-to-reducing and bidirectional oligosaccharide synthesis require the presence of an activatable group, which is inert as the sugar acts as a glycosyl acceptor and is then activated into a glycosyl donor for the next iteration. In principle, any of the anomeric protecting groups described in section 3 can be cleaved selectively to provide the free sugar, which can then be activated. However, thioglycosides are particularly popular activatable groups, as they are relatively inert yet can be activated oxidatively. Goto, Nuermair, and Mizuno reported the synthesis of a heavy fluororous thioglycoside **57** and showed its ability to act as glycosyl donor and glycosyl acceptor.<sup>363</sup> Activation of the fluororous thioglycoside-bound donor **57** by NIS/TMSOTf afforded the disaccharide **58** in 71% yield (Fig 26). The same thioglycoside **57** was transformed to its 3-*O*-acetyl-6-*O*-benzyl derivative to serve as a heavy fluororous acceptor. Glycosylation with the *N*-Phthglucosamine trichloroacetimidate with Cu(OTf)<sub>2</sub> in DCM at 0 °C gave the LacdiNPhth disaccharide **59**, a cancer-specific carbohydrate marker. Conversion of the thioglycoside with Br(CH<sub>2</sub>)<sub>6</sub>OH, NIS, and TMSOTf in DCM at 0 °C gave the disaccharide with an alkyl bromide chain for immobilization in 39% yield over six steps by partitioning between HFE7100:FC72 (2:1) and 95% aq. MeCN and single-column chromatography. These results clearly establish the use of this heavy fluororous tag for non-reducing-to-reducing oligosaccharide synthesis.

Jing and Huang reported a light tag fluororous anomeric thioglycoside activatable group in an armed and disarmed strategy for fluororous glycosyl building blocks **60-62** (Fig 26). The thioglycoside was stable under esterification, etherification, and deacetylation conditions. Still, it showed excellent reactivities in glycosylation reactions using several promotor systems such as *N*-iodosuccinimide (NIS)/AgOTf, NIS/TfOH, and *p*-TolSCl/AgOTf. Furthermore, the fluororous chain allowed for facile purification of the thioglycosides by fluororous solid-phase extraction. The fluororous thiol was recovered as the disulfide after the glycosylation reaction and could be recycled.<sup>364</sup> Although the authors did not demonstrate its use as a glycosyl acceptor; these results nonetheless set the basis for non-reducing-to-reducing F-tag assisted iterative oligosaccharide synthesis.

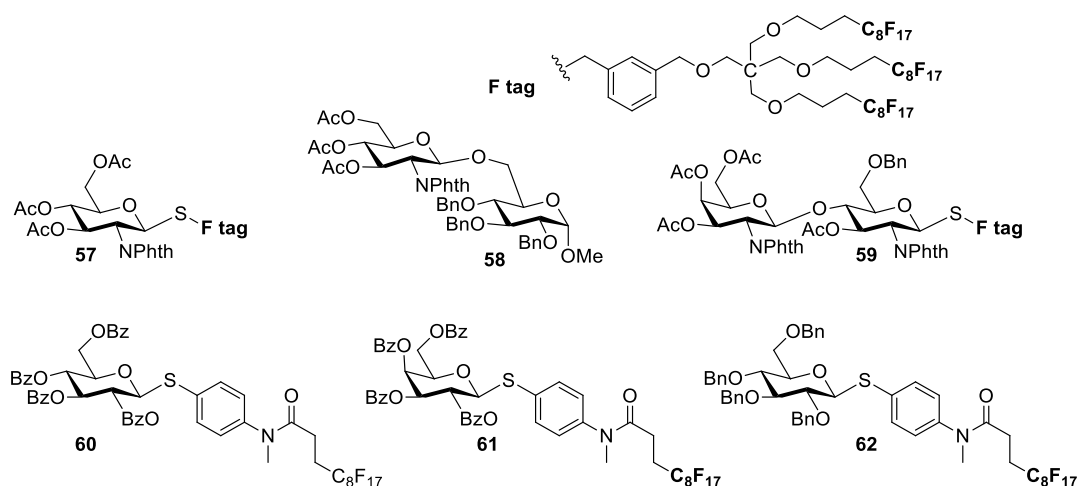

Figure 26: Activatable heavy and light thioglycoside fluorous tags

### Fluorous *N*-protecting groups

Carbohydrate compounds with amino functionality are the second most abundant group in the realm of sugar biology. In the context of polarity, basicity, or reactivity associated with the free amino, *N*-acetyl, or *N*-sulfate functionality of naturally occurring derivatives render them incompatible with many, if not most synthetic reaction conditions. Therefore, it is apparently necessary to be protected in the multistep synthetic scheme. Amino sugars are commonly protected using allyloxycarbonyl chloride (AllocCl), phthalic anhydride (Phth), 2,2,2-trichloroethyl chloroformate (TrocCl), and trichloroacetyl chloride (TCACl) to form carbamates or amides. Alternatively, the amino group can be carried as an azide ( $N_3$ ).

Most importantly, C2-participation by the protecting group of 2-aminosugars plays a crucial role in controlling the stereoselectivity of the glycosylation reactions. Still, the possibility of forming relatively stable oxazoline precludes the use of the acetyl group itself, as well as many of the more common amino protecting groups.<sup>365–367</sup> In most cases, deprotection of these groups in the target oligosaccharide affords the free amine, which is derivatized to the final *N*-acetyl or *N*-sulfate moiety. The trichloroacetyl amide, on the other hand, is transformed directly into an *N*-acetyl group in one step by reductive dehalogenation using AIBN and  $Bu_3SnH$ .<sup>368</sup> Unfortunately, inseparable mixtures may result from incomplete conversion when applied to higher oligosaccharides (e.g., hexamers), and removing the tin by-products can be a burden. Phthalimido groups require rather stringent deprotection conditions, which may lead to base-catalyzed side reactions, in particular in the case of uronic acids.<sup>369</sup> The Alloc group can be removed under mild conditions but does not tolerate *N*-iodosuccinimide and related halonium ion-mediated activation strategies of thioglycosides. To date, a small number of fluorous variants of nitrogen protecting groups that are amenable to fluorous separation and stereoselective glycosylation protocols of amines have been proposed. Of significant note is developing a new fluorous protecting group, Froc, analogous to the trichloroethoxycarbonyl (Troc) group frequently used in carbohydrate synthesis.<sup>370</sup> Tetra-*O*-acetylglucosamine was reacted with the FrocCl tagging agent with  $NaHCO_3/H_2O$  to give the corresponding Froc-protected glucosamine in excellent yield. Subsequent conversion steps afford the fluorous glycosyl acceptor **63**, which was then coupled with tetra-*O*-acetylgalactose trichloroacetimidate as glycosyl donor, mediated by TMSOTf in  $CH_2Cl_2$ , to furnish the desired fluorous tagged Gal- $\beta$ 1,3-GlcNAc disaccharide **64** in 85% yield (Fig 27). Purification of the products was generally performed by standard fluorous solid-phase extraction techniques (F-SPE), but standard chromatographic purifications are also possible. The Froc

group can be deprotected under mild conditions with zinc in acetic acid. By analogy to the Troc group and based on the results below, the Froc group is expected to act as an efficient C2-participating group, although its use as a glycosyl donor has not yet been explicitly demonstrated.

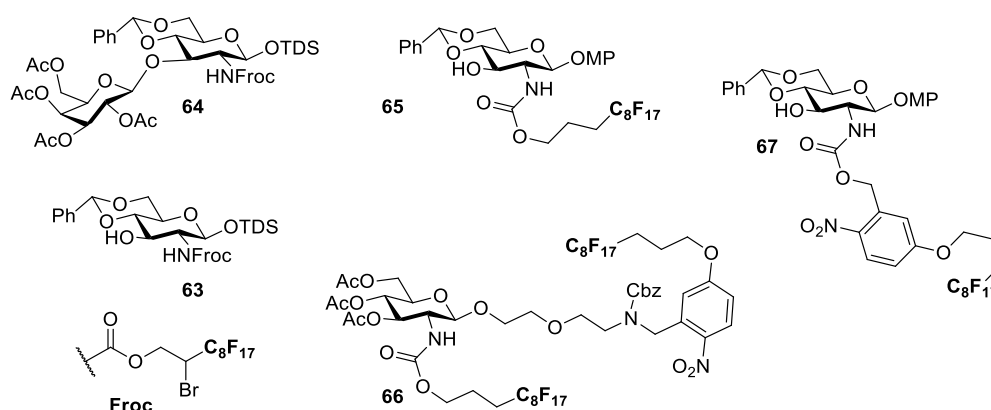

Figure 27: N-Fluorous tags for amino sugars.

Two new fluoruous photolabile-protecting groups (FNBC and FNB) and a base-labile protecting group (FOC) were reported by Roychoudhury and Pohl as new carbamate-type amine-protecting groups.<sup>371</sup> Their chemical precursors could be made from nontoxic reagents amenable to scale up. The FOC (1-(((4,4,5,5,6,6,7,7,8,8,9,9,10,10,11,11,11-heptadecafluoroundecyl)oxy)carbonyl) *N*-methyl imidazolium reagent could be added to tetra-*O*-acetyl glucosamine, leading to the FOC protected monosaccharide **65** after several common protection/deprotection steps, which the urethane was found to survive, including basic and acidic conditions. The FOC group was found to be an effective C2-participating group under  $\text{BF}_3$ -etherate mediated glycosylation of the tetracetate to yield **66**, for example. Given FOC stability under Zemplén conditions, a strongly basic medium was used for deprotection, as the free amine was obtained using refluxing 6 M aqueous sodium hydroxide and subsequently acetylated to provide the *N*-acetylated moiety.

A linker bearing a fluoruous amine protected with an FNB (fluoruous *o*-nitrobenzyl) group was coupled with the FOC-protected tetra-*O*-acetylglucosamine to provide the doubly tagged molecule **66**. The FNB could be cleaved in high yield in the presence of FOC by light sources of wavelengths ranging from 300 to 365 nm to provide the Cbz-protected amine. In addition, a fluoruous variant of the Cbz group, FNBC (fluoruous *o*-nitrobenzyl carbamate) group, was also prepared to facilitate stereoselective glycosylation through anchimeric assistance. The tagged substrate **67** was designed to show the group's tolerance to various protection/deprotection conditions and its ability to act as a C2-participating group to introduce *p*-methoxybenzyl alcohol (Fig 27). Unfortunately, the photochemical deprotection was relatively low yielding, but it may be possible to cleave the group under non-photochemical conditions.

### Fluorous phosphate protecting groups

Liu and Pohl reported a fluoruous protecting group for the phosphate groups.<sup>372</sup> The tag is designed based on the fluoruous halo alcohol to facilitate purification in the synthesis of sugar phosphates. Due to its stability towards glycosylation protocols and orthogonality to other protecting groups, its application for synthesizing a disaccharide **68** from *Leishmania* was demonstrated in 94% yield. Deprotection was successful under mild reducing conditions using  $\text{Zn}/\text{NH}_4\text{HCOO}$  in  $\text{CH}_3\text{CN}/\text{THF}$  within 2h. The fluoruous phosphate group was applied to synthesize maltotrioxide phosphate isomers to probe the Laforin enzyme activity by determining the most likely *in vivo* substrate for this enzyme.<sup>373</sup>

Unfortunately, the glycosylation of the fluoros phosphate gave the disaccharide **69** in poor yield as an inseparable  $\alpha,\beta$ -mixture. Nonetheless, the fluoros phosphate group eases purification of the intermediates and alternative to the late-stage installation of the phosphate group (Fig 28).

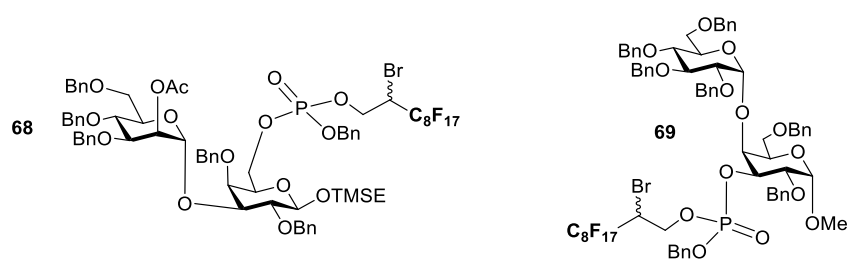

**Figure 28:** Fluorous tagged protecting group for phosphate.

## RESULTS AND DISCUSSION

As seen above, there are several strategies for the application of fluoros tags to oligosaccharide synthesis. Traditionally, a single fluoros tag, particularly on the glycosyl acceptor, was used for reducing to nonreducing oligosaccharide assembly. This permits separation of coupled product from excess non-fluorous-tagged glycosyl donor. A double fluoros tag approach employs fluoros motifs on both reaction substrates to separate the coupled oligosaccharide from both unreacted glycosyl donor and acceptor. Our interest focused on the application of differentially fluoros-tagged glucosamine glycosyl donors and acceptors, each bearing fluoros tags of different lengths, with the objective to separate the excess recovered donor, the unreacted acceptor, and the desired coupled glycoside, using simple purification protocols. Ideally, the precursors can be recovered in high purity, and thus be easily reusable for future couplings.

By virtue of these objectives, and with an eye to the synthesis of the *E. coli* O142 O-antigen (Figure 7), we set out to synthesize glucosamine  $\beta(1\rightarrow3)$  glucosamine disaccharides as model compounds to evaluate the feasibility of such a fluoros tag assisted strategy in our case. We chose to attach the fluoros tag on the C2 position of the glucosamine to study its capacity for anchimeric participation for the formation of 1,2-trans glycosidic bonds. The use of other C2 participating groups such as acetlys or most carbamates is particularly challenging because of the propensity for the formation of stable oxazolines. However, we cannot completely underestimate the utility of variety of non-fluorous N-protecting groups (preparation and deprotection conditions of selected groups mentioned earlier), applicable to glucosamines as depicted in the later table (table 1). Development of promising activatable anomeric leaving groups on the N-acetyl and other N-protected glucosamine have been clearly reviewed,<sup>374,375</sup> and advances in reagent combinations are evolving to enhance reactivity. Nonetheless, fluoros tagged glucosamine donors provide additional innovation to undoubtedly facilitate rapid oligosaccharide synthesis and facile purification, thereby raising final yield of the products. For this reason, we chose not to isolate the fluoros moiety from the carbonyl group, but instead, take full advantage of the inductive effects of the fluoros amides. Other issues to address include the poor reactivity and solubility of glucosamines, and thus, we hope that our synthetic design could help attenuate these problems to set the basis for assembly of more complex oligosaccharides.

In our initial studies, we chose to investigate the glycoside coupling reaction between two fluoros tagged D-glucosamine derivatives. We placed either a short or a long chain fluoros amide on nitrogen as a fluoros tag and a potential C-2 participating group (Fig 29). The combination of long and short tags may allow for easy separation of the two monosaccharides and the coupled product. The



trichloroacetimidate was chosen as the activating group on the donor and a thiophenyl glycoside as the activatable group on the glycoside acceptor for eventual iterative synthesis. A careful choice of convenient protecting groups on both the donor and the acceptor is also important in order to realize the synthesis. Acetate groups were chosen on the donor in preference over other commonly used ether groups such as TBS (tertbutyldimethylsilyl), TIPS (triisopropylsilyl), and PMB (4-methoxybenzyl) for convenience, but can be replaced with an orthogonal protecting group scheme for bidirectional synthesis. The 3-hydroxyl glucosamine acceptors are deactivated by the intramolecular hydrogen bond with the amide, which provides an additional challenge for the synthesis. We initially chose the 4,6-*O*-benzylidene group for its convenience, despite its limited stability to the glycosylation conditions. The synthesis of the glucosamine acceptors and donors are described in this chapter.

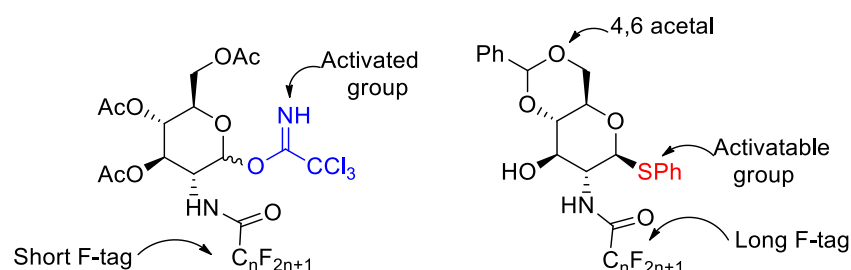

**Figure 29:** Initial design of the glycosyl donor and acceptor

## Synthesis of F-tag donors

### *C<sub>7</sub>F<sub>15</sub>* F-tag acetylated donor

The fluorous tag glycosyl donors were all derived from 1,3,4,6-tetra-*O*-acetyl- $\beta$ -D-glucosamine hydrochloride by amide formation with a fluorous carboxylic acid derivative, followed by deprotection at the C-1 position and conversion to the OTCA glycoside donor (Scheme 1). The long chain donor *N*-pentadecafluorooctanoyl glucosamine **71** was prepared using the commercial acid chloride (1.2 equiv.) catalyzed by DMAP (3 equiv.), which effectively yielded the long chain *N*-perfluorous amide **69** in 100% yield. Initial attempts by formation of the acid chloride from pentadecafluorooctanoic acid and thionyl chloride gave a very poor yield. The anomeric position was then selectively deprotected with hydrazine acetate to yield **70** in 87% yield. Treatment of trichloroacetonitrile (29.7 equiv.) in the presence of  $\text{Cs}_2\text{CO}_3$  (0.6 equiv.) base to the free hemiacetal **70** gave the long *N*-fluorous amide trichloroacetimidate donor **71** after chromatographic purification on silica gel in 98% exclusively as  $\alpha$  anomer.

### *C<sub>3</sub>F<sub>7</sub>* F-tag acetylated donor

Tetra-*O*-acetyl-glucosamine hydrochloride as starting material was treated with 3 equiv. of DMAP and heptafluorobutyric anhydride (1.2 equiv.) in anhydrous dichloromethane (DCM) to provide the perfluoropropyl fluorous amide **72** in 62% yield after silica gel chromatography. Selective deprotection of the anomeric ester with hydrazinium acetate in tetrahydrofuran (THF) gave the hemiacetal **73** in 79% yield as a mixture of  $\alpha$  and  $\beta$  isomers, in which the  $\alpha$ -anomer was major. Formation of the donor **74** with trichloroacetonitrile (29.7 equiv.) in the presence of  $\text{K}_2\text{CO}_3$  in dichloromethane provided a separable mixture of anomers in varying ratios up to 84% yield. The major alpha isomer was used in subsequent coupling reactions (Scheme 1).

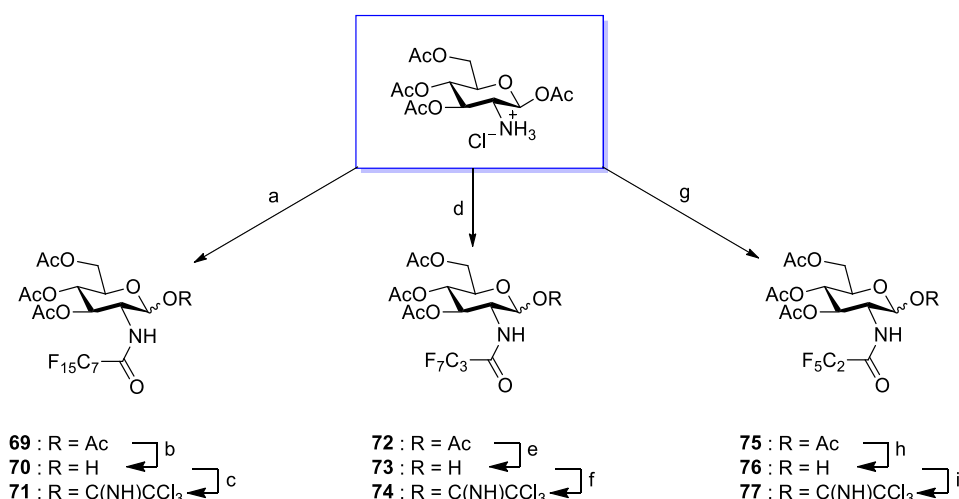

**Scheme 1: Reagents and condition:** a) C<sub>7</sub>F<sub>15</sub>COCl, DMAP, DCM, rt, 17h, 100%; (b) NH<sub>2</sub>NH<sub>3</sub>OAc, THF, 54 °C, 2h, 87%; (c) CCl<sub>3</sub>CN, Cs<sub>2</sub>CO<sub>3</sub>, DCM, MS 3Å, rt, 3.5h, 98%; (d) (C<sub>3</sub>F<sub>7</sub>CO)<sub>2</sub>O, DMAP, DCM, rt, 48h, 62%; (e) NH<sub>2</sub>NH<sub>3</sub>OAc, THF, 54 °C, 2h, 79%; (f) CCl<sub>3</sub>CN, K<sub>2</sub>CO<sub>3</sub>, DCM, MS 3Å, rt, 3.5h, 84%; (g) (C<sub>2</sub>F<sub>5</sub>CO)<sub>2</sub>O, DMAP, DCM, rt, 48h (h) NH<sub>2</sub>NH<sub>3</sub>OAc, THF, 54 °C, 2h, 74%; (i) CCl<sub>3</sub>CN, K<sub>2</sub>CO<sub>3</sub>, DCM, MS 3Å, rt, 3.5h, 50%.

### C<sub>2</sub>F<sub>5</sub> F-tag acetylated donor

The synthesis of perfluoroethyl (C<sub>2</sub>F<sub>5</sub>) tagged donor began in the same manner with tetra-*O*-acetylglucosamine hydrochloride with perfluoropropionic anhydride (1.2 equiv.) and 3 equiv. of DMAP catalyst in dry dichloromethane (DCM) to provide the fluorous amide **75** in 74% yield. Selective anomeric deacetylation was performed with hydrazinium acetate in tetrahydrofuran (THF), that afforded 74% free hemiacetal **76** as a mixture of  $\alpha$  and  $\beta$  isomers, in which the  $\alpha$ -anomer was again major. Finally, the mini fluorous tagged donor **77** was accomplished when treated with a combination of trichloroacetonitrile (29.7 equiv.) and K<sub>2</sub>CO<sub>3</sub> in dry dichloromethane, provided a separable mixture of anomeric acetimidates in varying ratios up to 50% yield (Scheme 1).

### C<sub>7</sub>F<sub>15</sub> F-tag perbenzoylated donor

In order to fully cover our studies, we prepared a donor with the more robust benzoyl protecting groups in place of the acetyls, in particular for the long C<sub>7</sub>F<sub>15</sub> fluorinated tagged building block. The previously prepared perbenzoylated-*N*-allyloxy-glucosamine **78** was deprotected to the free amine by the action of diethylmalonate (DEM) over tetrakis-(triphenylphosphino)-palladium Pd(PPh<sub>3</sub>)<sub>4</sub> in THF for 40hrs. After careful chromatographic separation of the yellow crude mixture on silica gel, the desired compound was obtained in 57% yield as a white foam **79**. Scaling up this step was less efficient because the recovered DEM was quite cumbersome to remove due to the similar R<sub>f</sub> value with desired product even when several eluent systems were tested. The fluorous amide functionality was introduced as with peracetate analogue using pentadecafluorooctanoyl chloride and DMAP at room temperature overnight. After purification, compound of interest **80** was obtained at 91% yield. In order to remove the anomeric benzoyl group selectively, we treated the 1,3,4,6-tetra-*O*-benzoyl-2-deoxy-2-(8,8,8,7,7,6,6,5,5,4,4,3,3,2,2-pentadecafluorooctanoyl-amido)- $\beta$ -D-glucopyranoside (**79**) with methylamine in absolute EtOH for 1h in THF. Chromatographic separation delivered the free hemiacetal mixture of  $\alpha/\beta$  anomers **81** as colorless crystal in 99% yield. This is followed by acetimidate formation as previously following similar procedures, to provide the trichloroacetimidate **82** exclusively with the  $\alpha$  configuration (Scheme 2).

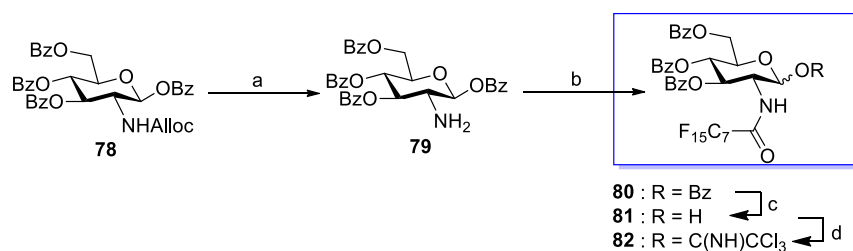

**Scheme 2: Reagents and conditions:** (a) DEM (8 eq.), Pd(PPh<sub>3</sub>)<sub>4</sub> (0.05eq.), THF, rt, 40 h, 57%; (b) C<sub>7</sub>F<sub>15</sub>C(O)Cl (1.1eq.), DMAP (3eq.), DCM, rt, overnight, 91%; (c) methylamine, THF, rt, 1h, 98%; (d) CCl<sub>3</sub>CN (31eq.), Cs<sub>2</sub>CO<sub>3</sub> (0.6eq.), MS 3Å, DCM, rt, overnight, 63%.

## Synthesis of F-tag acceptors

### C<sub>7</sub>F<sub>15</sub> F-tag acceptor

The synthesis of the first series of glycosyl acceptors was based on the strategy towards doubly tagged *N*-fluorous amide 1,3-disaccharides shown above (Scheme 1). The synthesis of the C<sub>7</sub>F<sub>15</sub>-tagged acceptor **85** began from the peracetylated *N*-fluorous amide **69** prepared above by acid-promoted substitution of the acetate at the C-1 position of the with thiophenol in the presence of BF<sub>3</sub>·OEt<sub>2</sub> in dichloromethane, which yielded the thioglycoside **83** in 87% yield with good β-selectivity (Scheme 3). The 3,4,6-*O*-triacetate-β-D-glucosamine thioglycoside **83** was deacetylated in the presence of MeOH:DCM and K<sub>2</sub>CO<sub>3</sub> as a base to form the corresponding triol **84** in 73% yield. This is followed by transacetalisation of the *O*-4 and *O*-6 hydroxyls with benzaldehyde dimethyl acetal in acetonitrile and toluenesulfonic acid (TsOH·H<sub>2</sub>O) to furnish the benzylidene **85** in 60% yield having the free *O*-3 hydroxy alcohol as the reactive position of the nucleophilic glycoside acceptor.

The triol intermediate **84** was subsequently dissolved in acetonitrile and treated with 2,2-dimethoxypropane (DMP), and 1.5eq. of TsOH·H<sub>2</sub>O in an attempt to prepare the corresponding 4,6-*O*-acetonide. Unfortunately, this was not successful, even when additional reagent was added, and the reaction was left stirring for some days. Delightfully, changing the solvent to dimethyl sulfoxide (DMSO) at elevated temperature (50 °C) overnight formed desired acetonide-protected glycosyl acceptor **86** in 41% yield.

### C<sub>3</sub>F<sub>7</sub> and C<sub>2</sub>F<sub>5</sub> F-tag acceptors

The previously prepared C<sub>3</sub>F<sub>7</sub> fluorous amide peracetate **72** was similarly converted to the phenyl thioglycoside **87**, which was deacetylated and transformed into the 4,6-*O*-benzylidene **89** by transacetalisation in the presence of benzaldehyde dimethyl acetal and TsOH·H<sub>2</sub>O in acetonitrile in 89% overall yield.

The C<sub>2</sub>F<sub>5</sub> F-tagged acceptor was similarly synthesized by an intern in our group, Aleida Gonzales, and it was utilized in the later studies below (Scheme 3).

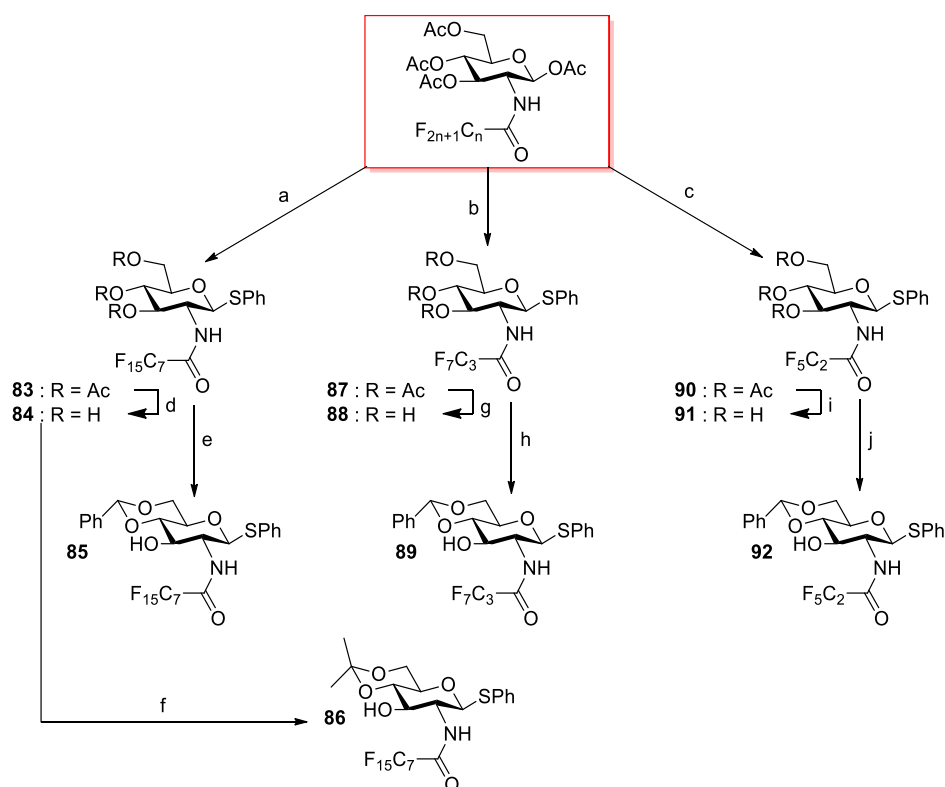

**Scheme 3: Reagents and conditions:** (a) PhSH (2eq.),  $\text{BF}_3\text{OEt}_2$  (5eq.), DCM, rt, 5h, 83%; (b) as a, 73%; (c) as in a, 82% (d)  $\text{K}_2\text{CO}_3$ , MeOH, rt, 4h, 89%; (e) benzaldehydedimethylacetal (2.9eq.), TsOH-H<sub>2</sub>O (1.5eq.), MeCN, rt, 48h, 60%; (f) DMP (6eq.), TsOH-H<sub>2</sub>O (1.5eq.), DMSO, 50 °C, 48h, 41%; (g) as in d, 75%; (h) as in e, 89%; (i) as in d, 87%; (j) as in e, 93%.

## Synthesis of non-fluorous glycosyl acceptors

In order to determine the effect of the fluorous amide on the glycoside coupling reaction, and in particular the effect of the hydrogen bond between the fluorous amide and the nucleophilic 3-hydroxyl group, we also prepared a number of non-fluorous glycoside acceptors. A number of common non fluorous glycosamine acceptors were available within the group, and their synthesis is not detailed here.

### Synthesis of 2-azido glycosyl acceptors

We undertook a plan to synthesize 1,6-anhydro-2-azido-2-deoxy-4-*O*-benzyl and or 4-*O*-p-methoxybenzyl glucoside derivatives with an eye towards biologically relevant molecules to be discussed in the coming chapters. Hence, we first envisioned to prepare both triacetyl glucal and galactal as illustrated in scheme 4.<sup>376</sup> One-pot preparation of peracetylated glycosyl bromides from glucose and galactose was carried out by the action of excess acetic anhydride and a catalytic amount of HBr/acetic acid to effect peracetylation at ambient temperature, followed by the addition of excess HBr/acetic acid to allow for complete transformation to the anomeric peracetyl glycosyl bromides. The lower temperature is significant to circumvent formation of a furanosyl acetate byproduct. The excess HBr of the reaction mixture was neutralized with sodium acetate and the resulting solution was poured into a suspension of Zn/CuSO<sub>4</sub> in water and acetic acid buffered with sodium acetate. Upon aqueous work-up, and solvent evaporation in vacuo, silica gel flash column chromatography delivered extremely pure samples of the two triacetylated glycols as clear oils (**95** and **96**) as confirmed by NMR analysis in good to excellent yields (Table 1). Removal of the acetyl groups from **95/96** under Zemplén conditions<sup>377</sup> was followed by oxidative cyclization of the glycols to 1,6-anhydro-2-deoxy-2-iodo-β-D-

glycopyranoses (**97** and **98**) in one step, by treatment with bis (tributyltin) oxide in anhydrous acetonitrile and later followed by the addition of iodine (I<sub>2</sub>) to afford the target compounds.

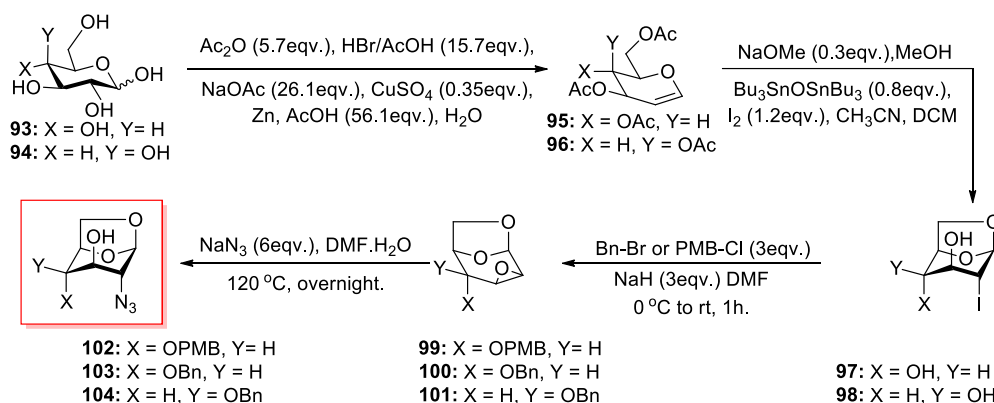

**Scheme 4:** (step 1) Ac<sub>2</sub>O (5.7eqv.), HBr/AcOH (15.7eqv.), NaOAc (26.1eqv.), CuSO<sub>4</sub> (0.35eqv.), Zn, AcOH (56.1eqv.), H<sub>2</sub>O; X = OAc, at 79%, Y = OAc at 76%; (step 2) NaOMe (0.3eqv.), MeOH, Bu<sub>3</sub>SnOSnBu<sub>3</sub> (0.8eqv.), I<sub>2</sub> (1.2eqv.), CH<sub>3</sub>CN, DCM; X = OH at 46%, Y = OH at 41% (step 3) PMB-Cl/ Bn-Br (3eqv.), NaH (3eqv.) DMF; Note: X = OPMB at 40%, X = OBn at 99% (Glc), Y = OBn at 93% (Gal); (step 4) X = OPMB at 76%, X = OBn at 70%, Y = OBn at 89%.

We observed in our case that it was quite imperative to ensure a highly inert atmosphere in this conversion and the later step involving addition of iodine could be performed in dry DCM by careful removal of former solvent (acetonitrile) with improved yield.

With this reactive intermediate in hand, we anticipated to employ the fast one-pot procedure to Cerny epoxides (1,6:2,3-dianhydrohexopyranoses) and at the same time protect the C-4 alcohol by treatment of the 2-iodo derivative above with either benzyl bromide and or *p*-methoxybenzyl chloride in DMF at 0 °C to rt. After purification on silica gel, the desired compounds (**99-101**, entry 3; table 1) are isolated in excellent yield and high purity. This method facilitates rapid alkylation of C-4 of the dianhydro epoxide in one step,<sup>378</sup> with a variety of protecting group reagents.

**Table 1:** Yields for the synthesis of 1,6-anhydro glycosyl intermediates **95-104**.

Entry	Compound	X/Y	Yield (%)
1	<b>95</b> -Glc	X = OAc	79
	<b>96</b> -Gal	Y = OAc	76
2	<b>97</b> -Glc	X = OH	46
	<b>98</b> -Gal	Y = OH	41
3	<b>99</b> -Glc	X = OPMB	40
	<b>100</b> -Glc	X = OBn	99
	<b>101</b> -Gal	Y = OBn	93
4	<b>102</b> -Glc	X = OPMB	76
	<b>103</b> -Glc	X = OBn	70
	<b>104</b> -Gal	Y = OBn	89

Finally, we selectively opened the 2,3-epoxide by nucleophilic addition of NaN<sub>3</sub> in aqueous DMF at 120 °C overnight to afford the trans diaxial adducts (**102-104**, entry 4; table 1) efficiently and in an appreciable yield. Henceforth, the number of steps is minimized, and other functionalities can be installed at the different positions via suitable reactions.

The established azido alcohol intermediates **102-104** are key molecules in our synthetic efforts towards both 1,3- and 1,4 linked glycosamine disaccharides and constitute in as of themselves potential glycosyl acceptors, albeit highly hindered ones. Further structural modification provides a 3-OH nucleophilic acceptors that are relatively analogous to the F-tagged amide acceptors prepared previously (Scheme 5). The intermediate 1,6-anhydro azido alcohol compounds **103-104** were dissolved in a separate reaction (for each compound) in dry DCM under an inert atmosphere which were treated with TMSSPh and ZnI<sub>2</sub> in the presence of flame-activated molecular sieves (3Å) to install the iterative thioglycoside functionality at the anomeric position that can be further activated selectively for oligosaccharide elongation. The 3-O/6-O diol thioglycosides formed a mixture of stereoisomers  $\alpha/\beta$ , 1:8 as determined by NMR for the glucoside (**105a, b**) and 2:3 separable mixture for the galactoside sugar (**106a, b**), respectively. Although the stereochemistry of the phenyl glycoside has no significant impact on the subsequent chemistry, it would be unreasonable to attempt to develop new chemistry on a mixture of compounds. The separation of the thioglycoside anomeric mixtures however was extremely difficult on either traditional silica gel or reverse phase column chromatography (table 1). The 6-O alcohol was regioselectively silylated with *tert*-butyl diphenyl silyl chloride and imidazole at room temperature to afford 6-O-silyl molecule after silica gel column in an excellent yield for both sugars (**107/108**, entry 2; table 2).

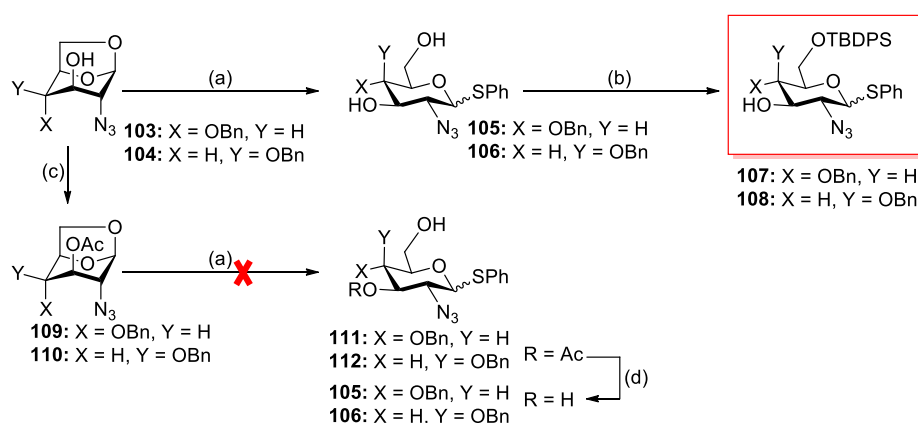

**Scheme 5: Reagents and Conditions:** (a) TMSSPh (3.4eqv.), ZnI<sub>2</sub> (3eqv.), DCM, 3 h, rt; (b) TBDPS-Cl (1.2eqv), Imidazole (2.3eqv.), DCM, 2.5 h, rt; (c) Ac<sub>2</sub>O (25.3eqv.), Pyr., 0 °C to rt, 2 h; (d) NaOMe, MeOH, rt. X/Y = OBn. See table 2 for yields.

In an attempt to improve the yield and stereochemical outcome for the 1,6-anhydro ring opening, and of particular importance, to avoid the tedious separation of thioglycopyranoside anomers, we investigated another approach by prior acetylation of the benzyl-protected azido alcohols (**103** and **104**) in acetic anhydride and pyridine delivering excellent yield of the acetates **109** and **110**, entry 3; table 2. It was hoped that the acetate may provide a kinetic 3-O-anchimeric assistance or facilitate thermodynamic equilibration of the product. Unfortunately, subjecting the acetylated compound to the same TMSSPh, ZnI<sub>2</sub>, molecular sieve combinations did not yield the desired product, thus only starting material was recovered with this derivative. Therefore, acetylation apparently stabilizes the bicyclic compound in this reaction, and hence, the target molecule was not obtained by this route. We sought an alternative route to successfully convert these intermediates to the thioglycosides of interest. The action of Ac<sub>2</sub>O in TFA on either the 3-O-acetylated or the unacetylated bicyclic galactopyranose **104** or **110** led to the formation of tri-O-acetyl compound **114** (Scheme 6 and entry 5; table 2), with improved yield (96%), though as an inseparable mixture of anomeric acetates ( $\alpha/\beta$ ; 3.7/1). Selective displacement of the anomeric acetate with thiophenol mediated by a Lewis acid (BF<sub>3</sub>·OEt<sub>2</sub>) gave di-O-acetates thiogalactopyranoside **116** in good yield 80% as an easily separable 1/2

mixture of  $\alpha/\beta$  anomeric products. This route incidentally solved the supply shortage of the TMSSPh reagent that we experienced at the time. Following deacetylation and selective silylation of 6-OH as shown previously delivers sufficient supplies of the target glycoside acceptors **108**, at least in the galactose series.

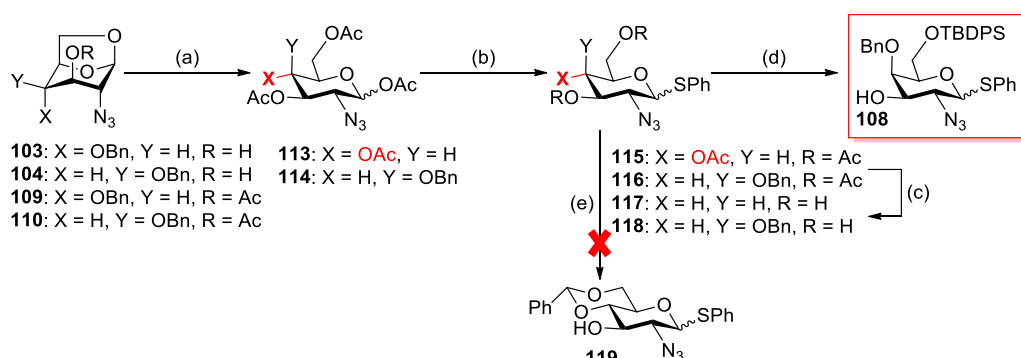

**Scheme 6: Reagents and Conditions:** (a) Ac<sub>2</sub>O (63.88eqv.), TFA (6.83eqv.), 0 °C rt, overnight; (b) Thiophenol, BF<sub>3</sub>-OEt<sub>2</sub>, DCM, rt, 4.5 h; (c) NaOMe (0.3eqv.), MeOH, rt, overnight; (d) TBDPS-Cl (1.2eqv), Imidazole (2.3eqv.), DCM, 2.5 h, rt. X/Y = OBn. See table 3 for yields.

The action of acetic anhydride on either 1,6-anhydro-2-azido-2-deoxy-4-*O*-benzyl- $\beta$ -D-glucopyranose **103** or its acetylated form **109** with trifluoroacetic acid and or triflic acid gave a rather a different outcome, and resulted in an unwanted product, 1,3,4,6-tetra-*O*-acetyl-2-azido-2-deoxy glucopyranose **113** in an excellent yield (69-99%, mixture of anomers). The 4-*O*-benzyl group unfortunately could not withstand these conditions in the glucose series (entry 5, table 2). On the other hand, the galactose series of similar compounds **103** and **110** does deliver the desired tri-*O*-acetyl-2-azido-4-*O*-benzyl-2-deoxy galactose compound **114** in excellent yield (entry 5, table 2). The origin of this difference in reactivity between the two epimers (**103/104** and **109/110**) is not immediately obvious.

**Table 2:** Yields for the synthesis of thioglycoside glycosyl acceptors **105-116**. Note: a) difficult separation, b) inseparable and c) separable mixtures.

Entry	Compound	X/Y	Acid	Yield (%)	$\alpha/\beta$
1	<b>105</b> -GlcN <sub>3</sub>	OBn	--	59	1/8 <sup>a</sup>
	<b>106</b> -GalN <sub>3</sub>		--	56	2/3 <sup>b</sup>
2	<b>107</b> -GlcN <sub>3</sub>	OBn	--	99	--
	<b>108</b> -GalN <sub>3</sub>		--	97	--
3	<b>109</b> -GlcN <sub>3</sub>	OBn	--	98	--
	<b>110</b> -GalN <sub>3</sub>		--	88	--
4	<b>111</b> -GlcN <sub>3</sub>	OBn	--	No rxn	--
	<b>112</b> -GalN <sub>3</sub>		--	--	--
5	<b>113</b> -GlcN <sub>3</sub>	OAc	TfOH	69	4.2/1 <sup>b</sup>
	<b>113</b> -GlcN <sub>3</sub>		TFA	99	8/1 <sup>b</sup>
	<b>114</b> -GalN <sub>3</sub>	OBn	TFA	96	3.7/1 <sup>b</sup>
6	<b>115</b> -GlcN <sub>3</sub>	OAc	BF <sub>3</sub> -OEt <sub>2</sub>	69	1/3 <sup>b</sup>
	<b>116</b> -GalN <sub>3</sub>	OBn		80	1/2 <sup>c</sup>

Transacetylation of the anomeric acetate with thiophenol and BF<sub>3</sub>-OEt<sub>2</sub> delivered a mixture of tri-*O*-acetyl phenyl thioglycosides **115a, b** with good yield and selectivity (69%;  $\alpha/\beta$  4.2/1). In order to utilize

this unexpected intermediate, we attempted to convert it into the azido thioglycoside **119** bearing the identical protecting groups to the fluororous amides above. The *O*-acetyl groups were deacetylated by the action of NaOMe in MeOH; unfortunately, attempts to generate 4,6-*O*-benzylidene were unsuccessful employing the usual conditions in this case. Further attempts at protecting group manipulation can be made if needed, but the galactose series is perfectly appropriate for our intended studies, and is the stereochemistry required for the synthesis of the Escherichia coli O142 *O*-antigen polysaccharide. One alternative route to access these precursors (**107** and **108**) could be one pot azidochlorination of glycols.<sup>379</sup> Then anomeric displacement of the 2-azido glycosyl chlorides with sodium thiophenolate will furnish  $\beta$ -thioglycoside,<sup>380</sup> and upon structural modification will deliver target compounds in the future studies.

Similarly, practical experience led us to seek out a variety of acceptors and to our delight, we could achieve this successfully by protecting group manipulations employing the synthetic intermediates above. Among our goals is enhanced yield and reactivity. In place of thiophenyl group, we prepared non fluororous tagged acceptors bearing an activatable *O*-pentenyl group starting from 1,3,6-triacetyl-2-azido-4-*O*-benzyl-2-deoxy- $\alpha/\beta$ -D-galactopyranose **114** by substitution of the anomeric acetate with 4-pent-1-ol and BF<sub>3</sub>-OEt<sub>2</sub> at rt in dry DCM overnight. The transformation was not complete however until we increased the number of equivalents of the pentenol from 3 to 5 and of the Lewis acid from 2 to 5, combined with longer reaction times, to provide appreciable yields of the pentenyl anomers, which could be robustly separated on silica gel. Initially, we aimed at a similar protocol as with thioglycosides, by 3-*O* and 6-*O* deacetylation followed by selective silylation of the 6-*OH* group, yet we observed a loss of regioselectivity as both free alcohols were protected by the silylating agent. The ratio of desired mono-silylated molecule **122** to the bis-silyl **123** is about 1:1.2, despite only using 1.2 equivalents of the silyl reagent. Desilylation of the unwanted compound in dry THF with a solution of tetrabutyl ammonium fluoride (TBAF) restored the diol compound in excellent yield. Thereafter, this effect was minimized with 1 eq. of TBDPSCl instead of 1.2 eq. and 2 eq. of imidazole from 2.3 eq. which provided the desired compound **122** in excellent yield (Scheme 7). Interestingly, this new 3-*O*- glycosyl acceptor will show increased reactivity in coupling reactions when compared to the corresponding thiophenyl glycoside, suggesting a remote effect by the anomeric *O*-pentenyl group.

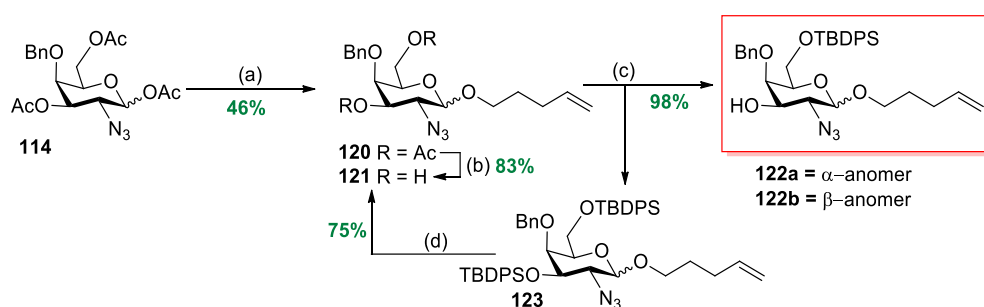

**Scheme 7: Reagents and Conditions:** (a) 4-Pent-1-ol, BF<sub>3</sub>-OEt<sub>2</sub>, DCM, rt, 46%; (b) NaOMe (0.3 eq.), MeOH, rt, overnight, 83%; (c) TBDPS-Cl (1 eq.), Imidazole (2 eq.), DCM, 3 h, rt, 98% for optimized route; (d) TBAF (1.1 eq.), THF, overnight, 75%.



## Conclusion

We have successfully prepared the synthetic precursors needed for oligosaccharide assembly of the model compounds and partial saccharide structures of the *E. coli* O-antigen. The details of these reactions will be shown in the forthcoming chapter. Furthermore, some of the intermediates described above will serve as starting materials in the chapter on the synthesis of peptidoglycan disaccharides.

Strategically designed carbohydrate monomers are the necessary precursors for efficient construction of linear and branched oligosaccharides of biological interest. Simple yet effective methods for their preparation is therefore a key requirement that has been re-imagining and re-shaping the field over many years. Fluorous tagging strategy is one invention that offers a helpful method to curtail the purification steps and recover excess reagents in excellent purity. The synthesis of fluorous tagged precursors, including donors and acceptors bearing tags of varying fluorous chain length ( $C_2F_5$ ,  $C_3F_7$  and  $C_7F_{15}$ ), were successfully performed in excellent yields for most part. While their purification was achieved on traditional silica gel columns without significant hurdles, preliminary studies in the group by Loic Valade showed that the use of home-made fluorous silica gel will significantly accelerate scale-up for future studies.

The tagging steps were high-yielding and the F-tag was found to be C2-participating during the substitution of the anomeric acetate by thiophenol, leading exclusively to the  $\beta$ -anomer, thus avoiding the laborious separations required in the 2-azido series. Further use of these fluorous tagged donors in glycosylation reactions will confirm its stereodirecting function, among other qualities.

# CHAPTER THREE: Synthesis of Trisaccharides Corresponding to a Partial *E coli* O142 O-Antigen Oligosaccharide

## INTRODUCTION

Carbohydrates are increasingly recognized as key targets in a variety of disease processes, yet their understanding and the development of glycotherapeutics have been restricted to some extent by the hurdles in accessing well-defined carbohydrate-based edifices, such as has been accomplished by automated synthesis of nucleic acids and peptides. After many research attempts and scientific discoveries to solve these challenges, a new approach built on solution-phase rather than solid-phase iterative protocols is the focus of the day. The synthesis of oligosaccharides is without doubt a laborious task, and light-fluorous tags allow for more rapid synthesis of carbohydrate molecules for biological applications as well as for the study of carbohydrate-protein interactions. Carbohydrates mediate many biological processes that include cell adhesion and differentiation, pathogen invasion, tumor cell metastasis, and inflammatory responses and are therefore of great interest for the era of carbohydrate-based pharmaceutical and vaccine development. Alas, the molecular basis for most of these carbohydrate interactions is not sufficiently well understood, in part because homogeneous well-defined oligosaccharides are still extremely difficult to obtain.<sup>381</sup>

Oligosaccharides of diverse origins (bacteria, fungi, plants, viruses, and synthetic) have long been used both as pharmacological agents and as food ingredients.<sup>382</sup> Vaccines based on carbohydrate antigens from biological sources have been used since 1923 against a host of diseases.<sup>383,384</sup> Later, researchers relied upon the use of well defined, synthetic carbohydrate antigens.<sup>76,385</sup> A *Haemophilus influenzae* type b (Hib) vaccine was the first licensed glycoconjugate based on a synthetic carbohydrate, which proved more effective at preventing meningitis than vaccines derived from natural carbohydrates.<sup>80,386</sup> The Pozsgay group reported the first synthesis of the shifted tetrasaccharide that mimics the O-Specific polysaccharide repeating unit of *B. burgdorferi* and of its bioconjugate form.<sup>387,388</sup> Mulard and co-workers then established the synthesis of a number of *Shigella flexneri* 2a O-SP-related saccharide fragments,<sup>389</sup> a major cause of the endemic form of *shigellosis*. Many new vaccines based on synthetic carbohydrate antigens, built with defined conjugate architectures are in development.<sup>384,390,391</sup>

The primary module for oligosaccharide synthesis is the diastereoselective glycosylation of a suitably protected glycosyl acceptor with a suitably protected glycosyl donor.<sup>98,392,393</sup> Koenigs and Knorr reported the first chemical glycosylation a century ago,<sup>394</sup> involving the coupling of a glycosyl bromide or chloride (glycosyl donor) with a hydroxyl component (glycosyl acceptor) upon activation of the former with an activating reagent.<sup>98</sup> As discussed in chapter one, trichloroacetimidates,<sup>395,396</sup> prepared by the reaction of free sugars with trichloroacetonitrile and a base ( $K_2CO_3$ ), are now used most frequently for glycoside coupling reactions, as are glycosyl sulfoxides,<sup>397-401</sup> phosphites,<sup>402,403</sup> and phosphates,<sup>404</sup> thio-<sup>190</sup> and pentenyl glycosides.<sup>405</sup> Other stable and efficient reactive glycosyl donors have been developed.<sup>406</sup> Several iterative strategies have been developed: linear reducing-to-non-reducing synthesis by selective deprotection of an orthogonal protecting group; non-reducing-to-reducing synthesis by selective activation of a non-reactive anomeric group e.g. thiophenyl or pentenyl glycoside; convergent two-directional synthesis; and sequential one pot strategies.

Oligosaccharides are generally not as easily accessible as oligopeptides and oligonucleotides by chemical and biological techniques. The major shortcomings with oligosaccharide synthesis include (a) an independent and multi-step sequence to access each precursor (b) a tedious work-up after each reaction step, (c) a time-consuming purification to separate the stereoisomers, and the overall low yield of the desired product. The control of the anomeric configuration of the product is among the major challenges contributing to low yields and difficult purifications. Glycosylation can occur via two possible reaction mechanisms, a stereoselective  $S_N1$  or a stereospecific  $S_N2$ , often in competition. In the  $S_N2$  strategy, the stereochemistry depends on the stereochemistry of the starting material, which itself must be controlled. Unfortunately, it is very difficult to robustly obtain a pure  $S_N2$  mechanism with an acetal functional group. Using the  $S_N1$  mechanism (Figure 30), the stereochemistry is independent of the starting material stereochemistry, but can be controlled either through C-2 participation or through the kinetic anomeric effect via a Fürst-Plattner-like transition state.<sup>407</sup> The presence of a participating group such as an ester at C-2, which can provide an anchimeric effect, favors the formation of the dioxocarbenium intermediate directing the attack of the nucleophile acceptor 1,2-trans to the C-2 group in the transition state.<sup>408</sup>

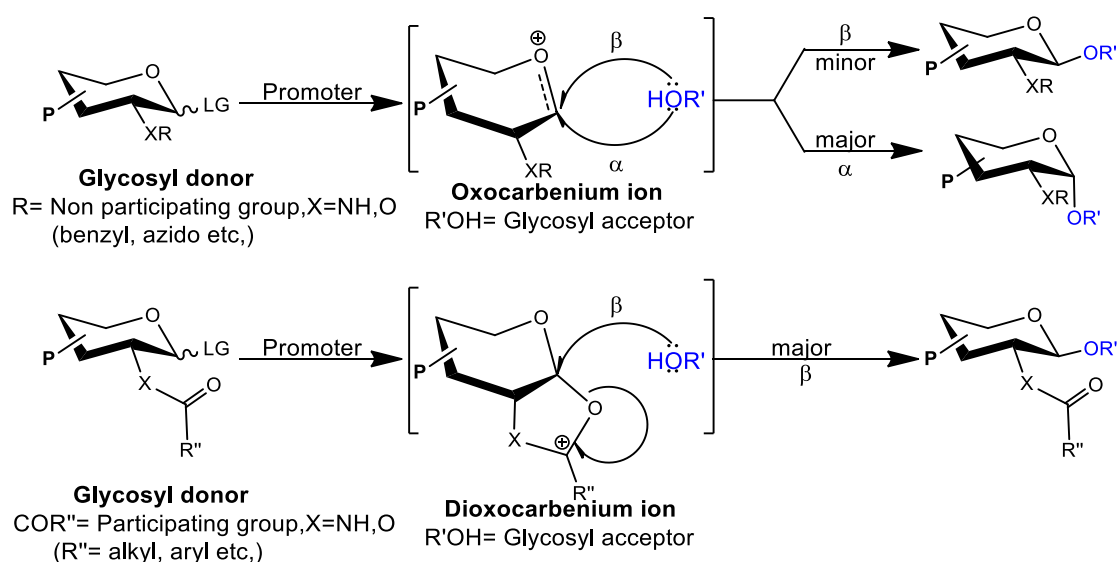

**Figure 30:** General mechanism of glycosylation reaction.

The regiochemistry of the glycosylation is determined by the protection scheme of the acceptor. This generally requires lengthy multistep synthesis with several orthogonal protecting groups, particularly for branched oligosaccharides. However, Hung and co-workers reported a combinatorial, regioselective, orthogonal, and sequential one-pot procedure to efficiently obtain differentially protected monosaccharide precursors.<sup>409,410</sup>

Fluorous technology has been utilized in many areas such as catalytic chemistry, combinatorial chemistry, parallel synthesis,<sup>411</sup> and of interest to us, in carbohydrate synthesis and carbohydrate microarrays.<sup>346</sup> As discussed in Chapter 2, Horváth and Rabái reported the first development in fluorous chemistry in 1994 using a fluorous biphasic system.<sup>293</sup> In addition, Curran and co-workers in 1997 came up with a novel fluorous synthetic approach, the “fluorous tag method”, using liquid-liquid extraction as a strategic alternative to solid-phase synthesis.<sup>295</sup> Fluorous solvents such as perfluorodecalin, FC-72, FC-770 are immiscible with organic solvents and water, hence form three layers upon mixing. Fluorous tags possess high solubility in fluorous solvents and thus easily isolated

from non-fluorinated compounds by partition between the fluoruous and organic solvents. Alternatively, fluorinated compounds have strong affinities with fluorinated silica gel. This characteristic is employed in fluoruous solid phase extraction F-SPE, which is an efficient technique that aid rapid purification and uses less solvent to elute the samples than traditional silica gel chromatography.<sup>305,412</sup> Fluoruous assisted solution-phase oligosaccharide synthesis is a relatively new technique. Perfluoroalkyl-tagged compounds offer efficient and speedy synthesis of oligosaccharides with minimum purification.<sup>295</sup> However, Tanaka and co-workers reported that while heavy-fluoruous tag provide selective extraction of the tagged compounds in fluoruous solvents, they often reduce the reactivity of the tagged compounds.<sup>413</sup> Light-fluoruous tags could overcome this shortcoming, and the target oligosaccharides could be separated by solid-phase extraction with minimum effects on their reactivity.<sup>414</sup>

Many carbohydrate antigens containing D-glucosamine and D-galactosamine have been reported.<sup>415</sup> During glycosylation, the  $\alpha$ -configuration at the anomeric position can be favored by the kinetic anomeric effect, while C-2 participation favors the  $\beta$ -stereochemistry.<sup>407</sup> The stereochemistry therefore depends very strongly on the protecting group on the nitrogen. The azide group appears to be the most efficient non-participating group in this regard. Relatively few common N-protecting groups work as C2-participating groups, because of the formation of a stable oxazoline.<sup>416</sup> The N-trichloroacetate, N-trifluoroacetate, trichloroethoxycarbonyl,<sup>417</sup> and phthalate<sup>418</sup> protecting groups have been successfully reported as C2-participating groups in oligosaccharide synthesis.

#### N-protected glucosamine donors in glycosylation

The choice of the C2-participating protecting group is a key element in the success of glycosylation reactions involving glucosamine donors, and several excellent reviews have been published on this topic.<sup>374,375,419–422</sup> It is difficult to properly evaluate the challenges based on the literature results alone: glycosylation reactions are highly structure-dependent, and the highest reported yield will not reflect the overall experience with a particular glycosyl donor; the more challenging the problem, the more innovative and efficient solutions will have been brought to bear, so one will find far more efficient results for a very difficult case than for a routine case; practical issues, such as solubility, purification, etc. are rarely addressed; and finally, the glycosyl donor is often used in excess, so that the result does not reflect the yield with respect to the donor. Ongoing progress in developing novel anomeric leaving groups, new activation conditions, and new protecting groups offer a wide variety of choices for glycosyl donors amenable to preparation of complex amino sugar oligosaccharide systems, as no single, universal solution has emerged. In the end, only the poor reputation of glucosamine among carbohydrate chemist attests to the challenges involved. Some specific examples of disaccharide syntheses with glucosamine donors are highlighted in Table 3. We have focused on the synthesis of GlcNAc disaccharides at the secondary positions (with few exceptions) of the acceptor using the most common C2-participating groups on the donor, using a small excess of donor. We have thus not discussed a number of significant novel protecting groups [N-allyloxycarbonyl (N-Alloc), N-carboxybenzyl (N-Cbz), N,N-dithiasuccinoyl (N-Dts), e.t.c], as well as the de novo approaches via glycals, which are covered in the reviews.

Christensen and coworkers investigated activation of anomeric acetate N-acetyl glucosamine donor activated via  $\text{Sc}(\text{OTf})_3$  promoter for rapid access to  $\beta$ -O-glycosides (entry 1, table 3). The Glycosyl acceptor (1 eq.) consumed the donor (2 eq.) in the presence of 1.1 eq. of the promoter at 80 °C in DCM, affording an excellent yield (90% with respect to the acceptor). Following examples display

application of N-acetyl glucosamine donor bearing different activatable groups such as halides, esters and phosphates. Glycosylations using the native GlcNAc group has recently been reviewed by Beau et al., and reported yields range from 15-90%.<sup>375</sup>



Equally important, thiomethyl-*N*, *N*-diacetyl glycosamines were reported to be activated by dimethyl (methylthio) sulfonium trifluoromethanesulfonate (DMTST). Coupling reaction was thus demonstrated with reactive acceptors containing 6-OH group affording 89% of  $\beta$ -linked disaccharide (entry 2, table 3). However, 6% oxazoline was isolated in this case and low yield of the glycosylation increases with weak glycosyl acceptors and hence raising oxazoline side product by 15%.<sup>423</sup>

Activation of the tetraacetyl donor bearing C2-N-chloroacetyl by FeCl<sub>3</sub> with glycosyl acceptor (entry 3, table 3) was demonstrated to afford  $\beta$ -O-glycoside at elevated temperature and prolonged reaction times.<sup>424</sup> This donor could be coupled with acceptors of different reactivity and the introduction of electron withdrawing atoms to the C2 directing group is a strategy to minimize side reactions byproducts of glucosamine donors and enhance donor reactivity. In the subsequent examples, anomeric bromide<sup>425,426</sup> bearing C2 dichloroacetyl glucosamine donor, Schmidt's donor<sup>427</sup> and thioethyl<sup>428</sup> anomeric glucosamines donors designed with C2 trichloroacetamide as directing groups have illustrated versatile application and have shown significant reactivity particularly with 6-OH. On another hand, poor to moderate yield for the 3 and 4-OH hydroxyl groups during glycosylation reactions was observed. Activation of anomeric S-benzoxazolyl (S-Box) leaving group on the C2 N-trifluoroacetimidate triacetate glucosamine donor with AgOTf in dichloroethane afforded excellent yield (89%) of the targeted disaccharide with O-3 secondary glycosyl acceptor. Subsequently, glycosylation with other type of acceptors similarly delivered excellent range yield (entry 6, table 3).

Formation of  $\alpha$ -O-glycoside requires a non-participating group on the glucosamine donor, hence, GlcNAz bearing anomeric chloride and trifluoro-N-phenyl-acetimidate activatable groups have yielded 30% and 73% respectively of the targeted disaccharide in the presence right conditions with 1,6-anhydro- $\beta$ -L-idopyranosyl 4-alcohol.<sup>429</sup> The authors have successfully prepared other glucosamine donors bearing different anomeric leaving groups and performing similar glycosylation have yielded excellent results (26-84% yields). Similarly, glycosylation of activatable thiophenyl glucosamine donor prepared with C2 N-trichloroethoxycarbonyl (Troc) group was accomplished by NIS/TfOH thiophilic system at excellent yield (86%) with suitably protected 4-OH acceptor (entry 8a, table 3).<sup>430</sup> The greater stability of this N-protecting group towards variety of functional group manipulation conditions (benzylation, hydrogenation, oxidation, glycosylation)<sup>431</sup> made it popular candidate for complex oligosaccharide synthesis. Other anomeric leaving groups such as trichloroacetimidate, and thioglycosides can be activated with different promoter system, giving attractive range yield of the products (entry 8b-c, table 3).

**Table 3:** Glycosylation of various N-protected and anomeric glucosamine donors. Note: d = glycosyl donor, a = glycosyl acceptor.

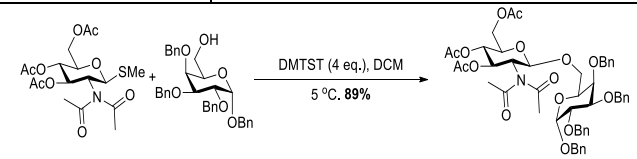
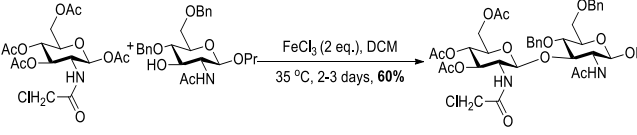
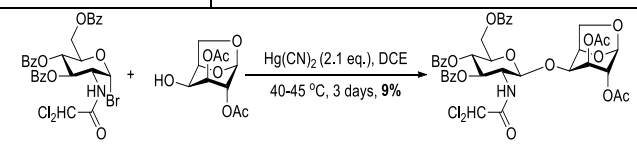
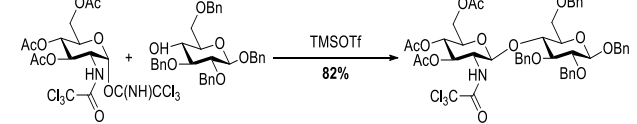
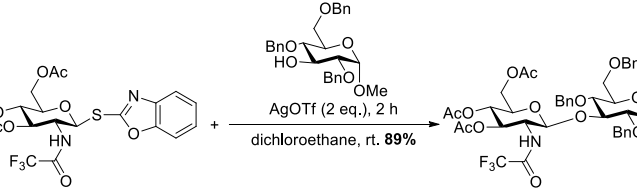
entry	d/a	glycosylation	Yield range (%)
1a <sup>432</sup>	2:1		90
		Activated group	Lewis acids
1b <sup>433-437</sup>		Cl, Br	Hg(CN) <sub>2</sub> , Sn(OTf) <sub>2</sub> , Ag <sub>2</sub> O/Ph <sub>2</sub> SnCl <sub>2</sub>

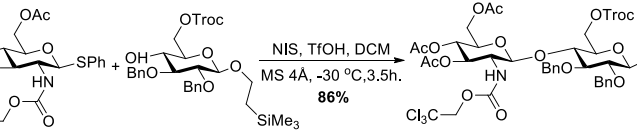
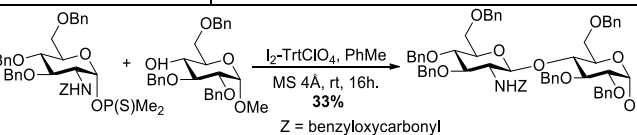
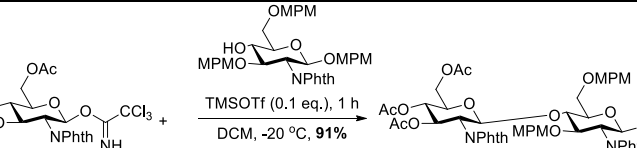
1c <sup>438</sup>		OPIv	Sc(OTf) <sub>3</sub> , Fe(OTf) <sub>3</sub> .6DMSO, Bi(OTf) <sub>3</sub> , Yb(OTf) <sub>3</sub>	Cu(OTf) <sub>2</sub>	15-90
1d <sup>439</sup>		phosphate	Tf <sub>2</sub> NH		65
1e <sup>440</sup>		trichloroacetimidate	TMSOTf, TfOH		13-18
2 <sup>423</sup>	--				89
3 <sup>424</sup>	1:1				60
		Activated group	Lewis acids		
3b <sup>441</sup>	2:1	OAll	FeCl <sub>3</sub>		72
4 <sup>425,426</sup>	1.4:1				9-47
5 <sup>427</sup>	--				56-90
6 <sup>442</sup>	1.1:1				78-93
7 <sup>429</sup>	1.2:1				30-73
8a <sup>430</sup>	--				54-88
		Activated group	Lewis acids		
8b <sup>418,443-445</sup>		trichloroacetimidate	TMSOTf, TBSOTf, BF <sub>3</sub> .OEt <sub>2</sub>		76-88
8c <sup>442,446</sup>		SPh, S-Box,	NIS/TfOH, MeOTf		81-82
9 <sup>447</sup>	1.3:1				33
10a <sup>448</sup>					91
		Activated group	Lewis acids		

10b <sup>449-452</sup>		STol, S'Pr	AgOTf/PTSCI, BSP/DTBMP/Tf <sub>2</sub> O	NIS/TMSOTf,	74-92
10c <sup>453</sup>		Br	AgOTf/collidine		51

Activation of anomeric dimethylphosphinothioate -N-benzyloxycarbonyl glucosamine donor in the presence of 4-OH acceptor affords 33% of stereoselective  $\beta$ -glycoside disaccharide. This yield doubled with an acceptor bearing 6-OH was coupled with similar donor in the presence of tritylperchlorate-iodine mixture (TrtClO<sub>4</sub>-I<sub>2</sub>), 0.6:1 (entry 9, table 3).<sup>447</sup> N-phthaloyl (N-Phth) protecting group has been widely employed across carbohydrate chemists to mask the amino sugars. Its application compatible with various anomeric leaving groups as glycosyl donors is particularly significant for developing  $\beta$  glycoside bond. Of interest here is the glycosylation between two glucosamine moieties where the donor was prepared with trichloroacetimidate leaving group and both substrates containing C2 N-phthaloyl protecting group. In this example, activation was achieved with catalytic amount of TMSOTf usually in DCM affording 91% of the desired disaccharide. Additionally, representative N-phthaloyl thioglycosides found useful application with different choice of Lewis acids (entry 10b-c, table3).

Effort to develop convenient methods for complex carbohydrate assembly never ceases. Detailed progress made in this regard (glucosamine donors) have been fully reviewed as mentioned above, particular cases were shown here for the widely employed designs and yield range was also highlighted to report the average yield of different cases in the literature. Similarly, majority of the cases showed excess of the glycosyl donor. Thus, there are very few reports in which the yield is reported based on the glycosyl donor.<sup>424, 439</sup> So, the yields are very high in general, but quite remarkable with respect to the donor. This is an essential feature for a fluorinated tagged donor, even better than recyclability.

The current research focuses on the coupling reaction between two fluorinated tagged D-glucosamine precursors in order to test whether the fluorinated tag could also serve as an efficient C-2 participating group, and address whether the fluorinated tag can provide additional advantages in the coupling reaction. In particular, we will focus on the synthesis of 1,3-glycosamine trisaccharides, such as the one that forms the core of the *E. coli* O142 O-antigen.

## RESULTS AND DISCUSSION

### Double F-tag glycosylation

Double F-tag glycosylation is an expedient route that combines monosaccharides bearing fluorinated tags of different length, in order to preclude the necessity to carry out tedious workups and time-consuming purifications at the glycosylation stage. Detailed steps for the regioselective protection of individual hydroxyls in monosaccharide units used here were described in the previous chapter. The fluorinated technology was therefore first investigated in order to speed up the synthesis of  $\beta(1\rightarrow3)$ -glucosamine-glucosamine disaccharides as a model compounds towards the *E. coli* O142 O-antigen. The coupling of a glucosamine donor **74** tagged with a C<sub>3</sub>F<sub>7</sub> amide chain with the glucosamine acceptor **85** incorporating a C<sub>7</sub>F<sub>15</sub> amide tag was first investigated by a procedure mediated by TMSOTf in DCM at -40 °C (table 4).<sup>454</sup>

**Table 4:** Differentially fluorinated tagged glycosylation with C<sub>3</sub>F<sub>7</sub>-tagged donor **74** and C<sub>7</sub>F<sub>15</sub>-tagged acceptor **85**.<sup>a</sup>

Entry	Acceptor <b>85</b> (eq.)	Solvent	Temperature (°C)	Duration (h)	Yield, <b>124</b> (%)
1	0.7	DCM	-40 → -10	3	0
2				0	
3	1.0	DCM:FC-770		5	0
4	0.7	ACN		0	
5	1.0	DCM		3	0

a. A mixture of **74** and **85** in the indicated solvent over flame activated 3Å sieves was stirred at -40 °C for 30 min and treated with TMSOTf (0.1 eq) and allowed to warm progressively to -10°C over the indicated duration

Much to our surprise, there was no sign of the expected compound **124** (Scheme 8) by any spectroscopic analysis conducted (<sup>1</sup>H, <sup>19</sup>F NMR, MS), under standard conditions (entry 1). However, it was apparent that the solubility of the precursors was poor at the glycosylation temperature. This is a possible physical explanation but finding the factors responsible for this deterrence requires further practical investigation. In entry 3, introduction of a fluorinated solvent such as FC-770 (50 μL) did not yield any improvement. Additional experiments were performed with longer reaction times (entry 2-4), substituting reaction solvent for acetonitrile (entry 4) or increasing the number of equivalents of the acceptor (entry 3 and 5). No trace of the target molecule **124** was observed.

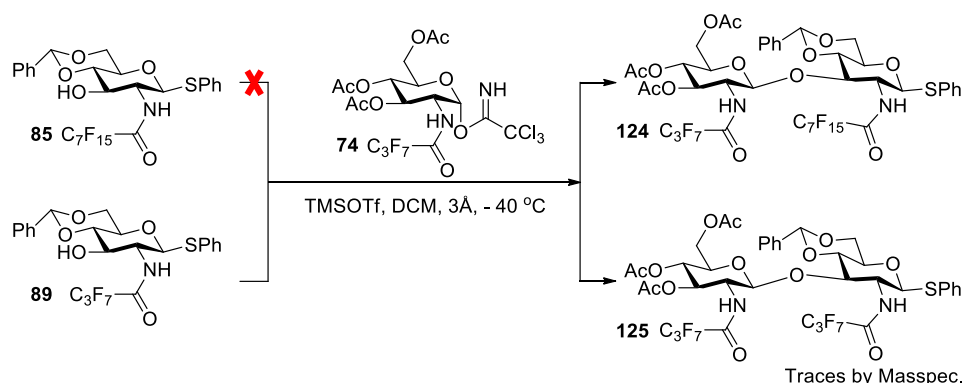

**Scheme 8:** Synthesis of double fluorinated tagged disaccharides **124-125**.

Poor solubility is a recurrent problem with glucosamine precursors in general. This led us to carry out solubility test of the starting materials in an effort to determine optimal solvent choices towards target molecules (table 4). Glucosamine donors modified with either C<sub>3</sub>F<sub>7</sub> **74** or C<sub>7</sub>F<sub>15</sub> **71** at the C2 amide dissolved completely at reaction condition and therefore passed the test. On the other hand, there is slight difference when the two fluorinated acceptors **89** and **85** were dissolved in DCM, however limited, but it means, as the number of fluorine decreases the solubility improves with our model fluorinated acceptors. Dissolution in other solvent systems such as acetonitrile and toluene did not provide any significant solubility even when stirring at room temperature for some hours, and addition of fluorinated solvent (25 → 100) μL has no positive effect on the solubility. The fluorinated acceptors were soluble in THF, however.



**Table 5:** Solubility test of fluorous precursors at -40 °C → rt

Entry	Compound	Solvent	Temperature	Solubility observation
1	C <sub>7</sub> F <sub>15</sub> donor	DCM	-40 °C → rt	Sufficiently soluble
2	C <sub>3</sub> F <sub>7</sub> donor	DCM		
3	C <sub>3</sub> F <sub>7</sub> acceptor	DCM		Poorly soluble
4	C <sub>7</sub> F <sub>15</sub> acceptor	DCM		Very insoluble; fluorous acceptors float out of the reaction phase upon stirring.
		DCM + FC-770		
		MeCN		
		MeCN + FC-770		
		PhMe		
		PhMe + FC-770		
5		THF		Sufficiently soluble

In a further effort toward either a two-phase or a single phase co-solvent system, we performed miscibility analysis for DCM, MeCN, PhMe, perfluorodecalin (PFD) and perfluoro compound (FC-770) at various admixture ratios (table 5). This is pertinent because certain fluorous molecules may be soluble in the fluorous droplets or at the solvent interface, making it possible to run the reaction at hand. All organic and fluorous solvents were mixed at 5:1 ratio and in every mixture the bottom fluorous phase was not miscible with the organic layer at room temperature (entry 1-6, table 5). Upon subjecting the heterogeneous mixture to the reaction temperature of -40 °C, the fluorous phase quickly turned to a white (solid-like) phase. The colorless phase reappears on approaching room temperature. Similarly, a mixture of each organic solvent above with two fluorous ones in the ratio of 20:2:1 (entry 7-9; Table 5) formed a homogeneous phase between the two fluorous solvents and immiscible with upper organic layers. In all cases, the fluorous solvents formed white phase at -40 °C. However, acetonitrile-fluorous admixture (entry 8), somewhat retained a colorless heterogeneous mixture below -20 °C, while other mixtures (entry 7 and 9) freeze near 0 °C.

**Table 6:** Miscibility test for organic and fluorous solvents.

Entry	Solvents	Admixture ratio	Temperature	Miscibility observation
1	DCM:FC-770	5:1	-40 °C → rt	Colorless heterogeneous mixture that formed white (solid-like) phase at -40 °C which melts near rt.
2	MeCN:FC-770			
3	PhMe:FC-770			

4	DCM:PFD			
5	MeCN:PFD			
6	PhMe:PFD			
7	DCM:PFD:FC-770	20:2:1		Heterogeneous 2 phase system; the white frozen fluoruous phase disappears near 0 °C.
8	MeCN:PFD:FC-770			
9	PhMe:PFD:FC-770			

With this result in hand, we attempted another glycosylation between the donor **74** and acceptor **85**, both carrying similar C<sub>3</sub>F<sub>7</sub> tags, motivated by the somewhat higher solubility of the acceptor (Scheme 8). In a glimmer of hope, under the same conditions used for acceptor **85** in table 3, entry 2, we observed the presence of the desired compound **125** by mass spectrometry analysis only. However, the yield remains vanishingly low, so solubility alone does not seem to explain the result. This led us to test other combinations to gain further insight. Hence, we attempted four additional combinations of donor-acceptor precursors C<sub>7</sub>F<sub>15</sub>-C<sub>3</sub>F<sub>7</sub>, C<sub>7</sub>F<sub>15</sub>-C<sub>2</sub>F<sub>5</sub>, as well as the matched tag C<sub>7</sub>F<sub>15</sub>-C<sub>7</sub>F<sub>15</sub> and C<sub>2</sub>F<sub>5</sub>-C<sub>2</sub>F<sub>5</sub> condensations.

In the following scheme (Scheme 9 and Table 6), we sought to condense the most challenging, poorly soluble and unreactive C<sub>7</sub>F<sub>15</sub> acceptor **85** with the similarly C<sub>7</sub>F<sub>15</sub> fluoruous tagged donor **71** activated by TMSOTf (0.1 eq.) in DCM at -40 °C to -5 °C without success (Entry 1). This reaction was repeated allowing reaction to reach room temperature with constant stirring, still failed (Entry 2). Adding FC-770 (25 μL) as a cosolvent in DCM did not afford desired product **126** (Entry 3). However, condensing a 1:1 molar ration of the precursors in dry DCM and 0.2 eq. of the promoter, a trace of the expected disaccharide **126** was picked up by mass spectrometry analysis after silica gel column (Entry 4). In the beginning, we thought of a self-aggregation effect as the possible explanation to describe the observed result, but the negligible yield and unreproducible reaction suggested otherwise. Efforts to further address the solubility issue by running the reaction in dry THF that dissolved the precursors similarly provided only traces of the coupled product (Entry 5). Solubility thus did not seem to be the dominant factor in this reaction. In most events, a very clean recovered acceptor and the hydrolyzed donor were isolated after silica gel chromatography.

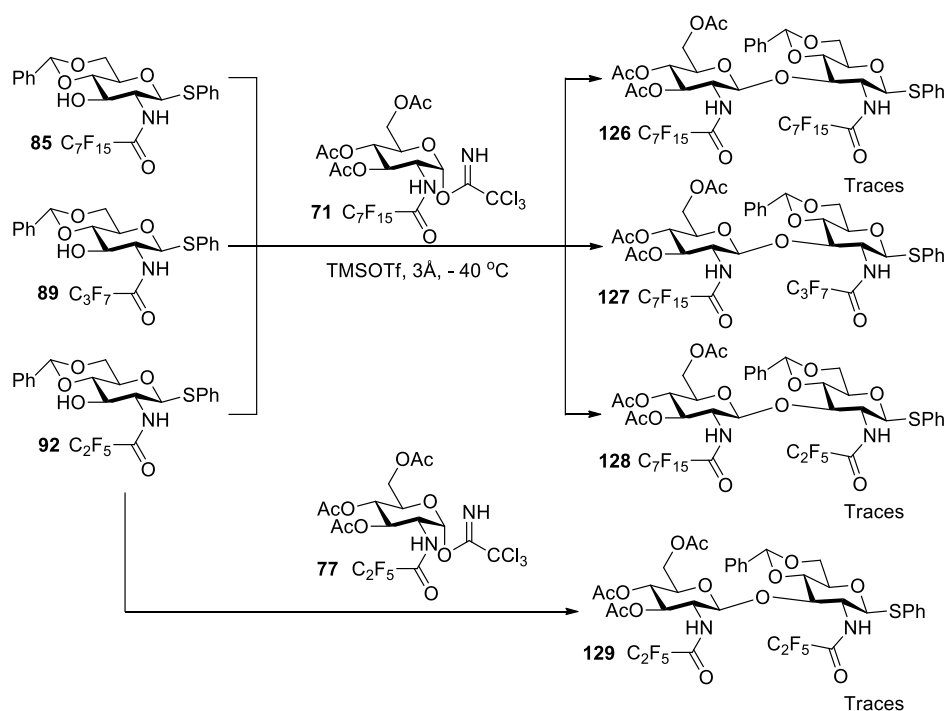

**Scheme 9:** Synthesis of double fluorinated tagged disaccharide **126-129**

Additional glycosylation reactions with shorter fluorinated chains on the acceptors were examined in Table 7. A more promising result for glycosylation with the C<sub>7</sub>F<sub>15</sub>-donor **71** and C<sub>3</sub>F<sub>7</sub> acceptor **89** in equimolar amounts (entry 6) afforded the disaccharide **127** in a low, but measurable yield in a single experiment. Further attempts with 1.5 eq. of C<sub>2</sub>F<sub>5</sub> acceptor **92** in dry acetonitrile gave traces of the expected compound **128** by mass spectrometry (entry 7). Completing this scheme, the coupling between the C<sub>2</sub>F<sub>5</sub> acceptor **92** and a donor **77** bearing a similar fluorinated tag are shown in table 6 (entry 8-9) under similar conditions gave the disaccharide **129** in trace amounts. The coupling reactions are thus very low yielding and poorly reproducible, and their failure cannot be attributed to solubility alone.

Finding a viable purification method remained truly challenging and problematic, as multiple traditional silica gel chromatographies did not allow us to isolate the desired product in sufficient purity for characterization. In the pursuit of improved purification, reverse phase chromatography or preparative silica gel TLC similarly afforded little separation. Therefore, it became extremely difficult to report yields even in the case where mass spectrometry revealed the presence of desired adduct after multiple purifications on a few milligram-scale reactions. Therefore, in an effort to test the original basis for the differential fluorinated tag methodology, the potential of fluorinated silica gel preparative TLC plate (Sigma Aldrich) was investigated.

This separation is based on the affinity between the fluorinated molecule and the fluorinated silica gel stationary phase. This was applied to the unresolved reaction mixture for the C<sub>7</sub>F<sub>15</sub>-C<sub>3</sub>F<sub>7</sub> disaccharide **127** and C<sub>2</sub>F<sub>5</sub>-C<sub>2</sub>F<sub>5</sub> disaccharide **129** and provided an extremely effective separation than neither standard nor reverse phase silica gel purification could provide. This is significant in making a first mild characterization in respect to our objectives. Pure samples of the disaccharides **127** and **129** were thus obtained for characterization, whereas traditional purification protocols prove fruitless. The disaccharides were obtained exclusively as the β-disaccharide ( $J = 8.4$  Herz,  $H'-1$ ). Henceforth, we can conclude that the fluorinated tagged amide acts as an efficient C2 participating group, but the fluorinated

tag on the acceptors exert a deactivating effect. The differentially double-tagged strategy does allow for efficient separation of the residual donor, acceptor, and coupled product on fluorosilica gel.

**Table 7:** Double fluorosilica tagged glycosylation **126-129**<sup>a</sup>.

Entry	Combination	A(eq.)	Solvent	T (°C)	d (h)	Yield (%)
1	C <sub>7</sub> F <sub>15</sub> -C <sub>7</sub> F <sub>15</sub>	0.7	DCM	-40 → -5	4	<b>126</b> ; 0
2				-40 → rt	5	
3			DCM:FC-770	-40 → -5	3	
4		1.0	DCM	-40 → -10	3	<b>126</b> ; traces
5		0.7	THF	-40 → -5	4	
6	C <sub>7</sub> F <sub>15</sub> -C <sub>3</sub> F <sub>7</sub>	1.0	DCM		3	<b>127</b> ; 18
7	C <sub>7</sub> F <sub>15</sub> -C <sub>2</sub> F <sub>5</sub>	1.5	MeCN	-40 → 0	4	<b>128</b> ; traces
8	C <sub>2</sub> F <sub>5</sub> -C <sub>2</sub> F <sub>5</sub>	1.0	DCM	-40 → -5	2	<b>129</b> ; traces
9					3	
10					3	

a. A = acceptor, T = temperature, d = duration. A mixture of the donor and acceptor (A= number of equivalents) bearing fluorosilica tags of the indicated chain length in the indicated solvent over flame activated 3Å sieves was stirred at -40 °C for 30 min and treated with TMSOTf (0.1 eq) and allowed to warm progressively to -10 °C over the indicated duration

### Traditional single F-tag glycosylation

Having exhausted the doubly tagged strategy with our model monosaccharide units, we then attempted to glycosylate the fluorosilica glucosamine donors **71**, **74**, **77** with available non fluorosilica acceptors bearing free nucleophilic 3-OH and 4-OH groups **130**, **131**, **132**. We hope in this way to determine whether the poor reactivity is due to the fluorosilica donor or the fluorosilica acceptors. Single fluorosilica tagging strategy will therefore be a proof of concept to determine whether broad application of the fluorosilica glucosamine donors can be envisioned as a reliable approach.

#### 1,3-glycosylation

In an endeavor to construct a β(1→3) glycoside bond by single fluorosilica tag strategy, the various fluorosilica glucosamine donors **71**, **74**, and **77** were reacted with equimolar amounts of two different 3-OH non fluorosilica glucosamine acceptors **130** or **131** by the action of TMSOTf promoter in DCM. The first attempts in this synthesis delivered more promising results based on the representative unoptimized yields in scheme 10, providing products **133**, **134**, and **135**, in 24, 28 and 51% isolated yield, as clearly identified by mass spectrometry and NMR analysis. The products were isolated by normal phase silica chromatography, so the isolated yields are probably somewhat understated. The first non fluorosilica acceptor **130** differs in three respects to the model fluorosilica version by a 4,6-acetonide functionality in place of the benzylidene, a C2 allyloxy carbonyl amide in place of fluorosilica amide and the *O*-pentenyl replacing the thiophenyl at the anomeric position. Similarly, the second acceptor **131** differs by N-phthaloyl group instead of C2 fluorosilica amide and the anomeric *O*-pentenyl

group. Coupling of the C<sub>3</sub>F<sub>7</sub> or the C<sub>7</sub>F<sub>15</sub> fluorous donors gave similar results, the yields being modest, but measurable; they were qualitatively far superior to the coupling with the fluorous acceptors. Coupling of a fluorous donor to the N-Phthaloyl protected acceptor gave an acceptable 51% yield, again, qualitatively significantly higher than the allyloxycarbonyl case. These results confirm the good reactivity associated with the fluorous amide glucosamine donor and highlight on the other hand the daunting issues observed with fluorous acceptors in the preceding approach.

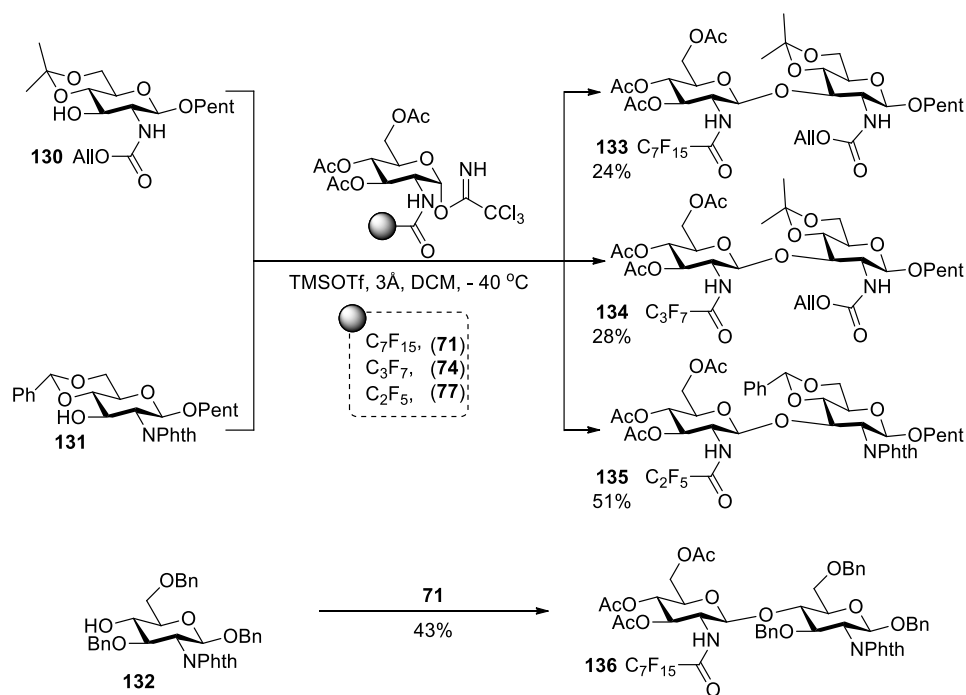

**Scheme 10:** Synthesis of singly fluorous tagged disaccharide. **133-136**

### 1,4-glycosylation

Accordingly, the C<sub>7</sub>F<sub>15</sub>-fluorous glucosamine donor **71** was coupled in the same manner with non fluorous 4-OH acceptor **132** catalyzed by TMSOTf as Lewis acid in dry DCM. Gratifyingly, the expected disaccharide **136** was isolated in a good 43% yield by preparative TLC on silica gel plate. Based on these experimental results, it is apparent that the nucleophilicity trend follows the order **N-phthalimide > NH-amide >> NH-fluorous amide**. The strong electron-withdrawing effect by the fluorous chain and the hydrogen bond for the fluorous amide to the nucleophile, rather than reduced solubility, is linked to the reduced nucleophilicity of the fluorous acceptors, and hence the very low yields. The electron-withdrawing effect of the fluorous amide is expected to strengthen the intramolecular hydrogen bond to the nucleophilic hydroxyl group. The fluorous tagged amides, however, act as excellent glycoside donors, with a complete β-directing effect, and relatively little influence of the length of the fluorous chain. The acceptor bearing N-allyloxy C2 protecting group then showed increased yields, with a lesser hydrogen bond effect on the nucleophilic alcohol. Finally, N-phthalimide-based acceptors that do not encounter any hydrogen-bond deactivation effect on the nucleophilic alcohol; hence, incrementally better yields (51%). The yield was similar for the less challenging glycosylation adduct **136**.

Optimal yields have not been obtained for these representative reactions, as purification protocols were not sufficiently efficient, and the disaccharides were isolated on small scale. Undeniably, fluorous preparative TLC systematically showed good resolving power, yet it is limited to a few milligrams and is obviously unsuitable for larger-scale synthesis or broad optimization. Thus, we were

bound by this undertaking to seek out better purification alternatives in the ensuing synthesis involving modified acceptors in addition to possible optimization of reaction conditions, in particular, for the preparation of biologically relevant oligosaccharide fragments.

### Modified F-tag glycosylation strategy

With the established C<sub>7</sub>F<sub>15</sub>-fluorous glucosamine donor, we embarked on another stride towards the synthesis of glucosamine oligomers using non-fluorous acceptors and extend the concept to the preparation of partial natural carbohydrate fragments. Additional methods for obtaining pure compounds will be investigated with the synthesized molecules, to allow for optimization and full characterization in a standard synthetic setting.

#### Glycosylation of 2-azido glucosyl acceptors

The singly fluorous tag strategy remains a coherent and dependable route to synthesize compounds for biological applications. Using the fluorous glucosamine donor **71**, we investigated glycosylation reactions with new acceptors bearing an azide group at the C2 position, and anomeric *O*-pentenyl, thiophenyl or 1,6-anhydro group for direct or indirect iteration, and 4-*O*-benzyl, 6-*O*-*tert*-butyl diphenyl silyl group, with the free 3-OH alcohol as glycosyl acceptor. We initially envisioned a differentially double tagged strategy in which the second fluorous tag could be introduced after the coupling reaction.

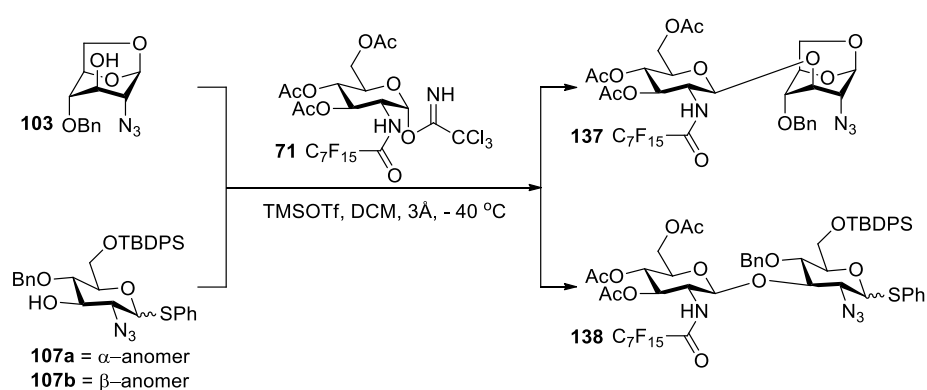

**Scheme 11:** Synthesis of modified singly fluorous tagged disaccharide **137-138**.

The 1,6-anhydro-2-azido-4-*O*-benzyl-2-deoxy-β-D-glucopyranose-1.6 eq. (**103**) as a synthetic intermediate was used as a potential acceptor in our first attempt in combination with the C<sub>7</sub>F<sub>15</sub>-glucosamine donor **71**, TMSOTf in anhydrous DCM (entry 1, table 8). The fluorous tagged donor bearing the highest number of fluorine atoms was chosen to serve in all further syntheses because it is expected to show maximum affinity with the fluorous and hydrophobic purification phases. The above reaction yielded the desired result, despite the considerable steric hindrance of the axial hydroxyl group, affording a clean fraction **137** in 38% yield after two purifications by silica gel chromatography that was fully characterized by spectroscopic analysis (Mass spectrometry and NMR). The difficulty still remains in separating excess glycosyl acceptor from the desired compound by this means. Encouraged by this development, we then proceeded to couple an equimolar mixture of phenyl 2-azido-4-*O*-benzyl-6-*O*-*tert*-butyl-diphenylsilyl-2-deoxy-1-thio-β-D-glucopyranoside acceptor **107** and fluorous donor **71**, in the presence of TMSOTf (0.1 equiv.) in DCM at -40 °C to -5 °C for 2 h (**138b**, entry 2, table 8). The optimum condition so far was found to be 2.1 equiv. of the acceptor, and 0.1 equiv. of the Lewis acid in this context (**138a**, entry 3, 34%, table 8), again based on silica gel chromatography.

**Table 8:** 1,3 glycosylation protocol for the synthesis of **137-138**.<sup>a</sup>

Entry	Acceptor	Equiv.	d(h)	T (°C)	Solvent	L. A. (eq.)	Yield (%)
1	1,4-anhydroGlcN <sub>3</sub> <b>103</b>	1.6	2	-40 → -5	DCM	0.1	38
2	β-GlcN <sub>3</sub> <b>107b</b>	1.0	2				19
3	α-GlcN <sub>3</sub> <b>107a</b>	2.1	3				34

a. d = duration, T = temperature, L.A. = Lewis acid. A mixture of the fluoros tagged donor **71** and the indicated acceptor (number of equivalents) in the indicated solvent over flame activated 3Å sieves was stirred at -40 °C for 30 min and treated with TMSOTf (0.1 eq) and allowed to warm progressively to -5 °C over the indicated duration.

Guided by previous experiences on purification, we intended to examine purification protocol by analytical fluoros HPLC column. Sadly, these types of instruments are no longer available from our suppliers. Henceforth, we anticipated that it will be desirable to observe the interaction between fluorophilic and hydrophobic effects on an analytical pentafluorophenyl (PFP) HPLC column. This type of column has been demonstrated to purify protected carbohydrates including fluorinated compounds by Pohl group in high purity.<sup>455</sup> Fortunately, our curiosity regarding this synergy yielded fruitful results. A robust analysis was performed by liquid chromatography/mass spectrometry (LC/MS) of the crude reaction mixture over a PFP column (gradient of 85/15 methanol/water to 100% methanol over 30 minutes). These results were obtained in a collaboration with the Casabianca group at the ISA UMR 5280. The result of the LC/MS analysis of **138a** is shown in Figure 31. The compounds were eluted in the order of combined fluorophilic and hydrophobic effects: shortly after the solvent front was peaks associated with glycosyl donor **71** that is weakly visible at either 210 or 254 nm because it lacks UV active groups. This is followed by the strongest absorbance peak at 9 minutes that corresponds to the acceptor **107**; then third peak at 16 minutes is the coupled product **138**. Other peaks correspond to artifacts not related to our reaction mixture. It is noteworthy that although the acetylated fluoros amide is fairly weakly retained on the column, the effect on the separation of the acceptor and the coupled product is quite dramatic. It is therefore reasonable to speak of a combined fluoros hydrophobic effect.

We became interested in trying a standard reverse phase (RP-C8) HPLC column and therefore compare with the result on the PFP column. Eluting the reaction mixture on a Poroshell C8 RP column by HPLC analytical mode (gradient of 85/15 acetonitrile/water + 0.1% TFA to 100% acetonitrile over 17.5 minutes), the solvent front peak is followed by peaks related to glycosyl donor **71** around 3.4 min area; then clearly visible peak at 5.7 min as the acceptor **107** and disaccharide of interest **138a** at 8.5 min as shown in the figure 3.2 (UV 254 nm). Although the resolution far superior with the PFP column, one again observes a strong fluoros-hydrophobic effect: the fluoros amide donor hemiacetal is only weakly retained by the C8 reverse phase column but exerts a significant effect on the separation of the fluoros coupled product from the non-fluoros acceptor.

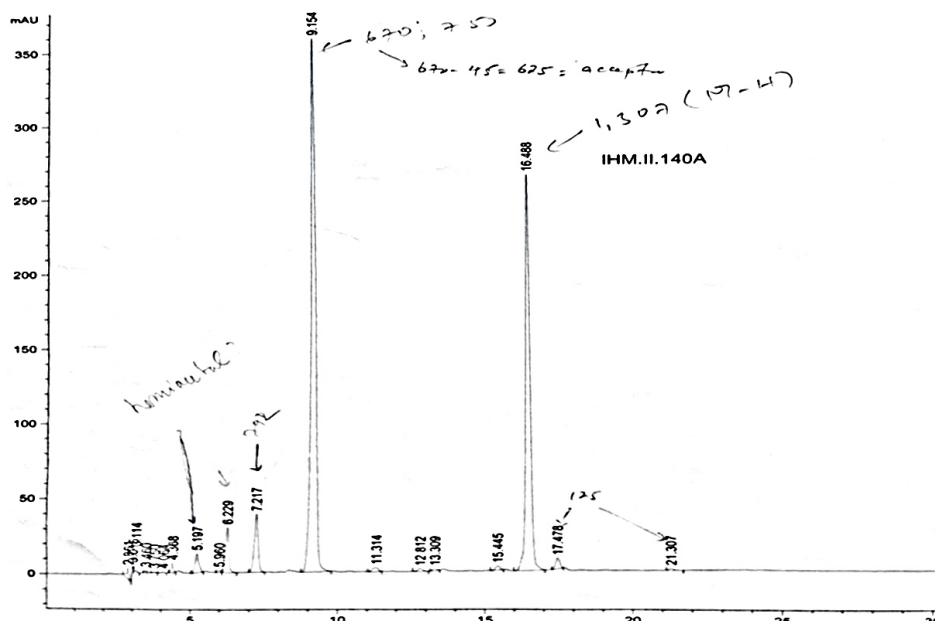

**Figure 31:** LC/MS analysis of the glycosylation reaction mixture of **138a**. PFP column (4.6 x 150 mm), gradient 85% MeOH-H<sub>2</sub>O to 100% MeOH in 30 min and then back to starting gradient over 10 min. UV detection is 254 nm and the flow rate 0.6 mL/min.

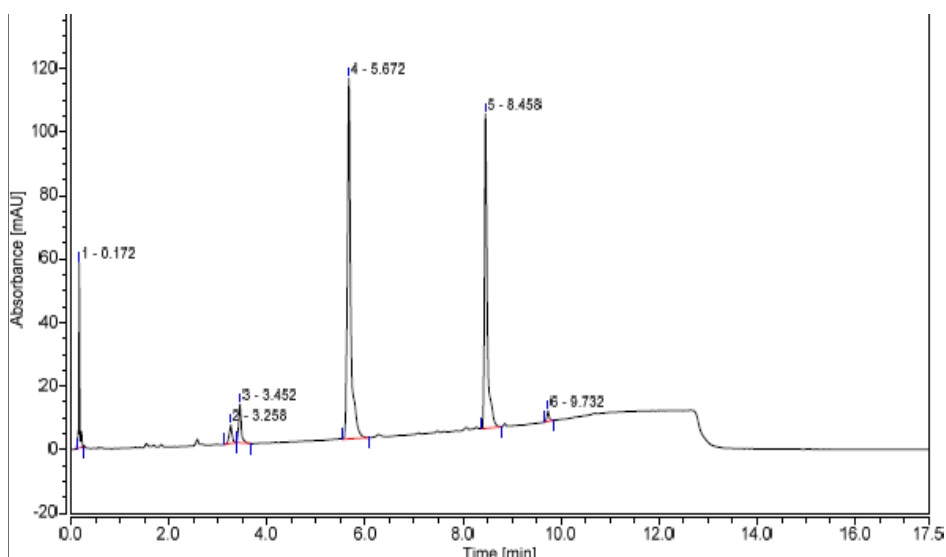

**Figure 32:** HPLC analysis of the glycosylation reaction mixture of **138a**. Poroshell RP C8 column (2.1 x 50 mm), gradient 85% MeCN-H<sub>2</sub>O + 0.1% TFA to 100% MeCN in 17.5 min. UV detection is 254 nm and the flow rate 0.8 mL/min.

Preparative HPLC on PFP column was not found to be convenient for routine optimization. As a result, we successfully explored a reliable separation technique that could purify reaction mixtures of this type on a much larger scale. Hence, with a 40g reverse phase C 18 column on a Combiflash chromatographic MPLC system, we purified and characterized the disaccharide **138a** at hand (entry 3, table 8). Similar purification conditions for fluoros tagged glycosides have been used previously by Kabotso and Pohl.<sup>337</sup> The first compound to be eluted was related to glycosyl donor **71**; then recovered acceptor **107** and lastly the desired disaccharide molecule (**138a**,  $\beta$ -isomer only) identified by mass spectrometry and NMR analysis. In the event, the hydrolyzed donor and recovered excess acceptor can be reused without further purification steps.



### Glycosylation of 2-azido galactosyl acceptor

Replacing the two azido-glucose acceptors **103** and **107** in scheme 11 with the corresponding azido-galactose derivatives **104** & **108** will allow us to construct the disaccharide fragment from E. coli O142 O-antigen and therefore reasonably invest our effort on the optimization of a compound from a biologically relevant setting. Encouraged by these preliminary results and with a robust purification protocol in hand, we expect that by varying the equivalents of acceptor and Lewis acid, reaction temperature and reaction duration would help us arrive at optimized conditions. The majority of reactions were performed by pre-stirring the mixed precursors over freshly flame-activated molecular sieves (4Å-powdered form) for at least an hour at room temperature before cooling and were run under intensely inert conditions to be the best empirical requirement for successful and high yielding glycosylation.

**Table 9:** 1,3 Glycosylation protocol for the synthesis of **139-142**.<sup>a</sup>

Entry	Acceptor	Equiv.	d(h)	T (°C)	Solvent	L. A. (eq.)	Yield (%)
1	1,4-anhydroGalN <sub>3</sub>	4.7	3	-40 → -5	DCM	0.1	40
2	α-GalN <sub>3</sub>	1.0	2	-40 → -25			17
3	α-GalN <sub>3</sub>	1.4	4	-40 → 0			20
4	α-GalN <sub>3</sub>	1.0	3	-40 → 20	THF	0.25	23
5	α-GalN <sub>3</sub>	1.5	4	-40 → 0		33	
6	α-GalN <sub>3</sub>	1.5	5	-78 → 0		23	
7	α-GalN <sub>3</sub>	1.5	4	-40 → 0		0.1	traces
8	β-GalN <sub>3</sub>	1.6	2	-40 → -25		40	
9	β-GalN <sub>3</sub>	0.75	4	-40 → 0		0	
10	β-GalN <sub>3</sub>	1.8	o/n	-40 → rt	BF <sub>3</sub> -OEt <sub>2</sub>	40	
11	β-GalN <sub>3</sub>	1.5	4	-40 → 0	DCM	0.1	57
12	β-GalN <sub>3</sub>	1.5	4	-40 → rt			40
13	β-GalN <sub>3</sub>	1.5	o/n	-40 → rt			62
14	β-GalN <sub>3</sub>	1.5		-40 → rt			71
15	β-GalN <sub>3</sub> -OPent	1.5		-40 → rt			90

a. d = duration, T = temperature, L.A. = Lewis acid, o/n = overnight. A mixture of the fluorour tagged donor **71** and the indicated acceptor (number of equivalents) in the indicated solvent over freshly flame-activated 4Å sieves was stirred at rt for one hour, cooled to -40 °C and stirred for 30 min and was treated with TMSOTf (0.1 eq) and allowed to warm progressively to the indicated temperature over the indicated duration.

In view of the above findings, 4.7 equivalents of the bicyclic acceptor **104** (entry 1, table 9) in the galactose series was glycosylated with usual fluorourous donor **71** in the presence of TMSOTf promoter (0.1 eq.) from -40 → -5 °C for 3h reaction time. Applying the crude reaction mixture to the reverse

phase (RP-40g) column and elution with 80% MeOH-H<sub>2</sub>O to 100% MeOH delivered the recovered clean acceptor **104** and the desired molecule **139** in 40% yield, as well as traces of hydrolyzed donor. Although modest, 40% is an acceptable yield, considering the 1,3-diaxial interactions of the nucleophilic hydroxyl group with both substituents of the 1,6-anhydro bridge. The 1,6-anhydro functionality of this disaccharide can in principle be opened by acetolysis to allow for structure extension, as a possible way forward. Next, we tried glycosylation with the C<sub>7</sub>F<sub>15</sub>-glucosamine donor **82** bearing benzoate groups instead of acetyls (entry 3, table 9). With 1.4 equivalents of the acceptor mediated by TMSOTf (0.1 equiv.) in dry DCM, 20% of the expected disaccharide was isolated after RP column purification. This could be attributed to reduced reactivity and may be optimized by screening the promoter and reaction time among others. However, it seems that the robustness of the acetyl groups is not the dominant factor in these cases, so further studies were carried out on the acetylated donor **71**.

An in-depth study of the coupling between the fluorous glucosamine donor **71** and the galactose phenyl thioglycoside acceptor **108** was then carried out. The reaction of **71** and **108** in equimolar ratio with TMSOTf (0.1 eq.) from -40 °C → -25 °C for 2 hours gave the desired compound in moderate yield (17%, entry 2 table 9). By varying the duration of the reaction, equivalents of the promoter and that of the glycosyl acceptor (entries 3-12; excluding entry 7 and 10) we arrived at a better yield (57%, entry 11), but the reaction was inconsistent (entry 12, even though, 57% was obtained by letting the reaction stir at 0 °C for 1 h and 0 °C for entry 12 was attained progressively from -40 °C). The result was improved upon letting the reaction stir overnight up to room temperature (62% entry). Gladly, the current conditions have shown excellent reproducibility, and raising the scale to grams has afforded an even higher yield (71%, entry 14 table 9). Conducting the reaction in dry THF has not given any positive effect, as only traces of expected disaccharide was identified by spectroscopic analysis (entry 7). Similarly, substituting the Lewis acid with BF<sub>3</sub>-OEt<sub>2</sub> (0.1 eq., entry 10, table 9) afforded only 40% of the named disaccharide, albeit with an aglycon transfer byproduct (phenyl tri-*O*-acetyl-2-deoxy-2-pentadecafluorooctanoylamido-β-thioglycoside) which was detected and fully isolated. It was established that 1.5 equivalent of the acceptor with fluorous donor **71** activated by TMSOTf is enough to drive the reaction to completion efficiently.

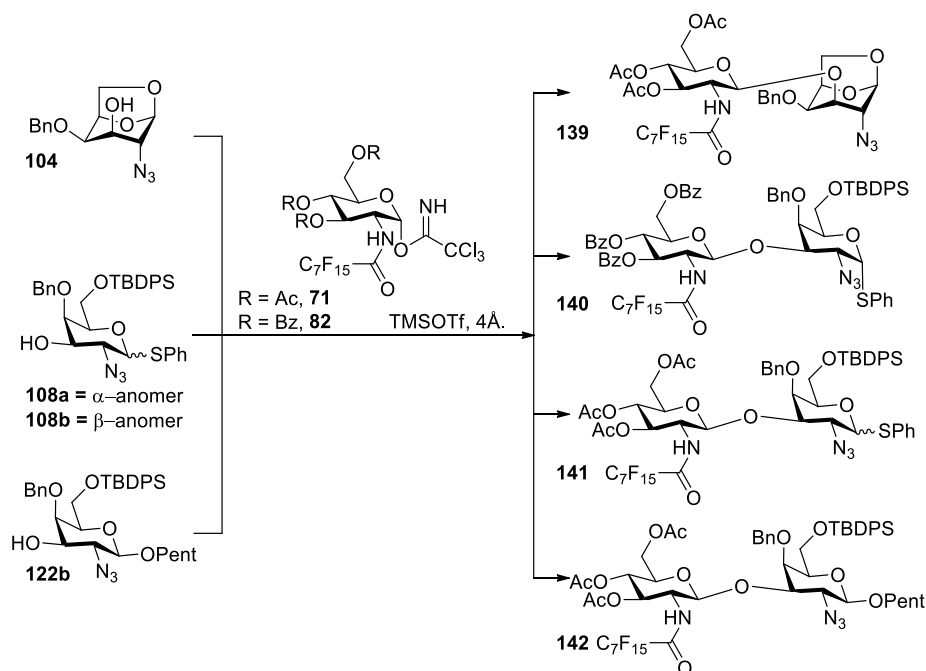

The potential of the purification system has also been demonstrated here with analytical LC/MS over PFP column and another by reverse phase (RP) in the HPLC analyses. The results in Figures 31 and 32 validate the preparative separation technique, as these molecules behaved smoothly on the preparative reverse phase C-18 MPLC column and were isolated cleanly. The recovered glycosyl acceptor and hydrolyzed donor could be reused without further purification.

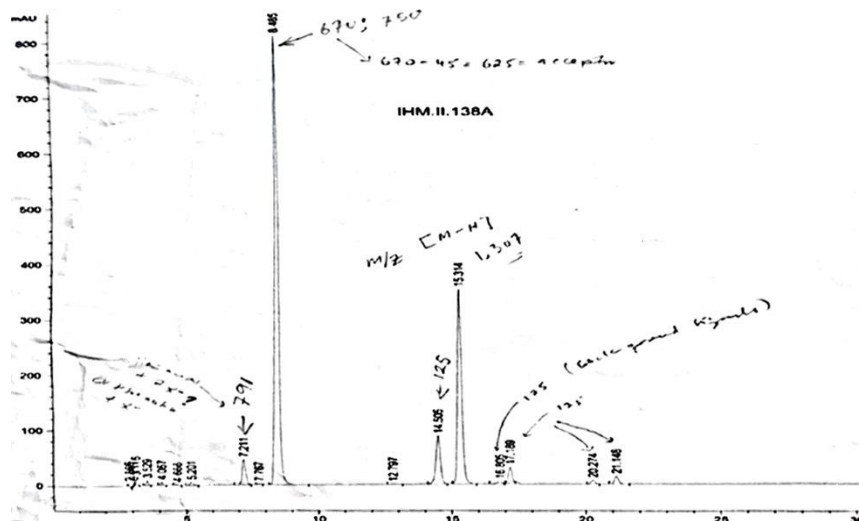

**Figure 33:** LC/MS analysis of the glycosylation reaction mixture of **141**. PFP HPLC column (4.6 x 150 mm), gradient 85% MeOH-H<sub>2</sub>O to 100% MeOH in 30 min and then back to starting gradient over 10 min. UV detection is 254 nm and the flow rate 0.6 mL/min.

In both cases, the peaks associated with glycosyl donor was first eluted after the solvent front. This is accompanied by recovered excess acceptor **108** and last, the desired disaccharide **141** was eluted at 15.3 min and 8.2 min on the PFP and RP by LC/MS and HPLC analysis respectively. Other small peaks are background noise or artifacts not related to our reaction mixture. The purification conditions by this method were similar to the tested compounds described in the previous section.

In the same vein, we made another acceptor replacing the anomeric thiophenyl by an *O*-pentenyl as an additional back-up in our synthetic design. With the optimized reaction protocol, 1.5 equivalents of this acceptor **122b** consumed the donor **71** in the presence of TMSOTf (0.1 eq.) from -40 °C to rt overnight. Surprisingly, this step offered an excellent yield (90%, entry 15). Using the RP purification method, pure molecules **141** and **142** were isolated from their respective crude reaction mixture by RP column (40g) as before and permit full characterization by spectroscopic analysis. The effect of the remote anomeric substituent is quite remarkable: The *O*-pentenyl group gave significantly better results than the thioglycoside, and the  $\beta$ -thiogalactoside gave consistently better results than the  $\alpha$ -thiogalactoside. It is unclear whether this is related to the transglycosylation reaction observed with BF<sub>3</sub>-etherate, or to a remote electronic effect. On this note, functional group manipulation, along with optimization of the other parameters have fully addressed the yield, reproducibility, solubility and reactivity challenges suffered initially. Although fluoruous HPLC on a PFP preparative column and the differentially double fluoruous tag after coupling strategy remain viable options, the fluoruous-hydrophobic strategy using a relatively polar fluoruous glycoside donor and a hydrophobic non-fluoruous glycoside acceptor turned to provide the most convenient and robust solution to the purification issue at the disaccharide level. This may also provide an interim solution for carbohydrate groups who do not have ready access to fluoruous SPE and HPLC columns, but routinely use MPLC chromatography.

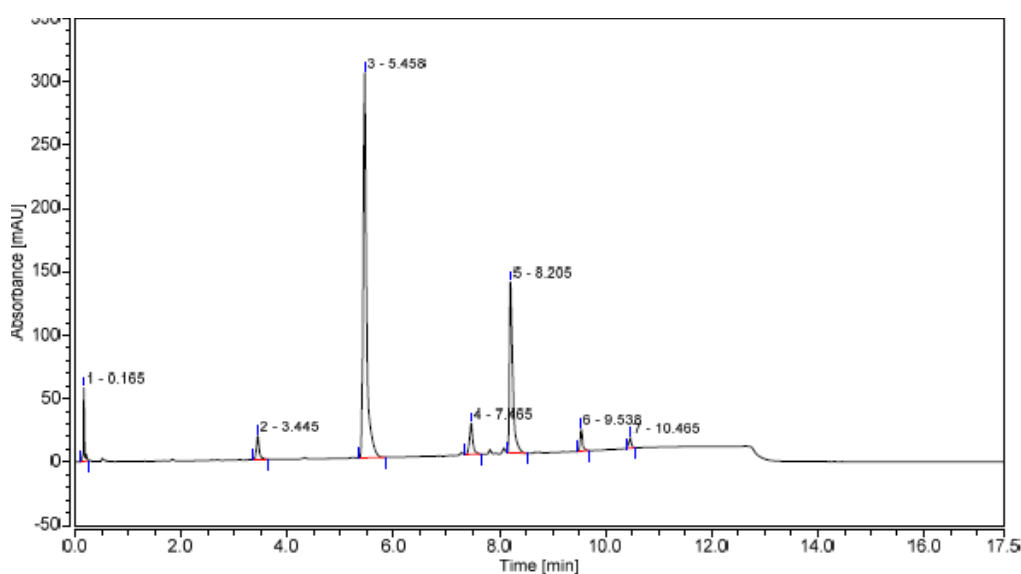
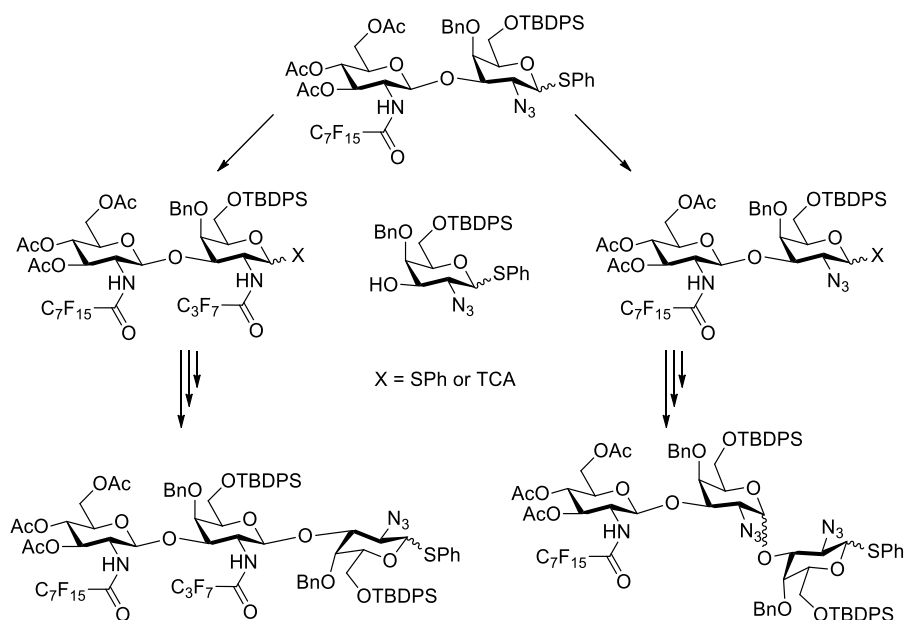

**Figure 34:** HPLC analysis of the glycosylation reaction mixture. Poroshell RP C8 column (2.1 x 50 mm), gradient 85% MeCN-H<sub>2</sub>O + 0.1% TFA to 100% MeCN in 17.5 min. UV detection is 254 nm and the flow rate 0.8 mL/min.

### Synthesis of *O*-antigen trisaccharides

Progressing in the synthesis from the optimized disaccharides to the partial antigen trisaccharide structure is aimed at a proof of the developed strategy. Iterative transformation of the fluoruous amide disaccharide towards either the  $\beta,\alpha$ - and  $\beta,\beta$ -trisaccharide will constitute a general validation of single or multiple-fluoruous tag non-reducing-to-reducing oligosaccharide synthesis. Two routes were designed in our synthesis to deliver these isomers within established protocols (Figure 35). After the single-fluoruous tag synthesis of the disaccharide described above, the  $\alpha$ -directing azide can be converted directly into the trisaccharide in the presence of the azidoglycosyl acceptor, leading to the differentially fluoruous GlcNAc- $\beta$ (1 $\rightarrow$ 3)GalNAc- $\alpha$ (1 $\rightarrow$ 3)GalNAc trisaccharide after reduction of both

azide groups and introduction of two short fluoruous tags. Alternatively, the disaccharide azide can be reduced and a second  $\beta$ -directing fluoruous amide tag can be introduced. Iterative glycosylation with the azidoglycosyl acceptor will then lead to GlcNAc- $\beta$ (1 $\rightarrow$ 3)GalNAc- $\beta$ (1 $\rightarrow$ 3)GalNAc after reduction of the azide and introduction of a third fluoruous amide, as depicted in the sections below.



**Figure 35:** Stereoselective synthesis of target trisaccharides.

#### *Coupling followed by F-tag afterwards*

The first step in this synthesis necessitates efficient activation of the anomeric thioglycoside to allow for successful nucleophilic attack by the glycosyl acceptor under appropriate conditions in a straightforward manner. Therefore, we set up a model reaction scheme to establish thioglycoside disaccharide activation optimally (Figure 35). With Phenyl 3,4,6-tri-*O*-acetyl-2-deoxy-2-(8,8,8,7,7,6,6,5,5,4,4,3,3,2,2-pentadecafluorooctanoylamido)-1-thio- $\beta$ -D-glucopyranoside (**83**) and Phenyl 2-azido-4-*O*-benzyl-6-*O*-tert-butyl-diphenylsilyl-2-deoxy-1-thio- $\alpha$  and or  $\beta$ -D-glucopyranoside (**107a/b**) in the presence of a thiophilic promoter system,<sup>195</sup> only 13% of the expected disaccharide **138** was isolated after purification over C-18 column (table 10, entry 1). This disaccharide resembles the previously made disaccharide by trichloroacetimidate activation. Despite changing certain conditions, such as the number of equivalents of BSP, the reaction duration, and the stereochemistry of the thioglycoside, only little improvement was achieved with 24% yield, using 4.2 eq of BSP and 4 hours reaction time (entry 2 and 3, table 10).

**Table 10:** Preliminary test for thioglycoside activation in the glycosylations shown in scheme 13.<sup>a</sup>

Entry	D:A ratio	Promoter system	T (°C)	d (h)	Yield (%)
1	1:1.5 ( $\beta$ )	TTBP (2.0), BSP (1.1), Tf <sub>2</sub> O (1.2)	-60 $\rightarrow$ rt	8	13
2	1:1.1 ( $\alpha$ )	TTBP (2.0), BSP (2.0), Tf <sub>2</sub> O (1.2)		6	15
3	1:1.5 ( $\beta$ )	TTBP (2.0), BSP (4.2), Tf <sub>2</sub> O (1.2)		4	24

4	1:1.1 ( $\alpha$ )	NIS (2.25), TfOH (0.75)	-25 $\rightarrow$ 0	5	0
---	--------------------	-------------------------	---------------------	---	---

a. A, D = glycosyl acceptor and donor respectively; T = temperature; d = duration. TTBP = 2,4,6-tri-tert-butylpyrimidine; BSP = benzenesulfinyl piperidine. A mixture of the fluoros tagged donor **83** and the acceptor **107a** ( $\alpha$ ) or **107b** ( $\beta$ ) in the indicated molar ratio in dichloromethane over freshly flame-activated powdered 4Å sieves was stirred at rt for one hour, cooled to the indicated temperature and stirred for 30 min, and was treated with the indicated promoter system and allowed to warm progressively to the indicated temperature over the indicated duration.

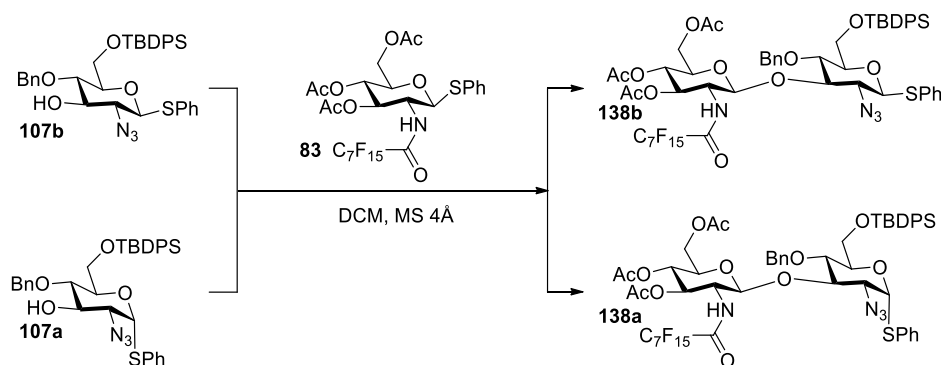

**Scheme 13:** Preliminary test for thioglycoside activation in glycosylation **138b-138a**.

An alternative thiophilic recipe was tested (TfOH/NIS) because in all three previous entries, unreacted fluoros donor was fully recovered (entry 4).<sup>456</sup> Substituting the promoter might activate the donor more adequately, thus raising the yield. Unfortunately, after 5 hr reaction time following the TfOH/NIS promoter combination, the compound of interest was not detected even by mass spectral analysis. Despite these results, we chose to test these coupling conditions in the real scenario towards trisaccharide.

The singly fluoros tag disaccharide **138** bearing an anomeric thiophenyl as a departing group was ventured to react with the glycosyl acceptor **108** possessing a similar activatable leaving group by the inverse addition procedure (Scheme 3.6). Upon donor activation by the reagent system (TTBP, BSP and Tf<sub>2</sub>O) at -60 °C in anhydrous DCM and flame activated molecular sieves (4Å), the acceptor was then introduced and stirred from -60°C to room temperature (Table 10, entry 1). Unfortunately, there was no trace of the expected trisaccharide **147** or of either recovered starting material detected by mass spectrometry or NMR (Scheme 13). Thorough screening for efficient complex carbohydrate assembly is limited by the extremely difficult and time-consuming number of steps to prepare the precursors, let alone the capital resource requirements for reagents and equipment. To address this setback, although we felt that selective activation of the thioglycoside was ultimately possible, we redirected our efforts to a rather less ambitious but more predictable course by transforming the thioglycoside into Schmidt's trichloroacetimidate donor combined with an acceptor having activatable anomeric *O*-pentenyl functionality.

Deprotection of thiophenyl iterative protecting group on the glucoside fluoros disaccharide **138** was achieved by the action of N-bromo succinimide (NBS) in acetone.<sup>260</sup> After chromatographic separation on silica gel, the desired inseparable mixture of disaccharide hemiacetals was isolated in moderate yield (**143**, 48%), and subsequent trichloroacetimidate formation was accomplished with CCl<sub>3</sub>CN (30 eq.) and Cs<sub>2</sub>CO<sub>3</sub> (0.6 eq.) which afforded separable anomeric mixtures of donor **145** ( $\alpha/\beta$ , 2/3) at 92% over silica gel. Surprisingly, in an analogy to the former deprotection, the phenyl thiogalactoside disaccharide **141** was not conveniently deprotected under similar conditions, providing inseparable mixtures of anomeric hemiacetal disaccharides and unreacted starting material. Hence, it became

imperative to seek out different reagents. To our delight, NIS/TFA in wet DCM overcame this difficulty in an excellent yield by driving the crude reaction mixture to complete product.<sup>457</sup> An  $\alpha/\beta$  mixture of anomeric hemiacetal disaccharides (**144**; 70%) was obtained in an improved yield. This was later successfully transformed to Schmidt's donor (**146**; 67%, Scheme 14).

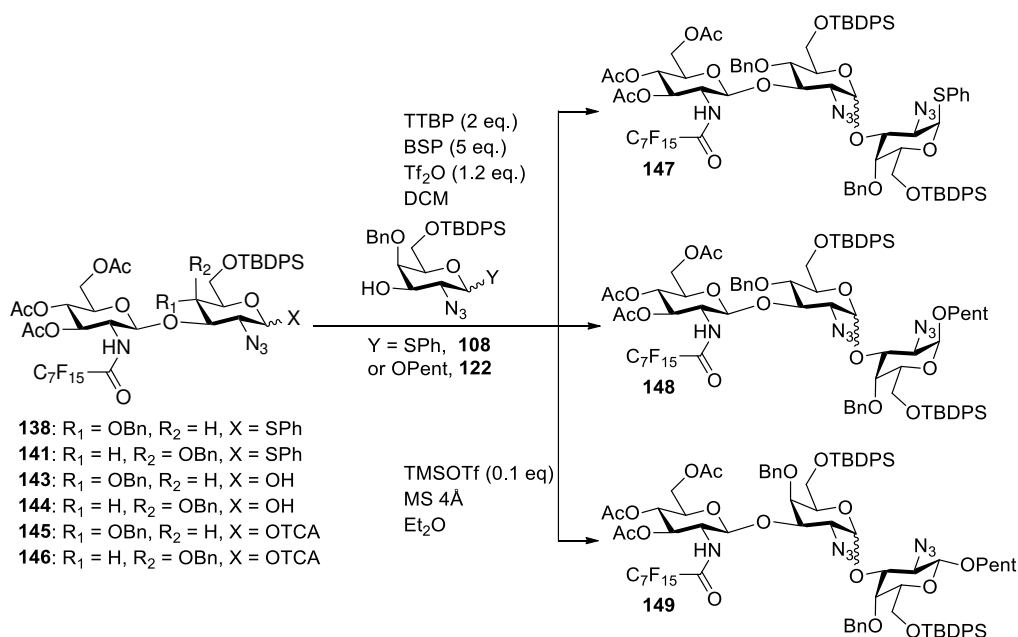

**Scheme 14:** Stereoselective synthesis of target trisaccharide **147-149**.

By reacting the glucosyl trichloroacetimidate disaccharide donor **145** and 1-*O*-pentenyl-galactosyl acceptor **122** in dry Et<sub>2</sub>O over the course of 4h with TMSOTf promoter system, the expected trisaccharide **148** was identified by mass spectrometric analysis. The crude reaction mixture was purified on RP C-18 column (4g), affording 20% of the expected trisaccharide. Improved separation was observed from NMR result when we deployed preparative HPLC separation over pentafluorophenyl column (table 11, entry 2), although the complexity of the NMR analysis could not allow us to evaluate selectivity in this reaction. A single pure molecule **148** was eluted after 9 minutes with a very small peak eluted after 10 minutes that is presumed to be the possible  $\beta$ -isomer (Figure 36).

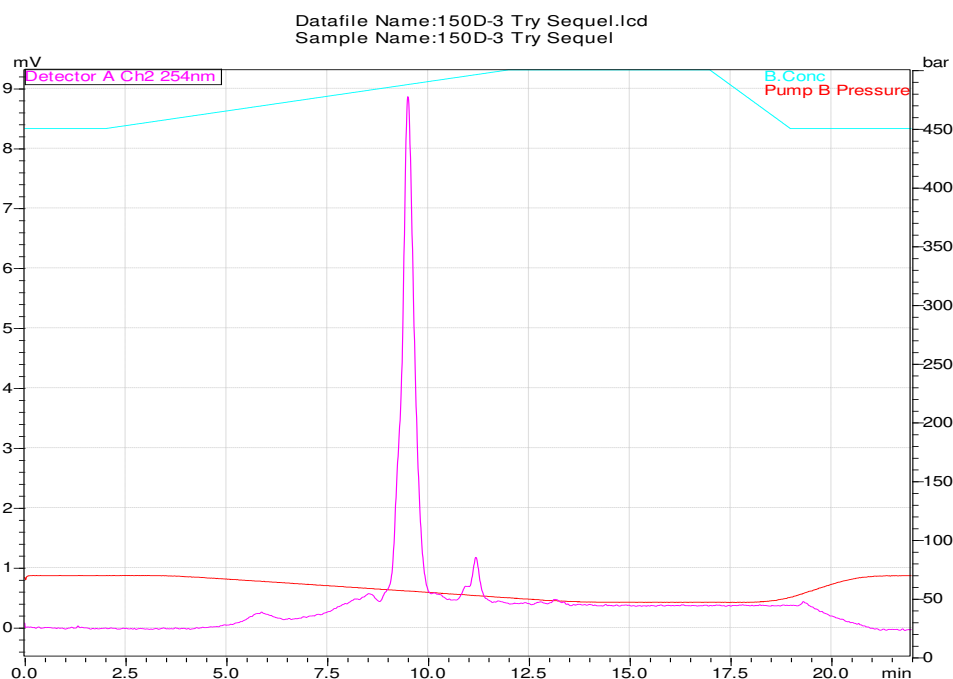

**Figure 36:** Retention time for trisaccharide **148** over preparative PFP HPLC column (10.0 x 125 mm), gradient 95% MeOH-H<sub>2</sub>O to 100% MeOH in 20 min. UV detection is 254 nm and the flow rate 7 mL/min.

**Table 11:** Synthesis of trisaccharides **147-149**.<sup>a</sup>

Entry	Disaccharide donor	A (equiv.)	Solvent	T (°C)	d (h)	Yield (%)
1	Thiophenyl fluorous glucoside ( <b>138</b> )	<b>108a</b> (3.6)	DCM	-60 → rt	o/n	0
2	Trichloroacetimidate fluorous glucoside ( <b>145</b> )	<b>122a</b> (1.9)	Et <sub>2</sub> O	-40 → 0	4	20
3	Trichloroacetimidate fluorous galactoside ( <b>146</b> )	<b>122b</b> (2.0)		-40 → rt	o/n	60

a. A = glycosyl acceptor; T = temperature; d = duration; o/n = overnight. TTBP = 2,4,6-tri-tert-butylpyrimidine; BSP = benzenesulfinyl piperidine. A mixture of the indicated fluorous tagged disaccharide donor **83** and the acceptor **108a**( $\alpha$ ) or **108b** ( $\beta$ ) in the indicated molar ratio in the indicated solvent over freshly flame-activated powdered 4Å sieves was stirred at rt for one hour, cooled to -40 °C and stirred for 30 min, and was treated with the promotor system indicated in Scheme 14 and allowed to warm progressively to the indicated temperature over the indicated duration.

In the same way, a mixture of two azidogalactose donor trichloroacetimidate anomers **146** and  $\beta$ -O-pentenyl galactoside acceptor **122b** were condensed in dry Et<sub>2</sub>O, activated by TMSOTf (0.1 eq.), on a much larger scale. Reverse phase (RP) separation on C-18 column efficiently resolved the mixture of stereoisomeric products ( $\alpha/\beta$ : 5:2; 60%) (Table 11). The eluting order follows, the recovered acceptor **122b**, hydrolyzed disaccharide donor **144**, and the two stereoisomers of compound **149**.

Purification of the reaction mixture by RP C-18 column allows us to separate and characterize pure  $\alpha$ -trisaccharide from  $\beta$ -anomer. RP columns' application in this regard has illustrated stronger hydrophobic interactions in going from the disaccharide to the trisaccharide molecules. Inserting multiple fluorous tags at this stage remains a viable option, in particular for very large-scale synthesis,



but has proven unnecessary at this stage. Although separation of the stereoisomers is possible, efforts are underway to improve the selectivity, for example with Lewis basic additives.

### *F-tag followed by coupling approach*

To develop a selective route towards the titled trisaccharide bearing two  $\beta$ -glycoside bonds, the azide functional group has to be converted to a C2 participating *N*-protecting group. We therefore decided to amidate the liberated amine upon azide reduction with another fluororous chain of different fluorine atom length. With limited number of effective C2 participating protecting group on glycosamines, an additional different fluororous chain from the previously established C<sub>7</sub>F<sub>15</sub> on the disaccharide donor will demonstrate further applicability and chemical suitability of this novel tags for the formation of reactive oxocarbenium ion intermediate during glycosylation. Furthermore, this effectively puts in place the differential double fluororous tag methodology as initially envisioned: increased fluorine content will result in higher fluorophilicity and by extension, may improve affinity on the solid phase in the course of an eventual fluororous phase purification. In a future incarnation, the crude coupling product can be carried through the reduction and fluoroacylation, and the various components separated by fluororous column chromatography.

In the beginning, azide reduction was attempted by the action of palladium metal on carbon and toluenesulfonic acid monohydrate (TsOH-H<sub>2</sub>O) in methanol at room temperature under an H<sub>2</sub> atmosphere. The amine formed would then be coupled with a fluororous acyl chloride or anhydride in the presence of DMAP in anhydrous DCM in a two-step procedure. Unfortunately, starting from compound **141**, the expected difluororous tagged disaccharide was not detected by either mass spectral or NMR analysis (entry 1, table 12). Instead, we chose to transform the azide to an amine group in the same disaccharide **141** by a Staudinger reaction (entry 2) with 3 eq. of triphenyl phosphine (Ph<sub>3</sub>P) in aqueous THF (v/v; 10:1).<sup>458,459</sup> Mass spectrometry confirmed the presence of the amine and iminophosphorane disaccharide intermediate. After solvent evaporation and without purification, fluororous amide disaccharide (**150**) was subsequently made with perfluorobutyryl chloride (1.2 eq.) catalyzed by DMAP (3 eq.) in dry DCM at room temperature for 4 h.<sup>460,461</sup> Upon purification by silica gel chromatography, the desired compound was obtained in moderate yield (49%) as a separable mixture of anomeric thioglycoside disaccharides (**150**).

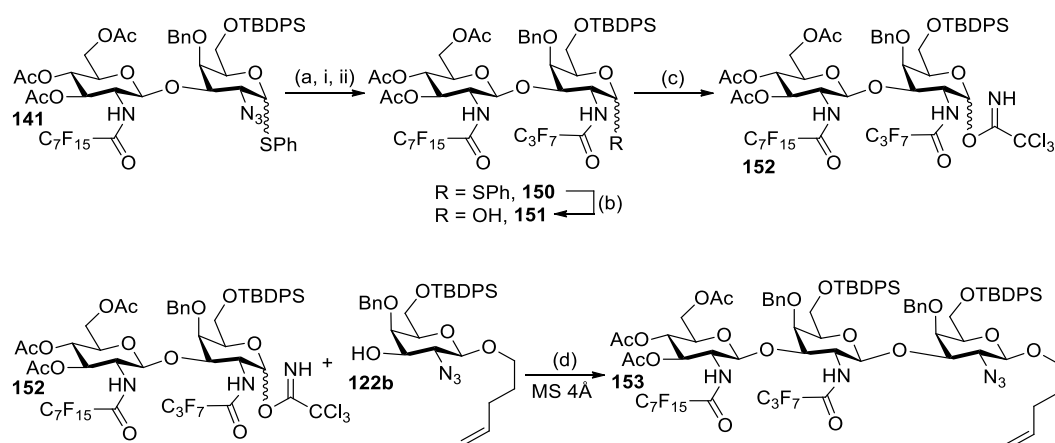

**Scheme 15:** Double fluororous tag  $\beta$ -stereoselective glycoside synthesis of trisaccharide **153**. **Reagents and conditions:** a) i) Ph<sub>3</sub>P (3.2 eq.), THF-H<sub>2</sub>O, 17 h, 60 °C; ii) F<sub>7</sub>C<sub>3</sub>C(O)Cl (1.2 eq.), DMAP (3 eq.), DCM, 3 h, 49% two steps, b) NBS (2 eq.), Acetone, 3 h, rt, 86%, c) CCl<sub>3</sub>CN (30 eq.), Cs<sub>2</sub>CO<sub>3</sub> (0.6), MS 3Å, DCM, 24 h, rt, 67%, d) TMSOTf (0.1 eq.), MS 4Å, DCM, overnight, -40 °C-rt, 97%.

The hydrolysis of the anomeric thioglycoside was successful with *N*-bromo succinimide (NBS, 2 eq.) in wet acetone at room temperature for 3 hours under constant stirring (Scheme 15). A separable mixture of hemiacetals ( $\alpha/\beta$ ; 1:11.2, **151**) was obtained in 86% yield. The action of trichloroacetonitrile and  $\text{Cs}_2\text{CO}_3$  base under inert condition in dry DCM gave the Schmidt donor **152**, as an inseparable mixture and in good yield (67%) after silica gel chromatography.

**Table 12:** Reagents and conditions towards double fluororous tagging and synthesis of 1,2-*trans* glycoside trisaccharide **153**.<sup>a</sup>

Entry	S.M.	Reagents	T (°C)	Solvent	d (h)	Yield (%)
1	<b>141</b>	(i) Pd/C (10% w), H <sub>2</sub> , TsOH-H <sub>2</sub> O (1 eq.)	rt	MeOH	1	0
		(ii) (F <sub>7</sub> C <sub>3</sub> CO) <sub>2</sub> O (1.2 eq.), DMAP (3 eq.)		DCM	48	
2	<b>141</b>	(i) Ph <sub>3</sub> P (3.2 eq.)	60	THF-H <sub>2</sub> O	o/n	49
		(ii) F <sub>7</sub> C <sub>3</sub> C(O)Cl (1.2 eq.), DMAP (3 eq.)	rt	DCM	3	
3	<b>150</b>	NBS (2 eq.)	rt	Aq. Acetone	3	86
4	<b>151</b>	CCl <sub>3</sub> CN (30 eq.), Cs <sub>2</sub> CO <sub>3</sub> (0.6), MS 3Å	rt	DCM	24	67
5	<b>152 + 122b</b>	TMSOTf (0.1 eq.),	-40 → rt	DCM	o/n	97

a. S.M. = starting material; T = temperature; d = duration; o/n = overnight, rt = room temperature. See experimental section for conditions of each reaction.

The usefulness of this strategy is validated in an advanced setting for the synthesis of different trisaccharides. The differentially fluororous tagged disaccharide donor **152** was then coupled with *O*-pentenyl  $\beta$ -galactoside acceptor **122b** catalyzed by TMSOTf (0.1 eq.) in dry DCM (entry 4, table 12 and Scheme 15) as in the optimized procedure for disaccharide synthesis in the previous section. In the same way, purification over RP C-18 column (4g) gave a clean desired trisaccharide **152** in just 20 minutes in a single separation. The excess glycosyl acceptor was eluted and recovered first, followed by the compound of interest collected in an excellent 97% yield and was identified by mass spectral and NMR analysis.

## Conclusion

The application of multiple fluororous precursors for convenient  $\beta$ -1,3-glycoside bond formation was challenged by the poor solubility and reactivity of the designed fluororous acceptors. As the number of fluorine atoms increase on the glycosyl acceptor, so does the deactivation of the neighboring nucleophilic hydroxyl group. Fluororous glycosyl donors, on the other hand, have proven to have considerable potential for oligosaccharide synthesis. Fluororous amides exhibit excellent C2-participating properties for high  $\beta$ -stereochemical control, and hence, may be adaptable to a wide diversity of contexts. The shift from poorly soluble and poorly reactive fluororous acceptors to the azido-substituted acceptors has thus led to excellent yields, up to 90%, and a paradigm for the control of the stereochemistry of subsequent stereocenters in the synthesis of aminosugar oligosaccharides. The

combined fluorophilic and hydrophobic effect of the compounds synthesized has demonstrated great separation behavior on both analytical and preparative pentafluorophenyl (PFP) HPLC columns. Furthermore, affordable and more widely available reverse phase (RP) C-18 MPLC columns present an effective alternative purification method. Differential fluorous tagging afterward for the construction of  $\beta$ -glycosidic bond on the model trisaccharide has in practice shown the best results with 97% isolated yield of trisaccharide molecule in a single separation step. The novel fluorous amides are therefore a promising purification handles and C2-directing N-protecting groups for glycosamines with a wide reagent tolerance for manipulation.



## CHAPTER FOUR: Studies Toward the Synthesis of Partial Peptidoglycan Structures

### INTRODUCTION

Peptidoglycan (PGN) is an essential component of many bacterial cell walls that has attracted research interest due to its immunostimulatory effects. It is the common bacterial cell wall component found on the outside of the cytoplasmic membrane of almost all bacteria.<sup>462</sup> Apart from preserving cell integrity by withstanding various physical stresses, among its many biological and structural functions, it has historically been one of the leading targets for antibiotic studies, in particular the penicillins. Recent discoveries have confirmed the interplay between these common microbial structures with the host's innate immune system in the response mechanism towards foreign organisms.<sup>463–465</sup> These extremely conserved components, termed as microbe-associated molecular patterns (MAMPs) or pathogen-associated molecular patterns (PAMPs), comprise a number of bacterial cell wall components, such as peptidoglycans (PGN) and lipoproteins present in both Gram-positive and Gram-negative bacteria, lipopolysaccharides (LPS) of the outer membrane peculiar to Gram negative bacteria, and lipoteichoic acids (LTA) found in Gram-positive bacteria. The central structural feature of PGN is an alternating  $\beta(1\rightarrow4)$ -linked N acetylglucosamine (GlcNAc) and N-acetylmuramic acid (MurNAc) polysaccharide chain. The polysaccharide moieties are crosslinked by an oligopeptide to form a rigid three-dimensional structure. On the peptide scaffold are usually found diamino acids, such as L-lysine (in Gram-positive bacteria) or meso diaminopimelic acid (meso-DAP) (in most Gram-negative and some Gram-positive bacteria) at AA3 (Figure 37). Eventually, other branched structures may be recognized as variation in some microbes: 1) diamino dicarboxylic acids, such as LL-DAP (*Streptomyces albus* and *Propionibacterium petersonii*), meso-lanthionine (*Fusobacterium nucleatum*), and 2,6-diamino-3-hydroxypimelate (*Ampuraliella regularis*); 2) diamino mono-carboxylic acids, such as a mixture of L- and D-lysine (*Thermo-toga maritima*), L-ornithine (*Spirochetes*, *Thermus thermophilus*, and *Bifidobacterium globosum* (incl. L-Lys)), L-2,4-diacetyl-L-2,4-minobutyrate (*Corynebacterium aquaticum*), Ng diaminobutyrate (*Corynebacterium insidiosum*), and L-5 hydroxylysine (*Streptococcus pyogenes*); and 3) cross-linking at AA2 (D-Glu) and containing L-homoserine (*Corynebacterium poinsettiae*), L-alanine (*Erysipelothrix rhusiopathiae*), and L-glutamic acid (*Arthrobacter* J. 39) at AA3.<sup>466,467</sup> The GlcNAc-MurNAc unit is condensed by transglycosylase action to form the glycan backbone of the peptidoglycan, which is subsequently followed by cross-linking to a neighboring strand to generate the cell wall.

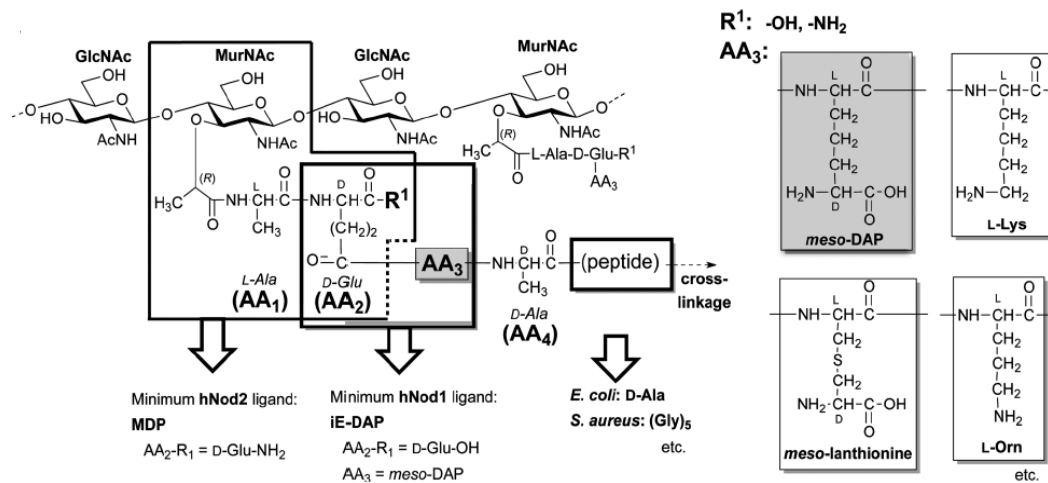

**Figure 37:** The basic structure of peptidoglycan. The glycan strands consist of alternating, ( $\beta 1 \rightarrow 4$ )-linked GlcNAc and MurNAc residues. Comprehensive reviews,<sup>466,467</sup> reported that *Staphylococcus aureus* (Gram-positive bacteria) peptide stem contains D-Glu-NH<sub>2</sub> at AA<sub>2</sub>, L-lysine at AA<sub>3</sub>, and cross-linkage with the pentaglycine bridge. The peptidoglycan structure of *Escherichia coli* (Gram-negative bacteria), has different amino acid variations (D-Glu-OH at AA<sub>2</sub>, and meso-diaminopimelic acid at AA<sub>3</sub>), and has D-Ala in the peptide stem. *Fusobacterium nucleatum* (Gram-negative bacteria), is known to have meso-lanthionine at AA<sub>3</sub>, whereas Spirochetes, *Thermus thermophilus* (Gram-negative bacteria) and *Bifidobacterium globosum* (Gram-positive bacteria), are known to have L-ornithine at AA<sub>3</sub>. Synthetic studies revealed that g-D-Glu-meso-diaminopimelic acid (iE-DAP) and muramyl dipeptide (MDP) are the minimal active structures for the hNod1 and hNod2 recognition, respectively. AA = Amino Acid.

MAMPs or PAMPs trigger the host innate immune system through several pattern-recognition receptors (PRRs), which are significant for host's defense against pathogenic bacteria. This phenomenon also results in the activation of the second class of defense mechanism in vertebrates, the adaptive (acquired) immune system.<sup>468</sup> Bacterial PAMPs, such as PGN, LPS, lipoproteins/peptides, DNA (bacterial CpG-DNA) and viral RNA, thus serve as potent immunopotentiators and adjuvants for antibody production.

A collection of PRRs, such as toll-like receptors (TLRs), nucleotide-binding oligomerization domain (NOD)-like receptors (NLRs), and retinoic acid inducible gene (RIG)-I-like receptors (RLRs), incorporating sensing mechanisms and roles have been well-reviewed.<sup>7,469-475</sup> It was later recognized, though still poorly elucidated, that human NLRs proteins have functions in addition to pathogen-mediated recognition, in many signal transduction mechanism such as tissue homeostasis, apoptosis, graft-versus-host disease and early development.<sup>476,477</sup>

The NOD1 and NOD2 subfamily of NOD PRRs are both involved in sensing structurally distinct substructures from bacterial peptidoglycan.<sup>11,478,479</sup> Peptidoglycan sensing by NOD1 or NOD2 triggers the production of proinflammatory cytokines and chemokines and the recruitment of neutrophils to the site of infection,<sup>480</sup> and genetic variations in these molecules are linked with susceptibility to inflammatory diseases such as NOD1 for asthma,<sup>481</sup> while NOD2 has been incriminated in the pathogenesis of Crohn's disease, with recent promising efforts in stabilizing NOD2 sensing through its interaction with chaperone proteins for potential novel Crohn's disease therapeutics.<sup>478,482</sup> NOD1 and NOD2 are cytosolic proteins that are composed of leucine-rich repeat (LRR) domain at the carboxy terminus for ligand recognition; a central NOD domain for self-oligomerization/ATPase activity; and an amino terminus caspase-recruitment domain (CARD) that engages distinct sensing pathways, which define the functional properties of the family members. NOD1 has one CARD domain, whereas NOD2 has two CARD domains. NOD2 detects muramyl dipeptide MDP, the largest molecular pattern common to Gram-negative and Gram-positive bacteria.<sup>11</sup> On the other hand, human and mouse NOD1 specifically recognizes structures containing L-Ala- $\gamma$ -D-Glu-meso-DAP and L-Ala-D-glu-meso DAP-D-

Ala, respectively; a meso-diaminopimelic acid (meso-DAP) peptidoglycan more common to Gram-positive bacteria (Figure 37).<sup>10</sup>

The release of cell wall substructures such as peptidoglycan into the environment is connected with bacterial cell growth and septation, but also in pathological situations such as sepsis, by antibiotic-induced bacterial necrosis.<sup>483,484</sup> In the former case, cell wall biosynthetic peptidoglycan turnover and recycling pathways have been elucidated, indicating that a range of 30%–60% of the original cell wall components are reused in Gram-negative bacteria. The fragments are discharged into the environment after cell wall degradation and then transported back into the cell for subsequent biosynthesis of the cell wall.<sup>485–487</sup> Lytic transglycosylase enzymes and an integral membrane protein AmpG permease are required for the recycling pathways, and for instance in *E. coli* and related enteric bacteria afford monomers of PGN to N-acetyl-1,6-anhydro-muramyl [(anh)MurNAc] moieties as the products, first detected, isolated, analyzed and reported in *Bordetella pertussis* as TCT.<sup>488–490</sup> AmpG is a significant protein and plays a key role in recycling. Mechanistically,<sup>491</sup> these enzymes are proposed to catalyze the acid activation of the GlcNAc-MurNAc glycosidic bond, initiating the formation of a reactive oxo-carbenium species. Subsequently, this undergoes intramolecular trapping by the C-6 hydroxyl of the MurNAc saccharide to give the N-acetyl- glucosamine-1,6-anhydro-N-acetylmuramyl moiety such as found in TCT (figure 37), which corresponds to a disaccharide-tetrapeptide monomer of peptidoglycan that is produced by all gram-negative bacteria as they break down and rebuild their cell wall during growth. Its defined structure is N-acetylglucosaminyl-1,6-anhydro-N-acetylmuramyl-(L)-alanyl- $\gamma$ -(D)-glutamyl-meso-diaminopimelyl-(D)-alanine in *Bordetella pertussis*.<sup>492</sup> PGN monomers released into the environment are transported by the cytoplasmic protein AmpG and eventually cleavage of the peptide chain is achieved by AmpD-a peptidoglycan amidase whereas a glycosidase NagZ hydrolyze the glycosidic bond of structures such as TCT. These fragments are then taken back for *de novo* synthesis of cell wall, although they are also responsible for inducing eukaryotic peptidoglycan-recognition receptors of the host immune system, for instance NOD1 and NOD2 in humans, eliciting a potent pro-inflammatory response. Much broader experimental studies on the toxicity, virulence factors, and molecular interaction of TCT and other truncated structures of bacterial cell wall origin continue to contribute the drive for solid vaccine development.<sup>493–498</sup> AmpG is inactive in *B. pertussis*, guaranteeing constant TCT expression into the external milieu<sup>499</sup> in the log growth and virulent phases.<sup>500,501</sup> This promotes ciliostasis and colonisation due to resulting damages of the ciliated cells of the airways (respiratory tract). In the event of failed ciliary movement, elimination of mucus, bacteria, and inflammatory debris from the respiratory tract is driven by coughing mechanism, causing eponymous paroxysmal cough.

Further application of fluorous glucosamine donors for glycosylation with 1,6-anhydro muramyl derivative acceptors will show its versatility in a biologically relevant context. Purification on RP C 18 column will also help determine the generality of the fluorous-hydrophobic protocol. In essence, purity, yield, and the opportunity for structural modification of the target molecules are the prime objectives for the chemical endeavor, therefore we envisaged to synthesize two peptidoglycan fragments in analogy to tracheal cytotoxin (TCT): A disaccharide GlcN-fluorous amide  $\beta(1\rightarrow4)$ -MurN<sub>3</sub>-L-Ala- $\gamma$ -D-Glu-L-Lys-D-Ala and monosaccharide 1,6-anhydro MurN-fluorous amide-L-Ala- $\gamma$ -D-Glu-L-Lys-D-Ala glyco/muramyl tetrapeptides respectively (Figure 38). The study aimed to fashion out structure-activity relations of this molecules as ligands with the NOD family of immune receptors. Although Lys-type fragments are common to gram positive bacteria, biological examination of the fluorous analogs may reveal fascinating results with respect to agonistic or antagonistic activities. This

may provide improved and less toxic agonists to be used as adjuvants or potential antagonists for the treatment of sepsis associated with antibiotic treatment of severe infection.

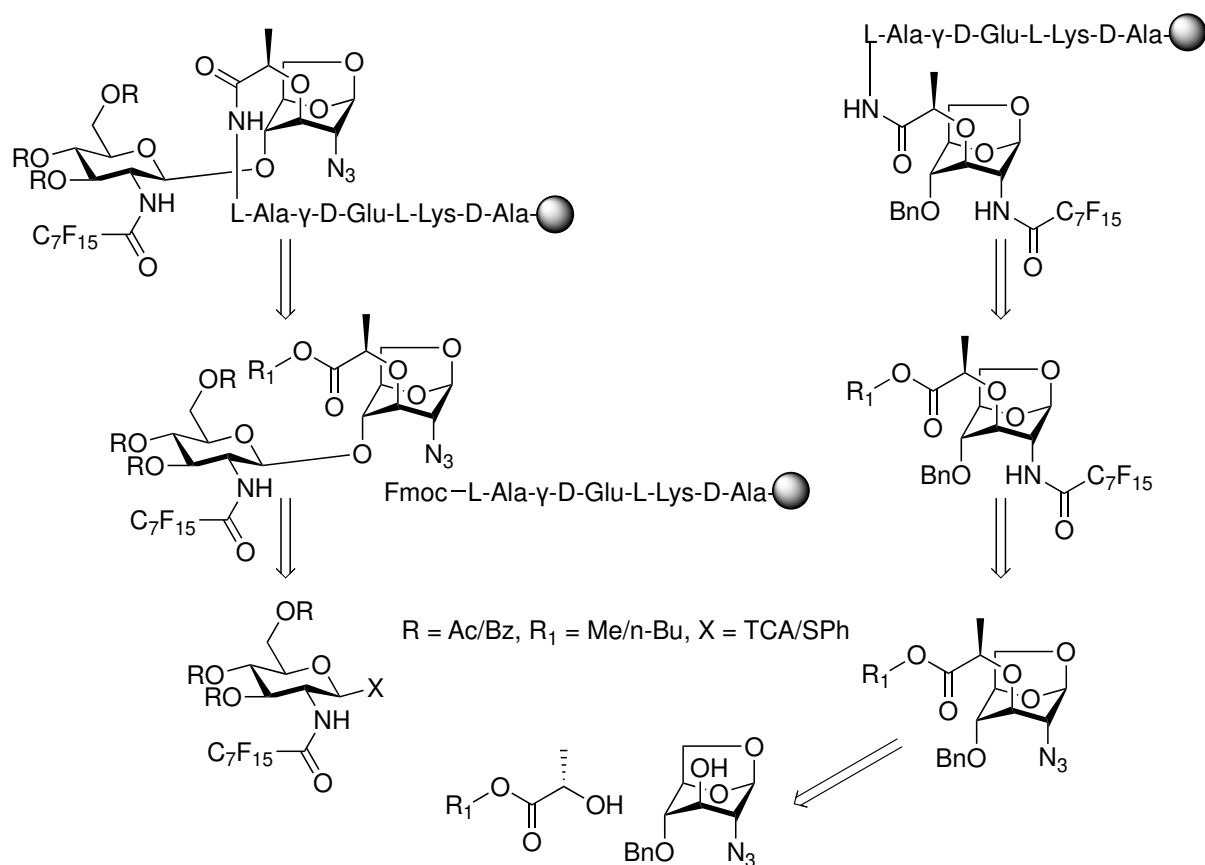

**Figure 38:** Fluorous peptidoglycan retrosynthesis

## RESULTS AND DISCUSSION

### Synthesis of acceptor for 1,4-peptidoglycan disaccharide

In this undertaking, we planned to first form the 1,6-anhydro muramic acid derivatives **158** or **159** for two purposes (Scheme 16). This molecule will serve as the potential acceptor after deprotection of the 4-O protecting group as the basis for the preparation of a partial peptidoglycan disaccharide. On the other hand, we anticipated its use for the synthesis of a fluorous 1,6-anhydro muramyl tetrapeptide that is lacking the glucosamine moiety for comparative screening of their structure-activity with respect to NOD2 agonistic or antagonistic activities. As analogues to natural peptidoglycan fragments, they are targeted for therapeutic interventions in several contexts. Correspondingly, the separation of both compounds from the crude reaction mixture will be aided by the affinity of fluorous tags in order to isolate clean target molecules quickly. In the first step (Scheme 16), formation of trifluoromethanesulfonyl-(S)-2-propionic acid methyl ester was attempted by the action of an equimolar amount of Tf<sub>2</sub>O and 2,6-lutidine on (S)-(-)-methyl lactate in dry DCM from -70 °C to rt. The reaction was quenched after 2 h by the addition of n-Hexane (20 mL). Upon chromatographic purification on silica gel, the desired intermediate was only observed in trace amounts by NMR analysis. This yield was obtained after careful solvent evaporation because in the preceding attempts, we lost desired molecule by evaporation when left unchecked. In the same effort,



substituting the base by pyridine at 0 °C to rt for 2 h allowed us to isolate 19% of the triflate methyl ester **155** (entry 2; table 13).

**Table 13:** Activation of lactate esters. Note: *d* = duration, *T* = temperature.

Entry	R <sub>1</sub>	R <sub>2</sub>	Reagents	T (°C)	d (h)	Yield (%)
1	CH <sub>3</sub>	Tf	Tf <sub>2</sub> O, 2,6-lutidine	-70 → rt	2	( <b>155</b> ) 0
2	CH <sub>3</sub>	Tf	Tf <sub>2</sub> O, pyridine	0 → rt	1.5	( <b>155</b> ) 19
3	CH <sub>3</sub>	Ts	TsCl, DMAP, TEA	0 → rt	48	( <b>156</b> ) 6
4	C <sub>4</sub> H <sub>9</sub>	Tf	Tf <sub>2</sub> O, pyridine	0 → rt	1.5	( <b>157</b> ) 99

To afford optimized conditions and to balance the volatility issue with this intermediate, we reasoned to replace triflate group with a tosylate (OTs) to better reflect the actual yield of the reaction. Addition of methyl (*S*)-(-)-lactate to a solution of TsCl in DCM at 0 °C was followed by DMAP (1 equiv.) and TEA (1.2 equiv.), and the mixture was stirred at room temperature for 2 days.<sup>502</sup> Unfortunately, only a 6% yield of the corresponding tosylate **156** was obtained. Switching the methyl lactate to the bulkier *n*-butyl (*S*)-(-)-lactate precursor allowed for efficient activation to the suitable intermediate trifluoromethanesulfonyl-(*S*)-2-propionic acid butyl ester **157**, which was isolated in excellent yield (99%) (entry 4). This success facilitates the synthesis of 1,6-anhydro muramyl saccharide derivative **158** as shown in scheme 16. Treatment of **102** and **103** with 1.5 eq. of NaH in a separate reaction followed by the triflate butyl ester **157** for 2 h afforded **158** and **159** in 53% and 96% yield respectively. Subsequently, the paramethoxyphenyl group of **157** was cleaved with DDQ in wet DCM in 62% yield. Attempts to remove the 4-*O*-benzyl functionality with BCl<sub>3</sub> at -78 °C in DCM was not effective. Oxidative deprotection with sodium bromate (NaBrO<sub>3</sub>) and sodium dithionite (Na<sub>2</sub>S<sub>2</sub>O<sub>4</sub>),<sup>503</sup> however, successfully exposed the free 4-hydroxyl to provide the glycosyl acceptor **160** from the benzyl protected precursor **159** in 54% yield.

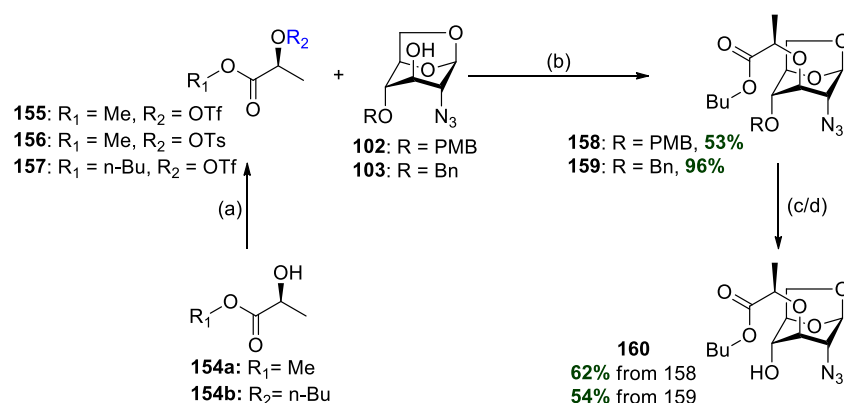

**Scheme 16:** Synthesis of 1,6-anhydro muramyl derivative acceptor **160**.

### Synthesis of peptidoglycan disaccharide

The prepared compound **160** was employed as a glycosyl acceptor with the previously established trichloroacetimidate donor **71**, using trimethylsilyl triflate (TMSOTf) over flame activated molecular sieves (MS, 4 Å) in dry DCM, at -40 °C, and delivered the disaccharide **161** in 67% yield. Pre-stirring the precursor mixtures for at least an hour and allowing the reaction to run overnight has a positive effect for ensuring complete glycosylation to provide an excellent 94% yield (table 14, entry 1-2). Similarly,

we tried to make same molecule with phenyl 3,4,6-tri-*O*-acetyl-2-deoxy-2-(8,8,8,7,7,6,6,5,5,4,4,3,3,2,2-pentadecafluorooctanoylamido)-1-thio- $\beta$ -D-glucopyranoside (**83**) with the thiophilic promoter systems: BSP, TTBP and Tf<sub>2</sub>O in DCM. Surprisingly, only a 1:1 inseparable mixture of the starting materials was observed by NMR after purification protocol and analytical TLC single spot was truly misleading. Therefore, the disaccharide **161** was not made in this case (entry 3, table 14). This indicates that the presence of a thioglycoside group on the acceptor was not the principal problem in the attempts described in the previous chapter.

To strengthen the versatility of our established synthetic and purification process, an additional donor tri-*O*-benzoyl trichloroacetimidate **82** that is analogous to **71** in all respects apart from the presence of the more robust *O*-benzoyl groups. It's intended coupling with acceptor **160** promoted by TMSOTf in dry DCM and activated MS (4 Å) while allowing it to warm to room temperature over 6 hours yielded the disaccharide **162**, also in a very satisfactorily 87% yield (entry 5, table 14). Although we had originally attributed the improved yields to the robustness of the protecting groups, the later result in entry 2 shows that it should be attributed to slightly faster rearrangement of the orthoamide to the *O*-glycoside. These disaccharides thus prepared were purified on RP C18 columns and showed excellent purification by reverse phase that allow us to recover excess acceptor in the first elution in MeOH: H<sub>2</sub>O, 80:20 while clean disaccharides were released with 95:05 MeOH: H<sub>2</sub>O.

**Table 14:** Protocols for partial peptidoglycan disaccharide synthesis **161-162**. Note: *T* = temperature, *d* = duration, *o/n* = overnight.

S/n	Donor	Reagents	T ( °C)	d (h)	Yield (%)
1	<b>71</b>	TMSOTf	-40 → 0	5	67
2	<b>71</b>	TMSOTf	-40 → rt	o/n	94
3	<b>83</b>	BSP, TTBP, Tf <sub>2</sub> O	-60 → rt	6	0
4	<b>82</b>	TMSOTf	-40 → 0	5	80
5	<b>82</b>	TMSOTf	-40 → rt	6	87

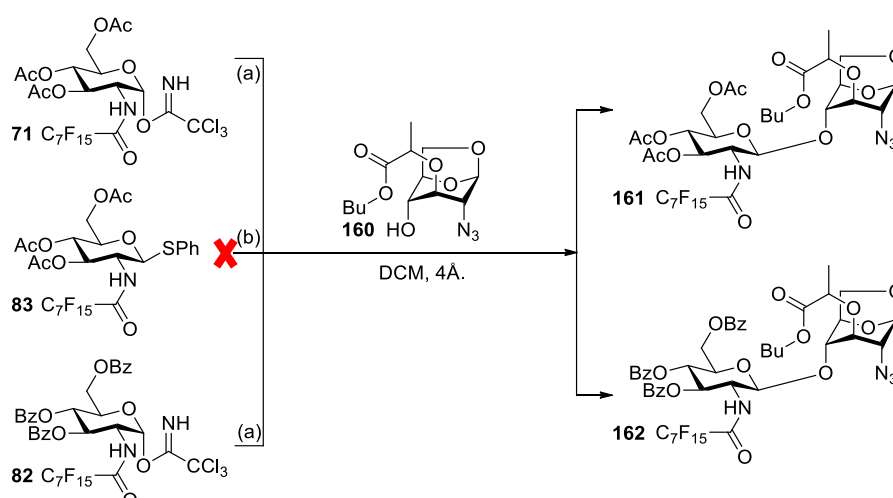

**Scheme 17:** Fluorous assisted disaccharide synthesis as partial structure for peptidoglycan **161-162**.

Subsequently, we were prompted to reduce the benzyl and azide groups of the muramic acid ester **159** by hydrogenation under H<sub>2</sub> (1.5 MPa) with Pd(OH)<sub>2</sub> in THF to afford free 4-O hydroxyl and 2-amino group. Fluorous amidation with heptafluoro butyric anhydride and DMAP after solvent evaporation in DCM was expected to result in the fluorous debenzylated compound **163** in a one-pot synthesis. This would serve as 1,6-anhydro fluorous muramyl acceptor in a differentially doubly fluorous tag strategy for the preparation of peptidoglycan fragment. Unfortunately, the ester functionality did not withstand the conditions, leading to the corresponding 1,6-anhydro fluorous muramic acid, isolated in moderate yield along with recovered starting material. Alternatively, the initially targeted fluorous muramic acid butyl ester **164** was obtained by hydrogenation over Pd/C 10% w/w and TsOH-H<sub>2</sub>O in MeOH under H<sub>2</sub> at rt for 1 h. Reaction with dodecafluorooctanoyl chloride and 3 equivalents of DMAP in DCM in this case, afforded **164** at 79% yield for the two steps. One expedient step to deliver glycosyl precursor for peptide coupling involved butyl ester cleavage of **162** and **164** with LiOH-H<sub>2</sub>O in THF/1,4-dioxane/H<sub>2</sub>O. The 1,6-anhydro fluorous muramic acid derivative **165** was obtained in 90%, while for the disaccharide **162**, the benzoates were partially cleaved in the reaction and the acid **166** was not isolated.

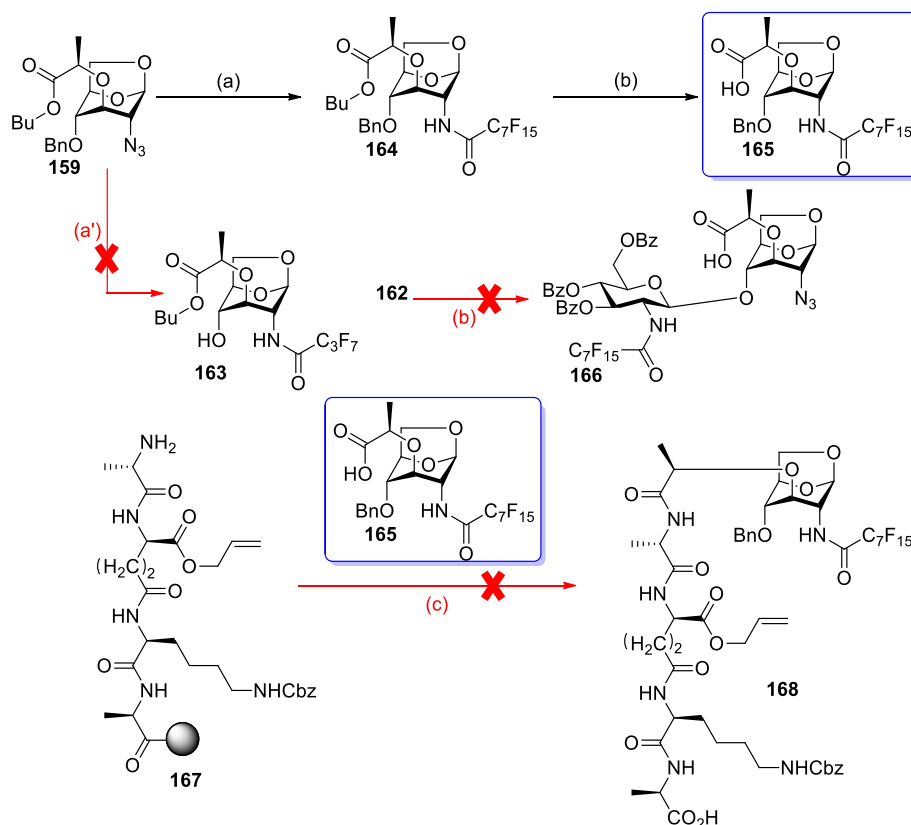

**Scheme 18: Fluorous glycopeptide synthesis: Conditions and Reagents:** (a') i. Pd(OH)<sub>2</sub>, THF, H<sub>2</sub> (1.5 MPa), rt, 1 h; ii. (F<sub>7</sub>C<sub>4</sub>)<sub>2</sub>O (1.1 eq.), DMAP (3 eq.), DCM, rt, overnight; (a) i. Pd/C 10% w, TsOH-H<sub>2</sub>O (1 eq.), MeOH, H<sub>2</sub> (1.5 MPa), rt, 1 h; ii. F<sub>15</sub>C<sub>7</sub>C(O)Cl (1.1 eq.), DMAP (3 eq.), DCM, rt, overnight, 79% over two steps; (b) LiOH-H<sub>2</sub>O (1.1 eq.), THF-1,4-Dioxane-H<sub>2</sub>O, rt, 4 h, 90%; (c) HOBT (1.3 eq.), WSCI-HCl (1.3 eq.), TEA (3 eq.), DMF, rt, 5 days. Red arrows indicate that the reaction was not successful.

Peptide synthesis was performed on ABI-433a synthesizer using the Fmoc/HBTU strategy on Rink amide AM resin (200-400 mesh). The standard conditions from the manufacturer (FastMoc 0.1 mmol and 0.25 mmol) were used without modification, and the yield of each Fmoc removal from D-Ala, L-Lys,  $\gamma$ -D-Glu, L-Ala series was determined by UV absorbance at 290.0 nm. At the completion of the tetrapeptide coupling sequence, after the Fmoc-N-protecting group of the terminal peptide was

cleaved, the peptide-bound resin was placed in the presence of the 1,6-anhydro fluorous muramic acid **165**, EDCI-HCl (1.3 eq). and HOBt in a round bottom flask. The set-up was dried under vacuum, suspended in anhydrous DMF under argon and after the addition of TEA the reaction was stirred for five days at rt. The resin was filtered and washed with DMF and was resuspended in 95% TFA to cleave the peptide/glycopeptide from the resin. Both the DMF and TFA fractions were concentrated in vacuo and were purified on TMS-capped fluorosilica gel. Sadly, mass spectrometry and NMR analysis confirmed only the presence of unconsumed muramic acid **165** in the DMF wash, which was recovered pure after fluorosilica chromatography, as the only identifiable product. Mass spectrometry and NMR analysis of the fractions from the TFA cleavage of the resin was unable to confirm the presence of either the glycopeptide **168** or the cleaved tetrapeptide from **167**. Further studies with shorter peptides and other coupling reagents and conditions are underway.

## CONCLUSION

We have demonstrated the utility of N-fluorous amide glucosamines as very reactive glycosyl donors that undergo clean coupling reactions with few side-reactions, and are able to provide oligosaccharides in high yields, often in the 90% yield range with appropriately chosen acceptors. While acyl glycosyl donors are considered less reactive (deactivated), in both the acetyl and benzoate series, the fluorosilica amide glucosamine donors afforded excellent yields and solubility. Our experience in these cases thus show that the electronic influence of the C2 fluorosilica amide has a very positive effect compared to their C2 acetamide counterparts, which often lead to poor reactivity and the isolation of stable oxazolines. Both GlcN-Fluorous amide  $\beta(1\rightarrow4)$ -1,6-anhydro MurN<sub>3</sub> disaccharide and 1,6-anhydro MurN-Fluorous amide monosaccharide were prepared in organic solvents efficiently using previously established procedures. The number of fluorine atoms has not restricted the synthetic schemes for reactivity or solubility. Therefore, the synthesis was performed free of fluorosilica co-solvents. The light fluorosilica tag synthesis permitted purification of the desired compound in a single chromatographic step over RP C 18 column. The desired molecule and recovered excess acceptor (in the case of the disaccharide) were isolated in pure form, best eluted from MeOH/H<sub>2</sub>O, 80:20 to pure MeOH gradient, and identification was achieved by spectroscopic means (NMR and MS). It is usually the case that some reaction conditions are incompatible with certain functionality, yet the fluorosilica amide has shown excellent tolerance with the chemistry tested and where incompatibility appears with other functionality, the pool of synthetic choices yielded alternative options. Although we have prepared the glycosyl starting materials and tetrapeptides, unfortunately, our first attempt to synthesize the fluorosilica muramic acid peptidoglycan derivative **168** was rather fruitless, and more study will be necessary.

## CHAPTER FIVE: Experimental Section

### GENERAL INFORMATION

#### Reagents and solvents

Commercially available reagents used were purchased from standard accredited companies comprising of Sigma-Aldrich, Thermo Fisher Scientific, Fluorochem and or Carbosynth. Solvents were purchased from Thermo Fisher Scientific and VWR. Anhydrous ones (DCM, THF, DMF, CAN, MeOH.....) were obtained from PureSolv solvent purification system of Innovative Technology, or purchased from Sigma-Aldrich and Thermo Fisher Scientific. Molecular sieves 3Å/4Å were purchased from Thermo Fisher Scientific and activated by heat gun. Analytical HPLC H<sub>2</sub>O was obtained on an ACCU 20 Ultra-Pure water system from Fisher Scientific. Analytical thin layer chromatography (TLC) was carried out on Macherey-Nagel silica gel 60 F254, viewed with a UV lamp at 254 nm or heated with heat gun after suspension on an acid stain (H<sub>2</sub>SO<sub>4</sub>/H<sub>2</sub>O/EtOH; 1/2/7). Preparative Fluorous silica gel 10cmx5cm and regular silica gel 20cmx10cm were all purchased from Sigma-Aldrich company. Flash silica gel column chromatography was performed with a Macherey-Nagel silica 60 M (0.04-0.063 nm).

#### Nuclear Magnetic Resonance

<sup>1</sup>H, <sup>13</sup>C, <sup>19</sup>F, COSY, HSQC, and HMBC NMR spectra were recorded on the Bruker spectrometers: Av 300, AVL 300, AV 400 and AV 500 at 298K by the CCRMN service team of the ICBMS, Lyon 1 as specified. The chemical shifts are indicated in ppm (parts per million) in reference to the residual deuterated solvent peak. Coupling constants (*J*-values) are recorded in Hz (Hertz). The abbreviations used for recording multiplicities were represented as follows: s = singlet, br = broad, d = doublet, dd = doublet of doublet, ddd = doublet of doublet of doublet, q = quartet and m = multiplicities.

#### Mass Spectrometry

High- and low-resolution mass spectrometry analysis were carried out on an MicroQTF II (50-20 000 m/z) apparatus from Bruker. This has been duly serviced by the CCSM team in the ICBMS, Lyon 1 with Electrospray ionization mode.

#### HPLC

HPLC analysis was performed on UPLC Thermo Scientific Dionex UltiMate 3000 system equipped with a binary pump, an automated sampler and a variable wavelength UV detector. The columns and conditions used are: analytical InfinityLab Poroshell 120 EC-C8 RP HPLC column (2.1 x 50 mm; 2.7 Micron) from Agilent gradient 85% MeCN-H<sub>2</sub>O + 0.1% TFA to 100% MeCN in 17.5 min. UV detection is 254 nm and the flow rate 0.8 mL/min. Furthermore, analytical PFP HPLC column (4.6 x 150 mm; 5 μm), gradient 85% MeOH-H<sub>2</sub>O to 100% MeOH in 30 min. UV detection is 254 nm and the flow rate 0.6 mL/min. Preparatory HPLC was carried out on preparative PFP HPLC column (10.0 x 125 mm; 5 μm), gradient 95% MeOH-H<sub>2</sub>O to 100% MeOH in 20 min. UV detection is 254 nm and the flow rate of 7 mL/min.

#### Reverse Phase C18 Chromatography

This was performed on a CombiFlash Companion chromatogram from Serlabo Technologies and puriFlash 210 from interchim all in 40g or 4g RP C 18 columns.

## EXPERIMENTAL SECTION

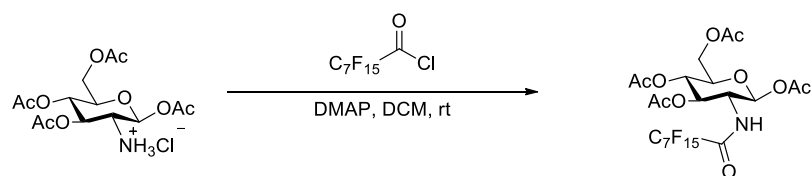

### 1,3,4,6-tetra-*O*-acetyl-2-deoxy-2-(8,8,8,7,7,6,6,5,5,4,4,3,3,2,2-pentadecafluorooctanoylamido)-β-D-glucopyranose (**69**)

To a solution of 1,3,4,6-tetra-*O*-acetyl-β-D-glucosamine hydrochloride (1g, 2.61mmol) in DCM (10mL) was added pentadecafluorooctanoyl chloride (0.7mL, 2.87mmol, 1.2eq.) gently followed by DMAP (955.1mg, 7.82mmol, 3equiv.) at rt under argon. The homogeneous mixture was stirred at this condition overnight (18h). TLC confirmed complete reaction and the set up was diluted with EtOAc (150mL), washed with distilled H<sub>2</sub>O (100mLx3), NH<sub>4</sub>Cl<sub>(aq)</sub> (100mL), NaHCO<sub>3(aq)</sub> (100mL) and sat. NaCl<sub>(aq)</sub> (100mL). The aqueous layers were individually back extracted with EtOAc, and the combined organic layers were dried with anhydrous Na<sub>2</sub>SO<sub>4</sub>. Silica gel chromatography in 20%-100% EtOAc:PE afforded compound **1** as a pure white solid (1.946 g, 2.62 mmol, 100%).

R<sub>f</sub> = 0.08 (EtOAc:PE; 8/2)

<sup>1</sup>H NMR (400 MHz, CDCl<sub>3</sub>) δ (ppm) 7.65 (d, *J* = 9.7 Hz, 1H, NH), 5.71 (d, *J* = 8.8 Hz, 1H, H-1), 5.47 (dd, *J* = 10.6, 9.7 Hz, 1H, H-3), 5.11 (t, *J* = 9.8 Hz, 1H, H-4), 4.46 (dd, *J* = 19.6, 9.7 Hz, 1H, H-2), 4.27 (dd, *J* = 12.5, 5.1 Hz, 1H, H-6), 4.16 (dd, *J* = 12.5, 2.0 Hz, 1H, H-6), 3.95 (ddd, *J* = 10.0, 5.0, 2.1 Hz, 1H, H-5), 2.08 (s, 9H, CH<sub>3</sub>C(O)<sub>2</sub>x3), 2.03 (s, 3H, CH<sub>3</sub>C(O)<sub>2</sub>).

<sup>19</sup>F NMR (376 MHz, CDCl<sub>3</sub>) δ (ppm) -80.94 (t, *J* = 9.7 Hz), -120.28 (m), -121.78 (m), -122.20 (m), -122.89 (m), -126.06 – -126.52 (m).

<sup>13</sup>C NMR (101 MHz, CDCl<sub>3</sub>) δ (ppm) 172.34, 170.78, 169.52, 169.36, 158.09 (t, *J* = 26.5 Hz, C(O)N), 91.84, 73.14, 72.33, 68.43, 61.91, 52.85, 20.76, 20.53, 20.26.

HRMS (ESI, positive mode) *m/z*: C<sub>22</sub>H<sub>20</sub>F<sub>15</sub>NNaO<sub>10</sub> [M+Na]<sup>+</sup>, calcd. 766.0732, found 766.0740.

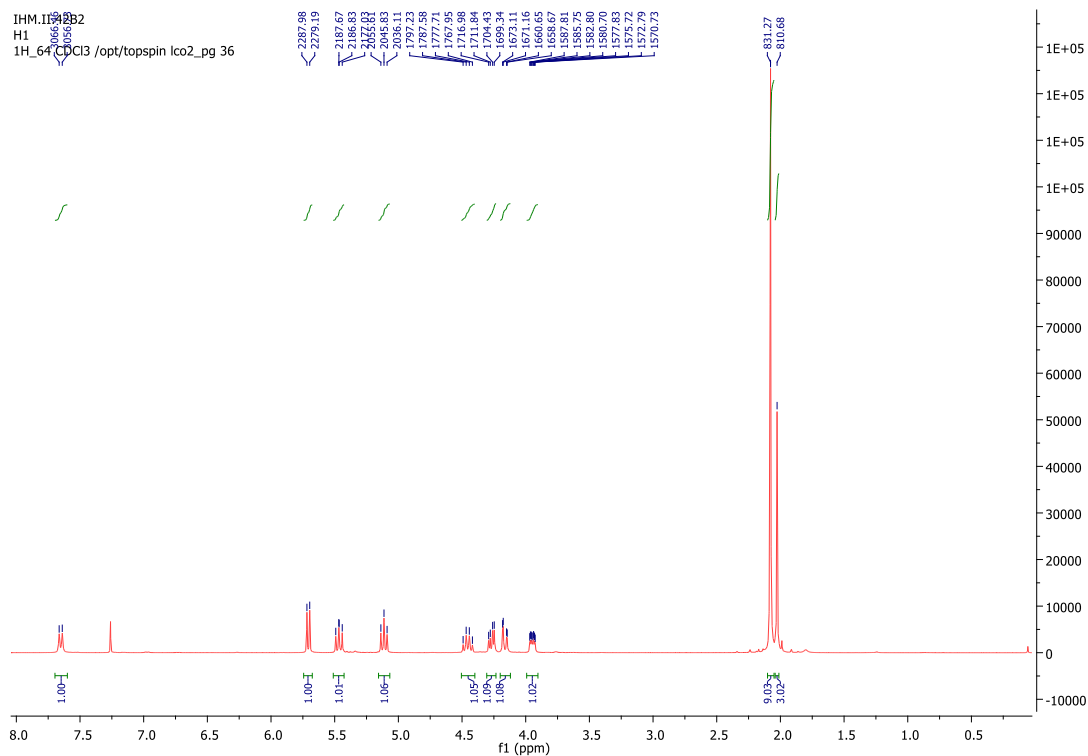

<sup>1</sup>H NMR (400 MHz) of Compound **69** in CDCl<sub>3</sub>

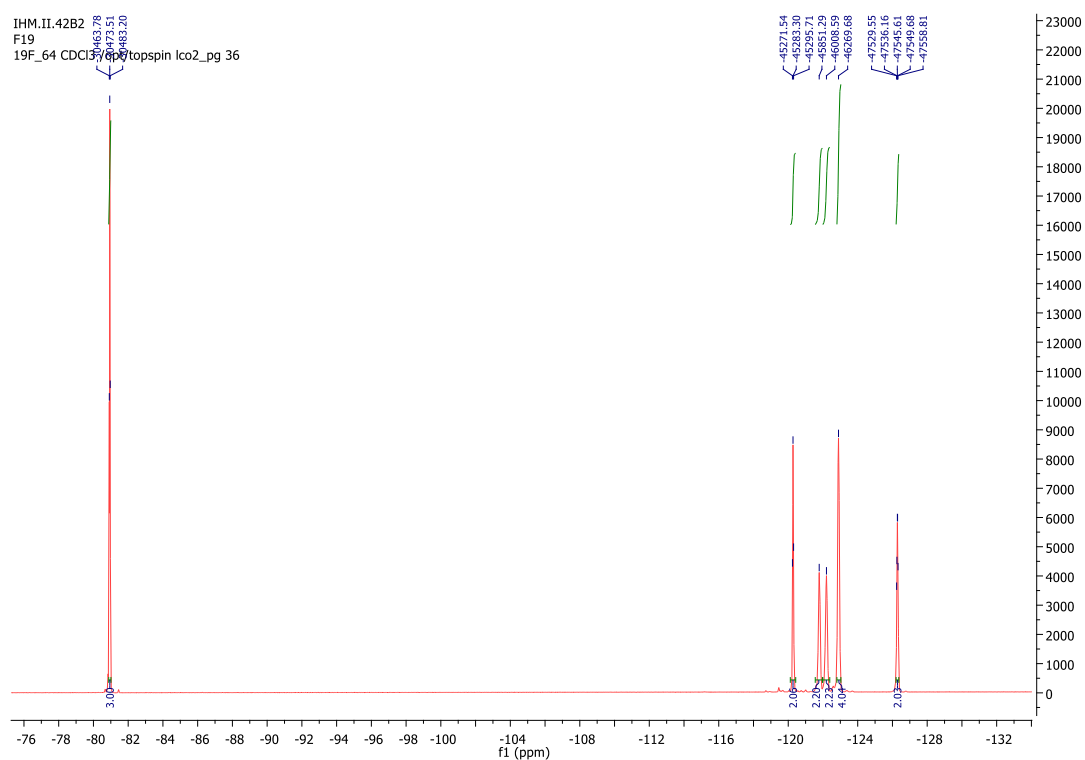

<sup>19</sup>F NMR (376 MHz) of Compound **69** in CDCl<sub>3</sub>

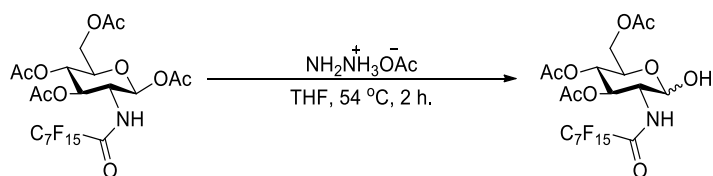

**3,4,6-tri-*O*-acetyl-2-deoxy-2-(8,8,8,7,7,6,6,5,5,4,4,3,3,2,2-pentadecafluorooctanoylamido)- $\alpha/\beta$ -D-glucopyranose (70)**

To a solution of 1,3,4,6-tetra-*O*-acetyl-2-deoxy-2-(8,8,8,7,7,6,6,5,5,4,4,3,3,2,2-pentadecafluorooctanoyl-amido)- $\beta$ -D-glucopyranose (873mg, 1.175mmol, Az. toluenex3) in THF (15mL) was added hydrazinium acetate (80mg, 0.877mmol) at 54 °C and stirred for 2h under argon. Reaction progress was monitored by TLC, and then cooled to 0 °C before it was quenched with distilled water, diluted with EtOAc and aqueous work up with sat NaCl<sub>(aq)</sub> (50mLx3), then back extracted with EtOAc (100mL) and dried with Na<sub>2</sub>SO<sub>4</sub>. Silica gel chromatography in 30%-50% EtOAc: cyclohexane yielded colorless solid **70** (718 mg, 1.024 mmol, 87%).

R<sub>f</sub> = 0.53 (EtOAc: cyclohexane = 1:1)

**<sup>1</sup>H NMR** (400 MHz, CDCl<sub>3</sub>)  $\delta$  (ppm) 6.84 (d,  $J$  = 9.1 Hz, 1H, N-H), 5.38 (dd,  $J$  = 10.6, 9.7 Hz, 1H, H-3), 5.34 (br s, 1H, H-1), 5.15 (t,  $J$  = 9.5 Hz, 1H, H-4), 4.34 (td,  $J$  = 10.6, 3.4 Hz, 1H, H-2), 4.28 – 4.21 (m, 2H, H-6; H-5), 4.15 (dd,  $J$  = 13.8, 4.0 Hz, 1H, H-6), 3.72 (br s, 1H, OH), 2.10 (s, 3H, CH<sub>3</sub>C(O)<sub>2</sub>), 2.04 (s, 3H, CH<sub>3</sub>C(O)<sub>2</sub>), 1.99 (s, 3H, CH<sub>3</sub>C(O)<sub>2</sub>).

**<sup>19</sup>F NMR** (376 MHz, CDCl<sub>3</sub>)  $\delta$  (ppm) -80.80 (t,  $J$  = 14.1, 5.7 Hz, 3F), -119.83 (qt,  $J$  = 277.4, 264.6 Hz, 2F), -121.59 (m, 2F), -122.02 (m, 2F), -122.31 – -123.02 (m, 4F), -126.14 (m, 2F).

**<sup>13</sup>C NMR** (101 MHz, CDCl<sub>3</sub>)  $\delta$  (ppm) 171.39, 171.10, 169.57, 157.83 (t,  $J$  = 26.1 Hz, C(O)N), 91.06, 70.27, 68.09, 67.93, 61.99, 53.04, 20.87, 20.70, 20.42.

**HRMS** (ESI, positive mode)  $m/z$ : C<sub>20</sub>H<sub>18</sub>F<sub>15</sub>NNaO<sub>9</sub> [M+Na]<sup>+</sup>, calcd. 724.0633, found 724.0634



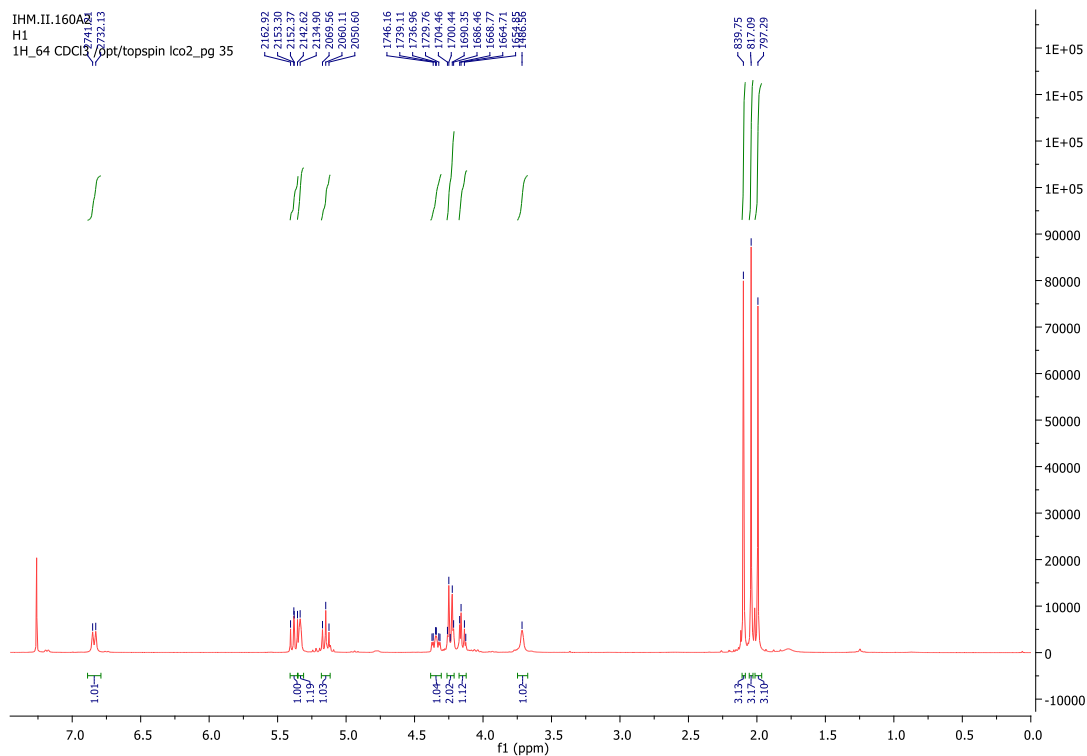

$^1\text{H}$  NMR (400 MHz) of Compound **70** in  $\text{CDCl}_3$

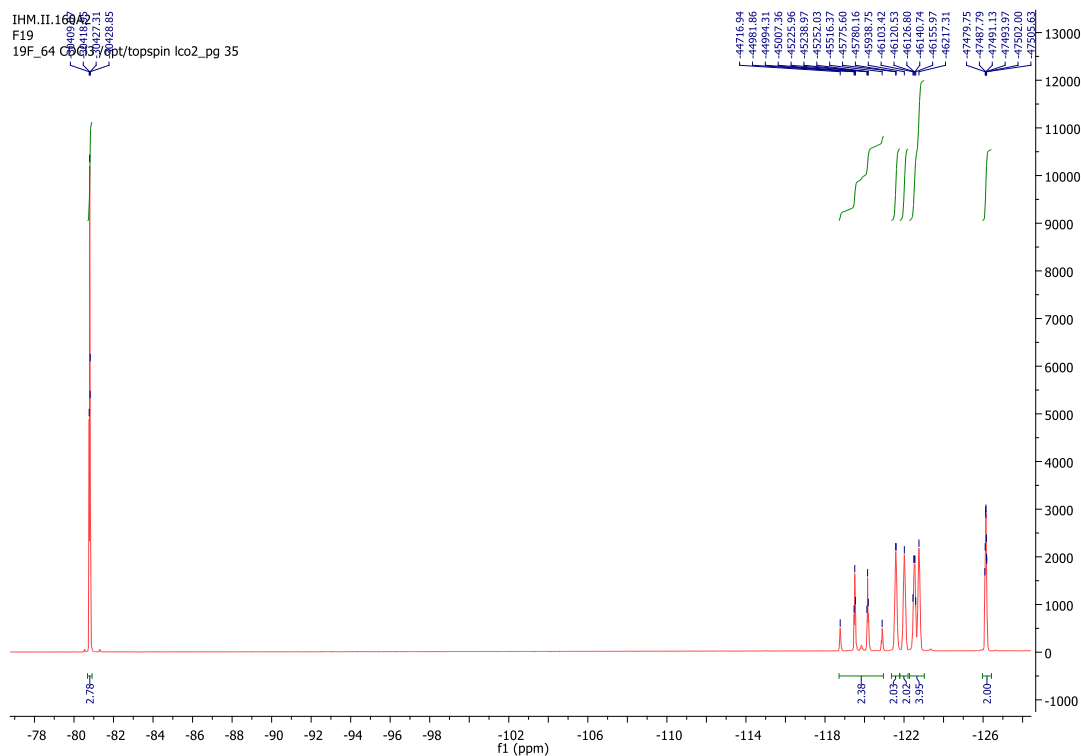

$^{19}\text{F}$  NMR (376 MHz) of Compound **70** in  $\text{CDCl}_3$

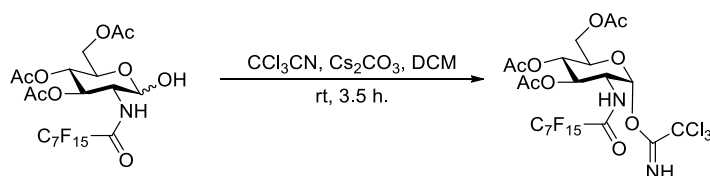

**3,4,6-tri-*O*-acetyl-2-deoxy-2-(8,8,8,7,7,6,6,5,5,4,4,3,3,2,2-pentadecafluorooctanoylamido)- $\alpha$ -D-glucopyranose-1-*O*-trichloroacetimidate (71)**

To a suspension of 3,4,6-tri-*O*-acetyl-2-deoxy-2-(8,8,8,7,7,6,6,5,5,4,4,3,3,2,2-pentadecafluorooctanoyl-amido)- $\alpha/\beta$ -D-glucopyranose (718mg, 1.024mmol Az. toluenex3) was added flame activated MS 3Å, Cs<sub>2</sub>CO<sub>3</sub> (19.5mg, 0.594mmol, 0.6eq) and dissolved in dry DCM (15mL) at rt and under argon. The reaction was further treated with CCl<sub>3</sub>CN (3.05mL, 30.413mmol, 29.7eq) and stirred for 3.5h. TCL in 30% EtOAc: cyclohexane confirmed complete reaction and was diluted with DCM and filtered over celite at vacuum. The aqueous work up was performed with sat NaCl (50mLx3) and back extracted the aqueous layers with DCM (100mL) and dried the combined organic layers with anhydrous Na<sub>2</sub>SO<sub>4</sub>. Silica gel chromatography in 20%-50% EtOAc: cyclohexane + 0.2% TEA yielded colorless form **71** as only  $\alpha$ -anomer product (603 mg, 0.713 mmol, 98%).

R<sub>f</sub> = 0.45; (EtOAc: cyclohexane, 3/7)

<sup>1</sup>H NMR (300 MHz, CDCl<sub>3</sub>)  $\delta$  (ppm) 6.77 (d, *J* = 8.4 Hz, 1H, NH), 6.45 (d, *J* = 3.6 Hz, 1H, H-1), 5.43 (dd, *J* = 10.6 Hz, 9.8 Hz, 1H, H-3), 5.27 (dd, *J* = 9.8 Hz, 1H, H-4), 4.53 (ddd, *J* = 10.6 Hz, 8.5 Hz, 3.6 Hz, 1H, H-2), 4.28 (dd, *J* = 12.6, 4.2 Hz, 1H, H-6), 4.19 – 4.07 (m, 2H, H-5, H-6), 2.07 (s, 3H, Ac), 2.05 (s, 3H, Ac), 2.03 (s, 3H, Ac).

<sup>19</sup>F NMR (376 MHz, CDCl<sub>3</sub>)  $\delta$  (ppm) -80.90 – -80.98 (m, 3F), -118.95 – -121.27 (m, 2F), -121.42 – -121.84 (m, 2F), -121.88 – -122.31 (m, 2F), -122.35 – -123.17 (m, 4F), -125.84 – -126.69 (m).

<sup>13</sup>C NMR (101 MHz, CDCl<sub>3</sub>)  $\delta$  (ppm) 171.68, 170.72, 169.31, 160.14, 93.61, 90.50, 70.53, 70.11, 67.07, 61.35, 52.83, 20.69, 20.57, 20.34.

HRMS (ESI, positive mode) *m/z*: C<sub>22</sub>H<sub>18</sub>Cl<sub>3</sub>F<sub>15</sub>N<sub>2</sub>NaO<sub>9</sub> [M+Na]<sup>+</sup>, calcd. 866.9731, found 866.9761.

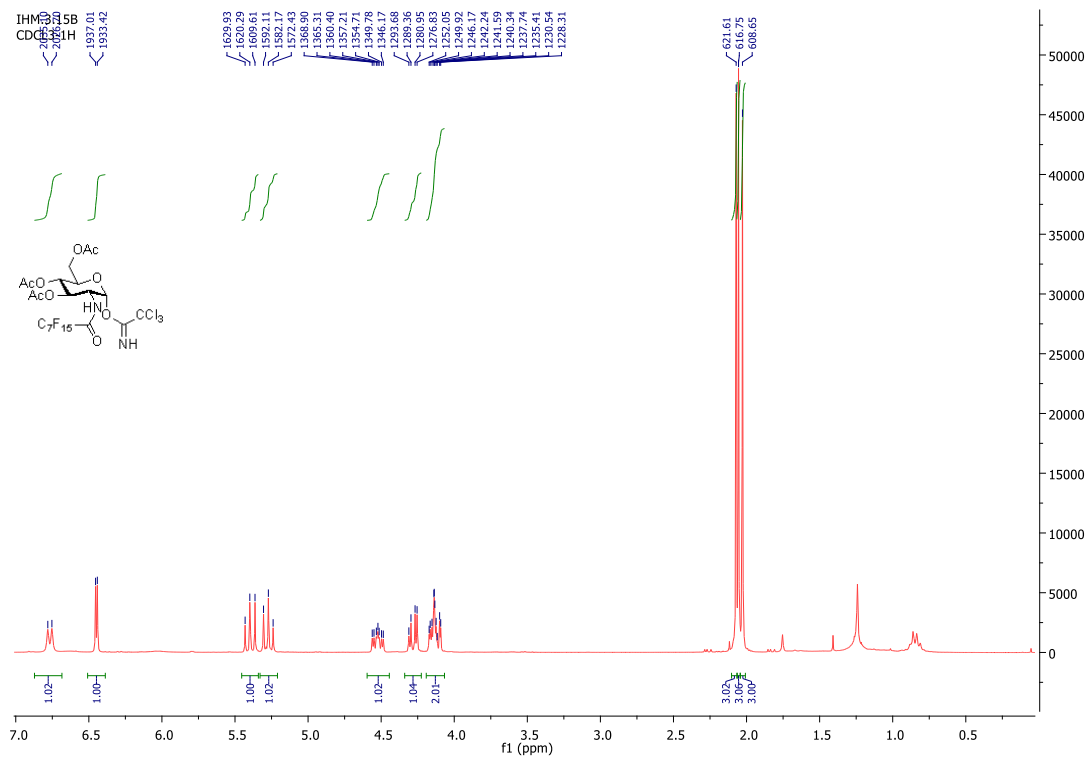

<sup>1</sup>H NMR (300 MHz) of Compound 71 in CDCl<sub>3</sub>

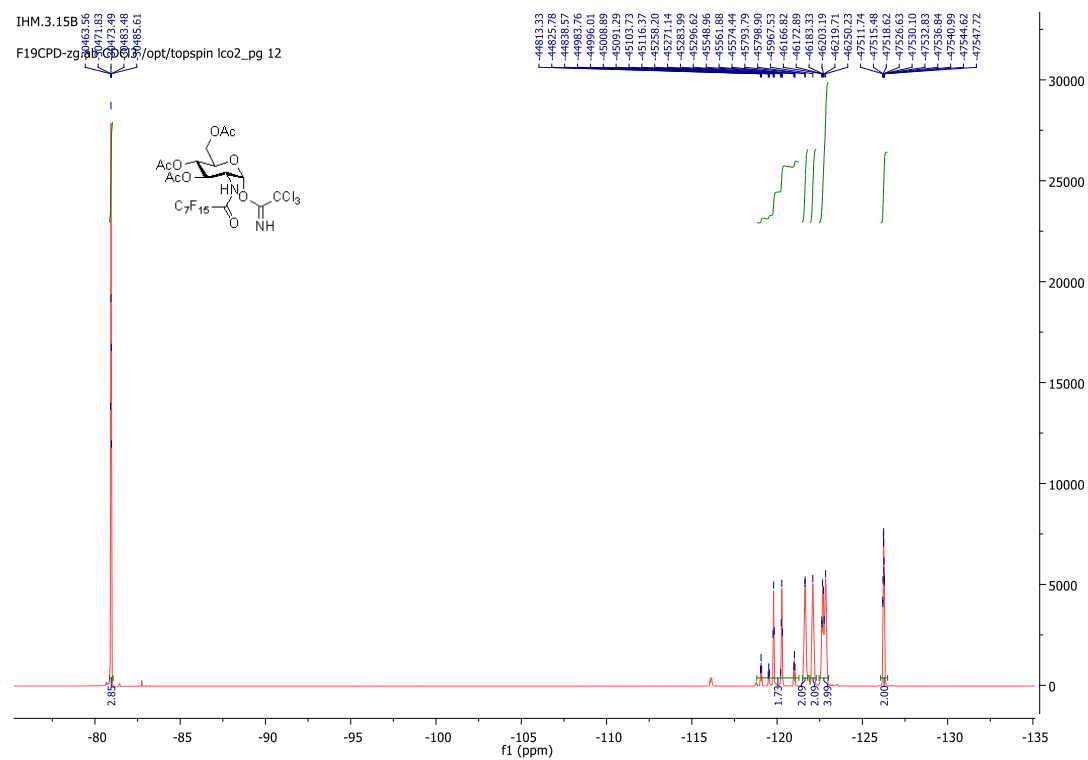

<sup>19</sup>F NMR (376 MHz) of Compound 71 in CDCl<sub>3</sub>

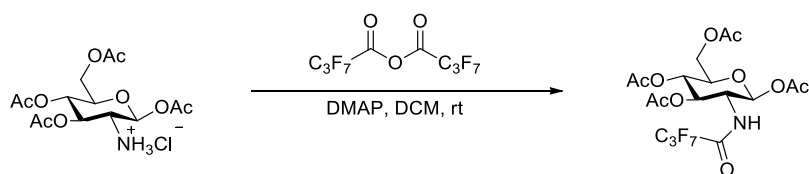

**1,3,4,6-tetra-*O*-acetyl-2-deoxy-2-(4,4,4,3,3,2-heptafluorobutyramido)- $\beta$ -D-glucopyranose (**72**)**

Compound **72** was synthesized in a similar manner to the synthesis of compound **69** with perfluorobutyric anhydride (0.4 mL, 1.563 mmol, 1.2 eq.). Silica gel chromatography in 20%-50% EtOAc: PE yielded the desired fluororous amide **72** as a white solid (436.1mg, 0.8026mmol, 88% yield).

R<sub>f</sub> = 0.07 (EtOAc: PE, 2/8)

**<sup>1</sup>H NMR** (300 MHz, CDCl<sub>3</sub>)  $\delta$  (ppm) 7.00 (d, *J* = 9.4 Hz, 1H, NH), 5.73 (d, *J* = 8.8 Hz, 1H, H-1), 5.31 (dd, *J* = 10.7, 9.4 Hz, 1H, H-3), 5.14 (t, *J* = 9.7 Hz, 1H, H-4), 4.39 (dd, *J* = 19.6, 9.4 Hz, 1H, H-2), 4.29 (dd, *J* = 12.6, 4.8 Hz, 1H, H-6), 4.15 (dd, *J* = 12.5, 2.2 Hz, 1H, H-6), 3.88 (ddd, *J* = 9.9, 4.7, 2.2 Hz, 1H, H-5), 2.10 (s, 3H, Ac), 2.10 (s, 3H, Ac), 2.07 (s, 3H, Ac), 2.04 (s, 3H, Ac).

**<sup>19</sup>F NMR** (282 MHz, CDCl<sub>3</sub>)  $\delta$  (ppm) -80.64 (t, *J* = 8.9 Hz, 3F), -121.08 (q, *J* = 8.9 Hz, 2F), -127.20 (m, 2F).

**<sup>13</sup>C NMR** (75 MHz, CDCl<sub>3</sub>)  $\delta$  (ppm) 172.02, 170.76, 169.47, 169.42, 91.93, 73.17, 72.14, 68.16, 61.76, 53.18, 20.81, 20.65, 20.60, 20.40.

**LRMS** (ESI, positive mode) *m/z*: C<sub>18</sub>H<sub>20</sub>F<sub>7</sub>NNaO<sub>10</sub> [M+Na]<sup>+</sup>, calcd. 566.1, found 566.1.

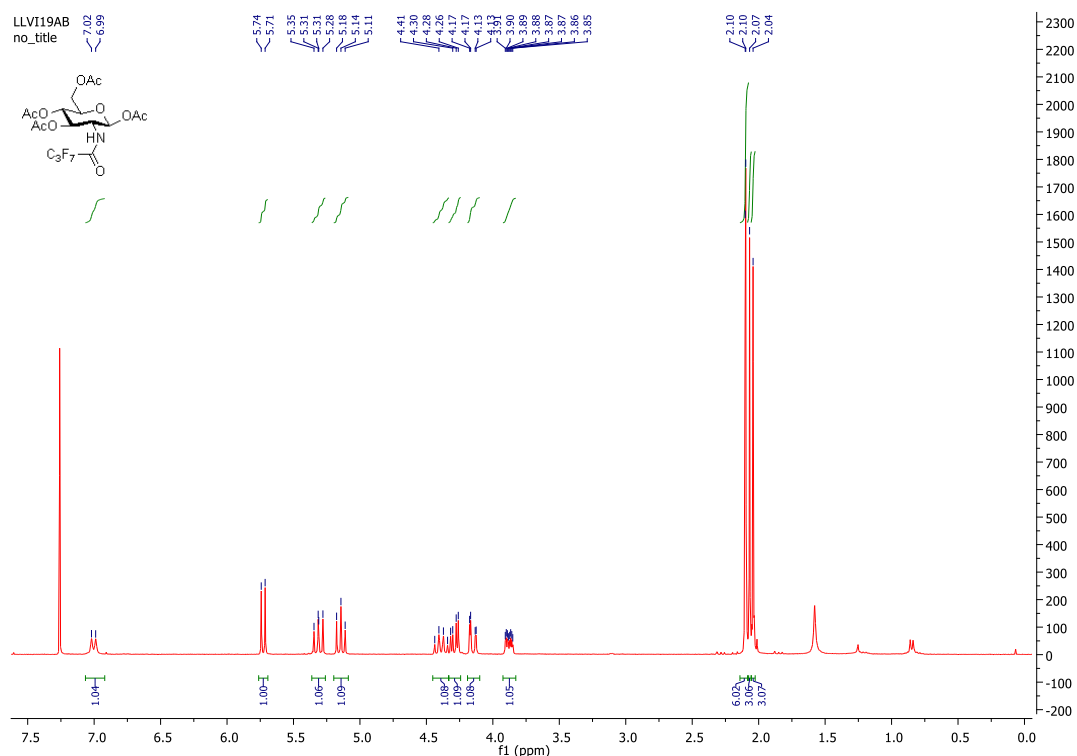

**<sup>1</sup>H NMR** (300 MHz) of Compound **72** in CDCl<sub>3</sub>

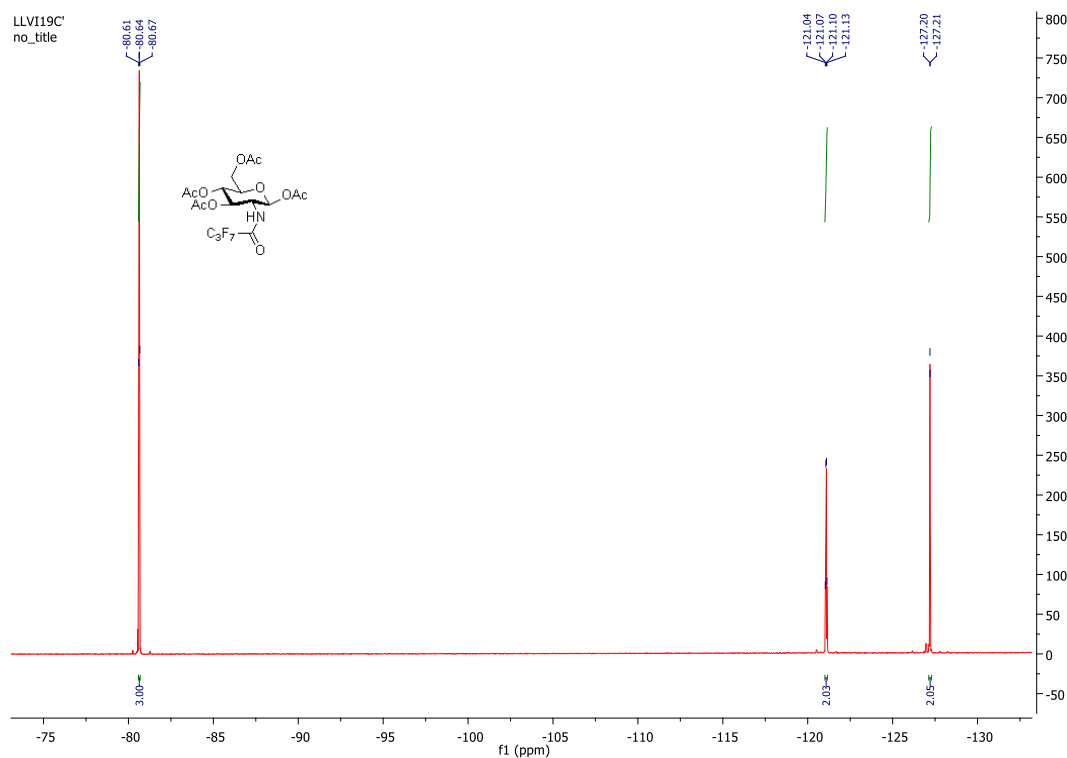

$^{19}\text{F}$  NMR (2882 MHz) of Compound **72** in  $\text{CDCl}_3$

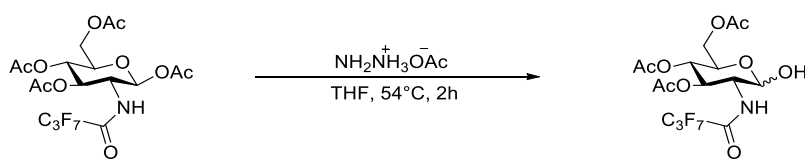

**3,4,6-tri-*O*-acetyl-2-deoxy-2-(4,4,4,3,3,2,2-heptafluorobutyramido)- $\alpha/\beta$ -D-glucopyranose (**73**)**

Compound **5** was synthesized in a similar manner to the synthesis of compound **70** and after complete reaction, silica gel chromatography in 20%-50% EtOAc: Cyclohexane yielded the desired hemiacetal **73** as a colorless form (183 mg, 0.365 mmol, 52% yield).

$R_f$  = 0.54 (EtOAc: Cyclohexane, 1/1)

$^1\text{H}$  NMR (300 MHz,  $\text{CDCl}_3$ )  $\delta$  (ppm): 6.86 (br d,  $J$  = 8.9 Hz, 1H, NH), 5.40 (dd,  $J$  = 10.7, 9.7 Hz, 1H, H-3), 5.33 (d,  $J$  = 3.5 Hz, 1H, H-1), 5.14 (t,  $J$  = 9.5 Hz, 1H, H-4), 4.46 – 4.09 (m, 4H, H-2, 2H-6, H-5), 3.80 – 3.70 (m, 1H, OH).

$^{19}\text{F}$  NMR (282 MHz,  $\text{CDCl}_3$ )  $\delta$  (ppm): -81.50 (br t, 3F,  $J$  = 8.9Hz), -121 (dq, 1F,  $J^d$  = 9.0Hz,  $J^2$  = 278.7Hz), -122.56 (dq, 1F,  $J^d$  = 9.9Hz,  $J^2$  = 277.8Hz), -127.87 – -127.99 (m, 2F).

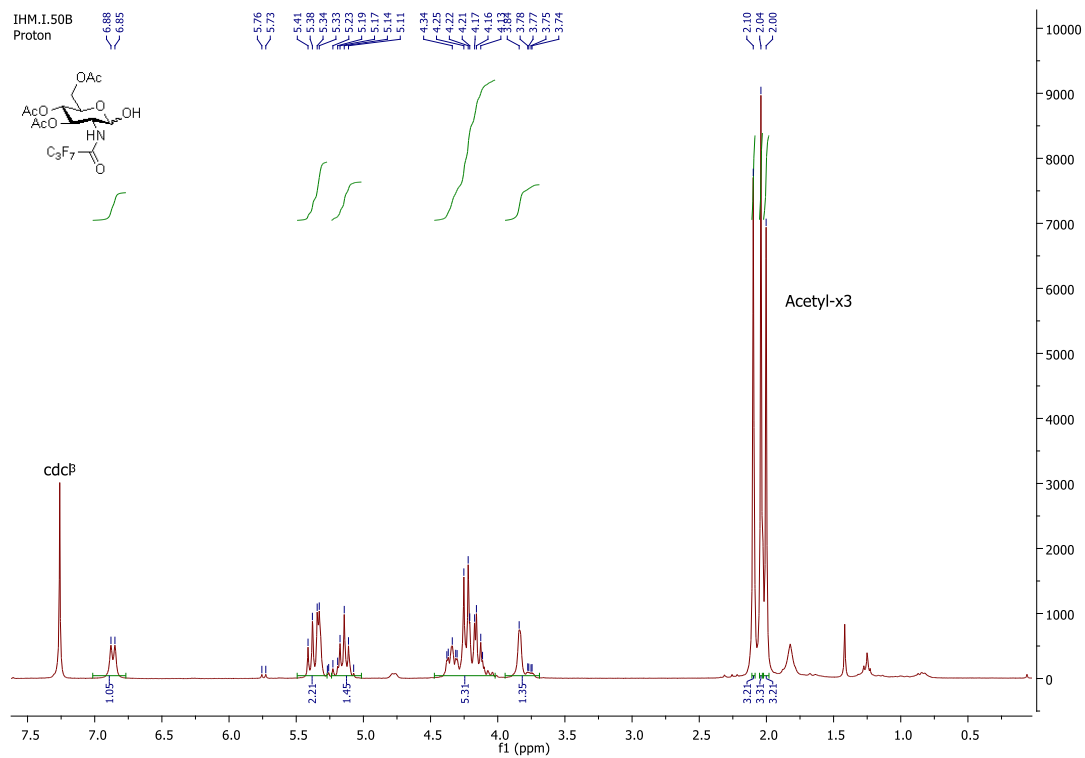

$^1\text{H}$  NMR (300 MHz) of Compound **73** in  $\text{CDCl}_3$

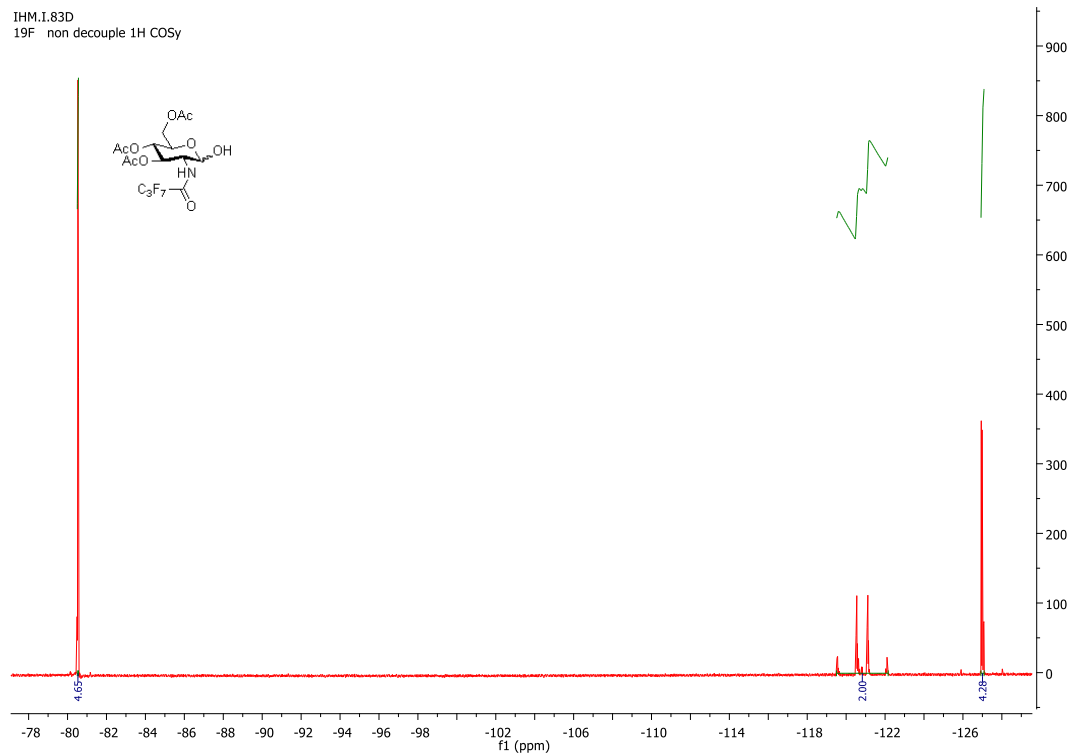

$^{19}\text{F}$  NMR (300 MHz) of Compound **73** in  $\text{CDCl}_3$

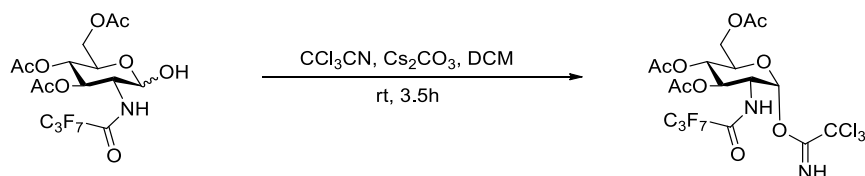

**3,4,6-tri-*O*-acetyl-2-deoxy-2-(4,4,4,3,3,2,2-heptafluorobutyramido)- $\alpha$ -D-glucopyranose-1-*O*-trichloroacetimidate (74)**

Compound **74** was synthesized in a similar approach to the synthesis of compound **71** and after complete reaction, silica gel chromatography in 20%-50% EtOAc: Cyclohexane +0.2% trimethylamine (TEA) gradient produced colorless fluorous amide **74** as a white solid (199mg, 0.308mmol, 84%).

Rf 0.43 = (EtOAc: cyclohexane, 3/7).

**$^1\text{H}$  NMR** (300 MHz,  $\text{CDCl}_3$ )  $\delta$  (ppm): 6.83 (br d,  $J = 8.3$  Hz, 1H, N-H), 6.42 (d,  $J = 3.6$  Hz, 1H, H-1), 5.38 (dd,  $J = 10.6, 9.6$  Hz, 1H, H-3), 5.24 (dd,  $J = 10.6, 9.7$  Hz, 1H, H-4), 4.50 (ddd,  $J = 14.0, 8.6, 3.6$  Hz, 1H, H-2), 4.26 (dd,  $J = 12.5, 4.3$  Hz, 1H, H-6), 4.03-4.18 (m, 2H, H-6, H-5), 2.04 (s, 3H, Ac), 2.03 (s, 3H, Ac), 2.01 (s, 3H, Ac).

**$^{19}\text{F}$  NMR** (282 MHz,  $\text{CDCl}_3$ ).  $\delta$  (ppm): -81.62 (br t,  $J = 8.7$  Hz, 3F), -121.8 (dq,  $J^d = 8.7$  Hz,  $J^2 = 278.8$  Hz, 1F), -122.7 (dq,  $J^d = 8.7$  Hz,  $J^2 = 278.8$  Hz, 1F), -127.9 – -128 (AB, 2F).

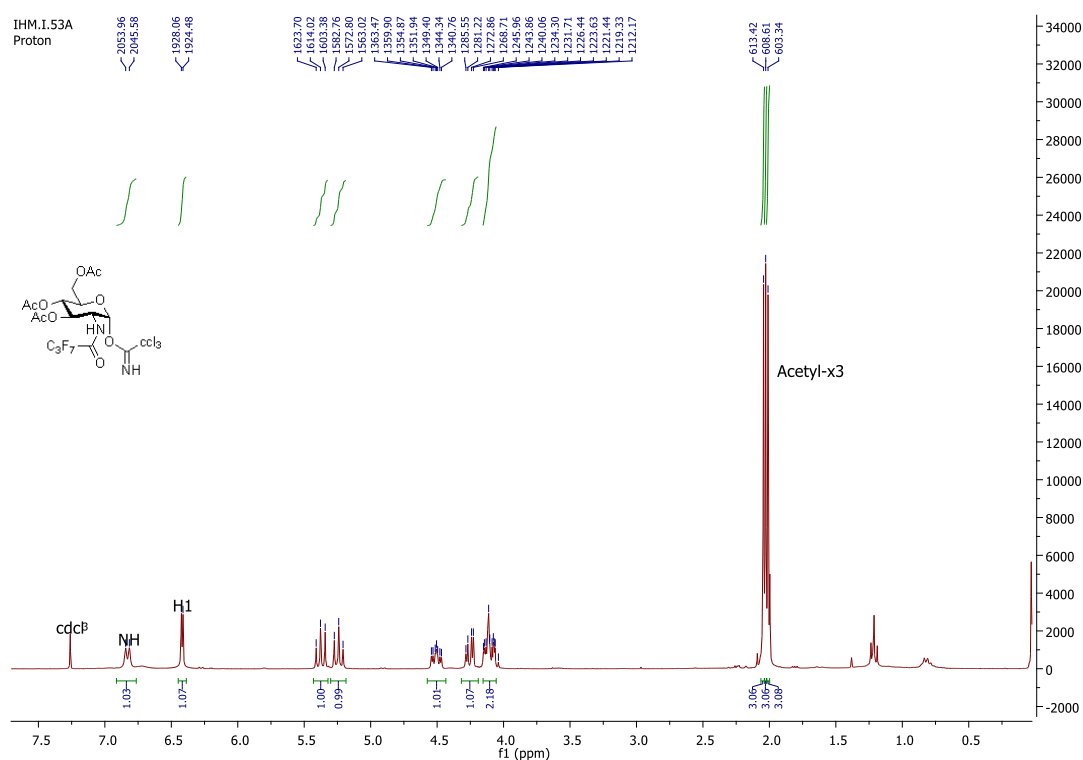

**$^1\text{H}$  NMR (300 MHz) of Compound **74** in  $\text{CDCl}_3$**

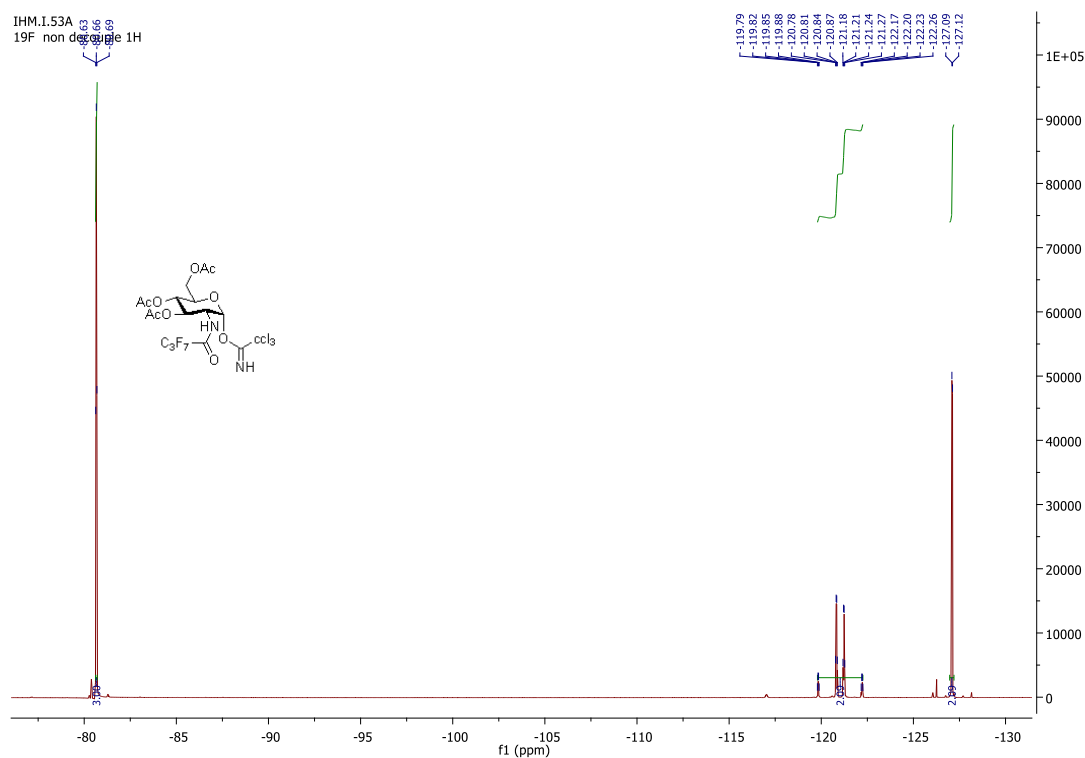

**<sup>19</sup>F NMR (300 MHz) of Compound 74 in CDCl<sub>3</sub>**

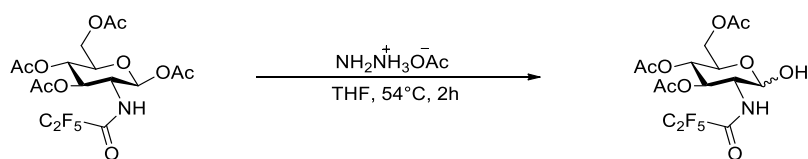

**3,4,6-tri-*O*-acetyl-2-deoxy-2-(3,3,3,2-pentafluoropropylamido)- $\alpha/\beta$ -D-glucopyranose (76)**

Compound **76** was synthesized in a similar manner to the synthesis of compound **70** from **75** and after complete reaction, the crude reaction mixture was purified by silica gel chromatography in 20%-50% EtOAc: Cyclohexane yielded the desired hemiacetal **76** as a colorless form (1.08 g, 1.402 mmol, 74% yield).

R<sub>f</sub> = 0.50 (EtOAc: Cyclohexane, 1/1)

**<sup>1</sup>H NMR** (300 MHz, CDCl<sub>3</sub>)  $\delta$  (ppm) 7.27 (d, *J* = 9.1 Hz, 1H, N-H), 5.51 (br s, 1H, O-H), 5.22 (t, *J* = 10.1 Hz, 1H, H-3), 5.13 (d, *J* = 3.2 Hz, 1H, H-1), 4.93 (t, *J* = 9.4 Hz, 1H, H-4), 4.24 – 4.07 (m, 2H, H-2, H-6), 3.98 → 3.89 (m, 2H, H-5, H-6), 1.88 (s, 3H, Ac), 1.84 (s, 3H, Ac), 1.78 (s, 3H, Ac).

**<sup>19</sup>F NMR** (282 MHz, CDCl<sub>3</sub>)  $\delta$  (ppm) -83.16 (m, 3F), -121.36 – -125.13 (m, 2F).



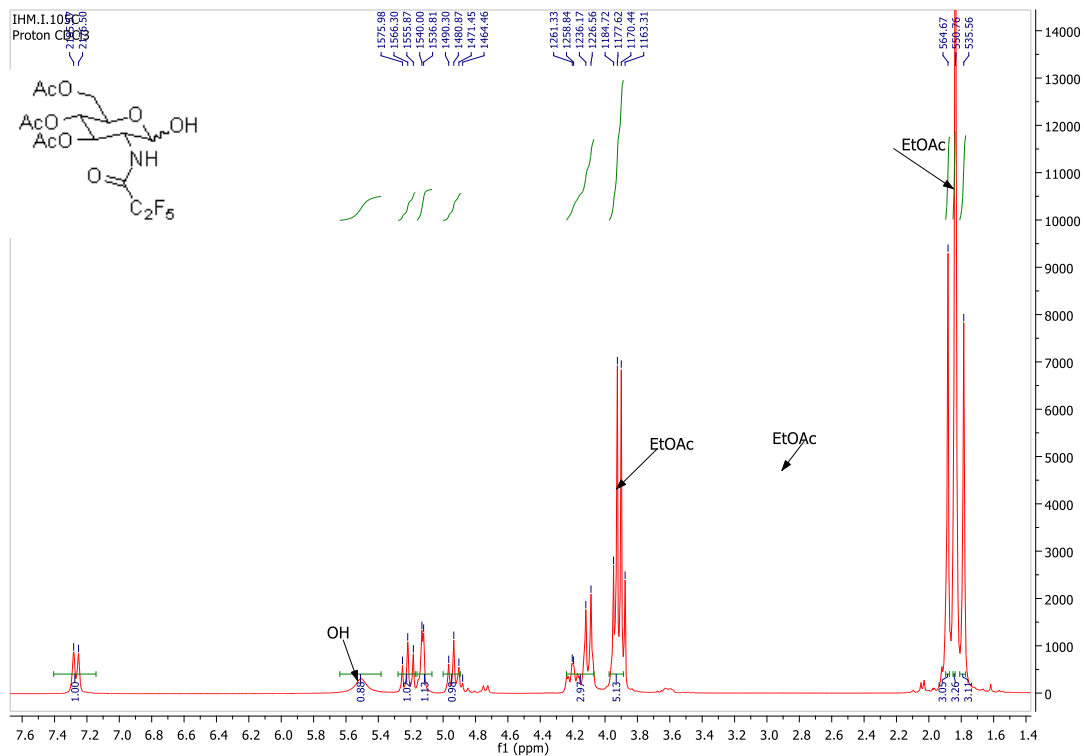

<sup>1</sup>H NMR (300 MHz) of Compound 76 in CDCl<sub>3</sub>

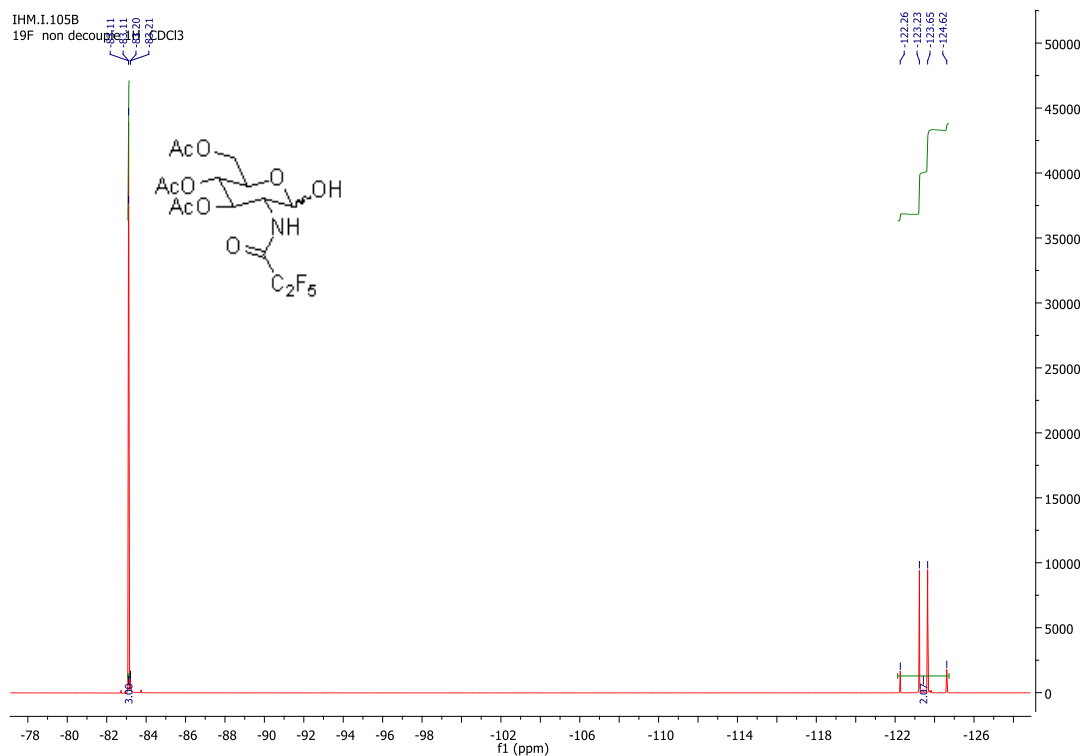

<sup>19</sup>F NMR (300 MHz) of Compound 76 in CDCl<sub>3</sub>

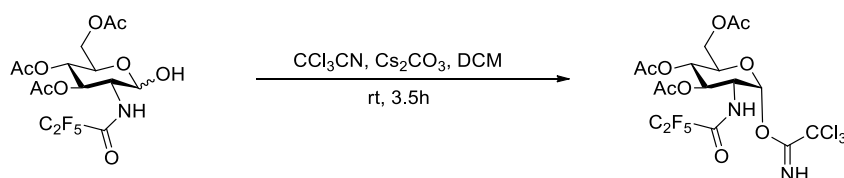

**3,4,6-tri-*O*-acetyl-2-deoxy-2-(3,3,3,2-pentafluoropropylamido)- $\alpha$ -D-glucopyranose-1-*O*-trichloroacetimidate (77)**

Compound **77** was synthesized in a similar methodology to the synthesis of compound **71** from **76** and after complete reaction and aqueous work-up, the crude residue was purified by silica gel chromatography in 20%-50% EtOAc: Cyclohexane +0.2% trimethylamine (TEA) gradient which after solvent evaporation afforded colorless fluororous imidate donor **77** as a colorless form (299 mg, 0.502 mmol, 50%).

R<sub>f</sub> = 0.45 (EtOAc: cyclohexane, 3/7).

<sup>1</sup>H NMR (300 MHz, CDCl<sub>3</sub>)  $\delta$  (ppm) 6.87 (d, *J* = 8.4 Hz, 1H, N-H), 6.42 (d, *J* = 3.6 Hz, 1H, H-1), 5.37 (dd, *J* = 10.6, 9.7 Hz, 1H, H-3), 5.24 (dd, *J* = 10.6, 9.9 Hz, 1H, H-4), 4.57 – 4.44 (ddd, *J* = 10.8, 8.6, 3.5 Hz, 1H, H-2), 4.25 (dd, *J* = 12.6, 4.3 Hz, 1H, H-6), 4.17 – 4.06 (m, 2H, H-5, H-6), 2.04 (s, 3H, Ac), 2.02 (s, 3H, Ac), 2.01 (s, 3H, Ac).

<sup>19</sup>F NMR (282 MHz, CDCl<sub>3</sub>)  $\delta$  (ppm) -83.01 (br s, 3F), -119.78 – -126.26 (m, 2F).

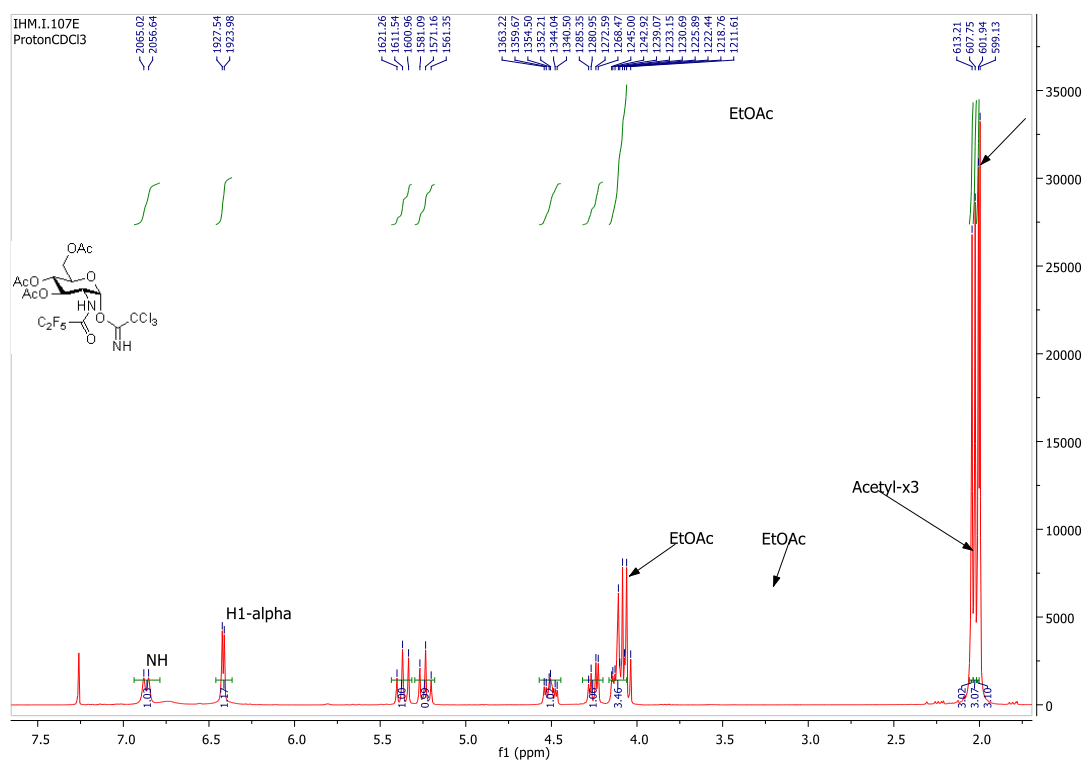

<sup>1</sup>H NMR (300 MHz) of Compound **77** in CDCl<sub>3</sub>

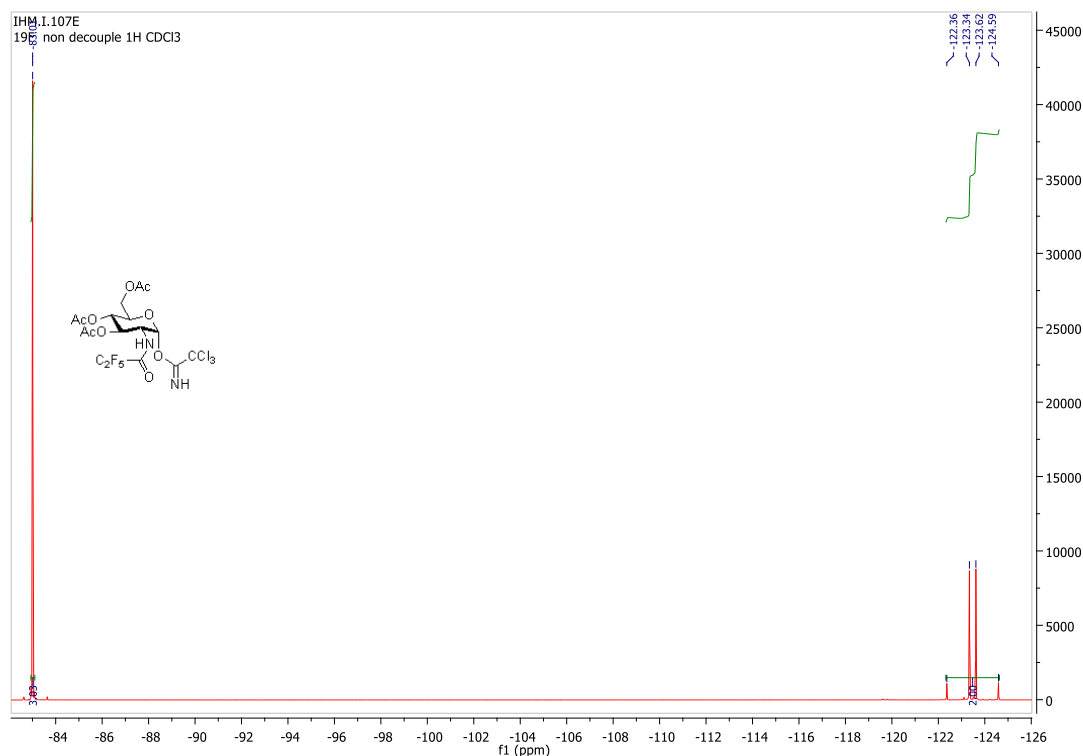

<sup>19</sup>F NMR (300 MHz) of Compound **77** in CDCl<sub>3</sub>

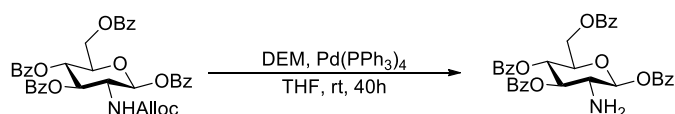

### 1,3,4,6-tetra-O-benzoyl-2-deoxy-β-D-glucosamine (**79**)

To the suspension of 2-allyloxycarbonyl-1,3,4,6-tetra-O-benzoyl-2-deoxy-β-D-glucopyranose (1.692 mmol, 1.15 g, 1 equiv.) azeotroped with toluene x3 was dissolved in anhydrous THF (25 mL) at room temperature under argon atmosphere. Diethyl malonate DEM (13.406 mmol, 2.04 mL, 7.92 equiv.) was added dropwise followed by tetrakis-(triphenylphosphino)-palladium Pd(PPh<sub>3</sub>)<sub>4</sub> (0.0798 mmol, 92 mg, 0.047 equiv.) gently and the resulting yellow solution was allowed to stir for about 40h at rt. When the TLC in cyclohexane: ethylacetate 7:3 confirmed complete consumption of the starting material, the reaction mixture was filtered through celite/silica plug, washed with ethylacetate and the filtrate was concentrated at reduced pressure in the vacuo. Purification of the crude residue on silica gel in cyclohexane: ethylacetate 80:20 → 70:30% eluent, afforded 575 mg as white form, 57% of desired compound **79**.

Rf = 0.23 (cyclohexane: ethylacetate, 7:3)

<sup>1</sup>H NMR (300 MHz, CDCl<sub>3</sub>) δ (ppm): 8.15 – 7.30 (m, 20H, 4xAr), 5.99 (d, *J* = 8.2 Hz, 1H, H-1), 5.74 – 5.56 (m, 2H, H-3, H-4), 4.60 (dd, *J* = 12.4, 3.1 Hz, 1H, H-6), 4.46 (dd, *J* = 12.4, 4.9 Hz, 1H, H-6), 4.33 – 4.25 (m, 1H, H-5), 3.49 (dd, *J* = 9.2, 8.8 Hz, 1H, H-2).

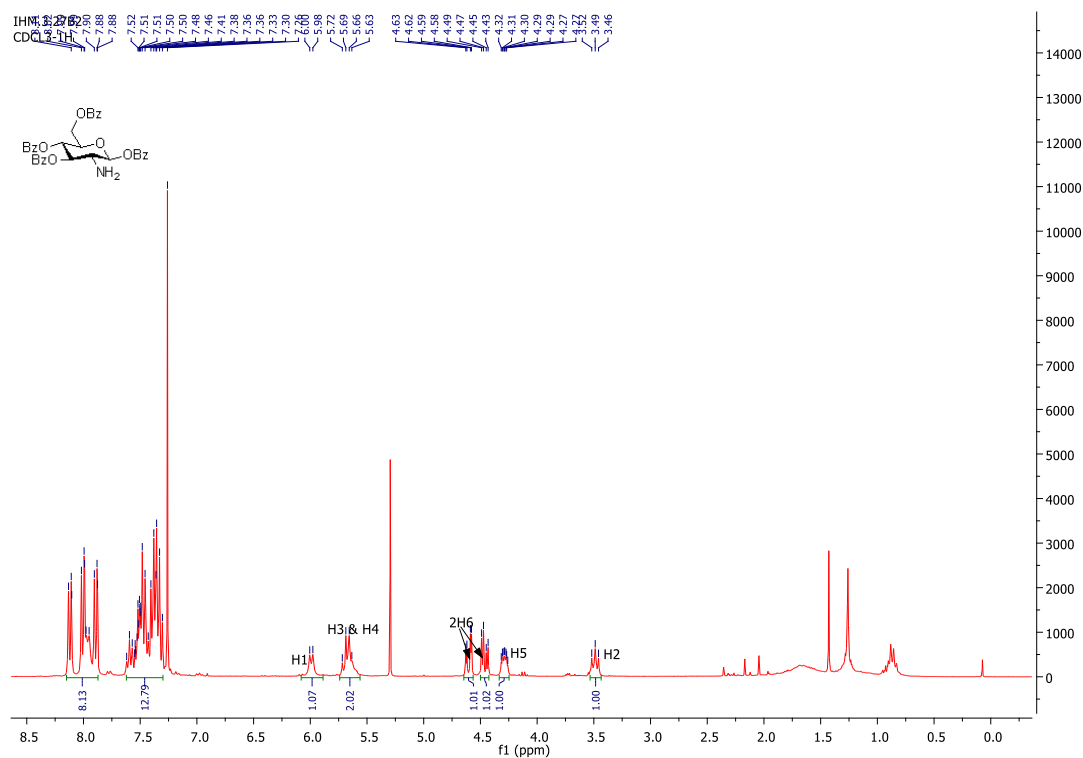

<sup>1</sup>H NMR (300 MHz) of Compound **79** in CDCl<sub>3</sub>

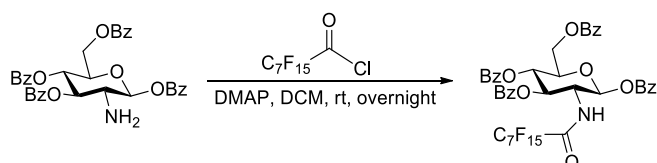

### 1,3,4,6-tetra-*O*-benzoyl-2-deoxy-2-(8,8,8,7,7,6,6,5,5,4,4,3,3,2,2-pentadecafluorooctanoylamido)-β-D-glucopyranose (**80**)

Compound **80** was synthesized via similar methodology as **69** with 1,3,4,6-tetra-*O*-benzoyl-2-deoxy-β-D-glucosamine (553mg, 0.928mmol, 1equiv., az. with toluenex3) and pentadecafluorooctanoyl chloride (1.021mmol, 0.25mL, 1.1eq.) in the reagent system. After complete reaction, the crude residue was purified by silica gel chromatography in cyclohexane: ethylacetate 80:20→70:30% gradient. Solvent evaporation of the desired fraction obtained compound **80** as a white form 836mg, 91%.

R<sub>f</sub> = 0.32 (cyclohexane: ethylacetate, 7:3)

<sup>1</sup>H NMR (300 MHz, CDCl<sub>3</sub>) δ (ppm): 8.20 – 7.28 (m, 21H, N-H 4xAr), 6.45 (d, *J* = 8.6 Hz, 1H, H-1), 6.13 (dd, *J* = 10.1, 10.0 Hz, 1H, H-3), 5.95 (dd, *J* = 10.2, 9.7 Hz, 1H, H-4), 5.10 (q, *J* = 19.3, 9.7 Hz, 1H, H-2), 4.68 (dd, *J* = 12.4, 2.8 Hz, 1H, H-6), 4.54 (dd, *J* = 12.4, 4.5 Hz, 1H, H-6), 4.38 (ddd, *J* = 9.7, 4.4, 3.1 Hz, 1H, H-5).

<sup>19</sup>F NMR (282 MHz, CDCl<sub>3</sub>) δ (ppm): -81.00 (t, *J* = 9.9 Hz, 3F, C-F<sub>3</sub>), -119.28 – -120.90 (AB, 2F, CF<sub>2</sub>), -121.66 – -122.08 (m, 2F, CF<sub>2</sub>), -122.21 – -122.64 (m, 2F, CF<sub>2</sub>), -122.62 – -122.96 (m, 2F, CF<sub>2</sub>), -122.93 – -123.45 (m, 2F, CF<sub>2</sub>), -125.95 – -127.01 (m, 2F, CF<sub>2</sub>).

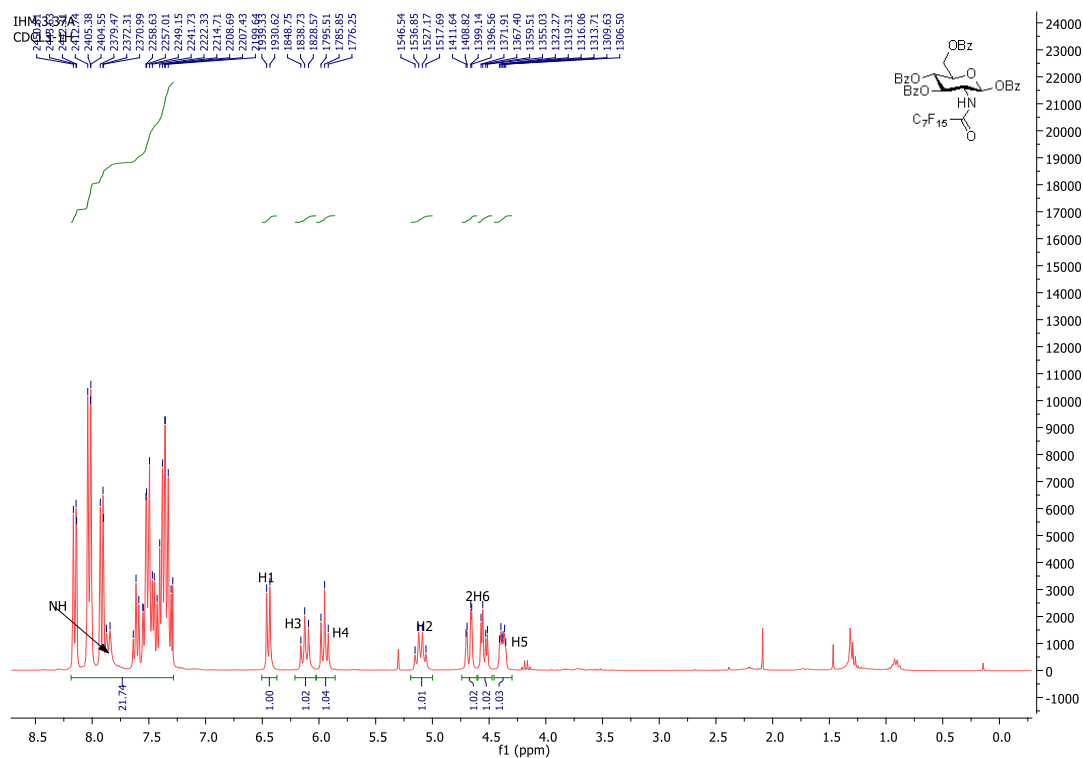

<sup>1</sup>H NMR (300 MHz) of Compound **80** in CDCl<sub>3</sub>

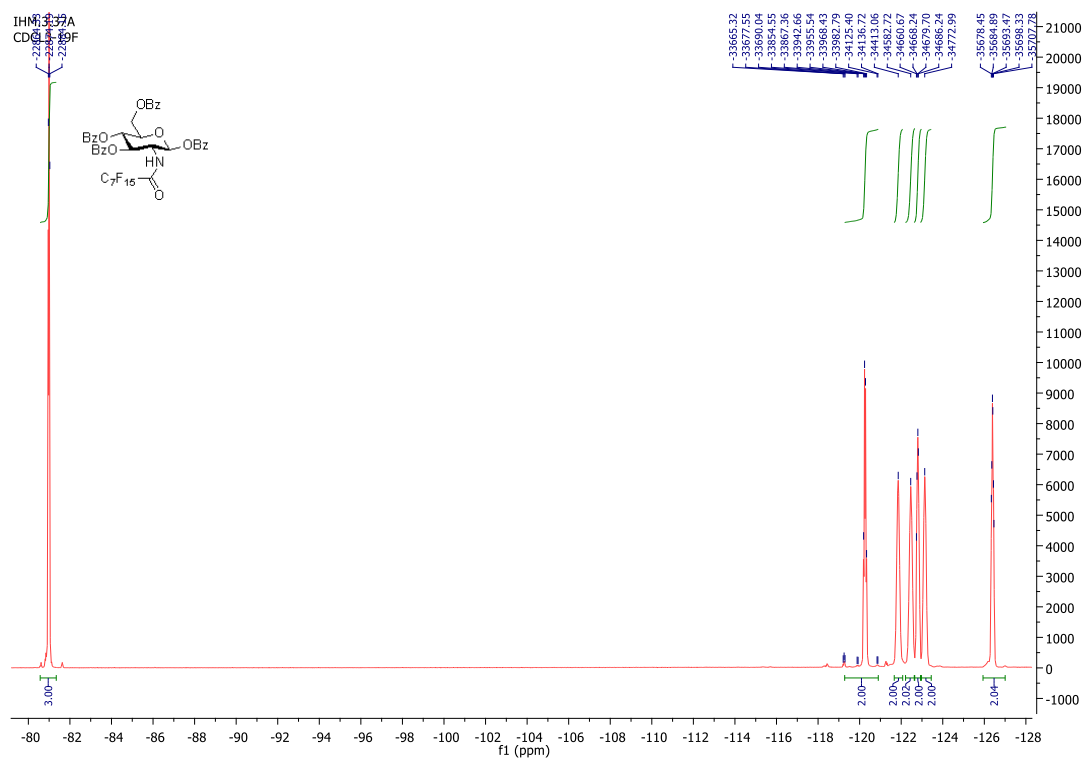

<sup>19</sup>F NMR (282 MHz) of Compound **80** in CDCl<sub>3</sub>

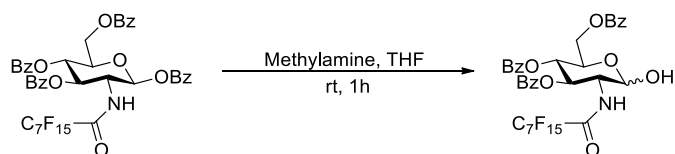

### 3,4,6-tetra-*O*-benzoyl-2-deoxy-2-(8,8,8,7,7,6,6,5,5,4,4,3,3,2,2-pentadecafluorooctanoylamido)- $\alpha/\beta$ -D-glucopyranose (**81**)

A solution of **80** (0.843mmol, 836mg, 1 equiv.) azeotroped with toluene was dissolved in anhydrous THF (9mL) and was added methylamine in absolute EtOH (33%, 1mL) at rt. The reaction set up was stirred for an hour, and analytical TLC confirmed disappearance of the starting material. The solvent was evaporated at vacuo and the crude residue was purified on silica gel column in cyclohexane: ethylacetate 80:20 $\rightarrow$ 70:30% gradient as eluent. Solvent evaporation of desired fraction yielded an  $\alpha/\beta$  mixtures of **81** as a white form. (745mg at 100%)

Rf = 0.29/0.19  $\alpha/\beta$  mixtures (cyclohexane: ethylacetate 8:2)

$^1\text{H NMR}$  (300 MHz,  $\text{CDCl}_3$ )  $\delta$  (ppm): 8.11 – 7.30 (m, 15H, 3xAr), 7.3 (d,  $J = 8.8$  Hz, 1H, N-H), 5.85 (dd,  $J = 10.0, 9.7$  Hz, 1H, H-3), 5.74 (dd,  $J = 10.1, 9.6$  Hz, 1H, H-4), 5.50 (br d,  $J = 3.1$  Hz, 1H, H-1), 4.71 – 4.38 (m, 4H, H-2, H-5, 2xH-6), 3.25 (br s, 1H, O-H).

$^{19}\text{F NMR}$  (282 MHz,  $\text{CDCl}_3$ )  $\delta$  (ppm): -80.76 (t,  $J = 9.9$  Hz), -118.64 – -121.26 (m, 2F), -121.62 – -121.84 (m, 2F), -122.12 – -122.38 (m, 2F), -122.62 – -123.11 (m, 4F), -125.90 – -126.43 (m, 2F).

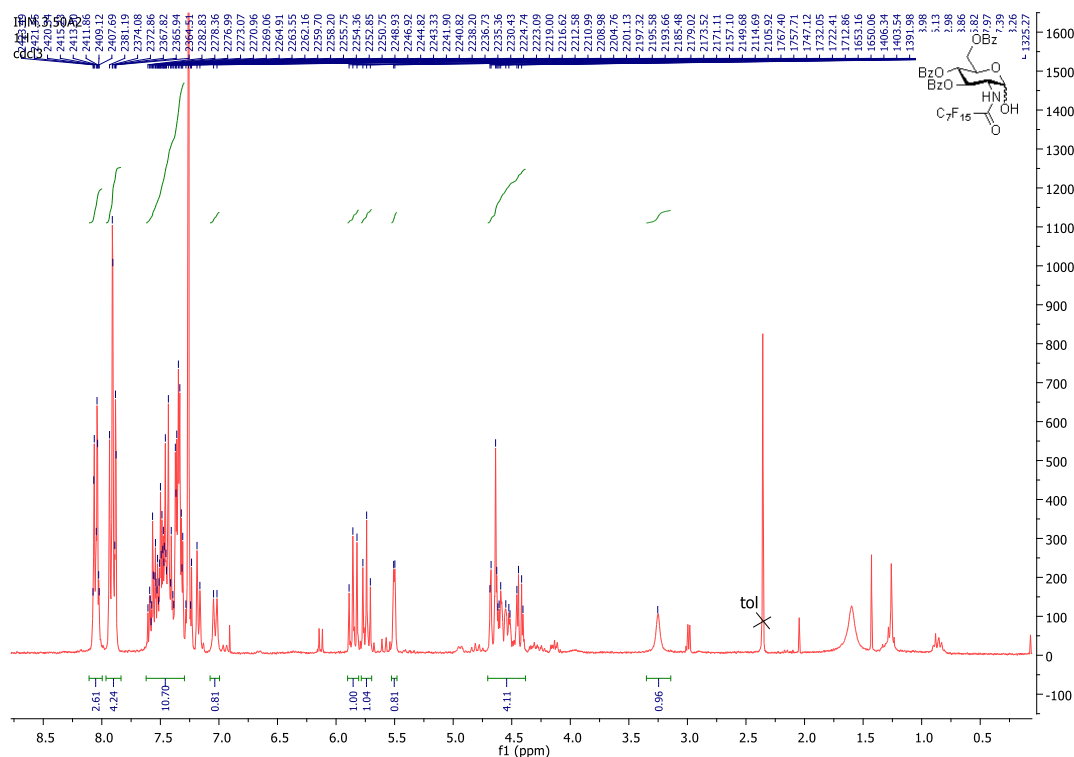

$^1\text{H NMR}$  (300 MHz) of Compound **81** in  $\text{CDCl}_3$

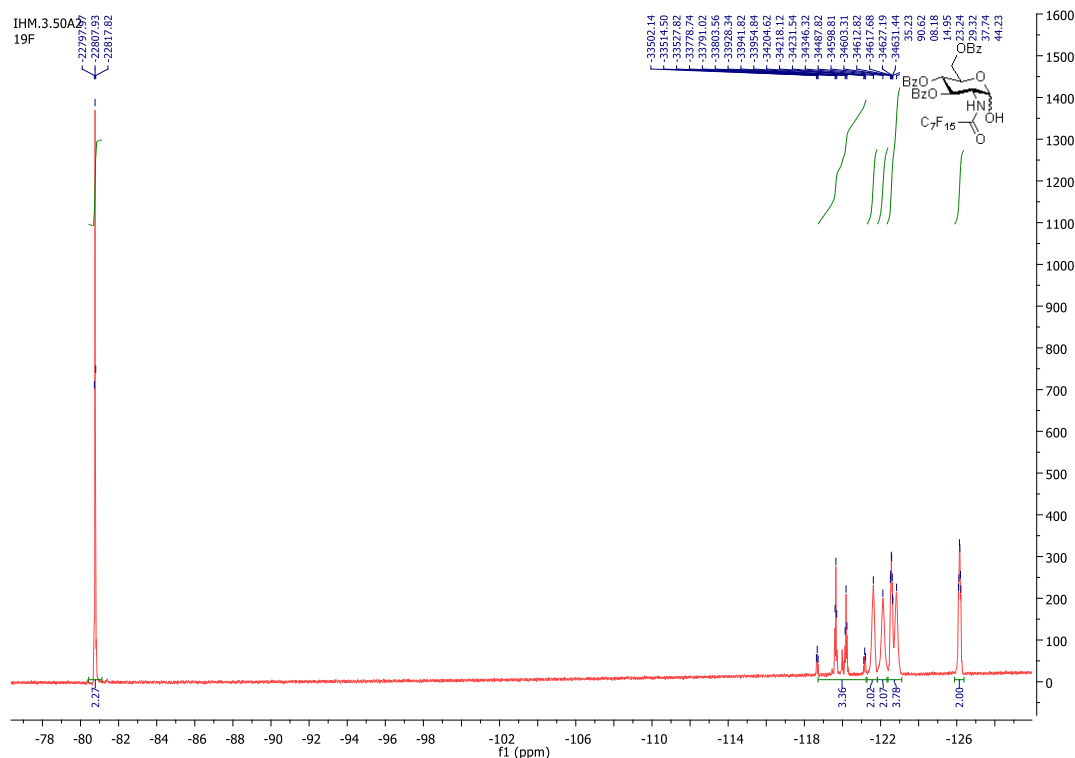

<sup>19</sup>F NMR (282 MHz) of Compound **81** in CDCl<sub>3</sub>

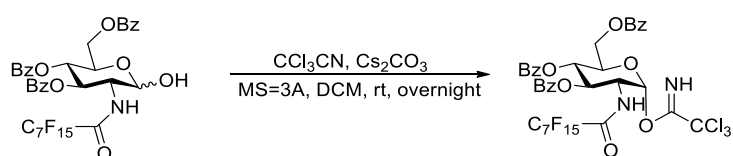

### 3,4,6-tetra-*O*-benzoyl-2-deoxy-2-(8,8,8,7,7,6,6,5,5,4,4,3,3,2,2-pentadecafluorooctanoylamido)- $\alpha$ -D-glucopyranose-1-*O*-trichloroacetimidate (**82**)

Compound **82** was prepared from **81** (0.834mmol, 749mg, 1 equiv.) in the same manner other fluororous imidates (**71**, **74** and **77**) were made. The crude mixture was eluted with cyclohexane: ethylacetate 80:20  $\rightarrow$  60:40% +0.2% TEA gradient by flash column chromatography and upon solvent removal, titled compound **82** was isolated as a white form. 543mg, 63%

R<sub>f</sub> = 0.52; (cyclohexane: ethylacetate, 8/2)

<sup>1</sup>H NMR (400 MHz, CDCl<sub>3</sub>)  $\delta$  (ppm): 8.06 – 7.33 (m, 15H, 3xAr), 7.19 (d,  $J$  = 7.9 Hz, 1H, N-H), 6.68 (d,  $J$  = 3.5 Hz, 1H, H-1), 5.94 – 5.86 (m, 2H, H-3, H-4), 4.82 – 4.75 (m, 1H, H-2), 4.66 (dd,  $J$  = 12.2, 2.5 Hz, 1H, H-6), 4.63 – 4.56 (m, 1H, H-5), 4.51 (dd,  $J$  = 12.2, 4.5 Hz, 1H, H-6).

<sup>13</sup>C NMR (101 MHz, CDCl<sub>3</sub>)  $\delta$  (ppm): 167.69, 166.09, 165.17, 160.22, 134.06, 133.83, 133.34, 130.01, 129.95, 129.86, 129.56, 128.61, 128.59, 128.55, 128.52, 127.97, 93.68, 90.63, 70.97, 70.82, 67.96, 62.31, 53.62.

<sup>19</sup>F NMR (376 MHz, CDCl<sub>3</sub>)  $\delta$  (ppm): -80.91 (t, 3F,  $J$  = 9.9 Hz, CF<sub>3</sub>), -118.81 – -121.34 (AB, 2F, CF<sub>2</sub>), -121.50 – -121.77 (m, 2F, CF<sub>2</sub>), -122.00 – -122.29 (m, 2F, CF<sub>2</sub>), -122.58 – -122.78 (m, 2F, CF<sub>2</sub>), -122.79 – -123.04 (m, 2F, CF<sub>2</sub>).

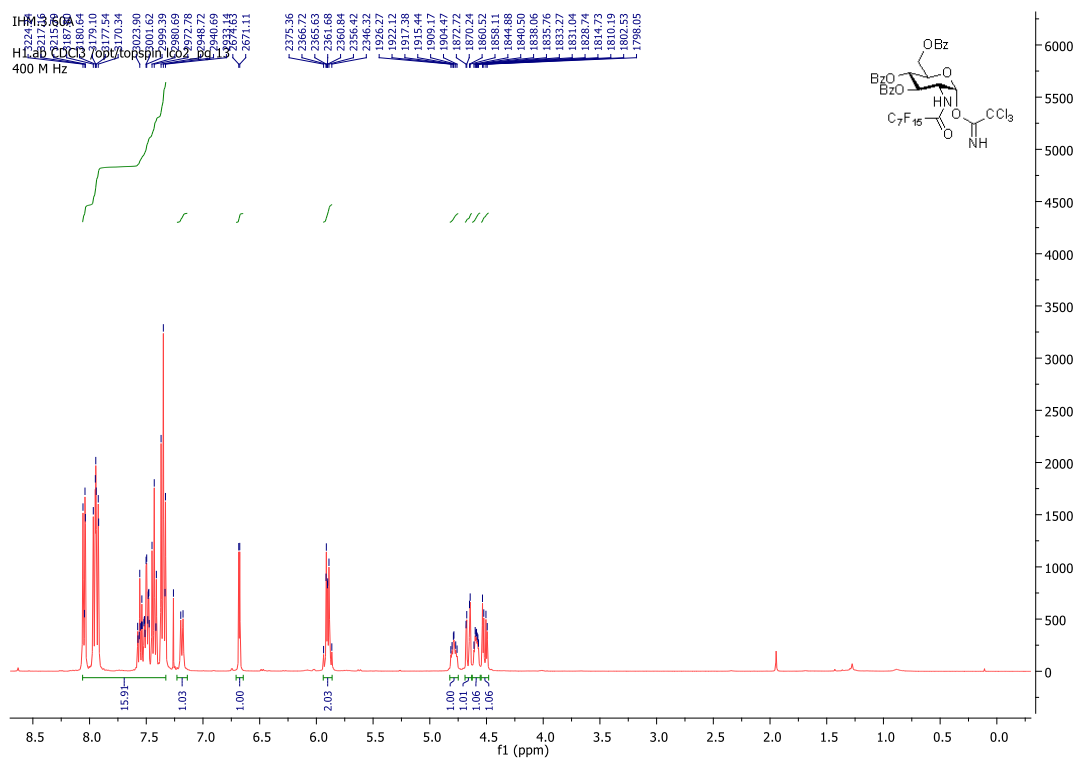

<sup>1</sup>H NMR (400 MHz) of Compound 82 in CDCl<sub>3</sub>

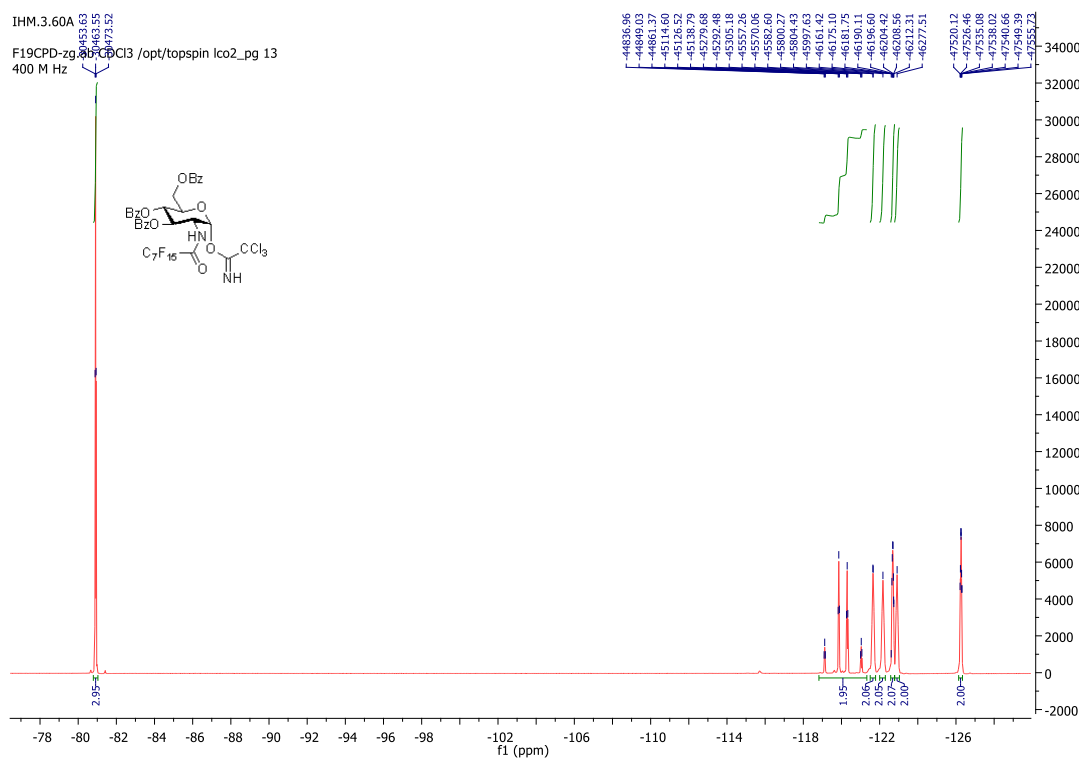

<sup>19</sup>F NMR (376 MHz) of Compound 82 in CDCl<sub>3</sub>



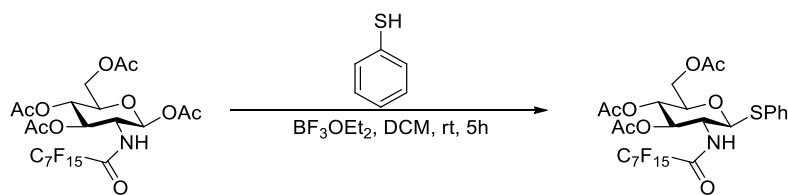

**Phenyl 3,4,6-tri-*O*-acetyl-2-deoxy-2-(8,8,8,7,7,6,6,5,5,4,4,3,3,2,2-pentadecafluorooctanoylamido)-1-thio- $\beta$ -D-glucopyranoside (**83**)**

To a suspension of 1,3,4,6-tetra-*O*-acetyl-2-deoxy-2-(8,8,8,7,7,6,6,5,5,4,4,3,3,2,2-pentadecafluorooctanoylamido)- $\beta$ -D-glucopyranose **69** (294mg, 0.53mmol, Az. toluene) dissolved in dry DCM (4mL) was treated with thiophenol (0.11mL, 1.06mmol, 2eq.),  $\text{BF}_3 \cdot \text{OEt}_2$  (0.33mL, 2.65mmol, 5eq.) and stirred at room temperature for 5h under argon balloon. The reaction mixture was quenched with 1M  $\text{Na}_2\text{CO}_3$  (20mL) and stirred additional 15mins after complete reaction, the mixture was diluted with DCM (50mL), washed with 2:1 sat  $\text{NaCl}_{(\text{aq})}$ :  $\text{Na}_2\text{CO}_{3(\text{aq})}$  (30mLx2). The aqueous layers were individually back extracted with DCM and the combined organic layers were dried with anhydrous  $\text{Na}_2\text{SO}_4$  and concentrated. Silica gel chromatography on the crude mixture was eluted with 20%-100% EtOAc: PE gradient and the titled fraction gave **83** as a white solid (259 mg, 0.326 mmol, 83%).

$R_f = 0.20$ ; (EtOAc:PE, 2/8)

$^1\text{H NMR}$  (300 MHz,  $\text{CDCl}_3$ )  $\delta$  (ppm): 7.53 – 7.46 (m, 2H, 2C-H, Ar), 7.43 (d,  $J = 9.6$  Hz, 1H, N-H), 7.37 – 7.26 (m, 3H, 3C-H, Ar), 5.37 (dd,  $J = 10.2, 9.9$  Hz, 1H, H-3), 5.01 (dd,  $J = 10.2, 9.8$  Hz, 1H, H-4), 4.70 (d,  $J = 10.4$  Hz, 1H, H-1), 4.28 – 4.14 (m, 3H, H-2, 2H-6), 3.78 (ddd,  $J = 10.0, 5.0, 3.0$  Hz, 1H, H-5), 2.06 (s, 3H, Ac), 1.98 (s, 3H, Ac), 1.79 (s, 3H, Ac).

$^{19}\text{F NMR}$  (282 MHz,  $\text{CDCl}_3$ )  $\delta$  (ppm): -80.88 (t,  $J = 10.0$  Hz, 3F,  $\text{CF}_3$ ), -118.66 – -121.12 (m, 2F,  $\text{CF}_2$ ), -121.30 – -121.82 (m, 2F,  $\text{CF}_2$ ), -122.83 – -122.28 (m, 2F,  $\text{CF}_2$ ), -122.26 – -122.62 (m, 2F,  $\text{CF}_2$ ), -122.30 – -123.00 (m, 2F,  $\text{CF}_2$ ), -125.94 – -126.42 (m, 2F,  $\text{CF}_2$ ).

$^{13}\text{C NMR}$  (75 MHz,  $\text{CDCl}_3$ )  $\delta$  (ppm): 171.51, 170.69, 169.29, 133.65, 131.52, 129.19, 128.95, 86.58, 76.14, 73.37, 68.52, 62.39, 53.39, 20.85, 20.47, 20.34.

**HRMS** (ESI, positive mode)  $m/z$ :  $\text{C}_{26}\text{H}_{22}\text{F}_{15}\text{NNaO}_8\text{S}$ ,  $[\text{M}+\text{Na}]^+$  calcd. 816.0686, found 816.0719

$[\alpha]_D^{23.8} = -3^\circ$  (C=10mg/mL in Acetone)

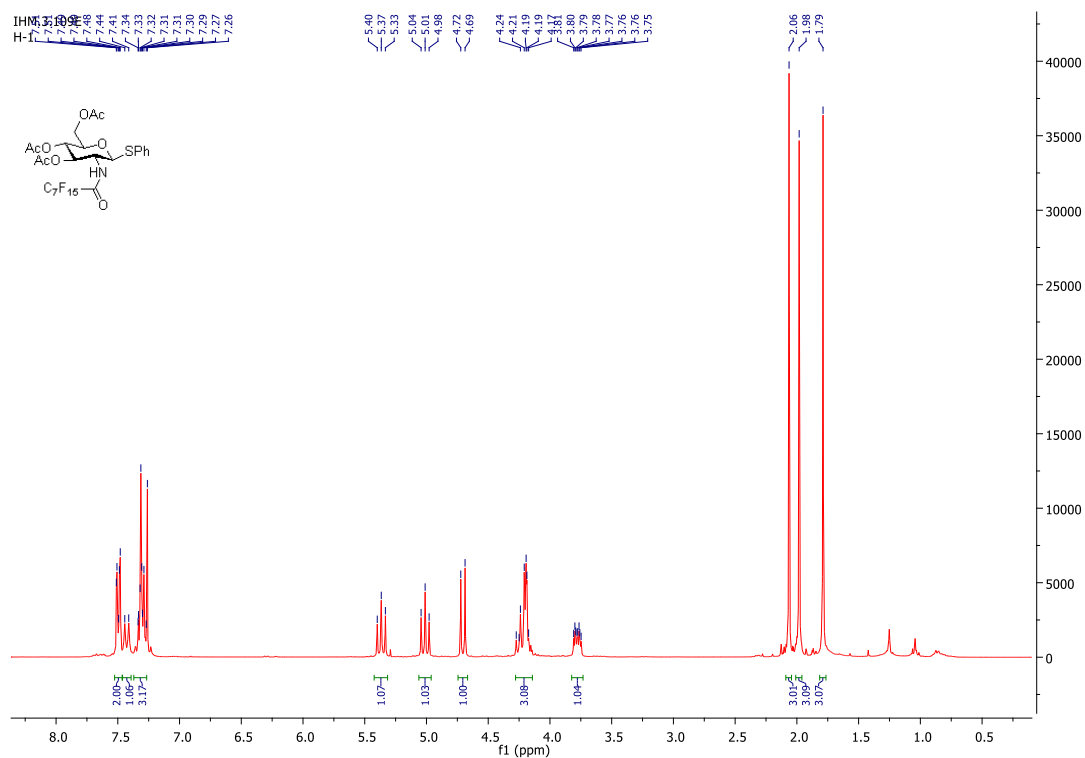

**<sup>1</sup>H NMR (300 MHz) of Compound 83 in CDCl<sub>3</sub>**

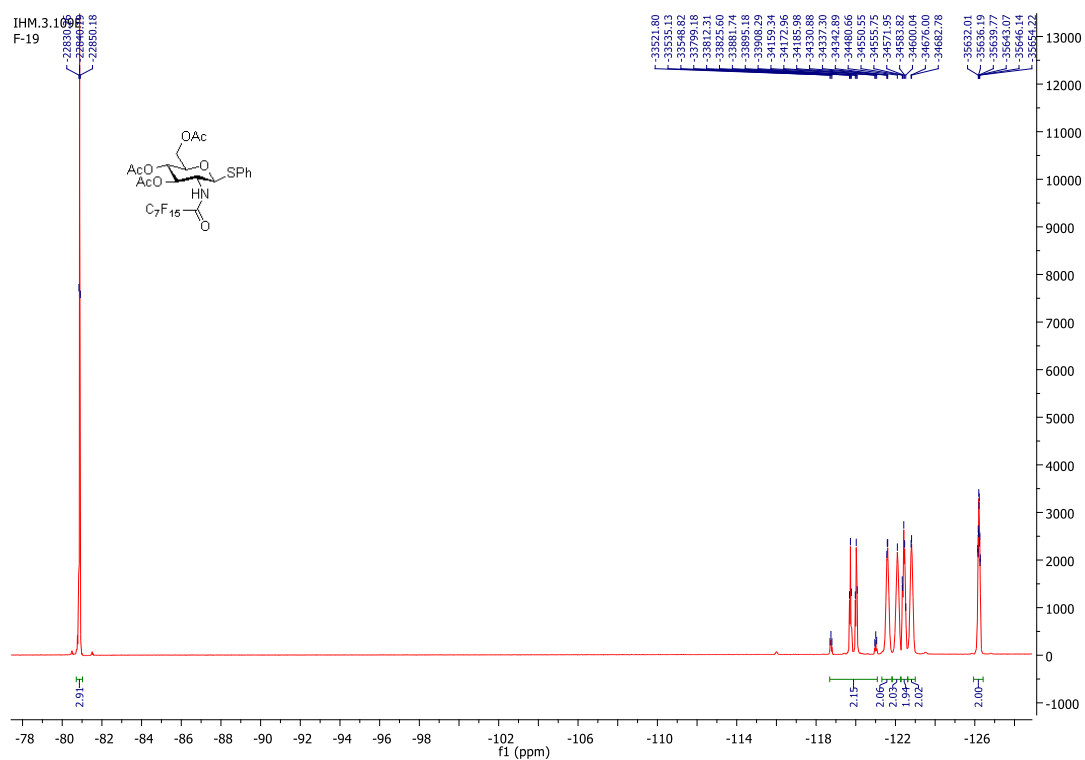

**<sup>19</sup>F NMR (282 MHz) of Compound 83 in CDCl<sub>3</sub>**

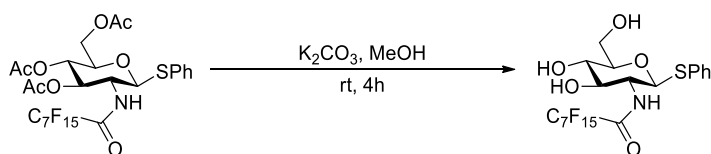

**Phenyl 2-deoxy-2-(8,8,8,7,7,6,6,5,5,4,4,3,3,2,2-pentadecafluorooctanoylamido)-1-thio- $\beta$ -D-glucopyranoside (**84**)**

To a solution of Phenyl 3,4,6-tri-*O*-acetyl-2-deoxy-2-(8,8,8,7,7,6,6,5,5,4,4,3,3,2,2-pentadecafluorooctanoylamido)-1-thio- $\beta$ -D-glucopyranoside **83** (1.361 g, 1.715 mmol) in anhydrous DCM: MeOH (22 mL, 1:3) was treated with catalytic amount of  $K_2CO_3$ . The homogeneous mixture was stirred for 4h at room temperature under argon. TLC in 10% MeOH: DCM confirmed complete conversion and the reaction was diluted with DCM: MeOH 10:1 (11mL), filtered over  $SiO_2$ /celite at vacuum, extracted with 10% MeOH: DCM (100mL) and dried over  $Na_2SO_4$  to afford **84** as a colorless form (1.019 g, 89%). This was used for further reaction without purification.

Rf = 0.52; (MeOH: DCM 1/9)

$^{19}F$  NMR (282 MHz, MeOD)  $\delta$  (ppm): -82.36 (tt,  $J$  = 10.2, 2.2 Hz, 3F,  $CF_3$ ), -120.70 (dt,  $J$  = 27.3, 13.3 Hz, 2F,  $CF_2$ ), -122.10 – -122.49 (m, 2F,  $CF_2$ ), -123.83 – -123.22 (m, 2F,  $CF_2$ ), -123.43 – -123.91 (m, 4F,  $2 \times CF_2$ ), -127.09 – -127.49 (m).

$^{13}C$  NMR (75 MHz, MeOD)  $\delta$  (ppm): 135.24, 132.58, 129.94, 128.56, 87.70, 82.22, 76.69, 71.90, 62.79, 56.73.

HRMS (ESI, positive mode)  $m/z$ :  $C_{14}H_{19}NaN_3O_9$   $[M+Na]^+$ , calc. 690.0395, found 690.0402.

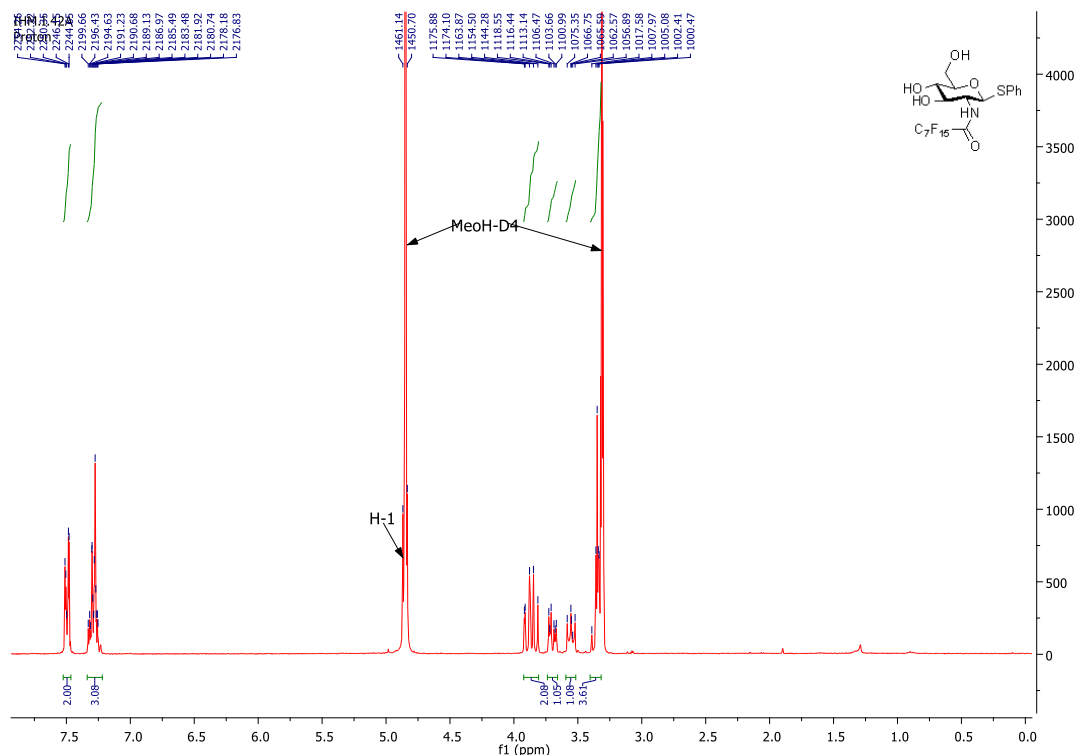

$^1H$  NMR (300 MHz) of Compound **84** in MeOD

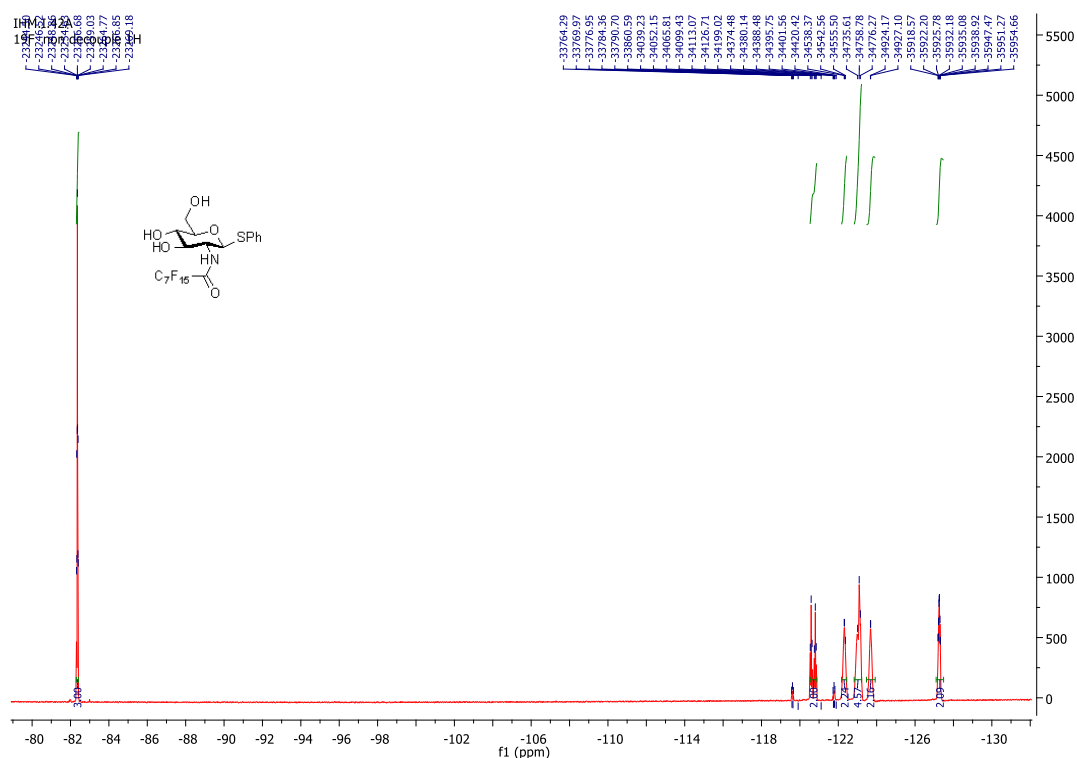

<sup>19</sup>F NMR (282 MHz) of Compound **84** in MeOD

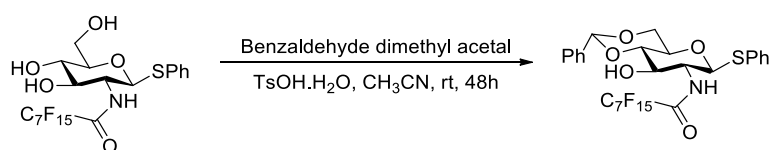

**Phenyl 4,6-*O*-benzylidene-2-deoxy-2-(8,8,8,7,7,6,6,5,5,4,4,3,3,2,2-pentadecafluorooctanoylamido)-1-thio-β-D-glucopyranoside (**85**)**

To a solution of Phenyl 2-deoxy-2-(8,8,8,7,7,6,6,5,5,4,4,3,3,2,2-pentadecafluorooctanoylamido)-1-thio-β-D-glucopyranoside (162mg, 0.24mmol) in CH<sub>3</sub>CN (6mL) was added tosylic acid (6.66mg, 0.035mmol, 1.5eq.) followed by benzaldehyde dimethyl acetal (0.11mL, 0.7mmol, 2.92eq.). The homogeneous mixture was stirred over the weekend at room temperature under argon balloon and closed septum. The reaction progress was monitored by TLC 10% MeOH: DCM, R<sub>f</sub> 0.59 and quenched with TEA (4mL). Product was extracted with EtOAc (100mL), aqueous work up with Na<sub>2</sub>CO<sub>3</sub> (100mL) and sat. NaCl (100mL) and dried with Na<sub>2</sub>SO<sub>4</sub>. The organic phase was concentrated and dried at vacuum. Silica gel chromatography 100%-50% DCM: MeOH yielded **85** as a white solid (109 mg, 0.144 mmol, 60%).

<sup>1</sup>H NMR (400 MHz, DMSO) δ (ppm): 9.57 (d, *J* = 8.8 Hz, 1H, N-H), 7.46 – 7.27 (m, 10H, 2xAr), 5.69 (d, *J* = 5.9 Hz, 1H), 5.64 (s, 1H, PhC-H), 5.04 (d, *J* = 10.1 Hz, 1H, H-1), 4.25 (dd, *J* = 10.1, 4.6 Hz, 1H, H-6), 3.87 – 3.70 (m, 3H, H-2, H-4, H-5), 3.58 – 3.44 (m, 2H, H-3, H-6), 3.34 (s, 1H, O-H).

<sup>19</sup>F NMR (376 MHz, DMSO) δ (ppm): -80.14 – -80.32 (m, 3F, CF<sub>3</sub>), -117.60 – -119.83 (m, 2F, CF<sub>2</sub>), -121.24 (m, 2F, CF<sub>2</sub>), -121.62 – -122.25 (m, 4F, 2xCF<sub>2</sub>), -122.52 (m, 2F, CF<sub>2</sub>), -125.78 (m, 2F, CF<sub>2</sub>).

$^{13}\text{C}$  NMR (101 MHz, DMSO)  $\delta$  (ppm): 137.59, 133.48, 130.24, 129.12, 128.94, 128.08, 127.30, 126.35, 100.66, 85.93, 80.50, 71.11, 70.18, 67.54, 55.58, 26.36.

HRMS (ESI, positive mode)  $m/z$ :  $\text{C}_{27}\text{H}_{20}\text{F}_{15}\text{NNaO}_5\text{S}$   $[\text{M}+\text{Na}]^+$ , calcd. 778.0717, found 778.0693.

$[\alpha]_{\text{D}}^{26} = -62^\circ$  (C=1mg/mL in  $\text{CHCl}_3/\text{Acetone}$ ; 10:1)

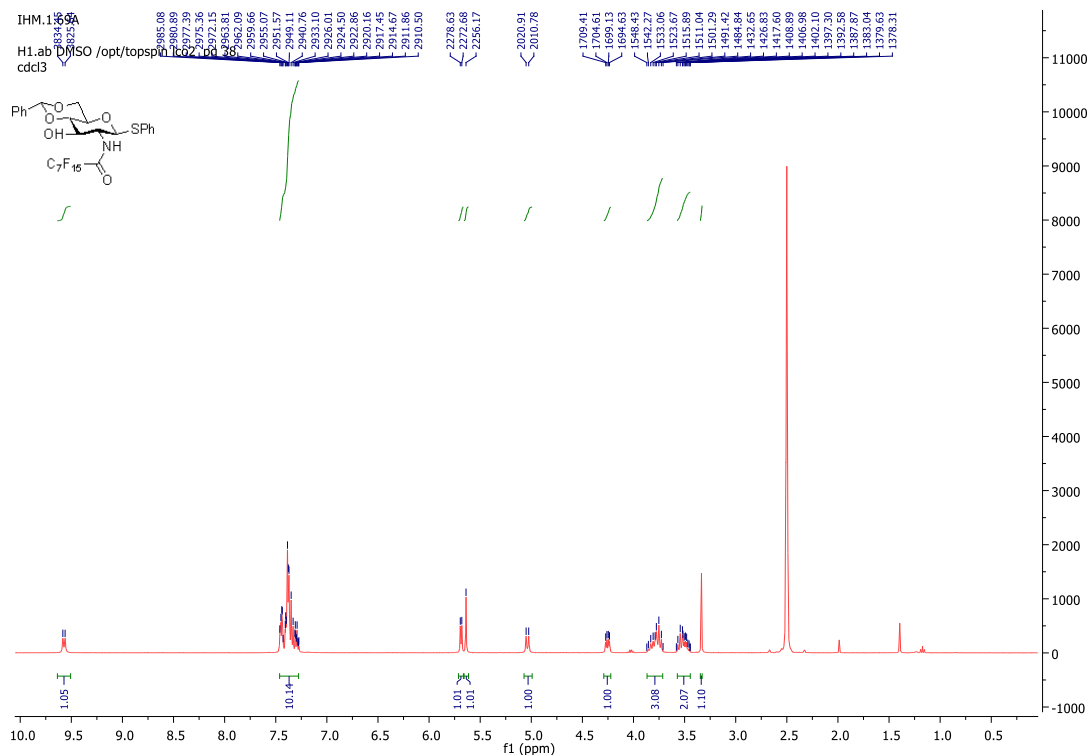

$^1\text{H}$  NMR (400 MHz) of Compound 85 in DMSO

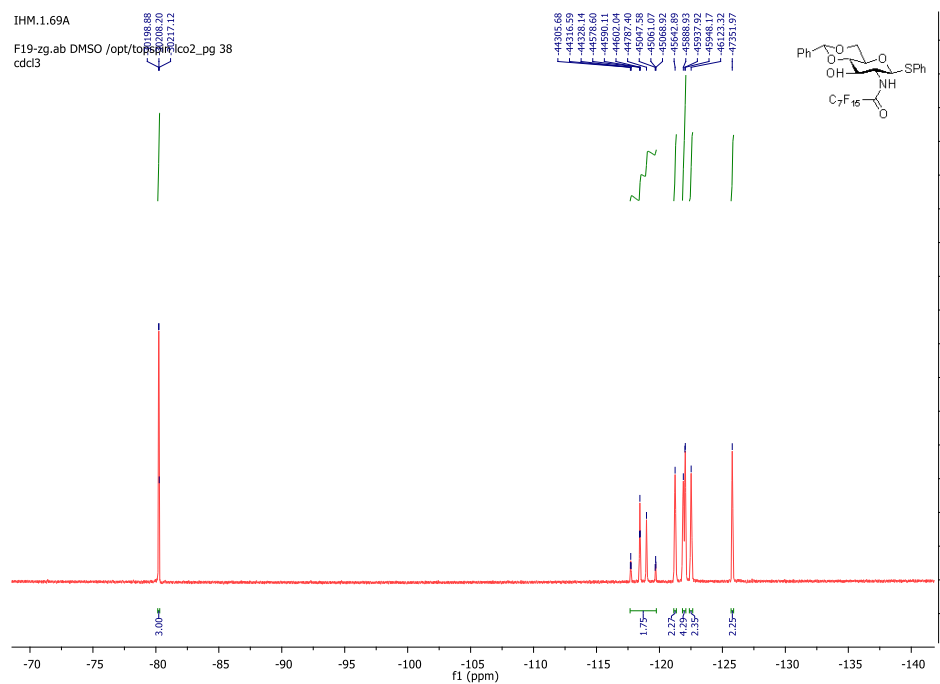

$^{19}\text{F}$  NMR (376 MHz) of Compound 85 in DMSO

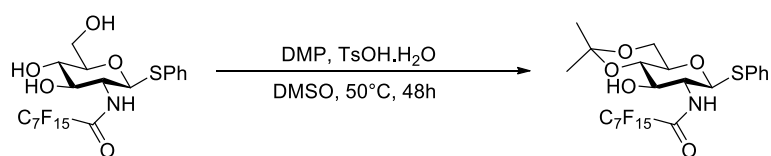

**Phenyl 4,6-*O*-acetonide-2-deoxy-2-(8,8,8,7,7,6,6,5,5,4,4,3,3,2,2-pentadecafluorooctanoylamido)-1-thio- $\beta$ -D-glucopyranoside (**86**)**

To the solution of **84** (0.321mmol, 214mg, 1 equiv., az. with toluene) in anhydrous DMSO (15mL) under argon atm and room temperature was treated with TsOH.H<sub>2</sub>O (0.482mmol, 92mg, 1.5equiv.), 2,2-dimethoxypropane DMP (1.926mmol, 0.24mL, 6equiv.) and the reaction temperature was raised to 50 °C under argon and stirred overnight. Analytical TLC revealed uncomplete reaction, hence, 3 equivalents of DMP was added to drive the reaction to completion for another day. The mixture was cooled down to rt, and diluted with H<sub>2</sub>O, washed with H<sub>2</sub>O (75mLx2), sat. Na<sub>2</sub>CO<sub>3(aq)</sub> (75mLx2), brine (100mL), dried over Na<sub>2</sub>SO<sub>4</sub>, filtered and concentrated at vacuo. Flash column chromatography of the crude mixture on silica gel in DCM: MeOH 95:05  $\rightarrow$  60:40% as eluent provided **86** (94mg, 41%) as pale brown solid and recovered starting material (78 mg).

R<sub>f</sub> = 0.32; (DCM: MeOH 9.5/0.5)

<sup>1</sup>H NMR (300 MHz, MeOD)  $\delta$  (ppm): 7.50 – 7.24 (m, 5H, Ar), 4.86 (d, *J* = 10.4 Hz, 1H, H-1), 3.96 – 3.85 (m, 2H, H-2, H-6), 3.79 (t, *J* = 10.4 Hz, 1H, H-6), 3.66 (t, *J* = 9.2 Hz, 1H, H-3), 3.57 (t, *J* = 9.2 Hz, 1H, H-4), 3.33 (m, 1H, H-5), 1.51 (s, 3H, CH<sub>3</sub>), 1.37 (s, 3H, CH<sub>3</sub>).

<sup>19</sup>F NMR (282 MHz, MeOD)  $\delta$  (ppm): -82.36 (tt, *J* = 10.2, 2.2 Hz, 3F, CF<sub>3</sub>), -120.76 (dt, *J* = 27.3, 13.3 Hz, 2F, CF<sub>2</sub>), -122.14 – -122.51 (m, 2F, CF<sub>2</sub>), -122.80 – -123.28 (m, 4F, 2xCF<sub>2</sub>), -123.48 – -123.87 (m, 2F, CF<sub>2</sub>), -127.10 – -127.42 (m, 2F, CF<sub>2</sub>).

<sup>13</sup>C NMR (75 MHz, MeOD)  $\delta$  (ppm): 134.37, 133.30, 129.99, 128.97, 100.96, 88.13, 75.22, 73.77, 72.78, 62.95, 57.16, 29.38, 19.33.

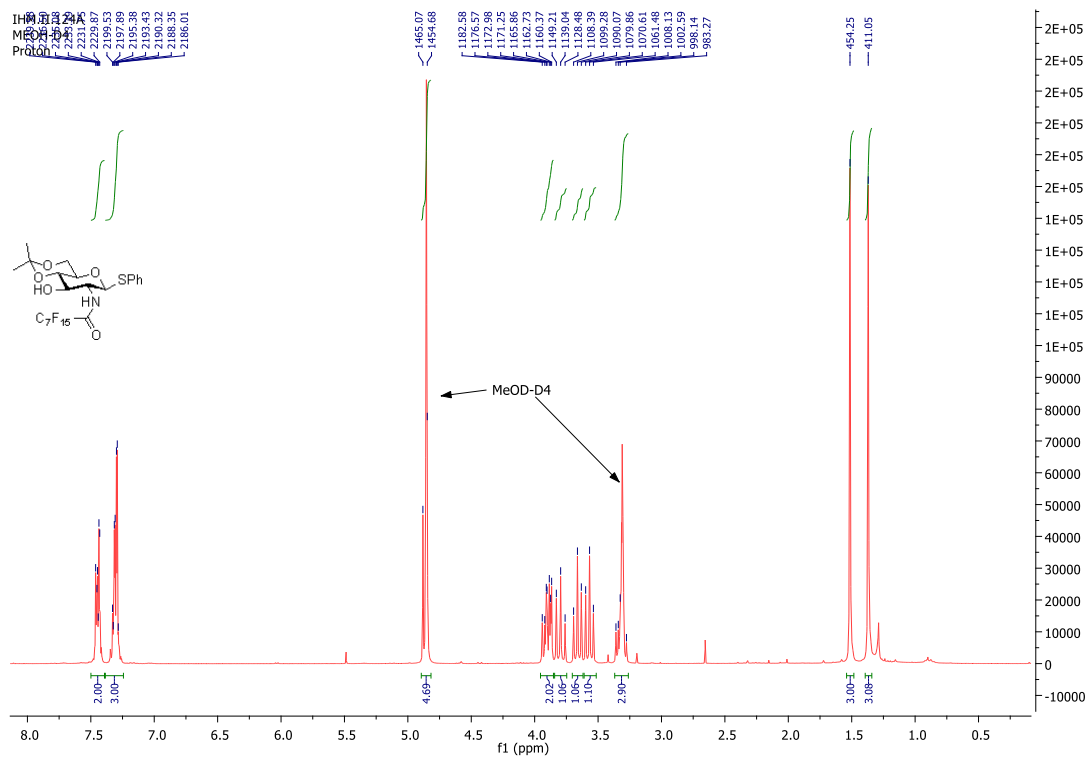

**<sup>1</sup>H NMR (300 MHz) of Compound 86 in MeOD**

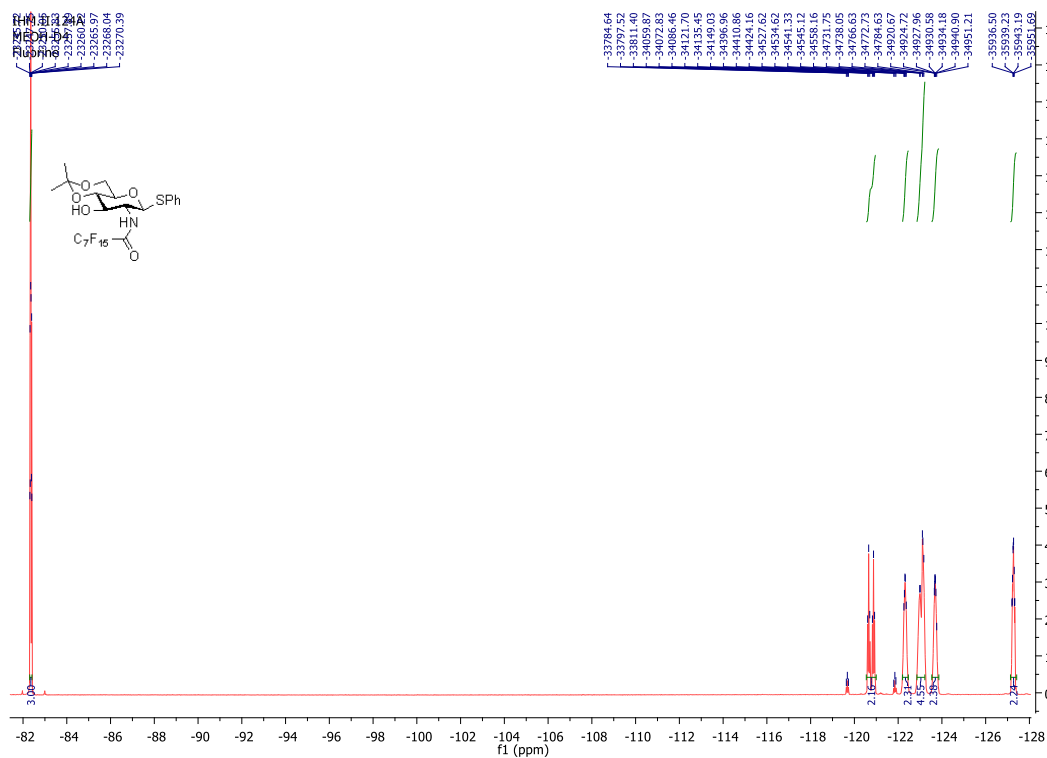

**<sup>19</sup>F NMR (282 MHz) of Compound 86 in MeOD**

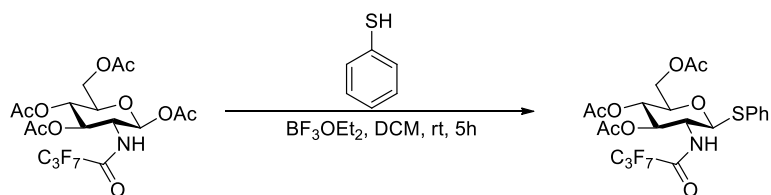

**Phenyl 3,4,6-tri-*O*-acetyl-2-deoxy-2-(4,4,4,3,3,2-heptafluoropropylamido)-1-thio- $\beta$ -D-glucopyranoside (87)**

Compound **87** was prepared from **72** (0.156 mmol, 85 mg, 1 equiv.) in the same manner **83** was made. The crude mixture was eluted with MeOH/H<sub>2</sub>O; 80%  $\rightarrow$  100% by fluorosilica gel extraction (F-SPE) and upon solvent removal, titled compound **87** was isolated as a white form. 68 mg, 73%

Rf = 0.20; (EtOAc: PE, 2/8)

$[\alpha]_D^{22.7} = +9^\circ$  (C=10mg/mL in Acetone)

**<sup>1</sup>H NMR** (300 MHz, CDCl<sub>3</sub>)  $\delta$  (ppm): 7.55 – 7.27 (m, 1H, Ar), 7.11 (d,  $J = 9.3$  Hz, 1H, N-H), 5.31 (dd,  $J = 10.2, 9.5$  Hz, 1H, H-3), 5.03 (t,  $J = 9.7$  Hz, 1H, H-4), 4.77 (d,  $J = 10.4$  Hz, 1H, H-1), 4.27 – 4.10 (m, 3H, H-2, 2H-6), 3.76 (ddd,  $J = 10.0, 5.0, 2.9$  Hz, 1H, H-5), 2.08 (s, 3H, Ac), 1.99 (s, 3H, Ac), 1.88 (s, 3H, Ac).

**<sup>19</sup>F NMR** (282 MHz, CDCl<sub>3</sub>)  $\delta$  (ppm): -80.49 (t,  $J = 9.1$  Hz, 3F, CF<sub>3</sub>), -120.71 (dq,  $J = 70.4, 9.0$  Hz, 2F, CF<sub>2</sub>), -126.83 (d,  $J = 12.7$  Hz, 2F, CF<sub>2</sub>).

**<sup>13</sup>C NMR** (75 MHz, CDCl<sub>3</sub>)  $\delta$  (ppm): 207.27, 171.44, 170.70, 169.30, 133.65, 131.51, 129.18, 128.91, 86.49, 76.10, 73.36, 68.55, 62.38, 53.35, 31.07, 20.84, 20.48, 20.40.

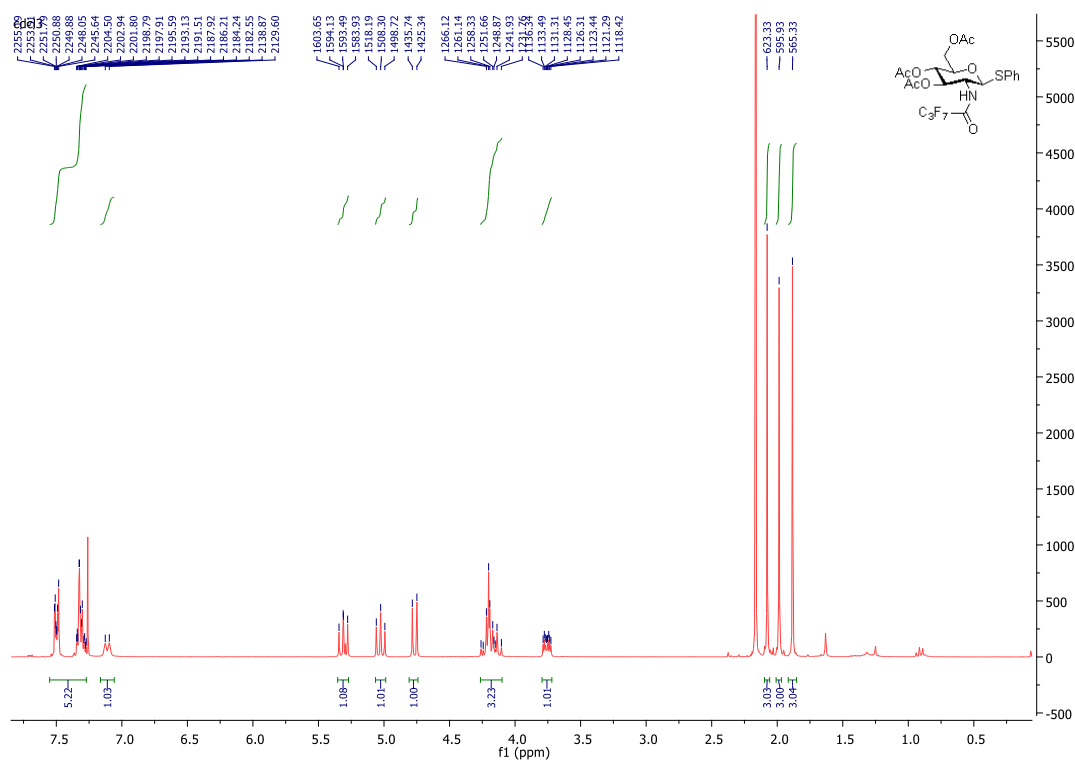

**<sup>1</sup>H NMR (300 MHz) of Compound 87 in CDCl<sub>3</sub>**



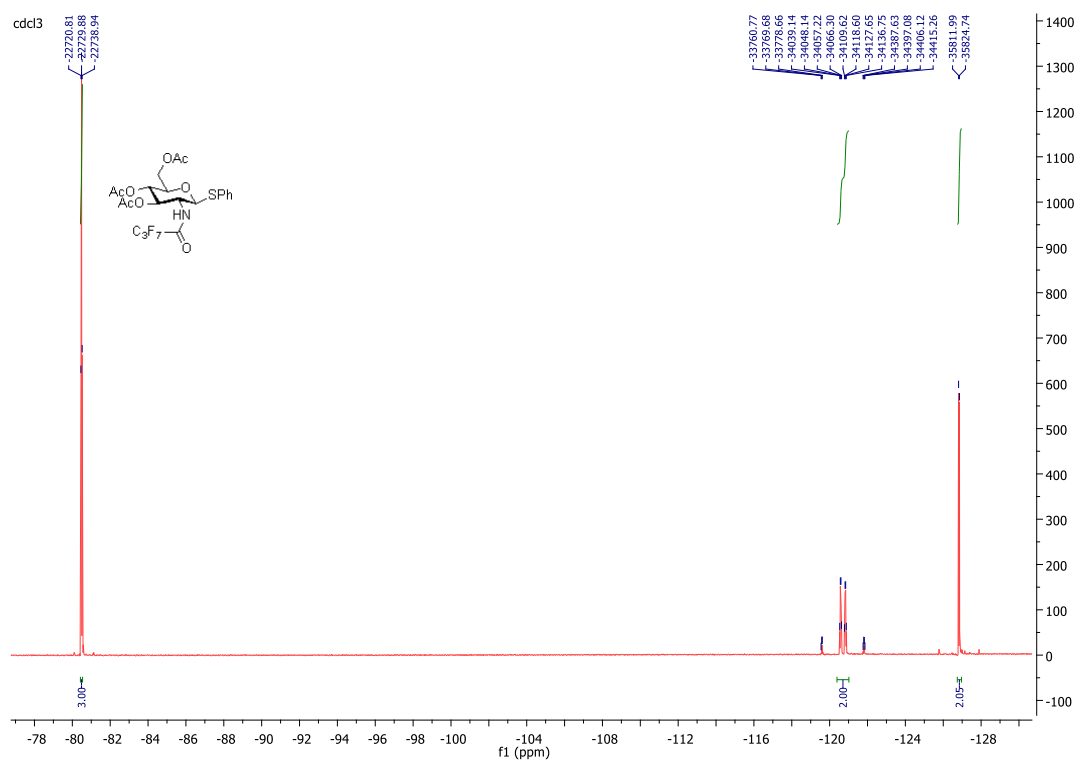

**<sup>19</sup>F NMR (282 MHz) of Compound **87** in CDCl<sub>3</sub>**

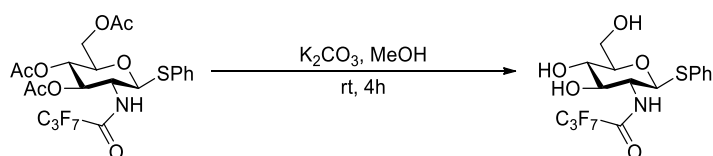

**Phenyl 2-deoxy-2-(4,4,4,3,3,2,2-heptafluoropropylamido)-1-thio- $\beta$ -D-glucopyranoside (**88**)**

Compound **88** was synthesized from **87** (0.115 mmol, 68 mg, 1 equiv.) in the same manner **84** was prepared. The crude mixture was eluted with MeOH: H<sub>2</sub>O (80:20%) by a fluorosilica gel extraction (F-SPE) and after solvent removal, titled compound **88** was obtained as a colorless form. 41mg, 75%  
R<sub>f</sub> = 0.20; (EtOAc: PE, 2/8)

**<sup>1</sup>H NMR** (300 MHz, DMSO)  $\delta$  (ppm): 9.40 (d,  $J$  = 9.1 Hz, 1H, N-H), 7.51 – 7.15 (m, 5H, Ar), 5.29 (d,  $J$  = 6.1 Hz, 1H, O-H), 5.18 (d,  $J$  = 5.1 Hz, 1H, O-H), 4.85 (d,  $J$  = 10.5 Hz, 1H, H-1), 4.65 (t,  $J$  = 5.7 Hz, 1H, H-3), 3.81 – 3.60 (m, 2H, H-2, H-6), 3.56 – 3.38 (m, 2H, H-4, H-6), 3.22 – 3.13 (m, 2H, H-5, O-H).

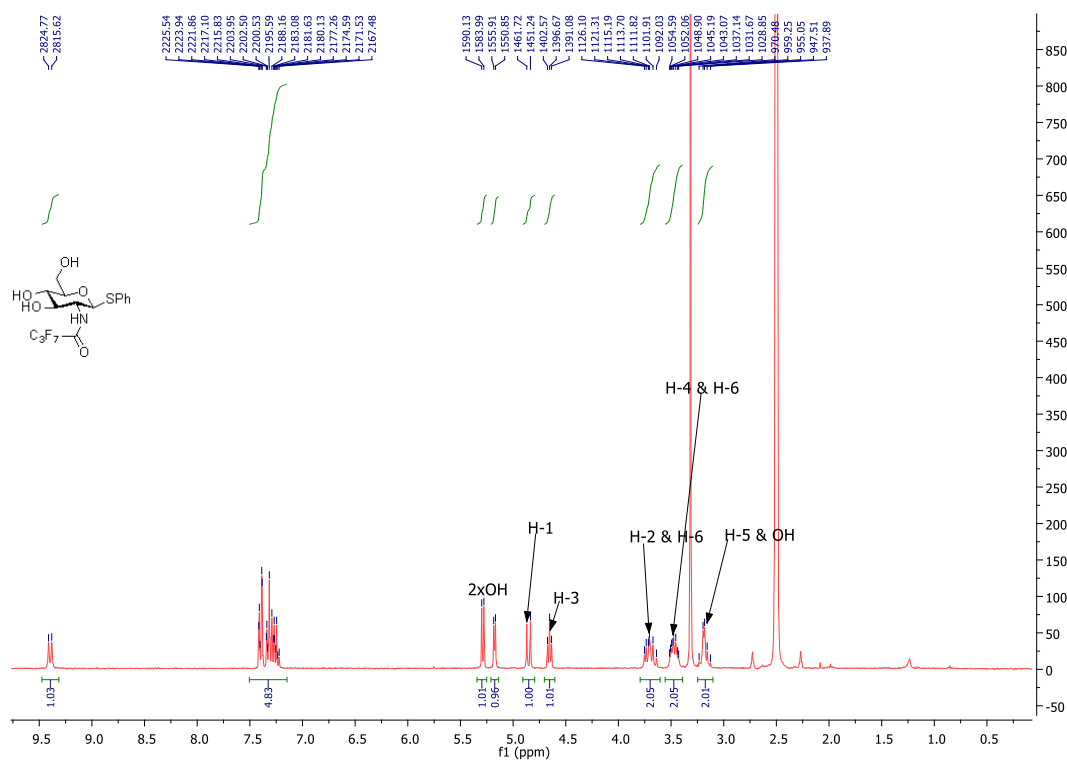

$^1\text{H}$  NMR (300 MHz) of Compound **88** in DMSO

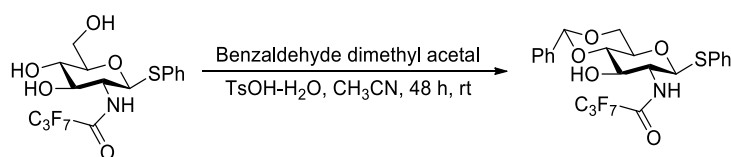

**Phenyl 4,6-*O*-benzylidene-2-deoxy-2-(4,4,4,3,3,2,2-heptafluoropropylamido)-1-thio- $\beta$ -D-glucopyranoside (**89**)**

Compound **89** was prepared from **88** (0.324 mmol, 151 mg, 1 equiv.) in the same manner **85** was made. The crude mixture was eluted with DCM: MeOH, 100%  $\rightarrow$  90:10 on silica gel flash column chromatography and upon solvent removal, titled compound **89** was isolated as a white form. 201 mg, 89%

R<sub>f</sub> = 0.56; (DCM: MeOH, 9/1)

$^1\text{H}$  NMR (400 MHz,  $\text{CDCl}_3$ )  $\delta$  (ppm): 7.54 – 7.30 (m, 10H, 2xAr), 6.60 (d,  $J$  = 8.0 Hz, 1H, N-H), 5.55 (s, 1H, PhC-H), 5.15 (d,  $J$  = 10.4 Hz, 1H, H-1), 4.40 (dd,  $J$  = 10.5, 4.9 Hz, 1H, H-6), 4.22 (t,  $J$  = 8.5 Hz, 1H, H-3), 3.80 (t,  $J$  = 10.1 Hz, 1H, H-6), 3.67 – 3.48 (m, 3H, H-2, H-4, H-5), 2.73 (br s, 1H, O-H).

$^{19}\text{F}$  NMR (376 MHz,  $\text{CDCl}_3$ )  $\delta$  (ppm): -80.39 (t,  $J$  = 8.7 Hz, 3F,  $\text{CF}_3$ ), -120.29 – -120.51 (m, 2F,  $\text{CF}_2$ ), -126.65 (s, 2F,  $\text{CF}_2$ ).

$^{13}\text{C}$  NMR (101 MHz,  $\text{CDCl}_3$ )  $\delta$  (ppm): 136.81, 133.45, 129.62, 129.38, 128.90, 128.57, 126.36, 102.11, 85.43, 81.36, 77.36, 71.43, 70.50, 68.58, 60.91, 56.89.

$[\alpha]_D^{25} = -10^\circ$  (C=7mg/mL in EtOAc)

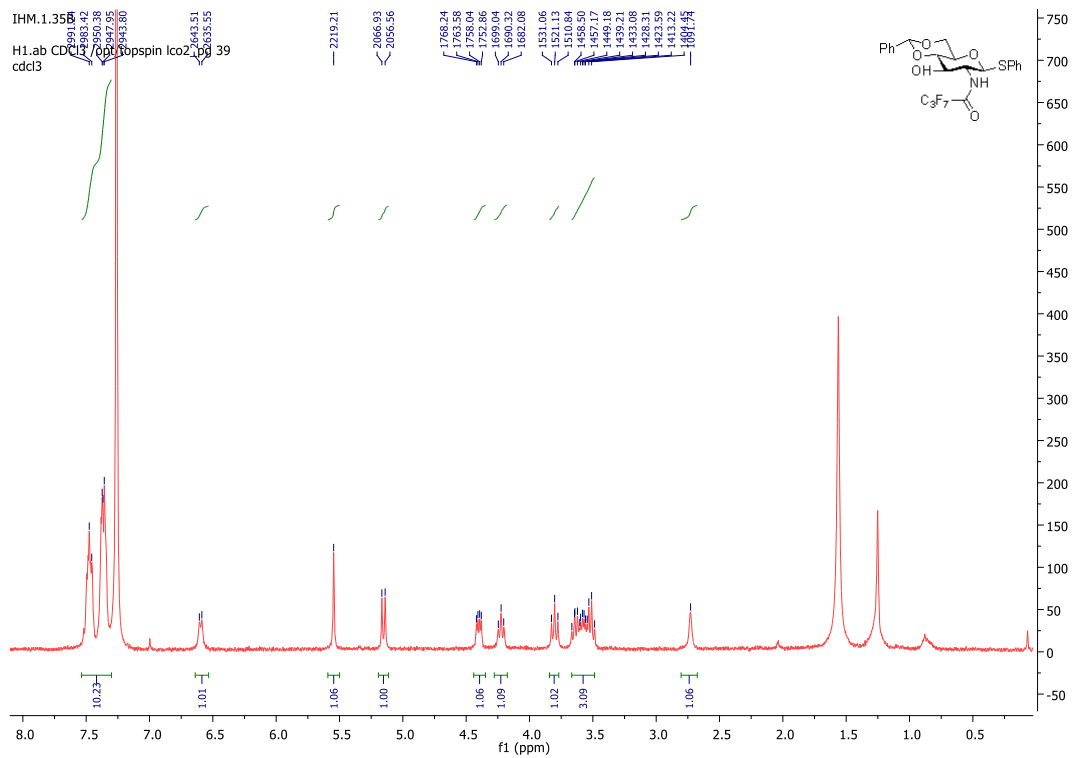

$^1\text{H NMR}$  (400 MHz) of Compound **89** in  $\text{CDCl}_3$

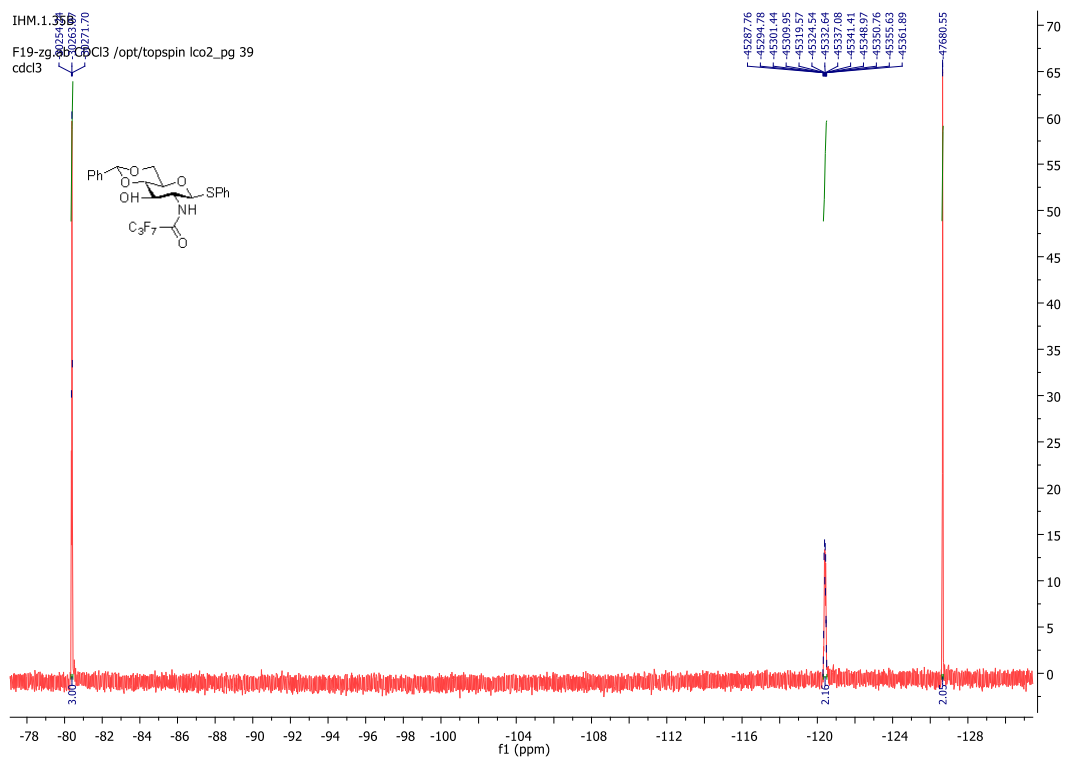

$^{19}\text{F NMR}$  (376 MHz) of Compound **89** in  $\text{CDCl}_3$

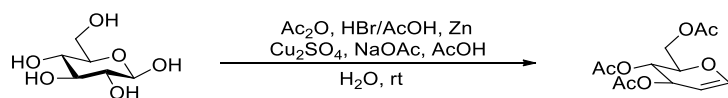

### 3,4,6- tri-O-acetyl-D-glucal (95)

To a suspension of D-glucose anhydrous (0.056mol, 10g) was treated with acetic anhydride (30mL), and HBr/AcOH (7.1mL) and allowed to stir for 1h at room temperature in a water bath, after which HBr/AcOH (43mL) was added and stirred overnight. Anhydrous NaOAc (0.24mol, 20g) was added subsequently followed by a mixture of  $\text{CuSO}_4 \cdot 5\text{H}_2\text{O}$  (0.020mol, 5.1g), Zn powder (1.928mol, 126g) in a solution of  $\text{H}_2\text{O}$  (100mL), AcOH (180mL) and NaOAc (100g) was also added into the reaction mixture and stirred vigorously for 1.5h. The solid was removed by filtration and washed with EtOAc first (300mL) and followed by distilled water (300mL) immediately. The organic layer (in the filtrate) washed with  $\text{NaHCO}_3$  (300mL), brine (150mL), dried in  $\text{MgSO}_4$  and the solvent was removed at rotovap. Silica gel chromatography in 30%  $\rightarrow$  100% EtOAc: cyclohexane as eluent yielded colorless oil **95** and NMR data consistent with literature<sup>376</sup> (11.86g, 79%).

Rf = 0.32; (cyclohexane: ethylacetate, 8/2)

<sup>1</sup>H NMR (300 MHz,  $\text{CDCl}_3$ )  $\delta$  (ppm): 6.46 (dd, 1H,  $J = 6.2, 1.3$  Hz, H-1), 5.33 (dddd, 1H,  $J = 3.3, 2.1, 1.3, 0.7$  Hz, H-3), 5.21 (dd, 1H,  $J = 7.5, 5.7$  Hz, H-4), 4.84 (dd, 1H,  $J = 6.2, 3.3$  Hz, H-2), 4.39 (dd, 1H,  $J = 11.7, 5.4$  Hz, H-6), 4.24 (ddd, 1H,  $J = 8.2, 5.8, 3.1$  Hz, H-5), 4.18 (dd, 1H,  $J = 11.7, 3.1$  Hz, H-6), 2.08 (s, 3H,  $\text{OCOCH}_3$ ), 2.07 (s, 3H,  $\text{OCOCH}_3$ ), 2.04 (s, 3H,  $\text{OCOCH}_3$ ).

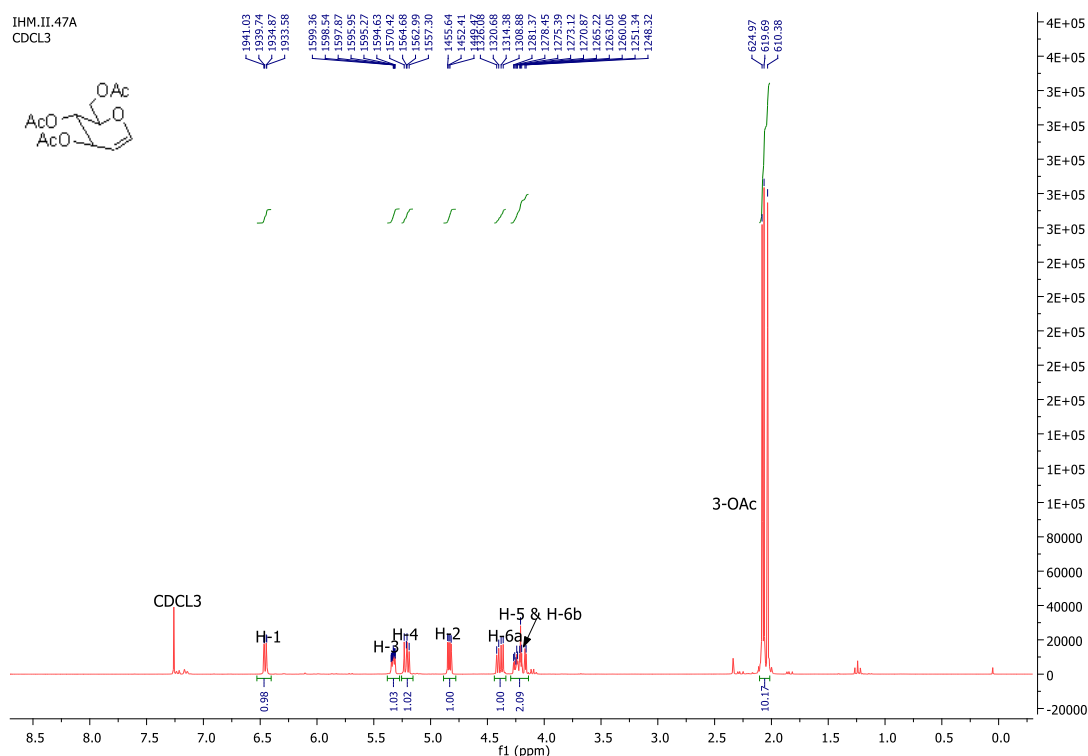

<sup>1</sup>H NMR (300 MHz) of Compound **95** in  $\text{CDCl}_3$

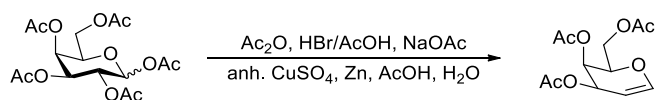

### 3,4,6-tri-O-acetyl galactal (**96**)

Compound **96** was prepared via slightly modified strategy as tri-O-acetyl glucal **95** but in this case from penta-O-acetyl galactopyranoside<sup>504</sup> (23.5mmol, 9.2g). Silica gel chromatography in 30% →100% EtOAc: cyclohexane eluent system yielded colorless oil (5.023g, 76%).

Rf = 0.35; (cyclohexane: ethylacetate, 7/3)

<sup>1</sup>H NMR (300 MHz, CDCl<sub>3</sub>) δ (ppm): 6.44 (dd, *J* = 6.3, 1.7 Hz, 1H, H-1), 5.54 (ddd, *J* = 4.4, 2.6, 1.0 Hz, 1H, H-3), 5.41 (dt, *J* = 4.5, 1.6 Hz, 1H, H-4), 4.71 (ddd, *J* = 6.3, 2.7, 1.5 Hz, 1H, H-2), 4.25 (m, 3H, H-5, 2H-6), 2.11 (s, 3H, OCOCH<sub>3</sub>), 2.07 (s, 3H, OCOCH<sub>3</sub>), 2.01 (s, 3H, OCOCH<sub>3</sub>).

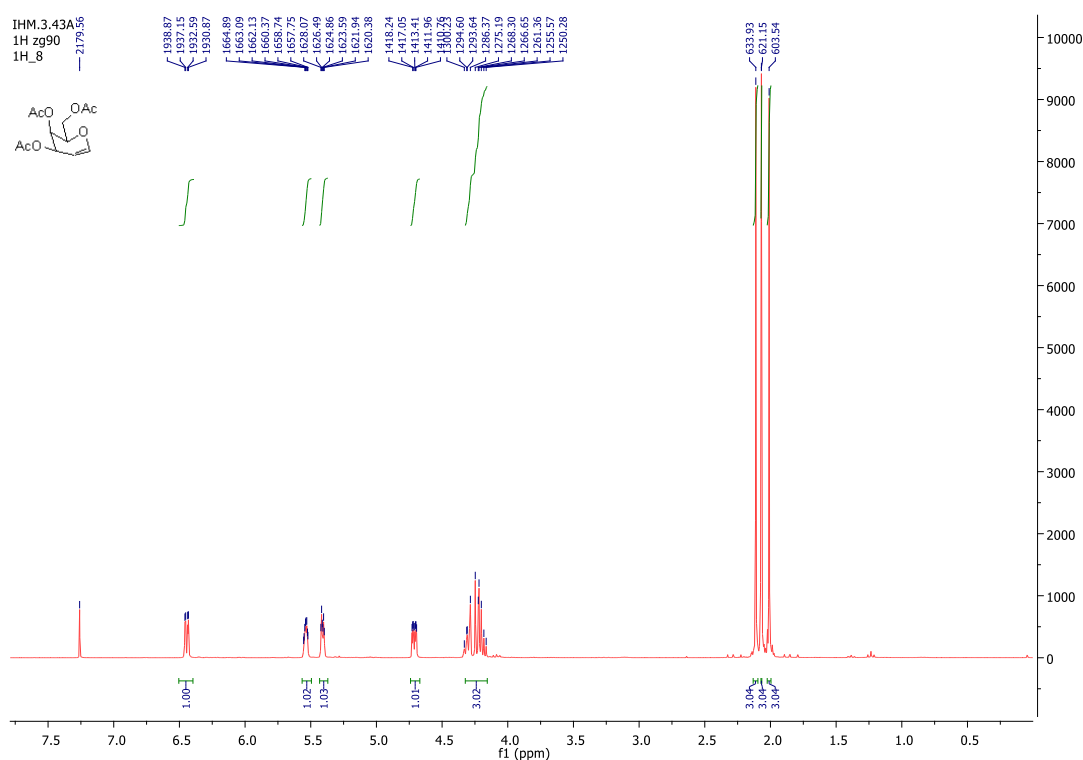

<sup>1</sup>H NMR (300 MHz) of Compound **96** in CDCl<sub>3</sub>

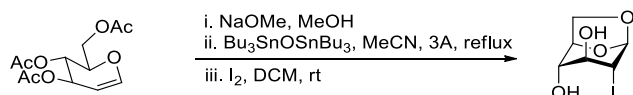

### 1,6-Anhydro-2-deoxy-2-iodo-β-D-glucopyranose (**97**)

To a tri-O-acetyl-D-glucal **95** (17mmol, 4.494g) azeotroped with toluene (3x5mL) was dissolved in dry methanol (40mL) under argon atm at room temperature. This was then treated with NaOMe (5.1mmol, 270mg and 0.3 equiv.) and the reaction mixture was allowed to stir for 25minutes. TLC analysis in 100% ethyl acetate and or 1:1 toluene/acetone confirmed triols adducts. The reaction mixture was quenched with DOWEX 2x8-100 ion-exchange resin until the pH was 7 by strip paper,

filtered the reaction mixture through vacuum-sintered glass, washed with ethyl acetate and concentrated. The yellow syrup D-glucal (azeotroped with toluene, 3x5mL) was treated with activated, powdered molecular sieves 3Å (6.12g) in a Schlenched flask equipped with condenser and stirrer. The complete reaction system was exposed to vacuum and argon (3 cycles), and dry acetonitrile (60mL) was then added into the set-up. The resulting mixture was stirred with warming until the substrate sugar dissolved. Bis(tributyltin) oxide (6.72mL, 0.132mol, 0.8equiv.) was similarly added, and the resulting mixture was heated under reflux and argon for 3h; the reaction mixture was allowed to cool to room temperature and the solvent was removed by evaporation at reduced pressure and the residual oil dried under high vacuum with argon (several cycles). The residue was taken up in dichloromethane (60mL) under argon at room temperature and subsequently cooled in an ice/water bath. Iodine (19.8mmol, 5.03g, 1.2equiv.) was introduced to the dichloromethane solution, and a color change to dark brown was immediately observed. After 15min of constant stirring, the reaction mixture was filtered through celite plug to remove tin salt and molecular sieves. The celite was washed with dichloromethane and the combined filtrate was reduced to approximately 5mL in the rotary evaporator. This was dissolved in hexane (100mL) and stirred with sat. aqueous sodium thiosulfate (100mL) for weekend, at which the aqueous and organic phases were colorless. The aqueous phase was extracted with ethyl acetate (4x100mL), dried over anhydrous Na<sub>2</sub>SO<sub>4</sub> and solvent evaporated. To the yellow oily crude residue was dissolved in methanol and some mixed silica gel and then concentrated. Flash column chromatography on silica gel, cyclohexane/acetone 3:2 as eluent afforded the desired product **97** as white solid that is consistent with previous literature (2.086g, 46% over two steps).

R<sub>f</sub> = 0.5; (toluene/acetone 1:1)

<sup>1</sup>H NMR (300 MHz, (CD<sub>3</sub>)<sub>2</sub>CO) δ (ppm): 5.66 (br s, 1H, H-1), 4.69 (d, 1H, *J* = 4.6 Hz, OH), 4.53 (ddd, 1H, *J* = 4.7, 2.9, 1.6 Hz, H-5), 4.19 (dd, 1H, *J* = 7.3, 1.0 Hz, H-6), 4.20 – 4.15 (m, 1H, H-4), 3.94 (d, 1H, *J* = 6.7 Hz, OH), 3.94 – 3.90 (m, 1H, H-2), 3.63 (dd, 1H, *J* = 7.0, 5.7 Hz, H-6), 3.68 – 3.62 (m, 1H, H-3);

<sup>13</sup>C NMR (75 MHz, (CD<sub>3</sub>)<sub>2</sub>CO) δ (ppm): 104.52, 77.61, 76.38, 73.74, 66.58, 30.24.

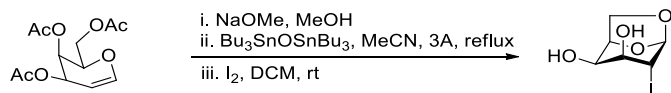
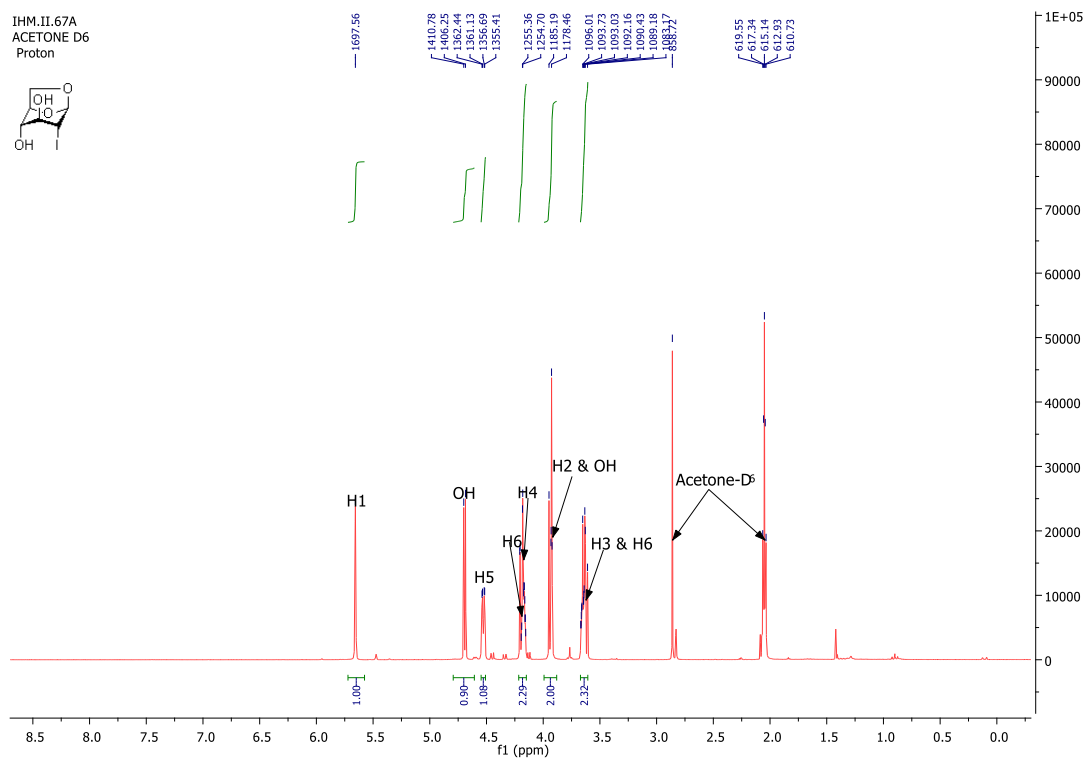

### 1,6-Anhydro-2-deoxy-2-iodo- $\beta$ -D-galactopyranose (**98**)

Compound **98** was synthesized from tri-O-acetyl-D-galactal **96** (3.706g, 13.612 mmol) in the same way **97** was prepared. The desired intermediate was purified over silica gel column with cyclohexane/acetone 60 $\rightarrow$ 70% as eluent afforded white form and NMR data consistent with precedence (1.512g, 41% over two steps).

R<sub>f</sub> = 0.6; (toluene/acetone 1:1)

**<sup>1</sup>H NMR** (300 MHz, (CD<sub>3</sub>)<sub>2</sub>CO)  $\delta$  (ppm): 5.51 (br s, 1H, H-1), 4.64 (d, 1H,  $J$  = 3.9 Hz, O-H), 4.45 (d, 1H,  $J$  = 7.2 Hz, H-5), 4.39 – 4.30 (m, 2H, H-3, H-6), 4.30 – 4.16 (m, 3H, H-6, O-H, H-2), 3.59 (dd, 1H,  $J$  = 7.5, 5.7 Hz, H-4).

**LRMS** (ESI, positive mode)  $m/z$ : C<sub>6</sub>H<sub>9</sub>I<sub>2</sub>NaO<sub>4</sub> [M+Na]<sup>+</sup>, calc. 294.9, found 294.9.

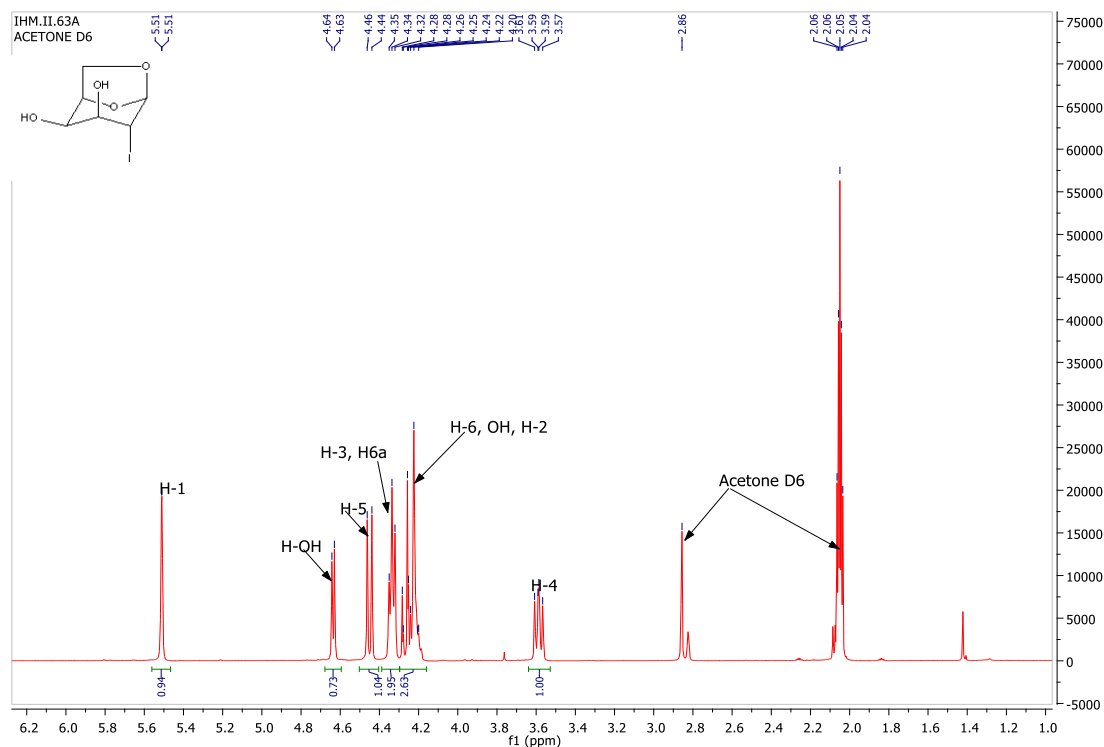

$^1\text{H NMR}$  (300 MHz) of Compound **98** in  $\text{CD}_3)_2\text{CO}$

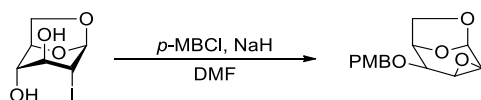

### 1,6:2,3-Dianhydro-4-O-*p*-methoxybenzyl- $\beta$ -D-glucopyranose (**99**)

To the 1,6-anhydro-2-deoxy-2-iodo- $\beta$ -D-glucopyranose **97** (272 mg, 1.0 mmol, 1 eqv.) coevaporated twice with toluene was dissolved in dry DMF (8mL) and cooled down to  $-20\text{ }^\circ\text{C}$  in a round bottomed flask equipped with stir bar and septum. The reaction mixture was then treated with *p*-methoxybenzyl chloride (391.53 mg, 2.5 mmol, 2.5 equiv.) followed by NaH (80 mg, 2 mmol, 2 equiv., 60% in mineral oil) and stirred over 3h ( $-20\text{ }^\circ\text{C} \rightarrow \text{rt}$ ). Water was added carefully and later diluted with  $\text{Et}_2\text{O}$  after complete reaction. The aqueous layer was extracted four times with  $\text{Et}_2\text{O}$  (75mL), the combined organic extracts was washed with brine (2x120mL), dried with  $\text{MgSO}_4$ , filtered, and the solvent was removed at vacuum. Several flash chromatography on silica gel with cyclohexane:  $\text{EtOAc}$ ; 9:1  $\rightarrow$  7:3 eluent afforded the titled epoxide as white solid (104mg, 0.394mmol, 40%),

$R_f = 0.7$  in cyclohexane: ethylacetate, 7:3.

$^1\text{H NMR}$  (300 MHz,  $\text{CDCl}_3$ )  $\delta$  (ppm): 7.29 (d, 2H,  $J = 8.6$  Hz, arom.), 6.89 (d, 2H,  $J = 8.6$  Hz, arom.), 5.68 (d, 1H,  $J = 3.1$  Hz,  $\underline{\text{H-1}}$ ), 4.65 (s, 2H,  $\text{CH}_2\text{-Ph}$ ), 4.49 – 4.43 (m, 1H,  $\underline{\text{H-5}}$ ), 3.79 (s, 3H, OMe), 3.72 – 3.58 (m, 3H,  $\underline{\text{H-4}}$ , 2 $\underline{\text{H-6}}$ ), 3.45 – 3.38 (m, 1H,  $\underline{\text{H-3}}$ ), 3.14 (ddd, 1H,  $J = 0.5, 1.5, 2.0$  Hz,  $\underline{\text{H-2}}$ ).



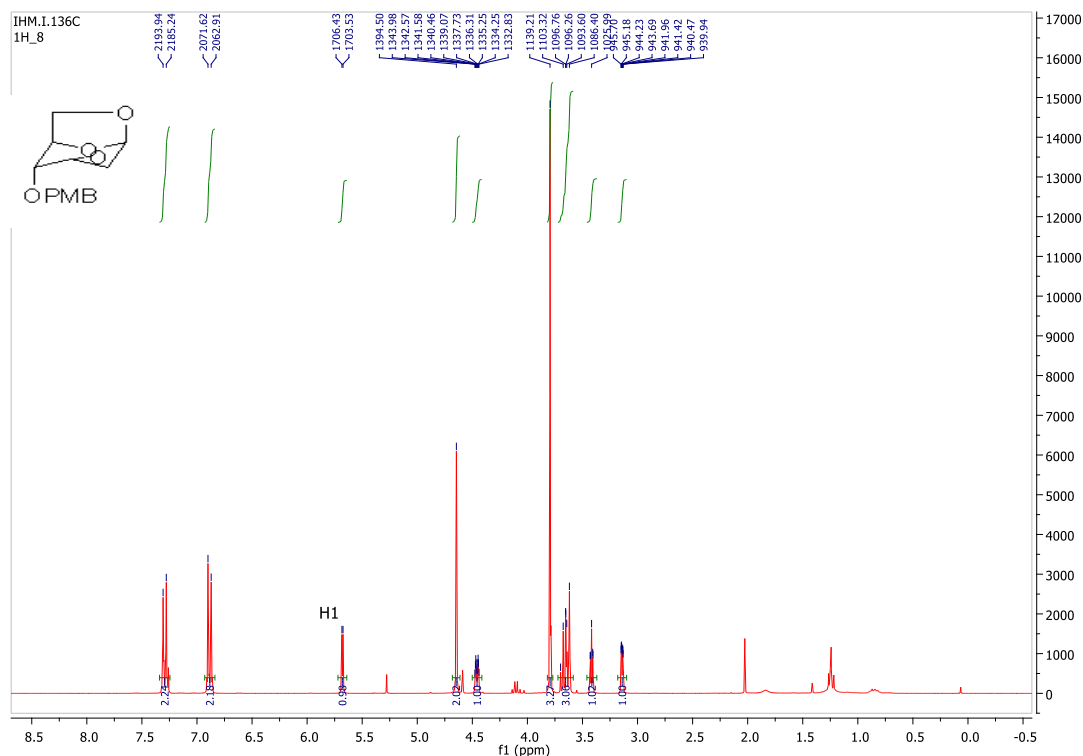

$^1\text{H}$  NMR (300 MHz) of Compound **99** in  $\text{CDCl}_3$

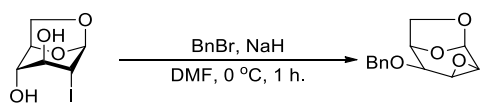

### 1,6:2,3-Dianhydro-4-O-benzyl- $\beta$ -D-glucopyranose (**100**)

The 1,6-anhydro-2-deoxy-2-iodo- $\beta$ -D-glucopyranose **97** (136 mg, 0.5 mmol, 1 equiv.) azeotroped with toluene (3x5mL) was dissolved in dry DMF (5mL) and cooled down to 0 °C in a round bottomed flask equipped with stir bar and septum. The reaction mixture was then treated with benzyl bromide (0.19 ml, 1.5 mmol, 3 equiv) followed by NaH (60 mg, 1.5 mmol, 3 equiv., 60% in mineral oil) and stirred over 1h (0 °C  $\rightarrow$  r.t). The reaction set up was carefully treated with a mixture of distilled  $\text{H}_2\text{O}$  and  $\text{Et}_2\text{O}$  after complete reaction. The aqueous layer was extracted four times with  $\text{Et}_2\text{O}$  (50mL), the combined organic extracts was washed with brine (2x100mL), dried with  $\text{MgSO}_4$ , filtered and concentrated in vacuo. Flash chromatography on silica gel in (toluene 100%, and cyclohexane: acetone 80  $\rightarrow$  60%) afforded the desired epoxide (130mg, 98%).

Rf = 0.6 in cyclohexane: acetone, 3:2.

$^1\text{H}$  NMR (300 MHz,  $\text{CDCl}_3$ )  $\delta$  (ppm): 7.45 – 7.34 (m, 5H, Arom), 5.69 (d, 1H,  $J$  = 3.0 Hz,  $\underline{\text{H}}-1$ ), 4.72 (br s, 2H,  $\text{CH}_2$ -Ph), 4.53 – 4.47 (m, 1H,  $\underline{\text{H}}-4$ ), 3.76 – 3.58 (m, 3H,  $\underline{\text{H}}-5$ , 2 $\underline{\text{H}}-6$ ), 3.49 – 3.35 (m, 1H,  $\underline{\text{H}}-2$ ), 3.24 – 3.13 (m, 1H,  $\underline{\text{H}}-3$ ).

$^{13}\text{C}$  NMR (75 MHz,  $\text{CDCl}_3$ )  $\delta$  (ppm): 137.36, 128.61, 128.11, 127.82, 97.58, 73.79, 72.10, 71.59, 65.77, 54.35, 47.78.

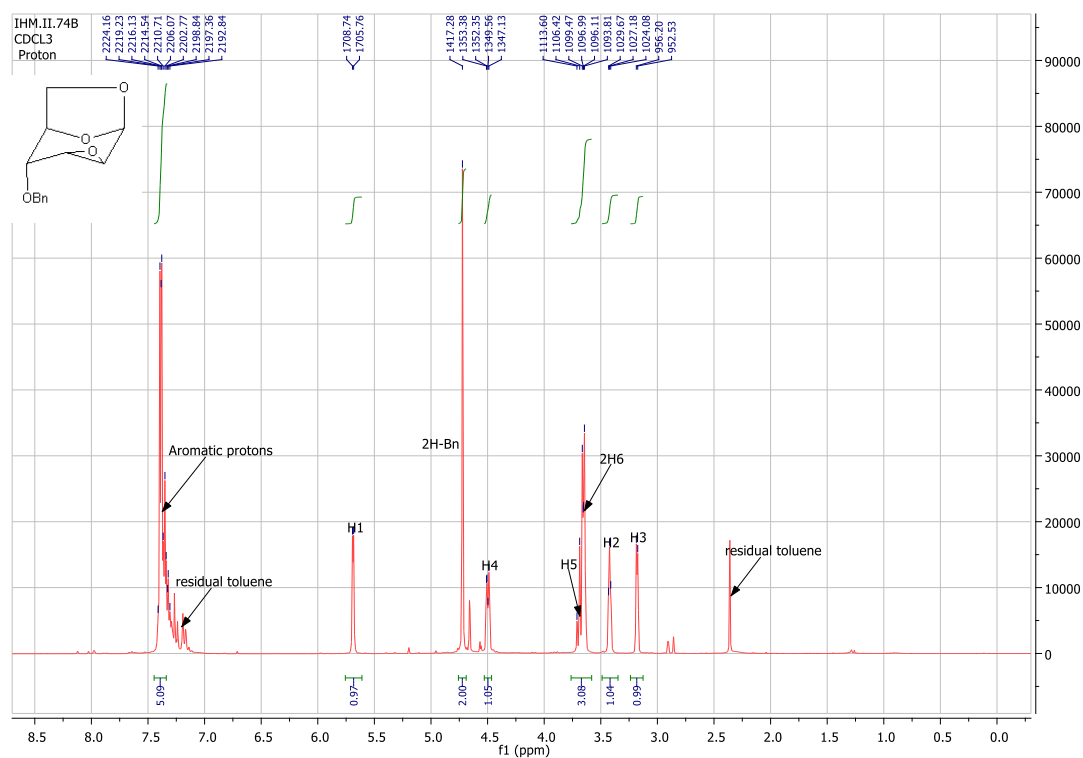

<sup>1</sup>H NMR (300 MHz) of Compound **100** in CDCl<sub>3</sub>

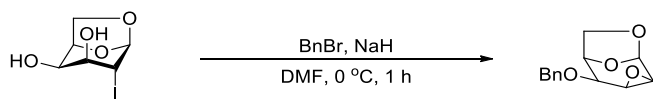

### 1,6:2,3-Dianhydro-4-O-benzyl- $\beta$ -D-galactopyranose (**101**)

The 1,6-anhydro-2-deoxy-2-iodo- $\beta$ -D-galactopyranose (1.5 g, 5.514 mmol, 1eqv) as starting material was transformed into the compound of interest in the same way as **100** was formed. Flash chromatography of the crude reaction mixture on silica gel in (toluene 100%, and cyclohexane: acetone 70%, and then finally 100% EtOAc as eluent) afforded the desired epoxide **101** (1.201 g, 93%), as colorless oil.

R<sub>f</sub> = 0.55 in cyclohexane: ethylacetate 6:4.

<sup>1</sup>H NMR (300 MHz, CDCl<sub>3</sub>)  $\delta$  (ppm): 7.40 – 7.30 (m, 5H, Arom), 5.62 (d, 1H,  $J$  = 4.8 Hz, H-1), 4.81 (d, 1H,  $J$  = 11.9 Hz,  $\frac{1}{2}$  CH<sub>2</sub>-Ph), 4.66 (d, 1H,  $J$  = 11.9 Hz,  $\frac{1}{2}$  CH<sub>2</sub>-Ph), 4.43 – 4.26 (m, 1H, H-5), 4.13 (dd, 1H,  $J$  = 7.1, 1.3 Hz, H-6), 3.99 (dd, 1H,  $J$  = 5.9, 2.9 Hz, H-4), 3.56 (dd, 1H,  $J$  = 6.9, 6.5 Hz, H-6), 3.51 (dd, 1H,  $J$  = 4.1, 2.9 Hz, H-2), 3.28 (ddd, 1H,  $J$  = 4.0, 2.9, 1.0 Hz, H-3).

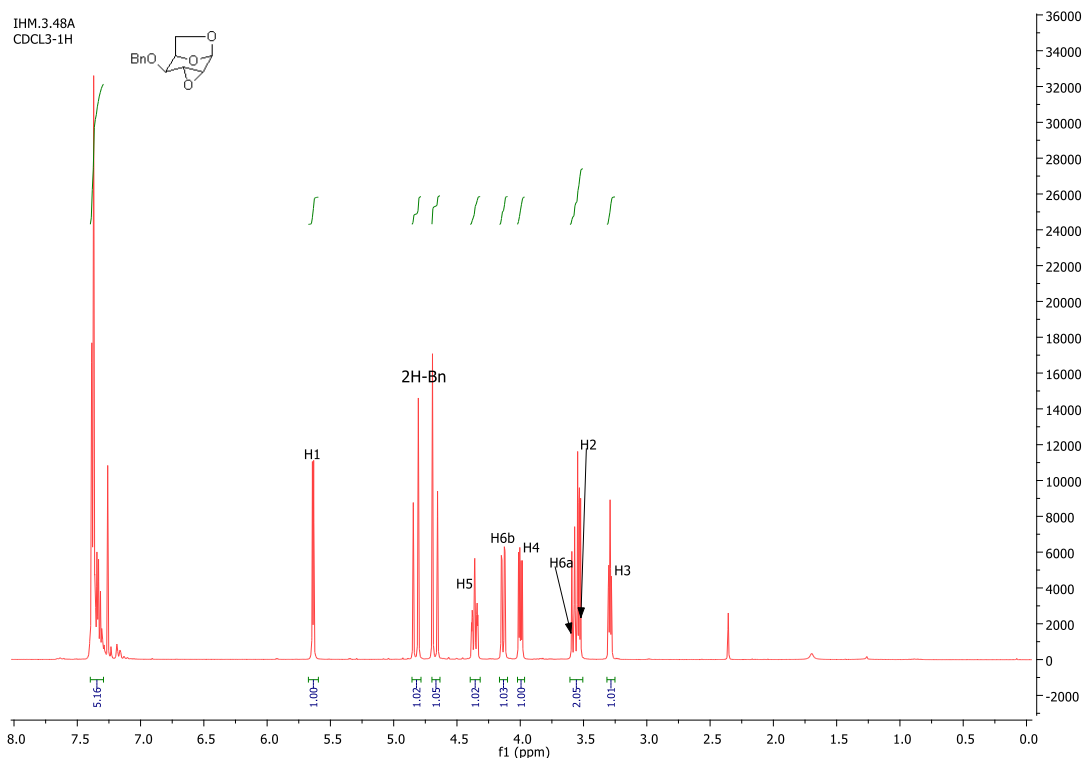

$^1\text{H}$  NMR (300 MHz) of Compound **101** in  $\text{CDCl}_3$

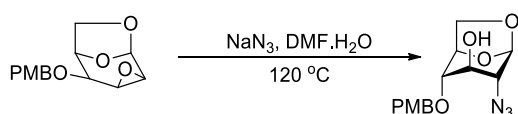

### 1,6-anhydro-2-azido-2-deoxy-4-O-*p*-methoxybenzyl- $\beta$ -D-glucopyranose (**102**)

To a solution of 1,6:2,3-dianhydro-4-O-*p*-methoxybenzyl- $\beta$ -D-glucopyranose **99** (0.14mmol, 37mg, azeot. in tol) in dry DMF:  $\text{H}_2\text{O}$  (9:1) was treated with  $\text{NaN}_3$  (0.84mmol, 54.61mg, 6 equiv.) and raised the reaction temperature from rt to 120 °C and stirred overnight in a round bottomed flask equipped with stir bar, septum and an argon balloon. The reaction mixture was cooled to room temperature after complete reaction for 18 hours and poured into a mixture of  $\text{H}_2\text{O}$  and  $\text{Et}_2\text{O}$ . The aqueous phase was extracted three times with  $\text{Et}_2\text{O}$  and the combined organic layers was washed with brine, dried over  $\text{Na}_2\text{SO}_4$  and the solvent was removed with rotovap. Flash chromatography of the residue on silica gel (cyclohexane: EtOAc 9:1  $\rightarrow$  7:3) afforded the desired azide as colorless oil (34mg, 79%).

$R_f$  = 0.6 in cyclohexane: ethylacetate 1:1.

$^1\text{H}$  NMR (300 MHz,  $\text{CDCl}_3$ )  $\delta$  (ppm): 7.30 (d, 2H,  $J$  = 8.8 Hz, arom.), 6.89 (d, 2H,  $J$  = 8.8 Hz, arom.), 5.45 (s, 1H, H-1), 4.67 – 4.53 (m, 3H, CH<sub>2</sub>-Ph, H-5), 3.93 (dd, 1H,  $J$  = 7.5, 0.6 Hz, H-6), 3.90 – 3.83 (m, 1H, H-3), 3.81 (s, 3H, OMe), 3.68 (dd, 1H,  $J$  = 5.3, 4.5 Hz, H-6), 3.39 – 3.30 (m, 1H, H-4), 3.22 (br d, 1H,  $J$  = 3.5 Hz, H-2), 2.55 (br s, 1H, O-H).

LRMS (ESI, positive mode)  $m/z$ :  $\text{C}_{14}\text{H}_{17}\text{NaN}_3\text{O}_5$  [ $\text{M}+\text{Na}$ ]<sup>+</sup>, calc. 330.1, found 330.1.

$[\alpha]_D^{22.6} = -10^\circ$  (C=10mg/mL in Acetone)

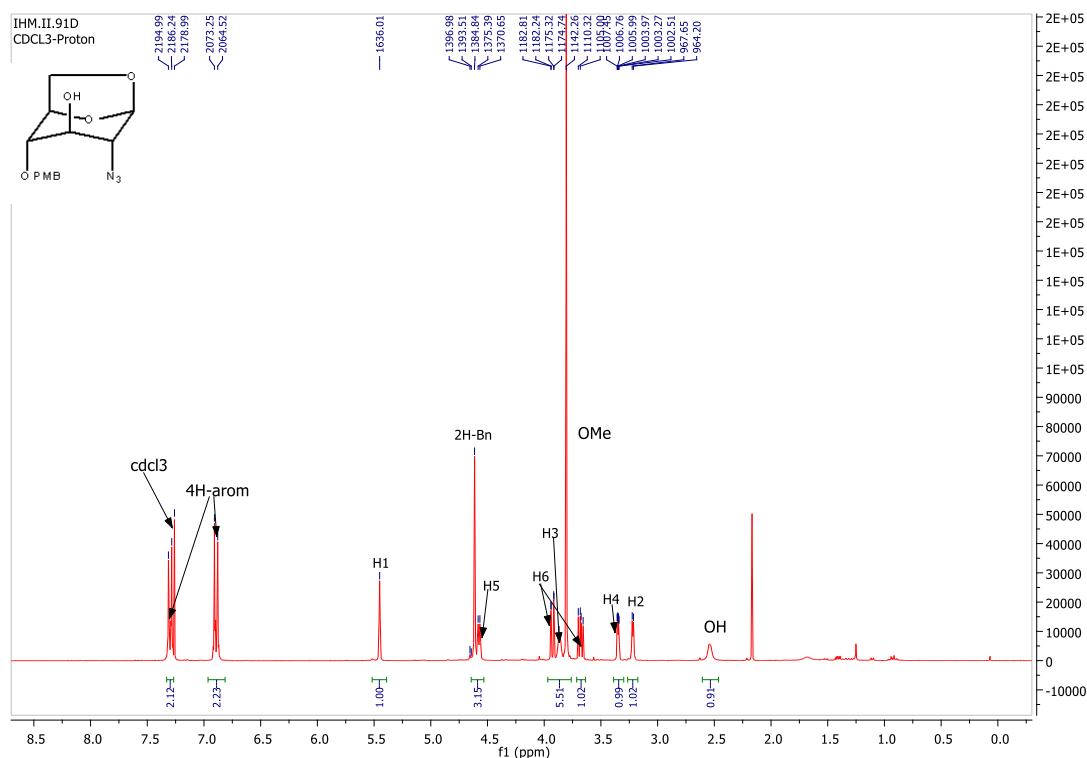

<sup>1</sup>H NMR (300 MHz) of Compound **102** in CDCl<sub>3</sub>

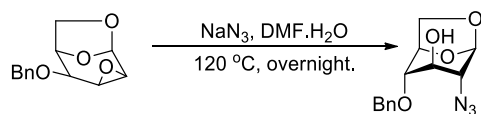

### 1,6-anhydro-2-azido-2-deoxy-4-O-benzyl-β-D-glucopyranose (**103**)

1,6:2,3-dianhydro-4-O-benzyl-β-D-glucopyranose (5.336 mmol, 1.25 g, azeot. in toluene) was converted into the titled compound **103** in the same manner **102** was prepared. Crude reaction mixture was purified by flash chromatography on silica gel in (cyclohexane: EtOAc 80 → 70% as eluent) which gave white solid (1.02 g, 70%) after solvent evaporation.

R<sub>f</sub> = 0.56 in cyclohexane: ethylacetate 1:1.

<sup>1</sup>H NMR (300 MHz, CDCl<sub>3</sub>) δ (ppm): 7.44 – 7.30 (m, 5H, Arom), 5.47 (br s, 1H, H-1), 4.69 (AB, 2H, CH<sub>2</sub>-Ph), 4.64 – 4.58 (m, 1H, H-5), 3.95 (dd, 1H, *J* = 7.6, 0.6 Hz, H-6), 3.93 – 3.87 (m, 1H, H-3), 3.70 (dd, 1H, *J* = 7.6, 5.4 Hz, H-6), 3.44 – 3.35 (m, 1H, H-4), 3.28 – 3.18 (m, 1H, H-2), 2.40 (br s, 1H, O-H).

[α]<sub>D</sub><sup>22.6</sup> = -9° (C=10mg/mL in Acetone)

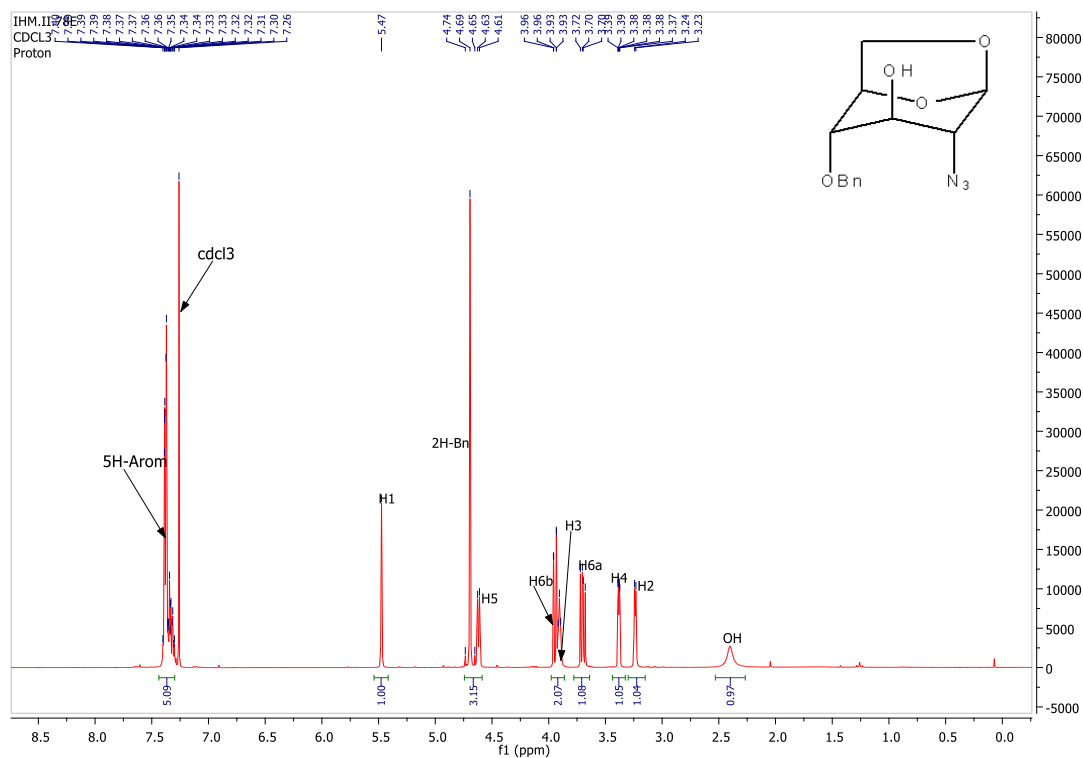

$^1\text{H}$  NMR (300 MHz) of Compound **103** in  $\text{CDCl}_3$

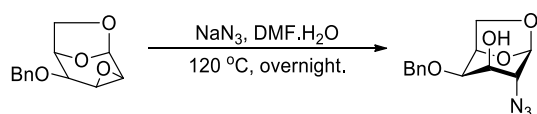

### 1,6-anhydro-2-azido-2-deoxy-4-O-benzyl- $\beta$ -D-galactopyranose **104**

To a solution of 1,6:2,3-dianhydro-4-O-benzyl- $\beta$ -D-galactopyranose (0.0157 mol, 3.679g, azeot. in tolu) was transformed into the desired compound **104** in the manner as **102**. Flash chromatography on silica gel in (toluene 100%; 200ml, cyclohexane: EtOAc 65% as eluent) delivered colorless oil (3.856g, 0.0139mmol, 89%).

$R_f$  = 0.68 in cyclohexane: ethylacetate 1:1.

$^1\text{H}$  NMR (300 MHz,  $\text{CDCl}_3$ )  $\delta$  (ppm): 7.48 – 7.28 (m, 5H, Arom), 5.51 – 5.26 (m, 1H, H-1), 4.82 – 4.57 (AB, 2H, CH<sub>2</sub>-Ph), 4.51 – 4.39 (m, 1H, H-5), 4.36 (d, 1H,  $J$  = 7.6 Hz, H-6), 4.17 – 4.01 (m, 1H, H-3), 3.82 (dd, 1H,  $J$  = 4.7, 4.5 Hz, H-4), 3.66 (dd, 1H,  $J$  = 7.1, 5.5 Hz, H-6), 3.62 – 3.52 (m, 1H, H-2), 2.80 (br s, 1H, O-H).

LRMS (ESI, positive mode)  $m/z$ :  $\text{C}_{13}\text{H}_{15}\text{NaN}_3\text{O}_4$  [ $\text{M}+\text{Na}$ ]<sup>+</sup>, calc. 300.1, found 300.1.

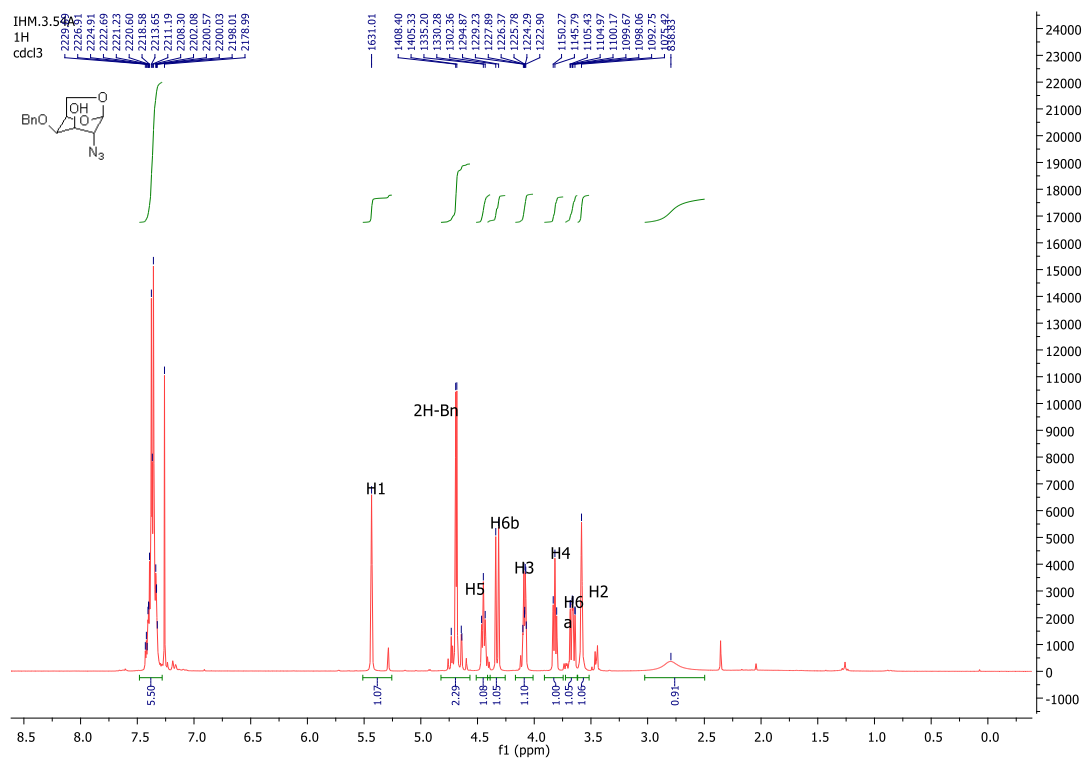

$^1\text{H}$  NMR (300 MHz) of Compound **104** in  $\text{CDCl}_3$

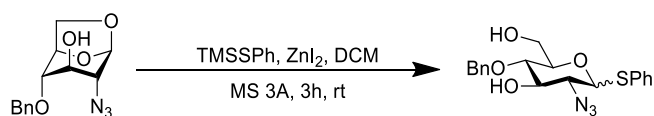

### Phenyl 2-azido-4-O-benzyl-2-deoxy-1-thio- $\alpha/\beta$ -D-glucopyranoside (**105**)

To a solution of 1,6-anhydro-2-azido-2-deoxy-4-O-benzyl- $\beta$ -D-glucopyranose (0.231mg, 0.833mmol, 1equiv., azeotroped with toluene) in anhydrous DCM (8mL) was added (thiophenyl)trimethyl silane TMSSPh (0.55mL, 2.891mmol, 3.472equiv.) in a round bottomed flask (50mL) equipped with clean stir bar, septum and an argon balloon. The mixture was heated until a clear solution of the reaction set up is obtained. Molecular sieves 3Å and  $\text{ZnI}_2$  (0.798g, 2.499mmol, 3 equiv.) were then added and allowed stirring at room temperature for 3h. The reaction mixture was filtered through celite plug, washed with DCM and concentrated in vacuo. The concentrated residue was dissolved in AcOH (20mL) and stirred at rt for 30 minutes, poured into separatory funnel, added some sat aq.  $\text{Na}_2\text{CO}_3$  and extracted with EtOAc. The combined organic layers were washed with sat aq.  $\text{Na}_2\text{CO}_3$  and brine, dried over  $\text{Na}_2\text{SO}_4$ , filtered and concentrated at vacuo. Flash column chromatography of the concentrated residue on silica gel in (toluene: ethylacetate 75  $\rightarrow$  25%) as eluent afforded separable compounds as white solids (191 mg, 59%).

Rf = 0.7 for  $\alpha$  anomer, 0.9 for  $\beta$  anomer in toluene: ethylacetate 1:1.

**Data for  $\alpha$ -anomer.**  $^1\text{H}$  NMR (300 MHz,  $\text{CDCl}_3$ )  $\delta$  (ppm): 7.56 – 7.27 (m, 10H, 2xArOm), 5.54 (d, 1H,  $J$  = 5.4 Hz,  $\text{H}_{-1\alpha}$ ), 4.85 – 4.73 (AB, 2H,  $\text{CH}_2$ -Ph), 4.22 (ddd, 1H,  $J$  = 9.9, 6.2, 3.1 Hz,  $\text{H}_{-3}$ ), 3.96 (dd, 1H,  $J$  = 10.1, 8.9 Hz,  $\text{H}_{-5}$ ), 3.88 – 3.69 (m, 3H,  $\text{H}_{-2}$ ,  $2\text{H}_{-6}$ ), 3.55 (dd, 1H,  $J$  = 9.9, 8.8 Hz,  $\text{H}_{-4}$ ), 2.66 (br s, 1H, O-H), 1.70 (br s, 1H, O-H).

Data for  $\beta$ -anomer.  $^1\text{H NMR}$  (300 MHz,  $\text{CDCl}_3$ )  $\delta$  (ppm): 7.45 – 7.26 (m, 10H, 2xArOm), 4.82 – 4.67 (AB, 2H,  $\text{CH}_2\text{-Ph}$ ), 4.48 (d, 1H,  $J = 10.2$  Hz,  $\text{H-1}\beta$ ), 3.92 (dd, 1H,  $J = 12.2, 2.6$  Hz,  $\text{H-6}$ ), 3.73 (dd, 1H,  $J = 12.2, 4.2$  Hz,  $\text{H-6}$ ), 3.62 (dd, 1H,  $J = 9.3, 9.0$  Hz,  $\text{H-3}$ ), 3.44 (dd, 1H,  $J = 9.6, 9.0$  Hz,  $\text{H-4}$ ), 3.35 (dddd, 1H,  $J = 9.6, 6.8, 4.3, 2.5$  Hz,  $\text{H-5}$ ), 3.27 (dd, 1H,  $J = 10.3, 9.3$  Hz,  $\text{H-2}$ ).

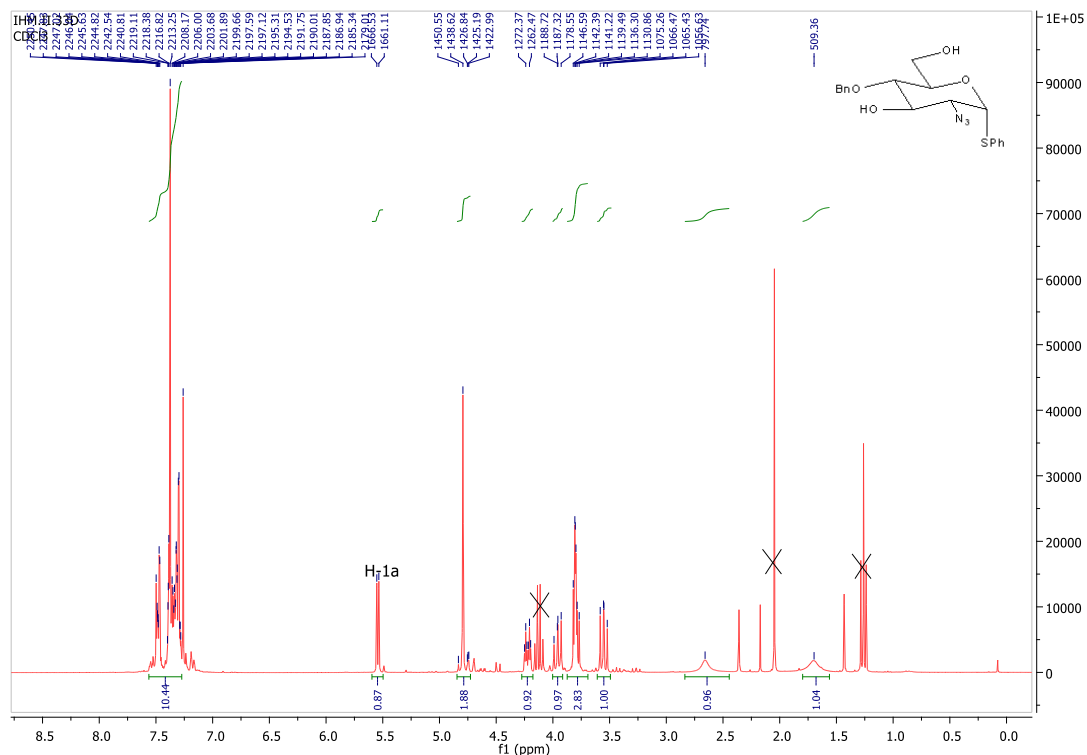

$^1\text{H NMR}$  (300 MHz) of Compound **105a** ( $\alpha$ -anomer) in  $\text{CDCl}_3$

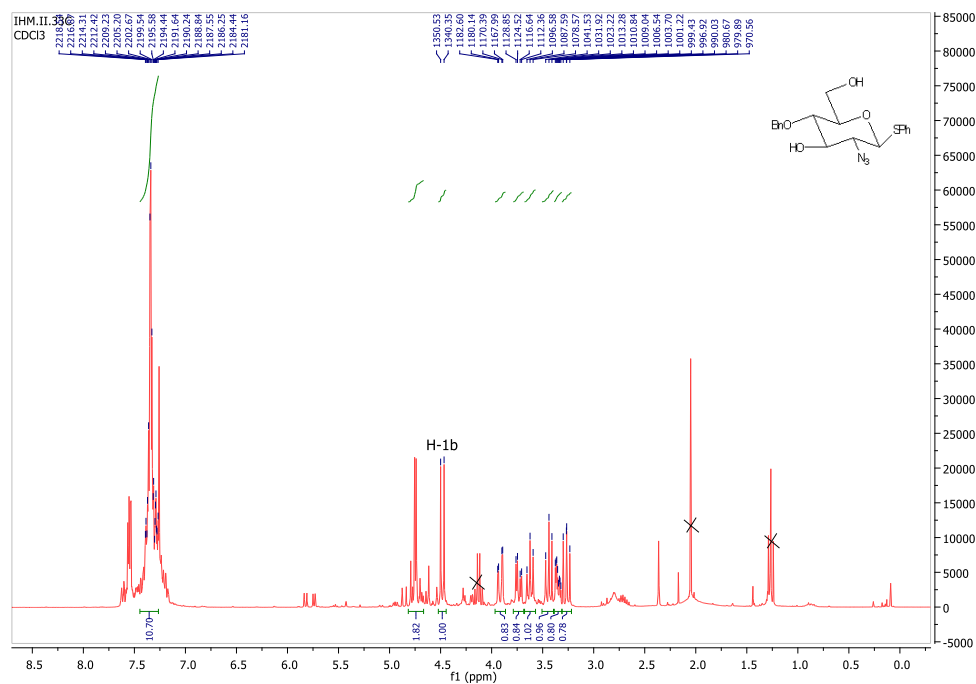

$^1\text{H NMR}$  (300 MHz) of Compound **105b** ( $\beta$ -anomer) in  $\text{CDCl}_3$

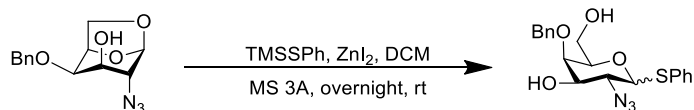

### Phenyl 2-azido-4-O-benzyl-2-deoxy- $\alpha/\beta$ -D-thio-galactopyranoside **106**

A solution of 1,6-anhydro-2-azido-4-O-benzyl-2-deoxy- $\beta$ -D-galactopyranose (1.778mmol, 493mg, 1equiv.) in anhydrous DCM (15mL) was converted to the titled compound overnight in a similar manner to the synthesis of **105**. The concentrated residue was purified on silica gel in cyclohexane: ethylacetate 80:20  $\rightarrow$  30: 70% as eluent afforded a separable anomer  $\alpha/\beta$  1/1.3 products (contrary to the glucopyranose sugar) 387mg, 0.999mmol, 56% as white solids.

Rf = 0.81/0.48 for  $\alpha/\beta$  in 1:1 CH: EA.

**Data for  $\alpha$  anomer**  $^1\text{H NMR}$  (300 MHz,  $\text{CDCl}_3$ )  $\delta$  (ppm): 7.53 – 7.28 (m, 10H, 2xArom), 5.66 (d, 1H,  $J$  = 5.3 Hz, H-1), 4.80 – 4.72 (AB, 2H,  $\text{CH}_2$ -Ph), 4.43 – 4.35 (m, 1H, H-5), 4.17 (ddd, 1H,  $J$  = 11.6, 5.4, 1.5 Hz, H-2), 3.95 – 3.89 (m, 2H, H-3, H-4), 3.81 (dd, 1H,  $J$  = 11.3, 6.9 Hz, H-6), 3.65 (dd, 1H,  $J$  = 11.3, 5.3 Hz, H-6), 1.56 (br s, 1H, OH).

**Data for  $\beta$  anomer**  $^1\text{H NMR}$  (300 MHz,  $\text{CDCl}_3$ )  $\delta$  (ppm): 7.61 – 7.27 (m, 10H, 2xArom), 4.77 – 4.68 (AB, 2H,  $\text{CH}_2$ -Ph), 4.45 (d, 1H,  $J$  = 9.8 Hz, H-1), 3.91 (dd, 1H,  $J$  = 11.3, 7.2 Hz, H-6), 3.81 (dd, 1H,  $J$  = 2.8, 0.9 Hz, H-3), 3.69 – 3.51 (m, 4H, H-6, H-5, H-2, H-4), 1.87 (br s, 1H, OH).

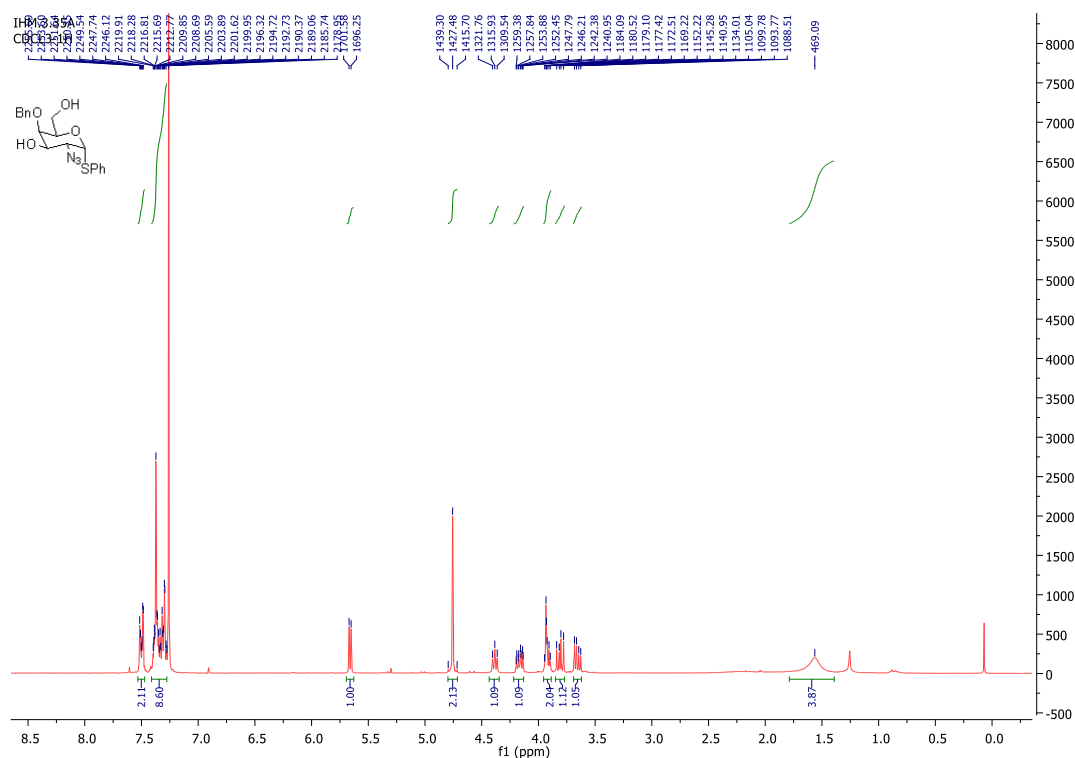



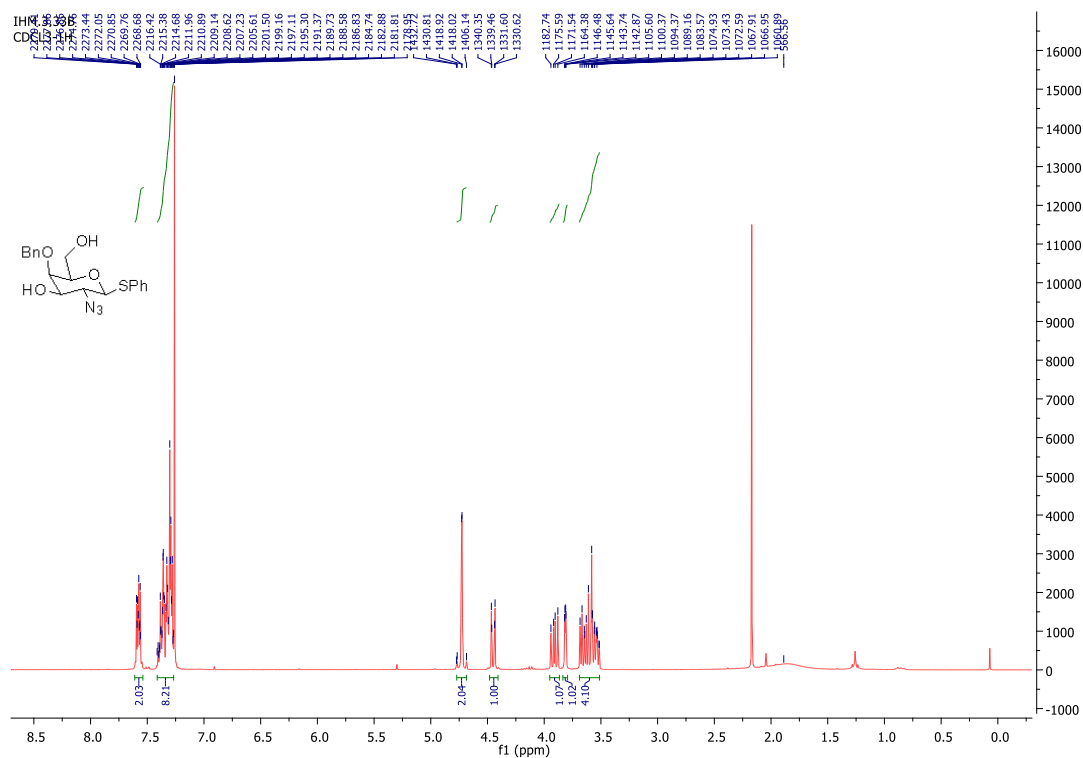

<sup>1</sup>H NMR (300 MHz) of Compound **106b** ( $\beta$ -anomer) in CDCl<sub>3</sub>

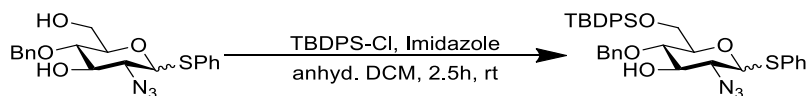

### Phenyl 2-azido-4-O-benzyl-6-O-tert-butyl-diphenylsilyl-2-deoxy-1-thio- $\alpha$ or $\beta$ -D-glucopyranoside **107**

The phenyl 2-azido-2-deoxy-4-O-benzyl-1-thio- $\alpha$  or  $\beta$ -D-glucopyranoside (0.232mmol, 90mg, 1 equiv., azeotroped with toluene) was dissolved in anhydrous DCM (2mL) under argon atmosphere in a round bottom flask equipped with stir bar, septum and an argon balloon. Imidazole (0.535mmol, 36.4mg, 2.3equiv) and TBDPS-Cl (0.278mmol, 71 $\mu$ L, 1.2equiv.) was subsequently added to the reaction set up. The reaction mixture was stirred at room temperature for 2h30mins after which TLC in cyclohexane: ethylacetate 8:1 confirmed complete reaction. The reaction mixture was quenched with MeOH (0.2 mL) and the solvent was evaporated at reduced pressure with rotovap. Flash column chromatography on silica gel (cyclohexane: ethylacetate; 95  $\rightarrow$  90%, afforded the desired compound as colorless oil in 99%.

Rf = 0.3/0.4;  $\alpha/\beta$  in cyclohexane: ethylacetate; 8:1.

**LRMS** (ESI, positive mode) m/z: C<sub>35</sub>H<sub>39</sub>N<sub>3</sub>NaO<sub>4</sub>SSi [M+Na]<sup>+</sup>, calc. 648.2, found 648.2

**Data for  $\alpha$ -anomer.** <sup>1</sup>H NMR (300 MHz, CDCl<sub>3</sub>)  $\delta$  (ppm): 7.76 – 7.24 (m, 20H, 4xArom), 5.63 (d, 1H, J = 5.3 Hz, H-1 $\alpha$ ), 4.91 – 4.75 (AB, 2H, CH<sub>2</sub>-Ph), 4.25 (ddd, 1H, J = 9.7, 2.9, 1.6 Hz, H-5), 4.04 (dd, 1H, J = 11.7, 3.4 Hz, H-6), 4.00 (m, 1H, H-3, H-2), 3.85 (dd, 1H, J = 10.3, 5.3 Hz, H-6), 3.76 (dd, 1H, J = 9.6, 8.8 Hz, H-4), 2.80 (br s, 1H, OH).

**Data for  $\beta$ -anomer.**  $^1\text{H NMR}$  (300 MHz,  $\text{CDCl}_3$ )  $\delta$  (ppm): 7.81 – 7.20 (m, 20H, 4xArom), 4.81 – 4.68 (AB, 2H,  $\text{CH}_2$ -Ph), 4.48 (d, 1H,  $J = 10.1$  Hz, H-1 $\beta$ ), 4.03 (dd, 1H,  $J = 11.5, 1.8$  Hz, H-6), 3.94 (dd, 1H,  $J = 11.5, 3.4$  Hz, H-6), 3.72 – 3.59 (m, 2H, H-3, H-4), 3.40 – 3.30 (m, 2H, H-2, H-5), 2.35 (br s, 1H, OH).

$[\alpha]_D^{25} = +10^\circ$  (C=32mg/mL in EtOAc,  $\alpha$ -anomer)

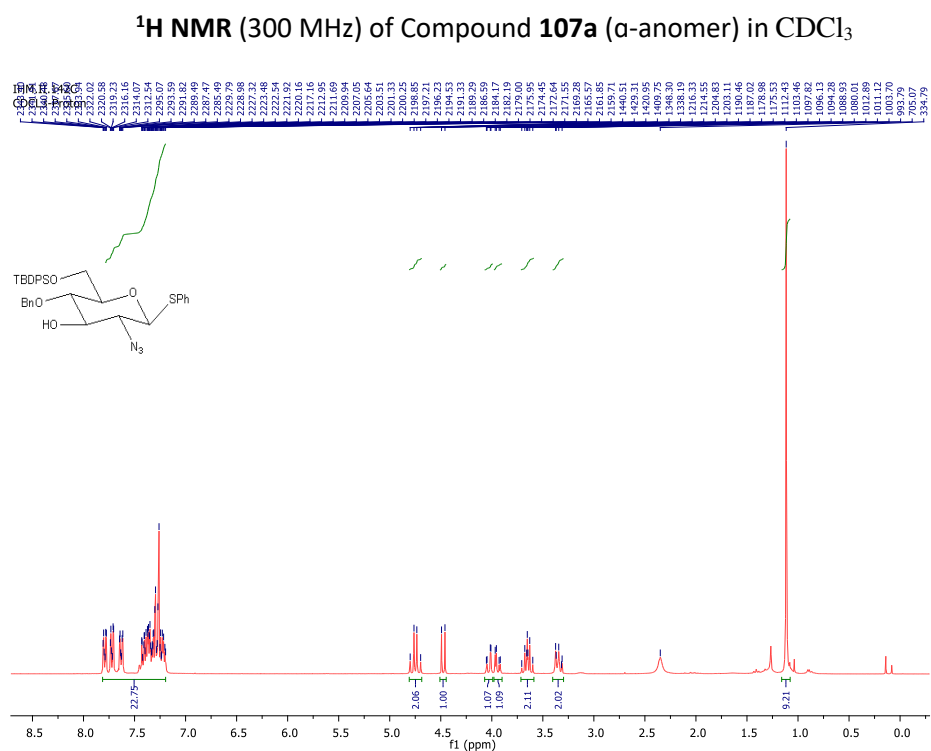
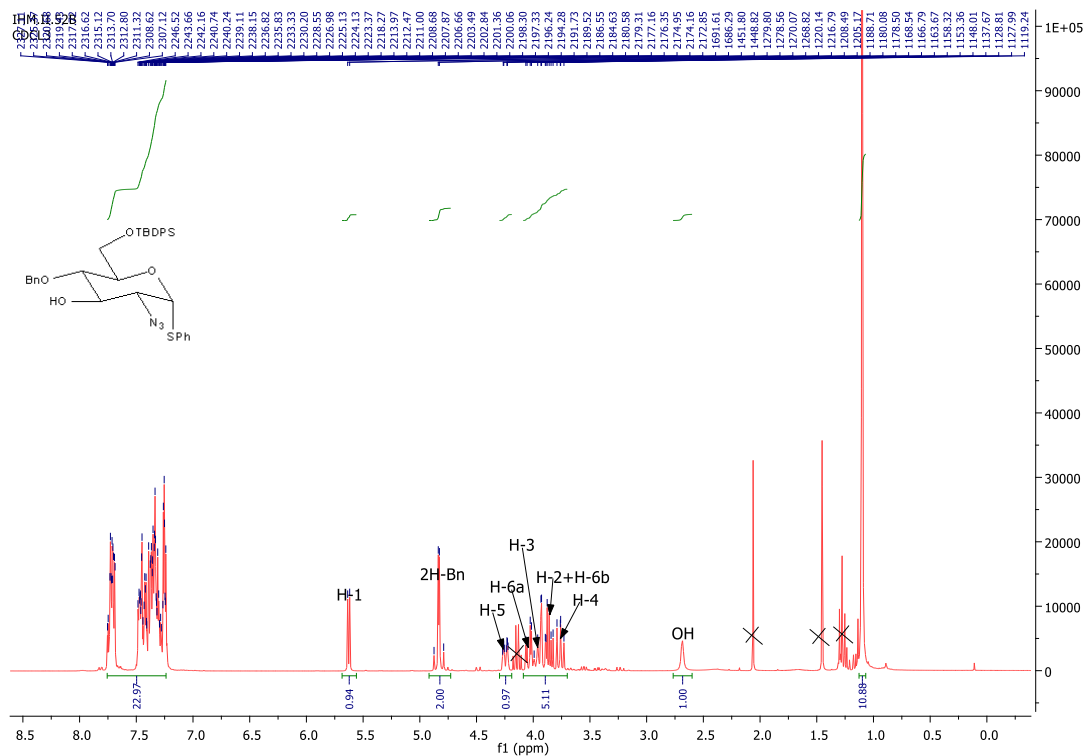

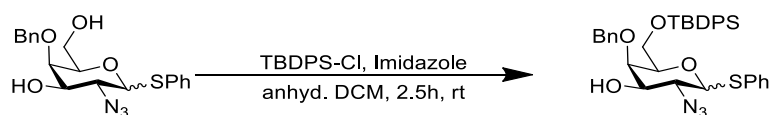

**Phenyl 2-azido-4-O-benzyl-6-O-tert-butyl-diphenylsilyl-2-deoxy-1-thio- $\alpha$  or  $\beta$ -D-galactopyranoside **108****

To the suspension of phenyl 2-azido-2-deoxy-4-O-benzyl-1- $\alpha$  or  $\beta$  -D-thio-galactopyranoside (0.431mmol, 167mg, 1 equiv., azeotroped with toluene) was transformed into the titled compound **108** in a similar methodology to the preparation of **107** above. Flash column chromatography on silica gel (cyclohexane: ethylacetate; 10:1,) afforded the desired compound 262mg as colorless oil in 97%.

Rf = 0.23 in cyclohexane: ethylacetate; 8:1.

**HRMS** (ESI, positive mode) m/z: C<sub>35</sub>H<sub>39</sub>N<sub>3</sub>NaO<sub>4</sub>SSi [M+Na]<sup>+</sup>, calc. 648.2315, found 648.2323.

**Data for  $\alpha$  anomer <sup>1</sup>H NMR** (300 MHz, CDCl<sub>3</sub>)  $\delta$  (ppm): 7.65 – 6.98 (m, 20H, 4xArom), 5.40 (d, 1H, *J* = 5.4 Hz, H-1), 4.80 – 4.61 (AB, 2H, CH<sub>2</sub>-Ph), 4.38 – 4.26 (m, 1H, H-5), 4.04 – 4.00 (m, 1H, H-4), 3.97 (dd, 1H, *J* = 10.6, 5.4 Hz, H-2), 3.87 – 3.73 (m, 1H, H-3), 3.80 (dd, 1H, *J* = 10.1, 8.5 Hz, H-6), 3.61 (dd, 1H, *J* = 10.1, 5.8 Hz, H-6), 2.25 (br s, 1H, OH), 1.00 (s, 9H, 3xCH<sub>3</sub>);

**<sup>13</sup>C NMR** (75 MHz, CDCl<sub>3</sub>)  $\delta$  (ppm): 138.05, 135.75, 135.71, 135.64, 134.93, 133.19, 133.06, 133.01, 132.96, 132.00, 130.10, 130.03, 129.77, 129.16, 129.10, 128.82, 128.76, 128.44, 128.35, 128.27, 128.08, 127.99, 127.98, 127.93, 127.89, 127.85, 125.43, 87.62, 76.45, 75.77, 71.51, 70.74, 62.25, 61.82, 29.83, 27.04, 26.98, 26.69, 19.33.

**Data for  $\beta$  anomer <sup>1</sup>H NMR** (300 MHz, CDCl<sub>3</sub>)  $\delta$  (ppm): 7.61 – 7.01 (m, 20H, 4xArom), 4.76 – 4.59 (AB, 2H, CH<sub>2</sub>-Ph), 4.28 (d, 1H, *J* = 9.8 Hz, H-1), 3.95 – 3.88 (m, 1H, H-5), 3.84 – 3.76 (m, 2H, H-6, H-4), 3.50 – 3.38 (m, 3H, H-3, H-2, H-6), 2.27 (br s, 1H, OH), 1.00 (s, 9H, 3xCH<sub>3</sub>);

**<sup>13</sup>C NMR** (75 MHz, CDCl<sub>3</sub>)  $\delta$  (ppm): 138.23, 135.68, 135.64, 133.04, 132.76, 130.08, 130.02, 128.99, 128.63, 128.01-127.92, 127.55, 86.43, 78.93, 75.28, 75.25, 74.60, 63.46, 61.97, 27.03, 19.31.

**[ $\alpha$ ]<sub>D</sub><sup>27</sup> = +107°** (C=7mg/mL in CHCl<sub>3</sub>- $\alpha$ -anomer)

**[ $\alpha$ ]<sub>D</sub><sup>27</sup> = +42°** (C=27mg/mL in CHCl<sub>3</sub>- $\beta$ -anomer)

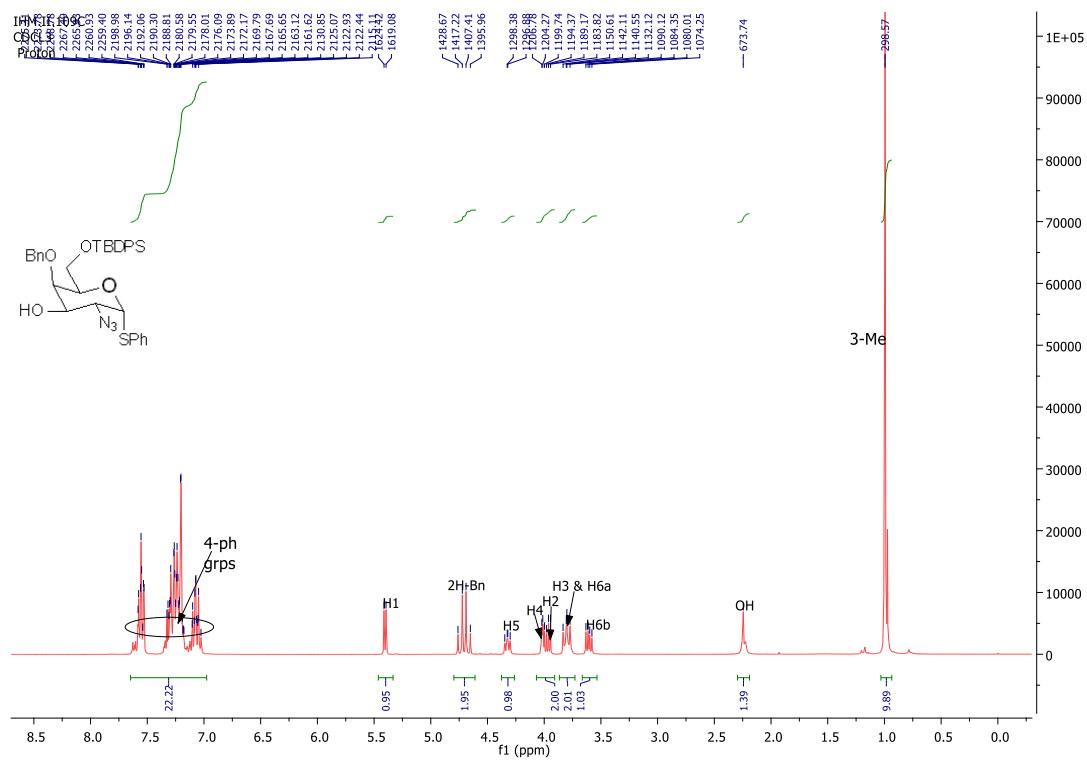

**<sup>1</sup>H NMR (300 MHz) of Compound 108a (α-anomer) in CDCl<sub>3</sub>**

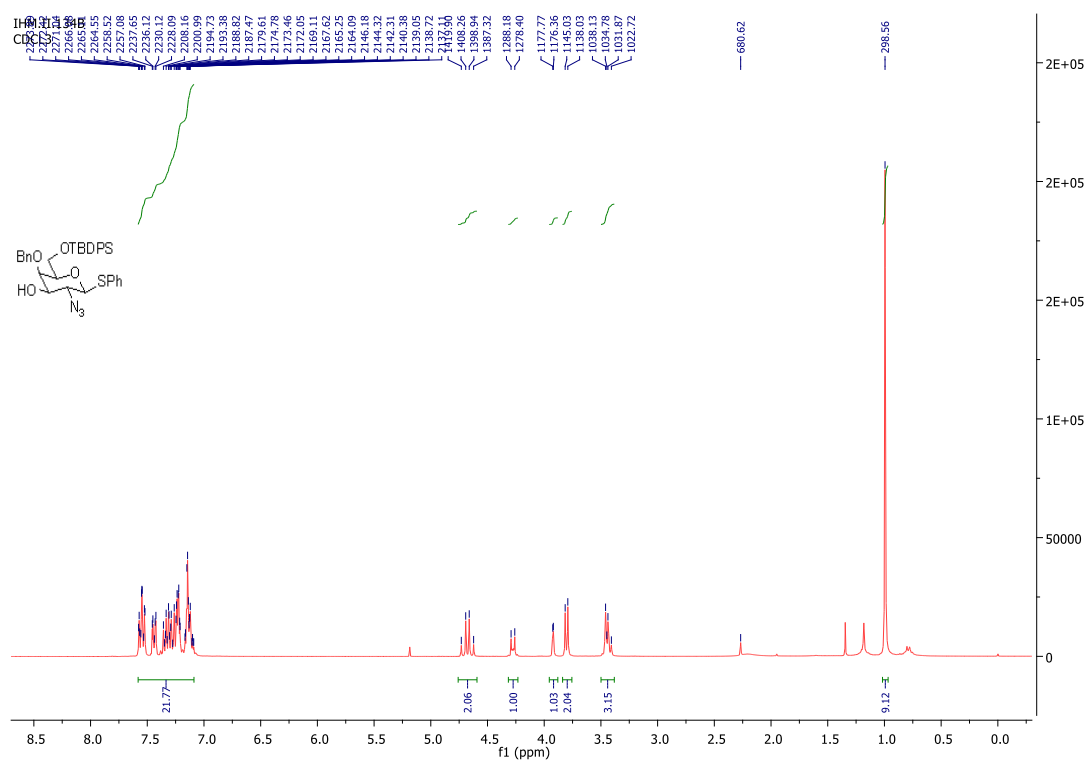

**<sup>1</sup>H NMR (300 MHz) of Compound 108b (β-anomer) in CDCl<sub>3</sub>**

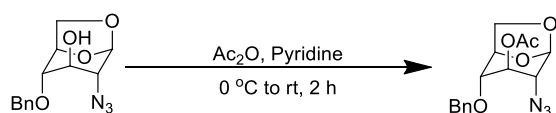

### 3-O-Acetyl-1,6-anhydro-2-azido-4-O-benzyl-β-D-glucopyranose (109)

To a solution of 1,6-anhydro-2-azido-4-O-benzyl-β-D-glucopyranose (1.01mmol, 280mg, 1equiv.) dissolved in anhydrous pyridine (6.06mmol, 4.9mL, 60equiv.) at rt in a clean round bottom flask equipped with clean stir bar, septum and argon atmosphere. The solution was cooled down to 0 °C in crushed ice bath, stirred for 15 minutes before the addition of Ac<sub>2</sub>O (25.553mmol, 2.4mL, 25.3equiv.). This was stirred for 2h at rt. The reaction progress was monitored by TLC analysis in cyclohexane: ethylacetate (2:1), quenched the reaction mixture with ethanol (10mL) at 0 °C and the solvent was removed at reduced pressure rotovap by coevaporation with toluene (2x10mL). The crude mixture was purified on silica gel in cyclohexane: ethylacetate 70:30 → 0:100% as eluent yielded the desired compound 316 mg, as colorless syrup 98%.

R<sub>f</sub> = 0.50 in cyclohexane: ethylacetate (2:1).

<sup>1</sup>H NMR (300 MHz, CDCl<sub>3</sub>) δ (ppm): 7.43 – 7.29 (m, 5H, Arom), 5.51 (br s, 1H, H-1), 5.10 – 5.01 (m, 1H, H-3), 4.48 (d, 1H, *J* = 12.4 Hz, ½ CH<sub>2</sub>-Ph), 4.70 (d, 1H, *J* = 12.4 Hz, ½ CH<sub>2</sub>-Ph), 4.65 – 4.56 (m, 1H, H-5), 3.94 (dd, 1H, *J* = 7.6, 0.9 Hz, H-6), 3.75 (dd, 1H, *J* = 7.6, 5.8 Hz, H-6), 3.30 – 3.25 (m, 1H, H-3), 3.23 – 3.17 (m, 1H, H-2), 2.09 (s, 3H, OCOCH<sub>3</sub>).

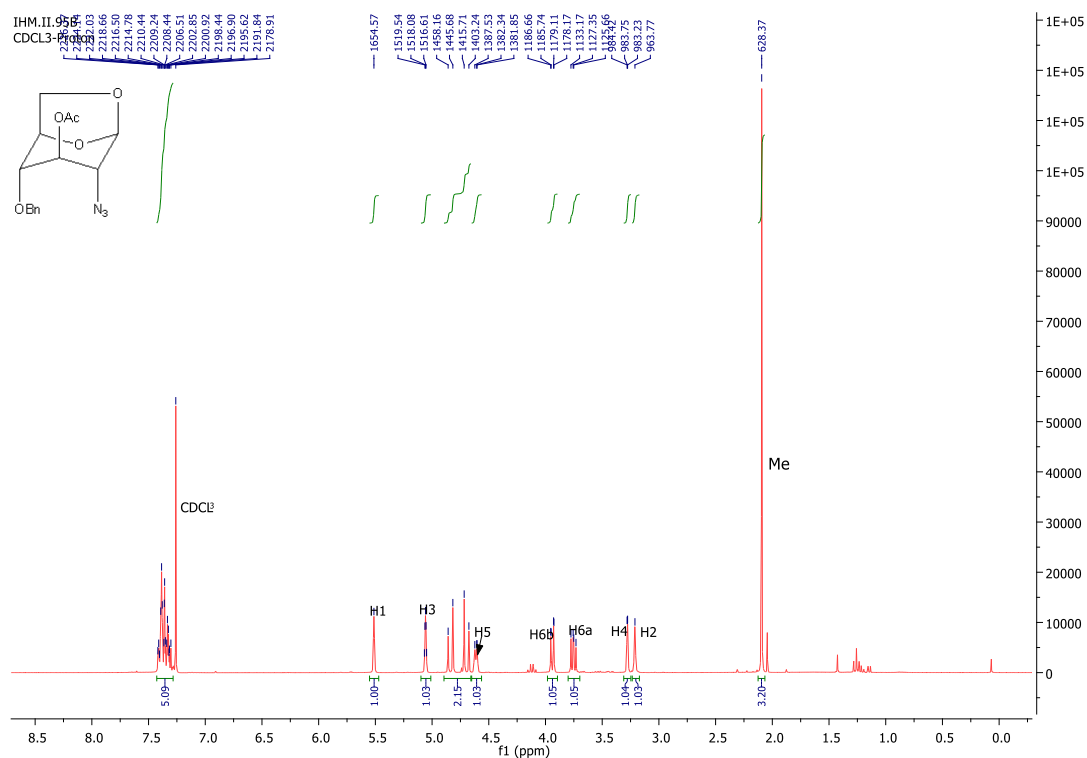

<sup>1</sup>H NMR (300 MHz) of Compound **109** in CDCl<sub>3</sub>

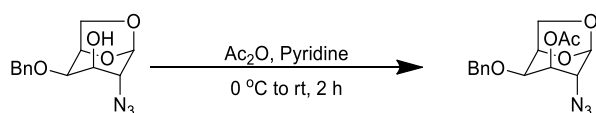

### 3-O-Acetyl-1,6-anhydro-2-azido-4-O-benzyl-2-deoxy- $\beta$ -D-galactopyranose **110**

A solution of 1,6-anhydro-2-azido-4-O-benzyl- $\beta$ -D-galactopyranose (1.616mmol, 448mg, 1equiv.) was converted into targeted compound **31b** via similar strategy for the preparation of **31a**. The crude mixture was purified on silica gel in cyclohexane: ethylacetate 70:30  $\rightarrow$  0:100% as eluent and after solvent evaporation gave the desired compound 453mg, as colorless syrup 88%.

R<sub>f</sub> = 0.65 in cyclohexane: ethylacetate (2:1).

<sup>1</sup>H NMR (300 MHz, CDCl<sub>3</sub>)  $\delta$  (ppm): 7.39 – 7.28 (m, 5H, Arom), 5.45 – 5.40 (m, 1H, H-1), 5.38 (ddd, 1H, *J* = 8.1, 3.0, 1.4 Hz, H-3), 4.62 (d, 1H, *J* = 11.5 Hz,  $\frac{1}{2}$  CH<sub>2</sub>-Ph), 4.48 (d, 1H, *J* = 11.6 Hz,  $\frac{1}{2}$  CH<sub>2</sub>-Ph), 4.46 – 4.41 (m, 1H, H-5), 4.39 (d, 1H, *J* = 7.6 Hz, H-6), 3.91 – 3.83 (m, 1H, H-4), 3.70 (dd, 1H, *J* = 7.6, 5.6 Hz, H-6), 3.55 – 3.40 (m, 1H, H-2), 2.12 (s, 3H, OCOCH<sub>3</sub>).

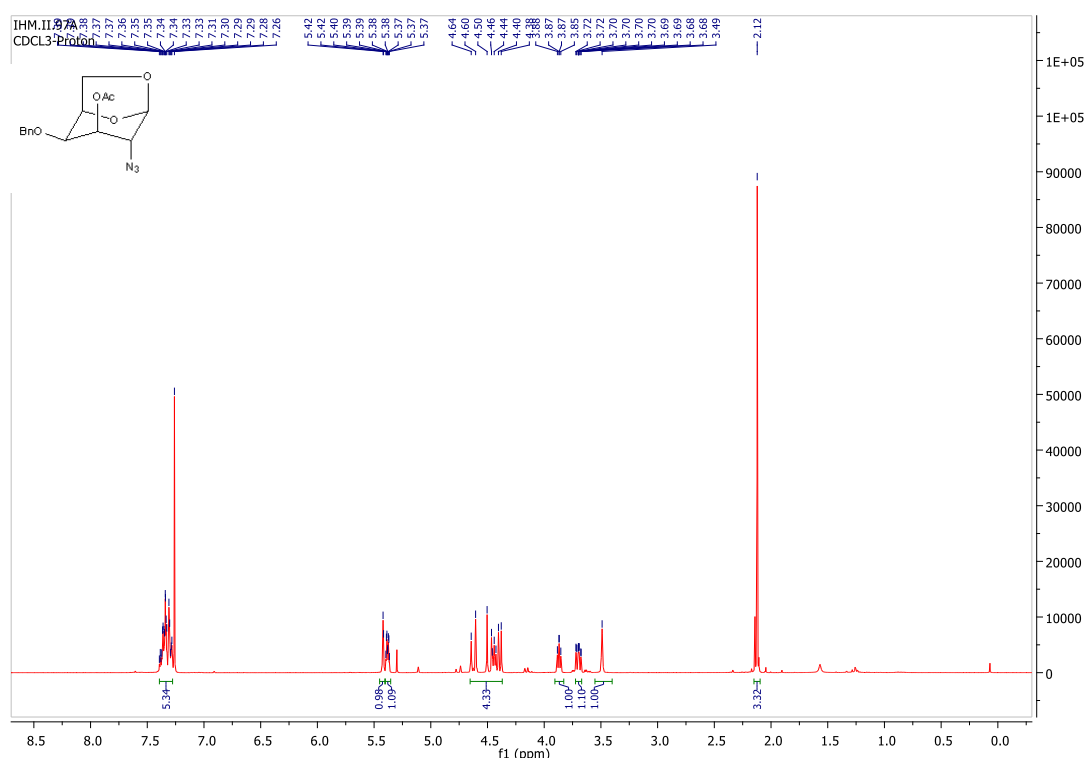

<sup>1</sup>H NMR (300 MHz) of Compound **110** in CDCl<sub>3</sub>

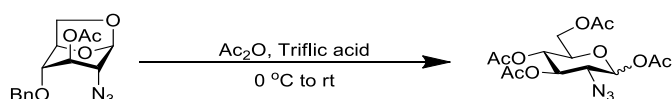

### 1,3,4,6-tetraacetyl-2-azido-2-deoxy- $\alpha/\beta$ -D-glucopyranose **113**

To a solution of 1,6-anhydro-2-azido-4-O-benzyl-2-deoxy- $\beta$ -D-glucopyranose and or 3-O-acetyl moiety (1.277mmol, 354mg, 1 equiv.) azeotroped with tol. was treated with acetic anhydride (81.575mmol, 7.7mL, 63.88equiv.) in a round bottom flask equipped with stir bar, septum and argon atmosphere at

rt. The reaction mixture was cooled down to 0 °C, added TfOH (8.722mmol, 0.77mL, 6.83equiv.) and the complete reaction set up was stirred overnight at rt. The reaction mixture was diluted with DCM after total transformation and then the solvent was coevaporated at vacuo with toluene. The residue was purified on silica gel in cyclohexane: ethylacetate 80:20 → 60:40% as eluent, afforded the titled compound as white solid 284mg, 60%.

R<sub>f</sub> = 0.39 in cyclohexane: ethylacetate 7:3.

<sup>1</sup>H NMR (300 MHz, CDCl<sub>3</sub>) δ (ppm): 6.30 (d, 1H, *J* = 3.6 Hz, H-1 $\alpha$ ), 5.55 (d, 1H, *J* = 8.6 Hz, H-1 $\beta$ ), 5.46 (dd, 1H, *J* = 10.5, 9.5 Hz, H-3), 5.11 (dd, 1H, *J* = 10.5, 9.5 Hz, H-4), 4.30 (dd, 1H, *J* = 12.4, 4.1 Hz, H-6), 4.12 – 4.00 (m, 2H, H-5, H-6), 3.66 (dd, 1H, *J* = 10.5, 3.6 Hz, H-2), 2.20 (s, 3H, OCOCH<sub>3</sub>), 2.11 (s, 3H, OCOCH<sub>3</sub>), 2.08 (s, 3H, OCOCH<sub>3</sub>), 2.05 (s, 3H, OCOCH<sub>3</sub>).

LRMS (ESI, positive mode) *m/z*: C<sub>14</sub>H<sub>19</sub>NaN<sub>3</sub>O<sub>9</sub> [M+Na]<sup>+</sup>, calc. 396.1, found 396.1.

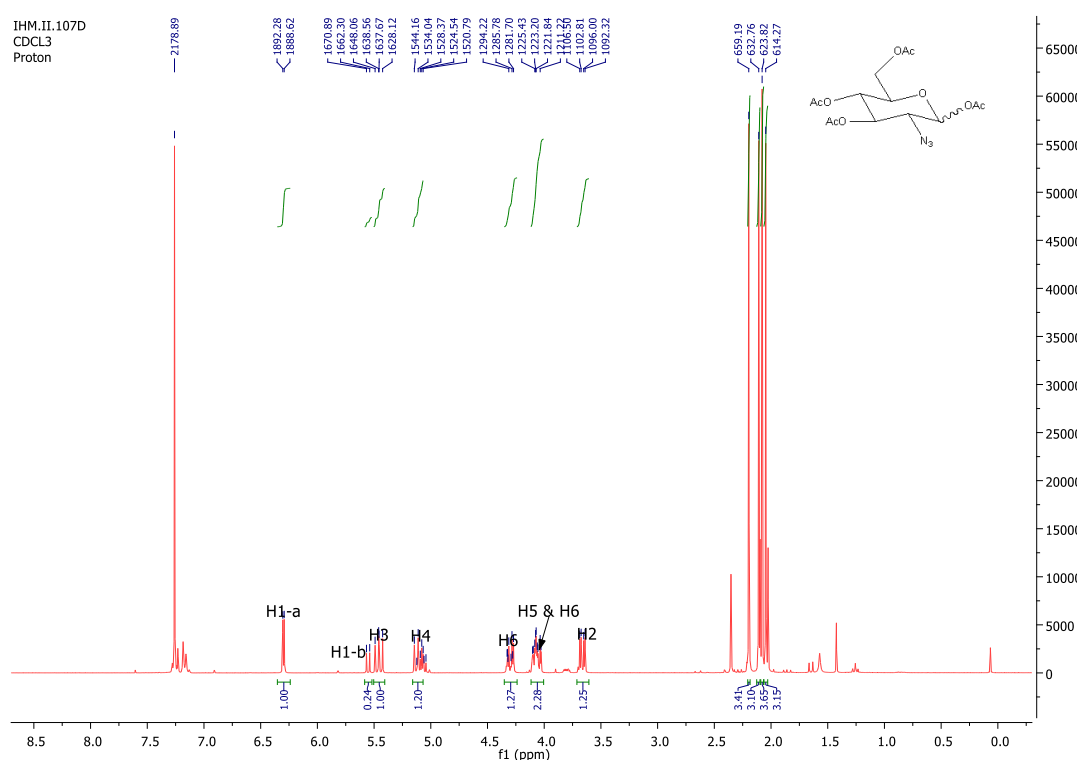

<sup>1</sup>H NMR (300 MHz) of Compound **113** in CDCl<sub>3</sub>

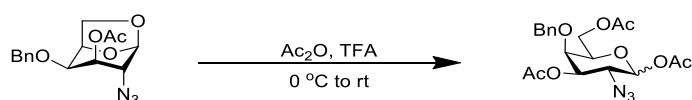

### 1,3,6-triacetyl-2-azido-4-O-benzyl-2-deoxy- $\alpha/\beta$ -D-galactopyranose **114**

1,6-anhydro-2-azido-4-O-benzyl-2-deoxy- $\beta$ -D-galactopyranose (9.943mmol, 2.757mg, 1equiv.) azeotroped with toluene (x2) was dissolved in Ac<sub>2</sub>O (50mL, 65 equiv.) at rt in RB flask equipped with stir bar, septum and argon balloon. The solution was cooled down to 0 °C in an ice bath, treated with TFA (68mmol, 5.2mL, 6.83equiv.) and then allowed to stir overnight at rt. Analytical TLC confirmed complete conversion and the reaction mixture was coevaporated with toluene at reduced pressure in

the vacuo. Concentrated residue was purified on silica gel in cyclohexane: ethylacetate 75:25 → 40:60% eluent that yielded inseparable α/β 4:1 compound 4.031g 96%, as colorless oil.

Rf = 0.55 in cyclohexane: ethylacetate 7:3.

<sup>1</sup>H NMR (300 MHz, CDCl<sub>3</sub>) δ (ppm): 7.41 – 7.30 (m, 5H, Arom), 6.29 (d, 1H, *J* = 3.6 Hz H-1<sub>α</sub>), 5.49 (d, 1H, *J* = 8.5 Hz, H-1<sub>β</sub>), 5.25 (dd, 1H, *J* = 11.1, 2.8 Hz, H-3), 4.71 (d, 1H *J* = 11.4 Hz, ½ CH<sub>2</sub>-Ph), 4.56 (d, 1H *J* = 11.4 Hz, ½ CH<sub>2</sub>-Ph), 4.23 – 4.02 (m, 5H, H-2, H-4, H-5, 2H-6), 2.15 (s, 3H, OCOCH<sub>3</sub>), 2.13 (s, 3H, OCOCH<sub>3</sub>), 2.01 (s, 3H, OCOCH<sub>3</sub>).

LRMS (ESI, positive mode) *m/z*: C<sub>19</sub>H<sub>23</sub>NaN<sub>3</sub>O<sub>8</sub> [M+Na]<sup>+</sup>, calc. 444.1, found 444.1.

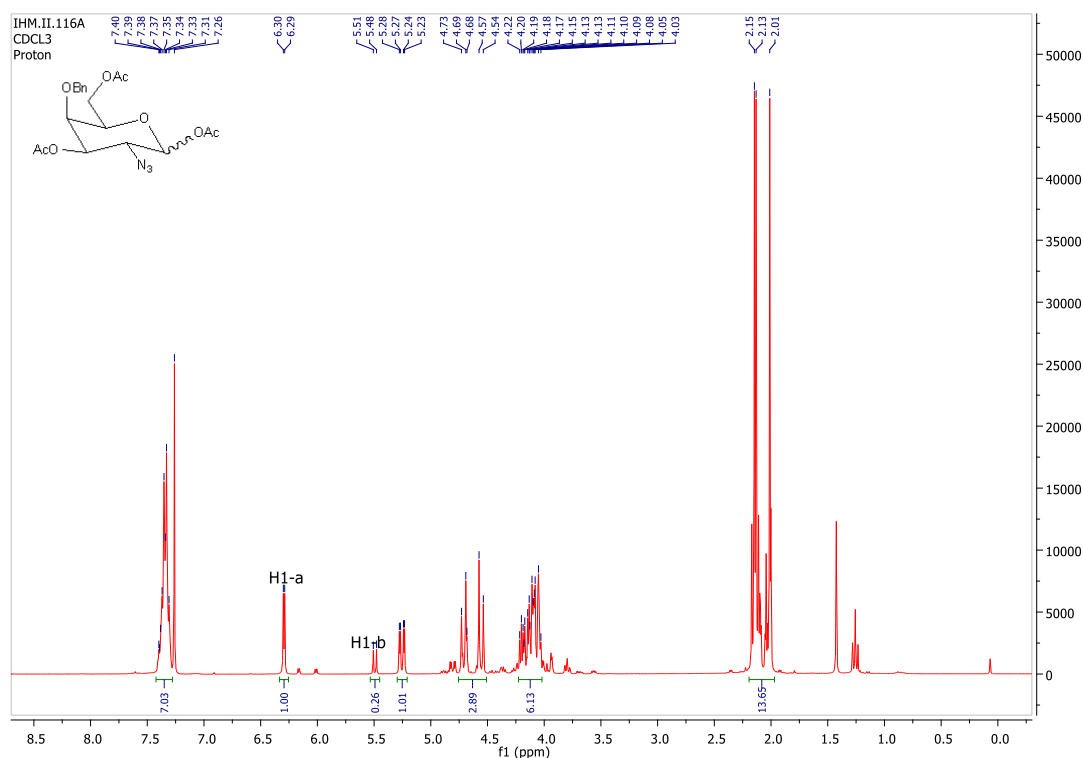

<sup>1</sup>H NMR (300 MHz) of Compound **114** in CDCl<sub>3</sub>

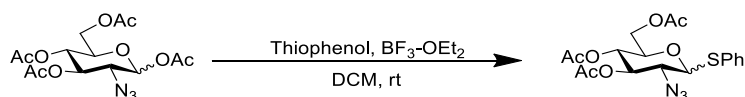

### Phenyl 3,4,6-triacetyl-2-azido-2-deoxy-1-thio-α/β-D-glucopyranoside **115**

To the suspension of 1,3,4,6-tetraacetyl-2-azido-2-deoxy-α/β-D-glucopyranose (0.429mmol, 160mg, 1equiv.) azeotroped with toluene was dissolved in anhydrous DCM (5mL) in a RB flask equipped with stir bar, septum and argon atmosphere at rt. The reaction flask was treated with thiophenol (1.5mmol, 0.154mL, 3.5equiv.) and followed by BF<sub>3</sub>·OEt<sub>2</sub> (1.797mmol, 0.463mL, 4equiv.) dropwise. This was stirred at rt under argon atmosphere overnight. Analytical TLC on the reaction mixture confirmed complete reaction, and saturated Na<sub>2</sub>CO<sub>3(aq)</sub> was added to the reaction flask and stirred for 10 minutes, washed with Na<sub>2</sub>CO<sub>3(aq)</sub>/NaCl (1:2, 150mL), and the aqueous was back extracted with DCM and the combined organic phase was dried over Na<sub>2</sub>SO<sub>4</sub>, filtered and concentrated at reduced pressure in the



rotovap. The crude mixture was purified on silica gel in cyclohexane: ethylacetate 70:30 → 60:40% as eluent, yielded  $\alpha/\beta$  mixture of the desired product 106mg, 69% colorless form.

Rf = 0.45 in cyclohexane: ethylacetate 7:3.

LRMS (ESI, positive mode) m/z: C<sub>18</sub>H<sub>21</sub>NaN<sub>3</sub>O<sub>7</sub>S [M+Na]<sup>+</sup>, calcd. 446.1, found 446.1.

**Data for  $\alpha$  anomer <sup>1</sup>H NMR (300 MHz, CDCl<sub>3</sub>)  $\delta$  (ppm):** 7.63 – 7.11 (m, 5H, Arom), 5.64 (d, 1H, *J* = 5.6 Hz, H-1), 5.35 (dd, 1H, *J* = 10.5, 9.3 Hz, H-3), 5.05 (dd, 1H, *J* = 10.2, 9.2 Hz, H-4), 4.60 (ddd, 1H, *J* = 10.3, 5.2, 2.2 Hz, H-5), 4.30 (dd, 1H, *J* = 12.4, 5.2 Hz, H-6), 4.08 (dd, 1H, *J* = 10.4, 5.6 Hz, H-2), 4.03 (dd, 1H, *J* = 12.4, 2.3 Hz, H-6), 2.10 (s, 3H, OCOCH<sub>3</sub>), 2.05 (s, 3H, OCOCH<sub>3</sub>), 2.03 (s, 3H, OCOCH<sub>3</sub>).

**Data for  $\beta$  anomer <sup>1</sup>H NMR (300 MHz, CDCl<sub>3</sub>)  $\delta$  (ppm):** 7.63 – 7.11 (m, 5H, Arom), 5.08 (dd, 1H, *J* = 10.2, 9.5 Hz, H-3), 4.93 (dd, 1H, *J* = 10.2, 9.5 Hz, H-4), 4.50 (d, 1H, *J* = 10.2 Hz, H-1), 4.28 (m, 2H, 2H-6), 3.69 (ddd, 1H, *J* = 10.0, 4.9, 2.5 Hz, H-5), 3.41 (dd, 1H, *J* = 10.0, 9.9 Hz, H-2), 2.08 (s, 3H, OCOCH<sub>3</sub>), 2.06 (s, 3H, OCOCH<sub>3</sub>), 2.01 (s, 3H, OCOCH<sub>3</sub>).

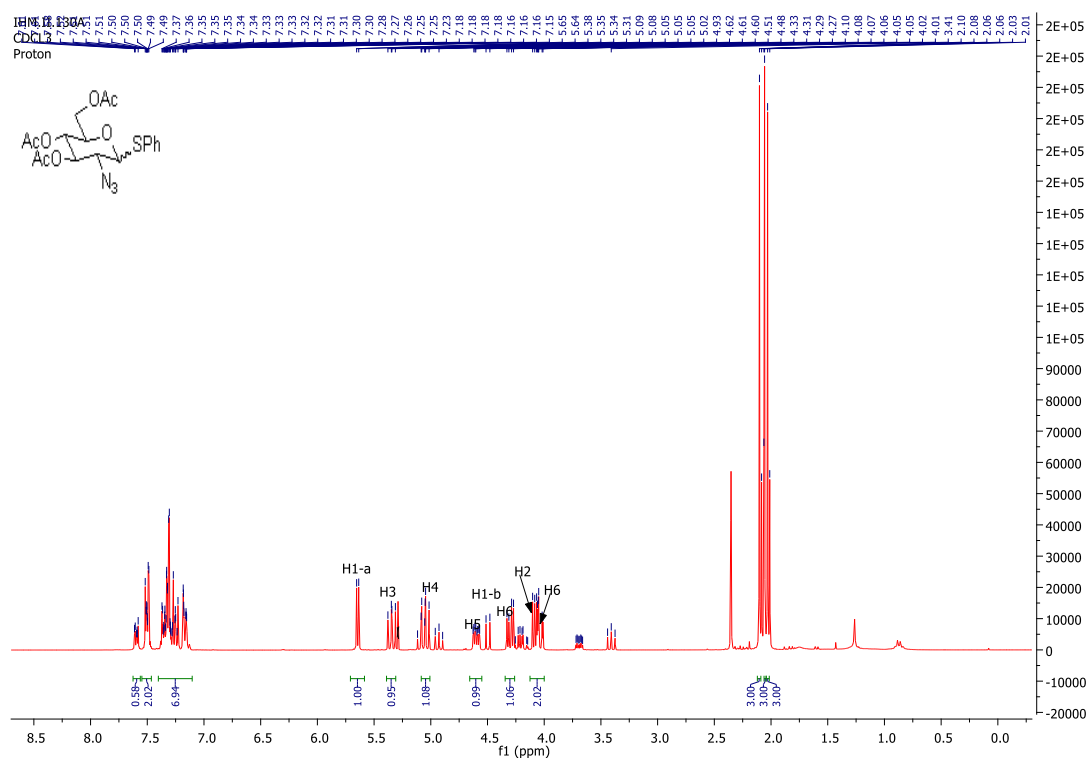

<sup>1</sup>H NMR (300 MHz) of Compound **115** in CDCl<sub>3</sub>

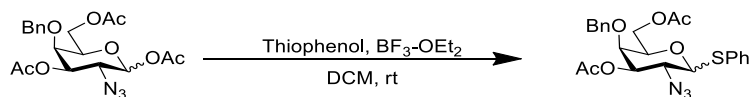

### Phenyl 3,6-diacetyl-2-azido-4-O-benzyl-2-deoxy- $\alpha/\beta$ -D-thio-galactopyranoside **116**

To the suspension of 1,3,6-triacetyl-2-azido-4-O-benzyl-2-deoxy- $\alpha/\beta$ -D-galactopyranose (0.532mmol, 224mg, 1equiv.) was transformed into the titled adduct in a similar way to compound

**115** over the course of 4h30mins. The crude mixture was purified on silica gel in cyclohexane: ethylacetate 80:20→60:40% as eluent, yielding separable  $\alpha/\beta$  product 202mg, 80% as pale brown oil.

Rf = 0.45/0.29  $\alpha/\beta$  in cyclohexane: ethylacetate 8:2.

**Data for  $\alpha$  anomer  $^1\text{H NMR}$  (300 MHz,  $\text{CDCl}_3$ )  $\delta$  (ppm):** 7.54 – 7.27 (m, 10H, 2xArom), 5.67 (d, 1H,  $J = 5.5$  Hz,  $\text{H}_{-1}$ ), 5.12 (dd, 1H,  $J = 11.1, 2.9$  Hz,  $\text{H}_{-3}$ ), 4.70 (d, 1H,  $J = 11.4$  Hz,  $\frac{1}{2}$   $\text{CH}_2\text{-Ph}$ ), 4.63 – 4.53 (m, 1H,  $\text{H}_{-5}$ ), 4.54 (d, 1H,  $J = 11.4$  Hz,  $\frac{1}{2}$   $\text{CH}_2\text{-Ph}$ ), 4.50 (dd, 1H,  $J = 11.1, 5.5$  Hz,  $\text{H}_{-2}$ ), 4.19 (dd, 1H,  $J = 11.3, 7.2$  Hz,  $\text{H}_{-6}$ ), 4.06 (dd, 1H,  $J = 11.3, 5.6$  Hz,  $\text{H}_{-6}$ ), 4.08 – 4.05 (m, 1H,  $\text{H}_{-4}$ ), 2.13 (s, 3H,  $\text{OCOCH}_3$ ), 1.96 (s, 3H,  $\text{OCOCH}_3$ ).

**Data for  $\beta$  anomer  $^1\text{H NMR}$  (300 MHz,  $\text{CDCl}_3$ )  $\delta$  (ppm):** 7.64 – 7.23 (m, 10H, 2xArom), 4.81 (dd, 1H,  $J = 10.1, 2.9$  Hz,  $\text{H}_{-3}$ ), 4.67 (d, 1H,  $J = 11.4$  Hz,  $\frac{1}{2}$   $\text{CH}_2\text{-Ph}$ ), 4.53 (d, 1H,  $J = 11.4$  Hz,  $\frac{1}{2}$   $\text{CH}_2\text{-Ph}$ ), 4.48 (d, 1H,  $J = 10.1$  Hz,  $\text{H}_{-1}$ ), 4.30 (dd, 1H,  $J = 11.2, 6.7$  Hz,  $\text{H}_{-6}$ ), 4.09 (dd, 1H,  $J = 11.2, 6.2$  Hz,  $\text{H}_{-6}$ ), 3.92 (dd, 1H,  $J = 2.8, 0.7$  Hz,  $\text{H}_{-4}$ ), 3.87 (dd, 1H,  $J = 10.1$  Hz,  $\text{H}_{-2}$ ), 3.71 (dd, 1H,  $J = 7.3, 6.1$  Hz,  $\text{H}_{-5}$ ), 2.09 (s, 3H,  $\text{OCOCH}_3$ ), 2.02 (s, 3H,  $\text{OCOCH}_3$ ).

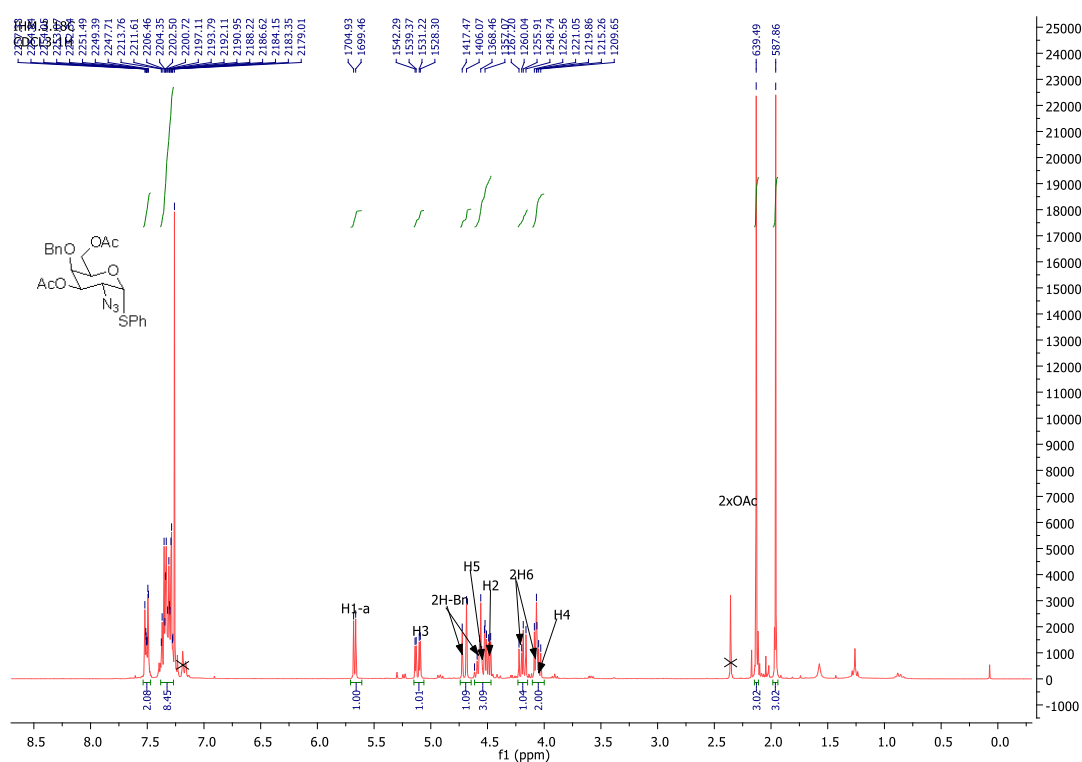

$^1\text{H NMR}$  (300 MHz) of Compound **116a** ( $\alpha$ -anomer) in  $\text{CDCl}_3$

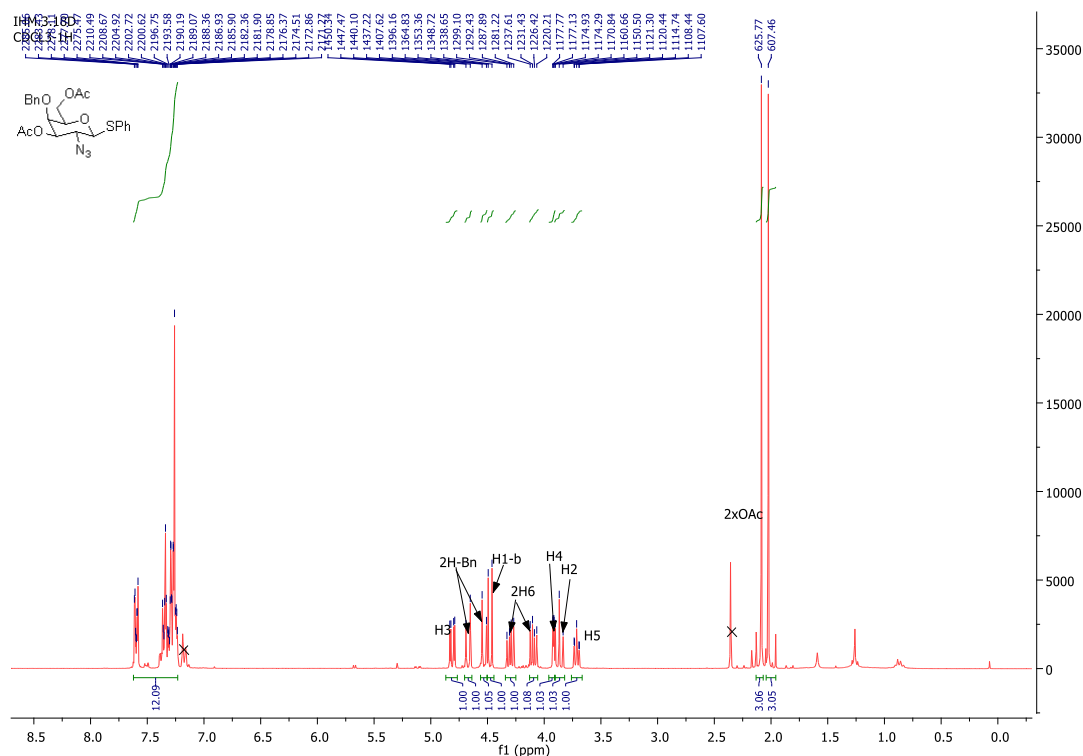

<sup>1</sup>H NMR (300 MHz) of Compound **116b** ( $\beta$ -anomer) in CDCl<sub>3</sub>

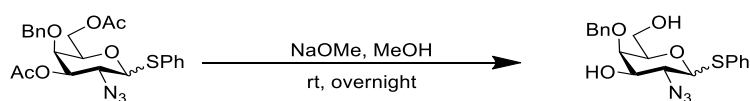

### Phenyl 2-azido-4-O-benzyl-2-deoxy- $\alpha$ and $\beta$ -D-thio-galactopyranoside **118**

#### General procedure

To the phenyl 3,4-diacetyl-2-azido-4-O-benzyl-2-deoxy- $\alpha/\beta$ -D-thio-galactopyranoside (1equiv.) azeotroped with toluene was dissolved in anhydrous MeOH in an RB flask equipped with stir bar, septum and argon atmosphere at rt. NaOMe (0.84equiv.) was added gently over reaction flask and then allowed to stir under above condition overnight. The set up was monitored by TLC in cyclohexane: ethylacetate and upon complete deacetylation, the solvent was evaporated at reduced pressure in the rotovap. The crude product was purified by flash column chromatography on silica gel in cyclohexane: ethylacetate 60:40  $\rightarrow$  1:1 as eluent, yielding target adduct as white solid.

R<sub>f</sub> = 0.20 in cyclohexane: ethylacetate 7:3 94% for  $\alpha$ -adduct.

R<sub>f</sub> = 0.13 in cyclohexane: ethylacetate 6:4 98% for  $\beta$ -adduct.

NMR data same as similar compound above.

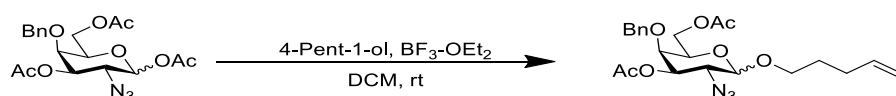

### Pentenyl 3,6-diacetyl-2-azido-4-O-benzyl-2-deoxy- $\alpha/\beta$ -D-galactopyranoside **120**

To the suspension of 1,3,6-triacetyl-2-azido-4-O-benzyl-2-deoxy- $\alpha/\beta$ -D-galactopyranose (2.895mmol, 1.220g, 1 equiv.) azeotroped with toluene was dissolved in dry DCM (25mL) under argon atmosphere in the RB flask equipped with stir bar, septum at rt.  $\text{BF}_3 \cdot \text{OEt}_2$  (14.24mmol, 3.66mL, 5 equiv., 48% in diethyl ether) was later added dropwise, then 4-pent-1-ol (17.8mmol, 1.84mL, 6.1 equiv.) and the complete reaction set up was allowed to stirred for a 48 hours at rt. TLC analysis was performed on the reaction mixture in CH: EA 7:3, with no substantive difference from the starting material. 1 equivalent of  $\text{BF}_3 \cdot \text{OEt}_2$  (0.91mL) was added and stirred additional 5h at rt. The reaction was cooled down to 0 °C, quenched with TEA (2.5mL) and stirred for 20 minutes. The solvent was evaporated at reduced pressure in the vacuo and the residue was purified by silica gel column in cyclohexane: ethylacetate 10:1  $\rightarrow$  8:2 as eluent, yielded separable  $\alpha/\beta$ ; 1/2.8 products 601mg as colorless oil at 46%.

Rf = 0.65( $\alpha$ ), 0.35( $\beta$ ), in cyclohexane: ethylacetate 7:3.

**Data for  $\alpha$  anomer  $^1\text{H NMR}$  (300 MHz,  $\text{CDCl}_3$ )  $\delta$  (ppm):** 7.40 – 7.28 (m, 5H, Arom.), 5.89 – 5.72 (m, 1H,  $\text{HC}=\text{CH}_2$ ), 5.31 (dd,  $J = 11.1, 2.9$  Hz, 1H,  $\text{H}_1$ ), 5.09 – 4.91 (m, 3H,  $\text{H}_3$   $\text{HC}=\text{CH}_2$ ), 4.71 (d,  $J = 11.5$  Hz, 1H,  $\frac{1}{2}$   $\text{CH}_2$ -Ph), 4.53 (d,  $J = 11.4$  Hz, 1H,  $\frac{1}{2}$   $\text{CH}_2$ -Ph), 4.18 (dd,  $J = 8.2, 5.1$  Hz, 1H,  $\text{H}_4$ ), 4.11 – 3.99 (m, 3H,  $\text{H}_2$ ,  $2\text{H}_6$ ), 3.80 (dd,  $J = 11.1, 3.5$  Hz, 1H,  $\text{H}_5$ ), 3.70 (dt,  $J = 9.7, 6.6$  Hz, 1H,  $\frac{1}{2}$   $\text{CH}_2$ ), 3.54 – 3.45 (m, 1H,  $\frac{1}{2}$   $\text{CH}_2$ ), 2.19 – 2.07 (m, 5H,  $\text{CH}_2$ ,  $\text{OCOCH}_3$ ), 2.02 (s, 3H,  $\text{OCOCH}_3$ ), 1.79 – 1.62 (m, 2H,  $\text{CH}_2$ ).

**Data for  $\beta$  anomer  $^1\text{H NMR}$  (300 MHz,  $\text{CDCl}_3$ )  $\delta$  (ppm):** 7.41 – 7.27 (m, 5H, Arom.), 5.81 (ddt,  $J = 16.9, 10.2, 6.7$  Hz, 1H,  $\text{HC}=\text{CH}_2$ ), 5.10 – 4.93 (m, 2H,  $\text{HC}=\text{CH}_2$ ), 4.75 – 4.65 (m, 2H,  $\text{H}_1$ ,  $\text{CH}_2$ -Ph), 4.56 (d,  $J = 11.5$  Hz, 1H,  $\text{CH}_2$ -Ph), 4.35 – 4.21 (m, 2H,  $\text{H}_6$ ,  $\text{H}_3$ ), 4.05 (dd,  $J = 11.1, 7.0$  Hz, 1H,  $\text{H}_4$ ), 3.93 (dt,  $J = 9.5, 6.3$  Hz, 1H,  $\frac{1}{2}$   $\text{CH}_2$ ), 3.88 – 3.78 (m, 2H,  $\text{H}_2$ ,  $\text{H}_6$ ), 3.69 – 3.49 (m, 2H,  $\text{H}_5$ ,  $\frac{1}{2}$   $\text{CH}_2$ ), 2.21 – 2.05 (m, 5H,  $\text{CH}_2$ ,  $\text{OCOCH}_3$ ), 2.00 (s, 3H,  $\text{OCOCH}_3$ ), 1.82 – 1.62 (m, 2H,  $\text{CH}_2$ ).

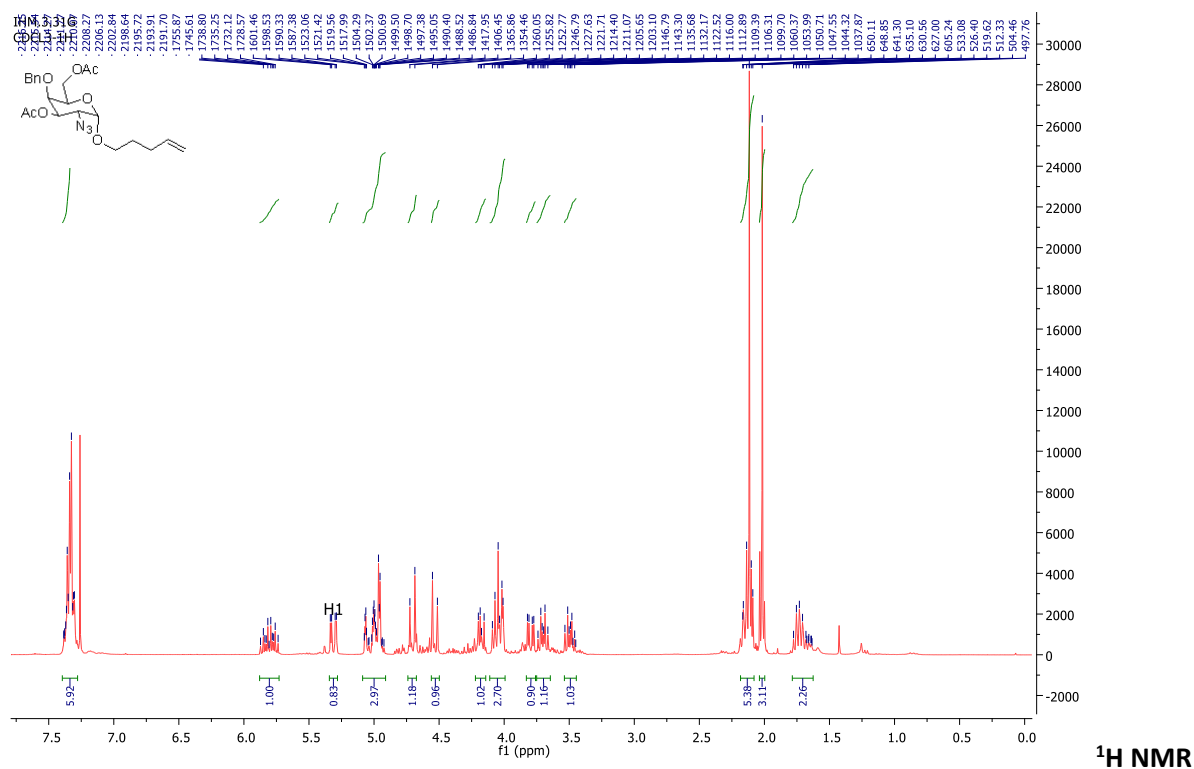

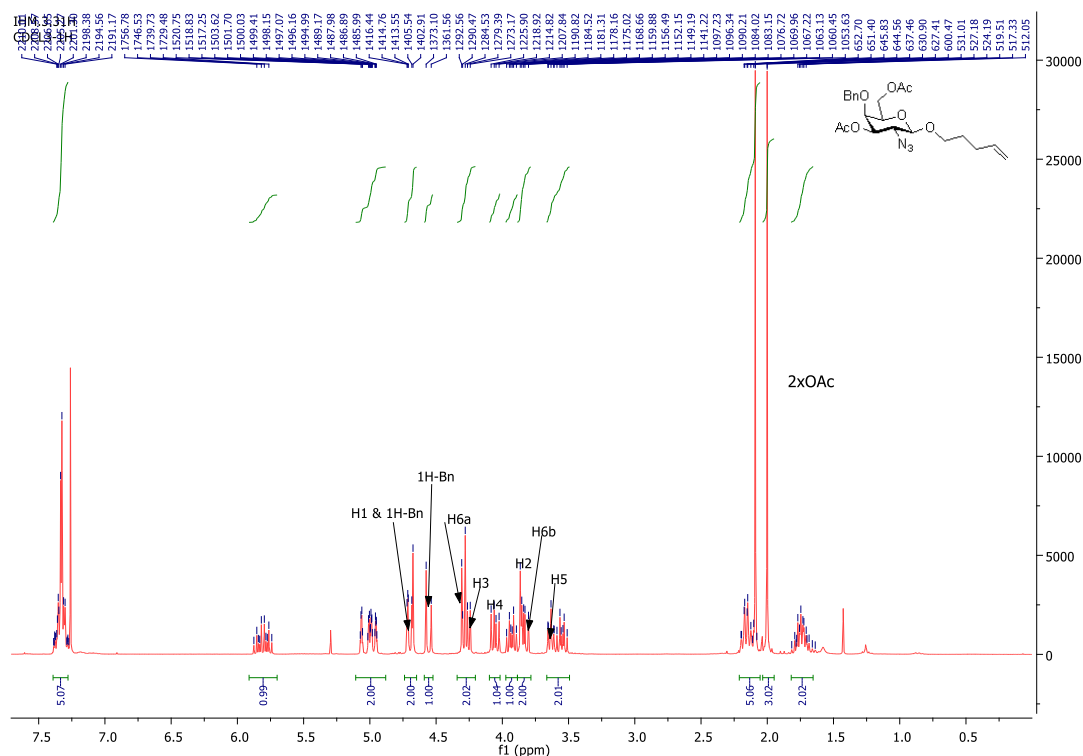

<sup>1</sup>H NMR (300 MHz) of Compound **120b** ( $\beta$ -anomer) in CDCl<sub>3</sub>

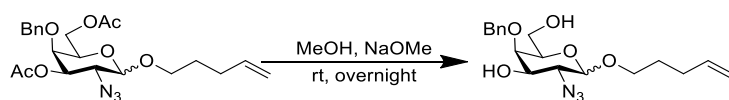

### Pentenyl 2-azido-4-O-benzyl-2-deoxy- $\alpha$ & or $\beta$ -D-galactopyranoside **121**

The titled compounds were synthesized in a similar way to deacetylation protocol above. The crude product was purified by flash column chromatography on silica gel in cyclohexane: ethylacetate 70:30 $\rightarrow$ 60:40%, yielded desired adduct as white solid.

Rf = 0.35; cyclohexane: ethylacetate 7:3, 76mg, 72% for  $\alpha$ -anomer.

Rf = 0.23; cyclohexane: ethylacetate 6:4, 301mg, 83% for  $\beta$ -anomer

**Data for  $\alpha$  anomer** <sup>1</sup>H NMR (300 MHz, CDCl<sub>3</sub>)  $\delta$  (ppm): 7.41 – 7.31 (m, 5H, arom.), 5.91 – 5.71 (m, 1H, HC=CH<sub>2</sub>), 5.14 – 4.85 (m, 3H, HC=CH<sub>2</sub>, H-1), 4.80 – 4.67 (m, 2H, CH<sub>2</sub>-Ph), 4.15 – 4.04 (m, 1H, H-3), 3.93 – 3.60 (m, 5H, H-4, 2H-6, H-5,  $\frac{1}{2}$  CH<sub>2</sub>), 3.53 – 3.41 (m, 2H, H-2,  $\frac{1}{2}$  CH<sub>2</sub>), 2.24 – 2.03 (m, 2H, CH<sub>2</sub>), 1.82 – 1.62 (m, 2H, CH<sub>2</sub>).

**Data for  $\beta$  anomer** <sup>1</sup>H NMR (300 MHz, CDCl<sub>3</sub>)  $\delta$  (ppm): 7.44 – 7.29 (m, 5H, arom.), 5.81 (ddt,  $J$  = 16.9, 10.2, 6.7 Hz, 1H, HC=CH<sub>2</sub>), 5.11 – 4.91 (m, 2H, HC=CH<sub>2</sub>), 4.76 (ABX,  $J$  = 11.7 Hz, 2H, CH<sub>2</sub>-Ph), 4.26 (d,  $J$  = 7.8 Hz, 1H, H-1), 3.94 (dt,  $J$  = 9.4, 6.3 Hz, 1H,  $\frac{1}{2}$  CH<sub>2</sub>), 3.84 (dd,  $J$  = 11.2, 7.0 Hz, 1H, H-3), 3.76 (dd,  $J$  = 3.2, 0.9 Hz, 1H, H-6), 3.66 – 3.41 (m, 5H, H-6, H-2,  $\frac{1}{2}$  CH<sub>2</sub>, H-4, H-5), 2.23 – 2.05 (m, 2H, CH<sub>2</sub>), 1.85 – 1.67 (m, 2H, CH<sub>2</sub>).

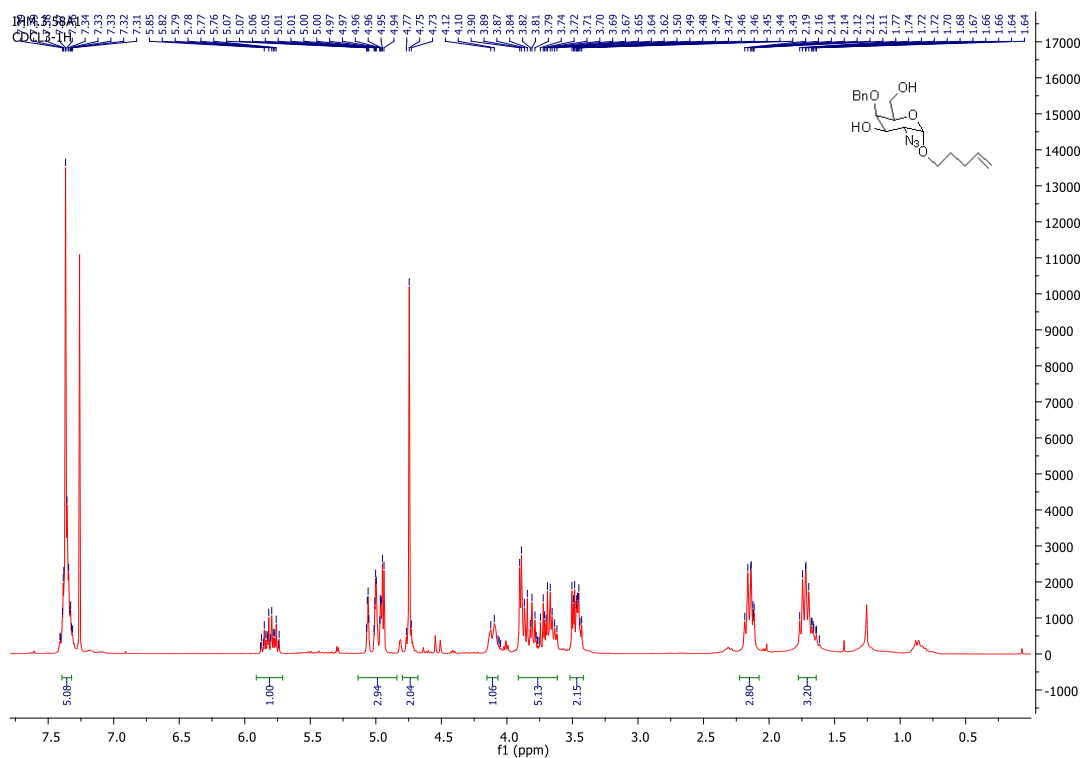

**<sup>1</sup>H NMR (300 MHz) of Compound 121a (α-anomer) in CDCl<sub>3</sub>**

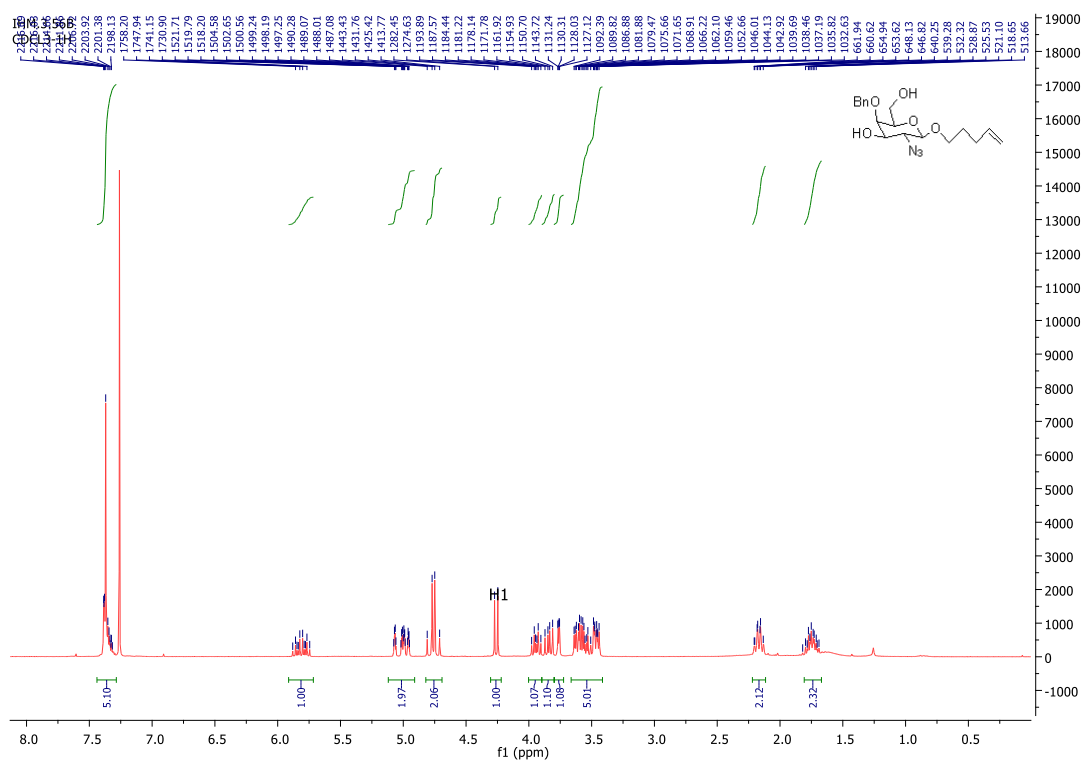

**<sup>1</sup>H NMR (300 MHz) of Compound 121b (β-anomer) in CDCl<sub>3</sub>**

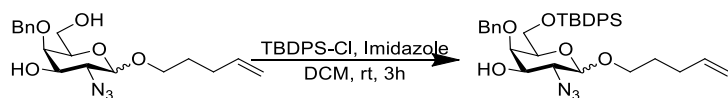

## Pentenyl 2-azido-4-O-benzyl-6-O-tert-butyl-diphenylsilyl-2-deoxy- $\alpha$ and $\beta$ -D-galactopranoside 122

The titled compounds were prepared in a similar manner to silylation protocol above with 2 equiv. of imidazole, 1 equiv. of TBDPS-Cl for 3h. The reaction progress was monitored by TLC in toluene: DCM 8:2 which confirmed complete reaction. MeOH (1mL) was added to the reaction mixture and the solvent was removed at reduced pressure in the vacuo. The residue was purified by column on silica gel in toluene: DCM 80: 20  $\rightarrow$  70: 30 as eluent, giving the target compound as colorless oil.

R<sub>f</sub> = 0.08, in toluene: DCM 70: 30 for  $\alpha$ -anomer. 53mg, 98%.

R<sub>f</sub> = 0.16, in toluene: DCM 80: 20 for  $\beta$ -anomer. 111mg, 74%.

**LRMS** (ESI, positive mode) m/z: C<sub>34</sub>H<sub>43</sub>NaN<sub>3</sub>O<sub>5</sub>Si [M+Na]<sup>+</sup>, calc. 624.3, found 624.3.

**Data for  $\alpha$  anomer <sup>1</sup>H NMR** (400 MHz, CDCl<sub>3</sub>)  $\delta$  (ppm): 7.71 – 7.27 (m, 15H, 3xArom.), 5.92 – 5.65 (m, 1H, HC=CH<sub>2</sub>), 5.14 – 4.91 (m, 2H, HC=CH<sub>2</sub>), 4.89 – 4.78 (m, 2H, H-1,  $\frac{1}{2}$  CH<sub>2</sub>-Ph), 4.72 (d, J = 11.6 Hz, 1H,  $\frac{1}{2}$  CH<sub>2</sub>-Ph), 4.14 – 4.03 (m, 2H, H-3,  $\frac{1}{2}$  CH<sub>2</sub>), 3.97 – 3.31 (m, 7H,  $\frac{1}{2}$  CH<sub>2</sub>, H-4, H-5, 2xH-6, O-H, H-2), 2.17 – 2.06 (m, 2H, CH<sub>2</sub>), 1.75 – 1.61 (m, 2H, CH<sub>2</sub>), 1.10 (s, 9H, C(CH<sub>3</sub>)<sub>3</sub>).

**<sup>13</sup>C NMR** (101 MHz, CDCl<sub>3</sub>)  $\delta$  (ppm): 138.16, 138.05, 135.75, 135.67, 135.64, 133.18, 133.16, 130.07, 130.03, 129.95, 128.82, 128.73, 128.26, 128.13, 127.96, 127.94, 115.20, 98.22, 76.95, 75.73, 70.73, 68.59, 67.72, 62.11, 61.38, 30.40, 28.72, 27.02, 19.34.

**Data for  $\beta$  anomer <sup>1</sup>H NMR** (300 MHz, CDCl<sub>3</sub>)  $\delta$  (ppm): 7.68 – 7.28 (m, 15H, 3xArom.), 5.79 (ddt, J = 16.9, 10.2, 6.7 Hz, 1H, HC=CH<sub>2</sub>), 5.09 – 4.87 (m, 2H, HC=CH<sub>2</sub>), 4.75 (ABX, J = 11.6 Hz, 2H, CH<sub>2</sub>-Ph), 4.17 (d, J = 7.6 Hz, 1H, H-1), 4.00 – 3.77 (m, 4H,  $\frac{1}{2}$  CH<sub>2</sub>, H-3, H-4, H-6), 3.56 – 3.37 (m, 4H, H-6, H-2, H-5,  $\frac{1}{2}$  CH<sub>2</sub>), 2.25 – 2.03 (m, 3H, CH<sub>2</sub>, O-H), 1.80 – 1.60 (m, 2H, CH<sub>2</sub>), 1.08 (s, 9H, C(CH<sub>3</sub>)<sub>3</sub>).

[ $\alpha$ ]<sub>D</sub><sup>27</sup> = +4° (C=17mg/mL in CHCl<sub>3</sub>- $\beta$ -anomer)

[ $\alpha$ ]<sub>D</sub><sup>27</sup> = +54° (C=33mg/mL in CHCl<sub>3</sub>- $\alpha$ -anomer)

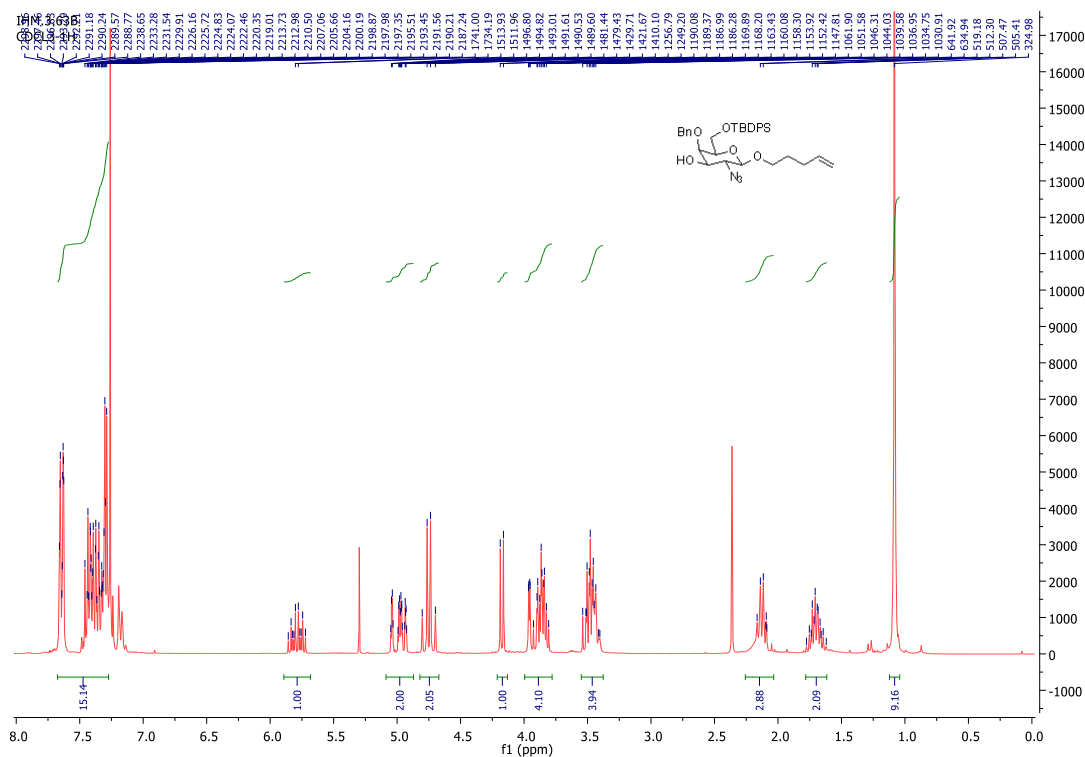
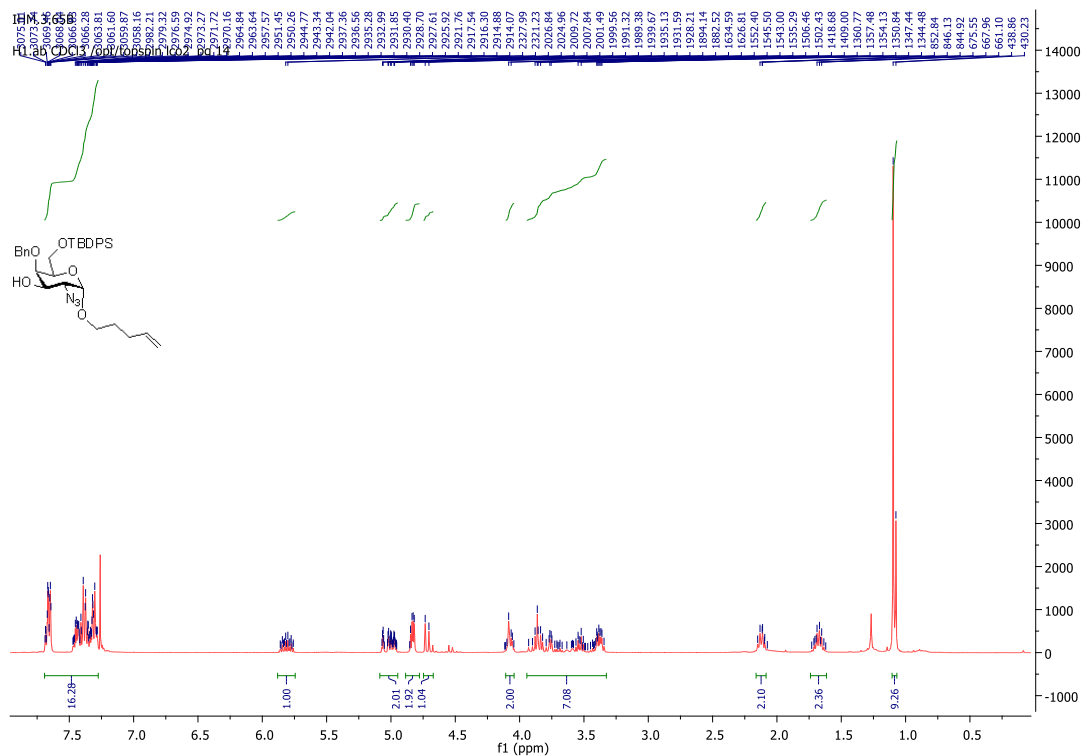



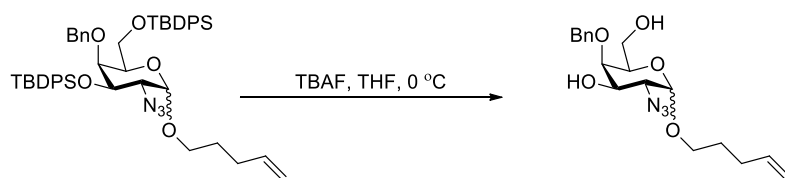

### General procedure for desilylation<sup>505</sup> of bis silylated compound 121.

To the solution of the starting material in dry THF in the round bottomed flask equipped with stir bar, septum and an argon atmosphere was added a solution of tetrabutyl ammonium fluoride TBAF (1.5 equiv.) at 0 °C and stirred for 24h till room temperature. After analytical TLC, reaction mixture was quenched with sat. aq. NaHCO<sub>3</sub> and the two layers separated. Aqueous layer was back extracted with EtOAc, and the combined organic phase dried over NaSO<sub>4</sub>, filtered and the solvent was evaporated with rotovap. Silica gel chromatography on the concentrated residue with cyclohexane: ethylacetate 8:2 → 6:4 gave the desired fraction as white solid after solvent evaporation.

Rf = 0.35; cyclohexane: ethylacetate 7:3, 26mg, 75% for α-anomer.

Rf = 0.23; cyclohexane: ethylacetate 6:4, 99mg, 69% for β-anomer.

NMR data same as similar compound above.

## EXPERIMENTAL FOR CHAPTER THREE

General optimized procedure for glycosylation with trichloroacetimidate donors

A mixture of glycosyl donor and acceptor was coevaporated with toluene (three times) in a flame-dried round bottomed flask and then dried under high vacuum pump overnight. Flame-dried molecular sieves (powder form) were added and exposed to argon-vacuum several times. The reaction flask was quickly equipped with stir bar, septum, argon balloon, dissolved in anhydrous solvent and stirred for 1-2 hours at room temperature. Reaction temperature was cooled down to – 40 °C and after 30 minutes of constant stirring, a solution of TMSOTf was added and kept for additional 30 minutes. The condition was raised to – 5 °C and then at 0 °C for 2 hours and subsequently to rt overnight. The reaction mixture was quenched with sat. aq. NaHCO<sub>3</sub>, stirred for 10 minutes and filtered. The filtrate was washed with distilled water, backed extracted with DCM and the combined organic solutions was dried over NaSO<sub>4</sub>, filtered and then concentrated with rotary evaporator at reduced pressure. The residue is purified according to the procedure described in each case and characterized below.

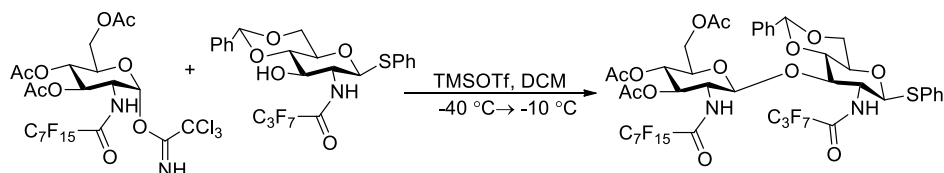

**Phenyl (3,4,6-tri-*O*-acetyl-2-deoxy-2-(8,8,8,7,7,6,6,5,5,4,4,3,3,2,2-pentadecafluorooctanamido)-β-D-glucopyranosyl)-(1→3)-4,6-*O*-benzylidene-2-deoxy-2-(4,4,4,3,3,2,2-heptafluorobutyramido)-1-thio-β-D-glucopyranoside. (127)**

A mixture of 3,4,6 tri-O-acetyl-2-deoxy-2-(8,8,8,7,7,6,6,5,5,4,4,3,3,2,2-pentadecafluorooctanamido)- $\alpha$ -D-glucopyranose-1-O-trichloroacetimidate donor (94mg, 0.111mmol) and phenyl 4,6-benzylidene-2-deoxy-(4,4,4,3,3,2,2-pentadecafluorotriamido)-1-thio- $\beta$ -D-glucopyranoside acceptor (60mg, 0.108mmol) was azeotroped with toluene (3mLx3) and dried at vacuum overnight. The mixture was then flushed with argon several times after being treated with flame-activated molecular sieves (3Å), stir bar and septum. The reaction set-up was dissolved in anhydrous DCM (2mL) and stirred for 1h under argon at rt. The mixture was cooled down to -40 °C and stirred additional 20 minutes before a solution of TMSOTf (0.2M in DCM, 50 $\mu$ L, 0.2mmol) was introduced to the reaction dropwise. The reaction stirred for 20 minutes at this temperature and then warmed up to -5 °C over a period of 1h33mins before it was quenched with TEA (0.1mL) and allowed to warm up to rt. The mixture was filtered over filter paper, with tiny solid residue left over the paper. The filtrate was washed with H<sub>2</sub>O, sat. NaCl, dried with anhydrous Na<sub>2</sub>SO<sub>4</sub>, filtered and concentrated at vacuum. The purification was performed with fluoruous preparative TLC in MeOH: H<sub>2</sub>O  $\rightarrow$  80:20% yielded improved separation. Silica gel chromatography on the remaining part of the residue in EtOAc: Cyclohexane 20% and monitored by TLC in 20% EtOAc: Cyclohexane, R<sub>f</sub> 0.1 gave quite a good result.

**LRMS** (ESI, positive mode) m/z: C<sub>43</sub>H<sub>36</sub>F<sub>22</sub>NaN<sub>2</sub>O<sub>13</sub>S [M+Na]<sup>+</sup>, calc. 1261.1, found 1261.1.

**<sup>1</sup>H NMR** (500 MHz, Acetone)  $\delta$  (ppm): 8.86 (d, *J* = 9.3 Hz, 1H, N'-H), 8.42 (d, *J* = 9.1 Hz, 1H, N-H), 7.57 – 7.29 (m, 10H, 2x Arom.), 5.78 (s, 1H, CH(O)<sub>2</sub>-Ph), 5.43 – 5.33 (m, 3H, H'-3, H'-1, H-1), 5.26 – 5.20 (m, 1H, H-3), 5.03 (dd, *J* = 10.2, 9.8 Hz, 1H, H'-4), 4.94 (dd, *J* = 10.1, 9.7 Hz, 1H, H-4), 4.35 – 3.99 (m, 6H, H-6a, H'-6a, H'-6b, H'-2, H-6b, H-2), 3.93 (ddd, *J* = 10.1, 5.5, 2.4 Hz, 1H, H'-5), 3.62 (ddd, *J* = 10.0, 8.7, 4.4 Hz, 1H, H-5), 2.03 (s, 3H, OC(O)CH<sub>3</sub>), 2.00 (s, 3H, OC(O)CH<sub>3</sub>), 1.93 (s, 3H, OC(O)CH<sub>3</sub>).

**<sup>13</sup>C NMR** (126 MHz, Acetone)  $\delta$  (ppm): 170.80, 170.72, 170.65, 170.36, 170.28, 170.00, 169.95, 138.63, 133.36, 133.10, 132.43, 129.88, 128.93, 128.57, 127.24, 102.03, 98.25, 87.69, 86.16, 79.54, 78.43, 76.57, 73.89, 72.73, 72.34, 71.33, 69.72, 69.43, 68.97, 62.94, 20.80, 20.66, 20.64, 20.59, 20.33.

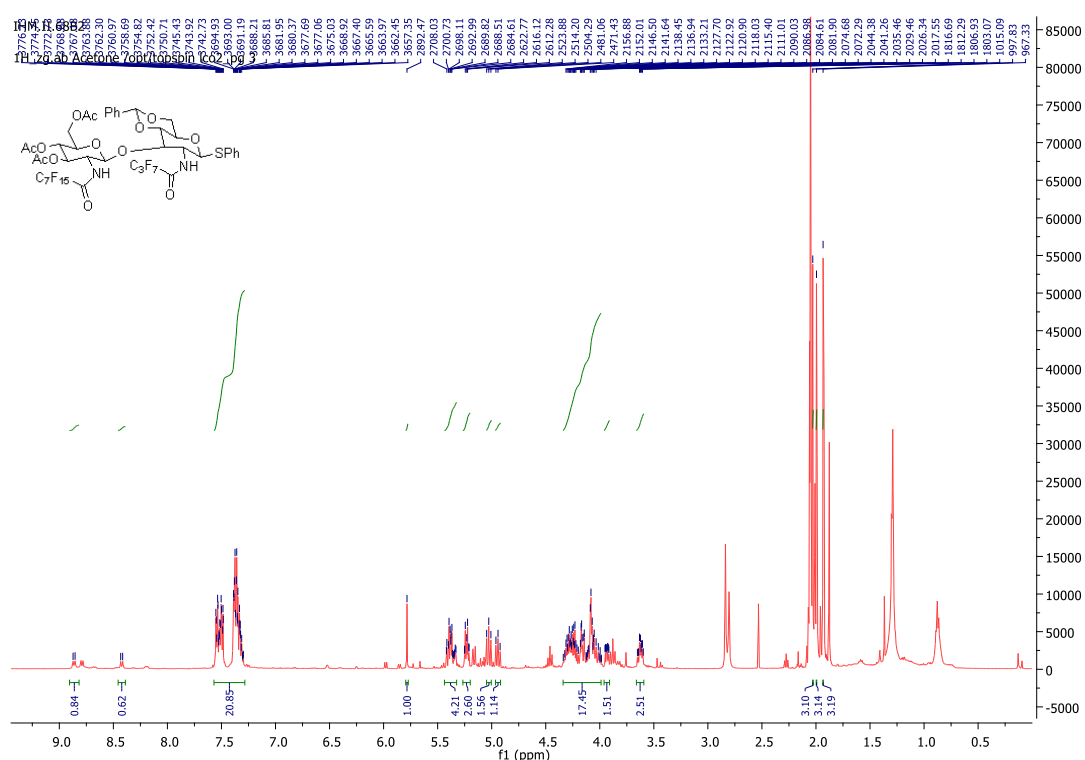

**<sup>1</sup>H NMR (500 MHz) of Compound 127 in Acetone D<sub>6</sub>**

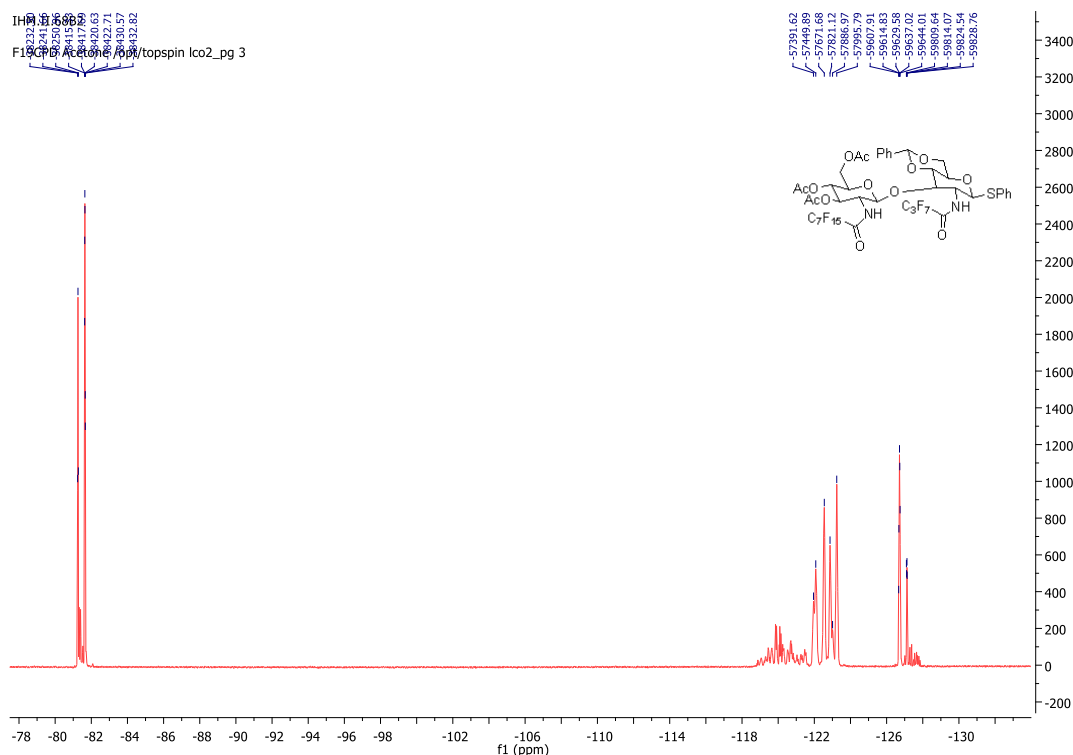

**<sup>19</sup>F NMR (471 MHz) of Compound 127 in Acetone D<sub>6</sub>**

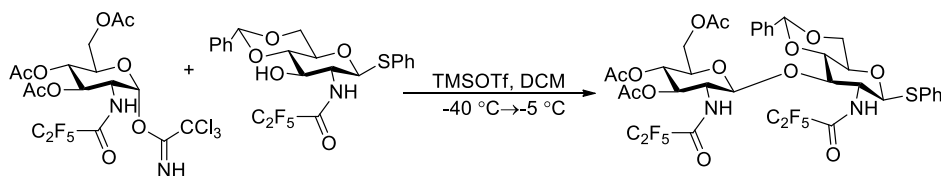

**Phenyl (3,4,6-tri-*O*-acetyl-2-deoxy-2-(3,3,3,2,2-pentafluorotriamido)- $\beta$ -D-glucopyranosyl)-(1 $\rightarrow$ 3)-4,6-*O*-benzylidene-2-deoxy-2-(3,3,3,2,2-pentafluorotriamido)-1-thio- $\beta$ -D-glucopyranoside. (129)**

A mixture of 3,4,6 tri-*O*-acetyl-2-deoxy-2-(3,3,3,2,2-pentafluorotriamido)- $\alpha$ -D-glucopyranose-1-*O*-trichloroacetimidate donor (70mg, 0.12mmol) and phenyl 4,6-benzylidene-2-deoxy-(3,3,3,2,2-pentafluorotriamido)-1-thio- $\beta$ -D-glucopyranoside acceptor (53mg, 0.10mmol) was azeotroped with toluene (2mLx3) and dried at vacuum. The mixture was dissolved in DCM (3mL) with activated molecular sieves being added (3Å) and stirred for 45 minutes under argon at room temperature. The reaction was then cooled to -40 °C and stirred additional 15 minutes before TMSOTf (0.2M in DCM, 70 $\mu$ L, 0.2mmol) was introduced to the reaction dropwise. The reaction stirred for 20 minutes at this temperature and then warmed up to -5 °C over a period of 1.45h before it was quenched with TEA (0.1mL) and allowed to warm to rt. The mixture was then diluted with DCM (10mL) and filtered over cotton using pipette. The residue was washed with distilled water (10mL), sat. NaCl (10mL) and the aqueous layer was back extracted with DCM and the combined organic layers were dried with anhydrous Na<sub>2</sub>SO<sub>4</sub> and concentrated at vacuum. Silica gel chromatography in 2%-10% MeOH: DCM

and monitored by TLC in 30% EtOAc: Cyclohexane gave a mixture of two inseparable spots **Rf** 0.1 and 0.5. Similarly, Silica gel preparatory TLC did not resolve this issue.

Fluorous preparatory TLC however afforded better fraction in tiny amount in MeOH: H<sub>2</sub>O; 80/20 eluent and therefore allowed for easy characterization.

**LRMS** (ESI, positive mode) *m/z*: C<sub>37</sub>H<sub>36</sub>F<sub>10</sub>NaN<sub>2</sub>O<sub>13</sub>S [M+Na]<sup>+</sup>, calc. 961.2, found 961.2.

**<sup>1</sup>H NMR** (300 MHz, Acetone) δ (ppm): 8.81 (d, *J* = 8.5 Hz, 1H, N-H'), 8.45 (d, *J* = 9.1 Hz, 1H, N-H), 7.61 – 7.25 (m, 10H, 2x Arom.), 5.78 (s, 1H, CH(O)<sub>2</sub>-Ph), 5.36 (d, *J* = 8.4 Hz, 1H, H'-1), 5.21 (dd, *J* = 10.5, 9.4 Hz, 1H, H'-3), 5.14 (d, *J* = 10.6 Hz, 1H, H-1), 4.94 (dd, *J* = 10.2, 9.5 Hz, 1H, H'-4), 4.43 (t, *J* = 10.0 Hz, 1H, H-3), 4.32 – 3.96 (m, 6H, H'-5, 2xH'-6, H'-2, 2xH-6), 3.88 (t, *J* = 10.0 Hz, 1H, H-4), 3.67 – 3.54 (m, 2H, H-2, H-5), 2.02 (s, 3H, OC(O)CH<sub>3</sub>), 1.92 (s, 3H, OC(O)CH<sub>3</sub>), 1.88 (s, 3H, OC(O)CH<sub>3</sub>).

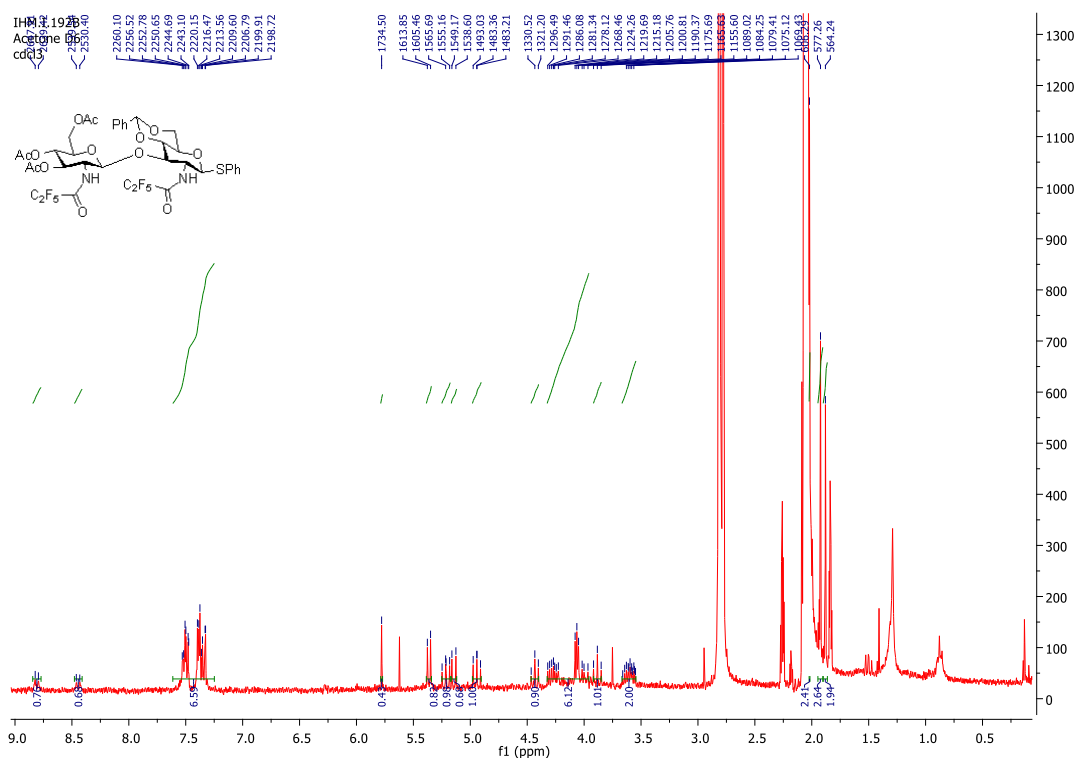

**<sup>1</sup>H NMR** (300 MHz) of Compound **129** in Acetone D<sub>6</sub>

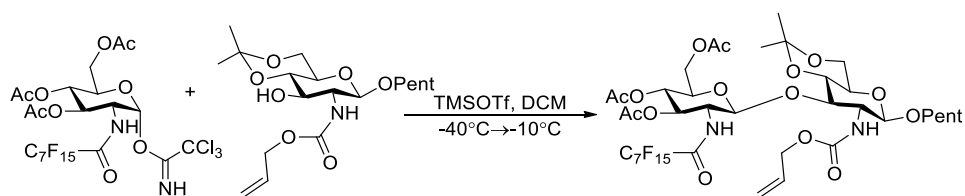

**Pentenyl (3,4,6-tri-O-acetyl-2-deoxy-2-(8,8,8,7,7,6,6,5,5,4,4,3,3,2,2-pentadecafluorooctanamido)-β-D-glucopyranosyl)-(1→3)-4,6-O-acetonide-2-deoxy-allyloxycarbonyl-β-D-glucopyranoside (133)**

A mixture of 3,4,6 tri-O-acetyl-2-deoxy-2-(8,8,8,7,7,6,6,5,5,4,4,3,3,2,2-pentadecafluorooctanamido)-α-D-glucopyranose-1-O-trichloroacetimidate donor (37mg, 0.044mmol) and pentenyl 4,6-O-

acetone-2-deoxy-allyloxycarbonyl- $\beta$ -D-glucopyranoside acceptor (30mg, 0.081mmol) was azeotroped with toluene (2mLx3) and dried at vacuum. The mixture was treated with activated molecular sieves (3Å), stir bar, septum, and an argon balloon. The reaction set-up was dissolved in anhydrous DCM (1mL) and stirred for 1h30 under argon at rt. The mixture was cooled down to -40 °C and a solution of TMSOTf (0.2M in DCM, 50 $\mu$ L, 0.2mmol) was introduced to the reaction dropwise. The reaction was stirred for 30 minutes at this temperature and then warmed up to -10 °C over a period of 1h before it was quenched with TEA (0.1mL) and allowed to warm to rt. The mixture was filtered over celite and washed with DCM. The filtrate was washed with sat. NaCl, dried with anhydrous Na<sub>2</sub>SO<sub>4</sub>, filtered and concentrated at vacuum. Silica gel chromatography of the residue in EtOAc: Cyclohexane 20 $\rightarrow$ 50%, monitored by TLC in 30% EtOAc: Cyclohexane, yielded a fraction with the desired compound (13mg, 24%) tied with other undesired fragments; oxazoline and acceptor as confirmed by mass spectral result.

**LRMS** m/z (ESI)<sup>+</sup> for C<sub>38</sub>H<sub>45</sub>O<sub>15</sub>F<sub>15</sub>N<sub>2</sub>, [M+Na]<sup>+</sup>, calc. 1077.2; found 1077.3.

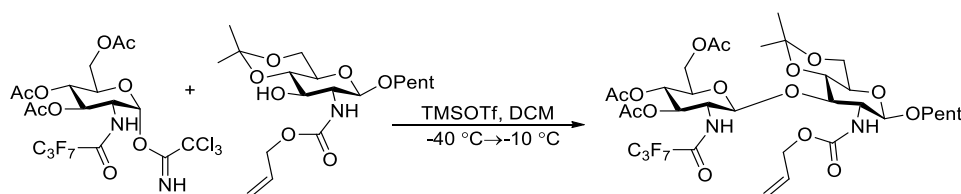

**Pentenyl (3,4,6-tri-O-acetyl-2-deoxy-2-(4,4,4,3,3,2,2-heptafluorobutyramido)- $\beta$ -D-glucopyranosyl)-(1 $\rightarrow$ 3)-4,6-O-acetonide-2-deoxy-propoxycarbonyl- $\beta$ -D-glucopyranoside (134)**

A mixture of donor (29.7mg, 0.046mmol) and acceptor (17.09mg, 0.046mmol) was azeotroped with toluene (2mLx3) and dried at vacuum overnight. The mixture was dissolved in dry DCM (1mL) with flame activated molecular sieves (3Å) added and stirred for 45 minutes at room temperature under argon atmosphere. The reaction was then cooled down to -40 °C and stirred additional 15 minutes before TMSOTf (0.2M in DCM, 50 $\mu$ L, 0.2mmol) was introduced to the reaction dropwise. The reaction stirred for 20 minutes at this temperature and then warmed up to -5 °C over a period of 2h before it was quenched with TEA and allowed to warm at rt. The mixture was then diluted with DCM (20mL) and washed with sat. aq. NaCl. The aqueous layer was back extracted with DCM and the combined organic layers were dried with anhydrous Na<sub>2</sub>SO<sub>4</sub> and concentrated at vacuum. Silica gel chromatography in 20%-50% EtOAc: cyclohexane afforded the disaccharide as a white solid (11 mg, 28%).

R<sub>f</sub> = 0.08 in 30% EtOAc: PE.

**HRMS** (ESI, positive mode) m/z: C<sub>34</sub>H<sub>45</sub>F<sub>7</sub>NaN<sub>2</sub>O<sub>15</sub> [M+Na]<sup>+</sup>, calcd 877.2600, found 877.2586; [M+H]<sup>+</sup>, calcd 855.2781, found 855.2802.

<sup>1</sup>H NMR (400 MHz, CDCl<sub>3</sub>)  $\delta$  (ppm): 5.91 (ddt, *J* = 11.2, 10.5, 5.7 Hz, 1H, CH=CH<sub>2</sub>), 5.85 – 5.71 (m, 1H, CH=CH<sub>2</sub>), 5.61 – 4.73 (m, 7H, 2xCH<sub>2</sub>=CH, H-1, H'-1, H'-3), 4.70 – 4.42 (m, 3H, H'-4, H'-5, H-4), 4.30 – 4.19 (m, 1H, H'-2), 3.98 – 3.64 (m, 5H, H-2, 2xH'-6, 2xH-6), 3.58 (t, *J* = 9.3 Hz, 1H, H-3), 3.52 – 3.43 (m, 1H, H-5), 3.41 – 3.21 (m, 2H, OCH<sub>2</sub>CH=CH<sub>2</sub>), 2.11 (s, 3H, OC(O)CH<sub>3</sub>), 2.03 (s, 3H, OC(O)CH<sub>3</sub>), 1.98 (s, 3H, OC(O)CH<sub>3</sub>), 1.77 – 1.60 (m, 4H, OCH<sub>2</sub>CH<sub>2</sub>CH<sub>2</sub>, CH<sub>2</sub>CH<sub>2</sub>CH=CH<sub>2</sub>), 1.54 – 1.43 (m, 2H, OCH<sub>2</sub>CH<sub>2</sub>CH<sub>2</sub>-), 1.42 (s, 6H, (CH<sub>3</sub>)<sub>2</sub>O<sub>2</sub>).

$^{19}\text{F}$  NMR (376 MHz,  $\text{CDCl}_3$ )  $\delta$  (ppm): -80.43 (t,  $J = 8.9$  Hz, 3F), -120.47 (ABq,  $J = 79.1, 8.6$  Hz, 2F), -126.88 – -126.98 (m, 2F).

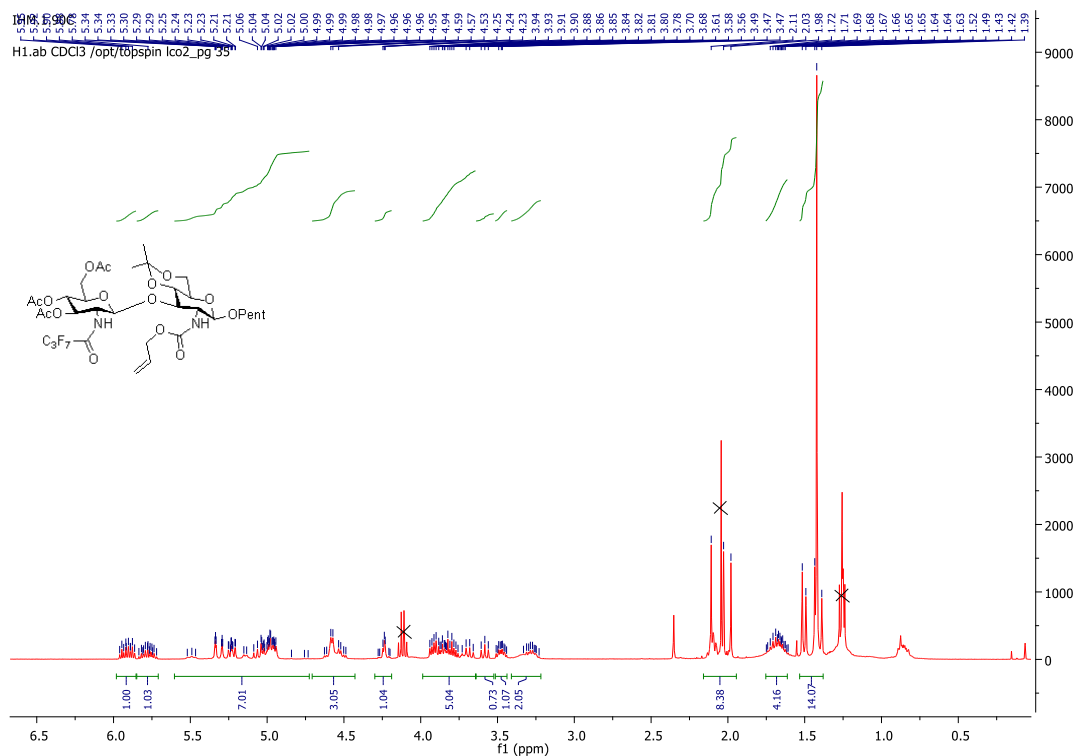

$^1\text{H}$  NMR (400 MHz) of Compound **134** in  $\text{CDCl}_3$

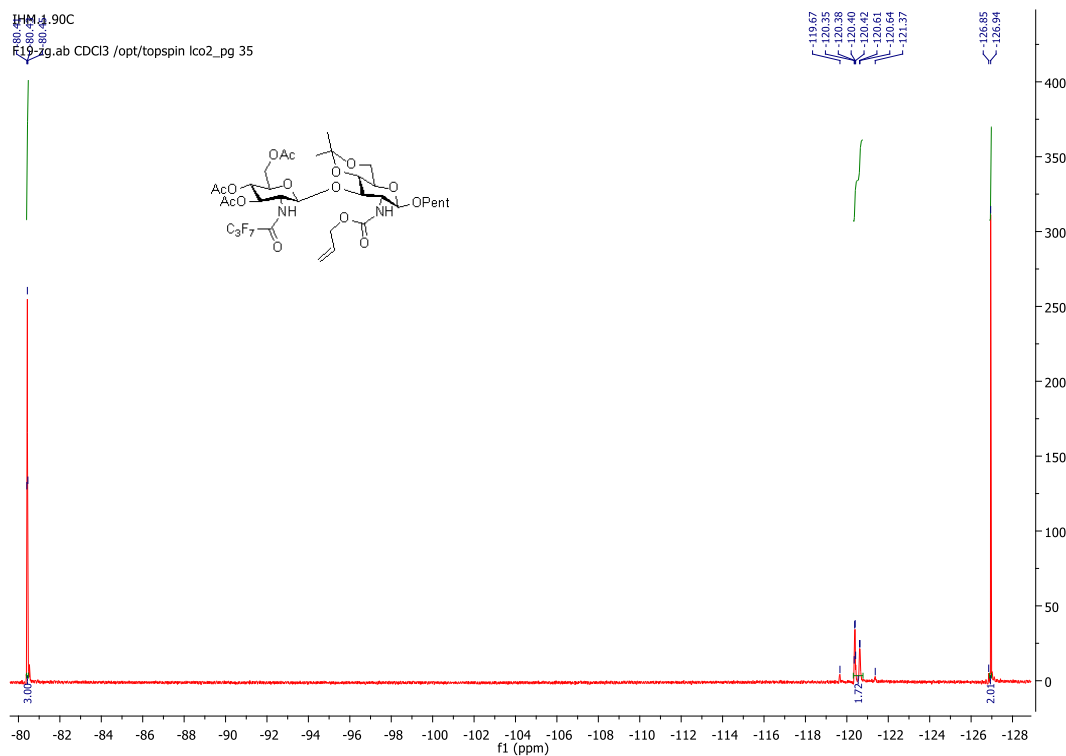

$^1\text{H}$ - $^1\text{H}$  COSY (400 MHz) of Compound **134** in  $\text{CDCl}_3$

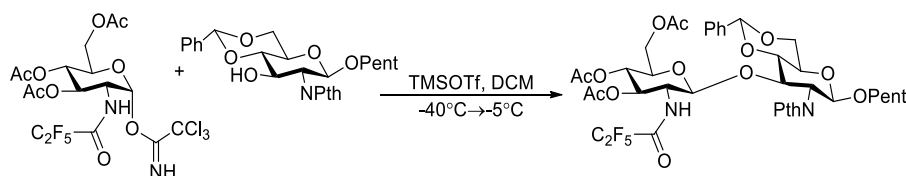

**Pentenyl (3,4,6-tri-O-acetyl-2-deoxy-2-(3,3,3,2,2-pentafluorotriamido)-β-D-glucopyranosyl)-(1→3)-4,6-O-benzylidene-2-deoxy-2-phthalimido-1-thio-β-D-glucopyranoside (135)**

A mixture of 3,4,6 tri-O-acetyl-2-deoxy-2-(3,3,3,2,2-pentafluorotriamido)-α-D-glucopyranose-1-O-trichloroacetimidate donor (43mg, 0.072mmol) and pentenyl 4,6-O-acetonide-2-deoxy-2-phthalimido-β-D-glucopyranoside acceptor (25mg, 0.054mmol) was azeotroped with toluene (3mLx2) and dried at vacuum overnight. The mixture was then flushed with argon several times after addition of flame activated molecular sieves (3Å), stir bar and septum. The reaction set-up was dissolved in anhydrous DCM (2mL) and stirred for 45minutes under argon at rt. The mixture was cooled down to -40 °C and stirred additional 20 minutes before a solution of TMSOTf (0.2M in DCM, 50μL, 0.2mmol) was introduced to the reaction dropwise. The reaction was stirred for 20 minutes at this temperature and then warmed up to -5 °C over a period of 1h10mins before it was quenched with TEA (0.1mL) and allowed to warm to rt. The mixture was filtered over cotton in the pipette. The filtrate was washed with distilled H<sub>2</sub>O, sat. NaCl, dried over anhydrous Na<sub>2</sub>SO<sub>4</sub>, filtered and concentrated at vacuum. The concentrated residue confirms the presence of the desired product by mass spectral analysis. Silica gel chromatography on the residue in EtOAc: Cyclohexane 10 → 30% and MeOH: EtOAc 10%, yielded a pale yellow form as the desired fraction 25mg, 51%.

R<sub>f</sub> = 0.2 in 30% EtOAc: Cyclohexane.

**LRMS** (ESI, positive mode) m/z: C<sub>41</sub>H<sub>43</sub>F<sub>5</sub>NaN<sub>2</sub>O<sub>15</sub> [M+Na]<sup>+</sup>, calc. 921.2, found 921.2.

**<sup>1</sup>H NMR** (300 MHz, CDCl<sub>3</sub>) δ (ppm): 8.01 – 7.31 (m, 9H), 6.34 (d, *J* = 7.0 Hz, 1H, N-H'), 5.70 – 5.43 (m, 3H, CH=CH<sub>2</sub>, CH(O)<sub>2</sub>-Ph, H'-3), 5.35 (d, *J* = 8.5 Hz, 1H, H'-1), 5.15 (d, *J* = 8.8 Hz, 1H, H-1), 4.96 (dd, *J* = 10.0, 9.5 Hz, 1H, H'-4), 4.82 – 4.61 (m, 3H, CH=CH<sub>2</sub>, H-4), 4.40 (dd, *J* = 10.5, 4.5 Hz, 1H, H'-6), 4.26 (dd, *J* = 10.1, 8.6 Hz, 1H, H-3), 3.92 – 3.66 (m, 5H, H'-6, 2xH-6, H'-2, H'-5), 3.48 – 3.30 (m, 3H, H-2, OCH<sub>2</sub>-CH<sub>2</sub>), 3.06 (dd, *J* = 12.4, 2.1 Hz, 1H, H-5), 2.08 – 1.82 (m, 12H, CH<sub>2</sub>CH=CH<sub>2</sub>, 3xOC(O)CH<sub>3</sub>; each singlet), 1.73 – 1.44 (m, 2H, OCH<sub>2</sub>-CH<sub>2</sub>-CH).

**<sup>19</sup>F NMR** (282 MHz, CDCl<sub>3</sub>) δ (ppm): -83.46 (t, *J* = 1.5 Hz, 3F), -123.58 (dq, *J* = 11.2, 1.3 Hz, 2F).

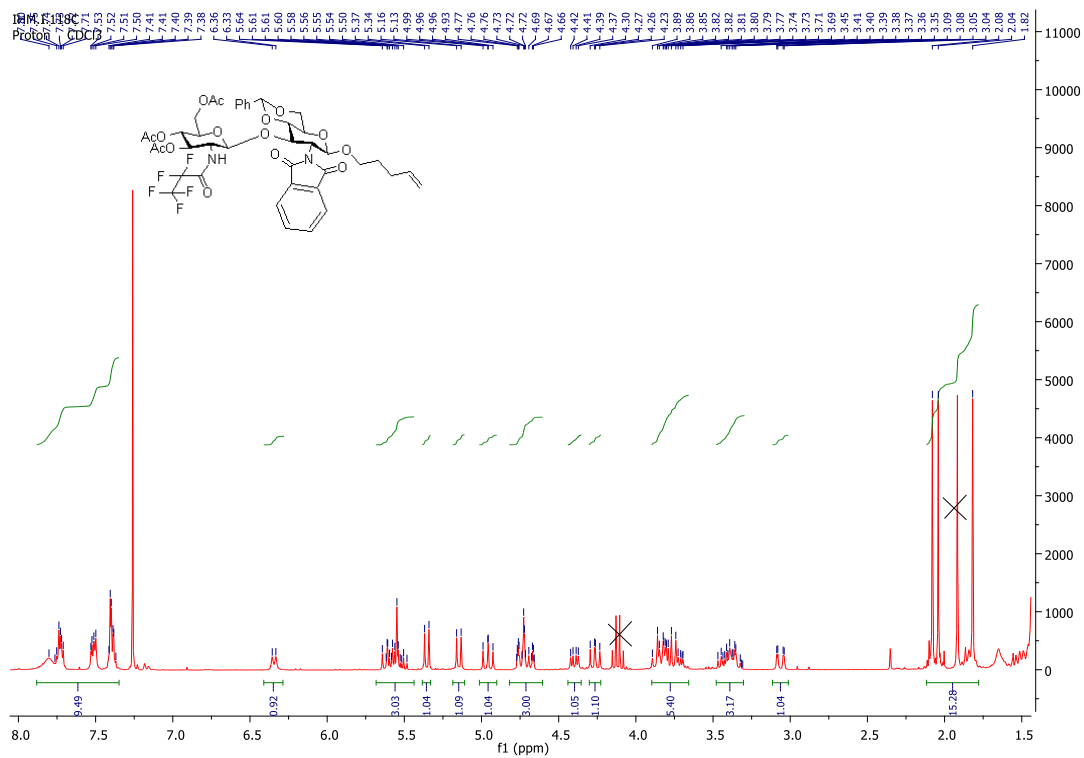

$^1\text{H}$  NMR (300 MHz) of Compound **135** in  $\text{CDCl}_3$

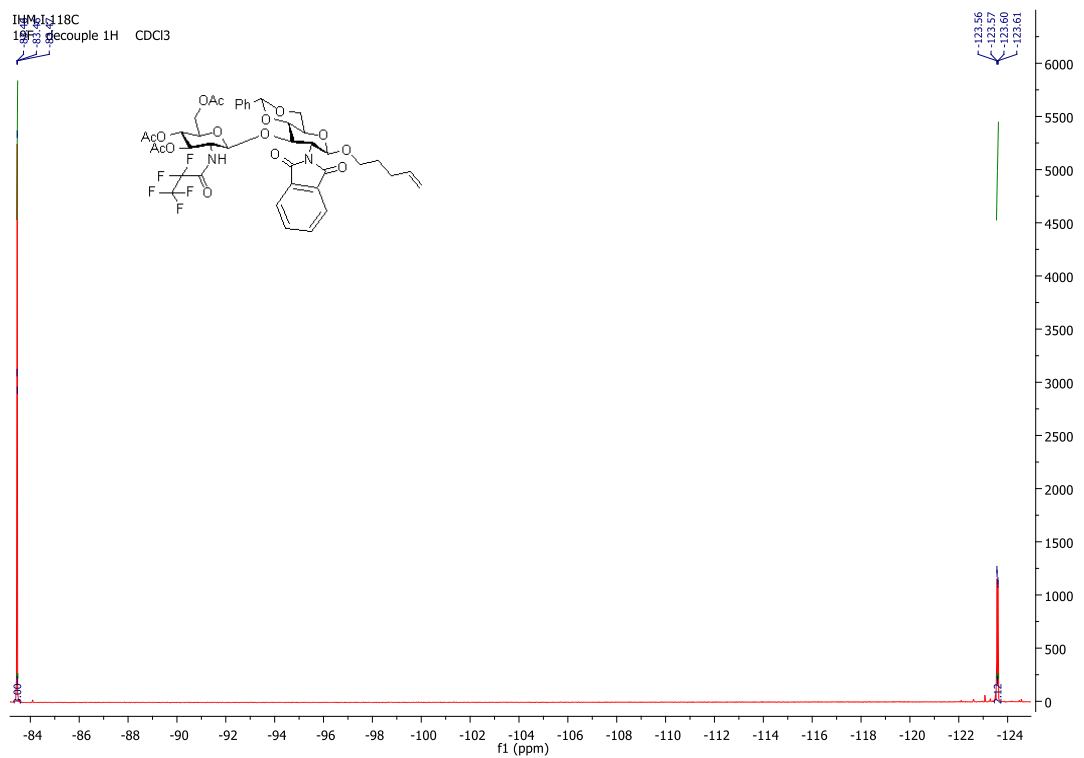

$^1\text{H}$ - $^1\text{H}$  COSY (282 MHz) of Compound **135** in  $\text{CDCl}_3$



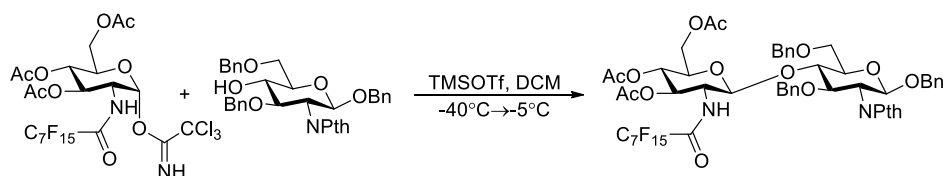

**Benzyl (3,4,6-tri-*O*-acetyl-2-deoxy-2-(8,8,8,7,7,6,6,5,5,4,4,3,3,2,2-pentadecafluorooctanamido)-β-D-glucopyranosyl)-(1→4)-3,6-*O*-benzyl-2-deoxy-2-phthalimido-β-D-glucopyranoside (136)**

A mixture of 3,4,6 tri-*O*-acetyl-2-deoxy-2-(8,8,8,7,7,6,6,5,5,4,4,3,3,2,2-heptafluorotriamido)-α-D-glucopyranose-1-*O*-trichloroacetimidate donor (128mg, 0.157mmol) and benzyl 4,6-dibenzyl-2-deoxy-phthalimido-β-D-glucopyranoside acceptor (110mg, 0.190mmol) was azeotroped with toluene (3mLx3) and dried at vacuum pump overnight. The mixture was then flushed with argon several times after being treated with flame activated molecular sieves (3Å), stir bar and septum. The reaction set-up was dissolved in anhydrous DCM (2mL) and stirred for 1h under argon at rt. The mixture was cooled down to -40 °C and stirred an additional 20 minutes before a solution of TMSOTf (0.2M in DCM, 75μL, 0.2mmol) was introduced to the reaction flask dropwise. After additional stirring for 20 minutes at this temperature was then warmed up to -5 °C over a period of 2h25mins before it was quenched with TEA (0.1mL) and warm to rt. The concentrated residue confirmed the presence of the desired product by mass spectral analysis and NMR in acetone D<sub>6</sub>. Preparative TLC on silica gel plate in Cyclohexane: EtOAc 70% yielded the following fractions.

R<sub>f</sub> = 0.75 in cyclohexane : ethylacetate; 70:30, 60mg, 42%.

**HRMS** (ESI, positive mode) *m/z*: C<sub>55</sub>H<sub>49</sub>F<sub>15</sub>NaN<sub>2</sub>O<sub>12</sub> [M+Na]<sup>+</sup>, calc. 1285.2781, found 1285.2786.

**<sup>1</sup>H NMR** (300 MHz, Acetone D<sub>6</sub>), δ (ppm): 8.82 (d, 1H, *J* = 9.5 Hz, N-H'), 7.93 – 6.79 (m, 19H, 3xArom, Ph), 5.39 (dd, 1H, *J* = 10.6, 9.3 Hz, H'-3), 5.19 (d, 1H, *J* = 8.4 Hz, H'-1), 5.17 (d, 1H, *J* = 8.4 Hz, H-1), 5.05 (dd, 1H, *J* = 10.1, 9.5 Hz, H'-4), 4.92 (d, 1H, *J* = 12.4 Hz, ½ CH<sub>2</sub>-Ph), 4.75 – 4.65 (AB, 2H, CH<sub>2</sub>-Ph), 4.67 (d, 1H, *J* = 12.5 Hz, ½ CH<sub>2</sub>-Ph), 4.52 (d, 1H, *J* = 12.5 Hz, ½ CH<sub>2</sub>-Ph), 4.51 (d, 1H, *J* = 12.4 Hz, ½ CH<sub>2</sub>-Ph), 4.34 – 3.92 (m, 8H, H-6, H'-6, H-4, H-3, H'-2, H-2, H'-6, H-6), 3.71 (ddd, 1H, *J* = 7.5, 4.9, 2.5 Hz, H'-5), 3.64 (m, 1H, H-5), 1.97 (s, 3H, OC(O)-CH<sub>3</sub>), 1.93 (s, 3H, OC(O)-CH<sub>3</sub>), 1.93 (s, 3H, OC(O)-CH<sub>3</sub>);

**<sup>19</sup>F NMR** (282 MHz, Acetone D<sub>6</sub>), δ (ppm): -81.56 (t, 3F, *J* = 10.2 Hz, CF<sub>3</sub>), -118.63 – -120.89 (dq, 2F, CF<sub>2</sub>), -121.70 – -122.15 (m, 2F, CF<sub>2</sub>), -122.24 – -122.67 (m, 2F, CF<sub>2</sub>), -122.66 – -123.44 (m, 4F, 2xCF<sub>2</sub>), -126.42 – -126.91 (m, 2F, CF<sub>2</sub>);

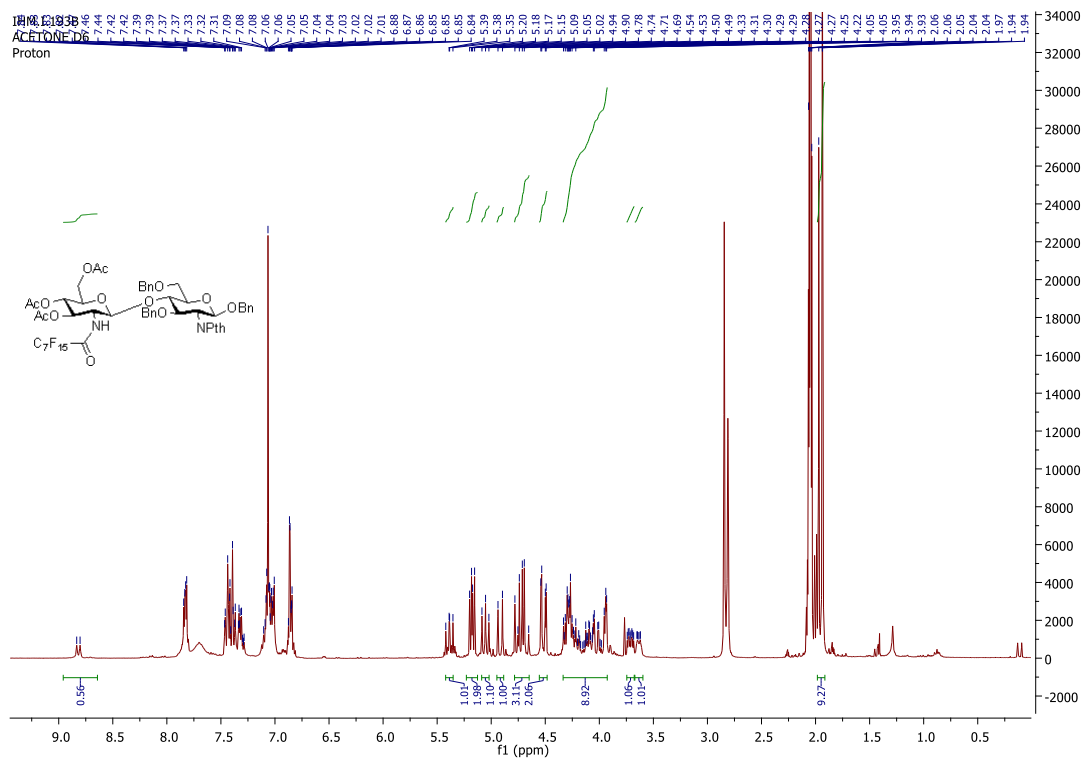

<sup>1</sup>H NMR (300 MHz) of Compound **136** in Acetone D<sub>6</sub>

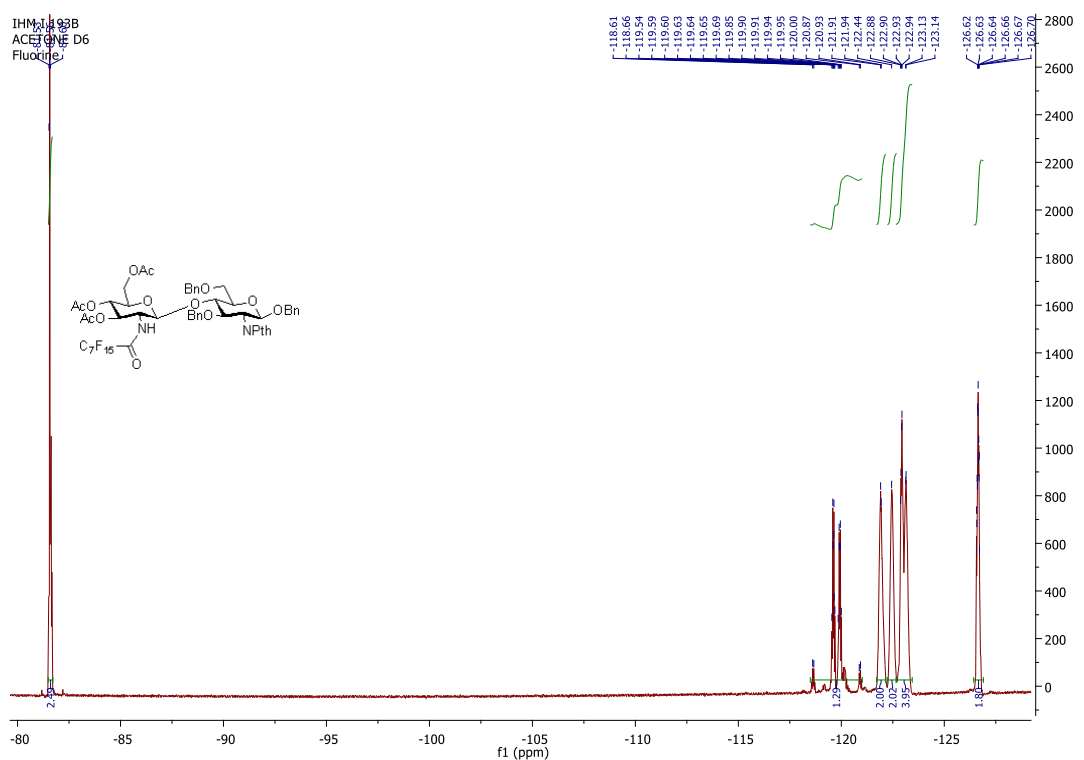

<sup>19</sup>F NMR (282 MHz) of Compound **136** in Acetone D<sub>6</sub>

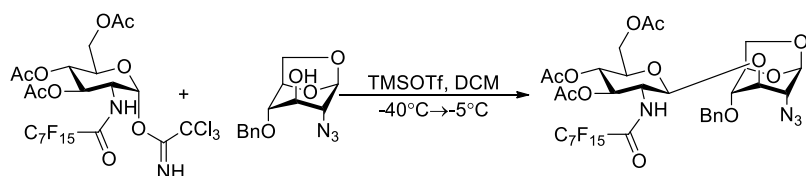

**3,4,6-tri-*O*-acetyl-2-deoxy-2-(8,8,8,7,7,6,6,5,5,4,4,3,3,2,2-pentadecafluorooctanamido)-β-D-glucopyranosyl-(1→3)-1,6-anhydro-2-azido-4-*O*-benzyl-2-deoxy-β-D-glucopyranose (137)**

A mixture of 3,4,6 tri-*O*-acetyl-2-deoxy-2-(8,8,8,7,7,6,6,5,5,4,4,3,3,2,2-heptafluorotriamido)-α-D-glucopyranose-1-*O*-trichloroacetimidate donor (105mg, 0.124mmol) and 1,6-anhydro-2-azido-4-*O*-benzyl-2-deoxy-β-D-glucopyranose acceptor (55mg, 0.198mmol) was coupled in a similar manner to the synthesis of compound (136) above. Purification of the crude reaction mixture on silica gel chromatography in Cyclohexane: ethyl acetate 60% as eluent yielded the desired compound as a white solid (61mg, 50%).

Rf = 0.8 in cyclohexane: ethylacetate; 1:1.

**<sup>1</sup>H NMR** (300 MHz, CDCl<sub>3</sub>), δ (ppm): 7.46 – 7.28 (m, 5H, Arom.), 6.81 (d, 1H, *J* = 9.3 Hz, N-H), 5.489 (br s, 1H, H-1), 5.26 (dd, 1H, *J* = 10.9, 9.2 Hz, H'-3), 5.08 (dd, 1H, *J* = 9.5, 9.2 Hz, H'-4), 4.24 (dd, 1H, *J* = 12.4, 4.6 Hz, H'-6), 4.79 – 4.48 (m, 4H, CH<sub>2</sub>-Ph, H'-1, d, *J* = 9.2 Hz, H-5), 4.19 – 3.95 (m, 3H, H'-2, H'-6, H-3), 3.90 (d, 1H, *J* = 7.5 Hz, H-6), 3.69 (ddd, 1H, *J* = 7.5, 4.9, 2.3 Hz, H'-5), 3.65 (dd, 1H, *J* = 7.5, 5.9 Hz, H-6), 3.49 (br s, 1H, H-4), 3.02 (s, 1H, H-2), 2.06 (s, 3H, OC(O)CH<sub>3</sub>), 2.05 (s, 3H, OC(O)CH<sub>3</sub>), 2.01 (s, 3H, OC(O)CH<sub>3</sub>);

**<sup>13</sup>C NMR** (75 MHz, CDCl<sub>3</sub>), δ (ppm): 171.77, 170.74, 169.39, 164.05, 137.44, 128.69, 128.20, 128.02, 100.09, 99.12, 75.15, 74.96, 74.29, 72.44, 71.62, 71.51, 68.44, 64.97, 61.98, 58.28, 54.33, 20.81, 20.67, 20.34;

**<sup>19</sup>F NMR** (282 MHz, CDCl<sub>3</sub>), δ (ppm): -80.72 (t, 3F, *J* = 9.9 Hz, CF<sub>3</sub>), -118.35 – -121.44 (dq, 2F, CF<sub>2</sub>), -121.40 – -121.72 (m, 2F, CF<sub>2</sub>), -121.81 – -122.14 (m, 2F, CF<sub>2</sub>), -122.38 – -122.87 (m, 4F, 2xCF<sub>2</sub>), -125.97 – -126.21 (m, 2F, CF<sub>2</sub>).

**HRMS** (ESI, positive mode) *m/z*: C<sub>33</sub>H<sub>31</sub>F<sub>15</sub>N<sub>4</sub>NaO<sub>12</sub> [M+Na]<sup>+</sup>, calc. 983.1593, found 983.1591.

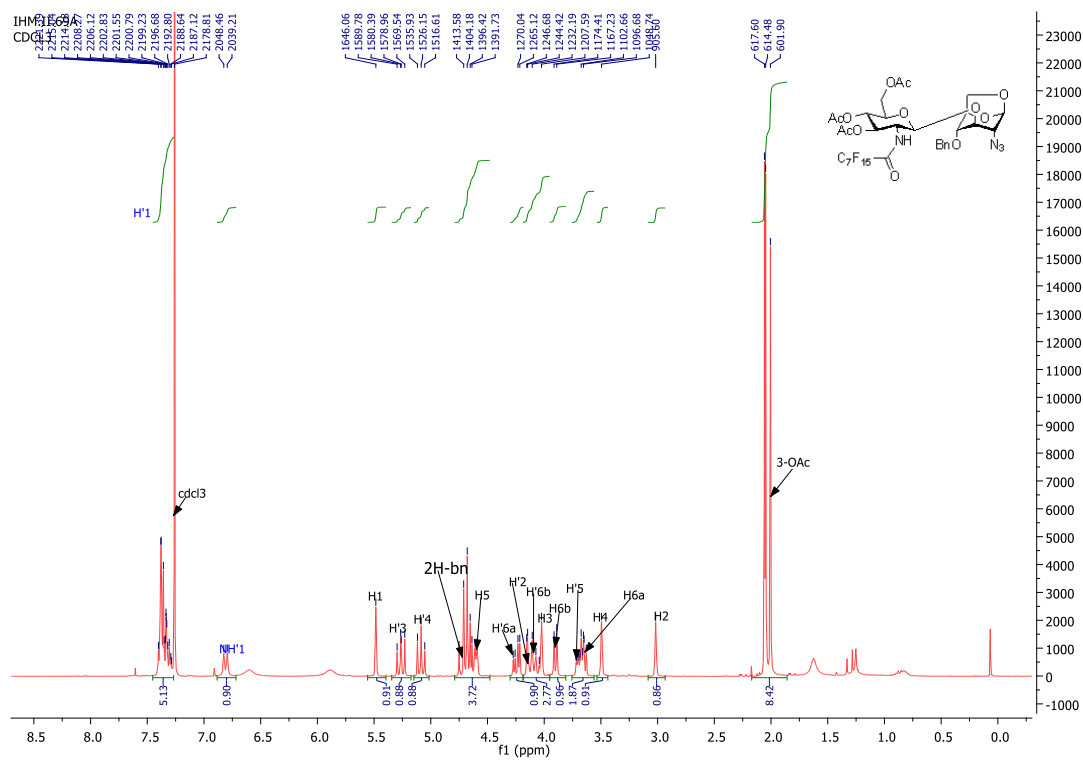

**<sup>1</sup>H NMR (300 MHz) of Compound 137 in CDCl<sub>3</sub>**

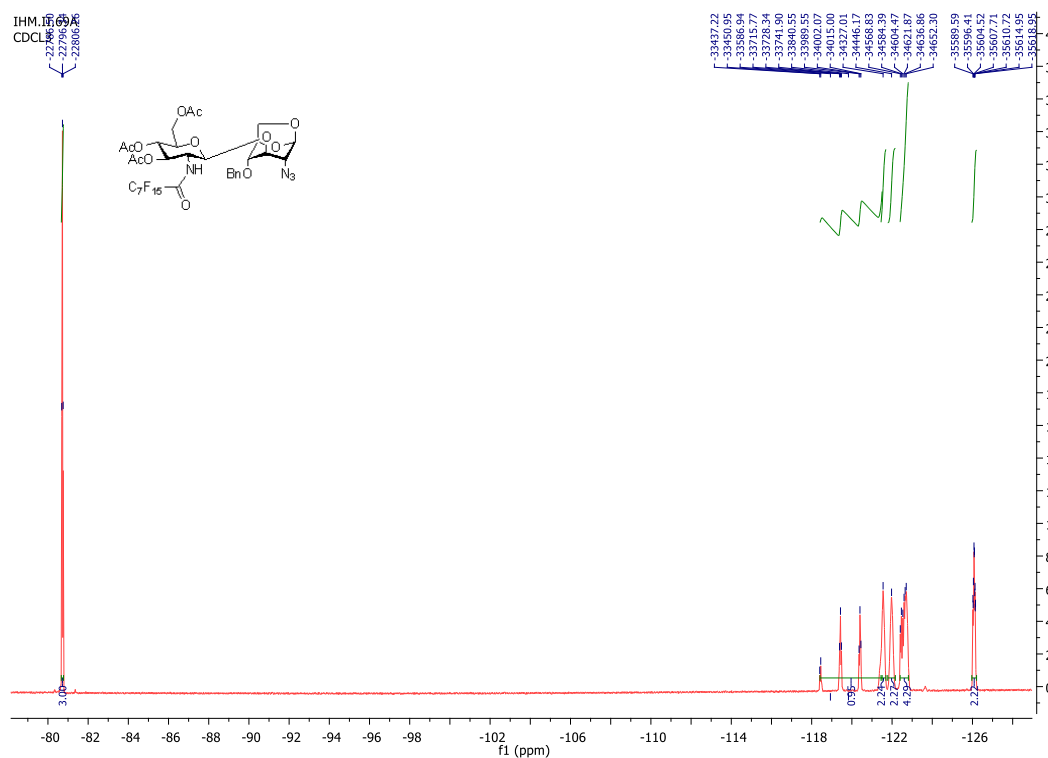

**<sup>19</sup>F NMR (282 MHz) of Compound 137 in CDCl<sub>3</sub>**

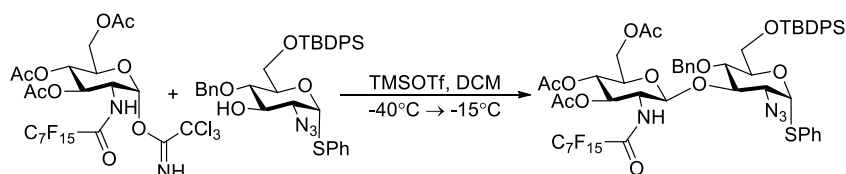

**Phenyl (3,4,6-tri-*O*-acetyl-2-deoxy-2-(8,8,8,7,7,6,6,5,5,4,4,3,3,2,2-pentadecafluorooctanamido)-β-D-glucopyranosyl)-(1→3)-2-azido-4-*O*-benzyl-6-*O*-tert-butyl-diphenylsilyl-2-deoxy-1-thio-α-D-glucopyranoside (138a)**

To the mixture of glycosyl donor (55mg, 0.065mmol, 1 equiv.) and glycosyl acceptor (85mg, 0.136mmol, 2.1 equiv.) was glycosylated as described in the general procedure in an anhydrous DCM (2.5mL) and TMSOTf (14μL of freshly prepared 0.5M solution in DCM, 0.0066mmol) dropwise. The crude reaction mixture was confirmed to contain the desired compound by LC-MS and Mass Spec. Purification on the reversed-phase column (40g) using Combiflash purification machine (MeOH: H<sub>2</sub>O; 75:25 → 100%) as eluent yielded the desired product 29mg, 34% as a white form.

R<sub>f</sub> = 0 in CH: EA 8:1

**<sup>1</sup>H NMR** (300 MHz, CDCl<sub>3</sub>), δ (ppm): 7.67 – 7.23 (m, 21H, 4xAr-H, N-H), 5.64 (d, 1H, *J* = 4.3 Hz, H-1), 5.33 (dd, 1H, *J* = 10.2, 9.9 Hz, H'-3), 5.14 (dd, 1H, *J* = 9.7, 9.6 Hz, H'-4), 5.07 (d, 1H, *J* = 10.7 Hz, ½ CH<sub>2</sub>-Ph), 4.89 (d, 1H, *J* = 8.4 Hz, H'-1), 4.54 (d, 1H, *J* = 10.7 Hz, ½ CH<sub>2</sub>-Ph), 4.39 – 4.23 (m, 3H, H'-2, H-4, H'-6), 4.05 (dd, 1H, *J* = 12.2, 1.5 Hz, H'-6), 3.97 – 3.75 (m, 5H, H-3, H-2, H-6, H-6, H'-5), 3.64 (ddd, 1H, *J* = 6.6, 4.2, 2.3 Hz, H-5), 2.10 (s, 3H, OC(O)CH<sub>3</sub>), 2.03 (s, 3H, OC(O)CH<sub>3</sub>), 1.99 (s, 3H, OC(O)CH<sub>3</sub>), 1.04 (s, 9H, *t*-Bu);

**<sup>19</sup>F NMR** (282 MHz, CDCl<sub>3</sub>), δ (ppm): -80.797 (t, 3F, *J* = 9.8, Hz, CF<sub>3</sub>), -118.65 – -120.94 (dq, 2F, CF<sub>2</sub>), -121.29 – -121.70 (m, 2F, CF<sub>2</sub>), -121.81 – -122.17 (m, 2F, CF<sub>2</sub>), -122.29 – -122.53 (m, 2F, CF<sub>2</sub>), -122.55 – -122.86 (m, 2F, CF<sub>2</sub>), -125.95 – -126.26 (m, 2F, CF<sub>2</sub>);

**HRMS** (ESI, positive mode) *m/z*: C<sub>55</sub>H<sub>55</sub>F<sub>15</sub>N<sub>4</sub>NaO<sub>12</sub>SSi [M+Na]<sup>+</sup>, calcd 1331.2959, found 1331.2952; [M+H]<sup>+</sup>, calcd 1309.3140, found 1309.3167.

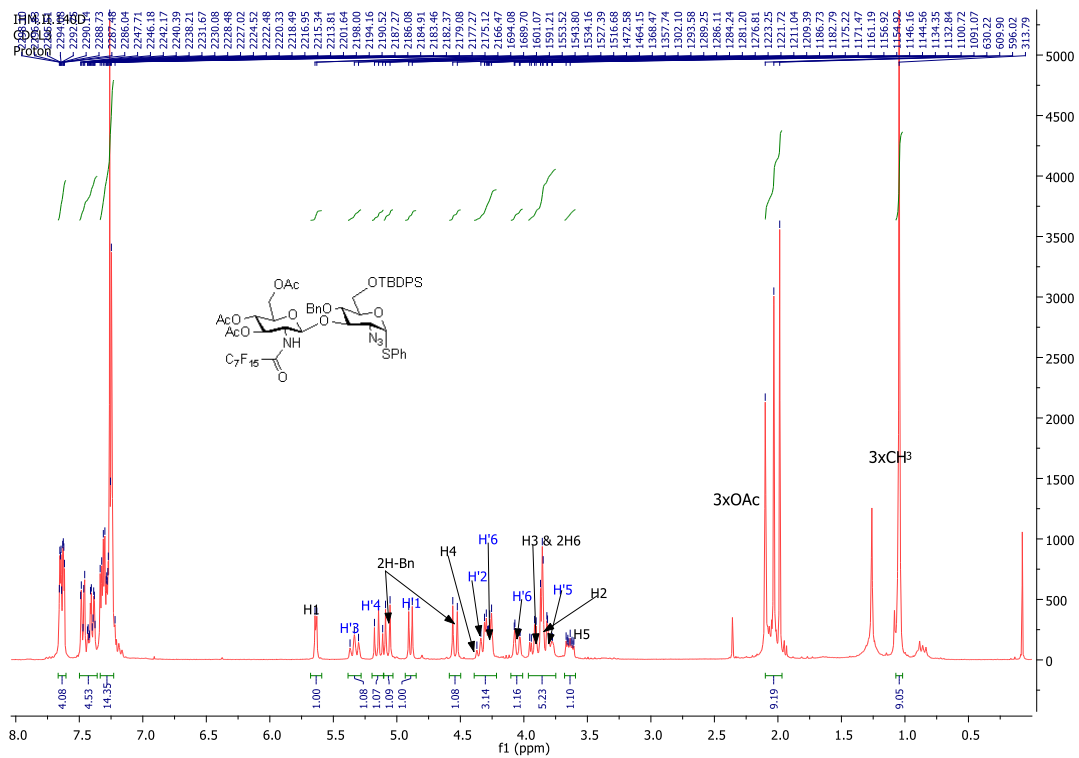

**<sup>1</sup>H NMR (300 MHz) of Compound 138a in CDCl<sub>3</sub>**

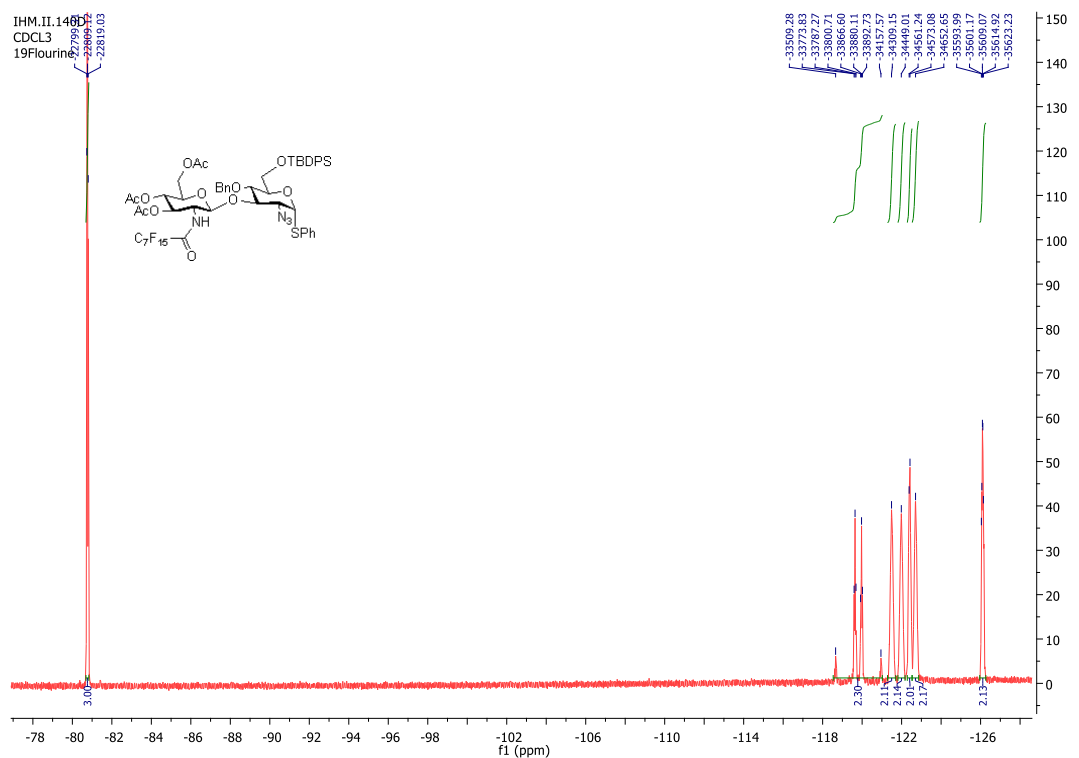

**<sup>19</sup>F NMR (282 MHz) of Compound 138a in CDCl<sub>3</sub>**

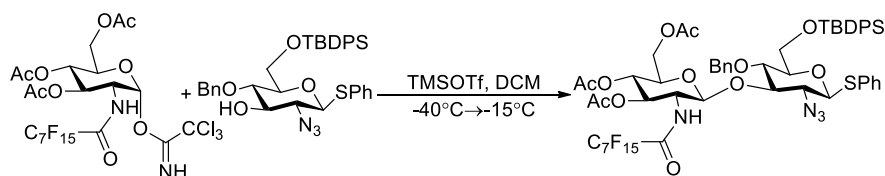

**Phenyl (3,4,6-tri-*O*-acetyl-2-deoxy-2-(8,8,8,7,7,6,6,5,5,4,4,3,3,2,2-pentadecafluorooctanamido)-β-D-glucopyranosyl)-(1→3)-2-azido-4-*O*-benzyl-6-*O*-tert-butyl-diphenylsilyl-2-deoxy-1-thio-β-D-glucopyranoside (138b)**

To the mixture of glycosyl donor (79mg, 0.093mmol, 1 equiv.) and glycosyl acceptor (61mg, 0.097mmol, 1 equiv.) was also glycosylated as described in the general procedure in an anhydrous DCM (2.5mL) and TMSOTf (19μL of freshly prepared 0.5M solution in DCM, 0.0094mmol) dropwise. The crude reaction mixture was confirmed to contain the desired compound by LC-MS and Mass Spec. Purification on the reversed-phase column (40g) using Combiflash purification machine (MeOH: H<sub>2</sub>O; 78:22 → 100%) as eluent yielded the desired product 23mg, 19% as a white form.

R<sub>f</sub> = 0.01 in CH: EA 8:1

**<sup>1</sup>H NMR** (300 MHz, CDCl<sub>3</sub>), δ (ppm): 7.79 – 7.14 (m, 20H, 4xArom-H), 6.93 (d, 1H, *J* = 9.3 Hz, N-H), 5.28 (dd, 1H, *J* = 11.2, 9.9 Hz, H'-3), 5.09 (dd, 1H, *J* = 9.8, 9.5 Hz, H'-4), 5.02 (d, 1H, *J* = 11.0 Hz, ½ CH<sub>2</sub>-Ph), 5.01 (d, 1H, *J* = 8.3 Hz, H'-1), 4.53 (d, 1H, *J* = 11.0 Hz, ½ CH<sub>2</sub>-Ph), 4.49 (d, 1H, *J* = 10.1 Hz, H-1), 4.27 – 4.14 (m, 2H, H'-2, H'-6), 3.95 (ddd, 1H, *J* = 14.0, 11.9, 1.7 Hz, H-6), 3.84 (dd, 1H, *J* = 11.4, 3.9 Hz, H-6), 3.72 (dd, 1H, *J* = 9.2, 9.0 Hz, H-3), 3.72 – 3.64 (m, 1H, H'-5), 3.60 (dd, 1H, *J* = 9.4, 8.9 Hz, H-4), 3.40 – 3.32 (m, 1H, H-5), 3.28 (dd, 1H, *J* = 9.9, 9.4 Hz, H-2), 2.02 (s, 3H, OC(O)CH<sub>3</sub>), 2.00 (s, 3H, OC(O)CH<sub>3</sub>), 1.93 (s, 3H, OC(O)CH<sub>3</sub>), 1.08 (s, 9H, *t*-Bu);

**<sup>19</sup>F NMR** (282 MHz, CDCl<sub>3</sub>), δ (ppm): -80.72 (t, 3F, *J* = 10.1, Hz, CF<sub>3</sub>), -118.21 – -120.59 (dq, 2F, CF<sub>2</sub>), -121.27 – -121.60 (m, 2F, CF<sub>2</sub>), -121.77 – -122.09 (m, 2F, CF<sub>2</sub>), -122.18 – -122.43 (m, 2F, CF<sub>2</sub>), -122.49 – -122.81 (m, 2F, CF<sub>2</sub>), -125.93 – -126.20 (m, 2F, CF<sub>2</sub>);

**HRMS** (ESI, positive mode) *m/z*: C<sub>55</sub>H<sub>55</sub>F<sub>15</sub>N<sub>4</sub>NaO<sub>12</sub>SSi [M+Na]<sup>+</sup>, calcd 1331.2959, found 1331.2908; [M+H]<sup>+</sup>, calcd 1309.3140, found 1309.3105.

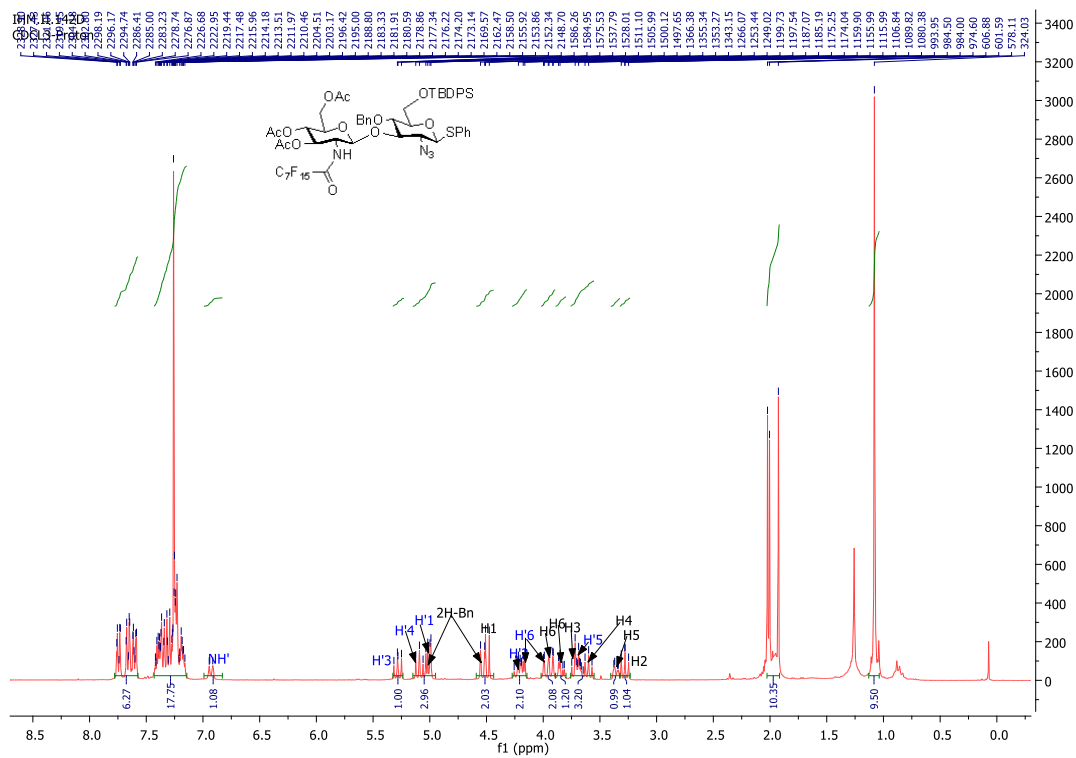

**<sup>1</sup>H NMR (300 MHz) of Compound 138b in CDCl<sub>3</sub>**

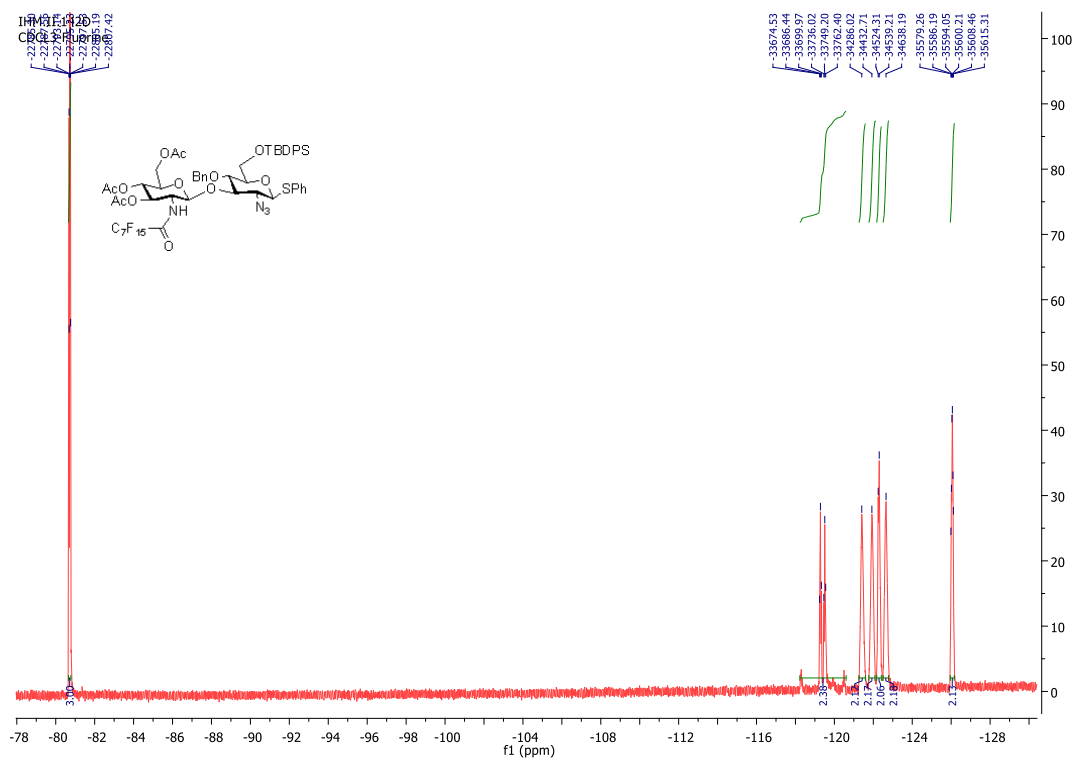

**<sup>19</sup>F NMR (282 MHz) of Compound 138b in CDCl<sub>3</sub>**



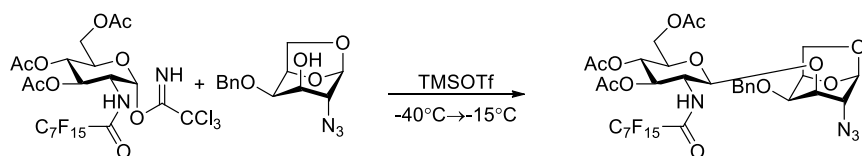

**3,4,6-tri-*O*-acetyl-2-deoxy-2-(8,8,8,7,7,6,6,5,5,4,4,3,3,2,2-pentadecafluorooctanamido)-β-D-glucopyranosyl-(1→3)-1,6-anhydro-2-azido-4-*O*-benzyl-2-deoxy-β-D-galactopyranose (139)**

A mixture of 3,4,6 tri-*O*-acetyl-2-deoxy-2-(8,8,8,7,7,6,6,5,5,4,4,3,3,2,2-heptafluorotriamido)-α-D-glucopyranose-1-*O*-trichloroacetimidate donor (73mg, 0.0863mmol) and 1,6-anhydro-2-azido-4-*O*-benzyl-2-deoxy-β-D-galactopyranose acceptor (137mg, 0.494mmol) was coupled in a similar manner to the synthesis of compound (136). Purification on the reversed-phase column (40g) using Combiflash purification machine (MeOH: H<sub>2</sub>O; 78:22 → 100%) as eluent yielded the desired compound as a white solid (35mg, 40%).

R<sub>f</sub> = 0.08 in cyclohexane: ethylacetate, 8:1.

**HRMS** (ESI, positive mode) *m/z*: C<sub>33</sub>H<sub>31</sub>F<sub>15</sub>N<sub>4</sub>NaO<sub>12</sub> [M+Na]<sup>+</sup>, calc. 983.1593, found 983.1591.

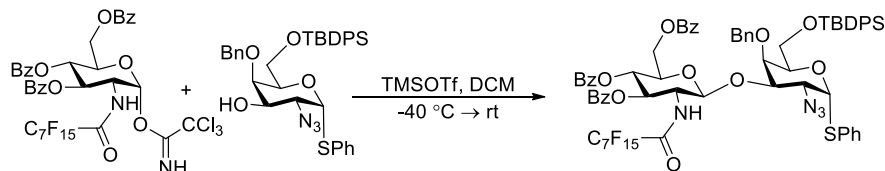

**Phenyl (3,4,6-tri-*O*-benzoyl-2-deoxy-2-(8,8,8,7,7,6,6,5,5,4,4,3,3,2,2-pentadecafluorooctanamido)-β-D-glucopyranosyl)-(1→3)-2-azido-4-*O*-benzyl-6-*O*-tert-butyl-diphenylsilyl-2-deoxy-1-thio-α-D-galactopyranoside (140)**

To the mixture of glycosyl donor (105mg, 0.102mmol, 1 equiv.) and glycosyl acceptor (90mg, 0.144mmol, 1.4 equiv.) was glycosylated as described in the general procedure in an anhydrous DCM (2mL) and TMSOTf (20μL of freshly prepared 0.5M solution in DCM, 0.01mmol) dropwise, run over a period of 5hrs. The crude reaction mixture was confirmed to contain the desired compound by Mass Spectral analysis and purification of the crude residue on the preparative silica gel plate (20x10) cm in cyclohexane: ethylacetate; 8:2 as eluent afforded the desired product 31mg, 20% as a pale-yellow form.

R<sub>f</sub> = 0.5 in cyclohexane: ethylacetate, 8:2.

**HRMS** (ESI, positive mode) *m/z*: C<sub>70</sub>H<sub>61</sub>F<sub>15</sub>N<sub>4</sub>NaO<sub>12</sub>SSi [M+Na]<sup>+</sup>, calcd. 1517.3429, found 1517.3472; [M+H]<sup>+</sup>, calcd. 1495.3609, found 1495.3647.

[α]<sub>D</sub><sup>27</sup> = +22° (C=21mg/mL in CHCl<sub>3</sub>)

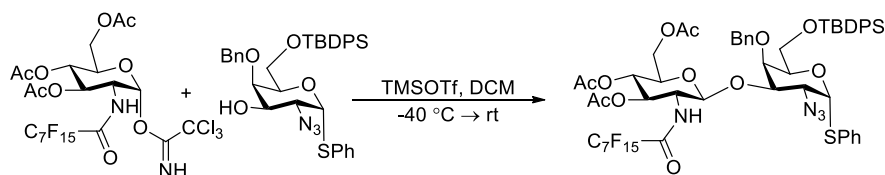

**Phenyl (3,4,6-tri-*O*-acetyl-2-deoxy-2-(8,8,8,7,7,6,6,5,5,4,4,3,3,2,2-pentadecafluorooctanamido)- $\beta$ -D-glucopyranosyl)-(1 $\rightarrow$ 3)-2-azido-4-*O*-benzyl-6-*O*-tert-butyl-diphenylsilyl-2-deoxy-1-thio- $\alpha$ -D-galactopyranoside (141a)**

To the mixture of glycosyl donor (72mg, 0.085mmol, 1 equiv.) and glycosyl acceptor (78mg, 0.125mmol, 1.5 equiv.) was glycosylated as described in the general procedure in an anhydrous DCM (1mL) and TMSOTf (17 $\mu$ L of freshly prepared 0.5M solution in DCM, 0.0085mmol) dropwise. The crude reaction mixture was confirmed to contain the desired compound by LC-MS and Mass Spec. Purification of the crude residue on the reversed-phase column (40g) using Combiflash purification machine (MeOH: H<sub>2</sub>O; 80:20  $\rightarrow$  100%) as eluent afforded the desired product 37mg, 33% as a white form.

**<sup>1</sup>H NMR** (300 MHz, CDCl<sub>3</sub>),  $\delta$  (ppm): 7.66 – 7.12 (m, 20H, 4xArom-H), 6.99 (d, 1H,  $J$  = 9.5 Hz, N-H), 5.57 (d, 1H,  $J$  = 5.5 Hz, H-1), 5.36 (dd, 1H,  $J$  = 10.6, 9.4 Hz, H'-3), 5.17 (dd, 1H,  $J$  = 9.7, 9.5 Hz, H'-4), 4.93 (d, 1H,  $J$  = 11.1 Hz,  $\frac{1}{2}$  CH<sub>2</sub>-Ph), 4.87 (d, 1H,  $J$  = 8.3 Hz, H'-1), 4.57 (d, 1H,  $J$  = 11.1 Hz,  $\frac{1}{2}$  CH<sub>2</sub>-Ph), 4.42 – 4.08 (m, 6H, H'-6, H-5, H-2, H'-2, H-3, H'-6), 3.89 – 3.63 (m, 4H, H'-5, H-4, 2H-6), 2.10 (s, 3H, OC(O)CH<sub>3</sub>), 2.06 (s, 3H, OC(O)CH<sub>3</sub>), 2.02 (s, 3H, OC(O)CH<sub>3</sub>), 1.04 (s, 9H, *t*-Bu);

**<sup>13</sup>C NMR** (126 MHz, CDCl<sub>3</sub>)  $\delta$  (ppm): 166.84, 166.73, 166.08, 166.03, 165.25, 138.54, 138.25, 135.77, 135.68, 133.84, 133.80, 133.78, 133.48, 133.42, 133.31, 133.28, 133.23, 133.16, 132.97, 132.39, 132.00, 129.99, 129.95, 129.93, 129.91, 129.88, 129.81, 129.77, 129.50, 129.48, 129.21, 129.00, 128.70, 128.66, 128.64, 128.60, 128.51, 128.34, 128.23, 128.17, 128.10, 128.02, 127.89, 127.87, 127.85, 127.76, 127.44, 101.98, 101.74, 87.74, 87.13, 82.66, 79.33, 78.98, 77.36, 76.49, 75.64, 75.20, 74.84, 72.69, 72.51, 72.30, 72.18, 71.80, 69.41, 69.28, 62.71, 62.69, 62.65, 61.63, 60.47, 55.60, 55.36, 29.85, 26.93, 19.24.

**<sup>19</sup>F NMR** (282 MHz, CDCl<sub>3</sub>),  $\delta$  (ppm): -80.76 (t, 3F,  $J$  = 10.0, 0.0 Hz, CF<sub>3</sub>), -119.84 (dt, 2F,  $J$  = 100.8, 13.2 Hz, CF<sub>2</sub>), -121.35 – -121.70 (m, 2F, CF<sub>2</sub>), -121.79 – -122.13 (m, 2F, CF<sub>2</sub>), -122.21 – -122.50 (m, 2F, CF<sub>2</sub>), -122.56 – -122.86 (m, 2F, CF<sub>2</sub>), -125.97 – -126.20 (m, 2F, CF<sub>2</sub>).

**HRMS** (ESI, positive mode)  $m/z$ : C<sub>55</sub>H<sub>55</sub>F<sub>15</sub>N<sub>4</sub>NaO<sub>12</sub>SSi [M+Na]<sup>+</sup>, calcd 1331.2982, found 1331.2959; [M+H]<sup>+</sup>, calcd 1309.3140, found 1309.3080.



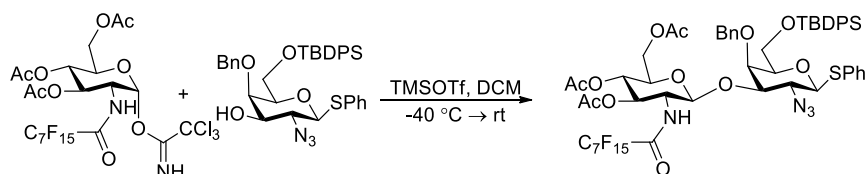

**Phenyl (3,4,6-tri-*O*-acetyl-2-deoxy-2-(8,8,8,7,7,6,6,5,5,4,4,3,3,2,2-pentadecafluorooctanamido)-β-D-glucopyranosyl)-(1→3)-2-azido-4-*O*-benzyl-6-*O*-tert-butyl-diphenylsilyl-2-deoxy-1-thio-β-D-galactopyranoside (141b)**

To the mixture of glycosyl donor (389mg, 0.46mmol, 1 equiv.) and glycosyl acceptor (445mg, 0.711mmol, 1.5 equiv.) was glycosylated as described in the general procedure in an anhydrous DCM (4mL) and TMSOTf (8μL of freshly opened, 0.046mmol, 0.1 equiv.) dropwise. The crude reaction mixture was confirmed to contain the desired compound by LC-MS and Mass Spec. Purification of the crude residue on the reversed-phase column (40g) using Combiflash purification machine (MeOH: H<sub>2</sub>O; 80:20 → 100%) as eluent afforded the desired product 425mg, 71% as a colorless form.

R<sub>f</sub> = 0.65 in cyclohexane: ethylacetate, 7:3.

**<sup>1</sup>H NMR** (500 MHz, CDCl<sub>3</sub>) δ (ppm): 7.69 – 7.09 (m, 21H, 4xArom-H, N-H'), 5.45 (dd, *J* = 10.7, 9.5 Hz, 1H, H'-3), 5.12 (t, *J* = 9.7 Hz, 1H, H'-4), 4.96 – 4.88 (m, 2H, ½ CH<sub>2</sub>-Ph, H'-1), 4.55 (d, *J* = 11.3 Hz, 1H, ½ CH<sub>2</sub>-Ph), 4.40 (d, *J* = 9.9 Hz, 1H, H-1), 4.32 (dd, *J* = 12.4, 4.5 Hz, 1H, H'-6), 4.23 – 4.13 (m, 2H, H'-2, H'-6), 4.02 (d, *J* = 2.3 Hz, 1H, H-4), 3.88 – 3.74 (m, 4H, H'-5, H-2, 2H-6), 3.56 – 3.48 (m, 2H, H-3, H-5), 2.05 (s, 3H, OC(O)CH<sub>3</sub>), 2.04 (s, 3H, OC(O)CH<sub>3</sub>), 2.01 (s, 3H, OC(O)CH<sub>3</sub>), 1.05 (s, 9H, *t*-Bu).

**<sup>13</sup>C NMR** (126 MHz, CDCl<sub>3</sub>) δ (ppm): 171.55, 170.56, 169.40, 138.54, 135.70, 135.64, 133.22, 133.13, 132.42, 131.84, 129.98, 129.95, 129.17, 128.99, 128.35, 128.23, 128.08, 127.96, 127.92, 127.90, 127.55, 125.43, 101.29, 87.15, 82.28, 79.20, 77.98, 74.85, 72.16, 71.66, 68.85, 62.43, 61.95, 61.78, 54.90, 29.83, 26.94, 20.76, 20.67, 20.24, 19.26.

**<sup>19</sup>F NMR** (470 MHz, CDCl<sub>3</sub>) δ (ppm): -80.79 (t, 3F, *J* = 0.0, 0.0 Hz, CF<sub>3</sub>), -119 – -120 (m, 2F, CF<sub>2</sub>), -121.42 – -121.74 (m, 2F, CF<sub>2</sub>), -121.90 – -122.16 (m, 2F, CF<sub>2</sub>), -122.31 – -122.54 (m, 2F, CF<sub>2</sub>), -122.61 – -122.90 (m, 2F, CF<sub>2</sub>), -126.02 – -126.27 (m, 2F, CF<sub>2</sub>);

**HRMS** (ESI, positive mode) *m/z*: C<sub>55</sub>H<sub>55</sub>F<sub>15</sub>N<sub>4</sub>NaO<sub>12</sub>SSi [M+Na]<sup>+</sup>, calcd 1331.2959, found 1331.2960; [M+H]<sup>+</sup>, calcd 1309.3140, found 1309.3135.

[α]<sub>D</sub><sup>27</sup> = +16° (C=9mg/mL in CHCl<sub>3</sub>)



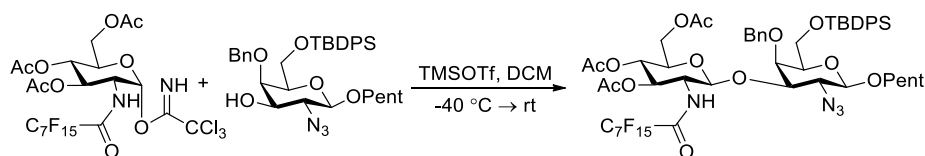

**Pentenyl (3,4,6-tri-*O*-acetyl-2-deoxy-2-(8,8,8,7,7,6,6,5,5,4,4,3,3,2,2-pentadecafluorooctanamido)- $\beta$ -D-glucopyranosyl)-(1 $\rightarrow$ 3)-2-azido-4-*O*-benzyl-6-*O*-tert-butyl-diphenylsilyl-2-deoxy- $\beta$ -D-galactopyranoside (142)**

To the mixture of glycosyl donor (95mg, 0.112mmol, 1 equiv.) and glycosyl acceptor (101mg, 0.168mmol, 1.5 equiv.) was glycosylated as described in the general procedure in an anhydrous DCM (3mL) and TMSOTf (2 $\mu$ L of freshly opened, 0.0112mmol, 0.1 equiv.) dropwise. The crude reaction mixture was confirmed to contain the desired compound by Mass Spectral data and purification was performed on the reversed-phase column (40g) using Interchim purification machine (MeOH: H<sub>2</sub>O; 75:25  $\rightarrow$  100%) as eluent afforded the desired product 129mg, 90% as a colorless form.

R<sub>f</sub> = 0.5 in cyclohexane: ethylacetate, 7:3.

**HRMS** (ESI, positive mode) m/z: C<sub>54</sub>H<sub>59</sub>F<sub>15</sub>N<sub>4</sub>NaO<sub>13</sub>Si [M+Na]<sup>+</sup>, calcd. 1307.3501, found 1307.3501.

**<sup>1</sup>H NMR** (400 MHz, CDCl<sub>3</sub>)  $\delta$  (ppm): 7.68 – 7.22 (m, 16H, 3xArom-H, N-H'), 5.80 (ddt, *J* = 16.9, 10.2, 6.7 Hz, 1H, CH<sub>2</sub>CH=CH<sub>2</sub>), 5.45 (dd, *J* = 10.7, 9.5 Hz, 1H, H'-3), 5.15 (t, *J* = 9.7 Hz, 1H, H'-4), 5.06 – 4.86 (m, 4H, CH=CH<sub>2</sub>, H'-1, ½ CH<sub>2</sub>-Ph), 4.58 (d, *J* = 11.2 Hz, 1H, ½ CH<sub>2</sub>-Ph), 4.34 (dd, *J* = 12.4, 4.5 Hz, 1H, H'-6), 4.28 – 4.19 (m, 3H, H'-6, H-1, H'-2), 3.95 – 3.72 (m, 6H, H-3, 2H-6, H-2, H-4, H'-5), 3.52 – 3.38 (m, 3H, H-5, OCH<sub>2</sub>-CH<sub>2</sub>), 2.20 – 2.10 (m, 2H, CH<sub>2</sub>-CH=CH<sub>2</sub>), 2.09 (s, 3H, OC(O)CH<sub>3</sub>), 2.06 (s, 3H, OC(O)CH<sub>3</sub>), 2.04 (s, 3H, OC(O)CH<sub>3</sub>), 1.78 – 1.64 (m, 2H, OCH<sub>2</sub>-CH<sub>2</sub>-CH=CH<sub>2</sub>), 1.07 (s, 9H, *t*-Bu).

**<sup>19</sup>F NMR** (376 MHz, CDCl<sub>3</sub>)  $\delta$  (ppm): -80.84 (t, *J* = 9.9 Hz, 3F), -119.98 (dt, *J* = 25.9, 12.6 Hz, 2F), -121.21 – -121.75 (m, 2F), -121.84 – -122.21 (m, 2F), -122.33 – -123.21 (m, 4F), -125.94 – -126.37 (m, 2F).

**<sup>13</sup>C NMR** (101 MHz, CDCl<sub>3</sub>)  $\delta$  (ppm): 171.52, 170.58, 169.33, 157.98 (t, *J* = 26.7 Hz, C-amide), 138.35, 138.09, 135.65, 135.62, 133.33, 129.91, 128.62, 128.22, 127.87, 127.84, 127.67, 114.97, 102.71, 101.53, 80.56, 75.30, 75.09, 74.95, 72.10, 71.84, 69.29, 68.83, 63.17, 62.56, 62.02, 54.75, 53.54, 30.14, 28.80, 26.89, 20.73, 20.64, 20.25, 19.26.

[ $\alpha$ ]<sub>D</sub><sup>27</sup> = -11° (C=10mg/mL in CHCl<sub>3</sub>)

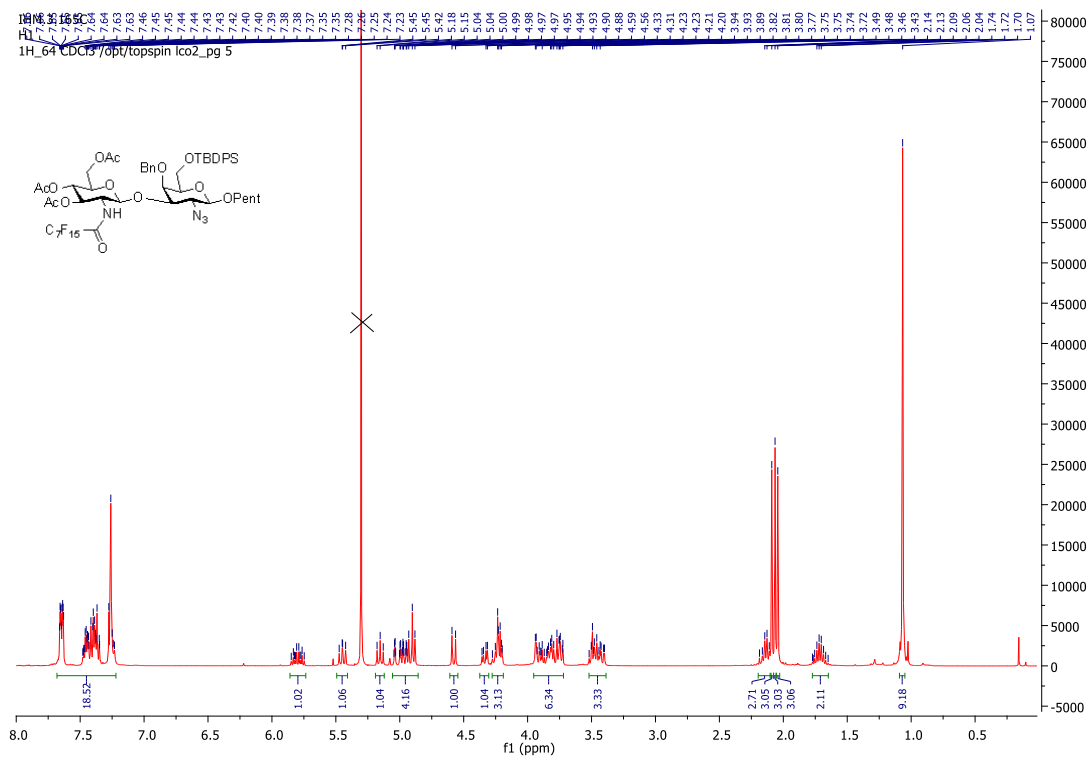

**<sup>1</sup>H NMR (400 MHz) of Compound 142 in CDCl<sub>3</sub>**

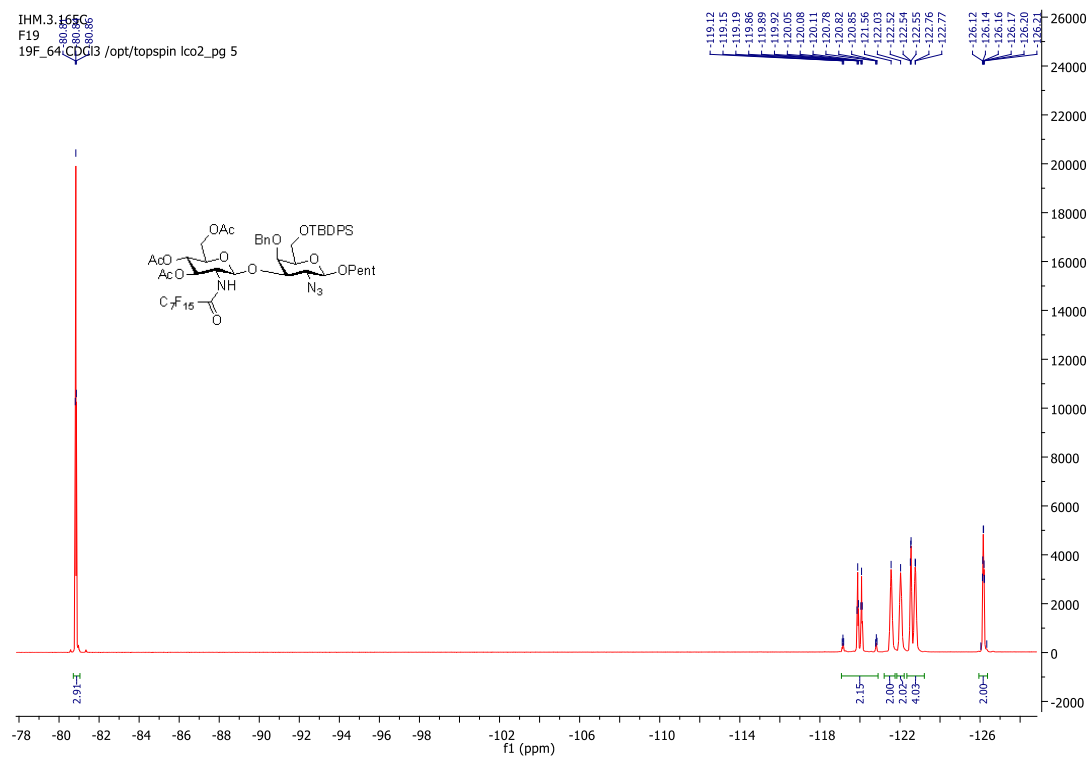

**<sup>19</sup>F NMR (376 MHz) of Compound 142 in CDCl<sub>3</sub>**

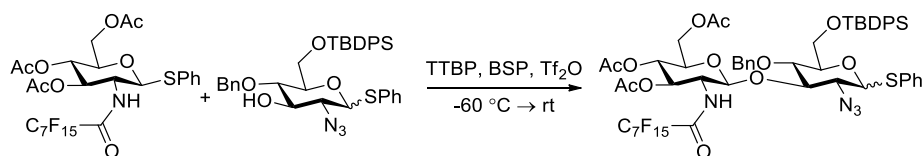

**Phenyl (3,4,6-tri-*O*-acetyl-2-deoxy-2-(8,8,8,7,7,6,6,5,5,4,4,3,3,2,2-pentadecafluorooctanamido)-β-D-glucopyranosyl)-(1→3)-2-azido-4-*O*-benzyl-6-*O*-tert-butyl-diphenylsilyl-2-deoxy-1-thio-α/β-D-glucopyranoside (138)**

To the suspension of glycosyl donor (0.095 mmol, 75mg) azeotroped with toluene, 1-(phenylsulfinyl) piperidene BSP (0.396 mmol, 83mg, 4.2 equiv.), 2,4,6-tri-tert-butylpyrimidine TTBP (0.190 mmol, 47mg, 2 equiv.) and flame activated molecular sieves (4Å-powdered form) was thoroughly dried under vacuum pump for 48 hrs. Stir bar and septum was equipped to this set-up and exposed to argon-vacuum several times, dissolved in dry DCM (1.5 mL) and stirred at room temperature under argon balloon for 30 minutes. Reaction temperature was cooled down to -60 °C and stirred additional 30 minutes, treated with Tf<sub>2</sub>O (0.114 mmol, 19μL, 1.2 equiv.), stirred for 5 minutes and then added a solution of glycosyl acceptor (0.141 mmol, 88mg, 1.5 equiv. in dry DCM; 2mL) gently and further stirred for 2 minutes all at -60 °C and finally warmed to rt (3 hrs). the reaction mixture was quenched with sat aq. NaHCO<sub>3</sub> (2mL), filtered and extracted through celite plug. The filtrate was then washed NaHCO<sub>3</sub> and brine (50mL each) and back extracted with DCM in each case. The combined organic phase was dried over anhydrous Na<sub>2</sub>SO<sub>4</sub>, filtered and the solvent was removed with rotary evaporator at reduced pressure. Concentrated residue was purified by the usual RP C-18 column 40g and additional preparative TLC on silica gel plate in cyclohexane: ethylacetate 8:2 to afford titled compound 30mg, 24%.

The characteristic analysis results are similar to the same compounds prepared by trichloroacetimidate donor above.

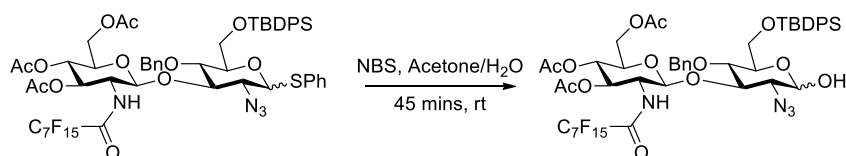

**(3,4,6-tri-*O*-acetyl-2-deoxy-2-(8,8,8,7,7,6,6,5,5,4,4,3,3,2,2-pentadecafluorooctanamido)-β-D-glucopyranosyl)-(1→3)-2-azido-4-*O*-benzyl-6-*O*-tert-butyl-diphenylsilyl-2-deoxy-1-α/β-D-glucopyranose (143)**

To the solution of thioglycoside disaccharide (0.0764mmol, 100mg; azeotroped with toluene) in acetone (2mL) was added Acetone/water (2mL, 9:1; v/v) followed by NBS (0.197mmol, 35mg, 2.6 equiv.) in one portion and stirred at rt over argon atmosphere for 45 minutes. Analytical TLC confirmed complete reaction and therefore quenched the reaction with NaHCO<sub>3</sub> (120mg) and stirred for 10 minutes. The solvent was evaporated at vacuo, diluted the residue with EtOAc (80mL). the organic layer was washed with distilled water until pH neutral, then brine (50mL), dried over Na<sub>2</sub>SO<sub>4</sub>, filtered and concentrated at vacuo under reduced pressure. The crude reaction mixture was purified on silica gel column chromatography in cyclohexane: ethylacetate 70:30 → 100% ethylacetate, affording a colorless oil 45mg, 48% after solvent evaporation.



R<sub>f</sub> = 0.61 in cyclohexane: ethylacetate 7:3

LRMS (ESI, positive mode) m/z: C<sub>49</sub>H<sub>51</sub>F<sub>15</sub>NaN<sub>4</sub>O<sub>13</sub>Si [M+Na]<sup>+</sup>, calcd. 1239.3, found 1239.3.

<sup>19</sup>F NMR (282 MHz, CDCl<sub>3</sub>) δ -80.78 (t, J = 9.9 Hz), -118.48 – -121.09 (ABX, m, 2F), -121.32 – -121.76 (m, 2F), -121.80 – -122.22 (m, 2F), -122.29 – -122.58 (m, 2F), -122.59 – -122.94 (m, 2F), -125.90 – -126.41 (m, 2F).

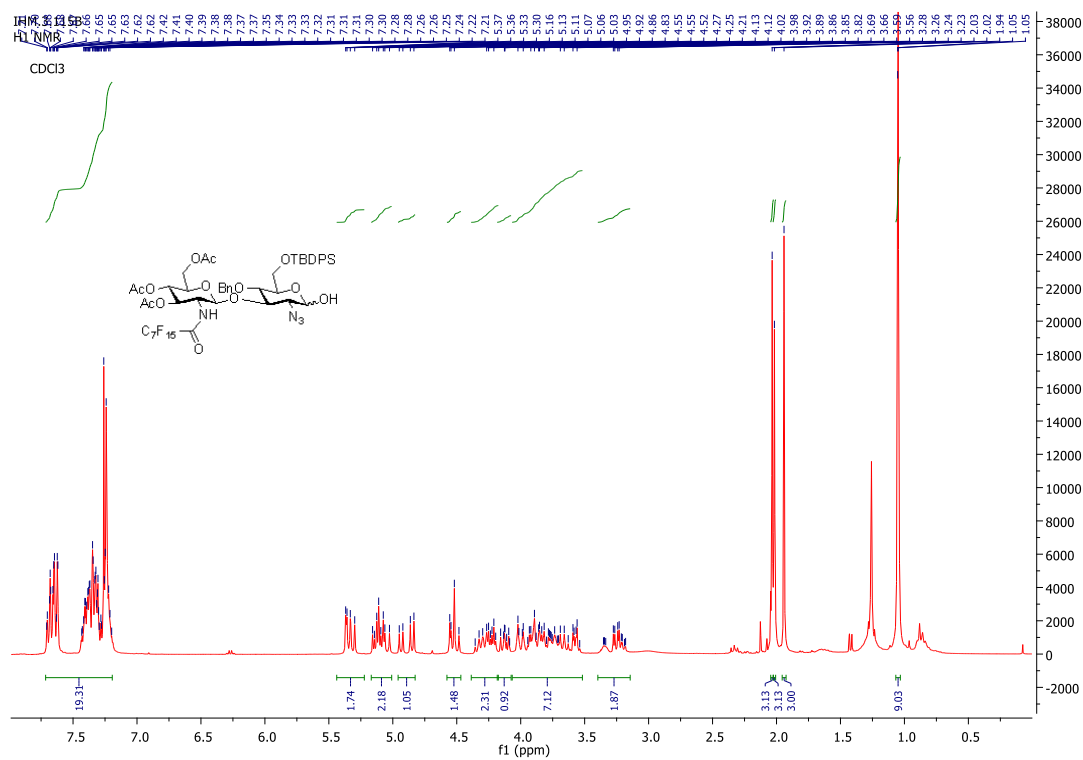

<sup>1</sup>H NMR (300 MHz) of Compound 143 in CDCl<sub>3</sub>

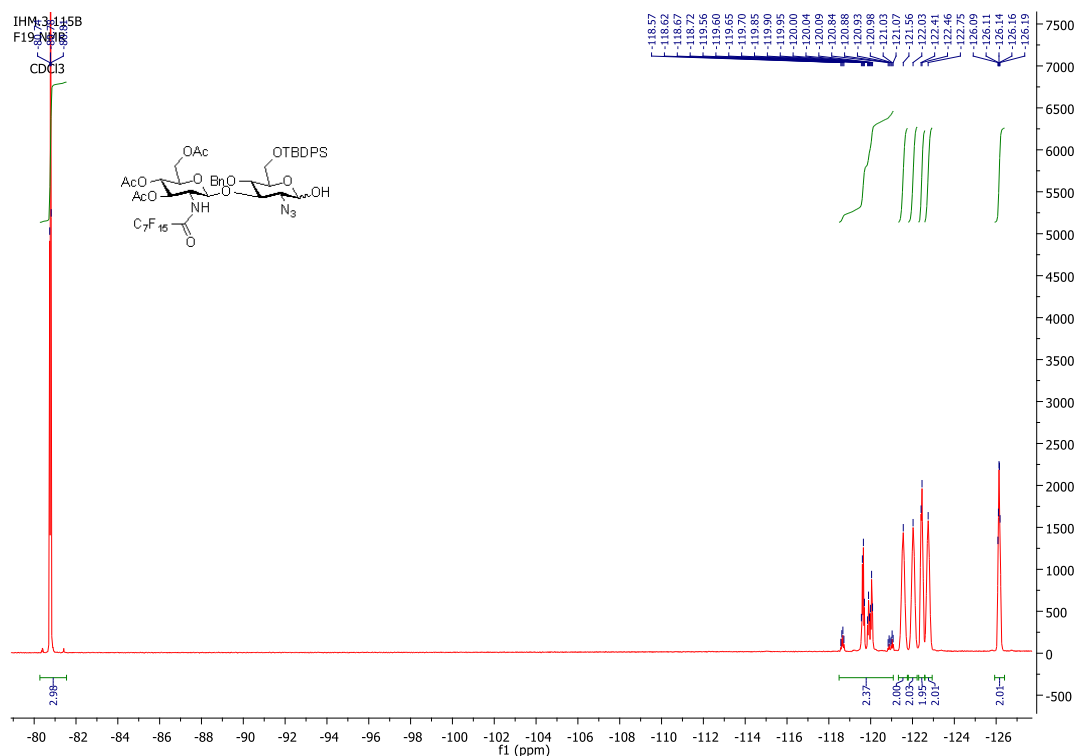

$^{19}\text{F}$  NMR (282 MHz) of Compound **143** in  $\text{CDCl}_3$

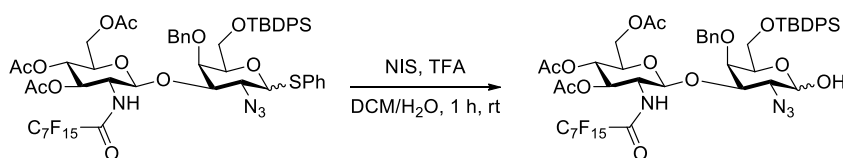

**(3,4,6-tri-*O*-acetyl-2-deoxy-2-(8,8,8,7,7,6,6,5,5,4,3,3,2-pentadecafluorooctanamido)- $\beta$ -D-glucopyranosyl)-(1 $\rightarrow$ 3)-2-azido-4-*O*-benzyl-6-*O*-tert-butyl-diphenylsilyl-2-deoxy-1- $\alpha/\beta$ -D-galactopyranose (**144**)**

To a vigorously stirred solution of the thiogalactoside disaccharide (0.276mmol, 361mg) dissolved in  $\text{DCM}/\text{H}_2\text{O}$  (3.3mL, 10:1; v/v) at rt was then added NIS (0.280mmol, 63mg, 1 equiv.) and TFA (21 $\mu\text{L}$ , 0.280mmol, 1equiv.) at 0  $^\circ\text{C}$  and allowed to stir at this condition in RB flask equipped with stir bar, septum and argon atmosphere for 1 hour. Analytical TLC confirmed complete transformation and sat.  $\text{Na}_2\text{S}_2\text{O}_3(\text{aq.})$  (2mL) and stirred additional 5 minutes. The reaction mixture was diluted with EtOAc, washed with sat.  $\text{NaHCO}_3(\text{aq.})$  and back extracted. The combined organic phase was dried over anhydrous  $\text{MgSO}_4$ , filtered and concentrated at reduced pressure in the rotary evaporator. The residue was purified by silica gel column chromatography in cyclohexane: ethylacetate 80:20  $\rightarrow$  100% ethylacetate as eluent and after solvent evaporation afforded 277mg, 70% desired adduct as colorless crystal.

Rf = 0.32/0.65 in cyclohexane: ethylacetate 7:3.

HRMS (ESI, positive mode) m/z:  $\text{C}_{49}\text{H}_{51}\text{F}_{15}\text{N}_4\text{NaO}_{13}\text{Si}$   $[\text{M}+\text{Na}]^+$ , calcd. 1239.2875, found 1239.2872.

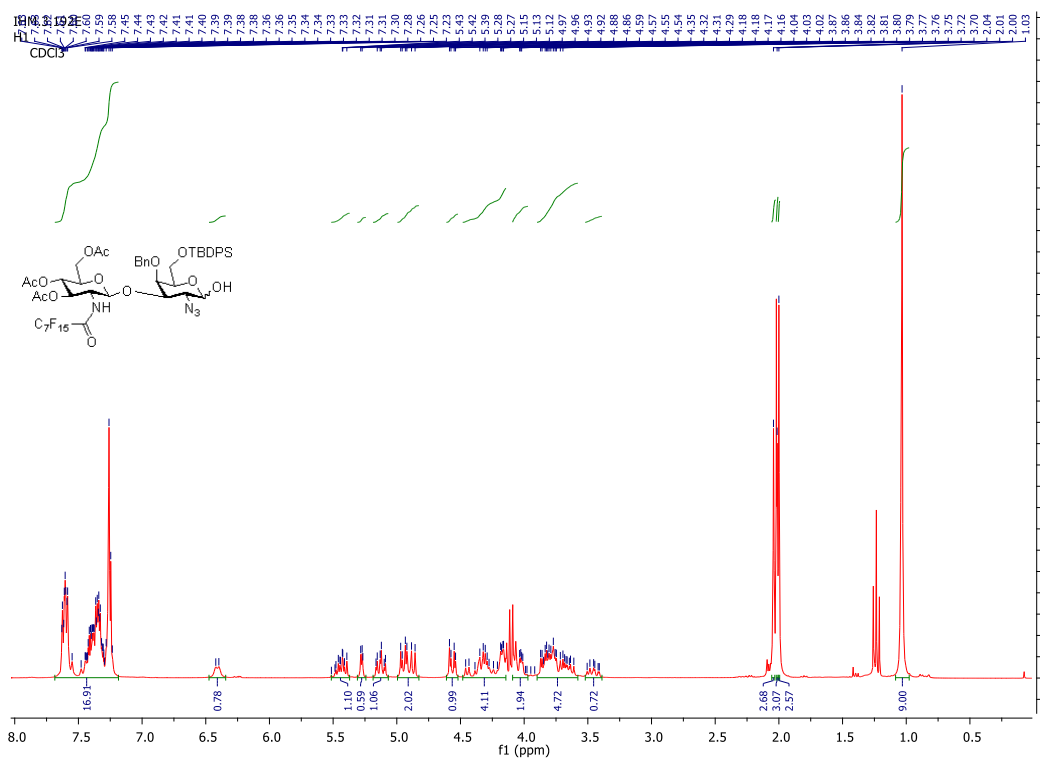

<sup>1</sup>H-<sup>1</sup>H COSY (300 MHz) of Compound **144** in CDCl<sub>3</sub>

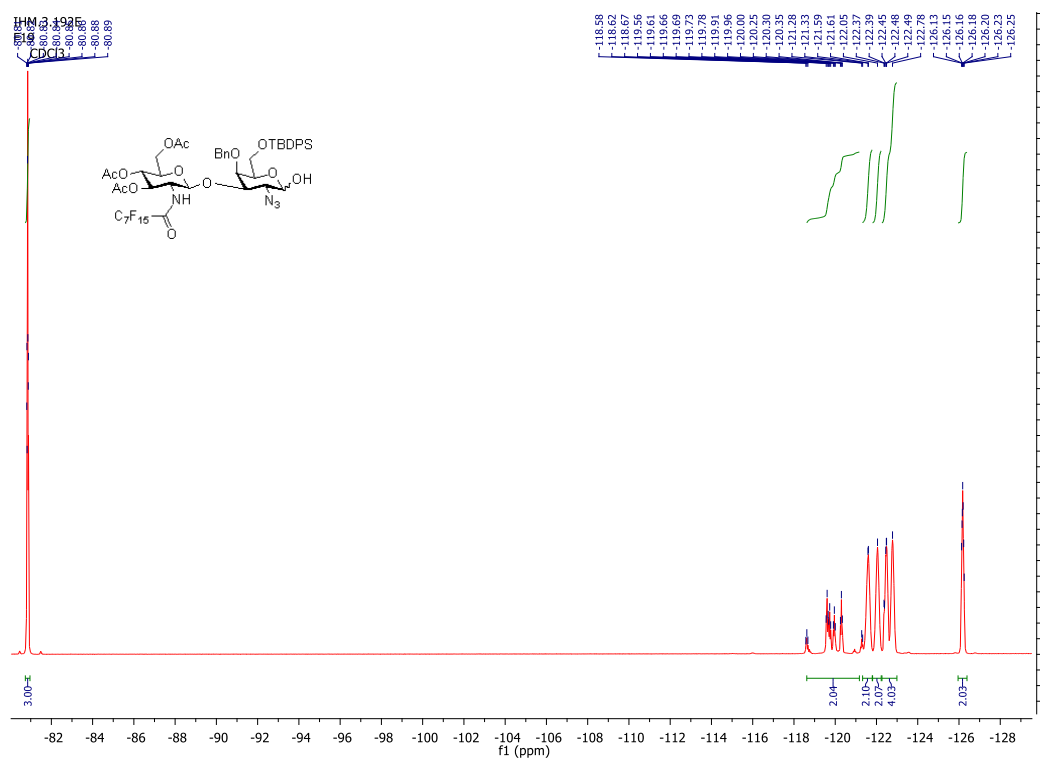

<sup>19</sup>F NMR (282 MHz) of Compound **144** in CDCl<sub>3</sub>

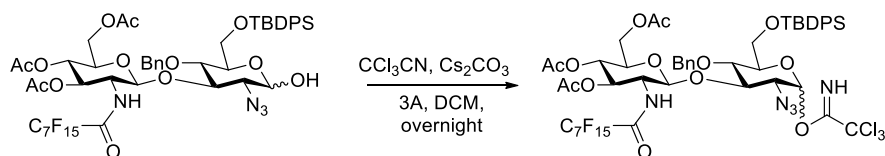

**(3,4,6-tri-*O*-acetyl-2-deoxy-2-(8,8,8,7,7,6,6,5,5,4,4,3,3,2-pentadecafluorooctanamido)- $\beta$ -D-glucopyranosyl)-(1 $\rightarrow$ 3)-2-azido-4-*O*-benzyl-6-*O*-tert-butyl-diphenylsilyl-2-deoxy- $\alpha/\beta$ -D-glucopyranose-1-*O*-trichloroacetimidate (**145**)**

Compound **145** was prepared from **138** (0.0361mmol, 44mg, 1 equiv.) in the same manner other fluoros imidates (**71**, **74**, **77** and **82**) were made. The crude mixture was eluted with cyclohexane: ethylacetate 70:30 $\rightarrow$ 60:40% +0.2% TEA gradient by flash column chromatography and upon solvent removal, titled compound **145** was isolated as a colorless form, 45mg, 3:2 separable mixture of  $\alpha/\beta$ , 92%.

Rf = 0.35/0.29;  $\alpha/\beta$  in cyclohexane: ethylacetate, 7/3.

HRMS (ESI, positive mode)  $m/z$ : C<sub>51</sub>H<sub>51</sub>Cl<sub>3</sub>F<sub>15</sub>N<sub>5</sub>NaO<sub>13</sub>Si [M+Na]<sup>+</sup>, calcd. 1382.1971, found 1382.1954.

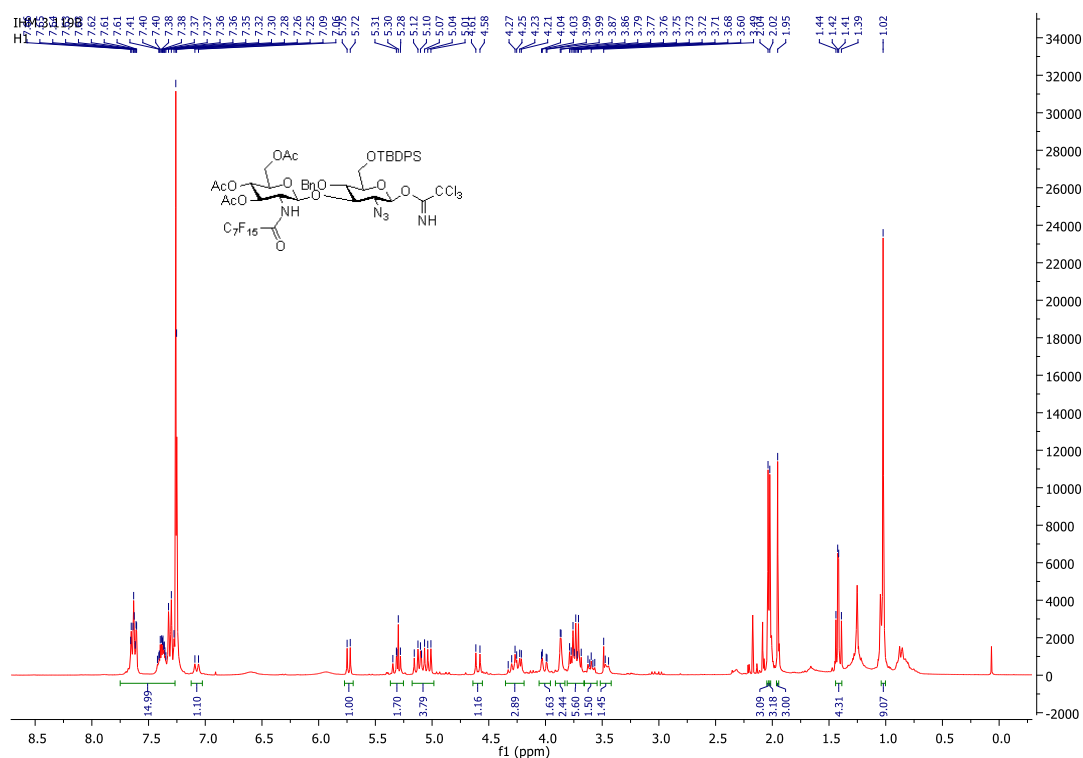

<sup>1</sup>H NMR (300 MHz) of Compound **145** in CDCl<sub>3</sub>

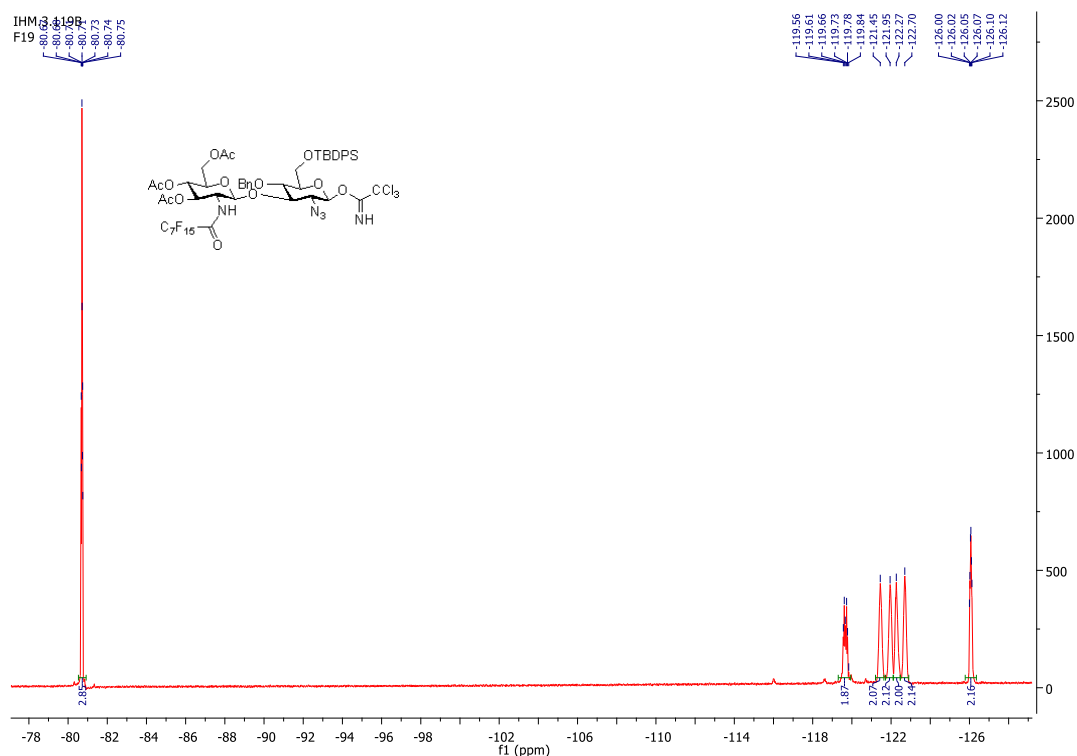

$^{19}\text{F}$  NMR (282 MHz) of Compound **145** in  $\text{CDCl}_3$

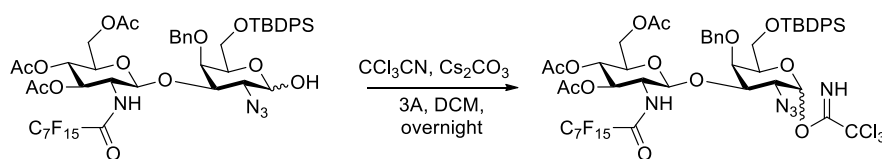

**(3,4,6-tri-*O*-acetyl-2-deoxy-2-(8,8,8,7,7,6,6,5,5,4,4,3,3,2-pentadecafluorooctanamido)- $\beta$ -D-glucopyranosyl)-(1 $\rightarrow$ 3)-2-azido-4-*O*-benzyl-6-*O*-tert-butyl-diphenylsilyl-2-deoxy- $\alpha/\beta$ -D-galactopyranose-1-*O*-trichloroacetimidate (**146**)**

Compound **146** was prepared from **144** (0.148mmol, 180mg, 1 equiv.) in the same manner other fluororous imidates (**71**, **74**, **77**, **82** and **145**) were made. The crude mixture was eluted with cyclohexane: ethylacetate 90:10 $\rightarrow$ 40:60% +0.2% TEA gradient by flash column chromatography and upon solvent removal, titled compound **146** was isolated as a colorless form, 176mg nearly 1:1 separable mixture of  $\alpha/\beta$ , 87%.

Rf = 0.55/0.39;  $\alpha/\beta$  in cyclohexane: ethylacetate, 7/3.

**HRMS** (ESI, positive mode)  $m/z$ :  $\text{C}_{51}\text{H}_{51}\text{Cl}_3\text{F}_{15}\text{N}_5\text{NaO}_{13}\text{Si}$   $[\text{M}+\text{Na}]^+$ , calcd. 1382.1971, found 1382.1954.

**$^1\text{H}$  NMR- $\alpha$ -anomer** (300 MHz,  $\text{CDCl}_3$ )  $\delta$  (ppm): 7.61 – 7.27 (m, 16H, 3xPh, N-H'), 6.42 (br. s, 1H, H-1), 5.47 (dd,  $J$  = 10.7, 9.5 Hz, 1H, H'-3), 5.14 (t,  $J$  = 9.7 Hz, 1H, H'-4), 5.01 (d,  $J$  = 11.0 Hz, 1H,  $\frac{1}{2}$  CH<sub>2</sub>-Ph), 4.92 (d,  $J$  = 8.3 Hz, 1H, H'-1), 4.65 (d,  $J$  = 11.0 Hz, 1H,  $\frac{1}{2}$  CH<sub>2</sub>-Ph), 4.39 – 4.19 (m, 4H, H'-2, H'-6, H-3, H'-6), 4.11 – 4.02 (m, 3H, H-2, H-4, H-5), 3.91 (ddd,  $J$  = 10.1, 4.4, 2.3 Hz, 1H, H'-5), 3.84 – 3.67 (m, 2H, 2H-6), 2.07 (s, 3H, C(O)<sub>2</sub>CH<sub>3</sub>), 2.01 (s, 6H, 2x C(O)<sub>2</sub>CH<sub>3</sub>), 1.03 (s, 9H, *t*-Bu).

$^{19}\text{F}$  NMR (282 MHz,  $\text{CDCl}_3$ )  $\delta$  (ppm): -80.80 (t,  $J = 10.0$  Hz, 3F), -119.90 (dt,  $J = 139.7, 13.1$  Hz, 2F), -121.31 – -121.71 (m, 2F), -121.71 – -122.23 (m, 2F), -122.34 – -122.95 (m, 4F), -126.01 – -126.29 (m, 2F).

For  $\alpha$ -anomer

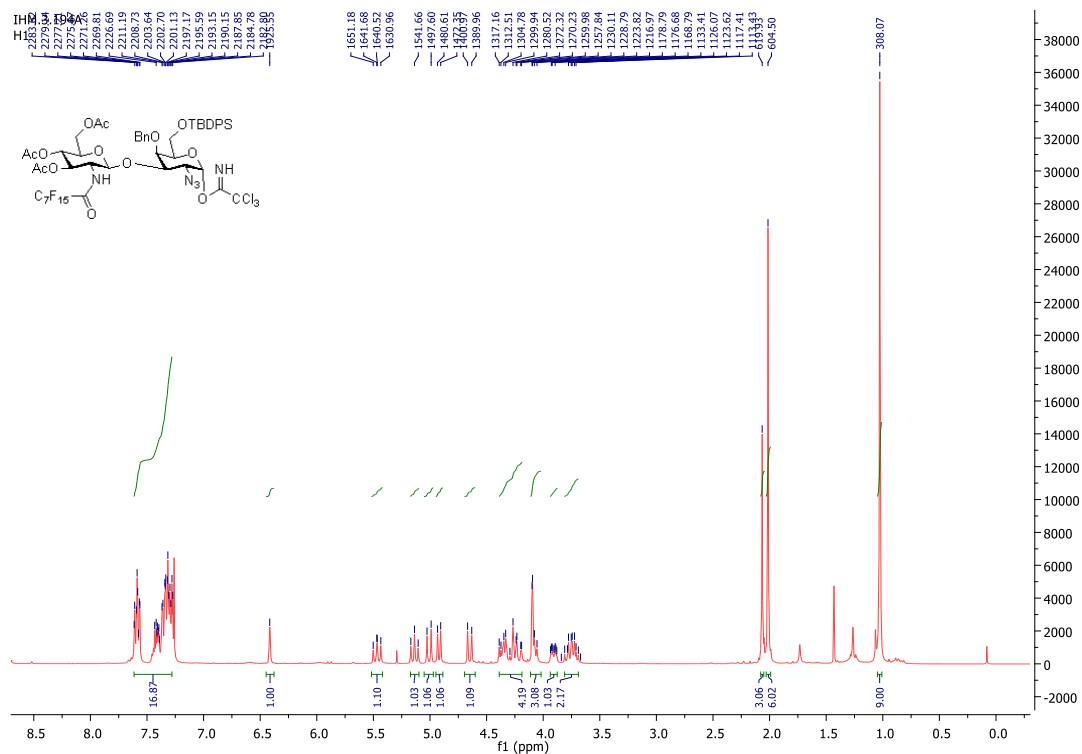

$^{1}\text{H}$  NMR (300 MHz) of Compound 146a in  $\text{CDCl}_3$

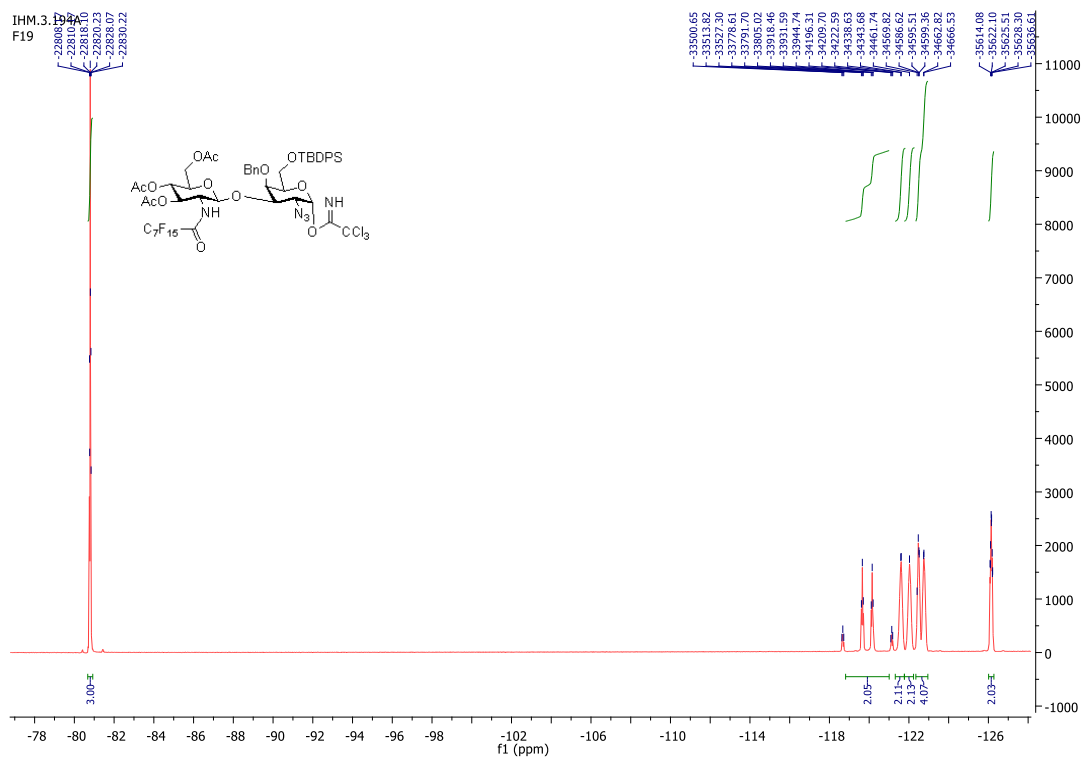



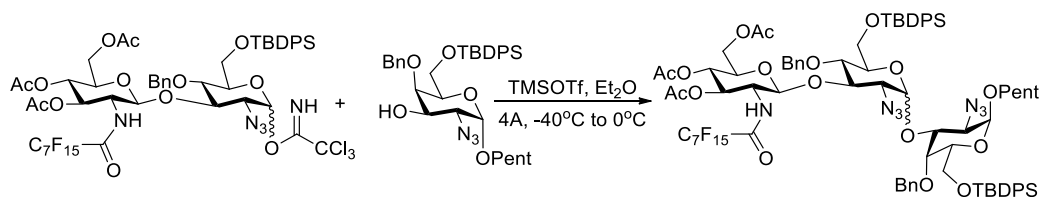

**Pentenyl (3,4,6-tri-*O*-acetyl-2-deoxy-2-(8,8,8,7,7,6,6,5,5,4,4,3,3,2-pentadecafluorooctanamido)-β-D-glucopyranosyl)-(1→3)-(2-azido-4-*O*-benzyl-6-*O*-tert-butyl-diphenylsilyl-2-deoxy-α/β-D-galactopyranosyl)-(1→3)-2-azido-4-*O*-benzyl-6-*O*-tert-butyl-diphenylsilyl-2-deoxy-α-D-galactopyranoside (148)**

A mixture of glycosyl donor (0.0330mmol, 45mg, 1eq.) and an acceptor (0.0498mmol, 30mg, 1.5eq.) was azeotroped with toluene three times and dried over high vacuum pump for 48 hrs. Flame activate mol. Sieves (4Å-powder), dried stir bar and septum were equipped to the reaction flask and exposed to argon-vacuum several times. This was dissolved in dry diethyl ether (2mL) and stirred at rt for 1 h. the reaction set-up was cooled down to -40 °C, stirred additional 30 mins before treatment with a solution of TMSOTf (0.00495 mmol, 10μL, 0.15 eq.; 0.5M in Et<sub>2</sub>O) gently with constant stirring over 30 mins. The temperature was raised to -20 °C and then stirred for 2h at 0 °C under crushed ice. The reaction was quenched as in the general procedure. Reaction mixture was purified over RP column (4g) with Interchim purification machine that affords 11mg, 20% of desired fraction as colorless oil. This fraction was used for additional preparative HPLC on PFP column.

R<sub>f</sub> = 0.56 in cyclohexane: ethylacetate 7:3.

**HRMS** (ESI, positive mode) *m/z*: C<sub>83</sub>H<sub>92</sub>F<sub>15</sub>N<sub>7</sub>NaO<sub>17</sub>Si<sub>2</sub> [M+Na]<sup>+</sup>, calcd. 1021.1959, found 1021.1971.

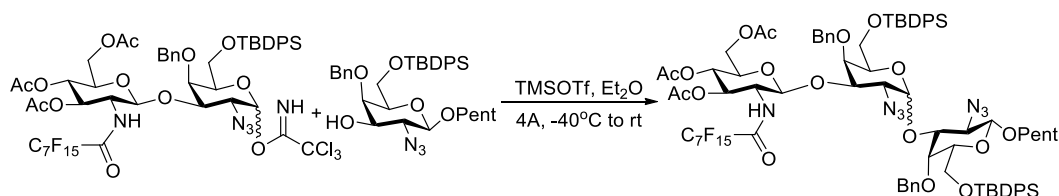

**Pentenyl (3,4,6-tri-*O*-acetyl-2-deoxy-2-(8,8,8,7,7,6,6,5,5,4,4,3,3,2-pentadecafluorooctanamido)-β-D-glucopyranosyl)-(1→3)-(2-azido-4-*O*-benzyl-6-*O*-tert-butyl-diphenylsilyl-2-deoxy-β-D-galactopyranosyl)-(1→3)-2-azido-4-*O*-benzyl-6-*O*-tert-butyl-diphenylsilyl-2-deoxy-β-D-galactopyranoside (149)**

A mixture of glycosyl donor (0.125mmol, 170mg, 1eq.) and an acceptor (0.259mmol, 1566mg, 2eq.) was glycosylated as in **148** above and the reaction was quenched as in the general procedure. Reaction mixture was purified over RP column (40g) with Interchim purification machine (eluent: MeOH: H<sub>2</sub>O; 75:25 → 100%) that affords 134mg separable mixture of α/β; 5:2, 60% of desired fraction as colorless oil. This fraction was used for additional preparative HPLC on PFP column.

R<sub>f</sub> = 0.65/0.48 α/β; in cyclohexane: ethylacetate 7:3.

**HRMS-α** (ESI, positive mode) *m/z*: C<sub>83</sub>H<sub>92</sub>F<sub>15</sub>N<sub>7</sub>NaO<sub>17</sub>Si<sub>2</sub> [M+Na]<sup>+</sup>, calcd. 1822.5741, found 1822.5733; [M+H]<sup>+</sup>, calcd. 1800.5921, found 1800.5914.



**HRMS- $\beta$**  (ESI, positive mode)  $m/z$ :  $C_{83}H_{92}F_{15}N_7NaO_{17}Si_2$   $[M+Na]^+$ , calcd. 1822.5741, found 1822.5745;  $[M+H]^+$ , calcd. 1800.5921, found 1800.5924.

**$^1H$  NMR-  $\alpha$ -anomer** (500 MHz,  $CDCl_3$ )  $\delta$  (ppm): 7.70 – 7.27 (m, 31H, 6xPh, N-H''), 5.82 (ddt,  $J = 16.9, 10.2, 6.6$  Hz, 1H,  $\underline{H}C=CH_2$ ), 5.42 – 5.35 (m, 1H,  $\underline{H}''-3$ ), 5.28 (d,  $J = 3.4$  Hz, 1H,  $\underline{H}''-1$ ), 5.15 (t,  $J = 9.7$  Hz, 1H,  $\underline{H}''-4$ ), 5.07 – 4.91 (m, 4H,  $\underline{CH}=\underline{CH}_2$ ,  $\underline{CH}_2$ -Ph), 4.80 (d,  $J = 8.3$  Hz, 1H,  $\underline{H}''-1$ ), 4.62 (t,  $J = 10.8$  Hz, 1H,  $\underline{CH}_2$ -Ph), 4.41 – 4.29 (m, 2H,  $\underline{H}''-2$ ,  $\underline{H}''-6$ ), 4.28 – 4.20 (m, 1H,  $\underline{H}''-3$ ), 4.18 – 4.13 (m, 2H,  $\underline{H}''-6$ ,  $\underline{H}'-4$ ), 4.06 (d,  $J = 7.9$  Hz, 1H,  $\underline{H}-1$ ), 4.02 (br. s, 1H,  $\underline{H}-3$ ), 3.92 (dd,  $J = 10.8, 3.5$  Hz, 1H,  $\underline{H}-6$ ), 3.88 – 3.75 (m, 7H,  $\underline{H}'-2$ ,  $\underline{H}-4$ ,  $\underline{H}''-5$ , 2x $\underline{H}'-6$ ,  $\underline{H}-2$ ,  $\underline{H}'-5$ ), 3.73 – 3.69 (m, 1H,  $\underline{H}-5$ ), 3.66 (dd,  $J = 10.3, 5.8$  Hz, 1H,  $\underline{H}-6$ ), 3.48 – 3.35 (m, 2H,  $\underline{CH}_2$ ), 2.20 – 2.12 (m, 2H,  $\underline{CH}_2$ ), 2.05 (s, 3H,  $C(O)_2\underline{CH}_3$ ), 2.01 (s, 3H,  $C(O)_2\underline{CH}_3$ ), 1.96 (s, 3H,  $C(O)_2\underline{CH}_3$ ), 1.79 – 1.64 (m, 2H,  $\underline{CH}_2$ ), 1.07 (s, 9H,  $t$ -Bu), 1.04 (s, 9H,  $t$ -Bu).

**$^{19}F$  NMR** (471 MHz,  $CDCl_3$ )  $\delta$  (ppm): -80.77 (t,  $J = 9.7$  Hz, 3F), -119.89 (q,  $J = 277.4$  Hz, 2F), -121.27 – -121.75 (m, 2F), -121.78 – -122.18 (m, 2F), -122.23 – -122.56 (m, 2F), -122.58 – -122.98 (m, 2F), -125.88 – -126.34 (m, 2F).

**$^{13}C$  NMR** (126 MHz,  $CDCl_3$ )  $\delta$  (ppm): 171.64, 170.57, 169.35, 138.25, 138.16, 138.08, 135.69, 135.63, 135.62, 133.44, 133.15, 133.08, 129.97, 128.73, 128.42, 128.32, 127.93, 127.92, 127.91, 127.67, 127.55, 115.14, 101.95, 101.86, 93.93, 77.77, 76.33, 75.35, 75.28, 74.97, 74.62, 72.33, 72.01, 71.93, 70.76, 70.21, 69.47, 68.45, 63.10, 62.85, 62.14, 61.86, 59.81, 54.59, 30.16, 29.84, 28.78, 26.98, 26.96, 26.65, 20.75, 20.69, 20.20, 19.38, 19.26.

$[\alpha]_D^{25.2} = +27^\circ$  (C=34mg/mL in  $CHCl_3$ - $\alpha$ -anomer)

$[\alpha]_D^{25.3} = +11^\circ$  (C=9mg/mL in  $CHCl_3$ - $\beta$ -anomer)

### For $\alpha$ -anomer

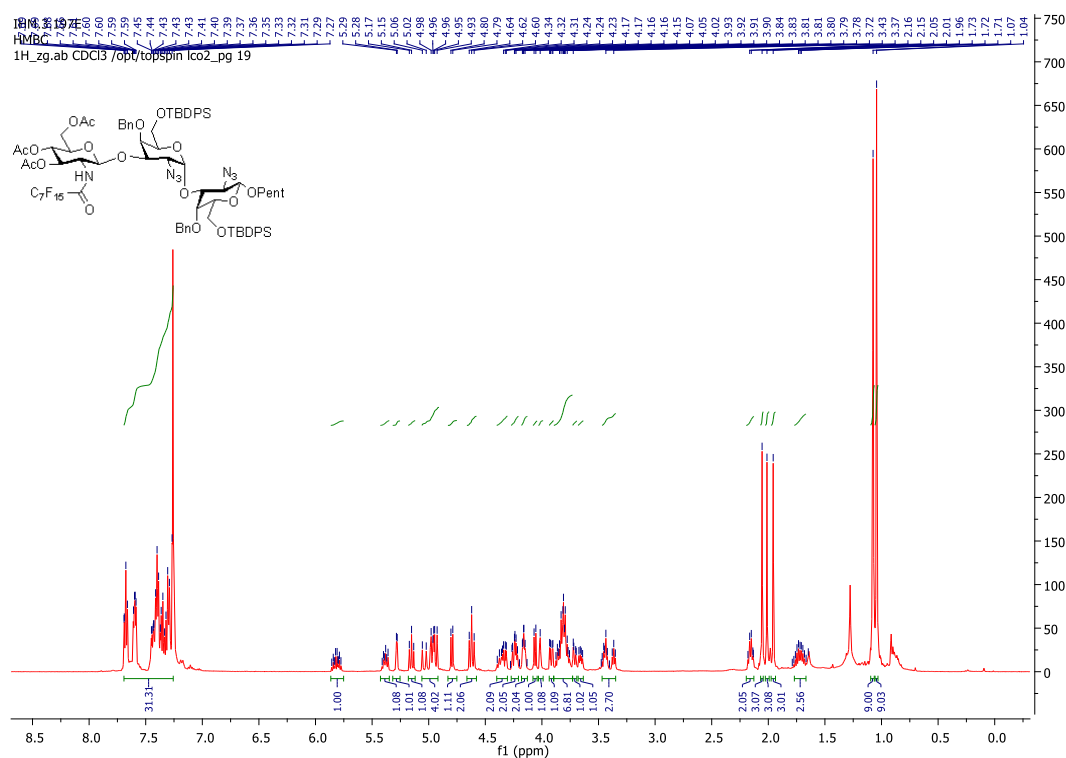

**<sup>1</sup>H NMR (500 MHz) of Compound 149a in CDCl<sub>3</sub>**

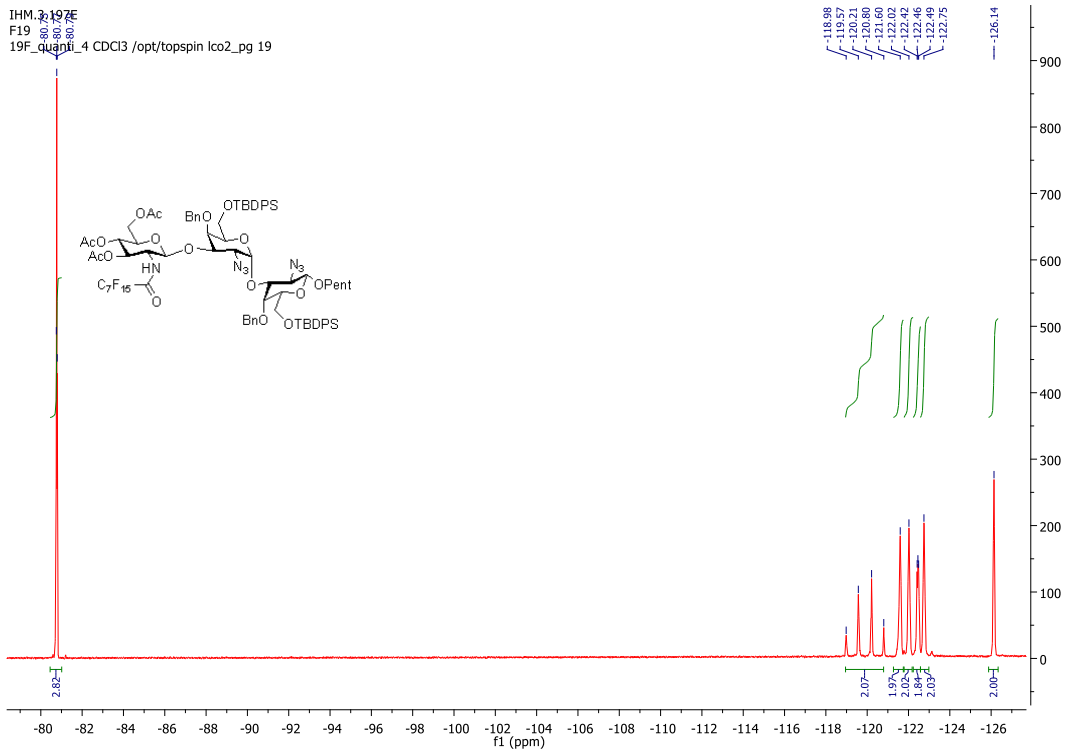

**<sup>19</sup>F NMR (471 MHz) of Compound 149a in CDCl<sub>3</sub>**

For  $\beta$ -anomer

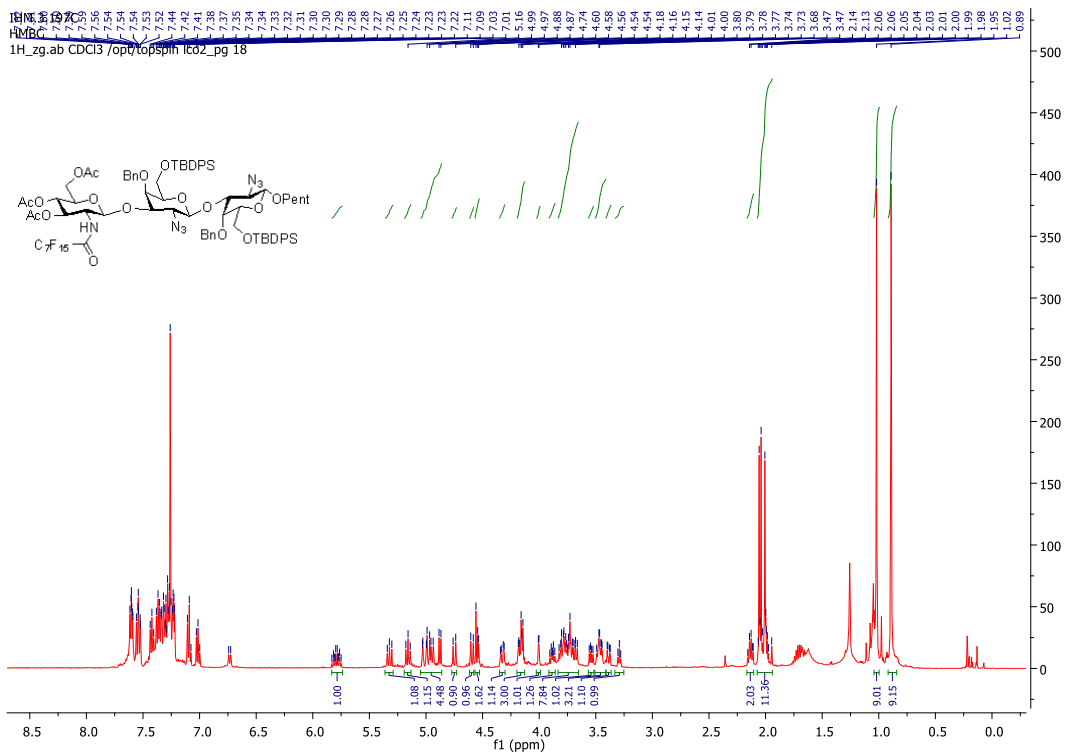

**<sup>1</sup>H NMR (500 MHz) of Compound 149b in CDCl<sub>3</sub>**

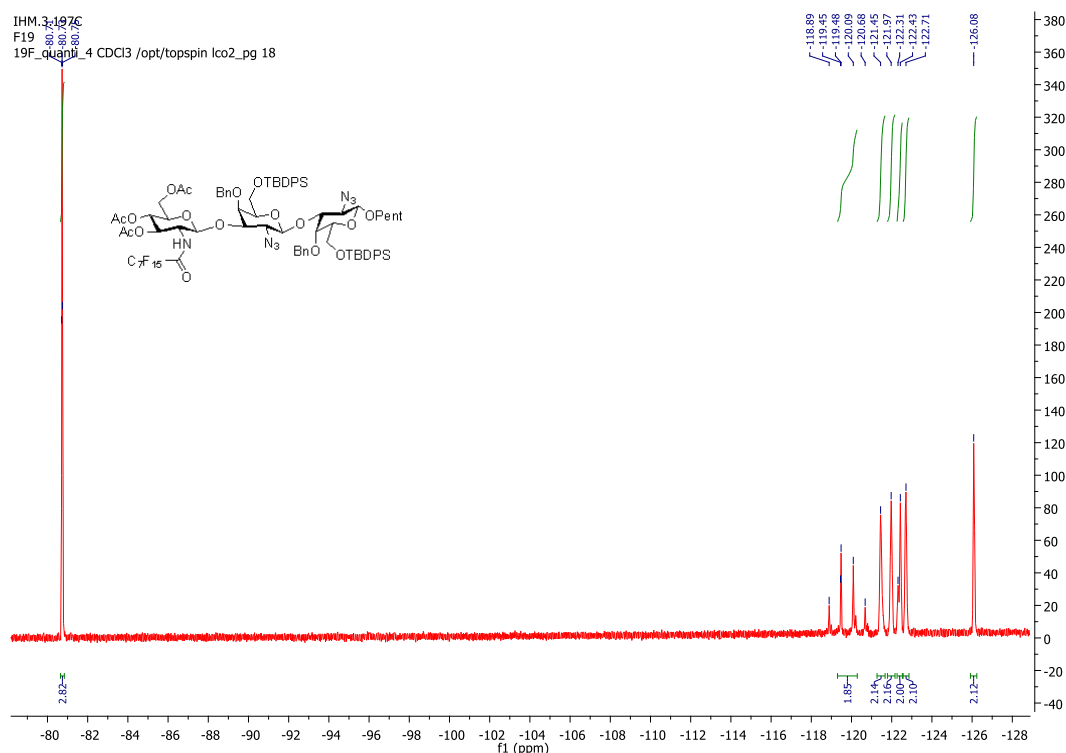

<sup>19</sup>F NMR (471 MHz) of Compound **149b** in CDCl<sub>3</sub>

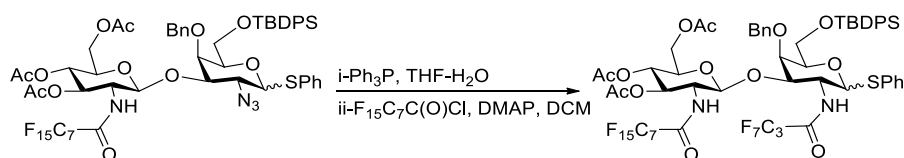

**Phenyl-(3,4,6-tri-*O*-acetyl-2-deoxy-2-(8,8,8,7,7,6,6,5,5,4,4,3,3,2,2-pentadecafluorooctanamido)- $\beta$ -D-glucopyranosyl) - (1 $\rightarrow$ 3)-4-*O*-benzyl-6-*O*-tert-butyl-diphenylsilyl-2-deoxy-2-(4,4,4,3,3,2,2-pentabutylamido) -1-thio- $\alpha/\beta$ -D-galactopyranoside (**150**)**

To the solution of starting material (0.210mmol, 275mg, 1eq., azeotroped three times with toluene) in dry THF-H<sub>2</sub>O (15mL, 10:1; v/v) in an RB flask equipped with stir bar, septum and argon atmosphere. The setup was stirred at 60 °C for few minutes and then treated with triphenyl phosphine (0.672mmol, 176mg, 3.2eq.), then connected to bubbler and stirred overnight. Analytical TLC in cyclohexane: ethylacetate, 7:3 confirmed complete reaction. The reaction mixture was cooled down and the solvent removed, coevaporated with toluene several times and finally the concentrated residue dried vacuo and used for further transformation without purification. Suspension of the dried residue (0.210mmol, 269mg, 1eq.-based on quantitative yield) was dissolved dry DCM (10mL) and was followed heptafluorobutyryl chloride (0.252mmol, 38 $\mu$ L, 1.2 eq.) dropwise at rt. DMAP (0.63mmol, 77mg, 3eq.) was subsequently added and the homogeneous solution was stirred under argon and after 4 hrs., analytical TCL in cyclohexane: ethylacetate confirmed consumed starting material. The reaction mixture was diluted with EtOAc and H<sub>2</sub>O, washed with saturated aqueous NH<sub>4</sub>Cl, NaHCO<sub>3</sub> (50mL each) and back extracted with EtOAc, dried over Na<sub>2</sub>SO<sub>4</sub>, filtered, and concentrated at vacuo. Purification was performed by silica gel column chromatography, eluted with cyclohexane: ethylacetate 80:20  $\rightarrow$  100% afforded separable mixture of  $\alpha/\beta$ ; 1:6.6, 152mg, 49% over two steps as colorless form.

R<sub>f</sub> = 0.45/0.52; α/β in cyclohexane: ethylacetate 7:3.

**LRMS**-amine intermediate -IHM.3.168A-(ESI, positive mode) m/z: C<sub>55</sub>H<sub>58</sub>F<sub>15</sub>N<sub>2</sub>O<sub>12</sub>SSi [M+H]<sup>+</sup>, calcd. 1283.3, found 1283.3.

**HRMS** (ESI, positive mode) m/z: C<sub>59</sub>H<sub>56</sub>F<sub>22</sub>N<sub>2</sub>NaO<sub>13</sub>SSi [M+Na]<sup>+</sup>, calcd. 1501.2813, found 1501.2815.

**<sup>1</sup>H NMR (β-anomer)** (400 MHz, CDCl<sub>3</sub>) δ (ppm): 7.66 – 7.12 (m, 20H, 4xPh), 6.83 (d, *J* = 9.1 Hz, 1H, N-H'), 6.68 (d, *J* = 6.7 Hz, 1H, N-H), 5.28 – 5.15 (m, 2H, H-3, H'-3), 5.08 (t, *J* = 9.6 Hz, 1H, H'-4), 4.93 (d, *J* = 11.2 Hz, 1H, ½ CH<sub>2</sub>-Ph), 4.71 (dd, *J* = 10.5, 1.8 Hz, 1H, H-1), 4.65 (d, *J* = 8.2 Hz, 1H, H'-1), 4.60 (d, *J* = 11.2 Hz, 1H, ½ CH<sub>2</sub>-Ph), 4.29 (dd, *J* = 12.4, 4.5 Hz, 1H, H'-6), 4.26 – 4.09 (m, 3H, H'-2, H-5, H'-6), 3.85 – 3.65 (m, 5H, H-4, 2xH-6, H'-5, H-2), 2.05 (s, 3H, C(O)<sub>2</sub>CH<sub>3</sub>), 2.00 (s, 3H, C(O)<sub>2</sub>CH<sub>3</sub>), 1.97 (s, 3H, C(O)<sub>2</sub>CH<sub>3</sub>), 1.04 (s, 9H, *t*-Bu).

**<sup>13</sup>C NMR** (101 MHz, CDCl<sub>3</sub>) δ (ppm): 171.60, 170.55, 169.47, 138.60, 135.69, 135.66, 133.21, 133.06, 132.36, 131.97, 130.00, 129.97, 129.14, 128.35, 128.25, 128.16, 127.94, 127.93, 127.71, 101.27, 83.74, 79.05, 78.00, 77.36, 75.94, 75.03, 72.36, 71.88, 68.19, 62.29, 61.77, 54.83, 54.14, 26.90, 20.76, 20.65, 20.17, 19.22.

**<sup>19</sup>F NMR** (376 MHz, CDCl<sub>3</sub>) δ (ppm): -80.43 (t, *J* = 8.9 Hz, 3F), -80.80 (t, *J* = 9.9 Hz, 3F), -118.92 – -120.64 (m, 4F), -121.51 – -121.75 (m, 2F), -121.95 – -122.22 (m, 2F), -122.28 – -122.51 (m, 2F), -122.66 – -122.90 (m, 2F), -126.03 – -126.28 (m, 4F).

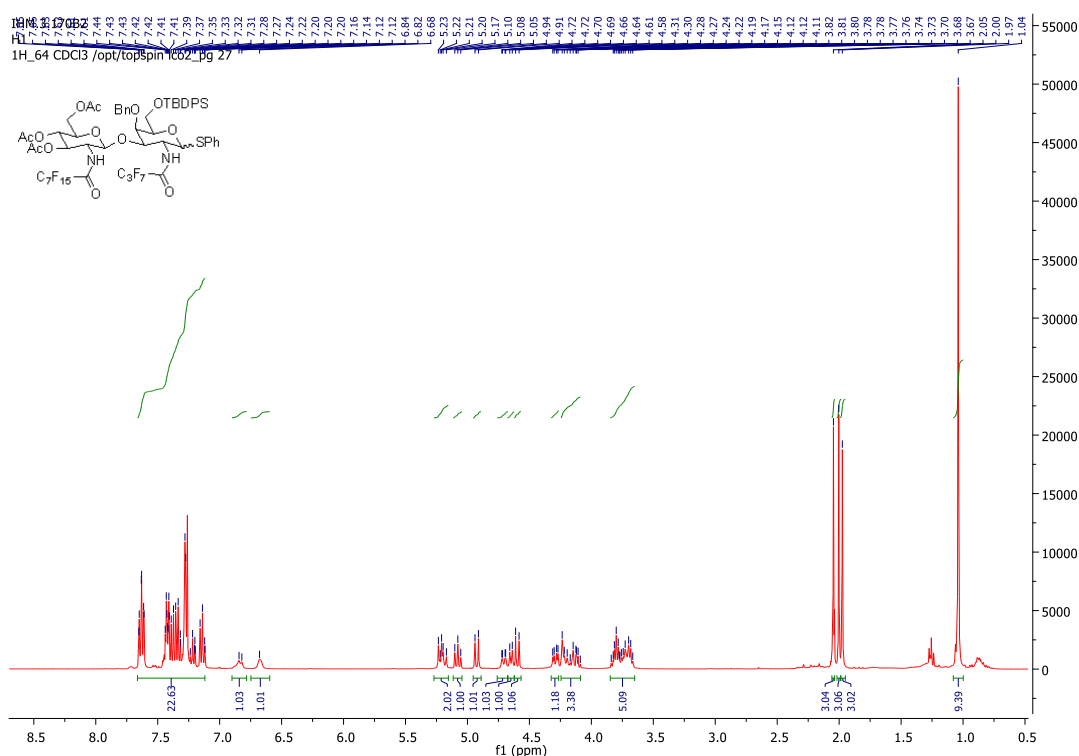

**<sup>1</sup>H NMR (400 MHz) of Compound 150b in CDCl<sub>3</sub>**

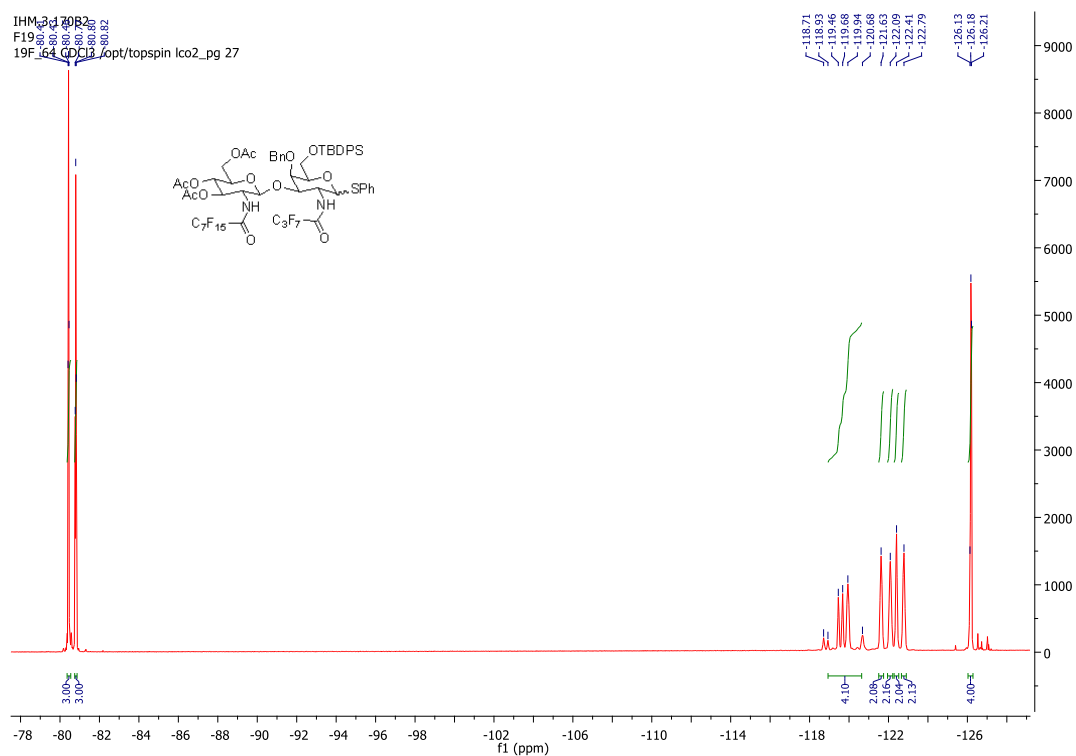

<sup>19</sup>F NMR (376 MHz) of Compound **150b** in CDCl<sub>3</sub>

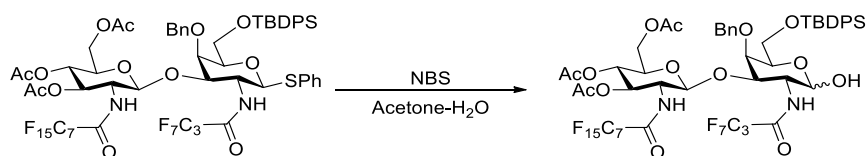

**(3,4,6-tri-*O*-acetyl-2-deoxy-2-(8,8,8,7,7,6,6,5,5,4,4,3,3,2,2-pentadecafluorooctanamido)-β-D-glucopyranosyl) - (1→3)-4-*O*-benzyl-6-*O*-tert-butyl-diphenylsilyl-2-deoxy-2-(4,4,4,3,3,2,2-pentabutyrarnido) -1-α/β-D-galactopyranose (**151**)**

To the solution of thioglycoside disaccharide (0.101mmol, 150mg; azeotroped with toluene) in acetone (1mL) was added Acetone/water (2mL, 9:1; v/v) followed by NBS (0.203mmol, 36mg, 2 equiv.) was transformed to the titled compound as compound **143**. The crude reaction mixture was purified on silica gel column chromatography in cyclohexane: ethylacetate 90:10 → 50% ethylacetate, affording a colorless form 110mg, α/β, 1:11, 86% after solvent evaporation.

R<sub>f</sub> = 0.42/0.32 in cyclohexane: ethylacetate 7:3.

**HRMS** (ESI, positive mode) *m/z*: C<sub>53</sub>H<sub>38</sub>F<sub>22</sub>N<sub>2</sub>NaO<sub>4</sub>Si [M+Na]<sup>+</sup>, calcd. 1409.2753, found 1409.2729.

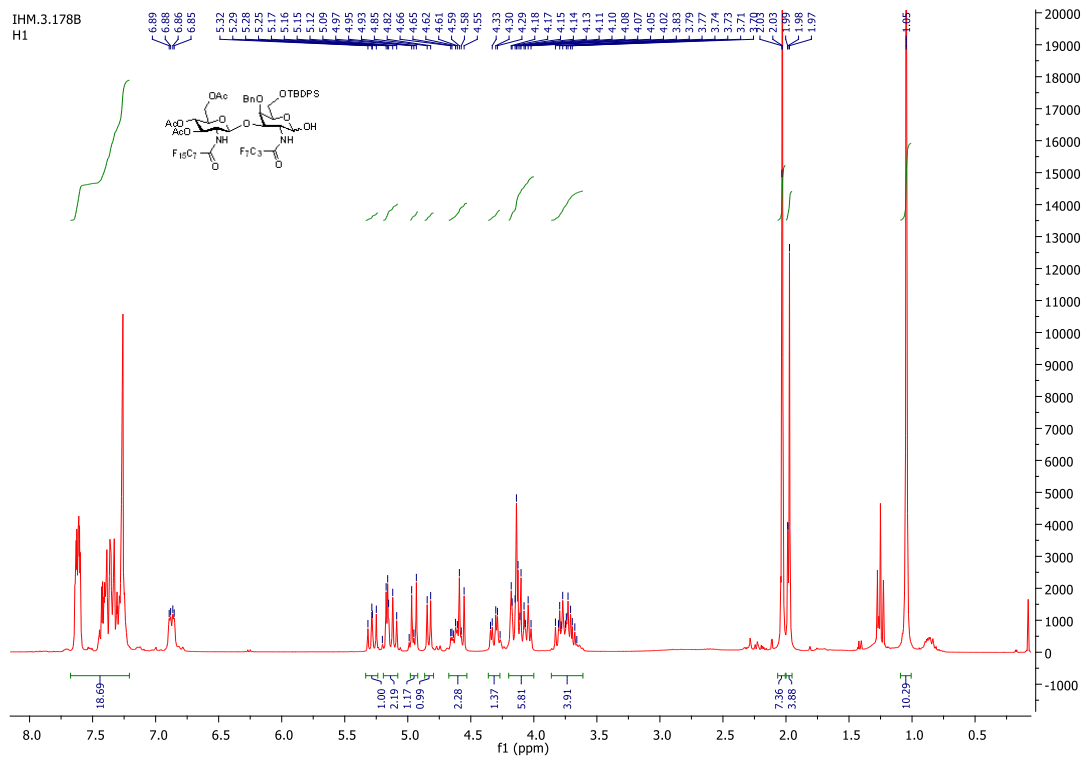

<sup>1</sup>H NMR (300 MHz) of Compound 151 in CDCl<sub>3</sub>

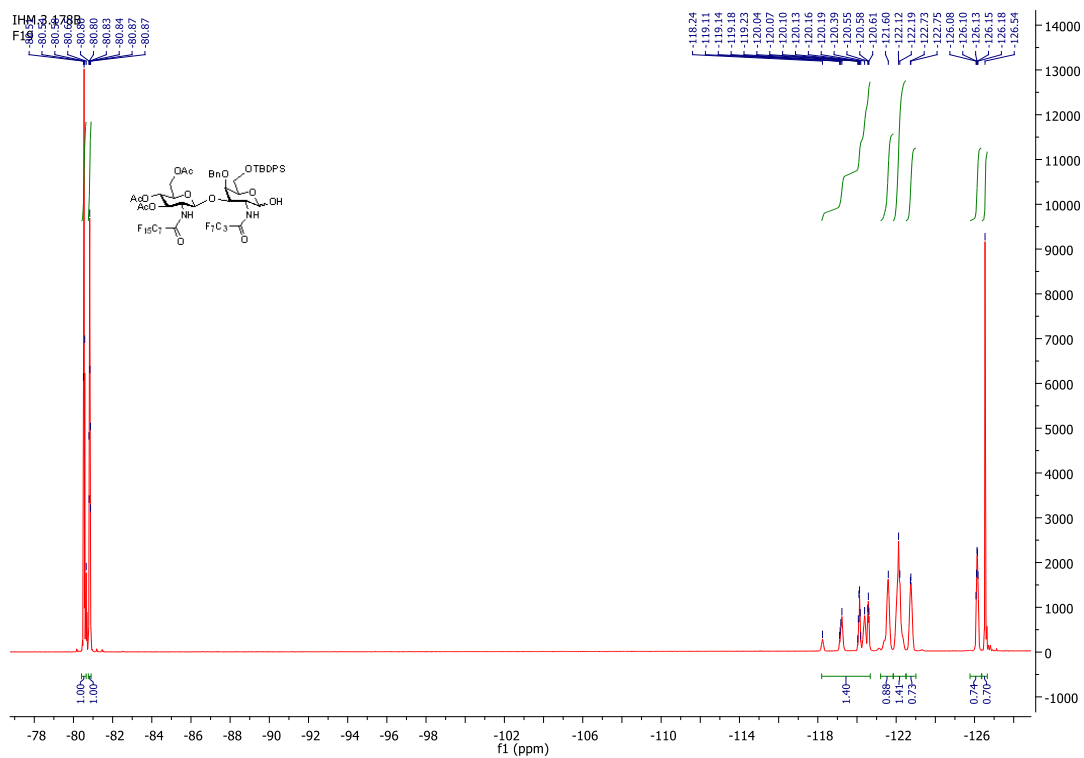

<sup>19</sup>F NMR (282 MHz) of Compound 151 in CDCl<sub>3</sub>

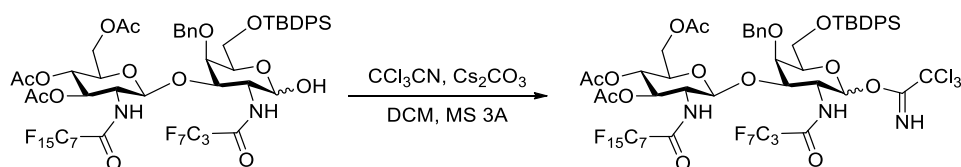

**(3,4,6-tri-*O*-acetyl-2-deoxy-2-(8,8,8,7,7,6,6,5,5,4,4,3,3,2-pentadecafluorooctanamido)- $\beta$ -D-glucopyranosyl)-(1 $\rightarrow$ 3)-4-*O*-benzyl-6-*O*-tert-butyl-diphenylsilyl-2-deoxy-2-(4,4,4,3,3,2-pentabutyr-amido)- $\alpha$ -D-galactopyranose-1-*O*-trichloroacetimidate (**152**)**

Compound **152** was prepared from **151** (0.0793mmol, 110mg, 1 equiv.) in the same manner other fluoros imidates (**71** etc.) were made. The crude mixture was eluted with cyclohexane: ethylacetate 90:10 $\rightarrow$ 70:30% +0.2% TEA gradient by flash column chromatography and upon solvent removal, titled compound **152** was isolated as a colorless oil, 81mg at 67%.

Rf = 0.58 in cyclohexane: ethylacetate, 7/3.

**HRMS** (ESI, positive mode) *m/z*: C<sub>55</sub>H<sub>52</sub>Cl<sub>3</sub>F<sub>22</sub>N<sub>3</sub>NaO<sub>14</sub>Si [M+Na]<sup>+</sup>, calcd. 1552.1825, found 1552.1815.

**<sup>1</sup>H NMR** (400 MHz, CDCl<sub>3</sub>)  $\delta$  (ppm): 7.67 – 7.13 (m, 7H, 3xPh, N-H', N-H), 6.05 (d, *J* = 6.6 Hz, 1H, H-1), 5.29 (dd, *J* = 10.5, 9.5 Hz, 1H, H'-3), 5.18 (t, *J* = 9.6 Hz, 1H, H'-4), 4.96 (d, *J* = 8.4 Hz, 1H, H'-1), 4.87 (d, *J* = 11.2 Hz, 1H, ½ CH<sub>2</sub>-Ph), 4.56 (d, *J* = 11.2 Hz, 1H, ½ CH<sub>2</sub>-Ph), 4.40 – 4.28 (m, 2H, H'-2, H'-6), 4.21 – 4.05 (m, 3H, H-2, H'-6, H-6), 3.96 (td, *J* = 6.6, 1.8 Hz, 1H, H-5), 3.85 – 3.64 (m, 4H, H'-5, H-3, H-4, H-6), 2.07 (s, 3H, C(O)<sub>2</sub>CH<sub>3</sub>), 2.05 (s, 3H, C(O)<sub>2</sub>CH<sub>3</sub>), 2.02 (s, 3H, C(O)<sub>2</sub>CH<sub>3</sub>), 1.05 (s, 9H, *t*-Bu).

**<sup>19</sup>F NMR** (376 MHz, CDCl<sub>3</sub>)  $\delta$  (ppm): -80.64 (t, *J* = 8.6 Hz, 3F), -80.81 (t, *J* = 9.9 Hz, 3F), -117.74 (q, *J* = 8.1 Hz, 2F), -119.58 (dt, *J* = 137.7, 13.0 Hz, 2F), -121.33 – -121.77 (m, 2F), -121.93 – -122.21 (m, 2F), -122.23 – -122.52 (m, 2F), -122.66 – -122.95 (m, 2F), -125.99 – -126.31 (m, 2F), -126.86 – -127.21 (m, 2F).

**<sup>13</sup>C NMR** (101 MHz, CDCl<sub>3</sub>)  $\delta$  (ppm): 171.21, 170.69, 169.42, 137.91, 135.70, 135.67, 133.13, 133.05, 130.05, 130.03, 128.40, 128.25, 127.95, 127.92, 127.91, 105.30, 100.68, 80.64, 77.36, 76.13, 74.94, 72.93, 72.44, 72.17, 68.26, 67.43, 61.84, 61.80, 54.62, 26.95, 20.77, 20.66, 20.30, 19.28.

IHM.3.182A  
 H1  
 1H\_64 CDCl3 /opt/topspin lco2\_pg 36

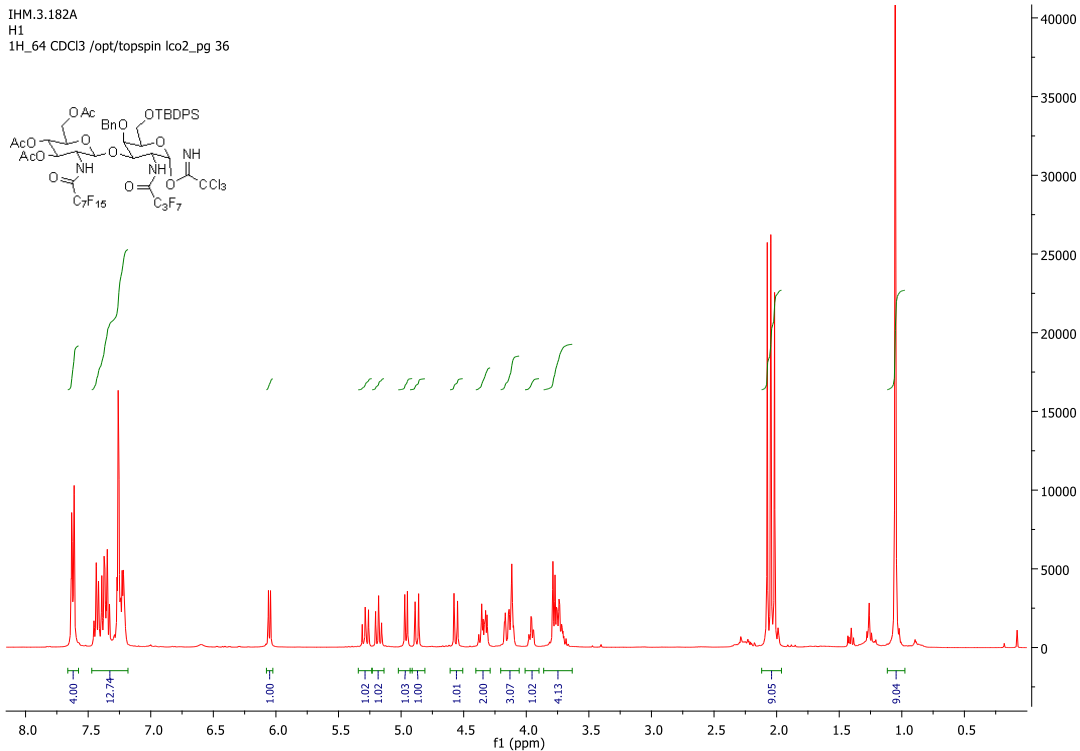
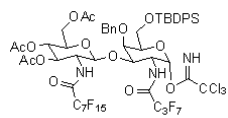

<sup>1</sup>H NMR (400 MHz) of Compound **152** in CDCl<sub>3</sub>

IHM.3.482A  
 H1  
 19F\_64 CDCl3 /opt/topspin lco2\_pg 36

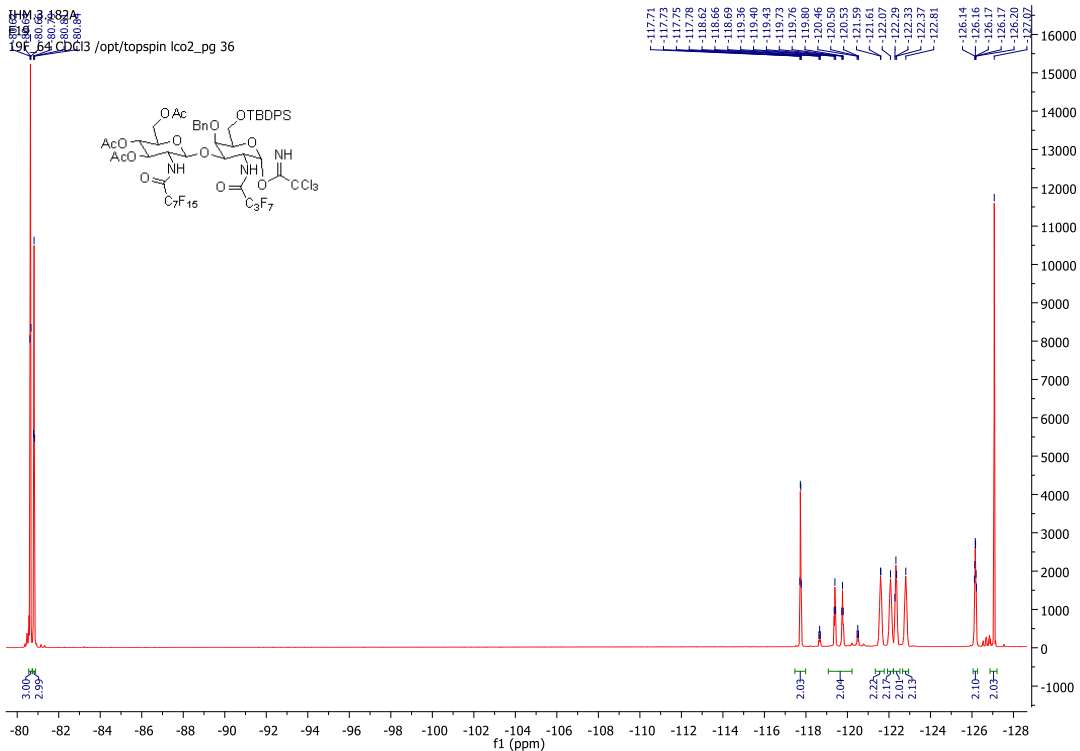
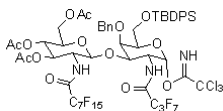

<sup>19</sup>F NMR (376 MHz) of Compound **152** in CDCl<sub>3</sub>





**Pentenyl (3,4,6-tri-*O*-acetyl-2-deoxy-2-(8,8,8,7,7,6,6,5,5,4,4,3,3,2,2-pentadecafluorooctanamido)-β-D-glucopyranosyl)-(1→3)-4-(*O*-benzyl-6-*O*-tert-butyl-diphenylsilyl-2-deoxy-2-(4,4,4,3,3,2,2-pentabutylamido)-β-D-galactopyranosyl)-(1→3)-2-azido-4-*O*-benzyl-6-*O*-tert-butyl-diphenylsilyl-2-deoxy-β-D-galactopyranoside (153)**

To the mixture of glycosyl donor (80mg, 0.0522mmol, 1 equiv.) and glycosyl acceptor (60mg, 0.0997mmol, 1.9 equiv.) was glycosylated as described in the general procedure in an anhydrous DCM (2mL) and TMSOTf (1.5μL of freshly opened, 0.00783mmol, 0.15 equiv.) dropwise. The crude reaction mixture was confirmed to contain the desired compound by Mass Spectral data and purification was performed on the reversed-phase column (4g) using Interchim purification machine (MeOH: H<sub>2</sub>O; 60:40 → 100%) as eluent afforded the desired product 100mg, 97% as a colorless form.

R<sub>f</sub> = 0.56, cyclohexane: ethylacetate, 7:3.

**HRMS** (ESI, positive mode) *m/z*: C<sub>87</sub>H<sub>93</sub>F<sub>22</sub>N<sub>5</sub>NaO<sub>18</sub>Si<sub>2</sub> [M+Na]<sup>+</sup>, calcd. 1992.5595, found 1992.5645.

**<sup>1</sup>H NMR** (400 MHz, CDCl<sub>3</sub>) δ (ppm): 7.66 – 7.00 (m, 30H, 6xPh), 6.70 (d, *J* = 9.1 Hz, 1H, N-H''), 6.61 (d, *J* = 5.9 Hz, 1H, N-H'), 5.79 (ddt, *J* = 16.9, 10.2, 6.7 Hz, 1H, HC=CH<sub>2</sub>), 5.21 – 4.93 (m, 6H, H'-3, H''-3, H''-4, ½ CH<sub>2</sub>-Ph, HC=CH<sub>2</sub>), 4.89 – 4.52 (m, 5H, H''-1, H'-1, ½ CH<sub>2</sub>-Ph, CH<sub>2</sub>-Ph), 4.41 – 4.28 (m, 2H, H''-6, H''-2), 4.22 – 4.10 (m, 2H, H-1, H''-6), 4.11 – 3.21 (m, 14H, ½ CH<sub>2</sub>, H'-6, H''-5, H'-6, H'-5, H-3, H-4, H-6, H'-2, H'-4, ½ CH<sub>2</sub>, H-6, H-2, H-5), 2.17 – 2.09 (m, 2H, CH<sub>2</sub>), 2.07 (s, 3H, C(O)<sub>2</sub>CH<sub>3</sub>), 2.03 (s, 3H, C(O)<sub>2</sub>CH<sub>3</sub>), 2.00 (s, 3H, C(O)<sub>2</sub>CH<sub>3</sub>), 1.03 (s, 9H, *t*-Bu), 0.86 (s, 9H, *t*-Bu).

**<sup>19</sup>F NMR** (376 MHz, CDCl<sub>3</sub>) δ (ppm): -80.35 (t, *J* = 9.3 Hz, 3F), -80.76 (t, *J* = 9.9 Hz, 3F), -118.78 – -120.24 (m, 4F), -121.41 – -121.64 (m, 2F), -121.86 – -122.17 (m, 2F), -122.17 – -122.42 (m, 2F), -122.60 – -122.87 (m, 2F), -125.91 – -126.20 (m, 4F).

**<sup>13</sup>C NMR** (101 MHz, CDCl<sub>3</sub>) δ (ppm): 171.40, 170.51, 169.46, 138.88, 138.86, 138.17, 135.69, 135.64, 135.59, 133.35, 133.30, 132.99, 132.92, 130.11, 130.08, 129.81, 128.43, 128.23, 128.15, 128.08, 128.04, 128.01, 127.95, 127.88, 127.79, 127.71, 127.29, 115.00, 102.80, 102.40, 101.25, 99.72, 79.67, 77.36, 76.71, 75.68, 75.53, 75.36, 75.19, 74.82, 74.59, 72.44, 71.90, 69.36, 68.03, 62.83, 62.63, 61.73, 61.50, 56.55, 54.82, 30.19, 28.81, 27.01, 26.97, 26.80, 26.72, 20.78, 20.66, 20.18, 19.15, 19.03.

[α]<sub>D</sub><sup>27</sup> = -14° (C=10mg/mL in CHCl<sub>3</sub>)

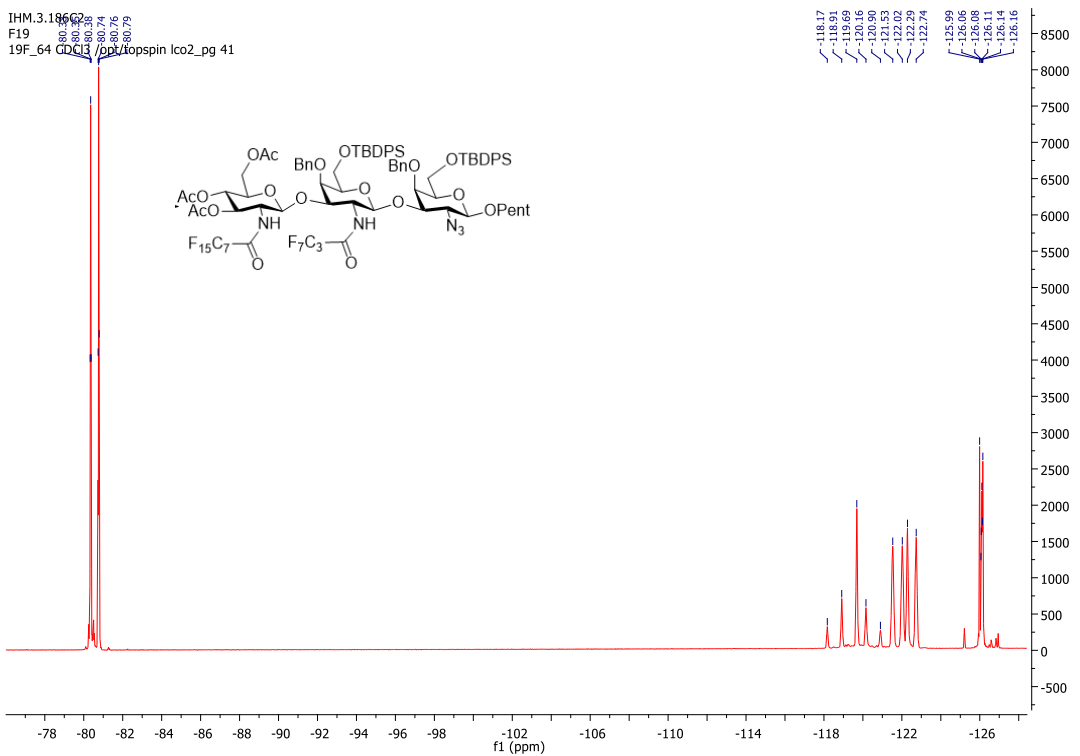
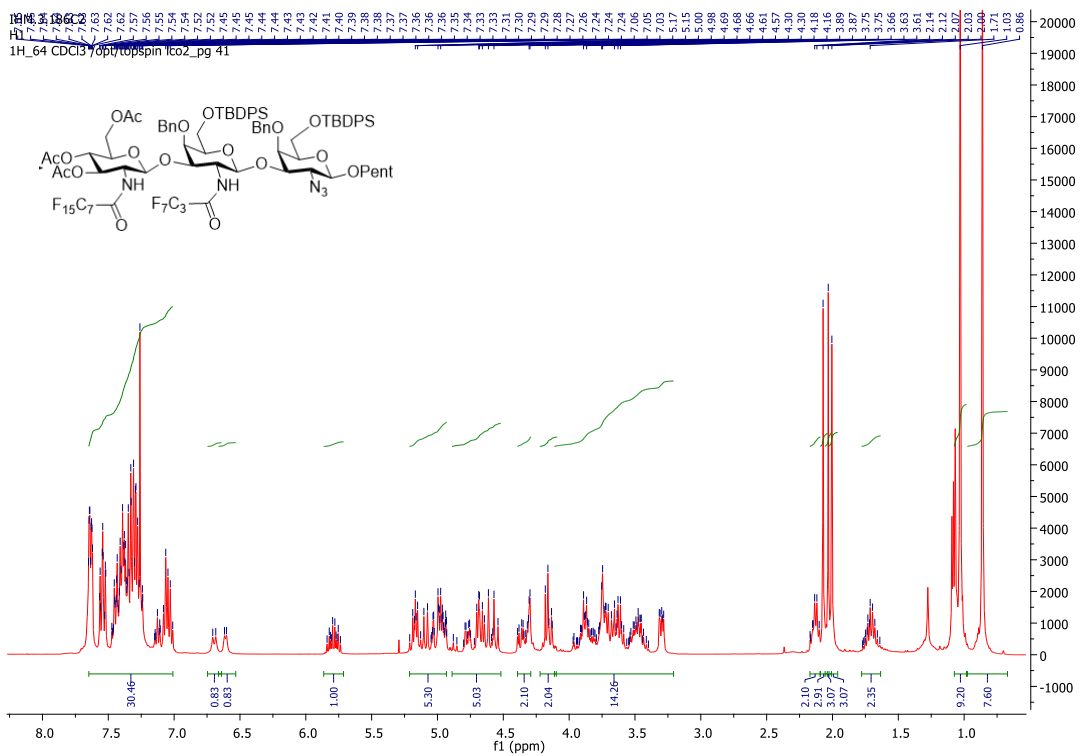

## EXPERIMENTAL FOR CHAPTER FOUR

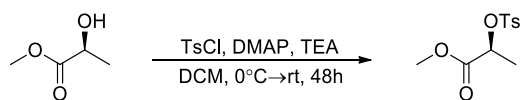

### 155

To a clean round bottom flask equipped with stir bar, septum and an argon balloon was introduced tosyl chloride (5.770mmol, 1.100g, 1.1 equiv.) dissolved in anhydrous DCM (10mL). The reaction mixture was cooled down to 0°C in an ice bath, then treated with methyl (s)-(-)-lactate (5.245mmol, 0.5mL, 1 equiv.), DMAP (5.245mmol, 0.641g, 1 equiv.), TEA (0.294mmol, 0.46mL, 1.2 equiv.) and finally stirred the reaction set up from 0°C to rt for two days. The reaction progress was monitored by TLC in cyclohexane: ethylacetate 4:1. The reaction was diluted with DCM (50mL), washed with sat aq. NH<sub>4</sub>Cl (50mLx2), back extracted the aqueous phases with DCM and the combined organic layers was dried over Na<sub>2</sub>SO<sub>4</sub>, filtered, and concentrated at vacuo. Flash column of the crude product on silica gel (cyclohexane: ethylacetate 80:20 → 60:40%) as eluent afforded the desired adduct in 6% yield as pale-yellow oil.

R<sub>f</sub> = 0.4 in cyclohexane: ethylacetate 80:20.

<sup>1</sup>H NMR (300 MHz, CDCl<sub>3</sub>) δ 9ppm): 7.78 (d, *J* = 8.3 Hz, 2H, 2xArom-CH), 7.33 (d, *J* = 8.1 Hz, 2H, 2xArom-CH), 4.92 (q, *J* = 6.9 Hz, 1H, CH-CH<sub>3</sub>), 3.64 (s, 3H, O-CH<sub>3</sub>), 2.42 (s, 3H, Ph-CH<sub>3</sub>), 1.48 (d, *J* = 6.9 Hz, 3H, CH-CH<sub>3</sub>).

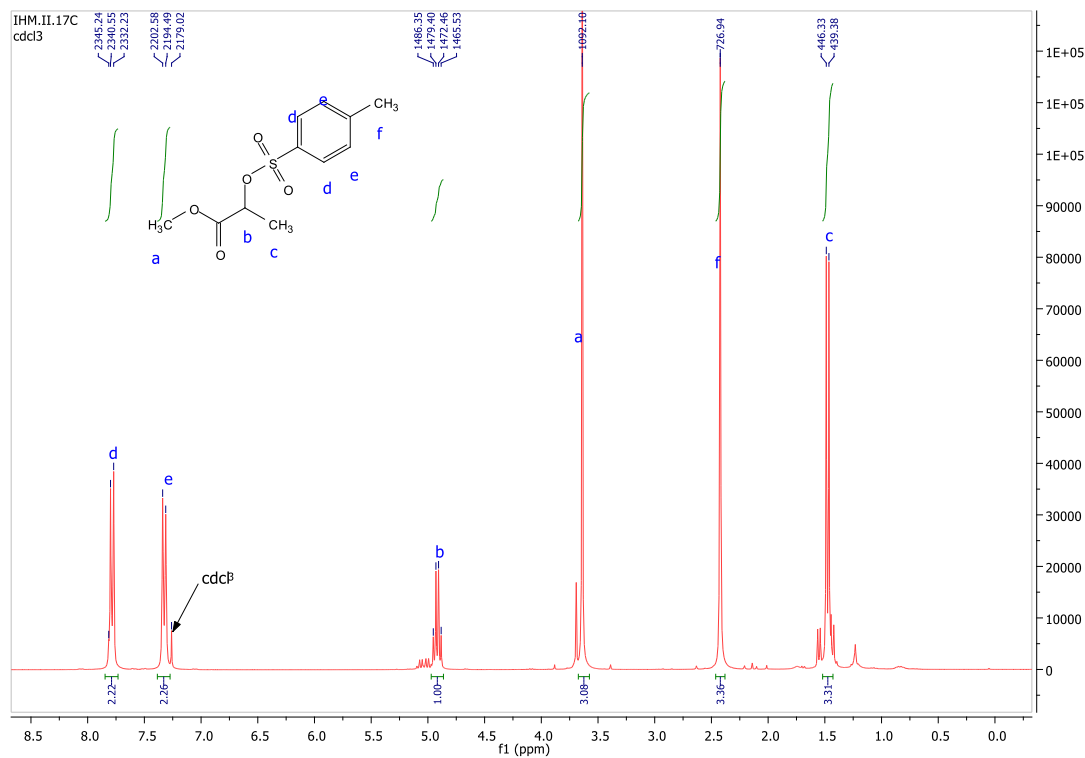

<sup>1</sup>H NMR (300 MHz) of Compound 155 in CDCl<sub>3</sub>

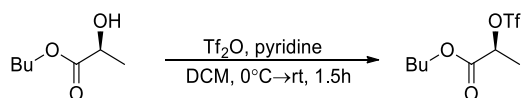

## 157

To a solution of anhydrous pyridine (0.53mL, 6.549mmol, 1.1 equiv.) in anhydrous DCM (30mL) was added Tf<sub>2</sub>O (1.1L, 6.546mmol, 1.1 equiv.) at 0°C in a clean round bottom flask equipped with stir bar, septum and an argon balloon. After 10 minutes of constant stirring, then was introduced to the reaction mixture Butyl (s)-(-)-lactate (0.86mL, 1.786mmol, 1 equiv.) dropwise under argon atmosphere and stirred at this condition for 1.5h. The reaction mixture was quenched with a mixture of distilled H<sub>2</sub>O and Et<sub>2</sub>O. The biphasic layer was separated, and the aqueous layer was back extracted with Et<sub>2</sub>O (x4). The combined organic layers were dried over Na<sub>2</sub>SO<sub>4</sub>, filtered, and concentrated at reduced pressure in the vacuo at 25°C, which afforded 1.656g, 99% of the concentrated residue as pale-yellow syrup.

<sup>1</sup>H NMR (300 MHz, CDCl<sub>3</sub>) δ (ppm): 5.20 (q, *J* = 7.0 Hz, 1H, CH-CH<sub>3</sub>), 4.31 – 4.14 (m, 2H, O-CH<sub>2</sub>), 1.68 (d, *J* = 7.0 Hz, 3H, CH-CH<sub>3</sub>), 1.74 – 1.56 (m, 2H, CH<sub>2</sub>-CH<sub>2</sub>-CH<sub>2</sub>-O), 1.48 – 1.28 (m, 2H, CH<sub>3</sub>-CH<sub>2</sub>-CH<sub>2</sub>), 0.92 (t, *J* = 7.4 Hz, 3H, CH<sub>3</sub>-CH<sub>2</sub>).

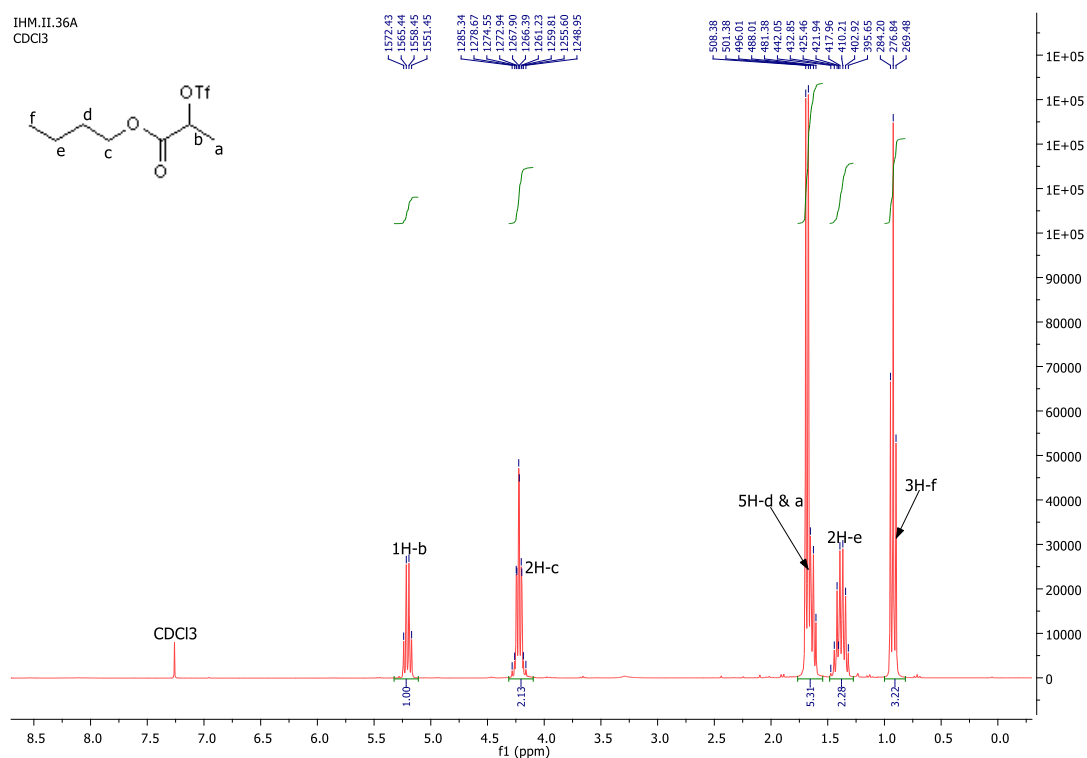

<sup>1</sup>H NMR (300 MHz) of Compound 157 in CDCl<sub>3</sub>

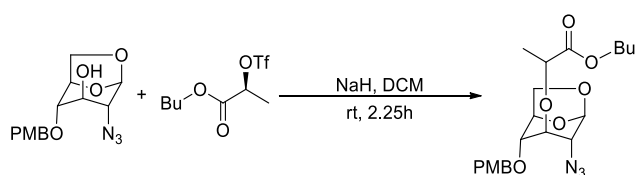

**1,6-anhydro-2-azido-4-O-*p*-methoxybenzyl-2-deoxy-3-O-[(1R)-1-(ethoxycarbonyl)-butyl]- $\beta$ -D-glucopyranose (158).**

A suspension of 1,6-anhydro-2-azido-4-O-*p*-methoxybenzyl-2-deoxy- $\beta$ -D-glucopyranose acceptor (2.154mmol, 662mg, 1equiv.) azeotroped with toluene was dissolved in dry DCM (20mL) in a clean RB flask equipped with stir bar, septum, and argon atmosphere at rt. NaH (3.231mmol, 78mg, 1.5equiv. 60% in mineral oil) was added to the reaction solution and stirred at rt for 15minutes. Lactic triflate donor (2.990mmol, 832mg, 1.3equiv. dissolved in DCM) was treated to the reaction flask dropwise and stirred for 2h. Reaction progress was monitored by TLC in chloroform: acetone 100:2, and then quenched the mixture with crushed ice, washed with NaHCO<sub>3(aq)</sub>(150mL), brine (150mL), back extracted the aqueous layer with DCM and the combined organic phase was dried over Na<sub>2</sub>SO<sub>4</sub>, filtered, and concentrated at vacuo. The crude mixture was purified on silica gel column in chloroform: acetone 100:1  $\rightarrow$  80:20 as eluent, yielding a pale-yellow syrup 498mg at 53%.

Rf = 0.23, in chloroform: acetone 100:2.

<sup>1</sup>H NMR (300 MHz, CDCl<sub>3</sub>)  $\delta$  (ppm): 7.30 (d, 2H, *J* = 8.7 Hz, CH<sub>2</sub>Arom), 6.89 (d, 2H, *J* = 8.7 Hz, CH<sub>2</sub>Arom), 5.71 – 5.10 (m, 1H, H-1), 4.68 – 4.44 (m, 3H, CH<sub>2</sub>-Ph, H-5), 4.26 (q, 1H, *J* = 13.9, 6.9 Hz, CH), 4.21 – 4.12 (m, 2H, OCH<sub>2</sub>), 3.94 (dd, 1H, *J* = 7.5, 6.9 Hz, H-6), 3.73 – 3.65 (m, 1H, H-6), 3.59 – 3.36 (m, 2H, H-3, H-2), 3.30 – 3.12 (m, 1H, H-4), 1.69 – 1.59 (m, 2H, CH<sub>2</sub>-H<sub>2</sub>C-O), 1.41 (d, 3H, *J* = 6.9 Hz, CH<sub>3</sub>-CH), 1.45 – 1.24 (m, 2H, CH<sub>2</sub>-CH<sub>3</sub>), 0.94 (t, 3H, *J* = 7.3 Hz, CH<sub>3</sub>-CH<sub>2</sub>).

LRMS (ESI, positive mode) *m/z*: C<sub>21</sub>H<sub>29</sub>NaN<sub>3</sub>O<sub>7</sub> [M+Na]<sup>+</sup>, calc. 458.2, found 458.2.

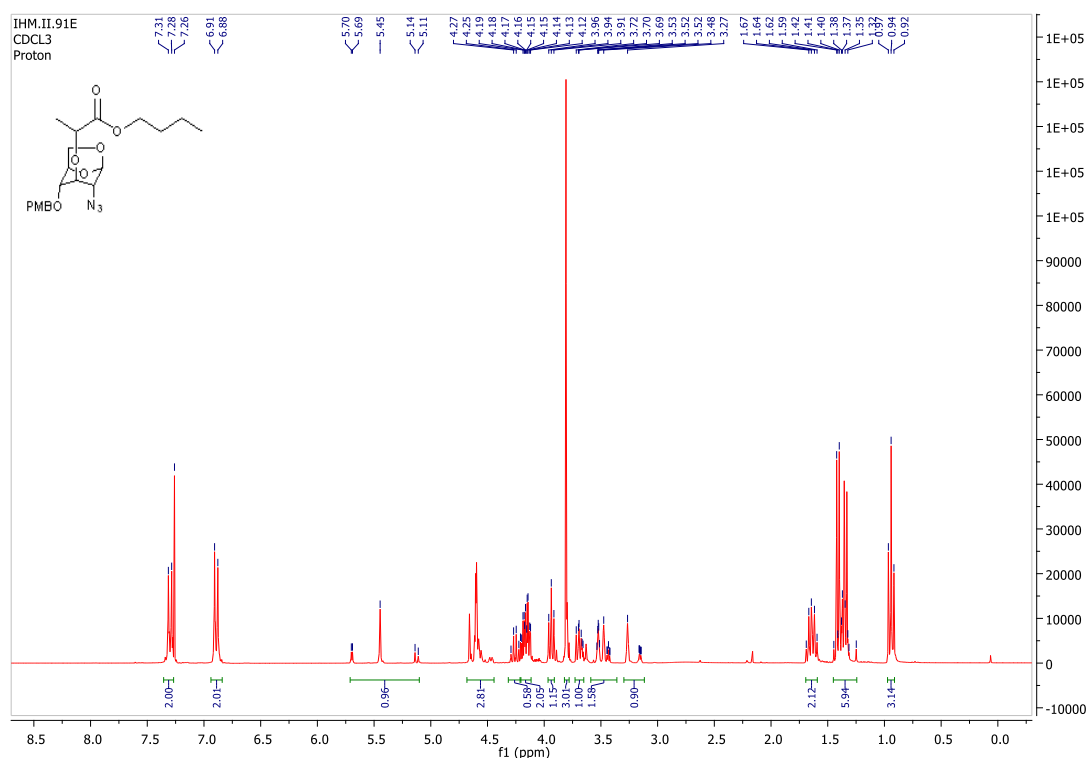

<sup>1</sup>H NMR (300 MHz) of Compound 158 in CDCl<sub>3</sub>

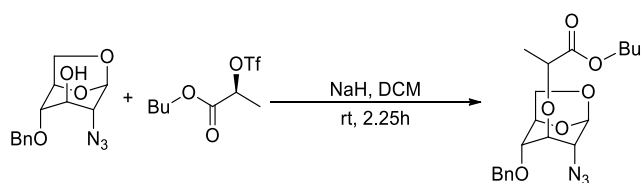

**1,6-anhydro-2-azido-4-O-benzyl-2-deoxy-3-O-[(1R)-1-(ethoxycarbonyl)-butyl]-β-D-glucopyranose (159)**

A suspension of 1,6-anhydro-2-azido-4-O-benzyl-2-deoxy-β-D-glucopyranose acceptor (1.042mmol, 289mg, 1equiv.) azeotroped with toluene was dissolved in dry DCM (12mL) in a clean RB flask equipped with stir bar, septum, and argon atmosphere at rt. NaH (1.563mmol, 38mg, 1.5equiv. 60% in mineral oil) was added to the reaction solution and stirred at rt for 15minutes. Lactic triflate (1.563mmol, 435mg, 1.5equiv. dissolved in DCM) was treated to the reaction flask dropwise and stirred for 2h. Reaction progress was monitored by TLC in chloroform: acetone 100:1, and then quenched the mixture with ice, washed with  $\text{NaHCO}_3(\text{aq})$ , brine, back extracted the aqueous layer with DCM and the combined organic phase was dried over  $\text{Na}_2\text{SO}_4$ , filtered, and concentrated at vacuo. The crude mixture was purified on silica gel column in chloroform: acetone 100:1 → 1:1 as eluent yielding pale yellow syrup 339mg at 96%.

R<sub>f</sub> = 0.30 in chloroform: acetone 100:1.

<sup>1</sup>H NMR (300 MHz, CDCl<sub>3</sub>) δ 9ppm): 7.43 – 7.24 (m, 5H, Ph), 5.44 (s, 1H, H-1), 4.75 – 4.53 (m, 3H, H-5, CH<sub>2</sub>-Ph), 4.13 (tt, *J* = 4.0, 2.1 Hz, 2H, O-CH<sub>2</sub>-CH<sub>2</sub>), 4.01 – 3.86 (m, 1H, CH-CH<sub>3</sub>, H-6), 3.69 (dd, *J* = 7.2, 6.0 Hz, 1H, H-6), 3.56 (s, 1H, H-3), 3.48 (s, 1H, H-2), 3.28 (s, 1H, H-4), 1.64 (dt, *J* = 14.7, 6.8 Hz, 2H, CH<sub>2</sub>-CH<sub>2</sub>-CH<sub>2</sub>), 1.50 – 1.22 (m, 5H, CH<sub>2</sub>-CH<sub>2</sub>-CH<sub>3</sub>, CH-CH<sub>3</sub>) 0.94 (t, *J* = 7.4 Hz, 3H, CH<sub>2</sub>-CH<sub>2</sub>-CH<sub>3</sub>).

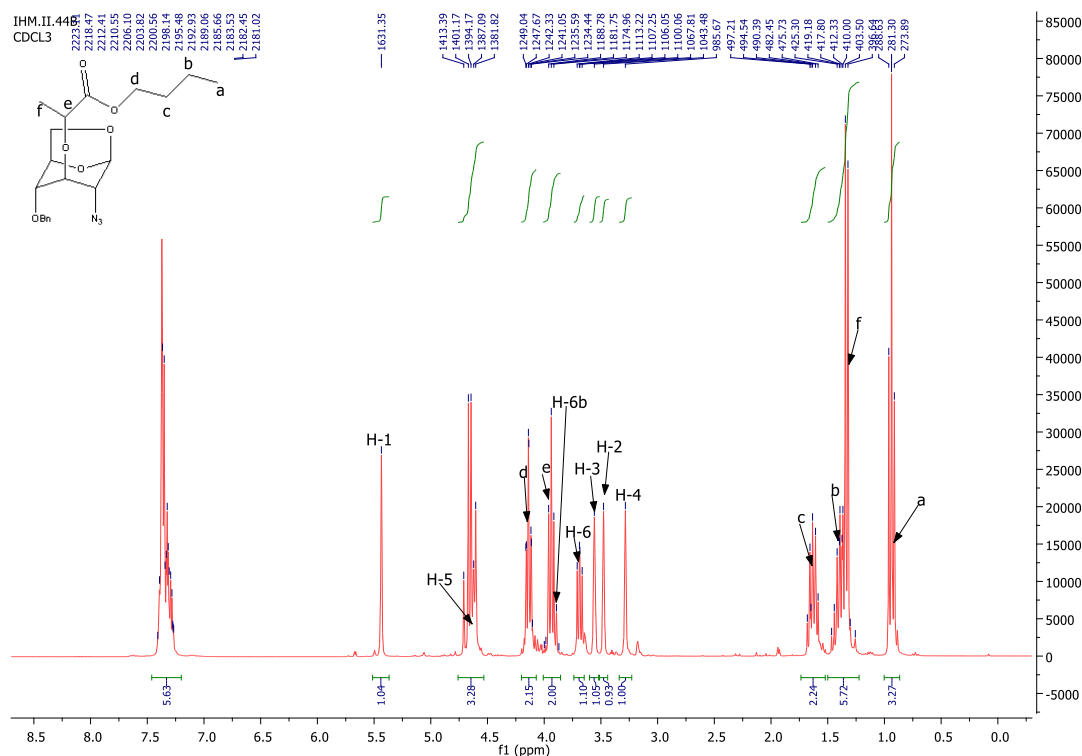

<sup>1</sup>H NMR (300 MHz) of Compound 159 in CDCl<sub>3</sub>

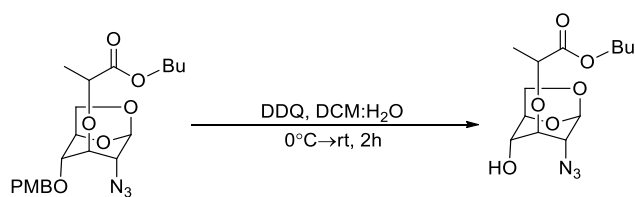

### 1,6-anhydro-2-azido-2-deoxy-3-O-[(1R)-1-(ethoxycarbonyl)-butyl]-β-D-glucopyranose (160)

A solution of 1,6-anhydro-2-azido-4-O-*p*-methoxybenzyl-2-deoxy-3-O-[(1R)-1-(ethoxycarbonyl)-butyl]-β-D-glucopyranose (1.010mmol, 440mg, 1equiv. azeotroped with tol.) was dissolved dry DCM:H<sub>2</sub>O (5mL; 10:1) and followed by the addition of DDQ (1.614mmol, 370mg, 1.6equiv.) at 0 °C in an ice bath, stirred the reaction flask equipped with stir bar, septum and argon atmosphere for 2h. TLC in cyclohexane:ethylacetate 8:2 confirmed complete reaction, filtered the reaction mixture through celite plug, washed with DCM and the filtrate was extracted with H<sub>2</sub>O (50mLx2), back extract with DCM (50mLx2) and the combined organic phase was washed with brine (75mL), dried over Na<sub>2</sub>SO<sub>4</sub>, filtered and concentrated at vacuo. The crude mixture was purified by flash column chromatography on silica gel in cyclohexane: ethylacetate 80:20 → 50:50 as eluent, 198mg at 62% yield.

R<sub>f</sub> = 0.065 in cyclohexane: ethylacetate 6:4.

<sup>1</sup>H NMR (300 MHz, CDCl<sub>3</sub>) δ (ppm): 5.45 – 5.40 (m, 1H, H-1), 4.57 – 4.50 (m, 1H, H-5), 4.22 – 4.12 (m, 4H, OCH<sub>2</sub>, CH, H-6), 3.83 – 3.79 (m, H-3), 3.77 (dd, 1H, *J* = 7.3, 5.9 Hz, H-6), 3.59 – 3.51 (m, 2H, H-4, H-2), 2.66 (br s, 1H, OH), 1.69 – 1.59 (m, 2H, CH<sub>2</sub>-H<sub>2</sub>CO), 1.42 (d, 3H, *J* = 6.9 Hz, CH<sub>3</sub>-CH), 1.45 – 1.32 (m, 2H, CH<sub>2</sub>-CH<sub>3</sub>), 0.94 (t, 3H, *J* = 7.4 Hz, CH<sub>3</sub>-CH<sub>2</sub>).

LRMS (ESI, positive mode) *m/z*: C<sub>13</sub>H<sub>21</sub>NaN<sub>3</sub>O<sub>6</sub> [M+Na]<sup>+</sup>, calc. 338.1, found 338.1.

[α]<sub>D</sub><sup>22.9</sup> = +53° (C=10mg/mL in Acetone)

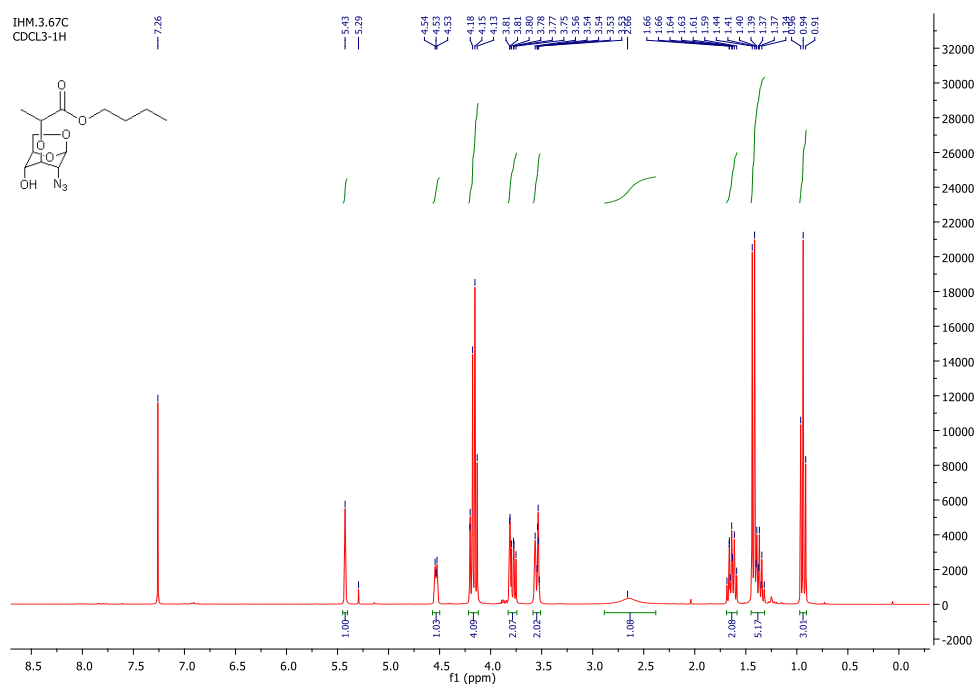

<sup>1</sup>H NMR (300 MHz) of Compound 160 in CDCl<sub>3</sub>

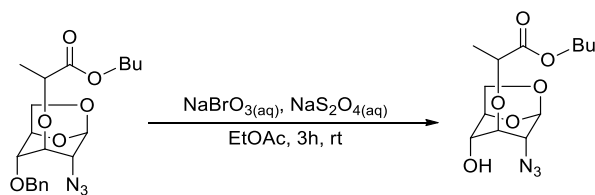

### 1,6-anhydro-2-azido-2-deoxy-3-O-[(1R)-1-(ethoxycarbonyl)-butyl]-β-D-glucopyranose (160)

To the azeotroped solution of 1,6-anhydro-2-azido-4-O-benzyl-2-deoxy-3-O-[(1R)-1-(ethoxycarbonyl)-butyl]-β-D-glucopyranose (0.528mmol, 214mg, 1equiv.) was added in EtOAc (5mL) and then a solution of NaBrO<sub>3</sub> (5.28mmol, 797mg, 10equiv.) in distilled H<sub>2</sub>O (20mL) was added to the reaction mixture. The set-up was allowed to stir vigorously in an Erlenmeyer flask (50mL) equipped with a rod stir bar and septum for 2h at rt and the two-phase system was treated with a solution of Na<sub>2</sub>S<sub>2</sub>O<sub>4(aq)</sub> (5.28mmol, 919mg, 10equiv.) dropwise over 10 minutes at rt at which the mixture turned orange in color, stirred for 1h and monitored by TLC in cyclohexane: ethylacetate; 6:4. The mixture was diluted with EtOAc after completion and separated the organic-phase in a separatory funnel, back extracted the aqueous phase with EtOAc and the combined organic layers was washed with sat. Na<sub>2</sub>S<sub>2</sub>O<sub>3(aq)</sub> at which the color changed from orange to colorless. Dried the organic phase over Na<sub>2</sub>SO<sub>4</sub>, filtered and concentrated at vacuo. The crude residue was purified on silica gel in cyclohexane: ethylacetate 70:30→50:50 as eluent, affording 90mg as colorless oil at 54%.

R<sub>f</sub> = 0.32 in cyclohexane: ethylacetate, 6:4.

<sup>1</sup>H NMR (300 MHz, CDCl<sub>3</sub>) δ (ppm): 5.50 – 5.35 (m, 1H, H-1), 4.60 – 4.45 (m, 1H, H-5), 4.20 – 4.09 (m, 4H, OCH<sub>2</sub>, CH, H-6), 3.81 – 3.76 (m, H-3), 3.75 (dd, 1H, *J* = 7.4, 6.0 Hz, H-6), 3.58 – 3.49 (m, 2H, H-4, H-2), 2.96 (br s, 1H, OH), 1.67 – 1.56 (m, 2H, CH<sub>2</sub>-H<sub>2</sub>CO), 1.40 (d, 3H, *J* = 6.9 Hz, CH<sub>3</sub>-CH), 1.43 – 1.30 (m, 2H, CH<sub>2</sub>-CH<sub>3</sub>), 0.92 (t, 3H, *J* = 7.4 Hz, CH<sub>3</sub>-CH<sub>2</sub>).

LRMS (ESI, positive mode) *m/z*: C<sub>13</sub>H<sub>21</sub>NaN<sub>3</sub>O<sub>6</sub> [M+Na]<sup>+</sup>, calc. 338.1, found 338.1.

[α]<sub>D</sub><sup>22.9</sup> = +53° (C=10mg/mL in Acetone)



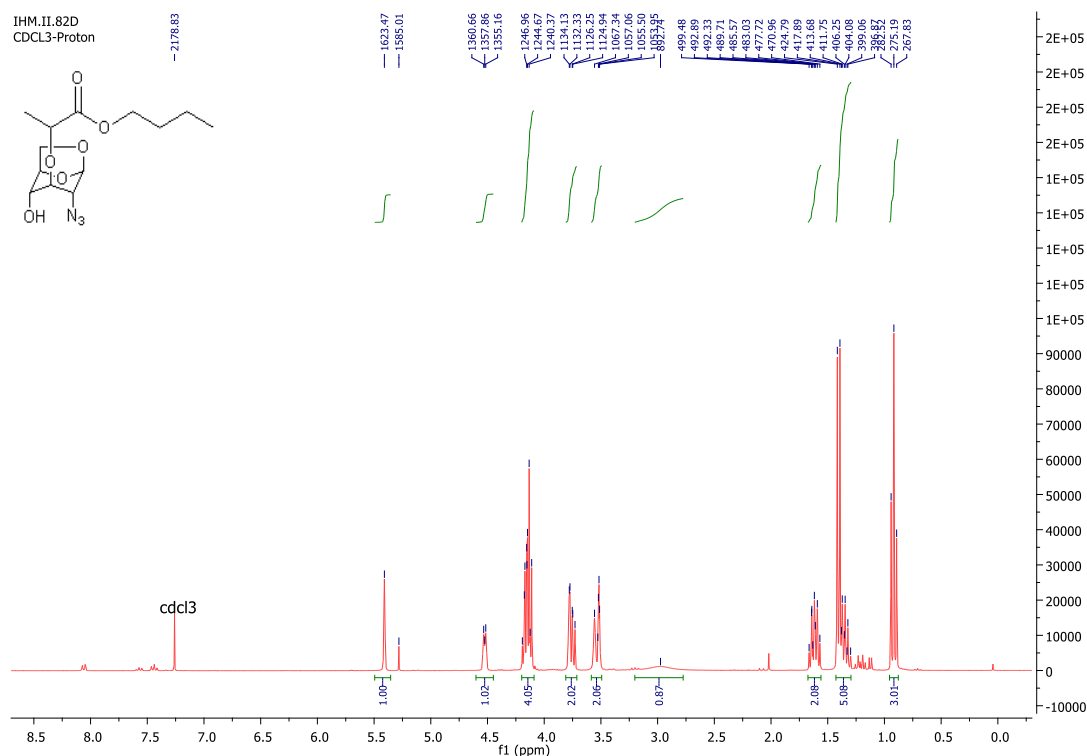

$^1\text{H}$  NMR (300 MHz) of Compound **160** in  $\text{CDCl}_3$

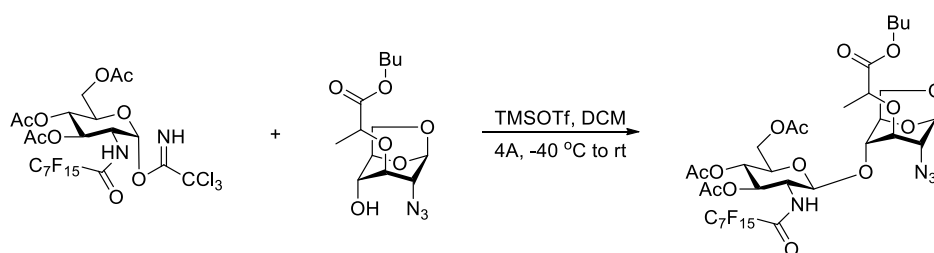

**(3,4,6-tri-O-acetyl-2-deoxy-2-(8,8,8,7,7,6,6,5,5,4,4,3,3,2-pentadecafluorooctanamido)- $\beta$ -D-glucopyranosyl)-(1 $\rightarrow$ 4)-1,6-anhydro-2-azido-2-deoxy-3-O-[(1R)-1-(ethoxycarbonyl)-butyl]- $\beta$ -D-glucopyranose (**161**)**

To the mixture of glycosyl donor (130mg, 0.154mmol, 1 equiv.) and glycosyl acceptor (73mg, 0.230mmol, 1.5 equiv.) was glycosylated as described in the general procedure in an anhydrous DCM (2.5mL) and TMSOTf (3 $\mu$ L of freshly opened bottle, 0.0154mmol, 0.1eq.) dropwise. The crude reaction mixture was confirmed to contain the desired compound by Mass Spec. Purification on the reversed-phase column (40g) using Interchim purification machine (MeOH:  $\text{H}_2\text{O}$ ; 70:30  $\rightarrow$  100%) as eluent yielded the desired product 144mg, 94% as a white form.

Rf = 0.081 in cyclohexane: ethylacetate, 7:3

HRMS (ESI, positive mode) m/z:  $\text{C}_{33}\text{H}_{37}\text{F}_{15}\text{N}_4\text{NaO}_{14}$  [ $\text{M}+\text{Na}$ ] $^+$ , calcd. 1021.1959, found 1021.1954.

$^1\text{H}$  NMR (400 MHz,  $\text{CDCl}_3$ )  $\delta$  (ppm): 7.21 (d,  $J$  = 7.9 Hz, 1H, N-H'), 5.61 (dd,  $J$  = 10.7, 9.3 Hz, 1H, H'-3), 5.43 (s, 1H, H-1), 5.31 (d,  $J$  = 8.3 Hz, 1H, H'-1), 5.05 (t,  $J$  = 9.7 Hz, 1H, H'-4), 4.47 (d,  $J$  = 5.4 Hz, 1H, H-5), 4.25 – 4.03 (m, 6H, 2H'-6, H'-2, H-3, H-6, CH), 3.87 – 3.65 (m, 5H, H-5, H-2, H-6, O-CH<sub>2</sub>-CH<sub>2</sub>), 3.45 (s,

$^1\text{H}$ ,  $\underline{\text{H}}-4$ ), 2.05 (s, 3H,  $\text{OCOCH}_3$ ), 2.01 (s, 3H,  $\text{OCOCH}_3$ ), 1.97 (s, 3H,  $\text{OCOCH}_3$ ), 1.66 – 1.55 (m, 2H,  $\text{CH}_2\text{-H}_2\text{CO}$ ), 1.40 (d,  $J = 6.9$  Hz, 3H,  $\text{CH}_3\text{-CH}$ ), 1.40 – 1.30 (m, 2H,  $\text{CH}_2\text{-CH}_3$ ), 0.91 (t,  $J = 7.4$  Hz, 3H,  $\text{CH}_2\text{-CH}_3$ ).

$^{19}\text{F}$  NMR (376 MHz,  $\text{CDCl}_3$ )  $\delta$  (ppm): -80.90 (t,  $J = 9.9$  Hz, 3F), -119.74 (q,  $J = 29.1, 15.2$  Hz, 2F), -121.40 – -121.82 (m, 2F), -121.95 – -122.25 (m, 2F), -122.33 – -122.62 (m, 2F), -122.69 – -122.98 (m, 2F), -126.04 – -126.41 (m, 2F).

$^{13}\text{C}$  NMR (101 MHz,  $\text{CDCl}_3$ )  $\delta$  (ppm): 172.68, 170.62, 170.43, 169.55, 100.64, 98.00, 77.10, 75.07, 74.93, 73.66, 72.22, 70.59, 68.78, 65.29, 64.83, 61.86, 60.32, 56.12, 30.62, 20.71, 20.60, 20.28, 19.13, 18.84, 13.68.

$[\alpha]_{\text{D}}^{27} = +30^\circ$  (C=11mg/mL in  $\text{CHCl}_3$ )

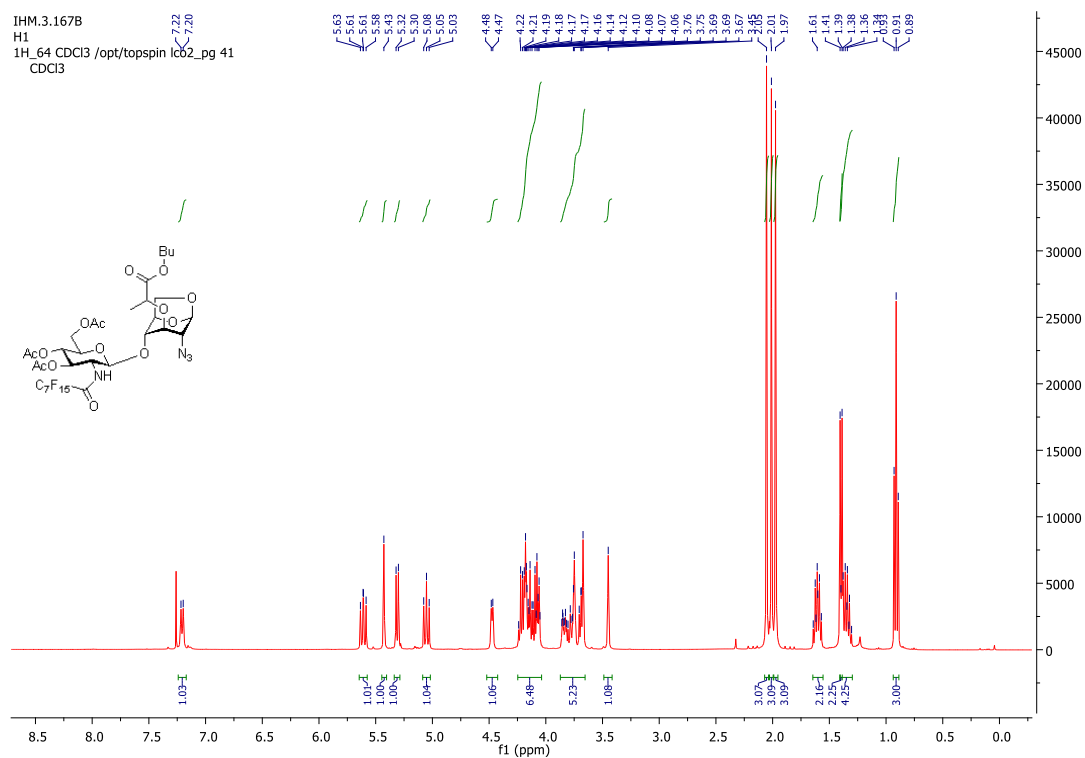

$^1\text{H}$  NMR (400 MHz) of Compound 161 in  $\text{CDCl}_3$

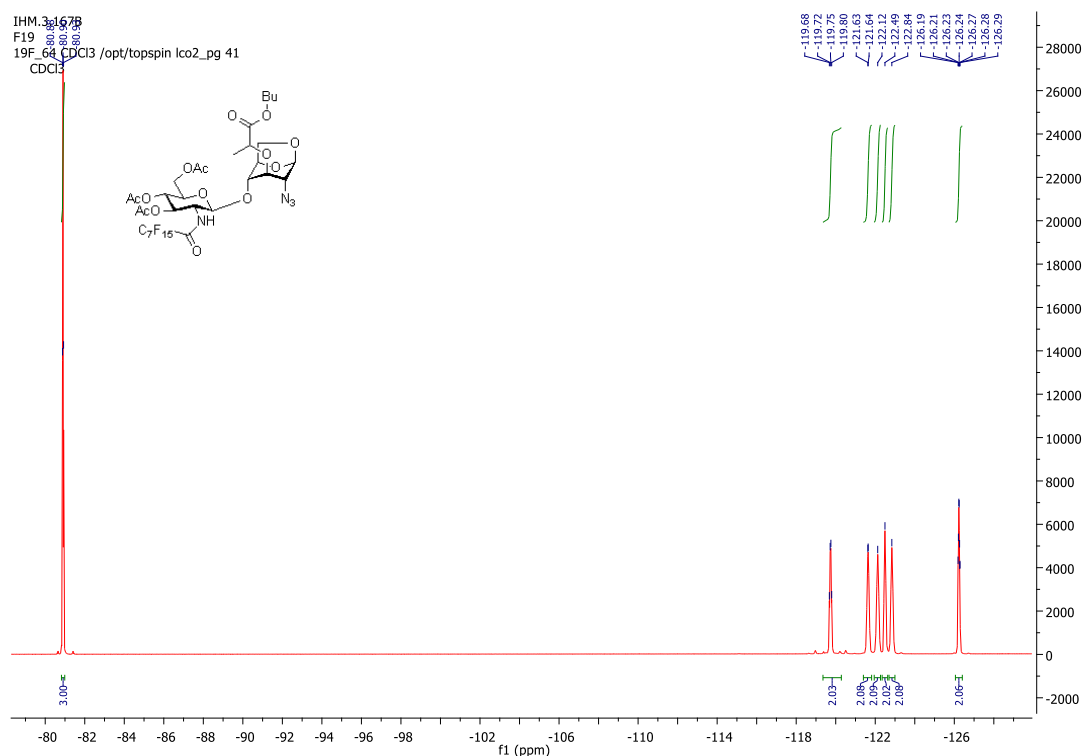

$^{19}\text{F}$  NMR (376 MHz) of Compound **161** in  $\text{CDCl}_3$

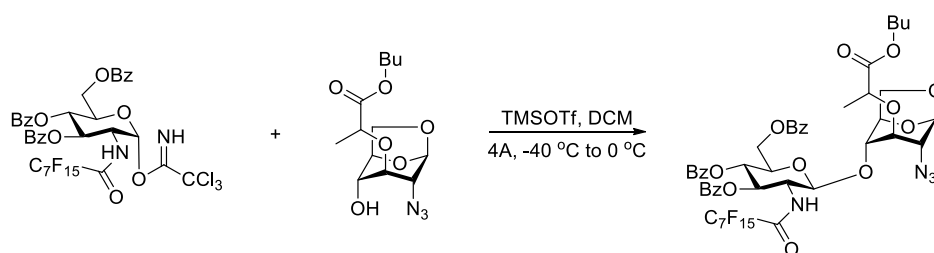

**(3,4,6-tri-*O*-benzoyl-2-deoxy-2-(8,8,8,7,7,6,6,5,5,4,4,3,3,2,2-pentadecafluorooctanamido)- $\beta$ -D-glucopyranosyl)-(1 $\rightarrow$ 4)-1,6-anhydro-2-azido-2-deoxy-3-*O*-[(1*R*)-1-(ethoxycarbonyl)-butyl]- $\beta$ -D-glucopyranose (**162**)**

To the mixture of glycosyl donor (179mg, 0.173mmol, 1 equiv.) and glycosyl acceptor (82mg, 0.260mmol, 1.5 equiv.) was glycosylated as described in the general procedure in an anhydrous DCM (2mL) and TMSOTf (40 $\mu$ L of freshly opened bottle, 0.02mmol, 0.1eq.) dropwise. After reaction time, the crude reaction mixture was confirmed to contain the desired compound by Mass Spec. Purification on the reversed-phase column (40g) using Combiflash purification machine (MeOH: H<sub>2</sub>O; 80:20  $\rightarrow$  100%) as eluent yielded the desired product 179mg, 87% as a white form.

R<sub>f</sub> = 0.32 in cyclohexane: ethylacetate, 7:3.

**HRMS** (ESI, positive mode) *m/z*: C<sub>48</sub>H<sub>43</sub>F<sub>15</sub>N<sub>4</sub>NaO<sub>14</sub> [M+Na]<sup>+</sup>, calcd. 1207.2428, found 1207.2435; [M+H]<sup>+</sup>, calcd. 1185.2609, found 1185.2626.

**<sup>1</sup>H NMR** (400 MHz, CDCl<sub>3</sub>)  $\delta$  (ppm): 8.03 – 7.11 (m, 16H, 3xPh, N-H'), 6.18 (dd, *J* = 10.6, 9.6 Hz, 1H, H'-3), 5.68 (t, *J* = 9.7 Hz, 1H, H'-4), 5.48 (d, *J* = 8.2 Hz, 1H, H'-1), 5.43 (s, 1H, H-1), 4.65 (dd, *J* = 12.3, 2.6 Hz,

$^1\text{H}$ ,  $\underline{\text{H}}-6$ ), 4.50 (dd,  $J = 12.3, 4.9$  Hz, 1H,  $\underline{\text{H}}-6$ ), 4.45 (d,  $J = 5.5$  Hz, 1H,  $\underline{\text{H}}-5$ ), 4.40 (ddd,  $J = 9.8, 4.7, 2.8$  Hz, 1H,  $\underline{\text{H}}'-5$ ), 4.26 – 4.01 (m, 4H,  $\underline{\text{H}}'-2$ ,  $\underline{\text{C}}\underline{\text{H}}$ ,  $\text{OCH}_2\text{-CH}_2$ ), 3.89 (d,  $J = 7.2$  Hz, 1H,  $\underline{\text{H}}-6$ ), 3.76 (s, 1H,  $\underline{\text{H}}-2$ ), 3.70 (s, 1H,  $\underline{\text{H}}-3$ ), 3.50 (t,  $J = 6.6$  Hz, 1H,  $\underline{\text{H}}-6$ ), 3.45 (s, 1H,  $\underline{\text{H}}-4$ ), 1.63 – 1.54 (m, 2H,  $\text{OCH}_2\text{-CH}_2$ ), 1.37 – 1.21 (m, 5H,  $\text{CH}_2\text{-CH}_2$ ,  $\text{CH-CH}_3$ ), 0.90 (t,  $J = 7.4$  Hz, 3H,  $\text{CH}_2\text{-CH}_3$ ).

$^{19}\text{F}$  NMR (376 MHz,  $\text{CDCl}_3$ )  $\delta$  (ppm): -80.92 (t,  $J = 9.9$  Hz, 3F), -119.53 – -120.22 (m, 2F), -121.57 – -121.91 (m, 2F), -122.09 – -122.37 (m, 2F), -122.37 – -122.61 (m, 2F), -122.81 – -123.06 (m, 2F), -126.18 – -126.42 (m, 2F).

$^{13}\text{C}$  NMR (101 MHz,  $\text{CDCl}_3$ )  $\delta$  (ppm): 172.63, 166.69, 166.11, 165.23, 133.86, 133.69, 133.39, 129.92, 129.76, 129.71, 129.50, 128.60, 128.55, 128.51, 128.28, 100.72, 98.01, 77.35, 75.11, 74.55, 73.33, 72.58, 71.52, 69.73, 65.23, 64.70, 62.86, 60.46, 56.09, 30.59, 19.10, 18.79, 13.68.

$[\alpha]_{\text{D}}^{25} = +11^\circ$  (C=15mg/mL in EtOAc)

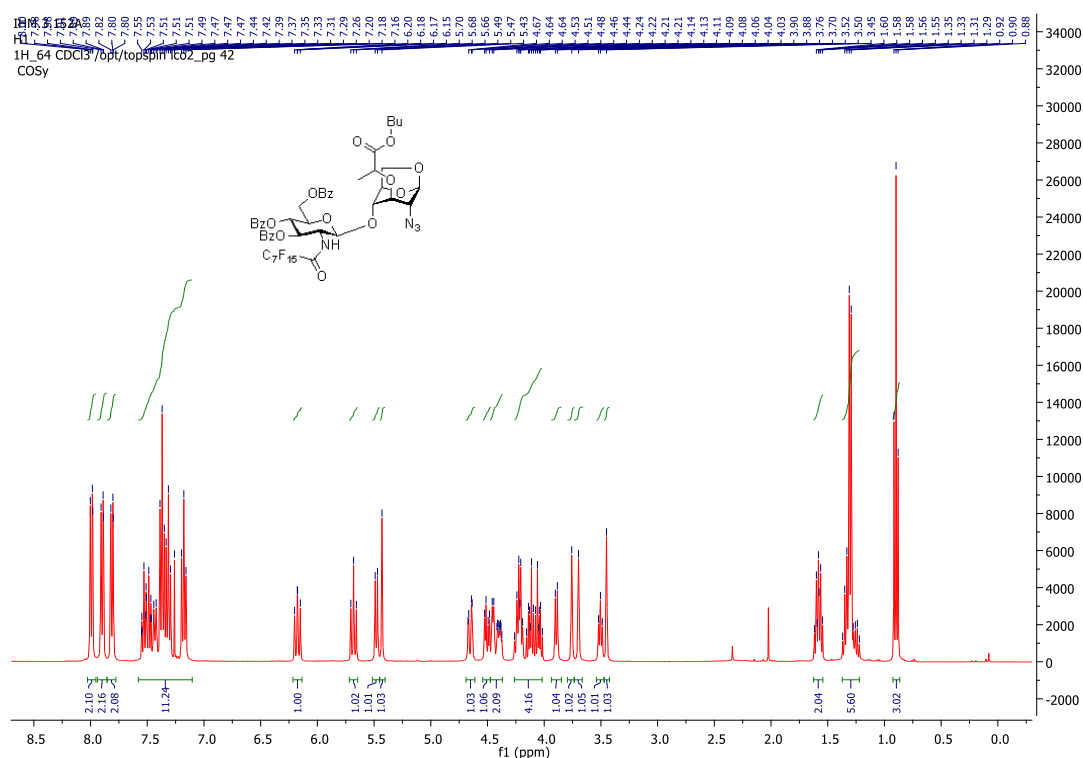

$^1\text{H}$  NMR (400 MHz) of Compound **162** in  $\text{CDCl}_3$

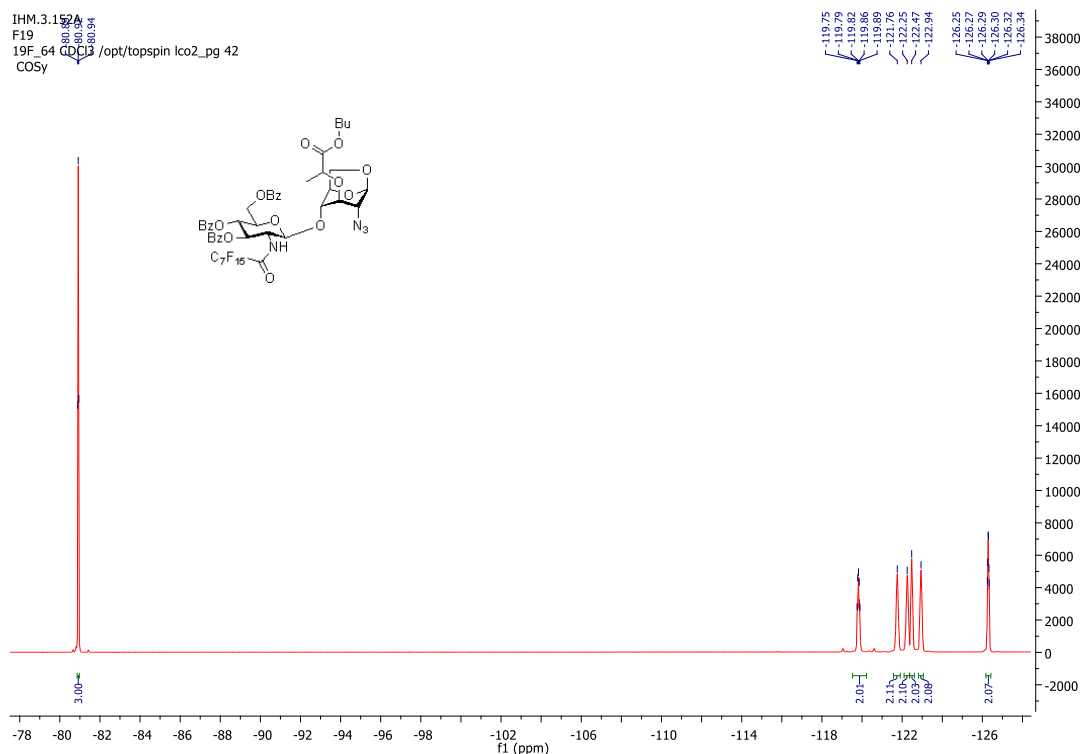

**<sup>19</sup>F NMR (376 MHz) of Compound 162 in CDCl<sub>3</sub>**

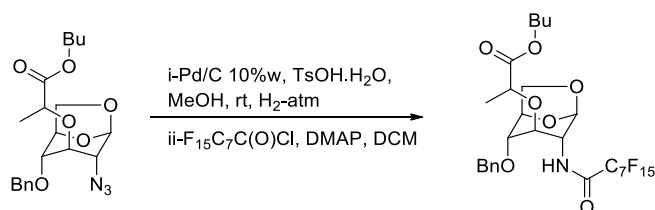

**1,6-anhydro-4-O-benzyl-2-deoxy-2-(8,8,8,7,7,6,6,5,5,4,4,3,3,2-pentadecafluorooctanamido)-3-O-[(1R)-1-(ethoxycarbonyl)-butyl]-β-D-glucopyranose (164).**

A mixture of starting material (1.356mmol, 550mg, 1 eq., azeotroped with tol.) and TsOH·H<sub>2</sub>O (1.356mmol, 258mg, 1eq.) in an RB reaction flask equipped with stir bar, septum and argon atmosphere was dissolved in dry MeOH (45mL). Another reaction flask, ovum-dried and exposed to argon several times was equipped with stir bar and added Pd/C 10% w of the starting material: 55mg). A solution of the first flask was transferred unto the second under argon at rt, purged three times with H<sub>2</sub>(g) under vacuum line and stirred under H<sub>2</sub>(g) for 50 minutes. Analytical TLC confirmed complete reaction and the reaction mixture was filter through celite plug, washed with MeOH and concentrated at vacuo and dried under vacuum pump. The residue was further dissolved in dry DCM (10mL), then treated with pentadecafluorooctanoyl chloride (1.492mmol, 370μL, 1.1 eq.), DMAP (4.065mmol, 497mg, 3 eq.) and the entire reaction set-up was stirred at rt overnight. Analytical TLC on the reaction mixture confirmed complete reaction and was diluted with H<sub>2</sub>O and EtOAc. Aqueous work-up was performed with sat. aq. NH<sub>4</sub>Cl, NaHCO<sub>3</sub>, NaCl. The combined organic layer was dried over anhydrous Na<sub>2</sub>SO<sub>4</sub>, filtered and concentrated at vacuo. Purification was carried out by silica gel column

chromatography eluted with cyclohexane: ethylacetate 70:30 → 60:40% which affords 835mg pale yellow oil at 79% after solvent evaporation.

Rf = 0.56 in cyclohexane: ethylacetate 6:4.

LRMS (ESI, positive mode) m/z: C<sub>28</sub>H<sub>28</sub>F<sub>15</sub>NaNO<sub>7</sub> [M+Na]<sup>+</sup>, calcd. 798.2, found 798.1.

<sup>1</sup>H NMR (300 MHz, CDCl<sub>3</sub>) δ (ppm): 7.54 (d, *J* = 8.3 Hz, 1H, N-H), 7.42 – 7.28 (m, 5H, Ph), 5.38 (s, 1H, H-1), 4.63 (ABX, CH<sub>2</sub>-Ph), 4.62 (d, *J* = 5.1 Hz, 1H, H-5), 4.24 – 4.08 (m, 5H, O-CH<sub>2</sub>-CH<sub>2</sub>, CH, 2H-6), 3.81 – 3.72 (m, 1H, H-3), 3.51 – 3.40 (m, 2H, H-2, H-4), 1.69 – 1.55 (m, 2H, O-CH<sub>2</sub>-CH<sub>2</sub>), 1.47 – 1.32 (m, 5H, CH-CH<sub>3</sub>, CH<sub>2</sub>), 0.93 (t, *J* = 7.3 Hz, 3H, CH<sub>2</sub>-CH<sub>3</sub>).

<sup>19</sup>F NMR (282 MHz, CDCl<sub>3</sub>) δ (ppm): -80.73 (tt, *J* = 9.9, 2.1 Hz), -119.64 – -120.04 (m, 2F), -121.40 – -121.75 (m, 2F), -121.75 – -122.11 (m, 2F), -122.40 – -122.84 (m, 4F), -125.93 – -126.25 (m, 2F).

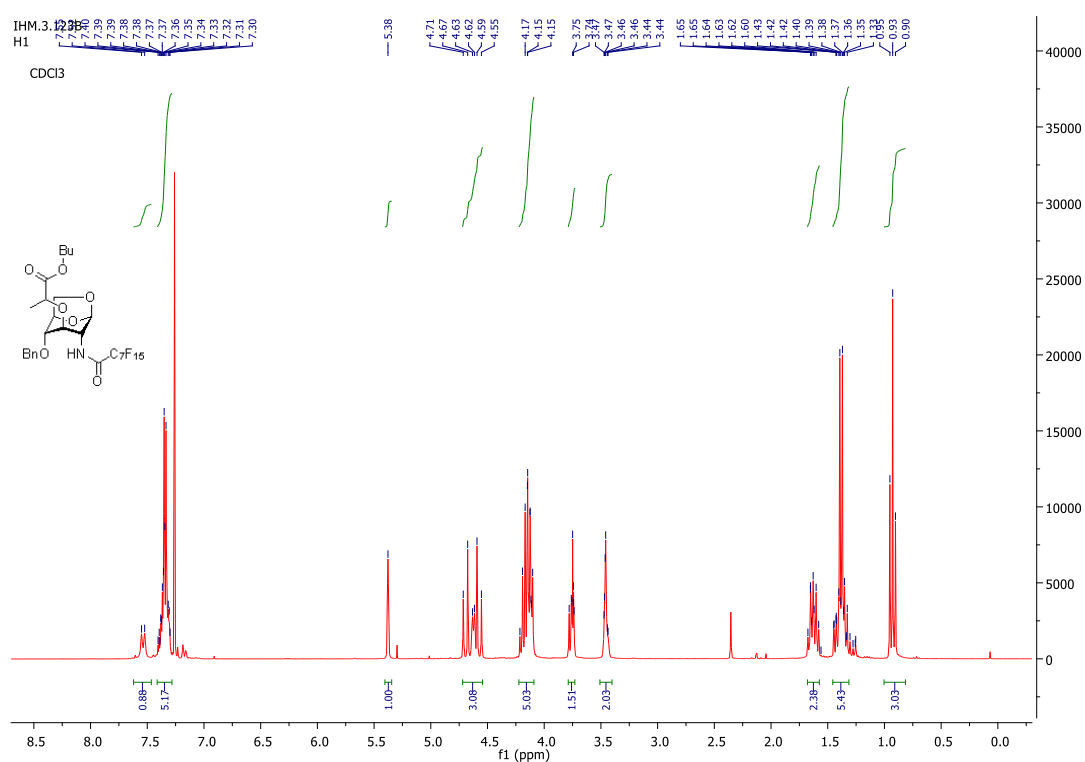

<sup>1</sup>H NMR (300 MHz) of Compound 164 in CDCl<sub>3</sub>

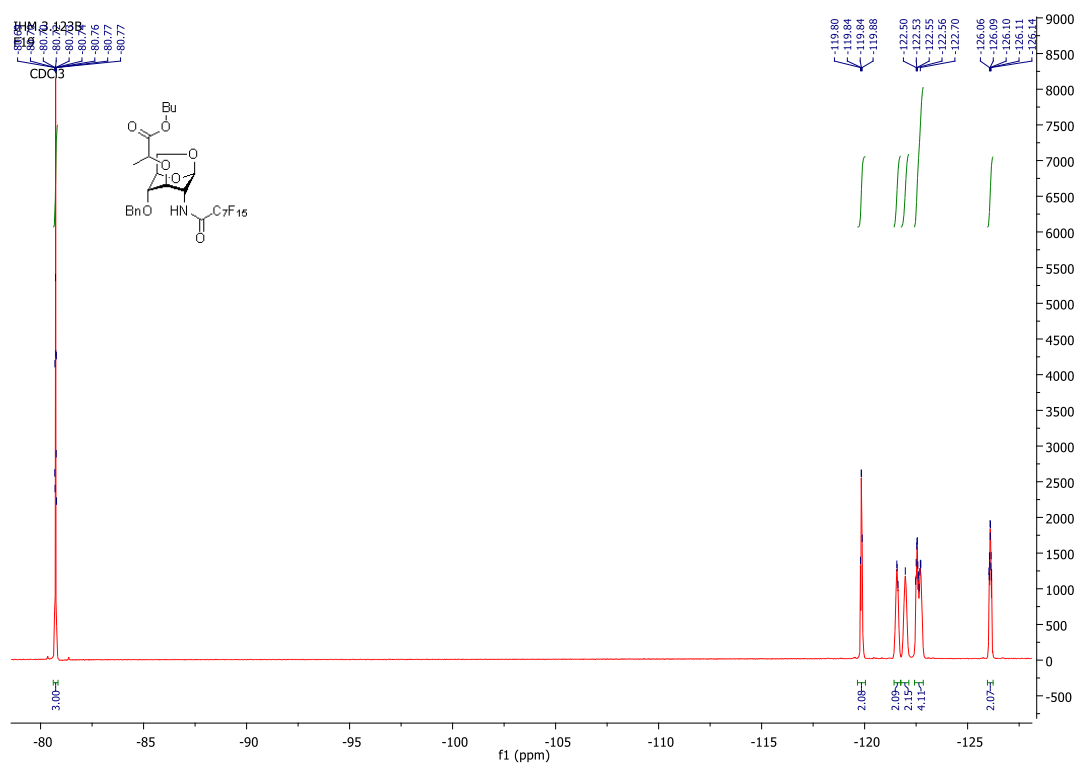

$^{19}\text{F}$  NMR (282 MHz) of Compound **164** in  $\text{CDCl}_3$

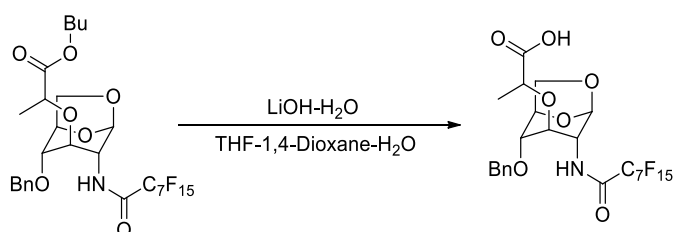

### Compound-165

To the solution of the starting material (0.722mmol, 50mg, 1 eq., azeotroped with tol.) was added a suspension of  $\text{LiOH}\cdot\text{H}_2\text{O}$  (0.795mmol, 33mg, 1.1 eq.) in an RB flask equipped with stir bar and glass stopper. THF—1,4-dioxane- $\text{H}_2\text{O}$  (14mL; 4:2:1 v/v) was added to the reaction flask and allowed to stir at rt for 4 hrs. Analytical TLC confirmed complete reaction. It was neutralized by Dowex  $\text{H}^+$  and filtered under vacuum line and concentrated. The residue was purified by silica gel column chromatography (eluent: cyclohexane: ethylacetate 80:20  $\rightarrow$  70:30%, DCM: MeOH 80:20  $\rightarrow$  60:40%, +0.01% AcOH in each gradient) and after solvent evaporation, a colourless oil 467mg was recovered at 90% yield.

Rf = 0 in cyclohexane: ethylacetate 7:3.

**HRMS** (ESI, positive mode) m/z:  $\text{C}_{24}\text{H}_{20}\text{F}_{22}\text{NNaO}_7$   $[\text{M}+\text{Na}]^+$ , calcd. 742.0892, found 742.0893;  $[\text{M}+\text{H}]^+$ , calcd. 720.1073, found 720.1075.

$^1\text{H}$  NMR (500 MHz,  $\text{CDCl}_3$ )  $\delta$  (ppm): 7.43 – 7.28 (m, 5H, Ph), 7.23 (d,  $J$  = 8.6 Hz, 1H, N-H), 5.49 (s, 1H, H-1), 4.74 – 4.55 (m, 3H,  $\text{CH}_2$ -Ph, H-5), 4.28 – 4.15 (m, 1H, H-6), 4.12 (d,  $J$  = 8.8 Hz, 1H, H-2), 3.83 (dd,  $J$  = 7.5, 5.6 Hz, 1H, H-6), 3.53 – 3.49 (m, H-3, H-4).

$^{13}\text{C}$  NMR (126 MHz,  $\text{CDCl}_3$ )  $\delta$  (ppm): 176.32, 173.92, 136.56, 128.92, 128.70, 128.00, 100.03, 77.36, 76.29, 75.88, 74.76, 74.20, 72.12, 65.73, 51.01, 48.54, 20.67, 17.81.

$^{19}\text{F}$  NMR (471 MHz,  $\text{CDCl}_3$ )  $\delta$  (ppm): -80.72 (t,  $J = 9.9$  Hz, 3F), -119.63 – -119.98 (m, 2F), -121.35 – -121.70 (m, 2F), -121.79 – -122.13 (m, 2F), -122.26 – -122.57 (m, 2F), -122.57 – -122.85 (m, 2F), -125.93 – -126.26 (m, 2F).

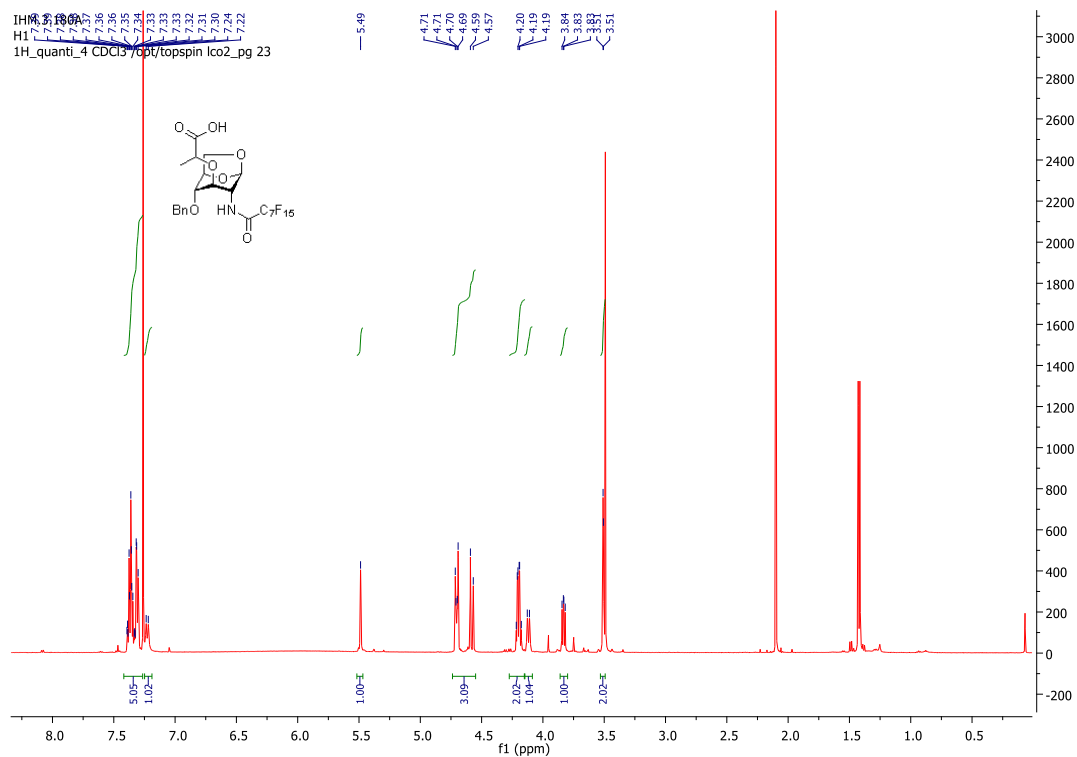



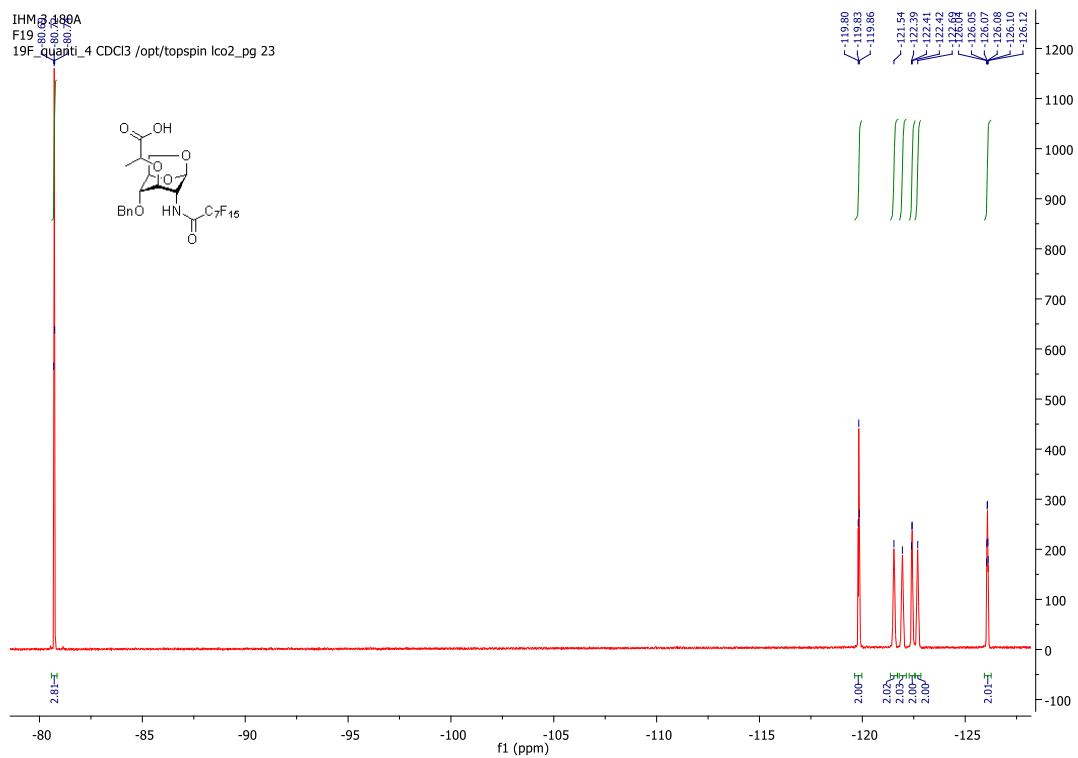

<sup>19</sup>F NMR (471 MHz) of Compound 165 in CDCl<sub>3</sub>

## CONCLUSION AND FUTURE PERSPECTIVES

The fluororous tag oligosaccharide assembly strategy has been developed in recent years to simplify purification steps during and after carbohydrate synthesis. Synthetic intermediates and final reaction products can be isolated in a straightforward manner in high purity. In our initial effort to employ this method for the preparation of model glucosamine  $\beta(1\rightarrow3)$  disaccharide has led to poorly soluble and unreactive fluororous glycosyl acceptors. All fluororous tag glycosyl precursors were prepared and purified by traditional silica gel column chromatography. However, fluororous TLC showed that the differential fluororous tag strategy did allow clean separation of the donor, acceptor and coupled disaccharide over fluororous solid phase. In addition, the C2 fluororous amides on the donors cleanly control the stereochemical outcome of the glycosylation as evident from then pure  $\beta$ -disaccharides isolated by fluororous TLC. Direct doubly fluororous tag  $\beta(1\rightarrow3)$  glycosylation was therefore hampered by the poor reactivity of the acceptors. Double fluororous tag glycosylation for the  $\beta(1\rightarrow4)$  linkage may confirm the extent of nucleophilic hydroxyl deactivation by the hydrogen bond of the fluororous amide acceptor.

In an alternative approach, traditional single fluororous tag glycosylation was tested with a fluororous glycosyl donor and previously prepared non-fluororous glycosyl acceptors, and thus revealed the deactivation trend effect from fluororous amide  $\gg$  to NH-amide  $>$  to phthalimide as confirmed by the relative recovered yields. Despite the somewhat lengthy synthetic schemes, new acceptors in this strategy were prepared and successfully furnished the desired disaccharides in the glycosylation reactions in yields reaching up to 90%. Consequently, from these model disaccharides we synthesized trisaccharides corresponding to a partial structure the *E. coli* O142 O-antigen. The trisaccharide synthesis allowed us to perform a strategy of differential fluororous tagging after coupling, which allowed us to control the newly formed stereocenter: whether the azide was reduced and acylated before or after the second coupling determined the stereochemistry of this step, providing either the  $\beta,\alpha$  or  $\beta,\beta$ -trisaccharides in excellent yields. We have therefore surmounted the deactivation challenge with a 2-azido glycosyl acceptors and have established a general scheme for stereocontrolled non-reducing-to-reducing fluororous-tag-assisted synthesis of aminosugar oligosaccharides.

At the beginning of this study, even trace amounts of coupled product could not be purified by traditional silica gel methodology. As fluororous silica gel and columns are no longer available from our suppliers, we proposed to try perfluorophenyl (PFP) columns by virtue of combined hydrophobic and fluorophilic properties associated with our target molecules. Analytical PFP column in LC/MS HPLC demonstrated its strong effect for isolating these compounds efficiently. Both preparative HPLC on PFP columns and preparative reverse phase MPLC on C18 cartridges proved extremely efficient. For the same purpose, we prepared homemade fluororous silica gel according to the straightforward published procedure, and as we expected, it demonstrated good affinity for purifying our synthetic intermediates. An apparent synergy between hydrophobic and fluorophilic effects of the relatively polar fluororous donor and the hydrophobic acceptors validate the concept of fluororous-hydrophobic programming for oligosaccharide synthesis.

Additionally, this progress inspired us to further extend the synthesis analogs of the tracheal cytotoxin (TCT) peptidoglycan disaccharide. The glycosidation reaction between fluororous donors and 1,6-anhydromuramic acid azide derivative again proved extremely successful, with yields around 90% and complete  $\beta$ -selectivity. Unfortunately, preliminary attempts at solid-state coupling these compounds

to the tetrapeptide moiety failed, and further studies will be needed to determine appropriate conditions and analytical methods for this reaction.

Future considerations involve completing the full synthesis of the *E. coli* O-antigen pentasaccharide according to the protocols developed in chapter 3. Conjugation of the resulting pentenyl pentasaccharide can be with a carrier protein such as keyhole limpet haemocyanin (KLH) by previously illustrated methods<sup>506,507</sup> could certainly furnish a glycoconjugate vaccine for immunological studies. This is conceivable based on the summary scheme (scheme 19). A modified *O*-pentenyl glycosyl acceptor bearing 4-*O*-*p*-methoxybenzyl protecting group will allow us to resynthesize trisaccharide analogue **A** with two different types of benzyl ethers for chemoselective cleavage of one group over the other. On another hand, a fluoros fucosamine donor can be coupled to the *O*-pentenyl acceptor of **B** can be transformed to anomeric trichloroacetimidate leaving group, and upon PMB deprotection of **A**, the two precursors will allow us to construct a branched doubly fluoros tagged pentasaccharide **C**. Conversely, converting the *O*-pentenyl group of **A** or of **149** (Scheme 14) to the trichloroacetimidate, fluoros tag cleavage of the corresponding disaccharide **B**, and subsequent condensation of these intermediates, will provide a linear singly fluoros tagged pentasaccharide **D**. Reduction of the azide groups and formation of fluoros or non-fluoros amides followed by global deprotection will yield the target compounds. We hope that these compounds will be actualized in the future through the established methodology and will be tested for vaccine design.

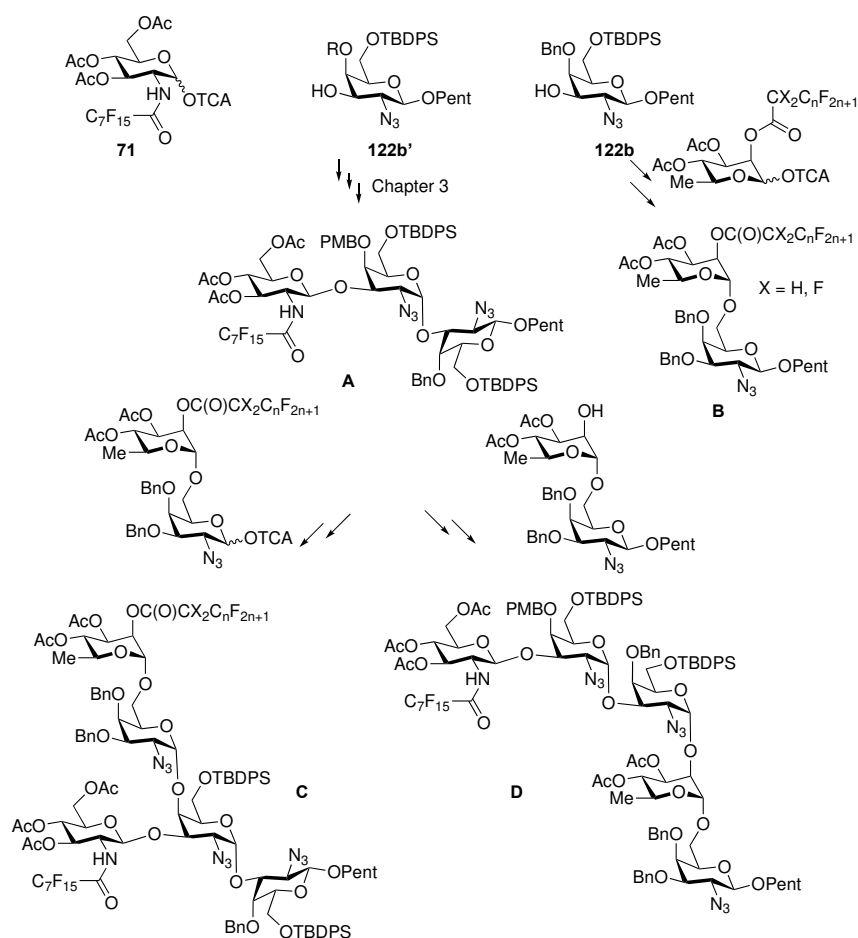

Scheme 19: Summary scheme for the synthetic pentasaccharide target compound.

## REFERENCES

- 1 T. Do, J. E. Page and S. Walker, *J. Biol. Chem.*, 2020, **295**, 3347–3361.
- 2 D. M. Ratner, E. W. Adams, M. D. Disney and P. H. Seeberger, *ChemBioChem*, 2004, **5**, 1375–1383.
- 3 J. Jimenez-Barbero, F. J. Canada and S. Martin-Santamaria, Eds., *Carbohydrates in Drug Design and Discovery*, Royal Society of Chemistry, 2015.
- 4 B. Beutler, Z. Jiang, P. Georgel, K. Crozat, B. Croker, S. Rutschmann, X. Du and K. Hoebe, *Annu. Rev. Immunol.*, 2006, **24**, 353–389.
- 5 I. Botos, D. M. Segal and D. R. Davies, *Structure*, 2011, **19**, 447–459.
- 6 S. Akira, S. Uematsu and O. Takeuchi, *Cell*, 2006, **124**, 783–801.
- 7 M. R. Thompson, J. J. Kaminski, E. A. Kurt-Jones and K. A. Fitzgerald, *Viruses*, 2011, **3**, 920–940.
- 8 D. J. Philpott, M. T. Sorbara, S. J. Roberston, K. Croitoru and S. E. Girardin, *Nat. Rev. Immunol.*, 2013, **14**, 9–23.
- 9 M. Chamaillard, M. Hashimoto, Y. Horie, J. Masumoto, S. Qiu, L. Saab, Y. Ogura, A. Kawasaki, K. Fukase, S. Kusumoto, M. A. Valvano, S. J. Foster, T. W. Mak, G. Nuñez and N. Inohara, *Nat. Immunol.*, 2003, **4**, 702–707.
- 10 S. E. Girardin, I. G. Boneca, L. A. M. Carneiro, A. Antignac, M. Jéhanno, J. Viala, K. Tedin, M. K. Taha, A. Labigne, U. Zähringer, A. J. Coyle, P. S. DiStefano, J. Bertin, P. J. Sansonetti and D. J. Philpott, *Science*, 2003, **300**, 1584–1587.
- 11 S. E. Girardin, I. G. Boneca, J. Viala, M. Chamaillard, A. Labigne, G. Thomas, D. J. Philpott and P. J. Sansonetti, *J. Biol. Chem.*, 2003, **278**, 8869–8872.
- 12 Y.-G. Kim, J.-H. Park, M. H. Shaw, L. Franchi, N. Inohara and G. Nunez, *Immunity*, 2008, **28**, 246–257.
- 13 G. Trinchieri and A. Sher, *Nat. Rev. Immunol.*, 2007, **7**, 179–190.
- 14 D. A. van Heel, S. Ghosh, M. Butler, K. Hunt, B. M. J. Foxwell, D. Mengin-lecreulx and R. J. Playford, *Eur. J. Immunol.*, 2005, **35**, 2471–2476.
- 15 J. H. Fritz, S. E. Girardin, C. Fitting, C. Werts, D. Mengin-, M. Caroff, J. Cavaillon, D. J. Philpott and M. Adib-conquy, *Eur. J. Immunol.*, 2005, **35**, 2459–2470.
- 16 R. Root-bernstein, *Int. J. Mol. Sci.*, 2020, **21**, 4645 (1–34).
- 17 M. G. Netea, G. Ferwerda, D. J. De Jong, L. Jacobs, M. Kramer, T. H. J. Naber, J. P. H. Drenth, S. E. Girardin, B. J. Kullberg, G. J. Adema and J. W. M. Van Der Meer, *J. Immunol.*, 2005, **174**, 6518–6523.
- 18 J. E. Wang, P. F. Jorgensen, E. A. Ellingsen, M. Almløf, C. Thiemermann, S. J. Foster, A. O. Aasen and R. Solberg, *Shock*, 2001, **16**, 178–182.
- 19 H. Tada, S. Aiba, K. I. Shibata, T. Ohteki and H. Takada, *Infect. Immun.*, 2005, **73**, 7967–7976.
- 20 A. I. Tikhvatulin, A. S. Dzharullaeva, N. M. Tikhvatulina, D. V Shcheblyakov, M. M. Shmarov, I. V Dolzhikova, P. Stanhope-baker, B. S. Naroditsky, A. V Gudkov, D. Y. Logunov and A. L. Gintsburg, *PLoS One*, 2016, **11**, (0155650)1–24.
- 21 Y. Kim, J. Park, S. Daignault, G. Núñez, N. Macrophages, Y. Kim, J. Park, S. Daignault, K. Fukase

- and G. Nunez, *J. Immunol.*, 2008, **181**, 4340–4346.
- 22 T. Volz, M. Nega, J. Buschmann, S. Kaesler, E. Guenova, A. Peschel, M. Rocken, F. Gotz and T. Biedermann, *FASEB J.*, 2010, **24**, 4089–4102.
- 23 H. Schaffler, D. D. Demircioglu, D. Kuhner, S. Menz, A. Bender, I. B. Autenrieth, P. Bodammer, G. Lamprecht, F. Gotz and J.-S. Frick, *Infect. Immun.*, 2014, **82**, 4681–4688.
- 24 H. J. Kim, J. S. Yang, S. S. Woo, S. K. Kim and C. Yun, *J. Leukoc. Biol.*, 2007, **81**, 983–989.
- 25 A. Uehara, S. Yang, Y. Fujimoto, K. Fukase, S. Kusumoto, K. Shibata, S. Sugawara and H. Takada, *Cell. Microbiol.*, 2005, **7**, 53–61.
- 26 A. Uehara and H. Takada, *J. Dent. Res.*, 2008, **87**, 682–686.
- 27 M. G. Netea and J. W. M. Van Der Meer, *Cell Host Microbe*, 2017, **21**, 297–300.
- 28 S. L. Foster, D. C. Hargreaves and R. Medzhitov, *Nature*, 2007, **447**, 972–978.
- 29 M. Hedl and C. Abraham, *Am. J. Gastrointest Liver Physiol*, 2013, **304**, G583–G597.
- 30 J. Cavillon, C. Adrie, C. Fitting and M. Adib-conquy, *J. Endotoxin Res.*, 2003, **9**, 101–107.
- 31 K. Onozuka, T. Saito-taki and M. Nakano, *Infect. Immun.*, 1984, **45**, 424–427.
- 32 M. D. Lehner, J. Ittner, D. S. Bundschuh, N. van Rooijen, A. Wendel and T. Hartung, *Infect. Immun.*, 2001, **69**, 463–471.
- 33 A. I. Tukhvatulin, I. I. Gitlin, D. V Shcheblyakov, N. M. Artemicheva, L. G. Burdelya, M. M. Shmarov, B. S. Naroditsky, A. V Gudkov, A. L. Gintsburg and D. Y. Logunov, *Infect. Immun.*, 2013, **81**, 3855–3864.
- 34 J. Kleinnijenhuis, J. Quintin, F. Preijers, L. A. B. Joosten, D. C. Iffrim, S. Saeed, C. Jacob, J. van Loenhout, D. De Jong, H. G. Stunnenberg, R. J. Xavia, J. W. M. Van der Meer, R. van Crevel and M. G. Netea, *Proc. Natl. Acad. Sci. U. S. A.*, 2012, **109**, 17537–17542.
- 35 P. Aaby, A. Roth, H. Ravn, B. M. Napirna, A. Rodrigues, I. M. Lisse, L. Stensballe, B. R. Diness, K. R. Lausch, N. Lund, S. Biering-sørensen, H. Whittle and C. S. Benn, *J. Infect. Dis.*, 2011, **204**, 245–252.
- 36 M. Fathi, N. Markazi-Moghaddam and A. Ramezankhani, *Aust. Crit. Care*, 2018, **32**, 155–164.
- 37 F. Ratzinger, M. Dedeyan, M. Rammerstorfer, T. Perkmann, H. Burgmann, A. Blacky, M. Ramharter, A. Makristathis, G. Dorffner and F. Lo, *PLoS One*, 2014, **9**, e106765.
- 38 A. Khojandi, V. Tansakul, X. Li, R. S. Koszalinski and W. Paiva, *Methods Inf. Med.*, 2018, **57**, 185–193.
- 39 S. M. Opal, B. Francois, S. P. Larosa, D. C. Angus, R. Schein, M. Lynn, D. P. Rossignol and J. L. Wheeler, *JAMA*, 2013, **309**, 1154–1162.
- 40 T. Kobayashi, T. Tani, T. Yokota and M. Kodama, *FEMS Immunol. Med. Microbiol.*, 2000, **28**, 49–53.
- 41 T. W. Rice, A. P. Wheeler, G. R. Bernard, J. Vincent, D. C. Angus, N. Aikawa, I. Demeyer, S. Sainati, N. Amlot, C. Cao, M. Li and O. To, *Crit. Care Med.*, 2010, **38**, 1685–1694.
- 42 K. K. Plešec, D. Urbancic, M. Gobec, A. Pekošak, T. Tomašic, M. Anderluh, K. Kec and I. Mlinaric, *Bioorg. Med. Chem.*, 2016, **24**, 5221–5234.

- 43 D. J. Rickard, C. A. Sehon, V. Kasparcova, L. A. Kallal, X. Zeng, M. N. Montoute, T. Chordia, D. D. Poore, H. Li, Z. Wu, P. M. Eidam, P. A. Haile, J. Yu, J. G. Emery, R. W. Marquis, P. J. Gough and J. Bertin, *PLoS One*, 2013, **8**, e69619.
- 44 S. Wang, J. Yang, X. Li, Z. Liu, Y. Wu, G. Si, Y. Tao, N. Zhao, X. Hu, Y. Ma and G. Liu, *J. Med. Chem.*, 2017, **60**, 5162–5192.
- 45 S. J. Oh, J. H. Kim and D. H. Chung, *PLOS Pathog.*, 2013, **9**, e1003351.
- 46 Y. Kim, M. H. Shaw, N. Warner, F. Chen, Y. Ogura, G. Núñez, Y. Kim, M. H. Shaw, N. Warner, J. Park and F. Chen, *J. Immunol.*, 2011, **187**, 2849–2852.
- 47 S. M. Coldewey, M. Rogazzo, M. Collino, N. S. A. Patel and C. Thiemermann, *Dis. Model. Mech.*, 2013, **6**, 1031–1042.
- 48 H. Li, W. Han, V. Polosukhin, F. E. Yull, B. H. Segal, C. Xie and T. S. Blackwell, *Mediat. Inflammationn*, 2013, **2013**, 503213 (1–9).
- 49 J. H. Choi, S. H. Park, J. Jae-kyung, W. Cho, B. Ahn, C. Yun, Y. P. Choi, J. H. Yeo, H. Lee and J. T. Hong, *Sci. Rep.*, 2017, **7**, 41180 (1–11).
- 50 J. Chen, J. E. Kieswich, F. Chiazza, A. J. Moyes, T. Gobetti, A. J. Hobbs, M. Collino, M. M. Yaqoob and C. Thiemermann, *J. Am. Soc. Nephrol.*, 2017, **28**, 94–105.
- 51 S. M. N. Udden, L. Peng, J. Gan, J. M. Shelton, J. S. Malter, L. V Hooper and M. H. Zaki, *Cell Rep.*, 2017, **19**, 2756–2770.
- 52 D. A. van Heel, S. Ghosh, K. A. Hunt, C. G. Mathew, A. Forbes, D. P. Jewel and R. J. Playford, *Gut*, 2005, **54**, 1553–1557.
- 53 G. Ferwerda, M. Kramer, D. De Jong, A. Piccini, L. A. Joosten, I. Devesaginer, S. E. Girardin, G. J. Adema, J. W. M. Van Der Meer, B. Kullberg, A. Rubartelli and M. G. Netea, *Eur. J. Immunol.*, 2008, **38**, 184–191.
- 54 T. Watanabe, A. Kitani, P. J. Murray and W. Strober, *Nat. Immunol.*, 2004, **5**, 800–808.
- 55 Y. Dahiya, R. K. Pandey and A. Sodhi, *PLoS One*, 2011, **6**, 27828(1–11).
- 56 M. E. A. Borm, A. A. van Bodegraven, C. J. J. Mulder, G. Kraal and G. Bouma, *Genes Immun.*, 2008, **9**, 274–278.
- 57 M. Hedl, J. Li, J. H. Cho and C. Abraham, *Proc. Natl. Acad. Sci. U. S. A.*, 2007, **104**, 19440–19445.
- 58 B. J. Kullberg, G. Ferwerda, D. J. De Jong, J. P. H. Drenth, A. B. Leo, J. W. M. Van der Meer and M. G. Netea, *Immunology*, 2008, **123**, 600–605.
- 59 T. Watanabe, N. Asano, P. J. Murray, K. Ozato, P. Taylor, I. J. Fuss, A. Kitani and W. Strober, *J. Clin. Invest.*, 2008, **118**, 545–559.
- 60 A. Bowie and L. A. J. O. Neill, *J. Leukoc. Biol.*, 2000, **67**, 508–514.
- 61 J. Stack, I. R. Haga, M. Schröder, N. W. Bartlett, G. Maloney, P. C. Reading, K. A. Fitzgerald, G. L. Smith and A. G. Bowie, *J. Exp. Med.*, 2005, **201**, 1007–1081.
- 62 G. Diperna, J. Stack, A. G. Bowie, A. Boyd, G. Kotwal, Z. Zhang, S. Arvikar, E. Latz, K. A. Fitzgerald and W. L. Marshall, *J. Biol. Chem.*, 2004, **279**, 36570–36578.
- 63 K. Li, E. Foy, J. C. Ferreon, M. Nakamura, A. C. M. Ferreon, M. Ikeda, S. C. Ray, M. Gale and S. M. Lemon, *Proceedings Natl. Acad. Sci. United States Am.*, 2005, **102**, 2992–2997.

- 64 J. Andrejeva, K. S. Childs, D. F. Young, T. S. Carlos, N. Stock, S. Goodbourn and R. E. Randall, *Proceedings Natl. Acad. Sci. United States Am.*, 2004, **101**, 17264–17269.
- 65 E. Meylan, J. Curran, K. Hofmann, D. Moradpour, M. Binder and R. Bartenschlager, *Nature*, 2005, **437**, 1167–1172.
- 66 R. Lin, R. S. Noyce, S. E. Collins, R. D. Everett and K. L. Mossman, *J. Virol.*, 2004, **78**, 1675–1684.
- 67 Y. Yu, S. E. Wang and G. S. Hayward, *Immunity*, 2005, **22**, 59–70.
- 68 E. Andersen-nissen, K. D. Smith, K. L. Strobe, S. L. R. Barrett, B. T. Cookson, S. M. Logan and A. Aderem, *Proceedings Natl. Acad. Sci. United States Am.*, 2005, **102**, 9247–9252.
- 69 S. M. Fortune, A. Solache, A. Jaeger, P. J. Hill, J. T. Belisle, B. R. Bloom, J. Eric, J. D. Ernst, S. M. Fortune, A. Solache, A. Jaeger, P. J. Hill, J. T. Belisle, B. R. Bloom, E. J. Rubin and J. D. Ernst, *J. Immunol.*, 2004, **172**, 6272–6280.
- 70 R. K. Pai, M. Convery, T. A. Hamilton, H. Boom and C. V Harding, *J. Immunol.*, 2003, **171**, 175–184.
- 71 A. Sing, D. Rost, N. Tvardovskaia, A. Roggenkamp, A. Wiedemann, C. J. Kirschning and M. Aepfelbacher, *J. Exp. Med.*, 2002, **196**, 1017–1024.
- 72 A. Kulp and M. J. Kuehn, *Annu. Rev. Microbiol.*, 2010, **64**, 163–184.
- 73 C. R. H. Raetz and C. Whitfield, *Annu. Rev. Biochem.*, 2002, **71**, 635–700.
- 74 J. T. Harty, A. R. Tinnereim and D. W. White, *Annu. Rev. Immunol.*, 2000, **18**, 275–308.
- 75 S. Radoja, A. B. Frey and S. Vukmanović, *Crit. Rev. Immunol.*, 2006.
- 76 C. Anish, B. Schumann, C. L. Pereira and P. H. Seeberger, *Chem. Biol.*, 2014, **21**, 38–50.
- 77 B. Schumann, C. Anish, C. L. Pereira and P. H. Seeberger, in *Biotherapeutics: Recent Developments using Chemical and Molecular Biology*, ed. L. H. J. and A. J. McKnight, Royal Society of Chemistry, 2013, pp. 68–104.
- 78 A. K. Abbas, A. H. H. Lichtman and S. Pillai, *Cellular and Molecular Immunology, 7th Edition*, Elsevier Saunders, Philadelphia, 2012.
- 79 H. L. Johnson, M. Deloria-Knoll, O. S. Levine, S. K. Stoszek, L. F. Hance, R. Reithinger, L. R. Muenz and K. L. O’Brien, *PLoS Med.*, 2010, **7**, e1000348.
- 80 V. Verez-Bencomo, V. Fernández-Santana, E. Hardy, M. E. Toledo, M. C. Rodriguez, L. Heynngnezz, A. Rodriguez, A. Baly, L. Herrera, M. Izquierdo, A. Villar, Y. Valdés, K. Cosme, M. L. Deler, M. Montane, E. Garcia, A. Ramos, A. Aguilar, E. Medina, G. Toraño, I. Sosa, I. Hernandez, R. Martínez, A. Muzachio, A. Carmenates, L. Costa, F. Cardoso, C. Campa, M. Diaz and R. Roy, *Science*, 2004, **305**, 522–525.
- 81 S. J. Danishefsky and J. R. Allen, *Angew. Chem. Int. Ed.*, 2000, **39**, 836–863.
- 82 T. I. Tsai, H. Y. Lee, S. H. Chang, C. H. Wang, Y. C. Tu, Y. C. Lin, D. R. Hwang, C. Y. Wu and C. H. Wong, *J. Am. Chem. Soc.*, 2013, **135**, 14831–14839.
- 83 C. M. Nycholat, W. Peng, R. McBride, A. Antonopoulos, R. P. De Vries, Z. Polonskaya, M. G. Finn, A. Dell, S. M. Haslam and J. C. Paulson, *J. Am. Chem. Soc.*, 2013, **135**, 18280–18283.
- 84 B. Liu, A. Furevi, A. V Perepelov, X. Guo, H. Cao, Q. Wang, P. R. Reeves, Y. A. Knirel, L. Wang and G. Widmalm, *FEMS Microbiol. Rev.*, 2020, **44**, 655–683.

- 85 R. U. Lemieux, K. B. Hendriks, R. V. Stick and K. James, *J. Am. Chem. Soc.*, 1975, **97**, 4056–4062.
- 86 H. Yao, M. D. Vu and X. W. Liu, *Carbohydr. Res.*, 2019, **473**, 72–81.
- 87 G. R. J. Thatcher, in *ACS Symposium Series 539*, American Chemical Society, Washington, DC, 1993, pp. 6–25.
- 88 M. Miljkovic, *Carbohydrates Synthesis, Mechanisms, and Stereoelectronic Effects*, Springer-Verlag New York, 1st edn., 2009.
- 89 E. Pacsu, *Chem. Ber.*, 1928, **61**, 1508–1513.
- 90 B. Lindberg, *Ark. Kemi, Miner. Geol.*, 1944, **18**, 1–7.
- 91 B. Lindberg, *Acta Chem. Scand.*, 1948, **2**, 426–429.
- 92 B. Lindberg, *Acta Chem. Scand.*, 1949, **3**, 1153–1169.
- 93 J. Edward, T., *Chem. Ind.*, 1955, 1102–1104.
- 94 E. J. Corey, *J. Am. Chem. Soc.*, 1953, **75**, 2301–2304.
- 95 S. Hung and M. M. L. Zulueta, Eds., *Glycochemical Synthesis: Strategies and Applications*, Wiley-VCH Verlag GmbH & Co. KGaA, 2016.
- 96 P. G. M. Wuts, *Greene's protective groups in organic synthesis*, John Wiley & Son, Inc., New Jersey, Fifth Edit., 2014.
- 97 S. Vidal, *Protecting groups: Strategies and Applications in Carbohydrate Chemistry*, Wiley-VCH Verlag GmbH & Co. KGaA, 2019, vol. 1.
- 98 H. Paulsen, *Angew. Chemie Int. Ed. English*, 1982, **21**, 155–173.
- 99 J. H. Kim, H. Yang, J. Park and G. J. Boons, *J. Am. Chem. Soc.*, 2005, **127**, 12090–12097.
- 100 S. L. Flitsch, *Nature*, 2005, **437**, 201–202.
- 101 C. R. Bertozzi and L. L. Kiessling, *Science*, 2001, **291**, 2357–2364.
- 102 L. Schofield, M. C. Hewitt, K. Evans, M. A. Slomos and P. H. Seeberger, *Nature*, 2002, **418**, 785–789.
- 103 J. A. Prescher, D. H. Dube and C. R. Bertozzi, *Nature*, 2004, **430**, 873–877.
- 104 T. Haradahira, M. Maeda, Y. Kai and M. Kojima, *J. Chem. Soc. Chem. Commun.*, 1985, 364–365.
- 105 T. Iversen and D. K. Bundle, *J. Chem. Soc. Chem. Commun.*, 1981, 1240–1241.
- 106 E. Peter, G. Ulrich, T. Huhn, N. Richter and C. Schmeck, *Tetrahedron*, 1993, **49**, 1619–1624.
- 107 S. Hatakeyama, H. Mori, K. Kitano, H. Yamada and M. Nishizawa, *Tetrahedron Lett.*, 1994, **35**, 4367–4370.
- 108 Y. Oikawa, T. Yoshioka and O. Yonemitsu, *Tetrahedron Lett.*, 1982, **23**, 885–888.
- 109 J. Xia, J. L. Alderfer, C. F. Piskorz and K. L. Matta, *Chem. - A Eur. J.*, 2000, **6**, 3442–3451.
- 110 J. M. Vatéle, *Synlett*, 2002, 507–509.
- 111 J. M. Vatéle, *Tetrahedron*, 2002, **58**, 5689–5698.
- 112 J. Hansen, S. Freeman and T. Hudlicky, *Tetrahedron Lett.*, 2003, **44**, 1575–1578.



- 113 G. Bartoli, G. Cupone, R. Dalpozzo, A. De Nino, L. Maiuolo, E. Marcantoni and A. Procopio, *Synlett*, 2001, **12**, 1897–1900.
- 114 E. J. Corey and J. W. Suggs, *J. Org. Chem.*, 1973, **38**, 3224.
- 115 O. Hindsgaul, T. Norberg, J. Le Pendu and R. U. Lemieux, *Carbohydr. Res.*, 1982, **109**, 109–142.
- 116 C. C. Wang, J. C. Lee, S. Y. Luo, H. F. Fan, C. L. Pai, W. C. Yang, N. D. Lu and S. C. Hung, *Angew. Chemie - Int. Ed.*, 2002, **41**, 2360–2362.
- 117 H. P. Wessel, T. Iversen and D. R. Bundle, *J. Chem. Soc. Perkin Trans. 1*, 1985, 2247–2250.
- 118 F. Guibe and Y. Saint M'leux, *Tetrahedron Lett.*, 1981, **22**, 3591–3594.
- 119 M. Honda, H. Morita and I. Nagakura, *J. Org. Chem.*, 1997, **62**, 8932–8936.
- 120 H. Murakami, T. Minami and F. Ozawa, *J. Org. Chem.*, 2004, **69**, 4482–4486.
- 121 P. A. Gent and R. Gigg, *J. Chem. Soc. Chem. Commun.*, 1974, 277–278.
- 122 R. Gigg, *J. Chem. Soc. Perkin Trans. 1*, 1980, 738–740.
- 123 K. C. Nicolaou, T. J. Caulfield, H. Kataoka and N. A. Stylianides, *J. Am. Chem. Soc.*, 1990, **112**, 3693–3695.
- 124 J. Cunningham, R. Gigg and C. D. Warren, *Tetrahedron Lett.*, 1964, 1191–1196.
- 125 A. B. Smith, R. A. Rivero, K. J. Hale and H. A. Vaccaro, *J. Am. Chem. Soc.*, 1991, **113**, 2092–2112.
- 126 H. Yamada, T. Harada and T. Takahashi, *J. Am. Chem. Soc.*, 1994, **116**, 7919–7920.
- 127 T. D. Nelson and R. D. Crouch, *Synthesis (Stuttg.)*, 1996, 1031–1069.
- 128 R. D. Crouch, *Tetrahedron*, 2004, **60**, 5833–5871.
- 129 B. Neises and W. Steglich, *Angew. Chemie Int. Ed. English*, 1978, **17**, 522–524.
- 130 P. A. Procopiou, S. P. D. Baugh, S. S. Flack and G. G. A. Inglis, *Chem. Commun.*, 1996, **03**, 2625–2626.
- 131 P. A. Procopiou, S. P. D. Baugh, S. S. Flack and G. G. A. Inglis, *J. Org. Chem.*, 1998, **63**, 2342–2347.
- 132 W. M. Best, R. W. Dunlop, R. V. Stick and S. T. White, *Aust. J. Chem.*, 1994, **47**, 433–440.
- 133 C. B. Reese, C. M. Stewart, J. H. Van Boom, H. P. M. De Leeuw, J. Nagel and J. F. M. de Rooy, *J. Chem. Soc. Perkin Trans. 1*, 1975, 934–942.
- 134 L. Jiang and T.-H. Chan, *J. Org. Chem.*, 1998, **63**, 6035–6038.
- 135 N. É. Byramova, M. V. Ovchinnikov, L. V. Backinowsky and N. K. Kochetkov, *Carbohydr. Res.*, 1983, **124**, C8–C11.
- 136 M. E. Evans, F. W. Parrish and L. Long, *Carbohydr. Res.*, 1967, **3**, 453–462.
- 137 E. J. Corey, S. Kim, S. Yoo, K. C. Nicolaou, J. Melvin, L. S., D. J. Brunelle, J. R. Falck and E. J. Trybulski, *J. Am. Chem. Soc.*, 1978, **100**, 4620–4622.
- 138 E. Fanton, J. Gelas and D. Horton, *J. Chem. Soc. Chem. Commun.*, 1980, **32**, 21–22.
- 139 P. B. Alper, S. C. Hung and C. H. Wong, *Tetrahedron Lett.*, 1996, **37**, 6029–6032.

- 140 J. Debenham, R. Rodebaugh and B. Fraser-Reid, *Liebigs Ann.*, 1997, 791–802.
- 141 Z. G. Wang, X. Zhang, M. Visser, D. Live, A. Zatorski, U. Iserloh, K. O. Lloyd and S. J. Danishefsky, *Angew. Chemie - Int. Ed.*, 2001, **40**, 1728–1732.
- 142 M. Lergenmuller, Y. Ito and T. Ogawa, *Tetrahedron*, 1998, **54**, 1381–1394.
- 143 H. Staudinger and J. Meyer, *Helv. Chim. Acta*, 1919, **4**, 635–646.
- 144 D. Urabe, K. Sugino, T. Nishikawa and M. Isobe, *Tetrahedron Lett.*, 2004, **45**, 9405–9407.
- 145 R. J. Bergeron, J. R. Garlich and N. J. Stolowich, *J. Org. Chem.*, 1984, **49**, 2997–3001.
- 146 R. J. Bergeron and J. S. McManis, *J. Org. Chem.*, 1988, **53**, 3108–3111.
- 147 G. Blatter, J. M. Beau and J. C. Jacquinet, *Carbohydr. Res.*, 1994, **260**, 189–202.
- 148 A. Vibert, C. Lopin-Bon and J. C. Jacquinet, *Tetrahedron Lett.*, 2010, **51**, 1867–1869.
- 149 R. H. Szumigala, E. Onofiok, S. Karady, J. D. Armstrong and R. A. Miller, *Tetrahedron Lett.*, 2005, **46**, 4403–4405.
- 150 F. Guibé, *Tetrahedron*, 1998, **54**, 2967–3042.
- 151 M. Bergmann and L. Zervas, *Ber. Dtsch. Chem. Ges.*, 1932, **65**, 1192–1201.
- 152 G. Just and K. Grozinger, *Synthesis (Stuttg.)*, 1976, 457–458.
- 153 B. K. S. Yeung, S. L. Adamski-Werner, J. B. Bernard, G. Poulenat and P. A. Petillo, *Org. Lett.*, 2000, **2**, 3135–3138.
- 154 B. Ghosh and S. S. Kulkarni, *Chem. - An Asian J.*, 2020, **15**, 450–462.
- 155 J. D. C. Codée, A. Ali, H. S. Overkleeft and G. A. Van Der Marel, *Comptes Rendus Chim.*, 2011, **14**, 178–193.
- 156 S. M. Polyakova, A. V. Nizovtsev, R. A. Kunetskiy and N. V. Bovin, *Russ. Chem. Bull. Int. Ed.*, 2015, **64**, 973–989.
- 157 K. Ágoston, H. Streicher and P. Fügedi, *Tetrahedron Asymmetry*, 2016, **27**, 707–728.
- 158 K. Toshima, in *Glycoscience*, 2008.
- 159 K. Jayakanthan and Y. D. Vankar, *Carbohydr. Res.*, 2005, **340**, 2688–2692.
- 160 T. Shirahata, J. ichi Matsuo, S. Teruya, N. Hirata, T. Kurimoto, N. Akimoto, T. Sunazuka, E. Kaji and S. Omura, *Carbohydr. Res.*, 2010, **345**, 740–749.
- 161 T. Mukaiyama, K. Miyazaki and H. Uchiro, *Chem. Lett.*, 1998, 635–636.
- 162 I. Azumaya, T. Niwa, M. Kotani, T. Iimori and S. Ikegami, *Tetrahedron Lett.*, 1999, **40**, 4683–4686.
- 163 S. Mehta and B. Mario Pinto, *Tetrahedron Lett.*, 1991, **32**, 4435–4438.
- 164 S. Mehta and B. M. Pinto, *J. Org. Chem.*, 1993, **58**, 3269–3276.
- 165 K. S. Kim, Y. J. Lee, H. Y. Kim, S. S. Kang and S. Y. Kwon, *Org. Biomol. Chem.*, 2004, **2**, 2408–2410.
- 166 R. R. Schmidt, M. Stumpp and J. Michel, *Tetrahedron Lett.*, 1982, **23**, 405–408.
- 167 O. J. Plante, E. R. Palmacci, R. B. Andrade and P. H. Seeberger, *J. Am. Chem. Soc.*, 2001, **123**,

- 9545–9554.
- 168 B. G. Davis, S. J. Ward and P. M. Rendle, *Chem. Commun.*, 2001, 189–190.
- 169 R. He, J. Pan, J. P. Mayer and F. Liu, *Curr. Org. Chem.*, 2019, **23**, 2802–2821.
- 170 K. S. Kim, J. H. Kim, Y. J. Lee, Y. J. Lee and J. Park, *J. Am. Chem. Soc.*, 2001, **123**, 8477–8481.
- 171 S. Hotha and S. Kashyap, *J. Am. Chem. Soc.*, 2006, **128**, 9620–9621.
- 172 A. K. Kayastha and S. Hotha, *Tetrahedron Lett.*, 2010, **51**, 5269–5272.
- 173 A. K. Kayastha and S. Hotha, *Chem. Commun.*, 2012, **48**, 7161–7163.
- 174 D. R. Mootoo, V. Date and B. Fraser-reid, *J. Am. Chem. Soc.*, 1988, **110**, 2662–2663.
- 175 P. Konradsson, D. R. Mootoo, R. E. Mcdevitt and B. Fraser-reid, *J. Chem. Soc. Chem. Commun.*, 1990, 270–272.
- 176 W. Koenigs and E. Knorr, *Chem. Ber.*, 1901, **34**, 957–981.
- 177 B. Helferich and J. Zirner, *Chem. Ber.*, 1962, **95**, 2604–2611.
- 178 D. D. Reynolds and W. L. Evans, *J. Am. Chem. Soc.*, 1938, **60**, 2559–2561.
- 179 K. Toshima, *Carbohydr. Res.*, 2000, **327**, 15–26.
- 180 W. Rosenbrook, D. A. Riley and P. A. Lartey, *Tetrahedron Lett.*, 1985, **26**, 3–4.
- 181 G. H. Posner and S. R. Haines, *Tetrahedron Lett.*, 1985, **26**, 5–8.
- 182 J. G. Buchanan, D. G. Hill and R. H. Wightman, *Tetrahedron*, 1995, **51**, 6033–6050.
- 183 M. Yokoyama, *Carbohydr. Res.*, 2000, **327**, 5–14.
- 184 M. Teruaki, Y. Murai and S. Shoda, *Chem. Lett.*, 1981, 431–432.
- 185 M. Yamaguchi, A. Horiguchi, A. Fukuda and T. Minami, *J. Chem. Soc. Perkin Trans. 1*, 1990, 1079–1082.
- 186 J. Thiem and B. Meyer, *Chem. Ber.*, 1980, **113**, 3075–3085.
- 187 S. Traboni, G. Vessella, E. Bedini and A. Iadonisi, *Org. Biomol. Chem.*, 2020, **18**, 5157–5163.
- 188 D. A. Niedbal and R. Madsen, *Tetrahedron*, 2016, **72**, 415–419.
- 189 H. Wang, Y. Cui, R. Zou, Z. Cheng, W. Yao, Y. Mao and Y. Zhang, *Carbohydr. Res.*, 2016, **427**, 1–5.
- 190 R. J. Ferrier, R. W. Hay and N. Vethaviasar, *Carbohydr. Res.*, 1973, **27**, 55–61.
- 191 S. Escopy, Y. Singh and A. V. Demchenko, *Org. Biomol. Chem.*, 2019, **17**, 8379–8383.
- 192 G. H. Veeneman, S. H. van Leeuwen and J. H. van Boom, *Tetrahedron Lett.*, 1990, **31**, 1331–1334.
- 193 P. Konradsson, U. E. Udodong and B. Fraser-reid, *Tetrahedron Lett.*, 1990, **31**, 4313–4316.
- 194 J. D. C. Codée, R. E. J. N. Litjens, R. Den Heeten, H. S. Overkleeft, J. H. Van Boom and G. A. Van Der Marel, *Org. Lett.*, 2003, **5**, 1519–1522.
- 195 D. Crich and M. Smith, *J. Am. Chem. Soc.*, 2001, **123**, 9015–9020.

- 196 C. Wang, H. Wang, X. Huang, L. H. Zhang and X. S. Ye, *Synlett*, 2006, 2846–2850.
- 197 P. Fügedi, P. J. Garegg, H. Lönn and T. Norberg, *Glycoconj. J.*, 1987, **4**, 97–108.
- 198 T. Y. R. Tsai, H. Jin and K. Wiesner, *Can. J. Chem.*, 1984, **62**, 1403–1405.
- 199 K. C. Nicolaou, S. P. Seitz and D. P. Papahatjis, *J. Am. Chem. Soc.*, 1983, **105**, 2430–2434.
- 200 V. Pozsgay and H. J. Jennings, *J. Org. Chem.*, 1987, **52**, 4635–4637.
- 201 J. O. Kihlberg, D. A. Leigh and D. R. Bundle, *J. Org. Chem.*, 1990, **55**, 2860–2863.
- 202 G. H. Veeneman and J. H. Van Boom, *Tetrahedron Lett.*, 1990, **31**, 275–278.
- 203 M. Sasaki, K. Tachibana and H. Nakanishi, *Tetrahedron Lett.*, 1991, **32**, 6873–6876.
- 204 K. Fukase, A. Hasuoka, I. Kinoshita and S. Kusumoto, *Tetrahedron Lett.*, 1992, **33**, 7165–7168.
- 205 K. P. R. Kartha, P. Cura, M. Aloui, S. K. Readman, T. J. Rutherford and R. A. Field, *Tetrahedron Asymmetry*, 2000, **11**, 581–593.
- 206 K. T. Huang and N. Winssinger, *European J. Org. Chem.*, 2007, 1887–1890.
- 207 K. Takeuchi, T. Tamura and T. Mukaiyama, *Chem. Lett.*, 2000, **1**, 124–125.
- 208 K. Takeuchi, T. Tamura, H. Jona and T. Mukaiyama, *Chem. Lett.*, 2000, 692–693.
- 209 H. Jona, K. Takeuchi, T. Saitoh and T. Mukaiyama, *Chem. Lett.*, 2000, 1178–1179.
- 210 D. C. Xiong, L. H. Zhang and X. S. Ye, *Adv. Synth. Catal.*, 2008, **350**, 1696–1700.
- 211 P. Peng and X. S. Ye, *Org. Biomol. Chem.*, 2011, **9**, 616–622.
- 212 S. Kaeothip, J. P. Yasomanee and A. V. Demchenko, *J. Org. Chem.*, 2012, **77**, 291–299.
- 213 S. Escopy, Y. Singh and A. V. Demchenko, *Org. Biomol. Chem.*, 2021, **19**, 2044–2054.
- 214 S. Escopy, Y. Singh, K. J. Stine and A. V. Demchenko, *Chem. - A Eur. J.*, 2021, **27**, 354–361.
- 215 C. M. Carthy, M. Tacke and X. Zhu, *European J. Org. Chem.*, 2019, **2019**, 2729–2734.
- 216 V. R. Kohout, A. L. Pirinelli and N. L. B. Pohl, *Pure Appl. Chem.*, 2019, **91**, 1243–1255.
- 217 M. P. Mannino, A. P. Dunteman and A. V. Demchenko, *J. Chem. Educ.*, 2019, **96**, 2322–2325.
- 218 N. Basu, S. Kumar Maity and R. Ghosh, *RSC Adv.*, 2012, **2**, 12661–12664.
- 219 S. K. Maity, N. Basu and R. Ghosh, *Carbohydr. Res.*, 2012, **354**, 40–48.
- 220 C. Mc Carthy and X. Zhu, *Org. Biomol. Chem.*, 2020, **18**, 9029–9034.
- 221 S. Mukherjee and B. Mukhopadhyay, *Synlett*, 2010, 2853–2856.
- 222 B. Mukhopadhyay, B. Collet and R. A. Field, *Tetrahedron Lett.*, 2005, **46**, 5923–5925.
- 223 P. R. Verma and B. Mukhopadhyay, *Carbohydr. Res.*, 2010, **345**, 432–436.
- 224 M. Goswami, A. Ellern and N. L. B. Pohl, *Angew. Chemie*, 2013, **125**, 8599–8603.
- 225 A. M. Vibhute, A. Dhaka, V. Athiyarath and K. M. Sureshan, *Chem. Sci.*, 2016, **7**, 4259–4263.
- 226 A. H. A. Chu, A. Minciunescu, V. Montanari, K. Kumar and C. S. Bennett, *Org. Lett.*, 2014, **16**, 1780–1782.

- 227 R. Z. Mao, D. C. Xiong, F. Guo, Q. Li, J. Duan and X. S. Ye, *Org. Chem. Front.*, 2016, **3**, 737–743.
- 228 N. Tanaka, F. Ohnishi, D. Uchihata, S. Torii and J. Nokami, *Tetrahedron Lett.*, 2007, **48**, 7383–7387.
- 229 R. R. Schmidt and J. Michel, *Angew. Chemie Int. Ed. English*, 1980, **19**, 731–732.
- 230 J. R. Pougny and P. Sinaÿ, *Tetrahedron Lett.*, 1976, **17**, 4073–4076.
- 231 R. R. Schmidt, J. Michel and M. Roos, *Liebigs Ann. Chem.*, 1984, 1343–1357.
- 232 B. Yu and H. Tao, *Tetrahedron Lett.*, 2001, **42**, 2405–2407.
- 233 P. Zimmermann, R. Sommer, T. Bär and R. R. Schmidt, *J. Carbohydr. Chem.*, 1988, **7**, 435–452.
- 234 R. Schaubach, J. Hemberger and W. Kinzy, *Liebigs Ann. Chemie*, 1991, 607–614.
- 235 B. Wegmann and R. R. Schmidt, *J. Carbohydr. Chem.*, 1987, **6**, 357–375.
- 236 A. Dobarro-rodriguez, M. Trumtel and H. P. Wessel, *J. Carbohydr. Chem.*, 1992, **11**, 255–263.
- 237 F. J. Urban, B. S. Moore and R. Breitenbach, *Tetrahedron Lett.*, 1990, **31**, 4421–4424.
- 238 S. P. Douglas, D. M. Whitfield and J. J. Krepinsky, *J. Carbohydr. Chem.*, 1993, **12**, 131–136.
- 239 Y. Li, H. Mo, G. Lian and B. Yu, *Carbohydr. Res.*, 2012, **363**, 14–22.
- 240 A. L. Mattson, A. K. Michel and M. J. Cloninger, *Carbohydr. Res.*, 2012, **347**, 142–146.
- 241 M. Adinolfi, G. Barone, A. Iadonisi and M. Schiattarella, *Synlett*, 2002, 269–270.
- 242 M. Adinolfi, G. Barone, L. Guariniello and A. Iadonisi, *Tetrahedron Lett.*, 2000, **41**, 9005–9008.
- 243 M. Adinolfi, G. Barone, A. Iadonisi, L. Mangoni and M. Schiattarella, *Tetrahedron Lett.*, 2001, **42**, 5967–5969.
- 244 M. Adinolfi, G. Barone, A. Iadonisi and M. Schiattarella, *Tetrahedron Lett.*, 2002, **43**, 5573–5577.
- 245 M. Adinolfi, A. Iadonisi, A. Ravida and S. Valerio, *Tetrahedron Lett.*, 2006, **47**, 2595–2599.
- 246 Y. Du, G. Wei, S. Cheng, Y. Hua and R. J. Linhardt, *Tetrahedron Lett.*, 2006, **47**, 307–310.
- 247 O. R. Ludek, W. Gu and J. C. Gildersleeve, *Carbohydr. Res.*, 2010, **345**, 2074–2078.
- 248 M. Adinolfi, G. Barone, A. Iadonisi and M. Schiattarella, *Org. Lett.*, 2003, **5**, 987–989.
- 249 Q. Tian, S. Zhang, Q. Yu, M. He and J. Yang, *Tetrahedron*, 2007, **63**, 2142–2147.
- 250 S. Tanaka, M. Takashina, H. Tokimoto, Y. Fujimoto, K. Tanaka and K. Fukase, *Synlett*, 2005, 2325–2328.
- 251 S. Gotze, R. Fitzner and H. Kunz, *Synlett*, 2009, 3346–3348.
- 252 R. Roy, K. Palanivel, A. Mallick and Y. D. Vankar, *European J. Org. Chem.*, 2015, 4000–4005.
- 253 P. Peng and R. R. Schmidt, *J. Am. Chem. Soc.*, 2015, **137**, 12653–12659.
- 254 J. Yang, C. Cooper-vanosdell, E. A. Mensah and H. M. Nguyen, *J. Org. Chem.*, 2008, **73**, 794–800.
- 255 C. Zandanel, L. Dehuyser, A. Wagner and R. Baati, *Tetrahedron*, 2010, **66**, 3365–3369.

- 256 A. Dubey, R. Sangwan and K. P. Mandal, *Catal. Commun.*, 2019, **125**, 123–129.
- 257 R. Iwata, K. Uda, D. Takahashi and K. Toshima, *Chem. Commun.*, 2014, **50**, 10695–10698.
- 258 J. Liu, S. Yin, H. Wang, H. Li and G. Ni, *Carbohydr. Chem.*, 2020, **490**, 107963.
- 259 K. C. Nicolaou and R. D. Groneberg, *J. Am. Chem. Soc.*, 1990, **112**, 4085–4086.
- 260 I. Damager, E. C. Olsen, L. B. Møller and S. M. Motawia, *Carbohydr. Res.*, 1999, **320**, 19–30.
- 261 S. Koto, K. Asami, M. Hirooka, K. Nagura, M. Takizawa, S. Yamamoto, N. Okamoto, M. Sato, H. Tajima, T. Yoshida, N. Nonaka, T. Sato, S. Zen, K. Yago and F. Tomonaga, *Bull. Chem. Soc. Jpn.*, 1999, **72**, 765–777.
- 262 S. Koto, N. Morishima, H. Sato, Y. Sato and S. Zen, *Bull. Chem. Soc. Jpn.*, 1985, **58**, 120–122.
- 263 S. Koto, H. Haigoh, S. Shichi, M. Hirooka, T. Nakamura, C. Maru, M. Fujita, A. Goto, T. Sato, M. Okada, S. Zen, K. Yago and F. Tomonaga, *Bull. Chem. Soc. Jpn.*, 1995, **68**, 2331–2348.
- 264 S. Koto, M. Hirooka, T. Yoshida, K. Takenaka, C. Asai, T. Nagamitsu, M. Sakurai, S. Masuzawa, M. Komiya, T. Sato, S. Zen, K. Yago and F. Tomonaga, *Bull. Chem. Soc. Jpn.*, 2000, **73**, 2521–2529.
- 265 S. Koto, N. Morishima, M. Owa and S. Zen, *Carbohydr. Res.*, 1984, **130**, 73–83.
- 266 S. R. Lu, Y. H. Lai, J. H. Chen, C. Y. Liu and K. K. T. Mong, *Angew. Chemie - Int. Ed.*, 2011, **50**, 7315–7320.
- 267 A. B. Ingle, C. S. Chao, W. C. Hung and K. K. T. Mong, *Org. Lett.*, 2013, **15**, 5290–5293.
- 268 S. N. Lam and J. Gervay-Hague, *Org. Lett.*, 2003, **5**, 4219–4222.
- 269 S. N. Lam and J. Gervay-Hague, *Carbohydr. Res.*, 2002, **337**, 1953–1965.
- 270 A. H. A. Chu, S. H. Nguyen, J. A. Sisel, A. Minciunescu and C. S. Bennett, *Org. Lett.*, 2013, **15**, 2566–2569.
- 271 Y. Kobashi and T. Mukaiyama, *Chem. Lett.*, 2004, **33**, 874–875.
- 272 T. Mukaiyama and Y. Kobashi, *Chem. Lett.*, 2004, **33**, 10–11.
- 273 J. Park, S. Kawatkar, J. H. Kim and G. J. Boons, *Org. Lett.*, 2007, **9**, 1959–1962.
- 274 T. Nokami, A. Shibuya, S. Manabe, Y. Ito and J. I. Yoshida, *Chem. - A Eur. J.*, 2009, **15**, 2252–2255.
- 275 B. A. Garcia and D. Y. Gin, *J. Am. Chem. Soc.*, 2000, **122**, 4269–4279.
- 276 D. Crich and W. Li, *Org. Lett.*, 2006, **8**, 959–962.
- 277 L. Wang, H. S. Overkleeft, G. A. Van Der Marel and J. D. C. Codee, *J. Am. Chem. Soc.*, 2018, **140**, 4632–4638.
- 278 J. P. Yasomanee and A. V. Demchenko, *J. Am. Chem. Soc.*, 2012, **134**, 20097–20102.
- 279 F. Andersson, P. Fúgedi, P. J. Garegg and M. Nashed, *Tetrahedron Lett.*, 1986, **27**, 3919–3922.
- 280 H. K. Chenault, A. Castro, L. F. Chafin and J. Yang, *J. Org. Chem.*, 1996, **61**, 5024–5031.
- 281 B. Wegmann and R. R. Schmidt, *J. Carbohydr. Chem.*, 1987, **6**, 357–375.
- 282 M. Nishizawa, W. Shimomoto, F. Momil and H. Yamada, *Tetrahedron Lett.*, 1992, **33**, 1907–

- 1908.
- 283 R. R. Schmidt and E. Rücker, *Tetrahedron Lett.*, 1980, **21**, 1421–1424.
- 284 H. Dohi, Y. Nishida, H. Tanaka and K. Kobayashi, *Synlett*, 2001, 1446–1448.
- 285 A. H. Haines, *Carbohydrate Chemistry, Chemical and Biological Approches*, Royal Society of Chemistry, 1st edn., 2018, vol. 39.
- 286 R. T. Sataloff, M. M. Johns and K. M. Kost, *Recent Trends in Carbohydrate Chemistry*, Elsevier Inc., 1st edn., 2020.
- 287 J. M. Herbert, M. Petitou, J. C. Lormeau, R. Cariou, J. Necciari, H. N. Magnani, P. Zandberg, R. G. M. Van Amsterdam, C. A. A. Van Boeckel and D. G. Meuleman, *Cardiovasc. Drug Rev.*, 1997, **15**, 1–26.
- 288 P. H. Seeberger, Ed., *Solid Support Oligosaccharide Synthesis and Combinatorial Carbohydrate Libraries*, John Wiley & Son, Inc., 1st edn., 2001.
- 289 J. A. Gladysz, P. Dennis and T. Horva, *HandBook of Fluorous Chemistry*, Wiley-VCH Verlag GmbH & Co. KGaA, 1st edn., 2004.
- 290 D. P. Curran, *Angew. Chemie-International Ed.*, 1998, **37**, 1174–1196.
- 291 W. Zhang and D. P. Curran, *Tetrahedron*, 2006, **62**, 11837–11865.
- 292 K. Goto and M. Mizuno, *Trends Glycosci. Glycotechnol.*, 2013, **25**, 203–213.
- 293 I. T. Horváth and J. Rábai, *Science*, 1994, **266**, 72–75.
- 294 D. P. Curran, in *Handbook of Fluorous Chemistry*, eds. J. A. Gladysz, D. P. Curran and I. T. Horváth, Wiley-VCH Verlag GmbH & Co. KGaA, Weinheim 2004, 2004, pp. 101–127.
- 295 A. Studer, S. Hadida, R. Ferritto, S. Y. Kim, P. Jeger, P. Wipf and D. P. Curran, *Science (80-. )*, 1997, **275**, 823–826.
- 296 D. P. Curran, S. Hadida and M. He, *J. Org. Chem.*, 1997, **62**, 6714–6715.
- 297 K. Todoroki, Y. Ishii, K. Toyoda, T. Ikawa, J. Z. Min, K. Inoue, S. Akai and T. Toyo'oka, *Anal Bioanal Chem*, 2013, **405**, 8121–8129.
- 298 M. Tojino and M. Mizuno, *Tetrahedron Lett.*, 2008, **49**, 5920–5923.
- 299 W. Zhang, *ARKIVOC*, 2004, **i**, 101–109.
- 300 H. Nakamura, B. Linclau and D. P. Curran, *J. Am. Chem. Soc.*, 2001, **123**, 10119–10120.
- 301 W. Zhang, *Curr. Opin. Drug Discov. Dev.*, 2004, **7**, 784–797.
- 302 Y. Fukui, A. M. Bru, Y. Shin, R. Balachandran, B. W. Day and D. P. Curran, *Org. Lett.*, 2006, **8**, 301–304.
- 303 D. P. Curran and M. Hoshino, *J. Org. Chem.*, 1996, **61**, 6480–6481.
- 304 Z. Luo, Q. Zhang, Y. Oderaotoshi and D. P. Curran, *Science*, 2001, **291**, 1766–1769.
- 305 D. P. Curran, *Synlett*, 2001, 1488–1496.
- 306 G. E. Berendsen, K. A. Pikaart and L. de Galan, *Anal. Chem.*, 1980, **52**, 1990–1993.
- 307 S. Kainz, Z. Luo and D. P. Curran, *Synthesis (Stuttg.)*, 1998, 1425–1427.

- 308 D. V. Filippov, D. J. Van Zoelen, S. P. Oldfield, G. A. Van Der Marel, H. S. Overkleeft, W. Drijfhout and J. H. Van Boom, *Tetrahedron Lett.*, 2002, **43**, 7809–7812.
- 309 D. Schwinn and W. Bannwarth, *Helv. Chim. Acta*, 2002, **85**, 255–264.
- 310 Z. Luo, J. Williams, R. W. Read and D. P. Curran, *J. Org. Chem.*, 2001, **66**, 4261–4266.
- 311 P. C. De Visser, M. Van Helden, D. V. Filippov, G. A. Van Der Marel, J. W. Drijfhout, J. H. Van Boom and H. S. Overkleeft, *Tetrahedron Lett.*, 2003, **44**, 9013–9016.
- 312 D. P. Curran, R. Ferritto and Y. Hua, *Tetrahedron Lett.*, 1998, **39**, 4937–4940.
- 313 S. Rover and P. Wipf, *Tetrahedron Lett.*, 1999, **40**, 5667–5670.
- 314 P. Wipf and J. T. Reeves, *Tetrahedron Lett.*, 1999, **40**, 5139–5142.
- 315 J. Pardo, E. Guitia and L. Castedo, *Org. Lett.*, 2001, **3**, 3711–3714.
- 316 M. Mizuno, K. Goto, T. Miura, D. Hosaka and T. Inazu, *Chem. Commun.*, 2003, 972–973.
- 317 M. Mizuno, K. Goto and T. Miura, *Tetrahedron Lett.*, 2004, **45**, 3425–3428.
- 318 T. Miura, Y. Hirose, M. Ohmae and T. Inazu, *Org. Lett.*, 2001, **3**, 3947–3950.
- 319 T. Miura and T. Inazu, *Tetrahedron Lett.*, 2003, **44**, 1819–1821.
- 320 K. Goto, T. Miura and M. Mizuno, *Tetrahedron Lett.*, 2005, **46**, 8293–8297.
- 321 W. Zhang, *Tetrahedron*, 2003, **59**, 4475–4489.
- 322 I. H. Mahmud and P. G. Goekjian, in *Carbohydrate Chemistry: Chemical and Biological Approaches*, In press, The Royal Society of Chemistry, Volume 45., 2021.
- 323 K. Goto, T. Miura and M. Mizuno, *Tetrahedron Lett.*, 2005, **46**, 8293–8297.
- 324 K. Goto, T. Miura, D. Hosaka, H. Matsumoto, M. Mizuno, H. K. Ishida and T. Inazu, *Tetrahedron*, 2004, **60**, 8845–8854.
- 325 K. Goto and M. Mizuno, *Tetrahedron Lett.*, 2007, **48**, 5605–5608.
- 326 K. Fukuda, M. Tojino, K. Goto, H. Dohi, Y. Nishida and M. Mizuno, *Carbohydr. Res.*, 2015, **407**, 122–130.
- 327 K. Fukuda, M. Tojino, K. Goto, H. Dohi, Y. Nishida and M. Mizuno, *J. Fluor. Chem.*, 2014, **166**, 52–59.
- 328 M. Mizuno, K. Goto, T. Miura and T. Inazu, *QSAR Comb. Sci.*, 2006, **25**, 742–752.
- 329 A. P. Dobbs and M. R. Kimberley, *J. Fluor. Chem.*, 2002, **118**, 3–17.
- 330 L. Manzoni, *Chem. Commun.*, 2003, 2930–2931.
- 331 L. Manzoni and R. Castelli, *Org. Lett.*, 2004, **6**, 4195–4198.
- 332 N. L. Pohl, in *ACS Symposium Series*, American Chemical Society, 2007, vol. 949, pp. 261–270.
- 333 N. L. Pohl, in *Chemical Glycobiology*, ed. Chen et al, American Chemical Society, 2008, pp. 272–287.
- 334 V. R. Kohout and N. L. B. Pohl, *Carbohydr. Res.*, 2019, **486**, 107829.
- 335 F. A. Jaipuri and N. L. Pohl, *Org. Biomol. Chem.*, 2008, **6**, 2686–2691.



- 336 S. Tang and N. L. B. Pohl, *Carbohydr. Res.*, 2016, **430**, 8–15.
- 337 D. E. K. Kabotso and N. L. B. Pohl, *Org. Lett.*, 2017, **19**, 4516–4519.
- 338 C. Zong, A. Venot, O. Dhamale and G. Boons, *Org. Lett.*, 2013, **15**, 342–345.
- 339 W. Huang, Q. Gao and G. J. Boons, *Chem. - A Eur. J.*, 2015, **21**, 12920–12926.
- 340 J. Hwang, H. Yu, H. Malekan, G. Sugiarto, Y. Li, J. Qu, V. Nguyen, D. Wu and X. Chen, *Chem. Commun.*, 2014, **50**, 3159–3162.
- 341 K. Hatanaka, *Top Curr Chem*, 2012, **308**, 291–306.
- 342 G. Huang, X. Mei, H. Zhang and P. Wang, *Appl Microbiol Biotechnol*, 2006, **16**, 2031–2033.
- 343 M. Lee and I. Shin, *Angew. Chemie - Int. Ed.*, 2005, **44**, 2881–2884.
- 344 M. B. Biskup, J. U. Müller, R. Weingart and R. R. Schmidt, *ChemBioChem*, 2005, **6**, 1007–1015.
- 345 E. W. Adams, D. M. Ratner, H. R. Bokesch, J. B. McMahon, B. R. O. Keefe and P. H. Seeberger, *Chem. Biol.*, 2004, **11**, 875–881.
- 346 K. S. Ko, F. A. Jaipuri and N. L. Pohl, *J. Am. Chem. Soc.*, 2005, **127**, 13162–13163.
- 347 G. S. Chen and N. L. Pohl, *Org. Lett.*, 2008, **10**, 785–788.
- 348 K. Goto and M. Mizuno, *Tetrahedron Lett.*, 2010, **51**, 6539–6541.
- 349 M. Kojima, Y. Nakamura and S. Takeuchi, *Tetrahedron Lett.*, 2007, **48**, 4431–4436.
- 350 T. Miura, K. Goto, H. Waragai, H. Matsumoto, Y. Hirose, M. Ohmae, H. K. Ishida, A. Satoh and T. Inazu, *J. Org. Chem.*, 2004, **69**, 5348–5353.
- 351 T. Miura, S. Tsujino, A. Satoh, K. Goto and M. Mizuno, *Tetrahedron*, 2005, **61**, 6518–6526.
- 352 T. Miura, A. Satoh, K. Goto, Y. Murakami, N. Imai and T. Inazu, *Tetrahedron Asymmetry*, 2005, **16**, 3–6.
- 353 S. Maza, J. de Paz and P. M. Nieto, *molecules*, 2019, **24**, 1591.
- 354 S. Maza, N. Gandia-aguado, J. L. De Paz and P. M. Nieto, *Bioorg. Med. Chem.*, 2018, **26**, 1076–1085.
- 355 M. Kojima, Y. Nakamura, A. Nakamura and S. Takeuchi, *Tetrahedron Lett.*, 2009, **50**, 939–942.
- 356 F. Zhang, W. Zhang, Y. Zhang and D. P. Curran, *J. Org. Chem.*, 2009, **74**, 2594–2597.
- 357 E. R. Palmacci, M. C. Hewitt and P. H. Seeberger, *Angew. Chem. Int. Ed.*, 2001, **40**, 4433–4437.
- 358 F. R. Carrel and P. H. Seeberger, *J. Org. Chem.*, 2008, **73**, 2058–2065.
- 359 B. Liu, F. Zhang, Y. Zhang and G. Liu, *Org. Biomol. Chem.*, 2014, **12**, 1892–1896.
- 360 M. Tojino and M. Mizuno, *Tetrahedron Lett.*, 2008, **49**, 5920–5923.
- 361 G. Park, K. S. Ko, A. Zakharova and N. L. Pohl, *J. Fluor. Chem.*, 2008, **129**, 978–982.
- 362 Y. Zhang, B. Liu and G. Liu, *Mol. Divers.*, 2013, **17**, 613–618.
- 363 K. Goto, N. Nuermairaiti and M. Mizuno, *Chem. Lett.*, 2011, **40**, 756–757.
- 364 Y. Jing and X. Huang, *Tetrahedron Lett.*, 2004, **45**, 4615–4618.

- 365 Z. Wang, Z. S. Chinoy, S. G. Ambre, W. Peng, R. McBride, R. P. De-Vries, J. Glushka, J. C. Paulson and G. J. Boons, *Science*, 2013, **341**, 379–383.
- 366 M. A. Oberli, P. Bindscha, D. B. Werz and P. H. Seeberger, *Org. Lett.*, 2008, **10**, 905–908.
- 367 K. R. Love and P. H. Seeberger, *J. Org. Chem.*, 2005, **70**, 3168–3177.
- 368 H. W. Pauls and B. Fraser-Reid, *Carbohydr. Res.*, 1986, **150**, 111–119.
- 369 C. A. Costello, A. J. Kreuzman and M. J. Zmijewski, *Tetrahedron Lett.*, 1996, **37**, 7469–7472.
- 370 L. Manzoni and R. Castelli, *Org. Lett.*, 2006, **8**, 955–957.
- 371 R. Roychoudhury and N. L. B. Pohl, *Org. Lett.*, 2014, **16**, 1156–1159.
- 372 L. Liu and N. L. B. Pohl, *Org. Lett.*, 2011, **13**, 1824–1827.
- 373 L. Liu and N. L. B. Pohl, *Carbohydr. Res.*, 2013, **369**, 14–24.
- 374 M. R. E. S. Aly and E. S. H. El Ashry, in *Advances in Carbohydrate Chemistry and Biochemistry*, Elsevier Inc., 1st edn., 2016, vol. 73, pp. 117–224.
- 375 J. M. Beau, F. D. Boyer, S. Norsikian, D. Urban, B. Vauzeilles and A. Xolin, *European J. Org. Chem.*, 2018, 5795–5814.
- 376 B. K. Shull, Z. Wu and M. Koreeda, *J. Carbohydr. Chem.*, 1996, **15**, 955–964.
- 377 G. Zemplén, *Ber. Dtsch. Chem. Ges.*, 1927, **60**, 1555–1564.
- 378 S. Arndt and L. C. Hsieh-wilson, *Org. Lett.*, 2003, **5**, 4179–4182.
- 379 C. Plattner, M. Höfener and N. Sewald, *Org. Lett.*, 2011, **13**, 545–547.
- 380 Y. Singh, M. C. Rodriguez Benavente, M. H. Al-Huniti, D. Beckwith, R. Ayyalasomayajula, E. Patino, W. S. Miranda, A. Wade and M. Cudic, *J. Org. Chem.*, 2020, **85**, 1434–1445.
- 381 P. H. Seeberger and D. B. Werz, *Nature*, 2007, **446**, 1046–1051.
- 382 A. Hussain, B. Claussen, A. Ramachandran and R. Williams, *Diabetes Res. Clin. Pract.*, 2007, **76**, 317–326.
- 383 C. Zhang and K. Huang, *Carbohydr. Polym.*, 2005, **59**, 75–82.
- 384 R. M. F. Van Der Put, T. H. Kim, C. Guerreiro, F. Thouron, P. Hoogerhout, P. J. Sansonetti, J. Westdijk, M. Stork, A. Phalipon and L. A. Mulard, *Bioconjug. Chem.*, 2016, **27**, 883–892.
- 385 L. Morelli, L. Poletti and L. Lay, *European J. Org. Chem.*, 2011, 5723–5777.
- 386 J. B. Robbins and R. Schneerson, *New English J. Med.*, 1990, **323**, 1145–1146.
- 387 V. Pozsgay, J. Kubler-Kielb, B. Coxon and G. Ekborg, *Tetrahedron*, 2005, **61**, 10470–10481.
- 388 V. Pozsgay and J. Kubler-Kielb, *Carbohydr. Res.*, 2007, **342**, 621–626.
- 389 L. A. Mulard, C. Costachel and P. J. Sansonetti, *J. Carbohydr. Chem.*, 2000, **19**, 849–877.
- 390 E. Miller, D. Salisbury and M. Ramsay, *Vaccine*, 2001, **20**, 58–67.
- 391 Y. V. Balbin, M. C. Rodríguez and V. V. Bencomo, *Antibacterial and antifungal vaccines based on synthetic oligosaccharides*, 2014, vol. 40.
- 392 J. P. Kamerling, *Comprehensive Glycoscience: From Chemistry to Systems Biology*, Elsevier:

- Oxford, UK, 1st edn., 2007, vol. 1–4.
- 393 T. J. Boltje, T. Buskas and G. J. Boons, *Nat. Chem.*, 2009, **1**, 611–622.
- 394 W. Koenigs and E. Knorr, *Ber. Dtsch. Chem. Ges.*, 1901, **34**, 957–981.
- 395 R. R. Schmidt and W. Kinzy, *Adv. Carbohydr. Chem. Biochem.*, 1994, **50**, 21–123.
- 396 J. Rademann, A. Geyer and R. R. Schmidt, *Angew. Chemie - Int. Ed.*, 1998, **37**, 1241–1245.
- 397 R. Liang, L. Yan, J. Loebach, M. Ge, Y. Uozumi, K. Sekanina, N. Horan, J. Gildersleeve, C. Thompson, A. Smith, K. Biswas, W. C. Still and D. Kahne, *Science*, 1996, **274**, 1520–1522.
- 398 D. Kahne, S. Walker, Y. Cheng and D. Van Engen, *J. Am. Chem. Soc.*, 1989, **111**, 6881–6882.
- 399 L. A. J. M. Sliedregt, G. A. Van Der Mare and J. H. Van Boom, *Tetrahedron Lett.*, 1994, **35**, 4015–4018.
- 400 H. Nagai, S. Matsumura and K. Toshima, *Tetrahedron Lett.*, 2002, **43**, 847–850.
- 401 J. S. Marsh, K. P. R. Kartha and R. A. Field, *Synlett*, 2003, 1376–1378.
- 402 T. J. Martin and R. R. Schmidt, *Tetrahedron Lett.*, 1992, **33**, 6123–6126.
- 403 H. Kondo, Y. Ichikawa and C. H. Wong, *J. Am. Chem. Soc.*, 1992, **114**, 8748–8750.
- 404 S. Hashimoto, T. Honda and S. Ikegami, *J. Chem. Soc. Chem. Commun.*, 1989, 685–687.
- 405 B. Fraser-Reid, J. R. Merritt, A. L. Handlon and C. W. Andrews, *Pure Appl. Chem.*, 1993, **65**, 779–786.
- 406 J. C. Castro-Palomino and R. R. Schmidt, *Tetrahedron Lett.*, 1995, **36**, 5343–5346.
- 407 I. Cumpstey, *Org. Biomol. Chem.*, 2012, **10**, 2503–2508.
- 408 D. E. Levy and P. Fügedi, Eds., *The Organic Chemistry of Sugars*, 2006.
- 409 C.-C. Wang, J.-C. Lee, S.-Y. Luo, S. S. Kulkarni, Y.-W. Huang, C.-C. Lee, K.-L. Chang and S.-C. Hung, *Nature*, 2007, **446**, 896–899.
- 410 C.-C. Wang, S. S. Kulkarni, J.-C. Lee, S.-Y. Luo and S.-C. Hung, *Nat. Protoc.*, 2008, **3**, 97–113.
- 411 A. G. M. Barrett, D. C. Braddock, D. Catterick, D. Chadwick, J. P. Henschke and R. M. McKinnell, *Synlett*, 2000, 847–849.
- 412 W. Zhang and D. P. Curran, *Tetrahedron*, 2006, **62**, 11837–11865.
- 413 H. Tanaka, Y. Tanimoto, T. Kawai and T. Takahashi, *Tetrahedron*, 2011, **67**, 10011–10016.
- 414 D. P. Curran and Z. Luo, *J. Am. Chem. Soc.*, 1999, **121**, 9069–9072.
- 415 M. Robb, C. S. Robb, M. A. Higgins, J. K. Hobbs, J. C. Paton and A. B. Boraston, *J. Biol. Chem.*, 2015, **290**, 30888–30900.
- 416 M. Noguchi, T. Tanaka, H. Gyakushi, A. Kobayashi and S. Shoda, *J. Org. Chem.*, 2009, **74**, 2210–2212.
- 417 I. A. Gagarinov, T. Fang, L. Liu, A. D. Srivastava and G. J. Boons, *Org. Lett.*, 2015, **17**, 928–931.
- 418 L. G. Melean, K. R. Love and P. H. Seeberger, *Carbohydr. Res.*, 2002, **337**, 1893–1916.
- 419 Y. Yang and B. Yu, *Tetrahedron*, 2014, **70**, 1023–1046.

- 420 J. Banoub, P. Boullanger and D. Lafont, *Chem. Rev.*, 1992, **92**, 1167–1195.
- 421 A. F. G. Bongat and A. V. Demchenko, *Carbohydr. Res.*, 2007, **342**, 374–406.
- 422 R. Enugala, L. C. R. Carvalho, P. M. J. Dias and M. M. B. Marques, *Chem. An Asian J.*, 2012, **7**, 2482–2501.
- 423 J. C. Castro-Palomino and R. R. Schmidt, *Tetrahedron Lett.*, 1995, **36**, 6871–6874.
- 424 M. Kiso, *Carbohydr. Res.*, 1985, **136**, 309–323.
- 425 D. Shapiro, A. J. Acher and E. S. Rachaman, *J. Org. Chem.*, 1967, **32**, 3767–3771.
- 426 A. J. Acher and D. Shapiro, *J. Org. Chem.*, 1969, **34**, 2652–2654.
- 427 M. L. Wolfrom and H. B. Bhat, *J. Org. Chem.*, 1967, **32**, 1821–1823.
- 428 L. G. Weaver, Y. Singh, J. T. Blanchfield and P. L. Burn, *Carbohydr. Res.*, 2013, **371**, 68–76.
- 429 M. M. L. Zulueta, S. Y. Lin, Y. T. Lin, C. J. Huang, C. C. Wang, C. C. Ku, Z. Shi, C. L. Chyan, D. Irene, L. H. Lim, T. I. Tsai, Y. P. Hu, S. D. Arco, C. H. Wong and S. C. Hung, *J. Am. Chem. Soc.*, 2012, **134**, 8988–8995.
- 430 H. Takaku, H. K. Ishida, M. Fujita, T. Inazu, H. Ishida and M. Kiso, *Synlett*, 2007, 818–820.
- 431 U. Ellervik and G. Magnusson, *Carbohydr. Res.*, 1996, **280**, 251–260.
- 432 H. Christensen, M. S. Christiansen, J. Petersen and H. H. Jensen, *Org. Biomol. Chem.*, 2008, **6**, 3276–3283.
- 433 A. K. Sarkar, J. R. Brown and J. D. Esko, *Carbohydr. Res.*, 2000, **329**, 287–300.
- 434 A. Lubneau, J. Le Gallic and A. Malleron, *Tetrahedron Lett.*, 1987, **28**, 5041–5044.
- 435 H. Ohrui, Y. Nishida, H. Hori, H. Meguro and S. Zushi, *J. Carbohydr. Chem.*, 1988, **7**, 711–731.
- 436 K. Miyai and R. W. Jeanloz, *Carbohydr. Res.*, 1972, **21**, 45–55.
- 437 H. Hohgardt, W. Dietrich, H. Kiihne, D. Miiller, D. Grzelak and P. Welzel-, *Tetrahedron*, 1988, **44**, 5771–5790.
- 438 M. R. Rasmussen, M. H. S. Marqvorsen, K. Kristensen and H. H. Jensen, *J. Org. Chem.*, 2014, **79**, 11011–11019.
- 439 R. Arihara, S. Nakamura and S. Hashimoto, *Angew. Chemie Int. Ed.*, 2005, **44**, 2245–2249.
- 440 A. Bernardi, D. Arosio, L. Manzoni, D. Monti, H. Posterl, D. Potenza and J. Jiménez-barbero, *Org. Biomol. Chem.*, 2003, **1**, 785–792.
- 441 T. Takahashi, S. Nakamoto, K. Ikeda and K. Achiwa, *Tetrahedron Lett.*, 1986, **27**, 1819–1822.
- 442 A. F. G. Bongat, M. N. Kamat and A. V Demchenko, *J. Org. Chem.*, 2007, **72**, 1480–1483.
- 443 Y. Fujimoto, M. Iwata, N. Imakita, A. Shimoyama, Y. Suda, S. Kusumoto and K. Fusake, *Tetrahedron Lett.*, 2007, **48**, 6577–6581.
- 444 G. Yang, M. Mansourova, L. Hennig, M. Findeisen, R. Oehme and S. Giesa, *Helv. Chim. Acta*, 2004, **87**, 1807–1824.
- 445 Z. Jiang, W. A. Budzynski, D. Qiu, D. Yalamatl and R. R. Koganty, *Carbohydr. Res.*, 2011, **342**, 784–796.

- 446 M. Fridman, D. Solomon, S. Yogev and T. Baasov, *Org. Lett.*, 2002, **4**, 281–283.
- 447 T. Inazu and T. Yamanoi, *Chem. Lett.*, 1989, **18**, 69–72.
- 448 H. Ochiai, M. Ohmae and S. Kobayashi, *Carbohydr. Res.*, 2004, **339**, 2769–2788.
- 449 L. Huang, Z. Wang, X. Li, X. Ye and X. Huang, *Carbohydr. Res.*, 2006, **341**, 1669–1679.
- 450 H. Shih, K. Chen, T. R. Cheng, C. Wong and C. Wei-Chieh, *Org. Lett.*, 2011, **13**, 4600–4603.
- 451 F. Yang, Y. Hua and Y. Du, *Carbohydr. Res.*, 2003, **338**, 1313–1318.
- 452 G. S. Hansen and T. Skrydstrup, *European J. Org. Chem.*, 2007, 3392–3401.
- 453 R. U. Lemieux, T. Takeda and B. Y. Chung, in *ACS Symposium Series; In Synthetic Methods for Carbohydrates*, 1977, pp. 90–115.
- 454 S. E. Tully, R. Mabon, C. I. Gama, S. M. Tsai, X. Liu and L. C. Hsieh-Wilson, *J. Am. Chem. Soc.*, 2004, **126**, 7736–7737.
- 455 G. Nagy, T. Peng, D. E. K. Kabotso, M. V. Novotny and N. L. B. Pohl, *Chem. Commun.*, 2016, **52**, 13253–13256.
- 456 Z. Zhang, I. R. Ollmann, X. Ye, R. Wischnat, T. Baasov, C. Wong, T. Scripps, N. Torrey, P. Road and L. Jolla, *J. Am. Chem. Soc.*, 1999, **121**, 734–753.
- 457 J. Dinkelaar, M. D. Witte, L. J. Van Den Bos, H. S. Overkleeft and G. A. Van Der Marel, *Carbohydr. Res.*, 2006, **341**, 1723–1729.
- 458 Y. G. Gololobov, I. N. Zhmurova and L. F. Kasukhin, *Tetrahedron*, 1981, **37**, 437–472.
- 459 A. S. Capes, A. Crossman, M. D. Urbaniak, S. H. Gilbert, M. A. J. Ferguson and I. H. Gilbert, *Org. Biomol. Chem.*, 2014, **12**, 1919–1934.
- 460 D. Lafont, M.-N. Bouchu, A. Girard-Egrot and P. Boullanger, *Carbohydr. Res.*, 2001, **336**, 181–194.
- 461 A. Bianchi and A. Bernardi, *Tetrahedron Lett.*, 2004, **45**, 2231–2234.
- 462 D. Mengin-Lecreux and B. Lemaitre, in *Journal of Endotoxin Research*, 2005, vol. 11, pp. 105–111.
- 463 Y. Fujimoto, S. Inamura, A. Kawasaki, Z. Shiokawa, A. Shimoyama, T. Hashimoto, S. Kusumoto and K. Fukase, *J. Endotoxin Res.*, 2007, **13**, 189–196.
- 464 F. Queda, G. Covas, S. R. Filipe and M. M. B. Marques, *Pharmaceuticals*, 2020, **13**, 392.
- 465 Y. Fujimoto, A. R. Pradipta, N. Inohara and K. Fukase, *Nat. Prod. Rep.*, 2012, **29**, 568–579.
- 466 K. H. Schleifer and O. Kandler, *Bacteriol. Rev.*, 1972, **36**, 407–477.
- 467 W. Vollmer, D. Blanot and M. A. De Pedro, *FEMS Microbiol. Rev.*, 2008, **32**, 149–167.
- 468 R. Medzhitov, *Nature*, 2007, **449**, 819–826.
- 469 N. W. Palm and R. Medzhitov, *Immunol. Rev.*, 2009, **227**, 221–233.
- 470 O. Takeuchi and S. Akira, *Cell*, 2010, **140**, 805–820.
- 471 A. Vasou, N. Sultanoglu, S. Goodbourn, R. E. Randall and L. G. Kostrikis, *Viruses*, 2017, **9**, 186.
- 472 M. Mancek-Keber and R. Jerala, *Eur. J. Immunol.*, 2015, **45**, 356–370.

- 473 W. Wang, X. Song, L. Wang and L. Song, *Int. J. Mol. Sci.*, 2018, **19**, 721 (1–20).
- 474 S. Tartey and O. Takeuchi, *Int. Rev. Immunol.*, 2017, **36**, 57–73.
- 475 E. C. Patin, A. Thompson and S. J. Orr, *Semin. Cell Dev. Biol.*, 2019, **89**, 24–33.
- 476 T. A. Kufer and P. J. Sansonetti, *Nat. Immunol.*, 2011, **12**, 121–128.
- 477 M. T. Sorbara and D. J. Philpott, *Immunol. Rev.*, 2011, **243**, 40–60.
- 478 N. Inohara, Y. Ogura, A. Fontalba, O. Gutierrez, F. Pons, J. Crespo, K. Fukase, S. Inamura, S. Kusumoto, M. Hashimoto, S. J. Foster, A. P. Moran, J. L. Fernandez-Luna and G. Nuñez, *J. Biol. Chem.*, 2003, **278**, 5509–5512.
- 479 J. H. Fritz, R. L. Ferrero, D. J. Philpott and S. E. Girardin, *Nat. Immunol.*, 2006, **7**, 1250–1257.
- 480 N. Inohara, M. Chamaillard, C. McDonald and G. Nuñez, *Annu. Rev. Biochem.*, 2005, **74**, 355–383.
- 481 P. Hysi, M. Kabesch, M. F. Moffatt, M. Schedel, D. Carr, Y. Zhang, B. Boardman, E. von Mutius, S. K. Weiland, W. Leupold, C. Fritzs, N. Klopp, A. W. Musk, A. James, G. Nunez, N. Inohara and W. O. C. Cookson, *Hum. Mol. Genet.*, 2005, **14**, 935–941.
- 482 M. L. Lauro, J. M. Burch and C. L. Grimes, *Curr. Opin. Biotechnol.*, 2016, **40**, 97–102.
- 483 J. W. Johnson, J. F. Fisher and S. Mobashery, *Ann. N. Y. Acad. Sci.*, 2013, **1277**, 54–75.
- 484 S. Dhar, H. Kumari, D. Balasubramanian and K. Mathee, *J. Med. Microbiol.*, 2018, **67**, 1–21.
- 485 M. Suvorov, M. Lee, D. Heseck, B. Boggess and S. Mobashery, *J. Am. Chem. Soc.*, 2008, **130**, 11878–11879.
- 486 J. Reith and C. Mayer, *Appl. Microbiol. Biotechnol.*, 2011, **92**, 1–11.
- 487 J. T. Park and T. Uehara, *Microbiol. Mol. Biol. Rev.*, 2008, **72**, 211–227.
- 488 D. Heseck, M. Lee, W. Zhang, B. C. Noll and S. Mobashery, *J. Am. Chem. Soc.*, 2009, **131**, 5187–5193.
- 489 A. TAYLOR, B. C. DAS and H. J. VAN, *Eur. J. Biochem.*, 1975, **53**, 47–54.
- 490 W. E. Goldman, D. G. Klapper and J. B. Baseman, *Infect. Immun.*, 1982, **36**, 782–794.
- 491 S. Mattoo, P. a Cotter and J. F. Miller, *Front. Biosci.*, 2001, **6**, 168–186.
- 492 B. T. Cookson, A. N. Tyler and W. E. Goldman, *Biochemistry*, 1989, **28**, 1744–1749.
- 493 K. E. Luker, J. L. Collier, E. W. Kolodziej, G. R. Marshall and W. E. Goldman, *Microbiology*, 1993, **90**, 2365–2369.
- 494 K. E. Luker, A. N. Tyler, G. R. Marshall and W. E. Goldman, *Mol. Microbiol.*, 1995, **16**, 733–743.
- 495 P. L. Kohler, K. A. Cloud, K. T. Hackett, E. T. Beck and J. P. Dillard, *Microbiology*, 2005, **151**, 3081–3088.
- 496 C. I. Chang, Y. Chelliah, D. Borek, D. Mengin-Lecreux and J. Deisanofer, *Science*, 2006, **311**, 1761–1764.
- 497 K. A. Cloud-Hansen, S. B. Peterson, E. V. Stabb, W. E. Goldman, M. J. McFall-Ngai and J. Handelsman, *Nat. Rev. Microbiol.*, 2006, **4**, 710–716.
- 498 D. Dorji, F. Mooi, O. Yantorno, R. Deora, R. M. Graham and T. K. Mukkur, *Med. Microbiol.*

- Immunol.*, 2018, **207**, 3–26.
- 499 S. Mattoo and J. D. Cherry, *Society*, 2005, **18**, 326–382.
- 500 S. Traub, S. von Aulock, T. Hartung and C. Hermann, *J. Endotoxin Res.*, 2006, **12**, 69–85.
- 501 T. A. Flak, L. N. Heiss, J. T. Engle and W. E. Goldman, *Infect. Immun.*, 2000, **68**, 1235–1242.
- 502 A. Armstrong, L. Challinor, R. S. Cooke, J. H. Moir and N. R. Treweeke, *J. Org. Chem.*, 2006, **71**, 4028–4030.
- 503 M. Niemietz, L. Perkams, J. Hoffman, S. Eller and C. Unverzagt, *Chem. Commun.*, 2011, **47**, 10485–10487.
- 504 D. Lafont and P. Boullanger, *Tetrahedron Asymmetry*, 2006, **17**, 3368–3379.
- 505 D. B. Berkowitz, M. Bose, T. J. Pfannenstiel and T. Doukov, *J. Org. Chem.*, 2000, **65**, 4498–4508.
- 506 L. M. Krug, G. Ragupathi, C. Hood, M. G. Kris, V. A. Miller, J. R. Allen, S. J. Keding, S. J. Danishefsky, J. Gomez, L. Tyson, B. Pizzo, V. Baez and P. O. Livingston, *Clin. Cancer Res.*, 2004, **10**, 6094–6100.
- 507 W. B. Ormann, M. S. Passova, A. Z. Atorski, D. S. Priggs, C. A. Ghajanian, S. S. Oignet, M. P. Eyton, C. O. F. Laherty, J. C. Urtin and K. O. L. Loyd, *Int. J. Cancer*, 2000, **85**, 79–85.