



**HAL**  
open science

# Climate change and decarbonisation of the industrial structure: an institutional-methodological investigation

Florian Dierickx

► **To cite this version:**

Florian Dierickx. Climate change and decarbonisation of the industrial structure: an institutional-methodological investigation. Economics and Finance. Université Clermont Auvergne, 2021. English. NNT : 2021UCFAD035 . tel-04550956

**HAL Id: tel-04550956**

**<https://theses.hal.science/tel-04550956>**

Submitted on 18 Apr 2024

**HAL** is a multi-disciplinary open access archive for the deposit and dissemination of scientific research documents, whether they are published or not. The documents may come from teaching and research institutions in France or abroad, or from public or private research centers.

L'archive ouverte pluridisciplinaire **HAL**, est destinée au dépôt et à la diffusion de documents scientifiques de niveau recherche, publiés ou non, émanant des établissements d'enseignement et de recherche français ou étrangers, des laboratoires publics ou privés.

**Université Clermont Auvergne, Clermont-Ferrand, France**  
Ecole Doctorale des Sciences Economiques, Juridiques, Politiques et de gestion  
*Centre d'Etudes et de Recherche sur le Développement International (CERDI)*

**Climate Change and Decarbonisation of the Industrial Structure**  
**An Institutional-Methodological Investigation**

Thèse  
présentée et soutenue publiquement le 29 janvier 2021 pour l'obtention du titre de Docteur  
en Sciences Economiques

par

**FLORIAN DIERICKX**

sous la direction de ARNAUD DIEMER

Composition du Jury

ALTIMIRAS MARTIN Aleix – Professor – Technological Transformations – Institute of Geosciences – UNICAMP, Brazil

DEFFUANT Guillaume (Président) – Directeur de Recherche – Socio-Ecological Complex Systems – INRAE, France

DIEMER Arnaud (Directeur de Thèse) – Assistant Professor – Université Clermont-Auvergne, France

FERRARI Sylvie (Rapporteur) – Assistant Professor – Ecological Economics – Université de Bordeaux, France

GIACOMELLI Jurij – Professor – Sustainability – Circular Business Academy, Slovenia

TRAJANOV Aneta – Assistant Professor – Computer Science – Jozef Stefan Institute, Slovenia

WIERLING August (Rapporteur) – Professor – Complex Systems – Western Norway University of Applied Sciences, Norway

Marie Skłodowska-Curie Action fellowship  
Grant Agreement No. 675153

L'université Clermont Auvergne n'entend donner aucune approbation ni improbation aux opinions émises dans cette thèse. Ces opinions doivent être considérées comme propres à leur auteur.

# Abstract

Our material footprint, our energetic metabolism, climate change and anthropogenic impacts on the environment are intrinsically linked, and increased considerably in magnitude over the last several decades in line with the expansion of industrial and economic activity. In order to design feasible mitigation pathways that could help overcome future degradation of our natural and societal environment, a systemic understanding is needed of possible transition and mitigation scenarios. These scenarios can and should be studied from a purely physical-energetic point of view in order to understand material and energetic limits, but designing effective transformation pathways is an inherently social and institutional process.

This dissertation relates to both the physical-energetic models that are used to study future transitions as well as related institutional-political structures that shape contemporary climate and energy policy, and aims to (i) contextualize the present and future climate mitigation challenge using historical insights on the dynamics of past transitions of our socio-economic metabolism, (ii) debate the institutional context, role and characteristics of integrated assessment models and energy system models in shaping mitigation scenarios and policies, and finally (iii) reflect on novel non-monetary methodological approaches that could help to design feasible and ambitious dematerialization and decarbonization trajectories. To study these aspects, the dissertation relies to several schools of practice: (i) social ecology, industrial ecology and (physical) input-output analysis, (ii) integrated assessment modelling, climate modelling and energy system modelling and (iii) system dynamics, dynamical system theory and process control theory.

Over the course of 8 chapters, the reader is invited to explore (1) how historical, present and future societal energy-revolutions relate to the energetic metabolism of the environment; (2) how renewable energy is represented in Integrated Assessment Models (IAMs); (3) the main characteristics of frequently used IAMs, their institutional context and historical evolution; (4) a brief introduction to the functioning of climate models, the most important climate modelling metrics and the implications of future carbon budget uncertainty for public policy making; (5) an exploration of the impact of differing discount and interest rates on the outcomes of major integrated assessment models and energy system models that are used for European and national policy-making, including a debate on the viability of monetary versus non-monetary climate and energy assessment and policy making; (6) an appraisal of the contemporary concept of circular economy; (7) a methodological-institutional exploration on how to dynamically model sectoral energy and material exchanges using physical input-output models and finally (8) an exploration of the application of input-output models on an urban scale.

**Keywords:** climate change, integrated assessment modelling, energy system modelling, physical input-output modelling

# Résumé

Notre empreinte matérielle, notre métabolisme énergétique, le changement climatique et les impacts anthropiques sur l'environnement sont intrinsèquement liés. Leur ampleur a considérablement augmenté au cours des dernières décennies, en fonction de l'expansion de l'activité industrielle et économique. Afin de concevoir des voies d'atténuation réalisables qui pourraient aider à surmonter la dégradation future de notre environnement naturel et sociétal, une compréhension systémique des scénarios de transition et d'atténuation possibles est nécessaire. Ces scénarios peuvent et doivent être étudiés d'un point de vue purement physico-énergétique afin de comprendre les limites matérielles et énergétiques, mais la conception des différentes voies de transformation envisageables est un processus intrinsèquement social et institutionnel.

Cette thèse porte à la fois sur les modèles physico-énergétiques utilisés pour étudier les transitions futures et sur les structures politico-institutionnelles connexes qui façonnent la politique climatique et énergétique contemporaine, et vise principalement à (i) contextualiser le défi actuel et futur de l'atténuation des effets du changement climatique en utilisant des aperçus historiques sur la dynamique des transitions passées de notre métabolisme socio-économique, (ii) débattre du contexte institutionnel, du rôle et des caractéristiques des modèles d'évaluation intégrée et des modèles de systèmes énergétiques dans l'élaboration des scénarios et des politiques d'atténuation climatique et environnementale, et enfin (iii) réfléchir à de nouvelles approches méthodologiques non monétaires qui pourraient aider à concevoir des trajectoires de dématérialisation et de décarbonatation réalisables et ambitieuses. Pour étudier ces aspects, la thèse s'appuie sur plusieurs approches : (i) l'écologie sociale, l'écologie industrielle et l'analyse (physique) input-output, (ii) la modélisation de l'évaluation intégrée, la modélisation du climat et la modélisation des systèmes énergétiques et (iii) la dynamique des systèmes, la théorie des systèmes dynamiques et la théorie du contrôle des processus.

Au cours de 8 chapitres, le lecteur est invité à explorer (1) comment les révolutions énergétiques sociétales historiques, présentes et futures sont liées au métabolisme énergétique de l'environnement; (2) comment les énergies renouvelables sont représentées dans les modèles d'évaluation intégrée (MEI) ; (3) les principales caractéristiques des MEI fréquemment utilisés, leur contexte institutionnel et leur évolution historique; (4) une brève introduction au fonctionnement des modèles climatiques, les principaux paramètres de modélisation du climat et les implications de l'incertitude de celles-ci sur le futur bilan carbone pour l'élaboration des politiques publiques; (5) une exploration de l'impact des différents taux d'actualisation et d'intérêt sur les résultats des principaux modèles d'évaluation intégrée et des modèles de systèmes énergétiques utilisés pour l'élaboration des politiques climatiques et énergétiques européennes et nationales, y compris un débat sur la viabilité de l'évaluation monétaire ou non monétaire du climat et de l'énergie dans le contexte des politiques publiques; (6) une évaluation du concept contemporain d'économie circulaire ; (7) une exploration méthodologico-institutionnelle sur la manière de modéliser d'une façon dynamique les échanges sectoriels d'énergie et de matières par des modèles physiques input-output et enfin (8) une exploration de l'application des modèles input-output à l'échelle urbaine.

**Mots-clés** : changement climatique, modèles d'évaluation intégrée, modélisation des systèmes énergétiques, modélisation physique input-output

# Pledge

I hereby certify this document to be the original and authentic output of the author's research work and co-authors, according to authorship sequence. All sources and references are duly listed and consist mostly of published scientific articles and papers, technical books, database sets from applied research institutes and official reports from international agencies or governmental organizations.

Florian Dierickx  
Clermont-Ferrand, France  
November 29<sup>th</sup>, 2020

## Supervisor

Prof. Doctor Arnaud DIEMER ([arnaud.diemer@uca.fr](mailto:arnaud.diemer@uca.fr))  
Université Clermont Auvergne (UCA) – School of Economic, Juridical, Political and Managerial Sciences, France

## Research Committee

Prof. Doctor Aleix ALTIMIRAS MARTIN  
UNICAMP, Brazil

Prof. Doctor Sylvie FERRARI  
Université de Bordeaux, France

# Acknowledgements

First of all, I want to thank my supervisor Arnaud Diemer, for having given me the chance of pursuing a PhD, but certainly for the way he inspired me (and I suspect many others) with enthusiasm and energy to adventurously challenge given ideas and broaden our mind to give up any dogm that might show up along the road. This has been a wonderful inspiration that I will carry a long road! Although the numerous intellectual adventures, projects, and writings on the road to the end of this PhD were worth pursuing on their own, your guidance, help and and patience until the end has made me pull everything together and overcome the occasional stubborn nuts to crack to land into a final structure.

Although the thesis touches upon different methods and schools of practice, I developed a preference for and became convinced of the potential of the (preferably physical) input-output theory in understanding the present and exploring potential futures, able to capture all the material and energy exchanges in society while remaining simple in its basic analytical form. I want to thank Aleix Altimiras-Martin for the guidance he gave me, primarily through his inspirational PhD, but also for the careful feedback on my first steps in exploring the framework. I also want to thank GWS and especially Mark Meyer for having given me the chance to learn, exchange and discuss applied input-output theory in Osnabruck. Finally, I want to thank the wider International Input-Output Association community, the NTNU Industrial Ecology team, JRC Regional Economic Modelling team in Sevilla, ... for the interesting works, presentations, and discussions during the IIOA Conference, email exchanges and workshops. The development of the (physical) input-output framework for environmental scenario-exploration is an 'unfinished journey', and I am curious for further collective developments of this promising modelling and data framework in the future.

However, luckily, the world does not turn around in disciplinary isolation. I want to thank the extended group of supervisors and fellow students of the AdaptEconII project and the PhD group in Clermont-Ferrand, for the wonderful collective intellectual and personal adventure. A special thank you to Kristin Vala Ragnarsdottir and the Icelandic PhD students, for the heartwarming welcome during my stay in Iceland. Driven with a shared purpose of understanding the past and shaping the future, our diversity opened my mind and heart along the journey and was of an invaluable richness that will stay with me forever.

On a personal level, I want to thank Madeleine de la Servette and family for all the moments we shared together, making me feel at home along the road. Also, a special thank you to my roommates and friends with whom I lived along the road. Vincent van Steenberghe, Tania Pisareva, Katty Loisel, Alice Mounissamy, Cyril Gicquiaux, Ludovic Henneron, Nicolas le Corvec, Thomas Amico Padula, Cristina Kujtiuk, merci pour tous ces moments ensemble!

Finally, I want to thank my parents, brother, friends, and family in Belgium. You were an inspiration to me before, at the start, during this journey, and well into the future.

# Table of Contents

|  |           |
|--|-----------|
| <b>ABSTRACT</b> .....  | <b>3</b>  |
| <b>RÉSUMÉ</b> .....  | <b>4</b>  |
| <b>PLEDGE</b> .....  | <b>5</b>  |
| <b>ACKNOWLEDGEMENTS</b> .....  | <b>6</b>  |
| <b>TABLE OF CONTENTS</b> .....   | <b>7</b>  |
| <b>GLOSSARY</b> .....  | <b>11</b> |
| <b>TABLES AND FIGURES</b> .....  | <b>15</b> |
| <b>INTRODUCTION</b> .....  | <b>17</b> |
| CONTEXT .....  | 17        |
| OVERARCHING RESEARCH QUESTION .....  | 18        |
| SCHOOLS OF PRACTICE .....  | 19        |
| <i>Social ecology, industrial ecology and (physical) input-output analysis</i> .....                         | 19        |
| <i>Schools of practice integrating physical input-output analysis with other disciplines</i> .....           | 20        |
| <i>Integrated assessment modelling, climate modelling and energy system modelling</i> .....                  | 21        |
| INTRODUCTION TO THE DIFFERENT CHAPTERS .....   | 22        |
| <b>1. ENERGY USE AND CLIMATE CHANGE: HISTORY AND FORESIGHT</b> .....   | <b>27</b> |
| SYNONYMS.....  | 27        |
| DEFINITIONS.....   | 27        |
| <i>Physical Energy Units</i> .....   | 27        |
| <i>Energetic Metabolism and Climate Change Definitions and Concepts</i> .....                                | 28        |
| <i>Climate Change and the Energy Balance of the Earth</i> .....  | 28        |
| INTRODUCTION .....   | 29        |
| HISTORICAL REVOLUTIONS IN ENERGY USE .....   | 30        |
| <i>Natural revolutions</i> .....   | 33        |
| <i>Human revolutions</i> .....   | 34        |
| CURRENT MATERIAL AND ENERGY USE .....  | 38        |
| ENERGY USE, ENERGY TECHNOLOGY AND THE CONCEPT OF EROI .....  | 42        |
| <i>Value of EROI concept to understand historical Change in energy use</i> .....                             | 42        |
| <i>Historical Societal and Technology Specific EROI Values</i> .....   | 43        |
| CONCLUSION .....   | 44        |
| REFERENCES .....   | 46        |
| <b>2. RENEWABLE ENERGY – CHARACTERISTICS AND REPRESENTATION IN MACROECONOMIC ENERGY-CLIMATE MODELS</b> ..... | <b>51</b> |
| CHARACTERISTICS OF RENEWABLE ENERGIES .....  | 52        |
| MODELLING RENEWABLES IN THE CONTEXT OF CLIMATE CHANGE, SOCIETAL VALUES, TERRITORY, ENERGY SECURITY.....      | 54        |
| CURRENT MACROECONOMIC ENERGY-CLIMATE MODELS.....   | 56        |
| MODELLING ENERGY AND CLIMATE SCENARIOS IN THE EU USING GEM-E3 AND PRIMES .....                               | 58        |
| CONCLUSION .....   | 61        |
| REFERENCES .....   | 62        |
| <b>3. INTEGRATED ASSESSMENT MODELS (IAMS) – HOW TO INTEGRATE ECONOMICS, ENERGY AND CLIMATE?</b> 65           |           |
| WORLD 3 – THE FIRST DESIGN OF AN IAM? .....  | 66        |
| DICE – THE CARBON DIOXIDE PROBLEM .....  | 69        |
| MESSAGE – SHARED SOCIOECONOMIC PATHWAYS.....   | 72        |
| GEM-E3 – A GENERAL EQUILIBRIUM MODEL .....   | 76        |
| IMAGE - A DETAILED BIOPHYSICAL SYSTEM .....  | 79        |
| REMIND-R - AN ECONOMIC GROWTH MODEL.....   | 81        |
| CONCLUDING REMARKS AND CHALLENGES .....  | 85        |
| REFERENCES .....   | 89        |



|  |           |
|--|-----------|
| <b>4. CLIMATE CHANGE RESEARCH AND IMPLICATIONS OF THE USE OF NEAR-TERM CARBON BUDGETS IN PUBLIC POLICY .....</b>   | <b>93</b> |
| KEYWORDS.....  | 93        |
| ABSTRACT .....   | 93        |
| INTRODUCTION .....   | 93        |
| STANDARD METRICS TO QUANTIFY AND COMPARE THE EXTENT OF CHANGES IN CLIMATE .....  | 95        |
| <i>Radiative forcing and an appraisal of climate feedbacks or tipping points</i> .....   | 95        |
| <i>Climate feedbacks or tipping points</i> .....   | 98        |
| CLIMATE MODELS .....   | 99        |
| <i>Climate sensitivity, equilibrium climate sensitivity and transient climate response</i> .....   | 99        |
| <i>Quantifying (equilibrium) climate sensitivity and transient climate response</i> .....  | 100       |
| <i>The transition from standardized Representative Concentration Pathways (RCPs) to Shared Socio-Economic Pathways (SSPs) as a baseline for climate modeling</i> ..... | 100       |
| <i>From individual models to collective model intercomparison efforts</i> .....  | 101       |
| THE IMPACTS OF CLIMATE CHANGE.....   | 102       |
| <i>From modelled climate metrics to projected impacts</i> .....  | 102       |
| <i>Sea level impact</i> .....  | 103       |
| <i>A brief description of other climate impacts</i> .....  | 104       |
| HOW TO MITIGATE? THE PROMISES AND PERILS OF MITIGATION OPTIONS .....   | 105       |
| <i>Afforestation as a climate mitigation solution?</i> .....   | 105       |
| <i>The perils of geoengineering and carbon capture</i> .....   | 105       |
| CLIMATE MITIGATION AND TRANSFORMATION OF THE INDUSTRIAL STRUCTURE: LINKING TEMPERATURE TARGETS TO CARBON BUDGETS .....   | 106       |
| <i>Temperature target and associated carbon budget</i> .....   | 106       |
| <i>The impact of modelling assumptions on the relevance of using global cumulative carbon budgets for public policy</i> .....  | 107       |
| <i>Division of carbon budgets</i> .....  | 107       |
| CONCLUSIONS AND PERSPECTIVES .....   | 108       |
| REFERENCES .....   | 110       |
| TABLES AND FIGURES .....   | 123       |
| <b>5. MONETARY VALUATION IN CLIMATE AND ENERGY MODELS AND POLICY: OBSCURING OR ILLUMINATING? 129</b>   |           |
| ABSTRACT .....   | 129       |
| KEYWORDS.....  | 129       |
| INTRODUCTION .....   | 130       |
| MONETARY VALUATION IN INTEGRATED ASSESSMENT MODELS AND ENERGY SYSTEM MODELS .....  | 130       |
| <i>Discount rates and interest rates: a conceptual synthesis</i> .....   | 130       |
| <i>Integrated Assessment Models</i> .....  | 132       |
| <i>Energy System Models and the European climate and energy modelling framework</i> .....  | 138       |
| INSTITUTIONAL CLIMATE AND ENERGY POLICY FRAMEWORKS .....   | 141       |
| <i>The administrative regulatory approach and economic instruments</i> .....   | 142       |
| <i>International and European emission trading</i> .....   | 145       |
| THE ROLE OF MONETARY VALUATION IN CLIMATE AND ENERGY POLICY: OBSCURING OR ILLUMINATING? .....  | 147       |
| <i>Cost-benefit and monetary optimization models versus socio-physical narratives</i> .....  | 148       |
| <i>Has the European Emission Trading Scheme been effective up to now?</i> .....  | 148       |
| CONCLUSION .....   | 151       |
| REFERENCES .....   | 154       |
| <b>6. CIRCULAR ECONOMY, A NEW PARADIGM FOR EUROPE?.....163</b>   |           |
| ABSTRACT .....   | 163       |
| KEYWORDS.....  | 163       |
| INTRODUCTION .....   | 163       |
| INDUSTRIAL SYMBIOSIS, THE DRIVING-FORCE OF CIRCULAR ECONOMY .....  | 166       |
| CIRCULAR ECONOMY, FROM SYSTEMS THINKING TO INTEGRATED TOOLS .....  | 169       |
| <i>Systems Thinking for Circular Economy</i> .....   | 169       |
| <i>Integrated tools for circular economy</i> .....   | 171       |

|  |            |
|--|------------|
| CIRCULAR ECONOMY AND ITS NEW CHALLENGES .....  | 174        |
| <i>New Ecological Challenges</i> .....   | 174        |
| <i>Social Dynamics Challenges</i> .....  | 174        |
| <i>Policies Framework Challenges</i> .....   | 175        |
| <i>Economic Paradigms Challenges</i> .....   | 175        |
| <i>Business Model Challenges</i> .....   | 176        |
| CONCLUSION .....   | 179        |
| REFERENCES .....   | 180        |
| <b>7. METHODOLOGICAL REFLECTIONS ON ANALYSING SECTORAL CYCLING OF MATERIALS AND INDUCED ENERGY USE OVER TIME .....</b> | <b>185</b> |
| ABSTRACT .....   | 185        |
| KEYWORDS .....   | 185        |
| INTRODUCTION .....   | 185        |
| INPUT-OUTPUT MODELLING AND THE SYSTEM OF NATIONAL ACCOUNTS (SNA) .....   | 189        |
| <i>Institutional context of economy-wide environmental accounting</i> .....  | 189        |
| <i>A brief overview of international accounting frameworks</i> .....   | 190        |
| FROM MONETARY TO PHYSICAL INPUT-OUTPUT ANALYSIS .....  | 191        |
| <i>Physical SUTs</i> .....   | 192        |
| <i>Balance Principles</i> .....  | 193        |
| DEVELOPMENT OF A METHODOLOGY TO ACCOUNT FOR TOTAL-SYSTEM ENERGY AND EMISSION IMPACTS OF MATERIAL RECYCLING .....       | 193        |
| PRODUCTION FUNCTIONS AND THE INPUT-OUTPUT MODEL .....  | 196        |
| <i>Demand-driven input-output formulation according to Leontief</i> .....  | 196        |
| <i>Supply-driven input-output formulation according to Ghosh</i> .....   | 198        |
| EXISTING ECONOMY-WIDE MATERIAL AND ENERGY EXCHANGE DATABASES .....   | 199        |
| AN ANALOGY BETWEEN DYNAMICAL SYSTEMS THEORY, SYSTEM DYNAMICS AND DYNAMICAL INPUT-OUTPUT ANALYSIS .....                 | 202        |
| <i>System dynamics and dynamical system theory</i> .....   | 203        |
| <i>Solving strategies (process control)</i> .....  | 207        |
| <i>State-space representation (process control)</i> .....  | 208        |
| <i>Dynamic input-output analysis</i> .....   | 209        |
| EXTENSION OF THE DYNAMIC LEONTIEF MODEL WITH RENEWABLE RESOURCES .....   | 211        |
| CONCLUSION .....   | 212        |
| REFERENCES .....   | 214        |
| <b>8. INPUT – OUTPUT ANALYSIS: A CITY SCALE REVIEW .....</b>   | <b>219</b> |
| THE IOA FRAMEWORK .....  | 219        |
| <i>Basics of IOA</i> .....   | 220        |
| <i>Assessing environmental impacts</i> .....   | 223        |
| <i>Assessing relationships and impacts between different regions</i> .....   | 227        |
| APPLICATIONS TO CITIES .....   | 229        |
| <i>Assessing economic impacts</i> .....  | 229        |
| <i>Assessing environmental impacts</i> .....   | 229        |
| IOA CHALLENGES AT CITY-SCALE .....   | 231        |
| REFERENCES .....   | 232        |
| <b>CONCLUSION .....</b>  | <b>237</b> |
| <i>Chapter 1</i> .....   | 237        |
| <i>Chapters 2 &amp; 3</i> .....  | 238        |
| <i>Chapter 4</i> .....   | 238        |
| <i>Chapter 5</i> .....   | 239        |
| <i>Chapter 6</i> .....   | 240        |
| <i>Chapters 7 &amp; 8</i> .....  | 240        |
| <b>REFERENCES .....</b>  | <b>242</b> |
| <b>ANNEX 1: VISUAL BIBLIOGRAPHY .....</b>  | <b>245</b> |
| <b>ANNEX 2: POSTER PRESENTATION .....</b>  | <b>246</b> |



# Glossary

|         |   |
|---------|---|
| AMV     | Atlantic Multidecadal Variability   |
| ATP     | Appropriable Technical Potential  |
| BC      | Before Christ   |
| BECCS   | Bioenergy with carbon capture and storage                                 |
| BP      | Before Present  |
| CCX     | Chicago Climate Exchange  |
| CE      | Circular Economy  |
| CEP     | Committee on Environmental Policy   |
| CER     | Certified Emission Reduction  |
| CES     | Constant Elasticity of Substitution                                       |
| CF      | Central Framework   |
| CFC     | Chlorofluorocarbon  |
| CGE     | Computable General Equilibrium  |
| CIRED   | Centre international de recherche sur l'environnement et le développement |
| CLD     | Causal Loop Diagram   |
| CLRTAP  | Convention on Long-range Transboundary Air Pollution                      |
| CMIP    | Coupled Model Intercomparison Project                                     |
| CN      | Combined Nomenclature   |
| CPA     | European Classification of Products                                       |
| CPC     | Central Product Classification  |
| DACCS   | Direct air capture with carbon storage                                    |
| DAMIP   | The Detection and Attribution Model Intercomparison Project               |
| DICE    | Dynamic Integrated Model of Climate and the Economy                       |
| DMC     | Domestic Material Consumption   |
| DME     | Domestic Material Extraction  |
| DMI     | Direct Material Input   |
| DPO     | Domestic Processed Output   |
| ECS     | Effective Climate Sensitivity   |
| EEA     | Experimental Ecosystem Accounting Framework                               |
| EEI     | Earth's energy imbalance  |
| EE-MIOT | Environmentally-Extended Monetary Input-Output Table                      |
| EGD     | European Green Deal   |
| EIB     | European Investment Bank  |
| EIOT    | Energy Input-Output Table   |
| EJ      | exajoule  |
| ENTSO-E | European Network of Transmission System Operators for Electricity         |
| ERF     | Effective Radiative Forcing   |
| ERO(E)I | Energy Return on (Energy) Investment                                      |
| ERU     | Emission Reduction Unit   |
| ESM     | Energy System Model or Earth System Model                                 |
| ESR     | Effort Sharing Regulation   |
| ESSC    | European Statistical System Committee                                     |
| ETS     | Emission Trading Scheme   |
| ETU     | Eligible Trading Unit   |

|                   |  |
|-------------------|--|
| EU                | European Union   |
| FAR               | First Assessment Report  |
| FUND              | Framework for Uncertainty, Negotiation, and Distribution                             |
| GAINS             | Greenhouse gas – Air pollution Interactions and Synergies                            |
| GCM               | Global Climate Model   |
| GDP               | Gross Domestic Product   |
| GEM-E3            | General Equilibrium Model for Energy Economy Environment                             |
| GHG               | Greenhouse Gas   |
| GLOBIOM           | Global BIOSphere Management  |
| GMST              | Global mean surface temperature  |
| Gt                | Gigatonnes   |
| GtC               | Gigatonnes carbon  |
| GtCO <sub>2</sub> | Gigatonnes carbon dioxide  |
| HANPP             | Human appropriation of net primary production  |
| HFC               | hydrofluorocarbon  |
| HOS               | Heckscher-Ohlin-Samuelson  |
| HS                | Harmonized Commodity Description and Coding System                                   |
| IAM               | Integrated Assessment Model  |
| IAMC              | Integrated Assessment Modelling Consortium   |
| IIASA             | International Institute for Applied Systems Analysis                                 |
| IMAGE             | Integrated Model to Assess the Global Environment                                    |
| IO                | Input-Output   |
| IOA               | Input-Output Analysis  |
| IPCC              | Intergovernmental Panel on Climate Change  |
| IPO               | Interdecadal Pacific Oscillation   |
| ISIC              | International Standard Industrial Classification                                     |
| ISWGNA            | Inter Secretariat Working Group on National Accounts                                 |
| JGCRI             | Joint Global Change Research Institute   |
| KOA               | local kind-of-activities   |
| LCA               | Life Cycle Analysis  |
| LULUCF            | Land use practices, land use change and forestry                                     |
| MAGICC            | Model for the Assessment of Greenhouse Gas Induced Climate Change                    |
| MESSAGE           | Model for Energy Supply Strategy Alternatives and their General Environmental Impact |
| MFA               | Material Flow Analysis   |
| MGM               | Macroeconomic Growth Model   |
| MIOT              | Monetary Input-Output Table  |
| MRIOA             | Multiregional Input-Output Analysis  |
| MR-IOT            | Multiregional Input-Output Table   |
| MSUT              | Monetary supply and use table  |
| NACE              | European Classification of Economic Activities                                       |
| NAS               | Net Addition to Stocks   |
| NECP              | National Energy and Climate Plan   |
| NET               | Negative Emission Technology   |
| NIES              | National Institute for Environmental Studies Japan                                   |
| NKP               | Non-linear programming   |
| NPP               | Net Primary Production   |

|         |   |
|---------|---|
| NPV     | Net Present Value   |
| NREA    | National Renewable Energy Action  |
| NSCOGI  | North Seas Countries' Offshore Grid Initiative  |
| OTEC    | Ocean Thermal Energy Conversion   |
| PAGE    | Policy Analysis of the Greenhouse Effect  |
| PBL     | Netherlands Environmental Assessment Agency   |
| PESETA  | Projection of Economic impacts of climate change in Sectors of the European Union based on bottom-up Analysis |
| PETM    | Paleocene-Eocene Thermal Maximum  |
| PFC     | perfluorocarbon   |
| PIK     | Potsdam Institute for Climate Impact Research   |
| PIOT    | Physical Input-Output Table   |
| PP      | Primary Production  |
| ppm     | parts per million   |
| PRIMES  | Price-Induced Market Equilibrium System   |
| PSUT    | Physical supply and use table   |
| PTB     | Physical Trade Balance  |
| PV      | Photovoltaic  |
| RCM     | Regional Climate Model  |
| RCP     | Representative Concentration Pathway  |
| RF      | Radiative Forcing   |
| RICE    | Regional Integrated Model of Climate and the Economy  |
| RuBisCO | Ribulose-1,5-bisphosphate carboxylase-oxygenase   |
| SEEA    | System of Environmental Economic Accounting   |
| SFD     | Stock and Flow Diagram  |
| SITC    | Standard International Trade Classification   |
| SLR     | Sea Level Rise  |
| SNA     | System of National Accounts   |
| SSP     | Shared Socioeconomic Pathway  |
| TCR     | Transient Climate Response  |
| TFC     | Total Final Energy Consumption  |
| TIMES   | The Integrated MARKAL-EFOM System   |
| TMC     | Total Material Consumption  |
| TMI     | Total Material Input  |
| TMO     | Total Material Output   |
| TMR     | Total Material Requirement  |
| TPES    | Total primary energy supply   |
| TYNDP   | Ten Year Network Development Plants   |
| UN      | United Nations  |
| UNCEEA  | UN Committee of Experts on Environmental-Economic Accounting  |
| UNECE   | United Nations Economic Commission for Europe   |
| WEMC    | World Energy and Meteorology Council  |
| ZECMIP  | Zero Commitment Model Intercomparison Project   |
| ZITCH   | World Induced Technical Change Hybrid model   |



# Tables and Figures

| Number      | Title   | Page |
|-------------|---|------|
| Figure 1.1  | Energy capture in the biosphere (marine & terrestrial) and society (biomass, fossil, solar, hydro, geothermal and OTEC) in the past, present and future expressed in EJ year <sup>-1</sup>  | 31   |
| Table 1.1   | Historical, present and future potential energy capture in the biosphere and society, expressed in EJ yr <sup>-1</sup>  | 32   |
| Figure 1.2  | Global CO <sub>2</sub> concentrations from (a) 796 562 years BC to 2014 and from (b) the year 0 to 2014.  | 33   |
| Figure 1.3  | Total Primary Energy Consumption (TFC) in the world by source from 1990 to 2015   | 40   |
| Figure 1.4  | Total Final Energy Consumption (TFC) in the world by source from 1990 to 2015.  | 40   |
| Figure 1.5  | Global carbon emissions, land sink, ocean sink and budget imbalance expressed in GtC/year   | 41   |
| Table 1.2   | EROEI values of different types of pre-industrial societies and historical EROEI values for crude oil.  | 44   |
| Table 2.1   | Disaggregated analysis of renewable energy technologies   | 53   |
| Figure 2.1  | Planned oil pipelines in the Middle-East  | 55   |
| Figure 2.2  | Renewable energy interconnection development plans  | 56   |
| Table 2.2   | Review of Macroeconomic Energy-Climate Models   | 57   |
| Figure 2.3  | GEM-E3 and PRIME MODELS (2016)  | 60   |
| Figure 3.1  | Concentration of CO <sub>2</sub> in the Atmosphere  | 67   |
| Figure 3.2  | Worldwide economic losses from weather-related disasters  | 68   |
| Figure 3.3  | Positive and negative loops in the scenario “more pollution”  | 69   |
| Figure 3.4  | Optimization model of energy and environmental system   | 70   |
| Figure 3.5  | Coupling climate system and economic system   | 71   |
| Figure 3.6  | Five shared Socioeconomics Pathways   | 73   |
| Figure 3.7  | Narratives of the Shared Socio-economic Pathways in IAMs  | 74   |
| Figure 3.8  | IIASA Integrated Assessment Framework   | 76   |
| Figure 3.9  | Economic circuit of GEM-3E  | 77   |
| Figure 3.10 | Computer General Equilibrium with financial sector  | 78   |
| Figure 3.11 | GEM-E3 model dimensions   | 78   |
| Figure 3.12 | IMAGE model schematic framework   | 79   |
| Figure 3.13 | IMAGE model scenario storylines   | 80   |
| Figure 3.14 | Structure of REMIND-R   | 82   |
| Table 3.1   | Main characteristics of REMIND-R  | 84   |
| Figure 3.15 | The role of expectations in REMIND-MAgPIE model   | 85   |
| Table 3.2   | Components of IAMs  | 86   |
| Figure 3.16 | Model – Scenarios and Indicators issues for IAM   | 87   |
| Figure 3.17 | Reference Scenario for EU, trends to 2050   | 88   |
| Table 4.1   | Summary table of global mean radiative forcing (RF, W m <sup>-2</sup> ) and effective radiative forcing (ERF, W m <sup>-2</sup> ) estimates over the 1750-2011 period. Volcanic radiative forcing is not considered here because of the periodic nature of eruptions.   | 123  |
| Figure 4.1  | Global CO <sub>2</sub> concentrations from (a) 796 562 years BC to 2014 and from (b) the year 0 to 2014.  | 124  |
| Figure 4.2  | Yearly global carbon emissions from fossil and industrial sources, land use change-induced emissions, ocean and land sink fluxes and the carbon budget imbalance (expressing the uncertainty on global estimates, equal to the estimated total emissions minus sinks), expressed in GtC per year. The main source of uncertainty is the uptake of carbon on land (land sink). | 125  |



|             |  |     |
|-------------|--|-----|
| Figure 4.3  | The global yearly temperature anomaly expressed in °C, compared to the 1951-1980 average temperature   | 126 |
| Figure 4.4  | Comparison of past modelling efforts (RCPs for CMIP5 and SSPs for CMIP6) with observed emissions (Global Carbon Project 2019) in recent history.   | 127 |
| Figure 4.5  | Emission trajectory of Australia calculated based on an equal global per-capita distribution of the remaining 2018 global carbon budget (recalculated to the year 2016, the signing of the Paris agreement), required to have a 50 % chance of staying below 1.5 degree warming. | 128 |
| Figure 5.1  | The role of complex social system on climate dynamics  | 138 |
| Figure 5.2  | The establishment of a norm  | 143 |
| Figure 5.3  | Historical carbon prices of the EU ETS   | 147 |
| Figure 6.1  | Outline of Circular Economy  | 164 |
| Figure 6.2  | European Green Deal  | 165 |
| Table 6.1   | Stages of industrial transition  | 167 |
| Figure 6.3  | The four key-drivers of strong sustainability for industrial symbiosis   | 169 |
| Figure 6.4  | The system Test  | 170 |
| Figure 6.5  | The Step Process   | 170 |
| Figure 6.6  | Toile Maker Project  | 172 |
| Figure 6.7  | Circular Economy for Living on One Planet  | 174 |
| Figure 6.8  | The five pillars of Circular Economy   | 177 |
| Figure 7.1  | Main international classifications of activities and products  | 191 |
| Figure 7.2  | Structure of a Physical Supply and Use Table   | 192 |
| Figure 7.3  | Input-Output Transactions Table  | 193 |
| Figure 7.4  | Flow table of two-sector economy   | 195 |
| Figure 7.5  | Material flow analysis (MFA) indicators  | 200 |
| Figure 7.6  | Major economy-wide material and energy exchange databases  | 201 |
| Figure 7.7  | Dynamic relationship   | 202 |
| Table 7.1   | Accumulation and rate of change - terminology differences in different academic fields   | 203 |
| Figure 7.8  | Feedback loop-representation in system dynamics (+: Reinforcing Loop, - : Balancing Loop)  | 204 |
| Figure 7.9  | System dynamics representation   | 205 |
| Figure 7.10 | Conceptual difference between exogenous and endogenous variables   | 206 |
| Figure 7.11 | Continuous and discrete change systems can all be modelled as discrete time systems  | 206 |
| Figure 7.12 | General representation of dynamic system model   | 207 |
| Figure 7.13 | Block diagram representation of the state-space model  | 209 |
| Figure 7.14 | System dynamics representation of dynamic input-output model   | 211 |
| Figure 7.15 | System dynamics representation of dynamic input-output model with a stock of renewable resources   | 212 |
| Table 8.1   | Monetary Input-Output Table with n sectors   | 221 |
| Table 8.2   | Monetary Input-Output Table with n sectors extended with 2 environmental inputs and 2 environmental outputs  | 224 |
| Table 8.3   | Physical Input-Output Table with n sectors, 3 disposals to nature and 2 natural resource inputs  | 226 |
| Table 8.4   | Multi-Regional Input-Output Table with 3 regions with n sectors per region   | 228 |
| Table 8.5   | Condensed notation for a Multi-Regional Input-Output Table with 3 regions with n sectors per region  | 228 |

# Introduction

## Context

Climate change, our material footprint, the energetic metabolism of economic activities and environmental impacts are intrinsically linked, and increased considerably in magnitude over the last several decades in line with the expansion of industrial and economic activity.

Over pre-industrial timescales, ranging from the Neolithic evolution through the emergence of agriculture until the onset of the Industrial Revolution in the 18<sup>th</sup> century, anthropogenic material use has been estimated to have increased slightly from 0.7 Gt/year per capita to around 2 Gt/year (Krausmann et al. 2008), primarily tied to the degree of agricultural activity. As our societal metabolism consisted historically primarily of biomass, our energetic metabolism did coincide with our material metabolism. From the onset of the industrial revolution in 1950 until recent history (2005), the biomass-based metabolism extended to other types of materials and processed materials, such as fossil fuels, industrial minerals and ores and construction minerals. This resulted in an exponential rise in material and energy consumption in which the quantity of extracted materials increased with a factor 19 and energy consumption with a factor 14 (Krausmann et al. 2008). In conjunction with increased production and consumption over the last decades, international trade in goods increased. Between 1950 and 2010, the share of exported materials in global extraction increased by a factor 2.5 (Krausmann et al., 2008). Subsequent research confirmed that countries use of non-domestic resources is on average threefold larger than the physical quantity of traded goods (Wiedmann et al., 2015).

The expansion of our societal material and energetic metabolism – also termed the ‘Great Acceleration’ in Earth System Science (Steffen et al, 2015) – does not stand on its own, as it results in a variety of impacts on the natural and social environment. Beyond the prominent systemic impact in the form of observed and projected change of climate due to fossil carbon emissions and land use changes (Steffen et al., 2018) – resulting in an increase in climate-related disaster occurrence (Van Aalst, 2006), systemic and interacting impacts extent to biodiversity loss (Cardinale et al, 2012) or the extinction of vertebrate species in a so-called ‘mass extinction’ (Ceballos et al., 2017). In line with the increase in anthropogenic material flows, the total stock of human-generated materials is currently estimated to equal all global living biomass<sup>1</sup> (Elhacham et al., 2020), amplifying arguments to name our current epoch the ‘Anthropocene’ in which human society became a geological force .

Those widely underpinned historical and present environmental impacts, as well as future environmental challenges, have resulted in a lively academic, institutional and civil society debate about possible and feasible transition pathways that limit future impacts. Prominent academic research on global climate mitigation pathways is synthesized in for example the IPCC Working Group III assessment reports (Corbera et al., 2016). Institutions that quantify and model transition pathways have united within the Integrated Assessment Modelling Consortium (IAMC). Evolving from historical simple cost-benefit models (Keen, 2020), integrated climate assessment tools are currently developed in an increasingly transparent manner, using open-source models and tools (Gidden et al., 2018).

We are at a crossroads of a societal transition, in order to keep climate change and environmental impacts within limits. In line with the above described challenges and observations, this dissertation aims to synthesise and contribute to the literature relating to

---

<sup>1</sup> Anthropogenic material mass in this study embody concrete, aggregates (gravel and sand), bricks, asphalt, metals, wood (in use), glass, plastic and waste, excluding sediment movements because of dredging. The living biomass weight estimate is a synthesis of previous study results, primarily consisting of plant biomass (90 %).

historical understanding of the interlinkage of natural and anthropogenic transitions, future decarbonisation scenario development and the wider methodological-institutional debate on integrated assessment modelling.

## Overarching research question

To understand the interlinkages between material flows and climate change on a systemic level, an understanding of the associated energy production and use over time is a key component. Material extraction, transformation, disposal and associated climate impacts are to a great extent linked to different sequential energy revolutions, and they will remain so in the future. When a material is recyclable, recycling rates of 100 % can theoretically be reached. However, in line with the importance of understanding the physical-energetic metabolism pointed out previously, the feasibility of increasing recycling rates depends in the first place on the energy available to do so (for transport, treatment, processing, remanufacturing, etc.) and secondly, to our societal behaviour related to the organization of material flows. As anthropogenic climate change is the result of historical energy revolutions and in particular the industrial revolution, an assessment of our energetic metabolism provides a contextual framework to understand how material flows and greenhouse gas emissions have evolved over time and what future dematerialization and climate mitigation scenarios could look like.

The works that follow in this dissertation, started initially with the overarching question: *‘how to characterize material flows on a global level and how are these material flows interlinked with climate change?’*. This broad research question evolved into specific research questions, reflections and collaborations, of which below articles and book chapters are the result.

Reflections and concerns related to material transformations and climate change can be studied from a purely physical-energetic point of view, but designing effective transformation pathways for identified issues is an inherently social process. To illustrate the importance of both of these aspects, it is informative to look at questions related to material recycling in the different sectors of our society: to understand the degree of recycling of materials and possible impact of increasing recycling rates on emissions and material throughput, in the first place a quantification is needed of where materials are coming from, where they are going to, and how much is being reused or recycled, using a sound methodology to assess the dynamics of material flows and material cycling. In a second stage, arguments can be laid out on the possible advantages and disadvantages of increasing recycling rates. Finally – as recycling does not happen within an experimental laboratory setup, an effective change in recycling rates is the result of the interactions between a wide variety of actors, institutions and organizations active in society. Climate change mitigation itself is an equally social transition challenge, informed by a quantitative assessment of emission and a socio-political exchange on mitigation actions.

In below introductory sections, I will (i) describe the main schools of practice this dissertation relates to (pp. 19-22) and (ii) provide an overview of specific research questions for each of the chapters and describe the contents of each chapter (pp. 22-27). In the conclusion at the end of this dissertation (pp. 237-242), I will (i) summarize the main chapter conclusions, (ii) reflect on interrelationships between the chapters and provide overarching conclusions, (iii) discuss the limits of the research and (iv) list possible future research avenues.

## Schools of practice

As this dissertation touches upon both physical-energetic and socio-economic aspects of material cycling and climate change, it is inspired by works from different disciplines, academic societies and institutions. To make the distinction of different schools of practice tangible, Annex 1 (p. 245) contains a visual representation of co-authored works that have been gathered in the preparation of this thesis, in which the 1000 most frequently occurring authors have been clustered according to co-authorship (clusters) and number of documents collected (size of nodes). In an attempt to distinguish the different research communities, below is a personal appreciation of their identifying features – including links to the respective chapters of this dissertation in [square brackets] – organized in three different groups: (i) social ecology, industrial ecology and (physical) input-output analysis, (ii) disciplines and research communities that link (physical) input-output theory and practice to other disciplines and finally (iii) integrated assessment modelling, climate modelling and energy system modelling.

### Social ecology, industrial ecology and (physical) input-output analysis

The primary established methodological school of practice of this dissertation lies at the intersection of **social ecology**, **industrial ecology** and **input-output analysis**, as most of the empirical work this dissertation relates to are from those communities. In each of these disciplines – although overlapping to a large extent, efforts are made to improve the understanding of the intersection of environmental impacts related to different activities and sectors in society. However, each school approaches this intersection from a slightly different angle, either with regard to the methodological approach, theoretical foundations, disciplinary links or scope of analysis.

**Social ecology [chapter 1]** (*upper half of the red author-cluster in Annex 1, A, p. 245*) can be considered the school of practice with the broadest viewing angle on the intersection of anthropogenic and natural material and energy metabolism, providing particular attention to the historical context of material and energetic transitions, termed *socioeconomic metabolism*. Within the community of social ecology, a broad viewing angle on societal change and interdisciplinary tools are used to put our present socioeconomic metabolism in perspective. Social ecology focusses specifically on the impacts of anthropogenic activities on the environment, by borrowing and adapting terminology that bridge social-science disciplines (sociology, geography) with ecology and earth system science. This adaptation facilitates the comparison of natural material and energetic metabolism with the magnitude of anthropogenic impacts on nature in an integrated manner. The scope of application tends to be global, although regional or local case-studies have been carried out as well. Methodological contributions have been primarily within the theoretical framework of society- or economy-wide Material Flow Analysis (MFA), describing the flows of all materials combined in an aggregated manner<sup>2</sup>, as well as the development of an integrated global material flow database (BOKU SEC, 2020). Although a community-wide effort, the ‘historical centre of gravity’ of the social ecology discipline could be argued to be at the Institute of Social Ecology at the Alpen-Adria University in Vienna, Austria. Complementary to the works cited in below chapters, the book *Social Ecology: Society-Nature Relations across Time and Space* (Haberl et al., 2016) provides a clear overview of the core concepts and applications. Key authors cited are Marina Fischer-Kowalski, Fridolin Krausmann, Helmut Haberl, Stefan Giljum, Stephan Lutter, Dominik Wiedenhofer, Nina Eisenmenger (SEC BOKU) and Heinz Schandl (CSIRO). Collected works appear most frequently in the

---

<sup>2</sup> Economy-wide MFA indicators have subsequently been incorporated in the institutional toolset of the European Communities (2001), the OECD and Eurostat (see also chapter 7).

journals *Ecological Economics* and *Nature Sustainability*, in addition to the *Journal of Industrial Ecology*.

**Industrial ecology (IE) and input-output analysis (IO) [chapters 7-8]** are closely-related academic communities of practice that focus on the same nature-society interactions, but with a more (open) data- and method-driven and engineering-based approach. In complement to aggregate and economy-wide Material Flow Analysis (MFA), industrial ecology research tends to focus more on specific sectors and products, while retaining the focus at a global or interregional scale. Key methodologies are life cycle analysis (LCA) and input-output analysis (IO), although these two methodologies (LCA and IO) can also conceptually be unified in a common theoretical framework (Majeau-Bettez et al., 2014). Because the works this dissertation relates to are primarily environmentally-extended IO applications and theoretical work on physical IO analysis (Altimiras-Martin, 2016), the schools of practice of IE and IO overlap to a large extent. **Environmentally-extended input-output analysis** (*lower half of the red cluster in Annex 1, B, p. 245*) is currently – guided by data availability and institutional data provision – the most frequently used empirical method to assess environmental impacts of international trade, based on monetary input-output tables extended with environmental accounts (describing the impacts of the different sectors on the environment). Collected works originate primarily from the Industrial Ecology Programme at NTNU Norway (Richard Wood, Konstantin Stadler, Anders Hammer Strømman, Johannes Többen, Kirsten Wiebe, ...), the University of Sydney and UNSW Australia (Manfred Lenzen, Thomas Wiedmann, ...), Department of Industrial Ecology at Leiden University (Arnold Tukker, ...), the University of Leeds (John Barrett, Anne Owen), Yale University (Edgar Hertwich, Niko Heeren, ...), etc. In addition to environmentally-extended IO works, methodological advances are also developed in the **monetary input-output analysis** community, as they strongly relate to each other on a mathematical and data-sources level (*bottom of the red cluster in Annex 1, C, p. 245*). Key journals for research on environmentally extended IO analysis and wider industrial ecology applications are for example the *Journal of Industrial Ecology* and the *Journal of Cleaner Production*. Methodological advances in (monetary) input-output theory have also frequently been published in the journals *Economic Systems Research*, hosted by the The International Input–Output Association (IIOA) and *Journal of Economic Structures*, hosted by the Pan-Pacific Association of Input-Output Studies (PAPAIOS).

In addition to the above-described academic research communities, there are different research organisations pursuing applied research works for institutional, governmental and private application. In the realm of economic input-output analysis, there is for example the work of GWS GmbH. in Osnabruck, Germany (Bernd Meyer, ...), Ecologic Institute (Martin Hirschnitz-Gabers) or VITO in Belgium (An Vercaulder, Evelien Dils) (*purple cluster in Annex 1, D*). Related to material flow analysis and life cycle analysis, the EU JRC has developed research activities related to for example criticality assessment of raw materials (*blue cluster in the centre in Annex 1, L*).

### **Schools of practice integrating physical input-output analysis with other disciplines**

Secondly, the methodological part of the thesis [chapters 7-8] is informed by works that relate physical input-output modelling with (i) **system dynamics** or **dynamical systems theory** and **process control** theory (adding the time dimension to IO analysis), (ii) **industrial ecology**, **material flow analysis** (providing theoretical grounds to model material flows and cycling in a systemic way), (iii) **ecology** (using the analogies in ecological systems theory to describe physical exchanges in the economy) and (iii) **power system engineering** (describing systemic energy use, production and energy losses). With the exception of system dynamics, which

received a recent increase in interest because of the cross-disciplinary and systemic approach of primarily economy-environment topics, most of the other methodological interlinkages linking to physical IO analysis have not been widely described in the physical climate and energy transition literature.

**System dynamics** research most closely related to this dissertation is the work carried out within the frame of the recent EU MEDEAS project (*purple on the left in Annex 1, M*), aiming at modelling a sustainable transition in the EU using system dynamics, linked to a certain extent to the input-output framework. The difference between system dynamics and **dynamical systems theory** is that the former is a multi-disciplinary school of practice integrating different disciplines in an accessible and collaborative modelling framework with a particular focus on the time-dimension and feedbacks of interacting elements in transitions, whether the latter is an area of mathematics describing the behaviour of complex dynamical systems frequently applied in engineering practice. The works that relate input-output modelling to **power system engineering** (*purple on the top in Annex 1, M*) are particularly interesting and provide novel theoretical developments to study energy exchange for the whole economy.

### **Integrated assessment modelling, climate modelling and energy system modelling**

Thirdly, the dissertation relates to the broader literature on integrated assessment modelling, climate change modelling, climate impact analysis and energy system modelling research.

**Integrated assessment modelling [chapters 2-3]** (*light green cluster in Annex 1, E, p. 245*) is the study of interrelationships between the energy system, climate change and the economy with so-called Integrated Assessment Models (IAMs), brought forward by several institutions associated in the Integrated Assessment Modelling Consortium<sup>3</sup> (IAMC) and institutionalized by multilateral and interregional organizations (UN bodies, IPCC, EU, etc.). IAMs are models that aim to capture historical links between material use, material throughput and the emissions of greenhouse gasses, as well as putting forward future transition pathways in a common framework and using common narratives, the Shared Socio-Economic Pathways (SSPs) framework. Active institutions are for example the International Institute for Applied Systems Analysis or IIASA (Elmar Kriegler, Volker Krey, ...) and Imperial College (Joeri Rogelj, ...). The IAM community is tied to the climate modelling community through common methodological and data-driven collaboration (Matthew Gidden, IIASA and Climate Analytics).

**Climate modelling and climate impact analysis [chapter 4]** are closely related communities of practice that study the characteristics and behavior of the climate system, primarily through the construction and analysis of climate simulation models<sup>4</sup> and impact models that simulate the climate impacts on the environment, infrastructure and economy. **Climate modelling** (*green cluster in the middle-right in Annex 1, F*) publications originating from a variety of cross-institutional collaborations are frequently published in *Nature Climate Change*, *Earth System Dynamics*, *Earth System Science Data*, *Climate Dynamics*, *Global Change Biology* and *Geoscientific Model Development*. Collected **climate impact** research are from collaborations within the international Inter-Sectoral Impact Model Intercomparison Project

---

<sup>3</sup> An overview of the institutions participating in the IAMC can be found at <https://www.iamconsortium.org/>

<sup>4</sup> Climate models can be broadly divided into Global Circulation Models (GCMs) and Regional Circulation Models (RCMs). For a hands-on and applied introduction to climate models and application of model outputs in sectoral climate impact analysis, the reader is warmly recommended to consult the Copernicus Climate Change Service (C3S) User Learning Service, implemented by ECMWF, at <https://climate.copernicus.eu/>

(ISIMIP), primarily published in *Proceedings of the National Academy of Sciences* (light blue in the middle in Annex 1, G), and a more European-centred institutional research community centred around subsequent PESETA-climate impact analysis projects organized by the European Joint Research Centre (EU JRC) (pink on the right in Annex 1, H).

Climate modelling outputs are an important consideration to conceptualise future renewable energy systems. Works from three distinct but overlapping communities that work on the convergence of climate and (renewable) **energy modelling** have been gathered. A first community is academic (dark green cluster in the center in Annex 1, I and I\*), for example the work on 100 % renewable energy systems from Tom Brown and Mark Jacobson. Secondly, applied climate-energy research and data exchange is facilitated by for example the World Energy & Meteorology Council (WEMC), hosted at the University of East Anglia (orange cluster on the right in Annex 1, J). Thirdly, applied EU-wide energy systems research and analysis is carried out at the EU Joint Research Centre (blue in the centre in Annex 1, K).

## Introduction to the different chapters

The chapters outlined below either have a link with the methodological, physical-energetic or socio-economic aspects of material flows, energy production and use, and climate change mitigation. The primary rationale for choice of topics and research questions of the first 4 chapters is the principal role of the energy system and energy transformations in facilitating material flows and driving climate change. Subsequently, chapter 5 focuses on the role of monetary valuation and market-based climate and energy policies, as well as a reflection on alternative policy strategies that could help overcome the identified shortcomings. Finally, chapters 6 to 8 reflect on a conceptual (chapter 6) and methodological (chapters 7-8) framework that enables the assessment of the physical interlinkage of material flows with the energy system. The main guiding research questions for each of the chapters are:

- 1 How do historical societal energy-revolutions relate to the energetic metabolism of the natural environment?  
How much renewable energy can sustainably be sourced from the natural environment in the future, and how do these estimates relate to our historical and present societal metabolism?
- 2 How is renewable energy represented in a selection of IAMs?
- 3 What are the main characteristics of frequently used IAMs and how did they evolve over time?
- 4 How do climate models work and what are the most important metrics to compare climate models?  
What is the extent of a set of projected climate impacts?  
What are the implications of recent climate modelling research for the use of carbon budgets in public policy?
- 5 What is the impact of discount and interest rate variations on the outcomes of prominent energy system models used in public policymaking?  
What are the shortcomings or advantages of either economic or monetary policies and regulatory or norm-setting policies?
- 6 How to define the contemporary concept of circular economy?
- 7 How to dynamically model material and energy flows over time, incorporating the link to the economy-wide sectoral structure and energy production and use?
- 8 What have been applications of input-output analysis on urban scale and how could those be further developed?

The **first chapter** (pp. 27-51) aims to provide an overview of historical order-of-magnitude estimates of energy production and use during successive natural and anthropogenic revolutions - greatly inspired by the work of professor Timothy Lenton, Peter-Paul Pichler and Helga Weisz<sup>5</sup> (pp. 30-42), compares these with future fully renewable energy production potential estimates collected from the literature and concludes with a section on whether an ERO(E)I value could be relevant to assess energy transitions on a systemic level (pp. 42-44). This chapter serves to contextualize our present material and energetic societal metabolism, and to provide the historical background of successive energetic revolutions.

**Chapter 2** (pp. 51-65) contains a concise introduction to the broad family of Integrated Assessment Models (IAMs), aiming to review whether and how renewable energies are represented in IAMs, introduces two key models that are used for EU climate and energy policy making (PRIMES by GEM-E3) and concluding on whether resource dynamics are incorporated in these models.

A historical and more detailed description of an extensive list of IAMs that have been used for macro-economic international and EU-policymaking and the assessment of climate policies and scenarios, can be found in **chapter 3** (pp. 65-93). The chapter starts with a generic description of IAMs, according to whether the functioning of the model is either optimization-based (using cost-optimization, cost abatement or uncertainty-based) or evaluation-oriented (assessing policy goals) (pp. 65-66). Secondly, a historical overview is given of models with a worldwide scope, ranging from aggregated economy-environment models<sup>6</sup> ('70s), aggregated cost-benefit assessment frameworks<sup>7</sup> ('90s) up to the currently used suite of models for international and European environmental policy assessment, used by respectively the International Institute for Applied Systems Analysis<sup>8</sup> (IIASA) and European institutions<sup>9</sup>. The chapter concludes with proposals for future research avenues that could help improve the utilization, transparency and application of IAMs.

In order to understand, debate and evaluate transition pathways that keep climate change at bay and reduce our environmental impact through material use and disposal, a basic understanding is needed on the state of play of climate modelling, climate impact research and carbon budget theory and related policy proposals. **Chapter 4** (pp. 93-**Error! Bookmark not defined.**) aims to put forward an overview of key climate metrics (pp. 95-99) and a concise overview of climate models and climate model intercomparison frameworks (pp. 99-102), and concludes – informed by recent climate impact research (pp. 102-105) and rebuttals of 'fake' one-shot climate mitigation solutions (pp. 105-106) – with a discussion on the potential role of using carbon budgets in public policy (pp. 106-110).

To bridge the understanding and assessment of existing modeling frameworks to the methodological discussion in chapter 6 and 7 and to lay the foundation for alternative methodological developments, **chapter 5** reviews the structure and functioning of models that use monetary optimization for either designing or assessing climate and energy policies (depending on the school of thought of those who designed the model) and aims to put forward

---

<sup>5</sup> Lenton, T. M., P.-P. Pichler, and H. Weisz. "Revolutions in Energy Input and Material Cycling in Earth History and Human History." *Earth Syst. Dynam.* 7, no. 2 (April 22, 2016): 353–70. <https://doi.org/10.5194/esd-7-353-2016>.

<sup>6</sup> World3 initiated by Forrester et al.

<sup>7</sup> DICE and RICE initiated by Nordhaus

<sup>8</sup> The IIASA modelling suite consist of MESSAGE (energy), GLOBIOM (land dynamics), GAINS (non-CO<sub>2</sub> greenhouse gasses), MACRO (economy), MAGICC (climate), integrated in the IMAGE modelling framework.

<sup>9</sup> Such as the macro-economic JRC-GEM-E3 model and energy-system model PRIMES.



advantages and shortcomings of either monetary climate and energy policy modelling and assessment, versus alternative policies (for example: physical target-based policies such as carbon budgets). The overarching research question of this chapter is to which extent monetary valuation helps or impedes the design and assessment of effective climate policies, exemplified by the role of discount or interest rates on both IAMs<sup>10</sup> (pp. 130-138) and energy system models<sup>11</sup> (pp. 138-141) – entailing a political and value-laden appraisal of speed of change of transition, and the use of economic instruments<sup>12</sup> versus regulatory instruments (pp. 141-147). Considering multiple deficiencies of monetary policies informed by monetary optimization models (pp. 147-151), some policy suggestions are brought forward that could help overcome the identified shortcomings (pp. 151-154).

Provided an understanding of energy and climate models and policies and bridging institutional energy and climate models to the methodological discussion in chapter 7 and 8, **chapter 6** (pp. 163-185) puts forward a conceptualization and discussion of the contemporary concept of circular economy. Considering the foundations and roots of the circular economy concept (pp. 166-169), a broad range of related tools at our disposal to evaluate circularity (pp. 169-174) and future challenges that put the concept to the test (pp. 174-179), the chapter concludes with policy suggestions that could help to refine or contest further refinements of the framework (pp. 179-180).

Finally, the last two chapters are working papers that outline some ideas for further development of a methodological framework that is capable of representing sectoral material flows, energy production, energy use and greenhouse gas emissions – rooted in principles of (physical) input-output theory, dynamical systems, system dynamics and process control theory, applied both on a multi-regional scale (chapter 7, pp. 185-219) and on the city-level (chapter 8, pp. 219-237). These chapters are greatly inspired (and written in the case of chapter 8) by Aleix Altimiras-Martin and his work in advancing the methodological basis for analysing and understanding the cycling of materials on an economy-wide level<sup>13</sup>.

**Chapter 7** starts with an argumentation on why the physical input-output modelling framework is deemed the most suitable framework to analyse systemic transitions of material flows, material cycling and energy production and use (pp. 185-189). Secondly, an overview of institutional organization of the system of national accounts is presented, together with a brief overview of the major sector- and product-classifications (pp. 189-191). Thirdly, a comparison is presented focusing on the advantages of using physical versus monetary input-output tables (pp. 191-193). Finally, the standard (static) input-output model is extended to a dynamic input-output model that evolves over time and that can be used to assess the replenishment rate of resources, including a visual analogy in with system dynamics or dynamical systems notation (pp. 193-212).

**Chapter 8** provides an overview of the basic principles of the Input-Output Analysis (IOA) framework (pp. 219-223), the assessment of environmental impacts with the IOA framework

---

<sup>10</sup> A distinction is made between ‘simple’ cost-benefit IAMs which aggregate costs and benefits into a single value (for example DICE, FUND, PAGE) and detailed-process IAMs that make distinction between sectors and greenhouse gasses (for example GCAM, IMAGE, MESSAGE, REMIND and WITCH)

<sup>11</sup> The chapter focuses on TIMES (as reference model for national energy policymaking) and PRIMES (as reference model for EU-wide energy system policymaking).

<sup>12</sup> Economic instruments considered are market-based climate policies such as the Kyoto protocol and the EU Emission Trading Scheme (EU ETS).

<sup>13</sup> Altimiras-Martin, A. (2016). *Managing human-induced material use: Adding cyclic inter-sectoral flows to Physical Input-Output Tables to analyse the environmental impact of economic activity* [Doctoral Thesis]. University of Cambridge.

(pp. 223-227) and exchanges between different regions (pp. 227-229), and provides an overview of IOA applications to cities, both for economic (pp. 229-229) and environmental (pp. 229-231) impact assessment, concluding with a discussion on what the role could be of Physical Input-Output Analysis (PIOA) for the analysis of environmental impacts and policies on the city-level (pp. 231-232).

Over the course of this dissertation, additional types of ‘ad-hoc’ works have been produced in line with the topics described above. Examples of those are exchanges on Twitter<sup>14</sup>, a crowdsourced platform to disseminate academic and policy events related to climate and energy policies<sup>15</sup>, presentations (Annex 2, p. 245), and a website where I shared news, event summaries and article reflections in the form of a blog, interactive libraries on topics of interest and an open-source national carbon budget calculator (see chapter 4)<sup>16</sup>. In collaboration with Bjarne Steffen from ETH<sup>17</sup>, I have provided inputs – primarily consisting of references to other works judged relevant for future energy and climate investment policy – to the European Investment Bank (EIB) Energy Lending Policy Consultation in 2019<sup>18</sup>, along with two blogposts<sup>19</sup> on the matter

---

<sup>14</sup> <https://twitter.com/FlorianDRX>

<sup>15</sup> <https://floriandierickx.github.io/agenda/> and <https://twitter.com/IndEcolAgenda>

<sup>16</sup> The blog can be found at <https://floriandierickx.github.io/blog/tags/index.html>, the libraries at <https://floriandierickx.github.io/library/>, and the carbon budget calculator at <https://floriandierickx.github.io/emission-budget/> (inspired by a 2019 blogpost of Stefan Rahmstorf: <http://www.realclimate.org/index.php/archives/2019/08/how-much-co2-your-country-can-still-emit-in-three-simple-steps/comment-page-3/>).

<sup>17</sup> An webinar on climate and energy finance organized by the research team of Bjarne Steffen was held in 2018, of which notes are available as a blogpost at <https://floriandierickx.github.io/blog/2018/11/27/cmcc>

<sup>18</sup> Dierickx, F. (2019). *Input to the EIB Energy Lending Policy Consultation* [Public Consultation]. European Investment Bank. <https://www.researchgate.net/publication/333895418> *Input to the EIB Energy Lending Policy Consultation*

<sup>19</sup> One blogpost considers the issue of monetary valuation of climate change in the institutional energy lending framework (<https://floriandierickx.github.io/blog/2019/09/24/eib-evaluation>), and another one focuses on the role of natural gas infrastructure (<https://floriandierickx.github.io/blog/2019/10/09/EIB-ENTSOG>).



# 1. Energy Use and Climate Change: History and Foresight

**Authors and affiliations:** Florian Dierickx<sup>1,2</sup>, Arnaud Diemer<sup>1</sup>

1: Jean Monnet Excellence Center on Sustainability (ERASME), University of Clermont Auvergne, CERDI, Clermont-Ferrand, France

2: University of Iceland, Reykjavik, Iceland

*Living reference work entry*

**First Online:** 13 October 2020

**DOI:** [https://doi.org/10.1007/978-3-319-71057-0\\_30-1](https://doi.org/10.1007/978-3-319-71057-0_30-1)

**Published in:** W. Leal Filho, A. M. Azul, L. Brandli, A. Lange Salvia, & T. Wall (Eds.), *Affordable and Clean Energy* (pp. 1–14). Springer International Publishing.

## Synonyms

Appropriable technical potential; Energetic metabolism; Energy consumption; Global primary energy consumption; Human appropriation of net primary production (HANPP); Social metabolism; Total primary energy supply (TPES); World energy consumption

## Definitions

An overview is given of physical energy unit definitions, climate change concepts, and standard institutional and academic energy terminology.

## Physical Energy Units

The standard measure for an amount of energy is *joule* (J), which equals the work done when a force of one *newton* (N) moves the point of its application a distance of one meter (m) in the direction of the force<sup>20</sup>. One newton (N) gives to a mass of 1 kilogram (kg) an acceleration of 1 meter per second<sup>21</sup>. The amount of energy or work (J) over time is expressed in a unit of power or *watt* (W), which is equal to 1 joule of work applied over 1 second<sup>22</sup>. The rate of energy transfer per unit area is the *energy flux density*, expressed in watt per square meter<sup>23</sup>. Energy is either *kinetic* (energy in motion such as radiant energy, thermal energy, motion energy, sound and electrical energy) or *potential* (stored energy such as chemical energy, mechanical energy, nuclear energy and gravitational energy). To enable comparison of energy vectors and sources – described in institutional energy balances – and energy availability in the natural world, all amounts of energy in the following chapter will be expressed in exajoules per year<sup>24</sup> (EJ y<sup>-1</sup>).

---

<sup>20</sup>  $1J = 1m \cdot N$

<sup>21</sup>  $1m \cdot N = 1kg \cdot \frac{m}{s^2}$

<sup>22</sup>  $1J = 1W \cdot s$

<sup>23</sup>  $1W \cdot m^{-2} = 1J \cdot s^{-1} \cdot m^{-2}$

<sup>24</sup>  $1 \frac{EJ}{y} = 10^{18} \frac{J}{y}$ . Traditional energy accounts are frequently expressed in ‘tonne of oil equivalent’ (toe). 1 toe = 11.63 megawatt-hours (MWh) = 41.868 gigajoules (GJ) = 4.18e-10 exajoules (EJ)

## Energetic Metabolism and Climate Change Definitions and Concepts

The availability, production and use of energy (energetic metabolism) differs in time and space, and can take many different forms.

In the natural world, Primary Production (PP) is the ‘rate at which biomass is produced by photosynthetic and chemosynthetic autotrophs (mainly green plants) in the form of organic substances, some of which are used as food material’ or ‘the synthesis of organic compounds from atmospheric or aqueous carbon dioxide through photosynthesis or chemosynthesis’. Gross Primary Productivity (GPP) is ‘the total rate of photosynthesis and chemosynthesis, including the portion of organic material produced which is used in respiration during the measurement period’. Net Primary Production (NPP) is ‘the rate of production after some has been lost to plant respiration during the measurement period’ (Allaby 1998).

The human appropriation of photosynthetic production in ecosystems and the harvest of products of photosynthesis, is the Human Appropriation of Net Primary Production (HANPP) (Haberl et al. 2007). The most frequently used institutional indicator for energy supply is the Total Primary Energy Supply (TPES) or the ‘calorific content of energy commodities such as coal, peat, shale oil, crude oil and by-products, nuclear, renewables and energy trade expressed on national or global scale’, accounting for trade and domestic storage (OECD 2015, 2016; International Energy Agency 2019). The most frequently used indicator for energy use is the Total Final Energy Consumption (TFC) or the ‘sum of energy consumption in both the end-use sectors and non-energy use sectors, excluding energy used for transformation processes, own non-final sectoral energy use and backflows from the petrochemical industry’, reflecting for the most part deliveries to the consumer (International Energy Agency 2019). World energy consumption is the total amount of energy consumed by the entire human civilization.

For the purpose of this article, energy will be categorized in renewable energy and fossil energy. Renewable energy is energy from a source that is not depleted when used, or otherwise stated, that is available in human timescales. Fossil energy is biological energy formed by natural processes over geological timescales, stored in the earth’s crust. For renewable energies, the appropriable technical potential (ATP) is the energy flux that can be diverted from the Earth system for societal use without crossing Earth system boundaries.

## Climate Change and the Energy Balance of the Earth

The primary source of energy for all life and activities on Earth is the incoming *solar energy flux* or *solar irradiance* from space, equal to  $1.7 \times 10^{17} \text{ W}$  (or 5 364 677 EJ/year<sup>22</sup>) before entering the Earth’s atmosphere. Thirty percent of this energy is reflected without much interaction with the Earth (reflectivity or albedo of the earth  $R$ ) and around twenty-one percent is absorbed in the atmosphere, of which approximately 2/3rd reaches the ocean and 1/3rd is absorbed on land.

A central notion in assessing the impacts of certain mechanisms on the climate system is the concept of radiative forcing or climate forcing, which is the “net change in radiative flux, expressed in  $\text{W m}^{-2}$ , at the tropopause or top of the atmosphere due to change in a driver of climate change” (IPCC 2018). Radiative forcing is thus a quantification of the difference between the radiation absorbed by the Earth and the energy radiated back to space, or - otherwise stated - imposed perturbations to the Earth’s energy balance. The factors affecting the energy balance of the earth can be either *natural*<sup>25</sup> – orbital forcing, solar forcing and

---

<sup>25</sup> Changes in solar irradiance and orbital changes result in a certain level of *solar forcing*, the change in the average amount of solar energy absorbed per square meter. The incoming solar energy is measured by the solar constant or total solar irradiance ( $\pm 1360.8 \text{ W m}^{-2}$ )<sup>25</sup>. Although not an official physical constant, the term is used because solar cycle variations in recent history over the 11-year solar cycle are only in the order of 0.1 % (Kopp et al. 2016). Until the 90s climate models used a solar constant of  $1365.4 \pm 1.3 \text{ W}$

volcanic aerosol forcing, or *anthropogenic* – greenhouse gas (GHG) forcing<sup>26</sup>, short-lived gas forcing and land use and land cover changes forcing. Anthropogenic drivers are currently the primary cause of climate change.

## Introduction

The availability of energy is a basic premise for all forms of life and activity on earth, both in the natural and anthropogenic world. Humanity always used energy to improve living conditions and enable progress and development, although the type and amount of energy used over historical timescales varied considerably. From the Industrial Revolution onwards, we started using historically biologically accumulated fossil fuels, thereby directly influencing the climate of the Earth.

The challenge of decarbonising the entire energy production system and industrial structure is considerable, and is far from being solved. Nevertheless, promising pathways can be seen on the horizon. Fossil fuels currently account for 81.7% of the world's energy consumption (IEA 2016). The most widely used source of energy is oil. In 2019, it accounted for 42% of the world's energy consumption. Gas and coal are just following behind, with a share of consumption of 15% and 12%. Most of the world's largest energy consuming countries have taken steps to promote green electricity and sustainable development. The Paris Agreement, drafted at COP21 in 2015 and reaching 197 signatory countries in 2017, shows that the desire to preserve natural resources, to reduce GHG emissions and to develop renewable energies is becoming more widespread. Despite these political engagements, considerable efforts are required. Around 3 billion people lack access to clean cooking solutions and are exposed to dangerous levels of air pollution and almost 1 billion people don't have electricity, of which 50% are living in sub-Saharan Africa. Ample progress has to be made, in order to avoid the worst effects of climate change and provide equal energy access to humanity.

In the pre-industrial period, our anthropogenic biological energy consumption and use was increasingly dependent on the energy that is captured by the sun through photosynthesis and chemosynthesis of plants. To understand and quantify our energetic metabolism of this pre-industrial "traditional" biomass-based period, it is sufficient to understand the human

---

$\text{m}^{-2}$ , but this has been revised in 2011 to  $1360.8 \pm 0.5 \text{ W m}^{-2}$  (Kopp and Lean 2011)(Kopp et al. 2016).

Natural variability in solar forcing is induced by orbital cycles over geological timescales, therefore having only a very marginal influence on the current climate compared to the magnitude of anthropogenic forcing<sup>25</sup>. Warming resulting from solar forcing needs to take account of the percentage of solar irradiance that is reflected back to space. The albedo is both affected by natural (black carbon aerosols on snow and ice) and anthropogenic (land use) processes, in recent history respectively resulting in a radiative forcing of  $+0.04$  ( $+0.02$  to  $+0.09$ ) and  $+0.04$  ( $+0.02$  to  $+0.09$ )  $\text{W m}^{-2}$  (Myhre et al. 2013, pp. 677–696).

<sup>26</sup> The four most important greenhouse gases are carbon dioxide ( $\text{CO}_2$ ), methane ( $\text{CH}_4$ ), dichlorodifluoromethane (CFC-12) and  $\text{N}_2\text{O}$ , in that order (Myhre et al. 2013). The concentration of carbon dioxide increased in recent history from around 278 (276–280) ppm in 1750 (Myhre et al. 2013) to a current maximum of 415 ppm (Keeling and Keeling 2017). In the last 800 000 years, before anthropogenic interference, carbon dioxide concentrations in the atmosphere have fluctuated between 170 and 280 ppm, and recent analysis of soil carbonates from the Loess Plateau in central China by Da et al. (2019) suggests that the exceedance of 320 ppm did not happen in the last 2.5 million years and that carbon dioxide concentrations averaged around 250 ppm in this period. This period goes beyond the existence of the *Homo erectus*, dated at 2.1 to 1.8 million years ago (Da et al. 2019). This natural variability of the atmospheric carbon dioxide concentration can be mainly explained by fluctuations in the amount of solar irradiance that is captured on the Earth due to orbital obliquity and precession changes, although uncertainty remains on the relative importance of those processes (Jouzel et al. 2007, p. 795). On a much shorter timeframe, carbon dioxide concentrations also fluctuate intra-annually because of seasonal dynamics in the biosphere. Compared to previous observations from the 50s and 60s, this intra-annual seasonal variation of carbon dioxide concentration has increased with around 50 % (Graven et al. 2013).

appropriation of the Net Primary Production (NPP) of the biosphere (HANPP). In order to understand the dynamics at play in this pre-industrial era – strongly intertwined with the natural energetic metabolism, the first part of this chapter provides (i) an overview of the most important historical revolutions in energy use, both in the natural and anthropogenic sphere.

Since the start of the Industrial Revolution, the HANPP is still relevant for certain types of societies depending on the context, but human energy use extended considerably when starting to use fossil energy or, otherwise stated, "historically embedded HANPP". The relevance of this biological baseline however shrinks to a certain extent when reflecting on a society that runs entirely on electric renewable energy. While "traditional" energy provision from biomass (either directly harvested or in the form of fossil fuels) is entirely dependent on the NPP of the biosphere over geological timescales, renewable electricity is directly harvested from kinetic energy (wind, wave, tidal and hydro), radiant energy (solar PV), chemical potential (forward osmosis) or temperature differences (solar, geothermal, OTEC) – assuming a decarbonised supply chains from material extraction to production facilities. Therefore, it could be argued that a future renewable energy system can scale and operate independently from the NPP of the biosphere. The only theoretical limiting factor for deployment of these energy technologies is material availability for these technologies together with land-use constraints and trade-offs.

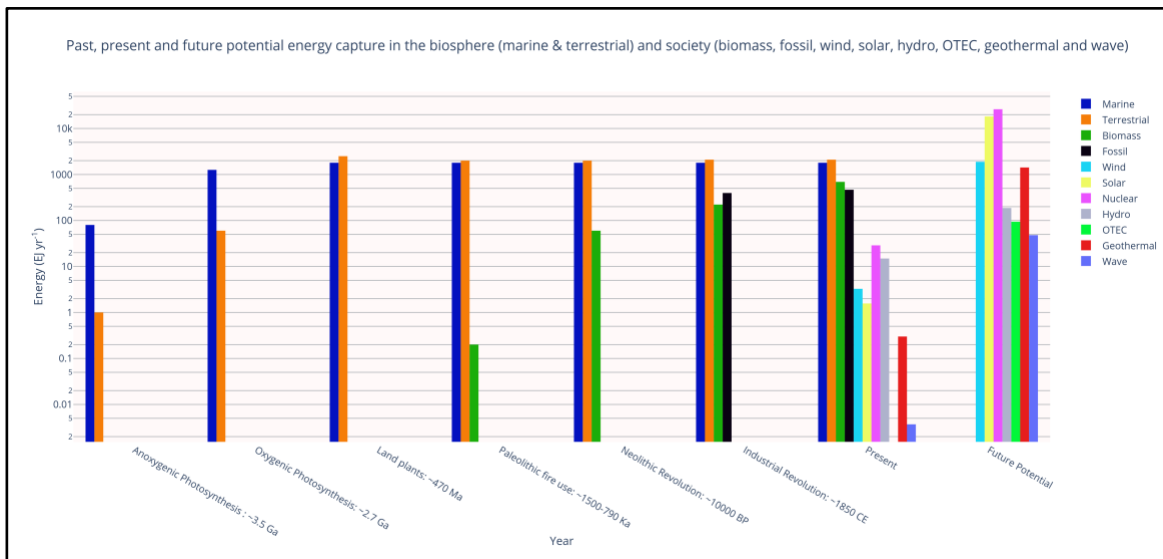
To understand the feasibility of moving towards such a fully decarbonised energy system, the second part provides a (ii) synthesis of the historical and contemporary anthropogenic energetic and material metabolism. The third part (iii) reflects on the feasibility of decarbonising all anthropogenic energy production and use in the coming decades by shifting towards renewable energy sources, considering Earth system boundaries and universal energy access.

## **Historical revolutions in energy use**

During successive energy revolutions, the magnitude and type of energy used in the natural world and our society changed extensively. Understanding the links between biogeochemical material cycles, energy use and anthropogenic influences is important to create insights in the environmental — and therefore socio-economic — characteristics of our contemporary and future energetic metabolism.

Lenton et al. (2016) describe historical natural and human material and energy changes by categorising them in six major revolutions, of which three took place before humans were present and three took place during human presence.

**Figure 1.1:** Energy capture in the biosphere (marine & terrestrial) and society (biomass, fossil, solar, hydro, geothermal and OTEC) in the past, present and future expressed in EJ year<sup>-1</sup>.



**Source:** Based on data from Lenton et al. (2016), complemented with future renewable energy availability estimates. More information on the data can be found in Table 1 and associated footnotes

**Table 1.1:** Historical, present and future potential energy capture in the biosphere and society, expressed in EJ yr<sup>-1</sup>.

| Year                                | Marine             | Terrestrial        | Biomass           | Fossil | Wind | Solar | Nuclear | Hydro | OTEC | Geothermal | Wave |
|-------------------------------------|--------------------|--------------------|-------------------|--------|------|-------|---------|-------|------|------------|------|
| Anoxygenic Photosynthesis [~3.5 Ga] | 80 <sup>27</sup>   | 1 <sup>28</sup>    | 0                 | 0      | 0    | 0     | 0       | 0     | 0    | 0          | 0    |
| Oxygenic Photosynthesis [~2.7 Ga]   | 1200 <sup>29</sup> | 60 <sup>30</sup>   | 0                 | 0      | 0    | 0     | 0       | 0     | 0    | 0          | 0    |
| Land plants [~470 Ma]               | 1800 <sup>31</sup> | 2500 <sup>32</sup> | 0                 | 0      | 0    | 0     | 0       | 0     | 0    | 0          | 0    |
| Paleolithic fire use [~1500-790 Ka] | 1800               | 2000 <sup>33</sup> | 0.2 <sup>34</sup> | 0      | 0    | 0     | 0       | 0     | 0    | 0          | 0    |
| Neolithic Revolution [~10000 BP]    | 1800               | 2000               | 60 <sup>35</sup>  | 0      | 0    | 0     | 0       | 0     | 0    | 0          | 0    |

<sup>27</sup> Estimate for Fe-recycling based on corresponding carbon flux of  $1.7 \times 10^{14}$  mol C yr<sup>-1</sup> (Don E Canfield et al., 2006; Lenton et al., 2016)

<sup>28</sup> Maximum productivity considering that terrestrial anoxygenic photosynthesis would be competing with marine anoxygenic photosynthesis for gaseous electron donors such as H<sub>2</sub> (Lenton et al., 2016)

<sup>29</sup> Derived from the model of Mills, Lenton, & Watson (2014)

<sup>30</sup> Derived from an estimate of net primary productivity of cyanobacterial desert (Brostoff, Sharifi, & Rundel, 2005) multiplied by global land surface (Lenton et al., 2016)

<sup>31</sup> Derived from the model of Mills et al. (2014)

<sup>32</sup> Derived from the model of Mills et al. (2014)

<sup>33</sup> Based on subtracting the current terrestrial net carbon sink of ~2.7 PgC yr<sup>-1</sup> from the 2000 AD estimate (Lenton et al., 2016)

<sup>34</sup> Based on Lenton et al., 2016)

<sup>35</sup> Based on Lenton et al., 2016)



|   |                    |                       |                   |                   |                           |                     |                     |                     |                  |                    |                      |
|---|--------------------|-----------------------|-------------------|-------------------|---------------------------|---------------------|---------------------|---------------------|------------------|--------------------|----------------------|
| <b>Industrial Revolution [~1850 CE]</b> | 1800 <sup>36</sup> | 2100[ <sup>af</sup> ] | 222 <sup>37</sup> | 396               | 0                         | 0                   | 0                   | 0                   | 0                | 0                  | 0                    |
| <b>Present</b>                          | 1800               | 2100                  | 691 <sup>38</sup> | 475 <sup>39</sup> | 3.5 - 4.08 <sup>40</sup>  | 1.57 <sup>41</sup>  | 28.8 <sup>42</sup>  | 14.9 <sup>43</sup>  | 0                | 0.3 <sup>44</sup>  | 0.0037 <sup>45</sup> |
| <b>Future Potential</b>                 |                    |                       |                   |                   | 1512 - 2260 <sup>46</sup> | 18290 <sup>47</sup> | 26192 <sup>48</sup> | 187.2 <sup>49</sup> | 94 <sup>50</sup> | 1419 <sup>51</sup> | 48 <sup>52</sup>     |

**Notes:** All carbon to energy conversions assume an energy content of 37 MJ kg C<sup>-1</sup>. The energy data for the six major revolutions comes from Lenton et al. (2016). Energy information from the present (2015) and future energy potential are sourced from other literature and databases (see footnotes). Biomass is the total human appropriation of Net Primary Production, fossil is the calorific content of extracted oil, natural gas and coal

<sup>36</sup> Based on a satellite-based measurement of global marine NPP (Field, Behrenfeld, Randerson, & Falkowski, 1998), a measure that is similar to global model results (Carr et al. (2006); Lenton et al., 2016)

<sup>37</sup> Based on Lenton et al., 2016)

<sup>38</sup> The total human appropriation of biomass in the year 2000 has been estimated to be 18.7 PgC/year, or 16% of global terrestrial Net Primary Production. Of this amount, 12% (12.1 Pg/yr) served as human food, 58% were used as feed for livestock, 20% as raw material and 10% as fuelwood (F. Krausmann et al., 2008a).

Using a carbon-to-energy conversion rate of 37 MJ per kg C, this equals to 692 EJ. In 2017, global energy generation from biological material is estimated to be 55 EJ (International Energy Agency, 2019a)

<sup>39</sup> Calorific energy content of extracted oil, natural gas and coal in 2017 (International Energy Agency, 2019a).

<sup>40</sup> 2017 wind energy production was around 3.5 EJ (International Energy Agency, 2019a) to 1134451 GWh or 4.08 EJ (???)

<sup>41</sup> Total solar energy generation (437287 GWh or 1.57 EJ) includes photovoltaic (425910 GWh) and concentrated solar (11476 GWh) (IRENA, 2019)

<sup>42</sup> Nuclear energy generation in 2017 from International Energy Agency (2019a).

<sup>43</sup> Hydropower generation in 2017 from International Energy Agency (2019a).

<sup>44</sup> Current 2018 global geothermal energy generation is estimated to be 85978 GWh or 0.3 EJ (Eisentrout & Brown, 2014; International Energy Agency, 2019a).

<sup>45</sup> Wave energy production in 2017 is estimated to be 1041 GWh or 0.0037 EJ (IRENA, 2019).

<sup>46</sup> Two sources have been used as a lower and upper bound of global future wind energy generation potential. One of the most cited sources is the paper from Archer & Jacobson (2005), who calculated the potential of on- and offshore wind energy generation with wind speeds of more than 6.9 m/s at a height of 80 m on a global level (12.5 % of land area) using six 77 m wind turbines per km<sup>2</sup> to be 2260 EJ. The extent of possible on- and offshore wind instalment area in this study has been limited because of available wind speed data. The total future near-shore and floating offshore wind energy potential has recently be estimated by Cozzi, Wanner, Donovan, Toril, & Yu (2019) to be 1512 EJ. Cozzi et al. (2019) considered areas viable for future deployment when there is an average minimum wind speed of 5 m/s - based on RenewabljesNinja wind data from Staffell & Pfenninger (2016) and ECMWF ERA5 reanalysis data (Dee et al., 2011)), near-shore maximum installation depth of 60 m, floating offshore maximum installation depth of 2000 m and maximum distance of shore of 300 km, excluding zones used for fishing, shipping, defence and oil and gas extraction.

<sup>47</sup> The incoming solar energy received by emerging continents, assuming 65% losses by atmosphere and clouds, is 2300 Twy or 23000 \* 8766 = 201618000 Twh = 725824 EJ (Perez & Perez, 2015). Jacobson & Delucchi (2011) calculated that globally, solar PV could provide 340 TW and concentrated solar power (CSP) could provide 240 TW. In total this is 580 TW = 580 \* 8760 TWh = 5080800 TWh yr<sup>-1</sup> = 18290 EJ.

<sup>48</sup> Total future nuclear energy reserves, assuming direct fission of all known exploitable sources, including uranium extractable from phosphate (Perez & Perez, 2015).

<sup>49</sup> Total maximum exploitable worldwide hydropower potential has been estimated by Hoes, Meijer, van der Ent, & van de Giesen (2017) to be 52 PWh/year or 187.2 EJ/year.

<sup>50</sup> Ocean thermal energy conversion (OTEC) is driven by the temperature difference between the solar energy stored as sensible heat in the upper mixed layer of tropical oceans and colder temperature in the deeper ocean. There are questions surrounding the feasibility of implementing this on a larger scale, but the total global potential has been estimated to be 3 TW (94 EJ yr<sup>-1</sup>) (Nihous, 2005).

<sup>51</sup> A highly cited paper from Stefansson (2005) estimates the global potential geothermal energy generation (both for electricity generation and direct use of thermal energy) to be around 45 ± 15 TWth (this is 45 \* 8760 TWh yr<sup>-1</sup> or 1419 EJ). In contrast, Eisentrout & Brown (2014) estimates more conservatively that global yearly energy production will be around 85 GWyear in 2050 (2.68 EJ).

<sup>52</sup> Mørk, Barstow, Kabuth, & Pontes (2010) estimated the global wave energy capacity to be 3.7 TW, equalling 48 EJ when harvesting at 100% capacity factor.

before conversion (International Energy Agency, 2015; OECD, 2015, 2016), wind is on- and offshore average yearly electricity generation, solar is photovoltaic and concentrated solar power generation, nuclear is total future nuclear energy generation potential, hydro is hydropower generation, OTEC is ocean thermal energy conversion, geothermal is both electricity and heat production from geothermal heat and wave is wave energy.

## Natural revolutions

Around 4.1 – 3.7 billion<sup>53</sup> years ago, organisms were able to fix carbon dioxide using sunlight in the form of small particles of graphite carbon by *anoxygenic photosynthesis*. These particles have likely a biogenic origin, as the isotopic signature is consistent with carbon fixation by the enzyme RuBisCO<sup>54</sup>. Hydrogen oxidises easiest, and may have fuelled the first photosynthesis. Dissolved sulphur or ferrous iron (Fe(II)) in ancient oceans further increased the photosynthetic capacity of living organisms (Canfield et al. 2006). Because of the relatively small supply of these compounds, the energy input to the early biosphere is roughly estimated to have been 80 EJ yr<sup>-1</sup> – based on a corresponding carbon flux of 1.7 x10<sup>14</sup> mol C yr<sup>-1</sup> – and only around 1 EJ in the terrestrial environment, although the estimates fluctuate. The large difference in the estimation is caused by uncertainties of the level of volcanic activity, methane production and ocean circulation. This production corresponds to around 0.1 % to 10 % of modern marine net primary production (Canfield et al. 2006)

Around 3.0 to 2.7 billion years ago, *oxygenic photosynthesis* – the type of photosynthesis plants use as an energy source to transform carbon dioxide to oxygen – emerged (Farquhar et al. 2011). Goldblatt et al. (2006) suggest that marine NPP could have been around 25 % of today's NPP, or around 250 EJ yr<sup>-1</sup>. This equates to around one order of magnitude more organic carbon production compared with the anoxygenic photosynthesis period. This novel type of oxygenic photosynthesis – with water as an electron donor and oxygen production as a waste product – required more initial energy, but it had the advantage of not being restricted by the supply of preceding reduced species. Water and carbon dioxide were abundant in the natural environment (Lenton et al. 2016). The only restriction was assumed to be nitrogen and phosphorus availability, as it is still the case today.

Oxygen remained a trace gas until 2.45 to 2.3 billion years ago, until the *Great Oxidation* event took place. During this event the oxygen levels increased with a factor 10<sup>5</sup>, allowing an ozone layer to form. The ozone layer protected the Earth from high energy ultraviolet radiation, inhibiting oxygen reaction with methane on the Earth's surface and causing a relatively abrupt rise in oxygen concentrations (Claire M. W. et al. 2006). Subsequently, marine productivity increased because of a supposed reaction of oxygen with rocks producing sulphuric acid, dissolving phosphorus out of apatite inclusions (Bekker and Holland 2012). It is estimated that the NPP after the great oxidation event (Proterozoic Eon) – mainly oceanic – was around 1300 EJ yr<sup>-1</sup>, or 70 % of today's value (Mills et al. 2014).

Without extra solar energy input, the *Great Oxidation* event caused an increase in energy consumption because of a respiration of organic matter with oxygen. Aerobic oxidation yields almost ten times more energy (2870 kJ mol<sup>-1</sup>) compared to anaerobic decomposition of organic matter (232 kJ mol<sup>-1</sup>, the energy released during alcohol fermentation). This increase in energy availability resulted in the emergence of heterotrophic eukaryotes using

---

<sup>53</sup> One billion years = 10<sup>9</sup> years = 1 Ga or 'giga-annum', not to confuse with the standard SI unit G which equals 10<sup>5</sup>

<sup>54</sup> Rubisco - ribulose 1,5-bisphosphate carboxylase/oxygenase - is an enzyme involved in the first major step of carbon fixation, a process by which atmospheric carbon dioxide is converted by plants and other photosynthetic organisms to energy-rich molecules such as glucose. It catalyzes the covalent attachment of CO<sub>2</sub> to the five-carbon sugar ribulose 1,5-bisphosphate and cleavage of the unstable six-carbon intermediate to form two molecules of 3-phosphoglycerate, one of which bears the carbon introduced as CO<sub>2</sub> in its carboxyl group (Nelson and Cox 2013, p. 802).

mitochondria for aerobic respiration, which led in the long term to a capacity to sustain complex life forms with multiple cell types (Lane and Martin 2010) around 1.2 billion years ago (Butterfield 2000).

The encapsulation of oxygenic photosynthesis in eukaryote organisms and symbioses – such as algae, lichens and *land plants* – allowed for an increased supply and utilisation of limiting resources and surface to perform photosynthesis (Lenton et al. 2016). The global terrestrial NPP could have been around 3 to 11 % of current terrestrial NPP, or even 25 % if assuming higher atmospheric CO<sub>2</sub> concentration and no competition from vascular plants (Porada et al. 2013).

After the rise of plants on land around 320 million years ago, the NPP raised and exceeded current values (Beerling 1999). After development of new mechanisms such as symbiosis of land plants with mycorrhizal fungi and nitrogen fixing bacteria, the chemical weathering of for example rock-bound phosphorus increased. Also, effective recycling developed, which resulted in a fifty-fold amount increase of phosphorus recycling within the terrestrial ecosystem before it reaches freshwaters (Volk 1998).

Today, the global energy flux through heterotrophic biomass is around 400 EJ yr<sup>-1</sup>, roughly distributed equally on land and in the ocean (Lenton et al. 2016). Natural-induced (55 EJ year<sup>-1</sup>) and human-induced (45 EJ year<sup>-1</sup>) fires currently make up around 100 EJ year<sup>-1</sup> biomass burning flux, or around 2.5 % of the yearly amount of energy captured during photosynthesis.

## Human revolutions

As heterotroph humans, our metabolism depends ultimately on the products of photosynthesis. But in contrast to most other animals, humans have the ability to extend greatly the biological metabolism of the human population itself by breeding plants and animals and by using specific constructions and technologies (Fischer-Kowalski and Hüttler 1998). In our modern society, everything combined, humans extend by a factor of 2 the basic biological metabolism of the human population. To better understand the influence of humans on the energy and material balance of the earth, Lenton et al. (2016) distinguish three different revolutions that influenced greatly our ability to expand and evolve into today's industrial society: *the Palaeolithic use of fire*, *the Neolithic revolution* with the emergence of domesticated animals and agriculture, and the ongoing *Industrial Revolution*.

The first extension of the naturally available energy and material cycles of the biosphere took place when humans discovered how to make fire, extending the human energy utilisation beyond its biological metabolism. Use of fire for cooking might have taken place already 1.5 million years ago (Wrangham et al. 1999) providing higher food energy, food diversity, brain growth and cooperation. It extended the average biophysical human energy demand of around 3.5 GJ cap<sup>-1</sup> year<sup>-1</sup> with 7 to 15 GJ cap<sup>-1</sup> year<sup>-1</sup> (Simmons 2008). Assuming a population of 2 to 4 million around 10 000 BC, the overall net energy capacity of humans - the biological metabolism plus extended energy - amounted to around 14 - 60 PJ yr<sup>-1</sup> or 1000 times less the energy use compared to 1850, and 10000 times less than the current energy use (Lenton et al. 2016). Because almost all the extra biomass input was used for energy input (making fire), the energetic and material metabolism of societies were almost identical.

Notwithstanding remaining questions about the reasons why the agricultural revolution started - early agriculture was more time-consuming and resulted in a less stable and diverse diet (Boserup 1965), within a few thousand years from the start of the Holocene (11 700 BC) a new socio-metabolic regime emerged that incorporated domesticated animals and plants. Population pressure might have initiated this emergence early agriculture. After around 7000 BC, a more complex agrarian civilisation evolved, where biomass was used for almost all energy uses: food, fodder, heat, mechanical power and chemical transformation

(Sieferle 1997). Wind and water power were already used (sailing ships and mills), but contributed marginally to the overall energy input (Lenton et al. 2016). The absence of extra energy input apart from naturally available biomass resulted in an upper energy boundary determined by the amount of land available per capita to produce biomass. Fischer-Kowalski, Krausmann, & Pallua (2014) estimated that the global average energy consumption of this agrarian society was around 45 - 75 GJ cap<sup>-1</sup> year<sup>-1</sup>, which is around 5 times more than what preceding foraging societies were using.

Although the impact of these agrarian societies is widely debated, there are arguments to consider the effects of humans on the Earth system already in this time. Irrigation might for example have led to salination and changing crop yields and types (Jacobsen and Adams 1958). The clearing of forests to create agricultural land and supply biomass from 8000 - 7000 BC reduced the carbon storage capacity of the land, resulting in a net cumulative emission of 300 PgC by 5000 BC and contributing around 20 ppm to atmospheric CO<sub>2</sub>-levels (Kaplan et al. 2011). Also, from around 5000 BC, anthropogenic sources of methane emerged because of irrigation of rice paddies. This contributed in turn to changes in atmospheric CH<sub>4</sub> concentration (Mitchell et al. 2013). These can be considered to be the first - indirect - anthropogenic effects on the global climate system, although not to the extent as the effect of direct emissions resulting from fossil fuel burning since the Industrial Revolution.

While population numbers were rising, the energy use increased gradually. From around 450 million people in the year 1500 and an energy consumption of around 20 EJ yr<sup>-1</sup> (Fischer-Kowalski et al. 2014) - a factor 300 above foraging societies energy use and 30 times less than today's energy use - population increased to 1.3 billion people at the start of the industrial revolution in 1850 and energy use increased up to around 60 EJ yr<sup>-1</sup> (Lenton et al. 2016). Because of increasing population and energy use, material inputs, waste and environmental impacts increased as well. Because of the energetic surplus, cities with more complex social organisation emerged around 5000 years after the beginning of agriculture (Sieferle 2010). Those societies were stockpiling resources and created social institutions to organise collective life, sometimes succeeding but also frequently collapsing in the long term (Tainter 1988). In these collective agrarian societies - on average - around 90 % of the population was required to work in agriculture and around 10 % could work on non-food producing activities (GEA 2012) still allowing concentration of non-food activities in urban centres.

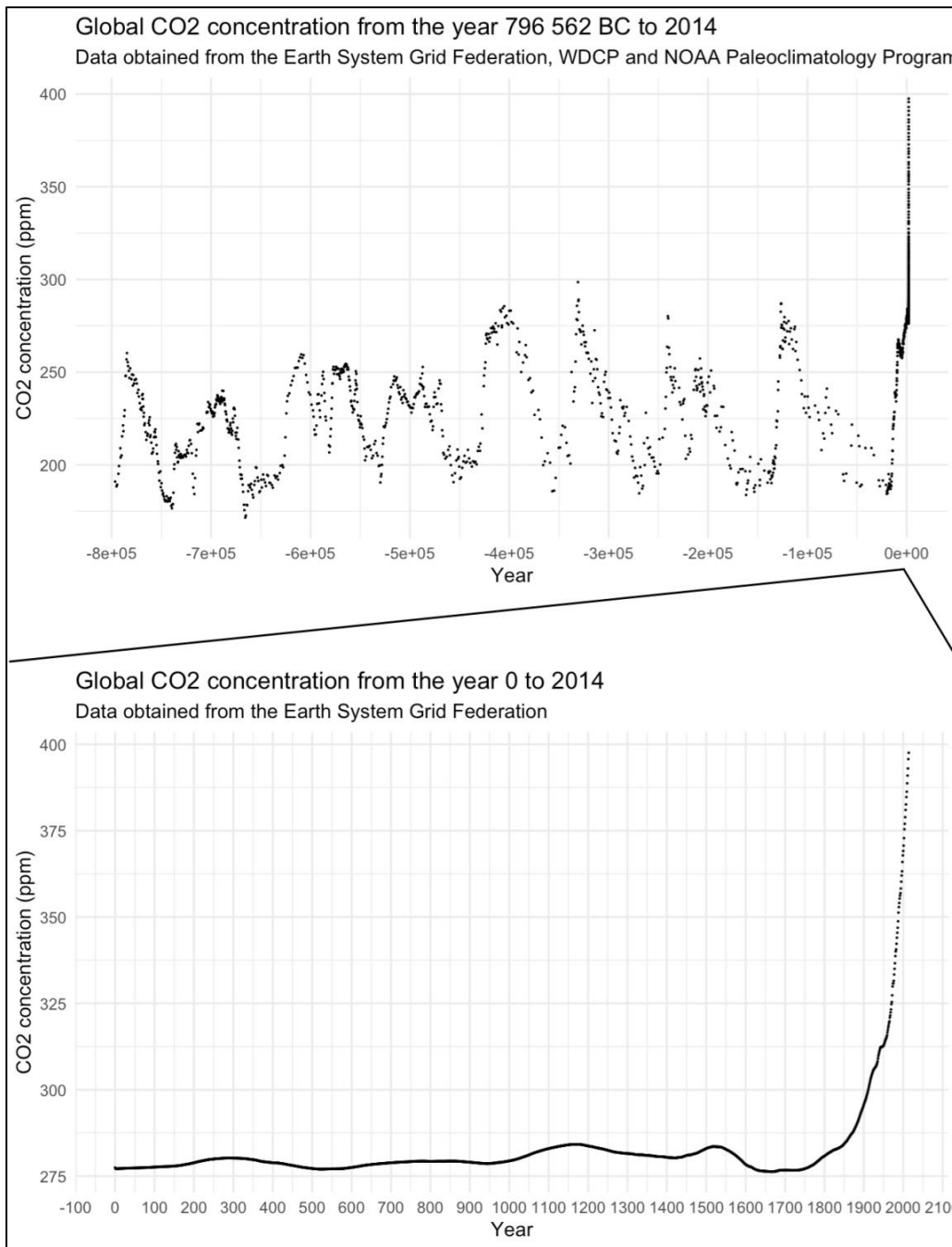
After a period of relatively low-scale use of fossil fuels (coal and peat) for hundreds of years in China, Burma, the Netherlands and England (Ayres 1956), the key transition in the industrial revolution happened in the 18th century in England when fossil fuel use was massively scaled up (Sieferle 1997; Wrigley 2010) and resulted in an ongoing industrial evolution with a worldwide expansion and increase of energy use.

A key notion related to the Industrial Revolution is that since then, energy use has been decoupled from the energy generated by bio-productive land and human labour (Krausmann et al. 2008). This revolution made that between 1850 and 2000, global human energy use increased tenfold from 56 to 600 EJ yr<sup>-1</sup> (Fischer-Kowalski et al. 2014) and world population increased from 1.3 to 6 billion (Fink-Jensen 2015), resulting in an annual global energy flux with a magnitude of one third of the global terrestrial NPP in the year 2000 (Haberl et al. 2007) and one third above the total global energy flux through all non-human heterotrophic biomass. Because of the significant increase in energy availability, material inputs to society extended during this period from mainly biomass to minerals. Global average per capita material use increased from 3.4 to 10 t cap<sup>-1</sup> yr<sup>-1</sup> from 1870 to 2000, with a rather constant biomass use of 3 t cap<sup>-1</sup> yr<sup>-1</sup>.

This increase in fossil energy utilization since the Industrial Revolution - currently increasing at a rate of around 42 ± 3 GtCO<sub>2</sub> per year (IPCC 2018), caused global CO<sub>2</sub> concentrations to increase with around 20 ppm per decade since the year 2000, which is up to

10 times faster than any sustained rise in CO<sub>2</sub> during the past 800,000 years (Lüthi et al. 2008a). In Figure 1.2 (b), it can be seen that the increase in carbon dioxide concentration started accelerating considerably in the second half of the 21th century.

**Figure 1.2:** Global CO<sub>2</sub> concentrations from (a) 796 562 years BC to 2014 and from (b) the year 0 to 2014.



**Source:** Data (Lüthi et al. 2008a) on CO<sub>2</sub> concentrations from 796 562 years BC to the year 0 BC have been downloaded from the World Data Center for Paleoclimatology & NOAA Paleoclimatology Program (2008), which is a compiled extension of previous work of Monnin et al. (2001) (0-22 kyear BP), Petit et al. (1999) (22-393 kyears BP), Siegenthaler et al. (2005) (393-664 kyears BP) and (Lüthi et al. 2008b, a) (664-800 kyear BP). Data from the year 0 to 2014 is taken from NASA/GISS (2019). Note that the historical data that originally is expressed in BP (Before Present) is converted to BC (Before Christ) using a base-year of 1950 to allow for compatibility of datasets, and geological timescale-data from ice-cores after the year 0 have been omitted (21 datapoints from the year 19 to 1813)

## Current material and energy use

An important note in assessing material use is on a systemic worldwide level is that, in a world with substantial use of fossil fuels and nuclear energy, the definition of materials used in the economy includes material used for energy production (fossil fuel extraction, nuclear material, ...) and coincides somehow. Therefore, for the purpose of giving a global overview, material and energy flows are discussed together. Focus will be primarily on energy materials or fuels. When moving towards a renewable energy system, fuel and derived fuel “materials” from refineries will gradually be replaced by construction materials and alternative production pathways for products that depend currently on fossil fuels. Therefore, to understand the feasibility of a future renewable energy system, in a second stage, specific focus is on material requirements for renewable energy production.

On a worldwide level, in 2005 around 62 Gt materials were processed in the economy of which 44% were used for energy production, of which 17 Gt per year are net addition to stocks, 41 Gt are waste outputs and only 4 Gt were recycled. Almost 30% of extracted materials are accumulated as in-use-stocks (Haas et al. 2015). Circular Economy is sometimes brought forward as a solution for the mitigation of greenhouse gas emissions, maintaining future resource security (Hislop and Hill 2011) and, in the longer term, protection from resource conflicts (Diemer et al. 2018). However, when looking at the level of circularity in the world and the EU (Haas et al. 2015), it appears that the current level of circularity is very low (respectively 3 % and 7 %) and that there are currently considerable limits to increasing circularity on a systemic level. This, because fossil fuels are for 98 % used for energy purposes and 80 % of the available and produced biomass is used for food, feed and fuel and are therefore not recyclable. Of the remaining 20 % of biomass, 12 % is wood used for construction (Haas et al. 2015). This premise is crucial in understanding the merits of proposed circular economy and material intensity reduction policies. It is important to focus on overall contribution in closing the loop (Diemer and Dierickx 2020), not only specific measures. Currently, recycling and reuse are the main policy focus, although these don't assure an effective reduction in material use, as it depends on the energy use for recycling, quality of materials, etc. (Moriguchi 2007). Recycling policies are inevitably sector-specific, and intertwined with global supply chains and production systems.

When accounting for energy production and use, the boundaries of the analysis are imperative to have a systemic understanding of the energy supply and use and to be able to compare fully the advantages and disadvantages (losses in the supply chain, efficiency of conversion processes) of different types of energy systems, for example fossil-based energy provision and use and renewable energy in a highly electrified consumption system. The larger the system boundaries, the more complete this picture becomes. One could say that the most fundamental and wide system boundary for a traditional human society is the human appropriation of net primary production, including both living biological material (plants and animals) and historically embedded in fossil energy carriers. With the emergence of the importance of renewable energy in energy systems, this system boundary is no longer sufficient to compare energy systems in an integral manner. To be able to compare fully the trade-offs between fossil/biological energy systems and renewable energy systems, one should start from the kinetic (wind, wave, hydro), solar (solar PV and solar thermal) or heat (geothermal) energy provided by renewable energy sources. Only when comparing energy systems taking into account the generation from the source (fossil, biomass, kinetic, solar or heat) and associated efficiency losses up to the final product in industry and households (industrial processes, household appliances, transport, heating), a comparison can be made on the overall system efficiency.

Human energy use is traditionally assessed by international agencies by accounting for the Total Primary Energy Supply (TPES) in energy balances. The OECD and IEA define

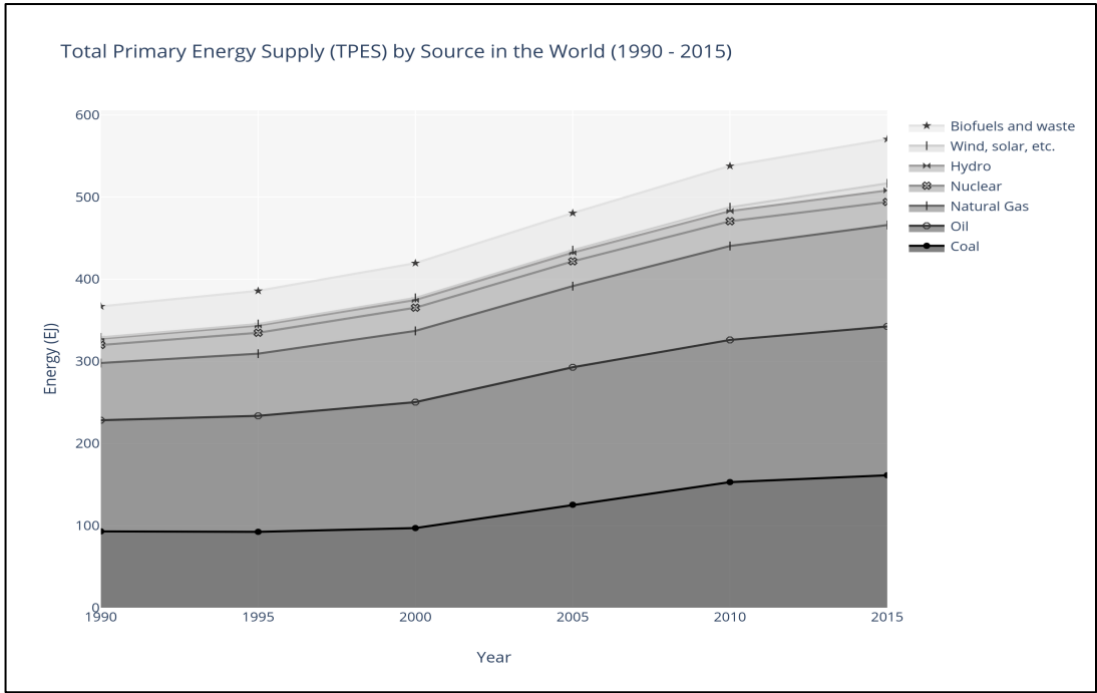
the TPES as the *calorific content of energy commodities such as coal, peat, shale oil, crude oil and by-products, nuclear, renewables and energy trade expressed on national or global scale* (International Energy Agency, 2015; OECD, 2015, 2016).

This definition however excludes plant biomass used for food and feed which makes the indicator unusable for a historical integrated reconstruction of human energy use. In the studies of Haberl (2001) and Lenton et al. (2016), the total societal energy requirement is more accurately defined as the TPES together with the primary energy used in technical conversion processes and the energy content of plants for human nutrition and feeding domesticated animals, as these energy sources are also essential to the functioning of society but are omitted in traditional classification systems. Because the emergence and existence of human society is granted by a continued stability of the Earth system, it is important to consider the total energy use and changes in total energy balance, chemical composition of the atmosphere, oceans or soils caused by humans. However, for designing policies that only relate to industrial energy production and use and associated emissions and for the purpose of getting insights in global energy consumption and conversation, the traditional TPES is a sufficiently clear starting indicator. TPES gives information on the supply of different “source” types of energy, converted to a common format. It is important to consider the system boundaries here.

The IEA uses tonnes of oil equivalent (toe) in its methodology, which are here converted to joules (EJ) using the 1 toe = 41.868 GJ equivalency. To compile the TPES from different energy products, the IEA accounts for the supply flows production + imports - exports - international marine bunkers - international aviation bunkers ± stock changes (OCDE, 2015). For worldwide TPES aggregates, the TPES is defined as production + imports - exports ± stock changes (International Energy Agency, 2019a). In figures 1.3 and 1.4 an overview is given of respectively the worldwide TPES and TFC statistics for the world from 1990 to 2015 (International Energy Agency, 2019a, 2019b). The data is compiled following the International Recommendations for Energy Statistics (IRES) from United Nations (2018).

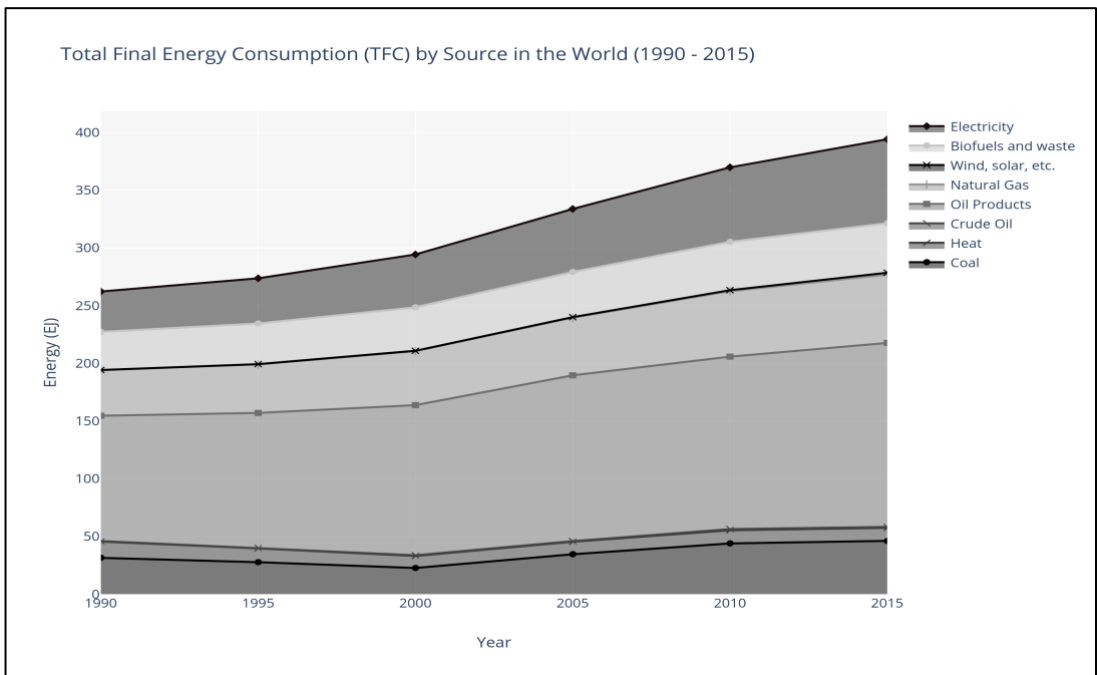


**Figure 1.3:** Total Primary Energy Supply (TPES) in the world by source from 1990 to 2015.



**Source:** International Energy Agency (2019b)

**Figure 1.4:** Total Final Energy Consumption (TFC) in the world by source from 1990 to 2015.

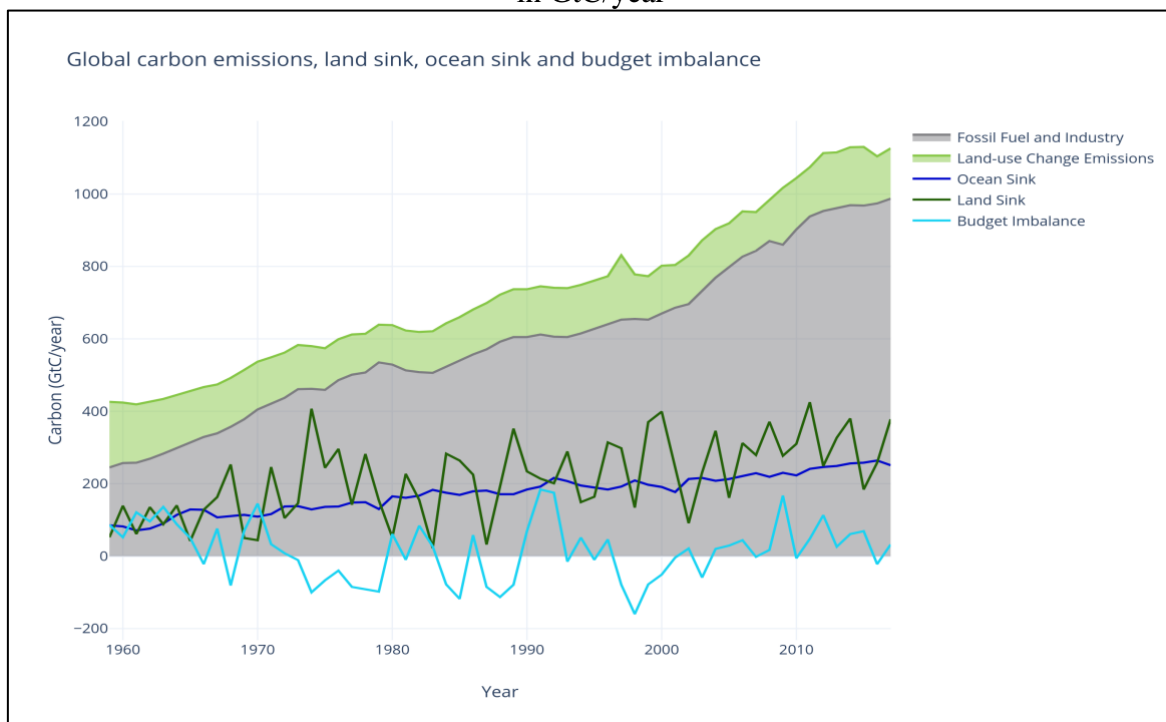


**Source:** International Energy Agency (2019b)

Worldwide, in 2015, 571 EJ were extracted, of which 466 EJ of fossil energy sources (coal, oil and natural gas). Accounting for losses, those are transferred to 394 EJ useful fossil energy

use per year of which 265 EJ is direct energetic use of fossil energy carriers (coal, crude oil and natural gas derived products) (IEA, 2016). Around 34 EJ (7.3%) were used for non-energy purposes. In the UK and US, this rate has fluctuated around the same rate between 5% and 7% (Brockway, Barrett, Foxon, & Steinberger, 2014). For a first-order general insight in the worldwide emissions from human industrial activity and land-use changes and associated uncertainties, Quéré et al. (2018) provide a collated database of anthropogenic carbon emissions and natural ocean and land carbon sinks (figure 1.5). The importance of fossil fuel use and industrial activity are apparent. Land-use change is a minor but important contributor to carbon emissions. Carbon capture on land and in the ocean, are two mechanisms that reduce carbon in the atmosphere. The ocean sink component has been estimated fairly reliable, but the land sink component has large uncertainties.

**Figure 1.5 :** Global carbon emissions, land sink, ocean sink and budget imbalance expressed in GtC/year



**Source:** Le Quere et al. (2018)

## Energy use, energy technology and the concept of EROI

When thinking about determining the best future renewable energy technology, two aspects are important to analyse: the energy and materials needed to produce the infrastructure and technology. A traditional way to analyse these two aspects is calculating the Energy Return on Energy Investment (EROEI) value for system-wide energy efficiency, and an assessment of material criticality and Hubbert curves to estimate material supply chain risks and material depletion.

### Value of EROI concept to understand historical Change in energy use

A frequently used method to measuring the overall use of different energy uses that helps pointing out the evolution of energy resource depletion over time, is the concept of Energy Return on Energy Invested (EROEI). It is a technological concept that points at the ratio of the amount of final appliance- or sector-specific *usable* or *useful* energy (termed frequently as *exergy*) delivered from a particular energy resource compared to the amount of *exergy* used to obtain that energy source.

*Exergy* is in its most fundamental thermodynamical form defined as the maximum useful work possible during a process that brings the system into equilibrium with a heat reservoir, reaching maximum *entropy*. It is measured in a closed environment. In Industrial Ecology, a broader definition is the thermodynamic end-use efficiency for different types of sectoral or appliance-specific end-use.

Important to note is the distinction between Energy Return on Investment (EROI) — pointing at the monetary investment required to obtain a certain amount of energy — and Energy Return on Energy Invested (EROEI), the physical energy required to obtain a certain amount of energy. Traditionally, in a fossil-based energy system, one could consider the fossil energy required to obtain a certain amount of energy (either heat or electricity). Because financial investment does not represent sufficiently accurate the energetic reality and is of less relevance in determining optimal decarbonisation trajectories, in below paragraph EROI refers to energy return on (fossil) energy invested. The importance of EROEI values also depends on the research question underpinning the study. For example, when decarbonisation is the main consideration, increasing or decreasing EROEI values are less of a concern compared to defining EROEI values of fossil energy systems (which would imply increasing emissions because of increased energy input required to extract a certain amount of fossil fuels). It is not the goal to advance the methodological base for EROI-studies in this chapter, but EROI analysis can provide a generic indicator of energy system efficiency and can be useful in contextualising past and future energy transitions and indicate energy-optimal pathways for future transition.

It has to be noted that defining an EROI value is not straightforward and depends heavily on the system boundaries and methodological choices that are defined for an energy provision system under study, both in space and time. It is important to take care of these boundaries, as the notion of “useful” energy is not straightforward to define, is technology-specific and requires careful consideration of the life cycle and induced energy use to extract certain resources. A widely used categorisation of EROI-methodologies has been developed by Murphy, Hall, Dale, & Cleveland (2011) and further refined by Hall, Lambert, & Balogh (2014). Hall et al. (2014) distinguishes 4 types of EROI, with increasing boundaries of the considered system:

1. Standard EROI (EROI<sub>ST</sub>) is the “division of energy output for a project, region or country by the sum of the direct (i.e. on site) and indirect (i.e. offsite energy needed to make the products used on site) energy used to generate the output”

2. Point of Use EROI ( $EROI_{POU}$ ) is the  $EROI_{ST}$  with additional cost associated with refining and transporting a fuel.
3. Extended EROI ( $EROI_{EXT}$ ) is an EROI for use in a specific purpose (driving, heating, ...).
4. Societal EROI ( $EROI_{SOC}$ ) is the overall EROI “that might be derived for all of a nation’s or society’s fuels by summing all gains and costs” to extract a certain amount of energy.

When the EROI value drops below 1, the original energy source becomes thus a net energy sink (within the defined boundaries), as societies need to invest more energy to extract the resource than the energy that could be obtained by using the resource. It helps framing the historical evolution of resource depletion over time, by providing a reasonable generic indicator to describe the evolution of the “difficulty” to extract a specific type of energy resource. When increasing system boundaries, the energy cost of the final usage point increases ( $EROI_{ST} > EROI_{POU} > EROI_{EXT}$ ).

### **Historical Societal and Technology Specific EROI Values**

Lee (1968) and Harris (1997) calculated the overall pre-industrial EROI values of different types of societies, which range from a value of around 5:1 as a minimum requirement for human survival, increasing to 53.5:1 for societies that use irrigation agriculture. In those EROI-analyses, the complexity of EROI calculations is not yet that complicated as they reduce to capture of net primary production for sustaining the biological needs of the human population. To contextualise the industrial revolution, the EROI values provided by Hall et al. (2008) suggest that a fossil-based society is — even without taking into account climate change concerns — achieving an energetic limit, and will naturally evolve towards a system where energy will be sourced from renewable sources. Capellán-Pérez, de Castro, & Miguel González (2019) extended further the EROI analyses — applied to fossil extraction — with a dynamic assessment over time that includes the energetic and economic costs of constructing a renewable energy system. An overview of pre-historical and recent EROI values is given in table 2.

**Table 1.2:** EROEI values of different types of pre-industrial societies and historical EROEI values for crude oil.

| Type   | EROI   |
|--|--------|
| Non-Fossil: Minimum EROI (complete societal devotion to energy production) | 5:1    |
| Non-Fossil: Hunter-gatherers   | 9.6:1  |
| Non-Fossil: Rain-dependent agricultural systems                            | 11.2:1 |
| Non-Fossil: Felling-and-burning agriculture                                | 18:1   |
| Non-Fossil: Irrigation agriculture   | 53.5:1 |
| Fossil: Crude Oil (1900)   | 100:1  |
| Fossil: Crude Oil (1950)   | 50:1   |
| Fossil: Crude Oil (2000)   | 20:1   |

**Source:** Hall et al. (2008), Harris (1997), Lee (1968)

Looking at future prospects of theoretically possible renewable energy provision from the different renewable energy technologies (without accounting for land or material competition) gives a first rudimentary insight in the possibility to change the global energy system to a renewable one.

According to recent analysis for each of the technologies, it should be possible on a worldwide scale to independently harvest each year:

- 1512 (Cozzi et al., 2019) to 2260 (Archer & Jacobson, 2005) EJ wind energy
- 18290 EJ of solar (Jacobson & Delucchi, 2011, Perez & Perez, 2015), (PV and concentrated solar)
- 187.2 EJ hydro (Hoes et al., 2017)
- 94 EJ Ocean Thermal Energy Conversion (OTEC) (Nihous, 2005)
- 1419 EJ geothermal (heat and electricity) (Stefansson, 2005)
- 48 EJ of wave energy (Mørk et al., 2010)

These assessments should provide a first-order estimate of the magnitude of each of the energy sources that can be harvested, irrespective of the systemic interlinkages and material dependency of each of the technologies. Both in terms of material availability and EROI values, wind energy appears to be the best suitable renewable energy technology for near-term evolution towards a renewable energy system.

## Conclusion

The foundation of all life on Earth is the ability of different forms of life to capture solar energy and to use it for moving and transforming matter in order to sustain an internal order. In the pre-industrial period, our anthropogenic biological energy consumption and use was dependent on the energy that is captured by the sun through photosynthesis and

chemosynthesis of plants. Therefore, in order to put anthropogenic energy use in perspective compared to natural energy cycles, it is illustrative to compare historical, contemporary and future energy use with the Net Primary Production of the biosphere. This baseline unit to compare energy use and evolution retains its relevance for anthropogenic “traditional” biomass-based and fossil-based energy systems, but it could be argued that the relevance of this baseline disappears to a certain extent when reflecting on fully renewable and electrified energy systems. While “traditional” energy provision from biomass (either directly harvested or in the form of fossil fuels) is over a geological timescale entirely dependent on the Net Primary Production of the biosphere, renewable electricity harvested directly from kinetic energy (wind, wave, tidal and hydro), radiant energy (solar PV) or temperature differences (solar, geothermal, OTEC) — assuming a decarbonised supply chains from material extraction to production facilities — can be argued to scale and operate independently from the Net Primary Production of the biosphere. The only theoretical limiting factor for deployment of these energy technologies is material availability and land-use constraints and trade-offs.

Although humans have altered natural energy and material cycles in the biosphere since their existence, it is only since we started burning historically embodied primary production from fossil energy sources during the Industrial Revolution that human society decoupled its energy use from bio-productive land. To ensure a long-term stability of the Earth system, we are required to stabilise disruptions in natural energy and material cycles. Today, this is exemplified by the need of decarbonising human activities in all sectors of the economy and closing of material cycles to avoid irreversible damages to the climate and possibly the extinction of a large part of the existing vertebrate species. The available estimates of worldwide renewable energy generation potentials (Figure 1.1, Table 1.1) point out that such a future is possible to attain, although the question remains at what pace the transformation will unfold.

## References

- Archer, C. L., & Jacobson, M. Z. (2005). Evaluation of global wind power. *Journal of Geophysical Research: Atmospheres*, 110(D12).  
<https://doi.org/10.1029/2004JD005462>
- Beerling, D. J. (1999). Quantitative estimates of changes in marine and terrestrial primary productivity over the past 300 million years. *Proceedings of the Royal Society of London B: Biological Sciences*, 266(1431), 1821–1827.  
<https://doi.org/10.1098/rspb.1999.0852>
- Bekker, A., & Holland, H. D. (2012). Oxygen overshoot and recovery during the early Paleoproterozoic. *Earth and Planetary Science Letters*, 317-318, 295–304.  
<https://doi.org/10.1016/j.epsl.2011.12.012>
- Boserup, E. (1965). *The Conditions of Agricultural Growth. The Economics of Agrarian Change under Population Pressure*. London: Allen & Unwin.
- Brockway, P. E., Barrett, J. R., Foxon, T. J., & Steinberger, J. K. (2014). Divergence of Trends in US and UK Aggregate Exergy Efficiencies 1960-2010. *Environmental Science & Technology*, 48(16), 9874–9881. <https://doi.org/10.1021/es501217t>
- Brostoff, W., Sharifi, R., & Rundel, P. (2005). Photosynthesis of cryptobiotic soil crusts in a seasonally inundated system of pans and dunes in the western Mojave Desert, CA: Field studies. *Flora - Morphology, Distribution, Functional Ecology of Plants*, 200(6), 592–600. <https://doi.org/10.1016/j.flora.2005.06.008>
- Butterfield, N. J. (2000). *Bangiomorpha pubescens* n. Gen., n. Sp.: implications for the evolution of sex, multicellularity, and the Mesoproterozoic/Neoproterozoic radiation of eukaryotes. *Paleobiology*, 26(3), 386–404.  
[https://doi.org/10.1666/0094-8373\(2000\)026<0386:BPNGNS>2.0.CO;2](https://doi.org/10.1666/0094-8373(2000)026<0386:BPNGNS>2.0.CO;2)
- Canfield, D. E., Rosing, M. T., & Bjerrum, C. (2006). Early anaerobic metabolisms. *Philosophical Transactions of the Royal Society of London B: Biological Sciences*, 361(1474), 1819–1836. <https://doi.org/10.1098/rstb.2006.1906>
- Capellán-Pérez, I., de Castro, C., & Miguel González, L. J. (2019). Dynamic Energy Return on Energy Investment (EROI) and material requirements in scenarios of global transition to renewable energies. *Energy Strategy Reviews*, 26, 100399.  
<https://doi.org/10.1016/j.esr.2019.100399>
- Carr, M.-E., Friedrichs, M. A. M., Schmeltz, M., Noguchi Aita, M., Antoine, D., Arrigo, K. R., Asanuma, I., Aumont, O., Barber, R., Behrenfeld, M., Bidigare, R., Buitenhuis, E. T., Campbell, J., Ciotti, A., Dierssen, H., Dowell, M., Dunne, J., Esaias, W., Gentili, B., ... Yamanaka, Y. (2006). A comparison of global estimates of marine primary production from ocean color. *Deep Sea Research Part II: Topical Studies in Oceanography*, 53(5), 741–770. <https://doi.org/10.1016/j.dsr2.2006.01.028>
- Cozzi, L., Wanner, B., Donovan, C., Toril, A., & Yu, W. (2019). *Offshore Wind Outlook 2019: World Energy Outlook Special Report* (p. 98). International Energy Agency.
- Dee, D. P., Uppala, S. M., Simmons, A. J., Berrisford, P., Poli, P., Kobayashi, S., Andrae, U., Balmaseda, M. A., Balsamo, G., Bauer, P., Bechtold, P., Beljaars, A. C. M., Berg, L. van de, Bidlot, J., Bormann, N., Delsol, C., Dragani, R., Fuentes, M., Geer, A. J., ... Vitart, F. (2011). The ERA-Interim reanalysis: Configuration and

- performance of the data assimilation system. *Quarterly Journal of the Royal Meteorological Society*, 137(656), 553–597. <https://doi.org/10.1002/qj.828>
- Diemer A., Dierickx F. (2020), Circular Economy, A New Paradigm for Europe? in Diemer A., Nedelciu E., Schellens M., Morales E.M, Oostdijk M. (eds), *Paradigms, Models, Scenarios and Practices for Strong Sustainability*. Oeconomia Editions.
- Eisentraut, A., & Brown, A. (2014). *Heating without Global Warming: Market Developments and Policy Considerations for Renewable Heat* (p. 92) [Featured Insight]. International Energy Agency.
- Farquhar, J., Zerkle, A. L., & Bekker, A. (2011). Geological constraints on the origin of oxygenic photosynthesis. *Photosynthesis Research*, 107(1), 11–36. <https://doi.org/10.1007/s11120-010-9594-0>
- Field, C. B., Behrenfeld, M. J., Randerson, J. T., & Falkowski, P. (1998). Primary Production of the Biosphere: Integrating Terrestrial and Oceanic Components. *Science*, 281(5374), 237–240. <https://doi.org/10.1126/science.281.5374.237>
- Fink-Jensen, J. (2015, April). Total Population (1500-2000). Retrieved from <https://www.clio-infra.eu/Indicators/TotalPopulation.html>
- Fischer-Kowalski, M., & Hüttler, W. (1998). Society's Metabolism.: The Intellectual History of Materials Flow Analysis, Part II, 1970-1 998. *Journal of Industrial Ecology*, 2(4), 107–136. <https://doi.org/10.1162/jiec.1998.2.4.107>
- Fischer-Kowalski, M., Krausmann, F., & Pallua, I. (2014). A sociometabolic reading of the Anthropocene: Modes of subsistence, population size and human impact on Earth. *The Anthropocene Review*, 1(1), 8–33. <https://doi.org/10.1177/2053019613518033>
- GEA. (2012). *Global Energy Assessment - Toward a Sustainable Future*. Cambridge University Press, Cambridge, UK and New York, NY, USA and the International Institute for Applied Systems Analysis, Laxenburg, Austria. Retrieved from [www.globalenergyassessment.org](http://www.globalenergyassessment.org)
- Goldblatt, C., Lenton, T. M., & Watson, A. J. (2006). Bistability of atmospheric oxygen and the Great Oxidation. *Nature*, 443(7112), 683–686. <https://doi.org/10.1038/nature05169>
- Haas, W., Krausmann, F., Wiedenhofer, D., & Heinz, M. (2015). How Circular is the Global Economy?: An Assessment of Material Flows, Waste Production, and Recycling in the European Union and the World in 2005. *Journal of Industrial Ecology*, 19(5), 765–777. <https://doi.org/10.1111/jiec.12244>
- Haberl, H. (2001). The Energetic Metabolism of Societies: Part II: Empirical Examples. *Journal of Industrial Ecology*, 5(2), 71–88. <https://doi.org/10.1162/10881980152830141>
- Hall, C. A. S., Lambert, J. G., & Balogh, S. B. (2014). EROI of different fuels and the implications for society. *Energy Policy*, 64, 141–152. <https://doi.org/10.1016/j.enpol.2013.05.049>
- Hall, C. A. S., Powers, R., & Schoenberg, W. (2008). Peak Oil, EROI, Investments and the Economy in an Uncertain Future. In D. Pimentel (Ed.), *Biofuels, Solar and Wind as Renewable Energy Systems* (pp. 109–132). Springer Netherlands. [https://doi.org/10.1007/978-1-4020-8654-0\\_5](https://doi.org/10.1007/978-1-4020-8654-0_5)



- Harris, M. (1997). *Culture, people, nature: An introduction to general anthropology*. Retrieved from <http://www.citeulike.org/group/1104/article/849666>
- Hoes, O. A. C., Meijer, L. J. J., van der Ent, R. J., & van de Giesen, N. C. (2017). Systematic high-resolution assessment of global hydropower potential. *PLOS ONE*, 12(2), e0171844. <https://doi.org/10.1371/journal.pone.0171844>
- IEA. (2016, September). World energy balances. OECD Publishing. <https://doi.org/10.1787/data-00512-en>
- International Energy Agency. (2015). *Key World Energy Statistics 2015*. Paris: OECD/IEA.
- International Energy Agency. (2019a). *World Energy Balances 2019 Edition* (Database Documentation). Retrieved from [http://wds.iea.org/wds/pdf/WORLDBAL\\_Documentation.pdf](http://wds.iea.org/wds/pdf/WORLDBAL_Documentation.pdf)
- International Energy Agency. (2019b). *World Energy Balances: Overview*. Retrieved from [https://webstore.iea.org/download/direct/2710?fileName=World\\_Energy\\_Balances\\_2019\\_Overview.pdf](https://webstore.iea.org/download/direct/2710?fileName=World_Energy_Balances_2019_Overview.pdf)
- IRENA. (2019). *Renewable Energy Statistics 2019* (p. 398). The International Renewable Energy Agency.
- Jacobson, M. Z., & Delucchi, M. A. (2011). Providing all global energy with wind, water, and solar power, Part I: Technologies, energy resources, quantities and areas of infrastructure, and materials. *Energy Policy*, 39(3), 1154–1169. <https://doi.org/10.1016/j.enpol.2010.11.040>
- Kaplan, J. O., Krumhardt, K. M., Ellis, E. C., Ruddiman, W. F., Lemmen, C., & Goldewijk, K. K. (2011). Holocene carbon emissions as a result of anthropogenic land cover change. *The Holocene*, 21(5), 775–791. <https://doi.org/10.1177/0959683610386983>
- Krausmann, F., Erb, K.-H., Gingrich, S., Lauk, C., & Haberl, H. (2008a). Global patterns of socioeconomic biomass flows in the year 2000: A comprehensive assessment of supply, consumption and constraints. *Ecological Economics*, 65(3), 471–487. <https://doi.org/10.1016/j.ecolecon.2007.07.012>
- Krausmann, F., Schandl, H., & Siefert, R. P. (2008b). Socio-ecological regime transitions in Austria and the United Kingdom. *Ecological Economics*, 65(1), 187–201. <https://doi.org/10.1016/j.ecolecon.2007.06.009>
- Lane, N., & Martin, W. (2010). The energetics of genome complexity. *Nature*, 467(7318), 929–934. <https://doi.org/10.1038/nature09486>
- Lee, R. B. (1968). What hunters do for a living, or, how to make out on scarce resources. Retrieved from <https://opus4.kobv.de/opus4-Fromm/frontdoor/index/index/docId/14495>
- Lenton, T. M., Pichler, P.-P., & Weisz, H. (2016). Revolutions in energy input and material cycling in Earth history and human history. *Earth Syst. Dynam.*, 7(2), 353–370. <https://doi.org/10.5194/esd-7-353-2016>
- Mills, B., Lenton, T. M., & Watson, A. J. (2014). Proterozoic oxygen rise linked to shifting balance between seafloor and terrestrial weathering. *Proceedings of the National Academy of Sciences*, 111(25), 9073–9078. <https://doi.org/10.1073/pnas.1321679111>

- Mitchell, L., Brook, E., Lee, J. E., Buizert, C., & Sowers, T. (2013). Constraints on the Late Holocene Anthropogenic Contribution to the Atmospheric Methane Budget. *Science*, 342(6161), 964–966. <https://doi.org/10.1126/science.1238920>
- Moriguchi, Y. (2007). Material flow indicators to measure progress toward a sound material-cycle society. *Journal of Material Cycles and Waste Management*, 9(2), 112–120. <https://doi.org/10.1007/s10163-007-0182-0>
- Murphy, D. J., Hall, C. A. S., Dale, M., & Cleveland, C. (2011). Order from Chaos: A Preliminary Protocol for Determining the EROI of Fuels. *Sustainability*, 3(10), 1888–1907. <https://doi.org/10.3390/su3101888>
- Mørk, G., Barstow, S., Kabuth, A., & Pontes, M. (2010). Assessing the Global Wave Energy Potential. In *ASME 2010 29th International Conference on ocean, offshore and Arctic Engineering* (Vol. 3). <https://doi.org/10.1115/OMAE2010-20473>
- Nelson, D. L., & Cox, M. M. (2013). *Lehninger principles of biochemistry* (6th ed). W.H. Freeman.
- Nihous, G. C. (2005). An Order-of-Magnitude Estimate of Ocean Thermal Energy Conversion Resources. *Journal of Energy Resources Technology*, 127(4), 328–333. <https://doi.org/10.1115/1.1949624>
- OECD. (2015). *Environment at a Glance 2015*. OECD Publishing. Retrieved from [http://www.oecd-ilibrary.org/environment/environment-at-a-glance-2015\\_9789264235199-en](http://www.oecd-ilibrary.org/environment/environment-at-a-glance-2015_9789264235199-en)
- OECD. (2016). *Primary energy supply*. OECD Publishing. Retrieved from <https://data.oecd.org/energy/primary-energy-supply.htm>
- Perez, M., & Perez, R. (2015). A Fundamental Look At Supply Side Energy Reserves For The Planet. *IEA-SHCP-Newsletter*, 62. Retrieved from <http://asrc.albany.edu/people/faculty/perez/2015/IEA.pdf>
- Porada, P., Weber, B., Elbert, W., Pöschl, U., & Kleidon, A. (2013). Estimating global carbon uptake by lichens and bryophytes with a process-based model. *Biogeosciences*, 10(11), 6989–7033. <https://doi.org/10.5194/bg-10-6989-2013>
- Quéré, C. L., Andrew, R. M., Friedlingstein, P., Sitch, S., Hauck, J., Pongratz, J., ... Zheng, B. (2018). Global Carbon Budget 2018. *Earth System Science Data*, 10(4), 2141–2194. <https://doi.org/https://doi.org/10.5194/essd-10-2141-2018>
- Schellens M., Diemer A. (2020) Natural Resources Conflict. In: Leal Filho W., Azul A., Brandli L., Özuyar P., Wall T. (eds) Sustainable Cities and Communities. Encyclopedia of the UN Sustainable Development Goals. Springer, Cham
- Sieferle, R. P. (1997). *Rückblick auf die Natur. Eine Geschichte des Menschen und seiner Umwelt*. München: Luchterhand. Retrieved from <https://www.alexandria.unisg.ch/17966/>
- Sieferle, R. P. (2010). Lehren aus der Vergangenheit: Expertise für das WBGU-Hauptgutachten „Welt im Wandel: Gesellschaftsvertrag für eine Große Transformation“ (Materialien). Berlin: WBGU.
- Staffell, I., & Pfenninger, S. (2018). The increasing impact of weather on electricity supply and demand. *Energy*, 145, 65–78. <https://doi.org/10.1016/j.energy.2017.12.051>
- Stefansson, V. (2005). World Geothermal Assessment. In *Proceedings World Geothermal Congress 2005* (p. 6). Antalya, Turkey.

- Tainter, J. (1988). *The Collapse of Complex Societies*. Cambridge University Press.
- United Nations. (2018). *International Recommendations for Energy Statistics (IRES)* (Statistical Papers No. ST/ESA/STAT/SER.M/93).
- Volk, T. (1998). *Gaia's body*. New York: Springer-Verlag New York.
- Wrangham, RW, Jones, JH, Laden, G, Pilbeam, D, & Conklin-Brittain, N. (1999). The Raw and the Stolen. Cooking and the Ecology of Human Origins. *Current Anthropology*, 40(5), 567–594.

## 2. Renewable Energy – Characteristics and representation in macroeconomic energy-climate models

**Authors and affiliations:** Ganna Gladkykh<sup>1</sup>, Nathalie Spittler<sup>1</sup>, Florian Dierickx<sup>1</sup>

1: University Clermont Auvergne, CERDI-OR2D, University of Iceland, AdaptEcon II

*Book chapter*

**Date:** November 2017

**Book:** European Union and sustainable development: challenges and prospects

**Publisher:** Éditions Oeconomia, Clermont-Ferrand, France

**ISBN:** 979-10-92495-04-1

The current energy system, which is fossil-fuel-based, has been identified as one of the main drivers of earth system change. Although impacts of human beings are observable even earlier, none of the changes before (e.g. change in the agricultural system) caused such a significant impact on the environment as the one of the energy system (Steffen et al., 2005). Hence, it is no surprise that the energy system is also modeled as a main driver for climate change in many macroeconomic energy-climate models. One of the suggested solutions to climate change mitigation is a transition from a fossil-fuel-based energy system to a renewable-energy-based one (Edenhofer, Pichs Madruga, & Sokona, 2012; Iiasa, 2012; International Energy Agency, 2014).

In the IPCC's report, renewable energy is defined as “*any form of energy from solar, geophysical or biological sources that is replenished by natural processes at a rate that equals or exceeds its rate of use. Renewable energy is obtained from the continuing or repetitive flows of energy occurring in the natural environment and includes low-carbon technologies such as solar energy, hydropower, wind, tide and waves and ocean thermal energy, as well as renewable fuels such as biomass*” (Edenhofer et al., 2012, p. 38). It is assumed by the authors that the definitions and assumptions made for various energy sources in macroeconomic energy-climate models are affecting the modelling results depending on how the relations between climate change and the energy system are analysed. Characteristics chosen to be considered when modelling renewable energy technologies can influence modelling results. Hence, the paper deals with the following research question: How are characteristics of renewable energy represented in macroeconomic energy-climate models? To answer this question we start from the above-mentioned definition of renewable energy. Then, in a disaggregated manner, we analyse characteristics of different renewable energy technologies, relevant for the interaction between climate change and the energy system. This is followed by an overview of several macroeconomic climate-energy models including a description of their assumptions about renewable energies and a description of the connection between renewable energy and climate change. Based on the former, the differences of definitions and theories of renewables, as well as their representation in models, are discussed. A special focus will be put on the energy models used for energy scenarios and policies for the European Union (EU) PRIMES and GEM-E3.

## Characteristics of renewable energies

There is no uniform definition of renewable energy. Other ways, than the above mentioned definition of renewable energy by the IPCC can be found in the literature. Some of the definitions are broad but others give a more detailed description of renewable energy or a subset of it. However, most commonly a definition of renewables similar to the one of renewable energy by the IPCC is provided. An example of this is the definition of the German Advisory Council on Global Change: “*These include the energy of the sun, water, wind, tides, modern biomass and geothermal energy. Their overall potential is in principle unlimited or renewable, and is CO<sub>2</sub>-free or -neutral*” (German Advisory Council on Global Change, 2003, p. 236). Furthermore, a definition of renewables can be distinguished between different types of renewables. The German Advisory Council on Global Change recognizes “*new renewables*” specifically, which are those that have only recently been discovered, developed and employed and therefore still bear great potential; this, for example, excludes hydropower. Another possible distinction is between combustible and non-combustible renewables. Every renewable energy source, apart from bioenergy can be considered non-combustible (Vera, Langlois, 2007). Those definitions despite not giving any more detail provide insights into the fact that renewables only in principle have unlimited renewable potential, as well as the categorizations suggest that different renewables have varying characteristics and environmental impacts. Some of these renewables cannot be seen to be 100% renewable despite the fact that the source might be constantly renewable. For example, the technology for harvesting the source might depend on scarce or critical resources (WWF 2014) and constrain the possibility to harvest a specific renewable resource at a certain point in time. Even if the energy source itself might be renewable, resource constraints with regards to harvesting it might exist and must be considered. This is in line with the argument of Garcia-Olivares that a future energy source “*must not depend on the exploitation and use of scarce materials*” (García-Olivares, Ballabrera-Poy, García-Ladona, Turiel, 2012).

By not including the arising constraints for renewables in macroeconomic energy-climate models, renewable energy might be represented in a way that allows for misleading conclusions based on modelling results. Table 1 displays renewable energy technologies, which from today’s perspective are considered technologically and economically feasible and are commonly referred to as alternative, that can help to combat climate change (Edenhofer, Pichs Madruga, Sokona, 2012; Iiasa, 2012; International Energy Agency, 2014). Additionally, the potential of renewables in a certain location can also be impacted by climate change. Hence, this is another component that is vital for modelling renewables in macroeconomic energy-climate models, as not only the energy system impacts on climate change but also the other way around (Schaeffer et al., 2012).

Based on the above, the categories to characterize each of the renewable technologies were chosen for the following reason:

(i) Unlimited energy source: This refers to the primary energy source (e.g. sun). Due to the rate of harvesting (if the rate of harvesting exceeds the sustainable harvesting rate), some resources that are considered renewable might become non-renewable (e.g. geothermal).

(ii) Critical materials for harvesting technology: A renewable resource is only 100% renewable if harvesting does not depend on any critical or scarce resources.

(iii) Impact of climate change on energy source: Climate change itself can impact on the availability of a certain energy source and its harvesting potential. For example, does climate change heavily impact on water resources and therefore on the water available for energy generation (de Queiroz et al. 2016).

(iv) Emissions during energy production processes: These emissions refer to those occurring during the conversion of primary energy to secondary and final energy. Not all renewables are CO<sub>2</sub>-neutral or -free, to a large extent this can depend on their harvesting rate.

**Table 2.1:** Disaggregated analysis of renewable energy technologies

| <b>Technology</b>  | <b>Unlimited source</b> | <b>Critical materials for harvesting technology</b>                  | <b>Impacts of Climate Change on source</b> | <b>Emissions during energy production</b> |
|--------------------|-------------------------|--|--|---|
| Solar PV           | yes - sun               | Copper, Gallium, Germanium, Indium, Selenium, Silver, Tellurium, Tin | yes  | no  |
| Solar Cells        | yes - sun               | -  | yes  | no  |
| Concentrated Solar | yes - sun               | Copper   | yes  | no  |
| Hydropower Small   | yes - water             | -  | yes  | no  |
| Hydropower Large   | yes - water             | -  | yes  | no  |
| Geothermal         | possible - earth        |  | no   | yes                                       |
| Biofuels           | possible - biomass      | -  | yes  | yes                                       |
| Biomass solid      | possible - biomass      | -  | yes  | yes                                       |
| Wind               | yes - wind              | Cobalt, Copper, Manganese, Molybdenum, Nickel, Rare Earths           | yes  | no  |

Each of the above-mentioned characteristics has an implication for integrating renewables into macroeconomic energy-climate models. According to the definition of renewable energy given by the IPCC, the energy can be classified as renewable only if its harvesting rate is below the recovery rate. This is especially relevant for biomass but also for geothermal energy. With regards to critical materials for the existing harvesting solutions, especially those technologies currently receiving a lot of attention (PV, solar and wind) require a number critical and potentially scarce materials. Almost all technologies require copper (including hydropower and geothermal). However, a study by the WWF (2014) found that only the copper use of PV, wind and concentrated solar power had a significant impact on its availability. Although emissions from biofuels and solid biomass (if harvested sustainably) do not cause net emissions, there still occur emissions during the combustion of biofuels. The emissions arising at geothermal plant sites vary for different sites. The availability of all renewable energy sources, apart from geothermal, at a certain location at a certain point in time can be influenced by climate change. Those impacts vary according to the specificities

of the region (e.g. change of solar radiation intensity; change in composition of crop availability due to temperature changes; less energy density in water flow due to lower precipitation) but should be considered when modelling the possible contribution of renewable energy to combating climate change on a regional and/or global scale.

In Table 1 only the interaction between renewable energy and its impacts on climate change were assessed, other environmental impacts were not taken into account. However, some of the carbon-neutral renewable energies (e.g. hydropower) do not affect climate but interfere with the proximate ecosystem, which might also lead to negative impacts on the climate in the long run. This means that even if a source is renewable it might not be fully sustainable. Other aspects that need to be considered when talking about sustainable energy are the following: spatial dependence due to environmental circumstances, resource competition with other sectors (e.g. food, transport) and global security issues. Environmental implications of building renewable energy infrastructure is another important issue. Table 1 does not take into account critical materials and emissions associated with building additional distributional infrastructure for different types of renewable energy. In case energy-climate models provide for the possibility of building up renewable energy capacities, environmental implications of such activities should be included in the models' assumptions.

## **Modelling renewables in the context of climate change, societal values, territory, energy security**

Biophysical aspect of renewable energy, including natural resource use and emissions, is a crucial but not the only dimension which needs to be addressed when building macroeconomic energy-climate models and designing scenarios for renewable energy development. The authors believe that the issues such as geopolitical interests and financial flows are of crucial importance in renewable energy models. Modelling practice is always driven by underlying assumptions based on cultural, personal and societal values and broader regional or national geopolitical interests. However, the opposite is also true - regional or national strategies and the political climate with regards to environmental issues might be influenced by modelling results, depending on the impact of past modelling reports and their dissemination into different layers of society.

An important issue is the one of spatial scale of models, and whether they consider the renewable energy to be produced on the spatial scale of the institution issuing the model and the users using the model. For example, an issue, which is rarely explicitly mentioned in such models is whether, for example, the EU has the right to explore and exploit (renewable) energy in other countries, assuming that these other countries would accept this in a democratic way, knowing that the EU stresses fiercely its values and even tries to export them around the world. In a recently published EU guideline, it is mentioned that : “[the EU] *is at the forefront of the fight against climate change and its consequences; as it plans to keep growing, it helps neighbouring countries prepare themselves for EU membership; and it is building a common foreign policy which will do much to extend European values around the world*” (European Parliament, n.d.).

It can be interesting to know, to which extent institutions reflect on whether the values associated with large-scale renewable energy projects around the world are compatible with the values it defends on its territory. In the EU context, an example of a large-scale deployment of renewable energy is currently proposed by the DESERTEC-Atlas project, an initiative of the German Association of the Club of Rome (“DESERTEC Foundation - About,” n.d.), or the Noor Ouarzazate Concentrated Solar Power Project of the World Bank (Mobarek, Sameh, 2016). When looking at the implementation plans of planned oil pipelines and planned solar

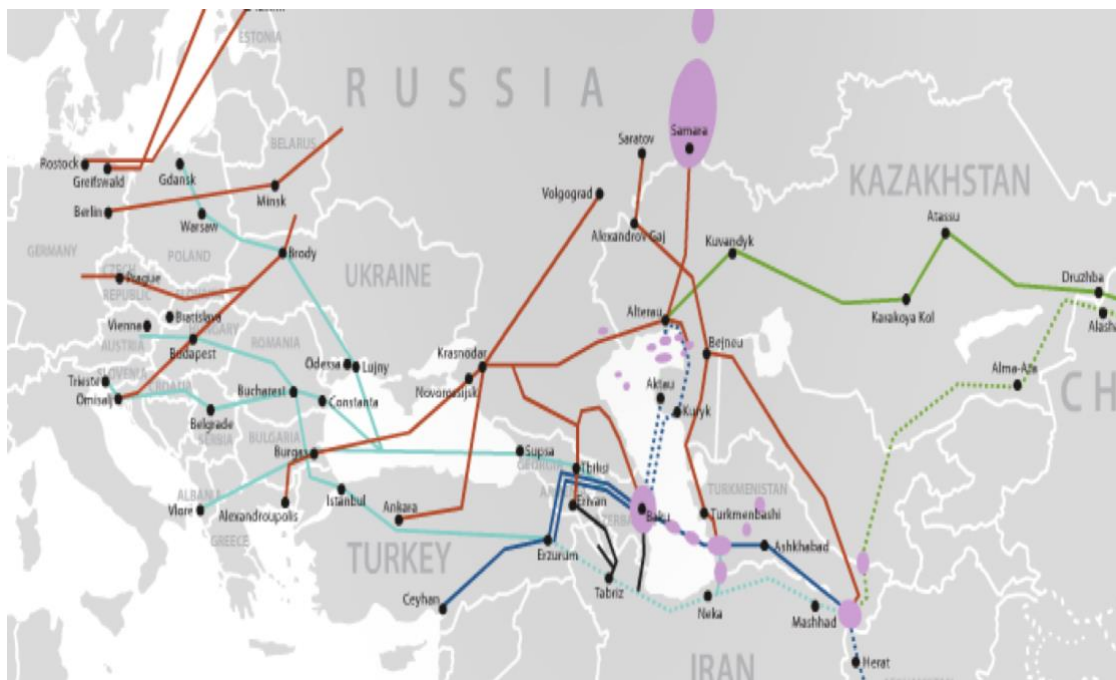
energy transmission lines (figure 2.1, figure 2.2), it is clear that there is still room for reflection on the issue of scale.

On the other hand, efforts are ongoing to integrate the renewable wind energy network of the North sea (Gruenig, O'Donnell, 2016). Two examples of these are the North Seas Countries' Offshore Grid Initiative (NSCOGI) in which 10 north sea-countries collaborate to establish a common distribution grid and the Kriegers Flak project, a collaboration between Denmark, Sweden and Germany to establish a common 600 MW offshore wind grid. The NSCOGI project started with a Memorandum of Understanding in 2010 and is still in its development stage (ENTSO-E 2015) and the Kriegers Flak project is in the stage of asking funding from the European Investment Bank.

A balance should be sought on European level between energy use and supply, and the associated risk of conflicts, disturbing cultural values and reverting efforts being carried out to ensure prosperity around the world. The current Syrian war, a result of conflicts on scarce oil, might be replicated in the future in the Middle-East and Africa because of renewable energy conflicts if no answers are sought to the question of scale and territory (Figures 2.1 and 2.2). The future will determine whether the European societies will arrive to consciously assess the consequences of a consistent energy demand and balance it with potential security issues originating from foreign resource extraction, be it renewable or nonrenewable.

Social and geopolitical aspects discussed here, despite being very important, are not usually taken into account in macroeconomic energy-climate models. To ensure feasible modelling results, those aspects are to be discussed in the models' assumptions.

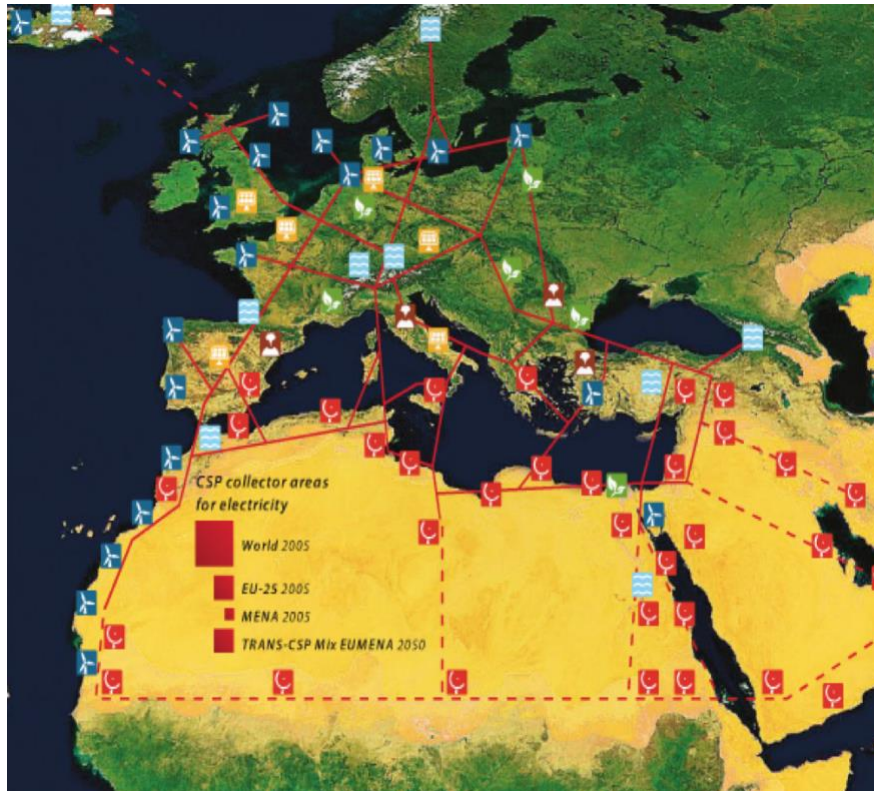
**Figure 2.1:** Planned oil pipelines in the Middle-East



**Source:** Desertec Foundation



**Figure 2.2:** Renewable energy interconnection development plans



Source: Desertec Foundation

## Current macroeconomic energy-climate models

There are two main types of macroeconomic energy-climate models. The first type is represented by the models that link extensive energy and climate models but do not fully integrate them. The MESSAGE-MAGICC model used by the IPCC is an example of such models, where the energy module is connected to the climate model via its emissions part; the energy sector outcomes are used as an exogenous input for atmospheric GHG emissions change. Such models usually belong to the optimization class of models and seek for minimizing energy costs and atmospheric emissions. Another type of macroeconomic energy-climate models are integrated models, where the energy and climate sectors are connected and designed as interconnected parts of the same model's structure. Macroeconomic energy-climate models started being widely used after the year 2000. They aim at exploring energy scenarios where carbon emissions can reach the level corresponding to a 2°C atmospheric temperature increase, and where technological, resource availability and costs limitations are addressed.

**Table 2.2 : Review of Macroeconomic Energy-Climate Models**

| <b>Name of the model</b>  | <b>Methodology ; Stand alone / Hybrid</b>  | <b>Addressing resource limitations</b>                               | <b>Assumptions about RES</b>   | <b>Addressing emissions</b>   | <b>Timescale</b> |
|---|--|--|--|---|------------------|
| C-Roads (MIT)   | System Dynamics Simulation model, stand alone  | Only fossil fuel resources limitations are addressed                 | No resource limitations for RES, no connection to material requirements for RES. Renewable energy sources are seen as carbon neutral ones. | Emissions modelled as a stock. No feedback from climate change to energy resource availability. | 1850-2100        |
| MINICAM (Mini Climate Assessment Model) (Pacific Northwest National Laboratory) | Partial equilibrium model; Stand alone   | Only fossil fuel and uranium resources and limitations are addressed | No resource limitations for RES. Renewable energy sources are seen as carbon neutral ones.   | Emissions modelled as variables.  | 1990-2095        |
| MARIA Model (Multiregional Approach for Resource and Industry Allocation)       | Non-linear optimization model to assess the interrelationships among economy, energy, resources, land use and global climate change; Stand alone | Only fossil fuel resources limitations are addressed.                | Renewable energy sources are seen as carbon neutral ones   | Emissions modelled as variables.  | 1980-2060        |
| Felix Model (Functional Enviro-economic Linkages Integrated neXus); IIASA       | System Dynamics Model of social, economic, and environmental earth systems and their interdependencies; Stand alone                              | Only fossil fuel resources limitations are addressed.                | Renewable energy sources are NOT seen as carbon neutral ones. There are CO <sub>2</sub> emissions from RES.                                | Climate sector and emissions in particular have the same structure as the C-ROADS Model.        | 1900-2100        |
| MESSAGE-MAGICC (Model for Energy Supply Energy Alternatives and Their General   | Hybrid model - Energy supply and energy service demand model connected to the probabilistic climate model  | Only fossil fuel resources limitations are addressed.                | Renewable energy sources are NOT seen as carbon neutral ones. There are carbon   | Climate is presented as a full-fledged model connected with the energy model via emissions part | 1990-2400        |

|  |  |  |                     |  |  |
|--|--|--|---------------------|--|--|
| Environmental Impact - Model for the Assessment of Greenhouse Gas Induced Climate Change); IIASA |  |  | emissions from RES. |  |  |
|--|--|--|---------------------|--|--|

None of the models analysed addresses the material resource limitations for renewable energy. Even though there are available studies addressing the problem of critical material need for renewable energy production (WWF report, 2014; Garcia-Olivares, 2011), their results are not reflected in the macroeconomic energy-climate models. Most of the models assume that renewable energy technologies are carbon neutral, and that there is no feedback from climate change effects to renewable energy resources availability. Addressing the limits of critical materials for renewable energy sources, as well as a feedback from climate change to renewable energy sources availability in energy-climate models, could help building more feasible renewable energy transition scenarios for the future and increase the accuracy of risk assessment associated with renewable energy use.

## Modelling energy and climate scenarios in the EU using GEM-E3 and PRIMES

A number of models used for analysing and simulating EU decarbonization pathways exist (Capros, 2014). Those models are used for informing better policy making and their modelling outputs serve as a guidance for EU policy documents. Considering the complexity policy making for the climate, it is important to be sure that such models produce feasible results and are based on realistic assumptions about economy, environment and energy systems.

GEM-E3 (Capros, 1997) and PRIMES (E3MLab, 2016) are two of the most widely used models for energy and climate change mitigation in the EU. Beyond this, together with the GAINS (Greenhouse Gas - Air Pollution Interactions and Synergies) model of the International Institute for Applied Systems Analysis (IIASA) it is possible to carry out an energy-economy-environment policy analysis in a closed-loop. The results of these models' simulations were used, in particular, for scenario analysis in the Energy Roadmap 2050 (2011) and for designing A Roadmap for Moving to a Competitive Low Carbon Economy in 2050 (2011).

Originally GEM-E3 and PRIMES were designed as stand-alone models used for analysing the global economy and EU energy markets. For the purpose of addressing the needs for climate and energy policy making at the EU level these two models were coupled into the one hybrid structure. The intention of coupling the models aimed to support better climate and energy decisions via addressing limitations of both GEM-E3 and PRIMES (Capros,1996).

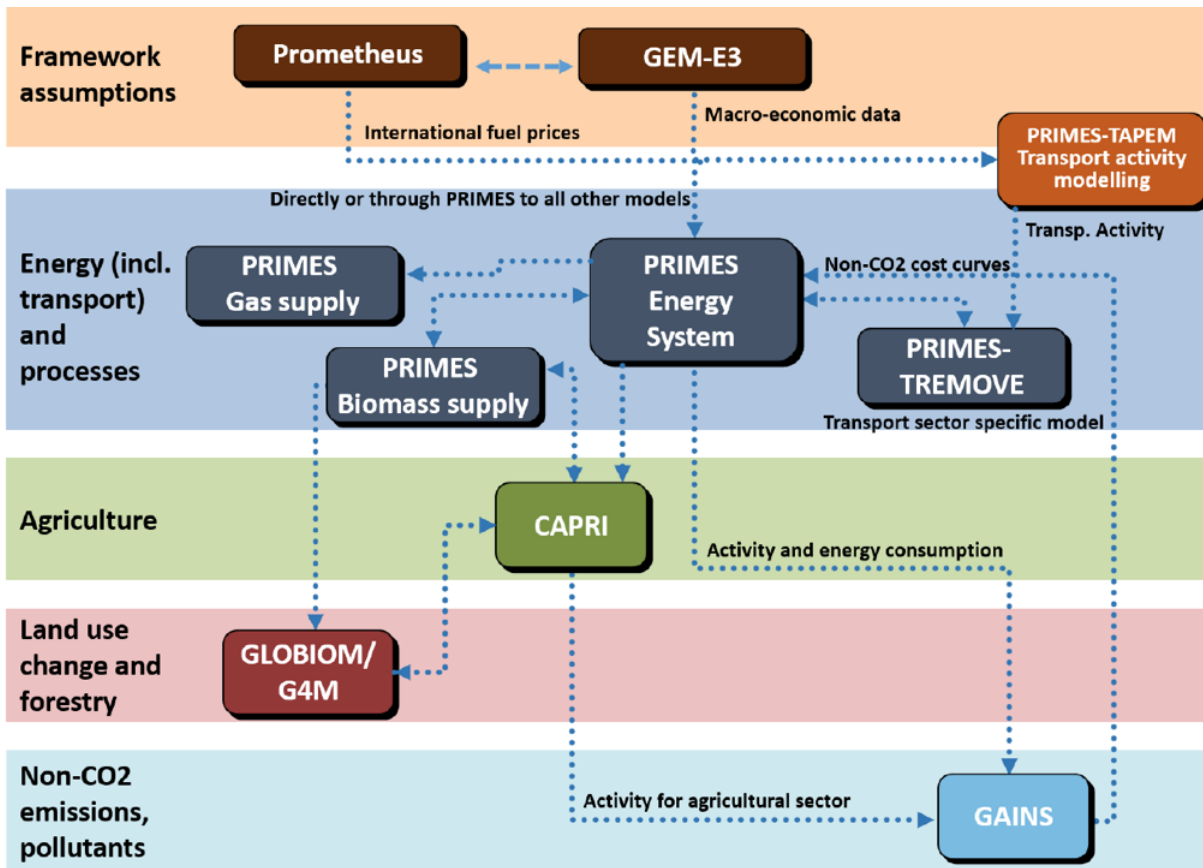
PRIMES is a partial equilibrium model which simulates equilibrium for energy supply and energy demand for all the EU member states until 2050. This model contains explicit and detailed information on energy technologies both on the supply and demand side. PRIMES is primarily directed to policy analysis in the field of security of energy supply, pricing policy, cost for climate mitigation, energy efficiency and standards on energy technologies (Capros, 2014).

GEM-E3 is a global scale multi-regional economic model which simultaneously represents 37 World regions including 24 European countries. It is a dynamic computable general equilibrium model that covers the interactions between the economy, the energy

system and the environment. It provides quantitative results until 2050. Analysing global climate issues is one of the intended policy applications of GEM-E3. For this, GEM-E3 calculates and evaluates atmospheric emissions and their damage using cost-benefit analysis as the main approach for selecting the best energy and climate policy combinations.

GEM-E3 as a stand-alone model cannot address technological aspects of different energy technologies which is important for assessing substitution possibilities and costs in production and consumption. At the same time PRIMES as a stand alone model lacks the interconnection between energy supply and demand and other economic sectors. Thus, GEM-E3 coupled with PRIMES performs energy-economy-environment policy analysis in a closed-loop computing energy prices in equilibrium and covering with engineering detail country-specific energy systems and the overall energy market in the EU.

**Figure 2.3 : GEM-E3 and PRIME MODELS (2016)**



**Source:** European Commission (2016, p. 16)

GEM-E3 and PRIMES are very oriented towards the price-driven equilibrium paradigm. They represent market clearing mechanisms and related behaviors of market agents as the main explanatory force in the models. Consequently, the assumptions of GEM-E3 and PRIMES mentioned in the models' documentation are mainly oriented at explaining market theories behind models' structures within existing technological limits.

Resulting scenarios from GEM-E3 and PRIMES simulations are focused on an energy technology mix and a climate policy mix that would simultaneously minimize cost and atmospheric emissions. Thus, the main outputs from such scenarios are numerical parameters as energy efficiency, renewable energy sources penetration, percentage of nuclear power use, CCS deployment and transport electrification.

Since deployment of renewable energy is one of the central elements of climate and energy policy simulations, the models' assumptions of modelling renewables are of a high importance. Renewable energy technologies assumptions mentioned in PRIMES documentation allow to conclude that both nonrenewable and renewable energy technologies are modelled in a conventional way. This means that limits of resource availability are present only for fossil fuels, and none of renewable energies is associated with resource scarcities for harvesting. Feedback between climate change and renewable energy availability is also not present in the model structure. However, there are some limitations for renewable energy of a technological origin and availability present in PRIMES. They include the difficulties of getting access to resources, the availability of sites, acceptance, grid connection difficulties, and for biomass land and waste energy resource availability are considered.

Considering the arguments made in the first part of this paper, the absence of assumptions on resource limitations for harvesting some types of renewable energy and the

absence of feedback between climate change and renewable energy availability can potentially lead to inaccurate modelling results, especially when it comes to long-term planning. Political aspects of energy resource availability associated with resource conflicts and additional cost could potentially have policy implications and demonstrate the need for trade-offs at both global and national levels.

Interestingly, there are studies and policy reports at the EU level, which analyse possible implications of material scarcity for harvesting renewables and potential economic and political risks associated with them. One of the elaborated reports of this kind is *Critical Metals in the Path towards the Decarbonization of the EU Energy Sector* (Moss, 2013). Integrating the findings of such reports with the assumptions of macroeconomic energy-climate models in the EU could bring new important policy insights and help better decision-making for mitigating climate change.

## **Conclusion**

Making feasible projections on the possible impact of the employment of particular renewables to minimize effects on climate change is only possible if all factors influencing the development of renewables are treated in a heuristic way. Moreover, they should all be treated based on empirical gathered knowledge.

## References

- CAPROS P., PAROUSSOS L., FRAGKOS P., TSANI S., BOITIER B., WAGNER F., BOLLEN J. (2014), « Description of models and scenarios used to assess European decarbonisation pathways », *Energy Strategy Reviews*, 2(3), p. 220-230.
- CAPROS P. (1996), PRIMES and GEM-E3 Contribution to Climate Change Policy Debate. *Athens, National Technical University of Athens.*
- CAPROS P.D, GEORGAKOPOULOS T., FILIPPOUPOLLITIS A., KOTSOMITI S., ATSAVES G., PROOST S., SCHMIDT T.F.N (1997). The GEM-E3 model : Reference manual. *National University of Athens, Athens.*
- COMMISSIE EUROPESE (2011), A Roadmap for moving to a competitive low carbon economy in 2050, *Europese Commissie, Brussel.*
- DESERTEC Foundation – About, (2016). Retrieved October 14, from <http://www.desertec.org/about-desertec>
- E3MLAB (2016), The Primes Energy System Model Description, <http://www.e3mlab.ntua.gr/e3mlab/PRIMES%20Manual/The%20PRIMES%20MODEL%202016-7.pdf> last accessed April 2017
- EDENHOFER O., PICHES MADRUGA R., SOKONA Y. (2012), « Renewable Energy Sources and Climate Change Mitigation”, *Special Report of the Intergovernmental Panel on Climate Change*, vol 6, p. 1 – 1088.
- EUROPEAN PARLIAMENT (n.d.), How the European Union works - Activities of the institutions and bodies. <https://doi.org/10.2775/20055>
- EUROPEAN COMMISSION (2016), *EU Reference Scenario 2016: Energy, transport and GHG emissions, trends for 2050*, Luxembourg, Publications Office of the European Union, 220 p.
- GARCIA-OLIVARES A., BALLABRERA-POY J., GARCIA-LADONA E., TURIEL A. (2011). « A global renewable mix with proven technologies and common materials”, *Energy Policy*, 41, p. 561–574.
- GERMAN ADVISORY COUNCIL ON GLOBAL CHANGE (2003), *World in Transition – Towards Sustainable Energy Systems*. Retrieved from [http://www.wbgu.de/fileadmin/templates/dateien/veroeffentlichungen/hauptgutachten/jg2003/wbgu\\_jg2003\\_engl.pdf](http://www.wbgu.de/fileadmin/templates/dateien/veroeffentlichungen/hauptgutachten/jg2003/wbgu_jg2003_engl.pdf)
- IIASA (2012), *Global Energy Assessment Toward a Sustainable Future*, 1884.
- INTERNATIONAL ENERGY AGENCY (2014), *World Energy Outlook*, Paris.
- MEADOWS D.H, MEADOWS D.L, RANDERS J., BEHRENS W.W (1972), *The Limits to Growth*, 1<sup>st</sup> Edition, New York, Universe Books.
- MOBAREK, SAMEH I. (2016), *Morocco - MA- Noor Ouarzazate Concentrated Solar Power Project : P131256 - Implementation Status Results Report : Sequence 03* (No. ISR23914) (p. 1–0). The World Bank. Retrieved from <http://www-wds.worldbank.org/external/default/WDSContentServer/WDSP//>
- MOSS R.L, TZIMAS E., WILLIS P., ARENDORF J., THOMPSON P., CHAPMAN A., TERCERO-ESPINOZA L. (2013), « Critical metals in the path towards the decarbonisation of the EU energy sector », *Assessing rare metals as supply-chain bottlenecks in low-carbon energy technologies. JRC Report EUR, 25994.*

- ROADMAP ENERGY (2011), 2050. Communication from the Commission to the European Parliament, the Council, the European Economic and Social Committee and the Committee of the Regions, Brussels, 15, 12.
- ROTMANS J., VAN ASSELT M. (1999), "Integrated Assessment Modelling " In *Climate Change : An Integrated Perspective*, edited by Pim Martens, Jan Rotmans, Darco Jansen, and Koos Vriese, p. 239–75. Dordrecht: Springer Netherlands.
- SCHAEFFER R. and Al. (2012) "Energy Sector Vulnerability to Climate Change : A Review ", *Energy*, vol 38, n° 1, p. 1–12.
- STEFFEN W., SANDERSON A., TYSON P., JAGER J., MATSON P., MOORE III B., VERA I., LANGOIS L. (2007), "Energy indicators for sustainable development", WASSON R.J. (2005). *Global Change and the Earth System*. Berlin Heidelberg New York: Springer.
- WWF (2014), Critical materials for the transition to a 100 % sustainable energy future contents.





### 3. Integrated Assessment Models (IAMs) – How to integrate Economics, Energy and Climate?

**Authors and affiliations:** Arnaud Diemer<sup>1</sup>, Ganna Gladkykh<sup>1</sup>, Nathalie Spittler<sup>2</sup>, David Collste<sup>3</sup>, Abdourakhmane Ndiaye<sup>1</sup>, Florian Dierickx<sup>1</sup>

1: Université Clermont Auvergne, CNRS, IRD, CERDI, ERASME, France

2: University of Iceland, Reykjavik, Iceland

3: Stockholm Resilience Centre, Stockholm, Sweden

*Book chapter*

**Date:** October 2019

**Book Title:** Integrated Assessment Models and other climate policy tools

**Publisher:** Oeconomia, France

From the pioneering work of Forrester (1965, 1969) and Meadows (1972) with the World 2 and World 3 models based on system dynamics methodology, to the models developed by IPCC experts (2001, 2015), modeling from a global environmental prospective (Matarasso, 2003) has become increasingly integrated. In the 1990's, some models were developed to combine different key elements of biophysical, social, and economic systems into one integrated system (Dowlatabadi, Morgan, 1993, 1995). What we call today Integrated Assessment Models (IAMs) became powerful tools for thinking, simulation and decision support.

Kelly and Kolstad (1999, p. 3) defined an integrated assessment model as “any model which combines scientific and socio-economic aspects of climate change primarily for the purpose of assessing policy options for climate change control”. Integrated assessment induces an "interdisciplinary and participatory process of combining, interpreting and communicating knowledge from various scientific disciplines to enable understanding of complex phenomena" (Parker, 2002).

Weyant et al (1996) gave three purposes for integrated assessment: (1) Assess climate<sup>55</sup> change control policies, (2) Constructively force multiple dimensions of the climate change problem into the same framework, (3) Quantify the relative importance of climate change in the context of other environmental and non-environmental problems facing mankind. The final goal of integrated assessment is to build the best possible response<sup>56</sup>, with present knowledge, to the questions asked by decision makers about environmental issues (Kieken, 2003). This goal is usually achieved by integrating work from various disciplines into an interactive process that includes researchers, managers, and stakeholders. The release and sharing of knowledge between communities is ensured by the implementation of three kinds of complementary tools<sup>57</sup>: (1) Integrated assessment computer models designed as methodological frameworks for interdisciplinary work which are the means to integrate

---

<sup>55</sup> If energy system and macroeconomic structure have been usually connected, the integration of climate in a global system is a recent practice. Climate has been invited to the debate following the various IPCC reports (1990, 2018) and the controversies related to global warming.

<sup>56</sup> Pearson and Fisher-Vanden (1997, p. 593) considered that IAMs brought four broad contributions: evaluating potential responses to climate change; structuring knowledge and characterizing uncertainty; contributing to broad comparative risk assessment; and contributing to scientific research.

<sup>57</sup> Rotmans and Dowlatabadi (1998) noted that current integrated assessment research used one or more of the following methods : (i) computer-aided IAMs to analyze the behavior of complex systems, (ii) simulating gaming in which complex systems are represented by simpler ones with relevant behavioral similarity; (iii) scenarios as tools to explore a variety of possible images of the future; (iv) qualitative integrated assessments based on a limited heterogeneous data set, without using any models.

knowledge from a variety of disciplines, (2) Qualitative scenarios to take into account what is not modellable, (3) Participatory methods involving stakeholders other than scientists and politicians, with the aim of improving the acceptability of decisions through a better understanding of the issues, legitimizing the decision-making process through the early involvement of stakeholders, and introducing non-expert knowledge of the issues).

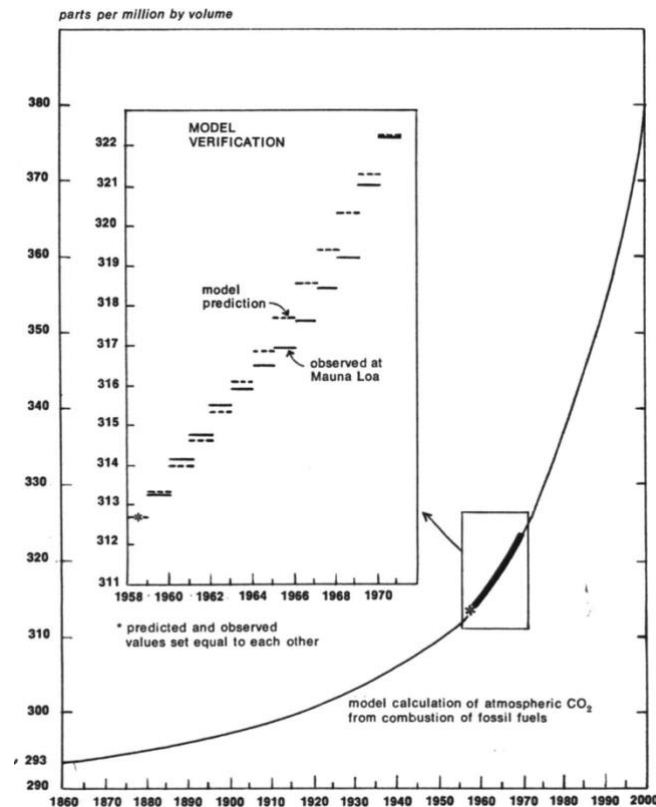
IAMs are usually divided into two categories: policy optimization IAMs and policy evaluation IAMs. Policy optimization IAMs search for the optimal policy. They can be split into three principal types: (i) Cost/benefit models which try to balance the costs and the benefits of climate policies, (ii) Target based models which simulate the effect of an efficient level of carbon abatement in the world economy, (3) Uncertainty based models which deal with decision making under conditions of uncertainty (Manne, Richels, 1992; Nordhaus, 1994). Many policy optimization models start with a market economy in which the regulatory instrument is a tax and then convert the model to an equivalent problem which finds the optimal emissions. Such models maximize the weighted sum of utilities where the weights are adjusted until individual budgets balance (which is equivalent to a Pareto Optimum (second welfare theorem)), or start with optimal emissions and convert the results into a tax. So optimization models are standardized and provide a description of the world, given the assumptions of the equivalence theorems. Policy evaluation IAMs are well-known as simulation models. They include deterministic projection models in which each input and output takes a single value, and stochastic projection models in which at least some inputs and outputs take a range of values. Policy evaluation models take actions by agents and governments as given, provided by policy proposals, assumption, observation and expert opinion.

In this article, we propose to review 6 IAMs (World 3, DICE, IMAGE, MESSAGE, GEM-E3 and REMIND) to understand how these models are able to integrate Energy, Climate and Economics. We will resume their main results in a table to present goals, structure, policy evaluation, policy optimization, and dynamics associated with the models. We will identify the future challenges for research design and policy decisions.

## **World 3 – the first design of an IAM?**

In the 1972 Limits to Growth report, the climate system is not part of the model. The pollution variable is captured by the concentration of carbon dioxide in the atmosphere. Meadows et al (1972, p. 71) introduced a positive loop: the more industrial production increases, the more fossil energy (coal, oil and natural gas) is used; this releases CO<sub>2</sub> into the atmosphere and causes an increase in mortality.

**Figure 3.1:** Concentration of CO<sub>2</sub> in the Atmosphere

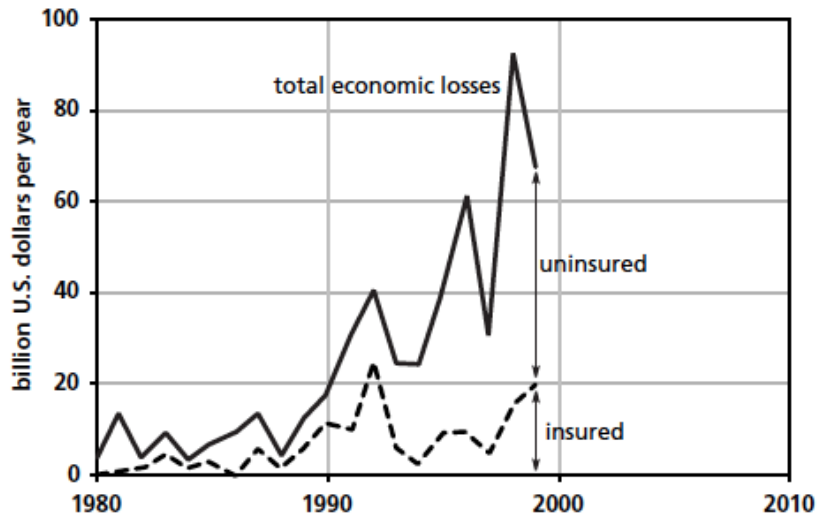


**Source :** Meadows et al. (1972, p. 72)

It would be necessary to wait for the publication of *Beyond The Limits* (1992) for climate to be explicitly integrated into system dynamics, but it was only mentioned in Chapter 3 (The Limits: Sources and Sinks) on pollution and waste. While global climate change is clearly presented as the new challenge for the coming years (scientific evidence of global warming is accumulating), its analysis continues to feed into the growth debates: "*Many scientists believe that the next global limit humanity will have to deal with is the one called the greenhouse effect, or the heat trap, or global climate change*" (1992, p. 92). Thus, global climate change cannot be detected in the short term, but over decades. To these long-term observations, three types of uncertainties must be added: 1. What would the global temperatures be without human intervention? A reduction in growth of emissions may not be sufficient to reduce CO<sub>2</sub> concentrations if temperature is projected to increase in the long term (termed 'committed warming'), 2. What are the consequences of global warming on precipitation, winds, ecosystems and human activities at particular locations on Earth and 3. How to understand all the loops associated with carbon and energy flows. The modelling of such a system is complex and control loops can be used to stabilize CO<sub>2</sub> emissions (the oceans can absorb some of them).

The publication of *Limits to growth, the 30 years update* (2004), deserves attention, as the climate generates many loops in World 3. The report does not hesitate to target economists, the main climate skeptics and to highlight the consequences of climate change on economic activities, and therefore on economic growth: "*More scientists, and now many economists as well, believe the next global limit humanity will have to deal with the greenhouse effect, or global climate change... Even some economists - a group well known for its skepticism about environmentalist alarmism - are becoming convinced that something unusual and significant is going on in the atmosphere, and that it may have human causes*" (2004, p. 113-115).

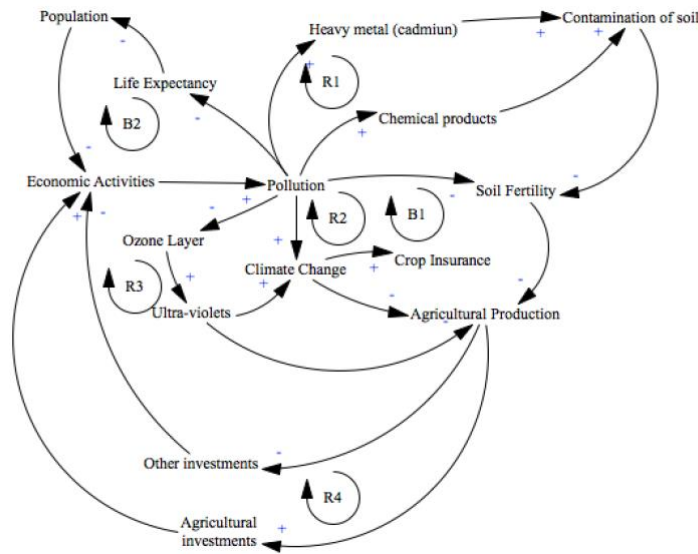
**Figure 3.2:** Worldwide economic losses from weather-related disasters



Source : Meadows et ali. (2004, p. 117)

Climate change is causing economic losses that call into question the viability of insurance systems (the 1990s and 2000s marked a break in the trend, with the share of damage not giving rise to big reimbursement increases). Scenario 2 (Global Pollution Crisis) introduces the damaging effects of pollution and climate change. The positive loop is as follows: an increase in pollution reduces land fertility, which in turn reduces agricultural production, investments move to agricultural sector to maintain food production and decrease in other sectors, pollution leads to lower life expectancy and increased mortality. This loop is reinforced by three effects: land contamination by heavy metals and chemicals, climate change that randomly and repeatedly alters agricultural production, and ultraviolet radiation related to ozone depletion.

**Figure 3.3:** Positive and negative loops in the scenario “more pollution”



This work has been widely criticized by economists, William Nordhaus (1972, 1973) was the main architect of this critique. In an article co-written with James Tobin entitled "Is Growth Obsolete? ", Nordhaus responded to the report: (*« We mention this point now because we shall return later to the ironical fact that the antigrowth men of the 1970s believe that it is they who represent the claims of a fragile future against a voracious present»*, 1972, p. 4) by mobilizing theory around three questions: 1. The measurement of economic growth, 2. The link between growth and natural resources, 3. The link between population growth rates and economic well-being.

A year later, Nordhaus (1973) repeated his critique, targeting Forrester's *World Dynamics*. The title "World Dynamics Measurement without data" and the content of the article are unequivocal. *« What is the overall impression after a careful reading of World Dynamics? First, the dynamic theory put forward in the work represents no advance over earlier work... Second, the economic theory put forth in World Dynamics is a major retrogression from current research in economic growth theory... Third, Forrester has made no effort in World Dynamics to identify any relation between his model and the real world... Fourth, the methodology of modelling in World Dynamics differs significantly from other studies of economic systems...Fifth, the predictions of the world's future are highly sensitive to the specification of the model... Sixth, there is a lack of humility toward predicting the future»* (1973, p. 1183).

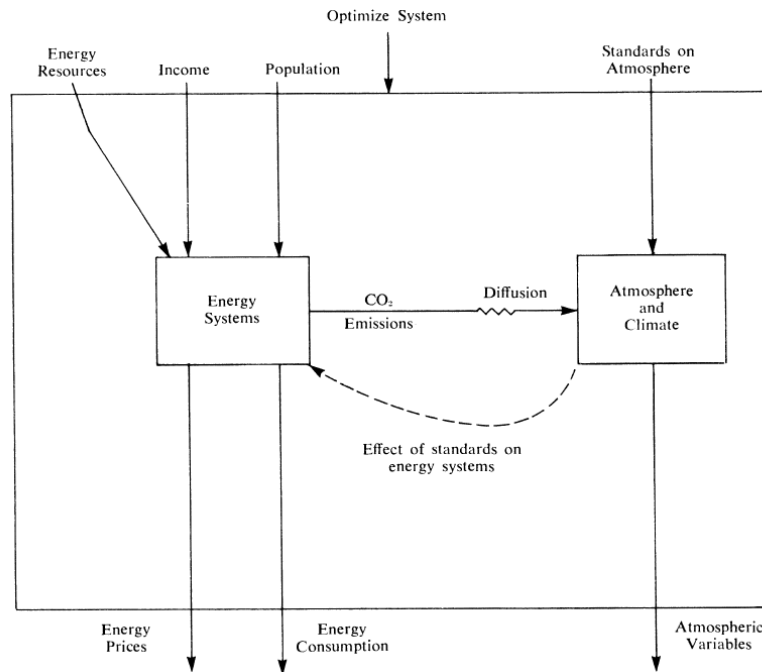
## DICE – the Carbon Dioxide Problem

It is in this context that Nordhaus would undertake his research "Resources as a constraint to growth" (1974), into the management of energy resources, and then take into account the impact of CO<sub>2</sub> concentration in the atmosphere. He concludes that assuming that "10 percent of the atmospheric CO<sub>2</sub> is absorbed annually (G. Skirrow), the concentration would be expected to rise from 340 ppm in 1970 to 487 ppm in 2030 - a 43 percent increase" (1974, p. 26). His paper is a first attempt at integrated climate modelling. It is rudimentary (only the CO<sub>2</sub> variable is taken into account), but it does reflect the debates of the 1970s. Against the backdrop of the energy crisis, Nordhaus intended to develop a global energy model that could be coupled with a climate model. Nordhaus presented this theoretical framework in two articles, one presented to the Cowles Commission (Strategies for the Control of Carbon

Dioxide, 1976), the other published in *The American Economic Review* (*Economic Growth and Climate: The Carbon Dioxide Problem*, 1977).

Figure 3.4 provides an overview of the model used by Nordhaus to study carbon dioxide emission control strategies.

**Figure 3.4:** Optimization model of energy and environmental system



**Source:** Nordhaus (1977, p. 343)

The "energy system" block is a system combining market mechanisms and economic policies. The key variables are energy, natural resources, income, and population. The interaction of supply and demand leads to a trajectory of optimization of prices and consumption over time. To take into account externalities, such as the carbon cycle, Nordhaus proposes to take into account CO<sub>2</sub> emissions and distribution. This step leads to the imposition of standards on atmospheric concentrations (right side of figure 3.4). By imposing such standards, it becomes possible to close the loop and force the energy system to act on the structure of supply and demand. Nordhaus is examining two strategies to keep atmospheric CO<sub>2</sub> concentrations at a reasonable level. The first strategy is to reduce carbon dioxide emissions. This means replacing high CO<sub>2</sub> fuels with low CO<sub>2</sub> fuels. The second strategy is to offset the effects of carbon dioxide emissions or use new industrial processes (environmental technologies) to "suck" carbon dioxide from the atmosphere. In order to avoid "*the odor of science fiction*" (1977, p. 343), Nordhaus favors the first strategy by seeking to optimize the system based on standards.

It was not until the 1990s that the DICE (Dynamic Integrated Model of Climate and the Economy) and RICE (Regional Integrated Model of Climate and the Economy) family of models was born (Nordhaus, 1992, 1994). The DICE model is a dynamic optimization model (Ramsey, 1920) which seeks to estimate the optimal GHG reduction trajectory. The optimal trajectory can be interpreted as the most effective way to slow climate change, taking into account inputs and technologies (Veille-Blanchard, 2007). It can also be interpreted as a competitive market balance in which externalities are adjusted using appropriate social prices for GHGs. In the DICE model, emissions include all GHGs, however, those associated with CO<sub>2</sub> are preferred. GHG emissions, which accumulate in the atmosphere, can be controlled by increasing the prices of inputs (such as energy) or GHG-intensive products. Climate change

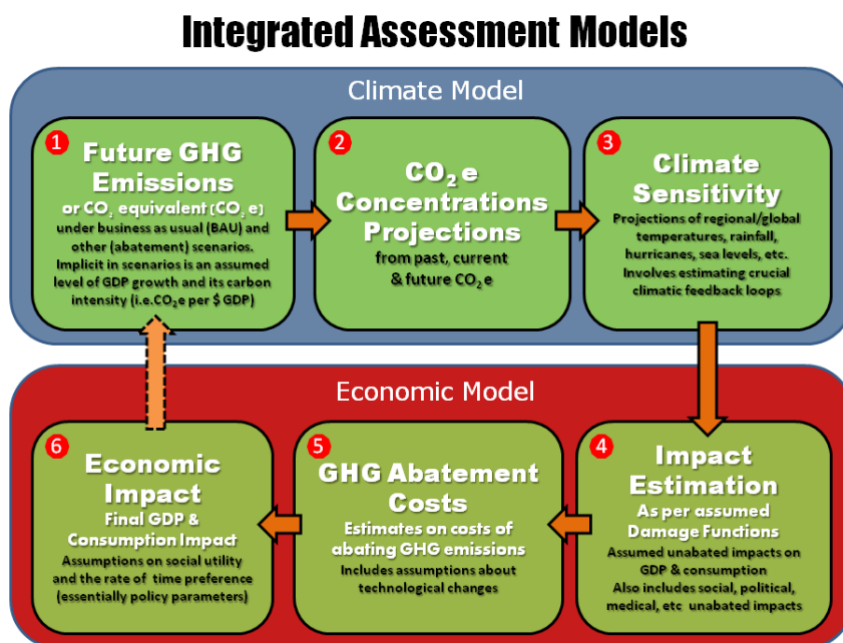
is captured by the overall average global temperature, a variable used in most current climate models. The economic impacts of climate change are assumed to increase as the temperature increases.

In the space of two decades, the DICE model has been a huge success, for which three reasons can be given. The first reason is the multiple revisions proposed by Nordhaus: an intermediate version (Nordhaus, 2008) and an updated version (Nordhaus 2017). The DICE model has been iterated many times, incorporating recent economic and scientific results and updated economic and environmental data. The second reason is based on a detailed description of the model (Nordhaus, Sztorc, 2013) with the availability of the DICE manual and the possibility of carrying out simulations. The third reason is the media coverage of DICE through the publications and work of the IPCC (since 1995) and many energy agencies (including the US agency).

To this, we add a fourth reason that affects the way Integrated Assessment Models (IAM) are approached today. This fourth reason is that the DICE model has initiated a way of thinking about integration, which can be summarized by the following process: integration of CO<sub>2</sub> emissions, impacts on economic activities, economic policy measures. As a result, Climate, Energy, and Economics are now the main building blocks for integrated assignment models (Ha-Dong, Matarasso, 2006; Gladkykh, Spittler, Dierickx, 2017).

Integrated models are not limited to the DICE model, other models emerged in the 1990s - ICAM (Dowlatabadi, Morgan, 1993), IMAGE (Alcamo, 1994), MERGE (Manne et al, 1995), MiniCAM (Edmonds et al, 1996). Some like IMAGE (Integrated Model to Assess the Global Environmental) even follow in the footsteps of World 2 and World 3, adopting an architecture built around the main drivers (population, economy, politics, technology, lifestyle and resources) of the human and earth ecosystems. Thus, alongside small, simplified and discipline-based models (DICE and economics), there are global, complex and interdisciplinary models (World 3, IMAGE). These two main families of models have contributed to enriching the debate about the integrated approach to climate change, each with its strengths and weaknesses.

**Figure 3.5:** Coupling climate system and economic system



Source: deconstructingrisk.com



The 2000s were marked, not by rivalry between models (although it does exist), but by a reflection about the processes of integration (Matarasso, 2003) and evaluation (Schwanitz, 2013) of IAMs (Pearson and Fisher-Vanden, 1997). This is particularly visible through the many definitions which have been used. Integrated assessment can thus be defined as "an interdisciplinary and participatory process aimed at combining, interpreting and communicating knowledge from various scientific disciplines to enable the understanding of complex phenomena" (Parker, 2002). It aims to build the best possible response, in the current state of knowledge, to questions asked by decision-makers on environmental issues (Kieken, 2003). This objective is generally achieved by integrating the ongoing work of various disciplines into an interactive process that includes researchers, managers, and stakeholders. The circulation and sharing of knowledge between communities is ensured by the implementation of three families of complementary tools: (1) Computer models of integrated assessment designed as a methodological frameworks for interdisciplinary work and the means of integrating knowledge from various disciplines, (2) Essentially qualitative scenarios to take into account what is not modellable, (3) Participatory methods involving stakeholders other than scientific and political (the aim here is to improve the acceptability of decisions through a better understanding of the issues; to legitimize the decision-making process through the early involvement of the actors concerned; to introduce non-expert knowledge).

These interdisciplinary computerized models, designed to address issues of climate impact, climate adaptation and climate change, are still not robust. While each discipline provides some knowledge about the processes which determine the evolution of the Earth/Society system, their interaction poses a number of problems. For example, climatologists' General Circulation Models (GCMs) do not allow us to study in detail the strategies for reducing greenhouse gas emissions. It is therefore necessary to look at the energy system in order to identify energy production and transformation technologies. These technologies must, in turn, be included in a macroeconomic model, designed to understand the major monetary and financial balances that regulate the economy. To address these limitations, the modelers have developed a modular approach, based on the coupling of existing models, which are themselves based on a discipline. Integration is based on the following: (1) Climate models (more or less complex), (2) Energy system models, (3) Macroeconomic models of global activity, (4) Carbon cycle models (often related to land use). These couplings generate a multitude of challenges (depending on whether the modules are solved simultaneously or successively or according to the finesse of the different representations of the modules), which demand the creation of a real network of modelers, users, and decision-makers at the IAM level. This is the price to pay for the necessary changes in our behavior with regard to climate change.

## **MESSAGE – Shared Socioeconomic Pathways**

The IIASA IAM framework is a combination of five different models – The energy model MESSAGE, the land use model GLOBIOM, the air pollution and GHG model GAINS, the aggregate macro-economic model MACRO, and the climate model MAGICC. These five models provide inputs, drivers and dynamics to describe alternatives futures for societal development. Scenarios of global development focus on the uncertainty of the future conditions of society, describing future societies that can be combined with climate change projections and climate policy assumptions to produce integrated scenarios to explore climate mitigation, climate adaptation and residual climate impacts in a consistent framework. Society's development scenarios consist of qualitative and quantitative components (Raskin et al, 2005). Quantitative components introduce assumptions for variables such as population, economic growth (GDP), technological progress, food, etc which are quantified and used as

inputs to model energy use, land use, GHG emissions (Rothmans et al, 2007). Qualitative storylines describe the evolution of society such as quality of institutions, environmental awareness, and political stability to “provide a certain logic to the multiple assumptions and to help to define possible developments for those areas where formal modeling is not meaningfully possible due to ignorance and complexity” (Van Vuuren et al, 2012, p. 888). If the process to develop a new set of integrated scenarios describing climate, society and environmental change, is still happening, a few researchers (Krieger et al, 2012, O’Neill et al, 2014, Kriegler et al, 2014, Riahi et al, 2017; O’Neill et al, 2017; Van Vuuren et al, 2017, Bauer et al, 2017) have introduced alternative pathways of future development of society called *shared socioeconomic pathways* (SSPs)<sup>58</sup>. A conceptual framework has been produced for the development of SSPs (O’Neill et al, 2014, 2015) and for the combination of Integrated Assessment Model (IAM) scenarios based on SSPs with future climate change outcomes and climate policy assumptions, to produce integrated scenarios and support other kinds of integrated climate change analysis. SSPs describe plausible alternative changes in aspects of society such as demographic, economic, technological, social, governance’ and environmental factors.

**Figure 3.6:** Five Shared Socioeconomics Pathways (SSPs)



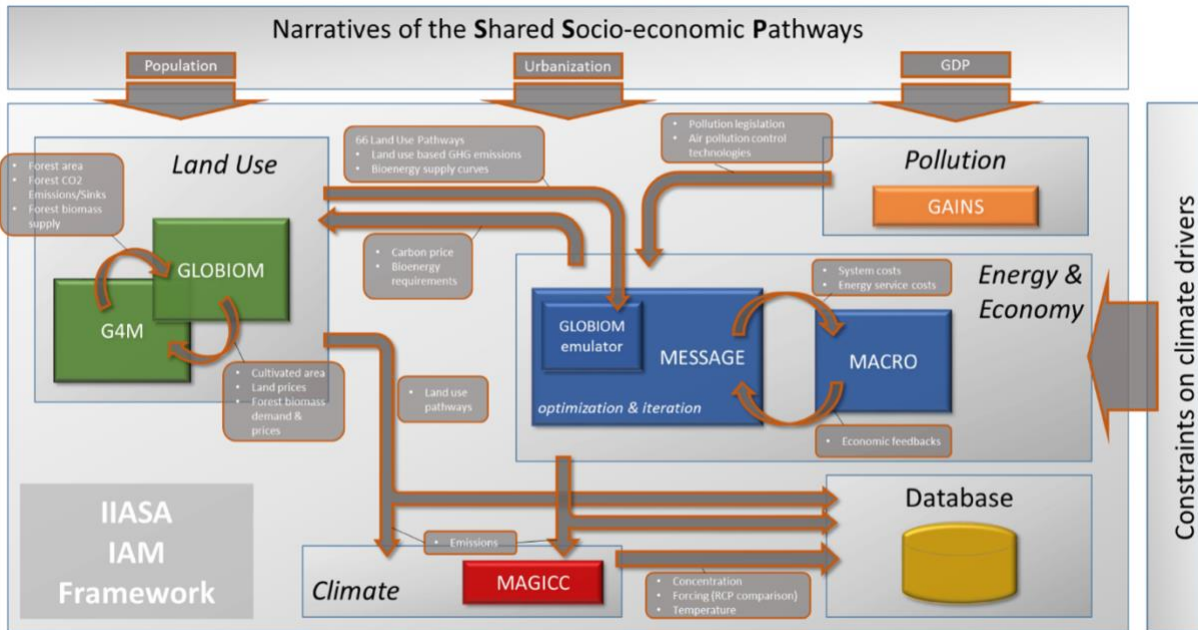
**Source:** O’Neill et al (2014, p. 391; 2015, p. 2)

Five shared socioeconomic pathways have been proposed to represent different combinations of challenges to climate change mitigation and to climate adaptation (O’Neill et al, 2014, 2015): SSP1 (Sustainability: taking the green road), SSP2 (Middle of road), SSP3 (High challenge: Regional Rivalry, a rocky road), SSP4 (Adaptation challenges Dominate: Inequality, a road divided), SSP5 (Mitigation challenges dominate: fossil fueled development, taking the highway).

From these five SSPs, three following narratives have been introduced into the IIASA – IAM framework: SSP1 (sustainability), SSP2 (middle of the road) and SSP3 (regional rivalry, a rocky road).

<sup>58</sup> “We define SSPs as reference pathways describing plausible alternative trends in the evolution of society and ecosystems over a century timescale, in the absence of climate change or climate policies » (O’Neill, 2014, p. 387 – 388).

**Figure 3.7:** Narratives of the Shared Socio-economic Pathways in IAMs



**Source:** <http://data.ene.iiasa.ac.at/message-globiom/overview/index.html>

MESSAGE (Model for Energy Supply Strategy Alternatives and their General Environmental Impact) represents the core of the IIASA (International Institute of Applied Systems Analysis) IAM framework. It was developed in the 1980s. While it is possible to use the model on a global scale it has also been applied to various national energy systems. The model is a technology-rich bottom-up energy system model, which is very detailed on the supply side but not on the demand side. It is used for modelling the supply side and its general environmental impacts, planning medium- to long-term energy systems, and analyzing climate change policies on a national level or for global regions. This is possible because the model has been developed further and many hybrid versions exist. Some important aspects of energy system modelling have been integrated into MESSAGE (i.e. Stochastic MESSAGE, Myopic MESSAGE, MESSAGE-Access), while other relevant models are linked to it to some extent (i.e. from soft to hard link). The various hybrids of MESSAGE make it possible to apply MESSAGE for a broad range of future scenario and policy analysis. The following hybrids exist:

(i) MESSAGE-MACRO: MACRO is a general equilibrium model (it was derived from GLOBAL 2100 and MERGE models) which maximizes the over time utility function of a single representative producer/consumer in each world region and evaluates energy demand. The main variables of the model are capital stock, available labor, and energy inputs, which together determine the total output of an economy according to a CES (Constant Elasticity of Substitution) production function. MACRO's production function includes seven energy service demands which are provided by MESSAGE (residential/commercial thermal, residential/commercial specific, industrial thermal, industrial specific, industrial feed stock, transportation, non-commercial biomass). The primary drivers of future energy demand in MESSAGE are forecasts of total population size and GDP at purchasing power parity exchange rates, denoted as GDP (PPP).

(ii) MESSAGE-MAGICC: MAGICC (Model for the Assessment of Greenhouse gas Induced Climate Change) covers several aspects related to climate change processes. These CLDs do not offer an exhaustive representation of GE3M dynamics. More precisely, MAGICC is a reduced-complexity coupled global climate and carbon cycle model which calculates projections for atmospheric concentrations of GHGs and other atmospheric climate

drivers, like air pollutants, together with consistent forecasts of radiative forcing, global annual mean surface air temperature, and ocean heat uptake. Through the link to MESSAGE it is possible to investigate the impact of different energy pathways on the economic and energy system.

(iii) Linkages to models such as the agricultural model GLOBIOM (Global BIOSphere Management) and the air pollution one GAINS (Greenhouse gas – Air pollution Interactions and Synergies) permit the assessment of other possible effects of energy system developments in other relevant fields. GLOBIOM is a partial equilibrium model which shows the competition between different land use based activities including the agriculture, forestry, and bioenergy sectors. Production adjusts to meet demand for 30 economic regions. GAINS<sup>59</sup> was launched in 2006 as an extension of the RAINS model, which is used to assess cost-effective response strategies for combating air pollution (fine particles and ground level ozone). GAINS gives the historic emissions of 10 air pollutants and 6 GHGs for each country based on data from international energy and industrial statistics. The model may be used in two ways: (i) scenario analysis mode - it follows emission pathways from source to impact; (ii) optimization mode - it identifies where emissions can be reduced most cost effectively.

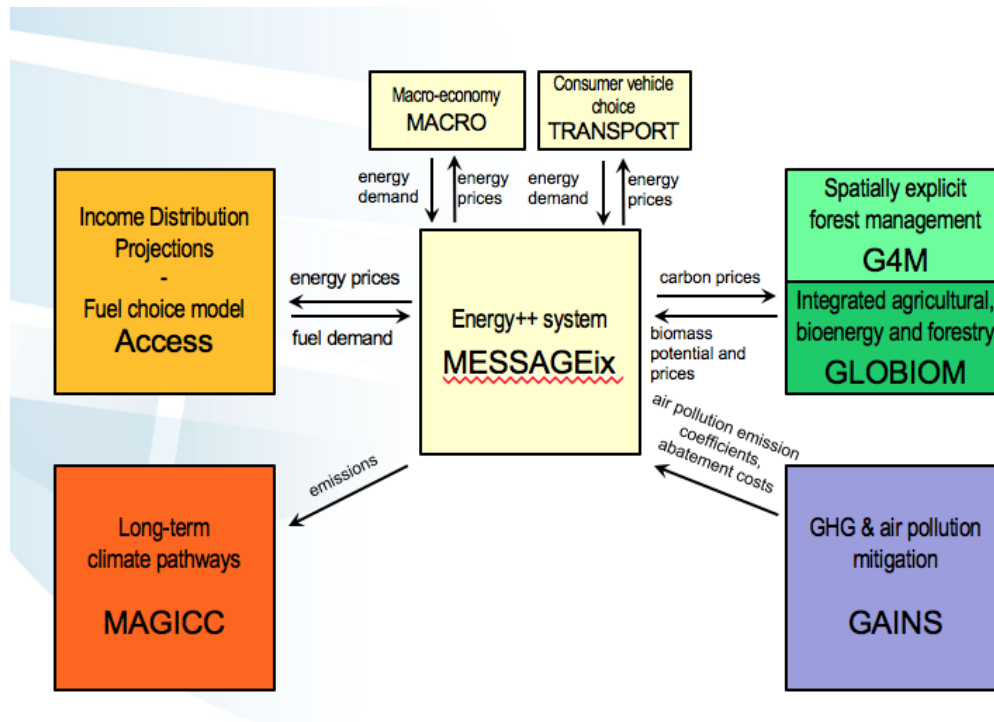
Today, GAINS tools offer three ways to explain policy interventions which have multiple benefits: (1) Cost simulation, (2) Cost-effectiveness analysis to identify lowest-cost packages of measures, (3) Cost-benefit assessments that maximize net benefits of policy interventions.

Despite MESSAGE being originally developed as a bottom-up, technology-rich, supply-side focused model it is used for a wide range of integrated assessments. These assessments are possible because of the continuous development of the model as well as its linkages to other models, covering important aspects related to sustainable (energy) system development.

---

<sup>59</sup> GAINS is used for policy analyses under the Convention on Long-range Transboundary Air Pollution (CLRTAP) e.g. for the revision of the Gothenburg Protocol, and by the European Commission for the EU Thematic Strategy on Air Pollution and the air policy review.

**Figure 3.8:** IIASA Integrated Assessment Framework



Source: Gidden (2018)

## GEM-E3 – a General Equilibrium Model

GEM-3E (General equilibrium Model for Energy Economy Environment), partly funded by the European Commission (DG Research, 5th Framework programme) and by national authorities, is the result of a collaborative effort by a consortium involving National Technical University of Athens (NTUA – E3M lab), Katholieke Universiteit of Leuven (KUL), University of Mannheim, the Centre for European Economic Research (ZEW), and the Ecole Centrale de Paris (ERASME).

The model is used “to examine the potential for the EU to gain a first mover advantage if adopts earlier than others ambitious GHG emissions reduction policies” (Paroussos, 2018, p. 2). GEM-E3 provides details on the macro-economy and its interaction with the environment and the energy system. The model is able to fix the optimum balance of energy demand and supply, atmospheric emissions, and pollution abatement, simultaneously with the optimizing behaviour of agents and the fulfilment of the overall equilibrium conditions.

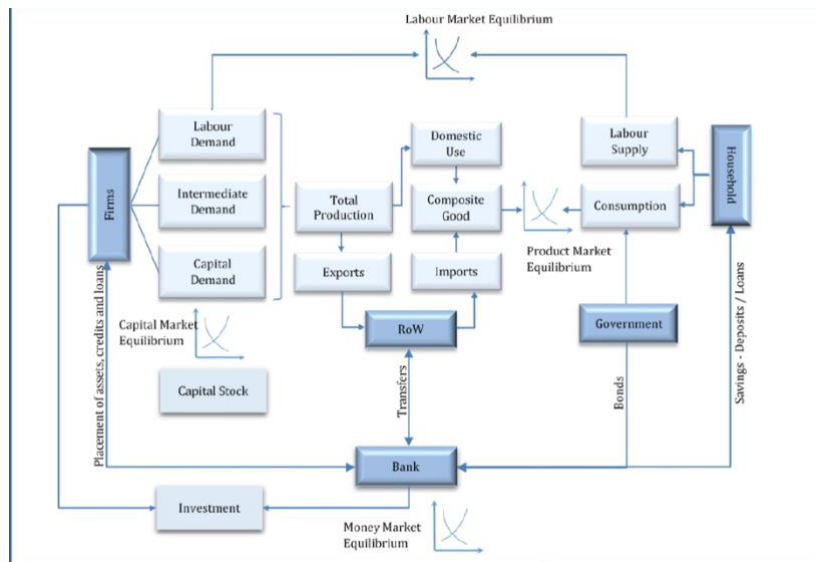
The model calculates the equilibrium prices of goods, services, labour, and capital which simultaneously clear all markets under the Walras Law (Capros, Van Regemorter, Paroussos, Karkatsoulis, 2015). The model follows a computable general equilibrium approach<sup>60</sup>.

<sup>60</sup> The distinguishing features of general equilibrium modelling derive from the Arrow-Debreu economic equilibrium theorem and the constructive proof of existence of the equilibrium based on the Brouwer-Kakutani theorem. The Arrow-Debreu theorem considers the economy as a set of agents, divided into suppliers and demanders, interacting in several markets for an equal number of commodities. Each agent is a price-taker, in the sense that the market interactions, and not the agent, are setting the prices. Each agent individually defines his supply or demand behavior by optimizing his own utility, profit, or cost objectives. The theorem states that, under general conditions, there exists a set of prices that bring supply and demand quantities into equilibrium and fully (and individually) satisfy all agents. The Brouwer-Kakutani existence theorem is constructive in the sense of implementing a sort of trial-and-error process around a fixed point where the equilibrium vector of prices stands. Models that follow such a process are called computable general equilibrium models.

The main features of the model are as follows (Paroussos, 2018):

- it is a global and multi-regional model, treating separately each EU-15 member state and linking them through endogenous trade of goods and services.
- it includes multiple industrial sectors and economic agents, which permits the consistent evaluation of the distributional effects of policies. An economic circuit describes the relations between agents (firms, households, banks, etc) and the main drivers (capital, investment, exportations, importations, consumption, etc).

**Figure 3.9:** Economic circuit of GEM-3E



**Source:** Paroussos (2018, p. 7)

- it covers the major aspects of public finance including all substantial taxes, social policy subsidies, public expenditures, and deficit financing, as well as policy instruments (for environment and energy system). A financial/monetary sub-model is connected to the macroeconomic structure, following the IS/LM methodology.
- it is a dynamic, recursive over time, model, which involves the dynamics of capital accumulation and technology progress (measured by R&D expenditure by private and public sectors), stock and flow relationships, historically-based forecasts and spill-over effects.
- it proposes an explicit description of a detailed financial sector for each country that includes agent specific debt profiles and market clearing interest rates.

### Figure 3.10: Computable General Equilibrium model with financial sector

- Demand for finance: Each agent (in deficit) can receive a loan from domestic capital markets that needs to be repaid in a given time period at a market clearing interest rate
- Supply of finance: Each agent (in surplus) owns a portfolio of financial products with different returns and risks.

| <u>without financial sector</u>  | <u>with financial sector</u>   |
|--|--|
| <ul style="list-style-type: none"> <li>▪ Debt accumulation <u>does not have an impact</u> on the real economy and/or interest rates</li> <li>▪ Depending on the closure rule the <u>financing</u> of an investment project takes place <u>in one period</u> (at the period where the investment products are constructed) and can be financed from the sector, country or abroad.</li> <li>▪ In a given year/period alternative investment projects compete for the same capital resources (<u>crowding out effect</u>)</li> </ul> | <ul style="list-style-type: none"> <li>▪ Agents <u>financing</u> is subject to their <u>financial position</u> (surplus – deficit).</li> <li>▪ Detailed representation of financial products and detailed accounting of the financial position of each economic agent. <u>Book keeping of stock/flow relationships</u> on debt accounting (domestic and external Private and Public debt)</li> <li>▪ <u>Endogenous computation of interest rates</u> for alternative uses of financial resources (deposits, bonds etc.) Use of the endogenous interest rates for <u>rationing financing decisions</u></li> <li>▪ The option to <u>create payback schedules</u> that span over many periods moderates considerably the crowding out effect</li> </ul> |

Source: Paroussos (2018, p. 18)

- it includes also a detailed representation of the power generation system (10 power generation technologies) and discrete representation of the sectors manufacturing clean energy technologies (wind, PV, electric cars, biofuels, etc).

### Figure 3.11 : GEM-E3 model dimensions

|                                 |  |
|---------------------------------|--|
| Countries/regions               | Each of the 28 EU MS, plus 18 other countries/global regions (All G-20 countries individually represented)   |
| Sectors                         | 51 production sectors including detailed representation of transport, power generation and clean energy technologies   |
| Energy users                    | 47 firms by country and households   |
| Fuels                           | Biomass, Ethanol, Bio-diesel, Coal, Crude Oil, Oil, Gas  |
| Emissions                       | All GHGs, both energy and process related  |
| Energy technologies             | Coal fired, Oil fired, Gas fired, Nuclear, Biomass, Hydro-electric, Wind, PV, CCS Coal, CCS Gas  |
| Economic agents                 | Households, Firms, Government, Banks, Foreign Sector   |
| Periodicity and time horizon    | <u>Annual</u> to 2020, five-year time step to 2070, more suited for medium and long-term analysis  |
| Policy applications             | Capable of analyzing a wide range of policy measures (like ETS allowances, carbon taxes, investments in alternative power generation technologies and energy efficiency) |
| External sensitivities          | Global energy prices, policy measures in non-EU countries, different uptake of low-carbon technologies   |
| Model results/impact assessment | GDP, jobs, energy prices, consumer prices, sectoral production, budget deficit, competitiveness, balance of payments, energy use, GHG emissions, welfare                 |

Source: Paroussos (2018, p. 4)

- it includes projections of the Input/Output Table (IOT) for country national accounts, employment, capital, monetary and financial flows, etc based on Eurostat data.

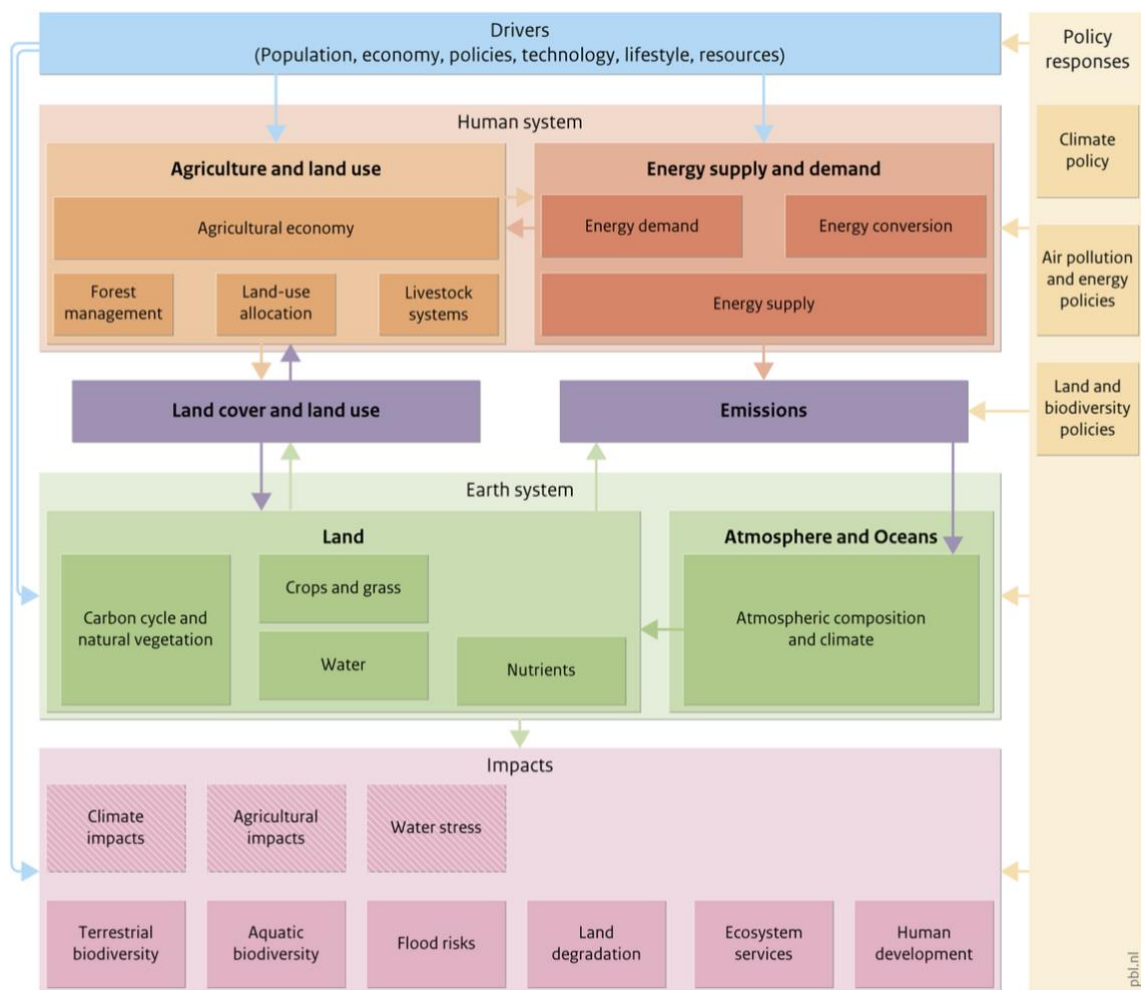
In general terms, the GEM-E3 model covers the general subject of sustainable economic growth and supports the study of related policy issues. Even if the model is based

on economic theory (general equilibrium, price adjustment, carbon tax, emissions permits), it aims to analyse the global climate change issues for Europe, and provides an analysis of distributional effects (distribution among European countries and distribution among social and economic groups within each country).

## IMAGE - a detailed biophysical system

IMAGE (Integrated Model to Access the Global Environment) is an ecological/environmental based model that simulates the environmental consequences of human activities. The first version of IMAGE was developed in the 1980s. Its main goal is exploring interactions between human and Earth systems to better understand how to approach multiple sustainability issues (i.e. climate change, biodiversity loss, human well-being). The objective of the IMAGE model is to explore the long-term dynamics and impacts of the global changes which result from interacting socio-economic and environmental factors (Stehfest et al, 2014). The latest improvements to IMAGE 3.0. focuses on human development and explores the dynamics and trade-offs between different model sectors to reach sustainability goals.

**Figure 3.12:** IMAGE model schematic framework



Source: Stehfest et al., (2014)

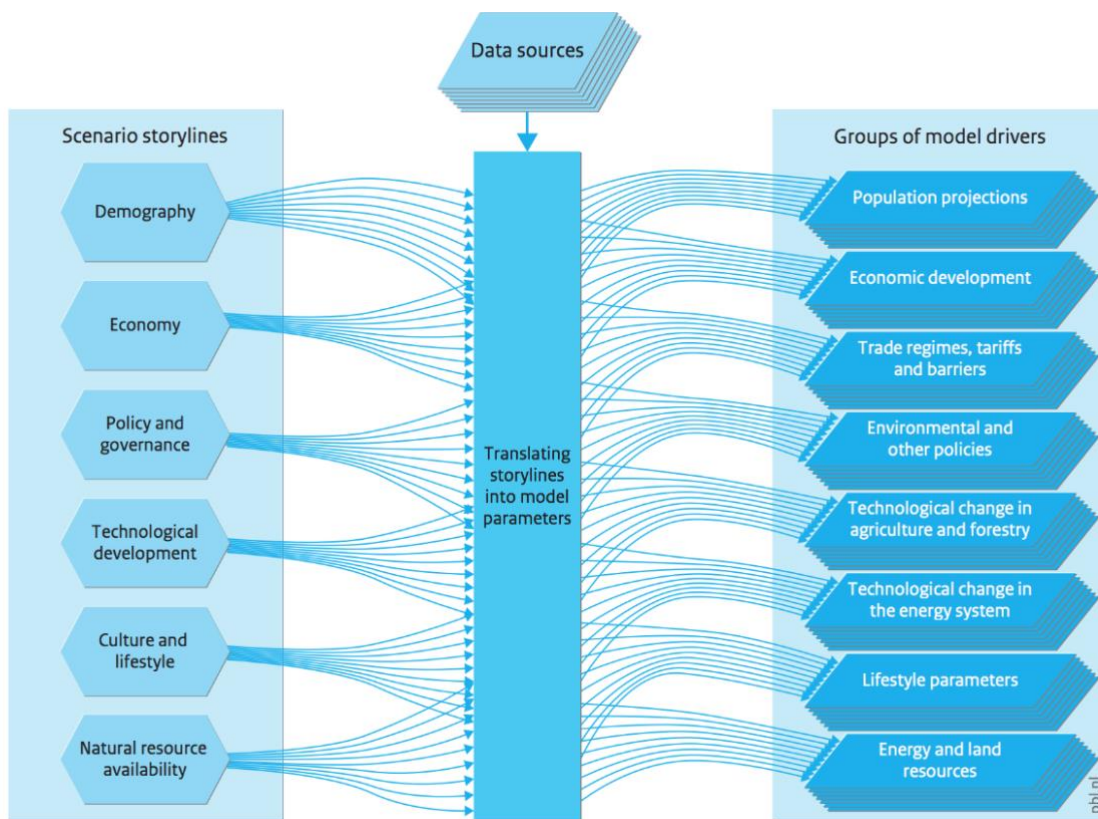


IMAGE is a simulation model, which implies the exploration of simulations of alternative scenarios for human and natural system developments over the long term and communicating them in a participatory setting.

Within the family of the IAMs, IMAGE developers classify the model within the IAM typology as a *Process-oriented energy/land IAM framework*. The models of this type are of an intermediate complexity for the human and the earth systems (van Vuuren et al, 2015).

IMAGE is a global/multi-regional model. It presents 26 world regions for the socio-economic system. Structurally, the model and the its documentation are designed in line with the *DPSIR* framework (Drivers Pressures State Impact Response). There are several models integrated into the IMAGE framework: GISMO (Global Integrated Sustainability Model) – sustainable development model, GLOBIOM – biodiversity model, PIK-LPJmL – land use model, TIMER (the IMAGE Regional Energy Model) – energy model, MAGICC (Model for the Assessment of Greenhouse-gas Induced Climate Change) – climate model.

**Figure 3.13:** IMAGE model scenario storylines



**Source:** Stehfest et al. (2014)

Originally designed to assess the global effect of greenhouse gas emissions, IMAGE now covers a broad range of environmental issues beyond climate change (e.g. land-use change, biodiversity loss, modified nutrient cycles, and water scarcity). Human societies harnessing natural resources to support their development are seen as the systems that put pressure on the earth system and create environmental problems. The authors of the model formulate the uniqueness of the model in the following way: “The unique aspect of IMAGE is that it contains a consistent description of the physical aspects of environmental change, both in the human economy (also in relation to monetary trends) and the earth system. This makes the framework well suited to analyse the impact of individual measures and combined strategies in terms of synergies and trade-offs” (van Vuuren et al., 2015).

The plans for the further development of the IMAGE model aim to make it a useful tool for exploring complex sustainability issues and trade-offs between the human and the

natural systems in the context of the SDGs agenda. The IMAGE scenario section, which is aimed at exploring potential long-term pathways for human and natural system development, contains several main storylines and drivers. There are six main scenario storylines which are translated into the model's parameters. The alternative simulation results based on these scenarios are explored.

IMAGE is aimed at providing an Integrated Environmental Assessment and at being used for policy analysis. The main clients of IMAGE include the Dutch Government, the European Commission, international organizations, such as IPCC, UNEP and OECD, and the research community. In the future, efforts will be made to “*expand this client base to sector and business associations*” (van Vuuren et al., 2015).

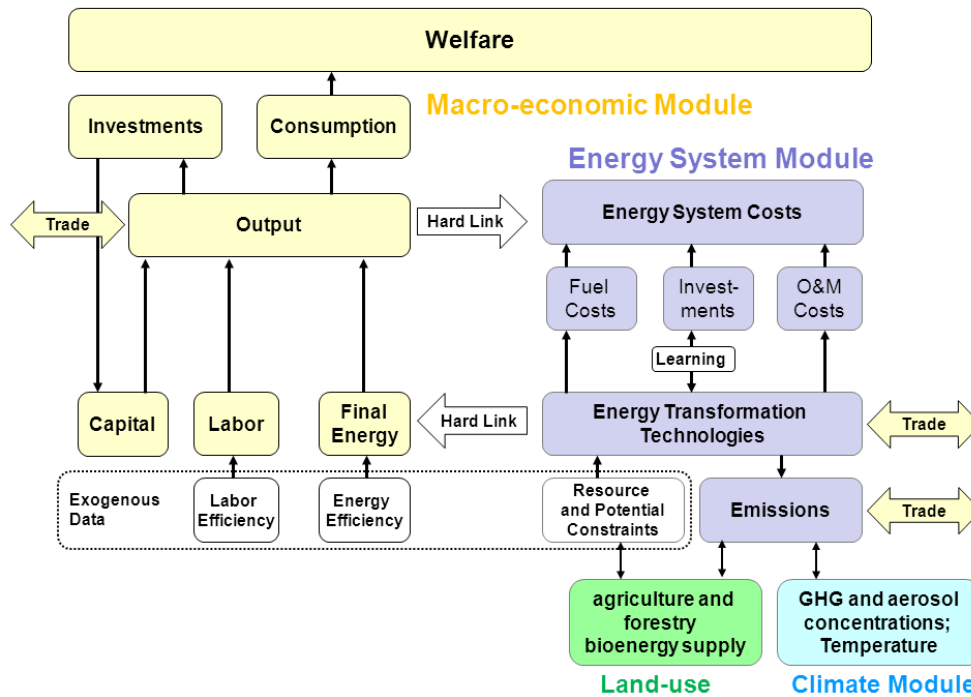
## **REMIND-R - an Economic Growth Model**

REMIND-R is a multi-regional hybrid model which incorporates an economic growth model, a detailed energy system model, and a simple climate model (Leimbach and al, 2010). The existence of interdependency between energy systems and macroeconomic systems over time is the core of REMIND-R (Bauer and al, 2009). Firstly, energy is a production factor in the macroeconomic growth model (MGM), and energy production requires financial means that are accounted for in the budget equation of the macroeconomic model. Secondly, the decision to couple the two systems is based on a “hard link”<sup>61</sup> approach which “integrates the technico-economic constraints of the energy system model (ESM) into the macroeconomic growth model (MGM) as an additional set of functions and constraints and solves one very complex non-linear programming (NKP) program” (Bauer and al, 2009, p. 97).

---

<sup>61</sup> A “soft link” approach separates the two models and integrates a reduced form model the ESM into the MGM resulting in a less complex model.

**Figure 3.14:** Structure of REMIND-R



Source: PIK (2017)

- *The macro-economic system* is a Ramsey-type optimal growth model in which global welfare over time is optimized subject to equilibrium constraints. It takes into account 11 world regions. Each region is modeled as a representative household with a utility function that depends upon per capita consumption.

$$U_r = \sum_t e^{-\rho t} L_t \log\left(\frac{C_{rt}}{L_{rt}}\right).$$

with Population (L), consumption (C) and pure rate of time preference ( $\rho$ ) of 3%. The objective of the REMIND-R model is to maximize a global welfare function that is a weighted sum of the regional utility functions:

$$W = \sum_r n_r U_r.$$

Economic output (gross domestic product, GDP) of each region is determined by a Constant Elasticity of Substitution (CES) function of the production factors, labor, capital, and end use of energy. In each region, GDP is used for consumption (C), investments into the capital stock (I), exports (X), and energy system expenditure (which consists of fuel cost (GF), investment costs (GI), and operation and maintenance cost (Go). Imports of the composite goods (M) increase GDP:

$$Y(t) - X_G(t) + M_G(t) \geq C(t) + I(t) + G_F(t) + G_I(t) + G_O(t)$$

REMIND-R follows the classical results from HOS (Heckscher-Ohlin-Samuelson) theorem and Ricardo's theory of comparative advantages. Trade between regions is induced by differences in factor endowments and technology.

All technologies are represented in the model as capacity stocks. The possibility to invest in different capital stocks provides high flexibility of technological evolution.

With its macro-economic formulation, REMIND-R is similar to the MERGE (Manne and al, 1995) and RICE (Nordhaus, Yang, 1996) models. The only difference is the high technological resolution of the energy system, and the trade relations between regions over time.

- **The energy system model (ESM)** has a detailed description of energy carriers and conversion technologies. Luderer et al (2011, p. 8) insist on the fact that ESM is embedded into the macro-economic growth model: “*the energy system can be regarded as an economic sector with a heterogeneous capital stock that demands primary energy carriers and supplies secondary energy carriers. The structure of the capital stock determines the energy related demand-supply structure. The macro-economy demands final energy as an input factor for the production of economic output. In return, the energy sector requires financial resources from the capital market that are allocated among a portfolio of alternative energy conversion technologies*”.

The primary carriers include both exhaustible resources (coal, gas, oil, uranium) which are characterized by extraction costs that increase over time as cheaply accessible deposits become exhausted and renewable resources (hydro, wind, solar, geothermal and biomass) whose potential are classified into different grades, each grade is characterized by a specific capacity factor. The secondary energy carriers include electricity, heat, hydrogen, other liquids, solid fuels, gases, transport fuel petrol, and transport fuel diesel. The energy system highlights the conversion of primary energy into secondary energy carriers via specific energy conversion technology.

The distribution of energy carriers to end-use sectors forms the interface between the macro-economic model and the energy system model. REMIND-R makes a difference between the stationary end-use sector (industry and residential buildings) and end-use in the transport sector.

- **The climate model** is represented as a set of equations that restrict welfare optimization. The climate system takes account of the impact of greenhouse gas emissions and sulphate aerosols on the level of global mean temperature (Leimbach, 2010). The REMIND-R model has two modes for climate policy analysis: 1. A *business as usual* scenario in which the global welfare function is optimized without constraints, this is a situation where the occurrence of climate change would have no effect on the economy and the decisions of households. 2. A *climate policy* scenario, in which an additional climate policy constraint is imposed on the welfare optimization (the constraint is the limit on temperature). REMIND-R is also able to analyze the impact of carbon tax as a penalty on emissions.

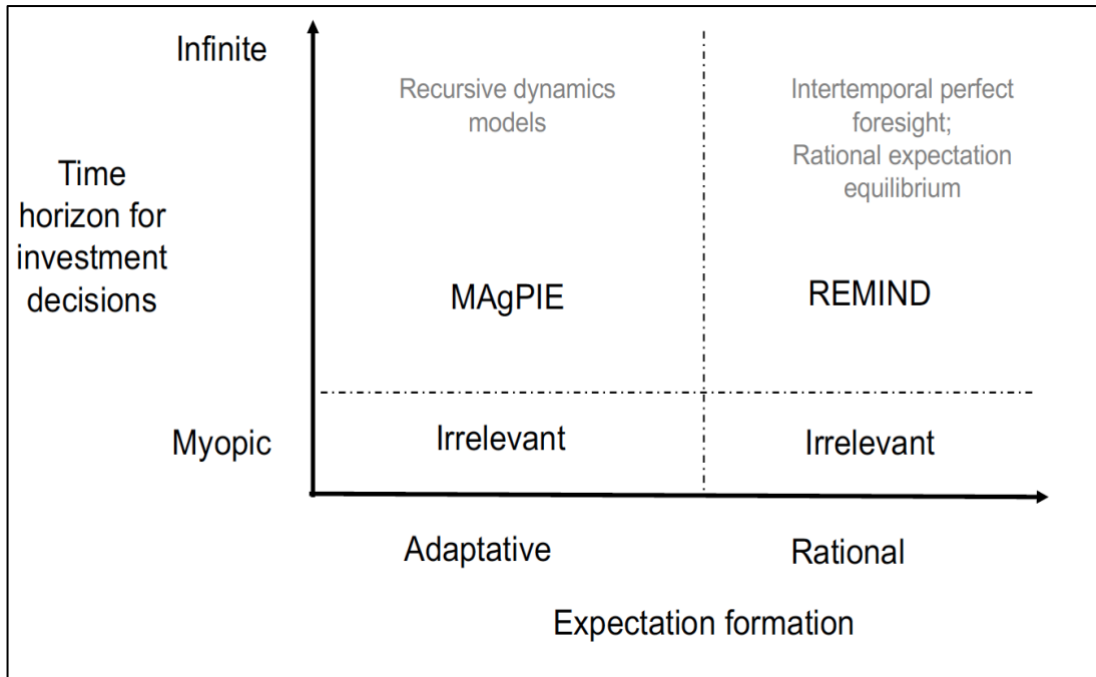
**Table 3.1:** Main characteristics of REMIND-R

| key distinguishing feature  | REMIND - R  |
|---|---|
| Macro-economic core and solution concept                                | Intertemporal optimization: Ramsey-type growth model, Negishi approach for regional aggregation   |
| Expectations/Foresight  | Default: perfect foresight.   |
| Substitution possibilities within the macro- economy/ sectoral coverage | Nested CES function for production of generic final good from basic factors capital, labor, and different end-use energy types  |
| Link between energy system and macro-economy                            | Economic activity determines demand; energy system costs (investments, fuel costs, operation and maintenance) are included in macro-economic budget constraint. Hard link, i.e. energy system and macro-economy are optimized jointly.                    |
| Production function in the energy system / substitution possibilities   | Linear substitution between competing technologies for secondary energy production. Supply curves for exhaustibles (cumulative extraction cost curves) as well as renewables (grades with different capacity factors) introduce convexities.              |
| Land use  | MAC curves for deforestation  |
| International macro- economic linkages / Trade                          | Single market for all commodities (fossil fuels, final good, permits)   |
| Implementation of climate policy targets                                | Pareto-optimal achievement of concentration, forcing or temperature climate policy targets under full when-flexibility. Allocation rules for distribution of emission permits among regions.<br>Other options: Emission caps & budgets, taxes equivalent. |
| Technological Change / Learning   | Learning by doing (LbD) for wind and solar. A global learning curve is assumed. LbD spillovers are internalized. Labor productivity and energy efficiency improvements are prescribed exogenously.  |
| Representation of end-use sectors                                       | Three energy end-use sectors: Electricity production, stationary non-electric, transport  |
| Cooperation vs. non- cooperation  | Pareto: full cooperation  |
| Discounting   | Constant rate of pure time preference (3%)  |
| Investment dynamics   | Capital motion equations, vintages for energy supply technologies, adjustment costs for acceleration of capacity expansion in the energy  |

**Source:** Luderer (2011, p. 3)

Recently, REMIND-R has been improved by work on the scenarios, expectations, and narratives. Problems applying optimization methods have been solved by using the partial equilibrium model (MAGPIE). The formation of expectations plays a key role: adaptive expectations (investors assume current prices to remain constant) vs rational expectations (investors know the models' outcome and form consistent expectations).

**Figure 3.15:** the role of expectations in REMIND-MAgPIE model



**Source:** Bauer (2018)

The applications of REMIND-R are interesting: 1. Analysis of decarbonization pathways in an integrated framework (interrelation of climate policy, trade, renewable resources, and mitigating climate policy), 2. Regional distribution of mitigation costs (cost distribution may be broken down into differences in domestic abatement costs, effects related to shifts in trade volumes, prices of fossil energy carriers, and financial transfers in the context of the global carbon market), 3. Exploration of very low stabilization targets (including technologies and cost reduction), 4. Analysis of best vs second-best mitigation strategies (large number of mitigation options).

## Concluding remarks and challenges

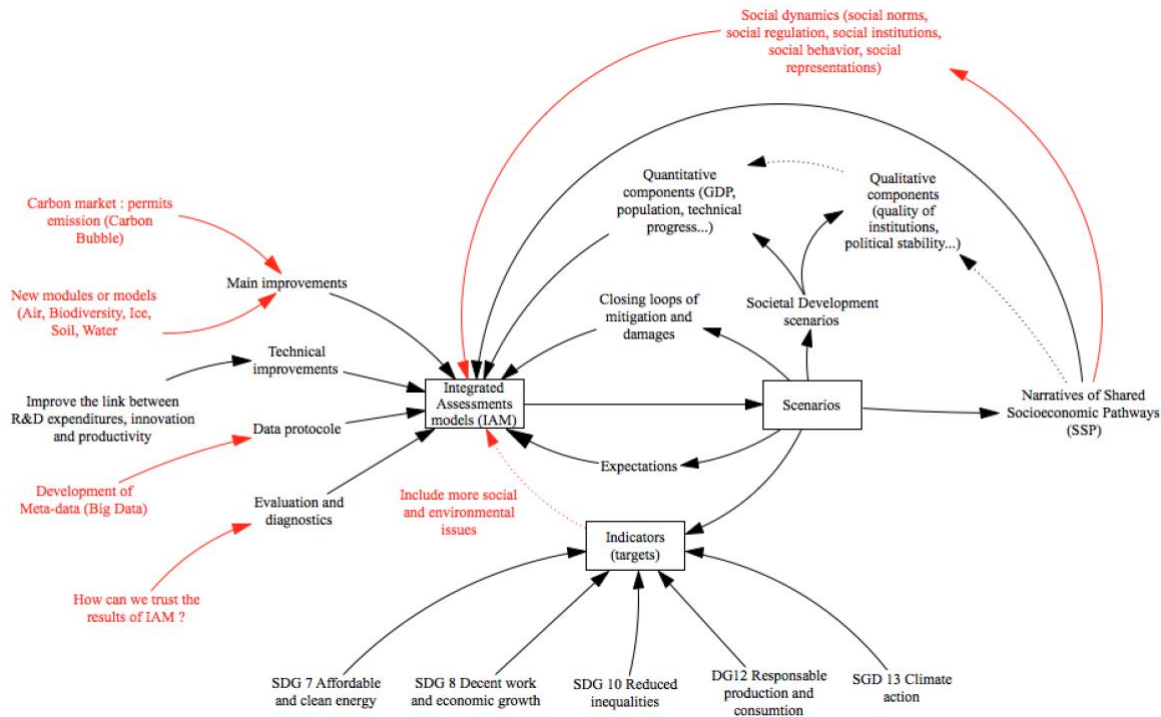
Over the past 20 years, IAMs have succeeded in bringing together a range of international institutions (IIASA, PIK, PBL, CIRED) around the issue of economics, energy, and climate change integration. These models are distinguished both by their structural forms (key variables, scale, representations, etc) and the level of complexity of the systems studied (economic system, energy system, climate system). While the nexus economy/energy/climate constitutes the main framework of the IAMs, it does not exhaust the subject nor the future developments of IAMs. The modular structure of IAMs makes it possible to integrate other nexuses (population/agriculture/food) or (biodiversity/water/air) which are equally important for the future of our societies. Table 3.2 presents many components (goals, macroeconomic structure, scale, type of models) of the different IAMs discussed.

**Table 3.2: Components of IAMs**

| <b>IAM</b>                             | <b>DICE</b>  | <b>MESSAGE</b>  | <b>IMAGE</b>   | <b>GEM-3E</b>  | <b>REMIND</b>   |
|--|--|---|--|--|---|
| <b>Macroeconomic core of the model</b> | Dynamic Optimization Model (Ramsey, 1920)                                      | None but soft-linked to general equilibrium model MACRO   | The economy is represented separately by different model components. The model is not suitable to assess detailed economic impacts, such as sector level impacts | Dynamic Optimization Model   | Dynamic Optimization Model (Ramsey, 1920) Perfect foresight   |
| <b>Goal</b>                            | Estimate the optimal GHG reduction trajectory                                  | Medium- to long-term energy system planning and analysis of climate change policies   | Exploring the long-term dynamics and impacts of global changes that result from interacting socio-economic and environmental factors                             | Examine the potential for the EU to gain a first mover advantage if it adopts earlier than others ambitious GHG emissions reduction policies | Analysis of decarbonization pathways in an integrated framework + regional distribution of mitigation costs |
| <b>Scale</b>                           | DICE – RICE Multiregional model  | National & Multiregional models (11 regions)  | Global (multi-regional)  | Multiregional model (38 regions and 31 sectors)  | Multiregional hybrid model (11 world regions)   |
| <b>Type of model Representation</b>    | Optimization policy  | Optimization policy Domestic resource utilization, energy imports and exports, trade-related monetary flows, investment requirements, types of technologies, pollutant emissions, inter-fuel substitution process | Simulation policy Say how and whether the transition is modelled   | Optimization Policy Economic circuit, energy technologies and GHG emissions  | Optimization Policy Trade in final goods, primary energy carriers, emissions allowance                      |
| <b>Key variables</b>                   | Energy, natural resources, income and population                               | Resource extraction, technology installation, technology activity   | Exogenous scenario drivers (demography, policy and governance, technological development, culture and lifestyle, natural resource availability)                  | GDP, jobs, energy prices, consumer prices, sectoral production, budget deficit   | Production, capital, labor and energy   |
| <b>Economic System</b>                 | Competitive Market Balance Intertemporal optimization of price and consumption | Supply cost minimization  |  | Economic circuit (national account + IOT) Public sector, transport and international trade, financial sector                                 | Economic system is hard linked to the energy system (economic activity results in demand for final energy)  |
| <b>Energy System</b>                   | System combining market mechanisms and economic policies                       | Detailed description of energy supply side and technologies   | TIMER energy model focusing on long-term trends in energy supply and demand  | Energy efficiency and Energy technologies (coal fired... CCS (SCC?) gas)   | Energy system consider exhaustible primary energy resource and renewable energy potentials                  |
| <b>Climate System</b>                  | Climate change is captured by global average temperature                       | Only GHG emissions but linked to climate model MAGICC   | Climate model MAGICC. Emissions beyond GHG are present   | Climate by GHG emissions (energy and process related)  | Carbon Cycle and temperature model  |
| <b>Technology</b>                      |  | Technological learning endogenous   | Endogenously modelled technological learning. Exogenous technological progress effects.  | Modelling technical progress (R&D decision)  | Technological change is exogenously driven  |

Today, the challenges of IAMs seem connected to the new aims of research design. The IAM framework links models, scenarios and indicators, especially Sustainable Development Goals. We can present the debate by the following diagram.

**Figure 3.16: Model – Scenarios and Indicators issues for IAM**



IAMs have to be improved, four possible key additions to IAMs may play roles: *main improvement* (carbon market introduces financial markets in the macroeconomic structure, the equilibrium between saving and investment is not realistic), *technical improvement* (knowledge of technology diffusion, learning curve, evaluation of transport costs, and cross elasticities), *data protocol* (development of spatial data exchange, big data, time series data), and *evaluation and diagnostic* of IAM.

Indicators, like targets, can help to introduce more social and environmental issues - Stakeholders would fix the targets they want to reach; national policies could explain the gap between expectations and results.

Scenarios can be deduced from the structure of IAM - different scenarios give signals about trajectories and pathways. Scenarios depend on basic assumptions (implemented in the model) but are not able to anticipate the future.

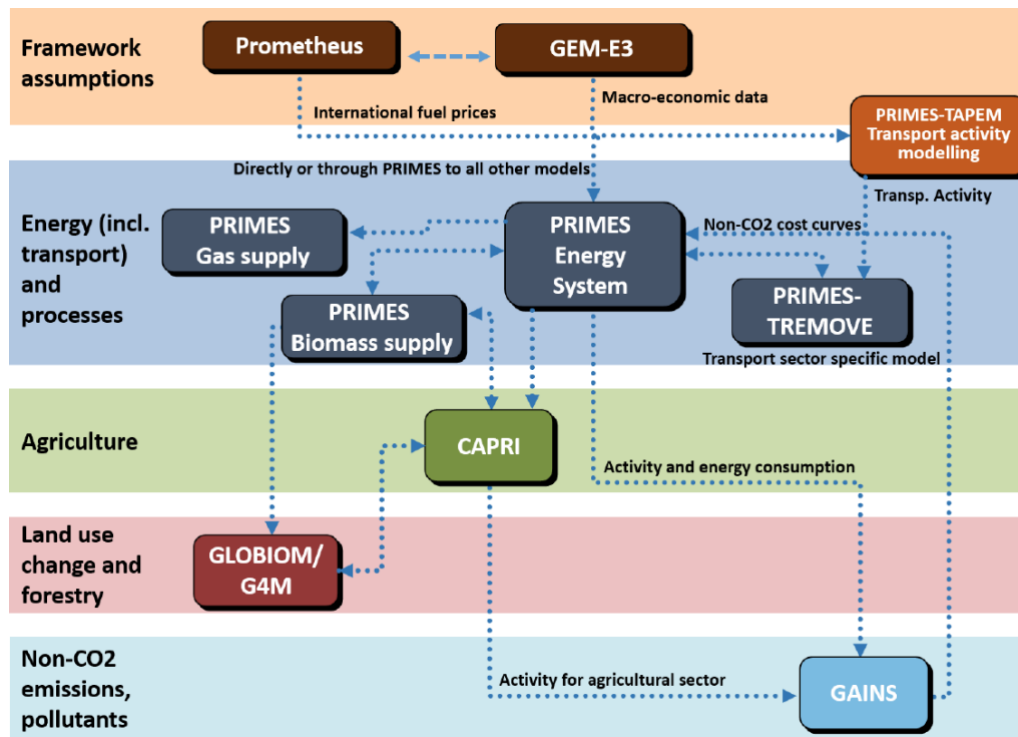
Future uncertainty may be captured by different narratives - these narratives transform qualitative data into quantitative scenarios and engage modelers to propose shared socioeconomic pathways (SSP). Social dynamics (social standards, social institutions, social regulation, social behavior, social representations) may be useful to connect to the narrative of shared socioeconomic pathways and to modify behaviors (reducing energy consumption, water consumption, waste, etc).

In 2007, the Integrated Assessment Model Consortium (IAMC) was created in response to a call from the Intergovernmental Panel on Climate Change (IPCC) for a research organization to lead the integrated assessment modelling community in the development of new scenarios that could be employed by climate modelers in the development of prospective computerized model research for both the near term and long term. In the report EU reference scenario 2016 (Energy, transport and GHG emissions: trends for 2050), the European Commission used a series of interlinked models which combine technical and economic methodologies. The models were used to produce detailed projections per sector and per country. Most of them followed an approach which is based on micro-economics - they



provided answers for a price-driven market equilibrium and combined engineering with economic representations for all sectors.

**Figure 3.17:** Reference Scenario for EU, trends to 2050



The PRIMES modelling suite is the core element for transport, energy, and CO2 emissions projections. The GAINS model is used for non-CO2 emissions projections. The GLOBIOMG4M models are used for LULUCF emission and removal projections. The GE3M macroeconomic model is used for value added (GDP) projections by branch of activity. The PROMOTHEUS global energy model is deployed for forecasts of world energy prices and the CAPRI model for agriculture activity forecasts.

These models were used to provide the fossil fuel price trajectories used for the EU modelling (Prometheus), to prepare consistent sectorial value added and trade projections which match given GDP and population projections by country (GEM-3E), to provide the transport activity projections (PRIMES – TAPEM), to provide the energy system projection for demand and supply side sectors included full energy balance, investment costs, prices and related CO2 emissions per country (PRIMES energy system model), to provide detailed forecasts for changes in the entire transport sector in terms of transport activity by mode and transport means (PRIMES – TREMOVE), to provide the supply and transformation projections of biomass / waste resources (PRIMES – biomass supply), to provide forecasts for gas imports by country of origin (PRIMES - gas supply), to provide an agricultural forecast (especially for livestock and fertilizers use (CAPRI)), to provide non-CO2 GHG and air pollutant emissions (GAINS), and to include the changes in land use and related CO2 emissions (GLOBIOM/G4M). If these models provide background information for international climate policy negotiations, they have started more debate about the evaluation of IAMs or trust in their results, especially when they are used to explain open and complex systems.

## References

- ALCAMO J. (1994), *IMAGE 2.0, Integrated Modelling of Global Climate Change*, Kluwer Academic Publishers.
- ALCAMO J., SHAW R., HORDIJK L. (1990), *The RAINS Model of Acidification: Science and Strategies in Europe*, Dordrecht, Netherlands, Kluwer.
- ALLEN T.F.H, TAINTER J.A, HOEKSTRA T.W (2003°), *Supply Side Sustainability*, Columbia University Press.
- AMBROSI P., COURTOIS P. (2004), « Impacts du changement climatique et modélisation intégrée, la part de l'arbitraire », *Natures, Sciences et Sociétés*, vol 12, 375 – 386.
- BALA G., DUFFY P.B, TAYLOR K.E (2008), « Impact of Geoengineering Schemes on the Global Hydrological Cycle”, *Proceedings of the National Academy of Sciences of the United States of America*, vol 105, n°22, june, 7664 – 7669.
- BARKER T., SERBAN-SCRIECIU S. (2010), “Modeling Low Climate with E3MG: Towards a New Economics Approach to Simulating Energy-Environment-Economy System Dynamics”, *The Energy Journal*, vol 31, Special Issue, January, 137 – 164.
- BLANCHARD E.V. (2011), « L'origine des modèles intégrés du changement climatique », *Recherches internationales*, n°89, janvier-mars, 181-211.
- BAUER N. (2018), REMIND – MAgPIE Model, *CNRS Summer School on IAM*, Clermont-Ferrand, France, june, 59 p.
- BAUER N., BAUMSTARK L., LEIMBACH M. (2012), The Remind-R Model : The role of renewables in the low carbon transformation – first best vs second best worlds, climate change, DOI : 10.1007/s10584-011-0129-2.
- BAUER N., EDENHOFFER O., KYPREOS S. (2008), Linking Energy System and Macroeconomic Growth Models, *Journal of Computational Management Science* 5, 95-117.
- BOUTRON C.F, CANDELONE J.P, HONG S. (1993), « Le plomb dans les neiges et les glaces du Groenland », *Pollution atmosphérique*, Juillet-Septembre, 128-131.
- BRUCKNER T. and al. (2014), Energy Systems. In: *Climate Change 2014: Mitigation of Climate Change. Contribution of Working Group III to the Fifth Assessment Report of the Intergovernmental Panel on Climate Change* [Edenhofer, O., R. Pichs-Madruga, Y. Sokona, E. Farahani, S. Kadner, K. Seyboth, A. Adler, I. Baum, S. Brunner, P. Eickemeier, B. Kriemann, J. Savolainen, S. Schlömer, C. von Stechow, T. Zwickel and J.C. Minx (eds.)]. Cambridge University Press, Cambridge, United Kingdom and New York, NY, USA.
- DALMEDICO D.A. (2007), *Les modèles du futur. Changement climatique et scénarios économiques : enjeux scientifiques et politiques*. Recherche La Découverte.
- DIEMER A., NDIAYE A., GLADKYKH G. (2017), « Le climat, du savoir scientifique aux modèles à intégration assignée », *Revue francophone du développement durable*, n°9, mars, 6 – 52.
- DIEMER A., DIERICKX F., GLADKHYK G., MORALES M., PARRIQUE T., TORRES J. (2017), *European Union and Sustainable Development*, Editions Oeconomia.

- DIEMER A. (2004), « Le développement durable et la dynamique des systèmes », *document de travail*, n°2004/05, HERMES, Université de Reims, 24 mai.
- D'ODORICA P., LAIO F., PORPORATO A., RIDOLFI L., RINALDO A., RODRIGUEZ-ITURBE I. (2010), "Ecohydrology of terrestrial Ecosystems", *BioScience*, vol 60, n°11, December, 898 – 907.
- DOWLATABADI H., MORGAN M.G (1993), « Integrated Assessment of Climate Change », *Science*, vol 259, (5103).
- EUROPEAN COMMISSION (2016), *EU Reference Scenario 2016 – Energy, transport and GhG emissions, trends to 2050*, July 15th, Luxembourg Publications Office, 220 p.
- GIDDENS M. (2018), MESSAGEix, Cutting Edge Research and Challenges, *CNRS Summer School*, Clermont-Ferrand, France, June, 33 p.
- GLADKYKH G., SPITTLER N., DIERICKX F. (2017), "Renewable Energy: Characteristics and Representation in Macroeconomic Energy-Climate Models sources for climate change models" in Diemer A. et al. (eds), *European Union and Sustainable Development*, Editions Oeconomia.
- HA-DONG M., MATARASSO P. (2006), « Comment intégrer l'économie, l'énergie et le climat ? », *Pour la Science*, dossier 52, 92 – 97.
- HOURCADE J.C, LE TREUT H. (2002), *Modélisation intégrée, évaluation des risques climatiques et des politiques de précaution*, CIRED, LMD, SMASH, Rapport de Synthèse, Juillet, 29 p.
- KELLY D.L, KOLSTAD C.D (1999), « Integrated Assessment Models For Climate Change Control » in Folmer H. and Tietenberg T. (eds), *International Yearbook of Environmental and Resource Economics 1999/2000: A Survey of Current Issues*, Cheltenham, UK, Edward Elgar.
- KIEKEN H. (2003), « Genèse et limites des modèles d'évaluation intégrée », *Annales des Ponts et Chaussées*, n°107-108, 84 – 91.
- KNORR W., SCHNITZLER K.G (2006), "Enhanced albedo feedback in North Africa from possible combined vegetation and soil formation processes", *Climate Dynamics*, 26, 55 – 63.
- IIASA MESSAGE 2017. International Institute of Applied Systems Analysis.  
<http://www.iiasa.ac.at/web/home/research/researchPrograms/Energy/MESSAGE.en.html> (accessed October 15, 2018).
- LEIMBACH M., BAUMSTARK L., EDENHOFER O. (2010), Mitigation costs in a globalized world : climate policy analysis with Remind-R, *Environmental Modeling and Assessment*, vol 15, 155 – 173.
- LEIMBACH M., BAUER N., BAUMSTARK L., LUKEN M., EDENHOFER O. (2010), Technological Change and International Trade, Insights from Remind, Special Issue of the *Energy Journal*, vol 31, 109 – 136.
- LUDERER G., LEIMBACH M., BAUER N., KRIEGLER E. (2011), *Description of the REMIND R Model*, <http://www.pik-potsdam.de/research/research-domains/sustainable-solutions/remind-code-1>
- MANNE A.S, MENDELSON R., ROCHELS R.G (1993), "MERGE: A Model for Evaluating Regional and Global Effects of GhG Reduction Policies", *Energy Policy*, vol 23, 17 – 34.

- MANNE A.S, ROCHELS R.G (1990), “CO2 Emission Limits, An Economic Cost Analysis for the USA”, *Energy Journal*, vol 12, 87 – 107.
- MATARASSO P. (2007), « La construction historique des paradigmes de modélisation intégrés : William Nordhaus, Alan Manne et l’apport de la Cowles Commission » in Dalmedico A.D (ed), *Les modèles du futur. Changement climatique et scénarios économiques : enjeux scientifiques et politiques*. Recherche La Découverte.
- MATARASSO P. (2003), « Evaluation intégrée et modélisation du changement climatique », *Annales des Ponts et Chaussées*, 71 – 79.
- MEADOWS D.H, RANDERS J., MEADOWS D. (2004), *Limits to Growth, The 30-year Update*, Chelsea Green Publishing.
- MEADOWS D.H, MEADOWS D.L, RANDERS J. (1992), *Beyond the Limits*, Earthscan Publications Limited.
- MEADOWS D.H, MEADOWS D.L, RANDERS J., BEHRENS III W.W (1972), *The Limits to growth*, Universe Books Publishers.
- MESSNER S., STRUBEGGER M. (1995), User ’ s Guide for MESSAGE III. Laxenburg, Austria.
- MESSNER S., SCHRATTENHOLZER L.. MESSAGE-MACRO: Linking an energy supply.
- NORDHAUS W. (2016), “Projections and Uncertainties About Climate Change in an Era of Minimal Climate Policies”, *Cowles Foundation*, Discussion Paper, n°257, 44 p.
- NORDHAUS W., BOYER J. (1999), “Roll the DICE Again: Economic Models of Global Warming”, Chapter 1, Yale University, October 25, 10 p.
- NORDHAUS W. (1998), *Economics and Policy Issues in Climate Change*, Resources for the Future, New York.
- NORDHAUS W. (1992), “An Optimal Transition Path for Controlling Greenhouse Gases”, *Science*, vol 258, November, 1315 – 1319.
- NORDHAUS W. (1991), “To Slow or not to slow: The Economics of the Greenhouse Effect”, *Economic Journal*, vol 101, 920 – 937.
- NORDHAUS W. (1977), “Economic Growth and Climate: The Carbon Dioxide Problem”, *The American Economic Review*, vol 67, n°1, 341 – 346.
- NORDHAUS W. (1974), « Resources as a Constraint on Growth », *American Economic Review*, vol 64, n°2, May, 22 – 26.
- NORDHAUS W. (1973), « The allocation of energy resources », *Cowles Foundation Papers*, n° 401.
- NORDHAUS W. (1973), “World Dynamics, Measurement Without Data”, *The Economic Journal*, vol 83, n° 332, 1156 – 1183.
- NORDHAUS W., TOBIN J. (1972), “IS Growth Obsolete?”, in Nordhaus W., Tobin J. (eds), *Economic Research, Retrospect and Prospect*, vol 5, *Economic Growth*, NBER, 1 – 80.
- PARSON E.A, FISHER-VANDEN K. (1997), “Integrated Assessment Models of Global Climate Change”, *Annual Review of Energy and Environment*, vol 22, 589 – 628.
- PRUYT E. (2013), *Small Dynamics Models for Big Issues*, Delft Library, The Netherlands.

- RASKIN P., MONKS F., RIBEIRO T., VAN VUUREN D., ZUREK D. (2005), Global scenarios in historical perspective. In: Carpenter, S.R., et al. (Eds.), *Ecosystems and Human Well-Being: Scenarios: Findings of the Scenarios Working Group*. Island Press, Washington, DC, 35–44.
- RIAHY K., ROEHRL R.A (2000), Greenhouse gas emissions in a dynamics-as-usual scenario of economic and energy development. *Technol Forecast Soc Change*, 63, 175–205. doi:10.1016/S0040-1625(99)00111-0.
- ROTHMAN D.S, AGARD J., ALCAMO J. (2007), *The Future Today*, in United Nations Environment Programme, in *Global Environment Outlook 4*. UNEP, Nairobi, 397–454.
- SCHNEIDER S., LANE J. (2005), “Integrated Assessment Modeling of Global Climate Change: Much Has Been Learned – Still a Long and Bumpy Road Ahead”, *The Integrated Assessment Journal*, vol 5, n°1, 41 – 75.
- SCHWANITZ V.J (2013), “Evaluating Integrated Assessment Models of Global Climate Change”, *Environmental Modeling and Software*, vol 50, 120 – 131.
- SHERWOOD S., BONY S., BOUCHER O., BRETHERTON C., FORSTER P., GREGORY J.M, STEVENS B. (2015), “Adjustments in the forcing – feedback framework for understanding climate change”, *Bulletin of the American Meteorological Society*, vol 96, n°2, February, 217 – 228.
- STEHFEST E., VAN VUUREN D., BOUWMAN L., KRAM T. (2014). *Integrated assessment of global environmental change with IMAGE 3.0: Model description and policy applications*. Netherlands Environmental Assessment Agency (PBL). ([http://www.pbl.nl/sites/default/files/cms/PBL-2014-Integrated\\_Assessment\\_of\\_Global\\_Environmental\\_Change\\_with\\_IMAGE\\_30-735.pdf](http://www.pbl.nl/sites/default/files/cms/PBL-2014-Integrated_Assessment_of_Global_Environmental_Change_with_IMAGE_30-735.pdf))
- SOKOLOV A.P and ali. (2005), The MIT Integrated Global System Model 5IGSM), Version 2, Model Description and Baseline Evaluation, Science Global Policy Change, Report n°124, July, 46 p.
- TOL R.S.J, FANKHAUSER S. (1998), “On the Representation of Impact in Integrated Assessment Models of Climate Change”, *Environmental Modeling and Assessment*, vol 3, 63 – 74.
- VAN VUUREN D., KRAM T., STEHFEST, E. (2015). IMAGE STRATEGY DOCUMENT 2015-2020.
- VAN VUUREN D.P, KOK M.T.J, GIROD B., LUCAS P.L, DE VRIES B. (2012), Scenarios in global environmental assessments: key characteristics and lessons for future use, *Global Environ. Change*, 22 (4), 884–895.
- VIEILLE-BLANCHARD E. (2007), “Croissance ou stabilité ? L’entreprise du Club de Rome et le débat autour des modèles », in Dalmedico D.A. (ed), *Les modèles du futur. Changement climatique et scénarios économiques : enjeux scientifiques et politiques*. Recherche La Découverte.
- WALSH K. (1994), « On the Influence of the Andes on the General Circulation of the Southern Hemisphere », *Journal of Climate*, vol 7, n°6, 1019 – 1025.

## 4. Climate change research and implications of the use of near-term carbon budgets in public policy

**Authors and affiliations:** Florian Dierickx<sup>1,2</sup>, Arnaud Diemer<sup>1</sup>

1: Jean Monnet Excellence Center on Sustainability (ERASME), University of Clermont Auvergne, CERDI, Clermont-Ferrand, France

2: University of Iceland, Reykjavik, Iceland

*Book chapter*

**Date:** February 1, 2021

**Book:** I. S. Thakur, A. Pandey, H. H. Ngo, C. R. Soccol, & C. Larroche (Eds.), *Climate Change Mitigation: Sequestration of Green House Gases for Biofuels and Biomaterials*. Biomass, Biochemicals, Biofuels. Elsevier Science, 2021.

**URL:** <https://staging.glose.com/book/biomass-biochemicals-biofuels>

**ISBN:** 9780128236093

### Keywords

Climate change, carbon budget, climate impacts, climate modelling, energy transition, scenarios, climate policy

### Abstract

Climate change modelling and climate policy should be closely linked in order to construct feasible mitigation and adaptation pathways. This chapter aims to reflect some of the major ongoing debates in climate modelling literature and to link those to contemporary climate policy.

For this purpose, first a description is given of key metrics to quantify the historical and future extent of climatic change (radiative forcing, climate feedbacks), the main concepts that are used to evaluate and model the extent of climate change (climate sensitivity, transient climate response) and standardised pathways used by the scientific community to evaluate different possible climate futures (representative concentration pathways and share socio-economic pathways).

To illustrate the need and extent to which adaptation and mitigation measures need to be deployed, a brief overview is given of recent literature on climate impacts, with a focus on the European continent and a case study of the impacts of sea-level rise.

In order to understand the mitigation spaces at our disposal, the chapter continues with a critical overview of key iconic mitigation strategies that have appeared in contemporary climate policy debate in academic literature and news outlets (such as afforestation and geo-engineering).

The chapter concludes with a description of the concept of carbon budgets, including an assessment of the uncertainty related to negative emissions, and touches upon the equity-issue of carbon budget-division between countries.

### Introduction

How to find a balance between mitigation of climate impacts, the degree of adaptation measures and speed of transition towards a carbon neutral economy and society? To find

answers to such a multi-layered question and clarify the (a) speed of transformation needed to transform to a carbon neutral or carbon negative economy and the (b) types of mitigation efforts required in the different sectors of our economy, we need – in order to assess the trade-offs of not implementing stringent or ambitious climate policies – some (1) rudimentary insight in how climatic changes and impacts are foreseen to change over time in response to different emission trajectories, and – in order to understand the “mitigation spaces” at our disposal – an (2) understanding of the feasibility of different mitigation options. Although there is a strong and solid knowledge base to conclude on the unprecedented rate and magnitude of a changing climate, we should at the same time acknowledge significant degrees of remaining uncertainty, specifically related to quantifications of future emission and transition trajectories.

Without pretending to constitute an extensive review and state-of-the-art climate science and impact review, this chapter aims to give a brief overview of the key metrics to evaluate the extent of climate change, how climate models are used to quantify those, the estimated projected impacts of different emission scenario’s, the feasibility and relevance of using global carbon budgets in designing emission trajectories and finally, some policy implications of the findings related to the different “mitigation spaces” at our disposal. It is accompanied with an interactive national carbon emission budget simulation tool [1]<sup>62</sup>.

With these purposes in mind, this chapter is divided in five parts. In order to understand how the climate system works from a physical point of view, first a broad description is given of the basic principles of climate change and standard metrics used in the literature to quantify changes in climate, including a brief outline of the importance of considering climate feedbacks in estimating these metrics. Secondly, a generic overview will be given of recent advances in climate modelling, as these models are the scientific tools at our disposal to estimate these metrics and model the effects of future greenhouse gas (GHG) emission- and concentration-trajectories. Thirdly, to shed light on the urgency of acting on climate change, an overview is given of a selection of major climate impacts. The fourth part discusses whether we can rely on climate mitigation solution proposed in recent discourse. The fifth part debates the usefulness of carbon budgets for public policy and finally, the sixth and final part discusses the dynamic trade-offs that will have to be sought between emitting a certain quantity of carbon emissions (carbon budgets) and the speed of change of industrial and societal transformation of different sectors and activities of our society, in relationship to projected impacts for different emission scenarios.

The content in this chapter is derived from reports of the IPCC and a broad range of climate change research literature. The chapter on climate modelling is to a great extent based on the information provided through the EU Copernicus Climate Change service. Where relevant, recent developments of the 6th phase of the Coupled Model Intercomparison Project (CMIP6) and reporting from the IPCC 6th Assessment Cycle, such as the Working Group I (WGI), Working Group II (WGII) and Working Group III (WGIII) contributions to the 6th Assessment Report (AR6) – at the time of writing under review for release in 2021 – IPCC special reports such as the special report on global warming of 1.5 °C [5] have been integrated.

Because of the clear proof of concept of the relatively simple principle of remaining carbon budgets associated with different emission (and therefore warming) trajectories, this concept occupies a central role in the course of the chapter, while at the same time acknowledging the shortcomings of the concept.

---

<sup>62</sup> The interactive carbon emission budget simulation tool is available online at <https://emission-budgets.herokuapp.com>. The code of the tool is open source and publicly [accessible and editable on GitHub](#). It is based on static calculations from data from Stefan Rahmstorf [2], extended with EDGAR JRC historical national country fossil CO<sub>2</sub> emission series [3] and World Bank population data [4].

## Standard metrics to quantify and compare the extent of changes in climate

The increased accumulation of greenhouse gases (GHGs) in the atmosphere changes the atmosphere's radiative properties. Since the Industrial Revolution, the main driver of change in radiative properties of the atmosphere is the release of human-induced carbon dioxide (CO<sub>2</sub>) emissions. The CO<sub>2</sub> concentration of the atmosphere is both directly determined by anthropogenic emissions and indirectly through land use practices, land use change and forestry (LULUCF), as well as biogeochemical source-sink interactions in the earth system that affect the exchange between carbon reservoirs. A good understanding of those mechanisms is necessary to quantify different mechanisms that could either lead to an acceleration, slowdown or abrupt transition in the rate of GHG accumulation. In the following, focus will be on two metrics that – on an aggregated level – are commonly used to quantify climatic changes and serve as standard metrics to compare different climate and earth system-models, or to discuss interactions in the climate system resulting from a change in GHG concentration. Three principal metrics will be discussed: recent Radiative Forcing (RF) [6] estimates – influenced by natural and anthropogenic drivers, (Effective) Climate Sensitivity (ECS) and Transient Climate Response (TCR).

### Radiative forcing and an appraisal of climate feedbacks or tipping points

A central notion in assessing the impacts of different types of GHGs on the climate system is the concept of radiative forcing or climate forcing, which quantifies how anthropogenic activities or natural processes perturb the flow of energy into and out of the Earth or climate system. It can be defined as the 'net change in radiative flux, expressed in W m<sup>-2</sup>, at the tropopause or top of the atmosphere due to change in a driver of climate change' [7].

Radiative forcing is thus a quantification of the difference between the radiation absorbed by the Earth and the energy radiated back to space. Otherwise stated, it represents the imposed perturbations to the Earth's energy balance. A positive forcing warms the climate and increases the thermal emissions to space until a balance is restored, a negative forcing cools the climate.

Radiative forcing can be estimated in different ways for different components, and depends on different factors. In general, the forcing strength of a process that influence the climate is expressed as a quantity of radiative forcing (RF, W m<sup>-2</sup>) over a period of time. Forcing values are rather straightforward to conceptualize, model and verify based on historical timeseries, but they are harder to model into the future because they can't be verified. Work is ongoing to refine and improve forcing estimates continuously, for example under the umbrella of the ongoing Detection and Attribution Model Intercomparison Project (DAMIP)<sup>63</sup>.

In subsequent IPCC reports, estimates of historical radiative forcing values always start from the year 1750 [6], with the exception of the First Assessment Report (FAR; 1765). Since the last AR5 synthesis report in 2013 — the concept of effective radiative forcing (ERF, W m<sup>-2</sup>) is used. The difference between RF and ERF manifests itself in the modelling process. While RF is calculated while keeping all surface and tropospheric variables fixed, the ERF value represents the radiative forcing when other physical variables in the modelled climate system — except those concerning the ocean and sea ice — are allowed to adjust. The ERF values are significantly different from RF values for anthropogenic aerosols because of the influence of aerosols on clouds and on snow cover, but they are argued to be a better

---

<sup>63</sup> Outcomes and background information of the DAMIP project can be found at <http://damip.lbl.gov/about>



representation of reality [8]. An overview of RF and ERF values over the industrial era (1750 to 2011) for different anthropogenic and natural mechanisms is given in Table 1. The main factors affecting the energy balance of the earth can be natural – orbital forcing, solar forcing and volcanic aerosol forcing – and anthropogenic – GHG forcing, short-lived gas forcing and land use and land cover changes forcing.

#### *Natural drivers: orbital, solar and volcanic aerosol forcing*

Changes in solar irradiance and orbital changes result in a certain level of solar forcing, a change in the average amount of solar energy absorbed per square meter. The incoming solar energy is measured by the total solar irradiance ( $\text{W m}^{-2}$ ) or solar constant. Although not an official physical constant<sup>64</sup>, the term ‘constant’ is sometimes used because variations in solar irradiance over the 11-year solar cycle are only in the order of 0.1 % [9]. Until the 90s, climate models used a solar constant of  $1365.4 \pm 1.3 \text{ W m}^{-2}$ , but this has been revised in 2011 to  $1360.8 \pm 0.5 \text{ W m}^{-2}$  [10]. Natural variability in solar forcing is induced by orbital cycles, also termed Milankovitch cycles. Those arise either from changes in the amount by which the orbit of the earth around the sun deviates from a perfect circle (eccentricity, cycle  $\pm 100\,000$  years), differences in the Earth’s tilt angle on its axis (obliquity, cycle  $\pm 40\,000$  years) and differences in the angle of rotation of the earth (precession, cycle  $\pm 20\,000$  years) [11]. Both solar and orbital cycles manifest themselves over geological timescales, and have thus only a very marginal influence on the current climate compared to different types of anthropogenic forcing.

The total increase in solar forcing over the last ~420 million years is calculated to be around  $\sim 9 \text{ W m}^{-2}$  [12]. However, this forcing was almost completely negated by a long-term decline in atmospheric  $\text{CO}_2$  over this period, likely due to silicate-weathering negative feedback and the expansion of land plants [12]. Over the industrial era, solar forcing has contributed to an increase in radiative forcing of  $+0.05$  ( $0.0$  to  $+0.10$ )  $\text{W m}^{-2}$  (Table 1).

In contrast to this long-term solar forcing mechanism, the main natural external forcing that has short-term effects on the total climate forcing are volcanic eruptions. When volcanoes erupt, they both release mineral particles and sulphate aerosol precursor gasses such as  $\text{SO}_2$  [8]. Those sulphate aerosols have been the main cause of abrupt and considerable changes in radiative forcing during the pre-industrial climate change of the last millennium. Because of the irregular nature of volcanic eruptions, it is only informative to calculate climate forcing of specific eruption events, unless they constitute a sustained long-term eruption event. Because the magnitude of radiative forcing resulting from volcanic eruptions vary considerably and can’t be controlled in the context of mitigation or adaptation actions, focus will be on those mechanisms that are interlinked with the natural and anthropogenic world.

Warming resulting from solar (and volcanic) forcing needs to take account of the percentage of solar irradiance that is reflected back to space (reflectivity, or albedo, of the earth  $R$ ). The albedo is mainly affected by either changes in ice and snow surfaces (for example, black carbon aerosols deposited on snow and ice) changes in land use, which in recent history respectively resulted in a radiative forcing of  $+0.04$  ( $+0.02$  to  $+0.09$ ) and  $+0.04$  ( $+0.02$  to  $+0.09$ )  $\text{W m}^{-2}$  (Table 1).

#### *Anthropogenic drivers*

Anthropogenic influences on the climate can be categorized in three main forcing categories: well-mixed greenhouse gasses forcing, short-lived gas forcing (both affecting outgoing radiation) and forcing induced by changes in land use and land cover (affecting the albedo).

---

<sup>64</sup> Official physical constants are defined by the Task Group on Fundamental Constants (TGFC) of the Committee on Data for Science and Technology (CODATA).

The four most important greenhouse gases are carbon dioxide (CO<sub>2</sub>), methane (CH<sub>4</sub>), dichlorodifluoromethane (CFC-12) and N<sub>2</sub>O, in that order [8] (Table 4.1).

The concentration of carbon dioxide increased since the onset of the Industrial Revolution from around 278 (276–280) ppm in 1750 [8] to a current maximum of 415 ppm [13]. In Figure 4.1, it can be seen that this increase in carbon dioxide concentration started accelerating considerably in the second half of the 21st century. In the last 800 000 years, before anthropogenic interference, carbon dioxide concentrations in the atmosphere have fluctuated between 170 and 280 ppm (Figure 4.1). This variability can be mainly explained by fluctuations in the amount of solar irradiance that is captured on the Earth due to orbital obliquity and precession changes, although uncertainty remains on the relative importance of each of those processes [14]. Recent analysis of soil carbonates from the Loess Plateau in central China suggests that carbon dioxide concentrations averaged around 250 ppm in the last 2.5 million years and that that an exceedance of 320 ppm did never happen over this extended period [15]. This period goes back in time beyond the existence of the Homo erectus, which is dated to have originated at around 2.1 to 1.8 million years ago [15].

On a much shorter timeframe, carbon dioxide concentrations also fluctuate intra-annually because of seasonal dynamics in the biosphere. Compared to previous observations from the 50s and 60s, this intra-annual seasonal variation of carbon dioxide concentration has increased with around 50 %, because of a growing imbalance between growing season and dormant season trends in the Northern hemisphere due to climate change [16].

The strong increase in fossil CO<sub>2</sub>-emissions since the Industrial Revolution – currently emitted a rate of around  $36.6 \pm 1.8^{65}$  GtCO<sub>2</sub> per year [17, 18] – combined with the effects of land-use changes – estimated at around  $5.5 \pm 2.6$  GtCO<sub>2</sub> [19]<sup>66</sup> (Figure 4.1), caused global CO<sub>2</sub> concentrations to increase with around 20 ppm per decade since the year 2000, which is up to 10 times faster than any sustained rise in CO<sub>2</sub> during the past 800,000 years [21]. Based on an estimated emission rate of less than 4 GtCO<sub>2</sub> per year during the period which is currently known to have had the highest carbon release rate since the Paleocene-Eocene Thermal Maximum (PETM), it could be concluded that the current yearly emission rate of CO<sub>2</sub> into the atmosphere did never occur since 66 million years [22]. Over the last 800 000 years, CO<sub>2</sub> concentrations and temperature are proven to be well correlated [23]. A recent compilation of the existing Holocene proxy temperature time series [24] brings additional evidence for this correlation, proving that the current global mean surface temperature has never been as warm as today compared to 12 000 years ago.

As mentioned before, the second and third most important greenhouse gasses are methane (CH<sub>4</sub>) and nitrous oxide (N<sub>2</sub>O), of which concentrations have been rising respectively from  $722 \pm 25$  ppb in 1750 to  $1803 \pm 2$  ppb by 2011, and from  $270 \pm 7$  ppb in 1750 to  $324.2 \pm 0.1$  ppb in 2011 [8].

The combined effect of the drivers described above result in an Earth's energy imbalance (EEI), defined as the difference between incoming solar energy and outgoing thermal infra-red radiation emitted to space<sup>67</sup>. A well-known result is the increase in global surface temperatures since the Industrial Revolution (Figure 4.3) [25], because it is directly related to increased climate impacts and risks [26]. The global mean surface temperature (GMST) in the decade from 2006 to 2015 is about  $+0.87$  °C ( $\pm 0.10$ °C) above the average pre-industrial (1850 – 1900) temperature value, reaching about  $+1.00$  °C ( $\pm 0.2$ °C) in 2017 [27].

---

<sup>65</sup> The error range represents a  $\pm 1$  sigma error (68 % chance of being in the range provided).

<sup>66</sup> For a comprehensive review of compilation routines and main differences between the major global fossil CO<sub>2</sub> emission datasets, see source [20].

<sup>67</sup> Recent advances in understanding of the Earth's Energy Imbalance were discussed during a WCRP Workshop in November 2018 ([workshop website](#)). Insights and results will be published in a forthcoming special issue in the Journal of Climate in 2020 ([special issue website](#)).

Important to note is that the oceans captured around 90 % of the additional energy (energy surplus) that accumulated in the atmosphere because of rising carbon and other GHG concentrations [28]. Over the period 2005-2010, the energy distribution of heat uptake from the atmosphere is distributed to 71 % in the upper ocean, 12 % in the Southern ocean, 8 % in ice mass, 4 % on land [29] and 5 % in the Abyssal oceanic zone<sup>68</sup> [30]. Because of ocean heat uptake dynamics, the GMST tend to fluctuate over decennial periods<sup>69</sup> [31]. The degree of efficiency of ocean heat uptake over time – both horizontally and vertically – explains for a large part the decadal variability in surface temperature [32]. Two important ocean dynamics explain a large part of this variability: the Atlantic Multidecadal Variability (AMV) and the Interdecadal Pacific Oscillation (IPO) [15, 33]. Because of the dynamic interdependencies between ocean temperature (and therefore surface temperature) due to differing heat uptake rates and GMST, the effect of an energy imbalance because of rising GHG concentrations – although temperature rise is the most tangible effect of climate change – is historically most clearly and constantly reflected in a measure of mean sea level rise (see also part 1.4.1 below on climate impacts), although this effect plays out over a longer time horizon due to the lag in ice-melt.

The existence of these dynamic effects and impacts with considerate time-lags imply that there is not one single metric (such as GMST) that can help to monitor the degree of climate change, but instead a variety of historical observations of different physical properties of the Earth (ocean temperature, surface temperature, ice sheet dynamics, etc.) need to be taken into account to provide a full picture of the changes that have occurred in the past and will occur in the future.

### **Climate feedbacks or tipping points**

As the cited forcing values in Table 4.1 [8] only constitute historical forcing mechanisms and do not cover all possible future (feedback) mechanisms, the question could be raised how the magnitude of potential additional climate feedbacks relate to historically calculated forcing values and whether they could amplify or accelerate the total combined warming in future scenarios, as has been regularly discussed in the last decade and has recently been referred to as a potential “Hothouse Earth” trajectory [34], whereby multiple biogeochemical feedbacks (such as permafrost thawing, relative weakening of land and ocean physiological carbon sinks, increased bacterial respiration in the ocean, amazon forest dieback and boreal forest dieback) are argued to have the potential to cause an additional 0.47 (0.24–0.66) °C temperature rise by 2100 [34] on top of the ‘traditional’ warming estimates. Although the risks and consequences of different climate feedback mechanisms over a multi-millennial horizon for different short-term contemporary emission trajectories are fairly well understood [35], the question remains how to evaluate mid- to long-term feedbacks. Considering the unmatched rise in carbon concentrations – see Figure 4.1 and earlier description of carbon concentration evolution and emission rates, possible future feedback mechanisms are an important aspect but remain difficult to quantify without a counterfactual historical verification on a shorter and more policy-relevant timeframe.

---

<sup>68</sup> The Abyssal oceanic zone is the part of the ocean between 3 and 6 km depth.

<sup>69</sup> Because of ocean heat uptake dynamics, the growth in GMST stalled to some extent over the period 1998 – 2014 (Figure 4.3), and has therefore sometimes (wrongly) be named the ‘climate hiatus’.

# Climate models

## Climate sensitivity, equilibrium climate sensitivity and transient climate response

Climate forcing values are used in climate models to derive estimates of climate sensitivity. Climate sensitivity is “the change in annual global mean surface temperature (GMST) in response to a change in the atmospheric CO<sub>2</sub> concentration or other radiative forcing” [7], expressed in °C. Otherwise stated, the climate sensitivity parameter is the equilibrium change in annual GMST following a unit of change in radiative forcing.

The climate sensitivity is the change in steady state or surface temperature ( $\Delta T_s$ , expressed in °C) – corrected with a feedback factor  $\lambda$  (expressed in  $(\text{W m}^{-2}) \text{ } ^\circ\text{C}^{-1}$ ) – resulting from a given radiative forcing ( $\Delta F$  expressed in  $\text{W m}^{-2}$ ). The sum of radiative forcing  $F$  and the corrected change in steady state temperature equals to the net top of atmosphere energy balance  $N$ :

$$N = F + \lambda \Delta T_s$$

To be able to compare different climate models and aggregate modelling results, standard measures are required. One of the main methods to categorize and compare the behavior of different models is to calculate the equilibrium climate sensitivity (ECS). The ECS is a measure that quantifies the ‘equilibrium global mean sea surface temperature change following a doubling of atmospheric CO<sub>2</sub> concentration, allowing for the climate system to equilibrate’ [36].

At equilibrium, the energy balance  $N$  is equal to zero. In this case – for a given forcing  $F$  associated with a doubling of atmospheric CO<sub>2</sub> – the temperature change is termed ‘equilibrium’ climate sensitivity (ECS)  $\Delta T_s$ :

$$\Delta T_s = \frac{-1}{\lambda} F$$

Because in reality it takes a long time for the climate system to achieve an equilibrium or, more strongly formulated, because the climate will never be in equilibrium [37] (because of, for example, deep ocean heat uptake dynamics [28, 30] or cloud feedbacks [38, 39]), a second concept is introduced to estimate a more realistic temperature response to rising GHG concentrations: the transient climate response to cumulative carbon emissions or transient climate response (TCR).

The TCR relates the ratio of temperature change to a cumulative amount of carbon emissions (the net carbon remaining in the atmosphere after accounting for relevant sources and sinks) by increasing the carbon concentration at a rate of 1% per year and examining the response at the time when carbon dioxide concentration has doubled<sup>70</sup>. The TCR value is argued to be a better representation of reality, because it allows the models to account for long term dynamics to stabilize, instead of modelling an instantaneous change of concentration changes [37] which is not plausible in the real world. Considering real-world interpretation and reliability of model-comparison, the TCR is considered to be the most reliable indicator. Despite the physical implausibility of a sudden strong increase of carbon dioxide, the ECS is a helpful indicator to compare and debate climate model structures and its relationship to the TCR [37].

---

<sup>70</sup> At a rate of 1% per year, doubling of the carbon concentration takes 70 years.

Because the effects of a doubling of CO<sub>2</sub> concentration in the atmosphere are not straightforward to analyze and quantify in the real world, climate models come into play.

### **Quantifying (equilibrium) climate sensitivity and transient climate response**

Climate models describing the climate, atmospheric and biogeochemical system interactions are used to compute standardized equilibrium climate sensitivity and transient climate responses. Climate models use the above described standardized increases in carbon concentrations to analyze possible future changes in climate. The global and regionally differentiated temperature responses manifest themselves relatively linear to increases in carbon concentrations, although there are strong regional variations such as large increases in the Arctic [40].

Previously calculated and consolidated average ECS typically range between 2 to 5 °C, while the TCR is smaller and fluctuates more in the range of 1 - 2.5 °C [41]. It should be noted however that a subset of recent ECS values of the ongoing collective CMIP6 modeling effort by the climate modeling community is much higher than those obtained during the CMIP5 model intercomparison phase (in the order of 1.8 to 5.6 °C [37]). In addition to these inter-model disparities, differences between historical and modeled ECS values have been observed as well [42]. The range of different modelled TCR values in the ongoing CMIP6 intercomparison nevertheless did remain fairly constant compared with the CMIP5 intercomparison project<sup>71</sup> [37], indicating a change in model properties rather than an alteration of the more realistic TCR value estimation. However, a fundamental issue remains in that the TCR value for zero or negative emissions (projected to be needed by the end of the century in order to remain within established carbon budgets) remains rather uncertain, both concerning uncertainties in land and ocean carbon sinks [44] and long-term dynamics of equilibrium response to forcing [45].

When converting the TCR and ECS values into the ratio TCR/ECS, it provides a measure of the fraction of committed warming already realized after a steady increase in radiative forcing [46] or, otherwise stated, a quantification of for how long global warming will continue after anthropogenic CO<sub>2</sub> emissions have ceased [47]. This ratio is called the realized warming fraction (RWF). The size of RWF thus depends on the magnitude of certain delays in the climate system. A notable example of such a delay is the heat uptake in the ocean, which slows down the effect of a sudden halt in carbon emissions.

### **The transition from standardized Representative Concentration Pathways (RCPs) to Shared Socio-Economic Pathways (SSPs) as a baseline for climate modeling**

Going beyond standardized physical modelling of changes in radiative forcing of certain drivers in response to changing concentrations, the climate modelling community uses Representative Concentration Pathways (RCPs, mainly used in the CMIP5 intercomparison – see further) and subsequent socio-economic narratives (Socio-Economic Pathways, SSPs [48, 49], mainly used in the ongoing CMIP6 intercomparison) to explore and compare broader trade-offs and plausible future scenarios and climate impacts [50, 51].

The four major RCPs are RCP2.6 – developed by the IMAGE modeling team at the Netherlands Environmental Assessment Agency [52], RCP4.5 – developed by the MiniCAM modeling team at the Pacific Northwest National Laboratory's Joint Global Change Research Institute (JGCRI) [53], RCP6.0 – developed by the AIM modeling team at the National Institute for Environmental Studies (NIES) Japan [54] and RCP8.5 – developed by the

---

<sup>71</sup> A good overview of the current CMIP5 and CMIP6 estimates of both ECS and TCR values can be found in the supplementary information of reference [43].

MESSAGE modeling team and the IIASA Integrated Assessment Framework at the International Institute for Applied Systems Analysis (IIASA). RCPs constitute well-defined and characterized concentration pathways of the main GHGs [51] and are named after their range of radiative forcing values in the year 2100 relative to pre-industrial values (+2.6, +4.5, +6.0 and +8.5 W m<sup>-2</sup>).

RCP2.6 is a pathway where radiative forcing peaks at approximately 3.1 W m<sup>-2</sup> mid-century and then declines to around 2.6 W m<sup>-2</sup> by 2100, probably leading to an average temperature increase of 2 °C by the end of the century [52]. RCP4.5 [53] and RCP6.0 are intermediate pathways in which radiative forcing is limited by approximately 4.5 W m<sup>-2</sup> and 6.0 W m<sup>-2</sup>, and RCP8.5 – sometimes referred to as the ‘worst case’ pathway where few measures are taken and few technological breakthroughs are used – leads to more than 8.5 W m<sup>-2</sup> forcing in 2100.

It should be noted however that the probability of RCP8.5 occurring in the real world over the entire projection horizon of the RCP scenario is not very probable, as it would require a fivefold increase of coal-consumption, exceeding some estimates of recoverable coal reserves [55]. However, for informing recent and near-future impact assessments (until 2030) the RCP8.5 scenario is a useful scenario, because observed emissions in recent history have been larger than the RCP8.5 emission and forcing trajectory and used in the CMIP5 intercomparison project (Figure 4.3) in 2005. Additionally, the RCP8.5 forcing trajectory can prove useful for prospective analysis on long-term mega-trends that might currently be considered out of the ordinary or to study unexpected and unanticipated future outcomes [56]. Beyond 2100, the concentration pathways used in modelling are called Extended Concentration Pathways (ECPs) [51].

A subsequent effort consisted in defining a multitude of different socio-economic pathways – associated with certain emission levels and a variety of several other socio-economic parameters – to be used in climate and earth system models [57, 58]. They are currently used as standard concentration (or radiative forcing) pathways for the ongoing CMIP6 intercomparison project.

## **From individual models to collective model intercomparison efforts**

Over the last centuries, climate models – the tools used to simulate impacts of different future RCPs and quantify climate forcing values – have become more and more complex. Subsequent integration took place of several processes and dynamics, such as ocean and sea ice dynamics (early 90s), the Sulphur cycle (late 90s), non-sulfate aerosol dynamics and carbon cycle (early 2000s) and the inclusion of vegetation dynamics and atmospheric chemistry [59]. Models that include biosphere dynamics (such as ocean ecology and biogeochemistry, plant ecology and land use) in addition to physical climate dynamics are called Earth System Models (ESMs). Climate models can be further divided into Global Climate Models (GCMs) and Regional Climate Models (RCMs), depending on the geographical scope of the model. They are nevertheless connected to each other, as RCMs use information from GCMs at their boundaries using the ‘nested regional climate modelling technique’ (such as, for example, GHG forcing values).

The IPCC organized subsequent aggregations of climate models to assess future effects of the different RCPs in five subsequent assessment reports, the first assessment report (“FAR”) published in 1990, second (“SAR”) in 1995, third (“TAR”) in 2001, fourth (“AR4”) in 2007 and the fifth (“AR5”) in 2014. The next review report (“AR6”) is currently under review for publishing in 2022.

Subsequent review reports are primarily informed by different model intercomparison projects since 1995, the so-called Coupled Model Intercomparison Projects (CMIPs). The CMIPs are coordinated efforts to harmonize both Regional and Global Climate and Earth

System Models. The previously discussed RCP-scenarios have historically mainly been used in the context of the CMIP5 assessment in 2005, in which 40 models have been compared and aggregated [60] based on common emission and forcing trajectories. The ongoing model intercomparing exercise review for the upcoming AR6 that started in 2015, CMIP6 [61–63], uses the Shared Socioeconomic Pathways (SSPs) trajectories as a modelling base (Figure 4.3). The umbrella CMIP6 intercomparison project consists of a group of 23 topic-specific model intercomparisons<sup>72</sup> such as, for example, the ScenarioMIP intercomparison project which is focusing on harmonization of scenarios to be used in Integrated Assessment Models [48, 64], the HighResMIP intercomparison project [65] focusing on increasing horizontal resolution of climate models, the C4MIP project with a focus on quantifying future changes in the global carbon cycle and linking CO<sub>2</sub>-emissions and climate change [66], and The Detection and Attribution Model Intercomparison Project (DAMIP) which is focusing primarily on improving the estimation of the contributions of anthropogenic and natural forcing changes to observed global warming [67] (see the previous section 1.2 for a description of the relevance of those indicators).

## The impacts of climate change

### From modelled climate metrics to projected impacts

In addition to nourishing intellectual curiosity to questions related to the functioning of the climate system and gain insights in subsequent impacts on the natural world, climate models also serve to estimate future impacts on our society and economic activities. A wide body of recent literature analyses the effects of temperature rise on the environment, disaster frequency and impacts on infrastructure. It is beyond the scope of this chapter to describe the different impacts for each sector, but for the sake of completeness a brief literature overview will be given. The chapter closes with a selection of climate impacts of the literature (mainly in a European context, although the degree of changes and impacts are applicable to the world as a whole because of the global nature of climate change).

In the context of the EU, a notable effort in quantifying and characterizing impacts of climate change is the subsequent series of PESETA-projects in which a collective effort was undertaken to project multi-sectoral impacts for different warming scenarios<sup>73</sup>. Subsequent projects have been concluded in 2009 (PESETA), 2013 (PESETA II), 2018 (PESETA III [68]) and recently PESETA IV (2020 [69]).

The PESETA projects have the objective to provide consistent multi-sectoral assessments of the impacts of climate change in Europe for the 2071 – 2100 time-horizon. The analysis is carried out using Regional Climate Models (RCMs) with – in the case of the PESETA III impact assessment series [70] – the high-end emission scenario (RCP8.5), used to estimate biophysical impact and value the associated impacts using a Computable General Equilibrium (CGE) model. Climate impact scenarios are calculated in a ‘business as usual’ manner, without taking into account planned future adaptation measures.

It should be noted that this choice for RCP8.5 for impact assessments is not an entirely neutral choice for impact assessments over a longer (century-scale) time horizon. As previously mentioned in section 1.3.3 (Figure 4.3), RCP8.5 would require a fivefold increase of coal-consumption over the 21<sup>st</sup> century, exceeding some estimates of recoverable coal reserves [55]. The impacts discussed and cited here should therefore not be interpreted as

---

<sup>72</sup> A good overview of the ongoing work in the CMIP6 intercomparison project is given on the [website of the World Climate Research Programme](#).

<sup>73</sup> A large body of literature related to the subsequent PESETA projects can be found on the [website](#) of the Joint Research Centre.

‘business as usual impacts’ but rather an extreme case that is rather unlikely to happen over the longer term. The advantage of such a high-end impact estimation however is that it can prove useful when analyzing ‘out of the ordinary’ future trajectories [56].

As can be seen in Figure 4.3, an additional advantage of considering the RCP8.5 trajectory for impact assessments, is that this high-end emission projection – used for the calculation of climate model outcomes during the CMIP5 project in 2005, is still very relevant for a short- to midterm analysis of climate impacts. It is impossible to have certainty on future emission pathways, but it can be stated that in recent history, observed emissions have overpassed this RCP8.5 scenario that was previously considered as a ‘worst case’ scenario. The PESETA impact assessment conclusions can thus reasonably be considered as probable scenario for the near term and coming decades, certainly considering the possible feedbacks that have not been accounted for in existing climate models.

Related to the ongoing debate on whether RCP8.5 could be considered as a “business as usual scenario”, it is a positive evolution that during the PESETA IV project – in addition to RCP8.5 – the RCP4.5 trajectory has been added as an additional possible ‘climate future’ [69] (referred to as a ‘low impact’ climate change scenario compared to the ‘high impact’ RCP8.5 climate change scenario).

Different types of impact methods have been developed in the context of the subsequent PESETA projects, ranging from physical impact assessment on infrastructure and the natural environment to impacts on the economy and society. Considering physical impacts, coastal impacts of sea level rise [71] and transport sector impacts [72] have been assessed. In the natural environment, there is an extensive body of policy relevant analysis on biological effects and impacts on the natural environment such as threats to soils [73], forest fires [74–76], habitat loss [74], impacts on agriculture [77] and changes in fresh water availability for food production [78].

Based on a conceptual framework to model the effects on the economy and society (such as impact on heating and cooling demand [79–81], heat wave frequency [82] and impacts on labor productivity [79], proposals have been made for short-term drought adaptation measures until 2030 [83], infrastructure protection [84, 85], flood monitoring and early warning [86, 87] and prediction of temperature extremes [88].

It is beyond the scope of this chapter to provide an extensive overview of the wide array of climate change impacts, but some of the effects will be discussed briefly to illustrate the extent of impacts likely to happen if we don’t act or – in the case of committed sea level rise and other impacts with a longer time-lag – that we should prepare for as a society regardless the establishment of mitigation policies.

## **Sea level impact**

Because climate change and global warming have widely ranging effects and depend on the degree of local resilience and adaptation in different places, the example of sea level rise<sup>74</sup> is an illustrative example to clarify the urgency of acting on climate change. Sea level rise is one of the most tangible and clear impacts of climate change, manifesting itself over a long time-horizon.

Sea level rise is a result of both ocean thermal expansion because of cumulative heat uptake, mountain glacier melt and melting of ice-sheets (Antarctic ice-sheet and Greenland) [90]. For a 2-degree warming scenario, median sea level rise (SLR) is expected to reach about 50 cm (36-65 cm likely range) over the 2081-20100 period. For a 1.5-degree warming scenario, it is estimated to be around 40 (30-55 cm likely range). Because of the slow melting

---

<sup>74</sup> Focused on the European context (but relevant for global climate policy), in line with the PESETA projects the EU funded the development of an integrated sea level impact assessment tool, LISCoAsT, for this purpose [89].



response to changes in temperature of ice-sheets and delays in ocean heat uptake, SLR will continue to rise beyond 2100 regardless short term mitigation efforts [90].

Sea level rise does not manifest itself equally, but varies according to place depending on the local thermal expansion rate, the origin of melting ice and whether the area under consideration experiences subsidence or uplift of the Earth's crust [91]. For example, regional differences can be up to 15 to 20 cm higher (as in the case of Northern Europe) or even 38 to 79 cm higher, as is the case in Denmark [72]. The combination of a projected median SLR of around 40 to 50 cm by 2100 together with regional disparities, result in sea level rise in Europe that can reasonably be expected to reach beyond 1 meter by 2100 – a low-end estimate – or even close to 2 meters.

To illustrate the impacts of these levels of local sea level rise, a brief overview of impacts on transport infrastructure in Europe is illustrative. For example, under an RCP8.5 emission pathway (which is still lower than historical observations, see Figure 4.3), this means that by respectively 2030 and 2080, 23 or 42 European airports will be inundated (1 to 3 m) and 124 to 196 airports will be at risk of inundation [72]. An even more impressive impact can be expected for sea ports in Europe, trading 80 % of the world freight (of which 74 % is extra-EU, 37 % intra-EU) and transporting yearly 385 million passengers. Under the same RCP8.5 trajectory by respectively 2030 and 2080, 517 and 852 ports will be inundated (of which 70 and 109 ports submerged under more than 3 meter water level), impacting 64 % of all European ports [72].

### **A brief description of other climate impacts**

The impact of climate change is not limited to impacts of sea level rise. An important effect of climate change is the increased frequency of heatwaves. This frequency will increase along the 21<sup>st</sup> century, whatever the emission scenario, even for 1.5 °C and 2 °C warming trajectories [92]. Current 100-year heatwave events could occur almost every year from 2080 onwards, and by the end of the century up to 60% of the Southern European regions could be annually exposed to a current 100-year heat wave intensity [93]. On a global level, one third of the global population is – in the absence of mitigation policies – projected to experience a mean annual temperature of more than 29 °C. This temperature range can currently only be found in 0.8 % of the Earth's land surface, mostly concentrated in the Sahara [94].

Another example is the retreat of glaciers. Models consistently predict relative volume losses of 76-97% for the European Alps and of 64-81% for Scandinavia for the end of the 21<sup>st</sup> Century [95, 96].

It is out of the scope of this chapter to provide an extensive overview of the different types of climate impacts (such as coastal hazards and flooding potential, acidification of the ocean, etc.), but the previous selection should clarify the need for mitigation to avoid these types of impacts. Considering the unknowns of ongoing research and the possibility for concurrence of multiple hazards, a precautionary approach is recommended when estimating and quantifying future climate impacts.

If anthropogenic fossil use continues unabated in the 21st century, by the middle of the century we risk achieving an atmospheric CO<sub>2</sub> concentration that has not been seen since the early Eocene or 50 million years ago. If CO<sub>2</sub> continues to rise further into the twenty-third century, the associated large increase in radiative forcing – and how the Earth responds – would likely be without geological precedent in the last half a billion years or 0.5 Ga [12]. This coincides with the genesis of land plants [97].

## **How to mitigate? The promises and perils of mitigation options**

In order to understand the need and variety of mitigation and adaptation measures that need to be deployed, one could explore the question whether frequently debated “one shot mitigation measures” – such as afforestation, geoengineering or large-scale carbon capture technology deployment – could help solving the complex climate change mitigation challenge and ease the efforts required to stay within the projected emission ceilings required to keep warming below a safe level. A follow-up question that needs to be asked (but is often forgotten in policy discourse) is whether these so-called solutions, although worthy to pursue in combination with emission reduction, can have a systemic impact. Unfortunately, the answer is often ‘no’.

### **Afforestation as a climate mitigation solution?**

Incited by the publication of a paper in *Science* [98], a recent discussion emerged on whether afforestation could prove to be a major solution for climate mitigation. The paper claimed that 205 GtC can be captured by creating an extra 0.9 billion ha of canopy cover, and that future environmental change will have a limited effect on existing forest carbon stocks. Compared to a presumed global anthropogenic carbon emission burden of 300 GtC to date, the authors claimed that such a tree planting effort would prove indeed a major step forward for climate mitigation.

However, the paper received multiple critiques that debunk these claims. Stefan Rahmstorf [99] notes that it is important to realize that the total emissions since the Industrial Revolution (1850) have been around 640 GtC, of which 31 % are induced emissions because of land use change, 67 % are fossil carbon emissions and 2 % are related to other sources. Because of the absorption of more than half of this amount of carbon by forests and the oceans, around 300 GtC ended up in the atmosphere to date. He further makes the important remark that if we would extract the same amount (300 GtC) from the atmosphere, the amount in the atmosphere would decrease with much less, because of the re-equilibration of atmospheric carbon concentrations due to release from the ocean and land. Therefore, the amount of carbon that is argued to be possible to capture with afforestation would be less than one third of the total historical anthropogenic emissions of 640 GtC. More importantly, it would take fifty to hundred years to store the 200 GtC at a rate of 2 to 4 GtC per year. This would be largely insufficient if we continue emitting 11 GtC (42 GtCO<sub>2</sub>) each year. He notes further that planting trees on land in the Northern hemisphere with a permanent snow or ice cover could even prove to be counterproductive, as darker forests decrease the albedo of the region and could offset the effect of increased carbon capture<sup>75</sup>.

### **The perils of geoengineering and carbon capture**

Considering the presence of negative emissions in a large subset of 1.5 or 2 degree warming scenarios and the consequent modelling of negative emissions in a large subset of Integrated Assessment Models (IAMs), as well as the increased political interest in considering geoengineering options – notably of Switzerland who tried to table a resolution at the Fourth Session of the UN Environment Assembly (UNEA4) UN conference citing concerns of international governance in 2019 – and Germany [101–106], both from a carbon budgeting perspective and modelling perspective this is a consideration that needs attention.

---

<sup>75</sup> A more detailed description and outline of the claims and rebuttals regarding the article in *Science* on afforestation can be found online [100].

# Climate mitigation and transformation of the industrial structure: linking temperature targets to carbon budgets

## Temperature target and associated carbon budget

On a global level, climate model estimates inform clearly about the scale of mitigation measures needed. Two concepts are crucial in understanding the urgency and timeline on climate action. These are the post-industrial temperature rise we deem socially and environmentally acceptable and feasible - such as those agreed during the Paris climate conference and the associated impacts (see part 1.4.1), and the estimation and distribution of associated carbon budgets that are left to achieve long-term stabilization at a collectively agreed temperature rise, as well as the estimation of the contribution and distribution of changes in other forcing drivers such as other well-mixed GHGs, halocarbons and land use changes.

Climate sensitivities or transient climate responses can be used to calculate carbon budgets, a central notion in climate negotiations and climate policy. The most authoritative synthesis of carbon budgets for specific temperature targets are in the latest IPCC report on limiting warming to 1.5 °C [107]. For example, for a 50 % probability to stay below 1.5°C we could still emit around 580 Gt CO<sub>2</sub> from January 2018 onwards. For a 67 % probability of achieving stabilization at 1.5 °C, the remaining budget is estimated to be 420 GtCO<sub>2</sub> [5] (Chapter C.1.3). In modelled pathways with limited overshoot of 1.5 °C, global net anthropogenic emissions decline by about 45 % by 2030 from 2010 levels (40-60 % interquartile range), reaching net zero by 2050. If we want to limit global average temperature rise to 2 °C, CO<sub>2</sub> emissions need to decline by about 25 % by 2030 in most pathways (10-30 % interquartile range) and reach net zero around 2070 (2065 - 2080 interquartile range) [5] (Chapter C.1). By the end of 2017, anthropogenic CO<sub>2</sub> emissions since the pre-industrial period are estimated to have reduced the total carbon budget for 1.5°C by approximately 2200 ± 320 GtCO<sub>2</sub>.

On a global level, we deplete the carbon budget by around 42 ± 3 GtCO<sub>2</sub> per year (2018 emissions [5, 17, 18]<sup>76</sup>), fossil CO<sub>2</sub> (36.6 ± 1.8 GtCO<sub>2</sub> [17]) and land use change effects (5.5 ± 2.6 GtCO<sub>2</sub>, average of [19] and [108]) combined (Figure 4.2). This means that, to obtain a 50% or 67% probability of achieving stabilization at 1.5 °C, the global carbon budget will be depleted in respectively 13.8 (14.8 - 12.8) or 10 (10.7 - 9.3) years if the future emission rate does not decrease. Simply stated, when reducing emissions linearly until the budget is depleted, there are respectively 27.6 or 20 years left for a 50% or 67% probability of achieving stabilization at 1.5 °C.

However, some uncertainties remain on this quantity. If earth system feedbacks are taken into account, this budget could further decrease with 100 Gt CO<sub>2</sub> [107]. Other factors not related to CO<sub>2</sub> emissions, uncertainties about the temperature response to other greenhouse gases, the distribution of the temperature response to changes in carbon dioxide, historical emissions uncertainty and recent emissions uncertainty can alter this budget with respectively ±250, -400 to + 200, + 100 to + 200, ± 250 and ± 20 Gt.

Following a precautionary principle, a part of this budget could thus already be depleted [107]. However, these budgets are the latest available best available knowledge and they continue to provide a robust framework for CO<sub>2</sub> emissions, therefore they continue to prove useful in the design and evaluation of global climate policy.

---

<sup>76</sup> Although the IPCC Special Report on Global Warming of 1.5°C [5] states a depletion rate of 42 ± 3 GtCO<sub>2</sub> for the year 2017, the actual estimated emissions were 41 ± 4 GtCO<sub>2</sub> in 2017. In 2018, global emissions have been estimated at 42 ± 4 GtCO<sub>2</sub> [17].

In addition to the different categories of uncertainties referred to earlier, methodological issues also come into play when assessing the rigor and relevance of carbon budgets for public policy.

### **The impact of modelling assumptions on the relevance of using global cumulative carbon budgets for public policy**

The possibility of feedbacks occurring in the future (see also section 1.2.2) and the lack of models that reliably can provide insights in the effects of net zero or even negative emissions – although frequently occurring in global climate mitigation scenarios, undermines to some extent the reliability of the proposed indefinite carbon budgets. The concern of not disposing of reliable zero emission estimates from the major set of climate models is currently being dealt with within the ZECMIP sub-project of CMIP6 (the Zero Commitment Model Intercomparison Project [109, 110]). The ZECMIP project analyses the “zero emission warming commitment” (ZEC) or the warming expected after emissions cease, for each of the main climate models in existence. It has recently been found that this effect can either be positive (warming) or negative (cooling) [110]. This finding has led to proposals to modify the cumulative emissions or standard carbon budgeting approach [111], allowing for temperature evolutions after net zero emissions have been achieved, thereby enabling the inclusion of unforeseen tipping points (see also section 1.2.2).

In addition, different modelling assumptions such as the conditioning that is employed to calibrate the model (based on historical emissions, temperature records, long term climate ECS, ...), can influence the range of future projections and reliability of carbon budgets [43]. Because of the aforementioned uncertainties, it has been proposed to focus rather on near-term carbon budget policies instead of long-term absolute commitments [112].

For example, it has been found that a late-century net negative carbon emission of  $-10 \text{ GtCO}_2 \text{ yr}^{-1}$  required to achieve the long-term temperature target of 1.5-degree warming with a 50 % probability [5] would constrain the carbon budget for the period 2020 – 2040 to 549  $\text{GtCO}_2$ , requiring over a 100 % cut in carbon emissions by around 2040 and that this estimate depends on the constraints that are employed within the climate model used to calculate this budget [43]. Therefore, the author suggests to focus mainly on the carbon budget for the period of 2040-2060, as augmenting the time horizon increases uncertainty (due to the uncertain warming effects of zero or negative emissions). In a future stage, improving insights in the dynamics of zero or negative emission could alter our policies in the longer term.

### **Division of carbon budgets**

Considering the above-described conceptualization and estimation of past and future climatic changes, impacts and the associated carbon budgets that relate to intensity of climatic changes and future impacts, the question arises on how climate policies should be spread over time and how mitigation efforts should be distributed over different countries.

The question on how to divide the emission reduction effort is undoubtedly a political and socio-economic question, although a simplified framework is presented here as a starting point to reflect on the role and responsibilities of different nation states in reducing emissions.

Multiple frameworks and calculation methods have been proposed to calculate carbon budgets, most of them relying on economic and GDP-values to distribute mitigation efforts [113, 114]. Regardless of the economic situation of countries, a pragmatic (but overly simple) first start in developing a carbon budgeting approach could be to divide the remaining carbon budget on an equal per capita basis, calculated backwards from the year 2016 onwards — the year of the Paris agreement — and to account for recent emissions that have occurred in the

meantime<sup>77</sup> [2]. It could be argued that this date is too recent because it consequentially ignores historical emissions of big emitters that should be accounted for, but – even if this argument would hold – in that case the historical emissions of a group of countries already overtook remaining national carbon budgets to stay within the Paris agreement objectives.

Historically corrected carbon budgets defined purely on the basis of historical responsibility in emissions are therefore — considering stringent climate targets — physically impossible or at least implausible for some countries that comparatively emitted more than other countries (unless negative emission technologies are immediately deployed on a large scale). An extreme example is for example the case of Australia. Even without accounting for historical emission responsibility and using the above-described Paris-agreement per-capita division of the carbon budget, Australia should get its emissions down to zero by the year 2023 if it would take up its per capita responsibility to collectively have a chance of 50 % of staying below a warming of 1.5 degrees (Figure 4.4). An option could be however that negative emissions should be pursued by historical emitters, but the uncertainties in such an approach and effort are considerable, and questions could and should be asked on whether large scale deployment of those negative emission technologies do not stand in the way of using resources (energy, land, materials) that belong to the ‘global commons’.

## Conclusions and perspectives

To conclude, some of the above-described uncertainties are put in perspective to contemporary policy debates.

Multiple remaining uncertainties have been pointed out related to future emission and carbon budget estimates, and remaining methodological issues that need to be resolved to obtain a reliable impact analysis of different emission scenarios. For example – despite vivid debates on the implausibility of the RCP8.5 warming scenario – it appears that since the year 2000 of the model intercomparison projects that inform the IPCC reports, historical CO<sub>2</sub> emissions have been higher than the worst-case modeled scenario. This finding confirms that, certainly considering current and near-term projected climate impacts, these impact assessments have probably not been overstated.

The issue of timing of the ongoing transition to a net zero future is of utmost importance. Research on historical transitions can help us to understand the dynamics that will play out in the future. Despite the grim trajectory we are on, there are also numerous positive signs on the horizon that prove systemic change is happening. It is impossible to project the further development of those, but it is encouraging to see that – for example – renewable energy deployment rates have consequently surpassed institutional estimates of the International Energy Agency, the United Kingdom is moving faster towards a zero-emission energy system than any other country on the European continent, and research and institutional efforts building on a technical and political framework for large-scale 100 % renewable energy deployment and interconnection are moving forward, or getting a new impulse as is the case for the Desertec project.

The continuous challenge will be to translate and “downscale” the insights from Global Circulation Models and long-term climate research to tangible concepts and numbers that policymakers and society can relate to. A good example of this, is the need for clear modelling frameworks and transition scenario’s. In the European policy area, it is encouraging to see both an increased attention for collaborative modelling on institutional climate and energy trajectories, and joint efforts to create alternative narratives from civil society

---

<sup>77</sup> To illustrate this approach, an online interactive tool available at <https://emission-budgets.herokuapp.com> has been developed to simulate the implications of this carbon budgeting approach on the remaining national carbon budgets around the world.

organizations. Examples of the former are the 2-yearly consultations on the ENTSO-E and ENTSO-G Ten Year Network Development Plans (TYNDP) scenario's that serve as a basis for selection of European Projects of Common Interest (PCIs), the consultation process on the EIB's Energy Lending Policy and the current draft EIB Climate Bank Roadmap. An example of the latter is the dissemination and outreach effort of numerous academic energy and climate modelling groups (of which the most notable pan-European and currently global online Open-Source Energy Modelling community) and the joint design of an alternative 'PAC Scenario' developed by the European energy and climate NGO community to complement and challenge the institutional scenario's (European Clean Planet For All long-term strategy, PRIMES and TYNDP scenarios). The scenario-lines and narratives should be owned by the public, both for the sake of transparency and awareness raising of the challenges and opportunities ahead.

Finally, the debate and insights on carbon budgets clarifies that there are considerable uncertainties on the impacts of future emission trajectories, and points at equity concerns that are currently not being dealt with enough at the international level. The issue of remaining uncertainties calls for a prudent approach in which measures are taken to prevent unknown or unforeseen impacts. The current net zero 2050 commitment of the EU is a step in the good direction, but considering the equity aspects of carbon budget repartition, this would be too late. Hopefully the accelerating renewable energy trends that can be observed, as well as increased political engagement for stronger 2030-targets, will bring us preferably sooner than later to this point.

Acknowledgments: This research was funded by the European Union's Horizon 2020 research (innovation programme under the Marie Skłodowska-Curie Innovative Training Network grant agreement no. 675153) and ERASMUS + Programme of the European Union (Jean Monnet Excellence Center on Sustainability, ERASME)



Co-funded by the  
Erasmus+ Programme  
of the European Union



## References

1. Dierickx, F.: *floriandierickx/emission-budgets: Carbon Emission Budget Calculator*. Zenodo (2019). <https://doi.org/10.5281/zenodo.3470668>.
2. Rahmstorf, S.: How much CO<sub>2</sub> your country can still emit, in three simple steps, <http://www.realclimate.org/index.php/archives/2019/08/how-much-co2-your-country-can-still-emit-in-three-simple-steps/>, last accessed 2019/10/03.
3. Muntean, M., Guizzardi, D., Schaaf, E., Crippa, M., Solazzo, E., Olivier, J.G.J., Vignati, E.: Fossil CO<sub>2</sub> emissions of all world countries: 2018 report. Publications Office of the European Union, Luxembourg (2018).
4. World Bank: Population, <https://databank.worldbank.org/reports.aspx?source=2&series=SP.POP.TOTL&country=#>, last accessed 2019/10/03.
5. Masson-Delmotte, V., Zhai, P., Pörtner, H.O., Roberts, D., Skea, J., Shukla, P.R., Pirani, A., Moufouma-Okia, W., Péan, C., Pidcock, R., Connors, S., Matthews, J.B.R., Chen, Y., Zhou, X., Gomis, M.I., Lonnoy, E., Maycock, T., Tignor, M., Waterfield, T. eds: Summary for Policymakers. In: Global Warming of 1.5°C. An IPCC Special Report on the impacts of global warming of 1.5°C above pre-industrial levels and related global greenhouse gas emission pathways, in the context of strengthening the global response to the threat of climate change, sustainable development, and efforts to eradicate poverty. p. 32. World Meteorological Organization, Geneva, Switzerland (2018).
6. Ramaswamy, V., Collins, W., Haywood, J., Lean, J., Mahowald, N., Myhre, G., Naik, V., Shine, K.P., Soden, B., Stenchikov, G., Storelvmo, T.: Radiative Forcing of Climate: The Historical Evolution of the Radiative Forcing Concept, the Forcing Agents and their Quantification, and Applications. *Meteor. Monogr.* 59, 14.1-14.101 (2018). <https://doi.org/10.1175/AMSMONOGRAPHS-D-19-0001.1>.
7. IPCC: Annex I: Glossary. In: Global Warming of 1.5°C. An IPCC Special Report on the impacts of global warming of 1.5°C above pre-industrial levels and related global greenhouse gas emission pathways, in the context of strengthening the global response to the threat of climate change, sustainable development, and efforts to eradicate poverty. In Press (2018).
8. Myhre, G., Shindell, D., Bréon, F.-M., Collins, W., Fuglestedt, J., Huang, J., Koch, D., Lamarque, J.-F., Lee, D., Mendoza, B., Nakajima, T., Robock, A., Stephens, G., Takemura, T., Zhang, H.: Anthropogenic and Natural Radiative Forcing. In: Stocker, T.F., Qin, D., Plattner, G.-K., Tignor, M., Allen, S.K., Boschung, J., Nauels, A., Xia, Y., Bex, V., and Midgley, P.M. (eds.) *Climate Change 2013: The Physical Science Basis. Contribution of Working Group I to the Fifth Assessment Report of the Intergovernmental Panel on Climate Change*. pp. 659–740. Cambridge University Press, Cambridge, United Kingdom and New York, NY, USA (2013).
9. Kopp, G., Krivova, N., Lean, J., Wu, C.J.: The Impact of the Revised Sunspot Record on Solar Irradiance Reconstructions. *Sol Phys.* 291, 2951–2965 (2016). <https://doi.org/10.1007/s11207-016-0853-x>.

10. Kopp, G., Lean, J.L.: A new, lower value of total solar irradiance: Evidence and climate significance. *Geophysical Research Letters*. 38, (2011). <https://doi.org/10.1029/2010GL045777>.
11. Simmons, M.D.: Chapter 13 - Sequence Stratigraphy and Sea-Level Change. In: Gradstein, F.M., Ogg, J.G., Schmitz, M.D., and Ogg, G.M. (eds.) *The Geologic Time Scale*. pp. 239–267. Elsevier, Boston (2012). <https://doi.org/10.1016/B978-0-444-59425-9.00013-5>.
12. Foster, G.L., Royer, D.L., Lunt, D.J.: Future climate forcing potentially without precedent in the last 420 million years. *Nature Communications*. 8, 14845 (2017). <https://doi.org/10.1038/ncomms14845>.
13. Keeling, R.F., Keeling, C.D.: Atmospheric Monthly In Situ CO<sub>2</sub> Data - Mauna Loa Observatory, Hawaii. In *Scripps CO<sub>2</sub> Program Data*, <http://library.ucsd.edu/dc/object/bb3859642r>, (2017). <https://doi.org/10.6075/j08w3bhw>.
14. Jouzel, J., Masson-Delmotte, V., Cattani, O., Dreyfus, G., Falourd, S., Hoffmann, G., Minster, B., Nouet, J., Barnola, J.M., Chappellaz, J., Fischer, H., Gallet, J.C., Johnsen, S., Leuenberger, M., Loulergue, L., Luethi, D., Oerter, H., Parrenin, F., Raisbeck, G., Raynaud, D., Schilt, A., Schwander, J., Selmo, E., Souchez, R., Spahni, R., Stauffer, B., Steffensen, J.P., Stenni, B., Stocker, T.F., Tison, J.L., Werner, M., Wolff, E.W.: Orbital and Millennial Antarctic Climate Variability over the Past 800,000 Years. *Science*. 317, 793–796 (2007). <https://doi.org/10.1126/science.1141038>.
15. Da, J., Zhang, Y.G., Li, G., Meng, X., Ji, J.: Low CO<sub>2</sub> levels of the entire Pleistocene epoch. *Nat Commun*. 10, 4342 (2019). <https://doi.org/10.1038/s41467-019-12357-5>.
16. Graven, H.D., Keeling, R.F., Piper, S.C., Patra, P.K., Stephens, B.B., Wofsy, S.C., Welp, L.R., Sweeney, C., Tans, P.P., Kelley, J.J., Daube, B.C., Kort, E.A., Santoni, G.W., Bent, J.D.: Enhanced Seasonal Exchange of CO<sub>2</sub> by Northern Ecosystems Since 1960. *Science*. 341, 1085–1089 (2013). <https://doi.org/10.1126/science.1239207>.
17. Friedlingstein, P., Jones, M.W., O’Sullivan, M., Andrew, R.M., Hauck, J., Peters, G.P., Peters, W., Pongratz, J., Sitch, S., Le Quéré, C., Bakker, D.C.E., Canadell, J.G., Ciais, P., Jackson, R.B., Anthoni, P., Barbero, L., Bastos, A., Bastrikov, V., Becker, M., Bopp, L., Buitenhuis, E., Chandra, N., Chevallier, F., Chini, L.P., Currie, K.I., Feely, R.A., Gehlen, M., Gilfillan, D., Gkritzalis, T., Goll, D.S., Gruber, N., Gutekunst, S., Harris, I., Haverd, V., Houghton, R.A., Hurtt, G., Ilyina, T., Jain, A.K., Joetzjer, E., Kaplan, J.O., Kato, E., Klein Goldewijk, K., Korsbakken, J.I., Landschützer, P., Lauvset, S.K., Lefèvre, N., Lenton, A., Lienert, S., Lombardozzi, D., Marland, G., McGuire, P.C., Melton, J.R., Metz, N., Munro, D.R., Nabel, J.E.M.S., Nakaoka, S.-I., Neill, C., Omar, A.M., Ono, T., Peregón, A., Pierrot, D., Poulter, B., Rehder, G., Resplandy, L., Robertson, E., Rödenbeck, C., Séférian, R., Schwinger, J., Smith, N., Tans, P.P., Tian, H., Tilbrook, B., Tubiello, F.N., van der Werf, G.R., Wiltshire, A.J., Zaehle, S.: Global Carbon Budget 2019. *Earth Syst. Sci. Data*. 11, 1783–1838 (2019). <https://doi.org/10.5194/essd-11-1783-2019>.



18. Global Carbon Project: Supplemental data of Global Carbon Project 2019, <https://www.icos-cp.eu/GCP/2019>, (2019). <https://doi.org/10.18160/GCP-2019>.
19. Houghton, R.A., Nassikas, A.A.: Global and regional fluxes of carbon from land use and land cover change 1850-2015: Carbon Emissions From Land Use. *Global Biogeochem. Cycles*. 31, 456–472 (2017). <https://doi.org/10.1002/2016GB005546>.
20. Andrew, R.M.: A comparison of estimates of global carbon dioxide emissions from fossil carbon sources. *Earth Syst. Sci. Data*. 12, 1437–1465 (2020). <https://doi.org/10.5194/essd-12-1437-2020>.
21. Lüthi, D., Le Floch, M., Bereiter, B., Blunier, T., Barnola, J.-M., Siegenthaler, U., Raynaud, D., Jouzel, J., Fischer, H., Kawamura, K., Stocker, T.F.: High-resolution carbon dioxide concentration record 650,000–800,000 years before present. *Nature*. 453, 379–382 (2008). <https://doi.org/10.1038/nature06949>.
22. Zeebe, R.E., Ridgwell, A., Zachos, J.C.: Anthropogenic carbon release rate unprecedented during the past 66 million years. *Nature Geosci.* 9, 325–329 (2016). <https://doi.org/10.1038/ngeo2681>.
23. Uemura, R., Motoyama, H., Masson-Delmotte, V., Jouzel, J., Kawamura, K., Goto-Azuma, K., Fujita, S., Kuramoto, T., Hirabayashi, M., Miyake, T., Ohno, H., Fujita, K., Abe-Ouchi, A., Iizuka, Y., Horikawa, S., Igarashi, M., Suzuki, K., Suzuki, T., Fujii, Y.: Asynchrony between Antarctic temperature and CO<sub>2</sub> associated with obliquity over the past 720,000 years. *Nat Commun.* 9, 961 (2018). <https://doi.org/10.1038/s41467-018-03328-3>.
24. Kaufman, D., McKay, N., Routson, C., Erb, M., Dätwyler, C., Sommer, P.S., Heiri, O., Davis, B.: Holocene global mean surface temperature, a multi-method reconstruction approach. *Scientific Data*. 7, 201 (2020). <https://doi.org/10.1038/s41597-020-0530-7>.
25. Fourier, J.: Mémoire sur les températures du globe terrestre et des espaces planétaires. *Mémoires de l'Académie Royale des Sciences de l'Institut de France*. 7, 570–604 (1827).
26. Arnell, N.W., Brown, S., Gosling, S.N., Hinkel, J., Huntingford, C., Lloyd-Hughes, B., Lowe, J.A., Osborn, T., Nicholls, R.J., Zelazowski, P.: Global-scale climate impact functions: the relationship between climate forcing and impact. *Climatic Change*. 134, 475–487 (2016). <https://doi.org/10.1007/s10584-013-1034-7>.
27. Bindi, M., Brown, S., Camilloni, I., Diedhiou, A., Djalante, R., Ebi, K.L., Engelbrecht, F., Guiot, J., Hijikata, Y., Mehrotra, S., Payne, A., Seneviratne, S.I., Thomas, A., Warren, R., Zhou, G.: Impacts of 1.5°C of Global Warming on Natural and Human Systems. In: *Global Warming of 1.5°C. An IPCC Special Report on the impacts of global warming of 1.5°C above pre-industrial levels and related global greenhouse gas emission pathways, in the context of strengthening the global response to the threat of climate change, sustainable development, and efforts to eradicate poverty*. In Press (2018).
28. Cheng, L., Trenberth, K.E., Fasullo, J., Boyer, T., Abraham, J., Zhu, J.: Improved estimates of ocean heat content from 1960 to 2015. *Science Advances*. 3, e1601545 (2017). <https://doi.org/10.1126/sciadv.1601545>.
29. Hansen, J., Sato, M., Kharecha, P., von Schuckmann, K.: Earth's Energy Imbalance. *NASA/GISS* (2012).

30. Purkey, S.G., Johnson, G.C.: Warming of Global Abyssal and Deep Southern Ocean Waters between the 1990s and 2000s: Contributions to Global Heat and Sea Level Rise Budgets. *J. Climate*. 23, 6336–6351 (2010). <https://doi.org/10.1175/2010JCLI3682.1>.
31. Cassou, C., Kushnir, Y., Hawkins, E., Pirani, A., Kucharski, F., Kang, I.-S., Caltabiano, N.: Decadal Climate Variability and Predictability: Challenges and Opportunities. *Bull. Amer. Meteor. Soc.* 99, 479–490 (2017). <https://doi.org/10.1175/BAMS-D-16-0286.1>.
32. Liu, W., Xie, S.-P., Lu, J.: Tracking ocean heat uptake during the surface warming hiatus. *Nat Commun*. 7, 1–9 (2016). <https://doi.org/10.1038/ncomms10926>.
33. Yeager, S.G., Robson, J.I.: Recent Progress in Understanding and Predicting Atlantic Decadal Climate Variability. *Curr Clim Change Rep.* 3, 112–127 (2017). <https://doi.org/10.1007/s40641-017-0064-z>.
34. Steffen, W., Rockström, J., Richardson, K., Lenton, T.M., Folke, C., Liverman, D., Summerhayes, C.P., Barnosky, A.D., Cornell, S.E., Crucifix, M., Donges, J.F., Fetzer, I., Lade, S.J., Scheffer, M., Winkelmann, R., Schellnhuber, H.J.: Trajectories of the Earth System in the Anthropocene. *PNAS*. 201810141 (2018). <https://doi.org/10.1073/pnas.1810141115>.
35. Clark, P.U., Shakun, J.D., Marcott, S.A., Mix, A.C., Eby, M., Kulp, S., Levermann, A., Milne, G.A., Pfister, P.L., Santer, B.D., Schrag, D.P., Solomon, S., Stocker, T.F., Strauss, B.H., Weaver, A.J., Winkelmann, R., Archer, D., Bard, E., Goldner, A., Lambeck, K., Pierrehumbert, R.T., Plattner, G.-K.: Consequences of twenty-first-century policy for multi-millennial climate and sea-level change. *Nature Clim Change*. 6, 360–369 (2016). <https://doi.org/10.1038/nclimate2923>.
36. IPCC: Climate Change 2007: Synthesis Report. Contribution of Working Groups I, II and III to the Fourth Assessment Report of the Intergovernmental Panel on Climate Change. IPCC, Geneva, Switzerland (2007).
37. Meehl, G.A., Senior, C.A., Eyring, V., Flato, G., Lamarque, J.-F., Stouffer, R.J., Taylor, K.E., Schlund, M.: Context for interpreting equilibrium climate sensitivity and transient climate response from the CMIP6 Earth system models. *Sci. Adv.* 6, eaba1981 (2020). <https://doi.org/10.1126/sciadv.aba1981>.
38. Silvers, L.G., Paynter, D., Zhao, M.: The Diversity of Cloud Responses to Twentieth Century Sea Surface Temperatures. *Geophys. Res. Lett.* 45, 391–400 (2018). <https://doi.org/10.1002/2017GL075583>.
39. Zhao, M., Golaz, J.-C., Held, I.M., Ramaswamy, V., Lin, S.-J., Ming, Y., Ginoux, P., Wyman, B., Donner, L.J., Paynter, D., Guo, H.: Uncertainty in Model Climate Sensitivity Traced to Representations of Cumulus Precipitation Microphysics. *J. Climate*. 29, 543–560 (2016). <https://doi.org/10.1175/JCLI-D-15-0191.1>.
40. Leduc, M., Matthews, H.D., de Elía, R.: Regional estimates of the transient climate response to cumulative CO<sub>2</sub> emissions. *Nature Climate Change*. 6, 474–478 (2016). <https://doi.org/10.1038/nclimate2913>.
41. Paynter, D., Winton, M.: Transient and Equilibrium Climate Sensitivity, <https://www.gfdl.noaa.gov/transient-and-equilibrium-climate-sensitivity/>, last accessed 2019/10/28.

42. Proistosescu, C., Huybers, P.J.: Slow climate mode reconciles historical and model-based estimates of climate sensitivity. *Sci Adv.* 3, e1602821 (2017). <https://doi.org/10.1126/sciadv.1602821>.
43. Sanderson, B.: The role of prior assumptions in carbon budget calculations. *Earth Syst. Dynam.* 11, 563–577 (2020). <https://doi.org/10.5194/esd-11-563-2020>.
44. Jones, C.D., Ciais, P., Davis, S.J., Friedlingstein, P., Gasser, T., Peters, G.P., Rogelj, J., van Vuuren, D.P., Canadell, J.G., Cowie, A., Jackson, R.B., Jonas, M., Kriegler, E., Littleton, E., Lowe, J.A., Milne, J., Shrestha, G., Smith, P., Torvanger, A., Wiltshire, A.: Simulating the Earth system response to negative emissions. *Environ. Res. Lett.* 11, 095012 (2016). <https://doi.org/10.1088/1748-9326/11/9/095012>.
45. Rugenstein, M., Bloch-Johnson, J., Abe-Ouchi, A., Andrews, T., Beyerle, U., Cao, L., Chadha, T., Danabasoglu, G., Dufresne, J.-L., Duan, L., Foujols, M.-A., Frölicher, T., Geoffroy, O., Gregory, J., Knutti, R., Li, C., Marzocchi, A., Mauritsen, T., Menary, M., Moyer, E., Nazarenko, L., Paynter, D., Saint-Martin, D., Schmidt, G.A., Yamamoto, A., Yang, S.: LongRunMIP: Motivation and Design for a Large Collection of Millennial-Length AOGCM Simulations. *Bulletin of the American Meteorological Society.* 100, 2551–2570 (2019). <https://doi.org/10.1175/BAMS-D-19-0068.1>.
46. Millar, R.J., Otto, A., Forster, P.M., Lowe, J.A., Ingram, W.J., Allen, M.R.: Model structure in observational constraints on transient climate response. *Climatic Change.* 131, 199–211 (2015). <https://doi.org/10.1007/s10584-015-1384-4>.
47. Pfister, P.L., Stocker, T.F.: The realized warming fraction: a multi-model sensitivity study. *Environ. Res. Lett.* 13, 124024 (2018). <https://doi.org/10.1088/1748-9326/aaebae>.
48. O’Neill, B.C., Tebaldi, C., Vuuren, D.P. van, Eyring, V., Friedlingstein, P., Hurtt, G., Knutti, R., Kriegler, E., Lamarque, J.-F., Lowe, J., Meehl, G.A., Moss, R., Riahi, K., Sanderson, B.M.: The Scenario Model Intercomparison Project (ScenarioMIP) for CMIP6. *Geoscientific Model Development.* 9, 3461–3482 (2016). <https://doi.org/10.5194/gmd-9-3461-2016>.
49. O’Neill, B.C., Oppenheimer, M., Warren, R., Hallegatte, S., Kopp, R.E., Pörtner, H.O., Scholes, R., Birkmann, J., Foden, W., Licker, R., Mach, K.J., Marbaix, P., Mastrandrea, M.D., Price, J., Takahashi, K., van Ypersele, J.-P., Yohe, G.: IPCC reasons for concern regarding climate change risks. *Nature Climate Change.* 7, 28–37 (2017). <https://doi.org/10.1038/nclimate3179>.
50. Matthews, H.D., Zickfeld, K., Knutti, R., Allen, M.R.: Focus on cumulative emissions, global carbon budgets and the implications for climate mitigation targets. *Environ. Res. Lett.* 13, 010201 (2018). <https://doi.org/10.1088/1748-9326/aa98c9>.
51. Meinshausen, M., Smith, S.J., Calvin, K., Daniel, J.S., Kainuma, M.L.T., Lamarque, J.-F., Matsumoto, K., Montzka, S.A., Raper, S.C.B., Riahi, K., Thomson, A., Velders, G.J.M., van Vuuren, D.P.P.: The RCP greenhouse gas concentrations and their extensions from 1765 to 2300. *Climatic Change.* 109, 213–241 (2011). <https://doi.org/10.1007/s10584-011-0156-z>.

52. van Vuuren, D.P., den Elzen, M.G.J., Lucas, P.L., Eickhout, B., Strengers, B.J., van Ruijven, B., Wonink, S., van Houdt, R.: Stabilizing greenhouse gas concentrations at low levels: an assessment of reduction strategies and costs. *Climatic Change*. 81, 119–159 (2007). <https://doi.org/10.1007/s10584-006-9172-9>.
53. Clarke, L.E., Edmonds, J.A., Jacoby, H.D., Pitcher, H.M., Reilly, J.M., Richels, R.G.: Scenarios of Greenhouse Gas Emissions and Atmospheric Concentrations; and Review of Integrated Scenario Development and Application. U.S. Climate Change Science Program (2007).
54. Junichi Fujino, R.N.: Multi-gas Mitigation Analysis on Stabilization Scenarios Using Aim Global Model. *The Energy Journal*. Multi-Greenhouse Gas Mitigation and Climate Policy, 343–354 (2006).
55. Hausfather, Z., Peters, G.P.: Emissions – the ‘business as usual’ story is misleading. *Nature*. 577, 618–620 (2020). <https://doi.org/10.1038/d41586-020-00177-3>.
56. McCollum, D.L., Gambhir, A., Rogelj, J., Wilson, C.: Energy modellers should explore extremes more systematically in scenarios. *Nat Energy*. 5, 104–107 (2020). <https://doi.org/10.1038/s41560-020-0555-3>.
57. Riahi, K., van Vuuren, D.P., Kriegler, E., Edmonds, J., O’Neill, B.C., Fujimori, S., Bauer, N., Calvin, K., Dellink, R., Fricko, O., Lutz, W., Popp, A., Cuaresma, J.C., Kc, S., Leimbach, M., Jiang, L., Kram, T., Rao, S., Emmerling, J., Ebi, K., Hasegawa, T., Havlik, P., Humpenöder, F., Da Silva, L.A., Smith, S., Stehfest, E., Bosetti, V., Eom, J., Gernaat, D., Masui, T., Rogelj, J., Strefler, J., Drouet, L., Krey, V., Luderer, G., Harmsen, M., Takahashi, K., Baumstark, L., Doelman, J.C., Kainuma, M., Klimont, Z., Marangoni, G., Lotze-Campen, H., Obersteiner, M., Tabeau, A., Tavoni, M.: The Shared Socioeconomic Pathways and their energy, land use, and greenhouse gas emissions implications: An overview. *Global Environmental Change*. (2016). <https://doi.org/10.1016/j.gloenvcha.2016.05.009>.
58. Gidden, M., Riahi, K., Smith, S., Fujimori, S., Luderer, G., Kriegler, E., van Vuuren, D.P., van den Berg, M., Feng, L., Klein, D., Calvin, K., Doelman, J., Frank, S., Fricko, O., Harmsen, M., Hasegawa, T., Havlik, P., Hilaire, J., Hoesly, R., Horing, J., Popp, A., Stehfest, E., Takahashi, K.: Global emissions pathways under different socioeconomic scenarios for use in CMIP6: a dataset of harmonized emissions trajectories through the end of the century. *Geoscientific Model Development Discussions*. 12, 1443–1475 (2019).
59. Puma, M.: Climate Modelers and the Moth, [https://www.giss.nasa.gov/research/briefs/puma\\_02/](https://www.giss.nasa.gov/research/briefs/puma_02/).
60. Flato, G., Marotzke, J., Abiodun, B., Braconnot, P., Chou, S.C., Collins, W., Cox, P., Driouech, F., Emori, S., Eyring, V., Flato GregoryMarotzke JochemAbiodun BabatundeBraconnot PascaleChou S ChanCollins WilliamCox PeterDriouech FatimaEmori SeitaEyring Veronika: Evaluation of Climate Models. In: Stocker, T.F., Qin, D., Plattner, G.-K., Tignor, M., Allen, S.K., Boschung, J., Nauels, A., Xia, Y., Bex, V., and Midgley, P.M. (eds.) *Climate change 2013: The physical science basis*. Contribution of Working Group I to the Fifth Assessment Report of the Intergovernmental Panel on Climate Change. Cambridge University Press, Cambridge, United Kingdom and New York, NY, USA (2013).

61. Eyring, V., Bony, S., Meehl, G.A., Senior, C.A., Stevens, B., Stouffer, R.J., Taylor, K.E.: Overview of the Coupled Model Intercomparison Project Phase 6 (CMIP6) experimental design and organization. *Geosci. Model Dev.* 9, 1937–1958 (2016). <https://doi.org/10.5194/gmd-9-1937-2016>.
62. Eyring, V., Gleckler, P.J., Heinze, C., Stouffer, R.J., Taylor, K.E., Balaji, V., Guilyardi, E., Joussaume, S., Kindermann, S., Lawrence, B.N., Meehl, G.A., Righi, M., Williams, D.N.: Towards improved and more routine Earth system model evaluation in CMIP. *Earth System Dynamics.* 7, 813–830 (2016). <https://doi.org/10.5194/esd-7-813-2016>.
63. Eyring, V., Righi, M., Lauer, A., Evaldsson, M., Wenzel, S., Jones, C., Anav, A., Andrews, O., Cionni, I., Davin, E.L., Deser, C., Ehbrecht, C., Friedlingstein, P., Gleckler, P., Gottschaldt, K.-D., Hagemann, S., Juckes, M., Kindermann, S., Krasting, J., Kunert, D., Levine, R., Loew, A., Mäkelä, J., Martin, G., Mason, E., Phillips, A.S., Read, S., Rio, C., Roehrig, R., Senftleben, D., Sterl, A., Ulft, L.H. van, Walton, J., Wang, S., Williams, K.D.: ESMValTool (v1.0) – a community diagnostic and performance metrics tool for routine evaluation of Earth system models in CMIP. *Geoscientific Model Development.* 9, 1747–1802 (2016). <https://doi.org/10.5194/gmd-9-1747-2016>.
64. Gidden, M.J., Fujimori, S., van den Berg, M., Klein, D., Smith, S.J., van Vuuren, D.P., Riahi, K.: A methodology and implementation of automated emissions harmonization for use in Integrated Assessment Models. *Environmental Modelling & Software.* 105, 187–200 (2018). <https://doi.org/10.1016/j.envsoft.2018.04.002>.
65. Haarsma, R.J., Roberts, M.J., Vidale, P.L., Senior, C.A., Bellucci, A., Bao, Q., Chang, P., Corti, S., Fučkar, N.S., Guemas, V., von Hardenberg, J., Hazeleger, W., Kodama, C., Koenigk, T., Leung, L.R., Lu, J., Luo, J.-J., Mao, J., Mizielinski, M.S., Mizuta, R., Nobre, P., Satoh, M., Scoccimarro, E., Semmler, T., Small, J., von Storch, J.-S.: High Resolution Model Intercomparison Project (HighResMIP v1.0) for CMIP6. *Geosci. Model Dev.* 9, 4185–4208 (2016). <https://doi.org/10.5194/gmd-9-4185-2016>.
66. Arora, V.K., Katavouta, A., Williams, R.G., Jones, C.D., Brovkin, V., Friedlingstein, P., Schwinger, J., Bopp, L., Boucher, O., Cadule, P., Chamberlain, M.A., Christian, J.R., Delire, C., Fisher, R.A., Hajima, T., Ilyina, T., Joetzjer, E., Kawamiya, M., Koven, C., Krasting, J., Law, R.M., Lawrence, D.M., Lenton, A., Lindsay, K., Pongratz, J., Raddatz, T., Séférian, R., Tachiiri, K., Tjiputra, J.F., Wiltshire, A., Wu, T., Ziehn, T.: Carbon-concentration and carbon-climate feedbacks in CMIP6 models, and their comparison to CMIP5 models. *Earth System Science/Response to Global Change: Climate Change* (2019). <https://doi.org/10.5194/bg-2019-473>.
67. Gillett, N.P., Shiogama, H., Funke, B., Hegerl, G., Knutti, R., Matthes, K., Santer, B.D., Stone, D., Tebaldi, C.: The Detection and Attribution Model Intercomparison Project (DAMIP v1.0) contribution to CMIP6. *Geosci. Model Dev.* 9, 3685–3697 (2016). <https://doi.org/10.5194/gmd-9-3685-2016>.
68. Ciscar, J.-C., Feyen, L., Baranzelli, C., Vandecasteele, I., Batista e Silva, F., Soria, A., Laval, C., Raes, F., Perry, M., Nemry, F., Demirel, H., Rozsai, M., Dosio, A., Donatelli, M., Srivastava, A., Fumagalli, D., Niemeier, S., Camia, A., Vrontisi, Z.,

- Shrestha, S., Ciaian, P., Himics, M., Van Doorslaer, B., Barrios, S., Forzieri, G., Rojas, R., Bianchi, A., Dowling, P., San Miguel, J., Rigo, D. de, Caudullo, G., Barredo, J.I., Paci, D., Pycroft, J., Saveyn, B., Van Regemorter, D., Revesz, T., Vandyck, T., Ibarreta, D., Institute for Prospective Technological Studies: Climate impacts in Europe the JRC PESETA II project. European Union, Luxembourg (2014).
69. Feyen, L., Ciscar Martinez Juan, C., Gosling, S., Ibarreta Ruiz, D., Soria Ramirez, A., Dosio, A., Naumann, G., Russo, S., Formetta, G., Forzieri, G., Girardello, M., Spinoni, J., Mentaschi, L., Bisselink, B., Bernhard, J., Gelati, E., Adamovic, M., Guenther, S., De Roo, A., Cammalleri, C., Dottori, F., Bianchi, A., Alfieri, L., Vousdoukas, M., Mongelli, I., Hinkel, J., Ward, P.J., Gomes Da Costa, H., De Rigo, D., Liberta', G., Durrant, T., San-Miguel-Ayanz, J., Barredo Cano Jose, I., Mauri, A., Caudullo, G., Ceccherini, G., Beck, P., Cescatti, A., Hristov, J., Toreti, A., Perez Dominguez, I., Dentener, F., Fellmann, T., Elleby, C., Ceglar, A., Fumagalli, D., Niemeyer, S., Cerrani, I., Panarello, L., Bratu, M., Després, J., Szewczyk, W., Matei, N.-A., Mulholland, E., Olariaga-Guardiola, M.: Climate change impacts and adaptation in Europe. Publications Office of the European Union (2020).
70. Ciscar, J.C., Ibarreta, D., Soria, A.: Climate impacts in Europe: final report of the JRCPESETA III project. (2018).
71. Vousdoukas, M., Mentaschi, L., Voukouvalas, E., Verlaan, M., Jevrejeva, S., Jackson, L., Feyen, L.: Global Extreme Sea Level projections. (2018). <https://doi.org/10.2905/jrc-liscoast-10012>.
72. Christodoulou, A., Demirel, H.: Impacts of climate change on transport: A focus on airports, seaports and inland waterways. Publications Office of the European Union (2018). <https://doi.org/10.2760/378464> (online).
73. Stolte, J., Tesfai, M., Øygarden, L., Kværnø, S., Keizer, J., Verheijen, F., Panagos, P., Ballabio, C., Hessel, R.: Soil threats in Europe. Publications Office of the European Union (2016). <https://doi.org/10.2788/828742> (online).
74. De Rigo, D., Caudullo, G., San-Miguel-Ayanz, J., Barredo Cano Jose, I.: Robust modelling of the impacts of climate change on the habitat suitability of forest tree species. Publications Office of the European Union (2017). <https://doi.org/10.2760/175227> (ePub).
75. De Rigo, D., Liberta', G., Durrant, T., Artes Vivancos, T., San-Miguel-Ayanz, J.: Forest fire danger extremes in Europe under climate change: variability and uncertainty. Publications Office of the European Union (2017). <https://doi.org/10.2760/13180>.
76. San-Miguel-Ayanz, J., Durrant Houston, T., Boca, R., Liberta', G., Branco, A., De Rigo, D., Ferrari, D., Maianti, P., Artes Vivancos, T., Costa, H., Lana, F., Loffler, P., Nuijten, D., Leray, T., Ahlgren Andes, C.: Forest Fires in Europe, Middle East and North Africa 2017. Publications Office of the European Union (2018). <https://doi.org/10.2760/27815> (print), [10.2760/663443](https://doi.org/10.2760/663443) (online).
77. Perez Dominguez, I., Fellmann, T.: PESETA III: Agro-economic analysis of climate change impacts in Europe. Publications Office of the European Union (2018). <https://doi.org/10.2760/179780> (online).

78. Betts, R., Alfieri, L., Bradshaw, C., Caesar, J., Feyen, L., Friedlingstein, P., Gohar, L., Koutroulis, A., Lewis, K., Morfopoulos, C., Papadimitriou, L., Richardson Katy, J., Tsanis Ioannis, K., Wyser, K.: Changes in climate extremes, fresh water availability and vulnerability to food insecurity projected at 1.5°C and 2°C global warming with a higher-resolution global climate model. *Philosophical Transactions of the Royal Society a-Mathematical Physical and Engineering Sciences*. 376, 20160452 (2018). <https://doi.org/10.1098/rsta.2016.0452>.
79. Gosling, S.N., Zaherpour, J., Ibarreta, D.: PESETA III: Climate change impacts on labour productivity. European Union, Luxembourg (2018).
80. Kitous Alban, G., Després, J.: Assessment of the impact of climate change on residential energy demand for heating and cooling. Publications Office of the European Union (2017). <https://doi.org/10.2760/96778>.
81. Spinoni, J., Vogt, J.V., Barbosa, P., Dosio, A., McCormick, N., Bigano, A., Füßel, H.-M.: Changes of heating and cooling degree-days in Europe from 1981 to 2100. *International Journal of Climatology*. 38, e191–e208. <https://doi.org/10.1002/joc.5362>.
82. Dosio, A., Mentaschi, L., Fischer, E.M., Wyser, K.: Extreme heat waves under 1.5 °C and 2 °C global warming. *Environ. Res. Lett.* 13, 054006 (2018). <https://doi.org/10.1088/1748-9326/aab827>.
83. Cammalleri, C., Marinho Ferreira Barbosa, P., Micale, F., Vogt, J.: Climate change impacts and adaptation in Europe, focusing on extremes and adaptation until the 2030s. Publications Office of the European Union (2017). <https://doi.org/10.2760/282880>.
84. Forzieri, G., Bianchi, A., Batista, E.S.F., Marín Herrera Mario, A., Leblois, A., Lavalle, C., Aerts, J., Feyen, L.: Escalating impacts of climate extremes on critical infrastructures in Europe. *Global Environmental Change-Human and Policy Dimensions*. 48, 97–107 (2018). <https://doi.org/10.1016/j.gloenvcha.2017.11.007>.
85. Gattinesi, P.: European Reference Network for Critical Infrastructure Protection: ERNCIP Handbook 2018 edition. Publications Office of the European Union (2018). <https://doi.org/10.2760/245080>.
86. Alfieri, L., Cohen, S., John, G., Schumann, G., Trigg, M., Zsoter, E., Prudhomme, C., Kruczkiewicz, A., Coughlan De Perez, E., Flamig, Z., Rudari, R., Wu, H., Adler, R., Brakenridge, G.R., Kettner, A., Weerts, A., Matgen, P., Islam, S., De Groeve, T., Salamon, P.: A global network for operational flood risk reduction. *Environmental Science & Policy*. 84, 149–158 (2018). <https://doi.org/10.1016/j.envsci.2018.03.014>.
87. Skoien, J., Salamon, P., Alagic, E., Alobeiaat, A., Andreyenka, A., Bari, D., Ciobanu, N., Doroshenko, V., El-Ashmawy, F., Givati, A., Kastrati, B., Kordzakhia, M., Petrosyan, Z., Spalevic, M., Stojov, V., Tuncok, K., Verdiyev, A., Vladikovic, D., Zaimi, K.: Assessment of the capacity for flood monitoring and early warning in Enlargement and Eastern/ Southern Neighbourhood countries of the European Union. Publications Office of the European Union (2018). <https://doi.org/10.2760/356400> (print).

88. Lavaysse, C., Naumann, G., Alfieri, L., Salamon, P., Vogt, J.: Predictability of the European heat and cold waves. *Climate Dynamics*. (2018). <https://doi.org/10.1007/s00382-018-4273-5>.
89. Vousdoukas, M., Mentaschi, L., Voukouvalas, E., Bianchi, A., Dottori, F., Feyen, L.: European Coastal Flood Risk, <http://data.europa.eu/89h/jrc-liscoast-10009>, (2018). <https://doi.org/10.2905/jrc-liscoast-10009>.
90. Schleussner, C.-F., Lissner, T.K., Fischer, E.M., Wohland, J., Perrette, M., Golly, A., Rogelj, J., Childers, K., Schewe, J., Frieler, K., Mengel, M., Hare, W., Schaeffer, M.: Differential climate impacts for policy-relevant limits to global warming: the case of 1.5 °C and 2 °C. *Earth Syst. Dynam.* 7, 327–351 (2016). <https://doi.org/10.5194/esd-7-327-2016>.
91. Kopp, R.E., Horton, R.M., Little, C.M., Mitrovica, J.X., Oppenheimer, M., Rasmussen, D.J., Strauss, B.H., Tebaldi, C.: Probabilistic 21st and 22nd century sea-level projections at a global network of tide-gauge sites. *Earth's Future*. 2, 383–406 (2014). <https://doi.org/10.1002/2014EF000239>.
92. Jacob, D., Kotova, L., Teichmann, C., Sobolowski, S.P., Vautard, R., Donnelly, C., Koutroulis, A.G., Grillakis, M.G., Tsanis, I.K., Damm, A., Sakalli, A., Vliet, M.T.H. van: Climate Impacts in Europe Under +1.5°C Global Warming. *Earth's Future*. 6, 264–285 (2018). <https://doi.org/10.1002/2017EF000710>.
93. Forzieri, G., Cescatti, A., e Silva, F.B., Feyen, L.: Increasing risk over time of weather-related hazards to the European population: a data-driven prognostic study. *The Lancet Planetary Health*. 1, e200–e208 (2017). [https://doi.org/10.1016/S2542-5196\(17\)30082-7](https://doi.org/10.1016/S2542-5196(17)30082-7).
94. Xu, C., Kohler, T.A., Lenton, T.M., Svenning, J.-C., Scheffer, M.: Future of the human climate niche. *PNAS*. 117, 11350–11355 (2020). <https://doi.org/10.1073/pnas.1910114117>.
95. Huss, M., Hock, R.: A new model for global glacier change and sea-level rise. *Front. Earth Sci.* 3, (2015). <https://doi.org/10.3389/feart.2015.00054>.
96. Marzeion, B., Nesje, A.: Spatial patterns of North Atlantic Oscillation influence on mass balance variability of European glaciers. *The Cryosphere*. 6, 661–673 (2012). <https://doi.org/10.5194/tc-6-661-2012>.
97. Lenton, T.M., Pichler, P.-P., Weisz, H.: Revolutions in energy input and material cycling in Earth history and human history. *Earth Syst. Dynam.* 7, 353–370 (2016). <https://doi.org/10.5194/esd-7-353-2016>.
98. Bastin, J.-F., Finegold, Y., Garcia, C., Mollicone, D., Rezende, M., Routh, D., Zohner, C.M., Crowther, T.W.: The global tree restoration potential. *Science*. 365, 76–79 (2019). <https://doi.org/10.1126/science.aax0848>.
99. Rahmstorf, S.: Can planting trees save our climate?, [http://www.realclimate.org/index.php/archives/2019/07/can-planting-trees-save-our-climate/?utm\\_campaign=Carbon%20Brief%20Daily%20Briefing&utm\\_medium=email&utm\\_source=Revue%20newsletter](http://www.realclimate.org/index.php/archives/2019/07/can-planting-trees-save-our-climate/?utm_campaign=Carbon%20Brief%20Daily%20Briefing&utm_medium=email&utm_source=Revue%20newsletter).
100. Dierickx, F.: Planting trees for climate mitigation?, <https://floriandierickx.github.io/blog/2019/10/18/trees>, last accessed 2020/07/02.



101. Umweltbundesamt: UBA Workshop – Governance of Geoengineering. German Environment Agency (2019).
102. Umweltbundesamt: Policy Brief: Governance of Geoengineering. German Environment Agency (2019).
103. Umweltbundesamt: Fact Sheet: Das De Facto-Moratorium für Geoengineering unter der Biodiversitätskonvention. German Environment Agency (2019).
104. Umweltbundesamt: UBA Position on Carbon Dioxide Removal. German Environment Agency (2019).
105. Bodle, R., Oberthür, S., Donat, L., Homann, G., Sina, S., Tedsen, E.: Options and Proposals for the International Governance of Geoengineering. Umweltbundesamt & Ecologic Institute, Berlin (2013).
106. Ginzky, H., Herrmann, F., Kartschall, K., Leujak, W., Lipsius, K., Mäder, C., Schwermer, S., Straube, G., Umweltbundesamt: Geoengineering: effective climate protection or megalomania? Methods – statutory framework – environment policy demands. Umweltbundesamt (2011).
107. Rogelj, J., Shindell, D., Jiang, K., Fifita, S., Forster, P., Ginzburg, V., Handa, C., Kheshgi, H., Kobayashi, S., Kriegler, E., Mundaca, L., Séférian, R., Vilariño, M.V.: Mitigation Pathways Compatible with 1.5°C in the Context of Sustainable Development. In: Masson-Delmotte, V., Zhai, P., Pörtner, H.O., Roberts, D., Skea, J., Shukla, P.R., Pirani, A., Moufouma-Okia, W., Péan, C., Pidcock, R., Connors, S., Matthews, J.B.R., Chen, Y., Zhou, X., Gomis, M.I., Lonnoy, E., Maycock, T., Tignor, M., and Waterfield, T. (eds.) Global Warming of 1.5°C. An IPCC Special Report on the impacts of global warming of 1.5°C above pre-industrial levels and related global greenhouse gas emission pathways, in the context of strengthening the global response to the threat of climate change, sustainable development, and efforts to eradicate poverty. p. 32. World Meteorological Organization, Geneva, Switzerland (2018).
108. Hansis, E., Davis, S.J., Pongratz, J.: Relevance of methodological choices for accounting of land use change carbon fluxes. *Global Biogeochemical Cycles*. 29, 1230–1246 (2015). <https://doi.org/10.1002/2014GB004997>.
109. Jones, C.D., Frölicher, T.L., Koven, C., MacDougall, A.H., Matthews, H.D., Zickfeld, K., Rogelj, J., Tokarska, K.B., Gillett, N.P., Ilyina, T., Meinshausen, M., Mengis, N., Séférian, R., Eby, M., Burger, F.A.: The Zero Emissions Commitment Model Intercomparison Project (ZECMIP) contribution to C4MIP: quantifying committed climate changes following zero carbon emissions. *Geosci. Model Dev.* 12, 4375–4385 (2019). <https://doi.org/10.5194/gmd-12-4375-2019>.
110. MacDougall, A.H., Frölicher, T.L., Jones, C.D., Rogelj, J., Matthews, H.D., Zickfeld, K., Arora, V.K., Barrett, N.J., Brovkin, V., Burger, F.A., Eby, M., Eliseev, A.V., Hajima, T., Holden, P.B., Jeltsch-Thömmes, A., Koven, C., Menviel, L., Michou, M., Mokhov, I.I., Oka, A., Schwinger, J., Séférian, R., Shaffer, G., Sokolov, A., Tachiiri, K., Tjiputra, J., Wiltshire, A., Ziehn, T.: Is there warming in the pipeline? A multi-model analysis of the zero emission commitment from CO<sub>2</sub>. *Biogeosciences Discussions*. 1–45 (2020). <https://doi.org/10.5194/bg-2019-492>.

111. Rogelj, J., Forster, P.M., Kriegler, E., Smith, C.J., Séférian, R.: Estimating and tracking the remaining carbon budget for stringent climate targets. *Nature*. 571, 335 (2019). <https://doi.org/10.1038/s41586-019-1368-z>.
112. Rogelj, J., Huppmann, D., Krey, V., Riahi, K., Clarke, L., Gidden, M., Nicholls, Z., Meinshausen, M.: A new scenario logic for the Paris Agreement long-term temperature goal. *Nature*. 573, 357–363 (2019). <https://doi.org/10.1038/s41586-019-1541-4>.
113. Messner, D., Schellnhuber, J., Rahmstorf, S., Klingensfeld, D.: The budget approach: A framework for a global transformation toward a low-carbon economy. *Journal of Renewable and Sustainable Energy*. 2, 031003 (2010). <https://doi.org/10.1063/1.3318695>.
114. van den Berg, N.J., van Soest, H.L., Hof, A.F., den Elzen, M.G.J., van Vuuren, D.P., Chen, W., Drouet, L., Emmerling, J., Fujimori, S., Höhne, N., Köberle, A.C., McCollum, D., Schaeffer, R., Shekhar, S., Vishwanathan, S.S., Vrontisi, Z., Blok, K.: Implications of various effort-sharing approaches for national carbon budgets and emission pathways. *Climatic Change*. (2019). <https://doi.org/10.1007/s10584-019-02368-y>.
115. Hoekstra, A., Steinbuch, M., Verbong, G.: Creating Agent-Based Energy Transition Management Models That Can Uncover Profitable Pathways to Climate Change Mitigation. *Complexity*. 2017, 1–23 (2017). <https://doi.org/10.1155/2017/1967645>.
116. Tagliapietra, S.: *Energy Relations in the Euro-Mediterranean*. Springer International Publishing, Cham (2017). <https://doi.org/10.1007/978-3-319-35116-2>.
117. Son, P.V., Isenburg, T.: Emission free energy from the deserts: How a crazy Desertec idea has become reality in North Africa and the Middle East. (2019).
118. World Data Center for Paleoclimatology, NOAA Paleoclimatology Program: EPICA Dome C Ice Core 800KYr Carbon Dioxide Data, [ftp://ftp.ncdc.noaa.gov/pub/data/paleo/icecore/antarctica/epica\\_domec/edc-co2-2008.txt](ftp://ftp.ncdc.noaa.gov/pub/data/paleo/icecore/antarctica/epica_domec/edc-co2-2008.txt), (2008).
119. Monnin, E., Indermühle, A., Dällenbach, A., Flückiger, J., Stauffer, B., Stocker, T.F., Raynaud, D., Barnola, J.-M.: Atmospheric CO<sub>2</sub> Concentrations over the Last Glacial Termination. *Science*. 291, 112–114 (2001). <https://doi.org/10.1126/science.291.5501.112>.
120. Petit, J.R., Jouzel, J., Raynaud, D., Barkov, N.I., Barnola, J.-M., Basile, I., Bender, M., Chappellaz, J., Davis, M., Delaygue, G., Delmotte, M., Kotlyakov, V.M., Legrand, M., Lipenkov, V.Y., Lorius, C., Pépin, L., Ritz, C., Saltzman, E., Stievenard, M.: Climate and atmospheric history of the past 420,000 years from the Vostok ice core, Antarctica. *Nature*. 399, 429–436 (1999). <https://doi.org/10.1038/20859>.
121. Siegenthaler, U., Stocker, T.F., Monnin, E., Lüthi, D., Schwander, J., Stauffer, B., Raynaud, D., Barnola, J.-M., Fischer, H., Masson-Delmotte, V., Jouzel, J.: Stable Carbon Cycle & Climate Relationship During the Late Pleistocene. *Science*. 310, 1313–1317 (2005). <https://doi.org/10.1126/science.1120130>.
122. Lüthi, D., Le Floch, M., Bereiter, B., Blunier, T., Barnola, J.-M., Siegenthaler, U., Raynaud, D., Jouzel, J., Fischer, H., Kawamura, K., Stocker, T.F.: CO<sub>2</sub> record from the EPICA Dome C 1999 (EDC99) ice core (Antarctica) covering 650 to 800 kyr

BP measured at the University of Bern, Switzerland,  
<https://doi.pangaea.de/10.1594/PANGAEA.710901>, (2008).  
<https://doi.org/10.1594/PANGAEA.710901>.

123. NASA/GISS: Global Land-Ocean Temperature index,  
[https://data.giss.nasa.gov/gistemp/graphs/graph\\_data/Global\\_Mean\\_Estimates\\_base\\_d\\_on\\_Land\\_and\\_Ocean\\_Data/graph.txt](https://data.giss.nasa.gov/gistemp/graphs/graph_data/Global_Mean_Estimates_base_d_on_Land_and_Ocean_Data/graph.txt), (2019).
124. Sanderson, B.: I couldn't find this plotted, but the question came up of how historical emissions compare to scenarios from past modeling efforts, which over time become alternative histories. This is what it looks like (for combined ff/land use)., <https://twitter.com/benmsanderson/status/1278306761485750272>, last accessed 2020/08/31.

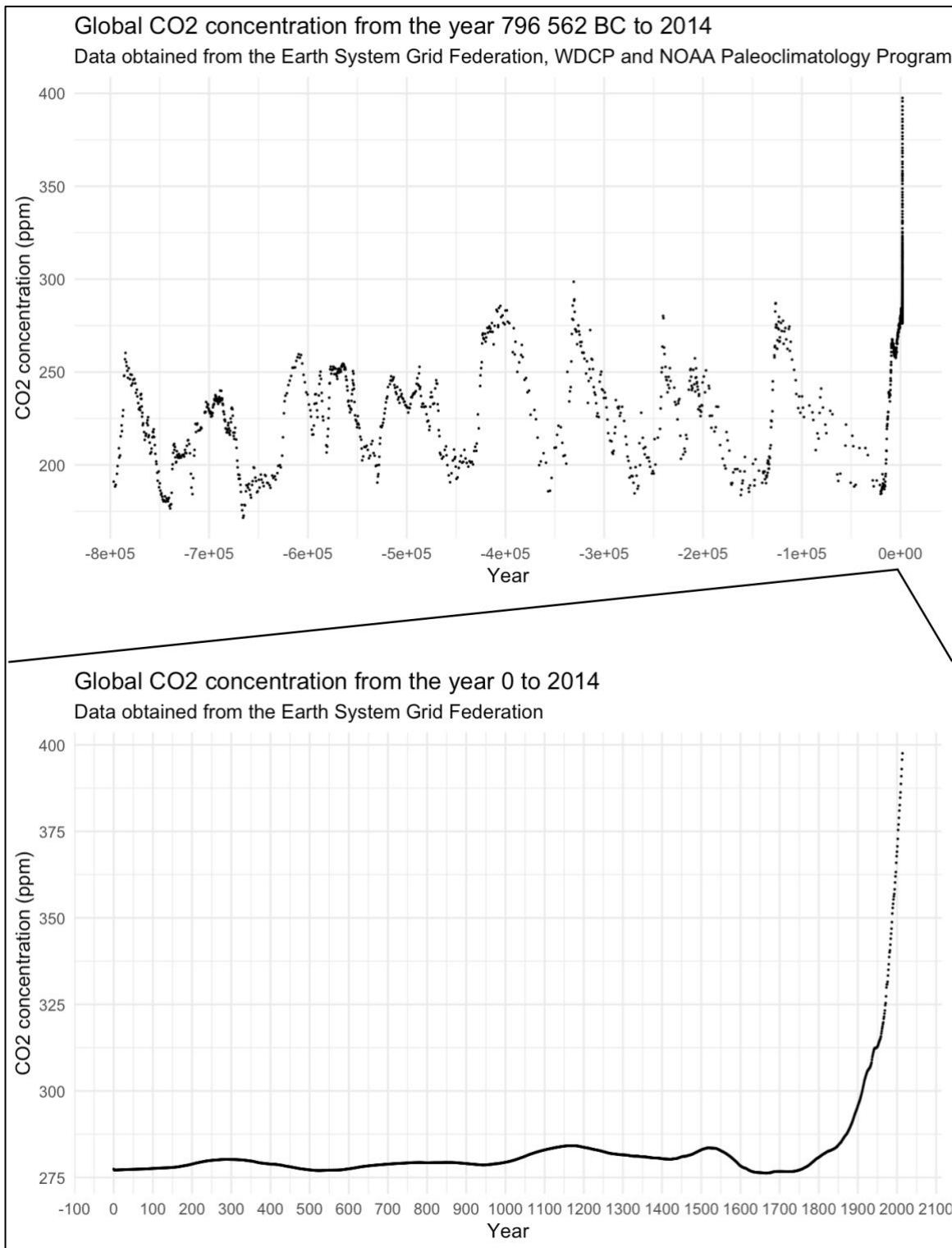
## Tables and Figures

**Table 4.1:** Summary table of global mean radiative forcing (RF,  $\text{W m}^{-2}$ ) and effective radiative forcing (ERF,  $\text{W m}^{-2}$ ) estimates over the 1750-2011 period. Volcanic radiative forcing is not considered here because of the periodic nature of eruptions.

| <b>Driver</b>   | <b>Global Mean Radiative Forcing (RF, <math>\text{W m}^{-2}</math>)</b> | <b>Effective Radiative Forcing (ERF, <math>\text{W m}^{-2}</math>)</b> |
|---|---|--|
| Well-mixed GHGs : total                               | +2.83 (2.54 to 3.12)  | 2.83 (2.26 to 3.40)  |
| Well-mixed GHGs : CO <sub>2</sub>                     | +1.82 (1.63 to 2.01)  | /  |
| Well-mixed GHGs : CH <sub>4</sub>                     | +0.48 (0.42 to 0.53)  | /  |
| Well-mixed GHGs : NO <sub>2</sub>                     | +0.17 (0.14 to 0.20)  | /  |
| Well-mixed GHGs : halocarbons                         | +0.360 (0.324 to 0.396)   | /  |
| Tropospheric Ozone                                    | +0.40 (0.20 to 0.60)  | /  |
| Stratospheric Ozone                                   | -0.05 (-0.15 to +0.05)  | /  |
| Stratospheric water vapour from CH <sub>4</sub>       | +0.07 (+0.02 to +0.12)  | /  |
| Aerosol-radiation interactions                        | -0.35 (-0.85 to +0.15)  | /  |
| Aerosol-cloud interactions                            | /   | -0.45 (-1.2 to 0.0)  |
| Surface albedo (land use changes)                     | -0.15 (-0.25 to -0.05)  | /  |
| Surface albedo (black carbon aerosol on snow and ice) | +0.04 (+0.02 to +0.09)  | /  |
| Contrails   | +0.01 (+0.005 to +0.03)   | /  |
| Solar irradiance                                      | +0.05 (0.0 to +0.10)  | /  |
| Combined contrails and contrail-induced cirrus        | /   | 0.05 (0.02 to 0.15)  |
| Total anthropogenic                                   | /   | 2.3 (1.1 to 3.3)   |
| Solar irradiance                                      | +0.05 (0.0 to +0.10)  | /  |

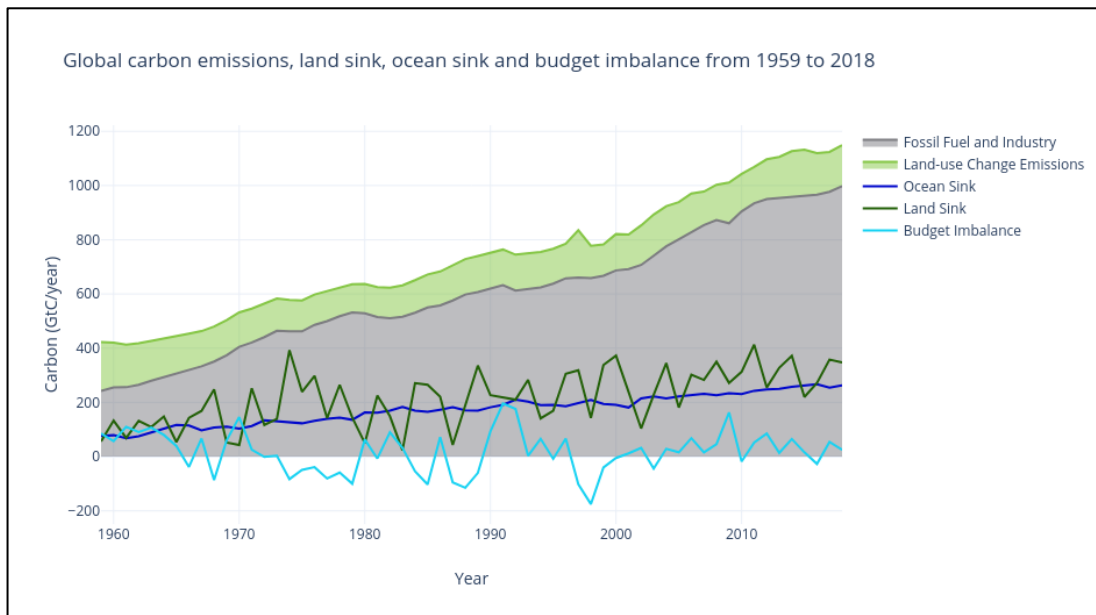
**Source:** [8]

**Figure 4.1:** Global CO<sub>2</sub> concentrations from (a) 796 562 years BC to 2014 and from (b) the year 0 to 2014.



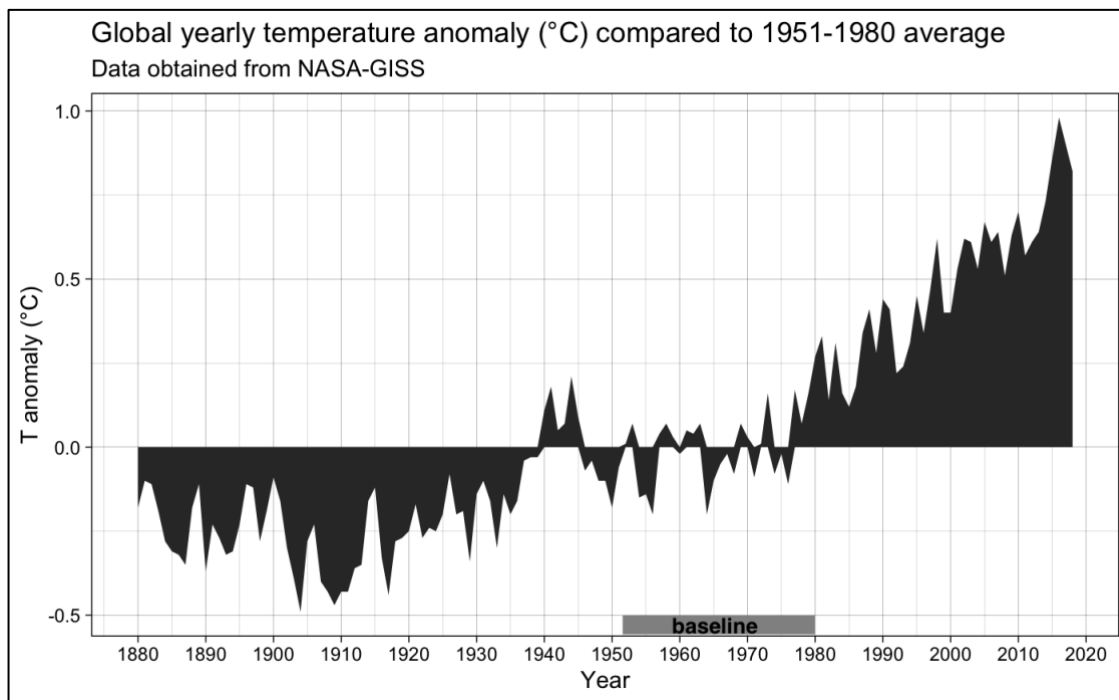
**Sources:** The data from 796 562 years BC to the year 0 BC [21, 118] is a compiled extension of separate datasets of 0-22 kyear BP [119], 22-393 kyears BP [120], 393-664 kyears BP [121] and 664-800 kyear BP [122]. The data from the year 0 to 2014 is taken from NASA/GISS [123]. Note that the historical data that originally is expressed in BP (Before Present) is converted to BC (Before Christ) using a base-year of 1950 to allow for compatibility of datasets, and geological timescale-data from ice-cores after the year 0 has been omitted (21 datapoints from the year 19 to 1813).

**Figure 4.2:** Yearly global carbon emissions from fossil and industrial sources, land use change-induced emissions, ocean and land sink fluxes and the carbon budget imbalance (expressing the uncertainty on global estimates, equal to the estimated total emissions minus sinks), expressed in GtC per year. The main source of uncertainty is the uptake of carbon on land (land sink).



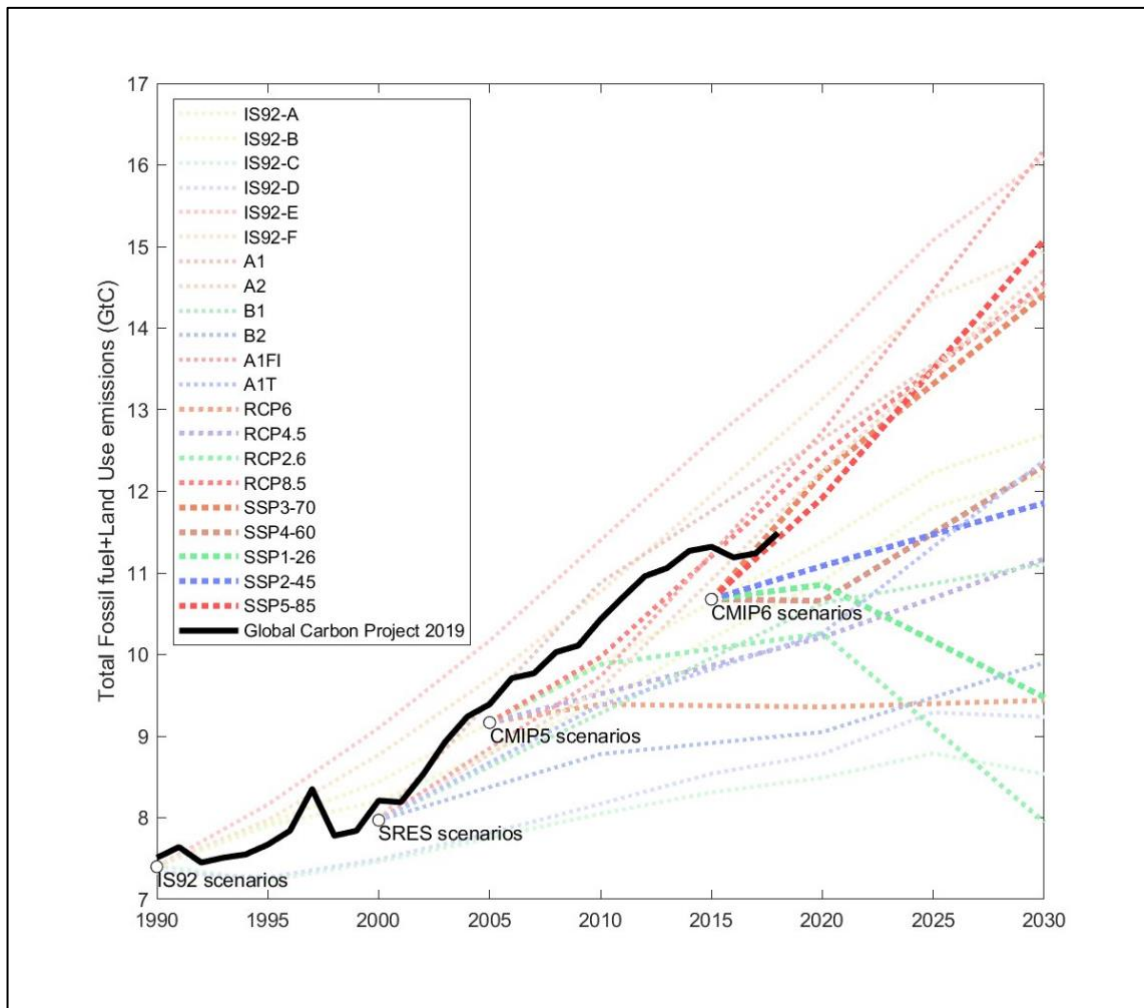
**Source:** Global Carbon Budget 2019 [17].

**Figure 4.3:** The global yearly temperature anomaly expressed in °C, compared to the 1951-1980 average temperature



. Source: NASA/GISS [123].

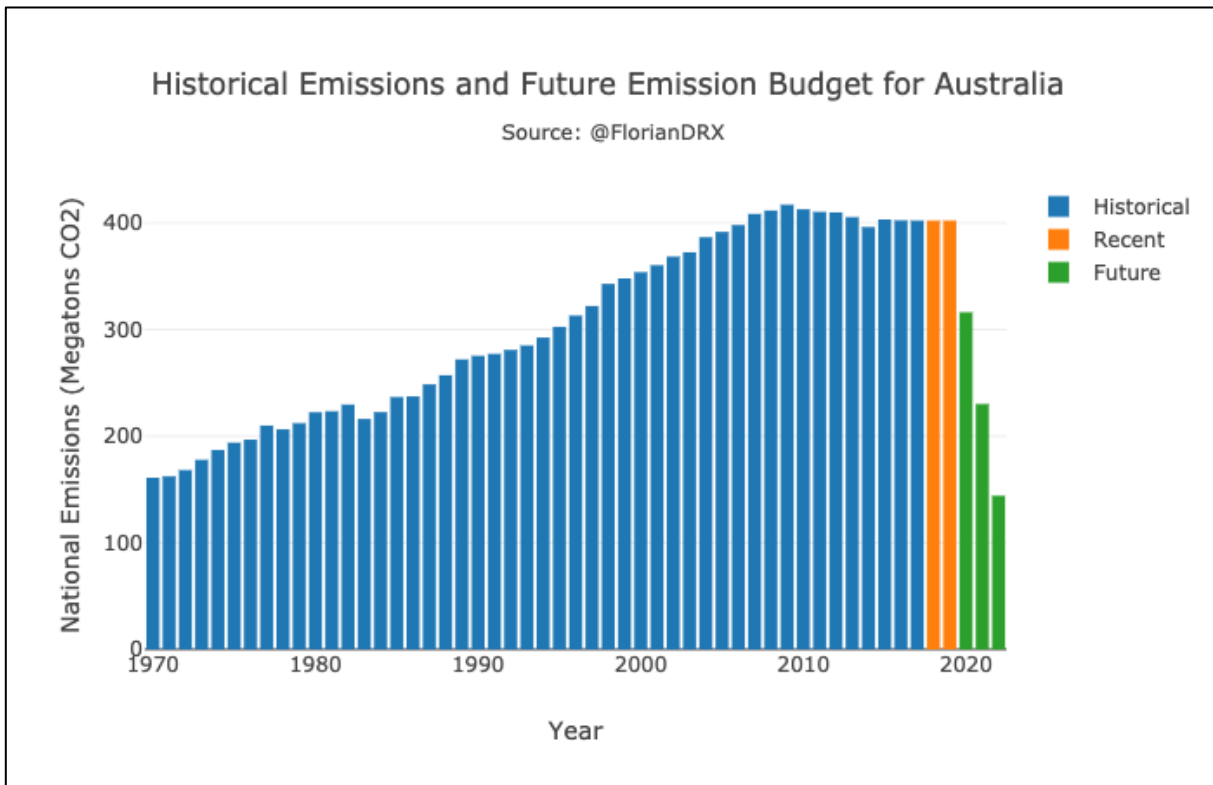
**Figure 4.4:** Comparison of past modelling efforts (RCPs for CMIP5 and SSPs for CMIP6) with observed emissions (Global Carbon Project 2019) in recent history.



**Notes:** Starting years of scenarios are below observations because of ex-post refinement of historical emission data, mainly due to uncertainties in land-use change estimates. The significant gap between the start of CMIP6 scenarios and observed emissions is a methodological shift from using a single land-use emission estimate methodology to the average of two major bookkeeping models in the Global Carbon Project database. **Source:** Reproduced from a public domain post of Ben Sanderson [124]



**Figure 4.5:** Emission trajectory of Australia calculated based on an equal global per-capita distribution of the remaining 2018 global carbon budget (recalculated to the year 2016, the signing of the Paris agreement), required to have a 50 % chance of staying below 1.5 degree warming.



Source: [1].

## 5. Monetary valuation in climate and energy models and policy: obscuring or illuminating?

**Authors and affiliations:** Florian Dierickx<sup>1</sup>, Arnaud Diemer<sup>1</sup>

<sup>1</sup>: Jean Monnet Excellence Center on Sustainability (ERASME), University of Clermont Auvergne, CERDI, Clermont-Ferrand, France

*Book chapter*

**Date:** February 1, 2021

**Book:** I. S. Thakur, A. Pandey, H. H. Ngo, C. R. Soccol, & C. Larroche (Eds.), *Climate Change Mitigation: Sequestration of Green House Gases for Biofuels and Biomaterials*. Biomass, Biochemicals, Biofuels. Elsevier Science, 2022.

**URL:** <https://staging.glose.com/book/biomass-biochemicals-biofuels>

**ISBN:** 9780128236093

### Abstract

Climate change is a global issue that demands a coordinated global, regional and national mitigation effort. To inform climate and energy policies, institutions make use of climate and energy models to construct policy narratives and implement specific policy instruments.

Until now, institutional focus has been primarily on monetary modelling and monetary based policies. Because mitigation efforts have historically not resulted in sufficiently effective emission reductions that respect the collectively decided Paris agreement carbon budget limits in order to stay well below 2 degree warming, this chapter aims to shed a critical light on some of the most prominent climate and energy modelling frameworks, exemplified by a group of prominent Integrated Assessment Models (IAMs) and Energy System Models (ESMs). Particular focus is on the type of models and the role of monetary parametrisation in these models, and to which extent they have shaped model outcomes and policy narratives. For example, small changes in discount or interest rates used in either IAMs or ESMs have far-reaching impacts on the rate and speed of modelled mitigation efforts or the deployment of capital-intensive renewables in the short term versus deploying negative emission technologies in the longer term.

From a modelling perspective, it is argued that using more fine-grained sector-specific models rooted in empirical data (such as input-output models) and that are driven by specific policy levers (instead of monetary optimisation) could improve the understanding of the mitigation spaces at our disposal. From a policy making perspective, choices between regulatory versus market-based climate policy approaches are debated and illustrated with two key institutional monetary climate policy frameworks on global and regional level: the Kyoto Protocol and the European Emission Trading Scheme.

The chapter concludes with an overview of alternative strategies that could overcome the identified modelling and policy shortcomings of monetary optimisation and monetary-based policies.

### Keywords

Climate change, carbon tax, cost-benefit analysis, Integrated Assessment Models, Social behaviour, Energy System Models, Time discount, interest rate

## **Introduction**

As climate change is a global phenomenon that demands mitigation and adaptation actions informed by global assessments [1], climate models with a global scope are prominent in the academic literature on climate policy [2]. These global models are complemented by regional academic and institutional models, either designed to help improve understanding the interactions within the Earth system that influence the climate (such as Atmosphere-Ocean General Circulation Models, AOGCMs, and Earth System Models representing the complete land-ocean-atmosphere system [3]), long-term interactions between the environment and the economy (Integrated Assessment Models, IAMs) or improving the understanding of primarily the energy system in the short- to mid-term (Energy System Models, ESMs).

The purpose of this chapter is to synthesize models and institutional frameworks that are used to evaluate and design global, regional (EU) and national climate and energy trajectories or policies, with a particular focus on the role of monetary valuation. Does using monetary variables and pricing in modelling obscure or illuminate a clear understanding of the energy-climate system? Do monetary-based policies help design and evaluate effective climate policies? What are the key monetary parameters used in models and climate policies and to which extent do they influence the outcome? And finally, what could be alternative modelling strategies or policies to overcome the identified shortcomings? To illustrate these questions, they are applied to key monetary optimisation models that are frequently debated in academic literature or used in the policy-making process [4]. In particular, focus is on the impact of using different discount or interest rates on the outcomes these models and the use of modelling outcomes to underpin European and national climate and energy policies.

To this end, the first section of this chapter aims to provide a general overview of (i) global IAMs – primarily focusing on single-cost-benefit optimisation models with a prominent role in international climate and energy policy, as well as (ii) ESMs exemplified by two key monetary optimisation models (TIMES and PRIMES) used by the European Commission and its Member States to inform climate and energy policy. A particular focus is on the choice and influence of key monetary parameters or rates (such as the discount rate) in each of these models and their influence on the outcome of the models.

The second section aims to outline some notable characteristics of the contemporary institutional global and regional climate policy framework, exemplified by the Kyoto protocol and the EU Emission Trading System (EU ETS). Particular focus is on how effective each of these market-based policy frameworks has been.

The third section concludes with a discussion on whether monetary valuation in each of the outlined academic and institutional models and policy frameworks has been effective so far, debates whether they could be effective in the future, and concludes with suggestions for alternative non-monetary modelling strategies and policies to overcome the shortcomings identified in the first two sections.

## **Monetary valuation in Integrated Assessment Models and Energy System Models**

### **Discount rates and interest rates: a conceptual synthesis**

A discount rate is the rate of return to which future prices are valued against the present moment. The discount rate is important in assessing economic activity over time (for example, using dynamic models) because it represents the time dependent value of money. Otherwise stated, the worth of money at any point of time can be calculated through this factor. A high discount rate makes future monetary values or actions (investments, costs, efforts, ...) less

interesting or “worth” to consider, whereas a low discount rate does the opposite and makes future values or efforts more valuable.

A discount rate can conceptually be defined from an institutional, societal or governmental point of view (termed ‘social discount rate’ or ‘institutional discount rate’), or from a private actor or private sector point of view (termed ‘financial discount rate’, ‘cost of finance’, ‘hurdle rate’ or ‘rate of return’). The former is subject to a lively debate in economic, academic and institutional literature, the latter can be defined as the observed or calculated difference in profits between investing in the project compared to the returns or losses when investing in another hypothetical project. In the real world, social discount rates are decided by central banks for loans to commercial banks or depository institutions, or – in some cases – to decide on whether public investments are to be pursued or not. Focus in this chapter is primarily on the social or institutional discount rate used in IAMs, as they play a pivotal role in defining the speed of change towards a certain ambition level or decarbonisation target in those models and consequentially influencing the resulting policy narratives [5]. In modelling exercises, one could use a unique discount rate on an aggregated investment, cost or benefit (for example in simple cost-benefit IAMs) or different discount values for different sectors (as is more frequently the case in ESMs).

Because the discount rate deals with time, within the climate and energy policy sphere it is closely linked to concepts such as intertemporal or intergenerational equity (how much future generations are valued compared to current society – frequently debated in the climate change literature), time preference or impatience (how much current goods or activities are valued compared to the future). It is therefore an inherent political ratio.

On the other hand, interest rates are the rates that private actors in the economy pay when reimbursing loans. These are defined through market interactions, which are in turn shaped by market design policies. Because the interest rate represents the cost of capital from a private perspective, interest rates are more frequently used in ESMs that model the behaviour of economic agents in the energy system. Both discount and interest rates are strongly tied to institutional frameworks, as they are conceptually defined or being the result of policy decisions. Nevertheless, the societal discount rate is decided directly by central banks or public institutions, whereas interest rates are the result of market interactions of private players.

Mathematically, the discount rate  $d$  can be used to calculate a discounting factor ( $D_N$ ) that can be used to discount a future value to the present (the Net Present Value, NPV). The discounting factor and the NPV for a series of future cash flows ( $C$ ) for each year  $n$  up to a total of  $N$  years can be mathematically be represented as [6] :

$$D_N = \frac{1}{(1 + d)^N}$$

$$NPV = \sum_{n=0}^N \frac{C_n}{(1 + d)^n}$$

Considering the full timescale considered (at time  $n = N$ , with  $\sum_{n=0}^N C_n = C$ ), the discount rate  $d$  can also be written as:

$$d = \frac{C - NPV}{C}$$

Following the same reasoning, the interest rate  $i$  can be written as

$$i = \frac{C - NPV}{NPV}$$

Depending on the design of the model, instead of defining exogenously the discount rate, it can also be defined endogenously using a so-called Ramsey function:

$$d = \delta + \eta \times g$$

With this function, the discount rate  $d$  can be derived from the pure rate of time preference  $\delta$ <sup>78</sup>, the elasticity of the marginal utility of consumption  $\eta$ <sup>79</sup> and the average growth rate of consumption  $g$ <sup>80</sup>.

As mentioned previously, discount rates and interest rates relate respectively to either an institutional or private perspective. From an institutional point of view, the central bank (or other institutional lending actor) lends an amount of  $NPV = C$  (total future cash flows) -  $dC$  (discounted with factor  $d$ ) to a private actor (or 'the society as a whole'). The higher the discount rate, the more cash flow needs to occur in the future to obtain an equal amount of NPV. From a societal point of view, a higher discount rate therefore represents conceptually a bigger effort in the future to obtain the same net benefits in the present moment.

Following the same logic from a private perspective, a private individual or company borrowing a total amount NPV, needs to pay back this same amount (NPV) plus a rate calculated on the basis of the NPV and the interest rate ( $NPV \times i$ ).

Although the ongoing value-laden debate between macro-economists on the social discount rate could be argued to be a rather conceptual or theoretical debate on how to value future generations or to assess how global economic activity might evolve in the future (in the case economic activity is measured in monetary values), numerical discount rates – and to a smaller extent interest rates – have tangible and far-reaching implications when they are used in modelling for designing climate or energy policies. Certainly, when these policies are informed by models that make use of monetary optimisation or investment decisions based on interest-rates and discount rates.

There is a lively academic debate in economic-political journals and climate and energy literature on whether the social discount rate value for the purpose of emission trajectory modelling should be “close to zero” or for example 0.01 % (as advocated by Stern [8]<sup>81</sup>), positive (as advocated by Nordhaus) or negative [9]. Most importantly, there are also strong and numerous arguments against using a single global constant discount rate at all for the purpose of evaluating climate policy [8] (p. 32, 160). The following sections go more into depth on how discount rates and interest rates affect modelling results in either IAMs (primarily influenced by social discount rates) and ESMs (primarily influenced by interest rates).

## Integrated Assessment Models

IAMs can be defined as “models which combine scientific and socio-economic aspects of climate change primarily for the purpose of assessing policy options for climate change control” [2] or more broadly, “any model that covers the whole world and, at a minimum,

---

<sup>78</sup> The pure rate of time preference is an economic conceptualization of the ethical issue of intergenerational equity. The higher this rate, the lower the well-being of future generations is valued.

<sup>79</sup> The elasticity of the marginal utility of consumption is an economic conceptualization of the increase in satisfaction (or “utility”) – termed “marginal” – resulting from an increase in consumption of goods. Multiplied with the expected growth rate, it conceptualizes the evolution of satisfaction in the future.

<sup>80</sup> For example, the model-average growth rate in the IPCC “middle of the road” SSP2 scenarios tends to 1.6 %. Source: Supplementary Information p. 11 of [7]

<sup>81</sup> Although a landmark report on climate economics with a fairly ambitious narrative, it was not spared from errors. For example, the report modelled the growth of global CO<sub>2</sub> emissions between 2000 and 2006 to be 0.95% per year, although empirical data suggests an increase of 2.4 % per year [5].

includes some key elements of the climate change mitigation and climate impacts systems at some level of aggregation” [10].

For the sake of clarity, a first distinction is made between models that use monetary values to optimize the resulting modelling trajectory and IAMs that do not make use of monetary optimization to define the modelling outcome. The first type of models are defined here as policy optimization IAMs [2], or models where the outcome is influenced by discount rates, interest rates, and prices. The second type of models are termed policy assessment IAMs. These are broadly categorized as models that provide scenarios that are not based on monetary cost-benefit assessment or monetary optimisation. As the purpose of this paper is to debate the role of monetary valuation in climate and energy modelling and policy, the focus here is mainly on the policy optimization IAMs that make use of optimization based on discounted prices. The last discussion section will provide some examples of policy assessment IAMs that deploy other methods. Policy assessment models however also frequently consider monetary parameters such as prices as a model output for policy purposes, although not as a core driver of the model.

Policy optimization models can be further subdivided in simple cost-benefit IAMs [10] or detailed process IAMs [10], depending on the degree of cost aggregation. Simple cost-benefit IAMs aggregate all costs within one single cost (or benefit), whereas detailed process IAMs make a distinction between different regions and sectors.

#### *A typology of Integrated Assessment Models*

Some of the most prominent aggregated simple cost-benefit policy optimization models in Anglo-Saxon academic and institutional literature are the Dynamic Integrated Climate-Economy model or DICE from William Nordhaus [11] (used by the US Federal Government [12]), the Framework for Uncertainty, Negotiation, and Distribution model or FUND from Richard Tol [13,14] (strongly critiqued before [15,16] and after [17] appearing in the IPCC WG II 5<sup>th</sup> Assessment Report [18]), the Policy Analysis of the Greenhouse Effect model or PAGE from Chris Hope [19] (used for the landmark Stern report [8]), the World Induced Technical Change Hybrid model or WITCH [20] (maintained by the RFF-CMCC European Institute on Economics and the Environment) and MERGE [21].

The simple cost-benefit IAMs described above all aim to aggregate all costs or benefits of climate change in one single metric, the so-called “Social Cost of Carbon” (SCC). Other common features of simple cost-benefit IAMs is that they consider only a simple linear relationship between emissions and temperature rise, only work with monetary values (or non-monetary elements converted to monetary values) and frequently neglect more complex features of the expert physical climate dynamics and climate impact modelling community [22].

The DICE model from Nordhaus is one of the best known simple cost-benefit IAM as it has been frequently discussed in an international institutional context [23]. The aim of the DICE model is to monetize and aggregate all advantages and disadvantages of climate change. Although the DICE model has institutional attention and the author received a Nobel prize, and therefore might have put climate change more prominently on the agenda of contemporary macro-economics, it is argued that such a model is not informative enough at all to inform global climate policy because it is too simple and aggregates all costs and impacts of climate change in one metric. The methodology and associated conclusions of Nordhaus and some of the other simple cost benefit IAMs seem not always consistent, documented in recent assessments of the literature [24,25]. One of the most surprising conclusions from Nordhaus is that the so-called “optimal” temperature rise in 2100 is around 4 degrees warmer above the pre-industrial temperature range, something he recently reiterated in a comparison of his results with other IAMs [11]. It should be noted that the DICE model by definition does not account for aspects (products, places, societies or impacts) that currently don’t have a

monetary market value, and it follows current market prices converted to US dollars, therefore neglecting a large part of global economic activities or non-monetized elements<sup>82</sup>. This might well be the reason why his main conclusion is that an optimal warming of 4 °C is something reasonable to pursue.

Another frequently used institutional IAM is the widely critiqued FUND model. An exemplary conclusion of this model is the assumption that for each doubling of CO<sub>2</sub>-concentrations, the agricultural yield would increase with the same amount and this even for very high temperatures of over 10 degrees of warming [15,16]. This is completely at odds with basic knowledge on the functioning of agriculture and ignores the impact of extreme weather events, uncertainty and more fine-grained impact analysis using Earth System Models.

In addition to the relatively small group of historical “iconic” and widely criticized and debated simple cost-benefit IAMs, there is a larger group of detailed-process IAMs that consider different regions and different sectors in more detail. Notable examples are AIM/CGE, GCAM, IMAGE, MESSAGE-GLOBIOM, REMIND-MAgPIE and WITCH-GLOBIOM [26]. These models are more closely linked to the ongoing academic debate and IPCC reports, compared to the simple cost-benefit IAMs that have or had a more prominent role in macro-economic discussions and institutional policy. For a detailed overview of these models, the reader is referred to a previous working paper [2]. Below, focus is primarily on the institutional context of simple cost-benefit Integrated Assessment Models.

#### *Institutional context of Integrated Assessment Modelling*

On a global level, a wide group of academic, civil society and institutional research communities debate and discuss global, regional and local contemporary and future societal climate policy trajectories. The most prominent climate science and policy debates take place within the IPCC, consisting primarily of three working groups that publish 6 or 7-yearly reviews of the state of physical climate science (WG I), climate change impacts, adaptation and vulnerability (WG II) and the mitigation of climate change (WG III). These assessments are accompanied by more regular topical IPCC reports, academic publications and institutional reports. Despite the rather long review cycle in comparison to the publication frequency of contemporary climate policy papers from the academic and institutional community, the IPCC reports help to constitute knowledge markers at regular intervals and serve as a benchmark against which more topical climate debates can be held. Because of this, the IPCC has authority in defining and shaping climate science discourse and policy development. On the other hand, because of the fairly lengthy review timeline, contemporary and alternative voices and opinions are inevitably left uncaptured between subsequent reviews.

In contrast to the physical climate science assessments of the wider WG I community - primarily focused on improving the understanding and modelling of the climate in response to historical emissions and different future emission trajectories, the work of the broad WG III community has a stronger socio-economic dimension. Notwithstanding the different scope of each WG, both research communities are tied to each other in respect to the analysis of future climate change impacts and emission trajectories. This, in the sense that debates and research on ‘possible futures’ of the WG III community provides the WG I community with a set of standard emission pathways – termed Shared Socio-Economic Pathways (SSPs) – that have been collectively defined by the academic community [26,27]. They span a wide range

---

<sup>82</sup> For a more detailed description of the DICE and RICE model family structure and functioning, the reader is referred to source [23]

of possible futures, and are therefore a helpful tool to debate and discuss a broad set of future pathways that our society could possibly evolve to. The SSP emission trajectories [28–30] have been defined within the ScenarioMIP project [31] to serve as scenario databases that are currently used in the ongoing Coupled Model Intercomparison Project Phase 6 (CMIP6) [32] for WG I of the IPCC.

The linkage of model development to the design and evaluation of climate policies is twofold. In the first place, there is a vivid debate within the IAM and SSP modelling community on the structure and parameterization of the models that are used to reflect on possible futures. Secondly, these global models influence the wider institutional policy debate on long-term climate policy [4]. On an institutional level, the global debate on IAM modelling takes to a great extent place within the Integrated Assessment Modelling Consortium (IAMC).

### *The influence of discount rates on the outcomes of IAMs*

To illustrate the impacts of using discount rates in the current generation of IAMs, this section aims to provide a brief overview of past assessments and the extent to which discount rates alter the outcome of these models.

The average discount rate of the models participating in the IAMC is around 5-6 % [33]. For example, the MESSAGE model from PBL Netherlands uses a discount rate of 5 % [34], although there are outliers of up to 20 % as is the case in the DNE21+ model of the RITE Institute in Japan [35]. As these models are frequently used to debate global or regional carbon pricing, it is informative to evaluate the impact of such levels of discounting on the timing of mitigation actions or, when simply expressed in monetary terms, the amount and evolution of a carbon price.

In order to evaluate the impact of discount rates on the full spectrum of IAMs that are available in the Shared Socio-Economics Pathways (SSP) database used for climate modelling to inform the upcoming IPCC assessment report [28,29], Emmerling et al. [33] created a conceptual model based on the rule of Hotelling<sup>83</sup> [37] to relate different discount rates to the timing and amount of emission overshoot and negative emission rates for a given total carbon budget, with the exhaustible resource being the remaining future carbon budget. In this model – for a carbon budget ranging from 400 to 1600 GtCO<sub>2</sub> equating to the maximum carbon budgets necessary to achieve the 1.5 or 2 °C temperature target, the discount rate has an enormous influence on the timing and rate of emissions overshoot or negative emissions. For example, a one percentage point increase in the discount rate leads up to a 50 % increase in emissions overshoot. When implementing a discount rate of 5 % for a carbon budget of 1000 GtCO<sub>2</sub>, net zero emissions are reached in 2075 with a budget overshoot of 14 %. When the carbon budget is reduced to 200-600 GtCO<sub>2</sub> (needed to stay within 1.5 °C global warming), there is a budget overshoot of respectively 2055 % and 91 % [33].

Surprisingly, these results appear to be in line with the average of a set of detailed process IAMs (AIM/CGE, GCAM, IMAGE, MESSAGE-GLOBIOM, REMIND-MAGPIE and WITCH-GLOBIOM [26]). The authors therefore argue that – however not mentioned in the latest IPCC special report on 1.5 °C global warming [38], reducing the discount rate in these models would considerably reduce the burden on future generations by moving net zero closer in time and reducing the overshoot.

A more generic effect of using positive discount rates to discount the future in IAMs, is that capital-intensive investments in the short term (for example renewables) are assumed to be comparatively more expensive compared to the deployment of specific technologies later in the future, for example the deployment of Negative Emission Technologies (NETs)

---

<sup>83</sup> The rule of Hotelling is a simple equation to calculate the rate of return on investment when holding an exhaustible resource stock in private ownership :  $dP/P = s$ . The rate of increase of the price P (dP/P) is in economic literature equal to the so-called “socially optimal rate of extraction” [36].



such as bioenergy with carbon capture and storage (BECCS) or direct air capture with carbon storage (DACCS) far in the future. To exemplify the impact of changing discount rates on IAMs, it is illustrative to look at a case study of the WITCH IAM [20]. Realmonte et al. [7] found that lowering the discount rate from the standard 5 % in the WITCH model to a rate close to zero, caused the model to simulate earlier decarbonisation.

### *Social Foundations of IAMs*

Scholarly and institutional research on IAMs has generally evolved from a narrow, disciplinary orientation to more complex and integrated structures. While the earlier generation of IAMs aimed at answering quite specific research questions (DICE [39]), the new generation of IAMs (such as detailed-process IAMs, e.g. the latest versions of IMAGE [40]) focus on a much wider range of research questions and on multidisciplinary and integrated approaches, also embracing questions of sustainable development (c.f. IAMC, conclusions from annual meetings).

However, despite a higher level of integration of different domains in the structure of IAMs, social complexity is rarely portrayed there beyond purely economic, aggregated behaviour [41]. IAMs are far from being able to resolve economic agents. Indeed, in terms of social dynamics, existing IAMs typically consider the whole world (or a small number of world regions for the RICE model) as just one or a small number of rational and farsighted agents with “rational expectations” (i.e. correct beliefs about the future) who make decisions that optimize social welfare (measured in monetary terms) over the analysed time period. The goal of this approach is the identification of cost - or welfare - optimizing pathways for climate change mitigation from a technological and economic point of view. Questions related to the implementation of the identified pathways in a complex social world and mitigation of social and environmental impacts are left to subsequent considerations. We believe that the identification of optimal pathways has merit by providing a benchmark for action, but that the transition pathways provided by IAMs are of limited guidance for the design of effective climate mitigation policies. It is argued that IAMs are at the moment not yet sufficiently integrating social drivers, impacts and complexity, in order to be of use in real-world policy making, despite the progress that has been made.

When it comes to improving the understanding of the role of the “social” dimension in this context, it is important to distinguish between social dynamics that drive climate change compared to social dynamics related to impacts of a changing climate. It is essential to understand whether and how actions of different parties are mutually dependent, and how they unfold synergies or counteract each other because of social complexity. For example, on the impact side of social dynamics, the concept of social cost of carbon (SCC) [42] currently dominates climate policy discourse. The SCC aims to address for example issues such as the effects of climate change on agricultural productivity, human health or property damages. In order to better account for social impacts, it is becoming increasingly important to incorporate aspects such as equality, welfare distribution, ethical, intergenerational or justice issues in IAMs and policy debates [43]. Increased accuracy of accounting for climate damages will be beneficial for an improved understanding of the either previously underestimated or overestimated share of social impacts.

The IPCC acknowledges that transition pathways need to include social aspects such as motivational factors, institutional feasibility or behavioural changes. However, we have to move forward from mere intentions to integrated, operational tools for policy making. In order to develop such operational tools, we suggest a “paradigm shift” in IAM development. In particular, the above outlined social drivers are so far neglected in IAMs and their use. They are however crucial for understanding the actual dynamics of climate change mitigation policy development. Moreover, including them in models becomes all the more important as soon as social impacts of climate change begin to affect social drivers – leading to a feedback loop

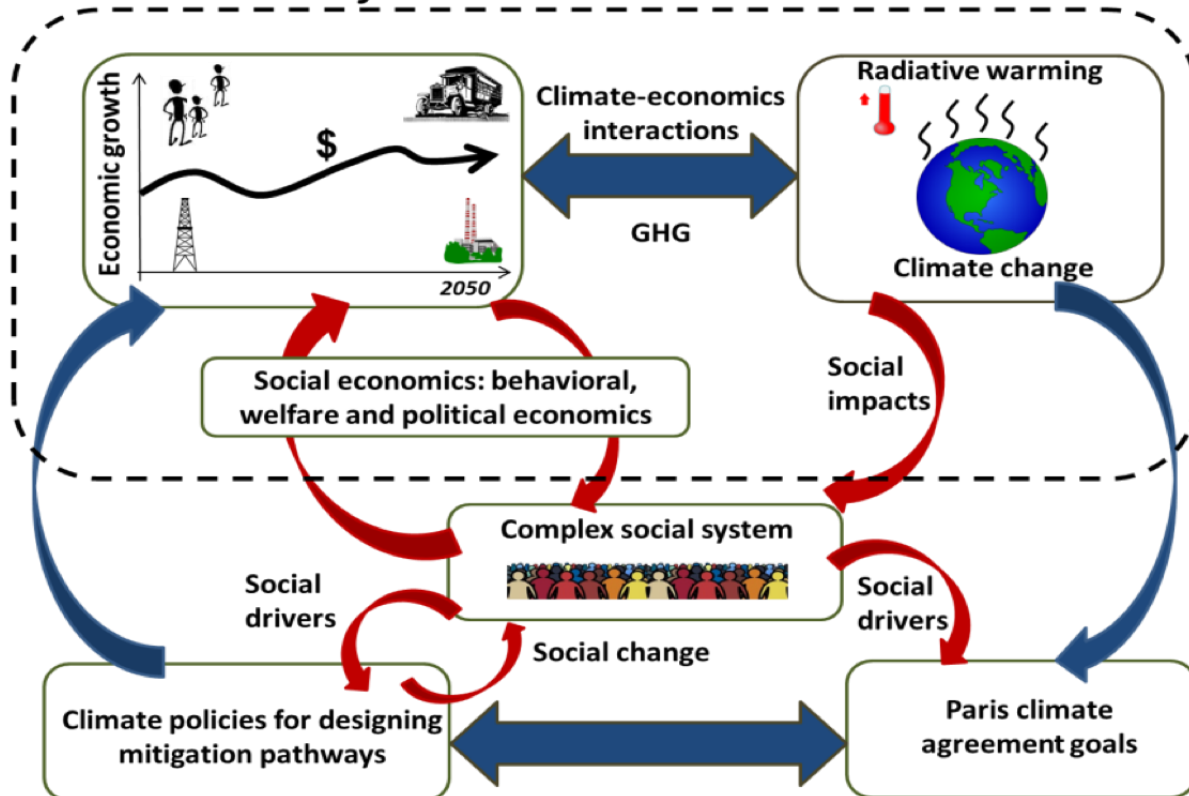
that may drive nonlinear dynamics (in either a positive or negative direction) that traditional IAMs are not able to capture.

As a starting point, we argue that IAMs should progressively include the results that connect economics with social or political sciences, as IAMs currently only connect economics with climate modelling, to a certain degree. More specifically, IAMs are mainly founded in neoclassical economics while several other pluralist branches of economics consider social aspects with different perspectives and theories. Among them, we point out three branches of economics from which social processes may be considered and formalized for tackling climate issues. For instance, behavioural economics may overcome the limitation of rational choice theory by formalizing psychological processes involved in climate-economics interactions. While most IAMs focus on economic decisions from the viewpoint of a hypothetical rational social planner, technological and behavioural change in the real world originate from many boundedly rational players at different societal levels that cooperate in different ways (as individual and collective actors), interacting not only via price signals but also through non-economic processes such as social norms, information exchange or preferences with non-monetary components. The emerging fields of social simulation and complexity economics suggest that such behavioural effects can cause much more nonlinear trajectories than represented in close-to-equilibrium economic models, containing tipping behaviour highly relevant for the transitions that IAMs are meant to study [44]. Formalizing components of welfare economics in IAMs may also evaluate inequity and distributional impacts that affect the feasibility of climate policies as exemplified for example by the “yellow jacket” crisis in France. A truly “integrated assessment” of climate protection measures should include an assessment of such distributional side-effects, because those side-effects are the most important to evaluate reliably the feasibility of measures. The current approach of simple cost-benefit IAMs to inequality is to disregard it or at best include it in some inequality-averse welfare measure that is then used as the optimization target. This ignores however the feedback effects of inequality on economic pathways and on the feasibility of policy measures. Welfare economics can therefore provide operational tools in order not to reinforce potential inequalities that may emerge from climate policies. Finally, political economics would highlight resistance or support dynamics on climate policies emerging from the effects of political power and lobbying. These political processes are neglected in IAMs whereas measures have to be decided within a socio-political context that renders some measures unfeasible while others may receive more support from influential actor groups.

Integrating these three main social and economic strands in IAMs requires not only the inclusion of state-of-the-art and cutting-edge model components, but also the acquisition of social data to drive and validate the models. Either such data are readily available (e.g. social impact data coupled to input-output tables [45] or data from social networks) or these have to be elicited and assessed (e.g. from social science databases). Eliciting and assessing new social data may be done through a variety of participatory modelling approaches to collect perceptions of large participant groups, focusing on social climate change issues connecting to geographical locations. Such data may be collected through qualitative surveys and expertise using participatory face-to-face exchanges. These qualitative data may then be used for preparing online surveys, yielding big data sources that can be used in modelling exercises. Once such datasets are collected, analysis becomes challenging due to its volume and heterogeneity (especially when data are gathered online). Artificial intelligence – based on data mining – combined with FAIR and collaborative open data processing could be a way to address the issues of quantity and heterogeneity of data for extracting social patterns. Methods for social media mining such as sentiment analysis, relational data mining and predictive modelling can be powerful tools for discovering social patterns in data, which enriches the existing process- or cost-based IAMs with an additional social component (Figure 5.1).

Figure 5.1 : The role of complex social system on climate dynamics

### IAMs with social foundations



Source : Mathias et al. (2020, p. 3) [41]

### Energy System Models and the European climate and energy modelling framework

The focus in this section is on the modelling tools that are used to shape European climate and energy policy, ranging from ESMs to broader macroeconomic models. The aim is to sketch an overview of the basic functioning of these models that are currently used for forecasting, with a particular focus on the influence of discount or interest rates in these models. Primary focus is on the TIMES modelling family (because it is frequently used for national energy policies and trajectories) and the PRIMES model. The PRIMES model is an interesting case, because it has a long history of use in policy making by the European Commission. It has for example been used for different long-term planning studies of the energy-climate system, to make the case for an EU-wide Emission Trading Scheme [46,47]<sup>84</sup> and to define baseline trajectories that serve as a benchmark for policy targets [48,49]. It is beyond the scope of this chapter to review other ESMs than TIMES and PRIMES, but the reader is referred to an interesting exchange between Egli et al. [50] and Bogdanov et al. [51,52] for an in-depth technical debate on the importance of using real-world and country-specific discount rates in energy system modelling, compared to using a generic discount rate.

<sup>84</sup> It is interesting to note that the PRIMES modelling exercise (underpinning the Green Paper on GHG emission trading of the European Commission from 2000) predicted a cumulative cost of independent Member State emission reduction policies to reach the EU-wide the Kyoto target of 0.075 % of the projected GDP in the year 2010, getting progressively cheaper (- 24 %) when implementing a carbon market in the energy sector. The average carbon price for one tonne of CO<sub>2</sub> was estimated to evolve around 30-33 EUR.

### *The Integrated MARKAL-EFOM System (TIMES)*

There exist a wide variety of EMSs, but one of the historically most prominent EMSs in institutional settings is the The Integrated MARKAL-EFOM System (TIMES) model, maintained by IEA-ETSAP. In the European institutional energy modelling context<sup>85</sup>, the Joint Research Centre maintains a European version of the TIMES model, JRC-EU-TIMES [55] – focused on assessment of the long-term development of energy sectors for the whole economy. Different member states adopted the TIMES modelling framework to the national context, such as TIMES-Sweden [56], TIMES\_Norway [57], Spain [58] and Belgium [59]. In addition to the JRC-EU-TIMES model that focuses on the whole economy, the Joint Research Centre develops and uses the Dispa-SET 2.0 model that focuses solely on the power sector [60]. The Dispa-SET model aims to minimize the total system cost of the power sector, broken down in fixed, variable, start-up, shut-down, ramp-up, ramp-down, shed load, transmission and loss of load costs [60]. The TIMES model computes for each region a total Net Present Value (NPP) of the stream of annual costs<sup>86</sup>, discounted to a predefined reference year. These costs are aggregated into a single total cost that is to be minimized by the model (the objective function of the model) [61]. The JRC-EU-TIMES model is also – as is the case for the original TIMES model – a linear optimization bottom-up model that models both supply and demand sectors (primary energy supply; electricity generation; industry; residential; commercial; agriculture; and transport), in which an equilibrium is calculated by maximizing the discounted present value of total surplus, acting as a proxy for welfare in each region of the model [55]. This maximisation is constrained by a set of constraints, such as supply bounds for primary resources, technical constraints for the creation, operation and closure of different technologies, balance constraints, timing of investment payments and sector-specific energy sector demands.

The JRC-EU-TIMES model uses both social and financial discount rates. The social discount rate is set at 5 % and the financial discount rates differ strongly depending on the sector considered, ranging from 17-18 % for the residential sector including passenger cars, 11-12 % for freight and public transport and 7-8 % for energy distribution and centralized electricity generation [55].

### *The influence of discount rates on the outcomes of the ETSAP-TIMES model family*

Several studies have assessed the impact of varying social discount rates and technology-specific financial discount rates (or 'hurdle rates') on model outcomes for the ETSAP-TIMES model. In the generic TIMES model (as well as many national or regional TIMES models such as the EU-JRC-TIMES model), by default a standard social discount rate of 5 % is used [55]. In the generic TIMES model structure, changing the social discount rate from 3 to 15 % has a strong influence on the relative share of renewable energy versus fossil energy. The higher the discount rate, the lower the relative share of renewables and the slower the uptake of renewables [62]. For example, when increasing all the technology-specific financial discount rates upwards with the same magnitude in the JRC-EU-TIMES model, wind and tidal energy technology expand and become competitive in an earlier stage compared to using lower technology-specific discount rates [55].

---

<sup>85</sup> The focus is here on the European institutional modelling framework, but energy system modelling has a long history of international exchange and debates. For a broader historical analysis and view on international institutional energy system analysis, the reader is referred to commentaries related to the IIASA Energy Studies from the 80s [53,54].

<sup>86</sup> The different types of costs that constitute total cost in the TIMES model are capital costs of investment or dismantling, operation and maintenance costs, costs for exogenous imports and domestic resource extraction and production, revenues from exogenous export, delivery costs for commodities, taxes and subsidies associated with commodity flows, revenues from recuperation of embedded commodities after dismantling and possibly damage costs for different types of pollutants.

The impact of changing discount rates on the outcomes of the ETSAP-TIMES model family is confirmed by several studies looking at the impacts on national or regional TIMES model versions. A study with the Indian TIMES model found that decreasing the discount rate from 8 % to 6.5 % caused the share of coal energy in the energy mix to decrease from 283 GW to 218 GW in 2045, and renewable (hydro) energy was found to decrease in share with increasing discount rates [63]. In the UK, it was found that shifting the discount rate in the UK TIMES model from 3.5 % to 15 % caused the total cost for decarbonisation of the energy system to more than double (as investments are delayed and required at a later stage) [64]. In the Swiss TIMES model, changing the discount rate from 6 to 10 % caused the share of gas in the energy system to increase from 5 % to 21 % [65]. In the Norwegian model (TIMES\_Norway) - acting on an energy system with large shares of hydropower, changing the social discount rate from 5 to 15 % mainly affects future wind energy production. As a general rule, for all TIMES models considered, a lower discount rate causes capital-intensive energy technologies (such as wind energy) to increase in magnitude and appear earlier in time and causes exports of energy to increase [62].

Considering the deployment of NETs – a technology traditionally associated with IAMs but also present in the TIMES model family, Realmonte et al. [7] found that decreasing the discount rate of the TIAM-Grantham model (a TIMES model maintained by the Grantham Institute) from the standard 5 % to a rate close to zero, caused the projected BECCS and DAC deployment to be respectively almost halved and reduced by a quarter by 2100 in a 2 C scenario, compared to the standard 5 % discount rate scenario.

In addition to a predefined discount rate, the JRC-EU-TIMES model is informed exogenously by other models that provide macroeconomic indicators for a set growth-target (GEM-E3), primary energy import prices and energy potentials (POLES), energy technology-specific data (ETRI) and technology-specific discount rates to indicate the cost of finance or expected annual return on investment (PRIMES) [55]. The financial discount rates used in the JRC-EU-TIMES model are provided by the PRIMES model, of which the structure and characteristics are outlined in the next section.

### *Price-driven and Agent-based Simulation of Markets Energy System (PRIMES)*

The Price-driven and Agent-based Simulation of Markets Energy System (PRIMES) model is a prominent model in the broad institutional setting of European policy making, as it has been used to inform different legislative frameworks and policies. For example, the PRIMES model outcomes have been used by the EIB to derive future investment needs for different technologies [66], the revised EU Energy Efficiency target for 2030 of 32.5 % from 2018 has been defined relative to 2007 PRIMES baseline projections [67,68] and the baseline scenario for the EU Long-Term Strategy ‘A Clean Planet for all – A European long-term strategic vision for a prosperous, modern, competitive and climate neutral economy’ [69] was based on PRIMES modelling. For the latter purpose, the PRIMES Reference Scenario 2016 was updated with technology-specific data provided by the ASSET project in 2018 [70].

### *The influence of discount rates on the outcomes of PRIMES*

As is the case for the TIMES model, the PRIMES model is also to a certain extent influenced by discount rates.

Despite that the PRIMES model is based on individual decision making and does not follow a least-cost optimisation of the entire economy or energy system and therefore the social discount rates play no direct role in determining model outcomes between sectors, nevertheless the social discount rate influences the ex post estimation of total and technology-specific energy system costs that are used to inform policy. These sectoral total system costs

– such as the energy system (capital expenditures, energy efficiency investment costs, ...) [69] (p. 207) or capital costs for the purchase of transport equipment [71] – are calculated after the model is solved using a general discount rate of 10 %. This discount rate is argued to be very high, as it is almost twice as high as the average discount rate used by different European member states. For example, France changed a formerly fixed social discount rate at 8 % to 4 % in 2005, Germany reduced its discount rate from 4 to 3 % in 2004, the UK reduced its national discount rate from 6 to 3.5 % in 2003 [72] and the Norwegian Ministry of Finance recommends a discount rate of 4 % [73]. The European Commission itself changed its recommended financial discount rate for the evaluation of long-term project-investments from 5.5 % for Cohesion countries and 3.5 % for the other member states in 2008 [72] to a general discount rate of 4 % [74] in 2013 (Regulation (EU) No 1303/2013 implemented by Commission Delegated Regulation (EU) No 480/2014 [75,76]).

Private or financial discount rates play an important direct role in the determination of the modelled output-shares for different sectors in the model [77]. For different types of investment in the energy supply sectors, PRIMES uses financial discount rates of 7 to 8 %. For the energy demand sectors, discount rates range from around 7 or 8 % (energy intensive industries and public transport) up to 9 or 11 % (non-energy intensive industry and service sectors). For individuals or households investing in private cars, renovation of houses or appliances, discount rates are higher (11-15 %) to reflect a so-called 'risk-aversion' for large investments from a private individual or household perspective.

In a study from 2018 commissioned by the European Commission on the macroeconomics of energy and climate policies [78], it was found that a slight increase in the discount rate in the PRIMES model (from 10 % to 13 %) increases the estimated levelized cost of electricity from wind or PV with more than 15 %. This proves that the discount rate, which is rather high in the PRIMES model, has an important effect on the outcome of cost modelling and therefore policy debates.

### *How does the PRIMES model projections compare to national policies?*

While being cautious about the limits of the PRIMES model (as for any model an din particular models based on monetary optimisation), it is informative to compare PRIMES forecasts and forecasts with individual projections from the European member states. Szabo et al. [79] compared in 2014 the sectoral renewable energy targets proposed in the National Renewable Energy Action (NREAs) plans, the predecessors of the current National Energy and Climate Plans (NECPs), with the theoretically renewable energy shares derived with the PRIMES model. They found that, for PV deployment, the level of 2030 in PRIMES would already be reached in 2020 on the basis of the combined PV shares derived from the NREAs. For wind and biomass, member state targets and model results were more in line with results from the PRIMES model. They note further that politically agreed binding targets give investors confidence to invest in specific technologies, and that NREAs (or NECPs) have legal value compared to models that use general market laws and are only a theoretical abstraction of the economy.

No ex-post comparison of the previously modelled PRIMES baseline scenario with historical sectoral emissions has been found in the literature, and neither an ex-post analysis or comparison of EU's modelling scenarios forecasts with the current NECPs. This might be an interesting avenue to pursue in future research.

## **Institutional climate and energy policy frameworks**

The cornerstones of European climate policy are the EU ETS [80] and the Effort Sharing Regulation (EU ESR [81]). The former is a market-based policy instrument with the purpose

of controlling industrial emissions under a predefined emission ceiling, and the latter is a regulation to distribute emission reduction efforts between the member states of the European Union. Clearly (and fortunately) the exhaustive set of European climate and energy policies is not limited to these two frameworks, but they provide the overarching legal framework that aim to target all territorial emissions within the European Union by providing upper emission limits and trajectories. As the scope of this chapter is to evaluate monetary policies, focus in this chapter is on whether the existence of the EU ETS market has caused emissions to decrease, or whether the observed emissions are the result of other policies and public or private initiatives (or could be in the future).

In the following, first a theoretical overview is given of the conceptual difference between norm-setting, taxation and tradable emission permits. It concludes with an appreciation of emission certificate trading markets, exemplified by the Kyoto protocol and the European EU ETS.

### **The administrative regulatory approach and economic instruments**

The activities usually considered by economic theory are market activities that lead to the setting of a price and the achievement of a voluntary exchange. Some economic activities can lead to resource scarcity or environmental degradation and cause environmental harm (sometimes termed externalities in economic theory). Pollution associated with the production and/or consumption of human societies is a good example. Furthermore, the environment is a collective good: it is non-appropriable, non-exclusive, often free, and provides well-being for the community. For example, the ozone layer is not produced by economic activity (historically rather depleted because of chlorine and bromine released by ozone-depleting substances) does not belong to anyone, and is useful for everyone (without needing to exclude anyone) even if it is not consumed. Nonetheless, the environment cannot be considered as a pure collective good, since its consumption by some can destroy the good or the qualities that made it attractive. The rules for allocating scarce resources usually defined by economists are difficult to apply here. How should the "true" price of pollution be determined? How should the economic value of the environment or climate be calculated? In order to re-establish the conditions of market exchange, economists have been led to identify what they call external effects and to propose solutions to internalise or eliminate them. Two diametrically opposed intervention policies are generally proposed : the administrative regulatory approach and the economic approach.

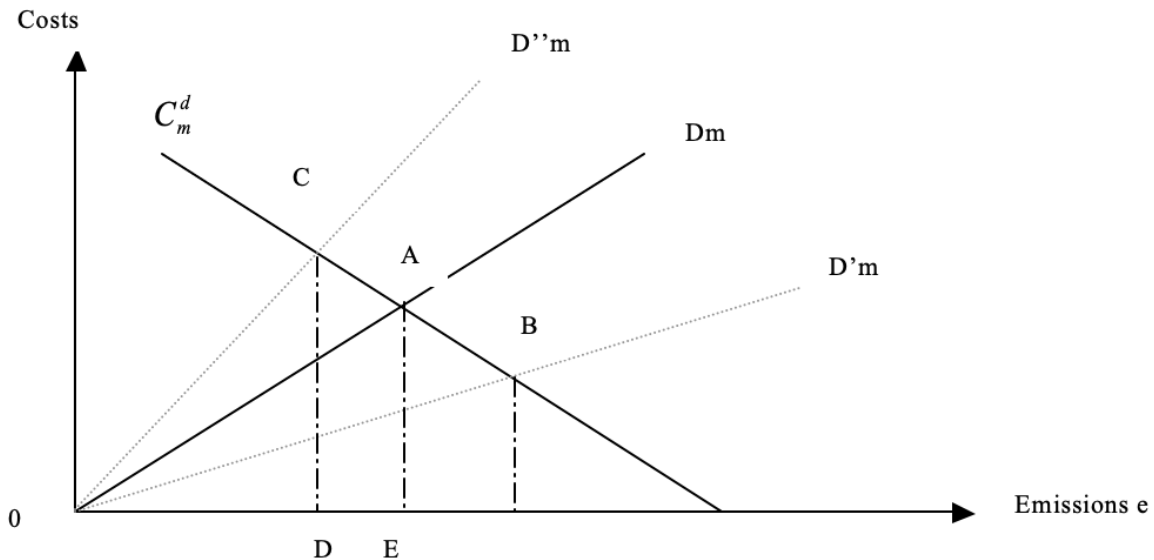
#### *The administrative regulatory approach*

A simple way to ensure that a theoretically acceptable level of pollution is achieved, is to impose norms of different kinds on them. A norm consists of a maximum impact ceiling which must not be exceeded, under penalty of administrative, penal or financial sanctions, for example sulphur dioxide emissions into the atmosphere or the emission level of cars. A norm or standard-setting process is inherently a political process, where different interests are balanced against each other (for example, protecting the environment versus avoiding a dreaded outsourcing of industry outside the policy region of interest). In some cases, it could be in the economic interest of polluting agents to pollute. For example, when agents don't incur the cost of environmental impacts and when profit is directly related to environmental impacts, a norm ensures that they won't exceed the maximum permitted level of pollution.. Process norms could for example require the agents to use certain depolluting equipment (catalytic exhausts, filters, etc.).

Norms can be chosen according to two types of criteria: environmental or economic. In the first case, they are often based on a predefined environmental or health protection objective that is then associated to a maximum physical concentrations or dosage of pollutants

that respects the predefined objective (such as the maximum allowed concentration fine particle emissions from cars in the air). In the second case, a norm is calculated based on a monetary cost-benefit assessment. A norm that compares benefits and costs should make it theoretically possible to achieve a balanced pollution level. However, the assessment by public authorities of the damage suffered by the victims of pollution then proves to be crucial. Figure 5.2 shows that setting an inappropriate norm may result in excessive total damage to the victims or, on the contrary, excessive total pollution costs to the polluters.

**Figure 5.2 :** The establishment of a norm



Source : Diemer (2009) [82]

The ABO surface is the excess damage due to a weak standard.

The CAED area corresponds to the excess cost of de-pollution due to a strict norm.

In order to achieve a certain GHG concentration target in the context of climate policy, process norms that cumulatively are expected not to exceed a certain emission level could be argued to be preferable because it is fairly straightforward to control and verify using specific pollution control equipment. The disadvantage of norms is their inability, if set at an optimal level, to encourage agents to increase their pollution control effort.

#### *The economic approach: principles behind market mechanisms*

The economic approach is to use market mechanisms by changing a relative price and causing a financial transfer. Economic instruments use market mechanisms to encourage producers and consumers to limit pollution and prevent the degradation of natural resources. The logic is straightforward: the aim is to raise the cost of polluting behaviour while leaving producers or consumers with the flexibility to find their own strategies for controlling production at lower cost. Economic instruments are generally classified into two main categories: (i) price regulation (carbon tax); (ii) quantity regulation (tradable emission permits).

#### *Carbon Tax*

The presence of negative externalities raises the problem of the inadequacy between private costs and the collective cost (social cost) of economic activities. When a company produces and emits greenhouse gases, the cost of production, which is a private cost, is lower than it should be and differs from the social cost of its activity, in particular the cost it inflicts on the society. The solution advocated by Pigou in 1920 [83] consists of introducing state



intervention through a 'Pigouvian tax'. In order for the private economic calculation of the polluting company to reflect the true social cost of its activity, it must internalise the external effect. Pigou argued that this is only possible by using a price signal that reflects the damage it inflicts on the society. It is the state that plays this role of price-maker by imposing a tax on the polluter, theoretically equal to the social damage caused by his polluting activity. This is the "polluter pays" principle: the polluting company is then properly informed of the true social costs of its activity.

Energy and climate models generally include a carbon tax. There are two reasons for this choice. On the one hand, the tax is charged on each unit of pollution emitted and it is therefore convenient to integrate this additional cost into an economic production function in modelling exercises. The cost of production becomes higher while the profit decreases. On the other hand, the procedure of internalising externalities does not require the prior choice of an environmental quality objective. The level of pollution deemed optimal by the society is the result of a simple cost-benefit analysis. However, in practice a cost-benefit analysis involves many difficulties, linked to imperfect information on the identity and behaviour of the agents emitting and receiving pollution and the associated cost, social damage functions, etc. The Pigouvian internalisation procedure is therefore not always easy to implement. Moreover, there is no consensus on the real value that this tax should take.

### *Tradable Emission Permits*

A carbon tax implies public intervention, but it is also possible to imagine this intervention by the existence of market mechanisms that are designed with the purpose of regulating pollution problems. The solution is to define a market, where there is none a priori, and to let competition mechanisms play a role in internalising externalities. Theoretically, it would be enough to define property rights or user rights to restore the proper functioning of the economy (without further state intervention). The coordination of the behaviour of economic agents (households, companies) is then ensured through either a direct negotiation or the emergence of a price signal (a price of the pollution permit) resulting from the confrontation of individual and collective preferences. There is thus a filiation between negotiated internalisation modes, as Ronald Coase proposed in the 1960s [84], and what are now called tradable emission permit systems (also referred to as pollution rights markets).

Tradable permits give polluters greater flexibility in allocating their pollution control efforts among different sources, while allowing governments to maintain a fixed cap on pollutant emissions. Increases in emissions from one source must be offset by reducing at least an equivalent amount of emissions from other sources. If, for example, a regulatory pollution ceiling is set for a given area, a polluting undertaking may only set up or expand its activities there if it does not increase the total pollution load. The company must therefore buy pollution rights or permits from other companies located in the same regulated area, which are then required to reduce their emissions in equivalent proportions (this is also called emissions trading). This strategy has a two-fold objective. On the one hand, to incentivise the implementation of low-cost solutions (by encouraging companies, for which reducing emissions would be very costly, to buy pollution rights from other companies for which reducing emissions would be less costly). On the other hand, to reconcile economic development and environmental protection by allowing new activities to locate in a regulated area without increasing the total amount of emissions in that area.

## **International and European emission trading**

### *The Kyoto Protocol*

The Kyoto protocol could be argued to have been the first landmark international carbon market agreement. It was voted in 1998 and entered into force in 2005 [85], and the first commitment period in which the 36 participating developed countries committed to reduce their collective emissions on average with 4.2 % compared to the 1990 emission (distributed over the countries depending on wealth according to a 'Burden Sharing' agreement) level took place between 2008 and 2012. In order to anticipate emissions trading between countries provided for in the Kyoto Protocol, various initiatives have emerged preceding the official entry into force.

Carbon dioxide (CO<sub>2</sub>), the most important GHG, became a stock exchange security on 2 April 2002 in London. Trading on this new market is based on emission reduction quotas for CO<sub>2</sub> and five other greenhouse gases covered by the Kyoto Protocol: methane (CH<sub>4</sub>), nitrous oxide (N<sub>2</sub>O), perfluorocarbons (PFCs), hydrofluorocarbons (HFCs) and sulphur hexafluoride (SF<sub>6</sub>). The main operators are highly polluting British companies which must reduce their emissions to enable London to comply with this international agreement to combat climate change. There are also foreign companies operating in other Kyoto countries, NGOs and individuals.

In 2003, the Chicago Climate Exchange (CCX) was launched. This was intended to help participating companies in meeting their commitments to reduce emissions (particularly CO<sub>2</sub> emissions) by 4% by 2006. The initiative brings together, among its founding members, the city of Chicago, universities and 22 international companies including America Electric Power, Bayer, BP America, Dupont, Ford, Stora Enzo, etc. Together, the members of the CCX alone account for the equivalent of 50% of all emissions in Great Britain and 30% of those in Germany. The membership fee varies from \$1,000 to \$10,000 depending on the degree of pollution emitted by the company. The creation of this market for the six noxious gases has allowed companies to buy or sell pollution rights in order to adjust their activities to their strategy or means (at the first trading session, 125,000 tonnes were auctioned). This system favours companies that have reduced their greenhouse gas emissions since they can sell their unused pollution rights at a good price. Members' allowances were calculated in tonnes based on an average baseline emission level calculated over the period 1998-2001.

An ex-post evaluation from 2016 reiterated that together the countries overcomplicated their Kyoto targets with a cumulative amount of 2.4 GtCO<sub>2e</sub>/year, most of it estimated to be hot air (2 Gt) – a term to identify the drop in emissions resulting from the collapse of the Soviet Union – and changing accounting rules of land use, land-use change and forestry (LULUCF, 0.4 Gt) [86].

Each region or country deploys their own policy framework in order to achieve their obligations to the Kyoto protocol or national or regional climate targets. As an example, the EU ETS system functioning and performance up to now, as well as the link with climate and energy modelling frameworks, is discussed in the next section.

### *The European emission trading scheme (EU ETS)*

The European EU ETS covers currently approximately 45% of the territorial European CO<sub>2</sub> emissions, mainly from the energy sector, energy-intensive industries and aviation (since 2013). It does not cover agriculture, housing and transport. The ETS obligates manufacturers, electricity producers and airline companies to buy a number of emission quotas corresponding to one tonne of CO<sub>2</sub>, or one tonne of CO<sub>2</sub> equivalent for the emission of N<sub>2</sub>O or perfluorocarbons (PFCs).

Inspired by a Green Paper from the European Commission in March 2000 [46] informed by economic modelling with the PRIMES model [47], Europe implemented the EU ETS in successive phases from 2005 onwards. The PRIMES model was used to calculate the total cost (calculated for the year 2010) of achieving the EU-wide Kyoto reduction target of 8 % over the period 2008-2012 (distributed over the different member states according to differing reduction shares decided in the Burden Sharing agreement of June 1999<sup>87</sup>) compared to a case with a European market starting from 2005 onwards, concluding that carbon trading would be less costly than member states pursuing their EU Kyoto reduction shares individually.

For the baseline case, an illustrative projection of decided policies or 'business as usual' scenario, the PRIMES model indicated an average marginal abatement cost of 54 EUR/tonne CO<sub>2</sub> for the EU, with strong outliers indicating either a cheap (Germany: 13.5 EUR/tonne CO<sub>2</sub>) or expensive member state-level emission reduction cost (Belgium: 89 EUR/tonne CO<sub>2</sub>, Finland: 63 EUR/tonne CO<sub>2</sub>, the Netherlands: 150 EUR/tonne CO<sub>2</sub>) totalling to an EU-wide abatement cost 9026 million EUR or 0.075 % of the, at the time, projected GDP of the EU in 2010. This 54 EUR/tonne carbon price stood in stark contrast with other scenarios where a carbon market would be implemented for energy production sectors only (marginal abatement cost of 32.3 EUR/tonne CO<sub>2</sub>) or an implementation for both the energy production and energy-intensive industries in the market system (32.6 EUR/tonne CO<sub>2</sub>). Both scenarios were around 24 % cheaper for the whole of the EU compared to individual measures at member state-level, in the PRIMES modelling exercise [47]. In a third theoretical case of full intra-EU trading, costs for achieving the Kyoto targets would be 34 % cheaper, with Germany, France, Spain, UK and Austria becoming net sellers of emission allowances at a price of 32 EUR/tonne CO<sub>2</sub> [47]. They further conclude that "*the additional costs of for the economic sectors arising from the higher costs in the provision of energy service do not represent a direct leakage from the economy*", because "*these funds are recycled within the economy in the form of additional purchases of goods and services, usually substituting domestically produced commodities for largely imported energy products*" [47]. Clearly, the model does not indicate a strong risk for carbon leakage. However, this became one of the central policy debates after the enactment of the EU ETS market and received a lot of attention by policy makers [89,90].

Based on the PRIMES model, the EC Green Paper and successive consultations, the first pilot phase (2005-2007) of the EU ETS system was voted [80]. In this first trial phase, emission limits were defined by each member state individually in so-called National Allocation Plans (NAPs) and all allowances were issued for free. Emission data were not yet available during this pilot phase, and total allowances exceeded the total annual verified emissions after this period.

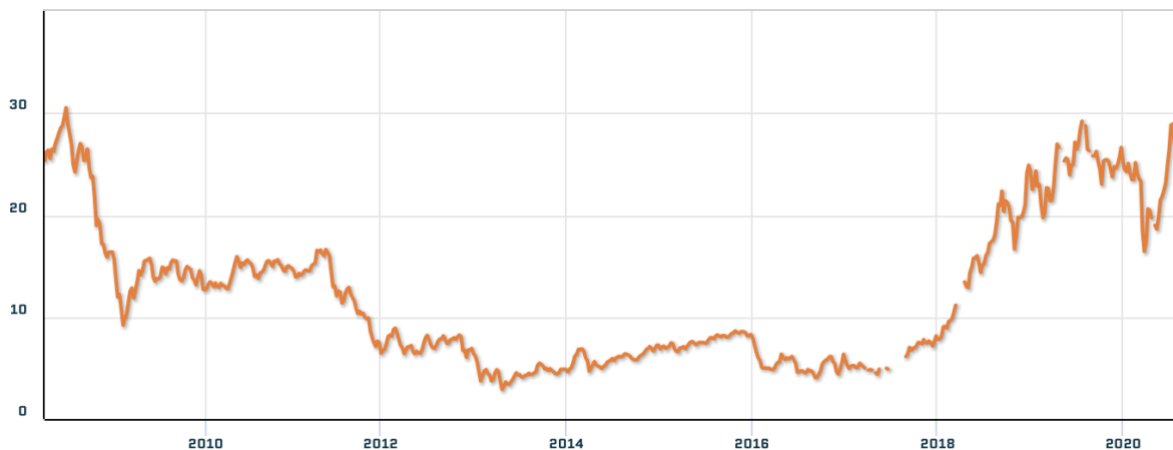
In the second phase between 2007 and 2012 – colliding with the first commitment period of the Kyoto protocol, 90 % of emission allowances were allocated for free based on a lower national allowance cap (around 6 %). It was possible for businesses to buy international credits, totalling to allowances for 1.4 billion tonnes of CO<sub>2</sub>. Because of the financial crisis of 2008, emissions were greater than those forecasted and therefore the price remained low. In the third phase (2013-2020) an EU-wide cap was set (2.08 billion) in line with the EU-wide climate action targets for 2020, decreasing each year with 1.74 % of the average yearly total allowances issued between 2008 and 2012 (38 million per year). In the ongoing phase 4 (2021-2030), the annual linear reduction factor increased from 1.74 % to 2.2 %. Surprisingly, although a fixed cap in phase 3, the emission cap in phase 4 became a function of market outcomes instead of a fixed cap [91].

---

<sup>87</sup> Even if the richer member states were allocated higher emission reduction shares, this has been argued not to go far enough considering intra-EU equity [87,88].

After reaching a ceiling of less than €10 between 2012 and 2018, the price per tonne of CO<sub>2</sub> rose to around €25 between 2018 and early 2020. Even if it is partly driven by the European Union via the "emission cap" and other mechanisms, this price is also dependent on market mechanisms, particularly demand and macro-economic dynamics or events. For example, in a few weeks, the Coronavirus crisis has led to a 20% reduction in this price, bringing it down to less than €20 per tonne of CO<sub>2</sub> at the beginning of May [92].

**Figure 5.3:** Historical carbon prices of the EU ETS



Source : Quandl [93]

## **The role of monetary valuation in climate and energy policy: obscuring or illuminating?**

A basic premise for the following discussion, is the notion that markets and monetary regulation should first and foremost adapt to the physical reality and (physical) policy goals, if climate policy is to be pursued seriously. Different aspects are important in determining the feasibility and evaluation progress towards global and regional decarbonization. The speed at which we will be able to decarbonize will depend on a variety of factors, not exclusively defined by monetary values. In the realm of monetary policy debates and theory, the discount rate and social cost of carbon discussions exemplify – on a generic level – the debate on how fast and at which pace emission reductions are to be pursued. But climate and energy policies are not limited to monetary accounting. There should be social acceptability, sensibilization of possibilities and knowledge in order to reach a common understanding, analysis and debate on labour implications and the availability of a labour force for sectors important for the decarbonisation transition, the exchange of knowledge and expertise on renewable energy technologies, collaboration between nation states and regions, the availability of sufficient material resources to organize such a transition, etc... It is argued that considering these aspects as a baseline for policy making – rather than an optimized trajectory based on aggregated monetary cost or benefit estimates – helps to reflect more clearly on existing or planned policies, in contrast to using aggregated least-cost or price assessments. Only using monetary parameters, one ignores a multitude of other aspects that are crucial for a successful transition. However, they could be useful for allocation discussions in a shorter time frame.

To substantiate these claims from a broader policy perspective, the following sections include a discussion on the role of monetary valuation in IAMs and ESMs and the European Emission Trading Scheme.

## **Cost-benefit and monetary optimization models versus socio-physical narratives**

A fundamental question is whether the use of “simple” cost-benefit assessment models – both in the context of cost-benefit IAMs or regional ESMS – is helping our society and democracies to understand better the possible consequences of climate change and whether they help design more effective mitigation or adaptation pathways.

Without having outlined the broad and complex field of climate change modelling and climate impact studies (as this resides in the field of climate modellers), one can however analyse how the detailed and prudent collective assessment of climate modelling compares to aggregating costs and damages within one single metric, at least considering simple cost-benefit IAMs. We would argue here that these modelling exercises and the surrounding debate on discount rates [33] are useful for policy-making on a conceptual level, but do not necessarily help to design effective climate policies. On the contrary, using positive discount rates favours the presence of large scale negative emission technologies in the longer term, as they are modelled cheaper than early mitigation actions [5].

Maybe the most fundamental problem of optimizing a trajectory based on forecasted costs and benefits far into the future, is that it is per definition impossible to monetize climate impacts (or benefits) far away in the future. For the purpose of policy making and increasing societal understanding of the challenges related to climate change, it would be much more sensible and reasonable to forecast physical impacts for each of the different economic sectors<sup>88</sup> instead of aggregating everything in a single price that is hard or rather impossible to verify or interpret. Neither physical climate models have a monopoly on the truth, as every attempt to understand the future, but at least these models have integrated consecutive knowledge on the functioning of the physical world and can be verified based on experimentally verified theory.

## **Has the European Emission Trading Scheme been effective up to now?**

In order to understand the historical and possible future performance of the EU ETS, below four points of critique are further outlined. First of all, one could ask whether the use of a market system in itself has been or is the best suited policy instrument to decrease emissions. Secondly, if a market system is used, the design of the system is important to ensure its effectiveness and should be subject to scrutiny if the policy goal of climate mitigation is to be pursued seriously. Thirdly, because of the system of free allocation, substantial windfall profits have been observed in the industries taking part in the EU ETS, undermining its effectiveness. And finally, there should be access to sufficient data in order to estimate its effects and increase the certainty to which (or not) observed changes in emissions can be attributed to the EU ETS [95]. A fifth topic that recently entered the policy debate, Carbon Border Taxation of imported GHGs, is briefly discussed in the end of this section.

### *Market-based versus non-market-based carbon pricing*

A first point of criticism in the literature is the existence of the market system itself and the way it has been set up. While the existence of the EU ETS market and the successive reforms it underwent are the result of a political compromise [96], using a market system for climate policy is – within the realm of fiscal or monetary climate and energy policies – not everywhere the policy instrument of choice. For example, Sweden implemented a fixed and progressively increasing carbon price from 1991 onwards at 23 EUR/tonne CO<sub>2</sub> – currently amounting to 110 EUR/tonne CO<sub>2</sub> [97] – and proves successful in both reducing emissions and protecting

---

<sup>88</sup> An interesting body of literature on climate impacts in the EU has been developed by the Joint Research Centre and associated research institutes in subsequent 'PESETA'-projects [94], focusing on transport, agriculture [84], water availability [95], etc..

or sustaining its economic activities [98]. There is strong evidence of the Swedish fixed carbon tax in the non-ETS sectors to have been responsible for emission reductions in the housing sector, and an average reduction in transport emissions of 6.3 % from 1990 onwards amounting to 9.4 % in 2005 [98]. In the industrial sector energy-related emissions decreased with 10 % between 1991 and 2004, primarily driven by decreasing energy intensity of production and decreasing emission intensity of energy [99], despite a production increase of 35 % [98].

### *Design flaws of the EU ETS*

A second critique is linked to the current design of the EU ETS market system itself. A Market Stability Reserve (MSR) was introduced in 2017 that came into effect in 2019, designed with the purpose of postponing the issue date of allowances as a function of the number of unused allowances, therefore increasing short-term scarcity in the short term but decreasing scarcity in the mid-to long term over the full timescale of the 4th phase of the EU ETS. This new version renders the long-term cap a function of past and future market outcomes [100].

Nevertheless, the introduction of the MSR made it easier and more coherent for member states to implement additional policies for sectors that are covered by the EU ETS, as possible emission reductions because of these national policies will finally result in more allowances being cancelled [100]. This resolves to some extent what has been called the 'waterbed effect', whereby additional policies at national or EU level that act on emissions covered by the EU ETS, weakened the effects of the carbon market [101]. To conclude, Perino argues that rules governing tradable emission permits should be consistent, as "changing this on short notice, retroactively and back and forth, makes it hard [...] to design a sensible mix of climate policies" and that "the complexity keeps scholars busy, but does not seem to serve any other meaningful purpose". This point of critique is closely linked to the previous point that it might be more straightforward to use a politically negotiated fixed carbon price. The example of the clear and consistent fixed Swedish carbon pricing outlined before helped to reduce emissions at a steady pace, whereas the rather complicated design of the EU ETS system did clearly not help reduce emissions. On the contrary, as further outlined in the following points.

### *Windfall profits*

A third point of critique on the historical functioning of the EU ETS is the existence of windfall profits or profits caused by free allocation of permits. Although transaction-level data is not publicly available, some conclusions can be derived about the past using data on free allocation and registered emission levels.

CE Delft analysed the degree to which windfall profits were gained by companies on a sectoral level per member state, calculated on the base of allowance allocation and submission during the first three phases of the EU ETS. They did not consider other costs or benefits resulting from the ETS such as carbon abatement costs, auxiliary input price changes, administrative costs, costs and benefits from hedging and banking or costs of indirect consequences such as market share shifts, dividends, labour market impacts, etc. [102] Neither does the analysis account for potential benefits that are accrued because of exchanging international Kyoto carbon credits in the years 2013 and 2014 (Certified Emission Reductions, CERs, and Emission Reduction Units, ERUs) for EU ETS allowances – termed Eligible Trading Units (ETUs), because it is impossible to trace how many ERUs and CERs were exchanged in a particular year since the start of phase 3 of the EU ETS.

They found that, despite not accounting for all possible benefits because of data constraints, industry has massively benefited from the EU ETS due to generous allocation of free allowances, widespread possibilities to use cheap international credits and the tendency

to base prices on marginal costs which includes cost pass through of freely obtained allowances. In all countries, except for Austria, industry received more free allowances than needed to cover their emissions and therefore made additional profits from overallocation, totalling for the whole of the EU to 1.6 billion EUR. The additional profits have been highest in Sweden (33 % of allocated emissions could be sold because they were not used), Ireland (27 %) and Spain (26 %) and the lowest in Slovenia and Poland (12 %) [102].

#### *Emission reduction attribution*

Finally, there is an ongoing debate on whether historically observed changes in emissions in the energy-intensive industries and the energy production sectors can be attributed to the EU ETS system. Because of data constraints it is not possible to get a fully reliable and clear-cut answer to this question, but some insights can be derived for specific cases. A case study of the strong decrease in coal energy production observed in 2019 in both Germany and the UK, frequently mentioned as a case study or example of proof of concept of the EU ETS [103,104], is discussed here as an example. In contrast to these claims, it is argued that the decline in coal generation is rather the result of national coal phase-out policies that – on the contrary – resulted in a suppression of the EU ETS price instead of reinforcing the ETS system [105].

The primary reason for the remarkable strong decline in coal energy generation in the year 2019 is to be attributed to a strong decrease in international gas prices, causing the price of energy generated with gas to drop below the price of energy generated by lignite or brown coal energy in Europe<sup>89</sup> [108]. This decrease in gas prices was multiple orders of magnitude greater compared to the slight increase in the price of emission allowances over the same period, therefore it could be argued that the EU ETS was certainly not the primary reason for decreasing coal energy generation in 2019.

Considering the questionable performance of the EU ETS until now, one could wonder if the EU ETS in itself has been counter-productive instead of helping to mitigate industrial emissions, or that it would have been more effective to set fixed prices without a market system (as is the case in Sweden), adapting when necessary. This would have resulted in increased transparency, avoid speculation and allow for a clear long-term perspective for the different market actors.

#### *The ongoing Carbon Border Taxation debate*

While the impact of the carbon market within the European territory on the emissions of the energy-intensive industries and energy sectors remains to be proven – as outlined before, imported emissions are not yet accounted for. Clearly, an industrial company producing a raw material in Europe must pay allowances corresponding to its CO<sub>2</sub> emissions. This is not the case for an American or Chinese company exporting this same raw material to Europe. For example, a ton of steel made in Europe could be taxed at around €45 (on the basis of 1.78 tons of CO<sub>2</sub> emitted per ton of steel produced) while imported steel is not subject to a carbon tax [109]. The European Union is the region with the highest imported emissions in the world. For example, in France and in Belgium they account for respectively 37.6% [110] and 40 % (2010, from 20 % in 2003 [111]) of the total carbon footprint of households.

In order to pursue an ambitious climate policy, Europe can therefore no longer continue to ignore the emissions linked to the consumption of imported products on its territory. To manage these emissions, a border carbon adjustment mechanism could be implemented that would subject non-European industrialists to the ETS. This extension of the carbon market to imported emissions would make it possible to give the same cost to the

---

<sup>89</sup> The same dynamics of decreasing coal generation with decreasing natural gas prices has been observed in the United States [106,107]

carbon of an imported product as that of a locally produced product. It could initially apply to high-emitting industries, such as those producing steel, aluminium and cement, and then gradually extend to a wider range of products (smartphones, computers, clothing, etc.) and services.

An important point of attention for the potential design of a future carbon border taxation policy, is the consideration of imports that are used to produce products that will be exported. Edgar Hertwich recently pointed out that this aspect is lacking in the current debate on border carbon taxation, and notes that the emissions associated with these 'exported imports' have been rising steadily since 1995 (peaking in 2012 and declining slightly since 2016 onwards), currently amounting to 10 % of global emissions. It considers mainly exported chemicals, vehicles, machinery and ICT products, produced with imported petroleum, iron and steel, chemicals and ICT components [112].

## Conclusion

The preceding sections focused on the role of monetary valuation in climate and energy policy or modelling. In particular, monetary optimisation (cost-benefit IAMs) directly driving model outcomes and ambition levels, cost assumptions influencing the policy debate on the longer term (detailed process IAMs and a large majority of ESMs), or the monetary parameters used for cost-benefit assessments with the purpose of directing public investments (for example, the energy lending policy of the EIB) or analysing climate and energy policy trajectories. All of the above examples and case studies are limited to monetary-based 'high-profile' institutional frameworks and policies. Alternative frameworks that are equally used in climate and energy policy making have not been the primary focus, but will be briefly discussed here. The focus on these high-profile debates and frameworks in this chapter is inspired by the fact that climate change is a global problem, therefore requiring global solutions and strong institutional frameworks. The limitations on the modelling strategy (and therefore to a certain extent the ethical framework) deployed by some of the multilateral institutions, prove that there is still room for manoeuvre.

There are numerous examples of how institutions have used price forecasts that proved completely wrong afterwards. A notable example is the persistent underestimated prediction of annual PV additions by the International Energy Agency. The IEA consistently predicted every year a stagnation or even decrease in PV additions since the 90's until 2018, while an exponential increase in yearly installed PV capacity could be observed [113]. One could argue that this is 'only the result of a model', but unfortunately these reports are highly influential and shape our collective and institutional mindset on possible policy futures.

Prices, discount rates, taxes, subsidies and financial regulation do certainly have a value in policy making. They allow us to organise exchanges, design fine-tuned policies, facilitate international exchange and redistribution of wealth in a practical manner. Nevertheless, we argue that – for the purpose of designing mid- to long term societal transition pathways – the usage of these monetary parameters and frameworks do not necessarily help to design effective climate and energy policies on a regional, societal and worldwide scale. On the contrary, they could even be counterproductive, depending on how and to which extent they are used. In particular, the lack of evidence of past performance of these frameworks (and evidence on the shortcomings of those) points strongly towards alternative modelling strategies.

Luckily alternative modelling strategies exist that go beyond monetary optimization and instead use predefined transition or policy pathways to examine a specific research or policy question. Two examples will be briefly described to illustrate alternative modelling strategies to either analyze the technical feasibility of achieving certain mitigation goals or



informing the policy spaces at our disposal: the broad family of input-output models and narrative-based policy lever models.

A well-known modelling strategy of economic activity rooted in empirical evidence is input-output (IO) modelling [114]. IO models are strongly tied to the System of National Accounts and build on sector-specific data of economic activity described in input-output tables (with either monetary or physical exchanges). Therefore, they benefit from a long historical and institutional linkage and extended data availability. The starting point for these models is a snapshot of the economic activity and exchanges between different sectors of the economy. Monetary IO models can be either used to (1) assess future sectoral activity by monetary optimization of an ‘optimal trajectory’ informed by macro-economic projections of GDP (so-called ‘General Equilibrium Models’) or to (2) evaluate the impacts of increasing or decreasing the activity of a certain sector (or different sectors) on the other sectors of the economy. A third IO modelling strategy is to use physical input-output data to construct a physical representation of the economic structure (represented by material or energy exchanges between sectors), and evaluate the impact of possible future changes in material input [115,116], changes in recycling ratios [117] or energy flows within the economy [118,119]. Unfortunately, most global or regional IO models aiming to evaluate the physical structure of the economy are obligated to rely on institutional monetary input-output tables, as physical exchange data is not yet sufficiently or reliably integrated in the institutional data collection process.

Another promising type of models that overcome the monetary optimization shortcomings outlined before are interactive and accessible models that allow to model different futures or narratives based on, for example, an emission trajectory constraint. Rather than using monetary optimization to predefine a typical emission-constrained climate trajectory, changes in sectoral activity, lifestyles, end-use service energy demand, etc. are to be defined independently to generate future emission trajectory pathways for each sector in the economy [120]. These models are a promising path forward, because they open up the traditional “black box” or poorly founded economic theory that underpins more traditional IAMs and ESMs.

An overarching concern with monetary optimization models, and in particular simple cost-benefit IAMs, is the limited usefulness for policy making. However, in order to inform societal transition pathways, a balance should inevitably be sought between complexity and simplicity. Nevertheless, we argue that more detailed models that are not driven by monetary optimization but rather by individual sector-specific levers will help to increase transparency and usefulness in policy making, as well as increase the support base needed for a successful implementation of climate mitigation policies. These models should also be tailored to the local context, excluding per definition global simple cost-benefit IAMs.

In order to understand the physical reality of climate change and design appropriate policy responses, we need more physical climate science, alternative modelling strategies (such as physical input-output modelling and narrative-based pathway development using policy-relevant levers) and better communication on the possible outcomes, instead of using modelled pathways that are limited in scope to monetary optimization. More importantly, we need more research, exchange and dissemination to the extent to which mitigation policies and actions are practically and physically feasible (in terms of labor market, material needs, spatial possibilities of renewables deployment, etc.), without considering current economic conjuncture, normative carbon prices or econometric price-forecasts [121]. Macroeconomic dynamics, and therefore also prices, can change at any moment, as has been proven by successive financial crises or other disruptions in the last decades. This does not, however, obstruct the possibility to design clear and feasible climate mitigation scenarios and policies based on well-informed physical targets, norms and policies.

Acknowledgments: This research was funded by the European Union's Horizon 2020 research (innovation programme under the Marie Skłodowska-Curie Innovative Training Network grant agreement no. 675153) and ERASMUS + Programme of the European Union (Jean Monnet Excellence Center on Sustainability, ERASME)



Co-funded by the  
Erasmus+ Programme  
of the European Union



## References

- [1] Diemer A, Ndiaye A, Gladkykh G. Le climat, du savoir scientifique aux modèles d'intégration assignée (Integrated Assessment Models) 2017:51.
- [2] Diemer A, Gladkykh G, Spittler N, Ndiaye A, Dierickx F. Integrated Assessment Models (IAM) - How to integrate Energy, Climate and Economics?, CIRED Paris: 2018, p. 45.
- [3] Cornell S, Prentice IC, House J, Downy C, Scholze M, Allen JI, et al., editors. Earth system models: a tool to understand changes in the Earth system. Understanding the earth system: global change science for application, Cambridge: Cambridge University Press; 2012.
- [4] Diemer A, Nedelciu E, Schellens M, Morales ME, Oostdijk M, editors. Paradigms, Models, Scenarios and Practices for Strong Sustainability. Clermont-Ferrand, France: Editions Oeconomia; 2020.
- [5] Anderson K, Jewell J. Debating the bedrock of climate-change mitigation scenarios. *Nature* 2019;573:348–9. <https://doi.org/10.1038/d41586-019-02744-9>.
- [6] Mitsel AA. Basics of financial mathematics - A study guide. Ministry of Education and Science of the Russian Federation - Federal State-Funded Educational Institution of Higher Vocational Education “National Research Tomsk Polytechnic University” - Department of Mathematics and Mathematical Physics; 2012.
- [7] Realmonte G, Drouet L, Gambhir A, Glynn J, Hawkes A, Köberle AC, et al. An inter-model assessment of the role of direct air capture in deep mitigation pathways. *Nature Communications* 2019;10:3277. <https://doi.org/10.1038/s41467-019-10842-5>.
- [8] Stern N. *The Economics of Climate Change: The Stern Review*. Cambridge: Cambridge University Press; 2007. <https://doi.org/10.1017/CBO9780511817434>.
- [9] Fleurbaey M, Zuber S. Climate Policies Deserve a Negative Discount Rate. *Chi J Int'l L* 2012;13:565.
- [10] Weyant J. Some Contributions of Integrated Assessment Models of Global Climate Change. *Review of Environmental Economics and Policy* 2017;11:115–37. <https://doi.org/10.1093/reep/rew018>.
- [11] Nordhaus W. Evolution of modeling of the economics of global warming: changes in the DICE model, 1992–2017. *Climatic Change* 2018:1–18. <https://doi.org/10.1007/s10584-018-2218-y>.
- [12] Interagency Working Group on Social Cost of Greenhouse Gases, United States Government. Technical Support Document: - Technical Update of the Social Cost of Carbon for Regulatory Impact Analysis - Under Executive Order 12866 -. Interagency Working Group on Social Cost of Greenhouse Gases, United States Government; 2016.
- [13] Anthoff D, Tol RSJ. The uncertainty about the social cost of carbon: A decomposition analysis using fund. *Climatic Change* 2013;117:515–30. <https://doi.org/10.1007/s10584-013-0706-7>.

- [14] Waldhoff S, Anthoff D, Rose S, Tol RSJ. The Marginal Damage Costs of Different Greenhouse Gases: An Application of FUND. *Economics E-Journal* 2014;8:1. <https://doi.org/10.5018/economics-ejournal.ja.2014-31>.
- [15] Ackerman F, Munitz C. Climate damages in the FUND model: A disaggregated analysis. *Ecological Economics* 2012;77:219–24. <https://doi.org/10.1016/j.ecolecon.2012.03.005>.
- [16] Ackerman F, Munitz C. Reply to Anthoff and Tol. *Ecological Economics* 2012;81:43. <https://doi.org/10.1016/j.ecolecon.2012.06.023>.
- [17] Ackerman F. Richard Tol on climate policy: A critical view of an overview. 2014.
- [18] Arent DJ, Tol RSJ, Faust E, Hella JP, Kumar S, Strzepek KM, et al. Key economic sectors and services. In: Field CB, Barros VR, Dokken DJ, Mach KJ, Mastrandrea MD, Bilir TE, et al., editors. *Climate Change 2014: Impacts, Adaptation, and Vulnerability. Part A: Global and Sectoral Aspects. Contribution of Working Group II to the Fifth Assessment Report of the Intergovernmental Panel on Climate Change*, Cambridge, United Kingdom and New York, NY, USA: Cambridge University Press; 2014, p. 659–708.
- [19] Hope CW. The social cost of CO<sub>2</sub> from the PAGE09 model. *Economics Discussion Papers*; 2011.
- [20] RFF-CMCC. WITCH documentation. 2019.
- [21] Manne AS, Richels RG. Merge: An Integrated Assessment Model for Global Climate Change. In: Loulou R, Waub J-P, Zaccour G, editors. *Energy and Environment*, Boston, MA: Springer US; 2005, p. 175–89. [https://doi.org/10.1007/0-387-25352-1\\_7](https://doi.org/10.1007/0-387-25352-1_7).
- [22] van Vuuren DP, Lowe J, Stehfest E, Gohar L, Hof AF, Hope C, et al. How well do integrated assessment models simulate climate change? *Climatic Change* 2011;104:255–85. <https://doi.org/10.1007/s10584-009-9764-2>.
- [23] Ndiaye A, Diemer A, Gladkykh G. Contributions of DICE and RICE to implement Integrated Assessment Models (IAM). *Integrated Assessment Models and Others Climate Policy Tools : Challenges and Issues*, Oeconomia; 2019.
- [24] Keen S. The Appallingly Bad Neoclassical Economics of Climate Change 2020:33.
- [25] Hickel J. The Nobel Prize for Climate Catastrophe. *Foreign Policy* 2018. <https://foreignpolicy.com/2018/12/06/the-nobel-prize-for-climate-catastrophe/> (accessed July 11, 2019).
- [26] Riahi K, van Vuuren DP, Kriegler E, Edmonds J, O’Neill BC, Fujimori S, et al. The Shared Socioeconomic Pathways and their energy, land use, and greenhouse gas emissions implications: An overview. *Global Environmental Change* 2016. <https://doi.org/10.1016/j.gloenvcha.2016.05.009>.
- [27] Kriegler E, Edmonds J, Hallegatte S, Ebi KL, Kram T, Riahi K, et al. A new scenario framework for climate change research: the concept of shared climate policy assumptions. *Climatic Change* 2014;122:401–14. <https://doi.org/10.1007/s10584-013-0971-5>.
- [28] Gidden M, Riahi K, Smith S, Fujimori S, Luderer G, Kriegler E, et al. Global emissions pathways under different socioeconomic scenarios for use in CMIP6: a

dataset of harmonized emissions trajectories through the end of the century. *Geoscientific Model Development Discussions* 2019;12:1443–75.

- [29] Gidden MJ, Fujimori S, van den Berg M, Klein D, Smith SJ, van Vuuren DP, et al. A methodology and implementation of automated emissions harmonization for use in Integrated Assessment Models. *Environmental Modelling & Software* 2018;105:187–200. <https://doi.org/10.1016/j.envsoft.2018.04.002>.
- [30] Gidden M. gidden/aneris: Initial release version for harmonization paper. Zenodo; 2017. <https://doi.org/10.5281/zenodo.802832>.
- [31] O’Neill BC, Tebaldi C, Vuuren DP van, Eyring V, Friedlingstein P, Hurtt G, et al. The Scenario Model Intercomparison Project (ScenarioMIP) for CMIP6. *Geoscientific Model Development* 2016;9:3461–82. <https://doi.org/10.5194/gmd-9-3461-2016>.
- [32] Eyring V, Bony S, Meehl GA, Senior CA, Stevens B, Stouffer RJ, et al. Overview of the Coupled Model Intercomparison Project Phase 6 (CMIP6) experimental design and organization. *Geosci Model Dev* 2016;9:1937–58. <https://doi.org/10.5194/gmd-9-1937-2016>.
- [33] Emmerling J, Drouet L, Wijst K-I van der, Vuuren D van, Bosetti V, Tavoni M. The role of the discount rate for emission pathways and negative emissions. *Environ Res Lett* 2019;14:104008. <https://doi.org/10.1088/1748-9326/ab3cc9>.
- [34] IAMC. Other sustainability dimensions - MESSAGE-GLOBIOM - IAMC-Documentation 2016. [https://www.iamcdocumentation.eu/index.php/Other\\_sustainability\\_dimensions\\_-\\_MESSAGE-GLOBIOM](https://www.iamcdocumentation.eu/index.php/Other_sustainability_dimensions_-_MESSAGE-GLOBIOM) (accessed August 20, 2020).
- [35] IAMC. Climate - DNE21+ - IAMC-Documentation 2016. [https://www.iamcdocumentation.eu/index.php/Climate\\_-\\_DNE21%2B](https://www.iamcdocumentation.eu/index.php/Climate_-_DNE21%2B) (accessed August 20, 2020).
- [36] Diemer A, Nedelciu E, Schellens M, Gisladottir J. Challenges for Sustainability in Critical Raw Material Assessments. *International Journal of Management and Sustainability* 2018;7:156–79. <https://doi.org/10.18488/journal.11.2018.73.156.179>.
- [37] Hotelling H. The Economics of Exhaustible Resources. *Journal of Political Economy* 1931;39:137–75.
- [38] Masson-Delmotte V, Zhai P, Pörtner HO, Roberts D, Skea J, Shukla PR, et al., editors. Summary for Policymakers. *Global Warming of 1.5°C. An IPCC Special Report on the impacts of global warming of 1.5°C above pre-industrial levels and related global greenhouse gas emission pathways, in the context of strengthening the global response to the threat of climate change, sustainable development, and efforts to eradicate poverty*, Geneva, Switzerland: World Meteorological Organization; 2018, p. 32.
- [39] Nordhaus W. Rolling the “DICE”: an optimal transition path for controlling greenhouse gases. *Resource and Energy Economics* 1993;15:27–50.
- [40] Alkemade T, Bakkenes M, Biemans H, Bouwman A, den Elzen M, Janse J, et al. *Integrated assessment of global environmental change with IMAGE 3.0: model description and policy applications*. The Hague: PBL Netherlands Environmental Assessment Agency; 2014.

- [41] Mathias J, Debeljak M, Deffuant G, Diemer A, Dierickx F, Donges JF, et al. Grounding social foundations for Integrated Assessment Models of climate change. *Earth's Future* 2020. <https://doi.org/10.1029/2020EF001573>.
- [42] Pindyck RS. The social cost of carbon revisited. *Journal of Environmental Economics and Management* 2019;94:140–60. <https://doi.org/10.1016/j.jeem.2019.02.003>.
- [43] Ackerman F, DeCanio SJ, Howarth RB, Sheeran K. Limitations of integrated assessment models of climate change. *Climatic Change* 2009;95:297–315. <https://doi.org/10.1007/s10584-009-9570-x>.
- [44] Rosen RA. Critical review of: “Making or breaking climate targets — the AMPERE study on staged accession scenarios for climate policy.” *Technological Forecasting and Social Change* 2015;96:322–6. <https://doi.org/10.1016/j.techfore.2015.01.019>.
- [45] Xiao Y, Lenzen M, Benoît-Norris C, Norris GA, Murray J, Malik A. The Corruption Footprints of Nations: The Corruption Footprints of Nations. *Journal of Industrial Ecology* 2017. <https://doi.org/10.1111/jiec.12537>.
- [46] European Commission. Green Paper on greenhouse gas emissions trading within the European Union. European Commission; 2000.
- [47] The Economic Effects of EU-Wide Industry-Level Emission Trading to Reduce Greenhouse Gases - Results from the PRIMES Energy Systems Model. Luxembourg: E3M Lab - Institute of Communication and Computer Systems of National Technical University of Athens; 2000.
- [48] Capros P, Mantzos L, Papandreou V, Tasios N. Model-based Analysis of the 2008 EU Policy Package on Climate Change and Renewables. 2008.
- [49] Capros P, Mantzos L. The European energy outlook to 2010 and 2030. *IJGEI* 2000;14:137. <https://doi.org/10.1504/IJGEI.2000.004353>.
- [50] Egli F, Steffen B, Schmidt TS. Bias in energy system models with uniform cost of capital assumption. *Nat Commun* 2019;10:4588. <https://doi.org/10.1038/s41467-019-12468-z>.
- [51] Bogdanov D, Child M, Breyer C. Reply to ‘Bias in energy system models with uniform cost of capital assumption.’ *Nat Commun* 2019;10:1–2. <https://doi.org/10.1038/s41467-019-12469-y>.
- [52] Bogdanov D, Farfan J, Sadovskaia K, Aghahosseini A, Child M, Gulagi A, et al. Radical transformation pathway towards sustainable electricity via evolutionary steps. *Nature Communications* 2019;10:1077. <https://doi.org/10.1038/s41467-019-08855-1>.
- [53] Wynne B. The institutional context of science, models, and policy: The IIASA energy study. *Policy Sci* 1984;17:277–320. <https://doi.org/10.1007/BF00138709>.
- [54] Thompson M. Among the Energy Tribes: A cultural framework for the analysis and design of energy policy. *Policy Sci* 1984;17:321–39. <https://doi.org/10.1007/BF00138710>.
- [55] Gago Da Camara Simoes S, Nijs W, Ruiz Castello P, Sgobbi A, Radu D, Bolat P, et al. The JRC-EU-TIMES model - Assessing the long-term role of the SET Plan

Energy technologies. Publications Office of the European Union; 2013.  
<https://doi.org/10.2790/97799> (print); [10.2790/97596](https://doi.org/10.2790/97596) (online).

- [56] Riekkola AK. National Energy System Modelling for Supporting Energy and Climate Policy Decision-making: The Case of Sweden. Chalmers University of Technology, 2015.
- [57] Seljom P, Rosenberg E, Fidje A, Haugen JE, Meir M, Rekstad J, et al. Modelling the effects of climate change on the energy system—A case study of Norway. *Energy Policy* 2011;39:7310–21. <https://doi.org/10.1016/j.enpol.2011.08.054>.
- [58] García-Gusano D, Cabal H, Lechón Y. Evolution of NO<sub>x</sub> and SO<sub>2</sub> emissions in Spain: ceilings versus taxes. *Clean Techn Environ Policy* 2015;17:1997–2011. <https://doi.org/10.1007/s10098-015-0923-z>.
- [59] Poncelet K, Delarue E, Duerinck J, Six D, D'haeseleer W. The Importance of Integrating the Variability of Renewables in Long-term Energy Planning Models. KU Leuven; 2014.
- [60] Quoilin S, Hidalgo Gonzalez I, Zucker A. Modelling Future EU Power Systems Under High Shares of Renewables: The Dispa-SET 2.1 open-source model. Publications Office of the European Union; 2017. <https://doi.org/10.2760/25400> (online).
- [61] Loulou R, Goldstein G, Kanudia A, Lettila A, Remme U. Documentation for the TIMES Model - PART I. Energy Technology Systems Analysis Programme; 2016.
- [62] García-Gusano D, Espegren K, Lind A, Kirkengen M. The role of the discount rates in energy systems optimisation models. *Renewable and Sustainable Energy Reviews* 2016;59:56–72. <https://doi.org/10.1016/j.rser.2015.12.359>.
- [63] Mallah S, Bansal NK. Parametric sensitivity analysis for techno-economic parameters in Indian power sector. *Applied Energy* 2011;88:622–9. <https://doi.org/10.1016/j.apenergy.2010.08.004>.
- [64] Kannan R. Uncertainties in key low carbon power generation technologies – Implication for UK decarbonisation targets. *Applied Energy* 2009;86:1873–86. <https://doi.org/10.1016/j.apenergy.2009.02.014>.
- [65] Kannan R, Turton H. Cost of ad-hoc nuclear policy uncertainties in the evolution of the Swiss electricity system. *Energy Policy* 2012;50:391–406. <https://doi.org/10.1016/j.enpol.2012.07.035>.
- [66] EIB's Operations Evaluation Division (EV). Ex-post evaluation of the EIB's Energy Lending Criteria, 2013-2017. European Investment Bank; 2019.
- [67] Directive 2012/27/EU of the European Parliament and of the Council of 25 October 2012 on energy efficiency, amending Directives 2009/125/EC and 2010/30/EU and repealing Directives 2004/8/EC and 2006/32/EC Text with EEA relevance. vol. OJ L. 2012.
- [68] Directive (EU) 2018/2002 of the European Parliament and of the Council of 11 December 2018 amending Directive 2012/27/EU on energy efficiency (Text with EEA relevance.). vol. OJ L. 2018.
- [69] European Commission. A Clean Planet for all A European long-term strategic vision for a prosperous, modern, competitive and climate neutral economy. Brussels, Belgium: 2018.

- [70] De Vita A, Kielichowska P, Capros P, Dimopoulou E, Evangelopoulou S, Fotiou T, et al. Technology pathways in decarbonisation scenarios. E3Modelling and Tractebel for the European Commission; 2018.
- [71] Siskos P, Zazias G, Petropoulos A, Evangelopoulou S, Capros P. Implications of delaying transport decarbonisation in the EU: A systems analysis using the PRIMES model. *Energy Policy* 2018;121:48–60. <https://doi.org/10.1016/j.enpol.2018.06.016>.
- [72] European Commission Directorate General Regional Policy. Guide to Cost Benefit Analysis of Investment Projects. 2008.
- [73] Ministry of Finance. Cost-Benefit Analysis. GovernmentNo 2013. <https://www.regjeringen.no/en/dokumenter/nou-2012-16/id700821/> (accessed August 24, 2020).
- [74] European Commission Directorate-General for Regional and Urban policy. Guide to cost-benefit analysis of investment projects: economic appraisal tool for cohesion policy 2014 - 2020. Luxembourg: Publ. Office of the Europ. Union; 2015.
- [75] Regulation (EU) No 1303/2013 of the European Parliament and of the Council of 17 December 2013 laying down common provisions on the European Regional Development Fund, the European Social Fund, the Cohesion Fund, the European Agricultural Fund for Rural Development and the European Maritime and Fisheries Fund and laying down general provisions on the European Regional Development Fund, the European Social Fund, the Cohesion Fund and the European Maritime and Fisheries Fund and repealing Council Regulation (EC) No 1083/2006. vol. 347. 2013.
- [76] Commission Delegated Regulation (EU) No 480/2014 of 3 March 2014 supplementing Regulation (EU) No 1303/2013 of the European Parliament and of the Council laying down common provisions on the European Regional Development Fund, the European Social Fund, the Cohesion Fund, the European Agricultural Fund for Rural Development and the European Maritime and Fisheries Fund and laying down general provisions on the European Regional Development Fund, the European Social Fund, the Cohesion Fund and the European Maritime and Fisheries Fund. vol. 138. 2014.
- [77] Commission européenne, Direction générale de la mobilité et des transports. EU energy, transport and GHG emissions: trends to 2050 : reference scenario 2016. Luxembourg: Office for official publications of the european communities; 2016.
- [78] Alexandri E, Fragkiadakis K, Fragkos P, Lewney R, Paroussos L, Pollitt H. A technical analysis on decarbonisation scenarios - constraints, economic implications and policies : Technical Study on the Macroeconomics of Energy and Climate Policies. Brussels: E3-Modelling and Cambridge Econometrics for the European Commission; n.d.
- [79] Szabo S, Jaeger-Waldau A, Szabo M, Monforti-Ferrario F, Szabo L, Ossenbrink H. European renewable government policies versus model predictions. *Energy Strategy Reviews* 2014;2:257–64. <https://doi.org/10.1016/j.esr.2013.12.006>.
- [80] European Commission. DIRECTIVE 2003/87/EC of the European Parliament and of the Council of 13 October 2003 establishing a scheme for greenhouse gas



emission allowance trading within the Community and amending Council Directive 96/61/EC. Official Journal of the European Union 2003;L:32–46.

- [81] Regulation (EU) 2018/842 of the European Parliament and of the Council of 30 May 2018 on binding annual greenhouse gas emission reductions by Member States from 2021 to 2030 contributing to climate action to meet commitments under the Paris Agreement and amending Regulation (EU) No 525/2013 (Text with EEA relevance). vol. 156. 2018.
- [82] Diemer A. *Economie Générale*. Editions Oeconomia; 2009.
- [83] Pigou AC. *The Economics of Welfare*. Palgrave Macmillan; 2013.
- [84] Coase RH. *The Problem of Social Cost*. University of Chicago Law School; 1960.
- [85] United Nations. 7. a). *Kyoto Protocol to the United Nations Framework Convention on Climate Change*. Kyoto, 11 December 1997. 1998.
- [86] Shishlov I, Morel R, Bellassen V. Compliance of the Parties to the Kyoto Protocol in the first commitment period. *Climate Policy* 2016;16:768–82. <https://doi.org/10.1080/14693062.2016.1164658>.
- [87] Böhringer C, Harrison GW, Rutherford TF. Sharing the Burden of Carbon Abatement in the European Union. In: Böhringer C, Löschel A, editors. *Empirical Modeling of the Economy and the Environment*, vol. 20, Heidelberg: Physica-Verlag HD; 2003, p. 153–79. [https://doi.org/10.1007/978-3-642-57415-3\\_8](https://doi.org/10.1007/978-3-642-57415-3_8).
- [88] Eyckmans J, Cornillie J, Regemorter DV. Efficiency and Equity in the EU Burden Sharing Agreement n.d.:34.
- [89] European Commission. *IMPACT ASSESSMENT Accompanying the document Commission Decision determining, pursuant to Directive 2003/87/EC of the European Parliament and the Council, a list of sectors and subsectors which are deemed to be exposed to a significant risk of carbon leakage for the period 2015-2019*. Brussels: European Commission; 2014.
- [90] Cambridge Econometrics. *EU Carbon Leakage List post-2020*. Cambridge Econometrics n.d. <https://www.camecon.com/what/our-work/eu-carbon-leakage-list-post-2020/> (accessed January 10, 2020).
- [91] Directive (EU) 2018/410 of the European Parliament and of the Council of 14 March 2018 amending Directive 2003/87/EC to enhance cost-effective emission reductions and low-carbon investments, and Decision (EU) 2015/1814 (Text with EEA relevance. ). vol. OJ L. 2018.
- [92] EMBER. *Carbon Price Viewer*. Ember 2020. <https://ember-climate.org/carbon-price-viewer/> (accessed August 25, 2020).
- [93] Quandl. *ECX EUA Futures, Continuous Contract #1 (C1) (Front Month) 2020*. <https://www.quandl.com> (accessed August 25, 2020).
- [94] Soria A, Dosio A, Naumann G, Russo S, Formetta G, Forzieri G, et al. *Climate change impacts and adaptation in Europe*. Luxembourg: Publications Office of the European Union; 2020.
- [95] Naumann G, Russo S, Formetta G, Ibarreta D, Forzieri G, Girardello M, et al. *Global warming and human impacts of heat and cold extremes in the EU*. 2020.
- [96] Fitch-Roy O, Fairbrass J, Benson D. Ideas, coalitions and compromise: reinterpreting EU-ETS lobbying through discursive institutionalism. *Journal of*

- European Public Policy 2020;27:82–101.  
<https://doi.org/10.1080/13501763.2019.1567573>.
- [97] World Bank, International Carbon Action Partnership. State and Trends of Carbon Pricing 2020. Washington DC: World Bank, with the support of Guidehouse and with contributions from the International Carbon Action Partnership; 2020.
- [98] Ackva J, Hoppe J. The Carbon Tax in Sweden. adelphi and Ecofys for the German Federal Ministry for the Environment, Nature Conservation and Nuclear Safety and the European Climate Initiative (EUKI); 2018.
- [99] Brännlund R, Lundgren T, Marklund P-O. Carbon intensity in production and the effects of climate policy—Evidence from Swedish industry. *Energy Policy* 2014;67:844–57.
- [100] Perino G. New EU ETS Phase 4 rules temporarily puncture waterbed. *Nature Climate Change* 2018;8:262–4. <https://doi.org/10.1038/s41558-018-0120-2>.
- [101] Rosendahl KE. EU ETS and the waterbed effect. *Nature Climate Change* 2019;9:734–5. <https://doi.org/10.1038/s41558-019-0579-5>.
- [102] de Bruyn S, Schep E, Cherif S. Calculation of additional profits of sectors and firms from the EU ETS. Delft: CE Delft; 2016.
- [103] Delbeke J. Very useful study by the World Bank Climate showing how carbon pricing policies are expanding, and bring down emissions. Last year the carbon price of 25 euro generated in the EU a spectacular reduction in the use of coal and lignite. Twitter 2020.  
[https://twitter.com/delbeke\\_jos/status/1215373745986195456?s=20](https://twitter.com/delbeke_jos/status/1215373745986195456?s=20).
- [104] Simon F. European coal power output sees “unprecedented” decline. *WwwEuractivCom* 2019. <https://www.euractiv.com/section/emissions-trading-scheme/news/european-coal-power-output-saw-unprecedented-drop-in-2019/> (accessed August 26, 2020).
- [105] Anke C-P, Hobbie H, Schreiber S, Möst D. Coal phase-outs and carbon prices: Interactions between EU emission trading and national carbon mitigation policies. *Energy Policy* 2020;144:111647. <https://doi.org/10.1016/j.enpol.2020.111647>.
- [106] Cohan D. Right, coal/gas split is extremely sensitive to small fluctuations in NG prices, even with NG prices low. Twitter 2017.  
[https://twitter.com/cohan\\_ds/status/863127722549268480?s=20](https://twitter.com/cohan_ds/status/863127722549268480?s=20).
- [107] Davidson FT, Rhodes JD, Webber ME, Deetjen T. Are solar and wind really killing coal, nuclear and grid reliability? *The Conversation* 2017.  
<http://theconversation.com/are-solar-and-wind-really-killing-coal-nuclear-and-grid-reliability-76741> (accessed September 10, 2020).
- [108] Capion K. Guest post: Why German coal power is falling fast in 2019. *Carbon Brief* 2019. <https://www.carbonbrief.org/guest-post-why-german-coal-power-is-falling-fast-in-2019> (accessed August 26, 2020).
- [109] Pauliuk S, Neuhoff K, Owen A, Wood R. Quantifying Impacts of Consumption Based Charge for Carbon Intensive Materials on Products. Rochester, NY: Social Science Research Network; 2016. <https://doi.org/10.2139/ssrn.2779451>.
- [110] Baude M, Baudry M, Chartin A, Colomb V, Dussud F-X, Ghewy X, et al. *Ménages & Environnement - Les chiffres clés – Édition 2017*. Commissariat général au

développement durable - Service de la donnée et des études statistiques (SDES); 2017.

- [111] Vercauteren A, Boonen K, Christis M, Dams Y, Dils E, Geerken T. Koolstofvoetafdruk van de Vlaamse consumptie. 2017.
- [112] Hertwich EG. Carbon fueling complex global value chains tripled in the period 1995–2012. *Energy Economics* 2020;86:104651. <https://doi.org/10.1016/j.eneco.2019.104651>.
- [113] Hoekstra A. 2018 UPDATE of my series about IEA versus reality in solar PV. Twitter 2018. <https://twitter.com/AukeHoekstra/status/1064529619951513600> (accessed August 26, 2020).
- [114] Miller RE, Blair PD. *Input-output analysis: foundations and extensions*. Cambridge; New York: Cambridge University Press; 2009.
- [115] Wieland H. FINEPRINT: A spatially explicit physical trade framework to trace environmental impacts of resource extraction along global supply chains 2019.
- [116] Wachs L, Singh S. A modular bottom-up approach for constructing physical input–output tables (PIOTs) based on process engineering models. *Journal of Economic Structures* 2018;7. <https://doi.org/10.1186/s40008-018-0123-1>.
- [117] Altimiras-Martin A. *Managing human-induced material use: adding cyclic inter-sectoral flows to Physical Input-Output Tables to analyse the environmental impact of economic activity*. Doctoral Thesis. University of Cambridge, 2016.
- [118] Casler S, Wilbur S. Energy input-output analysis: A simple guide. *Resources and Energy* 1984;6:187–201. [https://doi.org/10.1016/0165-0572\(84\)90016-1](https://doi.org/10.1016/0165-0572(84)90016-1).
- [119] Heun MK, Owen A, Brockway PE. A physical supply-use table framework for energy analysis on the energy conversion chain. *Applied Energy* 2018;226:1134–62. <https://doi.org/10.1016/j.apenergy.2018.05.109>.
- [120] Pestiaux J, Matton V, Cornet M, Costa L, Hezel B, Kelly G, et al. *Introduction to the EUCalc model - Cross-Sectoral Model description and documentation*. 2019.
- [121] Kikstra JS. *Benefit-Cost Integrated Assessment Modelling for Climate Change Mitigation: a critical review of its usefulness in the presence of Detailed-Process models*. 2019.

## 6. Circular Economy, A New Paradigm for Europe?

**Authors and affiliations:** Arnaud Diemer<sup>1</sup>, Florian Dierickx<sup>1</sup>

<sup>1</sup>: Jean Monnet Excellence Center on Sustainability (ERASME), University of Clermont Auvergne, CERDI, Clermont-Ferrand, France

*Book chapter*

**Date:** March 2020

**Book:** *Paradigms, Models, Scenarios and Practices for Strong Sustainability*, edited by Arnaud Diemer, Eduard Nedelciu, Marie Schellens, Manuel E Morales, and Maartje Oostdijk, 161–79. Clermont-Ferrand, France: Editions Oeconomia, 2020.

**URL:** [https://www.researchgate.net/publication/340772126\\_Paradigms\\_Models\\_Scenarios\\_and\\_Practices\\_for\\_Strong\\_Sustainability](https://www.researchgate.net/publication/340772126_Paradigms_Models_Scenarios_and_Practices_for_Strong_Sustainability)

**ISBN:** 979-10-92495-13-3

### Abstract

Circular economy generally refers to an economic model whose objective is to produce goods and services in a sustainable way, limiting the consumption of resources and the production of waste. The aim of circular economy is to decouple from the linear economic model, shifting from the extract-produce-consume-throw away model to a "circular" economic design. This study proposes contrasts with this narrow and reductive vision of circularity. The circular economy should not be reduced to an economic model, as it is mainly a paradigm shift that is part of strong sustainability. It renews industrial standards by advocating symbiotic relationships built on cooperation rather than competition. It implies the use of "Systems Thinking" to draw its foundations from interdisciplinarity and the study of complex systems. Finally, it refers to challenges that are ecological, political, social, economic and managerial at the same time. The article considers that this paradigmatic vision could lay the foundations for a new model for Europe.

### Keywords

Circular economy, Industrial symbiosis, Paradigm, System thinking, Sustainability

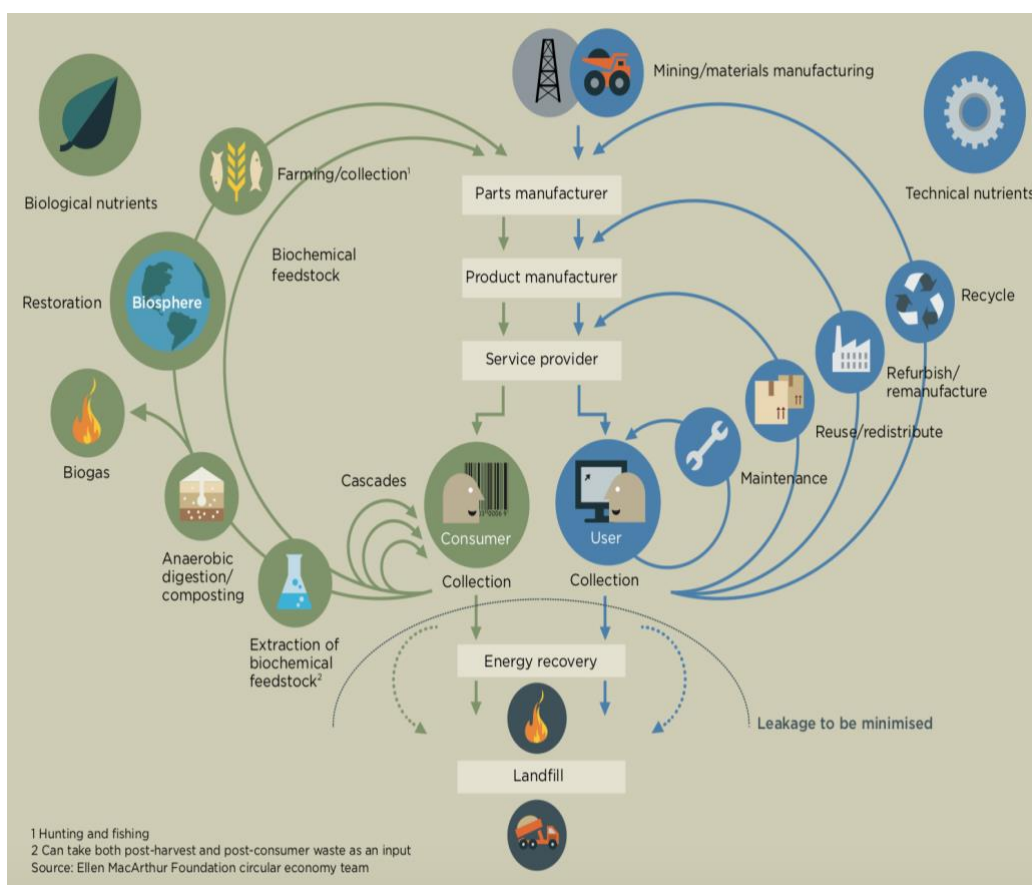
### Introduction

The contemporary understanding of the Circular Economy (CE) counts on abundant conceptual and theoretical literature (Pinto, 2019), ranging from its practical applications in industrial processes to its macro-economic effects, the 3R Principle (reduce, reuse, recycle) being a noteworthy example (Lewandowski, 2016; Haas et al., 2015). Geissdoerfer et al. (2017) defined Circular Economy as a regenerative system in which resource input, waste, emission, and energy leakage are minimized by slowing, closing, and narrowing material and energy loops, via long-lasting design, maintenance, repair, reuse, remanufacturing, refurbishing and recycling. Prieto-Sandoval et al. (2018) considered CE to be a paradigm shift that requires industries, policy-makers and consumers to innovate in the way they produce, legislate and consume, respectively. Circular Economy approaches materials from two

perspectives (EMF, 2012): (a) *biological nutrients*, which should eventually reintegrate into the biosphere without causing any harm –, and (b) *technical nutrients*, which circulate in the economy. In order to promote the shift from traditional linear production economies towards circular behaviour, CE suggests that all industrial activity should be performed by using waste flows as inputs, by adopting renewable and clean energy sources and by designing outputs in such a way that allows for collection, recycling, refurbishing, reuse, redistribution, maintenance and sharing throughout their life span (EMF, 2014, 2015, 2016, 2017).

Additionally, CE also suggests that the monetary flows that permeate the materials in circulation directly reflect the biophysical costs of their extraction, transformation, use and reinsertion into either economy or biosphere, minimizing speculation as much as possible in order to protect the cost-effectiveness of the model (Pinto, Sverdrup, Diemer, 2019). In 2012, Europe committed itself to the application of CE as its economic model, boosting a transition to resource-efficient practices that would eventually lead to regenerative progress towards nature (EMF, 2015, 2018, 2019).

**Figure 6.1:** Outline of Circular Economy



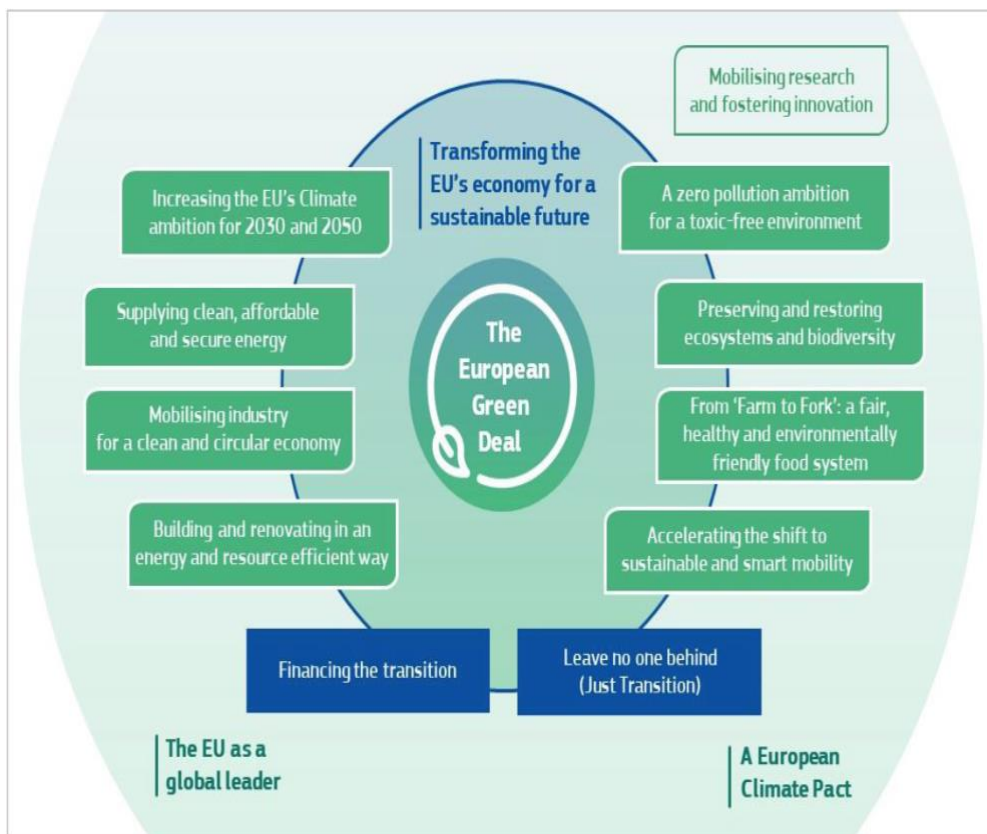
**Source:** EMF (2012, 2017)

The Ellen MacArthur Foundation played an important role not only in the popularization of the concept in the 2010s, but also in the development of many Circular Economy tools for businesses, academia and policy-makers. Circular Economy is defined as “*an industrial system that is restorative by intention and design. In a circular economy, products are designed for ease of reuse, disassembly and manufacturing – or recycling – with the understanding that it is the reuse of vast amounts of material reclaimed from end-of-life products, rather than the extraction of new resources, that is the foundation of economic growth*” (EMF, 2012). From a practical point of view, what caught the industry’s attention the most were the concepts within CE, some of which borrowed from the previous Green

Economy Framework: Biomimetics, Cradle-to-Cradle Design, Ecolabelling and Industrial Ecology (Winans et al., 2017; EMF, 2013).

In December 2019, the European Commission proposed a *European Green Deal* (EGD) for the European Union and its citizens (European Commission, 2019). This commitment is a new growth strategy that aims to transform the EU into a fair and prosperous society, with a modern, resource-efficient and competitive economy, decoupled from resource use and set to become carbon neutral by 2050. A roadmap of the key policies and measures needed to achieve the European Green Deal has been presented and today the EGD is an integral part of the Commission’s Strategy to implement the United Nation’s 2030 Agenda and the Sustainable Development Goals. The following figure illustrates the various elements of the Green Deal.

**Figure 6.2:** European Green Deal



**Source:** European Commission (2019)

In the Communication on the EGD, the European Commission committed to the adoption of a new Circular Economy Action Plan to accelerate and continue the transition towards a circular economy (COM 23/12/2019). For the Commission, Circular Economy is defined as an “*economic system in which the value of products and materials is maintained for as long as possible; waste and resource use are minimized, and resources are kept within the economy when a product has reached the end of its life, to be used again and again to create further value*” (EC, 2012). In March 2020, the action plan was to be associated with the EU industrial strategy in order to mobilize the industrial sector and all the value chains towards a model of sustainable and inclusive growth. Leverage points have been identified: (1) Move away from a linear economy and mitigate its associated impacts on the environment; (2) Boost design, production and marketing of sustainable products; (3) Empower consumers to contribute to the circular economy; (4) Reduce waste generation and support the modernisation of certain waste laws ; (5) identify actions to address high impacts sectors

(textiles, construction, electronics, plastics); (6) integrate social and geographic impacts of circular economy; (7) develop innovation and investment opportunities for circular business models.

While the European Green Deal is close to a real transformation of the European economy (the shift towards more sustainability), circular economy has also started a similar process, which can be associated with a new paradigm (Arnsperger, Bourg, 2016). By paradigm, it is meant a representation of the world, a way of seeing the world and taking distance from usual practices. This paper aims to engage the circular economy in a “*strong sustainability paradigm*”. By these terms it is meant, on the one hand, that the flows of matter and energy related to our human activities must be compatible with planetary boundaries. On the other hand, that humanity needs to close the loops of our ecosystem at the macro level. The following three issues are discussed in the following sections: (1) circular economy must rely on symbiotic relationships in order to reach the state of “industry 6.0”; (2) circular economy requires “Systems Thinking” and the integration of tools that draw their strength from interdisciplinarity; (3) circular economy must take up new challenges, including that of an economy of temperance and sobriety.

## **Industrial symbiosis, the driving-force of circular economy**

Within the framework of circular economy, the study and the promotion of Industrial Symbiosis (IS) plays an important role (Erkman, 1997; Chertow, 2000; Morales, Diemer, 2016; Diemer, 2017). In ecology, the concept of symbiosis describes a closed and often long-term interaction between two or more different biological species. This long-term association may, but does not necessarily, benefit both participants. Symbiotic relationships take place naturally in an ecosystem based on the concept of biophysical symbiotic exchanges, Industrial Symbiosis engages “*separate entities in a collective approach to competitive advantage involving physical exchange of materials, energy, water and by-products*” (Chertow, 2000) for mutual economic and environmental benefits (Christensen, 2006). Industrial Symbiosis closes loops by turning waste into valuable materials, which can then replace raw materials in an industrial system, emulating natural closed ecosystems.

Multiple references of industrial symbiosis can be traced back to the IS complex in Kalundborg, Denmark (e.g. Ehrenfeld, Gertler, 1997; Esty, Porter, 1998; Ehrenfeld, Chertow, 2002; Brings, Jacobsen, Anderberg, 2004; Christensen, 2006). This model can be viewed as either a paradigm or an isolated phenomenon, where a number of companies were coincidentally bound together by waste, water and energy exchanges based on mutual contractual dependency. The development of industrial symbiosis in Kalundborg has been described as an evolutionary process in which a number of independent by-product exchanges gradually evolved into a complex web of symbiotic interactions among five collocated companies and the local municipality (Ehrenfeld, Gertler, 1997). The symbiosis includes a powerplant (Asnaes), an oil refinery (Statoil), a biotech and pharmaceutical company (Novo Group), a producer of plasterboard (Gyproc), and a soil remediation company (Soilrem). The various material flows among these companies are based on water, solid waste and energy exchanges. For example, the power plant produces heat for the town of Kalundborg and steam for Novo Group and for the Statoil refinery. Heated cooling water leaving the Asnaes powerplant and is piped off to a nearby fish farm, which uses it to ensure full scale productivity of the fish. The Industrial Symbiosis exchanges at Kalundborg have significant economic and environmental benefits, as a result of direct substitution, utility sharing or water/energy redistribution. Nevertheless, it is also interesting to understand and interpret the success of Kalundborg. Jorgen Christensen (2006), consultant to the Symbiosis Institute, considers that the success of IS exchanges depends greatly on the historical context and perspectives in

which inter-firm arrangements are viewed. Industrial Symbiosis is not regarded as an isolated environmental solution, but rather as part of a process of improving the total performance (environmental, economic, social, cultural) of individual companies as well as the collective organization. Five factors are at the origin of the success of Kalundborg : (i) collaboration between different industries; (ii) the importance of identifying a market solution; (iii) short physical distance between the participants (Regional Industrial Ecology); (iv) willingness to work together and share values; and (v) good communication between partners.

In the State-of-the-Art, Industrial Symbiosis is often associated with process studies (industrial metabolism) and tools (material and energy flows, input-output analysis, life cycle analysis), efficiency improvements, social context, and dynamics of the learning process of inter-firm organizational strategy. While these approaches have made it possible to better understand the process of symbiosis emergence – as well as the diffusion of social innovations, to identify the economic and environmental benefits of such an approach, and to identify the constraints and opportunities of an inter-firm strategy; they have the great disadvantage of reducing symbiosis to its simplest expression, that of a collective organization built on synergies.

By insisting on the fact that industrial symbiosis is indeed a key driver in the transition to the second generation of circular economy, and thus to the emergence of a new paradigm, this study postulates that industrial symbioses (and thus the circular economy) will be led to redesign the industrial challenges of the future (industry 6.0). They are thus part of a transitional process, which started in the 19th century with the concept of Industry 1.0 (see table 6.1 below).

**Table 6.1:** Stages of industrial transition

| Industry 1.0   | Industry 2.0   | Industry 3.0  | Industry 4.0  | Industry 5.0  | Industry 6.0  |
|--|--|---|---|---|---|
| Mechanization and standardization of work. Performance focus on human productivity. Introduction of steam in the mechanization of work | Introduction of electricity in the various production processes. Use of assembly lines. No discontinuities in the production | Introduction of computer and automation to rule the industrial process. Use of robots in the production (linear program managed by human) | This is the era of Cyber Physical Systems (CPS) which comprises of smart machines, storage systems and production facilities capable of autonomously exchange information, triggering actions and control each other independently. | Willingness to reinject human beings into industrial production: this is the current worldwide trend, with the creation of intelligent factories, the development of the IoT ("Internet of Things") and collaborative industries. | To develop more sustainable societies, industries need to better understand how to respond to environmental, economic, social, cultural, technical and political challenges and transform industrial behaviour. Are Industries able to be |

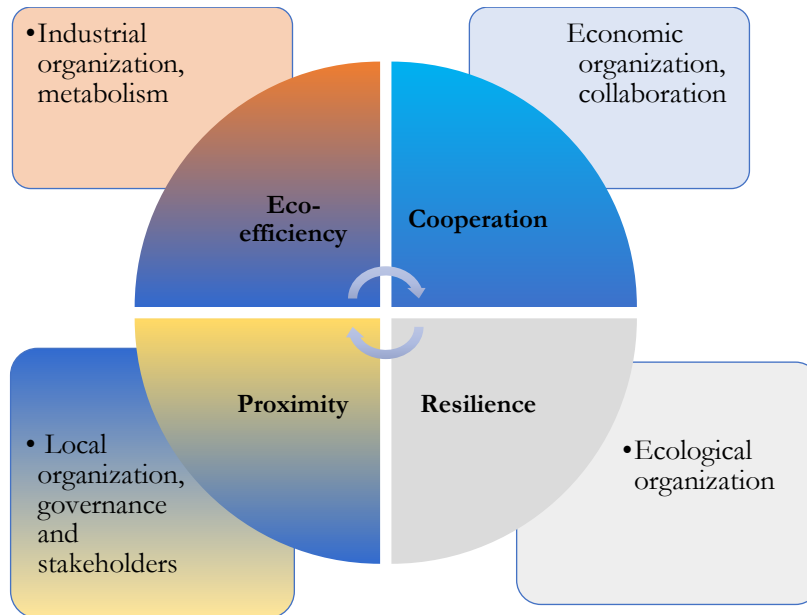


sustainable  
(oxymoron?)

Industry 6.0 should be the next step of a long process, the societal challenge which requires to drive industries toward sustainability and to convert traditional organizations into Industrial Symbiosis. This change of perspective makes it possible to consider Industrial Symbioses as forms of social innovation that can respond to the following eight challenges: (1) position the industry at the heart of sustainability; (2) define the industrial ecosystem at a local scale (eco-industrial parks or industrial corridors); (3) reintroduce industry into the urban ecosystem in a hybridisation process that no longer seeks to reject industry and remove it from a city's boundaries, but is based on the search for potential synergies within the sustainable city; (4) introduce agriculture and agricultural activities into symbioses and in particular urban symbioses (urban agriculture development); (5) develop Bio-Based Economy or Bioeconomics projects by linking matter, energy and information, and more generally, biology, thermodynamics (entropy) and information science); (6) transform CO<sub>2</sub> into products; (7) define a reference framework for industrial symbioses likely to identify islands of sustainability; (8) rethink the social dynamics accompanying the different phases of the industrial transition.

This transformation of industry (more especially European industries) should be able to cover many areas (understand local/global levels of IS - bottom-up vs top-down strategies- and cross-scales for urban and industrial symbiosis ; Social/environmental/economical/cultural aspects of the IS dynamics ; Industries and economic sectors challenging renewable energy transition, emissions of GhG, electronic waste, products with rare metals) and how integrate these challenges in the supply chain ; new opportunities for IS and circular economy in specific sectors and integration of end-of-life services) and to reach expected impacts (understanding the dynamics of industrial processes and closed loops in circular economy paradigm, modelling industrial symbiosis dynamics, identifying the strong sustainable pillars of IS - eco-efficiency, proximity, resilience and cooperation - ; understanding the learning process of IS emergence ; producing case-studies to improve the knowledge of the learning process necessary to create Industrial Symbioses ; reconnecting Urban Dynamics and Industrial Dynamics in the renewable energy transition and climate change context ).

**Figure 6.3:** The four key-drivers of strong sustainability for industrial symbiosis



**Source:** Revised figure from Diemer and Morales, 2016

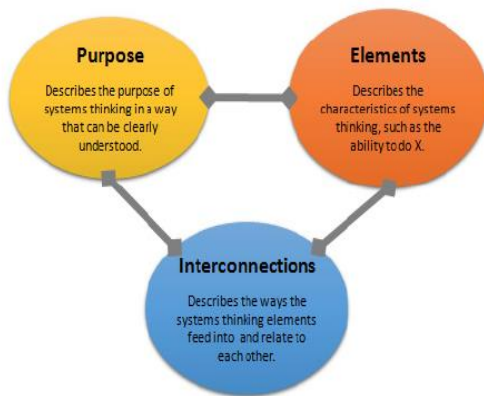
## Circular Economy, from Systems Thinking to integrated tools

As a new paradigm, circular economy needs a new research program integrating methodology and tools. “System Thinking” seems appropriate to redesign circular economy because it implies an underlying philosophy strongly embedded in interdisciplinarity. Integrated tools from interdisciplinarity reinforce the usefulness and broaden the spectrum of circular economy.

### Systems Thinking for Circular Economy

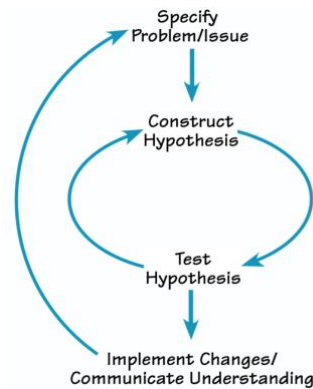
Donella Meadows (2008) defined a system as “a set of things of things – people, cells, molecules or whatever – interconnected in such a way that they produce their own pattern of behaviour over the time” (2008, p. 2). System thinking is the “ability to understand these interconnections in such a way as to achieve a desired purpose” (Stroh, 2015). Systems thinking is a sensitivity to the circular nature of the world we live in; an awareness of the role of structure in creating the conditions we face; a recognition that there are powerful laws of systems operating that we are unaware of; a realization that there are consequences to our actions that we are oblivious to. The overall concept underpinning this approach is that systems thinking is the art and science of making reliable inferences about behaviour (Richmond, 1994) or the discipline for seeing wholes and interrelationships (Senge, 1990), and thus it is helpful and relevant to raise and solve problems. Helpful (figure 6.4), because it is a simple way to describe the purpose, the elements and the interconnections. Relevant (figure 6.5), because it gives a clear picture of the interactive step process used in applying system thinking. Firstly, you specify the problem or the issue you wish to explore or resolve. Secondly, you construct hypothesis to explain the problem and test them using mental models and computer simulation models. When you are content with what you developed, you can communicate with clarity and begin to implement change, while continuously testing the impact of the measures you want to implement and thus monitor system behaviour. Systems Thinking describes how the world works and allows us to imagine how the world could be.

**Figure 6.4:** The system Test



**Source:** Arnold and Wade (2015)

**Figure 6.5:** The Step Process



**Source:** Richmond (2000)

The main ideas, assumptions and models for circular economy match what we call the seven critical Systems Thinking Skills (Richmond, 2000): Dynamic Thinking, System-as-Cause Thinking, Forest Thinking, Operational Thinking, Closed-Loop Thinking, Quantitative Thinking, and Scientific Thinking.

*Dynamic thinking* must help us to define the problem we want to tackle, in terms of a pattern of behaviour over time. The main hypothesis of the paper is that industrial and urban symbioses are the main pillars of circular economy. In particular, symbiosis dynamics tackles biophysical and socioeconomic circularity. The problem raises two questions: (i) How symbiotic relations may challenges climate action, environmental impacts, resource efficiency and scarcity of critical raw materials? and (ii) How symbiotic relations between different stakeholders of the circular economy entailed a systemic transformation of goals (eco-efficiency vs efficiency), entire value chains (shared value vs individual profit), business models (cooperation vs competition), space and time scales (local vs global), social issues (social norms, social behaviours). This transformation is complex and will take time, as the transitional process will follow different steps and pathways.

*System-as-Cause Thinking* is the following step. After proposing a pattern of behaviour over time, the next step is to construct a model to explain how behaviour patterns. It is necessary to define the boundaries of the system. The extensive boundary explains what to include and what to leave out. The intensive boundary defines the depth or level of detail at which the items included in the model are represented. Here, we postulate that the system is concerning relevant sectors selected from few criteria and is driven by internal/external forces. System-as-Cause thinking introduces the question of the resilience of the symbiosis and so on, the stability of circular economy.

*Forest Thinking* groups the details to give us an “average” picture of the system. It reduces the complexity of the model to similarities and main pathways. The project will use this approach to propose a biophysical model for companies and an integrated local dynamic model for Metropolises. For Metropolises, the model will challenge the Sustainable Development Goals (SDGs) with the hypothesis that circular economy – via industrial and urban symbiosis – may integrate different cross-sectoral issues to propose relevant actions for decisions makers.

*Operational Thinking* is dealing with causality and correlation issues. This step answers to the following questions: How is behaviour actually generated? What is the nature of the process? The project assumes that complex and interdependent relations between elements of the system make the correlation test and the success list of factors non-relevant.

The design of the system has to focus on causalities. This step captures the nature of the learning process by describing its structure. Mapping the industrial process in industry and identifying best practices for business companies or designing new policies tools should improve the dissemination of the circularity concept.

*Closed loops thinking* assumes that causality is not projected one way and that each cause is not independent of all the others. The effect usually feeds back to influence one or more of the causes and the causes themselves affect each other. In System Dynamics, Causal Loop Diagrams (CLD) are a simple map of a system with all its components and their interactions. ***CLDs aid in visualizing a system's structure and behaviour, and analysing the system qualitatively.*** In this project, driving forces can stimulate the transition to circular economy (CE) but CE may also reinforce the driving forces. There are two feedback loops in any CLD. The Reinforcing Feedback Loop (R) is positive and self-enhancing, leading to exponential growth or to runaway collapses over time. The Balancing Feedback Loop (B) is negative and is equilibrating structures in systems. This loop is a source of stability and of resistance to change. Here, implications of the transition to Circular Economy, both reinforcing and balancing for the economy, for the environment and for the society will be assessed qualitatively. In the step of closing the loops, key drivers are integrated as trade flows, value chains, use of energy, land, water, natural resources, governance, in order to map the overall structure of the system and adjust delays. Balancing and Reinforcing loops will be used to explain the behaviour of potential adopters to CE or the resistance to behaviour change.

*Quantitative thinking* reminds us that quantitative is not synonymous with measurable. To perform a more detailed quantitative analysis, a causal loop diagram (CLD) has to be transformed to a stock and flow diagram (SFD). This is the step to create the model, to study and analyse the system in a quantitative way. The Closing the loops step plans to integrate “soft variables” such as motivation, self-esteem, commitment or resistance to change and “hard variable” such as energy use, land, water, labour demand, raw materials by using stocks and flows. A stock is the term for any entity that accumulates or depletes over time. A flow is the rate of change of a stock.

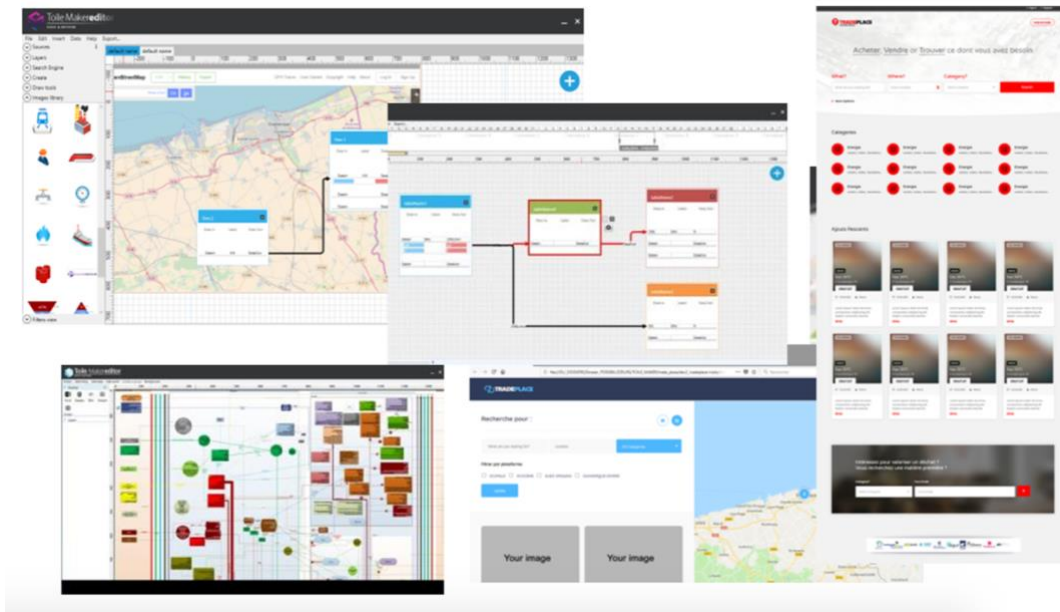
Finally, *scientific thinking* means that models should be useful. System thinkers use variables and data easy to understand, to make sense relatively to one another. They also want to know under what circumstances their model breaks down? What are the limits to their confidence that this model is useful? Where are the leverage points located? These different points engage the resilience of the Circular Economy Transition – as a process and not as a state.

## **Integrated tools for circular economy**

Interdisciplinary combination of different tools proposes a helpful and relevant design of circular economy.

*Tools for Industrial Ecology* such as Material Flows Analysis (MFA) - Life Cycle Analysis (LCA) - are typically used in circular economy. These tools provide insights into the embedded carbon, water and land footprint of materials. As such, they can help identify what resource use can be avoided when implementing circular economy by means of extending a product's life time, reusing products or recycling materials. *Toile Maker* is a software solution for visualizing and highlighting interactions and flows between stakeholders of an industrial park/municipality in a dynamic and interactive way (see Fig. 6.6). This interactive and visual mapping tool allows a better understanding and analysis of the local ecosystem. Additional functionalities in terms of the identification of industrial symbiosis are being developed using semantical analysis to foster circular economy and regional development by identifying potential complementary industries.

**Figure 6.6:** Toile Maker Project



**Source:** [www.toilemaker.com](http://www.toilemaker.com)

*Physical Input Output Tables* (PIOT) describe the flows of material and energy (*Energy Input Output Tables*, EIOT) within the economic system and between the economic system and the natural environment (Altimiras Martin, 2014). These tables are key to understanding the physical structure of economies, to having a snapshot of the actual physical productive structure and to devising environmental and industrial policies. This is even more the case as studying the transition towards a circular economy requires mapping and guiding the deep overhaul of the productive structure and associated technologies. Physical Input Output Tables have been suggested by the United Nations (UN) as the new backbone for the System of Economic and Environmental Accounts. However, no country is producing PIOTs mainly due to the huge statistical effort required to compile them. On average, it takes three years to consolidate each Monetary Input-Output Table, for which a system of national accounting is already in place; but Physical Input-Output Table have no equivalent system in place. Therefore, circular economy could use a new method and data sets that may help establish new procedures to build PIOTs with low data requirements.

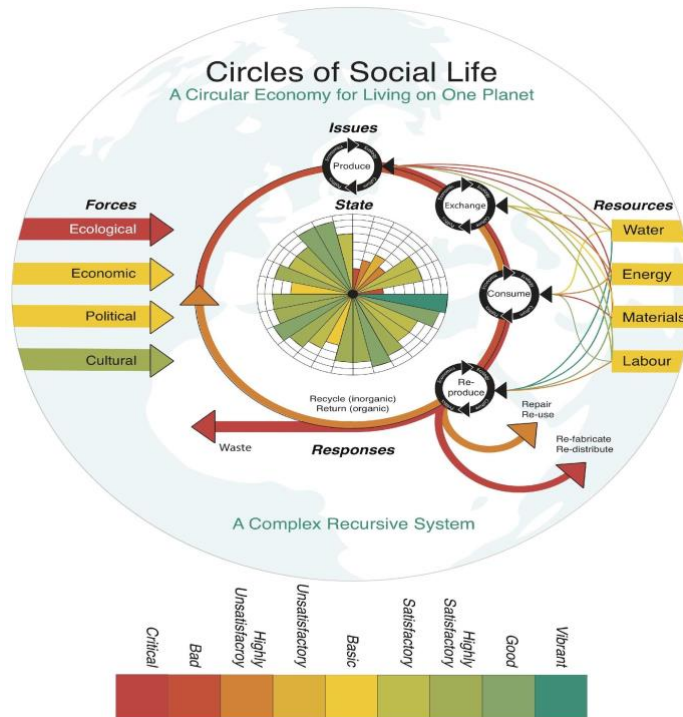
*Conception of an integrated dynamic model* (biophysical and socioeconomic) at different scales seems relevant for country, cities and companies. At the national and European level, it challenges the question of modelling the macroeconomic consequences of the transition to a circular economy. Literature review on circular economy (McCarthy & al., 2018) has two main variants. The first approach involves the development of scenarios regarding material circularity or technological progress in one or several sectors (Bastein & al., 2013, Ellen McArthur Foundation, 2015). Scenarios are based on expert opinion, and are typically described in terms of higher recycling, manufacturing, repair or re-use rates. The second approach involves the use of economy-wide quantitative models, such as Computable General Equilibrium (CGE) and Macro-Econometric (ME) models. These models have two limits: (i) they consider that prices play the main role in determining supply and demand for products, commodities and natural resources (this is important in the context of resource efficiency); and (ii) they are based on a simple social accounting matrix (SAM) that accounts for economic flows throughout the entire economy. It seems possible to combine PIOTs with a System Dynamics Model (T21) to capture material flows and stocks to match economic, environmental, cultural, political and technological loops, and support the design and

assessment of effective strategies to achieve the SDGs (Pedercini & al., 2019). At the metropole and city level, system dynamics (CLD, SFD) and key drivers, such as population, food, energy or employment, to map activities and actor networks, seem useful to facilitate the transition to circular economy and the convergence to SDGs. At this level, the question of measuring, collecting and monitoring data is crucial and open-source platforms seem relevant for policy makers. At the company level, LCA and MFA are introduced in a system dynamics model to produce a biophysical model and challenge ecological footprint (Pinto, Sverdrup, Diemer, 2018). This biophysical model may identify symbiotic synergies aimed to create collective added value, to reduce waste and water consumption, to optimize land use or to develop secondary raw material in eco-industrial parks or industrial symbiosis.

*Scenario planning* gathers and transforms information to explore the space of future options (Wack, 1985). Scenario planning is in particular useful when uncertainty is high, as it is the case in transformative processes. Therefore, the method is very interesting for strategic decision making on social, economic, political, technological and environmental issues. Scenario planning will allow a multidisciplinary group to identify the relevant focal questions to be addressed to circular economy and constructs narratives about the future that will incorporate the broadest imagined spectrum of uncertainties and trends. A scenario for circular economy (or transition to) is defined (1) as a description of a possible future situation and (2) as including paths of development, which may lead to that future situation (Li, Altimiras-Martin, 2015).

*Circles of sustainability* is a key method to provide a relatively simple view of the sustainability of a particular city, urban settlement, or region (James, 2015). The circular figure is divided into four domains: ecology, economics, politics and culture. Each of these domains is divided in seven subdomains, with the names of each of these subdomains read from top to bottom in the lists under each domain name. Assessment is conducted on a nine-point scale. The scale ranges from ‘critical sustainability’, the first step, to ‘vibrant sustainability’, the ninth step. The Circles of Sustainability method is a part of a larger project. Here, sustainability intersects with other social conditions, such as resilience, liveability, adaptation, innovation and reconciliation, as basic conditions of positive social life. Hence, the encompassing framework is called Circles of Social Life. The circles of social life can be used to design the *Circular Economy For Living On One Planet* (CE-LOOP). This initiative is about mapping a recursive system by identifying the different stages of the circular economy, the driving forces acting at each stage and the resources involved at each of these stages.

**Figure 6.7:** Circular Economy for Living on One Planet



Source: James, 2020, in this book

## Circular economy and its new challenges

Circular Economy as a new paradigm, intends to go beyond the 3Rs or 4Rs model and the strategy of decoupling the economy from the environment. It creates new challenges for the economy and the society that, in this study, are classified as follows: Ecological Challenge, Social Dynamics Challenge, Policies Framework Challenge, Economic Paradigms Challenge, Business Model Challenge.

### New Ecological Challenges

This challenge is based on three postulates. Firstly, it reminds us that human activities and economic growth have to be designed inside the planetary boundaries. These boundaries define what we can do and how we can do it. Secondly, mapping the economic system is not the first step of the analytical process, even for circular economy. Circularity is above all biophysical. The aim is to identify the flows, stocks and feedback structure that best explain the problem. Thirdly, if circular economy has often been presented as a way to reduce ecological footprint, the decoupling strategy (relative or absolute), which explains that economic activity could keep growing while reducing waste and greenhouse gas emissions, seems inefficient and counterproductive. By integrating environmental constraints, *circular economy emphasizes the importance of the resilience pillar - the ability of organizations to resist external shocks*, such as climate change.

### Social Dynamics Challenges

Social dynamics refers to the behaviour of groups that results from the interactions of individual group members, as well to the study of the relationships between individual interactions and group level behaviours. This field is really connected to complex adaptive systems, which concern most of the circular economy case studies. In the state of the art,

circular economy explains that good policy offers short and long term economic, social and environmental benefits (EMF, 2013). It is a win-win strategy for the companies, the consumers and the users. Social dimension cannot be reduced to social benefit. Social dynamics is allowed to track problematic behaviour, to understand the process of emergence and diffusion of social innovations, to identify the social drivers of the system, or to lay the foundations for a collective impact of the actions carried out by individuals, groups of individuals and communities. *A new social dynamic explains how the pillar of creativity can induce local solutions to meet societal, environmental and economic needs.*

## **Policies Framework Challenges**

Circular economy used to be connected to adapted policy and policy tools for policymakers, including regulation, taxation and subventions. In fact, the problem is not to adapt policy but to identify the obstacles and barriers to a transition to the circular economy. The policies framework concerns European level, national level, regional level and local level. A better implementation and enforcement of legislation, the promotion of green banking and socially responsible investments, or the taxation of businesses using no recycled materials are the main recommendations. Six policy interventions have been identified: (1) integrating circular economy and systems thinking into university curricula (European Chair on Circular Economy) with the help of all the partners; (2) creating a public - private platform at the city level to speed up the transition to circular economy ; (3) investing public funds in infrastructure; (4) mapping the different characteristics of European, national and local taxation to improve environmental tax and reduce labour tax and revenue tax; (5) spreading the development of industrial symbiosis and clusters at the three levels (European, national and local) to create more synergy between nations (energy solidarity), between companies (a waste becomes a good) and between Metropole and citizens (to reduce public waste) ; (6) improvement of policy tools at the metropole level, as an area where people, consumption, energy use and waste are the most important. The road to sustainable cities has to follow the circular economy pathway. **From the policy side, the proximity pillar (bottom up strategy) seems more relevant than globalization (top down strategy).**

## **Economic Paradigms Challenges**

In the last years, circular economy has been presented as a new paradigm, a possible pathway to increase the sustainability of our system. This paradigm has been coded from the 4Rs (reuse, repair, recycling and Renew) to the 9Rs (Recover, Recycle, Repurpose, Remanufacturer, Refurbish, Repair, Reuse, Reduce, Rethink and Refuse). We propose to go beyond this approach and to discuss the core of the economic system. The transition to circular economy introduces three critical challenges: (1) reconnect the economic system with strong sustainability and planet boundaries. In that case, circular economy could find new dynamic from alternative models, such as degrowth. The reduction of working time, the introduction of local currencies or local food products, the improvement in the quality of products, the decrease in demand, all introduce a new way of thinking and new drivers of circularity; (2) Prosperity in a finite world invites us to question and review our economic models. In particular, we need to revisit the foundations and mechanisms that define contemporary societies today, as exchange value, property, market, price or competition. The economy of functionality (widely emphasized by Michelin) or the economy of sharing favours use, utility or cooperation over ownership, exchange value or competition; (3) The association of the circular economy with the social and solidarity economy may reconnect producers and consumers, provide innovative solution ensuring social foundations for inclusive and sustainable development. For example, agroecology may induce a circular and solidarity economy that prioritizes local markets and supports local economic development.

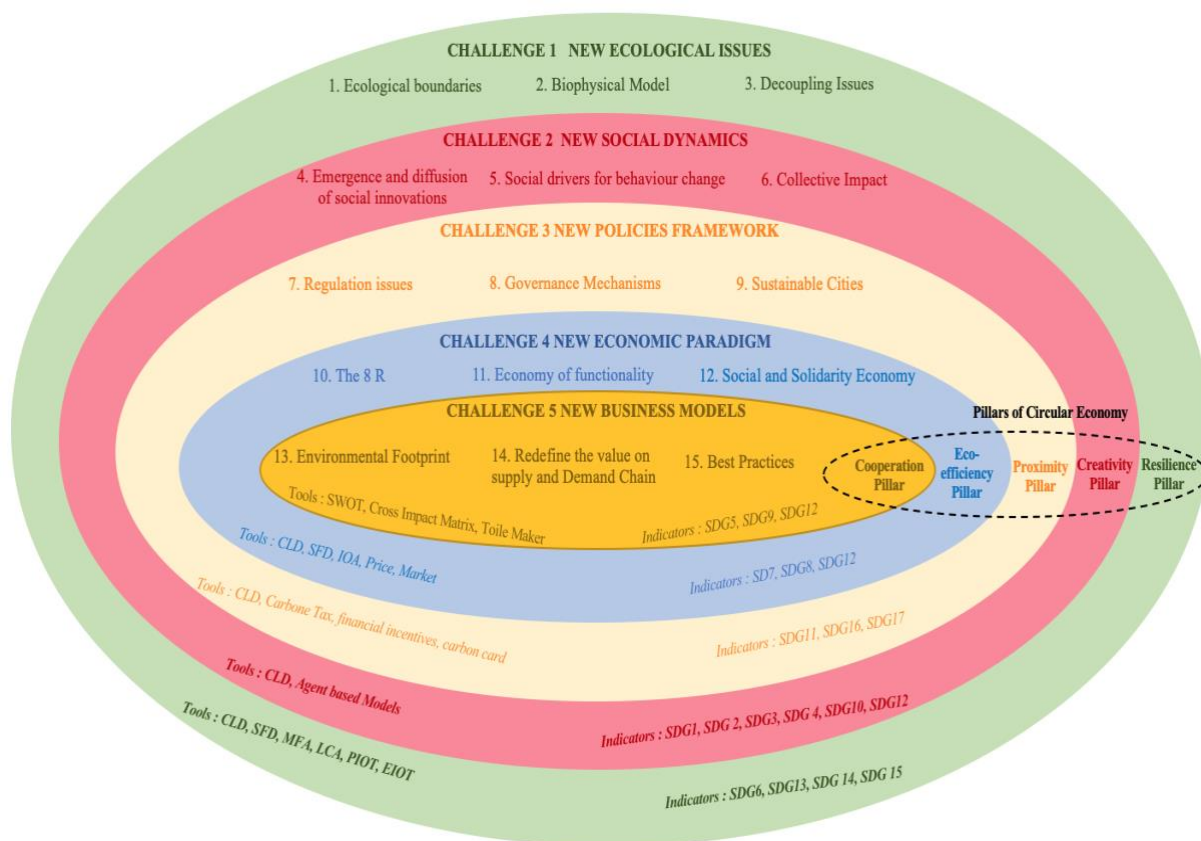


Agroecology promotes fair solutions based on local needs, resources and capacities, creating more equitable and sustainable markets. Social innovations examples are participatory guarantee schemes, local producers' markets, denomination of origin labelling, community supported agriculture and e-commerce scheme. These innovative markets respond to a growing demand for healthier diets. Another example concerns the recycling of textiles. The community EMMAUS (France and International) started the economic activity of recycling used textiles. Today, 85% of textiles is recycled and EMMAUS keeps improving its business model, while at the same time also engaging itself to promote human values and social integration of migrants. Economic and solidarity circularity design a new socio-economic system where profit is not a goal but a way to reach a level of social and human development. Social and solidarity organizations could accelerate the transitional process to circular economy and improve the eco-efficiency pillar.

### **Business Model Challenges**

New Economic paradigms suggest also new management and business models. Circular economy involves an operating framework that considers the high-level basis for value in an environmentally, economically and socially positive way. There is a set of business models that describes how an organization creates and delivers this value on the supply chain: (i) Dematerialization by reducing the amount of resources required to create products through digitalization on demand production or reusable products (Diemer and Dannequin, 2009); (ii) circular inputs for production (Diemer, Figuière, Praedel, 2013) ; (iii) Product life extension through design for durability, maintenance and repair, reuse, remanufacture (Pinto, Diemer, Sverdrup, 2019); (iv) Resource Recovery through recycling or composting (Diemer, 2012); (v) Product as a service including the Sharing Economy (Diemer and Nedelciu, 2020); (vi) social circular economy (Diemer, 2020). Beyond these business models, CE as a paradigm could suggest few recommendations to encourage new initiatives: diffusion of laws in Europe to prevent planned product obsolescence, creation of an educational program to ensure circular economy, tax break for social circular enterprises to develop their growth. All these challenges make it possible to identify what we will call the 5 pillars of the circular economy, illustrated in Fig.6.8.

**Figure 6.8:** The five pillars of Circular Economy



These challenges may also specify the positive impacts that Circular Economy could provide for Europe.

*Enabling more systemic policy decisions to further facilitate the transition to a safe, environmentally, friendly, efficient and effective circular economy in selected sectors*

If the circular economy can be an important lever to achieve key policymaker objectives such as generating economic growth, creating jobs, and reducing environmental impact, it is necessary to design adapted policies for different scales and for different sectors. At the macro level (Europe, countries), it is necessary to summarize the opportunities and obstacles to move towards circular economy and make proposals to accelerate this process. If resource efficiency seems a prerequisite for the economy to stay within the planetary boundaries, the shift of the paradigm will challenge energy efficiency, the use of renewable energy and the largest and most resource-intensive value chains. Circular economy could identify viable options for a shift in taxation from labour to natural resource use and consumption.

*Reducing waste-generation, negative health impacts, environmental pollution and greenhouse gas emissions, through efficient and effective use of both primary and secondary resources in Europe*

The EU Action Plan for Circular Economy established a concrete and ambitious programme of action, with measure covering the whole cycle, from production and consumption to waste

management and the market for secondary raw materials (bads become goods). The Circular Economy Paradigm aims to contribute to closing the loop of product life-cycles through greater recycling and re-use strategies and greater benefits for the environment, economy and civil society. Case studies have been selected to challenge the revised legislative framework on waste (July, 2018) : (i) EU target for recycling 65% of municipal waste by 2035; (ii) EU target for recycling 70% of packaging waste by 2030 ; (iii) Recycling targets for specific packaging materials (80% for ferrous metals, 75% for glass, 55% for plastic, 30% for wood) ; (iv) Reducing landfill to maximum of 10% of municipal waste by 2030.

*Creating incentives and support the development of strategic governance mechanisms that enable the transition to a circular economy and contribute to the effective implementation of the Sustainable Development Goals in Europe*

The circular economy concept has been presented at the United Nations Summits on Sustainable Development (1992) as a key to reduce demand for natural resources and to contribute to more sustainable patterns of production and consumption. Current arguments support that the growth of population and the increase of non-renewable resources exceeds several critical global, regional and local thresholds. This question is well known and the concept of “Planetary Boundaries” (Rockström, 2009) has been largely discussed. The circular economy must also be part of a logic of renewal of local governance mechanisms. Sustainable Development Goal 17 could be a factor in integrating stakeholders, initiating more systemic approaches and engaging the different actors to develop governance tools at the local level.

*Supporting the achievement of climate commitments and specific quantitative targets on resources efficiency, recycling rates or waste disposal quotas*

European Commission, Statistical Agencies, Foundations (EMF) and Companies have been engaged in measuring and following materials flows. Domestic material consumption or resource productivity are relevant to calculate environmental footprint. Climate change, air quality, municipality waste, land use or water scarcity introduce new scope and new targets. Modelling the biophysical flows and stocks of materials and services in a dynamic system creates increased complex challenges, especially if we are taking into account the cultural, political or ecological dimensions. Quantitative and qualitative indicators have to be considered to understand the transition to circular economy. New indicators have to be defined and tested. These include: the amount of municipal waste per capita for waste generation in metropolises; share of renewable energy and greenhouse gas emissions per capita (or GDP output) for countries; investments in human capital and non-profit indicators for companies; representations of circular economy in civil society (through surveys and interviews); share of circular economy in European and national programs of sustainable education. This last indicator is particularly crucial because companies and the civil society may lack the information, confidence and capacity to move from linear thinking to circular solutions. This is compounded by a lack of sustainability education in design, engineering, economics and other relevant subjects, and in business school. Problems may include a lack of training skills in repairing products, improving their lifetime or reusing them). European programs should integrate circular economy in education (universities, business companies, NGOs and cities) by supporting the creation of European Excellence Chairs on Circular Economy. Synergies could be developed with the Intergovernmental Panel on Climate Change to integrate circular

economy in different climate change scenarios to go beyond mitigation and adaptation's policies.

## Conclusion

In 2013, Paul Polman, Chief Executive Officer of Unilever signed the Foreword of the Ellen McArthur Foundation Report entitled "*Towards the Circular Economy*". In his words, circular economy promised a way out : « *Here products do not quickly become waste, but are reused to extract their maximum value before safely and productively returning to the biosphere. Most importantly for business leaders, such an economy can deliver growth. Innovative product designers and business leaders are already venturing into this space* » (EMF, 2013, Foreword). Circular economy generally refers to an economic model whose objective is to produce goods and services in a sustainable way, limiting the consumption of resources, as well as the production of waste. The aim is to decouple from the linear economy model (extract, produce, consume, throw away) for a "circular" economic model, with economic and financial benefit for all the stakeholders. The article that we propose contrasts with this narrow and reductive vision of circularity. The circular economy is not reduced to an economic model, it is mainly a paradigm shift that is part of strong sustainability. It renews industrial standards by advocating symbiotic relationships built on cooperation rather than competition. It implies the use of "Systems Thinking" to draw its foundations from interdisciplinarity and the study of complex systems. It refers to challenges that are ecological, political, social, economic and managerial at the same time. This paradigmatic vision could lay the foundations for a new model for Europe, more compatible with planet boundaries and social value. Circular economy is in line with Sustainable Development Goals (SDG), is an important way to achieve an ecologically civilized society and is opening huge opportunity to reach a sustainable urban development (cities should be the new landscape of circular economy).

## References

- Altimiras-Martin A. (2014). « Analysing the Structure of the Economy Using Physical Input – Output Tables », *Economic Systems Research*, 26 (4), 463 – 485.
- Andersen M.S (2017). « An Introductory Note on the Environmental Economics on the Circular Economy », *Global Journal of Human Social Science*, XVII, 7 – 13.
- Arnold R.D, Wade J.P (2015). « A Definition of Systems Thinking : A Systems Approach ». *Procedia Computer Science*, 44, 669 – 678.
- Arnsperger C., Bourg D. (2016). « Vers une économie authentiquement circulaire, réflexions sur les fondements d'un indicateur de circularité », *Revue de l'OFCE*, 145, 93 – 125.
- Bastein T. & al. (2013). Opportunities for a Circular Economy in the Netherlands. *The Netherlands Organisation for Applied Scientific Research (TNO)*. Delft.
- Brings Jacobsen N., Anderberg S. (2004), “Understanding the evolution of industrial symbiotic networks – the case of Kalundborg” in Van Den Bergh J. and Janssen M. (dir), *Economics of industrial ecology: Materials, structural change and spatial scale*, Cambridge, MIT Press.
- Chertow M.R (2007). “Uncovering Industrial Symbiosis”. *Journal of Industrial Ecology*, 11, 1, 11-30.
- Christensen J. (2006), “The history of the industrial symbiosis at Kalundborg, Denmark”, *IPTEH – UNIL, Workshop GSE*, Lausanne, November 30<sup>th</sup>, 49 p.
- Diemer A., Nedelciu E., Schellens M., Gisladdottir J. (2018), « Challenges for Sustainability in Critical Raw Material Assessments », *International Journal of Management and Sustainability*, 7, 3, 156 – 179.
- Diemer A., Nedelciu C.E. (2020) System Dynamics for Sustainable Urban Planning. In: Leal Filho W., Azul A., Brandli L., Özuyar P., Wall T. (eds) *Sustainable Cities and Communities*. Encyclopedia of the UN Sustainable Development Goals. Springer, Cham
- Diemer A., Nedelciu C.E. (2020) Shared Economy. In: Leal Filho W., Azul A., Brandli L., Özuyar P., Wall T. (eds) *Sustainable Cities and Communities*. Encyclopedia of the UN Sustainable Development Goals. Springer, Cham.
- Diemer A., Dierickx F., Gladkykh G., Morales M., Parrique T., Torres J., (2017), *European Union and Sustainable Development*, Editions Oeconomia.
- Diemer A., Figuière C., Pradel M. (2013), *Ecologie politique vs écologie industrielle, quelles stratégies pour le développement durable?*, Editions Oeconomia.
- Diemer A. (2013), « L'écologie industrielle, 40 années d'expériences, les leçons d'un succès », in Diemer A., Figuière C., Pradel M. (dir), *Ecologie politique vs écologie industrielle, quelles stratégies pour le développement durable?*, Editions Oeconomia, p. 133 – 161.
- Diemer A. (2012), « Technology and Sustainable Development » in Laperche B., Uzinidis D. (eds), *Crisis, innovation and Sustainable Development*, Edward Edgar Publisher.
- Diemer A., Dannequin F. (2009), « *Le capitalisme dématérialisé comme développement durable* » in Laperche B., Crétieneau A, Uzinidis D. (dir), *Le Développement Durable, pour une Nouvelle Economie*, Peter Lang.

- EMF (2019), *Completing the picture : How Circular Economy Tackles Climate Change*. Ellen McArthur Foundation. September 26th, 62 p.
- EMF (2019), *Reuse, Rethinking Packaging*, Ellen Mc Arthur Foundation, 43 p.
- EMF (2018). *The Circular Economt Opportunity for Urban and Industrial Innovation in China*. Ellen McArthur Foundation, 166 p.
- EMF (2017). *Cities in the Circular Economy : An Initial Exploration*. Ellen McArthur Foundation. 16 p.
- EMF (2016). *Circular Econom in India. Rethinking Growth for Long-Term Prosperity*. Ellen McArthur Foundation. 86 p.
- EMF (2015). *Delivering the Circular Economy : A Toolkit for Policymakers*. Ellen McArthur Foundation, 177 p.
- EMF (2015). *Circularity Indicators. An Approach to Measuring Circularity. Methodology*. Ellen McArthur Foundation. 98 p.
- EMF (2015). *Circularity Indicators. An Approach to Measuring Circularity. Project Overview*. Ellen McArthur Foundation. 12 p.
- EMF (2014). *Towards the Circular Economy, Accelerating the scale-up accross global supply chains*. Ellen McArthur Foundation, 41 p.
- EMF (2013). *Towards the Circular Economy, Opportunities for the Consumer Goods Sector*, Ellen Mc Arthur Foundation, 112 p.
- Ehrenfeld J.R, Gertler N. (1997), “Industrial Ecology in Practice: The evolution of interdependence at Kalundborg”, *Journal of industrial Ecology*, winter, 1, 1, 67-79.
- Ehrenfeld J.R, Chertow M. (2002), “Industrial Symbiosis: The Legacy of Kalundborg” in R. Ayres (dir), *Handbook of Industrial Ecology*, Northampton, UK: Edward Elgar.
- Erkman S. (1997), «Industrial Ecology: An Historical View ». *Journal of Cleaner Production*, 5, 1-2, 1 – 10.
- Esty D.C, Porter M.E (1998), « Industrial Ecology and Competitiveness: Strategic Implications for the Firm », *Journal of Industrial Ecology*, 2, 1, 35-43.
- European Commission (2019), *Report on the Implementation of the Circular Economy Action Plan*. SWD (2019) 90 final. Brussels, 4/3/2019.
- European Commission (2019). *The European Green Deal*. COM (2019) – 640 final. Brussels, 11/12/2019.
- European Commission (2019). *New Circular Economy Action Plan*, Ref Ares 7907872 – du 23/12/2019.
- European Commission (2018). *On Monitoring Framework for the Circular Economy*, COM 2018 – 29 final, Strasbourg, 16/01/2018.
- Geissdoerfer, M., Savaget, P., Bocken, N. M., & Hultnik, E. J. (2017). “The Circular Economy – A new sustainability paradigm?”. *Journal of Cleaner Production*, 11.
- Giacomelli J., Kozamernik D., Lah P. (2018). Evaluating and Monitoring Circularity. Macro Regularity Environment in the EU and in Slovenia, B 11, 42 – 54.
- Ghisellini P., Cialani C., Ulgiati S. (2015), « A Review on Circular Economy : The Expected Transition to a Balanced Interplay of environmental and economic systems ». *Journal of Cleaner Production*, XXX, 1 – 22.

- Haas, W., Krausmann, F., Wiedenhofer, D., & Heinz, M. (2015). "How Circular is the Global Economy? An Assessment of Material Flows, Waste Production, and Recycling in the European Union and the World in 2005". *Journal of Industrial Ecology*, 12.
- James P. (2015). *Urban Sustainability in Theory and Practice*. Circles of Sustainability. Routledge.
- Kalmykova Y., Sadagopan M., Rosado L. (2018), « Circular Economy – From Review of Theories and Practices to Development of Implementation Tools ». *Resources, Conservation and Recycling*, 135, 190 – 201.
- Kirchherr J., Reike D., Hekkert M. (2017), « Conceptualizing the circular economy : An analysis of 114 definitions ». *Resources, Conservation and Recycling*, 127, 221 – 232.
- Korhonen J., Nuur C., Feldmann A., Birkie S.E (2018), « Circular Economy as an Essentially Contested Concept », *Journal of Cleaner Production*, 175, 544 – 552.
- Lewandowski, M. (2016). Designing the Business Models for Circular Economy - Towards the Conceptual Framework. *Sustainability*, 8, 1-28.
- Li J., Altimiras-Martin A. (2015). "Scenario Design for a Global Low Carbon Economy" in T. Baker, D. Crawford Brown (eds), *Decarbonising the World's Economy*. Imperial College Press.
- McCarthy A., Dellink R., Bibas R. (2018), « The Macroeconomics of the Circular Economy Transition : A critical review of modelling approaches », *OECD Environment Working Papers*, 130, 53 p.
- Meadows D. (2008). *Thinking in Systems*. Chelsea Green Publishing.
- Morales M., Diemer A. (2019), « Industrial Symbiosis Dynamics, a Strategy to Accomplish Complex Analysis, the Dunkirk Case Study », *Sustainability*, 11, p. 1 – 18.
- Morales M., Diemer A., Cervantes G., Carrillo-Gonzales G. (2018), « By-product synergy changes in the industrial symbiosis dynamics at the Altamira Tampico industrial corridor, 20 years of industrial ecology in Mexico », *Resources, Conservation and Recycling*, 140, p. 235 – 245.
- Preston F. (2012). « A Global Redesign ? Shaping the Circular Economy ». *Energy, Environment and Resource Governance*. March, 20 p.
- Prieto-Sandoval V., Jaca C. Ormazabal M. (2018), « Towards a Consensus on the Circular Economy », *Journal of Cleaner Production*, 179, 605 – 615.
- Richmond B. (2000). *The Thinking in Systems Thinking : Seven Essential Skills*. Pegasus Communications.
- Robinson S. (2017). *Social Circular Economy, Social Circular Economy – opportunities for people, planet and profit*.
- Pedercini M., Arquitt S., Collste D., Herren H. (2019). « Harvesting Synergy From Sustainable Development Goal Interactions ». *Proceedings of the National Academy of Sciences of the United States of America*. 116 (46). 23021 – 23028.
- Pinto J.T (2019). *Sustainable Resource Management in European Steel Supply Chains*. Thesis. University of Clermont-Auvergne.

- Pinto J.T., Sverdrup H., Diemer A. (2019). « Supply Chain Integration Strategies and Circularity in the European Steel Industry », *Resources, Conservation and Recycling*,
- Pinto J.T, Sverdrup H., Diemer A. (2019). « Integrating Life Cycle Analysis into System Dynamics: The Case of Steel in Europe », *Environmental Systems Research*, vol 8, n°15, p. 1 – 21.
- Rockström J. & al. (2009). ‘Planetary Boundaries: Exploring the Safe Operating Space for Humanity’. *Ecology and Society*. 14 (2), 472 – 475.
- Wack P. (1985). “Scenarios: Shooting the Rapids”. *Harvard Business Review*. November-December.
- Wijkman A., Skanberg K. (2015). *The Circular Economy and Benefits for Society*. The Club of Rome. April. 36 p.
- Winans, K., Kendall, A., & Deng, H. (2017). The history and current applications of the circular economy concept. *Renewable and Sustainable Energy Reviews*, 8, 825 – 833.





# 7. Methodological reflections on analysing sectoral cycling of materials and induced energy use over time

**Authors and affiliations:** Florian Dierickx<sup>1,2</sup>, Arnaud Diemer<sup>1</sup>

1: Jean Monnet Excellence Center on Sustainability (ERASME), University of Clermont Auvergne, CERDI, Clermont-Ferrand, France

2: University of Iceland, Reykjavik, Iceland

*Article*

**Date:** October 13, 2020

**Journal:** Int J Environ Sci Nat Res. 2020; 26(4): 556191.

**URL:** <https://juniperpublishers.com/ijesnr/pdf/IJESNR.MS.ID.556191.pdf>

## Abstract

This article aims to outline and debate multi-disciplinary modelling strategies based on dynamical (physical) input-output modelling theory, in order to advance the understanding of the evolution from the current industrial structure towards a renewable energy driven industrial structure. The specific purpose is to review cross-disciplinary insights available in the literature that could help derive the least-energy (or emission) and least-material intensive pathway of a transition to a low-carbon industrial structure. Specific focus is on the conceptual link between dynamic input-output analysis (economics), system dynamics (economics), dynamical systems (mathematics) and process control theory (engineering).

## Keywords

Physical input-output analysis, dynamical system theory, system dynamics, time delays, material flow analysis

## Introduction

There are multiple environmental and societal issues in our society, each with different magnitudes, specificities and characteristics. The primary topic of interesting in this paper is how to transition from our current industrial structure to a renewable-based industrial structure in order to mitigate climate change. More specifically, the focus is on methods and economy-wide accounting frameworks at our disposal that enable a comparison of systemic economy-wide transition pathways in terms of material footprint and greenhouse gas emissions. Tackling climate change is a collective responsibility and effort to be made, to avoid a collapse of our environmental base in the long term (Ceballos, Ehrlich, & Dirzo, 2017). The decarbonisation challenge requires multidisciplinary solutions, as it is interlinked with almost all sectors of society.

One of the main driving forces of climate change is the use of fossil energy. We use energy to extract and transform materials for different goods, to heat or cool our homes, to extract fertilizer and produce food, to run electric appliances and to transport a variety of goods and services. The possibility to extract, transport, transform and recycle materials is thus strongly dependent on the energy available to do so. Therefore, the utilization of materials

should — in light of the decarbonisation challenge — be contextualized within a broader view on how we produce and use energy. Because we use energy in all our activities, almost every product or activity embodies a certain amount of ‘*embodied energy*’. When fossil energy reserves are used to generate this energy (without carbon capture and storage or reutilization), this entails a certain amount of ‘*embodied greenhouse gases (GHG)*’. In the industrial sphere one of the main solutions for tackling climate change is thus to reduce the amount of embodied greenhouse gases of economic activities and shift those to either fossil energy with carbon capture, or to renewable energies such as solar, wind, wave, tidal, geothermal, forward osmosis, nuclear and biomass. The challenge is to co-design wisely a transition scenario and decarbonize our economy in an intelligent manner, carefully considering trade-offs between different energy and material utilization choices and sequence of sectoral transition.

The main purpose of this working paper is to discuss features and shortcomings of available methodologies and related datasets – including links to the institutional framework – that can be used to improve understanding of how to systemically assess material, energy and emission flows and reflect on the trade-offs between several sectoral decarbonization and dematerialization pathways.

We suggest that the (physical) input-output analysis framework is the best suited starting point or ‘methodological backbone’ to theoretically advance the physical understanding of our economy and assess environmental impacts climate mitigation and/or dematerialisation strategies. Four arguments explain this choice:

**(i) Existing institutional linkages and prospects for advancing official statistics (system of national accounts and input-output tables).** In a world with strongly interlinked supply chains and worldwide economic interactions (Wiedmann et al., 2015), an internationally standardized methodology to account for economic activities is imperative to increase our understanding of material exchanges and calculate reliable footprints. The methodological framework that adheres most to international standards and provides a platform to progress towards unified datasets and reliable accounting of supply chains, is the system of national accounts. The institutional linkage and involvement of statistical institutes in empirical data collection and data processing, makes it the best suited framework that is able to inform policy making and become “institutionalized”.

**(ii) Actor-attribution of environmental impacts using consumption-based accounting (widening the system boundaries).** Because of the large extent of international material and energy exchange and interlinkage of supply-chains, harmonized datasets attributing physical impacts of production (CO<sub>2</sub>-emissions, raw material extraction, environmental impacts) to final consumption is a necessary first step in understanding the full supply-chain impact of consumption. Despite the fact that legislative and political processes mainly take place at national or supranational level and that policies are inevitably contained within territorial borders, analysis of downstream and upstream impacts and increased international collaboration are a prerequisite for a successful mitigation of environmental problems, specifically climate change. There are moral and ethical grounds to argue that beneficiaries of products and services should be held accountable for downstream material and environmental impacts of this consumption. A national or regional assessment of material consumption should strive towards extending system boundaries of analysis, particularly open economies that have an extensive trade pattern compared to their internal production and consumption. This knowledge can only be obtained with harmonized international data exchange, for which the IO framework is specifically designed (Poor & Nemecek, 2018). Thanks to subsequent projects that compiled international consumption-based carbon footprint accounts that use the sectoral classification of the input-output frameworks, the quality of these accounts can be argued to be of sufficient quality to be used in policy making

(Wood et al., 2018; Wood et al., 2019; Tukker et al., 2020). Of course, there should be a political and institutional willingness to collect and provide those data, so that the insights of IO modelling can be used in developing environmental policies or trade legislation. This notion of consumption- versus production-based accounting has been previously reviewed by Peters (2008) and, and further advanced by Malik, McBain, Wiedmann, Lenzen, & Murray (2019).

**(iii) Physical data versus monetary price data:** For a complete and reliable understanding of the material and energy exchanges in the economy, physical data is unsurprisingly best directly sourced from the different actors in the industrial system and collected in internationally harmonized datasets. Despite the advances in data harmonization (Wood et al., 2018; Wood et al., 2019; Tukker et al., 2020)., it is important to note that the source-data for the compilation of these accounts is monetary data. Using monetary data for that using monetary source data implicitly assumes homogeneity of prices. It has been previously shown that using monetary data decreases the reliability of input-output tables for physical carbon- and material-footprinting, specifically when there are differing prices for goods within one sector (Lenzen, 2000; Owen et al. 2017).

Unfortunately, physical sector emission, material and energy exchange data does not yet exist to the level required to reliably attribute environmental impacts to final consumption on a regional or worldwide scale, although different communities are pursuing this collaboratively and advances are made in this direction. Some reasons explain this situation: (1) the difficulty of collecting such data; (2) privacy and intellectual property concerns; (3) it has not been the primary interest of governments and statistical institutes to provide enough resources to do so; (4) it is not straightforward to create a harmonized data collection and accounting system with sufficient detail, designed for a wide array of factors that are adapted to different types of measurement and analysis ranging from monetary valuation on macro-level to, for example, tracing the amount of a specific rare earth metal within the economy.

A commodity flow can be analysed in monetary value or in weight of processed or traded materials. For the purpose of physical flow analysis and calculation of recycling efficiencies in the whole economy, avoiding the shortcomings of monetary analysis, the most accurate assessment would be making direct use of physical exchange data of goods between the different sectors in weight units (tonnes, kg, ...) for each material. To some extent, this entails going back to one of the first papers of Leontief - the inventor of the input-output method, in which he described the economy as a “Circular Flow” (Leontief, 1991; Miller & Blair, 2009).

A second-best option constrained by data-availability, is to estimate weights based on a price-weight relationship. Doing so implies the assumption that each sector produced homogeneous products and that there is a linear relationship between the price and the quantity of goods produced. However, as explained before, these assumptions rarely hold when using aggregated product categories.

Leontief (1991) concludes at the end of his seminal paper:

*“One need only look somewhat more closely at the basis of ‘pure price theory’ to be in a position to establish how strongly it is pervaded by the material point of view. In order to re-establish the correct relationship between the material and value points of view, one need only arrange the two views somewhat more systematically and locate them within the broader theoretical structure.*

*The question is not one of whether this or that point of view is correct. To each its due-although when the matter is judged impartially, the ‘value’*

*point of view ought to recognize a proper field of analysis in which the material approach will be of considerable importance.”*

Starting from monetary data to derive physical quantities using a price-weight relationship is problematic for many reasons. Firstly, the assumption of homogeneity of aggregated sectoral commodity prices across all uses is not guaranteed (Weisz & Duchin, 2006). If there is a transaction occurring with a different price than average, this decreases the quality of the estimation (Wiedmann et al., 2015). Secondly, physical IO tables derived from monetary IO tables could deliver biased results due to the violation of mass balance or absence of mass balance principles in monetary tables (Merciai & Heijungs, 2014). Thirdly, imbalances result from aggregating in homogenous products consumed in different proportions by the users (Majeau-Bettez et al., 2016a). Fourthly, a more fundamental problem arises from the fact that with monetary input-output data there is only accounting for flows that have a price, not for flows that are difficult to account for in monetary values such as grazed biomass and fuel wood from forests (Schandl et al., 2016).

The main obstacles for a valuable and useful analysis of both the monetary and physical structure of the economy are data availability and accounting frameworks, the compatibility of accounting frameworks in monetary and physical units and lack of transparency and inter-institutional collaboration. Efforts are pursued out to enable consistent analysis of relationships both in monetary and physical flows, for example in the System of Environmental Economic Accounting (SEEA) (United Nations et al., 2014). To cope with different conventions and definitions for Physical Input-Output Tables (PIOTs) and Monetary Input-Output Tables (MIOTs), a pragmatic approach has been developed by Többen (2017). Többen proposes to use the principle of maximum entropy to statistical inference as a least biased estimator for a system under study, in order to estimate simultaneously physical and monetary commodity flows from partial and incomplete data, different levels of aggregation and mismatching commodity classifications.

**(iv) Level of aggregation:** To achieve a full understanding of the material and energy exchanges in the economy, to design policies that take into account sectoral distinctions and to attribute impacts to final consumers, in principle there should exist a database which describes material exchange from and to the industrial system, but also between sectors in the economy. For an integrated analysis, a balance is to be sought between higher levels of aggregation that enable international comparison and harmonisation (for example, the IO-output framework), and product- and activity-specific analysis tailored to the different sectors that provides reliable information in a certain context (for example, Life Cycle Analysis, LCA). A disadvantage of the LCA framework is that there are no unified and harmonized analysis-conventions without an international institutionalisation of data collection and dissemination. In an ideal situation, these two methods converge to one framework where all material and energy flows are being recorded between different actors in the economy in a consistent way<sup>90</sup>.

The level of aggregation determines the level of detail in which transactions, monetary or physical, are registered or used. Currently, this has consequences for the type of analysis which is to be carried out. For example, if speciality metals are the focus of study, input-output tables are generally too aggregated to look at these specific flows. The high level of

---

<sup>90</sup> A promising initiative that aims to provide a consistent and collaborative open-source platform for systematic product footprinting is BONSAL. More information on the initiative can be found at <https://bonsai.uno>, the active development of BONSAL-projects is hosted at <https://github.com/BONSAMURAI>

aggregation in sectors of the input-output framework does not allow to look at specific materials (Wiedmann et al., 2015), but different efforts are being made to break down the sectors to a more granular level using a harmonized system.

All these issues will be explored in the following article. Firstly, we will present the institutional context and primary sector- and activity classifications that are used for input-output analysis (IOA). Secondly, we will explain the challenge to change the unit from monetary input-output analysis to physical input-output analysis. Thirdly, we will introduce a methodology to account for total system energy and emission impacts of material recycling. Finally, we will discuss the question of static and dynamic approach of input-output analysis.

## **Input-output modelling and the System of National Accounts (SNA)**

### **Institutional context of economy-wide environmental accounting**

On a global level, data compilation on economic activity is regulated in the international *System of National Accounts* (SNA), an internationally agreed standard set of recommendations on how to compile measures of economic activity. The SNA has been developed and revised by the *Inter Secretariat Working Group on National Accounts* (ISWGNA) and is issued by the *UN Statistics Division of the UN Department of Economic and Social Affairs* (UN DESA) (Eurostat, International Monetary Fund, OECD, & United Nations, 1993; United Nations, European Communities, International Monetary Fund, Organisation for Economic Co-operation and Development; World Bank, 2009).

A related accounting structure, the *System of Environmental-Economic Accounting* (SEEA) is used to derive indicators and statistics to describe the interactions between the economy and the environment. The main pillars of the SEEA are the *Central Framework* (SEEA-CF) (United Nations, European Union, et al., 2014) – an international statistical standard for environmental-economic accounting incorporating relevant environmental information concerning natural inputs, residual flows and environmental assets, and the *Experimental Ecosystem Accounting framework* (SEEA-EEA) (United Nations et al., 2014). The SEEA-EEA is an accounting framework that starts from the perspective of ecosystems, integrating biophysical data, tracking changes in ecosystems and linking those changes to economic and other human activities. Examples of applications of the SEEA framework are provided in United Nations, European Commission, FAO, OECD, & World Bank (2017).

The development of this environmental accounting system is coordinated at the international level by the UN Committee of Experts on Environmental-Economic Accounting (UNCEEAA), established by the UN Statistical Commission at its 36th session in March 2005. The UNCEEAA is group of high-level experts from national governments and international organizations with a broad range of experience in statistics and in the use of environmental-economic accounts. The mandate of the UNCEEAA is to mainstream environmental-economic accounting and related statistics, advocate for the SEEA to become an international standard and advance its implementation in different countries.

The UNCEEAA is assisted by several technical groups of which the most important one is the London Group on Environmental Accounting, established at the 27th Statistical Commission in 1993 as a City Group. When the UNCEEAA was formed in 2005, the role of the London Group as the primary expert body in charge of methodological issues was reconfirmed (UNSD, 2016). In March 2014, the Bureau of the UNCEEAA inaugurated two other technical groups, the *Technical Committee of the SEEA Central Framework* and the *Technical Committee on Experimental Ecosystem Accounting*, to advance the work and

development of core tables, accounts and associated technical notes for the SEEA-CF and SEEA-EEA. A more informal group consisting of practitioners, the *Expert Forum on Experimental Ecosystem Accounting*, also debates the development and advancement of the SEEA.

To provide methodological support and provide guidance to the implementation of the SEEA in the EU and specifically facilitate collaboration with Eastern and South-Eastern European countries, the Caucasus and Central Asia, the *ECE Joint Taskforce on Environmental Statistics and Indicators* was established in 2009. They serve under the oversight of the **Committee on Environmental Policy** (CEP) and the *Conference of European Statisticians* (CES).

A working group specifically focussing on climate change indicators is the *Task Force on a set of key climate change-related statistics and indicators using SEEA*, established in 2014 (United Nations Economic Commission for Europe, 2014) under the umbrella of the *United Nations Economic Commission for Europe* (UNECE). The objective of the Task Force is to define an internationally comparable set of key climate change-related statistics and indicators that can be derived from the System of Environmental-Economic Accounting.

These global rules and conventions are adapted at the European level (European Union, 2013). The main body that is responsible for harmonizing statistical data on a European level is the European Statistical System Committee (ESSC), established by Regulation (EC) No 223/2009 of the European Parliament and Council of 11 March 2009 on European statistics. The ESSC is chaired by the Commission (Eurostat) and composed of the representatives of Member States' National Statistical Institutes, and is tasked with setting priorities and harmonisation of statistical data collection and dissemination.

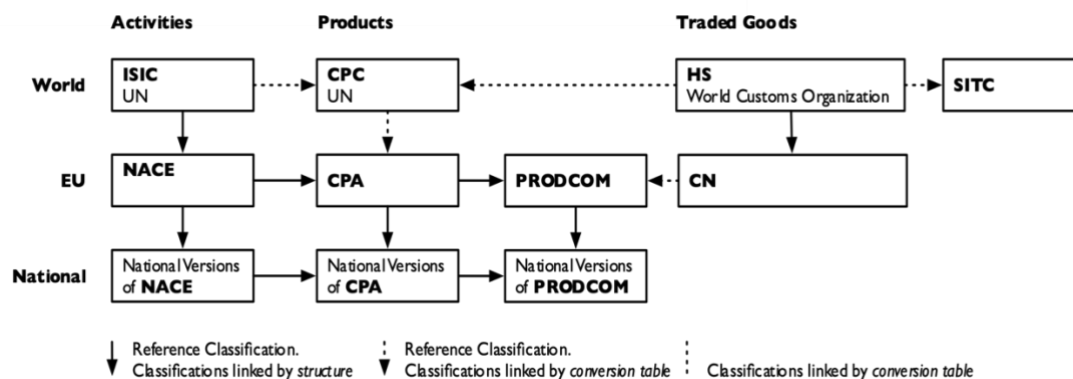
## **A brief overview of international accounting frameworks**

In the System of National Accounts, economic activities are classified depending on the type of analysis which is undertaken. The highest level of aggregation is usually on the level of *industries*, composed of different elementary units that undertake the same *activity* (agriculture, mining, ...). These elementary units are commonly termed *establishments* or *local kind-of-activities* (KOA) and they are commonly situated in a single location and carry out a single production activity. These *establishments* or *local KOA* are chosen to be homogeneous with regard to their activity. The UN has a set of guidelines in place to guide the classification of economic activities, the UN *International Standard Industrial Classification* (ISIC). In the EU, the classification used for grouping these elementary units is adopted from ISIC and further refined in the *European Classification of Economic Activities* (NACE) framework (EUROSTAT, 2008), after which it is adopted by the different Member States (fig. 7.1). ISIC and NACE have exactly the same items at the highest levels, where NACE is more detailed at lower levels (Eurostat, 2015). On a lower level of aggregation, the classification of products (both goods and services) follows a similar logic with a *UN Central Product Classification* (CPC) which is implemented on EU level in the form of the *European Classification of Products* (CPA), subsequently implemented on national level. The classification of goods and services on international, european and national level is embedded in the structure of economic activities.

For the purpose of organising international trade, a separate classification system - the *Harmonized Commodity Description and Coding System* (HS) - is maintained by the World Customs Organization to specifically classify goods that are traded. This classification is implemented at EU level as a *Combined Nomenclature* (CN) and feeds, together with the CPA, into a classification and database of manufactured goods (PRODCOM). A separate coding system based on the HS is used by the UN - the *Standard International Trade*

*Classification* (SITC) - to allow for international comparison of commodities and manufactured goods.

**Figure 7.1:** Main international classifications of activities and products.



**Source:** Adapted from Eurostat (2015, p. 13)

## From monetary to physical input-output analysis

A supply table (top half of fig. 7.2) contains the flows related to production, generation and supply of natural inputs, products and residuals. The use table (bottom half of fig. 7.2) contains the flows relating to the consumption and use of natural inputs, products and residuals. Supply and use tables give a detailed overview of the production process, interdependencies in production, use of goods and services and generation of income. Based on certain assumptions, these tables can be converted to symmetric input-output tables which can be used for input-output analysis.



**Figure 7.2: Structure of a Physical Supply and Use Table.**

| Production; generation of residuals   |   | Accumulation  |  |  |  |                                       |
|---|---|---|--|--|--|---------------------------------------|
| Production; generation of residuals by industries (including household production on own account), classified by ISIC |   | Generation of residuals by households   | Industries—classified by ISIC  | Flows from the rest of the world             | Flows from the environment   | Total                                 |
| Natural inputs  |   |   |  |  | A. Flows from the environment (including natural resource residuals)   | Total supply of natural inputs (TSNI) |
| Products  | C. Output (including sale of recycled and reused products)  |   |  | D. Imports of products                       |  | Total supply of products (TSP)        |
| Residuals   | I1. Residuals generated by industry (including natural resource residuals)<br>I2. Residuals generated following treatment | J. Residuals generated by household final consumption                               | K1. Residuals from scrapping and demolition of produced assets<br>K2. Emissions from controlled landfill sites | L. Residuals received from rest of the world | M. Residuals recovered from the environment  | Total supply of residuals (TSR)       |
| <b>Total supply</b>   |   |   |  |  |  |                                       |
| <b>Use table</b>  |   |   |  |  |  |                                       |
| Intermediate consumption of products; use of natural inputs; collection of residuals                                  |   | Final consumption <sup>a</sup>  | Accumulation   |  |  |                                       |
| Industries—classified by ISIC   |   | Households  | Industries—classified by ISIC  | Flows to the rest of the world               | Flows to the environment   | Total                                 |
| Natural inputs  | B. Extraction of natural inputs<br>B1. Extraction used in production<br>B2. Natural resource residuals                    |   |  |  |  | Total use of natural inputs (TUNI)    |
| Products  | E. Intermediate consumption (including purchase of recycled and reused products)  | F. Household final consumption (including purchase of recycled and reused products) | G. Gross capital formation (including fixed assets and inventories)  | H. Exports of products                       |  | Total use of products (TUP)           |
| Residuals   | N. Collection and treatment of residuals (excluding accumulation in controlled landfill sites)                            |   | O. Accumulation of waste in controlled landfill sites  | P. Residuals sent to the rest of the world   | Q. Residual flows to the environment<br>Q1. Direct from industry and households (including natural resource residuals and landfill emissions)<br>Q2. Following treatment | Total use of residuals (TUR)          |
| <b>Total use</b>  |   |   |  |  |  |                                       |

<sup>a</sup> No entries for government final consumption are recorded in physical terms. All government intermediate consumption, production and generation of residuals is recorded against the relevant industry in the first column of the PSUT.

**Source:** UN (2014)

Activities (\*) which are supplying products (•), can be aggregated in a product-by-activity supply table ( $V_{•*}$ ). Product requirements of these activities are recorded in a use table ( $U_{•*}$ ) and factors of production (★) requirements are recorded in an extension table ( $G_{**}$ ) (United Nations, 1999). This extension table describes all requirement flows that cannot be fulfilled by the ‘techno-sphere’ within a given time period. A column h represents the final consumption of products by households, governments and capital stock formation (Eurostat, 2008). Inputs and outputs of industries can be recorded as observed, without specifying allocation (for example: the supply of E and heat to electricity plant would be recorded as separate flows in the supply table and total use of fuel would be noted as one entry in the table (Lenzen & Rueda-Cantuche, 2012)).

## Physical SUTs

Although currently most data is collected in monetary units, physical supply and use tables are suggested to be used in the future to compile environmental accounts (United Nations et al., 2014). The current framework established by United Nations et al. (2014) is based on the classification of monetary supply and use tables (MSUT) and adds additional columns and rows with physical flows - a physical supply and use table (PSUT) - that can record flows (a) from the environment or natural inputs, (b) within the economy or products and (c) back to the environment or residuals. Three different subsystems are used for material flow accounting (products, air emissions, solid waste and other residual flows), water flows and energy flows to allow for specific aggregation needs and different unit conventions. This allows for material, water and energy flows to be respectively expressed in mass, volume or energy content. Within each of the subsystems greater refinement can be obtained, which is specifically relevant for the distinction between different material flows. A full articulation of all flows is generally most relevant for energy and water, where all flows can be meaningfully

expressed in a single unit (for example joules or cubic meters). The basic structure of a PSUT is given in fig. 7.2.

### Balance Principles

There are two important balancing principles, normally used to create a balance input-output table, which relate to the conservation of mass and energy in PIOTs.

The *supply-use-identity* states that the total supply of a given flow type is equal to the total use of the same flow type. For PIOTs, this can be applied to production (amount produced = amount consumed), natural input use and supply and use of residuals.

The *input-output identity* states that the physical flow into the economy (natural inputs, imports, residuals) is identical to the physical flow out of the economy (residuals, exports) plus net additions to stock (inventory changes, accumulation, residuals generated by industries) (Eurostat, 2014).

### Development of a methodology to account for total-system energy and emission impacts of material recycling

Input-output tables depict the exchange of goods between different sectors in the economy, expressed in either monetary or physical units. These exchanges can be expressed using a set of  $n$  linear equations with  $n$  unknowns, which can be easily represented in matrix notation. Traditionally, the focus is on a country (such as the System of National Accounts), but these matrices can be constructed for any particular economic region. An example of a typical input-output transactions table for a national economy is given in fig. 7.3. Historically, the idea of systemic interconnections in the economy was first developed by Petty (1690) and was later formalized by Quesnay (1758) and further developed as a paired accounting and modelling framework to account for indirect effects of inter-sectoral relationships by Leontief (1941). An interesting note here is that the Leontief framework described below was originally developed to analyse sectoral exchange in physical units.

**Figure 7.3:** Input-Output Transactions Table.

|             |                             | PRODUCERS AS CONSUMERS                                |        |        |        |       |         |          |       | FINAL DEMAND                      |                                   |                                     |                                 |
|-------------|-----------------------------|---|--------|--------|--------|-------|---------|----------|-------|-----------------------------------|-----------------------------------|-------------------------------------|---------------------------------|
|             |                             | Agric.  | Mining | Const. | Manuf. | Trade | Transp. | Services | Other | Personal Consumption Expenditures | Gross Private Domestic Investment | Govt. Purchases of Goods & Services | Net Exports of Goods & Services |
| PRODUCERS   | Agriculture                 |   |        |        |        |       |         |          |       |                                   |                                   |                                     |                                 |
|             | Mining                      |   |        |        |        |       |         |          |       |                                   |                                   |                                     |                                 |
|             | Construction                |   |        |        |        |       |         |          |       |                                   |                                   |                                     |                                 |
|             | Manufacturing               |   |        |        |        |       |         |          |       |                                   |                                   |                                     |                                 |
|             | Trade                       |   |        |        |        |       |         |          |       |                                   |                                   |                                     |                                 |
|             | Transportation              |   |        |        |        |       |         |          |       |                                   |                                   |                                     |                                 |
|             | Services                    |   |        |        |        |       |         |          |       |                                   |                                   |                                     |                                 |
|             | Other Industry              |   |        |        |        |       |         |          |       |                                   |                                   |                                     |                                 |
| VALUE ADDED | Employees                   | Employee compensation                                 |        |        |        |       |         |          |       | GROSS DOMESTIC PRODUCT            |                                   |                                     |                                 |
|             | Business Owners and Capital | Profit-type income and capital consumption allowances |        |        |        |       |         |          |       |                                   |                                   |                                     |                                 |
|             | Government                  | Indirect business taxes                               |        |        |        |       |         |          |       |                                   |                                   |                                     |                                 |

**Source:** Miller & Blair (2009)

The flows of products from one sector to each of the other sectors are inter-sectoral (or interindustry) flows, measured for a certain time period in a certain unit (monetary or physical). For example, the monetary transaction between sector  $i$  to sector  $j$  can be represented as  $z_{ij}$  (one of the grey cells in fig. 7.3). Inter-sectoral transactions typically equal

out, as the demand for inputs for a certain sector  $j$  from other sectors will normally be related to the number of goods produced by that sector  $j$ . On the other hand, there are *exogenous* sales to purchasers or consumers who are external to the industrial sectors that produce (termed *final demand*, depicted on the right in fig. 7.3). Examples of these are the government, households and foreign trade. In this case, demand is generally unrelated to the amount produced and goods are being used or consumed and are not used as input to another industrial or sector.

For the development of the fundamental relationships, the simplified table below will be used:

| Sectors | 1        | ... | j        | ... | n        | Final Demand | Total Output |
|---------|----------|-----|----------|-----|----------|--------------|--------------|
| 1       | $z_{11}$ | ... | $z_{1j}$ | ... | $z_{1n}$ | $f_1$        | $x_1$        |
| 2       | $z_{21}$ | ... | $z_{2j}$ | ... | $z_{2n}$ | $f_2$        | $x_2$        |
| ⋮       | ⋮        |     | ⋮        |     | ⋮        | ⋮            | ⋮            |
| n       | $z_{n1}$ | ... | $z_{nj}$ | ... | $z_{nn}$ | $f_n$        | $x_n$        |
| Labor   | $v_1$    | ... | $v_j$    | ... | $v_n$    | $f_{n+1}$    | $x_{n+1}$    |

Hence, in an economy of  $n$  sectors and with  $f_i$  the final demand of the products of sector  $i$ , the total output of sector  $i$   $x_i$  can be written as:

This final demand of a sector corresponds to one of the horizontal *producer's* rows in fig. 7.3. For each of the  $n$  sectors, such an equation can be formulated:

$$\begin{aligned}
 x_1 &= z_{11} + \dots + z_{1j} + \dots + z_{1n} + f_1 \\
 &\vdots \\
 x_i &= z_{i1} + \dots + z_{ij} + \dots + z_{in} + f_i \\
 &\vdots \\
 x_n &= z_{n1} + \dots + z_{nj} + \dots + z_{nn} + f_n
 \end{aligned}$$

This final demand of a sector corresponds to one of the horizontal *producer's* rows in fig. 7.3. For each of the  $n$  sectors, such an equation can be formulated:

$$\begin{aligned}
 x_1 &= z_{11} + \dots + z_{1j} + \dots + z_{1n} + f_1 \\
 &\vdots \\
 x_i &= z_{i1} + \dots + z_{ij} + \dots + z_{in} + f_i \\
 &\vdots \\
 x_n &= z_{n1} + \dots + z_{nj} + \dots + z_{nn} + f_n
 \end{aligned}$$

In matrix notation, this can be written as

$$\mathbf{x} = \mathbf{Z}\mathbf{i} + \mathbf{f} \quad (1)$$

with

$$\mathbf{x} = \begin{bmatrix} x_1 \\ \vdots \\ x_n \end{bmatrix}, \quad \mathbf{Z} = \begin{bmatrix} z_{11} & \dots & z_{1n} \\ \vdots & \ddots & \vdots \\ z_{n1} & \dots & z_{nn} \end{bmatrix} \quad \text{and} \quad \mathbf{f} = \begin{bmatrix} f_1 \\ \vdots \\ f_n \end{bmatrix} \quad (2)$$

Linking this with the general input-output transactions table in fig. 7.3, the column vector  $\mathbf{x}$  corresponds to the list of producers, matrix  $\mathbf{Z}$  corresponds to the grey matrix and column vector  $\mathbf{f}$  corresponds to the final demand. In the following, a lower case bold letter ( $\mathbf{x}$ ) will be used for column vectors, with  $\mathbf{x}^T$  the corresponding row vector, and matrices will be written as upper case bold letters ( $\mathbf{Z}$ ). In eq. 1, the "summation" column vector of 1's  $\mathbf{i}$  is used to

create a column vector whose elements are the sum of the rows of a matrix, as displayed for each sector individually in eq. 2. Similarly, pre-multiplication with the row vector of 1's  $\mathbf{i}^T$  creates a row vector with the column sums of a matrix.

In monetary terms, the  $j$ 'th column of  $\mathbf{Z}$  in eq. 2 represent the sales to sector  $j$  from all the different sectors. Apart from these *inter-* and *intra* industry (within the same sector) flows, a sector also pays for employees, business owners and taxes to the government, termed the *primary inputs* or *added value* of sector  $j$ . These also include imports from outside the national economy. The combination of primary inputs (or added value)  $\mathbf{v}$  and imports  $\mathbf{m}$  are lumped together as the *payments* sector. In fig. 7.3, this is the area *value added* under the grey matrix.

In the system of national accounts, the final demand  $\mathbf{f}_i$  is typically further divided into consumer or household purchases (C), purchases for private investment purpose (I), government purchases (G) and sales abroad (E). These are often grouped as *domestic* final demand (C+I+G) or *foreign* final demand (C+I+G+E).

The payments sector, consisting of primary inputs and added value, is typically divided in employee compensation (L) and other value-added items such as government services, capital, land, profit, ... (N). If there are imports used by the sector, these are traditionally recorded also in the payments sector (M). The *total value-added payments* of a sector  $i$  ( $v_i$ ) is thus equal to  $l_i + n_i$ .

**Figure 7.4:** Flow table of two-sector economy. Source: Miller & Blair (2009)

|                                 |                               | Processing Sectors |          | Final Demand |       |       |       | Total Output ( $\mathbf{x}$ ) |
|---------------------------------|-------------------------------|--------------------|----------|--------------|-------|-------|-------|-------------------------------|
|                                 |                               | 1                  | 2        |              |       |       |       |                               |
| Processing Sectors              | 1                             | $z_{11}$           | $z_{12}$ | $c_1$        | $i_1$ | $g_1$ | $e_1$ | $x_1$                         |
|                                 | 2                             | $z_{21}$           | $z_{22}$ | $c_2$        | $i_2$ | $g_2$ | $e_2$ | $x_2$                         |
| Payments Sectors                | Value Added ( $\mathbf{v}'$ ) | $l_1$              | $l_2$    | $l_C$        | $l_I$ | $l_G$ | $l_E$ | $L$                           |
|                                 |                               | $n_1$              | $n_2$    | $n_C$        | $n_I$ | $n_G$ | $n_E$ | $N$                           |
|                                 | Imports                       | $m_1$              | $m_2$    | $m_C$        | $m_I$ | $m_G$ | $m_E$ | $M$                           |
| Total Outlays ( $\mathbf{x}'$ ) |                               | $x_1$              | $x_2$    | $C$          | $I$   | $G$   | $E$   | $X$                           |

In the simplified two-sector flow table for a national economy given in fig. 7.4, the  $z$ -values are the inter-sectoral exchanges  $\mathbf{Z}$  (the grey area in fig. 7.3) and for each of these processing sectors, the sum of  $z$ ,  $c$ ,  $i$ ,  $g$  and  $e$  equals the total output of the sector  $x$ .

The three different types of payment (employee compensation, other value-added items and imports) are paid by both the suppliers (processing sectors  $z$ ) and the consumers (households  $c$ , private investment  $i$ , government  $g$  and sales abroad  $e$ ). For example, employee compensation  $l$  can be paid by the processing sector ( $l_i$ ), domestic help for households ( $l_C$ ) or government workers ( $l_G$ ). Imported items can be used by the processing sectors ( $m_1$ ), the government ( $m_G$ ) or re-exported ( $m_E$ ).

Reading the table horizontally, the totals on the right represent the total output (or production or revenue) of each of the processing sectors ( $\mathbf{x}$ ) to other processing sectors and payment sectors, and the total payment of employee compensation (L), other value-added items (N) and imports (M) by the different sectors.

When reading the table vertically, the totals on the bottom of the table represent the total outlays ( $\mathbf{x}'$ ) or the sum of all the expenditures by the processing sectors ( $x$ ) and the total

household purchases (C), private investment (I), government expenditure (G) and exports (E) from the processing and payment sectors.

The total gross output throughout the economy X can be either calculated vertically or horizontally, as the sum of payments (L, N and M) should equal the equal purchases by the different actors (C, I, G and E):

$$x_1 + x_2 + L + N + M = X = x_1 + x_2 + C + I + G + E$$

This can be rewritten as an equality between the *gross national income* (L + N, the total factor payments) and the totals spent on consumption and investment, government purchases and the total value of **net** exports as:

$$L + N = C + I + G + (E - M)$$

Assuming that there are no imports, another relationship can be observed, based on - in monetary terms - the added value  $v$ . In a physical input-output model, these values could be interpreted as the quantity of physical inputs required for production in each of the sectors. The value  $v_j$  is the total required labour (in monetary terms) or inputs (in physical terms) required for the outputs of sector  $j$ , so:

$$x_j = \sum_{i=1}^n z_{ij} + v_j$$

## Production functions and the input-output model

### Demand-driven input-output formulation according to Leontief

When it comes to analyse interdependencies between sectors, a frequently used concept is the concept of *technical coefficients*. That is, for a given  $z_{ij}$  (input from sector  $i$  to sector  $j$ ) and  $x_j$  (total output from sector  $j$ ), the ratio

$$a_{ij} = \frac{z_{ij}}{x_j} = \frac{\text{value/quantity of sector } i \text{ bought/used by sector } j}{\text{value/quantity of production of sector } j} \quad (3)$$

represents the ratio between inputs from a sector  $i$  required for sector  $j$  to produce its total output and the total output of sector  $j$  in a certain year. If - as in traditional IO analysis - monetary values are used, this technical coefficient represents the value worth of inputs from sector  $i$  to sector  $j$  per value worth of output of sector  $j$ . This relationship can be written for all the sectors in matrix form as

$$\mathbf{A} = \mathbf{Z}\hat{\mathbf{X}}^{-1}$$

where  $\hat{\mathbf{x}}$  is a diagonal matrix with the elements of the vector along the main diagonal, and  $\hat{\mathbf{x}}^{-1}$  is the inverted matrix with the main diagonal filled with the elements  $\frac{1}{x_n}$ . This matrix  $\mathbf{A}$  is called the *technical coefficient matrix*. The columns represent the *production recipes* per unit output for each of the sectors, in terms of its dependency on the other sectors.

To be able to extrapolate this relationship in time or use the technical coefficient to derive the inter-sectoral exchange ( $z_{ij}$ ) for a different total output ( $x_j$ ) using the relationship  $a_{ij}x_j = z_{ij}$ , a fundamental assumption must be made that is not always guaranteed. When

assuming that  $a_{ij}$  is a fixed relationship between a sector's output and inputs, economies of scale in production are ignored and the system operates under the assumption of 'constant returns to scale'. This is certainly problematic when assessing inter-industry relationships in monetary terms, but could be assumed to be less problematic when using physical exchange units.

Technical coefficients can also be used to assess the supply of two different sectors  $i$  and  $k$  to sector  $j$  using the proportion  $p_{ik} = \frac{z_{ij}}{z_{kj}} = \frac{a_{ij}x_j}{a_{kj}x_j} = \frac{a_{ij}}{a_{kj}}$ .

The assumption of constant technical coefficients results thus in another assumption of *fixed proportions*, being that a fixed input proportion of goods from different sectors is required for a certain final output of the receiving sector. Here again, this assumption is harder to make for monetary values than for physical exchange, as it can be assumed that for most products the physical requirement will be linearly related to the total production or that additional input from either one of the two inputs will not result in an increase in total output because of the fixed input proportion. This is an assumption that is different from the traditional production function structure in economics (isoquants), where the assumption of diminishing marginal productivity results in a decreasing or increasing proportion of inputs depending on the quantity used. This Leontief production function thus requires inputs in fixed proportions where a fixed amount of each input is required to produce one unit of output.

When accepting these assumptions, the production functions or output of the different sectors (eq. 2) can be rewritten using  $z_{ij} = a_{ij}x_j$  as:

$$\begin{aligned} x_1 &= a_{11}x_1 + \dots + a_{1i}x_i + \dots + a_{1n}x_n + f_1 \\ &\vdots \\ x_i &= a_{i1}x_1 + \dots + a_{ii}x_i + \dots + a_{in}x_n + f_i \\ &\vdots \\ x_n &= a_{n1}x_1 + \dots + a_{ni}x_i + \dots + a_{nn}x_n + f_n \end{aligned} \quad (4)$$

Knowing these inter-sectoral relations, and assuming that the final demand is known, a relationship can be developed which focuses on the effect of a change in final demand on the production rates of the different sectors. The set of equations in eq. 4 allow to analyse the effect of changes in total demand (or output) on the output of each of the other sectors. If the  $f_i$ 's and  $a_{ij}$ 's are known, after bringing the  $x$  terms to the left and grouping equal  $x$  terms in each of the functions, eq. 4 can be rewritten as:

$$\begin{aligned} (1 - a_{11})x_1 - \dots - a_{1i}x_i - \dots - a_{1n}x_n &= f_1 \\ &\vdots \\ -a_{i1}x_1 - \dots + (1 - a_{ii})x_i - \dots - a_{in}x_n &= f_i \\ &\vdots \\ -a_{n1}x_1 - \dots - a_{ni}x_i - \dots - (1 - a_{nn})x_n &= f_n \end{aligned} \quad (5)$$

These relationships can be rewritten in matrix form for the  $n \times n$  system as a set of  $n$  linear equations with  $n$  unknowns ( $x_1, x_2, \dots, x_n$ ):

$$(\mathbf{I} - \mathbf{A})\mathbf{x} = \mathbf{f} \quad (6)$$

with  $\mathbf{A}$  the *technical coefficient matrix* and  $\mathbf{I}$  the  $n \times n$  identity matrix with the value  $1$  on the diagonal. Whether there is a solution for this set of equations, depends on the fact whether or not  $(\mathbf{I} - \mathbf{A})$  is singular. Otherwise stated,  $(\mathbf{I} - \mathbf{A})^{-1}$  should exist. From the definition of

an inverse of a square matrix, it follows that  $(I-A)^{-1} = \frac{adj(I-A)}{|I-A|}$  with  $adj(I-A)$  the adjoin of the matrix  $(I-A)$ . If  $|I-A| \neq 0$ ,  $(I-A)^{-1}$  can be found, the unique solution to eq. 6 is given by

$$\mathbf{x} = (I-A)^{-1}\mathbf{f} = L\mathbf{f} \quad (7)$$

or

$$\begin{aligned} x_1 &= l_{11}f_1 + \dots + l_{1j}f_j + \dots + l_{1n}f_n \\ &\vdots \\ x_i &= l_{i1}f_1 + \dots + l_{ij}f_j + \dots + l_{in}f_n \\ &\vdots \\ x_n &= l_{n1}f_1 + \dots + l_{nj}f_j + \dots + l_{nn}f_n \end{aligned} \quad (8)$$

with  $(I-A)^{-1} = L = [l_{ij}]$  the *Leontief inverse* or the *total requirements matrix*. This relationship endogenously calculates the intermediate production and primary inputs (imports, value added, wages) required for a given exogenous final demand, and can thus be used to derive the total requirements of each of the sectors for a certain output  $f_j$ . The individual values  $l_{ij}$  of the Leontief inverse can also be formulated as the partial derivative of  $x_i$  to  $f_j$  ( $\frac{\partial x_i}{\partial f_j} = l_{ij}$ ).

To summarize, the inter-sectoral relations in the economy can thus be represented by a set of linear relations. The basic relation is that intermediate ( $\mathbf{Zi}$ ) and final ( $\mathbf{f}$ ) production are equal to total production for each of the sectors ( $\mathbf{x}$ ), as in eq. 1. The second relationship relates the intermediate production ( $\mathbf{Z}$ ) to the total production ( $\hat{\mathbf{x}}$ ) by means of a technical coefficient matrix  $\mathbf{A}$ . When substitution the second relation in the first, the relation of total production ( $\mathbf{x}$ ) to final production ( $\mathbf{f}$ ) can be derived, as in eq. 7. In matrix form, columns should be read as outputs or a sum of total outputs and rows are the inputs to the different sectoral activities or a sum of total inputs. Import and export are typically accounted respectively as primary inputs and final demand. The model described above can thus be used with different types of units. In the system of national accounts, these are typically monetary units. When using monetary units, the model above can be used to capture the direct and indirect (Altimiras-Martin, 2016) effects of a change in final demand on the required sectoral inputs using the Leontief inverse matrix.

### Supply-driven input-output formulation according to Ghosh

Instead of using *technical input-coefficients*, Ghosh (1958) suggested another way to look at the input-output structure to relate effects of a change in total inputs on the total output of each of the sectors, depending on the inter-sectoral matrix  $\mathbf{Z}$ . He suggests to use *direct output coefficients* or *allocation coefficients*  $b_{ij}$  represented in a matrix  $\mathbf{B}$ , instead of the technical coefficient matrix  $\mathbf{A}$ . In this matrix, the element  $b_{ij}$  represents the outputs of sector  $j$  that is used as an input to sector  $i$ . In matrix terms, this means that  $\mathbf{B}$  is constructed by dividing each row (inputs) of the inter-sectoral matrix  $\mathbf{Z}$  by the total output of each of each of the sectors, instead of dividing the columns (outputs) by the total output of each of the sectors.

In contrast to the technical coefficient matrix (eq. 3), this matrix  $\mathbf{B}$  can be derived as:

$$\mathbf{B} = \hat{\mathbf{x}}^{-1}\mathbf{Z}$$

with the elements  $b_{ij}$  describing the number of products used by sector  $j$  from sector  $i$  per output of sector  $i$ :

$$b_{ij} = \frac{z_{ij}}{x_i} = \frac{\text{value/quantity of sector } i \text{ bought/used by sector } j}{\text{value/quantity of production of sector } i}$$

Combining this with the description of supply to each of the sectors (eq. 3), this can be rewritten as:

$$\begin{aligned} x^T &= i^T \hat{x} B + v^T = x^T B + v^T \quad (\text{and } i^T \hat{x} = x^T) \\ x^T &= v^T (I - B)^{-1} \end{aligned}$$

In this relationship, the **output inverse** or **Ghosh matrix G** with elements  $g_{ij}$  can be defined in a similar manner as how the **input inverse** or **Leontief matrix** is defined for demand-driven models:

$$G = (I - B)^{-1}$$

Here, the element  $g_{ij}$  describes the total output of sector  $j$  per unit input of sector  $i$ . This can be interpreted in a monetary or physical way, as is the case for the Leontief inverse. This formulation allows to calculate the effect of a change in inputs  $\mathbf{v}$  on the outputs of the different sectors  $\mathbf{x}$ , which can be formulated in column or vector matrices:

$$\begin{aligned} \Delta x^T &= (\Delta v^T) G \\ \Delta x &= G^T (\Delta v) \end{aligned}$$

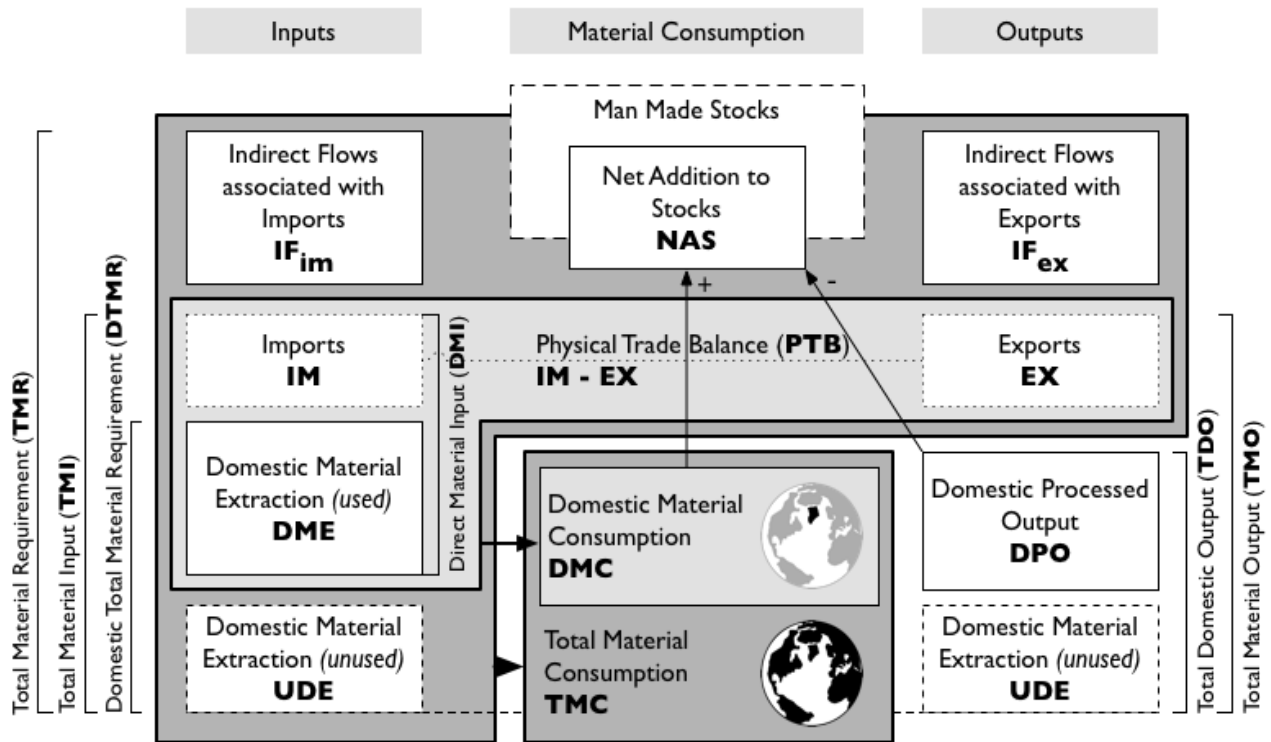
## Existing economy-wide material and energy exchange databases

To understand the amount of materials that passes through the economy and attribute it to final consumers, a coherent framework is needed. One of the most used frameworks at international level that serves at calculating and comparing indicators on material use is the framework developed by European Communities (2001) and OECD (2008). A generic definition of material use is provided by the European Statistical Office Eurostat, defining societal material use as all raw materials - except water and air - that serve production and reproduction of humans, livestock, built infrastructure, durable and non-durable goods and services as input to the human system (Fischer-Kowalski et al., 2011 ; Krausmann et al., 2015). The main raw material inputs are thus “plant harvest for food, feed, other energy uses and material input to industrial production; sand, gravel and crushed stone mainly for construction; metals and non-metallic minerals for industrial production and fossil energy carriers for both energetic and material applications” (Lenton et al., 2016).

To attribute material use on the national level, European Communities (2001) and OECD (2008) distinguish different indicators. An overview of the below described indicators is given in fig. 7.5.



**Figure 7.5:** Material flow analysis (MFA) indicators



**Source:** Own representation based on European Communities (2001) and OECD (2008)

- Domestic Material Extraction (DME)
  - Direct Material Input (DMI) = DME + imports
  - Total Material Input (TMI) = DMI + unused domestic extraction
- Total Material Requirement (TMR) = TMI + indirect flows (used and unused) associated to imports
- Domestic Total Material Requirement = DME + unused domestic extraction (additive along countries)
- Domestic Processed Output (DPO) = material flows released to the environment by the economy
- Total Material Output (TMO) = DPO + unused extraction
- Domestic Material Consumption (DMC) = domestically consumed products = DMI - imports
- Total Material Consumption (TMC) = TMR - exports and associated indirect flows
- Physical Trade Balance (PTB) = trade balance in physical units (how much does economy rely on domestic extraction vs imports?)
- Net Addition to Stocks (NAS) = accumulation of materials within economy

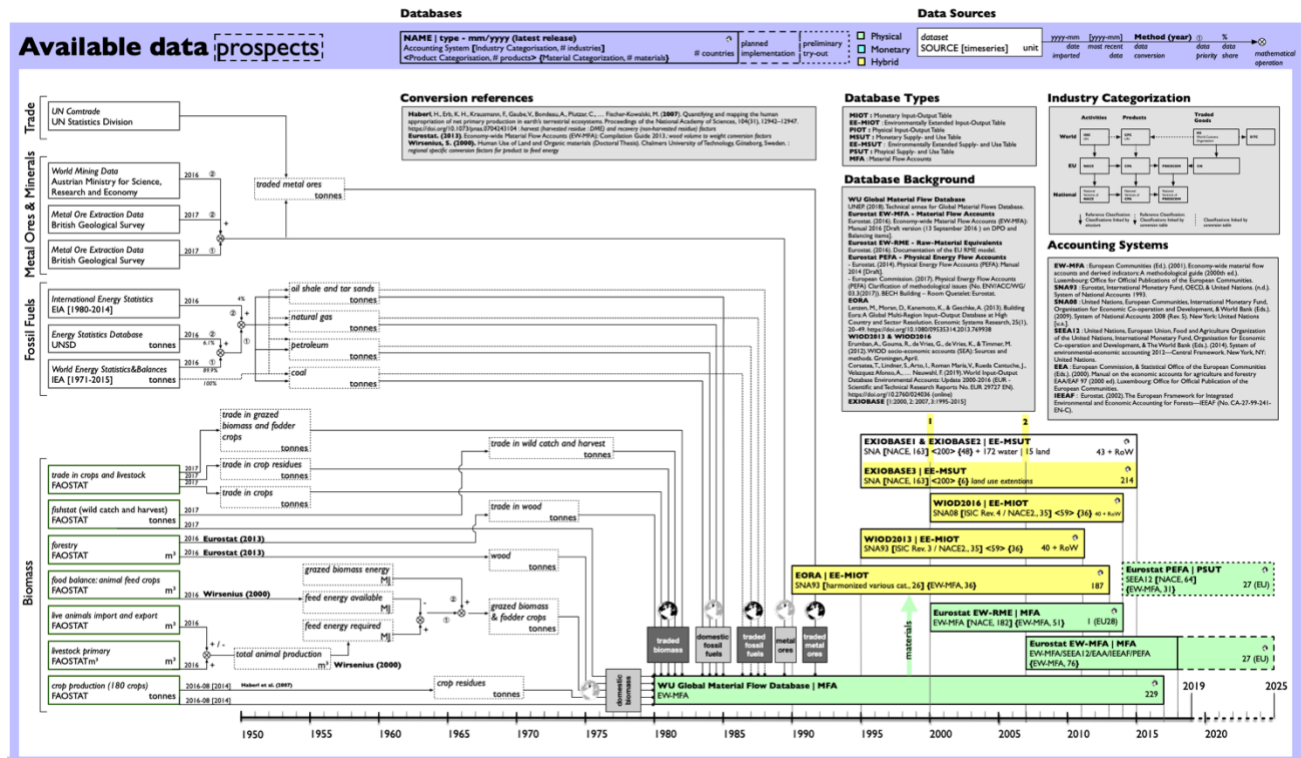
On the national level, the accumulated amount of these materials is called the Domestic Material Consumption (DMC). To calculate reliable consumption-based indicators of material use - taking into account global supply chains and trade, the calculation framework and availability of reliable data becomes critical.

Figure 7.6 provides an overview of existing economy-wide MFA as well as environmental extended or physical input-output datasets that provide data on energy flows or material flows on either an aggregate (in the case of MFA) or sectoral (in the case of input-

output) level, indicating a distinction between the type of dataset in terms of unit (monetary (light blue), physical (green) or hybrid (yellow)), the accounting system used, and the type of classification used to distinguish industries and products. An important database with an extensive historical range is the Material Flow Database from WU Vienna, used by UNEP and the Vienna Institute of Social Ecology for socioeconomic metabolism analysis (UNEP, 2018). This database has been added – including an overview of the sources that have been used to construct this database and conversion hypotheses, as one of the major environmentally extended input-output tables (EORA) is to a large extent based on this database. For the other databases (WIOD and EXIOBASE), I either did not find the sources for original data or did not spend enough time in looking for them. The overview is based on analysis undertaken in 2019, so there might be more recent data available at time of publication.

This overview of existing economy-wide material flow databases, proves that there is still a lack of sufficiently detailed physical material and energy exchange data on a sectoral level. Eurostat provides since the last two decades information on aggregate ‘Raw material equivalents’ of economic activity, European aggregate MFA-accounts (since 2007), and more recently, a promising experiment has been started on the European institutional level in gathering physical energy flow accounts (PEFA) in the form of physical supply and use tables (PSUTs).

Figure 7.6: Major economy-wide material and energy exchange databases



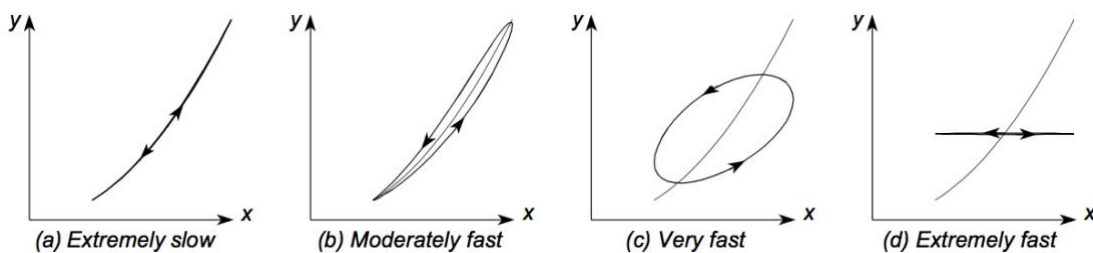
## An analogy between dynamical systems theory, system dynamics and dynamical input-output analysis

A model always starts with relationships between variables. An *independent variable*  $x$  is given, and the effect on a *dependent variable*  $y$  is measured under steady state conditions (all other variables influencing this relationship remaining equal). A line can be constructed that describe this relationship (a function), and the assumption could be made that this relationship can be used to predict or evaluate similar situations in the future or in another context. However, complications can arise in establishing this relationship and rendering it useful for analysis in a different context (Benyon, 2011):

The quantity of  $y$  may depend on other variables with a known quantity, unknown quantity or unknown existence; There might be errors in the measurement of  $y$ , and possibly also  $x$ ; It might not be possible or practical to obtain enough data to establish a clear relationship between  $x$  and  $y$ .

Case (1.a) requires to approximate data points by a function of more than one variable, cases (1.b) and (2) require assumptions about the random nature and case (3) requires assumptions on the degree of confidence of the type of relationship.

**Figure 7.7:** Dynamic relationship.



**Source:** Benyon (2011)

However, a fourth issue arises when the change of  $y$  depends on the **rate of change** of  $x$  over time. This is called a dynamic relationship of an independent variable on a dependent variable. An example of such a behaviour is given in fig. 7.6. Here, the effect of  $x$  on  $y$  is delayed, which becomes visible when changing the variable  $x$  fast enough. In cases where the rate of change of the independent variable  $x$  can possibly change fast and where there is possibly a time-dependent effect of independent variables, it is relevant to consider a function in time. It can be assumed that all relationships - be it in engineering, ecology, economics or any other field - must show dynamic effects if only the independent variable is made to change fast enough. On the other hand, the relevance of studying these dynamic effects depend on the cases considered. Another important aspect in assessing the behaviour of a system, is the difference between time-lags in reaction to the independent variable of the different components (dependent variables). If one such a relationship has a large time-lag, other relationships with a relative short time lag can be considered static relationships because the dynamic behaviour will never be apparent compared to other relationships in the considered system.

The practice of differentiating between static and dynamic relationships differs between different disciplines. However, a general common feature of dynamic relationships is the notion of storage (Benyon, 2011): “*We need to consider what it is about actual processes or components that gives rise to these dynamic effects. Since the effects consist, as we have seen, of a dependent variable being influenced not just by the value of an independent variable, but in addition by its speed and direction of change, there must be some means of*

sensing change. This implies some way of comparing current with immediate past values of the independent variable, and this in turn means retaining, somewhere in the system, something that is a measure or reflection of those recent past values. This amounts to saying that the system must incorporate some form of storage. We thus identify storage as being the key feature that we would expect to find in any mechanism, organism or process exhibiting dynamic effects”.

All dynamic relationships can be represented by combining relationships that are either (1) instantaneous functions of more variables [static relation] and (2) a relation between a flow and an accumulated amount [dynamic relation]. Mathematically, this notion of storage and interdependency between these two types of relationships can be represented by taking the *integral* (accumulation S) of the net rate of change (N) of the dependent variable (inflow I - outflow O) and the effect over time of the total accumulation S on the outflow O:

$$N = I - O$$

$$S = \int N dt$$

$$O = F(S)$$

This notion of accumulation and rate of change is approached with different terminology in different fields (see table 1), but they all have the same conceptual foundation.

**Table 7.1:** Accumulation and rate of change - terminology differences in different academic fields

|   | System Dynamics | Ecology     | Economics | Process Control                           |
|---|-----------------|-------------|-----------|---|
| Accumulation / variable of interest (dynamic) | Level           | Compartment | Stock     | State variable (not necessarily dynamic?) |
| Rate of change                                | Rate            | Flow        | Flow      |   |

### System dynamics and dynamical system theory

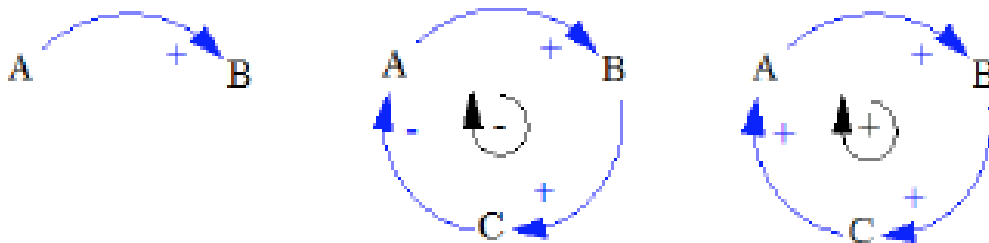
The system dynamics methodology starts with working on a conceptual overview of interrelationships between variables, transferring it to a software environment (such as STELLA<sup>91</sup>, VENSIM, ...). These graphical environments are intuitive and accessible, but do not expose all the information necessary to accurately understand the structure of the system

<sup>91</sup> Different possibilities were explored by Victor & Jackson (2013) to analyse an input-output framework in the STELLA environment. The first option is to use the link routine of STELLA. This function allows to export and import array values (input-output table) from and to an excel sheet between the different iterations in the STELLA environment. However, this approach appeared to be impractical and slow because the large amount of data imports and exports between each iteration. The function is rather designed to import excel values one time and not continuously during the iteration process. Another option explored by Victor & Jackson (2013) is using the array function in STELLA to include an input-output table and a table with associated technical coefficients in the model. This also appears to be unpractical and impossible to use, because STELLA is unable to calculate the inverse of a matrix which is required to calculate the Leontief equation. Finally, the third option is to directly replicate the set of linear equations, which allows the calculation of the change in sector output for each sector based on the initial values of sectoral outputs, final demands for each product and the direct input requirements per unit produced. A major drawback here is that it is still impossible to calculate the inverse of the matrix, which means that it is not possible to analyse the indirect effects of changes in sectoral outputs on other sectors

and its various behaviour when approaching it from a mathematical point of view. Any system dynamics model can be expressed as a system of differential equations. The main obstacle for comparison of either system dynamics and dynamical systems theory is the use of different terminology, symbols and definitions in system dynamics practice and classical mathematics and process control engineering. In an attempt to unify both disciplines, below an overview will be given to explain the similarities between the different approaches.

The basic approach in system dynamics is to describe causal links in a causal loop diagram, using arrows to indicate the link between an independent to a dependent variable. These can form circular feedback loops, either increasing the rate of increase or decrease of a quantity of interest or balancing the rate of increase or decrease of this variable. These effects are traditionally termed *reinforcing* (positive feedback) or *balancing* (negative feedback). These causal loops are useful to derive the polarity and character of an interaction between variables (Figure 7.8).

**Figure 7.8:** Feedback loop-representation in system dynamics (+: Reinforcing Loop, -: Balancing Loop)



To get more insights in the size and rate of change of a variable, in system dynamics stock and flow diagrams (SFD) are used. Stock and flow diagrams are designed to focus explicitly on the rate of change on a centrally defined variable of interest. They describe the relationship between two variables as derivative of a variable over time, as in system dynamics, time is always the independent variable. The main problem of using the terminology *stocks* and *flows* in system dynamics, is that this wording suggests that they apply to physical processes, but they are often used to describe a rate of change of any type of variable over time. If the in- and outflows of a stock-and-flow diagram are expressed as  $x = in - out$ , the **rate of change of a variable (stock)** over a specific time interval (the *time step*) can be expressed as:

$$\dot{x} = \frac{dx}{dt} = \frac{\Delta x}{\Delta t} = \frac{x_2 - x_1}{\Delta t} \quad \text{with } x = \text{inflow} - \text{outflow}$$

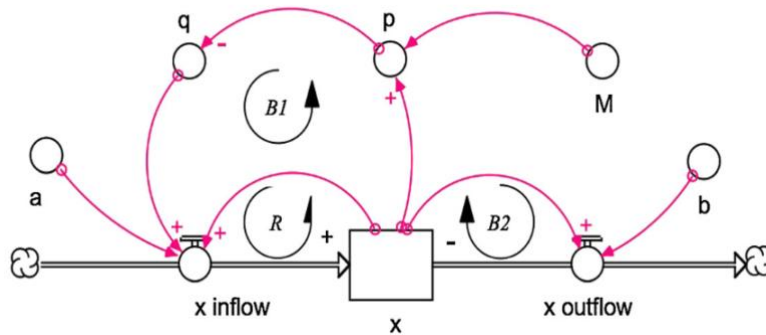
This gives an idea of how much the variable changes over time. The value of the stock (X) itself can be represented as the integral of the total in- and outflow (x) of a stock over a time  $t$ , taking into account the initial value of the stock itself ( $x(0)$ ):

$$X(t) = \int_0^t x(t)dt + x(0)$$

When combining the stock-and-flow notation with extra variables influencing the values of the stocks, this results in a system of differential equations describing the rate of change of the stocks over time, depending on the influence or relation to other defined variables in the model. This influence can be a linear relationship to either the inflow or

outflow, or they can be ‘loops’ resulting in a feedback when the value of the stock itself influences the in- or outflow. An example of such a system is given in fig. 7.9.

**Figure 7.9:** System dynamics representation.



**Source:** Hayward & Boswell (2014)

In this example, the change of  $x$  over time is dependent on the inflow ( $axq = ax(1 - p) = ax(1 - \frac{x}{M})$ ) and the outflow ( $bx$ ). The change of the variable  $x$  in time can thus be written as:

$$\dot{x} = ax \left(1 - \frac{x}{M}\right) - bx$$

This is a first order differential equation (it only involves the first derivative of  $x$ ), in which the input is determined by the effects of a reinforcing loop  $R$  ( $ax$ ) which is countered by a balancing loop  $B1$  ( $-ax^2/M$ ) and in which the output is determined by the balancing loop  $B2$  ( $bx$ ). When the derivative of  $x$  is zero (no input and no output), the non-zero equilibrium point is equal to  $x_{eq} = M \left(1 - \frac{b}{a}\right)$ . This means that the content of the stock is stable if  $a > b$ , or otherwise stated, if there is enough growth compared to losses.

The second derivative gives information about the magnitude of change of the first derivative over time (also termed *loop impact* in system dynamics, see Hayward & Boswell (2014)). For example, if the second derivative is increasing, the slope of the tangent line to the function is increasing and the graph is concave up. For the formula above, this gives:

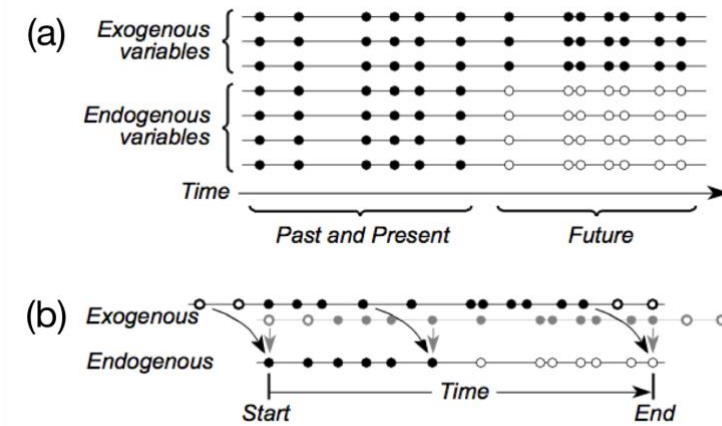
$$\ddot{x} = \left[ a \left(1 - \frac{x}{M}\right) - \frac{a}{M}x - b \right] \dot{x}$$

In this formula, the three terms  $a(1-(x/M))$ ,  $(a/M)x$  and  $b$  are the magnitudes of change of respectively loop  $R$ ,  $B1$  and  $B2$ . This tells us that, as  $x$  increases, the magnitude of loop  $R$  decreases and the one of loop  $B1$  increases. Therefore, loop  $R$  initially dominates (has an impact larger than the sum of the two balancing loops). To find the overall loop dominance, the magnitude of the loops of equal polarity (either  $R$  or  $B$ ) should be summed up to have an idea of the overall effect.

Depending on how system boundaries are defined, variables of interested that influence the behaviour of the system, can be defined to be either exogenous or endogenous. Exogenous variables are considered to be independent variables outside the system boundaries influencing the behaviour of the system by influencing the endogenous variables, and endogenous variables are generated inside the system as a result of interactions between the direct past of exogenous and endogenous variables (see fig. 7.9a). Even if there is an assumed

delayed effect of endogenous variables on the system, these can always be represented as a delayed effect so that all exogenous variables always and only depend on the immediate past of the state of a system (fig. 7.10b).

**Figure 7.10:** Conceptual difference between exogenous and endogenous variables

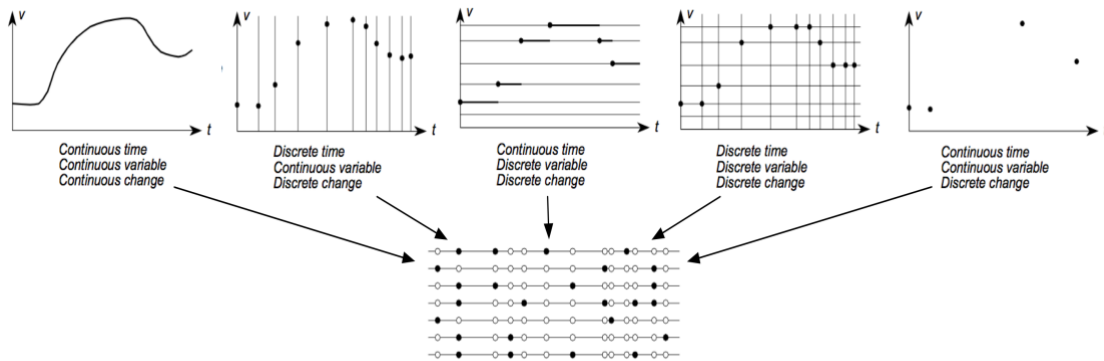


**Source:** Adapted from Benyon (2011)

If we consider the endogenous variables, these can be further broken down to the smallest possible subset of system variables that can represent the entire state of the system at a given time  $t$  (Nise, 2011), and of which the value from the past influences the behaviour of the system in the present. Otherwise stated, if there are variables that depend on an initial set of starting variables, they are not part of the set of state variables. In process control, those variables of interest are termed *state variables*.

The transition of the different state variables can be represented in a *state transition diagram*, indicating at which moment each variable changes over time. Although there are conceptual differences in considering time, the range of values a variable and the change itself as continuous or discrete, they can all be approximated by considering them all having discrete characteristics (see fig. 7.10). The distinction between discrete or continuous variables is a rather theoretical distinction, depending on whether it is appropriate to consider the system as continuously changing or only changing between certain time-intervals. Mathematically, complex systems are normally simulated in discrete time with approximation methods, but they can conceptually be considered continuous. If there are  $n$  different variables describing the state of the system, these can be represented as a vector in an  $n$ -dimensional Euclidian space or *state space* in which there is a different axis for each variable.

**Figure 7.11:** Continuous and discrete change systems can all be modelled as discrete time systems.



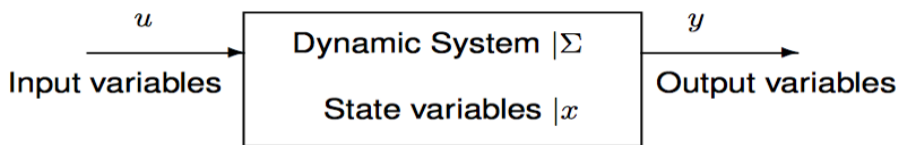
**Source:** adapted from Benyon (2011)

Another way of defining a system of interest is to distinguish between **inputs** (the exogenous variables or controlled or uncontrolled actions of the system’s environment on the system). The state variables are all those endogenous values that are needed to determine the current values of the endogenous variables. The **outputs** are the remaining endogenous variables that are of interest for the purpose of monitoring the system, measurable or observable. The analogy with system dynamics here is that state variables can be interpreted as stocks, and the inflow of a stock (derivative of the state variable) will be in its most general case a function of all the state variables (stocks) and the inputs. The order of the system’s set of defining differential equations  $n$  is equal to the number of stocks (variables changing over time), as this formulation is conceptually identical to first derivative of the stock variable, or the change of the stock variable over time.

**Solving strategies (process control)**

In dynamic systems theory, a system  $\Sigma$  is characterised by a set of state variables  $x(t)$ . These state variables are influenced by the input variables  $u(t)$  that represent the actions of the environment on the system. The output variables  $y(t)$  represent the observable or measurable aspects of the the system’s response. A basic representation of such a system is given in fig. 7.12.

**Figure 7.12:** General representation of dynamic system model



This model can be used in five different ways (Moura, 2016):

1. **Analysis or simulation:** Given a future trajectory of the inputs  $u(t)$  over time, what would be the future output of the system  $y(t)$ ?
2. **Model identification:** Given a history of inputs  $u(t)$  and outputs  $y(t)$ , how does the system  $\Sigma$  and its state variables  $x(t)$  look like? A ‘good’ model is one that is consistent with a large variety of inputs and outputs. This approach is often used in machine learning.



3. **State estimation:** Given a system  $\Sigma$  and a history of inputs  $u(t)$  and outputs  $y(t)$ , what are the state variables  $x(t)$  that best describe the behavior of the system? In this case, an algorithm is searched to estimate unmeasurable states if not every state is measurable.
4. **System design:** Given an input  $u(t)$  and a desired output  $y(t)$ , what would be the best possible system  $\Sigma$  such that the input results in the desired output? This approach is a typical engineering approach, useful to test prototypes of assumptions on the best design of a system.
5. **Control synthesis:** Given a system  $\Sigma$  with a current state  $x(t)$  and a desired output  $y(t)$ , what would be the inputs  $u(t)$  such that the system produces the desired output? **This approach is frequently used when trying to control the energy or material flow of a system**

The fifth method of control synthesis is thus very useful to look at the energy and material flows in an economy, and to determine what the possible downstream effects are when simulating a decrease or increase of final energy and material use. In this sense, a (physical) input-output model can be formulated as a dynamic relationship between inputs and outputs, related through the design of the system  $\Sigma$  (with the structure of the input-output relationships as input-output analogy) and the size of the variables  $x(t)$  describing the system (with the *technical coefficient matrix* or *Leontief-matrix* as input-output analogy).

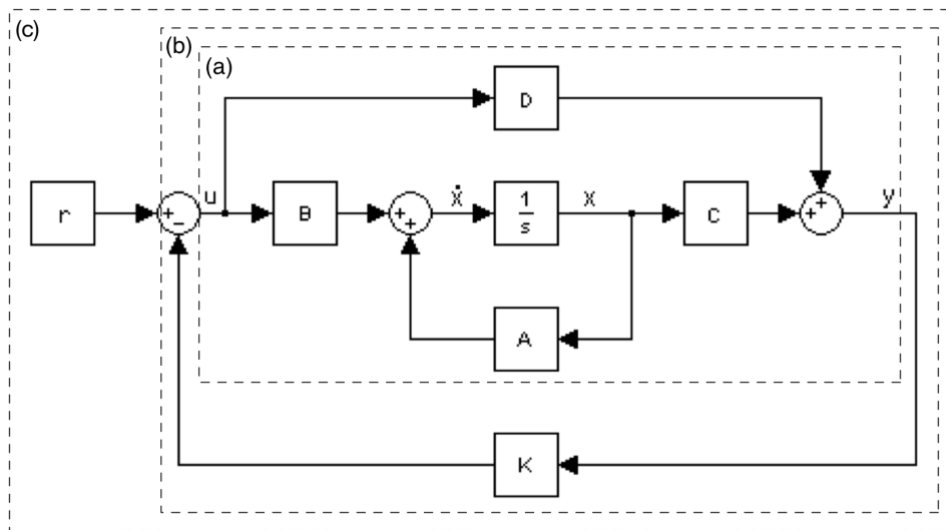
### State-space representation (process control)

If the outputs  $y(t) \in \mathbb{R}^q$  of a system  $\Sigma$  can be described as a linear combination of the inputs  $u(t) \in \mathbb{R}^p$  and state variables  $x(t) \in \mathbb{R}^n$  and if the rate of change of the state variables (first derivative  $\dot{x}$ ) is linearly dependent on the state variables and input variables, a generic representation of the state-space of a first-order linear system is:

$$\begin{aligned}\dot{x}(t) &= A(t)x(t) + B(t)u(t) \\ y(t) &= C(t)x(t) + D(t)u(t)\end{aligned}$$

With  $A$  the *state or system matrix* ( $\dim[A]=n \times n$ ),  $B$  the *input matrix* ( $\dim[B]=n \times p$ ),  $C$  the *output matrix* ( $\dim[C]=q \times n$ ) and  $D$  the *feedthrough matrix* ( $\dim[D]=q \times p$ ). In cases in which there is no direct feedthrough, the matrix  $D$  is equal to zero. This state-space model can be either in continuous or discrete time, and matrices are allowed to be time-variant. A block-diagram representation of such a system is represented in part (a) of fig. 7.13:

**Figure 7.13:** Block diagram representation of the state-space model.



**Source:** Adapted from Wikimedia Commons (2004)

To conclude this section, it is argued that the three different disciplines system dynamics, dynamical systems (mathematical theory of differential equations) and process control theory can be unified in one theoretical framework, opening up the exchange of solving strategies and design of complex systems.

In the following section, an analogy of dynamical systems with the input-output framework is presented.

### Dynamic input-output analysis

In traditional input-output analysis, the technical coefficient matrix  $A$  measures the flows between sectors, to serve current production in a particular time interval (or time-step, generally a year). Each of the inter-sectoral flows  $z_{ij}$  serves as the input for the final output  $x_j$  at a certain moment, and these are reflected in the technical coefficients  $a_{ij} = z_{ij} / x_j$  of matrix  $A$ . However, if the inputs contribute to the production but are not immediately used during the production during the specified time interval, they can be represented as stocks. This has also relevance when a sector needs a permanent stock of a certain input to function. An input from sector  $i$  that is held by sector  $j$  can be represented as the stock  $k_{ij}$ , and from this stock a coefficient  $b_{ij} = k_{ij} / x_j$  (traditionally named capital coefficient, or stock coefficient) can be derived that represents the amount of produce from sector  $i$  that is held as a stock per unit output of sector  $j$ . These coefficients form together the stock coefficient matrix  $B$  (Miller & Blair, 2009) and they might be considered as monetary or physical material stocks. For energy analysis, the stock concept might apply to the storage of energy, which is only meaningful if there are energy storage capabilities which exceed the time-step of the model.

A general way of working is to measure the products of sector  $i$  that are held as stocks in sector  $j$  in a certain year ( $k_{ij}$ ) and derive the stock of sector  $i$  needed to produce one unit (or kg) of sector  $j$ 's output ( $b_{ij}$ ). One could also assume that the number of new products from sector  $i$  that will be used as a stock for sector  $j$  in the next year ( $t+1$ ) will be linearly dependent on the difference between current and new production ( $b_{ij}(x_j^{t+1} - x_j^t)$ ). Taking into account the final demand for products from sector  $i$  ( $f_i$ ), the equation for the production of sector  $i$  in period  $t$  is thus:

$$x_i^t = \sum_{j=1}^n a_{ij} x_j^t + \sum_{j=1}^n b_{ij} (x_j^{t+1} - x_j^t) + f_i^t$$

or rewritten in function of final demand:

$$x_i^t - \sum_{j=1}^n a_{ij} x_j^t + \sum_{j=1}^n b_{ij} x_j^t - \sum_{j=1}^n b_{ij} x_j^{t+1} = f_i^t$$

This can be generalized in matrix form for all the different sectors:

$$\begin{aligned} (\mathbf{I} - \mathbf{A})\mathbf{x}^t - \mathbf{B}(\mathbf{x}^{t+1} - \mathbf{x}^t) &= \mathbf{f}^t \\ (\mathbf{I} - \mathbf{A} + \mathbf{B})\mathbf{x}^t - \mathbf{B}\mathbf{x}^{t+1} &= \mathbf{f}^t \\ \mathbf{B}\mathbf{x}^{t+1} &= (\mathbf{I} - \mathbf{A} + \mathbf{B})\mathbf{x}^t - \mathbf{f}^t \end{aligned}$$

This is a difference equation, representing the change over time in discrete time intervals. As with any difference equation, this relation can be converted to a continuous differential equation when the time-step is made very small (and the difference  $x_j^{t+1} - x_j^t$  approaches the derivative  $\frac{dx_j}{dt} = \dot{x}_j$ ). The continuous analog of the previous relationship is thus

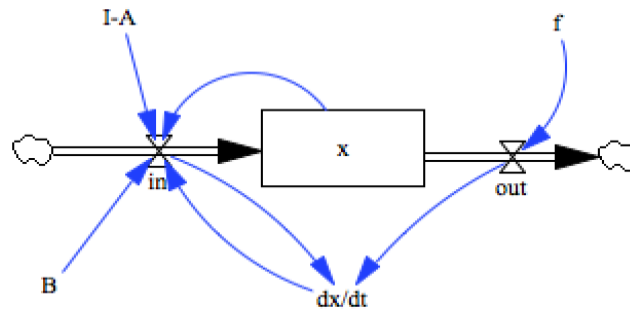
$$x_i = \sum_{j=1}^n a_{ij} x_j + \sum_{j=1}^n b_{ij} \dot{x}_j + f_i$$

which can be rewritten in matrix form as

$$\begin{aligned} \mathbf{B}\dot{\mathbf{x}} &= (\mathbf{I} - \mathbf{A})\mathbf{x} - \mathbf{f} \\ \mathbf{x} &= \mathbf{A}\mathbf{x} + \mathbf{B}\dot{\mathbf{x}} + \mathbf{f} \end{aligned} \quad (9)$$

Here,  $\dot{\mathbf{x}}$  denotes the time derivative of the production rates for the different producing sectors,  $\mathbf{f}$  denotes the final demand for each of the sectoral outputs,  $\mathbf{A}$  is the technical coefficient matrix with the elements  $ij$  indicating the ratio of products of sector  $i$  to sector  $j$  per output of goods produced by sector  $j$ ,  $\mathbf{B}$  is the stock coefficient matrix where the elements  $ij$  indicate the rate of the stock of goods produced by sector  $i$  that is held by sector  $j$  to the total output of sector  $j$ . To make the link with system dynamics clear, this formulation can be visually represented in a system dynamics diagram as:

**Figure 7.14:** System dynamics representation of a dynamic input-output model



## Extension of the dynamic Leontief model with renewable resources

An extension of the traditional Leontief demand-driven model to include the effect of renewable resources on dynamic inter-sectoral links was proposed by Dobos & Tallos (2013). Their main methodological aim is to assess whether the use of renewable resources can be controlled by altering the consumption, from a process control perspective, and how the rate of regeneration of the renewable resource influences the growth rate of consumption and production. To analyse this, eq. 9 should be complemented with a relationship describing the stock of renewable resources, rates of regeneration and input coefficients describing the use of natural resources in the economy. Therefore, the following relationship is used:

$$\dot{n} = \hat{g}n - Ex \quad (10)$$

with  $\dot{n}$  an  $m$ -dimensional positive vector of renewable resources,  $\hat{g}$  an  $m$ -diagonal matrix with the rates of regeneration of the renewable resources on the diagonal,  $E$  the  $m \times n$  matrix of input-coefficients of resources to the different sectors in the economy, with the element  $e_{ij}$  indicating the requirement of resource  $i$  to produce one unit output in sector  $j$  used to determine the extraction of renewable resources  $Ex$ .

The two relationships, eq. 9 describing the inter-sectoral relations and rate of change of the sectoral stocks and eq. 10 describing the depletion of renewable resources, can be summarized in matrix form as:

$$\begin{pmatrix} B & 0 \\ 0 & I \end{pmatrix} \begin{pmatrix} \dot{x} \\ \dot{n} \end{pmatrix} = \begin{pmatrix} I - A & 0 \\ -E & \hat{g} \end{pmatrix} \begin{pmatrix} x \\ n \end{pmatrix} - \begin{pmatrix} I \\ 0 \end{pmatrix} f$$

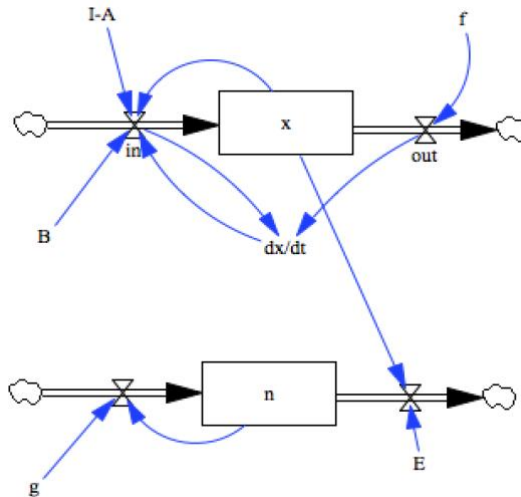
This system is controllable. That is, the system can be steered from any initial state to any other state in a finite time period by means of suitable choice of control function (which is in this case, consumption  $f$ ). A mathematical proof of this is given in Dobos & Tallos (2013). Because the controllability does not exclude negative control (consumption) values and negative state variables, the model is complemented with an additional assumption that there is a balanced growth path of both consumption and production. That means that  $x = x_0 e^{\alpha t}$  and  $f = f_0 e^{\alpha t}$  with  $\alpha \geq 0$  the growth rate. Combining these with eq. 9, learns that the initial output  $x_0$  of the balanced growth path depends on the growth rate  $\alpha$  and the initial consumption  $c_0$ :

$$\begin{aligned} (I - A - \alpha B)x_0 &= c_0 \\ \text{with } x_0(\alpha, c_0) &= (I - A - \alpha B)^{-1}c_0 \end{aligned}$$

In a similar manner, the evolution of the stock of renewable resources can be derived by substituting the balanced growth formulation of  $x$  into eq. 10:

$$n(t) = e^{\hat{g}t}n_0 - (e^{\hat{g}t} - e^{\alpha t})(-\hat{g}\alpha I)^{-1}Ex_0(\alpha)$$

which learns the intuitive thing that the renewable resources will not be fully exhausted if the consumption and production growth rate ( $\alpha$ ) is lower than the regeneration rate of the renewables ( $\hat{g}$ ). This system can be represented in a system dynamics formulation as:



**Figure 7.15:** System dynamics representation of dynamic input-output model with a stock of renewable resources

## Conclusion

To mitigate material and climate impacts along the supply chain, an integrated monitoring framework is necessary that enables the collection and exchange of physical impact data - from producers to consumers. Such a system is imperative to design environmental and social policies informed by physical sectoral exchange data, but needs to be integrated in existing data collection workflows and have institutional backup at different levels. Considering the interlinkages of our global economy, the statistical institutes that currently compile datasets on monetary exchange seems to be the first go-to actor to lay the foundations for such a common physical accounting framework.

At the same time, different aspects are important in determining the feasibility and progress towards global and regional decarbonisation. The speed at which we will be able to decarbonise, will depend on a variety of factors, but the baseline of such a transition is the availability of a labour force, the exchange of knowledge and expertise on renewable energy technologies, collaboration between nation states and regions, and last but not least, the availability of sufficient material resources to organise such a transition.

In this article, we argue that it is important to understand how to assess material, energy and emission flows and how to organize data collection. Because we use energy in all our activities, the challenge is to design a transition scenario and decarbonize our economy, considering trade-offs between different energy and material utilization choices and associated impacts. We suggest that input-output framework is the methodological backbone to account environmental impacts and physical footprint understanding of our economy,

informed by methodological insights from other disciplines such as dynamic systems, process control and energy systems modelling.

An interesting approach would be to bring the input-output analysis closer to System Dynamics. The economic sectors would continue to provide a relevant representation of economic reality. However, a flow - stock analysis, integrating feedback loops and time lags, would make it possible both to account for the different pathways of decarbonisation policies and to switch to physical accounting. In the official European System of Accounts, physical exchanges have historically not been recorded - *“The ESA 2010 system records all transactions in monetary terms. The values to be recorded for non-monetary transactions must therefore be measured indirectly or otherwise estimated”* (European Union, 2013, p. 14), but experiments are ongoing to integrated physical accounting in the existing trade data framework (Physical Energy Flow Accounts PEFA, see page 201). Considering the scale of the decarbonisation in the coming decade, and the need for a just and fair transition where everybody contributes a fair share of the decarbonisation, personal carbon quota systems and trading schemes seem promising avenues for new research developments in which physical accounting and analysis could play a prominent role.

Acknowledgments: This project has received funding from the European Union’s Horizon 2020 research and innovation programme under the Marie Skłodowska-Curie Innovative Training Network (grant agreement no. 675153) and the ERASMUS + Programme of the European Union (Jean Monnet Excellence Center on Sustainability, ERASME).



Co-funded by the  
Erasmus+ Programme  
of the European Union



## References

- Altimiras-Martin, A. (2016). Managing human-induced material use: Adding cyclic inter-sectoral flows to Physical Input-Output Tables to analyse the environmental impact of economic activity (Doctoral Thesis). University of Cambridge.
- Benyon, P. R. (2011). Modelling and Simulation of System Dynamics. International Environmental Modelling & Software Society
- Ceballos, G., Ehrlich, P. R., & Dirzo, R. (2017). Biological annihilation via the ongoing sixth mass extinction signaled by vertebrate population losses and declines. *Proceedings of the National Academy of Sciences*, 114(30), E6089–E6096. <https://doi.org/10.1073/pnas.1704949114>
- Dobos, I., & Tallos, P. (2013). A dynamic input-output model with renewable resources. *Central European Journal of Operations Research*, 21(2), 295–305. <https://doi.org/10.1007/s10100-011-0235-2>
- European Communities (Ed.). (2001). Economy-wide material flow accounts and derived indicators: A methodological guide (2000th ed.). Luxembourg: Office for Official Publications of the European Communities.
- European Union. (2013). European system of accounts: ESA 2010. Luxembourg: Publications Office of the European Union.
- Eurostat. (2015, March). NACE background. Eurostat. Statistics explained. Retrieved from [http://ec.europa.eu/eurostat/statistics-explained/index.php/NACE\\_background](http://ec.europa.eu/eurostat/statistics-explained/index.php/NACE_background)
- EUROSTAT. (2008). NACE Rev. 2 Statistical classification of economic activities in the European Community. Luxembourg: Office for Official Publications of the European Communities. Retrieved from <http://ec.europa.eu/eurostat>
- Eurostat (Ed.). (2008). Eurostat Manual of supply, use and input-output tables (2008 edition). Luxembourg: Office for Official Publications of the European Communities.
- Fischer-Kowalski, M., Krausmann, F., Giljum, S., Lutter, S., Mayer, A., Bringezu, S., ... Weisz, H. (2011). Methodology and Indicators of Economy-wide Material Flow Accounting. *Journal of Industrial Ecology*, 15(6), 855–876. <https://doi.org/10.1111/j.1530-9290.2011.00366.x>
- Ghosh, A. (1958). Input-Output Approach in an Allocation System. *Economica*, 25(97), 58–64. <https://doi.org/10.2307/2550694>
- Hayward, J., & Boswell, G. P. (2014). Model behaviour and the concept of loop impact: A practical method. *System Dynamics Review*, 30(1-2), 29–57. <https://doi.org/10.1002/sdr.1511>
- Krausmann, F., Weisz, H., Eisenmenger, N., Schütz, H., Haas, W., & Schaffartzik, A. (2015). Economy-wide Material Flow Accounting Introduction and Guide (Social Ecology Working Paper No. 151) (p. 134). Vienna: IFF Social Ecology. Retrieved from [www.aau.at/sec](http://www.aau.at/sec)
- Lenton, T. M., Pichler, P.-P., & Weisz, H. (2016). Revolutions in energy input and material cycling in Earth history and human history. *Earth Syst. Dynam.*, 7(2), 353–370. <https://doi.org/10.5194/esd-7-353-2016>

- Lenzen, M. (2000). Errors in Conventional and Input-Output—Based Life—Cycle Inventories. *Journal of Industrial Ecology*, 4(4), 127–148. <https://doi.org/10.1162/10881980052541981>
- Lenzen, M., & Rueda-Cantuche, J. M. (2012). A note on the use of supply-use tables in impact analyses. *SORT*, 36(2), 139–152. Retrieved from <https://upcommons.upc.edu/handle/2099/13317>
- Leontief, W. (1941). *Structure of the American Economy, 1919-1929*. Cambridge, Mass.: Harvard University Press.
- Leontief, W. (1991). The economy as a circular flow. *Structural Change and Economic Dynamics*, 2(1), 181–212. [https://doi.org/10.1016/0954-349X\(91\)90012-H](https://doi.org/10.1016/0954-349X(91)90012-H)
- Majeau-Bettez, G., Pauliuk, S., Wood, R., Bouman, E. A., & Strømman, A. H. (2016a). Balance issues in inputOutput analysis: A comment on physical inhomogeneity, aggregation bias, and coproduction. *Ecological Economics*, 126, 188–197. <https://doi.org/10.1016/j.ecolecon.2016.02.017>
- Malik, A., McBain, D., Wiedmann, T. O., Lenzen, M., & Murray, J. (2019). Advancements in Input-Output Models and Indicators for Consumption-Based Accounting. *Journal of Industrial Ecology*, 23(2), 300–312. <https://doi.org/10.1111/jiec.12771>
- Merciai, S., & Heijungs, R. (2014). Balance issues in monetary inputOutput tables. *Ecological Economics*, 102, 69–74. <https://doi.org/10.1016/j.ecolecon.2014.03.016>
- Miller, R. E., & Blair, P. D. (2009). *Input-output analysis: Foundations and extensions*. Cambridge; New York: Cambridge University Press. Retrieved from <http://dx.doi.org/10.1017/CBO9780511626982>
- Moura, S. (2016). Chapter 1: Modeling and Systems Analysis. In *Energy Systems and Control*. University of California, Berkeley.
- Nise, N. S. (2011). *Control systems engineering (6. ed., International student version)*. Hoboken, NJ: Wiley.
- OECD. (2008). *Measuring material flows and resource productivity: Volume 1. The OECD Guide*. OECD Publishing.
- Owen, A., Brockway, P., Brand-Correa, L., Bunse, L., Sakai, M., & Barrett, J. (2017). Energy consumption-based accounts: A comparison of results using different energy extension vectors. *Applied Energy*, 190(Supplement C), 464–473. <https://doi.org/10.1016/j.apenergy.2016.12.089>
- Peters, G. P. (2008). From production-based to consumption-based national emission inventories. *Ecological Economics*, 65(1), 13–23. <https://doi.org/10.1016/j.ecolecon.2007.10.014>
- Petty, S. W. (1690). *Political arithmetic: Or A discourse concerning the value of lands, people, buildings ... as the same relates to every country in general, but more particularly to the territories of His Majesty of Great Britain, and his neighbours of Holland, Zealand, and France*.
- Quesnay, F. (1758). *Tableau Économique*. Facsimile: [Http://Www. Taieb. Net/Auteurs/Quesnay/T1758m. Html Text: Http://Www. Taieb. Net/Auteurs/Quesnay/T1758. Html](http://www.taieb.net/Auteurs/Quesnay/T1758m.html). Retrieved from <http://www.sapili.org/livros/fr/mc00222x.pdf>



- Schandl, H., Fischer-Kowalski, M., West, J., Giljum, S., Dittrich, M., Eisenmenger, N., ... Fishman, T. (2016). *Global Material Flows and Resource Productivity (Assessment Report for the UNEP International Resource Panel)*. United Nations Environment Programme.
- Többen, J. (2017). On the simultaneous estimation of physical and monetary commodity flows. *Economic Systems Research*, 1–24. <https://doi.org/10.1080/09535314.2016.1271774>
- Tukker, A., Wood, R., & Schmidt, S. (2020). Towards accepted procedures for calculating international consumption-based carbon accounts. *Climate Policy*, 0(0), 1–17. <https://doi.org/10.1080/14693062.2020.1722605>
- UNEP. (2018). *Technical annex for Global Material Flows Database*.
- United Nations. (1999). *Handbook of Input-Output Table Compilation and Analysis*. New York: United Nations.
- United Nations. (2018). *International Recommendations for Energy Statistics (IRES)* (Statistical Papers No. ST/ESA/STAT/SER.M/93).
- United Nations Economic Commission for Europe. (2014). *TERMS OF REFERENCE OF A TASK FORCE ON A SET OF KEY CLIMATE CHANGE-RELATED STATISTICS USING SEEA*. In *Conference of European Statisticians* (p. 3).
- United Nations, European Commission, FAO, OECD, & World Bank. (2017). *System of Environmental-Economic Accounting 2012 - Applications and Extensions* (No. ST/ESA/STAT/Ser.F/114). New York: United Nations.
- United Nations, European Communities, International Monetary Fund, Organisation for Economic Co-operation and Development, & World Bank (Eds.). (2009). *System of National Accounts 2008 (Rev. 5)*. New York: United Nations [u.a.].
- United Nations, European Union, Food and Agriculture Organization of the United Nations, International Monetary Fund, Organisation for Economic Co-operation and Development, & The World Bank (Eds.). (2014). *System of environmental-economic accounting 2012 - Central Framework*. New York, NY: United Nations.
- United Nations, European Union, Food and Agriculture Organization of the United Nations, Organisation for Economic Co-operation and Development, & World Bank Group. (2014). *System of Environmental Economic Accounting 2012 - Experimental Ecosystem Accounting*. (No. ST/ESA/STAT/Ser.F/112). New York. Retrieved from <http://dx.doi.org/10.1787/9789210562850-en>
- UNSD. (2016). An overview of the international groups related to the SEEA. In *23rd Meeting of the London Group on Environmental Accounting*.
- Victor, P. A., & Jackson, T. (2013). *Developing a demographic sub-model and an Input-Output Structure for the Green Economy Macro-Model and Accounts (GEMMA) Framework*. Centre for International Governance Innovation and Institute for New Economic Thinking. Retrieved from [https://www.cigionline.org/sites/default/files/2013-09-10-victor-jackson-cigionet\\_final\\_report.pdf](https://www.cigionline.org/sites/default/files/2013-09-10-victor-jackson-cigionet_final_report.pdf)
- Weisz, H., & Duchin, F. (2006). Physical and monetary inputOutput analysis: What makes the difference? *Ecological Economics*, 57(3), 534–541. <https://doi.org/10.1016/j.ecolecon.2005.05.011>

- Wiedmann, T. O., Schandl, H., Lenzen, M., Moran, D., Suh, S., West, J., & Kanemoto, K. (2015). The material footprint of nations. *Proceedings of the National Academy of Sciences*, 112(20), 6271–6276. <https://doi.org/10.1073/pnas.1220362110>
- Wood, R., Moran, D., Stadler, K., & Rodrigues, J. F. D. (2018). Variation in trends of consumption based carbon accounts [dataset]. Zenodo. <https://doi.org/10.5281/zenodo.3187310>
- Wood, R., Moran, D. D., Rodrigues, J. F. D., & Stadler, K. (2019). Variation in trends of consumption based carbon accounts. *Scientific Data*, 6(1), 99. <https://doi.org/10.1038/s41597-019-0102-x>
- Wikimedia Commons. (2004, December). Typical State Space model with feedback and input. [https://en.wikipedia.org/wiki/File:Typical\\_State\\_Space\\_model\\_with\\_feedback\\_and\\_input.png](https://en.wikipedia.org/wiki/File:Typical_State_Space_model_with_feedback_and_input.png)



## 8. Input – Output Analysis: A City Scale Review

**Authors and affiliations:** Aleix Altimiras-Martin<sup>1</sup>, Arnaud Diemer<sup>2</sup>, Florian Dierickx<sup>2,3</sup>

1: University of Campinas, Brazil

2: Jean Monnet Excellence Center on Sustainability (ERASME), University of Clermont Auvergne, CERDI, Clermont-Ferrand, France

3: University of Iceland, Reykjavik, Iceland

*Book chapter*

**Date:** October, 2019

**Book Title:** Cities, the Long Road to Sustainability

**Editors:** Diemer, A., Coelho, P., Morales, M.

**Publisher:** Oeconomia, France

**ISBN:** 979-10-92495-14-0

Urban population exceeded 50% of total population in 2007 and is expected to reach 68% or global population by 2050 (UN 2018). Additionally, cities are a key node of economic activity, connecting several productive sectors and hosting many services. Sustaining both social and economic activities requires energy and materials to be transported, transformed, used and discarded (Jones, Williams, Lannon, 2000). Therefore, cities are also heavy drivers of environmental impacts. Some studies portrayed their material consumption through material flow analysis (Barles, 2009 ; Rosado, Niza & Ferrao, 2014; Wuang & al., 2018) or other bottom-up approaches (Kennedy et al. 2009, 2010). However, to be able to establish relationships between different system components, a framework explicitly linking the different urban elements is required. Input-Output Analysis (IOA) is a framework linking explicitly the different sectors of the system between themselves (Leontief, 1941) and to different final demand components (exports, household consumption, and private and public expenditure). Therefore, IOA has the potential to identify the underlying driver(s) of selected environmental impacts, even considering the whole set of simultaneous interactions between the different sectors and final consumers (Leontief, 1977). In order to identify the theoretical and methodological issues associated with the implementation of input-output analysis in the case of sustainable cities, we will proceed in three steps. firstly, the main models within the input-output framework will be briefly explained. Secondly, we will illustrate how these models have been used to study the economic activity and the associated environmental impacts. Thirdly, we will identify some challenges to better understand the impacts of urban activities using IOA.

### The IOA Framework

The IOA framework was originally developed to model the economy and capture the indirect effects associated to production. Miller and Blair (2009, p. 1) consider that “*the fundamental purpose of the input-output framework is to analyze the interdependence of industries in an economy*”. This framework has been extended in several ways to calculate the environmental impacts consequence of the direct and indirect effects of production<sup>92</sup> (Kitzes, 2013). IOA can

---

<sup>92</sup> Environmentally-extended input-output (EEIO) analysis provides a simple and robust method for evaluating the linkages between economic consumption activities and environmental impacts, including the harvest and degradation of natural resources. EEIO is now widely used to evaluate the upstream, consumption-

also be used to model the direct and indirect effects that sprawls between several regions, e.g. to assess the effects of trade between regions or to assess how final consumption in one region affects other regions (Wiedmann, Lenzen, Turner, Barrett, 2007).

## Basics of IOA

The input-output analysis is a modelling framework based on national accounts enabling researchers and policy makers to assess the structure of the economic system and account for the indirect effects associated to economic production (Miller, Blair, 2009). The foundational model is used for most input-output analyses, and is known as the Leontief model (Leontief 1941), which is a quantity output-driven model and an application of general equilibrium's theory: *"This modest volume describes an attempt to apply the economic theory of general equilibrium – or better, general interdependence – to an empirical study of interrelations among the different parts of a national economy as revealed through covariations of prices, outputs, investments and incomes"* (1941, p. 3). A typical application is calculating the effects induced by the activity of a single sector over the whole economy, e.g. how much the whole economy will need to produce in order to produce a new car, including all the direct transactions and materials (e.g. steel, glass, paint, etc.) and indirect (e.g. all activities related to mining of steel, production of glass, synthesis of paint, etc.). As it can be intuitively felt from this example, the production of any final good induces quite some indirect production, *multiplying* the effect of the original, final demand for the final product (Leontief, Strout, 1963). Quantifying the multiplying power of each sector is done through calculating the multipliers. Also, other types of analyses revealing different properties of the structure such as linkage analysis or structural decomposition analysis enable researchers to better understand how the different sectors rely on each other or whether it is final demand or technological change which is driving the change in the economic structure.

The model relies on linear algebra; the following notation will be used:

- lower case letters to denote scalars
- bold lower case letters to denote vectors
- bold upper case letters to denote matrices

Sub-indices denote:

- the row and column coordinate when there are 2 sub-indices (e.g.  $z_{12}$ )
- the row when it is a vector, e.g.  $f_2$

The  $i$  and  $j$  sub-indices are used to denote generic row and columns (e.g.  $z_{i,j}$  are the coordinates of the  $\mathbf{Z}$  matrix. A vector between angle brackets or with a hat means a diagonalised vector, e.g.  $\langle \mathbf{z} \rangle$  or  $\hat{\mathbf{z}}$ . The  $\mathbf{i}$  vector correspond to a vector filled with ones:  $\mathbf{i} = (1,1,1,\dots,1)$ . The  $\mathbf{I}$  matrix correspond to the identity matrix, i.e. a diagonalised  $\mathbf{i}$  vector:

$$\mathbf{I} = \langle \mathbf{i} \rangle = \begin{pmatrix} 1 & 0 & \dots & 0 \\ 0 & 1 & \dots & 0 \\ \vdots & \vdots & \ddots & \vdots \\ 0 & 0 & \dots & 1 \end{pmatrix}$$

---

based drivers of downstream environmental impacts and to evaluate the environmental impacts embodied in goods and services that are traded between nations (KITzes, 2013).

*The quantity output-driven model*

The first input-output model was developed by Leontief (1941) and represents all economic transactions engaged in the production of final goods. Input-Output models are applied to Monetary Input-Output Tables (MIOTs), which can be divided in three main quadrants (Weiz, Duchin, 2006):

- The *primary inputs* quadrant, which entails all elements required for productions, e.g. imports, wages, etc. Taxes, profits, rentals, etc. are also included in this quadrant. All these components constitute the added value component, which can be aggregated as vector  $\mathbf{v}'$ .
- The inter-sectoral quadrant represents all sectoral interactions, i.e. how much all sectors of the economy buy from each other. Therefore, all *intermediate production* is at the same time *intermediate demand* since it is produced to fulfil the demand of sectors requiring it in order to produce the final demand. All these interactions are represented by the inter-sectoral matrix  $\mathbf{Z}$ .
- The third quadrant represents *final demand*, represented by vector  $\mathbf{f}$ , also known as *final production*. Usually, it is disaggregated between 4 different vectors: household expenditures ( $\mathbf{c}$  for (final) consumption), government expenditure ( $\mathbf{g}$ ), gross capital formation ( $\mathbf{i}$  for investment) and exports ( $\mathbf{e}$ ).

A simple MIOT containing these three quadrants is presented as table 8.1. Inputs are read as columns, down-up, and outputs are read as row, left to right. E.g., supposing a 3 sectors economy:  $v_1, z_{3,1}, z_{2,1}$  and  $z_{1,1}$  are the inputs used by sector 1. Then,  $z_{1,1}, z_{1,2}, z_{1,3}$  and  $f_1$  are the outputs generated by sector 1. Note that  $z_{1,1}$  is both an output and input for the same sector; such event is common since most sectors produce some product required as intermediate product by some industries within the sector (e.g. seeds are produced within the agricultural sector to be used to plant crops within the same sector). Additionally, it is common practice to represent the total outputs as vector  $\mathbf{x}$ , i.e. the sum of intermediate production and final production. Since MIOTs are the result of double-entry book-keeping, debits equal credits and thus, total outputs equal total inputs. Hence, the sum of primary inputs and intermediate inputs add up to the same values  $\mathbf{x}'$ .

**Table 8.1:** Monetary Input-Output Table with n sectors

|              | Sector 1 ... Sector n | Final demand | Total outputs |
|--------------|-----------------------|--------------|---------------|
| Sector 1     |                       |              |               |
| ...          | $\mathbf{Z}$          | $\mathbf{f}$ | $\mathbf{x}$  |
| Sector n     |                       |              |               |
| Value added  | $\mathbf{v}'$         |              |               |
| Total inputs | $\mathbf{x}'$         |              |               |

The basic IO model can be derived from the variables portrayed in table 1 using some assumptions.

First, the explicit relationship between intermediate production, final production and total production is made:

$$\mathbf{Z} \cdot \mathbf{i} + \mathbf{f} = \mathbf{x} \quad (\text{Eq. 1})$$

Then, it assumed that intermediate production is linearly related to the total amount of activity. This implies that the model is linear and that production follows constant returns to scale, i.e. to duplicate the amount of final outputs, the amount of primary inputs and intermediate inputs will also be duplicated. This assumption is embedded in the following equation, where  $\mathbf{A}$  is known as the *technical coefficients matrix* (because each of its elements represents the technical coefficient of production, i.e. how many intermediate inputs are required for a sector to produce its output), or the *direct requirements matrix* (because these coefficients reveal only the first order relationship with the other sectors, i.e. how much a sector directly requires from the other sectors of the economy):

$$\mathbf{Z} = \mathbf{A} \cdot \hat{\mathbf{x}} \Leftrightarrow \mathbf{A} = \mathbf{Z} \cdot \hat{\mathbf{x}}^{-1} \quad (\text{Eq. 2})$$

However, the monetary flows represented in MIOTs represent the value of the amount of money exchanged, not quantities nor prices. To go around this issue, Leontief devised a simple workaround: he assumed that all prices are unitary. Hence, all values can be considered quantities since their prices are one monetary unit per corresponding physical unit – that is why this model is known as a quantity model.

Finally, to simplify the use of the model, it is also assumed that each sector produces a single, homogeneous type of good or service. If a certain level of aggregation is not satisfactory, a sector can be disaggregated to obtain the desired level of disaggregation to observe the desired product.

Given these three assumptions, the model can be built just by using eq. 2 in 1:

$$\mathbf{x} = (\mathbf{I} - \mathbf{A})^{-1} \cdot \mathbf{f} \quad (\text{Eq. 3})$$

Where

$$\mathbf{L} = (\mathbf{I} - \mathbf{A})^{-1} \quad (\text{Eq. 4})$$

$\mathbf{L}$  is known as the *Leontief inverse matrix* and also as the *total requirements matrix* since it embeds both the direct and indirect effects of production. Therefore, by using  $\mathbf{L}$ , one can find the total (intermediate) activity induced by a given final demand, including all indirect (recursive) effects (e.g. sector 1 requires some intermediate goods from sector 2 which in turn requires some intermediate goods from sector 1 which in turn requires some intermediate goods from sector 2 and so on ad infinitum). Therefore, eq. 4 is an elegant formulation that condenses all these interactions.

So, the model is output-driven because it responds to exogenously given variations of the final demand; the structure of the economy – represented of the by  $\mathbf{A}$  and  $\mathbf{L}$  – remains constant. To calculate the effects of a new final demand  $\mathbf{f}^*$  requires only to use eq. 3 with  $\mathbf{f}^*$ . In fact, due to the linear relationship  $\mathbf{f}^*$  can be understood as a new final demand vector or simply as a variation of the final demand. So,  $\mathbf{f}^{*'} = (100, 0, 0)$  can be understood as a new vector where 100 \$ final goods are produced by sector 1, or a variation in production of sector 1 of +100\$.

To calculate the new value added associated to a new final demand, the input coefficients associated to value added  $\mathbf{c}^v$  must be previously calculated as follows:

$$\mathbf{c}^{v'} = \mathbf{v}' \cdot \hat{\mathbf{x}}^{-1} \quad (\text{Eq. 5})$$

Then, assuming the coefficient  $\mathbf{c}^v$  remain constant, the new primary inputs associated to the new total outputs associated to the new final demand are:

$$\begin{aligned} \mathbf{v}^* &= \hat{\mathbf{c}}^v \cdot \mathbf{L} \cdot \mathbf{f}^* \\ &= \hat{\mathbf{c}}^v \cdot \mathbf{x}^* \end{aligned} \quad (\text{Eq. 6})$$

Also, the new intersectoral flows can be calculated using eq 2 with the new total outputs:

$$\mathbf{Z}^* = \mathbf{A} \cdot \hat{\mathbf{x}}^* \quad (\text{Eq. 7})$$

Thus, all components of table 1 can be recalculated to find their new values according to a new final demand.

### *Multiplier analysis*

The multiplier analysis enables researchers to find which sectors have more direct *and* indirect effects on a certain variable for each unit of each sector's production (Miller, Blair, 2009). E.g. the production multiplier analysis produces a vector with the total, economy-wide (direct and indirect) production induced by each sector; the added value multiplier analysis produces a vector with the total, economy-wide (direct and indirect) value added induced by each sector; the emission multiplier analysis produces a vector with the total, economy-wide (direct and indirect) emissions induced by each sector.

The production multiplier  $\mathbf{m}^x$  is the simplest multiplier vector to calculate:

$$\mathbf{m}^x = \mathbf{i}' \cdot \mathbf{L} \quad (\text{Eq. 8})$$

So,  $\mathbf{m}^x_1$  reveals the total, economy-wide production required for sector 1 to produce one unit.

The added value multipliers  $\mathbf{m}^v$  would be calculated

$$\mathbf{m}^v = \mathbf{i}' \cdot \hat{\mathbf{c}}^v \cdot \mathbf{L} \quad (\text{Eq. 9})$$

where,  $\mathbf{m}^v_1$  reveals the total, economy-wide value added generated when sector 1 produces one product unit.

## **Assessing environmental impacts**

### *Environmentally Extended Monetary Input-Output Analysis*

The framework depicted can also be used to assess environmental impacts by adding environmental variables, either using absolute values (e.g. total sectoral emissions or total sectoral natural resource consumption) or relative values, i.e. emission intensities per monetary unit or natural resource consumption intensities per monetary unit; such tables are called Environmentally-Extended Monetary Input-Output Tables (EE-MIOTs<sup>93</sup>).

EE-MIOTs consist of a core MIOT with additional environmental primary inputs (e.g. water use in litres or metric cubes, land-use in square kilometres, ores in tons, etc.) and/or environmental final outputs (e.g. greenhouse gas emissions (e.g. carbon dioxide emissions in

---

<sup>93</sup> In 1977, Leontief published a book in which he proposed using what is now commonly referred to as environmentally extended input – output analysis (EEIOA) to assess the amount of pollution associated with given levels of production and consumption: « *The basis for the present report is a study on the environmental aspects of the future world economy. This study includes – as a principal feature – a set of alternative projections of demographic, economic and environmental states of the world in benchmark years 1980, 1990 and 2000*” (Leontief, 1977, p.1).



tons), sewage (in litres), etc.). These extensions are completely independent from the MIOT and do not need to add up, nor be balanced in any way (Kitzes, 2013 ; Schaffartzik, Sachs, Wiedenhofer, Eisenmenger, 2014).

The underlying idea is to assume that the requirement of natural resources and the generation of emissions and wastes are proportional to total sectoral activity. Therefore, in case the absolute values for the environmental extensions are provided, the coefficients need to be calculated as in eq. 5. If the relative values are provided, i.e. natural resource or emissions intensities per monetary unit, they can be used directly as coefficients.

Table 8.2 represents a EE-MIOT with n sectors (as in table 1) plus two extended environmental primary inputs ( $\mathbf{r}_1$ , water use (in litres) and  $\mathbf{r}_2$ , land use in km<sup>2</sup>) and two extended environmental outputs ( $\mathbf{e}_1$ , carbon dioxide emissions (in tons) and  $\mathbf{e}_2$ , sewage production (in litres)). Note that sewage and water use do not need to balance.

**Table 8.1** : Monetary Input-Output Table with n sectors extended with 2 environmental inputs and 2 environmental outputs.

|                                 | Sector 1 ... Sector n | Final demand | Total outputs | Extended outputs                 |                 |
|---------------------------------|-----------------------|--------------|---------------|----------------------------------|-----------------|
|                                 |                       |              |               | CO <sub>2</sub> emissions [tons] | Sewage [litres] |
| Sector 1                        |                       |              |               |                                  |                 |
| ...                             | Z                     | f            | x             | e <sub>1</sub>                   | e <sub>2</sub>  |
| Sector n                        |                       |              |               |                                  |                 |
| Value added                     | v'                    |              |               |                                  |                 |
| Total inputs                    | x'                    |              |               |                                  |                 |
| <b>Extended primary inputs:</b> |                       |              |               |                                  |                 |
| Water use [litres]              | r <sub>1</sub>        |              |               |                                  |                 |
| Land use [km <sup>2</sup> ]     | r <sub>2</sub>        |              |               |                                  |                 |

Assuming all extended outputs are in absolute values, i.e. total sectoral natural resources or emission generated per sector, the corresponding coefficients can be calculated for environmental primary inputs and final outputs as in equation 5:

$$\mathbf{c}^{r_1'} = \mathbf{r}_1' \cdot \hat{\mathbf{x}}^{-1} \quad (\text{Eq. 10})$$

$$\mathbf{c}^{r_2'} = \mathbf{r}_2' \cdot \hat{\mathbf{x}}^{-1} \quad (\text{Eq. 11})$$

$$\mathbf{c}^{e_1'} = \mathbf{e}_1' \cdot \hat{\mathbf{x}}^{-1} \quad (\text{Eq. 12})$$

$$\mathbf{c}^{e_2'} = \mathbf{e}_2' \cdot \hat{\mathbf{x}}^{-1} \quad (\text{Eq. 13})$$

Therefore, the new amount of natural resources required to fulfil a new final demand  $\mathbf{f}^*$  are:

$$\mathbf{r}_1^* = \hat{\mathbf{c}}^{r_1} \cdot \mathbf{L} \cdot \mathbf{f}^* \quad (\text{Eq. 14})$$

$$\mathbf{r}_2^* = \hat{\mathbf{c}}^{r_2} \cdot \mathbf{L} \cdot \mathbf{f}^* \quad (\text{Eq. 15})$$

And the amount of emissions required to fulfil a new final demand  $\mathbf{f}^*$  are:

$$\mathbf{e}_1^* = \hat{\mathbf{c}}^{e_1} \cdot \mathbf{L} \cdot \mathbf{f}^* \quad (\text{Eq. 16})$$

$$\mathbf{e}_2^* = \hat{\mathbf{c}}^{e_2} \cdot \mathbf{L} \cdot \mathbf{f}^* \quad (\text{Eq. 17})$$

The corresponding multipliers can be calculated using eq. 9.

In some cases, the required environmental data is readily available from the System of Environmental and Economic Accounts. If that case, the data is usually compatible with the sectoral disaggregation of the IO accounts, although at lower resolution, i.e. at higher aggregation level. Then, the MIOT needs only to be aggregated to match the SEEA sectoral aggregation.

However, it is also common that environmental extensions need to be built to meet the researcher's criteria. Then, several data sources need to be merged in a consistent manner (e.g. see Chen and Zhang (2010) for an example of building greenhouse gas inventories for CO<sub>2</sub>, CH<sub>4</sub> and N<sub>2</sub>O).

Finally, a trend that has gained straighten within the IO community is to merge IO data (i.e. the MIOT) with LCA data to build the environmentally extended table; such procedure is called hybrid-EIO-LCA. The advantage of doing so is to have more detailed information about different environmental impact from the LCA databases which can then be used to calculate the impacts due to the direct and indirect production, i.e. overall economic activity (Suh et al. 2004; Hendrickson, Lave, and Matthews 2006).

#### *Hybrid Input-Output Analysis*

Hybrid Input-Output Tables and models were developed in the seventies to study issues related to energy consumption (Bullard & Herendeen, 1975). The main motivation was that the same fuel is sold at different prices to different sectors, thus, same monetary values could be masking different amounts of fuels delivered to different sectors. Directly using physical units (e.g. BTU or kWh) instead of monetary units would solve this issue. So, hybrid IOTs were devised so that the energy sector rows were disaggregated between different fuel types represented in physical units and the rest of sector rows would be represented as in a conventional MIOT, in monetary values. The energy rows of the final demand and total outputs are therefore also in energy units.

The model that is applied to hybrid IOTs is the Leontief model, with a new final demand coherent with the hybrid units. Then, finally, total fuel consumption associated to the new final demand can be found by calculating the energy use coefficients, as in eq. 5. The total consumption of each energy type can then be found by using eq. 6.

However, although this method provides more accurate results since sectoral price variation issues are avoided, the number of applications falls well behind analyses based on the EE-IOA framework. Also, the current review could not find any application to cities.

#### *Physical Input-Output Analysis*

So far, only a few Physical Input-Output Tables (PIOTs) have been compiled and almost not even used for analysis (Miller, Blair, 2009). This was due to the lack of IO models and methods able to deal with such tables. However, recently, the difference between different models and methods were clarified and a generalised model and a generalised method to deal with PIOTs with any amount of emissions were developed (Altimiras-Martin 2014).

The PIOT framework is the only one capable of revealing the actual physical metabolism of economies, i.e. showing how economies extract, transform and dispose of materials (Hoekstra, Van Den Bergh, 2006). The main issue is that monetary flows provide misleading information about the actual underlying physical flows so, until such tables are built, it is unknown how economies actually transform and mobilise the different materials through the different sectors.

This why the PIOT framework has been proposed as the backbone of the new System of Environmental and Economic Accounts (UN et al. 2014). This would mean that the environmental accounts would not be satellite accounts to the monetary accounts, but would have a coherent formulation allowing researchers to analyse the actual metabolism of economies. Unfortunately, this new accounting framework has not yet been implemented in the national statistical offices.

PIOTs do not use the homogeneous goods assumption because PIOTs entail disposals to nature as final outputs, i.e. wastes and emissions that are different from the goods produced by each sector. That is why Physical IOTs are fundamentally different from all IOT types, which consider that each sector produces a single homogeneous good – even hybrid-IOTs. This difference requires that a different type of model is used.

Table 8.3 represents a PIOT with 3 disposals to nature and 2 natural resource inputs; all components are in physical units and there must be sectoral material balance, i.e. total inputs equal total outputs. Here, total inputs and outputs are underscored to show that the units are different than conventional IOTs, not only because they are physical units, but because the flows entail *all* materials required for production, the materials finally embedded in final goods *and* the materials disposed to nature as emissions or waste. Therefore, there are two different types of final outputs: final goods<sup>94</sup> (**f**) and the disposals to nature (**w<sub>j</sub>**).

**Table 8.2:** Physical Input-Output Table with n sectors, 3 disposals to nature and 2 natural resource inputs

|              | Sector 1 ... Sector n | Final demand | Disposals to nature  |                      |                      | Total outputs   |
|--------------|-----------------------|--------------|----------------------|----------------------|----------------------|-----------------|
| Sector 1     |                       |              |                      |                      |                      |                 |
| ...          | <b>Z</b>              | <b>f</b>     | <b>w<sub>1</sub></b> | <b>w<sub>2</sub></b> | <b>w<sub>3</sub></b> | <b><u>x</u></b> |
| Sector n     |                       |              |                      |                      |                      |                 |
| Resource 1   | <b>r<sub>1</sub>'</b> |              |                      |                      |                      |                 |
| Resource 2   | <b>r<sub>2</sub>'</b> |              |                      |                      |                      |                 |
| Total inputs | <b><u>x'</u></b>      |              |                      |                      |                      |                 |

It is precisely the fact that there are heterogeneous final outputs that prevented previous researchers from gathering accurate results using the traditional Leontief model: the model is driven by an exogenously given final demand, but how can one know beforehand the amount of emissions generated by the new final demand. One cannot. The model itself must endogenise and calculate the emissions associated to the new final demand. Therefore, the traditional model must be modified so that all heterogeneous final outputs are endogenised. In particular, since IOA is based on constant returns to scale, i.e. assuming that that the amount of inputs is linearly related to the amount of outputs, so must be the disposals to nature. According to Altimiras-Martin (2014), the output-driven model able to endogenise any amount of heterogeneous final outputs is built as follows. First, let's consider the output identity:

$$\underline{\mathbf{x}} = \mathbf{Z} \cdot \mathbf{i} + \mathbf{f} + \mathbf{w}_1 + \mathbf{w}_2 + \mathbf{w}_3 \quad (\text{Eq. 18})$$

<sup>94</sup> Final goods also include services.

The technical coefficients matrix is calculated as in eq. 2, although since  $\mathbf{A}$  is related to  $\underline{\mathbf{x}}$ , it will be called  $\underline{\mathbf{A}}$  to highlight the difference with the conventional Leontief model:

$$\underline{\mathbf{A}} = \mathbf{Z} \cdot \hat{\mathbf{x}}^{-1} \quad (\text{Eq. 19})$$

Keeping this distinction is important since there is an alternate method presented in Altimiras-Martin (2014) that allows researchers to gather correct results by using the traditional Leontief model at the expense of having to alter the structure of the PIOT and not being able to use  $\mathbf{A}$  and  $\mathbf{L}$  to perform structural analyses. The technical coefficients matrix and total requirements matrix calculated below ( $\underline{\mathbf{A}}$  and  $\underline{\mathbf{L}}$ ) do enable researchers to perform structural analyses on the actual physical structure of the economy.

To endogenise the different disposal to nature vectors within the total requirements matrix, each disposal to nature vector can be diagonalised and made proportional to total sectoral outputs, as follows:

$$\mathbf{E}_j = \hat{\mathbf{w}}_j \cdot \hat{\mathbf{x}}^{-1} \quad (\text{Eq. 20})$$

Using eq. 19 and eq. 20 in eq. 18:

$$\begin{aligned} \underline{\mathbf{x}} &= \underline{\mathbf{A}} \cdot \underline{\mathbf{x}} + \mathbf{f} + \mathbf{E}_1 \cdot \underline{\mathbf{x}} + \mathbf{E}_2 \cdot \underline{\mathbf{x}} + \mathbf{E}_3 \cdot \underline{\mathbf{x}} \\ \underline{\mathbf{x}} &= (\mathbf{I} - \underline{\mathbf{A}} - \mathbf{E}_1 - \mathbf{E}_2 - \mathbf{E}_3)^{-1} \cdot \mathbf{f} \\ \underline{\mathbf{x}} &= \underline{\mathbf{L}} \cdot \mathbf{f} \end{aligned} \quad (\text{Eq. 21})$$

Where  $\underline{\mathbf{L}}$  is the new total requirements matrix, equivalent to the Leontief inverse matrix but with the disposals to nature endogenised within the model.

The main issue with PIOTs is data availability for inter-sectoral transactions. While aggregate values could be extracted from environmental accounts, specifically Economy-Wide Material Flow Accounts (Eurostat and European Commission 2001; OECD 2008), the exact allocation of these flows amongst sectors within economic activity would require specific statistical work. Material Flow Analysis, a systematic methodology to trace physical flows through the economy, enables researchers to estimate raw natural resource extraction and initial transformation with good resolution, however, inter-sectoral flows remain difficult to estimate (Graedel et al. 2002).

## Assessing relationships and impacts between different regions

### *Multiregional Input-Output Analysis*

Multiregional IOA (MRIOA) enables researchers to assess the effects of production through trade, i.e. to assess how the intermediate production or final demand in one region would pull intermediate production from other regions. Multiregional IOA is based on Multiregional Input-Output Tables (MR-IOTs), which are similar to MIOT but contain the regional and interregional flows and the analyses are usually performed using the traditional Leontief model. MRIOA is also used to identify the drivers of environmental impacts by extending MR-IOTs with environmental variables, as in EE-MIOT but for each region. Typically, MR-IOTs can represent several countries or several regions within a country, but different regional scales can be also used, e.g., a city, the region where the city is located, the other regions of the country and the rest of world.

A MR-IOT of  $m$  regions with  $n$  sectors per region would have an intersectoral matrix  $\mathbf{Z}$  of  $m \cdot n \times m \cdot n$  constituted of  $m$  matrices  $n \times n$  representing intraregional production  $\mathbf{Z}^{ii}$  (as in a single region inter-sectoral matrix) placed along the diagonal and the off-diagonal

matrices would represent the sectoral bilateral trade between regions  $Z^{ij}$ . The final demand would also be decomposed by the region demanding final goods (as columns) and by the region providing the final goods to that region (e.g.  $f^{ij}$  is the final demand from region  $j$  produced by region  $i$ ). Such a MRIOT with 3 regions is represented in table 8.4.

**Table 8.3** : Multi-Regional Input-Output Table with 3 regions with  $n$  sectors per region

|          |             | Region 1        | Region 2       | Region 3       | Final demand |          |          | Total outputs |
|----------|-------------|-----------------|----------------|----------------|--------------|----------|----------|---------------|
|          |             | Sectors 1 ... n | Sectors 1... n | Sectors 1... n | Region 1     | Region 2 | Region 3 |               |
| Region 1 | Sector 1    | $Z^{11}$        | $Z^{12}$       | $Z^{13}$       | $f^{11}$     | $f^{12}$ | $f^{13}$ | $x^1$         |
|          | ...         |                 |                |                |              |          |          |               |
| Reg. 2   | Sector 1    | $Z^{21}$        | $Z^{22}$       | $Z^{23}$       | $f^{21}$     | $f^{22}$ | $f^{23}$ | $x^2$         |
|          | ...         |                 |                |                |              |          |          |               |
| Reg. 3   | Sector 1    | $Z^{31}$        | $Z^{32}$       | $Z^{33}$       | $f^{31}$     | $f^{32}$ | $f^{33}$ | $x^3$         |
|          | ...         |                 |                |                |              |          |          |               |
|          | VA          | $v^{1'}$        | $v^{2'}$       | $v^{3'}$       |              |          |          |               |
|          | Tot. inputs | $x^1$           | $x^2$          | $x^3$          |              |          |          |               |

All intraregional ( $Z^{ii}$ ) and interregional ( $Z^{ij}$ ) inter-sectoral matrices (of dimensions  $n \times n$  each) can be understood as a single matrix  $Z$  (of dimension  $m \cdot n \times m \cdot n$ ), and the intraregional final demand ( $f^{ii}$ , dimension  $n \times 1$ ) and interregional demand ( $f^{ij}$ , each of dimension  $n \times 1$ ) from each region can be understood as a single final demand vector  $f^i$ , dimension  $(m \cdot n) \times 1$ ). The total outputs and value added vectors can also be aggregated as  $(m \cdot n) \times 1$  vectors. Then, table 4 can be rewritten as table 8.5 for which it becomes intuitive to use the Leontief model and analyses described in the last section.

**Table 8.4** : Condensed notation for a Multi-Regional Input-Output Table with 3 regions with  $n$  sectors per region.

|   | Intraregional and interregional intermediate transactions | Final demand |          |          | Total outputs |
|---|---|--------------|----------|----------|---------------|
|   |   | Region 1     | Region 2 | Region 3 |               |
| Intraregional and interregional intermediate transactions | $Z$   | $f^1$        | $f^2$    | $f^3$    | $x$           |
| VA  | $v'$  |              |          |          |               |
| Total inputs  | $x'$  |              |          |          |               |

The main difficulty to build a MR-IOT is building the interregional data, i.e. how much each sector imports from other regions' sectors, i.e. finding the data to fill all  $Z^{ij}$ . Ideally, one should know exactly how much a sector from one region imports from each sector from each other region. However, such detailed information is not available and approximations based on the total trade between regions of each product must be made. Using such type of

approximation is the basis to build Multi-regional IOTs, but other approaches can also be used depending on data availability (e.g. Inter-Regional input-output table and model, Balanced Regional and gravity model) (Miller and Blair 2009, chap. 3).

Several international multi-regional databases are available, each representing a different set of countries, with different environmental extensions (when available) and based on different data sources and premises (Owen et al. 2014). These type of MR-IOT have been used to explore several economic issues (trade, global value chains, etc.) and environmental issues (e.g. embedded carbon emissions, embedded energy, etc.). MRIOTs representing sub-national regions are also available, e.g. for China (Okamoto and Ihara 2016).

## **Applications to cities**

### **Assessing economic impacts**

Cities attracted interest from IO community since the early 70s, specially focussing on data gathering (Smith and Morrison [1974], 2007). Although city-level IOA is not a prominent field, specially due to the very localised implications of research (cities have very different regional, industrial and consumption structures) and difficulties in data compilation, several Input-Output Tables have been built at neighbourhood level (Cole 1999), city-level (Cole 1987), community level (Robison, 1997; Robison and Miller, 1988; Robison and Miller, 1991) and also using the MR-IOT framework to assess impacts between different metropolitan regions (Hewings, Okuyama, and Sonis, 2001).

### **Assessing environmental impacts**

The environmental assessment of a city is complex and there is no widely adopted method (Loiseau et al., 2012). Methods and tools are used such as the ecological footprint, material flow analysis, substance flow analysis and accounting energy analysis (Dias & al., 2014). Some of them are connected with environmentally extended input output analysis (Wang & al., 2013; Minx & al., 2011; Larsen & Hertwick, 2010; Rosado & Ferrao, 2009; Wang & al., 2009; Lenzen & Peters, 2009; Okadera & al., 2006; Lenzen & al. 2004), physical input output tables (Liang et al., 2010) and hybrid input output Life Cycle Assessment (Heinone, & al., 2011; Heinonen & Junnila, 2011).

### *Accounting approaches*

Typically, the System of Environmental and Economic Accounts (SEEA) provides information about the sectoral emissions within a country, i.e. they represent the total production-based emissions, but how many of these emissions are due to domestic final consumption and how many are due to foreign intermediate or final production? How to allocate these emissions generated during the production phase to final demand? These two types of approaches are called respectively production-based accounting and consumption-based accounting.

IOA fits perfectly to perform consumption-based accounting because it explicitly relates the different domestic and international final consumption drivers with intermediate production and imports. Using an EE-MIOT with greenhouse gas calculate the amount of domestically produced emissions that are either embedded in exports or actually consumed by domestic demand (Chen & Zhang, 2010).

The same issues arose at city level as city-based environmental accounting allows researchers to find out what emissions are generated within the city's boundaries but it is unknown what the underlying drivers are of these emissions. Since cities are a major focus of environmental impacts, a more detailed understanding of their underlying drivers is required,

in particular through the consumption-based approach: “*Consumption-based inventories therefore excludes GHG emissions from local production processes whose output is being consumed elsewhere. The more traditional production-based inventory, on the other hand, exclude GHG emissions in upstream processes located outside the municipal borders, but instead includes all direct GHG emissions from production processes located within the geographical boundaries of the municipality, regardless of where the output is consumed*” (Larsen and Hertwich, 2009, p. 792).

The challenge is to provide an overview of the environmental impacts associated with the consumption of goods and services by the households living in a city. The most of environmental impacts studied are greenhouse gas (GHG) emissions and fossil fuel consumption. Direct and indirect impacts are usually considered. Direct impacts are connected with household activities (heating, lighting, transportation) whereas indirect impacts concern the production of the goods and services consumed by the households (food, building materials, fuels...).

The consumption-based approach differs from conventional emissions inventories whose interest is to capture the life-cycle emissions associated to city activity, by defining different scopes considering different spatial boundaries and life-cycle perspectives (Kennedy et al. 2010).

Therefore, the IOA framework is well suited for both types of environmental accounting: production-based and consumption-based (see the formal discussion within IOA in Choi (2015)). In particular, IOA is especially useful for consumption-based accounting since it is not only an accounting framework but a modelling framework establishing explicit relationships between final demand and intermediate production, either “domestically” by using a single MIOT or between regions by using a MR-IOT, and these can also be related to different environmental impact by extending the IOTs with the required satellite accounts. For these reasons, EE-MRIOA is being established and accepted as the main approach to calculate carbon footprints of cities (Wright et al. 2011) and of nations (Tukker and Jansen 2006; Hertwich and Peters 2009; Minx et al. 2009).

#### *Data approaches at city level*

National IOT entail the consolidated monetary transaction between all sectors of an economy during a year, which require substantial statistical work. Therefore, MIOTs are not produced annually, instead national MIOTs are released one every few years with a few years of delay. Cities usually do not have statistical offices with enough resources to produce their own IOT, therefore city-based IOTs are not readily available. Therefore, IOA studies usually use national IOA to analyse the economic activity and environmental impacts associated to a particular city (Wiedmann, Chen, and Barrett, 2015). The idea is to consider that the city has the same productive structure than the country and, thus, the national MIOT can be used to model the city inter-sectoral relationships. Then, the final demand of the city is estimated by considering local demography and consumption data. The issue is that cities have very particular sets of industries, consumer habits, technologies and infrastructures, therefore production, consumption and emission patterns may differ considerably, even for cities within a country (Choi 2015). Thus, using national MIOTs to analyse either economic or environmental national data can mask local idiosyncrasies. That is why some studies complement national IO and environmental data with local bottom-up data (Dias & al., 2014; Ramaswami et al., 2008).

In some rare cases, city-based MIOTs are officially compiled by statistical offices when city-boundaries correspond to national sub-regions (Guo et al., 2012). Another option is to use regional MIOTs, which provide an intermediate solution between national and city-based IOTs, although they do not necessarily represent accurately a city’s production structure.

Finally, only one city-based PIOT has been constructed (Liang and Zhang, 2011) but not used for analysis. Note that some analyses in the literature are called Physical IO (PIO) analyses but correspond in fact to the EE-MIOT framework (Liang and Zhang 2012; H. Wang et al. 2018).

### *Analysis approaches*

The most common approach to assess environmental impacts associated to cities is the EE-MIOT framework using national MIOT and complementary local data to estimate local demand, e.g. to assess carbon emissions (Long & al., 2019; Wiedmann, Chen, and Barrett 2015) or virtual water flows (Okadera, Watanabe, and Xu 2006b).

However, EE-MR-IOTs are used precisely to be able to calculate the consumption-based perspective of different environmental impacts, e.g. for GHG (Wiedmann, Chen, and Barrett 2015) and water flows (Han et al. 2015). It is interesting to note that both studies nest different regional scales within the MR-IOT: a city-based, a regional, national and Rest-of-the-World (RoW) MR-IOT in the former and a city-based IOT, national and RoW MR-IOT in the latter.

## **IOA challenges at city-scale**

The main challenge remains having access to reliable city-scale inter-sectoral data. Most studies rely on national or regional IOTs to model city-level transactions, which is not appropriate since cities have very particular production, consumption and emission patterns (Choi, 2015). Some city-scale IOT are available in China (e.g. Beijing (Guo et al., 2012) and Xiamen (Vause et al., 2013)) but they are an exception. The challenge lies on producing data that would enable researchers to estimate the local production structure from the national or regional tables.

Also, all city-based analyses that aim to identify the environmental impacts use the environmentally extended IO framework (even if it is sometimes called physical input-output framework). However, using EE-MIOT implies that the structure of the studied system is based on monetary flows which do not represent the actual use of materials, which are the ultimate determinant of emission generation and resource consumption. In fact, EE-MIOT only reveal the flows that are embedded in final output, while PIOTs reveal *all* the actual flows – those embedded in production and those disposed to nature – induced by production (Altimiras-Martin, 2014). Thus, using the PIOT framework would be more appropriate to perform environmental IO analyses (UN et al., 2014). The PIOT framework could also be used in a multi-regional framework to assess consumption-based emissions between different regions. However, again, the availability of such data is a main issue, although some progresses have been made at city level since a PIOT has been constructed for the city of Suzhou (Liang and Zhang, 2011).



## References

- ALTIMIRAS-MARTIN A. (2014). “Analysing the Structure of the Economy Using Physical Input-Output Tables”, *Economic Systems Research*, 26 (4): 463–85. <https://doi.org/10.1080/09535314.2014.950637>.
- BARLES S. (2009). “Urban Metabolism of Paris and Its Region”, *Journal of Industrial Ecology*, 13 (6): 898–913. <https://doi.org/10.1111/j.1530-9290.2009.00169.x>.
- BULLARD C.W, HERENDEEN R.A (1975). “The Energy Cost of Goods and Services”. *Energy Policy* 3 (4): 268–78. [https://doi.org/10.1016/0301-4215\(75\)90035-X](https://doi.org/10.1016/0301-4215(75)90035-X).
- CHEN G. Q., ZHANG B. (2010). “Greenhouse Gas Emissions in China 2007: Inventory and Input–Output Analysis”. *Energy Policy*, The socio-economic transition towards a hydrogen economy - findings from European research, with regular papers, 38 (10): 6180–93. <https://doi.org/10.1016/j.enpol.2010.06.004>.
- CHOI T. (2015). “Understanding Environmental Responsibility of Cities and Emissions Embodied in Trade”. *Economic Systems Research* 27 (2): 133–53. <https://doi.org/10.1080/09535314.2015.1012638>.
- COLE S. (1987). “Growth, Equity and Dependence in a Restructuring City Region”. *International Journal of Urban & Regional Research* 11 (4): 461.
- COLE S. (1999). “In the Spirit of Miyazawa: Multipliers and the Metropolis”. In *Understanding and Interpreting Economic Structure*. Springer.
- DIAS A.C, LEMOS D., GABARRELL X., ARROJA L. (2014). “Environmentally Extended Input-Output Analysis on a City Scale – Application to Aveiro (Portugal)”. *Journal of Cleaner Production*, vol 75, p. 118 – 129.
- EUROSTAT (2001). *Economy-Wide Material Flow Accounts and Derived Indicators: A Methodological Guide*. 2000 ed. Luxembourg: Office for Official Publications of the European Communities.
- GRAEDEL T. E., BERTRAM M., FUSE K., GORDON R. B., LIFSET R., RECHBERGER H., SPATARI S. (2002). “The Contemporary European Copper Cycle: The Characterization of Technological Copper Cycles”. *Ecological Economics* 42 (1–2): 9–26. [https://doi.org/10.1016/S0921-8009\(02\)00101-5](https://doi.org/10.1016/S0921-8009(02)00101-5).
- GUA S., LING S., CHEN H., LI Z., LIU J.B, XU F.X, LI J.S (2012). “Inventory and Input–Output Analysis of CO2 Emissions by Fossil Fuel Consumption in Beijing 2007”. *Ecological Informatics* 12 (November): 93–100. <https://doi.org/10.1016/j.ecoinf.2012.05.005>.
- HAN M. Y., CHEN G. Q., MUSTAFA M. T., HAYAT T., SHAO L., LI S., XIA X. H. Xia, JI X. (2015). “Embodied Water for Urban Economy: A Three-Scale Input–Output Analysis for Beijing 2010”. *Ecological Modelling*, Ecological management for human-dominated urban and regional ecosystems, 318 (December): 19–25. <https://doi.org/10.1016/j.ecolmodel.2015.05.024>.
- HEINONEN J., KYRO R., JUNNILA S. (2011). “Dense Downtown Living More Carbon Intense Due to Higher Consumption: A Case Study of Helsinki”. *Environmental Resource Letters*. Vol 6, p. 1 – 9.
- HEINONEN J. JUNNILA S. (2011). “Case Study on the Carbon Consumption of Two Metropolitan Cities”. *International Journal of Life Cycle Assessment*, 16, p. 569-822.

- HENDRICKSON C.T, LAVE L.B, MATTHEWS H.S (2006). *Environmental Life Cycle Assessment of Goods and Services: An Input-Output Approach*. RFF Press. Washington, DC: Resources for the Future.
- HERTWICH E.G, PETERS G.P (2009). “Carbon Footprint of Nations: A Global, Trade-Linked Analysis”. *Environmental Science & Technology* 43 (16): 6414–20. <https://doi.org/10.1021/es803496a>.
- HEWINGS G.J.D, OKUYAMA Y., SONIS M. (2001). “Economic Interdependence Within the Chicago Metropolitan Area: A Miyazawa Analysis”. *Journal of Regional Science* 41 (2): 195–217. <https://doi.org/10.1111/0022-4146.00214>.
- HOEKSTRA R., VAN DEN BERGH J.C.J.M (2006), “Constructing Physical Input Output Tables for Environmental Modeling and Accounting: Framework and Illustrations”. *Ecological Economics*. Vol 59, Issue 3, September, p. 375 – 393.
- KENNEDY C., STEINBERGER J. & al. (2009). “Greenhouse Gas Emissions from Global Cities”. *Environmental Science & Technology* 43 (19): 7297–7302. <https://doi.org/10.1021/es900213p>.
- KENNEDY C. (2010). “Methodology for Inventorying Greenhouse Gas Emissions from Global Cities”. *Energy Policy*, Special Section on Carbon Emissions and Carbon Management in Cities with Regular Papers, 38 (9): 4828–37. <https://doi.org/10.1016/j.enpol.2009.08.050>.
- KITZES J. (2013). “An Introduction to Environmentally-Extended Input-Output Analysis”. *Resources*, vol 2, p. 489 – 503.
- JONES P., WILLIAMS J., LANNON S. (2000). “Planning for a sustainable city: An Energy and Environmental Prediction Model”. *Journal of Environment Planning and Management*, vol 43, 6, p. 855 – 872.
- LARSEN H.N, HERTWICH E.G (2010). “Implementing Carbon-Footprint Based Calculation Tools in Municipal Greenhouse Gas Inventories”. *Journal of Industrial Ecology*, vol 14, p. 965 – 977.
- LARSEN H.N., HERTWICH E.G (2009). “The Case for Consumption-Based Accounting of Greenhouse Gas Emissions to Promote Local Climate Action”. *Environmental Science and Policy* 12 (7): 791–798.
- LENZEN M., PETERS G.M (2009). “How City Dwellers Affect Their Resource Hinterland. A Spatial Impact Study of Australian Households”. *Journal of Industrial Ecology*, vol 14, p. 73 – 90.
- LEONTIEF W. (1977), *The Future of the World Economy*, A United Nations Study. New York. Oxford University Press.
- LEONTIEF W., STROUT A. (1963). Multiregional Input-Output Analysis. In: Barna T. (eds) *Structural Interdependence and Economic Development*. Palgrave Macmillan, London. [https://doi.org/10.1007/978-1-349-81634-7\\_8](https://doi.org/10.1007/978-1-349-81634-7_8)
- LEONTIEF W. (1941). *The Structure of American Economy, 1919-1929*. Cambridge, Mass.: Harvard University Press.

- LIANG S., ZHANG T. (2011). “Data Acquisition for Applying Physical Input-Output Tables in Chinese Cities: The Case of Suzhou”. *Journal of Industrial Ecology* 15 (6): 825–35. <https://doi.org/10.1111/j.1530-9290.2011.00372.x>.
- LIANG S., TIANZHU Z. (2012). “Comparing Urban Solid Waste Recycling from the Viewpoint of Urban Metabolism Based on Physical Input-Output Model: A Case of Suzhou in China”. *Waste Management* 32 (1): 220–25. <https://doi.org/10.1016/j.wasman.2011.08.018>.
- LOISEAU E., JUNQUA G., ROUX P., BELLON-MAUREL V. (2012). “Environmental Assessment of a Territory: An Overview of Existing Tools and Methods”. *Journal of Environmental Management*, 112, p. 213 – 225.
- LONG Y., YOSHIDA Y., FANG K., ZHANG H., DHONT M. (2019). “City-level Household Carbon Footprint from Purchaser Point of View by a Modified Input Output Model”. *Applied Energy*, 236, p. 379 – 387.
- MILLER R.E., BLAIR P.D (2009). *Input-Output Analysis: Foundations and Extensions*. 2nd ed. Cambridge UK: Cambridge University Press.
- MINX J. C., WIEDMANN T. R., WOOD G. P., LENZEN P.M, OWEN A., SCOTT K. (2009). “Input-Output Analysis and Carbon Footprinting: An Overview of Applications”. *Economic Systems Research* 21 (3): 187–216. <https://doi.org/10.1080/09535310903541298>.
- OECD (2008). ‘Measuring Material Flows and Resource Productivity: Synthesis Report’. OECD.
- OKADERA T., MASATAKA W., KAIQIN X. (2006). “Analysis of Water Demand and Water Pollutant Discharge Using a Regional Input-Output Table: An Application to the City of Chongqing, Upstream of the Three Gorges Dam in China”. *Ecological Economics* 58 (2): 221–237. <https://doi.org/10.1016/j.ecolecon.2005.07.005>.
- OKAMOTO N., TAKEO I. (2016). *Spatial Structure and Regional Development in China*. Place of publication not identified: Palgrave Macmillan.
- OWEN A., STEEN-OLSEN K. & al. (2014). “A Structural Decomposition Approach to Comparing MRIO Databases”. *Economic Systems Research* 26 (3): 262–83. <https://doi.org/10.1080/09535314.2014.935299>.
- RAMASWAMI A., HILLMAN T., JANSON B., REINER M., THOMAS G. (2008). “A Demand-Centered, Hybrid Life-Cycle Methodology for City-Scale Greenhouse Gas Inventories”. *Environmental Science & Technology* 42 (17): 6455–61. <https://doi.org/10.1021/es702992q>.
- ROBISON M H, MILLER J.R (1988). “Cross-Hauling and Nonsurvey Input-Output Models: Some Lessons from Small-Area Timber Economies”. *Environment and Planning A: Economy and Space* 20 (11): 1523–30. <https://doi.org/10.1068/a201523>.
- ROBISON M. H. (1997). “Community Input-Output Models for Rural Area Analysis with an Example from Central Idaho”. *The Annals of Regional Science* 31 (3): 325–51. <https://doi.org/10.1007/s001680050052>.

- ROBINSON M. H., MILLER J.R (1991). “Central Place Theory and Intercommunity Input-Output Analysis”. *Papers in Regional Science* 70 (4): 399–417. <https://doi.org/10.1007/BF01434596>.
- ROSADO L., NIZA S., FERRAO P. (2014). “A Material Flow Accounting Case Study of the Lisbon Metropolitan Area Using the Urban Metabolism Analyst Model”. *Journal of Industrial Ecology* 18 (1): 84–101. <https://doi.org/10.1111/jiec.12083>.
- SCHAFFARTZIK A., SACHS M., WIEDENHOFER D., EISENMENGER N. (2014), “Environmentally Extended Input-Output Analysis”. *Social Ecology Working Paper*, vol 154, September, Vienna. ISSN 1726-3816.
- SMITH P., MORRISSON W.I (1974) 2007. *Simulating the Urban Economy: Experiments with Input-Output Techniques*. 2nd (digital). London: Routledge.
- SUH S., LENZEN M., TRELOAR G., HONDO H., HORVATH A., HUPPES G., JOLLIET O. (2004). “System Boundary Selection in Life-Cycle Inventories Using Hybrid Approaches”. *Environmental Science & Technology* 38 (3): 657–64. <https://doi.org/10.1021/es0263745>.
- TUKKER A., JANSEN B. (2006). “Environmental Impacts of Products: A Detailed Review of Studies”. *Journal of Industrial Ecology* 10 (3): 159–82. <https://doi.org/10.1162/jiec.2006.10.3.159>.
- UN (2018). ‘World Urbanization Prospects: The 2018 Revision’. <https://population.un.org/wup/>.
- UN, European Union, FAO, IMF, OECD, and World Bank. (2014). *System of Environmental-Economic Accounting 2012: Central Framework*. New York; [Luxembourg]: UNO. <http://unstats.un.org/unsd/envaccounting/seearev/>.
- VAUSE J., LIJIE G., LONGYU S., JINGZHU Z. (2013). “Production and Consumption Accounting of CO2 Emissions for Xiamen, China”. *Energy Policy* 60 (September): 697–704. <https://doi.org/10.1016/j.enpol.2013.04.069>.
- WANG H., XIAN’EN W., JUNNIAN S., SHUO W., XIAOYU L. (2018). “Uncovering Regional Energy and Environmental Benefits of Urban Waste Utilization: A Physical Input-Output Analysis for a City Case”. *Journal of Cleaner Production* 189 (July): 922–32. <https://doi.org/10.1016/j.jclepro.2018.04.107>.
- WANG Y., PI-CHENG C., HWONG-WEN M., KUANG-LY C., CHIH-YU C. (2018). “Socio-Economic Metabolism of Urban Construction Materials: A Case Study of the Taipei Metropolitan Area”. *Resources, Conservation and Recycling* 128 (Supplement C): 563–71. <https://doi.org/10.1016/j.resconrec.2016.08.019>.
- WIEDMANN T., GUANGWU C., BARRETT J. (2015). “The Concept of City Carbon Maps: A Case Study of Melbourne, Australia: The Concept of City Carbon Maps”. *Journal of Industrial Ecology*, October, n/a-n/a. <https://doi.org/10.1111/jiec.12346>.
- WIEDMANN T., LENZEN M., TURNER K., BARRETT J. (2007). “Examining the Global Environmental Impact of Regional Consumption Activities – Part 2: Review of Input – Output Models for the Assessment of Environmental Impacts Embodied trade”. *Ecological Economics*, vol 61, p. 15 – 26.

- WEISZ H., DUCHIN F. (2006). “Physical and Monetary Input-Output Analysis: What makes the Difference?” *Ecological Economics*, 57, p. 534 – 541.
- WRIGHT L., COELLO J., KEMP S., IAN W. (2011). “Carbon Footprinting for Climate Change Management in Cities”. *Carbon Management* 2 (1): 49–60. <https://doi.org/10.4155/cmt.10.41>.
- ZHANG Y., YANG Z.F, FATH B.D (2010). “Ecological Network Analysis of an Urban Water Metabolic System: A Case Study of Beijing (China)”. *Science Total Environment*, 408, p. 4702 – 4711.

# Conclusion

In this conclusion I will provide a summary of conclusions for each of the chapters, identify the limitations of the research and possible contributions to the literature and suggest potential avenues for further research.

## Chapter 1

In chapter 1 (pp. 27-51), I tried to review the magnitude of our historical, present and estimates of future societal energetic metabolism, in order to obtain a generic understanding of the feasibility of moving towards a fully renewable-energy based societal metabolism in the future. The values obtained from different collected sources have all been converted to exajoules (EJ, p. 27), in order to enable comparison of anthropogenic energy use and production with the energy metabolism of the environment, the incoming energy flux from the sun, as well as future maximum planetary renewable energy harvest estimates per type of technology. It can be concluded, based on a rather rudimentary synthesis of previous literature estimates, that there is more than enough renewable energy available to replace more than the current worldwide energy consumption.

In addition, a brief review of the concept of energy return on energy invested (EROEI) was carried out – a frequently occurring metric inspired primarily by economic literature to describe the energy (or investment<sup>95</sup>) required for extraction of exhaustible resources such as fossil energy carriers. Based on this assessment, a second conclusion of chapter 1 is that the EROEI could be a useful metric to describe the historical depletion of exhaustible resources for a fixed energy system and system boundaries, but the EROEI is less suited to compare different trajectories or energy sources of a transition to a renewable energy-based society. The ERO(E)I concept is frequently misinterpreted because of shifting boundaries and the difficulty of comparing distinct energy systems with different characteristics and different types of energy sources, as has been for example the case for solar PV ‘total system efficiency’ (Ferroni and Hopkirk, 2016; Raugei et al., 2017; Ferroni et al., 2017). Another EROEI analysis of renewable energy transition was carried out by Schwartzman et al. (2016), with a particular focus on the feasibility of transitioning towards doubling energy provision solely by renewable resources. However, if climate change is the primary (and imperative) concern for a future energy transitions, it does not really matter how much energy is used to install the infrastructure, as long as the energy source is renewable. For example: even in the case that it is deemed highly energy intensive to produce solar PV panels compared to the resulting energy output of those panels (or even counterproductive in terms of energy requirement in a specific context), it might still be interesting to produce those panels – provided renewable energy is used – at a moment in time that there is an oversupply of renewable energy, for example from wind farms at a moment of high wind intensity. In this case, even considering a hypothetical highly energy-intensive solar PV production process, the energy is usefully converted in a solar PV panel, that later on will be able to provide energy when there is no wind but a relatively high solar PV output. Frequent misunderstandings and inconsistent system boundaries, make the EROEI method unsuitable for the comparison of energy transition scenarios.

The **limitations of chapter 1** reside in the rather ad-hoc collection of future renewable energy potential estimates, as I did not account for sector-specific requirements, material limits or

---

<sup>95</sup> Another well-known metric is EROI or Energy Return on Investment, describing the relative extraction of energy compared to financial investment. The chapter did not focus on this variant of EROEI.

environmental and planetary boundary limits. For a recent and more extended analysis of maximum planetary renewable energy harvest estimates that remain within the limits of planetary boundaries – including a comparison with estimates in the literature, the reader is referred to the excellent work of Desing et al. (2019). Design et al. (2019) modelled estimates for renewable energy potential in an integrated way (from the incoming solar energy flux to appropriate potential). They conclude also that there is ample renewable energy available, and that it is possible to provide every citizen on earth with 2000 watts of renewable energy power, without deploying solar energy capture in the deserts. When solar PV is deployed in the deserts, there could be 5000 watts renewable energy power available to every citizen on earth (equal to the current Swiss per capita energy provision). The estimates of Desing et al. (2019) – accounting for planetary boundaries – align fairly well with other estimates in the literature with respect to solar energy capture potential, terrestrial heat and hydro-power (already almost at its maximum potential), but are on the lower end (wind, tidal energy, wave energy) or substantially lower for other renewable energy estimates (wave, ocean heat and NPP (net primary production)).

## **Chapters 2 & 3**

**Chapter 2** is a collaborative paper characterizing the broad family of Integrated Assessment Models (IAMs), primarily focused on discussing how to characterize renewable energy according to a set of criteria (whether the resource is theoretically unlimited, whether critical materials are required in the production, whether climate change impacts the production of energy and whether emissions occur when producing energy), as well as to provide a generic review of IAMs (according to modelling methodology, whether the model addresses resource limitations, renewable energy assumptions, renewable energy emissions and timescale of the model). Subsequently, possible shortcomings of these models were discussed and a list of items were proposed that could help to broaden the debate around the application of IAMs and energy system models. The main conclusion of this chapter consists primarily of an exploration of the available set of integrated climate-energy models, informing subsequent chapters.

**Chapter 3** provides an overview of the historical development of a broad set of IAMs (World 3, DICE, IMAGE, MESSAGE, GEM-E3 and REMIND) that shaped contemporary climate and energy modelling and policy application, since the onset of integrated climate-energy modelling in the '70s. In addition to the historical overview, it provides a synthetic summary of the characteristics of the different modules (economy, energy, climate, biosphere) that are present in the models, and the solving strategy and model structure for each of the discussed models. The main conclusions are related to transparency, application of and model structure, and provides suggestions for further model development. The theoretical and applied contribution of IAMs to the understanding of climate and energy transition scenarios is evident from the historical overview, but questions remain on the transparency of model structure and model outputs. This criticism is in line with other recent research that questions the transparency and validity of those models for policy making, as well as suggest the enlargement of the theoretical framework of IAMs in order to improve and broaden applicability (Gambhir et al., 2019). Finally, the chapter concludes with an overview of climate-energy model application in the context of European policy making, opening up the question on the validity of model results for EU energy and climate policy (see also chapter 5).

## **Chapter 4**

Chapter 4 aims to synthesize current insights related to the functioning of climate models with a particular focus on the quantification of global and national carbon budgets, the role that

standard emission and concentration pathways play in climate modelling and integrated assessment modelling – linking to the ongoing debate on the viability of using the RCP8.5 representation concentration pathway as a possible future trajectory (Hausfather & Peters, 2020), as well as the implications of using carbon budgets for public policy.

The chapter questions primarily to which extent carbon budgets can be reliably quantified, and whether they are a sufficient and functional metric to assess future warming. The usefulness of a predefined carbon budget related to a maximum temperature increase, only holds if the assumption that temperature increase stops when emissions cease completely, also termed ‘Zero Emission Commitment’ (ZEC). In particular, considering existing uncertainty surrounding model intercomparisons on the magnitude of this ‘committed temperature rise’ (MacDougall, 2020) in the context of the ZEC-MIP model intercomparison project for the upcoming 2021 IPCC assessment, the chapter questions what kind of dynamics could be at play in determining the magnitude of the ZEC value. In the meantime, more recent research seems to suggest that this model-observed ‘near zero’ estimated temperature change might need to be revised upwards (Zhou et al., 2020).

Additionally, the chapter provides a review of recent literature that refute ‘one shot’ climate mitigation policy options such as geo-engineering and afforestation<sup>96</sup>.

Finally – considering the remaining uncertainties on zero emission commitment, the chapter concludes with a discussion on distribution of the remaining 1.5- and 2-degree warming carbon budget to different countries.

The main **limitations** of chapter 4 relate to an incomplete description and understanding of the functioning of the different climate models that informed the assessments that were used in the review. Nevertheless, according to recent research the proposed questions and observations related to committed warming after emissions cease proved to be viable to some extent, but only in the long term.

**Future research** in line with chapter 4 could be the further analysis of uncertainties related to carbon budgets, and a methodological assessment of quantification of carbon budgets on a scale below the national territory (regions, cities, up to personal carbon quota systems). Up to around the year 2008, a fairly wide range of research was carried out related to personal carbon quota exchange systems (with a notable mention of the work carried out by the Department for Environment, Food and Rural Affairs of the United Kingdom (Lane et al., 2008)), but I could not find more recent academic or institutional research that links recent methodological developments and more recent datasets to the concept of personal carbon quota for public policy making. Despite the low amount of institutional and academic publications on the matter, the Danish-French startup Tomorrow did create a mobile application to keep track of personal carbon emissions based on data accessible through personal accounts and mobile phones in 2019, but discontinued the development in exchange for a focus on helping companies to estimate their carbon footprint. The conceptualization and application of personal carbon budgeting schemes (especially from a public policy point of view) is deemed an especially promising avenue for future research.

## Chapter 5

Subsequent to chapter 3, chapter 5 aims to provide insights in the impact of uncertainties related to monetary valuation (such as the interest rate and social or institutional discount rate) on both

---

<sup>96</sup> A more detailed overview of the implausibility of using afforestation as a major and important climate mitigation policy has been published online at <https://floriandierickx.github.io/blog/2019/10/18/trees>.



global integrated assessment models and energy models used for European climate and energy policymaking, as well as discuss the shortcomings and characteristics of market-based versus regulatory climate policies. The main conclusion of the section on climate and energy modelling, is that the utilization of interest and discount rates in climate - or energy scenario modelling for short - to mid-term climate policy making renders model outcomes too uncertain to be of practical use if climate policy is to be pursued seriously. This observation or conclusion has recently been voiced in other literature (Anderson & Jewell, 2019). This modelling uncertainty adds up to the more fundamental uncertainty about future price developments of goods, services and technologies. In the realm of simple-cost benefit assessment models (such as DICE), it is prudently suggested that those models can be used to model any outcome due to their simplicity (as was for example the case in a modelling effort of PIK, and are therefore not a helpful tool to reflect in sufficient detail on possible future climate or mitigation scenarios. Criticism on these models was voiced recently by other scholars (Keen, 2020; Kuhnenn; 2020, p. 27). To overcome the uncertainties related to monetary valuation, it is suggested to use scenario-based models that do not use monetary optimization or discounting but rather explicit technology-specific and behavioral transition pathways as a basis for debating climate mitigation scenarios.

The chapter further outlines the literature that provide insights in the historical performance of the EU Emission Trading Scheme, concluding that this scheme did not work as designed, or at least proposed. It is not straightforward and would be intellectually dishonest to link the policy outcomes of the EU ETS solely to the use of monetary valuation in energy system modelling (used to argument for the set-up of the EU ETS), but it might be interesting to assess further the effectiveness of the use of market-based versus regulatory instruments and explore the advantages or disadvantages of each approach.

## **Chapter 6**

Chapter 6 aims proposes a narrative and review of the contemporary concept of circular economy, by reviewing the institutional background of organizations that helped the concept to ground in current discourse, the link between the circular economy concept and systems thinking and provides an overview of the existing toolset that can help to better understand the circular economy concept, as well as challenge the mainstream business-oriented interpretation of the concept and extend it to a paradigm that enables embedding sustainability solutions that are current not represented in the mainstream circular economy framework. Amongst others, we suggest for example to extend the focus to collaboration between regional and local actors, or adapting and further developing the existing methodologies (physical input-output modelling, systems analysis, ...) to be of use in guiding an informed transition.

## **Chapters 7 & 8**

Finally, **chapter 7** provides methodological reflections related to dynamical physical input-output modelling, in order to advance the systemic understanding of material cycling in relation to climate and energy modelling. Subsequent to a brief introduction of the input-output modelling framework, the chapter provides an an overview of the historical development and interrelationships between major existing material flow accounts, either on an aggregate (MFA) or sectoral (IO) level and using either monetary, physical or hybrid units. Finally, it provides a mathematical description of system dynamics models and proposes a conceptual link between system dynamics (or mathematically, dynamical systems) and input-output analysis, applied to recent work that proposes a dynamical input-output model that can be used to study the extraction of renewable resources in the input-output framework. This chapter

proposes to a certain extent a new link between system dynamics and input-output modelling, opening up avenues for further exploration and application of a dynamic and physical input-output modelling framework that enables the exploration of future energy and material transitions.

The **main limitation** of this chapter is that I did not take enough time to further develop and refine the method to be able to test a possible application of this framework applied to material flows, as this would help to better understand and further the methodological framework, and possibly compare results with existing energy and material flow assessments of physical exchanges between regions.

The question remains to which extent, in addition to studying material flows, energy use and production could be integrated in a dynamical input-output framework. This could be an interesting path for future research, for example to assess the energetic implications of increasing material recycling on an economy-wide scale. The research group of Emanuela Colombo at the Politecnico di Milano did work to a certain extent on the link between energy system models and input-output modelling in more details in recent years (*purple on the top in Annex I, M*), aiming at bridging energy systems modeling, thermodynamics and input-output modelling, albeit primarily from a monetary input-output perspective.

Finally, **chapter 8** provides a detailed overview of the different types of input-output models, input-output analysis, and concludes with a detailed analysis of the historical application of input-output analysis framework to cities, and suggests future research pathways for further development of the applicability of the input-output framework in urban areas.

# References

*References from the introduction and conclusion:*

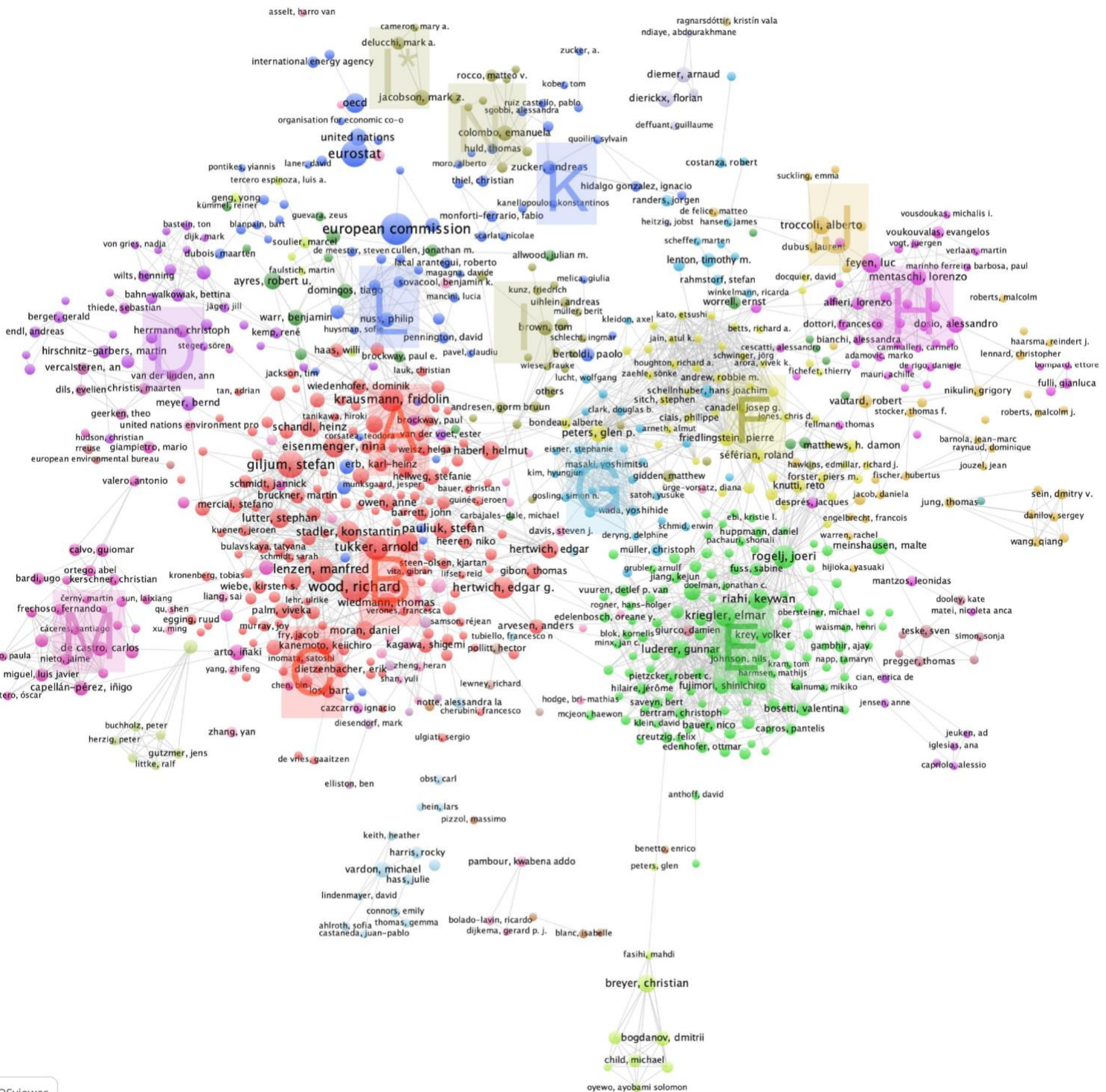
- Anderson, K., & Jewell, J. (2019). Debating the bedrock of climate-change mitigation scenarios. *Nature*, 573(7774), 348–349. <https://doi.org/10.1038/d41586-019-02744-9>
- BOKU SEC. (2020). *Data Download*. University of Natural Resources and Life Sciences, Institute of Social Ecology (SEC), Vienna, Austria. <https://boku.ac.at/en/wiso/sec/data-download>
- Ceballos, G., Ehrlich, P. R., & Dirzo, R. (2017). Biological annihilation via the ongoing sixth mass extinction signaled by vertebrate population losses and declines. *Proceedings of the National Academy of Sciences*, 114(30), E6089–E6096. <https://doi.org/10.1073/pnas.1704949114>
- Cardinale, B. J., Duffy, J. E., Gonzalez, A., Hooper, D. U., Perrings, C., Venail, P., Narwani, A., Mace, G. M., Tilman, D., Wardle, D. A., Kinzig, A. P., Daily, G. C., Loreau, M., Grace, J. B., Larigauderie, A., Srivastava, D. S., & Naeem, S. (2012). Biodiversity loss and its impact on humanity. *Nature*, 486(7401), 59–67. <https://doi.org/10.1038/nature11148>
- Corbera, E., Calvet-Mir, L., Hughes, H., & Paterson, M. (2016). Patterns of authorship in the IPCC Working Group III report. *Nature Climate Change*, 6(1), 94–99. <https://doi.org/10.1038/nclimate2782>
- Desing, H., Widmer, R., Beloin-Saint-Pierre, D., Hirschler, R., & Wäger, P. (2019). Powering a Sustainable and Circular Economy—An Engineering Approach to Estimating Renewable Energy Potentials within Earth System Boundaries. *Energies*, 12(24), 4723. <https://doi.org/10.3390/en12244723>
- Elhacham, E., Ben-Uri, L., Grozovski, J., Bar-On, Y. M., & Milo, R. (2020). Global human-made mass exceeds all living biomass. *Nature*, 1–3. <https://doi.org/10.1038/s41586-020-3010-5>
- Ferroni, F., & Hopkirk, R. J. (2016). Energy Return on Energy Invested (ERoEI) for photovoltaic solar systems in regions of moderate insolation. *Energy Policy*, 94, 336–344. <https://doi.org/10.1016/j.enpol.2016.03.034>
- Ferroni, F., Guekos, A., & Hopkirk, R. J. (2017). Further considerations to: Energy Return on Energy Invested (ERoEI) for photovoltaic solar systems in regions of moderate insolation. *Energy Policy*, 107, 498–505. <https://doi.org/10.1016/j.enpol.2017.05.007>
- Gambhir, A., Butnar, I., Li, P.-H., Smith, P., & Strachan, N. (2019). A Review of Criticisms of Integrated Assessment Models and Proposed Approaches to Address These, through the Lens of BECCS. *Energies*, 12(9), 1747. <https://doi.org/10.3390/en12091747>
- Gidden, M. J., Fujimori, S., van den Berg, M., Klein, D., Smith, S. J., van Vuuren, D. P., & Riahi, K. (2018). A methodology and implementation of automated emissions harmonization for use in Integrated Assessment Models. *Environmental Modelling & Software*, 105, 187–200. <https://doi.org/10.1016/j.envsoft.2018.04.002>
- Hausfather, Z., & Peters, G. P. (2020). Emissions – the ‘business as usual’ story is misleading. *Nature*, 577(7792), 618–620. <https://doi.org/10.1038/d41586-020-00177-3>

- Haas, W., Krausmann, F., Wiedenhofer, D., & Heinz, M. (2015). How Circular is the Global Economy?: An Assessment of Material Flows, Waste Production, and Recycling in the European Union and the World in 2005. *Journal of Industrial Ecology*, 19(5), 765–777. <https://doi.org/10.1111/jiec.12244>
- Haberl, H., Fischer-Kowalski, M., Krausmann, F., & Winiwarter, V. (Eds.). (2016). *Social Ecology: Society-Nature Relations across Time and Space*. Springer International Publishing. <http://link.springer.com/10.1007/978-3-319-33326-7>
- Keen, S. (2020). The appallingly bad neoclassical economics of climate change. *Globalizations*, 1–29. <https://doi.org/10.1080/14747731.2020.1807856>
- Kuhnhenh, K., Costa, L., Mahnke, E., Schneider, L., & Lange, S. (n.d.). *A Societal Transformation Scenario for Staying Below 1.5C* (Volume No. 23; Publication Series Economic + Social Issues). Heinrich Böll Stiftung.
- Krausmann, F., Fischer-Kowalski, M., Schandl, H., & Eisenmenger, N. (2008). The Global Sociometabolic Transition. *Journal of Industrial Ecology*, 12(5–6), 637–656. <https://doi.org/10.1111/j.1530-9290.2008.00065.x>
- Lane, C., Harris, B., & Roberts, S. (2008). *An analysis of the technical feasibility and potential cost of a personal carbon trading scheme*. A research report completed for the Department for Environment, Food and Rural Affairs by Accenture, working with the Centre for Sustainable Energy. Department for Environment, Food and Rural Affairs. <https://www.flemingpolicycentre.org.uk/TechnicalFeasibility.pdf>
- Majeau-Bettez, G., Wood, R., & Strømman, A. H. (2014). Unified Theory of Allocations and Constructs in Life Cycle Assessment and Input-Output Analysis: Unified Theory of Allocations and Constructs. *Journal of Industrial Ecology*, 18(5), 747–770. <https://doi.org/10.1111/jiec.12142>
- MacDougall, A. H., Frölicher, T. L., Jones, C. D., Rogelj, J., Matthews, H. D., Zickfeld, K., Arora, V. K., Barrett, N. J., Brovkin, V., Burger, F. A., Eby, M., Eliseev, A. V., Hajima, T., Holden, P. B., Jeltsch-Thömmes, A., Koven, C., Menviel, L., Michou, M., Mokhov, I. I., ... Ziehn, T. (2020). Is there warming in the pipeline? A multi-model analysis of the zero emission commitment from CO<sub>2</sub>. *Biogeosciences Discussions*, 1–45. <https://doi.org/10.5194/bg-2019-492>
- Raugei, M., Sgouridis, S., Murphy, D., Fthenakis, V., Frischknecht, R., Breyer, C., Bardi, U., Barnhart, C., Buckley, A., Carbajales-Dale, M., Csala, D., de Wild-Scholten, M., Heath, G., Jäger-Waldau, A., Jones, C., Keller, A., Leccisi, E., Mancarella, P., Pearsall, N., ... Stolz, P. (2017). Energy Return on Energy Invested (ERoEI) for photovoltaic solar systems in regions of moderate insolation: A comprehensive response. *Energy Policy*, 102, 377–384. <https://doi.org/10.1016/j.enpol.2016.12.042>
- Schwartzman, P. D., Schwartzman, D. W., & Zhang, X. (2016). Climatic implications of a rapid wind/solar transition. *ArXiv Preprint ArXiv:1603.06929*. <https://arxiv.org/abs/1603.06929>
- Steffen, W., Broadgate, W., Deutsch, L., Gaffney, O., & Ludwig, C. (2015). The trajectory of the Anthropocene: The Great Acceleration. *The Anthropocene Review*, 2(1), 81–98. <https://doi.org/10.1177/2053019614564785>
- Steffen, W., Rockström, J., Richardson, K., Lenton, T. M., Folke, C., Liverman, D., Summerhayes, C. P., Barnosky, A. D., Cornell, S. E., Crucifix, M., Donges, J. F.,

- Fetzer, I., Lade, S. J., Scheffer, M., Winkelmann, R., & Schellnhuber, H. J. (2018). Trajectories of the Earth System in the Anthropocene. *Proceedings of the National Academy of Sciences*, 201810141. <https://doi.org/10.1073/pnas.1810141115>
- Van Aalst, M. K. (2006). The impacts of climate change on the risk of natural disasters. *Disasters*, 30(1), 5–18. <https://doi.org/10.1111/j.1467-9523.2006.00303.x>
- van Eck, N. J., & Waltman, L. (2017). Citation-based clustering of publications using CitNetExplorer and VOSviewer. *Scientometrics*, 111(2), 1053–1070. <https://doi.org/10.1007/s11192-017-2300-7>
- Wiedmann, T. O., Schandl, H., Lenzen, M., Moran, D., Suh, S., West, J., & Kanemoto, K. (2015). The material footprint of nations. *Proceedings of the National Academy of Sciences*, 112(20), 6271–6276. <https://doi.org/10.1073/pnas.1220362110>
- Zhou, C., Zelinka, M. D., Dessler, A. E., & Wang, M. (2021). Greater committed warming after accounting for the pattern effect. *Nature Climate Change*, 1–5. <https://doi.org/10.1038/s41558-020-00955-x>

# Annex 1: Visual Bibliography

Below visualization displays the 1000 most frequently occurring authors that co-authored documents in the works (n = 11 165) that have been collected in the preparation of this dissertation. Authors have been clustered in 33 groups based on co-authorship using the VOSviewer application (van Eck & Waltman, 2017). Larger author-names indicate a higher number of documents in the bibliography. A detailed description of the different research communities displayed below can be found in the section ‘Schools of practice’ on page 19.



# Annex 2: Poster presentation



## Climate Change and Decarbonisation of the Industrial Structure Consumption-Based Accounting of Energy and Material Circularity

Florian Dierickx \*<sup>1, 2</sup>

Promotor : Arnaud Diemer<sup>1</sup>

Co-promoters : Kristín Vala Ragnarsdóttir<sup>2</sup>, Brynhildur Davíðsdóttir<sup>2</sup>

<sup>1</sup> Université Clermont Auvergne, CNRS, IRD, CERDI, F-63000 Clermont-Ferrand, France

<sup>2</sup> University of Iceland, 101 Reykjavik, Iceland



This project has received funding from the European Union's Horizon 2020 research and innovation programme under the Marie Skłodowska-Curie grant agreement No 675153

### [1] Problem statement and context

**Climate change** is a complex problem caused by a plethora of interlinked dependencies, but it can be summarized - *not considering land use change effects and biogeochemical processes and feedbacks* - to be a problem that is rooted in **how we produce, transform and transport materials, energy and ourselves**. A prerequisite for all of these processes is the need for **energy**. Knowledge on the [1] **scale & time** and [2] **characteristics** of those processes are imperative to think about solutions and put proposed policies in perspective:

**[a] Scale & Time** : biological and human energy revolutions altered fundamentally the energy captured by humans and the rest of the biological system on earth. **By 2000, the annual global energy flux through human societies was one third of the global terrestrial Net Primary Production (NPP) and one third above the total global energy flux through all non-human heterotrophic biomass.** This can be attributed largely to the industrial revolution and fossil fuel use increase in the last 150 years, by decoupling socially usable energy from bio-productive land and human labour. This has led to a **10-fold increase in global human energy use from 56 to 600 EJ/year** (Lenton et al., 2016; Haberl et al., 2007)

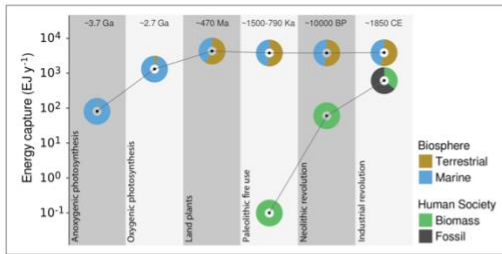


Figure 1: Energy capture in the biosphere and human society. Dates indicate beginning of the respective revolution, energy estimates are given for dates where energy regimes had matured (Lenton et al., 2016)

**[b] Characteristics of emission sources** : a contemporary snapshot of the current energy and material use in the EU learns that emissions originate from a variety of sectors, but the **energy sector is the main contributor**. Depending on future evolutions - assuming unchanged policy and consumption habits, energy production and use set to increase substantially with a decarbonisation and electrification of the transport system and industrial production (Wiebe, 2016)

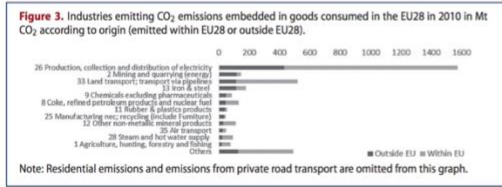


Figure 3: Industries emitting CO₂ emissions embedded in goods consumed in the EU28 in 2010 in Mt CO₂ according to origin (emitted within EU28 or outside EU28).

### [2] Focus and research questions

Inspired by the past and ongoing work on physical accounting by the **input-output, industrial ecology and open energy modelling** communities, this PhD zooms into the degree, types and scale of **interlinkages between material and energy cycles in the industrial structure**, with the hope of finding some parts of methodological and sector-specific answers on 'optimal' pathways to decarbonise our economy, energy and material use. To this extent, the PhD is divided in parts that try to answer:

**[a] What the most important energy-material interdependencies in the industrial structure are, how they developed over time (history), and how those activities impacted GHG emission levels** (see problem statement)

**[b] What the best suited method** is to analyse energy and material flows, including cycling of materials, in the whole economy. This is largely an integration of Input-Output, Life Cycle Analysis and (open source) Energy Model methods and tools.

**[c] What the available energy and material data are, what the institutional roles and responsibilities are, and what the institutional working groups plan to collect and provide in the future.**

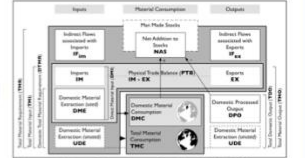
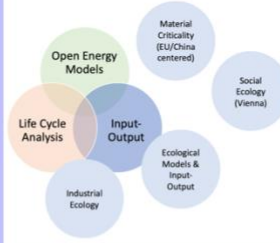


Figure 2: Material flow indicators. Based on OECD (2008).

**[d] What the policy implications** of having a strong methodological framework and data collection and availability could be.

### [3] Modelling Framework

A dynamic physical input-output (PIO) model that is capable to link with fine-grained LCA studies (Ecoinvent, ...)

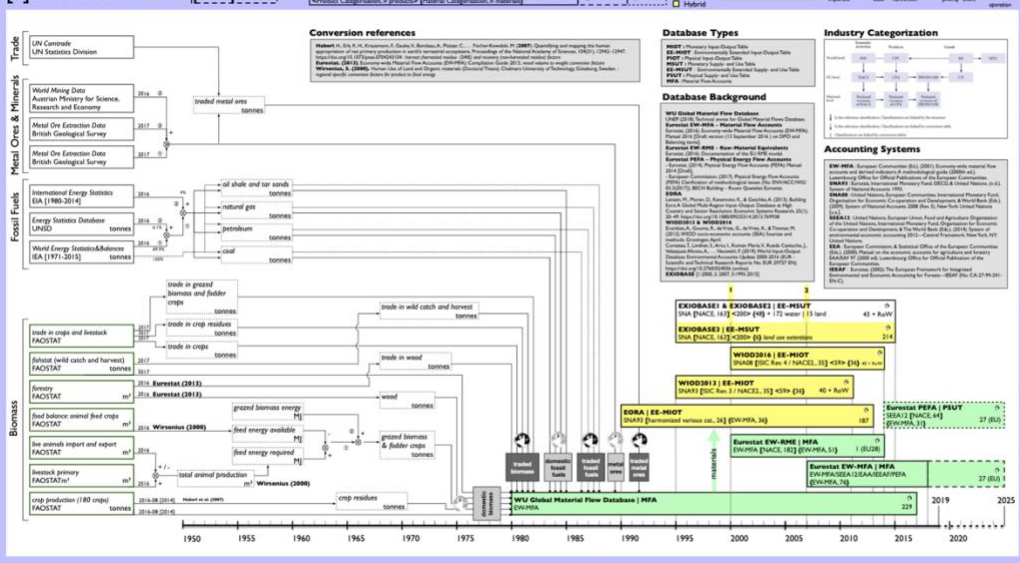
| Region i        | Region j | Region k | Foreign exports | Total |
|-----------------|----------|----------|-----------------|-------|
| Industry demand |          |          |                 |       |
| Final demand    |          |          |                 |       |
| Foreign imports |          |          |                 |       |
| Value added     |          |          |                 |       |
| Total           |          |          |                 |       |

Figure 2: Input-output table structure

Table 1: Types of IO models. <sup>1</sup> = physical, <sup>2</sup> = monetary

| Type                                  | Characteristics   |
|---------------------------------------|---|
| Monetary Input Output Model (IOM)     | Only production, no emissions   |
| Pollution Abatement IOM               | Including sectoral emissions (formulated as monetary 'damage' estimate)                                 |
| Environmentally Extended IOM          | External accounting of natural resources / environmental impact (based on calculation for given demand) |
| Hybrid IOM                            | Partially expressed in physical and monetary units (based on extrapolation of LCA studies)              |
| Physical IOM with emissions to nature | Representation of material/energy flows embedded in final production, including sectoral emissions      |

### [4] Available data prospects?



### [5] Policies

- Targeted consumption-based policies
- Personal carbon credit systems
- Fairer UNFCCC reporting
- Dynamic optimization of decarbonisation trajectories
- Reduced uncertainty and more efficient sector-based policies
- Fact-based climate diplomacy
- Labour-implications of planned climate transition
- Basis for a planning economy