



HAL
open science

Ecosystem Causal Analysis Using Petri Net Unfoldings

Giann Karlo Aguirre-Samboní

► **To cite this version:**

Giann Karlo Aguirre-Samboní. Ecosystem Causal Analysis Using Petri Net Unfoldings. Computer science. Université Paris-Saclay, 2023. English. NNT : 2023UPASG105 . tel-04556225

HAL Id: tel-04556225

<https://theses.hal.science/tel-04556225>

Submitted on 23 Apr 2024

HAL is a multi-disciplinary open access archive for the deposit and dissemination of scientific research documents, whether they are published or not. The documents may come from teaching and research institutions in France or abroad, or from public or private research centers.

L'archive ouverte pluridisciplinaire **HAL**, est destinée au dépôt et à la diffusion de documents scientifiques de niveau recherche, publiés ou non, émanant des établissements d'enseignement et de recherche français ou étrangers, des laboratoires publics ou privés.

Ecosystem Causal Analysis using Petri Net Unfoldings

Analyse Causale d'Ecosystèmes par dépliages

Thèse de doctorat de l'université Paris-Saclay

École doctorale n°580 (STIC)
Spécialité de doctorat : Informatique
Graduate School : Informatique et sciences du numérique
Réfèrent : ENS Paris-Saclay

Thèse préparée dans la unité de recherche Laboratoire Méthodes Formelles,
(Université Paris-Saclay, CNRS, ENS Paris-Saclay)
sous la direction de Stefan HAAR, INRIA senior scientist (directeur de recherche)
et le co-encadrement de Franck POMMEREAU, Professeur des universités.

Thèse soutenue à Paris-Saclay, le 14 Décembre 2023, par

Giann Karlo AGUIRRE-SAMBONÍ

Composition du jury

Alain DENISE Professeur, Université Paris-Saclay	Président
Dimitri LEFEBVRE Professeur, Université Le Havre Normandie	Rapporteur & Examineur
Madalena CHAVES Directrice de recherche, Inria d'Université Côte d'Azur	Rapporteuse & Examinatrice
Cédric LHOSSAINE Professeur, Université de Lille	Examineur
Jérôme FERET Chargé de recherche, Inria	Examineur

Titre: Analyse Causale d'Ecosystèmes par dépliages

Mots clés: Concurrence, Analyse causale, Systèmes de règles, Systèmes d'événements discrets, Dépliages

Résumé: De nombreux problèmes de vérification des systèmes concurrents ont été traités avec succès par diverses méthodes au fil des ans, en particulier les dépliages de réseaux de Petri. Cependant, les questions de comportement et de stabilisation à long terme ont reçu relativement peu d'attention. Par exemple, les caractéristiques cruciales de la dynamique à long terme des écosystèmes, telles que les *bassins d'attraction* et les *points de basculement*, restent difficiles à identifier et à quantifier avec une bonne couverture. L'une des principales raisons en est l'accent mis, dans la modélisation écologique, sur les modèles continus, qui fournissent des simulations raffinées mais ne permettent généralement pas d'étudier la manière dont l'évolution du système serait modifiée en cas d'événements supplémentaires ou dans des situations différentes. Dans ce travail, nous visons à fournir une boîte à outils pour l'analyse et la modélisation de la dynamique des écosystèmes. Nous proposons des *réseaux de Petri à réinitialisation sûre* pour la modélisation, car ils

ont le potentiel de donner une vue d'ensemble exhaustive des différents scénarios d'évolution possibles. Le dépliage des réseaux de Petri nous fournit les bons outils pour déterminer les trajectoires du système menant à l'effondrement et/ou à la survie, et finalement caractériser les actions ou inactions qui aident à soutenir la stabilisation de l'écosystème. Cette caractérisation de la production/consommation de jetons a été utilisée pour séparer les configurations *minimalement condamnées* des configurations *libres*, c'est-à-dire les exécutions conduisant inévitablement à l'effondrement du système même si ces exécutions ne sont pas identifiées a priori comme *mauvaises* et les exécutions qui maintiennent le système *stable*, en excluant les états *mauvais* ou *condamnés*, respectivement. Le déploiement des réseaux de réinitialisation sûrs et la partie algorithmique permettant de trouver des configurations *minimalement condamnées* ont été mis en œuvre avec succès dans un outil logiciel appelé Ecofolder et testés à l'aide de quelques exemples intrigants.

Title: Ecosystem Causal Analysis using Petri Net Unfoldings

Keywords: Concurrency, Causal analysis, Rule systems, Discrete event systems, Unfoldings

Abstract: Many verification problems for concurrent systems have been successfully addressed by various methods over the years, particularly Petri net unfoldings. However, questions of long-term behavior and stabilization have received relatively little attention. For instance, crucial features of the long-term dynamics of ecosystems, such as *basins of attraction* and *tipping points*, remain difficult to identify and quantify with good coverage. A central reason for this is the focus, in ecological modeling, on continuous models, which provide refined simulations but do not generally allow a survey of how the system evolution would be altered under additional events or in otherwise different situations. In this work, we aimed to provide a toolkit for modeling and analyzing ecosystem dynamics. We advocate for *safe contextual reset* Petri nets for modeling since they have the potential to give an exhaustively

tic overview of the different feasible evolution scenarios. The unfolding of Petri nets provides us with the right tools to determine system trajectories leading to collapse or survival and eventually characterize those actions or inactions that help to support ecosystem stabilization. This characterization of token's production/consumption was used to separate *minimally doomed* configurations from *free* ones, meaning executions leading *inevitably* to the system's collapse even though these executions are not identified a priori as *bad* ones and executions that keep the system *stable*, excluding *bad* or *doomed* states, respectively. The unfolding of safe reset nets and the algorithmic part for finding *minimally doomed* configurations have been successfully implemented in a software tool called Ecofolder and tested with some intriguing examples.

Contents

1	Context & Motivation	9
2	Ecosystem Modeling	13
2.1	Agent/Individual-based models (ABM or IBM)	14
2.2	Bayesian (belief) network (BN)	15
2.3	Co-occurrence analysis	15
2.4	End-to-end models	16
2.5	Ensemble ecosystem models	16
2.6	Fuzzy cognitive mapping (FCM)	16
2.7	Signed digraph/loop analysis models	17
2.8	Mass-balance models	17
2.9	Models of intermediate complexity for ecosystem assessments (MICE)	18
2.10	Interaction network analysis	19
2.11	Population dynamic models	19
2.12	State-and-transition models (STMs)	20
2.13	Structural equation models (SEMs)	20
2.14	Discrete Event Systems	22
2.15	Contextual Reset Petri Nets	23
2.15.1	Why Reset Nets?	23
2.15.2	Definitions	23
2.15.3	Attractors and fairness	26
2.15.4	Encoding of contextual reset nets	28
3	Unfolding Semantics For Complete Reset Nets	33
3.1	Occurrence nets	34
3.2	Branching processes	34
3.3	Configurations and cuts	36
3.4	Unfolding algorithm	38
4	Causal Analysis	45
4.1	Example: a model of a termite colony	45
5	Doom Avoidance	57
5.1	Case study: doom avoidance	59
5.2	The Bad, the Good, the Doomed, and the Free	60
5.3	Verification of freeness	61
5.3.1	Search for loops	61
5.4	Cliff-Edges and Ridges	63
5.5	Finding Minimally Doomed Configurations	64
5.5.1	Preparations: Shaving.	64
5.5.2	Algorithm MINDOO	65
5.5.3	Comments on MINDOO	68
5.6	Protectedness	68

5.6.1	Measuring the Distance from Doom	68
5.6.2	Defining protectedness	70
5.6.3	Computing Protectedness is Feasible	71
6	Case Studies	73
6.1	Microcosms of protists	73
6.1.1	The experiment	74
6.1.2	Rule system for microcosms of protists	76
6.1.3	Contextual reset net for microcosms of protists	76
6.1.4	A prefix of the unfolding for the microcosms of protists example	77
6.1.5	Analysis of $\{A+, B-, P+, E+, C+, T+\}$	78
6.1.6	Analysis of $\{A+, B+, P+, E+, C+, T+\}$	80
6.1.7	Analysis of $\{A-, B-, P+, E+, C-, T+\}$	81
6.1.8	Analysis of $\{A-, B-, P-, E+, C+, T+\}$	82
6.1.9	Analysis of $\{A+, B-, P-, E+, C+, T+\}$	83
6.1.10	Analysis of $\{A-, B+, P+, E+, C+, T+\}$	84
6.1.11	Analysis of $\{A-, B-, P+, E+, C+, T+\}$	84
6.1.12	Analysis of $\{A-, B-, P+, E-, C-, T+\}$	85
6.1.13	Analysis of $\{A+, B+, P-, E+, C+, T+\}$	86
6.2	Revisited termites colony	88
7	Conclusion & Outlook	91
7.1	Doom avoidance control	91
7.2	Regimes	91

“The love and maybe even the pride my dad felt the week before when his daughter asked if she could tell him she loved him—that emotion beat dementia and allowed him to form a new long-term memory that has lasted to this day”.

Healthy Brain, Happy Life
Wendy Suzuki

“The world will be saved not by calculation but by compassion (...).

It has at times seemed to me that killer whales and elephants are among the few who do”.

“We see the whole universe through a human lens. The harder step is to get outside ourselves, look back at where and how we live, and then take that understanding deep. Otherwise the likely ending is the saddest: there will be much less world left for people to fight over”.

Beyond words: What Animals Think and Feel
Carl Safina

“But the single most remarkable and defining moment of the past 500 years came at 05:29:45 on 16 July 1945. At that precise second, American scientists detonated the first atomic bomb at Alamogordo, New Mexico. From that point onward, humankind has the capability not only to change the course of history, but to end it”.

Sapiens: A Brief History of Humankind
Yuval Noah Harari

Acknowledgements

For three years, in the course of a pandemic, packing your life into suitcases to arrive in a foreign country (with a language other than Spanish or English), there are many people and metaphysical parties to whom I am grateful.

First of all, thank God, I myself consider it as a metaphysical structure that exists out there. I feel grateful to God because He allowed me to stay motivated with good physical and mental health to reach the milestone of finding and finishing my PhD. God gave me the opportunity to have two degrees, one in biology and one in computer science. Having two degrees in a country with scarce investment in science like Colombia, and managing to merge them in graduate studies beyond bioinformatics, was quite a challenge. In addition, the fact that we went through numerous difficulties, as human beings, can be considered miraculous, hence my gratitude to a powerful force that goes beyond our egos.

Secondly, many thanks to my family, who have always been by my side throughout my education. My siblings and my parents deserve recognition for their efforts in raising me (I am the youngest in the family). Being part of a low-income family in a developing country and that you can be the only one to have a PhD, that is teamwork and it is a feat for everyone. Thanks to them for their dedication as a family and their drive to see that we were all educated and economically stable; that achievement is not a trivial matter.

Thirdly, a huge thank you to Stefan, Franck, and Cédric for hosting, guiding, and discussing with me over these three years. All the effort, in terms of science and administrative procedures, has been worth it. Ecofolder was born thanks to all the entanglements we got to model side effects and side conditions in ecosystems and the disentanglements we achieved to integrate Petri net unfoldings in a software while performing causal analysis.

Fourthly, special thanks to all my friends (some colleagues too) who have influenced me (and to some extent) the person I am and who have impacted favorably the achievements I have reached. Some of my friends and colleagues are the people from the AVISPA research group in Colombia; Carlos, Jaime, Franck, Juan Francisco, Camilo Rueda, and Camilo Rocha were mentors and exemplary researchers to follow. Also, my French friends have been fundamental to my integration into French culture, having a social life, enjoying dance, and making routine more pleasant (during and after COVID lockdowns); namely, they are Gabriel, Céline, Nathan, Jeanne, and Emilie. Part of this list is also Rish, who, despite not being French, has been an excellent officemate to be accompanied by. And my Colombian friends who have been there even if distance and time have been between us, their constant support through kind words, sincere acts, and commitment to friendship are pivotal to staying uplifted in hard times; they are JS Herrera, JS Rojas, S Valencia, D Romo, Álvaro, Alomía, Marmolejo, Gloria, Vivian, Karol, Camilo S, Sofía A, Alejandra B, Nathalia S, JD Valencia, Laura R, Franciso V, Paula A, JL Marulanda, Diana R, Juliana, JD Moreno, Paula M, Harol T, Juan Pablo R, S Lozano, Natalia J, Natalia R, Jonathan S, Camilo V, Exneyder, Yi Lun, Sarah, Luisa, Carlos, Carolina, Braian, Alejandra L, Rocío, Isabel O, Marcela F, Jhon T, John R, Marcela C, Guillermo P and Arlen M. Daniel and Carlos, who were also PhD students at the same time I was, are now my friends that I met by coincidences of life; I admire their bravery and dedication to their fields, the best of luck for their careers!

Last but not least, I want to compliment Catalina Jaramillo for being my girlfriend

because life has put us together in a weird way: she is also Colombian, she graduated from the same university in Cali (my home city), but the first time we met was in Paris. Her emotional support and comradeship through thin and thick over daily life in Paris was and continues to be invaluable; this has been such a blessing.

For all of this, I dedicate this work to all the people mentioned above.

Agradecimientos

Durante tres años, en el transcurso de una pandemia, al empacar tu vida en unas maletas para llegar a un país extranjero (con un idioma diferente al español o al inglés), hay muchas personas y parte metafísica a las que me siento agradecido.

En primer lugar, gracias a Dios, yo mismo lo considero como una estructura metafísica que existe ahí fuera. Me siento agradecido a Dios porque me permitió mantenerme motivado con buena salud física y mental para alcanzar el hito de encontrar y terminar mi doctorado. Dios me dio la oportunidad de tener dos carreras, una en biología y otra en ciencias de la computación. El hecho de tener dos títulos en un país con poca inversión en ciencia como Colombia, y lograr fusionarlos en estudios de posgrado más allá de la bioinformática, fue todo un reto. Además, el hecho de atravesar numerosas dificultades, como seres humanos, puede considerarse milagroso, de ahí mi gratitud a una fuerza poderosa que va más allá de nuestros egos.

En segundo lugar, muchas gracias a mi familia, que siempre ha estado a mi lado durante toda mi formación. Mis hermanos y mis padres merecen un reconocimiento por su esfuerzo en criarme (soy el menor de la familia). Ser parte de una familia de bajos ingresos en un país en desarrollo y que tú puedas ser el único en tener un doctorado, eso es trabajo en equipo y es una hazaña para todos. Gracias a ellos por su dedicación como familia y su empuje por buscar que todos fuéramos educados y tener estabilidad económica; ese logro no es un asunto trivial.

En tercer lugar, un enorme agradecimiento a Stefan, Franck y Cédric por acogerme, guiarme y debatir conmigo durante estos tres años. Todo el esfuerzo, tanto científico como administrativo, ha merecido la pena. Ecofolder nació gracias a todos los enredos que conseguimos para modelizar los efectos secundarios y las condiciones secundarias en los ecosistemas y a los desenredos que logramos para integrar los desdoblamientos de las redes de Petri en un software mientras realizábamos análisis causales.

En cuarto lugar, un agradecimiento especial a todos mis amigos (algunos colegas también) que me han influenciado (y hasta cierto punto) en la persona que soy y que han impactado favorablemente en los logros que he alcanzado. Algunos de mis amigos y colegas son las personas del grupo de investigación AVISPA en Colombia; Carlos, Jaime, Franck, Juan Francisco, Camilo Rueda y Camilo Rocha fueron mentores e investigadores ejemplares a seguir. También, mis amigos franceses han sido fundamentales para mi integración en la cultura francesa, tener una vida social, disfrutar del baile, y hacer la rutina más agradable (durante y después de los encierros COVID); a saber, son Gabriel, Céline, Nathan, Jeanne, y Emilie. También forma parte de esta lista Rish, que, a pesar de no ser francés, ha sido una excelente compañía para compartir oficina. Y mis amigos colombianos que han estado ahí aunque la distancia y el tiempo se hayan interpuesto entre nosotros, su apoyo constante a través de palabras amables, actos sinceros y compromiso de amistad son fundamentales para mantenerme animado en tiempos difíciles; ellos son JS Herrera, JS Rojas, S Valencia, D Romo, Álvaro, Alomía, Marmolejo, Gloria, Vivian, Karol, Camilo S, Sofía A, Alejandra B, Nathalia S, JD Valencia, Laura R, Franciso V, Paula A, JL Marulanda, Diana R, Juliana, JD Moreno, Paula M, Harol T, Juan Pablo R, S Lozano, Natalia J, Natalia R, Jonathan S, Camilo V, Exneyder, Yi Lun, Sarah, Luisa, Carlos, Carolina, Braian, Alejandra L, Rocío, Isabel O, Marcela F, Jhon T, John R, Marcela C, Guillermo P y Arlen M.

Daniel y Carlos, quienes también fueron estudiantes de doctorado al mismo tiempo que yo, son ahora mis amigos que conocí por coincidencias de la vida; admiro su valentía y dedicación en sus campos, ¡la mejor de las suertes para sus carreras!

Por último, pero no menos importante, quiero agradecer a Catalina Jaramillo por ser mi novia porque la vida nos ha juntado de una manera extraña: ella también es colombiana, se graduó de la misma universidad en Cali (mi ciudad natal), pero la primera vez que nos conocimos fue en París. Su apoyo emocional y compañerismo en las buenas y en las malas de la vida diaria en París fue y sigue siendo invaluable; ha sido una gran bendición.

Por todo ello, dedico este trabajo a todas las personas mencionadas anteriormente.

Remerciements

Pendant trois ans, au cours d'une pandémie, en mettant sa vie dans des valises pour arriver dans un pays étranger (avec une langue autre que l'espagnol ou l'anglais), il y a beaucoup de personnes et de parties métaphysiques à qui je suis reconnaissant.

Tout d'abord, je remercie Dieu, que je considère moi-même comme une structure métaphysique qui existe. Je suis reconnaissant à Dieu parce qu'il m'a permis de rester motivé, avec une bonne santé physique et mentale, pour franchir l'étape de la recherche et de l'obtention de mon doctorat. Dieu m'a donné l'opportunité d'avoir deux diplômes, l'un en biologie et l'autre en informatique. Avoir deux diplômes dans un pays qui investit peu dans la science comme la Colombie, et réussir à les fusionner dans des études supérieures au-delà de la bio-informatique, a été un véritable défi. En outre, le fait que nous ayons traversé de nombreuses difficultés, en tant qu'êtres humains, peut être considéré comme miraculeux, d'où ma gratitude à l'égard d'une force puissante qui dépasse notre ego.

Deuxièmement, un grand merci à ma famille, qui a toujours été à mes côtés tout au long de mes études. Mes frères et sœurs et mes parents méritent d'être reconnus pour les efforts qu'ils ont déployés pour m'élever (je suis le plus jeune de la famille). Faire partie d'une famille à faibles revenus dans un pays en développement et être le seul à avoir un doctorat, c'est un travail d'équipe et c'est un exploit pour tout le monde. Merci à eux pour leur dévouement en tant que famille et leur volonté de faire en sorte que nous soyons tous éduqués et économiquement stables ; cette réussite n'est pas anodine.

Troisièmement, un grand merci à Stefan, Franck et Cédric pour m'avoir accueilli, guidé et discuté avec moi pendant ces trois années. Tous les efforts, en termes de science et de procédures administratives, en ont valu la peine. Ecofolder est né grâce à tous les enchevêtrements que nous avons obtenus pour modéliser les effets secondaires et les conditions secondaires dans les écosystèmes et les désenchevêtrements que nous avons réalisés pour intégrer les dépliages de réseaux de Petri dans un logiciel tout en effectuant une analyse causale.

Quatrièmement, je remercie tout particulièrement tous mes amis (et certains collègues) qui ont influencé (et dans une certaine mesure) la personne que je suis et qui ont eu un impact favorable sur les résultats que j'ai obtenus. Certains de mes amis et collègues sont les membres du groupe de recherche AVISPA en Colombie ; Carlos, Jaime, Franck, Juan Francisco, Camilo Rueda et Camilo Rocha ont été des mentors et des chercheurs exemplaires à suivre. Par ailleurs, mes amis français ont joué un rôle fondamental dans mon intégration à la culture française, en me permettant d'avoir une vie sociale, d'apprécier la danse et de rendre la routine plus agréable (pendant et après les fermetures de COVID) ; il s'agit de Gabriel, Céline, Nathan, Jeanne et Emilie. Une partie de cette liste comprend également Rish, qui, bien qu'il ne soit pas français, a été un excellent compagnon de bureau pour être accompagné. Et mes amis colombiens qui ont été là même si la distance et le temps nous ont séparés, leur soutien constant à travers des mots gentils, des actes sincères, et l'engagement de l'amitié sont essentiels pour rester optimiste dans les moments difficiles ; Il s'agit de JS Herrera, JS Rojas, S Valencia, D Romo, Álvaro, Alomía, Marmolejo, Gloria, Vivian, Karol, Camilo S, Sofía A, Alejandra B, Nathalia S, JD Valencia, Laura R, Franciso V, Paula A, JL Marulanda, Diana R, Juliana, JD Moreno, Paula M, Harol T, Juan Pablo R, S Lozano, Natalia J, Natalia R, Jonathan S, Camilo V, Exneyder, Yi Lun,

Sarah, Luisa, Carlos, Carolina, Braian, Alejandra L, Roc io, Isabel O, Marcela F, Jhon T, John R, Marcela C, Guillermo P et Arlen M. Daniel et Carlos, qui étaient également doctorants en même temps que moi, sont maintenant mes amis que j'ai rencontrés par les hasards de la vie ; j'admire leur courage et leur dévouement à leurs domaines, je leur souhaite bonne chance pour leur carrière !

Et pour conclure, je tiens à remercier Catalina Jaramillo d'être ma petite amie, car la vie nous a réunis d'une manière étrange : elle est également colombienne, elle est diplômée de la même université que moi à Cali (ma ville natale), mais nous nous sommes rencontrées pour la première fois à Paris. Son soutien émotionnel et sa camaraderie dans la vie quotidienne à Paris ont été et continuent d'être inestimables ; cela a été une telle bénédiction.

Pour tout cela, je dédie ce travail à toutes les personnes mentionnées ci-dessus.

1 - Context & Motivation

The significant changes brought about by human activities in atmospheric conditions, global-scale cycles of chemicals and biology, and biodiversity strongly indicate a notable shift in the Earth's epoch, commonly known as the Anthropocene³¹. Modern humans may have produced such alterations when they arose between 260,000 and 350,000 years ago¹²², a tiny portion regarding the age of Earth 4.56 billion years²⁹. Since then, humanity has reached a weight of only a quarter of terrestrial biomass (0.01%) compared to viruses (0.04%), which remains insignificant compared to plants (82.54%) or bacteria and archaea (14.12%)¹². Despite their insignificance in time and biomass, the Anthropocene epoch might be true since humans have altered ecosystems across a vast portion of the terrestrial biosphere, ranging from 75% to 95%³⁷.

Among these affections on Earth, there is a critical one: *climate change*. The combustion of fossil fuels, the extensive clearing of forests, and certain agricultural and industrial activities contribute to the emission of greenhouse gases, particularly carbon dioxide and methane¹¹⁶. These greenhouse gases act like a blanket, absorbing a portion of the heat that the Earth emits as it warms in response to solar radiation. Increased concentrations of these gases lead to greater heat retention in the Earth's lower atmosphere, resulting in the phenomenon known as *global warming*. Nonetheless, climate change recognizes that the consequences of global warming are not limited to rising temperatures alone. It encompasses the broader and more complex shifts in the Earth's climate system, which include both warming and its associated effects, such as altered weather patterns, melting ice caps, rising sea levels, and disruptions to ecosystems.

Therefore, this multifaceted impact on Earth's climate system influences across ecosystems and, notably, their *processes* and *services*.

Ecosystem processes: may be explained as the flow of energy and matter within an ecosystem that triggers transformations in its inner abiotic and biotic complexes, e.g., decomposition (bacteria and fungi desintegrate dead organic matter), nutrient cycling (like carbon, nitrogen and phosphorus are constantly cycling between the living and non-living components of the ecosystem), primary production (plants and photosynthetic organisms convert sunlight into energy through photosynthesis which forms the basis of food chains), root competition and shading (plants compete for space to reach resources like water and nutrients, and also for light, which in turn shapes distribution, abundance and composition of plant species), pollination (pollen transfer to enabling fertilisation and production of seeds, typically carried out by animals or wind) natural disturbances (like wildfires and rainfall create opportunities for new species to arise), species interaction (relations among species in an ecosystem such as predation, competition, comensalism, mutualism, and parasitism which shape ecosystem's structure and function).

Ecosystem services: mean the range benefits *healthy* ecosystems and the natural environment have on humans; these services are essential for human survival, quality of life, and overall prosperity. They are divided in four categories⁵:

Provisioning services: are tangible products obtained by ecosystems like water

(drinkable and non-drinkable), raw materials (timber, fiber, medicinal components on plants or corals) and food resources (fruits, vegetables, seafood, etc.).

Regulating services: are the *benefits obtained from the regulation of ecosystem processes*. This includes the control of climate through carbon sequestration, purification of water through wetlands and forests, disease regulation through the control of pests and pathogens, erosion regulation like coral reefs protecting from the pounding of waves, and moderation of extreme events like aquifers during droughts.

Cultural services: refer to the *non-material world like spiritual (religious retreats, heritage value), aesthetics (e.g. relief or wonder sensation when looking at a landscape or seascape), recreational (eco-tourism, snorkelling, diving, hiking and other outdoor sports), cognitive (scientific discovery, fieldwork) and cultural (flag species, use of nature as inspirations for films, books, national symbols) activities derived from ecosystems that humans enjoy*. They are hard to quantify as whole in monetary terms, for example, small-scale fishing goes beyond of income and food, it is tightly attached to fishers' way of life⁴³.

Supporting services: mainly understood as the *backbone* of the other three services. Supporting services are strongly tied to ecosystem processes because they encompass essential functions like nutrient cycling, primary production, soil formation, and habitat provision. These functions enable ecosystems to sustain the delivery of vital services for humans like food supply, agriculture, livestock, flood regulation, and water purification.

In short, ecosystem services are the foundation of human well-being and economic development. They underpin various industries like crop and livestock production, aquaculture, fisheries and forestry for food and non-food products, and provide the basis for economic activities. However, we may find a contradiction because despite of the significance of ecosystem services, they often go unnoticed until ecosystems are disrupted or degraded, and thereafter this degradation distorts human's lives and economies.

To be precise, the contradiction goes as follows: human activities such as deforestation, overfishing, urbanization, and pollution can jeopardize ecosystems, but humans rely on ecosystems to *survive*, so why do humans base their economies on *de facto* destructive actions of their habitat? The answer to this question goes beyond this manuscript's scope, but historical reasons like wars and industry development laid the stage wherein humans are the main actors of climate change. See figure 1.1.

Now, on one hand we have ecosystems and their corresponding services for humans and on the other hand we have manufacturing processes and supply chains (raw materials --> production --> product delivery --> consumer utilization --> disposal). While, the latter has a major and lasting understanding throughout economies, societies and industries, even the creation of new ways of implement supply chains as of by reusing or recycling products (instead of disposing)^{88,23}, the former is poorly understood and investigated, in comparison to the latter.

To see this point more clear and illustrate the immense disproportion, children around 3 to 5 year old have already emerging knowledge of identifying industrial brands rele-

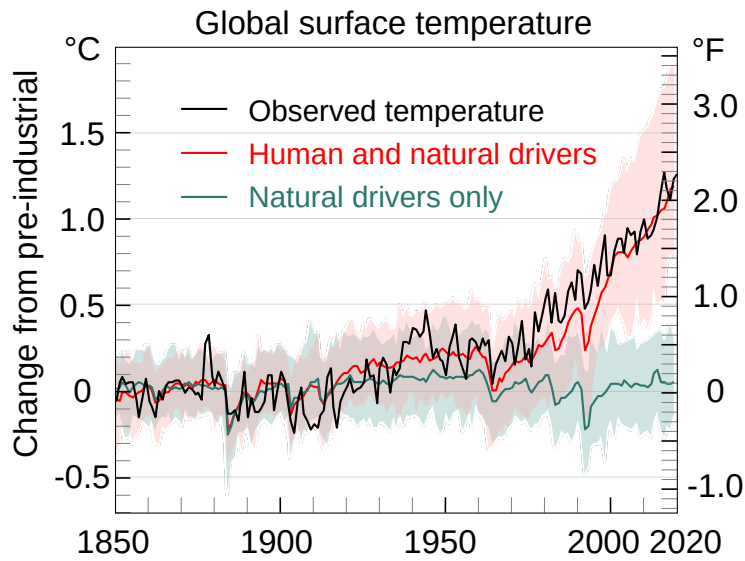

Figure 1.1: Shift in average surface air temperature from the onset of the Industrial Revolution to the present, along with the factors driving this transformation. Human actions have been the primary drivers of rising temperatures²⁷. Source: Efbrazil ©.

vant in their lives (irrespective whether those brands are marketed primarily to teens and adults)⁹¹, whereas humanity have been unable to identify and to provide a complete catalogue of the diversity of life on Earth: only around one sixth of the planet’s life is known. Estimation says that there are approximately 8.7 million eukaryotic species globally but only 1.2 million species have been already catalogued, then it is suggested that around 86% of existing species on Earth and 91% of species in the ocean still await description⁹⁷. To close this knowledge gap, humans would need 1,200 years and demand the efforts of an estimated 303,000 taxonomists with the current rates of species identification, and with associated costs reaching approximately 345 billion EUR⁹⁷ (less than the production value of the automotive retail industry in France ~397 billion EUR in 2017²²). Nevertheless, a stark reality is that extinction rates surpass natural background rates by a staggering factor of 100 to 1,000¹⁰⁷, then many species may vanish before humans even uncover their existence. Consequently, this significant disproportion, the suggestion of humans overall disconnection with nature which could potentially lead to significant repercussions regarding human emotions, values, and attitudes toward nature^{25,124}, and the alarming pace of biodiversity decline present a compelling imperative to accelerate discovering the Earth’s remaining species and understanding their interrelated ecosystems.

In this work we address the paramount issue of understanding ecosystems by providing a tool for modeling and studying their joined dynamics. Although we do not resolve the underlying problem of climate change, we contribute with a method to understand long-term behaviors of ecosystem dynamics. In chapter 2 we present an overview of known approaches to model ecosystems and our modeling method using contextual safe reset Petri nets and encodings. In chapter 3 we present the general procedure to unfold these nets with well-known cutoff criteria, namely, McMillan (1993), and Esparza, Römer and Vogler approaches (2002). In chapter 4 we examine thoroughly a toy model of termites conceptualizing notions said in the previous chapters and interpreting outcomes of the

example. In chapter 5 we offer the means to avoid *doom*. In essence, we explore methods for steering clear of concurrent executions (configurations) in which any maximal extension inevitably ends up in a state considered to be fatal. In chapter 6 we explore some examples of ecosystems to pinpoint how our approach is well-suited when some states are desired or undesired in different scenarios. In chapter 7 we conclude this work, and envisage future avenues and remaining questions to solve after this research.

2 - Ecosystem Modeling

Ecosystem modeling is the process of developing mathematical or conceptual models to simulate and analyze the interactions between biotic (living) and abiotic (non-living) components of an ecosystem. It implies a complex array of interacting complexes, processes, social and policy dimensions, and scientific disciplines³⁴. The lack of information base available for assessments to combine all these relationships has historically interfered with the implementation of complex ecosystem modeling⁵⁴. This phenomenon has gradually changed over recent decades with an increasing demand on ecosystem modeling approaches⁵⁴.

Ecosystem models aim to include all the components that conform an ecosystem such as different groups of organisms, populations, and interactions between them, along with the processes like the effects of disturbances, predator-prey relationships, and migration patterns. All of these components are integrated into a single framework for modeling purposes⁵⁴. Ecosystem models are parametrized using data gathered from field studies, experiments, or the input of experts. These models are used to make predictions or inferences about specific parts of an ecosystem, such as individual species, the ecosystem as a whole, or even the larger socio-ecological system. Parameters are set in the model based on the data collected, which is then used to generate these predictions^{106,47,54}.

Ecosystem models are frequently represented as networks, in which the nodes represent the different ecological components that interact with one another, and the edges illustrate the causal relationships between them. These models were created to help ecologists separate and anticipate the results of intricate interactions among various components of an ecosystem in a meaningful manner^{140,106,41}.

When creating ecosystem models, there is often a trade-off between using highly complex approaches that are limited to the specific system being studied, and simpler approaches that sacrifice some complexity in order to apply the model to a broader range of ecosystems and situations⁹⁹. Finding the right balance between these two approaches is crucial, as overly complex models may not be applicable outside of the sample system, while overly simplistic models may not capture the nuances and intricacies of the ecosystem being studied^{114,147}.

In order for ecosystem models to be practical and effective, it is essential that their qualities and structure are tailored to the specific decision problem or management application being addressed⁴⁷. This means that the model should be designed to capture the relevant ecological processes and factors that are important to the particular management or decision-making context⁸³. Failure to properly match the model's structure to the specific application may lead to inaccurate predictions or ineffective management strategies. Therefore, it is crucial to carefully consider the purpose and goals of the model before designing and implementing it⁴⁷. In addition, an ecosystem modeling selection needs to contemplate caveats proper to natural environments:

lack of specification: Unlike human-made systems, which are typically designed with a specific purpose and structure in mind, ecosystems are complex and dynamic, making them difficult to fully understand and model. This means that predicting how an ecosystem will behave or respond to changes can be challenging, as there is

no standardized set of rules or expectations that can be applied. Notwithstanding, when comparing to biological systems, of which many copies probably exist, the majority of ecosystems are unique and nobody can tell how they comport in the future¹¹³.

lack of data: When compared to biological or molecular systems, observations of ecosystems are often much sparser, meaning that there are fewer data points available to analyze and model the system. At the same time, ecosystems are typically much more complex systems than individual organisms or populations¹¹³.

wrong behavior are expected: Undesirable behaviors or outcomes are a natural and expected part of ecosystem dynamics, and must be taken into account when creating models to understand or manage them. For example, the extinction of species is a possibility in any ecosystem, and must be considered as a potential outcome in ecosystem models. By incorporating these potential undesirable outcomes into the model, it becomes possible to explore different scenarios and management strategies that can help to mitigate or avoid them¹¹³.

When there is a lack of specification or data, it may be necessary to use abstract models in order to make predictions or draw conclusions. However, it is important to note that the presence of inaccurate or wrong behaviors within the system can have a greater impact on the analysis than the actual modeling approach¹¹³. Next, we present briefly several common and broad approaches typically used in applied contexts. These approaches aim to solve real-world problems and often involve a combination of theoretical and empirical methods.

2.1. Agent/Individual-based models (ABM or IBM)

ABMs are a type of computational modeling used in ecological research that make an emphasis on individual agents or organisms and their interactions within an ecosystem⁶¹. In an ABM or IBM, individual agents are represented as autonomous, interacting entities with their own set of characteristics, behaviors, and decision-making rules. These agents can interact with each other and with their environment, and their behavior can be influenced by external factors such as resource availability, competition, predation, and environmental variability¹⁸.

The interactions between ecological components in an ecosystem can give rise to emergent properties, such as responses to disturbances or management actions. These interactions can involve different types of organisms and influence the overall properties of populations and ecosystems⁵⁴.

Therefore, ABMs and IBMs can be used to explore a wide range of ecological questions, such as the dynamics of invasive species, the impact of climate change on species distributions, the consequences of management interventions, spatial patterns in population dynamics and so forth. For example, Momeni and colleagues (2013) have identified two characteristics of spatial patterns in two-population microbial communities when the formation of patterns is influenced by fitness effects that are related to ecological interactions between cells⁹⁵. The first characteristic is that interactions providing considerable benefits to at least one of the populations can potentially result in a stable community. The second

one is that whereas two competing populations tend to segregate, cooperation may result in the members of the two populations mixing together⁹⁵.

2.2. Bayesian (belief) network (BN)

BN is an approach to represent ecosystem interactions as a graphical structure or as a chain of probabilistic events with causal relationships. The resulting network shows how changes in the probability of one ecosystem component flow through to affect the probability of other events occurring (e.g. absence of a species)⁵⁴.

In the graphical structure, nodes represent different variables or components, and edges between nodes represent the probabilistic dependencies between them¹⁹. The network structure can be learned from observational data, or it can be designed based on expert knowledge or literature review. The relationships in a Bayesian network can be independently quantified using a submodel suitable for the type and scale of information available¹⁹. This approach is particularly useful for ecological modeling because predictable patterns may emerge at a variety of scales, necessitating a multiplicity of model forms¹⁹.

For example, Borsuk et al. (2004) described a Bayesian network, integrating disparate models, to display the various processes related to eutrophication in the Neuse River estuary, North Carolina¹⁹. And Hradsky et al. (2017) utilized non-parametric (do not require prior specification of the number of parameters or structure of the network) BN to develop models that could predict the distributions of native fauna in a landscape with varying conditions. Their approach included explicit incorporation of interactions between factors such as habitat structure, invasive predators, fire, and other environmental conditions⁷¹. However, BNs have limitations in representing crucial feedback loops for ecosystem equilibria and cyclical dynamics (such as predator-prey cycles)⁵⁴.

2.3. Co-occurrence analysis

It is a statistical technique to identify and quantify the co-occurrence patterns of different species or taxa within a community or ecosystem⁵⁴. It involves analyzing the presence or absence of species across different samples or sites, and identifying patterns of associations or correlations between them²⁰. Co-occurrence analysis can be used to investigate a wide range of ecological questions, such as understanding the factors that drive the assembly of communities, predicting the impacts of environmental change on species interactions, or identifying potential keystone species that play important roles in maintaining community structure and function¹³.

One fundamental question has consistently revolved around the extent to which co-occurrence patterns are random or structured as a result of organizing processes. This question needs consideration within the context that species do not occur randomly in nature; rather, they all respond to variations in the environment¹³⁶. There are different methods for conducting co-occurrence analysis, including correlation-based approaches such as Pearson's correlation coefficient⁴⁹ or Spearman's correlation coefficient⁶², as well as network-based approaches that visualize and quantify the relationships between species as a network.

2.4. End-to-end models

This method differs from other models by attempting to represent the *entire* ecological system⁴⁷. It includes the entire food web and the corresponding abiotic environment, integrating physical and biological processes at different scales, allowing for two-way interactions between ecosystem components, and considering the dynamic effects of climate and human impacts across multiple trophic levels¹³³. However, developing such models can be challenging due to the high complexity of the represented species and functional groups, the variability of their biology, and the number and nature of their interactions. Moreover, the spatio-temporal scales of the processes involved can vary significantly, ranging from viruses to whales. Additionally, environmental factors can affect most ecosystem organisms, directly and/or indirectly, resulting in increased process complexity¹³³.

End-to-end models are well-suited for long-term planning purposes, but they are less effective in providing precise predictions for management strategies at an operational level, such as year-to-year planning. When the goal is to analyze a broader range of components and processes, such as predator-prey interactions across various trophic levels and perturbations at single-node and whole-of-ecosystem levels, an end-to-end model is suitable because it accounts for increasingly remote processes and components⁵⁴. The Atlantis end-to-end ecosystem model is an illustration of this, as it integrates various forms and scales of interactions, including those between predators and prey and between humans and species, in order to inform long-term, strategic management decisions⁴⁸.

2.5. Ensemble ecosystem models

They provide a technique that combines multiple models to improve predictions and reduce uncertainty. This approach involves constructing an ensemble of multiple ecosystem models, which may differ in their assumptions, parameters, or structure. The ensemble of models (based mainly on Lotka-Volterra differential equations or similar) is pivotal when anticipating the future dynamics of a complex and nonlinear system⁵⁴. In these scenarios, the collective predictions of numerous plausible models are preferable even if one single model offers the best fit to the available validation data⁸¹. The models are run simultaneously or sequentially, and the outputs are combined to produce a single prediction or set of predictions that account for the uncertainties in the individual models.

Ensemble ecosystem models have been used to address a wide range of ecological questions, including forecasting the impacts of climate change, predicting the distribution of species⁸⁷, and assessing the effects of management actions on ecosystem dynamics⁷.

2.6. Fuzzy cognitive mapping (FCM)

It is called “fuzzy” because it starts as qualitative conceptual models that can then be parametrized using experimental or field data or expert opinion⁵⁴. FCM is a type of causal network model that represents the relationships and interactions between ecological variables in a diagram. FCMs share connections with Bayesian and neural network models as they represent concepts or state variables along with their causal relationships or interactions within a signed graphical model⁷⁸. FCMs are particularly useful in ecological modeling because they can handle complex and uncertain relationships between

ecological variables⁸.

An FCM comprises nodes that represent species or other entities, interconnected by edges that represent the interactions between the nodes. The value assigned to each node usually ranges from 0 to 1, while the interaction strengths are between -1 and 1. A positive value indicates a positive impact of a node on the target node, while a negative value indicates a detrimental impact⁸. By allowing for the representation of uncertain and imprecise information, FCMs can account for the inherent uncertainty in ecological systems³⁶.

For example, Dexter et al. (2012)³⁶ used FCMs to predict relative estimates of abundance for different species in various scenarios at Booderee National Park, south-eastern Australia. They use fuzzy sets (linguistic description (e.g., "low", "moderate", "high")) to account for uncertainty regarding the true abundance of each species. Additionally, they incorporated a Monte-Carlo approach to aggregate predictions from multiple alternative models, thereby capturing uncertainty surrounding the impacts of poorly understood interactions in the system³⁶.

2.7. Signed digraph/loop analysis models

They are a graphical representation of an interacting ecological community, including both biotic and abiotic variables. The approach quantifies alterations in system components away from equilibrium based on feedback loops and other ecological changes, employing solely the interaction signs (+/-) between components⁵⁴. In a signed digraph model, nodes represent species, and edges represent ecological interactions, such as predation, competition, or mutualism⁶. Signed digraph models have been used to study a variety of ecological systems, from the dynamics of predator-prey relationships to the spread of invasive species. For example, in a predator-prey interaction, the positive benefit to a predator of consuming a prey represents a rate of birth, and the negative effect to the prey represents a rate of mortality⁶.

Signed digraph models offer the advantage of incorporating various life stages of a population, which proves valuable for integrating information across different habitats utilized by a species throughout its life cycle³². In these models, the connections represent processes that support or contribute to each life stage, including factors like fecundity rates, survival rates, or mortality rates⁶.

Additionally, many of these models incorporate links known as modified interactions³³, which account for environmental or ecological variables that can regulate the intensity of interactions among other variables. For instance, a predator's capacity to capture juvenile prey may be diminished if the juvenile prey seek refuge in coral structures. In this case, the coral structure modifies or suppresses the predator-prey interaction⁶.

2.8. Mass-balance models

They focus on the flows of energy and matter through an ecosystem, they simulate the transfer of energy and nutrients between ecosystem components (e.g. plants, herbivores, predators)⁵⁴. These models represent the various components of an ecosystem as pools of energy or matter, which can be modeled using mathematical equations⁸⁵. The models are typically based on the principles of conservation of mass and energy, which require

that the inflow of energy or matter into a pool must balance the outflow¹²⁷. Mass-balance models can be used to simulate the effects of various disturbances on an ecosystem, such as changes in climate or land use.

For example, Tesfaye and colleagues (2018)¹²⁷ analyzed the energy flow and trophic structure, evaluated the ecological maturity stage, assessed the impact of introduced exotic carp species, and examined the existing fishery within the Lake Koka ecosystem (Ethiopia) using a mass-balance model. They found that the introduced exotic carp species (*Cyprinus carpio*) occupies an unutilized niche and contributes to the system's recycling of organic matter¹²⁷.

One of the widely recognized models in this category is Ecopath, initially created by Polovina (1984)¹¹² to elucidate the net primary production necessary to sustain a tropical reef system. Over time, Ecopath has undergone modifications and expansions to accommodate various aquatic ecosystems and even terrestrial systems⁴⁵.

One advantage of mass-balance models like (Ecopath) is that they can work together in an ecosystem-based management context. They can identify and quantify significant energy flows within the system, provide descriptions of ecosystem resources and their interactions, assess the impacts of fishing activities or environmental changes on the ecosystem, and explore various management policy options^{85,109}. However, mass-balance models can be challenging to develop and require a significant amount of data on the flows of energy and matter in the system.

2.9. Models of intermediate complexity for ecosystem assessments (MICE)

They integrate ecological, human, and environmental components, where the model structure and format are designed based on individual decision-making problems⁵⁴. MICE models attempt to combine the best features of existing single-species models of relative simplicity and the capability to use standard statistical methods for parameter estimation, but also deem larger ecosystem considerations given a few well-defined objectives¹¹⁰. While whole-of-ecosystem models can be applied to specific parts of an ecosystem, they tend to be complex and cover significant portions of an ecosystem. On the other hand, MICE models are focused solely on the ecological components that are essential for addressing the specific management question at hand, making them less complex than whole-of-ecosystem models, yet more complex than single-species models since they still incorporate multiple components such as species or functional groups, as well as relevant processes¹¹⁰.

One example is the model conducted by Tulloch et al. (2019). They used a climate-biological coupled MICE that linked krill and whale population dynamics with climate change drivers: ocean temperature, primary productivity, and sea ice¹³⁴. Their models predicted future adverse impacts of climate change on krill and all whale species, i.e., predicted decreases in whale populations resulting from diminished prey (copepods/krill) due to warming and intensified inter-species competition. Nonetheless, they modeled whale population recovery under an alternative scenario whereby whales adapt their migratory patterns to align with changing sea ice and a shifting prey base¹³⁴. They found that plasticity in range size and migration would improve ice-associated whales' recovery, highlighting the importance of local management and protection to ensure the krill prey base and help depleted whale populations recover¹³⁴.

2.10. Interaction network analysis

It focuses on understanding the patterns and dynamics of species interactions within an ecosystem. It involves constructing a network of interactions between species, where each species (or ecosystem component) is represented as a node and their interaction relationships (e.g. predation, competition, facilitation) are represented as links between nodes⁵⁴. The analysis is delimited by ecological complexity (characterized by the number of interacting ecosystem components and the frequency of their interactions) which in turn has an intricate association with the ecological system's stability⁹⁰. This means that the assemblage and stability of an interaction network depends on ecosystem complexity.

Although, ecosystem complexity and stability can be related to different types of interaction networks, many studies have accentuated their research on trophic interactions¹²⁸. Nonetheless, architectural patterns observed in real food webs (or trophic interactions), including patterns of interaction strength in omnivory loops¹⁰² and allometric degree distributions¹⁰⁴, have been found to promote stability and facilitate species coexistence⁹⁶.

Therefore, one of the key advantages of interaction network analysis is that it allows ecologists to take a holistic view of an ecosystem by considering the interactions between multiple species^{68,126}. Thebault and Fontaine (2010) showed that (1) a combination of various architectural patterns (in food webs) permit to gain insights into the mechanisms driving community stability, and (2) the emergence of distinct network architectures is specific to different types of interactions¹²⁸.

2.11. Population dynamic models

They use life history traits (e.g. rates of birth, growth and death) to estimate size and structure of populations over time. These models are used to understand how populations grow, decline, and interact with each other and their environment⁵⁴. Population dynamic models can be used to study a wide range of organisms, from single-celled microbes to large mammals. They are typically represented by the age, size, or location of a species (or individuals) in mathematical equations to represent variation in vital rates within and between species populations^{54,67,24}.

These equations can be based on empirical data or theoretical assumptions about how populations function. One common type of population dynamic model is the predator-prey model, which explores the interactions between predator and prey populations. Other models focus on factors such as competition for resources, disease transmission, and the effects of environmental factors like climate change on population growth.

For example, Fordham et al. (2013) employed metapopulation models (include interactions of multiple interconnected populations occupying distinct habitat patches within a larger landscape) to project the spatial distribution and extinction risk of the Iberian lynx (*Lynx pardinus*) in the face of climate change, considering trophic interactions such as prey availability and disease dynamics⁴⁴. By integrating data on lynx movement, habitat suitability, and ecological processes, the models allowed for predictions of lynx population dynamics and the potential effects of changing environmental conditions^{44,54}. The results of their dynamic metapopulation model clearly demonstrated that the current level of habitat connectivity is insufficient to facilitate the necessary range movement for an effective natural adaptation response to the anticipated rate of environmental change for

the Iberian lynx in this century⁴⁴. Hence, the model allowed them to establish that a well-designed relocation strategy that considers the impacts of climate change, prey availability influenced by disease, and habitat connectivity will be paramount for the long-term persistence of the species, regardless of global decisions regarding greenhouse gas emissions mitigation⁴⁴.

2.12. State-and-transition models (STMs)

State-and-transition models were initially developed by the United States Department of Agriculture-Natural Resources Conservation Service (USDA-NRCS) for rangeland management as they enable the characterization of potential vegetation communities, describing the transitions between different vegetation communities resulting from management interventions, and providing insights into the anticipated benefits associated with each potential vegetation community^{17,15,77,84}.

STMs offer a broad scope for capturing vegetation dynamics. They have the capacity to incorporate various factors that influence vegetation change, such as fire regimes, soil erosion, weather variability, and management interventions²¹. However, the development of these models relies on available literature and expert opinion, rather than being primarily derived from or extensively tested with field data (although Bestelmeyer et al. (2011) mention the utilization of targeted experiments)^{82,14}.

STMs represent an ecosystem as a set of *alternative stable states*, whereby transitions occur between states when a set of parameters are altered, leading the system to shift into a new state⁵⁴. The technique is based on the idea that different biotic assemblages, referred to as “states,” can exist in a specific region due to varying physico-chemical conditions, and the changes between these assemblages (“transitions”) are influenced by identifiable and predictable processes¹⁴⁵. As previously said, STMs were created and applied specifically in the context of rangelands, which are characterized by discontinuous and non-reversible vegetation dynamics²¹. Hence, these models have found extensive application in rangeland management both in the United States¹⁶ and other regions⁵⁹.

Notwithstanding, other authors have widely conceived the application of STMs on ecosystems of any kind. Westoby et al. (1989) indicated that STMs serve as a versatile framework for organizing information about ecosystem change, and provide a flexible approach that can incorporate various concepts related to ecosystem dynamics¹⁴⁴. For example, Ludwig et al. (2007) discovered that the configuration of vegetation cover within a catchment plays a crucial role in sediment loss dynamics. Specifically, they observed that a catchment with a significant extent of eroding bare ground and 54% grass cover experienced 43 times greater sediment loss compared to another catchment where the grass cover, although lower at 43%, was distributed more evenly. This finding highlights the significance of the spatial arrangement of vegetation cover in certain ecosystems, emphasizing that the pattern of cover can have a greater impact on state transition processes than the average amount of cover alone^{86,14}.

2.13. Structural equation models (SEMs)

They are an analytical technique that assesses how changes in one factor, such as the abundance of a species, can propagate through a network and affect other factors through

causal links, which are established using regression models or similar approaches⁵⁴. SEMs are useful for investigating cause-and-effect relationships between variables and for testing hypotheses about the mechanisms that drive ecological processes⁵⁸. SEMs can be used to analyze both observational and experimental data, and can be particularly useful for studying complex ecological systems with multiple interacting components⁵⁷. SEM incorporates graphical as well as mathematical representations⁵⁸.

For example, Schweiger et al. (2016) used SEMs because they permit for the specification of system-level network hypotheses¹²³. As SE models are of the form $Y = f(X, Y)$, each variable is seen to be part of a system of variables¹²³ which implies that they were able to test whether variable C is influenced by variable A through the mediating effect of B (i.e., $A \rightarrow B \rightarrow C$). This flexibility in how equations are represented offers several advantages, such as the ability to capture more comprehensive hypotheses and uncover unexpected relationships, such as the indirect effects of variable A on variable C that do not involve variable B¹²³.

Greenville et al. (2017) used structural equation modeling to combine findings from remote camera trapping and long-term regional-scale datasets on vegetation and small vertebrates in order to investigate the impact of biotic processes and two key abiotic drivers (rainfall and wildfire) on the composition of a diverse desert biota assemblage in central Australia⁶⁰. They discovered that although vegetation cover is anticipated to decrease as a result of climate change (increases in extreme rainfall events and decreases in wildfires due to changes in rainfall patterns), the main factor influencing prey populations is the top-down suppression caused by introduced predators (rapidly capitalize on the newly created open spaces after wildfire⁹², and the anticipated reduction in vegetation cover resulting from climate change could potentially establish a negative feedback loop)⁶⁰.

From this overview we can say that challenges in Ecology requires hybrid modeling approaches which shall be appropriate for the decision or management problem⁵⁴. However, based on information available to us, there is no approach to capture all particularities like ecosystem's resilience, and to account for *wrong behaviors*. The resilience concept was first introduced by Crawford Holling who described it as *a measure that quantifies the ability of systems to endure and adapt to change or disturbance while preserving the relationships between populations or state variables*⁷⁰. However, nowadays, the resilience concept has been most widely used to describe manifold properties or abilities of socioecological systems in response to sudden changes, including (a) *resistance*, which refers to the system's capacity to withstand disturbance; (b) *recovery*, indicating the ability to return to the original state; (c) *stability*, representing the capacity to maintain function and structure; (d) *vulnerability*, denoting the system's susceptibility to disturbance; and (e) *adaptive capacity*, reflecting the system's ability to cope with and adapt to change^{139,148}.

When an ecosystem is resilient it has *basins of attraction* or *wells*, and it can possess several potential basins between which it can alternate^{50,129,51}. As a result, the system exhibits a variety of potential trajectories that fall within or between these basins, which are considered relatively stable regions where the system is commonly observed⁵¹. When the system shifts from one basin to another, it is referred to as crossing a tipping point (TP) or undergoing a catastrophic shift^{69,120,51}. Quantifying and identifying TPs as well as basin's depth characterize resilience and its properties, which is notorious difficult. There-

fore, we need a new type of model that can decide: (a) the behavior of these basins of attraction; (b) its depth; and (c) the relative positions of these basins within the potential landscape in order to determine potential TPs that connect the basins to each other^{139,121}. Consequently, and for this endeavor, we believe *discrete event systems* are suitable.

2.14. Discrete Event Systems

Until recently, *discrete event systems* have been mostly ignored in ecology and environmental sciences, with the exception of Gaucherel et al. (2022)⁵³. However, they have the potential to give an exhaustive possibilistic overview of the different scenarios under which an ecosystem can evolve, whereas continuous models give in general little insight into the changes that even small internal or external variations may provoke⁵¹.

We examine the expressiveness of Petri nets to model ecosystems. A **Petri net** is a bipartite directed graph whose nodes are either *places* or *transitions*, and places may carry tokens. Petri nets can be bounded, in other words, places can carry a maximum number of tokens; or unbounded when places can carry arbitrarily many tokens. When places carry either one or no token in any reachable marking, we call the net *safe*. The set of currently active places, those with a token, form the state, or marking, of the net. Petri nets are similar to Boolean networks as they are highly effective in formalizing changes in network topology, yet enable a more fine-grained specification of the conditions for triggering value changes.

We take advantage of context and reset semantics in Petri nets (use of read and reset arcs, respectively) to demonstrate how side conditions and side effects operate in these systems, as well as the unfolding methodology of Esparza et al. (2002)⁴⁰. In our view, Petri net unfolding provides the right tools to determine system trajectories leading to collapse and/or survival, and eventually characterize those actions or inactions that help to support *ecosystem stabilization*. For this purpose, we will draw on and extend the modeling approach proposed in Gaucherel et al. (2022)⁵³.

The approach here builds upon nets with both read and reset arcs (our motivation for this choice will be discussed below). While the branching concurrent semantics of contextual nets (i.e. those exhibiting read arcs) has been well studied in the literature^{117,119,11,118,10}, there is, to the best of our knowledge, no formalization of branching processes for reset nets in the literature. Indeed, the work that comes closest to studying them is Jezequel et al. (2018)⁷⁴, in which the authors study concurrent processes unfolded, in our terminology, into *causal nets*, i.e. occurrence nets without branching conditions and conflicts.

Since our purpose is to exhibit divergence of trajectories, it is essential to go all the way to defining branching process unfoldings for reset nets. As the discussion below shows, some subtle changes to both the definition and the algorithmics of unfolding had to be made. Essentially, the problem is to account for the intrinsic ambiguity of reset net firing, in which the same transition may fire with its reset places marked or unmarked, indiscriminately; the definition developed below aims at avoiding to translate this ambiguity into inconsistencies, without replicating transition instances which would dramatically slow down any automatic analysis. The approach has been successfully implemented in the ECOFOLDER tool³, used to study examples in the upcoming chapters.

2.15. Contextual Reset Petri Nets

2.15.1. Why Reset Nets?

Reset nets are not commonly used in the modeling of physical systems; a few words are thus in order to show their interest in biological systems in general and for ecosystems in particular. Many events or processes in a system consume, destroy, produce and/or simply require the presence of certain resources.

The latter case, of *side conditions*, is well covered by read arcs, and consumption is adequately rendered by an ordinary arc from a place to a transition. *Side effects* are more subtle to handle, as such actions do not require any particular state (present/absent) of a resource to occur. Indeed, condensation produces water, irrespective of whether or not water was present previously, or not; a herd of big animals stampeding through an area will leave wasteland, whether or not there was grass that their passage could destroy; from a molecular level, photosynthesis produces oxygen, no matter whether O_2 acted as reactant or not; from a bacterial level, dental plaque produces metabolites when microorganisms are present but regardless of metabolites concentration in advance, and so forth (our examples show several analogous situations).

Now, consider Figure 2.1. It shows a simple, reset net model of some action t that consumes resource p_1 , produces resource p_4 , and has two side effects that destroy, respectively, resources p_2 and p_3 . Obviously, a token on place p_1 is required for t to fire, and if the net is safe, p_4 will be empty whenever p_1 carries a token. No such property can, however, be asserted for p_2 and p_3 . In fact, if a binary vector (x, y) is used to describe the token distribution on p_2 and p_3 , then we would have, in a model using ordinary nets, four distinct instances of t , for $(0, 0)$, $(0, 1)$, $(1, 0)$ and $(1, 1)$. We argue that such a modeling approach would represent both an algorithmic nuisance (since it increases the number of different pathways to follow) and a difficulty in the modeling itself, forcing to change the number of actions every time that another side effect is to be added. On the other hand, the overhead that the use of reset arcs causes in constructing the unfolding can be kept rather small, see below.

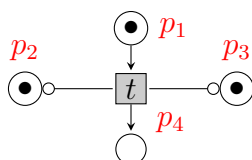

Figure 2.1: The interest of modeling ecosystems via reset arcs.

2.15.2. Definitions

The Petri net model we use here will therefore contain, like⁵³, ordinary, reset and read arcs; however, we will restrain our model to these types, and will not use inhibitor arcs, so as to keep the unfolding semantics tractable. Note that in the case of 1-safe Petri nets on which we focus here, inhibitor nets can be equivalently translated into contextual nets, so there is no loss of generality here. The following generalizes Definitions 1-4 from⁷⁴:

Definition 1 (Net). A contextual net with resets or cr-net is a tuple $\mathcal{N}_{CR} = (P, T, F, R, C, M_0)$ such that

- P is a nonempty set of places,

- T is a nonempty set of transitions such that $T \cap P = \emptyset$,
- $F \subseteq [(P \times T) \cup (T \times P)]$ is the flow relation,
- $R \subseteq [(P \times T) \cup (T \times P)]$ is a symmetric binary relation called reset,
- $C \subseteq [(P \times T) \cup (T \times P)] \setminus (F \cup R)$ is a symmetric binary relation called read or context, and
- $M_0 : P \rightarrow \mathbb{N}_0$ is an initial marking.

A cr-net $\mathcal{N}_{C\mathcal{R}}$ is a reset net or (pure) r-net ($\mathcal{N}_{\mathcal{R}}$) iff $C = \emptyset$, and a contextual net or (pure) c-net ($\mathcal{N}_{\mathcal{C}}$) iff $R = \emptyset$. $\mathcal{N}_{C\mathcal{R}}$ is an ordinary net iff it is both an r-net and a c-net.

For $x \in P \cup T$, write its preset and postset as $\text{pre}(x) \triangleq \{y \in P \cup T : F(y, x)\}$ and $\text{post}(x) \triangleq \{y \in P \cup T : F(x, y)\}$, respectively, and write further $\text{con}(t) \triangleq \{p \in P : C(p, t)\}$ for the context of transition t and $\text{res}(t) \triangleq \{p \in P : R(p, t)\}$ for the re-set of transition t . Finally, write $\text{con}(p) \triangleq \{t \in T : C(p, t)\}$ and $\text{res}(p) \triangleq \{t \in T : R(p, t)\}$ for the context and the re-set of place p , respectively.

Definition 2 (Marking). A marking is a subset of P which may enable transitions. A marking M enables transition t , written $M \xrightarrow{t}$, if and only if $\text{pre}(t) \cup \text{con}(t) \subseteq M$. In that case, t can fire and transform M into

$$\hat{M} \triangleq [M \setminus (\text{pre}(t) \cup \text{res}(t))] \cup \text{post}(t),$$

written $M \xrightarrow{t} \hat{M}$. A marking M is reachable from M_0 if and only if there exist markings $M_1, \dots, M_k = M$ and transitions t_1, \dots, t_k such that

$$M_0 \xrightarrow{t_1} \dots \xrightarrow{t_k} M_k = M. \quad (2.1)$$

If (2.1) holds, write $M_0 \xrightarrow{\sigma} M$ with $\sigma = t_1 \dots t_k$; call σ a firing sequence or run.

For a set of transitions $\tau = \{t_1, \dots, t_k\}$, we write $M \xrightarrow{\tau} \hat{M}$ iff

1. $M \xrightarrow{t_1 \dots t_k} \hat{M}$ and
2. for any $i, j \in \{1, \dots, k\}$ s.t. $i \neq j$, one has $\text{pre}(t_i) \cap (\text{pre}(t_j) \cup \text{con}(t_j)) = \emptyset$.

A cr Petri net in which all reachable markings M and transitions t such that $M \xrightarrow{t}$ satisfy $\text{post}(t) \cap M \subseteq \text{pre}(t)$, is called safe. We denote the set of markings reachable from some marking M in $\mathcal{N}_{C\mathcal{R}}$ by $\mathbf{R}_{\mathcal{N}}(M)$ (dropping the subscript \mathcal{N} if no confusion can arise).

In figures, places are represented by circles and the transitions by boxes (each one with a label identifying it). Firing a transition requires all its pre- and context places to be marked; no requirement is put on the re-set. We assume that no place is a pre-place for a transition that resets it, i.e. $\forall p \in P : \text{post}(p) \cap \text{res}(p) = \emptyset$. Indeed, such a double connection between a transition $t \in \text{post}(p) \cap \text{res}(p)$ would be redundant, as it implies no restriction on the net's behavior: if $t \in \text{post}(p)$, only the presence of a token in p could contribute to an enabling of t . The reset arc is therefore redundant both if p is marked and if p is empty, it can be removed without loss.

Definition 3 (Marking graph). The marking graph of a cr-net, c-net, r-net or ordinary net (\mathcal{N}) is a directed graph $\mathcal{G} = (V, A)$ such that V is the set of all reachable markings obtained from all possible firing sequences σ in \mathcal{N} , and A is the set of connections (arrows) from one marking to another, i.e., $A \subseteq V \times V \wedge t \in T : (M, M') \in A$ iff $M \xrightarrow{t} M'$.

Definition 4 (Attractor). An attractor $\mathbf{A} \subseteq 2^P$ is a bottom (terminal) Strongly Connected Component (SCC) of \mathcal{G} . Denote the set of attractors of \mathcal{N} reachable from a marking M in \mathcal{N} by \mathcal{A} ; a set of markings such that either for every $M \in \mathbf{A}$, the set of markings reachable from M is precisely \mathbf{A} ; or there is only one marking in \mathbf{A} , in other words, $\mathbf{A} = \{M\}$ and no transition is enabled from M (which we call a fixed point).

Definition 5 (Cycle). A cycle is a tuple $\langle M_1, \dots, M_n \rangle$ of reachable markings such that there exists a finite firing sequence $\sigma = t_1 t_2 \dots t_n$ for which $M_1 \xrightarrow{t_1} M_2 \xrightarrow{t_2} M_3 \xrightarrow{t_3} \dots \xrightarrow{t_n} M_1$. Clearly, $\langle M_1, \dots, M_n \rangle$ is a cycle iff $\langle M_2, \dots, M_n, M_1 \rangle$ is (a weaker notion of attractor). Note that we may call fixed points as trivial cycles and those with more than one reachable marking as non-trivial cycles.

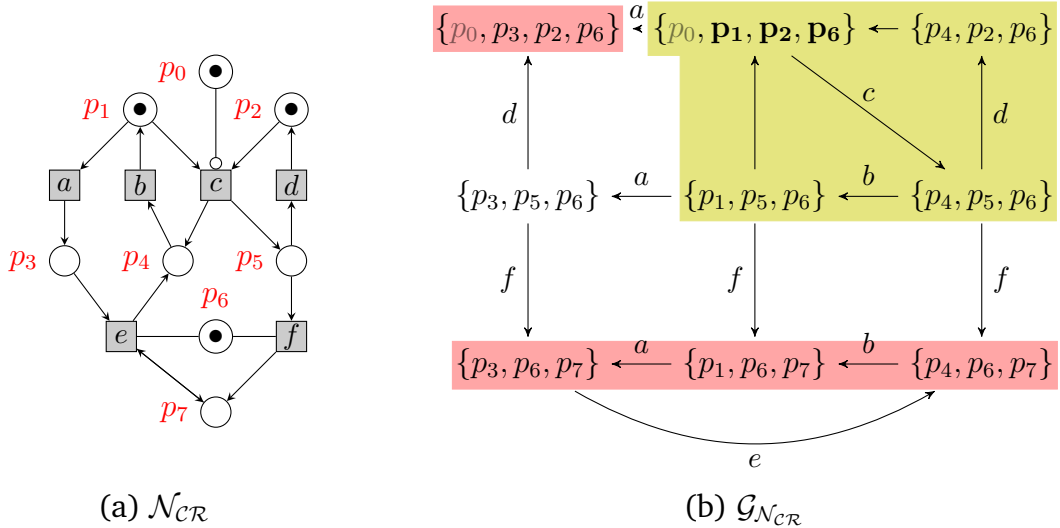

Figure 2.2: A safe cr-net (a) and to the right, its marking graph. In (b), the initial marking is bold, attractors are highlighted in red and one of the cycles are colored in dark yellow. See that p_0 has transparency, meaning it is part of the initial marking but since it has no incoming arc to put a token back on, it never appears again after the first firing of c . Note that both read and reset arcs have no significant change onto the marking graph's topology original from Chatain et al. (2014)²⁶ which are intentionally drawn here to emphasize attractor and cycle's notions for cr-nets. Intricacies and encodings about these arcs will be explained in the next section, see below.

Markings are represented by dots (or tokens) in the marked places. From an initial marking of the net, one can recursively derive all possible transitions and reachable markings, resulting in the *marking graph*. The marking graph is always finite in the case of safe Petri nets; all nets considered in this work are assumed safe.

2.15.3. Attractors and fairness

An attractor, by its very definition, comprises an *absorbing* set of states that the system cannot escape from once it enters. However, a distinct question arises: will every infinite execution eventually reach an attractor? In general, the answer is no, as the system can demonstrate transient loops where it continues to operate indefinitely without ever transitioning into a recurring state.

One of our central objectives in the following section is to determine whether a system state allows looping in a manner that avoids a critical attractor, which we refer to as *doom*. To clarify this concept and address a gap in the literature regarding attractors, we will delve into *fairness* properties that serve to prevent transient loops. Consequently, our conclusion, in line with our title’s implication, will be as follows: broadly speaking, promoting fairness in behavior may steer the system toward doom. In other words, averting doom necessitates the implementation of some form of control within the system to avoid fatal consequences resulting from unrestricted actions.

Fairness

In the context of (contextual) Petri nets (with resets) *fairness* refers to the *broad* allocation of opportunities among *competing* transitions to fire. It refers to a property that ensures that transitions in the net have an opportunity to fire over time, preventing certain transitions from blocking others indefinitely. Fairness ensures that each process is given a fair share of resources so that all tokens progress through the net and not remain in a deadlock state where no further transitions can occur¹²⁵.

Besides one can distinguish two well-known concepts regarding fairness like *weak* and *strong* fairness. Weak fairness means that if a transition has the potential to be continuously enabled, it will eventually fire. This notion guarantees no immediate firing of a transition but rather that it will not perpetually postponed. In contrast, strong fairness ensures that if a transition is infinitely often enabled, it *must* fire infinitely often⁷⁹. Strong fairness ensures that no transition is unfairly suppressed, and it imposes a more rigid form of fairness on the system when comparing with *weak* fairness. More formally¹⁰⁰:

Definition 6 (Weak fairness). *An infinite firing sequence σ is considered weakly fair when, starting from some point along the sequence, every continuously enabled transition will ultimately execute in σ .*

Definition 7 (Strong fairness). *An infinite firing sequence σ is considered strongly fair if every transition enabled infinitely often fires infinitely often in σ .*

Despite these concepts have been widely used in the literature^{101,100,143,125,138,75,79,35}, we need another notion which will help us to analyze attractors further and, that to the best of our knowledge, has no previous definitions, we call it *situation fairness* (initially proposed in unpublished work by Stefan Schwoon).

Although “attractors,” are called in such way, it is important to note that these structures do not exert any force to draw the system’s behavior towards them, nor is it guaranteed that the system will eventually enter an attractor. See figure 2.3 as an illustration. This system could potentially cycle indefinitely within the set of states where p_3 and p_4 are never jointly marked. However, it is essential to note that this set is not contained in an attractor. When aiming to provide a dynamic description of attraction, particularly

concerning *basins of attraction*, it is insufficient to simply demand the presence of infinite runs that remain within a specific state set. Instead, we must focus on those runs that ‘eventually explore all accessible branches.’ Such an intuition is often captured by the aforementioned notion of (*strong*) *fairness* cf.^{100,138,75,79}: any transition that becomes enabled an infinite number of times must also occur an infinite number of times (see Def. 7). Nevertheless, strong fairness alone cannot guarantee that a concurrent system will eventually enter a terminal SCC. Figure 2.3 displays this.

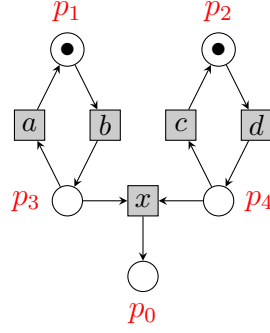

Figure 2.3: Illustration of the fairness condition underlying the attractor notion. Clearly, the system has exactly one attractor, given by fixed point $\mathbf{A} \triangleq \{\{p_0\}\}$. However, sequence $(badc)^\infty$ is strongly fair and never reaches \mathbf{A} ; on the other hand, every situation fair execution leads, after finitely but unboundedly many steps, into \mathbf{A} .

In this ordinary net, a finite firing sequence can be strongly fair only if its final marking is $\{p_0\}$; on the other hand, no infinite strongly fair firing sequence in this net would be allowed to enable x infinitely often. There exist nonetheless infinite strongly fair executions that avoid to enable x too often, e.g. the sequences $(badc)^\infty$ or $(babadc)^\infty$, etc. However, these sequences must inevitably be unfair to at least one transition *in the context of the same marking*; in the example, the sequence $(badc)^\infty$ passes infinitely often by the marking $M \triangleq \{p_2, p_3\}$, and in this marking it ‘chooses’ a consistently, although d is also enabled in M . Still, strong fairness is satisfied since d does fire infinitely often, just not from instances of M . To exclude such denials of opportunity, we introduce a more refined fairness concept, which, to the best of our knowledge, has not been previously introduced. We will refer to an execution scenario as *situation fair* iff any transition that is enabled in a marking visited infinitely often also fires infinitely often *from that particular marking*. Consequently, if a firing sequence is *situation-fair* then it is *strongly fair*. More formally:

Definition 8 (Situation fairness). In a \mathcal{N} as above, a firing sequence $M_0 \xrightarrow{t_1} M_1 \xrightarrow{t_2} \dots$ with $\sigma = t_1 \dots t_n$ is situation-fair iff either (i) it is finite, strongly fair and its last marking enables no transition, i.e. runs of the form $M_i \xrightarrow{t_{i+1}} M_{i+1} \xrightarrow{t_{i+2}} \dots \xrightarrow{t_n} M_{n-1}$ or (ii) it is strongly fair and for all $t \in T$ and all $M \subseteq P$ such that $M \xrightarrow{t}$:

$$|\{i \in \mathbb{N} : M_i = M\}| = \infty \implies |\{j \in \mathbb{N} : M_j = M \wedge t_{j+1} = t\}| = \infty \quad (2.2)$$

Please note that such executions are always possible to achieve; one way to obtain them is by implementing a round-robin firing policy, in which, for $\{t_1, \dots, t_n\}$ the transitions enabled at marking M , the transition selected at the k -th visit to marking M is $t_{(k \bmod n)}$. Before establishing the link between *fairness* and *attractors*, let us introduce one more auxiliary notion:

Definition 9 (Minimal Distance to an attractor). For any reachable marking M , let K_M be the smallest integer d such that there exist an attractor \mathbf{A} and $t_1, \dots, t_d \in \mathbb{T}$ such that $M \xrightarrow{t_1, \dots, t_d} M_{\mathbf{A}}$ with $M_{\mathbf{A}} \in \mathbf{A}$. Moreover, let $K_{\mathcal{N}} \triangleq \max_{M \in \mathbf{R}(\mathcal{N})} (K_M)$.

Note that in safe Petri nets, both K_M and $K_{\mathcal{N}}$ are well-defined and finite. Obviously K_M must be finite for all reachable markings M of \mathcal{N} ; since \mathcal{N} is finite and safe, $K_{\mathcal{N}}$ is finite as well.

The following Theorem 1 asserts that in any situation-fair execution of a safe net, whether it follows a round-robin or alternative policy, the execution will eventually depart from any transient SCC and, sooner or later, permanently enter a terminal SCC.

Theorem 1. Let $\sigma = M_0 \xrightarrow{t_1} M_1 \xrightarrow{t_2} \dots$ be a situation-fair execution of a safe Petri net \mathcal{N} . Then either σ is finite and its final marking is a fixed point, or σ is infinite and there exists an attractor \mathbf{A} and $d \in \mathbb{N}$ such that $\forall i \in \mathbb{N} : M_{d+i} \in \mathbf{A}$.

Proof: By the definition of situation fairness, if σ is finite, its final marking must be a fixed point. Thus assume that σ is infinite; it then suffices to show that σ eventually reaches an attractor, since by definition no markings outside the attractor are reachable from there. Since σ is infinite and \mathcal{N} is safe, there must be at least one marking M that is visited infinitely often by σ . We shall prove that M is part of an attractor. Indeed, suppose this is *not* the case. Then M is part of a transient SCC, and by definition, some attractor \mathbf{A} is reachable from M . Thus, we have an executable path $M \xrightarrow{t_1} M_1 \xrightarrow{t_2} \dots \xrightarrow{t_n} M_n \in \mathbf{A}$, for $n = K_M$ and some attractor \mathbf{A} . Since σ is situation fair vis-à-vis t_1 in M_σ , it must visit M_1 infinitely often as well. Repeating this argument, we obtain that all M_i , for $i = 1, \dots, n$, must be visited infinitely often, too. But M is not reachable from M_n , which is a contradiction. Thus M must be part of an attractor. \square

We will may shift our focus to categorizing states based on the long-run behaviors that follow them. Attractors can vary in their desirability; as long as the system retains some infinite behavior that avoids reaching any undesirable or *bad* state, we will label it as *free*. Conversely, if it inevitably leads to a bad state in all its infinite behaviors, we will consider it *doomed*. Before delve into precise definitions for these concepts, we need fundamental transformations to allow the unfolding operation. The discussion about determining long-run behaviors in a safe Petri net will continue in chapter 5. In the meanwhile, let us encode contextual reset nets.

2.15.4. Encoding of contextual reset nets

Our goal is to represent the dynamics of a general safe cr-net \mathcal{N}_{CR} in an ordinary occurrence net via an unfolding procedure that takes the specificities of both read and reset arcs into account.

First, note that read arcs and the unfolding of contextual net have been studied in the literature, see^{117,119,11,118,10}, with essentially two options: (i) prior encoding as ordinary nets plus unfolding into ordinary occurrence nets, or (ii) unfolding directly into *contextual occurrence nets*, with dedicated history semantics to account for asymmetric conflict that typically arises in contextual nets (but is impossible in ordinary nets). We will use here a technique from the first group, namely the so-called *place replication* or *PR-encoding* (see¹¹). There, any place p that is read by k different read arcs is replaced by a set of k

places, all of which have the same ordinary pre-and postsets as p and which encode each a different read arc of p via two-way ordinary arcs.

Definition 10 (PR-encoding¹¹). For a cr-net \mathcal{N}_{CR} , the place-replication (PR-) encoding of \mathcal{N}_{CR} is the net $\mathcal{N}_{\mathcal{R}}$ obtained by substituting every place p in the context of one or more transitions ($n \geq 1$) t_1, \dots, t_n by places p_1, \dots, p_n , and update F and R of $\mathcal{N}_{\mathcal{R}}$ as follows: $\forall i \in \{1, \dots, n\}$ such that:

1. transition t_i resets place p_i , i.e., $p_i \in \text{res}'(t_i)$;
2. transition t_i consumes and produces place p_i , i.e., $p_i \in \text{pre}'(t_i)$ and $p_i \in \text{post}'(t_i)$;
3. any transition t producing p in \mathcal{N}_{CR} produces p_i in $\mathcal{N}_{\mathcal{R}}$, i.e., $p_i \in \text{post}'(t)$;
4. any transition t consuming p in \mathcal{N}_{CR} consumes p_i in $\mathcal{N}_{\mathcal{R}}$, i.e., $p_i \in \text{pre}'(t)$.

PR-encoding preserves not only the reachability of markings but also concurrency of transitions that share a read place (but no input place, of course), see Figure 2.4.

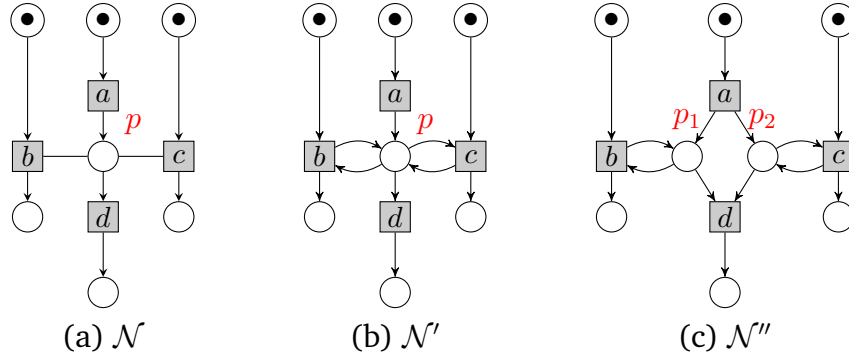

Figure 2.4: Illustrating direct versus PR-encoding, cited from Baldan et al. (2012)¹¹. The contextual net (a) is transformed into an ordinary net by plain encoding (in (b)) and by PR-encoding (in (c)). Both encodings preserve marking reachability (modulo the splitting of p into p_1 and p_2 in (c)). However, the concurrent firing of transitions b and c that the contextual (a) allows, is sequentialized in (b), whereas it is preserved in (c). We therefore prefer the PR-encoding in (c).

Definition 11 (Reset complement). For a cr-net \mathcal{N}_{CR} , its reset complement is the net \mathcal{N}'_{CR} obtained by creating a complementary place p_{\neg} for every p in the re-set of one or more transitions ($n \geq 1$) t_1, \dots, t_n in such a way that p_{\neg} 's marking is consumed or reset in a 'complimentary' way. Formally,

1. any transition t resetting p in \mathcal{N}_{CR} resets p_{\neg} in \mathcal{N}'_{CR} , i.e., $\text{res}(p_{\neg}) \stackrel{\Delta}{=} \text{res}(p)$;
2. any transition t that properly produces onto p in \mathcal{N}_{CR} properly consumes from p_{\neg} in \mathcal{N}'_{CR} , i.e., $\text{post}(p_{\neg}) \stackrel{\Delta}{=} (\text{pre}(p) \setminus \text{post}(p)) \setminus \text{res}(p) = \text{pre}(p) \setminus (\text{post}(p) \cup \text{res}(p))$;
3. and any transition t that properly consumes from p or resets p properly produces onto p_{\neg} , i.e. $\text{pre}(p_{\neg}) \stackrel{\Delta}{=} (\text{post}(p) \cup \text{res}(p)) \setminus \text{pre}(p)$;

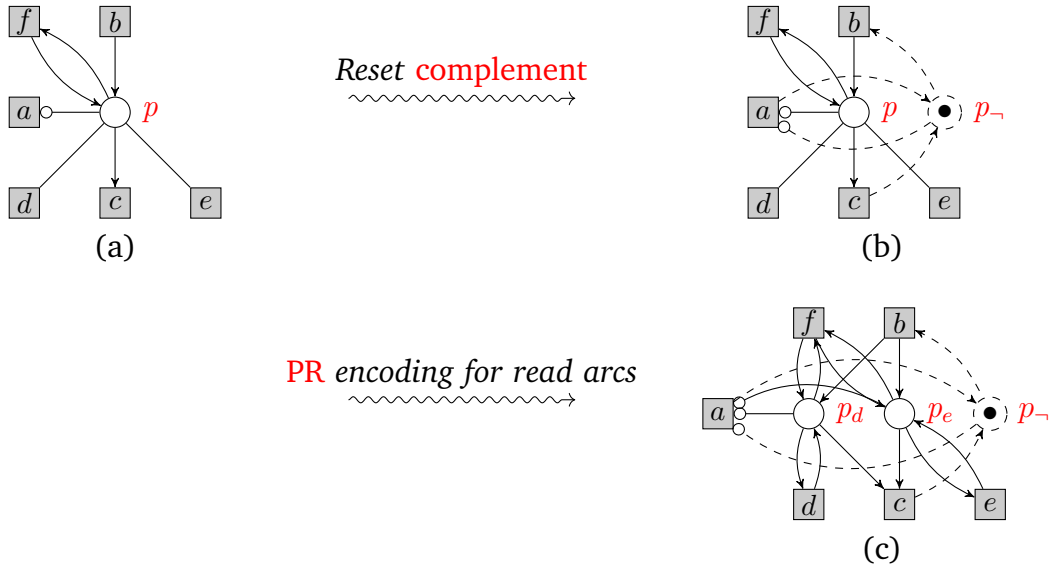

Figure 2.5: Successive application of reset complement (top row) and PR-encoding (bottom). Complementation for place p duplicates the reset arc to a ; the complementary place p_{\neg} receives a token upon a firing of a that empties p . Note that neither loops nor read arcs must be duplicated by reset complement; therefore, only the original place p needs to be replicated in the PR-encoding. Conversely, the reset action by a empties *all* instances of p , hence the replication of the reset arcs in the place replication.

In addition to this, $M'_0 \triangleq M_0 \cup \{p_{\neg} : p \notin M_0 \wedge \text{res}(p) \neq \emptyset\}$. A net which contains all reset complements is called a complete reset net.

Note that, in particular, loops of p are not taken into account by the reset complement, neither as consumptions nor as productions; they are thus not transferred to p_{\neg} , which is therefore guaranteed to be loop-free. Also, read arcs that involve p do not at all impact p_{\neg} ; in fact, for all these complement places, one always has $\text{con}(p_{\neg}) = \emptyset$ if there are not exclusive read arcs for p_{\neg} . Figures 2.5 and 2.6 illustrate the effect of combining reset complement and PR-encoding. Further, we note the following simple invariant:

Lemma 1 (Complementary place). *In \mathcal{N}_{cR} as above, any reachable marking M satisfies $|M \cap \{p, p_{\neg}\}| = 1$ for every complemented place p .*

Proof: Clearly, M_0 satisfies the property by construction; for all reachable markings it follows recursively since, by the construction of \mathcal{N}_{cR} , any transition removing a token from p (p_{\neg}) must create a token on p_{\neg} (p) and vice versa. \square

The motivation for the reset complement lies in the unfolding semantics developed below. Roughly, it is important to record for every instance of a transition t that has a reset place $p \in \text{res}(t)$, whether t fires from an empty or a marked p . Indeed, although both states of p enable t , in the case of an empty place the occurrence of t has to “consume” a condition representing p empty; otherwise, the event representing this firing of t could occur concurrently with another copy of t , which needs to be excluded in unfoldings for both semantical and efficiency reasons.

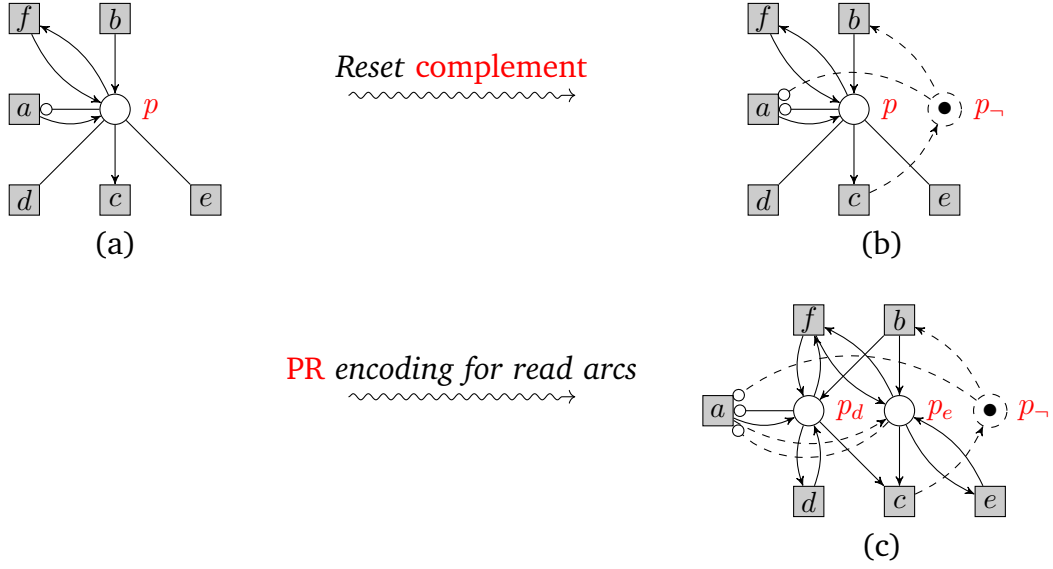

Figure 2.6: Successive application of reset complement (top row) and PR-encoding (bottom) under a slight modification w.r.t. figure 2.5. Place p is now an output place of transition a in (a). The complementation for place p duplicates the reset arc to a ; but the complementary place $p_{\bar{\cdot}}$ receives no token upon a firing of a since a empties p and produces a token on it. Loops, read arcs and reset action are treated as in figure 2.5.

Theorem 2. Let $\mathcal{N}_{\mathcal{CR}} = (\mathbf{P}, \mathbf{T}, F, R, C, M_0)$ be a safe contextual reset Petri net and $\mathcal{N}'_{\mathcal{CR}} = (\mathbf{P}', \mathbf{T}', F', R', C', M'_0)$ its reset complement version. Then one has

1. **Reachability equivalence:** for every firing sequence

$$M_0 \xrightarrow{t_1} \dots \xrightarrow{t_n} M_n \quad (2.3)$$

of $\mathcal{N}_{\mathcal{CR}}$ there exists a firing sequence

$$M'_0 \xrightarrow{t_1} \dots \xrightarrow{t_n} M'_n \quad (2.4)$$

of $\mathcal{N}'_{\mathcal{CR}}$ such that for all $i \in \{0, \dots, n\}$, $M_i = M'_i \cap \mathbf{P}$, and vice versa.

2. **Equivalence w.r.t. concurrent firing:** For every pair of reachable markings M_- , M_+ and set of transitions $\{t_1, \dots, t_k\}$ of $\mathcal{N}_{\mathcal{CR}}$ such that $M_- \xrightarrow{\{t_1, \dots, t_k\}} M_+$, there exist unique reachable markings M'_- , M'_+ of $\mathcal{N}'_{\mathcal{CR}}$ such that

(a) $M_- = M'_- \cap \mathbf{P}$, $M_+ = M'_+ \cap \mathbf{P}$, and

(b) $M'_- \xrightarrow{\{t_1, \dots, t_k\}} M'_+$ in $\mathcal{N}'_{\mathcal{CR}}$,

and vice versa.

Proof: Let $\bar{\mathbf{P}}$ be the set of complementary places added for all reset places in $\mathcal{N}_{\mathcal{CR}}$ according to definition 11, and any transition t s.t. $\overline{\text{res}(t)} \triangleq \{p_{\bar{\cdot}} : p \in \text{res}(t)\}$. For Part 1, assume $M \xrightarrow{t} \hat{M}$ in $\mathcal{N}_{\mathcal{CR}}$, which is equivalent to the conjunction of the following

properties:

$$\text{con}(t) \subseteq (M \cap \hat{M}) \quad (2.5)$$

$$\text{pre}(t) \subseteq M \quad (2.6)$$

$$\text{post}(t) \subseteq \hat{M} \quad (2.7)$$

$$\text{post}(t) \cap M \subseteq \text{pre}(t) \quad (2.8)$$

$$\text{res}(t) \cap \hat{M} \subseteq \text{post}(t) \quad (2.9)$$

Observation shows that, from (2.5), one obtains $\text{con}(t) \subseteq (M' \cap \hat{M}')$ in $\mathcal{N}'_{\mathcal{CR}}$, where $M' \triangleq M \cup \overline{\text{res}(t)}$ and $\hat{M}' \triangleq (M' \setminus [\text{res}'(t) \cup \text{pre}'(t)] \cup \text{post}'(t))$. We claim that (2.6) implies $\text{pre}'(t) \subseteq M'$ in $\mathcal{N}'_{\mathcal{CR}}$. Indeed, under $\text{pre}(t) = \text{pre}'(t)$ the claim follows; otherwise, i.e. if $\text{pre}(t) \subsetneq \text{pre}'(t)$, any $p \in \text{pre}'(t) \setminus \text{pre}(t)$ satisfies $p_{\neg} \in \text{post}(t) \setminus \text{pre}(t)$. Therefore, $p_{\neg} \notin M'$, thus by Lemma 1, $p \in M'$ as claimed. Now, let $p \in \text{res}(t)$, which implies $p_{\neg} \in \text{res}(t)$. By Lemma 1, exactly one place among p and p_{\neg} is in \hat{M}' . If $p \in \hat{M}'$, then $p \in \hat{M}$, and thus in $\text{post}(t)$ by property (2.9). Since $p_{\neg} \in \text{res}'(t)$ by construction, we are done, and $M' \xrightarrow{t} \hat{M}'$ must hold in $\mathcal{N}'_{\mathcal{CR}}$. Recursively, this shows the implication in part 1.

Assume now that, with the above definitions, $M' \xrightarrow{t} \hat{M}'$ holds in $\mathcal{N}'_{\mathcal{CR}}$; this implies as above

$$\text{con}'(t) \subseteq (M' \cap \hat{M}') \quad (2.10)$$

$$\text{pre}'(t) \subseteq M' \quad (2.11)$$

$$\text{post}'(t) \subseteq \hat{M}' \quad (2.12)$$

$$\text{post}'(t) \cap M' \subseteq \text{pre}'(t) \quad (2.13)$$

$$\text{res}'(t) \cap \hat{M}' \subseteq \text{post}'(t). \quad (2.14)$$

As argued above, properties (2.10) and (2.11) imply (2.5) and (2.6). Concerning (2.12) and (2.7), notice that $(\text{post}'(t) \setminus \text{post}(t)) \subseteq \overline{\text{res}(t)}$.

We further claim that (2.13) implies (2.8). Indeed, let $p \in ((\text{post}(t) \cap M) \setminus \text{pre}(t))$. Then $p \in \text{post}'(t)$ and thus $p_{\neg} \in \text{pre}'(t)$. By Lemma 1, we have $p_{\neg} \notin M'$ since $p \in M \subseteq M'$; but this contradicts $M' \xrightarrow{t}$.

Finally, (2.14) entails (2.9) because $\text{post}'(t) \subseteq \text{post}(t) \cup \overline{\text{res}(t)}$.

For Part 2, taking M' and \hat{M}' as above, we have to check that Property 2 of Definition 2 is preserved and respected by reset complementation; but this follows since (i) $\text{con}(t) = \text{con}'(t)$, and (ii) any for place p_{\neg} added in the complementation process such that $p_{\neg} \in (\text{pre}'(t_i) \cap \text{pre}'(t_j))$, we would necessarily have $p \in (\text{post}(t_i) \cap \text{post}(t_j)) \setminus (\text{pre}(t_i) \cup \text{pre}(t_j))$. But in that case, Property 2 of Definition 2 implies that \hat{M} is not safe, contradicting the safeness assumption. \square

Given that the PR-encoding for contextual arcs is known to preserve both reachability and concurrency (see¹¹), the above theorem 2 asserts the same equivalence for the reset complement introduced here. This theorem allows us henceforth to apply *Reset complement* as well as *PR-encoding* to cr-nets, transforming them into complete r-nets, and to apply the unfolding procedure presented in the next chapter to those transformed nets while preserving all essential semantic properties.

3 - Unfolding Semantics For Complete Reset Nets

Branching processes^{40,38} are a partial-order semantics for ordinary Petri nets, “unfolded” into labelled *occurrence nets* or tree-like structures. In other words, branching processes correspond to the resulting labelled occurrence nets. These occurrence nets are obtained from unfolding a (reset) net, and their nodes are labelled with the places and transitions of this net. There is a unique (up to isomorphism) maximal branching process referred to as *the unfolding*. The process of producing an unfolding can be halted at different and various times yielding different and several *occurrence nets*. When applying no halting criterion to the unfolding process you may unfold “as much as possible” which is generally an infinite process. Figure 3.1 shows a branching process as part of an unfolding prefix. Below, we extend the unfolding procedure from Esparza et al. (2002)⁴⁰ in such a way that complete (pure) reset nets can be input to it; its *output* is an ordinary occurrence net, i.e. *without* reset arcs.

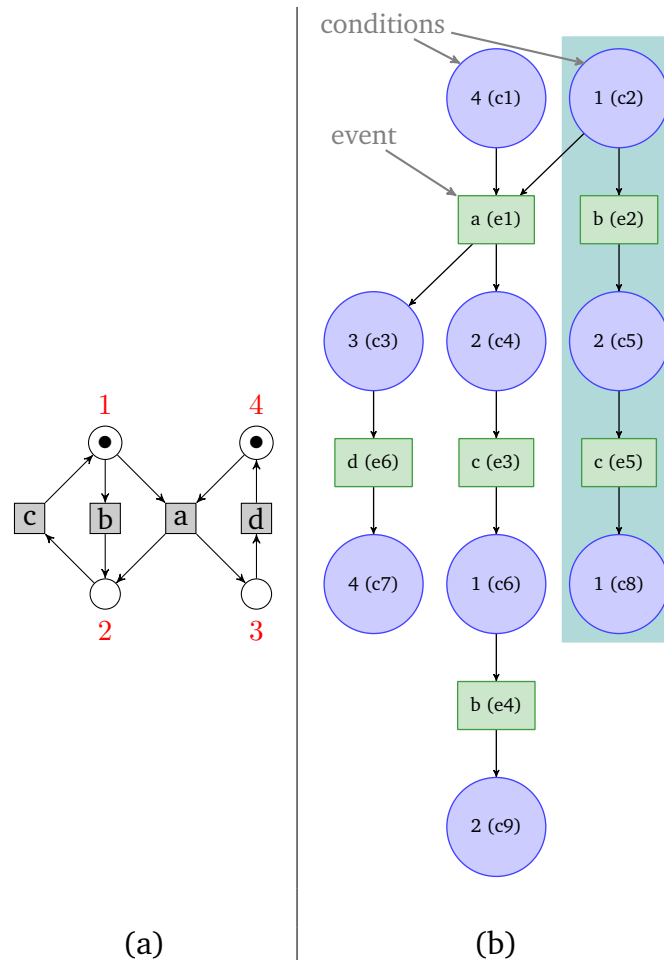

Figure 3.1: A Petri net system \mathcal{N}_{eg} (a), and an occurrence net \mathcal{O}_{eg} (b) showing an unfolding prefix of \mathcal{N}_{eg} , and a *branching process* is highlighted in teal blue. \mathcal{O}_{eg} will be our running example for illustrating the following concepts.

3.1. Occurrence nets

Primarily, we need to specify useful relations between nodes of a net.

Definition 12 (Node relations). *Causality, concurrency and conflict in an ordinary net \mathcal{N} ⁴⁰ (see figure 3.2 for illustration):*

- Node x precedes y , denoted by $x < y$, iff \mathcal{N} contains a path with at least one arc leading from x to y , i.e. $< \triangleq F^+$. If $x < y$, we say that x is a causal predecessor of y . We remark $x \leq y$ if $x < y$ or $x = y$. If $x \leq y$ or $y \leq x$, then x and y are defined to be causally related.
- x and y are in conflict relation, denoted by $x \# y$, if \mathcal{N} contains two paths $pt_1 \dots x$ and $pt_2 \dots y$ starting at the same place p , with $t_1 \neq t_2$. In addition, we say that t_1 and t_2 are in direct conflict, noted $t_1 \#_\delta t_2$ iff $\text{pre}(t_1) \cap \text{pre}(t_2) \neq \emptyset$.
- x and y are in concurrency relation, denoted by $x \text{ co } y$, if neither $x < y$ nor $y < x$ nor $x \# y$.

An occurrence net is a net $\mathcal{O} = (B, E, G)$, where B and E are sets of elements called conditions (Bedingungen) and events, respectively, such that:

1. $|\text{pre}(b)| \leq 1$ for every $b \in B$.
2. \mathcal{O} is acyclic, or, equivalently, the causal relation $< \triangleq G^+$ is a partial order.
3. \mathcal{O} is finitely preceded, i.e., for every $x \in B \cup E$, the set of elements $y \in B \cup E$ such that $y < x$ is finite;
4. no elements is in conflict with itself.

Clearly, two nodes of an occurrence net are either in causal, conflict, or concurrency relation. $\text{Min}(\mathcal{O})$ denotes the set of minimal elements of $B \cup E$ with respect to the causal relation, i.e., those nodes that have an empty preset. In this work, we will only consider nets in which every transition has a nonempty preset; therefore, all elements of $\text{Min}(\mathcal{O})$ are conditions. We note in passing, and for use in visualization below, that the projection of the relational structure of any occurrence net to the events alone yields a *prime event structure* in the sense of Winskel et al. (1979)¹⁰³.

3.2. Branching processes

In contrast with the situation in the unfolding of ordinary Petri nets as in⁴⁰, we will need conditions that are mapped to empty reset places; a discussion for the reasons behind this choice will follow below. As a consequence, we require of any condition b in an unfolding to store an additional bit of information, namely whether b corresponds to a marked (1) or unmarked (0) place.

Definition 13 (Branching process). *A branching process of a reset Petri net $\mathcal{N}_{\mathcal{R}} = (P, T, F, R, M_0)$ is a labelled occurrence net $\beta = (\mathcal{O}, \pi)$, where $\mathcal{O} = (B, E, G)$ is an occurrence net such that $B \subset P \times \{0, 1\} \times E$, and $\pi : (B \cup E) \rightarrow (P \cup T)$ is a labelling function that satisfies the following properties:*

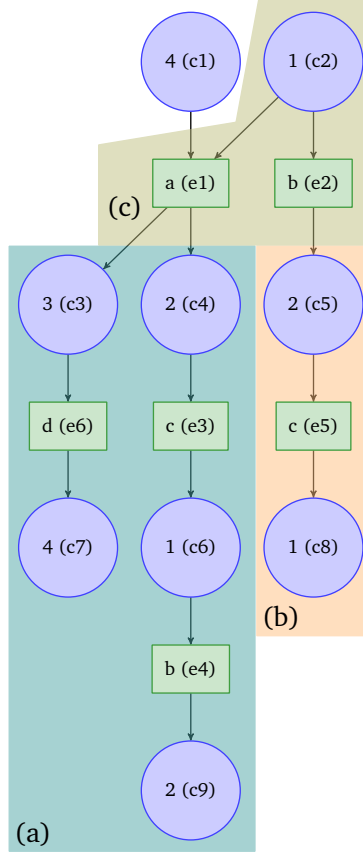

Figure 3.2: Illustration of concurrency (a), causality (b) and conflict (c) relations in \mathcal{O}_{eg} .

(i) $\pi(\mathbf{B}) \subset \mathbf{P}$ and $\pi(\mathbf{E}) \subset \mathbf{T}$ (π preserves the nature of nodes);

(ii) $\forall e \in \mathbf{E}$, the folding morphism π induces isomorphisms between the immediate neighborhoods of e in \mathcal{O} and of $\pi(e)$ in $\mathcal{N}_{\mathcal{R}}$:

$$\begin{aligned} \pi(\text{pre}(e)) &\xleftrightarrow{\pi} \text{pre}(\pi(e)) \cup \text{res}(\pi(e)) \cup \text{con}(\pi(e)) \\ \pi(\text{post}(e)) &\xleftrightarrow{\pi} \text{post}(\pi(e)) \cup \text{res}(\pi(e)) \cup \text{con}(\pi(e)) \end{aligned}$$

(iii) Let $\text{Init} \triangleq M_0 \cup R^{-1}(\mathbf{T})$; then $\text{Min}(\mathcal{O}) \xleftrightarrow{\pi} \text{Init}$ (β “starts” at an initial cut given by M_0 and by the empty places that are connected to a transition via a reset arc);

(iv) $\forall e_1, e_2 \in \mathbf{E} : \text{pre}(e_1) = \text{pre}(e_2) \wedge \pi(e_1) = \pi(e_2) \Rightarrow e_1 = e_2$ (β does not create duplicate events).

(v) $\pi(\{(s, 1, \emptyset) \in \beta\}) = M_0$ and $\pi(\{(s, 0, \emptyset) \in \beta\}) \subset \mathbf{P} \setminus M_0$.

Branching processes are partially ordered by inclusion. Thus, let $\beta = (\mathcal{O}, \pi)$ and $\beta' = (\mathcal{O}', \pi')$ be two branching processes of a reset Petri net system. β' is a *prefix* of β if $\mathcal{O}' = (\mathbf{B}', \mathbf{E}', G')$ is a subnet of $\mathcal{O} = (\mathbf{B}, \mathbf{E}, G)$ satisfying:

- $\text{Min}(\mathcal{O}') = \text{Min}(\mathcal{O})$;
- If $b \in \mathbf{B}'$ and $\text{pre}(b) = \{e_b\}$, then $e_b \in \mathbf{E}'$;

- If $e \in E'$, then $\text{pre}(e) \cup \text{post}(e) \subseteq B'$; and
- $\pi' \equiv \pi|_{(B' \cup E')}$.

As mentioned before, here we specify conditions mapped to empty reset places, which subtly differ from those in Esparza et al. (2002)⁴⁰ by having this new bit of information. Conditions that correspond to either marked or unmarked places allow us to model *side effects* in a system, i.e., since one cares no value in the number of tokens in those places part of a transition's re-set, then event's firing has no restriction to enable succeeding conditions (modulo π). As a consequence, a branching process can be infinite, when no restriction has imposed in a transition's preset, even if its corresponding net system is initially acyclic. Figure 3.3 gives a graphical demonstration of this phenomenon.

Let us note finally that unfolding reflects faithfully the dynamics of the unfolded net, in the following sense:

Let $\mathcal{N}_{\mathcal{R}}$ a reset net system, and let β be its unfolding.

$$\begin{aligned} \exists M, M' \subseteq \beta, M'' \subseteq \mathcal{N}_{\mathcal{R}}, e \in \beta \wedge t \in \mathcal{N}_{\mathcal{R}} : \\ \pi(M') = M'' \wedge \pi(e) = t \wedge M \xrightarrow{e} M' \text{ in } \beta \Leftrightarrow \pi(M) \xrightarrow{t} M'' \text{ in } \mathcal{N}_{\mathcal{R}} \end{aligned}$$

3.3. Configurations and cuts

A *configuration* C of a branching process in an occurrence net \mathcal{O} is a set of events satisfying the following two conditions:

- $e \in C \implies \forall e' \leq e : e' \in C$ (C is causally closed).
- $\forall e, e' \in C : \neg(e \# e')$ (C is conflict-free).

Intuitively, a configuration is a set of events ‘firable’ from the initial cut, i.e., there is a firing sequence from c_0 in which each event of the configuration occurs exactly once. Denote the set of \mathcal{O} 's configurations by $\mathcal{C}(\mathcal{O})$, and the subset of *finite* configurations by $\mathcal{C}^f(\mathcal{O})$. For every $e \in E$, the *cone* $[e] \triangleq \{e' \in E : e' \leq e\}$ as well as the *stump* $\langle e \rangle \triangleq \{e' \in E : e' < e\}$ of e are finite configurations; configurations obtained as event cones are called *prime*. Two configurations C_1 and C_2 are in *conflict*, written $C_1 \# C_2$, iff $C_1 \cup C_2$ is not a configuration. Note that

- $C_1 \# C_2$ iff there exist $e_1 \in C_1$ and $e_2 \in C_2$ such that $e_1 \# e_2$, and
- the conflict relation between events is a special case of the relation for configurations, since $e_1 \# e_2$ iff $[e_1] \# [e_2]$.

A configuration ω is *maximal*, or a *run* of \mathcal{O} (maximal element of $\mathcal{C}(\mathcal{O})$), iff $e \notin \omega$ implies $\omega \# [e]$; denote the set of \mathcal{O} 's runs as $\Omega(\mathcal{O})$ and its elements generically by ω . Denote by $\hat{\mathcal{C}}^\infty(\mathcal{O})$ the set of all *infinite* configurations, and let

$$\mathcal{C}^\infty(\mathcal{O}) \triangleq \hat{\mathcal{C}}^\infty(\mathcal{O}) \cup \Omega(\mathcal{O})$$

If $C \in \mathcal{C}^f$, let the *crest* of C be the set $\text{crest}(C) \triangleq \max_{<}(C)$ of its maximal events. We say that configuration C *enables* event e , written $C \rightsquigarrow e$, iff (i) $e \notin C$ and (ii) $C \cup \{e\}$ is a configuration.

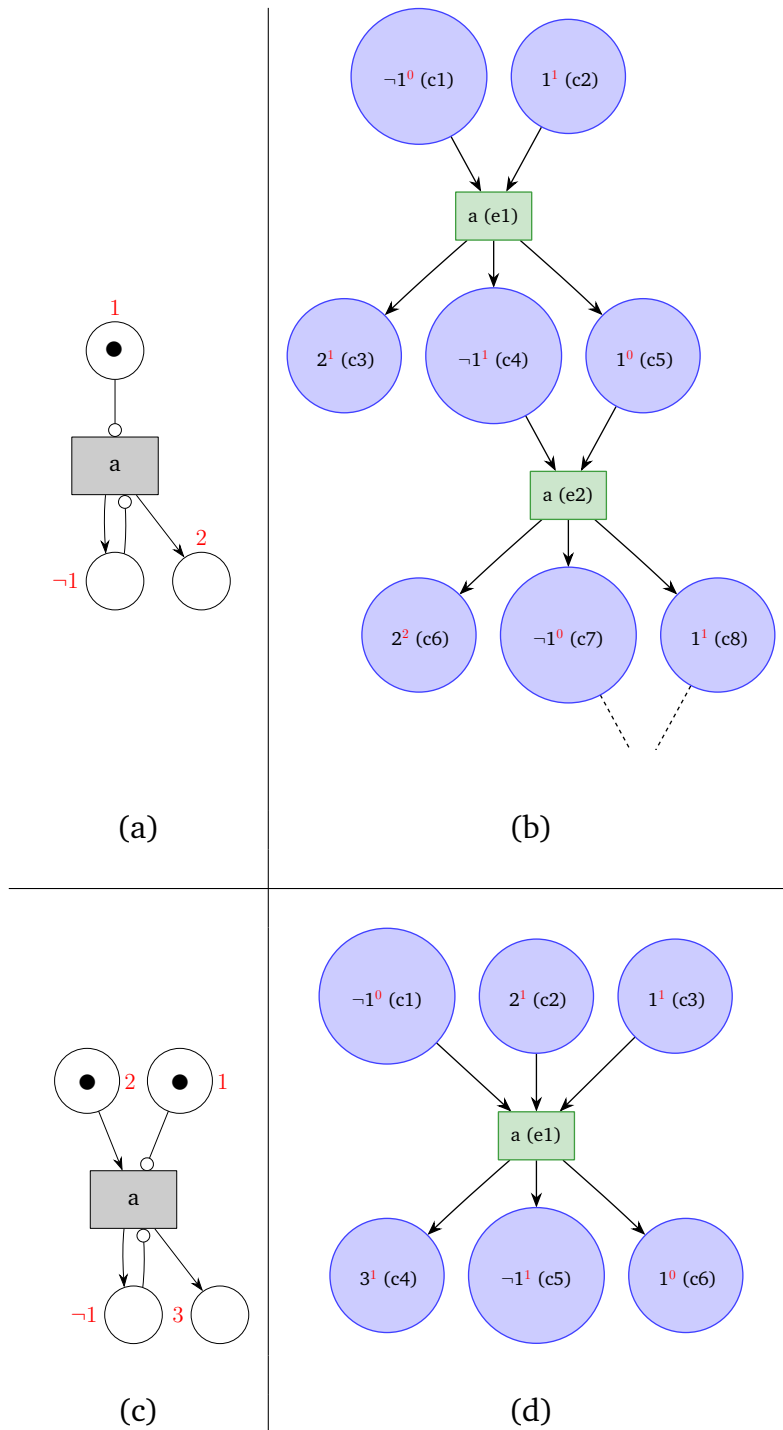

Figure 3.3: An example to show unrestricted and restricted behaviors in two nets. Note that reset complement has been encoded and so either a place or its complement must be marked (a) and (c), a red superscript in the unfolding (b) and (d) has been added to account for number of tokens. Dashed lines represent the infinite behavior of the unfolding (b). As no restriction has been imposed to transition a , then place 2 will be accumulating tokens to the infinity (b). This is an example of a unbound net (a). On the other hand, the net in (c) is bounded, has a consuming arc which makes it restricted, and then its unfolding is finite.

Co-sets and cuts. A set X of conditions of an occurrence net is a *co-set* if its elements are pairwise in *co* relation; write $\text{cosets}(\mathcal{O})$ for the set of cosets in an occurrence net \mathcal{O} . A maximal co-set with respect to set inclusion is called a *cut* and denoted \mathbf{c} . In other words, if we have a co-set to which we can not add any other element without destroying the co-set property, then every element that lies outside of \mathbf{c} is either in conflict or in causal relation with at least one element of \mathbf{c} . Denote the set of \mathcal{O} 's cuts by $\mathbf{Cuts}(\mathcal{O})$. Given a marking M of a system $\mathcal{N}_{\mathcal{R}}$ and its branching process $\beta = (\mathcal{O}, \pi)$, M is *represented* in β if for all $s \in \mathcal{N}_{\mathcal{R}}$ there exists $\mathbf{c} \in \mathbf{Cuts}(\mathcal{O})$ such that $\text{Mark}(\mathbf{c}) \triangleq \{p \in \mathbf{P} : \exists b = (p, 1, e) \in \mathbf{c}\} = M$.

Finite configurations and cuts are tightly related. Let C be a finite configuration of a branching process $\beta = (\mathcal{O}, \pi)$. Then the co-set

$$\mathbf{cut}(C) \triangleq (\text{Min}(\mathcal{O}) \cup \text{post}(C)) \setminus \text{pre}(C)$$

is a cut. By abuse of notation, let $\text{Mark}(C) \triangleq \text{Mark}(\mathbf{cut}(C))$. In addition, let C be a configuration and $E \cap C = \emptyset$ such that $C \cup E$ is a configuration. Write $C \oplus E \triangleq C \cup E$ in that case; we call $C \oplus E \triangleq C \cup E$ an *extension* of C , and E a *suffix* of C . Clearly, let C' be a configuration, if $C \subset C'$ then the suffix E of C is nonempty and $C \oplus E = C'$. A configuration is maximal iff it has no extension. Note that \emptyset is a configuration, that $\mathbf{crest}(\emptyset) = \emptyset$, and that \mathbf{c}_0 is the cut of the configuration \emptyset . The crest of a prime configuration $[e]$ is $\{e\}$.

3.4. Unfolding algorithm

We implement a branching process of a reset net system $\mathcal{N}_{\mathcal{R}}$ as a set $\{n_1, \dots, n_k\}$ of *nodes*. A node is either a condition or an event. An *event* is a record with two fields: a transition of $\mathcal{N}_{\mathcal{R}}$, and a list of pointers to conditions (the input conditions of the event). A *condition* b is a record composed of three fields: the *place* p of $\mathcal{N}_{\mathcal{R}}$ such that $\pi(b) = p$, the number $\#(b)$ of tokens currently present on p (0 or 1), and a pointer to either event E_b (the unique input event of the condition), or to NIL, in case the condition has an empty preset. We thus represent a condition as triplets $(p, 0, e)$, $(p, 1, e)$, $(p, 0, \emptyset)$ or $(p, 1, \emptyset)$.

Let,

$$\begin{aligned} \mathbf{B}^1 &\triangleq \{b \in \mathbf{B} : \#(b) = 1\} \\ \mathbf{B}^0 &\triangleq \mathbf{B} \setminus \mathbf{B}^1 = \{b \in \mathbf{B} : \#(b) = 0\}. \end{aligned}$$

Contrary to the unfolding of ordinary nets⁴⁰, the initial data contain conditions not only for places that are marked in M_0 . In fact, the labelling of conditions explained below needs to be initialized for *every* place that is in the reset-relation with any transition. We will therefore start the algorithm below with an initial cut formed by copies of

- every initially marked place, i.e. of M_0 , whether it is a reset place or not, and
- every reset place that is not initially marked.

First, the following definition captures the events that can be appended to a given branching process.

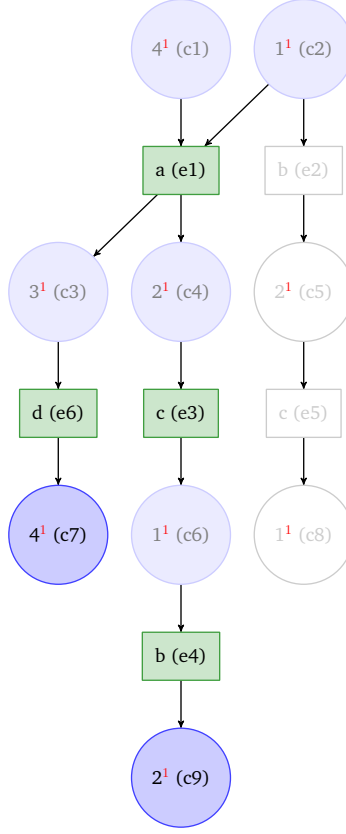

Figure 3.4: Representation of a configuration $\{e1, e3, e4, e6\}$ and its cut $\{c7, c9\}$ using our running example from figure 3.1. Those uncolored nodes are in conflict with our highlighted configuration. Moreover, we can say there are prime configurations, e.g., $\{e1\}$, $\{e2\}$, $\{e1, e3, e4\}$, $\{e2, e5\}$, etc, and non-prime configurations $\{e1, e3, e6\}$, $\{e1, e3, e4, e6\}$ (the colored one), etc. Note that all superscripts denoting number of tokens are in 1 since we are not employing *reset arcs*.

Definition 14 (Possible extensions). Let $\beta = (\mathcal{O}, \pi)$ with $\mathcal{O} = (\mathbf{B}, \mathbf{E}, G, \mathbf{c}_0)$ be a branching process of a reset net system $\mathcal{N}_{\mathcal{R}} = (\mathbf{P}, \mathbf{T}, F, R, M_0)$. The possible extensions of β are the pairs (t, X) , where X is a co-set of conditions of β and t is a transition of $\mathcal{N}_{\mathcal{R}}$ enabled by $\pi(X)$, as follows:

$$PE(\beta) \triangleq \left\{ (t, X) \notin \mathbf{E} : \begin{array}{l} X \in \mathbf{cosets}(\mathcal{O}) \\ \wedge \text{pre}(t) \subseteq \pi(\mathbf{B} \cap X) \\ \wedge [\text{res}(t) \cup \text{pre}(t)] = \pi(X) \end{array} \right\}$$

The algorithm for the construction of the unfolding starts with the branching process having the conditions corresponding to the initial marking of $\mathcal{N}_{\mathcal{R}}$, those places with a non-empty re-set, and no events. New events are added one at a time together with their output conditions.

Algorithm 1: Unfolding reset Petri nets.

Input: A reset net system $net_{\mathcal{R}} = (\mathsf{P}, \mathsf{T}, F, R, M_0)$, where $M_0 = \{s_1, \dots, s_n\}$ and

$$X \triangleq (\text{res}(\mathsf{T}) \setminus M_0) = \{s_{n+1}, \dots, s_{n+k}\}.$$

Output: The unfolding Unf of $net_{\mathcal{R}}$.

begin

$Unf := \{(s_1, 1, \emptyset), \dots, (s_n, 1, \emptyset), (s_{n+1}, 0, \emptyset), \dots, (s_{n+k}, 0, \emptyset)\};$

$pe := PE(Unf);$

while $pe \neq \emptyset$ **do**

add to Unf an event $e = (t, X)$ of pe such that $\text{post}(e)$ contains exactly one condition $(p, 1, e)$ added to B^1 for every place $p \in (\text{post}(t))$, and one condition $(p, 0, e)$ added to B^0 for every place $p \in \text{res}(t)$;

$pe := PE(Unf)$

end

end

The algorithm has no necessarily a termination because its stopping argument does not hold, in fact, it terminates only when the input reset net system $\mathcal{N}_{\mathcal{R}}$ has no any infinite occurrence sequence nor a transition with an empty preset but with at least one place in its re-set.

Figure 3.5 shows a prefix of our running example's unfolding converted in a reset net system, which has been previously encoded with *reset complement* (figure 3.5b). As mentioned before, we keep a tally of tokens in each condition (superscript numbers) to point out the difference when they are added to the branching process either with a token or not. The remaining conditions with no tokens are still part of the branching process, and are added according to algorithm 1.

Generally, by definition, $\mathcal{U}_{\mathcal{N}}$ may be infinite and represent all possible behaviors of $\mathcal{N}_{\mathcal{R}}$. However, a finite prefix *marking-complete* Π can be constructed, i.e. any marking M is reachable in $\mathcal{N}_{\mathcal{R}}$ if and only if there exists a marking M' reachable in Π with $f(M') = M$.

Configurations and markings. The following information from existing literature will be valuable:

Lemma 2 (see⁴⁰). *Fix a safe reset Petri net system $\mathcal{N} = \langle \mathsf{P}, \mathsf{T}, F, R, M_0 \rangle$ and its unfolding $\mathcal{U} = \langle B, E, G, \mathbf{c}_0, \pi \rangle$. Then for any two conditions (events) b, b' (e, e') such that b **co** b' (e **co** e'), one has $\pi(b) \neq \pi(b')$ ($\pi(e) \neq \pi(e')$). Moreover, every finite configuration C of \mathcal{U} represents a possible firing sequence whose resulting marking corresponds, due to the construction of \mathcal{U} , to a reachable marking of \mathcal{N} . This marking is defined as $Mark(C) \triangleq \{\pi(b) \mid b \in \mathbf{cut}(C)\}$. Moreover, for any two distinct configurations C_1, C_2 that satisfy $Mark(C_1) = Mark(C_2)$, we have an isomorphism of labeled occurrence nets*

$$\mathbf{I}_{(C_1, C_2)} : \mathcal{U}_{/C_1} \rightarrow \mathcal{U}_{/C_2} \tag{3.1}$$

where $\mathcal{U}_{/C_1}$ is the suffix of \mathcal{U} after removing configuration C_1 and all nodes in conflict with C_1 .

In simpler terms, this implies that any configuration of the system can be divided into consecutive parts. Each of these parts represents a configuration obtained by extending the net with the marking reached in the previous part.

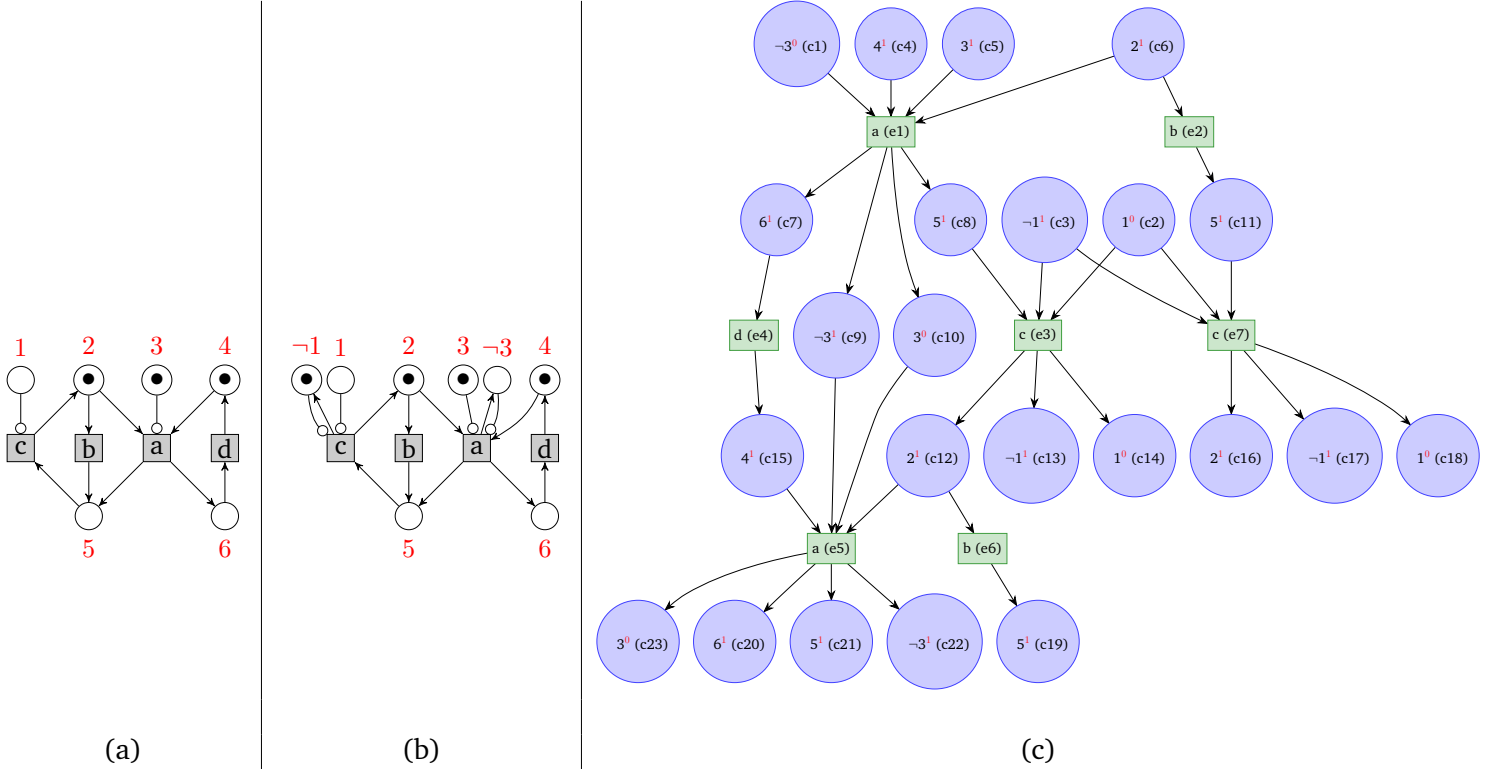

Figure 3.5: Our running example from figure 3.1 transformed into a r-net system (a), its reset-complement (b) and a prefix of its unfolding (c).

Definition 15 (Complete finite prefix). Let $\mathcal{N}_{\mathcal{R}} = (P, T, F, R, M_0)$ be a safe reset Petri net, and $\mathcal{U}_{\mathcal{N}} = (B, E, G, \mathbf{c}_0)$ its unfolding. A finite occurrence net $\Pi = (B', E', G', \mathbf{c}_0)$ is said to be a prefix of $\mathcal{U}_{\mathcal{N}}$ if $E' \subseteq E$ is causally closed, $B' = \mathbf{c}_0 \cup \text{post}(E')$, and G' is the restriction of G to B' and E' . A prefix Π is said to be complete if for every reachable marking M of $\mathcal{U}_{\mathcal{N}}$ there exists a configuration C of Π such that (i) $\text{Mark}(C) = M$, and (ii) for each transition $t \in T$ enabled in M , there is an event $\langle t, B'' \rangle \in E'$ enabled in $\text{cut}(C)$.

We shall write $\Pi_0(\mathcal{N}_{\mathcal{R}}, M_0)$ to denote an arbitrary complete prefix of $\mathcal{N}_{\mathcal{R}}$ from initial marking M_0 . It is known^{93,40} that the construction of such a complete prefix is indeed possible. The precise details of this construction are out of scope for this work; for what follows it suffices to know that it essentially follows the construction of $\mathcal{U}_{\mathcal{N}}$ outlined above but that certain events are flagged as *cut-offs* because the marking generated by their cone is represented by another event already present in the prefix. The construction then does not continue beyond any such cut-off event. Nonetheless, an ordering relation \prec is needed to compare two configurations and it must be *adequate*:

Definition 16 (Adequate order see Def. 4.5 of⁴⁰). A partial order \prec on \mathcal{C}^f is called adequate order iff

- \prec is well-founded,
- $C_1 \subseteq C_2$ implies $C_1 \prec C_2$, and
- \prec preserves extensions, i.e. for any $C_1 \prec C_2$ such that $\text{Mark}(C_1) = \text{Mark}(C_2)$, one has $C_1 \oplus E \prec C_2 \oplus \mathbf{I}_{(C_1, C_2)}(E)$ for the isomorphism $\mathbf{I}_{(C_1, C_2)}$ from (3.1).

As demonstrated in a prior work by Esparza et al. (2002)⁴⁰, for certain selections of the adequate order \prec , the resulting prefix can be larger than the reachability graph for some safe nets. However, when \prec is a *total* adequate order, it ensures that the number of non-cutoff events in the obtained prefix Π_0 will never exceed the size of the reachability graph.

Figure 3.6 shows the difference between unfolding with two well-known cutoff criteria, namely McMillan’s and Esparza, Römer and Vogler’s (we will call it Esparza’s for short) prefixes. Loosely speaking, McMillan’s approach flag an event as cutoff *iff its cone* has yielded previously the new discovered marking, whereas Esparza’s flag cutoff events *if the prefix* has produced already the new discovered marking. Figure 3.7 illustrates different maximal configurations present on figure 3.6(b). Note that as we select from configurations then Esparza’s and McMillan’s criteria produce the same since there are no conflicts, i.e., the corresponding prefix is just *one branching process*.

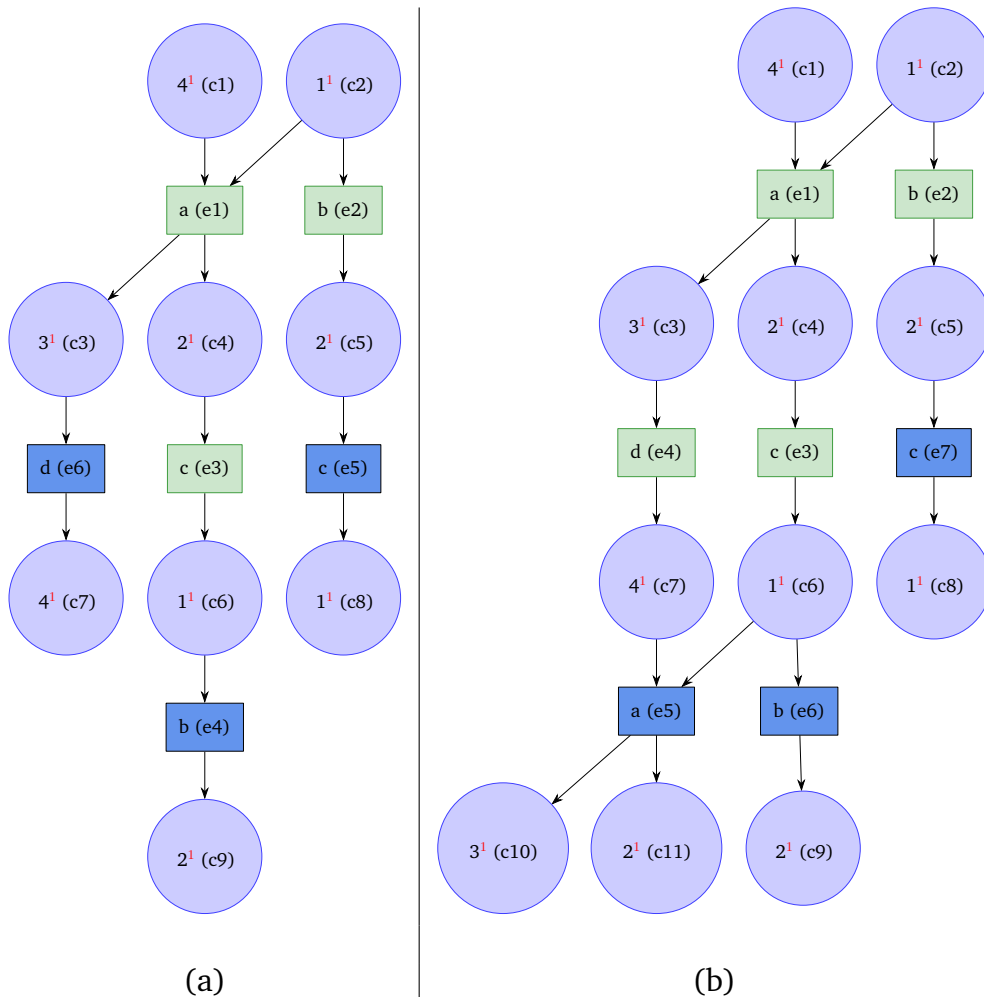

Figure 3.6: Comparing Esparza’s (a) and McMillan’s (b) cutoff criteria from our running example (fig. 3.1). Events colored in blue are those flagged as *cutoffs*.

Both approaches are complete and while Esparza’s prefix is smaller, McMillan’s is still useful for several scenarios. We will not detail here how to compute a finite complete prefix; for this, the reader is referred to Esparza et al. (2002)⁴⁰ or McMillan (1993)⁹³. The

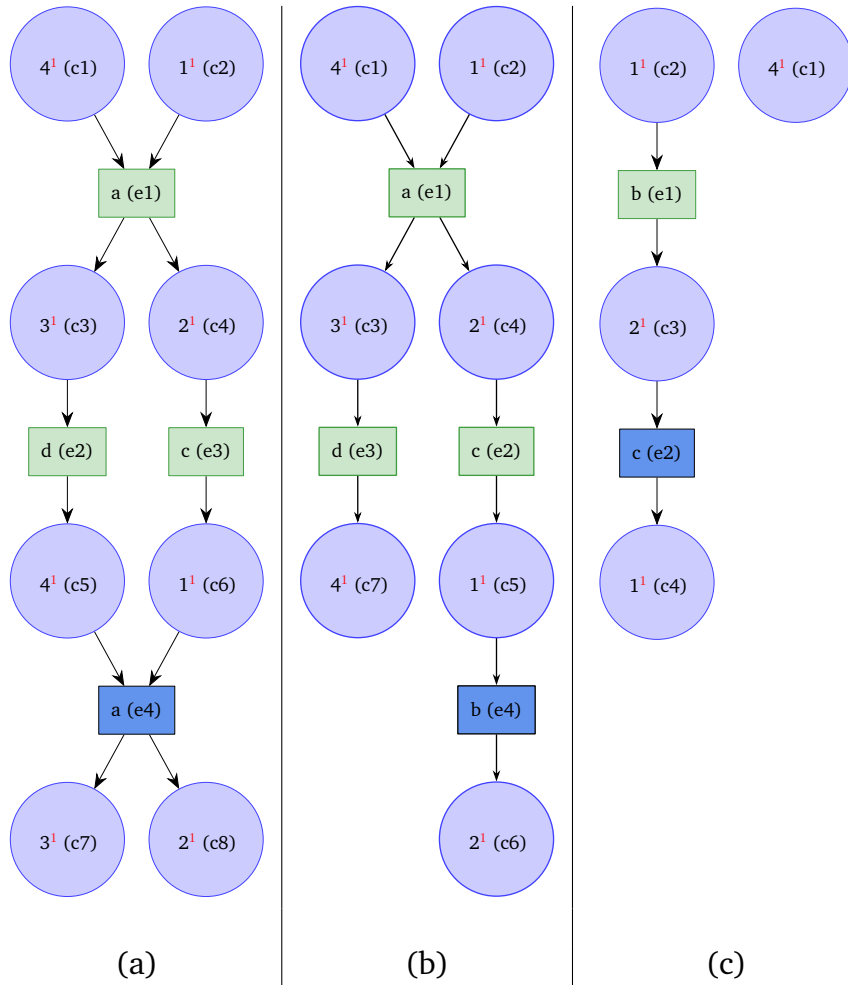

Figure 3.7: Illustration of three different maximal configurations (including conditions) of our running example from 3.1. The diagrams were achieved using ECOFOLDER with `-confmax` parameter which enables an interactive mode to choose from different configurations.

former obtains the prefix using a method which is bounded above in size by that of the reachability graph; whereas the latter may be exponentially larger than the reachability graph (see section 5 in⁴⁰). Both unfolding mechanisms are implemented in ECOFOLDER³ program. Note that no change in the definition and treatment of cut-off events is necessary to account for reset arcs. In what remains of the manuscript, Esparza's prefix is assumed to use for obvious reasons unless otherwise indicated.

4 - Causal Analysis

4.1. Example: a model of a termite colony

We illustrate the modeling of an ecosystem by an *ecosystem network* and a *Petri net*, initially proposed and developed in^{51,52}. Such ecosystem models have been proved useful in many case-studies, some of which exhibit a large number of ecosystem components and processes, to answer realistic questions in managed systems³⁰. Here, we consider as an example of an ecosystem the network of dominant interactions occurring in a termite colony, directly inspired from Gaucherel and Pommereau (2019)⁵¹. Termites are *eusocial* insects, i.e., adults live in groups, individuals cooperate in caring for the offspring, generations are overlapped, and reproductive and non-reproductive groups are divided in labor¹⁴⁶. Our model includes the following variables:

Inhabitants:

Rp: reproductive termites, i.e. the queen, the king, the eggs and the nymphs.

Wk: termite workers, i.e. all termites able to work.

Sd: termite soldiers.

Te: *termitomyces*, i.e. fungi grown by termites for nutrition.

Structures:

Fg: fungal gardens are chambers in the termite mound set by growing fungi.

Ec: egg chambers are built in the mound to serve as a nursery.

Resources:

Wd: wood is used by termites to build their mound and to grow fungi.

Competitors:

Ac: ant competitors that may attack the colony.

Those components can evolve (from an initial state) according to their interactions; we represent the functional presence or absence of any of them by adding ‘-’ or ‘+’ to their respective labels. For example, in figure 4.1, one say that for r1: *in the presence of Rp (Rp+), then Ec can be built or maintained (Ec+)*. By combining several rules mimicking such ecological processes, one construct a rule system similar to the one given in Gaucherel and Pommereau (2019)⁵¹.

Certainly, these rules (figure ??) can be translated into a reset net. Rules are depicted as transitions and their variables are represented as places in a net. Table 4.1 illustrates how elements of a rule system are encoded in cr-nets, and shows the convention for double arcs that we display in the cr-net for our termites colony (figure 4.2).

It is critical to maintain the duality between *absence* and *presence* for the elements in the colony, i.e., whenever a token is found in a place tagged with ‘+’, then no token

r1:	$Rp+$	\gg	$Ec+, Rp+$
r2:	$Rp+, Ec+$	\gg	$Wk+, Rp+, Ec+$
r3:	$Wk+$	\gg	$Wd+, Te+, Fg+, Ec+, Wk+$
r4:	$Wk+, Wd+$	\gg	$Sd+, Rp+, Wk+, Wd+$
r5:	$Wk+, Te+$	\gg	$Wd-, Wk+, Te+$
r6:	$Wd-$	\gg	$Wk-, Te-, Wd-$
r7:	$Wk-$	\gg	$Fg-, Sd-, Te-, Wk-$
r8:	$Wk-, Rp-$	\gg	$Ec-, Wk-, Rp-$
r9:	$Ac+, Sd-$	\gg	$Wk-, Rp-, Ac+, Sd-$

Figure 4.1: Rule system for the termites colony.

Rule system	Cr-net	
	long version	short version & firing
$P+ \gg \emptyset$ $P+ \gg P+$		
$P- \gg \emptyset$ $P- \gg P-$		
$P+ \gg P-$		
$P- \gg P+$		
$\emptyset \gg P+$		
$\emptyset \gg P-$		

Table 4.1: Graphical translations from variables in rule system to cr-net. Right Arrows (\rightarrow) and left arrows (\leftarrow) are production and consumption arcs, respectively. A line ($-$) is a read arc, and lines with a unique white dot ($-o$) or an inverted arrow ($\leftarrow o$) reset arcs. Arcs with arrow and white dot endings ($\leftarrow o$) must be interpreted as *reset and then produce*. Orange background color on transitions shows the consequence of firing.

must be found in its associated place tagged with ‘-’. As explained above, resetting places enables us to model *side effects*; by contrast, read arcs indicate *side conditions*. Notably, in ecosystems one frequently encounters *events* that occur removing resources, even though these are not required for the event. Consider r_8 in figure ??; in such rule we have no evidence about Ec^- prior to r_8 ’s occurrence, which means that we have no way to know whether Ec^- had any token or not, neither we have evidence about Ec^+ ’s tokens. Therefore, r_8 ’s firing will produce a token in Ec^- , and will remove a token from Ec^+ (a *side effect* on Ec^+).

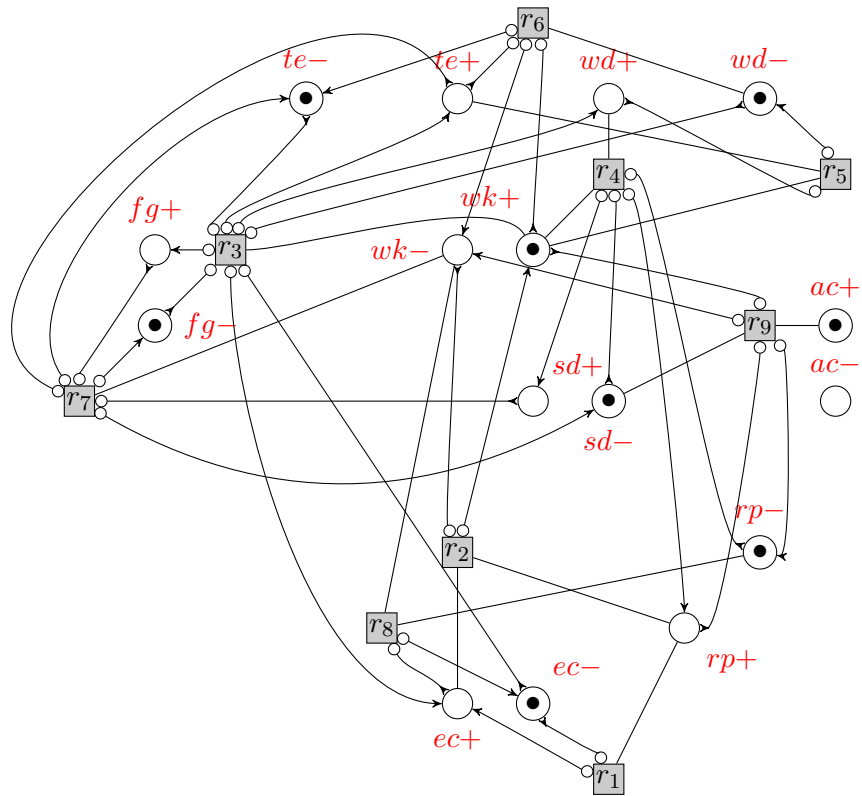

Figure 4.2: An example of a termites ecosystem using a contextual net with resets.

Additionally, one may note that there are places which change no tokens despite of being used by a transition. For those places, we may use read arc’s semantics; thus, we make no change in say place p ’s tokens whenever a transition fires. Read arcs allow modeling *side conditions*, meaning that a transition t is still enabled by p even if t fires, and then there is no change in p ’s tokens, neither in other places chained with read arcs to t . Indeed, ecosystems often trigger events by *reading* resources or components without consuming them, allowing events *coexistence*. For instance, r_3 ’s occurrence has no consumption in the tokens deposited in Wk^+ , then termite’s workers have no limitation to enable more transitions in their postset.

After encoding read arcs as shown in section 2.15.4, we obtain a reset net whose unfolding is computed according to algorithm 1. As previously employed, we make use of ECOFOLDER³ for this endeavor. Figure 4.2 shows the termites colony net using reset

and read arcs, whereas figure 4.3 exhibits the termites colony after *PR-encoding*; both nets already enjoy *reset complement*. Figure 4.4 describes the corresponding unfolding with a visual modification to shrink its illustration; here condition labels are merged into one node (circle) if and only if their presets and postsets are identical.

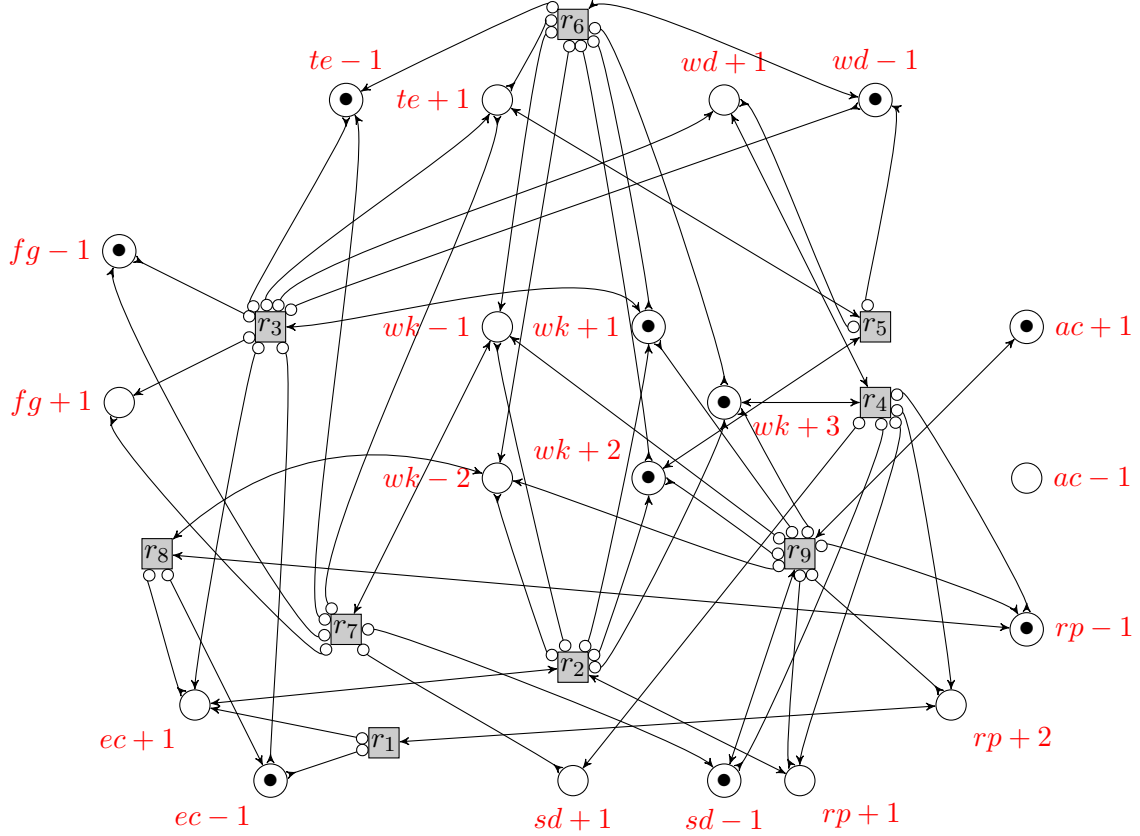

Figure 4.3: An example of a termites ecosystem using a reset net after PR-encoding.

An exhaustive examination of figure 4.4 unveils particular patterns of the net's dynamics and its connected ecosystem's evolution. From rules in figure ??, one may see that: r_1 produces $Ec+$, r_2 generates $Wk+$ and r_3 produces inhabitants, structures and resources; namely, such rule feeds the system when *workers* are present (as long as r_2 can fire). Likewise, r_4 's occurrence leaves creation or increment on soldiers and reproductives. While all previous rules reflect production of the colony's elements, r_5 's occurrence consumes wood and allows thereby firing of the remaining rules r_6 , r_7 , r_8 and r_9 . This behavioral duality is interesting and deserves analysis. See below. As mentioned, assume that we use as initial marking:

$$M_0 = \{wk+, sd-, wd-, ac+, rp-, ec-, te-, fg-\}, \quad (4.1)$$

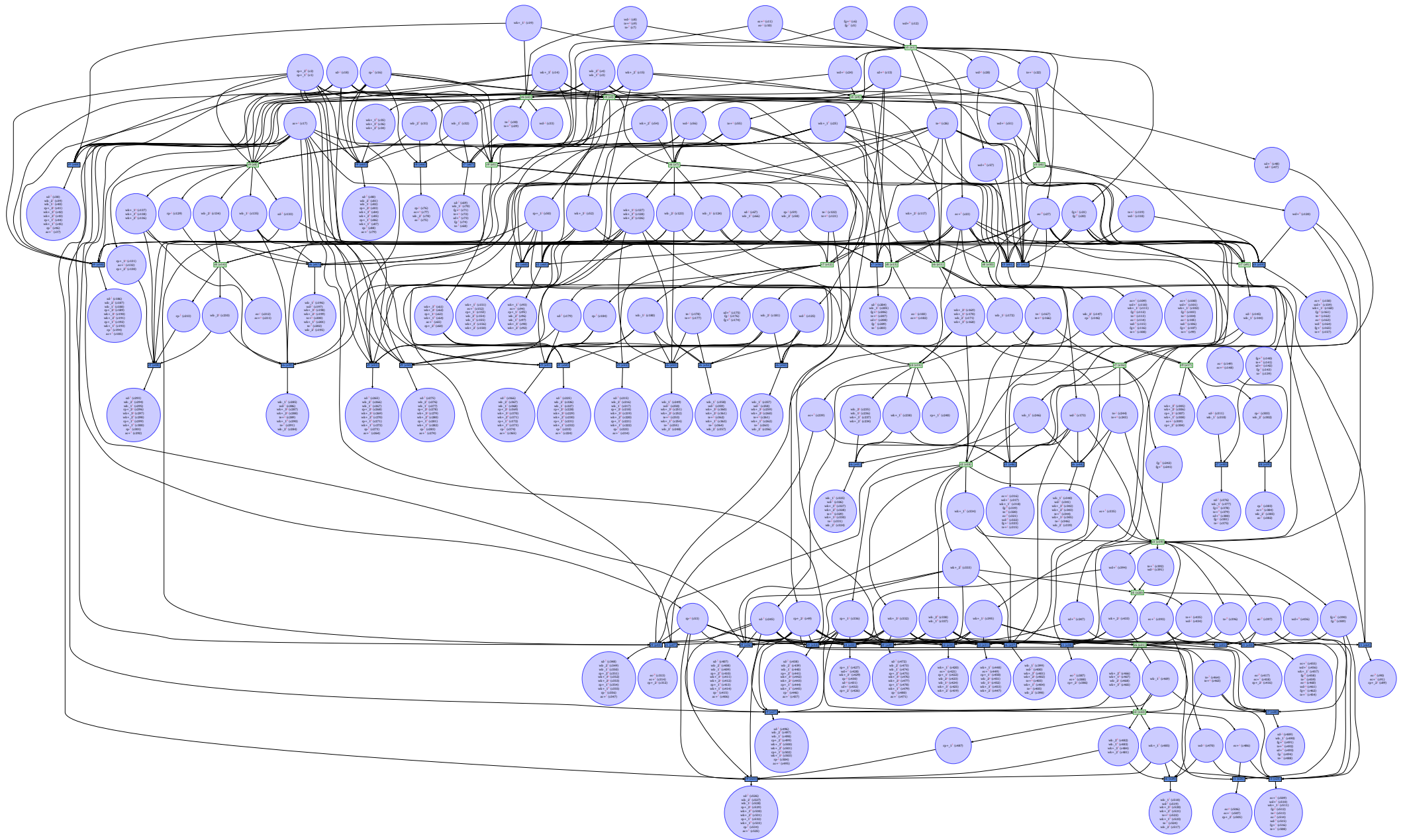
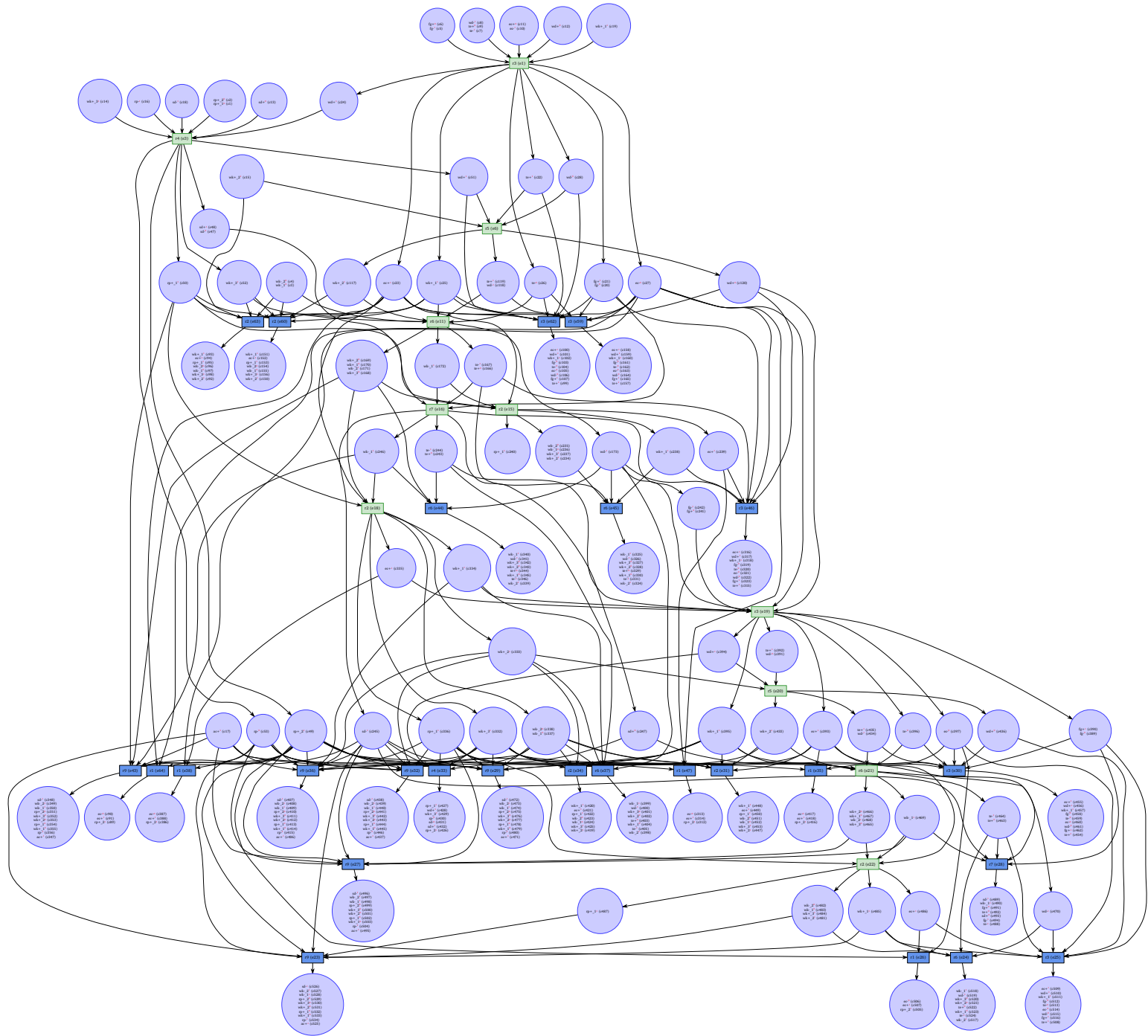

Figure 4.4: Unfolding of the termites example. Conditions are merged to favor graphical view.

The marking (or initial state) means that workers and ants are present, but all other elements are absent. Consequently, when firing r3, two different scenarios can be devised depending on how away (in terms of the number of fired events) is r9 to fire. Reproductives are the basis of the colony, and r9 kills reproductives and workers which leaves no chance for the colony's recovery. Figure 4.5 shows that while r5, r6 and r7 decrease wood, workers, termitomyces, fungal gardens and soldiers, they have no effect on reproductives nor egg chambers. Thus, the colony can recover and there is no irreversible loss. In contrast, 4.6 shows that firing of r9 or r8 lead to irreversible changes and losses like depletion of all colony-related entities and arrival of ants which are unrecoverable states, i.e, the colony's collapse. When there is a way to revert losses or depletion, we describe this scenario as *temporarily stable* (fig. 4.5) because the colony can *survive* as long as soldiers are present (which in turn means the colony is operational to keep soldiers) because they hinder r9's firing. In the case of soldiers' reduction or absence, the colony may fall into its deterioration; when there is no remedy we call such scenario as *collapse* or the *downfall* (fig. 4.6).

Loosely speaking, workers, reproductives and egg chambers in the colony have to keep laboring (and functioning) at a sufficient *rate* to prevent a successful attack by the ants. This phenomenon of *arms race* is suggested by *Red Queen hypotheses* as proposed by L. Van Valen in 1973; it states that species must constantly adapt, evolve and proliferate while being pitted against other ever-evolving opposing species, not for gaining advantages but simply to survive¹³⁵.



(a)

Figure 4.5: Unfolding of the first scenario from the termites example showing a *temporal stabilization* of the colony (a) and (b - see next page for a more clear illustration displaying the event structure).

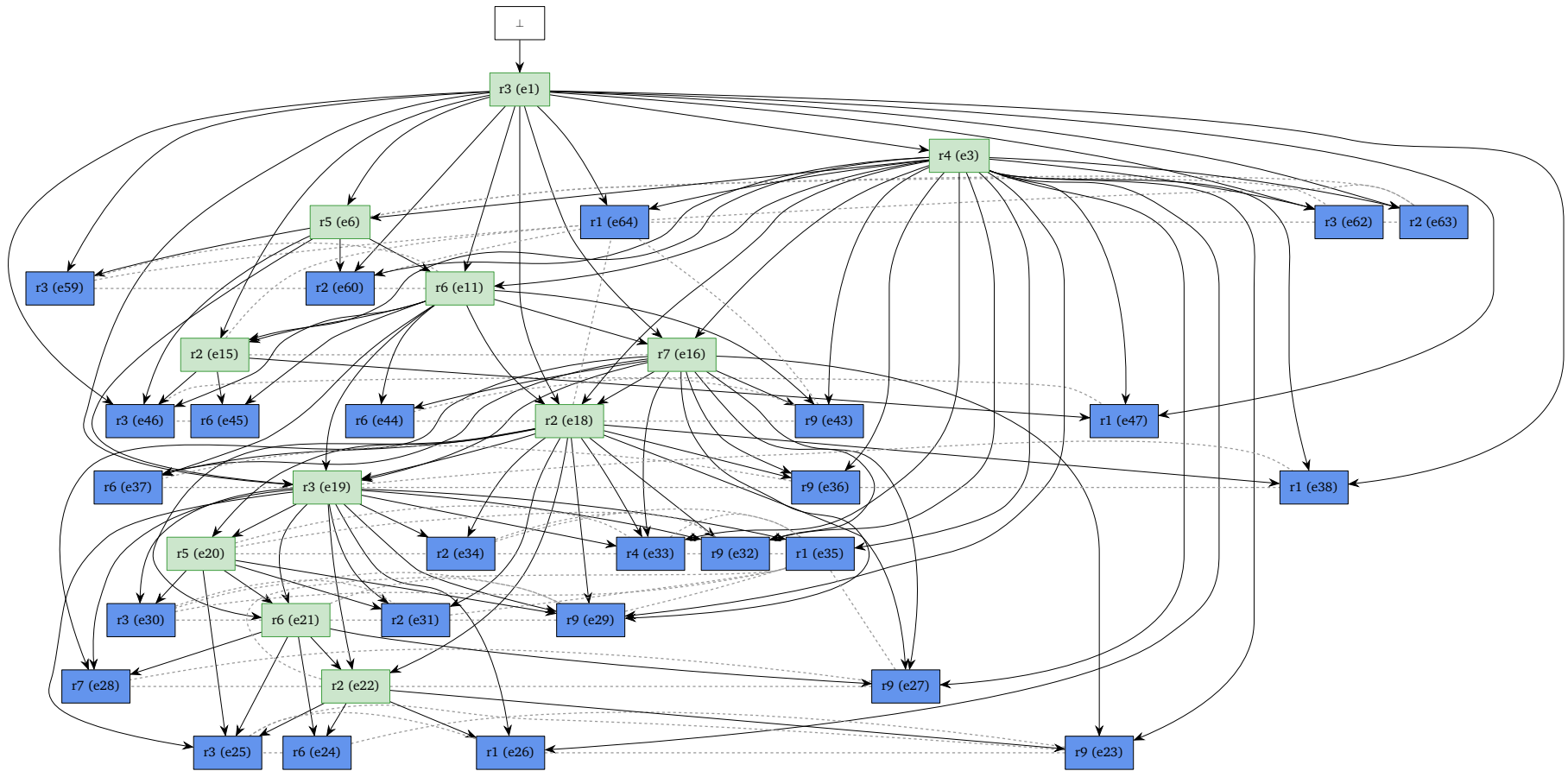

(b)

Figure 4.5: Extension of the previous figure displaying the colony's stabilization *temporarily stable* as an event structure. On this scenario r_9 never overcome stabilizing rules like r_1 , r_2 , r_3 and r_4 . The causal firing of other rules like r_5 , r_6 and r_7 may lead to irreversible changes (through r_8 and r_9 - fig. 4.6) but here, by means of Esparza's cutoff criterion, any of these stabilizing rules end up being enabled. Dashed lines represent immediate conflicts of events, thus they can not be in the same configuration.

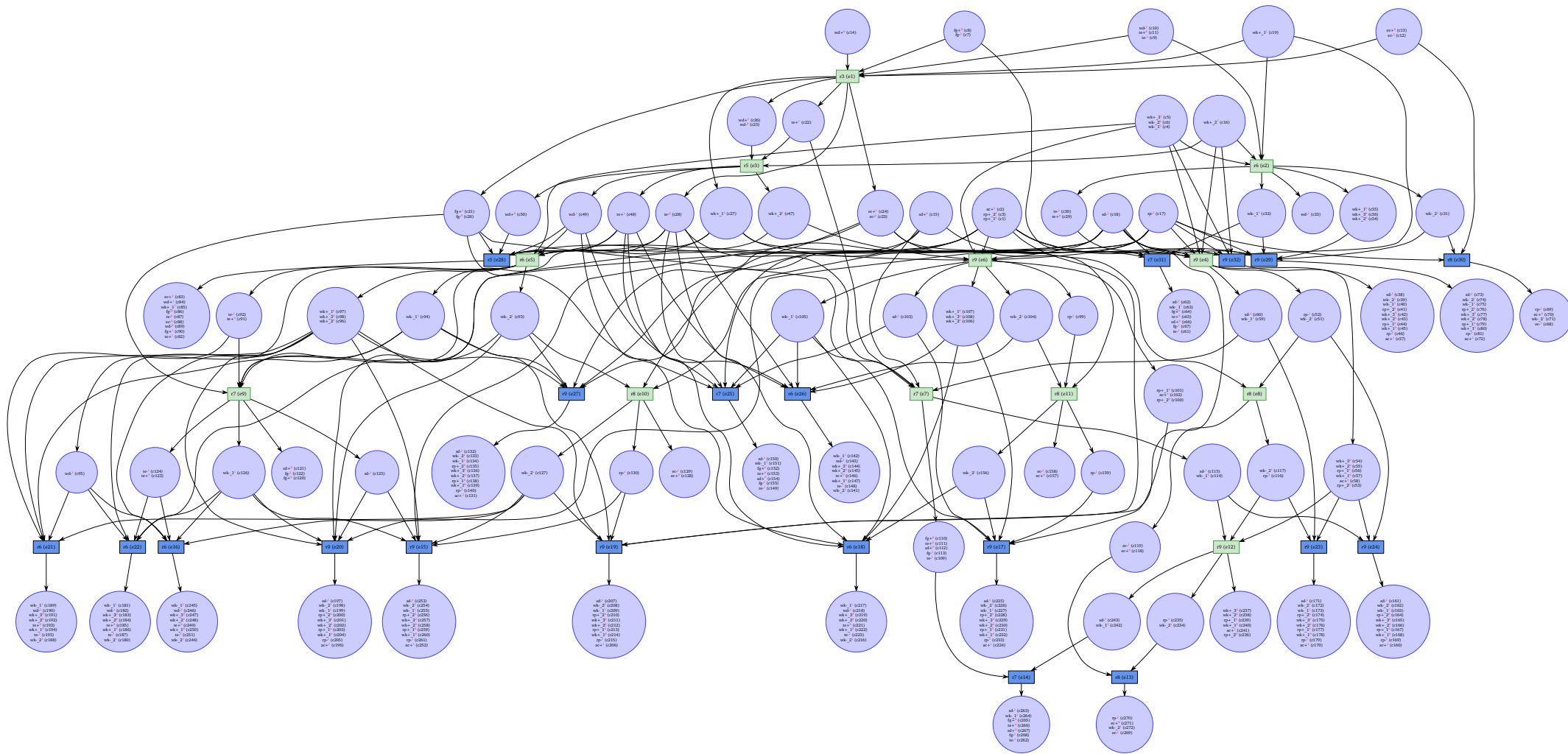

(a)

Figure 4.6: Unfolding of the second scenario from the termites example showing different paths to the colony's collapse (a) and (b - see next page for a more clear illustration displaying the event structure).

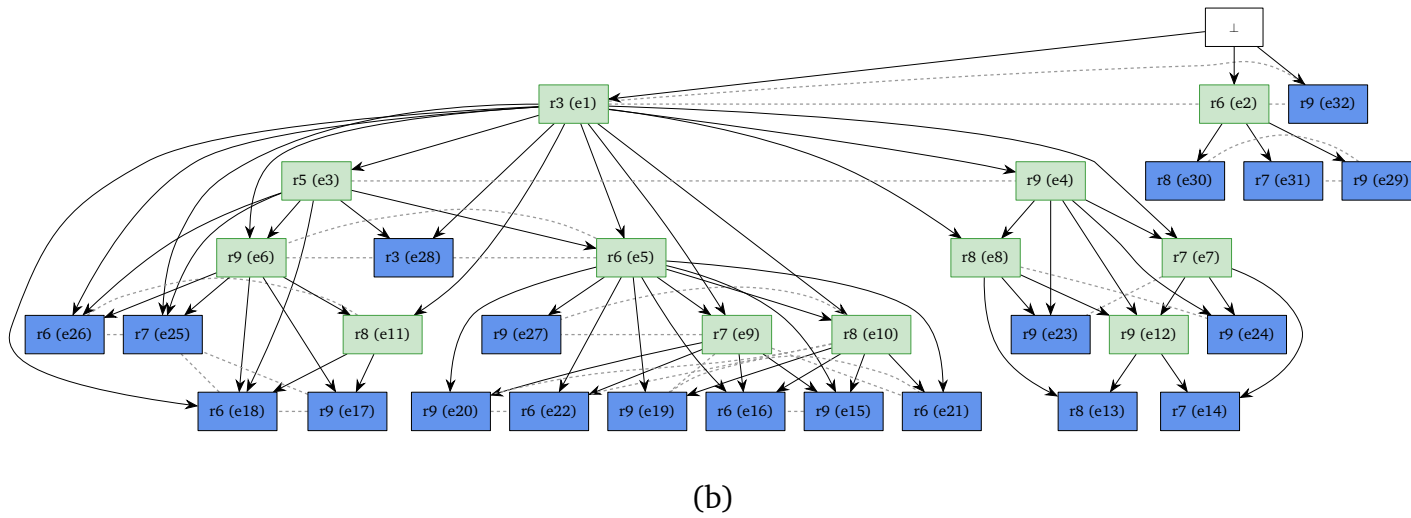

Figure 4.6: Extension of the previous figure displaying the colony's *downfall* as an event structure. In this scenario r9 and r8 are prone to fire leading to the depletion of resources, inhabitants, and structures with no opportunity to recover. What is present here are ant competitors, whereas all entities regarding the colony are *absent* and have *perished*. Dashed lines represent immediate conflicts of events; thus, they can not be in the same configuration.

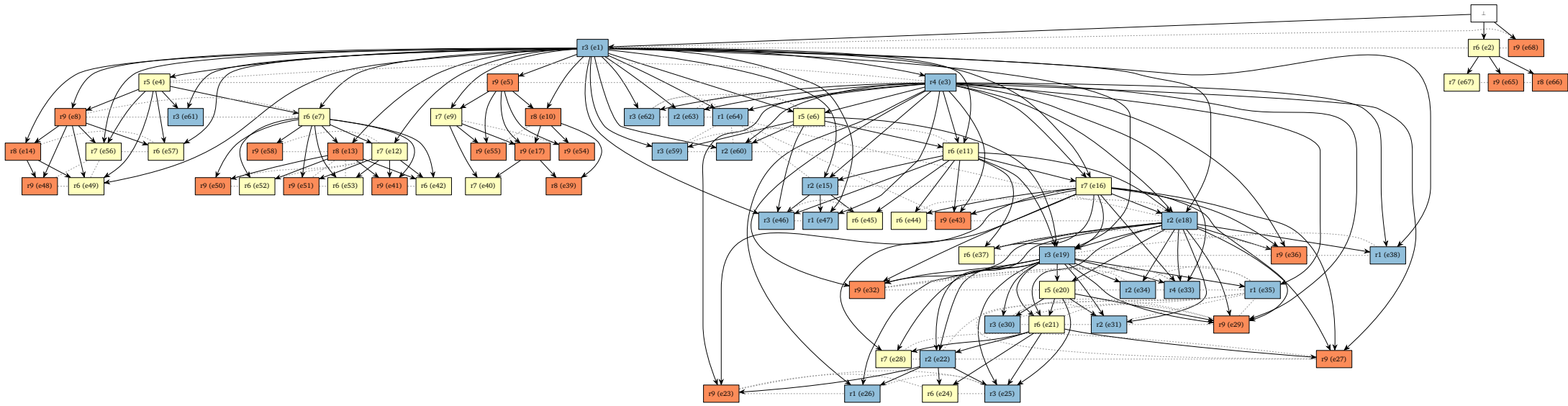

Figure 4.7: Representation of the event structure from figure 4.4. The two scenarios where the termite colony is *temporarily stable* or have *collapsed* are more conspicuous. Blue-like events are those that correspond to the stabilizing rules, yellow-like are the events that can lead to stabilization or collapse, and orange-like ones are the *bad* ones, i.e., they steer towards the colony's downfall.

Ecofolder allows to set some restrictions on states of the system, e.g. assume that we modify our initial marking from (eq. 4.1) so that we have soldiers in the colony while the others variables remain the same; and we want to see the dynamics where there is *always* wood, then we enforce $wd+$ to be always marked. So our initial marking is:

$$M_0 = \{wk+, sd+, wd-, ac+, rp-, ec-, te-, fg-\}, \quad (4.2)$$

where for any firing sequence σ and marking M such that $M_0 \xrightarrow{\sigma} M$ (M is reachable from M_0), M must satisfy $M \cap \{wd-\} = \emptyset$. Note that we can start with absence of wood because anyways $r3$ will provide it. There would be a slight difference if wood is presence as initial state because it would enable $r4$ from M_0 but as said, $r3$ produces wood and thereby enables $r4$. This assumption produces the following prefix:

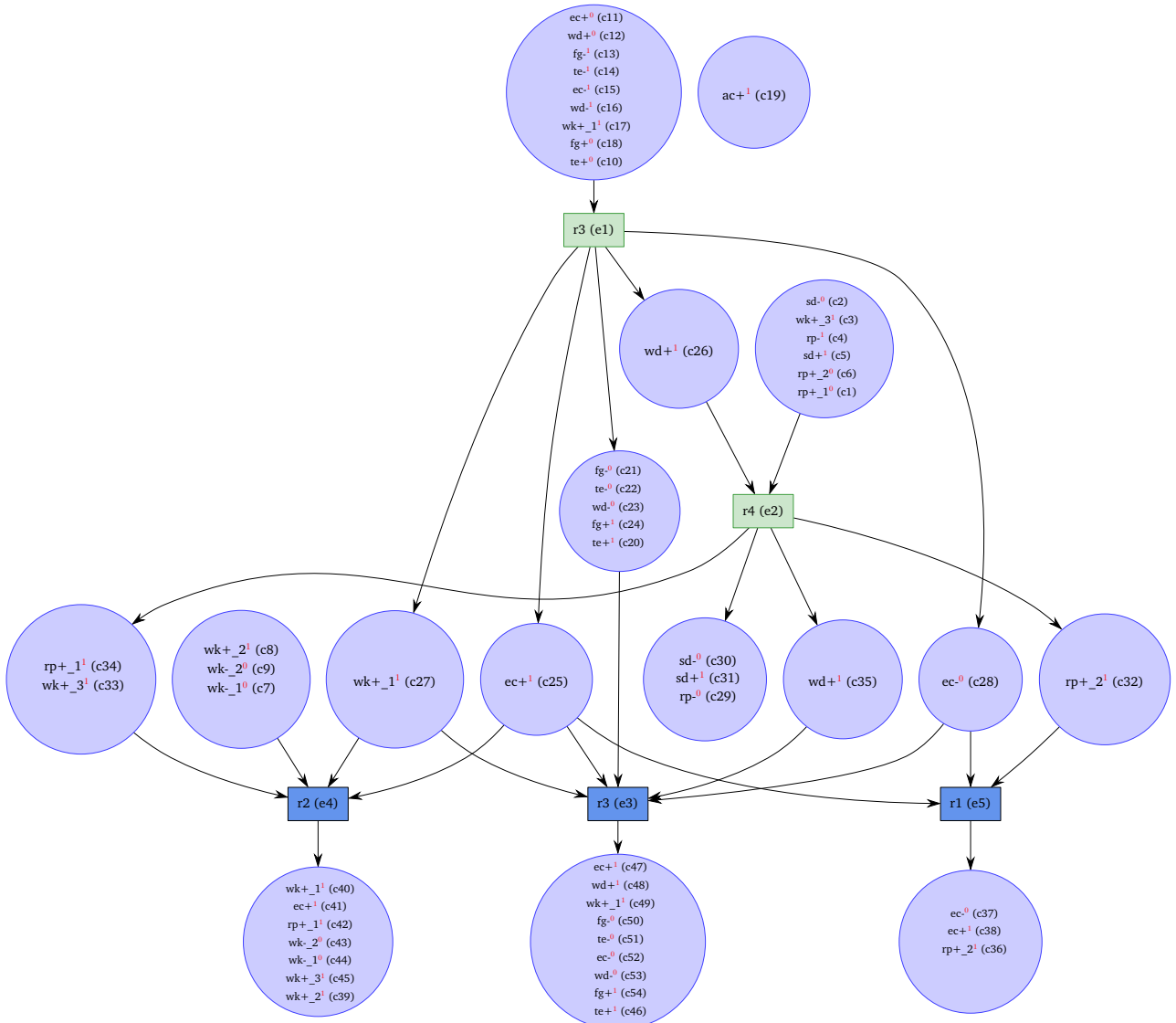

Figure 4.8: Unfolding of the termite's colony example when soldiers are initially present and wood is never depleted.

On the contrary, say we have no soldiers as initial state (w.r.t. 4.1), and we want to

see the dynamics where there is *never* wood, then we enforce wd^- to be always marked. Therefore, our initial marking is:

$$M_0 = \{wk+, sd-, wd-, ac+, rp-, ec-, te-, fg-\}, \quad (4.3)$$

where for any firing sequence σ and marking M such that $M_0 \xrightarrow{\sigma} M$ (M is reachable from M_0), M must satisfy $M \cap \{wd+\} = \emptyset$. This premise gives us the following prefix:

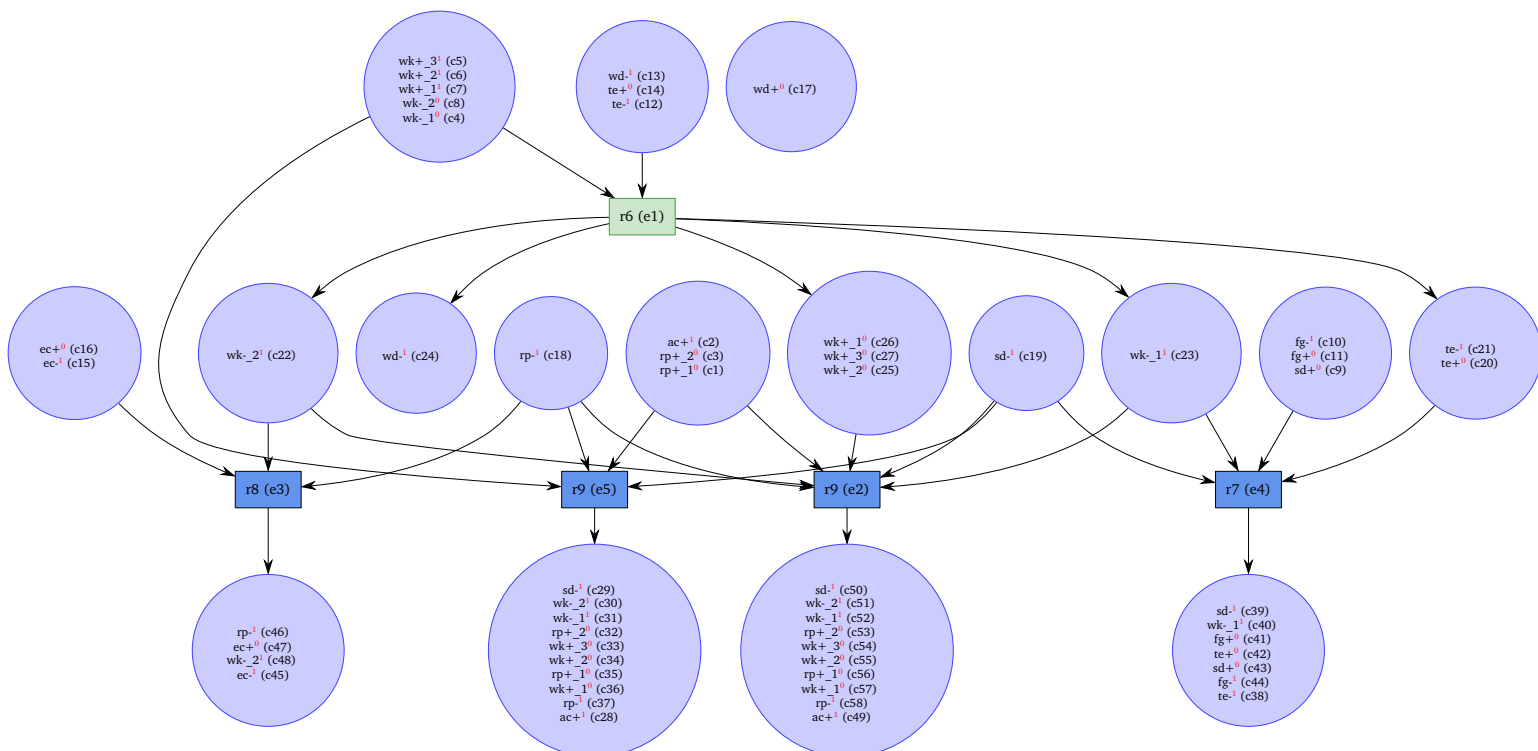

Figure 4.9: Unfolding of the termite’s colony example when soldiers are initially absent and wood is never produced.

The last two suppositions and prefixes exhibit a relevant feature of Ecofolder because it allows identifying key variables in a particular ecosystem that are not so obvious. In essence, we found that the absence of wood is enormously detrimental to the colony, even if its fundamental role is not evident in the colony’s well-being. Reproductives, egg chambers, and workers seem to be foundational, but without wood, one cannot produce soldiers, and in the presence of ants, it is a catastrophe.

It is intriguing to observe that $r5$ is not enabled in figure 4.8 or figure 4.9. This phenomenon is explained due to $r5$ ’s behavior, it can lead to stabilization or collapse; its products combine a reduction of wood with an unchanged presence of workers and termitomyces. Thus, in fig. 4.8 we have workers and termitomyces, but due to the restriction on wd^- we have no reduction of wood; in contrast, fig. 4.9 shows that we have no way to enable $r3$ (it produces wood), which in turn would produce termitomyces for enabling $r5$.

This fact of combining transitions or places to enable runs in the prefix is a subject to discuss. The next chapter will develop the idea of being doomed or free in a prefix.

5 - Doom Avoidance

In the analysis of concurrent systems like ecosystems, a fundamental question arises regarding their long-term behavior, specifically focusing on whether irreversible choices exist in their evolution. These choices can lead the system into regions of the reachability space from which there is no return to other regions. In general, questions of long-term behavior and stabilization have received relatively little attention. Given the increasing attention to formal methods in the field of biology, and more recently in ecology⁵³, a notable aspect being explored is the phenomenon of multistability in systems^{131,111,105,108}. This phenomenon has been investigated in alternative qualitative models like Boolean and multivalued networks^{130,132,115}. Multistability is a defining attribute of numerous critical biological processes, including cellular differentiation, cellular reprogramming, and cell-fate determination. In essence, the stabilization of a cell regulatory network corresponds to reaching one of the various possible cell phenotypes. This underscores the significant contribution of multistability to cellular dynamics. Nonetheless, multistability also arises in numerous other domains within the life sciences; our particular interest lies in the qualitative examination of the fate of *ecosystems*⁵³.

Multistability is succinctly defined by the existence of multiple attractors within the studied system. Attractors represent stable behaviors and are the smallest subsets of states from which the system cannot escape; essentially, they are terminal strongly connected components of the corresponding transition system. In the long run, the system will settle into one of its attractors and persist within it. Multistability occurs when there are multiple such attractors present. The basin of attractor **A** encompasses states from which the system inevitably approaches and remains within attractor **A**. The basin encompasses not only the attractor itself but also potentially incorporates one or several transient states⁷⁶.

Our objective is to identify *tipping points* at which the system transitions from an indeterminate or *free* state into a specific basin. While this concept holds broader significance, it frequently arises in the examination of signaling and gene regulatory networks^{28,94}. Fitime et al. (2017) present a technique for identifying, within a boolean network model, the states where a transition leads to the loss of reachability for a designated attractor⁴² (called *bifurcation transitions* there; we prefer to speak of *tipping points* instead). Yet, enumerating the states influenced by these identified transitions, causing the system to deviate from the attractor, can become exceedingly complex and impedes a nuanced comprehension of the branching process. Hence, the primary challenge lies in pinpointing the precise contexts and sequences of transitions that result in the establishment of a *strong basin*.

The use of a bounded unfolding prefix allows to obtain all reachable attractors²⁶, and the particular shape of basins visible in a concurrent model⁶⁵. In this chapter, we

extend the scope of these previous analyses. Our perspective here is that all attractors signify the termination of the system's free behavior, i.e., to its *doom*. The latter means that in various application domains, there are typically different types of attractors, some of which have more negative implications than others. For example, in cell regulation, certain attractors represent healthy phenotypes to which a cell can differentiate, while others may indicate a cancerous state. In ecological systems, there might not even be a single attractor that can be considered *healthy* because *stable* regions may involve the extinction of certain species, the decline of biodiversity, the loss of some ecological processes, the collapse of sub-ecosystems, etc. Survival, or the ability to avoid undesirable outcomes (referred to as *doom* in this context), often involves staying within a transient but *doom-free* loop.

To aim at this purpose, we provide characterizations of basin boundaries (referred to as *cliff-edges* below) and the behaviors that remain *free*, regarding unfolding's properties. Furthermore, we introduce a novel quantitative measure termed *protectedness*, indicating the extent to which a system is distant from, or close to, its eventual doom while still being in a state of inherent *freedom*. In broad terms, this chapter introduces formal tools for addressing these forms of *doom avoidance* within the context of concurrent systems modeled using safe Petri nets.

5.1. Case study: doom avoidance

Consider the next net from Haar et al. (2020)⁶⁵:

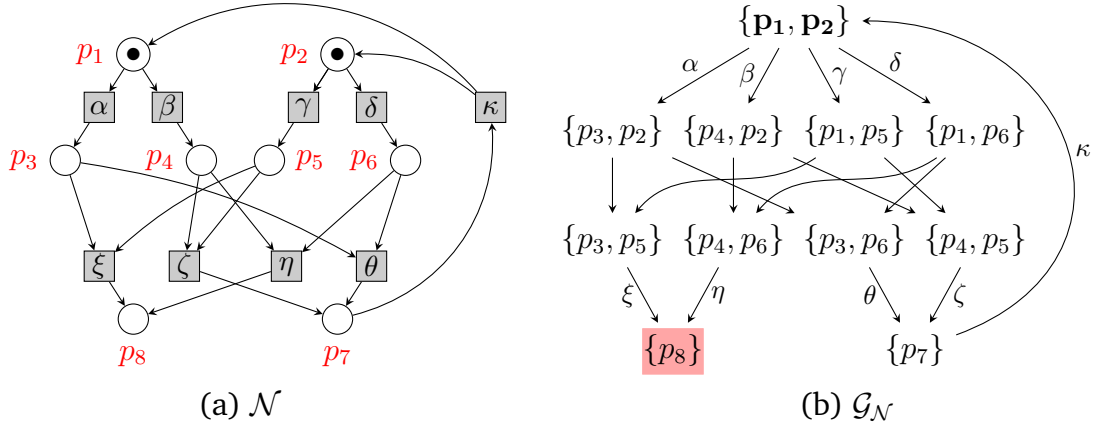

Figure 5.1: An ordinary safe net (a) and to the right, its marking graph (b). The initial marking is bold and its unique attractor is highlighted in red.

Let us say that we want to ‘escape’ from the *fixed point* $\{p_8\}$ as well as we wanted to evade certain states in the termites’ example like $\{wk-, sd-, wd-, ac+, rp-, ec-, te-, fg-\}$. From the marking graph (figure 5.1b) is evident that before reaching $\{p_8\}$, we reach either markings $\{p_3, p_5\}$ or $\{p_4, p_6\}$ which from there on, there is no way to escape the fixed point, even if these markings are not ‘bad’. Prior to enabling ξ and η , we have a collection of markings $\{\{p_3, p_2\}, \{p_4, p_2\}, \{p_1, p_5\}, \{p_1, p_6\}\}$ which are transient states before allowing another transition to fire and from which we may say nothing about the system’s fate. The latter implies that firings of α, β, γ , and δ give no clue about how the system will evolve but rather their combination, which is unclear from the marking graph. Thus, it may be helpful to have a look at its unfolding:

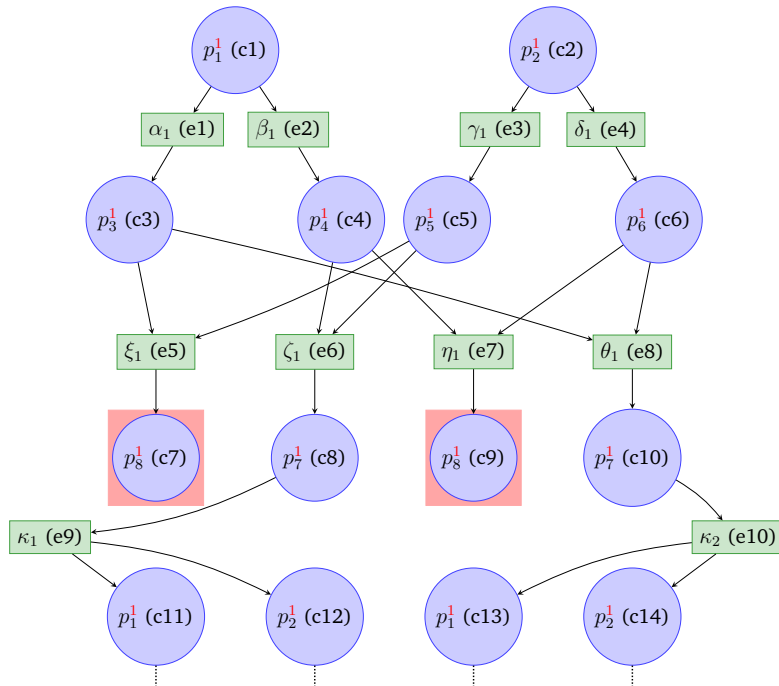

Figure 5.2: A prefix of the unfolding for the ordinary net for figure 5.1. The cuts of configurations: $\{\alpha_1, \gamma_1, \xi_1\}$ and $\{\beta_1, \delta_1, \eta_1\}$ are highlighted in red because $\pi(\{c7\}) = \pi(\{c9\}) = \{p_8\}$.

From figure 5.2 one may comfortably say $C_1 = \{\alpha_1, \gamma_1, \xi_1\}$ and $C_2 = \{\beta_1, \delta_1, \eta_1\}$ produce a cut which corresponds to the fixed point in figure 5.1b. One also may say $C'_1 = \{\alpha_1, \gamma_1\}$ and $C'_2 = \{\beta_1, \delta_1\}$ produce analogous cuts to markings $\{p_3, p_5\}$ and $\{p_4, p_6\}$, respectively; from where we know is impossible to evade the attractor even though these markings are not *bad*. We describe configurations and markings with this behavior *doomed*. Moreover, all markings out of the ones classified as *bad* or *doomed* are *good*, i.e., $\{p_1, p_2\}, \{p_3, p_2\}, \{p_4, p_2\}, \{p_1, p_5\}, \{p_1, p_6\}, \{p_3, p_6\}, \{p_4, p_5\}, \{p_7\}$ are *good*; and all configurations whose cuts correspond to a *good* marking are *free*, e.g., $\emptyset, \{\beta_1, \gamma_1\}, \{\alpha_1, \delta_1\}$, etc. Now, we shall formalize these concepts.

5.2. The Bad, the Good, the Doomed, and the Free

Taking inspiration from Giua and Xie (2005)⁵⁵ where the authors propose a way to avoid a set of forbidden (in our case bad) markings, and from Aguirre-Samboní et al. (2022)'s definitions, we say:

Definition 17 (Bad states or markings). Assume that a set of bad markings is given such that $\mathcal{M}_B \subseteq \mathbf{R}(M_0)$. Since we are interested in long-term behaviors, we assume that \mathcal{M}_B is reachability-closed, i.e., $\exists M, M' \in \mathcal{M}_B \wedge t \in \mathbb{T} : M \xrightarrow{t} M' \implies M' \in \mathcal{M}_B$.

Definition 18 (Good states or markings). Simply from a given set of bad markings \mathcal{M}_B , we write $\mathcal{M}_G \triangleq \mathbf{R}(M_0) \setminus \mathcal{M}_B$ the set of good markings. Note that \mathcal{M}_G is not reachability-closed since we may reach a bad marking from a good one.

Now, let $\mathcal{C}_B \triangleq \{C \in \mathcal{C}^f : \text{Mark}(C) \in \mathcal{M}_B\}$ be the set of bad finite configurations, and define \mathcal{C}_B^0 as the set of configurations in \mathcal{C}_B that is included in Π_0 . $\mathcal{C}_B \subseteq \mathcal{C}$ is *absorbing* or *upward closed*, that is, for all $C_1 \in \mathcal{C}_B$ and $C_2 \in \mathcal{C}^f$ such that $C_1 \subseteq C_2$, one must have $C_2 \in \mathcal{C}_B$.

This upward closure supports the following expansion of our terminology: let $C \in \mathcal{C}^\infty$, then C is bad iff there exists $C' \in \mathcal{C}_B$ such that $C' \subseteq C$.

For any $C \in \mathcal{C}$, let $\Omega_C \triangleq \{\omega \in \Omega : C \subseteq \omega\}$ denote the maximal runs into which C can evolve. Our focus lies on finite configurations, and specifically, those for which all of their maximal extensions are deemed 'bad.' Here, we categorize infinite configurations as bad if they contain a bad finite configuration. We shall refer to these configurations as 'doomed' because from them, it becomes inevitable for the system to reach a bad marking sooner or later; and from then on, all reachable markings are bad.

Definition 19 (Doomed configurations). A configuration $C \in \mathcal{C}^f$ is *doomed* iff

$$\forall C^* \in \mathcal{C}^\infty : C \subseteq C^* \implies \exists C' \in \mathcal{C}^f : \begin{cases} C' \subseteq C^* \\ \wedge \text{Mark}(C') \in \mathcal{M}_B \end{cases} \quad (5.1)$$

The set of \mathcal{D} denotes doomed configurations and its minimal elements by $\check{\mathcal{D}}$. We call configurations that are not doomed *free*. The set of free configurations is denoted by \mathcal{F} .

For all reachable markings M , we assume that the *badness problem* ‘ $M \in \mathcal{M}_B$?’ has been decided. Given that all bad markings are inherently doomed, our task is to distinguish between the good markings that are also doomed and those that remain *free*. The next sections will tackle this particular challenge.

5.3. Verification of freeness

In order to check whether a given marking M is partially free, the key question is whether it is possible to reach, from M , some $M' \in \mathcal{M}_G$ such that M' admits a non-empty firing sequence σ with $M' \xrightarrow{\sigma} M'$. Indeed, under the assumption that \mathcal{N} is *deadlock-free* in the sense that no maximal configuration contains any maximal event, it is easy to see that the existence of such an M' is equivalent to partial freedom of M . Of course, deadlock-freeness can always be obtained by introducing dummy loop transitions into any partially deadlocked marking. Therefore, this assumption does not compromise generality. It is worth noting that the traditional algorithms used for detecting loops in a *transition system* are not applicable in this context due to the impractical size of the state graph in most Petri nets we work with. We will customize unfolding-based approaches in accordance with Esparza and Heljanko (2008)³⁹. A procedure that extends beyond McMillan’s complete prefix⁹³ starting from any reachable marking M , will generate a comprehensive data structure capable of verifying the freedom of M .

5.3.1. Search for loops

The crucial factor in achieving this is undoubtedly the ability to detect loops in the reachability relation. We need to catch such loops as early as possible, in a small prefix.

Definition 20 (Marking equivalence and loops). $C_1, C_2 \in \mathcal{C}^f$ are marking equivalent, written $C_1 \sim_M C_2$, iff $Mark(C_1) = Mark(C_2)$. Say that C_1 and C_2 form a loop, written $loop(C_1, C_2)$, iff

1. they exhibit a cycle in the state graph, i.e. $C_1 \sim_M C_2$ and $C_1 \subsetneq C_2$, and
2. there are no configurations between C_1 and C_2 that exhibit such a cycle, i.e. there do not exist $C_3, C_4 \in \mathcal{C}^f$ such that

- (a) $C_1 \subseteq C_3 \subsetneq C_4 \subsetneq C_2$
- (b) $C_3 \sim_M C_4$
- (c) $\{C_1, C_2\} \neq \{C_3, C_4\}$.

Write $mloop(C_1, C_2)$ iff C_1 and C_2 form a minimal loop wrt inclusion, i.e. iff

- (a) $loop(C_1, C_2)$
- (b) for $C'_1, C'_2 \in \mathcal{C}^f$, $C'_1 \subsetneq C_1$ and $C'_2 \subseteq C_2$ together imply that $\neg loop(C'_1, C'_2)$.

We have:

Lemma 3 (Loop-free configurations). *Every loop-free configuration $C_M \in \mathcal{C}^f$ such that $\text{Mark}(C_M) = M$ is in McMillan's⁹³ prefix $\Pi_0^{McM}(M) \triangleq \Pi_0^{\subseteq}(M)$.*

Proof: Follows from the construction of $\Pi_0^{McM}(M)$ since configurations are only truncated by the cutoff criterion when they produce a loop. \square

Lemma 4 (Minimal-loop containment). $\forall C_1, C_2 \in \mathcal{C}^f(M_0)$: *if $\text{mloop}(C_1, C_2)$, then C_2 is a configuration of $\Pi_0^{McM}(M)$ (and a fortiori, so is C_1).*

Proof: Suppose that under the assumptions of the lemma, C_2 is not a configuration of $\Pi_0^{McM}(M)$. In that case, it must contain $C_2^a \subseteq C_2^b \subsetneq C_2$ such that $\text{loop}(C_2^a, C_2^b)$. But $\text{mloop}(C_1, C_2)$ implies this is impossible unless $C_1 = C_2^a$ and $C_2 = C_2^b$. But if this is the smallest loop in C_2 , then C_2 must be in $\Pi_0^{McM}(M)$. \square

Lemma 5. *For every marking sequence $M \xrightarrow{t_1} \dots M$ that contains no properly smaller loop, there is a configuration C_M in $\Pi_0^{McM}(M)$ such that $\text{mloop}(\emptyset, C_M)$.*

Proof: A consequence of the definition of $\Pi_0^{McM}(M)$ and of Lemma 4. \square

This informal algorithm can be accelerated by specifying, in addition to loop-cutoffs, any event e such that $\text{Mark}([e]) \in \mathcal{M}_{\mathcal{B}}$ (or equivalently, $[e \in \mathcal{C}_{\mathcal{B}}]$) as a cutoff event in the unfolding procedure. However, the remaining computational challenge lies in verifying whether a given marking M is bad, based on the initial information $\mathcal{M}_{\mathcal{B}_0}$ (initial set of bad markings), which may not necessarily be an absorbing set. The computational complexity of this verification process depends on the structure of $\mathcal{M}_{\mathcal{B}}$.

The case of indicator places. In a common and convenient scenario, the markings within $\mathcal{M}_{\mathcal{B}}$ can be identified using a straightforward predicate. This situation frequently arises in practical applications, where there is often an indicator place p such that M belongs to $\mathcal{M}_{\mathcal{B}}$ if and only if p is present in M (and this implies that if p is marked in a state M , it remains marked in all states M' reachable from M). This verification can be readily performed during the runtime of the unfolding algorithm. In fact, any event e for which p is a member of $\text{post}(\pi(e))$ can be designated as a cutoff.

In cases where such fast criteria are not available, it becomes necessary to verify whether a marking M is reachable in $\mathcal{N} = \langle P, T, F, R, M_0 \rangle$ after reaching some marking in $\mathcal{M}_{\mathcal{B}_0}$. This is equivalent to determining if there exists a $M_{\mathcal{B}_0} \in \mathcal{M}_{\mathcal{B}_0}$ such that M is reachable in $\mathcal{N}_{M_{\mathcal{B}_0}} = \langle P, T, F, R, M_{\mathcal{B}_0} \rangle$. Now, the verification of reachability using a complete prefix, as described in Esparza et al. (2002) or an Esparza-CFP for short⁴⁰, is known to be efficient and can be employed in this context. In practical applications, we recommend avoiding the re-instantiation and re-starting of the process for every $M_{\mathcal{B}_0} \in \mathcal{M}_{\mathcal{B}_0}$. Instead, unfolding the complete prefix and verifying the reachability of M can be conducted using an auxiliary construction: Replace $\mathcal{N} = \langle P, T, F, R, M_0 \rangle$ with a

modified version $\mathcal{N}_{\mathcal{B}}$ where only an added dummy place is initially marked, and new dedicated transitions within $\mathcal{N}_{\mathcal{B}}$ will produce exactly one marking from $\mathcal{M}_{\mathcal{B}_0}$.

Formally, consider $\mathcal{N}_{\mathcal{B}} = \langle P \uplus p_{\mathcal{B}}, T \uplus T_{M_{\mathcal{B}_0}} : M_{\mathcal{B}_0} \in \mathcal{M}_{\mathcal{B}_0}, F_{\mathcal{B}}, R_{\mathcal{B}}, \{p_{\mathcal{B}}\} \rangle$, where:

- $P \uplus \{p_{\mathcal{B}}\}$ represents the union of places from the original net and the newly added place $p_{\mathcal{B}}$.
- $T \uplus T_{M_{\mathcal{B}_0}} : M_{\mathcal{B}_0} \in \mathcal{M}_{\mathcal{B}_0}$ is the union of transitions from the original net and the set of dedicated transitions $T_{M_{\mathcal{B}_0}}$ for each $M_{\mathcal{B}_0} \in \mathcal{M}_{\mathcal{B}_0}$.
- $F_{\mathcal{B}}$ denotes the flow relation in the modified net, specifically:

$$F_{\mathcal{B}} = F \uplus \left\{ (p_{\mathcal{B}}, t_{\mathcal{B}}) : t_{\mathcal{B}} \in T_{M_{\mathcal{B}_0}} \right\} \uplus \left\{ (t_{\mathcal{B}}, p_{\mathcal{B}_0}) : M_{\mathcal{B}_0} \in \mathcal{M}_{\mathcal{B}_0}, p_{\mathcal{B}_0} \in M_{\mathcal{B}_0} \right\}.$$

- $R_{\mathcal{B}}$ means the reset symmetric binary relation in the modified net, where:

$$R_{\mathcal{B}} = R \uplus \left\{ (p, t_{\mathcal{B}}) : p \in P, t_{\mathcal{B}} \in T_{M_{\mathcal{B}_0}} \right\}$$

- $\{p_{\mathcal{B}}\}$ is the set containing the added dummy place as initial marking.

Under this convention, M corresponds to a marking in $\mathcal{N}_{M_{\mathcal{B}_0}}$, and you can efficiently and effectively check its reachability in $\mathcal{N}_{\mathcal{B}}$. Moreover, due to the construction of $\mathcal{N}_{\mathcal{B}}$, M is reachable in $\mathcal{N}_{\mathcal{B}}$ if and only if it is a bad state in \mathcal{N} .

For readers familiar with the construction of the complete prefix in Eparza et al. (2002), note that the above-mentioned construction will typically result in a prefix that is smaller than the sum of the prefixes obtained for individual $M_{\mathcal{B}_0} \in \mathcal{M}_{\mathcal{B}_0}$. This is because the cutoff criterion will be met more quickly on each branch, reducing the depth of the prefix.

5.4. Cliff-Edges and Ridges

All reachable markings are represented by at least one configuration of the unfolding. Moreover, since the future evolution of \mathcal{N} depends only on the current marking, $Mark(C_1) = Mark(C_2)$ for two configurations C_1 and C_2 implies that either both C_1 and C_2 are free, or both are doomed. Therefore, by extension, we call $Mark(C)$ free or doomed whenever C is.

Running Example. Now we continue our discussion in the context of Figures 5.2 and 5.1a. As mentioned before, let us consider $\mathcal{M}_{\mathcal{B}}$ the singleton set containing the marking $M_{\mathcal{B}} = \{p_8\}$. Clearly, $C_1 = \{\alpha_1, \gamma_1, \xi_1\}$ and $C_2 = \{\beta_1, \delta_1, \eta_1\}$ satisfy $Mark(C_1) = Mark(C_2) = M_{\mathcal{B}}$ and therefore $C_1, C_2 \in \mathcal{C}_{\mathcal{B}}$. But note that $C'_1 = \{\alpha_1, \gamma_1\}$ and $C'_2 = \{\beta_1, \delta_1\}$ produce markings outside $\mathcal{M}_{\mathcal{B}}$, but they are doomed since any extension of

these configurations leads into \mathcal{M}_B . Therefore, $C'_1, C'_2 \in \mathcal{C}_B$. On the other hand, \emptyset is free, as well as $\{\beta_1, \gamma_1\}, \{\alpha_1, \delta_1\}$, etc. We note in passing that the net in Fig 5.1a allows to refine the understanding of the ‘tipping point’ by showing that doom is not brought about by a single transition but rather the combined effect of two independent choices; this fact is obscured, or at least far from obvious, in the state graph shown in Figure 5.1b.

Identifying free and doomed configurations belongs to the core objectives of this chapter. From the minimal doomed configurations, we derive the critical ‘points’ at which a run becomes doomed:

Definition 21 (Cliff-edges and ridges). *An event set $\gamma \subseteq E$ is called a cliff-edge iff there exists a minimally doomed configuration $C \in \check{\mathcal{D}}$ such that $\gamma = \text{crest}(C)$. The set of cliff-edges is denoted Γ . The folding $\chi \triangleq \pi(\gamma) \subseteq \mathbb{T}$ of a cliff-edge γ is called a ridge.*

To comprehensively chart the evolutionary landscape for \mathcal{N} , it is crucial to identify all ridges in a bounded prefix of the unfolding that determine the viability of a trajectory. It is important to note that the completeness of prefix Π_0 ensures that all reachable markings of \mathcal{N} are covered by at least one configuration in Π_0 . However, this assurance has no extension to guaranteeing that all concurrent steps leading to a doomed marking can also be found in Π_0 . Fortunately, there is:

Lemma 6. *For every ridge χ of \mathcal{N} there is a witness in Π_0^{\subseteq} , i.e. there exists a minimally doomed configuration C in Π_0^{\subseteq} such that $\pi(\text{crest}(C)) = \chi$.*

Proof: Fix χ , and let C_χ be any configuration such that $\pi(\text{crest}(C_\chi)) = \chi$; set $M^C \triangleq \text{Mark}(C_\chi)$, and let M_χ^C the unique reachable marking such that $M_\chi^C \xrightarrow{x} M^C$. Then any such M_χ^C is represented by some C_χ in Π_0^{\subseteq} by completeness. \square

5.5. Finding Minimally Doomed Configurations

Considering the points mentioned above, our approach involves two main steps. Firstly, a configuration that concludes with *unchallenged* events (events without immediate conflicts) cannot be considered minimal. Therefore, we initially outline a process for *shaving* existing configurations to approximate minimally doomed ones contained within them. Secondly, we move on to verifying whether a specific configuration is either doomed or free. The algorithm, named MINDOO, will seamlessly integrate both of these functions into a comprehensive search for minimally doomed configurations.

5.5.1. Preparations: Shaving.

Let us start by observing that \mathcal{C}_B , an upward closed set by construction, also has some downward closure properties, meaning one can restrict control to act on ‘small’ configurations. The first idea is to remove maximal events e from a configuration C if they are not involved in any direct conflict; the idea is that in such a case, the reduced

configuration $C \setminus \{e\}$ has exactly the same maximal extensions as C . In fact, $C \setminus \{e\}$ reveals e in a sense made precise in^{9,63,64,66}; however, we will not be using exactly the relations introduced there.

Definition 22 (Unchallenged event). An event e is unchallenged iff there is no e' such that $e \#_\delta e'$, i.e. $\text{post}(\text{pre}(e)) = \{e\}$.

Lemma 7. Let $C \in \mathcal{C}^f$ and $e \in \text{crest}(C)$ unchallenged; set $C' \triangleq C \setminus \{e\}$. Then $C' \in \mathcal{C}^f$, and $\Omega_C = \Omega_{C'}$.

Proof: $C' \in \mathcal{C}^f$ holds by construction. Also, $\Omega_C \subseteq \Omega_{C'}$ follows from $C' \subseteq C$; it remains to show the reverse inclusion. Assume there exists $\omega \in \Omega_{C'} \setminus \Omega_C$; then $C \setminus \omega = \{e\}$, and $\langle e \rangle \subseteq \omega$. By maximality, ω must contain some e' such that $e \# e'$. Then by definition, there are events $u \neq v$, $u \leq e$, $v \leq e'$, and $u \#_\delta v$. In particular, $u \# e'$, and since $\{e'\} \cup \langle e \rangle \subseteq \omega$, this implies $u = e$. But e is unchallenged, so v cannot exist, and neither can ω . \square

Definition 23 (Shaved configurations). A configuration $C \in \mathcal{C}^f$ such that $\text{crest}(C)$ contains no unchallenged event is called shaved.

Clearly, every $C \in \mathcal{C}^f$ contains a unique maximal shaved configuration, which we call $\text{shave}(C)$; it can be obtained from C by recursively ‘shaving away’ any unchallenged $e \in \text{crest}(C)$, and then continuing with the new crest, until no unchallenged events remain.

Example. In the context of Figure 5.3, for $C_1 = \{x, y, z\}$ and $C_2 = C_1 \cup \{\beta, \gamma, u\}$, one has $\text{shave}(C_1) = \emptyset$ since x , y , and z are unchallenged, and $\text{shave}(C_2) = C_1 \cup \{\beta, \gamma\}$ since u is unchallenged but neither β nor γ are. Note that in the unfolding of the running example shown in Figure 5.2, the κ -labeled events are the only unchallenged ones.

As a consequence of Lemma 7, any $C \in \mathcal{C}^f$ is in \mathcal{C}_B iff $\text{shave}(C)$ is. Still, it may be possible that such a $\text{shave}(C)$ can still be reduced further by removing some of its crest events. This would be the case, e.g., if two conflicting events both lead to a bad state. Thus, given a crest event e , we test whether $C \setminus \{e\}$ is free (e.g. because some event in conflict with e may allow to move away from doom) or still doomed. If the latter is the case, then C was not minimally doomed, and analysis continues with $C \setminus \{e\}$ (we say that we ‘rub away’ e). If $C \setminus \{e\}$ is free, we leave e in place and test the remaining events from $\text{crest}(C)$. A configuration that is shaved and from which no event can be rubbed away is *minimally doomed*.

5.5.2. Algorithm MINDOO

Algorithm 2 uses a ‘worklist’ set wl of doomed, shaved configurations to be explored; wl is modified when a configuration is replaced by a set of rubbed (and again, shaved) versions of itself, or when a configuration C is identified as minimally doomed, in which case it is removed from wl and added to \mathcal{D} .

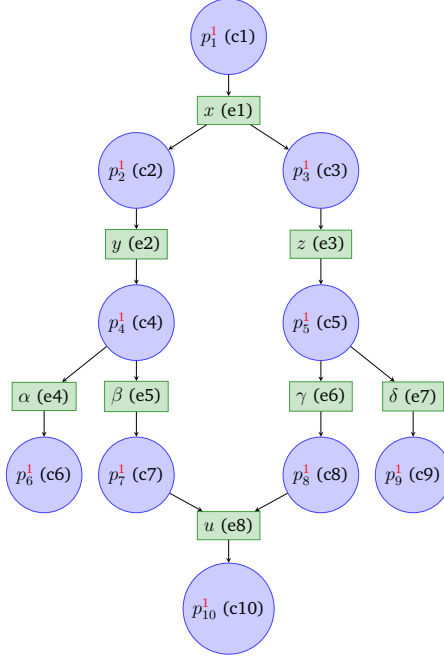

Figure 5.3: An occurrence net. With $C \triangleq \{x, y, z, \beta, \gamma\}$ and $C' \triangleq C \cup \{u\}$, suppose $\mathcal{M}_B = \{\text{Mark}(C')\} = \pi(\{c_{10}\})$. Then $\text{shave}(C') = C$, and C is doomed. Moreover, $C \in \check{\mathcal{D}}$ since both $C_3 \triangleq C \setminus \{\beta\}$ and $C_4 \triangleq C \setminus \{\gamma\}$ are free.

Every branch of MINDOO stops when a minimally doomed configuration is reached, i.e., a doomed configuration C such by rubbing off any crest event e from C makes it free, i.e. $C \setminus \{e\}$ is free for all $e \in \text{crest}(C)$. When the worklist is empty, all minimally doomed configurations have been collected in \mathfrak{D} . Note that if $\emptyset \in \text{wl}$ at any stage during the execution of Algorithm MINDOO, then \emptyset will be added to \mathfrak{D} , since MINDOO will not enter the second **foreach**-loop in that case. In fact, if this situation arises, *every* configuration is doomed, and thus \emptyset is the unique minimally doomed configuration.

The configurations generated during the search consistently decrease in terms of both their size and their inclusion. Additionally, an upper bound on the prefixes examined at each stage is defined by \mathcal{C}_B , a set that is itself strictly smaller than the comprehensive finite prefix employed to identify all bad markings. As outlined in Esparza et al. (2002), this prefix can be chosen to be equal in size or smaller, typically significantly smaller, than the reachability graph of \mathcal{N}^{40} .

Algorithm 2: Algorithm MINDOO

Data: Safe Petri Net $\mathcal{N} = \langle P, T, F, M_0 \rangle$ and the set \mathcal{C}_B^0 of bad configurations of Π_0

Result: The set \mathcal{D} of \mathcal{N} 's \subseteq -minimal doomed configurations

$\mathcal{D} \leftarrow \emptyset$; $wl \leftarrow \emptyset$;

foreach $C \in \min_{\subseteq}(\mathcal{C}_B^0)$ **do**

$C' \leftarrow \text{shave}(C)$;

$wl \leftarrow wl \cup \{C'\}$;

end

while $wl \neq \emptyset$ **do**

 Pick $C \in wl$; $\text{add} \leftarrow \text{true}$;

if NOT FREECHECK($\text{Mark}(C \setminus \text{crest}(C))$) **then**

$\text{add} \leftarrow \text{false}$;

$C' \leftarrow \text{shave}(C \setminus \text{crest}(C))$;

$wl \leftarrow (wl \cup \{C'\})$;

else

foreach $e \in \text{crest}(C)$ **do**

if NOT FREECHECK($\text{Mark}((C \setminus \{e\}))$) **then**

$\text{add} \leftarrow \text{false}$;

$C' \leftarrow \text{shave}(C \setminus \{e\})$;

$wl \leftarrow wl \cup \{C'\}$;

end

end

end

$wl \leftarrow wl \setminus \{C\}$;

if add then

$\mathcal{D} \leftarrow \mathcal{D} \cup \{C\}$;

end

end

return \mathcal{D}

Theorem 3. For any safe Petri net $\mathcal{N} = \langle N, M_0 \rangle$ and bad states set $\mathcal{M}_B \subseteq \mathbf{R}_{\mathcal{N}}(M_0)$, Algorithm MINDOO terminates, with output set \mathcal{D} containing exactly all minimal doomed configurations, i.e. $\mathcal{D} = \check{\mathcal{D}}$.

Proof: Termination follows from the finiteness of $\min_{\subseteq}(\mathcal{C}_{B_0})$, since in each round of MINDOO there is one configuration C that is either replaced by a set of strict prefixes or removed from wl . Therefore, after a finite number of steps wl is empty. As shown in Section 5.3.1, the status (doomed or free) of a given finite configuration can effectively be checked on a fixed finite prefix of \mathcal{U} . Assume that after termination of MINDOO,

one has $C \in \mathfrak{D}$; we need to show $C \in \check{\mathfrak{D}}$. Clearly, when C was added to \mathfrak{D} , it had been detected as doomed; it remains to show that C is also minimal with this property. Assume that there is $C' \subsetneq C$ that is doomed as well. But in that case there exists $e \in \mathbf{crest}(C)$ such that $C' \subseteq (C \setminus \{e\}) \subsetneq C$, which implies that this $(C \setminus \{e\})$ is doomed as well. But then \mathbf{add} has been set to false in the second **foreach**-loop, before C could have been added to \mathfrak{D} .

Conversely, let $C \in \check{\mathfrak{D}}$. Then $(C \setminus \{e\})$ is free for all $e \in \mathbf{crest}(C)$; the variable \mathbf{add} remains thus at the value true because no round of the second **foreach**-loop can flip it. Thus C is added to \mathfrak{D} , from which MINDOO never removes any configuration. \square

5.5.3. Comments on MINDOO

The time required for identifying minimally doomed configurations appears to be primarily influenced by the size of the prefix Π used for verifying the doom property of a configuration through ASP solving. In all instances, the quantity of minimally doomed configurations is a fraction of the overall size of the finite complete prefix Π . An improvement may be to investigate more efficient ways to represent the set of minimally doomed configurations, as these configurations often share a significant number of events, potentially simplifying ecological/biological interpretations.

5.6. Protectedness

5.6.1. Measuring the Distance from Doom

Decisional Height. With the above, we have the tools to draw a map of the ‘landscape’ in which the system evolves, with doomed zones and cliff-edges highlighted. What we wish to add now is to assist *navigation* in this landscape: we intend to give a meaningful measure of how well, or badly, a current system state is protected against falling from a cliff-edge, that is, how far the system is from entering a doomed state. We have chosen to measure this distance in terms not of the *length* of paths, or of similar notions, but rather in terms of the *choices* that are made by the system in following a particular path.

Consider a configuration C and the non-sequential process that it represents. Some of the events in C can be seen as representing a *decision*, in the sense that their occurrence took place in conflict with some event that was enabled by some prefix of C . The number of such events gives a measure of the information contained in C , in terms of the decisions necessary to obtain C :

Definition 24 (Decisional height). Let $C \in \mathcal{C}^f$, and define

$$\mathbf{dech}(C) \triangleq |\{e \in C : \exists e' \in E : e \#_{\sigma}^C e'\}|,$$

where $\#_{\sigma}^C$ is the strict C -conflict relation defined, for all $e \in C$, by

$$e \#_{\sigma}^C e' \iff e \#_{\delta} e' \wedge \langle e' \rangle \subseteq C.$$

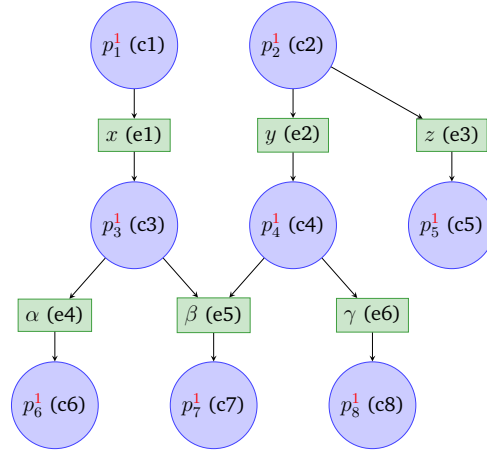

Figure 5.4: Illustration of direct conflict.

$\mathbf{dech}(C)$ is called the decisional height of C .

In Figure 5.2, the configuration $C_1 = \{\xi_1, \alpha_1, \gamma_1\}$ satisfies $\mathbf{dech}(C_1) = 2$, whereas for $C_0 = \{\beta_1\}$, one has $\mathbf{dech}(C_0) = 1$.

Figure 5.4 shows an occurrence net with configuration $C_\beta \triangleq \{x, y, \beta\}$ that has $\mathbf{dech}(C_\beta) = 3$ (because of z, α , and γ) and configuration $C_\alpha \triangleq \{x, z, \alpha\}$ with $\mathbf{dech}(C_\alpha) = 1$ (because of y).

Note that $\#_\sigma^C$ is more restrictive than direct conflict $\#_\delta$; it is also more restrictive than the *immediate conflict* in the literature (e.g. Abbes and Benveniste (2006)¹). It is closely dependent on the configuration C under study, and describes precisely those events *against* which the process had to decide in performing C .

One may wonder why we choose this particular definition of *decision*, rather than using the customary direct or immediate conflicts. The reason is that we wish to consider as decisions only deliberate actions against or in favor particular branches in a bifurcation situation, and *not* any resolution of conflicts brought about by the nondeterminism in the ‘race’ between two concurrent processes.

Consider Figure 5.5, assuming that the only bad configuration is $C_{C_B} = \{\alpha, \gamma, x, y\}$. Then clearly, the configurations $C_\alpha \triangleq \{\alpha, x\}$ and $C_\gamma \triangleq \{\gamma, y\}$ are both doomed. Their height, measured by either direct or immediate conflict, would be 1; in our definition, it is 0, since α (or γ , respectively) was enabled by $C_\alpha \setminus \{\alpha\}$ (or $C_\gamma \setminus \{\gamma\}$) without any conflict, since neither $C_\alpha \setminus \{\alpha\}$ nor $C_\gamma \setminus \{\gamma\}$ enabled β . Underlying this is the fact that the ‘decision’ against β is taken here without any choice, merely by the fact that of the two concurrent events x and y , one may occur much faster than the other, creating a situation in which α (or γ) has no competitor.

5.6.2. Defining protectedness

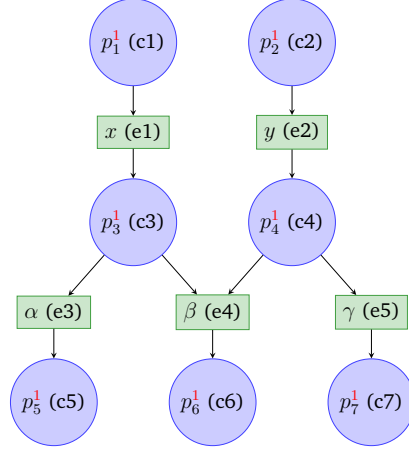

Figure 5.5: An unprotected branching process.

Now, with respect to any free marking M (or equivalently, any free configuration C such that $\text{Mark}(C) = M$), we aim to assess the risk posed by doomed markings that can be reached from M . Specifically, we want to determine how distant the system is from impending doom when it finds itself in M . Leveraging the earlier established concept of decisional height, we can quantify this difference in terms of the conflicts that lead from one marking to another:

Definition 25 (Protectedness). For $C \in \mathcal{C}^f$, let

$$\check{\mathcal{D}}_C \triangleq \begin{cases} \{C' \in \check{\mathcal{D}} : C \subseteq C'\} & : C \in \mathcal{F} \\ \{C\} & : C \in \mathcal{C}_{\mathcal{B}} \end{cases} \quad (5.2)$$

The protectedness of C is then

$$\mathbf{prot}(C) \triangleq \min_{C' \in \check{\mathcal{D}}_C} \{\mathbf{dech}(C' \setminus C)\} \quad (5.3)$$

In Figure 5.3, with the definitions introduced there, $\mathbf{prot}(C) = \mathbf{prot}(C') = 0$. Setting $C_1 \triangleq \{x\}$, $C_2 \triangleq \{x, y\}$, $C_3 \triangleq \{x, z\}$, $C_4 \triangleq C_2 \cup C_3$, $C_5 \triangleq C_4 \cup \{\beta\}$, $C_6 \triangleq C_4 \cup \{\gamma\}$, one further has

$$\begin{aligned} \mathbf{prot}(C_1) = \mathbf{prot}(C_2) = \mathbf{prot}(C_3) = \mathbf{prot}(C_4) &= 2 \\ \mathbf{prot}(C_5) = \mathbf{prot}(C_6) &= 1. \end{aligned}$$

Returning to Figure 5.4, suppose that $C' = \{x, y, \beta\}$ is the only minimally doomed configuration. Then for $C = \{x, z, \alpha\}$ as above, we have $\mathbf{prot}(C) = 1$, because the only direct (and strict) conflict here is the one between z and y .

Note that the definition of protectedness is parametrized by the choice of conflict relation in computing $\mathbf{dech}(\bullet)$. Using direct conflict instead of strict conflict would increase $\mathbf{dech}(\bullet)$ and lead to an overevaluation of protectedness.

To see the point, consider the occurrence net in Figure 5.4. Let $C_\alpha = \{x, z, \alpha\}$, $C_\beta = \{x, y, \beta\}$ and $C_\gamma = \{x, y, \alpha, \gamma\}$. We have $\text{dech}(C_\alpha) = 1$, $\text{dech}(C_\beta) = 3$ and $\text{dech}(C_\gamma) = 2$. Were $\#_\sigma$ replaced by $\#_\delta$ in the computation of $\text{dech}(\bullet)$, these values would not change *except* for C_α where it would change to 2. As a result, if $C \in \check{\mathcal{D}}$, the protectedness of the empty configuration would be evaluated as 2, whereas by our definition $\text{prot}(\emptyset) = 1$. Indeed, \emptyset is *just one wrong decision away from doom*, and this is what protectness is meant to express. An even starker illustration is once again provided by Figure 5.5: in fact, we have $\text{prot}(\emptyset) = 0$, as follows from the discussion above.

5.6.3. Computing Protectedness is Feasible

Computation of $\text{prot}(\bullet)$ does not require any larger data structure than those already required for computing $\check{\mathcal{D}}$. In fact, an alternative - and often much smaller prefix - is also sufficient:

Lemma 8 (Feasibility of protectedness). *There exists an adequate total order \prec such that the associate complete prefix scheme producing Π_0^\prec whose size is bounded by the number of reachable markings, and such that for every finite configuration C , $\text{prot}(C)$ can be computed on $\Pi_0^\prec(\text{Mark}(C))$.*

Proof: If $\check{\mathcal{D}} \cap \mathcal{C}(\Pi_0) = \emptyset$, then all extensions of C are free, and we are done. Otherwise, we have to find an adequate *total* order \prec on finite configurations, that ensures that Π_0^\prec contains at least one minimally doomed configuration that minimizes $\text{dech}(\bullet)$ over all minimally doomed configurations in $\mathcal{U}(\text{Mark}(C))$. The following order \prec is obtained by modifying the total order \prec_F introduced in⁴⁰, Def. 6.2.: For $C_1, C_2 \in \mathcal{C}^f$, write $C_1 \prec C_2$ iff either

- $\text{dech}(C_1) < \text{dech}(C_2)$, or
- $\text{dech}(C_1) = \text{dech}(C_2)$ and $C_1 \ll C_2$, or
- $\text{dech}(C_1) = \text{dech}(C_2)$ and $C_1 \equiv C_2$, and $FC(C_1) \ll FC(C_2)$,

where $\ll (\equiv)$ denote lexicographic ordering (lexicographic equivalence) wrt some total ordering of the transition set T , and FC denotes Cartier-Foata normal form. The proof of Theorem 6.4. of⁴⁰ extends immediately, proving that \prec is an adequate total order; therefore, Lemma 5.3. of⁴⁰ applies, hence any complete prefix Π_0^\prec obtained via the scheme using \prec is bounded in size by the reachability graph. Now, let C^* be the set of configurations from $\check{\mathcal{D}}(\text{Mark}(C))$ that minimize $\text{dech}(\bullet)$; by construction of \prec , one has $C^* \cap \mathcal{C}(\Pi_0^\prec) \neq \emptyset$. \square

In this chapter we presented findings that encompass and extend our conference paper in². This endeavor lets us to provide a toolkit designed for analyzing tipping scenarios within a safe reset Petri net, elucidating when and how a basin boundary is crossed.

Additionally, a metric termed *protectedness* has been introduced to gauge the degree of safeguarding (in terms of *decisions*) separating a free state from impending doom. This metric relies on an inherent concept of ‘decisional height,’ which serves as an effective early warning system for potential dangerous situations. Simultaneously, this height is well-suited for unfoldings, as it establishes an adequate linear order conducive to the computation of bounded-size complete prefixes.

At a broader scope, the outcomes presented here contribute to a larger initiative aimed at offering a discrete, Petri-net oriented framework for the analysis of dynamical systems in the life sciences, with specific applications in the domains of systems biology and ecology.

In the following chapter, we will explore these findings through case studies.

6 - Case Studies

6.1. Microcosms of protists

In natural ecosystems, a number of species coexist to form intricate networks of inter-specific interactions. These species have reached a specific location and can establish viable populations under the prevailing environmental conditions. This set of species is so called *ecological community*, and contradicts a theoretical expectation that complex communities should be inherently unstable^{90,98}. Certainly, differences in species composition between several locations are largely driven by variations in the abiotic environment across these locations. Nevertheless, mixing various types of inter-specific interactions may also trigger combinations from the species pool as well^{142,98}. In other terms, under given abiotic conditions, there will be a chance of multiple species subsets from the species pool that can coexist even though not all subsets would *persist* due to different interaction types e.g. systems of predators without prey or subtle imbalances^{142,4,98,46}.

Using the interaction network of the species pool, one can formulate a set of logical rules that describe how these interactions influence the composition of the community and the events they may trigger, such as extinctions or invasions^{51,137,89,56}. The specific subset of species present within the system at any given time dictates which of these rules can be applied and what alterations in composition they would induce in the system. Consequently, this determines the potential sets of new species that can follow⁵⁶. As stated previously regarding Discrete Event Systems, this model does not offer insights into the probability of one subset being more likely than another. Instead, it distinguishes between what is possible and what is *not*. In other words, it reveals which subsets can be reached from a given starting point and the feasible pathways, irrespective of traits, population sizes, or stochastic variations⁵⁶.

This example is drawn from an experiment involving protist species¹⁴². The experiment employed replicated analyses to systematically investigate the outcomes of all potential communities that could be assembled from a pool of six species (i.e., a powerset of $2^6 - 1 = 63$ communities in total (excluding \emptyset)). The original purpose of the experiment was to identify all *persistent* species sets within the powerset¹⁴². And so to do that, data were collected through monthly censuses of replicate communities, documenting changes in species composition as communities progressed along their pathways toward the ultimate persistent communities¹⁴². These time series data offer valuable insights into the sequence of species loss, including random variations across replicates, which can be used to evaluate the effectiveness of rule-based models. We utilize this experiment to test and validate our method, showcasing how it can enhance our comprehension of long-term community dynamics.

In the literature, this example has sequels. The first assesses the invasibility of

the persistent communities by introducing each of the other species separately and then examining which species could successfully invade to establish in a newly formed community⁸⁰. And the second uses the resulted data from the previous ones to construct a comprehensive map of potential community assembly pathways as a set of persistent communities whose transitions are facilitated by invasions¹⁴¹. While a thorough dissection would include the three studies, we focus on the first one (Weatherby et al. (1998)) for the scope of this manuscript¹⁴².

6.1.1. The experiment

To systematically enumerate persistent communities, one would need to consider every possible combination of species from a species pool, also known as the *power set*. Subsequently, the task involves identifying which of these communities have the capability to persist over time. In principle the study is easy to imagine, however, it is unfeasible in natural systems. Therefore, Weatherby et al. (1998) undertake this problem with a more tractable system of laboratory *microcosms of protists*.

The selection of the six species used in the study was based on their capacity to thrive under identical laboratory environmental conditions, but not on prior knowledge of their long-term coexistence abilities¹⁴². Additionally, the predators among them were selected because they could sustain themselves by exclusively preying on at least one of the other species within the set for extended periods during the experiment¹⁴². Namely, the species were: *Amoeba proteus* (predator), *Blepharisma japonicum* (bacterivore), *Colpidium striatum* (bacterivore), *Euplotes patella* (predator), *Paramecium caudatum* (bacterivore) and *Tetrahymena pyriformis* (omnivore). See figure 6.1.

To implement the experiment, there were six replicates for each of the 63 species combinations, resulting in a total of 378 microcosms. Each microcosms consisted of low organic content medium, bacterial culture (the bacterial species were not identified), and the protist species. Assuming that on day 0 microcosms were established (not including protists), then bacterivore introductions were on day 3 and on day 7, predator and omnivore introductions were on day 7 and on day 10 (each protist species was introduced on two separate occasions, to minimize the impact of demographic stochasticity in small initial populations, meaning, environmental conditions that can affect population's decline).

On day 17, each microcosm underwent a thorough examination using a stereomicroscope. During this examination, the presence or absence of each protist species was recorded, marking the first census. This process was then repeated at 28-day intervals. If a species was found to be absent on two consecutive sampling dates, it was considered extinct.

In the study the authors claim that the ideal scenario would have been to determine which combinations of species can coexist indefinitely, however, experimental *in-vitro* limitations only allow to observe which sets of species persist over an *extended* period. To define this *long* period, they closely monitored each system until the composition of

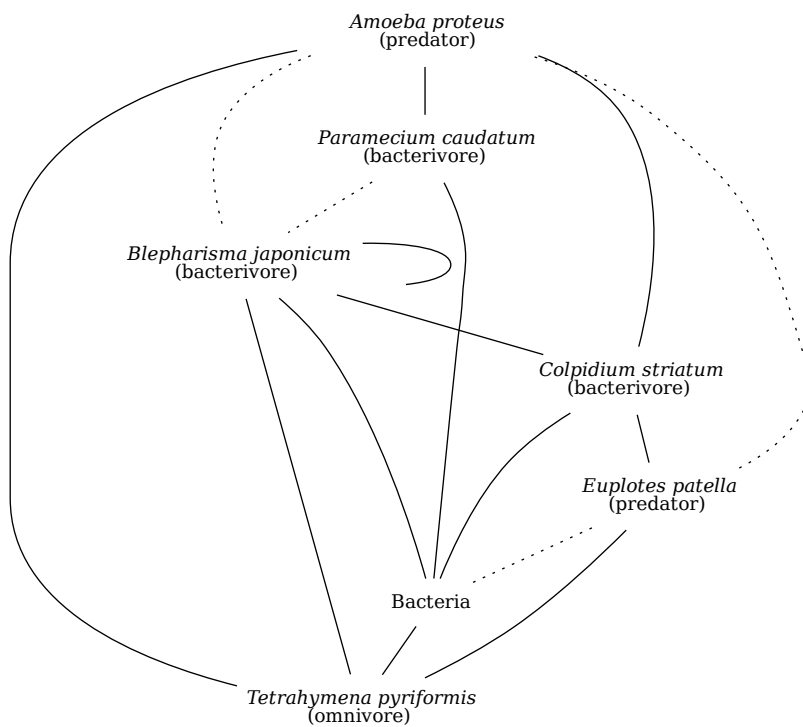

Figure 6.1: Trophic interactions of protists species pool. Solid lines show a relation where a predator is sustained for a number of generations. Dotted lines show relations where a predator cannot be sustained for a number of generations.¹⁴²

species within it reached a state where changes ceased to occur. Although, there was a caveat when indefinite coexistence of species is still affected by *occasional stochastic extinctions*.

Therefore, microcosms were considered to have reached their final states if one of the following conditions was met:

1. If the species composition remained unchanged for three consecutive sampling occasions, which translates to approximately two months of no change.
2. If only one species persisted in the system, and it was known to always survive in isolation.
3. If only one species remained, but it was known never to persist alone, resulting in the end state being recorded as an empty set.

4. If all species in the system had gone extinct.

With all the description aforementioned, we consider this example of protist species developed by Weatherby and others (1998) suitable to be implemented as a contextual reset net and to avoid stochasticity of environmental conditions (widely mentioned in the article)¹⁴².

6.1.2. Rule system for microcosms of protists

This rule system was previously developed by De Göer De Herve et al. (2022)⁵⁶, and was gently shared by Colin Thomas to conduct the following experiments.

Species:

- A: presence (+) or absence (-) of *Amoeba proteus*.
- B: presence (+) or absence (-) of *Blepharisma japonicum*.
- C: presence (+) or absence (-) of *Colpidium striatum*.
- T: presence (+) or absence (-) of *Tetrahymena pyriformis*.
- E: presence (+) or absence (-) of *Euplotes patella*.
- P: presence (+) or absence (-) of *Paramecium caudatum*.

r1:	A+	»	P-, A+	[predation]
r2:	P-	»	A-, P-	[starvation]
r3:	A+, P-	»	B-, A+, P-	[predation]
r4:	A+, P-	»	T-, A+, P-	[predation]
r5:	B+	»	T-, B+	[predation]
r6:	E+	»	E-	[starvation]
r7:	E+	»	T-, E+	[predation]
r8:	C+	»	T-, C+	[competition]
r9:	P+	»	T-, P+	[competition]
r10:	C+	»	C-	[starvation]

Figure 6.2: Rule system for the microcosms of protists.

6.1.3. Contextual reset net for microcosms of protists

From figure 6.3 one can derive a pure reset net by applying PR-encoding and Reset Complement transformations accordingly (see definitions 10 and 11). The resulting graph is ready to unfold and prone to draw interpretations.

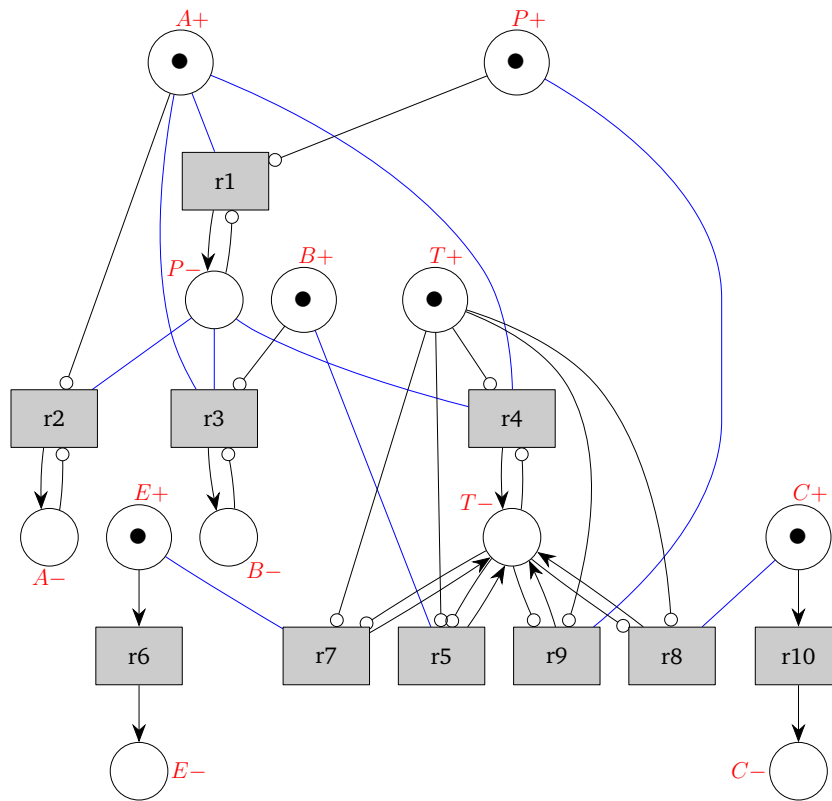

Figure 6.3: Contextual reset net for the microcosms of protists. Read arcs have been colored in blue to distinguish them from others.

6.1.4. A prefix of the unfolding for the microcosms of protists example

Given that the authors in the article conducted 63 combinations for the starting community, we are not conducting the same due to practical reasons, instead we will take one starting community with the most possible presence of species for each persistent community obtained (including the undecided one). For example, in table 2 from¹⁴², there are 3 starting communities replicating the same persistent community $\{P+\}$ (we take the upper letter in the article as presence ($P+$) for our work), from these 3 we will take the community with more starting species, i.e., $\{P+, E+, T+\}$. The motivation behind choosing the most possible presence of species is allowing as many interactions as possible. It is worth to note that all rules in the system have effects on disappearing or reducing species then the absence of all species can be considered as *absorbing* sets, however, the challenge lies on identifying species that persist under certain scenarios. Thus, when there is at least one persistent species thriving after different configurations of the system, we will identify bifurcation points between its *thriving* path and the path when everything collapses (if any). First of all, our initial nine communities (markings) will be:

$\{A+, B-, P+, E+, C+, T+\}$	$\{A+, B+, P+, E+, C+, T+\}$
$\{A-, B-, P+, E+, C-, T+\}$	$\{A-, B-, P-, E+, C+, T+\}$
$\{A+, B-, P-, E+, C+, T+\}$	$\{A-, B+, P+, E+, C+, T+\}$
$\{A-, B-, P+, E+, C+, T+\}$	$\{A-, B-, P+, E-, C-, T+\}$
$\{A+, B+, P-, E+, C+, T+\}$	

Table 6.1: List of initial markings used in this example.

We will next analyze each starting community to search for attractors (referred as persistent communities in the article) using algorithm in section 4.3 from²⁶ but adapted to reset nets; then check possible paths that lead to persistent communities (or species), especially, where a bifurcation point arises in the prefix to assess species interaction that may occur at that point.

6.1.5. Analysis of $\{A+, B-, P+, E+, C+, T+\}$

The prefix of the unfolding using the marking in this example is:

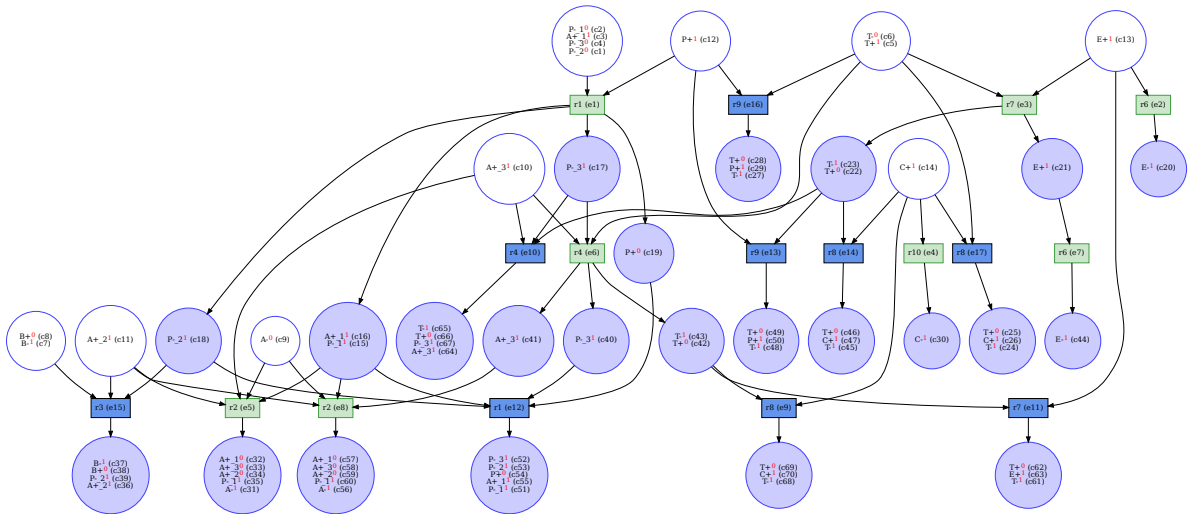

Figure 6.4: Unfolding prefix using $\{A+, B-, P+, E+, C+, T+\}$ as initial marking for the protists example. Conditions in white outlined in blue represent the initial marking. Events in blue are cutoffs.

While the prefix is wide enough to hinder interpretation, we may use it to extract their attractors, which, in this case, there are two fixed points: $\{A-, B-, C-, E-, P-, T-\}$

and $\{A-, B-, C-, E-, P-, T+\}$. When producing the event structure of the unfolding and tracking the run where the attractors are found, we may discover some insights about species interaction:

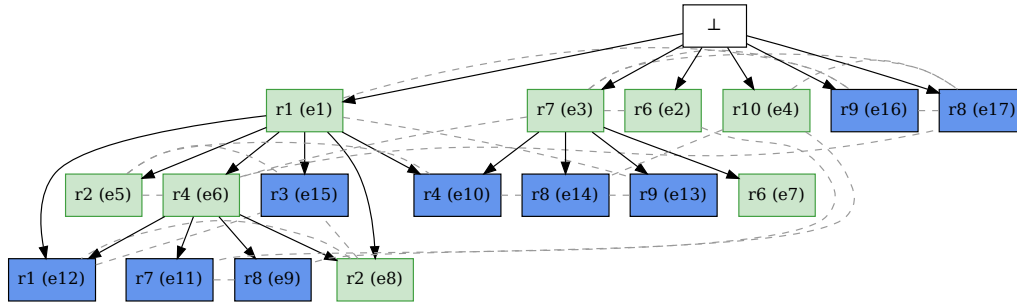

Figure 6.5: Event structure using $\{A+, B-, P+, E+, C+, T+\}$ as initial marking for the protists example. Events in blue mean cutoff events and dashed lines show *immediate* conflict relations.

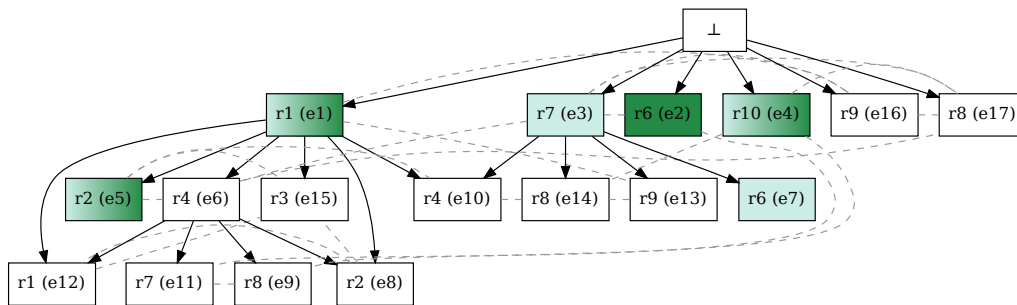

Figure 6.6: Event structure showing two persistent communities found with the initial marking. Events in the darkest green show the only possibility for *T. pyriformis* to persist (*C. striatum* and *E. patella* perish before), whereas the lightest one shows events that particularly lead to an empty set (predation or competition with *T. pyriformis*) and boxes colored in gradient greens represent common events between both fates (predation of *P. caudatum* and starvation of *A. proteus*).

Performing a reachability check on the prefix allows us to see two different and conflicting configurations $C_{dgreen} = \{e_1(r_1), e_2(r_6), e_4(r_{10}), e_5(r_2)\}$ and $C_{lgreen} = \{e_1(r_1), e_3(r_7), e_4(r_{10}), e_5(r_2), e_7(r_6)\}$ (figure 6.6). The first one produces an alternative marking to what we expected, no persistent species¹⁴², this configuration allow *T. pyriformis* to survive predation from *A. proteus* (r4) and *E. patella* (r7) and outcompete *C. striatum* (r8) and *P. caudatum* (r9). This outcome highlights the possibilistic view enabled

by unfoldings. Despite of Weatherby and others (1998) may have discarded the alternative fate by using tests for non-randomness, we illustrate *how* it is indeed reachable and possible. Moreover, in the event structure fig. 6.5 is remarkable the different paths to the same empty set of non-persistent communities and the unique opportunity of *T. pyriformis* to persist.

In the next analyses we will continue producing prefixes but instead of showing it complete, we will restrain to event structures to: (1) make evident different runs to possible persistent communities and (2) avoid unnecessary big graphs.

6.1.6. Analysis of $\{A+, B+, P+, E+, C+, T+\}$

Giving same treatment as before, we are able to extract the persistent species: *emptyset* ($\{A-, B-, C-, E-, P-, T-\}$), *T. pyriformis* ($\{A-, B-, C-, E-, P-, T+\}$) and *B. japonicum* ($\{A-, B+, C-, E-, P-, T-\}$). And from the event structure we may see bifurcation points to the different fates (persistent species):

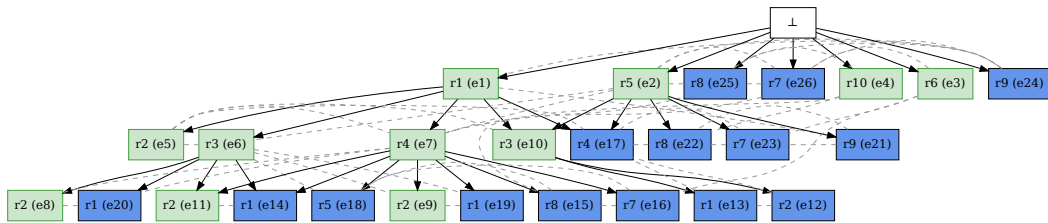

Figure 6.7: Event structure using $\{A+, B+, P+, E+, C+, T+\}$ as initial marking for the protists example. Events in blue mean cutoff events and dashed lines show *immediate* conflict relations.

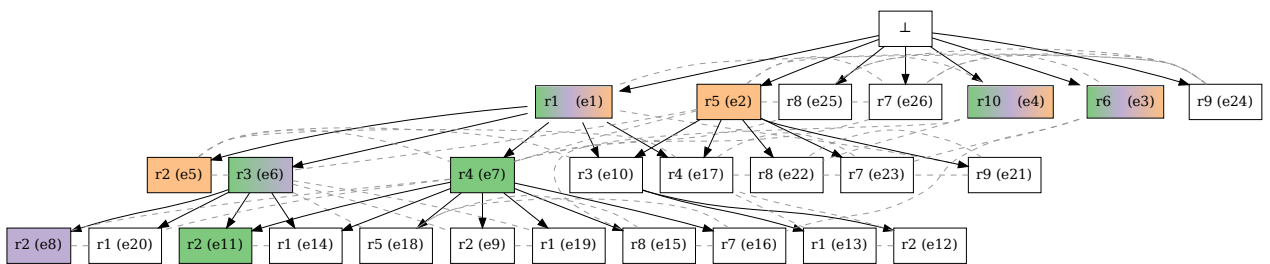

Figure 6.8: Event structure showing three persistent communities found with the initial marking. Events in green show a path where there is no persistent species; events in violet show the only path possible for *T. pyriformis* to persist (*C. striatum*, *E. platella*, *A. proteus* and *B. japonicum* perish before); and events in orange show one way in which only *B. japonicum* persist whereas the others starve or are predated (the other way is via r4 instead of r5).

In figure 6.8 we may see three different persistent communities of what was reported in¹⁴². One in common is *B. japonicum* whereas the emptyset and *T. pyriformis* are excluded in the study. In the same figure we can describe two bifurcation points: (1) when the occurrence of e_1 enables e_6 and e_7 but they are not *together* in *both* configurations thereafter, i.e., $C_{green} = \{e_1(r_1), e_3(r_6), e_4(r_{10}), e_6(r_3), e_7(r_4), e_{11}(r_2)\}$ and $C_{violet} = \{e_1(r_1), e_3(r_6), e_4(r_{10}), e_6(r_3), e_8(r_2)\}$. This means that *A. proteus* may starve to death (r_2) before it predate *T. pyriformis* (r_4) and then *T. pyriformis* will be the only species to persist; (2) when from the initial cut $\{e_1, e_2, e_3, e_4\}$ occur concurrently yielding a marking $\{A+, B+, C-, E-, P-, T-\}$ and from here e_5 occurs which means that *A. proteus* starves to death instead of predate *B. japonicum*.

6.1.7. Analysis of $\{A-, B-, P+, E+, C-, T+\}$

Following the same method as before, we are able to extract one persistent species: $\{A-, B-, C-, E-, P+, T-\}$. And from the event structure we may see *one run* to the *unique fate* (persistent species):

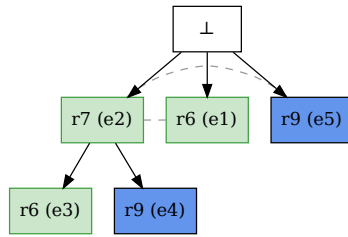

Figure 6.9: Event structure using $\{A-, B-, P+, E+, C-, T+\}$ as initial marking for the protists example. Events in blue mean cutoff events and dashed lines show *immediate* conflict relations.

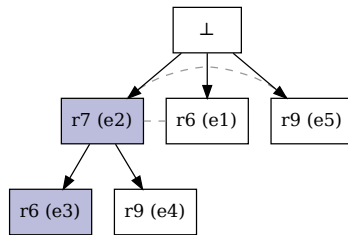

Figure 6.10: Event structure highlighting *one path* to the only persistent species *P. caudatum*.

In figure 6.10 one may see the only persistent species $P+$ after one possible run to

this fate. There is no more possibilities since the initial marking has few species present, and this result is equal to what Weatherby et al. (1998) obtained.

6.1.8. Analysis of $\{A-, B-, P-, E+, C+, T+\}$

In this case, there is one persistent species *T. pyriformis* and the emptyset, contrary to what Weatherby et al. (1998) found. In the study they showed that after the current starting community one would obtain $\{C\}$ as persistent species, however, for our list of rules this outcome is impossible since *C. striatum* will always starve with the sole fact of being present. *r8* may delay its destiny but its *fatal* fate is inevitable no matter the initial state you start from. Therefore, our findings are:

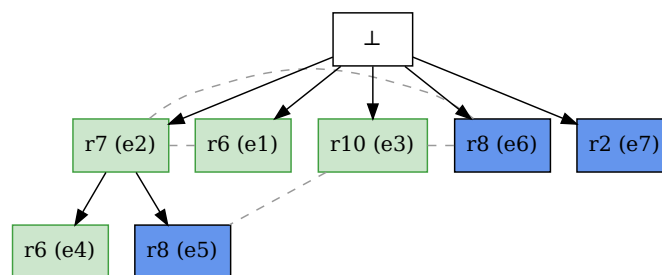

Figure 6.11: Event structure using $\{A-, B-, P-, E+, C+, T+\}$ as initial marking for the protists example. Events in blue mean cutoff events and dashed lines show *immediate* conflict relations.

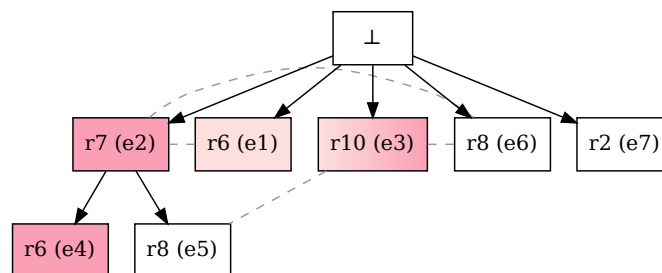

Figure 6.12: Event structure showing two different paths to possible persistent species or attractors, one where there is no species that persist (dark pink) and another where only *T. pyriformis* is left (light pink). An event has a gradient because it is shared for the two configurations, meaning starvation of *C. striatum*.

In fig.6.6 there is one bifurcation point from the initial cut where either *r7* or *r6* fires first, so $C_{lpink} = \{r_6(e_1), r_{10}(e_3)\}$ leads to the starvation of *E. patella* and of *C. striatum*

which leaves opportunity to *T. pyriformis* to persist; and $C_{dipink} = \{r_7(e_2), r_{10}(e_3), r_6(e_4)\}$ drives to extinction of all species in the microcosm.

6.1.9. Analysis of $\{A+, B-, P-, E+, C+, T+\}$

Applying the same procedure as before, we found again, when doing *attractors search*, one persistent species *T. pyriformis* which is in accord to what Weatherby and others (1998) discovered for this starting species. Also, there is a case when no species persists as we have ascertained with previous cases. Let us see where the bifurcation point occurs:

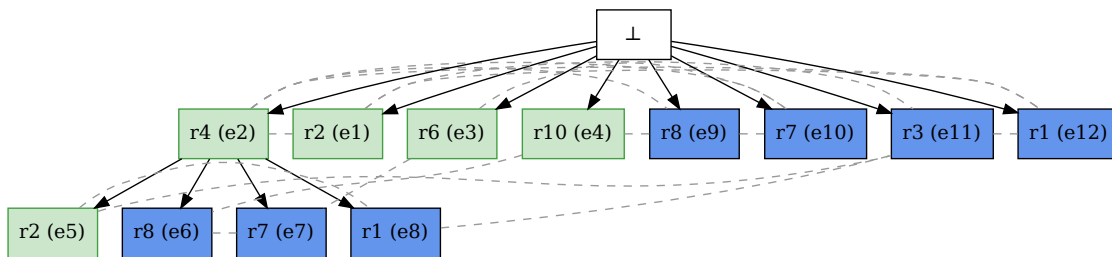

Figure 6.13: Event structure using $\{A+, B-, P-, E+, C+, T+\}$ as initial marking for the protists example. Events in blue mean cutoff events and dashed lines show *immediate* conflict relations.

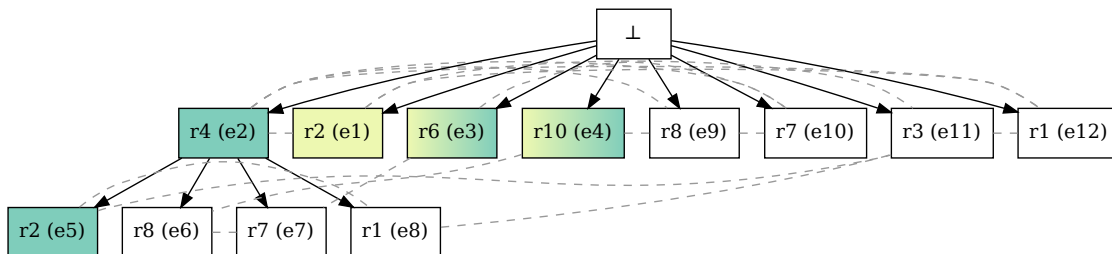

Figure 6.14: Event structure showing two different paths to possible persistent species or attractors, in one there is no species that persist (lime) and another where only *T. pyriformis* escapes of being predated (pale teal). Events with gradient are common for both paths. In particular, $r_2(e_1)$ gives the opportunity to *T. pyriformis* to survive, otherwise it would have been predated by *A. proteus* ($r_4(e_2)$), *E. patella* (r_7), or outcompeted by *C. striatum* (r_8).

In fig.6.16 one may see two different configurations leading each one to the two possible fates in this scenario. There is one bifurcation point starting from the initial cut when either $e_1(r_2)$ or $e_2(r_4)$ occurs first. If the former is the case, *T. pyriformis*

will survive and persist as the only long-lasting species else the latter will result in the downfall of everything.

6.1.10. Analysis of $\{A-, B+, P+, E+, C+, T+\}$

In this initial marking we found two persistent species in the same state: $A-, B+, C-, E-, P+, T-$. Interestingly, for this starting community, there is no emptyset as a fate despite of all rules collapsing to the extinction of different species. Also, the result is exactly what Weatherby et al. (1998) found¹⁴² in their experiments, no other choice is possible nor bifurcation point exists.

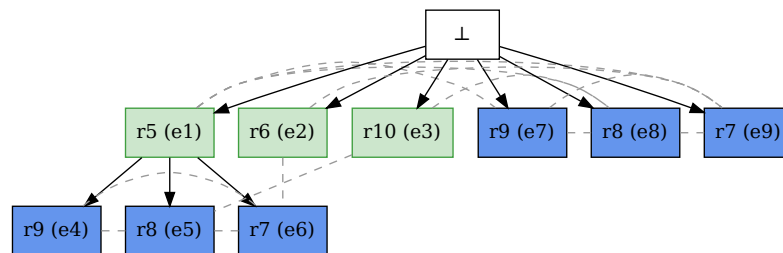

Figure 6.15: Event structure using $\{A-, B+, P+, E+, C+, T+\}$ as initial marking for the protists example. Events in blue mean cutoff events and dashed lines show *immediate* conflict relations.

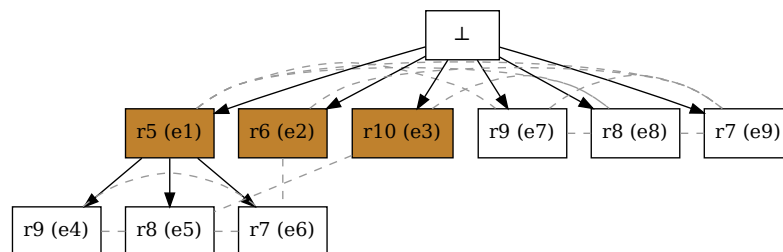

Figure 6.16: Event structure showing the only possible path to the two persistent species *B. japonicum* and *P. caudatum*. In this case there is no bifurcation point.

6.1.11. Analysis of $\{A-, B-, P+, E+, C+, T+\}$

In this instantiation of the reset net we found one persistent species in the same marking, *P. caudatum*. However, our finding is different of what Weatherby and others (1998) showed because for them there were two persistent species with the same starting species, *P. caudatum* and *C. striatum*; this is due our r10 which makes *C. striatum* to

perish, whereas *P. caudatum* is only predated by *A. proteus* but the latter is absent since in the starting community. In this case, as well as from the previous one, there is only one option of fate, so no bifurcation point identified.

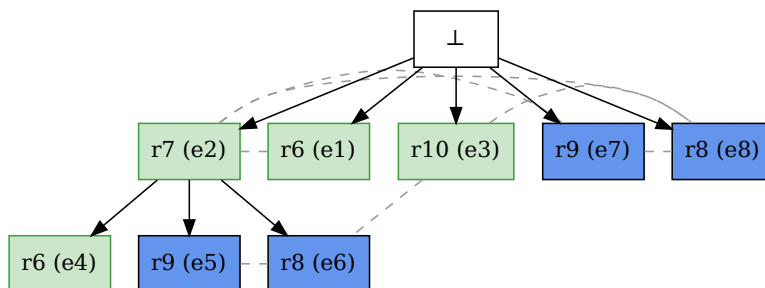

Figure 6.17: Event structure using $\{A-, B-, P+, E+, C+, T+\}$ as initial marking for the protists example. Events in blue mean cutoff events and dashed lines show *immediate* conflict relations.

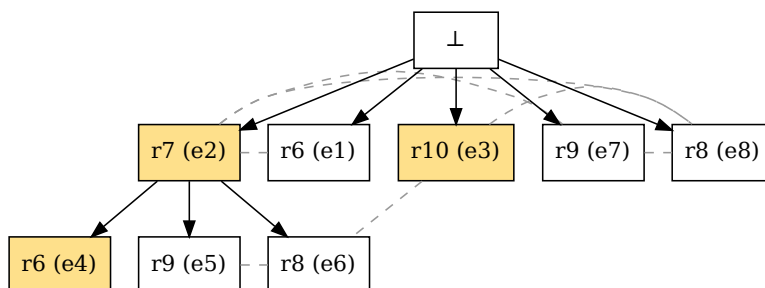

Figure 6.18: Event structure showing the only possible path to the only persistent species *P. caudatum*. In this case there is no bifurcation point.

6.1.12. Analysis of $\{A-, B-, P+, E-, C-, T+\}$

In this case we had one resulting persistent species, *P. caudatum* $\{A-, B-, P+, E-, C-, T-\}$. It is trivial to follow and see that r9 is the only transition able to fire. In spite of this minor size of the unfolding prefix (fig. 6.19), there is a contradiction between Weatherby and others' (1998) result and ours because for them *P. caudatum* and *T. pyriformis* can coexist and persist in a community whereas for us this is not possible. R9 defines clearly that in presence of both species, *P. caudatum* will outcompete *T. pyriformis* driving it to death. Evidently, there are no bifurcation points.

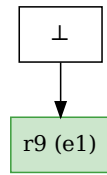

Figure 6.19: Event structure using $\{A-, B-, P+, E-, C-, T+\}$ as initial marking for the protists example. Events in blue mean cutoff events and dashed lines show *immediate* conflict relations.

6.1.13. Analysis of $\{A+, B+, P-, E+, C+, T+\}$

Similarly to case 6.1.6, we saw the same three sets of persistent species: *empty-set* ($\{A-, B-, C-, E-, P-, T-\}$), *T. pyriformis* ($\{A-, B-, C-, E-, P-, T+\}$) and *B. japonicum* ($\{A-, B+, C-, E-, P-, T-\}$). And from the event structure we may see bifurcation points to the different fates:

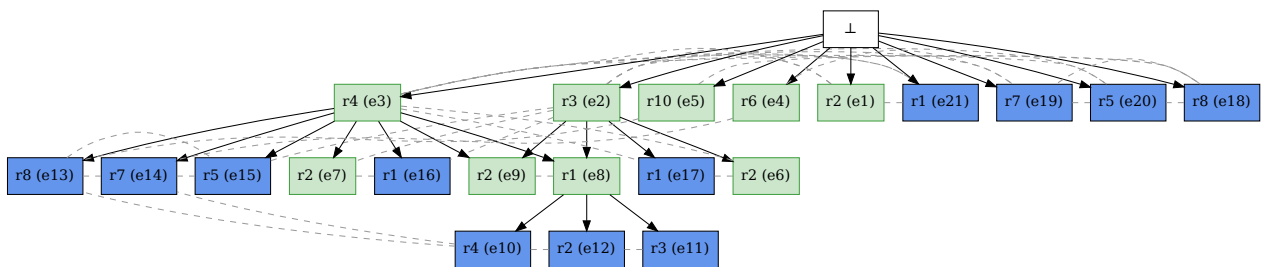

Figure 6.20: Event structure using $\{A+, B+, P-, E+, C+, T+\}$ as initial marking for the protists example. Events in blue mean cutoff events and dashed lines show *immediate* conflict relations.

In the figure 6.21 we may see three different persistent communities that were not reported in¹⁴². In the paper, they said that for this starting community, there is a *undecided* persistent community because their statistical models were not rejected. In short, they used two null models for assessing whether the level of consistency among the results of a group of replicated microcosms significantly deviates from what would be anticipated by random chance¹⁴². The first model assumed that *all* end communities possible from the powerset of the initial one have the same probability to occur. By contrary, the second model uses the relative frequency with which different numbers of species are present in the observed end communities¹⁴². They conducted non-randomness tests and obtained a probability for each model for each possible starting community, if the probability of the null model 2 was *greater* than 0.06 then the persistent community was

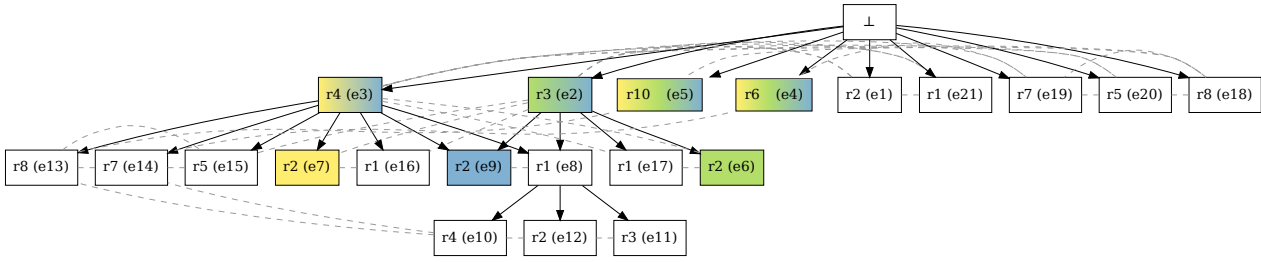

Figure 6.21: Event structure showing three persistent communities found using the initial marking. Events in *oy* shows a path where *B. japonicum* is left because it is not predated by *A. proteus*; events in *gy* shows a path where *T. pyriformis* is left because *A. proteus* starves to death first; and events in *cb* shows a path where there is no persistent species, *A. proteus* has preyed on everything it could.

undecided; The starting community $\{A+, B+, P-, E+, C+, T+\}$ was the case so it is undecided.

Our findings show that two persistent communities are indeed possible plus the emptyset according to the established list of rules. Moreover, let us define these colors for the figure 6.21: *gy* = greenish – yellow, *oy* = orangy – yellow and *cb* = cyan – blue, in there, we observe two bifurcation points:

1. When from the initial cut e_2 is produced and *potentially* enables e_6 and e_9 resulting in two conflicting configurations, namely, $C_{gy} = \{e_2(r_3), e_4(r_6), e_5(r_{10}), e_6(r_2)\}$ and $C_{cb} = \{e_2(r_3), e_3(r_4), e_4(r_6), e_5(r_{10}), e_9(r_2)\}$. This means that the former shows the path when *A. proteus* does not predate *T. pyriformis* and dies of starvation, leaving *T. pyriformis* as a persistent species; whereas the latter *T. pyriformis* is predated by *A. proteus* before perishing and leaving empty behind.
2. Analogous to the first one but this time with *B. japonicum*, after the initial cut, e_3 is produced and *potentially* enables e_7 and e_9 yielding two conflicting configurations, that is to say, $C_{oy} = \{e_3(r_4), e_4(r_6), e_5(r_{10}), e_7(r_2)\}$ and C_{cb} . This time *A. proteus* makes the difference leading to either of the two paths, the first one by perishing before predated *B. japonicum* (but extinguishing *T. pyriformis*) and the second one by predated both the bacterivore and the omnivore.

Microcosms of protists example is a convenient example to show how unfoldings of reset nets are suitable to check *which* and *how* persistent species thrive until the end community (if any). Assuming that our initial list of rules are well established, we were able to infer some persistent communities who were not reported in the source study. For example, *C. striatum* was reported as a persistent species when $\{A-, B-, P-, E+, C+, T+\}$ and $\{A-, B-, P+, E+, C+, T+\}$ were in the starting community, however, according to

our rule r10 this is impossible because as long as *C. striatum* is present, it can die of starvation sooner or later (same situation for *E. patella* with r6). Although, this work has unveiled some insights, it does not aim to replace the original experiment because it only includes modeled variables so if the focus is to include environmental conditions, it is important to refer the work of Weatherby et al. (1998). Moreover, a thorough examination of the powerset would be needed to continue the assessment of given a focal species, how it does relates with others in terms of disruption and persistency¹⁴². Nevertheless, our findings are already a proof of what to expect when considering variables in the stated model, and it serves as a complement as well as the work done by Herve et al. (2022)⁵⁶. Finally, aiming to become this experiment exhaustive, it would be interesting to verify all outcomes using the remaining part of the powerset as initial markings, which in turn would pave the way to continue with the following studies in the sequel^{80,141}.

6.2. Revisited termites colony

Returning to our example in chapter 4. Now, we can analyse its minimally doomed configurations applying algorithm 2:

By looking with detail at rules 4.1, one may find that all configurations in figure 6.22 lead indeed to bad markings. Specifically, fig.6.22a drives the ecosystem to a state where only fungal gardens and egg chambers are left, $wk-, sd-, wd-, ac+, rp-, ec+, te-, fg+$. fig.6.22b accounts for the presence of egg chambers, fungal gardens and termitomyces but this is insufficient to allow a recovery for the colony, $wk-, sd-, wd-, ac+, rp-, ec+, te+, fg+$. fig.6.22c has the initial effect of not event producing workers for the colony's establishment and leaves termites at the mercy of ants from the very beginning, $wk-, sd-, wd-, ac+, rp-, ec-, te-, fg-$. fig.6.22d shows an advantage of ants over termites because the latter has no soldiers even though there are workers who create everything except reproductives and soldiers, and then r9 vanishes any hope of stabilization, $wk-, sd-, wd+, ac+, rp-, ec+, te+, fg+$. fig.6.22e is long *run* and although it traverses rules for the creation of elements, it lands on the depletion of vital elements like reproductives and workers, $wk-, sd-, wd-, ac+, rp-, ec+, te-, fg-$. And finally, fig.6.22f shows a shorter sequence of fig.6.22e when doom can be reached before in the same state by r7 and following an imminent collapse. Fortunately, for all this minimally doomed configurations, one has the option of deciding to stay stable; respective dashed events in blue are meant to illustrate this opportunity of restore for each case figs.6.22a-f.

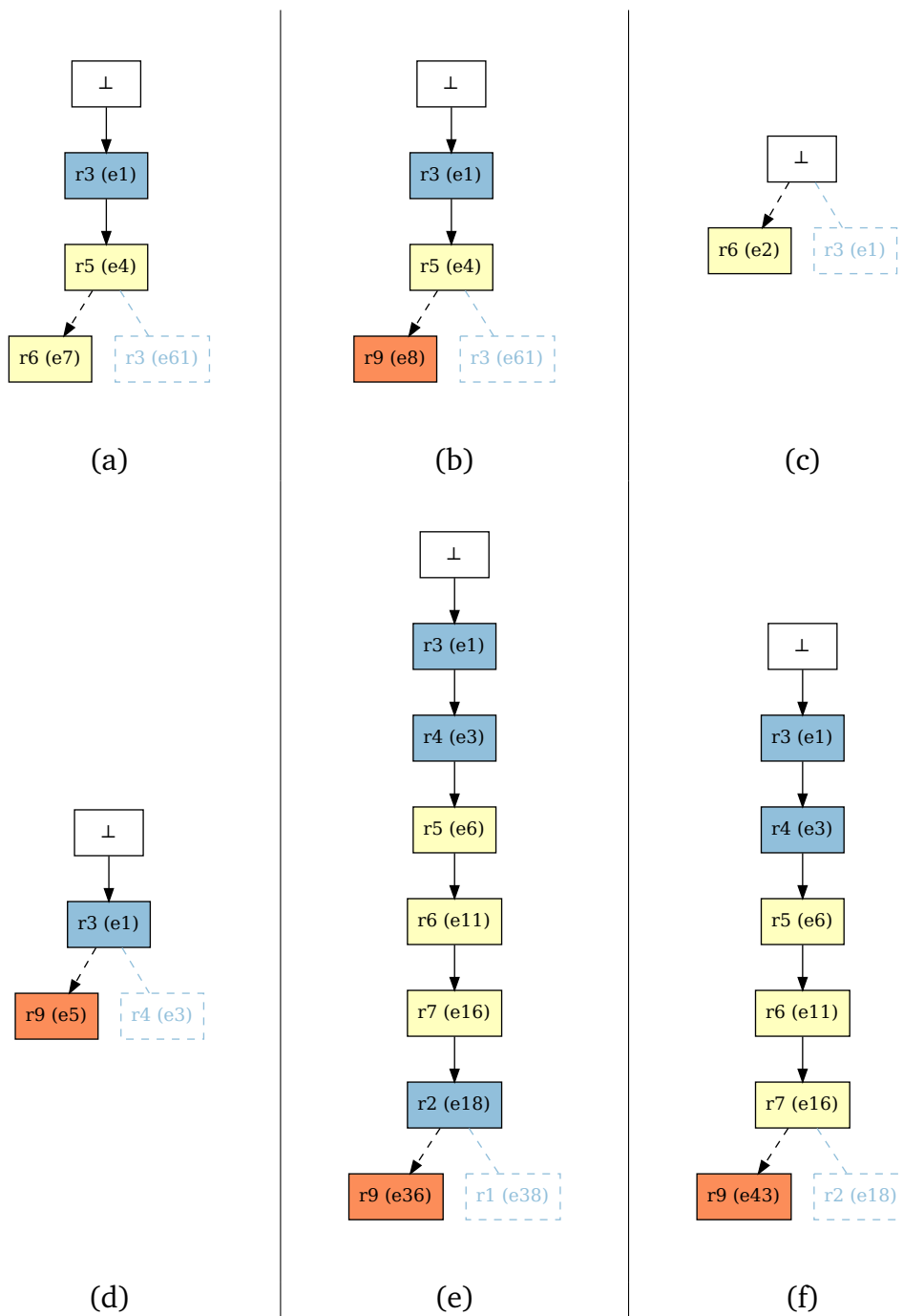

Figure 6.22: Some of minimally doomed configurations extracted from the termites colony prefix using algorithm 2. Colors are used alike in figure 4.7. Dashed lines represent a minimally doomed event which can be removed to be *free*. Dashed events in blue-like represent a chance to escape from *doom*. \perp represents the initial cut.

7 - Conclusion & Outlook

In this manuscript, we have achieved methods for modeling and analyzing ecosystems using *safe reset* Petri nets and their corresponding unfoldings. The results shown here represent the toolkit we built along with our approaches and algorithms. Potential applications in several domains abound, in particular in the life sciences. Nonetheless and beyond the above, we still have some ideas to develop further.

7.1. Doom avoidance control

Future research will delve into the realm of Doom Avoidance Control, aiming to develop strategies that guide systems away from impending *doom*. This work is expected to complement existing approaches, such as the structural methods proposed by Iordache and Antsaklis^{72,73} and the unfolding construction by Giua and Xie⁵⁵. A critical aspect to address is the level of knowledge available to any control player, which serves as the basis for selecting control actions. We consider that the protectedness measure is a promising candidate for encoding this information, allowing a controller to act when the system approaches doom (according to predefined thresholds) but still offers opportunities to avert it.

7.2. Regimes

Taking inspiration from ecological successions in nature when a strong enough disturbance modifies an already established behavior in an ecosystem, making it shift its *stage*. We *believe* a *regime* is the set of *stages* an ecosystem can loop in. Moving from one stage to another would imply an *input cause* to the regime that will change the looping behavior leading into another stage within the same regime. See figure 7.1.

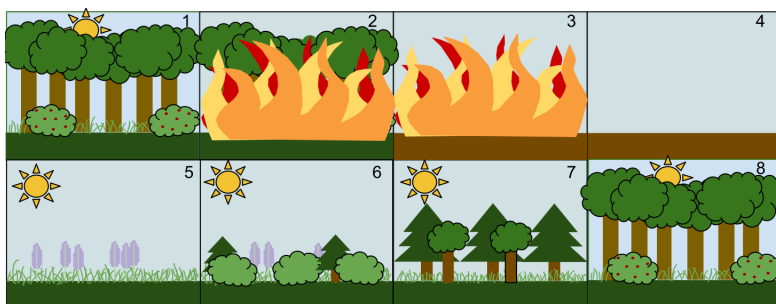

Figure 7.1: Image illustrating secondary succession commonly found in a forest. See details in text for a thorough explanation. Source: Katelyn Murphy ©.

In figure 7.1 we may see several stages a forest can be transformed in when: (1) from a stable forest ecosystem there is (2) a disturbance like fire which (3) destroys and converts everything in ashes, then (4) fire stops but has left empty behind except soil; (5) after some time 1-5 years herbaceous plants start to grow making conditions for (6) pioneering short-lived small bushes and shrubs to colonize because they are light-tolerant (5-20 years); (7) then pioneering long-lived evergreen species develop to their fullest for increasing area of light-absorption and creating an understory for shade-tolerant ones (20-100 years); finally, (8) deciduous trees grow taller than evergreen ones and compete for space resulting in a displacement of short-lived and shade-intolerant species, however, the forest has *recovered* a *similar* state from where it began (100-400 years). This inspirational description of stages and its shifts could be modeled in a Petri net, for instance, with some modifications over our running example in figure 5.1a.

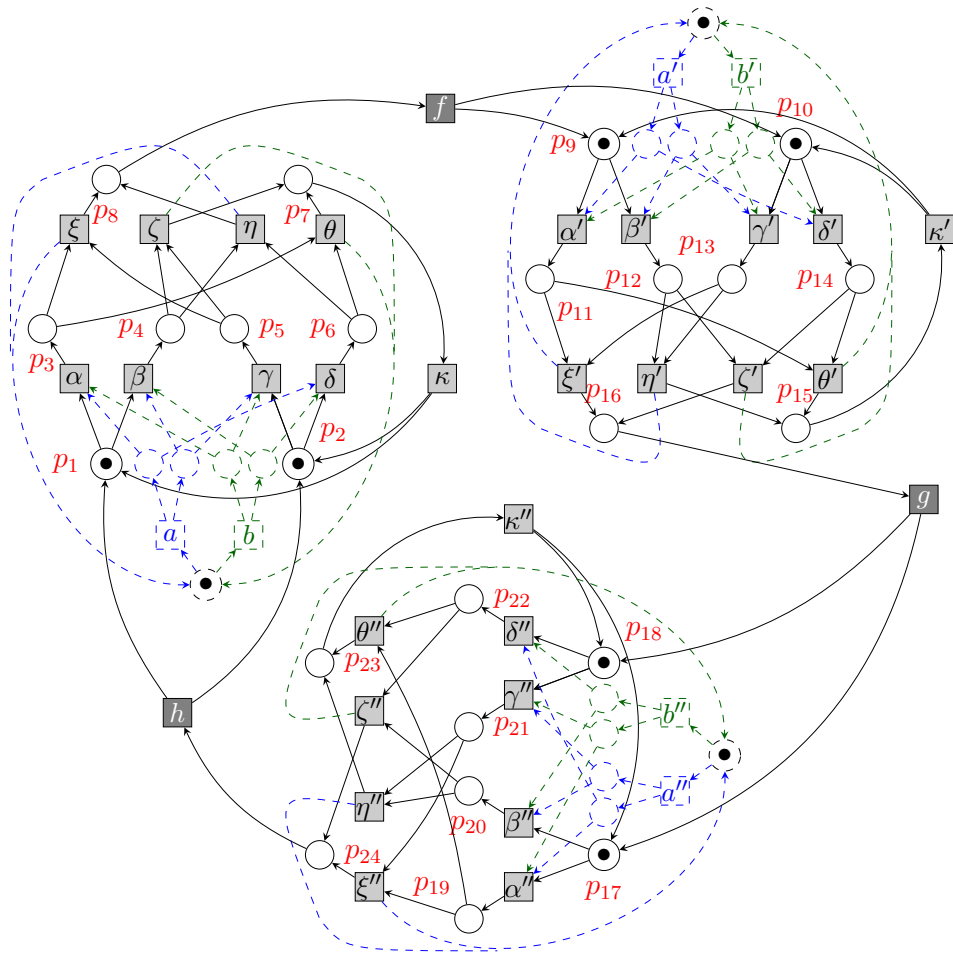

Figure 7.2: A sketch to represent a regime in nature.

In fig.7.2 we observe three interconnected instances of the net in fig.5.1a. The connection between one another is through transitions f , g and h which are enabled by previous fixed points, p_8 , p_{16} and p_{24} . Furthermore, there are control places and transitions which steer the net's dynamics. Take, for example, transition a and b which are in conflict, whenever one is fired, it will determine whether transition κ or transition f be enabled. Indeed, assuming that:

1. a has fired, it enables either α and γ or β and δ which in turn after firing, will enable ξ or η , respectively. Once either of the latter two has fired, f will be enabled and when fired, it produces tokens on p_9 and p_{10} that will continue the flow of tokens according to the conflict resolution in a' and b' .
2. b has fired, it enables either α and δ or β and γ which in turn after firing, will enable ζ or θ , respectively. Once either of the latter two has fired, κ will be enabled and when fired, it produces tokens back on p_1 and p_2 that will continue the flow of tokens according again to the conflict resolution in a and b .

Analogously, when comparing both figures, activation of f , g and h means the move from one stage into another in fig.7.1 and they allow the cycling behavior that eventually will stop to start another stage. Hence, we know conflict resolution is key to determine whether a looping behavior is continued or not since it permits to steer the system from a cycle into other parts of the net. And here it is why *attractors'* definition falls short to represent a cycling behavior that *eventually* will escape from it. The latter implies that we need to *devise control strategies* to *pilot* the dynamics of the system which will resolve the regime's behavior. While this option, alongside other approaches (sec. 7.1), warrants further investigation, it remains a subject for future research.

References

- [1] Samy Abbes and Albert Benveniste. “True-concurrency probabilistic models: branching cells and distributed probabilities for event structures”. In: *Information and Computation* 204.2 (2006), pp. 231–274. DOI: [10.1016/j.ic.2005.10.001](https://doi.org/10.1016/j.ic.2005.10.001).
- [2] Gianni Aguirre-Samboní et al. “Avoid One’s Doom: Finding Cliff-Edge Configurations in Petri Nets”. In: *Proceedings 13th International Symposium on Games, Automata, Logics and Formal Verification*. Ed. by Pierre Ganty and Dario Della-Monica. Vol. 370. Madrid, Spain: Open Publishing Association, 2022, pp. 178–193. DOI: [10.4204/eptcs.370.12](https://doi.org/10.4204/eptcs.370.12).
- [3] Gianni Karlo Aguirre-Samboní. ECOFOLDER. URL: <https://github.com/giannkas/ecofolder>. 2022.
- [4] Stefano Allesina and Si Tang. “Stability criteria for complex ecosystems”. In: *Nature* 483.7388 (2012), pp. 205–208. DOI: [10.1038/nature10832](https://doi.org/10.1038/nature10832).
- [5] Millennium Ecosystem Assessment. *Ecosystems and human well-being: synthesis*. Island Press, 2005. ISBN: 1597260401.
- [6] Russell Babcock et al. “Assessing different causes of crown-of-thorns starfish outbreaks and appropriate responses for management on the great barrier reef”. In: *PloS one* 11.12 (2016), e0169048. DOI: [10.1371/journal.pone.0169048](https://doi.org/10.1371/journal.pone.0169048).
- [7] Christopher Baker, Ascelin Gordon, and Michael Bode. “Ensemble ecosystem modeling for predicting ecosystem response to predator reintroduction”. In: *Conservation Biology* 31.2 (2017), pp. 376–384. DOI: [10.1111/cobi.12798](https://doi.org/10.1111/cobi.12798).
- [8] Christopher Baker et al. “Informing network management using fuzzy cognitive maps”. In: *Biological Conservation* 224 (2018), pp. 122–128. DOI: [10.1016/j.biocon.2018.05.031](https://doi.org/10.1016/j.biocon.2018.05.031).
- [9] Sandie Balaguer, Thomas Chatain, and Stefan Haar. “Building occurrence nets from reveals relations”. In: *Fundamenta Informaticae* 123.3 (2013), pp. 245–272. DOI: [10.1109/ACSD.2011.16](https://doi.org/10.1109/ACSD.2011.16).

- [10] Paolo Baldan et al. “On the Computation of McMillan’s Prefix for Contextual Nets and Graph Grammars”. In: *Proceedings of the 5th International Conference on Graph Transformations (ICGT’10)*. Ed. by Hartmut Ehrig et al. Vol. 6372. Lecture Notes in Computer Science. Enschede, The Netherlands: Springer, Sept. 2010, pp. 91–106. DOI: [10.1007/978-3-642-15928-2_7](https://doi.org/10.1007/978-3-642-15928-2_7).
- [11] Paolo Baldan et al. “Efficient unfolding of contextual Petri nets”. In: *Theoretical Computer Science* 449 (2012), pp. 2–22. DOI: [10.1016/j.tcs.2012.04.046](https://doi.org/10.1016/j.tcs.2012.04.046).
- [12] Yinon Bar-On, Rob Phillips, and Ron Milo. “The biomass distribution on Earth”. In: *Proceedings of the National Academy of Sciences* 115.25 (2018), pp. 6506–6511. DOI: [10.1073/pnas.1711842115](https://doi.org/10.1073/pnas.1711842115).
- [13] David Berry and Stefanie Widder. “Deciphering microbial interactions and detecting keystone species with co-occurrence networks”. In: *Frontiers in Microbiology* 5 (2014). DOI: [10.3389/fmicb.2014.00219](https://doi.org/10.3389/fmicb.2014.00219).
- [14] Brandon Bestelmeyer, Darroc Goolsby, and Steven Archer. “Spatial perspectives in state-and-transition models: a missing link to land management?” In: *Journal of Applied Ecology* 48.3 (757), p. 746. DOI: [10.1111/j.1365-2664.2011.01982.x](https://doi.org/10.1111/j.1365-2664.2011.01982.x).
- [15] Brandon Bestelmeyer et al. “Development and use of state-and-transition models for rangelands”. In: *Journal of Range Management* 56.2 (2003), pp. 114–126. DOI: [10.2307/4003894](https://doi.org/10.2307/4003894).
- [16] Brandon Bestelmeyer et al. “Land management in the american southwest: a state-and-transition approach to ecosystem complexity”. In: *Environmental Management* 34.1 (2004), pp. 38–51. DOI: [10.1007/s00267-004-0047-4](https://doi.org/10.1007/s00267-004-0047-4).
- [17] Brandon Bestelmeyer et al. “Practical guidance for developing state-and-transition models”. In: *Rangelands* 32.6 (2010), pp. 23–30. DOI: [10.2111/Rangelands-D-10-00077.1](https://doi.org/10.2111/Rangelands-D-10-00077.1).
- [18] André Bogdanowski et al. “McComedy: A user-friendly tool for next-generation individual-based modeling of microbial consumer-resource systems”. In: *PLoS Computational Biology* 18.1 (2022), e1009777. DOI: [10.1371/journal.pcbi.1009777](https://doi.org/10.1371/journal.pcbi.1009777).
- [19] Mark Borsuk, Craig Stow, and Kenneth Reckhow. “A Bayesian network of eutrophication models for synthesis, prediction, and uncertainty analysis”. In: *Ecological Modelling* 173.2 (2004), pp. 219–239. DOI: [10.1016/j.ecolmodel.2003.08.020](https://doi.org/10.1016/j.ecolmodel.2003.08.020).

- [20] Ana Borthagaray, Matías Arim, and Pablo Marquet. “A probabilistic model for analysing species co-occurrence”. In: *Proceedings Biological Sciences* 281.1792 (2014). DOI: [10.1098/rspb.2014.1425](https://doi.org/10.1098/rspb.2014.1425).
- [21] David Briske, Samuel Fuhlendorf, and Fred Smeins. “State-and-transition models, thresholds, and rangeland health: a synthesis of ecological concepts and perspectives”. In: *Rangeland Ecology & Management* 58.1 (2005), pp. 1–10. DOI: [10.2111/1551-5028\(2005\)58<1:SMTARH>2.0.CO;2](https://doi.org/10.2111/1551-5028(2005)58<1:SMTARH>2.0.CO;2).
- [22] Mathilde Carlier. *Automotive retail industry in France*. 2022. URL: <https://www.statista.com/topics/6407/automotive-retail-industry-in-france/%5C#topicOverview>.
- [23] Ruth Carrasco-Gallego, Eva Ponce-Cueto, and Rommert Dekker. “Closed-loop supply chains of reusable articles: a typology grounded on case studies”. In: *International Journal of Production Research* 50.19 (2012), pp. 5582–5596. DOI: [10.1080/00207543.2011.649861](https://doi.org/10.1080/00207543.2011.649861).
- [24] Hal Caswell. *Matrix population models: construction, analysis, and interpretation*. 2nd. Sinauer Associates Inc, 2000. ISBN: 9780878930968.
- [25] Victor Cazalis, Michel Loreau, and Gladys Barragan-Jason. “A global synthesis of trends in human experience of nature”. In: *Frontiers in Ecology and the Environment* 21.2 (2023), pp. 85–93. DOI: [10.1002/fee.2540](https://doi.org/10.1002/fee.2540).
- [26] Thomas Chatain et al. “Characterization of reachable attractors using petri net unfoldings”. In: *Computational Methods in Systems Biology*. Ed. by Pedro Mendes, Joseph Dada, and Kieran Smallbone. Cham: Springer International Publishing, 2014, pp. 129–142. ISBN: 978-3-319-12982-2. DOI: [10.1007/978-3-319-12982-2_10](https://doi.org/10.1007/978-3-319-12982-2_10).
- [27] Intergovernmental Panel on Climate Change (IPCC). “Summary for Policymakers”. In: *Climate Change 2021 - The Physical Science Basis: Working Group I Contribution to the Sixth Assessment Report of the Intergovernmental Panel on Climate Change*. Cambridge University Press, 2023, pp. 3–32. DOI: [10.1017/9781009157896.001](https://doi.org/10.1017/9781009157896.001).
- [28] David Cohen et al. “Mathematical modelling of molecular pathways enabling tumour cell invasion and migration”. In: *PLoS computational biology* 11.11 (2015), e1004571. DOI: [10.1371/journal.pcbi.1004571](https://doi.org/10.1371/journal.pcbi.1004571).
- [29] Kim Cohen et al. “The ICS International Chronostratigraphic Chart”. In: *International Union of Geological Sciences* 36.3 (2013), pp. 199–204. DOI: [10.18814/epiiugs/2013/v36i3/002](https://doi.org/10.18814/epiiugs/2013/v36i3/002).
- [30] Maximilien Cosme et al. “Qualitative modeling for bridging expert-knowledge and socialecological dynamics of an east African savanna”. In: *Land* 11.42 (2022), pp. 1–26. DOI: [10.3390/land11010042](https://doi.org/10.3390/land11010042).

- [31] Paul Crutzen. “Geology of mankind”. In: *Nature* 415.6867 (2002), p. 23. DOI: [10.1038/415023a](https://doi.org/10.1038/415023a).
- [32] Jeffrey Dambacher, Richard Levins, and Philippe Rossignol. “Life expectancy change in perturbed communities: derivation and qualitative analysis”. In: *Mathematical Biosciences* 197.1 (2005), pp. 1–14. DOI: [10.1016/j.mbs.2005.06.001](https://doi.org/10.1016/j.mbs.2005.06.001).
- [33] Jeffrey Dambacher and Rodrigo Ramos-Jiliberto. “Understanding and predicting effects of modified interactions through a qualitative analysis of community structure”. In: *The Quarterly Review of Biology* 82.3 (2007), pp. 227–250. DOI: [10.1086/519966](https://doi.org/10.1086/519966).
- [34] Ruth DeFries and Harini Nagendra. “Ecosystem management as a wicked problem”. In: *Science* 356.6335 (2017), pp. 265–270. DOI: [10.1126/science.aal1950](https://doi.org/10.1126/science.aal1950).
- [35] Jörg Desel and Görkem Kılın.8c. “Observable liveness of Petri nets”. In: *Acta Informatica* 52.2 (2015), pp. 153–174. DOI: [10.1007/s00236-015-0218-1](https://doi.org/10.1007/s00236-015-0218-1).
- [36] Nick Dexter et al. “Predicting ecosystem wide impacts of wallaby management using a fuzzy cognitive map”. In: *Ecosystems* 15 (2012), pp. 1363–1379. DOI: [10.1007/s10021-012-9590-7](https://doi.org/10.1007/s10021-012-9590-7).
- [37] Erle Ellis et al. “People have shaped most of terrestrial nature for at least 12,000 years”. In: *Proceedings of the National Academy of Sciences* 118.17 (2021), e2023483118. DOI: [10.1073/pnas.2023483118](https://doi.org/10.1073/pnas.2023483118).
- [38] Joost Engelfriet. “Branching Processes of Petri Nets”. In: *Acta Informatica* 28 (1991), pp. 575–591. DOI: [10.1007/BF01463946](https://doi.org/10.1007/BF01463946).
- [39] Javier Esparza and Keijo Heljanko. *Unfoldings: a partial-order approach to model checking*. Springer Publishing Company, Incorporated, 2008. ISBN: 3540774254.
- [40] Javier Esparza, Sefan Römer, and Walter Vogler. “An Improvement of McMillan’s Unfolding Algorithm”. In: *Formal Methods in System Design* 20 (2002), pp. 285–310. DOI: [10.1023/A:1014746130920](https://doi.org/10.1023/A:1014746130920).
- [41] Matthew Evans, Ken Norris, and Tim Benton. “Predictive ecology: systems approaches”. In: *Philosophical Transactions of the Royal Society B: Biological Sciences* 367.1586 (2012), pp. 163–169. DOI: [10.1098/rstb.2011.0191](https://doi.org/10.1098/rstb.2011.0191).
- [42] Louis Fitime et al. “Identification of bifurcation transitions in biological regulatory networks using answer-set programming”. In: *Algorithms for Molecular Biology* 12.1 (2017), p. 19. DOI: [10.1186/s13015-017-0110-3](https://doi.org/10.1186/s13015-017-0110-3).

- [43] Food and Agriculture Organization of the United Nations. *Ecosystem Services & Biodiversity*. 2023. URL: <https://www.fao.org/ecosystem-services-biodiversity/background/cultural-services/en/>.
- [44] Damien Fordham et al. “Adapted conservation measures are required to save the Iberian lynx in a changing climate”. In: *Nature Climate Change* 3.10 (2013), pp. 899–903. DOI: [10.1038/nclimate1954](https://doi.org/10.1038/nclimate1954).
- [45] Sarah Fretzer. “Implementing the habitats directive in Germany: case conventions versus Ecopath, Ecosim & Ecospace”. In: *Ecopath 30 years conference proceedings: extended abstracts*. Ed. by Jeroen Steenbeek et al. Vancouver, Canada, 2014, pp. 64–65.
- [46] Tadashi Fukami. “Historical contingency in community assembly: integrating niches, species pools, and priority effects”. In: *Annual Review of Ecology, Evolution, and Systematics* 46.1 (2015), pp. 1–23. DOI: [10.1146/annurev-ecolsys-110411-160340](https://doi.org/10.1146/annurev-ecolsys-110411-160340).
- [47] Elizabeth Fulton. “Approaches to end-to-end ecosystem models”. In: *Journal of Marine Systems* 81.1 (2010), pp. 171–183. DOI: [10.1016/j.jmarsys.2009.12.012](https://doi.org/10.1016/j.jmarsys.2009.12.012).
- [48] Elizabeth Fulton et al. “Lessons in modelling and management of marine ecosystems: the Atlantis experience”. In: *Fish and Fisheries* 12.2 (2011), pp. 171–188. DOI: [10.1111/j.1467-2979.2011.00412.x](https://doi.org/10.1111/j.1467-2979.2011.00412.x).
- [49] Cheng Gao et al. “Co-occurrence networks reveal more complexity than community composition in resistance and resilience of microbial communities”. In: *Nature Communications* 13.1 (2022). DOI: [10.1038/s41467-022-31343-y](https://doi.org/10.1038/s41467-022-31343-y).
- [50] Cédric Gaucherel. “Self-organization of patchy landscapes: hidden optimization of ecological processes”. In: *Journal of Ecosystem & Ecography* 1.2 (2011), pp. 1–3. DOI: [10.4172/2157-7625.1000105](https://doi.org/10.4172/2157-7625.1000105).
- [51] Cédric Gaucherel and Franck Pommereau. “Using discrete systems to exhaustively characterize the dynamics of an integrated ecosystem”. In: *Methods in Ecology and Evolution* 10.9 (2019), pp. 1615–1627. DOI: [10.1111/2041-210X.13242](https://doi.org/10.1111/2041-210X.13242).
- [52] Cédric Gaucherel, Franck Pommereau, and Christelle Hély. “Understanding Ecosystem Complexity via Application of a Process-Based State Space rather than a Potential Surface”. In: *Ecological Complexity* 2020.7163920 (2020), pp. 1–14. DOI: [10.1155/2020/7163920](https://doi.org/10.1155/2020/7163920).

- [53] Cédric Gaucherel, Franck Pommereau, and Colin Thomas. “Petri Nets Semantics of Reaction Rules (RR), a Language for Ecosystems Modelling”. In: *Application and Theory of Petri Nets and Concurrency*. Ed. by Luca Bernardinello and Laure Petrucci. Bergen, Norway, 2022, pp. 175–194. ISBN: 978-3-031-06653-5. DOI: [10.1007/978-3-031-06653-5_10](https://doi.org/10.1007/978-3-031-06653-5_10).
- [54] William Geary et al. “A guide to ecosystem models and their environmental applications”. In: *Nature ecology & evolution* 4.11 (2020), pp. 1459–1471. DOI: [10.1038/s41559-020-01298-8](https://doi.org/10.1038/s41559-020-01298-8).
- [55] Alessandro Giua and Xiaolan Xie. “Control of safe ordinary petri nets using unfolding”. In: *Discrete Event Dynamic Systems* 15.4 (2005), pp. 349–373. DOI: [10.1007/s10626-005-4057-z](https://doi.org/10.1007/s10626-005-4057-z).
- [56] Matthieu de-Goëer-de-Herve et al. “Is a community state reachable, and why?” In: *Authorea* (2022), pp. 1–22. DOI: [10.22541/au.164301558.85072720/v1](https://doi.org/10.22541/au.164301558.85072720/v1).
- [57] James Grace. *Structural equation modeling and natural systems*. Cambridge University Press, 2006. ISBN: 9780511617799.
- [58] James Grace et al. “Guidelines for a graph-theoretic implementation of structural equation modeling”. In: *Ecosphere* 3.8 (2012), art73. DOI: [10.1890/ES12-00048.1](https://doi.org/10.1890/ES12-00048.1).
- [59] Carl Grant. “State-and-transition successional model for bauxite mining rehabilitation in the jarrah forest of western Australia”. In: *Restoration Ecology* 14.1 (2006), pp. 28–37. DOI: [10.1111/j.1526-100X.2006.00102.x](https://doi.org/10.1111/j.1526-100X.2006.00102.x).
- [60] Aaron Greenville, Glenda Wardle, and Chris Dickman. “Desert mammal populations are limited by introduced predators rather than future climate change”. In: *Royal Society open science* 4.11 (2017), p. 170384. DOI: [10.1098/rsos.170384](https://doi.org/10.1098/rsos.170384).
- [61] Volker Grimm, Daniel Ayllón, and Steven Railsback. “Next-Generation Individual-Based Models Integrate Biodiversity and Ecosystems: Yes We Can, and Yes We Must”. In: *Ecosystems* 20 (2017), pp. 229–236. DOI: [10.1007/s10021-016-0071-2](https://doi.org/10.1007/s10021-016-0071-2).
- [62] Bing Guo et al. “Microbial co-occurrence network topological properties link with reactor parameters and reveal importance of low-abundance genera”. In: *npj Biofilms and Microbiomes* 8.1 (2022). DOI: [10.1038/s41522-021-00263-y](https://doi.org/10.1038/s41522-021-00263-y).
- [63] Stefan Haar. “Types of asynchronous diagnosability and the reveals-relation in occurrence nets”. In: *IEEE Transactions on Automatic Control* 55.10 (2010), pp. 2310–2320. DOI: [10.1109/TAC.2010.2063490](https://doi.org/10.1109/TAC.2010.2063490).

- [64] Stefan Haar, Christian Kern, and Stefan Schwoon. “Computing the reveals relation in occurrence nets”. In: *Theoretical Computer Science* 493 (2013), pp. 66–79. DOI: [10.1016/j.tcs.2013.04.028](https://doi.org/10.1016/j.tcs.2013.04.028).
- [65] Stefan Haar, Loïc Paulevé, and Stefan Schwoon. “Drawing the line: basin boundaries in safe Petri nets”. In: (2020). Ed. by Alessandro Abate, Tatjana Petrov, and Verena Wolf, pp. 321–336. DOI: [10.1007/978-3-030-60327-4_17](https://doi.org/10.1007/978-3-030-60327-4_17).
- [66] Stefan Haar, Cesar Rodríguez, and Stefan Schwoon. “Reveal your faults: it’s only fair!” In: *Proceedings of the 2013 13th International Conference on Application of Concurrency to System Design*. USA: IEEE Computer Society, 2013, pp. 120–129. ISBN: 9780769550350. DOI: [10.1109/ACSD.2013.15](https://doi.org/10.1109/ACSD.2013.15).
- [67] Alan Hastings and Louis Gross. *Encyclopedia of Theoretical Ecology*. Berkeley: University of California Press, 2012. ISBN: 9780520269651.
- [68] Ruben Heleno et al. “Ecological networks: delving into the architecture of biodiversity”. In: *Biology Letters* 10.1 (2014), p. 20131000. DOI: [10.1098/rsbl.2013.1000](https://doi.org/10.1098/rsbl.2013.1000).
- [69] Marina Hirota et al. “Global resilience of tropical forest and savanna to critical transitions”. In: *Science* 334.6053 (2011), pp. 232–235. DOI: [10.1126/science.1210657](https://doi.org/10.1126/science.1210657).
- [70] Crawford Holling. “Resilience and stability of ecological systems”. In: *Annual Review of Ecology and Systematics* 4.1 (1973), pp. 1–23. DOI: [10.1146/annurev.es.04.110173.000245](https://doi.org/10.1146/annurev.es.04.110173.000245).
- [71] Bronwyn Hradsky et al. “Bayesian networks elucidate interactions between fire and other drivers of terrestrial fauna distributions”. In: *Ecosphere* 8.8 (2017), e01926. DOI: [10.1002/ecs2.1926](https://doi.org/10.1002/ecs2.1926).
- [72] Marian Iordache and Panos Antsaklis. “Decentralized Control of Petri Nets”. In: *Proceedings of the Workshop on Discrete Event Systems Control at the 24th International Conference on Application and Theory of Petri Nets (ATPN 2003)*. Eindhoven, The Netherlands, 2003, pp. 143–158.
- [73] Marian Iordache and Panos Antsaklis. *Supervisory control of concurrent systems: a Petri net structural approach*. Birkhäuser, Boston, 2006. ISBN: 978-0-8176-4357-7.
- [74] Loïg Jezequel et al. “Pomsets and Unfolding of Reset Petri Nets”. In: *LATA 2018 - 12th International Conference on Language and Automata Theory and Applications*. Ed. by Shmuel Tomi Klein, Carlos Martín-Vide, and Dana Shapira. Language and Automata Theory and Applications. Ramat Gan, Israel: Springer, Apr. 2018.

- [75] Ekkart Kindler and Rolf Walter. “Mutex needs fairness”. In: *Information Processing Letters* 62.1 (1997), pp. 31–39. DOI: [10.1016/S0020-0190\(97\)00033-1](https://doi.org/10.1016/S0020-0190(97)00033-1).
- [76] Hannes Klarner et al. “Basins of attraction, commitment sets, and phenotypes of boolean networks”. In: *IEEE/ACM Transactions on Computational Biology and Bioinformatics* 17.4 (2020), pp. 1115–1124. DOI: [10.1109/TCBB.2018.2879097](https://doi.org/10.1109/TCBB.2018.2879097).
- [77] Corrine Knapp et al. “Using participatory workshops to integrate state-and-transition models created with local knowledge and ecological data”. In: *Rangeland Ecology & Management* 64.2 (2011), pp. 158–170. DOI: [10.2111/REM-D-10-00047.1](https://doi.org/10.2111/REM-D-10-00047.1).
- [78] Bart Kosko. “Fuzzy cognitive maps”. In: *International Journal of Man-Machine Studies* 24.1 (1986), pp. 65–75. DOI: [10.1016/S0020-7373\(86\)80040-2](https://doi.org/10.1016/S0020-7373(86)80040-2).
- [79] Timo Latvala and Keijo Heljanko. “Coping with strong fairness”. In: *Fundamenta Informaticae* 43.1-4 (2000), pp. 175–193. DOI: [10.3233/FI-2000-43123409](https://doi.org/10.3233/FI-2000-43123409).
- [80] Richard Law, Anita Weatherby, and Philip Warren. “On the invasibility of persistent protist communities”. In: *Oikos* 88.2 (2000), pp. 319–326. DOI: [10.1034/j.1600-0706.2000.880210.x](https://doi.org/10.1034/j.1600-0706.2000.880210.x).
- [81] CE Leith. “Theoretical Skill of Monte Carlo Forecasts”. In: *Monthly Weather Review* 102.6 (1974), pp. 409–418. DOI: [10.1175/1520-0493\(1974\)102<0409:TSOMCF>2.0.CO;2](https://doi.org/10.1175/1520-0493(1974)102<0409:TSOMCF>2.0.CO;2).
- [82] Rebecca Lester and Peter Fairweather. “Ecosystem states: creating a data-derived, ecosystem-scale ecological response model that is explicit in space and time”. In: *Ecological Modelling* 222.15 (2011), pp. 2690–2703. DOI: [10.1016/j.ecolmodel.2011.05.009](https://doi.org/10.1016/j.ecolmodel.2011.05.009).
- [83] David Lindenmayer et al. “A checklist for ecological management of landscapes for conservation”. In: *Ecology Letters* 11.1 (2008), pp. 78–91. DOI: [10.1111/j.1461-0248.2007.01114.x](https://doi.org/10.1111/j.1461-0248.2007.01114.x).
- [84] Sapana Lohani et al. “Linking ecosystem services with state-and-transition models to evaluate rangeland management decisions”. In: *Global Ecology and Conservation* 8 (2016), pp. 58–70. DOI: [10.1016/j.gecco.2016.08.003](https://doi.org/10.1016/j.gecco.2016.08.003).
- [85] Sean Lucey, Sarah Gaichas, and Kerim Aydin. “Conducting reproducible ecosystem modeling using the open source mass balance model Rpath”. In: *Ecological Modelling* 427 (2020), p. 109057. DOI: [10.1016/j.ecolmodel.2020.109057](https://doi.org/10.1016/j.ecolmodel.2020.109057).

- [86] John Ludwig et al. “Patch configuration non-linearly affects sediment loss across scales in a grazed catchment in north-east Australia”. In: *Ecosystems* 10.5 (2007), pp. 839–845. DOI: [10.1007/s10021-007-9061-8](https://doi.org/10.1007/s10021-007-9061-8).
- [87] Miguel Lurgi, Euan Ritchie, and Damien Fordham. “Eradicating abundant invasive prey could cause unexpected and varied biodiversity outcomes: The importance of multispecies interactions”. In: *Journal of Applied Ecology* 55.5 (2018), pp. 2396–2407. DOI: [10.1111/1365-2664.13188](https://doi.org/10.1111/1365-2664.13188).
- [88] Monirehalsadat Mahmoudi and Irandokht Parviziomran. “Reusable packaging in supply chains: a review of environmental and economic impacts, logistics system designs, and operations management”. In: *International Journal of Production Economics* 228 (2020), p. 107730. ISSN: 0925-5273. DOI: [10.1016/j.ijpe.2020.107730](https://doi.org/10.1016/j.ijpe.2020.107730).
- [89] Zhun Mao et al. “Maintaining biodiversity promotes the multifunctionality of social-ecological systems: holistic modelling of a mountain system”. In: *Ecosystem Services* 47 (2021), p. 101220. DOI: [10.1016/j.ecoser.2020.101220](https://doi.org/10.1016/j.ecoser.2020.101220).
- [90] Robert May. “Will a large complex system be stable?” In: *Nature* 238 (1972), pp. 413–414. DOI: [10.1038/238413a0](https://doi.org/10.1038/238413a0).
- [91] Anna McAlister and Bettina Cornwell. “Children’s brand symbolism understanding: links to theory of mind and executive functioning”. In: *Psychology & Marketing* 27.3 (2010), pp. 203–228. DOI: [10.1002/mar.20328](https://doi.org/10.1002/mar.20328).
- [92] Hugh McGregor et al. “Landscape management of fire and grazing regimes alters the fine-scale habitat utilisation by feral cats”. In: *PLOS ONE* 9.10 (2014), pp. 1–9. DOI: [10.1371/journal.pone.0109097](https://doi.org/10.1371/journal.pone.0109097).
- [93] Ken McMillan. “Using unfoldings to avoid the state explosion problem in the verification of asynchronous circuits”. In: *Computer Aided Verification*. Ed. by Gregor von Bochmann and David Karl Probst. Berlin, Heidelberg: Springer Berlin Heidelberg, 1993, pp. 164–177. ISBN: 978-3-540-47572-9. DOI: [10.1007/3-540-56496-9_14](https://doi.org/10.1007/3-540-56496-9_14).
- [94] Nuno Mendes et al. “Estimating attractor reachability in asynchronous logical models”. In: *Frontiers in Physiology* 9.1161 (2018). DOI: [10.3389/fphys.2018.01161](https://doi.org/10.3389/fphys.2018.01161).
- [95] Babak Momeni et al. “Strong inter-population cooperation leads to partner intermixing in microbial communities”. In: *eLife* 2 (2013), e00230. DOI: [10.7554/eLife.00230](https://doi.org/10.7554/eLife.00230).

- [96] José Montoya, Stuart Pimm, and Richard Solé. “Ecological networks and their fragility”. In: *Nature* 442.7100 (2006), pp. 259–264. DOI: [10.1038/nature04927](https://doi.org/10.1038/nature04927).
- [97] Camilo Mora et al. “How Many Species Are There on Earth and in the Ocean?” In: *PLOS Biology* 9.8 (2011), pp. 1–8. DOI: [10.1371/journal.pbio.1001127](https://doi.org/10.1371/journal.pbio.1001127).
- [98] Akihiko Mougi and Michio Kondoh. “Diversity of interaction types and ecological community stability”. In: *Science* 337.6092 (2012), pp. 349–351. DOI: [10.1126/science.1220529](https://doi.org/10.1126/science.1220529).
- [99] Felix Müller, Broder Breckling, and Fred Jopp and Hauke Reuter. “What are the general conditions under which ecological models can be applied?” In: *Modelling Complex Ecological Dynamics: An Introduction into Ecological Modelling for Students, Teachers & Scientists*. Ed. by Fred Jopp, Hauke Reuter, and Broder Breckling. Springer Berlin Heidelberg, 2011, pp. 13–28. ISBN: 978-3-642-05029-9. DOI: [10.1007/978-3-642-05029-9_2](https://doi.org/10.1007/978-3-642-05029-9_2).
- [100] Tadao Murata and Manuel Silva. “Petri-net-based fairness concepts for discrete event systems”. In: *Realization and Modelling in System Theory: Proceedings of the International Symposium MTNS-89, Volume I*. Ed. by Marinus-Adriaan Kaashoek, Jan-Hendrik van-Schuppen, and André Ran. Boston, MA: Birkhäuser Boston, 1990, pp. 549–557. ISBN: 978-1-4612-3462-3. DOI: [10.1007/978-1-4612-3462-3_61](https://doi.org/10.1007/978-1-4612-3462-3_61).
- [101] Tadao Murata and Zhehui Wu. “Fair relation and modified synchronic distances in a petri net”. In: *Journal of the Franklin Institute* 320.2 (1985), pp. 63–82. DOI: [10.1016/0016-0032\(85\)90028-6](https://doi.org/10.1016/0016-0032(85)90028-6).
- [102] Anje-Margriet Neutel, Johan Heesterbeek, and Peter de-Ruiter. “Stability in Real Food Webs: Weak Links in Long Loops”. In: *Science* 296.5570 (2002), pp. 1120–1123. DOI: [10.1126/science.1068326](https://doi.org/10.1126/science.1068326).
- [103] Mogens Nielsen, Gordon Plotkin, and Glynn Winskel. “Petri nets, event structures and domains”. In: *Semantics of Concurrent Computation*. Ed. by Gilles Kahn. Berlin, Heidelberg: Springer Berlin Heidelberg, 1979, pp. 266–284. ISBN: 978-3-540-35163-4.
- [104] Sonja Otto, Björn Rall, and Ulrich Brose. “Allometric degree distributions facilitate food-web stability”. In: *Nature* 450.7173 (2007), pp. 1226–1229. DOI: [10.1038/nature06359](https://doi.org/10.1038/nature06359).
- [105] Ertugrul Ozbudak et al. “Multistability in the lactose utilization network of *Escherichia coli*”. In: *Nature* 427.6976 (2004), pp. 737–740. DOI: [10.1038/nature02298](https://doi.org/10.1038/nature02298).

- [106] Debra Peters and Gregory Okin. “A Toolkit for Ecosystem Ecologists in the Time of Big Science”. In: *Ecosystems* 20 (2017), pp. 259–266. DOI: [10.1007/s10021-016-0072-1](https://doi.org/10.1007/s10021-016-0072-1).
- [107] Stuart Pimm et al. “The Future of Biodiversity”. In: *Science* 269.5222 (1995), pp. 347–350. DOI: [10.1126/science.269.5222.347](https://doi.org/10.1126/science.269.5222.347).
- [108] Alexander Pisarchik and Ulrike Feudel. “Control of multistability”. In: *Physics Reports* 540.4 (2014), pp. 167–218. DOI: [10.1016/j.physrep.2014.02.007](https://doi.org/10.1016/j.physrep.2014.02.007).
- [109] Éva Plagányi. *Models for an ecosystem approach to fisheries*. Food, Agriculture, and Organization of the United Nations, 2007.
- [110] Éva Plagányi et al. “Multispecies fisheries management and conservation: tactical applications using models of intermediate complexity”. In: *Fish and Fisheries* 15.1 (2014), pp. 1–22. DOI: [10.1111/j.1467-2979.2012.00488.x](https://doi.org/10.1111/j.1467-2979.2012.00488.x).
- [111] Erik Plahte, Thomas Mestl, and Stig Omholt. “Feedback loops, stability and multistationarity in dynamical systems”. In: *Journal of Biological Systems* 3.2 (1995), pp. 409–413. DOI: [10.1142/S0218339095000381](https://doi.org/10.1142/S0218339095000381).
- [112] Jeffrey Polovina. “Model of a coral reef ecosystem”. In: *Coral Reefs* 3 (1984), pp. 1–11. DOI: [10.1007/BF00306135](https://doi.org/10.1007/BF00306135).
- [113] Franck Pommereau, Colin Thomas, and Cédric Gaucherel. “EDEN Framework for Interactive Analysis of Ecosystems Models”. In: *Petri Nets and Software Engineering 2022*. Ed. by Michael Köhler-Bussmeier, Daniel Moldt, and Heiko Rölke. Bergen, Norway, 2022, pp. 119–138.
- [114] Edward Rastetter. “Modeling for Understanding v. Modeling for Numbers”. In: *Ecosystems* 20.2 (2017), pp. 215–221. DOI: [10.1007/s10021-016-0067-y](https://doi.org/10.1007/s10021-016-0067-y).
- [115] Adrien Richard. “Positive and negative cycles in Boolean networks”. In: *Journal of Theoretical Biology* 463 (2019), pp. 67–76. DOI: [10.1016/j.jtbi.2018.11.028](https://doi.org/10.1016/j.jtbi.2018.11.028).
- [116] Hannah Ritchie. “Sector by sector: where do global greenhouse gas emissions come from?” In: *Our World in Data* (2020). URL: <https://ourworldindata.org/ghg-emissions-by-sector>.
- [117] César Rodríguez and Stefan Schwoon. “Verification of Petri Nets with Read Arcs”. In: *CONCUR 2012 - Concurrency Theory*. Ed. by Maciej Koutny and Irek Ulidowski. Springer, 2012, pp. 471–485. ISBN: 978-3-642-32940-1. DOI: [10.1007/978-3-642-32940-1_33](https://doi.org/10.1007/978-3-642-32940-1_33).

- [118] César Rodríguez, Stefan Schwoon, and Paolo Baldan. “Efficient contextual unfolding”. In: *Proceedings of the 22nd International Conference on Concurrency Theory (CONCUR’11)*. Ed. by Joost-Pieter Katoen and Barbara König. Vol. 6901. Lecture Notes in Computer Science. Aachen, Germany: Springer, Sept. 2011, pp. 342–357. DOI: [10.1007/978-3-642-23217-6_23](https://doi.org/10.1007/978-3-642-23217-6_23).
- [119] César Rodríguez, Stefan Schwoon, and Victor Khomenko. “Contextual Merged Processes”. In: *Application and Theory of Petri Nets and Concurrency*. Ed. by José-Manuel Colom and Jörg Desel. Berlin, Heidelberg: Springer Berlin Heidelberg, 2013, pp. 29–48. ISBN: 978-3-642-38697-8.
- [120] Marten Scheffer et al. “Catastrophic shifts in ecosystems”. In: *Nature* 413 (2001), pp. 591–596. DOI: [10.1038/35098000](https://doi.org/10.1038/35098000).
- [121] Marten Scheffer et al. “Generic indicators of ecological resilience: inferring the chance of a critical transition”. In: *Annual Review of Ecology, Evolution, and Systematics* 46.1 (2015), pp. 145–167. DOI: [10.1146/annurev-ecolsys-112414-054242](https://doi.org/10.1146/annurev-ecolsys-112414-054242).
- [122] Carina Schlebusch et al. “Southern African ancient genomes estimate modern human divergence to 350,000 to 260,000 years ago”. In: *Science* 358.6363 (2017), pp. 652–655. DOI: [10.1126/science.aao6266](https://doi.org/10.1126/science.aao6266).
- [123] William Schweiger et al. “Using structural equation modeling to link human activities to wetland ecological integrity”. In: *Ecosphere* 7.11 (2016), e01548. DOI: [10.1002/ecs2.1548](https://doi.org/10.1002/ecs2.1548).
- [124] Masashi Soga and Kevin Gaston. “Extinction of experience: the loss of human-nature interactions”. In: *Frontiers in Ecology and the Environment* 14.2 (2016), pp. 94–101. DOI: [10.1002/fee.1225](https://doi.org/10.1002/fee.1225).
- [125] Ramavarapu Sreenivas and Bruce Krogh. “On fairness and conflicts in Petri nets”. In: *Proceedings of the 32nd Midwest Symposium on Circuits and Systems*. Vol. 1. 1989, pp. 406–409. DOI: [10.1109/MWSCAS.1989.101877](https://doi.org/10.1109/MWSCAS.1989.101877).
- [126] Tanya Strydom et al. “A roadmap towards predicting species interaction networks (across space and time)”. In: *Philosophical Transactions of the Royal Society B* 376.1837 (2021), p. 20210063. DOI: [10.1098/rstb.2021.0063](https://doi.org/10.1098/rstb.2021.0063).
- [127] Gashaw Tesfaye and Matthias Wolff. “Modeling trophic interactions and the impact of an introduced exotic carp species in the Rift Valley Lake Koka, Ethiopia”. In: *Ecological Modelling* 378 (2018), pp. 26–36. DOI: [10.1016/j.ecolmodel.2018.04.003](https://doi.org/10.1016/j.ecolmodel.2018.04.003).

- [128] Elisa Thébault and Colin Fontaine. “Stability of ecological communities and the architecture of mutualistic and trophic networks”. In: *Science* 329.5993 (2010), pp. 853–856. DOI: [10.1126/science.1188321](https://doi.org/10.1126/science.1188321).
- [129] Rene Thom. “Structural stability and morphogenesis”. In: *Pattern Recognition* 8.1 (1976), p. 61. DOI: [10.1016/0031-3203\(76\)90030-3](https://doi.org/10.1016/0031-3203(76)90030-3).
- [130] René Thomas. “On the relation between the logical structure of systems and their ability to generate multiple steady states or sustained oscillations”. In: *Numerical Methods in the Study of Critical Phenomena*. Ed. by Jean Della-Dora, Jacques Demongeot, and Bernard Lacolle. Berlin, Heidelberg: Springer Berlin Heidelberg, 1981, pp. 180–193. ISBN: 978-3-642-81703-8. DOI: [10.1007/978-3-642-81703-8_24](https://doi.org/10.1007/978-3-642-81703-8_24).
- [131] René Thomas and Richard d’Ari. *Biological Feedback*. CRC Press, Inc, 1990. URL: <https://hal.science/hal-00087681>.
- [132] René Thomas, Denis Thieffry, and Marcelle Kaufman. “Dynamical behaviour of biological regulatory networks—I. Biological role of feedback loops and practical use of the concept of the loop-characteristic state”. In: *Bulletin of Mathematical Biology* 57.2 (1995), pp. 247–276. DOI: [10.1007/BF02460618](https://doi.org/10.1007/BF02460618).
- [133] Morgane Travers et al. “Towards end-to-end models for investigating the effects of climate and fishing in marine ecosystems”. In: *Progress in Oceanography* 75.4 (2007), pp. 751–770. DOI: [10.1016/j.pocean.2007.08.001](https://doi.org/10.1016/j.pocean.2007.08.001).
- [134] Vivitskaia Tulloch et al. “Future recovery of baleen whales is imperiled by climate change”. In: *Global Change Biology* 25.4 (2019), pp. 1263–1281. DOI: [10.1111/gcb.14573](https://doi.org/10.1111/gcb.14573).
- [135] Leigh Van Valen. “A new evolutionary law”. In: *Evolutionary Theory* 1 (1973), pp. 1–30.
- [136] Joseph Veech. “A probabilistic model for analysing species co-occurrence”. In: *Global Ecology and Biogeography* 22.2 (2013), pp. 252–260. DOI: [10.1111/j.1466-8238.2012.00789.x](https://doi.org/10.1111/j.1466-8238.2012.00789.x).
- [137] Tomas Veloz. “The complexity-stability debate, chemical organization theory, and the identification of non-classical structures in ecology”. In: *Foundations of Science* 25.1 (2020), pp. 259–273. DOI: [10.1007/s10699-019-09639-y](https://doi.org/10.1007/s10699-019-09639-y).
- [138] Walter Vogler. “Fairness and partial order semantics”. In: *Information Processing Letters* 55.1 (1995), pp. 33–39. DOI: [10.1016/0020-0190\(95\)00049-I](https://doi.org/10.1016/0020-0190(95)00049-I).

- [139] Brian Walker et al. “Resilience, Adaptability and Transformability in Social–ecological Systems”. In: *Ecology and Society* 9.2 (2004).
- [140] David Waltner-Toews et al. “Perspective changes everything: managing ecosystems from the inside out”. In: *Frontiers in Ecology and the Environment* 1.1 (2003), pp. 23–30. DOI: [10.1890/1540-9295\(2003\)001\[0023:PCEMEF\]2.0.CO;2](https://doi.org/10.1890/1540-9295(2003)001[0023:PCEMEF]2.0.CO;2).
- [141] Philip Warren, Richard Law, and Anita Weatherby. “Mapping the assembly of protist communities in microcosms”. In: *Ecology* 84.4 (2003), pp. 1001–1011. DOI: [10.1890/0012-9658\(2003\)084\[1001:MTAOPC\]2.0.CO;2](https://doi.org/10.1890/0012-9658(2003)084[1001:MTAOPC]2.0.CO;2).
- [142] Anita Weatherby, Philip Warren, and Richard Law. “Coexistence and collapse: an experimental investigation of the persistent communities of a protist species pool”. In: *Journal of Animal Ecology* 67.4 (1998), pp. 554–566. DOI: [10.1046/j.1365-2656.1998.00212.x](https://doi.org/10.1046/j.1365-2656.1998.00212.x).
- [143] Lu Weiming. “Marking fairness in Petri nets”. In: *Journal of Computer Science and Technology* 1.1 (1986), pp. 61–69. DOI: [10.1007/BF02943302](https://doi.org/10.1007/BF02943302).
- [144] Mark Westoby, Brian Walker, and Imanuel Noy-Meir. “Opportunistic management for rangelands not at equilibrium”. In: *Journal of Range Management* 42.4 (1989), pp. 266–274. DOI: [10.2307/3899492](https://doi.org/10.2307/3899492).
- [145] Sarah Wilkinson, Anne Naeth, and Fiona Schmiegelow. “Tropical Forest Restoration within Galapagos National Park: Application of a State-transition Model”. In: *Ecology and Society* 10.1 (2005). DOI: [10.5751/es-01371-100128](https://doi.org/10.5751/es-01371-100128).
- [146] Edward Osborne Wilson. *The Insect Societies*. Cambridge, MA: Belknap Press of Harvard University Press, 1971.
- [147] Katherine Yates et al. “Outstanding Challenges in the Transferability of Ecological Models”. In: *Trends in Ecology & Evolution* 33.10 (2018), pp. 790–802. DOI: [10.1016/j.tree.2018.08.001](https://doi.org/10.1016/j.tree.2018.08.001).
- [148] Chuixiang Yi and Nathan Jackson. “A review of measuring ecosystem resilience to disturbance”. In: *Environmental Research Letters* 16.5 (2021), p. 053008. DOI: [10.1088/1748-9326/abdf09](https://doi.org/10.1088/1748-9326/abdf09).