



HAL
open science

Acute and chronic impact of heat exposure on muscle-tendon properties and interplay : from muscle to movement

Adèle Mornas

► **To cite this version:**

Adèle Mornas. Acute and chronic impact of heat exposure on muscle-tendon properties and interplay : from muscle to movement. Tissues and Organs [q-bio.TO]. Université Paris Cité, 2023. English. NNT : 2023UNIP7105 . tel-04561170

HAL Id: tel-04561170

<https://theses.hal.science/tel-04561170>

Submitted on 26 Apr 2024

HAL is a multi-disciplinary open access archive for the deposit and dissemination of scientific research documents, whether they are published or not. The documents may come from teaching and research institutions in France or abroad, or from public or private research centers.

L'archive ouverte pluridisciplinaire **HAL**, est destinée au dépôt et à la diffusion de documents scientifiques de niveau recherche, publiés ou non, émanant des établissements d'enseignement et de recherche français ou étrangers, des laboratoires publics ou privés.

Université Paris Cité

École doctorale 566 : Sciences du sport, de la motricité et du mouvement humain

Laboratoire Sport, Expertise et Performance

Acute and chronic impact of heat exposure on muscle-tendon properties and interplay: from muscle to movement

Impact aigu et chronique de l'exposition à la chaleur sur les propriétés et les interactions muscle-tendon : du muscle au mouvement

Par Adèle Mornas

Thèse de doctorat en Sciences du Mouvement Humain

Dirigée par Gaël Guilhem et Sébastien Racinais

Présentée et soutenue publiquement le 14 Mars 2023

Devant un jury composé de :

Rapportrices : **Janet Taylor**, Professeure, Université Edith Cowan, Perth, Australie

Caroline Nicol, Professeure, Université Aix-Marseille, Marseille, France

Examineurs : **Michal Horowitz**, Professeure Émérite, Université Hébraïque de Jérusalem, Jérusalem, Israël

Olivier Seynnes, Professeur, École Norvégienne des Sciences du Sport, Oslo, Norvège

Directeur de thèse : **Gaël Guilhem**, Directeur de Recherche, HDR, INSEP, Paris, France

Co-directeur : **Sébastien Racinais**, Professeur, Aspetar, Doha, Qatar

Co-encadrant : **Franck Brocherie**, Chercheur, INSEP, Paris, France

ACKNOWLEDGMENTS

This thesis work was funded by a French Ministry of Research scholarship, and conducted in the Sport, Expertise and Performance laboratory, within the French Institute of Sport (INSEP, Paris, France), in collaboration with Aspetar (Doha, Qatar). This INSEP's adventure started almost 4 years ago, for my Master 2 internship. I would like to thank everyone, who from near or far, helped me along the way and enabled me to complete this PhD work.

First of all, I wanted to thank **Prof Caroline Nicol** and **Prof Janet Taylor** for accepting to report this thesis, as well as **Prof Olivier Seynnes** and **Prof Michal Horowitz** for accepting to examine it. It is a great honor to have your expert opinion on this work.

I would also like to thank **Prof Sylvain Dorel**, **Dr Olivier Girard** and **Dr Antonio Jesús Morales-Artacho** for agreeing to be members of my supervising PhD committee and our exchanges.

Dr Daniel Gagnon, je suis ravie de très prochainement intégrer ton équipe, merci d'avance pour ta confiance, et merci de me permettre de terminer sereinement cette thèse. J'ai hâte de commencer cette nouvelle aventure !

Un grand merci à mes encadrants, **Dr Gaël Guilhem**, **Prof Sébastien Racinais** et **Dr Franck Brocherie**, qui m'ont faite grandir dans le monde de la recherche. Je reconnais la chance que j'ai eu d'être encadrée par trois grands chercheurs comme vous.

Gaël, merci pour ta confiance, pour m'avoir tout d'abord accueillie en tant que stagiaire, puis pour m'avoir proposé de continuer notre travail ensemble, à travers cette thèse. Merci pour ton soutien, ta disponibilité et ta rigueur qui ont, je n'en doute pas, en grande partie contribué à construire l'apprentie-chercheuse que je suis aujourd'hui. Promis j'ai bientôt fini de t'embêter avec mes « encore une petite question ».

Sébastien, merci d'avoir été mon co-directeur de thèse. Merci d'être venu à l'INSEP pour mes premières expérimentations. La visio c'est bien, mais avoir pu découvrir ton environnement de travail et ton quotidien, cet été au cours de mon séjour à Aspetar, c'était quand même beaucoup plus sympa ! Encore merci pour cette belle opportunité et ton suivi ces quelques années.

Franck, last but not least! Merci d'avoir co-encadré ma thèse. Merci pour ton soutien pendant les manip et surtout pour ton accompagnement qui est allé bien au-delà de ces travaux de thèse.

Quand après seulement quelques mois de thèse tu me parlais déjà de l'après-thèse, je n'aurais jamais cru que cela arriverait si vite ! Hâte de finaliser cette méta... ;-))

Je remercie chaleureusement l'ensemble des membres du laboratoire, pour m'avoir accompagné pendant ma thèse, pour avoir pris des nouvelles de l'avancement de mon travail, mais pas que ! Un merci particulier à **Antoine, Giuseppe, Hélène et Claire**, mais également **Isabelle** pour ton aide. Merci ma chère **Vihra** pour tes conseils et tes solutions à tout !

Antonio, merci d'avoir suivi mon travail avec intérêt, merci pour tes encouragements, ta gentillesse et ton superbe français. Muchas gracias amigo ! Merci également à ton collègue de bureau, le **Dr Ruffault**, peut-être un peu moins pour l'intérêt porté à mes travaux, mais merci d'avoir bien souvent répondu présent pour aller boire des coups, car ça aussi c'est important ! Merci à **Mathilde et Caro** pour votre bonne humeur, nos sorties footing et votre recul sur l'aventure qu'est la thèse ! **Janne**, merci pour tes supers encouragements dans cette dernière ligne droite, merci de m'avoir nourrie et de me faire autant rire. **Julie**, je te remercie pour ton soutien et bien plus encore. Merci également à **Canelle** et à mon ancien super coloc **Valentin**.

Thanks to the **Aspetar team**, and especially my dear **Maha**, for welcoming me in the Qatari heat this summer. This adventure by your side was unique (biopsies at 6:30 am were a real joy).

Merci à **Marine** et au **Dr Sébastien Le Garrec** pour les mesures de température musculaire et votre adaptabilité. Maintenant que je suis formée, je n'ai plus peur de ces petites aiguilles !

Et bien évidemment merci à mes collègues du quotidien, les occupants du RDJ. Ce superbe sous-sol, un peu hostile au premier abord, qui s'est révélé être un endroit agréable pour travailler (bien sûr), papoter, prendre des petits-déjeuners, des goûters, mais aussi trinquer pour fêter les grandes étapes parcourues dans nos thèses, ou tout simplement décompresser. **Simon**, bienvenue à toi ! Merci à **Mathilde, Quentin et Rafael** et aux anciens doctorants, notamment **Mildred, Joffrey** et bien évidemment **Jérôme. Vincent**, bon courage pour cette superbe usine à gaz ! **Maxime** je te remercie de m'avoir laissée photographier ta belle jonction myotendineuse et d'avoir participé à une grande partie de mes pré-manips, c'était un plaisir de t'envoyer des stims (by the way, merci **Hubert**, et tout pareil pour les stims !). **Valentine**, commencer et terminer sa thèse en même temps qu'un autre doctorant c'est super, avec toi c'était encore plus chouette ! Je suis très contente d'avoir partagé cette aventure avec toi, hâte de t'appeler **Dr Duquesne**. Merci également aux stagiaires qui, chaque année, amènent un peu de fraîcheur au RDJ. Merci en dikke kusjes à mon petit belge **Ritse**, et au meilleur stagiaire de la décennie, le grand poète **Adrien**, le RDJ n'est plus le même sans toi ! Enfin, **BigBen** ! Bon courage pour

cette dernière grande ligne droite, évite de prendre 57.8% de virage. Plus sérieusement, je te souhaite de trouver un·e collègue de bureau aussi chouette que moi, qui saura apprécier tes affaires qui traînent partout à leur juste valeur, et qui prendra soin de tes plantes. Merci à toi de m'avoir supporté depuis plus de 3 ans, on a eu nos hauts et nos bas mais je reste convaincue que tu es le meilleur co-bureau du monde (surtout le matin quand tu ronfles) !!

Merci à mes stagiaires, **Yanis, Arthur et Thomas**, votre aide et votre motivation sans failles sont les clés de mes expérimentations de thèse ! Sans vous, il aurait tout simplement été impossible de mener à bien ces études. Ce fut un plaisir de vous avoir formés et d'avoir appris à vos côtés. Merci d'être venus tôt au labo et d'avoir consacré vos soirées pour la science, j'ai été très chanceuse de tomber sur vous, merci, merci, merci !

Merci **Robin** de m'avoir formée sur la partie expérimentale, merci pour ta bienveillance, ton aide, et tes anecdotes de manips. **Enzo**, merci de m'avoir toujours laissé ta porte ouverte, merci pour tes idées et ton aide précieuse. C'était un plaisir de travailler avec toi sur cette dernière manip. A bien des égards vous m'avez tous les deux guidée au cours de ma thèse, et sans forcément vous en rendre compte, vous m'avez énormément apporté.

Merci à toutes les personnes qui ont participé à mes expérimentations. Merci pour votre temps, votre patience, votre sueur, votre motivation et votre intérêt. Ce n'était pas toujours une partie de plaisir de vous envoyer des stims !

Sinéad, merci ! Tu es la transition parfaite entre le boulot et les amis, la famille. Merci d'avoir toujours été là pour moi, merci pour nos fous rires que nous seules pouvons comprendre (et encore pas toujours), mais qui font tellement de bien. Hâte de t'accueillir dans mon nouveau chez moi, tu vas me manquer ♥

Julien, cousin ! Merci de m'avoir ouvert la porte de ce bel Institut. Même si peu exprimée, ma gratitude envers toi est très grande, car sans toi tout cela n'aurait certainement pas été possible.

Merci à mes amis de Fronton, de Chambé et d'ailleurs de m'avoir permis de déconnecter ces dernières années, autour d'un verre, d'un bon plat, ou lors d'un weekend Parisien. **Jeanne, Édith, Lyna, Armelle et Lucile**, un sincère merci pour votre amitié, je suis vernie de vous avoir comme amies.

Enfin, un grand MERCI à ma **petite famille**. Merci à **mes parents** d'être aussi géniaux ! **Dr Diane Mornas**, je suis fière de te succéder, merci pour tout grande sœur. Et enfin, **Isaure et Téo**, merci tout simplement d'être qui vous êtes.

PUBLICATIONS AND CONFERENCE PRESENTATIONS

Published peer-reviewed articles related to the thesis

Mornas A, Racinais S, Brocherie F, Alhammoud M, Hager R, Desmedt Y and Guilhem G (2021). Hyperthermia reduces electromechanical delay via accelerated electrochemical processes. *Journal of applied physiology*. <https://doi.org/10.1152/jappphysiol.00538.2020>

Mornas A, Racinais S, Brocherie F, Alhammoud M, Hager R, Desmedt Y and Guilhem G (2022). Faster early rate of force development in a warmer muscle: an in vivo exploration of fascicle dynamics and muscle-tendon mechanical properties. *Am J Physiol Regul Integr Comp Physiol*. <https://doi.org/10.1152/ajpregu.00280.2021>

Mornas A, Brocherie F, Guilhem G, Guillotel A, Le Garrec S, Gouwy R, Beuve S, Genisson JL and Racinais S. Active heat acclimation does not alter muscle-tendon unit properties. *Med Sci Sports Exerc*. [Epub ahead of print]

Mornas A, Brocherie F, Hollville E, Derouck T, Racinais S and Guilhem G. Running in the heat does not affect operating fascicle lengths compared to temperate environment. *Submitted*

Conference communications related to the thesis

Mornas A, Racinais S, Brocherie F, Alhammoud M, Hager R, Desmedt Y and Guilhem G (2021). The effects of passive hyperthermia on muscle-tendon unit mechanical properties. XXVIII Congress of the International Society of Biomechanics, Digital Congress. *Poster communication*

Mornas A, Racinais S, Brocherie F, Alhammoud M, Hager R, Desmedt Y and Guilhem G (2021). Passive-induced hyperthermia decreases soft tissues stiffness. 19ème congrès de l'Association des Chercheurs en Activités Physiques et Sportives, Montpellier, France. *Oral communication*

Mornas A, Brocherie F, Guilhem G, Guillotel A, Le Garrec S, Gouwy R, Beuve S, Genisson JL and Racinais S (2021). The effects of active heat acclimation on muscle-tendon unit mechanical properties. *26th congress of the European College of Sport Science*, Digital Congress. *Oral communication*

Mornas A, Brocherie F, Guilhem G, Guillotel A, Le Garrec S, Gouwy R, Beuve S, Genisson JL and Racinais S (2022). Active heat acclimation does not alter muscle-tendon unit properties. *27th congress of the European College of Sport Science*, Sevilla, Spain. *Oral communication*

Conference communication outside of the scope of the thesis

Dablainville V, **Mornas A**, Al Mula M, Bernardi H, Nadeer N, Cardinale M, Olory B, Papakostas E, Alhammoud M, Marin T and Racinais S (2022). Thermal therapies to accelerate muscle recovery. *Exercise performance and training of the top-class athlete, PhD School of Science*, Copenhagen, Denmark. *Poster communication*

INTERNATIONAL RESEARCH STAY

From **July to September 2022** I assisted in a research project within Aspetar (Doha, Qatar), as part of my international thesis co-supervision. The project is part of the PhD work of another student and is called “**Heat therapy to accelerate muscle recovery**” ([see p.189](#)). The objectives of this stay were:

- to collaborate on a new project with a new team in a new environment;
- to discover new research methodologies: an eccentric exercise protocol to induce muscle damage, a new thermal intervention (*i.e.*, cold and hot water immersion), thermal imaging (*i.e.*, Thermal Image Camera) and attend muscle biopsy samples taking;
- to bring my skills; for this we sent an ultrafast ultrasound machine, and I performed shear wave elastography measurements for the project.

I received an International mobility grant awarded from the University of Paris (1000€).

LIST OF ABBREVIATION

ANOVA	Analysis of variance	Na⁺	Sodium ions
AGR	Architectural gear ratio	POST	Post-intervention tests
ATP	Adenosine tri-phosphate	PRE	Pre-intervention tests
Ca²⁺	Calcium ions	PT	Peak twitch
CMJ	Counter-movement jump	RFD	Rate of force development
CON	Testing session in temperate environment/control group	RFD_{0-X}	RFD from 0 to X ms
CT	Contraction time	RH	Relative humidity
EMG	Electromyographic activity	RPE	Rating of perceived exertion
F₀	Maximal theoretical force	RTD	Rate of torque development
F_{max}	maximal force	RTD_{0-X}	RTD from 0 to X ms
GL	<i>Gastrocnemius lateralis</i>	SJ	Squat jump
GM	<i>Gastrocnemius medialis</i>	SOL	<i>Soleus</i>
HA	Heat acclimation	SWE	Shear wave elastography
HOT	Testing/running sessions in hot environment	T_{core}	Core temperature
HRT	Half-relaxation time	TEMP	Testing/running sessions in temperate environment
HSPs	Heat shock proteins	T_{musc}	Muscle temperature
L₀	Optimal length	T_{skin}	Skin temperature
L_F	Fascicle length	V₀	Maximal theoretical velocity
MRJ	Multi-rebound jump	VA	Voluntary activation
mTOR	Mammalian target of rapamycin	V_F	Fascicle shortening velocity
MVC	Maximal voluntary contraction	USG	Urine specific gravity

TABLE OF CONTENT

GENERAL INTRODUCTION	1
LITERATURE REVIEW	5
PART 1 – Documented effects of heat stress on physiological and neuromuscular function	6
1. Physiological responses to heat stress	6
1. Physiological responses under acute heat exposure	6
2. Heat acclimation as an ergogenic intervention to reduce physiological strain	8
2. Temperature as a fundamental determinant of muscle physiology	9
1. Muscle activation by the nervous system to produce force is temperature sensitive	10
2. Muscle contraction and underlying temperature sensitivity mechanisms	12
3. Musculo-tendinous system and potential heat-induced responses	15
3. Heat stress effects on neuromuscular function	18
1. Acute effects	18
i. Heat stress impairs voluntary force production	18
ii. Temperature-mediated influence on electrically-evoked contractions	19
iii. Heat stress reduces electromechanical delay via accelerated electrochemical processes	22
2. Chronic effects	23
i. Repeated heat stress induces skeletal muscle adaptations	23
ii. Repeated heat stress as a potential muscle strength primer	25
4. Are physiological and neuromuscular function responses under heat stress influenced by sex?	26
PART 2 - Transfers on human motor skills: experimental approach of muscle-tendon interactions and potential heat-related responses	29
1. Influence of temperature on muscle fundamental properties	29
1. Muscle mechanical properties	29
i. Force-length relationship: principles and inputs	29
ii. Muscle force-velocity relationship: unrevealed role of temperature	34
iii. Explosive force production: mechanisms and heat-related effects	40
iv. Muscle architecture and mechanical properties: a debated relationship	43
2. Soft tissues: even softer with heat?	46
i. Muscle stiffness: assessment and reported heat effects	47
ii. Tendon stiffness: <i>in vivo</i> investigation and heat responses	47
iii. Muscle-tendon unit stiffness considered as a whole exhibit unequivocal heat sensitivity	48
2. Do heat-mediated alterations translate into changes in daily motor tasks biomechanics?	49
1. Heat stress may impact motor skills	49

2.	Transfer to <i>in situ</i> sport settings	51
i.	Running mechanics	51
ii.	Time effect	52
iii.	The role of muscle-tendon interactions in movement mechanics	54
RESEARCH QUESTIONS AND AIMS OF THE THESIS		61
GENERAL EXPERIMENTAL METHODOLOGY		65
1.	Participants	65
2.	Design of studies	65
3.	Physiological monitoring	66
1.	Body temperature	66
2.	Heart rate	67
3.	Hydration and Sweat rate	67
4.	Perceptual responses	67
4.	Mechanical measurements	67
1.	Ergometry	67
i.	Ballistic and isometric contractions	67
ii.	Isokinetic contractions	68
2.	Mechanical output	69
i.	Voluntary contractions	70
ii.	Electrically-evoked contractions	72
5.	Mechanical properties of the muscle-tendon unit	72
1.	Ultrafast ultrasound	72
i.	Principles	72
ii.	Force-length relationship: measurement and reliability	76
iii.	Force-velocity relationship	78
iv.	Achilles tendon stiffness	78
v.	Running applications	79
2.	Shear wave elastography	80
6.	Signals synchronization	82
7.	Statistical analyses	83
STUDY 1: FASTER EARLY RATE OF FORCE DEVELOPMENT IN WARMER MUSCLE: AN IN VIVO EXPLORATION OF FASCICLE DYNAMICS AND MUSCLE-TENDON MECHANICAL PROPERTIES		85
STUDY 2: RUNNING IN THE HEAT DOES NOT AFFECT OPERATING FASCICLE LENGTHS COMPARED TO TEMPERATE ENVIRONMENT		101
STUDY 3: ACTIVE HEAT ACCLIMATION DOES NOT ALTER MUSCLE-TENDON UNIT PROPERTIES		121
GENERAL DISCUSSION		141
1.	Contribution of experimental work, insights and issues	141
1.	Heat exposure effects on muscle-tendon unit properties	141

2.	Are heat exposure and exercise compatible to induce mechanical adaptations?	142
3.	Are heat stress amplitude and muscle responses related?	145
4.	Influence of sex on heat-mediated responses?	147
2.	A pioneer exploration of muscle-tendon mechanics under heat stress	148
1.	Relevance of ultrafast ultrasound to investigate fascicle dynamics in the heat	148
i.	Methodological considerations	148
ii.	Sensitivity of muscle fundamental properties to heat	153
2.	Persistent barriers to neuromuscular investigations under hot conditions	155
3.	Research perspectives	157
4.	Practical recommendations	158
CONCLUSION		161
REFERENCES		163
APPENDICES		189

GENERAL INTRODUCTION

The planet is heating up! This will intensify in the coming years, with extreme heat events becoming more frequent and intense (Patz et al., 2014; Watts et al., 2018). Sport practice is not spared by this global warming issue. Athletes, independently of their practice level, are increasingly exposed to hot and/or humid environmental conditions during training and competition. Heat is well recognized as a stressor conferring strain on several physiological systems, and impairing prolonged exercise capacity (Périard and Racinais, 2015; Racinais et al., 2015b; Racinais et al., 2019a).

During passive exposure, heat may induce increases in core, skin and muscle temperatures (T_{core} , T_{skin} and T_{musc} , respectively) that the thermoregulatory system aims to minimize through increased skin blood flow and sweat rate to promote heat dissipation (Johnson et al., 2014; Shibasaki et al., 2006). During exercise, these physiological strains and accompanying thermoregulatory processes are amplified due to the metabolic heat production associated with the muscle contraction (Doi, 1920; Woledge, 1971), and may negatively impact health and performance (Bregelmann et al., 1977; Shibasaki et al., 2006). These effects may, however, be partly mitigated through repeated passive or active heat exposure, a phenomenon known as heat acclimatization (natural condition) or acclimation (simulated environment; both HA). Such approach elicits specific physiological adaptations, improving exercise capacity in the heat (Lorenzo et al., 2010; Nielsen et al., 1993; Périard et al., 2015) and potentially in temperate conditions (Lorenzo et al., 2010; Racinais et al., 2014).

Nonetheless, the effect of heat stress on muscle function is not yet fully understood. On the one hand, a passive rise in T_{core} or T_{musc} is known to affect muscle metabolism (Bäckman et al., 1988; Febbraio et al., 1994), and impairs muscle force-generating capacity (Morrison et al., 2004; Todd et al., 2005; Racinais et al., 2008). On the other hand, it increases nerve conduction velocity (Rutkove et al., 1997; Todnem et al., 1989) and potentially explosive force production measured during electrically-evoked or voluntary contractions (Denton et al., 2016; Racinais et al., 2017c; Rodrigues et al., 2021). *In vitro*, heat exposure has been shown to increase maximal muscle shortening velocity in animals (Ranatunga, 1984) and in humans (Bottinelli et al., 1996). *In vivo*, hot environments also impair force production in active participants, with a decrease in maximal voluntary force production and in voluntary activation (VA), for example, after a cycling session or a tennis match (Girard and Racinais, 2014; Girard et al., 2014; Saboisky et

al., 2003). Nevertheless, the limited data in the literature restricts the interpretation of the heat stress-induced effects. Furthermore, their underlying processes remain unknown, given that it is challenging to deepen the analysis of such mechanisms *in vivo*. Interestingly, neuromuscular responses to repeated heat exposure are different from a single acute exposure. Passive HA appears to protect the central nervous system in the heat (Racinais et al., 2017b), and to induce a panel of molecular adaptations (Horowitz, 2014). Repeated heat exposure has been reported to induce muscle hypertrophy in animals and humans (Goto et al., 2011; Yamashita-Goto et al., 2002), as well as an increase in muscle force and adaptations of contractile properties (Goto et al., 2011; Racinais et al., 2017c). However, the putative muscle-tendon adaptations associated with these increases in muscle force remain under-investigated.

In the last decades, the evolution of ultrasound allowed to capture musculoskeletal images at a very high frame rate (up to 10 kHz). Such technique provides an *in vivo* and non-invasive access to the instantaneous behavior of human muscle fascicle and tendinous tissue during brief movements (Hager et al., 2018; Hauraix et al., 2015; Nordez et al., 2009). By capturing the displacement of the shear wave at high sampling frequency, this technique also allows to explore resting and active mechanical properties of a given muscle by measuring muscle shear elastic modulus, used as an index of muscle stiffness, in real time (Bercoff et al., 2004; Lacourpaille et al., 2012). As a result, many studies have used this technique to describe muscle-tendon properties and interactions during single-joint contractions (Hager et al., 2020; Hauraix et al., 2015; Ito et al., 1998), multi-joint movements (Hollville et al., 2019; Kurokawa et al., 2003) or daily-life motor tasks such as walking and running (Fukunaga et al., 2002; Lai et al., 2018; Lichtwark and Wilson, 2006). These research works allow to explore the fundamental mechanical properties of a muscle, such as maximal fascicle shortening velocity, maximal fascicle force-generating capacity or optimal fascicle length. All these metrics are crucial determinants of human muscle performance (Hager et al., 2020). Previous studies also highlighted the importance of the contribution of muscle and tendon elastic properties in the understanding of isometric and dynamic contractions (Bojsen-Møller et al., 2005; Mayfield et al., 2016; Monte and Zignoli, 2021), or muscle efficiency during running (Lichtwark et al., 2007; Lichtwark and Wilson, 2008).

Using the advantage of high-frame-rate ultrasound, we conducted a preliminary study to this PhD thesis work. Our findings demonstrated a reduction in the electromechanical delay of plantar flexors following passive heat exposure. This heat-mediated effect was associated with accelerated electromechanical processes, while mechanical processes involved in force

transmission were unchanged ([see p.189](#)). This study allowed us to determine the respective contribution of electromechanical and mechanical processes to heat-induced changes in the electromechanical delay and raised the question of the role of muscle-tendon dynamics in heat-induced effects.

Therefore, it seems relevant to study the changes in muscle-tendon unit properties and interactions elicited in response to acute or chronic heat stress, to provide a better understanding of muscle mechanics, and therefore motor performance under heat stress. From a fundamental point of view, this research is sought to improve current knowledge of the influence of temperature in muscle physiology and human movement. From a practical point of view, such work would potentially provide concrete evidence-based recommendations dealing with the impact of heat stress on muscle mechanics and to better cope in hot environments.

This thesis aimed to understand the biomechanical processes involved upon changes in core and muscle temperatures elicited by heat exposure.

We used the advantage of the non-invasive and *in vivo*-compliant ultrasound technique to explore muscles crossing the ankle joint. We focused on the *gastrocnemius medialis* (GM) muscle-tendon unit, a multi-joint muscle for which ultrasound technique uses are well established, during electrically-evoked, explosive and isometric maximal voluntary contractions (MVC), and dynamic contractions (*i.e.*, ballistic and isokinetic). The use of ultrasound also allowed us to investigate fascicle dynamics during physical activity (*i.e.*, running). Shear wave elastography (SWE) enabled to measure the stiffness of soft tissue in passive conditions, before and after heat exposure. The experimental part of this work is based on three studies, aiming:

- 1) to determine the effects of an acute passive heat exposure on muscle-tendon unit properties;
- 2) to investigate the effects of an acute active (*i.e.*, running) heat exposure on muscle-tendon interactions and fascicle dynamics;
- 3) to measure the impact of repeated active heat exposures (*i.e.*, HA) on muscle-tendon unit properties.

This manuscript is composed of **four main chapters**. The **first chapter** comprises a review of the literature on the effects of heat stress on physiological and neuromuscular function and on their transfer to human motor skills. In the **second chapter**, we will present the general methodology associated with our work. The **third chapter** includes the experimental contribution and the three studies carried out in the framework of the present PhD. Finally, we will discuss overall the results, provide research perspectives and propose practical recommendations in the **fourth chapter**.

LITERATURE REVIEW

Studying the effects of thermal stress on the human body involves testing different temperature ranges: from decreasing to increasing T_{core} from its baseline value. The Shelford's Law of Tolerance (Shelford, 1931) established that the abundance or distribution of an organism is controlled by a complex set of conditions (*e.g.*, the climatic, topographic, and biological requirements of species). Therefore, there is an optimal temperature range for the life of a species, comprised between low and high levels of temperature (Figure 1).

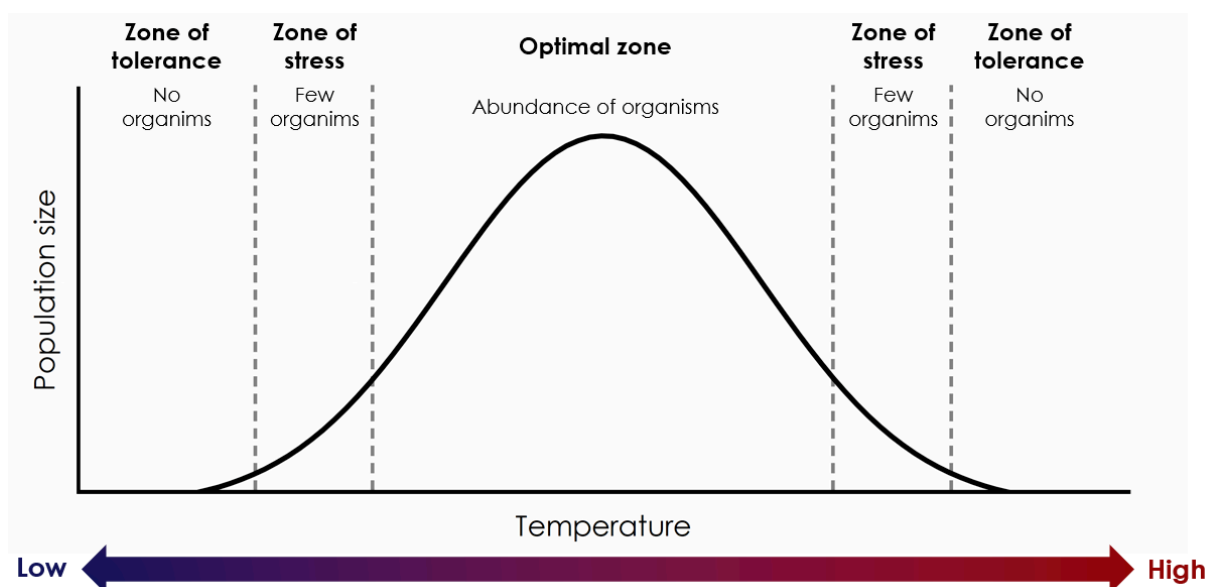

Figure 1. Graphical representation of Shelford's Law of Tolerance, as a function of the environmental factor of temperature.

Only a complex experimental framework would make it possible to study this continuum of temperatures. Therefore, this PhD work and literature review focuses on the effects of an increase in T_{core} and T_{musc} , in response to heat stress.

PART 1 – Documented effects of heat stress on physiological and neuromuscular function

1. Physiological responses to heat stress

1. Physiological responses under acute heat exposure

Thermoregulation corresponds to the ability of an organism to maintain its T_{core} within a narrow range, even when the ambient temperature changes from one extreme to the other. The human body is homeothermic, with T_{core} variations between 36.1 and 37.8°C, depending on the time of the day. This may be increased significantly (*i.e.*, $\geq 40^{\circ}\text{C}$) due to exercise, illness or extreme environmental conditions (Wilmore et al., 2017). In humans, T_{core} is the main regulated variable in thermoregulation (Benzinger, 1969), and is commonly measured in the digestive system (*i.e.*, oral, esophageal, gastrointestinal and rectal) or at the level of the head (*i.e.*, ear and forehead). To remain constant, T_{core} needs a balance between heat gains, from metabolism or environment, and heat losses related to exchanges with the environment via sensible (*i.e.*, conduction, radiation and convection) and insensible (*i.e.*, evaporation) heat transfer. This theoretical principle is summarized by the conceptual heat balance equation (1):

$$S = M - W \pm K \pm R \pm C - E \quad (\text{Equation 1})$$

with the rate of heat storage (S), the metabolic rate (M), the external work rate (W), the rates of heat transfer via conduction (K), radiation (R), convection (C) and evaporation (E).

Thereby, physical exchanges of heat between the human body and its surrounding environment occur at the skin level. However, T_{skin} is not consistently regulated (Romanovsky, 2007), and varies across the body in response to its thermal environment (Bierman, 1936).

When ambient temperature cannot be compensated by the human body (*e.g.*, under high level of ambient temperature), heat balance is impaired despite the stimulation of the body's autonomic heat loss responses. In this case, unless the rate of metabolic heat dissipation is reduced via behavioral means (*e.g.*, clothing), the body will store more heat, potentially leading to hazardous increases in T_{core} (Flouris et al., 2014). Sensitive receptors, thermoreceptors, allow to inform the hypothalamus on the temperature change in the human body which, in return, will activate the effectors via the sympathetic nervous system. Specifically, increases in peripheral and/or T_{core} stimulate heat dissipation mechanisms: eccrine sweating, skin vasodilatation and tachypnea (Benzinger, 1969; Hardy, 1961). Under heat stress and/or exercise, the most relevant

thermoregulatory mechanisms observed in humans to increase body heat loss are eccrine sweat secretion and skin vasodilatation. Cardiac output allows blood to drift to the skin to eliminate heat, and ensure the supply of muscles if the body is in motion, it is therefore greater than in the temperate environment, and results in heart rate increases (González-Alonso et al., 2008). Human body can dissipate or gain heat by convection/conduction if the surrounding ambient temperature is respectively lower or higher than the T_{skin} . Similarly, the human body can lose or gain heat via radiation depending on the radiative load.

At rest, the human body produces heat, to ensure the proper functioning of its basic metabolism. During exercise, the heat production due to metabolism and thermoregulatory responses are amplified and increased in proportion to exercise intensity, due to the additional metabolic heat production associated to muscle contraction (Doi, 1920; Woledge, 1971). All the mechanisms previously described are in turn enhanced, leading to increased physiological strain and may negatively impact health and potentially performance (Bregelmann et al., 1977; Shibasaki et al., 2006). T_{musc} may be monitored to provide a more accurate estimate of entire body temperatures under heat stress and/or during exercise. Such measurements require the insertion of a needle into the muscle belly. This technique is however invasive which complicates its collection and is therefore not consistently adapted to *in vivo* exploration.

When considering physiological temperature responses, ambient temperature should not be the only environmental parameter to be considered. Indeed, relative humidity (RH), which refers to the ratio of the partial pressure of water vapor in the air to the saturated vapor pressure of water at a given temperature, compromises the capacity to evaporate sweat from the skin. In humid conditions, the difference in water vapor between the skin surface and the environment is low, potentially leading to higher levels of T_{core} for a same ambient temperature. Air velocity must also be considered since it increases convective heat exchange and helps evaporative heat loss (Périard et al., 2021).

Thermal perceptions may lead to increased perceived exertions (Pandolf, 1982) and reduced exercise work rate (Schlader et al., 2011; Tucker et al., 2006). Taking them into account, Flouris and Schlader (2015) proposed a model of behavioral thermoregulation during exercise in hot environment (Figure 2). Heat can be considered as a stressor conferring strain on the physiological system, which results in prolonged exercise capacity impairment (Périard and Racinais, 2015; Racinais et al., 2015b; Racinais et al., 2019a). From a physiological point of view, heat stress effects are well described in the literature.

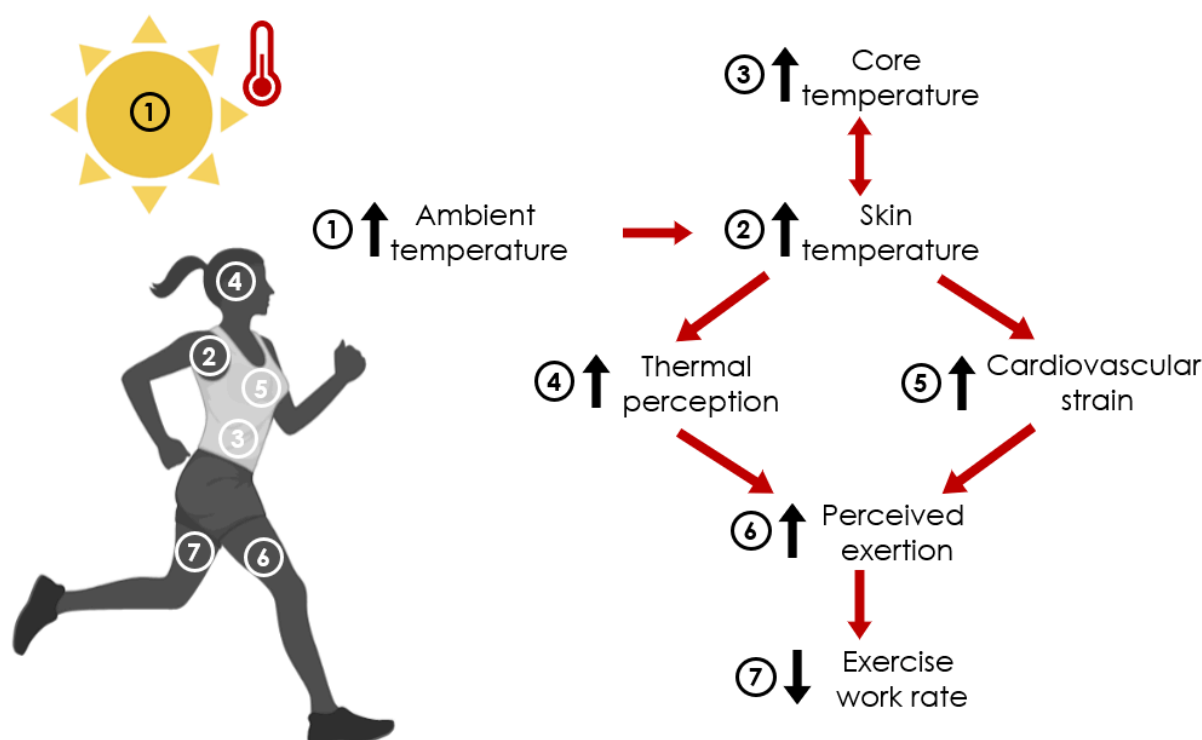

Figure 2. Illustration of how thermal perception and cardiovascular strain mediate reduction in exercise work rate in the heat, via their impact on perceived exertion. Adapted from Flouris and Schlader (2015).

Therefore, the description of such physiological heat-related responses (*e.g.*, T_{core} , T_{skin} and T_{musc} , sweat rate, heat rate) will allow us to ensure a sufficient level of heat-induced stress to investigate the associated muscle-tendon properties in this PhD work.

2. Heat acclimation as an ergogenic intervention to reduce physiological strain

In order to reduce thermoregulatory and physiological strain induced by heat and humidity exposure, scientists strongly recommend acclimatizing before training and/or competing in the heat (Périard et al., 2015; Racinais et al., 2015a). For this, athletes perform natural or simulated (*e.g.*, environmental chamber, saunas, baths) HA, both techniques sharing similar physiological adaptations.

Repeated passive or active HA elicits specific physiological adaptations including an increase in sweat rate (Dill et al., 1938; Eichna et al., 1950), an increase in plasma volume (Glaser, 1949; Patterson et al., 2004), a decrease in sweat sodium concentration (Allan and Wilson, 1971; Sawka et al., 2011), a decrease in T_{core} and T_{skin} during exercise (Eichna et al., 1950; Ladell, 1951), and a decrease in heart rate for the same intensity (Flouris et al., 2014; Nielsen et al.,

1993). HA allows to reduce physiological strain, and to improve exercise capacity in the heat (Lorenzo et al., 2010; Nielsen et al., 1993; Périard et al., 2015) and potentially in temperate conditions (Lorenzo et al., 2010; Racinais et al., 2014). Therefore, HA is considered as the most important countermeasure to protect the athletes health and performance when competing in the heat (Racinais et al., 2015a, 2022). It is recommended to train (or to be exposed) in the heat for 60-90 min per day (Périard et al., 2015; Racinais et al., 2015a) for one to two weeks (Racinais et al., 2015b; Racinais et al., 2012).

Interestingly, following the various studies mentioned above, the number of athletes using HA prior competing in the heat is increasing. Before the 2015 International Association of Athletics Federations World Championships held in Beijing, only 15% of athletes, from all disciplines, were acclimated before taking part in the competition (Périard et al., 2017), while before the same competition in Doha in 2019, 63% of road-race endurance athletes used HA (Racinais et al., 2022), but its usage remains under-represented (*i.e.*, 32%), among athletes in explosive disciplines (*i.e.*, sprinters, jumpers and throwers; unpublished data; Figure 3).

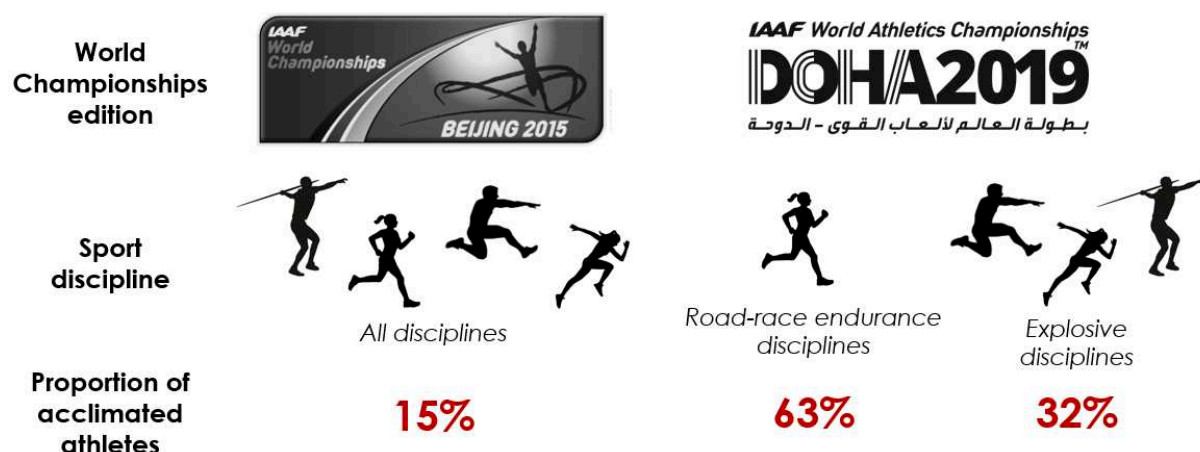

Figure 3. Schematically representation of the proportion of athletes who used heat acclimation prior competing in the International Association of Athletics Federations (IAAF) World Championships held in Beijing (2015) and Doha (2019).

2. Temperature as a fundamental determinant of muscle physiology

The ability to generate muscle contraction, and therefore to produce force resulting in movement, is influenced by the neural drive transmission to the muscle, the propagation of the action potentials, the excitation-contraction coupling processes, and the muscle force transmission along the series elastic component (Maffiuletti et al., 2016; Nordez et al., 2009).

Potential heat effect on one or more components of the chain and of force production and transmission, can therefore impact movement production.

1. Muscle activation by the nervous system to produce force is temperature sensitive

The neuromuscular system defines all the structures involved in the production of muscle strength generating movement. Briefly, it is composed of a central component, the central nervous system, and a peripheral component, the musculo-tendinous system. Respectively, these two components ensure the generation and the propagation of nervous signal from the motor cortex to the muscles, then the production and transmission of muscle forces from muscle contractile component to the skeleton.

Therefore, the initiation of muscle contraction occurs in response to a signal from the nervous system. Briefly, voluntary movement results from a command generated in a specific area of the cerebral cortex located in the frontal lobe: the motor cortex (Penfield and Rasmussen, 1950). The drive control is then transmitted from the motor cortex to the spinal cord via pyramidal neurons (Wilmore et al., 2017). From the spinal cord, the nerve control moves along an α -motoneuron to the muscles. This α -motoneuron is considered as the '*final common pathway*', through which the central nervous system transmits an electrical signal resulting in a muscle contraction and thus producing a mechanical action. Muscle fibers are innervated by α -motoneurons where an α -motoneuron innervate several muscle fibers, one α -motoneuron can innervate hundreds of muscle fibers in large muscles although for small muscles, like those controlling the eye, α -motoneuron might innervate fewer than ten muscle fibers. All muscles fibers innervated by the ramifications of the same α -motoneuron constitute a motor unit (Enoka and Fuglevand, 2001). The neuromuscular junction corresponds to the synapse between an α -motoneuron and a muscle fiber, and represents the link between the nervous and the muscular system (Figure 4).

The α -motoneuron generates a muscle fiber contraction via the action potential in response to either a voluntary, reflex or electrically-evoked stimulation. When the nerve impulse reaches the synapse, the neurotransmitter acetylcholine is released, and once attached to the sarcolemma, a conjunctive membrane within the muscle fibers ([see p.12](#)) will trigger the muscle action potential. The nervous system controls force production by varying the number of motoneurons that are recruited, and the rate at which they discharge action potentials (Enoka

and Duchateau, 2019; Mota et al., 2019). The sum of all motoneuron action potentials forms the neural drive to the muscle (Enoka and Duchateau, 2015).

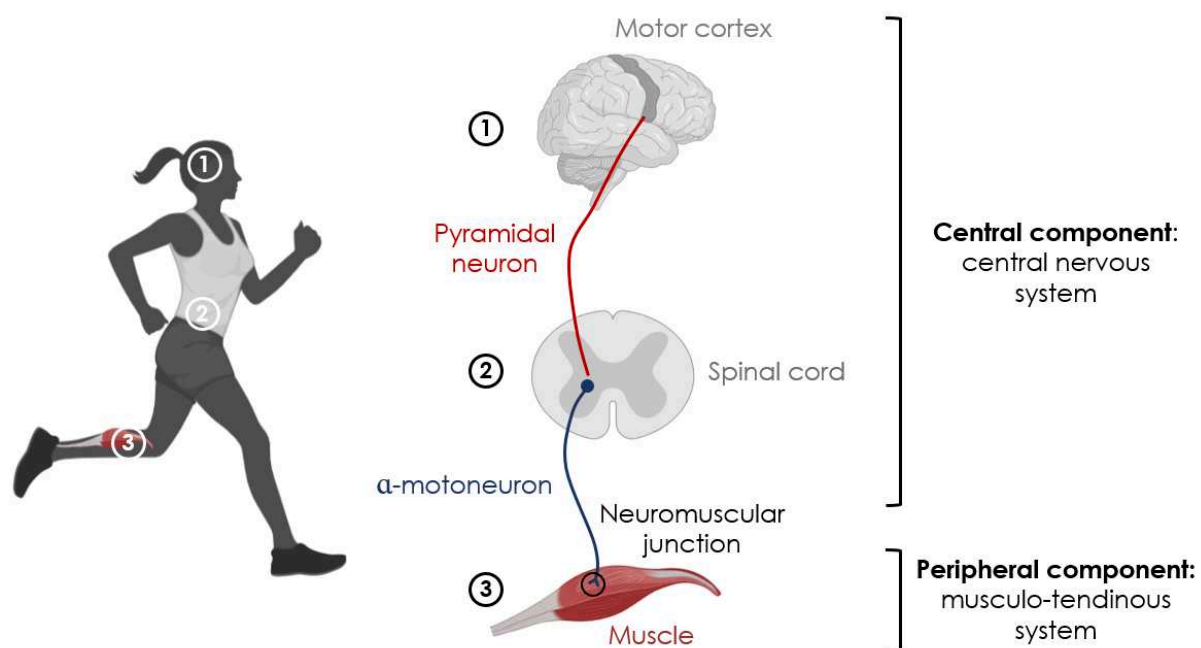

Figure 4. Schematic representation of the central nervous control of motion production via the peripheral component.

Motor units are classified according to their structural and functional properties. They are generally separated into two types: the small motor unit, so-called *slow* motor units (*i.e.*, type I) associated with low strength level but less fatigable, and larger motor units, said *fast* (*i.e.*, type II) producing higher strength level and being more fatigable (Duchateau and Enoka, 2011). The excitation or recruitment of muscle fibers by the action potential is carried out according to certain principles. Smaller motor units are recruited earlier during a contraction, as they have a lower recruitment threshold, and larger motor units are recruited later, at higher task intensity. This is the *size principle* (Henneman, 1957). An increase in the frequency of discharge of a motoneuron will allow to increase the force produced by the same motor unit, it is the temporal recruitment (Enoka and Fuglevand, 2001). *In vivo* investigation of muscle contractility provides a lot of information on neuromuscular function. Thus, its investigation under heat stress would permit to deepen heat-related effects on this function, and therefore on force production. Nevertheless, it is not so simple to measure such parameters *in vivo* in humans. It is possible to investigate non-invasively the activity of the neuromuscular system through the use of surface electromyographic activity (EMG) (Moritani and Yoshitake, 1998). The recording of surface EMG represents the algebraic sum of the action potentials propagating along muscle fibers (*i.e.*,

muscle action potentials). The quantification of the EMG allows to determine indirectly the level of muscle activity associated with the level of force produced (Disselhorst-Klug et al., 2009). EMG is also used to determine when muscles are activated (*i.e.*, activation sequences or muscle coordination). However, such investigation under heat stress must be interpreted with caution (Racinais, 2013). Indeed, peripheral vasodilation in response to heat stress, may shift more blood between the EMG signal and the surface (Bell, 1993), increasing the fluid between EMG signal and skin surface and therefore attenuating the EMG recording in hot environment. Following an acute passive heat exposure, supraspinal drive generation (*i.e.*, upstream of the spinal cord) is decreased (Racinais et al., 2008), leading to a decrease in VA ([see p.18](#)). Literature reports that the peripheral nervous system is also temperature sensitive. An increase in T_{musc} may increase the opening and closing of voltage-gated sodium ions (Na^+) channels, thereby reducing nerve fibers potential amplitude, duration and area of action potential. Indeed, a negative linear correlation has been observed between T_{skin} and the latency, amplitude, duration and area of the action potential, which are decreasing with T_{skin} (Bolton et al., 1981). These mechanisms could lead to a faster depolarization onset and muscle fiber conduction sensitivity and in turn challenges the production of a muscle fiber action potential (Rutkove et al., 1997; Rutkove, 2001). However, an increase in T_{musc} accelerates synaptic transmission (Racinais and Oksa, 2010; Rutkove, 2001), and it is well established that axonal conduction velocity increase in hot environments (Rutkove et al., 1997; Todnem et al., 1989). Altogether, in their review, Racinais and Oksa (2010) described a positive relationship between T_{musc} and neuromuscular function. However, when T_{core} increases leading to hyperthermia, this positive relation is stopped, due to a reduced amount of voluntary neural drive. Interestingly, repeated whole-body heat exposure (*i.e.*, HA) suggested to induce beneficial central, but not peripheral nervous system adaptations (Racinais et al., 2017b).

2. Muscle contraction and underlying temperature sensitivity mechanisms

Muscle is the central organ of human movement, responsible for a wide range of movements from postural maintenance up to more complex movements, as locomotion. It is under control of the central nervous system. Skeletal muscles are well-structured and multi-scale hierarchized organs consisting of bundles of fibers running alongside each other. A muscle fiber consists of a set of myofibrils enclosed in a thin membrane, the sarcolemma. The formation and maintain of the hierarchical muscle organization is permitted thanks to the connective tissue: endomysium, perimysium and epimysium (Figure 5A). Each myofibril consists of serially

connected elements, sarcomeres. These sarcomeres represent the most microscopic functional unit of the organization of skeletal muscle and consist of two types of overlapping myofilaments: a thin filament made of actin, troponin and tropomyosin proteins, and a thick filament made of myosin proteins. Each sarcomere is composed of two sets of actin filaments, arranged along the non-extensible protein nebulin. This makes the thin filament inelastic, and are attached to Z-membranes at the ends of the sarcomere. Myosin filaments extend from the M-line, at the center of the sarcomere and are maintained to the Z-membranes by titin filaments (Herzog, 2017) (Figure 5B).

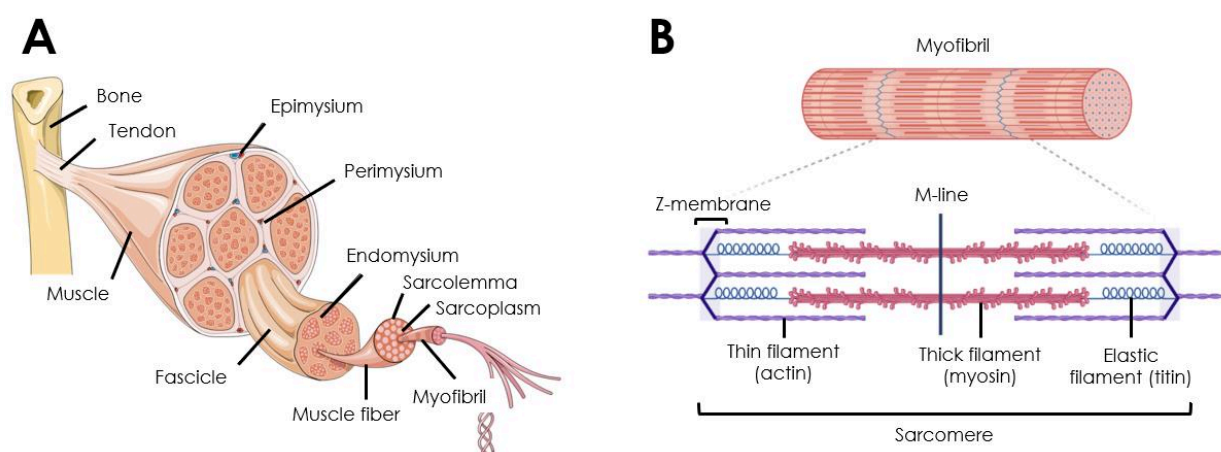

Figure 5. Hierarchical representation of the main elements of a muscle (A) and schematic representation of a sarcomere, formed by thin and thick filaments between Z-membranes (B). Adapted from Zatsiorsky and Prilutsky (2012).

Muscle contraction is the mechanical resultant of chemical reactions which generate interactions between actin and myosin (cross-bridge). This elicits the sliding of thick myosin filaments on thin actin filaments, and in turn the shortening of the muscle, which is called the *theory of sliding filaments* (Huxley, 1957). The force is generated along the direction of the rotation movement of the myosin heads (*i.e.*, toward the M-line). Therefore, as force develops, the sarcomere shortens, resulting in increased overlap of thin and thick filaments. When the contraction is complete, the large elastic titin proteins bring the sarcomere back to its resting position (Biewener and Patek, 2018). Titin, is associated with a variety of functions, including mechanical role in force regulation, whether active or passive, and stabilization of sarcomeres (Herzog, 2018). Thereby, the muscle contraction process is composed of successive stages, whose efficiency is influenced by T_{musc} . This fundamental parameter must not be neglected when understanding its effects on muscle contraction and finally on movement.

Muscle contraction is an active process requiring energy. Within skeletal muscles, in animals and humans, it is the adenosine triphosphate (ATP) which provides the energy required for cross-bridge cycling. In animal muscle fibers, an increase in ambient temperature, over the range $\sim 5\text{-}38^{\circ}\text{C}$, has been shown to enhance the rate of ATPase activity of the myosin (Bárány, 1967; Stein et al., 1982), suggesting an increase in the rate of cross-bridge cycling (Schertzer et al., 2002; Stein et al., 1982), and can thus lead to an acceleration of muscle contraction process. Energy metabolism in the exercised muscle is therefore increased, and ATP utilization is increased to a greater extent when exercising in the heat (Febbraio et al., 1994).

Skeletal muscle contraction is also regulated by the calcium ions (Ca^{2+}), which are primarily controlled by the sarcoplasmic reticulum (MacLennan, 1990), an elaborate muscle membrane system at the junction between the transverse tubule, the sarcolemma and the contractile apparatus (Berchtold et al., 2000). Sarcolemma and transverse tubule depolarization induce a release of Ca^{2+} resulting in muscle contraction. *In vitro*, a decrease in the amount of Ca^{2+} released by the sarcoplasmic reticulum in response to an action potential, usually results in a reduction of the force produced (Godt, 1974). Temperature increases have been reported to increase the Ca^{2+} retention by the sarcoplasmic reticulum (Stein et al., 1982) and to alter Ca^{2+} sensitivity between 5 and 35°C (Stephenson and Williams, 1985). This alteration may be deleterious to force production since Ca^{2+} sensitivity can be defined as “*an increase in cross-bridge-generated muscle force for a given level of muscle or fiber activation*” (Blazevich and Babault, 2019). This could be linked to a reduced organization of the myosin heads relative to the filament axis, with heads aligned closer to the thick filament and thus further from actin (Xu et al., 2003), reducing the likelihood of myosin binding to actin in the presence of Ca^{2+} . Although the effects of temperature on Ca^{2+} sensitivity appear modest and probably not a critical factor influencing cross-bridge formations with rising T_{musc} (Blazevich and Babault, 2019), it should not be disregarded.

In a recent review, Rodrigues et al. (2022) summarized that heat exposure increases muscle cell Ca^{2+} kinetics without being able to clearly distinguish the underpinning processes, but explaining some heat-related effects on muscle contractile properties, which will be presented later in this manuscript. In addition, local muscle blood flow has been shown to increase linearly with T_{musc} (Pearson et al., 2011), decreasing ionic strength and thus increasing cross-bridge formation for a given muscle activation in relaxed muscle fibers (Rodrigues et al., 2022).

However, it remains difficult to locate specific changes, but it seems likely that at high ambient temperature (*i.e.*, $> 38^{\circ}\text{C}$), proteins are modified, without being able to dissociate them and to dissociate their changes within the actin-myosin complex (Hartshorne et al., 1972).

The aforementioned processes involved in muscle contraction are not exhaustive, often studied in animals, and not always investigated at physiological temperature ranges, due to the complexity of the assessment of such mechanisms. Although not measurable in a non-invasive way *in vivo*, the consideration of these mechanisms is necessary to try to explain the changes in contractile properties measured following heat stress ([see p.19](#)).

3. Musculo-tendinous system and potential heat-induced responses

During muscle contraction, the force produced by the muscle is transmitted to the bone via the structures placed in series within the contractile component, mainly the tendon and the aponeurosis, forming the muscle-tendon unit.

The tendon is mainly composed of water, (*i.e.*, 50-70% of its total weight). And thereafter, composed of type I collagen fibers and, in a lesser extent, of elastin (Kannus, 2000). The tendon is located between the muscle and the bone on which it acts. The myotendinous junction is the interface between the muscle and the tendon, connecting myofibrils and tendon fibers. Force transmission generated by muscle fibers to tendon collagen fibers is possible through their insertion into myofibroblasts (Wang, 2006). The tendon has an intermediate role on the transmission of the force produced by the muscle to the joint. For this, the tendon has a high resistance to tension, which is much greater than that produced by the muscle (Seyrès, 1991). When the tendon is stretched, the alignment of the collagen fibers allows to have a role of shock absorber thanks to its viscoelastic and elastic properties.

Aponeurosis maintains the organization of the muscle and corresponds to the connective tissue present in the muscle: sarcolemma, endomysium, perimysium and epimysium (Zuurbier et al., 1994). Aponeurosis structure compliance is similar to tendon, with comparable mechanical properties (Arampatzis et al., 2005; Scott and Loeb, 1995).

These anatomical structures combine in a complex way, which had led to the development of rheological models allowing to describe the structures of the musculo-tendinous system. Such models usually consist of a limited number of components and refer to simple mechanical properties. Initial attempts at modelling the musculo-tendinous system were initiated by Hill (Hill, 1938, 1951), and later evolved (Huxley and Simmons, 1971; Zajac, 1989). Nowadays,

this model is still used for the interpretation of numerous experiments conducted on isolated muscle *in vitro* and *in situ* (Goubel and Linsel-Corbeil, 2003), and is generally modeled by three components:

- a contractile component (CC), corresponding to the actin-myosin cross-bridges, at the origin of force generation;
- a series elastic components (SEC), divided in two parts: an active part (*i.e.*, elasticity of actin-myosin cross-bridges) and a passive part (*i.e.*, tendon structures);
- a parallel component to the two preceding components (PEC), localized within the muscle tissue, sarcolemma and muscular envelop (endomysium, perimysium and epimysium), and residual interaction between contractile proteins.

The model proposed by Zajac (1989) dissociates muscles structures from tendons structures, as well as structures whose mechanical characteristics are evaluated under active or passive conditions (Figure 6).

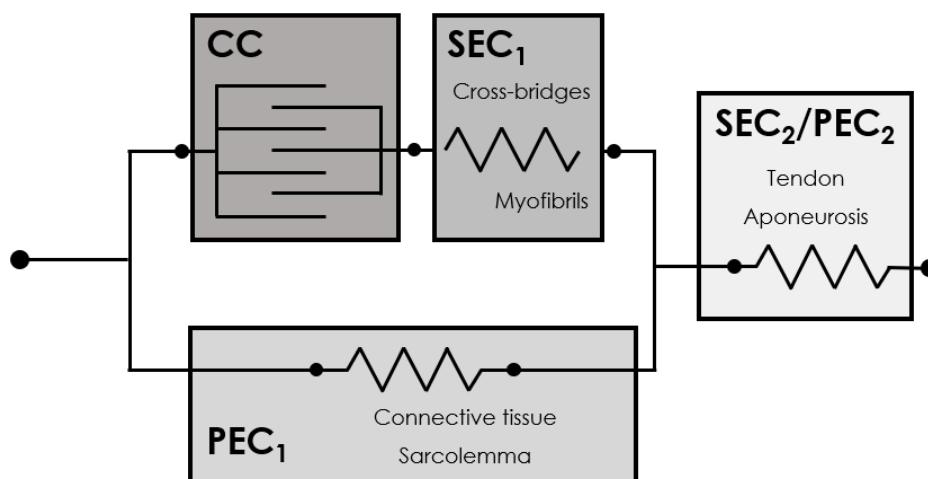

Figure 6. Schematic representation of the musculo-tendinous system. CC: contractile component; SEC: series elastic component; PEC: parallel elastic component. Adapted from the model proposed by Zajac (1989).

During a muscle contraction, the force generated by sarcomeres at the muscle level will be transmitted to the joints through the tendons that will be able to lengthen or shorten according to the stress and thus produce an elastic force (Alexander and Bennet-Clark, 1977). In addition to their force transmission to the skeleton, elastic structures, especially tendon tissue, also store and release elastic energy when the musculo-tendinous system deforms. The elastic components can therefore participate in the force production at the joint level, so they must not be neglected.

Muscle fiber stiffness is linked to three components: viscoelastic, viscous and elastic. The viscoelastic component is reported to be the most heat sensitive component in rats' muscles (Mutungi and Ranatunga, 1998). The processes of force production and transmission could be impacted by changes in the elasticity of a joint, which increases after local heat exposure (Wright and Johns, 1961). Due to its viscoelastic nature, some of the energy transmitted to the musculo-articular complex is dissipated (Nordez et al., 2006). Viscosity thus seems to be an important parameter to consider in order to understand the effect of heat stress on force transmission.

In human tendons, an exponential relationship has been shown between the supraspinatus tendon viscosity and the temperature (Huang et al., 2009). These authors investigated the effect of ambient temperature variation (range: 17-42°C) on the viscoelastic properties of the human supraspinatus tendon, using stress-relaxation experiments and the quasi-linear viscoelastic theory. They reported an increase in viscous behavior with ambient temperature, indicating the potential of this tissue to absorb more energy due to its increasing viscosity at elevated temperatures. In contrast, this study did not report changes in elastic behavior with changing ambient temperature. Smooth cultured cells heated to 65°C for 60 s reported a significant elevation in elastin and collagen production (Kozma et al., 2018), without knowing the effects obtained at lower temperature levels. In cultures cells of bone tissue, the extent of native collagen I matrix was significantly increased when cultures were maintained at 39°C, compared to 37°C (Mauney and Volloch, 2009). Regarding the titin, an elastic protein involved in the rate of actin-myosin cross-bridge cycling, increasing the temperature of *in vitro* manipulations induced transitions from 50°C, with no structural changes at more physiological temperatures (*i.e.*, $\leq 40^\circ\text{C}$) (Somkuti et al., 2013).

The mechanisms involved in musculo-tendinous system are complex and impossible to investigate non-invasively *in vivo*. To the best of our knowledge, few effects have been reported under heat stress *in vitro*, even at non-physiological temperature, limiting potential transfer from *in vitro* to *in vivo* conditions.

3. Heat stress effects on neuromuscular function

1. Acute effects

i. Heat stress impairs voluntary force production

Maximal voluntary force production is typically measured during a maximal voluntary isometric contraction (*i.e.*, without movement velocity) and defined as the MVC peak force. The effects of heat exposure on MVC peak force have been described in several studies, which reported a trend towards reduced force production. It is well established that heat exposure induces a decrease in the level of force produced during prolonged contractions (Racinais et al., 2008; Racinais et al., 2017b). When contractions are sustained (*i.e.*, > 5 s), the force decrement would be due to the central nervous system, which is reported to be more easily affected (*i.e.*, supraspinal failure), compared to shorter contractions (Todd et al., 2005). Regarding brief MVC (*i.e.*, ≤ 5 s), the effects are less univocal.

Indeed, a total passive heat exposure, increasing T_{core} up to ~38.5-40.1°C, showed a reduction in maximal voluntary force production in knee extensors¹ (Gordon et al., 2021) and plantar flexors (Racinais et al., 2008, 2017c). This decrease is associated with a reduction in the level of VA, measured during a MVC, using a superimposed and a potentiated doublet (Gordon et al., 2021; Racinais et al., 2008, 2017c). However, studies also reported unaffected MVC peak force and VA, with T_{core} reaching ~38.5-39°C in plantar flexors (Thomas et al., 2006) and knee extensors (Morrison et al., 2004; Périard et al., 2014a), with decreasing values when T_{core} reaches ~39-39.5°C.

A partial passive heat exposure also reported different effects following water immersion up to the waistline, with reduced MVC peak force of knee extensors (Brazaitis et al., 2012) or unchanged knee extensors or plantar flexors MVC peak force (Brazaitis et al., 2010; Davies et al., 1982; Spillane and Bampouras, 2020). Interestingly, local heat application using short-wave diathermy or hot pack, does not affect T_{core} but increases T_{musc} , with unchanged MVC peak force, in same muscle groups after the intervention (Chastain, 1978; Denton et al., 2016; Dewhurst et al., 2010). Moreover, when assessed, VA was unchanged (Brazaitis et al., 2010; Spillane and Bampouras, 2020).

¹ Here and bellow, the effects reported concern short contractions (*i.e.*, ≤ 5 s).

Taken together, these studies suggest that there would be a T_{core} threshold, rather than a more localized effect, at which brief voluntary force production decreases. Passive heat exposure may alter the central and the peripheral nervous system, and the central nervous system may be more easily affected during sustained contractions.

Active heat exposure tends to decrease knee extensors and/or plantar flexors MVC peak force measured after sprint cycling (Duffield et al., 2009; Girard et al., 2013), cycling time trial over 20 and 40 km (Baillot et al., 2021; Périard et al., 2011), cycling to exhaustion (Goodall et al., 2015; Martin et al., 2005; Saboisky et al., 2003) or tennis match (Girard et al., 2014; Périard et al., 2014b), with T_{core} reaching between 38.3 and 39.8°C. Nevertheless, for studies including a control condition, the MVC peak force is also reduced when performing the same exercise in a temperate environment (Baillot et al., 2021; Goodall et al., 2015; Périard et al., 2011). It should be noted that studies reported unchanged MVC peak force in plantar flexors after a football match (Nybo et al., 2013), or in knee extensors after cycling to exhaustion (Nybo and Nielsen, 2001), with T_{core} reaching up to 39.6-40°C. The effect on the level of VA is less clear, with studies reporting decreases in VA of knee extensors (Goodall et al., 2015; Périard et al., 2011; Périard et al., 2014b; Saboisky et al., 2003), and others reporting no significant changes in VA measured on knee extensors or plantar flexors (Girard et al., 2013; Martin et al., 2005; Périard et al., 2014b). As with MVC peak force, the same effects are generally observed after the same exercise performed in temperate environment. Overall, these elements could suggest a potential lack of heat-related differential effect on MVC peak force and VA measured after an exercise. However, others observed similar impairments in the VA of both the exercising (knee extensors) and non-exercising (handgrips) muscles after cycling to exhaustion in hot environment (Nybo and Nielsen, 2001). Overall, this suggests that the reduction in VA was linked with T_{core} rather than exercise-induced fatigue (Nybo and Nielsen, 2001).

ii. Temperature-mediated influence on electrically-evoked contractions

Electrically-evoked contractions are often used to describe muscle contractile properties at the peripheral level. After a nervous stimulation, the activated muscle, or muscle group, generates a response commonly referred to as a twitch contraction. After a latency period, the twitch response consists of two phases, a contraction and a relaxation phase, and four parameters are generally extracted (Figure 7):

1. peak twitch (PT) amplitude, which corresponds to the highest value of twitch force production;

2. contraction time (CT), the time between the onset of force rise and PT;
3. half relaxation time (HRT), the time to obtain half of the decline in twitch maximal force;
4. and the electrically-evoked rate of force development (RFD), calculated as PT/CT. The PT amplitude represents the number of interactions between actin and myosin (cross-bridge), whereas CT and HRT are respectively an index of release and reuptake of Ca^{2+} (Fitts and Holloszy, 1978).

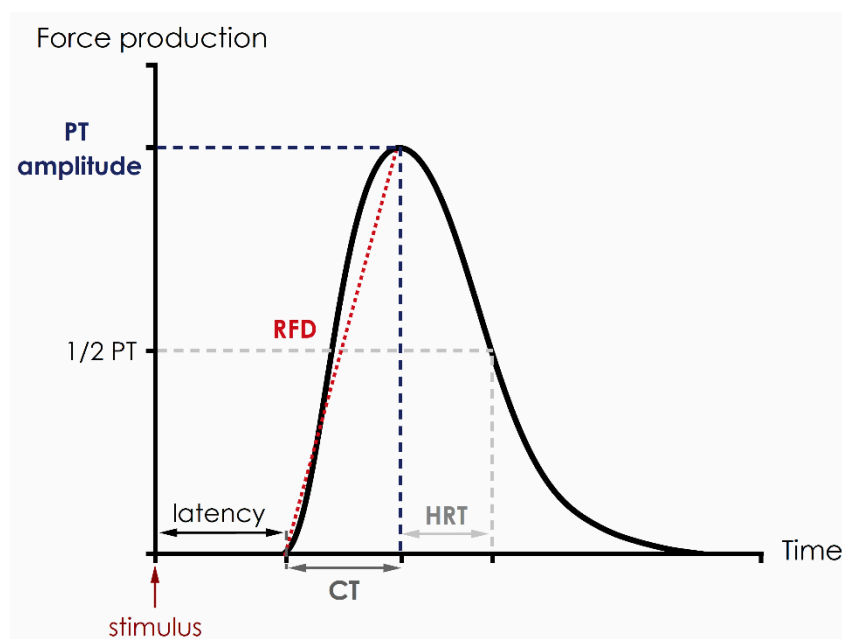

Figure 7. Force signal obtained following a nervous stimulations and associated twitch characteristics: peak twitch (PT) amplitude; contraction time (CT), half-relaxation time (HRT) and rate of force development (RFD).

In vitro and in animals, PT amplitude is unchanged (Kössler and Küchler, 1987; Lännergren and Westerblad, 1987) or reduced (Truong et al., 1964; Wylie and Ranatunga, 1987) with increasing air or water temperature. Studies also reported an inverse relationship between temperature and CT and HRT inferred from a muscle twitch (Segal et al., 1986), and reported that electrically-evoked RFD increased (Close and Hoh, 1968; Ranatunga, 1982).

In vivo and in humans, the same effects are generally reported, without consensus. A rise in T_{core} following heat exposure elicits unaffected knee extensors or plantar flexors PT amplitude (Racinais et al., 2008; Racinais et al., 2017c; Thomas et al., 2006), while studies reported an increase in knee extensors PT amplitude with an increasing T_{core} (Rodrigues et al., 2021; Ross et al., 2012). Regardless of the method used (e.g., partial water immersion, hot pack

application), partial heat exposure does not impact PT amplitude (Brazaitis and Paulauskas, 2019; Davies et al., 1982; De Ruiter et al., 1999; Mallette et al., 2019).

Regarding CT and HRT, *in vitro* effects are confirmed *in vivo* in humans, but could also be impacted by a temperature threshold. CT and HRT decreased in plantar flexors after a total passive heat exposure which increased T_{core} up to $\sim 38.4\text{--}39.2^{\circ}\text{C}$ (Mornas et al., 2021; Racinais et al., 2017c), and after partial water immersion (Davies et al., 1982). However, Gordon et al. (2021) reported unchanged knee extensor CT under T_{core} reaching 38.5°C , with a decrease thereafter (*i.e.*, when T_{core} reached 39.5°C), and Thomas et al. (2006) reported unchanged plantar flexors CT and HRT up to 38.5°C , with reduced times from 39°C . The different threshold between these studies may be explained by the fact that they measured and reported T_{core} and not T_{musc} , which reached $\sim 37\text{--}38.9^{\circ}\text{C}$ in the *triceps surae* muscles [*i.e.*, GM or *soleus* (SOL) (Davies et al., 1982; Mornas et al., 2021; Thomas et al., 2006)], but which was not reported in knee extensors (Gordon et al., 2021).

With increasing T_{core} and/or T_{musc} , slight, or lack of effects on PT amplitude and unchanged or decreased CT, lead to increased electrically-evoked RFD (De Ruiter et al., 1999; Gordon et al., 2021; Mallette et al., 2019; Mornas et al., 2021; Racinais et al., 2017c).

Taken together, these results therefore mostly suggest that an acute passive heat exposure (partial or total) tends to increase the rate of cross-bridge cycling, rather than the number of interactions between actin and myosin formed.

After a 20-km time trial performed in hot conditions, knee extensors PT amplitude was unchanged (Baillot et al., 2021). Others studies reported a decrease in knee extensors and/or plantar flexors PT amplitude after sprint cycling (Duffield et al., 2009; Girard et al., 2013), cycling to exhaustion (Girard and Racinais, 2014; Racinais and Girard, 2012) or a football match (Nybo et al., 2013). In many instances, a similar decrease is observed following the same exercise performed in temperate environment (Duffield et al., 2009; Girard et al., 2013; Girard and Racinais, 2014; Nybo et al., 2013). Racinais and Girard (2012) reported that plantar flexors and knee extensors CT decreased following cycling exercise and decreased to a greater extent under hot conditions, as well as knee extensors HRT, while plantar flexors HRT decreased regardless of the environmental condition.

Thus, for the majority of contractile properties measured in active participants in hot environment, exercise and/or heat effects remain difficult to differentiate. The origins of such

phenomenon remain to be explored (*e.g.*, type and duration of exercise, temperature, muscle group).

iii. Heat stress reduces electromechanical delay via accelerated electrochemical processes

The ability to rapidly generate force is influenced by electrochemical and mechanical processes (Maffiuletti et al., 2016; Nordez et al., 2009). It is well established that nerve conduction velocity increases in hot environments (Rutkove et al., 1997; Todnem et al., 1989), however, little is known regarding the impact of heat exposure on force transmission efficiency by the contractile and elastic components. Electromechanical delay, which corresponds to the time between the muscle activation onset and force production, reflects both electrochemical processes (*i.e.*, synaptic transmission, action potential propagation through the sarcolemma, and excitation-contraction coupling) and mechanical processes [*i.e.*, force transmission along the active and passive parts of the series elastic component) (Cavanagh and Komi, 1979)]. Using very high-frame-rate ultrasound, it is possible to determine the respective contribution of electrochemical and mechanical processes in electromechanical delay (Nordez et al., 2009). A preliminary study to this PhD work allowed to determine these respective contributions to heat-related effects in electromechanical delay following GM muscle stimulation (Mornas et al., 2021). Our results reported that passive heat exposure, increasing T_{core} to 38.4°C, reduced the delay between GM muscle stimulation and the onset of plantar flexor force production, and that this reduction was concomitant with a shorter delay between GM muscle stimulation and fascicle motion, corresponding to electrochemical processes. Thereafter, the delay between GM muscle fascicle motion and force production was unchanged, indicating no effects of heat exposure on force transmission along elastic components (Figure 8).

The acceleration of electromechanical processes may be due to accelerated axonal conduction velocity with heat (Rutkove et al., 1997; Todnem et al., 1989), accelerated synaptic transmission (Racinais and Oksa, 2010), increased ATPase activity of myosin heavy chains (Bárány, 1967), and increased rate of cross-bridge cycling (Schertzer et al., 2002; Stein et al., 1982), without being able to dissociate the respective contribution of each process involved in heat exposure-induced changes.

These findings suggest a major effect of increasing T_{core} and T_{musc} on the electrochemical and contractile component properties of the GM muscle, without completely excluding an opposite effect at the level of the series elastic component. A shortening of electromechanical delay and

electrochemical processes might explain the improvement in explosive strength reported in the literature. Future investigations of muscle-tendon dynamics involved during voluntary contractions are warranted for a better understanding of motor performance under heat stress.

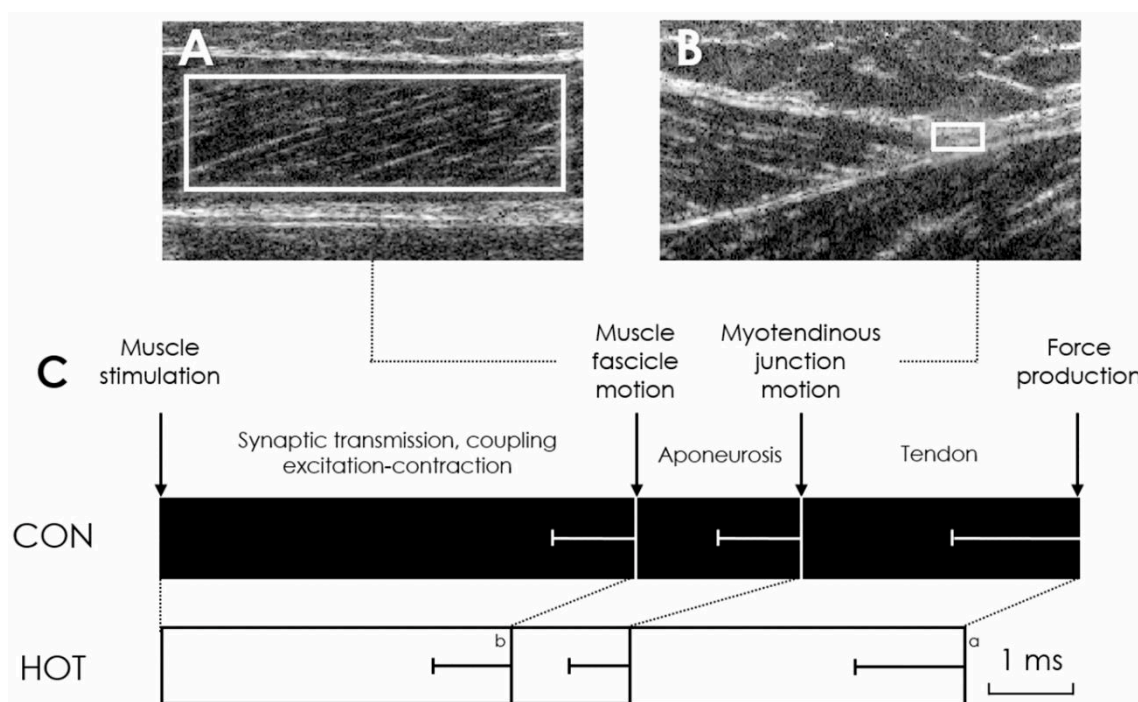

Figure 8. *A and B:* ultrasound images showing the regions of interest delineated white squares for the gastrocnemius medialis (GM) muscle (A) and myotendinous junction (B). *C:* representation of the electromechanical delay and its components in control (CON) and hot ambient (HOT) environments. Horizontally stacked bar plots represent means \pm SD. The delay between electrical muscle stimulation and the onset of muscle fascicle motion is attributed to electrochemical processes. The delay between the onset of fascicle motion and the onset of force production is attributed to force transmission along the aponeurosis and the tendon. ^a and ^b Significant difference between HOT and CON for electromechanical delay and electrochemical processes; $P < 0.001$. Figure from Mornas et al. (2021).

2. Chronic effects

i. Repeated heat stress induces skeletal muscle adaptations

Whilst the effects of an acute heat stress on muscle contractile function have been well described in the literature, long-term heat stress adaptations remain poorly investigated.

In rats' SOL muscle, a single 1-h heat exposure at 42°C increased cell proliferation and muscle protein content (Uehara et al., 2004). After 4 days of heat exposure, hypertrophy was facilitated in cultured muscle cells (Goto et al., 2003). These results suggest that heat stress could induce muscular hypertrophy. Previous work also reported that repeated heat exposure may reduce muscle atrophy during immobilization (Selsby and Dodd, 2005) and enhance the restoration of

muscle mass in atrophied muscles (Goto et al., 2004; Selsby et al., 2007). In SOL, collected from heat-acclimated rats, it was reported that the combination of HA and exercise (*i.e.*, treadmill training) enhanced force generation, induced by muscle stimulations (Kodesh and Horowitz, 2010). These changes were accompanied with molecular skeletal muscle adaptations (*i.e.*, increase in the expression of genes linked to energy metabolism and Ca²⁺ regulation).

In human skeletal muscle, repeated passive heat exposure could enhance mitochondrial function and increase mitochondrial biogenesis (Hafen et al., 2018), improve muscle capillary growth (Kuhlenhoelter et al., 2016), and may promote the activation of the hypertrophic and the inhibition of atrophic signaling pathways respectively (Ihsan et al., 2020; Kobayashi et al., 2005; Yoshihara et al., 2013). Taken together, these effects could explain that repeated heat exposure resulted in increased muscle mass and muscle capillaries.

When considering HA, key contributors serving as molecular chaperones for a myriad of cellular pathways are involved, Heat Shock Proteins (HSPs), are proteins responding to stress within the body, and Hypoxia-Inducible Factors (HIFs), transcription factors in response to decreases in available oxygen. With HA, the body develops cross tolerance mechanisms (*i.e.*, HA-mediated cross-tolerance), in which HSPs and HIFs positively contribute, leading to systemic acclimation responses (Ely et al., 2014). Following HA, HIFs increased, and may contribute to systemic acclimation responses [*e.g.*, increase in splanchnic blood flow, in blood volume, and maximal skin blood flow; (Ely et al., 2014)]. HSPs are implicated in the mechanisms of regulation of muscle mass following heat stress. Their actions result in attenuation of muscle mass loss or in enhancement of muscle re-growth in atrophied muscle (Goto et al., 2004; Selsby et al., 2007). Heat stress has also been purposed to enhance anabolic signaling through the Akt-mTOR (mammalian target of rapamycin) pathway, a crucial regulator of skeletal muscle hypertrophy, which can prevent muscle atrophy (Bodine et al., 2001). Indeed, the Akt-mTOR signaling pathway was stimulated in animal muscles under hot temperature (37-41°C), with a most important activation at 41°C (Yoshihara et al., 2013). It has also been shown that Akt-mTOR downregulates key muscle-specific ligases of the ubiquitin proteasome system (Stitt et al., 2004), which is a major pathway of muscle protein degradation (Lagrand-Cantaloube et al., 2009). These mechanisms, by which heat stress is suggested to increase muscle mass are resumed in Figure 9.

Thus, recent studies indicate that heat may confer benefits, compared to no intervention, in humans, but treatment modality (*i.e.*, local *vs.* whole-body heat exposure) and involved mechanisms remain equivocal.

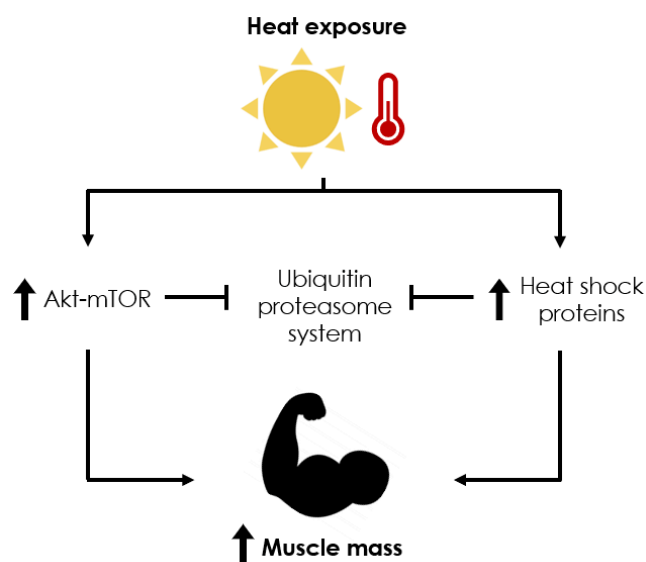

Figure 9. Schematic representation of mechanisms suggested to increase muscle mass under heat exposure. Adapted from (Racinais et al., 2019b).

Ishan et al. (2020) reported that whole-body heat stress upregulated HSPs, activated anabolic signaling (Akt-mTOR), enhanced the gene expression of several targets associated with mitochondrial biogenesis and induced other cellular responses, while single leg heat treatment induced no changes in the investigated signaling pathways.

ii. Repeated heat stress as a potential muscle strength primer

Using localized heat therapy (*i.e.*, hot pack application) previous studies reported an increase in knee extensors maximum torque after 10-weeks [8 h/day, 4 days/week; (Goto et al., 2011)] or after 8-weeks of application [90 min/day, 5 days/week; (Kim et al., 2020)], accompanied by an increase in mean cross-sectional areas of *vastus lateralis* and *rectus femoris* (Goto et al., 2011). However, Labidi et al. (2020) reproduced the aforementioned localized heat therapy protocol during 6-weeks (*i.e.*, 8 h/day using heat pads, 5 days/week) and reported no effect on plantar flexors torque and muscle mass. These data may suggest a dose-response relationship between heat dose and potential and chronic structural adaptations, or a possible effect depending on the muscle group investigated. To the best of our knowledge, only one study reported the effect of HA, using whole-body heat exposure, on electrically-evoked and voluntary force-generating capacity. This study reported that eleven days of passive HA (*i.e.*, 1 h/day at 44-50°C, 50% of RH), induced effective physiological adaptations, improved PT amplitude as well as MVC peak force produced in temperate and hot environments (Racinais et al., 2017c). Could these effects be transferable during active HA? Recently, it was shown that adding local repeated heat stress during a long period (*i.e.*, 10-12 weeks) of resistance

training had no effect on hypertrophy and strength gains (Chandrasiri et al., 2021; Stadnyk et al., 2018). That may suggest that repeated heat exposure may not further increase muscle force in participants already exposed to a mechanical stress elicited by strength training. However, future studies are required before drawing conclusions.

4. Are physiological and neuromuscular function responses under heat stress influenced by sex?

The Olympics Games of Tokyo 2020 were the first gender-balanced Games in history, with almost 49% of female athletes according to the International Olympic Committee. In the context of sport performance, including females in research protocols was strongly encouraged in the last few years (Stachenfeld, 2018). Potential differences in responses to interventions between sexes have been suggested and should therefore be considered, since the effects obtained in males are not necessarily generalizable in females. On the research topic specific to this thesis, experimental protocols are increasingly including females. After a PubMed research, using the following terms in ‘all fields’: [muscle properties AND heat AND (male* OR men)], 281 studies were identified, against 132 when researching: [muscle properties AND heat AND (female* OR women)]². Figure 10 represents the publications number as a function of the year for each sex, highlighting that despite more represented in research studies, females remain underrepresented in comparison to males.

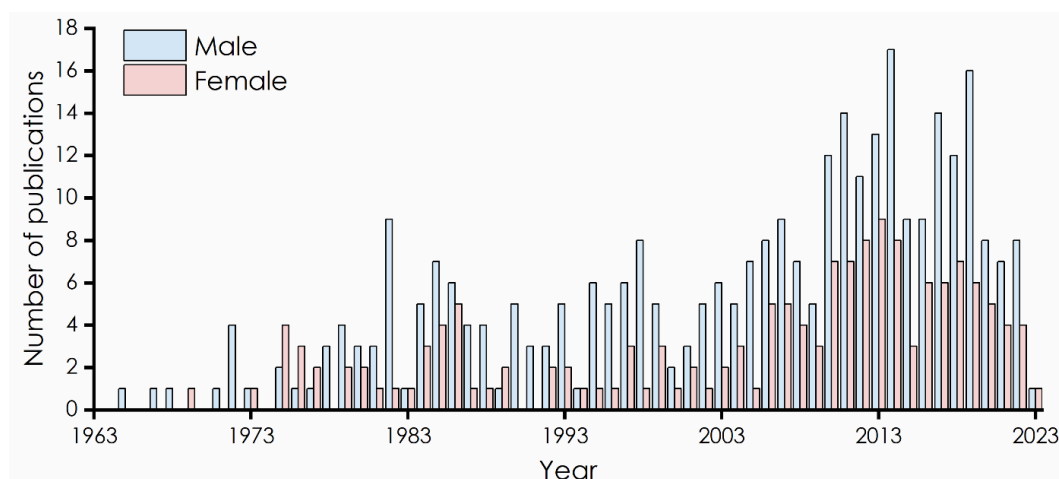

Figure 10. PubMed research and corresponding number of publications as a function of the year for males (blue; research terms in ‘all fields’: [muscle properties AND heat AND (male* OR men)]) and females (pink; research terms in ‘all fields’: [muscle properties AND heat AND (female* OR women)]).

² Research performed in December 2022.

Physiologically, males and females reported similar variations in T_{core} and heart rate with an increase in Wet-Bulb Globe Temperature during moderate intensity work, (Notley et al., 2022). To the best of our knowledge heat-mediated responses of the neuromuscular function was few investigated. Forearm immersion in hot water at 40°C during 20 min resulted in similar responses of males and females – *i.e.*, unchanged MVC peak force and RFD of wrist extensors – (Cornwall, 1994). Casadio et al. (2017) reported that resistance exercise session performed in hot condition reported varying results between male and females’ participants. For instance, an enhancement of jump height was shown in males but not in females. An increase in MVC force production was also observed with heat exposure in females but not in males. Although the existing literature does not allow us to hypothesize the existence, or not, of differentiated responses between males and females, future investigations appear essential given that heat-responses of males and females are not necessarily similar.

However, in the absence of heat-related intervention, it was reported that MVC peak force production and voluntary RFD were higher in males than females (Cornwall, 1994; Ema et al., 2020; Hannah et al., 2012), as well as jump height performance (Mackala et al., 2020). This sex-difference is due to males’ higher force production capabilities which is largely explained by greater muscle size (Hannah et al., 2012).

PART 1 - Summary

- Passive or active heat exposure induces a thermoregulatory and physiological strain that can lead to impairments in exercise capacity. Repeated heat exposure, known as HA, induces physiological adaptations lowering physiological strain and improving exercise capacity in the heat.
- *In vitro* studies reported that temperature may impact muscle contraction mechanisms. Axonal conduction velocity and ATPase activity are enhanced under heat stress, as well as muscle cell Ca^{2+} kinetics, suggesting improved neuromuscular processes with increasing temperature.
- Although not always unequivocal, and potentially depending on a temperature threshold, acute heat stress tends to impair voluntary force production, while passive HA improves skeletal muscle contractility in humans (Figure 11).

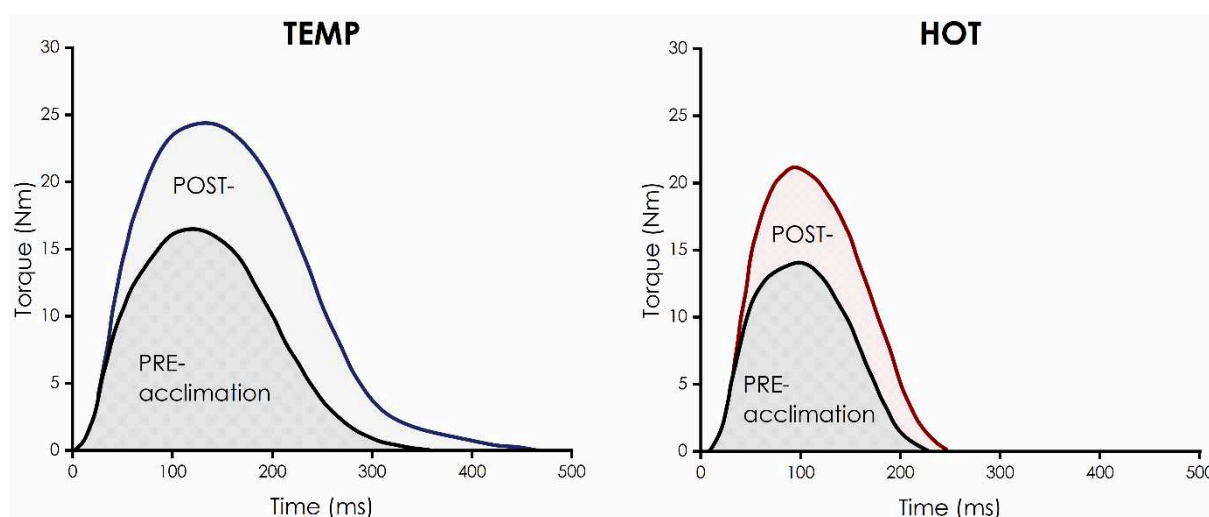

Figure 11. Muscle twitch measured in temperate (**TEMP**) and hot (**HOT**) environment, before (**PRE**) and after (**POST**) heat acclimation intervention. An acute heat exposure reduced contraction and half-relaxation times without changing peak twitch amplitude, while heat acclimation increased peak twitch amplitude in **TEMP** and **HOT**. Adapted from Racinais et al. (2017c).

- Acute and chronic underlying mechanisms involved in force production capacity remain to be investigated to provide a better understanding of muscle performance, and therefore motor performance under heat stress.

PART 2 - Transfers on human motor skills: experimental approach of muscle-tendon interactions and potential heat-related responses

1. Influence of temperature on muscle fundamental properties

The maximal voluntary force, or torque, production is specific to the mechanical condition in which it is measured. The ability to produce force during daily activities or sport practice depends on the state of length muscles are operating during a given movement (*i.e.*, force-length properties), and their contraction velocity as well (*i.e.*, force-velocity properties). These two fundamental relationships allow evaluation of the contractile properties of a muscle and/or a group of muscles. Explosive force, which is referred to as the ability of the human skeletal muscle to generate force as fast as possible, and influenced by neural and contractile properties, is also paramount in motor performance and daily functional tasks (Maffiuletti et al., 2016; Tillin et al., 2013). Understanding the effects of heat stress on these force production determinants and force transmission along the elastic components would allow us to better understand the movement within hot conditions. Although such heat-induced effects have been rarely investigated, temperature-related effects of some underlying mechanisms may deepen our knowledge.

1. Muscle mechanical properties

The amount of contractile material, and therefore the number and the size of muscle fibers strongly conditions the ability of the muscle to produce maximum force. Therefore, the maximum isometric strength that can be produced by the muscle depends on its physiological cross-sectional area and its specific strength. The force production capacity of a muscle is thus influenced by the number of fibers it contains. The organization of these fibers, which refers to the architecture, can modulate the amount of contractile material and therefore the level of force produced. Other fundamental properties of the muscle affect its force production, especially its length and contraction velocity.

i. Force-length relationship: principles and inputs

According to the *sliding filaments theory* (Huxley, 1957), the force produced by a muscle fiber depends on the number of actin-myosin cross-bridges formed. When a muscle fiber length changes, actin and myosin myofilaments slide in opposite direction, resulting in either a

decrease or increase in actin-myosin cross-bridges. It is therefore necessary to measure the force generated by the structure at fixed lengths (*i.e.*, during isometric contractions) to examine the force-length relationship. Gordon et al. (1966) described the effects of the muscle fiber lengths on the force produced, showing that the force generated varies with the overlap between actin and myosin filaments. The force-length relationship of the contractile component can be considered as an inverted parabola, on which three remarkable states of length were exposed (Figure 12). First, the optimal length (L_0) of a muscle fiber corresponds to the length at which the muscle is able to create the greatest number of actin-myosin cross-bridges, and thus the maximum force, corresponding to the top of the relationship (Figure 12). When the muscle fiber length decreases, there is an overlap of the thin and thick filaments within sarcomeres causing a decrease in the number of actin-myosin cross-bridges, and thus a decreased force produced, being on the ascending limb of the relationship (Figure 12). Finally, the opposite effect is observed when a muscle fiber is too stretched. Almost always, there is no possible force production as there is no overlap between actin and myosin filaments, corresponding to the descending limb of the relationship (Figure 12). These mechanisms result in a parabolic relationship between force and sarcomere length as illustrated by Figure 12.

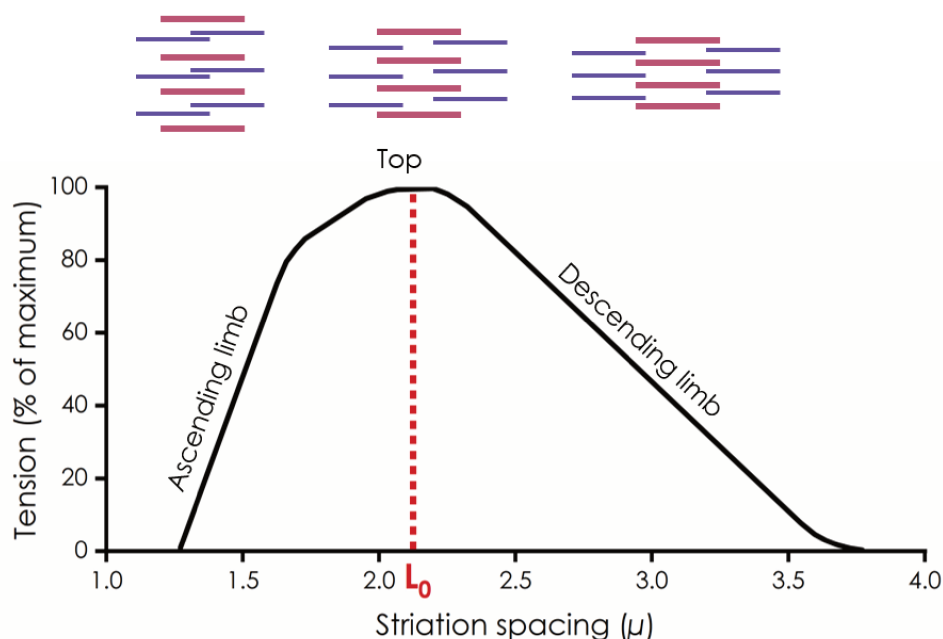

Figure 12. Relationship between the force developed by the sarcomere and the sarcomere length, measured *in vitro* and based on the sliding filaments theory, and the corresponding sarcomere optimal length (L_0). At the top, filaments schematic as a function of the striation spacing, with thick filaments (myosin, pink) and thin filaments (actin, purple). From left to right, the overlap between thick and thin filaments decreases and sarcomere length increases. Adapted from Gordon et al. (1966).

From shortened state (ascending limb) to L_0 , the force produced by the muscle mainly results from its contractile properties. Thereafter, at a given stretching state (descending limb), the muscle starts to develop a passive elastic force. The slack-length of a muscle corresponds to the length beyond which the muscle begins to develop its passive elastic force (Hug et al., 2013). For the GM, the slack-length is obtained at $\sim 65-71^\circ$ (90° corresponding to the foot perpendicular to the tibia, angle $< 90^\circ$ corresponding to the plantar flexion direction), depending of the knee angle (Hug et al., 2013). Therefore, the passive force must be considered, given that it is present over a large range of motion. This passive force is attributed to the stretching of the connective tissues (*i.e.*, endomysium, perimysium and epimysium) and sarcomere (*i.e.*, titin filaments) connective tissue (Gajdosik, 2001; Horowitz, 1999). At small size scales (*e.g.*, sarcomeres, myofibrils, fibers), titin was reported to be the most significant predictor of passive tension, while when considering the whole muscle, collagen content was reported to be the strongest predictor of whole muscle passive function (Ward et al., 2020). As represented in Figure 13, the total force measured at the muscle level is therefore the sum of the active force produced by the contractile component and the passive force mentioned above.

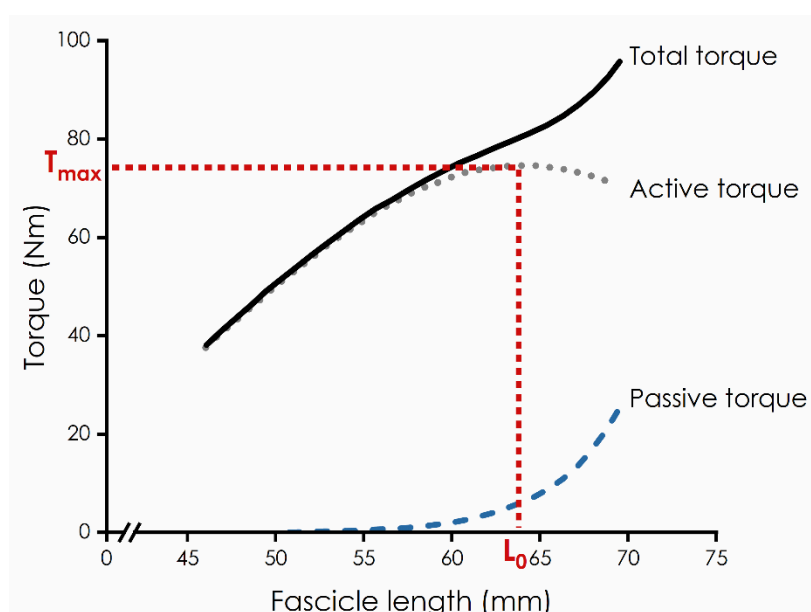

Figure 13. Total torque-length relationship (black solid line), resulting from the contribution of contractile (grey dotted line) and passive (blue dashed line) components. L_0 is the optimal fascicle length and T_{max} the maximum corresponding torque produced. Adapted from Hoffman et al. (2012).

This force-length relationship is variable as a function of the muscle investigated (Lieber and Ward, 2011). This variability is dependent on the amount and distribution of the muscle connective tissue (Lieber et al., 2017), as well as the muscle fiber type. For example, muscles composed mainly of type I fibers contain a larger volume of collagen proteins than muscles

composed mainly of type II fibers (Kovanen et al., 1984). Therefore, at an equivalent muscle length, the passive muscle force mostly composed of type I fibers (*e.g.*, SOL), is higher than in muscle mostly composed of type II fibers [*e.g.*, *rectus femoris*; (Kovanen et al., 1984)]. Thus, it has been suggested that connective tissue properties and elastic elements may influence muscle mechanics and functions, and therefore force-length properties (Lieber et al., 2017). Temperature-related responses of these structures may thus be translated to force production. Even if few studies investigated the effect of temperature on biological tissues such as collagen, and not necessarily at physiological temperatures (Kozma et al., 2018; Mauney and Volloch, 2009; Somkuti et al., 2013), all together, their heat-related responses might have importance when considering muscle mechanical properties.

At the muscle level, the force-length relationship is defined as the relationship between the muscle maximum active isometric force and its entire muscle-tendon unit length. As joint angle impacts muscle-tendon unit length, researchers often rely on the muscle torque-angle relationship to explore this question. The torque-length relationship measured is typically obtained from voluntary or electrically-evoked contractions at different joint angles, representing the maximum muscular capacity as a function of joint angle (Hahn et al., 2011; Leedham and Dowling, 1995). The relationship between joint torque and joint angle often presents a typical parabolic bell-shape: there is an optimal angle, at which the torque is the greatest. Ascending and descending limbs of the relationship show that below and above the corresponding joint angle, the joint torque is lower (Figure 14).

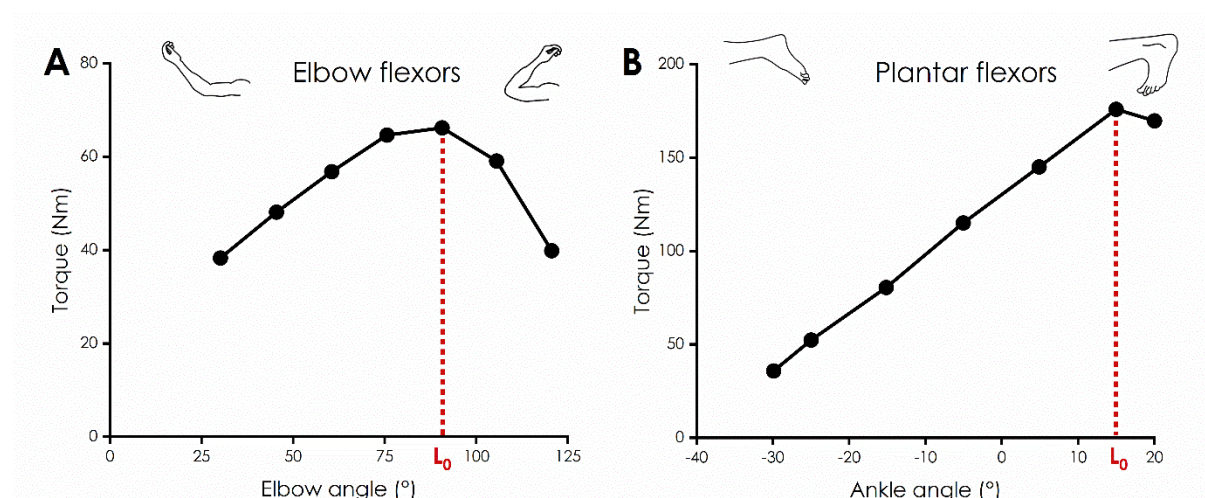

Figure 14. Torque-angle relationship for elbow flexors (A) and plantar flexors (B). Adapted from Enoka and Duchateau (2019).

For example, the optimal angle of elbow flexors to produce force is commonly reported around 90° (0° being full elbow extension; Figure 14A) (Enoka and Duchateau, 2019). Due to

anatomical constraints, the optimal joint angle may be outside of the physiological range for some muscles (Buchanan, 1995). In plantar flexion, the force produced tends to increase linearly with the angle of dorsiflexion (Maganaris, 2003) (Figure 14B). Indeed, plantar flexors reach their optimal angle at 15° of dorsiflexion (Sale et al., 1982), close to the maximal physiological angle of dorsiflexion (~20°).

The work of Hoffman et al. (2012, 2014), who studied this relationship over a large amplitude, using electrically-evoked contractions, tends to confirm the classical results obtained *in vitro* with a stagnation and then a decrease in the force generated by plantar flexors from a given ankle angle.

In vivo, the advances of ultrasound imaging allowed to investigate the force-length relationship at the muscle level, by measuring the muscle fascicle length (L_F) at which a given muscle force is produced (Maganaris, 2001). This relationship was built in GM during electrically-evoked (Hoffman et al., 2012, 2014) or voluntary (Hager et al., 2020) plantar flexions in humans using ultrafast ultrasound. The authors report a L_0 comprised between 5.9-6.2 cm with electrically evoked contractions (Hoffman et al., 2012, 2014), or around 5.6 cm (Hager et al., 2020) with voluntary contractions.

The force-length relationship could be influenced by multiple factors. To the best of our knowledge, its behavior, as well as the behavior of the various mechanisms involved, have not been investigated during or after heat stress. This modification was hypothetically attributed to tendon compliance, which plays an important role in protecting muscles from stretch during energy absorbing activities. Recently, Beck et al. (2022) reported that muscle fascicle operating length have a measurable effect on the metabolic energy expended during cyclic locomotion-like contractions, with an increase of metabolic energy expenditure at relatively shorter L_F . Therefore, an increasing muscle fascicle operating length may reduce the metabolic energy expended during locomotion. These results highlight the importance of mechanical properties from a physiological point of view. Therefore, it seems relevant to investigate whether a parameter, which has a known physiological influence, has consequences on muscle mechanics, during a running exercise for example.

Literature suggests that although the mechanical conditions of movement realization may influence the muscular mechanics, like shortening length, systems involved may modulate these effects in order to optimize mechanical production. During walking, muscle fascicles behavior has been shown to act relatively isometrically in the stance phase, while during running

gastrocnemii muscles fascicles get shorter and an increase in the strain of the series elastic elements is observed. The involvement of series elastic elements, which are compliant, allows to slowdown the muscle fascicles shortening velocity and to optimize maximal power output and efficiency (Lichtwark et al., 2007). Studying different movements, such as ankle-bending exercise, vertical jumping, walking or pedaling, it was reported that muscle fascicle contracts at close lengths of L_0 , whereas the Achilles tendon performs its stretch-shortening cycle. These findings highlight that the muscle-tendon unit system allows to match the capacity of the muscle to generate force and the tendon compliance to allow for efficient movement performance (Fukunaga et al., 2002).

Thus, the complex interaction between fascicles muscle and attached tendon may facilitate the muscle to operate in more optimal conditions, demonstrating that tendon properties are necessary to provide a global vision of the mechanisms implicated in force production.

Altogether, these previous studies highlight that the investigation of force-length properties *in vivo* is an essential parameter to be taken into consideration when assessing the intrinsic muscle properties. Its investigation would provide information on the muscle-tendon interactions and behavior and therefore mechanisms involved in force production, and consequently in movement, under temperate and hot conditions.

ii. Muscle force-velocity relationship: unrevealed role of temperature

The force-velocity relationship was originally studied *in vitro* on isolated muscle (Gasser and Hill, 1924), and mathematically described (Fenn and Marsh, 1935; Hill, 1938). Collected by dissection, frog muscle was attached by both ends to a force sensor and a displacement sensor (Figure 15A), allowing to measure the muscle fiber force produced according to its shortening velocity. For this sake, the muscle fiber was electrically tetanized. Once the maximum level of activation reached, the muscle fiber was released against a constant load. The velocity at which the muscle fiber is shortened is raised. This process is repeated by varying the external load imposed, in order to assess the effect of this load on the muscle fiber shortening velocity. The force production decreased with the increased shortening velocity.

The force-velocity relationship (Figure 15B) is thereafter determined using the hyperbolic equation proposed by Hill:

$$V = b \times (F_0 - F) / (F + a) \quad (\text{Equation 2})$$

where F is force, V is velocity, a and b are coefficients and F_0 the maximal theoretical force.

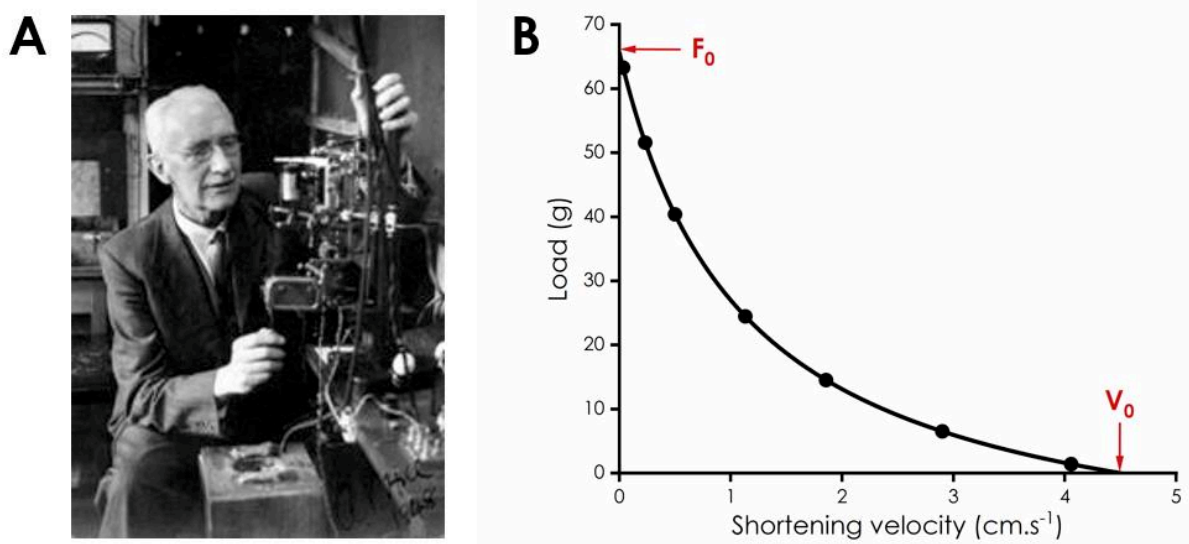

Figure 15. **A:** Experimental device used by Hill (1938) to measure muscle fiber shortening velocity capabilities as a function of the load. **B:** Experimental points obtained and relationship modeled once the equation applied, with the maximum theoretical force produced (F_0), and the maximal theoretical shortening velocity (V_0).

Equation 2 is used to model the force-velocity relationship and to extract intrinsic muscle properties. From a physiological point of view, the intersection points of this curve with the axes have a particular significance. The maximal theoretical shortening velocity (V_0) corresponds to the muscle fiber shortening velocity that would be reached when the exerted force is null and inversely, the maximal theoretical force (F_0) is the force that could be produced by a fiber with no change in fiber length (shortening velocity is zero; Figure 15B). These two basic characteristics are upon anatomical and physiological influences. F_0 is particularly dependent on the area of muscle section and more precisely on the number of sarcomeres placed in parallel in the muscle (MacIntosh and Holash, 2000). V_0 is mainly influenced by the type of fibers determining the attachment and detachment velocities of myosin heads on actin (Edman et al., 1988). Both are purely theoretical values which must be considered as target values towards which force production capacities tend. F_0 and V_0 should be interpreted as capacities of force and velocity of intrinsic muscle fibers properties, more than simple numerical values.

While F_0 is an indicator of maximum force production capacities, which is dependent of sarcomeres configuration, V_0 has been reported to reflect the kinetic properties of actomyosin interactions (Bottinelli and Reggiani, 2000). On isolated muscle, V_0 reflects the velocity of the fastest muscle fibers. Indeed, the slowest fibers do not participate in the early development of the force due to their lower shortening velocity (Edman, 1979). The maximum shortening

velocity obtained from the Hill equation theoretically reflects all the muscles fibers of a muscle, but in practice, it depends on the fibers' typology within a muscle.

This relationship was confirmed by the *sliding filaments theory* (Huxley and Brown, 1967). The force-velocity relationship indicates that higher is the velocity of muscle contraction, lower is the force that the muscle is able to produce, and inversely. According to this theory, there is a relationship between the number of actin-myosin cross-bridges and the level of force produced and, a relationship between the sarcomere shortening velocity and the velocity of attachment and detachment of the actin-myosin cross-bridges. The decrease in force generation is explained by a reduction in the number of cross-bridges formed and the force produced by each cross-bridge (Piazzesi et al., 2007). First measured *in vitro* in animals muscle fibers, this relationship was later built in humans, with a similar shape, on muscle fibers taken by biopsies (Bottinelli et al., 1996; Widrick et al., 1996).

The intrinsic properties measured from this force-velocity relationship may be influenced by different parameters, such as muscle typology, muscle mechanical properties or muscle fiber and temperature.

- Typology:

In humans, there are a continuum types of muscle fibers: I, IIa and IIx (Pette and Staron, 2000). Type I muscle fibers are small, with a slow maximum shortening velocity and level of force produced, but are much better at resisting fatigue (Bottinelli et al., 1996). The *size principle* assumes that type I muscle fibers are the first recruited as muscle force increases ([see p.10](#)). Conversely, type IIa and IIx, considered as fast-twitch muscle fiber, with a maximum shortening velocity and maximal force production higher than type I, with a lower fatigue resistance. Thus, the muscle shortening velocity is strongly influenced by its fibers' typology. The proportion of slow and fast muscle fibers depends on each muscle. GM muscle typology can be considered as balanced with 51% of type I fibers, while the SOL comprised 87% of type I fiber (Johnson et al., 1973).

- Mechanical properties:

As described in the previous section ([see p.29](#)), the force produced by a fiber will depend on its length. Since the sarcomere length is constant at a given force level, an increase in the number of sarcomeres placed in series will increase the muscle fiber length (Close, 1972). The

shortening velocity of a muscle fiber corresponds to the sum of the sarcomere's shortening velocity. As a result, the longer the muscle fiber, the higher its shortening velocity.

Muscle pennation angle (*i.e.*, the fascicle orientation in relation to the direction of muscle shortening) and the physiological cross-sectional area (*i.e.*, muscle section measured perpendicular to the orientation of the muscle fiber), significantly influence the force produced by a muscle (Blazevich, 2006). In a pennated muscle, the axis by which its fibers shorten differs from that of the muscle and must therefore be considered. Thus, only a part of the force produced by the fibers of the pennated muscle is exercised in the direction of its line of action, leading to a loss in muscle force in comparison to a muscle with the same mass and fiber length but without pennation angle. However, it is not that simple. Pennation angle allows a large number of fibers to be contained in a muscle, and acts as space-saving strategy. Indeed, pennation angle allows to increase the number of fibers within a muscle, the physiological cross-sectional area of a muscle and therefore increase its force production, even if individually a fiber can produce less force (Lieber and Fridén, 2000).

- Temperature:

In vitro, force-velocity relationship measurements are typically performed at non-physiological temperatures [*i.e.*, 12-22°C; (Bottinelli et al., 1996)]. Literature reported that V_0 is more sensitive to temperature than F_0 (Ranatunga, 1982; Stienen et al., 1996; Woledge et al., 1985). Shortening velocity is mostly related to the rate of cross-bridge cycling, which is dependent of myosin ATPase activity. It was reported that myosin ATPase activity is enhanced with increasing temperature, thus suggesting an increase in the rate of cross-bridge cycling (Schertzer et al., 2002; Stein et al., 1982). Therefore, fiber shortening velocity is influenced by the temperature at which it is tested (Ranatunga, 1984; Ranatunga et al., 1987; Seow, 2013). Ranatunga (1984) measured shortening velocity in fast-twitch (*extensor digitorum longus*) and slow-twitch (SOL) muscles from rats following muscle stimulation imposed at different ambient temperatures. The author reported an increase in muscle fiber shortening velocity in both the fast- and the slow-twitch oriented muscles with an increase in temperature (Figure 16A). As an illustration of this process, when ambient temperature changes from 15° to 35°C, SOL muscle shortening velocity is multiplied by 5.6 vs. 3.6 for the *extensor digitorum longus*. These results highlight that fibers temperature sensitivity may differ depending on their typology, which was also observed in humans muscle fibers (Lionikas et al., 2006), with higher sensibility in slow fibers.

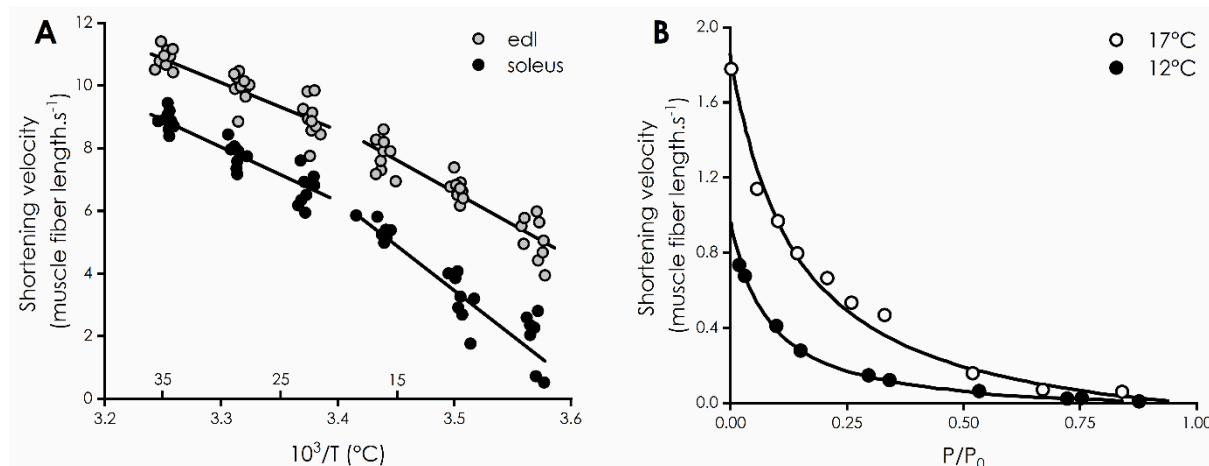

Figure 16. **A:** Shortening velocity of extensor digitorum longus (*edl*, grey) and soleus (black) in rats according to ambient temperature. Adapted from Ranatunga (1984). **B:** Force-velocity relationship obtained from the same muscle fiber (type IIa), in humans, at 12°C (black) and at 17°C (white). Adapted from Bottinelli et al. (1996).

Similarly, Bottinelli et al. (1996) reported an increase in maximum shortening velocity with temperature in human fibers tested *in vitro*. At lower temperature levels (*i.e.*, 12-17°C), increasing shortening velocity with higher temperature resulted in a rightward shift of the force-velocity relationship (Figure 16B). Within the sarcomere, temperature induced a change in the kinetics of contractile proteins, impacting the velocity and the muscle fibers force (Woledge et al., 2009). This temperature sensitivity underlines the fact that it is difficult to rely on *in vitro* values, which have been recorded at non-physiological T_{musc} .

Although the force-velocity relationships of muscle and isolated fiber are well documented *in vitro*, their properties cannot be consistently transferred to *in vivo* conditions (Ahn et al., 2006). *In vivo*, force-velocity relationship has classically been explored on single-joint movements (*e.g.*, plantar flexion, knee extension), or on multi-joint movements (*e.g.*, vertical jump, sprint), considering the whole (upper or lower) limb muscles as a force generator. The mechanical variables are no longer measured at the muscle level, but at the segment or joint level. Based on force and velocity values produced during multi-articular functional tasks (*e.g.*, lower limb ballistic movement, vertical jump, sprint), force-velocity relationship has a linear form (Giroux et al., 2015; Samozino et al., 2012; Samozino et al., 2016). Due to the complexity of multi-articular movement and the diversity of mechanisms involved, it was explained in the literature that force-velocity relationship obtained from a multi-articular movement tends to from a linear rather than a hyperbolic form as reported on an isolated muscle or fiber (Bobbert, 2012).

The joint force-velocity (or torque-velocity) relationship can be obtained through the use of specific ergometers (*e.g.*, isokinetic), allowing to modify and control the velocity of a movement at a given joint. Mechanical variables (*i.e.*, torque, position and velocity) are therefore obtained using sensors integrated in the ergometer. The force-velocity relationship is modeled by the hyperbolic equation of Hill (1938) (*Equation 2*). In order to reach higher joint velocity, ballistic contractions are often used, in order to avoid over or under estimation of maximum velocity (Forrester et al., 2011; Hahn et al., 2014). The torque produced is thereafter calculated including the measurement of inertia, the weight of the limb estimated by an anthropometric model and the angular acceleration.

More recently, the advent of ultrafast ultrasound allowed to capture musculoskeletal images at very high frame rate (up to 10 kHz), providing an *in vivo* access to the behavior of muscle fascicle during various motor tasks. Using this technology, Hauraix et al. (2015) measured the instantaneous changes in fascicle architecture to infer fascicle velocity and in turn modeled the force-velocity relationship of GM muscle during plantar flexion movements using the *Equation 2*, from of Hill (1938). Similarly to *in vitro* conditions, this relationship describes a decrease in force with increasing shortening velocity at the fascicle level.

This technique is relatively recent and, to the best of our knowledge, has not been used under changing environmental conditions, such as heat stress. A previous study reported a higher wrist flexion angular velocity (Binkhorst et al., 1977) in response to an increase in T_{musc} from $\sim 22^{\circ}\text{C}$ to $\sim 37.5^{\circ}\text{C}$ in *palmaris longus* and *flexor digitorum* muscles composed of a heterogeneous fiber-type composition (Johnson et al., 1973; Moore et al., 2021). Similarly, an increase in estimated T_{musc} from $\sim 22^{\circ}\text{C}$ to $\sim 37^{\circ}\text{C}$ in *adductor pollicis* muscle, mainly composed by slow-twitch fibers (Round et al., 1984), resulted in a higher angular velocity of the thumb (De Ruiter and De Haan, 2000). It is however difficult to determine to what extent it is possible to relate these effects to temperature sensitivity, which has mainly been addressed *in vitro*. Given that the fiber type composition is balanced in the GM muscle (Johnson et al., 1973), an increase in GM T_{musc} could lead to an increase in the ankle joint velocity. The rightward shift of the force-velocity relationship and the increase in V_0 with an increase in T_{musc} (De Ruiter and De Haan, 2000) could also suggest an increase in the maximum fascicle shortening velocity after heat stress, since at high velocity (*i.e.*, ballistic contraction without load) the maximal GM shortening velocity and the maximal ankle joint velocity are related (Hauraix et al., 2015). This would be consistent with an aforementioned study, which reported an increase in V_0 in humans muscle fibers, at non-physiological temperatures [*i.e.*, $12\text{-}17^{\circ}\text{C}$; (Bottinelli et al., 1996)].

F_0 must also be considered when investigating force-velocity properties of a muscle, as this is a key parameter in this relationship. Indeed, if MVC peak force tends to decrease following an acute heat exposure ([see p.18](#)), then this relationship could be shifted to lower ranges of shortening velocity (*i.e.*, leftward shift), with lower force levels produced. And inversely, a potential increase in the maximum force produced following repeated heat exposure could induce a rightward shift of the force-velocity relationship. After water immersion (temperature range: 18-39°C), muscle power and contraction velocity were increased with a rise in T_{musc} , whereas muscle force remained unchanged (Binkhorst et al., 1977), suggesting that high-velocity movements are more sensitive to temperature than low-velocity movements.

iii. Explosive force production: mechanisms and heat-related effects

Although previous studies have explored the effects of heat stress on maximal force production ([see p.18](#)), less attention has been given to explosive (*i.e.*, ballistic) contractions. The evaluation of the RFD, or rate of torque development (which will be commonly called RFD below) is popular to characterize explosive strength in various types of populations (*e.g.*, athletes, elderly, patients) or to quantify the effects of an intervention program (*e.g.*, training, environmental stress). In comparison to the evaluation of MVC force production, RFD is closer to performance of sport-specific and daily tasks (Maffiuletti et al., 2016; Tillin et al., 2013), and more sensitive to detect changes in neuromuscular function (Angelozzi et al., 2012; Jenkins et al., 2014). Referred as the ability of the human skeletal muscle to generate force as fast as possible, RFD is largely explained by neural and contractile properties. This quality is classically evaluated with an isometric explosive contraction [*i.e.*, a short contraction ~ 1 s, with the intention to contract “*as fast and hard as possible*” (Maffiuletti et al., 2016)], by dividing the variation in force produced by the duration over a given period of time. In their review, Maffiuletti et al. (2016) highlighted the factors influencing the RFD (Figure 17).

More specifically, neural activation is an important determinant in the initial 50 ms of explosive contraction, whereas the subsequent 50-ms period is correlated to contractile capacity (Folland et al., 2014). Most recently, some studies investigated the various determinants of explosive force depending on time period from the onset of explosive contraction (Del Vecchio et al., 2019; Hager et al., 2020; Maffiuletti et al., 2016) (Figure 18A). At the onset of the motor impulse (*i.e.*, 0–100 ms), explosive movement is strongly influenced by the recruitment velocity and the firing rate of the activated motor unit (Del Vecchio et al., 2019). From 100 to 200 ms, voluntary RFD amplitude will thereafter be submitted to muscle mechanical constraints, as

reflected by muscle fascicle dynamics which fit to the fascicle force-velocity relationship (Hager et al., 2020) (Figure 18B).

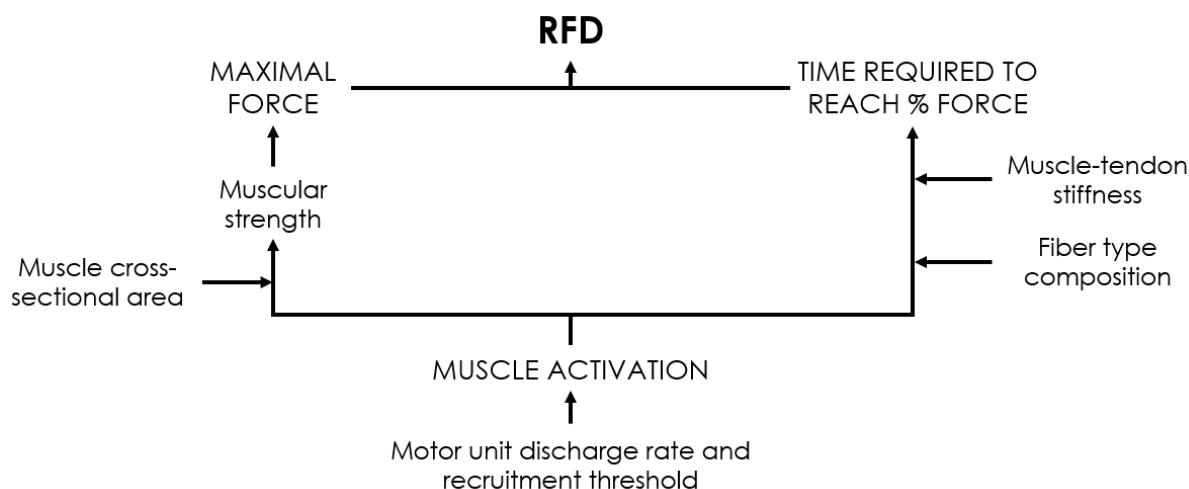

Figure 17. Factors influencing the voluntary rate of force development (RFD). It is classically characterized by the maximum force produced and the time to develop its highest percentage of force. Adapted from Maffiuletti et al. (2016).

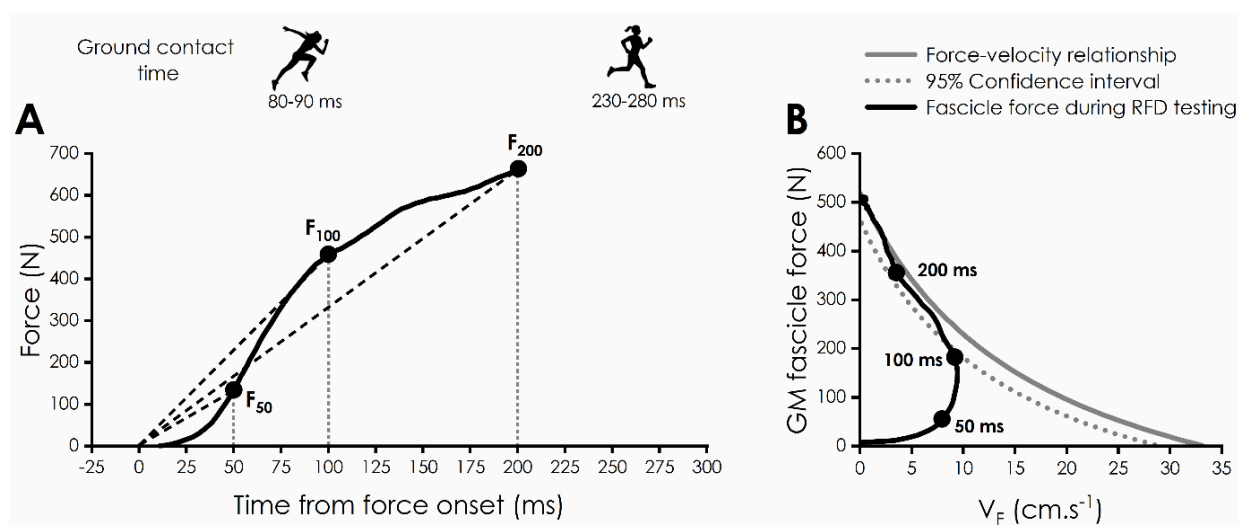

Figure 18. A: Representation of force as a function of time, 0 corresponding to force onset during explosive isometric contractions. Force is represented at specific time points (F_{50} , F_{100} and F_{200}) and corresponding classical phases measured (0-50, 0-100, 0-200 ms). Adapted from Maffiuletti et al. (2016). At the top: ground contact time to apply ground force of ~80-90 ms in sprint and ~230-280 ms in marathon. **B:** Gastrocnemius medialis (GM) fascicle force-velocity relationship (grey line), associated lower 95% confidence interval (grey dotted line) and fascicle force as a function of fascicle shortening velocity (V_F) measured during rate of force development (RFD) testing (black line). The circles correspond to the values obtained at 50, 100 and 200 ms from the contraction onset. Adapted from Hager et al. (2020).

RFD may also be influenced by the elastic properties of the muscle-tendon unit and the muscle-tendon interactions, with their stiffness positively correlated with RFD (Maffiuletti et al., 2016;

Rodríguez-Rosell et al., 2018; Tillin et al., 2018). In addition to give information about the determinants involved in each specific phase, the use of time periods facilitates the interpretation of the transfer between muscle capacity and *in situ* specific motor task (Andersen and Aagaard, 2006; Oliveira et al., 2013). For example, the ground contact time necessary to apply ground reaction force is ~80-90 ms in sprint (Taylor et al., 2012), vs. ~230-280 ms in marathon (Giovanelli et al., 2016) (Figure 18A).

The evaluation of specific changes in the various phases of the RFD in response to thermal stress would thus allow to investigate heat-mediated effects on the neural and mechanical determinants of explosive force. Such approach may also help to identify the biological tissues and processes affected by temperature. Increasing temperature leads to increased electrically-evoked RFD in humans ([see p.19](#)) (De Ruyter et al., 1999; Gordon et al., 2021; Mallette et al., 2019; Mornas et al., 2021; Racinais et al., 2017c). This phenomenon was strengthened by our preliminary study (Mornas et al., 2021), which reported a faster electromechanical delay, due to accelerated electrochemical processes, after a passive heat exposure. However, it seems that such effects are less unequivocal during voluntary explosive contractions. Some studies reported an increase in voluntary RFD between 0 and 50 ms after contraction onset following local muscle heating (Denton et al., 2016; Rodrigues et al., 2021). Inversely, a recent experimentation demonstrated no changes in early (0-50 ms) and middle (50-100 ms) RFD with progressive heat exposure performed in an environmental chamber (Gordon et al., 2021). These results suggest that increased temperature may accelerate or not alter motoneuron recruitment process and the subsequent early rise in force production. Although this difference could be explained by the difference in heat stress used (partial vs. total), further studies are required to deepen the understanding of heat-related effects on RFD and the determinants of explosive force.

The RFD late phase (*i.e.*, between 100-150 ms from force onset) was reported to decrease after a whole-body heat exposure (Gordon et al., 2021). Therefore, it appears that heat effects on voluntary RFD seem to be time-phase dependent. MVC peak force is considered as an important determinant of voluntary RFD in the late phase of contraction (Andersen and Aagaard, 2006; Folland et al., 2014). Indeed, RFD in its late phase of contraction reach high levels of force (> 50% of MVC peak force, typically after ~90 ms). Therefore, it appears rational that explosive force production is increasingly influenced by MVC peak force, which corresponds to the ultimate plateau of voluntary force production. The fact that MVC peak force tends to decrease under heat stress ([see p.18](#)) may subsequently impact the contractile

determinants of RFD. Conversely, repeated heat exposure, potentially leading to increased MVC peak force ([see p.25](#)), would suggest enhanced late RFD. Plantar flexors RFD has been reported to be constrained by the force-velocity properties from 100 ms after force onset (Hager et al., 2020). The authors suggested that due to the inherent interplay between muscle and tendon *in vivo*, the contribution of contractile properties to the ability to generate force rapidly may also be modulated by the mechanical properties of elastic tissues. Indeed, it had previously been demonstrated that an increase in stiffness of the *triceps surae*'s series elastic element, induced by ankle dorsiflexion, was accompanied with greater contractile performances, and more particularly a greater electrically-evoked RFD (Mayfield et al., 2016). Although barely investigated ([see p.46](#)), the literature suggests that the soft tissue stiffness tends to decrease with heat, and could impact and reduce the late phase of RFD, given that more compliant tissues reduce the efficiency of the force transmission along their structures.

Others parameters, including muscle typology and muscle architecture may impact the RFD. It has been shown *in vitro* that type II fibers had greater explosive capacities than type I fibers (Buchthal and Schmalbruch, 1970; Harridge et al., 1996). The mechanisms underlying this greater explosive strength would be associated to an increased velocity in the processes of cross-bridge detachment (Close, 1972), which may in turn accelerate cross-bridge cycling (Bottinelli et al., 1996). The amount of contractile material (*i.e.*, sarcomeres) influences the maximum force production capacity, as well as muscle thickness. These variables related to muscle size have also been described as RFD potential determinant (Andersen and Aagaard, 2006). Muscle hypertrophy resulting in an increase in MVC force production, and therefore in RFD, especially in its late phase, a potential increase in muscle thickness, due to hypertrophy following repeated heat exposure ([see p.23](#)), could positively impact explosive force production. The same applies to force-length and force-velocity relationships. Hypertrophy increasing force production capacities could lead to an improvement of these relationships (*e.g.*, rightward shift of the force-velocity relationship, increase in the level of force produced at L_0).

iv. Muscle architecture and mechanical properties: a debated relationship

It was recently reported that the anatomical structures of the calf affect power production and could be used to predict athletic ability (Lee et al., 2022). Therefore, these structures should be considered when investigating muscle-tendon unit properties, and more generally human movement and performance.

The link between muscle architecture and mechanical properties remains complex to investigate. Muscle architecture can be defined as “*the arrangement of muscle fibers within a muscle relative to the axis of force generation*” (Lieber, 1992). Muscle architecture is highly variable between muscles and affects their function (Lieber and Fridén, 2000). It is well established that the muscle force production is strongly correlated to its amount of contractile materials (*i.e.*, sarcomeres). Therefore, an increase in the muscle cross-sectional area, facilitating the increase in contractile materials, results in an increase in force production (Fukunaga et al., 2001). Thus, as mentioned earlier ([see p.25](#)), repeated heat exposure potentially leading to muscle hypertrophy might lead to an improvement of MVC peak force and therefore an increase in late RFD. Force-velocity properties might also be impacted, with a potential rightward shift of the force-velocity relationship with HA. While MVC peak force production and late RFD could be decreased following an acute heat exposure, reducing the level of maximum force production, and potentially leftward shifting the force-velocity relationship.

In recent years, a growing number of studies have focused on the relationship between muscle architecture and mechanical properties, which is initially not so obvious. Within the same muscle, there is architectural variability, which was reported in humans' and animals' *gastrocnemius* muscle (Huijing, 1985; Zuurbier and Huijing, 1993). This regional variability may impact the whole muscle force-generating capacity, due to different L_F and thus reaching their optimum length at various muscle lengths (Zuurbier and Huijing, 1993). Focusing on the GM, discrepancies exist in the literature. Studies reported uniform L_F and variable pennation angle throughout the muscle (Kawakami et al., 2000; Muramatsu et al., 2002). More recently, diffusion tensor imaging, an *in vivo* non-invasive technique, was used to quantify GM muscle architecture in three-dimension (Aeles et al., 2022; Takahashi et al., 2022). They found a regional variation in muscle fiber length across muscle regions, with for example in the middle region shorter fibers on the medial side compared to the lateral side of the muscle, and longer L_F in the middle compared to distal regions. The magnitude of architectural regional variation was positively correlated to the muscle size, indicating muscle-size dependence on the variability of fascicle architecture (Takahashi et al., 2022). While such variation may have functional implications and must be considered when investigating muscle-tendon unit properties, further investigations are required to clarify these implications. Reassuringly, Litchwark et al. (2007) reported that despite variability of fascicles behavior between distal,

mid belly and proximal sites along the GM muscle during running, the mid belly position provided a good indicator of the fascicle dynamics across the whole muscle.

A phenomenon such as muscle hypertrophy, which has been suggested to be induced by repeated heat exposure ([see p.23](#)), and potentially enhancing structural changes, could have effects on muscle mechanical properties. For instance, it was reported that longitudinal fascicle growth, which may occur in response to overstretching (Aoki et al., 2009), or eccentric training (Butterfield and Herzog, 2006), have effects on muscle mechanical function (Hinks et al., 2022). In their recent review, Hinks et al. (2022) reported an evidence between longitudinal muscle fascicle growth and muscle force-length relationship in animals, with a rightward shift of this relationship, which is less noticeable in humans. In this review, it was also supported that fascicle longitudinal growth may increase maximum shortening velocity, or reduce passive tension. Although these phenomena are difficult to investigate *in vivo*, muscle-tendon unit properties could in turn be impacted.

More usually associated as a parameter of force production parameter, pennation angle could also have an influence on fascicle shortening velocity (V_F) (Blazevich, 2006). During a concentric contraction, muscle length decreases leading to an increase in its thickness and width, in parallel with a decrease in L_F and pennation angle (Zuurbier and Huijing, 1992). Pennation angle is a dynamic parameter, which vary during a muscle contraction (Azizi et al., 2008). The increase in pennation angle during a contraction provides a mechanical advantage through the fascicle rotation, inducing an amplification of muscle shortening velocity. This amplification is quantified with the Architectural Gear Ratio (AGR), corresponding to the ratio between the horizontal L_F variation to the L_F variation (Azizi and Roberts, 2014). This ratio is generally greater than 1 for pennate muscles (Figure 19).

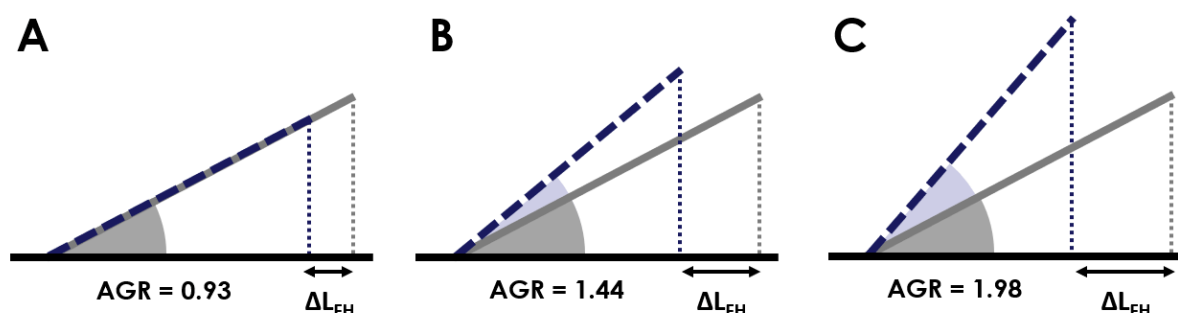

Figure 19. Graphical representation of the effect of pennation angle variation on the variation of muscle horizontal length (ΔL_{FH}) and Architectural Gear Ratio (AGR). **A:** no pennation angle variation; **B:** pennation angle variation of 10° ; **C:** pennation angle variation of 20° . This representation reports muscle shortening optimization through pennation angle variation. Adapted from the PhD work of Hugo Hauraix (2015).

While the functional significance of pennation angle was recently challenged (Lieber, 2022), its underlying mechanism must be considered when investigating muscle-tendon unit properties and motor performance, especially under heat stress which may induce changes in muscle architecture (*e.g.*, muscle hypertrophy).

An inverse relationship was found between *vastus lateralis* muscle fiber diameter and normalized stiffness (Noonan et al., 2020). This inverse relationship may suggest that muscle hypertrophy could lead to a potential reduction in muscle stiffness. The link between contractile material, muscle typology and stiffness remain complex, with effects not always univocal. Moreover, it is important to keep in mind that the morphological adaptations at the origin of muscle hypertrophy are difficult to generalize (Ruple et al., 2022). Investigating such effects is warranted to deepen our knowledge between muscle structural and functional properties. And, in a context of heat exposure, to better understand the potentials changes induced by heat and their potential subsequent impacts on muscle mechanical properties. Even if the described mechanisms are complex to link, it seems important to take into consideration each parameter that could influence muscle mechanical properties.

2. Soft tissues: even softer with heat?

Stiffness or its reverse, compliance, are muscle-tendon unit mechanical properties that had been extensively studied in the literature to assess, understand and improve performance in clinical and sports fields. An increase in muscle-tendon stiffness attests of an improvement in the ability of the system to transmit force (Kubo et al., 2001; Spurrs et al., 2003). Indeed, a soft tissue characterized by a greater stiffness (*i.e.*, greater resistance to elongation), has greater force transmission capacity than more compliant tissues, because it is characterized by a greater tensile force per unit of length change. Soft tissues have as fundamental properties viscosity and elasticity, allowing them to function as a shock absorber in case of lengthening or shortening. Therefore, muscle and tendon stiffness properties are important to consider in the chain of force production and transmission. The mechanical properties of these tissues are typically characterized by an *in vitro* strain-elongation relationship (Wang, 2006; Woo et al., 2000). Stiffness and shear modulus are the two most characterized parameters. Stiffness corresponds to the tissue resistance at its own elongation. Shear modulus is measured in a tissue by the tissue deformation against an imposed constraint.

i. Muscle stiffness: assessment and reported heat effects

The non-invasive evaluation of passive muscle stiffness *in vivo* has been facilitated thanks to the development of SWE, which was developed in the early 2000s (Bercoff et al., 2004). SWE allows to estimate the mechanical properties of different biological tissues, including muscle, through the study of the shear wave propagation in the considered tissue ([see p.80](#)).

In vitro studies in animals reported decreased muscle stiffness with an increase in temperature (Buchthal et al., 1944; Noonan et al., 1993). Using *in vivo* SWE in cats, SOL shear wave velocity decreased with an increase in T_{musc} (Bernabei et al., 2020). The same effect was reported *ex vivo* in bovine muscles. The shear modulus decreased linearly from 20°C with increasing bath temperature up to 44°C (Sapin-de Broses et al., 2010), with a lower slope from 37°C, which was attributed to myosin aggregation (Tornberg, 2005). Thereafter, the shear modulus continues to decrease with the thermally-controlled bath temperature to 56°C and exponentially increased for higher temperatures. This change in muscle properties may originate from the gelation of myosin that tends to soften (Tornberg, 2005). The shear modulus increased with increasing temperatures may be due to the collagen denaturation and to the longitudinal shrinkage of myofibrils and collagen (Tornberg, 2005; Wright and Humphrey, 2002). However, the aforementioned effects occur at non-physiological T_{musc} .

In humans, no changes in *vastus lateralis* shear modulus measured deeply or superficially were reported after 10 or 20 min of hot pack application over the skin (Ichikawa et al., 2015). With tensiomyography, which can be used as a stiffness indicator (Garcia-Manso et al., 2011), water immersion at 42°C increased *biceps femoris* muscle displacement, suggesting a decrease in muscle stiffness (Gimeno et al., 2020). The same effect was measured on *rectus femoris* after running a marathon in hot and humid conditions (Gutierrez-Vargas et al., 2020). To the best of our knowledge, no study has investigated muscle stiffness after a whole-body heat exposure, whether acute or chronic.

ii. Tendon stiffness: *in vivo* investigation and heat responses

For the *gastrocnemii* muscle group, tendon tissue (*i.e.*, Achilles tendon) has been shown to contribute to nearly 80% of muscle-tendon extension during a passive stretching (Herbert et al., 2002; Herbert et al., 2011). Although the duration of force transmission along the tendon is short [*i.e.*, 3.2-3.3 ms after GM muscle electrical stimulation; (Mornas et al., 2021; Nordez et al., 2009)], this high proportion is explained by a longer tendon structure compared to muscle fibers. Mechanical interactions between muscle and tendon are mainly due to the elastic

properties of the tendon (Ettema et al., 1990). Indeed, the mechanical properties of the tendon would alter the nature of muscle-tendon interactions during contraction (Ichinose et al., 2000). A stiffer tendon permits to transmit directly the force created by the muscle to the joint, without being significantly deformed. Inversely, a more compliant tendon will be able to lengthen and store elastic energy that will then be returned (Kubo et al., 2011; Stenroth et al., 2012). Altogether, these processes highlight the importance of considering Achilles tendon when investigating GM muscle-tendon unit properties. It is therefore more than necessary to consider these structures when evaluating the effects of heat stress on motor performance, and not solely muscle properties.

Animals' studies reported an increase in tendon compliance, measured *in vitro*, following heat exposure (Walker et al., 1976; Wang et al., 2005). As far as we know, only one study conducted in humans reported the effect of heat stress on tendon stiffness. After 30 min of hot water immersion, Achilles tendon stiffness, measured through an isometric ramp contraction, remained unaffected (Kubo et al., 2005).

Aponeuroses correspond to the muscle envelop. These structures maintain the organization of the muscle and comprises all the connective tissue present in the muscle: from sarcolemma to epimysium (Zuurbier et al., 1994). The stiffness of these structures is very similar to the tendon, when normalized to the length of the studied structures (Arampatzis et al., 2005), and have comparable mechanical properties (Scott and Loeb, 1995). Following passive heat exposure, force transmission along the active and the passive part of the series elastic component remained unchanged (Mornas et al., 2021). In accordance with the current scientific literature, this advocates that tendinous stiffness could thus be unchanged or slightly diminished with heat. Such variations in in-series elastic properties may in turn impact muscle mechanics and motor performance.

iii. Muscle-tendon unit stiffness considered as a whole exhibit unequivocal heat sensitivity

Muscle-tendon unit stiffness is involved in the process of force transmission and should be then considered when investigating muscle performance. This mechanical property is an important determinant in the production of explosive force, especially in its late phase (Maffiuletti et al., 2016; Rodriguez-Rosell et al., 2018; Tillin et al., 2018), and in the production of angular velocity (Fontana Hde et al., 2014; Hauraix et al., 2015). Its responses under heat stress could thus impact mechanical heat-potential induced effects. Taken as a whole, muscle-tendon unit

stiffness reported unequivocal response to heat stress. Metacarpophalangeal joint stiffness has been reported to increase following infra-red radiation aiming to increase tissue temperature (Wright and Johns, 1961). In their review, Bleakley and Costello (2013) reported that such heat-mediated increase in range of motion exists for various joints (*e.g.*, hip, knee, ankle, shoulder). More recently, following local heat application, repeated slow stretches decreased passive stiffness in ankle dorsiflexion (Denton et al., 2016), while no changes have been reported in knee muscle-tendon unit passive stiffness (Fujita et al., 2018). However, an increase in passive maximal range of motion is not necessarily accompanied by a decrease in muscle-tendon unit stiffness (Fujita et al., 2018; Kubo et al., 2005). Therefore, these results cannot be consistently generalized to muscle-tendon unit stiffness properties after heat stress.

Altogether, although unequivocal, current evidences suggest that soft tissue stiffness could be either unchanged or slightly decreased after an acute heat exposure, while the response to repeated exposures remains to be investigated. Tissue stiffness being an important determinant in a multitude of mechanisms involved in muscle-tendon unit mechanical properties (*i.e.*, force-length and force-velocity properties, explosive force production, force transmission), exploring the heat-related effects seems paramount to better understand the dependence of muscle mechanical properties and therefore force production and movement to temperature.

2. Do heat-mediated alterations translate into changes in daily motor tasks biomechanics?

1. Heat stress may impact motor skills

Heat has been shown to be an environmental stressor that can significantly decrease the ability to optimally perform in both occupational and sports settings (Périard and Racinais, 2015; Racinais et al., 2015b; Smallcombe et al., 2022). Heat exposure, leading to an increase in T_{core} , induced alterations in efferent and afferent signals to and from the muscle (Nybo and Nielsen, 2001; Racinais et al., 2008; Thomas et al., 2006), which might influence human motor skills. Therefore, heat environment alters physical work capacity, as described by Smallcombe et al. (2022). Based on an advanced empirical equation for physical work capacity (Foster et al., 2021), the authors established a negative relationship between physical work capacity and the Wet-Bulb Globe Temperature. This allowed the development of an experimental forecast tool indicating the expected heat stress on human body in direct sunlight (Figure 20).

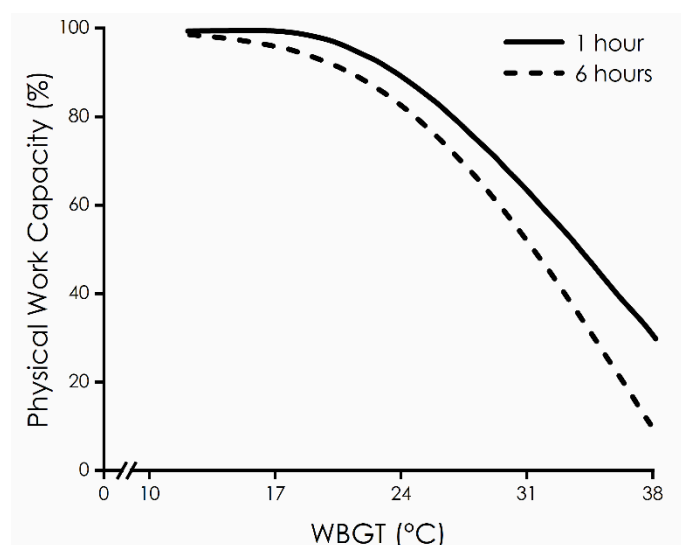

Figure 20. Interaction between Physical Work Capacity and Wet-Bulb Globe Temperature (WBGT) measured during the first (solid line) and the sixth (dashed line) work hours. Adapted from Smallcombe et al. (2022).

This alteration has been widely studied in the context of physical work, such as in firefighters, military and outdoor workers. For example, functional balance is decreased with heat stress in firefighters increasing the risk of slips, trips and falls (Games et al., 2020). During military operations, heat stress impairs performance (Périard et al., 2022) and for outdoor workers it diminishes the manual labor capacity (Ioannou et al., 2022). Therefore, strategies, including HA, are required to prevent disruptions in health and performance (Ashworth et al., 2022).

In sport settings, heat also seems to impair functional capacities. We already know that exercise capacity is reduced, due to physiological stress (Périard and Racinais, 2015; Racinais et al., 2015b; Racinais et al., 2019a), and that heat exposure impairs cognitive function (Gaoua et al., 2011; Racinais et al., 2008). With heat, cycling or prolonged running performance decreases (Marino et al., 2004; Périard and Racinais, 2015), while dynamic jumping and sprinting performance (*e.g.*, running or cycling) increases (Davies and Young, 1983; Gray et al., 2006; Guy et al., 2015). Endurance tasks are impaired by the physiological strain. The improvement of explosive tasks seems to stem from an increase in T_{musc} improving explosive power during activities such as jumping and sprinting by enhancing muscle contractile properties (Racinais and Oksa, 2010; Racinais et al., 2017a). However, the effects of heat on biomechanical parameters remain less investigated.

Proprioception is also altered under passive and active (*i.e.*, running) exposure (Mtibaa et al., 2018; Mtibaa et al., 2019). Passive heat exposure similarly impairs postural stability (*i.e.*, dynamic and static balance), due to putative alterations in efferent and afferent signals to and

from the muscle (Mtibaa et al., 2018). Therefore, investigating the mechanics of movement and underlying the behavior of the muscle-tendon unit during exercise in hot environment appears fundamental to extend our knowledge on human motor skills responses to temperature variations.

2. Transfer to *in situ* sport settings

i. Running mechanics

Recent research showed that running 30 min in the heat at a self-paced velocity (13.9 ± 1.6 km.h⁻¹) decreases the distance covered and alters proprioception but not running mechanics compared with similar exercise (14.7 ± 1.5 km.h⁻¹) performed in a temperate environment (Mtibaa et al., 2019). This study reported a significant increase in step length and a decrease in step frequency, over time and independently from environmental conditions, with a non-significant increase in aerial and contact time ($P \geq 0.090$). A hot water immersion (42°C) of the lower limbs for 40 min was associated with a significant elevation in T_{core} (up to $38.8 \pm 0.3^\circ\text{C}$) and did not affect movement kinematics during 10 min of treadmill runs at 70% of peak oxygen consumption, compared to temperate environment (Folland et al., 2006). However, it is not clear whether these effects persist if running time and/or heat exposure is prolonged. Competing a marathon in hot and humid conditions induces a significant reduction in lower-limb muscle stiffness, measured with tensiomyography (Gutiérrez-Vargas et al., 2020). One should note that this observation was not compared to a marathon performed in a temperate environment, which requires further investigations to strongly conclude on this point. To the best of our knowledge, such effects have not been measured for an intermediate running time. Given that the behavior of the tendon and its mechanism of storage-restitution are highly stressed during running [Figure 21A; (Roberts and Azizi, 2011)], a modification of the latter could have an impact on running mechanics and finally motor performance. Tendon acts as a spring, which may be characterized according to different functions. The storage-restitution mechanism regulating the mechanisms of the lower limbs is modulated by the objective and the intensity of the task performed. When running or bouncing, stability and conservation of the mechanical energy of the system are required [Figure 21A; (Roberts and Azizi, 2011)]. The level of nervous control involved, as well as the variation in lower limb muscles length, are smaller (Ferris et al., 1998; Roberts et al., 1997) compared to other activities such as incline running or landing, which require amplifying (Figure 21B) or attenuating (Figure 21C) the mechanical power produced by the muscle (Roberts and Azizi, 2011).

Therefore, the behavior of the tendon is an essential element to consider when investigating locomotion, and a change in its stiffness can impact the length of the muscle and the mechanical power mechanisms involved (*i.e.*, conservation, amplification or attenuation).

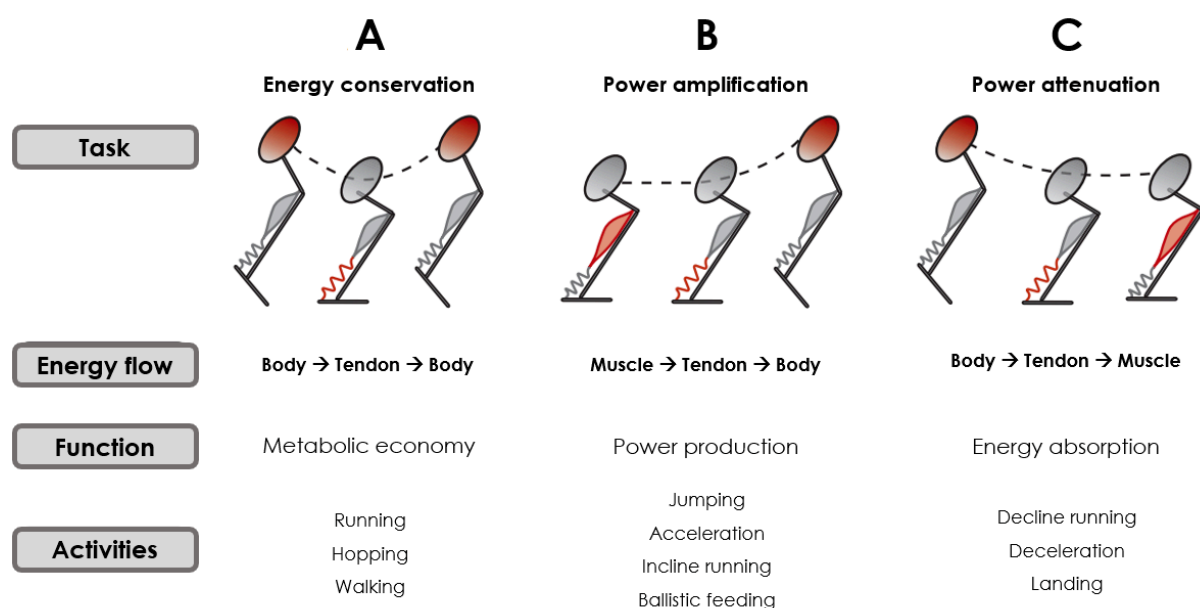

Figure 21. Illustration of the directional flow of energy in muscle-tendon system during running. **A:** Mechanical energy is conserved: elastic structures store and recover cycling changes in the mechanical energy of the body. **B:** Power is amplified: muscle-tendon units loaded directly by the work of muscle contraction and release that energy rapidly to the body. **C:** Power is attenuated: a decline in the mechanical energy of the body can be temporarily stored as elastic strain energy in soft tissues, followed by the release of this strain energy. Red color indicates energy flow between active muscle, strain energy of tendons and the potential and kinetic energy of the body. Adapted from Roberts and Azizi (2011).

At high running velocity, repeated sprints performed on a treadmill, reported lower step frequency and vertical stiffness as well as higher contact and swing time measured under heat stress, while aerial time and step length were unchanged (Girard et al., 2017). The authors potentially attributed the higher contact time, at least in part, to a decreased capacity of the neuromuscular system to generate force rapidly with fatigue, due to a reduced efficiency of the stretch-shortening cycle (Nicol et al., 2006), which acts more as a power amplifier during running acceleration (Fig 20B). However, it is important to keep in mind that it remains complicated to compare running mechanics from different types of exercises (*e.g.*, duration, intensity) and to interpret them.

ii. Time effect

During a prolonged exercise, neuromuscular fatigue appears, the muscles are no longer activated to their maximum, due to a decrease in the ability of the nervous system to activate them (Taylor and Gandevia, 2011). Neuromuscular fatigue can be described as a decrease in

MVC force production induced by exercise, which can lead to exercise cessation (Enoka and Duchateau, 2008; Gandevia, 2001).

As synthesized by Enoka and Duchateau (2008), neuromuscular fatigue may involve motor deficit, perception or decline in central function. The origin of the neuromuscular fatigue can thus be central (*i.e.*, alteration of spinal and supra/spinal mechanisms) and/or peripheral [*i.e.*, dysfunction at, or below, the neuromuscular junction; Figure 22 (Taylor and Gandevia, 2011)].

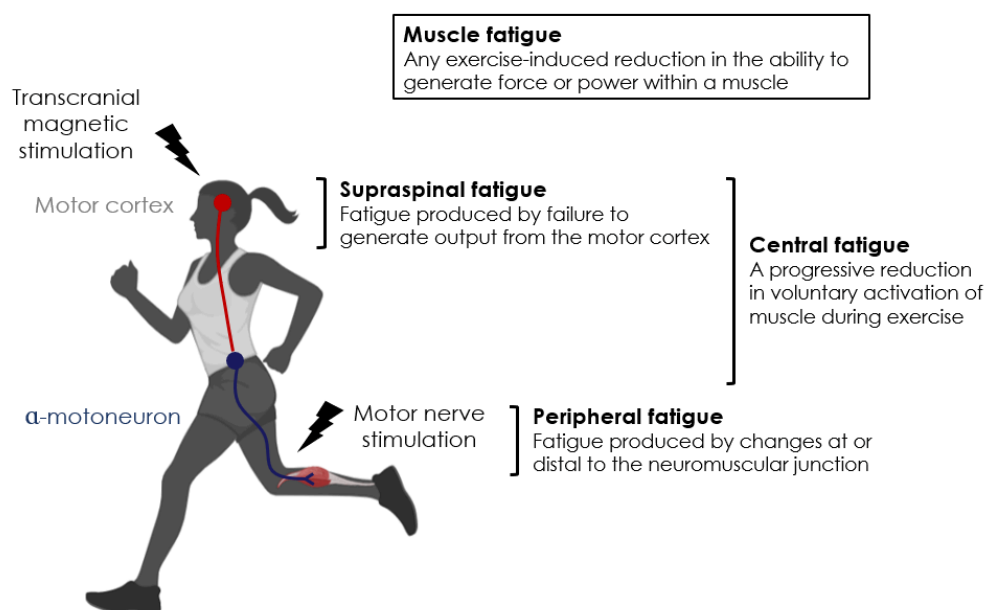

Figure 22. Components of muscle fatigue: peripheral, central and supraspinal fatigue. Peripheral and central fatigue can be detected using nerve stimulations, while supraspinal fatigue is evaluated using transcranial stimulation over the motor cortex. Adapted from Taylor and Gandevia (2011).

As a function of the duration and the intensity of the exercise, it was reported that endurance exercise, including running, generates central and/or peripheral fatigue, which increases with the duration and/or the intensity of the exercise (Azevedo et al., 2021). A recent review (Apte et al., 2021) reported that running-induced acute fatigue results in an increase in contact and aerial time, as well as a decrease in vertical stiffness, MVC peak force produced at the end of the protocols and maximum ground reactions forces. As previously described (Mtibaa et al., 2019), running 30 min at $\sim 15 \text{ km}\cdot\text{h}^{-1}$, induced a decrease in step frequency and an increase in step length, while contact time, aerial time and spring-mass characteristics were unchanged. Running in the heat may exacerbate the fatigue induced by a running exercise given that central nerve control is altered under heat stress ([see p.18](#)).

Hot ambient conditions do not intensify the extent of fatigue-induced changes in sprint kinetics, kinematics and spring-mass characteristics during repeated treadmill sprints (Girard et al.,

2016). In addition, Mtibaa et al. (2019) shows that running mechanics were not impacted differently after a running exercise at self-paced velocity (*i.e.*, 14-15 km.h⁻¹) performed in temperate or hot environment. Although Gutierrez-Vargas et al. (2020) reported an increase in neuromuscular fatigue after running a marathon in hot and humid conditions, neuromuscular performance is also impaired after running a marathon in temperate environment³ (Nicol et al., 1991). Thus, the absence of temperate condition in the study of Gutierrez-Vargas et al. (2020), does not allow to affirm that the observed effects were only due to environmental conditions.

To the best of our knowledge, few studies have reported the effects of heat on the mechanics of running under heat stress. Moreover, the differences observed within the protocols (*i.e.*, duration and velocity of running exercise) make it difficult to develop hypothesis. In the context of sport performance, it seems essential to understand the mechanics of running as well as its underlying mechanisms.

iii. The role of muscle-tendon interactions in movement mechanics

Although, to our knowledge, no study has investigated muscle-tendon unit interactions in an ecological context of heat stress, such measurements are increasingly used to characterize muscle-tendon unit behavior during dynamic tasks (Van Hooren et al., 2020). Ultrafast ultrasound was used to characterize the dynamics of the muscle-tendon unit during walking (Fukunaga et al., 2002; Lichtwark and Wilson, 2006), running (Lai et al., 2018; Ishikawa and Komi, 2007; Swinnen et al., 2022), and jumping (Farris et al., 2016; Hollville et al., 2019). The measurement of GM fascicles length and pennation angle at a sampling frequency of 43 Hz during treadmill running at 10.8 km.h⁻¹ reported a good intra-session and inter-session reproducibility (Giannakou et al., 2011). The use of ultrasound may represent a viable approach to improve our understanding of the contribution of muscle and tendon structures to running stride patterns.

It has been shown that the variation of GM L_F is significantly smaller than the shortening of the muscle-tendon unit during walking and running, highlighting the role of soft tissue in such locomotor tasks (Ishikawa et al., 2007). Previous studies have also demonstrated the importance of elastic properties of muscle and tendon in understanding muscle efficiency during running (Lichtwark et al., 2007; Lichtwark and Wilson, 2008). During running, GM fascicles shorten throughout the stance phase, while the Achilles tendon and other series elastic elements

³ The environmental conditions and/or the season not being specified in the study, we suggest that the environmental conditions were temperate.

involved an initial stretch prior to a recoil during the following push-off phase (Lichtwark et al., 2007). Varying tendon stiffness may therefore constitute a mean to modulate muscle contractile behavior, muscle mechanical work and metabolic energy consumption (Lichtwark et al., 2007; Lichtwark and Wilson, 2008). Indeed, a change in tendon stiffness would affect the functional range of fascicles, and thus their fascicles operating length and shortening velocity. This adaptation may influence mechanical output during contraction (Hager et al. 2020; Mayfield et al. 2016) and in turn alter the conditions for muscle work production. However, after a specific training protocol increasing Achilles tendon stiffness, Werkhausen et al. (2019b) reported unchanged GM and SOL fascicle dynamics during running at $\sim 10 \text{ km}\cdot\text{h}^{-1}$, despite a tendon recoil reduced. These results highlight that studying muscle-tendon interaction is complex, and that all mechanisms must be investigated to allow a more complete understanding of the task performed. Studying the dynamic of fascicles during running allowed to highlight that an increase in running velocity induces an increase in V_F (Farris and Sawicki, 2012) and a greater contribution of elastic structures to the energy generated by the muscle-tendon unit (Monte et al., 2020).

Lichtwark et al. (2013) found that Achilles tendon lengthened during a 5-min self-paced run (*i.e.*, $10\text{-}14 \text{ km}\cdot\text{h}^{-1}$), which could conduct to a decreasing sensitivity of short-latency reflex, present in muscle fatigue (Avela et al., 1999). However, this effect was small in amplitude and not accompanied by a change in Achilles tendon stiffness (Lichtwark et al., 2013), suggesting a mechanical creep rather than an exercise-induced fatigue. When extending this consideration to various muscle groups, the shear modulus of *flexor digitorum longus* and *tibialis posterior* has been reported to increase immediately after a 30-min running task at $12 \text{ km}\cdot\text{h}^{-1}$ on treadmill, while *gastrocnemius lateralis* (GL), GM, *peroneus longus* and *peroneus brevis* shear modulus was unchanged (Ohya et al., 2017). The same exercise does not affect the Achilles tendon stiffness or the Achilles tendon properties (*i.e.*, peak Achilles tendon strain during the stance phase; obtained at 1, 15 and 30 min) measured before and after a running exercise (Farris et al., 2012). One could wonder whether the effects are maintained over 30 min?

Beyond 30 min, even at relatively low intensity, the appearance of fatigue could impact the behavior of fascicle, with a decrease in proximal GM V_F , as demonstrated in animals (Higham and Biewener, 2009). Achilles tendon stiffness assessed one hour after a marathon (average velocity: $11.2 \text{ km}\cdot\text{h}^{-1}$) was unchanged (Peltonen et al., 2012), without providing the obtained effects just at the end of the race. Therefore, it is not possible to state that Achilles tendon stiffness just at the end of the marathon would also be unchanged. As the morphological and

mechanical properties of the Achilles tendon and the architecture of *triceps surae* muscle are correlated with running metabolism (Machado et al., 2021), understanding their responses during running, and especially in hot environment, appears to be a major challenge in understanding performance under heat stress.

Muscle mechanical properties, such as force-velocity and force-length relationship were previously used to characterize operating length and velocity of lower limb muscle (*e.g.*, GM, SOL, *vastus lateralis*) during running. These works have highlighted the important contribution of the series-elastic components to *vastus lateralis* fascicles dynamic (Bohm et al., 2018), or an inverse relationship between the force-length-velocity potential of the SOL and the energetic cost (Bohm et al., 2019). In studies investigating different running velocity, it was reported that the operating L_F behaved differently depending on the muscle considered [*i.e.*, GM and *vastus lateralis*; (Monte et al., 2020)]. While both muscles contracted close to their L_0 , as running velocity increased, the GM L_F operated toward a smaller length, and the *vastus lateralis* L_F toward a longer length (Figure 23A). Force-velocity relationships were also built, reporting a higher contraction velocity with increasing running velocity for GM fascicles, whereas the contraction velocity was decreased with increasing running velocity in *vastus lateralis* (Figure 23B).

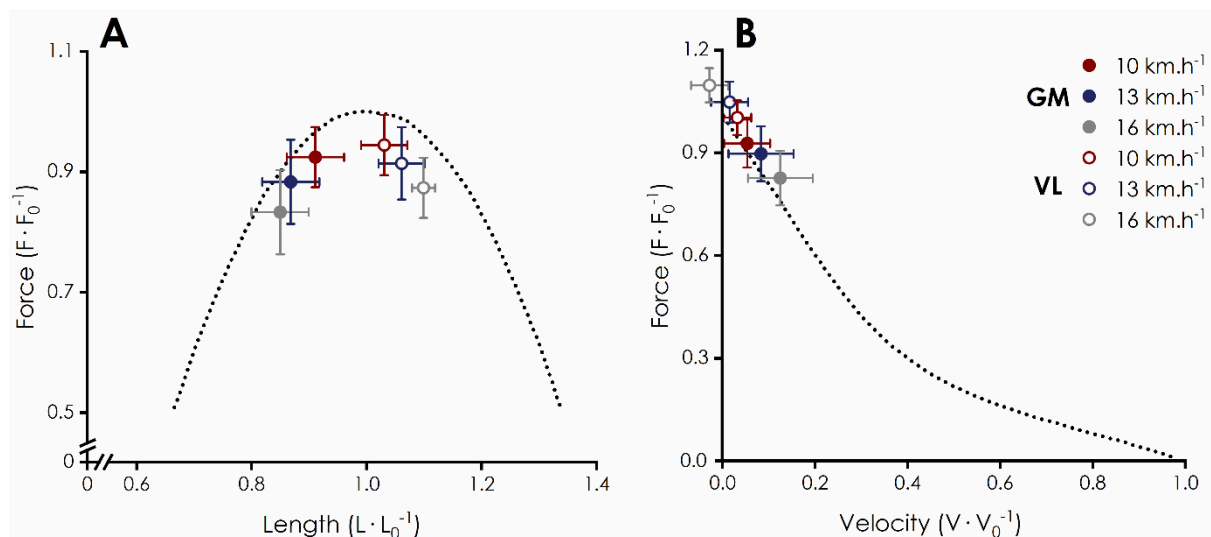

Figure 23. Operating fascicle length (A) and velocity (B) of gastrocnemius medialis (GM, full circles) and vastus lateralis (VL, empty circles) during the stance phase of running on the normalized force-length and force-velocity relationships. Each color corresponds to a running velocity: 10 (red), 13 (blue) and 16 (grey) km·h⁻¹. Adapted from Monte et al. (2020).

This study also highlights that the contribution of elastic storage energy increases more for GM than *vastus lateralis* with increasing running velocity, which is attributed to the fact that distal

limb muscle may facilitate the storage and recovery of elastic strain energy from the tendon (Biewener and Roberts, 2000).

The SOL force-length relationship revealed a significant relationship between the operating length of the muscle fascicle and the metabolic cost of cyclic production: increasing the operating muscle L_F may reduce metabolic energy expended during locomotion (Beck et al. 2022). Indeed, when producing a constant force, shorter L_F elicits neuromechanical changes leading to an increase in the metabolic energy expenditure required to produce force. This effect can be attributed to the higher cost of cross-bridge cycling and ion pumping, given that at a lower L_F action-myosin overlap is reduced and lengthening force increased.

Recently, Swinnen et al. (2022) reported that increasing or reducing preferred stride frequency during running exercise at 12 km.h⁻¹ resulted in less optimal fascicles force production, operating at shorter lengths. These findings could explain the augmentation in metabolic energy expenditure observed when deviating from the preferred stride frequency, for which the metabolic energy expenditure was more optimal. This study highlights a link between stride frequency, L_F , muscle metabolic energy expenditure and therefore whole-body metabolic energy expenditure. As a result, investigating fascicle operating length during running appears interesting from a biomechanical point of view, with direct implications on the physiological parameters involved during running.

In the context of damaging exercise, backward downhill walking has been shown to rightward shift GM optimal L_F measured 2 h post-exercise. Moreover, the contribution of tendon tissues to the overall stretch of the muscle-tendon unit reached up to ~91%, suggesting that Achilles tendon plays a major role in attenuating muscle fascicle strain during the damaging protocol (Hoffman et al., 2014). The trend of decreasing soft tissue stiffness with increasing tissue temperature ([see p.46](#)) may suggest that the manipulation of tissue temperature could influence the processes of internal energy storage-release during each running stride and thus the mechanics and economy of running. A reduction in tissue stiffness could lower the velocity of muscle shortening (Roberts et al., 1997), and shorten the initial muscle L_F at the onset of contraction (Ishikawa et al., 2007). If the fascicles operate at shorter lengths, the force generated could also be modified, especially if this operating length is shifted to the left, toward the ascending part of the force-length relationship. A decrease in soft tissue stiffness, which may be potentially induced by heat exposure, may therefore decrease the efficiency of the muscle-tendon unit during muscle contraction, and could lead to an increase in metabolic cost (Núñez

Lisboa et al., 2021). Such mechanism could add physiological stress to the overall stress that would already be present when running in hot environment.

Overall, studying fascicle dynamics *in vivo* during running and the associated muscle and tendon stiffness would provide a better understanding of tendon elastic energy storage and muscle contractile behavior during running. Such investigations offer the opportunity to better understand the mechanical factors underlying movement production, their sensitivity to any form of intervention, as well as the consequences involved on different functions (*i.e.*, metabolic, energetic and mechanical). Adding heat stress would address current issues by providing an *in vivo* integrative dynamics of muscle function in response to hot conditions.

PART 2 – Summary

- Literature reported that heat-induced effects would tend to increase the velocity of muscle shortening and decrease soft tissue stiffness. However, such effects remain to be investigated *in vivo* in humans under physiological temperatures.
- The mechanisms underlying the changes in muscle mechanical properties observed following heat stress (acute or chronic) could be investigated *in vivo*, thanks to the advent of ultrafast ultrasound. This approach allows to explore the role of muscle-mechanical properties (*i.e.*, force-length and force-velocity relationships) and soft tissue stiffness *in vivo* in human movement and their sensitivity to heat stress.
- Although muscle-tendon unit interactions are increasingly investigated during locomotion (*i.e.*, walking, running), such interactions remain poorly studied under hot conditions and *in situ*. Muscle-tendon unit properties being highly solicited during running, their contribution appears fundamental to understand and to describe the effects induced by heat on mechanical properties and motor performance.
- The limited data in the literature do not allow to characterize or to build strong hypotheses about the mechanical properties of muscle-tendon unit in response to chronic heat exposure. The study of muscle mechanics could therefore improve our understanding on muscle performance after HA, and potentially explain some of the mechanisms involved in the potential increase in force production, which has been previously described in the literature.

RESEARCH QUESTIONS AND AIMS OF THE THESIS

Heat exposure, whether acute or chronic, passive or active, is a strong modulator of human physiology. By inducing an increase in T_{core} , hot environment impacts the ability to produce and transmit force and therefore to generate movement. This sensitivity of human motor skills to temperature may result in substantial alterations of performance in sport settings. In the current context of global warming, human athletes are increasingly exposed to such hot environmental conditions: to train, to prepare for competitions and to compete. **While physiological responses are well described in the literature, muscle-tendon properties and interplay still require investigations to provide a more comprehensive understanding of human body responses under heat stress.**

In vivo, acute heat stress inducing high levels of T_{core} (*i.e.*, $\geq 38.5^{\circ}\text{C}$) may impact muscle contraction mechanisms. Conversely, repeated heat exposure would tend to have a positive effect on force-generating capacity, although the underlying mechanisms remain to be elucidated. The advent of ultrasound techniques allows to better understand the mechanisms involved in muscle force production, movement and sport performance.

We focused on GM muscle-tendon unit complex, a multi-joint model for which the application of ultrasound techniques is particularly suitable and demonstrated to be reliable. The main advantage of assessing plantar flexors is that the investigated muscles have short fascicles compared to thigh muscles. Ultrasound probes having limited analysis area (*i.e.*, usually between 4 and 8 cm), an extrapolation of the length of fascicles should therefore be performed when a part of the fascicle is not visible on the collected images.

In the context of sport performance, the experimental contribution of this PhD has focused on whole-body heat exposure, commonly encountered by the athletes during preparation phase (*i.e.*, HA), regular training and/or competitions in the heat.

A preliminary study to this thesis work ([see p.189](#)), investigated **the effect of a passive heat exposure on the electromechanical delay and its components**. This study reported a reduction in electromechanical delay under heat stress associated with an acceleration of electrochemical processes (*i.e.*, synaptic transmission, action potential propagation through the sarcolemma, and excitation-contraction coupling), while force transmission along the

aponeurosis and Achilles tendon was unchanged. This first step improved our understanding of the mechanisms involved in the improvement of contractile properties previously reported following an acute heat exposure. This preliminary investigation also opens the opportunity to further describe the role of muscle-tendon dynamics in heat-mediated effects on motor capacities.

Sequencing the different phases composing the voluntary RFD (*i.e.*, early: 0-100 ms and late phase: 100-200 ms, from the onset of force production) would further explore this research path and would allow us to dissociate the potential effects of heat on the different mechanisms involved in explosive force production. Constructing the force-velocity relationship at the ankle joint level and at the GM fascicle level, together with an assessment of soft tissue stiffness, would serve to characterize the contribution of muscle-tendon unit in force production and transmission processes involved under heat exposure. Therefore, the main objective of the [study #1](#) was **to examine the effects of passive heat exposure on GM muscle-tendon complex properties, to characterize the role of the muscle-tendon unit interactions in the heat-induced changes in RFD**. It was hypothesized that V_F might increase, resulting in a rightward shift in the force-velocity relationship for a given fascicle force. We also expected that soft tissue stiffness would remain unchanged or even decrease.

Fascicle force-length relationship allows to characterize the operating length of fascicles during locomotion (*i.e.*, walking, running). Investigating fascicle dynamics during a running exercise coupled with the assessment of force-length properties would improve our understanding of the mechanistic of muscle involved and its responses to heat. The changes associated with soft tissue stiffness to heat would likely play an important role in protecting muscles from stretch during energy absorbing activities, including running. The objective of [study #2](#) was **to investigate the acute effects of heat exposure on muscle-tendon interactions and fascicle dynamics during running. This work allowed to position fascicle dynamics of the GM fascicle during the running exercise in regards to the theoretical fascicle force-length relationship, to describe the mechanical factors underlying the production of movement, and to assess the effect on such exercise on soft tissue stiffness**. We hypothesized that soft tissue stiffness could be reduced during running in the heat, potentially shifting the operating length of the fascicles on the ascending limb of the force-length relationship.

Lastly, repeated heat exposure (*i.e.*, HA) is increasingly used by athletes to cope with the physiological impairments induced by exercising in a hot environment. A better understanding would provide practical recommendations to coaches and athletes on HA-induced effects on properties involved in processes of force production and transmission. Therefore, the aim of [study #3](#) was **to determine the mechanical adaptations of GM muscle-tendon unit and their subsequent impact on motor performance following active HA** (*i.e.*, training in the heat) *vs.* a similar training under temperate conditions. It was hypothesized that active HA would improve skeletal muscle contractility. Nevertheless, the effect on muscle-tendon unit properties was exploratory since, to the best of our knowledge, there is no investigation exploring the effect of such intervention on tissue stiffness and force-velocity relationships of joint and fascicle

GENERAL EXPERIMENTAL METHODOLOGY

This chapter describes the general methodology of the experiments carried out within the framework of this thesis. A specific part is thereafter dedicated to the experimental protocol of each study. All the experiments were carried out within the Sport, Expertise, and Performance (SEP) laboratory, at the French Institute of Sport (INSEP).

All the measures presented below have been approved by the Sud-Ouest et Outre-mer III ethics committee (approval reference: 3849, ID-RCB: 2019-A00596-51) and conformed to the standards of the Declaration of Helsinki.

1. Participants

Healthy and active participants, males and females, took part in the three studies of this thesis, their characteristics are represented in Table 1. For all studies, exclusion criteria were: recent temperature-manipulation program, lower-limb injury, involvement in lower-limb resistance training, illness, pregnancy, being under 18 years of age. Participants were instructed to avoid vigorous activity for the 24 h preceding each testing session.

Table 1. Characteristics of participants recruited in each study.

Study	Number of participants	Age (years)	Height (cm)	Weight (kg)
1	16 (9♂, 7♀)	24.9 ± 5.7	174.8 ± 7.5	69.8 ± 9.9
2	15 (8♂, 7♀)	26.2 ± 3.0	172.9 ± 5.7	64.9 ± 8.0
3	30 (16♂, 14♀)	26.6 ± 3.4	172.7 ± 8.7	68.9 ± 8.5

2. Design of studies

The three experiments used whole-body heat exposures performed in an environmental chamber (Thermo-training room, Paris, France). The **study #1** used a model of passive heat exposure ($47.4 \pm 1.8^\circ\text{C}$, $18.5 \pm 4.7\%$ RH). The **studies #2** and **#3** used a model of active heat exposure, and the environmental temperature was lower than for **study #1** ($37.9 \pm 0.7^\circ\text{C}$, 41.9

$\pm 4.6\%$ RH and $38.1 \pm 0.4^\circ\text{C}$, $57.9 \pm 2.3\%$ RH for **study #2** and **#3**, respectively). The measurements were carried out in temperate environments (*i.e.*, control, or pre- and post-intervention testing for **study #3**) and took place at ambient temperature and RH of the laboratory ($\sim 22\text{-}25^\circ\text{C}$; 34-40% RH).

For **study #1**, the 16 participants were tested before and immediately after the end of the passive heat exposure (*i.e.*, cross-over study design). In **study #2**, the 15 participants were tested before and immediately after the end of an active heat exposure performed randomly in hot or temperate environment (*i.e.*, cross-over study design). The participants of **study #3** were evenly distributed in two distinct experimental groups, 15 in each, who were tested before and two days after a training protocol performed either in hot or temperate environment (*i.e.*, cohort study⁴).

3. Physiological monitoring

1. Body temperature

The T_{core} was monitored rectally using an electronic capsule (e-Celcius; BodyCap, Caen France) self-inserted by the length of a gloved finger. This technique is more comfortable than conventional rectal probes and has been shown to provide reliable measurements of T_{core} (Gosselin et al., 2019).

To measure T_{skin} , participants were instrumented with four data loggers (iButtons, Maxim Integrated, USE), attached to the skin with tape. The average T_{skin} was calculated as (Ramanathan, 1964):

$$T_{\text{skin}} = 0.3 \times T_{\text{arm}} + 0.3 \times T_{\text{chest}} + 0.2 \times T_{\text{thigh}} + 0.2 \times T_{\text{shin}} \quad (\text{Equation 3})$$

In **studies #1** and **#3**, T_{musc} was measured in a subsample of participants (respectively, 6 and 15), while it was not measured in **study #2**, due to logistical constraints. T_{musc} was measured by a medical doctor immediately at the end of the intervention, whether passive or active, in the middle of the GM belly, at its thickest portion. An intramuscular thermistor needle (MKA08050-A, Ellab, Roedovre, Denmark) was inserted at ~ 1.5 cm from below the skin under local anesthesia (Xylocaïne, 3 mL).

⁴ Designation of studies are in accordance with the categorization proposed by the American Journal of Sports Medicine in the submission Guidelines.

2. Heart rate

Heart rate was measured with a chest strap heart rate monitor (Garmin, Olathe, United-States). In **study #1** (passive), heart rate data was measured to check participants' health and safety without specific post-collection analysis. In **studies #2** and **#3** heart rate was monitored continuously to check participants' cardiovascular heat-responses during the intervention, and thereafter averaged over the session, or analyzed at specific time points (see methods of each study).

3. Hydration and Sweat rate

Before starting heat exposure, urine specific gravity (USG) was collected, using a calibrated refractometer (PAL-10S, Atago, Tokyo, Japan), in order to check the level of hydration of the participants. If $USG \geq 1.020$, participants had to drink 500 mL of water before starting the session. During the experimental procedures, participants could drink *ad libitum* and body mass was measured before and after heat exposure. Sweat loss was calculated from the loss in body mass measured after the end of the considered exercise corrected with the amount of water consumed during the intervention.

4. Perceptual responses

For active studies (*i.e.*, **studies #2** and **#3**), perceptual ratings were collected. Thermal sensation [1 to 7: cold to hot (ASHRAE, 1966)], thermal comfort [1 to 7: too cool to much too warm (Bedford, 1936)] and rate of perceived exertion [RPE; 6 to 20: no exertion at all to maximal exertion (Borg, 1982)] were asked to participants throughout the sessions. These ratings were thereafter averaged over the session, or analyzed at specific time points.

4. Mechanical measurements

1. Ergometry

i. Ballistic and isometric contractions

A customized ergometer (Goubex, Bio2M, Compiègne, France; Figure 24A) was used for mechanical measurements during ballistics (Figure 24B), or isometric contractions (Figure 24C).

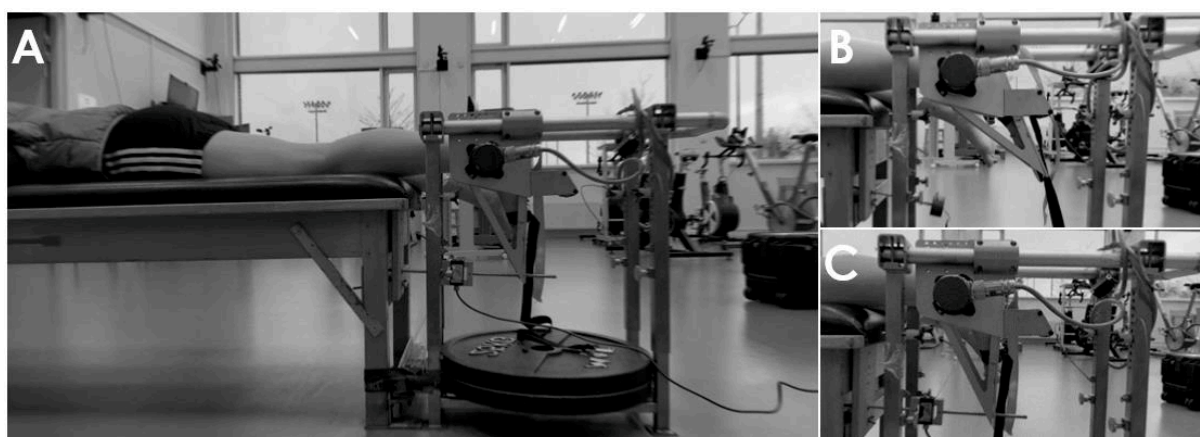

Figure 24. **A:** Goubex ergometer, composed of a bench and an aluminum pedal connected to an angle sensor. **B:** The footplate rotates when force is applied, e.g., during ballistic contractions (**studies #1 and #3**). **C:** The footplate was fixed at 90°, and connected to a force sensor allowing plantar flexor force measurements during isometric contractions performed in the environmental chamber (**studies #1 and #2**).

Regardless of the contraction type considered, participants lay prone on a bench with extended hip (0°) and knee (0°), with their right ankle flexed at 90° (foot perpendicular to the tibia), and their right foot firmly fixed on a footplate. For ballistic contractions, the footplate rotated between 110 and 60° (Figure 24B), and was connected to an angle sensor to provide ankle angle measurements (Lambertz et al., 2008). An electromagnet was used to maintain the starting position in dorsiflexion (*i.e.*, at 110°), its resistance was adjusted for each participant to compensate passive force resulting from elastic structures stretching at a 90° ankle angle. Participants performed plantar flexions in isoinertial mode with no external load (0 kg), or loaded at light loads (*i.e.*, 1.2 and/or 2.6 kg; **studies #1 and #3**).

This specific ergometer was also used to perform isometric contractions in hot conditions (**studies #1 and #2**). To do so, the footplate was secured at 90° (Figure 24C) with a force sensor (2712-100 daN-0.02-B; Sensy, Charleroi, Belgium) fixed below the plate at the level of the third metatarsal. For both contractions' types, the position of thighs and hips of the participants was secured with adjustable belts, to avoid compensation.

ii. Isokinetic contractions

A mechatronic ergometer, co-developed by the French start-up Eracles-technology and our laboratory⁵ was used for measurements in isokinetic resistance modality. Just as described

⁵ Laboratory Sport, Expertise and Performance (SEP, INSEP). This development was done in 2016 as a part of the PhD work of Robin Hager (2019).

above with the Goubex, participants lay prone on the bench with extended hip (0°), knee (0°), and their right ankle between ~ 113 and 60° (90° corresponding to the ankle perpendicular to the tibia, angles $> 90^\circ$ corresponding to the dorsiflexion and $< 90^\circ$ to the plantar flexion). Their right foot was firmly fixed to a specific accessory adapted for foot fixation (Figure 25A).

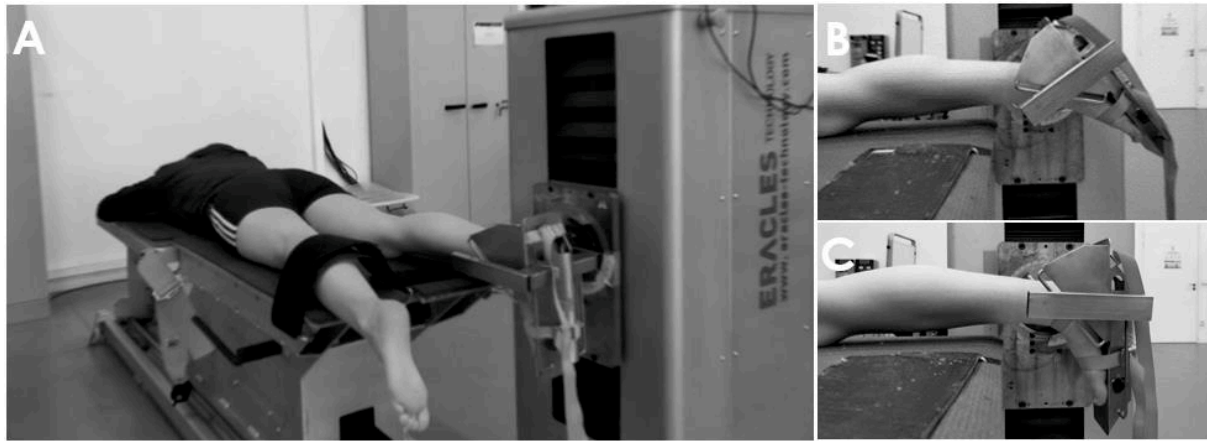

Figure 25. **A:** Eracles ergometer, composed of a bench and recording torque, angle and velocity signals. **B:** Ergometer used in isokinetic mode (active or passive; **studies #2 and #3**). **C:** Ergometer used in isometric mode (**studies #2 and #3**).

This ergometer was used to perform contractions against isokinetic resistance modality (at 30, 200 and $400^\circ \cdot s^{-1}$; Figure 25B; **study #3**), passive torque measurements (at $5^\circ \cdot s^{-1}$; Figure 25B; **study #2**), and isometric contractions (at 90° , or over the range: ~ 113 - 60° ; Figure 25C; **studies #2 and #3**), which were performed in temperate environments. Torque, velocity and angle mechanicals signals were recorded by the ergometer. For each type of measurements, the thighs and hips of the participants were blocked with adjustable belts, to avoid compensation or body movements.

2. Mechanical output

All mechanical signals provided by the ergometers (*i.e.*, Goubex and Eracles) were digitized by a 12-bit analog to digital converter (DT 9804, Data Translation, Marlboro, USA) at a sampling frequency comprised between 1000 and 4000 Hz (see methods section of each study for details). Data were thereafter analyzed using custom-written scripts (Origin 2020-2021, OriginLab Corporation, Northampton, PA; and Matlab 2017-2021, The Mathworks, Natick, MA). Mechanical signals were filtered using Butterworth low-pass forward-backward filtering, for zero phase shifting. Orders and cut-off frequencies were adapted to the considered movements and sampling frequency used. The torque measured by the Eracles ergometer was corrected for

the inertia and gravity of the accessory and foot, to obtain the external torque exerted by the participant at the considered joint (*i.e.*, ankle).

i. Voluntary contractions

In each study, 5-s isometric MVC, interspaced by a 2-min rest period, were performed. MVC peak force values corresponded to the maximal force value over a 500 ms moving window, and the best trial was considered for further analysis.

The RFD was determined during explosive isometric contractions in **studies #1** and **#3**. For **study #1**, RFD and MVC peak force were assessed in the same repetition to avoid fatigue occurrence (Hager et al., 2020), while the trials were separate for **study #3**, with shorter contractions (*i.e.*, ~1 s) for RFD measurements. Participants were instructed to contract “*as fast and hard as possible*” without any countermovement or pre-tension prior to the contraction onset (Maffiuletti et al., 2016). Force onset was detected using a semi-automatic script. Briefly, force signals were viewed with a constant scale (*e.g.*, 500 ms vs. 1 N). Then, a vertical cursor was placed on force onset displayed with a higher resolution to verify the position of the vertical cursor (Tillin et al., 2010). After low-pass forward–backward filtering, the two trials resulting in the highest RFD over 200 ms from contraction onset were averaged for analysis. RFD was calculated for specific time phases as the change in force divided by the corresponding time window: from 0 to 100 ms, 0 to 200 ms and 100 to 200 ms.

Regarding high velocity conditions (*i.e.*, ballistic contractions performed on the Goubex; **studies #1** and **#3**), angular velocity was computed as the derivative of ankle angle over time, and the external torque was calculated from the following equation:

$$C_{ext} = \dot{\omega} \times \Sigma I + C_p \quad (\text{Equation 4})$$

where $\dot{\omega}$ is the acceleration of the joint, ΣI corresponds to the sum of the inertias present in the system considered (*i.e.*, foot and additional loads), and C_p represents the moment of inertia and the weight of the foot.

The inertia of the foot in relation to the center of rotation of the ankle (I_p , Equation 5), and the inertia of additional loads (I_{CA} , Equation 6), were calculated according to the parallel axis theorem (De Leva, 1996):

$$I_p = m_p \times d_{C-CM_p}^2 + m_p \times r_C^2 \quad (\text{Equation 5})$$

$$I_{CA} = m_{CA} \times r_{CA}^2 \quad (\text{Equation 6})$$

where m_p is the mass of the foot, calculated by the multiplication of the total weight of the participant (in kg) by a segment mass coefficient, which was adapted according to the sex of the participant (*model 1*; Table 2). d_{C-CM_p} is the distance between the center of rotation of the ankle and the center of mass of the foot, obtained with the multiplication of the foot length (in m) by *model 2* (Table 2). r_C corresponds to the radius of rotation of the foot relative to the center of the ankle joint, obtained with the multiplication of the foot length (in m) by *model 3* (Table 2). m_{CA} is the mass of the additional load (*i.e.*, 1.2 or 2.6 kg), and r_{CA} the radius of rotation of the additional load relative to the ankle joint (El H elou, 2011).

Table 2. Applied anthropometrical coefficients according to the sex of the participant.

	<i>model 1</i>	<i>model 2</i>	<i>model 3</i>
♂	0.0137	0.4415	0.257
♀	0.0129	0.4014	0.299

For isokinetic contractions (**study #3**), mechanical signals (*i.e.*, torque, velocity and angle) were directly obtained from the ergometer and retrieved through the analog to digital converted data, before being filtered and analyzed, as well as for passive torque measurements (**study #2**).

The Goubex provided force values in N (*i.e.*, isometric measurements), while other tests performed on the Goubex or the Eracles provided us torque values in N.m (*e.g.*, external torque calculated from ballistic contractions on the Goubex, isometric and isokinetic torque provided by the Eracles). Therefore, the value of the lever arm of the ankle joint was required to convert the torque in force, by dividing the torque by the level arm.

The lever arm (L_{BDL}) was estimated using the model proposed by Grieve et al. (1978), from the ankle joint angle and an anthropometric measurement (Hoang et al., 2005):

$$L_{BDL} = \frac{1.8}{\pi} \times L_S \times [A_1 + (2A_2 \times \theta)] \quad (\text{Equation 7})$$

where L_S (in m) corresponds to the length of the shank, defined as the distance between the assumed centers of rotation of the knee and ankle joints (Grieve et al., 1978), the coefficients A_1 and A_2 respectively correspond to 0.30141 and -0.00061, and θ (in $^\circ$) is the instantaneous angle ankle.

We decided to choose this method as a correct and simple technique which allows to adapt the lever arm for each ankle angle.

ii. Electrically-evoked contractions

For electrically-evoked contractions, the tibial nerve was electrically stimulated using a constant current stimulator (DS7AH, Digitimer, Letchworth Garden City, UK), delivering a single or double electrical pulse through a cathode placed in the popliteal cavity and an anode placed distally to the patella. The intensity was adjusted for each participant by a progressive increase in amperage until plantar flexors force reached a plateau. Thereafter, stimulations were delivered at 150% of the electrical intensity required to elicit peak force (Racinais et al., 2013). Single pulses (200 μ s) were used to describe muscle contractile properties, and to obtain the following characteristics: PT amplitude, CT, HRT and RFD (calculated as PT/CT) ([see p.19](#); Figure 7).

The level of VA was measured during MVC with two doublets stimulations (100 Hz): a superimposed stimulation when force reached a plateau, and a potentiated stimulation delivered \sim 2 s after the end of the contraction. VA was determined as follows:

$$VA = (1 - \text{superimposed doublet} / \text{potentiated doublet}) \times 100 \quad (\text{Equation 8})$$

Then, to determine the torque produced at each muscle length or joint angle (*i.e.*, force-length relationship, **study #2**) supramaximal peripheral nerve stimulation were applied using a double-pulse stimulation (200 μ s, frequency: 100 Hz).

5. Mechanical properties of the muscle-tendon unit

1. Ultrafast ultrasound

i. Principles

All the studies of this thesis were based on the analysis of GM fascicles dynamics, performed using an ultrafast ultrasound (Aixplorer, Supersonic Imagine, Aix en Provence, France), and an ultrasound probe (5-12 MHz, SuperLinear 15-4, Vermon, Tours, France). It was possible to save up to 1000 images. The sampling frequency was therefore set specifically according to the velocity of the analyzed movement, between 100 Hz (*i.e.*, 10 s recording) and 2000 Hz (*i.e.*, 0.5 s recording; details are provided in the methodological part of each study). The probe was encapsulated into a custom cast over the right GM muscle belly, to secure the probe on

participants' calf muscle and to ensure that it does not move throughout the various tests performed. The probe was systematically placed on the surface of the skin, by the same investigator, in the same plane as the muscle fascicles, to minimize two-dimensional measurements errors, due to the established three-dimensional behavior during muscle contraction (Bénard et al., 2009; Randhawa and Wakeling, 2018). Ultrasonic gel was applied between the probe and the skin to exclude the presence of air and to obtain a better conduction of the ultrasound waves within the tissues. The probe was placed on the GM muscle belly, ensuring that no veins appear during muscle contraction, while maintaining optimal probe angulation and rotation to align ultrasound images with fascicle plan [Figure 26A; (Bolsterlee et al., 2016)].

Near-optimal alignment was permitted by maintaining probe tilt at 0° and applying a slight rotation of the probe [Figure 26B; (Bolsterlee et al., 2016)].

Ultrasonic images recorded in resting condition, ankle angle at 90° , were analyzed (Image J, National Institutes of Health, Bethesda, USA) to determine GM muscle architecture: L_F , pennation angle and muscle thickness.

For studies requiring multiple visits (**studies #2** and **#3**), it was necessary to reposition the ultrasound probe as identical as possible between two testing sessions. For that purpose, once the probe was positioned at an optimal location, as described above, the probe was moved until a vein appears on the image. This technique provided an anatomical marker for repositioning the probe in the next session without affecting the image quality. Once the probe was attached, an ultrasound image was captured to ensure proper repositioning of the probe for the next testing session. In addition, once the probe was fixed, a marker was used to identify the location of the cast on the skin to facilitate its repositioning.

The ultrasound image modality used for muscle tracking was the “B-mode” for “Brightness mode”. Plane waves are first transmitted within the tissue via the ultrasound transducers. Then, the probe acts as a receiver, receiving the reflected signals from the tissues located under the probe before digitalizing them into raw radiofrequency signals. Finally, the raw radio frequency signals are converted into B-mode images following a conventional beam-forming procedure considering the reception-transmit time shifts to estimate distances from a constant ultrasonic velocity (beamforming). B-mode images distinguish the contrasts between the tissues and thus differentiate the connective tendinous tissues, which are very echogenic (white-oriented color)

due to their collagen content, from muscle fascicles which are less echogenic (black-oriented color) due to their high-water content (Brennan et al., 2017).

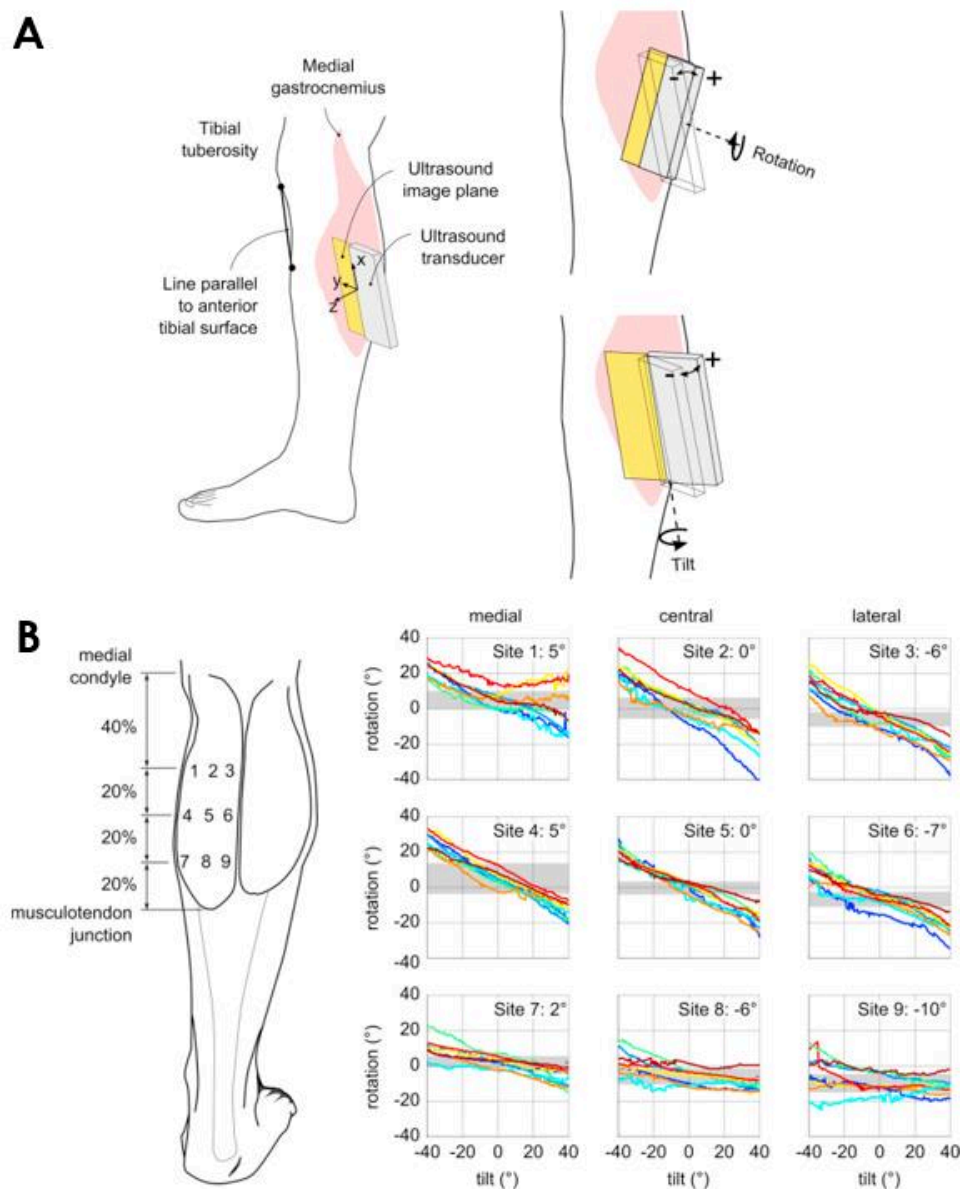

Figure 26. A: Left panel: schematic drawing of the probe (gray rectangular box) positioning in regard to the gastrocnemius medialis (GM) muscle (pink), with the corresponding image plane (yellow plane). **Right panel:** effect of the orientation of the ultrasound probe on the corresponding image plane. **B: Left panel:** location of probes sites used to compare ultrasound probe alignments to the GM. **Right panel:** relationships between probe location and tilt amplitude, based on the different probe location sites (one color per participant). The number in the top right corner of each panel indicates the rotation at which the best alignment was achieved (on average, across participants) at 0° tilt. Grey shaded regions are the mean \pm SD of the optimal rotation at 0° tilt across participants. Figures from Bolsterlee et al. (2016).

Once acquired, the B-mode images were exported. Then a treatment script developed by Farris and Litchwark (2016), and modified by the laboratory Movement, Interaction, Performance

(Nantes University, France)⁶ was used: the UltraTrack method. Two to three muscle fascicles and superficial and deep aponeurosis were systematically identified on the first image of the ultrasound acquisition (Figure 27A), and then tracked automatically on each image of the acquisition to obtain the position of fascicles at each moment of the acquisition, and finally their displacement over time. The L_F corresponds to the distance between the two points crossing the superficial and deep aponeurosis [Figure 27B; (Finni et al., 2003; Hauraix et al., 2015; Werkhausen et al., 2017)].

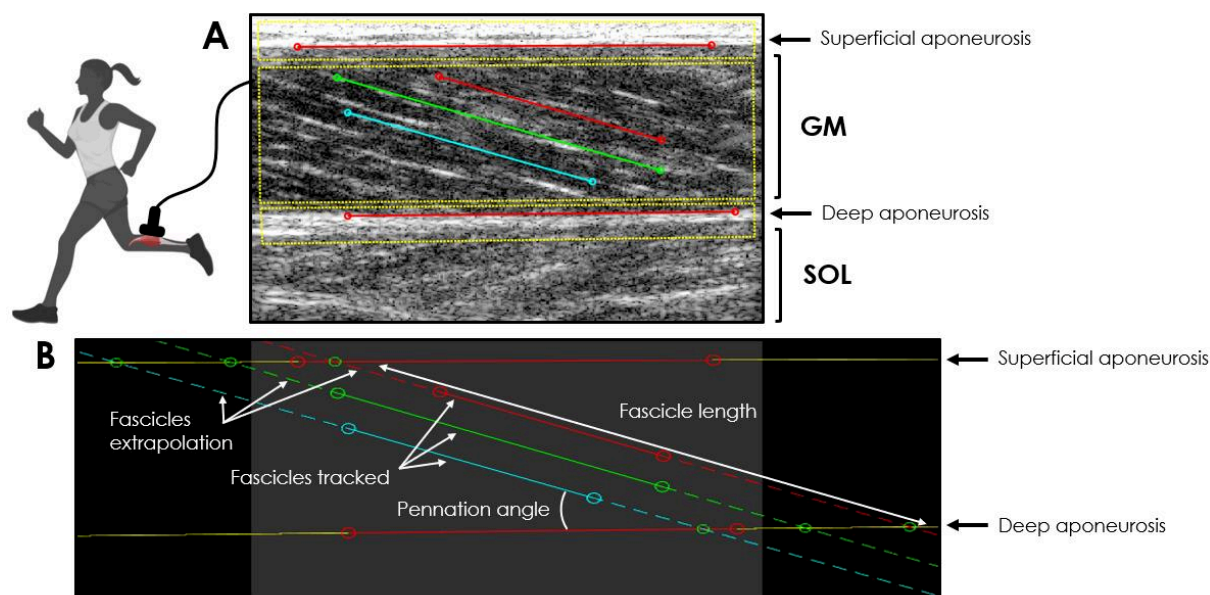

Figure 27. *A: Experimental setup used to collect and process ultrasound images of the gastrocnemius medialis (GM) muscle using UltraTrack software. Muscle fascicles, superficial and deep aponeuroses of the GM identified for tracking. Under the deep aponeurosis there is the soleus (SOL). B: Tracking results from the script: fascicles previously selected (full blue, green and red lines) and fascicles extrapolated (dashed blue, green and red lines), the grey area corresponding to the ultrasound area. Fascicle lengths are calculated for each fascicle as the distance between the two points crossing the aponeuroses (superficial and deep), and pennation angles correspond to the angle of each fascicle with the deep aponeurosis.*

Before calculating the extracted metrics, L_F and pennation angle were low-pass filtered with cutting frequencies adapted to the movement and to the sampling frequency. V_F was obtained from the first derivative of L_F data over time.

Fascicle force was calculated from the GM muscle force [*i.e.*, 20.9% of total plantar flexion force; (Crouzier et al., 2018)], divided by the cosine of the pennation angle.

⁶ Development work carried out by Hugo Hauraix and Valentin Doguet between 2015 and 2019.

ii. Force-length relationship: measurement and reliability

In **study #2**, the force production as a function of L_F was measured, in temperate environment, using the method proposed by Hoffman et al. (2012), which was thereafter used with electrically-evoked contractions (Hoffman et al., 2014), or voluntary contractions (Hager et al., 2020). Briefly, the ergometer was used to set various ankle joint angles as a mean to measure plantar flexor force at various GM L_F from a short length (*i.e.*, plantarflexion), to a longer length (*i.e.*, dorsiflexion), using ultrafast ultrasound (sampling frequency: 1000 Hz). At each tested joint angle, the tibial nerve was electrically stimulated with doublets stimulations (100 Hz). For the five most dorsiflexed angles, stimulations were applied at the maximal dorsiflexion and then every 2° towards plantar flexion (*e.g.*, for a participant with a maximal dorsiflexion angle of 113° , stimulations were applied at $113, 111, 109, 107$ and 105° ; Figure 28A). Other ankle joint angles were evaluated using further stimulations applied with an increment of 5° , until 80° (*i.e.*, slight plantar flexion; *e.g.*, $100, 95, 90, 85$ and 80° for the aforementioned participant; Figure 28A). At each angle change, participants performed brief plantar flexion contractions prior to stimulations to minimize any thixotropic effects (Proske et al., 1993). The peak force and the corresponding L_F were obtained for each tested ankle position. According to the method proposed by Hoffman et al. (2012), the parallel elastic component was considered parallel to the contractile element only (*i.e.*, *model B*). Active force was calculated as the difference between the GM fascicle force (obtained from plantar flexors torque, converted in force and then in GM fascicle force, see above) during the stimulation and the passive force during the contraction. Passive force was determined from the fascicle force-length curve, built using data collected during passive cycles performed at $5^\circ.s^{-1}$ from the maximum dorsiflexion angle to 70° . The torque values at each angle were measured by the Eracles, and thereafter converted in GM force values (see above). Simultaneously, GM L_F was assessed in time with plantar flexor torque, with an ultrasound acquisition (sampling frequency: 100 Hz). Thus, the individual fascicle force-length curve was determined by fitting passive fascicle force data as:

$$passive\ force = Ae^{kL_F} \quad (Equation\ 9)$$

where A is a constant, k is the stiffness of the curve, and L_F the fascicle length (Hoffman et al., 2012).

The peak fascicle force and the corresponding GM L_F were extracted from each ankle angle, and the two trials were averaged to build the fascicle force-length relationship. For each point, the *x*-coordinate was the L_F and the *y*-coordinate was the peak force minus the corresponding

passive force (*i.e.*, at the same L_F on the passive force-length curve). Finally, the active force-length relationship was fitted using a Levenberg-Marquardt algorithm (Hager et al., 2020), and the L_0 and maximal force (F_{\max}) were used to build the normalized force-length relationship.

Although this method has been shown to be consistent and reliable across different sessions (Hoffman et al., 2012), we do not know if this method has a good inter-day reliability. Since this relationship was built to characterize the fascicle operating length during two running sessions (*i.e.*, one in temperate and one in hot conditions), on two separate days, we decided to measure this fascicle force-length relationship before each running session (Figure 28).

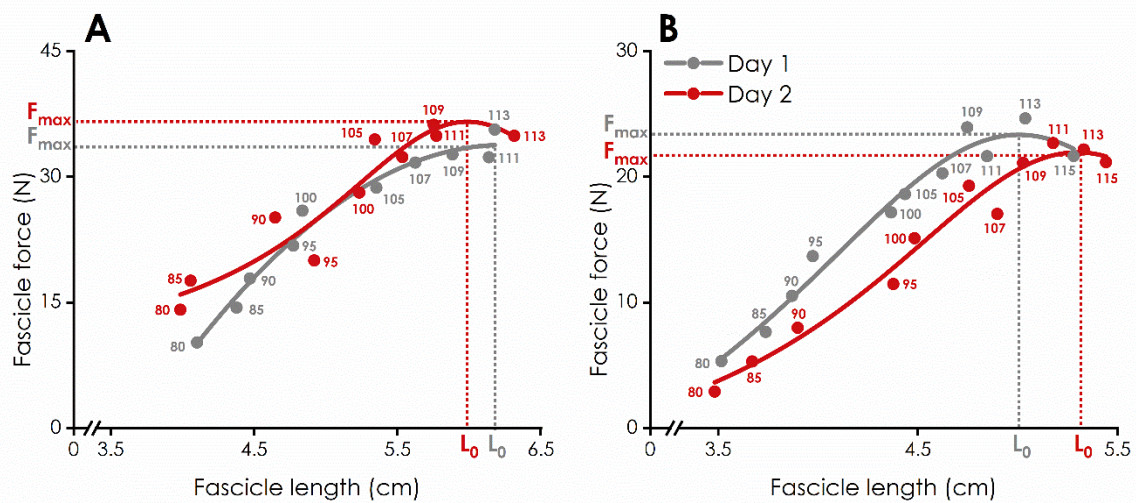

Figure 28. Individual force-length relationship obtained for two participants (**A**, **B**: one panel per participant). The force-length relationship was assessed in temperate environment, before the running exercise whether in temperate or hot conditions. We decided to represent the curves as a function of the measurement day (*i.e.*, Day 1 for the first session and Day 2 for the second), and not according to the environmental condition subsequently tested. For each point, the value of the tested ankle angle is labelled in the graph.

Building the individual force-length relationship before each running session allowed to accurately and confidently describe the fascicle dynamics during running on their force-length relationship, given that the probe was maintained on the calf between the force-length assessment and the running session. Between the two measurements, the key parameters of this relationship (*i.e.*, absolute L_0 and F_{\max}), demonstrated an excellent reliability for L_0 , and a moderate to good reliability for F_{\max} (Table 3).

Table 3. Inter-day reliability indicator obtained for the optimal length (L_0) and the corresponding maximal force (F_{max}).

	Coefficient of variation (%)	Intraclass correlation coefficient	Standard error measurement (%)
L_0	0.31	0.91	2.83
F_{max}	7.05	0.73	8.20

iii. Force-velocity relationship

The force-velocity relationship was determined at the joint and fascicle level for **studies #1** and **#3**. For the **study #1**, four points were used to build this relation, based on ballistic contractions at light loads (0, 1.2 and 2.6 kg), and on the MVC condition. For the **study #3**, five points were used, based on ballistic contractions (0 and 2.6 kg) and isokinetic contractions (30, 200 and 400°.s⁻¹). For each condition three trials were performed. For each trial, velocity and force values (joint and fascicle level) were computed and averaged between 100 and 70° (Hauraix et al., 2015). For each condition, the two trials with the highest mean joint velocity were averaged. Except for the MVC condition for which the trial with the highest force produced was considered.

Then, joint and fascicle force-velocity relationships were determined using the hyperbolic equation (*Equation 2*) proposed by Hill (1938). V_0 was considered as the x -intercept of the force-velocity relationship, and F_0 as the y -intercept, except for the relationships built in **study #1** where F_0 corresponded to the peak force and corresponding fascicle force elicited during MVC.

iv. Achilles tendon stiffness

The method developed in the literature to characterize the mechanical properties of the tendon is based on an incremental isometric contraction, in the form of a ramp. During this progressive contraction, the developed joint force and the displacement of the myotendinous junction are simultaneously measured. Modelling then permits to estimate the force produced by the tendon, and to establish the force-length relation of the tendon (Fouré et al., 2013; Kubo et al., 2007; Maganaris and Paul, 1999) (Figure 29).

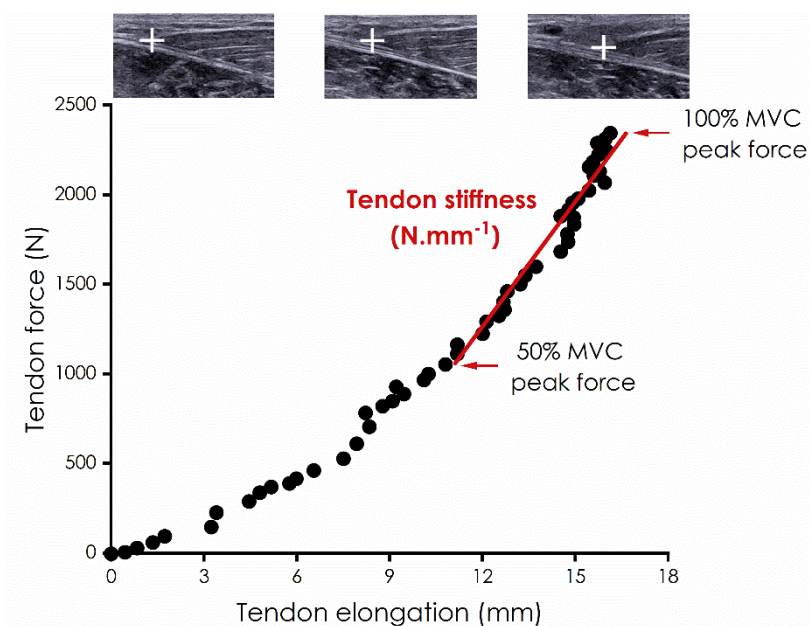

Figure 29. Tendon force-elongation relationship and ultrasound images corresponding to different percentages of maximal voluntary contraction (MVC) peak force production. The slope between 50 and 100% of MVC peak force represents the stiffness of the Achilles tendon. Adapted from Kubo et al. (2007).

Therefore, to determine the active Achilles tendon stiffness (**studies #1, #2 and #3**), participants performed progressive plantarflexions, with the ankle at 90°. They were instructed to linearly increase their isometric plantar flexor force from 0 to 90% of the MVC peak force, within 9 s, using a force visual feedback. The task was performed two or three times (3 min apart) at each test session. The trial resulting in the lowest dispersion of produced force signal according to the targeted force during ramp contraction was considered for analysis. The horizontal displacement of the insertion of GM fascicle on the deep aponeurosis was simultaneously measured by ultrasound (sampling frequency: 100 Hz). The active tendon stiffness corresponded to the ratio between the change in force (converted from torque divided by the lever arm, in **study #3**) and the displacement of the aponeurosis (in mm), extrapolated from the displacement of the crossover point between the muscle fascicle and the deep aponeurosis, between 50 and 80% of MVC peak force (Fouré et al., 2013).

v. Running applications

In **study #2**, GM fascicle dynamics was measured at 2 and 40 min of running on a treadmill (Cosmed, Rome, Italy), at 10 km.h⁻¹. For this, a homemade SL15-4 probe with 6 m long cable was used, and fixed on the GM as previously described ([see p.72](#)). At each measurement period (*i.e.*, 2 and 40 min), three successive ultrasound sequences were acquired from the right GM muscle at a sampling frequency of 500 Hz (*i.e.*, 2 s of acquisition), allowing to analyze between

three to six strides. To synchronize fascicle patterns with the stride (*i.e.*, heel-strike, toe off), a camera (GoPro HERO9; sampling frequency: 240 Hz) was used, and a trigger system was implemented ([see p.82](#)). Before being filtered, L_F and pennation angle data were split into stance and swing phases. Due to the variability in stance and swing phases duration between steps and individuals, data were resampled and interpolated (*i.e.*, spline interpolation) to obtain evenly distributed number of points (*i.e.*, 101 points; time normalization) for both phases to allow between-participants and between-conditions comparisons. Thereafter, fascicle patterns were averaged across steps at each measurement period.

2. Shear wave elastography

The shear modulus was measured as an index of the passive stiffness of the GM (**studies #1, #2 and #3**), and of the GL and SOL (**study #2**). For this, the Supersonic Shear Imaging technique (Bercoff et al., 2004) was used. Briefly, an ultrasonic beam produced by the transducer of the ultrasound probe is focused for several hundred microseconds on the tissue. The different waves generated in the muscle interfere like a Mach cone in which the source propagates faster than the generated shear wave, and creates a flat wave front in the imaging plane [Figure 30; (Deffieux et al., 2008)].

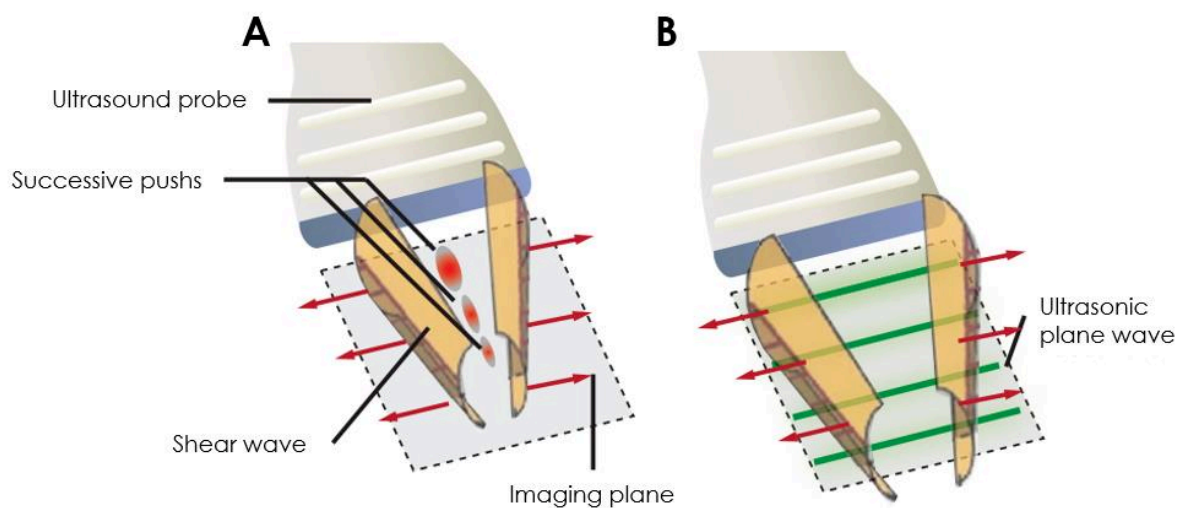

Figure 30. Shear wave elastography method. **A:** Ultrasounds are focused on the tissue to create two shear waves propagating on either side of the probe. **B:** Ultrafast ultrasound mode is used to quantify the propagation velocity of this wave. Adapted from Deffieux et al. (2008).

This disturbance generates shear wave propagating within the muscle. The propagation of this wave is captured via ultrasound images at very high frequency (*i.e.*, 20 kHz). Measuring the

displacement of the shear wave between two successive images allows to quantify the velocity of propagation. The velocity of propagation of this wave is directly related to the tissue shear modulus, and reflects the elasticity, or stiffness, of the tissue. This propagation velocity is proportional to the tissue shear modulus (μ), which reflects the elasticity, or the stiffness of the targeted tissue (*Equation 10*). The higher the propagation, the stiffer the tissue is as reflected by the following equation:

$$\mu = \rho V_s^2 \quad (\text{Equation 10})$$

where ρ is the muscle density (1000 kg.m^{-3}), and V_s is the velocity of propagation (in m.s^{-1}).

The shear elastic modulus is one of the most important parameters to characterize the mechanical behavior of soft tissues. In biomechanics, ultrasound elastography is the gold standard for measuring and mapping it locally in skeletal muscle *in vivo*.

The SWE mode provides a 2-dimensional elasticity map of the region of interest (Figure 31). This region of interest, superimposed to the standard ultrasound image (*i.e.*, B-mode) informs in real time on the stiffness of the tissue, with a color map.

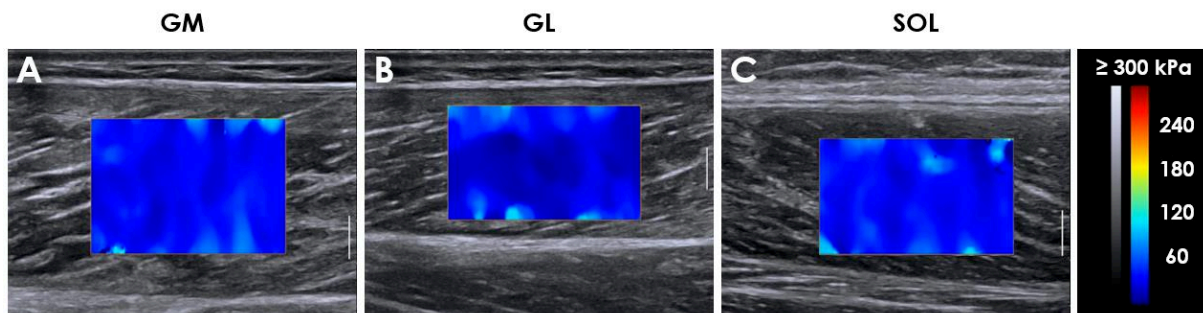

Figure 31. Typical example of elasticity maps obtained for the gastrocnemius medialis (GM; A), gastrocnemius lateralis (GL; B) and soleus (SOL; C).

Spatial resolution of the measurement is $1 \times 1 \text{ mm}$, and the size of the region of interest is more or less adjustable according to the selected acquisition mode. The temporal resolution is 1 Hz, providing a stiffness measurement every second. For each measurement, three video clips of 10 s were recorded, to improve the reliability of the measurement (Lacourpaille et al., 2012). Then, the region of interest was inspected to exclude non-muscular structures and artifacts. The five successive maps that resulted in the lowest standard deviation (SD) of the shear modulus were averaged across trials. The ultrasound probe was adapted to the explored muscle. A 15-4 was used for GM and GL muscles, and a 10-2, allowing deeper measurement, was used for the SOL.

6. Signals synchronization

For the three studies, the ultrasound and mechanical signals were synchronized via their respective external trigger on an external acquisition unit (DT9800, Data Translation, Marlboro, MA), connected to a computer.

For the **study #2**, the synchronization system was more complex as illustrated on Figure 32.

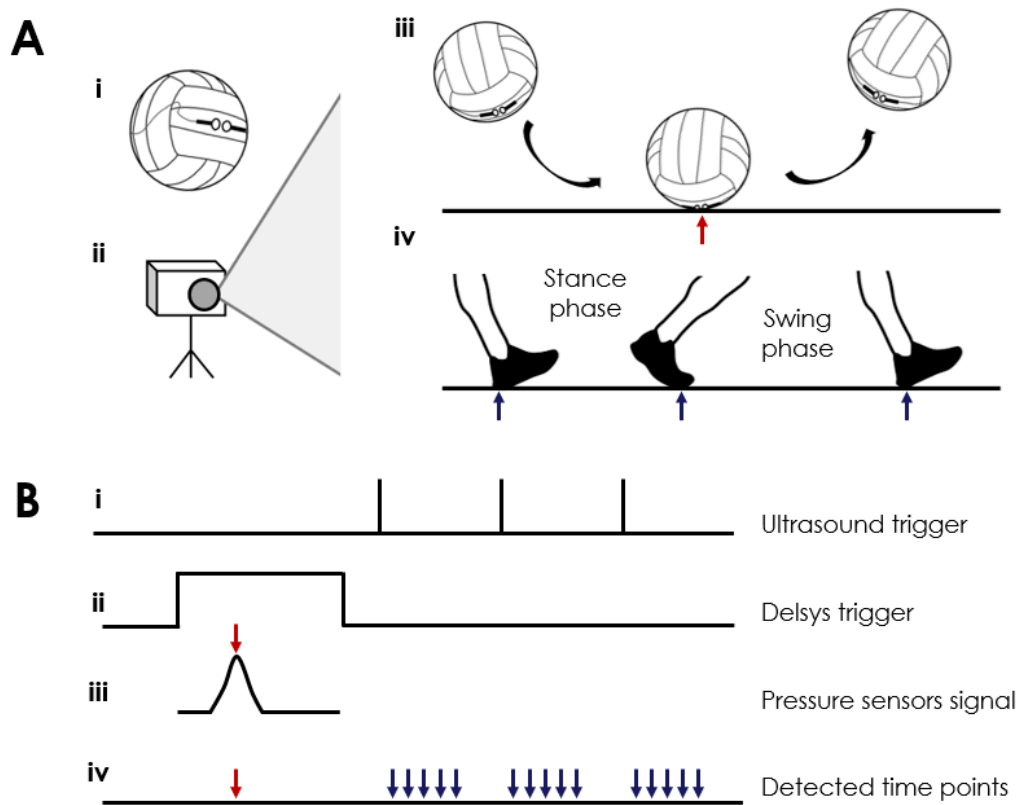

Figure 32. Basic representation of the synchronization system used for the **study #2**, to synchronize fascicle length changes patterns with the running stance phase. **Ai**: Pressure sensors fixed on a ball. **Aii**: Camera used to capture running pattern. The image corresponding to the ground contact of the ball was used to synchronize the video with the mechanical signals. **Aiii**: Ball thrown onto the ground (red arrow). **Aiv**: Detection of heel-strike and toe-off with the camera, a-posteriori analyzed using a specific software (blue arrows; Kinovea). **Bi**: Mechanical signal: trigger from ultrasound acquisition. **Bii**: Mechanical signal: trigger from Delsys system. **Biii**: Pressure sensors signal. **Biv**: Contact of the ball (red arrow), heel-strike and toe-off (blue arrows) determined using the Kinovea software.

The procedure consisted on the following steps:

- pressure sensors (Delsys Trigno wireless EMG system, Delsys, Boston, MA, USA) were fixed on a ball (Figure 32Ai);
- mechanical signals (allowing to record ultrasound and Delsys trigger; Figure 32Bi-ii) were launched;
- camera (Figure 32Aii) started recording;

- Delsys system was started, launching a trigger (Figure 32Bii);
- the ball was thrown to the ground in the field of the camera, with the pressure sensors face down (Figure 32Aiii);
- the contact of the ball on the ground was detected by the signal from the pressure sensors (Figure 32Biii) and the video, analyzed *a-posteriori* using Kinovea [Computer software, Version 0.9.5 (Charmant and contributors, 2021); (Figure 32Biv)];
- ultrasound acquisitions were performed successively, starting a new trigger for each acquisition (Figure 32Bi);
- the camera recorded the running pattern (Figure 32Aiv) and *a-posteriori* heel-strike and toe-off moments were analyzed (Figure 32Biv).

After this signal's synchronization procedure, fascicle dynamic patterns, obtained with the ultrasound, were identified in time with to the phase of the stance (*i.e.*, stance or swing phase).

7. **Statistical analyses**

Statistical analyses were performed using Statistica (v. 13.0, StatSoft, Tulsa, OK) for **study #1** and with Jamovi [2.0.0.0, The jamovi project (2021)], for **studies #2** and **#3**. The distribution of the data was first checked using a Shapiro-Wilk (**study #1**), or Kolmogorov-Smirnov (**studies #2** and **#3**) normality test. Values were reported as means \pm SD unless otherwise stated. Depending on the variables analyzed, parametric tests: t-test, analysis of variance (ANOVA) with repeated measures, or non-parametric tests: Kruskal-Wallis, Friedman, were performed. For each ANOVA, the homogeneity and the sphericity (Mauchly's test) were checked, and a Geisser-Greenhouse correction was used when necessary. When appropriate, post-hoc analyses were performed using a Bonferroni correction. Effect sizes were described in terms of partial eta-squared (η_p^2 , with $\eta_p^2 \geq 0.06$ representing a moderate effect and $\eta_p^2 \geq 0.14$ a large effect), or Kendall's W (W) for Friedman tests. Statistical significance was set at $P < 0.05$.

STUDY 1

Faster early rate of force development in warmer muscle: an in vivo exploration of fascicle dynamics and muscle-tendon mechanical properties

Associated publication

Mornas A, Racinais S, Brocherie F, Alhammoud M, Hager R, Desmedt Y and Guilhem G (2022). Faster early rate of force development in a warmer muscle: an in vivo exploration of fascicle dynamics and muscle-tendon mechanical properties. *Am J Physiol Regul Integr Comp Physiol*. <https://doi.org/10.1152/ajpregu.00280.2021>

Associated communications

Mornas A, Racinais S, Brocherie F, Alhammoud M, Hager R, Desmedt Y and Guilhem G (2021). The effects of passive hyperthermia on muscle-tendon unit mechanical properties. XXVIII Congress of the International Society of Biomechanics, Digital Congress. **Poster communication**

Mornas A, Racinais S, Brocherie F, Alhammoud M, Hager R, Desmedt Y and Guilhem G (2021). Passive-induced hyperthermia decreases soft tissues stiffness. 19ème congrès de l'Association des Chercheurs en Activités Physiques et Sportives, Montpellier, France. **Oral communication**

ABSTRACT

While heat exposure has been shown to increase the skeletal RFD, the underlying processes remain unknown. This study investigated the effect of heat on GM muscle-tendon properties and interactions. Sixteen participants performed electrically-evoked and voluntary contractions combined with ultrafast ultrasound under temperate (CON: $25.8 \pm 1.8^{\circ}\text{C}$, T_{core} : $37.0 \pm 0.3^{\circ}\text{C}$, T_{musc} : $34.0 \pm 1.1^{\circ}\text{C}$) and passive heat exposure (HOT: $47.4 \pm 1.8^{\circ}\text{C}$, T_{core} : $38.4 \pm 0.3^{\circ}\text{C}$, T_{musc} : $37.0 \pm 0.8^{\circ}\text{C}$) conditions. Maximal voluntary force changes did not reach statistical significance ($-5.0 \pm 11.3\%$; $P = 0.052$) while VA significantly decreased ($-4.6 \pm 8.7\%$; $P = 0.038$) in HOT. Heat exposure significantly increased voluntary RFD before 100 ms from contraction onset ($+48.2 \pm 62.7\%$; $P = 0.013$), without further changes after 100 ms. GM fascicle dynamics during electrically-evoked and voluntary contractions remained unchanged between conditions. Joint velocity at a given force was higher in HOT ($+7.1 \pm 6.6\%$; $P = 0.004$) but the fascicle force-velocity relationship remained unchanged. Passive muscle stiffness and active tendon stiffness were lower in HOT than CON ($P \leq 0.030$). This study showed that heat-induced increases in early voluntary RFD may not be attributed to changes in contractile properties. Late voluntary RFD was unaltered, possibly due to decreased soft tissues' stiffness in heat. Further investigations are required to explore the influence of neural drive and motor unit recruitment in the enhancement of explosive strength elicited by heat exposure.

Keywords: muscle temperature, explosive strength, muscle-tendon interactions, force-velocity properties, stiffness, ultrafast ultrasound

1. **Introduction**

Explosive force, referred to as the ability of the human skeletal muscle to generate force as fast as possible, is paramount in motor performance and daily functional tasks (Maffiuletti et al., 2016; Tillin et al., 2013). This muscle capacity is classically evaluated through the RFD during the first 200 ms (or less) of an electrically-evoked or maximal voluntary isometric contraction (Aagaard et al., 2002; Maffiuletti et al., 2016). Explosive force production is largely explained by neural and contractile properties which change during muscle contraction. Neural activation is an important determinant in the initial 50 ms of explosive contraction, while the subsequent 50-ms period is correlated to contractile capacity (Folland et al., 2014). More recently, some studies investigated the various determinants of explosive force depending on time period from the onset of explosive contraction (Del Vecchio et al., 2019; Hager et al., 2020; Maffiuletti et al., 2016). At the onset of the motor impulse (*i.e.*, 0-100 ms), explosive movement is strongly influenced by recruitment velocity and the firing rate of the activated motor unit (Del Vecchio et al., 2019). From 100 to 200 ms, voluntary RFD amplitude will thereafter be submitted to muscle mechanical constraints, as reflected by muscle fascicle dynamics which fit to the fascicle force-velocity relationship (Hager et al., 2020). RFD may also be influenced by the elastic properties of the muscle-tendon unit and the muscle-tendon interactions (Maffiuletti et al., 2016; Rodríguez-Rosell et al., 2018; Tillin et al., 2018).

It is well established that an increase in T_{core} , with its repercussion on T_{musc} , contributes to a reduction in voluntary force production (Morrison et al., 2004; Racinais et al., 2008; Todd et al., 2005), while increasing maximum muscle shortening velocity in animals (Ranatunga, 1984) and humans (Bottinelli et al., 1996). Furthermore, a rise in T_{core} or T_{musc} increases electrically-evoked RFD (Malette et al., 2019; Mornas et al., 2021; Racinais et al., 2017c). Some studies reported an increase in voluntary RFD (Denton et al., 2016; Rodrigues et al., 2021), while a recent experiment demonstrated no changes in early and middle RFD (Gordon et al., 2021), reflecting that the effects of hyperthermia on voluntary RFD remains to be elucidated. An increase in T_{musc} has been shown to enhance the rate of ATPase activity, *in vitro* in animals (Barany, 1967; Stein et al., 1982), suggesting an increase in the rate of cross-bridge cycling (Stein et al., 1982). Although increasing T_{musc} has been reported to alter Ca^{2+} sensitivity (Stephenson and Williams, 1985), an increase in T_{musc} tends to improve muscle function, which has not been attributed to its putative influence on Ca^{2+} sensitivity of the acto-myosin complex (Blazevich and Babault, 2019). Altogether, the aforementioned mechanisms could contribute

to the improvement in maximal muscle shortening velocity (Bolton et al., 1981; Farina et al., 2005; Gray et al., 2006) with concomitant changes in the force-velocity relationship, shifted rightward (Bottinelli et al., 1996; De Ruiter and De Haan, 2000). Although the aforementioned studies mainly focused on the effect of temperature on RFD and contractile properties, there is to date no report investigating the effect of temperature on joint and fascicle force-velocity relationships *in vivo*. Given that muscle fascicles and tendinous tissues contribute to muscle-tendon shortening velocity [*i.e.*, 60 and 40%, respectively (Hauraix et al., 2015)], their mechanical properties could both influence the joint and fascicle force-velocity relationships. Yet, it is unclear whether passive heat exposure impacts muscle-tendon interactions and could explain improved electrically-evoked and voluntary RFD together with decreased voluntary force production. Using high-frame-rate ultrasound, our group recently demonstrated a reduction in the electromechanical delay of plantar flexors under heat exposure via accelerated electrochemical processes, while mechanical processes involved in force transmission were unchanged (Mornas et al., 2021). These findings suggest a major effect of increasing T_{core} and T_{musc} on the electrochemical and contractile component properties of the GM muscle, without completely excluding an opposite effect at the level of the series elastic component.

The present study aimed to examine the effect of passive heat exposure on GM muscle-tendon complex properties in order to characterize the role of the muscle-tendon interaction in the heat-induced changes in RFD. We hypothesized that V_F might increase, translating into a rightward shift of the force-velocity relationship for a given fascicle force. We also expected an unchanged or even a potential decrease in soft tissue stiffness. To test these assumptions, muscle fascicle dynamics were explored using high-frame-rate ultrasound during electrically-evoked and voluntary isometric RFD, together with an assessment of dynamic joint and fascicle force-velocity relationships, passive muscle stiffness and active tendon stiffness.

2. Materials and methods

1. Participants

Sixteen healthy, recreationally active participants (9 males, 7 females, age: 24.9 ± 5.7 years, height: 174.8 ± 7.5 cm, body mass: 69.8 ± 9.9 kg, practicing 5.5 ± 3.2 h of sport per week) volunteered to participate in the study after completing a pre-inclusion medical visit.

2. Experimental design

Two to four days after a familiarization session, participants underwent two identical testing sequences in a single session: the first sequence was in temperate condition (CON; $25.8 \pm 1.8^\circ\text{C}$, $33.6 \pm 8.6\%$ RH); the second in a hot ambient condition (HOT; $47.4 \pm 1.8^\circ\text{C}$, $18.5 \pm 4.7\%$ RH, after 127 ± 33 min of heat exposure). The effect of heat was assessed on GM muscle-tendon properties and interactions (muscle fascicle dynamics during electrically-evoked and voluntary isometric RFD, joint and fascicle force-velocity relationships, muscle and tendon stiffness).

3. Testing protocol

General procedures. As previously described ([see p.67](#)) participants lay prone on the customized Goubex ergometer (Figure 33A). The footplate of the ergometer rotated between 110° and 60° for dynamic contractions (*i.e.*, ballistic contractions) or was firmly immobilized at 90° for isometric contractions (*i.e.*, electrically-evoked contractions, voluntary isometric explosive and ramp contractions). The force and ankle angle signals were digitized at 2000 Hz, and low-pass filtered (150 Hz, zero-lag 3rd order Butterworth). During contractions, GM images were collected and L_F was low-pass filtered (50 Hz, zero-lag 3rd order Butterworth).

Electrically-evoked contractions. The tibial nerve was electrically stimulated (single electrical pulse; Figure 33A). The mechanical response to the five electrically-evoked stimulations realized was analyzed and averaged to determine electrically-evoked RFD. GM images were collected at 1000 Hz.

Voluntary isometric contractions. Participants performed three 5-s isometric MVC (Figure 33B). RFD and MVC peak force were assessed on the same repetition to avoid fatigue occurrence (Hager et al., 2020). RFD was calculated for specific time phase as the change in force divided by the time windows from 0 to 100 ms (RFD₀₋₁₀₀), 0 to 200 ms (RFD₀₋₂₀₀) and 100 to 200 ms (RFD₁₀₀₋₂₀₀; Figure 33B). For each overlapping time interval from force onset, force was divided by the time to calculate RFD₀ to 'X' ms, to identify the maximal RFD (RFD_{0-Xmax}; Figure 33B). RFD_{0-Xmax} thus corresponding to the average RFD between force onset and 'X' ['X' varied in the range 1-250 ms; (Del Vecchio et al., 2019)]. GM images were collected at 1000 Hz. VA was assessed during two additional MVC (Figure 33C).

Joint and fascicle force-velocity relationships. Participants performed maximal plantar flexions from 110° to 60° of ankle flexion on the Goubex ergometer. Three conditions (1 min rest) were

tested in a randomized order: with 0 (five trials), 1.2 and 2.6 kg (three trials) attached to the pedal. GM images were collected at 2000 Hz. Joint and fascicle force-velocity relationships were built (Figure 33G-H), as described in our methodological section ([see p.78](#)).

Passive muscle stiffness. The ultrasound scanner was used in SWE mode to measure (3 measurements per condition) the shear modulus of the GM at rest (Figure 33D).

Active tendon stiffness. Participants linearly increased in 9-s their isometric plantar flexor force from 0 to 90% of the MVC peak force, determined in CON (Figure 33E), to determine the active stiffness of tendon ([see p.78](#)).

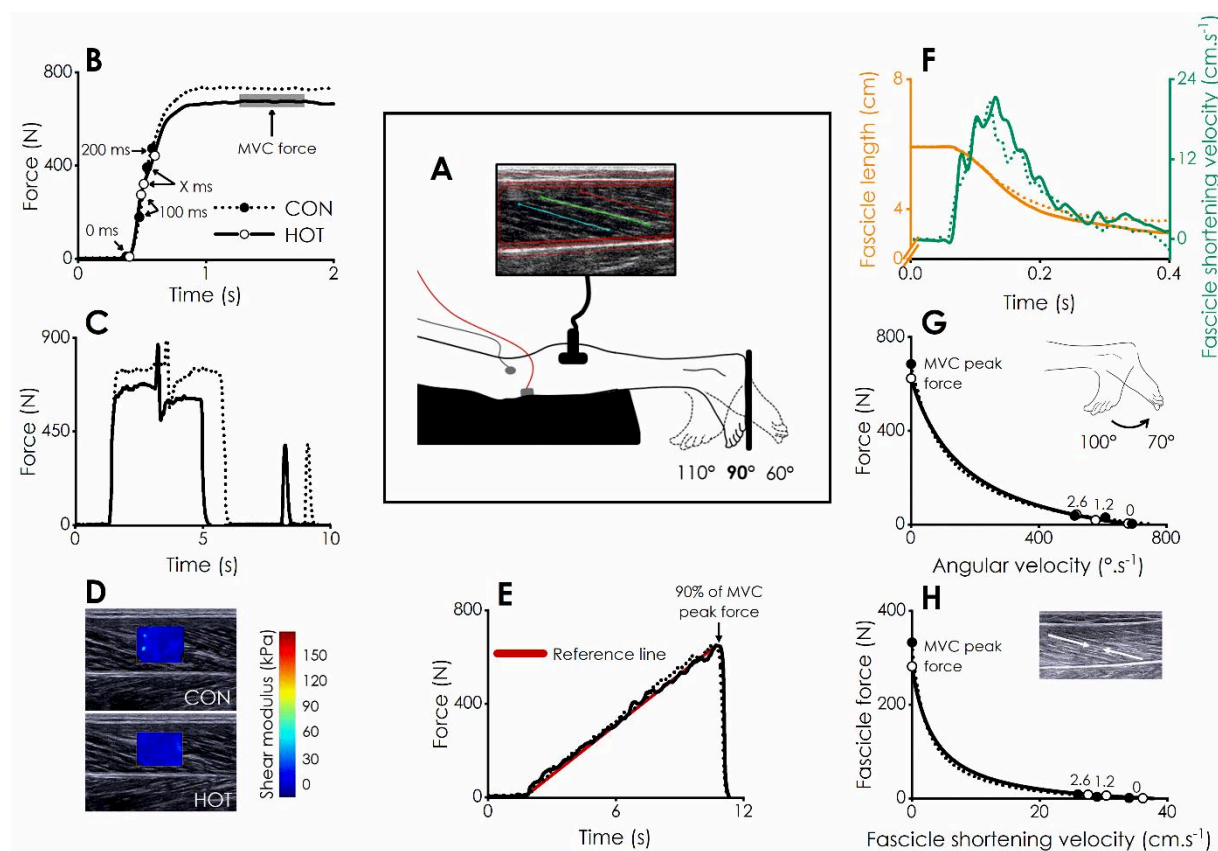

Figure 33. Experimental design and data collection (A). In hot (HOT) and control (CON) conditions; maximal voluntary contraction (MVC) peak force, voluntary rate of force development (RFD; B), voluntary activation (VA; C) and shear modulus of the gastrocnemius medialis (GM) were assessed at 90° of ankle angle (D). Ramp contraction performed from 0 to 90% of MVC peak force (E) assessed active Achilles tendon stiffness. Fascicle dynamics were obtained from GM ultrasound images acquired at 1000 Hz or 2000 Hz (A, F), to compute fascicle shortening velocity (F). Joint and fascicle force-velocity relationships were built using ballistic contractions at 0, 1.2, 2.6 kg and MVC peak force (G, H).

Physiological monitoring. Before starting the intervention, USG was collected to check the level of hydration of the participants ($USG = 1.015 \pm 0.008$). T_{core} and T_{skin} were monitored

continuously. T_{musc} of the contralateral GM was measured immediately before each testing sequence, in a subsample of six participants.

4. Statistical analysis

A paired 1-tailed t-test was used to compare the effect of the condition (HOT vs. CON) on T_{core} , T_{skin} and T_{musc} , MVC force, VA, electrically-evoked RFD, GM shear modulus and tendon active stiffness. RFD_{0-200} , $\text{RFD}_{0-X_{\text{max}}}$, the duration of $\text{RFD}_{0-X_{\text{max}}}$, peak V_F , time to peak V_F , L_F at 90° (isometric position) and at 110° (passive dorsiflexion, before ballistic contractions), joint and fascicle V_0 , joint and fascicle F_0 were compared between conditions (HOT vs. CON) using a 2-tailed t-test. The effects of the condition (HOT, CON) and time phase (0-100 and 100-200 ms) on RFD were tested by a two-way ANOVA with repeated measures (condition \times time phase). Differences in V_F and fascicle force during RFD, at 50, 100, 150 and 200 ms from MVC onset, were tested using two-way ANOVAs (condition \times time) with repeated measures. The effects of condition (HOT, CON) and load (0, 1.2, 2.6 kg) on joint velocity, plantar flexor force, V_F and fascicle force were tested using two-way ANOVAs (condition \times load) with repeated measures.

3. Results

1. Thermoregulatory responses

Average T_{core} , T_{skin} and T_{musc} were significantly higher in HOT than CON ($38.4 \pm 0.3^\circ\text{C}$, $38.8 \pm 0.4^\circ\text{C}$ and $37.0 \pm 0.8^\circ\text{C}$ in HOT vs. $37.0 \pm 0.3^\circ\text{C}$, $34.7 \pm 0.7^\circ\text{C}$ and $34.0 \pm 1.1^\circ\text{C}$ in CON, respectively; all $P < 0.001$, $\eta_p^2 \geq 0.75$). There was no significant difference in body mass between HOT and CON ($P = 0.890$, $\eta_p^2 < 0.01$).

2. Impact of heat on muscle performance

In reference to CON, MVC force did not reach statistical significance in HOT ($P = 0.052$, $\eta_p^2 = 0.18$; Table 4). VA was $4.6 \pm 8.7\%$ lower in HOT than CON ($P = 0.038$, $\eta_p^2 = 0.24$; Table 4). Electrically-evoked RFD was faster in HOT than CON ($+16.9 \pm 32.8\%$, $P = 0.029$, $\eta_p^2 = 0.15$; Table 4). RFD_{0-200} and $\text{RFD}_{0-X_{\text{max}}}$ were not significantly different between the two conditions (all $P \geq 0.238$, $\eta_p^2 \leq 0.02$). Two-way ANOVA revealed no main effect of condition ($P = 0.647$, $\eta_p^2 = 0.01$), while a significant main effect of time phase ($P = 0.001$, $\eta_p^2 = 0.54$) and a condition \times time phase interaction ($P < 0.001$, $\eta_p^2 = 0.58$) were observed on RFD during the

time phase 0-100 and 100-200 ms. *Post-hoc* showed that RFD_{0-100} was higher in HOT ($+48.2 \pm 62.7\%$; $P = 0.013$, $\eta_p^2 = 0.09$), while $RFD_{100-200}$ remained unchanged compared to CON ($P = 0.156$, $\eta_p^2 = 0.03$).

Table 4. Mechanical parameters and fascicle dynamics in hot (HOT) and control (CON) conditions.

	HOT	CON	<i>n</i>
<i>Mechanical parameters</i>			
MVC force (N)	531 ± 138	558 ± 128	15
VA (%)	93 ± 11*	97 ± 5	13
Electrically-evoked RFD (N.ms ⁻¹)	0.65 ± 0.11*	0.56 ± 0.12	16
RFD ₀₋₁₀₀ (N.s ⁻¹)	1397 ± 439*	1097 ± 554	15
RFD ₀₋₂₀₀ (N.s ⁻¹)	1560 ± 414	1526 ± 524	15
RFD ₁₀₀₋₂₀₀ (N.s ⁻¹)	1750 ± 607	1949 ± 620	15
RFD _{0-Xmax} (N.s ⁻¹)	1729 ± 488	1600 ± 563	15
Duration of RFD _{0-Xmax} (ms)	157 ± 26***	198 ± 42	15
V ₀ joint (°.s ⁻¹)	752 ± 130	707 ± 109	13
F ₀ joint (N)	519 ± 145	542 ± 148	13
<i>Fascicle behavior</i>			
Initial L _F at 90° (cm)	5.61 ± 0.61	5.60 ± 0.68	16
Initial L _F at 110° (cm)	6.27 ± 0.63	6.30 ± 0.59	14
Peak V _F electrically-evoked (cm.s ⁻¹)	14.0 ± 2.1	13.6 ± 2.0	16
Peak V _F voluntary (cm.s ⁻¹)	15.8 ± 4.9	14.4 ± 5.3	14
Time to peak V _F voluntary (ms)	72.4 ± 17.8	88.6 ± 29.6	14
V ₀ fascicle (cm.s ⁻¹)	33.8 ± 8.5	32.7 ± 6.2	13
F ₀ fascicle (N)	172.1 ± 67.0	180.3 ± 62.5	13

Values are presented as mean ± SD. MVC, maximal voluntary contraction; VA, voluntary activation; RFD, rate of force development; RFD₀₋₁₀₀, rate of force development between MVC onset and 100 ms; RFD₀₋₂₀₀, rate of force development between MVC onset and 200 ms; RFD₁₀₀₋₂₀₀, rate of force development between 100 and 200 ms after MVC onset; RFD_{0-Xmax}, RFD from MVC onset to the maximal RFD; V₀, maximal theoretical velocity (joint and fascicle level); F₀, maximal theoretical force and fascicle force; V_F, fascicle shortening velocity; *n*, sample size, which has often been reduced due to missing data.

* Significant difference between HOT and CON, $P < 0.05$; ***, $P < 0.001$.

3. Fascicle dynamics during electrically-evoked and voluntary contractions

Initial L_F at which fascicle contracts did not change between 0° and 110° of plantar flexion (all $P \geq 0.577$, $\eta_p^2 \leq 0.02$; Table 4). No effect of condition on peak V_F in electrically-evoked and voluntary isometric explosive contractions nor in time to peak shortening velocity were found during RFD evaluation (all $P \geq 0.105$, $\eta_p^2 \leq 0.10$; Table 4, Figure 34). V_F increased (time effect: $P < 0.001$, $\eta_p^2 = 0.65$) between 0 and 100 ms and then decreased until 200 ms, with neither a

significant effect of condition nor time \times condition interaction (all $P \geq 0.092$, $\eta_p^2 \leq 0.17$; Figure 34C). Two-way ANOVA applied to fascicle force revealed an effect of time ($P < 0.001$, $\eta_p^2 = 0.88$), which increased from 0 to 200 ms, with neither main effect of condition nor time \times condition interaction (all $P \geq 0.074$, $\eta_p^2 \leq 0.28$; Figure 34C).

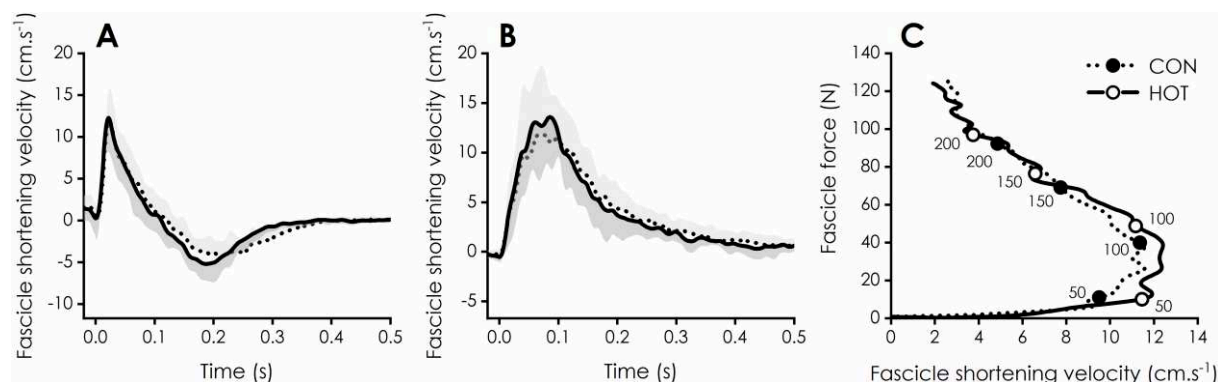

Figure 34. Fascicle shortening velocity during electrically-evoked (A) and MVC (B) and fascicle force as a function of fascicle shortening velocity during RFD (C). Low and dark grey areas represent SD, and the circles in panel C correspond to the values obtained at 50, 100, 150 and 200 ms from the contraction onset ($n = 16$ for A, $n = 15$ for B and $n = 14$ for C).

4. Joint and ankle force-velocity relationship

During ballistic contractions, a main effect of load ($P < 0.001$, $\eta_p^2 = 0.96$) was found on joint velocity, which decreased with increasing load. A main effect of condition, with a high effect size ($P = 0.004$, $\eta_p^2 = 0.51$) on data points, showed a rightward shift of the force-velocity relationship, indicative of a higher force for a given velocity in HOT ($+7.1 \pm 6.6\%$). There was no condition \times load interaction effect ($P = 0.408$, $\eta_p^2 = 0.07$; Figure 35A). However, there was a main effect of load ($P < 0.001$, $\eta_p^2 = 0.93$) on V_F , which decreased with increasing load, without any effect of condition or condition \times load interaction (all $P \geq 0.244$, $\eta_p^2 \leq 0.11$; Figure 35B). Joint V_0 tended to increase ($P = 0.065$, $\eta_p^2 = 0.04$; Table 4) and fascicle V_0 remained unchanged across conditions ($P = 0.430$, $\eta_p^2 = 0.01$; Table 4). A significant main effect of load on plantar flexion and fascicle force was observed (all $P < 0.001$, $\eta_p^2 \geq 0.89$), which increased with increasing load, without further effect (all $P \geq 0.142$, $\eta_p^2 \leq 0.17$; Figure 35). No difference in plantar flexor and fascicle F_0 was found between HOT and CON (all $P \geq 0.266$, $\eta_p^2 \leq 0.01$; Table 4).

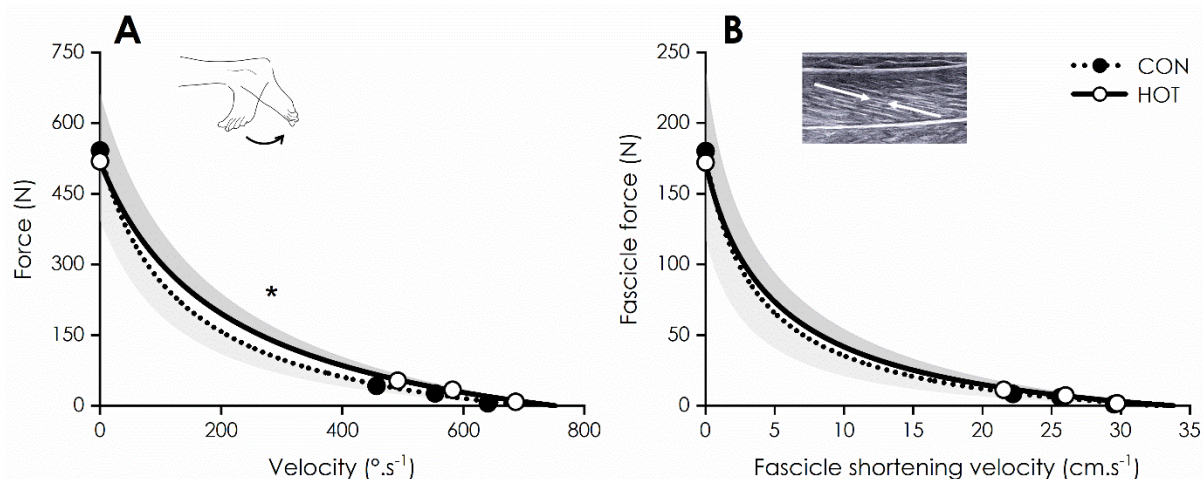

Figure 35. Joint (A) and fascicle force-velocity relationship (B). Filled area represents SD and circles represent data obtained during MVC and during ballistic contractions performed against 2.6, 1.2 and 0 kg ($n = 13$). * Significant effect of condition on joint velocity.

5. Muscle and tendon stiffness

Shear modulus measured in the GM was significantly lower in HOT than CON ($-11.7 \pm 22.2\%$; $P = 0.030$, $\eta_p^2 = 0.04$; Figure 36A). Active Achilles tendon stiffness was lower in HOT than CON ($-12.7 \pm 19.5\%$; $P = 0.038$, $\eta_p^2 = 0.10$; Figure 36B).

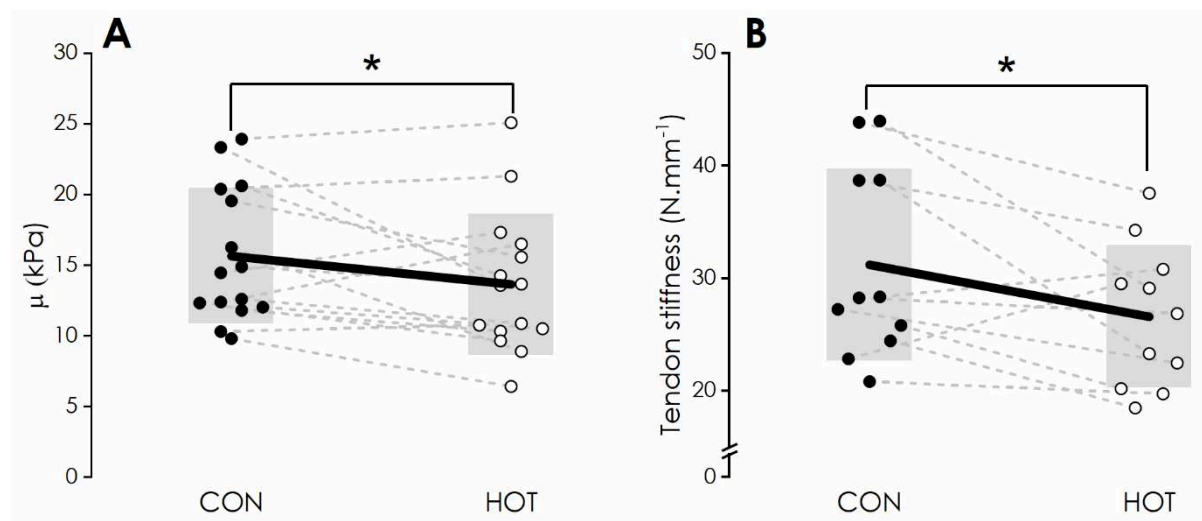

Figure 36. Shear modulus measured at rest (A) and active Achille tendon stiffness (B) in HOT and CON. The bold trace represents the mean change of the whole sample ($n = 15$ for A and $n = 11$ for B), box charts correspond to SD and dashed traces connect individual values. * Significant difference between HOT and CON.

4. Discussion

The present study aimed to determine the effect of passive heat exposure on mechanical properties of the muscle-tendon unit, in order to better understand the underlying mechanisms involved in RFD improvements during electrically-evoked and voluntary contractions. Heat-induced increases in T_{core} and T_{musc} accelerated the early phase of plantar flexor RFD (*i.e.*, < 100 ms from contraction onset), which was not accompanied by neither change in late and global RFD (*i.e.*, 0-200 ms and 100-200 ms, respectively) nor in muscle fascicle force-velocity properties (*i.e.*, peak V_F , fascicle force at a given shortening velocity). Conversely, soft tissues' stiffness decreased in warmer muscle.

1. Influence of warmer muscle on muscle performance

In line with previous research (Morrison et al., 2004; Racinais et al., 2008; Todd et al., 2005), MVC peak force tended to decrease and VA decreased with increasing T_{core} . Yet, the decrease in MVC force did not reach statistical significance, likely due to the lower amplitude of hyperthermia elicited in the present study ($\sim 38.4^\circ\text{C}$) as compared to previous investigations [38.5°C - 39.5°C ; (Morrison et al., 2004; Racinais et al., 2017c; Périard et al., 2014a)]. These were similar conditions to previous studies that investigated the effects of passive heat exposure on voluntary RFD and their underlying mechanisms.

Heat exposure increased early voluntary RFD (*i.e.*, 0-100 ms; $+48.2 \pm 62.7\%$), with no further changes thereafter. The increase in voluntary RFD₀₋₁₀₀ was greater than electrically-evoked RFD ($+16.9 \pm 32.8\%$), suggesting that neural effects occurred following heat exposure. Previous studies reported an increase in voluntary RFD between 0 and 50 ms after contraction onset after muscle heating (Denton et al., 2016; Rodrigues et al., 2021). In this early phase of RFD, the ability to produce force rapidly, highly depends on motor unit recruitment and discharge rate (Del Vecchio et al., 2019). Elevated T_{musc} may accelerate the opening and closing of voltage-gated Na^+ channels, thereby decreasing potential amplitude, duration and area of axonal action potential. These mechanisms could lead to a faster depolarization onset and muscle fiber conduction velocity (Rutkove et al., 1997), resulting in greater Ca^{2+} release and re-uptake from the sarcoplasmic reticulum (Gray et al., 2006). Alternatively, an increase in temperature is associated with a decrease in Ca^{2+} sensitivity (Stephenson and Williams, 1985). However, Rodrigues et al. (2021) recently suggested that passive heating may improve Ca^{2+} sequestration kinetics, it is likely that this effect is different from the present findings obtained

after a whole-body exposure in an environmental chamber. It is also well-established that nerve conduction velocity increases with temperature (Todnem et al., 1989). Neural drive is an important determinant of rapid force production, especially in the early phase of contraction (Del Vecchio et al., 2019; Folland et al., 2014). Interestingly, this heat-induced effect on explosive force was concomitant to a trend for increased V_F ($+1.6 \pm 4.5 \text{ cm}\cdot\text{s}^{-1}$; Figure 34C) over the initial 50 ms from contraction onset. This finding may reflect a translation of improved neural drive to muscle fascicle dynamics at the peripheral level. While $\text{RFD}_{0-X_{\max}}$ was unchanged, the time period required to achieve maximal RFD decreased with heat ($-19.3 \pm 10.6\%$). This result strengthens the crucial influence of temperature on the processes involved in the early phase of rapid force production. Gordon et al. (2021) demonstrated that early and middle phase of knee extensors voluntary RFD were not affected by increased T_{core} elicited by whole body heat exposure (at 38.5 and 39.5°C). The difference with the present results may partly originate from the different muscle groups investigated. Further studies are required to strongly conclude on the effect of hyperthermia on plantar flexor muscles properties.

MVC peak force being an important determinant of voluntary RFD in the late phase of contraction (Andersen and Aagaard 2006; Folland et al., 2014), the trend to decreased MVC peak force in a hot environment may act as a compensatory mechanism underlying the increase in RFD_{0-100} , leading to similar RFD amplitude thereafter. From 100 to 200 ms, RFD was unchanged (Table 4). In the present study, peak V_F occurred in the first 100 ms from contraction onset in both conditions. In addition, this parameter was unchanged during MVC performed in HOT (Figure 34C). These findings confirm the lack of influence of temperature on late RFD time-course, which has been reported to be reflective of muscle mechanics and force-velocity properties (Hager et al., 2020).

2. Influence of warmer muscle on force-velocity relationships properties

While joint F_0 , and V_0 were unchanged, increasing T_{core} during a ballistic contraction resulted in a rightward shift of the joint force-velocity relationship, indicating a higher plantar flexor force for a given joint velocity in a hot environment (Figure 35A). A previous study reported a higher wrist flexion angular velocity (Binkhorst et al., 1977) in response to an increase in T_{muscle} from ~ 22 to $\sim 37.5^\circ\text{C}$ in *palmaris longus* and *flexor digitorum*, composed of a heterogeneous fiber type composition (Johnson et al., 1973; Moore et al., 2021). Similarly, an increase in estimated T_{muscle} from ~ 22 to $\sim 37^\circ\text{C}$ in *adductor pollicis*, mainly composed by slow-twitch fibers (Round et al., 1984), resulted in a higher angular velocity of the thumb (De Ruiter and De Haan,

2000). Temperature is known to influence maximal shortening velocity to a greater extent in slow-twitch compared to fast-twitch muscle fibers (Bottinelli et al., 1996; Ranatunga, 1984). The balanced fiber type composition of GM muscle (Johnson et al., 1973) could thus partly explain the present increase in plantar flexion angular velocity resulting from a T_{musc} increase. It is however difficult to determine to what extent fiber type composition may account for temperature sensitivity, which has mainly been addressed *in vitro*.

Heat did not alter fascicle peak force, maximal theoretical fascicle velocity or fascicle force-velocity relationship of GM muscle (Figure 35B). *In vitro*, a rise in ambient temperature has been reported to increase the maximum muscle shortening velocity and force for a given velocity in rodent and human muscle cell culture (Bottinelli et al., 1996; Ranatunga, 1984). In the present study, the lack of a heat-induced effect on the fascicle force-velocity relationship may originate from different amplitude of T_{musc} changes in response to heat exposure (~34-37°C vs. ~10-35°C in the aforementioned studies). In fact, the thermal dependency of maximum shortening velocity tends to decrease with increasing temperature from ~6 to ~34°C (Bennett, 1984). In the absence of additional information beyond 34°C, *in vitro* data may not apply within the range of T_{musc} observed *in vivo*.

3. Heat reduces soft tissue stiffness

Heat exposure elicited a decrease in GM shear modulus ($-11.7 \pm 22.2\%$) compared with temperate condition. This temperature-induced effect may be attributed to changes in the gap filament that have been shown to exhibit elastomer-like behavior, particularly within the more extensible region of the titin molecule (Mutungi and Ranatunga, 1998). This alteration in muscle mechanical properties may reduce the effectiveness of force transmission during active contractions, thereby negatively impacting RFD amplitude.

Passive heat exposure also reduced active Achilles tendon stiffness measured during contraction ($-12.3 \pm 19.3\%$). Previous studies reported increase passive maximal range of motion without modifying muscle-tendon unit stiffness in response to local heat application (Fujita et al., 2018; Kubo et al., 2005). In the present study, heat exposure was systemic (*i.e.*, increase in ambient air temperature), generating a larger physiological and biomechanical strain compared to localized application [*e.g.*, hot water immersion, hot pack application (Campbell et al., 2022)]. This may have induced a deeper soft tissue heat exposure with putatively larger effects on tendon mechanical properties.

An increase in elastic properties may reduce the efficiency of force transmission along the muscle-tendon unit and the contribution of contractile properties in modulating force rapidly, especially in the late phase of voluntary RFD (Maffiuletti et al., 2016; Rodríguez-Rosell et al., 2018; Tillin et al., 2018). Therefore, the decreases in soft tissue stiffness observed in warmer muscle could explain the unchanged, or even slightly reduced, RFD₁₀₀₋₂₀₀ between conditions. The present results strongly suggest that alternative mechanisms (*e.g.*, improved neural drive) may contribute to higher RFD amplitude.

Since passive tissue stiffness is involved in the production of angular velocity (Fontana Hde et al., 2014; Hauraix et al., 2015), a decrease in soft tissue stiffness following heat exposure could explain the lack of effects of heat on maximum joint velocity. Stiffness in soft tissues might also impact V_F , given that increasing the effective series elastic element stiffness showed a modest reduction in the amplitude and velocity of active fascicle shortening of GL and SOL muscle (Mayfield et al., 2016). However, initial L_F and fascicle dynamics were unchanged in the present study (Figure 34A-B, Table 4), despite more compliant soft tissues in the hot environment. In turn, these heat-induced changes in muscle and tendon stiffness did not impact initial L_F , at 90° and 110°. Further, GM operated over L_F (5.6 ± 0.5 cm) that are centered on the plateau of the force-length relationship [*i.e.*, L_0 comprised between 4.9 ± 1.0 cm and 5.6 ± 0.8 cm at 90°; (Hager et al., 2020)] in participants with similar anthropometric data. Given that RFD does not change over these muscle lengths (Hager et al., 2020), it is very unlikely that heat-induced slight changes in operating L_F would have influenced RFD amplitude. Although the starting position of the ankle was the same between conditions, reduced soft tissue stiffness following heat exposure may reduce the energy restitution of the elastic component during ballistic contractions. More compliant tissues could thus sustain larger stresses, thereby shifting the amplitude of strain at which failure may occur (Kalkhoven et al., 2020; Peterson, 1950). Overall, the use of heat to reduce muscle and tendon stiffness might thus potentially be valuable for reducing the stress applied to the muscle during exercise and potentially reduce the risk of strain injury.

4. Methodological considerations

All measurements were done in the same testing session to allow data collection with an ultrasound probe positioned at the same location. This experimental procedure strongly improved the robustness of between-condition comparisons of muscle fascicle behavior, which represents a technical challenge in such environmental conditions. However, this procedure was

unable to randomize the temperature-dependent testing sequences. Previous research reported that RFD does not change after a passive rest interval of 60 min (Tavakkoli Oskouei et al., 2021). In line with these data, we conducted pilot experiments which showed that all the measured parameters (*i.e.*, MVC force, VA, electrically-evoked RFD, voluntary RFD over the different time periods, passive shear modulus and active tendon stiffness) did not change over a time period (*i.e.*, ~127 min) corresponding to the interval between pre- and post-tests included in the present experimental design. Overall, these elements strongly suggest that the mechanical variables computed in the present study were not affected by the order of the measurements, or the rest period, between the two testing sessions.

One note to consider is that the force-velocity relationships were estimated from Hill's model, fitted from maximal isometric force and three dynamic conditions performed upon very light loading (at 0, 1.2 and 2.6 kg). Due to the logistical constraint associated with the use of an isokinetic ergometer in an environmental chamber, we could not explore the *in vivo* intermediate portion of the force-velocity relationship (Hauraix et al., 2015) in response to heat exposure. Although not optimal, this approach included more conditions than a previous procedure (Hager et al., 2020) and the maximal fascicle shortening velocity obtained in the temperate condition using our method ($32.7 \pm 6.2 \text{ cm}\cdot\text{s}^{-1}$) was also similar to those obtained with nine tested loading conditions [*i.e.*, $30.8 \pm 5.8 \text{ cm}\cdot\text{s}^{-1}$; (Hauraix et al., 2015)]. Furthermore, the present inter-trial variability in angular velocity was very low (*i.e.*, $1.96 \pm 1.48\%$; range: 0.01-5.95%). Overall, we are confident about the reliability of this experimental procedure to investigate fascicle force-velocity properties.

VA was lower in a hot environment, suggesting acute neural adaptations in response to heat. The current developments in high-density surface EMG electrodes and blind source separation can be used to non-invasively extract the activity of a given pool of motor units (Holobar and Zazula, 2007; Merletti et al., 1999). Using such an approach could represent a promising perspective built on the current work and advance our understanding of the effects of heat on muscle force generation. Another interesting perspective from this work would be to compare the impact of localized calf-heating on the neuromuscular properties presented in the present study to provide insights into the role of central and peripheral neuromuscular adaptations to heat on muscle properties.

5. **Conclusion**

This study explored for the first-time *in vivo* changes in muscle-tendon interactions elicited by passive heat exposure. Increasing T_{core} and T_{musc} tended to accelerate V_F during the 50 ms of voluntary explosive isometric contraction translating into an improved RFD during the first 100 ms of a rapid contraction onset. The fascicle force-velocity relationship and maximal fascicle shortening velocity were not affected by heat while passive muscle and active tendon stiffness decreased, resulting in an unchanged late and global phase of RFD. These findings evidence the decoupled effects of heat on contractile and passive properties of the muscle-tendon unit, and strongly encourage further investigations of the role of motor unit recruitment and discharge rate found in the improved explosive force in response to heat exposure in humans.

STUDY 2

Running in the heat does not affect operating fascicle lengths compared to temperate environment

Associated publication

Mornas A, Brocherie F, Hollville E, Derouck T, Racinais S and Guilhem G. Running in the heat does not affect operating fascicle lengths compared to temperate environment. *Submitted*

ABSTRACT

During human locomotion, fascicle dynamics are fundamental in the understanding of motor performance. However, little is known regarding their behavior during a prolonged exercise in temperate and hot environments, the latter inducing additional physiological stress. Using ultrafast ultrasound, this study investigated fascicles dynamics, as well as muscle-tendon unit responses, in fifteen participants during running (40 min at 10 km.h⁻¹) in temperate (TEMP: ~23°C, ~38% RH) and hot (HOT: ~38°C, ~45% RH) conditions. Although physiological stress elicited, with T_{core} , T_{skin} and heart rate increasing from the beginning to the end of the exercise and being higher in HOT than TEMP (all $P < 0.001$), running mechanics and fascicle operating lengths, were unaffected by the time (2 vs. 40 min) and the condition (TEMP vs. HOT; all $P \geq 0.248$). Maximal voluntary force production tended to decrease after exercise ($P = 0.060$), while soft tissue stiffness measured (*i.e.*, passive shear modulus of the three muscles of the *triceps surae* and active Achilles tendon stiffness) did not show time ($P \geq 0.281$) nor condition ($P \geq 0.256$) effects. This study revealed that prolonged running exercise at low/moderate intensity and/or high ambient temperature does not alter muscle-tendon unit properties and interplay.

Keywords: hot exposure, exercise, force-length properties, tissue stiffness

1. Introduction

Muscle mechanics is a major driver of human locomotion. The behavior of muscle fascicle in relation to the basic mechanical properties of the muscle (*i.e.*, force-velocity and force-length relationships) may substantially influence force-generating capacity, joint mechanics and in turn motor performance. Therefore, muscle fascicle dynamics is paramount to describe human motor skills. GM muscle fascicle shortening during running was shown to be significantly lower than the shortening of the muscle-tendon unit during running, highlighting the crucial role of soft tissue dynamics during locomotion (Ishikawa et al., 2007). The description of the operating L_F in reference to the force-length relationship has been recently demonstrated sensitive to running stride frequency (Swinnen et al., 2022) or muscle damage (Hoffman et al., 2014). Furthermore, GM operating L_F demonstrated a leftward shift over the force-length relationship in response to an increase in running velocity (Monte et al., 2020; Monte et al., 2023). Of note, a reduction in operating L_F decreases the resulting muscle force, which may increase the metabolic energy expenditure, due to larger metabolic energy consumed per unit of active muscle at shorter L_F (Beck et al., 2022). Ohya et al. (2017), found that the shear modulus (*i.e.*, index of muscle stiffness) of *flexor digitorum longus* and *tibialis posterior* increased immediately after a 30-min treadmill running task at 12 km.h⁻¹, while GM muscle stiffness remained unchanged. Other authors reported that the same running exercise does not affect the Achilles tendon stiffness (Farris et al., 2012).

At a more macroscopic scale, running mechanics (*i.e.*, stance, swing and stride durations) was not affected by a 30-min run at self-paced velocity (Mtibaa et al., 2019), while the stance duration was increased during a marathon (Nicol et al., 1991), certainly attributed to fatigue (Apte et al., 2021). One could wonder if increasing T_{musc} with prolonged exercise may alter muscle mechanics and therefore running motor performance, and if such potential alterations would be exacerbated in hot environments.

Heat stress is known to impair prolonged exercise capacity (Périard and Racinais, 2015; Racinais et al., 2015b) with endurance sports being more impacted than shorter duration disciplines such as sprint, which even reported to be improved in the heat (Girard et al., 2015; Guy et al., 2015). While the cardiovascular challenges associated to endurance sports in the heat are well known (Périard and Racinais, 2016), the effects of hot ambient environments on biomechanical parameters remain unclear. Running 30 min in the heat (39°C, 21% RH) at self-paced velocity (*i.e.*, ~14 km.h⁻¹) decreases the distance covered and alters proprioception but

not running mechanics of highly trained participants (*i.e.*, maximal aerobic velocity $\geq 18 \text{ km}\cdot\text{h}^{-1}$), compared to a similar exercise (*i.e.*, $\sim 15 \text{ km}\cdot\text{h}^{-1}$) performed in temperate environment (Mtibaa et al., 2019). During longer exercise (*i.e.*, marathon performed at $\sim 9.5 \text{ km}\cdot\text{h}^{-1}$) in hot and humid environment, lower-limb muscle stiffness, measured with tensiomyography, was reduced (Gutierrez-Vargas et al., 2020). While passive whole-body heat exposure reduced passive GM muscle stiffness and active Achilles tendon stiffness (**study #1**), it is currently unknown whether these effects would transfer to active runners. A reduction in tendinous tissues stiffness could decrease muscle V_F (Roberts et al., 1997) and, in turn, shorten the initial operating length of muscle fascicles at the onset of muscle contraction (Ishikawa et al., 2007).

This study therefore aimed to determine fascicle dynamics *in vivo* during running in temperate and hot conditions. We assessed GM muscle and tendon stiffness as well as fascicle force-length properties in order to provide insights on tendon elastic energy storage and associated muscle contractile behavior when running in temperate and hot environments. We hypothesized that soft tissue stiffness would be reduced when running at moderate velocity in the heat ($\sim 38^\circ\text{C}$, $\sim 45\%$ RH) compared to temperate conditions ($\sim 23^\circ\text{C}$, $\sim 38\%$ RH), potentially shifting fascicle operating length on the ascending limb of their force-length relationship, and potentially increasing the physiological stress already elicited by exercising in the heat.

2. Materials and methods

1. Participants

Fifteen volunteers participated in the study (8 males, 7 females, age: 26 ± 3 years, height: 173 ± 6 cm, body mass: 65 ± 8 kg). All of the participants were trained runners (McKay et al., 2022), who ran at least 2 to 3 times a week.

2. Experimental design

Two to four days after a familiarization session, participants took part in two identical sessions performed at the same time of the day in a randomized order TEMP or HOT ambient conditions, and separated by 3-4 days. For each TEMP and HOT session, participants first underwent pre-tests (PRE) in temperate environment ($22 \pm 1^\circ\text{C}$, $38 \pm 4\%$ RH). Then, they performed a running exercise (*i.e.*, 40 min at $10 \text{ km}\cdot\text{h}^{-1}$), either in TEMP ($23 \pm 1^\circ\text{C}$, $38 \pm 4\%$ RH) or HOT ($38 \pm 1^\circ\text{C}$,

45 ± 5% RH) and were re-tested (POST) in similar environmental condition than the running exercise (respectively: 23 ± 1°C, 36 ± 4% RH in TEMP, and 38 ± 1°C, 43 ± 6% RH in HOT).

3. Testing protocol

General procedures. PRE and POST neuromuscular tests were performed immediately before and after the running protocol. PRE-tests consisted of MVC, isometric ramp contractions and passive SWE measurements. Then, the force-length relationship was assessed using electrically-evoked contractions in TEMP and HOT, but only during PRE-tests. As previously described participants lay prone on the customized Goubex ergometer, in isometric configuration ([see p.67](#)). Mechanical data were digitized at 1000 Hz. Force, torque and angle signals were low-pass filtered (50 Hz, zero-lag 3rd order Butterworth). GM ultrasound images were collected during neuromuscular testing and running. The probe was fixed on the GM during the PRE-tests, to ensure a similar position of the ultrasound probe for the neuromuscular testing and the running protocol.

Voluntary isometric contractions. Participants performed three 5-s isometric MVC to determine MVC peak force.

Active tendon stiffness. Participants produced a linearly increased isometric plantar flexor force from 0 to 90% of the MVC peak force of the corresponding session within 9-s, to determine the active stiffness of tendon ([see p.78](#)).

Passive muscle stiffness. The ultrasound scanner was used in SWE mode (musculoskeletal preset) to measure (three measurements) the shear modulus of GM, GL and SOL muscles at rest. Measurements were performed with the free probe.

Force-length relationship. For this test, participants moved on the mechatronic Eracles ergometer ([see p.68](#)) on the same position as for previous tests (*i.e.*, lay prone with the knees fully extended). Briefly, the ergometer was used to set various ankle joint angles as a mean to measure plantar flexor force, during electrically-evoked contractions (doublets stimulations), at various GM L_F ([see p.76](#)). The amplitude of the stimulations was determined for each participant from their maximum dorsiflexion angle (*i.e.*, 113 ± 3°), to 80° (*i.e.*, slight plantarflexion), resulting in a total of 9 to 13 measurements angles, with two trials by angle (*i.e.*, 18 to 26 stimulation in total). GM images were collected at 2000 Hz, L_F and pennation

angle was low-pass filtered (50 Hz, zero-lag 3rd order Butterworth), and force-length was built as previously described ([see p.76](#)).

4. Running protocol

General procedures. For both TEMP and HOT conditions, participants ran on a treadmill (Valiant 2 sport, Lode, Groningen, The Netherlands) placed in an environmental chamber. The protocol consisted of a standardized 5-min warm-up (2 min walking at 4.5 km.h⁻¹, 1 min 30 s running first at 8 km.h⁻¹ and then 1 min 30 s at 10 km.h⁻¹), following by 40-min running at 10 km.h⁻¹, either in TEMP or in HOT. The 5-min warm-up ensured that the positioning of the probe did not bother the participant and provided satisfactory images. During the familiarization, participants performed the aforementioned warm-up and ran for 10 min to be familiarized to running with the probe fixed on their calf.

Data representativity. Three ultrasounds acquisitions were recorded at 500 Hz (*i.e.*, 2 s) for each measurement period (*i.e.*, 2 and 40 min in TEMP and HOT). Only complete strides (*i.e.*, heel-strike – toe-off – heel-strike) were thereafter analyzed for running mechanics and fascicle dynamics, resulting in one-two right stride(s) for each acquisition, or three-six right strides per participant per measurement period. Then, eighty strides were analyzed in TEMP at 2 and 40 min, eighty-six at 2 min and seventy-nine at 40 min in HOT.

Mechanicals parameters. Strides were recorded using a camera, therefore providing stance, swing and stride phases duration. Then, fascicle dynamics patterns were synchronized with the strides ([see p.82](#)).

Ultrasound parameters. GM fascicle tracking (two fascicles), started on a heel-strike. When required, manual changes to the tracking were made at each heel-strike to help the algorithm account for tracking drift. Ultrasound data were split according to the phase (*i.e.*, stance or swing), and then low-pass filtered, with a cut-off frequency dynamically computed according to the Shannon Theorem (50 Hz, zero-lag 3rd order Butterworth). Due to the between-individual and between-stride variability in stance and swing phases duration, data were resampled and interpolated for both phases ([see p.79](#)), to allow between-participants and between-conditions comparisons. Before stride averaging, the amplitude of variation in L_F and pennation angle was computed on three phases: the stance phase, and the swing phase divided in two parts, the first part corresponding to the fascicle shortening (*i.e.*, from the toe-off to the minimum L_F ; shortening part of the swing phase), and the second part corresponding to the fascicle

lengthening (*i.e.*, from the minimum L_F to the heel-strike; lengthening part of the swing phase). For each participant, L_F patterns of complete strides (*i.e.*, heel-strike – toe-off – heel-strike) were averaged within acquisitions and between acquisitions at the same time period in each TEMP and HOT sessions, resulting in three to six strides considered for each moment. The L_F patterns were then normalized by L_0 , measured during the PRE-tests either in TEMP or in HOT. AGR was computed to characterize the effect of fascicle rotation. AGR was calculated by the ratio between the horizontal L_F variation (*i.e.*, L_F multiplied by the cosine of pennation angle) to the L_F variation during the phases considered (*i.e.*, stance phase, shortening part of the swing phase and lengthening part of the swing phase) (Hollville et al., 2019; Werkhausen et al., 2019b). This ratio was used to determine how the fascicle lengthening could be minimized by the fascicle rotation.

5. Physiological monitoring

Before starting the intervention, USG was collected to check the level of hydration of the participants ($USG = 1.015 \pm 0.003$). T_{core} and T_{skin} were continuously recorded during testing and running protocols. Values were averaged during PRE and POST, and recorded at 2 and 40 min (*i.e.*, corresponding to ultrasound measurements). Heart rate was recorded at 2 and 40 min of running, and sweat loss calculated in TEMP and HOT. Perceptual ratings (*i.e.*, TS, TC, and RPE) were collected after ultrasound measurements (*i.e.*, at 2 and 40 min).

6. Statistical analyses

Two-way ANOVAs (condition \times time) for repeated measures were used to assess the effect of the condition (TEMP, HOT) and time (PRE, POST) on T_{core} , T_{skin} , MVC peak force, GM L_F , pennation angle and muscle thickness, GM shear modulus, and Achilles tendon active stiffness. Non-parametric tests were performed to observe the effect of condition and time (Friedman) on GL and SOL shear modulus (non-normalized data). Two-way ANOVAs (condition \times time) for repeated measures were used to assess the effect of the condition (TEMP, HOT) and time (2 min, 40 min) on T_{core} , T_{skin} , heart rate, stance, swing and stride phase durations, on the amplitude of variation of L_F and pennation angle and on the AGR during the stance phase, the shortening part of the swing phase and the lengthening part of the swing phase. When appropriate, post-hoc analyses were performed using a Bonferroni correction. Non-parametric tests were used to determine the effect of condition and time (Friedman) on thermal sensation, thermal comfort

and RPE (non-normalized data), with pairwise-comparisons to localize the differences. Paired t-test was used to compare the sweat loss between tested environmental conditions. Statistical parametric mapping [SPM; (Pataky et al., 2013)] with two-way ANOVAs was used to compare fascicle dynamics over swing and stance phases during running between condition (TEMP, HOT) and time (2 min, 40 min), using Origin. Conceptually, the SPM analysis process is similar to the calculation and interpretation of a scalar two-sample t-test, considering each point of the pattern.

3. Results

1. Testing sessions

Thermoregulatory responses. There was a main effect of condition, time and an interaction effect on T_{core} and T_{skin} (all $P \leq 0.001$, $\eta_p^2 \geq 0.38$), with a significant increase in T_{core} and T_{skin} from PRE to POST (respectively, $+0.6 \pm 0.3^\circ\text{C}$ and $+1.5 \pm 0.8^\circ\text{C}$ in TEMP and $+2.2 \pm 0.5^\circ\text{C}$ and $+4.1 \pm 1.0^\circ\text{C}$ in HOT; all $P \leq 0.003$, $\eta_p^2 \geq 0.38$), higher T_{core} and T_{skin} in HOT vs. TEMP during POST (respectively, $+1.5 \pm 0.7^\circ\text{C}$ and $+2.6 \pm 1.2^\circ\text{C}$; both $P \leq 0.001$, $\eta_p^2 \geq 0.64$), while PRE ambient temperature was similar for TEMP and HOT ($P \geq 0.988$, $\eta_p^2 \leq 0.01$; Table 5).

Muscle-tendon unit properties. MVC peak force revealed no effect of condition ($P = 0.765$, $\eta_p^2 < 0.01$), tended to decrease over time ($P = 0.060$, $\eta_p^2 = 0.06$), with no condition \times time interaction ($P = 0.465$, $\eta_p^2 = 0.01$; Figure 37).

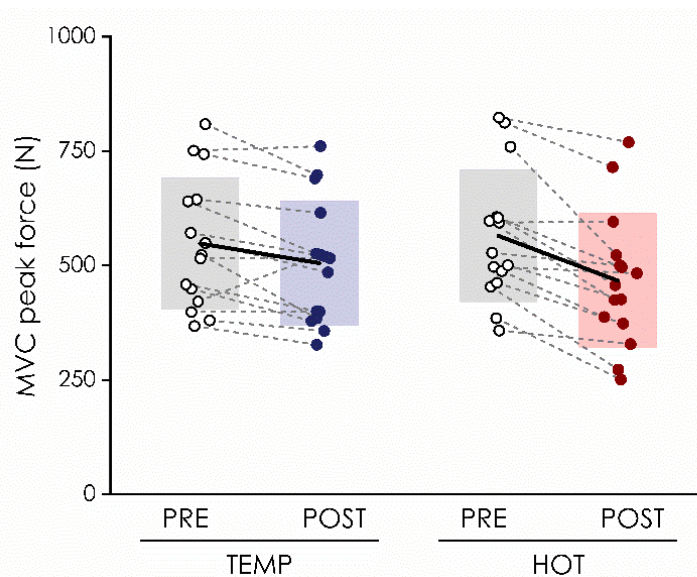

Figure 37. Maximal voluntary contraction (MVC) peak force obtained before (PRE) and after (POST) running in temperate (TEMP) or hot (HOT) environment. Open circles connected by dashed traces show individual values, while bold straight trace represent mean values. $n = 15$.

Two-way ANOVAs revealed neither an effect of condition (all $P \geq 0.641$, $\eta_p^2 < 0.01$), time (all $P \geq 0.159$, $\eta_p^2 \leq 0.04$) nor interaction (all $P \geq 0.420$, $\eta_p^2 \leq 0.01$) on L_F and muscle thickness (Table 5). Pennation angle increased over time ($P = 0.028$, $\eta_p^2 = 0.08$), with neither an effect of condition, nor condition \times time interaction (both $P \geq 0.559$, $\eta_p^2 < 0.01$; Table 5).

Shear modulus measured in GM, GL and SOL at rest were unaffected by condition or time (all $P \geq 0.145$; Table 5). Active Achilles tendon stiffness was not affected by condition ($P = 0.256$; $\eta_p^2 = 0.02$) or time ($P = 0.281$; $\eta_p^2 = 0.02$) with no condition \times time interaction effect ($P = 0.465$; $\eta_p^2 = 0.01$; Table 5).

Fascicle force-length relationship revealed a L_0 of 6.18 ± 0.72 cm in TEMP and 6.19 ± 0.76 cm in HOT. F_{max} was 30.9 ± 4.6 N in TEMP and 31.8 ± 5.8 N in HOT (Figures 37-38).

2. Running sessions

Thermoregulatory responses. There was a main effect of condition, time and interaction effect on T_{core} (all $P \leq 0.001$, $\eta_p^2 \geq 0.19$), with increasing values from 2 min to 40 min ($+1.1 \pm 0.3^\circ\text{C}$ in TEMP and $+2.1 \pm 0.4^\circ\text{C}$ in HOT; both $P < 0.001$, $\eta_p^2 \geq 0.57$), higher T_{core} in HOT vs. TEMP at 40 min ($+1.0 \pm 0.4^\circ\text{C}$; $P < 0.001$, $\eta_p^2 = 0.40$), while T_{core} was similar for TEMP and HOT at 2 min ($P = 0.989$, $\eta_p^2 = 0.01$; Table 6). T_{skin} was higher in HOT vs. CON, and increased from 2 min to 40 min (both $P < 0.001$, $\eta_p^2 \geq 0.59$), without reporting an interaction effect ($P = 0.077$, $\eta_p^2 = 0.06$; Table 6). There was a main effect of condition, time and condition \times time interaction effect on heart rate (all $P \leq 0.019$, $\eta_p^2 \geq 0.10$). Post-hoc tests revealed that heart rate increased in HOT over time ($P < 0.001$, $\eta_p^2 = 0.47$), with higher heart rate in HOT than TEMP at 40 min ($P < 0.001$, $\eta_p^2 = 0.48$; Table 6). Sweat loss was higher in HOT than TEMP ($P < 0.001$, $\eta_p^2 = 0.431$; Table 6).

Perceptual ratings. Pairwise-comparisons revealed that thermal sensation increased with running in TEMP and HOT, and that thermal sensation was higher in HOT than CON at 2 and 40 min (all $P < 0.001$, $W \geq 0.58$; Table 6). Thermal comfort was higher in HOT than CON at 2 and 40 min, and was unchanged in TEMP ($P = 0.085$, $W = 0.22$), while it increased with running in HOT (all $P < 0.001$, $W \geq 0.67$; Table 6). As for TS, pairwise-comparisons revealed that RPE was higher in HOT than CON at 2 and 40 min, and that RPE increased with running in TEMP and HOT (all $P < 0.004$, $W \geq 0.54$; Table 6).

Table 5. Thermoregulatory responses and muscle-tendon unit properties measured before (PRE) and after (POST) the running protocol performed in temperate (TEMP) and hot (HOT) conditions.

		TEMP		HOT		Main effect		
		PRE	POST	PRE	POST	Condition	Time	Interaction
Thermoregulatory responses	T _{core} (°C)	37.1 ± 0.3	37.8 ± 0.5 [‡]	37.1 ± 0.3	39.2 ± 0.6 ^{†‡}	P < 0.001 η _p ² = 0.38	P < 0.001 η _p ² = 0.71	P < 0.001 η _p ² = 0.42
	T _{skin} (°C)	33.3 ± 0.8	37.8 ± 0.8 [‡]	33.3 ± 0.9	37.4 ± 0.9 ^{†‡}	P < 0.001 η _p ² = 0.66	P < 0.001 η _p ² = 0.70	P < 0.001 η _p ² = 0.42
Muscle architecture	L _F (cm)	5.7 ± 0.6	5.5 ± 0.6	5.8 ± 0.8	5.3 ± 0.5	<i>P</i> = 0.886 η _p ² < 0.01	<i>P</i> = 0.159 η _p ² = 0.04	<i>P</i> = 0.420 η _p ² = 0.01
	Pennation angle (°)	17.8 ± 2.5	19.1 ± 2.6	17.2 ± 2.2	19.4 ± 2.1	<i>P</i> = 0.835 η _p ² < 0.01	P = 0.028 η _p ² = 0.08	<i>P</i> = 0.559 η _p ² < 0.01
	Muscle thickness (cm)	1.66 ± 0.14	1.72 ± 0.13	1.65 ± 0.16	1.69 ± 0.17	<i>P</i> = 0.641 η _p ² < 0.01	<i>P</i> = 0.324 η _p ² = 0.02	<i>P</i> = 0.854 η _p ² < 0.01
Tissues stiffness	GM shear modulus (kPa)	11.1 ± 2.6	10.5 ± 2.2	10.8 ± 2.2	10.7 ± 1.4	<i>P</i> = 0.952 η _p ² < 0.01	<i>P</i> = 0.579 η _p ² = 0.01	<i>P</i> = 0.739 η _p ² < 0.01
	GL shear modulus (kPa)	8.8 ± 2.5	10.3 ± 4.0	8.5 ± 2.0	10.0 ± 2.8	Friedman non-parametrical test: <i>P</i> = 0.145		
	SOL shear modulus (kPa)	6.4 ± 2.6	6.9 ± 2.8	7.6 ± 3.1	8.0 ± 2.6	Friedman non-parametrical test: <i>P</i> = 0.272		
	Active Achilles tendon stiffness (N.mm ⁻¹)	34.1 ± 8.1	33.2 ± 10.0	33.0 ± 6.9	28.1 ± 7.1	<i>P</i> = 0.256 η _p ² = 0.02	<i>P</i> = 0.281 η _p ² = 0.02	<i>P</i> = 0.465 η _p ² = 0.01

Values are represented as mean ± SD. T_{core}, core temperature; T_{skin}, skin temperature; L_F, fascicle length; GM, *gastrocnemius medialis*; GL *gastrocnemius lateralis*; SOL, *soleus*. *n* = 15, except for T_{skin}, GM, GL and SOL shear modulus where *n* = 14. † significant difference between TEMP and HOT for the same time, ‡ significant difference between PRE and POST for the same condition, *P* < 0.05.

Table 6. Thermoregulatory responses, perceptual ratings, running mechanics and fascicle dynamics measured at the beginning (2 min) and at the end (40 min) of the running protocol performed in temperate (TEMP) and in hot (HOT) conditions.

		TEMP		HOT		Main effect		
		2 min	40 min	2 min	40 min	Condition	Time	Interaction
<i>Thermoregulatory responses</i>	T _{core} (°C)	37.4 ± 0.4	38.5 ± 0.5 [‡]	37.4 ± 0.4	39.4 ± 0.6 ^{†‡}	P < 0.001 η _p ² = 0.19	P < 0.001 η _p ² = 0.74	P < 0.001 η _p ² = 0.23
	T _{skin} (°C)	32.7 ± 0.9	34.9 ± 0.9	36.2 ± 0.8	37.7 ± 0.5	P < 0.001 η _p ² = 0.81	P < 0.001 η _p ² = 0.59	P = 0.077 η _p ² = 0.06
	Heart rate (bpm)	132 ± 12	143 ± 14	146 ± 16	175 ± 16 ^{†‡}	P < 0.001 η _p ² = 0.41	P < 0.001 η _p ² = 0.33	P = 0.019 η _p ² = 0.10
	Sweat loss (L)	0.69 ± 0.26		1.42 ± 0.56*		T-test:		P < 0.001 η _p ² = 0.431
<i>Perceptual ratings</i>	Thermal sensation	4.1 ± 0.6	4.6 ± 0.7 [‡]	5.6 ± 0.6 [†]	6.5 ± 0.5 ^{†‡}	Friedman non-parametrical test: P < 0.001		
	Thermal comfort	4.1 ± 0.4	4.5 ± 0.6	4.8 ± 0.4 [†]	6.0 ± 0.7 ^{†‡}	Friedman non-parametrical test: P < 0.001		
	RPE	7.9 ± 1.6	8.8 ± 2.2 [‡]	9.4 ± 2.4 [†]	13.3 ± 3.0 ^{†‡}	Friedman non-parametrical test: P < 0.001		
<i>Running mechanics</i>	Stance duration (ms)	251 ± 22	252 ± 22	248 ± 22	253 ± 23	P = 0.837 η _p ² < 0.01	P = 0.548 η _p ² < 0.01	P = 0.759 η _p ² < 0.01
	Swing duration (ms)	486 ± 28	493 ± 31	489 ± 32	495 ± 40	P = 0.785 η _p ² < 0.01	P = 0.459 η _p ² = 0.01	P = 0.978 η _p ² < 0.01
	Stride duration (ms)	732 ± 31	745 ± 36	737 ± 32	748 ± 41	P = 0.905 η _p ² < 0.01	P = 0.291 η _p ² = 0.02	P = 0.862 η _p ² < 0.01

Fascicle dynamics: Stance phase	Amplitude of L _F variation (cm)	-1.48 ± 0.57	-1.43 ± 0.47	-1.45 ± 0.55	-1.44 ± 0.46	<i>P</i> = 0.946 $\eta_p^2 < 0.01$	<i>P</i> = 0.809 $\eta_p^2 < 0.01$	<i>P</i> = 0.867 $\eta_p^2 < 0.01$
	Amplitude of pennation angle variation (°)	7.7 ± 3.5	7.8 ± 3.6	8.3 ± 3.7	9.2 ± 4.3	<i>P</i> = 0.301 $\eta_p^2 = 0.02$	<i>P</i> = 0.624 $\eta_p^2 < 0.01$	<i>P</i> = 0.688 $\eta_p^2 < 0.01$
	AGR	1.10 ± 0.05	1.10 ± 0.12	1.11 ± 0.04	1.11 ± 0.06	<i>P</i> = 0.728 $\eta_p^2 < 0.01$	<i>P</i> = 0.934 $\eta_p^2 < 0.01$	<i>P</i> = 0.987 $\eta_p^2 < 0.01$
Fascicle dynamics: Swing phase – Shortening part	Amplitude of L _F variation (cm)	-0.70 ± 0.36	-0.65 ± 0.31	-0.72 ± 0.27	-0.63 ± 0.34	<i>P</i> = 0.958 $\eta_p^2 < 0.01$	<i>P</i> = 0.377 $\eta_p^2 = 0.01$	<i>P</i> = 0.813 $\eta_p^2 < 0.01$
	Amplitude of pennation angle variation (°)	1.6 ± 4.1	1.9 ± 4.7	3.0 ± 4.1	1.6 ± 4.6	<i>P</i> = 0.649 $\eta_p^2 < 0.01$	<i>P</i> = 0.612 $\eta_p^2 < 0.01$	<i>P</i> = 0.438 $\eta_p^2 = 0.01$
	AGR	1.00 ± 0.14	0.99 ± 0.15	1.03 ± 0.16	1.04 ± 0.13	<i>P</i> = 0.248 $\eta_p^2 = 0.02$	<i>P</i> = 0.979 $\eta_p^2 < 0.01$	<i>P</i> = 0.811 $\eta_p^2 < 0.01$
Fascicle dynamics: Swing phase – Lengthening part	Amplitude of L _F variation (cm)	2.27 ± 0.38	2.14 ± 0.42	2.28 ± 0.50	2.16 ± 0.44	<i>P</i> = 0.925 $\eta_p^2 = 0.02$	<i>P</i> = 0.271 $\eta_p^2 < 0.01$	<i>P</i> = 0.962 $\eta_p^2 < 0.01$
	Amplitude of pennation angle variation (°)	-9.8 ± 4.8	-9.0 ± 5.0	-10.9 ± 4.6	-9.3 ± 4.4	<i>P</i> = 0.550 $\eta_p^2 < 0.01$	<i>P</i> = 0.335 $\eta_p^2 = 0.02$	<i>P</i> = 0.733 $\eta_p^2 < 0.01$
	AGR	1.05 ± 0.07	1.07 ± 0.07	1.06 ± 0.07	1.07 ± 0.06	<i>P</i> = 0.679 $\eta_p^2 < 0.01$	<i>P</i> = 0.281 $\eta_p^2 = 0.02$	<i>P</i> = 0.768 $\eta_p^2 < 0.01$

Values are represented as mean ± SD. T_{core}, body core temperature; T_{skin}, skin temperature; thermal sensation (1 to 7, cold to hot); thermal comfort (1 to 7; too cool to much too warm) and RPE, rate of perceived exertion (6 to 20, no exertion at all to maximal exertion); L_F, fascicle length; AGR, architectural gear ratio. *n* = 15. † Significant difference between TEMP and HOT for the same time, ‡ significant difference between PRE and POST for the same condition, * significant difference between TEMP and HOT, *P* < 0.05.

Running mechanics. Running kinematics showed no effect of condition (all $P \geq 0.785$, $\eta_p^2 < 0.01$), time (all $P \geq 0.291$, $\eta_p^2 \leq 0.02$), or condition \times time interaction (all $P \geq 0.759$, $\eta_p^2 < 0.01$) for stance, swing and stride phases duration (Table 6).

Fascicle dynamics. Two-way ANOVAs reported neither an effect of condition (all $P \geq 0.248$, $\eta_p^2 \leq 0.02$), time (all $P \geq 0.271$, $\eta_p^2 \leq 0.02$), nor condition \times time interaction (all $P \geq 0.438$, $\eta_p^2 \leq 0.01$), on the amplitude of variation of L_F , pennation angle and on the AGR during stance phase, shortening and lengthening parts of the swing phase (Table 6, Figure 38).

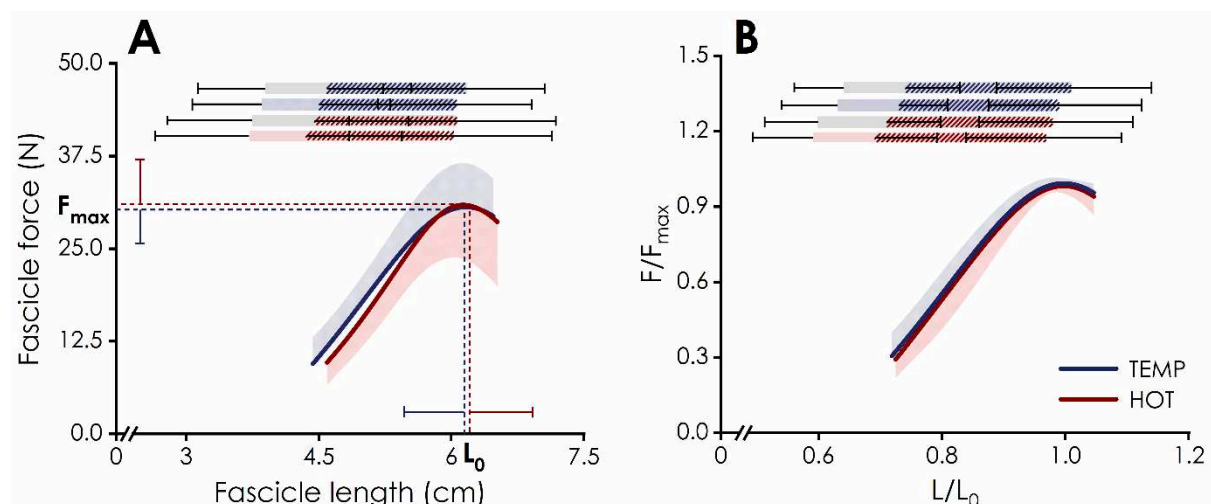

Figure 38. Mean group (thick lines) and standard deviation (shaded area) gastrocnemius medialis force-length relationship in absolute (A) and relative values (B), measured before running in temperate (TEMP) or hot (HOT) conditions. At the top, histograms represent the operating fascicle lengths \pm SD during stance phase (shaded) and swing phase (full) at 2 min (grey) and 40 min (blue for TEMP and red for HOT). Optimal fascicle length (L_0) and maximal force (F_{max}) are represented (mean \pm SD) on the corresponding axes for both conditions. $n = 15$.

SPM analyses reported no difference in L_F patterns over time, whether expressed in absolute (*i.e.*, cm) or relative values (*i.e.*, L/L_0), with no significant condition, time and condition \times time interaction effect (Figure 39).

4. Discussion

The present study reveals for the first time that fascicle operating lengths assessed during running ($10 \text{ km}\cdot\text{h}^{-1}$) in TEMP (23°C , 38% RH) or HOT conditions (38°C , 45% RH) were unchanged between the beginning and the end of the run (*i.e.*, 2 vs. 40 min). Maximal voluntary force production tended to decrease, while resting shear modulus of the three muscles of the *triceps surae*, and active Achilles tendon stiffness measured PRE- and POST-running exercise were unchanged in both TEMP and HOT conditions. Overall, our results demonstrate that

muscle-tendon unit properties and fascicle dynamics during running are unaffected by environmental temperatures (*i.e.*, 15°C apart).

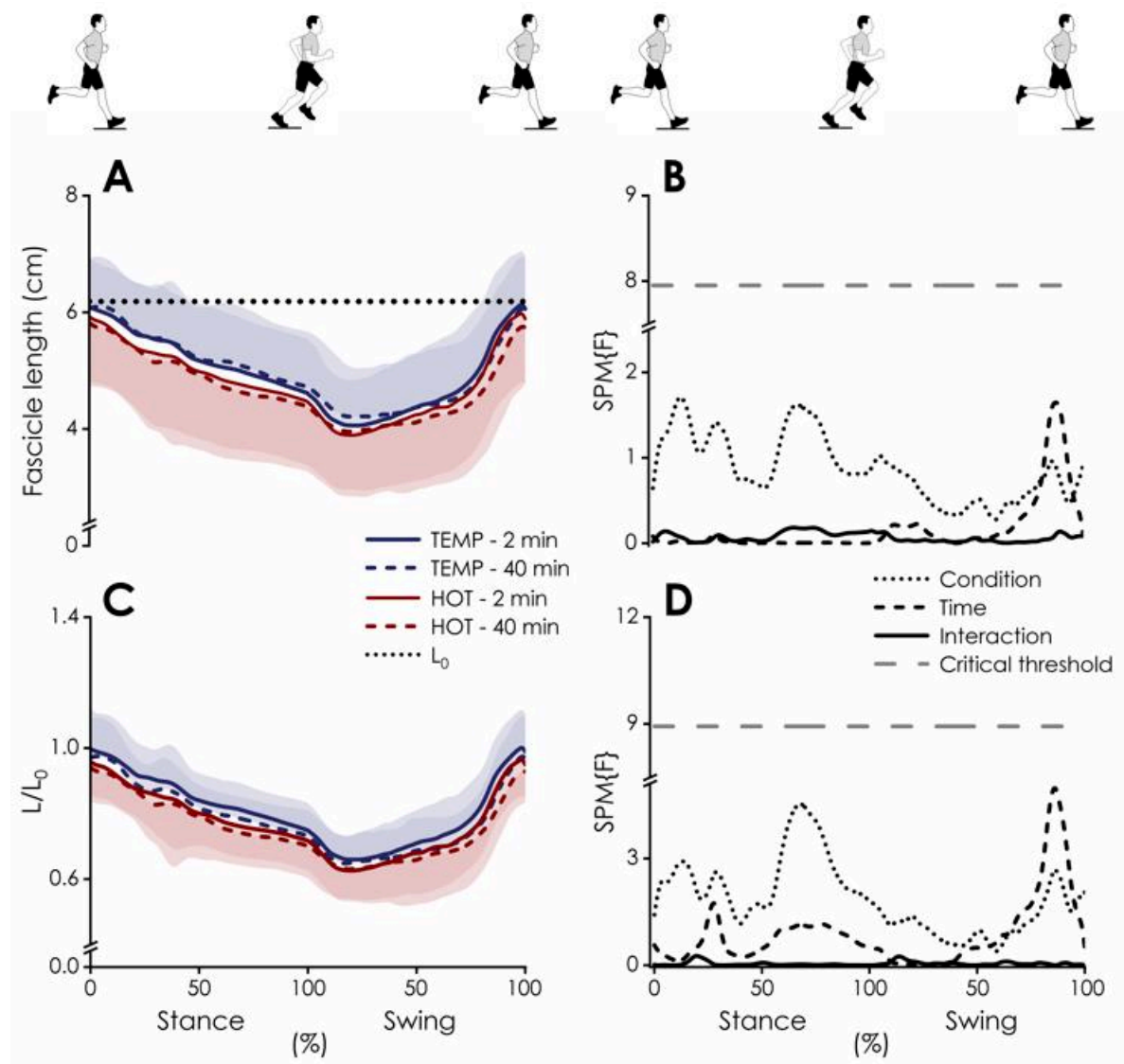

Figure 39. Gastrocnemius medialis fascicle length changes during a stride presented as the mean and standard deviation (shaded area) at 2 min (thick line) and 40 min (dashed line) in temperate (TEMP) and hot (HOT) conditions, expressed in absolute (A) and relative (C) values. The optimal fascicle length (L_0) is represented as a dashed horizontal line (6.18 ± 0.72 cm in TEMP and 6.19 ± 0.79 cm in HOT; for clarity represented by a single line at 6.185 cm). The results of the statistical parametric mapping (SPM) analyses are presented for absolute (B) et relative (D) patterns, with condition effect (dotted), time effect (dashed), interaction effect (solid), and significance threshold (dashed dotted). $n = 15$.

1. Muscle fascicle operating lengths

As previously observed in studies investigating GM fascicle dynamics during running (Monte et al., 2023; Swinnen et al., 2022; Werkhausen et al., 2021), muscle fascicle shortens (*i.e.*, from

5.9 ± 0.9 to 4.5 ± 1.0 cm; pooled data between time and condition), corresponding to an increase in the strain of the series elastic elements during the stance phase (Litchwark et al., 2007). After the toe-off, L_F further decreased until a minimum of 3.8 ± 0.9 cm (considered as the swing shortening part). From this point, GM fascicle then elongated, initiating the lengthening part of the swing phase, which starts 117 ± 38 ms (*i.e.*, 23.4 ± 7.4% of the swing phase) after the toe-off. Although the swing phase is less often explored than stance phase in the literature, this pattern is in line with fascicle dynamics previously reported during running at 7.5-10 km.h⁻¹ (Lichtwark and Wilson, 2006; Lichtwark et al., 2007). At the end of the swing phase, muscle fascicle lengthened even more, likely corresponding to a more pronounced dorsiflexion before the heel-strike, as previously described around the contact (Deschamps et al., 2022).

During running at low velocity (*i.e.*, 10 km.h⁻¹), GM fascicle operated over ascending limb of the force-length relationship, with only 6.2 ± 10.5% of operating lengths being higher than L_0 (all phases considered; Figure 39). This result confirms previous reports during running at similar velocity (Monte et al., 2020; Swinnen et al., 2022) and suggests the mainly non-traumatic nature (*i.e.*, absence of active eccentric contraction inducing fascicles overstretching) of 10 km.h⁻¹ run (Lieber and Fridén, 1993). During the run, GM fascicle mainly operated close to L_0 , especially during the stance phase (5.12 ± 0.97 cm; 0.83 ± 0.09 L/L_0), then developing high levels of contractile force.

We observed larger muscle fascicle rotation (*i.e.*, AGR values) during the stance phase compared to the two parts of the swing phase (*i.e.*, shortening and lengthening part). AGR values obtained during the stance phase (1.10 ± 0.08) were slightly higher compared to values obtained when running at similar velocity [*i.e.*, 8.3-10.1 km.h⁻¹; AGR: ~1.06-1.07; (Werkhausen et al., 2019)] while, to our knowledge, no study reported AGR during swing phase. This difference can be partly attributed to the participants characteristics, with putatively stiffer tendon, given that AGR was increased with increasing Achilles tendon stiffness (Werkhausen et al., 2019b), which could be attributed to stiffer connective tissue (Eng and Roberts, 2018). However, our results seem contradictory with the literature. Decreasing values of AGR were reported with increasing force contraction, to facilitate muscle force transmission to the tendon in concentric contractions (Azizi et al., 2008), or AGR reported to be higher during lengthening than shortening contractions (Azizi and Roberts, 2014). This second observation was confirmed during the two parts of the swing phase, with higher AGR during the lengthening than the shortening part, but not observed in the stance phase (*i.e.*, GM fascicle shortening). However, it is important to remind that the role of AGR still remains to be elucidated in running.

Elastic strain energy, attributed to muscle and tendon elastic properties is considered as a major contributor of muscle efficiency during running (Lichtwark et al., 2007). This property was likely unchanged, given that muscle fascicle operating lengths were stable, and active Achilles tendon stiffness measured POST-running exercise was unaffected (in TEMP and HOT conditions). These data also suggest unchanged muscle-tendon unit length behavior during running.

2. Influence of running time on muscle mechanics

In line with a previous study (Mtibaa et al., 2019), stance, swing and stride durations were not affected over time. To our knowledge, the present study is the first to investigate fascicle dynamics with high ultrasound sampling frequency (*i.e.*, 500 Hz), and during a prolonged exercise. Although operating GM L_F shift towards the ascending limb of the force-length relationship over time (*i.e.*, at 40 min; Figure 38), no significant effect was observed. Unchanged GM fascicle operating lengths during running over time suggests that metabolic energy expenditure may not be altered by this parameter (Beck et al., 2022), at least until 40 min.

3. Running in the heat

Although HOT imposed an additional physiological stress, with T_{core} reaching $39.4 \pm 0.6^\circ\text{C}$ and heart rate 175 ± 16 bpm at 40 min (*vs.* $38.5 \pm 0.5^\circ\text{C}$ and 143 ± 14 bpm in TEMP), and intensified perceptual responses (Table 6), none of the properties measured during the running exercise were different than TEMP. As well as for exercise duration, running mechanics remained similar in both environmental conditions. These results are in accordance with an aforementioned study which reported unchanged running mechanics after running 30 min at ($13.9 \pm 1.6 \text{ km}\cdot\text{h}^{-1}$) in hot conditions [39°C , 21% RH; (Mtibaa et al., 2019)]. To the best of our knowledge, no other study reported running mechanics when running at slow or moderate velocity under hot conditions. A graphically trend for a leftward shift of operating L_F over the force-length relationship in HOT (Figure 38) was not statistically observable. Therefore, muscle fascicle dynamics and operating length were unaffected by environmental conditions.

4. Post-exercise responses

Maximal force-generating capacity tended to decrease at the end of the running exercise (Figure 37), while this trend was not exacerbated in HOT. Therefore, the protocol induced no or low plantar flexors fatigue, regardless of the environmental conditions. There were no temperature effects, which is in accordance with previous research on cycling and football (Girard and Racinais, 2014; Nybo et al., 2013).

Pennation angle increased after the running exercise ($+1.3 \pm 2.1^\circ$ in TEMP and $+2.0 \pm 2.0^\circ$ in HOT), with no effect of the environmental condition. This result is in accordance with the trend for L_F to decrease after exercise (5.7 ± 0.8 cm in PRE vs. 5.4 ± 0.7 cm in POST; pooled data between time and condition), and muscle thickness to increase (1.65 ± 0.19 cm in PRE vs. 1.71 ± 0.20 cm in POST), despite no statistical effect. This effect was not observed during running, considering that pennation angle variation during stance and swing phases was not affected by time nor condition. Pennation angle increased was probably linked to the residual force-enhancement after the stretch-shortening cycle (De Monte and Arampatzis, 2008), and as previously suggested (Thomas et al., 2015) could be attributed to an increase in blood volume in the GM certainly induced by the exercise (Buchheit et al., 2009).

The shear modulus measured in *triceps surae* (*i.e.*, GM, GL and SOL) was not affected when running in TEMP or HOT, confirming previous results with unchanged *gastrocnemii* shear modulus after a 30-min running task [(12 km.h⁻¹; (Ohya et al., 2017)]. While we might have expected a decrease in muscle stiffness as reported using tensiomyography after an active heat exposure [*i.e.*, marathon performed in the heat; (Gutierrez-Vargas et al., 2020)], or assessed using SWE after a passive heat exposure (**study #1**), the absence of changes in muscle stiffness following TEMP and HOT testing sessions.

Active Achilles tendon stiffness was also unchanged POST-running exercise in TEMP and HOT, in accordance with previous findings (Farris et al., 2012), which is in accordance with unchanged fascicle dynamics obtained in our study. While passive heat exposure was reported to decrease Achilles tendon stiffness (**study #1**), to our knowledge, no study had yet reported the effect of running in hot conditions on Achilles tendon stiffness. Unchanged tendon compliance in both TEMP and HOT suggests that the tendon storage-release processes of elastic energy are independent from ambient temperature below 40 min of active exposure.

5. Methodological considerations

The present GM force-length relationship was built from 9-13 tested joint angle conditions, which covers more conditions than previous report (Hager et al., 2020). The L_0 inferred from this method (*i.e.*, ~6.2 cm in both conditions) was similar to the GM L_0 previously reported using electrically-evoked contractions [*i.e.*, 5.9-6.2 cm; (Hoffman et al., 2012, 2014)]. One could note that thorough care was given to the probe repositioning between the two conditions (*i.e.*, TEMP and HOT), using ultrasound images and anatomical landmarks. The resulting average L_0 was almost exactly the same between the two sessions (*i.e.*, 6.18 ± 0.72 cm in TEMP and 6.19 ± 0.79 cm in HOT). Although the probe may have slightly moved during running, the muscle thickness obtained between PRE- and POST-running measurements remained stable as well. Therefore, we are confident this experimental procedure reflects actual fascicle force-length properties. Despite variability of fascicles behavior between distal, mid belly and proximal sites along the muscle, the mid belly position provided a good indicator of the fascicle dynamics across the whole GM muscle during running (Lichtwark et al., 2007). Moreover, the changes in GM L_F measured using dynamic ultrasound, were reported to be reproducible during treadmill running (Giannakou et al., 2011).

A longer exercise could have reported different muscle and tendon responses (*e.g.*, shorter fascicle lengthening, softer tissues). However, it is important to mention that the duration and the intensity of the running exercise was chosen to allow all participants to complete the running protocol in the heat, where heat stress increases the physiological stress.

6. Perspectives

The properties presently investigated could have different responses with participants of a higher level (*e.g.*, highly trained) with an increase in the duration, velocity or slope of the running exercise. It was reported that contact time decreased from the fourth hour of a 24-h treadmill run, leading to an increased step frequency (Morin et al., 2011). Increasing step frequency may reduce mean SOL operating length (Swinnen et al., 2022), potentially leading to an increase in SOL muscle metabolic energy expenditure and therefore whole-body metabolic energy expenditure (Beck et al., 2022). Similarly, increasing running velocity (from 10 to 16 km.h⁻¹) decreased GM operating L_F (Monte et al., 2020), probably leading to an increase in metabolic energy expenditure, and increasing the contribution of elastic structures to the energy generated by the muscle-tendon unit.

Although no statistical effect was reported, with HOT, Achilles tendon stiffness and fascicle operating lengths were lower than in TEMP in the present study. If an effect would have occurred (potentially during a prolonged exercise or at higher running velocity) it would have been probably in this direction, with decreasing operating L_F requiring an increasing contribution of the elastic structures to force generation and movement.

7. Practical considerations

The absence of time (at least until 40 min) and condition effects on muscular properties may reassure coaches and athletes on the absence of alterations of muscle-tendon unit properties, when running at low intensity under temperate and hot conditions. In a context of global warming, our findings may rule out potential detrimental effects of heat on muscle properties for middle distance disciplines.

5. Conclusion

This study explored for the first-time *in vivo* changes in muscle-tendon interactions when running a prolonged exercise (*i.e.*, 40 min) in temperate (23°C, 38% RH) and hot (38°C, 45% RH) environments. While higher ambient temperature increased T_{core} and T_{skin} , it did not alter muscle-tendon properties and interplay when running at low/moderate velocity (*i.e.*, 10 km.h⁻¹). These findings strongly encourage further investigations on longer and more intense running exercise.

STUDY 3

Active heat acclimation does not alter muscle-tendon unit properties

Associated publication

Mornas A, Brocherie F, Guilhem G, Guillotel A, Le Garrec S, Gouwy R, Beuve S, Genisson JL and Racinais S. Active heat acclimation does not alter muscle-tendon unit properties. *Med Sci Sports Exerc.* [Epub ahead of print]

Associated communications

Mornas A, Brocherie F, Guilhem G, Guillotel A, Le Garrec S, Gouwy R, Beuve S, Genisson JL and Racinais S (2021). The effects of active heat acclimation on muscle-tendon unit mechanical properties. *26th congress of the European College of Sport Science*, Digital Congress. **Oral communication**

Mornas A, Brocherie F, Guilhem G, Guillotel A, Le Garrec S, Gouwy R, Beuve S, Genisson JL and Racinais S (2022). Active heat acclimation does not alter muscle-tendon unit properties. *27th congress of the European College of Sport Science*, Sevilla, Spain. **Oral communication**

ABSTRACT

HA is recommended before competing in hot and humid conditions. HA has also been recently suggested to increase muscle strength, but its effects on human's muscle and tendon mechanical properties are not yet fully understood. This study investigated the effect of active HA on GM muscle-tendon properties. Thirty recreationally active participants performed 13 low-intensity cycling sessions, distributed over a 17-days period in hot (HA: $\sim 38^{\circ}\text{C}$, $\sim 58\%$ RH; $n = 15$) or in temperate environment (CON: $\sim 23^{\circ}\text{C}$, $\sim 35\%$ RH; $n = 15$). Mechanical data and high-frame rate ultrasound images were collected during electrically-evoked and voluntary contractions pre- and post-intervention. Shear modulus was measured at rest in GM and vertical jump performance was assessed. T_{core} decreased from the first to the last session in HA ($-0.4 \pm 0.3^{\circ}\text{C}$; $P = 0.015$), while sweat rate increased ($+0.4 \pm 0.3 \text{ L}\cdot\text{h}^{-1}$; $P = 0.010$), suggesting effective HA; whereas no changes were observed in CON (both $P \geq 0.877$). Heart rate was higher in HA vs. CON and decreased throughout intervention in groups (both $P \leq 0.008$), without an interaction effect ($P = 0.733$). Muscle-tendon unit properties (*i.e.*, maximal and explosive isometric torque production, contractile properties, VA, joint and fascicular force-velocity relationship, passive muscle and active tendon stiffness) and vertical jump performance did not show training ($P \geq 0.067$) or group \times training interaction ($P \geq 0.232$) effects. Effective active HA does not alter muscle-tendon properties. Preparing hot and humid conditions with active HA can be envisaged in all sporting disciplines without the risk of impairing muscle performance.

Keywords: repeated hot exposure, exercise, strength, force-velocity properties, stiffness, performance

1. **Introduction**

Exercising in the heat induces cardiovascular and neuromuscular impairments which may in turn limit exercise capacity (Périard and Racinais, 2015; Racinais et al., 2015b). However, repeated passive or active heat exposures, known as HA, elicit specific physiological adaptations that may mitigate these alterations, improving exercise capacity in the heat (Lorenzo et al., 2010; Nielsen et al., 1993; Périard et al., 2015) and potentially in temperate conditions (Lorenzo et al. 2010). It is therefore recommended to train (or to be exposed) in the heat for 60-90 min per day (Périard et al., 2015; Racinais et al., 2015a) for one to two weeks (Racinais et al., 2012; Racinais et al., 2015b) before competing in the heat. HA notably increases sweat rate (Eichna et al., 1950) and plasma volume (Patterson et al., 2004), and decreases sweat sodium concentration (Allan and Wilson, 1971), T_{core} (Eichna et al. 1950) and heart rate (Nielsen et al. 1993).

Moreover, passive HA appears to protect the central nervous system in the heat (Racinais et al., 2017b), and to increase electrically-evoked and voluntary force-generating capacity of plantar flexor muscles (Racinais et al., 2017c). To the best of our knowledge, few studies have investigated the effects of HA on such properties, and the underlying mechanisms are unknown. Interestingly, using repeated local heat exposure, muscle force was increased in humans (Goto et al., 2011; Kim et al., 2020), and induced muscle hypertrophy in both animals and humans (Goto et al., 2011; Yamashita-Goto et al., 2002). It was reported that repeated passive heat exposures may promote the activation and inhibition of the hypertrophic and atrophic signaling pathways, respectively (Ihsan et al., 2020; Yoshihara et al., 2013). Altogether, these previous studies may suggest that repeated heat exposure leads to increased force production, due to muscular adaptations. However, the muscle-tendon adaptations accompanying these increases in muscle force are unknown. Notably, they have not been investigated after an active HA, despite the fact that changes in muscle-tendon properties may impact athletic performance, especially the force-velocity relationship.

The anatomical structures of the calf can be used as a predictor of athletic ability (Lee et al., 2022), therefore a potential modification of these structures should be considered when investigating performance. Muscle size is considered to be dependent of fascicle architecture (Takahashi et al., 2022). Thus, muscle hypertrophy, potentially inducing structural changes, could have effects on muscle mechanical properties. For example, it was reported that maximum shortening velocity is increased with longitudinal fascicle growth (Hinks et al.,

2022). Although these phenomena are difficult to investigate *in vivo*, muscle-tendon unit properties could in turn be impacted. Explosive force production, commonly measured through the rate of torque development (RTD), is dependent of maximum voluntary force production (Folland et al., 2014). Therefore, RTD might be increased by repeated heat exposure inducing muscle hypertrophy which increases force-generating capacity. HA, possibly enhancing force production, could also impact force-velocity properties, by inducing a potential rightward shift of the force-velocity relationship. Recently, an inverse relation was found between *vastus lateralis* muscle fiber diameter and normalized stiffness (Noonan et al., 2020). Whether a potential reduction in muscle stiffness may be elicited by such heat-mediated hypertrophy remains yet to be investigated. The relationship between contractile material, muscle typology and stiffness remain complex, with effects not always univocal.

This study, therefore, aimed to determine the mechanical adaptations of GM muscle-tendon unit and their subsequent impact on motor performance following active HA (*i.e.*, training in the heat) *vs.* a similar training in temperate conditions. Based on a previous study (Racinais et al., 2017c), it was hypothesized that HA would improve skeletal muscle contractility and enhance multi-joint performance during vertical jumps. Nevertheless, the effect on muscle-tendon unit properties were exploratory since, to the best of our knowledge, there is no investigation exploring the effect of such intervention on tissue stiffness and joint and fascicle force-velocity relationships.

2. Materials and methods

1. Participants

Thirty volunteers participated in the study and were separated into two intervention groups: HA or CON group, each group being composed of fifteen participants (8 males and 7 females). Both groups presented similar anthropometrical profile (HA: 27 ± 5 years, 172 ± 9 cm, 67 ± 8 kg, 4.6 ± 2.9 h of training per week; CON: 26 ± 4 years, 174 ± 12 cm, 69 ± 15 kg, 4.3 ± 2.4 h of training per week).

2. Experimental design

Two to four days after a familiarization session, participants were tested before (*i.e.*, 3-4 days; PRE) and after (*i.e.*, ~ 48 h; POST) 13 low-intensity cycling sessions (Figure 40A). According

to their group assignment, participants performed the cycling sessions either in a hot (HA: $38.1 \pm 0.4^\circ\text{C}$, $57.9 \pm 2.3\%$ RH) or a temperate environment (CON: $23.0 \pm 0.7^\circ\text{C}$, $35.3 \pm 3.8\%$ RH). All neuromuscular testing was performed in temperate condition ($22.8 \pm 1.7^\circ\text{C}$, $34.3 \pm 8.0\%$ RH). Environmental conditions in HA group were based on previous studies reporting effective active HA with conditions ranging $37\text{--}40^\circ\text{C}$ and $55\text{--}65\%$ RH (Corbett et al., 2022; Garrett et al., 2009), while temperate environment corresponded to the ambient laboratory conditions (*i.e.*, $\sim 23^\circ$, $\sim 35\%$ RH).

3. Training protocol

Cycling sessions. Both HA and CON groups performed 13 training sessions of 1 h each, on an ergocycle (Wattbike Pro, Nottingham, United Kingdom), distributed over a 17-days period, the weekend being off (Figure 40A). Pedaling intensity was adjusted for each participant, according to body mass, and varied from one session to another (between 1.3 and $2.5 \text{ W}\cdot\text{kg}^{-1}$), except for the first and the last session which were identical ($1.4 \text{ W}\cdot\text{kg}^{-1}$ during 1 h).

Physiological monitoring. Before starting the intervention, USG was collected to check the level of hydration of the participants (USG = 1.009 ± 0.008). Physiological responses (*i.e.*, T_{core} , T_{skin} , heart rate and sweat rate) were measured in each group during the first and the last cycling session (Figure 40B). T_{muscle} was measured in a subsample of participants from each group ($n = 8$ in HA group and $n = 7$ in CON group) immediately at the end of a single cycling session. Perceptual responses were also collected during the first and the last cycling session. We monitored thermal sensation, thermal comfort and RPE every 10 min and then averaged to obtain a value for each session. Heart rate and perceptual ratings were monitored, and experimenters supervised participants throughout each cycling session in order to consistently check their health and safety.

4. Testing protocol

General procedures. PRE and POST neuromuscular tests were performed at the same time of day, with POST tests performed ~ 48 h after the thirteenth cycling session (*i.e.*, the fifteenth day) to exclude potential acute session effect. The testing sessions consisted of electrically-evoked, explosive and maximal voluntary isometric contractions, ballistic and isokinetic contractions, ramp contractions, passive SWE measurements and verticals jumps, performed in the same order (Figure 40C). As previously described ([see p.68](#)) participants lay prone on the

mechatronic Eracles ergometer for the isometric and isokinetic contractions, and on the Goubex ergometer for ballistic contractions. Mechanical data were digitized at 4000 Hz.

Passive muscle stiffness. The ultrasound scanner was used in SWE mode to measure (3 measurements per condition) the shear modulus of the GM at rest (Figure 40Cii).

Electrically-evoked contractions. The tibial nerve was electrically stimulated (single electrical pulse; Figure 40Ci). The mechanical response to the five electrically evoked stimulations realized was low-pass filtered (50 Hz, zero-lag 3rd order Butterworth), analyzed and averaged to determine PT amplitude, CT, HRT and electrically-evoked RTD (Figure 40Ciii).

Voluntary isometric contractions. Participants performed five explosive rapid contractions (~1 s) to measure the RTD, the contractions were interspaced by ~30 s rest. RTD was calculated for specific time phase as the change in force divided by the time windows from 0 to 100 ms (RTD₀₋₁₀₀), 0 to 200 ms (RTD₀₋₂₀₀) and 100 to 200 ms (RTD₁₀₀₋₂₀₀). Thereafter, participants performed three 5-s MVC (Figure 40Civ). VA was assessed during two additional MVC (Figure 40Cv). Torque signals were low-pass filtered (150 Hz, zero-lag 3rd order Butterworth).

Active tendon stiffness. Participants linearly increased their isometric plantar flexor torque from 0 to 90% of the MVC peak torque within 9-s (Figure 40Cvi), to determine the active stiffness of tendon ([see p.78](#)). The participants followed the same force visual feedback for both sessions based on the PRE MVC peak torque. The ankle joint torque measured by the ergometer was converted to tendon force (F_t) as $F_t = T/mg$ (Arya and Kulig, 2010) where mg is the moment arm length of GM at 90° of ankle joint and knee fully extended, which was estimated from the limb length of each participant ([see p.70](#)).

Joint and fascicle force-velocity relationships. Participants performed maximal plantar flexors contractions over a 50° range of motion (*i.e.*, from 110 to 60°) at three isokinetic angular velocities (30, 200 and 400°·s⁻¹; three trials each) in a randomized order (similar between PRE and POST tests for each participant), with 1 min of rest between each trial. Then, participants performed maximal plantar flexions from 110° to 60° of ankle flexion on the Goubex ergometer, as previously described ([see p.78](#)). Two conditions (1 min rest) were tested in a randomized order (similar between PRE and POST): with 0 (five trials) or 2.6 kg (three trials) attached to the pedal. Angular velocity and plantar flexion torque were low-pass filtered (100 Hz, zero-lag 3rd order Butterworth). Ultrasound sampling frequency was adapted to the condition (500 Hz, 1000 Hz and 2000 Hz for angular velocity at 30°·s⁻¹, 200-400°·s⁻¹ and high-velocity conditions, respectively), and L_F was low-pass filtered (50 Hz, zero-lag 3rd order

Butterworth). For isokinetic and ballistic contractions, joint velocity, V_F , torque and fascicle force were computed and averaged from 100 to 70° to obtain the joint and fascicle force-velocity relationships (Figure 40Cvii-viii).

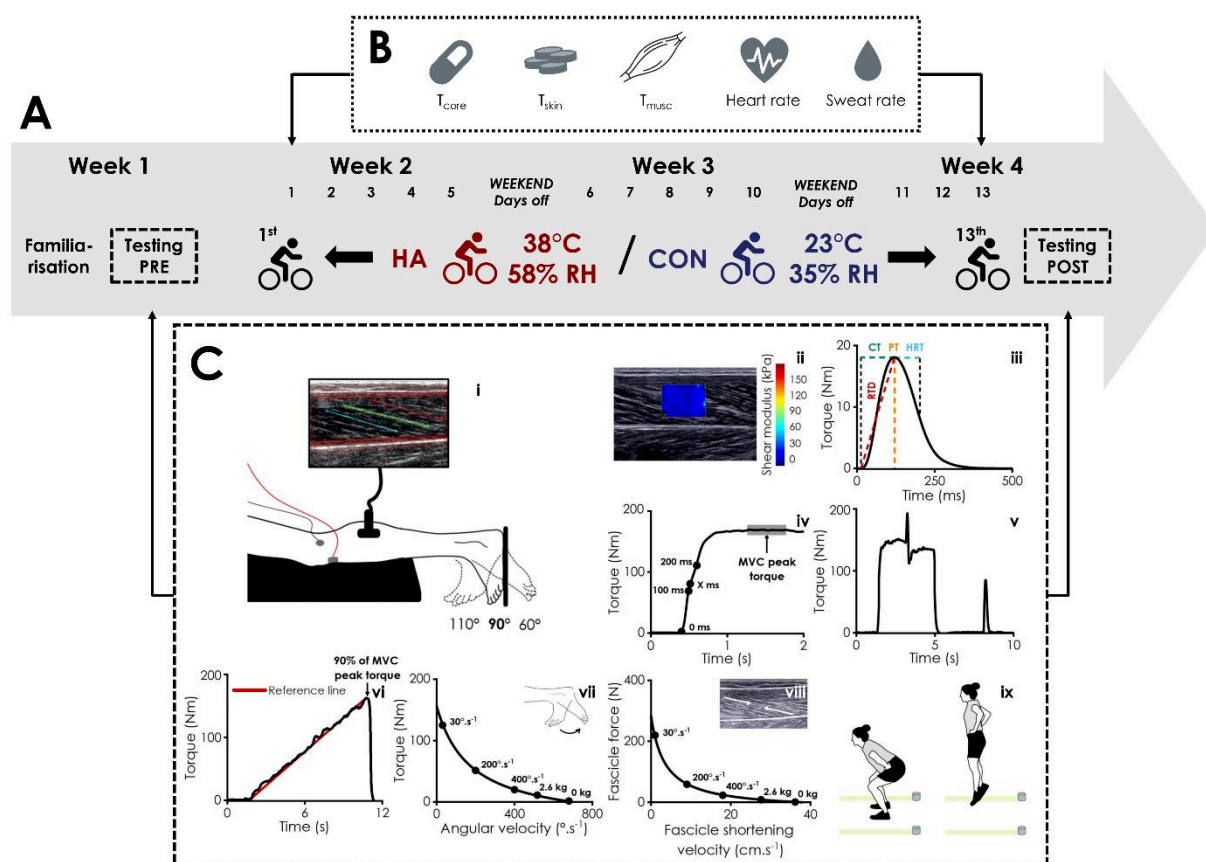

Figure 40. Experimental design: general overview (A), physiological monitoring during cycling sessions (B) and data collection during testing sessions (C). Neuromuscular testing (Ci), shear modulus of the gastrocnemius medialis (Cii), peak twitch amplitude (PT), contraction time (CT), half-relaxation time (HRT) and rate of torque development (RTD) from electrically-evoked contractions (Ciii), maximal voluntary contraction (MVC) peak torque, voluntary RTD (Civ), voluntary activation (VA; Cv), ramp contraction performed from 0 to 90% of MVC peak torque (Cvi), joint and fascicle force-velocity relationships (Cvii, Cviii) and vertical jumps (Cix) performed before (PRE) and after (i.e., 15th day, POST) intervention in heat acclimation (HA) and control (CON) groups.

Vertical jumps performance. After the neuromuscular tests and a standardized warm-up, three squat jumps (SJ), three counter-movement jumps (CMJ) and three multi-rebound jumps (MRJ; Figure 40Civ) (Dalleau et al., 2004; Girard et al., 2020) were performed in a randomized order (similar between PRE and POST). Participants were instructed to jump “as high as possible”. All jumps were recorded (flight times for SJ, CMJ and MRJ and ground contact for MRJ) using a sensor system (Optojump Next, Microgate, Bolzano, Italy). Then, participants were required to perform repeated CMJ, for 15 s (Mohr et al., 2010). Participants were instructed to keep their hands on their hips throughout the preparatory and jump phases. Jump height from the best SJ

and CMJ trials was retained for analysis. Mean jump height and jump decrement were calculated from the 15-s period of repeated CMJ. Lower limb stiffness (K_N in $N.m^{-1}$), was measured from MRJ as:

$$K_N = \frac{M \times \pi(T_f + T_c)}{T_c^2 \left(\frac{T_f + T_c}{\pi} - \frac{T_c}{4} \right)} \quad (\text{Equation 11})$$

where M is the total body mass (kg), T_c is the ground contact time and T_f the flight time (Dalleau et al. 2004). From repeated CMJ mean jump height and jump height decrement were computed (Mohr et al. 2010).

5. Statistical analysis

T_{musc} was compared between the groups using a Student paired t-test. Two-way ANOVAs (group \times training) were used to assess the effect of the group (HA, CON) and training protocol (Session 1, Session 13) on physiological parameters and perceptual ratings measured during training sessions: T_{core} , heart rate, sweat rate, thermal sensation, thermal comfort and RPE. Non parametric tests were performed to observe the effect of group (Kruskal-Wallis) and repeated training session (Friedman) on T_{skin} (non-normalized data). Two-way ANOVAs (group \times training) were used to assess the effect of the group (HA, CON) and training protocol (PRE, POST) on: electrically-evoked characteristics (PT, CT, HRT, RTD), MVC, VA, RTD voluntary (RTD₀₋₁₀₀, RTD₀₋₂₀₀ and RTD₁₀₀₋₂₀₀), muscle architecture (L_F , pennation angle and muscle thickness), GM shear modulus, tendon active stiffness and vertical jump performance (SJ, CMJ, lower limb stiffness, repeated CMJ jump height and jump height decrement). On joint and fascicle force-velocity relationships, three-way ANOVAs (group \times training \times load) were used to determine the potential effect of group (HA, CON), training protocol (PRE, POST) and load (ballistic and isokinetic contractions) on joint velocity, joint torque, V_F and fascicle force.

3. Results

1. Protocol compliance

All participants completed all cycling sessions except one from HA group who replaced three cycling sessions by fast treadmill walking due to cycling discomfort and one from CON group who missed the eleventh cycling session, and so completed 12 cycling sessions. Two

participants from CON group performed a 1-week break during the training protocol due to COVID-19 contact case declaration, the experimental design was shifted one week to complete the 13 cycling sessions. Compliance with the protocol was 98.5% and 94.4% for HA and CON groups, respectively.

2. Thermoregulatory responses

There was a main effect of group, training and an interaction effect on T_{core} (all $P \leq 0.037$, $\eta_p^2 \geq 0.08$) due to a higher T_{core} in HA group vs. CON group during the first session ($+0.6 \pm 0.3^\circ\text{C}$; $P < 0.001$, $\eta_p^2 = 0.37$) and a decreased in T_{core} in HA group following intervention ($-0.4 \pm 0.3^\circ\text{C}$; $P = 0.015$, $\eta_p^2 = 0.22$), leading to similar average T_{core} for each group during the thirteenth session ($P = 0.879$, $\eta_p^2 = 0.06$; Figure 41A). Average T_{skin} was higher in HA group vs. CON group during the first and the thirteenth cycling session ($+3.8 \pm 0.6^\circ\text{C}$ and $+3.4 \pm 0.6^\circ\text{C}$; both $P < 0.001$, $\eta_p^2 \geq 0.81$), decreased in HA group following intervention ($-0.4 \pm 0.3^\circ\text{C}$; $P < 0.001$, $\eta_p^2 = 0.82$) and was not impacted by training in CON group ($P = 0.405$, $\eta_p^2 = 0.02$; Figure 41B). T_{musc} measured at the end of a single cycling session was higher in HA group vs. CON group [38.4 ± 0.5 ($n = 8$) vs. $37.3 \pm 1.1^\circ\text{C}$ ($n = 7$); $P = 0.017$, $\eta_p^2 = 0.36$]. Heart rate was higher in HA group vs. CON group from first to thirteenth session ($P < 0.001$, $\eta_p^2 = 0.32$) and decreased throughout intervention ($P = 0.008$, $\eta_p^2 = 0.12$), without an interaction effect ($P = 0.733$, $\eta_p^2 < 0.01$; Figure 41C). Sweat rate was higher in HA group first to thirteenth session ($P < 0.001$, $\eta_p^2 = 0.58$) and increased along intervention ($P = 0.035$, $\eta_p^2 = 0.08$) with an interaction effect ($P = 0.014$, $\eta_p^2 = 0.10$) due to a higher sweat rate in HA group vs. CON group from the first to the thirteenth session ($+0.5 \pm 0.3 \text{ L}\cdot\text{h}^{-1}$ and $+0.8 \pm 0.3 \text{ L}\cdot\text{h}^{-1}$; both $P < 0.001$; $\eta_p^2 \geq 0.53$) and to an increasing sweat rate following intervention in HA group ($+0.4 \pm 0.3 \text{ L}\cdot\text{h}^{-1}$; $P = 0.010$, $\eta_p^2 = 0.19$; Figure 41D).

In line with these physiological responses, perceptual ratings were higher in HA group vs. CON group ($P \leq 0.004$; $\eta_p^2 \geq 0.14$), and decreased throughout intervention ($P \leq 0.001$; $\eta_p^2 \geq 0.26$), without presenting an interaction effects ($P \geq 0.167$; $\eta_p^2 \leq 0.03$; Table 7).

3. Neuromuscular responses

Neither effect of group (all $P \geq 0.299$, $\eta_p^2 \leq 0.02$) or training (all $P \geq 0.225$, $\eta_p^2 \leq 0.03$) nor interaction (all $P \geq 0.659$, $\eta_p^2 < 0.01$) were revealed for PT, CT, HRT and RTD in electrically-evoked contractions, RTD voluntary measures, MVC torque production and VA (Table 8).

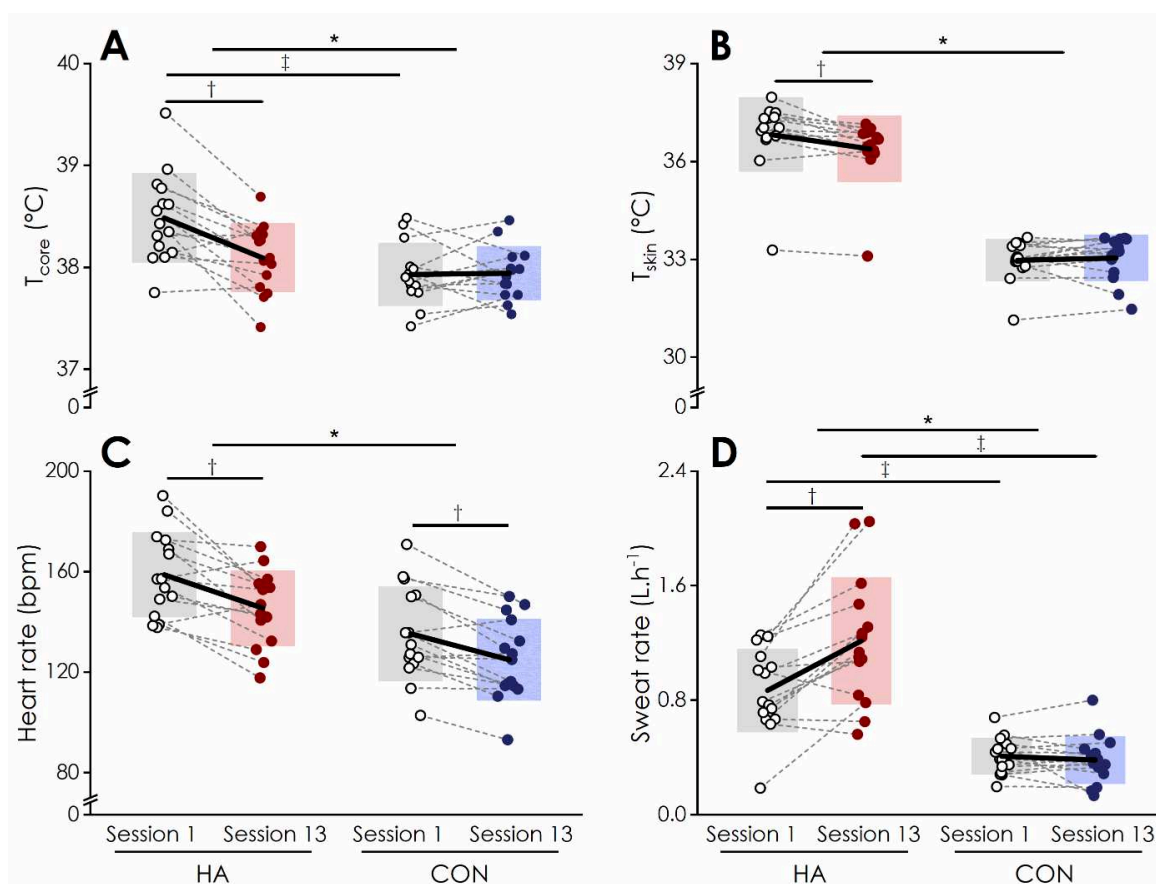

Figure 41. Mean core temperature [T_{core} ; (A)], mean skin temperature [T_{skin} ; (B)], mean heart rate (C) and sweat rate (D) measured during the first (Session 1) and the last (Session 13) cycling session in heat acclimation (HA) and control (CON) groups. The bold trace represents the mean change of the whole sample ($n = 15$ for each parameter in each group, except for T_{skin} : $n = 14$ in each group), box charts correspond to SD and dashed traces connect individual values. * Significant difference between HA and CON, † significant difference between session 1 and session 13, ‡ significant difference between HA and CON for the same cycling session, $P < 0.05$.

Table 7. Mean perceptual responses measured during the first (Session 1) and the thirteenth (Session 13) cycling session of the training protocol in heat acclimation (HA) and control (CON) group.

	HA		CON		Main effect		
	Session 1	Session 13	Session 1	Session 13	Group	Training	Interaction
TS	6.4 ± 0.4	5.9 ± 0.4	5.3 ± 0.3	4.8 ± 0.4	$P < 0.001$ $\eta_p^2 = 0.61$	$P < 0.001$ $\eta_p^2 = 0.26$	$P = 0.859$ $\eta_p^2 < 0.01$
TC	6.1 ± 0.3	5.4 ± 0.4	4.9 ± 0.2	4.5 ± 0.4	$P < 0.001$ $\eta_p^2 = 0.28$	$P < 0.001$ $\eta_p^2 = 0.63$	$P = 0.199$ $\eta_p^2 = 0.03$
RPE	14.3 ± 1.9	12.1 ± 1.4	10.8 ± 1.5	10.0 ± 1.5	$P = 0.004$ $\eta_p^2 = 0.14$	$P < 0.001$ $\eta_p^2 = 0.36$	$P = 0.167$ $\eta_p^2 = 0.03$

Values are presented as mean ± SD. TS, thermal sensation (1 to 7, cold to hot); TC, thermal comfort (1 to 7; too cool to much too warm) and RPE, rate of perceived exertion (6 to 20, no exertion at all to maximal exertion). $n = 15$ in each group.

Joint velocity revealed a main effect of group ($P = 0.032$, $\eta_p^2 = 0.02$), which was higher in HA group, and a main effect of load ($P < 0.001$, $\eta_p^2 = 0.79$), without a training or an interaction effect (all $P \geq 0.232$, $\eta_p^2 \leq 0.01$; Figure 42A-B). There was no significant effect of group and training on joint torque (both $P \geq 0.195$, $\eta_p^2 \leq 0.01$), but a main effect of load ($P < 0.001$, $\eta_p^2 = 0.79$) on joint torque, which decreased with decreasing load. No interactions were found on joint torque (all $P \geq 0.479$, $\eta_p^2 \leq 0.01$; Figure 42A-B).

4. Muscle-tendon unit properties

Two-way ANOVAs revealed neither an effect of group (all $P \geq 0.213$, $\eta_p^2 \leq 0.03$), training (all $P \geq 0.583$, $\eta_p^2 \leq 0.01$) nor interaction (all $P \geq 0.793$, $\eta_p^2 \leq 0.01$) on L_F , pennation angle and muscle thickness (Table 9).

Three-way ANOVA revealed a main effect of group ($P = 0.007$, $\eta_p^2 = 0.02$) on V_F , which was higher in HA group, and a main effect of load ($P < 0.001$, $\eta_p^2 = 0.71$). No effect of training or interactions (group \times training, group \times load, training \times load or group \times training \times load) were shown (all $P \geq 0.370$, $\eta_p^2 \leq 0.02$; Figure 42C-D). There was no significant effect of group and training (both $P \geq 0.067$, $\eta_p^2 \leq 0.01$) but a main effect of load ($P < 0.001$, $\eta_p^2 = 0.83$) on fascicle force. No interactions (group \times training, group \times load, training \times load or group \times training \times load) were shown on fascicle force (all $P \geq 0.458$, $\eta_p^2 \leq 0.01$; Figure 42C-D).

Shear modulus measured in GM at rest showed an effect of group ($P = 0.012$, $\eta_p^2 = 0.11$). Shear modulus was lower in HA group, with neither an effect of training ($P = 0.454$, $\eta_p^2 = 0.01$) nor interaction ($P = 0.508$, $\eta_p^2 = 0.01$; Table 9). Active Achilles tendon stiffness was not affected by group ($P = 0.172$; $\eta_p^2 = 0.04$) or training ($P = 0.920$; $\eta_p^2 < 0.01$) with no interaction effect ($P = 0.923$; $\eta_p^2 < 0.01$; Table 9).

5. Jump performance

There was no significant effect of group (all $P \geq 0.244$, $\eta_p^2 \leq 0.03$), training (all $P \geq 0.332$, $\eta_p^2 \leq 0.02$) or interaction (all $P \geq 0.899$, $\eta_p^2 \leq 0.03$) on SJ and CMJ height, lower limb stiffness, repeated CMJ mean jump height or jump height decrement (Table 9).

Table 8. Mechanical parameters measured before (PRE) and after (POST) training protocol in heat acclimation (HA) and control (CON) group.

	HA		CON		Main effect		
	PRE	POST	PRE	POST	Group	Training	Interaction
PT (Nm)	16.9 ± 4.4	16.2 ± 3.8	18.1 ± 4.2	17.5 ± 3.6	$P = 0.305$ $\eta_p^2 = 0.02$	$P = 0.926$ $\eta_p^2 < 0.01$	$P = 0.689$ $\eta_p^2 < 0.01$
CT (ms)	107 ± 8	103 ± 9	108 ± 8	105 ± 7	$P = 0.299$ $\eta_p^2 = 0.02$	$P = 0.558$ $\eta_p^2 < 0.01$	$P = 0.822$ $\eta_p^2 < 0.01$
HRT (ms)	92 ± 7	97 ± 9	95 ± 12	93 ± 12	$P = 0.848$ $\eta_p^2 < 0.01$	$P = 0.497$ $\eta_p^2 = 0.01$	$P = 0.976$ $\eta_p^2 < 0.01$
RTD electrically-evoked (Nm.ms⁻¹)	0.16 ± 0.05	0.16 ± 0.04	0.17 ± 0.04	0.17 ± 0.03	$P = 0.549$ $\eta_p^2 < 0.01$	$P = 0.898$ $\eta_p^2 < 0.01$	$P = 0.659$ $\eta_p^2 < 0.01$
RTD₀₋₁₀₀ (Nm.s⁻¹)	575 ± 152	574 ± 161	549 ± 147	548 ± 136	$P = 0.588$ $\eta_p^2 < 0.01$	$P = 0.983$ $\eta_p^2 < 0.01$	$P = 0.996$ $\eta_p^2 < 0.01$
RTD₀₋₂₀₀ (Nm.s⁻¹)	483 ± 110	511 ± 134	501 ± 116	509 ± 108	$P = 0.847$ $\eta_p^2 < 0.01$	$P = 0.643$ $\eta_p^2 < 0.01$	$P = 0.795$ $\eta_p^2 < 0.01$
RTD₁₀₀₋₂₀₀ (Nm.s⁻¹)	391 ± 111	448 ± 122	452 ± 99	469 ± 121	$P = 0.847$ $\eta_p^2 < 0.01$	$P = 0.643$ $\eta_p^2 < 0.01$	$P = 0.795$ $\eta_p^2 < 0.01$
MVC peak torque (Nm)	129 ± 20	136 ± 23	126 ± 32	131 ± 31	$P = 0.669$ $\eta_p^2 < 0.01$	$P = 0.508$ $\eta_p^2 < 0.01$	$P = 0.875$ $\eta_p^2 < 0.01$
VA (%)	96 ± 2	95 ± 4	93 ± 7	93 ± 5	$P = 0.778$ $\eta_p^2 < 0.01$	$P = 0.225$ $\eta_p^2 = 0.03$	$P = 0.693$ $\eta_p^2 < 0.01$

Values are presented as mean ± SD. PT, peak twitch amplitude; CT, contraction time; HRT, half-relaxation time; RTD, rate of torque development; RTD₀₋₁₀₀, rate of torque development between contraction onset and 100 ms; RTD₀₋₂₀₀, rate of torque development between contraction onset and 200 ms; RTD₁₀₀₋₂₀₀, rate of torque development between 100 and 200 ms after contraction onset; MVC, maximal voluntary contraction; VA, voluntary activation. $n = 15$ in each group, except for VA ($n = 12$ in HA group and $n = 11$ in CON group).

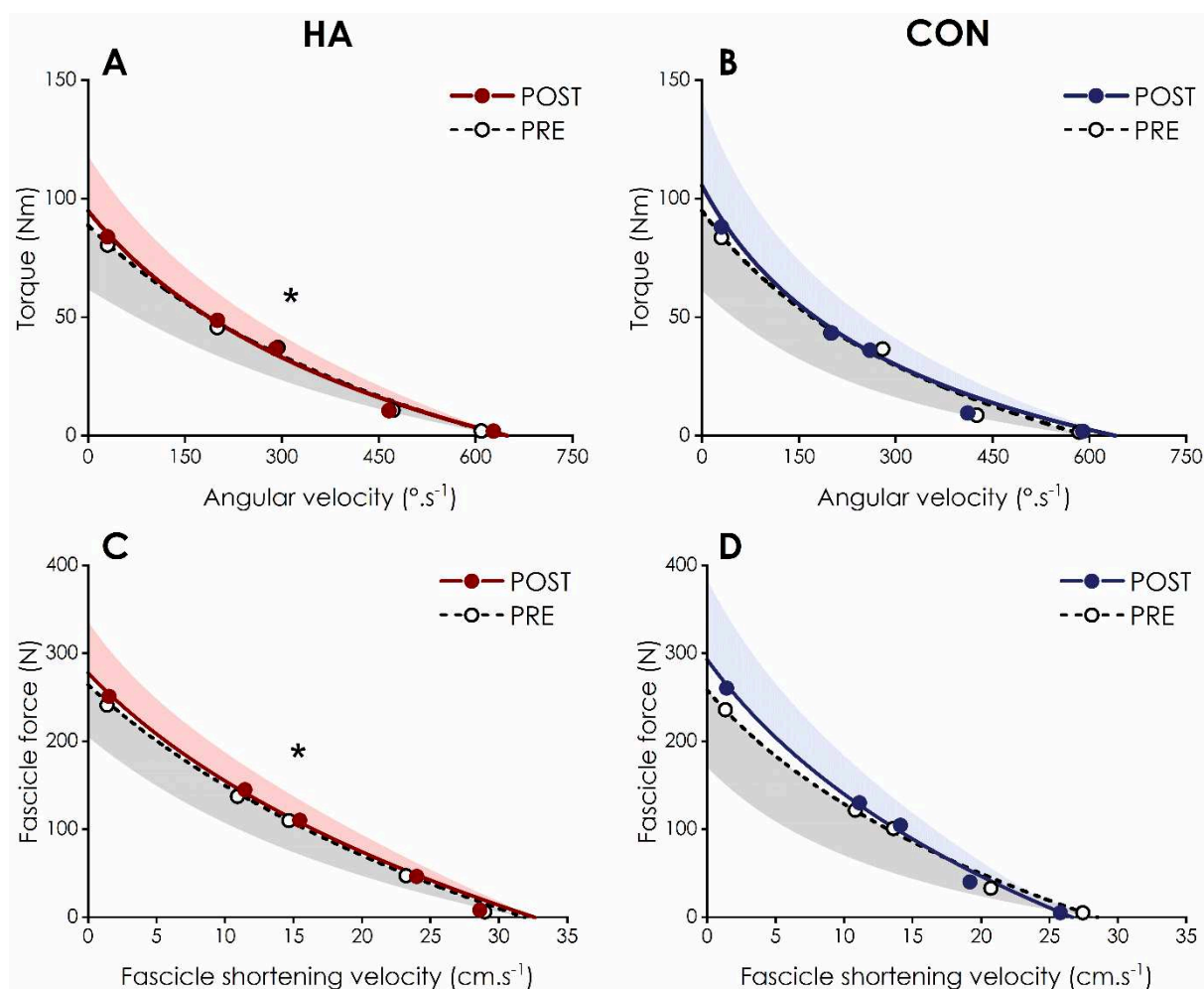

Figure 42. Joint (A, B) and fascicle (C, D) force-velocity relationship obtained before (PRE) and after (POST) intervention in heat acclimation (HA) and control (CON) groups. Filled area represents SD and circles represent mean data obtained during isokinetic contractions (30 , 200 and $400^{\circ}\cdot\text{s}^{-1}$) and ballistic contractions (0 and 2.6 kg). * Significant differences between HA and CON groups on joint and fascicle shortening velocity, $P < 0.05$. $n = 15$ in each group for panel A and B; $n = 14$ for panel C and $n = 13$ for panel D.

4. Discussion

The present study investigated for the first time the effect of an active HA on the muscle-tendon unit properties. While the current 13-session active HA elicited effective physiological adaptation (*i.e.*, decrease in T_{core} and heart rate, and increase in sweat rate from the first to the last session), none of the muscle-tendon unit properties (*i.e.*, force-velocity properties, tissue stiffness, VA) and multi-joint dynamic performance were affected, positively or negatively, from PRE to POST. These findings improve the understanding of human adaptations of motor performance to repeated heat exposure and provide relevant mechanistic understanding that may help to update current HA prescription in reference to sport-specific neuromuscular

requirements. Active HA, essential to induce physiological adaptations, is not detrimental to motor performance and force-velocity properties and can therefore be used by all athletes preparing competition in hot environments, whatever their sporting discipline, without fear of altering their muscle-tendon unit properties.

1. HA phenotype

While the CON group showed a decrease in heart rate (-10 ± 7 bpm) with training, they did not show any changes in T_{core} , T_{skin} or sweat rate (Figure 41). Conversely, the HA group showed a decrease in T_{core} and T_{skin} (both, $-0.4 \pm 0.3^{\circ}\text{C}$), a decrease in heart rate (-13 ± 11 bpm) and an increase of sweat rate ($+0.4 \pm 0.3 \text{ L}\cdot\text{h}^{-1}$) from the first to the last cycling session. These results reflect a reduced physiological strain and better thermoregulatory abilities while exercising in the heat after intervention (Eichna et al., 1950; Racinais et al., 2015a). Reduced T_{core} and increased sweat rate, together with faster sweating onset at lower threshold (Nadel et al., 1974) are indicative of central and peripheral physiological adaptations (Périard et al., 2015) to heat. These results are in line with the existing literature on human HA (Périard et al., 2015) and the fact that HA is the primary countermeasure recommended before competing in the heat (Racinais et al. 2015a). Accordingly, perceptual ratings were higher in the HA group and decreased with training, showing that acclimation was also perceptually effective.

However, recent observations reported that athletes requiring explosive strength are less likely to use HA; with only 16 of 50 elite sprinters, jumpers and throwers (*i.e.*, 32%) adopting HA before the 2019 IAAF World Championships in Doha (unpublished data), while the proportion is double (*i.e.*, 63%) in road-race endurance athletes using HA (Racinais et al., 2022). Thus, the current study investigating the effect of HA on muscle-tendon unit mechanical properties is likely to support those athletes in taking an informed decision by determining the positive or negative effect of active HA on sport-specific muscle capabilities.

2. Active HA does not impact single-joint performance

In line with Racinais et al. (2017c), CT and HRT inferred from electrically-evoked contractions were unchanged following intervention in HA and CON groups. However, those authors noted an increase in PT amplitude and MVC torque from PRE- to POST-HA, that were not observed in the current study. Importantly, despite analyzing the same muscle, the HA protocol was different (*i.e.*, passive vs. active).

Table 9. Muscle architecture, tissues stiffness and jump performance measured before (PRE) and after (POST) training protocol in heat acclimation (HA) and control (CON) group.

		HA		CON		Main effect		
		PRE	POST	PRE	POST	Group	Training	Interaction
<i>Muscle architecture</i>	L _F (cm)	5.2 ± 0.5	5.2 ± 0.5	5.4 ± 0.5	5.5 ± 0.5	<i>P</i> = 0.213 η_p^2 = 0.03	<i>P</i> = 0.743 η_p^2 < 0.01	<i>P</i> = 0.793 η_p^2 < 0.01
	Pennation angle (°)	16.4 ± 1.6	16.3 ± 2.3	16.6 ± 1.9	16.6 ± 2.1	<i>P</i> = 0.667 η_p^2 < 0.01	<i>P</i> = 0.934 η_p^2 < 0.01	<i>P</i> = 0.922 η_p^2 < 0.01
	Muscle thickness (cm)	1.52 ± 0.20	1.55 ± 0.25	1.59 ± 0.24	1.65 ± 0.23	<i>P</i> = 0.267 η_p^2 = 0.02	<i>P</i> = 0.583 η_p^2 < 0.01	<i>P</i> = 0.797 η_p^2 < 0.01
<i>Tissues stiffness</i>	GM shear modulus (kPa)	13.2 ± 1.6	13.1 ± 1.5	15.2 ± 2.3	14.3 ± 1.9	<i>P</i> = 0.012 η_p^2 = 0.11	<i>P</i> = 0.454 η_p^2 = 0.01	<i>P</i> = 0.508 η_p^2 = 0.01
	Active Achilles tendon stiffness (N.mm ⁻¹)	25.2 ± 7.6	25.2 ± 7.3	22.0 ± 5.4	22.4 ± 5.8	<i>P</i> = 0.172 η_p^2 = 0.04	<i>P</i> = 0.920 η_p^2 < 0.01	<i>P</i> = 0.923 η_p^2 < 0.01
<i>Jump performance</i>	SJ (cm)	27.6 ± 6.6	25.9 ± 6.4	26.6 ± 5.4	24.7 ± 4.5	<i>P</i> = 0.529 η_p^2 < 0.01	<i>P</i> = 0.332 η_p^2 = 0.02	<i>P</i> = 0.973 η_p^2 = 0.03
	CMJ (cm)	29.6 ± 7.1	28.3 ± 6.8	28.6 ± 5.9	28.2 ± 5.1	<i>P</i> = 0.889 η_p^2 < 0.01	<i>P</i> = 0.780 η_p^2 < 0.01	<i>P</i> = 0.899 η_p^2 < 0.01
	Lower limb stiffness (kN.m ⁻¹)	27.1 ± 6.2	26.8 ± 6.0	25.1 ± 4.1	24.4 ± 4.0	<i>P</i> = 0.244 η_p^2 = 0.03	<i>P</i> = 0.767 η_p^2 < 0.01	<i>P</i> = 0.904 η_p^2 < 0.01
	Repeated CMJ mean height (cm)	26.5 ± 6.9	25.7 ± 6.8	24.9 ± 5.0	24.6 ± 4.4	<i>P</i> = 0.475 η_p^2 = 0.01	<i>P</i> = 0.741 η_p^2 < 0.01	<i>P</i> = 0.899 η_p^2 = 0.03
	Jump decrement (%)	11.9 ± 3.9	12.4 ± 3.9	11.8 ± 3.2	11.4 ± 2.8	<i>P</i> = 0.504 η_p^2 = 0.01	<i>P</i> = 0.770 η_p^2 < 0.01	<i>P</i> = 0.964 η_p^2 = 0.03

Values are presented as mean ± SD. L_F, fascicle length; GM, *gastrocnemius medialis*; SJ, squat jump; CMJ, counter movement jump; lower limb stiffness measured during multi-rebound jumps and jump decrement measured during repeated CMJ. *n* = 15 in each group except for active tendon stiffness where *n* = 12 in CON group and for SJ and CMJ in HA group where *n* = 14.

Using localized heat therapy (*i.e.*, hot pack application increasing *vastus lateralis* T_{muscle} from $34.9 \pm 0.5^{\circ}\text{C}$ to $38.3 \pm 0.1^{\circ}\text{C}$), others studies have reported an increase of knee extensors maximum torque after 10-weeks [8 h/day, 4 days a week; (Goto et al., 2011)] or after 8-weeks of application [90 min/day, 5 days a week; (Kim et al., 2020)]. Nevertheless, 6-weeks of local heat therapy on plantar flexors (*i.e.*, 8 h/day using heat pads, 5 days/week) induced no effect on strength and contractile properties of plantar flexors in active participants (Labidi et al., 2021). Active short-term HA also showed no impact on knee extensor maximal force and VA (Périard et al., 2020). Recent studies also showed that adding local repeated heat stress during a long period (*i.e.*, 10-12 weeks) of resistance training had no effect on muscle strength production (Chandrasiri et al., 2021; Stadnyk et al., 2018). Therefore, repeated heat exposure may not further increase muscle force in participant already exposed to mechanical, and metabolic, stress elicited by strength training (Chandrasiri et al. 2021; Stadnyk et al. 2018).

The current study adds to these previous observations that joint force-velocity properties, including maximal theoretical joint torque and joint velocity, were unchanged in HA and CON groups following intervention (Figure 42). Moreover, the absence of effects described above during voluntary and electrically-evoked isometric contractions was also observable during ballistic and isokinetic contractions, leading to no changes in velocity indices. Taken together, the current data confirm that repeated heat exposure is not detrimental to muscle force production.

3. Active HA does not impact muscle-tendon interactions

Muscle-tendon unit properties were also unaffected from PRE to POST in HA and CON groups. Muscle architecture (*i.e.*, L_F , pennation angle and muscle thickness) remained unchanged at the end of the intervention ($P \geq 0.583$), while we might have expected an increase in muscle thickness in the HA group, based on the findings from a previously mentioned study. Indeed, an increase in cross-sectional areas of *vastus lateralis* and *rectus femoris* was reported after 10-weeks of localized heat therapy (Goto et al., 2011), suggesting that heat stress might stimulate the intracellular signaling(s) responsible for protein synthesis and therefore muscle hypertrophy. However, the 6-weeks protocol, investigating the same muscle group as in the current study, did not induce change neither plantar flexors MVC peak force nor GM or GL cross-sectional area (Labidi et al. 2021). As described above, adding local repeated heat stress during a resistance training protocol has not consistently shown beneficial effects on muscle

hypertrophy, depending on the dose of heat exposure and the activity of the participants beside the heat exposures (Chandrasiri et al. 2021; Stadnyk et al. 2018). The present lack of change in muscle thickness after HA suggested an absence of hypertrophy and therefore may explain unchanged strength production, this absence of effect is in accordance with the unaffected single-joint performance results, following HA. While aforementioned studies used long-term and partial repeated heat exposure (*i.e.*, between 6 and 10 weeks, and local heat application), it differs from our 13 sessions of total active heat exposure, potentially insufficient to induces similar adaptations. The different heating methods could thereafter lead to different effects.

T_{musc} measured at the end of a single cycling session was higher in the HA group *vs.* CON group (38.4 ± 0.5 *vs.* $37.3 \pm 1.1^{\circ}\text{C}$), however, T_{musc} was probably not sufficiently high enough to induce changes in hypertrophy-related skeletal muscle signaling. Indeed, Ihsan et al. (2020) showed that increasing *vastus lateralis* T_{musc} to $38.8 \pm 0.5^{\circ}\text{C}$ enhanced anabolic signaling through the Akt/mTOR pathway, while an increase of T_{musc} to $38.1 \pm 0.6^{\circ}\text{C}$ induced none of these changes. This is in line with an activated Akt/mTOR signaling pathways, a crucial mediator of protein synthesis and hypertrophy, reported in animals' study after heat stress (Yoshihara et al., 2013), with higher responses at 41°C , and might suggest that a larger dose of heat stress may be required to observe the aforementioned effects. Thus, the present findings could highlight an insufficient T_{musc} increase in response to heat to activate anabolic signaling pathways involved in muscle hypertrophy. However, it is an assumption that should be investigated since muscle groups and temperatures range were different. Moreover, the current data showed that active HA did not alter maximal theoretical fascicle force and shortening velocity, or fascicle force-velocity relationship of GM muscle (Figure 42C). To the best of our knowledge, these muscle-tendon unit properties have been investigated, for the first time *in vivo* in humans. Thereby, irrespectively of the methodological aspect discussed above (*i.e.*, activity of the participants, level of temperature, muscle group investigated) the current data showed that repeated heat exposure has neither advantageous, nor detrimental effect on fascicle force-velocity properties.

Soft tissue stiffness, measured through passive GM and active Achilles tendon stiffness, was also unaffected from PRE to POST in HA and CON groups. Although our recent study reported an acute decrease in passive GM muscle and active Achille tendon stiffness at the end of a passive acute heat exposure (**study #1**), no study has yet reported the effects of active HA on soft tissue stiffness. These findings suggest that changes in tissues stiffness induced by acute heat exposure are transient and do not translate into chronic adaptations after repeated active

HA sessions. Unaffected muscle and tendon stiffness suggest no impact on the metabolic cost, at least linked to soft tissue stiffness (Machado et al., 2021), reinforcing the non-alteration of muscle-tendon unit interactions and their absence of negative effect on performance following active HA.

4. Active HA does not impact multi-joint dynamic performance

In accordance with the previous sections, the absence of HA effect at the muscle and fascicle level is similar at multi-joint level. Vertical jump performance (*i.e.*, SJ and CMJ height, repeated CMJ mean jump height and jump height decrement) and lower limb stiffness measured during MRJ were unchanged in HA and CON groups following intervention. Peak vertical height during SJ and CMJ was also unchanged following 5-day active HA, cycling at high- or low-intensity at 32°C (Wingfield et al., 2016). These data reinforce the fact that active HA does not impact coordination and muscle control and their potential impact on motor performance, given that multi-joint dynamic movements, closer to *in situ* situations encountered in many sports activities and related to performance, were also unchanged.

5. Significance and perspectives

Even if muscle architecture was unchanged in the current study, it is however important to keep in mind that the morphological adaptations at the origin of muscle hypertrophy remain difficult to generalize (Ruple et al., 2022). Moreover, although the absence of changes in two-dimensional architecture suggest an absence of modifications in three-dimensional, it would be interesting to investigate the effects of repeated heat exposure, with precedent protocol inducing muscle hypertrophy, using three-dimensional shape and architecture of human muscles from *in vivo* imaging data.

This study includes novel practical information potentially useful to the coaches and athletes, who may be reluctant to use HA in sporting disciplines requiring explosive movements. Our findings showed that 13 low-intensity cycling sessions performed in hot and humid environment is beneficial to acclimate athletes from a physiological point of view without altering muscle-tendon mechanical properties, nor muscle and multi-joint performance. Therefore, the current data suggest that active HA before competing in the heat will not alter isometric and dynamic strength capacities, joint velocity, explosivity, soft tissue stiffness and vertical jump performance. Reluctant practitioners and athletes from explosive sporting

disciplines may therefore use active HA without altering muscle performance. It also opens up a perspective: it would be interesting to understand why some coaches and athletes, especially in explosive activities, are reluctant to use HA although the benefits from a physiological point of view are well known, and whether our study could help the more reluctant to use HA. It would also be interesting to investigate the effect of active HA in a more practical context, in a view to better implement such strategy on ballistic performance in a field sport context, for example.

Of note, the effects described in the current study are resulting from testing performed in temperate environment; and it remains unclear how this absence of effects may impact, or not, the acute muscle-tendon unit properties responses to heat exposure during exercise, especially since we have recently demonstrated a modification of some of these properties [*i.e.*, faster early RTD, rightward shift of the joint force-velocity relationship and reduced soft tissue stiffness following an acute passive heat exposure (**study #1**)]. An interesting perspective from this work would be to investigate the effects of an active HA on the acute responses of a low-intensity cycling session performed in hot and humid environment.

5. Conclusion

This study explored for the first time the *in vivo* changes in muscle-tendon properties and interactions elicited by active HA. Low-intensity cycling sessions protocol performed in heat (~38°C and 58% RH) induced HA, as evidenced by a decrease in physiological stress/strain from the first to the last session. However, active HA did not impact muscle-tendon unit properties (*i.e.*, electrically-evoked contractile properties, maximal voluntary peak and explosive torque production, VA, joint force-velocity relationship, muscle architecture, passive muscle and active Achille tendon stiffness and fascicle force-velocity relationship) and did not modified dynamic movements such as vertical jump performance. These findings may contribute to refine recommendations dealing with HA in reference to sport-specific muscle and tendon mechanical properties. This may further reassure coaches and athletes preparing for hot and humid environments that an active HA, necessary to induce physiological adaptations and to cope with the heat, will not impact muscular properties and sport-specific related performance.

GENERAL DISCUSSION

The main objective of this PhD thesis was to improve our understanding of the sensitivity of human muscle-tendon unit properties and interplay to heat stress. Using ultrafast ultrasound, we described the heat-induced responses of the fundamental properties involved in muscle contractions mechanisms (*i.e.*, force-velocity and force-length relationships, soft tissues mechanical properties). Our findings showed that: *i*) passive heat exposure increases early-phase voluntary RFD, and decreases soft tissue stiffness; *ii*) active heat exposure (*i.e.*, running) does not impact neither fascicle operating length during running nor soft tissue stiffness; *iii*) active HA at moderate intensity, although physiologically effective, does not induce chronic adaptations in muscle-tendon unit properties. These results allow to complete the knowledge about the peripheral effects of thermal stress, with a focus on the mechanical properties of contractile and passive tissues of the musculoskeletal system. However, it seems essential to discuss them with regard to the specific context of the dose-response relationship and the exploration conditions considered.

In this section, we will develop four main lines of discussion. The **first part** will aim to discuss the **contribution of this PhD work**, its insights and issues. In the **second part**, we will detail **the relevance of the use of ultrafast ultrasound to analyze muscle-tendon mechanics under heat exposure** and the challenges associated. In the **third part**, we will discuss the **research perspectives** that emanate from our findings. Finally, in the **fourth part**, we will propose **practical recommendations** emerging from our investigations.

1. Contribution of experimental work, insights and issues

1. Heat exposure effects on muscle-tendon unit properties

To the best of our knowledge, no study reported the effect of heat stress, either passive or active, acute or chronic, on muscle-tendon unit mechanical properties using ultrafast ultrasound. This observation could at least partly originate from the substantial challenges associated with the study of such experimental conditions *in vivo* in humans.

This PhD work reported that the passive heat-induced increase in early voluntary RFD is not accompanied with changes in contractile properties. In addition, the unaltered late voluntary

RFD is possibly due to decreased soft tissue stiffness. When running in the heat, despite a trend for MVC peak force to decrease, none of the muscle-tendon unit properties or fascicle dynamics presently explored differed from running in a temperate environment. Then, we showed that, although physiologically effective, active HA did not alter muscle-tendon properties. These main results are summarized in Figure 43.

In addition to providing practical information potentially useful to coaches and athletes, altogether our findings did not evidence the existence of combined effect of heat stress and exercise on muscle-tendon properties. In the light of the current body of knowledge, our findings raise the question of the dose-response relationship between the amplitude of heat stress on muscle-tendon adaptations. These aspects are further developed below.

2. Are heat exposure and exercise compatible to induce mechanical adaptations?

Study #1 reported the changes in muscle-tendon unit properties after acute heat stress. While active acute and chronic studies (**study #2** and **study #3**) reported no changes after heat exposure, these results question the additive effect of a thermal stress to an exercise-mediated mechanical response on muscle-tendon properties.

Active heat exposure reported undifferentiated effects in the literature. Previous studies showed that MVC peak force decreased after an exercise in the heat, but this effect was not different in comparison to a similar cycling exercise performed in temperate environment (Baillot et al., 2021; Goodall et al., 2015; Périard et al., 2011), suggesting a potential lack of heat-related impact on MVC peak force measured after an exercise. To the best of our knowledge, little is known regarding the changes in maximal force-generating capacity after running in the heat. After a run of 40 min, at 65% of maximal aerobic velocity, Ftaiti et al. (2001) reported decreasing values in knee isometric and isokinetic (at $60^{\circ} \cdot s^{-1}$) extension torques. However, the participants were dehydrated, wearing an impermeable jacket in temperate environment to induce heat stress, and the study does not allow a comparison to a running exercise without additional heat stress. In the context of muscle damage, downhill running in a hot environment did not report aggravated muscle damage in comparison to temperate environment (Li et al., 2022).

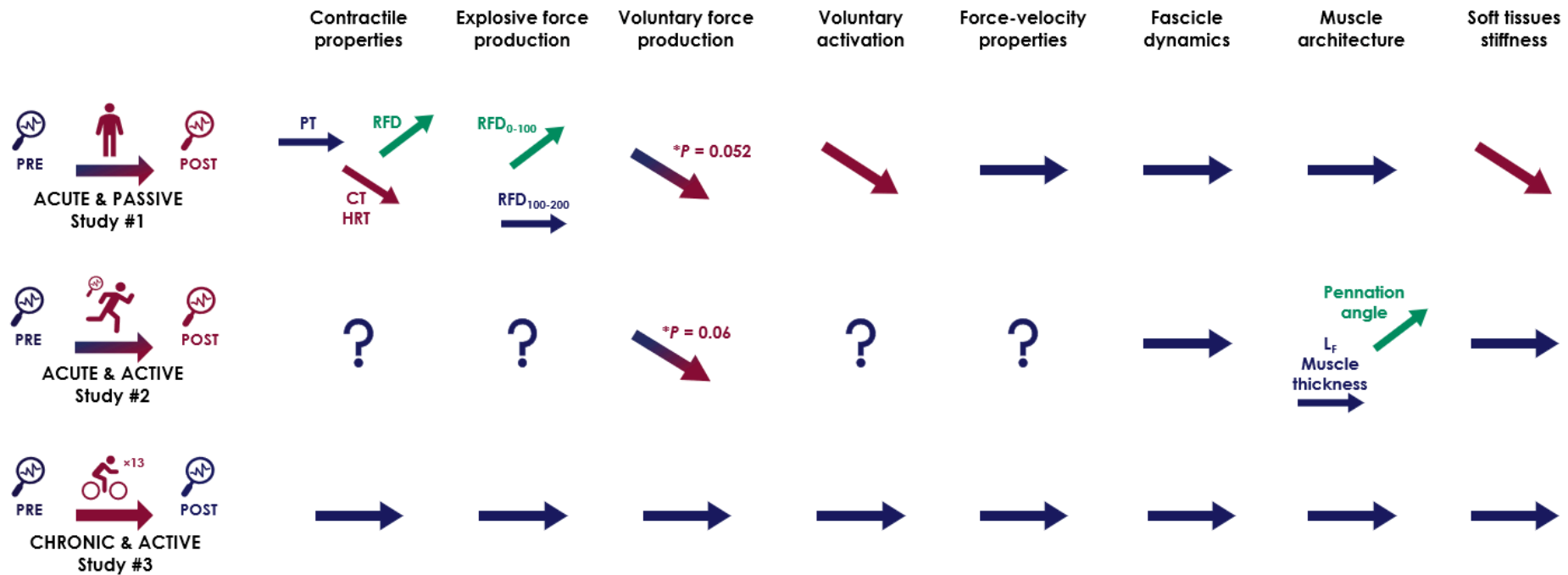

Figure 43. Schematic representation of the gastrocnemius medialis muscle-tendon unit heat-related responses obtained in the three studies of this PhD work. The effects indicated correspond to the comparison of the parameters measured before (PRE), and after (POST) heat exposure. PT, peak twitch amplitude; RFD, rate of force development; CT, contraction time; HRT, half-relaxation time; L_F, fascicle length. The rising arrows (green) indicate a significant increase in the measured parameter, the declining arrows (red) reflect a significant decrease and the horizontal arrows depict an absence of heat effect ($P \leq 0.05$). Specifications are added (multiple arrows) when within the same grouping of parameters (e.g., “Contractile properties”) effects are different.

Racinais et al. (2017c) reported an increase in plantar flexor voluntary and electrically-evoked force production, after a passive HA protocol. Recent studies showed that adding local repeated heat stress during a long period (*i.e.*, 10-12 weeks) of resistance training had no effect on muscle force production (Chandrasiri et al., 2021; Stadnyk et al., 2018). Therefore, repeated heat exposure may not further increase muscle force in participants already exposed to mechanical and metabolic stress elicited by strength training (Chandrasiri et al., 2021; Stadnyk et al., 2018).

These findings differ from previous conclusions observed either after upper-limb training (Goto et al., 2007), suggesting a potential influence of exercising muscle group exposed to heat or in elderly females, which reported that over a 12-weeks period, muscle force and hypertrophy was induced by low-intensity resistance training of knee extensors combined with heat stress, caused by protein synthesis, stimulated anabolic hormones and HSPs (Yoon et al., 2017).

The expression of HSPs, molecular chaperones involved in protein synthesis, via heat stress preconditioning the muscle to mechanical stress for ~72 h, has been shown to potentially impair chronic mechanical adaptations, suggesting that prior heat stress and/or a consequent accumulation of HSPs may inhibit skeletal muscle hypertrophy (Frier and Locke, 2007), potentially being at the origin of the absence of modifications of muscle properties observed in **study #3**. Therefore, it would be interesting to investigate the effects of the interventions implemented in the present work on muscle signaling to explain potential heat-induced molecular markers/pathways. In animals, an increase in T_{musc} increased protein breakdown in a higher amplitude than protein synthesis (Baracos et al., 1984), and hyperthermia favored such catabolic balance (Luo et al., 2000). If these effects transfer to humans, it could at least partly explain the absence of cumulative effect of heat stress on the top of mechanical stress-related adaptations. However, rats exposed to heat exposure combined to aerobic exercise over a longer period (*i.e.*, > 30 days) increased their force-generating capacity in SOL. This adaptation coincided with specific gene up-regulation, such as cellular Ca^{2+} regulation (Kodesh and Horowitz, 2010). These outcomes strongly suggest that a dose-response relationship exists between the amplitude of heat-stress and changes in muscle properties. A recent review (Fennel et al., 2022) encouraged further research on mechanisms involved upon heat stress, with and without resistance exercise on skeletal muscle function, to validate HSPs-mediated responses and to determine the efficiency of heat-interventions.

3. Are heat stress amplitude and muscle responses related?

Some acute studies reported the time-course of neuromuscular heat-induced responses. For example, Gordon et al. (2021) reported the effects of passive heat exposure, performed in an environmental chamber, on maximal and rapid voluntary force production, and their associated neuromuscular determinants. When T_{core} reached 38.5°C , MVC peak force of knee extensors decreased from baseline, while VA decreased only when T_{core} exceeded 39.5°C . Almost similarly, knee extensor MVC peak force and VA decreased when T_{core} reached $\sim 39.4\text{-}39.5^{\circ}\text{C}$, which was not the case at $\sim 38.5\text{-}39^{\circ}\text{C}$ (Morrison et al., 2004; Périard et al., 2014a). The same effects were reported on the peripheral nervous system with decreasing PT amplitude, CT and HRT only when T_{core} was higher than 39.5°C . Under acute passive heat stress (**study #1**), T_{core} was below this threshold, reaching $38.4 \pm 0.3^{\circ}\text{C}$ at the end of the heat exposure, with no measurements thereafter. Interestingly, plantar flexor MVC peak force reported a downward trend ($P = 0.052$). In these conditions VA significantly decreased, as well as CT and HRT, highlighting a potential difference in heat-induced changes in contractile muscle properties between muscle groups.

During active heat exposure a threshold could also exist since cycling in the heat, causing an increase in T_{core} at 38.5°C , does not alter knee extensor MVC peak force and VA, while these parameters decrease when T_{core} reached 39.5°C (Périard et al., 2014a). Thus, the MVC peak force trend to decrease when running in the heat, measured at a T_{core} of 39.2°C in **study #2** might results in a significant decrease in MVC peak force if the exercise has been more intense and/or longer. As often observed though, the various differences in experimental conditions challenge between-studies comparisons (*e.g.*, muscle group investigated, method and duration of heat exposure, exercise performed if applicable, induced changes in T_{core} and T_{musc}). To our knowledge, no study, passive or active, reported a time-course of the effects of increasing T_{core} on the aforementioned neuromuscular properties of plantar flexors. It would therefore be interesting to investigate such effects to compare knee extensor and plantar flexor adaptations to heat stress over time.

Active or passive acute heat exposure previously demonstrated unequivocal effects on MVC peak force production, VA and contractile properties, which reported to be different according to the heat exposure employed, the muscle group studied or the intensity of the heat stress. This observation encouraged us to initiate a meta-analysis focusing on the impact of acute heat stress,

passive or active, on muscle performance⁷. The results are expected to lighten our understanding of heat-related effects on muscle properties.

This dose-response relationship could also differ from one muscle to another. Interestingly, studies considering repeated heat exposure reported no effect on force-generating capacity of *gastrocnemii* muscles (Labidi et al., 2021; **study #3**), while previous studies reported force production improvements in knee extensors (Goto et al., 2011; Kim et al., 2020). In another context than heat exposure, it was for example reported that HSPs increased in *biceps brachii* but not *vastus lateralis* 48 h after an eccentric exercise, reinforcing the muscle group-dependence of heat-mediated responses (Thompson et al., 2003). One should remind that tendon is a major contributor to the shortening of the GM muscle-tendon unit (Farcy et al., 2014), therefore compensatory mechanisms may be involved between muscle and tendon tissues.

As discussed in **study #2** ([see p.118](#)), increasing exercise duration and/or intensity might also decrease fascicle operating lengths and therefore alter metabolic energy expenditure, due to a larger metabolic energy consumed per unit of active muscle contracting at shorter L_F (Beck et al., 2022). Indeed, when producing a constant force, shorter L_F elicits neuromechanical changes leading to an increase in the metabolic energy expenditure required to produce force. This reinforces the idea of a dose-response relationship between the amplitude of heat exposure (*e.g.*, duration and exercise intensity) and adaptations in muscle properties.

Chronically, there may be a temperature threshold to exceed for changes in skeletal muscle signaling to occur. Indeed, it was reported that increasing *vastus lateralis* T_{musc} to $38.8 \pm 0.5^\circ\text{C}$ enhanced anabolic signaling through the protein kinase B (Akt)/mTOR pathway, while an increase in T_{musc} to $38.1 \pm 0.6^\circ\text{C}$ induced none of these changes (Ihsan et al., 2020). This is in line with an activated Akt/mTOR signaling pathway, a crucial mediator of protein synthesis and hypertrophy, reported in animals' study after heat stress (Yoshihara et al., 2013), with higher responses at 41°C . This might suggest that a larger dose of heat stress may be required to observe muscle adaptations. T_{musc} being an important factor regarding the effect of heat impact on HSPs expression, different heat stress level/dose may impact the activation of the hypertrophic pathways (Goto et al., 2004; Uehara et al., 2004). Thus, the present findings could highlight an insufficient increase in T_{musc} in response to heat to activate muscle signaling

⁷ This meta-analysis was deposited on Prospero (ID: CRD42020153859), and data from the seventy-three studies included (*i.e.*, meeting the inclusion criteria) have been recovered and are being statistically analyzed.

pathways in the tested experimental conditions. However, as previously mentioned, the investigation of such parameters is not measurable non-invasively *in vivo* in humans. Moreover, it is an assumption that should be investigated since explored muscle groups and changes in T_{musc} were different from the previous studies evoked. It would have been interesting to have T_{musc} values for the study on which our assumptions were based, which reported an enhancement of contractile properties after 11 days of HA (Racinais et al., 2017c).

At non-physiological T_{core} , and almost systemically in animals, more effects were reported on muscle-tendon unit properties. For example, the shear modulus explored in bovine muscles decreased linearly when temperature increased from 20 to 44°C with less important changes above 37°C [*i.e.*, closer to physiological temperatures; (Sapin-de Brosses et al., 2010)]. *In vitro* humans' fibers (Bottinelli et al., 1996) and rats' muscles fibers showed increasing shortening velocity from 12 to 17°C and 15 to 35°C⁸, respectively, while GM fascicles maximum shortening velocity was unchanged when T_{musc} reached 37.0°C (**study #1**). It is however important to keep in mind that *in vitro* and *in vivo* responses are not directly comparable due to substantial influence of very different environmental conditions on muscle mechanics.

4. Influence of sex on heat-mediated responses?

For each study of this PhD thesis, males and females were included almost evenly ([see p.65](#)). Except for sweat loss, which was amplified for males when running in the heat, no further parameter measured (*i.e.*, physiological or biomechanical) reported any interaction with condition/group and/or time/training. Thus, for all studies the results were therefore analyzed and reported irrespective of sex.

For this, we conducted a pilot analyses considering the effect of sex. Two-way ANOVAs (condition × sex) were used for **study #1**, and three-way ANOVAs (condition/group × time/training × sex) were used for studies **#2** and **#3** on the physiological and biomechanical parameters to assess the effect of condition/group, time/training and sex. Analyses revealed that sweat rate, heart rate (in **study #2**) and several parameters including neuromuscular responses (*i.e.*, PT amplitude, MVC peak force, RFD voluntary measures), muscle architecture (*i.e.*, L_F , muscle thickness, amplitude of fascicle shortening during running) and jump performance (*i.e.*, SJ and CMJ), were higher in males than females ($P \leq 0.032$, $\eta_p^2 \geq 0.08$), due to males' higher

⁸ It corresponds to muscles samples temperature manipulation, therefore suggested to be close, or at least representative of T_{musc} .

force production capabilities. For active studies (*i.e.*, #2 and #3), analyses revealed that males sweat more than females (sex effect: $P \leq 0.005$). This effect was exacerbated in hot environment when running (**study #2**; $P < 0.001$), while it was not different between environmental conditions when cycling (**study #3**; $P = 0.351$). Higher sweat loss in males might be explained by higher activation of receptors involved in sweating (Amano et al., 2020). All other analyses did not show any time/training \times sex interactions ($P \geq 0.062$, $\eta_p^2 \leq 0.08$). The others measured parameters (*e.g.*, T_{core} , T_{skin} , T_{musc} , perceptual ratings, PT, CT, HRT, VA, SWE, tendon stiffness) reported no effect of sex (all $P \geq 0.072$).

Therefore, we can confidently assume that the effects of acute passive heat exposure on muscle-tendon properties (**study #1**), and the absence of effects observed with acute and chronic active heat exposures (**studies #2 and #3**) occurred independently of sex, allowing to independently apply the present findings to males and females.

In the same way, it would seem interesting to investigate muscle-tendon unit responses to heat stress as a function of other characteristics such as the age, the discipline and the level of sport practice. In this view, the sample of participants required to achieve sufficient statistical power would be larger than those involved in the present studies.

2. A pioneer exploration of muscle-tendon mechanics under heat stress

1. Relevance of ultrafast ultrasound to investigate fascicle dynamics in the heat

i. Methodological considerations

The development of ultrafast ultrasound imaging (Bercoff et al., 2004; Deffieux et al., 2008) provided access to high levels of image sampling frequency (up to 10 kHz). Compared to standard ultrasound systems (30-150 Hz), this technology increases the temporal accuracy of real-time muscle tracking during fast motion. Ultrafast ultrasound has been widely used to quantify the relative contribution of electrochemical and mechanical processes to the electromechanical delay (Nordez et al., 2009), to evaluate the GM maximum shortening velocity during plantar flexions (Hauraix et al., 2015), or to highlight the importance of dynamic behavior and associated V_F on rapid force-generating capacity (Hager et al., 2020). It was recently reported that passive heating, using microwave diathermy, reduced echo intensity (Pinto et al., 2022). Echo intensity being used as an indicator of skeletal muscle quality (Stock

and Thompson, 2021), this reassures us that it should not affect the muscle-tendon unit properties assessed during the thesis experimental work presented in the present manuscript. To our knowledge, no study investigated these properties at high frequency upon heat stress.

Likewise, during a running exercise, to the best of our knowledge, no study has ever attempted to report fascicle dynamics with sampling frequency higher than 170 Hz in temperate and hot conditions. However, low ultrasound frequency might smooth L_F patterns assessed during high-velocity movements, potentially leading to loss of information (Van Hooren et al., 2020). Therefore, high frequencies seem relevant when it comes to investigate fast movements in order to reliably capture fascicle behavior. We gathered studies investigating GM fascicle dynamic during running (for which running velocity and ultrasound frame rate were clearly described, non-exhaustive list), and represented the operating frame rate as a function of the running velocity in Figure 44A. To check the effect of frame rate on fascicle dynamic during running ($10 \text{ km}\cdot\text{h}^{-1}$) we compared our sampling frequency (*i.e.*, 500 Hz) to 80 Hz, the frequency used by Werkhausen et al. (2019b)⁹.

For this, the raw signal obtained at 500 Hz was filtered (anti-aliasing filter according to the Shannon Theorem) and resampled to simulate a sampling frequency of 80 Hz (Figure 44B). Then, we filtered the raw signal acquired at 500 Hz according to our low-pass filter used for L_F during running in **study #2** (*i.e.*, ~ 50 Hz, cut-off frequency computed according to the Shannon Theorem), and the raw signal acquired at 80 Hz with the filter previously used by Werkhausen et al. (15 Hz, 4th order Butterworth; Figure 44C). In addition to facilitating tracking (Drazan et al., 2019), higher sampling frequency allows to more accurately capture fascicle behavior during high-velocity movements, and to potentially better detect changes in L_F during brief and precise moments. Graphically, the sampling frequency used and the corresponding filter does not seem to impact L_F pattern (Figure 44B-C). However, we cannot exclude that short variations are not appreciated, and it is important to consider that we represented L_F and not V_F , for which small variations may have greater impact. Sampling frequency is therefore an important parameter that must be considered when assessing fascicle operating lengths in regard to force-velocity properties [*e.g.*, Monte et al. (2020)]. Moreover, it would be interesting to make the same comparisons at higher running velocity.

⁹ We choose this study because the running velocity was similar to our **study #2** and because the authors provided details on the filter used for L_F .

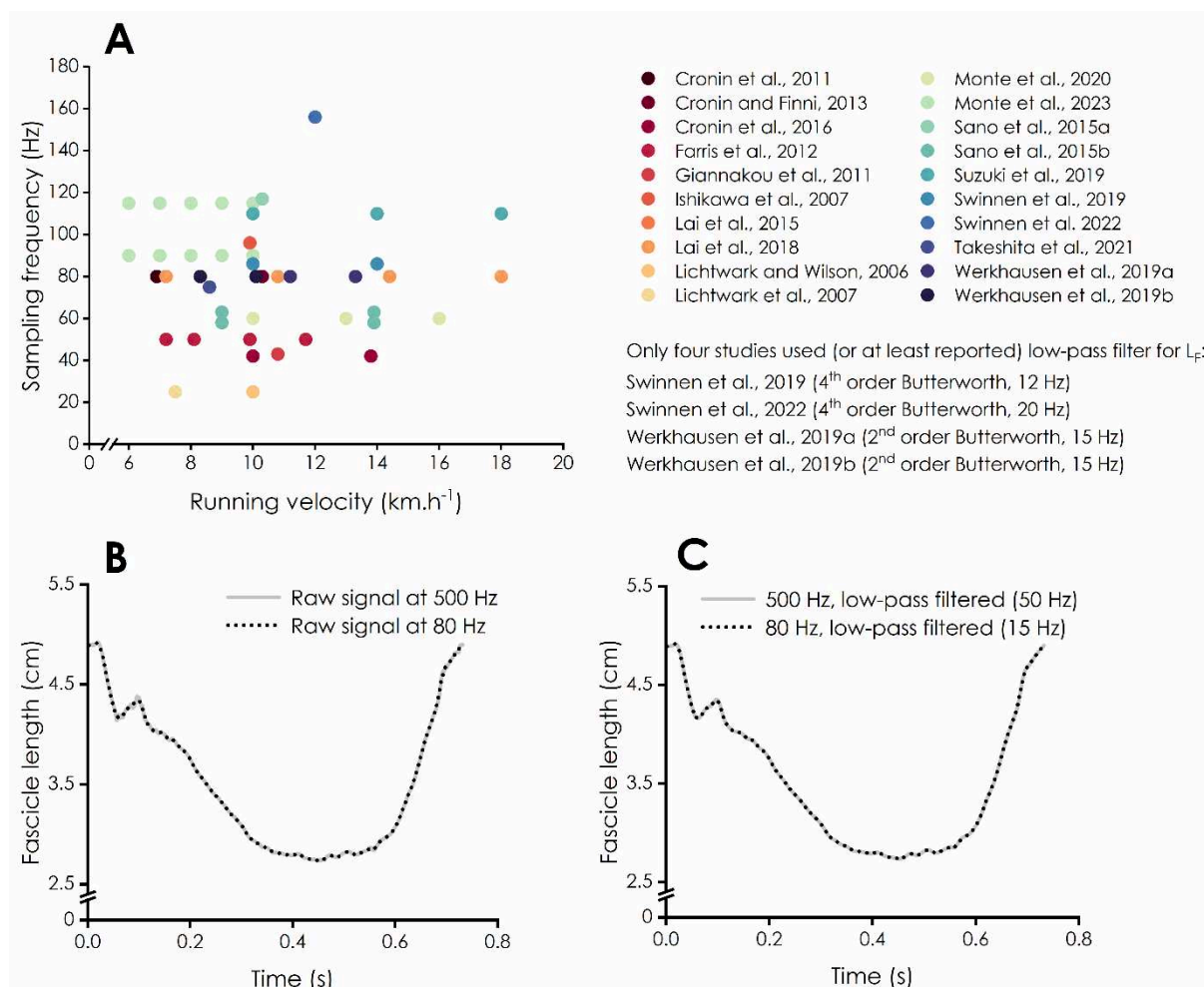

Figure 44. **A:** Ultrasound sampling frequency used according to the running velocity explored in previous studies investigating fascicle dynamics during running. **B:** Raw signal of fascicle length as a function of time during running (at 10 km.h⁻¹) of one complete stride (from heel-strike to toe-off) tracked at 500 Hz (full grey line) and resampled at 80 Hz (dotted black line). **C:** Fascicle patterns from panel B low-pass filtered at ~50 Hz (according to the Shannon Theorem) for the signal sampled at 500 Hz (full grey line) and at 15 Hz for the signal sampled at 80 Hz [as proposed by Werkhausen et al. (2019b); dotted black line].

The main metrics reflecting basic properties of the muscle measured in the present PhD work (*i.e.*, force-velocity and force-length properties) are in the common ranges reported in the literature for these populations. Force-velocity relationship was previously reported in GM, with V_0 reaching 30.8-33.3 cm.s⁻¹ (Hager et al., 2020; Hauraix et al., 2015). We obtained V_0 values in the same range (*i.e.*, 30.2-32.7 cm.s⁻¹; **studies #1 and #3**). Similarly, the mean L_0 obtained for GM in **study #2** of 6.2 cm was similar to those previously obtained using nervous

stimulations [*i.e.*, 5.9-6.2 cm; (Hoffman et al., 2012, 2014)]. In addition, the values were similar between the two days of measurements (*i.e.*, 6.18 ± 0.72 cm in TEMP and 6.19 ± 0.79 cm in HOT). In **studies #2** and **#3**, special care was given to probe repositioning between testing sessions, using ultrasound images and anatomical landmarks. The reproducibility of fascicle dynamics was previously shown during treadmill running at ~ 10.8 km.h⁻¹, with a sampling frequency of 43 Hz (Giannakou et al., 2011). The authors suggested a minimum number of trials to perform to provide reliable ultrasound-derived parameters (~ 9 and ~ 14 trials of five strides were recommended for L_F and pennation angle measurements, respectively). We still wonder if these recommendations are applicable when higher sampling frequency is used to capture muscle fascicle dynamics (*i.e.*, 500 Hz, 2 s of acquisition). Moreover, in the aforementioned study (Giannakou et al., 2011), the patterns were compared across time points throughout the running trial (from 2 to 10 min of running). It is however unclear if L_F patterns are reproducible over such time scale. Thus, we conducted pilot experiments to guide us in our methodological choices. We measured GM fascicle dynamics during eight successive image sequences collected at different measurements time (*i.e.*, 2 vs. 5 min) for two participants running on a treadmill at 10 km.h⁻¹. Only complete strides (*i.e.*, heel-strike – toe-off – heel-strike), resulting between one and two full right stride(s) for each acquisition were analyzed. The objectives of these data collections were to determine the number of strides to record for each period of interest for our analyzes, and to determine from how long of the running exercise fascicle patterns are stabilized (*i.e.*, 2 vs. 5 min).

It is important to note that the number of strides is not consistently reported in the literature, as well as the timing of acquisitions. Based on these pilot experiments (*e.g.*, in Figure 45), we noticed that there does not seem to be any alteration of the pattern across three acquisitions (*i.e.*, six strides), compared to the mean obtained from 15 strides (Figure 45A-D). Therefore, we decided to monitor three acquisitions per measurement period for **study #2** (*i.e.*, 2 and 40 min in both environmental conditions). Following this preliminary procedure, we decided to record fascicle dynamics at the beginning of the running exercise at 2 min (patterns between 2 and 5 min being similar, suggesting that pattern is stable from 2 min; Figure 45E).

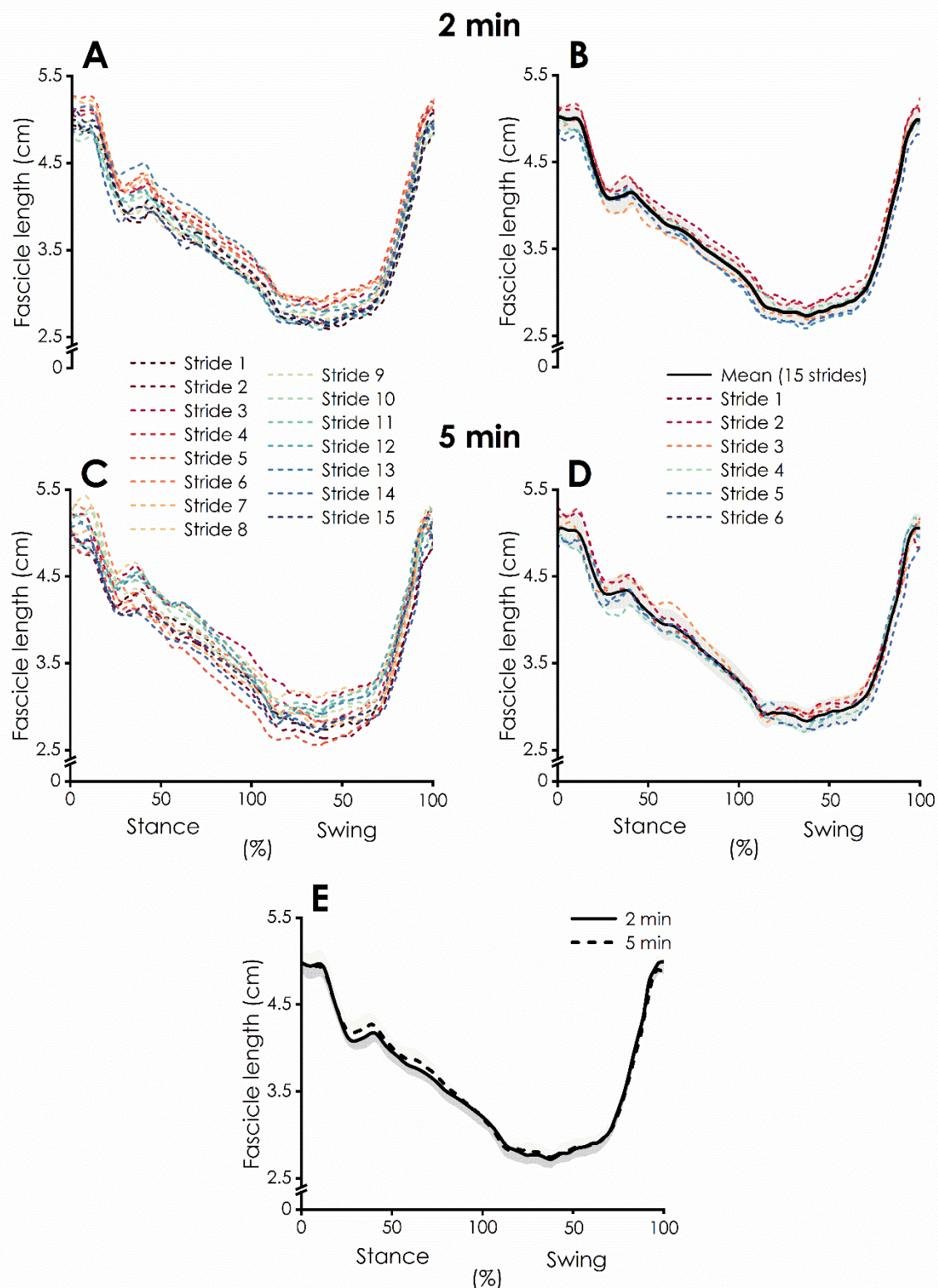

Figure 45. Fascicle patterns obtained for one participant (male, 24 years, 170 cm, 60 kg, trained runner) during pilot running trials at $10 \text{ km}\cdot\text{h}^{-1}$ on a treadmill. **A** and **B**: fascicle patterns obtained at 2 min of the run. **C** and **D**: fascicle patterns obtained at 5 min of the run. **A** and **C**: representation of all the strides obtained (i.e., 15 for each panel) from the 8 acquisitions. **B** and **D**: mean (black line) and standard deviation (shaded area) of the 15 strides obtained at 2 (**B**) and 5 (**D**) min, and the six first strides obtained from the first three acquisitions (dashed colored lines). **E**: fascicle patterns of the first three acquisitions at 2 min (full line) and 5 min (dashed line), and their corresponding standard deviation (shaded areas).

ii. Sensitivity of muscle fundamental properties to heat

Our methodological choices allowed to cope with the density of the tests realized in each study, the difficulty to assess some muscle properties (*e.g.*, force-length properties) in hot environment, and the necessity to perform our measurements in a restricted time period (to avoid participants fatigue, to ensure that participants reached high T_{core} during measurements performed in hot conditions, and that the acute effects of exercise were measured with acceptable data quality for **study #2**). Thus, force-velocity relationship was not assessed for our running study (**study #2**), which did not permit to describe GM force-velocity properties during running in temperate and hot conditions. Force-length relationship was neither assessed in our acute passive study (**study #1**), nor for our chronic study (**study #3**). Nevertheless, by combining the data of our studies, for which participants had similar anthropometric characteristics, we strived to estimate the correspondence between muscle fascicle dynamics during the explored exercise and theoretical muscle properties.

Figure 46, represents the force-velocity relationship obtained in **study #3** before the training protocol for all participants (CON and HA groups average). We positioned the values of V_F obtained in **study #2** during the stance phase (*i.e.*, $\sim 0.4\text{-}14.3 \text{ cm}\cdot\text{s}^{-1}$) and the shortening part of the swing phase (*i.e.*, $\sim 0.1\text{-}8.9 \text{ cm}\cdot\text{s}^{-1}$; due to the absence of condition and time effects, data were pooled across conditions and time) on top of the relationship. Fascicle force-velocity relationship was chosen from **study #3** rather than **study #1** due to the higher number of conditions used to build this relationship, which is likely to provide more robust relationship. Mean fascicle lengthening velocity during the lengthening phase of the swing phase was $5.06 \pm 1.51 \text{ cm}\cdot\text{s}^{-1}$. This representation must therefore be considered with caution given that the force-velocity relationship was built from contractions with maximal activation. In these specific conditions muscle shortening comes from the contraction of all plantar flexor muscles, while muscle activation during running is unlikely to be near maximal and shortening of the muscle result from the activation of a portion of the muscle fibers comprised into muscle bundles.

If this force-velocity relationship had been measured at the end of the running protocol in temperate and hot conditions, this could have informed us about a potential change in GM fascicle force-velocity properties after running.

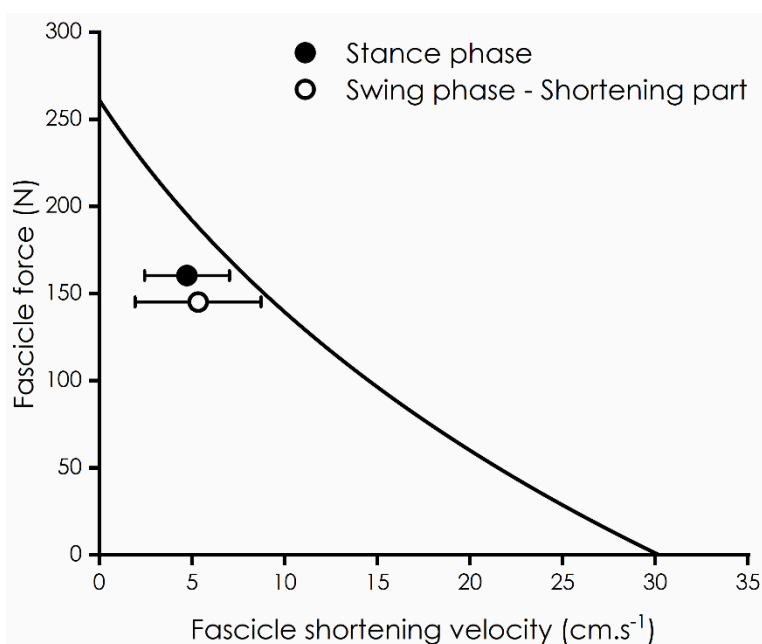

Figure 46. Amplitude of gastrocnemius medialis (GM) shortening velocity obtained during the stance phase (full line) and the shortening part of the swing phase (dashed line) of the running exercise performed in study #2, according to theoretical GM fascicle force-velocity relationship measured before the training protocol in study #3. Given that fascicle force values were not measured during the running protocol, amplitude of shortening velocity are placed arbitrarily with respect to the y-axis. Participants exhibited similar anthropometrical characteristics ([see p.65](#)).

However, the absence of changes in fascicle force-velocity properties after a passive heat exposure (**study #1**), the lack of effects of running in temperate and hot environments on L_F and V_F during running as well as the unchanged MVC peak force production (or trend to decrease) suggest that this relationship would have been likely unchanged after the running protocol (**study #2**).

The acute effect of passive or active heat stress effects, on the shape of the force-length relationship remains uncertain, since we did not measure it, and to our knowledge it was not previously reported in the literature. The impact of passive heat exposure, or exercise performed in temperate or hot environment on force-length properties would provide elements for understanding the intrinsic properties of the muscle following an increase in T_{muscle} , induced by a passive heat exposure or exercise. While we could not measure the force-length relationship following an acute heat exposure, due to methodological constraints, we can make some assumptions. Various parameters must be considered in this perspective. For example, more compliant tissues obtained in **study #1** may shift the slack-length of the muscle towards longer

lengths. This may delay the development of passive force in response to stretch, potentially leading to an increase in L_0 . Moreover, the whole relationship may be reduced (downward shift of the whole curve), in the case of reduced force-capacities production. However, the unchanged muscle properties obtained in our studies seem also to suggest that the force-length properties of GM fascicle would have been unchanged after an acute passive heat exposure (**study #1**), an acute active exposure (**study #2**) and a chronic active heat exposure (**study #3**). Although the work conducted in this thesis is rather applicative, it would be interesting to describe the sensitivity of fundamental mechanical properties of the muscle to temperature *in vivo*.

While muscle dynamics were measured in two dimensions in our studies, the present results may suggest that muscle architecture was also unchanged in three dimensions. In addition, the AGR measured during running was not affected by time or environmental condition (**study #2**). Even if AGR does not properly reflect three-dimension muscle architecture, it allows us to estimate fascicle rotation during muscle contraction. The GM investigated in mid belly position reported to be a good indicator of the fascicle dynamics across the whole muscle (Lichtwark et al., 2007), at least during walking and running tasks. Therefore, even if L_F , pennation angle and muscle thickness are not homogeneous in a whole muscle, we can generalize that the absence of muscle fundamental properties changes under heat stress would be observed within the whole muscle.

2. Persistent barriers to neuromuscular investigations under hot conditions

Due to logistical constraints it is not always easy to investigate neuromuscular properties in hot environments. In our studies (**studies #1 and #2**) such investigation was possible thanks to the use of an ergometer equipped with a force sensor ([see p.67](#)). To ensure proper measurement, the force sensor was calibrated before each testing session (*i.e.*, in temperate and hot environments), to ensure that the regular ambient temperature change around the sensor did not impact the values provided. The calibration values measured in **study #1** were not affected, so the procedure was not repeated for **study #2**.

While EMG allows to investigate the activity of the neuromuscular system, we did not perform such measurements in our experiments. It was a methodological choice, due to the already present complexity of experiments, and since EMG was recommended to be interpreted with caution in hot environment (Racinais, 2013). Indeed, heat exposure induces skin vasodilation

which may shift more fluid between the EMG signal and the surface (Bell, 1993) and therefore underestimate muscle activity amplitude in hot environment. However, a study reported that the neural drive to the muscle during an increase in body temperature depend of the task performed and the relative contribution of core and skin thermal afferents, T_{core} influencing EMG amplitude during isometric contractions and T_{skin} impacting EMG amplitude during position task (Coletta et al., 2018). Therefore, temperature suggested to have a task-dependent impact on neuromuscular responses which should not be neglected.

Taking a step back, using EMG for the **study #2** would allow, regardless of heat stress, to characterize the active/inactive behavior of GM muscle during the running exercise (Lin et al., 2021). However, the time-sequence of muscle contraction was not a central focus in reference to the objectives of this PhD thesis.

Central and peripheral components were however appreciated, with respectively the assessment of the level of VA, and muscle contractile properties obtained from electrically-evoked contractions (PT amplitude, CT, HRT and RFD). The various parameters measured have been altered after an acute passive heat exposure (**study #1**), and unchanged after the HA training protocol (**study #3**). However, the level of VA and contractile properties were not measured in our running study (**study #2**), since we prioritized the assessment of MVC peak force, to characterize the level of fatigue induced by the exercise, and the measures of soft tissues stiffness, which have a crucial role during locomotion (Ishikawa et al., 2007). Passive heat exposure (**study #1**) also reported increased RFD in its early phase (*i.e.*, 0-100 ms). This effect is certainly mainly attributed to neural drive, given that nerve conduction velocity increases in hot environments (Rutkove et al., 1997; Todnem et al., 1989). Therefore, it would have been interesting to extract the activity of a given pool of motor unit, by using high-density surface EMG (Holobar and Zazula, 2007; Merletti et al., 1999). Recent works (Del Vecchio et al., 2019) based on high-density EMG decomposition showed that the recruitment velocity and the instantaneous motor unit discharge rate in the early phase of RFD strongly condition the amplitude of explosive force production. Although our study did not use such technique, the increase in early RFD could thus be linked to these nervous adaptations [*i.e.*, decrease in the recruitment threshold and increase in the discharge rate of motor units; (Del Vecchio et al., 2019)]. To our knowledge, no study used high-density EMG with heat stress, questioning the feasibility of such a procedure in hot environments. Very recently, ultrafast ultrasound is increasingly used to identify motor unit characteristics (Carbonaro et al., 2022a; Carbonaro et

al., 2022b). Such technique could be interesting to non-invasively investigate the electrical, anatomical and mechanical properties of motor unit during contractions.

3. Research perspectives

Several scientific perspectives may emanate from the present findings. The first perspective stems from **study #1**. It would be interesting to describe the time-course of the muscle-tendon unit heat-related effects. This could be obtained from different heat stress levels/doses, with neuromuscular assessments performed every 0.5°C increase in T_{core} under passive heat exposure, as previously done for knee extensors (Gordon et al., 2021; Morrison et al., 2004). A parallel measurement of T_{musc} would provide additional information on this time-course, with information on the effects of heat stress at a more localized scale. Investigating the effect of localized calf heating (*e.g.*, short wave diathermy, water immersion, heat pads) on the muscle-tendon unit mechanical properties would provide insights into the role of central and peripheral neuromuscular adaptations to heat on muscle properties. Additional use of high-density EMG would provide information of motor unit behavior in response to heat stress (Martinez-Valdes et al., 2016), which would deepen heat effects on muscle mechanics.

A second research perspective would be to investigate muscle-tendon unit responses and interplay when performing strenuous exercise (*e.g.*, longer, more intense or more traumatic). **Study #2** reported unchanged muscle-tendon interactions when for running a prolonged period (*i.e.*, 40 min) in temperate and hot environments. Longer exercise may change running mechanics and therefore increase step frequency, due to shorter stance time (Morin et al., 2011). Such process may potentially lead to decrease fascicle operating length (Swinnen et al., 2022) and therefore metabolic energy expenditure (Beck et al., 2022). Similar effects could be induced by increasing running velocity (from 10 km.h⁻¹, to 13 and 16 km.h⁻¹) which was reported to decrease GM L_F during the stance phase of running (Monte et al., 2020). However, it was also reported that increasing running velocity, from ~11.2 km.h⁻¹ to 13.3 km.h⁻¹, does not result in changes in GM and SOL muscle L_F (Werkhausen et al., 2019a), suggesting that further studies are needed to clarify the effects of increasing running velocity on fascicle dynamics. Moreover, with an increase in running velocity, runners may tend to perform midfoot or forefoot strike pattern, and a difference could occur depending on the running pattern. On the one hand, rearfoot strike pattern was reported to be more advantageous than forefoot strike pattern, with less muscular work and a reduction in excessive muscle-tendon dynamics when running at 8.6

km.h⁻¹ (Takeshita et al., 2021). On the other hand, forefoot strike pattern is more advantageous to use elastic energy during the propulsion phase (Takeshita et al., 2021). Therefore, with increasing running velocity and the tendency to use forefoot strike pattern, while muscular work may increase, the use of elastic energy recoil during the propulsion could compensate shorter fascicle lengths.

Our third research perspective may be related to HA. Although the present exercised-based HA protocol, did not elicit perceptible modifications in muscle-tendon unit properties (**study #3**), we cannot attest that similar results would have been obtained for another muscle group. The aforementioned ([see p.145](#)) muscle-group dependence of heat-mediated responses (Thompson et al., 2003) may lead to different adaptations according to exercised muscle group. However, it is important to keep in mind that plantar flexors have a crucial role in locomotion, with a stretch-shortening cycle more pronounced than knee extensors for example, and thus with potentially greater implications for human locomotion.

In addition, the cycling exercise intensity (and duration) of the HA protocol may have different effects on neuromuscular properties. During a 5-days HA cycling protocol, it was reported that knee extensor MVC peak force and PT amplitude were reduced after 90-min low-intensity sessions and unchanged after 30-min high-intensity sessions (Wingfield et al., 2016). This suggests that the intensity of exercise may also modulate muscle properties responses to HA. It would therefore be interesting to investigate the effects of active HA on muscle-tendon unit properties by modulating the HA protocol. HA process may indeed vary depending on the duration of daily exposition (*i.e.*, from 30 min to 90 min), and the duration of the intervention [*i.e.*, from one to two weeks; (Racinais et al., 2015a)]. Investigating muscle-tendon responses to HA protocol varying the intensity of heat stress (*i.e.*, based on modulation of ambient temperature and RH), as well as the environment used (*e.g.*, natural *vs.* simulated), would allow to highlight if our results are transferable to other HA protocols. The aforementioned possibilities may have more or less significant effects on T_{core} and T_{musc} , potentially leading to different amplitude of skeletal muscle signaling responses ([see p.145](#)).

4. Practical recommendations

From a practical point of view, heat stress seems to have some effects on muscle-tendon properties when the heat exposure is passive, while active acute or chronic heat stress reported

unchanged muscle-tendon unit properties. Passive heat exposure reduces soft tissue stiffness which may in turn sustain larger stresses. Nevertheless, running in the heat does not report equivalent effects, then the present findings observed in passive conditions may not systematically translate to a potential reduction in the stress applied to the muscle during exercise. However, it could suggest a transfer to heat therapy which may reduce soft tissue strain after damaging exercise for example¹⁰.

Regarding active heat exposure, the present work provides more practical recommendations to coaches and athletes:

- running at low-/moderate-intensity in temperate and hot conditions have no detrimental effects on muscle-tendon properties and interplay. Unchanged fascicle operating lengths during running over time suggests that metabolic energy expenditure may not be altered by this parameter, regardless of environmental conditions, at least until 40 min of running;
- active HA is beneficial to acclimate athletes from a physiological point of view without altering neither muscle-tendon mechanical properties, nor muscle or multi-joint performance. Athletes from all disciplines may therefore use active HA, to cope with heat, without facing putative detrimental effects on their muscular performance.

It is however important to keep in mind that this absence of muscle and tendon property alterations were observed in the specific context explored in the present PhD work. Therefore, the interpretation and the practical use of these findings should be considered with caution when transferring to other level of practice, intensity, duration and type of exercise.

¹⁰ Outside of the scope of this PhD thesis, I was involved this summer in a research project which aimed to determine the effect of repeated hot- and cold-water immersions on muscle regeneration after a damaging protocol ([see p.189](#)).

CONCLUSION

Muscle tendon unit interactions and interplay provide crucial information in the description and understanding of motor performance. The present experimental work offers the opportunity to improve our understanding of human motor performance explored at various scales (from muscle fascicle to multi-joint movement) under heat stress and to provide practical recommendations to coaches and athletes facing such challenging environments.

Using ultrafast ultrasound, it was possible to investigate muscle fascicle behavior *in vivo* during dynamic contractions *in situ* (*i.e.*, running task), and therefore to provide relevant mechanistic information of muscle-tendon responses to heat stress. Our findings can be summarized into two key messages. First, we reported that an acute passive heat exposure improved explosive force production in its early phase which may be attributed to an improved neural drive, while the stiffness of soft tissue was reduced. These findings evidence the decoupled effects of heat on contractile and passive properties of the muscle-tendon unit. Secondly, active heat exposure, whether acute (during a running exercise), or chronic (during a cycling heat acclimation protocol), induced no changes in muscle-tendon unit properties and interplay. The present lack of influence of ambient temperature on muscle properties allows to provide novel practical information useful to the athletes, when they exercise in hot environment or when they use heat acclimation to prepare a competition in the heat.

In short, the present PhD work showed that exercising in the heat at moderate intensity does not alter muscle-tendon unit properties. Further research may extend the present findings to longer and/or more intense exercises.

REFERENCES

- Aagaard P, Simonsen EB, Andersen JL, Magnusson P, and Dyhre-Poulsen P** (2002). Increased rate of force development and neural drive of human skeletal muscle following resistance training. *J Appl Physiol (1985)* **93**: 1318-26.
- Aeles J, Bolsterlee B, Kelp NY, Dick TJM, and Hug F** (2022). Regional variation in lateral and medial gastrocnemius muscle fibre lengths obtained from diffusion tensor imaging. *Journal of Anatomy* **240**: 131-44.
- Ahn AN, Meijer K, and Full RJ** (2006). In situ muscle power differs without varying in vitro mechanical properties in two insect leg muscles innervated by the same motor neuron. *J Exp Biol* **209**: 3370-82.
- Alexander RM, and Bennet-Clark HC** (1977). Storage of elastic strain energy in muscle and other tissues. *Nature* **265**: 114-7.
- Allan JR, and Wilson CG** (1971). Influence of acclimatization on sweat sodium concentration. *J Appl Physiol* **30**: 708-12.
- Amano T, Fujii N, Kenny GP, Nishiyasu T, Inoue Y, and Kondo N** (2020). The relative contribution of α - and β -adrenergic sweating during heat exposure and the influence of sex and training status. *Exp Dermatol* **29**: 1216-24.
- Andersen LL, and Aagaard P** (2006). Influence of maximal muscle strength and intrinsic muscle contractile properties on contractile rate of force development. *Eur J Appl Physiol* **96**: 46-52.
- Angelozzi M, Madama M, Corsica C, Calvisi V, Properzi G, McCaw ST, and Cacchio A** (2012). Rate of force development as an adjunctive outcome measure for return-to-sport decisions after anterior cruciate ligament reconstruction. *J Orthop Sports Phys Ther* **42**: 772-80.
- Aoki MS, Soares AG, Miyabara EH, Baptista IL, and Moriscot AS** (2009). Expression of genes related to myostatin signaling during rat skeletal muscle longitudinal growth. *Muscle & Nerve* **40**: 992-99.
- Apte S, Prigent G, Stöggel T, Martínez A, Snyder C, Gremeaux-Bader V, and Aminian K** (2021). Biomechanical Response of the Lower Extremity to Running-Induced Acute Fatigue: A Systematic Review. *Front Physiol* **12**: 646042.
- Arampatzis A, Stafilidis S, DeMonte G, Karamanidis K, Morey-Klapsing G, and Brüggemann GP** (2005). Strain and elongation of the human gastrocnemius tendon and aponeurosis during maximal plantarflexion effort. *J Biomech* **38**: 833-41.
- Arya S, and Kulig K** (2010). Tendinopathy alters mechanical and material properties of the Achilles tendon. *J Appl Physiol (1985)* **108**: 670-5.
- Ashrae** (1966). Thermal comfort condition. *ASHRAE Standard*
- Ashworth E, Cotter J, and Kilding A** (2022). Post-exercise, passive heat acclimation with sauna or hot-water immersion provide comparable adaptations to performance in the heat in a military context. *Ergonomics* 1-12.

- Avela J, Kyröläinen H, and Komi PV** (1999). Altered reflex sensitivity after repeated and prolonged passive muscle stretching. *J Appl Physiol* (1985) **86**: 1283-91.
- Azevedo RA, Silva-Cavalcante MD, Lima-Silva AE, and Bertuzzi R** (2021). Fatigue development and perceived response during self-paced endurance exercise: state-of-the-art review. *Eur J Appl Physiol* **121**: 687-96.
- Azizi E, Brainerd EL, and Roberts TJ** (2008). Variable gearing in pennate muscles. *Proc Natl Acad Sci U S A* **105**: 1745-50.
- Azizi E, and Roberts TJ** (2014). Geared up to stretch: pennate muscle behavior during active lengthening. *Journal of Experimental Biology* **217**: 376-81.
- Bäckman E, Lennmarken C, Rutberg H, and Henriksson KG** (1988). Skeletal muscle contraction characteristics in vivo in malignant hyperthermia susceptible subjects. *Acta Neurol Scand* **77**: 278-82.
- Baillet M, Hue O, Tran TT, and Antoine-Jonville S** (2021). Neuromuscular Activity during Cycling Performance in Hot/Dry and Hot/Humid Conditions. *Life (Basel)* **11**:
- Baracos VE, Wilson EJ, and Goldberg AL** (1984). Effects of temperature on protein turnover in isolated rat skeletal muscle. *Am J Physiol* **246**: C125-30.
- Bárány M** (1967). ATPase activity of myosin correlated with speed of muscle shortening. *J Gen Physiol* **50**: Suppl:197-218.
- Beck ON, Trejo LH, Schroeder JN, Franz JR, and Sawicki GS** (2022). Shorter muscle fascicle operating lengths increase the metabolic cost of cyclic force production. *J Appl Physiol* (1985) **133**: 524-33.
- Bedford T** (1936). The Warmth Factor in Comfort at Work. A Physiological Study of Heating and Ventilation.
- Bell DG** (1993). The influence of air temperature on the EMG/force relationship of the quadriceps. *Eur J Appl Physiol Occup Physiol* **67**: 256-60.
- Bénard MR, Becher JG, Harlaar J, Huijing PA, and Jaspers RT** (2009). Anatomical information is needed in ultrasound imaging of muscle to avoid potentially substantial errors in measurement of muscle geometry. *Muscle Nerve* **39**: 652-65.
- Bennett AF** (1984). Thermal dependence of muscle function. *Am J Physiol* **247**: R217-29.
- Benzinger TH** (1969). Heat regulation: homeostasis of central temperature in man. *Physiol Rev* **49**: 671-759.
- Berchtold MW, Brinkmeier H, and Müntener M** (2000). Calcium ion in skeletal muscle: its crucial role for muscle function, plasticity, and disease. *Physiol Rev* **80**: 1215-65.
- Bercoff J, Tanter M, and Fink M** (2004). Supersonic shear imaging: a new technique for soft tissue elasticity mapping. *IEEE Trans Ultrason Ferroelectr Freq Control* **51**: 396-409.
- Bernabei M, Lee SSM, Perreault EJ, and Sandercock TG** (2020). Shear wave velocity is sensitive to changes in muscle stiffness that occur independently from changes in force. *J Appl Physiol* (1985) **128**: 8-16.
- Bierman W** (1936). The temperature of the skin surface. *JAMA* **106**: 1158-62.
- Biewener A, and Patek S** (2018). *Animal Locomotion*. OUP Oxford.
- Biewener AA, and Roberts TJ** (2000). Muscle and tendon contributions to force, work, and elastic energy savings: a comparative perspective. *Exerc Sport Sci Rev* **28**: 99-107.

- Binkhorst R, Hoofd L, and Vissers A** (1977). Temperature and force-velocity relationship of human muscles. *Journal of Applied Physiology* **42**: 471-75.
- Blazevich AJ** (2006). Effects of physical training and detraining, immobilisation, growth and aging on human fascicle geometry. *Sports Med* **36**: 1003-17.
- Blazevich AJ, and Babault N** (2019). Post-activation Potentiation Versus Post-activation Performance Enhancement in Humans: Historical Perspective, Underlying Mechanisms, and Current Issues. *Frontiers in Physiology* **10**:
- Bleakley CM, and Costello JT** (2013). Do thermal agents affect range of movement and mechanical properties in soft tissues? A systematic review. *Arch Phys Med Rehabil* **94**: 149-63.
- Bobbert MF** (2012). Why is the force-velocity relationship in leg press tasks quasi-linear rather than hyperbolic? *Journal of Applied Physiology* **112**: 1975-83.
- Bodine SC, Stitt TN, Gonzalez M, Kline WO, Stover GL, Bauerlein R, Zlotchenko E, Scrimgeour A, Lawrence JC, Glass DJ, and Yancopoulos GD** (2001). Akt/mTOR pathway is a crucial regulator of skeletal muscle hypertrophy and can prevent muscle atrophy in vivo. *Nat Cell Biol* **3**: 1014-9.
- Bohm S, Marzilger R, Mersmann F, Santuz A, and Arampatzis A** (2018). Operating length and velocity of human vastus lateralis muscle during walking and running. *Scientific Reports (Nature Publisher Group)* **8**: 1-10.
- Bohm S, Mersmann F, Santuz A, and Arampatzis A** (2019). The force-length-velocity potential of the human soleus muscle is related to the energetic cost of running. *Proc Biol Sci* **286**: 20192560.
- Bojsen-Møller J, Magnusson SP, Rasmussen LR, Kjaer M, and Aagaard P** (2005). Muscle performance during maximal isometric and dynamic contractions is influenced by the stiffness of the tendinous structures. *J Appl Physiol (1985)* **99**: 986-94.
- Bolsterlee B, Gandevia SC, and Herbert RD** (2016). Ultrasound imaging of the human medial gastrocnemius muscle: how to orient the transducer so that muscle fascicles lie in the image plane. *J Biomech* **49**: 1002-08.
- Bolton CF, Sawa GM, and Carter K** (1981). The effects of temperature on human compound action potentials. *J Neurol Neurosurg Psychiatry* **44**: 407-13.
- Borg GA** (1982). Psychophysical bases of perceived exertion. *Med Sci Sports Exerc* **14**: 377-81.
- Bottinelli R, Canepari M, Pellegrino M, and Reggiani C** (1996). Force-velocity properties of human skeletal muscle fibres: myosin heavy chain isoform and temperature dependence. *The Journal of physiology* **495**: 573-86.
- Bottinelli R, and Reggiani C** (2000). Human skeletal muscle fibres: molecular and functional diversity. *Prog Biophys Mol Biol* **73**: 195-262.
- Brazaitis M, and Paulauskas H** (2019). Motor performance is preserved in healthy aged adults following severe whole-body hyperthermia. **36**: 65-74.
- Brazaitis M, Skurvydas A, Pukėnas K, Daniusevičiūtė L, Mickevicienė D, and Solianik R** (2012). The effect of temperature on amount and structure of motor variability during 2-minute maximum voluntary contraction. *Muscle Nerve* **46**: 799-809.

- Brazaitis M, Skurvydas A, Vadopalas K, and Daniusevičiūtė L** (2010). Force variability depends on core and muscle temperature. *Journal of Thermal Biology* **35**: 386-91.
- Brengelmann GL, Johnson JM, Hermansen L, and Rowell LB** (1977). Altered control of skin blood flow during exercise at high internal temperatures. *J Appl Physiol Respir Environ Exerc Physiol* **43**: 790-4.
- Brennan SF, Cresswell AG, Farris DJ, and Lichtwark GA** (2017). In vivo fascicle length measurements via B-mode ultrasound imaging with single vs dual transducer arrangements. *J Biomech* **64**: 240-44.
- Buchanan TS** (1995). Evidence that maximum muscle stress is not a constant: differences in specific tension in elbow flexors and extensors. *Med Eng Phys* **17**: 529-36.
- Buchheit M, Laursen PB, and Ahmaidi S** (2009). Effect of prior exercise on pulmonary O₂ uptake and estimated muscle capillary blood flow kinetics during moderate-intensity field running in men. *Journal of Applied Physiology* **107**: 460-70.
- Buchthal F, Kaiser E, and Knappeis GG** (1944). Elasticity, Viscosity and Plasticity in the Cross Striated Muscle Fibre. *Acta Physiologica Scandinavica* **8**: 16-37.
- Buchthal F, and Schmalbruch H** (1970). Contraction times and fibre types in intact human muscle. *Acta Physiol Scand* **79**: 435-52.
- Butterfield TA, and Herzog W** (2006). The magnitude of muscle strain does not influence serial sarcomere number adaptations following eccentric exercise. *Pflügers Archiv* **451**: 688-700.
- Campbell HA, Akerman AP, Kissling LS, Prout JR, Gibbons TD, Thomas KN, and Cotter JD** (2022). Acute physiological and psychophysical responses to different modes of heat stress. *Exp Physiol*
- Carbonaro M, Meiburger KM, Seoni S, Hodson-Tole EF, Vieira T, and Botter A** (2022a). Physical and electrophysiological motor unit characteristics are revealed with simultaneous high-density electromyography and ultrafast ultrasound imaging. *Sci Rep* **12**: 8855.
- Carbonaro M, Zaccardi S, Seoni S, Meiburger KM, and Botter A** (2022b). Detecting anatomical characteristics of single motor units by combining high density electromyography and ultrafast ultrasound: a simulation study. *Annu Int Conf IEEE Eng Med Biol Soc* **2022**: 748-51.
- Casadio J, Storey A, Merien F, Kilding A, Cotter J, Laursen P, Casadio JR, Storey AG, Kilding AE, Cotter JD, and Laursen PB** (2017). Acute effects of heated resistance exercise in female and male power athletes. *European Journal of Applied Physiology* **117**: 1965-76.
- Cavanagh PR, and Komi PV** (1979). Electromechanical delay in human skeletal muscle under concentric and eccentric contractions. *Eur J Appl Physiol Occup Physiol* **42**: 159-63.
- Chandrasiri S, Nelson A, Storey A, Garnham A, Hadiyan H, Hameed A, and Peteresen A** (2021). Long Term Concurrent Heat Stress does not Improve upon Performance Gains by Resistance Training. *The FASEB Journal* **35**:
- Chastain PB** (1978). The effect of deep heat on isometric strength. *Phys Ther* **58**: 543-6.
- Close R, and Hoh JF** (1968). Influence of temperature on isometric contractions of rat skeletal muscles. *Nature* **217**: 1179-80.
- Close RI** (1972). The relations between sarcomere length and characteristics of isometric twitch contractions of frog sartorius muscle. *J Physiol* **220**: 745-62.

- Coletta NA, Mallette MM, Gabriel DA, Tyler CJ, and Cheung SS** (2018). Core and skin temperature influences on the surface electromyographic responses to an isometric force and position task. *13*: e0195219.
- Corbett J, Massey HC, Costello JT, Tipton MJ, and Neal RA** (2022). The effect of medium-term heat acclimation on endurance performance in a temperate environment. *Eur J Sport Sci* **22**: 190-99.
- Cornwall MW** (1994). Effect of temperature on muscle force and rate of muscle force production in men and women. *J Orthop Sports Phys Ther* **20**: 74-80.
- Cronin NJ, Carty CP, Barrett RS, and Lichtwark G** (2011). Automatic tracking of medial gastrocnemius fascicle length during human locomotion. *J Appl Physiol (1985)* **111**: 1491-6.
- Cronin NJ, and Finni T** (2013). Treadmill versus overground and barefoot versus shod comparisons of triceps surae fascicle behaviour in human walking and running. *Gait Posture* **38**: 528-33.
- Cronin NJ, Hanley B, and Bissas A** (2016). Mechanical and neural function of triceps surae in elite racewalking. *J Appl Physiol (1985)* **121**: 101-5.
- Crouzier M, Lacourpaille L, Nordez A, Tucker K, and Hug F** (2018). Neuromechanical coupling within the human triceps surae and its consequence on individual force-sharing strategies. *J Exp Biol* **221**:
- Dalleau G, Belli A, Viale F, Lacour JR, and Bourdin M** (2004). A simple method for field measurements of leg stiffness in hopping. *Int J Sports Med* **25**: 170-6.
- Davies C, and Young K** (1983). Effect of temperature on the contractile properties and muscle power of triceps surae in humans. *Journal of Applied Physiology* **55**: 191-95.
- Davies CT, Mecrow IK, and White MJ** (1982). Contractile properties of the human triceps surae with some observations on the effects of temperature and exercise. *Eur J Appl Physiol Occup Physiol* **49**: 255-69.
- De Leva P** (1996). Adjustments to Zatsiorsky-Seluyanov's segment inertia parameters. *J Biomech* **29**: 1223-30.
- De Monte G, and Arampatzis A** (2008). Influence of different shortening velocities preceding stretch on human triceps surae moment generation in vivo. *J Biomech* **41**: 2272-8.
- De Ruyter C, and De Haan A** (2000). Temperature effect on the force/velocity relationship of the fresh and fatigued human adductor pollicis muscle. *Pflügers Archiv* **440**: 163-70.
- De Ruyter C, Jones D, Sargeant A, and De Haan A** (1999). Temperature effect on the rates of isometric force development and relaxation in the fresh and fatigued human adductor pollicis muscle. *Experimental physiology* **84**: 1137-50.
- Deffieux T, Gennisson JL, Tanter M, and Fink M** (2008). Assessment of the mechanical properties of the musculoskeletal system using 2-D and 3-D very high frame rate ultrasound. *IEEE Trans Ultrason Ferroelectr Freq Control* **55**: 2177-90.
- Del Vecchio A, Negro F, Holobar A, Casolo A, Folland JP, Felici F, and Farina D** (2019). You are as fast as your motor neurons: speed of recruitment and maximal discharge of motor neurons determine the maximal rate of force development in humans. *J Physiol* **597**: 2445-56.
- Denton A, Bunn L, Hough A, Bugmann G, and Marsden J** (2016). Superficial warming and cooling of the leg affects walking speed and neuromuscular impairments in people with spastic paraparesis. *Ann Phys Rehabil Med* **59**: 326-32.

- Deschamps K, Eerdeken M, Peters H, Matricali GA, and Staes F** (2022). Multi-segment foot kinematics during running and its association with striking patterns. *Sports Biomech* **21**: 71-84.
- Dewhurst S, Macaluso A, Gizzi L, Felici F, Farina D, and De Vito G** (2010). Effects of altered muscle temperature on neuromuscular properties in young and older women. *European Journal of Applied Physiology* **108**: 451-58.
- Dill DB, Hall FG, and Edwards HT** (1938). Changes in composition of sweat during acclimatization to heat. *American Journal of Physiology-Legacy Content* **123**: 412-19.
- Disselhorst-Klug C, Schmitz-Rode T, and Rau G** (2009). Surface electromyography and muscle force: limits in sEMG-force relationship and new approaches for applications. *Clin Biomech (Bristol, Avon)* **24**: 225-35.
- Doi Y** (1920). Studies on muscular contraction: I. The influence of temperature on the mechanical performance of skeletal and heart muscle. *J Physiol* **54**: 218-26.
- Drazan JF, Hullfish TJ, and Baxter JR** (2019). An automatic fascicle tracking algorithm quantifying gastrocnemius architecture during maximal effort contractions. *PeerJ* **7**: e7120.
- Duchateau J, and Enoka RM** (2011). Human motor unit recordings: origins and insight into the integrated motor system. *Brain Res* **1409**: 42-61.
- Duffield R, King M, and Skein M** (2009). Recovery of voluntary and evoked muscle performance following intermittent-sprint exercise in the heat. *Int J Sports Physiol Perform* **4**: 254-68.
- Edman KA** (1979). The velocity of unloaded shortening and its relation to sarcomere length and isometric force in vertebrate muscle fibres. *J Physiol* **291**: 143-59.
- Edman KA, Reggiani C, Schiaffino S, and te Kronnie G** (1988). Maximum velocity of shortening related to myosin isoform composition in frog skeletal muscle fibres. *J Physiol* **395**: 679-94.
- Eichna LW, Park CR, Nelson N, Horvath SM, and Palmes ED** (1950). Thermal regulation during acclimatization in a hot, dry (desert type) environment. *Am J Physiol* **163**: 585-97.
- El Hérou A** (2011). Caractérisation Biomécanique de la cheville et analyse de l'équilibre du sujet âgé en reprise d'autonomie. *Thesis manuscript*
- Ely BR, Lovering AT, Horowitz M, and Minson CT** (2014). Heat acclimation and cross tolerance to hypoxia: Bridging the gap between cellular and systemic responses. *Temperature (Austin)* **1**: 107-14.
- Ema R, Kawaguchi E, Suzuki M, and Akagi R** (2020). Plantar flexor strength at different knee positions in older and young males and females. *Exp Gerontol* **142**: 111148.
- Eng CM, and Roberts TJ** (2018). Aponeurosis influences the relationship between muscle gearing and force. *Journal of Applied Physiology* **125**: 513-19.
- Enoka RM, and Duchateau J** (2008). Muscle fatigue: what, why and how it influences muscle function. *J Physiol* **586**: 11-23.
- Enoka RM, and Duchateau J** (2015). Inappropriate interpretation of surface EMG signals and muscle fiber characteristics impedes understanding of the control of neuromuscular function. *J Appl Physiol (1985)* **119**: 1516-8.

- Enoka RM, and Duchateau J** (2019). Chapter 7 - Muscle Function: Strength, Speed, and Fatigability. In: *Muscle and Exercise Physiology*, edited by Zoladz JA Academic Press, p. 129-57.
- Enoka RM, and Fuglevand AJ** (2001). Motor unit physiology: some unresolved issues. *Muscle Nerve* **24**: 4-17.
- Ettema GJ, van Soest AJ, and Huijijng PA** (1990). The role of series elastic structures in prestretch-induced work enhancement during isotonic and isokinetic contractions. *J Exp Biol* **154**: 121-36.
- Farcy S, Nordez A, Dorel S, Hauraix H, Portero P, and Rabita G** (2014). Interaction between gastrocnemius medialis fascicle and Achilles tendon compliance: a new insight on the quick-release method. *J Appl Physiol* (1985) **116**: 259-66.
- Farina D, Arendt-Nielsen L, and Graven-Nielsen T** (2005). Effect of temperature on spike-triggered average torque and electrophysiological properties of low-threshold motor units. *J Appl Physiol* (1985) **99**: 197-203.
- Farris DJ, and Lichtwark GA** (2016). UltraTrack: Software for semi-automated tracking of muscle fascicles in sequences of B-mode ultrasound images. *Comput Methods Programs Biomed* **128**: 111-8.
- Farris DJ, Lichtwark GA, Brown NA, and Cresswell AG** (2016). The role of human ankle plantar flexor muscle-tendon interaction and architecture in maximal vertical jumping examined in vivo. *J Exp Biol* **219**: 528-34.
- Farris DJ, and Sawicki GS** (2012). Human medial gastrocnemius force-velocity behavior shifts with locomotion speed and gait. *Proc Natl Acad Sci U S A* **109**: 977-82.
- Farris DJ, Trewartha G, and McGuigan MP** (2012). The effects of a 30-min run on the mechanics of the human Achilles tendon. *Eur J Appl Physiol* **112**: 653-60.
- Febbraio MA, Snow RJ, Stathis CG, Hargreaves M, and Carey MF** (1994). Effect of heat stress on muscle energy metabolism during exercise. *J Appl Physiol* (1985) **77**: 2827-31.
- Fenn WO, and Marsh BS** (1935). Muscular force at different speeds of shortening. *J Physiol* **85**: 277-97.
- Fennel ZJ, Amorim FT, Deyhle MR, Hafen PS, and Mermier CM** (2022). The heat shock connection: skeletal muscle hypertrophy and atrophy. *Am J Physiol Regul Integr Comp Physiol* **323**: R133-r48.
- Ferris DP, Louie MT, and Farley CT** (1998). Running in the real world: adjusting leg stiffness for different surfaces. *Proceedings of the Royal Society of London Series B: Biological Sciences* **265**: 989 - 94.
- Finni T, Ikegawa S, Lepola V, and Komi PV** (2003). Comparison of force-velocity relationships of vastus lateralis muscle in isokinetic and in stretch-shortening cycle exercises. *Acta Physiol Scand* **177**: 483-91.
- Fitts RH, and Holloszy JO** (1978). Effects of fatigue and recovery on contractile properties of frog muscle. *J Appl Physiol Respir Environ Exerc Physiol* **45**: 899-902.
- Flouris AD, Poirier MP, Bravi A, Wright-Beatty HE, Herry C, Seely AJ, and Kenny GP** (2014). Changes in heart rate variability during the induction and decay of heat acclimation. *Eur J Appl Physiol* **114**: 2119-28.

- Flouris AD, and Schlader ZJ** (2015). Human behavioral thermoregulation during exercise in the heat. *Scand J Med Sci Sports* **25 Suppl 1**: 52-64.
- Folland JP, Buckthorpe MW, and Hannah R** (2014). Human capacity for explosive force production: neural and contractile determinants. *Scand J Med Sci Sports* **24**: 894-906.
- Folland JP, Rowlands DS, Thorp R, and Walmsley A** (2006). Leg heating and cooling influences running stride parameters but not running economy. *Int J Sports Med* **27**: 771-9.
- Fontana Hde B, Roesler H, and Herzog W** (2014). In vivo vastus lateralis force-velocity relationship at the fascicle and muscle tendon unit level. *J Electromyogr Kinesiol* **24**: 934-40.
- Forrester SE, Yeadon MR, King MA, and Pain MT** (2011). Comparing different approaches for determining joint torque parameters from isovelocity dynamometer measurements. *J Biomech* **44**: 955-61.
- Foster J, Smallcombe JW, Hodder S, Jay O, Flouris AD, Nybo L, and Havenith G** (2021). An advanced empirical model for quantifying the impact of heat and climate change on human physical work capacity. *Int J Biometeorol* **65**: 1215-29.
- Fouré A, Nordez A, and Cornu C** (2013). Effects of eccentric training on mechanical properties of the plantar flexor muscle-tendon complex. *J Appl Physiol (1985)* **114**: 523-37.
- Frier BC, and Locke M** (2007). Heat stress inhibits skeletal muscle hypertrophy. *Cell Stress Chaperones* **12**: 132-41.
- Ftaiti F, Grélot L, Coudreuse JM, and Nicol C** (2001). Combined effect of heat stress, dehydration and exercise on neuromuscular function in humans. *Eur J Appl Physiol* **84**: 87-94.
- Fujita K, Nakamura M, Umegaki H, Kobayashi T, Nishishita S, Tanaka H, Ibuki S, and Ichihashi N** (2018). Effects of a Thermal Agent and Physical Activity on Muscle Tendon Stiffness, as Well as the Effects Combined With Static Stretching. *J Sport Rehabil* **27**: 66-72.
- Fukunaga T, Kawakami Y, Kubo K, and Kanehisa H** (2002). Muscle and tendon interaction during human movements. *Exerc Sport Sci Rev* **30**: 106-10.
- Fukunaga T, Miyatani M, Tachi M, Kouzaki M, Kawakami Y, and Kanehisa H** (2001). Muscle volume is a major determinant of joint torque in humans. *Acta Physiologica Scandinavica* **172**: 249-55.
- Gajdosik RL** (2001). Passive extensibility of skeletal muscle: review of the literature with clinical implications. *Clin Biomech (Bristol, Avon)* **16**: 87-101.
- Games KE, Winkelmann ZK, McGinnis KD, McAdam JS, Pascoe DD, and Sefton JM** (2020). Functional Performance of Firefighters After Exposure to Environmental Conditions and Exercise. *J Athl Train* **55**: 71-79.
- Gandevia SC** (2001). Spinal and supraspinal factors in human muscle fatigue. *Physiol Rev* **81**: 1725-89.
- Gaoua N, Racinais S, Grantham J, and El Massioui F** (2011). Alterations in cognitive performance during passive hyperthermia are task dependent. *Int J Hyperthermia* **27**: 1-9.
- Garcia-Manso JM, Rodriguez-Ruiz D, Rodriguez-Matoso D, de Saa Y, Sarmiento S, and Quiroga M** (2011). Assessment of muscle fatigue after an ultra-endurance triathlon using tensiomyography (TMG). *Journal of Sports Sciences* **29**: 619-25.
- Garrett AT, Goosens NG, Rehrer NJ, Patterson MJ, and Cotter JD** (2009). Induction and decay of short-term heat acclimation. *Eur J Appl Physiol* **107**: 659-70.

- Gasser HS, and Hill AV** (1924). The Dynamics of Muscular Contraction. *Proceedings of The Royal Society B: Biological Sciences* **96**: 398-437.
- Giannakou E, Aggeloussis N, and Arampatzis A** (2011). Reproducibility of gastrocnemius medialis muscle architecture during treadmill running. *J Electromyogr Kinesiol* **21**: 1081-6.
- Gimeno EM, Campa F, Badicu G, Castizo-Olier J, Palomera-Fanegas E, and Sebio-Garcia R** (2020). Changes in Muscle Contractile Properties after Cold- or Warm-Water Immersion Using Tensiomyography: A Cross-Over Randomised Trial. *Sensors* **20**:
- Giovanelli N, Taboga P, Rejc E, Simunic B, Antonutto G, and Lazzer S** (2016). Effects of an Uphill Marathon on Running Mechanics and Lower-Limb Muscle Fatigue. *Int J Sports Physiol Perform* **11**: 522-9.
- Girard O, Bishop DJ, and Racinais S** (2013). Hot conditions improve power output during repeated cycling sprints without modifying neuromuscular fatigue characteristics. *Eur J Appl Physiol* **113**: 359-69.
- Girard O, Brocherie F, and Bishop DJ** (2015). Sprint performance under heat stress: A review. *Scand J Med Sci Sports* **25 Suppl 1**: 79-89.
- Girard O, Brocherie F, and Ihsan M** (2020). Does ischemic pre-conditioning during the recovery period between two successive matches preserve physical performance in badminton doubles players? *International Journal of Racket Sports Science* **2**:
- Girard O, Brocherie F, Morin JB, and Millet GP** (2016). Running mechanical alterations during repeated treadmill sprints in hot versus hypoxic environments. A pilot study. *J Sports Sci* **34**: 1190-8.
- Girard O, Brocherie F, Morin JB, Racinais S, Millet GP, and Périard JD** (2017). Mechanical Alterations Associated with Repeated Treadmill Sprinting under Heat Stress. *PLoS One* **12**: e0170679.
- Girard O, and Racinais S** (2014). Combining heat stress and moderate hypoxia reduces cycling time to exhaustion without modifying neuromuscular fatigue characteristics. *Eur J Appl Physiol* **114**: 1521-32.
- Girard O, Racinais S, and Periard JD** (2014). Tennis in hot and cool conditions decreases the rapid muscle torque production capacity of the knee extensors but not of the plantar flexors. *British Journal of Sports Medicine* **48**:
- Giroux C, Rabita G, Chollet D, and Guilhem G** (2015). What is the best method for assessing lower limb force-velocity relationship? *Int J Sports Med* **36**: 143-9.
- Glaser EM** (1949). Acclimatization to heat and cold. *J Physiol* **110**: 330-7.
- Godt RE** (1974). Calcium-activated tension of skinned muscle fibers of the frog. Dependence on magnesium adenosine triphosphate concentration. *J Gen Physiol* **63**: 722-39.
- González-Alonso J, Crandall CG, and Johnson JM** (2008). The cardiovascular challenge of exercising in the heat. *J Physiol* **586**: 45-53.
- Goodall S, Charlton K, Hignett C, Prichard J, Barwood M, Howatson G, and Thomas K** (2015). Augmented supraspinal fatigue following constant-load cycling in the heat. *Scandinavian Journal of Medicine & Science in Sports* **25**: 164-72.
- Gordon AM, Huxley AF, and Julian FJ** (1966). The variation in isometric tension with sarcomere length in vertebrate muscle fibres. *J Physiol* **184**: 170-92.

- Gordon R, Tyler CJ, Castelli F, Diss CE, and Tillin NA** (2021). Progressive hyperthermia elicits distinct responses in maximum and rapid torque production. *J Sci Med Sport*
- Gosselin J, Béliveau J, Hamel M, Casa D, Hosokawa Y, Morais JA, and Goulet EDB** (2019). Wireless measurement of rectal temperature during exercise: Comparing an ingestible thermometric telemetric pill used as a suppository against a conventional rectal probe. *J Therm Biol* **83**: 112-18.
- Goto K, Honda M, Kobayashi T, Uehara K, Kojima A, Akema T, Sugiura T, Yamada S, Ohira Y, and Yoshioka T** (2004). Heat stress facilitates the recovery of atrophied soleus muscle in rat. *Jpn J Physiol* **54**: 285-93.
- Goto K, Oda H, Kondo H, Igaki M, Suzuki A, Tsuchiya S, Murase T, Hase T, Fujiya H, Matsumoto I, Naito H, Sugiura T, Ohira Y, and Yoshioka T** (2011). Responses of muscle mass, strength and gene transcripts to long-term heat stress in healthy human subjects. *European Journal of Applied Physiology* **111**: 17-27.
- Goto K, Oda H, Morioka S, Naito T, Akema T, Kato H, Fujiya H, Nakajima Y, Sugiura T, Ohira Y, and Yoshioka T** (2007). Skeletal Muscle Hypertrophy Induced by Low-Intensity Exercise with Heat-Stress in Healthy Human Subjects. *Jpn J Aerosp Environ Med* **44**: 13-16.
- Goto K, Okuyama R, Sugiyama H, Honda M, Kobayashi T, Uehara K, Akema T, Sugiura T, Yamada S, Ohira Y, and Yoshioka T** (2003). Effects of heat stress and mechanical stretch on protein expression in cultured skeletal muscle cells. *Pflugers Arch* **447**: 247-53.
- Goubel F, and Linsel-Corbeil G** (2003). Biomécanique : éléments de mécanique musculaire. Masson.
- Gray SR, De Vito G, Nimmo MA, Farina D, and Ferguson RA** (2006). Skeletal muscle ATP turnover and muscle fiber conduction velocity are elevated at higher muscle temperatures during maximal power output development in humans. *Am J Physiol Regul Integr Comp Physiol* **290**: R376-82.
- Grieve DW, Pheasant S, and Cavanagh P** (1978). Prediction of gastrocnemius length from knee and ankle joint posture. *Biomechanics* 405-12.
- Gutierrez-Vargas R, Martin-Rodriguez S, Sanchez-Urena B, Rodriguez-Montero A, Salas-Cabrera J, Gutierrez-Vargas JC, Simunic B, and Rojas-Valverde D** (2020). Biochemical and Muscle Mechanical Postmarathon Changes in Hot and Humid Conditions. *Journal of Strength and Conditioning Research* **34**: 847-56.
- Guy JH, Deakin GB, Edwards AM, Miller CM, and Pyne DB** (2015). Adaptation to hot environmental conditions: an exploration of the performance basis, procedures and future directions to optimise opportunities for elite athletes. *Sports Med* **45**: 303-11.
- Hafen PS, Preece CN, Sorensen JR, Hancock CR, and Hyldahl RD** (2018). Repeated exposure to heat stress induces mitochondrial adaptation in human skeletal muscle. *J Appl Physiol (1985)* **125**: 1447-55.
- Hager R** (2019). Vitesse et explosivité musculaire : influence des interactions muscle-tendon. *Thesis manuscript*
- Hager R, Dorel S, Nordez A, Rabita G, Couturier A, Hauraix H, Duchateau J, and Guilhem G** (2018). The slack test does not assess maximal shortening velocity of muscle fascicles in humans. *J Exp Biol* **221**:

- Hager R, Poulard T, Nordez A, Dorel S, and Guilhem G** (2020). Influence of joint angle on muscle fascicle dynamics and rate of torque development during isometric explosive contractions. *J Appl Physiol (1985)* **129**: 569-79.
- Hahn D, Herzog W, and Schwirtz A** (2014). Interdependence of torque, joint angle, angular velocity and muscle action during human multi-joint leg extension. *Eur J Appl Physiol* **114**: 1691-702.
- Hahn D, Olvermann M, Richtberg J, Seiberl W, and Schwirtz A** (2011). Knee and ankle joint torque-angle relationships of multi-joint leg extension. *J Biomech* **44**: 2059-65.
- Hannah R, Minshull C, Buckthorpe MW, and Folland JP** (2012). Explosive neuromuscular performance of males versus females. *Exp Physiol* **97**: 618-29.
- Hardy JD** (1961). Physiology of temperature regulation. *Physiol Rev* **41**: 521-606.
- Harridge SD, Bottinelli R, Canepari M, Pellegrino MA, Reggiani C, Esbjörnsson M, and Saltin B** (1996). Whole-muscle and single-fibre contractile properties and myosin heavy chain isoforms in humans. *Pflugers Arch* **432**: 913-20.
- Hartshorne DJ, Barns EM, Parker L, and Fuchs F** (1972). The effect of temperature on actomyosin. *Biochim Biophys Acta* **267**: 190-202.
- Hauraix H** (2015). Étude des interactions muscle-tendon : contribution à l'analyse des déterminants de la performance explosive. *Thesis manuscript*
- Hauraix H, Nordez A, Guilhem G, Rabita G, and Dorel S** (2015). In vivo maximal fascicle-shortening velocity during plantar flexion in humans. *J Appl Physiol (1985)* **119**: 1262-71.
- Henneman E** (1957). Relation between size of neurons and their susceptibility to discharge. *Science* **126**: 1345-7.
- Herbert RD, Clarke J, Kwah LK, Diong J, Martin J, Clarke EC, Bilston LE, and Gandevia SC** (2011). In vivo passive mechanical behaviour of muscle fascicles and tendons in human gastrocnemius muscle-tendon units. *J Physiol* **589**: 5257-67.
- Herbert RD, Moseley AM, Butler JE, and Gandevia SC** (2002). Change in length of relaxed muscle fascicles and tendons with knee and ankle movement in humans. *J Physiol* **539**: 637-45.
- Herzog W** (2017). Skeletal muscle mechanics: questions, problems and possible solutions. *Journal of Neuroengineering and Rehabilitation* **14**:
- Herzog W** (2018). The multiple roles of titin in muscle contraction and force production. *Biophys Rev* **10**: 1187-99.
- Higham TE, and Biewener AA** (2009). Fatigue alters in vivo function within and between limb muscles during locomotion. *Proc Biol Sci* **276**: 1193-7.
- Hill AV** (1938). The heat of shortening and the dynamic constants of muscle. *Proceedings of the Royal Society of London Series B - Biological Sciences* **126**: 136-95.
- Hill AV** (1951). The effect of series compliance on the tension developed in a muscle twitch. *Proceedings of the Royal Society of London Series B - Biological Sciences* **138**: 325-29.
- Hinks A, Franchi MV, and Power GA** (2022). The influence of longitudinal muscle fascicle growth on mechanical function. *J Appl Physiol (1985)* **133**: 87-103.

- Hoang PD, Gorman RB, Todd G, Gandevia SC, and Herbert RD** (2005). A new method for measuring passive length-tension properties of human gastrocnemius muscle in vivo. *J Biomech* **38**: 1333-41.
- Hoffman BW, Lichtwark GA, Carroll TJ, and Cresswell AG** (2012). A comparison of two Hill-type skeletal muscle models on the construction of medial gastrocnemius length-tension curves in humans in vivo. *J Appl Physiol (1985)* **113**: 90-6.
- Hollville E, Nordez A, Guilhem G, Lecompte J, and Rabita G** (2019). Interactions between fascicles and tendinous tissues in gastrocnemius medialis and vastus lateralis during drop landing. *Scand J Med Sci Sports* **29**: 55-70.
- Holobar A, and Zazula D** (2007). Multichannel Blind Source Separation Using Convolution Kernel Compensation. *IEEE Transactions on Signal Processing* **55**: 4487-96.
- Horowitz R** (1999). The physiological role of titin in striated muscle. *Rev Physiol Biochem Pharmacol* **138**: 57-96.
- Horowitz M** (2014). Heat acclimation, epigenetics, and cytoprotection memory. *Compr Physiol* **4**: 199-230.
- Huang C-Y, Wang VM, Flatow EL, and Mow VC** (2009). Temperature-dependent viscoelastic properties of the human supraspinatus tendon. *Journal of Biomechanics* **42**: 546-49.
- Hug F, Lacourpaille L, Maisetti O, and Nordez A** (2013). Slack length of gastrocnemius medialis and Achilles tendon occurs at different ankle angles. *J Biomech* **46**: 2534-8.
- Huijing PA** (1985). Architecture of the human gastrocnemius muscle and some functional consequences. *Acta Anat (Basel)* **123**: 101-7.
- Huxley AF** (1957). Muscle structure and theories of contraction. *Prog Biophys Biophys Chem* **7**: 255-318.
- Huxley AF, and Simmons RM** (1971). Mechanical properties of the cross-bridges of frog striated muscle. *J Physiol* **218 Suppl**: 59p-60p.
- Huxley HE, and Brown W** (1967). The low-angle x-ray diagram of vertebrate striated muscle and its behaviour during contraction and rigor. *J Mol Biol* **30**: 383-434.
- Ichikawa K, Takei H, Usa H, Mitomo S, and Ogawa D** (2015). Comparative analysis of ultrasound changes in the vastus lateralis muscle following myofascial release and thermotherapy: a pilot study. *J Bodyw Mov Ther* **19**: 327-36.
- Ichinose Y, Kawakami Y, Ito M, Kanehisa H, and Fukunaga T** (2000). In vivo estimation of contraction velocity of human vastus lateralis muscle during "isokinetic" action. *J Appl Physiol (1985)* **88**: 851-6.
- Ihsan M, Deldicque L, Molphy J, Britto F, Cherif A, and Racinais S** (2020). Skeletal Muscle Signaling Following Whole-Body and Localized Heat Exposure in Humans. *Frontiers in Physiology* **11**:
- Ioannou LG, Foster J, Morris NB, Piil JF, Havenith G, Mekjavic IB, Kenny GP, Nybo L, and Flouris AD** (2022). Occupational heat strain in outdoor workers: A comprehensive review and meta-analysis. *Temperature (Austin)* **9**: 67-102.
- Ishikawa M, and Komi PV** (2007). The role of the stretch reflex in the gastrocnemius muscle during human locomotion at various speeds. *J Appl Physiol (1985)* **103**: 1030-6.

- Ishikawa M, Pakaslahti J, and Komi PV** (2007). Medial gastrocnemius muscle behavior during human running and walking. *Gait Posture* **25**: 380-4.
- Ito M, Kawakami Y, Ichinose Y, Fukashiro S, and Fukunaga T** (1998). Nonisometric behavior of fascicles during isometric contractions of a human muscle. *J Appl Physiol (1985)* **85**: 1230-5.
- Jenkins ND, Housh TJ, Traylor DA, Cochrane KC, Bergstrom HC, Lewis RW, Schmidt RJ, Johnson GO, and Cramer JT** (2014). The rate of torque development: a unique, non-invasive indicator of eccentric-induced muscle damage? *Int J Sports Med* **35**: 1190-5.
- Johnson JM, Minson CT, and Kellogg DL, Jr.** (2014). Cutaneous vasodilator and vasoconstrictor mechanisms in temperature regulation. *Compr Physiol* **4**: 33-89.
- Johnson MA, Polgar J, Weightman D, and Appleton D** (1973). Data on the distribution of fibre types in thirty-six human muscles. An autopsy study. *J Neurol Sci* **18**: 111-29.
- Kalkhoven JT, Watsford ML, and Impellizzeri FM** (2020). A conceptual model and detailed framework for stress-related, strain-related, and overuse athletic injury. *J Sci Med Sport* **23**: 726-34.
- Kannus P** (2000). Structure of the tendon connective tissue. *Scand J Med Sci Sports* **10**: 312-20.
- Kawakami Y, Ichinose Y, Kubo K, Ito M, Imai M, and Fukunaga T** (2000). Architecture of Contracting Human Muscles and Its Functional Significance. *Journal of Applied Biomechanics* **16**: 88-97.
- Kim K, Reid BA, Casey CA, Bender BE, Ro B, Song Q, Trewin AJ, Petersen AC, Kuang S, Gavin TP, and Roseguini BT** (2020). Effects of repeated local heat therapy on skeletal muscle structure and function in humans. *J Appl Physiol (1985)* **128**: 483-92.
- Kobayashi T, Goto K, Kojima A, Akema T, Uehara K, Aoki H, Sugiura T, Ohira Y, and Yoshioka T** (2005). Possible role of calcineurin in heating-related increase of rat muscle mass. *Biochem Biophys Res Commun* **331**: 1301-9.
- Kodesh E, and Horowitz M** (2010). Soleus Adaptation to Combined Exercise and Heat Acclimation: Physiogenomic Aspects. *Medicine & Science in Sports & Exercise* **42**: 943-52.
- Kössler F, and Küchler G** (1987). Contractile properties of fast and slow twitch muscles of the rat at temperatures between 6 and 42 degrees C. *Biomed Biochim Acta* **46**: 815-22.
- Kovanen V, Suominen H, and Heikkinen E** (1984). Collagen of slow twitch and fast twitch muscle fibres in different types of rat skeletal muscle. *Eur J Appl Physiol Occup Physiol* **52**: 235-42.
- Kozma B, Candiotti K, Póka R, and Takács P** (2018). The Effects of Heat Exposure on Vaginal Smooth Muscle Cells: Elastin and Collagen Production. *Gynecol Obstet Invest* **83**: 247-51.
- Kubo K, Ikebukuro T, Yata H, Tomita M, and Okada M** (2011). Morphological and mechanical properties of muscle and tendon in highly trained sprinters. *J Appl Biomech* **27**: 336-44.
- Kubo K, Kanehisa H, and Fukunaga T** (2005). Effects of cold and hot water immersion on the mechanical properties of human muscle and tendon in vivo. *Clin Biomech (Bristol, Avon)* **20**: 291-300.

- Kubo K, Kanehisa H, Kawakami Y, and Fukunaga T** (2001). Effects of repeated muscle contractions on the tendon structures in humans. *Eur J Appl Physiol* **84**: 162-6.
- Kubo K, Morimoto M, Komuro T, Tsunoda N, Kanehisa H, and Fukunaga T** (2007). Influences of tendon stiffness, joint stiffness, and electromyographic activity on jump performances using single joint. *Eur J Appl Physiol* **99**: 235-43.
- Kuhlenhoelter AM, Kim K, Neff D, Nie Y, Blaize AN, Wong BJ, Kuang S, Stout J, Song Q, Gavin TP, and Roseguini BT** (2016). Heat therapy promotes the expression of angiogenic regulators in human skeletal muscle. *Am J Physiol Regul Integr Comp Physiol* **311**: R377-91.
- Kurokawa S, Fukunaga T, Nagano A, and Fukashiro S** (2003). Interaction between fascicles and tendinous structures during counter movement jumping investigated in vivo. *J Appl Physiol (1985)* **95**: 2306-14.
- Labidi M, Ihsan M, Behan FP, Alhammoud M, Smith T, Mohamed M, Tourny C, and Racinais S** (2021). Six weeks of localized heat therapy does not affect muscle mass, strength and contractile properties in healthy active humans. *Eur J Appl Physiol* **121**: 573-82.
- Lacourpaille L, Hug F, Bouillard K, Hogrel JY, and Nordez A** (2012). Supersonic shear imaging provides a reliable measurement of resting muscle shear elastic modulus. *Physiol Meas* **33**: N19-28.
- Ladell WS** (1951). Assessment of group acclimatization to heat and humidity. *J Physiol* **115**: 296-312.
- Lagirand-Cantaloube J, Cornille K, Csibi A, Batonnet-Pichon S, Leibovitch MP, and Leibovitch SA** (2009). Inhibition of Atrogin-1/MAFbx Mediated MyoD Proteolysis Prevents Skeletal Muscle Atrophy In Vivo. *PLoS One* **4**:
- Lai A, Lichtwark GA, Schache AG, Lin YC, Brown NA, and Pandy MG** (2015). In vivo behavior of the human soleus muscle with increasing walking and running speeds. *J Appl Physiol (1985)* **118**: 1266-75.
- Lai AKM, Lichtwark GA, Schache AG, and Pandy MG** (2018). Differences in in vivo muscle fascicle and tendinous tissue behavior between the ankle plantarflexors during running. *Scand J Med Sci Sports* **28**: 1828-36.
- Lambertz D, Paiva MG, Marinho SM, Aragão RS, Barros KM, Manhães-de-Castro R, Khider N, and Canon F** (2008). A reproducibility study on musculotendinous stiffness quantification, using a new transportable ankle ergometer device. *J Biomech* **41**: 3270-3.
- Lännergren J, and Westerblad H** (1987). The temperature dependence of isometric contractions of single, intact fibres dissected from a mouse foot muscle. *J Physiol* **390**: 285-93.
- Lee KL, Sung JY, Oh TW, and Kim HJ** (2022). Functional relationship between the anatomical structures of the calf and athletic ability. *Clin Anat* **35**: 544-49.
- Leedham JS, and Dowling JJ** (1995). Force-length, torque-angle and EMG-joint angle relationships of the human in vivo biceps brachii. *Eur J Appl Physiol Occup Physiol* **70**: 421-6.
- Li Z, McKenna Z, Fennel Z, Nava RC, Wells A, Ducharme J, Houck J, Morana K, Mermier C, Kuennen M, Magalhaes FC, and Amorim F** (2022). The combined effects of exercise-induced muscle damage and heat stress on acute kidney stress and heat strain during subsequent endurance exercise. *Eur J Appl Physiol* **122**: 1239-48.

- Lichtwark GA, Bougoulas K, and Wilson AM** (2007). Muscle fascicle and series elastic element length changes along the length of the human gastrocnemius during walking and running. *J Biomech* **40**: 157-64.
- Lichtwark GA, Cresswell AG, and Newsham-West RJ** (2013). Effects of running on human Achilles tendon length-tension properties in the free and gastrocnemius components. *J Exp Biol* **216**: 4388-94.
- Lichtwark GA, and Wilson AM** (2006). Interactions between the human gastrocnemius muscle and the Achilles tendon during incline, level and decline locomotion. *J Exp Biol* **209**: 4379-88.
- Lichtwark GA, and Wilson AM** (2008). Optimal muscle fascicle length and tendon stiffness for maximising gastrocnemius efficiency during human walking and running. *J Theor Biol* **252**: 662-73.
- Lieber RL** (1992). Skeletal Muscle Structure and Function: Implications for Rehabilitation and Sports Medicine.
- Lieber RL** (2022). Can we just forget about pennation angle? *J Biomech* **132**: 110954.
- Lieber RL, and Fridén J** (1993). Muscle damage is not a function of muscle force but active muscle strain. *J Appl Physiol (1985)* **74**: 520-6.
- Lieber RL, and Fridén J** (2000). Functional and clinical significance of skeletal muscle architecture. *Muscle Nerve* **23**: 1647-66.
- Lieber RL, Roberts TJ, Blemker SS, Lee SSM, and Herzog W** (2017). Skeletal muscle mechanics, energetics and plasticity. *Journal of Neuroengineering and Rehabilitation* **14**:
- Lieber RL, and Ward SR** (2011). Skeletal muscle design to meet functional demands. *Philos Trans R Soc Lond B Biol Sci* **366**: 1466-76.
- Lin JZ, Chiu WY, Tai WH, Hong YX, and Chen CY** (2021). Ankle Muscle Activations during Different Foot-Strike Patterns in Running. *Sensors (Basel)* **21**:
- Lionikas A, Li M, and Larsson L** (2006). Human skeletal muscle myosin function at physiological and non-physiological temperatures. *Acta Physiol (Oxf)* **186**: 151-8.
- Lorenzo S, Halliwill JR, Sawka MN, and Minson CT** (2010). Heat acclimation improves exercise performance. *J Appl Physiol (1985)* **109**: 1140-7.
- Luo GJ, Sun X, and Hasselgren PO** (2000). Hyperthermia stimulates energy-proteasome-dependent protein degradation in cultured myotubes. *Am J Physiol Regul Integr Comp Physiol* **278**: R749-56.
- Machado E, Lanferdini FJ, da Silva ES, Geremia JM, Sonda FC, Fletcher JR, Vaz MA, and Peyré-Tartaruga LA** (2021). Triceps Surae Muscle-Tendon Properties as Determinants of the Metabolic Cost in Trained Long-Distance Runners. *Front Physiol* **12**: 767445.
- MacIntosh BR, and Holash RJ** (2000). Power Output and Force Velocity Properties of Muscle. *Biomechanics and Biology of Movement* 193-210.
- Mackala K, Rauter S, Simenko J, Kreft R, Stodolka J, Krizaj J, Coh M, and Vodigar J** (2020). The Effect of Height on Drop Jumps in Relation to Somatic Parameters and Landing Kinetics. *Int J Environ Res Public Health* **17**:
- MacLennan DH** (1990). Molecular tools to elucidate problems in excitation-contraction coupling. *Biophys J* **58**: 1355-65.

- Maffiuletti NA, Aagaard P, Blazevich AJ, Folland J, Tillin N, and Duchateau J** (2016). Rate of force development: physiological and methodological considerations. *Eur J Appl Physiol* **116**: 1091-1116.
- Maganaris CN** (2001). Force-length characteristics of in vivo human skeletal muscle. *Acta Physiol Scand* **172**: 279-85.
- Maganaris CN** (2003). Force-length characteristics of the in vivo human gastrocnemius muscle. *Clin Anat* **16**: 215-23.
- Maganaris CN, and Paul JP** (1999). In vivo human tendon mechanical properties. *J Physiol* **521 Pt 1**: 307-13.
- Mallette MM, Green LA, Hodges GJ, Fernley RE, Gabriel DA, Holmes MWR, and Cheung SS** (2019). The effects of local muscle temperature on force variability. **119**: 1225-33.
- Marino FE, Lambert MI, and Noakes TD** (2004). Superior performance of African runners in warm humid but not in cool environmental conditions. *J Appl Physiol (1985)* **96**: 124-30.
- Martin PG, Marino FE, Rattey J, Kay D, and Cannon J** (2005). Reduced voluntary activation of human skeletal muscle during shortening and lengthening contractions in whole body hyperthermia. *Exp Physiol* **90**: 225-36.
- Martinez-Valdes E, Laine CM, Falla D, Mayer F, and Farina D** (2016). High-density surface electromyography provides reliable estimates of motor unit behavior. *Clin Neurophysiol* **127**: 2534-41.
- Mauney J, and Volloch V** (2009). Collagen I matrix contributes to determination of adult human stem cell lineage via differential, structural conformation-specific elicitation of cellular stress response. *Matrix Biology* **28**: 251-62.
- Mayfield DL, Cresswell AG, and Lichtwark GA** (2016). Effects of series elastic compliance on muscle force summation and the rate of force rise. *J Exp Biol* **219**: 3261-70.
- McKay AKA, Stellingwerff T, Smith ES, Martin DT, Mujika I, Goosey-Tolfrey VL, Sheppard J, and Burke LM** (2022). Defining Training and Performance Caliber: A Participant Classification Framework. *Int J Sports Physiol Perform* **17**: 317-31.
- Merletti R, Farina D, and Granata A** (1999). Non-invasive assessment of motor unit properties with linear electrode arrays. *Electroencephalogr Clin Neurophysiol Suppl* **50**: 293-300.
- Mohr M, Mujika I, Santisteban J, Randers MB, Bischoff R, Solano R, Hewitt A, Zubillaga A, Peltola E, and Krstrup P** (2010). Examination of fatigue development in elite soccer in a hot environment: a multi-experimental approach. *Scand J Med Sci Sports* **20 Suppl 3**: 125-32.
- Monte A, Baltzopoulos V, Maganaris CN, and Zamparo P** (2020). Gastrocnemius Medialis and Vastus Lateralis in vivo muscle-tendon behavior during running at increasing speeds. *Scand J Med Sci Sports* **30**: 1163-76.
- Monte A, Tecchio P, Nardello F, Bachero-Mena B, Ardigò LP, and Zamparo P** (2023). The interplay between gastrocnemius medialis force-length and force-velocity potentials, cumulative EMG activity and energy cost at speeds above and below the walk to run transition speed. *Exp Physiol* **108**: 90-102.
- Monte A, and Zignoli A** (2021). Muscle and tendon stiffness and belly gearing positively correlate with rate of torque development during explosive fixed end contractions. *J Biomech* **114**: 110110.

- Moore CW, Fanous J, and Rice CL** (2021). Fiber type composition of contiguous palmaris longus and abductor pollicis brevis muscles: Morphological evidence of a functional synergy. *J Anat* **238**: 53-62.
- Morin JB, Samozino P, and Millet GY** (2011). Changes in running kinematics, kinetics, and spring-mass behavior over a 24-h run. *Med Sci Sports Exerc* **43**: 829-36.
- Moritani T, and Yoshitake Y** (1998). 1998 ISEK Congress Keynote Lecture: The use of electromyography in applied physiology. International Society of Electrophysiology and Kinesiology. *J Electromyogr Kinesiol* **8**: 363-81.
- Mornas A, Racinais S, Brocherie F, Alhammoud M, Hager R, Desmedt Y, and Guilhem G** (2021). Hyperthermia reduces electromechanical delay via accelerated electrochemical processes. *J Appl Physiol (1985)* **130**: 290-97.
- Morrison S, Sleivert GG, and Cheung SS** (2004). Passive hyperthermia reduces voluntary activation and isometric force production. *Eur J Appl Physiol* **91**: 729-36.
- Mota JA, Gerstner GR, and Giuliani HK** (2019). Motor unit properties of rapid force development during explosive contractions. *J Physiol* **597**: 2335-36.
- Mtibaa K, Thomson A, Nichols D, Hautier C, and Racinais S** (2018). Hyperthermia-induced Neural Alterations Impair Proprioception and Balance. *Med Sci Sports Exerc* **50**: 46-53.
- Mtibaa K, Zarrouk N, Girard O, Ryu JH, Hautier C, and Racinais S** (2019). Heat stress impairs proprioception but not running mechanics. *J Sci Med Sport* **22**: 1361-66.
- Muramatsu T, Muraoka T, Kawakami Y, and Fukunaga T** (2002). Intramuscular variability of the architecture in human medial gastrocnemius muscle in vivo and its functional implication. *Advances in Exercise and Sports Physiology* **8**: 17-21.
- Mutungi G, and Ranatunga KW** (1998). Temperature-dependent changes in the viscoelasticity of intact resting mammalian (rat) fast- and slow-twitch muscle fibres. *J Physiol* **508 (Pt 1)**: 253-65.
- Nadel ER, Pandolf KB, Roberts MF, and Stolwijk JA** (1974). Mechanisms of thermal acclimation to exercise and heat. *J Appl Physiol* **37**: 515-20.
- Nicol C, Avela J, and Komi PV** (2006). The stretch-shortening cycle : a model to study naturally occurring neuromuscular fatigue. *Sports Med* **36**: 977-99.
- Nicol C, Komi PV, and Marconnet P** (1991). Fatigue effects of marathon running on neuromuscular performance. *Scandinavian Journal of Medicine & Science in Sports* **1**: 10-17.
- Nielsen B, Hales JR, Strange S, Christensen NJ, Warberg J, and Saltin B** (1993). Human circulatory and thermoregulatory adaptations with heat acclimation and exercise in a hot, dry environment. *J Physiol* **460**: 467-85.
- Noonan AM, Zwambag DP, Mazara N, Weersink E, Power GA, and Brown SHM** (2020). Fiber Type and Size as Sources of Variation in Human Single Muscle Fiber Passive Elasticity. *J Biomech Eng* **142**:
- Noonan TJ, Best TM, Seaber AV, and Garrett WE, Jr.** (1993). Thermal effects on skeletal muscle tensile behavior. *Am J Sports Med* **21**: 517-22.
- Nordez A, Cornu C, and McNair P** (2006). Acute effects of static stretching on passive stiffness of the hamstring muscles calculated using different mathematical models. *Clin Biomech (Bristol, Avon)* **21**: 755-60.

- Nordez A, Gallot T, Catheline S, Guevel A, Cornu C, and Hug F** (2009). Electromechanical delay revisited using very high frame rate ultrasound. *J Appl Physiol (1985)* **106**: 1970-5.
- Notley SR, Akerman AP, Friesen BJ, Poirier MP, McCourt E, Flouris AD, and Kenny GP** (2022). Heat tolerance and the validity of occupational heat exposure limits in women during moderate-intensity work. *Appl Physiol Nutr Metab* **47**: 711-24.
- Núñez Lisboa M, Peñailillo LE, Cancino J, Zbinden-Foncea H, and Dewolf AH** (2021). Influence of sports background on the bouncing mechanism of running. *Sports Biomech* 1-12.
- Nybo L, Girard O, Mohr M, Knez W, Voss S, and Racinais S** (2013). Markers of muscle damage and performance recovery after exercise in the heat. *Med Sci Sports Exerc* **45**: 860-8.
- Nybo L, and Nielsen B** (2001). Hyperthermia and central fatigue during prolonged exercise in humans. *J Appl Physiol (1985)* **91**: 1055-60.
- Ohya S, Nakamura M, Aoki T, Suzuki D, Kikumoto T, Nakamura E, Ito W, Hirabayashi R, Takabayashi T, and Edama M** (2017). The effect of a running task on muscle shear elastic modulus of posterior lower leg. *J Foot Ankle Res* **10**: 56.
- Oliveira FB, Oliveira AS, Rizzato GF, and Denadai BS** (2013). Resistance training for explosive and maximal strength: effects on early and late rate of force development. *J Sports Sci Med* **12**: 402-8.
- Pandolf KB** (1982). Differentiated ratings of perceived exertion during physical exercise. *Med Sci Sports Exerc* **14**: 397-405.
- Pataky TC, Robinson MA, and Vanrenterghem J** (2013). Vector field statistical analysis of kinematic and force trajectories. *J Biomech* **46**: 2394-401.
- Patterson MJ, Stocks JM, and Taylor NA** (2004). Sustained and generalized extracellular fluid expansion following heat acclimation. *J Physiol* **559**: 327-34.
- Patz JA, Frumkin H, Holloway T, Vimont DJ, and Haines A** (2014). Climate change: challenges and opportunities for global health. *Jama* **312**: 1565-80.
- Pearson J, Low DA, Stöhr E, Kalsi K, Ali L, Barker H, and González-Alonso J** (2011). Hemodynamic responses to heat stress in the resting and exercising human leg: insight into the effect of temperature on skeletal muscle blood flow. *Am J Physiol Regul Integr Comp Physiol* **300**: R663-73.
- Peltonen J, Cronin NJ, Stenroth L, Finni T, and Avela J** (2012). Achilles tendon stiffness is unchanged one hour after a marathon. *J Exp Biol* **215**: 3665-71.
- Penfield W, and Rasmussen T** (1950). The cerebral cortex of man; a clinical study of localization of function. Oxford, England: Macmillan, p. xv, 248-xv, 48.
- Périard JD, Christian RJ, Knez WL, and Racinais S** (2014a). Voluntary muscle and motor cortical activation during progressive exercise and passively induced hyperthermia. *Experimental Physiology* **99**: 136-48.
- Périard JD, Cramer MN, Chapman PG, Caillaud C, and Thompson MW** (2011). Neuromuscular function following prolonged intense self-paced exercise in hot climatic conditions. *Eur J Appl Physiol* **111**: 1561-9.
- Périard JD, DeGroot D, and Jay O** (2022). Exertional heat stroke in sport and the military: epidemiology and mitigation. *Exp Physiol* **107**: 1111-21.

- Périard JD, Eijssvogels TMH, and Daanen HAM** (2021). Exercise under heat stress: thermoregulation, hydration, performance implications, and mitigation strategies. *Physiol Rev* **101**: 1873-979.
- Périard JD, Girard O, and Racinais S** (2014b). Neuromuscular adjustments of the knee extensors and plantar flexors following match-play tennis in the heat. *Br J Sports Med* **48 Suppl 1**: i45-i51.
- Périard JD, Pyne DB, Bishop DJ, Wallett A, and Girard O** (2020). Short-Term Repeated-Sprint Training in Hot and Cool Conditions Similarly Benefits Performance in Team-Sport Athletes. *Front Physiol* **11**: 1023.
- Périard JD, and Racinais S** (2015). Self-paced exercise in hot and cool conditions is associated with the maintenance of $\dot{V}O_{2peak}$ within a narrow range. *J Appl Physiol (1985)* **118**: 1258-65.
- Périard JD, and Racinais S** (2016). Performance and Pacing during Cycle Exercise in Hyperthermic and Hypoxic Conditions. *Med Sci Sports Exerc* **48**: 845-53.
- Périard JD, Racinais S, and Sawka MN** (2015). Adaptations and mechanisms of human heat acclimation: Applications for competitive athletes and sports. *Scand J Med Sci Sports* **25 Suppl 1**: 20-38.
- Périard JD, Racinais S, Timpka T, Dahlström Ö, Spreco A, Jacobsson J, Bargoria V, Halje K, and Alonso JM** (2017). Strategies and factors associated with preparing for competing in the heat: a cohort study at the 2015 IAAF World Athletics Championships. *Br J Sports Med* **51**: 264-70.
- Peterson R** (1950). Discussion of a century ago concerning the nature of fatigue, and review of some of the subsequent researches concerning the mechanism of fatigue. *ASTM Bulletin* **164**: 50-6.
- Pette D, and Staron RS** (2000). Myosin isoforms, muscle fiber types, and transitions. *Microsc Res Tech* **50**: 500-9.
- Piazzesi G, Reconditi M, Linari M, Lucii L, Bianco P, Brunello E, Decostre V, Stewart A, Gore DB, Irving TC, Irving M, and Lombardi V** (2007). Skeletal muscle performance determined by modulation of number of myosin motors rather than motor force or stroke size. *Cell* **131**: 784-95.
- Pinto MD, Pinto RS, Nosaka K, and Blazevich AJ** (2022). Do Intramuscular Temperature and Fascicle Angle affect Ultrasound Echo Intensity Values? *Med Sci Sports Exerc*
- Proske U, Morgan DL, and Gregory JE** (1993). Thixotropy in skeletal muscle and in muscle spindles: a review. *Prog Neurobiol* **41**: 705-21.
- Racinais S** (2013). Hot ambient conditions shift the Force / EMG relationship. *Springerplus* **2**: 317.
- Racinais S, Alonso JM, Coutts AJ, Flouris AD, Girard O, González-Alonso J, Hausswirth C, Jay O, Lee JK, Mitchell N, Nassis GP, Nybo L, Pluim BM, Roelands B, Sawka MN, Wingo J, and Périard JD** (2015a). Consensus recommendations on training and competing in the heat. *Br J Sports Med* **49**: 1164-73.
- Racinais S, Buchheit M, Bilsborough J, Bourdon PC, Cordy J, and Coutts AJ** (2014). Physiological and performance responses to a training camp in the heat in professional Australian football players. *Int J Sports Physiol Perform* **9**: 598-603.

- Racinais S, Casa D, Brocherie F, and Ihsan M** (2019a). Translating Science Into Practice: The Perspective of the Doha 2019 IAAF World Championships in the Heat. *Front Sports Act Living* **1**: 39.
- Racinais S, Cocking S, and Périard JD** (2017a). Sports and environmental temperature: From warming-up to heating-up. *Temperature (Austin)* **4**: 227-57.
- Racinais S, Gaoua N, and Grantham J** (2008). Hyperthermia impairs short-term memory and peripheral motor drive transmission. *J Physiol* **586**: 4751-62.
- Racinais S, and Girard O** (2012). Neuromuscular failure is unlikely to explain the early exercise cessation in hot ambient conditions. *Psychophysiology* **49**: 853-65.
- Racinais S, Havenith G, Aylwin P, Ihsan M, Taylor L, Adami PE, Adamuz MC, Alhammoud M, Alonso JM, Bouscaren N, Buitrago S, Cardinale M, van Dyk N, Esh CJ, Gomez-Ezeiza J, Garrandes F, Holtzhausen L, Labidi M, Lange G, Lloyd A, Moussay S, Mtibaa K, Townsend N, Wilson MG, and Bermon S** (2022). Association between thermal responses, medical events, performance, heat acclimation and health status in male and female elite athletes during the 2019 Doha World Athletics Championships. *Br J Sports Med* **56**: 439-45.
- Racinais S, Ihsan M, and Périard JD** (2019b). Neural and Muscular Function in the Heat. In: *Heat Stress in Sport and Exercise: Thermophysiology of Health and Performance*, edited by Périard JD, and Racinais S. Cham: Springer International Publishing, p. 67-88.
- Racinais S, Maffiuletti NA, and Girard O** (2013). M-wave, H- and V-reflex recruitment curves during maximal voluntary contraction. *J Clin Neurophysiol* **30**: 415-21.
- Racinais S, Mohr M, Buchheit M, Voss SC, Gaoua N, Grantham J, and Nybo L** (2012). Individual responses to short-term heat acclimatisation as predictors of football performance in a hot, dry environment. *Br J Sports Med* **46**: 810-5.
- Racinais S, and Oksa J** (2010). Temperature and neuromuscular function. *Scand J Med Sci Sports* **20 Suppl 3**: 1-18.
- Racinais S, Périard JD, Karlsen A, and Nybo L** (2015b). Effect of heat and heat acclimatization on cycling time trial performance and pacing. *Med Sci Sports Exerc* **47**: 601-6.
- Racinais S, Wilson MG, Gaoua N, and Périard JD** (2017b). Heat acclimation has a protective effect on the central but not peripheral nervous system. *J Appl Physiol (1985)* **123**: 816-24.
- Racinais S, Wilson MG, and Periard JD** (2017c). Passive heat acclimation improves skeletal muscle contractility in humans. *American Journal of Physiology-Regulatory Integrative and Comparative Physiology* **312**: R101-R07.
- Ramanathan NL** (1964). A new weighting system for mean surface temperature of the human body. *J Appl Physiol* **19**: 531-3.
- Ranatunga K** (1982). Temperature-dependence of shortening velocity and rate of isometric tension development in rat skeletal muscle. *The Journal of Physiology* **329**: 465-83.
- Ranatunga K** (1984). The force-velocity relation of rat fast-and slow-twitch muscles examined at different temperatures. *The Journal of physiology* **351**: 517-29.
- Ranatunga K, Sharpe B, and Turnbull B** (1987). Contractions of a human skeletal muscle at different temperatures. *The Journal of physiology* **390**: 383-95.
- Randhawa A, and Wakeling JM** (2018). Transverse anisotropy in the deformation of the muscle during dynamic contractions. *J Exp Biol* **221**:

- Roberts TJ, and Azizi E** (2011). Flexible mechanisms: the diverse roles of biological springs in vertebrate movement. *J Exp Biol* **214**: 353-61.
- Roberts TJ, Marsh RL, Weyand PG, and Taylor CR** (1997). Muscular force in running turkeys: the economy of minimizing work. *Science* **275**: 1113-5.
- Rodrigues P, Trajano GS, Stewart IB, and Minett GM** (2022). Potential role of passively increased muscle temperature on contractile function. *Eur J Appl Physiol* **122**: 2153-62.
- Rodrigues P, Trajano GS, Wharton L, Orssatto LBR, and Minett GM** (2021). A passive increase in muscle temperature enhances rapid force production and neuromuscular function in healthy adults. *Journal of Science and Medicine in Sport*
- Rodríguez-Rosell D, Pareja-Blanco F, Aagaard P, and González-Badillo JJ** (2018). Physiological and methodological aspects of rate of force development assessment in human skeletal muscle. *Clin Physiol Funct Imaging* **38**: 743-62.
- Romanovsky AA** (2007). Thermoregulation: some concepts have changed. Functional architecture of the thermoregulatory system. *Am J Physiol Regul Integr Comp Physiol* **292**: R37-46.
- Ross EZ, Cotter JD, Wilson L, Fan JL, Lucas SJ, and Ainslie PN** (2012). Cerebrovascular and corticomotor function during progressive passive hyperthermia in humans. *J Appl Physiol (1985)* **112**: 748-58.
- Round JM, Jones DA, Chapman SJ, Edwards RH, Ward PS, and Fodden DL** (1984). The anatomy and fibre type composition of the human adductor pollicis in relation to its contractile properties. *J Neurol Sci* **66**: 263-72.
- Ruple BA, Mesquita PHC, Godwin JS, Sexton CL, Osburn SC, McIntosh MC, Kavazis AN, Libardi CA, Young KC, and Roberts MD** (2022). Changes in vastus lateralis fibre cross-sectional area, pennation angle and fascicle length do not predict changes in muscle cross-sectional area. *Exp Physiol* **107**: 1216-24.
- Rutkove SB** (2001). Effects of temperature on neuromuscular electrophysiology. *Muscle Nerve* **24**: 867-82.
- Rutkove SB, Kothari MJ, and Shefner JM** (1997). Nerve, muscle, and neuromuscular junction electrophysiology at high temperature. *Muscle Nerve* **20**: 431-6.
- Saboisky J, Marino FE, Kay D, and Cannon J** (2003). Exercise heat stress does not reduce central activation to non-exercised human skeletal muscle. *Exp Physiol* **88**: 783-90.
- Sale D, Quinlan J, Marsh E, McComas AJ, and Belanger AY** (1982). Influence of joint position on ankle plantarflexion in humans. *J Appl Physiol Respir Environ Exerc Physiol* **52**: 1636-42.
- Samozino P, Rabita G, Dorel S, Slawinski J, Peyrot N, Saez de Villarreal E, and Morin JB** (2016). A simple method for measuring power, force, velocity properties, and mechanical effectiveness in sprint running. *Scand J Med Sci Sports* **26**: 648-58.
- Samozino P, Rejc E, Di Prampero PE, Belli A, and Morin JB** (2012). Optimal force-velocity profile in ballistic movements--altius: citius or fortius? *Med Sci Sports Exerc* **44**: 313-22.
- Sano K, Akiyama M, Hoffrén-Mikkola M, Ito A, Komi PV, and Ishikawa M** (2015a). Age-specific neuromuscular interaction during elderly habitual running. *Acta Physiol (Oxf)* **215**: 79-88.

- Sano K, Nicol C, Akiyama M, Kunimasa Y, Oda T, Ito A, Locatelli E, Komi PV, and Ishikawa M** (2015b). Can measures of muscle-tendon interaction improve our understanding of the superiority of Kenyan endurance runners? *Eur J Appl Physiol* **115**: 849-59.
- Sapin-de Brosse E, Gennisson JL, Pernot M, Fink M, and Tanter M** (2010). Temperature dependence of the shear modulus of soft tissues assessed by ultrasound. *Phys Med Biol* **55**: 1701-18.
- Sawka MN, Wenger CB, and Pandolf KB** (2011). Thermoregulatory Responses to Acute Exercise-Heat Stress and Heat Acclimation. In: *Comprehensive Physiology*. 157-85.
- Schertzer JD, Green HJ, and Tupling AR** (2002). Thermal instability of rat muscle sarcoplasmic reticulum Ca(2+)-ATPase function. *Am J Physiol Endocrinol Metab* **283**: E722-8.
- Schlader ZJ, Simmons SE, Stannard SR, and Mündel T** (2011). The independent roles of temperature and thermal perception in the control of human thermoregulatory behavior. *Physiol Behav* **103**: 217-24.
- Scott SH, and Loeb GE** (1995). Mechanical properties of aponeurosis and tendon of the cat soleus muscle during whole-muscle isometric contractions. *J Morphol* **224**: 73-86.
- Segal SS, Faulkner JA, and White TP** (1986). Skeletal muscle fatigue in vitro is temperature dependent. *J Appl Physiol (1985)* **61**: 660-5.
- Selsby JT, and Dodd SL** (2005). Heat treatment reduces oxidative stress and protects muscle mass during immobilization. *Am J Physiol Regul Integr Comp Physiol* **289**: R134-9.
- Selsby JT, Rother S, Tsuda S, Prakash O, Quindry J, and Dodd SL** (2007). Intermittent hyperthermia enhances skeletal muscle regrowth and attenuates oxidative damage following reloading. *J Appl Physiol (1985)* **102**: 1702-7.
- Seow CY** (2013). Hill's equation of muscle performance and its hidden insight on molecular mechanisms. *J Gen Physiol* **142**: 561-73.
- Seyrès P** (1991). Le système tendineux : Constitution, organisation et capacités mécaniques. *Ann Kinésithér* **18**: 185-96.
- Shelford VE** (1931). Some Concepts of Bioecology. *Ecology* **12**: 455-67.
- Shibasaki M, Wilson TE, and Crandall CG** (2006). Neural control and mechanisms of eccrine sweating during heat stress and exercise. *J Appl Physiol (1985)* **100**: 1692-701.
- Smallcombe JW, Foster J, Hodder SG, Jay O, Flouris AD, and Havenith G** (2022). Quantifying the impact of heat on human physical work capacity; part IV: interactions between work duration and heat stress severity. *Int J Biometeorol* **66**: 2463-76.
- Somkuti J, Mártonfalvi Z, Kellermayer MS, and Smeller L** (2013). Different pressure-temperature behavior of the structured and unstructured regions of titin. *Biochim Biophys Acta* **1834**: 112-8.
- Spillane P, and Bampouras TM** (2020). Effect of environmental temperature change on the neuromechanical function of the quadriceps muscles. *Eur J Sport Sci* 1-0.
- Spurrs RW, Murphy AJ, and Watsford ML** (2003). The effect of plyometric training on distance running performance. *Eur J Appl Physiol* **89**: 1-7.
- Stachenfeld NS** (2018). Including women in research. It's necessary, and really not so hard to do. *Experimental Physiology* **103**: 1296-97.

- Stadnyk AMJ, Rehrer NJ, Handcock PJ, Meredith-Jones KA, and Cotter JD** (2018). No clear benefit of muscle heating on hypertrophy and strength with resistance training. *Temperature (Austin)* **5**: 175-83.
- Stein RB, Gordon T, and Shriver J** (1982). Temperature dependence of mammalian muscle contractions and ATPase activities. *Biophys J* **40**: 97-107.
- Stenroth L, Peltonen J, Cronin NJ, Sipilä S, and Finni T** (2012). Age-related differences in Achilles tendon properties and triceps surae muscle architecture in vivo. *J Appl Physiol (1985)* **113**: 1537-44.
- Stephenson D, and Williams D** (1985). Temperature-dependent calcium sensitivity changes in skinned muscle fibres of rat and toad. *The Journal of physiology* **360**: 1-12.
- Stienen G, Kiers J, Bottinelli R, and Reggiani C** (1996). Myofibrillar ATPase activity in skinned human skeletal muscle fibres: fibre type and temperature dependence. *The Journal of physiology* **493**: 299-307.
- Stitt TN, Drujan D, Clarke BA, Panaro F, Timofeyva Y, Kline WO, Gonzalez M, Yancopoulos GD, and Glass DJ** (2004). The IGF-1/PI3K/Akt pathway prevents expression of muscle atrophy-induced ubiquitin ligases by inhibiting FOXO transcription factors. *Mol Cell* **14**: 395-403.
- Stock MS, and Thompson BJ** (2021). Echo intensity as an indicator of skeletal muscle quality: applications, methodology, and future directions. *Eur J Appl Physiol* **121**: 369-80.
- Suzuki T, Ogane R, Yaeshima K, and Kinugasa R** (2019). Forefoot running requires shorter gastrocnemius fascicle length than rearfoot running. *J Sports Sci* **37**: 1972-80.
- Swinnen W, Hoogkamer W, Delabastita T, Aeles J, De Groote F, and Vanwanseele B** (2019). Effect of habitual foot-strike pattern on the gastrocnemius medialis muscle-tendon interaction and muscle force production during running. *J Appl Physiol (1985)* **126**: 708-16.
- Swinnen W, Mylle I, Hoogkamer W, De Groote F, and Vanwanseele B** (2022). Triceps surae muscle force potential and force demand shift with altering stride frequency in running. *Scand J Med Sci Sports* **32**: 1444-55.
- Takahashi K, Shiotani H, Evangelidis PE, Sado N, and Kawakami Y** (2022). Three-dimensional architecture of human medial gastrocnemius fascicles in vivo: Regional variation and its dependence on muscle size. *J Anat* **241**: 1324-35.
- Takeshita T, Noro H, Hata K, Yoshida T, Fukunaga T, and Yanagiya T** (2021). Muscle-Tendon Behavior and Kinetics in Gastrocnemius Medialis During Forefoot and Rearfoot Strike Running. *J Appl Biomech* **37**: 240-47.
- Tavakkoli Oskouei S, Malliaras P, K DH, Garofolini A, Clark R, and Perraton L** (2021). Assessment of ankle plantar flexor neuromuscular properties: A reliability study. *J Electromyogr Kinesiol* **61**: 102603.
- Taylor D, Smith MF, and Vleck V** (2012). Reliability of performance and associated physiological responses during simulated sprint-distance triathlon. *Journal of Science and Cycling* **1**: 21-29.
- Taylor J, and Gandevia S** (2011). Central mechanisms limiting muscle performance in fatigue. *Regulation of Fatigue in Exercise* 63-77.

- Thomas MM, Cheung SS, Elder GC, and Sleivert GG** (2006). Voluntary muscle activation is impaired by core temperature rather than local muscle temperature. *J Appl Physiol* (1985) **100**: 1361-9.
- Thomas NM, Dewhurst S, and Bampouras TM** (2015). Homogeneity of fascicle architecture following repeated contractions in the human gastrocnemius medialis. *Journal of Electromyography and Kinesiology* **25**: 870-75.
- Thompson HS, Maynard EB, Morales ER, and Scordilis SP** (2003). Exercise-induced HSP27, HSP70 and MAPK responses in human skeletal muscle. *Acta Physiologica Scandinavica* **178**: 61-72.
- Tillin NA, Jimenez-Reyes P, Pain MT, and Folland JP** (2010). Neuromuscular performance of explosive power athletes versus untrained individuals. *Med Sci Sports Exerc* **42**: 781-90.
- Tillin NA, Pain MT, and Folland J** (2013). Explosive force production during isometric squats correlates with athletic performance in rugby union players. *J Sports Sci* **31**: 66-76.
- Tillin NA, Pain MTG, and Folland JP** (2018). Contraction speed and type influences rapid utilisation of available muscle force: neural and contractile mechanisms. *J Exp Biol* **221**:
- Todd G, Butler JE, Taylor JL, and Gandevia SC** (2005). Hyperthermia: a failure of the motor cortex and the muscle. *J Physiol* **563**: 621-31.
- Todnem K, Knudsen G, Riise T, Nyland H, and Aarli JA** (1989). The non-linear relationship between nerve conduction velocity and skin temperature. *J Neurol Neurosurg Psychiatry* **52**: 497-501.
- Tornberg E** (2005). Effects of heat on meat proteins - Implications on structure and quality of meat products. *Meat Sci* **70**: 493-508.
- Truong XT, Wall BJ, and Walker SM** (1964). Effects of temperature on isometric contraction of rat muscle. *Am J Physiol* **207**: 393-6.
- Tucker R, Marle T, Lambert EV, and Noakes TD** (2006). The rate of heat storage mediates an anticipatory reduction in exercise intensity during cycling at a fixed rating of perceived exertion. *J Physiol* **574**: 905-15.
- Uehara K, Goto K, Kobayashi T, Kojima A, Akema T, Sugiura T, Yamada S, Ohira Y, Yoshioka T, and Aoki H** (2004). Heat-Stress Enhances Proliferative Potential in Rat Soleus Muscle. *The Japanese Journal of Physiology* **54**: 263-71.
- Van Hooren B, Teratsias P, and Hodson-Tole EF** (2020). Ultrasound imaging to assess skeletal muscle architecture during movements: a systematic review of methods, reliability, and challenges. *J Appl Physiol* (1985) **128**: 978-99.
- Walker P, Amstutz HC, and Rubinfeld M** (1976). Canine tendon studies. II. Biomechanical evaluation of normal and regrown canine tendons. *J Biomed Mater Res* **10**: 61-76.
- Wang JC, Kabo JM, Tsou PM, Halevi L, and Shamie AN** (2005). The effect of uniform heating on the biomechanical properties of the intervertebral disc in a porcine model. *Spine J* **5**: 64-70.
- Wang JH** (2006). Mechanobiology of tendon. *J Biomech* **39**: 1563-82.
- Ward SR, Winters TM, O'Connor SM, and Lieber RL** (2020). Non-linear Scaling of Passive Mechanical Properties in Fibers, Bundles, Fascicles and Whole Rabbit Muscles. *Front Physiol* **11**: 211.

- Watts N, Amann M, Arnell N, Ayeb-Karlsson S, Belesova K, Berry H, Bouley T, Boykoff M, Byass P, Cai W, Campbell-Lendrum D, Chambers J, Daly M, Dasandi N, Davies M, Depoux A, Dominguez-Salas P, Drummond P, Ebi KL, Ekins P, Montoya LF, Fischer H, Georgeson L, Grace D, Graham H, Hamilton I, Hartinger S, Hess J, Kelman I, Kiesewetter G, Kjellstrom T, Kniveton D, Lemke B, Liang L, Lott M, Lowe R, Sewe MO, Martinez-Urtaza J, Maslin M, McAllister L, Mikhaylov SJ, Milner J, Moradi-Lakeh M, Morrissey K, Murray K, Nilsson M, Neville T, Oreszczyn T, Owfi F, Pearman O, Pencheon D, Pye S, Rabhaniha M, Robinson E, Rocklöv J, Saxer O, Schütte S, Semenza JC, Shumake-Guillemot J, Steinbach R, Tabatabaei M, Tomei J, Trinanés J, Wheeler N, Wilkinson P, Gong P, Montgomery H, and Costello A (2018). The 2018 report of the Lancet Countdown on health and climate change: shaping the health of nations for centuries to come. *Lancet* **392**: 2479-514.
- Werkhausen A, Albracht K, Cronin NJ, Meier R, Bojsen-Møller J, and Seynnes OR (2017). Modulation of muscle-tendon interaction in the human triceps surae during an energy dissipation task. *J Exp Biol* **220**: 4141-49.
- Werkhausen A, Cronin NJ, Albracht K, Bojsen-Møller J, and Seynnes OR (2019a). Distinct muscle-tendon interaction during running at different speeds and in different loading conditions. *J Appl Physiol (1985)* **127**: 246-53.
- Werkhausen A, Cronin NJ, Albracht K, Paulsen G, Larsen AV, Bojsen-Møller J, and Seynnes OR (2019b). Training-induced increase in Achilles tendon stiffness affects tendon strain pattern during running. *PeerJ* **7**: e6764.
- Werkhausen A, Willwacher S, and Albracht K (2021). Medial gastrocnemius muscle fascicles shorten throughout stance during sprint acceleration. *Scand J Med Sci Sports* **31**: 1471-80.
- Widrick JJ, Trappe SW, Costill DL, and Fitts RH (1996). Force-velocity and force-power properties of single muscle fibers from elite master runners and sedentary men. *Am J Physiol* **271**: C676-83.
- Wilmore JH, Costill DL, and Kenney L (2017). *Physiologie du sport et de l'exercice*. Human Kinetics.
- Wingfield GL, Gale R, Minett GM, Marino FE, and Skein M (2016). The effect of high versus low intensity heat acclimation on performance and neuromuscular responses. *J Therm Biol* **58**: 50-9.
- Woledge RC (1971). Heat Production and chemical change in muscle. *Progress in Biophysics and Molecular Biology* **22**: 37-74.
- Woledge RC, Barclay CJ, and Curtin NA (2009). Temperature change as a probe of muscle crossbridge kinetics: a review and discussion. *Proc Biol Sci* **276**: 2685-95.
- Woledge RC, Curtin NA, and Homsher E (1985). Energetic aspects of muscle contraction. *Monogr Physiol Soc* **41**: 1-357.
- Woo SL, Debski RE, Zeminski J, Abramowitch SD, Saw SS, and Fenwick JA (2000). Injury and repair of ligaments and tendons. *Annu Rev Biomed Eng* **2**: 83-118.
- Wright NT, and Humphrey JD (2002). Denaturation of collagen via heating: an irreversible rate process. *Annu Rev Biomed Eng* **4**: 109-28.
- Wright V, and Johns RJ (1961). Quantitative and qualitative analysis of joint stiffness in normal subjects and in patients with connective tissue diseases. *Ann Rheum Dis* **20**: 36-46.

- Wylie SR, and Ranatunga KW** (1987). Temperature dependence of contraction characteristics in developing rat muscles. *J Exp Biol* **10**: 775-82.
- Xu S, Offer G, Gu J, White HD, and Yu LC** (2003). Temperature and ligand dependence of conformation and helical order in myosin filaments. *Biochemistry* **42**: 390-401.
- Yamashita-Goto K, Ohira Y, Okuyama R, Sugiyama H, Honda M, Sugiura T, Yamada S, Akema T, and Yoshioka T** (2002). Heat stress facilitates stretch-induced hypertrophy of cultured muscle cells. *J Gravit Physiol* **9**: P145-6.
- Yoon SJ, Lee MJ, Lee HM, and Lee JS** (2017). Effect of low-intensity resistance training with heat stress on the HSP72, anabolic hormones, muscle size, and strength in elderly women. *Aging Clin Exp Res* **29**: 977-84.
- Yoshihara T, Naito H, Kakigi R, Ichinoseki-Sekine N, Ogura Y, Sugiura T, and Katamoto S** (2013). Heat stress activates the Akt/mTOR signalling pathway in rat skeletal muscle. *Acta Physiol (Oxf)* **207**: 416-26.
- Zajac FE** (1989). Muscle and tendon: properties, models, scaling, and application to biomechanics and motor control. *Crit Rev Biomed Eng* **17**: 359-411.
- Zuurbier CJ, Everard AJ, van der Wees P, and Huijing PA** (1994). Length-force characteristics of the aponeurosis in the passive and active muscle condition and in the isolated condition. *J Biomech* **27**: 445-53.
- Zuurbier CJ, and Huijing PA** (1992). Influence of muscle geometry on shortening speed of fibre, aponeurosis and muscle. *J Biomech* **25**: 1017-26.
- Zuurbier CJ, and Huijing PA** (1993). Changes in geometry of actively shortening unipennate rat gastrocnemius muscle. *J Morphol* **218**: 167-80.

APPENDICES

- 1. Preliminary study**
- 2. Study 1: Associated publication**
- 3. Study 3: Associated publication**
- 4. Study 1: Poster presentation**
- 5. Study 1: Oral communication**
- 6. Study 3: Oral communication**
- 7. Study 3: Oral communication**
- 8. International research stay: Project summary**

RESEARCH ARTICLE

Physiology of Thermal Therapy

Hyperthermia reduces electromechanical delay via accelerated electrochemical processes

Adèle Mornas,^{1,2} Sébastien Racinais,^{1,3} Franck Brocherie,¹ Marine Alhammad,³ Robin Hager,¹ Yanis Desmedt,¹ and Gaël Guilhem¹

¹French Institute of Sport (INSEP), Laboratory Sport, Expertise and Performance, Paris, France; ²Université de Paris, Paris, France; and ³Aspetar Orthopaedic and Sports Medicine Hospital, Athlete Health and Performance Research Centre, Doha, Qatar

Abstract

The present study aimed to determine the effect of hyperthermia on both electrochemical and mechanical components of the electromechanical delay (EMD), using very-high-frame-rate ultrasound. Electrically evoked peak twitch force, EMD, electrochemical (D_m ; i.e., delay between stimulation and muscle fascicle motion), and mechanical (T_m ; i.e., delay between fascicle motion and force production onset) components of EMD were assessed in 16 participants. Assessments were conducted in a control ambient environment (CON; 26°C, 34% relative humidity) and in a hot ambient environment (HOT; 46–50°C, 18% relative humidity, after ~127 min of heat exposure). Following heat exposure, *gastrocnemius medialis* temperature was 37.0±0.6°C in HOT vs. 34.0±0.8°C in CON ($P < 0.001$). EMD was shorter (9.4±0.8 ms) in HOT than in CON (10.8±0.6 ms, $P < 0.001$). Electrochemical processes were shorter in HOT than in CON (4.0±0.8 ms vs. 5.5±0.9 ms, respectively, $P < 0.001$), whereas mechanical processes were unchanged ($P = 0.622$). These results demonstrate that hyperthermia reduces electromechanical delay via accelerated electrochemical processes, whereas force transmission along the active and passive parts of the series elastic component is not affected following heat exposure. The present study demonstrates that heat exposure accelerates muscle contraction thanks to faster electrochemical processes. Further investigations during voluntary contractions would contribute to better understand how these findings translate into motor performance.

NEW & NOTEWORTHY Hyperthermia (targeted core temperature: 38.5°C) reduces the time between *gastrocnemius medialis* stimulation and the onset of plantar flexor force production in vivo. This reduction in electromechanical delay is concomitant to an earlier motion of muscle fascicle compared with thermoneutral environment. However, hyperthermia has no impact on the duration of force transmission along aponeurosis and tendon, thereby reflecting different effects of heat exposure on contractile and elastic properties of the muscle-tendon unit.

contractile properties; force transmission; muscle fascicle motion; muscle temperature

INTRODUCTION

A rise in core or muscle temperature affects muscle metabolism (1, 2), neural drive (3), contractile properties (4), and overall force production (5). Indeed, tissue temperature is recognized to influence mechanical and biochemical properties of skeletal muscle (6, 7). In vitro, a rise in temperature increases electrically evoked rate of force development (RFD) (8, 9), with an inverse relationship between temperature and contraction time (CT; i.e., the time between the onset of force rise and peak twitch force) and half-relaxation time (HRT; i.e., the time to obtain half of the decline in twitch maximal force) inferred from a muscle twitch (10). In vivo, a rise in muscle temperature has been reported to

consistently shorten CT and HRT of peak twitch, whereas its amplitude increased (11) or was not altered with heat (12–14). Although these findings reflect an improvement in neuromuscular function during explosive motor tasks, the origins of this effect remain unsolved.

The ability to generate force rapidly is influenced by the neural drive transmission to the muscle, the propagation of the action potential, the excitation-contraction coupling processes, and the muscle force transmission along the series elastic component (15, 16). On the one hand, it is well established that axonal conduction velocity increases in hot environments (17, 18). On the other hand, little is known regarding the impact of hyperthermia on force transmission efficiency by the contractile and elastic components. Diverse



effects have been reported on electromechanical processes involved in force transmission efficiency in response to an increase in temperature. Heat increases ATPase activity of the myosin head (19), whereas it promotes calcium retention by the sarcoplasmic reticulum (20). In addition, heat may differently impact the mechanical properties of the active myofibrils (21) and the passive aponeurosis and tendon within the series elastic components (22). Because the respective contributions of contractile and elastic materials may be challenging to dissociate *in vivo*, further evidence is required to clarify the acute effects of heat exposure on the muscle-tendon unit components.

The measurement of time between the muscle activation onset and force production (EMD; *i.e.*, electromechanical delay) reflects both electrochemical processes (*i.e.*, synaptic transmission, action potential propagation through the sarcolemma, and excitation-contraction coupling) and mechanical processes (*i.e.*, force transmission along the active and passive parts of the series elastic component) (23). Thus, the investigation of EMD would provide more information about the mechanisms and muscle-tendon components involved in force transmission efficiency. EMD has been shown to be sensitive to cooling (24, 25). Indeed, the decrease in muscle or skin temperature, subsequent to the localized application of cold, induces an increase in EMD in humans (25–27). Using mechanomyography, Cè *et al.* (24) reported a lengthening of the electrochemical but not the mechanical processes in response to muscle cooling. Using very high-frame-rate ultrasound, it is possible to detect the onset of muscle fascicle and myotendinous junction motions in response to myostimulation (16, 28–30). This technique offers the opportunity to determine the respective contribution of electrochemical and mechanical processes to heat-induced changes in EMD in humans. Thus, the present study may contribute to better identify the steps of force production and transmission potentially responsible for the improvement in explosive strength reported in the literature following heat exposure.

The present study aimed to determine

- the influence of hyperthermia on EMD;
- the respective heat-mediated alterations in electrochemical and/or force transmission processes.

We hypothesized that EMD would decrease in response to heat exposure likely because of faster electrochemical processes.

MATERIALS AND METHODS

Participants

Sixteen recreationally active participants (9 men and 7 women, age 24.9 ± 5.7 yr, height 174.8 ± 7.5 cm, and body mass 69.8 ± 9.9 kg) with no recent history of ankle disorder or injury participated in this study. Participants completed a preinclusion medical visit consisting of a clinical examination a medical history questionnaire and anthropometric measurements before entering into the study. They were informed regarding the nature, aims, and risks associated with the experimental procedures before providing written consent. This study was approved by the Sud-Ouest et Outremer III Ethics Committee (approval reference: 3849, ID-RCB:

2019-A00596-51) and conformed to the standards of the Declaration of Helsinki.

Experimental Design

Two to four days after a familiarization session allowing the participants to be accustomed to the procedures, the participants performed two identical testing sequences during a single visit, including electrically evoked peak twitch and EMD assessment. The tests were first performed in a control ambient environment (CON; $25.8 \pm 1.8^\circ\text{C}$, $33.6 \pm 8.6\%$ relative humidity) and then in a hot ambient environment (HOT; $47.4 \pm 1.84^\circ\text{C}$, $18.5 \pm 4.7\%$ relative humidity) after the participants passively reached a core temperature of 38.5°C (*i.e.*, after 127 ± 33 min from the onset of heat exposure). After heat exposure, muscle temperature increased from $34.0 \pm 0.8^\circ\text{C}$ to $37.0 \pm 0.6^\circ\text{C}$ ($P < 0.001$) in a subsample of six participants. The hyperthermia was controlled by an environmental chamber (Thermo-training room, Paris, France), and participants could drink *ad libitum*. Body mass was measured before and after heat exposure to evaluate the weight loss due to dehydration.

Twitch Force

A custom-built ergometer composed of a specific footplate (Bio2M, Compiègne, France) was used to measure plantar flexor force evoked by electrical nerve stimulations. Participants laid prone with their legs fully extended and their ankle flexed at 90° (*i.e.*, foot perpendicular to the tibia). Their right foot was firmly fixed on the footplate connected to a force sensor (2712-100 daN-0.02-B; Sensy, Charleroi, Belgium). The force signal was digitized at a sampling rate of 2 kHz, using an analog-to-digital converter designed in our laboratory. The tibial nerve was electrically stimulated using a constant current stimulator (Digitimer DS7AH; Digitimer, Letchworth Garden City, UK), delivering a single electrical pulse (1,000 μs , 400 V) through a cathode placed in the popliteal cavity and an anode placed distally to the patella. The intensity was adjusted for each participant by progressive increase in current (*i.e.*, incremental step of 10 mA) until plantar flexor force reached a plateau. Thereafter, five stimulations were delivered at the electrical intensity required to elicit peak force multiplied by 1.5.

Electromechanical delay.

Participants laid prone with their legs fully extended on a second homemade ergometer previously used to measure the EMD on plantar flexor muscles (16, 28, 29). Their right foot was firmly attached in a rigid cycling shoe (chosen to avoid possible dynamics in coupling between the shoe and the force sensor) fixed on an adjustable system connected to a force sensor (2712-50 daN-0.02-B; Sensy, Charleroi, Belgium) near the metatarsal joint. Percutaneous electrical stimulations were applied over gastrocnemius medialis (GM) to elicit contraction by a single electrical pulse (1,000 μs , 400 V) through two electrodes, one placed on the motor point (previously determined as the location inducing the strongest twitch with a low electrical stimulation) and the other placed on the distal portion of GM. The stimulation intensity corresponded to the intensity necessary to obtain

peak force. An ultrafast ultrasound scanner (version 12, Aixplorer; Supersonic Imagine, Aix en Provence, France) coupled with a linear transducer array (4–15 MHz, SuperLinear 15-4; Vermon, Tours, France) was used to acquire raw radiofrequency signals at 4 kHz. Muscle stimulations were delivered 50 ms after the onset of ultrasound image acquisition through an automatized trigger signal transmitted from the ultrasound scanner to the stimulator, thereby ensuring a consistent synchronization between mechanical and ultrasound data. For each participant, two bouts (muscle and tendon trials) composed of three electrically evoked contractions with 1 min of rest between each trial were performed. During the muscle trials, the ultrasound probe was placed over the GM muscle belly to detect the onset of muscle fascicle motion, reflective of electrochemical processes. During tendon trials, the ultrasound probe was maintained over the distal myotendinous junction of GM to detect the onset of myotendinous junction motion, reflective of mechanical processes. These two bouts were performed alternating the order, which was the same in CON and HOT. Participants were instructed to fully relax before each stimulation.

Temperature Monitoring

Prior to testing, participants were instrumented to control their core and skin temperatures. Core temperature was monitored rectally using an electronic capsule (e-Celsius; BodyCap, Caen, France) self-inserted by the length of a gloved finger. Participants were instrumented with four data loggers (iButtons; Maxim Integrated) measuring skin temperature at the arm, chest, thigh, and shin to calculate the average skin temperature according to the following equation (31): $0.3 \times \text{chest temperature} + 0.3 \times \text{arm temperature} + 0.2 \times \text{thigh temperature} + 0.2 \times \text{shin temperature}$.

Core and skin temperatures were continuously measured throughout the testing sequences and heat exposure. To obtain temperatures values in HOT, the mean values of core and skin temperatures were averaged during the testing sequence after heat exposure. In addition, muscle temperature of contralateral GM was measured immediately before each testing sequence in a subsample of six participants by using a needle intramuscular thermistor (MKA08050-A; Ellab, Roedovre, Denmark) inserted under local anesthesia after skin disinfection.

Data Analysis

Data were analyzed using custom-written scripts (Origin 2020, OriginLab Corporation; and Matlab 2010a-2017b, The Mathworks, Natick, MA).

Twitch force.

First, force signals were low-pass filtered (20 Hz, zero lag 3rd order Butterworth). Then, the mechanical response to the five electrically evoked stimulations was analyzed and averaged to determine peak twitch amplitude (PT; i.e., the highest value of twitch force production), CT, and HRT. The average RFD was calculated as PT/CT (14).

EMD. Force signals were low-pass filtered (200 Hz, zero lag 3rd order Butterworth). We defined the EMD as the delay between electrical stimulation and the force production onset. For each participant, six values of EMD were obtained

in each test sequence: three muscle trials and three tendon trials. As previously described by Nordez et al. (16) and Lacourpaille et al. (29), ultrasound B-mode images were used to determine the region of interest for each stimulation in order to detect the motion onset for GM fascicle during muscle trials (i.e., between the 2 aponeuroses) and myotendinous junction during tendon trials (i.e., on the myotendinous; Fig. 1). The displacements of the regions of interest along the ultrasound beam axis were calculated using a one-dimensional cross-correlation of the windows of consecutive ultrasound images. Thus, the tissue motion between two consecutive images (i.e., particle velocity) was measured with micrometric precision. Absolute particle velocities were averaged within previously determined regions of interest and then used to detect the onset of GM fascicle (Fig. 1A) and myotendinous junction (Fig. 1B) motion. The onset of motion was detected as the first point with a negative derivative of tissue motion in the reverse direction time (16). The same method was used to automatically detect the onset of the force production over time. Visual inspection was performed to check and validate the onset detection for each signal. Then, we determined the delay (in ms) between the onset of electrical stimulation (which corresponded to the trigger output signal collected from the electrical stimulator) and either the onset of muscle fascicle motion (D_m ; for muscle fascicle trials) or the onset of myotendinous junction motion (D_t ; for tendon trials). The delay between the onset of GM fascicle motion and the onset of force production is attributed to the force transmission (T_m ; time delay to force transmission). The differences between D_m and D_t and between D_t and EMD were calculated to respectively compute the delay of force transmission along aponeurosis and tendon. Using the same technique as described elsewhere, Nordez et al. (16) and Lacourpaille et al. (30), respectively, demonstrated a good repeatability [standard error (SE) < 0.88 ms; coefficient of variation (CV): 5.0–11.6%] and a good interday reliability of EMD, D_m , and D_t (SE < 0.79 ms; CV: 6.8–12.5%). In the present study, SE were < 0.40 ms, and CV values ranged from 8.2 to 15.2% across EMD, D_m , and D_t .

Statistical Analysis

All statistical analyses were performed with Statistica (version 13.0; StatSoft, Tulsa, OK). Therefore, values were reported as means \pm SD. The assumptions of normality of the data were verified using a Shapiro-Wilk's test. Paired *t* tests were used to compare the effect of the environmental condition (CON vs. HOT) on core, skin, and muscle temperatures, mechanical responses to the electrically evoked stimulation (PT, CT, HRT, and RFD) and EMD. A two-way analysis of variance (ANOVA) for repeated measures [condition (CON, HOT) \times delay (D_m , T_m)] was used to test whether heat exposure affected absolute (in ms) and relative (in %EMD) values of D_m and T_m . Then, a two-way ANOVA for repeated measures [condition (CON, HOT) \times delay (aponeurosis, tendon)] was used to test the effect of heat exposure on force transmission independently of electrochemical process in absolute and relative values. When the sphericity assumption in repeated-measures ANOVAs was violated (Mauchly's test), a Geisser-Greenhouse correction was used. When appropriate,

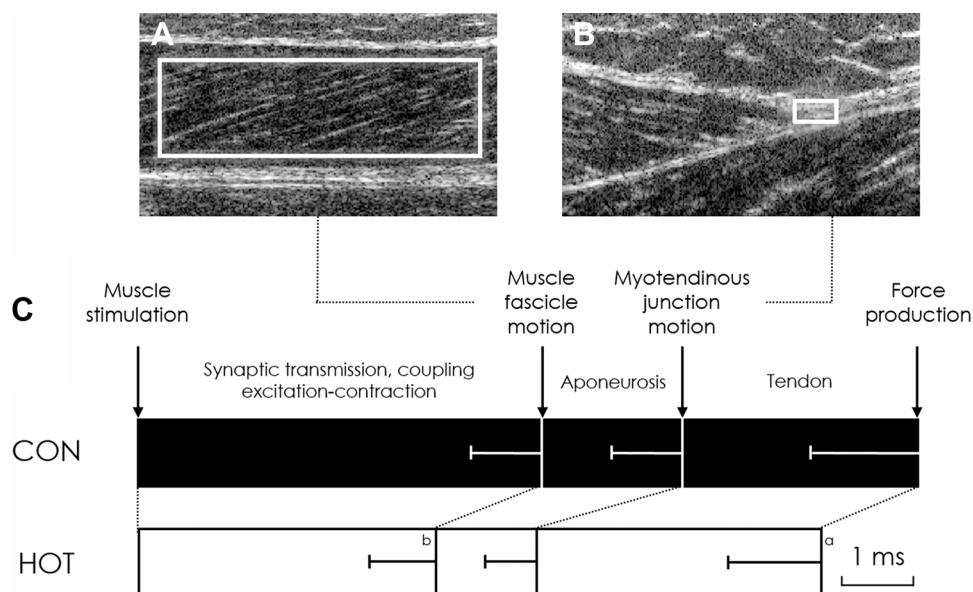

Figure 1. A and B: ultrasound images showing the regions of interest delineated with white squares for the gastrocnemius medialis (GM) muscle (A) and myotendinous junction (B). C: representation of the electromechanical delay (EMD) and its components in control ambient (CON) and hot ambient (HOT) environments. Horizontally stacked bar plots represent means \pm SD. The delay between electrical muscle stimulation and the onset of muscle fascicle motion is attributed to electrochemical processes (D_m). The delay between the onset of fascicle motion and the onset of force production is attributed to force transmission (T_m). The delay between muscle electrical stimulation and the onset of myotendinous junction motion (D_t) reflects the time required for electrochemical processes and force transmission along aponeurosis. ^a and ^bSignificant difference between HOT and CON for EMD and D_m (ms); $P < 0.001$.

post hoc analyses were performed using Bonferroni tests. Effect sizes were described in terms of partial eta-squared (η^2_p , with $\eta^2_p \geq 0.06$ representing a moderate effect and $\eta^2_p \geq 0.14$ a large effect). Statistical significance was set as $P < 0.05$.

RESULTS

Heat Exposure

Mean core and skin temperatures were significantly higher in HOT ($38.4 \pm 0.3^\circ\text{C}$ and $38.8 \pm 0.4^\circ\text{C}$, respectively) than CON ($37.0 \pm 0.3^\circ\text{C}$ and $34.7 \pm 0.7^\circ\text{C}$, respectively) (all P values < 0.001). Shin skin temperature was significantly higher in HOT ($38.8 \pm 0.9^\circ\text{C}$) than in CON ($34.3 \pm 0.9^\circ\text{C}$) ($P < 0.01$). Muscle temperature measured in a subsample ($n = 6$) from the 16 participants was $37.0 \pm 0.6^\circ\text{C}$ in HOT versus $34.0 \pm 0.8^\circ\text{C}$ in CON ($P < 0.001$). Heat exposure, which lasted 127 ± 33 min, had no statistical effect on body mass measured in HOT versus CON ($P = 0.89$).

Twitch Force

No difference was found in PT amplitude between HOT and CON ($P = 0.301$, $\eta^2_p = 0.036$; Table 1). Both CT and HRT were shorter in HOT than in CON ($-9.0 \pm 6.5\%$ and $-15.1 \pm 10.1\%$ respectively, $P < 0.001$, $\eta^2_p \geq 0.419$; Table 1). RFD was

Table 1. Main characteristics of the nervous electrically evoked twitch in CON and HOT

	CON	HOT	P	η^2_p
PT, N	66.9 ± 12.9	71.8 ± 13.9	0.301	0.036
CT, ms	121.2 ± 7.5	$110.2 \pm 5.7^{***}$	< 0.001	0.419
HRT, ms	88.8 ± 6.1	$75.4 \pm 8.1^{***}$	< 0.001	0.485
RFD, N/ms	0.56 ± 0.12	$0.65 \pm 0.11^*$	0.029	0.149

Values are presented as means \pm SD. CON, control ambient environment; CT, contraction time; HOT, hot ambient environment; HRT, half relaxation time; PT, peak twitch amplitude; RFD, rate of force development. *Significant difference between HOT and CON, $P < 0.05$; *** $P < 0.001$.

faster in HOT than in CON ($+16.9 \pm 32.8\%$, $P = 0.029$, $\eta^2_p = 0.149$; Table 1).

Electromechanical delay.

EMD was 1.37 ± 0.87 ms ($-12.6 \pm 7.7\%$) shorter in HOT than in CON ($P < 0.001$, $\eta^2_p = 0.523$; Fig. 1). This reduction in EMD consistently occurred for all participants (range: -0.08 to -2.98 ms). We observed an effect of heat exposure on absolute D_m and T_m (condition effect: $P < 0.001$, $\eta^2_p = 0.509$). Post hoc analysis revealed that D_m was significantly shorter in HOT than in CON ($-26.5 \pm 18.2\%$, $P < 0.001$, $\eta^2_p = 0.416$; Figs. 1 and 2), whereas no significant difference was found for T_m between HOT and CON ($P = 0.622$, $\eta^2_p = 0.008$; Fig. 1). Two-way ANOVA revealed a main effect of hyperthermia on relative contribution of D_m and T_m to EMD ($P = 0.015$, $\eta^2_p = 0.182$). Post hoc analysis showed that the relative contribution of D_m to EMD was smaller in HOT than in CON ($-8.0 \pm 11.1\%$, $P = 0.015$, $\eta^2_p = 0.182$). Conversely, the relative contribution of T_m to EMD was higher in HOT than in CON ($+8.0 \pm 11.1\%$, $P = 0.015$, $\eta^2_p = 0.182$). We found no significant main effect of heat exposure on absolute force transmission delays (aponeurosis and tendon; $P = 0.270$, $\eta^2_p = 0.086$). However, two-way ANOVA revealed a main effect of hyperthermia on relative contribution of force transmission to EMD (aponeurosis and tendon, $P = 0.034$, $\eta^2_p = 0.208$). Post hoc showed that the relative contribution of force transmission along aponeurosis to EMD was not altered by heat exposure ($P = 0.294$, $\eta^2_p = 0.037$), whereas relative contribution of force transmission along the tendon to EMD was greater in HOT than in CON ($+10.8 \pm 11.5\%$, $P = 0.012$, $\eta^2_p = 0.192$).

DISCUSSION

The aim of this study was to determine the influence of hyperthermia induced by heat exposure on EMD and the subsequent alterations in electrochemical and mechanical processes involved in EMD. In accord with our initial hypothesis, hyperthermia reduced the delay between muscle stimulation and the onset of plantar flexor force production

Figure 2. Delay between the onset of electrical stimulation and the onset of muscle fascicle motion (D_m ; A) and delay between the onset of muscle fascicle motion and the onset of force production (T_m ; B) obtained in control ambient (CON) and hot ambient (HOT) environments. Bold traces represent the mean change, and box charts correspond to standard deviation. ***Significant difference between HOT and CON, $P < 0.001$.

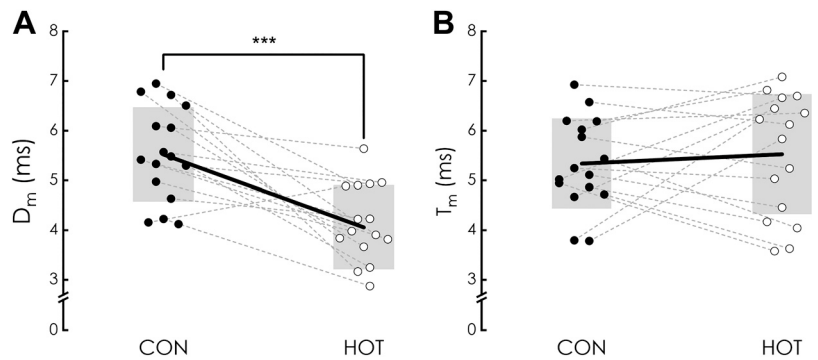

in vivo. This reduction was concomitant with shorter electrochemical processes (i.e., decreased delay between muscle stimulation and the onset of muscle fascicle motion) compared with control conditions. The delay between muscle fascicle motion and force production was unchanged in a hot environment, reflecting no impact of hyperthermia on force transmission along elastic components.

In line with previous reports, contraction time and half-relaxation time were shortened and rate of force development increased after heat exposure (11, 14). In comparison with Racinais et al. (14), the smaller reduction in contraction time (-9.0% vs. -36.5%) and half relaxation time (-15.1% vs. -25.2%) and the smaller increase in rate of force development ($+16.9\%$ vs. $+64.7\%$) observed in the present study was probably due to the smaller amplitude of core temperature increase with heat exposure ($+1.4$ vs. $+2.6^\circ\text{C}$). The main aim of the present experimental protocol was to identify the phases of force production and transmission that could account for this heat-mediated improved explosive performance.

The delay between muscle stimulation and the onset of force production measured under thermoneutral environment (10.8 ± 0.6 ms) was in the range of EMD reported in the literature on plantar flexors muscles [i.e., 7.9 ms to 18.8 ms (16, 32–34)]. With muscle temperature increase, EMD consistently decreased in all participants by 1.37 ± 0.87 ms on average (i.e., $-12.6 \pm 7.7\%$) as compared with the values obtained in a thermoneutral environment. In line with the present findings, a previous study reported a 16% decrease in EMD in malignant hyperthermia-susceptible participants [i.e., $+4.3\%$ of muscle temperature (1)]. Conversely, Kubo et al. (26) observed an increase in EMD of plantar flexors after a 30-min immersion in hot water of the lower limbs. The partial immersion, the difference in heat medium (water versus ambient air), or the contraction modality and the shorter duration of heat application compared with the present study (i.e., 30 min vs. 127 min) may partly explain this discrepancy, although it is not possible to attest the impact of hot water immersion on core or muscle temperature in the aforementioned study. Using local application of heat (i.e., hot packs), Zhou et al. (25) measured EMD during voluntary quadriceps contractions at muscle temperatures between 30°C and 38°C . EMD decreased from 30°C to 36°C , and then it increased up to 36 – 38°C . Our results showed a decrease in EMD from a muscle temperature of 34°C in a thermoneutral environment to 37°C in a hot environment, suggesting that the impact of heat on EMD may differ between voluntary

and electrically evoked contraction and between muscle groups. Given the different properties between knee extensor and plantar flexor muscles, these findings may also illustrate a possible muscle-dependent effect of heat exposure (14, 21, 22). Overall, our findings merged with previous works collectively suggest a continuum of temperature-mediated effect on EMD in vivo, reflected by a negative relationship between muscle temperature and EMD. Further investigations exploring EMD under various muscle temperatures are required to conclude with certainty on the nature of this potential relation.

By coupling ultrafast ultrasound to EMD assessments, we aimed to distinguish the contribution of the electrochemical processes from the muscle force transmission along the series elastic component to EMD. In line with our hypothesis, we observed substantial differences in the delay between muscle stimulation and the onset of muscle fascicle motion in a hot compared with thermoneutral environment (-1.46 ± 1.12 ms, $-26.5 \pm 18.2\%$). This reduction could be attributed to faster synaptic transmission, propagation of action potential through the sarcolemma, and/or excitation-contraction coupling (16, 23, 35). Interestingly, when normalized to EMD, the relative contribution of electrochemical processes also decreased with hyperthermia ($-8.0 \pm 11.1\%$), demonstrating that the electrochemical processes were accelerated to a greater extent than the impact on global EMD. At a muscle temperature of 23°C achieved through localized cold application, Cè et al. (24) reported a lengthening of electrochemical processes that were multiplied by ~ 1.5 . These variations in the duration of electrochemical processes upon hot and cold environments could be related to temperature-mediated effects on axonal conduction velocity. Indeed, axonal conduction velocity can decrease with cold and inversely increase with heat (17, 36). On the one hand, a decrease in muscle temperature is recognized to slow down both the opening and closing of Na^+ channels, whereas an increase in muscle temperature accelerates synaptic transmission (5, 37). However, the depolarization of muscle fibers depends on the influx of Na^+ ions through cell membrane. Increasing ambient temperature reduces the amplitude and the duration of depolarization due to reduced Na^+ influx. This effect in turn challenges the production of a muscle fiber action potential (37), which could suggest an increase in the duration of electrochemical processes with heat. On the other hand, an increase in ambient temperature additionally increases ATPase activity of myosin heavy chains (19) and reduces Ca^{2+} uptake in the sarcoplasmic reticulum, thereby

increasing the rate of cross-bridge cycling (20, 38). Thus, the literature reports heat-mediated effects that would inversely impact the duration of electrochemical processes after a heat exposure. The present experimental approach does not allow us to dissociate the respective contribution of each process involved in hyperthermia-induced changes. However, Nordez et al. (16) suggested a minor role of the active part of the series elastic component to electrochemical processes. Therefore, it is likely that synaptic transmission and excitation-contraction coupling may be affected primarily by hyperthermia. One could note that an acceleration of synaptic transmission is associated with a lower amplitude of action potential, which could impact the action potential response (37). A faster synaptic transmission would reduce electrochemical processes duration, which has yet to be shown to be associated with a lower amplitude of the action potential response with heat. Hyperthermia could thus likely reduce the amplitude of the action potential. However, our results showed a faster response.

Our findings showed that absolute delay for force transmission along the aponeurosis and the tendon was not affected by ambient temperature. In their systematic review, Bleakley and Costello (39) reported an equivocal effect of heat or cold on passive stiffness in soft tissues. In vitro, tendon viscosity and temperature follow an exponential relationship (22), whereas animal studies reported an increase in tendon compliance following heat exposure (40, 41). In vivo, local application of heat on lower limbs does not change the stiffness of tendinous tissues, assessed in passive and active conditions, despite an extended range of motion (26, 42). Such an effect of hyperthermia on the mechanical properties of the series elastic component could impair the effectiveness of force transmission. In contrast, cooling resulted in increasing tendon stiffness in vitro (43) and in vivo after 30 min of local icing (44) or four sets of 4 min, with 1 min of recovery in between, of cryotherapy (45). These results suggest that absolute force transmission processes are unchanged with heat. In accordance with the present scientific literature, this advocates that tendinous stiffness could thus be unchanged or slightly diminished with heat. One could note that an alteration of tendon mechanical properties may subsequently shift the operating lengths of muscle fascicles and in turn force production due to the influence of the force-length relationship. Such impact may influence force production mechanisms, reflecting the complex role of muscle-tendon interactions in force generation and transmission. If present, it is likely that such processes do not substantially impact force transmission when muscle temperature rises to 37°C.

Methodological Considerations

Our findings showed a decrease in electrically induced EMD with hyperthermia. Given that viscoelastic responses of muscle and tendon may differ between electrically induced and voluntary contractions, the present results may not directly reflect the effects in voluntary contractions. However, one may assume that EMD measurements during voluntary contraction also present some drawbacks. As suggested by Hug et al. (46), EMD measurements obtained during voluntary contractions could be influenced by methodological artefacts and should be interpreted with caution. Indeed, EMD

measured during voluntary contraction, with the use of electromyography, is insufficient to precisely detect the onset of activation of the studied muscle fibers. Therefore, further investigations are required to overcome present methodological limitations to measure the effect of heat on voluntary EMD in order to better appraise the subsequent impact on motor performance. Although the assessment of EMD is challenging in voluntary conditions, voluntary RFD has been shown to increase with increased muscle temperature induced by hot environments. Although electromechanical processes appeared to be mainly responsible for the reduction in EMD in vivo, the relative contributions of the synaptic transmission, the excitation-contraction coupling, and the active part of the series elastic component could not be directly quantified in the present study. Further assessments of EMD and its various components in several cold and hot conditions may contribute to determine the nature of the relationships between temperature and EMD suggested in the literature (25). Given that EMD plays a major role in explosive motor task performance, the present findings demonstrate that tissue temperature is a determinant factor of explosive strength evaluations and EMD measurements. The present study allowed us to locate the phases of force production and transmission potentially altered following heat exposure that could impact explosive strength and in turn sport performance. We might expect similar effects in voluntary EMD more representative to voluntary performance. With an electrically induced electromechanical delay reduction of 1.37 ms (i.e., 12.6% of EMD in GM muscle), the effect of hyperthermia during voluntary electromechanical delay could impact longer force production delays and could be meaningful for performance. Further investigations during voluntary contractions are warranted to improve our understanding of the effects of heat exposure on the different components of the muscle-tendon unit in hot conditions and their consequences on motor performance.

Conclusions

The present study showed that hyperthermia decreased the time elapsed between the onset of muscle activation and force production, mainly through an acceleration of electrochemical processes. However, mechanical processes involved in force transmission during electromechanical delay were unchanged following heat exposure. These findings contribute to our understanding to elucidate the mechanisms involved in the enhanced contractile properties previously reported following an acute heat exposure. Although future research is required to further describe the role of muscle-tendon dynamics in heat-mediated effects, the present results suggest a major role of synaptic transmission and excitation-contraction coupling in electromechanical delay shortening. This study allowed determination of the respective contributions of electromechanical and mechanical processes to heat-induced changes in EMD. A shortening of electromechanical delay and electrochemical processes might explain the improvement in explosive strength reported in the literature. Future investigations of muscle-tendon dynamics involved during voluntary contractions are warranted for a better understanding of motor performance following hyperthermia.

ACKNOWLEDGMENTS

We are grateful to Lilian Lacourpaille (University of Nantes, France) for support in electromechanical delay measurements. We thank the participants for their commitment.

GRANTS

A. Mornas is supported by a scholarship funded by the French Ministry of Research. S. Racinais was supported by a grant from Aspire Zone Foundation for this project. The Laboratory Sport, Expertise and Performance, is a partner of the French network ReFORM, recognized as a Research Center for the Prevention of Injury and Illness and the Protection of Athletes by the International Olympic Committee (IOC). As a member of the IOC Medical Research Network, ReFORM has received funding from the IOC to establish long-term research programs on the prevention of injuries and illnesses in sport for the protection of athlete health.

DISCLOSURES

No conflicts of interest, financial or otherwise, are declared by the authors.

AUTHOR CONTRIBUTIONS

A.M., S.R., F.B. and G.G. conceived and designed research; A.M., S.R., F.B., M.A., R.H., Y.D. and G.G. performed experiments; A.M., R.H. and G.G. analyzed data; A.M., S.R., F.B., M.A. and G.G. interpreted results of experiments; A.M., S.R., F.B. and G.G. prepared figures; A.M. and G.G. drafted manuscript; A.M., S.R., F.B., M.A. and G.G. edited and revised manuscript; A.M., S.R., F.B., M.A., R.H., Y.D. and G.G. approved final version of manuscript.

REFERENCES

- Bäckman E, Lennmarken C, Rutberg H, Henriksson KG. Skeletal muscle contraction characteristics in vivo in malignant hyperthermia susceptible subjects. *Acta Neurol Scand* 77: 278–282, 1988. doi:10.1111/j.1600-0404.1988.tb05910.x.
- Febbraio MA, Snow RJ, Stathis CG, Hargreaves M, Carey MF. Effect of heat stress on muscle energy metabolism during exercise. *J Appl Physiol* (1985) 77: 2827–2831, 1994. doi:10.1152/jap.1994.77.6.2827.
- Racinais S, Gaoua N, Grantham J. Hyperthermia impairs short-term memory and peripheral motor drive transmission. *J Physiol* 586: 4751–4762, 2008. doi:10.1113/jphysiol.2008.157420.
- Davies CT, Young K. Effect of temperature on the contractile properties and muscle power of triceps surae in humans. *J Appl Physiol Respir Environ Exerc Physiol* 55: 191–195, 1983. doi:10.1152/jap.1983.55.1.191.
- Racinais S, Oksa J. Temperature and neuromuscular function. *Scand J Med Sci Sports* 20: 1–18, 2010. doi:10.1111/j.1600-0838.2010.01204.x.
- Bottinelli R, Canepari M, Pellegrino MA, Reggiani C. Force-velocity properties of human skeletal muscle fibres: myosin heavy chain isoform and temperature dependence. *J Physiol* 495: 573–586, 1996. doi:10.1113/jphysiol.1996.sp021617.
- Edman KA. The velocity of unloaded shortening and its relation to sarcomere length and isometric force in vertebrate muscle fibres. *J Physiol* 291: 143–159, 1979. doi:10.1113/jphysiol.1979.sp012804.
- Close R, Hoh JF. Influence of temperature on isometric contractions of rat skeletal muscles. *Nature* 217: 1179–1180, 1968. doi:10.1038/2171179a0.
- Ranatunga KW. Temperature-dependence of shortening velocity and rate of isometric tension development in rat skeletal muscle. *J Physiol* 329: 465–483, 1982. doi:10.1113/jphysiol.1982.sp014314.
- Segal SS, Faulkner JA, White TP. Skeletal muscle fatigue in vitro is temperature dependent. *J Appl* 61: 660–665, 1986. doi:10.1152/jappl.1986.61.2.660.
- de Ruiter CJ, Jones DA, Sargeant AJ, de Haan A. Temperature effect on the rates of isometric force development and relaxation in the fresh and fatigued human adductor pollicis muscle. *Exp Physiol* 84: 1137–1150, 1999. doi:10.1111/j.1469-445X.1999.01895.x.
- Périard JD, Racinais S, Thompson MW. Adjustments in the force-frequency relationship during passive and exercise-induced hyperthermia. *Muscle Nerve* 50: 822–829, 2014. doi:10.1002/mus.24228.
- Racinais S, Girard O. Neuromuscular failure is unlikely to explain the early exercise cessation in hot ambient conditions. *Psychophysiol* 49: 853–865, 2012. doi:10.1111/j.1469-8986.2012.01360.x.
- Racinais S, Wilson MG, Périard JD. Passive heat acclimation improves skeletal muscle contractility in humans. *Am J Physiol Regul Integr Comp Physiol* 312: R101–R107, 2017. doi:10.1152/ajpregu.00431.2016.
- Maffiuletti NA, Aagaard P, Blazevich AJ, Folland J, Tillin N, Duchateau J. Rate of force development: physiological and methodological considerations. *Eur J Appl Physiol* 116: 1091–1116, 2016. doi:10.1007/s00421-016-3346-6.
- Nordez A, Gallot T, Catheline S, Guevel A, Cornu C, Hug F. Electromechanical delay revisited using very high frame rate ultrasound. *J Appl Physiol* (1985) 106: 1970–1975, 2009. doi:10.1152/jap.2009.106.11.1970.
- Rutkove SB, Kothari MJ, Shefner JM. Nerve, muscle, and neuromuscular junction electrophysiology at high temperature. *Muscle Nerve* 20: 431–436, 1997. doi:10.1002/(SICI)1097-4598(199704)20:4<431::AID-MUS5>3.0.CO;2-B.
- Todnem K, Knudsen G, Riise T, Nyland H, Aarli JA. The non-linear relationship between nerve conduction velocity and skin temperature. *J Neurol Neurosurg Psychiatry* 52: 497–501, 1989. doi:10.1136/jnnp.52.4.497.
- Bárány M. ATPase activity of myosin correlated with speed of muscle shortening. *J Gen Physiol* 50: 197–218, 1967. doi:10.1085/jgp.50.6.197.
- Stein RB, Gordon T, Shriver J. Temperature dependence of mammalian muscle contractions and ATPase activities. *Biophys J* 40: 97–107, 1982. doi:10.1016/S0006-3495(82)84464-0.
- Sapin-de Brosses E, Gennisson JL, Pernot M, Fink M, Tanter M. Temperature dependence of the shear modulus of soft tissues assessed by ultrasound. *Phys Med Biol* 55: 1701–1718, 2010. doi:10.1088/0031-9155/55/6/011.
- Huang CY, Wang VM, Flatow EL, Mow VC. Temperature-dependent viscoelastic properties of the human supraspinatus tendon. *J Biomech* 42: 546–549, 2009. doi:10.1016/j.jbiomech.2008.11.013.
- Cavanagh PR, Komi PV. Electromechanical delay in human skeletal muscle under concentric and eccentric contractions. *Europ J Appl Physiol* 42: 159–163, 1979. doi:10.1007/BF00431022.
- Cè E, Rampichini S, Agnello L, Limonta E, Veicsteinas A, Esposito F. Effects of temperature and fatigue on the electromechanical delay components. *Muscle Nerve* 47: 566–576, 2013. doi:10.1002/mus.23627.
- Zhou S, Carey MF, Snow RJ, Lawson DL, Morrison WE. Effects of muscle fatigue and temperature on electromechanical delay. *Electromyogr Clin Neurophysiol* 38: 67–73, 1998.
- Kubo K, Kanehisa H, Fukunaga T. Effects of cold and hot water immersion on the mechanical properties of human muscle and tendon in vivo. *Clin Biomech (Bristol, Avon)* 20: 291–300, 2005. doi:10.1016/j.clinbiomech.2004.11.005.
- Mallette MM, Cheung SS, Kumar RI, Hodges GJ, Holmes MWR, Gabriel DA. The effects of local forearm heating and cooling on motor unit properties during submaximal contractions. *Exp Physiol*, 2020. doi:10.1113/EP088256.
- Lacourpaille L, Gross R, Hug F, Guével A, Péron Y, Magot A, Hogrel JY, Nordez A. Effects of Duchenne muscular dystrophy on muscle stiffness and response to electrically-induced muscle contraction: A 12-month follow-up. *Neuromuscul Disord* 27: 214–220, 2017. doi:10.1016/j.nmd.2017.01.001.
- Lacourpaille L, Nordez A, Doguet V, Hug F, Guilhem G. Effect of damaging exercise on electromechanical delay. *Muscle Nerve* 54: 136–141, 2016. doi:10.1002/mus.25024.

30. **Lacourpaille L, Nordez A, Hug F.** Influence of stimulus intensity on electromechanical delay and its mechanisms. *J Electromyogr Kinesiol* 23: 51–55, 2013. doi:10.1016/j.jelekin.2012.06.010.
31. **Ramanathan NL.** A new weighting system for mean surface temperature of the human body. *J Appl Physiol* 19: 531–533, 1964. doi:10.1152/jappl.1964.19.3.531.
32. **Grosset JF, Piscione J, Lambertz D, Pérot C.** Paired changes in electromechanical delay and musculo-tendinous stiffness after endurance or plyometric training. *Eur J Appl Physiol* 105: 131–139, 2009. doi:10.1007/s00421-008-0882-8.
33. **Hopkins JT, Feland JB, Hunter I.** A comparison of voluntary and involuntary measures of electromechanical delay. *Int J Neurosci* 117: 597–604, 2007. doi:10.1080/00207450600773764.
34. **Muraoka T, Muramatsu T, Fukunaga T, Kanehisa H.** Influence of tendon slack on electromechanical delay in the human medial gastrocnemius in vivo. *J Appl Physiol (1985)* 96: 540–544, 2004. doi:10.1152/japplphysiol.01015.2002.
35. **Chen HY, Liau JJ, Wang CL, Lai HJ, Jan MH.** A novel method for measuring electromechanical delay of the vastus medialis obliquus and vastus lateralis. *Ultrasound Med Biol* 35: 14–20, 2009. doi:10.1016/j.ultrasmedbio.2008.06.011.
36. **Denton A, Bunn L, Hough A, Bugmann G, Marsden J.** Superficial warming and cooling of the leg affects walking speed and neuromuscular impairments in people with spastic paraparesis. *Ann Phys Rehabil Med* 59: 326–332, 2016. doi:10.1016/j.rehab.2016.04.006.
37. **Rutkove SB.** Effects of temperature on neuromuscular electrophysiology. *Muscle Nerve* 24: 867–882, 2001. doi:10.1002/mus.1084.
38. **Schertzer JD, Green HJ, Tupling AR.** Thermal instability of rat muscle sarcoplasmic reticulum Ca(2+)-ATPase function. *Am J Physiol Endocrinol Metab* 283: E722–E728, 2002. doi:10.1152/ajpendo.00204.2002.
39. **Bleakley CM, Costello JT.** Do thermal agents affect range of movement and mechanical properties in soft tissues? A systematic review. *Arch Phys Med Rehabil* 94: 149–163, 2013. doi:10.1016/j.apmr.2012.07.023.
40. **Walker P, Amstutz HC, Rubinfeld M.** Canine tendon studies. II. Biomechanical evaluation of normal and regrown canine tendons. *J Biomed Mater Res* 10: 61–76, 1976. doi:10.1002/jbm.820100107.
41. **Wang JC, Kabo JM, Tsou PM, Halevi L, Shamie AN.** The effect of uniform heating on the biomechanical properties of the intervertebral disc in a porcine model. *Spine J* 5: 64–70, 2005. doi:10.1016/j.spinee.2004.10.047.
42. **Fujita K, Nakamura M, Umegaki H, Kobayashi T, Nishishita S, Tanaka H, Ibuki S, Ichihashi N.** Effects of a thermal agent and physical activity on muscle tendon stiffness, as well as the effects combined with static stretching. *J Sport Rehabil* 27: 66–72, 2018. doi:10.1123/jsr.2015-0165.
43. **Huang H, Zhang J, Sun K, Zhang X, Tian S.** Effects of repetitive multiple freeze-thaw cycles on the biomechanical properties of human flexor digitorum superficialis and flexor pollicis longus tendons. *Clin Biomech (Bristol, Avon)* 26: 419–423, 2011. doi:10.1016/j.clinbiomech.2010.12.006.
44. **Alegre LM, Hasler M, Wenger S, Nachbauer W, Csapo R.** Does knee joint cooling change in vivo patellar tendon mechanical properties? *Eur J Appl Physiol* 116: 1921–1929, 2016. doi:10.1007/s00421-016-3444-5.
45. **Point M, Guilhem G, Hug F, Nordez A, Frey A, Lacourpaille L.** Cryotherapy induces an increase in muscle stiffness. *Scand J Med Sci Sports* 28: 260–266, 2018. doi:10.1111/sms.12872.
46. **Hug F, Lacourpaille L, Nordez A.** Electromechanical delay measured during a voluntary contraction should be interpreted with caution. *Muscle Nerve* 44: 838–839, 2011. doi:10.1002/mus.22139.

RESEARCH ARTICLE

Don't Deny Your Inner Environmental Physiologist: Investigating Physiology with Environmental Stimuli

Faster early rate of force development in warmer muscle: an in vivo exploration of fascicle dynamics and muscle-tendon mechanical properties

Adèle Mornas,^{1,2} Sébastien Racinais,^{1,3} Franck Brocherie,¹ Marine Alhamoud,³ Robin Hager,¹ Yanis Desmedt,¹ and Gaël Guilhem¹

¹Laboratory Sport, Expertise and Performance (EA 7370), French Institute of Sport (INSEP), Paris, France; ²Faculty of Sport Science, University of Paris, Paris, France; and ³Department of Research and Scientific Support, Aspetar, Orthopaedic and Sports Medicine Hospital, Doha, Qatar

Abstract

Although heat exposure has been shown to increase the skeletal rate of force development (RFD), the underlying processes remain unknown. This study investigated the effect of heat on gastrocnemius medialis (GM) muscle-tendon properties and interactions. Sixteen subjects performed electrically evoked and voluntary contractions combined with ultrafast ultrasound under thermoneutral [control (CON): 25.8±1.8°C, core temperature 37.0±0.3°C, muscle temperature 34.0±1.1°C] and passive heat exposure [hot (HOT): 47.4±1.8°C, core temperature 38.4±0.3°C, muscle temperature 37.0±0.8°C] conditions. Maximal voluntary force changes did not reach statistical significance (−5.0±11.3%, $P = 0.052$) whereas voluntary activation significantly decreased (−4.6±8.7%, $P = 0.038$) in HOT. Heat exposure significantly increased voluntary RFD before 100 ms from contraction onset (+48.2±62.7%; $P = 0.013$), without further changes after 100 ms. GM fascicle dynamics during electrically evoked and voluntary contractions remained unchanged between conditions. Joint velocity at a given force was higher in HOT (+7.1±6.6%; $P = 0.004$) but the fascicle force-velocity relationship remained unchanged. Passive muscle stiffness and active tendon stiffness were lower in HOT than CON ($P \leq 0.030$). This study showed that heat-induced increases in early voluntary RFD may not be attributed to changes in contractile properties. Late voluntary RFD was unaltered, possibly due to decreased soft tissues' stiffness in heat. Further investigations are required to explore the influence of neural drive and motor unit recruitment in the enhancement of explosive strength elicited by heat exposure.

explosive strength; force-velocity properties; muscle temperature; muscle-tendon interactions; stiffness

INTRODUCTION

Explosive force, referred to as the ability of the human skeletal muscle to generate force as fast as possible, is paramount in motor performance and daily functional tasks (1, 2). This muscle capacity is classically evaluated through the rate of force development (RFD) during the first 200 ms (or less) of an electrically evoked or maximal voluntary isometric contraction (2, 3). Explosive force production is largely explained by neural and contractile properties which change during muscle contraction. Neural activation is an important determinant in the initial 50 ms of explosive contraction, whereas the subsequent 50-ms period is correlated to contractile capacity (4). More recently, some studies investigated the various determinants of explosive force depending on time period from the onset of explosive contraction (2, 5, 6). At the onset of the motor impulse (i.e., 0–100 ms), explosive movement is strongly influenced by recruitment velocity and the firing rate

of the activated motor unit (5). From 100 to 200 ms, voluntary RFD amplitude will thereafter be submitted to muscle mechanical constraints, as reflected by muscle fascicle dynamics which fit to the fascicle force-velocity relationship (6). RFD may also be influenced by the elastic properties of the muscle-tendon unit and the muscle-tendon interactions (2, 7, 8).

It is well established that an increase in core temperature (T_{core}), with its repercussion on muscle temperature (T_{musc}), contributes to a reduction in voluntary force production (9–11) while increasing maximum muscle shortening velocity in animals (12) and humans (13). Furthermore, a rise in T_{core} or T_{musc} increases electrically evoked RFD (14–16). Some studies reported an increase in voluntary RFD (17, 18), whereas a recent experiment demonstrated no changes in early and middle RFD (19), reflecting that the effects of hyperthermia on voluntary RFD remains to be elucidated. An increase in T_{musc} has been shown to enhance the rate of ATPase activity in vitro in animals (20, 21), suggesting an increase in the rate

Medicine & Science in Sports & Exercise

Active heat acclimation does not alter muscle-tendon unit properties

--Manuscript Draft--

Manuscript Number:	MSSE-D-22-00704R1	
Full Title:	Active heat acclimation does not alter muscle-tendon unit properties	
Article Type:	Original Investigation	
Corresponding Author:	Sébastien Racinais, PhD Aspetar, Qatar Orthopedic and Sports Medicine Hospital Doha, QATAR	
Corresponding Author Secondary Information:		
Corresponding Author's Institution:	Aspetar, Qatar Orthopedic and Sports Medicine Hospital	
Corresponding Author's Secondary Institution:		
First Author:	Adèle Mornas	
First Author Secondary Information:		
Order of Authors:	Adèle Mornas	
	Franck Brocherie	
	Gaël Guilhem	
	Arthur Guillotel	
	Sébastien Le Garrec	
	Ritse Gouwy	
	Jean-Luc Gennisson	
	Steve Beuve	
	Sébastien Racinais, PhD	
Order of Authors Secondary Information:		
Funding Information:	Ministère de l'Enseignement Supérieur et de la Recherche	Not applicable
	International Olympic Committee	Not applicable

Active heat acclimation does not alter muscle-tendon unit properties

Adèle Mornas^{1,2}, Franck Brocherie¹, Gaël Guilhem¹, Arthur Guillotel¹, Sébastien Le Garrec³, Ritse Gouwy^{1,4}, Jean-Luc Gennisson⁵, Steve Beuve⁵, Sébastien Racinais^{1,6}

¹French Institute of Sport (INSEP), Laboratory Sport, Expertise and Performance (EA 7370), Paris, France

²University Paris Cité, Paris, France

³French Institute of Sport (INSEP), Medical Department, Paris, France

⁴Katholieke Universiteit Leuven, Human Movement Biomechanics Research Group, Department of Movement Sciences, Leuven, Belgium

⁵Université Paris-Saclay, Laboratoire d'Imagerie Biomédicale Multimodale (BioMaps), CEA, CNRS, Inserm, Service Hospitalier Frédéric Joliot, Orsay France

⁶Aspetar Orthopaedic and Sports Medicine Hospital, Research and Scientific Support, Doha, Qatar

Short title: Heat acclimation and muscle properties

***Correspondence and reprints:**

Sébastien Racinais

Aspetar Orthopaedic and Sports Medicine Hospital, Research and Scientific Support Department, PO Box 29222, Doha, Qatar

E-mail: sebastien.racinais@aspetar.com

Phone: +974.4413.2650

Fax: +974.4413.2020

ABSTRACT

Purpose: Heat acclimation (HA) is recommended before competing in hot and humid conditions. HA has also been recently suggested to increase muscle strength, but its effects on human's muscle and tendon mechanical properties are not yet fully understood. This study investigated the effect of active HA on *gastrocnemius medialis* (GM) muscle-tendon properties.

Methods: Thirty recreationally active participants performed 13 low-intensity cycling sessions, distributed over a 17-days period in hot (HA: $\sim 38^{\circ}\text{C}$, $\sim 58\%$ relative humidity [RH]; $n = 15$) or in temperate environment (CON: $\sim 23^{\circ}\text{C}$, $\sim 35\%$ RH; $n = 15$). Mechanical data and high-frame rate ultrasound images were collected during electrically-evoked and voluntary contractions pre- and post-intervention. Shear modulus was measured at rest in GM and vertical jump performance was assessed.

Results: Core temperature decreased from the first to the last session in HA ($-0.4 \pm 0.3^{\circ}\text{C}$; $P = 0.015$), while sweat rate increased ($+0.4 \pm 0.3 \text{ L}\cdot\text{h}^{-1}$; $P = 0.010$), suggesting effective HA; whereas no changes were observed in CON (both $P \geq 0.877$). Heart rate was higher in HA vs. CON and decreased throughout intervention in groups (both $P \leq 0.008$), without an interaction effect ($P = 0.733$). Muscle-tendon unit properties (*i.e.*, maximal and explosive isometric torque production, contractile properties, voluntary activation, joint and fascicular force-velocity relationship, passive muscle and active tendon stiffness) and vertical jump performance did not show training ($P \geq 0.067$) or group \times training interaction ($P \geq 0.232$) effects.

Conclusion: Effective active heat acclimation does not alter muscle-tendon properties. Preparing hot and humid conditions with active heat acclimation can be envisaged in all sporting disciplines without the risk of impairing muscle performance.

Key-words: repeated hot exposure, exercise, strength, force-velocity properties, stiffness, performance.

The effects of passive hyperthermia on muscle-tendon unit mechanical properties

Adèle Mornas^{1,2}, S. Racinais^{1,3}, F. Brocheffe¹, M. Alhammou³, R. Hager¹, Y. Desmedt¹, G. Guilhem¹
¹French Institute of Sport (INSEP), Laboratory Sport, Expertise and Performance (EA 7370), Paris, France,
²Université de Paris & ³Aspetar Orthopaedic and Sports Medicine Hospital, Doha, Qatar

✉ adele.mornas@insep.fr

INTRODUCTION

- 👉 RFD used to evaluate explosive force [1].
- 👉 RFD increased with Tcore [2].
- 👉 Aim: Understanding the underlying mechanisms behind an improved RFD.

METHOD



GASTROCNEMIUS MEDIALIS (GM) muscle-tendon unit:

- Electrically-evoked and MVC,
- Ballistic contractions,
- Isometric ramp contraction,
- Resting shear modulus.

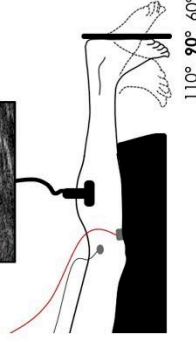
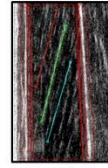

RESULTS

	CON	HOT
MVC force (N)	558 ± 128	531 ± 138
VA (%)	97 ± 5	93 ± 11*
RFD ₀₋₁₀₀ (N.s ⁻¹)	1097 ± 554	1397 ± 439*
RFD ₁₀₀₋₂₀₀ (N.s ⁻¹)	1949 ± 620	1750 ± 607
Muscle shear modulus (kPa)	15.6 ± 4.7	13.6 ± 4.9*
Active tendon stiffness (N.mm ⁻¹)	33.2 ± 8.5	28.5 ± 7.7*

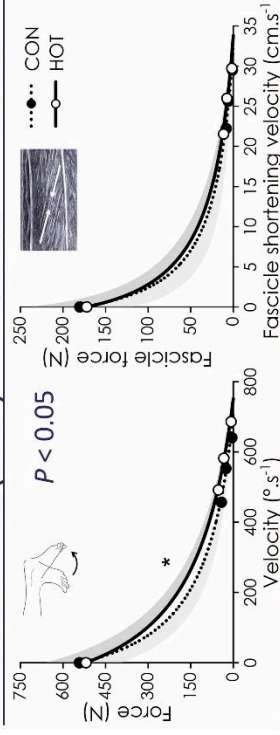

Key results following heat exposure

- 👉 Early RFD (RFD₀₋₁₀₀) increased while late RFD (RFD₁₀₀₋₂₀₀) was unchanged,
- 👉 Fascicle force-velocity properties were unchanged, joint force-velocity relationship shifted to the right,
- 👉 Resting GM muscle and active Achilles tendon stiffness decreased.

REFERENCES

- [1] Maffiuletti et al. (2016). Eur J Appl Physiol, 116: 1091–1116.
- [2] Racinais et al. (2017). Am J Physiol Regul Integr Comp Physiol, 312: 101–107.
- [3] Del Vecchio et al. (2019). J Physiol, 597: 2445–2456.

DISCUSSION

RFD₀₋₁₀₀ is strongly influenced by motor unit recruitment and discharge rate [3]. Results suggest that improved RFD₀₋₁₀₀ was due to faster nerve conduction velocity while soft tissues stiffness decreased could explain unchanged RFD₁₀₀₋₂₀₀.

Perspectives: 1. Addressing the nerve component under heat stress would strengthen our results **2.** These results can help in lessening soft tissue injury using heat therapy.

Passive-induced hyperthermia decreases soft tissues stiffness

Adèle Mornas^{*†1,2}, Sébastien Racinais³, Franck Brocherie¹, Marine Alhamoud³, Robin Hager¹, Yanis Desmedt¹, and Gaël Guilhem¹

¹French Institute of Sport (INSEP), Research Department, Laboratory Sport, Expertise and Performance (EA7370) – Institut National du Sport, de l'Expertise et de la Performance – France

²Université de Paris – Université de Paris – France

³ASPETAR Orthopaedic and Sports Medicine Hospital [Qatar] – Qatar

Résumé

Introduction. It is well established that hyperthermia influences force production and improves muscle contraction velocity [1]. Yet, the underlying mechanisms of these adaptations are poorly understood. Recently, our group demonstrated a reduction in electromechanical delay of plantar flexor muscles following passive heat exposure [2]. Our findings suggested a major putative effect of hyperthermia on the properties of the contractile component of *gastrocnemius medialis* (GM) muscle, with faster electrochemical processes, without fully excluding an opposite effect on the elastic properties of the muscle-tendon unit. Previous works showed that shear modulus (*i.e.*, index of muscle stiffness) measured in passive conditions, increased after the application of cold pulsed air in humans [3], questioning about a possible opposite effect in hot environment. The aim of this study was to investigate the effect of passive-induced hyperthermia on muscle-tendon unit of GM and Achille tendon stiffness properties.

Materials and methods. Nine men and seven women, recreationally active, voluntarily participated in this study. Participants performed two testing sessions in control (CON, 26 °C) and hot environments (HOT, 46-50 °C) following a passive heat exposure inducing hyperthermia. Participants laid prone with their knee fully extended and their ankle flexed at 90° (0° = neutral position) on a customized ergometer. Resting shear modulus of GM was assessed using shear wave elastography and isometric ramp contraction were assessed. The ultrasound probe was firmly attached to the GM muscle belly in a place where fascicles and aponeuroses were clearly visible. For active tendon stiffness, participants performed ramp isometric contractions following a linear increase in isometric plantar flexor force from 0 to 90 % of maximal voluntary contraction peak force, previously determined during two maximal voluntary contraction trials.

Results and discussion. Mean core and muscle temperatures were higher in HOT than CON: 38.4 ± 0.3 °C *vs.* 37.0 ± 0.3 °C and 37.0 ± 0.6 °C *vs.* 34.0 ± 0.8 °C (both $P < 0.001$), respectively. Shear modulus values obtained in resting condition were significantly lower in HOT than CON: 13.7 ± 4.9 kPa *vs.* 15.7 ± 4.7 kPa ($P = 0.03$). Active Achilles tendon stiffness was significantly lower in HOT than CON: 27.8 ± 8.5 *vs.* 32.3 ± 8.2 N.mm⁻¹ ($P = 0.023$). This outcome is in agreement with a recent study conducted in humans. Specifically,

*Intervenant

†Auteur correspondant: adele.mornas@insep.fr

Gimeno et al. [4] reported a decrease in active *biceps femoris* stiffness, by measuring muscle displacement using tensiomyography, following 20-min of warm water immersion. These muscle and tendon mechanical properties may increase the amount of stretch that the muscle tissue is able to sustain. Such effect could be useful in the context of prevention of muscle injury.

Conclusion. Passive-induced hyperthermia decreases the passive muscle stiffness and active tendon stiffness. As such, the muscle-tendon unit properties should be considered when using passive exposure, training, or competing in hot environment.

REFERENCES

Racinais et al. (2017). *Am J Physiol Regul Integr Comp Physiol*, **312**: 101–107.

Mornas et al. (2021). *J Appl Physiol*, **130**: 290-297.

Point et al. (2018). *Scand J Med Sci Sports*, **28**: 260-266.

Gimeno et al. (2020). *Sensors*, **20**: 3193.

Mots-Clés: heat, muscle temperature, core temperature, shear wave elastography, active tendon stiffness

26th ECSS Anniversary Congress, 8-10 September 2021

The effects of active heat acclimation on muscle-tendon unit mechanical properties

MORNAS, A., BROCHERIE, F., GUILHEM, G., GUILLOTEL, A., LE GARREC, S., GOUWY, R., BEUVE, S., GENNISSON, J.L., RACINAIS, S.

French Institute of Sport <INSEP, France>

INTRODUCTION:

Repeated whole-body or localized heating has been suggested to increase muscle strength (1, 2), potentially due to positive changes in skeletal muscle contractile apparatus (3). However, the changes in the mechanical properties of muscle-tendon unit underlying these heat-induced effects remain unclear (4). This study aimed to determine the adaptations in the mechanical properties of gastrocnemius medialis (GM) muscle-tendon unit and their subsequent impact on motor performance elicited by repeated cycling exercise performed in heat. We expected an improvement in muscle contractile responses, potentially explained by positive changes in skeletal muscle structure, while the effect on muscle-tendon unit properties were exploratory.

METHODS:

Twenty-six recreationally active participants (27±5 yrs) were tested before (PRE) and after (POST) 13 low-intensity cycling sessions, distributed over a 17-days period, either in control (CON: 22°C, 35% relative humidity [RH]; n=13) or in hot ambient environment (HOT: 38°C, 60% RH; n=13). During testing, participants laid prone with their knee fully extended and their ankle flexed at 90°. Mechanical data, GM electromyographic activity and high-frame rate ultrasound images were collected during electrically-evoked twitch, explosive and maximal voluntary contractions (MVC), ballistic contractions (0 and 2.6 kg load), isokinetic contractions (30, 200 and 400°s⁻¹) and isometric ramp contractions (from 0 to 90% of MVC). Shear modulus was measured at rest by shear wave elastography in GM in neutral ankle position and in Achilles tendon using a dedicated ultrasound sequence with -25° of plantar flexion. Vertical jumps (i.e. squat jump, counter movement jump and multi-rebound jumps) were also assessed.

RESULTS:

Muscle and core temperature increased after exercising in HOT vs. CON (+2.4°C and +1.7°C, respectively, in HOT vs. +1.5°C and +0.8°C in CON; all P<0.01), resulting in effective heat acclimation with significant decreased core temperature and heart rate from the first to the last session (-0.46°C and -14 beats.min⁻¹; both P<0.01), while core temperature was unchanged (P=0.126) and heart rate decreased in CON (-10 beats.min⁻¹; P=0.004). PRE and POST peak twitch amplitude did not change in HOT and in CON (respectively, 16.4±6.6 vs. 15.9±5.0 N.m⁻¹ in HOT and 17.9±5.3 vs. 17.3±4.7 N.m⁻¹ in CON; both P=0.48), did not affect MVC peak torque (129±25 vs. 137±32 N.m⁻¹ in HOT and 134±42 vs. 135±40 N.m⁻¹ in CON; both P=0.17) and maximal power during vertical jump (P=0.64).

CONCLUSION:

Despite effective heat acclimation, no mechanical variables were altered, conversely to literature (2). The exploration of fascicle dynamic during variable loading conditions will provide insights regarding the alterations in muscle force-velocity properties with heat acclimation.

REFERENCES:

- 1) Kim et al., J Appl Physiol, 2020a
- 2) Racinais et al., Am J Physiol Regul Integr Comp Physiol, 2017
- 3) Kim et al., J Appl Physiol, 2020b
- 4) Mornas et al., J Appl Physiol, 2021

Topic: Neuromuscular Physiology

Presentation form: Oral

European Database of Sport Science (EDSS)

Supported by SporTools GmbH



31805

27th ECSS Anniversary Congress, 30.08 - 02.09.2022

Active heat acclimation does not alter muscle-tendon unit properties

MORNAS, A., BROCHERIE, F., GUILHEM, G., GUILLOTEL, A., LE GARREC, S., GOUWY, R., BEUVE, S., GENNISSON, J.L., RACINAIS, S.

French Institute of Sport <INSEP, France>

INTRODUCTION:

Heat acclimation is strongly recommended before competing in hot and humid conditions (1). Repeated heat exposures have also been suggested to increase muscle strength (2), potentially related to positive changes in skeletal muscle contractile properties (3). However, such effects on muscle and tendon mechanical properties are not yet fully understood in humans. This study aimed to determine the mechanical adaptations of gastrocnemius medialis (GM) muscle-tendon unit elicited by repeated acclimation cycling sessions in the heat (38°C). We expected positive changes in skeletal muscle structure (i.e., increased in muscle thickness), while the effect on muscle-tendon unit properties were exploratory.

METHODS:

Thirty recreationally active male (n=16) and female (n=14) participants (26.6±3.4 yrs) were tested before and after 13 low-intensity cycling sessions (1.3-2.5 W/kg), distributed over a 17-days period. Participants performed cycling sessions in control (CON: 23°C, 35% relative humidity [RH]; n=15) or in hot ambient environment (HOT: 38°C, 58% RH; n=15). During testing, maximal voluntary contraction (MVC) torque, GM muscle architecture, ankle joint and fascicle force-velocity relationship, passive muscle stiffness (i.e., shear modulus) and active tendon stiffness were assessed.

RESULTS:

Muscle (38.4±0.5°C vs. 37.3±1.1°C) and core (39.4±0.4°C vs. 38.3±0.3°C) temperatures were higher after cycling 1 hour in HOT vs. CON (P<0.01). Core temperature and heart rate decreased from the first to the last session in HOT (-0.39±0.3°C and -13±10 beats.min⁻¹; both P<0.01), suggesting heat acclimation. MVC torque was not affected in HOT and in CON (129±20 vs. 136±23 N.m⁻¹ in HOT and 127±32 vs. 131±31 N.m⁻¹ in CON; all P=0.508). Fascicle length, pennation angle and muscle thickness were unchanged (respectively, 5.2±0.5 vs. 5.2±0.5 cm, 16.4±1.6 vs. 16.3±2.3° and 1.5±0.2 vs. 1.5±0.2 cm in HOT; 5.4±0.5 vs. 5.5±0.5 cm, 16.6±1.9 vs. 16.6±2.1° and 1.6±0.2 vs. 1.6±0.2 cm in CON; all P=0.267). Muscle joint and fascicle force-velocity relationship did not change in HOT and in CON (all P=0.22). Passive muscle stiffness and active tendon stiffness were not affected (respectively, 13.2±1.6 vs. 13.1±1.5 kPa and 26.0±8.1 vs. 25.6±7.4 N.mm⁻¹ in HOT and 15.2±2.3 vs. 14.3±1.9 kPa and 23.4±6.1 vs. 23.6±6.7 N.mm⁻¹ in CON; all P=0.30).

CONCLUSION:

The present findings show that 13 sessions of effective heat acclimation did not modify muscle-tendon unit properties. Previously reported improvement in muscle strength was not observed and may not be associated to such adaptations in muscle-tendon mechanical properties (2, 3). These data suggest that an active heat stress acclimation is beneficial from a physiological point of view without altering muscle architecture and muscle-tendon mechanical properties.

REFERENCES:

- 1) Racinais et al., Br J Sports Med P, 2015
- 2) Racinais et al., Am J Physiol Regul Integr Comp Physiol, 2017
- 3) Kim et al., J Appl Physiol, 2020

Topic: Biomechanics

Presentation form: Oral

European Database of Sport Science (EDSS)

Supported by SporTools GmbH



31805



- Dissemination of findings
 None of the above

Give details of involvement, or if none please justify the absence of involvement

(Please delete the explanatory text under each point once you have filled in your information)

1.2 Project summary

The use of cold on muscle (Ice, Cold Water Immersion - CWI or cryotherapy) is a widespread practice used by health professionals, athletes or non-athletic population in the treatment of muscle soreness and soft tissue injuries. Application of cold on muscle is well known to decrease inflammation and reduce pain perception^{1,2}. However, some studies in humans and animals have reported contrasted effects of cold on muscle regeneration³⁻⁶. On the other hand, recent studies in humans suggest that passive heat exposure can impact positively muscle protein synthesis, mitochondrial content⁷ and muscle torque^{8,9} in different types of populations. Rodent studies comparing heat and cold modalities following a muscle injury have reported that only repeated heat exposure enhances cross sectional area, accelerate macrophage infiltration in damaged fibers and enhances satellite cells activation which led to a faster muscle regeneration^{4,5}. As such heat therapy may be a promising tool to accelerate recovery after muscle injury¹⁰. This study will investigate the effect of three distinct thermal interventions (Hot, Cold and Thermoneutral water immersion) on human skeletal muscle regeneration after an eccentric exercise. 36 participants will be distributed in a counterbalanced way into 3 groups being immersed for 15min to 1h per day in either HEAT or COLD or NEUTRAL water for 10 days following eccentric contractions.

AZF IRB APPROVED

1.3 Background information & study rationale

Cold exposure is a therapeutic modality supposed to enhance regeneration by alleviating pain, reducing tissue metabolism and restricting swelling and inflammation process². However, in light of some recent studies in animal models and in humans, cold application on injury might delay and impair muscle regeneration^{3,6,11}. At the same time, passive heat therapy emerges as a novel powerful strategy to enhance muscle recovery¹⁰. Indeed, in healthy subjects it has been shown that 1H/day of passive heat exposure during 11 days enhances muscle torque through an improvement in contractile muscle function⁹. In an immobilization context, it was recently reported that repeated passive heat exposure may reduce muscle atrophy and induce mitochondrial adaptations⁷.

In rats, heat exposure following chemically-induced injury has been shown to enhance muscle regeneration by increasing muscle weight and cross-sectional area compared to non-heated^{4,12,13} or cold exposed rats^{5,14}. Macrophage infiltration were reported to migrate to injury site earlier in heated animals compared to non-heated⁴ and icing-treated groups⁵. In the same way, heat exposure was associated with an increase in satellite cells number in injured muscle fibers^{4,5,12}. In addition, Shibagushi et al. (2019) have shown that ice application immediately after injury has delayed the recovery of Myosin Heavy Chain (MyHC) profile and in contrast, repeated heat application has facilitated the recovery of an uninjured MyHC profile. Interestingly, collagen fibers area and TGF- β 1 (a collagen precursors) were shown to be lower in heated groups than in control and iced groups suggesting less muscle fibrosis^{4,5,15}. Animal studies suggest that heat exposure may be a potent stimulus to enhance soft tissue regeneration after injury.

Very few human studies have examined the impact of local heat exposure on regeneration after muscle injury. A recent study from Kim et al. focusing on muscle regeneration in humans, have investigated the effects of a heat therapy protocol composed of five daily 90 minutes sessions with heating garment performed after an exercise-based injury protocol composed of 300 maximal voluntary eccentric contractions. Compared to

RÉSUMÉ SUBSTANTIEL EN FRANÇAIS

De nos jours, les athlètes, quelque soit leur niveau de pratique, sont de plus en plus exposés à des conditions environnementales (température et humidité) contraignantes. Bien que de nombreuses études ont permis d'approfondir notre compréhension des effets du stress thermique (chaleur) sur la physiologie humaine et sa thermorégulation (*i.e.*, augmentation du stress physiologique induit par la chaleur, qui est réduit par des adaptations qui font suite à des expositions répétées à la chaleur), les effets induits par un stress aigu ou chronique sur les propriétés musculaires et tendineuses sont encore mal connus *in vivo*.

Il est établi qu'une exposition passive à la chaleur, induisant une augmentation de la température centrale, altère la production maximale de force volontaire et accélère la vitesse de conduction nerveuse, sans pour autant que les mécanismes sous-jacents ne soient maîtrisés. À notre connaissance, bien que la dynamique des faisceaux musculaires soit essentielle dans la compréhension de la performance motrice, peu d'études se sont attachées à décrire leur comportement lors d'un exercice réalisé en environnement chaud. Des expositions répétées à la chaleur semblent induire une augmentation de la force musculaire, potentiellement liée à une hypertrophie musculaire suite à des adaptations cellulaires, sans pour autant que les effets d'une telle exposition ne soient rapportés en ce qui concerne les propriétés et les interactions muscle-tendon. Ainsi, les mécanismes sous-jacents responsables de ces adaptations restent à élucider pour mieux comprendre les effets du stress thermique sur la performance motrice, qu'il s'agisse d'une exposition aiguë ou chronique, et passive ou active.

Ce travail de thèse vise à décrire les réponses des systèmes neuromusculaires et musculo-tendineux (*i.e.*, production de force maximale et explosive électro-induite et volontaire, relations force-vitesse et force-longueur, raideur musculaire et tendineuse) induites par une exposition à la chaleur engendrant une augmentation de la température centrale et musculaire. La partie expérimentale de ce travail de thèse rassemble trois études, ayant explorées les propriétés de l'unité muscle-tendon par échographie ultrarapide, afin d'étudier la dynamique des faisceaux *in vivo* lors de mouvements brefs, telles que des contractions électro-induites et des contractions volontaires isométriques et balistiques. Nous nous sommes concentrés sur l'unité muscle-tendon du *gastrocnemius medialis*, muscle pluri-articulaire pour lequel les mesures d'échographie ultrarapide sont particulièrement adaptées et dont la fiabilité a été

démontrée. Dans un contexte de performance sportive, la contribution expérimentale de cette thèse s'est concentrée sur une exposition totale à la chaleur (*i.e.*, corps entier), couramment utilisée par les athlètes lors de leurs entraînements et/ou de leur préparation à des compétitions réalisées en environnement chaud.

Une étude préliminaire à ce travail de thèse nous a permis d'identifier les effets d'une exposition passive à la chaleur sur le délai électromécanique et ses composantes. Cette étude a rapporté une diminution du délai électromécanique avec l'exposition à la chaleur, associée à une accélération des processus électrochimiques (*i.e.*, transmission synaptique, propagation des potentiels d'action le long du sarcolemme et couplage excitation-contraction), alors que le délai de transmission de la force le long de l'aponévrose et du tendon d'Achille restait inchangé. Cette première étape a permis d'améliorer notre compréhension des mécanismes impliqués au niveau des propriétés contractiles suite à une exposition aiguë à la chaleur. Ce travail préliminaire ouvre également la possibilité de décrire plus en détail le rôle de la dynamique muscle-tendon dans les effets de la chaleur sur les capacités motrices.

La première étude de ce travail de thèse avait pour objectif de déterminer les effets d'une exposition passive à la chaleur sur les propriétés de l'unité muscle-tendon du *gastrocnemius medialis*. Pour cela, seize participants ont réalisé des contractions électro-induites et volontaires (*i.e.*, contractions maximales isométriques, contractions isométriques suivant une rampe de force progressive et contractions balistiques), combinées avec des mesures d'échographie ultrarapide. Les tests ont été réalisés tout d'abord en environnement tempéré ($\sim 26^{\circ}\text{C}$), puis en environnement chaud après une exposition passive à la chaleur ($\sim 47^{\circ}\text{C}$), d'une durée de 127 ± 33 min, ayant induit une augmentation de la température centrale jusqu'à $38.4 \pm 0.3^{\circ}\text{C}$. Les résultats ont rapporté une tendance à une diminution du niveau de force maximale volontaire produite ($-5.0 \pm 11.3\%$; $P = 0.052$) et une diminution significative du niveau d'activation volontaire ($-4.6 \pm 8.7\%$; $P = 0.038$) après exposition à la chaleur. Nous avons également observé une augmentation significative du taux de montée en force dans sa phase précoce (*i.e.*, de l'initiation de la contraction à 100 ms), sans changement dans la phase plus tardive du taux de montée en force (*i.e.*, après 100 ms). La dynamique des faisceaux lors des contractions électro-induites et volontaires restait inchangée entre les deux conditions environnementales. Bien que la vitesse angulaire à un niveau de force donné était plus importante avec l'exposition à la chaleur ($+7.1 \pm 6.6\%$; $P = 0.004$), la relation force-vitesse au niveau fasciculaire n'a pas été affectée. La raideur musculaire passive et la raideur tendineuse active étaient diminuées

avec l'exposition à la chaleur ($P \leq 0.030$). Cette étude a montré que l'augmentation du taux de montée en force dans sa phase précoce ne serait pas due à des modifications des propriétés contractiles. L'absence de modification du taux de montée en force dans sa phase tardive pourrait être liée à la diminution de raideur des tissus obtenue. De nouvelles investigations semblent nécessaires pour étudier les effets de la chaleur sur la transmission nerveuse et le recrutement des unités motrices, et ainsi mieux comprendre les facteurs responsables de l'amélioration de la force explosive induite par une exposition passive à la chaleur.

La deuxième étude de ce travail de thèse a investigué les effets d'une exposition aiguë à la chaleur sur les interactions muscle-tendon et la dynamique des faisceaux chez des participants actifs (*i.e.*, lors d'un exercice de course à pied). Pour cela, quinze participants ont couru 40 min à 10 km.h⁻¹ sur un tapis roulant en environnement tempéré (~23°C) et en environnement chaud (~38°C), lors de deux visites effectuées dans un ordre randomisé. La force maximale volontaire, ainsi que la raideur passive des trois chefs du *triceps surae* et la raideur active du tendon d'Achille étaient mesurées avant et après l'exercice de course à pied réalisé dans les deux conditions environnementales. Lors de la course à pied, la dynamique des faisceaux du *gastrocnemius medialis* était mesurée grâce à des acquisitions échographiques ultrarapides, puis le comportement des faisceaux a été positionné sur la relation force-longueur préalablement déterminée (*i.e.*, avant l'exercice). Les résultats ont montré des paramètres spatiotemporels de course (*i.e.*, temps de contact, temps de vol), ainsi que des longueurs d'action des faisceaux inchangées avec la durée de l'exercice (*i.e.*, 2 min vs. 40 min) et avec l'environnement (tempéré vs. chaud). La production de force maximale volontaire a eu tendance à diminuer avec l'exercice ($P = 0.060$), alors que la raideur des tissus (*i.e.*, la raideur passive des trois chefs du *triceps surae* et la raideur active du tendon d'Achille) n'a rapporté aucun effet de la durée de l'exercice ($P \geq 0.281$) ou de la condition environnementale ($P \geq 0.256$). Cette étude a révélé qu'un exercice de course à pied prolongé à intensité modérée et/ou réalisé à une température ambiante élevée n'altère pas les propriétés et les interactions de l'unité muscle-tendon du *gastrocnemius medialis*.

Enfin, la troisième étude de ce travail de thèse a mesuré les effets d'une acclimatation active à la chaleur sur les propriétés de l'unité muscle-tendon. Trente participants actifs ont effectué treize séances sur cycloergomètre à faible intensité (*i.e.*, entre 1.3 et 2.5 W.kg⁻¹), réparties sur une période de dix-sept jours et effectuées en environnement chaud (~38°C, $n = 15$) ou tempéré (~23°C, $n = 15$). Des données mécaniques et échographiques ont été collectées lors de

contractions électro-induites et volontaires (*i.e.*, contractions maximales et explosives volontaires, contractions balistiques et isocinétiques, contractions isométriques suivant une rampe de force progressive) avant et après l'intervention (*i.e.*, treize séances de pédalage). La raideur passive du *gastrocnemius medialis* ainsi que la performance lors de sauts verticaux ont également été évaluées avant et après l'intervention. Le protocole d'entraînement a induit une acclimatation à la chaleur effective d'un point de vue physiologique, avec une diminution de la température centrale entre la première et la dernière séance ($-0.4 \pm 0.3^{\circ}\text{C}$; $P = 0.015$) et une augmentation du taux de sudation ($+0.4 \pm 0.3 \text{ L}\cdot\text{h}^{-1}$; $P = 0.010$) pour le groupe ayant réalisé l'intervention en environnement chaud, alors qu'aucun changement n'a été observé pour le groupe contrôle ($P \geq 0.877$). Cependant, ni les propriétés de l'unité muscle-tendon mesurées (*i.e.*, propriétés contractiles des contractions électro-induites, production volontaire de force maximale et explosive, niveau d'activation volontaire, relations force-vitesse articulaire et fasciculaire, raideur passive du *gastrocnemius medialis* et raideur active du tendon d'Achille), ni la performance mesurée lors de sauts verticaux n'ont rapporté d'effet de l'intervention ($P \geq 0.067$) ou d'effet d'interaction groupe \times intervention ($P \geq 0.232$). Cette étude nous a permis d'améliorer notre compréhension de la motricité humaine avec le stress thermique, et permet d'apporter des recommandations pratiques aux entraîneurs et aux athlètes. L'acclimatation à la chaleur, nécessaire pour induire des adaptations physiologiques et mieux supporter le stress thermique lors d'entraînements ou compétitions en environnement chaud, n'altère ni les propriétés de l'unité muscle-tendon, ni les performances musculaire et multi-articulaire.

Les interactions muscle-tendon fournissent des informations cruciales dans la description et la compréhension de la performance motrice. Ce travail de thèse nous a permis de mieux comprendre les impacts d'un stress thermique sur la performance motrice humaine à différentes échelles du mouvement (*i.e.*, des faisceaux musculaires aux mouvements pluri-articulaires) et de fournir des recommandations pratiques aux entraîneurs et athlètes confrontés à des environnements chauds. Grâce à l'échographie ultrarapide, il a été possible d'étudier le comportement des faisceaux musculaires *in vivo* lors de contractions dynamiques *in situ* (*i.e.*, lors d'un exercice de course à pied), et de fournir ainsi des informations mécanistiques sur les réponses de l'unité muscle-tendon au stress thermique. Les résultats de nos études peuvent être résumés en deux messages clés. Premièrement, nous avons montré qu'**une exposition passive aiguë à la chaleur améliorerait la production de force explosive dans sa phase précoce, ce qui peut être attribué à une amélioration de la commande nerveuse, alors que la raideur des tissus musculaires et tendineux était diminuée**. Ces résultats mettent en évidence des

effets découplés de la chaleur sur les propriétés contractiles et passives de l'unité muscle-tendon. Deuxièmement, **l'exposition active à la chaleur, qu'elle soit aiguë (lors d'un exercice de course à pied) ou chronique (lors d'un protocole actif d'acclimatation à la chaleur), n'induit aucune altération des propriétés de l'unité muscle-tendon.**

En quelques mots, ce travail de thèse a montré qu'un exercice modéré réalisé en environnement chaud n'altère pas les propriétés musculaires. D'autres recherches pourraient étendre les résultats actuels à des exercices plus longs et/ou plus intenses ainsi qu'à différentes populations (*e.g.*, âge, sexe, sport pratiqué).

Acute and chronic impact of heat exposure on muscle-tendon properties and interplay: from muscle to movement

Abstract: Nowadays, athletes are increasingly exposed to high environmental temperatures. While many studies investigated the effects of heat stress on human physiology, the effects of acute or repeated heat exposure on muscle-tendon properties and function are not fully understood *in vivo*. Therefore, the purpose of this PhD thesis is to describe the responses of the neuromuscular and musculotendinous system (*i.e.*, voluntary and electrically-evoked maximal and explosive force production, force-velocity and force-length relationships and elastic properties) *in vivo*, using ultrafast ultrasound, under heat stress. The experimental part of this work is based on three studies, focused on *gastrocnemius medialis* muscle-tendon unit. The first study aimed to determine the effects of passive heat exposure on muscle-tendon unit properties. Our results showed an acceleration of rate of force development in the early phase, while soft tissue stiffness decreased. The second study investigated the acute effects of heat exposure on muscle-tendon interactions and fascicle dynamics in active participants (*i.e.*, during running). We demonstrated that muscle-tendon unit properties and operating fascicle lengths during running were unaffected by environmental temperatures up to 40 min of running at 10 km.h⁻¹. The third study measured the impact of active heat acclimation on muscle-tendon unit properties. While the training protocol (*i.e.*, repeated low-intensity cycling sessions) induced effective physiological adaptations, the properties of muscle-tendon unit assessed and the performance in vertical jump were unchanged. These findings offer the opportunity to improve our understanding of human motor skills responses to heat stress and to provide practical recommendations to coaches and athletes exposed to hot environments.

Keywords: heat exposure, muscle-tendon interactions, force-velocity properties, force-length properties, tissue stiffness, muscle performance, ultrafast ultrasound

Impact aigu et chronique de l'exposition à la chaleur sur les propriétés et les interactions muscle-tendon : du muscle au mouvement

Résumé : De nos jours, les athlètes sont de plus en plus exposés à des températures environnementales élevées. Bien que de nombreuses études aient étudié les effets de la chaleur sur la physiologie humaine, les effets induits par un stress aigu ou chronique sur les propriétés musculaires et tendineuses sont encore méconnus *in vivo*. L'objectif de cette thèse de doctorat était de décrire les réponses des systèmes neuromusculaires et musculo-tendineux (*i.e.*, production de force maximale et explosive électro-induite et volontaire, relations force-vitesse et force-longueur, et raideurs des tissus) *in vivo*, à l'aide de l'échographie ultrarapide, suite à un stress thermique. La partie expérimentale de cette thèse est basée sur trois études, focalisées sur l'unité muscle-tendon du *gastrocnemius medialis*. La première étude avait pour objectif de déterminer les effets d'une exposition passive à la chaleur sur les propriétés de l'unité muscle-tendon. Les résultats montrent une accélération du taux de montée en force dans sa phase précoce, alors que la raideur des tissus était diminuée après une exposition passive à la chaleur. La deuxième étude a investigué les effets d'une exposition aiguë à la chaleur sur les interactions muscle-tendon et la dynamique des faisceaux lors d'un exercice de course à pied. Nos résultats ont démontré que les propriétés de l'unité muscle-tendon et que la longueur d'action des faisceaux pendant la course ne sont pas affectées par les températures environnementales au cours de l'exercice (*i.e.*, 40 min à 10 km.h⁻¹). Enfin, la troisième étude de cette thèse consistait à mesurer les effets d'une acclimatation active à la chaleur sur les propriétés de l'unité muscle-tendon. Bien que le protocole d'entraînement (*i.e.*, des sessions répétées de pédalage à faible intensité) ait effectivement induit des adaptations physiologiques, les propriétés musculaires et tendineuses ainsi que la performance lors de sauts verticaux n'ont pas été modifiées. Ces résultats offrent l'opportunité d'améliorer notre compréhension de la motricité humaine en réponse au stress thermique et nous permettent d'apporter des recommandations pratiques aux entraîneurs et aux athlètes confrontés à des environnements chauds.

Mots-clés : exposition à la chaleur, interactions muscle-tendon, propriétés force-vitesse, propriétés force-longueur, raideur des tissus, performance musculaire, échographie ultrarapide