



**HAL**  
open science

# Long-term Energy Pathways in Ecuador: transition Scenarios for the Transport Sector up to 2050

Daniel Villamar

► **To cite this version:**

Daniel Villamar. Long-term Energy Pathways in Ecuador: transition Scenarios for the Transport Sector up to 2050. Electric power. Université de Perpignan, 2023. English. NNT : 2023PERP0014 . tel-04564352

**HAL Id: tel-04564352**

**<https://theses.hal.science/tel-04564352>**

Submitted on 30 Apr 2024

**HAL** is a multi-disciplinary open access archive for the deposit and dissemination of scientific research documents, whether they are published or not. The documents may come from teaching and research institutions in France or abroad, or from public or private research centers.

L'archive ouverte pluridisciplinaire **HAL**, est destinée au dépôt et à la diffusion de documents scientifiques de niveau recherche, publiés ou non, émanant des établissements d'enseignement et de recherche français ou étrangers, des laboratoires publics ou privés.

# THÈSE

Pour obtenir le grade de  
Docteur

Délivré par

**UNIVERSITE DE PERPIGNAN VIA DOMITIA**

Préparée au sein de l'école doctorale

Et de l'unité de recherche

ED 305 - PROMES

Spécialité :

Physique et sciences de l'ingénieur

ED 305 - PROMES

Présentée par

Daniel Villamar Cabezas

## TITRE DE LA THESE

Chemins énergétiques à long terme en Équateur :  
scénarios de transition pour le secteur des  
transports jusqu'en 2050

Soutenue le 17 avril 2023

devant le jury composé de :

Professeur <b>Rick Greenough</b> , Université De Monfort, UK;	Rapporteur
Professeur <b>Ludovic Montastruc</b> , Lab. LGC, Université de Toulouse, France;	Examineur
Professeur <b>Pierre Neveu</b> , Lab. PROMES, Perpignan, France;	Examineur
Professeur <b>Martin Schmidt</b> , University of Trier, Germany;	Rapporteur
Associate Professor <b>David Rey</b> , SKEMA Business School, Nice, France;	Examineur
Professeur <b>Didier Aussel</b> , Professeur, Université de Perpignan Via Domitia, France;	Directeur de thèse
Professeur <b>Freddy Ordoñez</b> , Escuela Politécnica Nacional, Ecuador;	Co-directeur de thèse
Professeur <b>Rafael Soria</b> , Universidad San Fancisco de Quito, Ecuador	Co-encadrant de thèse



---

## **Acknowledgements**

The development of this study would not have been possible without the support of the FSPI Project - Doctoral Schools of the French Embassy in Ecuador, financed by the Ministry of Europe and Foreign Affairs.

A big thank you to the professors who were part of my CSI and my thesis jury.

During my research I had the support of three amazing professors: I thank Rafael Soria for including me in the research group with which we created the ELENA model and for all his support during all these years, Freddy Ordoñez for his always relevant help and guidance, and Didier Aussel for leading me through the uneasy and exciting waters of Game Theory, always with patience and dedication.

I would like to thank my family for their constant support, which has always allowed me to push my limits. Finally, I would like to thank my wife Paola, ruler of my outbursts, antidote of my bad moods and watcher of my sleepless nights, thanks to her everything is possible.



# Table of Contents

Acknowledgements . . . . .	i
<b>1 Introduction (French and English version)</b>	<b>1</b>
1.1 Présentation des modèles énergétiques . . . . .	5
1.1.1 Modèle d'équilibre général (MEG) . . . . .	6
1.1.2 Modèle d'équilibre partiel (MEP) . . . . .	6
1.1.3 Modèles descendants et ascendants . . . . .	6
1.2 Modèles énergétiques pour l'Équateur . . . . .	7
1.3 Modèle ELENA . . . . .	8
1.4 Approche SLMF . . . . .	10
1.5 Energy models overview . . . . .	15
1.5.1 General equilibrium model (GEM) . . . . .	16
1.5.2 Partial equilibrium model (PEM) . . . . .	16
1.5.3 Top-down and bottom-up models . . . . .	16
1.6 Energy models for Ecuador . . . . .	16
1.7 ELENA model . . . . .	18
1.8 SLMF approach . . . . .	19
<b>2 The ELENA Model</b>	<b>21</b>
2.1 Introduction and context . . . . .	21
2.2 Paper Long-term deep decarbonisation pathways for Ecuador: Insights from an integrated assessment model . . . . .	22
<b>3 Review of Elena and urbs soft-link analysis</b>	<b>65</b>
3.1 Introduction and context . . . . .	65
3.2 Preparing the Ecuador's power sector to enable a large-scale electric land transport . . . . .	66
3.2.1 Results . . . . .	69
3.2.2 Conclusions . . . . .	70
<b>4 ELENA in the buildings sector</b>	<b>73</b>
4.1 Introduction and context . . . . .	73
4.2 A global comparison of building decarbonization scenarios by 2050 towards 1.5-2C° targets . . . . .	74
<b>5 A short introduction to Multi-Leader-Follower games</b>	<b>97</b>
5.1 Review of the Single Leader Multi Follower Games . . . . .	97
5.1.1 Game theory's milestones overview . . . . .	97
5.1.2 The Stackelberg model . . . . .	98
5.1.3 Game Theory applications . . . . .	98

---

5.2	Basic facts on optimization . . . . .	99
5.2.1	Optimization primal formulation . . . . .	99
5.2.2	Associated KKT . . . . .	100
5.2.3	Constraints Qualification . . . . .	101
5.3	Nash Games . . . . .	102
5.3.1	Nash equilibrium games . . . . .	102
5.3.2	The Generalized Nash Equilibrium Problem (GNEP) . . . . .	104
5.3.3	Concatenated KKT . . . . .	105
5.4	Bilevel optimization . . . . .	105
5.5	Multi-Leader-Follower Game . . . . .	108
5.5.1	Multi-Leader-Single-Follower Game . . . . .	108
5.5.2	Single-Leader-Multi-Follower Game . . . . .	110
5.6	On the reformulation of Single-Leader-Multi-Follower games . . . . .	111
5.6.1	A first MPCC reformulation . . . . .	111
5.6.2	MPCC reformulation by the penalty method . . . . .	112
5.6.3	Reformulation using the Big M method . . . . .	113
5.7	Explicit resolution of an example of Single-Leader-Two-Followers Game . . . . .	114
<b>6</b>	<b>A bilevel optimization approach of energy transition in freight trans- port: SOS1 method and application to the Ecuadorian case</b>	<b>127</b>
6.1	Abstract . . . . .	127
6.2	Introduction . . . . .	128
6.3	Problem and Model . . . . .	129
6.3.1	Transport and carbon emissions . . . . .	129
6.3.2	The Single-Leader-Multi-Follower game . . . . .	129
6.4	Methodology for solving the SLMFG . . . . .	136
6.4.1	The MPCC reformulation . . . . .	136
6.4.2	MPCC Resolution . . . . .	138
6.5	Application to the Ecuadorian freight transport . . . . .	140
6.5.1	Context and data . . . . .	140
6.5.2	Results and discussion . . . . .	141
6.6	Conclusion . . . . .	145
<b>7</b>	<b>Conclusions and Future Perspectives</b>	<b>147</b>
7.1	Conclusions . . . . .	147
7.2	Future perspectives . . . . .	149
	<b>Bibliography</b>	<b>151</b>
	Appendices . . . . .	158
	Abstract . . . . .	166

---

# Chapter 1

## Introduction (French and English version)

### Introduction

Le changement climatique est l'un des plus grands défis auxquels l'humanité est confrontée aujourd'hui. Dans les années 1970, la communauté scientifique a commencé à alerter sur la façon dont les activités humaines ont un impact marqué sur la planète et sur la façon dont les émissions anthropiques de CO<sub>2</sub> affecteront le climat mondial. En 1975, le géochimiste Wallace Broecker a été le premier à parler de "réchauffement climatique" lorsqu'il a mis en garde contre l'altération des cycles de refroidissement de la Terre due à l'accumulation de dioxyde de carbone et a prédit une augmentation sans précédent de la température au cours du siècle prochain<sup>1</sup>. Ce concept a pris beaucoup d'ampleur et met la communauté scientifique en alerte. En 1979, la première conférence mondiale sur le climat s'est tenue à Genève et met en garde contre les effets possibles du réchauffement de la planète. Près d'un demi-siècle s'est écoulé, les effets du changement climatique commencent à se faire sentir et nous sommes toujours à la recherche de technologies qui nous permettront de réduire les émissions de CO<sub>2</sub> que nous produisons. De nombreux progrès ont été réalisés en matière de planification, de communication et de cadres juridiques pour faire face à ce phénomène. En 1988, le Groupe d'experts intergouvernemental sur l'évolution du climat (GIEC) a été créé pour coordonner les actions internationales visant à réduire les émissions. Les conférences sur le climat ont fait place à des accords mondiaux tels que le protocole de Kyoto ou l'accord de Paris, dans lesquels les pays signataires s'engagent à réduire leurs émissions.

L'un des outils dont nous disposons pour évaluer les effets possibles du changement climatique mondial est le modèle mathématique. Un modèle est une représentation simplifiée d'un phénomène réel, régie par des équations et des inéquations qui cherchent à émuler le comportement du phénomène représenté face à des variations de l'environnement. Parmi les nombreuses définitions de ce qu'est un modèle, il est proposé dans<sup>2</sup> qu'une caractéristique commune partagée par tous les modèles est qu'ils sont une représentation intentionnelle et simplifiée d'aspects de la réalité.

Les modèles sont utilisés pour recréer une partie de la réalité en cherchant à comprendre les processus et les interactions qui régissent cette réalité. Les modè-

---

les permettent de tester la réaction d'un système à un stimulus externe. Enfin, les résultats du modèle sont utilisés pour revenir à la réalité afin de mettre en œuvre ce qui a été appris, en cherchant à le comprendre et, si possible, à l'organiser. En termes de modélisation du changement climatique, les outils les plus connus pour comprendre l'interaction globale sont le modèle de circulation générale (GCM) et les modèles du système terrestre (ESM). Les premiers sont basés sur des équations physiques telles que les équations de Navier-Stokes pour modéliser les processus atmosphériques ou océaniques. Les seconds incluent également l'interaction entre les processus physiques, chimiques et biologiques dans l'analyse, ce qui les rend plus complexes et exigeants en termes de calcul. L'objectif de ces modèles est d'étudier les circonstances climatiques du passé ou d'étudier les scénarios futurs possibles. Le GIEC fonde ses analyses sur de tels modèles pour simuler l'effet des "Representative Concentration Pathways" décrivant les niveaux de concentration des gaz à effet de serre<sup>3</sup>. Malgré l'intérêt mondial pour la décarbonisation, le GIEC prévient qu'avec les politiques mises en place, le risque d'atteindre des augmentations de température allant jusqu'à 4°C au-dessus des niveaux préindustriels subsiste<sup>3</sup>. La figure 1.1 montre l'évolution des émissions de GES analysées par le GIEC. Chaque trajectoire d'émission comporte une part d'incertitude, mais la différence entre les trajectoires qui maintiennent la tendance actuelle et celles qui cherchent à réduire les émissions est claire. Les tendances actuelles ne diffèrent pas beaucoup de celles établies il y a 15 ans, ni des perspectives catastrophiques que cette augmentation aurait<sup>4</sup>. L'évolution des émissions du scénario, y compris les politiques mises en œuvre, double les objectifs qui ont été fixés dans le cadre d'un consensus mondial pour réduire les effets du changement climatique mondial. Trois autres voies sont envisagées par le GIEC, dont deux comprennent une vision de réduction immédiate des émissions, limitant le risque de dépassement des seuils de température de 1°C et 2°C. Une troisième voie, marquée en bleu, représente une décarbonisation plus tardive qui implique à un moment donné de dépasser l'augmentation de température. Ce dépassement mettrait en danger la biodiversité de certaines espèces marines et terrestres<sup>5</sup>.



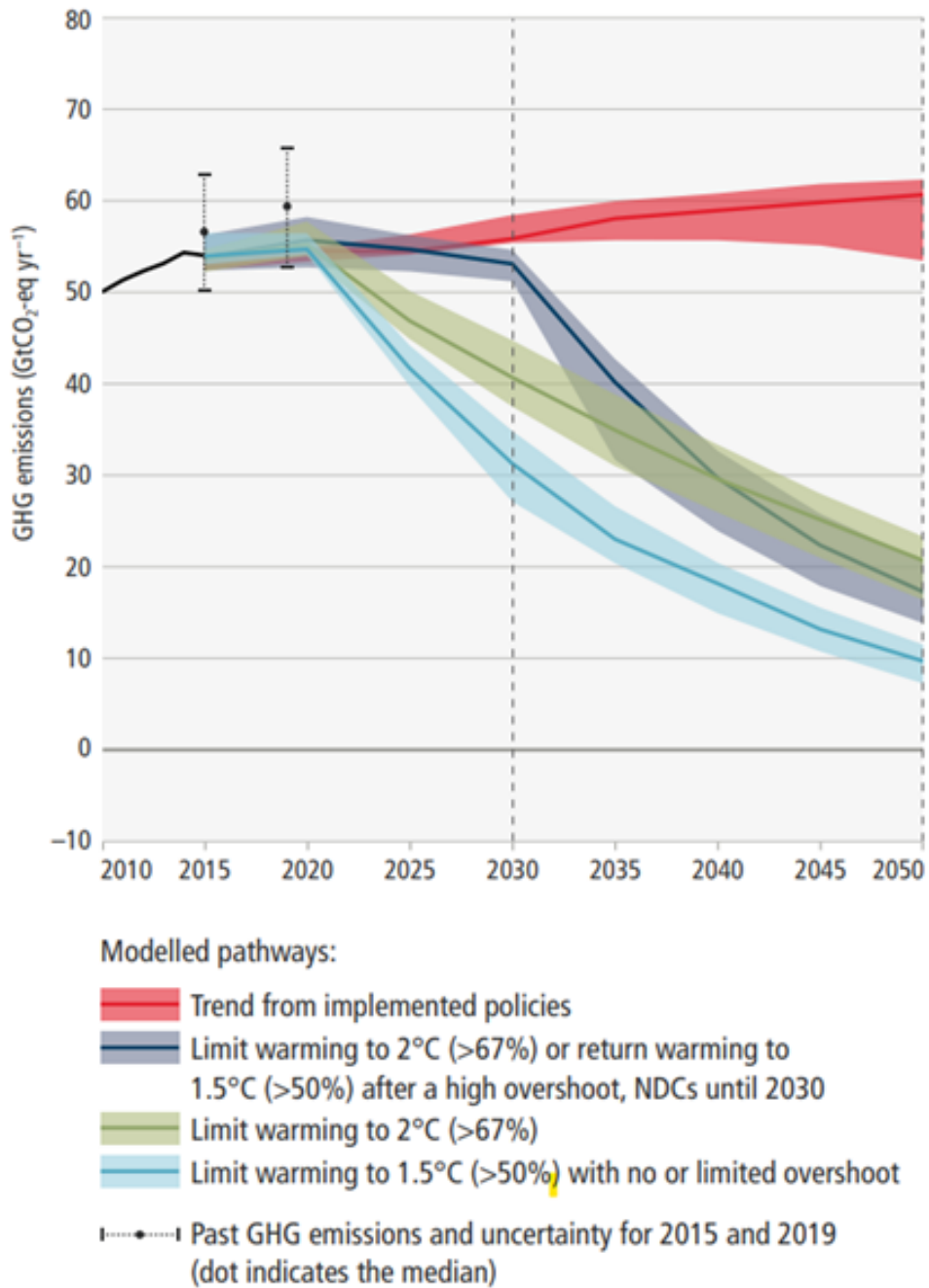
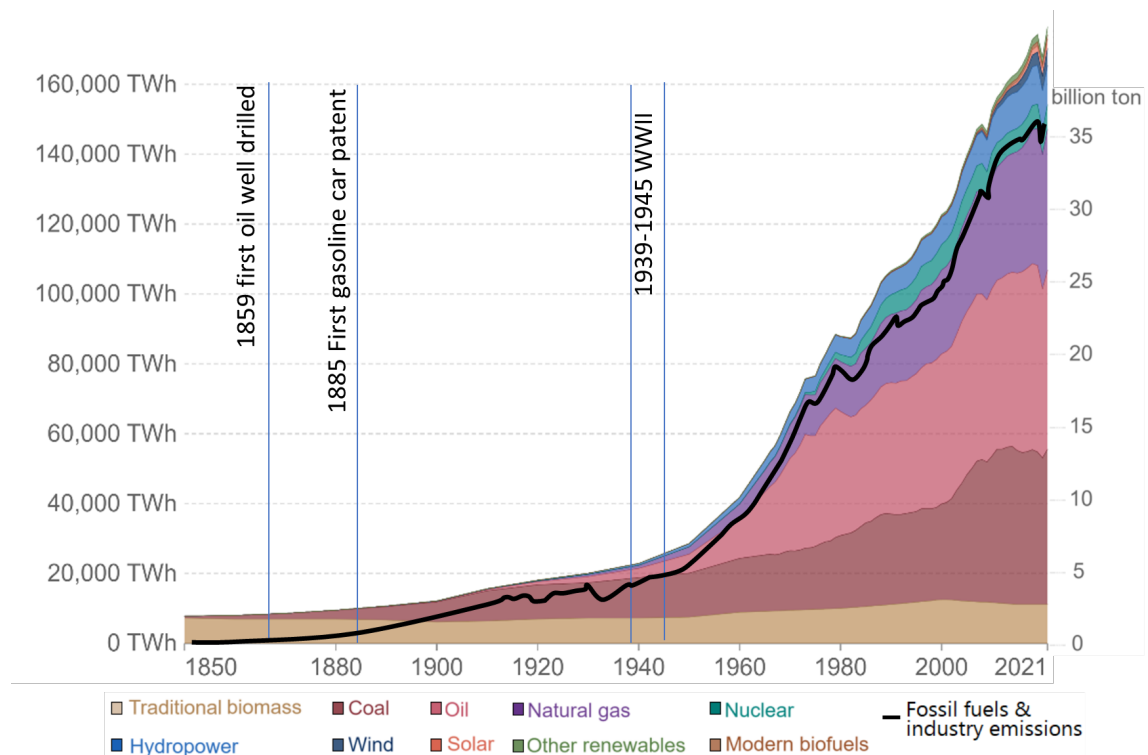

Figure 1.1: Projection à 2050 des émissions globales de gaz à effet de serre<sup>6</sup>

L'accord de Paris stipule que, jusqu'à la fin du siècle, la température moyenne mondiale doit être maintenue à 2°C au-dessus des niveaux préindustriels pour éviter des changements catastrophiques. Un objectif plus ambitieux consiste à maintenir l'augmentation de la température à moins de 1,5°C, mais il nécessite une réduction importante des émissions à partir de 2020. Sans aucun doute, la lutte contre le changement climatique est un effort mondial, où des institutions telles que le GIEC et des instruments tels que les accords mondiaux, englobent certains des efforts entrepris. Toutefois, sans sous-estimer les synergies régionales qui peuvent être réalisées, la lutte contre le changement climatique exige, dans une large mesure, des efforts individuels de chaque pays pour poursuivre la décarbonisation. Chaque pays devra concevoir les stratégies les plus appropriées et

les moins coûteuses pour atteindre les objectifs mondiaux. Il existe un consensus mondial, avec peu de voix discordantes, sur le fait que les émissions de gaz à effet de serre (GES) sont la cause du changement climatique. Les processus qui génèrent ces gaz doivent donc être évalués et reformulés. La figure 1.2 montre l'évolution des émissions (axe de gauche) depuis 1950, ainsi que l'historique de la demande en énergie primaire (axe de droite). D'après les données présentées, la relation entre les émissions et les énergies, en particulier celles basées sur les ressources fossiles, est claire.



Il est possible d'identifier différentes étapes dans l'évolution des émissions. L'exploitation du pétrole commence en 1859 et, à court terme, on observe des applications utiles du pétrole, notamment le premier véhicule équipé d'un moteur à essence en 1885. Toutefois, c'est au cours de la Seconde Guerre mondiale que ce produit commence à acquérir une grande importance dans l'économie<sup>8</sup>. Parallèlement à la croissance de la production de pétrole, de charbon et de gaz naturel, les émissions de CO<sub>2</sub> liées à la combustion des carburants et également les émissions industrielles augmentent. La consommation d'énergie est liée aux activités humaines quotidiennes telles que le transport, l'industrie, le commerce. Même dans le secteur résidentiel, la demande d'énergie est importante. Ce besoin d'énergie pour les activités quotidiennes montre l'influence particulière qu'il a sur le développement économique ; par conséquent, réduire la consommation d'énergie n'est pas une tâche facile. Il faut savoir que les populations des pays en voie de développement n'ont toujours pas accès à l'énergie et que cet accès ne doit pas être restreint afin d'avoir une transition énergétique équitable<sup>9</sup>. Cependant, le développement des technologies actuelles vise à découpler la consommation d'énergie des émissions de CO<sub>2</sub> qu'elle génère. Pour réaliser ce découplage, il est nécessaire d'adopter des mesures d'efficacité énergétique, et de remplacer

les combustibles fossiles par des sources d'énergie renouvelables. Comme nous l'avons vu plus haut, les voies de décarbonisation décrites par des entités telles que le GIEC s'inscrivent dans des analyses à long terme, car il n'est pas possible de voir des résultats immédiats en matière de réduction des émissions de carbone. C'est pourquoi les plans de décarbonisation doivent également être établis sur le long terme en recherchant les technologies et les voies de décarbonisation qui correspondent le mieux à la vision de développement du pays. Afin d'explorer les différentes options, il est nécessaire d'examiner les modèles d'évaluation intégrée (MEI). Nous nous concentrerons, dans la prochaine section, sur le rôle des modèles dans l'analyse des systèmes énergétiques et sur leur interaction avec d'autres secteurs.

## 1.1 Présentation des modèles énergétiques

En raison de certaines caractéristiques que les modèles peuvent partager, il n'est pas simple de créer une classification des modèles. Néanmoins, une classification qui présente une vue d'ensemble des modèles est décrite dans la figure 1.3.

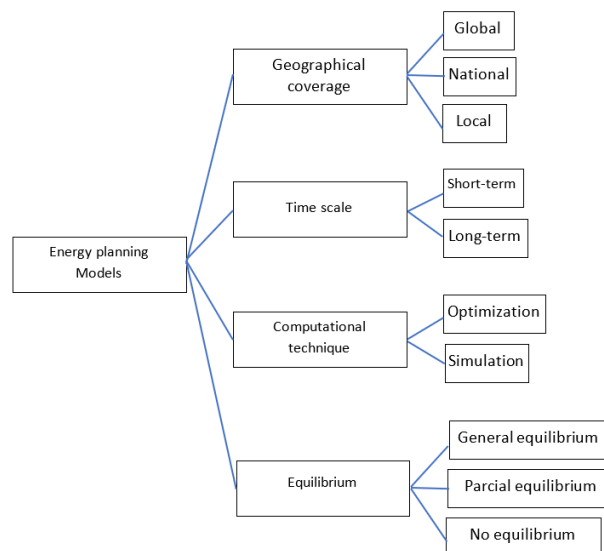

Figure 1.3: Classification des modèles<sup>10</sup>

Selon cette classification, il existe certaines caractéristiques que les modèles de différents types peuvent partager. Une catégorisation très large sépare selon l'approche de modélisation en : modèles ascendants et modèles descendants. En termes de couverture géographique, il peut s'agir d'une couverture mondiale, régionale, nationale ou même plus petite. La couverture géographique peut être exprimée en nœuds. Ainsi, un modèle peut être à nœud unique ou à nœuds multiples. Un autre paramètre pourrait être le niveau d'agrégation, en fonction des différents secteurs considérés dans le modèle. En ce qui concerne les techniques de calcul incluses dans le modèle, il existe des modèles de simulation et d'optimisation. Ce dernier peut également comprendre un objectif unique ou une optimisation multi-objectifs. Outre la classification présentée, les modèles peuvent également être classés en fonction des techniques de programmation qu'ils

---

utilisent, à savoir les modèles dynamiques, linéaires, non linéaires, mixtes ou heuristiques.

### **1.1.1 Modèle d'équilibre général (MEG)**

Ce type de modèle représente le comportement des différents acteurs de l'économie, tels que les consommateurs, les producteurs et les régulateurs du marché qui demandent ou produisent des biens, des services et des moyens de production dont les coûts sont régulés par un équilibre fixé par l'offre et la demande. Les MEG sont excellents pour décrire les détails macroéconomiques des politiques et des chocs commerciaux, des dépenses publiques, de la fiscalité, de la démographie, des ressources, des investissements, etc.<sup>11</sup>. Dans un contexte d'équilibre général, tous les marchés interagissent simultanément.

### **1.1.2 Modèle d'équilibre partiel (MEP)**

Contrairement au MEG, un modèle d'équilibre partiel ne considère qu'un seul marché et ne tient pas compte de l'interaction économique avec les autres marchés dont l'activité est supposée constante. Pour cette raison, dans le MEP, la plupart des informations telles que les prix des produits et la demande sont déterminées de manière exogène. Ce modèle nécessite une plus petite quantité de données pour fonctionner qu'un MEG, mais il perd également l'interaction et la rétroaction des autres marchés. Les modèles d'évaluation intégrée (MEI) constituent un autre type de modèle énergétique. La principale caractéristique de ces modèles est leur capacité à représenter l'interaction entre différents secteurs, y compris les aspects humains ou naturels. La force d'un MEI réside dans sa capacité à calculer les conséquences de différentes hypothèses et à mettre en relation de nombreux facteurs simultanément. Cela en fait des candidats parfaits pour être utilisés comme outils d'évaluation des politiques<sup>12</sup>.

### **1.1.3 Modèles descendants et ascendants**

Il existe une catégorisation des modèles basée sur leur approche analytique, les approches Bottom Up (ascendant) et Top Down (descendant). Ceux du premier type sont considérés comme l'approche d'ingénierie, car ils partent d'une description technologique générale pour créer chacun des secteurs qui composent le système énergétique. Cette description comprend la caractérisation de l'évolution des technologies dans le futur, ainsi que la pénétration du marché et l'évolution des coûts des nouvelles technologies. Cette approche fournit une représentation détaillée de scénarios énergétiques plausibles et permet d'évaluer des politiques sectorielles ou technologiques spécifiques. Ces modèles sont pilotés par une demande exogène qui doit être satisfaite au coût le plus bas possible. Cependant, la représentation des implications macroéconomiques sera limitée<sup>13</sup>.

Dans l'analyse ascendante, il y a une caractérisation détaillée des options technologiques qui composent la chaîne énergétique. Les différentes caractéristiques d'une technologie opérant entre deux niveaux d'énergie sont illustrées dans la figure 1.4 en utilisant le processus de raffinage du pétrole.

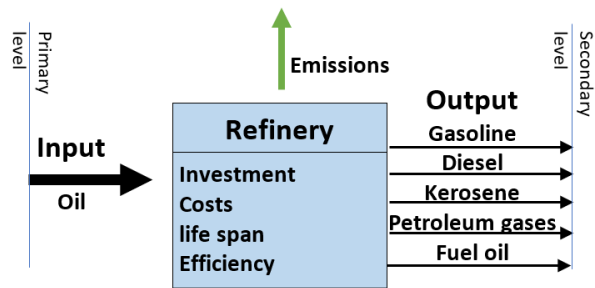

Figure 1.4: Exemple d'une raffinerie

## 1.2 Modèles énergétiques pour l'Équateur

L'importance de disposer de modèles énergétiques permettant d'évaluer les politiques à long terme réside dans la création de capacités pour la planification énergétique d'un pays. Les ressources naturelles, comme le pétrole, que nous utilisons aujourd'hui comme source d'énergie dans les activités productives de transport et même à la maison, sont limitées. De plus, l'exploitation et l'utilisation de ces ressources sont à l'origine du phénomène de réchauffement climatique. Un pays doit avoir une ligne claire sur la manière de décarboniser son économie et de rechercher des sources d'énergie renouvelables pour éviter qu'une crise énergétique ne débouche sur une crise économique. Ceci est d'autant plus important pour les pays en voie de développement où l'inégalité d'accès à l'énergie est un phénomène existant. Dans ce travail de thèse, le cas de l'Équateur est présenté. Il s'agit d'un pays qui, en raison de sa petite taille, de sa matrice énergétique et de ses conditions naturelles, pourrait être considéré comme un laboratoire du changement. L'Équateur est un pays d'Amérique latine situé entre le Pérou et la Colombie, Figure 1.5. La présence de la cordillère des Andes divise géographiquement le pays en trois zones bien définies, la côte, les hauts plateaux et la région amazonienne. Son économie est basée sur un modèle d'exportation primaire. Ses ressources pétrolières sont un élément fondamental puisqu'elles contribuent à environ 30% des revenus du pays, et ses exportations contiennent également une forte composante de produits agricoles et aquacoles. En Équateur, il existe peu d'expériences en matière de modèles énergétiques. L'un des modèles les plus utilisés est le LEAP (Long-range Energy Alternatives Planning), qui peut fonctionner comme un modèle intégré permettant de simuler des scénarios pour évaluer les politiques. Il est très utile pour obtenir des bilans énergétiques. Cependant, ce modèle n'est pas basé sur une logique d'optimisation intégrée, mais uniquement sur la simulation de scénarios. Même s'il peut être utilisé pour optimiser le secteur électrique, son objectif est de comparer des scénarios déterminés par l'utilisateur. Ce modèle permet des projections énergétiques avec des horizons à long terme et est utilisé pour la planification énergétique.

En plus de LEAP, d'autres modèles sont utilisés pour l'exploitation et l'expansion du secteur de l'électricité en Équateur. Pour analyser la répartition de l'électricité, on utilise le modèle SDDP pour l'Équateur. Le nom du modèle provient de la méthode de programmation (Stochastic Dual Dynamic Programming) qu'il utilise. Ce modèle permet d'analyser à court terme les marges de réserve dans le cadre du fonctionnement du système électrique, en tenant

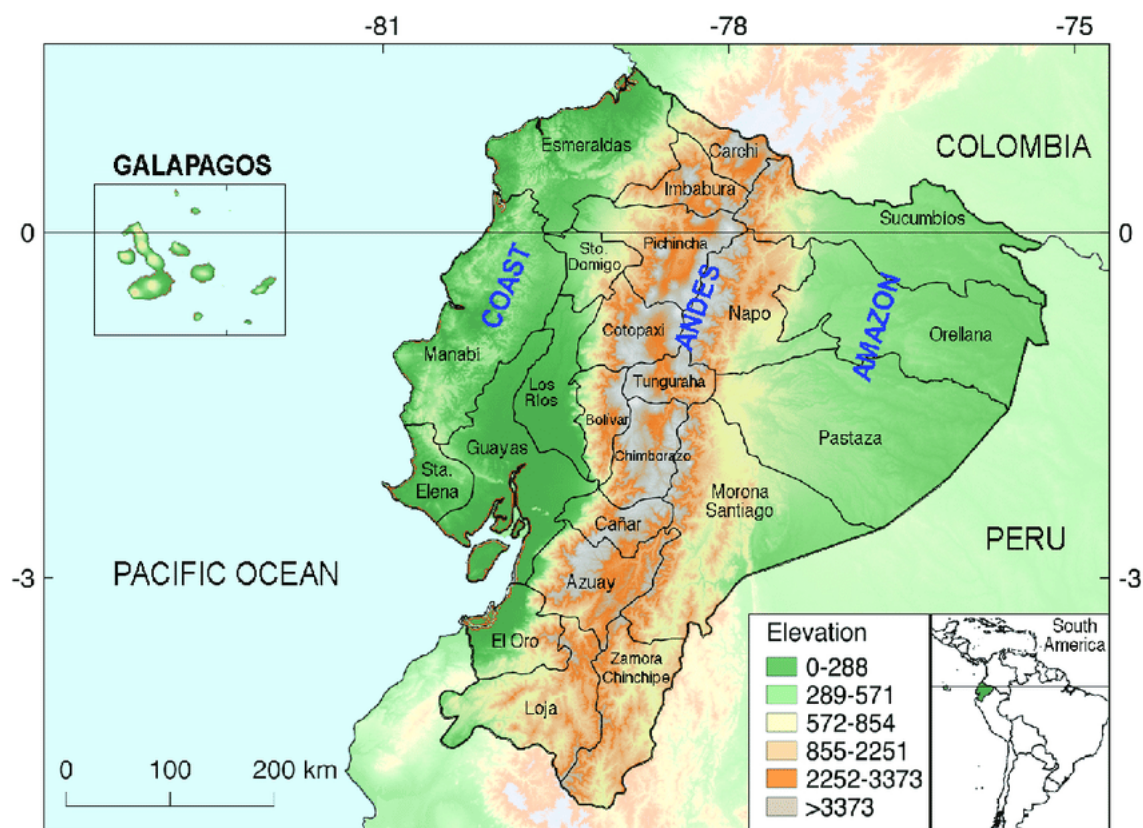

Figure 1.5: Carte de l'Equateur<sup>14</sup>

compte des incertitudes inhérentes aux systèmes issus de ressources renouvelables telles que le solaire, l'éolien et même l'hydraulique. Ce modèle évalue le coût variable par le biais d'une analyse probabiliste, en générant de multiples scénarios hydrologiques équiprobables, sur la base desquels de multiples répartitions économiques sont simulées pour couvrir la demande d'électricité prévue<sup>15</sup>.

D'autre part, il existe le modèle OptGen (planification de l'expansion de la production et des interconnexions régionales), qui est également utilisé pour le secteur de l'électricité. Ce modèle optimise l'expansion du secteur de l'électricité en tenant compte des coûts d'investissement, d'exploitation et de maintenance. Il est utilisé en Équateur pour calculer l'expansion à coût minimal à moyen terme. Ce modèle est utilisé par le gouvernement équatorien pour concevoir le plan directeur de l'électricité. Un autre modèle énergétique local est le modèle TIMES (The Integrated MARKAL-EFOM System) pour l'Équateur. Il s'agit d'un modèle d'optimisation ascendant créé par l'Agence internationale de l'énergie. Il représente un outil utile pour le secteur énergétique car il permet d'évaluer les impacts des politiques publiques énergétiques ou environnementales dans ce secteur. Il répond à une demande exogène qui doit être satisfaite par une expansion au moindre coût avec un horizon à long terme<sup>16</sup>.

### 1.3 Modèle ELENA

Sur la base des exercices de modélisation qui existaient déjà en Equateur, le besoin a été identifié d'un modèle qui intégrerait divers secteurs énergétiques et

---

qui pourrait répondre à des scénarios de politiques publiques où les impacts sur le secteur énergétique ainsi que sur les émissions de carbone pourraient être étudiés. Dans le cadre du projet DDPLAC financé par la Banque interaméricaine de développement, la possibilité de créer le modèle ELENA est née. ELENA, qui signifie Ecuador Land use and Energy Network Analysis (analyse de l'utilisation des terres et du réseau énergétique en Équateur), est une application de la plateforme MESSAGE qui utilise les méthodes et le cadre du modèle BLUES (Brazil Land Use and Energy System), appliqué à l'Équateur.

Le modèle ELENA a été créé avec le soutien technique du laboratoire Cenergia de l'université fédérale de Rio de Janeiro (COPPE/UFRJ). Il s'agit d'un modèle intégré d'équilibre partiel qui optimise l'expansion en fonction du coût minimum. Le modèle permet de construire des scénarios, à travers différentes contraintes imposées, pour comparer les alternatives de développement. Il s'agit d'un modèle qui ne se concentre pas uniquement sur le secteur de l'électricité ou de l'énergie, mais qui englobe d'autres secteurs. Comme il est intégré, il permet d'évaluer le comportement des secteurs de la production et de la consommation d'énergie à mettre en relation avec le secteur de l'utilisation des sols. Il s'agit d'une avancée importante pour un pays agricole comme l'Équateur, car elle permet d'étudier l'intérêt croissant pour des questions telles que les biocarburants et l'utilisation des forêts comme actifs d'atténuation. Comme il s'agit d'un modèle axé sur l'expansion du secteur de l'énergie et non sur la répartition, il ne sera pas possible de procéder à une analyse détaillée du fonctionnement électrique. Dans le cas de l'électricité, dont le stockage en grandes quantités n'est pas réalisable pour le moment, elle doit être consommée dans un délai relativement court (quelques heures maximum) après avoir été produite. C'est sur ce point qu'ELENA devrait compléter ses capacités par des modèles de répartition tels que SDDP ou urbs (présentés au Chapitre 3).

Les premières simulations réalisées avec le modèle ELENA ont été faites pour plusieurs scénarios. Le premier est un scénario "Business as Usual", qui est celui qui décrit une évolution tendancielle du secteur énergétique et qui servira de référence pour voir les améliorations produites par les autres scénarios. Ensuite, des scénarios de décarbonisation jusqu'en 2050 ont été créés. Tous les aspects de cette première étape du modèle ELENA sont décrits au Chapitre 2. Après cet exercice d'analyse de la décarbonisation, il a été observé que le secteur le plus complexe pour la décarbonisation est le secteur des transports, principalement le transport lourd. Pour cette raison, l'objectif était d'explorer davantage les moyens de décarboniser le secteur des transports. Le Chapitre 3 de cette thèse présente une étude dans laquelle le modèle ELENA couplé au modèle de répartition urbs est utilisé pour évaluer la réduction des émissions dans le secteur des transports. Pour réaliser cette analyse, les modèles sont combinés par une liaison logicielle complétant les capacités intégrées du modèle MEI avec la résolution du modèle de répartition. L'étude décrite au Chapitre 3 analyse si la matrice énergétique de l'Équateur serait capable de supporter une électrification massive des transports. Dans le Chapitre 4, les résultats du modèle ELENA sont analysés dans un contexte international. Seul le secteur des bâtiments, regroupant les secteurs résidentiel et commercial dans ELENA, est considéré dans le cadre d'une analyse comparative pour différents pays. Cette étude s'inscrit également dans une évaluation à long terme dans un contexte de décarbonisation.

---

## 1.4 Approche SLMF

Enfin, les Chapitres 5 et 6 utilisent une approche fondamentalement différente. Premièrement, elle se concentre exclusivement sur le secteur des transports, en fait uniquement sur le secteur du fret, sans aucune interaction avec les autres secteurs. Deuxièmement, elle est basée sur des modèles de théorie des jeux et plus précisément sur des jeux de type Single-Leader-Multi-Follower. Enfin, l'objectif de ce modèle/analyse est de déterminer une politique gouvernementale optimale en matière de taxe carbone, optimale dans le sens de la décarbonisation. A notre connaissance, c'est la première fois qu'une telle approche est utilisée pour piloter l'impact CO<sub>2</sub> d'un secteur des transports à l'échelle d'un pays.

Dans le Chapitre 5, en guise d'introduction, les concepts de base de la théorie des jeux sont décrits, car ils sont peu connus dans le domaine de la modélisation énergétique. Cette introduction passe en revue les concepts d'optimisation à deux niveaux, de jeux de Nash et de jeux à plusieurs leaders et suiveurs (SLMF).

Dans le Chapitre 6, le transport de marchandises est analysé en utilisant les préceptes des modèles biniveaux hiérarchiques, en particulier le jeu Single-Leader-Multi-Follower. Ce type de modélisation hiérarchique a déjà été utilisé dans le secteur de l'énergie, en relation avec les marchés dérégulés de l'électricité, pour analyser les stratégies dans les enchères de type Pay-as-bid<sup>17</sup> ou Pay-as-clear<sup>18</sup>. Des études récentes dans le secteur du transport de passagers utilisent également l'approche de modélisation SLMF pour analyser les stratégies des acteurs dans un schéma de Mobilité en tant que Service, où différents fournisseurs de services de transport sont connectés via une plateforme aux utilisateurs et où une interaction a lieu dirigée par l'administrateur de la plateforme et où le demandeur de service et le fournisseur de service sont des suiveurs<sup>19</sup>. L'étude présentée au Chapitre 6 se concentre sur le transport lourd de marchandises, qui s'est avéré être l'un des secteurs les plus énergivores et l'un des plus difficiles dans la mutation technologique vers la décarbonisation. Un modèle Single-Leader-Multi-Follower a été créé pour évaluer l'impact d'une taxe carbone sur la transition vers des véhicules à technologie plus propre. Dans le système proposé, le gouvernement est le leader et son principal objectif est de réduire les émissions. Les entreprises de transport jouent le rôle de suiveurs et leur objectif est de minimiser les coûts d'investissement et d'exploitation. L'investissement est considéré comme l'achat de véhicules neufs et moins polluants. Dans le cas de l'Équateur, l'effet de différentes politiques de taxe sur le carbone est comparé, fournissant ainsi au gouvernement des moyens potentiels de forcer le secteur du fret à utiliser une flotte plus propre.



---

Associés à ce travail de thèse, trois articles ont été publiés et un article est soumis:

- *Long-term deep decarbonisation pathways for Ecuador: Insights from an integrated assessment model*, Daniel Villamar, Rafael Soria, Pedro Rochedo, Alexandre Szklo, Mariana Imperio, Pablo Carvajal, Roberto Schaeffer, *Energy Strategy Reviews* 35 (2021) 100637.
- *Preparing the Ecuador's Power Sector to Enable a Large-Scale Electric Land Transport*, Janeth Carolina Godoy, Daniel Villamar, Rafael Soria, César Vaca, Thomas Hamacher and Freddy Ordonez, *Energies* 2021, 14, 5728.
- *A global comparison of building decarbonization scenarios by 2050 towards 1.5-2C° targets*, Clara Camarasa, Érika Mata, Juan Pablo Jiménez Navarro, Janet Reyna, Paula Bezerra, Gerd Brantes Angelkorte, Wei Feng, Faidra Filippidou, Sebastian Forthuber, Chioke Harris, Nina Holck Sandberg, Sotiria Ignatiadou, Lukas Kranzl, Jared Langevin, Xu Liu, Andreas Müller, Rafael Soria, Daniel Villamar, Gabriela Prata Dias, Joel Wanemark and Katarina Yaramenka, *Nature Communications* volume 13, Article number: 3077 (2022).
- *A bilevel optimization approach of energy transition in freight transport: SOS1 method and application to the Ecuadorian case*, submitted to *Computational Management Science*, 2022, 32 pp.

---

## Introduction in English

Climate change is one of the greatest challenges that mankind is facing today. In the 1970s the scientific community began to alert about how human activities have a marked impact on the planet and how anthropogenic CO<sub>2</sub> emissions will affect the global climate. In 1975 the geochemist Wallace Broecker was the first to speak about "climate warming" when he warned of the alteration in the earth's cooling cycles due to the accumulation of carbon dioxide and predicted an unprecedented rise in temperature in the next century<sup>1</sup>. This concept gained a lot of momentum and puts the scientific community on alert. In 1979, the first World Climate Conference was held in Geneva, warning of the possible effects of Global Warming. Almost half a century has passed, the effects of climate change are beginning to be felt and we are still searching for technologies that will allow us to reduce the CO<sub>2</sub> emissions we produce. Much progress has been made in planning, communication and legal frameworks to address this phenomenon. In 1988, the Intergovernmental Panel on Climate Change (IPCC) was established to coordinate international action to reduce emissions. Climate conferences have given way to global agreements such as the Kyoto protocol or the Paris agreement, where signatory countries commit to reduce their emissions.

One of the tools we have at our disposal to assess the possible effects of global climate change are mathematical models. A model is a simplified representation of a real phenomenon which is governed by equations and inequalities that seek to emulate the behaviour of the represented phenomenon when faced with variations in the environment. Among many definitions of what a model is, in<sup>2</sup> it is proposed that a common characteristic shared by all models is that they are an intentional and simplified representation of aspects of reality.

Models are used to recreate a part of reality looking forward understanding the processes and interactions that govern this reality. Models allow testing the reaction of a system to external stimulus. Finally, the results of the model are used to return to reality in order to implement what has been learned, seeking to understand it and, if possible, to organise it. In terms of climate change modelling, the best known tools to understand the global interaction are the General Circulation Model (GCM) and the Earth System Models (ESM). The former are based on physical equations such as the Navier-Stokes equations for modelling atmospheric or ocean processes. The latter also includes interaction between physical, chemical and biological processes in the analysis, which makes them more complex and computationally demanding. The aim of these models is to investigate climatic circumstances in the past or to investigate possible future scenarios. The IPCC bases its analyses on such models to simulate the effect of Representative Concentration Pathways describing concentration levels of greenhouse gases<sup>3</sup>. The IPCC, despite the global interest in decarbonisation, warns that, with the policies in place, there is still a risk of reaching temperature increases of up to 4°C above pre-industrial levels<sup>3</sup>. Figure 1.6 shows the evolution of GHG emissions analysed by the IPCC. Each emission trajectory includes a range of uncertainty, but the difference between pathways that maintain the current trend and those that seek to reduce emissions is clear. Current trends do not differ much from those set 15 years ago, neither in the catastrophic prospects this increase would have<sup>4</sup>. The

emissions evolution of the scenario including implemented policies, doubles the targets that have been set as a global consensus to reduce the impacts of global climate change. Three other pathways are envisioned by the IPCC, two of which include a vision of immediate emissions reduction, limiting the risk of exceeding the 1°C and 2°C temperature thresholds. A third pathway, marked in blue, represents a later decarbonisation that means at one point exceeding the temperature increase. This overshoot would endanger biodiversity of certain marine and terrestrial species<sup>5</sup>.

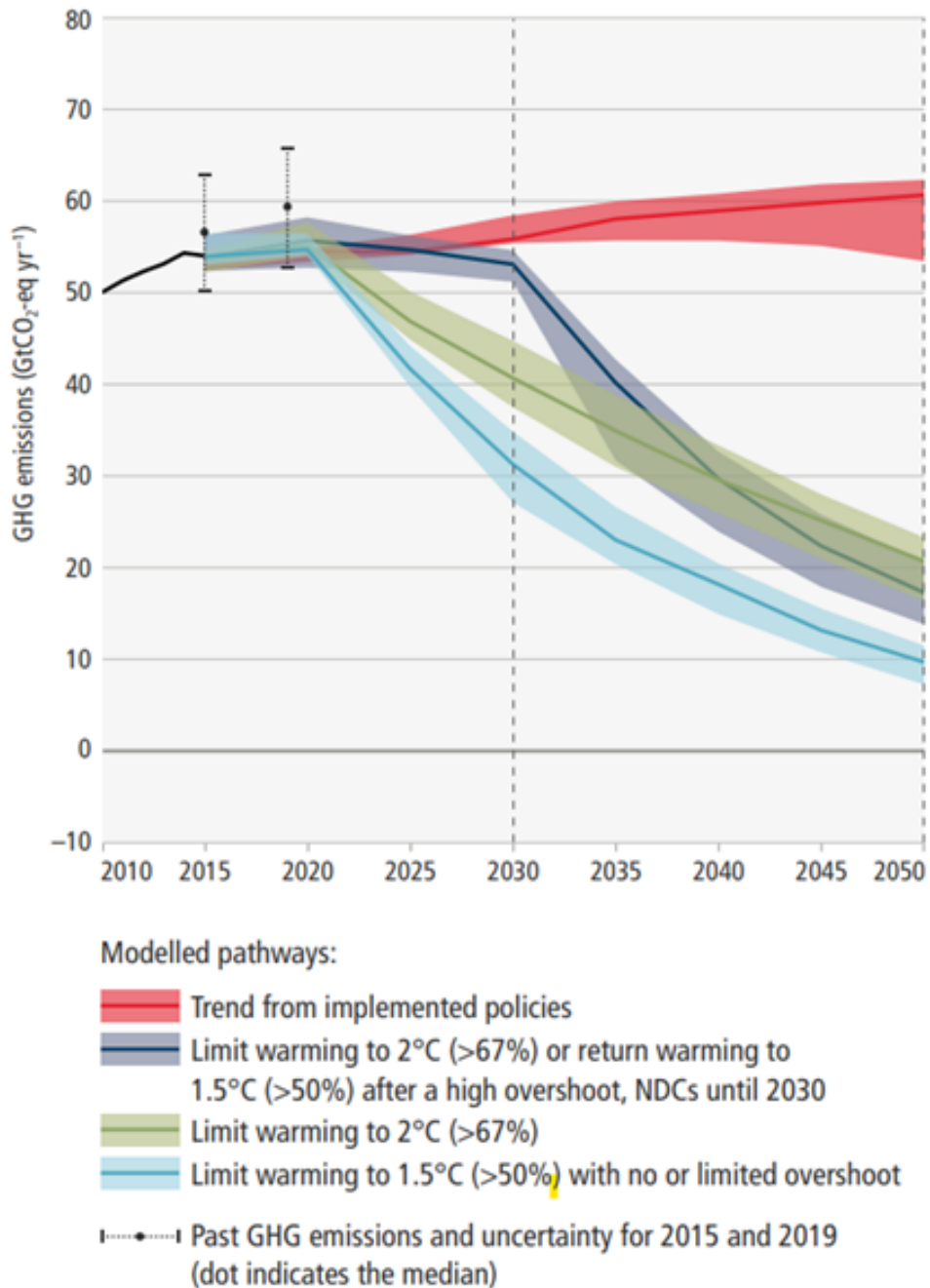

Figure 1.6: Global GHG emissions projections to 2050<sup>6</sup>

The Paris Agreement states that, until the end of the century, the global average temperature must be kept within 2°C above pre-industrial levels to avoid

catastrophic changes. A more ambitious target is to keep the temperature increase under 1.5°C, but it requires a major emission reduction starting at 2020. Undoubtedly, the fight against climate change is a global effort, where institutions such as the IPCC and instruments such as global agreements, encompass some of the endeavours undertaken. However, without underestimating the regional synergies that can be achieved, combating climate change requires, in large extent, individual efforts from each country to pursue decarbonisation. Every country will have to design the most appropriate and least costly strategies to achieve the global goals. There is global agreement, with few dissenting voices, about greenhouse gas (GHG) emissions being the cause of climate change. Thus, the processes that generate these gases must be evaluated and reformulated. Figure 1.7 shows the evolution of global emissions (left axis) since 1950, as well as the history of primary energy demand (right axis). From the data presented, the relationship between emissions and energy, particularly those based on fossil resources, is clear.

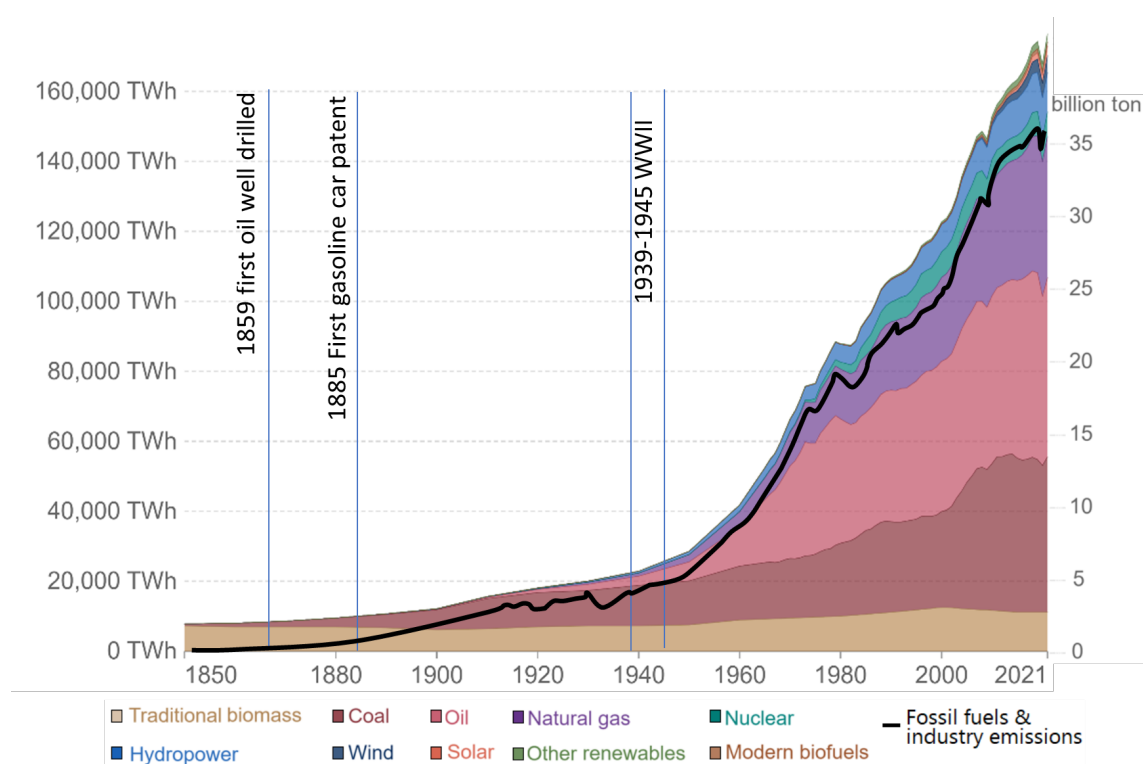

Figure 1.7: Historic evolution for global energy and emissions<sup>7</sup>

It is possible to identify different stages in the emissions evolution. Oil exploitation began in 1859, and in the short-term useful applications of oil were seen, including the first vehicle with a petrol engine in 1885. However, it is during the Second World War that this product begins acquiring great importance in the economy<sup>8</sup>. Along with the growth of oil, coal and natural gas production, CO<sub>2</sub> emissions related to fuel combustion and also industrial emissions grew. Energy consumption is linked to everyday human activities such as transport, industry, commerce. Even in the residential sector there has a large energy demand. This energy need for everyday activities shows the particular influence it has on economic development; therefore, reducing energy consumption is not an easy task. It must be stated that people from developing countries still lack access to energy and for them must not be restricted in order to have a just energy transition<sup>9</sup>.

However, the development of current technology aims to decouple energy consumption from the CO<sub>2</sub> emissions it generates. To achieve this decoupling, it is necessary to adopt energy efficiency measures, and replace fossil fuels with renewable energy sources. As seen above, the decarbonisation pathways described by entities such as the IPCC are part of long-term analyses, as it is not possible to see immediate results in carbon reductions. For this reason, decarbonisation plans must also be made in the long term by looking for the technologies and decarbonisation pathways that best fit the country's development vision. In order to explore the different options, it is necessary to look at Integrated Assessment Models (IAMs). Let's focus, in the forthcoming section, on the role of models in the analysis of energy systems and also its interaction with other sectors.

## 1.5 Energy models overview

Due to certain characteristics that models could share, create a model classification is not straightforward. Nevertheless, a classification that presents a general overview of models is depicted in figure 1.8.

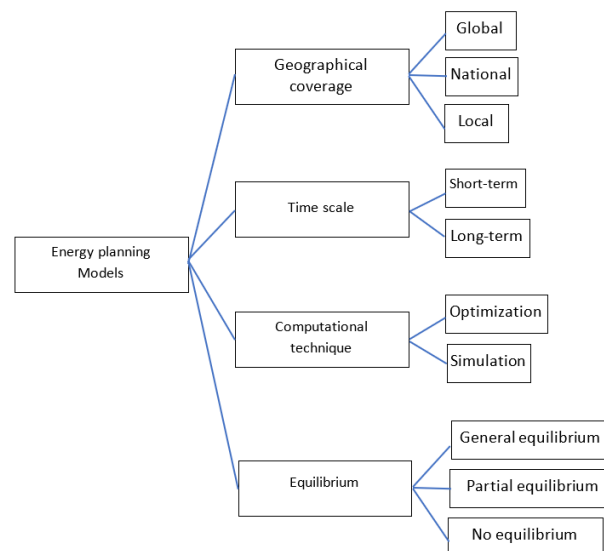

Figure 1.8: Models classification<sup>10</sup>

Among this classification there are certain characteristics that the models of different types might share. A very broad categorization segregates according to the modelling approach in: Bottom-up and Top-Down models. In terms of their geographical coverage, there could be global, regional, national or even have an smaller coverage. Geographical coverage could be expressed in nodes. Thus, a model could be single node or multi-node. Another parameter could be the level of aggregation, depending on the different sectors considered within the model. Considering the computational techniques included in the model, there are simulation and optimization models. This last could also comprise a single objective or multi-objective optimization. Besides the classification presented, models could also be classified by the programming techniques it uses, being dynamic, linear, non-linear, mixed-integer or heuristic models.

---

### **1.5.1 General equilibrium model (GEM)**

This kind of model represents the behaviour of different agents in the economy, such as consumers, producers and market regulators who require or produce goods, services and means of production whose costs are regulated by an equilibrium set by supply and demand. GEMs are excellent for describing the macroeconomic details of trade policies and shocks, government spending, taxation, demographics, resources, investment, etc.<sup>11</sup>. In a general equilibrium context all markets interact simultaneously.

### **1.5.2 Partial equilibrium model (PEM)**

In contrast to GEM, a partial equilibrium model considers only one market and does not take into account the economic interaction with other markets whose activity is assumed to be constant. For this reason in PEM much of the information such as commodity prices and demand are determined exogenously. This model requires a smaller amount of data to operate than a GEM, but also loses the interaction and feedback from other markets. Other kind of energy model are the Integrated assessment models (IAM). The main feature of these models is their ability to represent the interaction between different sectors including human or natural aspects. The strength of an IAM lies in its ability to calculate the consequences of different assumptions and to interrelate many factors simultaneously. This makes them perfect candidates to be used as policy evaluation tools<sup>12</sup>.

### **1.5.3 Top-down and bottom-up models**

There is a categorisation of models based on its analytical approach, the bottom up and the top down approaches. Those of the first type are considered the engineering approach, as they start from a broad technological description to create each of the sectors that build up the energy system. This description includes the characterisation of the evolution of technologies in the future, as well as market penetration and cost evolution of new technologies. This approach provides a detailed representation of plausible energy scenarios and allows for the assessment of specific sectorial or technology policies. These models are driven by an exogenous demand that must be satisfied at the lowest possible cost. However, the representation of macroeconomic implications will be limited<sup>13</sup>.

In the bottom-up analysis there is a detailed characterisation of the technology options that make up the energy chain. The different characteristics of a technology operating between two energy levels are exemplified in Figure 1.9 using the oil refining process.

## **1.6 Energy models for Ecuador**

The importance of having energy models that allow for the evaluation of long-term policies lies in the creation of capacities for a country's energy planning. Natural resources, such as oil, which we use today as a source of energy in productive transport activities and even at homes, are finite. Moreover, the exploitation and use of these resources is the cause of the global warming phenomenon.

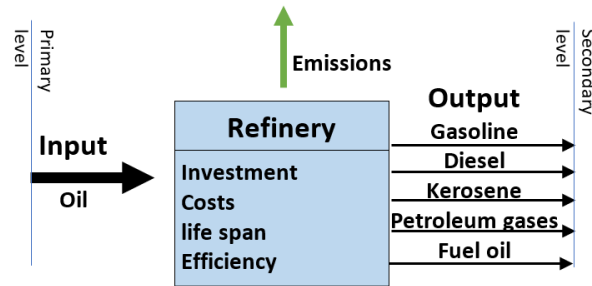

Figure 1.9: Refinery technology example

A country must have a clear line on how to decarbonise its economy and how to look for renewable sources of energy to avoid an energy crisis resulting in an economic crisis. This is even more important for developing countries where inequality on the access to energy is an existing phenomena. In this PhD work the case of Ecuador is presented. It is a country that due to its small size, energy matrix and natural conditions could be seen as a laboratory for change. Ecuador is a Latin American country located between Peru and Colombia, Figure 1.10. The presence of the Andes mountain range divides the country geographically into three well-defined zones, the Coast, the Highlands and the Amazon region. Its

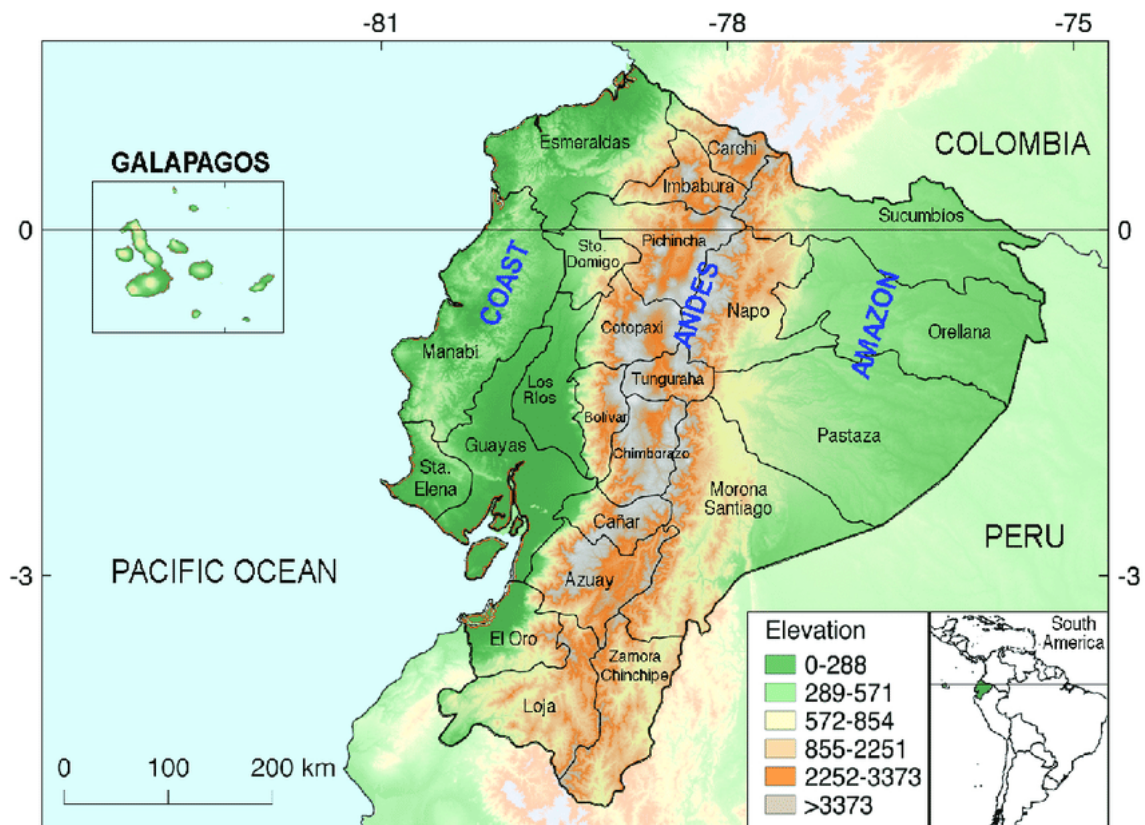

Figure 1.10: Geographic map of Ecuador<sup>14</sup>

economy is based on a primary export model. Its oil resources are a fundamental element since they contribute around 30% of the country's income, and its exports also contain a strong component of agricultural and aquaculture products. In Ecuador there are few experiences with energy models. One of the most used

---

models is the LEAP (Long-range Energy Alternatives Planning), which can perform as an integrated model that allows simulating scenarios to evaluate policies. It is very useful to obtain energy balances. However, this model is not based on an integrated optimization logic, but only scenarios simulation. Even if it can be used to optimize the power sector, its objective is to compare scenarios determined by the user. This model allows energy projections with long-term horizons and is used for energy planning<sup>20</sup>.

In addition to LEAP, other models are used for the operation and expansion of the power sector in Ecuador. To analyse the dispatch of electricity, the SDDP model for Ecuador is used. The name of the model comes from the Stochastic Dual Dynamic Programming method it used. This model allows short-term analysis of the reserve margins within the operation of the electricity system, considering the uncertainties inherent to systems from renewable resources such as solar, wind and even hydro. This model evaluates variable cost through a probabilistic analysis, generating multiple equiprobable hydrological scenarios, based on which multiple economic dispatches are simulated to cover the projected electricity demand<sup>15</sup>.

On the other hand, there is the OptGen model (generation expansion planning and regional interconnections), which is also used for the electricity sector. This model optimises the expansion of the electricity sector by considering investment, operation and maintenance costs. It is used in Ecuador to calculate minimum cost expansion in the mid-term<sup>21</sup>. This model is used by the Ecuadorian government to design the Electricity Master Plan. Another local energy model is the TIMES (The Integrated MARKAL-EFOM System) model for Ecuador. This is a bottom-up optimization model created by the International Energy Agency. It represents a useful tool for the energy sector as it allows to evaluate the impacts of public energy or environmental policies in this sector. It responds to an exogenous demand that has to be met through a least-cost expansion with a long-term horizon<sup>16</sup>.

## **1.7 ELENA model**

Based on the modeling exercises that already existed in Ecuador, the need was identified for a model that would integrate various energy sectors and that could respond to public policy scenarios where the impacts on the energy sector as well as on carbon emissions could be studied. Within the DDPLAC project financed by the Inter-American Development Bank, the possibility of creating the ELENA model was born. ELENA, which stands for Ecuador Land use and Energy Network Analysis is an application of the MESSAGE platform, using the methods and framework of the Brazil Land Use and Energy System (BLUES) model<sup>22</sup>, applied to Ecuador.

The ELENA model was created with the technical support of the Cenergia Lab from the Federal University of Rio de Janeiro (COPPE/UFRJ). This is an integrated, partial equilibrium model that optimises expansion based on minimum cost. The model allows the construction of scenarios, through different imposed restrictions, to compare development alternatives. It is a model that does not only focus on the electricity or energy sector, but encompasses other sectors. As it is integrated, it allows to assess the behaviour of the energy production and consumption sectors to be related to the Land Use sector. This is an important step



---

forward for an agricultural country like Ecuador as it allows studying the growing interest in issues such as biofuels, energy crops and the use of forests as mitigation assets. As it is a model focused on the expansion of the energy sector and not on dispatch, it will not be possible to have a detailed analysis of electric operation. In the case of electricity, the storage of which in large quantities is not feasible at the moment, it must be consumed within a relatively short period of time (maximum a few hours) after been produced. This would be a point where ELENA would have to complement its capabilities with dispatch models such as SDDP or urbs (presented in Chapter 3).

The first simulations performed with the ELENA model were made for several scenarios. The first is a Business as Usual scenario, which is the one that describes a trend evolution of the energy sector and will serve as a reference to see the improvements that other scenarios produce. Then, decarbonisation scenarios up to 2050 were created. All aspects of this first stage of the ELENA model are described in Chapter 2. After this decarbonisation analysis exercise, it was observed that the most complex sector for decarbonisation is the transport sector, mainly heavy-duty transport. For this reason, the aim was to further explore ways to decarbonise the transportation sector. In Chapter 3 of this thesis a study is presented where the ELENA model coupled with the dispatch model urbs are used to assess the reduction of emissions in transport sector. To perform this analysis the models are combined by a softlink complementing the integrated capacities of the IAM with the resolution of the dispatch model. The study described in Chapter 3 analyses whether the energy matrix of Ecuador would be able to support a massive electrification of transport. In Chapter 4 the results from the ELENA model are analysed in an international context. Only the Buildings Sector, regrouping the Residential and Commercial sectors in ELENA, is considered under a comparative analysis for different countries. This study is also part of a long-term assessment in a context of decarbonisation.

## **1.8 SLMF approach**

Finally, in Chapter 5 and 6 a fundamentally different approach is used. First it exclusively focuses on the transport sector, actually only on the freight sector, without any interaction with other sectors. Second it is based on game theory models and more precisely on Single-Leader-Multi-Follower games. Third the aim of this model/analysis is to determine an optimal government carbon tax policy, optimal in the sense of decarbonisation. To our knowledge, it is the first time that such an approach is used to drive the CO<sub>2</sub> impact of a transport sector at the scale of a country.

In Chapter 5, as an introduction, the basic concepts of game theory are depicted, since they are little known in the field of energy modeling. This introduction goes through concepts of Bilevel Optimization, Nash Games, and Multi-Leader-Follower games (SLMF).

In Chapter 6, freight transport is analysed using the precepts of hierarchical bilevel models, in particular the Single-Leader-Multi-Follower game. This type of hierarchical modeling has been used previously in the energy sector in relation to deregulated electricity markets, to analyse strategies in Pay-as-bid<sup>17</sup> or Pay-as-clear<sup>18</sup> auctions. Recent studies in the passenger transport sector also use the

---

SLMF modelling approach to analyse the strategies of agents in a Mobility as a Service scheme, where different transport service providers are connected via a platform to the users and an interaction takes place led by the platform administrator and the service requester and the service provider are followers<sup>19</sup>. The study presented in Chapter 6 focuses on heavy freight transport, which has proven to be one of the most energy-intensive sectors and one of the most challenging in the technology shift towards decarbonisation. A Single-Leader-Multi-Follower model was created to evaluate the impact of a carbon tax on the transition to cleaner technology vehicles. In the proposed scheme, the government is the leader and its main objective will be to reduce emissions. Transport companies play the followers role and their objective is to be to minimise investment and operating costs. The investment is considered to be the purchase of new and less polluting vehicles. In the study case of Ecuador, the effect of different carbon tax policies are compared, thus providing government with potential ways to force the freight sector to the use of cleaner fleet.

Associated with this thesis work three papers have been published and one has been submitted:

- *Long-term deep decarbonisation pathways for Ecuador: Insights from an integrated assessment model*, Daniel Villamar, Rafael Soria, Pedro Rochedo, Alexandre Szklo, Mariana Imperio, Pablo Carvajal, Roberto Schaeffer, *Energy Strategy Reviews* 35 (2021) 100637.
- *Preparing the Ecuador's Power Sector to Enable a Large-Scale Electric Land Transport*, Janeth Carolina Godoy, Daniel Villamar, Rafael Soria, César Vaca, Thomas Hamacher and Freddy Ordonez, *Energies* 2021, 14, 5728.
- *A global comparison of building decarbonization scenarios by 2050 towards 1.5-2C° targets*, Clara Camarasa, Érika Mata, Juan Pablo Jiménez Navarro, Janet Reyna, Paula Bezerra, Gerd Brantes Angelkorte, Wei Feng, Faidra Filippidou, Sebastian Forthuber, Chioke Harris, Nina Holck Sandberg, Sotiria Ignatiadou, Lukas Kranzl, Jared Langevin, Xu Liu, Andreas Müller, Rafael Soria, Daniel Villamar, Gabriela Prata Dias, Joel Wanemark and Katarina Yaramenka, *Nature Communications* volume 13, Article number: 3077 (2022).
- *A bilevel optimization approach of energy transition in freight transport: SOS1 method and application to the Ecuadorian case*, submitted to *Computational Management Science*, 2022, 32 pp.

# Chapter 2

## The ELENA Model

### 2.1 Introduction and context

Energy models allow understanding and exploring behaviours within energy chains. Across this chains, a variety of technologies interact to transform the energy from the resource stage to the final energy consumption. This kind of analysis acquired a great importance in the oil crisis in the 1970s<sup>23</sup>. Since then, to assess scenarios that consider: energetic resources, exploitation, and consumption strategies, became crucial in the economic analysis of a country. Energy planning is considered a key element for every country's development<sup>24</sup>. A few decades later, the energy debate became the energy-emissions discussion. In 1994 the United Nations Framework Convention on Climate Change (UNFCCC) entered into force as the entity in charge to develop coordinated strategies to cope with the threat of climate change. The ultimate goal of this entity is to stabilise greenhouse gas concentrations to avoid interference with the climate system<sup>25</sup>. Then, in 1997 the first climate global strategy was created, the Kyoto Protocol. This policy instrument committed industrialized countries and economies in transition to limit and reduce global greenhouse gases (GHG) emissions in accordance with agreed individual targets. This protocol entered into force in 2005 and presented the Clean Development Mechanisms as an emission reduction method. On this context, the energy models evolved and became Integrated assessment models (IAM)<sup>12</sup>. The main idea behind these models is assessing a wide range of long-term integrated scenarios, analysing multiple areas and disciplines in a tool capable to guide researchers, governments and multilateral agencies in energy-climate issues, in order to take better inform decisions. Different countries have developed these tools. In the case of Ecuador, in the context of the Deep Decarbonization Pathways project, the ELENA (Ecuador Land Use and Energy Network Analysis) model was created with the support of the Cenergia Lab from the Federal University of Rio de Janeiro (COPPE/UFRJ). The BLUES model, an IAM from Brazil, was used as starting point to create ELENA<sup>22</sup>. The structure of both models and the technologies available are similar. With regard to its temporal structure, ELENA has a time horizon to 2050 and the base year of the model is 2015. This time span is divided in 5-year steps. Each modelling year has a seasonality of 12 months. Also, a typical day divided in five time slices (night, morning, PV peak, day and load peak) is defined. This time desegregation is suitable for capturing the behaviour of variable renewable resources and electricity demand. The ELENA model accounts six eco-

---

conomic sectors (transportation, residential, commercial, industry, agriculture and others). One of the main goals of this kind of models is to provide policy-relevant insights from the interaction between the energy and the land use sectors. It must be stated that ELENA considers a demand of agricultural products, but the main idea of the land sector is to analyse the behaviour of energy crops and forestation scenarios. This IAM uses a Linear Programming structure to define the minimal total cost expansion of the energy and the land system. The model is built on the Model for Energy Supply Strategy Alternatives and their General Environmental Impacts (MESSAGE). The software MESSAGE is a modelling platform containing the structure to create integrated models. The MESSAGE software was developed by the International Institute for Applied Systems Analysis (IIASA). It presents an integrated optimization methodology where the objective function, representing the total expansion cost of the scenario, is optimized under a set of constraints such as: resource extraction capabilities, fuel availability, investment and penetration of new technologies, GHG emissions, energy losses, among others. This optimization is used to formulate and evaluate strategies from the energy supply side to respond to an existing demand and its evolution in long-term scenarios<sup>26</sup>. With this tool it is also possible to evaluate demand side strategies, by considering useful energy as the last energy level of the model. In the study presented at next, policies related with energy efficiency are evaluated also from the demand side.

## **2.2 Paper Long-term deep decarbonisation pathways for Ecuador: Insights from an integrated assessment model**

Article authors: Daniel Villamar<sup>1,2</sup>, Rafael Soria<sup>1</sup>, Pedro Rochedo<sup>3</sup>, Alexandre Szklo<sup>3</sup>, Mariana Imperio<sup>3</sup>, Pablo Carvajal<sup>1,4</sup> and Roberto Schaeffer<sup>3</sup>.

Journal: Energy Strategy Reviews

Volume: 35

year: 2021

pages: 100637-100651

url: <https://www.sciencedirect.com/science/article/pii/S2211467X21000237>

This paper was written as part of the DDP-LAC project where 6 Latin American countries participate. My personal contribution to the article, as part of the Ecuadorian team, was on providing part of the data collection necessary for the model programming as well as for the design of the scenarios. I run some of the scenarios and participate in the results analysis and paper writing. All these activities were carried out with the technical support of Cenergia Lab of the

---

<sup>1</sup>Departamento de Ingeniería Mecánica, Escuela Politécnica Nacional, Ladrón de Guevara E11-253, 17-01-2759, Quito, Ecuador

<sup>2</sup>University of Perpignan - Domitian, 52 Avenue Paul Alduy, 66860, Perpignan, France

<sup>3</sup>Energy Planning Program, Graduate School of Engineering, Universidade Federal Do Rio de Janeiro, Centro de Tecnologia, Bloco C, Sala 211, Cidade Universitaria, Ilha Do Fund~ao, 21941-972, Rio de Janeiro, RJ, Brazil

<sup>4</sup>International Renewable Energy Agency, Innovation and Technology Centre, Willy-Brandt-Allee 20, 53113, Bonn, Germany

---

Federal University of Rio de Janeiro (COPPE/UFRJ) and the supervision of Dr. Rafael Soria.

---

## Abstract:

This work presents an Integrated Assessment Model (IAM) developed for Ecuador, the so-called Ecuador Land Use and Energy Network Analysis model (ELENA). This model includes six distinctive sectors of the economy and displays the four geographic regions composing the country. The model enables to capture sectorial interactions, under a set of scenarios designed to evaluate the energy and land perspectives until 2050. The model is a crucial planning instrument to evaluate public policies, such as National Determined Contributions (NDC) and even more ambitious decarbonisation scenarios. Findings show that Ecuador's NDC are not aligned with the "well below" 2°C target, committed in the Paris Agreement. Moreover, to achieve deep decarbonisation it is necessary to endorse disruptive strategies in which bioenergy and reforestation play a main role. To keep under the 1.5°C temperature threshold above pre-industrial levels, Ecuador's energy matrix must be diversified with higher shares of low carbon technologies and electrification of energy end use in the transport, buildings and industry sectors. Biomass with carbon capture and storage (BECCS) and biofuels could transform the energy sector in a CO<sub>2</sub> sink.

## 1. Introduction

Global climate change (CC) requires structured, decarbonisation action plans from every country. By the end of the century, temperature increase must reach a threshold value of 1.5°C above preindustrial levels to avoid major ecosystem alterations [1]. Aligned with this goal, Paris agreement signatory countries, including Ecuador, have pledged their National Determined Contributions (NDCs) [2]. The agreement encourages the parties to develop and follow long-term development strategies toward limiting temperature increase to a "well below" 2°C target and pursue efforts to attain the 1.5°C limit [3]. It also stipulates that greenhouse-gas (GHG)emissions peak must be reached as soon as possible and points out the difficulties that this could generate for developing countries [3]. However, concerns were raised about the convergence of NDC strategies with the GHG emissions level required to achieve the Paris Agreement global temperature targets [4]. Moreover, reaching a long term goal with short-term actions is not guaranteed [4–6]. In this context, building local modelling capacities is key to state national long-term decarbonisation strategies complying with the Paris agreement while consistently dealing with energy and Agriculture, Forestry and Other Land Use (AFOLU) GHG emissions.

---

The analysis of decarbonisation pathways requires a framework that captures the relations and trade-offs between the different sectors and strategies. Long-term integrated assessment models (IAMs) are established tools to study interlinkages between the human and the natural system at national and global scales [7–10]. Insights from these complex models are widely used to advise policymakers and to inform the general public [11]. Besides, the interaction between reforestation, deforestation, agricultural practices and the energy sector are well captured only by few IAMs [12]. This gap is a constant in low-developing economies of the Global South. Particularly in Latin America countries, where, to our knowledge, only Brazilian experts have developed a tool which is based on hard-link modelling between energy and land systems [13]. Understanding this sort of interaction is emblematic for Ecuador's case, where trade-offs between protecting its massive biodiversity [14] and the increased risk of land-use changes for agriculture and energy activities must be appropriately understood to create suitable and structured policies.

Moreover, Ecuador must prepare its energy sector to a substantial oil production reduction due to the resource exhaustion expected for the next decades [15]. To partially replace oil energy supply, bioenergy can be used, creating an additional land dispute controversy. In this context to assess sustainable transition pathways, Ecuador requires a model that assesses the long-term interaction between energy and land-use sectors. This work contributes to filling this gap.

The objective of this paper is to present an IAM developed for Ecuador, the so-called Ecuador Land Use and Energy Network Analysis model (ELENA). ELENA is used to test whether the current policies and proposed NDC would allow Ecuador to be aligned with the 1.5°C target. In addition, this study applies a nested optimization of ELENA with a global IAM, the COFFEE<sup>1</sup> model [17], which provides national carbon budgets to regional and national IAMs [18]. By doing this, the ELENA model tackles decarbonisation strategies coherent with a global trajectory to limit GHG emissions. Thus, this study also assesses Long-term strategies (LTSs) to reduce GHG emissions in Ecuador to a global 1.5°C-compatible level by 2050. ELENA is the first Ecuadorian IAM able to model energy and AFOLU sectors in a detailed manner and in a single modelling framework, by hard linking both sectors. The tool has the potential to evaluate different policies and LTSs to better inform Ecuadorian and international stakeholders in the ongoing global climate change negotiations. The model was nationally developed under the aegis of the “Deep

---

<sup>1</sup> The COmputable Framework For Energy and the Environment (COFFEE) model is a global integrated model created in the Center for Energy and Environmental Economics (Cenergia Lab), an integrated research laboratory of the [Energy Planning Program](#), Graduate School of Engineering, *Universidade Federal do Rio de Janeiro* (PPE/[COPPE/UFRI](#)), in Brazil. For more details, see [16]

---

Decarbonisation Pathways Project for Latin America and the Caribbean (DDP-LAC<sup>2</sup>). It is based on the methods and framework of the Brazil Land Use and Energy System (BLUES) model [13], which modelling procedure could well be replicated, with adjustments, in other Latin American countries.

## 2. Literature review

The DDP-LAC project included other five countries in the region, namely Argentina, Colombia, Costa Rica, Mexico and Peru, which developed long-term decarbonisation pathways scenarios. All participating countries had the same objective; however, they applied different modelling tools and methodologies [19].

To our knowledge, at the time of writing, there is no literature that evidence using an IAM to assess Ecuador's energy and land use sectors in the context of decarbonisation, or in any other context for that matter. Several studies explore long-term energy system pathways for Ecuador for the transport sector [20,21], the impacts of energy efficiency [22,23], renewable energy for power generation [24] and NDC scenarios [25]. Nevertheless, none of these studies explore Paris Agreement-compliant scenarios for deep decarbonisation by mid-century, nor take an integrated methodological approach. Ecuador's NDC itself was indeed informed with long-term scenarios modelled with the LEAP platform [26]. However, only the energy sector was modelled without considering interlinkages with the AFOLU sector.

The current expansion and operation planning of the Ecuadorian electric power system [27], carried out by the Ministry of Energy is based on two computational tools: OPTGEN (model for generation expansion planning and regional interconnections), and SDDP (stochastic hydrothermal dispatch with network restrictions), both commercial software provided by PSR [28]. The OPTGEN model starts with an exogenous demand forecast and project inventory and determines the least-cost expansion plan (investment, operation and maintenance). These results are subsequently integrated into the SDDP model, which considers the uncertainty of runoff and the operational restrictions of generation plants. However, a significant drawback of this planning process is its time horizon (10 years), limited by the number of years that can be assessed at the hourly level with the mentioned models. Considering that GHG emissions are notably a long-term issue, with horizons from mid-century onwards, it is myopic to base long-term planning only with a 10-year horizon. Moreover, these tools only refer to the electric power system, not including an overall assessment of other energy-related facilities, such as oil

---

<sup>2</sup> This project was financed by the Inter-American Development Bank (IADB) and technically managed by the Institute for Sustainable Development and International Relations (IDDRI).



---

production and refining and detailed analysis of end uses. Finally, the mentioned models were not developed to deal with GHG emissions, mitigation options and climate policy.

Following this introductory section, section two gives an overview of Ecuador's energy and AFOLU sectors; section three showcases the methodology used for this study; section 4 presents results, and section 5 discusses them. Section 6 gives the overall conclusions and areas for further work.

### 3. Ecuador's energy and land use overview

The country's largest share of GHG emissions derives from fossil fuel combustion and land-use change (see Figure 1). Emissions in the latter sector are mainly related to the expansion of the agricultural frontier and illegal deforestation [29]. The energy industry sector ranks only fourth given that generation heavily relies on hydropower, mostly on large scale plants built during the last decade [30].

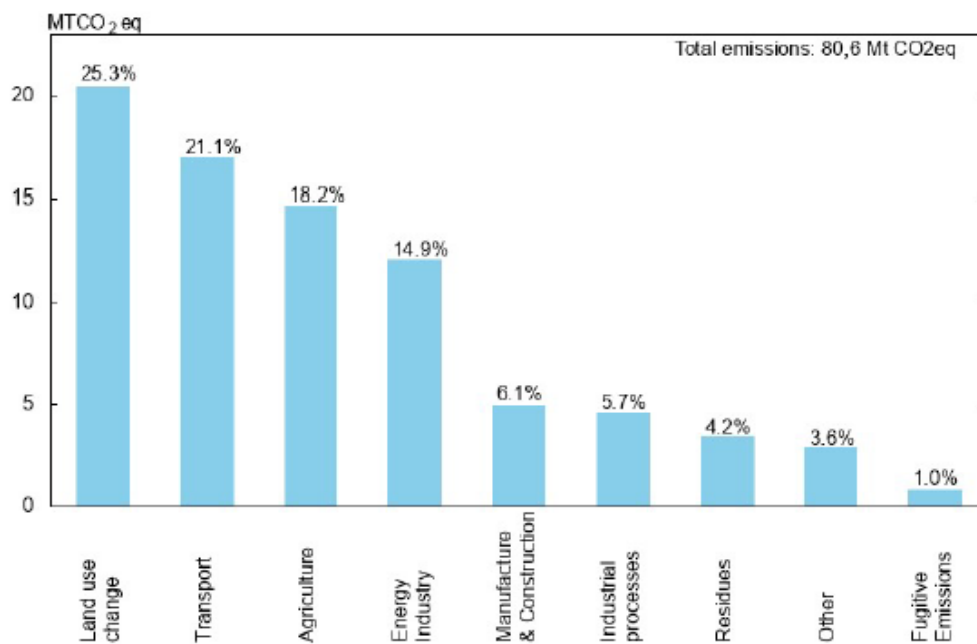

Figure 1: GHG emissions Ecuador by sector in 2012 [29].

Hydropower accounted for 84% of total electricity generation share in 2018 [31]. Most of the remaining Ecuadorian hydroelectric potential lay in the Amazon region [32], with some 13 GW of techno-economic and environmental potential [33]. Nevertheless, using this potential with large hydropower plants would cause substantial local environmental and social impacts [34,35]. Moreover, including more hydropower plants in the Amazon

watershed would not solve the production reduction due to the drought season (October to December) [36]. This situation will likely worsen because of the effects of climate change on the rain pattern in the region [37,38].

Electricity access is relatively high (97.3%) [39,40], but electricity represents less than 16% of the total final energy consumption (see Figure 2). The commercial sector has the highest electrification share with almost 60%, while electricity in the transport sector only represents 0.01% of the total energy consumed in this sector [40]. Meanwhile, households and industrial electricity consumption account for, respectively, 37% and 46% of the total energy consumed by each sector [40]. Thus, there is a significant margin to increase electrification in most of the sectors, especially transportation.

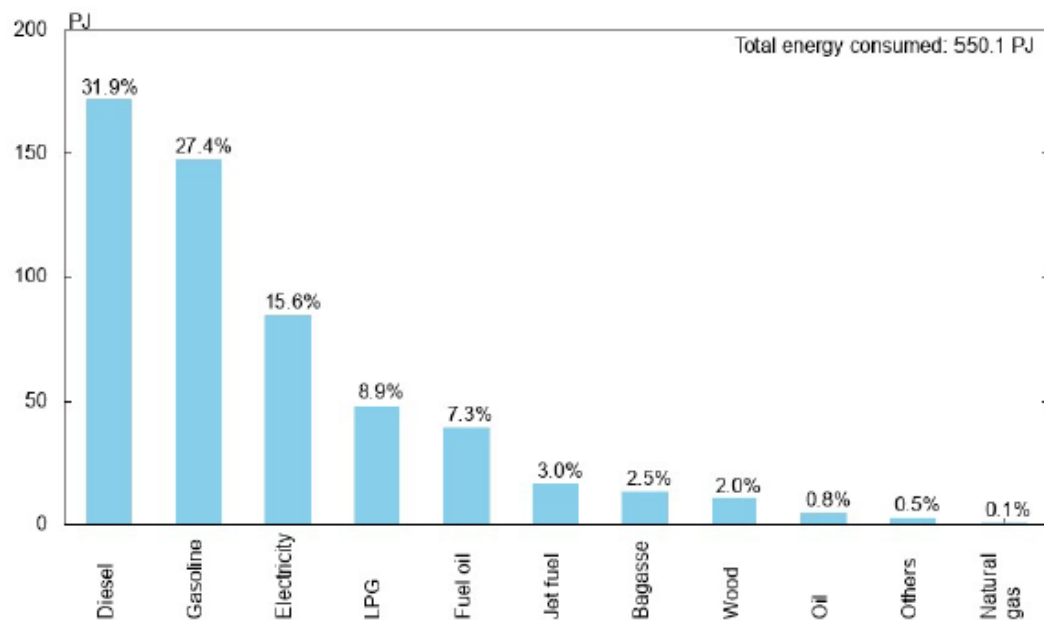

Figure 2: Final energy consumption in 2016, share by source [41].

The transport sector accounts for almost a fifth of the country's GHG emissions and almost half of the total final energy consumption. Road transport dominates in Ecuador, and 63% of energy is consumed by heavy, medium, and light freight transport (see Figure 3).

Consequently, the main fuels used are diesel and gasoline, representing 52.7% and 45.6% of the final energy consumed in the transport sector, respectively [40]. It should be pointed out that 60% of these oil products are currently imported [30]. Furthermore, fuels in Ecuador are highly subsidised [42], leading to inefficiency in consumption and accelerated growth of private vehicles fleet for individual use, generating mobility issues in the main cities. The two largest cities in

Ecuador, Quito and Guayaquil, are among the 30 most congested cities in the world, being respectively at place 20<sup>th</sup> and 23<sup>rd</sup> in the “time lost in congestion” ranking [43]. There are significant challenges to making structural changes to the current state of transportation in Ecuador. For instance, current efforts in 2019 to deal with fuel subsidies led to major turmoil in the country [42]. Despite the difficulties, local governments in the main cities make efforts to develop massive public electric transport systems, such as the Quito metro, the Cuenca tram, and the Guayaquil airway. Finally, an eventual shift toward electrification in passenger transportation still presents significant challenges such as infrastructure, high cost of battery electric vehicle (BEV) and effects on the power sector. Despite that, the government has claimed an ambitious plan to electrify urban busses [44].

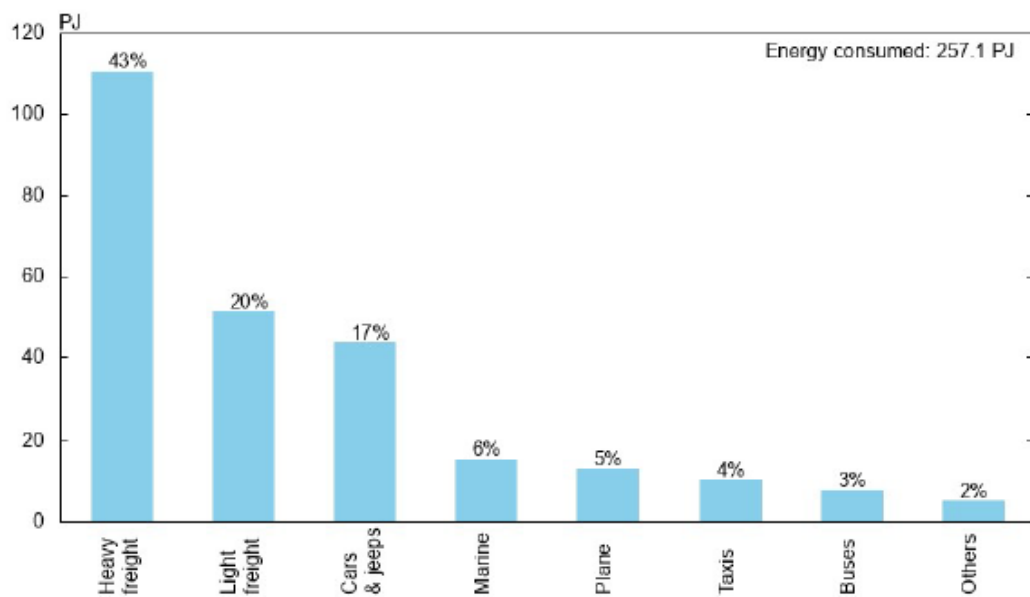

Figure 3: Energy consumed in the transport sector in 2016 [41].

Ecuador faces economic and energy security risks associated with its significant dependency on oil production. In 2015, crude oil represented more than one-third of the export revenues [30,45]. Besides, under current production rates Ecuador could reach its crude oil production peak between 2024 and 2027 [15,46]. This would be a turning point for the country's energy and economic policies, bringing challenges not only for the energy sector but also consequences in terms of trade deficits. This situation will be exacerbated if the current level of energy subsidies is maintained. Besides its macro-economic importance, crude oil and oil products represent 80% of the Ecuadorian final energy consumption – see Figure 2. Although Ecuador is a net oil exporter with an average daily production of 518 thousand barrels per day [40], 70% is exported and

---

domestic refineries process the remainder. Local refining supplies less than 50% of oil product demand, whilst the rest is imported [40].

In this context, Ecuador faces a challenging combination of problems in the energy sector that can have a repercussion in the land sector. As the remaining petroleum resources are available mainly in the Amazon region, its extraction implies a constant peril to the ecosystem [32,47]. New oil projects imply new roads that would give access to new human settlements [48], increasing pressure in the rain forest. The same analysis is valid for large hydropower projects [32]. In the last decades, the government improved the road network in most of the country, enhancing the connectivity in the Amazon region, which may speed up the expansion of the agricultural frontier and also the deforestation of the native forest [49].

Additionally, new agro-industrial stakeholders and market requirements can increase the pressure over forest lands. For example, a massive deployment of biofuels or monocultures would require land-use changes, most likely with the expansion of the agricultural frontier. Thus, land devoted to agricultural activities, including those for energy purposes, must follow adequate management practices to reduce deforestation [50,51].

## **4. Methodology**

Ecuador Land Use and Energy Network Analysis model (ELENA) was created in the context of the Deep Decarbonisation Pathways in Latin America and the Caribbean (DDP-LAC) project. This project seeks to improve the modelling capacity of the academic community in LAC countries to develop and use IAMs. During this endeavour, a team from the Escuela Politécnica Nacional (EPN) was advised by the Cenergia Lab from the Graduate School of Engineering, Universidade Federal do Rio de Janeiro (UFRJ/COPPE) to develop the ELENA model from scratch. To the authors knowledge ELENA is the first IAM for Ecuador. The model is built following the methods and framework of the Brazilian BLUES model [13,52], and uses outputs from the COFFEE global model [17], both applications of the MESSAGE platform. However, BLUES, COFFEE and ELENA, contain their own modelling structure, set of constraints and specific datasets, corresponding to the individual realities they represent, which make them unique in their own way.

### **4.1 MESSAGE platform and the BLUES and COFFEE models**

The MESSAGE platform, developed by the International Institute of Applied Systems Analysis (IIASA), is a mixed-integer and linear programming model,

---

with a perfect foresight optimization platform<sup>3</sup>. It is designed to evaluate different strategies of supply development to meet a given demand in competitive market conditions [53]. This tool allows for the development of IAMs that combine techno-economic and environmental variables to generate cost-optimal solutions. Originally built for the energy system, it minimizes the total cost of expanding and operating the energy system to meet energy service demands. Constraints are used to represent real-world restrictions to explore the full range of the variables [54]. Such restrictions include, for example, the total amount of GHG emissions, availability of resources, activity and capacity of processes, international trades, environmental regulations, investment limitations, availability and price of fuels, market penetration rates of new technologies, among others [13]. Techno-economic input parameters considered include specific investment costs, operation and maintenance (O&M) cost, construction times, life span, process conversion efficiency, GHG emission factor by process, and any technical or economic specifications that may be required to appropriately model the performance and expansion of an energy technology [54]. The generic version of the objective function and main restrictions used by MESSAGE are presented in Appendix A 1.

Since 2003, the Brazilian team at Cenergia Lab (UFRJ/COPPE) has gained much experience using MESSAGE, applied at a national and global level. Several studies have been carried out for Brazil with the MESSAGE-base models [8,37,53–61]. The last version of the national MESSAGE-Brazil<sup>4</sup> is the so-called Brazilian Land Use and Energy System (BLUES) [38,60,62,64]. The BLUES model is a novel application of the MESSAGE platform adapted to promote the integration of the land-use system into the energy system [13,52], in a hard-link approach. Different types of land covers can be converted into each other while accounting the GHG emissions (CO<sub>2</sub>, CH<sub>4</sub> and N<sub>2</sub>O) resulting from this process. Also, a certain type of land covers can be used for agricultural production, to meet food and energy demand. Furthermore, agricultural products can be traded between regions. BLUES minimizes the cost of the expansion of the entire energy and land systems, subject to fulfil energy and new additional land-use restrictions. The additional main equations to incorporate the modelling of the land use system in BLUES are presented in Appendix A 1. At the global level, the COFFEE integrated model was developed in the MESSAGE platform to provide long-term (up to 2100) assessments of the interaction between the energy and land-use systems and the economy at the global scale. COFFEE works with a similar approach to the BLUES model. A detailed description of COFFEE is shown in [16,17].

---

<sup>3</sup> MESSAGE is the platform where the ELENA model is built. IIASA also calls their application in the platform as MESSAGE, being MESSAGE-IIASA, then, the model developed in the MESSAGE platform.

<sup>4</sup> The name of the application of the MESSAGE platform to Brazil developed at Cenergia Lab, at COPPE/UFRJ, has changed over time. The most recent version of MESSAGE-Brazil is called BLUES.

## 4.2 ELENA - Ecuador Land Use and Energy Network Analysis model

The ELENA model is an application of the MESSAGE platform, using the methods and framework of the BLUES model [13], applied to Ecuador. ELENA considers four regions: Coast, Andes, Amazon and Galápagos<sup>5</sup>. The base year is 2015, the time horizon is 2050<sup>6</sup>, and it uses 5-year time steps. Each modelling year has a seasonality of 12 months, and for each month there is a typical day. Each day is divided in five time slices (night, morning, PV peak, day and load peak) defined to appropriately model the behaviour of variable renewable resources and electricity demand. The ELENA model considers six economic sectors (transportation, residential, commercial, industry, agriculture and others). The industrial sector is disaggregated in nine subsectors: food and beverage, textile, wood and paper, steel, mining, non-ferrous, chemicals, non-metals, and others. The general structure of ELENA model is presented in Figure 4.

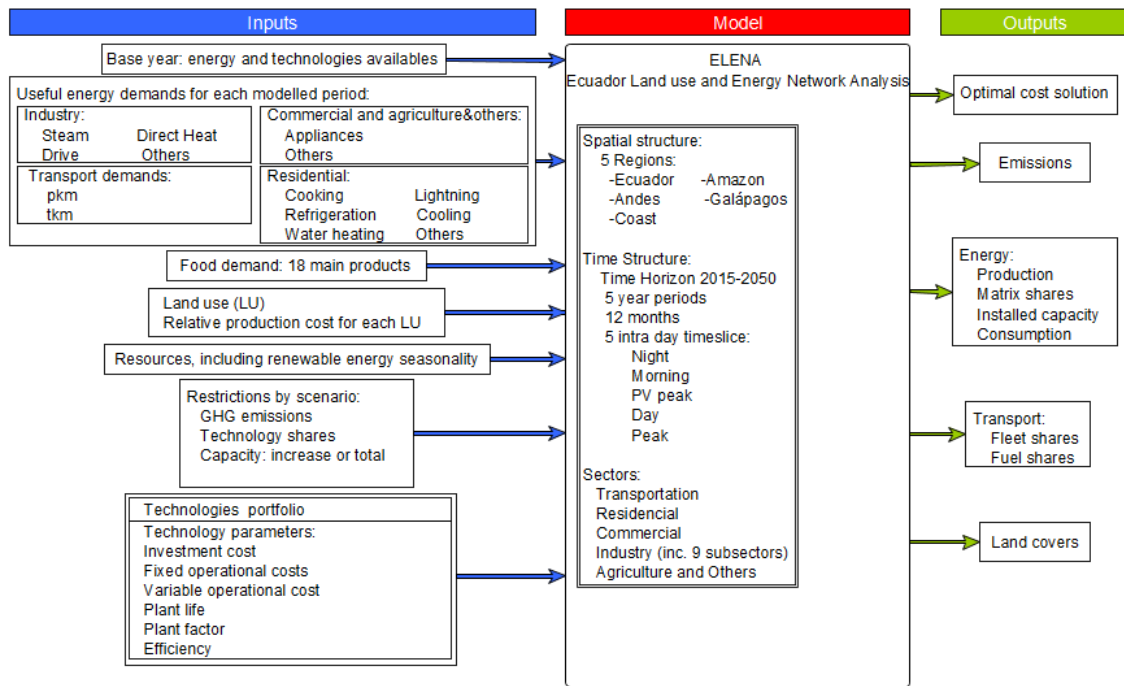

Figure 4: ELENA model structure, inputs, and outputs

The model must satisfy the primary constraint, which is meeting the demands allocated to each sector. In addition to that, the model works under a set of assumptions that build a scenario, providing different results at each case. These scenarios are not meant to predict the future, but to represent hypothetical realities that would be reached by varying the assumptions that

<sup>5</sup> Galápagos region exist in the model architecture, nevertheless in this model version this region is not being used. All energy demands from this region are included in the Coast region.

<sup>6</sup> Optimization runs up to 2055, results are shown up to 2050.

govern the model. In this sense, the model is able to evaluate policies by implementing certain constraints (e.g. effects of a reforestation policy)<sup>7</sup>. The useful energy demand is calculated exogenously. The main drivers used to forecast the demand growth were GDP [65] and population [66] depicted in Figure 5. Sectorial GDPs were also used to improve sectoral energy demand projections.

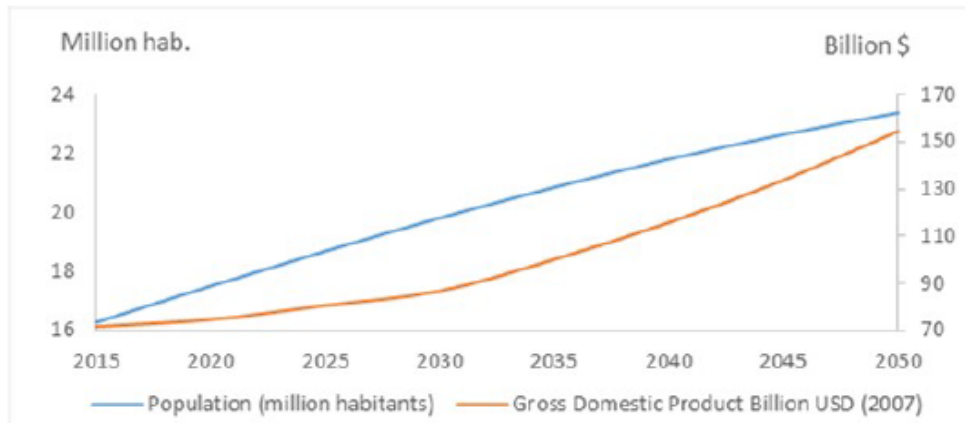

**Figure 5: Main drivers: GDP and population forecast to 2050 [65] [66]**

Transport demand is divided into passenger (pkm) and freight (tkm). The main driver to forecast the passenger demand is population evolution. Assumptions in mileage and vehicle load capacity evolution framed the transport demand; details are presented in Table 2. Passenger transport is classified into individual vehicles and buses. Regarding freight demand projection, the main driver is the GDP, and three truck categories (light, medium and heavy) are considered.

The useful demand in the industrial subsectors is divided in four categories: steam, direct heat, drive and others. The main drivers for industry demand are the sectorial GDP and the specific energy consumption by physical production. Household (HH) energy service demand was calculated in a bottom-up approach that includes population, HH size evolution and specific consumption per HH. A distinction between existing and new HH allows assessing improvements in energy efficiency, by considering improved technologies in new HH. Energy services for HH include refrigeration, air-cooling, lighting, water heating, cooking and appliances.

Commercial and Agriculture & Others energy demand are built using the sectorial GDP. For the commercial sector, the energy services are separated

<sup>7</sup> In the present work, six scenarios were modelled; detailed information of the scenarios is presented in section 2.3.

between electric appliances and others, while for Agriculture and Others the demand was estimated in terms of final energy.

In Figure 6, energy inputs and outputs for the different sectors modelled in ELENA are presented. Appendix A 4 across multiple tables shows the most important technical and economic considerations in ELENA model. The sectoral energy service demands up to 2050 are presented in Table A- 4 and Table A- 5. The set of technologies considered in the power sector is presented in Table A- 6 (including thermal plants with carbon capture and storage (CCS)). Table A- 7 presents the details to model hydro power plants. Finally, Table A- 8 presents the set of technologies considered in the transport sector.

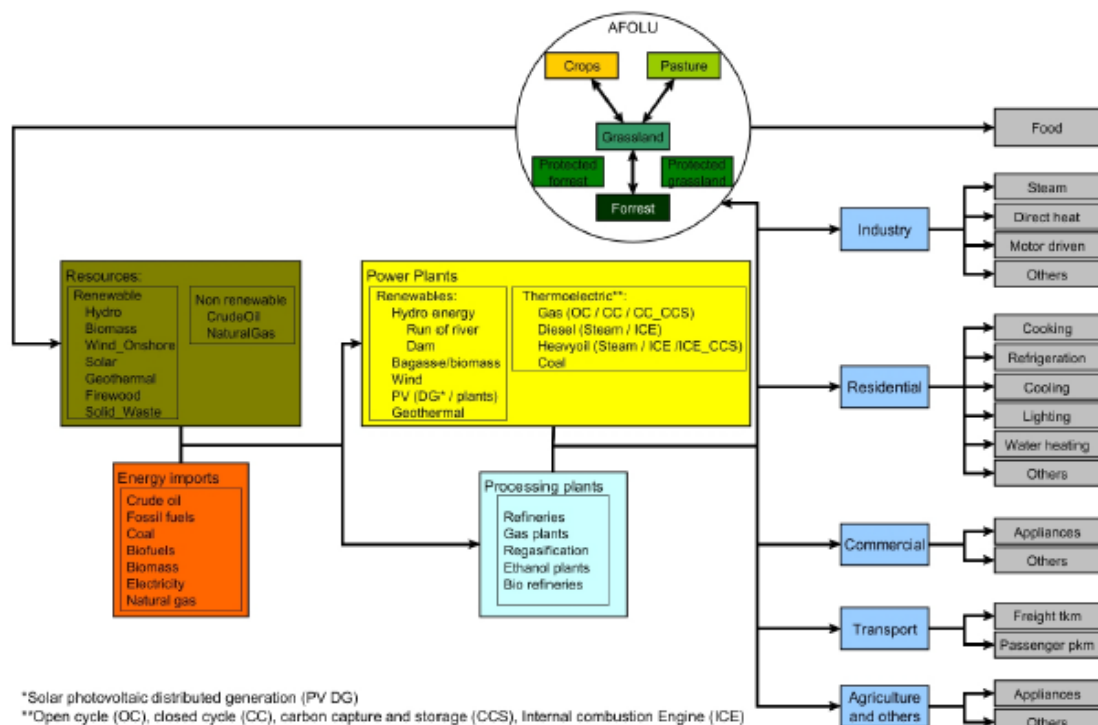

**Figure 6: Representation of the energy and land use system conversion chain in the ELENA model**

The land-use modelling considers three regions (Coast, Andes and Amazon). The Ecuadorian land cover map, which has 16 classes [67,68], was geoprocessed in Arcgis to create a new map with eight aggregated land cover types: forest, protected forest, planted forest, grassland, protected grassland<sup>8</sup>, pasture, cropland and others. Edaphoclimatic conditions data from GAEZ/IIASA [69] was processed to generate an area-weighted average crop suitability index (CSI) map for Ecuador. This average CSI map was calculated considering the specific CSI of the 11 most essential crops [70] in the country that accounts for 85% of the planted area. Detailed information about the data used to produce the

<sup>8</sup> Protected grasslands are mostly moorlands called “*páramo*” in Ecuador.



national CSI map is shown in Appendix A 3. Additionally, the travel time to main cities was used to consider the preference for using first the land closest to the main population centres. The global map of accessibility to high-density urban centres for 2015 [71] was used. As a next step, the travel time and CSI rasters were reclassified into seven relative cost classes as detailed in [52].<sup>9</sup> Then the average CSI and travel time rasters containing the relative values were multiplied. This procedure resulted in 56 relative production cost classes. In order to improve computational performance, these are aggregated into seven cost classes in the ELENA model (See Figure 7). Cost classes are identified with letters, from A to G, representing A the lowest production cost and G the highest. As the last step, the information on agricultural production costs was disaggregated by region. ELENA considers this relative production cost class data to decide the land-use changes by the period under the least cost criteria to supply energy and food demands, subject to restrictions (e.g. reforestation and deforestation scenarios).

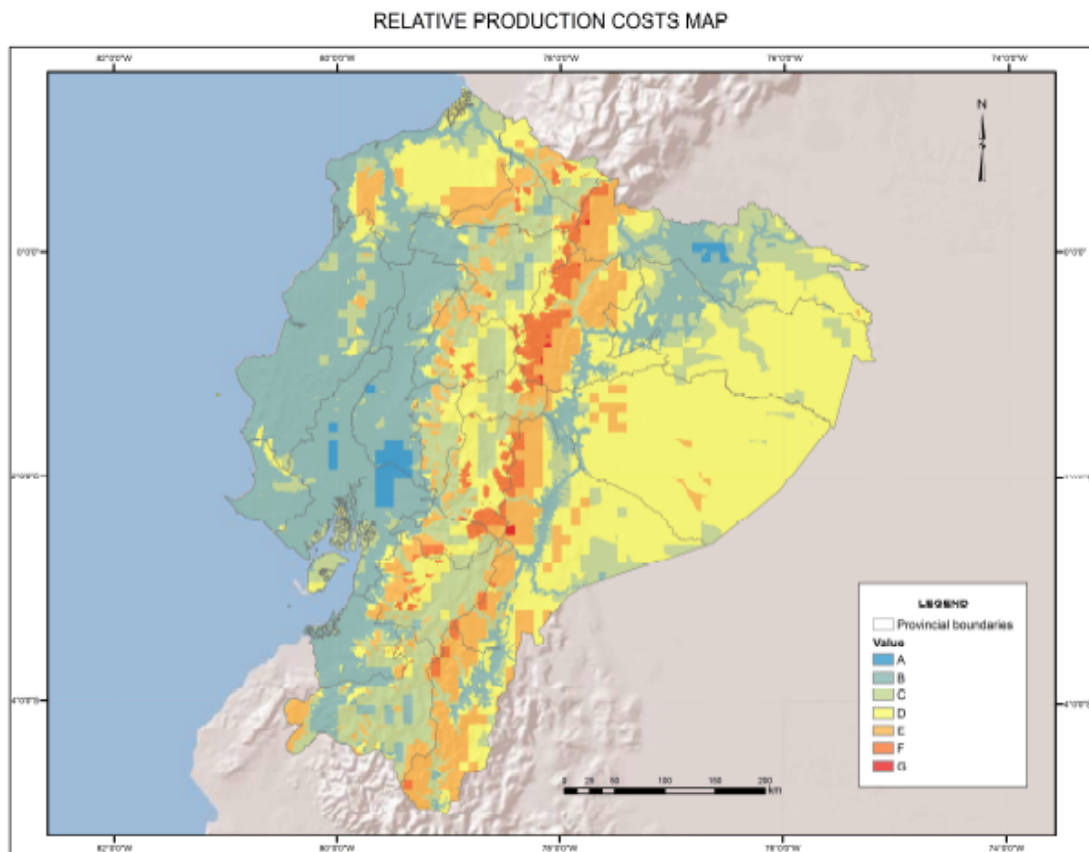

**Figure 7. Relative agricultural production cost map for Ecuador**

<sup>9</sup> The amount of 7 classes is an arbitrary number to regroup the 56 original categories. Since the MESSAGE platform was not originally built for integrating land use and energy in the same tool, in ELENA the energy equations were adapted for land use. This creates a large number of equations and increases the modelling time resolution. Therefore, we decided to aggregate the classes onto 7 to reduce the number of equations and decrease computational time, without losing the needed information required by the model.

Figure 8 shows the land use conversion possibilities in ELENA model. Protected forest and grasslands areas can be accounted for in ELENA by constraining the minimum area subject to land-use change for each category. This establishes a minimum threshold that is therefore protected and not influenced by the pressure of agricultural expansion.

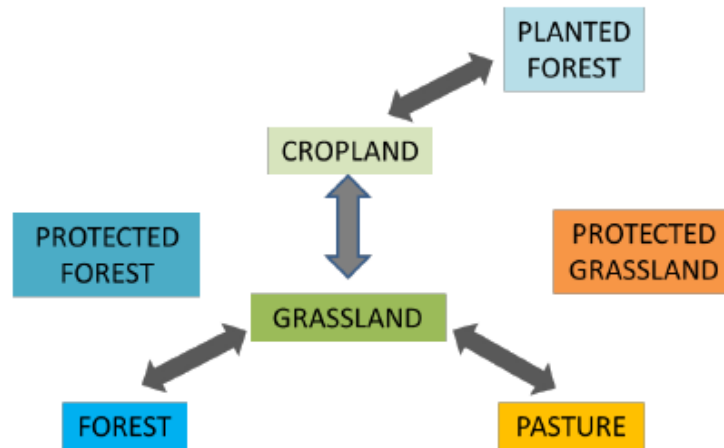

Figure 8. Land use conversion possibilities in ELENA model

For every time step, national food production is calculated by adding total national consumption and exports and excluding food imports. Food imports and exports forecast are determined by means of a linear projection of historic values obtained from FAOSTAT [72]. From the FAO database, 18 categories containing relevant agricultural products for Ecuador are considered (See Appendix A 2). The food supply projection is calculated to account for dietary changes and food waste [73] evolution, which is important in decarbonisation scenarios. Food supply projection is driven by population growth and an increased caloric content diet that would reach current developed countries food intake levels until 2050. The annual demand (metric-tons) of a certain product is calculated by multiplying the share of the product in the daily diet, the daily diet (kcal/day/person), population, 365 days, the inverse of the percentage for its food waste, and an appropriate conversion factor [73].

#### 4.3 Scenarios description

Six different scenarios are evaluated to assess the impact of energy, land, and environmental policies in the ELENA model. Each scenario is constructed with a specific storyline, which affects a set of assumptions on input data, such as those relevant for demand projection and determining technological perspectives. Public policies are implemented by applying specific constraints, being the carbon budget an example of that. These scenarios are described in Table 1.

Table 1: Scenarios modelled with ELENA

Commitment level	Scenario Name	Description
Reference scenario	Minimum Cost* (MinC)	This is a reference scenario that maintains the policies that are in place and the ones already established to come in a near future. Any carbon restriction is applied.
Government engagement scenarios	Unconditional (NDCu)	This is a scenario containing the National Determined Contributions policies that Ecuador is committed to achieve by itself.
	Conditional NDC (NDCc)	This scenario contains the National Determined Contributions policies that Ecuador is committed to achieve with financial and technical support from the international community.
Deep decarbonisation (Disruptive scenarios)	DDP <sub>High</sub>	This scenario is restricted by a cumulative carbon budget of 1.46 Gt CO <sub>2</sub> for the period 2010-2050. It is aligned with a well below 2°C limiting temperature.
	DDP <sub>Low</sub>	Similar to scenario DDP <sub>High</sub> but with a carbon budget of 1.25 Gt CO <sub>2</sub> aligned with a 1.5°C limiting temperature.
	DDP <sub>High_Refo</sub>	This scenario has the same carbon budget that DDP <sub>High</sub> but includes a constraint simulating a reforestation policy.

Note: \* Although all the scenarios are optimized under the vision of minimum total cost, subject to restrictions, the MinC scenario uses few restrictions, so that ELENA optimizes more freely.

---

Scenarios must be endorsed with a narrative that connects them with a possible future reality. The narratives considered in the present work are based on the results of the Laboratory of Energy Transition in Ecuador [74] following the methodology of [75]. This project lasted for three years, in which ideas of interdisciplinary stakeholders of the energy sector were combined to build transition scenarios for Ecuador. Nevertheless, these narratives contained qualitative storylines that had to be transformed into quantitative data to be implemented in ELENA. This quantitative data shapes the model in the form of demands, restrictions, or technological parameters (e.g. efficiency changes over time). One of the main constraints used to shape the DDP scenarios was the national carbon budget, limiting cumulative CO<sub>2</sub> emissions from 2010 to 2050. This carbon budget is specific for Ecuador and it was calculated based on the South America region's carbon budget, defined by the global COFFEE model [17]. That carbon budget was distributed to South American countries based on the GDP per capita<sup>10</sup> proxy. Due to uncertainties in the global carbon budgets calculations, there is an interval for the decarbonisation levels corresponding to a global limiting temperature of 1.5°C. Thus, this study assumes that the value of 1.46 GtCO<sub>2</sub> represents a well below 2°C target, whilst the 1.25 GtCO<sub>2</sub> represents the strictest 1.5°C limit.

Table 2 presents the main assumptions of all scenarios, and a detailed description of each scenario is presented in Appendix A 5. Table A- presents the evolution of the values of many parameters and the premises in each scenario in the period 2015-2050.

---

<sup>10</sup> Several exercises were done to distribute the South America carbon budget by country: by total GDP, population, GDP per capita, etc. We took the most restrictive budget, which is based on the GDP per capita relation.

Table 2: Scenario main assumptions

Sector	Parameters	MinC	NDCu	NDCc	DDP*
		(compared to base year)		(compared to MinC scenario)	
Transport	Private mobility share	Increase 36%	"	"	Reduced 60%
	Average travel distance (cars)	Increase 13%	"	"	Reduced 25%
	Share of EV in fleet	Increase	"	Increase	Increase
	Occupancy	1.7 people/car	"	"	Increase 6%
	Tonnage rate	20 people/bus	"	"	Increase 25%
Motorized demand in Gpkm	Motorized demand in Gpkm	134	"	"	121
	Demand in Gtkm	75.9	"	"	75.9
Industry	Production's energy intensity	2% reduction	Reduction in cement	14% reduction	14% reduction
	Use of Bio-energies	15% in food&beverage industry	"	"	Up to 10% increase in cement ind.
Residential	Electric shower share	65%	"	"	78%
	Induction stoves share in urban areas	11.5 %	"	30 %	50%
Power plants (installed capacity)	Hidro	6.2 GW	"	8.6 GW	8.6 GW
	Thermal	3.5 GW	"	"	"
AFOLU	deforestation rates (ha/year)	108 000	3% reduction	12% reduction	94% reduction
	reforestation rate (ha/year)	31000	None constraint used	None constraint used	2.6 times increase**.
Food production	Diet (Kcal/cap/day)	42% Increase	"	"	50% meat replaced by soy
	Food waste	Same as base year	"	"	50% reduction

\* Between DDP scenarios, the carbon budget and the reforestation policies are the only variants.

\*\* This value represents the reforestation policy used only in the DDP<sub>High Reso</sub> scenario.

Quote mark (") is used when the parameter of the MinC scenario is maintained

---

## 4.4 Data

Official data from government entities were considered when available. The National Energy Balance from different years [30,40,41] was used for general energy information and trends. For the transport sector, there is available a complete compendium of fleet evolution for passenger and freight [76]. Nevertheless, there are a few national statistics related to transport activity. Thus ICCT<sup>11</sup> and COFFEE data were used to have some detailed parameters [17,77]. In the electric power sector, high-quality data with information of powerplants, from prefactibility projects [78] to operational statistics [79], is available.

Moreover, electric power load curves were used to define the intraday time periods for Ecuador, which was implemented in ELENA. For renewable sources, comprehensive studies of wind resource measurements [80] and residues availability [81] were used. In the case of solar resources, simulations using the System Advisor Model (SAM) , which uses the information of the National Renewable Energy Laboratory (NREL) [82], allowed to determine the global horizontal irradiance. A major challenge was to determine the final energy use for the industrial sector. At first, the overall final energy consumed was obtained from the National Energy Balance report [41]. Then, it was attributed to the industrial production, using the reports of companies, which led to the specific energy required by metric-ton of product [83–85]. Finally, since the input variable into ELENA is useful energy, energy conversion, efficiencies were defined considering different processes and fuels. For the AFOLU sector, a variety of data was collected. In order to set the base year, crops' yield and livestock densities were required [86]. Historical averages for reforestation and deforestation from 1990 were analysed to create the required model constraints. As explained before, the mapping of different crops were created to analyse the land-use change. To determine the food production demand FAO database was considered [72]. Besides, as explained before, geoprocesed data in Arcgis and Edaphoclimatic conditions data were used to create the land use category classes that determine land use interactions.

In order to project the data through the entire studied period, different techniques were applied. In the residential and commercial sector, a bottom-up approach was developed using demographic parameters. For the transport sector, a dashboard created by IDDRI at the DDP project was used considering the different goals for each scenario [19]. For the industrial sector, the projection was driven by the GDP, with adjustments made according to induced changes on efficiency considering figures from developed countries taken from the RETScreen database [87].

---

<sup>11</sup> ICCT=International Council of Clean Transport

---

Regarding food production, the FAO database provides a historical tendency for agricultural production. It was linearly extrapolated, maintaining a coherence between the increase in productivity and the limits for the crop yield improvements. In addition, food losses[73] and dietary parameters were included in the calculations, which allowed to perform variations in dietary tendencies and include its effects on the food demand. The food projections considered a dietary intake as the base for the calculations, allowing to reach developed countries dietary level.

## 5. Results

Results for MinC, DDP<sub>High</sub>, DDP<sub>Low</sub>, DDP<sub>High\_Refo</sub> scenarios are present in this section. Analysis of the NDC scenarios is only considered while comparing the emissions level to picture the different decarbonisation trajectories. Despite the results available for all scenarios, the comparison between the MinC and the DDP scenarios is prioritized.

In the MinC scenario, it is expected a slight diversification of the primary energy matrix in the coming decades, due to an increase of non-conventional renewable energies (Figure 9). Nevertheless, primary energy would remain based on, roughly, 80% of fossil fuels. Oil dependence for Ecuador will continue, despite the local production reduction. Under the MinC scenario, Ecuador becomes a net oil importer by 2045. This is an energy problem and an economic issue, as well, as discussed previously. Historically, coal is not part of Ecuador's energy matrix, but there is no prohibition for its usage. Without GHG emission constrains, results in the MinC scenario show an increase of coal use, since imported coal would be a cheap source for the electric power sector expansion.

In all DDP scenarios, the highest increase occurs in bioenergy. By 2050 biomass contribute with around 700 PJ becoming even more important than oil, which contributes less than 400 PJ in the primary energy supply. Oil trade deficits and, hence, Ecuadorian oil vulnerability, a major issue in the MinC scenario, is controlled in the DDP scenario, by means of liquid fuel switches. In 2050, half of domestic supply primary energy is supplied by advanced bioenergy, while fossil energy represents 41%, and other renewable energy represents the rest.

A counter-intuitive finding is the higher increase of primary energy supply by 2050 in the scenario with higher carbon restrictions (DDP<sub>Low</sub>). This occurs because biomass is commonly applied in less efficient processes, which results in higher primary energy demand. Alternatively, in the DDP<sub>High\_Refo</sub> scenario, where GHG emissions are mitigated mainly by means of reforestation, reducing the role of bioenergy, the primary energy supply decreases by 2050, relative to MinC.

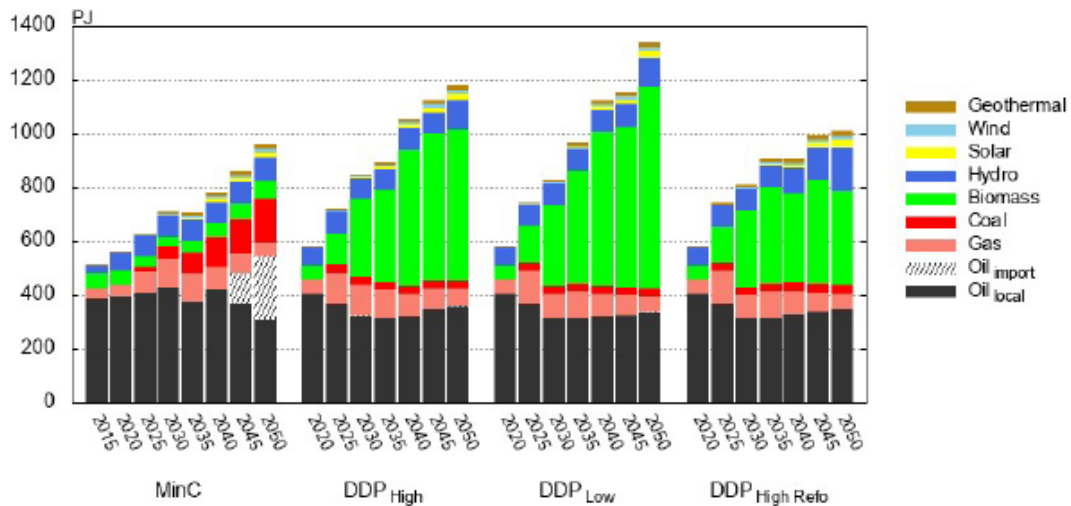

Figure 9: Primary energy supply

Electricity demand continuously grows in the coming years, as shown in Figure 10. In the MinC scenario, coal power plants will be used to supply the additional demand in the future. It is one of the least-cost options especially for the Coast region, due to its increased international trade and access at seaports. By 2050, 30% of the electricity is produced from coal, 40% from hydropower and the rest is mainly non-conventional renewables.

On the contrary, with carbon restrictions in place, a massive deploy of coal technology is no longer an option for the power sector. Thus, in the DDP<sub>High</sub> and DDP<sub>Low</sub> scenarios, biomass electricity generation equipped with CCS develops faster (BECCS<sup>12</sup>), supplying around 30% of the electricity from 2035. Mostly woody biomass would be used to produce electricity. For these scenarios, hydropower represents the base of the electric generation, maintaining a stable electricity production until 2045, and increasing it in around 30% only in the last periods.

Finally, the scenario accounting for reforestation policies (DDP<sub>High\_Refo</sub>) does not rely heavily on energy crops and thermal biomass power plants with CCS as much as the other DDP scenarios. The DDP<sub>High\_Refo</sub> scenario shows a minor share for BECCS, 12% by 2050, while hydropower almost doubled its production in the last three periods.

<sup>12</sup> BECCS means “Bioenergy Carbon Capture and Storage”.



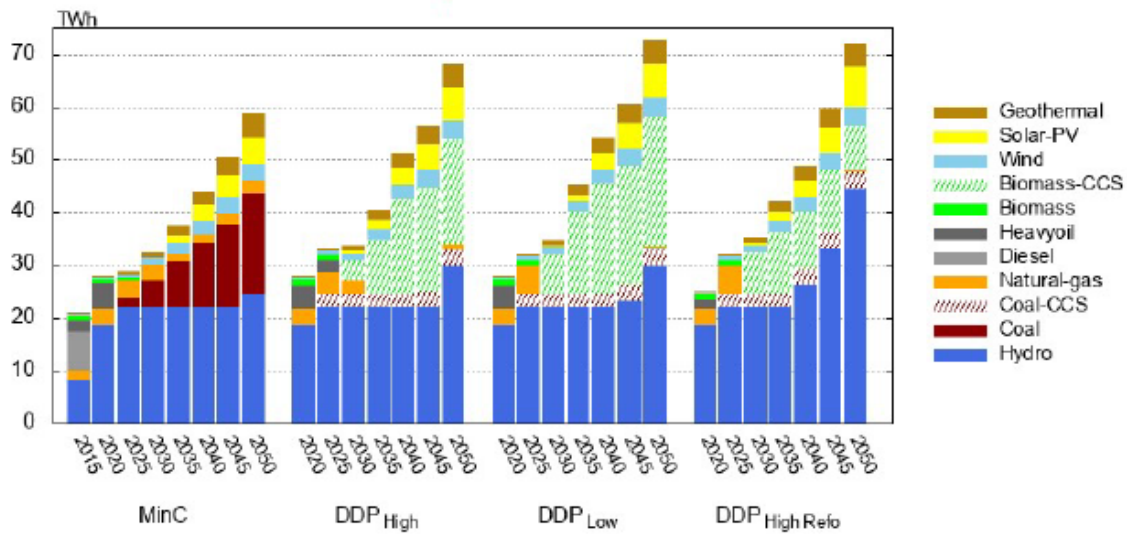

Figure 10: Electric generation

Figure 11 shows the evolution of installed capacity in the electricity sector. Hydropower is the dominant technology in all scenarios, but its share in the electricity generation reduces in the coming years, due to the expansion of other sources. There is an increased capacity in solar PV systems, both distributed systems and utility-scale plants. In the MinC scenario, the expansion of PV systems is the most prominent, followed by coal. In the  $DDP_{High}$  and  $DDP_{Low}$  scenarios, biomass and solar PV increase similarly, while coal is used in a small share and only equipped with CCS. In the  $DDP_{High\_Refo}$ , biomass capacity expansion is less important than that of the former DDP scenarios, while hydropower share represents more than half of the installed capacity. In all scenarios, natural gas fuelled-thermal power plant capacity increases in the mid-term but then decreases. Thus, it acts as a transition technology.

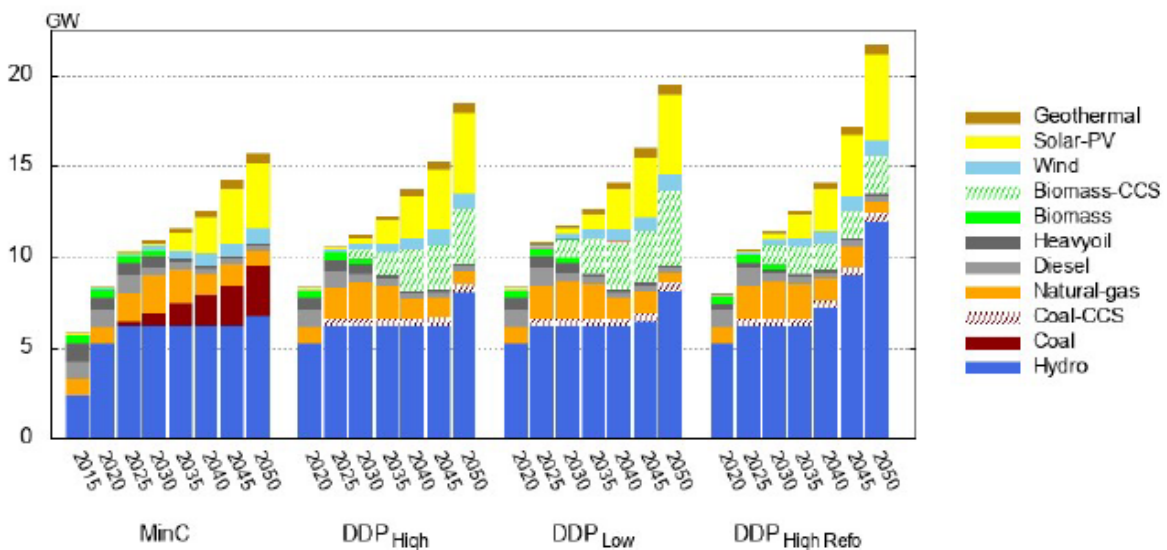

Figure 11: Power installed capacity

Figure 12 shows GHG emissions decomposed by sector. As expected, GHG emissions increase in the MinC scenario. AFOLU sector is the main contributor at first, but then it is overtaken by the increase in the transport sector.

On the contrary, DDP scenarios indicate an increasing trend towards negative CO<sub>2</sub> emissions in the energy sector, due to the large amount of BECCS deployed. In the DDP<sub>Low</sub> scenario, the stricter carbon budget requires even higher use of negative emission technologies. However, DDP<sub>High\_Refo</sub> scenario presents a decrease in the need for negative CO<sub>2</sub> emissions from the energy sector, due to increased negative emission from the land sector. Thus, negative emissions options consistently play an essential role in all DDP trajectories.

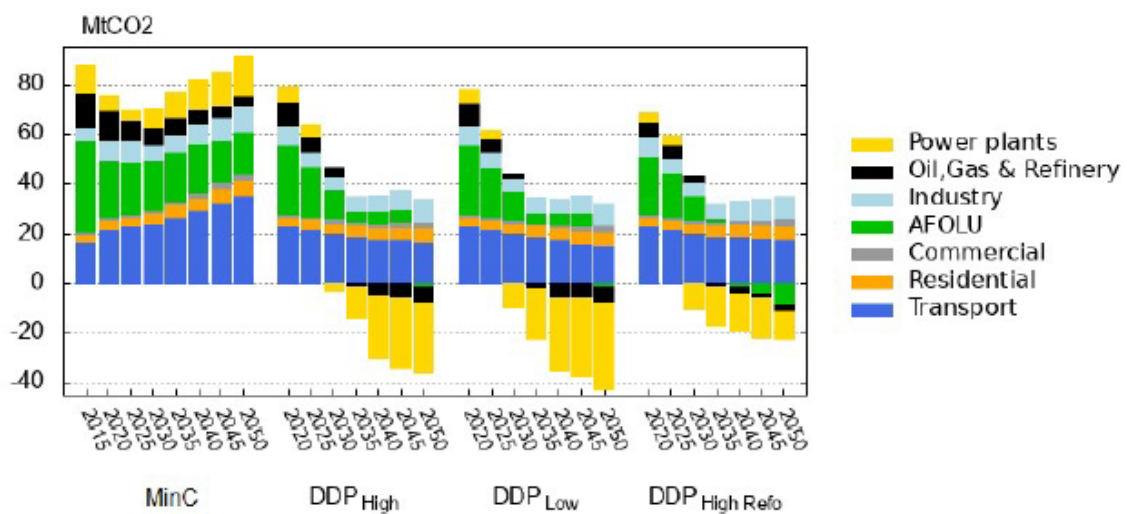

Figure 12: GHG emissions, by sector

The reduction of transport sector emissions in the DDP scenarios is mainly explained by activity effects, as individual mobility reduces more than 50% in 2050 compared to 2020, and structural effects, due to the increasing use of public modes of transport (See Figure 13, Figure 14 and Figure 15)

Moreover, conventional fuels such as gasoline and diesel are replaced by advanced biofuels, natural gas, and electricity. Notably, electric vehicles play an important role for both individual and public transport. Electric light-duty vehicles also play a role in the decarbonisation of freight transport (Figure 16).

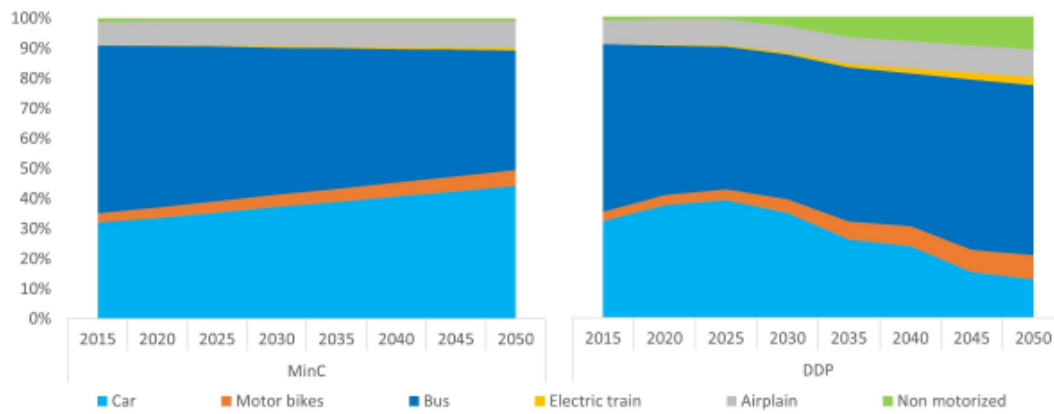

Figure 13: Modal share evolution for passenger transport in MinC and DDP scenarios

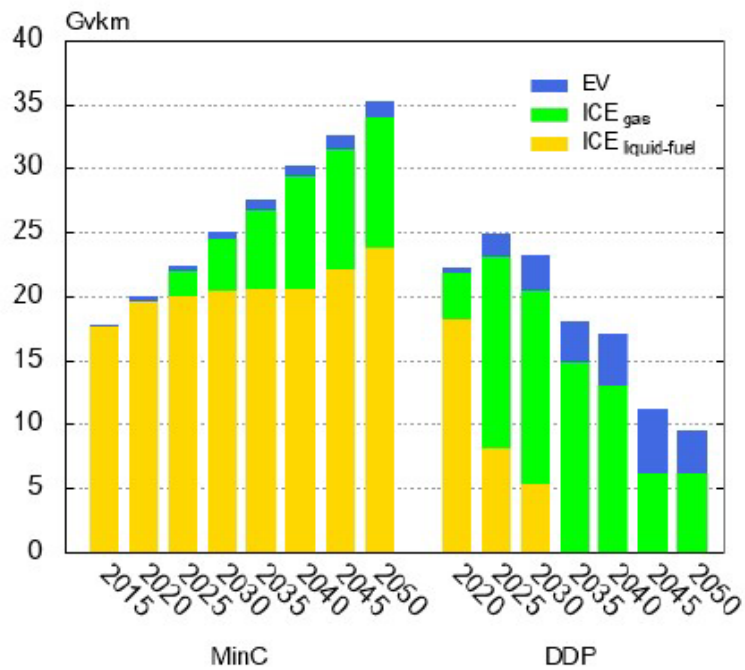

Figure 14: Individual vehicles mobility for cars by fuel (vkm)

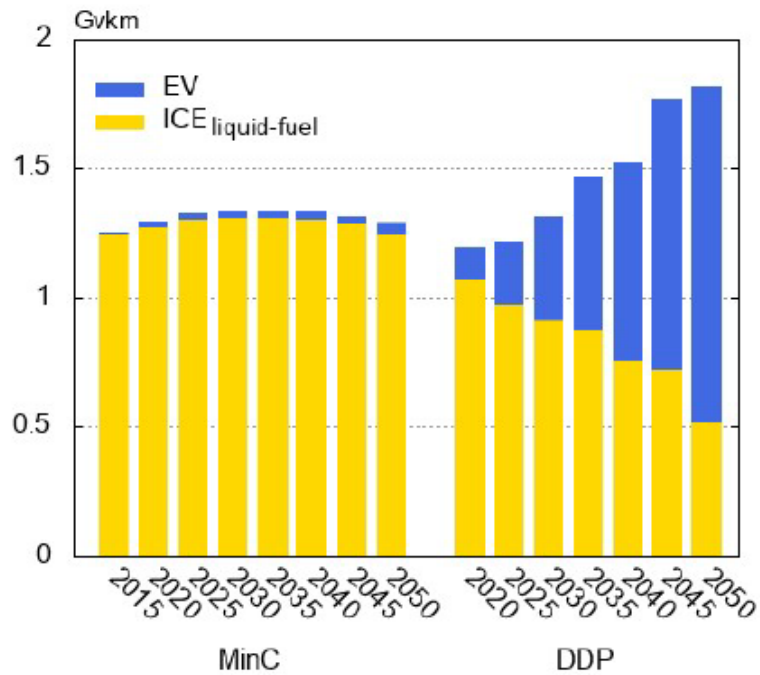

Figure 15: Public transport mobility for bus by fuel (vkm)

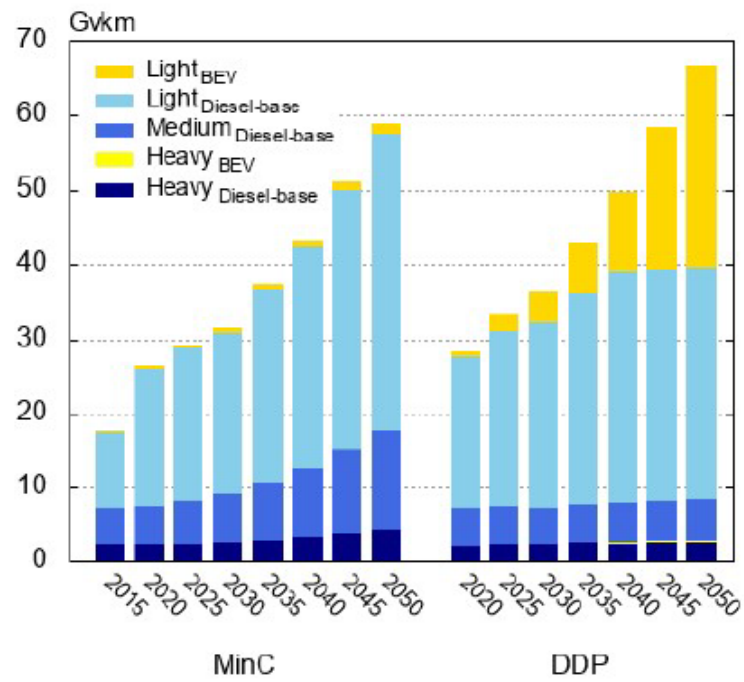

Figure 16: Freight transport mobility for trucks by fuel (vkm)

Figure 17 represents the emissions per year for different scenarios. NDCs and MinC scenarios follow a similar trend. This confirms that the policies

implemented in the Ecuadorian NDCs consider only a short-term strategy. Without new policies in place for the long-term, from 2030 the model optimises the system seeking for the least-cost configuration. Therefore, emissions constrained in the short-term under the NDC strategy start to grow again. Even if there is a reduction in cumulative GHG emissions, it is clear that the NDCs trajectories are not in line with the goals of the Paris Agreement.

On the contrary, the DDP scenarios demonstrate different decarbonisation pathways, compatible with a well below 2°C and a 1.5 °C scenarios. For scenarios DDP<sub>High</sub> and DDP<sub>Low</sub>, emissions decrease constantly until 2040 when the GHG emissions decline decelerates and the curve starts to flatten. DDP<sub>High</sub> Refo scenario shows decreasing emissions up to 2040 when its emissions level remains stable. The most restrictive carbon budget of the DDP<sub>Low</sub> scenario achieves the lowest annual emissions from 2030 onwards. Results show that, until 2050, Ecuador does not need to be carbon neutral to comply with the 1.5°C global target.

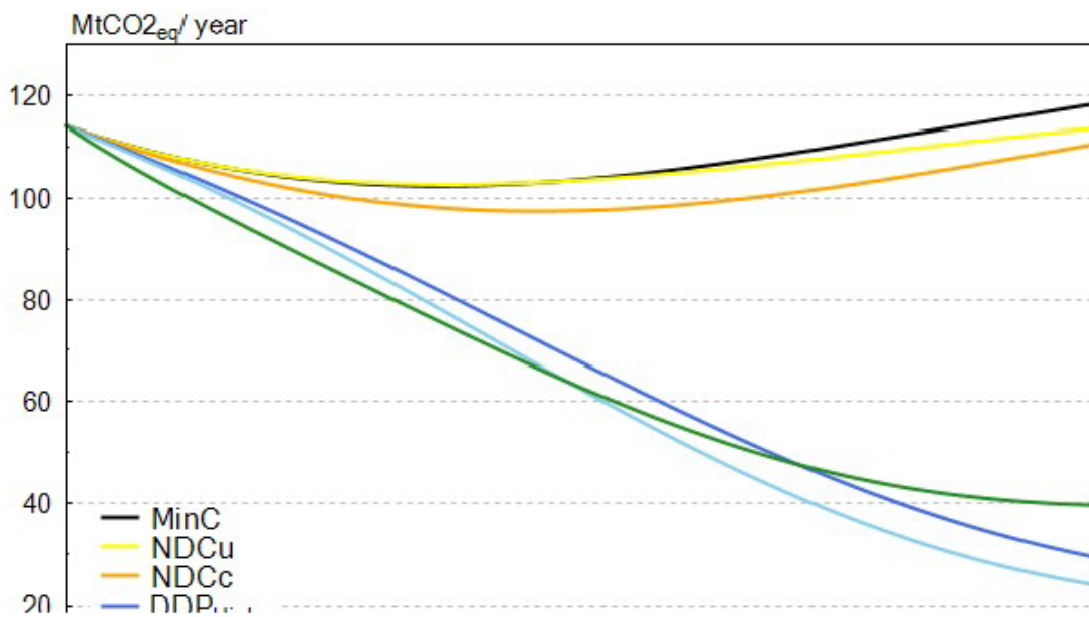

Figure 17: Total annual national emissions, by scenario (MtCO<sub>2</sub>eq)

Figure 18 describes the evolution of cumulative land-use changes with respect to the base year. In a MinC scenario, deforestation increases, resulting in increased areas of pastures and grasslands. In the DDP (High and Low) scenarios, forest area is maintained after 2030. Only in DDP<sub>High</sub> Refo there is a positive forest balance in 2050, meaning that there is more forest area in 2050 than there were in 2015 due to reforestation policies. The DDP<sub>High</sub> and DDP<sub>Low</sub> show an increase in croplands, as planted forest for woody biomass are also considered in that category.

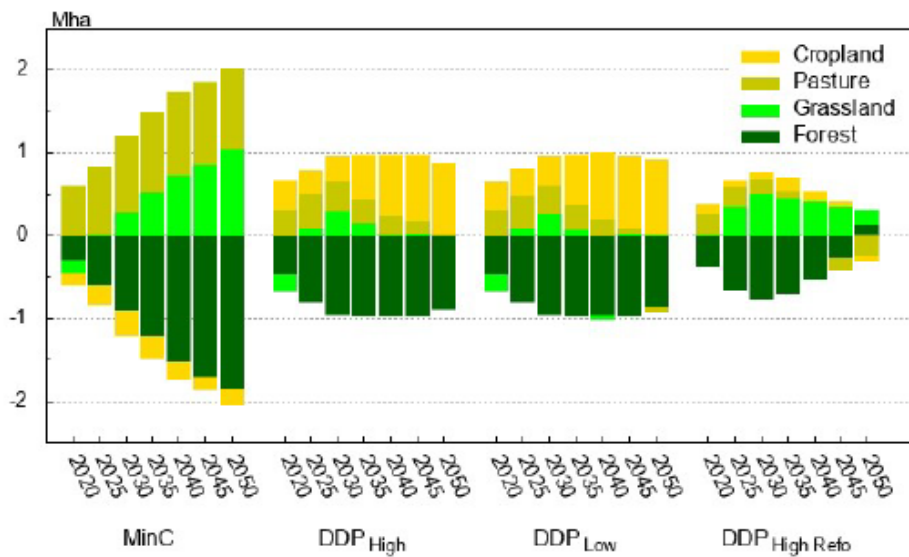

Figure 18: Cumulative land use change (relative to base year)

## 6. Discussion

The deep decarbonisation pathways,  $DDP_{High}$  and  $DDP_{Low}$ , going from a “well below”  $2^{\circ}C$  to a  $1.5^{\circ}C$  target, represents a variation on the national carbon budget of around 15% when compared to each other. These scenarios’ results, with respect to energy, land use and emissions, do not change substantially amongst themselves. This gives certain robustness to the results and provides a clear path to policymakers. On the other hand, they differ considerably from both MinC and  $DDP_{High\_Refo}$ .

Findings indicate that crude oil (local or imported) remains an important energy source in Ecuador for the coming decades, regardless of the scenario. In a GHG emission mitigation context, this means that the emissions provided by fossil fuels must be compensated. Biomass-related technologies compose the leading solution to this challenge, not only as a renewable source for thermal power plants and biofuels, but also associated with CCS. It results both in negative emissions in the energy sector and in a fast increase of biomass as primary energy, in  $DDP_{High}$  and  $DDP_{Low}$  scenarios. This happens even counting for direct and indirect land-use change emissions (as ELENA is able to account for both). Nevertheless, this stark biomass energy conversion ramp-up is smoothed in the DDP scenario that simulates an aggressive reforestation policy ( $DDP_{High\_Refo}$ ), since the forest itself would be a natural carbon sink. A large portion of the biomass energy conversion happens in thermal power plants equipped with carbon capture and storage systems, although an afforestation

---

scenario such as the DDP<sub>High Refo</sub> scenario proves to be much less dependent on BECCS.

This is a crucial result since it shows that BECCS is used to compensate for GHG emissions produced in other sectors. Therefore, a common issue of all ambitious DDP scenarios refers to BECCS feasibility in Ecuador. Actually, BECCS feasibility is a major issue for every country in the world as acknowledged in [88,89], even in countries with a large record on converting biomass to energy carriers [13]. Except for the very specific case of CO<sub>2</sub> capture from process emissions in ethanol production (which is easier than the capture from flue gas of combustion processes), the CO<sub>2</sub> capture at large scale in biomass energy conversion facilities is not yet fully mature nor deployed. From the 19 large-scale carbon capture facilities operating in the world in 2019, the majority refers to natural gas processing plants (also easier capture processes than combustion ones), and there is only one BECCS plant operating, and, as expected, capturing CO<sub>2</sub> from ethanol fermentation in the USA [90].

It is somehow a vicious cycle: without extensive and permanent near-term reductions in the world energy demand, scenarios that aim to cope with the “well-below 2.0-degree target” need negative emission technologies (NETs), particularly BECCS, to be feasible [91,92]. However, at the same time BECCS, beyond the option related to ethanol fermentation, can only become a viable option at large-scale after passing through a learning curve starting from now. Interestingly enough, this was already acknowledged by [93] for all CCS facilities (biomass and fossil fuel ones), who notes that GHG mitigation emission policies lead to a type of system inertia, where decision-makers simultaneously affirm that the cost of CCS technologies is high, which makes current investment difficult, but that these technologies are promising, so their cost will be reduced by technological learning. In other words, the current investment in CCS does not occur, because it is high, but at the same time, the prospect of reducing the cost of CCS options in the future is affirmed, which will hardly occur without the current investment. In the end, should countries follow a DDP strategy, all will need to join efforts and share results to be able to allow a spread and large-scale deployment of BECCS, particularly in countries where biomass energy conversion is or can become relevant [94]. Possibly this will also depend on a boost on climate finance for supporting BECCS deployment in emerging countries [95].

In the end, a central discussion that arises is the trade-off observed between BECCS and forest as emissions reduction strategies in Ecuador, as it was observed in other South American countries where LUC emissions are relevant [13]. By running the ELENA model, it was possible to carry out this trade-off analysis between two decarbonisation scenarios. Being it a game changer situation, further studies should deepen this discussion. For example, a reforestation program must account for the economic benefit that the forest delivers. Forest ecosystem services, provide resources, regulates cycles (in

---

water, soil and weather) and encompasses cultural services [96]. All these benefits must be included from an economic perspective to better evaluate the  $DDP_{High\_Refo}$  scenario, while the DDP scenarios relying on BECCS should account for its advantages (e.g. oil substitution, labour and income creation) and risks (not yet mature and regulated high-cost option).

## 7. Conclusions

The decarbonisation of a country could be achieved according to several different strategies. Nonetheless, it should be consistent in terms of avoiding leakages between sectors and sub-optimal solutions. One advantage of building and running a national integrated assessment model (IAM) is to perform this task, particularly in tools prepared to handle the detailed modelling of land and energy systems simultaneously. The Ecuador Land Use and Energy Network Analysis (ELENA) model was prepared under the aegis of the project “Deep Decarbonisation Pathways Project for Latin America and the Caribbean (DDP-LAC)” precisely for that purpose. This paper presented decarbonisation scenarios developed with ELENA but sets up a tool able to explore many other scenarios and detailed sectoral analysis. Accordingly, the modelling procedure applied in Ecuador (from a matrix firstly created in Brazil) could be well reproduced in other countries that share similarities (relevant emissions from Land Use Change (LUC), deforestation issues, the role of the transport sector in GHG emissions, and so on), such as other Latin American countries.

Deep decarbonisation pathways ( $DDP_{High}$  and  $DDP_{Low}$ ) tested in Ecuador present consistent and similar results in terms of technological needs and overall transformative pathways. On the other hand, a notorious change happened when a reforestation policy was modelled in the  $DDP_{High\_Refo}$  scenario. This scenario highlighted the climate significance of land protection policies, which can have repercussions on the evolution of the energy system. As such, these results provide a clear set of actions needed for policymakers to develop climate policies and long-term energy planning in Ecuador.

Thus ELENA model, the first Ecuadorian IAM, proved to be an appropriated tool to evaluate scenarios and validate policies in a decarbonisation framework. There is neither perfect model nor a model that does not require a good analyst. The model serves to organize and test assumptions. In turn, ELENA has a limited representation of all economic sectors and, therefore, may not be enough to assess all the socioeconomic and environmental repercussions of each strategy. Nevertheless, the structure of the model allows for the continuous update of the structure and data (such as increasing representation of an individual sector or aggregating other sustainable development issues). Moreover, as is, ELENA already provided insights for Ecuadorian policies, as well as interconnections on the energy and land-use nexus.



---

Findings show that DDP scenarios are challenging, but do not compromise socio-economic development. The scenarios built in ELENA hold the same premises of Gross Domestic Product and population growth, and the different demands allocated to each sector do not consider any limitations on energy access to attain decarbonisation. On the contrary, the DDP scenarios were built over premises that considered modern energy services access like those of developed countries. Even when the food demand was estimated (daily food intake), the aim was to emulate the average food intakes of developed countries. In this case, DDP scenarios also considered food waste reductions that could be achieved by public policies. Consequently, the scenarios modelled, far from compromising development, even support a better living condition.

Ecuador is at the edge of a forced energy transition due to imminent petroleum resources depletion. Specific sectors, like transport, will continue to depend mainly on fossil fuels, but it is possible to palliate the effects of a forced transition by starting to design now a future energy matrix. Bioenergy seems to be an excellent candidate to replace oil products (particularly diesel<sup>13</sup>) to some extent. In this case, biorefineries and Bioenergy Carbon Capture and Storage (BECCS) must be studied in the Ecuadorian context. Planted crops may be sustainably managed to provide woody biomass to bio-refineries and thermal power plants. Around 500 thousand hectares of sustainably managed planted forest would be required by 2050. Ambitious reforestation could avoid the dependence on risky and expensive Carbon Capture and Storage (CCS). Reforestation and conservation of an additional 300 thousand hectares, in comparison to the 2015 base year, would provide enough negative emissions to avoid the deployment of an additional 900 MW of BECCS.

Moreover, findings show that increasing electric mobility for passengers and for freight transportation can also pave an energy transition in Ecuador with less GHG emissions and under a less-risky position in terms of oil vulnerability. By 2050, 70% of buses, and 33% of private cars would run electric. Besides, around 10% of passenger transportation demand would be supplied by non-motorized options (walking, biking, skates, and skateboards) in urban cities. For freight, by 2050 40% of light and medium trucks and 10% of heavy trucks could be electrified.

As the country has already an electric power system relying on hydro, and there remains a deployment potential for new renewable electricity generation sources, adequate long-term strategies smooth down the effects of the energy transition, by responding to the electricity demand increase, which duplicates by 2050.

---

<sup>13</sup> DDP scenarios indicate that approximately 25% of final energy consumption in the transport sector would be supplied by biorefinery diesel, while around 4% would be supplied by traditional biodiesel.

---

Finally, ELENA is a suitable tool to follow and assess Ecuador's National Determined Contribution (NDC) initiative. Findings of this study show that the country's NDCs are not yet aligned with a deep decarbonisation pathway. Indeed, Ecuadorian NDC must increase its level of commitment to be aligned with the Paris agreement and the well-below 2°C temperature limit. A long-term strategy is ideal to guarantee that the new NDCs are aligned with a deep decarbonisation goal designed with ELENA. Moreover, a long-term strategy could also be useful to avoid negative externalities that might arise from a trend-based scenario where petroleum is increasingly imported, coal expands<sup>14</sup> in Ecuador as a low-cost source for electricity generation and deforestation might compromise biodiversity and ecosystem services in the future.

## 8. Future work

The ELENA model, as stated before, is the first attempt of an IAM for Ecuador. The model structure is dynamic, and more detail and new technologies can be added to it. For instance, given the scarce direct normal irradiance (DNI) resources in continental Ecuador, solar thermal options were disregarded in the current version of ELENA. However, low-quality solar thermal applications could have been considered due to its significant potential [97], according to a recent release of Ecuador solar map 2019 [98]. Galápagos region has the highest DNI of the country, and a techno-economic potential of concentrated solar power technologies must be studied. Any renewable energy project carried in the archipelago is always emblematic due to its environmental importance. The same holds for other energy conversion technologies that were disregarded in this version of Elena: hydrogen-fuelled cars, trucks and ships, nuclear plants, and bio-digesters.

Another vital challenge refers to a better economic analysis required to complete the assessment of decarbonisation pathways in Ecuador. This significant drawback could be overcome in a second stage of the DDP project, where an economic model could be linked to ELENA. The economic analysis is fundamental, especially for developing countries. Socio-economic parameters are key to attain the decarbonisation pathways.

Given the relevance of BECCS in DDP scenarios, especially those with less reforestation, it is crucial to evaluate co-benefits and impacts of BECCS and reforestation, to propose the best decarbonisation strategy for Ecuador. A multi-criteria assessment could be a suitable methodology for that. It is necessary to

---

<sup>14</sup> Coal expansion is not a minor challenge for Ecuador, since it has never been part of the country's energy system. Nevertheless, it is a mature and cheap technology that could be considered in a poor planned transition from petroleum. The country does not have this resource nationally, but currently there is no legislation avoiding it to be imported or applied in the power sector.

---

understand the viability of CCS for Ecuador, and storage availability is fundamental. Studies must be conducted to understand the storage capacity on depleted oil wells and in saline aquifers.

To properly assess emission and energy reductions related to efficiency, it is necessary to have detailed information of final energy uses. In Ecuador, some studies on this topic are available [99]. It is highly recommended to develop further studies to increase the data of final energy uses and increase the detail present in the model.

Finally, this study does not quantify co-benefits associated with public health, (e.g. lower local impact atmospheric emissions), jobs and income creation, local industry development, biodiversity, eco-tourism, etc. This is an important subject in emerging countries where other sustainable development goals must be aligned with DDP strategies.

## Acknowledgement

We thank the Deep Decarbonisation Pathways in Latin America and the Caribbean (DDP-LAC) project, financed by the Inter-American Development Bank (IADB) Sustainable Energy and Climate Change Initiative fund (RG-T3028), the IADB French Climate Fund (RG-T3193), the 2050 Pathways Platform, and the *Agence Française de Développement* (AFD). We thank *Institut du Développement Durable Et des Relations Internationales* (IDDRI) by their technical support and coordination during the DDP project. We thank to Alejandra Guevara, Eduardo Noboa and Freddy Ordóñez for their support during initial stages of this work. We also value the information and feedback to our work provided by Verónica Guayanlema and Paúl Melo. We thank the Ministry of Environment (MAE), Ministry of Energy and Non-Renewable Natural Resources (MERNNR), Operator of the Ecuadorian Power System (CENACE) and Electric Corporation of Ecuador (CELEC) for sharing technical data. We thank to the *Escuela Politécnica Nacional* (EPN) for the research time to work on project PIE-DIM-BID-2019. Finally, we thank to the public company EPN-TECH for their administrative support. In the case of the Brazilian researchers, they also thank the Brazilian agency CNPq for the financial support.

---

**Appendix A.** Supplementary data Supplementary data to this article can be found online at: <https://doi.org/10.1016/j.esr.2021.100637>.

## References

- [1] IPCC, Global warming 1.5 DS An IPCC Special Report on the impacts of global warming of 1.5°C above pre-industrial levels and related global greenhouse gas emission pathways, in the context of strengthening the global response to the threat of climate change, sustainable development, and efforts to eradicate poverty [Masson-Delmotte, V., P. Zhai, H.-O. Pörtner, D. Roberts, J. Skea, P.R. Shukla, A. Pirani, W. Moufouma-Okia, C. Péan, R. Pidcock, S. Connors, J.B.R. Matthews, Y. Chen, X. Zhou, M.I. Gomis, E. Lonnoy, T. Maycock, M. Tignor, and T. Waterfield (eds.)], IPCC, 2018.
- [2] MAE, Primera Contribución Determinada A Nivel Nacional Para El Acuerdo De París Bajo La Convención Marco De Naciones Unidas Sobre Cambio Climático, (2019).
- [3] UNFCCC, Adoption of the Paris Agreement. Report No. FCCC/CP/2015/L.9/Rev.1, (n.d.).  
<http://unfccc.int/resource/docs/2015/cop21/eng/l09r01.pdf>.
- [4] J. Rogelj, M. den Elzen, N. Höhne, T. Fransen, H. Fekete, H. Winkler, R. Schaeffer, F. Sha, K. Riahi, M. Meinshausen, Paris Agreement climate proposals need a boost to keep warming well below 2 °C, *Nature*. 534 (2016) 631–639. <https://doi.org/10.1038/nature18307>.
- [5] A. Vogt-Schilb, S. Hallegatte, Climate policies and nationally determined contributions: reconciling the needed ambition with the political economy, *WIREs Energy and Environment*. 6 (2017) e256.  
<https://doi.org/10.1002/wene.256>.
- [6] X. Pan, M. den Elzen, N. Höhne, F. Teng, L. Wang, Exploring fair and ambitious mitigation contributions under the Paris Agreement goals, *Environmental Science & Policy*. 74 (2017) 49–56.  
<https://doi.org/10.1016/j.envsci.2017.04.020>.
- [7] B. Cointe, C. Cassen, A. Nadaï, Organising Policy-Relevant Knowledge for Climate Action:, *Science & Technology Studies*. 32 (2019) 36–57.  
<https://doi.org/10.23987/sts.65031>.
- [8] R. Soria, A.F.P. Lucena, J. Tomaschek, T. Fichter, T. Haasz, A. Szklo, R. Schaeffer, P. Rochedo, U. Fahl, J. Kern, Modelling concentrated solar power (CSP) in the Brazilian energy system: A soft-linked model coupling approach, *Energy*. 116, Part 1 (2016) 265–280.  
<https://doi.org/10.1016/j.energy.2016.09.080>.

- 
- [9] A. Gambhir, Planning a Low-Carbon Energy Transition: What Can and Can't the Models Tell Us?, *Joule*. 3 (2019) 1795–1798. <https://doi.org/10.1016/j.joule.2019.07.016>.
- [10] R. Miranda, S. Simoes, A. Szklo, R. Schaeffer, Adding detailed transmission constraints to a long-term integrated assessment model – A case study for Brazil using the TIMES model, *Energy*. 167 (2019) 791–803. <https://doi.org/10.1016/j.energy.2018.11.036>.
- [11] V.J. Schwanitz, Evaluating integrated assessment models of global climate change, *Environmental Modelling & Software*. 50 (2013) 120–131. <https://doi.org/10.1016/j.envsoft.2013.09.005>.
- [12] IPCC, Summary for Policymakers. In: *Climate Change and Land: an IPCC special report on climate change, desertification, land degradation, sustainable land management, food security, and greenhouse gas fluxes in terrestrial ecosystems* [P.R. Shukla, J. Skea, E. Calvo Buendia, V. Masson-Delmotte, H.- O. Pörtner, D. C. Roberts, P. Zhai, R. Slade, S. Connors, R. van Diemen, M. Ferrat, E. Haughey, S. Luz, S. Neogi, M. Pathak, J. Petzold, J. Portugal Pereira, P. Vyas, E. Huntley, K. Kissick, M. Belkacemi, J. Malley, 2019].
- [13] P.R.R. Rochedo, B. Soares-Filho, R. Schaeffer, E. Viola, A. Szklo, A.F.P. Lucena, A. Koberle, J.L. Davis, R. Rajão, R. Rathmann, The threat of political bargaining to climate mitigation in Brazil, *Nature Clim Change*. 8 (2018) 695–698. <https://doi.org/10.1038/s41558-018-0213-y>.
- [14] WCMC, UNEP, Carbono, biodiversidad y servicios ecosistémicos: explorando los beneficios múltiples ECUADOR.pdf, (2011).
- [15] V.S. Espinoza, J. Fontalvo, J. Martí-Herrero, P. Ramírez, I. Capellán-Pérez, Future oil extraction in Ecuador using a Hubbert approach, *Energy*. 182 (2019) 520–534. <https://doi.org/10.1016/j.energy.2019.06.061>.
- [16] IAMC, IAMC wiki - The common Integrated Assessment Model (IAM) documentation, (2020). [https://www.iamcdocumentation.eu/index.php/IAMC\\_wiki](https://www.iamcdocumentation.eu/index.php/IAMC_wiki) (accessed June 16, 2020).
- [17] P. Rochedo, Development of a global integrated energy model to evaluate the Brazilian role in Climate Change Mitigation Scenarios, Tese de Doutorado, Universidade Federal do Rio de Janeiro, 2016. <http://www.ppe.ufrj.br/index.php/pt/publicacoes/teses-e-dissertacoes/2016/207-development-of-a-global-integrated-energy-model-to-evaluate-the-brazilian-role-in-climate-change-mitigation-scenarios> (accessed April 10, 2017).
- [18] E. Kriegler, C. Bertram, H. van Soest, D. van Vuuren, R. Schaeffer, K. Riahi, Research on National and Global Mitigation Pathways to Keep the Paris Climate Goals in Reach: The Case for Enhanced Action, (2019) 1.
- [19] C. Bataille, H. Waisman, Y. Briand, J. Svensson, A. Vogt-Schilb, M. Jaramillo, R. Delgado, R. Arguello, L. Clarke, T. Wild, F. Lallana, G. Bravo,

- 
- G. Nadal, G. Le Treut, G. Godinez, J. Quiros-Tortos, E. Pereira, M. Howells, D. Buira, J. Tovilla, J. Farbes, J. Ryan, D. De La Torre Ugarte, M. Collado, F. Requejo, X. Gomez, R. Soria, D. Villamar, P. Rochedo, M. Imperio, Net-zero deep decarbonization pathways in Latin America: Challenges and opportunities, *Energy Strategy Reviews*. 30 (2020) 100510. <https://doi.org/10.1016/j.esr.2020.100510>.
- [20] P.L.C. Verdezoto, J.A. Vidoza, W.L.R. Gallo, Analysis and projection of energy consumption in Ecuador: Energy efficiency policies in the transportation sector, *Energy Policy*. 134 (2019) 110948. <https://doi.org/10.1016/j.enpol.2019.110948>.
- [21] L. Rivera-Gonzalez, D. Bolonio, L.F. Mazadiego, S. Naranjo-silva, Long-Term Forecast of Energy and Fuels Demand Towards a Sustainable Road Transport Sector in Ecuador ( 2016 – 2035 ): A LEAP Model Application, *Sustainability*. (2020).
- [22] V.S. Espinoza, V. Guayanlema, J. Martínez-gómez, Energy Efficiency Plan Benefits in Ecuador : Long-range Energy Alternative Planning Model, *International Journal of Energy Economics and Policy*. 8 (2018) 42–54.
- [23] M.F. Chavez-rodriguez, P.E. Carvajal, J.E. Martinez, A. Egüez, R. Esperanza, G. Mahecha, R. Schaeffer, A. Szklo, A.F.P. Lucena, S. Arango, Fuel saving strategies in the Andes : Long-term impacts for Peru, Colombia and Ecuador, *Energy Strategy Reviews*. 20 (2018) 35–48. <https://doi.org/10.1016/j.esr.2017.12.011>.
- [24] L. Rivera-Gonzalez, D. Bolonio, L.F. Mazadiego, R. Valencia-Chapi, Long-Term Electricity Supply and Demand Forecast ( 2018-2040 ): A LEAP Model Application towards a Sustainable Power Generation System in Ecuador, *Sustainability*. (2019). <https://doi.org/10.3390/su11195316>.
- [25] P.E. Carvajal, F.G.N. Li, Challenges for hydropower-based nationally determined contributions : a case study for Ecuador, *Climate Policy*. 0 (2019) 1–14. <https://doi.org/10.1080/14693062.2019.1617667>.
- [26] UNFCCC, Ecuador’s First Nationally Determined Contribution, 2019.
- [27] MEER, Plan Maestro de Electricidad 2016-2025, Ecuador, 2017.
- [28] PSR, PSR, (2018). <https://www.psr-inc.com/en/> (accessed June 30, 2018).
- [29] MAE, Tercera Comunicación Nacional del Ecuador a la Convención Marco de las Naciones Unidas sobre el Cambio Climático, 1st ed., MAE, Quito, Ecuador, 2017. <http://www.ambiente.gob.ec/wp-content/uploads/downloads/2017/10/TERCERA-COMUNICACION-BAJA-septiembre-20171-ilovepdf-compressed1.pdf> (accessed February 4, 2018).
- [30] MEER, Balance Energético Nacional 2017, (2017).
- [31] CENACE, Informe Anual 2018, Operador Nacional de Electricidad - CENACE, Quito, Ecuador, 2019. [http://www.cenace.org.ec/index.php?option=com\\_phocadownload&view=category&id=6:phocatinfanuales&Itemid=50](http://www.cenace.org.ec/index.php?option=com_phocadownload&view=category&id=6:phocatinfanuales&Itemid=50) (accessed March 22, 2020).
-

- 
- [32] R. Schaeffer, A. Szklo, A. Frossard Pereira de Lucena, R. Soria, M. Chavez-Rodriguez, The Vulnerable Amazon: The Impact of Climate Change on the Untapped Potential of Hydropower Systems, *IEEE Power and Energy Magazine*. 11 (2013) 22–31. <https://doi.org/10.1109/MPE.2013.2245584>.
- [33] P.E. Carvajal, F.G.N. Li, R. Soria, J. Cronin, G. Anandarajah, Y. Mulugetta, Large hydropower, decarbonisation and climate change uncertainty: Modelling power sector pathways for Ecuador, *Energy Strategy Reviews*. 23 (2019) 86–99. <https://doi.org/10.1016/j.esr.2018.12.008>.
- [34] A. Botelho, P. Ferreira, F. Lima, L.M.C. Pinto, S. Sousa, Assessment of the environmental impacts associated with hydropower, *Renewable and Sustainable Energy Reviews*. 70 (2017) 896–904. <https://doi.org/10.1016/j.rser.2016.11.271>.
- [35] J.L. da S. Soito, M.A.V. Freitas, Amazon and the expansion of hydropower in Brazil: Vulnerability, impacts and possibilities for adaptation to global climate change, *Renewable and Sustainable Energy Reviews*. 15 (2011) 3165–3177. <https://doi.org/10.1016/j.rser.2011.04.006>.
- [36] MERNNR, Plan Maestro de Electricidad 2018 - 2027, Ministerio de Energía y Recursos Naturales No Renovables, Quito, Ecuador, 2020.
- [37] P.E. Carvajal, The long-term role of hydropower in Ecuador's power system: Assessing climate change and cost uncertainties, (2019) 375.
- [38] A.F.P. de Lucena, R. Schaeffer, A.S. Szklo, Least-cost adaptation options for global climate change impacts on the Brazilian electric power system, *Global Environmental Change*. 20 (2010) 342–350. <https://doi.org/10.1016/j.gloenvcha.2010.01.004>.
- [39] OLADE, Panorama Energético de América Latina y el Caribe 2018, (2018).
- [40] MERNNR, Balance Energético Nacional 2018, (2020).
- [41] MICSE, Balance Energético Nacional 2016, (2016).
- [42] F. Schaffitzel, M. Jakob, R. Soria, A. Vogt-Schilb, H. Ward, Can government transfers make energy subsidy reform socially acceptable? A case study on Ecuador, *Energy Policy*. 137 (2020) 111120. <https://doi.org/10.1016/j.enpol.2019.111120>.
- [43] INRIX, Global Traffic Scorecard, (2018). <https://inrix.com/scorecard/>.
- [44] Asamblea Nacional de la República de Ecuador, Ley Orgánica de Eficiencia Energética, (2019).
- [45] BCE, Balanza Comercial: Exportaciones Petroleras/No Petroleras e Importaciones por uso o destino económico, (2019). <https://contenido.bce.fin.ec/home1/estadisticas/bolmensual/IEMensual.jsp>.
- [46] M.F. Chavez-Rodriguez, P.E. Carvajal, J.E. Martinez Jaramillo, A. Egüez, R.E.G. Mahecha, R. Schaeffer, A. Szklo, A.F.P. Lucena, S. Arango Aramburo, Fuel saving strategies in the Andes: Long-term impacts for Peru, Colombia and Ecuador, *Energy Strategy Reviews*. 20 (2018) 35–48. <https://doi.org/10.1016/j.esr.2017.12.011>.
-

- 
- [47] M. Orta-Martínez, M. Finer, Oil frontiers and indigenous resistance in the Peruvian Amazon, *Ecological Economics*. 70 (2010) 207–218. <https://doi.org/10.1016/j.ecolecon.2010.04.022>.
- [48] C.F. Mena, F. Laso, P. Martinez, C. Sampredo, Modeling road building, deforestation and carbon emissions due deforestation in the Ecuadorian Amazon: the potential impact of oil frontier growth, *Journal of Land Use Science*. 12 (2017) 477–492. <https://doi.org/10.1080/1747423X.2017.1404648>.
- [49] C. Vasco, R. Bilsborrow, B. Torres, V. Griess, Agricultural land use among mestizo colonist and indigenous populations: Contrasting patterns in the Amazon, *PLoS ONE*. 13 (2018) e0199518. <https://doi.org/10.1371/journal.pone.0199518>.
- [50] A.M. Lerner, T.K. Rudel, L.C. Schneider, M. McGroddy, D.V. Burbano, C.F. Mena, The spontaneous emergence of silvo-pastoral landscapes in the Ecuadorian Amazon: patterns and processes, *Reg Environ Change*. 15 (2015) 1421–1431. <https://doi.org/10.1007/s10113-014-0699-4>.
- [51] S. Sellers, R. Bilsborrow, V. Salinas, C. Mena, S. Sellers, R. Bilsborrow, V. Salinas, C. Mena, Population and development in the Amazon: A longitudinal study of migrant settlers in the Northern Ecuadorian Amazon, *Acta Amazonica*. 47 (2017) 321–330. <https://doi.org/10.1590/1809-4392201602663>.
- [52] A.C. Köberle, Implementation of land use in an energy system model to study the long-term impacts of large scale use of bioenergy in Brazil, PhD thesis, Universidade Federal do Rio de Janeiro, 2018. <http://www.ppe.ufrj.br/index.php/pt/publicacoes/teses-e-dissertacoes/2018/130-implementation-of-land-use-in-an-energy-system-model-to-study-the-long-term-impacts-of-bioenergy-in-brazil-and-its-sensitivity-to-the-choice-of-agricultural-greenhouse-gas-emission-factors> (accessed March 28, 2020).
- [53] IIASA, MESSAGE: A modeling framework for medium- to long-term energy system planning, energy policy analysis, and scenario development, (2019). [https://iiasa.ac.at/web/home/research/researchPrograms/Energy/MESSAG\\_E.en.html](https://iiasa.ac.at/web/home/research/researchPrograms/Energy/MESSAG_E.en.html) (accessed March 30, 2020).
- [54] A.C. Köberle, R. Garaffa, B.S.L. Cunha, P. Rochedo, A.F.P. Lucena, A. Szklo, R. Schaeffer, Are conventional energy megaprojects competitive? Suboptimal decisions related to cost overruns in Brazil, *Energy Policy*. 122 (2018) 689–700. <https://doi.org/10.1016/j.enpol.2018.08.021>.
- [55] IAEA, Brazil: A Country Profile on Sustainable Energy Development, IAEA, Vienna, 2006. [http://www-pub.iaea.org/MTCD/publications/PDF/Pub1247\\_web.pdf](http://www-pub.iaea.org/MTCD/publications/PDF/Pub1247_web.pdf) (accessed May 23, 2013).
- [56] A. Szklo, G. Machado, R. Schaeffer, Avaliação de cenário de Matriz Energética Nacional no Plano de Longo Prazo do Ministério de Minas e
-



- 
- Energia: Impactos na indústria de óleo e gás., in: Anais da Rio Oil & Gas Expo and Conference 2004., 2004: pp. 1–8.
- [57] R. Schaeffer, A.S. Szklo, L. Nogueira, A. Santos, Matriz Energética do Estado de Minas Gerais 2030. Relatório Técnico – Programa de Planejamento Energético/COPPE/UFRJ e UNIFEL, (2007).  
<http://www.conselhos.mg.gov.br/coner/page/publicacoes/matriz-energetica-de-mg> (accessed June 1, 2013).
- [58] S. Margulis, C. Dubeux, Economia da Mudança do Clima no Brasil: Custos e Oportunidades, SBD/FEA/USP, São Paulo, 2010.  
[http://www.colit.pr.gov.br/arquivos/File/Publicacoes/Economia\\_do\\_clima.pdf](http://www.colit.pr.gov.br/arquivos/File/Publicacoes/Economia_do_clima.pdf) (accessed June 1, 2013).
- [59] A.F.P. de Lucena, A.S. Szklo, R. Schaeffer, R.R. de Souza, B.S.M.C. Borba, I.V.L. da Costa, A.O.P. Júnior, S.H.F. da Cunha, The vulnerability of renewable energy to climate change in Brazil, *Energy Policy*. 37 (2009) 879–889. <https://doi.org/10.1016/j.enpol.2008.10.029>.
- [60] B. Soares M.C. Borba, A. Szklo, R. Schaeffer, Plug-in hybrid electric vehicles as a way to maximize the integration of variable renewable energy in power systems: The case of wind generation in northeastern Brazil, *Energy*. 37 (2012) 469–481. <https://doi.org/10.1016/j.energy.2011.11.008>.
- [61] D. Malagueta, A. Szklo, B.S.M.C. Borba, R. Soria, R. Aragão, R. Schaeffer, R. Dutra, Assessing incentive policies for integrating centralized solar power generation in the Brazilian electric power system, *Energy Policy*. 59 (2013) 198–212. <https://doi.org/10.1016/j.enpol.2013.03.029>.
- [62] L.P. Nogueira de Oliveira, P.R. Rodriguez Rochedo, J. Portugal-Pereira, B.S. Hoffmann, R. Aragão, R. Milani, A.F.P. de Lucena, A. Szklo, R. Schaeffer, Critical technologies for sustainable energy development in Brazil: technological foresight based on scenario modelling, *Journal of Cleaner Production*. 130 (2016) 12–24.  
<https://doi.org/10.1016/j.jclepro.2016.03.010>.
- [63] D. Malagueta, A. Szklo, R. Soria, R.M. Dutra, R. Schaeffer, B. Borba, Potential and impacts of Concentrated Solar Power (CSP) integration in the Brazilian electric power system, *Renewable Energy*. 68 (2014) 223–235.  
<https://doi.org/10.1016/j.renene.2014.01.050>.
- [64] MCTIC, ONU Meio Ambiente, Modelagem integrada e impactos econômicos de opções setoriais de baixo carbono, Ministério da Ciência, Tecnologia, Inovações e Comunicações, ONU Meio Ambiente, Brasília, 2017.  
[http://www.mctic.gov.br/mctic/opencms/ciencia/SEPED/clima/opcoes\\_mitigacao/paginas/tecnologias\\_bc.html](http://www.mctic.gov.br/mctic/opencms/ciencia/SEPED/clima/opcoes_mitigacao/paginas/tecnologias_bc.html) (accessed March 27, 2020).
- [65] MAE-SCC, Informe sobre el proceso de formulación de la Contribución Determinada a Nivel Nacional, Subsecretaría de Cambio Climático - Ministerio del Ambiente de Ecuador, Quito, Ecuador, 2019.
- [66] INEC, Proyección población nacional 2010\_2050, (2012).
-

- 
- [67] MAE, Mapa de uso/cobertura del suelo de Ecuador, (2014).
- [68] MAE, Mapa de Sistema Nacional de Áreas Protegidas de Ecuador, (2018).
- [69] FAO/IIASA, Global Agro-ecological Zones (GAEZ) ver.3.0., (2010).  
<http://webarchive.iiasa.ac.at/Research/LUC/GAEZv3.0/> (accessed March 31, 2020).
- [70] FAOSTAT, FAOSTAT: Datos sobre alimentación y agricultura-Ecuador, (2019). <http://www.fao.org/faostat/es/#home>.
- [71] D.J. Weiss, A. Nelson, H.S. Gibson, W. Temperley, S. Peedell, A. Lieber, M. Hancher, E. Poyart, S. Belchior, N. Fullman, B. Mappin, U. Dalrymple, J. Rozier, T.C.D. Lucas, R.E. Howes, L.S. Tusting, S.Y. Kang, E. Cameron, D. Bisanzio, K.E. Battle, S. Bhatt, P.W. Gething, A global map of travel time to cities to assess inequalities in accessibility in 2015, *Nature*. 553 (2018) 333–336. <https://doi.org/10.1038/nature25181>.
- [72] FAO, Food Balance Sheet, (2017). <http://www.fao.org/faostat/en/?#data/>.
- [73] SIK, Food waste, (2011).
- [74] FES-Ecuador, Laboratorio de Transición Energética, (2017). <http://www.fes-ecuador.org/news-list/e/laboratorio-de-transicion-energetica/> (accessed April 9, 2017).
- [75] E. Noboa, P. Upham, Energy policy and transdisciplinary transition management arenas in illiberal democracies: A conceptual framework, *Energy Research & Social Science*. 46 (2018) 114–124.  
<https://doi.org/10.1016/j.erss.2018.07.014>.
- [76] Agencia Nacional de Tránsito, I.N. de E. y C. INEC, Anuario de Transporte, (2015).
- [77] ICCT, Data for ICCT global fuel efficiency comparison charts, (2019).  
<https://theicct.org/chart-library-passenger-vehicle-fuel-economy> (accessed June 14, 2020).
- [78] MEER, Inventario De Recursos Energéticos Del Ecuador Con Fines De Producción Eléctrica, (2015).
- [79] Arconel, Estadística Anual y Multianual-Sector Eléctrico, (2016).
- [80] MEER, Atlas Eólico del Ecuador, con fines de Generación Eléctrica, Ministerio de Electricidad y Energía Renovable - MEER, Quito, Ecuador, 2012.
- [81] Instituto Nacional de Preinversión-INP, Atlas Bioenergético del Ecuador, Quito, Ecuador, 2014.
- [82] NREL Geospatial Data Science, NSRDB Data Viewer -Layer: Multi Year PSM DNI, 2019. <https://maps.nrel.gov/nsrdb-viewer/?aL=0&bL=groad&cE=0&IR=0&mC=-84.05256097843035%2C-592.03125&zL=1> (accessed August 28, 2018).
- [83] PRONACA, Informe de Responsabilidad Corporativa, (2010).
- [84] Grupo Familia, Informe de sostenibilidad Grupo Familia, (2017).  
<http://www.grupofamilia.com.co/es/sostenibilidad/DTLCCentroDocumento>
-

- 
- s/Informe%20de%20sostenibilidad%20Grupo%20Familia%202017.pdf (accessed October 5, 2018).
- [85] Arca Continental, Informe de Responsabilidad Social y Sustentabilidad, (2015).
- [86] M. de A. y G. MAGAP, I.N. de E. y C. INEC, Encuesta de Superficie y Producción Agropecuaria Continua, (2015).
- [87] RETScreen, RETScreen International Software and Data. Government of Canada - Natural Resources Canada., (2019).  
<http://www.retscreen.net/pt/version4.php> (accessed June 16, 2019).
- [88] S. Fuss, W.F. Lamb, M.W. Callaghan, J. Hilaire, F. Creutzig, T. Amann, T. Beringer, W. de O. Garcia, J. Hartmann, T. Khanna, G. Luderer, G.F. Nemet, J. Rogelj, P. Smith, J.L.V. Vicente, J. Wilcox, M. del M.Z. Dominguez, J.C. Minx, Negative emissions—Part 2: Costs, potentials and side effects, *Environ. Res. Lett.* 13 (2018) 063002.  
<https://doi.org/10.1088/1748-9326/aabf9f>.
- [89] C. Gough, S. Garcia-Freites, C. Jones, S. Mander, B. Moore, C. Pereira, M. Röder, N. Vaughan, A. Welfle, Challenges to the use of BECCS as a keystone technology in pursuit of 1.5°C, *Global Sustainability*. 1 (2018).  
<https://doi.org/10.1017/sus.2018.3>.
- [90] Global CCS Institute, Global CCS Institute- Facilities database, (2020).  
<https://co2re.co/FacilityData> (accessed June 16, 2020).
- [91] D.P. van Vuuren, E. Stehfest, D.E.H.J. Gernaat, M. van den Berg, D.L. Bijl, H.S. de Boer, V. Daioglou, J.C. Doelman, O.Y. Edelenbosch, M. Harmsen, A.F. Hof, M.A.E. van Sluisveld, Alternative pathways to the 1.5 °C target reduce the need for negative emission technologies, *Nature Climate Change*. 8 (2018) 391–397. <https://doi.org/10.1038/s41558-018-0119-8>.
- [92] J. Rogelj, G. Luderer, R.C. Pietzcker, E. Kriegler, M. Schaeffer, V. Krey, K. Riahi, Energy system transformations for limiting end-of-century warming to below 1.5 °C, *Nature Climate Change*. 5 (2015) 519–527.  
<https://doi.org/10.1038/nclimate2572>.
- [93] F. Bowen, Carbon capture and storage as a corporate technology strategy challenge, *Energy Policy*. 39 (2011) 2256–2264.  
<https://doi.org/10.1016/j.enpol.2011.01.016>.
- [94] M. Fajardy, A. Köberle, N. Mac Dowell, A. Fantuzzi, BECCS deployment: a reality check, Imperial College London, Grantham Institute, London, UK, 2019. <https://www.imperial.ac.uk/media/imperial-college/grantham-institute/public/publications/briefing-papers/BECCS-deployment---a-reality-check.pdf> (accessed June 16, 2020).
- [95] World Bank, Strategic use of climate finance to maximize climate action: A guiding framework, (2018).  
<http://documents.worldbank.org/curated/en/879251537779825585/pdf/130066-REPLACEMENT-PUBLIC-WBG-Strategic-Use-of-Climate-Finance-Sept2018.pdf> (accessed June 16, 2020).
-

- 
- [96] J. Alcamo, *Ecosystems and human well-being: a framework for assessment*, Island, Washington, DC, 2003.
- [97] R. Soria, G. Caiza, N. Cartuche, J. López-Villada, F. Ordoñez, Market potential of linear Fresnel collectors for solar heat industrial process in Latin-America-a case study in Ecuador, *AIP Conference Proceedings*. 2303 (2020) 120003. <https://doi.org/10.1063/5.0028503>.
- [98] D. Vaca-Revelo, F. Ordoñez, *Mapa solar del Ecuador 2019*, (2019). <https://meteo-scinergy.epn.edu.ec/mapa-solar> (accessed June 16, 2020).
- [99] MEER, *Resultdos de la consultoría para estudio de demanda en el sector residencial y usos finales de la energía*, (2017).
- [100] D. Malagueta, A. Szklo, R. Soria, R. Dutra, R. Schaeffer, B.S. Moreira Cesar Borba, Potential and impacts of Concentrated Solar Power (CSP) integration in the Brazilian electric power system, *Renewable Energy*. 68 (2014) 223–235. <https://doi.org/10.1016/j.renene.2014.01.050>.
- [101] BCE, *Cuentas Nacionales Anuales*, (2016). <https://contenido.bce.fin.ec/docs.php?path=/documentos/PublicacionesNotas/Catalogo/CuentasNacionales/Anuales/Dolares/indicecn1.htm> (accessed October 18, 2018).
- [102] MAE/FAO, *Contribución Determinada a Nivel Nacional del Ecuador - Propuesta Técnica - Escenarios de referencia y de mitigación de las emisiones de GEI sector USCUS.*, (2019).
- [103] INEC, *Proyecciones Poblacional 2010*, INEC. (n.d.). <http://www.ecuadorencifras.gob.ec/proyecciones-poblacionales/> (accessed August 6, 2018).
- [104] Instituto Nacional de Eficiencia Energética y Energías Renovables - INER, *Manual para el Procesamiento de Información del Balance Energético.pdf*, (2015).
- [105] MDMQ, *Plan maestro de Movilidad 2009-2025*, (2009).
- [106] MEER, *Balance Energético Nacional 2017*, (2017).
- [107] Asociación de Empresas Automotrices del Ecuador, *Anuario AEADE*, (2018).
- [108] Metro-Q, *DMQ Encuesta domiciliaria de transporte-EDM11*, (2012).
- [109] MEER, *Plan Nacional de Eficiencia Energética 2016-2035*, (2017).
- [110] C.G. Jorge Peñaherrera, *Diseño Óptimo de una Red Eléctrica con Criterios de Eficiencia Energética en la Demanda, a Partir de la Infraestructura Electrica Existente en el Sector del Parque Bicentenario en el Área de Servicios de la Empresa Electrica Quito.*, 2017.
- [111] CONELEC, *Plan Maestro de Electrificación 2013-2022 - Estudio y Gestión de la Demanda Eléctrica*, (2013).
- [112] J. Jara Alvear, *Solar photovoltaic potential to complement hydropower in Ecuador : a GIS-based framework of analysis*, (2018).
- [113] C. Cañizares, D. Jácome, *Estudio de prospectiva de la geotermia y su influencia en la matriz eléctrica en Ecuador*, (2018).
-

- 
- [114] Secretaría de Hidrocarburos, Revista Informe Anual del Potencial Hidrocarburífero 2017, 2018.  
<http://www.secretariahidrocarburos.gob.ec/wp-content/uploads/downloads/2017/09/Revista-Informe-Anual-del-Potencial-Hidrocarburi%CC%81fero-2017.pdf> (accessed December 2, 2018).
- [115] Informe estadístico, Petroecuador EP, 2016.
- [116] PLI, Proyecto OGE Alcance Iniciativa Publica – Privada Cambio Matriz Energetica, (2016).
- [117] MAE, Mapas de cobertura y uso de la tierra del Ecuador continental 1990, 2000, 2008, 2014, 2016, (2016).  
<http://mapainteractivo.ambiente.gob.ec/portal/>.
- [118] MAE, Estadísticas de Patrimonio Natural.pdf, (2015).
- [119] N.D. Mueller, J.S. Gerber, M. Johnston, D.K. Ray, N. Ramankutty, J.A. Foley, Closing yield gaps through nutrient and water management, *Nature*. 490 (2012) 254–257. <https://doi.org/10.1038/nature11420>.
- [120] N. Alexandratos, *World Agriculture towards 2030/2050: the 2012 revision*, (2012) 154.

---

# Chapter 3

## Review of Elena and urbs soft-link analysis

### 3.1 Introduction and context

During the DDP project, possible decarbonisation scenarios for Ecuador were modelled with ELENA within the range of 1.5-2°C temperature increase limit by the end of the century. After this study, it was clear that the sector with the greatest difficulty to decarbonise is transport and within it, freight transport. Several decarbonisation alternatives could be considered, for instance: traditional biofuels (ethanol and biodiesel), advanced fuels from biomass produced in biorefineries, electrification, fuel cells or a mix of all these. At the current research state, electrification seems one of the closest solutions, at least to achieve a partially decarbonisation of freight transport. This option requires a production of electricity based on renewable energy sources. Ecuador's electricity matrix is based on hydropower and it is expected, according to the data presented in the Electrification Master Plan 2020, that the percentage of installed capacity from renewable sources in the electricity matrix will grow in 64% during the next decade. Meanwhile, in the same period the installed capacity for thermal energy will grow only in 19.9%. However, if we consider a high electrification for Transport, this energy-intensive sector would represent a huge additional burden on Ecuador's electricity system. This raises the question of whether the system can absorb the duty of partially powering the transport sector, maintaining the expected renewable electricity matrix. To analyse this, it is necessary not only to evaluate the expansion of total installed capacity, but also to carry out an analysis that includes the dispatch of electricity. Electricity dispatch analysis is useful to design a system capable of responding in an efficient manner during periods of high demand.

This chapter presents a collaborative work performed between the Technical University of Munich (TUM) and the National Polytechnique School of Ecuador (EPN). The paper resulting from this collaboration is presented as part of two doctoral studies. The ELENA Model is linked to an electricity dispatch model called urbs to analyse the requirements of the energy matrix in a context of transport electrification. The name of the study is:

---

## 3.2 Preparing the Ecuador's power sector to enable a large-scale electric land transport

Authors: Janeth Carolina Godoy<sup>1</sup>, Daniel Villamar<sup>2</sup>, Rafael Soria<sup>3</sup>, César Vaca<sup>4</sup>, Thomas Hamacher<sup>1</sup> and Freddy Ordóñez<sup>2</sup>.

Journal: Energies – MDPI in September 2021.

Volume: 14

Issue: 18

Published: 11 September 2021

pages: 5728-5749

url: <http://doi.org/10.3390/en14185728>

The universities collaboration consisted in, for the EPN side, running the ELENA model with different levels of decarbonisation scenarios for all the sectors (transport, industry, residential, commercial and land use) for Ecuador and deliver these results as input for the urbs model, which was carried out by the TUM. Once the interaction between models was done, both universities collaborate in analysing the data obtained and in the paper writing. This article focuses on designing the mix of technologies that the Ecuadorian electricity system should have in order to be entirely renewable and cope with an increase in demand, due to the electrification of land transport in the passenger and freight sector. The interest of the study comes from the strong investment in hydroelectric plants that Ecuador's Government made between 2008 and 2015. Nowadays, the country's electricity matrix is one of the cleanest in the region, with more than 80% of annual electricity generated from renewable sources in 2020<sup>27</sup>. Still there is an upcoming investment in renewable electricity planned by the Government<sup>28</sup>. Remains to be studied if the future renewable electricity generation will be sufficient to supply a demand that includes electric land transport. There is still much uncertainty about which will be the dominant energy source for land transport in the upcoming decades. In passenger transport, battery-powered buses and light-duty vehicles are gaining ground in cities. In the light-duty freight segment there are also electrification options. Governments are currently including targets for the transition to zero-emission vehicles in their decarbonisation planning<sup>29,30</sup>. Still, It is not yet clear which technologies could replace diesel trucks, but electric and hydrogen trucks appear as the most promising alternatives<sup>30</sup>. Both of these technologies involve a higher consumption of electricity, either for direct use in the trucks, or as a precursor for hydrogen production through electrolysis. In this context, the analysis of the study presented is highly relevant.

With the ELENA model, it was observed that it is possible for Ecuador to achieve a long-term energy transition<sup>31</sup> complying with the 1.5 or 2 C global ob-

---

<sup>1</sup>Renewable and Sustainable Energy Systems, Technical University of Munich, Lichtenbergstr. 4a, 85748 Garching bei München, Germany

<sup>2</sup>Departamento de Ingeniería Mecánica, Escuela Politécnica Nacional, Ladrón de Guevara E11-253, Quito 170525, Ecuador

<sup>3</sup>Department of Mechanical Engineering, Universidad San Francisco de Quito, Diego de Robles y Vía Interoceánica, Campus Cumbayá, Quito 170901, Ecuador

<sup>4</sup>b4Future, Guangüiltagua N37-266, Quito 170528, Ecuador



jectives to stabilize the global temperature increment by the end of the century. As mentioned in Chapter 2, ELENA contains a 12-month seasonality in its temporal structure, which allows it to capture the behaviour of the two main water basins of Ecuador. ELENA also contains a typical day divided into 5 periods, allowing it to capture the temporal behaviour of electricity consumption and some renewable sources. ELENA assess the energy transformation by considering the entire energy conversion chain, from energy resources to useful energy demand. If we focus on the road transport sector, a simplified diagram of the energy chains for this sector is presented in Figure 3.2

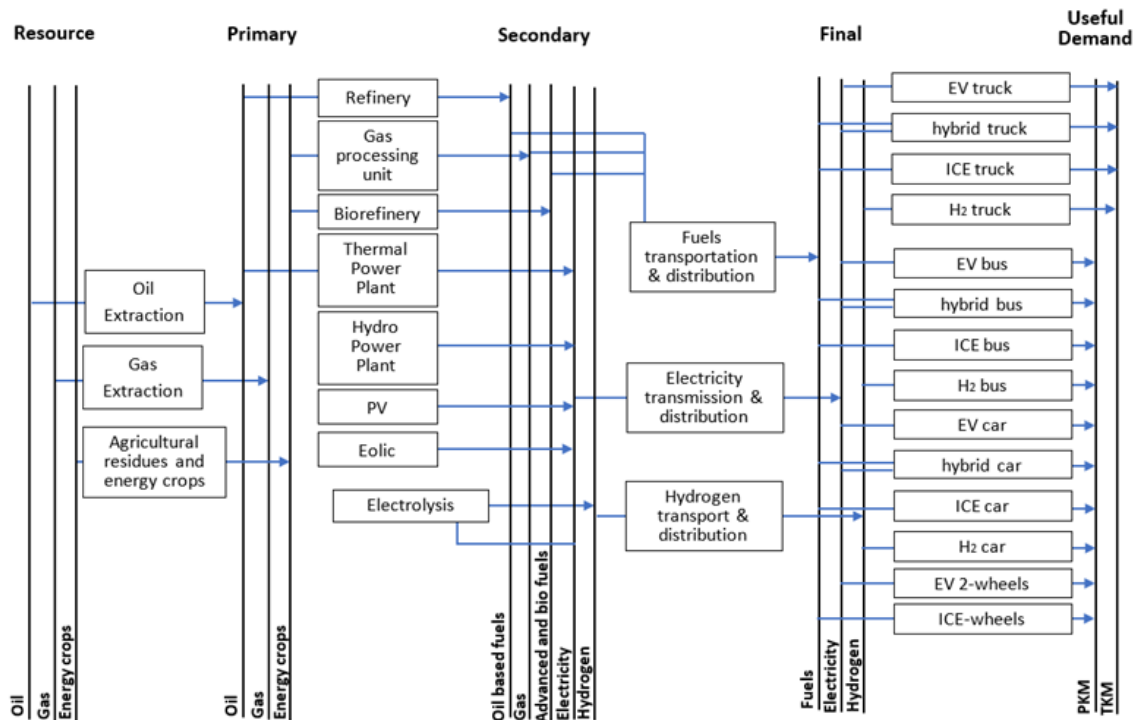

Photovoltaic= PV, Electric vehicle = EV, Internal combustion engine = ICE

Figure 3.1: Simplified energy chain for the transport sector

While this energy chain is detailed and allows modelling the expansion of the energy system, it does not have enough sensitivity for analysing the dispatch of electricity. This, as mentioned above, is crucial in a transition scenario towards electric mobility. For this reason, the ELENA model was coupled with the urbs model by means of a soft link. Urbs is a linear optimization model for distributed energy systems, it is an electricity dispatch model with a time resolution of one hour which allows analysing in detail the supply of electrical energy. Notice that contrary to ELENA, that integrates the entire energy chain, urbs focuses only on the power system. Figure 3.2 shows the representation of Ecuador's power system considered in urbs.

Urbs analyses separately energies from variable renewable sources and storable energies. Solar radiation, wind speed and seasonality of the water inflow (specially in run-of-the river hydro plants) are considered among the variable energies. Thermal generation is considered stable. The modelling of renewable energies requires information associated with their geographical location and the availability of space to be deployed. As in ELENA, fixed and variable opera-

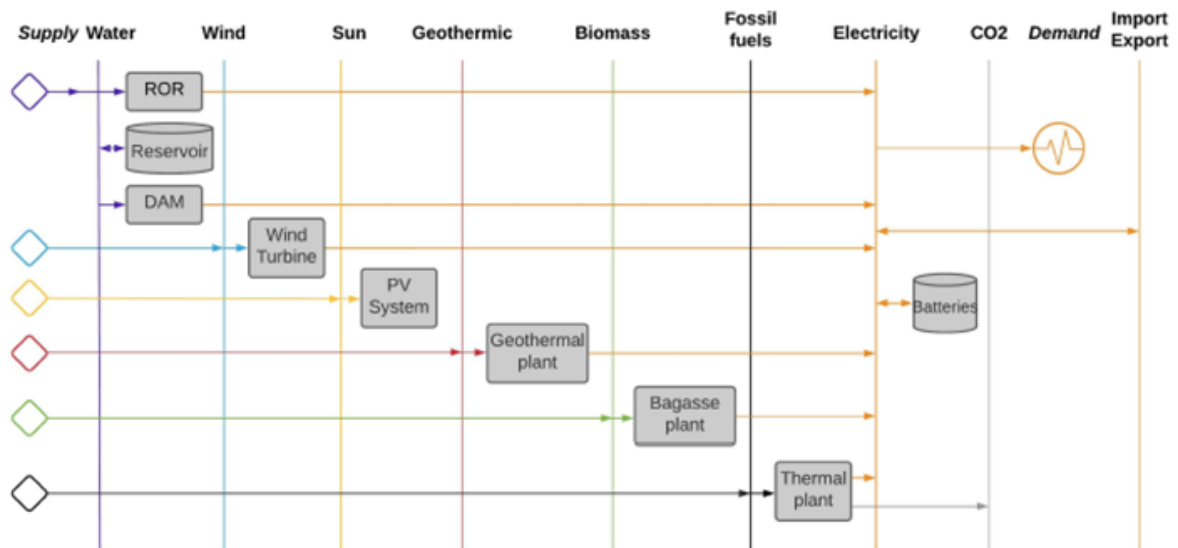

Run-of-the river=ROR, Photovoltaic= PV

Figure 3.2: Ecuadorian power system representation in Urbs<sup>32</sup>

tion and maintenance (O&M) cost, investment costs and technical specifications for each technology are required. Urbs also requires an exogenous electricity demand. In this study three scenarios were modelled. Two of them are decarbonisation scenarios modelled in the study<sup>31</sup>, presented previously in Chapter 2 The first is a moderate global climate change scenario, called Mod which relates with a maximum global temperature increase close to 1.5 °C by the end of the century, above pre-industrial levels. A second scenario called DDP ensures a deeper decarbonisation below 1.5°C. And finally, a third scenario, not limited by the temperature increase, but only with a minimal cost logic, called Least Cost scenario (LC) is modelled like in<sup>31</sup>.

The energy demands required in the transport sector used in Urbs come from the integrated ELENA model. Considering the distribution of the technologies used, this demand is transformed into electrical energy. Table 3.1 presents the evolution of the electricity demand for passenger and freight transport for each scenario until 2050.

Electricity [TWh]	Scenario								
	LC			Mod			DDP		
Year	2030	2040	2050	2030	2040	2050	2030	2040	2050
Passenger transport	0.12	0.19	0.27	0.54	1.1	1.58	5.97	5.18	4.25
Freight transport	0.01	0.02	0.03	1.16	2.5	4.28	1.16	2.5	4.29
Total	0.13	0.21	0.30	1.70	3.60	5.86	7.13	7.68	8.54

Table 3.1: Electricity demand by scenario

For the sectors other than transport, the demand used as input for the Urbs model corresponds to the official projection made until 2050<sup>33</sup>

In 2050, in the higher decarbonisation scenario electricity demand increases by 35.7% relative to the LC scenario. For the same year, the Mod scenario presents only an 18.4% increase in electricity demand compared to LC scenario. Mod diverge from LC scenario only by the inclusion of land transport and mining in

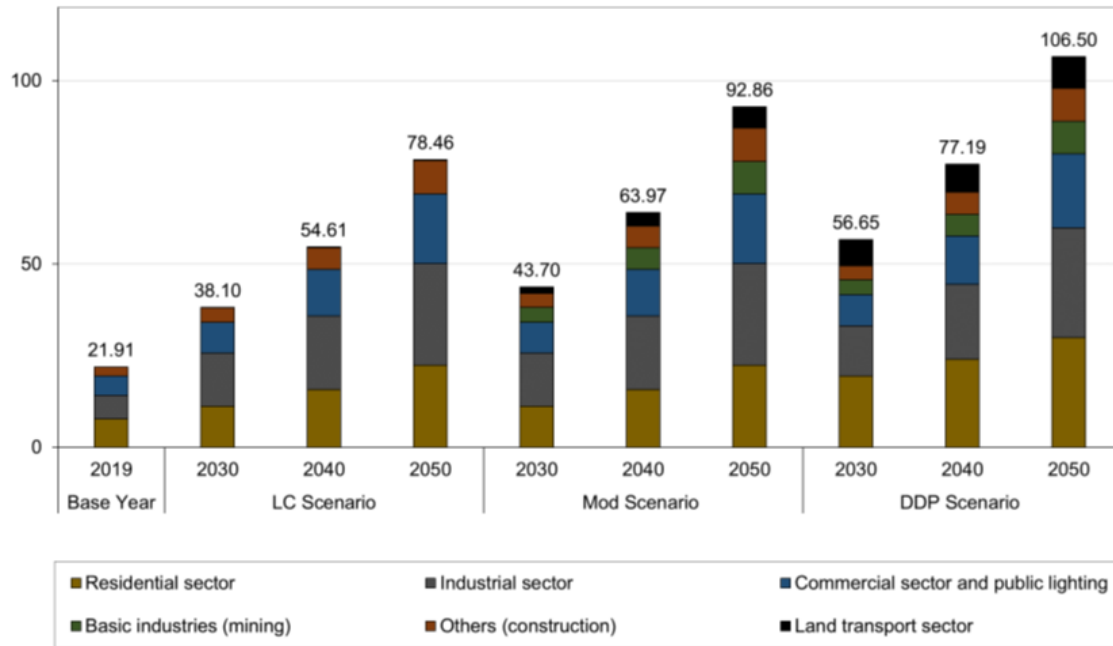

Figure 3.3: Electricity demand per sector in TWh for the LC, Mod, and DDP scenarios<sup>32</sup>

electricity demand. For the DDP scenario there is also an increase of electricity consumption in residential and industrial sectors due to the electrification perspectives included in the official projection from the government<sup>33</sup>

### 3.2.1 Results

The urbs model, fed with exogenous demand values for the electricity, calculates the capacity expansion for Ecuador until 2050. Figure 3.4 shows this increasing expansion for the three scenarios designed. It must be stated that urbs uses official projection values for electricity demand in all the sectors other than transport. The demand for the transport sector comes from the projection calculated in<sup>31</sup> with ELENA.

In 2050, installed electricity capacity will be 43% higher in the DDP scenario than in the Mod scenario. In turn, up to 2050 the Mod scenario requires 19.9% more capacity than the base scenario. Only in a DDP scenario the decarbonisation of the generation matrix is achieved, even considering a growth in demand due to the electrification of the transport sector. The Mod scenario still shows a dependence on thermal power from combined-cycle gas turbines (CCGT) and open-cycle gas turbines (OCGT). The base of the electricity system would be hydroelectric power plants which would represent about 70% of the installed capacity. There is a diversification of non-conventional renewable energy based on solar with a 24.5% of the installed capacity and wind that reaches 4.1%.

In the case of generation (Figure 3.5), hydroelectric power plants supply about 85% of the energy. By 2050 it can be seen that the electric generation mix is completely composed of technologies using renewable sources of energy. The analysis of these results can be seen in more detail in<sup>32</sup>. The DDP scenario show a much

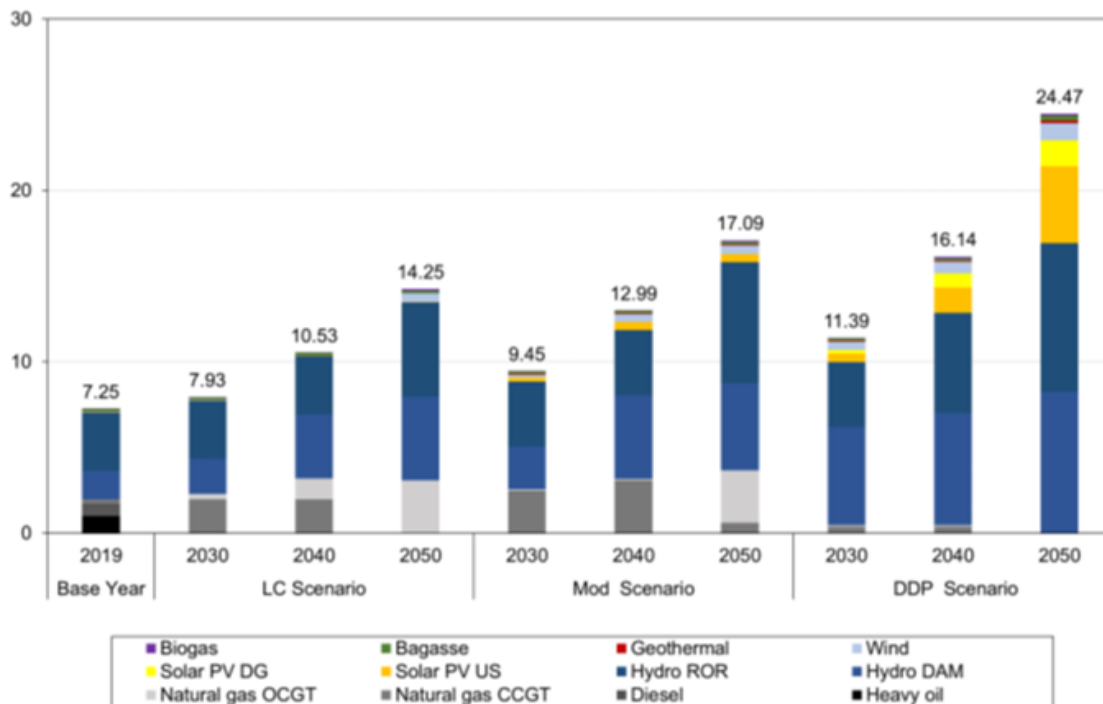

Distributed generation = DG, Utility scale = US, Combined-cycle gas turbines = CCGT  
 Open-cycle gas turbines = OCGT, Photo voltaic = PV, Run-of-the river = ROR

Figure 3.4: Expansion of installed capacity in GW for the Ecuadorian power sector by scenario<sup>32</sup>

lower presence of generation from biomass, than the results obtained in<sup>31</sup>, where the participation of biomass with carbon capture technologies was very significant in the generation matrix. This difference between scenarios is explained by the methodological approach between an integrated land use and energy model analysis, and a sectorial analysis.

Now, because the urbs model is a dispatch model, it is possible to see how power is generated in an hourly format (Figure 3.6). Again, it is clear that in Ecuador the base generation comes from hydroelectric power plants. Due to its fluctuating character, centralized solar PV generation can only be used during the day. It has an important share, but at peak consumption time (19h-22h) it is no longer available, which places higher demands on the hydropower plants.

### 3.2.2 Conclusions

With the information from the hourly dispatch of electricity, it is possible to foster the creation of public policies avoiding expending additional investment costs in unnecessary electricity capacity. Undoubtedly, electricity transport will represent an additional burden on the electricity system. Policies should be anticipated so that this extra load does not occur at the time of greatest demand on the electricity grid (peak hour). There is a valley in demand at night (0h00 to 6h00), which should be the preferred time for charging electric vehicles. Policies focused on increasing the electric load demand at night can be implemented through prices reduction at night or a penalised prices at peak hour. With the right policies, electric cars could even reduce peak electricity demand by being used as a home

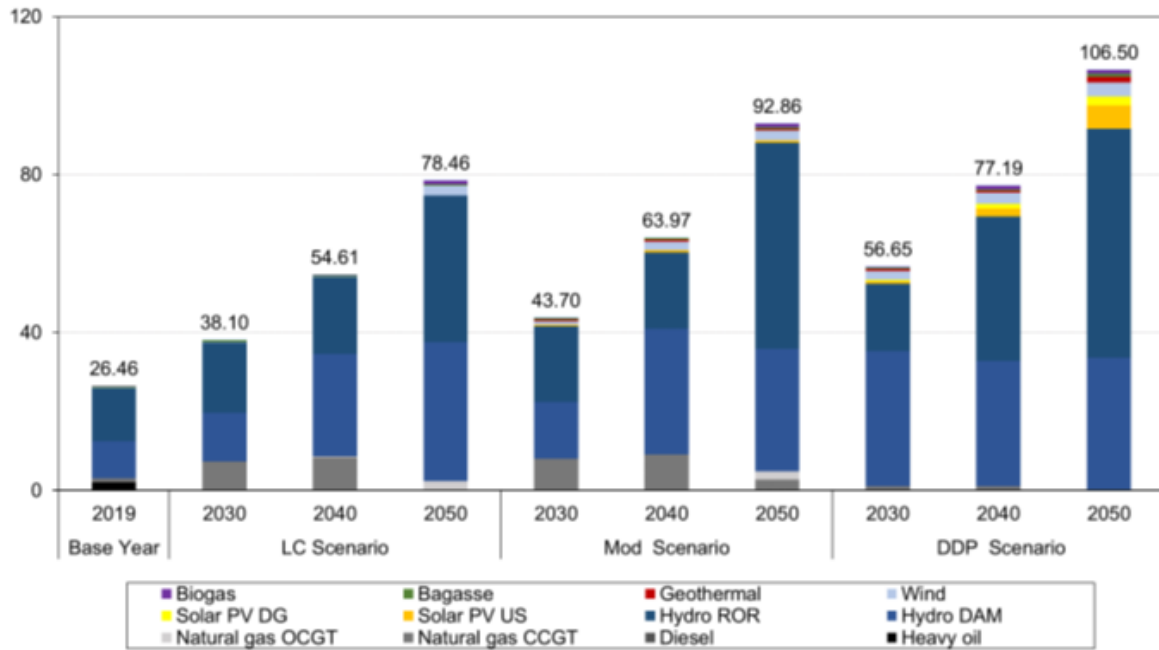

Distributed generation = DG, Utility scale = US, Combined-cycle gas turbines = CCGT  
 Open-cycle gas turbines = OCGT, Photo voltaic = PV, Run-of-the river = ROR

Figure 3.5: Expansion of power generation in TWh for the Ecuadorian power sector per scenario<sup>32</sup>

battery. On the other hand, with inappropriate behaviour, they could represent an additional load at peak time, forcing the use of thermal power plants. This generates not only additional costs due to the higher variable cost of thermal energy, but also higher emissions. This type of analysis leads to questions that can be considered in future research. For example, the role of electric vehicles in stabilising energy demand. Also, it should be analysed the role of hydrogen from renewable sources (green hydrogen) in transport and as an energy storage media.

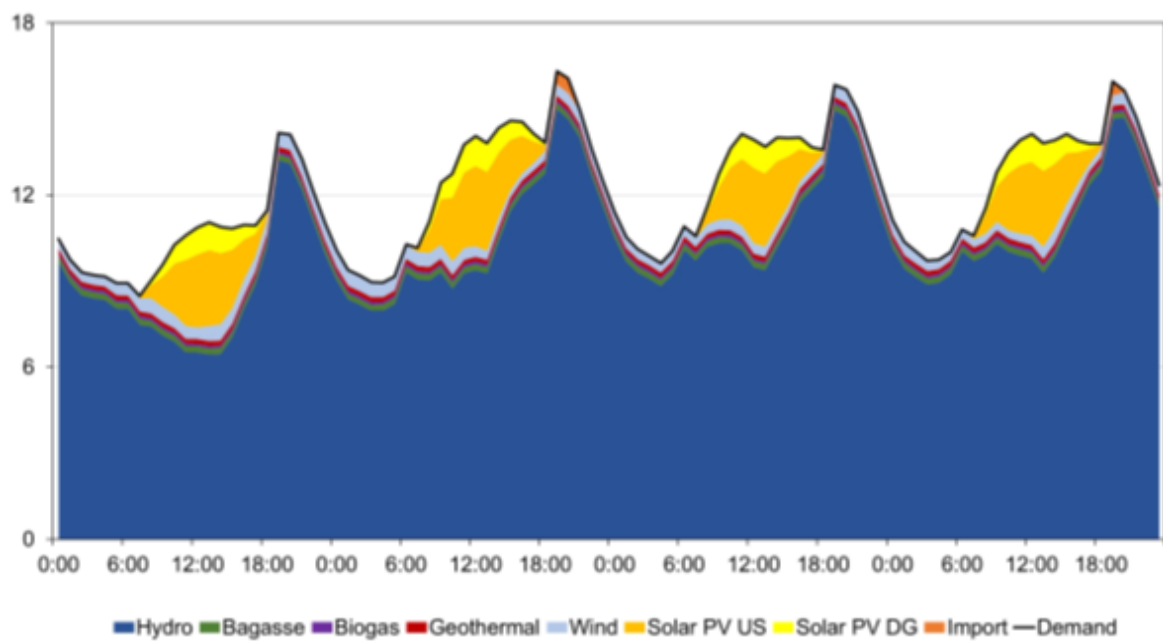

Photo voltaic = PV, Distributed generation = DG, Utility scale = US

Figure 3.6: Electricity dispatch per hour in TWh during four days in October 2050 for the DDP scenario<sup>32</sup>

# Chapter 4

## ELENA in the buildings sector

### 4.1 Introduction and context

This thesis project has focused on the energy sector and more specifically on the transport sector, as it is the main energy consumer and GHG emitter. Moreover, transport is still a sector with great challenges for decarbonisation. However, the integrated capacity of the model allows other sectors to be analysed as well. The following publication is a synthesis study focusing on the building sector. It analyses data from 8 models that bring together information from 32 countries. North and South America, Europe and Asia are the regions represented. Brazil and Ecuador are the only two South American countries participating in this synthesis with the BLUES and ELENA models respectively. Each of the countries analysed present a referential scenario, as well as (at least) one for decarbonisation. In the case of Ecuador, the decarbonisation scenario is in line with a 2° C vision. The data obtained within the decarbonisation scenario is used to assess the buildings sector, which for ELENA includes the residential and commercial sectors. In The calculation of the residential sector, ELENA uses a bottom-up approach to estimate the energy service demand. This calculation includes population and premises for household size evolution and specific consumption. Also, a distinction between existing and new households allows assessing improvements in energy efficiency, by considering improved technologies in this sector. In ELENA, energy services for residential include: refrigeration, air-cooling, lighting, water heating, cooking and appliances. On the other hand, the energy demand for the commercial sector are built using the sectorial GDP as macroeconomic proxy and discriminating between electric appliances and others energy services.

Carrying out these analyses, using different models and taking into account several countries, allow monitoring the evolution of decarbonisation programs and could contribute to the creation of regional or global policies focused on climate change. Besides, a global synthesis study provides the right dimension to the fight against climate change by showing that it must be a globally coordinated effort.

Although, Ecuador is not considered a big player in the context of climate change, because of its relatively small economy, in the last decade it has presented a positive evolution of its energy matrix, by increasing its share on renewable.

In Ecuador, buildings sector is the third sector with the highest  $CO_2$  emissions after transport and industry<sup>27</sup>. Within the global picture, this sector is considered

---

responsible for more than one third of greenhouse gas emissions<sup>34</sup>. This shows that this sector is an important sector to be considered in abatement plans.

## **4.2 A global comparison of building decarbonization scenarios by 2050 towards 1.5-2C° targets**

Article authors: Clara Camarasa<sup>1</sup>, Érika Mata<sup>2</sup>, Juan Pablo Jiménez Navarro<sup>3</sup>, Janet Reyna<sup>4</sup>, Paula Bezerra<sup>5</sup>, Gerd Brantes Angelkorte<sup>5</sup>, Wei Feng<sup>6</sup>, Faidra Filippidou<sup>3</sup>, Sebastian Forthuber<sup>7</sup>, Chioke Harris<sup>4</sup>, Nina Holck Sandberg<sup>8</sup>, Sotiria Ignatiadou<sup>2</sup>, Lukas Kranzl<sup>7</sup>, Jared Langevin<sup>6</sup>, Xu Liu Andreas Müller<sup>4,9</sup>, Rafael Soria<sup>10</sup>, Daniel Villamar<sup>11</sup>, Gabriela Prata Dias<sup>1</sup>, Joel Wanemark<sup>2</sup> and Katarina Yaramenka<sup>2</sup>.

Journal: Nature Communications

Volume: 13

Published: 02 June 2022

pages: 3077-3087

url: <https://doi.org/10.1038/s41467-022-29890-5>

The idea behind this study was conceived by Clara Camarasa, Érika Mata, Juan Pablo Jiménez Navarro. The research group that created the ELENA model was one of the two Latin American countries invited to participate in this endeavour. My contribution in this study was to run two scenarios from the ELENA model, a baseline scenario and a decarbonisation scenario and to format the data obtained so that they could be compared with the results from other countries. Also, I contributed in the relevant part of the writing that considered Ecuador and the ELENA model. Dr Rafael Soria guided all the work performed by the ELENA team.

---

<sup>1</sup>UNEP-DTU Partnership, Marmorvej 51, 2100 Copenhagen, Denmark.

<sup>2</sup>IVL Swedish Environmental Research Institute, Aschebergsgatan 44, 411 33 Gothenburg, Sweden.

<sup>3</sup>European Commission, Joint Research Centre (JRC), Westerduinweg 3, 1755 LE Petten, The Netherlands.

<sup>4</sup>National Renewable Energy Laboratory (NREL), 15013 Denver W Pkwy, Golden, CO 80401, USA.

<sup>5</sup>Universidade Federal do Rio de Janeiro, Av. Pedro Calmon 550, Rio de Janeiro 21941-901, Brazil.

<sup>6</sup>Lawrence Berkeley National Laboratory (LBNL), Cyclotron Rd, Berkeley, CA 94720, USA.

<sup>7</sup>TU Wien, Energy Economics Group, Gußhausstraße 25, 1040 Vienna, Austria.

<sup>8</sup>SINTEF Community, Høgskoleringen, 7B 7034 Trondheim, Norway.

<sup>9</sup>National School of Development, Peking University, 5 Yiheyuan Rd, Haidian District, 100871 Beijing, China.

<sup>10</sup>Universidad San Francisco de Quito, Diego de Robles y Vía Interoceánica, Department of Mechanical Engineering. Campus Cumbayá, 170901 Quito, Ecuador.

<sup>11</sup>Escuela Politécnica Nacional (EPN), Departamento de Ingeniería Mecánica, Av. Ladrón de Guevara 253, Quito, Ecuador.



---

**Abstract:**

Buildings play a key role in the transition to a low-carbon-energy system and in achieving Paris Agreement climate targets. Analysing potential scenarios for building decarbonization in different socioeconomic contexts is a crucial step to develop national and transnational roadmaps to achieve global emission reduction targets. This study integrates building stock energy models for 32 countries across four continents to create carbon emission mitigation reference scenarios and decarbonization scenarios by 2050, covering 60% of today's global building emissions. These decarbonization pathways are compared to those from global models. Results demonstrate that reference scenarios are in all countries insufficient to achieve substantial decarbonization and lead, in some regions, to significant increases, i.e., China and South America. Decarbonization scenarios lead to substantial carbon reductions within the range projected in the 2 °C scenario but are still insufficient to achieve the decarbonization goals under the 1.5 °C scenario.

Buildings make up around one-third of total final energy consumption (FEC) and CO<sub>2</sub> emissions globally in 2020<sup>1</sup>, and they will likely play a critical role in the global low carbon transition. However, without further climate policy, the energy used in buildings can increase by 46–73% in 2050 from 128 EJ in 2019, driven by population growth, greater diffusion and use of energy-consuming devices, and increasing living standards in developing countries. In particular, the baseline scenarios of the five “shared socioeconomic pathways” (SSPs) show a paradigm shift in the energy demand of buildings: the demand of appliances, lighting and space cooling increases, whereas that of space heating and cooking declines over the next three decades. Furthermore, these scenarios show that the importance of developing countries to GHG mitigation strategies increases, and electricity becomes the main energy carrier globally [2–4]. Meanwhile, to restrict the increase of global temperature to less than 1.5 °C–2 °C, we need CO<sub>2</sub> emissions reductions within the range of 50–60%<sup>[5]</sup> to 90%<sup>[6]</sup> in 2050, depending on the scenario and model [5–8]. These reductions can be realized even with increases in energy demand (changes between –3% and +50% in energy demand are foreseen depending on the decarbonization scenario). To achieve these targets, the building sector will need to employ a suite of strategies including new construction of net-zero carbon buildings, high rates of energy renovation in existing buildings, low-energy-consumption behavioural practices, development of new low-energy building technologies and appliances, deployment of centralized and decentralized renewable energy sources (RESs), and widespread electrification of building technologies [6,8–12]. The design of these strategies at scale will require the development of national and transnational roadmaps based on feasible decarbonization Scenarios [10,11]. Existing global models [5–10] can be valuable for identifying key paths as they

**Table 1 Model overview per region and country. Subsectors: R, Residential; C, Commercial.**

Continent/Region/ Country [Subsector]	Model	Classification: Quadrant* according to ref. 13	Spatiotemporal resolution**	Scenarios (Reference scenario)	Reference
<b>Europe</b>					
Northern and Western (NW Europe) Sweden (SWE) [R, C], Germany (DEU) [R], France (FRA) [R, C], United Kingdom (GBR) [R, C] Norway (NOR) [R, C]	ECCABS	Q4 (Bottom- up/White- box)	Hourly energy demand, annual investment decisions, national climate zones	BAU-TE BAU-T	33
Austria (AUT) [R, C], Belgium (BEL) [R, C], Denmark (DNK) [R, C], Estonia (EST) [R, C], Finland (FIN) [R, C], France (FRA) [R, C], Germany (DEU) [R, C], Ireland (IRL) [R, C], Latvia (LVA) [R, C], Lithuania (LTU) [R, C], Luxembourg (LUX) [R, C], The Netherlands (NLD) [R, C], Norway (NOR) [R, C], Sweden, (SWE) [R, C], United Kingdom (GBR) [R, C]	RE-BUILDS  Invert/EE- lab	Hybrid: Q1/Q2/Q4 (technological, system dynamics and physics simulation) Q4 (Bottom- up/White- box)	Annual, national scale  Monthly, national scale	Baseline Ambitious zero-emission building scenario Reference Diversification Directed vision Localization National_ champions	30  34
Germany (DEU) [R]	CoreBee	Q4 (Bottom- up/White- box)	Annual energy demand and consumption, national scale  Annualized investment costs (50-year building lifetime)	1 2 3	35
<b>Southern and Eastern (SE Europe)</b>					
Greece (GRC) [R]	CoreBee	Q4 (Bottom- up/White- box)	Annual energy demand and consumption, national scale	1 2 3	35
Spain (ESP) [R, C]	ECCABS	Q4 (Bottom- up/White- box)	Hourly energy demand, annual investment decisions, national climate zones	BAU-TE BAU-T	33
Bulgaria (BGR) [R, C], Cyprus (CYP) [R, C], Croatia (HRV) [R, C], Greece (GRC) [R, C], Italy (ITA) [R, C], Malta (MLT) [R, C], Portugal (PRT) [R, C], Slovenia (SVN) [R, C], Spain (ESP) [R, C], Czech Republic (CZE) [R, C], Hungary (HUN) [R, C], Poland (POL) [R, C], Portugal (PRT) [R, C], Romania (ROU) [R, C], Slovakia (SVK) [R, C], North America United States of America United States of America (USA) [R, C]	Invert/EE- lab	Q4 (Bottom- up/White- box)	Monthly, national scale	Reference Diversification Directed_vision Localization National_champions	34
United States of America (USA) [R, C]	Scout	Hybrid Q1/Q4 (technological-econometric + end-use distribution)	Annual, AIA (American Institute of Architects) Climate Zone	AEO2019-SDS AEO2019-Ref AEO2019-HR	36
South America and Caribbean South America (SA) Brazil (BRA) [R, C]	BLUES v2.0	Multiple Quadrants (Hybrid)	Annual, five Brazilian macro-regions	adb ssp1_bau ssp1_pol ssp3_bau ssp3_pol ssp4_bau ssp4_pol ssp5_bau ssp5_pol	37
Ecuador (ECU) [R, C]	ELENA	Q2 (Top-down/ White-box)	12-month resolution, with a typical day divided into five time periods 4 regions	RS DDP	38
Asia Eastern Asia (excluding Japan) China (CHN) [R, C]	DREAM	Q4 (Bottom- up/White- box)	Annual, Chinese climate zone division	Reference Techno-economic-potential (TEP) Electrification plus efficiency plus clean transformation (Electrification)	39
*Q1 (Top-down/ Black-box) estimates aggregate building energy use from sector-wide socioeconomic and/or technological variables. Q2 (Top-down/ White-box) represents physical causality at the aggregate building and technology stock level. Q3 (Bottom- up/Black- box) attributes building-level energy use to particular energy end uses (e.g., space heating, hot water usage, and household appliances) based on statistical analysis of historical data. Q4 (Bottom- up/White- box) simulates the physical relationships of processes at the building or energy end-use level. Multiple quadrants (Hybrid) combine elements of the modeling approaches across the four classification quadrants.					
** Each model makes specific assumptions for the calculation of the energy requirements. This includes decisions on the level of resolution, geographical scope or set-point temperatures among others.					

---

encompass major socioeconomic trends, but they are frequently limited by their spatial and temporal scopes and resolutions and levels of technology details. On the other hand, sector-specific models, though lacking some of the socioeconomic indicators in global models, can provide a more detailed understanding of both the current conditions and possible future evolution of building energy demand patterns and insights into technology trends, implementation costs, and resulting energy use [13,14].

Against this background, our study aims to share insights from national building sector models to describe carbon mitigation scenarios by 2050, including descriptions of factors such as energy, CO<sub>2</sub> emissions, and associated socioeconomic indicators, and compare them to results from global models in line with 1.5 °C–2 °C scenario goals that provide information on mitigation measures on sub-sectoral levels. To this end, we compiled results from 32 countries across four continents, namely, Asia, Europe, and South and North Americas—a sample that we consider sufficiently representative of the building stock worldwide as it together covers more than 60% of global building emissions while accounting for most of the world regions and building typologies according to energy structure and development [15,16]. To the best of our knowledge, this is the most comprehensive transnational compilation of building carbon mitigation bottom-up sectoral studies, and it provides a strong, data-informed foundation for developing coordinated international building decarbonization plans. The large array of sector-specific models used in this study to examine decarbonization pathways for building is, therefore, of potentially great value to understanding the technologies and efficiency measures, including the interactions between them. More importantly, the level of aggregation also allows for comparison of key decarbonization indicators between national sectoral and global modeling. In the compilation of sectoral and national modeling studies, we identify two scenarios for each country: a reference scenario (RS), which assumes the energy and climate policies currently enacted along with moderate, expected policy enhancements, and various decarbonization scenarios (DSs), which represent the most ambitious potential actions based on techno-economic and policy feasibility within each national context. The DSs include the combined efforts for energy saving, efficiency, and decarbonization of both energy demand and supply. The specific measures depend on each country's framework conditions. Table 1 presents an overview of the models used in this study, including model classification [13] and spatial and temporal resolution for the regions and countries covered. The detailed assumptions of each model and respective scenarios for the drivers behind technology and demand development (i.e., policy instruments, energy price, demographic and floor area development, demand drivers, primary model inputs, and accounting of RES) are provided in Supplementary Table 1 and 2. This work integrates building stock energy models for 32 countries across four

---

continents to create carbon emission mitigation reference scenarios and decarbonization scenarios by 2050, covering 60% of today's global building emissions. These decarbonization pathways are compared to those from global models. Results demonstrate that reference scenarios are in all countries insufficient to achieve substantial decarbonization and lead, in some regions, to significant increases, i.e., China and South America. Decarbonization scenarios lead to substantial carbon reductions within the range projected in the 2 °C scenario but are still insufficient to achieve the decarbonization goals under the 1.5 °C scenario.

## **Results:**

Status quo: socioeconomic, climate, and energy indicators. National socioeconomic contexts and climate heavily affect the energy demand and resulting carbon emissions from buildings [17]. Figure 1 shows that in 2020 the gross domestic product (GDP) is related to the floor area, energy demand, and CO<sub>2</sub> emissions of a region. The USA has the highest GDP per capita (65 kUS\$/capita) and FEC (~10,000 kWh/capita), followed by Northern and Western (NW) European countries (36 kUS\$/capita and ~5,000 kWh/capita). CO<sub>2</sub> emissions per capita are, on average, higher in residential buildings than in commercial buildings in all regions; however, this is not so for FEC. This means that per capita the residential sector is more carbon intensive than the commercial sector. Similarly, floor area is higher for residential buildings than for commercial buildings in all countries except the USA and China. Among the climatic indicators, heating degree days (HDD) are much higher to cooling degree days (CDD) across countries compared. As a result, HDD show a strong correlation with FEC. Note that the impact of future climate change on building energy demand is not considered in any of these scenarios, though related models were previously used to investigate the effects of climate change in buildings energy consumption for the USA [18] and Sweden [19].

Considering individual countries in these regions, Sweden (NW Europe) has the most heating-intensive climate with 5,225 HDD and almost no CDD, whereas Ecuador (in South America) has the lowest heating intensity with no HDD and 224 CDD. The USA is climatically diverse with regions of both high HDD and CDD, but considering the population-weighted average, the USA has the largest cooling need in this study at nearly 1,200 CDD. The countries with the highest GDPs are Luxembourg (NWEurope) and the USA (69 kUS\$/capita and 65 kUS\$/capita, respectively). In terms of regions, the floor area follows a similar trend, with the highest value in the USA (R: 61 m<sup>2</sup>/capita, C: 26 m<sup>2</sup>/capita) and the lowest in Ecuador (R: 16 m<sup>2</sup>/capita, C: 2 m<sup>2</sup>/capita). The CO<sub>2</sub> intensity of energy demand also varies significantly across countries (see Supplementary Table 3.1 and Supplementary Table 3.2), depending on both the energy carrier

mix and the CO<sub>2</sub> intensity of electricity and heat generation. In 2020, China had the highest CO<sub>2</sub> intensity of FEC at 0.48 kg CO<sub>2</sub>/ kWh, followed by the USA at

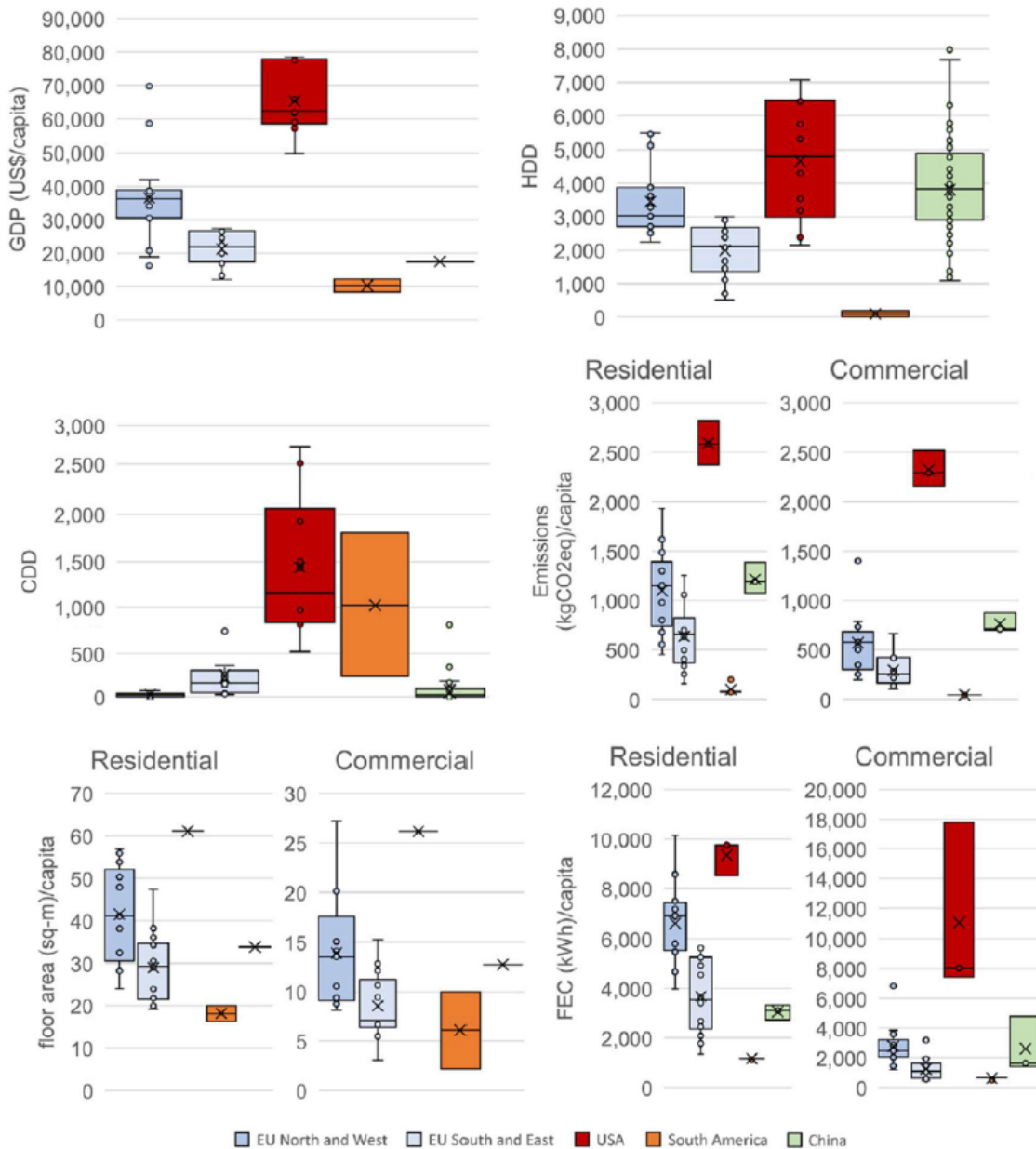

Fig. 1 Status quo (Year 2020): median of the gross domestic product (GDP), floor area, heating degree days (HDD) and cooling degree days (CDD), final energy consumption (FEC), and CO<sub>2</sub> emissions by the studied region (Northern and Western (NW) Europe and Southern and Eastern (SE) Europe, and South America) or country (the USA and China). In this plot, each region is described by the countries within the region. In the case of the USA and China, as they are the only countries within their region modelled in this study, their distributions are taken as the distributions of their administrative divisions.

0.30 kg CO<sub>2</sub>/kWh, Europe at 0.20 kg CO<sub>2</sub>/kWh, and finally South America at 0.11 kg CO<sub>2</sub>/kWh, which can be explained by the abundance of hydroelectric plants. As a consequence of these trends, the USA had the highest CO<sub>2</sub> emissions rate (~2.5 t CO<sub>2</sub>/capita), followed by China (~1.0 t CO<sub>2</sub>/capita), NW Europe and Southern and Eastern (SE) Europe (<0.5 t CO<sub>2</sub>/capita), and South America (~0.1 t

---

CO<sub>2</sub>/capita). Thus, it is clear that effective decarbonization strategies will differ with regions. For instance, the expected growth of the Brazilian building stock can lead to an increase in the energy demand. This, in turn, offers the possibility of implementing adequate urban design and roadmaps toward 2050. In regions with higher GDP and floor area per capita, such as the USA or NW Europe, the focus in the upcoming years is expected to be on the adoption of energy efficiency measures and decarbonization of the energy supply, among others. Thus, the socioeconomic, climate, and energy indicators considered in this work have a strong impact on the definition of scenarios and decarbonization pathways.

**Reference and decarbonization scenarios: Ambitious enough to achieve 15 and 2 °C targets?** For each study region we ran the individual sectoral models and scenarios listed in Table 1. The resulting FEC and CO<sub>2</sub> emissions towards 2050 are presented in Fig. 2. A more comprehensive and granular description of the mitigation actions in these models are presented in Supplementary Table 2. Additionally, a high-level comparison of key components of the decarbonization strategies (floor area, renovation rates, share of electricity in total FEC, electricity from RES, carbon intensity of electricity, and total emissions) between sectoral and global models is summarized in Supplementary References 1. In the subsections below, we discuss region-wise the scenario ambitions, in terms of FEC and CO<sub>2</sub> emissions, and the required measures to achieve them for various national contexts. This is followed by a comparison of CO<sub>2</sub> emission reduction between the global aggregation of DS from sectoral models and the 1.5 °C–2 °C scenarios of global models.

In NW Europe, the FEC and CO<sub>2</sub> emissions are similar across the residential and commercial sectors. The four DSs conducted with Invert/EE-Lab yield FEC reductions in the range of 29%–32% in 2050 compared to 2020. The highest reduction is seen in the scenarios Directed Vision and National Champions. The former focuses on energy efficiency and district heating policies, with emissions reductions of 89% between 2020 and 2050. The latter assumes differentiated country-specific policies to meet individual national targets and leads to a 70% reduction. In this second scenario, we see considerable shares of natural gas for heat remaining in some countries, with the open question whether, and at what cost, this could be supplied by green gas. Further, in the two scenarios Diversification, which includes a highly diversified heating technology stock, and Localization, which focuses on local resources, the FEC decreases by roughly 30% in both scenarios. The resulting emission reductions are similar to the reduction in Directed Vision. Technology wise, Diversification and Localization include greater deployment of heat pumps and direct use of biomass than Directed Vision. An additional fifth DS was modelled with ECCABS (BAU-T) for three countries (the United Kingdom, Sweden, and France), and it yielded in FEC and CO<sub>2</sub> emissions reductions of 13%–52% and 47%–76%, respectively, in 2050 compared to the 2020 values.

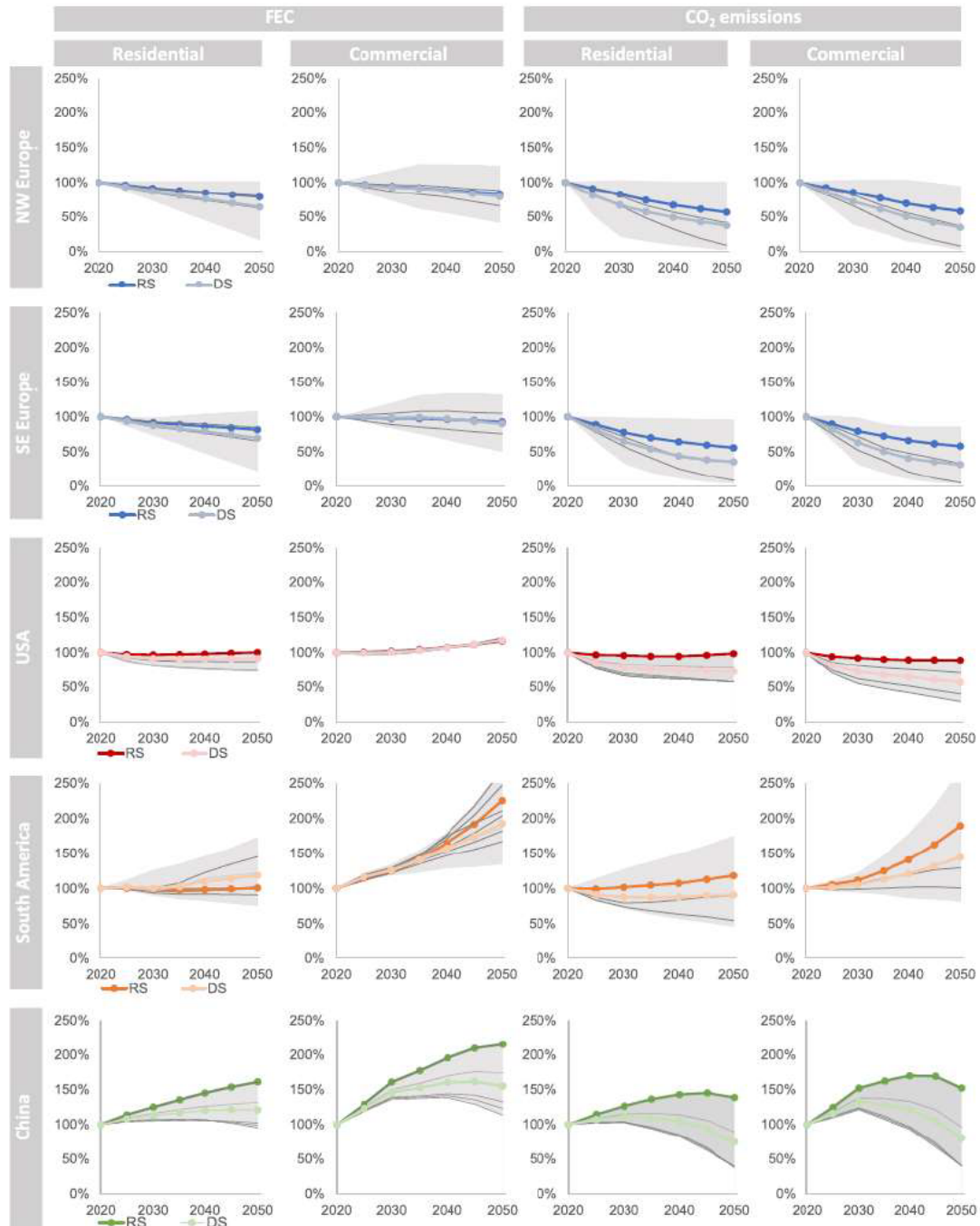

Fig. 2 Annual FEC and CO<sub>2</sub> emissions in residential and commercial subsectors region-wise (NW and SE Europe, South America) and country-wise (USA and China) in the reference scenario (RS) and decarbonization scenarios (DSs) until 2050, shown as percentages of the corresponding value in 2020. The gray area shows the range of values between the minimum and maximum from both the RS and DSs across the regions.

---

In the results of the ECCABS model, the energy reduction potentials for Sweden and the United Kingdom are substantially higher than the estimates from Invert/EE model but the reduction potential is lower for France. Similar to the energy reductions, ECCABS estimates higher reductions of CO<sub>2</sub> emissions compared to Invert/EE because of the comparatively increased decarbonization of the energy supply and large rollout of heat pumps. A separate scenario modelled in CoreBee for the residential stock of Germany estimates that an annual 3% refurbishment rate of building envelopes and heating/cooling system upgrades combined with small-scale RES, and prosumer strategies for micro combined heat and power (3%\_RR), can reduce FEC by 85% and emissions by 89% in 2050, compared with the RS.

The Norwegian DS modelled in RE-BUILDS, results in a 56% energy demand reduction compared to 2020, assuming a large-scale rapid introduction of zero-emission building technologies in new and renovated buildings. The absolute savings in the DS vary largely from 0.7 to 16 Mt CO<sub>2</sub> and are generally half of the RS. About 70% of the emissions saving potential comes from residential buildings including the decarbonization of the power sector. The differences in the model results are driven by the specific techno-economic and policy assumptions (as shown in Supplementary Table 2.1).

For SE Europe, the results from the Invert/EE-lab model show reductions of 27%–31% in FEC in 2050 compared to 2020. Using the same scenarios as those for NW Europe, the highest CO<sub>2</sub> emission reductions are achieved in Directed Vision, with a decrease of 90%. In Diversification and Localization, the FEC decreases by 27% owing to a strong uptake of heat pumps, photovoltaics, solar thermal systems, and biomass. National Champions leads to reductions of 27% in FEC and 85% in CO<sub>2</sub> emissions. As in the case of NW Europe, this scenario has the highest remaining share of natural gas in 2050. Compared to NW Europe, SE Europe shows considerable electricity demand for space cooling because of the warmer regional climate. All scenarios for NW and SE Europe presume a strong decarbonization of the electricity-based and district heating supply systems. ECCABS-DS shows that the FEC of buildings in Spain reduce by 53% in 2050 compared to 2020, with a corresponding decrease of 59% in emissions. The resulting energy use from these scenarios is substantially lower than the more conservative estimates of ~20% reductions from the Invert/EE-lab model. Nonetheless, the resulting emission reductions are lower in the Invert/EE-lab model. This is partially attributed to the fact that Invert/EE-Lab model adopts more conservative policy assumptions that affect the cost-effectiveness of technology options and renovation measures, while simultaneously assuming a more radical decarbonization of the energy system. Results from CoreBee show that the residential sector in Greece (3% RR scenario) can reduce its FEC by 79% and CO<sub>2</sub> emissions by 88% in 2050, compared with the RS.

In the USA, the population growth between 2020 and 2050 is expected to be 17%. This population growth will drive baseline increases in energy demand.



---

In a DS with aggressive deployment of building efficiency measures, incentivized electrification of building technologies, and a high share of renewable electricity generation (AEO2019-SDS), the building FEC can be reduced by 21% in 2050 with associated emission reductions of 1,018 Mt CO<sub>2</sub>. Total emissions under this scenario are 64% lower than those in 2020, while the modelled RS (AEO2019-Ref) has reductions of just 6% compared to 2020. A second DS assumes only higher renewable electricity supply without further demand reductions (AEO2019-HR), and this scenario achieves reductions by 53% in 2050, indicating the strong influence of electricity supply decarbonization on potential emissions reductions from buildings in the USA. There are minimal demand reductions in the commercial sector compared to the reductions in the residential sector, partially due to the lower floor area in the commercial sector. Of the avoided emissions in AEO2019-SDS that can be directly attributed to reductions in building demand, the greatest contribution comes from residential building efficiency measures (91% in 2050)—including the deployment of heat pumps for residential space and water heating, improved building controls, highly insulating thermal envelopes, and air sealing technologies.

South America shows an increase in FEC and CO<sub>2</sub> emissions in both the residential and commercial sectors—the latter presents the steepest increase across all studied regions. In Brazil, the energy demand is expected to increase annually by 0.9% between 2020 and 2050 because of a higher demand from commercial activities, which are an effect of economic development. However, in a scenario assuming an increase in energy efficiency and electrification of building technologies (SSP4\_pol), FEC and electricity consumption will fall by 5% and 42%, respectively, in 2050, with 82% of the avoided emissions originating from residential buildings. This reduction is achieved by considerable deployment of energy efficient residential technologies (e.g., more efficient lighting technologies and electrical appliances such as refrigerators, water heaters, air conditioning, and fans), combined with a shift from traditional fuels (e.g., firewood and coal) to natural gas and liquefied petroleum gas (LPG). In Ecuador, the FEC in the commercial sector is the same for both the RS and DS, whereas that in the residential sector varies in each scenario. FEC in the DS is lower than that in the RS for most of the final energy uses, except cooking (which is constant) and electric appliances (which significantly increases). In 2050, the total FEC is ~60 TWh for both scenarios, but the emissions for 2050 in the DS are 6% lower than those modelled in the RS (8 and 9 Mt CO<sub>2</sub>, respectively). The RES for electricity generation is expected to reach a share of 95% in 2050 in the DS. Additionally, two specific ambitious strategies can further support the decarbonization of the Ecuadorian building sector beyond what was included in the DS. First, cooking can be electrified to a greater extent by replacing LPG stoves by induction stoves. Second, increased shares of old appliances can be replaced with new and more efficient equipment.

---

In the Chinese RS, economic growth drives the increase in energy demand and CO<sub>2</sub> emissions in both residential and commercial buildings. Heating and cooling demands also increase with economic growth. The cooling demand per unit floor area in China's northern climate zones rise from 5–7 kWh/m<sup>2</sup> in 2020 to 4–19 kWh/m<sup>2</sup> in 2050. In the transition climate zones, the heating demands per unit floor area evolve from ~25 kWh/m<sup>2</sup> to 10–68 kWh/m<sup>2</sup> over the same time period. The DS (High efficiency) assumes an increasing market penetration of net-zero energy buildings (NZEB), large-scale deployment of high efficiency appliances, retrofits in the existing buildings (particularly in northern China), and a significant uptake of distributed RES. Furthermore, in the DS, the CO<sub>2</sub> emissions intensity of electricity production is reduced from 0.54 kg CO<sub>2</sub>/kWh in 2020 to 0.09 kg CO<sub>2</sub>/kWh in 2050, with the share of carbon-free generation sources increasing from 41% in 2020 to 89% in 2050. To leverage the lower-emission electricity from the power grid, an additional DS building electrification scenario was modelled. This scenario reflects a replacement of 50% of coal and natural gas equipment by heat pumps by 2050 for space heating needs in urban commercial and residential buildings in northern China. As a result, 70% of FEC is met by electricity in 2050 (~80% for commercial buildings and ~62% for residential buildings).

By adding up regional results, RS leads to a global 18% CO<sub>2</sub> emissions increase — from 5.7 GtCO<sub>2</sub> in 2020 up to 6.7 GtCO<sub>2</sub> in 2050. This is mainly driven by China, responsible of 70% of this increase. Per region, EU (both NW and SE) and the USA show reductions of 42% and 6% respectively, while China and SA show increases of 44% and 32%. Conversely, DS leads to emission decreases of around two thirds of current levels by 2050 down to 1.9 GtCO<sub>2</sub>. This means that the level of ambition of the national developments represented in the DSs would achieve the 2 °C scenario goals, yet appear insufficient to maintain global temperature below 1.5 °C. In the conclusions, based on the data of Supplementary Notes/Methods 1, we elaborate on the additional efforts that would be required to achieve the 1.5 °C scenario goals.

**Socioeconomic insights from the DSs.** Each of the DS is built on the distinct socioeconomic and climatic conditions of each country, resulting in different FEC per capita by 2050 (Fig. 3). Of the five regions, the USA continues to have the highest relative FEC in 2050 at ~8,100 kWh/cap, followed by NW Europe and China. Although the USA has the highest total FEC value, the reduction compared to the RS is still substantial (~15%). NW and SE Europe have the greatest relative FEC reductions at 40%, with NW Europe finishing at ~3,000 kWh/capita in 2050 and SE Europe at ~1,500 kWh/capita. The floor area varies substantially across regions but is approximately the same in both the DS and RS. In both cases, the USA has the highest floor area (~100 m<sup>2</sup>/cap) of which nearly 70% is in the residential sector; furthermore, 75% of the 2050 modeled floor area already exists in 2020.

---

In 2050, China has the second highest average FEC at ~4000 kWh/capita, which represents a 25% increase from the FEC in 2020, mostly because of a socioeconomic growth — characterized by a rapid urbanization (from 61% of the population living in urban areas in 2020 to 80% in 2050) —, and standards of living; thus, a larger diffusion and use of appliances. The FEC increase is mainly due to a rise in the floor area per capita in the residential buildings. In developing economies, increased living standards are expected by 2050. In South America, the DSs have an average annual FEC of ~1,000 kWh/cap by 2050: an increased demand for energy services is offset by the electrification of most building energy uses and the adoption of efficient technologies. In Brazil, the FEC in the DS does not increase remarkably in most scenarios for the residential sector. In Ecuador, by 2050, the population is expected to increase by nearly 45%, while the average household size is expected to fall from 3.8 members to 2.7, thereby doubling the number of households. However, new construction homes are expected to adopt the electrification of water heating and cooking, thereby reducing onsite GHG emissions from LPG combustion and firewood stoves. In parallel, the demand for electric appliances is predicted to double because of an increased uptake of smart appliances.

Figure 4 shows the relative evolution (with 2020 as the reference year) of both socioeconomic and energy variables. The comparison of the relative evolution across regions provides valuable insights. First, graphs (i-iii, y-axis: average building consumption per floor area) show that in developed regions, namely, the USA and NW and SE Europe, energy consumption per floor area decreases in both scenarios (the RS and DSs). The opposite is observed for South America, with energy consumption increasing per unit floor area, while in China, it depends on the scenario: FEC increases in the RS and decreases in the DSs. From the population and floor area relationships (represented on the x-axes of charts i and ii, respectively), South America shows the largest population growth (18%), while the USA has the largest floor area growth (34%), partially because of its 17% population growth. Europe has a modest population growth of 6%, whereas the population in China decreases by 3%. In all regions, the ratio of floor area per capita increases remarkably, especially in China. Particularly interesting is the comparison between FEC and carbon intensity (chart iii), which shows that energy consumption plunges more rapidly than carbon intensity in developed regions (the USA and NW/SE Europe) in the RS, while the DSs are driven by large carbon intensity reductions and moderate efficiency improvements. In South America, there are steep increases in energy use but modest improvements in carbon intensity. With regard to China, the RS and DS yield drastically diverging cases and energy and carbon intensity relationships. In terms of the average emissions per capita (charts iv-vi), although South America has the largest population change (19%), its emissions remain consistently the lowest along with those of SE European countries, in terms of both per population and floor area change (~0.1 tCO<sub>2</sub>/cap). In the USA, which has the second largest population

---

growth (17%), CO<sub>2</sub> emissions per capita decreases to 2tCO<sub>2</sub>/cap in the DS. The carbon intensity of FEC (chart vi), decreases in all the DS of the five studied regions. A comparison of the results shown in Fig. 4 to the socioeconomic 2050 conditions shown in Fig. 3 clearly shows the interdependent relationships of GDP, population, floor area, FEC, and emissions. The floor area per capita increases among the developing economies (China, Brazil and Ecuador), while in developed economies, it remains consistently high. Our assumptions are generally aligned with the global models in that these models assume increases of 32% (to 29 m<sup>2</sup>/cap) and 50% (to 9 m<sup>2</sup>/cap) for residential and commercial buildings, respectively, for the global south, or that half of the floor area additions will be in sub-Saharan Africa and India [7,20]. Our assumptions for developed economies and conclusions are aligned with the observed trends of declining household sizes [21–24] but are in contrast with the embedded assumptions of maintaining or reducing floor areas per capita in many global models [1,6,7] (see Supplementary Notes/Methods 1). The assumptions vary in the global models: in the global north, the density of residential buildings is roughly constant, whereas that of commercial premises increases by 44% to 23 m<sup>2</sup>/cap. Worldwide, estimates from the global models range from absolute (not per capita) increases of more than twofold by 2070 [20] to constant trends converging to 30 m<sup>2</sup>/cap in 2050, with other studies assuming no changes from the baseline scenario. Recent studies suggest that 10–15 m<sup>2</sup>/capita can provide decent living standards globally with minimum energy demand [23,24]. However, a remaining question is whether developed countries that maintain most of their building stock into the future will transition to a more densified living arrangement.

## Discussion

This study clarifies potential decarbonization pathways for the building sector towards 2050 climate targets by comparing national sectoral models results with global models. The contribution of this work is to: (1) provide detailed analysis of decarbonization scenarios based on measures defined by national contexts; (2) offer a high level of granularity and disaggregation of the results based on an empirical characterization of the stock defined by buildings' physical properties (e.g., size, age, thermal properties, etc.); and (3) compare and discuss the results with those from global models in terms of total FEC and CO<sub>2</sub> emission savings. Such a detailed analysis had not been done before using building stock bottom-up sectoral models covering world regions totaling 60% of the global sector CO<sub>2</sub> emissions. Our study presents an analysis of the RS and DSs in buildings through 2050 across 32 countries based on national building sector models. The RS scenarios, which assume the progression of current policy and techno-economic frameworks, show approximately 1 GtCO<sub>2</sub> emission increase by 2050 globally. The DSs, which built upon the most ambitious techno-economic and policy pathways within each national context, result on average renovation rates by

Fig. 3 Decarbonisation Scenarios (Year 2050). Gross domestic product (GDP), floor area, annual total final energy consumption (FEC) and CO<sub>2</sub> emissions per capita and per m<sup>2</sup> across regions and countries.

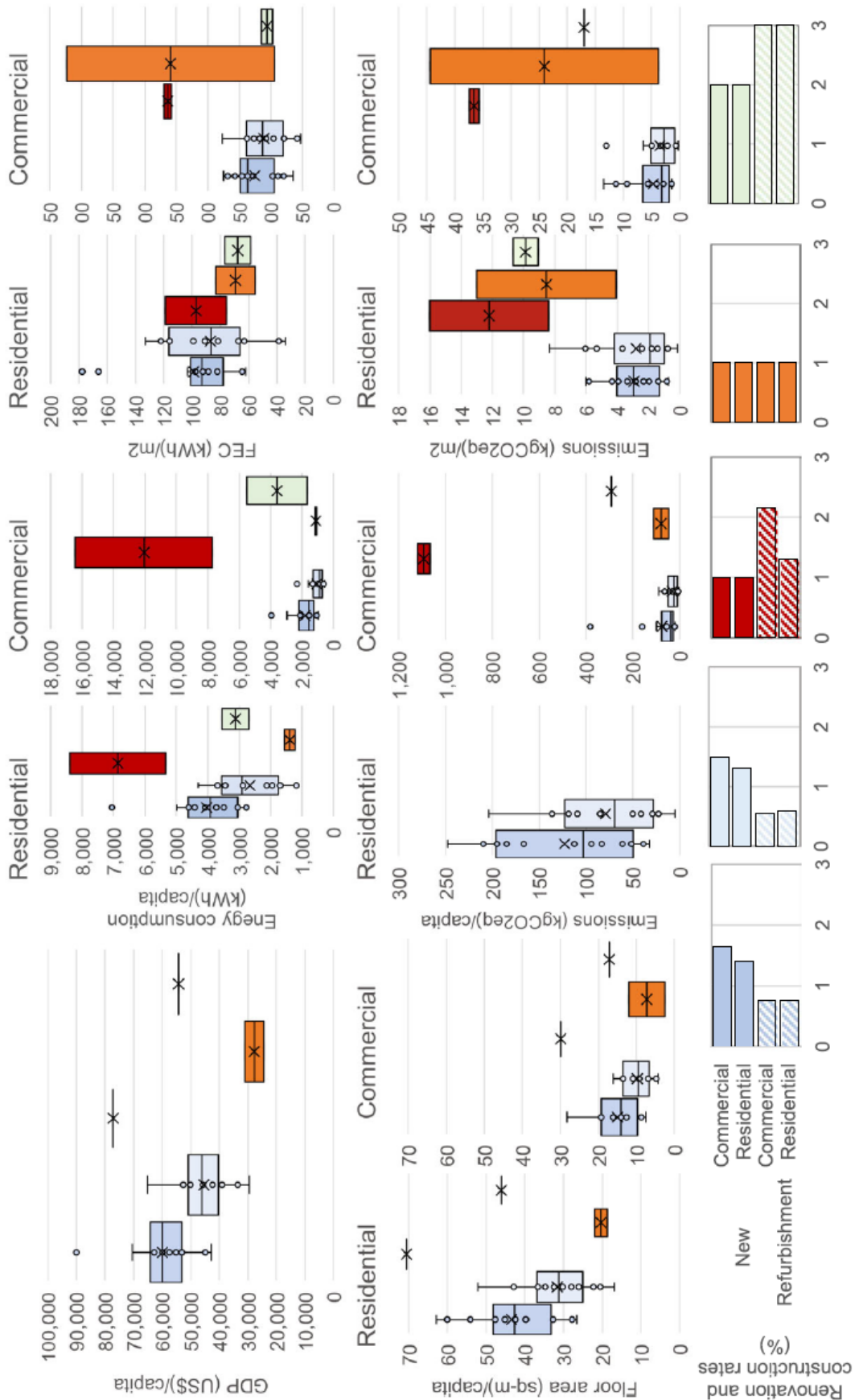
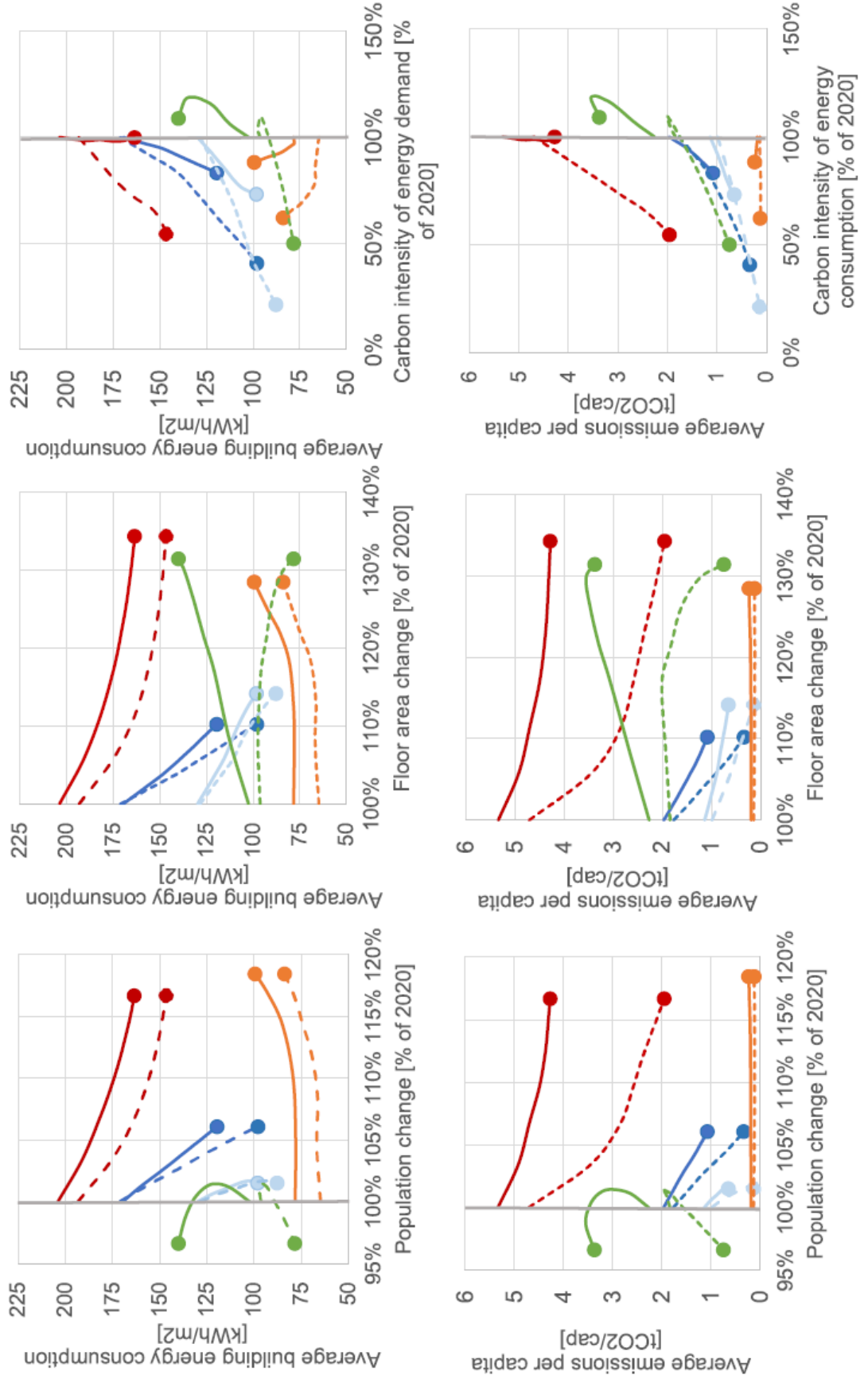

Fig. 4 Changes in demands and services from 2020 to 2050 (X-axes: population, floor area, and carbon intensity of final energy consumption (FEC) change. Y-axes: average building energy demand and CO<sub>2</sub> emissions per capita in the different scenarios by regions and countries). The oval arrow shows the direction of evolution over time, and the oval indicates the value for 2050.



---

1.4%, an average share of direct RES of 38%, and electrification of FEC by 38–80%. These attain a total reduction of almost 4 GtCO<sub>2</sub> emissions by 2050 within the range projected in the 2 °C degrees scenario but still insufficient to achieve the decarbonization goals for the 1.5 °C degrees scenario [9]. To align with 1.5 °C scenarios, the national decarbonization strategies are required to increase current annual renovation rates to a total of 2.4%, and to increase the share of electrification of buildings' FEC by 4–14% to an average of around 50% in all regions. Furthermore, by increasing the share of direct RES in the energy mix by 3–30% to a global share of around 70%, the carbon intensity of electricity production should be 4–6 times lower than that assumed in the DSs (at least below 40 gCO<sub>2</sub>/kWh globally). To this aim, only a comprehensive set of sufficiency, efficiency, and RES actions in the building sector allows to achieve the most ambitious climate goals. Our analysis concludes that the aggregation of national models complements assessments made by global models in the building sector. Further, it provides a more detailed overview based on the incorporation of specific national/regional contexts, including building stock characteristics and socioeconomic trends. Therefore, there is a great potential for national models to be tailored to government decisions addressing context-specific challenges and, ultimately, contributing to build evidence towards global climate goals.

## Methods

**Study design.** We build on the outputs of published national bottom-up building sectoral modeling studies. These models assess the energy demand and carbon emissions of building stocks and develop pathways and scenarios for energy and carbon emission reduction. Unlike global models, the assessment of the scenarios is done through the characterization of building stocks defined by buildings' physical properties such as geometry, U-values, climate data, indoor temperature and energy end-use supply systems (e.g., heating and cooling systems) [13]. Different modeling approaches can be undertaken depending on the available data. Some defined a set of synthetic buildings reflecting building stock averages, others applied a set of “generic” example buildings from the national typologies. The bottom-up building sectoral modeling studies. The sectoral in this study also provide additional data that are not explicitly presented in the existing publications while layering on additional socioeconomic data from worldwide databases. The method to align the models is composed of three main steps: (1) definition of a common framework, including outcome variables, assumptions, and viable scenarios; (2) collection of modeling results; and (3) comparative visualization and analysis of the results. The study standardizes common parameters from country-specific conditions: start year (2020), target year (2050), time interval (5-year), subsectors (disaggregation to “residential” and other non residential services as “commercial”), outcome variables (FEC, CO<sub>2</sub> emissions, floor area, carbon intensity of electricity production, and shares of electricity in

---

the total demand and heating demand). Country-specific descriptions of the building stock and contextual parameters required as the input in the modeling exercise are as follows: current building structure, building technological systems, fuel mix in the energy supply, CO<sub>2</sub> emissions of fuels, and policy instruments such as codes, standards and regulations, economic instruments, and information and education programs. Some countries in Europe are addressed by more than one model, and in such cases, we calculate the mean of the results per county. National results are aggregated in accordance with the IPCC division into world regions, similar to standard M49. The results of the bottom-up sectoral models and the mean values for the European clusters are population-weighted. Descriptions of participating models. We employed eight state-of-the-art sectoral building stock models, which are briefly described below. Additional details and references can be found in Supplementary Table 2.

Brazilian Land-Use and Energy System model (BLUES) was developed using the MESSAGE platform (Model for Energy Supply System Alternatives and their General Environmental Impacts) by the International Institute for Applied Systems Analysis. It is a mixed-integer linear optimization model, which minimizes the total cost of expanding the energy system to meet an expected demand for energy services. It combines technical, economic, and environmental variables for more than 8,000 technologies with imposed constraints to obtain an optimal solution for the energy sector. The model can have endogenous or exogenous demand responding elastically to the variables of population growth and GDP, which can also respond to price signals. BLUES provides detailed geographical coverage of Brazil and has 1-h time resolution.

CoreBee developed by JPJN and FF is a bottom-up-model that focuses on the cost-optimal renovation of national building stocks. It is based on quasi-steady state assumptions for calculating the energy demand for both heating and cooling. It identifies the cost-optimal renovation options (building envelopes, technical systems, and renewable energy generation) for each national building stock with regards to both primary energy savings and CO<sub>2</sub> emissions. The model is primarily designed for application to the existing European Union (EU) building stock represented by reference buildings defined by their construction period, typology, envelope insulation levels, and heating and cooling supply systems. It also explores the effects of both the current and future energy system fuel mixes on carbon intensity and the supply of heating and cooling.

China 2050 Demand Resources Energy Analysis Model (DREAM) is a bottomup energy and emissions analysis model developed by the Lawrence Berkeley National Laboratory in California. The model consists of China's five energy demand sectors (residential buildings, commercial buildings, industry, transport, and agriculture) and an energy transformation module that includes energy production, transmission, and distribution. The DREAM model is implemented by using the Long-range Energy Alternatives Planning platform. The building sector module captures the building stock turnover to reflect China's rapid urbanization by 2050. By using

---



---

China's major climate zones, the results are segmented to characterize building sector energy use in cold, transition, and warm climate zones. The model allows scenario analysis for different energy saving and emission reduction measures, including energy efficiency retrofits to the existing building stock and implementation of different building codes and standards in new construction. Furthermore, DREAM can model energy and technologies at the end-use level (including fuel type). These energy end uses are connected to DREAM's transformation module to analyze the primary energy use and CO<sub>2</sub> emissions of the building sector. Energy, Carbon and Cost Assessment for Building Stocks (ECCABS) is a bottom-up model used to assess energy conservation measures (ECMs) and CO<sub>2</sub> mitigation strategies in existing building stocks. The model is based on a one-zone hourly heat balance that calculates the net energy demand for a number of representative buildings and then extrapolates the results to the entire stock via weighting coefficients. The model generates results in terms of net and final energy values, associated CO<sub>2</sub> emissions, and the costs of implementing different ECMs; these results are then applied according to cost-efficiency over a timeline for a series of scenarios (e.g., the cost of renovations changes in and energy prices). Ecuador Land-Use and Energy Network Analysis (ELENA) is the first integrated assessment model (IAM) for Ecuador. It was developed by the Escuela Politécnica Nacional with the technical assistance of the Federal University of Rio de Janeiro (COPPE/UFRJ) in Brazil during the DDP-LAC project. ELENA's [25] structure is based on the BLUES model [26] and uses some outputs of the COFFEE model. ELENA assesses from a bottom-up modeling approach the expansion of the energy-land-use system and the evolution of CO<sub>2</sub> emissions through 2050. It is a partial equilibrium, integrated, optimization model using a perfect foresight approach that considers the whole energy conversion chain, from primary energy to useful energy. Five economic sectors, including buildings, are represented in the model. ELENA also models the land-use system by calculating land-use changes according to the demand for food and deforestation/reforestation scenarios up to 2050. Useful energy and food demands, as well as deforestation/reforestation, are exogenously calculated. Invert/EE-Lab is a dynamic bottom-up simulation tool that evaluates the effects of different framework conditions (especially different economic and regulatory incentives) on possible evolution of energy demand, energy carrier mix, CO<sub>2</sub> reductions, and the cost of space heating, cooling, and hot water in buildings. The model describes the building stock and heating, cooling, and hot water systems at highly disaggregated levels, calculates related energy needs and delivered energy, determines reinvestment cycles and new investments of building components and technologies, and simulates the decisions of various agents (i.e., owner types), assuming that an investment decision is due for a specific building segment. The core of the tool is a myopic, multinomial logit approach, which optimizes the objectives of "agents" under conditions of imperfect information and thus represents the decision-maker taking building-related decisions.

---

---

Although the spatial resolution of the tool is national, climate zones and sub-regions are distinguished for some countries. Furthermore, the energy-demand-related outputs of these tools can be displayed on a 100 m<sup>2</sup>m<sup>2</sup> raster cell level. The model Invert/ EE-Lab has until now been applied to the building stock in all EU-27 (+GBR) countries [1,27–29]. RE-BUILDS [30] utilizes dynamic Material Flow Analysis for studying the long-term development of the Norwegian building stock. The driving force in the model is a population's need for housing and various types of commercial buildings. The demand for floor area in buildings of various types is estimated for each year. Demolition and renovation activities are estimated using probability functions. Floor area is distributed among archetypes based on building type, construction year, and renovation status. Archetype-specific energy intensities, fuel mix, and use of local RESs are used to estimate the aggregated energy demand from the building stock, as well as the use of various energy carriers. Carbon emission intensities per energy carrier are used to estimate the aggregated CO<sub>2</sub> emissions. The model is used for scenario analyses, wherein various inputs are varied among the scenarios, and in particular, the scenarios that affect the energy intensities assumed for new construction and renovated buildings from various archetypes. Scout is a bottom-up model of the USA residential and commercial building sectors that estimates the impact of various ECMs on building sector energy demand. This model characterizes ECMs using their relative or absolute energy performance, installed cost, service lifetimes, and year of introduction into the market. Probability distributions can be placed on ECM performance, cost, and lifetime inputs, which then filter through to final energy and carbon impacts. Furthermore, the ECM energy performance can be calculated using whole-building energy simulation via EnergyPlus and can be applied to the Scout prototype building models. This approach compares ECMs on a level playing field using identical assumptions, thus eliminating the need for normalization. It also produces savings estimates disaggregated by end-use, thereby facilitating the evaluation of ECM packages. Scout ECMs are applied to a baseline USA building stock that is defined in the Annual Energy Outlook (AEO) [31,32] of the Energy Information Administration with the granularity of building type (e.g., office, hospital, and single-family home), building vintage (e.g., new and existing), climate zone (e.g., hot and humid and cold), end-use (e.g., heating and lighting), and fuel type (e.g., electricity and natural gas). Scout also uses the AEO to project growth and stock turnover in each baseline market segment. Various AEO scenarios are used for the renewable penetration of electricity supply for this study. Data availability All data generated or analyzed during this study used in the graphs are included in this published article and its supplementary information files: "Supplementary References 1. Numerical output per figure". Further data are available from the corresponding autor on reasonable request.

---

## References

1. International Energy Agency (IEA). World Energy Outlook 2021. <https://www.iea.org/reports/world-energy-outlook-2021>.
2. Ürge-Vorsatz, D., Cabeza, L. F., Serrano, S., Barreneche, C. & Petrichenko, K. Heating and cooling energy trends and drivers in buildings. *Renew. Sustain. Energy Rev.* 41, 85–98 (2015).
3. Riahi, K. et al. The shared socioeconomic pathways and their energy, land use, and greenhouse gas emissions implications: An overview. *Glob. Environ. Chang.* 42, 153–168 (2017).
4. Levesque, A. et al. How much energy will buildings consume in 2100? A global perspective within a scenario framework. *Energy* 148, 514–527 (2018).
5. Wang, H., Chen, W. & Shi, J. Low carbon transition of global building sector under 2- and 1.5-degree targets. *Appl. Energy* 222, 148–157 (2018).
6. Levesque, A., Pietzcker, R. C., Baumstark, L. & Luderer, G. Deep decarbonization of buildings energy services through demand and supply transformations in a 1.5 °C scenario. *Environ. Res. Lett.* 16, 054071 (2021).
7. Grubler, A. et al. A low energy demand scenario for meeting the 1.5 °C target and sustainable development goals without negative emission technologies. *Nat. Energy* 3, 515–527 (2018).
8. Levesque, A., Pietzcker, R. C. & Luderer, G. Halving energy demand from buildings: The impact of low consumption practices. *Technol. Forecast. Soc. Change* 146, 253–266 (2019).
9. Rogelj, J. et al. Chapter 2: Mitigation pathways compatible with 1.5 °C in the context of sustainable development Global Warming of 1.5 °C, an IPCC Special Report on the Impacts of Global Warming of 1.5 °C above Preindustrial Levels and Related Global Greenhouse Gas Emission Pathways, in the Context of Strengthening the Global Response to the Threat of Climate Change (Geneva: Intergovernmental Panel on Climate Change) (2018).
10. Luderer, G. et al. Residual fossil CO<sub>2</sub> emissions in 1.5–2 C pathways. *Nat. Clim. Change* 8, 626–633 (2018).
11. Ürge-Vorsatz, D. et al. Advances toward a net-zero global building sector. <https://doi.org/10.1146/annurev-environ-012420> (2020).
12. Mata, É. et al. A map of roadmaps for zero and low energy and carbon buildings worldwide. *Environ. Res.* <https://doi.org/10.1088/1748-9326/abb69f> (2020).
13. Langevin, J. et al. Developing a common approach for classifying building stock energy models. *Renew. Sustain. Energy Rev.* 133, 110276 (2020).
14. Kavgić, M. et al. A review of bottom-up building stock models for energy consumption in the residential sector. *Build. Environ.* 45, 1683–1697 (2010).
15. Guo, S., Yan, D., Hu, S. & An, J. Global comparison of building energy use data within the context of climate change. *Energy Build.* 226, 110362 (2020).

- 
16. IPCC. Summary for Policymakers. Climate Change 2014, Mitigation of Climate Change. Contribution of Working group III to the fifth assessment report of the Intergovernmental Panel on Climate Change. (Cambridge University Press, 2014).
  17. Mata, É. et al. A systematic map of determinants for buildings' energy demand and climate impact. *Environ. Res. Lett.* 16, 55011 (2020).
  18. Reyna, J. L. & Chester, M. V. Energy efficiency to reduce residential electricity and natural gas use under climate change. *Nat. Commun.* 8, 1–12 (2017).
  19. Mata, É., Wanemark, J., Nik, V. M. & Kalagasidis, A. S. Economic feasibility of building retrofitting mitigation potentials: Climate change uncertainties for Swedish cities. *Appl. Energy* 242, 1022–1035 (2019).
  20. International Energy Agency (IEA). Energy Technology Perspectives 2020.[cited 2021 Aug 20]; Available from: [www.iea.org/t&c/](http://www.iea.org/t&c/).
  21. Viggers, H., Keall, M., Wickens, K. & Howden-Chapman, P. Increased house size can cancel out the effect of improved insulation on overall heating energy requirements. *Energy Policy* [Internet]. 107, 248–257 (2017).
  22. Ellsworth-Krebs, KatherineL. & Hunter, C. J. Home comfort and “peak household”: implications for energy demand. *housing. Theory Soc.* [Internet]. 38, 1–20 (2021).
  23. Cohen, M. J. New conceptions of sufficient home size in high-income countries: are we approaching a sustainable consumption transition? *Housing. Theory Soc.* [Internet]. 38, 173–203 (2021).
  24. Millward-Hopkins, J., Steinberger, J. K., Rao, N. D. & Oswald, Y. Providing decent living with minimum energy: A global scenario. *Global Environ. Change* 65, 102168 (2020).
  25. Rua Rodriguez Rochedo, P. Development of a global integrated energy model to evaluate the brazilian role in climate change mitigation scenarios. PhD Thesis. COPPE-UFRJ (2016).
  26. Köberle, A. C., Rochedo, P. R. R., Lucena, A. F. P., Szklo, A. & Schaeffer, R. Brazil's emission trajectories in a well-below 2 °C world: the role of disruptive technologies versus land-based mitigation in an already low-emission energy system. *Clim. Change* 162, 1823–1842 (2020).
  27. Kranzl, L., Hummel, M., Müller, A. & Steinbach, J. Renewable heating: Perspectives and the impact of policy instruments. *Energy Policy* 59, 44–58 (2013).
  28. Kranzl, L. et al. Are scenarios of energy demand in the building stock in line with Paris targets? *Energy Effic.* 12, 225–243 (2019).
  29. Hartner, M. et al. H2020 SET-Nav D.5.8: WP5 Summary report—Energy Systems: Demand perspective. (2019).
  30. Sandberg, N. H., Naess, J. S., Brattebø, H., Andresen, I. & Gustavsen, A. Large potentials for energy saving and greenhouse gas emission reductions from large-scale deployment of zero emission building technologies in a national building. *Energy Policy* 152, 12114 (2021).
-

- 
31. Annual Energy Outlook 2020. U.S. Energy Information Administration (2020) <https://www.eia.gov/outlooks/aeo/>.
  32. U.S. Energy Information Agency. Annual Energy Outlook 2019 with projections to 2050. *Annu. Energy Outlook 2019 Proj. 2050* 44, 1–64 (2019)
  33. Mata, É., Kalagasidis, A. S. & Johnsson, F. Contributions of building retrofitting in five member states to EU targets for energy savings. *Renew Sustain. Energy Rev.* 93, 759–774 (2018).
  34. Müller, A. Energy Demand Assessment for Space Conditioning and Domestic Hot Water: A Case Study for the Austrian Building Stock. 285 [http://www.invert.at/Dateien/Dissertation\\_AndreasM.pdf](http://www.invert.at/Dateien/Dissertation_AndreasM.pdf) (2015).
  35. Filippidou, F. & Jiménez Navarro, J. P. Achieving the cost-effective energy transformation of Europe’s buildings Energy renovations via combinations of insulation and heating & cooling technologies: Methods and data. European Commission, Joint Research Centre <https://doi.org/10.2760/278207> (2019).
  36. Langevin, J., Harris, C. B. & Janet, R. J. Assessing the Potential to Reduce U.S. Building CO<sub>2</sub> Emissions 80% by 2050. *Joule* <https://doi.org/10.1016/j.joule.2019.07.013> (2019).
  37. Rochedo, P. R. R. et al. The threat of political bargaining to climate mitigation in Brazil. *Nat. Clim. Change* 8, 695–698 (2018).
  38. Villamar, D. et al. Long-term deep decarbonization pathways for Ecuador: Insights from an integrated assessment model. *Energy Strateg. Rev.* 35, 100637 (2021).
  39. Wang, R., Lu, S. & Feng, W. A novel improved model for building energy consumption prediction based on model integration.

---

# Chapter 5

## A short introduction to Multi-Leader-Follower games

In this chapter the mathematical tools that will be used in Chapter 6 are described. First, an introductory historical review of game theory and its applications is presented. Then a mathematical recall of optimization concepts and principles is proposed, followed by a focus on the concept of Nash equilibrium and its generalized form. Afterwards bilevel optimization is introduced. All these tools are combined in the last part where Multi-Leader-Follower games are presented, with a special focus on Single-Leader-Multi-Follower games (SLMFG), and finally the resolution of an example of SLMFG is developed.

### 5.1 Review of the Single Leader Multi Follower Games

#### 5.1.1 Game theory's milestones overview

Game theory is a complex subject that could be situated at the frontier between economics and mathematical modelling. It is an ally in market decision making processes by modelling the interaction between rational players, whose self-interests to pursue a benefit are interlinked. The study of game theory was originally related to economic sciences, but its applicability has migrated to other subjects. In order to introduce the topic of game theory, the most important breakthrough of this subject will be outlined here. The origins of game theory can be found in strategic games; thus, they can be traced even to ancient philosophers as Plato and Socrates. Nevertheless, it is John von Neumann who is considered as the father of game theory, for proving the Minmax theorem (1928) and for his pivotal work to integrate game theory in the economics domain with the book *Theory of Game and Economic Behaviour* (1944) co-authored with Oskar Morgenstern<sup>35</sup>. Another milestone was reached in 1950 with John Nash's paper *Equilibrium points in N-person games*<sup>36</sup>. Its work extended Neumann's theory to an n-players game not restrained by a zero-sum requirement, generalizing the equilibrium of a non-cooperative game in, what is now called, a Nash equilibrium. Subsequently, Gerard Debreu in 1952 introduced the concept of "social equilibrium"<sup>37</sup> and, in 1954 with Kenneth Arrow, the concept of "Abstract Economy"<sup>38</sup>. Their work gener-

---

alized the Nash equilibrium concept introducing shared constraints among the players. This type of problems is known as Generalized Nash Equilibrium problems (GNEP). Finally, a recent breakthrough in game theory came in 2016 with the work of Phillippe Reny, who proposed a new extension of the Nash equilibrium with discontinuous games<sup>39</sup> (see also Aussel et al<sup>40</sup> for further developments on discontinuous Nash games).

### 5.1.2 The Stackelberg model

The Nash equilibrium concept describes the interaction between players, but these players are usually in a similar decision level. In order to depict a hierarchical structure between agents, the Stackelberg game is evoked. The Stackelberg model presents a multi-optimization problem (let's for sake of simplicity stay in a bilevel problem). This model is named after the economist Heinrich von Stackelberg who defined it in 1934 in his famous book *Market Structure and Equilibrium*<sup>41</sup>. The model, in its simplest form, presents a duopoly interaction in which a hierarchy relation exists between the players. Thus, there is a leader, who imposes conditions to the other player that is considered a follower. As already quoted in Stackelberg's book, this model could be complemented by analysing the interaction of the different players of the same level, implementing a Nash game among them. This combination produces a game called Multi-Leader-Multi-Follower game (MLMFG). In the present work, we consider a model where multiple players in the follower level interact in a game parameterized by a single leader. This kind of game is called Single Leader Multi-Follower Game (SLMFG)

### 5.1.3 Game Theory applications

Game theory has some didactic application examples, like the Prisoner's dilemma or the Stag hunt game, which applicability could seem limited and even trivial. Nevertheless, this apparently simple games could be extrapolated to market scenarios where they become an important decision-making tool under certain ground rules: competition, rationality, self-interest, etc. The applicability of Cournot's duopoly model (1838), and its Nash's avant-garde equilibrium, are an example of this. Most of the applications were centered in Economics, but game theory is used in other ambits as well. As an example, agents in conflict or cooperation could portrait military strategy application<sup>42</sup>. In fact, during Cold war, game theorists like Thomas Schelling<sup>43,44</sup> and Robert Aumann were consulted by governments to avoid the conflict to escalate. As well, other more ordinary conflicts, like sports or politics, are also attained by game theory. Moreover, biological applications were also considered even if rationality premise among players has to be reformulated when dealing with life in general<sup>45</sup>. At this point is worthy to make a distinction between two group of games, cooperative games and non-cooperative games. In the first type of game coalition between players is expected and thus it does not reflect the opposed interest of players. It models scenarios where binding agreements between players is of mutual benefit. Vicious examples of cooperative games could rise in the market ambit, and thus there are some rules to prevent them, but alliances could have positive effects when dealing with pool resources or fighting global pollution<sup>46</sup>. Despite its applications, cooperative games are not



---

analysed in this work. On the other hand, non-cooperative games, that are based in opposed interests, depict other kind of interaction between players. There exists a huge literature on game theory application but let us just quote few topics of engineering where this approach has been recently used: eco-park design<sup>47,48,49</sup>, transport<sup>19</sup>, supply chain, electricity markets<sup>50,51,18,52,17,53,54</sup>. This work will deal with some concepts and type of non-cooperative games beginning by the concept of Nash equilibrium, one of the pillars of this sort of games.

## 5.2 Basic facts on optimization

At this point it is worthy to review some mathematical concepts that would become useful in the coming pages. The principles for optimization will be recalled in this section.

### 5.2.1 Optimization primal formulation

Optimization is a familiar concept in engineering, economics and mathematics. In its broadest sense, to optimize a problem is simply to find among the feasible points the one that minimizes losses (or maximizes a benefit). An optimization problem has this standard form:

$$\begin{aligned} \min_x \quad & f(x) \\ \text{subject to:} \quad & x \in C \end{aligned} \tag{1}$$

with  $f : \mathbb{R}^n \rightarrow \mathbb{R}$ , and a set  $C$  being the set of feasible points. If there is a  $x^* \in C$  and  $f(x^*) \leq f(x)$  for any  $x \in C$ , then  $x^*$  is called a solution of the minimization problem.

The function  $f(x)$  that must be optimised is called objective function and the variables composing the objective function are called decision variables. In an unconstrained optimization problem, the set  $C = \mathbb{R}^n$ , while usually in a constrained optimization problem the constraint set  $C$  is defined by equality and inequality constraints, here represented respectively by the functions  $h(x)$  and  $g(x)$ , with  $g : \mathbb{R}^n \rightarrow \mathbb{R}^l, h : \mathbb{R}^n \rightarrow \mathbb{R}^m$ . This constraints shape the set  $C \subseteq \mathbb{R}$ . Thus, the general form of a constrained problem is as follows:

$$\begin{aligned} \min_x \quad & f(x) \\ \text{subject to:} \quad & \begin{cases} h(x) = 0 \\ g(x) \geq 0 \end{cases} \end{aligned} \tag{2}$$

Constraints are very handy to model real life problems since the constraints could represent the existence of a limited resource or the fluxes interacting on a process. Equality constraints could represent for instance a mass balances, while an example of inequality constraint could be the budget that an enterprise has for financing a certain procedure.

To categorize the optimization problem, the first distinction refers to the variables. If all the variables are continuous the problem is called nonlinear (NLP), while if there is any discrete variable the problem becomes a mixed-integer nonlinear problem (MINLP); discrete variables are very important since they could

represent boolean decision variables. If all the functions in an (NLP) (respectively (MINLP)) are linear, the problem becomes a linear programming problem (LP) (respectively a mixed-integer linear problem (MILP)).

Considering the (NLP), if the the objective function is quadratic convex and the feasible set  $C$  is convex, then it is called a convex quadratic problem (QP).

To have an optimal solution for a (NLP) some conditions must be satisfied. First for the existence of a solution,  $C$  must be non-empty. Then if  $C$  is closed and the function  $f$  is continuous and coercive in  $C$  then the existence of a global minimum is guaranteed. Other possibility to ensure the existence of a solution is by following the Weierstrass theorem, where the minimum (resp. maximum) of a function is achieved for a lower semi-continuous (resp. upper semicontinuous) function on a compact non-empty set  $C$ .

Afterwards, the uniqueness of the solution could be proved by ensuring that  $C$  is convex and that the function  $f$  is strictly convex in  $C$ , that is for every  $\alpha \in ]0, 1[$

$$\alpha f(x_1) + (1 - \alpha)f(x_2) > f(\alpha x_1 + (1 - \alpha)x_2), \text{ with } x_1, x_2 \in C \text{ and } x_1 \neq x_2 \quad (3)$$

## 5.2.2 Associated KKT

On a constrained optimization problem, as the one presented on the previous subsection, if all the functions are assumed to be differentiable, there are some necessary (and sometime sufficient) conditions which can be used to solve the problem in a systematic manner. These conditions are four and they are known as the Karush-Kuhn-Tucker (KKT) conditions. The concept of the Lagrangian function must be introduced to understand the KKT conditions. In optimization problems that only considers equality constraints the term Lagrangian multiplier defines a proportional constant between the objective function and the function representing the equality constraints of the problem. The approach of the KKT conditions extends the concept of the Lagrange multiplier to include inequality constraints among the optimization restrictions<sup>55</sup>. The Lagrangian function for the constrained problem presented in (2) will be as follows:

$$\mathcal{L}(x, \lambda, \mu) = f(x) - \mu^\top g(x) - \lambda^\top h(x) \quad (4)$$

with  $\lambda$  and  $\mu$  being the Lagrange multipliers. In the above case only one equality and one inequality are used in the problem, but the KKT method is also valid when multiple constraints are applied, in that case the Lagrangian would take the form:

$$\mathcal{L}(x, \lambda, \nu) = f(x) - \sum_{i=1}^l \mu_i g_i(x) - \sum_{j=1}^m \lambda_j h_j(x) \quad (5)$$

where  $m$  and  $l$  are respectively the number of equality and inequality constraints. Now let's focus on the four KKT condition mentioned before. The first condition, called the feasibility condition, is applicable to equality and inequality constraints. As the name feasibility implies, this condition guarantees that the optimal solution ( $x^*$ ) for the problem is feasible, meaning that it has to comply with the constraints  $g(x)$  and  $h(x)$  of the original problem. So, for the problem (2) this KKT conditions are:

$$\begin{aligned} h(x) &= 0, & j &= 1, \dots, m \\ g(x) &\geq 0, & i &= 1, \dots, l \end{aligned}$$

---

If the problem has several equality and inequality constraints the primal feasibility condition ensures that all the constraints are met. The second KKT condition, known as the Stationarity Condition, expresses the fact that the search of a solution of the constrained problem is, in a sense, replaced by computing a solution of an auxiliary unconstrained problem in which the objective function has been replaced by the Lagrangian function. This condition is applicable to equality and inequality constraints, and for the model problem treated it will be as follows:

$$\min_x \quad \mathcal{L}(x, \lambda, \mu) = f(x) - \mu^\top g(x) - \lambda^\top h(x) \quad (6)$$

This minimization is a relaxation of the constrained problem (2) and to solve it, it is possible to apply a first order condition, namely that the derivative of the Lagrangian function in term of the primal variable  $x$  is null:

$$\nabla_x f(x) - \mu^\top \nabla_x g(x) - \lambda^\top \nabla_x h(x) = 0 \quad (7)$$

The condition of the positiveness for the Lagrangian multiplier, that is considered a slack variable, is only applicable for inequality constraints, since for equality constraints the sign of the Lagrangian lacks of importance.

$$\mu_i \geq 0 \quad (8)$$

Finally, the last condition is the so called complementarity condition that sets the multiplication of the Lagrangian multiplier with its inequality constraint to 0. For the example being used:

$$\mu_i g_i(x) = 0 \quad (9)$$

Meaning that at least one of the factors in this multiplication must be null, also denoted as  $\mu_i \perp g_i(x)$ .

### 5.2.3 Constraints Qualification

After transforming the optimization problem by means of its KKT conditions and in order to guarantee that the obtained solution of the KKT is also the solution of the original problem, constraints qualifications (CQ) must be checked. Then, roughly speaking, if convexity assumptions are satisfied on  $f$  and  $C$ , a point  $\bar{x}$ , solution of the KKT, is a solution of the optimization problem if some constraints qualification condition is satisfied. To introduce the concept of CQ, first let's determine which are the active constraints of a problem. The equality constraints must be complied by every point in the feasible set, thus they are always active. On the other hand, the inequality constraints could be binding or not for a candidate point. To be more precise, the set of the active constraint set  $\mathcal{A}(x)$  represents all the equality constraints and all the inequality constraints that are binding at point  $x$  and is defined as  $\mathcal{A}(x) = \{i \in I : g_i(x) = 0\}$ . Now, the Linear independent constraints qualification (LICQ), holds if the family of the gradients of the active constraints  $\{\nabla g_i(x) \forall i \in \mathcal{A}(x), \nabla h_j(x) \forall j \in \{1 \dots m\}\}$  are linearly independent at  $\bar{x}$ . LICQ is a strong condition in the sense that it implies the validity of other constraints qualifications such as Mangasarian-Fromowitz, Abadie or Guignard<sup>56</sup>.

---

## 5.3 Nash Games

In this section, the concepts of Nash Game and Generalized Nash Equilibrium are presented.

### 5.3.1 Nash equilibrium games

A game is defined by a set of players, rules, and payoffs. In economics, the elements present in game are usually defined in the following form:

$$G = \{I; X_i; U_i\} \quad \text{with } i \in I$$

where  $G$  is the game,  $I$  the set of players,  $X = \prod_{i=1}^{Card(I)} X_i$  the set of strategies and  $U = \{U_1, \dots, U_{Card(I)}\}$  the utility functions.

Nash equilibrium (NE) is a possible outcome of some non-cooperative games. Nash equilibrium is achieved at a point  $x = (x_i)_{i \in I}$  ensuring that no player can improve his benefit by changing unilaterally his strategy. The main particularity of a non-cooperative Nash game is that the objective (or cost) function of one player depends not only on his strategy but also on other players strategies. In this study, the normal form of the game will be replaced by a mathematical expression that allows to observe more easily the interaction between players. Using this notation, a N-person Non-cooperative Nash game looking to minimize an outcome is described as follows:

$$\text{for any } i \in I, \quad \begin{array}{ll} \min_{x_i} & f_i(x_i, x_{-i}) \\ \text{subject to:} & x \in X_i \end{array} \quad (10)$$

with  $i \in \{1, \dots, N\}$ , where  $N$  is the number of players. For player  $i$ ,  $x_i$  is the vector of strategies,  $X_i$  is the set of admissible strategies, and  $f_i(x_i, x_{-i})$  is the objective function.

Following classical notations, the variable  $x_{-i}$  is the vector of strategies selected by all the players but  $i$ . Having  $x_{-i}$  in the objective function is the core of Nash equilibrium theory. It means that the outcome for each player depends also on the choices made by the other players. The Nash equilibrium of the above game would be the strategy profile  $x^* = (x_1^*, \dots, x_N^*)$  which verifies that, for any  $i = 1, \dots, N$ ,  $x_i^* \in X_i$  and

$$f_i(x_i^*, x_{-i}^*) \leq f_i(x_i, x_{-i}^*), \quad x_i \in X_i \quad (11)$$

In order to better understand the concept of a Nash equilibrium, let's review two classic and didactic examples of its application: Prisoners Dilemma and the Hawk-Dove game.

#### Prisoner's Dilemma

Two people are arrested and charged with some minor crimes but suspected of having committed a major felony. The prisoners are interrogated separately, and the same cooperation deal is offered to each of them. By confessing the crime, while the other prisoner denies it, he would only receive a month in jail, whereas the denier would be incarcerated for 5 years. The second possibility is that both deny the crime and have a one-year sentence each. Finally, if both confess, they have a sentence of 2 years.

		Prisoner 2	
		Confess	Deny
Prisoner 1	Confess	2, 2	0, 5
	Deny	5, 0	1, 1

*With payoffs: 0 > 1 > 2 > 5*

Table 5.1: Payoff matrix for Prisoner’s Dilemma

Table 5.1 shows the sentences depending on the choices of the prisoners where the years of prison for prisoner 1 and prisoner 2 are presented respectively as the first and second value of the couples presented in each case of the table. The payoffs of this game are ranked from 0 as the best possible payoff, and 5 as the worst. The best response of each player according to the choice made by the other player is marked in the table according to the colour allocated to the prisoner. The rational behaviour assumption supposes that each prisoner wants to minimize the time in jail. Analysing Prisoner 1 options, despite the election of prisoner 2, is always the best response to confess, although his payoff is different depending on the other player decision. If there is one strategy that is better to follow despite what the other player does, this is called a dominant strategy. A symmetric analysis could be done for prisoner 2. Thus, both confessing would be the rational outcome of the game. The existence of a best response corresponds to a so called Pure-strategy NE. Notice that the social optimum would have been both denying the crime, but this optimum is not a stable result since each prisoner could improve the outcome by unilaterally changing his declaration. If prisoners were able to cooperate, denying the crime would be the best, but the prisoner’s dilemma is a non-cooperative game. Thus, both confessing is a stable solution, from which the unilaterally deviation of a player will not improve its outcome, meaning that this is a NE of this game.

### Hawk-Dove Game

A second game that is analysed under the perspective of Nash equilibria is the Hawk-Dove. In this game two pilots drive in frontal collision course. The one who swerve the drive wheel, to avoid the collision, lose. The winner collects a price  $V$  while the looser  $L$ , doesn’t obtain anything. If no driver swerves the drive wheel they share the price, but the collision would have a cost  $C$ . If both avoid the collision they also share the price. it is assumed that the objective of the pilots is to maximize their profit. If  $C \geq V/2$ , the payoff ordered by increasing value are:  $V/2 - C$  (because it is a negative value),  $L$  that has a null value,  $V/2$  when the price is shared between players, and  $V$  when only one player wins. Table 5.2 presents the results of the game. The tuples in each case reflect the payoffs for Pilot 1 and 2, being respectively the first and second values in the tuples.

Let’s analyse if there is a pure strategy in this game: If Driver 2 plays Dove, it is better for Player 1 to play Hawk. If Driver 2 plays Hawk, it is better for Player 1 to play Dove. Thus, there is not a dominant strategy for the game. Two NE are

		Driver 2	
		Dove	Hawk
Driver 1	Dove	V/2, V/2	$\textcircled{L}$ $\textcircled{V}$
	Hawk	$\textcircled{V}$ $\textcircled{L}$	V/2-C, V/2-C

With payoffs:  $V > V/2 > L > V/2-C$

Table 5.2: Payoff matrix for Hawk-Dove game

found in this game, when one of the players is a Hawk and the other a Dove. Once this hawk-dove balance is reached, the player who changes its decision will loose and even make the other player loose as well.

There are actually two type of NE, the so called pure strategy, depicted in the previous examples, and the mix-strategy NE. This last equilibrium is achieved when at least one of the players randomizes his decision among its strategies. In his famous paper presented in 1950-1951 John Nash demonstrated that there must be at least one mixed Nash Equilibrium for all finite game; finite game meaning finite number of players and finite number of strategies. For the existence of pure Nash strategy, it should be assumed that the objective functions of the players are continuous and convex and that the constraint set of each player is nonempty convex and compact.

Applications of NE are vast. For networking and traffic applications, a variety of models displaying Nash equilibrium are used. An overview of different models is presented in<sup>57</sup>. For transit and network modelling applications, some authors prefer a variation of the NE called the Wardrop equilibrium<sup>58</sup>.

### 5.3.2 The Generalized Nash Equilibrium Problem (GNEP)

The Generalized Nash Equilibrium is an extension of the NE principle. In a GNEP it is considered that the inter-dependency among players is not only in the payoffs received but also in the strategies set that each player could have. The limited access to a resource required by the players would create a GNEP. There would be some constraints among the players that would create the inter-dependency of strategies. For example, if there is a shared limited resource among players that will be presented as a shared constraint for both, the set of admissible strategies of one player would be affected by other players strategy. In this case, the problem would slightly change in form:

$$\text{for any } i \in I, \quad \begin{array}{ll} \min_{x_i} & f_i(x_i, x_{-i}) \\ \text{subject to:} & x \in X_i(x_{-i}) \end{array} \quad (12)$$

As in the NE problem, the objective function depends on the player's own decision as well as on the other players decision, but the strategy set in this case is also dependent on the other players strategies. This means that the equations and inequalities that shape the set  $X_i$  are dependent on the other players strategies, or, in other words:

$$X_i(x_{-i}) = \{x_i : h_i(x_i, x_{-i}) = 0, g_i(x_i, x_{-i}) \geq 0\}$$

Note that if one of the component-wise inequality constraint of  $g_i$  is the same for any  $i \in I$ , then this constraint is called "shared constraint". To exemplify this, let's imagine that there are two companies that due to their productive activities, release greenhouse gas in the air. The local environmental authority, to reduce the air contamination, decides to limit the amount of emissions in the air. Also imagine that the measures of air pollution are made in a zone where it is impossible to determine the amount of contaminant produce by each company. The restriction imposed will be then shared by both companies, and since the excess of emissions will be taxed, and the production of the companies and the emissions are related, it is clear that both the objective of the companies (maximize the profits from the sales) and the restrictions (amount of emissions) depend not only on their actions but also on the other company actions as well, becoming a GNEP with a shared constraint.

### 5.3.3 Concatenated KKT

In Subsection 5.2.2 the Karush-Kuhn-Tucker conditions to solve constrained optimization problems were depicted. This method is adapted to solve a GNEP between  $N$  players, with  $N \in \mathbb{N}$ . A concatenation of the KKT conditions of the different players' optimization problems of players that are on a Nash equilibrium will be called the *concatenated KKT conditions* of the GNEP<sup>59</sup>. As stipulated before, all the individual functions must be at least differentiable. Let's consider the Lagrangian function for player  $i$ , in the GNEP described in the previous subsection:

$$\mathcal{L}_{x_i}(x_i, x_{-i}, \lambda_i, \mu_i) = f(x_i, x_{-i}) - \sum_{j=1}^{m_i} \mu_i^j g_i^j(x_i, x_{-i}) - \sum_{j=1}^{n_i} \lambda_i^j h_i^j(x_i, x_{-i})$$

with  $m_{x_i}$  and  $n_{x_i}$  (both  $\in \mathbb{N}$ ), representing respectively the number of inequality and equality constraints for player  $i$ . The KKT conditions for the GNEP will be:

$$\left\{ \begin{array}{ll} \nabla_{x_i} \mathcal{L}_{x_i}(x_i, x_{-i}, \lambda_i, \mu_i) = 0, & i = 1, \dots, N \\ g_i^j(x_i, x_{-i}) \geq 0, & j = 1, \dots, m_i, i = 1, \dots, N \\ h_i^j(x_i, x_{-i}) = 0, & j = 1, \dots, n_i, i = 1, \dots, N \\ \mu_i^j \geq 0, & j = 1, \dots, m_i, i = 1, \dots, N \\ \mu_i^j g_i^j(x_i, x_{-i}) = 0, & j = 1, \dots, m_i, i = 1, \dots, N \end{array} \right.$$

## 5.4 Bilevel optimization

The first bilevel optimization problem is attributed to Heinrich Stackelberg<sup>41</sup>. The author presented a duopoly in which one of the players made the first move and the second player does his move afterwards. A Bilevel optimization problems, as its name suggests, is a type of optimization containing two levels. It is considered that a hierarchy rules the relation between the levels, and the problem is stated as follows:

$$\begin{array}{ll} \min_{x,y} & F(x, y) \\ \text{subject to:} & \left\{ \begin{array}{l} H(x, y) = 0 \\ G(x, y) \geq 0 \\ y \in S(x) \end{array} \right. \end{array} \quad (13)$$

---

where  $S(x)$  is the solution set of the lower level optimization problem, parameterized by  $x$ ,

$$\begin{aligned} \min_y \quad & f(x, y) \\ \text{subject to: } & \begin{cases} h(x, y) = 0 \\ g(x, y) \geq 0 \end{cases} \end{aligned}$$

It must be noticed that the solution set  $S$  of the lower level problem depends on  $x$  which is a variable of the upper level problem. Thus, the interdependence of the two levels is clear, as also is the hierarchy of having a variable of the upper-level problem that parameterizes the optimization of the lower-level problem. This hierarchy is outlined by naming respectively the player at upper and lower level as leader and follower respectively. The leadership in this bilevel arrangement is carried by a player that holds some power over the mutual relation. This power allows the leader to make a first move, conditioning the scenario for the players of the lower level. The leader could be for example a regulatory entity or large company that “owns” the market. This has been well studied for electricity markets<sup>60,61</sup>, thus an example on this field is chosen to illustrate the concept.

Imagine an hegemonic company in the market able to influence in prices and quantity of electricity, competing against a smaller firm that instead is price taker. The big company acts as the leader and the small company is the follower. The leader, based on its assumptions about the behaviour of the follower, will create an optimal strategy for his variable  $x$ . As a leader, it will make his move first according to its strategy. This first move fixes the variable  $x$  parameterizing the follower’s choices. Then, in a second step, follower solves the lower level problem, obtaining the best strategy for its variable  $y$  in responds to the leader’s choice. It is important to note that the follower’s problem corresponds in fact to the understanding that the leader has on the follower’s behaviour/reaction. Then actually it is thus possible that the choice of the follower for  $y$  is different than the one anticipated by the leader.

Besides, in case that the solution set of the lower level problem present multiple points  $y$  (also called best responses), the leader would have to make a choice between them. Several techniques are available to perform this selection, two of them, the optimistic and pessimistic approaches, are presented in the next section.

### **Optimistic and pessimistic optimization approaches**

As stated before, for some (or all) leader’s decision  $x$ , the optimization problem of the follower could have more than one solution. Thus the leader would have to choose which of these results/best reactions will used to create the optimization strategy for the upper level problem. If the leader assumes that the result selected by the follower are aligned with the leader interests, meaning that both levels of the problem look to minimize (or maximize) the problem, the approach is called *optimistic*. Indeed is quite optimistic to think that in the market a company will play in favour of his competitor. An optimistic approach for a minimization prob-



lem for the leader is of the form:

$$\begin{aligned} & \min_{x \in \mathbb{R}^m} \min_{y \in \mathbb{R}^n} F(x, y) \\ \text{subject to: } & \begin{cases} H(x, y) = 0 \\ G(x, y) \geq 0 \\ y \in S(x) \end{cases} \end{aligned} \quad (14)$$

with  $S(x)$  solution of the lower-level optimization. It is the one which has been used in 13.

On the other hand, a different approach that the leader could use to predict the reaction solution of the lower level is the *pessimistic approach*. In this case the leader thinks that the follower is antagonistic with the leader and to limit risk, the leader will select the solution with the worst results. To reduce the damage created by the follower decision, the optimization of the lower and upper level will be opposed, the form of this leader pessimistic minimization problem will be then:

$$\begin{aligned} & \min_{x \in \mathbb{R}^m} \max_{y \in \mathbb{R}^n} F(x, y) \\ \text{subject to: } & \begin{cases} H(x, y) = 0 \\ G(x, y) \geq 0 \\ y \in S(x) \end{cases} \end{aligned} \quad (15)$$

The optimistic and pessimistic approaches are also possible if the leader's optimization problem is a maximization instead of a minimization. A profound analysis on the difference of the optimistic and pessimistic approaches is described by Stephan Dempe<sup>62</sup>.

Considering the Bilevel problems applications, this type of modelling could portrait different kind of conflicts. Some application examples are related to: pollution regulation<sup>63</sup>, markets pricing<sup>64</sup>, networking or production programming designs<sup>65</sup>. In reference to the optimistic and pessimistic approaches, this last approach has a minor share in literature, even if its application range is the same of the optimistic approach. Nevertheless, in recent years, it seems to be capturing more attention<sup>66</sup>.

## First order reformulation

Bilevel optimization problems become a "one level" optimization problem when the follower's problem is replaced by their first optimality conditions. Different methods are available to reformulate such processes, quasi variational inequalities and mathematical programs with complementarity constraints<sup>60,67</sup>. When the first order conditions on the follower's problem are expresses through the KKT condition the "one level reformulation" is a Mathematical problem with complementarity constraints :

$$\begin{aligned} & \min_{x, y, \lambda, \mu} F(x, y) \\ \text{subject to: } & \begin{cases} H(x, y) = 0 \\ G(x, y) \geq 0 \\ \nabla_y f(x, y) - \sum_{k=1}^m \mu_k \nabla_y g_k(x, y) - \sum_{k=1}^n \lambda_k \nabla_y h_k(x, y) = 0 \\ h_k(x, y) = 0, \quad k = 1, \dots, n \\ 0 \leq \mu_k \perp g_k(x, y) \geq 0, \quad k = 1, \dots, m \end{cases} \end{aligned}$$

---

where the notation  $0 \leq \mu_k \perp g_k(x, y) \geq 0$  stands for  $0 \leq \mu_k, \mu_k g_k(x, y) = 0$  and  $g_k(x, y) \geq 0$ . Observe that the Lagrange multipliers  $\lambda$  and  $\mu$  are the new variables of the (optimistic) MPCC reformulation of the initial (optimistic) bilevel problem.

Now the question is if the solution that is obtained from the MPCC would be also the solution for the original bi-level optimization problem. This is true under certain conditions, first the lower level problem has to be convex. If the lower level problem is non-convex, the feasible set from the KKT approach will be larger than the one on the original problem<sup>68</sup>. Even if this requirement is fulfilled, there is no guarantee that the MPCC bring us closer to the result of the original problem<sup>68,69</sup>. In both of these references, constraint qualification conditions have been proposed to guarantee that one can extract a global or local solution of the (optimistic or pessimistic) bilevel problem from a global or local solution of the MPCC.

This type of non-linear programming is difficult to solve and is reformulated to be processed in a solver. Some reformulation method for MPCC will be presented in Subsection 5.5.2 in the case of Single-Leader-Multi-Follower and can of course be applied when there is only one follower.

## 5.5 Multi-Leader-Follower Game

A Multi-Leader-Follower game (MLFG) is a generalization of the Stackelberg game. It has a multi-level optimization structure, but several players are possibly considered for each level. There would then be more than one leader and multiple followers interacting to reach their own optimum. This structure shows the complexity that this kind of problems could reach. Players at the same decision level perform a non-cooperative strategic interaction, until reaching a GNE. Leaders, from a non-cooperative competition determine a strategy set to which followers respond while also competing with the other followers in a GNEP. The Multi-Leader-Multi-Follower Game consist of  $N$  leaders and  $M$  followers. The leader player  $i = 1, \dots, N$  has a decision variable  $x_i \in \mathbb{R}^{n_i}$ , and each follower player  $j = 1, \dots, M$  has a response variable  $y_j \in \mathbb{R}^{m_j}$ . A diagram of the general form of the problem is presented below.

It should be nevertheless emphasized that the above MLFG problem is actually intrinsically carrying a serious ambiguity. One of the main ones comes from the fact that, as soon as the best response of the followers is not unique, each leader can have a different conjecture of the followers' response therefore meaning that it is impossible to give a common sense to a solution  $(x, y)$  of this MLFG. An interesting analysis of such situation and possible remedies have been presented by A. Kulkarni<sup>70</sup>. Another difficulty is that in many applications is not so natural that all the leader are positioning themselves in an optimistic attitude with regards to the followers's response. In this case again some serious ambiguity can occur.

### 5.5.1 Multi-Leader-Single-Follower Game

Among the different games that can be represented by the MLMFG presented in Figure 5.1, a simplified version is the Multi-Leader-Single-Follower Game (MLSFG). This game considers a GNEP among upper-level players but a single player acting as follower. Examples of this structures are found in the study of

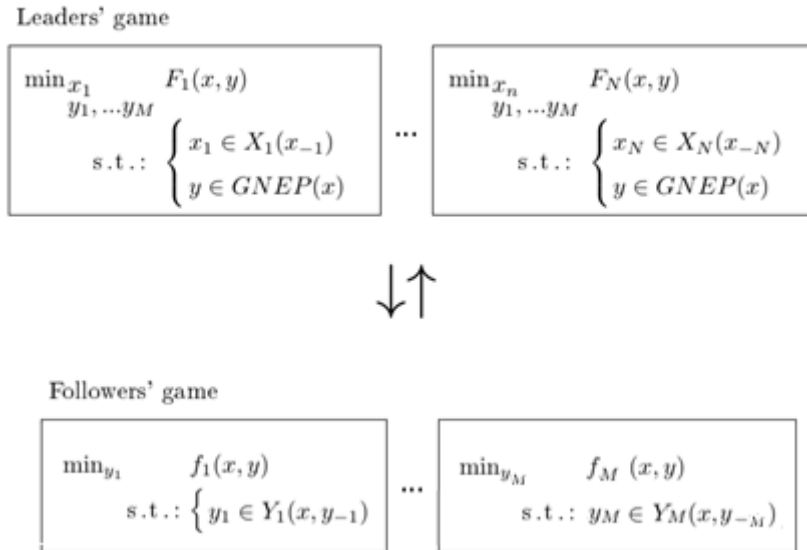

Figure 5.1: Multi-Leader-Multi-Follower Game (full optimistic version)

deregulated electricity markets<sup>61,71</sup> and also in eco-industrial parks<sup>72</sup> to mention few application examples. The complexity of this game comes from the ambiguity quoted just above, that is the possible ambiguity of the follower's response. In the case where for any possible decision vector  $x = x_1, \dots, x_N$  there is a unique follower's response, then MLSFG are well-posed<sup>60,67</sup>.

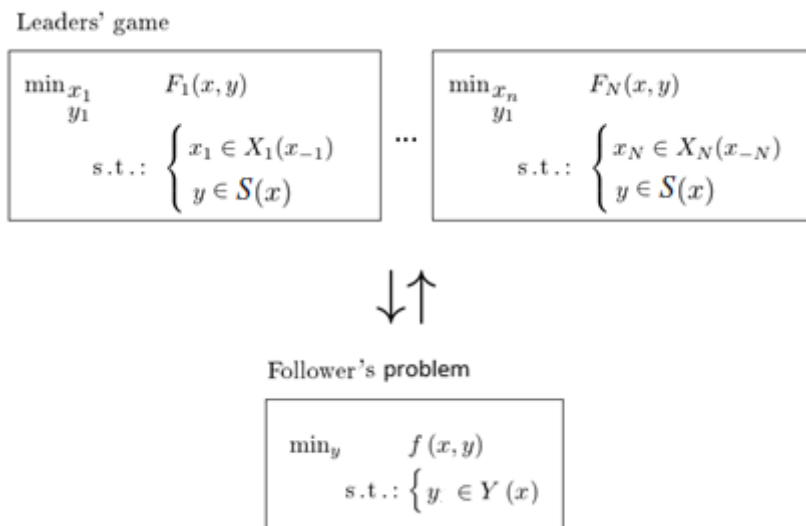

Figure 5.2: Multi-Leader-Single-Follower Game

### 5.5.2 Single-Leader-Multi-Follower Game

Another particularization of the MLMFG that reduces somehow the complexity of the game described previously, is the general Stackelberg game, also known as Single-Leader-Multi-Follower Game (SLMFG). In this problem, a regulatory entity, the leader, tries to anticipate the followers' game. Leader's variable parameterizes the lower level game. Then, the players at the lower level compose a GNEP in response to the parameter given by the leader. An illustrative example comparing the SLMFG and MLSFG is developed by M. Ramos<sup>72</sup>.

In case of a unique leader, his decision variable  $x$  and his conjecture about the follower's reaction  $y_j$  reduces to a single set, avoiding the excessive complexity of the MLSFG. Nevertheless, no guarantee of finding a unique solution, or even a solution, is given.

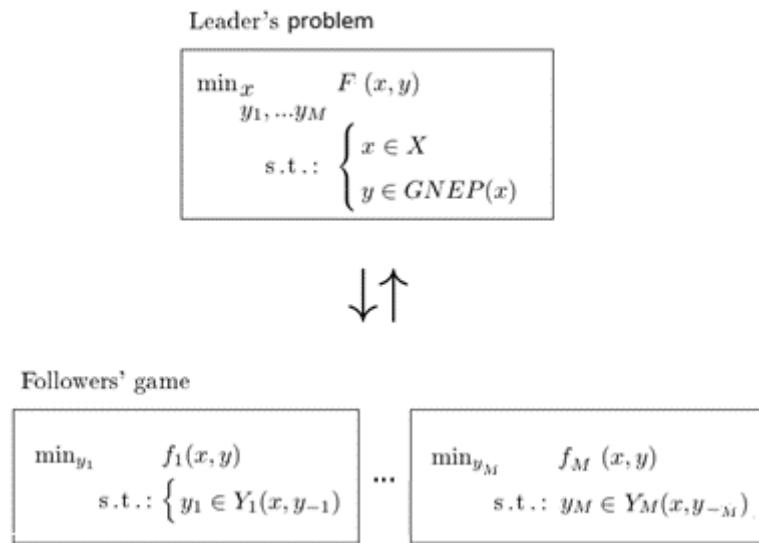

Figure 5.3: Multi Leader Single Follower Game

The simplest SLMFG occurs when there is a unique followers' response  $y(x) \in Y$ , set of followers' variables, for each decision variable  $x \in X$ , then the problem can be solved like a conventional programming problem of the following form:

$$\begin{aligned} \min_x \quad & F(x, y(x)) \\ \text{subject to:} \quad & x \in X \end{aligned}$$

where  $y(x)$  is the unique generalized Nash equilibrium of the GNEP between the followers

Having a non-unique followers' response, which is usually the case for a GNEP, requires a method to deal with the possible multiplicity. The selection of an optimistic or pessimistic approach deals with the problem raised by multiple equilibriums at the lower level<sup>67</sup>. Let's focus on the optimistic approach. Using some classical properties of set-valued map theory, closeness and lower semi-continuity, the following set of rules ensuring the existence of an optimistic global solution for the SLMFG is stated:

**Theorem 1** (<sup>67</sup>) *If  $F$  is lower semi-continuous,  $X$  is closed, for each  $j = 1, \dots, M$ ,  $f_j$  is continuous and  $Y_j$  is lower semi-continuous relative to its non-empty domain and has*

---

closed graph. Assume furthermore that the graph of the lower level GNEP map is non-empty and that either  $F$  is coercive or  $X$  is compact and at least for one  $j$ , the images of  $Y_j$  are uniformly bounded. Then the SLMFG admits at least a global solution.

## 5.6 On the reformulation of Single-Leader-Multi-Follower games

A Single-Leader-Multi-Follower game (SLMFG) is characterized by a bilevel structure with one player on the top level that parameterized the multi player's game in the bottom level. Combining the "first order approach" presented in Subsection 5.3.3 and Section 5.4, a classical way to solve a Single-Leader-Multi-Follower game is to reformulate it as a Mathematical Programming with Complementarity Constraints (MPCC). Without loss of generality, let us assume that all the constraints at the upper and lower level are defined by inequalities and that all variables are non-negative.

### Followers problem

Knowing the leader decision  $x$ , each follower  $j$  minimizes its objective function according to its variable  $y_j$ , this function also depending on the variable  $y_{-j}$  representing all the  $V$  followers except for follower  $j$ . Follower  $j$ 's problem, with  $j = 1, \dots, V$ , is shaped by  $M_j$  constraints, not all followers having necessarily the same number of restrictions.

$$(P_{F_j}) \quad \min_{y_j \geq 0} f_j(x, y_j, y_{-j})$$

$$\text{s.t.:} \quad g_{j,m}(x, y) \geq 0, \quad m = 1, \dots, M_j$$

### Leader problem

In this type of game, the followers display among them a Generalized Nash equilibrium Problem (GNEP). The leader aims to minimize his objective function in his variable  $x$  and in the followers variable  $y$  that comes from the set of followers' GNEP. The leader problem is restricted by  $N$  constraints.

$$(P_L) \quad \min_{\substack{x \geq 0 \\ y \geq 0}} F(x, y)$$

$$\text{s.t.:} \quad \begin{cases} G_n(x, y) \geq 0, & n = 1, \dots, N \\ y \in GNEP(x) \end{cases}$$

### 5.6.1 A first MPCC reformulation

The bi-level optimization problem is reformulated under the structure of a mathematical problem with complementarity constraints (MPCC) where all the Karush–Kuhn–Tucker (KKT) conditions of the different followers are concatenated with the leader's optimization constraints. Thus the associated MPCC re-

formulation is ( $P_{SLMF}$ )

$$\begin{aligned} \min_{\substack{x \geq 0, \\ y \geq 0}} \quad & F(x, y) \\ \text{s.t.:} \quad & \begin{cases} G_n(x, y) \geq 0 & n = 1, \dots, N \\ 0 \leq y_j \perp \nabla_{y_j} f_j(x, y_j, y_{-j}) \\ \quad - \sum_{m=1}^{M_j} \mu_{j,m} \nabla_{y_j} g_{j,m}(x, y) \geq 0 & j = 1, \dots, V \\ 0 \leq \mu_{j,m} \perp g_{j,m}(x, y) \geq 0 & j = 1, \dots, V, \quad m = 1, \dots, M_j \end{cases} \end{aligned}$$

The complementarity constraints issued from the KKT conditions create non-convex restrictions. In order to avoid some difficulties in the numerical resolution of the MPCC, it must be reformulated.

### 5.6.2 MPCC reformulation by the penalty method

In this method the complementarity constraints are included in the objective function accompanied by the positive penalisation parameter  $\rho$ . As a first step, Leyffer-Munson<sup>73</sup> proposed the following modification: for any  $j = 1, \dots, V$ , the restrictions and variables are grouped as follows:

$$q_j(x, y_j, y_{-j}) = \left( \begin{array}{c} \left( \nabla_{y_j} f_j(x, y_j, y_{-j}) - \sum_{m=1}^{M_j} \mu_{j,m} \nabla_{y_j} g_{j,m}(x, y) \right) \\ (g_{j,m}(x, y))_{m=1, \dots, M_j} \end{array} \right)$$

$$w_j = (y_j, \mu_{j,m}) \quad m = 1, \dots, M_j$$

Then a new variable is included, a slack variable  $s$  that has the same dimension as  $q$ :

$$q_j(x, y_j, y_{-j}) - s_j = 0 \quad j = 1, \dots, V$$

$$0 \leq w_j \perp s_j \geq 0 \quad j = 1, \dots, V$$

with this modification the MPEC becomes:

$$\begin{aligned} (P_{SLMF}) \quad \min_{\substack{x \geq 0, \\ w \\ s}} \quad & F(x, y) \\ \text{s.t.:} \quad & \begin{cases} G_n(x, y) \geq 0 & n = 1, \dots, N \\ q_j(x, y_j, y_{-j}) - s_j = 0 & j = 1, \dots, V \\ 0 \leq w_j \perp s_j \geq 0 & j = 1, \dots, V \end{cases} \end{aligned}$$

Slack variables  $s$  are included as part of the reformulation. By including complementarity constraints into the objective function, most difficulties of the nonlinear complementarity problem are overcome<sup>72</sup>.

---

$$(P_{SLMF_\rho}) \min_{\substack{x \geq 0, \\ w \geq 0 \\ s}} H = F(x, y) + \rho \sum_{j=1}^V s_j w_j$$

$$\text{s.t.:} \begin{cases} G_n(x, y) \geq 0 & n = 1, \dots, N \\ q_j(x, y) = s_j & j = 1, \dots, V \\ s_j \geq 0 & j = 1, \dots, V \\ w_j \geq 0 & j = 1, \dots, V \end{cases}$$

The penalization parameter in the objective function will increase its value. Since this is a minimization problem, the expression  $\rho \sum_{j=1}^V s_j^T w_j$ , (being always positive) penalizes the objective function. A major drawback of this transformation is the number of variables that increases drastically. In the first reformulation, by creating the stationarity conditions of the KKT, a  $\mu$  variable is created for each followers' condition. Also the slack variables  $s_j$  are related with the number of followers' restrictions. Besides, the parameter  $\rho$ , included in the penalty function, increases the possible difficulty in fitting the parameters in this reformulation.

### 5.6.3 Reformulation using the Big M method

There is an alternative method to deal with the complementarity constraints of the concatenated KKT, the non-convexity created by the multiplication of the dual variables and the terms including the primal variables complicates the solution of the problem. The idea behind the complementarity condition is the cancellation of the dual variables when the primal variable is active, and vice-versa. This switching task for activating or nullifying a variable could be performed by a binary variable ( $z_{j,m} = 0, 1$ ) along with a constant  $\mathcal{M}$ . The fact of introducing new variables to the model would increase the complexity but will also eliminate the problem of the non-convexity created by the complementarity constraints. Also, the size of the constant  $\mathcal{M}$  is another unknown. To determine the size of  $\mathcal{M}$  a trial and error method is not uncommon, but this can lead to sub-optimal solutions<sup>74</sup>. One binary variable would be included for each complementarity constraint. Let's use one of the constraints on the MPEC to exemplify:

$$0 \leq \mu_{j,m} \perp g_{j,m}(x, y) \geq 0$$

$$\mu_{j,m} = 0 \quad \text{or} \quad g_{j,m}(x, y) = 0$$

$$\mu_{j,m} \leq \mathcal{M} z_{j,m} \quad \text{and} \quad g_{j,m}(x, y) \leq \mathcal{M}(1 - z_{j,m})$$

Notice that the value of  $\mathcal{M}$  has to be large enough to contain the dual variables. For this reason, this method that is used to linearized the complementarity constraints from the MPEC is called Big M<sup>75</sup>. The problem reformulated as a linearized problem is denoted by ( $P_{SLMF}$ ):

---

$$\begin{array}{l}
\min_{\substack{x \geq 0, \\ y \geq 0 \\ \mu}} F(x, y) \\
\text{s.t.:} \left\{ \begin{array}{ll}
z_{j,m} \in \{0, 1\} & j = 1, \dots, V, \quad m = 1, \dots, M_j \\
G_n(x, y) \geq 0 & n = 1, \dots, N \\
\mathcal{M}z_j \geq y_j \geq 0 & j = 1, \dots, V \\
\mathcal{M}(1 - z_j) \geq \nabla_{y_j} f_j(x, y_j, y_{-j}) \\
\quad - \sum_{m=1}^{M_j} \mu_{j,m} \nabla_{y_j} g_{j,m}(x, y) \geq 0 & j = 1, \dots, V \\
\mathcal{M}z_{j,m} \geq \mu_{j,m} \geq 0 & j = 1, \dots, V, \quad m = 1, \dots, M_j \\
\mathcal{M}(1 - z_{j,m}) \geq g_{j,m}(x, y) \geq 0 & j = 1, \dots, V, \quad m = 1, \dots, M_j
\end{array} \right.
\end{array}$$

Notice that in this case, the amount of binary variables introduced to the problem would depend on the number of players in the game and in the number of constraints of the problem. As it will be explained in Chapter 6, the choice of a "good" big M can turn out to be very difficult.

## 5.7 Explicit resolution of an example of Single-Leader-Two-Followers Game

In order to reinforce the optimization techniques presented so far, a resolution example of SLMFG is presented. Only two players are considered at the followers level. Let's begin with the leader optimization problem:

$$\begin{array}{l}
(P_L) \quad \min_{x, y_1, y_2} \quad F(x, y_1, y_2) = (x - 1)^2 + y_1^2 + y_2^2 \\
\text{subject to:} \quad \left\{ \begin{array}{l} x \geq 0 \\ (y_1, y_2) \in GNEP(x) \end{array} \right.
\end{array}$$

Notice that the objective function of the leader enjoys very nice properties since it is quadratic and convex in the leader's and followers' variables. Both followers' problem, of course parameterized by  $x$ , displays also quadratic objective functions, with respect to the follower variable  $y_1$  or  $y_2$ , while the constraints of the followers include a positiveness restriction and a shared constraint including the leader variable:

$$\begin{array}{l}
(P_{F1}) \quad \min_{y_1} \quad f_1(y_1, y_2) = y_1^2 - y_1 y_2 - y_1 \\
\text{subject to:} \quad \left\{ \begin{array}{l} y_1 \geq 0 \\ y_1 + y_2 \leq x \end{array} \right.
\end{array}$$

and

$$\begin{array}{l}
(P_{F2}) \quad \min_{y_2} \quad f_2(y_1, y_2) = y_2^2 - \frac{1}{2} y_1 y_2 - 2y_2 \\
\text{subject to:} \quad \left\{ \begin{array}{l} y_2 \geq 0 \\ y_1 + y_2 \leq x \end{array} \right.
\end{array}$$



Following the procedure, the concatenated KKT containing the problem of the lower level is created:

$$\text{KKT conditions: } \begin{cases} 2y_1 - y_2 - 1 - \mu_1 + \mu_2 = 0 \\ \frac{-1}{2}y_1 + 2y_2 - 2 - \mu_3 + \mu_4 = 0 \\ y_1 \geq 0 \\ y_2 \geq 0 \\ y_1 + y_2 \leq x \\ \mu_1 \geq 0, \quad \mu_2 \geq 0, \quad \mu_3 \geq 0, \quad \mu_4 \geq 0 \\ \mu_1 \cdot y_1 = 0 \\ \mu_2(x - y_1 - y_2) = 0 \\ \mu_3 \cdot y_2 = 0 \\ \mu_4(x - y_1 - y_2) = 0 \end{cases}$$

In order to solve manually the KKT, the problem is broken in different cases where assumptions of the variables values are made. Replacing the variables by the assumptions a system of equations is obtained and solved for each case.

Case 1: Assume  $\mu_1 = 0 \quad \mu_2 = 0 \quad \mu_3 = 0 \quad \mu_4 = 0$

$$\begin{cases} 2y_1 - y_2 - 1 = 0 & \textcircled{1} \\ \frac{-1}{2}y_1 + 2y_2 - 2 = 0 & \textcircled{2} \\ y_1 \geq 0 & \textcircled{3} \\ y_2 \geq 0 & \textcircled{4} \\ x \geq y_1 + y_2 & \textcircled{5} \end{cases}$$

from  $\textcircled{1}$  and  $\textcircled{2} \rightarrow y_1 = \frac{8}{7}$  and  $y_2 = \frac{9}{7}$   
 from  $\textcircled{5} \rightarrow x \geq \frac{17}{7}$

Case 2: Assume  $\mu_1 > 0 \quad \mu_2 = 0 \quad \mu_3 = 0 \quad \mu_4 = 0$

$$\begin{cases} 2y_1 - y_2 - 1 - \mu_1 = 0 & \textcircled{1} \\ \frac{-1}{2}y_1 + 2y_2 - 2 = 0 & \textcircled{2} \\ y_1 = 0 & \textcircled{3} \\ y_2 \geq 0 & \textcircled{4} \\ x \geq y_1 + y_2 & \textcircled{5} \end{cases}$$

from  $\textcircled{1}$  ,  $\textcircled{3}$  and  $\textcircled{4} \rightarrow \mu_1 = -y_2 - 1$ ; Impossible

Case 3: Assume  $\mu_2 > 0 \quad \mu_1 = 0 \quad \mu_3 = 0 \quad \mu_4 = 0$

$$\begin{cases} 2y_1 - y_2 - 1 + \mu_2 = 0 & \textcircled{1} \\ \frac{-1}{2}y_1 + 2y_2 - 2 = 0 & \textcircled{2} \\ y_1 \geq 0 & \textcircled{3} \\ y_2 \geq 0 & \textcircled{4} \\ x - y_1 - y_2 = 0 & \textcircled{5} \end{cases}$$

from  $\textcircled{2}$  and  $\textcircled{5} \rightarrow y_1 = \frac{4x-4}{5}$   $\textcircled{6}$  and  $y_2 = \frac{x+4}{5}$   $\textcircled{7}$   
 from  $\textcircled{1}$ ,  $\textcircled{3}$ ,  $\textcircled{6}$  and  $\textcircled{7} \rightarrow 1 \leq x < \frac{17}{7}$

Case 4: Assume  $\mu_3 > 0$   $\mu_1 = 0$   $\mu_2 = 0$   $\mu_4 = 0$

$$\begin{cases} 2y_1 - y_2 - 1 = 0 & \textcircled{1} \\ \frac{-1}{2}y_1 + 2y_2 - 2 - \mu_3 = 0 & \textcircled{2} \\ y_1 \geq 0 & \textcircled{3} \\ y_2 = 0 & \textcircled{4} \\ x \geq y_1 + y_2 & \textcircled{5} \end{cases}$$

from  $\textcircled{2}$ ,  $\textcircled{3}$  and  $\textcircled{4} \rightarrow \mu_3 = -\frac{1}{2}y_1 - 2$ ; Impossible

Case 5: Assume  $\mu_4 > 0$   $\mu_1 = 0$   $\mu_2 = 0$   $\mu_3 = 0$

$$\begin{cases} 2y_1 - y_2 - 1 = 0 & \textcircled{1} \\ \frac{-1}{2}y_1 + 2y_2 - 2 + \mu_4 = 0 & \textcircled{2} \\ y_1 \geq 0 & \textcircled{3} \\ y_2 \geq 0 & \textcircled{4} \\ x - y_1 - y_2 = 0 & \textcircled{5} \end{cases}$$

from  $\textcircled{1}$  and  $\textcircled{5} \rightarrow y_1 = \frac{x+1}{3}$   $\textcircled{6}$  and  $y_2 = \frac{2x-1}{3}$   $\textcircled{7}$   
 from  $\textcircled{2}$ ,  $\textcircled{3}$ ,  $\textcircled{6}$  and  $\textcircled{7} \rightarrow \frac{1}{2} \leq x < \frac{17}{7}$

Case 6: Assume  $\mu_1 > 0$   $\mu_2 > 0$   $\mu_3 = 0$   $\mu_4 = 0$

$$\begin{cases} 2y_1 - y_2 - 1 - \mu_1 + \mu_2 = 0 & \textcircled{1} \\ \frac{-1}{2}y_1 + 2y_2 - 2 = 0 & \textcircled{2} \\ y_1 = 0 & \textcircled{3} \\ y_2 \geq 0 & \textcircled{4} \\ x - y_1 - y_2 = 0 & \textcircled{5} \end{cases}$$

from  $\textcircled{3}$  and  $\textcircled{2} \rightarrow y_2 = 1$   $\textcircled{6}$   
 from  $\textcircled{3}$  and  $\textcircled{5} \rightarrow x = y_2 = 1$   
 from  $\textcircled{1}$ ,  $\textcircled{3}$  and  $\textcircled{6} \rightarrow \mu_2 = \mu_1 + 2$

Case 7: Assume  $\mu_1 > 0$   $\mu_3 > 0$   $\mu_2 = 0$   $\mu_4 = 0$

$$\begin{cases} 2y_1 - y_2 - 1 - \mu_1 = 0 & \textcircled{1} \\ \frac{-1}{2}y_1 + 2y_2 - 2 - \mu_3 = 0 & \textcircled{2} \\ y_1 = 0 & \textcircled{3} \\ y_2 = 0 & \textcircled{4} \\ x \geq y_1 + y_2 & \textcircled{5} \end{cases}$$

from  $\textcircled{1}$ ,  $\textcircled{3}$  and  $\textcircled{4} \rightarrow \mu_1 = -1$ ; Impossible

Case 8: Assume  $\mu_1 > 0$   $\mu_4 > 0$   $\mu_2 = 0$   $\mu_3 = 0$ ;

$$\begin{cases} 2y_1 - y_2 - 1 - \mu_1 = 0 & \textcircled{1} \\ \frac{-1}{2}y_1 + 2y_2 - 2 + \mu_4 = 0 & \textcircled{2} \\ y_1 = 0 & \textcircled{3} \\ y_2 \geq 0 & \textcircled{4} \\ x - y_1 - y_2 = 0 & \textcircled{5} \end{cases}$$

from  $\textcircled{1}$ ,  $\textcircled{3}$  and  $\textcircled{4} \rightarrow \mu_1 = -y_2 - 1$ ; Impossible

Case 9: Assume  $\mu_2 > 0$   $\mu_3 > 0$   $\mu_1 = 0$   $\mu_4 = 0$ ;

$$\begin{cases} 2y_1 - y_2 - 1 + \mu_2 = 0 & \textcircled{1} \\ \frac{-1}{2}y_1 + 2y_2 - 2 - \mu_3 = 0 & \textcircled{2} \\ y_1 \geq 0 & \textcircled{3} \\ y_2 = 0 & \textcircled{4} \\ x - y_1 - y_2 = 0 & \textcircled{5} \end{cases}$$

from  $\textcircled{2}$ ,  $\textcircled{3}$  and  $\textcircled{4} \rightarrow \mu_3 = -\frac{1}{2}y_1 - 2$ ; Impossible

Case 10: Assume  $\mu_2 > 0$   $\mu_4 > 0$   $\mu_1 = 0$   $\mu_3 = 0$

$$\begin{cases} 2y_1 - y_2 - 1 + \mu_2 = 0 & \textcircled{1} \\ \frac{-1}{2}y_1 + 2y_2 - 2 + \mu_4 = 0 & \textcircled{2} \\ y_1 \geq 0 & \textcircled{3} \\ y_2 \geq 0 & \textcircled{4} \\ x - y_1 - y_2 = 0 & \textcircled{5} \end{cases}$$

from  $\textcircled{5} \rightarrow y_2 = x - y_1$   $\textcircled{6}$

from  $\textcircled{3}$ ,  $\textcircled{4}$  and  $\textcircled{6} \rightarrow x \geq y_1 \geq 0$

from ①, ③ and ⑥  $\rightarrow 0 \leq y_1 < \frac{x+1}{3}$   
 from ② and ⑥  $y_1 > \frac{4x-4}{5}$

Case 11: Assume  $\mu_3 > 0 \quad \mu_4 > 0 \quad \mu_1 = 0 \quad \mu_2 = 0$

$$\begin{cases} 2y_1 - y_2 - 1 = 0 & \text{①} \\ \frac{-1}{2}y_1 + 2y_2 - 2 - \mu_3 + \mu_4 = 0 & \text{②} \\ y_1 \geq 0 & \text{③} \\ y_2 = 0 & \text{④} \\ x - y_1 - y_2 = 0 & \text{⑤} \end{cases}$$

from ④ and ⑤  $\rightarrow y_1 = x$  ⑥  
 from ① and ⑥  $\rightarrow y_1 = x = \frac{1}{2}$  ⑦  
 from ②, ④ and ⑦  $\rightarrow \mu_3 = \mu_4 - \frac{9}{4}$  and  $\mu_4 > \frac{9}{4}$

Case 12: Assume  $\mu_1 > 0 \quad \mu_2 > 0 \quad \mu_3 > 0 \quad \mu_4 = 0$

$$\begin{cases} 2y_1 - y_2 - 1 - \mu_1 + \text{lambdau}_2 = 0 & \text{①} \\ \frac{-1}{2}y_1 + 2y_2 - 2 - \mu_3 = 0 & \text{②} \\ y_1 = 0 & \text{③} \\ y_2 = 0 & \text{④} \\ x - y_1 - y_2 = 0 & \text{⑤} \end{cases}$$

from ②, ③ and ④  $\rightarrow \mu_3 = -2$ ; Impossible

Case 13: Assume  $\mu_2 > 0 \quad \mu_3 > 0 \quad \mu_4 > 0 \quad \mu_1 = 0$

$$\begin{cases} 2y_1 - y_2 - 1 + \mu_2 = 0 & \text{①} \\ \frac{-1}{2}y_1 + 2y_2 - 2 - \mu_3 + \mu_4 = 0 & \text{②} \\ y_1 \geq 0 & \text{③} \\ y_2 = 0 & \text{④} \\ x - y_1 - y_2 = 0 & \text{⑤} \end{cases}$$

from ④ and ⑤  $\rightarrow y_1 = x$  ⑥  
 from ①, ⑥ and ③  $\rightarrow 0 \leq x < \frac{1}{2}$   
 from ②, ④ and ⑥  $\rightarrow \mu_3 = \frac{-(x+4)}{2} + \mu_4$   
 $\rightarrow \mu_4 > \frac{x+4}{2}$

---

Case 14: Assume  $\mu_1 > 0$   $\mu_3 > 0$   $\mu_4 > 0$   $\mu_2 = 0$

$$\begin{cases} 2y_1 - y_2 - 1 - \mu_1 = 0 & \textcircled{1} \\ \frac{-1}{2}y_1 + 2y_2 - 2 - \mu_3 + \mu_4 = 0 & \textcircled{2} \\ y_1 = 0 & \textcircled{3} \\ y_2 = 0 & \textcircled{4} \\ x - y_1 - y_2 = 0 & \textcircled{5} \end{cases}$$

from  $\textcircled{1}$ ,  $\textcircled{3}$  and  $\textcircled{4} \rightarrow \mu_1 = -1$ ; Impossible

Case 15: Assume  $\mu_1 > 0$   $\mu_2 > 0$   $\mu_4 > 0$   $\mu_3 = 0$

$$\begin{cases} 2y_1 - y_2 - 1 - \mu_1 + \mu_2 = 0 & \textcircled{1} \\ \frac{-1}{2}y_1 + 2y_2 - 2 + \mu_4 = 0 & \textcircled{2} \\ y_1 = 0 & \textcircled{3} \\ y_2 \geq 0 & \textcircled{4} \\ x - y_1 - y_2 = 0 & \textcircled{5} \end{cases}$$

from  $\textcircled{3}$  and  $\textcircled{5} \rightarrow y_2 = x$   $\textcircled{6}$

from  $\textcircled{2}$ ,  $\textcircled{6}$  and  $\textcircled{4} \rightarrow 0 \leq x < 1$

from  $\textcircled{1}$ ,  $\textcircled{3}$  and  $\textcircled{6} \rightarrow \mu_2 = x + 1 + \mu_1$

and  $\mu_1 > -(x + 1)$

Case 16: Assume  $\mu_1 > 0$   $\mu_2 > 0$   $\mu_3 > 0$   $\mu_4 > 0$

$$\begin{cases} 2y_1 - y_2 - 1 - \mu_1 + \mu_2 = 0 & \textcircled{1} \\ \frac{-1}{2}y_1 + 2y_2 - 2 - \mu_3 + \mu_4 = 0 & \textcircled{2} \\ y_1 = 0 & \textcircled{3} \\ y_2 = 0 & \textcircled{4} \\ x - y_1 - y_2 = 0 & \textcircled{5} \end{cases}$$

from  $\textcircled{3}$ ,  $\textcircled{4}$  and  $\textcircled{5} \rightarrow x = 0$

from  $\textcircled{1}$ ,  $\textcircled{3}$  and  $\textcircled{4} \rightarrow \mu_2 = \mu_1 + 1$

from  $\textcircled{2}$ ,  $\textcircled{3}$  and  $\textcircled{4} \rightarrow \mu_4 = \mu_3 + 2$

As a final conclusion of this first step, the best response function  $R$  is explicitly described as:

---

$$\begin{aligned}
R(x) = \left\{ \begin{array}{ll}
\{(y_1 = 0, y_2 = 0, \mu_1 = 0, \mu_2 = 1, \mu_3 = 0, \mu_4 = 2)\} & \text{if } x = 0 \quad (\text{case : 10}) \\
\{(y_1 = 0, y_2 = 0, \mu_1 = 0, \mu_2 = 1, \mu_3 > 0, \mu_4 > 2)\} & \text{if } x = 0 \quad (\text{case : 13}) \\
\{(y_1 = 0, y_2 = 0, \mu_1 > 0, \mu_2 > 0, \mu_3 = 0, \mu_4 = 2)\} & \text{if } x = 0 \quad (\text{case : 15}) \\
\{(y_1 = 0, y_2 = 0, \mu_1 > 0, \mu_2 > 0, \mu_3 > 0, \mu_4 > 0)\} & \text{if } x = 0 \quad (\text{case : 16}) \\
\\
\{(y_1, x - y_1, \mu_1 = 0, \mu_2 > 0, \mu_3 = 0, \mu_4 > 0) : y_1 \in [0, x]\} & \text{if } x \in ]0, \frac{1}{2}[ \quad (\text{case : 10}) \\
\{(y_1, x - y_1, \mu_1 = 0, \mu_2 > 0, \mu_3 > 0, \mu_4 > 0) : y_1 \in [0, x]\} & \text{if } x \in ]0, \frac{1}{2}[ \quad (\text{case : 13}) \\
\{(y_1, x - y_1, \mu_1 > 0, \mu_2 > 0, \mu_3 = 0, \mu_4 > 0) : y_1 \in [0, x]\} & \text{if } x \in ]0, \frac{1}{2}[ \quad (\text{case : 15}) \\
\\
\{(y_1, \frac{1}{2} - y_1, \mu_1 = 0, \mu_2 = 0, \mu_3 = 0, \mu_4 > 0) : y_1 \in [0, \frac{1}{2}]\} & \text{if } x = \frac{1}{2} \quad (\text{case : 5}) \\
\{(y_1, \frac{1}{2} - y_1, \mu_1 = 0, \mu_2 > 0, \mu_3 = 0, \mu_4 > 0) : y_1 \in [0, \frac{1}{2}]\} & \text{if } x = \frac{1}{2} \quad (\text{case : 10}) \\
\{(y_1, \frac{1}{2} - y_1, \mu_1 = 0, \mu_2 = 0, \mu_3 > 0, \mu_4 > 0) : y_1 \in [0, \frac{1}{2}]\} & \text{if } x = \frac{1}{2} \quad (\text{case : 11}) \\
\{(y_1, \frac{1}{2} - y_1, \mu_1 > 0, \mu_2 > 0, \mu_3 = 0, \mu_4 > 0) : y_1 \in [0, \frac{1}{2}]\} & \text{if } x = \frac{1}{2} \quad (\text{case : 15}) \\
\\
\{(y_1, x - y_1, \mu_1 = 0, \mu_2 = 0, \mu_3 = 0, \mu_4 > 0) : y_1 \in [0, \frac{x+1}{3}]\} & \text{if } x \in ]\frac{1}{2}, 1[ \quad (\text{case : 5}) \\
\{(y_1, x - y_1, \mu_1 = 0, \mu_2 > 0, \mu_3 = 0, \mu_4 > 0) : y_1 \in [0, \frac{x+1}{3}]\} & \text{if } x \in ]\frac{1}{2}, 1[ \quad (\text{case : 10}) \\
\{(y_1, x - y_1, \mu_1 > 0, \mu_2 > 0, \mu_3 = 0, \mu_4 > 0) : y_1 \in [0, \frac{x+1}{3}]\} & \text{if } x \in ]\frac{1}{2}, 1[ \quad (\text{case : 15}) \\
\\
\{(y_1, 1 - y_1, \mu_1 = 0, \mu_2 > 0, \mu_3 = 0, \mu_4 > 0) : y_1 \in [0, \frac{2}{3}]\} & \text{if } x = 1 \quad (\text{case : 3}) \\
\{(y_1, 1 - y_1, \mu_1 = 0, \mu_2 = 0, \mu_3 = 0, \mu_4 > 0) : y_1 \in [0, \frac{2}{3}]\} & \text{if } x = 1 \quad (\text{case : 5}) \\
\{(y_1, 1 - y_1, \mu_1 > 0, \mu_2 > 0, \mu_3 = 0, \mu_4 = 0) : y_1 \in [0, \frac{2}{3}]\} & \text{if } x = 1 \quad (\text{case : 6}) \\
\{(y_1, 1 - y_1, \mu_1 = 0, \mu_2 > 0, \mu_3 = 0, \mu_4 > 0) : y_1 \in [0, \frac{2}{3}]\} & \text{if } x = 1 \quad (\text{case : 10}) \\
\\
\{(y_1, 1 - y_1, \mu_1 = 0, \mu_2 > 0, \mu_3 = 0, \mu_4 > 0) : y_1 \in [\frac{4(x-1)}{5}, \frac{x+1}{3}]\} & \text{if } x \in ]1, \frac{17}{7}[ \quad (\text{case : 3}) \\
\{(y_1, 1 - y_1, \mu_1 = 0, \mu_2 = 0, \mu_3 = 0, \mu_4 > 0) : y_1 \in [\frac{4(x-1)}{5}, \frac{x+1}{3}]\} & \text{if } x \in ]1, \frac{17}{7}[ \quad (\text{case : 5}) \\
\{(y_1, 1 - y_1, \mu_1 = 0, \mu_2 > 0, \mu_3 = 0, \mu_4 > 0) : y_1 \in [\frac{4(x-1)}{5}, \frac{x+1}{3}]\} & \text{if } x \in ]1, \frac{17}{7}[ \quad (\text{case : 10}) \\
\\
\{(y_1, 1 - y_1, \mu_1 = 0, \mu_2 = 0, \mu_3 = 0, \mu_4 = 0) : y_1 \in [\frac{4(x-1)}{5}, \frac{x+1}{3}]\} \cup \{(\frac{8}{7}, \frac{9}{7})\} & \text{if } x \geq \frac{17}{7} \quad (\text{cases : 1 and 10}) \\
\{(y_1, 1 - y_1, \mu_1 = 0, \mu_2 > 0, \mu_3 = 0, \mu_4 > 0) : y_1 \in [\frac{4(x-1)}{5}, \frac{x+1}{3}]\} \cup \{(\frac{8}{7}, \frac{9}{7})\} & \text{if } x \geq \frac{17}{7} \quad (\text{cases : 1 and 10})
\end{array} \right.
\end{aligned}$$

It is important to note that, even if the objective functions of the different players are quadratic and convex and that all the constraints are defined by affine functions, for many values of the leader's variable  $x$ , the GNE  $y$  is not unique or, in other words, response map  $R$  is set-valued. Thus bring to the fore the fact that, even for very simple problems, generalized Nash games and then as a consequence SLMFG could lead to very complex situations.

Now thanks to the knowledge of the explicit expression of the response map, one can consider to "inject" this response map into the leader's problem. Nevertheless this is usually not easy due to the non-uniqueness of the best response. In our case and if we restrict  $x$  to be lower than  $1/2$  the same explicit expression for  $(y_1, y_2)$  in the best response can be used for the three first case ( $x = 0, x \in ]0, 1/2[$  and  $x = 1/2$ ) and in this case the response  $(y_1, y_2)$  is characterized by the following set of inequality/equality

$$\begin{cases} x \geq y_1 \geq 0 \\ y_2 = x - y_1 \end{cases}$$

Hence, taking into account that  $1/2 \geq x$ , the initial Single-Leader-Multi-Follower problem can be equivalently reformulated as follows:

$$\begin{aligned}
\min_{x, y_1, y_2} \quad & F(x, y_1, y_2) = (x - 1)^2 + y_1^2 + y_2^2 \\
\text{subject to:} \quad & \begin{cases} \frac{1}{2} \geq x \geq 0 \\ x \geq y_1 \geq 0 \\ y_2 = x - y_1 \end{cases}
\end{aligned}$$

The associated KKT system is thus

$$\text{KKT conditions}_{MPCC_L}: \begin{cases} 2x - 2 + \mu_1 - \mu_2 - \mu_4 + \lambda = 0 \\ 2y_1 - \mu_3 + \mu_4 - \lambda = 0 \\ 2y_2 - \lambda = 0 \\ \frac{1}{2} \geq x \geq 0 \\ x \geq y_1 \geq 0 \\ x = y_1 + y_2 \\ \mu_1 \geq 0, \mu_2 \geq 0, \mu_3 \geq 0, \mu_4 \geq 0 \\ \mu_1 \cdot (\frac{1}{2} - x) = 0 \\ \mu_2 \cdot x = 0 \\ \mu_3 \cdot y_1 = 0 \\ \mu_4(x - y_1) = 0 \end{cases}$$

Sixteen different cases must be considered:

Case 1: Assume  $\mu_1 = 0 \quad \mu_2 = 0 \quad \mu_3 = 0 \quad \mu_4 = 0$

$$\begin{cases} 2x - 2 + \lambda = 0 & \textcircled{1} \\ 2y_1 = \lambda & \textcircled{2} \\ 2y_2 = \lambda & \textcircled{3} \\ \frac{1}{2} \geq x \geq 0 & \textcircled{4} \\ x \geq y_1 \geq 0 & \textcircled{5} \\ x = y_1 + y_2 & \textcircled{6} \end{cases}$$

from  $\textcircled{1} \rightarrow x = \frac{2-\lambda}{2} \textcircled{7}$

from  $\textcircled{2}$  and  $\textcircled{3} \rightarrow y_1 = y_2 = \frac{\lambda}{2} \textcircled{8}$

from  $\textcircled{6}$ ,  $\textcircled{7}$  and  $\textcircled{8} \rightarrow \lambda = \frac{2}{3} \textcircled{9}$

from  $\textcircled{7}$  and  $\textcircled{9} \rightarrow x = \frac{2}{3}$ ; Impossible

Case 2: Assume  $\mu_1 > 0 \quad \mu_2 = 0 \quad \mu_3 = 0 \quad \mu_4 = 0$

$$\begin{cases} 2x - 2 + \mu_1 + \lambda = 0 & \textcircled{1} \\ 2y_1 = \lambda & \textcircled{2} \\ 2y_2 = \lambda & \textcircled{3} \\ \frac{1}{2} \geq x \geq 0 & \textcircled{4} \\ x \geq y_1 \geq 0 & \textcircled{5} \\ x = y_1 + y_2 & \textcircled{6} \\ x = \frac{1}{2} & \textcircled{7} \end{cases}$$

from  $\textcircled{1}$ ,  $\textcircled{7} \rightarrow \mu_1 + \lambda = 1 \textcircled{8}$

from  $\textcircled{2}$ ,  $\textcircled{3} \rightarrow y_1 = y_2 = \frac{\lambda}{2} \textcircled{9}$

from  $\textcircled{9}$ ,  $\textcircled{6}$  and  $\textcircled{7} \rightarrow \lambda = \frac{1}{2} \textcircled{10}$

from  $\textcircled{10}$ ,  $\textcircled{9} \rightarrow y_1 = y_2 = \frac{1}{4}$

from  $\textcircled{8}$ ,  $\textcircled{10} \rightarrow \mu_1 = \frac{1}{2}$

---

Case 3: Assume  $\mu_2 > 0$   $\mu_1 = 0$   $\mu_3 = 0$   $\mu_4 = 0$

$$\begin{cases} 2x - 2 - \mu_2 + \lambda = 0 & \textcircled{1} \\ 2y_1 = \lambda & \textcircled{2} \\ 2y_2 = \lambda & \textcircled{3} \\ \frac{1}{2} \geq x \geq 0 & \textcircled{4} \\ x \geq y_1 \geq 0 & \textcircled{5} \\ x = y_1 + y_2 & \textcircled{6} \\ x = 0 & \textcircled{7} \end{cases}$$

from  $\textcircled{2}$ ,  $\textcircled{3} \rightarrow y_1 = y_2 = \frac{\lambda}{2}$   $\textcircled{8}$   
 from  $\textcircled{6}$ ,  $\textcircled{8}$  and  $\textcircled{7} \rightarrow \lambda = x = 0$   $\textcircled{9}$   
 from  $\textcircled{1}$ ,  $\textcircled{9} \rightarrow \mu_2 = -2$ ; Impossible

Case 4: Assume  $\mu_3 > 0$   $\mu_1 = 0$   $\mu_2 = 0$   $\mu_4 = 0$

$$\begin{cases} 2x - 2 + \lambda = 0 & \textcircled{1} \\ 2y_1 - \mu_3 - \lambda = 0 & \textcircled{2} \\ 2y_2 = \lambda & \textcircled{3} \\ \frac{1}{2} \geq x \geq 0 & \textcircled{4} \\ x \geq y_1 \geq 0 & \textcircled{5} \\ x = y_1 + y_2 & \textcircled{6} \\ y_1 = 0 & \textcircled{7} \end{cases}$$

from  $\textcircled{7}$ ,  $\textcircled{6} \rightarrow x = y_2$   $\textcircled{8}$   
 from  $\textcircled{3}$  and  $\textcircled{8} \rightarrow \lambda = 2x$   $\textcircled{9}$   
 from  $\textcircled{1}$ ,  $\textcircled{9} \rightarrow \lambda = 1$   $\textcircled{10}$   
 from  $\textcircled{2}$ ,  $\textcircled{7}$  and  $\textcircled{10} \rightarrow \mu_3 = -1$ ; Impossible

Case 5: Assume  $\mu_4 > 0$   $\mu_1 = 0$   $\mu_2 = 0$   $\mu_3 = 0$

$$\begin{cases} 2x - 2 - \mu_4 + \lambda = 0 & \textcircled{1} \\ 2y_1 + \mu_4 - \lambda = 0 & \textcircled{2} \\ 2y_2 = \lambda & \textcircled{3} \\ \frac{1}{2} \geq x \geq 0 & \textcircled{4} \\ x \geq y_1 \geq 0 & \textcircled{5} \\ x = y_1 + y_2 & \textcircled{6} \\ x = y_1 & \textcircled{7} \end{cases}$$

from  $\textcircled{6}$ ,  $\textcircled{7} \rightarrow y_2 = 0$   $\textcircled{8}$   
 from  $\textcircled{8}$ ,  $\textcircled{3} \rightarrow \lambda = 0$   $\textcircled{9}$   
 from  $\textcircled{2}$ ,  $\textcircled{9} \rightarrow \mu_4 = -2y_1$ ; Impossible

Case 6: Assume  $\mu_1 > 0$   $\mu_2 > 0$   $\mu_3 = 0$   $\mu_4 = 0$

---



$$\begin{cases} 2x - 2 + \mu_1 - \mu_2 + \lambda = 0 & \textcircled{1} \\ 2y_1 = \lambda & \textcircled{2} \\ 2y_2 = \lambda & \textcircled{3} \\ \frac{1}{2} \geq x \geq 0 & \textcircled{4} \\ x \geq y_1 \geq 0 & \textcircled{5} \\ x = y_1 + y_2 & \textcircled{6} \\ x = \frac{1}{2} & \textcircled{7} \\ x = 0 & \textcircled{8} \end{cases}$$

from  $\textcircled{8}$ ,  $\textcircled{7} \rightarrow x = 0 = \frac{1}{2}$   $\textcircled{8}$ ; Impossible

Case 7: Assume  $\mu_1 > 0$   $\mu_3 > 0$   $\mu_2 = 0$   $\mu_4 = 0$

$$\begin{cases} 2x - 2 + \mu_1 + \lambda = 0 & \textcircled{1} \\ 2y_1 - \mu_3 - \lambda = 0 & \textcircled{2} \\ 2y_2 = \lambda & \textcircled{3} \\ \frac{1}{2} \geq x \geq 0 & \textcircled{4} \\ x \geq y_1 \geq 0 & \textcircled{5} \\ x = y_1 + y_2 & \textcircled{6} \\ x = \frac{1}{2} & \textcircled{7} \\ y_1 = 0 & \textcircled{8} \end{cases}$$

from  $\textcircled{6}$ ,  $\textcircled{7}$  and  $\textcircled{8} \rightarrow y_2 = x = \frac{1}{2}$   $\textcircled{9}$

from  $\textcircled{9}$ ,  $\textcircled{2} \rightarrow \lambda = 1$   $\textcircled{10}$

from  $\textcircled{2}$ ,  $\textcircled{10} \rightarrow \mu_3 = -1$ ; Impossible

Case 8: Assume  $\mu_1 > 0$   $\mu_4 > 0$   $\mu_2 = 0$   $\mu_3 = 0$

$$\begin{cases} 2x - 2 + \mu_1 - \mu_4 + \lambda = 0 & \textcircled{1} \\ 2y_1 + \mu_4 - \lambda = 0 & \textcircled{2} \\ 2y_2 = \lambda & \textcircled{3} \\ \frac{1}{2} \geq x \geq 0 & \textcircled{4} \\ x \geq y_1 \geq 0 & \textcircled{5} \\ x = y_1 + y_2 & \textcircled{6} \\ x = \frac{1}{2} & \textcircled{7} \\ y_1 = x & \textcircled{8} \end{cases}$$

from  $\textcircled{6}$ ,  $\textcircled{7}$  and  $\textcircled{8} \rightarrow y_2 = 0$  and  $y_1 = \frac{1}{2}$   $\textcircled{9}$

from  $\textcircled{9}$ ,  $\textcircled{2} \rightarrow \lambda = 0$   $\textcircled{10}$

from  $\textcircled{2}$ ,  $\textcircled{10} \rightarrow \mu_4 = -1$ ; Impossible

Case 9: Assume  $\mu_2 > 0$   $\mu_3 > 0$   $\mu_1 = 0$   $\mu_4 = 0$

$$\left\{ \begin{array}{ll} 2x - 2 - \mu_2 + \lambda = 0 & \textcircled{1} \\ 2y_1 - \mu_3 - \lambda = 0 & \textcircled{2} \\ 2y_2 = \lambda & \textcircled{3} \\ \frac{1}{2} \geq x \geq 0 & \textcircled{4} \\ x \geq y_1 \geq 0 & \textcircled{5} \\ x = y_1 + y_2 & \textcircled{6} \\ x = 0 & \textcircled{7} \\ y_1 = 0 & \textcircled{8} \end{array} \right.$$

from  $\textcircled{6}$ ,  $\textcircled{7}$  and  $\textcircled{8} \rightarrow y_2 = 0$   $\textcircled{9}$

from  $\textcircled{9}$ ,  $\textcircled{3} \rightarrow \lambda = 0$   $\textcircled{10}$

from  $\textcircled{2}$ ,  $\textcircled{10} \rightarrow \mu_3 = 0$ ; Impossible

Case 10: Assume  $\mu_2 > 0$   $\mu_4 > 0$   $\mu_1 = 0$   $\mu_3 = 0$   
Similar to case 9,  $\mu_4 = 0$ ; Impossible

Case 11: Assume  $\mu_3 > 0$   $\mu_4 > 0$   $\mu_1 = 0$   $\mu_2 = 0$   
Similar to case 9,  $\mu_4 = -2$ ; Impossible

Case 12: Assume  $\mu_1 > 0$   $\mu_2 > 0$   $\mu_3 > 0$   $\mu_4 = 0$   
Similar to case 6,  $x = \frac{1}{2}$ ,  $x = 0$ ; Impossible

Case 13: Assume  $\mu_1 > 0$   $\mu_2 > 0$   $\mu_4 > 0$   $\mu_3 = 0$   
Similar to case 6,  $x = \frac{1}{2}$ ,  $x = 0$ ; Impossible

Case 14: Assume  $\mu_2 > 0$   $\mu_3 > 0$   $\mu_4 > 0$   $\mu_1 = 0$   
Similar to case 9,  $\mu_2 + \mu_4 = -2$ ; Impossible

Case 15: Assume  $\mu_1 > 0$   $\mu_3 > 0$   $\mu_4 > 0$   $\mu_2 = 0$

$$\left\{ \begin{array}{ll} 2x - 2 + \mu_1 - \mu_4 + \lambda = 0 & \textcircled{1} \\ 2y_1 - \mu_3 + \mu_4 - \lambda = 0 & \textcircled{2} \\ 2y_2 = \lambda & \textcircled{3} \\ \frac{1}{2} \geq x \geq 0 & \textcircled{4} \\ x \geq y_1 \geq 0 & \textcircled{5} \\ x = y_1 + y_2 & \textcircled{6} \\ x = \frac{1}{2} & \textcircled{7} \\ y_1 = 0 & \textcircled{8} \\ y_1 = x & \textcircled{9} \end{array} \right.$$

from  $\textcircled{7}$ ,  $\textcircled{8}$  and  $\textcircled{9} \rightarrow x = 0, x = \frac{1}{2}$ ; Impossible

Case 16: Assume  $\mu_1 > 0$   $\mu_2 > 0$   $\mu_3 > 0$   $\mu_4 > 0$   
Similar to case 6,  $x = \frac{1}{2}$ ,  $x = 0$ ; Impossible

---

The only candidate solution is from case 2:  $S = \{(\bar{x}, \bar{y}_1, \bar{y}_2)\} = \{(\frac{1}{2}, \frac{1}{4}, \frac{1}{4})\}$   
This candidate is qualified by the Mangasarian–Fromovitz qualification constraint ( $CQ_{MF}$ ). The family of saturated constraints is:  
 $\mathcal{F} = \{\nabla h(\bar{x}, \bar{y}_1, \bar{y}_2), \nabla g_1(\bar{x}, \bar{y}_1, \bar{y}_2)\} = \{(1, -1, -1), (1, 0, 0)\}$  This vectors are linearly dependent, thus the solution is  $CQ_{MF}$  qualified.

---

# Chapter 6

## **A bilevel optimization approach of energy transition in freight transport: SOS1 method and application to the Ecuadorian case**

Article authors: Daniel Villamar, Didier Aussel.

Journal: Computational Management Science

Submitted: December 2022

This study was carried out within the framework of the project Fond de Solidarité pour les Projets Innovant, sponsored by the French Ministry of Europe and Foreign Affairs. My contribution to this study included the creation of a mathematical model of freight transport, the coding of this model in Julia software, the analysis of the results obtained and the writing of the scientific article presented in this section. All these steps were accompanied and supervised by Professor Didier Aussel.

### **6.1 Abstract**

In this work we propose a new model to evaluate the effect of possible governmental policy as a green transition to decarbonise the road freight transport. Contrary to the classical literature on the topic, our approach is based on a bilevel structure optimization scheme. More precisely, a Single-Leader-Multi-Follower (SLMF) model is created in which the state represents the leader and the freight companies the followers. A carbon tax is the public policy chosen to foster the shift to less pollutant freight technologies. The model responds to an exogenously determined demand that must be satisfied by a fleet that remains constant in size through time. The aim is thus to determine to what extent the tax policy will generate an evolution of the fleets of the different companies towards greener ve-

---

hicles. Implementation is done in the case of the Ecuadorian freight transport and the results emphasize interesting evolution of the fleets. An additional scientific input of the paper is that the Single-Leader-Multi-Follower model is solved thanks to a new numerical approach based on the so-called SOS1 technique.

## 6.2 Introduction

Global warming has been a trending topic for decades. There is a general agreement on the necessity of reducing emissions, but for each country different pathways could be implemented to achieve such goal. In Ecuador, located in South America, the transport sector produces 47% of the annual emissions<sup>27</sup> and, within the transport emissions, 70% correspond to road freight transport alone<sup>27</sup>. Ecuador's case is neither a new or isolated example; transport is known to be largely dominated by combustion engine vehicles. On the other hand, the freight transport is closely linked to the economic development of a country, making it a sensitive sector of the economy. A model that evaluates emissions reduction related to certain policies comes very handy to analyse possible impacts on the freight transport.

In this study an approach based on game theory is used to create a mathematical model that simulates the effects of a carbon tax as a mean of reducing emissions on the transport sector and this model is then implemented for Ecuador. More precisely we use a Multi-Leader-Follower game structure (MLFG), that is a mixture of a Stackelberg bilevel optimization problem with a non-cooperative game<sup>67</sup>. These games are adapted to emulate different market applications such as electricity markets modelling<sup>61</sup> or even environmental applications focused on saving resources as in eco-parks<sup>72</sup>. In the present study the considered bilevel structure represents the freight transport sector. At the upper level of the game, the government acts as a leader that imposes conditions (ground rules) to the freight transport companies which, at the lower level, would act as followers. This Multi-Leader-Follower game structure is therefore a Single-Leader-Multi-Follower (SLMF) game.

The advantages of using a game theory approach is to capture, at the same time, the non-cooperative interactions between the rational players -the freight companies- and their hierarchical dependence with government through a carbon tax policy. To our knowledge it is the first time that such approach is used to describe a decarbonisation process in freight sector.

Following a classical scheme<sup>67</sup>, this game is then transformed into a Mathematical Program with Complementarity Constraints (MPCC) by means of the Karush-Kuhn-Tucker conditions but instead of solving this MPCC reformulation by strong duality or big-M techniques, we apply an adaptation of the Special Order Set (SOS) method very recently developed<sup>76</sup>.

The paper is structured as follows, Section 6.3 describes the problem of the transport pollution and the mathematical model created to address the problem. Section 6.4 presents the methodology used to solve the mathematical program while in Section 6.5 a practical application of the model in the case of Ecuadorian freight sector is developed and results from the simulation are discussed. Finally Section 6.6 is devoted to the conclusion of the study.

---

## 6.3 Problem and Model

This section presents an overview of road freight transport problem related to emissions and proposes a mathematical model that will be used to explore the effects of a carbon tax as a policy to regulate emissions.

### 6.3.1 Transport and carbon emissions

Freight is perceived as a main driver of the economy but it is still a pending problem worldwide to decouple emissions from freight transport. Despite a dent on the energy consumed by this sector during the Covid pandemic, within the actual policies frame it is estimated that energy demand for this sector could increase in 70% for Latin America countries until 2050<sup>77</sup>. The road freight transport consumes around 50% of all diesel fuel<sup>78</sup>. It is vital, even more for developing countries, to maintain the economic growth while reducing the emissions produced from freight. Nowadays, the technology advancements present alternatives to the internal combustion trucks' engines, pointing to reduce and even eliminate the "tank to wheel" emissions of road transport sector. Still, clean technologies lack of competitiveness against traditional diesel trucks. To overcome this issue, public policies must be implemented and, to avoid a costly trial and error approach, it is important to analyse the impact of the policies by means of mathematical models. In this paper a model, that evaluates the effectiveness of a carbon budget policy to endorse the electrification of transport, is proposed. It is based on a SLMFG structure which allows to capture, at the same time the non-cooperative interrelations between the freight agents and the hierarchical dependence between these agents and the governmental policy.

### 6.3.2 The Single-Leader-Multi-Follower game

In game theory a bilevel Stackelberg game combined with a Nash equilibrium at the lower level creates the so-called Single-Leader-Multi-Followers Game. At the upper level the government aims to reduce the emissions level from freight transport without affecting the economic growth; so that the objective of the government will be to minimize the total emissions produced by the companies at the tank to wheel level. On the other side, the companies are motivated by the economic objective of minimizing the capital an operational costs.

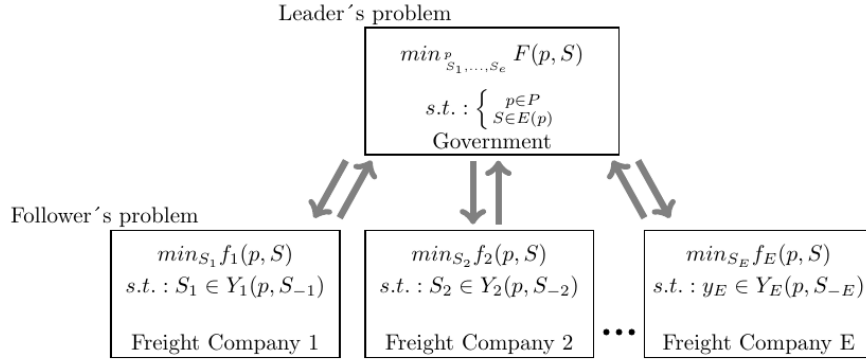

Figure 6.1: Scheme for a SLMF game

Notice that in the scheme shown in Figure 6.1, the leader's problem aim to minimise both on the leader's variables and on the follower's variables, which means that the so-called *optimistic approach* will be used here, while other approaches are available<sup>79</sup>. For an overview on SLMFG the interested reader can consider the work of D. Aussel<sup>67</sup> and the reference therein. Note that here the decision vector  $S$  is the concatenation of the decision vectors of all the followers, that is  $S = (S_1, \dots, S_E)$ . Following a classical notation in game theory, the vector  $S_{-e}$  is composed of the strategy decision vectors of each of the companies/followers except company  $e$ , that is,  $S_{-e} = (S_1, \dots, S_{e-1}, S_{e+1}, \dots, S_E)$ .

Thus the carbon tax/transport model developed in this study has a SLMFG structure which will be depicted in the forthcoming subsections. But before starting the description of the model, let us get acquainted with the notations to be used, which are presented in Table 6.1.

As it will be explained in Subsection 6.5, if the model aims to cover the freight transport sector at a national level, then the freight companies can be grouped by categories.

### Leader problem - upper level

As stated before, the government, as the leader, would impose some conditions/tax to the freight companies so that the followers would adapt/reacting in a way which would diminish the environmental impact of the freight.

The time horizon of the analysis is split into  $K$  time spans/periods  $k \in \{1, \dots, K\}$  thus the time horizon being finally  $K \times$  time span. It is supposed that the first period is ongoing, and that no conditions have been imposed yet. So for this reason the index of the variables will start at period 2. Note that in our analysis the time span is chosen at five years but other time spans can be considered without modifying the model. Sub-index  $e \in \{1, \dots, E\}$  stands for the company/enterprise competing in the lower level. The index  $t \in \{1, \dots, T\}$  represents technology and refers to the different truck types, according to the engine power source. As a basic example one can consider that there are three technologies available: Diesel, Hybrid and Electric. Of course more technologies could be included, if required. The family of technology will be split into two



Indexes	Definitions	Units
$k$	Time periods of 5 years	$\in \{1, \dots, K\}$
$e$	Companies accounted in the study	$\in \{1, \dots, E\}$
$t$	Truck's energy source technology Diesel, EV, hybrid	$\in \{1, \dots, T\}$
<b>Variables</b>		
$S_{e,t}^k$	Share of technology $t$ , for company $e$ at period $k$	$\in [0, 1]$
$p_k$	Carbon tax price for period $k$	US\$/kgCO <sub>2</sub>
<b>Parameters</b>		
$V_e^0$	Number of vehicles for company $e$ at base year	
$Q_k$	Maximum CO <sub>2</sub> emissions at period $k$	CO <sub>2</sub> Tonnes x10 <sup>3</sup>
$D_{t,k}$	Distance travelled	km
$\eta_{t,k}$	Vehicle efficiency	MJ/km
$G_t$	Fuel emissions factor	kg/MJ
$B_{e,k}$	Company $e$ budget at period $k$	US\$
$S_{e,t}^i$	Share of technology $t$ for company $e$ at base year	$\in [0, 1]$
$\mu_{t,k}$	Unitary cost of technology $t$ at period $k$	US\$/truck
$R_{t,k}$	Transport capacity for technology $t$ at period $k$	tonnes/truck
$H_k$	Transport demand for period $k$	TKM
$F_{t,k}$	Fuel or electricity cost for technology $t$ at period $k$	US\$/MJ
<b>Objective function</b>		
$Z_e(S_e, p)$	Cost function for company $e$ parameterized by $p$	US\$
$\theta(S)$	Emissions function	kg

Table 6.1: Mathematical notations

subfamilies: the "carbon-based/polluting ones" (only diesel in our example) for  $t \in \{1, \dots, T_c\}$  and the "green technologies" (only Hybrid and Electric in our example) for  $t \in \{T_c + 1, \dots, T\}$ .

The leader's variable is a tax vector  $(p_k)_{k=2, K}$  which represent, for each period  $k$ , the carbon tax price which will be applied all along period  $k$ . On the other hand the followers' variables are  $S_{e,t}^k$  which corresponds to the share of technologies. More precisely the fleet of vehicles of a company  $e$  is assumed to be constant over the time horizon, with value  $V_e^0$ , and thus, for any time period  $k$ ,  $S_{e,t}^k$  represents the percentage of this fleet being of technology  $t$ . In practice, freight companies fleets are composed of hundred of vehicles and  $S_{e,t}^k \times V_e^0$  is an adequate continuous approximation to the vehicles quantities being of technology  $t$  at time period  $k$  in the fleet of company  $e$ . Thanks to this continuous approximation we avoid integer variables and the numerical treatment of the SLMF game, known to be delicate, is highly simplified. Moreover as soon as the freight analysis is done at a large scale (region, country) such an approximation is sufficient to describe the "trends". In our model, at base period  $k = 1$  all the companies start with a fleet composed exclusively of diesel trucks and, as represented in Figure 6.2, an evolution to a "less carbonized" fleet is expected thanks to the policy of the leader/the government.



Figure 6.2: Transport matrix green transition scheme

Therefore, even if the total number of company vehicles remains constant, the evolution of share of each technology will create the transition.

According to the desired transition, the leader objective is to minimize the total  $CO_2$  emissions generated in the freight transport activity. This emissions are represented by

$$\theta(S) = \sum_{k=2}^K \sum_{e=1}^E \sum_{t=1}^T V_e^0 \times S_{e,t}^k \times D_{t,k} \times \eta_{t,k} \times G_t \quad (OF_L)$$

The function  $\theta(S)$  includes the emissions generated by the different truck technologies of all the freight companies in the entire time horizon if the analysis. To calculate the emissions of a single vehicle three parameters are considered, the distance  $D_{t,k}$  travelled in km, the vehicle efficiency  $\eta_{t,k}$  in  $MJ/km$  of the vehicle and the emission factor  $G_t$  in  $kg/MJ$  related with the truck energy source. To calculate the total emissions in a year, the emissions of one vehicle type is multiplied by the total number of vehicles of this type. Note that since no tax will be applied during the first period, the total emission during this base year is a constant and is thus not included in the objective function  $\theta$ . Notice that in the expression  $(OF_L)$  and the forthcoming ones, notations  $e'$  is used to sum up on the companies while we keep the notations  $e$  to refer to a specific company.

The leader's problem is of course framed by some constraint: first the government, aiming to reduce  $CO_2$  emissions, imposes a threshold,  $Q_k$ , limiting the  $CO_2$  emission level permitted in each period  $k$ :

$$\sum_{e'=1}^E \sum_{t=1}^T (V_{e'}^0 \times S_{e',t}^k \times D_{t,k} \times \eta_{t,k} \times G_t) \leq Q_k, \quad \forall k = 2, K \quad (C_L1)$$

The second condition imposes an activity level  $H_k$  to guarantee that there is enough freight service to address the transport demand that is in tonnes per kilometre (tkm).

$$\sum_{e'=1}^E \sum_{t=1}^T S_{e',t}^k \times V_{e'}^0 \times D_{t,k} \times R_{t,k} \geq H_k, \quad \forall k = 2, K \quad (C_L2).$$

This restriction is associated with the country economy. It is necessary to establish a minimum on the tkm carried per year. This tkm level must be supplied by the transport companies modelled. For a single truck, the amount of tkm transported results from multiplying the distance travelled by the load capacity of the truck. As before, to obtain the total tkm carried, the capacity of one vehicle type is multiplied by the total share of vehicles of the same type and for the total number of vehicles.

A third condition stipulates that the carbon tax price must be positive:

$$p_k \geq 0, \quad \forall k = 2, K \quad (C_L3).$$

A last and important condition for the leader's problem is that the vector  $S = (S_{e,t}^k)_{e,t,k}$  grouping the followers' variables is a generalized Nash equilibrium of the lower level problem parameterised by the tax policy vector  $p$ . Denoting by  $Eq(p)$  the set of such generalized Nash equilibriums, the last constraint of leader's problem is

$$S \in E(p)$$

and the problem of the government can be finally synthesised as follows

$$(P) \quad \min_{p,S} \theta(S)$$

$$\text{s.t.} \quad \begin{cases} (C_L1), (C_L2) \text{ and } (C_L3) \\ S \in Eq(p) \end{cases}$$

### **Follower problem with Carbon Tax - Lower level**

The freight companies, for  $e = 1, E$ , play the role of followers in the SLMF structure and they look forward minimising the cost  $Z_e(S_e, p)$  that is a sum of their variable and fixed costs. Therefore the objective of companies is to minimize the investment cost of acquiring new vehicles as well as the cost of fleet operation and maintenance. The operation cost is parameterized by the carbon tax defined by the leader.

$$Z_e(S_e, S_{-e}, p) = V_e^0 \left( \sum_{t \in \{T_c\}} \left[ (S_{e,t}^2 - S_{e,t}^1) \times \mu_{t,2} + \sum_{k=3}^K [(S_{e,t}^k - S_{e,t}^{k-1}) \times \mu_{t,k}] \right] \right. \\ \left. + \sum_{t=1}^T \sum_{k=2}^K [S_{e,t}^k \times D_{t,k} \times \eta_{t,k} \times (p_k \times G_t + F_{t,k})] \right)$$

As explained above, the primal variable at the lower level is the share,  $S_e = (S_{e,t}^k)_{\substack{k=2,K \\ t=1,T}}$  of each truck technology  $t$  in the company  $e$  fleet for time period  $k$ . The nature of the variable  $S_e$  imposes two constraints on the follower problem: first by representing the percentage of each of the truck technologies available, within a company for each year, the sum of all technologies must result in 100% of the vehicles:

$$\sum_{t=1}^T S_{e,t}^k = 1, \quad \forall k = 2, K \quad (C_F1)$$

and, of course, being a percentage its value would always be constrained as

$$0 \leq S_{e,t}^k \leq 1, \quad \forall k = 2, K, \quad \forall t = 1, T \quad (C_F2)$$

Thus, for any time period  $k$ , the variable  $S_{e,t}^k$  must be comprised between 0, if there is no vehicle of type  $t$ , and 1 if all the vehicles in the fleet of company  $e$  are

of the same type  $t$ . The inequality  $1 \leq S_{e,t}^k$  can be omitted since it is implied in the constraint  $(C_F1)$ . In the base year, the share for diesel vehicles  $S_{e,1}^1$  is equal to 1 while for electric and hybrid vehicles the share  $S_{e,2}^1$  and  $S_{e,3}^1$  are 0.

Another constraint is that the expenditures of company  $e$  must remain under the company's budget  $B_{e,k}$  for period  $k$ , which must cover new vehicles purchases and the payment of the carbon tax related to its transport activity. This restriction is represented by two inequalities, one for the period 2 and the other for the periods  $k = 3, K$

$$\sum_{t \in \{T_c\}} [V_e^0 \times (S_{e,t}^2 - S_{e,t}^i) \times \mu_{t,2}] + \sum_{t=1}^T [S_{e,t}^2 \times D_{t,2} \times \eta_{t,2} \times (p_2 \times G_t + F_{t,2})] \leq B_{e,2} \quad (C_F3)$$

$$\sum_{t \in \{T_c\}} [V_e^0 \times (S_{e,t}^k - S_{e,t}^{k-1}) \times \mu_{t,k}] + \sum_{t=1}^T [S_{e,t}^k \times D_{t,k} \times \eta_{t,k} \times (p_k \times G_t + F_{t,k})] \leq B_{e,k}, \quad \forall k = 3, K \quad (C_F4)$$

The cost of acquiring new vehicles of a technology is obtained from multiplying the share difference of this technology in consecutive periods with the number of vehicles of the company and with the unitary cost of a truck. This calculation is performed for vehicles other than diesel-type. The cost of operation and maintenance is obtained by adding the emissions and fuel costs of a single vehicles of a certain technology and multiplying this value with the number of vehicles of that technology. Note that, in constraint  $(C_F3)$ ,  $S_{e,t}^i$  is not a variable but the known value of the share of technology  $t$  for base period 1. To stress this difference the expressions containing  $S_{e,t}^i$  are divided as  $(C_F3)$  and  $(C_F4)$ .

The next two restrictions that shape the followers problem constraint the evolution of variable  $S$  over the years, to guarantee that the number of cleaner vehicles in the fleet increases between two consecutive years:

$$S_{e,t}^k \geq S_{e,t}^{k-1}, \quad \forall t \in \{T_c\}, \quad \forall k = 3, K \quad (C_F5)$$

$$S_{e,t}^2 \geq S_{e,t}^i, \quad \forall t \in \{T_c\} \quad (C_F6)$$

In the same vein, the next two restrictions prevent the number of polluting vehicles ( $T_c$ ) from increasing between consecutive years:

$$S_{e,t}^k \leq S_{e,t}^{k-1}, \quad \forall t \in \{T_c\}, \quad \forall k = 3, K \quad (C_F7)$$

$$S_{e,t}^2 \leq S_{e,t}^i, \quad \forall t \in \{T_c\} \quad (C_F8)$$

The chronology of the periods and investments in vehicles is described in Figures 6.3.

During period 1 the fleet of company  $e$  is composed of  $V_e^0$  diesel trucks. At the end of period 1, company  $e$  takes the decision of investment. According to

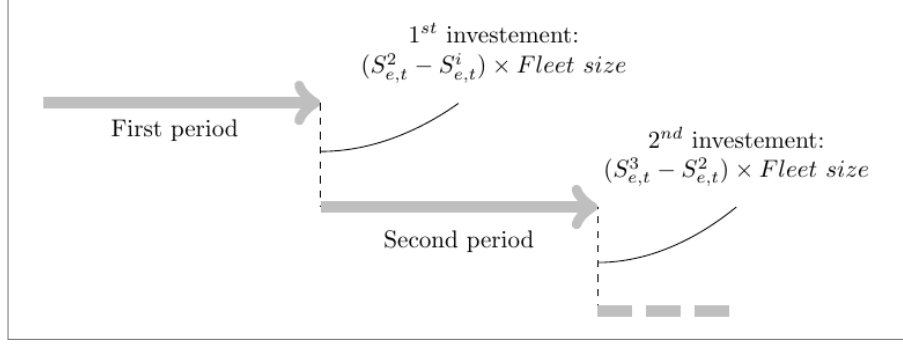

Figure 6.3: Chronology of the model

constraints  $(C_F5) - (C_F8)$  and since the fleet is assumed to be constant, if company  $e$  decides to invest into new vehicles, it is in vehicles of green technology (that is with  $t \setminus \{T_c\}$ ) and the same number of vehicles of carbon-based technology (that is with  $t = \{T_c\}$ ) is scrapped. As a consequence one has

$$\sum_{t \notin \{T_c\}} [S_{e,t}^2 - S_{e,t}^i] = \sum_{t \in \{T_c\}} [S_{e,t}^i - S_{e,t}^2].$$

The problem  $P_e(p)$  of each follower  $e \in \{1, \dots, E\}$ , parameterized by the carbon tax vector  $p$ , can be thus synthesised as follows

$$\begin{aligned} P_e(p) \quad & \min_{S_e} Z_e(S_e, p) \\ & \text{s.t.} \quad (C_F1), \dots, (C_F8) \end{aligned}$$

It is important to note that since, for each of the followers' problem, neither the objective function nor the constraints depend on the decision variables  $\left( (S_{e',t}^k)_{t,k} \right)_{e' \neq e}$  of the other followers, the SLMF game turns out to be a so-called Single-Leader-Disjoint-Followers (SLDF) game (see e.g.<sup>80</sup> where this terminology has been defined) where the followers' problem are explicitly independent from each other but are implicitly dependent through the leader's variables and, more importantly, through the leader's constraints, here constraints  $(C_L1)$  and  $(C_L2)$ . As it will be explained in the forthcoming section, the fact to face a SLDF game instead of a general SLMF game will simplify the structure of the reformulation of problem  $(P)$  and thus also its numerical treatment.

**Proposition 2** *If the constants of problem  $(P)$  are such that, for any  $e \in \{1, \dots, E\}$ , there exists at least one feasible point and if the carbon price vector  $p$  is assumed to be bounded, then the carbon tax problem admits at least a solution.*

*Proof.* It is a consequence of<sup>67</sup> Theorem 3.3.4. Indeed conditions (1) and (2) of this result are clearly satisfied since the involved objective functions are differentiable. Now the lower semi-continuity and graph closedness of the constraint map of each of the follower/company's problem can be deduced from the proof of Theorem 4.3 in<sup>68</sup> pp. 92-93 while the non emptiness of the domain of the constraint map comes directly from assumption. Moreover, thanks to constraint  $(C_F2)$  this

constraint map has uniformly bounded values. Finally since the carbon price vector is assumed to be bounded, then the feasible set of vector  $p$  is a closed box and thus a compact set.  $\diamond$

## 6.4 Methodology for solving the SLMFG

In this section, the method implemented to solve the SLMF carbon tax problem is described. The somehow classical reformulation as a Mathematical Program with Complementarity Constraints (MPCC) is detailed in Subsection 6.4.1 while in Subsection 6.4.2 a new numerical scheme very recently proposed in<sup>76</sup> is applied for the first time to a carbon tax model.

### 6.4.1 The MPCC reformulation

Bilevel problems and even more SLMF problems are known to be difficult to solve problems. One of the difficulties comes from the fact that the solution map  $Eg$  of the lower level problem is usually set-valued, even in the SLDF case and that only few and specific algorithms are known to find equilibriums of a parameterized GNEP. Thus a classical and widely used numerical scheme to solve such SLMF game problems is to concatenate the Karush-Kuhn-Tucker systems associated to the each of the follower's problem into a unique set-valued map  $p \mapsto KKT(p)$ , to replace in the upper level problem the solution/equilibrium map  $Eg$  by this  $KKT$ -map and to solve the resulting MPCC. See<sup>67</sup> for a presentation of this scheme in a more general context.

The first part of the concatenated KKT system expresses the fact that, for any  $e = 1, E$ , the gradient of the Lagrangian, with respect to variable  $S_e = (S_{e,t}^k)_{t,k'}$  associated to the lower level problem of company  $e$ , is a zero vector

$$\nabla_{S_e} \mathcal{L}(S_e, S_{-e}, p, \lambda, \pi) = 0$$

with

$$\begin{aligned} \nabla_{S_e} \mathcal{L}_e(S_e, S_{-e}, p, \lambda, \pi) &= \nabla_{S_e} Z_e(S_e, S_{-e}, p) + \sum_{k=2}^K \pi_e^k \nabla_{S_e} h_e^k(S_e, S_{-e}) \\ &\quad - \sum_{k=2}^K \sum_{t=1}^T \lambda_{I_e,t}^k \nabla_{S_e} g_{I_e,t}^k(S_e, S_{-e}) - \sum_{k=2}^K \sum_{t=1}^T \lambda_{II_e,t}^k \nabla_{S_e} g_{II_e,t}^k(S_e, S_{-e}) \\ &\quad \quad \quad - \lambda_{III_e}^2 \nabla_{S_e} g_{III_e}^2(S_e, S_{-e}) - \sum_{k=3}^K \lambda_{IV_e}^k \nabla_{S_e} g_{IV_e}^k(S_e, S_{-e}) \\ &\quad - \sum_{k=3}^K \sum_{t=I_e+1}^T \lambda_{V_e,t}^k \nabla_{S_e} g_{V_e,t}^k(S_e, S_{-e}) - \sum_{t=I_e+1}^T \lambda_{VI_e,t}^2 \nabla_{S_e} g_{VI_e,t}^2(S_e, S_{-e}) \\ &\quad - \sum_{k=3}^K \sum_{t=1}^{T_c} \lambda_{VII_e,t}^k \nabla_{S_e} g_{VII_e,t}^k(S_e, S_{-e}) - \sum_{t=1}^{T_c} \lambda_{VIII_e,t}^2 \nabla_{S_e} g_{VIII_e,t}^2(S_e, S_{-e}) \end{aligned}$$

where  $\lambda$  and  $\pi$  stands for the Lagrangian multipliers for the different inequalities and equality conditions of the problem. Note that the functions  $h_e^k(S_e)$  and  $g_{I-VIII}^k(S_e)$  are rewriting of the follower's constraints  $(C_F1)$  to  $(C_F8)$ . The expressions of this functions and their gradients are given in Appendix 7.2.

The second part of the concatenated KKT system is composed of the constraints and complementarity constraints

$$\left\{ \begin{array}{l} 0 \leq \lambda_{Ie,t}^k \perp S_{e,t}^k \geq 0, \quad \forall k = 2, K, \forall t = 1, T, \forall e = 1, E \\ 0 \leq \lambda_{IIe,t}^k \perp 1 - S_{e,t}^k \geq 0, \quad \forall k = 2, K, \forall t = 1, T, \forall e = 1, E \\ 0 \leq \lambda_{IIIe}^2 \perp B_{e,2} - \sum_{t=T_c+1}^T [V_e^0 \times (S_{e,t}^2 - S_{e,t}^i) \times \mu_{t,2}] - \\ \sum_{t=1}^T [S_{e,t}^2 \times D_{t,2} \times \eta_{t,2} \times (p_2 \times G_t + F_{t,2})] \geq 0, \quad \forall e = 1, E \\ 0 \leq \lambda_{IVe}^k \perp B_{e,k} - \sum_{t=T_c+1}^T [V_e^0 \times (S_{e,t}^k - S_{e,t}^{k-1}) \times \mu_{t,k}] - \\ \sum_{t=1}^T [S_{e,t}^k \times D_{t,k} \times \eta_{t,k} \times (p_k \times G_t + F_{t,k})] \geq 0, \quad \forall k = 3, K, \forall e = 1, E \\ 0 \leq \lambda_{Ve,t}^k \perp S_{e,t}^k - S_{e,t}^{k-1} \geq 0, \quad \forall t = T_c + 1, T, \forall k = 3, K, \forall e = 1, E \\ 0 \leq \lambda_{VIe,t}^2 \perp S_{e,t}^2 - S_{e,t}^i \geq 0, \quad \forall t = T_c + 1, T, \forall e = 1, E \\ 0 \leq \lambda_{VIIe,t}^k \perp S_{e,t}^{k-1} - S_{e,t}^k \geq 0, \quad \forall t = 1, T_c, \forall k = 3, K, \forall e = 1, E \\ 0 \leq \lambda_{VIIIe,t}^2 \perp S_{e,t}^i - S_{e,t}^2 \geq 0, \quad \forall t = 1, T_c, \forall e = 1, E \\ \sum_{t=1}^T S_{e,t}^k = 1, \quad \forall k = 2, K \end{array} \right.$$

Thus the MPCC associated to the government's problem ( $P$ ) is

$$\begin{array}{l} \min_{p,S,\lambda,\pi} \theta(S) \\ \text{s.t.} \left\{ \begin{array}{l} (C_L1), (C_L2) \text{ and } (C_L3) \\ (S, \lambda, \pi) \in KKT(p) \end{array} \right. \end{array}$$

where  $KKT(p)$  denotes the set of solutions  $(S, \lambda, \pi)$  of the concatenated KKT grouping the KKT system of all companies. Note that the variables of the MPCC problem are now not only the variables  $p$  and  $S$  of the government and the companies but also the dual variables  $\lambda$  and  $\pi$ . Here an optimistic version of the MPCC is used<sup>81</sup>.

It is now well-known that it is not possible in general to extract from the global optimal solutions of an MPCC the global optimal solutions of the original SLMF game problem. Indeed specific constraint qualifications conditions are required to take into account the bilevel structure of the problem since classic constraint qualifications like the Mangasarian–Fromowitz or the linear independence constraint qualification are violated at every feasible point<sup>82</sup>. For more detail, the interested reader can consult other authors<sup>68,79,83,67</sup>. Nevertheless, taking into account the SLDF structure of problem ( $P$ ), the linearity of the constraints and the differentiability of the objective function of the followers, we obtain the following proposition as an immediate consequence of<sup>67</sup> Th. 3.3.8. Indeed, in this case, for each leader's strategy  $p$ , for each follower  $e \in \{1, \dots, E\}$  and for each feasible point

$S_e$  the Guignard's CQ holds automatically at  $S_e$  for the constraint  $(C_F1) - (C_F8)$ . Thus we have

**Proposition 3** *If  $(p, S, \lambda, \pi)$  is a solution of the MPCC then  $(p, S)$  is a solution of the carbon tax problem  $(P)$ .*

## 6.4.2 MPCC Resolution

Since standard nonlinear programming algorithms cannot be used to solve the non-convex optimization problem of a MPCC, several specific techniques have been developed. The most classical one is the so-called "big-M" technique for linear bilevel problems which usually turns out to lead to suboptimal solutions, see below. More recently a penalization approach has been developed by Leyffer-Munson<sup>73</sup> and enlargement techniques, that is a technique in which the subset defined by the complementarity constraints is enlarged and this enlargement is reduced step after step, has been extensively analysed by Mounir and coauthors (see e.g.<sup>84,85</sup>). Finally strong duality approaches, when it can be applied, can be used, like in<sup>19</sup>. In the present study, facing some unstable behaviours of the Big-M and Leyffer-Munson approaches where the results changed drastically for close values of the variable, we decided to implement an alternative algorithm based on Special Order Set of order 1 (SOS1). This tree-based approach was known for classical Stackelberg games (one leader-one follower) and has been extremely recently extended in Aussel-Schmidt<sup>76</sup> to linear SLMF game. It is thus the first time that such an approach is used for transport problem.

Since the classical Big-M technique and the SOS1 share some decomposition techniques, let us first recall the Big-M approach which consists in the transformation of the MPCC in a linearised problem by decoupling the complementarity constraints. In the Big-M method, a positive constant  $M$  and a binary variables,  $z_{e,t}^k$  must be added for each of the complementarity constraints. For example, constraint  $(*)$  is transformed as follows:

$$(*) \quad 0 \leq \lambda_{1e,t}^k \perp S_{e,t}^k \geq 0 \quad ; \quad k = 2, \dots, K, \quad t = 1, \dots, T, \quad e = 1, \dots, E$$

becomes

$$k = 2, \dots, K, \quad t = 1, \dots, T, \quad e = 1, \dots, E, \quad \begin{cases} z_{e,t}^k = \{0, 1\} \\ 0 \leq \lambda_{1e,t}^k \leq z_{e,t}^k M \\ 0 \leq S_{e,t}^k \leq (1 - z_{e,t}^k) M \end{cases}$$

For each complementarity constraint the new variable  $z_{e,t}^k$  and its complement  $(1 - z_{e,t}^k)$  would act as a switch that enables one of the constraints while disabling the other. Besides, the constant  $M$  must be large enough to bound the lower level's dual feasible set without leaving aside any possible solution. Using this transformation across the complementarity constraints, it is possible to convert the MPCC in a mixed-integer linear program (MILP) that can be solved using a suitable optimization software. Despite the fact that this is a classic transformation method, the number of variables increases with each complementarity constraint, resulting in a more computationally demanding problem for the solver. In addition,



---

the added variables are binary, which poses an extra challenge to the solver's capabilities. Finally, the value  $M$  used in this transformation represents another well-known difficulty: finding the appropriated value for  $M$  is not so trivial. Indeed first its value must be big enough to be an upper bound for all the primal and dual constraints of the problems otherwise some local and global solutions can be dropped, thus leading to suboptimal solutions. Second this coefficient could lead to numerical instability in the problem<sup>74,86</sup>.

Due to the stability problems observed while using the Big M method on the carbon tax problem ( $P$ ), an alternative and novel transformation was followed, the Aussel-Schmidt method<sup>76</sup>. This last process corresponds to a branch and bound technique where a Special Ordered Set (SOS) is used to restrict the number of nonzero solution values among a set of variables. In the case of complementarity conditions, where there are two constraints (one for each variable) and each of the constraints are mutually excluding, the SOS type 1 method can be used. The SOS1 approach evaluates each possible outcome by systematically considering only 1 of the complementarity conditions at the time. The SOS method is presented among the algorithms for linear bilevel problems<sup>75</sup>. The advantage of using an SOS1 method is avoiding to define an arbitrary  $M$  parameter, and it is a branching strategy that can significantly improve performance of the algorithm<sup>87</sup>. The SOS1 method has been intensively used to solve bilevel problems with linear follower's problem, and has been proved to be more efficient than Big-M approach. The use of SOS1 method for SLMF game has been proposed only very recently<sup>76</sup> and the present work constitutes the first implementation for an energy application in the transport sector.

As it was performed with the Big-M method, the complementarity constraints of the model are reformulated with the SOS1 method. Here is an illustration with complementarity constraint

$$(*) \quad 0 \leq \lambda_{1e,t}^k \perp S_{e,t}^k \geq 0, \quad k = 2, \dots, K, \quad t = 1, \dots, T, \quad e = 1, \dots, E$$

which becomes

$$\forall k = 2, K, \quad \forall t = 1, T, \quad \forall e = 1, E,$$

$$\lambda_{1e,t}^k \geq 0 \quad , \quad S_{e,t}^k \geq 0 \quad , \quad SOS1(\lambda_{1e,t}^k, S_{e,t}^k) := \{\lambda_{1e,t}^k = 0 \text{ or } S_{e,t}^k = 0\}$$

This reformulation is applied through the whole set of complementarity constraints of the MPCC problem. The carbon tax model ( $P$ ) described in Section (6.3), once reformulated with the SOS constraints, is ready to be programmed. In this study, Julia programming language on its version 1.5.3 was used. This language has been chosen because it is a free and open-source high-level language able to work with well-known solvers as Gurobi, Cplex or IPOpt. The solver used in the application model was Gurobi on its version 9.1.2, a version able to support SOS constraints. The characteristics of the computer used to run the problem include an hexa-core processor of 2.20GHz with 16GB in Ram memory.

---

## 6.5 Application to the Ecuadorian freight transport

The carbon tax model defined in Section 6.3 was created as a tool to analyse the influence of carbon tax policies on the transition to greener freight transport. The model is fed by data tables containing specific information that represent the situation of a country. In this section the model was tested for the Ecuadorian context.

### 6.5.1 Context and data

In order to model the transport sector in Ecuador, some simplifications have been done. First, to define the freight transport fleet, all the range of possible truck sizes have been reduced to 3 categories: light, medium and heavy trucks. The main characteristics of the fleet are described in Table 6.2.

Truck type	Fleet (Trucks x10 <sup>3</sup> )	Distance (VKM x10 <sup>6</sup> )	Cargo (Tonnes)	Transportation (tkm x10 <sup>6</sup> )
Light	224.1	10.09	0.7	7.06
Medium	72.6	3.63	2.8	10.16
Heavy	24.7	1.61	12.0	19.29

Source:<sup>88,31</sup>

Table 6.2: Fleet characteristics in 2020

At the base year all the trucks are considered to have exclusively internal combustion engines using diesel fuel, because this is currently the widely prevailing technology. Besides diesel, two other truck technologies are considered on the study: Hybrid (diesel-electric) and electric. The transport analysis intended in this application corresponds to a long-term perspective, that has 2020 as base year and reaches 2050 as final horizon; meaning that the number of periods  $k$  is 6, each corresponding to 5 years. Even if the time horizon is quite long, three decades, we do not consider potential evolution of the capacities of the trucks/technologies because the profile of evolution is quite difficult to evaluate. Thus characteristics like efficiency, maximum distance per year and load capacity have been fixed to constant values chosen as a mean value between the current ones and possible values in 2050, evaluated for Ecuador<sup>31</sup>. The only value that evolves over time is the price of trucks. Today, greener vehicles are more expensive than diesel ones, which are considered a mature technology. It is considered this price gap will narrow in the coming decades, when electric and hybrid trucks become more popular. Table 6.3 presents the values of the parameters and prices for the different truck technologies.

Another consideration of the model is that all the company sizes existing in Ecuador would be represented by 4 company types. The size of the company is directly related with the number of vehicles in its fleet (100, 200, 250 and 350 trucks). The size of each company's fleet is not supposed to evolve in time, thus

Year		2020	2030	2040	2050
Investment	Diesel	100.0	99.5	99.2	99.0
Trucks prices (US\$ x 10 <sup>3</sup> )	Hybrid	160.0	140.8	120.0	112.0
	Electric	495	346.5	247.5	198.0

Period		Mean values 2020 - 2050		
Efficiency (MJ/km)	Diesel	9.48		
	Hybrid	6.98		
	Electric	4.15		
Distance (km x 10 <sup>3</sup> )	Diesel	65.0		
	Hybrid	65.0		
	Electric	53.0		
Load capacity (tonnes)	Diesel	15.0		
	Hybrid	15.0		
	Electric	12.5		

Source:<sup>89</sup>

Table 6.3: truck parameters

the number of vehicles in companies remain the same until 2050.

The model was conceived to evaluate different scenarios and different parameters, allowing to perform sensibility analysis on company budgets or vehicle prices. To perform these changes, the model inputs are provided by means of data tables representing each of the evaluated scenarios.

## 6.5.2 Results and discussion

The application model described in Section 6.3 is used to assess freight transport trends in Ecuador. The model minimizes the carbon emission while determining the best carbon tax policy of the government and the modified fleet composition reaching this minimum value. As a byproduct of the minimization, the evolution the carbon budget required is depicted and determines the transition to cleaner technologies by modifying the fleet composition through the share  $S$  of each truck type/technology. A first analysis intends to compare the behaviour of Company 1, that is the smallest with 100 vehicles and the lower budget, and Company 4 that has 350 vehicles and a budget 3.5 times higher than the budget allocated to Company 1. The results from this simulation are presented in Figure 6.4 where the evolution of the fleet composition is depicted. The first thing that stands out is that both companies attain a fleet free of diesel vehicles in 2050 with a fairly similar path followed by each technology. A small difference between the share of cleaner vehicles is observed in 2050. With budgets proportional to the fleet size, there is thus no difference in the trend of technology change between companies.

In order to study the importance of the budget on the company transition to

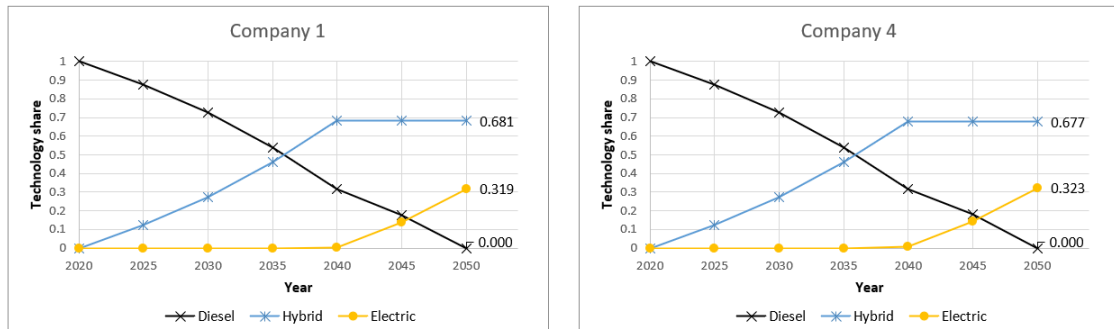

Figure 6.4: Companies with budget proportional to the fleet size

a cleaner fleet, a sensitivity analysis in company 1 is performed by increasing its budget. In Figure 6.5 the evolution of the fleet composition is evaluated using three budgets, the first one is 50000 US\$/year, budget 2 is 100000 US\$/year and the last budget is 200000 US\$/year. The positive impact of a higher company

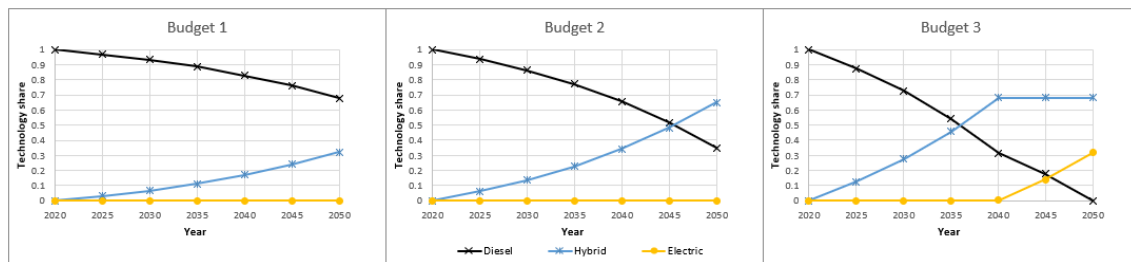

Figure 6.5: Technology evolution with budget

budget on the technological transition is clear, with Budget 1 the Diesel trucks reduce their share to 70% and the rest of the fleet become hybrid. By doubling the budget, this relation switches over obtaining almost 70% for hybrid vehicles but still no electric trucks in the fleet. With the highest budget the transition to cleaner technologies is faster, electric trucks attaining a quarter share of the fleet and the rest of the trucks being hybrids. Due to the high cost of electric vehicles, a large enough budget must be devoted to have battery electric trucks (BET) in the company fleet. Besides the carbon tax, another policy that could be tested in the model is a subsidy to reduce the price gap between diesel and BETs, or even better, to devote the revenue from the carbon tax to clean vehicles subsidies, but this analysis is out of the scope of this study.

Maintaining the budget of 200000 US\$/year used in the last simulation, let us now analyse the carbon tax obtained as result of the optimization. Figure 6.6 shows a counter-intuitive result, with a carbon tax that is null until 2040 and then increases very fast on the last two periods, reaching a value of 6.9 US\$ per kilogram of CO<sub>2</sub>.

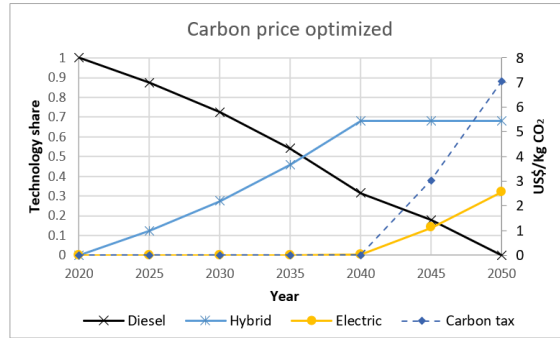

Figure 6.6: Carbon tax optimized

The above results seems to show that when the carbon tax is "freely optimized", that no evolution profile is imposed throughout the time horizon then, the optimized profile leads to too high values compared with referential values<sup>90</sup>. Therefore we conducted a sensitivity analysis by fixing, from the end of the first year, the carbon tax to a constant value ranging from 1.5 to 3 US\$ per kg of CO<sub>2</sub>, see Figure 6.7.

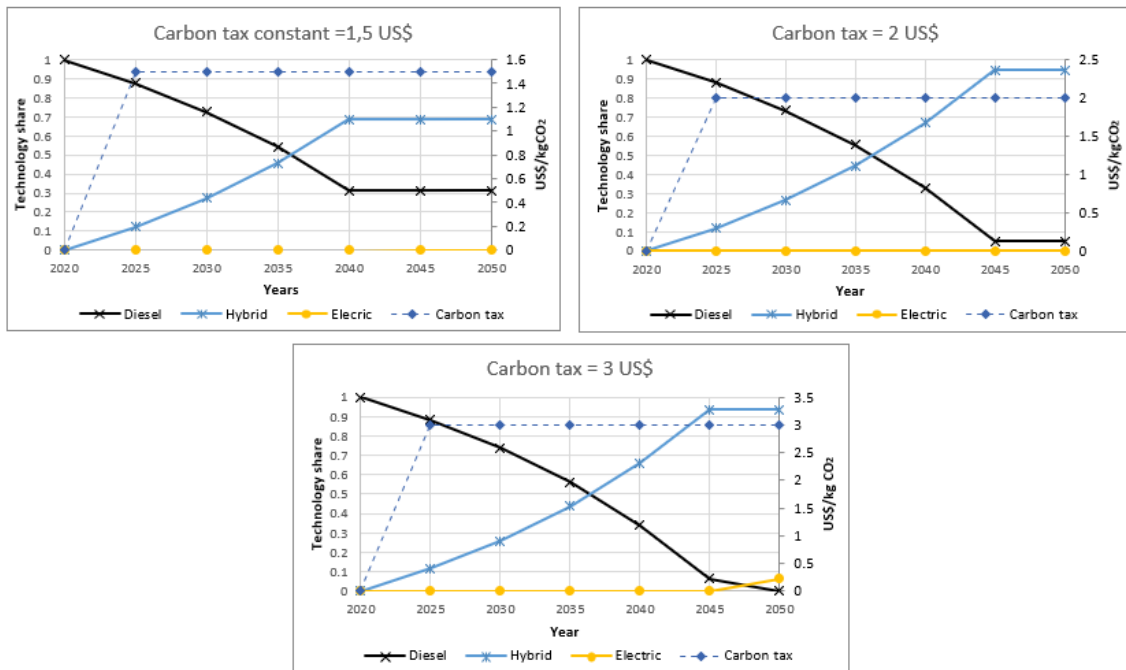

Figure 6.7: Carbon tax fixed as constant values 1.5, 2 and 3 US\$

For values lower than 1.5 US\$ the model didn't converge to a solution. It must be noticed that for a constant carbon tax of 1.5 US\$ the model reaches an equilibrium between hybrid and diesel trucks, while for a tax of 3US\$ almost all the fleet is converted to hybrid vehicles and at the end of the analysis a small portion of electric vehicles appears.

Another approach that we tested to control the carbon tax is by constraining its maximum value by adding such a constraint in the carbon tax model ( $p$ ). Figure 6.8 presents the results from a mode's run where the carbon tax was limited to 5 and to 2 US\$. In both cases the fleet by 2050 is virtually free of diesel vehicles,

even if for the lower carbon tax bound, no electric vehicles are used during the time horizon.

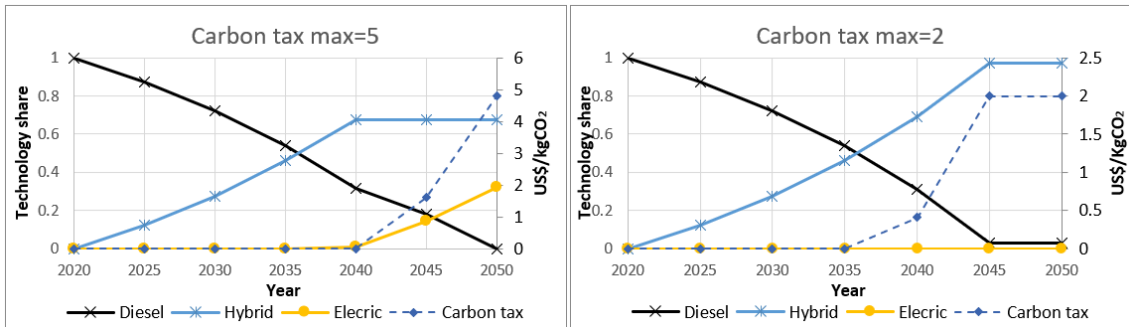

Figure 6.8: limited value for carbon tax

Finally, in the last simulation, we forced the carbon tax to follow a linear profile. The slope of the line described by the carbon tax becomes then a variable of the carbon tax model ( $P$ ). As it can be seen in Figure 6.9, the evolution to cleaner technologies for this linear carbon tax is very similar to the ones obtained in Figure 6.6 and Figure 6.8 both with higher carbon taxes. Under this carbon profile, by 2050 the diesel trucks are fully replaced by the other technologies, specially by hybrid vehicles that represents almost 70% of the fleet.

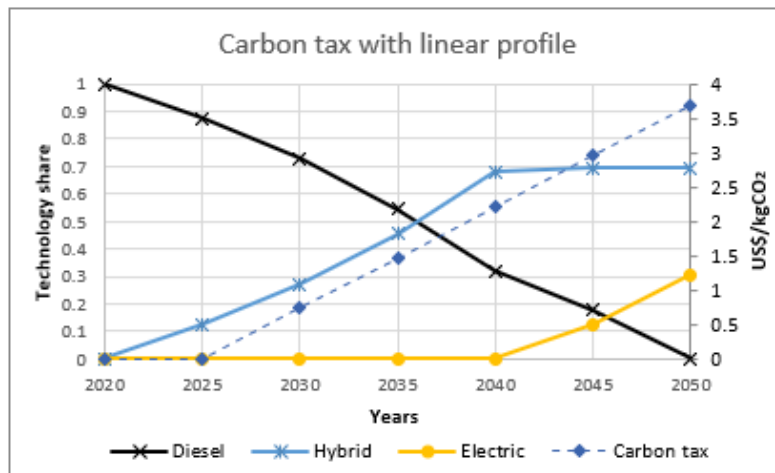

Figure 6.9: Linear Carbon tax optimized

The linear profile is clearly the most interesting outcome. First, the carbon tax resulting from this optimization is almost half of the one obtained in the free optimization approach while the transition is quite similar. Also, having an increasing carbon tax sends the message that polluting technologies will become more expensive in the future. From the analysis performed in this work, a carbon tax with a linear optimized profile would be the most advisable form to implement this policy.

Nevertheless a carbon tax at 3.5 US\$/kgCO<sub>2</sub> is too high compared to the carbon tax corridor recommended by the world Bank<sup>90</sup>. This comes from the fact that our analysis is optimizing with the aim to reduce the CO<sub>2</sub> emission at their maximum, thus, as it can be observed in the figures above, often reducing the

---

number of diesel vehicles to zero. This represents in a sense an "ideal situation" but it could appear to be extrem. A more reasonable approach could be to have as a target of a certain maximum percentage  $b_t$  of carbon-based vehicles (diesel in our application) at the time horizon of 2050. This could be easily inserted into the carbon tax model by adding a constraint like  $S_{e,t}^K \leq b_t$ , for any  $e = 1, E$  and any  $t = 1, T_c$ .

## 6.6 Conclusion

The main contribution of this study is the analysis of a transition towards a cleaner transport using a Single Leader Multi Follower Game approach. To the best of our knowledge this approach has not been used before in a similar subject. In addition to this innovation, the resolution of a SLMFG by means of a Special Order Set type 1 technique is also an novelty of this work. Moreover, the model developed represents the first steps of a powerful analysis tool that could become much more complex. The model created was tested for Ecuador's transport freight with promising results. It is considered that the bilevel structure of a Single-Leader-Multi-Follower model captures the interaction between the government and the freight companies while a carbon tax policy is applied. The novel application of the SOS1 technique was an adequate approach to solve SLMF problems. The model allowed to test different variations on the policy and some of them correspond to a fully achieved transition to greener vehicles. Hybrid trucks are close to compete with diesel trucks, on the contrary BET would require specific policies to compete with diesel or hybrid technologies.

The model represents a tool to evaluate different scenarios allowing to run sensitivity analysis that would contribute to create robust policies to endorse a green transition. Future work could include other carbon tax profiles than the linear one or the incorporation of more operating costs like battery replacement or more technologies like Hydrogen or could generate a scenario were the money collected with the carbon tax is used to reduce battery electric trucks price.

---



# Chapter 7

## Conclusions and Future Perspectives

### 7.1 Conclusions

The decarbonisation pathways explored in this study are consistent with the objective of keeping the average global temperature increase below 1.5°C or 2°C by the end of the century, with respect to pre-industrial levels. The analysis was carried out for Ecuador, whose transport sector is similar to that of many countries. It is largely dominated by road transport and dependent on fossil fuels. Thus, the conclusions presented can be extrapolated to other countries.

The decarbonisation pathways analysed in this study represent a radical change in the direction that society and therefore technology development have taken in the last century. For this reason, it is necessary to plan with a long-term vision how society should evolve to reduce the effects of climate change. Energy planning models are useful tools to study possible decarbonisation futures. However, it must be understood that such models are not crystal balls; their objective is not to predict the future, but, give insights for good decisions. Each type of model has specific characteristics (strengths and weakness) and therefore it is necessary to combine several models to achieve a better understanding of the reality.

Optimization models, such as ELENA, are driven by the premise of supplying a long-term demand with minimum total cost, subject to restrictions. It is then necessary to have models that complement these characteristics, helping for example to understand how that demand may evolve. This is where sectorial tools such as the urbs model described in Chapter 3 and the SLMF model presented in Chapter 6 come into play. The first is a dispatch model that provides insights into the load curves of the electricity sector while the second is a pioneering model that aims to provide inputs about how consumer preferences may evolve in the face of a given policy.

In the soft-link interaction that was presented between the ELENA and urbs models a demand-side management is assessed. The dispatch analysis determined that it is possible to have an electricity matrix based exclusively on renewable energies in 2050 operating in a reliable way, even considering the increase in demand due to the electrification of land transport calculated in ELENA. The urbs' dispatch results shown that it is possible to supply electricity demands at peak hours with a power matrix highly based on renewable energy. Instead of

---

representing an additional burden to the electric system, with adequate public policies, electric transport could become a stabilizer of the electric load curve. By applying economic penalties to electric consumption at peak hours and lower rates at night hours, electric vehicles (EV) would be used as batteries that discharge to avoid costly electricity rates and use low-cost electricity to charge during the night. This would create a consumption shift, reducing the demand at peak hours, avoiding the use of thermal generation from fossil sources. Besides, the use of electric vehicles as stabilizers of the load curves would increase the plant factor for the existing power infrastructure avoiding the need of new power plants. Also, the dispatch model showed a big electricity share from photovoltaic technology during the day, which could also be used to charge EV batteries.

The results of the SLMF model showed that in order to replace 70% of the freight fleet with hybrid trucks by 2050 requires a carbon tax more than 10 times higher than the most expensive carbon tax existing today. Such a high tax might raise some eyebrows. However, the value reflects once again the limitations of working with a single model. Creating a carbon tax for a specific sector fails to appreciate the synergies that need to exist between different energy sectors. In other words, the results of the SLMF model show the optimal value of a tax implemented as a single vector of change towards the decarbonisation of freight transport. Contrasting the results of the SLMF model with those of ELENA reveals two things. First, ELENA shows that decarbonising freight transport could be optional, or could be done with different ambitiousness levels, to achieve the environmental targets of a 1.5°C scenario. By taking an integrated view, the model finds economically less costly pathways, such as reforestation, carbon capture in the power sector, or electrification of other energy sectors (e.g. residential). Second, in the SLMF model transport electrification is the only pathway to reduce emissions, while ELENA has a wider range of energy options such as natural gas, biofuels and, in a more recent version of the model, hydrogen. The SLMF model, being a new model, has not yet evolved to have more technological options, and for the moment this is one of its limitations.

The study conducted for the buildings sector, found in Chapter 4, represents an opportunity to assess the current situation of local decarbonisation in a global picture. This study shows that the situation in Latin America is very different in relation to other countries in its perspective to decarbonise the Residential and Commercial Sectors. Ecuador should increase its electrification targets in the Buildings Sector in order to take advantage of its renewable electricity matrix as a key element for its decarbonisation. The commercial sector, that has a high consumption during day hours could benefit from the availability of electricity from PV panels as shown by the urbs model.

An integrated model is able to show where it is less costly to achieve decarbonisation or in which sectors policies should be focused more. Integrated analysis is a good guide to determine the level of effort required to decarbonise a sector. On the other hand, the analysis of a sector-specific model will help to envision how much the sector can be decarbonised by a given policy. So, the specifics of each sector must be assessed closely by a sectorial model, while the big picture is governed by an integrated model.

---

## 7.2 Future perspectives

My experience with the integrated ELENA model has shown me that a model must be continuously updated. The structure of the model already includes the regions of Highlands, Coast and Amazon, but it would be very positive to include the island region of Galapagos in order to be able to model the energy system of this emblematic region in order to define exclusive policies for it.

In order to develop more appropriate energy scenarios, further work must be done on the drivers that govern demand in the models. To this end, in the transport sector, the SLMF model should be extended to include more technologies in the freight segment. Less ambitious decarbonisation targets should also be pursued with the SLMF model until a carbon tax value, less controversial than the current one, is found.

Another pending issue is to be able to work together the SLMF and ELENA models. Once the SLMF model is modified and a lower tax value is obtained, this tax will be included in the structure of the ELENA model to analyse the effect it has on the electrification of transport. In turn, the new electrification percentages can be used in the SLMF model to calculate another value for the tax and see if it is possible to reach an equilibrium situation between the value of the tax and the degree of transport electrification.

The experience of the SLMF model in the transport sector invites to extend this exercise to other energy sectors that can be represented by hierarchical bi-level relationships. Now that there is a growing market for the purchase and sale of electricity generated with distributed systems, the relationship between consumers and prosumers could be modelled within a multi-leader-multi-follower structure.

Work must continue with dispatch models such as urbs to verify a reliable operation of the power system, and to assess the impacts of higher electrification in other consumption sectors, not only transport, whose electricity consumption will continue to grow in the future. It is also necessary to take advantage of the tools provided by a dispatch model to analyse the role of electric vehicles as load curve stabilizers. This analysis should also be extended to understand the role that smart grids could achieve related to consumption shifting. Economic incentives could be applied to foster the deployment of such technology.

---

# Bibliography

- [1] Broecker, W. S. Climatic Change: Are We on the Brink of a Pronounced Global Warming? *Science* **1975**, *189*, 460–463.
- [2] Starfield, A. M. *How to model it*; Burgess International Group, 1994.
- [3] IPCC, *Climate Change 2021: The Physical Science Basis. Contribution of Working Group I to the Sixth Assessment Report of the Intergovernmental Panel on Climate Change*; Cambridge University Press: Cambridge, United Kingdom and New York, NY, USA, 2021; Vol. In Press.
- [4] Oxford-UK, 4 Degrees and Beyond International Climate Conference: Implications of a Global Climate Change of 4+ Degrees for People, Ecosystems and the Earth-system.
- [5] Meyer, A. L. S.; Bentley, J.; Odoulami, R. C.; Pigot, A. L.; Trisos, C. H. Risks to biodiversity from temperature overshoot pathways. *Philosophical Transactions of the Royal Society B: Biological Sciences* **2022**, 377.
- [6] IPCC, In *Climate Change 2021: The Physical Science Basis. Contribution of Working Group I to the Sixth Assessment Report of the Intergovernmental Panel on Climate Change*; Masson-Delmotte, V. et al. , Eds.; Cambridge University Press: Cambridge, United Kingdom and New York, NY, USA, 2021; pp 3–32.
- [7] Ritchie, H.; Roser, M.; Rosado, P. Energy. *Our World in Data* **2022**, <https://ourworldindata.org/energy>.
- [8] Administration For War Petroleum, In *A history of the petroleum administration for war, 1941-1945*; Frey, J. W., Chandler Ide, H., Eds.; University Press of the Pacific, 2005.
- [9] Carley, S.; Konisky, D. M. The justice and equity implications of the clean energy transition. *Nature Energy* **2020**, *5*, 569–577.
- [10] de Energía (OLADE), O. L. *Manual de Planificaciín Energética*; OLADE, 2017.
- [11] Dixon, P., Jorgenson, D., Eds. *Handbook of Computable General Equilibrium Modeling*, 1st ed.; Elsevier, 2012; Vol. 1.
- [12] Arnaud Diemer, N. S., Ganna Gladkykh *Integrated Assessment Models and other climate policy tools*; Oeconomia, 2019; Chapter Integrated Assessment Models (IAM) How to integrate Economics, Energy and Climate?

- 
- [13] Hourcade, J.-C.; Jaccard, M.; Bataille, C.; Gherzi, F. Hybrid Modeling: New Answers to Old Challenges Introduction to the Special Issue of The Energy Journal. *The Energy Journal* **2006**, SI2006.
- [14] Calvopiña, M.; Vásquez, J.; Coral, M.; Romero-Álvarez, D.; García Bereguian, M. A.; Orlando, A. Leptospirosis: Morbidity, mortality, and spatial distribution of hospitalized cases in Ecuador. A nationwide study 2000-2020. *PLoS Neglected Tropical Diseases* **2022**, 16.
- [15] Cardenas, V.; Echeverria, D.; Cepeda, J. Determinación de los Modelos Estocásticos de Generación de las Centrales del Sistema Nacional Interconectado. *Revista Técnica "Energía"* **2016**, 12.
- [16] Carvajal, P. E.; Li, F. G.; Soria, R.; Cronin, J.; Anandarajah, G.; Mulugetta, Y. Large hydropower, decarbonisation and climate change uncertainty: Modelling power sector pathways for Ecuador. *Energy Strategy Reviews* **2019**, 23, 86–99.
- [17] Aussel, D.; Bendotti, P.; Pištěk, M. Nash equilibrium in a pay-as-bid electricity market: Part 1—existence and characterization. *Optimization* **2017**, 66, 1013–1025.
- [18] Allevi, E.; Aussel, D.; Riccardi, R. On an equilibrium problem with complementarity constraints formulation of pay-as-clear electricity market with demand elasticity. *J. Global Optim.* **2018**, 70, 329–346.
- [19] Xi, H.; Aussel, D.; Liu, W.; Waller, S. T.; Rey, D. Single-leader multi-follower games for the regulation of two-sided mobility-as-a-service markets. *Eur. J. Oper. Res.* **2022**, to appear.
- [20] Stockholm Environment Institute, Long-range Energy Alternatives Planning System User Guide for LEAP 2005. Stockholm Environment Institute, 2005.
- [21] Salinas Herrera, D. A. Expansión de la Generación en el Ecuador - Evaluación del Riesgo del Diferimiento de las Inversiones. 2016; <http://bibdigital.epn.edu.ec/handle/15000/3785>.
- [22] Rochedo, P. R. R.; Soares-Filho, B.; Schaeffer, R.; Viola, E.; Szklo, A.; Lucena, A. F. P.; Koberle, A.; Davis, J. L.; Rajão, R.; Rathmann, R. The threat of political bargaining to climate mitigation in Brazil. *Nature Climate Change* **2018**, 8, 695–698.
- [23] Rath-Nagel, S.; Voss, A. Energy models for planning and policy assessment. *European Journal of Operational Research* **1981**, 8, 99–114.
- [24] Hofbauer, L.; McDowall, W.; Pye, S. Challenges and opportunities for energy system modelling to foster multi-level governance of energy transitions. *Renewable and Sustainable Energy Reviews* **2022**, 161, 112330.
- [25] United Nations Climate Change About the secretariat. <https://unfccc.int/about-us/about-the-secretariat#:~:text=The%20ultimate%20objective%20of%20all,naturally%20and%20enables%20sustainable%20development.>, Accessed: 2023-01-10.
-

- 
- [26] *Modelling Nuclear Energy Systems with MESSAGE: A User's Guide*; Nuclear Energy Series NG-T-5.2; INTERNATIONAL ATOMIC ENERGY AGENCY: Vienna, 2016.
- [27] IIGE, I. d. I. G. y. E. *Balance Energético Nacional 2020*; 2020.
- [28] de Energía y Recursos Naturales No Renovables, M. *Plan Maestro de Electricidad 2018 - 2027*; 2020.
- [29] Hinicio, *Estrategia nacional de Electromobilidad para Ecuador*; 2121.
- [30] *Future of Freight: a long-term plan*; 2022.
- [31] Daniel Villamar, Rafael Soria, Pedro Rochedo, Alexandre Szklo, Mariana Imperio, Pablo Carvajal, Roberto Schaeffer, Long-term deep decarbonisation pathways for Ecuador: Insights from an integrated assessment model. *Energy Strategy Reviews* **2021**, 35.
- [32] Godoy, J. C.; Villamar, D.; Soria, R.; Vaca, C.; Hamacher, T.; Ordóñez, F. Preparing the Ecuador's Power Sector to Enable a Large-Scale Electric Land Transport. *Energies* **2021**, 14.
- [33] Sebastián Espinoza,; Verónica Guayanlema,; Paola Ramírez,; Guillermo Fernández, *Escenarios de Prospectiva Energética Para Ecuador a 2050*; 2016.
- [34] International Energy Agency, U. N. E. P. 2018 Global Status Report: Towards a Zero-emission, Efficient and Resilient Buildings and Construction Sector. 2018; <https://wedocs.unep.org/20.500.11822/27140>.
- [35] von Neumann, J.; Morgenstern, O.; Rubinstein, A. *Theory of Games and Economic Behavior (60th Anniversary Commemorative Edition)*; Princeton University Press, 1944.
- [36] Nash, J. F. Equilibrium Points in N-Person Games. *Proceedings of the National Academy of Sciences of the United States of America* **1950**, 36, 48–49.
- [37] Debreu, G. A Social Equilibrium Existence Theorem. *Proceedings of the National Academy of Sciences of the United States of America* **1952**, 38, 886–893.
- [38] Arrow, K. J.; Debreu, G. Existence of an Equilibrium for a Competitive Economy. *Econometrica* **1954**, 22, 265–290.
- [39] Reny, P. J. Nash Equilibrium in Discontinuous Games. *Economic Theory* **2016**, 61, 553–569.
- [40] Aussel, D.; Cao Van, K.; Salas, D. Existence results for generalized Nash equilibrium problems under continuity-like properties of sublevel sets. *SIAM J. Optim.* **2021**, 31, 2784–2806.
- [41] Stackelberg, H. *Market Structure and Equilibrium*; 1934.
- [42] Haywood, O. G. Military Decision and Game Theory. *Journal of the Operations Research Society of America* **1954**, 2, 365–385.
-

- 
- [43] Schelling, T. *The Strategy of Conflict*; Library of Congress, 1960.
- [44] SCHELLING, T. C. *Arms and Influence*; Yale University Press, 1966.
- [45] van Damme, E. In *Stability and Perfection of Nash Equilibria*; van Damme, E., Ed.; Springer Berlin Heidelberg: Berlin, Heidelberg, 1991; pp 214–258.
- [46] Zara, S.; Dinar, A.; Patrone, F. Cooperative Game Theory and Its Application to Natural, Environmental, and Water Resource Issues : 2. Application to Natural and Environmental Resources. 2006.
- [47] Aussel, D.; Cao Van, K.; Salas, D. Optimal design of exchange water networks with control inputs in Eco-Industrial Parks. *Energy Economics* **2023**, to appear, 25pp.
- [48] Salas, D.; Cao Van, K.; Aussel, D.; Montastruc, L. Optimal design of exchange networks with blind inputs and its application to Eco-Industrial parks. *Computers & Chemical Engineering* **2020**, *143*, 107053.
- [49] Ramos, M.; Boix, M.; Aussel, D.; Ludovic, M.; Domenech, S. Water integration in Eco-Industrial Parks Using a Multi-Leader-Follower Approach. *Computers & Chemical Engineering* **2016**, *87*, 190–207.
- [50] Aussel, D.; Lepaul, S.; von Niederhäusern, L. A multi-leader-follower game for energy demand-side management. *Optimization* **2022**, *71*, 4571–4601.
- [51] Aussel, D.; Brotcorne, L.; Lepaul, S.; von Niederhäusern, L. A trilevel model for best response in energy demand-side management. *European J. Oper. Res.* **2020**, *281*, 299–315.
- [52] Aussel, D.; Bendotti, P.; Pištěk, M. Nash equilibrium in a pay-as-bid electricity market Part 2—best response of a producer. *Optimization* **2017**, *66*, 1027–1053.
- [53] Heitsch, H.; Henrion, R.; Kleinert, T.; Schmidt, M. On convex lower-level black-box constraints in bilevel optimization with an application to gas market models with chance constraints. *J. Global Optim.* **2022**, *84*, 651–685.
- [54] Egerer, J.; Grimm, V.; Kleinert, T.; Schmidt, M.; Zöttl, G. The impact of neighboring markets on renewable locations, transmission expansion, and generation investment. *European J. Oper. Res.* **2021**, *292*, 696–713.
- [55] Ghogh, B.; Ghodsi, A.; Karray, F.; Crowley, M. KKT Conditions, First-Order and Second-Order Optimization, and Distributed Optimization: Tutorial and Survey. 2021; <https://arxiv.org/abs/2110.01858>.
- [56] Peterson, D. W. A Review of Constraint Qualifications in Finite-Dimensional Spaces. *SIAM Review* **1973**, *15*, 639–654.
- [57] Hollander, Y.; Prashker, J. N. The Applicability of Non-Cooperative Game Theory in Transport Analysis. *Transportation* **2006**, *33*, 481–496.
-



- 
- [58] WARDROP, J. G. ROAD PAPER. SOME THEORETICAL ASPECTS OF ROAD TRAFFIC RESEARCH. *Proceedings of the Institution of Civil Engineers* **1952**, *1*, 325–362.
- [59] Facchinei, F.; Kanzow, C. Generalized Nash Equilibrium Problems. *Annals of Operations Research* **2010**, *175*, 177–211.
- [60] Hu, M.; Fukushima, M. Multi-Leader-Follower Games: Models, Methods And Applications. *Journal of the Operations Research Society of Japan* **2015**, *58*, 1–23.
- [61] Allevi, E.; Aussel, D.; Riccardi, R. On an Equilibrium Problem with Complementarity Constraints Formulation of Pay-as-Clear Electricity Market with Demand Elasticity. *Journal of Global Optimization* **2018**, *70*, 329–346.
- [62] Dempe, S. *Foundations of Bilevel Programming*; Kluwer Academic Publishers, 2002.
- [63] Amouzegara, M.; Moshirvazirib, K. Determining Optimal Pollution Control Policies: An Application of Bilevel Programming. *European Journal of Operational Research* **1999**, *119*, 100–120.
- [64] Fampa, M.; Barroso, L.; Candal, D.; Simonetti, L. Bilevel Optimization Applied to Strategic Pricing in Competitive Electricity Markets. *Computational Optimization and Applications* **2008**, *39*, 121–142.
- [65] Bard, J. *Practical Bilevel Optimization: Algorithms and Applications*, 1st ed.; 30; Springer US, 1998.
- [66] June, L.; Yuxin, F.; Zhong, C.; Yue, Z. Pessimistic Bilevel Optimization: A Survey. *International Journal of Computational Intelligence Systems* **2018**, *Vol. 11*, 725–736.
- [67] Aussel, D.; Svensson, A. *A Short State of the Art on Multi-Leader-Follower Game*; 2020.
- [68] Dempe, S.; Dutta, J. Is Bilevel Programming a Special Case of a Mathematical Program with Complementarity Constraints? *Mathematical Programming* **2012**, *131*, 37–48.
- [69] Aussel, D.; Svensson, A. Is Pessimistic Bilevel Programming a Special Case of a Mathematical Program with Complementarity Constraints? *Journal of Optimization Theory and Applications* **2019**, *181*, 504–520.
- [70] Kulkarni, A. A.; Shanbhag, U. V. A shared-constraint approach to multi-leader multi-follower games. *Set-Valued Var. Anal.* **2014**, *22*, 691–720.
- [71] B. F. Hobbs,; C. B. Metzler,; J. -. Pang, Strategic Gaming Analysis for Electric Power Systems: An MPEC Approach. *IEEE Transactions on Power Systems* **2000**, *15*, 638–645.
- [72] Ramos, M.; Boix, M.; Aussel, D.; Montastruc, L.; Domenech, S. Water Integration in Eco-Industrial Parks Using A multi-Leader-Follower Approach. *Computers and Chemical Engineering* **2016**, *87*, 190–207.
-

- 
- [73] Leyffer, S.; Munson, T. Solving multi-leader–common-follower games. *Optimization Methods and Software* **2010**, *25*, 601–623.
- [74] Pineda, S.; Morales, J. M. Solving Linear Bilevel Problems Using Big-Ms: Not All That Glitters Is Gold. *IEEE Transactions on Power Systems* **2019**, *34*, 2469–2471.
- [75] Beck, Y.; Schmidt, M. A Gentle and Incomplete Introduction to Bilevel Optimization. **2021**,
- [76] Aussel, D.; Schmidt, M. An sos1-reformulation of a class of linear single-leader multi-follower problems. 2023; Preprint.
- [77] Agency, I. E. Energy Technology Perspectives 2020. 2020; <https://www.iea.org/reports/energy-technology-perspectives-2020>.
- [78] Forum, T. I. T. Towards Road Freight Decarbonisation Trends, Measures and Policies. 2018; no note.
- [79] Aussel, D.; Svensson, A. Some remarks about existence of equilibria, and the validity of the epcc reformulation for multi-leader-follower games. *Journal of Nonlinear and Convex Analysis* **2018**, *19*, 1141–1162.
- [80] Aussel, D.; Bouza, G.; Dempe, S.; Lepaul, S. *Multi-leader Disjoint-follower Game: Formulation as a Bilevel Optimization Problem*; Preprint; TU Bergakademie Freiberg, Fakultät für Mathematik und Informatik, 2018.
- [81] Aussel, D.; Červinka, M.; Marechal, M. Deregulated electricity markets with thermal losses and production bounds: models and optimality conditions. *RAIRO Oper. Res.* **2016**, *50*, 19–38.
- [82] Ye, J. J.; Zhu, D. L.; Zhu, Q. J. Exact Penalization and Necessary Optimality Conditions for Generalized Bilevel Programming Problems. *SIAM Journal on Optimization* **1997**, *7*, 481–507.
- [83] Aussel, D.; Svensson, A. Towards tractable constraint qualifications for parametric optimisation problems and applications to generalised Nash games. *J. Optim. Theory Appl.* **2019**, *182*, 404–416.
- [84] Osmani, E. H.; Haddou, M.; Bensalem, N.; Abdallah, L. A new smoothing method for nonlinear complementarity problems involving  $Cal P_0$ -function. *Stat. Optim. Inf. Comput.* **2022**, *10*, 1267–1292.
- [85] Dussault, J.-P.; Haddou, M.; Migot, T. *Optimization, variational analysis and applications*; Springer Proc. Math. Stat.; Springer, Singapore, 2021; Vol. 355; pp 35–67.
- [86] Yu, B.; Mitchell, J. E.; Pang, J.-S. Solving linear programs with complementarity constraints using branch-and-cut. *Mathematical Programming Computation* **2018**, *11*, 267–310.
- [87] Corp, I. CPLEX 8.1 User’s Manual. IBM Corp, 2002.
-

- 
- [88] Hidalgo, G.; León, J.; Chaves, R. *Anuario Estadístico de Transporte*; 2020.
- [89] Villamar, D.; Soria, R.; Rochedo, P.; Szklo, A.; Imperio, M.; Carvajal, P.; Schaeffer, R. Long-term deep decarbonisation pathways for ecuador: Insights from an integrated assessment model. *Energy Strategy Reviews* **2021**, *35*, 100637.
- [90] *State and Trends of Carbon Pricing 2021*; The World Bank, 2021.

---

## Appendices

Rewriting the  $C_F1$  to  $C_F8$  constraints

$$h_e^k(S_e) = \sum_{t=1}^T S_{e,t}^k - 1 = 0; \quad \forall k = 2, K$$

$$g_{Ie,t}^k(S_e) = S_{e,t}^k \geq 0; \quad \forall k = 2, K; \quad \forall t = 1, T$$

$$g_{IIe,t}^k(S_e) = 1 - S_{e,t}^k \geq 0; \quad \forall k = 2, K; \quad \forall t = 1, T$$

$$g_{IIIe}^2(S_e) = B_{e,2} - \sum_{t=T_c+1}^T [V_e^0 \times (S_{e,t}^2 - S_{e,t}^i) \times \mu_{t,2}] \\ - \sum_{t=1}^T [S_{e,t}^2 \times D_{t,2} \times \eta_{t,2} \times (p_2 \times G_t + F_{t,2})] \geq 0$$

$$g_{IVe}^k(S_e) = B_{e,k} - \sum_{t=T_c+1}^T [V_e^0 \times (S_{e,t}^k - S_{e,t}^{k-1}) \times \mu_{t,k}] \\ - \sum_{t=1}^T [S_{e,t}^k \times D_{t,k} \times \eta_{t,k} \times (p_k \times G_t + F_{t,k})] \geq 0; \quad \forall k = 3, K$$

$$g_{Ve,t}^k(S_e) = S_{e,t}^k - S_{e,t}^{k-1} \geq 0; \quad \forall t = T_c + 1, T; \quad \forall k = 3, K$$

$$g_{VIe,t}^2(S_e) = S_{e,t}^2 - S_{e,t}^i \geq 0; \quad \forall t = T_c + 1, T$$

$$g_{VIIe,t}^k(S_e) = S_{e,t}^{k-1} - S_{e,t}^k \geq 0; \quad \forall t = 1, T_c; \quad \forall k = 3, K$$

$$g_{VIIIe,t}^2(S_e) = S_{e,t}^i - S_{e,t}^2 \geq 0; \quad \forall t = 1, T_c$$

Derivatives of the functions  $Z$ ,  $h$  and  $g$

$$\nabla_{S_e} Z_e(S_e, p) = \begin{pmatrix} \left( \begin{array}{c} \frac{\partial Z_e}{\partial S_{e,1}^2} \\ \dots \\ \frac{\partial Z_e}{\partial S_{e,T_c}^2} \\ \frac{\partial Z_e}{\partial S_{e,T_c+1}^2} \\ \dots \\ \frac{\partial Z_e}{\partial S_{e,T-1}^2} \\ \frac{\partial Z_e}{\partial S_{e,T}^2} \end{array} \right) & \dots & \left( \begin{array}{c} \frac{\partial Z_e}{\partial S_{e,1}^k} \\ \dots \\ \frac{\partial Z_e}{\partial S_{e,T_c}^k} \\ \frac{\partial Z_e}{\partial S_{e,T_c+1}^k} \\ \dots \\ \frac{\partial Z_e}{\partial S_{e,T-1}^k} \\ \frac{\partial Z_e}{\partial S_{e,T}^k} \end{array} \right) & \dots & \left( \begin{array}{c} \frac{\partial Z_e}{\partial S_{e,1}^K} \\ \dots \\ \frac{\partial Z_e}{\partial S_{e,T_c}^K} \\ \frac{\partial Z_e}{\partial S_{e,T_c+1}^K} \\ \dots \\ \frac{\partial Z_e}{\partial S_{e,T-1}^K} \\ \frac{\partial Z_e}{\partial S_{e,T}^K} \end{array} \right) \end{pmatrix}$$

---

$$\begin{pmatrix} \frac{\partial Z_e}{\partial S_{e,1}^2} \\ \dots \\ \frac{\partial Z_e}{\partial S_{e,T_c}^2} \\ \frac{\partial Z_e}{\partial S_{e,T_c+1}^2} \\ \dots \\ \frac{\partial Z_e}{\partial S_{e,T-1}^2} \\ \frac{\partial Z_e}{\partial S_{e,T}^2} \end{pmatrix} = \begin{pmatrix} V_e^0[D_{1,2} \times \eta_{1,2} \times (p_2 \times G_1 + F_{1,2})] \\ \dots \\ V_e^0[D_{T_c,2} \times \eta_{T_c,2} \times (p_2 \times G_{T_c} + F_{T_c,2})] \\ V_e^0[\mu_{T_c+1,2} + D_{T_c+1,2} \times \eta_{T_c+1,2} \times (p_2 \times G_{T_c+1} + F_{T_c+1,2}) - \mu_{T_c+1,3}] \\ \dots \\ V_e^0[\mu_{T-1,2} + D_{T-1,2} \times \eta_{T-1,2} \times (p_2 \times G_{T-1} + F_{T-1,2}) - \mu_{T-1,3}] \\ V_e^0[\mu_{T,2} + D_{T,2} \times \eta_{T,2} \times (p_2 \times G_T + F_{T,2}) - \mu_{T,3}] \end{pmatrix}$$

$$\begin{pmatrix} \frac{\partial Z_e}{\partial S_{e,1}^k} \\ \dots \\ \frac{\partial Z_e}{\partial S_{e,T_c}^k} \\ \frac{\partial Z_e}{\partial S_{e,T_c+1}^k} \\ \dots \\ \frac{\partial Z_e}{\partial S_{e,T-1}^k} \\ \frac{\partial Z_e}{\partial S_{e,T}^k} \end{pmatrix} = \begin{pmatrix} V_e^0[D_{1,k} \times \eta_{1,k} \times (p_k \times G_1 + F_{1,k})] \\ \dots \\ V_e^0[D_{T_c,k} \times \eta_{T_c,k} \times (p_k \times G_{T_c} + F_{T_c,k})] \\ V_e^0[\mu_{T_c+1,k} + D_{T_c+1,k} \times \eta_{T_c+1,k} \times (p_k \times G_{T_c+1} + F_{T_c+1,k}) - \mu_{T_c+1,k+1}] \\ \dots \\ V_e^0[\mu_{T-1,k} + D_{T-1,k} \times \eta_{T-1,k} \times (p_k \times G_{T-1} + F_{T-1,k}) - \mu_{T-1,k+1}] \\ V_e^0[\mu_{T,k} + D_{T,k} \times \eta_{T,k} \times (p_k \times G_T + F_{T,k}) - \mu_{T,k+1}] \end{pmatrix}$$

$$\begin{pmatrix} \frac{\partial Z_e}{\partial S_{e,1}^K} \\ \dots \\ \frac{\partial Z_e}{\partial S_{e,T_c}^K} \\ \frac{\partial Z_e}{\partial S_{e,T_c+1}^K} \\ \dots \\ \frac{\partial Z_e}{\partial S_{e,T-1}^K} \\ \frac{\partial Z_e}{\partial S_{e,T}^K} \end{pmatrix} = \begin{pmatrix} V_e^0[D_{1,K} \times \eta_{1,K} \times (p_K \times G_1 + F_{1,K})] \\ \dots \\ V_e^0[+D_{T_c,K} \times \eta_{T_c,K} \times (p_K \times G_{T_c} + F_{T_c,K})] \\ V_e^0[\mu_{T_c+1,K} + D_{T_c+1,K} \times \eta_{T_c+1,K} \times (p_K \times G_{T_c+1} + F_{T_c+1,K})] \\ \dots \\ V_e^0[\mu_{T-1,K} + D_{T-1,K} \times \eta_{T-1,K} \times (p_K \times G_{T-1} + F_{T-1,K})] \\ V_e^0[\mu_{T,K} + D_{T,K} \times \eta_{T,K} \times (p_K \times G_T + F_{T,K})] \end{pmatrix}$$

---

---

$$\begin{aligned}
\nabla_{S_e} h_e^k(S_e) &= \left( \begin{array}{c} \left( \begin{array}{c} \frac{\partial h_e^k}{\partial S_{e,1}^2} \\ \frac{\partial h_e^k}{\partial S_{e,2}^2} \\ \cdot \\ \cdot \\ \cdot \\ \frac{\partial h_e^k}{\partial S_{e,T}^2} \end{array} \right) \\ \left( \begin{array}{c} \frac{\partial h_e^k}{\partial S_{e,1}^3} \\ \frac{\partial h_e^k}{\partial S_{e,2}^3} \\ \cdot \\ \cdot \\ \cdot \\ \frac{\partial h_e^k}{\partial S_{e,T}^3} \end{array} \right) \\ \dots \\ \left( \begin{array}{c} \frac{\partial h_e^k}{\partial S_{e,1}^k} \\ \frac{\partial h_e^k}{\partial S_{e,2}^k} \\ \cdot \\ \cdot \\ \cdot \\ \frac{\partial h_e^k}{\partial S_{e,T}^k} \end{array} \right) \\ \dots \\ \left( \begin{array}{c} \frac{\partial h_e^k}{\partial S_{e,1}^K} \\ \frac{\partial h_e^k}{\partial S_{e,2}^K} \\ \cdot \\ \cdot \\ \cdot \\ \frac{\partial h_e^k}{\partial S_{e,T}^K} \end{array} \right) \end{array} \right) \\
&= \left( \begin{array}{c} \left( \begin{array}{c} 0 \\ 0 \\ \cdot \\ \cdot \\ \cdot \\ 0 \end{array} \right) \\ \left( \begin{array}{c} 0 \\ 0 \\ \cdot \\ \cdot \\ \cdot \\ 0 \end{array} \right) \\ \dots \\ \left( \begin{array}{c} 1 \\ 1 \\ \cdot \\ \cdot \\ \cdot \\ 1 \end{array} \right) \\ \dots \\ \left( \begin{array}{c} 0 \\ 0 \\ \cdot \\ \cdot \\ \cdot \\ 0 \end{array} \right) \end{array} \right)
\end{aligned}$$

$$\begin{aligned}
\nabla_{S_e} g_{1e,t}^k(S_e) &= \left( \begin{array}{c} \left( \begin{array}{c} \frac{\partial g_{1e,t}^k}{\partial S_{e,1}^2} \\ \frac{\partial g_{1e,t}^k}{\partial S_{e,2}^2} \\ \cdot \\ \cdot \\ \cdot \\ \frac{\partial g_{1e,t}^k}{\partial S_{e,T}^2} \end{array} \right) \\ \left( \begin{array}{c} \frac{\partial g_{1e,t}^k}{\partial S_{e,1}^3} \\ \frac{\partial g_{1e,t}^k}{\partial S_{e,2}^3} \\ \cdot \\ \cdot \\ \cdot \\ \frac{\partial g_{1e,t}^k}{\partial S_{e,T}^3} \end{array} \right) \\ \dots \\ \left( \begin{array}{c} \frac{\partial g_{1e,t}^k}{\partial S_{e,1}^k} \\ \dots \\ \dots \\ \frac{\partial g_{1e,t}^k}{\partial S_{e,t}^k} \\ \dots \\ \frac{\partial g_{1e,t}^k}{\partial S_{e,T}^k} \end{array} \right) \\ \dots \\ \left( \begin{array}{c} \frac{\partial g_{1e,t}^k}{\partial S_{e,1}^K} \\ \frac{\partial g_{1e,t}^k}{\partial S_{e,2}^K} \\ \cdot \\ \cdot \\ \cdot \\ \frac{\partial g_{1e,t}^k}{\partial S_{e,T}^K} \end{array} \right) \end{array} \right) \\
&= \left( \begin{array}{c} \left( \begin{array}{c} 0 \\ 0 \\ \cdot \\ \cdot \\ \cdot \\ 0 \end{array} \right) \\ \left( \begin{array}{c} 0 \\ 0 \\ \cdot \\ \cdot \\ \cdot \\ 0 \end{array} \right) \\ \dots \\ \left( \begin{array}{c} 0 \\ \dots \\ \dots \\ 1 \\ \dots \\ 0 \end{array} \right) \\ \dots \\ \left( \begin{array}{c} 0 \\ 0 \\ \cdot \\ \cdot \\ \cdot \\ 0 \end{array} \right) \end{array} \right)
\end{aligned}$$

$$\begin{aligned}
\nabla_{S_e} g_{\text{II}^e, t}^k(S_e) &= \begin{pmatrix} \left( \frac{\partial g_{\text{II}^e, t}^k}{\partial S_{e,1}^2} \right) & \left( \frac{\partial g_{\text{II}^e, t}^k}{\partial S_{e,1}^3} \right) & \left( \frac{\partial g_{\text{II}^e, t}^k}{\partial S_{e,1}^k} \right) & \left( \frac{\partial g_{\text{II}^e, t}^k}{\partial S_{e,1}^K} \right) \\ \frac{\partial g_{\text{II}^e, t}^k}{\partial S_{e,2}^2} & \frac{\partial g_{\text{II}^e, t}^k}{\partial S_{e,2}^3} & \dots & \frac{\partial g_{\text{II}^e, t}^k}{\partial S_{e,2}^K} \\ \cdot & \cdot & \dots & \cdot \\ \cdot & \cdot & \dots & \cdot \\ \frac{\partial g_{\text{II}^e, t}^k}{\partial S_{e,T}^2} & \frac{\partial g_{\text{II}^e, t}^k}{\partial S_{e,T}^3} & \left( \frac{\partial g_{\text{II}^e, t}^k}{\partial S_{e,T}^k} \right) & \left( \frac{\partial g_{\text{II}^e, t}^k}{\partial S_{e,T}^K} \right) \end{pmatrix} \\
&= \begin{pmatrix} \begin{pmatrix} 0 \\ 0 \\ \cdot \\ \cdot \\ 0 \end{pmatrix} & \begin{pmatrix} 0 \\ 0 \\ \cdot \\ \cdot \\ 0 \end{pmatrix} & \dots & \begin{pmatrix} 0 \\ \dots \\ \dots \\ -1 \\ \dots \\ 0 \end{pmatrix} & \dots & \begin{pmatrix} 0 \\ 0 \\ \cdot \\ \cdot \\ 0 \end{pmatrix} \end{pmatrix}
\end{aligned}$$

$$\begin{aligned}
\nabla_{S_e} g_{\text{III}^e}^2(S_e) &= \begin{pmatrix} \left( \frac{\partial g_{\text{III}^e}^k}{\partial S_{e,1}^2} \right) & \left( \frac{\partial g_{\text{III}^e}^k}{\partial S_{e,1}^{k-1}} \right) & \left( \frac{\partial g_{\text{III}^e}^k}{\partial S_{e,1}^k} \right) & \left( \frac{\partial g_{\text{III}^e}^k}{\partial S_{e,1}^K} \right) \\ \dots & \dots & \dots & \dots \\ \frac{\partial g_{\text{III}^e}^k}{\partial S_{e,T_c}^2} & \frac{\partial g_{\text{III}^e}^k}{\partial S_{e,2}^{k-1}} & \frac{\partial g_{\text{III}^e}^k}{\partial S_{e,2}^k} & \frac{\partial g_{\text{III}^e}^k}{\partial S_{e,2}^K} \\ \frac{\partial g_{\text{III}^e}^k}{\partial S_{e,T_c+1}^2} & \cdot & \cdot & \cdot \\ \dots & \cdot & \cdot & \cdot \\ \frac{\partial g_{\text{III}^e}^k}{\partial S_{e,T}^2} & \left( \frac{\partial g_{\text{III}^e}^k}{\partial S_{e,T}^{k-1}} \right) & \left( \frac{\partial g_{\text{III}^e}^k}{\partial S_{e,T}^k} \right) & \left( \frac{\partial g_{\text{III}^e}^k}{\partial S_{e,T}^K} \right) \end{pmatrix} \\
&= \begin{pmatrix} \begin{pmatrix} -D_{1,2} \times \eta_{1,2} \times (p_2 \times G_1 + F_{1,2}) \\ \dots \\ -D_{T_c,2} \times \eta_{T_c,2} \times (p_2 \times G_{T_c} + F_{T_c,2}) \\ -V_e^0 \times \mu_{T_{c+1},2} - D_{T_{c+1},2} \times \eta_{T_{c+1},2} \times (p_2 \times G_{T_{c+1}} + F_{T_{c+1},2}) \\ \dots \\ -V_e^0 \times \mu_{T,2} - D_{T,2} \times \eta_{T,2} \times (p_2 \times G_T + F_{T,2}) \end{pmatrix} & \dots & \begin{pmatrix} 0 \\ 0 \\ \cdot \\ \cdot \\ 0 \end{pmatrix} & \begin{pmatrix} 0 \\ 0 \\ \cdot \\ \cdot \\ 0 \end{pmatrix} & \dots & \begin{pmatrix} 0 \\ 0 \\ \cdot \\ \cdot \\ 0 \end{pmatrix} \end{pmatrix}
\end{aligned}$$

---

$$\begin{aligned}
\nabla_{S_e} g_{IV^e}^k(S_e) &= \left( \begin{array}{c} \left( \frac{\partial g_{IV^e}^k}{\partial S_{e,1}^2} \right) \\ \frac{\partial g_{IV^e}^k}{\partial S_{e,2}^2} \\ \cdot \\ \cdot \\ \frac{\partial g_{IV^e}^k}{\partial S_{e,T}^2} \end{array} \right) \cdots \left( \begin{array}{c} \frac{\partial g_{IV^e}^k}{\partial S_{e,1}^{k-1}} \\ \cdots \\ \frac{\partial g_{IV^e}^k}{\partial S_{e,T_c}^{k-1}} \\ \frac{\partial g_{IV^e}^k}{\partial S_{e,T_c+1}^{k-1}} \\ \cdots \\ \frac{\partial g_{IV^e}^k}{\partial S_{e,T}^{k-1}} \end{array} \right) \left( \begin{array}{c} \frac{\partial g_{IV^e}^k}{\partial S_{e,1}^k} \\ \cdots \\ \frac{\partial g_{IV^e}^k}{\partial S_{e,T_c}^k} \\ \frac{\partial g_{IV^e}^k}{\partial S_{e,T_c+1}^k} \\ \cdots \\ \frac{\partial g_{IV^e}^k}{\partial S_{e,T}^k} \end{array} \right) \cdots \left( \begin{array}{c} \frac{\partial g_{IV^e}^k}{\partial S_{e,1}^K} \\ \frac{\partial g_{IV^e}^k}{\partial S_{e,2}^K} \\ \cdot \\ \cdot \\ \frac{\partial g_{IV^e}^k}{\partial S_{e,T}^K} \end{array} \right) \\
= & \left( \begin{array}{c} \left( \begin{array}{c} 0 \\ 0 \\ \cdot \\ \cdot \\ 0 \end{array} \right) \\ \cdots \\ \left( \begin{array}{c} 0 \\ \cdots \\ 0 \\ V_e^0 \times \mu_{T_c+1,k-1} \\ \cdots \\ V_e^0 \times \mu_{T,k-1} \end{array} \right) \end{array} \right) \left( \begin{array}{c} -[D_{1,k} \times \eta_{1,k} \times (p_k \times G_1 + F_{1,k})] \\ \cdots \\ -[D_{T_c,k} \times \eta_{T_c,k} \times (p_k \times G_{T_c} + F_{T_c,k})] \\ -V_e^0 \times \mu_{T_c+1,k} - [D_{T_c+1,k} \times \eta_{T_c+1,k} \times (p_k \times G_{T_c+1} + F_{T_c+1,k})] \\ \cdots \\ -V_e^0 \times \mu_{T,k} - [D_{T,k} \times \eta_{T,k} \times (p_k \times G_T + F_{T,k})] \end{array} \right) \left( \begin{array}{c} 0 \\ 0 \\ \cdot \\ \cdot \\ 0 \end{array} \right)
\end{aligned}$$

---



$$\nabla_{S_e} g_{V_e, t}^k(S_e) = \left( \begin{array}{c} \left( \frac{\partial g_{V_e^k}}{\partial S_{e,1}^2} \right) \\ \frac{\partial g_{V_e^k}}{\partial S_{e,2}^2} \\ \cdot \\ \cdot \\ \frac{\partial g_{V_e^k}}{\partial S_{e,T}^2} \end{array} \right) \cdots \left( \begin{array}{c} \frac{\partial g_{V_e^k}}{\partial S_{e,1}^{k-1}} \\ \cdots \\ \frac{\partial g_{V_e^k}}{\partial S_{e,T_c}^{k-1}} \\ \frac{\partial g_{V_e^k}}{\partial S_{e,T_c+1}^{k-1}} \\ \cdots \\ \frac{\partial g_{V_e^k}}{\partial S_{e,T}^{k-1}} \end{array} \right) \left( \begin{array}{c} \frac{\partial g_{V_e^k}}{\partial S_{e,1}^k} \\ \cdots \\ \frac{\partial g_{V_e^k}}{\partial S_{e,T_c}^k} \\ \frac{\partial g_{V_e^k}}{\partial S_{e,T_c+1}^k} \\ \cdots \\ \frac{\partial g_{V_e^k}}{\partial S_{e,T}^k} \end{array} \right) \cdots \left( \begin{array}{c} \frac{\partial g_{V_e^k}}{\partial S_{e,1}^K} \\ \frac{\partial g_{V_e^k}}{\partial S_{e,2}^K} \\ \cdot \\ \cdot \\ \frac{\partial g_{V_e^k}}{\partial S_{e,T}^K} \end{array} \right)$$

$$= \left( \begin{array}{c} \left( \begin{array}{c} 0 \\ 0 \\ \cdot \\ \cdot \\ 0 \end{array} \right) \\ \cdots \\ \left( \begin{array}{c} 0 \\ \cdots \\ 0 \\ -1 \\ \cdots \\ 0 \end{array} \right) \\ \left( \begin{array}{c} 0 \\ \cdots \\ 0 \\ 1 \\ \cdots \\ 0 \end{array} \right) \\ \cdots \\ \left( \begin{array}{c} 0 \\ 0 \\ \cdot \\ \cdot \\ 0 \end{array} \right) \end{array} \right)$$

$$\nabla_{S_e} g_{V_e}^2(S_e) = \left( \begin{array}{c} \left( \frac{\partial g_{V_e^k}}{\partial S_{e,1}^2} \right) \\ \cdots \\ \frac{\partial g_{V_e^k}}{\partial S_{e,T_c}^2} \\ \frac{\partial g_{V_e^k}}{\partial S_{e,T_c+1}^2} \\ \cdots \\ \frac{\partial g_{V_e^k}}{\partial S_{e,T}^2} \end{array} \right) \left( \begin{array}{c} \frac{\partial g_{V_e^k}}{\partial S_{e,1}^3} \\ \frac{\partial g_{V_e^k}}{\partial S_{e,2}^3} \\ \cdot \\ \cdot \\ \frac{\partial g_{V_e^k}}{\partial S_{e,T}^3} \end{array} \right) \cdots \left( \begin{array}{c} \frac{\partial g_{V_e^k}}{\partial S_{e,1}^k} \\ \frac{\partial g_{V_e^k}}{\partial S_{e,2}^k} \\ \cdot \\ \cdot \\ \frac{\partial g_{V_e^k}}{\partial S_{e,T}^k} \end{array} \right) \cdots \left( \begin{array}{c} \frac{\partial g_{V_e^k}}{\partial S_{e,1}^K} \\ \frac{\partial g_{V_e^k}}{\partial S_{e,2}^K} \\ \cdot \\ \cdot \\ \frac{\partial g_{V_e^k}}{\partial S_{e,T}^K} \end{array} \right)$$

$$= \left( \begin{array}{c} \left( \begin{array}{c} 0 \\ \cdots \\ 0 \\ 1 \\ \cdots \\ 0 \end{array} \right) \\ \left( \begin{array}{c} 0 \\ 0 \\ \cdot \\ \cdot \\ 0 \end{array} \right) \\ \cdots \\ \left( \begin{array}{c} 0 \\ 0 \\ \cdot \\ \cdot \\ 0 \end{array} \right) \\ \cdots \\ \left( \begin{array}{c} 0 \\ 0 \\ \cdot \\ \cdot \\ 0 \end{array} \right) \end{array} \right)$$

---

$$\begin{aligned} \nabla_{S_e} g_{\text{VII}e,t}^k(S_e) &= \begin{pmatrix} \begin{pmatrix} \frac{\partial g_{\text{VII}e}^k}{\partial S_{e,1}^2} \\ \frac{\partial g_{\text{VII}e}^k}{\partial S_{e,2}^2} \\ \vdots \\ \frac{\partial g_{\text{VII}e}^k}{\partial S_{e,T}^2} \end{pmatrix} & \cdots & \begin{pmatrix} \frac{\partial g_{\text{VII}e}^k}{\partial S_{e,1}^{k-1}} \\ \cdots \\ \frac{\partial g_{\text{VII}e}^k}{\partial S_{e,T_c}^{k-1}} \\ \frac{\partial g_{\text{VII}e}^k}{\partial S_{e,T_c+1}^{k-1}} \\ \cdots \\ \frac{\partial g_{\text{VII}e}^k}{\partial S_{e,T}^{k-1}} \end{pmatrix} & \begin{pmatrix} \frac{\partial g_{\text{VII}e}^k}{\partial S_{e,1}^k} \\ \cdots \\ \frac{\partial g_{\text{VII}e}^k}{\partial S_{e,T_c}^k} \\ \frac{\partial g_{\text{VII}e}^k}{\partial S_{e,T_c+1}^k} \\ \cdots \\ \frac{\partial g_{\text{VII}e}^k}{\partial S_{e,T}^k} \end{pmatrix} & \cdots & \begin{pmatrix} \frac{\partial g_{\text{VII}e}^k}{\partial S_{e,1}^K} \\ \frac{\partial g_{\text{VII}e}^k}{\partial S_{e,2}^K} \\ \vdots \\ \frac{\partial g_{\text{VII}e}^k}{\partial S_{e,T}^K} \end{pmatrix} \end{pmatrix} \\ &= \begin{pmatrix} \begin{pmatrix} 0 \\ 0 \\ \vdots \\ 0 \end{pmatrix} & \cdots & \begin{pmatrix} 0 \\ \cdots \\ 1 \\ 0 \\ \cdots \\ 0 \end{pmatrix} & \begin{pmatrix} 0 \\ \cdots \\ -1 \\ 0 \\ \cdots \\ 0 \end{pmatrix} & \cdots & \begin{pmatrix} 0 \\ 0 \\ \vdots \\ 0 \end{pmatrix} \end{pmatrix} \end{aligned}$$

$$\begin{aligned} \nabla_{S_e} g_{\text{VIII}e,t}^2(S_e) &= \begin{pmatrix} \begin{pmatrix} \frac{\partial g_{\text{VIII}e}^k}{\partial S_{e,1}^2} \\ \cdots \\ \frac{\partial g_{\text{VIII}e}^k}{\partial S_{e,T_c}^2} \\ \frac{\partial g_{\text{VIII}e}^k}{\partial S_{e,T_c+1}^2} \\ \cdots \\ \frac{\partial g_{\text{VIII}e}^k}{\partial S_{e,T}^2} \end{pmatrix} & \begin{pmatrix} \frac{\partial g_{\text{VIII}e,t}^k}{\partial S_{e,1}^3} \\ \frac{\partial g_{\text{VIII}e,t}^k}{\partial S_{e,2}^3} \\ \vdots \\ \frac{\partial g_{\text{VIII}e,t}^k}{\partial S_{e,T}^3} \end{pmatrix} & \cdots & \begin{pmatrix} \frac{\partial g_{\text{VIII}e,t}^k}{\partial S_{e,1}^k} \\ \cdots \\ \frac{\partial g_{\text{VIII}e,t}^k}{\partial S_{e,t}^k} \\ \cdots \\ \frac{\partial g_{\text{VIII}e,t}^k}{\partial S_{e,T}^k} \end{pmatrix} & \cdots & \begin{pmatrix} \frac{\partial g_{\text{VIII}e,t}^k}{\partial S_{e,1}^K} \\ \frac{\partial g_{\text{VIII}e,t}^k}{\partial S_{e,2}^K} \\ \vdots \\ \frac{\partial g_{\text{VIII}e,t}^k}{\partial S_{e,T}^K} \end{pmatrix} \end{pmatrix} \\ &= \begin{pmatrix} \begin{pmatrix} 0 \\ \cdots \\ -1 \\ 0 \\ \cdots \\ 0 \end{pmatrix} & \begin{pmatrix} 0 \\ \vdots \\ \vdots \\ 0 \end{pmatrix} & \cdots & \begin{pmatrix} 0 \\ \cdots \\ 0 \\ \cdots \\ 0 \end{pmatrix} & \cdots & \begin{pmatrix} 0 \\ 0 \\ \vdots \\ 0 \end{pmatrix} \end{pmatrix} \end{aligned}$$

---

---

## **Abstract-EN**

This thesis explores the use of mathematical models to support a low carbon energy transition for Ecuador. A first approach considers a least-cost linear optimization to evaluate the expansion of energy and land-use sectors and the integrated model ELENA is used. It is combined with the dispatch model urbs to go further in the evaluation of electric system face to a massification of electric transport and it is also considered on the context of a synthesis study focused on the decarbonization of the Buildings Sector. The second modelling approach uses concepts of game theory and specifically of Single-Leader-Multi-Follower (SLMF) models. An implementation of the SLMF model is done for freight transport to capture the effect of a carbon tax in the transition to cleaner vehicles. This work highlights the need to use multiple models in order to have a better idea of the interactions and measures to be put in place to support the energy transition. Although the study is carried out for Ecuador, the methodologies are of general applicability.

## **Abstract-FR**

Cette thèse explore l'utilisation de modèles mathématiques pour accompagner une transition énergétique à faible émission de carbone pour l'Équateur. Une première approche considère une optimisation linéaire pour évaluer l'expansion des secteurs de l'énergie et de l'utilisation des terres et le modèle intégré ELENA est utilisé. Il est combiné avec le modèle de répartition urbs pour aller plus loin dans l'évaluation du système électrique face à une massification du transport électrique et il est également considéré dans le contexte d'une étude de synthèse axée sur la décarbonisation du secteur des bâtiments. La seconde approche de modélisation utilise les concepts de la théorie des jeux et plus particulièrement les modèles Single-Leader-Multi-Follower (SLMF). Une mise en œuvre du modèle SLMF est effectuée pour le transport de marchandises afin de saisir l'effet d'une taxe carbone dans la transition vers des véhicules plus propres. Ce travail souligne la nécessité d'utiliser plusieurs modèles afin d'avoir une meilleure idée des interactions et des mesures à mettre en place pour soutenir la transition énergétique. Bien que l'étude soit réalisée pour l'Équateur, les méthodologies sont d'application générale.