



HAL
open science

Third-generation heritage Spanish acquisition and socialization in Los Angeles, California. : a cognitive-functional and socio-interactional mixed methods case study of Spanish-English bilingualism.

Eric Alvarez

► **To cite this version:**

Eric Alvarez. Third-generation heritage Spanish acquisition and socialization in Los Angeles, California. : a cognitive-functional and socio-interactional mixed methods case study of Spanish-English bilingualism.. Linguistics. Université de la Sorbonne nouvelle - Paris III, 2023. English. NNT : 2023PA030004 . tel-04576179

HAL Id: tel-04576179

<https://theses.hal.science/tel-04576179>

Submitted on 15 May 2024

HAL is a multi-disciplinary open access archive for the deposit and dissemination of scientific research documents, whether they are published or not. The documents may come from teaching and research institutions in France or abroad, or from public or private research centers.

L'archive ouverte pluridisciplinaire **HAL**, est destinée au dépôt et à la diffusion de documents scientifiques de niveau recherche, publiés ou non, émanant des établissements d'enseignement et de recherche français ou étrangers, des laboratoires publics ou privés.

Université Sorbonne Nouvelle

ED 625 – MAGIE

(Monde Anglophones, Germanophones, Indiens, Iraniens et Études Européens)

EA 4398 – PRISMES

(Langues, Textes, Arts et Cultures du Monde Anglophone)

Thèse de doctorat en linguistique anglaise

Eric ALVAREZ

**Third-generation heritage Spanish acquisition
and socialization in Los Angeles, California**
*A cognitive-functional and socio-interactional mixed
methods case study of Spanish-English bilingualism*

Thèse dirigée par
Madame la Professeure Aliyah MORGENSTERN

Soutenue le 27 janvier 2023

Jury :

Mme Joëlle ADEN, Professeure, Université Paris-Est Créteil

Mme Annick DE HOUWER, Professeure Émérite, Universität Erfurt

Mme Lourdes DE LEÓN, Professeure, Centro de Investigaciones y Estudios Superiores en Antropología Social (CIESAS)

Mme Aliyah MORGENSTERN, Professeure, Université Sorbonne Nouvelle

Mme Caroline ROSSI, Professeure, Université Grenoble Alpes

Mme Anne SALAZAR ORVIG, Professeure, Université Sorbonne Nouvelle

Abstract

Title: Third-generation heritage Spanish acquisition and socialization in Los Angeles, California. *A cognitive-functional and socio-interactional mixed methods case study of Spanish-English bilingualism.*

Based on ethnographic data collected in a bilingual setting and subsequently turned into a plurilingual corpus, this dissertation examines some aspects of the acquisition and socialization into the use of heritage Spanish by a third-generation child. LIN's use of heritage Spanish, but also of English, and language mixing is examined between 3;10 and 4;9 as she is engaged in spontaneous interaction with her family. This study is rooted in cognitive-functional, and social-interactionist-based paradigms which argue that language acquisition and socialization are driven by the interaction of cognition, exposure, and use. Each chapter accounts for the impact of the input quantity and quality on LIN's heritage Spanish use, but also of the role that English, and language mixing have on heritage Spanish transmission. Quantitative measures based on 10 linguistic and social factors present LIN's bilingual language learning environment. The results show that overall English is spoken the most in the family, and Spanish is kept to a minimum. Qualitative analyses allow us to untangle the multimodal language production in multigenerational, and multiparty encounters. The results show that heritage bilingualism is not just about acquiring abstract grammatical rules. Rather, heritage bilingualism in LIN's case is also about inheriting bilingual and bicultural practices constructed by, with, and for her community of practice that cannot be measured by the number of Spanish words that she produces. Encouragement, speech stream segmentation, play, child-directed, and overheard speech, but also the presence of Spanish monolingual great-grandparents are also indispensable to her use of heritage Spanish. Finally, linguistic, and cultural practices whether they are hybrid or not are telling about how identities, both hers and her family's, have been constructed through the multiple voices echoed across space and time.

Key-words: heritage acquisition, heritage socialization, heritage Spanish, third-generation bilingualism, multigenerational, multimodality, discourse strategies, participation frameworks

Résumé

Titre : Acquisition et socialisation à l'espagnol d'héritage de troisième génération à Los Angeles, Californie. *Une étude de cas cognitive-fonctionnelle et socio-interactionnelle à méthodes mixtes du bilinguisme espagnol-anglais.*

Basée sur des données ethnographiques, collectées dans un environnement bilingue et transformées par la suite en un corpus plurilingue, cette thèse examine certains aspects de l'acquisition et de la socialisation à l'usage de l'espagnol d'héritage par un enfant de troisième génération. L'usage par LIN de l'espagnol d'héritage, mais aussi de l'anglais, et le mélange des langues sont examinés entre 3;10 et 4;9 alors qu'elle est engagée dans des interactions spontanées avec sa famille. Cette étude est ancrée dans les paradigmes cognitif-fonctionnels et socio-interactionnistes selon lesquelles l'acquisition d'une langue et la socialisation sont déterminées par l'interaction de la cognition, de l'exposition et de l'usage. Chaque chapitre rend compte de l'impact de la quantité et de la qualité de l'input sur l'usage de l'espagnol d'héritage de LIN, mais aussi du rôle que l'anglais et le mélange des langues ont sur la transmission de l'espagnol d'héritage. Des mesures quantitatives basées sur 10 facteurs linguistiques et sociaux présentent l'environnement d'apprentissage bilingue de LIN. Les résultats montrent que, dans l'ensemble, l'anglais est le plus parlé dans la famille, et que l'espagnol est réduit au minimum. Les analyses qualitatives nous permettent de démêler et de décrire finement la production linguistique multimodale dans des rencontres multigénérationnelles et multipartites. Les résultats montrent que le bilinguisme d'héritage ne se limite pas à l'acquisition de règles grammaticales abstraites. Dans le cas de LIN, le bilinguisme d'héritage consiste plutôt à hériter de pratiques bilingues et biculturelles construites par, avec et pour sa communauté de pratique, qui ne peuvent être mesurées par le nombre de mots d'espagnol qu'elle produit. L'encouragement, la segmentation du flux de la parole, le jeu, le discours adressé à l'enfant et le discours entendu par celui-ci, mais aussi la présence d'arrière-grands-parents monolingues en espagnol sont également indispensables à son usage de l'espagnol d'héritage. Enfin, les pratiques linguistiques et culturelles, qu'elles soient hybrides ou non, révèlent la manière dont les identités, la sienne et celle de sa famille, se sont construites à travers les multiples voix qui se font écho dans l'espace et le temps.

Mots-clés : acquisition d'héritage, socialisation d'héritage, espagnol d'héritage, bilinguisme de troisième génération, multigénérationnel, multimodalité, stratégies de discours, cadres participatifs

To my dad Teodoro, because your Spanish *dicho* resonated in my mind when the going got tough, RIP,

De granito en granito la gallina se llena el buche¹.

To Lini's dad Marcos, because your Spanish idiom allowed me to conceive of Spanish as light that sometimes shines bright, and at others more subtly, but shines it does, RIP,

El sol brilla para todos².

¹ Rome wasn't built in a day.

² The sun shines for all.

Acknowledgements

I would first like express my gratitude to my scientific mother Aliyah Morgenstern. I contacted Aliyah sometime around 2014, or 2015. Straight away she took me under her wing, and guided me along the path to a Ph.D. Not only did she introduce me to the field of language acquisition, but she also taught me that language is much more than a vocal modality. Aliyah also showed me that language could, and perhaps should be apprehended through a cognitive-functional paradigm, a school of thought I was unfamiliar with. Her guidance, encouragement, rigor, and overall never-ending support even in my darkest moments, have not only shaped, but also allowed this dissertation to emerge, like the light that seeps through in the thicket of the forest. Aliyah's un-matched work ethic, enthusiasm, and dedication to her students and her work are inspirational. Thank you, Aliyah, thank you for everything.

I would also like to thank Annick De Houwer and Caroline Rossi for accepting to pre-appraise my work, as well as Lourdes De León, Joëlle Aden, and Anne Salazar Orvig who all accepted to be members of my Ph.D. committee. It is truly an honor to have you evaluate this research project.

Anne Salazar Orvig, Isabelle Léglise, and Hélène Josse, thank you for accepting to be in my monitoring committee. It was wonderful exchanging with you three throughout these past years.

I am also grateful to the colleagues that I met since I started my Ph.D., especially the members of SeSyLIA. With you, I was able to share my work and gain precious feedback. I would especially like to thank Alice Brunet for kindly answering my questions, and for always letting me know that you were happy to help. Also, a special thanks to Claire Tardieu for your warmth, and for the interest you took in my work since I first stepped foot at Sorbonne Nouvelle.

I am thankful for having met Maria Polinsky in France back in 2017. She has been so generous with her time, and resources as a leading scholar of heritage linguistics in the U.S.

Thanks to her I received an invitation to the National Heritage Language Resource Center at UCLA to collect the data for my dissertation. Her work has also been influential in my Ph.D.

A heartfelt thank you to all those friends near and far. You have helped me re-read parts of my work (Asmarrah, Amanda, Chris, Bob,), deal with software glitches (Johanna, Amine, Irene), given me tons of research-related books (Ingrid), and provided emotional support when life got tough (Andrea, Nadia, Banu, Ouiza, Maryann, Hédia). This also goes for my emotional support pets for keeping me warm (Belami), grounded (Xochitl, Gloria), and for reminding me when it was time to go out for a walk (Luna). Finally, Arnaud, thank you for doing your best to create a cozy and comfortable environment in which to finish this dissertation, and where our pets would thrive.

Of course, it takes a multigenerational *familia* to raise a child. This child, or dissertation came into being thanks to my mom and dad who inculcated in me the value of hard work and perseverance, and for always providing anything I needed. Without their implicit teachings and their generous support, I would not be who, or where I am today. This also includes my sister Gloria for being like the glue that keeps the *familia* together, and for always picking me up at LAX for over a decade now. To my nieces Roxy and Alex, and their husbands Ricardo and Marcos who left us too early, and my great-nieces and nephews Lini, Julian, Gloria-Juliette, and Ignacious, thank you all for the rich bilingual, multimodal, multigenerational, and multiparty data. I have enough material now to last me a lifetime, that is, a lifetime of precious memories.

Preface

Before you lies the doctoral thesis “Third-generation heritage Spanish acquisition and socialization in Los Angeles, California. *A cognitive-functional and socio-interactive mixed methods case study of Spanish-English bilingualism*.” I wrote it to fulfill the graduation requirements of the English Linguistics program at Université Sorbonne Nouvelle in Paris, France. While I was engaged in the research and writing of this thesis from September 2017 to October 2022, the seeds of this work were planted in my childhood and cultivated, through my mom’s affirmations about the importance of maintaining Spanish, throughout my adolescence. Her positive discourse about Spanish is therefore at the root of this work, *gracias ma*.

In the early 80’s I began formal education at the same place, and in the same community where Lini our target-child is presently enrolled. I remember learning Spanish in school before its instruction was abruptly interrupted. By the late 90’s from the same institution I received a certificate of participation for taking part in their “School Readiness Language Development Program³”, a requirement for Lini’s mom (my niece) to start kindergarten. Finally, in May 2019 the same school awarded me a certificate of appreciation⁴ for taking part in their volunteer program when Lini began kindergarten. In briefly presenting a chronological timeline, I want to show that the seeds of this work revolving around language contact, bilingualism, family, and society may be traced back to nearly 40 years. It took 40 years for a voice from within the community to emerge. I describe this as a *komorebi* moment, a term borrowed from the Japanese.

This dissertation is therefore written with the joy of a great-uncle who feels that the study of Lini and her family may help us understand heritage bilingual development in general, and the human capacity for language in particular not as a set of abstract grammatical rules, but as a unique and dynamic system of linguistic and cultural practices that are transmitted from one generation to the next. These practices emerge out of tension ridden contact zones or *imagined communities* (Anderson, 1983). However, by imagined I do not mean fictitious interactional states entertained merely in the minds of speakers but imagined as conceived in

³ Included in appendices

⁴ Included in appendices

the minds of these speakers, and subsequently spoken into being in their everyday lives. This is what I have sought to show in this study since “Language is the place where actual and possible forms of social organization and their likely social and political consequences are defined and contested. Yet it is also the place where our senses of ourselves, our subjectivity, is constructed.” (Weedon, 1987/1997: 21).

Everyday life is truffled with challenges, and change, so for the most part this has been a long, but deeply fulfilling research journey. But the main difficulties that I would like to acknowledge were those related to dealing with my father’s passing in 2019, followed by the passing of my two older brothers only three weeks later. Then earlier this year (2022) Lini’s father passed in a tragic motorcycle accident, and his death was followed by my grandmother’s passing a couple of months later. Finally, nearly a year ago my dog was left paralyzed in one leg after a car ran into her. Although she is still alive, sometimes it is difficult to not be sad. Also, continuously reviewing the many hours of video recordings that form the data used in this study has given me the opportunity to relive these moments in time, and thus to relive the marvel of heritage bilingual development. However, it has also confronted me over again to footage of my dad, and Marcos, Lini’s father who are no longer with us. This has been difficult the last three years. Nevertheless, I have tried to pour my soul into this work, because it could not be any other way. The Greek called this *meraki*, or when we leave little pieces of ourselves in our creative work. I therefore dedicate this work to my dad, brothers, Lini’s dad, and my grandmother. We are with you, and through your voices you are with us, and you will be honored this *Día de Muertos* as the veil grows thinner between life and death, or transformation.

Finally, this study is primarily grounded in usage-based, sociolinguistic, and linguistic anthropological paradigms to understand a heritage bilingual child’s language development within her community of practice. However, this investigation would not be complete without evoking post-colonial concepts that richly complement these more linguistic traditions. Moreover, in line with this interdisciplinary approach, I also turned to contemporary writers and philosophers, translators, and poets from Mexico, Brazil, France, and Portugal, as well as to notions from Japan and Greece to help me capture the essence of this work. As such, I hope that readers will embark on this journey with the same joy and the same open mind as I did.

Table of Contents

ABSTRACT	II
RESUME.....	III
ACKNOWLEDGEMENTS.....	V
PREFACE	VII
TABLE OF CONTENTS.....	IX
APPENDICES	XIII
LIST OF TABLES	XIV
LIST OF FIGURES	XVI
LIST OF PLURILINGUAL TRANSCRIPTS.....	XVIII
INTRODUCTION.....	1
CONCEPTUAL, THEORETICAL, & CONTEXTUAL BACKGROUND	6
BRIEF HISTORY OF SPANISH IN L.A.	10
L.A.'S UNINCORPORATED FLORENCE-FIRESTONE DISTRICT	14
<i>Population</i>	18
<i>Race & Ethnicity</i>	18
<i>Age</i>	19
<i>Language use in the community</i>	20
<i>Language contact & Language mixing</i>	22
<i>Educational outcomes in the community</i>	24
<i>Income</i>	26
THE PARTICIPANTS: A THREE-GENERATION FAMILY IN L.A.'S FLORENCE-FIRESTONE DISTRICT.....	28
REVISITING THE RESEARCH PROBLEM, AIMS, & OBJECTIVES	32
SIGNIFICANCE & LIMITATIONS.....	34
OVERVIEW OF PH.D.	36
1 THEORETICAL BACKGROUND: BILINGUALISM & BILINGUAL LANGUAGE ACQUISITION.....	41
1.1 DEFINING BILINGUALISM	46
1.1.1 <i>Bilingualism: A working definition</i>	47
1.1.2 <i>Bilingualism: Between broad & narrow perspectives</i>	48
1.1.3 <i>Bilingualism: Moving away from the notion of narrowness</i>	50
1.1.3.1 <i>Bilingualism: As seen from monolingual eyes</i>	51
1.1.4 <i>Bilingualism: Typologies of bilingual families</i>	52
1.1.4.1 <i>Bilingualism: Conceived as a continuum</i>	56
1.1.4.2 <i>Bilingualism: Les modes langagiers</i>	58
1.2 MODELING BILINGUAL LANGUAGE ACQUISITION.....	59
1.2.1 <i>Factors affecting bilingual language development</i>	61
1.2.2 <i>Input quantity</i>	62
1.2.3 <i>Input quality</i>	63
1.2.4 <i>Attitudes & Identity</i>	66
1.3 THEORIES OF NATIVE LANGUAGE ACQUISITION	73
1.3.1 <i>Universal Grammar (UG)</i>	74
1.3.2 <i>Emergentism</i>	77
1.3.3 <i>Variationist sociolinguistics</i>	80
1.4 THEORETICAL APPROACHES TO HERITAGE LANGUAGE ACQUISITION.....	82
1.4.1 <i>Sociolinguistics</i>	83
1.4.2 <i>Formal linguistics</i>	86
1.4.3 <i>Emergentism</i>	89
1.4.4 <i>Processability Theory & Optimality Theory</i>	92

1.4.4.1	Language differentiation models: One system or two?	95
1.4.4.2	The unitary language systems hypothesis (ULS).....	96
1.4.4.3	The separate development model (SDM)	97
1.4.4.4	The autonomy with interdependence model	98
1.5	DEGREES OF BILINGUALISM.....	103
1.5.1	<i>Early & Late bilinguals</i>	104
1.5.2	<i>Balanced & Dominant bilinguals</i>	107
1.5.3	<i>Compound, Coordinate, & Subordinate bilinguals</i>	110
1.5.4	<i>Additive & Subtractive bilinguals</i>	112
2	THEORETICAL BACKGROUND: HERITAGE BILINGUALISM & HERITAGE LANGUAGE	
	SOCIALIZATION	121
2.1	HERITAGE SPEAKERS & THEIR LANGUAGE(S): LAYING THE FOUNDATIONS IN THE FIELD.....	122
2.1.1	<i>Heritage speakers & their language(s)</i>	127
2.1.2	<i>Heritage speakers: A historical and social classification</i>	134
2.1.3	<i>Heritage language transmission: The three-generation rule & the GIDS</i>	136
2.1.4	<i>From incomplete acquisition to divergent grammar</i>	141
2.1.5	<i>So how native are heritage speakers?</i>	144
2.1.5.1	High proficiency heritage speakers.....	146
2.1.5.2	Low proficiency heritage speakers	147
2.2	NOVEL APPROACHES TO HERITAGE BILINGUALISM	151
2.2.1	<i>Social interactionist theory</i>	154
2.2.2	<i>Language socialization & Language acquisition: A historical overview</i>	158
2.2.3	<i>On the emergence of language socialization</i>	160
2.2.4	<i>Heritage language socialization</i>	165
2.2.5	<i>Language socialization & Family dinners</i>	170
2.2.6	<i>Language socialization, Parental Discourse Strategies, & Language mixing</i>	173
2.2.7	<i>Language socialization, Bilingualism, & Multimodality</i>	177
2.2.8	<i>Language socialization & Participation frameworks</i>	179
3	DATA & RESEARCH METHODS IN BILINGUAL SETTINGS.....	187
3.1	DOCUMENTING BILINGUAL LANGUAGE PRACTICES	189
3.1.1	<i>Collecting language data through participant observation</i>	194
3.1.2	<i>Relationships with the participants</i>	196
3.1.3	<i>Data collection in bilingual communities</i>	197
3.1.3.1	The Observer's Paradox.....	200
3.1.4	<i>Primary requisites & Tools used for data collection</i>	203
3.2	THE NEED FOR MULTIGENERATIONAL STUDIES	204
3.2.1	<i>The family tree</i>	206
3.2.2	<i>Making a case for case studies</i>	207
3.2.3	<i>The baseline input language issue</i>	210
3.2.4	<i>Advantages of longitudinal studies</i>	212
3.2.4.1	Field notes	214
3.2.4.2	Sociolinguistic questionnaires.....	223
3.3	PLURILINGUAL CORPUS CREATION.....	224
3.3.1	<i>Funding & Networks</i>	226
3.3.2	<i>Describing & Managing the data</i>	228
3.3.3	<i>Using CLAN: Transcription hardware</i>	233
3.3.4	<i>CHAT Transcription Conventions</i>	235
3.3.4.1	A note on transcription hardware.....	238
3.4	TRANSCRIBING BILINGUAL DATA.....	239
3.4.1	<i>Challenges in interpreting child language</i>	240
3.4.2	<i>Disentangling overlapping bilingual interactions</i>	243
3.4.3	<i>Using CHAT format</i>	249
3.4.4	<i>CHAT (some adaptations)</i>	251
3.4.5	<i>Using Excel</i>	252
3.5	ETHICAL & TECHNICAL ISSUES.....	257
3.5.1	<i>On recording</i>	258
3.5.2	<i>On handling the camera</i>	260
3.5.3	<i>Recording in public spheres</i>	261
3.5.4	<i>On dissemination</i>	262

4	CHARACTERISTICS OF THE BILINGUAL LANGUAGE LEARNING ENVIRONMENT	265
4.1	BILINGUAL INPUT & OUTPUT	267
4.2	A 10-FACTOR QUANTITATIVE ANALYSIS.....	268
4.3	LINGUISTIC SOUNDSCAPE: THE FAMILY’S SPANISH, ENGLISH, & MIXED INPUT	270
4.3.1	<i>February 2018</i>	276
4.3.2	<i>August 2018</i>	276
4.3.3	<i>January 2019</i>	277
4.4	LANGUAGE PRESENTATIONS: THE MATERNAL LINE’S SPANISH, ENGLISH, & MIXED INPUT.....	277
4.4.1	<i>Language presentations: Male versus Female Spanish, English, & mixed input</i>	278
4.4.2	<i>English</i>	282
4.4.3	<i>Spanish</i>	285
4.4.4	<i>Mixed</i>	286
4.5	LIN’S DIRECTED INPUT <i>VERSUS</i> THE ADULTS’ DIRECTED INPUT: SPANISH, ENGLISH, & MIXING	291
4.5.1	<i>English first</i>	293
4.5.2	<i>Spanish second</i>	294
4.5.3	<i>Mixed third</i>	294
4.6	LIN’S OUTPUT: SPANISH, ENGLISH, & MIXING IN CHILD-ADULT DYADS	295
4.7	LIN’S OUTPUT: SPANISH, ENGLISH, MIXING, & INTERLOCUTOR GENERATION	300
4.7.1	<i>English</i>	302
4.7.2	<i>Spanish</i>	302
4.7.3	<i>Mixed</i>	302
4.8	LIN’S OUTPUT: SPANISH, ENGLISH, MIXING, & THE LANGUAGE OF PREVIOUS UTTERANCE	305
4.8.1	<i>Spanish</i>	306
4.8.2	<i>English</i>	307
4.8.3	<i>Mixed</i>	307
4.9	LIN’S MEAN LENGTH OF UTTERANCE (MLU): BILINGUAL LANGUAGE DEVELOPMENT?.....	308
4.9.1	<i>February 2018</i>	312
4.9.2	<i>August 2018</i>	313
4.9.3	<i>January 2019</i>	314
4.10	LIN AND ADULT TYPE/TOKEN RATIO (TTR): LEXICAL RICHNESS?.....	315
4.10.1	<i>February 2018</i>	318
4.10.2	<i>August 2018</i>	320
4.10.3	<i>January 2019</i>	322
4.11	LIN’S SEMANTIC DOMAINS IN SPANISH, & ENGLISH TRANSLATION EQUIVALENTS	326
5	HERITAGE LANGUAGE SOCIALIZATION: ATTITUDES ABOUT SPEAKING SPANISH... 345	
5.1	A NOTE ON THE CULTURAL FRAMEWORK.....	349
5.2	HERITAGE LANGUAGE SOCIALIZATION	353
5.3	ATTITUDES ABOUT SPEAKING SPANISH: BETWEEN NO & YES.....	363
5.3.1	<i>I don’t have to talk español@s</i>	363
5.3.2	<i>No gracias</i>	370
5.3.3	<i>Sí español</i>	378
5.4	ACCEPTING SPANISH <-> ENGLISH TRANSLATION EQUIVALENTS, OR NOT	394
5.4.1	<i>You’re my tío@s</i>	394
5.4.2	<i>They called fruits loop puta@s!</i>	403
6	HERITAGE LANGUAGE SOCIALIZATION: BILINGUAL INPUT & OUTPUT	415
6.1	SEGMENTING THE SPEECH STREAM: SPANISH ONE PIECE AT A TIME	416
6.1.1	<i>Ponme el vestido por favor</i>	416
6.1.2	<i>Chile jalapeño</i>	433
6.1.3	<i>Toronja</i>	439
6.2	FOOD FOR THOUGHT & CHILD-DIRECTED SPANISH	444
6.2.1	<i>Pozole</i>	444
6.2.2	<i>Salsa</i>	454
6.3	FOOD FOR THOUGHT & OVERHEARD SPANISH	458
6.3.1	<i>Tortilla</i>	458
6.3.2	<i>Mosca</i>	464
6.3.3	<i>Chile</i>	470
	DISCUSSION	481

RESTATING THE RESEARCH QUESTION & AIMS.....	482
SUMMARIZING THE KEY FINDINGS IN CHAPTER 4, 5, & 6	483
MERGING AND INTERPRETING THE RESULTS	492
<i>Questions related to the Linguistic soundscape & Language presentations</i>	493
<i>Questions related to LIN's bilingual input & output</i>	499
ACKNOWLEDGING LIMITATIONS OF THE STUDY	509
MAKING RECOMMENDATIONS	511
CONCLUSION	515
BIBLIOGRAPHY	521
APPENDICES	577

Appendices

ANNEX 1: CERTIFICATE-SCHOOL READINESS LANGUAGE DEVELOPMENT PROGRAM.....	577
ANNEX 2: CERTIFICATE OF APPERCIATION	578
ANNEX 3 FLORENCE-FIRESTONE COMMUNITY LEADERS MEETING AGENDA.....	579
ANNEX 4: BILINGUAL FLORENCE-FIRESTONE COMMUNITY LEADERS 2018 MEETING SCHEDULE.....	580
ANNEX 5: FLORENCE-FIRESTONE’S COMMUNITY PLAN ZONE CHANGE: CSU UPDATE	581
ANNEX 6: BILINGUAL WELCOME LETTER TO THE LAUSD SCHOOL VOLUNTEER PROGRAM.....	592
ANNEX 7: LOS ANGELES UNIFIED SCHOOL DISTRICT STUDENT ENROLLMENT FORM.....	594
ANNEX 8: ELEMENTARY EL PROFILES BASED ON FOCUS: REPORTING & DASHBOARDS.....	597
ANNEX 9: MASTER PLAN ROSTER OF LIN’S CLASS.....	598
ANNEX 10: PARENT PERMISSION FOR MINOR TO PARTICIPATE IN RESEARCH	599
ANNEX 11: APPROVED PROJECT PROPOSAL NUMBER 348 TO GAIN ACCESS TO LIN’S ELEMENTARY SCHOOL	614
ANNEX 12: LETTER OF APPROVAL FROM THE LAUSD COMMITTEE FOR EXTERNAL RESEARCH REVIEW	623
ANNEX 13: BILINGUAL LANGUAGE PROFILES: ENGLISH-SPANISH	624
ANNEX 14: LETTER OF INVITATION-VISITING GRADUATE RESEARCHER (VGR) AT UCLA	664
ANNEX 15: LABEX EFL MOBILITY GRANT PROJECT	665
ANNEX 16: LIN’S VISUAL REPRESENTATION OF ENGLISH & SPANISH	672

List of Tables

TABLE 1: RACE & ETHNICITY ADAPTED FROM TABLE 4 IN LA COUNTY DEPARTMENT OF REGIONAL PLANNING (2019: 32).....	19
TABLE 2: LANGUAGES SPOKEN IN THE HOME ADAPTED FROM TABLE 5 IN LA COUNTY DEPARTMENT OF REGIONAL PLANNING (2019: 33)	21
TABLE 3: EDUCATIONAL ATTAINMENT ADAPTED FROM TABLE 7 IN LA COUNTY DEPARTMENT OF REGIONAL PLANNING (2019: 36)	25
TABLE 4: SUMMARY OF EACH FAMILY TYPE	54
TABLE 5: ADAPTED FROM TABLE 8.6 IN AALBERSE ET AL. (2019: 181) & FROM TABLE 5.1 IN MONTRUL (2016: 149): MAIN FEATURES BETWEEN THE DIFFERENT THEORETICAL PARADIGMS (NATIVISM, EMERGENTISM, & VARIATIONISTS).....	94
TABLE 6: THE VARIOUS TYPES OF BILINGUALS ADAPTED FROM TABLE 0.1 IN WEI (2000: 6-7).....	114
TABLE 7: SIX CENTRAL QUESTIONS TO CHARACTERIZE HERITAGE SPEAKERS AND THEIR LANGUAGES AS SUMMARIZED FROM AALBERSE ET AL. (2018: 2-10)	129
TABLE 8: CLASSIFYING HERITAGE LANGUAGES, A SUMMARY AS PUT FORWARD BY FISHMAN (2001); & CITED BY KELLEHER (2010: 2).....	135
TABLE 9: THE GRADED INTERGENERATIONAL DISRUPTION SCALE (GIDS) USED TO DIAGNOSE LANGUAGE VITALITY IN BILINGUAL COMMUNITIES; SUMMARIZED FROM (PAUWELS, 2016: 155-160)	138
TABLE 10: GRAMMATICAL ASPECTS STUDIED IN HERITAGE BILINGUALS.....	145
TABLE 11: PART V ON LANGUAGE AND CULTURE CONTACT IN THE HANDBOOK OF LANGUAGE SOCIALIZATION	167
TABLE 12: FIVE PARENTAL DISCOURSE STRATEGIES IN BILINGUAL SETTINGS ADAPTED FROM LANZA (1997: 261-269) & FROM FIGURE 2.1 IN DE HOUWER AND NAKAMURA (2021: 33)	175
TABLE 13: KEY CONCEPT OF GOFFMAN’S PARTICIPATION FRAMEWORKS ADAPTED FROM ERVING GOFFMAN’S ANALYSIS OF PARTICIPATION FRAMEWORKS (2020)	181
TABLE 14: REQUISITES FOR CONDUCTING FIELDWORK IN BILINGUAL COMMUNITIES	204
TABLE 15: LONGITUDINAL DESIGN, SAMPLING PERIODS, & NUMBER OF HOURS TRANSCRIBED	214
TABLE 16: HANDWRITTEN AND DIGITAL FIELD JOURNAL ENTRIES	221
TABLE 17: DATA FILES AS ARCHIVED ACCORDING TO MONTH & YEAR OF SAMPLING	229
TABLE 18: FIRST TWO VIDEO DESCRIPTIONS IN EXCEL LABELED: FEB_2018_BILINGUAL CORPUS DESCRIPTION_LA, CALIFORNIA	232
TABLE 19: SOCIAL AND LINGUISTIC CODING CATEGORIES	253
TABLE 20: EXAMPLE OF EXCEL WORKSHEET WITH SOCIOLINGUISTIC CODING CATEGORIES	256
TABLE 21: EXAMPLE FROM DATA DESCRIPTION FILE DEPICTING A VIDEO THAT WAS NOT TRANSCRIBED DUE TO ETHICAL REASONS	259
TABLE 22: HANDLING THE CAMERA	261
TABLE 23: FLOWCHART FOR DATA DISSEMINATION	263
TABLE 24: ABSOLUTE & RELATIVE FREQUENCY: SPANISH, ENGLISH & MIXED UTTERANCES LONGITUDINALLY	272
TABLE 25: RELATIVE FREQUENCY: NUMBER OF UTTERANCES LONGITUDINALLY: SPANISH, ENGLISH, & MIXED UTTERANCES	277
TABLE 26: RELATIVE FREQUENCY: MALE VS FEMALE LANGUAGE PRESENTATION OF SPANISH, ENGLISH & MIXED UTTERANCES	279
TABLE 27: RELATIVE FREQUENCY: GENDER & LANGUAGE PRESENTATION OF SPANISH, ENGLISH & MIXED UTTERANCES	280
TABLE 28: RELATIVE FREQUENCY: LANGUAGE PRESENTATION OF SPANISH, ENGLISH & MIXED UTTERANCES ..	282
TABLE 29: RELATIVE FREQUENCY: PRODUCTION OF SPANISH, ENGLISH & MIXED UTTERANCES IN ADULT & CHILD-DIRECTED INPUT	292
TABLE 30: RELATIVE FREQUENCY: PRODUCTION OF SPANISH, ENGLISH & MIXED UTTERANCES IN CHILD-ADULT DYADS	296
TABLE 31: LIN’S OUTPUT IN CHILD-ADULT DYADS	297
TABLE 32: RELATIVE FREQUENCY: GENERATIONAL DISTRIBUTION OF LIN’S SPANISH, ENGLISH, & MIXED UTTERANCES	301
TABLE 33: RELATIVE FREQUENCY: GENERATIONAL DISTRIBUTION OF LIN’S SPANISH, ENGLISH, & MIXED UTTERANCES	306
TABLE 34: MLU VALUES: ENGLISH & SPANISH.....	310

TABLE 35: LONGITUDINAL DEVELOPMENT OF ENGLISH MLUW.....	314
TABLE 36: TTR VALUES: ENGLISH FOR LIN & SPANISH & ENGLISH FOR THE ADULTS	317
TABLE 37: NUMBER OF TYPES & TOKENS IN SPANISH FOR LIN IN FEBRUARY 2018 (3;10)	319
TABLE 38: NUMBER OF TYPES & TOKENS IN SPANISH FOR LIN IN AUGUST 2018 (4;4)	321
TABLE 39: NUMBER OF TYPES & TOKENS IN SPANISH FOR LIN IN JANUARY 2019 (4;9)	323
TABLE 40: LONGITUDINAL DEVELOPMENT OF SPANISH TYPES & TOKENS.....	325
TABLE 41: LIN'S EMERGENT BILINGUAL REPERTOIRE AS DISTRIBUTED LONGITUDINALLY.....	327
TABLE 42: LONGITUDINAL DEVELOPMENT OF SPANISH & ENGLISH TRANSLATION EQUIVALENTS.....	331
TABLE 43: 19 SEMANTIC DOMAINS OF HERITAGE SPANISH USE	331
TABLE 44: LONGITUDINAL USE OF SPANISH ACROSS SEMANTIC DOMAINS	332
TABLE 45: 10 BIVALENT AND CULTURE SPECIFIC WORDS	334
TABLE 46: LIN'S LONGITUDINAL USE OF MIXED UTTERANCES.....	335
TABLE 47: LONGITUDINAL SEMANTIC ANALYSES OF MIXED LANGUAGE UTTERANCES.....	338
TABLE 48: SUMMARY OF KEY ANALYTICAL FEATURES IN EXAMPLES 1 & 2	369
TABLE 49: SUMMARY OF KEY ANALYTICAL FEATURES IN EXAMPLE 3.....	378
TABLE 50: SUMMARY OF KEY ANALYTICAL FEATURES IN EXAMPLE 4 & 5	393
TABLE 51: SUMMARY OF KEY ANALYTICAL FEATURES IN EXAMPLE 6, 7 & 8	402
TABLE 52: SUMMARY OF KEY ANALYTICAL FEATURES IN EXAMPLE 9 & 10.....	412
TABLE 53: SUMMARY OF KEY ANALYTICAL FEATURES IN EXAMPLES 11, 12, & 13.....	432
TABLE 54: SUMMARY OF KEY ANALYTICAL FEATURES IN EXAMPLE 14.....	439
TABLE 55: SUMMARY OF KEY ANALYTICAL FEATURES IN EXAMPLE 15.....	444
TABLE 56: SUMMARY OF KEY ANALYTICAL FEATURES IN EXAMPLES 16 & 17	453
TABLE 57: SUMMARY OF KEY ANALYTICAL FEATURES IN EXAMPLE 18.....	457
TABLE 58: SUMMARY OF KEY ANALYTICAL FEATURES IN EXAMPLE 19.....	464
TABLE 59: SUMMARY OF KEY ANALYTICAL FEATURES IN EXAMPLE 20.....	470
TABLE 60: SUMMARY OF KEY ANALYTICAL FEATURES IN EXAMPLE 21	478
TABLE 61: CENTRAL RESEARCH QUESTION & SUB-QUESTIONS.....	483
TABLE 62: SUMMARY OF KEY MULTIMODAL DISCURSIVE FEATURES OF THE QUALITATIVE ANALYSES ACCORDING TO LIN'S AGE.....	489
TABLE 63: COMPARISON BETWEEN "SR" FAMILY'S CHILD-ADULT DYADS & LIN<->ROX DYAD ADAPTED FROM ALLEN ET AL.'S TABLE 1 & 2 (2002: 174).....	505
TABLE 64: RELATIVE FREQUENCY: LIN'S INPUT VS OUTPUT OF SPANISH, ENGLISH & MIXED UTTERANCES.....	508

List of Figures

FIGURE 1: A STUDY OF HERITAGE SPEAKERS FROM A MULTIDISCIPLINARY PERSPECTIVE.....	8
FIGURE 2: HERITAGE SPEAKERS AS EMBEDDED IN THE MULTIDIMENSIONAL INTERACTIONAL PROCESS.....	9
FIGURE 3: FLORENCE-FIRESTONE & NEIGHBORING COMMUNITIES (LEFT) & STREETS SURROUNDING LIN'S GENERAL AREA (RIGHT).....	15
FIGURE 4: FLORENCE-FIRESTONE RELATIVE TO OTHER AREAS IN L.A.....	16
FIGURE 5: POPULATION TRENDS IN FLORENCE-FIRESTONE ADAPTED FROM FIGURE 2 IN LA COUNTY DEPARTMENT OF REGIONAL PLANNING (2019: 31).....	18
FIGURE 6: AGE GROUPS ADAPTED FROM FIGURE 3 IN LA COUNTY DEPARTMENT OF REGIONAL PLANNING (2019: 33).....	20
FIGURE 7: HOUSEHOLD INCOME DISTRIBUTION ADAPTED FROM FIGURE 4 IN LA COUNTY DEPARTMENT OF REGIONAL PLANNING (2019: 35)	26
FIGURE 8: LIN'S HOME, THE ORANGE "BIG HOUSE" (LEFT) NEXT TO THE YELLOW "LITTLE HOUSE" (RIGHT).....	27
FIGURE 9: THREE-GENERATION FAMILY TREE & THE MATERNAL LINE	28
FIGURE 10: THE BILINGUAL CONTINUUM ADAPTED FROM VALDÉS AND FIGUEROA (1994: 8).....	58
FIGURE 11: ADAPTED FROM FIGURE 4.9. IN MONTRUL (2016: 123): FACTORS AFFECTING BILINGUAL LANGUAGE DEVELOPMENT.....	72
FIGURE 12: LIN POINTS AT CAMERA TO ACKNOWLEDGE ITS PRESENCE.....	202
FIGURE 13: THREE-GENERATION FAMILY TREE.....	207
FIGURE 14: EXAMPLE FROM FIELD JOURNAL WRITTEN IN PENCIL ON 09/09/18.....	216
FIGURE 15: EXAMPLE FROM FIELD JOURNAL WRITTEN IN PEN ON 18/09/18.....	217
FIGURE 16: EXAMPLE FROM DIGITAL FIELD JOURNAL I.E., RUNNING WORD DOCUMENT	219
FIGURE 17: TWO DYADS ROX <-> GUI AND LIN <-> GLO IN MULTIPARTY INTERACTION	247
FIGURE 18: THE ERI <-> RIC <-> ROX TRIAD IS FORMED IN MULTIPARTY INTERACTION	248
FIGURE 19: LINGUISTIC SOUNDSCAPE EVOLUTION: FEBRUARY 2018 TO JANUARY 2019.....	275
FIGURE 20: GENDER & LANGUAGE PRESENTATIONS: SPANISH, ENGLISH & MIXED UTTERANCES	281
FIGURE 21: LANGUAGE PRESENTATIONS	290
FIGURE 22: ADULT- & CHILD-DIRECTED INPUT.....	293
FIGURE 23: GENERATIONAL-GRADATION GROUPED BY SAMPLING PERIOD: SPANISH, ENGLISH, & MIXED UTTERANCES	303
FIGURE 24: GENERATIONAL-GRADATION GROUPED BY GENERATION: SPANISH, ENGLISH, & MIXED UTTERANCES	304
FIGURE 25: LANGUAGE OF PREVIOUS UTTERANCE: SPANISH, ENGLISH, & MIXED UTTERANCES	308
FIGURE 26: MLUW VALUES FEBRUARY 2018: ENGLISH	312
FIGURE 27: MLUW VALUES AUGUST 2018: ENGLISH	313
FIGURE 28: MLUW VALUES JANUARY 2019: ENGLISH	314
FIGURE 29: LIN'S TTR VALUES IN FEBRUARY 2018: ENGLISH.....	318
FIGURE 30: LIN'S TTR VALUES AUGUST 2018: ENGLISH.....	320
FIGURE 31: LIN'S TTR VALUES JANUARY 2019: ENGLISH	322
FIGURE 32: GRC EMBODIES JUL'S CONFUSION FOLLOWING HER QUESTION IN SPANISH.	356
FIGURE 33: GRC EMBODIES JUL AS HE POINTS TO THE LARGE BOWL.	357
FIGURE 34: ERI POINTS AT NAPKINS WHEN ADDRESSING LIN & LIN LOOKS AT HIM.	372
FIGURE 35: LIN LOOKS AT THE NAPKINS THAT GLO HANDS HER.	373
FIGURE 36: ERI & ROX SARCASTICALLY THANK LIN FOR THE NAPKINS.	374
FIGURE 37: MULTIMODALLY LIN SAYS NO THANK YOU IN SPANISH AS SHE CROSSES HER ARMS.	375
FIGURE 38: MULTIMODALLY LIN REFUSES IN ENGLISH TO SAY THANK YOU.	376
FIGURE 39: LIN LOOKS AT ERI TO AFFIRM THAT SHE SPEAKS SPANISH.	382
FIGURE 40: ERI GAZES AT LIN ASKING HER TO REPEAT HERSELF.	383
FIGURE 41: LIN MAINTAINS HER GAZE ON ERI & BEGINS TO COUNT TO PROVE THAT SHE SPEAKS SPANISH.....	384
FIGURE 42: GRC ADDRESSES LIN WHILE POINTING TO ROX TO TELL HER TO SPEAK SPANISH.....	426
FIGURE 43: GRC SEGMENTS A SPANISH UTTERANCE FOR LIN & ROX NODS TO LET LIN KNOW THAT SHE IS LISTENING.....	428
FIGURE 44: LIN & ROX ARE ENGAGED IN DYADIC INTERACTION WHILE ROX POINTS AT PIZZA TOPPING.....	435
FIGURE 45: MULTIMODALLY LIN ASKS ROX TO SAY "JALAPEÑO" ONE MORE TIME.	436
FIGURE 46: JUL'S MULTIMODAL PRODUCTION TO REFERENCE A "MOSCA"	466

FIGURE 47: LIN CAPTURES AND REPEATS THE OVERHEARD SPANISH WORD "MOSCA" AS SHE LOOKS OVER THE COUCH.....	467
FIGURE 48: LIN ENTERS INTERACTION MULTIMODALLY WITH HER LATE FATHER MAR THROUGH SPEECH & AFFECTION.....	473
FIGURE 49: LIN TAKES HER FINGERS TO HER MOUTH AFTER OVERHEARING HER MOTHER ROX SAY THE WORD "CHILE".....	474
FIGURE 50: MULTIMODALLY LIN REPEATS THE OVERHEARD WORD "CHILE" & POINTS IN MAR'S DIRECTION...	475
FIGURE 51: LANGUAGE RECIPROCITY LIN <-> ROX: SPANISH, ENGLISH & MIXED UTTERANCES.....	506

List of Plurilingual Transcripts

PLURILINGUAL TRANSCRIPT 1: LABOV'S OBSERVER'S PARADOX: AUG_26_2018_LIN_GLO_JUL_ALE_GOY_ERI_GUI.....	201
PLURILINGUAL TRANSCRIPT 2: CHAT CODING CONVENTIONS AS THEY APPEAR IN THE TRANSCRIPTIONS: AUG_26_2018_JUL_GLO_ROX_ROC_ERI_LIN_JUL.....	237
PLURILINGUAL TRANSCRIPT 3: EXAMPLE OF DIFFICULTY IN INTERPRETING CHILD LANGUAGE IN INTERACTION: AUG_30_2018_LIN_ROX_ALE_ERI_GLO_JUL_RIC_MAR.CHA.....	242
PLURILINGUAL TRANSCRIPT 4: EXAMPLE OF CHALLENGES IN TRANSCRIBING OVERLAPPING SPEECH FROM: AUG_26_2018_GLO_ROX_GUI_ALE_ERI_LIN_RIC.CHA.....	245
PLURILINGUAL TRANSCRIPT 5; EX. 1: FEB_20_2018_GRC_ERI_JUL_LIN_I DON'T HAVE TO TALK ESPAÑOL_A	365
PLURILINGUAL TRANSCRIPT 6; EX. 2: FEB_20_2018_GRC_ERI_JUL_LIN_I DON'T HAVE TO TALK ESPAÑOL_B	368
PLURILINGUAL TRANSCRIPT 7; EX. 3: AUG_30_2018_LIN_ROX_ALE_ERI_GLO_JUL_RIC_MAR_No GRACIAS.CHA	371
PLURILINGUAL TRANSCRIPT 8; EX. 4: JAN_11_2019_ROX_LIN_JUL_GRC_RIC_ERI_sí ESPAÑOL_A.....	380
PLURILINGUAL TRANSCRIPT 9; EX. 5: JAN_11_2019_ROX_LIN_JUL_GRC_RIC_ERI_sí ESPAÑOL_B.....	388
PLURILINGUAL TRANSCRIPT 10; EX. 6: FEB_22_2018_LIN_ROX_JUL_RIC_GRC YOU'RE MY TÍO_A.....	395
PLURILINGUAL TRANSCRIPT 11; EX. 7: FEB_22_2018_LIN_ROX_JUL_RIC_GRC YOU'RE MY TÍO_B.....	397
PLURILINGUAL TRANSCRIPT 12; EX. 8: FEB_22_2018_GRC_LIN_RIC_ERI_JUL_GLO YOU'RE MY TÍO_C..	399
PLURILINGUAL TRANSCRIPT 13; EX. 9: FEB_21_2018_GRC_ROX_ERI_LIN THEY CALLED FRUITS LOOP PUTA!_A.....	405
PLURILINGUAL TRANSCRIPT 14; EX. 10: FEB_21_2018_GRC_ROX_ERI_LIN THEY CALLED FRUITS LOOP PUTA!_B.....	408
PLURILINGUAL TRANSCRIPT 15; EX. 11: FEB_21_2018_LIN_GRC_ERI_ROX_MAR_PONME EL VESTIDO POR FAVOR_A.....	418
PLURILINGUAL TRANSCRIPT 16; EX. 12: FEB_21_2018_LIN_GRC_ERI_ROX_MAR_PONME EL VESTIDO POR FAVOR_B.....	422
PLURILINGUAL TRANSCRIPT 17; EX. 13: FEB_21_2018_LIN_GRC_ERI_ROX_MAR_PONME EL VESTIDO POR FAVOR_C.....	426
PLURILINGUAL TRANSCRIPT 18; EX. 14: FEB_13_2018_RIC_ALE_LIN_GLO_ROX_JUL_GRT_CHILE JALAPEÑO	434
PLURILINGUAL TRANSCRIPT 19; EX. 15: FEB_22_2018_ERI_LIN_JUL_GRC_TORONJA	441
PLURILINGUAL TRANSCRIPT 20; EX. 16: FEB_1_2018_ERI_LIN_JUL_ROX_POZOLE_A	446
PLURILINGUAL TRANSCRIPT 21; EX. 17: FEB_1_2018_ERI_LIN_JUL_ROX_POZOLE_B.....	450
PLURILINGUAL TRANSCRIPT 22; EX. 18: JAN_12_2019_GLO_ARA_ALE_LIN_JUL_GOY_ROX_SALSA.....	455
PLURILINGUAL TRANSCRIPT 23; EX. 19: FEB_21_2018_ROX_ERI_GRC_GRT_JUL_LIN_TORTILLA.....	460
PLURILINGUAL TRANSCRIPT 24; EX. 20: FEB_15_GLO_JUL_LIN_ERI_2018_MOSCA	465
PLURILINGUAL TRANSCRIPT 25; EX. 21: JAN_09_2019_LIN_GLO_ERI_ROX_MAR_CHILE.....	471

Introduction

Modern linguistic research (Chomsky, 1965) advanced that the perfect monolingual speaker anchored in his or her homogeneous speech community met the ideal conditions in which to study how languages are acquired, and the nature of linguistic competence to name a couple of basic issues. Central to this theoretical linguistic perspective is that language is largely an internal, language specific mental affair. However, before Chomsky, researchers argued (Jakobson et al., 1953) that “le bilinguisme est ... le problème fondamental de la linguistique” (Jakobson, 1963/2003: 35), that is, the central problem of linguistics was bilingualism. The notions *bilingualism* and *bilingual*, as we will see in our literature review have been the objects of diverse and unsettled definitions. In the present study the term bilingual refers to an individual who speaks or at least understands more than one language. In the next chapter, the varied definitions of bilingualism will be more aptly discussed. For now, we define a bilingual speaker as someone who may not have productive abilities in his or her weaker language. In our study we refer to this as passive Spanish bilingualism. Inherent to our definition is also the idea that perfect bilinguals if indeed such speakers exist, are rare. The term bilingualism refers to an ever-shifting socio-cultural, and socio-linguistic state that is rooted in heterogenous, often conflictual speech communities. Furthermore, based on several key factors that will be covered in the ensuing chapters bilingualism as a social, cultural, and cognitive condition may strengthen or weaken across the lifespan, and it is largely dependent on social interaction. In our cognitive-functional, and social-interactionist-based paradigm, learning languages is very much an external affair. Language learning is also at the intersection of internal, cognitive mechanisms that are general and not language specific. The ability to speak and/or to understand two (or more) languages is rooted at the overlapping individual, familial, and societal levels the world over, or since humans through their incessant movements across the globe began to encounter *others* with unique linguistic and cultural backgrounds. Indeed, migration is what makes us distinctly human, and it is “un aspect human qui ne changera pas.” (Heyer, 2022: 241) (a human aspect that will not change.) It is within these distinct language contact contexts that children acquire and are socialized to and by the languages to which they are exposed through both *child-directed* and *overheard* speech. Child-directed speech will refer to utterances that are intentionally addressed to a child as the term implies while overheard speech will refer to the ambient discourse in the bilingual language learning environment that is not specifically addressed to the child.

The discussion above suggests that language contact engenders different degrees of bilingualism, or distinct types of bilingual speakers. These are notions that will be discussed in

the ensuing chapters. But in doing so, it also infers a definition of language. Many linguists have dedicated their life's work to studying languages as a rule-governed system. That is, as a systematic way of combining smaller units to create larger ones (i.e., from sounds to words, to sentences) in the meaning making process. However, from this prism language may seem like an abstract object that does not account for non-linguistic factors. In the rich languages of specific communities of practice other extra-linguistic factors should be considered. To make this point clear, if we wanted to work on Spanish as a rule-governed system, first we would have to agree on what Spanish refers to. If Spanish is defined, or referenced as the language of Spain, what is then the language spoken in Mexico, Argentina, and Chile⁵? In the U.S., what is the language spoken by the many Hispanic immigrants who reside in Miami, Chicago, and L.A.? These types of questions, and many others that we will not discuss here have encouraged linguists to suggest an alternative notion of language. While there is no simple answer to what a *language* is, we may define it as a social notion. A definition of language should account for its speakers, and its context of use. The concept of language

is essentially a social one in the sense that it is defined in terms of the people who speak it, and that as people vary in terms of their social characteristics – such as age, gender, place of origin and ethnicity – the language they will speak will have various manifestations. (Wei, 2000: 9).

From this perspective, the borders between people engender the borders between languages, and the same may be argued for language contact situations i.e., contact between languages is driven by contact between people. The position taken in this study is that language may not be reduced to an abstract, and rule-governed system of sounds, words, and sentences. On the contrary language is a social construct. Language is used for specific purposes such as to communicate, and to structure social life (Tomasello, 1999/2022). Based on its unique characteristics, speakers use it not only to communicate, but also to identify themselves from other communities of practice. Of course, these practices are heightened in bilingual settings.

Researchers (Grosjean, 2010; Tucker, 1998) have estimated that globally at least half if not more of the population is bilingual. Bilingualism is thus a naturally occurring phenomenon that blooms everywhere, for example in often tension ridden *third spaces*, or interstitial communities where languages and cultures have come into contact, and at times *hybridize*. By hybridization we refer to the fusion of linguistic and cultural practices that may

⁵ We do understand that there are a great number of indigenous languages spoken in these countries, but for all intents and purposes, here we refer to Spanish since it is the language spoken by most of the population.

lead to the emergence of a third linguistic identity, for example the use of language mixing in interaction. In our dissertation language mixing is defined as the use of Spanish and English in or between utterances by a speaker, and language mixing is detached from pejorative connotations. We will develop on language contact and language mixing further below. Nevertheless, it is an additional mode of communication that is deployed along the side of English, and Spanish for Mexican-American bilinguals in Southern California (Bustamante-López, 2008). Notwithstanding, within the framework of our investigation, bilingual speakers, and by extension their ever-shifting states of bilingualism are grounded in what has been coined a *tercera Hispanidad*. For Fuentes, it is a geographical location where

El mundo hispánico no vino a los Estados Unidos, sino que los Estados Unidos vinieron al mundo hispánico. Quizás sea un acto de equilibrio y aún de justicia poética que hoy el mundo hispánico regrese tanto a los Estados Unidos como a una parte a veces olvidada de su herencia ancestral en el hemisferio americano⁶. (Fuentes, 1992/2016: 444-445).

The argument that the U.S. came to the Hispanic world and not the other way around may set an underlying and uneasy political tone at the national level. Language is both a socio-political (Wei, 2000), and a socio-cultural issue (Jakobson, 1963/2003; Duranti, 1997). To put into question which nation came first in the present-day U.S. undeniably creates social, cultural, and linguistic friction since “a lot of ... social identification is accomplished through language choice.” (Wei, 2000: 12) in many countries around the world. Moreover, the Hispanic world’s re-emergence is justified through two key reasons. First, it is a way to bring balance, or even social justice to the minoritized people who both survive and thrive in this contact zone. Second, it is also a way for them to bring back to the territory the sometimes-forgotten ancestral *heritage* ingrained in the Northern Hemisphere. By heritage we mean any number of inherited social, cultural, and linguistic traditions which are unique to the human species (Tomasello, 1999/2022). For example,

A common view of culture is that of something learned, transmitted, passed down from one generation to the next, through human actions, often in the form of face-to-face interaction, and, of course, through linguistic communication. This view of culture is meant to explain why any human child, regardless of his genetic heritage will grow up to follow the cultural patterns of the people who raised him. (And) Largely through language socialization, he will acquire the culture (language included) of the people he lives with. (Duranti, 1997: 24).

⁶ The Hispanic world did not come to the United States, rather the United States came to the Hispanic world. Perhaps it is a balancing act and even an act of poetic justice that today the Hispanic world returns not only to the United States, but also to a part of its sometimes-forgotten ancestral heritage in the American hemisphere. – My translation.

We may apply Duranti's view of linguistic and cultural transmission through socialization to the Spanish language and the Mexican-American culture within the framework of this study because "There is a linguistic homology at work" (Duranti, 1997: 27) between these two very real mental realities. Language and culture are related because they share a common origin. Even so, we must also keep in mind that communities vary in terms of the sociocultural diversity that they represent. Evolution is a powerful universal force (Heyer, 2022), therefore diversity is the rule and not the exception, and this even at the individual level within a family. This aspect of culture was rather evident to Edward Sapir. He argued that "Every individual is, then, in a very real sense, a representative of at least one sub-culture which may be abstracted from the generalized culture of the group of which he is a member" (Sapir, 1949a: 515). By heritage we thus mean the diverse cultural and linguistic inheritance that we observe and that children, but also adults imitate as a result of the language socialization process. We will briefly describe heritage speakers and heritage languages below, but they will be more amply discussed in Chapter 2.

For now, suffice is to say that heritage bilingualism has been largely studied through grammatical, rule-governed lenses emanating from theoretical linguistics. These studies have frequently been based on second-generation heritage speakers recruited in university settings with little, or no account of their input, or their social interactions within their speech communities. Moreover, through experiments and other language related tasks their heritage grammars have often been described as incomplete, an issue that is problematic and that will be dealt with later in this dissertation. However, there are conflicting views of this linguistic deficit perspective, as well as of the methodological approaches used to arrive at these results. Also, there is an overall lack of research regarding how heritage bilingual children, as opposed to adults, acquire, and are socialized to and by language in naturalistic contexts to bicultural and bilingual practices, as opposed to laboratory-like settings. For example, what is missing from the picture in studies of heritage bilingualism is how heritage language transmission takes place within their unique and dynamic communities of practice. More specifically, in this investigation I seek to address the following research issue: *How is LIN, a third-generation child acquiring and socialized to use heritage Spanish in her L.A.-based multigenerational family where English is the socially dominant language?* This longitudinal case study therefore aims to explore and evaluate LIN's use of Spanish, but also her use of English, and language mixing in her highly dynamic and ever-shifting bilingual language learning environment. Now that we have highlighted our main research question, in the remainder of our introduction will

underscore the necessary context for the study. After discussing the background, we will reframe the research problem, and then underscore our overall research aims, objectives, significance, and limitations. Finally, the introduction will end with an overview of the present investigation.

Conceptual, theoretical, & contextual background

Defined broadly, heritage speakers include children and adults who are growing up in or grew up exposed to a language spoken primarily, but not exclusively in the home. Exposure to the home language i.e., child-directed, or overheard speech may also fluctuate and thereby displaying varying levels of balanced-ness in the bilingual language learning environment across the lifespan. In these types of language contact settings, the majority, often official language is omnipresent. It is spoken and used within the larger speech community (in public), whereas the home language is typically used on the side (in private). The home language is therefore the heritage language. Generally defined, heritage languages are thus cultural minority languages that emerge in tension ridden bilingual contexts where another majority language is spoken. In our case study Spanish in L.A. is the minority heritage language and English is the dominant majority language. However, for reasons that we will expand on later

Spanish has become subordinate to English, not because of linguistic reasons, but because of the socio-political and historical factors which have made English officially, socially, practically, and economically superordinate, a status which this language to a large extent enjoys at the international level as well. (Silva-Corvalán, 1994: 9).

Furthermore, in perhaps most cases immigrants (the first-generation) speak a monolingual language variety from their home country. Their children (the second-generation and beyond) who are born in, or who are brought to the new socio-politically charged linguistic context at an early age typically speak the heritage language. The issue of time of arrival to define generation status will be further defined in Chapter 2. Heritage languages may also be spoken within their own nation states too for example, in places where an indigenous language such as Nahuatl shares space with a majority language like Spanish in Mexico, but this issue will not be entertained further here.

Heritage speakers and their languages as we will see in our literature review have existed since the onset of linguistics as an established scientific field of inquiry. However, this population of speakers and their languages have often been described with varied names.

Nevertheless, the term heritage language, which was developed in the 70's (Aalberse et al., 2019) is likely the most widely used denomination at least in North America. *Heritage language acquisition* may therefore be defined as a type of early bilingual acquisition which unfolds in unique, and highly politicized sociolinguistic environments (Silva-Corvalán, 1994; Wei, 2000; Montrul, 2016). Specifically, heritage language acquisition research seeks not only to understand the developmental stages and the outcomes of heritage language learning from childhood to adulthood, but also it aims to apprehend the impact of the ever-fluctuating input on heritage language development. For theoretical and practical reasons, the study of heritage bilinguals has considerably grown since the early 2000's even if sociolinguists have since the 40's (Guardado, 2018) delved into language change related issues, and the emergence of new language varieties (Weinrich, 1953). Nevertheless, theoretical linguists, psycholinguists, and language acquisition scholars of bilingualism have generated a wealth, if not most of the research on heritage speakers who are considered special kinds of bilingual language learners (Polinsky, 2018). They have aimed to answer many questions, for example those relevant to general theories of acquisition (Genesee, 2000), as well as those related to language contact and change (Yip & Matthews, 2007). Notwithstanding, even though heritage languages emerge within their natural language contact environment, in the last two decades focus turned to investigating heritage speakers and their languages as an individual phenomenon, or as mind-internal. Even if studies of heritage bilingualism have been grounded both on *nativist* and on non-nativist *constructivist* theories of monolingual acquisition, as we will see in Chapter 1 nativist theories have produced a greater amount of research overall. However, the present longitudinal case study is multidisciplinary bridging bilingual language acquisition and language socialization research, while also drawing on other established research methods and paradigms such as sociolinguistics. We will discuss some of these next, but first the figure below illustrates our multidisciplinary approach to the study of heritage speakers and heritage languages.

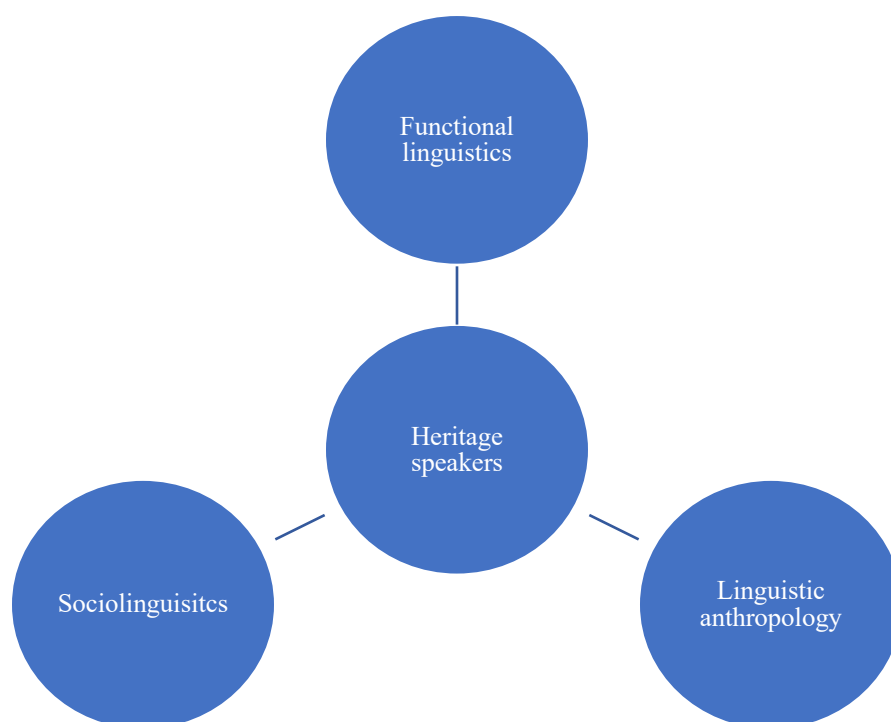

Figure 1: A study of heritage speakers from a multidisciplinary perspective

Our investigation is grounded on constructivist cognitive-functional and social-interactionist-based frameworks for example the *usage-based theory* (Tomasello, 2003) for the former and the *language socialization theory* (Ochs & Schieffelin, 2011) for the latter. Taken together these theories regard language development as the result of the dynamic interplay between young children, and their general cognitive mechanisms. Some of these include joint attention, gaze following, pattern finding, and the ability to solve problems etc. which are anchored in the language learning environment where young language learners receive rich social cues. Language acquisition is therefore driven by language socialization, “a fluid, unstable, and changeable process.” (Guardado, 2020: 39) in the family ecology that considers rich interactional aspects. First for example (and in no particular order) is the *participation framework*, or the ever-shifting roles of multiple bi- and monolingual interlocutors in dyadic, triadic, and multiparty social interaction where “all those who happen to be in perceptual range of the event will have some sort of participation status relative to it.” (Goffman, 1981: 4). Second, it accounts for the rich *multimodal* communicative functions, or how visual-gestural resources support the meaning making process in the varying social encounters where multiple linguistic resources are deployed orally such as the use of Spanish, English, and language mixing. Third, language socialization and usage-based theories consider implicit and explicit *discursive* input features to be at the heart of the language acquisition process. This is especially true in *multigenerational* bilingual settings where the speakers are defined by their order of

birth (Ortman & Stevens, 2008) and where discursive strategies lend themselves to (re)creating a mono- or bilingual language learning environment. Heritage language acquisition and language socialization by nature are highly complex. In these types of bilingual language learning environments, a plethora of elements interact including, but not limited to biological, social, cultural, and cognitive factors (Tomasello, 1999/2022). This is precisely the case of heritage Spanish in L.A., the site where the present investigation is rooted. The figure below shows the overlapping interactional complexity in which heritage speakers are rooted, and that we will use to organize our qualitative analyses.

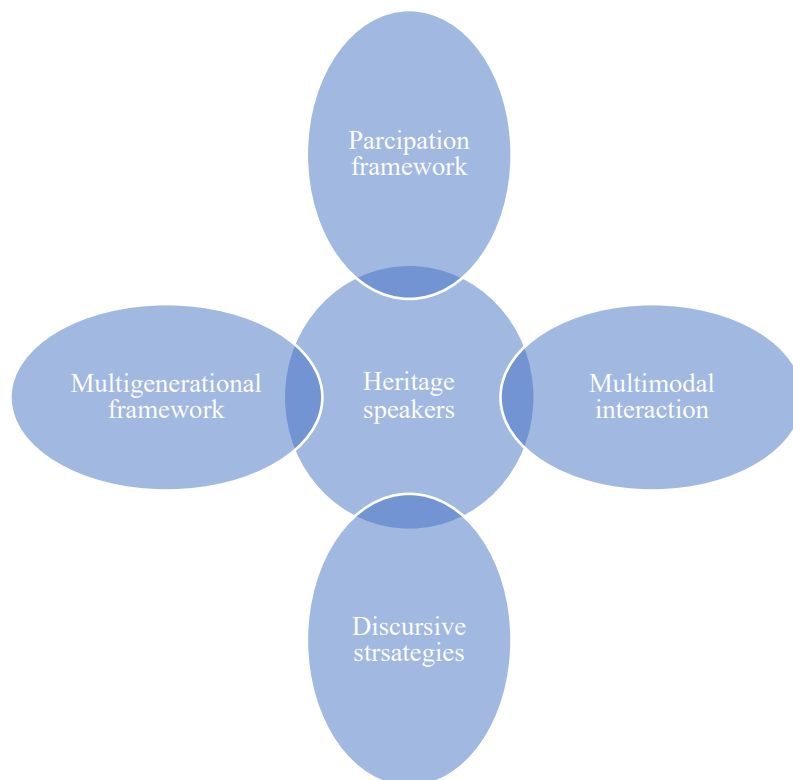

Figure 2: Heritage speakers as embedded in the multidimensional interactional process

Previously we underscored that globally bilingualism is the norm. Naturally then, bilingualism is also present in the Spanish-speaking world. It permeates across social classes, and age groups, and in countries where the official, or co-official language is Spanish. This is the case for example with Mayan languages in Mexico, Quechua in Peru, or Galician in Spain. Nevertheless, even if bilingualism is spread across the world “research interest in the acquisition of Spanish with another language is rather recent.” (Silva-Corvalán, 2014: 2). However, it is argued that Fantini (1985) conducted the first in-depth longitudinal study of Spanish-English bilingualism where he studied his son’s language development between 0 and

10 years old. Notwithstanding, Spanish bilingualism also takes root in countries where it is *not* an official language for example in many parts of the U.S., and namely in its large cosmopolitan cities. Therefore, the present dissertation is grounded in this bicultural and bilingual context, or in the historical case of Spanish-English language contact in L.A. In this region, some experts even argue that this contact situation may lead to a stable form of bilingualism for the first time within the linguistic history of the country. While this issue will not be addressed here, we insist that Spanish-English language contact is in part attributed to political, social, and economic factors to name a few, all of which are interrelated and that have engendered long and steady flows of immigration from Mexico to the U.S. Thus, heritage bilingualism has resulted from the intimate and sustained contact between Spanish and English for just about 175 years now. This language contact situation has naturally given rise to new cultural and linguistic patterns that are unlike what may be found in monolingual, monocultural middle-class American families with perhaps fewer speakers that span fewer generations in their intimate social encounters. These socio-cultural and socio-linguistic patterns may also be responses to new, ever-changing, and tension ridden social environments. In other words, minority communities in *third spaces*, try to merge, or hybridize with the dominant, majority culture, to fight, or push back against the dominant culture (Bhabha, 1994), or at least to renegotiate their identities. The capacity to hold on to one's heritage language in contact where another language is dominant helps ethnic minorities to cultivate not only a firm cultural identity, but also a strong sense of self (Guardado, 2006). In this light, ethnicity seems to be sustained across generations for many Mexican-Americans in the U.S. (Telles & Sue, 2019). Furthermore, a result of having a strong cultural identity is also a key factor that promotes language maintenance. This cultural struggle is real, *the struggle is real*, and it implicitly translates into a linguistic struggle between heritage, minority languages and majority languages as well. Below we will thus provide current contextual factors and what this means for heritage Spanish research in the U.S., and in particular within the L.A.-based context.

Brief history of Spanish in L.A.

An approximately 2,500-mile-long border divides the U.S. and Mexico, and it is argued that “la tercera hispanidad, la de los Estados Unidos, constituye no sólo un hecho político o económico. Es, sobre todo, un hecho cultural. Toda una civilización ha sido creada en los Estados Unidos con un pulso hispánico.” (Fuentes, 1992/2016: 445-446) (The third Hispanic wave, that of the United States, is not only a political or economic fact. Above all, it is a cultural

construct. An entire civilization infused with a Hispanic pulse has been created in the United States.). The Mexican-American border, or *la frontera* as it is commonly known to Spanish speakers on either side of it represents a political distinction between a first-world country, the U.S., and a developing country, Mexico. This area has also been theorized as the *borderland* (Anzaldúa, 1987), but we will not dwell on this issue here. Nevertheless, while in theory the border imposes a linguistic, and a cultural division, we will see later through our quantitative measures and especially through our qualitative analyses how in practice English is enriched with a Spanish pulse thereby engendering heritage bilingual speech communities where Spanish, English, and language mixing are readily used. The U.S. is unofficially an English-speaking nation, while Mexico is officially a Spanish speaking country. Nevertheless, this has not always been the case. Therefore, to better understand the bilingual and bicultural context of Spanish heritage speakers in L.A., it is important to consider a brief history of Spanish in L.A. 30 years ago Fuentes boldly stated that “Actualmente Los Ángeles es la tercera ciudad de lengua española del mundo, después de México y Buenos Aires y antes que Madrid o Barcelona⁷.” (Fuentes, 1992/2016: 445) (Today, Los Angeles is the third largest Spanish-speaking city in the world after Mexico City, and Buenos Aires, but before Madrid and Barcelona.). While we will not dwell on these precise demographic figures, we may ask how L.A. became one of the largest Spanish speaking cities in the world. We will thus briefly sketch out the historical-political underpinnings and move from the larger U.S. context, to California, and then on to L.A., before focusing on the Florence-Firestone district of L.A. where the family in question has resided since the late 70’s.

Spanish was spoken in what is now the western part of the U.S. since its founding in 1777 by the first Spanish governor of Alta California as the city of Los Angeles. Along with about eight other states California belonged to Spain and then to Mexico, until the signing of the *Treaty of Guadalupe Hidalgo*⁸ in 1848 (Macias, 2001), after nearly 400 years of Spanish colonial history in the Americas. Indeed, “Nearly two-thirds of the current mainland jurisdiction of the United States was, at one time, under a Spanish-Speaking sovereign-Spain

⁷ When Fuentes made this assertion in 1992, according to source data from the United Nations Department of Economic and Social Affairs Population Division (2018) there were roughly 16.1 million Spanish speakers in Mexico City, and 11.3 million in Buenos Aires. Today there are almost 22 million Spanish speakers in Mexico City, and almost 15.3 million in Buenos Aires. Various estimates suggest that in the greater L.A. metropolitan area there are nearly 1 and 8 million Spanish speakers less than there are in Bogotá, and in Lima, but still more than in Madrid and in Barcelona.

⁸ This was a Treaty of peace, friendship, limits, and settlement between Mexico and the U.S. It ended the war between these two nations, and by its terms Mexico ceded 55% percent of its territory.

or Mexico.” (Macias, 2001: 335). Moreover, at that moment in time estimates suggested (Romo, 1983; Macias, 2001) that there were approximately 100,000 Mexicans already living in the newly gained U.S. territory following the treaty since “The Spanish-Mexican population stayed at first in the original core area of the city” (Silva-Corvalán, 1994: 9). In other words, 100,000 Spanish speakers were already established in the present-day U.S. when the Spanish-speaking land became part of the U.S., an unofficial English-speaking country. By the 30’s however L.A. grew to a metropolis of over one million, and following the Second World War, the population greatly multiplied, and the city expanded to a megalopolis of over seven million. In the late 60’s, or in the years that proceeded WWII “Los Angeles had become the major destination for Mexican immigrants and Mexican in-migrants from other areas of the southwest” (Romo, 1993: 170). Thus, 400 years of Spanish colonial rule, and by extension Spanish linguistic history before the arrival of English, as well as the city’s rapid growth and attraction for Mexican immigrants may be considered the most substantial reasons that in part, explain the importance of Spanish not only in the western zones of the U.S., but also its maintained use in L.A.

Furthermore, through the creation and enforcement of language policies where “only English was permitted for instruction” (Romo, 1983: 25), “By the beginning of the 20th century, California had subjugated non-English languages, especially Spanish, which had a special status as the official language of the prior sovereign”, which lasted “for most of the 20th century” (Macias, 2001: 347). Nevertheless, “Southern California, however, remained ‘Mexican’ in population well into the 1870’s” (Macias, 2001: 346) as mentioned above, and this allowed Spanish to thrive in the region. Furthermore, the steady flow of immigration of Spanish speakers undoubtedly benefited the maintenance of Spanish in California across the generations. In 1990, Spanish was the prevailing language in 39 states with 8.6 million Spanish speakers in California alone (Macias, 2001) Then, ten years later it was suggested that “Para el año 2000 los hispanos aumentaron aún más, pues abarcaban el 45% de los 9.5 millones de personas que vivían en el condado de Los Ángeles. ... Entre éstos, el 76% era de origen mexicano.” (Hayes-Bautista, 2000; cited by Parodi, 2003: 24) (By the year 2000, the Hispanic population increased even more, indeed, they represented 45% of the 9.5 million people that lived in Los Angeles county ... And among them, 76% were of Mexican origin.) Through the 20th century then, and the beginning of the 21st century, the number of Hispanics living in L.A. county increased dramatically. Moreover, approximately 76% percent of the Hispanics living in L.A. were of Mexican origin. Thus, it may be sustained that along with the 400 years of

Spanish colonial history that contributed to the large number of Spanish speakers in the city was population growth. That is, the number of Spanish speakers increased both through immigration (largely from Mexico), in-migration (those coming from other states), but also from the birth of the second-generation children of these immigrants, followed of course by the second-generations' offspring who belong to the third-generation such as LIN, the target-child in our study.

Next, according to Field (2011) a milestone was reached between July 1, 2005, to July 1, 2006. During this time, the U.S.s' "Hispanic population (the largest and fastest growing minority) had reached 44.3 million" with "California at 57 percent" (Field, 2011: 12). Furthermore, according to a study published by the *Instituto Cervantes*, there were an estimated 11.6 million bilingual Spanish and English speakers in the U.S. in addition to the 41 million native speakers of Spanish in the country (Burgen, 2015). Finally, "the US Census Office ... estimates that the US will have 138 million Spanish speakers by 2050, making it the biggest Spanish-speaking nation on Earth, with Spanish the mother tongue of almost a third of its citizens." (Burgen, 2015: 1). According to these figures, the number of heritage Spanish speakers will inevitably continue to rise in the U.S. and in about 25 years the U.S. could become one of the largest Spanish speaking countries on the planet. However, as it stands "Spanish is indeed a global language in its range of world-wide uses and status." (Mar-Molinero, 2010: 162) with over 400 million speakers across the globe (Gordon, 2005), and its world-wide influence is led by Latinos in the U.S. (Mar-Molinero, 2010).

Considering the history and figures presented above, it may become clearer how Spanish in L.A. in 1992, according to Fuentes was the third largest Spanish speaking city in the world. Furthermore, the idea that the U.S. is set to become the largest Spanish speaking country, the issues of Spanish as a heritage language, heritage bilingualism, heritage language acquisition and language socialization as well as the characteristics of the Spanish of Los Angeles are bound to take center stage at educational, political, social, cultural, and linguistic levels. For example, at the linguistic level researchers have already shown that "Esta situación numérica y de convivencia de la población hispana motiva que los dialectos del español se nivelen y se forme una *koiné* o español general de base mexicana o *español chicano*." (Parodi, 2003: 28) (This numerical situation and of coexistence of the Hispanic community has motivated leveling among Spanish dialects and that a *koiné* is formed, a general Spanish with a strong Mexican base, or Chicano Spanish.). Parodi thus argues that the sheer number of

Spanish speakers living together in L.A. has engendered a variety of Spanish with a Mexican base through the levelling of the various Spanish dialects spoken in the area. However, the linguistic characteristics of this variety of Spanish will not be dwelled upon here. Nevertheless, we see that the continued growth of the Spanish speaking population has impacted Spanish at the linguistic level in L.A. in that it has motivated it to change. Moreover, this variety of Spanish is used along with English, and language mixing and this is unlikely to change as well. This long-lasting linguistic influence may be likened to the process of colonization, for example “if the process of colonization was very long and enduring, then the impact was greater” on the cultural and linguistic practices of the local population (C. Ní Ríordáin, personal communication, January 25th, 2016).

The present research dissertation is therefore rooted in this historical yet current context of Spanish in the U.S., in California, and in L.A., but we should keep in mind that “Los Angeles is not easy to classify neatly into one category of bilingual community with reference to its genesis, boundedness, and stability” (Silva-Corvalán, 1994: 9). While LIN was 3;10 years old at the onset of recording, as a third-generation heritage Spanish speaker, her family has lived in L.A. since the late 1970’s. Her multigenerational family of Mexican origin has both contributed to the maintenance of Spanish at the individual, familial, and societal level, but they have also been impacted by the bilingual and bicultural landscape in which they live. Finally, below we will briefly zoom in on the local language learning context, or the unincorporated Florence-Firestone district.

L.A.’s unincorporated Florence-Firestone district

The Florence-Firestone Community Plan (henceforth, FFCP) of September 2019⁹ was proposed by the L.A. County Department of Regional Planning. This part of the city is a mostly Hispanic community six miles south of Downtown L.A. and it has a total surface area of 3.6 square miles (5.8 kilometers). In the first picture below on the left, we see a red circle. It targets the crisscross shaded unincorporated area in question. Several other Spanish-speaking enclaves border this community such as the City of L.A. to the north, west, and south, and the City of Huntington Park, the City of South Gate, and Walnut Park, another unincorporated community

⁹ The Florence-Firestone Community Plan is 175 pages long and it is composed of five chapters, and a glossary. It was recommended for approval to the Board of Supervisors by the Regional Planning Commission on November 15th, 2017, adopted by the Board on September 3rd, 2019, and effective October 3rd, 2019.

to the east. These neighboring communities are all locked in the middle of a blue oddly-shaped square. Each of these lines corresponds to a highway. The following four highways are: the Long Beach Freeway (the 710) on the right which runs north to south, the short Central Freeway at the bottom with the ticked lines runs east to west, the Harbor Freeway (the 110) on the left also runs north to south, and finally the Santa Monica Freeway (the 10) that run east to west. These blue veins represent major axes of transportation in the city, and they are indeed (in)famous and indispensable to L.A. since they have accelerated the interaction and the interconnection between the largely Mexican culture, and the Spanish language across the state.

Florence-Firestone, 1968

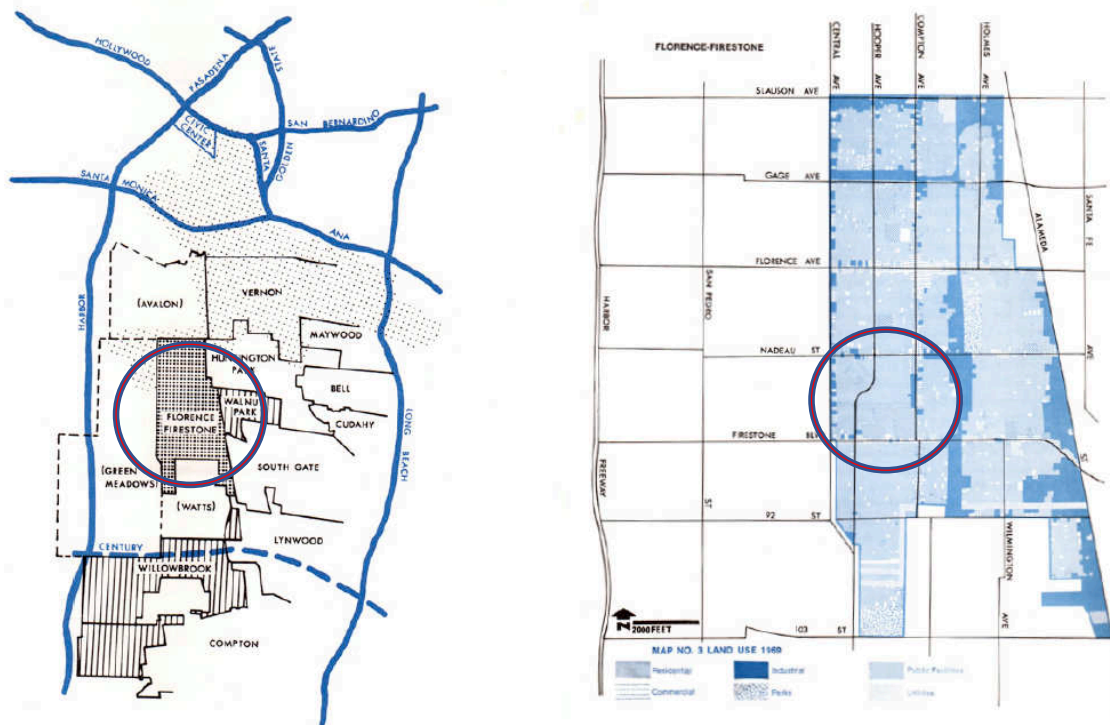

Figure 3: Florence-Firestone & neighboring communities (left) & streets surrounding LIN's general area (right)

Next, the second image to the right above in the area shaded in blue shows a closeup of the Florence-Firestone district. It gives a broad overview of the crisscross pattern which correspond to street, avenue, and boulevard names. Our study is situated between Nadeau Street and Firestone Boulevard which run east to west (horizontal lines), and between Central Avenue and Compton Avenue which run north to south (vertical lines). The general area is identified with the red circle. Overall, Florence-Firestone is centrally located with everything being within a more-or-less 30 minutes' drive from for example LAX, UCLA, Downtown L.A.,

the beach etc. The image below identifies Florence-Firestone relative to the locations mentioned above which are roughly depicted with the red stars.

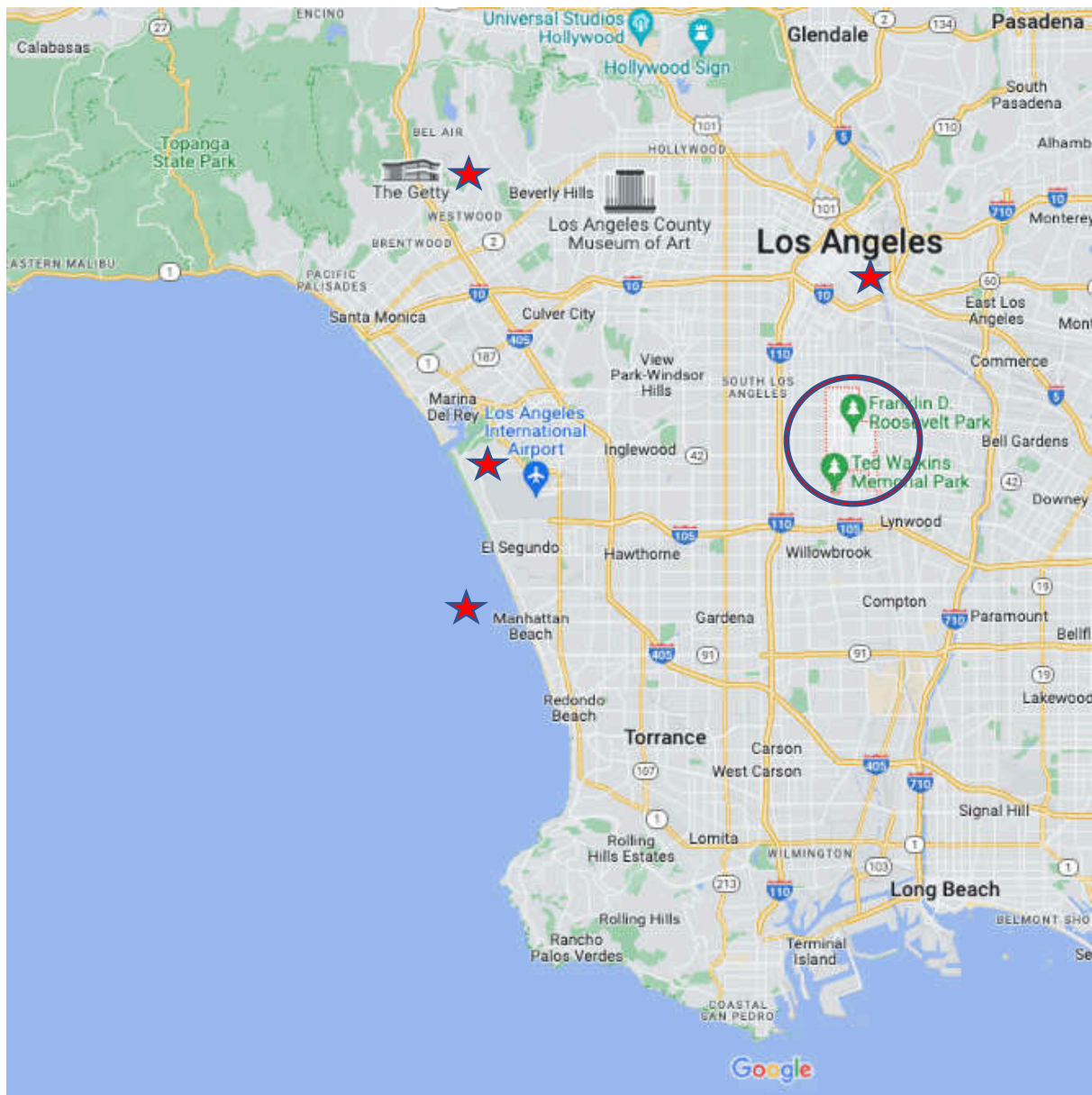

Figure 4: Florence-Firestone relative to other areas in L.A.

Having identified the general area under investigation and how it is spatially orientated, according to the vision statement¹⁰ of this plan

¹⁰ I became aware of this document after attending the monthly Community Leaders’ meeting. I learned about these meetings while conversing with a librarian at the local library where I would go work on a weekly basis. This shows the importance of field work and becoming a “regular” where after several conversations one bit of information that is revealed (though not secret) in casual conversation leads to another.

Florence-Firestone (an unincorporated¹¹ district of South L.A.) is a resilient and healthy community with a strong identity, vibrant local economy, high quality and affordable housing, ample greenery, safe and efficient transportation system, high quality education, quality jobs and inviting commercial corridors where people gather and socialize. (LA County Department of Regional Planning, 2019: 3).

The draft underscores that among many other qualities this contact zone is a place where identity is strong, housing is affordable, and educational offerings are top-notch. Therefore, we will briefly analyze some of their demographic data as it pertains to the community along these three lines. We will briefly examine the population trends, then race and ethnicity, and finally language as it is spoken in the home. Spanish and English use is the object of our investigation, and it is also intrinsic to identity. It therefore presents a solid point of departure for the ensuing discussions, measures, and analyses because it paints a vivid picture of the dynamic bilingual language learning environment that exists outside the home, but that the multigenerational family is part of. Then, we will consider education, which may be measured by overall attainment in terms of degrees. Education has been arguably considered a strong indicator of upward social mobility, and financial stability although this is not always the case. Finally, we will consider what is meant by affordable housing, but through the prism of income. In L.A. housing prices, and property values have grown exponentially as a whole, especially in the most affluent communities. As such, affordable housing is relative to income level.

It is also critical to highlight that even though the “Community Plan is a land use development guide intended to direct development and land use decisions to achieve the community’s vision” (LA County Department of Regional Planning, 2019: 9), it nevertheless provides useful statistics about the population at large. It is within this population of speakers in which LIN’s family is rooted, and LIN’s linguistic and cultural life is an extension of this family. She has also begun formal, dual language education at the local elementary school, so she is socialized to and with language, and with and by the other younger (classmates) and older (family, friends, public acquaintances etc.) heritage Spanish speakers in her life. This is a great advantage within the framework of the present research project. In the plan, the third chapter entitled “Existing Conditions” we find information related to demographics such as population, race and ethnicity, and language use data is also underscored. Other areas that are covered in the remainder of the chapter include education, income, employment, transportation, and public facilities but not all of them will be entertained here. We will thus

¹¹ Unincorporated: according to Dictionary.Cambridge.org, the adjective ‘unincorporated’ refers to the lack of corporate status, or a designated area that is not officially part of a town or city.

focus on population, race and ethnicity, age, and language first, then we will turn to education, and finally income. These characteristics will serve as a rough guide with which to see how the family, and thus the present study fit within the community of heritage Spanish speakers.

Population

An estimated 64,334 people inhabit Florence-Firestone according to data provided by the American Community Survey (2016), but since 2010 the growth rate has been around 1.6%, and it was projected to grow 2.2% by 2021. Overall, however, population growth has declined despite that in the past the average rate of growth was 5% with a strong increase between the 60's and 80's. The bar graph below depicts the population shifts from 1960 and projects them to 2030 (eight years from now). Population growth in the area is thus predicted to remain stable at 2.2% as depicted by the blue dots for the next few years.

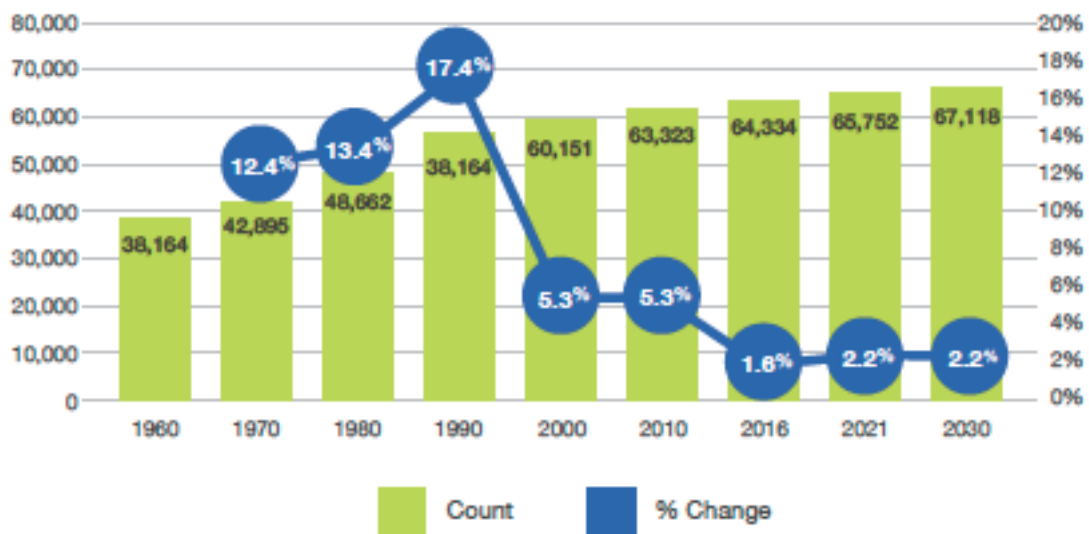

Figure 5: Population trends in Florence-Firestone adapted from Figure 2 in LA County Department of Regional Planning (2019: 31)

Race & Ethnicity

99.42% of the community was of minority origin in 2016 in the area (bottom box, third column from the left under Florence-Firestone). Of these, 90.73% of the population were made up of Hispanics (uppermost box, third column). At the L.A. county level 74.07% are minorities (bottom box, fifth column), and 49.04% are Hispanic (top box, fifth column). The figures in the table below thus show that even if at the county level Hispanics make up nearly half of the

population, at the community level they make up an outstanding majority at over 90%. LIN and her family therefore reside in a community with whom they share their ethnic origin.

Table 1: Race & Ethnicity adapted from Table 4 in LA County Department of Regional Planning (2019: 32)

	Florence-Firestone		Countywide	
Hispanic	58,368	90.73%	4,976,734	49.04%
Non-Hispanic	5,966	9.27%	5,171,031	50.96%
Non-Hispanic White	372	0.58%	2,631,532	25.93%
Non-Hispanic Black	5,212	8.10%	802,973	7.91%
Non-Hispanic Other	382	0.59%	1,736,526	17.11%
Total Minority Population	63,963	99.42%	7,516,233	74.07%

Age

In terms of age, most of the population is between the ages of 20 to 64 amounting to 57.19% in Florence-Firestone (yellow wedge in the pie chart below). Moreover, the dark blue, lime green, and light blue wedges show that a large fraction of the residents are in the elementary, middle, or high school age. As such, “the quality of education and opportunities for well-paying, stable employment are of high concern.” (LA County Department of Regional Planning, 2019: 32-33). Also, within the framework of this study, except for GRC who is over 64, and LIN, her brother (JUL), and cousins (GOY and IGN) who are under 20, everyone else (ROX, MAR, ALE, RIC, GLO, and GUI) make up the majority in terms of age. The pie chart below presents these figures as parts of a whole.

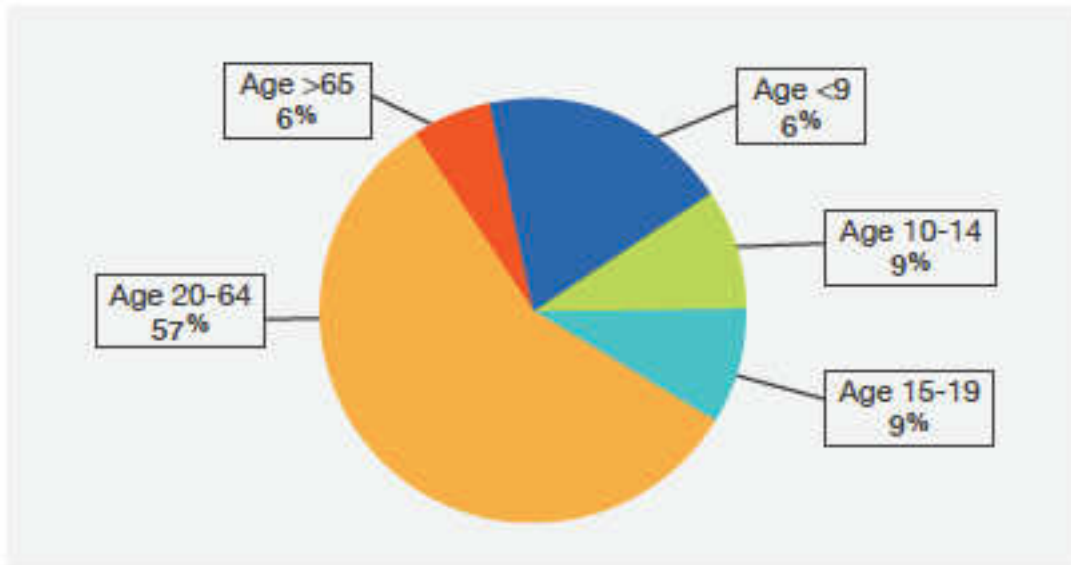

Figure 6: Age groups adapted from Figure 3 in LA County Department of Regional Planning (2019: 33)

Language use in the community

The Florence-Firestone community mostly speaks Spanish. Overall, Spanish speakers amount to 86.77% (second column from the left, second row), which is rather high. However, when compared at the county level this figure drops to 39.2% (third column, second row), but even if it is lower, it remains elevated. Moreover, the draft suggest that “a majority of the population is bilingual, fluently speaking Spanish and English” (LA County Department of Regional Planning, 2019: 33). Bilingual speakers make up 63.43% of the community members, but they do not give further details as to what they mean by bilingualism, or what it means to speak a language fluently. Details related to language mixing are also not available, therefore we will expand on language mixing, on more general terms below. Nevertheless, the notions of bilingualism, and fluency will be covered in Chapter 1 of our literature review. Furthermore, the table shows that 36.57% of the residents either do not speak English well (second column, fourth row), or do not speak English at all (second column, fifth row). As such “This reality greatly impacts residents’ ability to access resources, advocate for their needs, and attain stable, well-paying employment.” (LA County Department of Regional Planning, 2019: 33). Perhaps, for this reason, efforts have been made to provide bilingual documentation in the community at large for example a recent bilingual book entitled *A Paseo through Time in Florence-*

*Firestone*¹²/*Un paseo (a)*¹³ *través del tiempo en Florence-Firestone* published in 2017, at the onset of the present study. The table below illustrates how Spanish, and English are used at the community level and countywide.

Table 2: Languages spoken in the home adapted from Table 5 in LA County Department of Regional Planning (2019: 33)

Language	Florence-Firestone	Countywide
Speak Only English	12.88%	43.22%
Speak Spanish	86.77%	39.42%
*Speak Spanish and English	63.43%	72.02%
*Speak English Not Well	19.50%	18.03%
*Speak No English	17.07%	9.95%

In LIN’s multigenerational family, GRC and GRT are the only ones who speak Spanish only, and almost no English although they may be able to infer what is said in English, or language mixed conversations based on contextual and discursive cues. GUI does not speak English well, but he does use it at work as well as to interact with LIN, and his other grandchildren. GLO, ROX, MAR, ALE, RIC, and ERI are all on the bilingual continuum and speak Spanish and English. LIN may be going through language shift, and thus mainly speaks English with instances of Spanish, and other moments of language mixing. Given these figures, we may thus suggest that the bilingual and multigenerational family members fall within the populations’ bilingual speakers which make up the second majority after the Spanish speakers. We will turn our attention to educational attainment at the community level next. However, before we do so a brief discussion of language mixing is in order.

¹² I learned of and was gifted this richly colored and illustrated 126-page bilingual book during one of the Community Leader meetings. It was published as part of the *Some Place Chronicles*, a L.A. County Arts Commission project in partnership with the Temporary Institute for Unincorporated Studies at the California Institute of the Arts (CalArts), and East of Borneo. It was funded by Mark Ridley-Thomas, the Office of Los Angeles County Supervisor.

¹³ I was surprised to see that the Spanish preposition “a” was left out in the title on the cover page of the book. It might be indicative of the state of Spanish, or of the level of attention that is paid to this language within the community.

Language contact & Language mixing

Language loss through language shift is only one of the multiple results of language contact, language mixing being another since “languages are in contact when they are shared by members of a single community; two languages “live” in the head of one speaker. It is axiomatic in linguistics that languages in contact will influence each other.” (Field, 2011: 7). Field describes language contact when one person, after they have moved to a different linguistic community, speaks two languages. He further adds that languages in contact influence each other in various ways. For other researchers “Contact varieties of language have developed in very different types of settings all over the world, most frequently as a result of a socio-historical background involving nation-building, conquest, colonisation, and immigration.” (Valdés, 2005: 414). Language contact is thus a global phenomenon and due to socio-political reasons, that have caused people to migrate to different regions of the world. Within the language contact context of the U.S., Parodi argues that “Si esto se mantiene a través del tiempo, podrá dar origen a una situación bilingüismo estable, poco frecuente en la historia del contacto de lenguas en los Estados Unidos.” (Parodi, 2003: 36) (If this is maintained through time, it could give rise to a situation of stable bilingualism, not very frequent in the language contact history of the U.S.) In other words, if English and Spanish language contact continues as it has over the decades, this could eventually engender a stable form of bilingualism which is rare in the history in the U.S. as it pertains to language contact. Regardless of how language contact is defined or what it could lead to, what is clear is that language contact produces a variety of linguistic phenomena and language mixing is one of them.

Among the linguistic phenomena that result from language contact is language mixing which has also been described as code-switching, code-mixing along with many other terms. In our study, we will use the term language mixing, or mixed language use and we will define it as “the use of two language varieties in the same conversation. It can occur between speakers, or between sentences in the same speaker’s turn, or within a sentence.” (Myers-Scotton, 2006: 161). For example, the use of Spanish and English by one speaker, or between two speakers qualifies as language mixing. Furthermore, mixed language use in social interaction is a common mode of communication between heritage bilinguals. Researchers argue that it is also “a form of language use determined by a complex network of sociolinguistic variables and constrained by grammatical properties of the utterances” (Meisel, 2004: 9-10). Not only is

language mixing a result of interrelated social, cultural, and environmental factors, but it is also a form of communication between bilinguals that is not random, but rather guided by (abstract) grammatical rules. In our study we will not be concerned by the grammatical properties of language mixing, but rather how as a form of linguistic and cultural diversity they are used in the social encounter, to whom they are addressed, and what their role is in helping heritage Spanish development. Nevertheless, mixed language utterances in our study may be broadly defined (Poplack, 1980) as *intersentential*, and *intrasentential*. The former describes the language mixing of the same or different speakers at sentence boundaries while the latter depicts mixing patterns of the same speaker within a sentence. Later we will present several examples that show how language mixing may lead to negative evaluations. Finally, another type of language mixing is *extrasentential*, or *emblematic*. It is argued that this type of language mixing, used for example in interjections, is rarely subject to syntactic constraints, and readily appears without violating grammatical rules.

Considering the proposed language mixing typology, this mode of communication appears to have a principled basis and that “It is not haphazard – speakers don’t just mix words from two languages together freely.” (Myers-Scotton, 2006: 249). Furthermore, this typology helps to dispel the idea that language mixing is the result of confusion or lack of linguistic mastery. On the contrary, it may be telling not only of young children’s increasing command at the linguistic and cognitive levels (Bhatt & Bolonyai, 2011), but also that language mixing is perhaps used more frequently by bilingual speakers who feel more comfortable and more competent in each of the languages (Poplack, 1980) across their rich and diverse cultural and linguistic settings. Moreover, Myers-Scotton (2006) states that bilingual language mixing is an integral and normal language characteristic that falls within the continuum of the human language capacity much like acquisition itself, and the ability to speak any language. Within the context of my research dissertation, LIN was 3;10 years old when the data collection began. This is also around the time when “adult-like code-switching emerges early during the third year” (Meisel, 2004: 11). We will pay close attention to LIN’s use of language mixed utterances throughout her multigenerational social encounters to see if she may be socialized into this form of talk. We will also consider the role of bilingual adults’ language mixing in interaction to see how it supports her use of heritage Spanish.

This brief overview of language mixing will thus allow us to look at this phenomenon in a positive light, as well as to consider that “The fact, then, that young bilinguals mix their

languages is, more than anything else, a sign of increasing sensitivity to the linguistic behaviour of their environment.” (Meisel, 2004: 11). This is also in line with our general definition of language in that it is a mode of communication that is proper to a specific community of practice. In heritage bilingual communities where language contact is and has been the norm for centuries, as in the case of L.A., language mixing may therefore be expected. Thus, we may advance that language mixing in L.A. is the hybridized response of two distinct linguistic and cultural realities which are manifested through the creation of a third multimodal mode of communication and deployed in a unique bilingual and bicultural context. It is a *tercera Hispanidad* that oscillates between English and Spanish that responds to a new reality “And by exploring this hybridity, this “Third Space” we may elude the politics of polarity and emerge as the others of ourselves.” (Bhabha, 2006: 157). That is because “we know that communities are successful, that is, they survive with a manageable degree of internal conflict, not when everyone thinks the same (something that seems impossible), but when different points of view and representations can co-exist.” (Duranti, 1997: 32-33).

Educational outcomes in the community

According to the draft “A majority of this population has had some high school education or less. While 43.28% of Florence-Firestone residents earned at least a high school diploma ... the level of higher educational attainment in the community is significantly lower than countywide.” (LA County Department of Regional Planning, 2019: 35-36). These figures are based on a population base of 34,363 residents 25 years of age and older. The table below illustrates the educational attainment factor of the community members.

Table 3: Educational attainment adapted from Table 7 in LA County Department of Regional Planning (2019: 36)

Educational Attainment	Florence-Firestone	Countywide
2016 Educational Attainment Base	34,363	6,712,842
Less than 9th Grade	38.08%	13.28%
High School/No Diploma	18.65%	8.91%
High School Diploma	22.65%	19.06%
GED	1.68%	1.75%
Some College/No Degree	11.66%	19.16%
Associate's Degree	3.04%	6.88%
Bachelor's Degree	3.06%	20.01%
Grad/Professional Degree	1.19%	10.95%

In the community only 6.1% have earned an Associate's or a Bachelor's degree (second column, row seven and eight) which is much lower than the educational attainment countywide at 26.89% (third column, row seven and eight). Finally, only 1.19% (second column, last row) of community has attained a graduate, or professional degree. In other words, of the 64,334 residents, in 2016 roughly only 765 of them had an advanced degree. In our study, GRC, a first-generation Spanish speaker did not have the opportunity to attend formal education in Mexico before coming to the U.S. GUI and GRT had a few years of formal education in Mexico as did GLO before they came to the U.S. ROX, MAR, ALE, RIC, and GLO have all attained a high school diploma. While ERI is no longer a resident of Florence-Firestone, we may consider that he makes up part of the 1.19% since he began formal education in the early 80's at the local school where LIN is currently enrolled. This may also make the present research project quite special, or even unusual. Not only is ERI's voice from within the community as many bilingualism scholars have argued in favor for, but also given the fact that so few community members attain advanced education his voice subtly, but surely resonates out of this tension ridden contact zone. As we will see throughout our study, this may be considered

a moment of *komorebi*, which the Japanese use to depict the light, sometimes soft, sometimes strong, and other times fragmented that manages to filter through dense and overlapping leaves every now and again. Notwithstanding, in terms of educational attainment then the family seems to line up with the statistics provided above. Finally, the last factor that we will consider in this section is the income.

Income

Today, homeowners who acquired their properties in the 70’s, 80’s, and 90’s may no longer be able to purchase a home in the unincorporated Florence-Firestone district since the median transaction price is between \$580,000¹⁴ and \$655,000¹⁵. However,

The median household income in Florence-Firestone was \$35,097 in 2016 compared to a median household income of \$57,190 county wide. According to the 2010-2014 US Census American Community Survey estimate, 9,431 households (66%) were at or above the poverty level and 4,873 households (34%) were below the poverty level. (LA County Department of Regional Planning, 2019: 35).

With a median income of roughly \$35,000, it is therefore highly unlikely that the community members can buy homes in the price ranges mentioned above. Next, half or more of the households were above the poverty line, while another third of the households were below it. The bar graph below shows the income distribution at the community level.

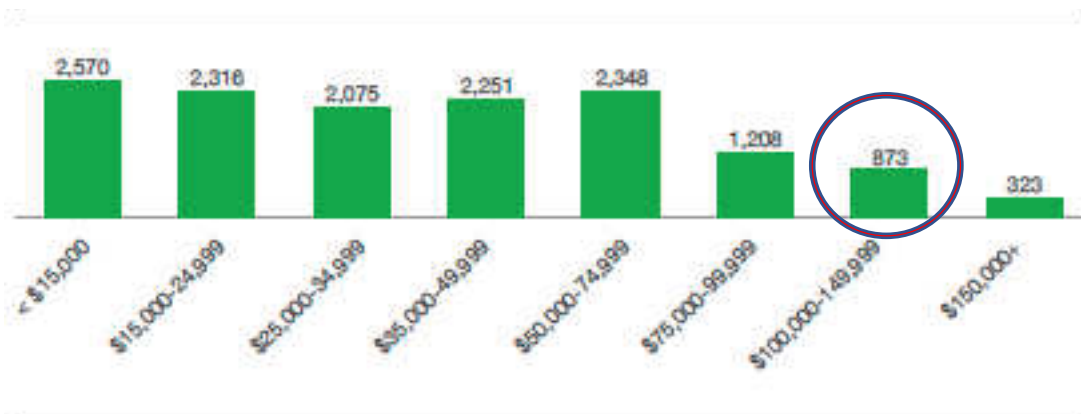

Figure 7: Household income distribution adapted from Figure 4 in LA County Department of Regional Planning (2019: 35)

In many respects, the family under study is just about average broadly speaking. This is the case for example in terms of educational attainment, language use, age, and ethnic origin.

¹⁴ <https://www.rockethomes.com> Listing available in September 2022.

¹⁵ https://www.realtor.com/realestateandhomes-search/Florence_Los-Angeles_CA/show-recently-sold

However, in considering the multigenerational family’s data regarding their household income things are different when compared to the Florence-Firestone population. According to these measures, they are above average. Moreover, despite the family’s overall lack of educational attainment beyond a high school diploma each household including the first- (GRC), first-and-a-half- (GLO and GUI) and second-generation (ROX and MAR, and ALE and RIC) have annual salaries, or return on investments between \$100,000 and \$149,000 per year. This is depicted by the red circle above. To this end, each of the four family units are well beyond the median household income not only within Florence-Firestone, but also at the county level (\$57,190). In the image¹⁶ below we see a bright orange, owner-occupied, single-family, two-story home. LIN lives here with her parents (ROX and MAR) at her grandparents’ (GLO and GUI) home which they bought in the late 90’s, and re-built in the early 2000’s. Most of the interactions used in this project took place in what we have called the “big house”. Next to this home, we also see a smaller yellow, owner-occupied, single-family, single-story home, and we have referred to it as the “little house”. LIN’s aunt (ALE) and uncle (RIC) live next door with her cousins (GOY and IGN), so interaction between these three families is frequent. Now that we have presented an overview of some of the main characteristics of the Florence-Firestone community, and their living arrangements below we will take a closer look at the multigenerational family.



Figure 8: LIN's home, the orange “big house” (left) next to the yellow “little house” (right)

¹⁶ Screen shot from Google Maps. The precise address will not be provided for privacy reasons.

The participants: A three-generation family in L.A.'s Florence-Firestone district

The color-coded family tree below charts the family's organization on the maternal side. At the top of the tree, we have the first-generation maternal great-grandparents GRC and GRT all the way down to their third-generation great grandchildren GOY, IGN, LIN, and JUL. The personalized three-letter uppercase codes identify each speaker. The number to the right of the three-letter code indicates each speaker's generation. Finally, the color scheme represents their biological gender. The third-generation target child LIN is identified with the red circle at the bottom of the tree. Following the maternal line, we will further focus on the female caregivers. This decision will be elaborated on later, but it is essentially based on two reasons. First, it is for the sake of clarity and analytical feasibility within the framework of this research project focused on the bilingual, multimodal, and multiparty socialization practices multigenerationally. Second, the quantification process on Excel as will be discussed in Chapter 4 showed that the female caregivers interacted most regularly with LIN, and thus provided richer social encounters to thickly qualify in Chapter 5 and 6. Therefore, the sociolinguistic profiles of the four female adult caregivers also identified with the red circles will be presented as well.

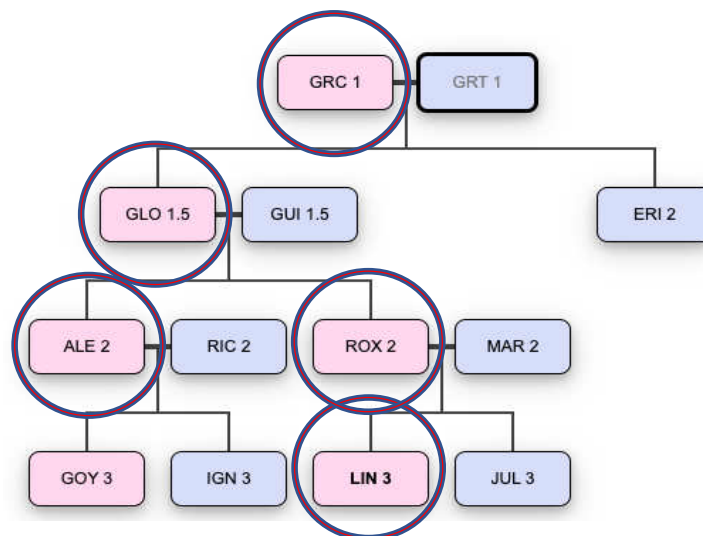

Figure 9: Three-generation family tree & the maternal line

Since the present longitudinal case study is centered around LIN, a third-generation child going through heritage Spanish-English bilingual language acquisition and socialization, the table that we present below will start with her sociolinguistic profile first. We should keep in mind that the personalized codes were intentionally adapted for each of the speakers. They will be further explained in Chapter 3. Moreover, in describing each participant's language practices

this section will also attempt at making a brief, but general assessment of each of the multigenerational adults' socioeconomic status (SES). Using any grid to measure SES is not only difficult, but sensitive since it involves considering, and in a sense exposing interrelated personal factors such as education, income, age, occupation etc. Therefore, for privacy reasons I do not pretend to be exhaustive in this section even though in a sociolinguistic study such as this one it is imperative to consider these type factors, and many more. However, since it is suggested that a family's social status influences factors such as lifestyle, health, and in particular educational attainment, perhaps shedding some light on their SES can help us better apprehend the multigenerational family's individual, and familial language practices. This also includes issues related to heritage language maintenance or shift since "the family has usually been identified as the nucleus of the community interactions that are vital to language socialization" (Guardado, 2020: 39), but furthermore, socialization into the co-use of linguistics resources like English and Spanish. In other words, regarding language maintenance and shift "Some factors influencing LM and LS concern individual characteristics (variables) such as age, gender, educational background, social class, race/ethnicity, religious affiliation, or marital status." (Pauwels, 2016: 83).

Generation	Description
Third-Generation Heritage Spanish Target Child	
LIN	LIN was 3;10 at the time of recording and had not yet started formal schooling. She is the first-born daughter of ROX and MAR, thus a third-generation heritage Spanish speaker. LIN was born and is being raised in the Florence-Firestone district of South L.A. It can be argued that she benefits from varying degrees of English, Spanish, and mixed language input. Alvarez's (2020) results that peered into her language use when she was 1;10, showed that overall English was the most frequently used language. Therefore, it would come as no surprise if today English also accounts for the largest proportion of her utterances ¹⁷ . LIN used English utterances at almost 57%, there were slightly over 22% of Spanish utterances, and less than 1% of them were mixed. Thus, LIN uses English the most in terms of frequency. It also matched that of her environmental input, and it was followed by Spanish. The proportion of her language mixing was not quite 1%, placing language mixing as her third mode of communication. The present study will allow us to see if as a third-generation heritage Spanish speaker she continues to use heritage Spanish. We may also be able to see if LIN also uses mixed language type utterances that are salient in her bilingual language learning environment, and furthermore we may assess the functions that they play in social interaction. Moreover, we need to consider that she is also growing up with three other children: GOY her older cousin, IGN her younger cousin (both the children of ALE and RIC) and JUL, LIN's younger brother. Of the bunch LIN is the second eldest after GOY, but

¹⁷ These figures are based on data that was collected in February 2016, analyzed, and presented within the framework of my "M2 Recherche" dissertation, and subsequently published. However, it is important to highlight that the research methodology, namely the transcription was carried out exclusively on Excel as opposed to CLAN as is presently the case. Therefore, while it is evident that clear-cut comparisons are not entirely possible for methodology related reasons, the figures presented above may help give a general overview, or glimpse into the family's dynamic bilingual practices.

	before IGN and then JUL. In this scenario, except for LIN all three of the other children are going through atypical language development. Thus, we may ask, in terms of linguistic socialization: How does growing up with atypically developing children help or hinder her own linguistic development?
Second-Generation Heritage Spanish Speakers	
ROX	ROX is ALE's younger sister. She also displays a similar linguistic profile as ALE, as we will see below. Most importantly, ROX is LIN's mother, so we may safely assume that she is one of LIN's main sources of bilingual input. Furthermore, while she was 23;10 at the time of recording for the present project, the figures presented below reflect her age when she was 21;10. ROX is a second-generation heritage Spanish speaker who was born and raised in Florence-Firestone. In terms of education, ROX graduated from a local public high school where she had some formal instruction in Spanish. Like her older sister ALE, she has taken some non-degree granting courses at the local community college. Also, she is a stay-at-home mother. Linguistically, as a native Angeleno, she grew up using English, Spanish, and mixed language utterances regularly in her everyday life. I consider ROX to be an English dominant bilingual as reflected in the following measures. Well over 72% of her utterances are in English (Alvarez, 2020). Like ALE and RIC (her brother-in-law) she is on the bilingual continuum which entails language mixing in conversation. The measures reflect this tendency as her mixed language utterances represent slightly under 20%, establishing them as the second most used mode of communication. Like ALE, this is slightly more than two times the frequency of her Spanish language use which stands at a little less than 8%. Overall, ROX's language use appears to reflect the way in which both ALE and RIC and more generally, the way that second-generation heritage speakers use their languages. As an English dominant bilingual, ROX used her languages as follows: English at 72%, mixing at 20%, and finally Spanish at under 8%. Finally, in terms of SES if we take her education, occupation, and her husband MAR's income (+\$100,000 USD/year) they are in the middle-class, or the top 25% in terms of income distribution ¹⁸ .
ALE	ALE is LIN's maternal aunt. Within the framework of the present study, she was 25;10 at the time of recording. She too is a second-generation heritage Spanish speaker who was born and raised in Florence-Firestone. ALE graduated from a local high school where she had some formal instruction in Spanish. Also, like her younger sister ROX, she has also taken some non-degree granting courses at the local community college. Moreover, she is a stay-at-home mother. Considering that she is a native Angeleno, she has grown up using English, Spanish, and language mixing regularly in her everyday life. Much like her mother GLO, she also uses Spanish to assist community members who cannot read English deal with administrative related issues. When she was 23;10 ALE could be considered an English dominant bilingual. This linguistic dominance is reflected in the measures at just over 49% (Alvarez, 2020). As a second-generation speaker she is also on the bilingual continuum, and thus mixes languages. This too is reflected in the measures as her mixed language utterances represent an astonishing 30%, establishing itself as the second most used mode of communication. This is just about double the frequency of her Spanish language use which stands at a little under 15%. Overall, ALE's language use appears to reflect the way second-generation heritage speakers use their languages. ALE, as an English dominant bilingual, tends to use her languages as follows: English at 49%, language mixing at 30%, and finally Spanish at slightly under 15%. Finally, in terms of SES if we take ALE's education, occupation, and her husband RIC's income (+\$100,000 USD/year) they may be placed in the middle-class, or between the 20% and 25% in terms of income distribution.
First-and-a-half-Generation Native Spanish Speaker	
GLO	GLO is LIN's maternal grandmother. She is a first-and-a-half-generation native Spanish speaker. She was brought to L.A. in the late 70's from the state of Jalisco, Mexico when she was around 13 years old. For the present project GLO was 48;9. Furthermore, almost since graduating from high school, she has been a social worker for the county of Los

¹⁸ Household income distribution is based on the U.S. Census Bureau's (2006) income statistics for the 2005.

	<p>Angeles for nearly 30 years now. Her employment allows her to use Spanish regularly with the community members that she assists. Over the years, she has become a point of reference within her Spanish speaking community. Neighbors often ask her for assistance, and advice especially when dealing with administrative questions of everyday life for people who cannot read English. While GLO may be considered a balanced bilingual, the measures taken when she was 46;9 show that contrary to the trends displayed by the second-generation bilinguals in the data, she most frequently used Spanish to communicate at over 58% (Alvarez, 2020). This may come as no surprise since again, she is a native speaker of Spanish. Interestingly, GLO's second mode of communication is language mixing at just under 28%. This aligns with the second mode of communication displayed by her the second-generation daughters ALE and ROX. Finally, GLO used English to a much lesser extent. At just over 12%, for GLO, English ranked third in language use even though she masters it well. Overall, GLO's language use appears to be the opposite reflection of how the second-generation speakers are using their languages. GLO's language tendency is as follows: Spanish at 58%, language mixing at 28%, and English at 12%. In terms of SES if we take GLO's education, occupation, and her husband GUI's income (+\$150,000 USD/year) they are firmly in the upper middle-class, or between the 20% and 25% in terms of income distribution.</p>
First-Generation Native Spanish Speaker	
GRC	<p>GRC is LIN's semi-retired maternal great-grandmother. With no formal education, she and her husband GRT immigrated to the Florence-Firestone district of South L.A. in the late 70's and resided there almost permanently during the first decade-and-a-half or so. Soon after however, they began taking regular trips south of the border into the Mexican state of Baja California, Mexico to invest in various business ventures. They eventually settled into their secondary country home. Thus, for the last two decades or so GRC has been living in Baja California, Mexico. In terms of language, there is no data available prior to the present project when she was 68;2. However, due to the researcher's proximity to the family, even though GRC may be described as a Spanish only speaker, the plurilingual corpus shows that she has some passive comprehension of English as well as the capacity to produce single word utterances in English. GRC's passive understanding of English may be related to the context, as well as to the bilingual adults' language mixing that takes place both to her, and around her. GRC frequently goes to L.A. both to see her medical specialists as well as to manage to her properties in L.A. Due to these regular visits, her children, grandchildren, and great-grandchildren are exposed to native monolingual Spanish. As such, GRC may act as the maternal source, or baseline input language from which LIN is inheriting heritage Spanish. Finally, in terms of SES if we consider GRC's education, occupation, and income, not including additional assets built with GRT (+\$100,000 USD/year) she is also safely in the middle-class, or between the 20% and 25% in terms of income distribution.</p>

The family is thus critical to the process of language socialization which is why according to Tannenbaum and Berkovich (2005) it is no surprise that a clear link has been drawn between the family and heritage language acquisition and socialization research. However, “the presence of the family alone is insufficient to foster HLD – nor is any one person or group.” (Guardado, 202: 39). For Fishman (2004) for example, for a heritage language to be developed and maintained it is crucial that the heritage language is used in more domains and by more groups of people in and outside the home. The table presented above was therefore intended to give a snapshot of some of the sociolinguistic variables that may be attributed to LIN's extended range of communicative partners in the home. In the ensuing measures and analyses

we will see that each of these bi- and monolingual multigenerational speakers use Spanish, English, and language mixed utterances to variable degrees throughout their multimodal, and often multiparty social encounters. Also, throughout the remainder of this Ph.D. the three-letter code corresponding to each of these speakers (as well as of other speakers) will be used exclusively. Finally, the abovementioned sociolinguistic data has provided us with richer background information. This allows us to better apprehend the bi- and monolingual speaker profiles along with their dynamic linguistic practices, and how they fit together at the community level. It also gives us some of the necessary information to revisit our research problem its aims, and its objectives.

Revisiting the research problem, aims, & objectives

Spanish-English language contact has led to the emergence of stable bicultural and bilingual contact zones across the U.S. One such place is the Florence-Firestone community in L.A. Broadly speaking, Fuentes coined these types of areas as being rooted in a *tercera Hispanidad*, where American culture and the English language is infused with a Hispanic pulse. Our argument is in line with Jakobson when he stated that “Les anthropologues n’ont cessé d’affirmer, et de prouver, que le langage et la culture s’impliquent mutuellement, que le langage doit être conçu comme une partie intégrante de la vie sociale, que la linguistique est étroitement liée à l’anthropologie culturelle.” (Jakobson, 1963/2003 : 27) (Anthropologists have not stopped affirming, and showing, that language and culture are mutually implicated, that language must be conceived as an integrated part of social life, that linguistics is directly tied to cultural anthropology). Indeed, in addressing the cultural origins of human cognition, this stance is also ascertained by Tomasello (1999/2022). Immersed in this linguistic and cultural context, heritage bilinguals and their languages are a novel, but not a new population of speakers who have already contributed to practical and theoretical paradigms of language. Numerous studies have investigated for the most part second-generation heritage bilinguals, and heritage languages through formal linguistic approaches. However, through their largely experimentally-based methods these investigations have typically focused on the heritage languages of university-level heritage bilingual students through grammatical prisms since in this approach language learning mechanisms are specific, and internal to the mind. The rich social, multimodal, and often multigenerational input that heritage speakers receive is generally not central to their explanations of how heritage bilinguals get from here to there. As it stands, this body of work presents a problem for the study of heritage bilinguals who blossom in

heterogeneous, and often tension ridden communities of practice. This is the case for example of the heritage speakers who thrive in the Florence-Firestone district of L.A. Here, unique language socialization practices where Spanish, English, and language mixing are used, but also cultural practices frequently emerge given the complexity of their daily social interactions that are rooted in their dynamic bilingual language learning environment. As a result, the bulk of the existing research is inadequate to explain how third-generation heritage bilinguals, from average middle-class families acquire and are socialized to use heritage Spanish in their diverse communities of practice since formal linguistic theories consider language to be internal, and linguistic input peripheral. Moreover, heritage bilinguals, their families, and the key community actors for example schools find themselves ill-informed in terms of understanding how the interrelated cognitive, social, discursive, and interactional factors come together in the process of heritage language acquisition and socialization.

Given the lack of research regarding heritage language acquisition and socialization from a cognitive-functional and social-interactionist-based paradigm, this dissertation through a longitudinal case study of LIN, a third-generation child seeks to identify and evaluate how she is acquiring and socialized to use heritage Spanish in L.A. Of course, to do so we will also need to account for LIN and her multigenerational family's use of English, and language mixing since these language modes may also play a critical role in facilitating the meaning making process when heritage Spanish is used with and around her. By studying the speech patterns of this third-generation child, and her bi- and monolingual multigenerational family within their bilingual and bicultural environment, the present study will also consider the context in which one language is used over the other and with whom, or when both languages are used together. In studying heritage bilingual children's linguistic behavior, the immediate family naturally becomes an important locus of study as well. A family's everyday cultural and linguistic practices generally create an ideal habitat where children are exposed to child-directed and overheard speech, and where they are free to use language in naturalistic interaction. In other words,

In anthropology a culture is the learned and shared behavior patterns characteristic of a group of people. Your culture is learned from relatives and other members of your community as well as from various material forms such as books and television programs. You are not born with culture but with the ability to acquire it by such means as observation, imitation, and trial and error. (Oswalt, 1986: 25).

In helping us answer the main research question we may outline five objectives. The first one is to explore some of the characteristic of the bilingual language learning environment. LIN

and her family's language use will be measured according to multiple linguistic and social variables. Next, we will aim to analyze the parental discourse strategies to see if they lend themselves to creating a bilingual language learning environment where more bi- or monolingual language use is encouraged. Then, we will try to untangle who speaks what language to whom since it allows us to give a qualitative account of how or if language choices are impacted by the previous language choices in the dynamic bilingual language learning environment. Moreover, because social encounters are not only limited to two interlocutors, we will also evaluate the participation frames. The interactional complexity of on-going communication beyond the dyad may show how participation frameworks are constantly shifting in and out of dyadic, triadic, or multiparty configurations. Finally, another objective is to consider the role of multimodality in a heritage bilingual setting since gestures and verbal productions also account for and heighten the dynamic and ever-shifting modes of communication in this L.A.-based multigenerational bilingual family.

The present research project will aim to look at the family's multimodal, multigenerational, and multiparty interactive construction of everyday communicative exchanges in heritage Spanish. However, many questions remain, and thus motivate studies of heritage bilingual development. For example, how does a third-generation heritage Spanish speaking child growing up in a bilingual family where both parents maintain two cultures learn to use her two languages? How do Hispanic families maintain Spanish in L.A.? What quantity and quality of input is required for heritage Spanish development? Do multigenerational families wish to maintain Spanish, and if so, what are their motivations? What makes it possible to keep this English-Spanish heritage bilingualism in L.A. across generations? What is the role of California in promoting, or not, heritage Spanish maintenance? In what language are children going through heritage language acquisition dominant? Does each language have a specific function in communication? The ensuing chapters will aim to address some of these questions.

Significance & Limitations

The significance of this study may be articulated around two main axes. First it may provide a base for a practical, real-world application for example at the community level. Second, it may also benefit academia in that it may provide fruitful points of departure for future research. In practical terms, it may be used to develop awareness of how Spanish may be used in

multigenerational familial interactions since families, especially those in Florence-Firestone believe that enough Spanish is spoken in the home for their children to acquire it. Moreover, our research may be used to show how family discourse strategies in interaction implicitly and explicitly socialize children to use one language over another. Also, in multigenerational homes language mixing may be frequently used and it is dependent on the degree of individual bilingualism of each generation. Language mixing then may be conceived as a rich cultural practice that includes Spanish words that refer to Mexican culture and customs for example. The present investigation may be most valuable to the communities it seeks to understand.

In academic terms, the present investigation may point to future directions for studies in the field of bilingualism. For example, other researchers could consider the *multi* aspect in their future work and build a corpus that is truly plurilingual. Moreover, researchers should code language multimodally since visual-gestural productions heighten the meaning making process, which is especially true in heritage bilingual settings. Another recommendation is that the ever-shifting multiparty participation frameworks are also coded for. This will allow for the quantification, and thus to better understand how much children may gain from their dynamic social encounters. It would also be interesting to quantify the multigenerational aspect within these participation frameworks. In this way, it may be easier to demonstrate how it takes a family where multiple generations of speakers each with their language abilities facilitate heritage language use.

Despite these aspects of the study that may be applied to academia, and to the real-world, the present investigation presents a certain number of limitations. Below, we will briefly look at four of them. First, our investigation is not generalizable. The present case study privileged understanding how one third-generation child was using heritage Spanish at a deeper level in terms of her bilingual language learning environment, and in terms of her socialization to and by language. Nevertheless, it allowed me to meet the requisite of having insider knowledge of the special linguistic and cultural practices of the family under investigation for which many prominent bilingualism researchers have favorably argued. However, being a community member engendered unforeseen challenges. One was related to my conviction that heritage Spanish must be maintained. This position is therefore evident throughout my research. For example, when I insisted that LIN should speak Spanish even when ROX did not. It was hard to remove myself from the role of the great-uncle, and into the role of a linguist

that observed and described. In this regard, one of the limits is that my desire to maintain heritage Spanish could have influenced how the social encounters unfolded.

Another limit of this work is its focus on the women in the family. It would have been interesting to look further into the men's linguistic practices, especially since men seem to be lacking in the literature. Also, because in the present investigation the men tended to speak heritage Spanish a bit more than the women. However, this limit became apparent to me too late. Moreover, another limit of the study was even related to the women during a few occasions. In some cases, the data was not rich enough to derive conclusive measures.

Lastly, another limit to our study was related to the multimodal analyses. When I began my research, the role of the visual-gestural means in communication did not seem obvious to me. Thus, I did not transcribe these non-oral communicative aspects. The main issue is that I was not able to generate quantitative measures. Therefore, while these results were not measured, I tried compensating for this limitation by highlighting their role through rich descriptions and explanations. Despite the non-exhaustive list of limitations, I have come to understand and to accept the Japanese notion of *wabi-sabi*, or the idea that nothing is ever finished, and that nothing is ever perfect, but rather that everything much like bilingual individuals lie on an ever-shifting, and never-ending continuum. Nevertheless, these limits have allowed me to consider practical applications, and to make suggestions for future research in the field.

Overview of Ph.D.

Based on the rich naturalistic data that was collected in a bilingual setting, and subsequently turned into a plurilingual corpus, this Ph.D. examines in thorough detail some aspects of the acquisition and socialization into the use of heritage Spanish by LIN, a third-generation child. Our focus is on the analyses of multimodal language production in multigenerational, and ever-shifting multiparty social encounters. Each chapter accounts for the impact of the input quantity and quality on LIN's heritage Spanish use, but also of the role that the use of English, and language mixing have on heritage language transmission throughout her multigenerational social encounters. Moreover, LIN and her bi- and monolingual family members' diverse linguistic, social, and cultural behavior will be compared with studies of other Spanish and English bi- and monolingual children and adults, as well as with bilingual speakers of many

other language pairs. Perhaps most importantly, the present investigation will show that heritage bilingualism is not just about abstract grammatical rules that concern phonology, morphology, or syntax etc. Rather, heritage bilingualism in LIN's case is also about inheriting bilingual and bicultural practices constructed by, with, and for her community of practice that cannot be measured by the number of Spanish words that she produces. These linguistic and cultural practices whether they are hybrid or not are telling about how identities, both hers and her family's, have been constructed through the multiple voices echoed across space and time. LIN's use of heritage Spanish, but also of English, and language mixing are examined between the age of 3;10 and 4;9.

Our Introduction presented key conceptual and theoretical underpinnings. Then it focused on the study's background. It gave a brief history of Spanish in L.A., then it considered various characteristics of the Florence-Firestone district before zooming in on Spanish and English language use in the community. Next, because data was not available, language contact and language mixing were discussed. Following these analyses, we presented portraits of the key members in LIN's multigenerational family. Finally, the research objectives and questions were identified, and the value, and limitations of the study were underscored.

In Chapter 1, the existing literature is reviewed. First, the various definitions of bilingualism are presented, the types of bilingual families, and the bilingual continuum. We then consider input quantity, quality, and attitudinal factors thought to impact bilingual language development. Then, the main theories of both native, and heritage language acquisition are discussed and evaluated. Formal linguistic theories have traditionally underscored native language acquisition research, while sociolinguistic theories were foundational in heritage language research. The chapter ends by looking at the degrees of bilingualism.

Chapter 2 also reviews the literature, but it is centered around heritage speakers and heritage languages. It begins by laying the foundations in the field before defining heritage speakers and their languages. The three-generation rule is also accounted for before turning to the contested issue of incomplete acquisition. Then, we justify how social interactionist theories are ideal approaches to study heritage bilingual populations, and in particular the heritage language socialization paradigm. This chapter also focuses on family dinners, parental

discourse strategies, multimodality, and participation frameworks with the backdrop of language socialization, interactional models that will help organize are qualitative analyses.

In Chapter 3, we cover the data and research methods in bilingual settings, and we underscore the need for multigenerational studies. As such, it discusses how the dynamic Spanish, English, and language mixed practices were documented, managed, and transcribed to create a plurilingual corpus using both CLAN and Excel. In this chapter we also discuss ethical issues related to recording and dissemination.

Following our research methods, Chapter 4 characterizes LIN's bilingual language learning environment. After discussing some of the varied issues related to bilingual input and output, it justifies the ensuing 10-factor quantitative measures. For example, the linguistic soundscape, the language presentations of LIN's maternal line, LIN's output according to generation, as well as to the language of previous utterances are examined. This chapter thus gives a quantitative panorama of how LIN and her family uses not only Spanish, but also English, and language mixing.

Chapter 5 and 6 are our two qualitative chapters that thickly describe and explain the bilingual data through a series of 21 analyses. Chapter 5 centers around heritage language socialization and LIN's attitudes about speaking Spanish. It begins by first discussing the cultural framework in which the multigenerational social interactions are rooted. We then place the heritage language paradigm within the cultural framework that we have already touched on in the present discussion, of the family under study. Following these two sections, LIN's shifting attitude is first considered with respect to her use of Spanish. Then, we also see how her attitude emerges when the bilingual speakers provide her both Spanish and English translation equivalents.

Chapter 6 is focused on LIN's bilingual input and output, and it is composed of three sections. The first part shows how she uses heritage Spanish when the speech stream is segmented. Then, the second part considers the importance of child-directed speech whereas the third section underscores the role of overheard speech in using heritage Spanish. Finally, to organize the analyses of these dynamic social encounters, they are guided by the interactional models presented in Chapter 2, namely the role of the parental discourse strategies,

multimodality, the participation frameworks, and the question of who speaks what language to whom.

The discussion restates the central research question and aims before summarizing the major findings in Chapter 4, 5, and 6. It then acknowledges the investigation's limitations, and makes recommendations for future studies in the field, as well for implementing useful applications in the real world. Finally, our conclusion brings our longitudinal case study of third-generation heritage Spanish acquisition and socialization in L.A. to a close, even if in reality, it is perhaps only at the end of the germination phase, which organically implies new beginnings.

1 Theoretical Background:
Bilingualism & Bilingual Language
Acquisition

INTRODUCTION

Multilingual children, as they grow up in complex, urban, hybrid neighborhoods, are the communicative meaning makers of tomorrow and we must focus on what they bring to literacy and language practices. (Pahl, 2008: 124).

Much like Tomasello (1999/2022), Pahl asserts that “Language and culture are inextricably intertwined. The home is where cultural practices are first experienced, and within that context, children born into multilingual families experience this identity through language.” (Pahl, 2008: 115). This is the case for heritage speakers “who only recently have been recognized as a group separate from those (“balanced”) bilinguals (and) for whom one of the languages is strongly dominant.” (Polinsky, 2008: 40). Heritage bilinguals also often grow up in multigenerational familial constellations, so an interest in multilingual, multigenerational, and multimodal language practices in multiparty participation frameworks renders investigations such as the present one quite unique. These hybrid linguistic and cultural practices are “not very middle-class American” since typically in the average middle-class American family “there are fewer people and fewer generations” (A. Morgenstern, personal communication, August 15th, 2022). Moreover, Pahl’s statement cannot be truer today, especially as heritage bilingualism research, historically overshadowed by studies in monolingualism, has steadily moved into the limelight in the last 20 years. Bi- and multilingual children, or emerging heritage speakers have therefore experienced life in complex, overlapping social, cultural, and linguistic constellations where two, or more languages have been in continual contact intergenerationally at the individual, familial, and societal levels. However, despite heritage speakers’ relatively recent recognition as a fruitful site of study in fields including psycholinguistics (Sorace, 2004; Tsimpli et al. 2004; Grosjean, 2015), language teaching (Kagan & Dillon, 2001; Bermel & Kagan, 2000; Geislerik, 2005), general linguistics (Dorian, 1989; Seliger & Vago, 1991), and sociolinguistics (Andrews, 1999; Fenyvesi, 2005; Pauwels, 2016; Heller et al., 2018), “language scholars ought to observe and examine what language users actually produce.” (Guardado, 2018: v) within their rich interactional frameworks. Along with oral productions, we should also account for the pragmatic functions of multimodal discourse in interaction as children are socialized by, and into language.

To look at heritage language development through the prism of language socialization, we may thus move away from the notion of linguistic ‘deficit’ as Halliday (1978) pointed out, and as has typically and unjustly been attributed to heritage bilinguals. After all, research shows that “language develops ontogenetically because of its functional relevance to the living of life,

so almost all language users develop ‘functional’ knowledge of language as a system, unless there is radical impairment to the brain function” (Williams, 2008: 64). Language(s), following Dell Hymes, William Labov, and Michael Halliday should be examined from “cultural, social, and functional stand points respectively” (Guardado, 2018: v), and heritage language bilinguals should not be considered ‘incomplete’ speakers of their minority, or dominated language(s).

Indeed, “heritage speakers provide a crucial missing link between competent L1 learners, balanced bilinguals, and possible L2 learners” (Polinsky, 2008: 40). These are observations that have been shown time and again in the often, experimentally-based, and quantitatively driven fields of inquiry mentioned earlier. However, a wealth of multi-layered, and equally interesting linguistic phenomena that merges language *with* culture remains to be discovered regarding heritage bilinguals from a developmental perspective that anchors its analyses on a language socialization paradigm. This is precisely what is declared in the introduction of Martin Guardado’s recent book where he states that

Language is central to human life. It is intricately interknitted in culture and in how people see themselves in the world. Language is the main vehicle of cultural values and meanings and therefore plays a role in shaping the worldview of individuals and communities. (Guardado, 2018: 1).

Within these dynamic, socio-cultural, and linguistically hybrid contexts, initial research on children’s multi-modal and -lingual practices stemming out of anthropology (Pahl, 2008) found that “the greatest part of sociocultural information is keyed implicitly” (Ochs, 1990: 291). Children are socialized through naturalistic language use in diverse, and ever-shifting participation frameworks including dyadic, triadic, and multiparty interactions. In the case of the present investigation, heritage language socialization is augmented through a multigenerational prism where sometimes the adult caregivers’ desires do not coincide within and across generations. Nevertheless, caregivers in their effort to guide their children into (in)appropriate¹⁹ language use, as well as other social, and cultural practices whether the setting is bi- or monolingual, or even multigenerational also resort to explicit language socialization strategies. This is what is called “socialization to use language” (Ochs, 1990: 291). Explicit language socialization may thus be defined as “the process used when caregivers clearly teach

¹⁹ Many would wonder why in some cultures children are guided, through language socialization into inappropriate language use. In fact, for some communities of practice, what may be seen as impolite language for example to us, for them it is just for humor like when a child repeats an overheard word, or when the child is explicitly taught. Thus, the () around (in) above indicate those moments that are both appropriate, and not, and that are sometimes interweaved in the flow of the ongoing interaction.

social norms shared by members of society.” (Li, 2008: 72). Whether language socialization is implicit or explicit, we may agree that children are tasked with carrying the meaning making processes into the future (Pahl, 2008), which may also imply intergenerationally, for example in the innumerable instances of heritage bilingualism. It is therefore crucial to examine not only how children, but also how the adult caregivers in their immediate interactional networks shape each other’s dynamic, and bidirectional language practices (Duff, 2008; Pontecorvo et al., 2001; King & Fogle, 2013).

To better apprehend the present longitudinal case study and the issues related to third-generation heritage language use and socialization, we will place it within the current frameworks of cognitive-functional, and social-interactional theories of language acquisition and socialization. Before we do so however, we must highlight that research considering the acquisition of Spanish by third-generation children shows that

There is no clear-cut linguistic differences between these groups, but rather global trends that characterize each generation in general. One of these trends is the gradual preference for using English with family and friends across the three generations. Bilingualism may be common among second-generation children, but English monolingualism tends to be the predominant pattern by the third generation. (Silva-Corvalán, 2014: 2).

In Chapter 4 we quantify *per se* the characteristics of the bilingual language learning environment in which LIN’s heritage language socialization is anchored. In line with the Silva-Corvalán’s (2014) findings above, we too see emerge similar global linguistic trends intergenerationally. Aside from her first-generation great-grandparents (GRC and the late GRT) and her 1.5-generation grandfather (GUI) who mainly speak Spanish, a gradual shift to English is detected among the bilingual speakers. They include her 1.5-generation grandmother (GLO) as well as the second-generation heritage speakers. They include her mother (ROX) and late father (MAR), her maternal aunt (ALE) and her husband (RIC). Finally, we also see a more dramatic shift to English among the third generation including the target-child LIN, her little brother (JUL), and her two cousins (GLO and IGN). Nevertheless, the usage-based framework will provide us with the tools to analyze LIN and her family’s bilingual, multimodal, and multigenerational productions across different social encounters including multiparty participation frameworks allowing us to seize the plethora of socio-linguistic phenomena as it considers not just language, but rather language *and* culture. For the most part the dyadic, triadic, or multiparty interactions analyzed in this dissertation take place during the family’s dinnertime activities,

a major site for the negotiation of linguistic, cognitive, cultural, social, political, and emotive concerns ... (since) the role of dinners, as multiparty and intergenerational occasions, (provide) children an apprenticeship in cultural ways of speaking and seeing, thereby paving their way to becoming fully-fledged members of their cultures. (Blum-Kulka, 2008: 90).

Our literature review is composed of seven parts spread across two main chapters. I briefly present each chapter below. In Chapter 1 we will explore the various and somewhat controversial definitions of bilingualism. These multifaceted definitions as they are attributed to speakers of two languages or more will as a result allow us to place bilingualism on a continuum where monolingualism lies on either end of the spectrum. Bilingual continuity is subject to shift, becoming stronger or weaker across the lifespan. In the second section, we will consider the issues of input quantity and quality, as well as the influence of language attitudes that are thought to affect bilingual language development. Next, section three overviews the key theoretical paradigms that have traditionally attempted to explain how native language acquisition occurs, or how children may get from here (novices) to there (experts). Then, Universal Grammar and usage-based theories are juxtaposed before presenting in section four the three leading theories of heritage language acquisition. This section will naturally lead us to a brief discussion of the models of early, and simultaneous bilingual acquisition that have been traditionally advanced in the literature. Building on the previous four parts, section five discusses the various outcomes, or the degrees of bilingualism as related to chronological and social factors that may also be attributed to heritage bilinguals. In doing so, we make clear that

heritage speakers are not a homogenous group, but rather form a cline of those who may understand the language (“overhearers”-cf. Au & Romo, 1997; Au & Oh, 2005) to very advanced heritage speakers who may simply miss some registers in their language (Polinsky, 2008: 40-41).

The multiple degrees of bilingualism will be presented with relation to the onset of bilingual language acquisition. Furthermore, this discussion will organically lead to the effects of language contact on bilingual language practices such as language mixing, especially among multigenerational heritage language communities.

Chapter 2 is composed of two dense, but richly interrelated parts. They are section six and seven of our literature review. Chapter 2 thus presents who and what heritage speakers and their languages are after introducing Joshua A. Fishman in the first part of section six. His “seminal scholarship may be seen as early precursors to what has come to be known as HL development” (Guardado, 2018: 20). This section in Chapter 2 will also cover the contentious historical and social issues in classifying heritage speakers, as well as discussing the three-

generation rule, and the GIDS. The former suggest minority language shift by the third-generation, while the latter is a tool to analyze language endangerment in a given community of practice. Section six (in Chapter 2) will end with a discussion on the prickly issue of incomplete acquisition as many scholars from the generative tradition initially advanced. Finally, the last section seven of our literature review will underscore novel theoretical frameworks for the present research project. We will first discuss the social interactionist theory that accounts for both cognitive and social aspects in the process of language acquisition. The section then discusses how language socialization and language acquisition research found common ground after being historically split. The next part of this section then gives a historical account of the rise of language socialization as a theoretical paradigm, and subsequently how it paved the path to heritage language socialization research as it is rooted in linguistic anthropology. Moreover, we will also gain a deeper understanding of key approaches that are in harmony with studies in language socialization in the final part of section seven. We will first present why family mealtime activities are a prime site for multigenerational studies such as the present one. Then the models and approaches that will guide the organization of our qualitative analyses will be discussed. These include Lanza's (1997) Parental Discourse Strategies, why multimodal analyses are ideal for accounting for the plurisemiotic nature of interaction beyond the oral mode, and of course Goffman's (1974, 1981) Participation Frameworks.

1.1 Defining bilingualism

Defining bilingualism may seem intuitive, and rather simple when one conjures up the term. However, since Hamers and Blanc (1983), Altarriba and Heredia (2008), and on to Grosjean (2015), attempts at defining bilingualism have been met with great difficulty, "since linguists themselves are not agreed on how bilingualism should be defined." (Romaine, 1989: 26). In large part this is not only related to the breadth of what bilingualism represents, and the diversity of the bilingual individuals, families, and societies under study, but also in relation to the complexity of the phenomena, and the bilingual language learning environments it aims to both describe and explain. Furthermore, difficulties also emerge when bilingualism is apprehended through biological, linguistic, developmental, and psychological perspectives just to name a few. As a result, a clear-cut and simplified definition of bilingualism that scholars may agree upon, for the most part has been impossible to find. In the last few decades, the literature centered around bilingualism (Hall & Ithaca, 1952; Oksaar, 1989; Romaine, 1995;

Heller, 2007; García & Wei, 2014; amongst many others) have brought to light the multiple dimensions that contribute to the difficulty in defining bilingualism. Nevertheless, often this somewhat obvious yet illusive concept at its core, refers to individuals that can understand and speak two languages. While we may consider this as the most basic working definition of bilingualism, to have a more complete picture of the multiple dimensions, and its related issues, we should consider bilingualism not as having only one definition, but rather apprehended within its multiple descriptions. In this way, we may be better equipped to illustrate the facets of the bilingual continuum more closely, as well as the unique bilingual abilities to which these speakers are socialized.

1.1.1 Bilingualism: A working definition

Therefore, in accounting for these multifaceted definitions, our goal is not to give an exhaustive list, but rather to present only a few pertinent ones that will allow us to better frame the present study. We thus start with an understanding of bilingualism from the perspective of a layman. It is important to start here because in general people interested in the subject outside of academia do not have specialized knowledge, and often turn to online resources to gain better a understanding. In turn, laymen in discussing bilingualism matters with their community members' heavily influence, for better and for worse, their understanding of what it means to be bilingual. Thus, a quick search according to Merriam-Webster's (2022) online dictionary, defines bilingualism as 1) "the ability to speak two languages", 2) "the frequent use (as by a community) of two languages", and 3) "the political or institutional recognition of two languages". In another definition, Le Petit Larousse²⁰ (2002), describes bilingualism as a "pratique de deux langues par un individu ou une collectivité" (practice of two languages by an individual or a collectivity). These first two definitions, accessible to communities at large are in part in line with our initial notion of bilingualism. A bilingual individual is considered as someone who can speak and understand two languages. Moreover, while Merriam-Webster's definition considers the issue of *frequency*, Le Petit Larousse highlights the notion of *practice* in the use of both languages. As we will see both in Chapter 4 (quantitative measures), and in Chapter 5 and 6 (qualitative measures) frequency and practice respectively are primordial components to heritage language development, the result of minority language use and socialization within the family. Finally, only the first definition underscores the socio-political dimensions of bilingualism, an aspect that is also crucial in the transmission, and

²⁰ A French-language encyclopedic dictionary published by Éditions Larousse

maintenance of minority languages, especially for disabled children, in heritage bilingual communities. Through various testimonies, many examples of these socio-political issues as tied to educational settings, that will not be the object of discussion here, may be found in María Cioè-Peña's (2021) book. In my review, I state that Cioè-Peña

delves into the lives of historically ignored mothers in the U.S. Minoritized women's social and personal challenges are brought to light as they raise their children, labeled emergent bilinguals, and disabled by their school systems. We learn how institutional decisions related to language, disability, and thus academic placement influence family dynamics (Alvarez, 2022: 1).

1.1.2 Bilingualism: Between broad & narrow perspectives

The initial definitions of bilingualism presented above, along with their general scope that touch on the issues of frequency and practice are in line with other researchers. Often cited in the literature, Macnamara (1967) proposes a broader, more open, or even holistic definition of bilingualism. In an article that studied bilingual performance and internal factors from a psycholinguistic perspective he states the following:

I will use the term bilingual of persons who possess at least one of the language skills even to a minimal degree in their second language. That is, I shall consider as bilingual a person who, for example, is an educated native speaker of English and who can also read a little French. This means that we consider bilingualism to be a continuum, or rather a whole series of continua, which vary amongst individuals along a whole variety of dimensions. (Macnamara, 1967: 59-60).

For Macnamara, a bilingual speaker is anyone who possesses minimal competence in at least one of the four linguistic skills, reminding us of Hall's (1952) work who considered the degree of efficiency when two linguistic systems are in contact. These include comprehension and expression skills in listening, reading, writing, and speaking in a language other than the language of primary socialization. Moreover, in his article only minimal reference is made regarding the functions of language in situations of diglossia, or the social aspects of bilingualism. Only by briefly citing Gumperz's (1964) work, were parental educational decisions evoked, decisions which are critical in raising bilingual children. Again, these challenges were recently depicted in Cioè-Peña's (2021) work that, through an intersectional approach, compiled the powerful testimonies of 10 Latinx women living in the U.S. raising emerging bilingual children. However, challenges related to the lives of multilingual children in public education have been raised as far back as the early 90's for example by Romaine (1989), and the early 2000's in an edited volume by Otto Santa Ana (2004).

Even though the previous definitions place bilingualism within a broad framework and essentially exclude the idea of *perfect bilinguals*, early studies on bilingualism have been guided by the notion of flawless fluency in both languages. In this popular, but perhaps misguided view, and in contrast to the more catch-all, flexible or harmonious definitions, other researchers have proven to be far more demanding. One of them is another often cited scholar in studies of bilingualism. In his pioneering book, Bloomfield (1933) defines bilingualism along stricter terms as we see below.

In the extreme case of foreign-language learning the speaker becomes so proficient as to be indistinguishable from the native speakers around him. This happens occasionally ... frequently in childhood shift ... In the cases where this perfect foreign-language learning is not accomplished by loss of the native language, it results in bilingualism, native-like control of two languages ... Of course, one cannot define a degree of perfection at which a good foreign speaker becomes bilingual: the distinction is relative. (Bloomfield, 1933: 55-56).

Through the citation above, Bloomfield makes explicit the criteria of mastering two languages, or essentially that of a bilingual speaker composed of two native monolinguals. The bilingual speaker is seen as someone with ideal competencies in both languages that have resulted from foreign-language learning. While his first criteria related to perfection does not fit with the actual lived realities of bilingual speakers, his reference to “foreign-language learning” not only alludes to formal, institutional settings, but also completely disregards the process of bilingual language acquisition, and socialization in informal, familial contexts. Moreover, this strict view of bilingualism was subsequently adopted by other scholars (Lebrun, 1982) who studied aphasia in polyglots. Hagege, also in direct opposition to Macnamara states that “Être vraiment bilingue implique que l’on sache parler, comprendre, lire et écrire deux langues avec la même aisance.” (Hagege, 2005; as cited by Grosjean, 2015) (to be truly bilingual implies that one knows how to speak, comprehend, read, and write in both languages with the same ease). Thus, we begin to etch out a picture, according to several researchers of what bilingualism is, what it is not, and by extension the trouble of establishing a common definition. On the one hand, the notion of bilingualism is broad, encompassing the various degrees of proficiency that a bilingual speaker may manifest. On the other hand, the notion of bilingualism is narrow, and for certain experts it is represented by the idea of the perfect bilingual, a notion that has been criticized by many.

1.1.3 Bilingualism: Moving away from the notion of narrowness

Despite the inherent issues in establishing one solid definition of bilingualism, psycholinguists such as Grosjean (1989, 2008, 2012), Grosjean and Li (2012), Grosjean (2015), acquisitionists interested in bilingualism like Genesee (2016), and sociolinguists for example Dabène (1994) have critiqued the narrow stance. For the psycholinguists and acquisitionists, the fragmented view of bilingualism is a cause of concern. For the sociolinguists, the very definition of what a maternal language is, is put into question. The very notion of language is innately ambiguous, composite, and of course subject to variation. We touched on this issue in our Introduction. Variation starts at the individual level, and it is a direct result of the bidirectional language socialization processes that are necessarily anchored in the ever-shifting participation frameworks within a family. Finally, other issues that emerge are the likelihood of finding, with such a restrictive definition of bilingualism, the coveted ‘ideal’ bilingual speaker, and if ever they are found, there would be much difficulty in measuring the perfect mastery of their languages (Deprez, 1994).

Given the multiple challenges mentioned thus far, researchers have started to recognize, and perhaps come to terms with the idea that a perfect type of bilingualism is rarely attained. One reason may be attributed to the fact that there may be significant differences between the needs and the uses of two languages (Grosjean, 2008). For researchers like Grosjean “le bilinguisme est l’utilisation régulière de deux ou plusieurs langues ou dialectes dans la vie de tous les jours.” (Grosjean, 2015: 16) (bilingualism is the regular use of two or more languages or dialects in everyday life.). Therefore, he argues that what is important in defining the notion of bilingualism is not necessarily the question of *equal-ness*, but rather the regular, or frequent use of both languages in ordinary, and daily situations. Furthermore, Elizabeth Lanza, another prominent researcher in the field of bilingualism also considers the primary issue in bilingualism to be less about perfect fluency in both languages, and more about communicative competence. That is, learning through, and by language socialization how and when to use language in appropriate circumstances. She argues that “the bilingual child is not only acquiring two linguistic systems but is more generally acquiring communicative competence, as he or she develops a social identity simultaneous with the development of the language” (Lanza, 1997: 7). Within the framework of the present dissertation, we argue that communicative competence is the path that leads emerging bilingual children towards

becoming fully-fledged members within their community of practice. Finally, in discussing bilingual children, or LIN, the target bilingual child in this study the term bilingual

refers to typically developing, normally hearing children under age 12 who need to learn to communicate in more than a single language in daily life, leaving unspecified to what extent children are able to communicate in two languages. The focus is on the untutored, so-called “naturalistic” learning of several languages as a result of life circumstances that are not easy to change. Children are born into a bilingual family (BFLA).” (De Houwer, 2021: 3).

De Houwer’s definition of bilingualism thus works for the present investigation. LIN is a normally developing child under 12. Given that some of her older family members only speak Spanish, there seems to be a need for her to communicate in English and in Spanish. However, the definition above further works in this investigation because it leaves undetermined the extent to which a bilingual child is able to communicate in each of their languages. We will see through our qualitative analyses how LIN communicates with her bi- and monolingual family members. Finally, our data is based on the spontaneous interaction of a child born into a bilingual family. In other words, LIN began hearing Spanish and English from birth.

1.1.3.1 Bilingualism: As seen from monolingual eyes

So far, we have explored both broad and narrow definitions of bilingualism from several authorities in the field. Nevertheless, it is equally insightful to look at two other perspectives as we define bilingualism. These views consider the perceptions of non-academics, or the very people we seek to study. First, Hagège claims that “Souvent celui que l’on répute parfait bilingue l’est surtout dans les déclarations d’unilingues étonnés d’entendre parler par quelqu’un une langue étrangère qui leur paraît inaccessible.” (Hagège, 2005: 245) (Often s/he who we consider to be perfectly bilingual is especially considered as such through the surprised (or intrigued?) declarations of monolinguals when they hear someone speak a foreign language that is out of their reach.). In this sense, bilinguals are qualified as being perfect, or not, through monolingual speakers’ purely biased definition of what they assume bilingualism to be. However, as we saw earlier, we must keep in mind that these bilingual biases are typically formed from the general definitions gathered online.

Moreover, along this same line of thought, it is worth mentioning another subjective point of view, or the bilingual speaker’s *own* perception, or outlook of his, or her bilingual abilities. At one point or another, we have all had the opportunity to interact with bilingual speakers possessing various degrees of language skills in each of their language combinations.

In these situations, when a bilingual speaker judges their own bilingual skills, we may sometimes notice that there tends to be mismatches. A speaker who may be unbalanced, or that has very basic notions of his second language could very proudly, and without the least amount of hesitation declare him/herself as being perfectly bilingual. On the other hand, however, we have the speaker who may be highly competent across the four language skills, even if not equally proficient in two languages, who may not dare label him/herself as bilingual due to their stricter idea of what bilingualism is, or ought to be. Nevertheless, in both cases it is important to point out that being bilingual, and defining bilingualism is a highly subjective, and even contentious matter at best. Moreover, that often what we read in the literature about how bilingualism is defined, are views of the experts in the field, which may not necessarily consider the views of the bilingual speakers themselves. For the layman, ideas of what it means to be bilingual, or how they have gotten from here to there are often anchored within their families, and communities. The next part of this section thus presents the different types of bilingual families.

1.1.4 Bilingualism: Typologies of bilingual families

Following Tomasello (1999/2022) we too have argued that both culture and language are interconnected. They are also very much distinctly human characteristics that together bring about “ways of being in the world.” (Duranti, 1997: 1). For children, the acquisition of their linguistic and cultural norms begins within the family, “which is highly variable across cultures and times.” (Pauwels, 2016: 118). Therefore, for linguists, sociolinguists, and linguistic anthropologists studying language acquisition and socialization, it is indispensable to understand the importance of individual family compositions. Research has shown that “An early start (preferably from birth) not only facilitates the process of gaining more advanced levels of linguistic competence (at least verbal) but also establishes bilingualism as a normal state of affairs.” (Pauwels, 2016: 119). From a heritage language development perspective, understanding the different types of bilingual families, that are often multigenerational in nature is even more relevant since these groups of children are dealing with the acquisition of, and socialization into two sets of linguistic and cultural norms, one of which is minoritized. For example, “In the case of linguistic minorities, children are usually under strong pressure to learn the language of the society at large and may also be under internal family pressure to keep the home language.” (Romaine, 1989: 25). Furthermore, as Field highlights, “With ethnic and language minority children, the worldview that they have may not come from the dominant

culture ... During their initial encounters, at least, a child's worldview will come from their heritage languages and cultures" (Field, 2011: 54). The way heritage bilinguals view, and subsequently be-come into the world may therefore differ greatly from the mainstream culture that is generally composed of mono nuclear families which are often limited to two generations in their familial interactions. As we will see in Chapter 4, 5, and 6, within the context of the present Ph.D. that considers the bilingual, multimodal, and multigenerational use of Spanish in Los Angeles, the American Anglo-Saxon language, and by extension culture seems to prevail. However, Mexican language and culture still pulses following Fuentes (1992/2016), in the hearts of the speakers in this family. This linguistic and cultural capital will pulse and unevenly appear throughout the family's varied social encounters. But they will emerge as if in a dance between the dominant shadows (English) and the subtle light (Spanish) that comes through in the thickets of the forest. In one word, the Japanese call this delicate environmental spectacle *komorebi*²¹. In our study this bilingual and bicultural interaction between Spanish and English as linked to the family's Mexican origin will be demonstrated through the particular cultural practices such as spending time with several generations at the same time, through cooking, eating, playing, and living together and most importantly it will be a result not of need, but of choice. This also includes taking care of each other, sometimes according to an interlocutor's ability, or their proximity, and other times according to their hierarchy as will be underscored later in the qualitative analyses. To illustrate this point, I turn your attention to the following journal entry. It was made nearly a month after my arrival to L.A., or on September 21st, 2018, in the handwritten version of my field journal. GLO and GUI, LIN's grandparents have prepared to take a two-week vacation to Mexico, and they are in the taxi ready to head to the airport. After they leave, I observe the following:

So, my sister GLO is finally off on her trip. She says (in Spanish) from the car window: *allí te encargo a mi raza* (I entrust my family to you).

ERI: mhuh.

GLO: Please.

ERI: Of course.

It's a powerful moment when your older sister upon going on holiday essentially puts you in charge of her children, my nieces, with children of their own, who are also adults. I felt something resonate in my core when I said "of course", like if I was signing a verbal pact. To engage in a responsibility that you are deemed worthy of. Now I bare the responsibility of my sister's family's well-being while she's absent

²¹ Komorebi "is the Japanese word for sunlight, which is filtered through the leaves of trees. In particular, it means the visible light rays." <https://thekomorebicollecion.com/pages/komo-what>

... I also asked GUI for the first time to look after my sister (little sister that is) I said (in Spanish): mi hermanita. (Alvarez, 2018).

As GLO was heading out, her last preoccupation, and thus request to her brother emerged in Spanish and it was to take care of her family. This is likely because in her absence I would be the oldest in line in L.A. My response may have seemed dismissive to her, so after she pleaded, I said ok, and this is when I felt that my responsibility was truly cemented. Moreover, at the same time I asked GUI in Spanish to take care of her. This illustrates how taking care of each other is an essential trait of this family, and it is made possible through the bilingual, and multigenerational living arrangements that are present in some households of Mexican heritage in the U.S such as the one under investigation.

Thus, in the present section we will look at six types of bilingual families, arguably the most critical sites for heritage language use and socialization. These typologies were adapted by Field but established (mainly within a European context) by Romaine (1989). Moreover, “These types can be applied in almost any bilingual setting worldwide, but they tend to be generalizing.” (Field, 2011: 54-55). Worldwide bilingualism is the normal situation (Harding-Esch & Riley, 2003; Kroll & De Groot, 2005; Daviault, 2011; amongst others). It may therefore seem too ambitious of a project to reduce the wealth of heterogenous familial constellations into merely six types. Nevertheless, the models presented below do provide a solid point of departure for the present research project. The six types of bilingual families include the following: Type 1: ‘One person-one language’, Type 2: ‘One language-one environment, Type 3: ‘Non-dominant home language without community support’, Type 4: ‘Double non-dominant language without community support’, Type 5: ‘Non-native parents’, and Type 6: ‘Mixed languages’. The following table briefly summarizes each of the six family types:

Table 4: Summary of each family type

Family Type	Description
Type 1: One person-one language	Parents have different native languages, native language of one parent is dominant language of community, each parent speaks his language to child
Type 2: One language-one environment	Parents have different native languages, native language of one parent is dominant language in community, both parents only speak non-dominant language to child at home
Type: 3: Non-dominant home language without community support	Parents share same culturally non dominant native-language, both have learned dominant language as a second language, essentially without support of extended family because they are still establishing residence, employment, and educational opportunities for their children

Type 4: Double non-dominant language without community support	Parents have different native languages, and neither is community's dominant language, each parent speaks his language to child from birth producing a multilingual child
Type 5: Non-native parents	Rare, but not unheard of, in this situation both parents are native speakers of dominant language, but one parent speaks to child in a non-native non culturally dominant language ex. both parents speak English, but one uses French or ASL with child which may or may not be a heritage language of either parent (Romaine, 1995: 185)
Type 6: Mixed languages	Best understood in third-generation homes, both parents are proficient bilinguals as well as large segments of community, no patterned bilingualism like in Type 1 and 2 families, social conditions for bilingual behaviors and language mixing always present, bilingual phenomena accepted, encouraged and even valued in the community, both parents mix languages in various ways through rapid conversational code-switching and different levels of borrowing, typically native bilinguals are perpetually in bilingual language mode (Field, 2011: 55-59)

While this is a condensed overview of six different types of bilingual families, we must remember to keep in mind the individual family differences that exist in terms of living arrangements in the evaluation of each household. Indeed,

two dominant constellations of family described ... are those of 'nuclear family' and the 'extended family'. The former refers to a social unit made up of (usually biological) parents and their children. Whereas the latter is used to describe social units in which other (blood-related) family members such as grandparents, uncles, nieces or nephews are found. (Pauwels, 2016: 118).

For example, 'American' households typically tend to favor the nuclear family which often only consists of the parents and their children under one roof. On the other hand, Latin American households, for any number of reasons such as help with child rearing, or help with finances, may tend to favor living as an extended family. Parents, and children, as well as grandparents, and great-grandparents, cousins, and even close family friends (non-blood-related) may live together under one roof. Even within extended family situations since several generations may live together there "may be more than one type within the same household." (Field, 2011: 55). Within the context of the present research project, this overview of family types allows us to place LIN in the Type 6 family. Both of her parents are proficient bilinguals, she lives in a community that is also largely bilingual, and bilingual behaviors in conversation such as language mixing are not only present, but also frequent, and accepted in interaction. Moreover, LIN and her parents live according to the characteristic extended family style since she and her parents live with her maternal grandparents, both 1.5-generation immigrants, where

only one of them (GLO) is a fully proficient bilingual. Furthermore, LIN's maternal great-grandparents (who only speak Spanish) have a home across the street. This is where they stay during their frequent visits from Mexico. Finally, LIN's aunt and uncle who are also proficient bilinguals, live in their own home next-door. LIN is living in an extended family type of arrangement. However, we may also conceive of her living arrangement as living in a small village given the immediate physical proximity of her other family members.

Defining bilingualism is a challenging task and there is no clear consensus within the scientific community. However, bilingual speakers emerge within their unique bilingual language learning environments. For this reason, in considering the diverse definitions of bilingualism, it was necessary to account for six different types of bilingual families. For example, we learn that

Type 6 is perhaps a more common category than it might seem to be on the basis of its representation in the literature. In other words, multilingual communities are the majority, so many children grow up in cases where individual and societal multilingualism coincide. (Romaine, 1989: 168-169).

Furthermore, individual, familial, and societal multilingualism engender dynamic language practices ranging from attested passive bilingualism to the imaginary perfect bilingual. I qualify perfect, or balanced bilinguals as imaginary since equal fluency across topics is rarely attained amongst bilinguals (Fishman, 1971). It is for this reason that bilingualism should be apprehended within a broad continuum of linguistic practices as discussed below.

1.1.4.1 Bilingualism: Conceived as a continuum

The broad definition with which we began defines bilingualism as the use of two languages by an individual. Moreover, for Baetens-Beardsmore “bilingualism is situated somewhere along a cline which ranges from non-diglossic monolingualism ... to the use of two distinct languages at varying levels of ability” (Baetens-Beardsmore, 1982: 36). Bilingualism is best regarded as occurring on a continuum which echoes Macnamara's stance, but distances itself from Bloomfield's view. These are conceptions that are centered around language mastery dating back to more than 60 years.

Si l'on cherche dans l'abondante littérature scientifique publiée depuis les années 60, on s'aperçoit qu'il y a autant de définitions que de chercheurs, et que ces définitions vont d'un point de vue maximaliste (parler deux langues comme un locuteur natif) à un point de vue minimaliste (être capable de dire ou de comprendre quelques phrases

en LE), incluant toute la gamme de possibilités que se situent entre ces deux pôles²².
(Hélot, 2006 : 193).

The monolingual speaker ('A' in the figure below), along with the passive bilingual ('Ab' in the figure below) next to it are on one end of this continuum. Around the center ('Ab, AB, aB') we find the bilingual speakers with greater proficiency in both languages. These bilinguals may also have acquired both languages from birth, but not necessarily. De Houwer refers to language acquisition from birth as bilingual first language acquisition (BFLA) and defines it as "the development of language in young children who hear two languages spoken to them from birth." (De Houwer, 2009: 2). Moreover, these speakers' linguistic abilities, due to their lived experiences are in direct contrast with those of monolingual speakers. Thus, some speakers who have acquired both languages in naturalistic contexts during childhood could potentially be described as having equal, and native-like fluency in both his Language A and Language Alpha. Nevertheless, between these two extremes, there are those individuals who have acquired greater, and lesser degrees of bilingualism. They thus fall at different points along the bilingual continuum, even if they acquired both languages from birth. Among these speakers are those who speak both languages with a high degree of proficiency but become more dominant in one language overtime for example in cases of language shift ('aB' in the figure below). We can witness this in the many accounts of heritage bilingual speakers who after having become dominant in English, have decided to reverse for personal or professional reasons, the shift of their minority language, from less towards more advanced proficiency later in life. The figure below illustrates the fluidity, as well as the degrees of bilingualism that may be accounted for along the dynamic continuum between monolingualism to bilingualism to monolingualism (Valdés & Figueroa, 1994).

²² If we search in the abundant scientific literature published since the 60's, we learn that there are as many definitions as there are researchers, and that those definitions range from a maximalist point of view (speaking two languages like a native speaker) to a minimalist point of view (be capable of saying or understanding some phrases in a foreign language), including the entire range of possibilities that are situated between those two poles.
– My translation.

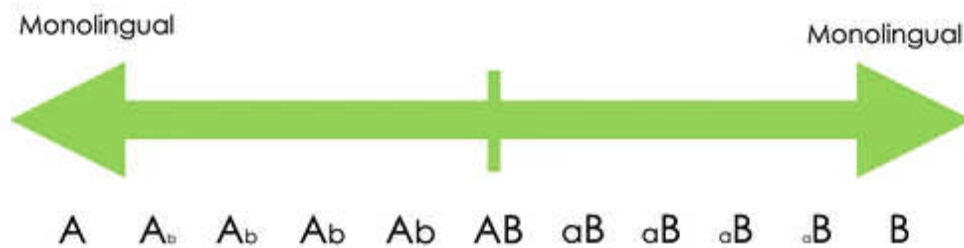

Figure 10: The bilingual continuum adapted from Valdés and Figueroa (1994: 8)

1.1.4.2 Bilingualism: Les modes langagiers

Within the concept of the bilingual continuum, we find diverse language practices that may be associated to the notion of language modes. François Grosjean evokes the idea of “Les modes langagiers” (Grosjean, 2009: 56) (The language modes) to highlight the observations that bilinguals can find themselves at various points of the language mode continuum embedded within the bilingual continuum. He declares that

Dans ses activités quotidiennes, la personne bilingue navigue donc entre différents modes langagiers appartenant tous au même continuum. À l’une des extrémités de celui-ci, elle est dans un mode monolingue : devant des monolingues qui ne connaissent pas son ou ses autres langues ... elle se trouve dans l’obligation de n’utiliser qu’une seule langue avec son interlocuteur. À l’autre bout du continuum, elle communique avec d’autres bilingues qui parlent les mêmes langues qu’elles et qui acceptent le mélange des langues (le parler bilingue). Entre ces deux extrêmes se trouvent une série de modes intermédiaires²³. (Grosjean, 2015: 57).

For him, on one end of the language mode continuum bilinguals may be in a monolingual mode. This happens when they interact with speakers who they know only speak one of their languages. In this case, only one of the languages is activated, and the other one is deactivated. On the other end of the language mode continuum bilinguals communicate with other bilinguals with whom the same languages are shared, and with whom language mixing (bilingual talk) is accepted. In this case, both languages are active, and bilinguals are in a bilingual mode as they communicate with other bilinguals.

It is crucial to highlight the idea that in being in a bilingual mode, speakers also accept what Grosjean calls “bilingual talk” i.e., when a bilingual speaker uses both of his/her linguistic

²³ In his/her daily activities, the bilingual individual navigates between different language modes that all belong to the same continuum. At one of these extremities, s/he is in a monolingual mode: with monolinguals who do not know one or more of her/his languages ... s/he finds her/himself obligated to use only one language with his/her interlocutor. On the other end of the continuum, s/he communicates with other bilinguals who speak the same languages as s/he does and that accept language mixing (bilingual talk). Between those two extremes a series of intermediate modes may be found. – My translation.

resources in interaction. This linguistic practice is readily observed in the present project. Furthermore, in the literature, these types of bilingual behaviors are referred to as language mixing, code-switching, code-mixing among other denominations. Regardless, these language modes also fall along the bilingual continuum. Moreover, we can see evidence of language mixing in the early stages of language acquisition, and socialization in bilingual communities, and this too is attested in LIN's interactions with her caretakers. Nevertheless, we will take a closer look at this language mode and linguistic phenomena in further detail later in Chapter 4, 5, and 6. For now, it is important to understand the end points of the bilingual continuum described above, as well as to be aware that factors such as the "interlocuteurs, leurs connaissances des mêmes langues, leur attitude face au parler bilingue, le contexte dans lequel à lieu l'échange, le contenu de celui-ci, le but de l'échange, etc." (Grosjean, 2015: 58) (interlocutors, their knowledge of their languages, their attitudes regarding bilingual talk, the context where the exchange takes place, its content, the goal of the exchange etc.), play a major role in determining where bilinguals will find themselves along the continuum.

1.2 Modeling bilingual language acquisition

In the early 80's Grosjean (1982) suggested that there was hardly a country in the world where bilingualism was not manifest. He advanced that the number of bilingual speakers worldwide accounted for at least half of the global population. Just over a decade later Genesee et al. (1995) estimated that there were as many children growing up acquiring two languages as there were children learning only one. Finally, Dörnyei and Csizer (2002) stated that bilingualism was an international norm and estimated that about two-thirds of the world's population was considered at the very least to understand and to speak two languages, and at the very best, to speak and to understand more than two. Today, in 2022, or just about 40 years after Grosjean's initial observations, there is no denying that international mobility has become more accessible to a greater number of people on a global scale. Indeed, migration according to Heyer (2022) has always been a trait common to humankind. Therefore, it may be safe to assume that there still may be as many children, if not more who are in the process of acquiring two languages (or more) in their communities of practice as there are children only acquiring one. While it is difficult to establish any conclusive results, it would not be imprudent to assume that the number of children growing up bilingual may perhaps represent more than half of the world's population. Nevertheless, even though bilingualism has been considered as prevalent as

monolingualism since the early 80's, childhood bilingual acquisition has been poorly understood because

Many studies in modern linguistics as it developed in the 1960s and 1970s were carried out in the generative framework, and some influential research on HLs has been carried out within this framework. It is impossible to even attempt to do justice to this model in a few paragraphs, given its long history, research output, and large number of practitioners. (Aalberse et al., 2019: 162).

Many researchers have underscored the fact that the generative framework to language acquisition, traditionally focused on monolingualism, has had a tremendous grip on investigations related to bilingualism matters. This has led to a poor understanding of childhood bilingual acquisition. For example, Carmen Silva-Corvalán (2014) in her six-year study of Spanish-English childhood bilingualism further states that

Studies of BFLA have been done within the framework of the theories proposed for monolingual acquisition, in particular, *nativist* and non-nativist *constructivist* theories. The latter have included functionalist, emergentist, socio-pragmatic, usage-based proposals, and the competition model. (Silva-Corvalán, 2014: 5).

Silva-Corvalán thus highlights that childhood bilingualism has been apprehended both by nativist and non-nativist theoretical perspectives. However, as discussed above nativist studies have led to the belief that monolingualism is the norm as compared to bilingualism. Another consequence, as we saw in the first section of the chapter is the need for some linguists to define bilinguals as if they were two monolinguals in one, or to define bilingualism narrowly. Closely related to the two-in-one agenda, has been the need to compare bilingual speakers' skills according to corresponding monolingual speakers baseline languages. The baseline language issue poses both theoretical and methodological challenges. Like other scholars (Montrul, 2016), I have decided to cover this matter as a methodological issue in Chapter 3 on Data and Research Methods since it guided the data collection protocol for this work. Generative frameworks have also paid little attention to the impact of the input, in this case the (bilingual) language learning environments in which languages are used and acquired. Their language acquisition models either ignore, or downplay the role of the input (Montrul, 2016), otherwise conceived as language use, and practice as anchored within interactional familial frameworks.

On the other hand, researchers such as De Houwer have witnessed an explosion of interest in BFLA studies. She states that

The number of scholars studying BFLA has greatly increased over the last 20 years, and the field has really ‘come into its own’. Not only has the number but also the geographic diversity of the researchers studying BFLA grown dramatically. Previously, BFLA scholars were mainly of Western European descent; nowadays, BFLA research is carried out by scholars of different ethnic backgrounds in many countries across the globe, spanning from Australia over China to Russia, Norway, Portugal and the Americas. This geographic diversity of researchers brings with it much needed diversity in the languages that are being studied. It also holds the promise that soon we will be able to start teasing apart those aspects of BFLA that are specific to particular cultural contexts and those that are of a more universal nature. (De Houwer, 2009: 13).

The growth of researchers interested in bilingual language acquisition has allowed the field of bilingualism to mature. In turn, this has resulted in new approaches and theories specifically related to bilingual studies internationally. Therefore, the next section gives an account of the theories related to bilingual acquisition with relation to the child studied in this research dissertation. But first, we finish the present one below with a discussion of the factors that are said to impact the bilingual language learning trajectory in children.

1.2.1 Factors affecting bilingual language development

The study of bilingualism from multidisciplinary perspectives has shown that these two conditions – exposure to the language since early childhood and fluent use of the two languages in adulthood – are not always met because unbalanced bilingualism ... is actually the norm. (Montrul, 2016: 91).

Certainly, external factors like language exposure and language use from child- to adulthood may be said to directly influence the level of bilingual ability of the two languages of a speaker at any given point in time. Moreover, these factors also play a role regarding the internal relationship of the two languages throughout the developmental path of the individual. In other words, these impacts may occur across many different, but heavily interweaved levels for example, the cognitive, psycholinguistic, sociological, and political levels to name a few. As unbalanced early bilinguals who have acquired their two languages from birth, heritage speakers’ language proficiency is subject to wide individual variation. Furthermore, a discussion of language exposure and use is intrinsically associated to the bilingual language learning environment. These environments provide a multitude of socio-linguistic indicators that socialize children into ways of acting and interacting at the linguistic and nonlinguistic levels within their unique, and often multigenerational family types as seen in the first section of the chapter. Thus, unlike monolingual acquisition,

A bilingual environment presents additional challenges since all these linguistic milestones must be achieved in two languages when the quantity of input in each

language is not 100%, but it must be a proportion of 100% (i.e., 30-70% or 50-50%, etc.). (Montrul, 2016: 117-118).

Analyses strictly related to the quantity of input in Spanish, English, and language mixing as a proportion of 100% in LIN's bilingual language learning environment will be examined in greater detail in Chapter 4. For now, the takeaway message is that insufficient input quantity and quality in the immediate language learning environment may lead to the acquisition of a heritage language that displays uneven mastery regarding some, or many grammatical aspects across the lifespan. For example, "many second-generation adult Latinos (heritage speakers) have reduced grammars in such aspects of Spanish as tense and aspect morphology, direct object marking, and the production of overt and null subject pronouns." (Silva-Corvalán, 2014: 23). Moreover, these are aspects of the heritage language that may be transmitted to, and potentially transformed by later generations. Thus, the linguistic outcomes of bilingual first language acquisition depend on both input quantity and quality in early childhood. Below we take a look at the former, or what is meant by input quantity.

1.2.2 Input quantity

That amount of input and opportunities for language use play a very important role in the bilingual acquisition process cannot be disputed, especially in view of the reduced grammars of adult heritage speakers, who use the majority language in a much broader number of functional domains. (Silva-Corvalán, 2014: 23).

Children who have benefited from bilingual exposure since birth, or shortly thereafter are those who researchers claim to have had the most input in terms of quantity. As a result, chronologically they may be perceived as having been presented with the best chances in terms of input quantity to master their heritage language(s). However, the issue of input quantity is not so straight forward in and of itself since we see that

in general, young adult sequential bilingual heritage speakers show stronger language acquisition and maintenance in several areas than heritage speakers who are simultaneous bilinguals ... operationalized as an age of onset of bilingualism effect (early in simultaneous bilinguals and later in sequential bilinguals.) (Montrul, 2016: 118).

It would thus seem as though bilingual input from birth which implies greater overall input quantity is in fact detrimental to the development of heritage languages, contrary to what one would presuppose. At the end of the chapter, in discussing the various degrees of bilingualism the issue of early and late bilinguals with relation to age of onset, and the "Critical period" as it is called in generative linguistic circles will be presented. Nevertheless, as far as LIN is concerned, having been exposed to Spanish and English since birth we can classify her as a

simultaneous bilingual. Furthermore, much like Montrul (2016) has found in cases of simultaneous bilingualism, in the present study LIN does not show strong heritage Spanish acquisition as the quantitative measures (Chapter 4) show, or use, as the qualitative analyses (Chapter 5 and 6) indicate. The quantity of Spanish input in LIN's bilingual language learning environment while strong in the first sampling period (relative frequency of 50% in February 2018), significantly dropped in the last two sampling periods (relative frequencies of 19% in August 2018, and 22% in January 2019). These input quantity figures are important to consider since researchers for example Pearson et al. (1997) suggested that a threshold of 25% was necessary for a minority language to be acquired, but it is unclear to what extent. On the other hand, Thordardottir (2013) found that for children to develop monolingual levels in each of their languages, 50% exposure is enough. Of course, the study of French-English bilingual children was conducted in Montréal, a cosmopolitan city where French and English both are valued, and widely used at the community levels. We will see further below how positive attitudes, and stances related to identity deeply influence heritage language use, and transmission. Finally, the fact is that the relative frequencies, or the input quantities that bilingual children (over)hear may fluidly oscillate between 0% to 100% in any language pair which is also highly dependent on the sociolinguistic contexts in which they unfold. These fluctuations in the input quantity are precisely what we saw longitudinally in LIN's bilingual language learning environment. For this reason, it is also critical to account not just for the input quantity, but also the input quality, including the contexts of language use as we see below.

1.2.3 Input quality

Aside from the input quantity alone, the input quality including the interactional situations also play a key role in bilingual language development. By the quality of input, and by extension the quality of output, Jia and Paradis (2014) mean the depth of richness, or the range and sophistication of vocabulary, and linguistic structures to which a child is exposed. The input quality refers to

the type of vocabulary the bilingual is exposed to and actually uses, the specific syntactic structures used when speaking in a particular context or about a particular topic, and the type of discourse required depending on topic/context; that is, familial and presentational versus descriptive, hypothetical, argumentative, etc. (Montrul, 2016: 118).

Thus, the stakeholders to which the input quality may be directly related is to the diversity, and the number of people who speak the heritage language to, and around the child. In this study speech directed to the child will be referred to as child-directed input, and non-directed speech that is in the child's environment will be referred to as overheard input. Moreover, an interlocutor's language proficiency in a language contact situation is likely to differ from one speaker to the next, and these individual differences, which impact the input quality, may be subject to change over the lifespan. For example, aspects of grammar may display attrition in parents, or caregivers who have lived in a context of immigration for a decade or more. Sorace (2000), Tsimpli et al. (2004), Nagy et al. (2011), and Benmamoun et al. (2013a,b) have all revealed that an area where grammar attrites in first-generation speakers is in the use of null, and overt subjects in null subject languages. Research has shown that "Two types of languages have been distinguished with respect to subjects: pro-drop or null-subject (NS) languages, which license the absence of the phonetic realization of a subject argument" (Silva-Corvalán, 2014: 120). Spanish for example is a null subject language that morphologically embeds the subject in the verb. Therefore, the phonetic realization of the subject argument in Spanish is typically not realized, except in contextually specific circumstances, such as for contrast and emphasis, or to resolve ambiguity (Torres Cacoullos & Travis, 2018).

Take for example the following hypothetical case where one Spanish speaker asks two others if they would like a taco. Spanish speaker one may ask something like "¿Pablo, quieres un taco?" (Pablo, do you want a taco?), and Pablo may answer something like "Sí, sí quiero uno por favor." (Yes, yes (I) do want some please.). However, before Spanish speaker one has a chance to ask Perla if she wants a taco too, Perla says something like "¡Yo quiero un taco también!" (I want a taco too.). Since Pablo grew up in Mexico, it is likely that he does not realize (phonetically) the subject in his reply, and there is also no need for him to be emphatic or resolve ambiguity. However, Perla, a heritage Spanish speaker who grew up in L.A., perhaps feels that she might be left out, so she overtly marks the subject in her statement. Since she is a heritage speaker of Spanish, the function of her overt subject realization may be for emphasis, and it works given her imagined (that she will be left out) contextually specific circumstance. But the Spanish adverb "también" (too) may also serve to mark emphasis in Perla's utterance without having to phonetically realize the subject "yo" (I). Nevertheless, her overt subject realization could be the result of crosslinguistic influence from English, a language that requires the phonetic realization of the subject. This seems to be the case with some members of the heritage Spanish speaking community as Silva-Corvalán (1994) has found in second-

generation heritage Spanish speakers in L.A. It could also be the result of having acquired a variety of Spanish that overtly marks subjects because of diachronic change. For example, Flores and Toro (2000) have found that a speaker's dialect is a good predictor of the distribution of null subjects in U.S. Spanish. Thus, regarding the discussion on the input quality we must keep in mind that for some heritage bilinguals, their heritage grammars are the result of being exposed to input that is thought to be different from the start. That is, input that has incurred changes for example by attrition in the previous (their parents') generation.

Research has shown that heritage speakers without exception report that they use their heritage languages almost exclusively with their parents, and grandparents. Furthermore, as is the case with the participants in the present multimodal and multigenerational study, the heritage speakers also use heritage Spanish with other heritage, and non-heritage speakers alike such as their great-grandparents for the latter, and their siblings, cousins, aunts, uncles, and close friends for the former. Thus, the quality of input that heritage speakers are exposed to may be thought as boiling down to their social networks. Both the richness in terms of the number of interlocutors, and level of mastery of their (heritage) language contribute greatly to the input quality. Furthermore, the quality of input is also a critical point that was recently highlighted by Brehmer and Treffers-Daller (2020) in the introductory article of their edited volume. The authors suggest comparing young heritage speakers with adult heritage speakers who belong to the same sociolinguistic community since "input in the heritage language is usually provided by parents who are themselves (late sequential) bilinguals." (Brehmer and Treffers-Daller, 2020: 4). In this respect, they align with Rothman (2007), Pires and Rothman (2009), and Pascual y Cabo and Rothman's (2012) "input quality approach". Their approach to the input quality issue

challenges the notion that the linguistic structures available to heritage speakers in their input always conform to the standard variety that monolinguals have access to. Thus, heritage speakers depend on input from their parents. This input might already differ from monolingual varieties because of L1 attrition, cross-linguistic influence or general diachronic language change which might build on changes already extant in monolingual speech (Brehmer & Treffers-Daller, 2020: 4).

The issue of a monolingual standard variety as a baseline input language with which to compare heritage speakers will be dealt with in detail in Chapter 3 as mentioned above. Nevertheless, regarding linguistic changes, Silva-Corvalán (1994) points out in her study of language contact with English, and the change of Spanish in L.A., that the absence of exposure to standard norms such as written forms accelerate linguistic changes. Thus, "Following the "input quality

approach”, data from first generation immigrants (or any preceding generation) need to be taken into account when analyzing structures in heritage languages and establishing the variety that heritage speakers were exposed to.” (Brehmer & Treffers-Daller, 2020: 4). In our study, we account for both the input quantity and quality multigenerationally, that is across three generations of speakers. We may thus argue that we meet the input quality approach’s standard for comparison. In sum, the input quality, as well as the input quantity presented above, due to their impact, are critical factors that must be explored when assessing bilingual language development. Other major factors have to do with attitudes and identity at the individual, familial, and societal levels. We turn to these issues next.

1.2.4 Attitudes & Identity

The display of positive attitudes towards one’s heritage language, and culture seems like sound advice for communities seeking to transmit it intergenerationally. However, “the evidence from studies around the world clearly shows that this is often a very challenging task for minority or immigrant language families wishing to engage in LM²⁴.” (Pauwels, 2016: 126). Nevertheless, attitudes towards heritage languages extend beyond the immediate family. In other words, the “Attitudes of the extended family, the school, and society at large are also important.” (Romaine, 1989: 212). For example, Søndergaard (1981) discussed his failed attempt at raising his children bilingually in Finnish and in Dutch in Denmark. In part, he explains his unsuccessful bilingual transmission as related to his monolingual Dutch speaking family members who believed that bilingual development would be too strenuous for his children. There are many more anecdotal accounts similar to this one in the literature, and often we find that familial beliefs about the do’s and don’ts regarding how to best raise bilingual children are beliefs that trickle into the family sphere from the school.

How schools’ impact bilingual language development is related to negative attitudes towards bilingualism, a common mindset still shared by many teachers. Recently in the U.S. context Cioè-Peña (2021) underscored educators’ attitudes, and more broadly educational institutions’ roles in hindering bilingual development. I too witnessed a negative stance towards Spanish-English bilingualism during my fieldwork in L.A. After gaining access into the school, and then permission by LIN’s teacher to make observations in class, on one

²⁴ In her book, Pauwels designates LM as language maintenance, and LS as language shift.

occasion I discussed the expanding²⁵ Dual Language (DL) program with one of the teacher's assistants (T.A.). The observation is taken from my handwritten journal and dated October 17th, 2018. The T.A. which I identified as BAR stated, "I'm not sure about the Dual Language program since it could cause delays in English." (Alvarez, 2018). To me this was astonishing for several reasons. First, she was a pregnant Latina mother who with that mindset would certainly discourage bilingualism in her own children, let alone the children within her social network, including the parents whose children are enrolled in that school. Second, The DL program, that she believed could cause delays in English, was in fact an institutional response²⁶ that sought to build, once again, upon the linguistic, and cultural needs of its Hispanic community members. Research suggests that there is nothing better than institutional support for bilingual and biliterate development. According to Dosi et al., (2016) bilingual education not only seems to favor abilities in language, but also for Andreou (2015), and Dosi (2016; cited by Andreou et al., 2020) abilities in cognition. Furthermore, as we saw in the introduction, LIN's community is made up in large part of Latinos who already speak Spanish at a rate of 87%, so the role of, and advocacy for biliteracy through bilingual education is critical for the harmonious bilingual development of this population. Third, the last aspect that was astonishing was that the T.A. at the time that the observation was made, was in the process of working towards her bachelor's degree in the field of child development. If a child is to develop harmoniously, s/he needs to be valued as whole as De Houwer (2009, 2021) has incessantly claimed, which means that both of their languages should be nurtured for the communicative well-being in the family (De Houwer, 2015). It is thus hard to imagine that in today's day and age, given the wealth of research that dispels the idea that bilingual education is detrimental, that she has not reconsidered the role of dual language learning within the framework of her degree granting program.

²⁵ When I began my research, the DL program had recently been implemented, starting with the lowest level first, and not in all classes of the same level (not all parents wanted their children in the DL program since they believed it would negatively impact their children's English, and that anyway, their children could learn Spanish at home.). Nevertheless, by expanding the DL program, the school's goal was to add one higher level DL class per year.

²⁶ The state of California has historically been erratic regarding their policies concerning the implementation, and then eradication of DL programs. Studies suggest that it takes nearly a decade to roll out a fully functioning DL program school-wide. Unfortunately, due to these erratic policies, underscored by sociopolitical decisions, dismantling a DL program can be done from one year to the next. Macias (2001) goes further in discussing the language debates in the U.S. since the 1980's and beyond. In his paper he concludes that two decades worth of language politics have not only challenged, but more critically shifted the foundations of educational policy in the state.

While these examples are relatively recent, they are not new, but they are however toned down compared to the two we see next. In a study that took place in the mid 70's of Greek-speaking children in Sydney, Australia, Isaacs (1976) gave an account of overhearing a teacher who suggested that children who used languages other than English should have their mouths scrubbed out with soap. This is indeed an extreme example of *linguistic terrorism* as the American scholar, and guiding force of Chicana cultural theory Gloria Anzaldúa (1987) boldly claimed in her pioneering book²⁷. However, in the example above punishment for using one's heritage language did not go as far as involving physical abuse, although getting one's mouth washed out with soap is not far from it, and either is putting into question one's citizenship (verbal/psychological abuse). In her personal example of *linguistic terrorism* at the institutional level Anzaldúa reflects upon her educational past where she experiences both physical abuse and verbal abuse after speaking Spanish in class. She writes:

I remember being caught speaking Spanish at recess-that was good for three licks on the knuckles with a sharp ruler. I remember being sent to the corner of the classroom for "talking back" to the Anglo teacher when all I was trying to do was tell her how to pronounce my name. "If you want to be American, speak 'American.' If you don't like it, go back to Mexico where you belong. (Anzaldúa, 1987: 75).

Here, Anzaldúa as a student is a victim of both physical and psychological punishment. On the one hand, her hands were literally struck with an object where the intention was likely to inflict pain. On the other hand, her psyche as related to her national identity was put into question simply because she wanted her teacher to say her name correctly. As we have seen thus far, "A number of contextual factors play a crucial role in the development of different types of bilingualism. Among them ... their social status ... and family and community attitudes toward each of the languages and toward bilingualism." (Silva-Corvalán, 2014: 22).

Community, or societal attitudes also have a powerful influence on heritage language use, and acquisition. The greater social, cultural, and political environment in which heritage bilinguals are immersed is also very much instrumental in guiding their already fragile linguistic development. For children, this includes peer pressure from friends in, and out of school since "Children do not want to appear different from their friends²⁸." (Romaine, 1989:

²⁷ Semiautobiographical, Anzaldúa's book, through a mixture of prose and poetry, and mixing between Spanish and English, is based on her experience growing up on the Mexico-Texas border. She examines the Chicano/Latino experience through the prism of issues related to identity, race, gender, and colonialism.

²⁸ I too vividly remember, during my elementary school years, wishing, before bedtime that I would wake up the next morning not being able to speak Spanish to be like most of my other Latino (who had likely undergone language shift), and monolingual speaking friends. While my wish never came true (fortunately), I do not ever

214). Therefore, heritage language use is compromised, even in familial circles “Because they want to fit in and their main point of reference is their majority language-speaking friends, during the school-aged period heritage speakers refuse to use the heritage language at home.” (Montrul, 2016: 121). Moreover, Sherkina-Lieber et al. (2011) who researched Labrador Inuit communities found that it was not just children’s attitudes that influence heritage language development. Older, more proficient speakers in this community were found to judge the heritage speaker’s language abilities, namely their non-fluent speech in Inuit. Furthermore, because of the adults’ negative feedback, the study reported that non-fluent speakers were discouraged from trying. Anzaldúa too described being insulted and criticized for the way she spoke Spanish.

*Pocho*²⁹, cultural traitor, you’re speaking the oppressor’s language by speaking English, you’re ruining the Spanish language,” I have been accused by various Latinos and Latinas. Chicano Spanish is considered by the purist and by most Latinos deficient, a mutilation of Spanish. (Anzaldúa, 1987: 77).

With this second example we have thus seen how external, sometimes extremely judgmental factors may contribute to the level of mastery of heritage language development. At times, these criticisms come from the members of one’s very own speech community who may also deem their Spanish, or Chicano Spanish as impure. We will see below how monolingual speakers are often the ones who are found to stigmatize how heritage bilinguals speak, or rather how they mutilate Spanish. To further illustrate this point, I will use an example drawn from the present study. The following journal entry was made several months after my arrival to L.A., or on November 4th, 2018. It is extracted from the handwritten version of my field journal. It shows how criticism from peers may resonate in the minds of speakers across the lifespan, and moreover that criticisms related to language and identity were not limited to Texas, but also prevailed in the west, or California and specifically in L.A. GLO and ERI have gone to Morelia, Michoacán, Mexico for a week to get in touch with their culture and experience firsthand the ancestral festivities of *Día de los Muertos*³⁰ (Day of the Dead). During one of our first

remember refusing to speak Spanish with my parents in public spaces. This experience is one of the motivational factors that has encouraged me to pursue my Ph.D. on the topic of heritage language acquisition, and socialization.
²⁹ Considered an insult for generations and aimed at Mexican-Americans who were thought not to be sure about their identity, and not good in speaking Spanish. Today it refers to a U.S. citizen of Mexican origin, or a culturally Americanized Mexican.

³⁰ Traditionally celebrated on November 1 and 2, the Day of the Dead is classified by the UNESCO in their list of Intangible Cultural Heritage of Humanity. It is thought to have largely originated in Mexico and it is a national holiday that celebrates through various key rituals such as the building of altars where offerings are placed, the memory of our dearly departed. In short, it places a prime on remembering, rather than forgetting those that have moved on to the other side.

meals in the colonial historic center GLO made the following declaration. Since her reflection really lingered on my mind, I tried to recall what she said a few days later.

(Context) Sunday sitting at Morelia International Airport waiting for our flight back to Tijuana

GLO on the very first day on our vacation in Mexico made a comment about her Spanish. She used the term ‘Pocho’ a term used to describe someone who has been ‘Americanized’ and said something to the tune of ‘I hate it’ when speaking Spanish in Morelia. So, this leads me to believe that contrary to what I thought, she is (might be) complexed about speaking her first language since when GLO got to L.A. at around the age of 10, she stopped learning Spanish formally. (Alvarez, 2018).

In her early fifties, GLO thus demonstrated to me that not only was she aware of her Spanish accent, but moreover that she perceived it negatively, evoking the term ‘Pocho’ as Anzaldúa did. This negative affirmation was apparently heightened when in social interaction with other monolingual speakers in the motherland, Mexico. Much like Anzaldúa these ideas undoubtedly came from the (unintentionally?) hurtful commentary of both close and extended social actors, including monolingual Spanish speakers in private and public settings both in Mexico and in the U.S. For example, Parodi reported “que son estigmatizadas en mayor o menor grado entre monolingües, pero que se usan en Los Ángeles” (Parodi, 2003: 26) (that they are stigmatized to greater or lesser degrees among monolinguals, but that they are used (rural American Spanish) in Los Angeles). To further underscore how negative stigma as tied to language, and how its associated notions permeate across generations, I turn your attention to another example drawn from the present study. The following journal entry was made only two days after my arrival to L.A. on August 8th, 2018, in the digital version of my field journal. It shows how ALE, a second-generation heritage bilingual through her anecdote also uses the term ‘Pocha’ adopted by GLO, and by Anzaldúa in the mid 80’s. I thus write:

ALE described a woman that ‘looks’ Mexican, but who doesn’t speak Spanish as ‘Pocha’. Ideologically this may have negative connotations, but it also highlights the idea that passive heritage bilinguals may indeed be described/identified based on their perceived heritage (what they look like) and whether these individuals have productive use of the language they are perceived to speak (in this case Spanish). Is then a ‘pocho’ not bilingual? But more generally, what is a ‘pocho’? According to Urbanictionary, a ‘Pocho’ is a Mexican that has been Americanized. This means they have lost their cultural heritage. Indeed, it is suggested that one of the key criteria for this label is not having acquired at least in part productive ability in Spanish, only receptive. Moreover, as suggested previously, ‘Pocho’ is considered not only derogatory, but also used to label someone who is trying to “act white”. Nevertheless, members of the Chicano community have embraced the term. The term ‘Pocho’ has thus become more empowering and playful, than devastating and hurtful. (Alvarez, 2018).

For ALE the inability to speak Spanish but look Mexican in the U.S. is representative of a ‘Poch@³¹’. Passive bilingualism may be considered a linguistic state along the bilingual continuum that engenders, and thus imposes a pessimistic *cosmovisión*, or way of interpreting the world upon other Latino community members where these speakers may not even be considered bilingual. Furthermore, the present observation suggests the term ‘Poch@’ as someone who has lost touch with his/her heritage culture in their be-coming ‘American’, and as such was used to put one’s identity into question. However, with time, we see how the relationship between power and language is changing. Within this *tercera Hispanidad*, heritage bilinguals have re-interpreted, through a process of semantic shift the term ‘Poch@’ in a more positive light where they hold the power to (re)define themselves. According to Bhabha (1994), minority communities in *third spaces*, try to fuse, or hybridize with the dominant, or majority culture (in this case monolingual Spanish speakers in the U.S. and in Mexico), to *fight* the dominant culture. This cultural struggle implicitly translates into a linguistic struggle between heritage, or minority languages and majority languages as well. As we have seen, less than positive ideas, and even attitudes about our linguistic identities may be implicitly transmitted to future generations. The problem is that these negative thoughts have a strong bearing on the level of overall mastery of the heritage language since they may curtail motivation for deeper learning. Aspects that are related to sociopolitical status, and thus heritage bilingual development are internal to the individually lived experiences of heritage speakers. Specifically, they are related with their attitudes and their identities. As reviewed above, the other key factors have to do with the quality, and quantity of input in the heritage language. Notwithstanding, these factors are interlinked contextually, affectively, ideologically, and socio-politically which ultimately “determine the degree of acquisition and proficiency in the heritage language.” (Montrul, 2016: 122). The figure below gives a visual representation of how the three factors previously discussed, as well as how the other factors touched upon in the discussion are embedded into one another, and subsequently play a critical role in heritage language use, and development.

³¹ Unlike in Anzaldúa’s writing, GLO’s self-talk, and ALE’s anecdote, in my discussion of the term I have decided to use the @ symbol in the term ‘Poch@s’. It is my attempt to capture its use for both feminine and masculine subjects.

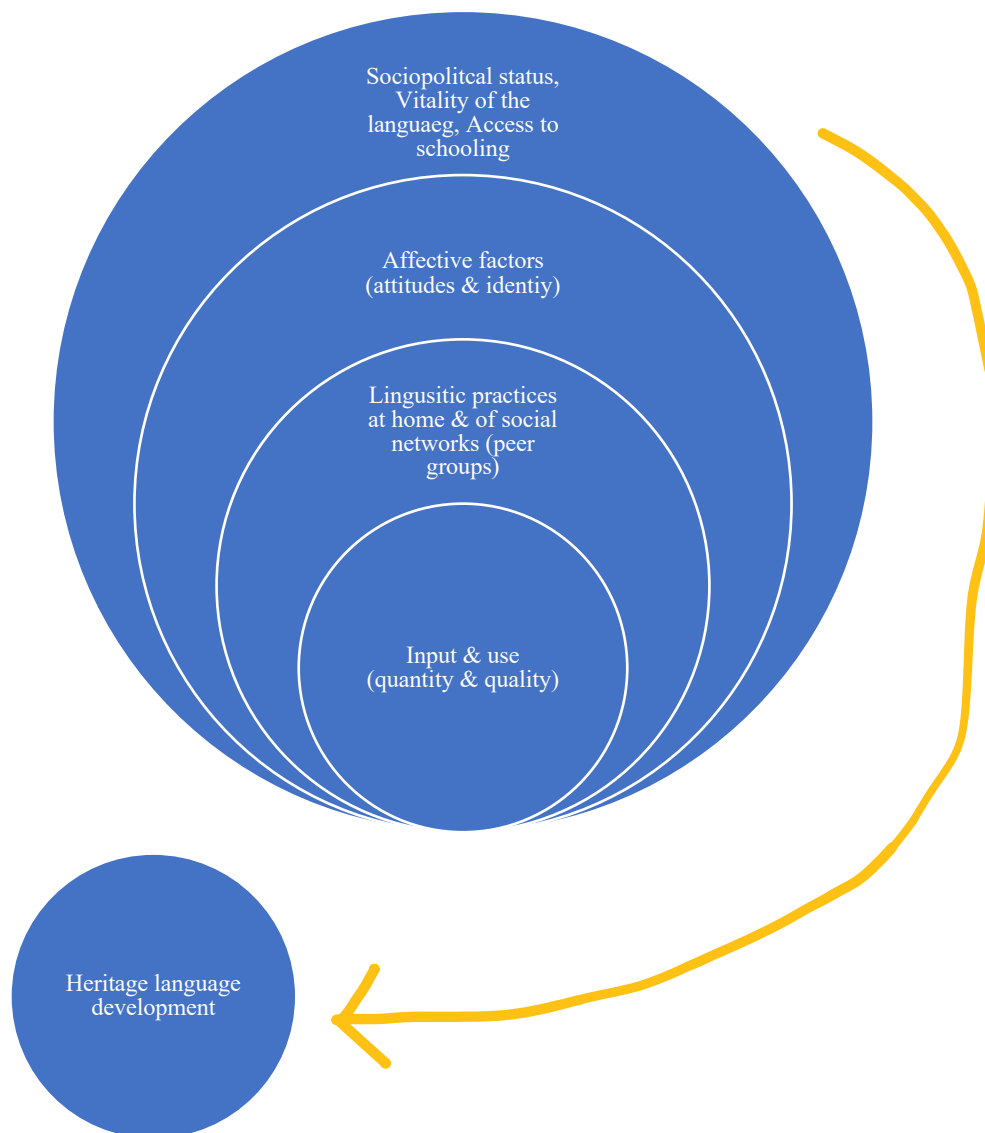

Figure 11: Adapted from Figure 4.9. in Montrul (2016: 123): Factors affecting bilingual language development

As we may gather from the figure above, once we are able to determine the relationship between some of the key factors said to affect bilingual language development in heritage populations, we are also better able to understand that there are many complex and interrelated causes that through their interaction engender lower proficiencies in the heritage languages of many heritage bilinguals, as opposed to the majority language which is generally their dominant one. We discussed for example, the input factor in terms of quality and quantity (smallest embedded circle). Next, we discussed factors related to attitudes and identity (third largest embedded circle). Moreover, we briefly considered issues related to a language's sociopolitical status as related to access to schooling (largest circle). Finally, we did not thoroughly address the issue of linguistic practices (second smallest circle) since Chapter 5 and 6 are entirely devoted to qualitatively analyzing the bilingual and multimodal language

practices in the home between LIN and her family members. Nevertheless, these factors alone do not suffice in explaining how languages are acquired, or more specifically, how heritage speakers get from here to there, even if the ‘there’ is for example, a passive form of bilingualism as we see will see is the case with LIN. Thus, to better understand this developmental process, the next two parts of this section focus on the main theories of language acquisition. We begin by briefly presenting three of the dominant theories of native language acquisition below.

1.3 Theories of native language acquisition

Before turning our attention to the theories that attempt to explain the underpinnings of bilingual first language acquisition, it is necessary that we first consider the nativist and empiricist debate in first language acquisition. It may help us better understand BFLA by placing it within the current theoretical perspectives of native language learning. Moreover, considering that research in modern linguistics was carried out within the generative framework (Aalberse et al., 2019), and based on monolingual acquisition (Silva-Corvalán, 2014; Montrul, 2016), the breadth and depth of work that accounts for, and explains native language acquisition from this perspective is monumental. Therefore, the goal here, and within the framework of this Ph.D. interested in bilingual language acquisition and socialization is not to give an exhaustive review. Rather the aim is to give a succinct overview of key similarities and differences between three representative theoretical approaches that attempt to explain the language acquisition process. Of course, one theory alone is certainly not enough to explain processes that are equally multifaceted, and complex. In part this is because for any given phenomenon, say for example language mixing in heritage bilingualism, each of these theories will focus on a particular aspect of said phenomena. For example,

language is both a grammatical system that develops in the minds of the individual speakers and a social construct that allows individual speakers to communicate, to form groups on the basis of their communication and use of language, and at the same time to define their own linguistic identities through sociolinguistic and communicative practices. (Montrul, 2016: 131).

Thus, on the one hand for generativists language is approached as an internal grammatical system while on the other hand, for emergentists it is external to the mind. It is the result of the cumulative social interactions, with a diverse range of interlocutors and social settings across the lifespan. Furthermore, for Tomasello (1999/2022) cumulative experience may be apprehended as cultural transmission which is an evolutionary process allowing individual organisms to save time, reduce effort, and take risks. This dichotomy is also commonly referred

to in the literature as the nature-nurture debate. As such, “Existing theoretical approaches tend to emphasize either one of these aspects of language or the other, often presenting themselves as oppositional rather than as complementary approaches. The same applies to theories of language acquisition ... and theories of bilingualism.” (Montrul, 2016: 131). Below we begin by considering the theory of Universal Grammar (UG), a generativist view of language acquisition put forward by Noam Chomsky. Then, emergentism will be discussed, namely through the lens of the usage-based approach to language acquisition as outlined by Michael Tomasello. Finally, variationist sociolinguistics is the third theoretical approach, and it is attributed to William Labov. This third theory may not be generally seen as linked to language acquisition research (A. Morgenstern, personal communication, August 12th, 2022). However, it is pertinent in this investigation since sociolinguistic approaches not only account for a language’s structure, but also how social factors impact linguistic development, change, and use. The use of heritage Spanish, English, and language mixing by LIN, but also by her extended, and multigenerational range of communicative partners will be examined and explained at the intersection of a breadth of social factors in this study. While input has more, or less of a role to play in each of these theories, all of them may find it difficult to disagree, to certain degrees on the following: In the human species there lies a special aptitude that together with linguistic and cultural exposure engenders full attainment in native languages. For example, this unique human predilection could be attributed to the FOXP2 gene “reconnu chez l’humain comme une des briques génétiques majeures du langage.” (Heyer, 2022: 214) (recognized in humans as one of the major genetic building blocks of language.). Moreover, these internal and external interactions must be anchored in meaningful, substantial, and sustained social interactions that open a space to use, and thus to acquire the target language. We will therefore begin by looking at the theory of universal language below.

1.3.1 Universal Grammar (UG)

The theory of Universal Grammar (UG) is essentially a paradigm of genetic faculty, or of linguistic nativism. While this was a clear stance within the community of theoretical linguists³² since the 60’s, this idea was broadcasted to a general audience in the mid 90’s.

³² To fulfill the degree-granting requirements in Spanish & Linguistics as an undergraduate student at UCLA I needed to take a directed research seminar. Dr. Quicoli based his entire seminar entitled Language & Cognition (SPAN 191A) on Pinker’s (1994) book. Not only did I find this approach fascinating at the time, but it also had a deep impact in my understanding of language. Only decades later, would I learn about Tomasello’s (2003) usage-based theory to language acquisition which to me, is more powerful in explaining how young language learners get from here to there. What I find amazing is that as a Spanish & Linguistics major, I was only exposed to

Pinker (1994) for example in his book brought together cognitive science, behavioral genetics, and evolutionary psychology. Not only did he introduce the language sciences to a larger readership, but in doing so he also pushed forward Chomsky's theory that language was an innate faculty of the mind. Pinker thus first argued that universal grammar is the cornerstone upon which languages are constructed. Second, he advanced that the human brain is pre-wired with a language specific mechanism. The UG approach to language may be resumed as one of human biological endowment. It assumes that the basic structures of language, and its associated linguistic behaviors are not only innate, but also unique to humans. In other words, language is a central feature of the human genome and therefore, complex linguistic insight is coded at the genetic level. Indeed, for the sociolinguist Silva-Corvalán nativists "argue that children are genetically endowed with a UG, a set of linguistic principals and constraints common to all the worlds languages, which, together with language-specific parameters, guide acquisition once children are exposed to a particular language." (Silva-Corvalán, 2014: 5). Put differently, guidance begins as children receive input such that "The theory assumes that young children implicitly make hypotheses about what is possible in their language as they receive input." (Montrul, 2016: 134). Thus, in this light, contrary to both emergentist and variationist theories, language acquisition is not viewed as an interactional, social, or cultural construction that is bidirectional in nature.

Moreover, regarding language variation, or what they call "errors" that deviate from the adult speech, "UG also defines the range of variation observed across languages (parameters, in Chomsky 1981) and characterizes the notion of possible human language." (Montrul, 2016: 134). We may think of UG as providing children with "a 'template' which specifies the (universal) structure of phrases and clauses" (Radford, 1996: 43), including the range of errors to be made within the template. Furthermore, within this theoretical approach, while adult input is a criterium for child language development, it is nevertheless insufficient. As generativists see it, at birth children are equipped with abstract grammatical knowledge. This innate knowledge is subsequently prompted by the input found in the linguistic environment. However, because "the input is frequently messy and unstructured, and does not provide negative evidence" (Silva-Corvalán, 2014: 5), the environmental input according to generativists "is not sufficiently detailed or transparent for children to derive the totality of the

generativist theories to language in the Spanish and Linguistics Departments. This would likely not have been the case had I been in the Anthropology Department where Dr. Ochs had been appointed since the early 90's.

syntactic and semantic complexity of human language entirely from it” (Montrul, 2006: 135). Thus, according to the theory of UG, children must acquire language based on their innate endowment, or *template* as Radford suggests, and this in part explains why adult input is seemingly unimportant in the language acquisition process. We may thus resume the generative approach as follows:

Linguistic theory is concerned primarily with an ideal speaker-listener, in a completely homogeneous speech-community, who knows its [the speech community’s] language perfectly and is unaffected by such grammatically irrelevant conditions as memory limitations, distractions, shifts of attention and interest, and errors (random or characteristic) in applying his knowledge of the language in actual performance. (Chomsky, 1965: 3).

For Chomsky, theoretical linguists thus focus on uniform communities of practice that bring about ideal speakers through the interaction of innate linguistic mechanisms. Moreover, these idealized community members not only speak their language flawlessly, but they are also not perturbed by the more general cognitive mechanisms i.e., sharing joint attention, pattern making, memorization, interaction, and input etc. that are crucial to the language learning process as viewed by emergentists. Furthermore, through Chomsky’s declaration in the mid 60’s we also see how the notion of perfect (monolingual) speakers has permeated into the definitions of the so-called perfect bilingual speakers discussed at the start of the chapter. In sum, under the UG paradigm input sparks the abstract and innate linguistic constraints unique to humans for language to subsequently unfold. However, input does not account for the totality of children’s sociolinguistic performance in interaction, and this includes their “errors”. Children’s non-target productions for theoretical linguists are accounted for within the spectrum of variation of UG, and as such comply with the innate structures of the human language faculty upon which languages are built, as opposed to the rich and dynamic adult input in the environment. Nevertheless, as it concerns the present investigation, although “A great deal of thought-provoking research on bilingual language acquisition (BFLA, adult L2 acquisition, etc.) has been conducted within the nativist generativist model.” (Silva-Corvalán, 2014: 6), for Tomasello (1995, 1999/2022), the UG paradigm does not adequately (if at all) rely on the behavioral observations that are typical of the scientific study of human behavior, and thus cognition. UG excludes from scientific inquiry what emergentist approaches, for example the usage-based theory to language acquisition bring to the forefront. We therefore turn our attention to emergentism next.

1.3.2 Emergentism

Emergentist theories may be thought of as being on the opposite end of the spectrum with regard UG. While these linguists are also concerned with the nature of grammatical knowledge, emergentists' theoretical position is in stark opposition to the nativist perspective. The emergentist theory of language acquisition underscores the complexity of social interactions. From this perspective, the emergence of language is rooted in the “interactions at all levels from brain to society” (Ellis, 1998: 631), and general language learning mechanisms are sufficient to engender the emergence of complex language representations and use. I consider Tomasello's usage-based theory of language acquisition to fall within the emergentist paradigm. Tomasello for example argues that

human beings cannot be born with any specific set of communicative behaviors. Young children must learn during their individual ontogenies the set of linguistic conventions used by those around them, which for any given language consists of tens of thousands, or perhaps even hundreds of thousands, of individual words, expressions, and constructions. The human species is biologically prepared for this prodigious task in ways that individuals of other species are not, of course, this preparation cannot be too specific, as human children must be flexible enough to learn not only all of the different words and conventional expressions of any language but also all the different types of abstract constructional patterns that these languages have grammaticized historically. It thus takes many years of daily interaction with mature language users for children to attain native-like skills, which is a longer period of learning with more things to be learned – by many orders of magnitude – than is required of any other species on the planet. (Tomasello, 2003: 1-2).

The essence of the emergentist paradigm is that language, which is unique to humans (Heyer, 2022), is a secondary phenomenon that is engendered by the dynamic interaction of skills, or abilities that are general to cognition, as opposed to an innate language specific apparatus. Moreover, these general-purpose cognitive abilities through their own mutual interaction (internal), as well as through their interaction with their language learning environment (external), i.e., mature language users, is what propels the emergence of language in the young speaker after sustained, and substantial, but dynamic and flexible language use. For emergentists what is innate is cognition in general, and language in this perspective stems from cognition rather than being an independent, and pre-wired language specific mechanism in the brain. The central concern here (Bates et al., 1996; Ellis, 2002; O'Grady, 2005, 2008) is how language is produced, or that what leads to its production is a result of the rich interplay between the environment, and our genes. To be precise, it has been advanced that “les individus héritent de leur environnement autant qu'ils héritent de leur génome.” (Tomasello, 1999/2022 : 103) (individuals inherit from their environment as much as they inherit from their genes.).

Through Tomasello's (2003) usage-based theory of language acquisition, substantial evidence has shown that children across their interactional frames obtain enough input from their parents, and their extended network of communicative partners. Furthermore, he argues that the input is not only clear, but it is also patterned. Children begin to learn language through the "various kinds of *pattern finding* – categorization, broadly defined (which) begin to emerge early in human development" (Tomasello, 2003: 4). Furthermore, frequent exposure to these patterns are embedded at the phonological, morphological, semantic, and syntactic levels. However, it is critical to keep in mind that language in general, and bilingualism in particular "is not just having syntax, lexicon, morphology (etc.), but also (about) inheriting language practices that are specific to a culture" (A. Morgenstern, personal communication, August 15th, 2022). Notwithstanding, young language learners from their frequent linguistic exposure, i.e., the varied examples in the data draw both on analogy and statistical learning. As a result, they can seize the underlying expected distributions of language as conventionally used in their environments. It is thus, through these interactional transactions that "the child automatically learns to recognize complex patterns from stress, prosody, syllable, and lexical patterns." (Montrul, 2016: 138), and from which the child subsequently makes assumptions with the aim of reproducing the input as output in novel social encounters.

The varied interactions that provide patterned input are anchored in environments such that language is rendered understandable to children. Thus, the interplay between patterned input, interaction, context, and cognition in turn make not only language structure, but also language use easier for children to apprehend, and to produce respectively. This is also made possible due to children's agency in interaction. The role of agency is brought to light throughout this investigation. For now, Tomasello and Farrar (1986) have highlighted that children are attuned not only to the social interactional frames in which they find themselves (i.e., as ratified participants, overhearers etc. according to Goffman (1974, 1981), but also to the social-intentional cues because

knowledge is not always all in the individual mind. It is also in the tools that a person uses, in the environment that allows for certain solutions to become possible, in the joint activity of several minds and bodies aiming at the same goal (Duranti, 1997: 31).

Children, as well as adults are thus continuously working hard through their *Intention-reading skills* to disentangle the communicative functions of the structural patterns in their languages. According to Tomasello

Intention-reading skills are very likely unique to human beings, and they probably emerged relatively recently in human evolution (Tomasello, 1999). They are domain-general in the sense that they do not just enable linguistic communication, but also enable a variety of other cultural skills and practices that children routinely acquire (such as tool use, pretend play, rituals). (Tomasello, 2003: 4).

Viewed from this perspective, Ambridge and Lieven (2011) see it impossible to explain language without accounting for its communicative functions. Moreover, together these arguments are a direct response to the nativist generativists' poverty of stimulus stance which argues that input does not provide enough information for the passive child to acquire a language.

Much like construction grammar (Goldberg, 1995) where rather than abstract categories, constructions are treated as the basic units of language, the emergentist paradigm accepts functional and cognitive linguistics as a theoretical approach to language. Tomasello, an ardent defender and key contributor of the usage-based constructivist theory, asserts the paradigm on the opposite theoretical camp with respect to UG. This theoretical approach accounts for an important part of a growing amount of literature on language acquisition where the basic tenet is that children's language development is the result of experience in interaction with cognition. There are no *templates*, no guiding principles, and no constraints, or "a set of domain domain-general procedures ... and a set of language specific learning mechanisms" (Silva-Corvalán, 2014: 5) that have been the backbone of UG accounts of grammar. Rather, it is the complex interplay between nature and nurture, or the biology of an individual in co-construction with his/her peers, as well as with the environment that engenders language learning. Children's emergent linguistic knowledge is therefore conceived as local associations and memorized chunks (Ellis, 2002), constructions (Tomasello, 2003; Goldberg, 1999), or memorized processing routines (O'Grady, 2005, 2008). The usage-based approach argues that what is *innate* and common to all, is general cognition and children's natural ability to learn. Tomasello in his book advances Croft's argument that

The specific items and constructions of a given language are not invented all at once, but rather they emerge, evolve, and accumulate modifications over historical time as human beings use them with one another and adapt them to changing communicative circumstances. (Croft, 2000; as cited by Tomasello, 2003: 14).

Thus, there is a couple of striking differences in this approach, contrary to UG. First, that varied input both from adults as well as other children is the main source of linguistic information from which children build their grammars. Second, that input therefore plays a major role during the language acquisition process over time. Moreover, in this approach, language

development is dynamic and subject to fluctuating environmental, and communicative factors, and as such we may add inherently diverse.

Within the context of my research project, we see how longitudinal changes in LIN's multigenerational and bilingual language learning environment seem to have a direct impact not only on her Spanish language use, and development, but also on her cultural practices. I will align with Tomasello's usage-based theory in examining my data since it considers both cultural and linguistic variations, as well as input and experience as determining factors in the language acquisition process. The usage-based approach through input and interaction may help explain the emergence and development not only of Spanish and English, but it will also give us a framework through which to consider instances of language mixing as it is anchored in a bicultural and bilingual sociolinguistic environment. Finally, the emergentist, and in particular the usage-based approach may be summarized as follows:

Usage-based constructivist theories assume that language emerges from the interaction of cognition with experience. What is innate is general cognition and the ability to learn. From birth, the child is endowed with cognitive abilities and general learning mechanisms that make possible the learning of language from the input received in situated instances of communication – that is, in instances of social interaction. Language is learned like other cognitive skills (e.g., how to read, solve puzzles, organize materials) by pragmatic inference, analogy making, imitation, sensitivity to frequencies in the input, and by social interaction with caregivers and others. (Silva-Corvalán, 2014: 6).

We have thus considered some of the central aspects between UG which underscores language development essentially as a feat internal to the mind, and the usage-based theory which explains language emergence as the result of external experience, as well as through the dynamic interplay between input and cognition. The usage-based theory, which we have concluded to be the most adequate paradigm regarding the present research project creates a bridge between the nature and nurture debate. However, there are approaches that accentuate the role of social factors in the process of language development. Next, we turn our attention to variationist sociolinguistics for a brief account.

1.3.3 Variationist sociolinguistics

As with both UG and emergentism, the structure of language is also focused upon in some sociolinguistic approaches. However, in apprehending language development, these perspectives generally tend to underscore the role of social factors. Labov (1972) for example has suggested that variationist studies are interested in how linguistic, and social factors drive

both variation and language change within certain languages. Furthermore, within this paradigm, variation and change is accounted for at the intra- (within) and interspeaker (between) levels (Otheguy et al., 2008; Nagy et al., 2011). Some examples of the relationship between linguistic forms and social factors that may be found intra- and interspeaker include but are not limited to gender, social class, ethnicity, generation, age, and place (i.e., local, regional, national). Furthermore, according to Montrul (2016) variationist sociolinguistic approaches also accept the existence of a standard language with which they gauge the language use of diverse social groups. The notion of a standard language, as it pertains to studies in language acquisition will be dealt with in Chapter 3 and will be referred to as the baseline input language. Notwithstanding, Eckert (1989), and Labov (2001, 2006) have found that typically lower- and working-class individuals, as well as women are at the forefront of linguistic variation and change in monolingual contexts. However, these driving forces are not as straight forward in bilingual settings. For Silva-Corvalán (1994) in a language contact setting it is a question of language dominance. Speakers who are more dominant in the majority language (English in the case of the present study) than they are in the minority language (Spanish in the present study) is what stimulates change and variation in the weaker, often minority language. Nevertheless, as we may have gathered thus far, adults have typically been the sources of linguistic data in these investigations.

Indeed, “Variationist sociolinguistics has been primarily concerned with describing sociolinguistic variation and change in adult speakers, and studies of language development in children have been less common” (Montrul, 2016: 141), although not entirely absent. For example, Roberts (1997) researched the acquisition of variable rules in preschool children. Smith et al. (2007) studied community, caregiver, and child acquisition of variation in a Scottish dialect. Miller (2013) investigated variability in the speech of Chilean Spanish-speaking children and their caregivers. The present study interested in the bilingual language acquisition, and socialization of a third-generation child in multigenerational, multimodal, and multiparty participation frameworks will also add to the growing body of literature as it demonstrates the variable use of language intra- and intergenerationally, and this, both through quantitative measures and qualitative analyses. To conclude, unlike UG, but much like the emergentist perspective, the concern of variationist sociolinguists has more to do with language use than with how language is an abstract and independent entity in the mind. Therefore, a feature of central concern within this paradigm is the idea of linguistic input, typically by expert speakers as a social phenomenon, at least to a greater degree than the UG approach.

Following several leading researchers in the field of heritage bilingualism, we briefly outlined the three main positions of native language development. The main goal was to explain child language acquisition from these distinct theoretical stances. In the UG approach a child gets from here to there by way of innate, abstract knowledge of grammar, and little input. In the emergentist perspective language is input, and interaction driven, and it emerges from the sociolinguistic environment despite linguistic variation, an aspect that is shared with the variationist sociolinguistic paradigm. However, for some scholars the variationist sociolinguistic approach may not be considered pertinent to native language development. Nevertheless, this theory is relevant, even if not widely applied in child language studies as attested in the brief review of studies above. It places a prime on language use in socially meaningful contexts as related to a myriad of sociolinguistic variables. Subsequently this interaction results in language change in certain communities of practice, and it is within these speech communities that children emerge as competent language speakers. Notwithstanding, in the end, and regardless of the varied sociolinguistic variables such as education, region, SES, sex, generation and so forth, children as they mature become expert native speakers of the languages to which they are exposed. Finally, if we have examined the theories above it is also because they are relevant, or they act as a preface to the theoretical approaches that attempt to explain heritage language acquisition which is the subject of the discussion below.

1.4 Theoretical approaches to heritage language acquisition

Heritage language acquisition is a special type of bilingual acquisition, thus it is natural to contrast it with other types of bilingualism. To date, the study of heritage languages has been approached from well-established theoretical traditions within linguistics and education such as sociolinguistics, anthropological linguistics, and generative linguistics, among others, and all these approaches are valid and relevant to advance the field. (Montrul, 2016: 132).

Montrul, much like Polinsky (2008) suggests that the acquisition of heritage languages is a distinct form of bilingual language acquisition. Therefore, it is normal to confront it to other types of bilingualism through a varied prism of theoretical paradigms. While we have already defined bilingualism at the start of the chapter, as well as some of the factors that are said to affect bilingual language development, the degrees of bilingualism, and the characterizations of heritage speakers and their languages will be the object of discussion in the following two sections. For the time being, we will present the diverse theoretical approaches that have aimed at explaining heritage language acquisition in particular. However, we must keep in mind that “a theory of heritage languages should not look different from a theory of a monolingual or

second language speaker of a language.” (Montrul, 2016: 149-150). Moreover, as in the discussions that were presented above that centered around native language acquisition, here too we briefly outline the dominant approaches to heritage language acquisition.

The reasons behind the following five succinct overviews are the following. First, it is crucial within the framework of this study of heritage language acquisition, and socialization to account for the depth and breadth of work amassed in studies of monolingual acquisition. As advanced above, theories of monolingual (or second language) acquisition should be the same as those that explain heritage language acquisition. Second, as Polinsky (2008) has previously suggested, in the last two decades studies involving heritage speakers and their bilingual acquisitional paths have emerged across many fields of inquiry. However, one of the most prominent of these sites of investigation has been in formal, or generative linguistics. As we saw with UG, theoretical approaches to heritage language acquisition have also, and essentially sought explanations of grammatical phenomena as represented internally. Perhaps more importantly though, much like UG, this approach has marginalized relevant issues such as the dynamic interplay between language context and expert adult input as primary factors that contribute to language output. The last three, and the following five brief overviews will provide us with a much-needed backdrop. They will set the stage for the theory in which the present dissertation is anchored, namely the emerging area of heritage language socialization (Guardado, 2018). We thus start with sociolinguistics since from a historical point of view “this was the first approach to heritage language grammars; generative, emergentist, and processability theory approaches are more recent developments.” (Montrul, 2016: 151) and a discussion of these approaches will follow. Finally, as reported by Pauwels (2016), sociolinguistics from a LM and LS perspective, and from a linguistic anthropological paradigm (Guardado, 2018) was the motor behind the burgeoning studies of heritage language development.

1.4.1 Sociolinguistics

Scientific inquiry into heritage speakers and their languages is underscored by a rich history in sociolinguistics, “especially in variationist sociolinguistics, sociology of language, and ethnolinguistics.” (Montrul, 2016: 151). Furthermore, of these, many investigations have aimed to explain and, or describe heritage speakers’ languages with relation to their more often than not diverse, dynamic, and emerging communities of practices within the linguistic

diaspora. For example, as it pertains to the present investigation, we may consider that after many centuries of contact with English, the Spanish of Los Angeles is a linguistic variety of its own (Parodi, 2003) since the early 2000's. Moreover, Los Angeles Spanish, Chicano Spanish, or Los Angeles Vernacular Spanish (LAVS) as it has often been named has been fueled by a strong and steady base of monolingual³³ Spanish speakers that have hailed mainly from Mexico, but also from other rural parts of Central America according to the depth and breadth of Parodi's (2003) research focused on L.A. Spanish. This language variety has also been nourished by the language practices of second-generation heritage Spanish speakers in bilingual, and multigenerational familial settings whose minority language has typically been dominated by English. In this vein, we may argue along with Silva-Corvalán that

sociolinguistics focuses on the social forces which shape language structure and use, as well as on internally motivated variation. Sociolinguists have shown that language is inherently and systematically heterogeneous and variable, and that the seeds of change lie precisely in the existence of this variation. (Silva-Corvalán, 1994: 1).

Thus, sociolinguistics has been successful in challenging the long-established structuralist perspective regarding language change arguing that the seeds of this change are the result of linguistic variation. In Chapter 2, by taking the idea of a *seed*, we will discuss with more precision the notion of language change, or linguistic *transformation* and how this process renders languages *original*. We will question whether a seed must die, understood here as a language, for it to bare its fruits and nourish the community across space and time. Nevertheless, as it pertains to language change, (socio)linguists as well as other language analysts may find common ground by agreeing with one of Weinreich et al.'s (1968) general principles, or that

Linguistic and social factors are closely interrelated in the development of language change. Explanations which are confined to one or the other aspect, no matter how well constructed, will fail to account for the rich body of regularities that can be observed in empirical studies of language behavior. (Weinreich et al., 1968: 188).

From a theoretical perspective, sociolinguists (Dorian, 1989) have frequently attempted to address issues such as language contact, variation, and change as a phenomenon with deep sociohistorical roots.

³³ We should keep in mind that immigration to the U.S. was not limited to monolingual Spanish speakers. It is very likely that some of these speakers were bilingual in Spanish and another of the many Amerindian languages spoken throughout Latin America.

One such study is attributed to Carmen Silva-Corvalán (1994). Her investigation proposes the most in-depth sociolinguistic investigation to date of Spanish heritage speakers in Los Angeles. Her aim was to better apprehend Spanish language change in ‘real time’ because of its contact with English. More specifically, Silva-Corvalán sought to understand the possible simplification of the tense-aspect-mood (TAM) verb system across three generations. To carry about her work, Mexican-American’s oral productions (interviews and conversations) who lived in L.A. between 1983 and 1988 were collected, and later transcribed for analysis. Within the three generations of immigrants, participants included both adults and adolescents. Silva-Corvalán (1994) thus discovered a plethora of changes to Spanish. To name a few, in second-generation speakers she reported on the absence of the synthetic future, the pluperfect indicative, as well as the conditional. Furthermore, she documented the use of overt pronominal subjects where null subjects were more appropriate pragmatically speaking. We have already discussed this issue further up on the issue of input quality as a factor that affects bilingual language development. In sum, her findings showed that intergenerational simplification, or loss of Spanish tenses is not caused by transfer from English. On the contrary, cognitive, and additional interactional factors along with limited exposure to, and use of Spanish resulted in these linguistic changes. Finally, Silva-Corvalán (1994) suggested that the changes in heritage speakers’ verbal system was propelled by a fast-moving process of internal linguistic change that was already taking place in other varieties of monolingual Spanish.

Following the variationist sociolinguistic paradigm, Nagy et al. (2011) conducted a more recent investigation of three heritage languages in Toronto, Canada. The goal of their study was to account for the impact of English influence on the phonetic subject pronoun realization in Cantonese, Russian, and Italian. As a reminder, English is a non-null subject language whereas the former are all null subject languages. These researchers collected a corpus of recorded spoken language that included 40 native speakers that was subsequently transcribed and coded for analysis. Moreover, much like in Silva-Corvalán’s study discussed above, the participants spanned three generations. Nagy et al.’s work was interested in the degree of transfer, and attrition from the dominant language in these three unique speech communities. Their findings thus showed that “no effect of contact with English on any of the HLs examined: there is no correlation between either rate or constraint hierarchies and either generation or any ethnic orientation measure.” (Nagy et al., 2011: 143). That is, the influence from English was insignificant. Furthermore, that language contact with English did not engender a change in null subject heritage languages in Toronto since comparable rates of null

subjects were produced by both the first-generation and the other heritage speakers alike. Finally, although English transfer seemed to be minor in the three heritage languages studied, a curious finding did emerge at the international level. When comparing the findings on null subject languages to what research in the U.S. has indicated, the Canadian heritage speakers' results seem to deviate from those of their heritage speaker counterparts in the United States.

Potential divergence of heritage grammars as compared to the monolingual norm, or the baseline input language have traditionally been the focus of sociolinguistic studies. Heritage speakers' variable grammatical outcomes are at the heart of the debate in this perspective. A pertinent question they seek to answer is whether variability may be attributed to the diachronic change already in progress within the language, or on the other hand is direct contact from the majority language engendering these changes. These questions though interesting, will not be the focus of this investigation at present. However, as we will see next, language change from the generative approach is internal to the individual speaker.

1.4.2 Formal linguistics

A developing interest in heritage speakers and their languages from formal and psycholinguistic approaches took place in the mid 1990's. Moreover, in general from these perspectives the process of linguistic change is viewed as an individual (rather than a social) phenomenon that is rooted in the speaker's mind. This stance is of course contrary to the sociolinguistic paradigm discussed above, and the emergentist approach that we will consider next. Furthermore, a salient feature of generativist studies is that they have largely anchored their investigations on experimental methods. For example, Brehmer and Treffers-Daller's (2020) recently edited a collection of 10 articles that addressed the heritage language development of second-generation speakers. However, in a review of the volume I found that while inspiring and methodologically rigorous in the study of a variety of heritage language pairs, "This collection ... centered around experimental studies. Only Chapter 4 used a corpus containing transcribed interviews. Not one study used naturalistic data. Thus, the question of attrition and input in HDL (heritage language development) based on spontaneous talk-in-interaction remains." (Alvarez, 2022: 208). In terms of methods then, formal linguists have studied heritage speakers' grammatical abilities mainly through a battery of experimental designs. These include but are certainly not limited to truth value, and grammaticality judgment tasks, elicited written and oral production tasks such as oral narratives, as well as online

exercises used to measure processing speed in real time. Nevertheless, even if these types of methods have traditionally been the case, Polinsky, explains that

It is common to contrast linguistic fieldwork with lab-based experimental work on language, but the two are less different than they seem. Both lines of inquiry try to understand the mental representations of language by a native speaker; both are guided by testable hypotheses; both are designed to evaluate predictions based on theoretical considerations; both conduct those evaluations by constructing minimal contrasts; both deal with variation within and across language users. Fieldwork essentially consists of tiny experiments that are fine-tuned in situ based on consultant feedback. In short, there is no irreconcilable difference between fieldwork culture and the culture of laboratory linguistics (Polinsky, in press: 1).

For the most part by way of experimental methods, that are seemingly not so different from naturalistic ones, Polinsky (1995, 2000, 2006) is also one of the pioneers in the study of heritage speakers in North America³⁴. She has conducted in-depth research on second-generation Russian heritage speakers in the U.S. context. Her aim has been to understand how under reduced input conditions, the grammatical systems of heritage speakers develop. Furthermore, her interest is centered on proposing explanations for morphosyntax, and heritage speakers' linguistic competence. These lines of inquiry fall within formal linguists' idea of language as an internal, individual construct in the mind. Nevertheless, while external variables such as generation, gender, age, SES, and the like are not accounted for, in Polinsky's work, heritage Russian as spoken by these speakers in the U.S. is also regarded as a particular language variety. This is much in tune with what Parodi (2003) has advanced for heritage Spanish in L.A. In this regard, or the conception that heritage Russian in the U.S. for Polinsky, or heritage Spanish in L.A. for Parodi (both generativists) are language varieties distinct from the monolingual norms aligns in a big way with the sociolinguistic paradigm. Notwithstanding, in her studies, for example in Polinsky (2006) she reported that in light of reduced input conditions, the incompletely, or partially acquired heritage grammar is nonetheless highly systematic at the individual level. This account was based on research conducted on 21 American Russian speakers in their 20's and 30's who immigrated to the U.S. with their parents when they were between 3 and 11 years old.

A more recent investigation closely related to the present study in that it examines Spanish-English language contact in the U.S. was carried out by Jessica Diebowski. Her paper

³⁴ Dr. Polinsky has also pursued field research on K'iche' in Central America as the Director of the Guatemala Field Station in Nahualá. The Language Science Center's Summer Field School to which I was accepted as a participant between July 6 and August 4, 2019, is part of the University of Maryland. Unfortunately, I was unable to attend due to personal circumstances.

investigated “the effect of language contact on the knowledge of Spanish gender assignment and agreement in adult second language learners and simultaneous bilinguals (heritage speakers of Spanish), all residing in the Geneva area of New York state.” (Diebowski, 2020: 125). Moreover, her study, even if experimental in nature, considered language use as a critical factor in heritage language acquisition, an aspect that is crucial in emergentist frameworks. She compared data of simultaneous adult heritage Spanish speakers to that of advanced English-speaking Spanish language learners. Her findings showed that heritage Spanish speakers performed at ceiling despite their use of heritage Spanish in terms of both oral and written gender accuracy. Furthermore, her findings diverge from what was found for L2 Spanish language learners. For this group, exposure and use of Spanish were critical in determining target gender acquisition. Finally, “the author observes that perhaps the fact that all participants were enrolled in Spanish-language classes, though not HL (heritage language) classes, may have played a role in the overall high accuracy of gender assignment and agreement.” (Alvarez, 2022: 205). This observation is also in line with studies suggesting that educational programs that promote biliteracy have a positive impact on heritage language development. For example, Kupisch and Rothman (2018) in their study demonstrated that linguistic competence appears to be the same as that of monolingual children when child heritage speakers are formally instructed in their heritage language.

There are many more examples stemming from formal linguistic approaches to the study of heritage languages. However, one investigation that applies sociolinguistic methods in that it analyzes data from audio recordings is attributed to Larsson and Johannessen (2015). Their work focused on word order in *that* clauses in heritage Scandinavian (both Swedish and Norwegian) in the U.S. They found that while verb-adverb order is allowed in European Scandinavian, it is more frequently produced in heritage Scandinavian, and considered it to be a result of incomplete acquisition in second-generation heritage speakers, as opposed to a loan from English. Another more recent study that focused on Scandinavian languages in the U.S. is that of Anderssen and Westergaard (2020). Unique to this investigation is that it considered input a critical factor that drives heritage language acquisition. They investigated the way subjects and objects are positioned in relation to negation markers by heritage Norwegian speakers. Furthermore, unlike traditional experimental methods, these researchers used the Corpus of American-Norwegian Speech and compared it to corpora of monolinguals. As mentioned further up, this is the only contribution in Brehmer and Treffers-Daller’s (2020) volume that used a corpus. Nevertheless, their results showed that

despite differences in frequency in monolingual Norwegian, both subject and object shifts are affected by restructuring in heritage Norwegian, so frequency does not play a critical part. On the other hand, structural similarity between heritage Norwegian and English does produce changes in the heritage language. (Alvarez, 2016: 205).

The studies above have all deployed largely experimental designs in their investigations of heritage bilingualism as is tradition in formal linguistics. However, within their largely controlled methods, we saw that some align with sociolinguistic protocols, for example by collecting data through interviews, while others emphasize the importance of input like in the emergentist approaches. Moreover, while some have attributed the grammatical outcomes of heritage speakers to the frequency of input, others have found otherwise. Similarly, some of these studies have argued that the linguistic changes taking place in the heritage speakers' languages under study are due to contact with the dominant languages. They advance that language change is the result of incomplete acquisition, and not related to natural diachronic linguistic change, and of course, others have sustained otherwise. Considering these intriguing findings, "the results are a fertile point of departure to investigate the role of attrition and input in HLD from a usage-based perspective that is grounded in naturalistic data." (Alvarez, 2022: 208). This is where the present study of heritage Spanish bilingual acquisition, and socialization in contact with English fits in. It aims to contribute to the growing body of literature, but from an emergentist perspective. Below we will thus review emergentism as a framework from which to ground studies of heritage bilingual populations.

1.4.3 Emergentism

The formal linguistic paradigms described above have typically centered their investigations both on linguistic knowledge and mental representations. Furthermore, their results were generally drawn from data elicited from production and comprehension tasks designed to focus on heritage speakers' variable grammars in relation to reduced input. Overall, formal linguistic approaches "have also emphasized the relationship between heritage language grammars and stages of development in child language, the implicitness of the heritage language acquisition process, and the role of dominant language transfer." (Montrul, 2016: 158). The emergentist perspective has not been widely applied to heritage language acquisition research. Only few studies tackle heritage speakers and their languages with theories and methods emanating from usage-based approaches. This was also underscored above in discussing Brehmer and Treffers-Daller's (2020) thought provoking volume on the role of attrition and input in heritage language

development. Only one of 10 studies used a corpus, but not one was based on naturalistically collected data, or grounded on emergentist frameworks.

Despite this, heritage languages have been “studied from a usage-based perspective, the dominant approach in Cognitive Linguistics and Construction Grammar.” (Aalberse et al., 2019: 178). We may trace the emergence of a usage-based model back to Ronald Langacker’s (1978) book which he subsequently updated in 2008. Furthermore, while we may also credit Joan Bybee (2010) for further developing Langacker’s proposed model of cognitive grammar, it is Michael Tomasello’s (2003) work mentioned further up that cemented the usage-based theory of language acquisition within the emergentist paradigm. The aims for this framework were previously discussed, so here we will consider its implications for heritage language studies. Children are not viewed as creative agents of language change in the generative tradition. However, in usage-based models “most changes will emerge through ordinary adult usage” (Aalberse et al., 2019: 179) and the active engagement of children in interactional frameworks.

A relevant illustration of this approach is Doğruöz and Backus’ (2009) work that investigated Turkish spoken in the Netherlands and Turkey Turkish. Their goal was to better apprehend the extent to which particular constructions could be attributed to Netherlands Turkish, or rather if they differed considerably from Turkey Turkish in terms of frequency. Netherlands Turkish was based on a corpus of informal speech, while Turkey Turkish was a corpus used as a control. Their results confirmed that many constructions either appeared more frequently, or exclusively in Netherlands Turkish. Two examples include the semantic intensification of negative adjectives, as well as the specific interpretation of the use of an indefinite determiner. Through their work, they ascertained that “heritage Turkish in the Netherlands is developing Dutch-influenced constructions with the help of perceived semantic equivalence between Dutch and Turkish lexical items.” (Aalberse et al., 2019: 180). Rather than Dutch grammar being imitated in Turkish, complex lexical items are subjected to a process of translation into Turkish. The implications of Doğruöz and Backus’ work is that heritage language use, and by extension competence may be apprehended at the constructional level where both grammar and lexicon are merged. Furthermore, these researchers seemed to show that linguistic variation between heritage speakers and their native monolingual counterparts are gradual, as opposed to definite. This idea aligns with the definition of bilingualism proposed at the start of the chapter. That is, we may conceive bilingualism on a gradient scale, or

continuum. From this perspective, some heritage speakers may differ in the use of certain constructions regarding frequency and shifts in frequency may also be engendered by contact with the dominant language. In another investigation, Backus et al. (2011) suggested that the linguistic variation accounted for was the result of diachronic contact-induced change. As is the case with Spanish in L.A. where language contact has endured for centuries in multigenerational settings, the typological profile of a language may change dramatically, and individual constructions are the points, or seeds of departure for these changes in heritage languages.

Other research that departs from the usage-based perspective while highlighting that input though critical, is not the only essential aspect to consider in heritage language acquisition is attributed to O’Grady et al. (2011a). Within the theoretical perspective under discussion, in heritage grammars many of the features that are found to arise in them as a result of insufficient exposure to input may be found, though not necessarily all of them. Nevertheless, O’Grady et al. defended the legitimacy of the emergentist approach to study the development of heritage languages. They advanced much like Pienemann (1998) that form-meaning mappings made available by other cognitive structures were reinforced by the “language processor” that requires enough exposure. O’Grady et al. (2011b³⁵) examined case marking and scope interpretation, two types of phenomena in Korean. Moreover, the former despite it being acquired early, and it being frequent in the input is generally not mastered or occasionally lost in heritage language acquisition. Through four truth value judgment tasks (an experimental method despite the theoretical approach) that included pictures and stories, they aimed to analyze the preferred interpretation of two types of sentences. The truth value judgement tasks were carried out one each with Korean children and with adults in Korea, Korean heritage speakers in the U.S., and young adult Korean heritage speakers in the U.S. Their study allowed them to show that both the child and the adult Korean heritage speakers had a sharp preference for what they called a full set reading (versus a partitioned set reading) of “*not all*” sentences in Korean. Perhaps more strikingly is that the heritage speakers’ preferred choices were much like those of the child and the adult native Korean speakers that were tested in Korea. Finally, O’Grady et al. (2011a) argue that if the full set reading was favored it was likely due to the

³⁵ In 2011 O’Grady et al. published two papers. To distinguish between the two works cited in this discussion I have added a “b” following the year in the second paper that I refer to.

“language processor”. The full set reading placed fewer demands on the processor as compared to the partitioned set reading, thus dispelling the assumption of innate knowledge.

In this discussion we have seen a couple of things. First, that heritage language acquisition may be readily investigated by the emergentist paradigm (and even complemented by experimental methods). Second, that heritage language acquisition is not distinct from monolingual acquisition, and each of these stances are advanced by O’Grady et al. (2011a). Both bilingual and monolingual acquisitional settings call for similar types of input conditions and moreover they both rely on identical resources. According to O’Grady’s (2013) Amelioration Hypothesis, the “language processor” is keenly attuned not only to the input frequency, but also to the consistency of mappings between form and meaning, and it is an inclination to those mappings that the overload on working memory is reduced. The “language processor” seems to remind us of the language specific mechanism that generativists advance as innate. However, here the “language processor” may be likened to those aspects of cognition that in interaction with frequent and sustained input, pattern finding, and intention-reading skills in social interaction reinforce the links between the form of words, with their functions.

1.4.4 Processability Theory & Optimality Theory

Emergentist, generativist, variationist approaches as we have seen thus far have formed the bedrock on which heritage language studies have been grounded. However, if emergentist theories account for fewer studies overall of the three, two additional theories have also been extended to heritage languages to a lesser degree. Therefore, in this final part we will briefly expose these two theoretical paradigms. In doing so, we will not, as we did above, go into the details of the studies that are anchored in these paradigms. Rather, we will point to the initial researchers, and succinctly discuss the aims of their approaches.

The first approach, from a generative perspective for which little work has been carried out on heritage languages is Optimality Theory (OT) (Holt, 2018). OT is fundamentally a constraint-based model as opposed to being rule-based. Moreover, this paradigm underscores that the constraints are not absolute (universal), but rather violable. Speakers from their input forms produce linguistic forms, or output that result from the possibly opposing constraints. This approach emerged in the early 90’s through the collaboration of the phonologist Alan Prince and computational linguist Paul Smolensky and they resume it as such:

The heart of the proposal is a means for precisely determining which analysis of an input *best satisfies* (or least violates) a set of conflicting conditions. For most inputs, it will be the case that every possible analysis violates many constraints. The grammar rates these analyses according to how well they satisfy the whole constraint set and produces the analysis at the top of this list as the output. This is the *optimal* analysis of the given input, and the one assigned to that input by the grammar. The grammatically well-formed structures are those that are optimal in this sense. (Prince & Smolensky, 1993/2004: 2).

Moreover, considering that Prince was a phonologist, phonology “with extensions and applications to other domains of linguistic as well” (Holt, 2018: 31) has been the main area of study within this framework. In their book they declare that “Although we shall be entirely concerned in this work with phonology and morphology, we note the implications for syntax and semantics.” (Prince & Smolensky, 1993: 3). These researchers are interested in exploring how the general constraints on sound patterns dynamically interact, and furthermore how a constraint may be governed by another conflicting constraint. For a recent case study that examined stochastic variation³⁶ in OT see Koontz-Garboden (2004) who reanalyzed data to apprehend the Spanish progressive aspect, and its irregular use in monolingual Spanish and the Spanish of Spanish-English bilingual speakers.

The second approach that has recently framed heritage language studies despite it being around for some time is Processability Theory (PT). Pienemann’s (1998) approach was conceived as a theory of second language (L2) development, and it is grounded on the structure of the human language processor. Language-specific processing requirements are based on hypothesized common hierarchy of processing resources. Independently of native speaker norms, PT is concerned with how speech is processed, and how words, morphology, and syntax are linked according to stages of development. Regarding heritage language acquisition, it thus seems favorable to this population of bilingual speakers. This is especially true since it may be feasibly applied to longitudinal studies which are far and few between, but that the scientific community needs more of to better understand the variable developmental paths of heritage speakers and their languages. Pienemann and Keßler (2011) in their edited volume argue that PT theory other than serving as a framework for L2 processing, may be extended to other fields of inquiry. For example, PT may be applied to bilingual first language acquisition, L1 transfer, and interlanguage variation to name a few lines of investigation that are relevant to heritage bilinguals. Nevertheless, Bayram (2013) was among the first to apply Processability Theory in

³⁶ The stochastic approach allows for the quantitative measuring of different constraints, or the formal analysis of variable data where quantitative differences can be accounted for.

an investigation of heritage Turkish in Germany. However, while the study was not longitudinal, what was striking was that through oral production tasks it focused on 24 young third-generation heritage Turkish speakers. Subsequently, in terms of theory not only does the study provide additional understanding of the acquisition of Turkish in general, but also of the broader study of heritage language acquisition, and in particular research that deals with heritage language development. That is, different linguistic structures develop according to their own schedules. Thus, the variability attested in the levels of acquisition in the heritage grammars are the result of heritage bilinguals who are at distinct stages of development.

We have reviewed the three main theoretical approaches, as well as two more recent paradigms that according to heritage language scholars, have attempted to explain heritage language acquisition across a wide range of linguistic pairs. Before moving forward, the theories described above may be arranged according to their main features. Therefore, we propose the table below as a succinct presentation of the five theories discussed in this section.

Table 5: Adapted from Table 8.6 in Aalberse et al. (2019: 181) & from Table 5.1 in Montrul (2016: 149): Main features between the different theoretical paradigms (nativism, emergentism, & variationists)

Nativist Universal Grammar Processability Theory	Emergentist/usage- based/cognitive approaches	Variationist sociolinguistics/Stochastic OT grammars
<ul style="list-style-type: none"> -language innate & independent of cognition -focus on competence & judgment tasks -frequency not relevant to language acquisition -abstract knowledge & linguistic representations emphasized -knowledge triggered by input, but does not determine complexity of linguistic system -Processability Theory underscores developmental issue regarding processing competence -UG & language processor limit acquisition which is itself implicit -developmental & transfer errors target of explanations -L2 acquisition is the same as monolingual acquisition -L2 acquisition guided by L1 knowledge, processing routines & innate knowledge 	<ul style="list-style-type: none"> -cognition is innate, not language -focus on naturalistic interaction/spontaneous language use in context -acquisition driven by input frequencies & memorized chunks/constructions -language is an epiphenomenon & part of cognition -language use in social interaction emphasized -language use & cognitive processes (pattern building, statistical learning etc.) engenders grammar -in children, implicit knowledge precedes explicit knowledge -explicit learning drives L2 acquisition -L1 transfers syntactic, morphological & phonological signals to L2 	<ul style="list-style-type: none"> -interaction between different principles -structured experiments -frequency interacts with varied cognitive aspects -language use is underscored -language function & social context engenders language learning -systematic variability along with social variables (age, sex, generation, education etc.) are highlighted -language use patterns with various speakers is of interest in L2 -language standards based on context is determined by L2 learners -formal & informal contexts drive systematic variation

The table above synthesizes into three main columns the theoretical underpinnings of each paradigm, their main goals, research methods, and the importance they place on aspects such as input, frequency, context, as well as the effects of ‘first’ languages (L1) on ‘second’ ones (L2). Moreover, if we were to place them on a continuum, UG would be on one end considering their conception of language as innate, and placing little importance on input and interaction, and of course relying on experimental methods for their studies. On the other hand, emergentist approaches could be placed on the other end of the continuum. Emergentists see language as emerging from the interaction of general cognitive abilities (which are innate) and social interaction with mature, more experienced speakers. Input in the language learning environment and its use in meaningful interaction is vital to language acquisition. Finally, emergentists often (though not always) rely on naturalistic language data which is not the case for researchers under the UG umbrella. Variationist theories could find themselves somewhere in between the two. For these paradigms, even if there are principled cognitive interactions at work, it is not without the rich interplay of external, social factors. Even if they play up language use, or the input variable in language acquisition, methodologically they typically rely on structured experiments. Despite their unique characteristics, these approaches are all equally valid and complementary in the study of heritage languages. In moving forward, the next section will present a brief discussion of whether bilingual children begin their bilingual language acquisition with one, or two systems. This debate seems to be in favor of the two-system model (De Houwer, 1990; Silva-Corvalán, 2014). However, it is important to review this controversy first to highlight how theoretical interrogations related to bilingual development are not only centered around the nature-nurture divide, and second because the debate has generated insightful work in the field (Lanza, 1997).

1.4.4.1 Language differentiation models: One system or two?

One fruitful debate has revolved around the question of whether bilingual children begin their language acquisition process with one fused system or, on the contrary with two independent ones. This controversial issue therefore showed that “The study of bilingual language development presents specific theoretical questions beyond those that nativists and non-nativists engage in.” (Silva-Corvalán, 2014: 8). Within this context, two opposing models emerged as the top contenders. The first one included the ‘*unitary language systems hypothesis*’ (ULS) as it was referred to both by Volterra and Taeschner (1978), and then by Genesee (1989). But Redlinger and Park (1980) called it the ‘one-system theory’. Nevertheless,

the ULS was pitted against the *separate development model* (SDM). However, according to Silva-Corvalán it is neither of them, but rather a model related to the former, or the *autonomy with interdependence* of systems that “appears to have the clearest support from current research” (Silva-Corvalán, 2014: 9). In the following section, I will thus summarize each of the models. We will gain important insight into this well-known contentious, but insightful issue in bilingualism research. Moreover, an understanding of this debate will allow us to better apprehend the different degrees of bilingualism in the next section. That is, the language differentiation models will be considered in relation to factors such as the onset of acquisition, notions of dominance, how bilinguals organize their semantic units, and finally situations of additive and subtractive bilingualism. The following two sections will provide us with additional understanding of heritage bilingual acquisition, and development, the result of language use, and language socialization as it is defended within the framework of this bilingual, multigenerational, and multimodal research project anchored in multiparty (but not only) participation frameworks.

1.4.4.2 The unitary language systems hypothesis (ULS)

Volterra and Taeschner (1978) using audio recordings and diary notes asserted that children who are exposed to two languages from birth simultaneously go through three main ‘stages’ of linguistic development. However, to begin, Lanza underscored the fact that “what is embodied in the term *stage* ... is missing in Volterra and Taeschner’s work.” (Lanza, 1997: 28), making it thus difficult to assess the validity of these stages considering their evidence. Nevertheless, their model was based on Taeschner’s two daughters, going through nearly balanced simultaneous Italian-German acquisition in Rome, Italy. Their results allowed them to sketch out a three-stage model that depicts “the gradual learning process through which a child becomes bilingual from early infancy” (Volterra & Taeschner, 1978: 312). The linguistic stages that they proposed include an initial stage in which a child’s bilingual lexical inventory is represented by a unitary system. During the second stage there is distinction of lexicons, but the child continues to use the same syntactic rules in both languages. Finally, in the third stage lexical and syntactic differentiation occurs according to each language. Volterra and Taeschner coined this model the *unitary language systems hypothesis* and described it in the following terms:

In the first stage the child has one lexical system which includes words from both languages ... in this stage the language development of the bilingual child seems to

be like the language development of the monolingual child. ... In the second stage, the child distinguishes two different lexicons, but applies the same syntactic rules to both languages. In the third stage the child speaks two languages differentiated both in lexicon and syntax (Volterra & Taeschner, 1978: 312).

Thus, according to their hypothesis they proposed that at the onset of language acquisition, the bilingual child develops like a monolingual speaker with only one language system before moving towards bilingualism. This is not the only issue, however. At the start of their article Volterra and Taeschner suggested that the linguistic aspects in their study would be teased apart from the other external (social, pedagogical), and internal (psychological) aspects of bilingualism. They advanced that they were cognizant “of the fact that this kind of bilingualism involves various problems from the social, pedagogical and psychological points of views, but in our study, we intend to consider only linguistic development” (Volterra & Taeschner, 1978: 311). This therefore poses an additional concern regarding the validity of their model. Contrary to the present study, how can, and perhaps most importantly why would social-psychological factors be dissociated from descriptions and, or explanations of linguistic output? Although their work has been subject to much criticism, especially concerning syntactic development (Meisel, 1989, 1990; De Houwer, 1990), Silva-Corvalán also argues that “This “early confusion” view of bilingual acquisition is no longer supported however, at least not for morphosyntactic development.” (Silva-Corvalán, 2014: 9). Therefore, “while their work has generated much discussion and fruitful work in the field.” (Lanza, 1997: 28) researchers interested in bilingualism have also proposed that bilingual children’s language development begins with two systems, and not one.

1.4.4.3 The separate development model (SDM)

While “the importance of their (Volterra and Taeschner’s) contribution to the issue of bilingual language acquisition cannot be underestimated” (Lanza, 1997: 28) a plethora of other researchers, as we will see below, have ascertained that “numerous studies have shown that bilingual children follow a path of development that is comparable to that of monolinguals in each of their languages, and produce mostly language specific structures from the start of bilingual production.” (Silva-Corvalán, 2014: 9). Contrary to the ULS model discussed above, we find the separate development model (SDM). The SDM ascertains that “from the earliest appearance of phonology, morphology, and syntax, forms are used in a language-specific manner.” (Silva-Corvalán, 2014: 9). This is also echoed by Montanari (2010) who provides evidence of language differentiation from a trilingual case study. That is, bilingual speakers’

language systems are deemed not only self-sustaining, but also their linguistic systems develop autonomously (De Houwer, 1995, 2005; Deuchar & Quay, 2000; Miesel, 1989, 2001; Paradis & Genesee, 1996). These researchers further highlight that the conditions needed for separate development to take place include 1) consistent bilingual exposure from birth and 2) acquisition of a reasonably balanced level of proficiency in each of the languages. Chapter 4 will consider various factors tied to LIN's bilingual language learning environment. It will thus provide us with a snapshot of her bilingual language exposure over time and allow us to determine whether Spanish and English are used consistently by the expert speakers (point 1 above) and in a balanced manner by LIN (point 2 above). Also, through both mean length of utterance (MLU) and type-token (TTR) measures that allow us to determine language development, we may be able to determine her overall level of balanced-ness in each of her languages. Nevertheless, to further support the SDM, for Hagège "L'acquisition des structures phonétiques des deux langues commence très tôt chez l'enfant né en milieu bilingue" (Hagège, 2005: 49) (the acquisition of phonetic structures of each language starts very early for children born in bilingual environments). Hagège therefore argues that the bilingual infant begins to acquire the sounds of each language early on, and thus aligns with the SDM as well. Even so, while it may be difficult to distinguish some aspects of two languages in the early stages of bilingual acquisition, according to Silva-Corvalán (2014) there appears to be consensus in support of the SDM as opposed to the ULS. However, even though studies advancing the SDM have shown that bilingual children's language development follow paths similar to monolingual acquisition in each language, research has also shown that simultaneous bilingual speakers are prone to produce unique patterns that are not found in accounts of monolingual acquisition, or in the child-directed and overheard input in their bilingual language learning environments. As a result, these findings have been suggested to account for cross language interaction, the third and final model to be discussed next.

1.4.4.4 The autonomy with interdependence model

Unusual linguistic patterns such as "crosslinguistic interaction or transfer of features between the languages" (Silva-Corvalán, 2014: 9) by bilingual children that are not attested in monolingual acquisition, or in the input have been put forward as evidence to advance our final model in bilingual acquisition. It is referred to as *the autonomy with interdependence* model. For Silva-Corvalán

This model assumes, then differentiated development with some degree (to be empirically determined) of crosslanguage interaction – that is, interdependence. The interesting question is no longer whether the two languages are acquired in a separate fashion, but rather what it is that may be affected when two languages are acquired from birth, and why. (Silva-Corvalán, 2014: 9).

While this model is clearly in tune with the SDM in which a bilingual's languages are acquired in language-specific manners, it goes a step further to account for the additional phenomena previously mentioned. It sustains that there exists a degree of crosslinguistic interaction between the two languages being acquired by the child. Furthermore, the term crosslinguistic “refers to the effect that the lexicon and grammar of one language has on the lexicon and grammar of the other language spoken by a (developing) bilingual³⁷.” (Silva-Corvalán, 2014: 10). Furthermore, within this model, not only is this effect prone to manifest itself in a varied number of ways, but it may also be permanent, temporary, or anywhere in between i.e., maintained over an undetermined length of time. Finally, crosslinguistic interaction could affect the other language's development “by delaying or accelerating acquisition, by causing the production of non-target constructions not attested in monolingual development, by promoting the use of superficially parallel constructions in inappropriate discourse-pragmatic contexts, or by transferring forms and meanings.” (Silva-Corvalán, 2014: 10).

Within the framework of the present investigation, whether LIN is a balanced bilingual or not, she has been exposed simultaneously to two languages from birth. Therefore, this model may allow us to explain in part the development, or not, of third-generation heritage Spanish acquisition as an effect of crosslinguistic interaction with English's omnipresence in her bilingual language learning environment. Thus, I will try to find evidence for the separate development of her languages by assessing both quantitatively and qualitatively her use of Spanish and English in multigenerational, and multiparty participation frameworks. Moreover, as a third-generation heritage Spanish speaker, LIN is receiving a substantial amount of child-directed and overheard mixed language input. Language mixing is a mode of communication that is present at the individual, familial, and societal levels. Almost all her family members partake in this mixed language practice in the private sphere. Additionally, my deep familiarity with the field allows me to confirm that language mixing is abundant not only in the broader public sphere i.e., stores, restaurants etc., but also in the more controlled, but nonetheless public sphere such as in school.

³⁷ This footnote was added to Silva-Corvalán's original statement. It reads “The influence may also involve the phonetics and phonology of a language, but this book considers phonetic aspects only when required by the discussion of a lexical or grammatical phenomenon.”

To further illustrate this point, I will use a few examples drawn from observations in LIN's school, as well as from her classroom. The first entry is drawn from the digital journal, and it is dated August 28th, 2018. Therefore, it corresponds to the start of my data collection in the field in L.A. It is also the beginning of LIN's first academic school year, and all parents, guardians, and other caregivers were invited to attend a short parent-teacher meeting in the morning. It began in the school's large auditorium and the Latino school Principal welcomed everyone first before releasing the parents, students, and teachers alike to attend the more intimate teacher-parent meetings that were scheduled to take place in class. During the Principal's welcome speech I observe the following:

The parent-teacher conference went well. The Latino principal of the school code-mixed from the beginning to the end and then introduced the interim vice-principal, an African-American man who spoke what seemed to be Caribbean Spanish really well. Of course, faced with brown faces, or Latino parents who wondered if he spoke Spanish, he instantly dispelled any preconceived idea over his linguistic ability in *their* language. The teachers were presented and later joined by the parents in their classrooms. As it turns out, LIN's teacher is bilingual English-Spanish. Her accent may be influenced by Caribbean sounds and speaks with what appears to be advanced/native competency in Spanish. Not very many parents showed up to the meeting that followed: two at the start and then a total of four. (Alvarez, 2018).

I thus note the saliency of LIN's school Principal language mixing throughout his brief introduction. However, it was also striking to hear that while Vice-Principal (who was assigned to the school temporarily) spoke Spanish to a very advanced degree, he did not seem to mix languages. Perhaps this was related to the fact that the Principal was Latino. As such, he partook in language mixing as a mode of communication as practiced within the community. On the other hand, the Vice-Principal was African-American and likely not part of a dominant Spanish speaking community. Nevertheless, for him, to show that he could speak flawless Spanish was perhaps enough to establish the *we* code among the parents in the auditorium, and thus rendered him legitimate. Next, when I met LIN's Latina teacher, I also gathered that she was a native Spanish speaker (I later confirmed that she was from Cuba). As we will see below, LIN's teacher was likely to language mix in the classroom. The overarching observation is that language mixing was abundant in the school from the highest-ranking school administrator down.

The next four entries were made at different points during my fieldwork in L.A. Respectively they correspond to October 15th, 2018, for the first entry, October 17th, 2018, for the next two entries, and October 22nd, 2018, for the last entry. They were all taken from the handwritten version of my field journal. Together they show how LIN's teacher, coded here as

COM language mixed either by inserting Spanish into her English utterances, or simply by moving from English to Spanish, also often referred to as *translanguaging*, when in pedagogical interaction with students. But what is translanguaging? According to Wei (2018) translanguaging is a practical theory of language, or a theory of language use, and it was conceived not as a theoretical concept, but rather as a language practice described by the specific notion in question. Below, we will thus look at the language practices that I witnessed as they were anchored in the classroom setting.

1. (Context) Upon seeing a black sweater outside in a puddle of water during recess

COM: ¿Y ese sweater@s de quién es? (And who does that black sweater belong to?)

2. (Context) In reference to the ‘ugly’ word “fat” in the fairy tale *The Three Billy Goats Gruff* that she was reading out loud

COM: Ni modo that’s@s just@s how@s it@s is@s (Too bad that’s just how it is.)

3. (Context) And later that day as the kids get up prematurely before being officially let out for recess

COM: No estas lista. I need everyone to sit on their bottoms. (You’re not ready. I need everyone to sit on their bottoms.)

4. (Context) When talking about playing music to enhance their creativity

COM: ... music to stimulate our brain, el@s cerebro@s (... music to stimulate our brain, the brain).

The examples above therefore show the various ways COM language mixed in the classroom. In number one (the examples above will be referred to as “n” followed by a number) n.1 she inserted an English word into her otherwise Spanish utterance. In n.2 and n.3 she began her utterances in Spanish before translanguaging into English. Finally, in n.4 she did the opposite. She began her utterance in English before translanguaging into Spanish. Moreover, in example n.5 below we even see COM’s T.A. coded as BAR partake in language mixing, or translanguaging.

As a reminder, BAR was presented earlier in the section on factors affecting bilingual language development, and more specifically on attitudes and identity. Her stance was that dual language education or the teaching of Spanish along the side of English “could cause delays in English”. However, the journal entry below is dated October 24th, 2018. It is also drawn from the handwritten version of my field journal, and it shows that despite BAR’s monolingual pedagogical position, language mixing, through the use of Spanish inevitably and

naturally emerges like light in the dark, *komorebi* despite the overall dominance of English in the classroom.

5. (Context) To insist that students hurry up in washing their hands to get back in the classroom

BAR: Let's go KEN, vámonos@s. (Le'ts go KEN, let's go.) (Alvarez, 2018).

BAR whether she intended to or not, translated herself from English to Spanish while addressing one of LIN's classmates. Additionally, whether it was child-directed speech to a specific child, it was nonetheless mixed language input that was undoubtedly overheard by the other students. In Chapter 2 we will see the understudied impact of overheard speech on language development. Nevertheless, concerning BAR's bilingual language practices, this was likely not the first time, and likely not to be the last, especially in this community.

Wei has argued that "Over the years, Translanguaging has proven to be an effective pedagogical practice in a variety of educational contexts where the school language, or language-of-instruction is different from the languages of the learners." (Wei, 2018: 15). For researchers like García (2009), and Creese and Blackledge (2015) a conscious and voluntary push to dismantle the divides that are not only artificial, but also ideological between majority and minority languages, or within LIN's classroom the target language (English) and the mother languages (largely Spanish), translanguaging renders the power back to learners and teachers alike. Translanguaging centers the process of learning and teaching on meaning making and through these trans-formed relations of power educational experiences are enhanced, and social identities not only emerge, but are also forged. Finally, regarding our discussion on language mixing and crosslinguistic influence as underscored in the autonomy with interdependence model, I will try to confirm if the instances where LIN is producing unusual structures, or in this case language mixing are present in the input provided by her caregivers, or not as BFLA research has shown.

In conclusion the three language differentiation models, or the one system versus two systems conundrum in bilingual language acquisition have been a cause for lively debate. While some researchers may consider this discussion redundant in a Ph.D. project (A. Ghimenton, personal communication, December 4th, 2021), others find it otherwise due to the historical impact as well as its fruitful yield in bilingualism studies (M-A. Akinici, personal communication, May 3rd, 2022). In aligning with the former view, the initial model proposed

was the unitary language system (ULS) which was confronted with the separate development model (SDM). Research has provided substantial evidence favoring the two-system model. Nevertheless, other linguists who agree with the SDM also point to autonomy with interdependence. Languages undergo differentiated development, but with crosslinguistic interaction. This model thus allows for unusual patterns not found in monolingual acquisition, or in the input to be explained. It was thus important to underscore this controversial issue. It shows that theoretical questions related to bilingual language development go beyond the nature-nurture divide, but also helps explain the different degrees of bilingualism as we will see next.

1.5 Degrees of bilingualism

As we have seen in the previous section the path to bilingual language acquisition is a complex issue. Subsequently this makes understanding, and thus defining the many degrees of bilingualism a challenge. The language differentiation models presented above moved away from the nature-nurture divide and focused on whether bilingual children begin their language acquisition process with one system, or with two independent ones. Naturally, this discussion will make more sense when considered in relation to the contrasting internal and external aspects that engender the various degrees of bilingualism at the individual level. Therefore, next we will specifically discuss the different types of bilingualism that have been the focus of attention within the field. Through this overview of the distinct types of bilingualism, I will consider the case of the target child in this dissertation to determine how these diverse descriptions come together, and thus get a better sense of LIN's type of bilingualism. Finally, before delving into this last section of the chapter I must recognize that readers might find it a bit strange to find this discussion here, rather than after the first section where bilingualism was defined. However, as I envisioned my literature review, I felt that discussing in more detail the degrees of bilingualism would make more sense only after the theoretical approaches that explained how heritage bilinguals got from here to there were presented, including the factors that affect bilingual language development. I also felt that discussing the degrees of bilingualism here would create a nice transition into the first part of the next chapter that delves specifically into the issues of heritage speakers and their languages.

1.5.1 Early & Late bilinguals

A significant amount of research has focused on the age of acquisition of more than one language by very young children. This work has led researchers to classify children into early and late bilinguals based on the age of exposure to two or more languages. Baetens-Beardsmore argues that “By early bilingualism is meant the acquisition of more than one language in the pre-adolescent phase of life” (Baetens-Beardsmore, 1986: 28), while De Houwer (2009) describes early bilingualism as “bilingual first language acquisition” (BFLA) and situates BFLA between one and six years of age. In contrast to early bilingualism is late bilingualism, which refers to children who have been exposed to their second language at a stage where language acquisition is more difficult. Baetens-Beardsmore advances that “Late bilingualism occurs when the first language is acquired before the age of more or less 11 and further languages are learned at some age beyond this period.” (Baetens-Beardsmore, 1986: 28). In both cases, whether the age of exposure to a second language begins after the age of eleven as suggested by Baetens-Beardsmore or after the age of six as advanced by De Houwer, we are dealing with what is referred to as a “critical period” by formal linguists.

For example, Montrul (2016) explains that the critical period is suggested to describe the degree of L1 and L2 acquisition in relation to age, or the age after which language learning becomes more difficult. For Hagège “La période critique se situe entre sept mois, âge où apparaissent les premiers signes d’un déclin des aptitudes ... et dix ans, âge au-delà duquel ce déclin, encore largement réversible jusqu’à-là, cesse de l’être.” (Hagège, 2005: 28) (the critical period is situated between seven months, the age at which the first decline in aptitude appear ... and 10 years, age after which this decline, still largely reversible up to that point, ends.). Moreover, it is crucial to keep in mind that for Hagège, the critical period of eleven years only affects the phonetic aspects of acquisition since “une langue étrangère peut être fort bien apprise à l’âge adulte.” (Hagège, 2005: 29) (a foreign language can be learned very well in adulthood.). Finally, even if indirect assessment of language abilities may provide indications for a critical period, it is important to highlight that this evidence has come from monolingual studies. Indeed, “Original supporting claims came from a number of case studies of linguistic deprivation in children acquiring their first and only language” (Montrul, 2016: 110). There are several examples, but two famous ones include the case of Genie in the U.S. who after being found at around the age of 13 in a suburb of Los Angeles County was studied by Curtis (1977) a UCLA linguist. In Europe, a French feral child found at the age of nine in the Massifs

of the Aveyron³⁸ was studied by Itard (1801/2012) a physician who was interested in seeing what he could learn. While these children were discovered at different ages, where the former was subjected to severe abuse and neglect, but both were victims of social isolation, beyond learning some words, language learning was not successful for these then young adolescents. Thus, regarding the critical period, these two cases point to the severe and irreversible consequences in the ability to develop one's native language when there is insufficient exposure in the language learning environment before the age of six to seven years old.

With regard to LIN our target child under investigation, she was 3;10 years of age at the initial time of recording. Therefore, we may easily consider her to be an early bilingual since she began the process of acquiring both of her languages since birth, or well before the critical period. Moreover, this coincides with De Houwer who considers that the input of two languages within the first week of life is a requisite for bilingual first language acquisition. One of the main differentiating factors between early and late bilinguals is the attainment of linguistic competence. According to Baetens-Beardsmore

Many specialists have demonstrated the positive aspects of early bilingualism, both for the ease with which it can be achieved and the superior level of attainment when compared with late bilingualism, particularly with respect to the acquisition of a flawless, native-like accent and intonation patterns in more than one language. (Baetens-Beardsmore, 1986: 33).

Thus, early bilingualism is considered to pave the way to native-like competence in both languages, while late bilinguals are presumed not to attain native-like competence in their Language Alpha. Nevertheless, as previously discussed, there is still considerable difficulty in determining what native-like competence is, since not only is the notion of native-like competence subject to variation across researchers, but it is also subject to variation even across monolingual communities. The issue of early and late bilingualism is also highly pertinent to the present dissertation. Even if LIN has been exposed to both English and Spanish since birth, this does not guarantee that she will be competent in both of her languages. As a third-generation heritage bilingual, the quality and quantity of Spanish input as grounded in her multigenerational, multimodal, and multiparty participation frameworks, will surely play a determining factor in the overall attainment of native-like linguistic proficiency, or not. On the other hand, even if there is very little Spanish in terms of words, the bilingual

³⁸ In the Occitan region, the Aveyron department is named after the Aveyron river in southern France. The source of the Aveyron is in the southern Massif Central, an elevated region in south-central France with mountains and plateaux.

multigenerational, and multiparty social encounters are extremely rich, and dense in terms of the varied use of plurisemiotic resources by all the speakers. As a result, in parallel to the meaning making process, a specific linguistic and cultural identity for LIN is being created, and this cannot be measured by the amount alone of the heritage Spanish she does produce.

Moreover, for Lanza the “Age of acquisition has been an important variable in discussions of the process of acquiring two languages.” (Lanza, 1997: 11). Therefore, early bilingualism can be further classified into simultaneous, and sequential bilingualism. Grosjean defines simultaneous bilingualism when “L’enfant reçoit alors deux apports linguistiques et développe les deux langues en même temps” (Grosjean, 2015: 90) (When the child receives two sources of linguistic input and develops both languages at the same time). Furthermore, he defines sequential bilingualism, also referred to as successive bilingualism when children “acquièrent une première langue à la maison et sont ensuite mis en contact avec une deuxième langue à l’extérieur, principalement lorsqu’ils entrent à l’école.” (Grosjean, 2015: 94) (acquire a first language in the home and are then put in contact with a second language outside the home, principally when they start school.). In the first case, the child acquires both languages at once and generally at home, while in the second case, the child learns one language first and then acquires the second one later, generally at the start of formal education. However, in both cases, research shows that sequential bilingualism is more advantageous for bilingual language acquisition. Nevertheless, within the context of this dissertation, LIN is going through both early and simultaneous language acquisition, a common linguistic situation in the U.S. context, and Padilla and Lindholm (1984) concur. These researchers have highlighted that Spanish-English bilinguals in the USA typically begin acquiring their languages both early and simultaneously. They advance that in simultaneous acquisition, a child is exposed to both of his or her languages from birth where the parents and grandparents speak Spanish for example, and the other extended range of family members, friends, and acquaintances may generally speak English. Nevertheless, in our study we must not forget that we are also dealing with the case of third-generation bilingualism, which we will discuss in more detail later. Therefore, in LIN’s case, her parents and grandparents may be at various points of a bilingual, or even monolingual continuum respectively, for reasons ranging from attrition to natural diachronic change. In this context, in trying to determine when LIN is using either heritage Spanish, English or mixing languages, we may also see if her patterns of language use reflect a certain dominance of one language over the other, and if so, what those situations are.

Finally, we have seen that late bilingualism is when acquisition of the second language comes after ‘full’ acquisition of the first one. In this situation, it is believed that bilinguals may use their first language, or Language A to learn their second language, or Language Alpha. Grosjean argues that children who have acquired one language “peuvent se servir de la première pour faciliter leur apprentissage de la nouvelle.” (Grosjean, 2015: 95) (can use the first (language) to facilitate the learning of the new one.). However, since LIN in the present research dissertation was exposed to both of her languages since birth, she certainly cannot be considered as a late bilingual. Nevertheless, we may be able to determine if she relies on either of her languages, but especially on her dominant one in her simultaneous path of bilingual language acquisition.

1.5.2 Balanced & Dominant bilinguals

Different types of bilingualism are possible. We find in the literature that two distinct types of bilingual individuals have been sketched out including 1) balanced bilinguals, and 2) dominant bilinguals. This distinction takes into consideration the fluency, or proficiency of the languages at the disposal of the bilingual speaker. Baker (2001) for example advances that balanced bilingualism refers to those individuals whose competencies in both languages are well-developed. On the other hand, for Fishman (1971), the term dominant bilingualism refers to speakers who have one dominant language. This means that these speakers display a higher level of proficiency in one of their languages, or at least in certain domains of use of one of their languages which is often the case with heritage speakers. Stated differently, dominant bilinguals tend to be more proficient in one of their two languages, while balanced bilinguals tend to show somewhat equal proficiency in both of their languages. The concepts of balanced, or dominant bilinguals thus brings us back the issue of defining bilingualism that we presented at the onset of the chapter, but which will no longer be the object of discussion here.

By taking a closer look at LIN’s emerging language use patterns, we may be able to determine if she will display signs of balance, or dominance in her use of heritage Spanish and English. In learning more about how much she is using Spanish, English, or mixing both languages, we may be able to determine if she is equally proficient, or not in English and in heritage Spanish. Even though LIN is growing up in a bilingual, and bicultural community where Spanish is widely and frequently spoken and accepted, I start from the assumption that she is dominant in English because it appears to be the default input language in the home

among her bilingual family members. This is further supported by the fact that her parents who are both bilingual were educated in monolingual English programs. They were in school at a time when biliteracy programs were either previously dismantled, or simply not in place at the local level. Furthermore, English is also the official language in the state of California which has historically set the tone for monolingual language policies. This too was covered above and will no longer be entertained here. Furthermore, in conversations that I have had with LIN's mother, aunt, and grandmother, they seemed to agree that she most often expressed herself in English in social interaction. This also appeared to be the case with her Spanish speaking grandfather GUI.

To underscore this point, I turn your attention to an example drawn from a brief exchange that I had with GUI around the dining room table while having breakfast one day. The entry was made during my fieldwork on October 15th, 2018, in the handwritten version of my field journal. I write:

ERI: I ask (GUI) if LIN speaks to him only in English.

GUI: (GUI) says "yes". (Alvarez, 2018).

In our brief exchange not only does GUI confirm that LIN only addresses him in English, but what is also interesting to note is that in his response he addresses me in English too. However, it is not very clear from the very short observation in my field journal that day if GUI's language choice (the use of English) was a response to the language of the previous utterance. This assumes that I would have spoken English to GUI, but my default mode of communication has, and continues to be in Spanish nearly 100% of the time. Thus, in answering the question, GUI reproduced the bilingual conversational style where a speaker receives the message in one code (Spanish), and the same speaker delivers his/her message in another code (English). In this sense, not only are we the bilingual voices that have resonated in the past, but we also reproduce their interactional, bicultural practices in present, and in future multigenerational, and plurisemiotic social encounters. Notwithstanding, the short but direct exchange with GUI as related to how he communicates with LIN allowed me to confirm the following two observations that were made in the digital version of my field journal about six weeks prior. The first one is dated September 1st, 2018. It thus take place about one week after my arrival to L.A. I state:

GUI actually does speak English to LIN and has good comprehension of English (Alvarez, 2018).

A few days later, on September 4th, 2018, in the second entry I note:

I overheard GUI speaking English with LIN as well as code-mix in conversation with other members of the household though not nearly as much as the second-generation (Alvarez, 2018).

The two observations above taken a few days apart were subsequently validated by GUI, namely that he also speaks English with LIN, or that the underlying idea of communication over code prevails. Moreover, they allowed me to affirm two more aspects related to GUI's language practices. First, that he has good understanding of English. Second, that he language mixes with the other bilingual speakers in his community of practice. It is thus no surprise that when LIN communicates with GUI, that she too languages mixes. Indeed, the same day that the present observation was made, I also noted the following:

LIN said 'Grandpa we're listos', or we're ready, to let GUI know that they were ready to head out of the house. I think this is the first word in Spanish that LIN has independently uttered. (Alvarez, 2018).

In addressing her grandfather GUI, LIN thus language mixed by inserting a Spanish word into her otherwise English utterance. Lastly, what is special about this moment that I captured in my field journal is that it seemed to be the first time that LIN spoke Spanish on her own in spontaneous interaction. For LIN it was a moment of *komorebi* where Spanish broke through the strong presence of English, and likely motivated by her need to interact with GUI. Furthermore, it was yet another Spanish term that was not attested in the primary data, i.e., the video-recordings. In the end, even if GUI tends to speak English to LIN, and perhaps even language mixes with her and the other bilingual family members, his presence in the home nevertheless serves to foster a bilingual language learning environment where more Spanish is spoken. According to an observation that I recorded on September 11th, 2018; in the digital field journal I state the following:

GUI spent the entire week last week at home in L.A. More Spanish is spoken in the home when he's in town that's for sure since almost all family members speak to him in Spanish. (Alvarez, 2018).

My general impression was thus that the use of Spanish increased overall when GUI was present, but this situation was exceptional. Typically, GUI was absent during the week and only returned on the weekends since he worked out of state. Nevertheless, to learn more about LIN's language use, later in the study I will present quantifiable results that may reveal if indeed she is dominant in English, or if on the contrary she is one of those rare balanced

bilingual speakers, a situation that is unlikely to occur in the North American context (Montrul, 2016).

1.5.3 Compound, Coordinate, & Subordinate bilinguals

Hagège following Weinreich distinguishes between three distinct types of bilingualism, or rather “types possibles d’organisation des connaissances des mots dans la situation de bilinguisme: les types coordonné, composé et subordonné.” (Weinreich, 1953/1968; cited by Hagège, 2005: 225) (possible ways in which knowledge of words in situations of bilingualism are organized including: coordinate, composite, and subordinate.). These distinctions aim at identifying how the knowledge of words (lexicon) are organized and stored by bilingual speakers. Moreover, an understanding of this organization will be useful, especially in Chapter 4 when through the prism of translation equivalents, we discuss LIN’s semantic domains in Spanish and English.

Coordinate bilinguals maintain two separate yet simultaneous conceptual systems for each language. For them, language is separated into two meaning units, which results in two semantic systems, one for each word. One system organizes words in Language A, in this case English, for example the word “book”, while the other system organizes the same word in Language Alpha, Spanish here such as the word “libro”. This claim is in line with the SDM that has the most currency in the literature, and that we reviewed further up suggesting that languages develop separately. On the other hand, the compound bilingual’s two lexical items “book” and “libro” are stored and organized in one meaning unit, as opposed to two. Therefore, the compound bilingual’s two semantic systems are said to be stored in one unit of meaning that is used for both languages. However, this claim aligns with the first phase of the ULS model which suggested that bilingual children only have one lexical system at the onset of development which is even prone to engendering confusion. This model of language development is no longer supported by the research. Nevertheless, the third type of lexical organization is attributed to subordinate bilinguals. These bilingual speakers are characterized by the organization of their linguistic codes in one single meaning unit as is the case for compound bilinguals. However, it is suggested that they use their stronger, or dominant language to understand the weaker one. Hagège, states that “le mot à apprendre, au lieu d’être relié directement à un contenu conceptuel, est rapporté à son équivalent dans la langue maternelle.” (Hagège, 2005: 226) (the word to learn in question, instead of it directly being

... tied to its conceptual content, is sent to its equivalent in the mother language.). This claim seems to merge the ULS's idea of one meaning unit for two semantic codes which is outdated, with the autonomy with interdependence model that suggests a degree of crosslinguistic interaction between the two languages. Subordinate bilinguals are thought to use their stronger language to learn their weaker one, and in a sense, by way of direct translation at times. For Silva-Corvalán (2014) crosslinguistic influence may engender the transferring of linguistic forms and meanings at many levels including in phonology, morphology, syntax, semantics etc., and as such at the visual-gestural levels.

Within the framework of the present investigation, I will therefore try to find extracts in the data to determine if LIN shows signs of coordinate, compound, or simultaneous bilingualism. Along with her semantic domain analysis of Spanish and English translation equivalents that we will consider in Chapter 4, in Chapter 5 and 6 these moments will be further described and analyzed multimodally as they are anchored in their bilingual and dyadic, triadic, or multiparty, and multigenerational interactional frames. As proposed earlier, I have classified LIN's bilingualism as *early simultaneous*. Moreover, we should note that determining in absolute terms whether her words in English and Spanish are organized separately in two meaning units, or together in only one semantic unit is no longer the question in bilingualism research (and if it were, it would fall within the scope of psycho- or neurolinguistics). Therefore, LIN in naturalistic interaction may show signs of using her stronger language, English, to make sense of her weaker one Spanish. I do have a couple of examples to illustrate this point. The first one is a recollection of an interaction with LIN, while the second one is found in my secondary data. The first one took place while out on the back balcony of my bedroom in L.A. during my fieldwork. I remember myself describing to LIN the color of a doll's hair in Spanish. The color was "rosa", or pink. LIN responded with a mixed language question, something like: The color rosa@s means pink? The second example was noted on September 10th, 2018, and it is drawn from the digital version of my field journal. While my observation does not allow me to give richer contextual information, i.e., the topic of the conversation, the number of speakers in the participation framework etc. the linguistic information that I was able to recall demonstrates yet again how LIN uses her stronger language English to understand her weaker one, Spanish. I thus observe the following:

LIN: 'Sí' is Spanish?

ROX: Yes (Alvarez, 2018).

From these two brief interactional examples where the former is drawn from memory³⁹, and the latter is drawn from my field journal we may thus see that by using English, the meaning making process with Spanish is achieved in social interaction with the assistance of her bilingual interlocutors. This would reflect, to an extent the lexical organization of subordinate bilingualism where crosslinguistic interaction is manifest, a more relevant question in studies of bilingual language acquisition.

1.5.4 Additive & Subtractive bilinguals

The attainment of bilingual proficiency may be classified in two different ways. This categorization largely depends on the impact of acquisition of the second language on the first one. Bilinguals may be thought of as belonging to additive, or subtractive bilingualism. According to Lambert's (1984) model, additive bilingualism refers to positive cognitive, and affective outcomes from being bilingual. As we saw in our discussion of factors affecting bilingual language development, a positive attitude is essential in promoting a healthy bilingual identity. This may be further illustrated in cases where bilingual speakers are in the process of improving their second language, but without losing proficiency in their first one. Concretely, a native English speaker will not become less competent in English because s/he is learning a second language French. Often this is the developmental path of second, or foreign language learners. It may also be considered an elitist way to learn a second language, and therefore accessible to only a small fraction of society. This discussion is not of concern here.

On the other hand, subtractive bilingualism refers to the negative affective and cognitive effects of bilingualism. Subtractive bilinguals are those that are said to lose proficiency in their first language through the acquisition of their second one. Substantial research has shown that this is often the case for example in second-generation heritage Spanish speakers in L.A. These heritage speakers begin life with exposure to their monolingual immigrant parents' (first-generation) language(s), which is typically Spanish. However, at the onset of schooling i.e., with more intense, regular, and structured exposure to English, even if

³⁹ For the integrity of the present research project anchored in established theoretical, and methodological paradigms, I will limit references to my memory alone. This investigation is in part a retrospective account of lived events in the field as I, a community member and researcher experienced them. However, I recognize the inherent issues of memory, for example in autobiographies. Lejeune (1975) a French literary theorist and specialist in autobiographical writing highlights that even if there is a pact (implicit, or explicit) between the writer and reader that what is related is the truth, issues such as memory failure, or memory lapses may put the pact, and thus the account into question.

with some moments of Spanish use through translanguaging as we previously saw, proficiency in Spanish is lost, or shifts to variable degrees as many others have shown. Firm institutional, and thus state level policies supporting bilingualism are therefore critical for bilingual and bicultural development. Furthermore, this path only seems to depict the cognitive, or linguistic effects. To that may be added the effects of negative attitudes that are internalized throughout this process of identity construction through and by language.

Next, these effects may be further amplified the further out the target child is removed from the first-generation of speakers in their bilingual, multigenerational language learning environments. That is, a third-generation speaker as is the case for LIN in the present study can be thought of as already being subjected to subtractive bilingualism as a natural (?) result of intergenerational transmission embedded within the social, and political issues that it entails both in the minds of individual speakers, but also in their frequent social encounters in the eb and flow of daily life. Remember, not only may her input be reduced, or limited to use in specific domains, but also attrited which is not as common as it seems. Accordingly, even though attrition in adults seems to be uncommon in general (Schmid, 2011), it does happen, and it is possible that some first-generation speakers may undergo attrition in a certain number of grammatical areas, or areas that correspond to those that are incompletely acquired by heritage bilinguals. Furthermore, if the transmitted input is not attrited, diachronic change is another factor that may reduce, and/or modify the quality of input across generations. Nevertheless, in both cases, additive and subtractive bilingualism are directly related to the gain or loss of a heritage, or minority language, culture, and identity at the individual, familial, and societal levels. In additive bilingualism, language minority speakers are more likely than not to become proficient in both of their languages. This is complemented by the fact that positive attitudes towards both of their languages are valued in the society in which they live. In contrast, for researchers such as Field “subtractive kinds of bilingualism typically yield very different cognitive and social effects. It involves the neglect and eventual loss of the original, heritage language.” (Field, 2011: 39) which is also a result of negative attitudes often amplified by the lack of instructional support across the lifespan, but especially at the onset of formal schooling.

In the present research project, we will thus look at both quantifiable measures and qualifiable analyses to see if LIN is acquiring proficiency in English at the expense of heritage Spanish. That is, if she is going through additive or subtractive bilingualism even though both

Spanish and English seem to be valued in her bilingual community, and she has been regularly and simultaneously exposed to both languages. In the best-case scenario, she may be described as an additive bilingual in that she is simultaneously improving both of her languages. However, shortly after beginning this longitudinal case study LIN began formal instruction, therefore, we cannot dismiss the fact that any hopes of additive bilingualism may be in danger of turning into a subtractive form of bilingualism. As we have seen, “The question of who is and who is not a bilingual is more difficult to answer than it first appears.” (Wei, 2000: 5). This is further compounded by the plethora of terms that have been used to depict bilingual speakers which are presented in the table below, and in which we will find the terms discussed in the present section.

Table 6: The various types of bilinguals adapted from Table 0.1 in Wei (2000: 6-7)

Type of bilingualism	Definition
1. achieved bilingual	same as <i>late bilingual</i>
2. additive bilingual	someone whose two languages complement and enrich each other
3. ambilingual	same as <i>balanced bilingual</i>
4. ascendant bilingual	someone whose second language abilities are developing because of increased use
5. ascribed bilingual	same as <i>early bilingual</i>
6. asymmetrical bilingual	see <i>receptive/passive bilingual</i>
7. balanced bilingual	someone who can use both of their languages to the same degree
8. compound bilingual	someone whose languages are learned at the same time and stored in one semantic unit
9. consecutive bilingual	same as <i>successive bilingual</i>
10. coordinate bilingual	someone whose two languages are maintained in two separate yet simultaneous conceptual systems
11. covert bilingual	someone who hides knowledge of a language for any number of reasons
12. diagonal bilingual	someone who is bilingual in a non-standard language, or dialect and an unrelated language
13. dominant bilingual	someone with stronger proficiency in one language
14. dormant bilingual	someone who emigrated to a foreign country and uses their first language very little
15. early bilingual	someone who has acquired both languages in early childhood
16. equilingual	same as <i>balanced bilingual</i>
17. functional bilingual	someone with or without full fluency who can function in a language for specific tasks
18. horizontal bilingual	someone whose two languages have similar sociopolitical status
19. incipient bilingual	someone at the early stages of bilingualism where one language does not fully develop
20. late bilingual	someone who has become bilingual in adulthood
21. maximal bilingual	someone with near native control in both languages
22. minimal bilingual	someone with only a few words or phrases in a second language
23. natural bilingual	someone without specific training and generally not capable of fluid translation/interpretation between languages
24. passive bilingual	same as <i>receptive/asymmetrical bilingual</i>
25. primary bilingual	same as <i>natural bilingual</i>
26. productive bilingual	someone who understands, speaks, and possibly writes in both languages
27. receptive bilingual	someone who understands a second language, but does not speak, or write it

28.	recessive bilingual	someone who has difficulty understanding, or expressing themselves for lack of use
29.	secondary bilingual	someone whose second language has been added to the first through instruction
30.	semibilingual	same as <i>receptive bilingual</i>
31.	semilingual	someone with insufficient knowledge of either language
32.	simultaneous bilingual	someone who has acquired both languages from birth
33.	subordinate bilingual	someone who shows interference in language use by reducing the patterns of the second language to those of the first
34.	subtractive bilingual	someone who loses proficiency in their first language through the acquisition of their second one
35.	successive bilingual	someone whose second language is added at some stage after the first one began to develop
36.	symmetrical bilingual	same as <i>balanced bilingual</i>
37.	vertical bilingual	someone who is bilingual in a standard language and in a distinct but related language or dialect

The table above presents what may appear to be an overwhelming list of 37 types of bilinguals. Furthermore, each type of bilingualism is accompanied by a brief definition. In yellow we find the nine types of bilingualism and their short characteristics as discussed in the present section. In blue we have included terms that were not directly evoked here, but that we have already, or will refer to throughout the remainder of this Ph.D. I draw your attention to the fact that in blue except for number 32 which describes LIN’s path to bilingual first language acquisition, all the others are essentially synonyms of each other. There are six types of bilinguals that seem to refer to the same characteristics or limited productive (oral/written) use of their weaker language. These characteristics are also used to describe heritage bilinguals. Unfortunately, research has shown that this seems to happen to individuals, such as heritage speakers who “are brought up in a society where monolingualism and uniculturalism are promoted as the normal way of life (and who) often think that bilingualism is only for a few ‘special’ people.” (Wei, 2000: 5). Finally, this discussion is an organic way to transition to the next main chapter of this literature review that focuses on heritage speakers and their languages.

CONCLUSION

In Chapter 1 we began reviewing the state of the art. Through five main discussions, one of the aims was to better understand LIN’s bilingual language learning environment at the intersection of multigenerational, multimodal, and multiparty participation frameworks. Aspects of these unique social and linguistic characteristics will be presented quantitatively per se in terms of input and output in Chapter 4. The second overarching aim of the literature review was to apprehend how she is being socialized to use heritage Spanish throughout these plurisemiotic social encounters. Thus, Chapter 5 and 6 will thickly qualify how LIN uses

heritage Spanish. Furthermore, we will consider her, as well as her family members' language use multimodally, and account for how Spanish is interwoven with the use of English, language mixing, as well as in dilingual conversations. Through dilingual conversations LIN may show her passive bilingual abilities depending on who she is addressing according to the various participation frameworks that are made available to her.

Since the present Ph.D. is essentially an investigation of childhood bilingualism, the first section of Chapter 1 began by defining the term bilingualism. Depending on the scholar, bilingualism may be defined strictly, or broadly. For some researchers a bilingual speaker is basically two monolinguals in one which implicitly means equal proficiency in both languages. However, our study favors a broad definition i.e., including bilingual speakers who can at least communicate dilingually which often suggests only passive knowledge of the minority language. Second, we also conceived of bilingual abilities as being on an ever-shifting continuum that strengthens and/or weakens across the lifespan. The characteristics of different types of bilingual families were also presented. We found that LIN may be in a Type 6, or a Mixed language family typical of third-generation homes where language mixing is not only common, but frequent because it is accepted.

In section two we began our discussion of bilingual language acquisition. We focused on three factors thought to affect bilingual language development. The first factor was related to the question of input quantity as measured from birth, but that may also be measured by the number of multigenerational speakers in the family, or the community. The second factor was related to input quality as measured by the richness of vocabulary, syntax etc. Quality of input may be impacted by attrition for speakers who have been in the new country for over 10 years, but it may also be related to natural diachronic language change. Finally, we considered the issue of attitudes and identity, and how they help and hinder multigenerational language use, even in the public school system. These three aspects are intimately interrelated, and they should all be accounted for when assessing bilingual language development.

Next, two related and extremely important sections were discussed. The first section started with a discussion of the three main theories of native language acquisition. First, we presented UG, a largely language internal, or nativist paradigm that pays little attention to input, and that dismisses the issue of language variation. Next, we discussed emergentism. Our study aligns with this theoretical framework since contrary to nativists, it considers that what

is innate and drives language acquisition is the general cognitive capacities to learn like memorization, pattern finding, as well as interactional skills and their interaction with input. The third theory discussed was variationist sociolinguistics which underscores the role of social factors and how they drive variation and change. Our study though not explicitly interested in variation and change accounts for the role of social factors affecting bilingual language development.

The other critical section presented five theoretical approaches to heritage language acquisition, but it focused on the first three that have conducted the most research in this area. Sociolinguistics was the first research paradigm to take interest in what today we may call heritage linguistics. To date the most in-depth sociolinguistic investigation of Spanish heritage speakers in L.A. is attributed to Carmen Silva-Corvalán. The next approach is formal linguistics. Studies under this framework have a numerically significant representation in the literature. In one recent review of a collection on heritage language transmission, nearly all 10 contributions were grounded on formal linguistic approaches, and as such almost entirely used experimental methods. The third theory that we considered was emergentism even if it has not been widely applied to heritage language acquisition research. Nevertheless, the body of work is growing and as such we considered a couple of studies that looked at heritage Turkish in Europe, and another at heritage Korean in North America. Thus, the present investigation will add to the literature under the emergentist paradigm.

We discussed the impact of early (simultaneous) versus late (sequential) bilingual input. The former refers to bilingual exposure from birth, or very early thereafter. This type of bilingualism is often called BFLA. It is the type of bilingualism that we are dealing with in this study. The latter refers to exposure to a second language at a developmental stage where acquisition is more difficult. The onset of bilingualism may determine a bilingual's dominant-ness or balanced-ness. In our study LIN is English dominant. Moreover, balanced bilingualism is the exception, not the rule. We also covered the possible ways that bilingual lexical knowledge is organized. They included coordinate, composite, and subordinate bilingualism, and LIN an early simultaneous bilingual may reflect a subordinate lexical organization. Finally, additive, and subtractive bilingualism was related to attainment of bilingual proficiency. In the former, learning another language enhances both languages, but the opposite is true in the latter.

In Chapter 2 we will delve specifically into the issue surrounding heritage bilingualism. This includes foundational work, how heritage speakers and their languages are defined, and how they are classified socially and historically. Other significant issues will be covered such as how heritage languages are transmitted, and why there has been a call to shift from the widely used notion of incomplete acquisition. The second part of the chapter will then consider novel approaches to heritage bilingualism. The social interactionist theory will be presented, as well as the emergence of language socialization which in part bridges socialization and acquisition research. Next, the heritage language socialization framework is discussed which is central to this investigation. Finally, we discuss the importance of anchoring our analyses on family dinners, and on a combination of models and methods used to organize our analyses. The models include the Parental Discourse Strategies, and the Participation Frameworks. A key method of analysis includes accounting for the multimodal nature of talk-in-interaction.

2 Theoretical Background: Heritage Bilingualism & Heritage Language Socialization

INTRODUCTION

2.1 Heritage speakers & their language(s): Laying the foundations in the field

Although relevant research published prior to Fishman's seminal scholarship may be seen as early precursors to what has come to be known as HL (heritage language) development, arguably, it was Fishman's work in the 1940s, 1950s, and 1960s that marked the beginning of heritage language studies. Due to his pioneering and lifelong dedication to a vast array of aspects around language and society, with a particular commitment to linguistic minorities both as a scholar and activist, Fishman has been called a teacher, a leader, a visionary, and even an intellectual prophet. (Guardado, 2018: 20).

As argued in the citation above, the groundwork for heritage language studies may be attributed to Joshua Fishman. Moreover, in our previous discussion on the theoretical approaches to heritage language acquisition we began with the sociolinguistic paradigm that Spolsky (2010) attributes to Ferguson as the founding father. Not only was it defended as the first approach to heritage language grammars (Montrul, 2016), but the sociology of language approach founded by Fishman also advanced by Spolsky (2010) was among the first paradigm to consider the interrelation of minority languages and society, and their implications regarding their maintenance, or shift. Both sociolinguistics, and the sociology of language share many points of interest, and it is through this pluri-disciplinarity that heritage language studies emerged.

To talk about heritage speakers, their languages, and the process of acquiring heritage bilingualism, it is thus necessary to begin by mentioning the varied number of terms that have been applied across pluri-disciplinary research agendas over time. The specific notions heritage speaker and heritage language(s) will be defined and discussed further below. For the time being, we will remain focused on the foundations in the field. This will help us better apprehend the multifaceted outcomes of heritage bilingualism. As such,

An array of themes and processes are investigated across disciplines in connection with the terms *language maintenance* and *loss*, including *language shift*, *language attrition*, *language forgetting*, *language obsolescence*, *multilingual development*, and *heritage language development*. Although the term *language maintenance* is arguably more widely known and understood, and it is the term that leading scholars originally used to launch this and related areas of study. (Guardado, 2018: 5).

At least seven terms are proposed to define the process of heritage speakers' language development. Within the framework of this investigation, we will refer to this process as heritage language development. We therefore seek to understand how through multigenerational, and multimodal interaction in multiparty participation frameworks children are taught their minority language, and the broader conceptions of the world including their

place in it. To apprehend this process, we will turn once again to emergentist, usage-based approaches. Furthermore, we will draw from the language socialization paradigm which has its roots in linguistic anthropological methods. Our theoretical approach will be fleshed out in the next section of the chapter, like what has been done with the approaches reviewed thus far. Notwithstanding, one of the leading figures who propelled this area of study is Fishman. He is considered even by sociolinguists as “The scholar who has ... done the most to elevate the investigation of LM and LS to a genuine and legitimate field of inquiry” (Pauwels, 2016: 13). In Fishman’s (1964) seminal article⁴⁰ *Language maintenance and language shift as a field of inquiry. A definition of the field and suggestions for its further development*, the issue of LM and LS was approached through the prism of the social sciences. This was especially the case for disciplines such as sociology and social psychology given their keen attention to social and societal issues as related to language. Through his approach to the study of language, he brought both a theoretical and a methodological shift in comparison to for example, formal linguists. In other words, “The main focus in such an approach is on the users and uses of language rather than on the language itself, i.e., the linguistic features of language.” (Pauwels, 2016: 13). We may therefore argue that his agenda was in line with both the emergentist, and sociolinguistic theoretical paradigms discussed earlier. Nevertheless, in defining the field, Fishman was a staunch advocate of LM and LS studies through pluridisciplinary approaches, and in so doing, he underscored the sociological aspects that were inherently interrelated with language.

Fishman thus identified three key areas in this field of inquiry. They include: 1) defining and examining ‘habitual language use’, 2) identifying and analyzing the social factors that affect LM and LS, and 3) considering the role of language attitudes, and language policy as factors affecting LM and LS. These three areas of focus continue to define and shape the field, and this is particularly true with the second, and third points (Pauwels, 2016). These are also sociolinguistic aspects that we will develop through both our quantitative measures and our qualitative analyses throughout the present investigation. Chapter 4 will examine habitual language use at the intersection of social factors. Chapter 5 and 6 will thickly describe how heritage Spanish, English, and language mixing are used at the crossroads of social factors including language attitudes, and multigenerational interaction in multiparty participation frameworks, a cultural aspect tied to this family in their use of Spanish, and English. Moreover,

⁴⁰ In subsequent years Fishman (1970, 1972) further revised and expanded his work.

our qualitative analyses may indicate finer bilingual skills through the use of passive bilingualism which our quantitative measures may not be apt to highlight. Furthermore, Fishman's (1966/1978) research "with several ethnolinguistic groups in the United States focused on the rationales, efforts, and successes in language maintenance from the perspective of community leaders." (Guardado, 2018: 7) who most likely spoke the languages under study, as opposed to the perspective of linguists as has traditionally been the case.

I too aligned with this aspect. I sought to learn more about the community leaders' areas of concern, to see if Spanish language maintenance would be one of them, by joining the Florence-Firestone Community Leaders⁴¹ public discussion group during their meetings that took place every second Wednesday of the month. I therefore turn your attention to two extracts of my notes that are drawn from one of these meetings. The first entry was made during the October 10th, 2018, meeting in the handwritten version of my field journal. I write:

(Context) After presentation of the Florence-Firestone Community Plan

What are the major community concerns?

*What about Spanish?

You're leaving out almost 90% of the voices. (Alvarez, 2018).

After a brief introduction for the evening, the community leaders were asked to voice their concerns (point V) of the first three points on the agenda. As they did so I remained quiet and attentive to the issues that emerged. Some of the challenges that were raised were related to the general beautification of the neighborhood, safety concerns, economic aid for local businesses, and subsidized extracurricular activities to help keep the youth busy, and out of trouble. It seemed as if not one leader was concerned about maintaining Spanish in the community which is what engendered my brief notes above. Only at the end did I raise my voice, even if I felt that this could potentially be out of place since I was a newcomer (it was my first meeting). The second observation took place three days after the meeting in the digital version of my field journal back home. I write:

⁴¹ In the appendices I have included various documents that I managed to collect during these meetings. They include: 1) a Meeting Agenda from February 14th, 2018, 2) a bilingual Florence-Firestone Community Leaders 2018 Meeting Schedule, and 3) the Florence-Firestone's Community Plan Zone Change: CSU update which was distributed by the L.A. County Department of Regional Planning during the February 14th, 2018, meeting. The 24-page pamphlet covers many topics. One of these is Community Identity (page 13) where people, place, and shared history are briefly presented through three images. I note in the pamphlet that linguistic identity, or how Spanish, a huge part of the shared history of the people and the place is absent.

Florence-Firestone Community Leaders meeting

I came here to present my project and to try to recruit more families.

The meeting revolved around community members bringing up local concerns, none of which were remotely related to language, or heritage Spanish instruction. I did meet two women. Both were of Latin descent, but one only spoke Spanish. I don't know if the other lady had working knowledge of Spanish, but the point is that she blatantly said that learning Spanish was not important in the community and that it was an issue that didn't matter- ouch! Fortunately, the other woman who spoke only Spanish agreed that teaching or maintaining Spanish in the community was important and that she would invite me to her next community meeting to present my project. It helps that she is the president of the association. I've contacted her to get times and dates. (Alvarez, 2018).

The aim of the reunion was to discuss a diverse set of local problems that the community faced, but none of them were related to language. Critically however, when I spoke to two Latina women during the meeting, one of them unapologetically stated that Spanish maintenance at the community level as an issue was essentially irrelevant to their cause. On the other hand, the other Latina woman with whom I spoke disagreed. To help me meet the goals that I had initially set forth (recruiting several multigenerational families), she even invited me to a meeting for an association that she presided, and in which many Hispanic community members took part. This was certainly an opportunity since I was fully aware from the onset of my study that it was essential that I not only build strong relationships with the family in question, but also that I try to forge strong ties with the community. This motivation is underlined in the entry below. It is dated August 29th, 2018, or nearly two months prior to the Florence-Firestone Community Leaders meeting. It may be found in the digital version of my field journal shortly after my arrival to L.A. In it I reflect that:

I think that this is a good idea (volunteering at the school⁴², joining meetings) if I want to become more present, meet more parents, gain trust and acceptance to eventually have a larger candidate pool from where to choose participants from. I feel that this is what puts the 'socio' in my linguistic research. This going 'deeper' into the social, cultural, and linguistic fabric of the community that I am immersed in is what makes this PhD project anthro-linguistic (does this term even exist?) in nature. (Alvarez, 2018).

Nevertheless, during the meeting I suggested that Spanish may be kept alive through diverse and enriching bilingual activities where older bi- and monolingual Spanish speakers established ties with the emergent heritage bilingual youth. In doing so, I underscored that this had the potential of fostering a stronger link to the dominant Hispanic culture and language, and one result could be a positive impact to the community. However, the overwhelming

⁴² I have included in the appendices a letter dated October 6th, 2018, from the Los Angeles Unified School District welcoming me to the Volunteer Program.

consensus seemed to be that Spanish was of no concern⁴³. Despite these field-related obstacles, we may thus argue that Fishman's methods were well before his time since scholars like Wei (2000), and De Houwer (2009) have insisted on the importance of describing and analyzing bilingual language practices by linguists who speak those languages or at best are native speakers of those languages. For other scholars, this methodological shift could also help pave a path towards more equitable social justice for these bilingual speakers as Ortega (2019) advanced in her conceptual review paper. Nevertheless, aside from Fishman's (1964) agenda-setting article, a plethora of other publications (his own, his students, and his colleagues) over the last six decades "have further shaped the study of LM and LS." (Pauwels, 2016: 13).

Another one of Fishman's (1965) seminal articles is *Who speaks what language to whom and when?* Not only is it a pertinent research question in heritage language settings, but it also "still resonates loudly today." (Guardado, 2018: 238). To answer these questions, it is necessary to analyze and describe "patterns of language use in relation to ... key domains" (Pauwels, 2016: 117) including for example the home and family, community-based schools, religion, media etc. The present investigation will limit its thick descriptions and analyses to the naturalistic interactions recorded in or around the home. However, we will continue to consider additional observations based on my handwritten and digital field journal notes that took place in other public settings like LIN's school to support our findings. Nevertheless, in his article Fishman pinpoints two key areas of investigation. The first one naturally seeks to identify as the title suggests "who speaks what language to whom and when". The second one is concerned with examining the changing uses of language across groups. These two specific points, which are intertwined with other social aspects will be further examined in the next chapter longitudinally, and multigenerationally (across three generations) in this study. However, even if Fishman (1971) outlined two main foci, in his definition all aspects between society and languages, and their relationship were considered. That is to say, "(the sociology of language approach) focuses on the entire gamut of topics related to the social organization of language behavior, including not only language usage per se but also language attitudes and overt behaviors towards language and language users" (Fishman, 1971: 271). Thus, we will

⁴³ There was about 20 to 25 people in the room. About half of them were of Hispanic origin. Perhaps the community leaders felt that Spanish as a community issue was the schools' concern, or responsibility, though this is not what they said to me. What is interesting is that Hispanic parents in the community seem to think that English should be the language of instruction in the school as opposed to Spanish, since they believe that their children will learn Spanish in the home, and by extension in the community, a community beyond the reach of the school that paradoxically does not see Spanish as a key area of concern.

also extend some of these additional topics as related to the relationship between heritage language development and society to our study. For example, we will consider LIN's attitudes towards speaking Spanish, and to receiving corrective repetitions, and to her behavior towards more competent bilinguals to name a few. Additionally, we will consider her behavior multimodally which seems to have been left out of the definition above. Stance, gaze, gesture, and other non-oral semiotic modes used to convey meaning will be analyzed (with oral modes) as tied to their bilingual, multigenerational, and multiparty participation frameworks. To conclude, Fishman's work has exerted great influence across the decades, and it continues to do so to this day such as in Morgenstern et al.'s (2021) study. This influence is also reflected in the present project since *Who speaks what language to whom and when?* is one of our guiding questions. Having laid the foundations to heritage language studies, we now turn our attention to defining heritage speakers, and heritage languages.

2.1.1 Heritage speakers & their language(s)

This section begins by examining the unique and dynamic descriptions of heritage speakers and their languages. Much like above we will first discuss the current definitions of the term *heritage speakers* as well as *heritage languages*, since

There are many terms in circulation to denote the languages linked to migrant or diasporic settings: migrant language, immigrant language, community language, heritage language, ethnic language, language other than [fil in the name of the majority language], or home language. (Pauwels, 2016: 23).

Indeed, "Several research communities in the last 20 years have turned their attention to HL (heritage language) speakers" (Ortega, 2019: 2), and as a result the terms to describe heritage bilinguals and their languages have proliferated across disciplines. This may be exemplified by the seven labels above to which we may also include the term: unofficial language. Nevertheless, "the term 'heritage language' is probably the most widely used one, at least in the Northern Hemisphere." (Pauwels, 2016: 23). This makes sense considering that "The term heritage speakers was developed in Canada in the seventies in the context of the Ontario Heritage Languages program⁴⁴" (Aalberse et al., 2019: 2). Decades later, the same term was subsequently adopted in the 90's by American language policy makers (Cummins, 2005). Furthermore, nearly a decade ago Kupisch (2013) advanced that the term was gaining ground in the European context. According to the Research lab *Structures Formelles du Langage*

⁴⁴ This was a government funded program that provided school systems the means to put in place 2.5 hours of heritage language instruction per week.

(SFL) (Formal Structures of Language's) website⁴⁵ “les recherches sur les langues d’héritage sont encore à leurs débuts en Europe. En France, les premières recherches ont été coordonnées par Hamida Demirdache” (research on heritage languages are still nascent in Europe. In France, initial research was coordinated by Haimida Demirdache), an MIT trained theoretical linguist based in Nantes, France. In the next chapter I briefly discuss how I was fortunate to participate in (and meet Dr. Demirdache⁴⁶) during the first summer school on heritage languages in 2017, thus becoming in my own right a Franco-Mexican-American researcher based in France seeking to tackle a “wonderful set of problems” (Polinsky, 2018: xiii). Notwithstanding, since the present investigation is grounded within the North American context where Spanish and English are widely spoken by large multigenerational swaths of the population at the hemispheric level, we too will favor the term *heritage languages*, and *heritage speakers*. Furthermore, if we accept the proposal that bilingualism is an international fact of life and that estimates predict that at least half of the world’s population may speak two or more languages, then we may certainly argue that we are also dealing with heritage speakers and the development of their heritage languages on a global scale. As such, Benmamoun et al. (2013) highlighted that in many countries, immigrant languages are acquired as heritage languages by heritage speakers.

Even so, for other researchers “The terms *heritage language* and *heritage speaker* are fairly new, and they are still poorly misunderstood outside of North America” (Benmamoun et al., 2013: 132). In Canada heritage languages were defined as “a mother tongue that is neither an official language, nor an indigenous [i.e., Aboriginal] language” (Harrison, 2000; Cummins, 2005). Moreover, for Aalberse et al. (2019) six central questions are thought to play a role in how heritage speakers and their languages are characterized. The table below summarizes these questions and their implications. However, before proceeding, it is important to highlight that some researchers may have differing stances not only in what labels they choose to describe their populations under study, but also in the answers to the types of questions posed.

⁴⁵ SFL is an “Unité Mixte de Recherche (UMR 7023) assurant la recherche et la formation de la recherche sur les 5 thématiques suivantes : phonologie, interfaces et modélisation, syntaxe et sémantique, sourds et langues des signes, acquisition et psycholinguistique, dynamique interactionnelle et multimodalité” (a mixed research unit that carries out research and research training in the 5 following themes: phonology, interfaces, and modalisation, syntax and semantics, the deaf and sign languages, acquisition and psycholinguistics, interactional dynamics and multimodality) – My translation.

⁴⁶ Dr. Demirdache’s theoretical approach to heritage languages is indeed different from mine. However, as a formal linguist credit is attributed to her for having organized initial heritage language research in France.

Table 7: Six central questions to characterize heritage speakers and their languages as summarized from Aalberse et al. (2018: 2-10)

Questions characterizing heritage speakers & their languages	Implications for heritage speakers & their languages
1. What is the official status of the language in the country where it is spoken?	A heritage language is generally unofficial. For Louden (2016) the term coincides with the notion of ‘minority language’. A result of this status is very limited exposure in formal settings like schools. In other words, limited local, and state funding restricts general implementation of teaching ‘other’ languages. The heritage language is left to be used informally in the home.
2. Does the speaker display a shift in language dominance?	Language dominance shift is considered by many researchers a critical characteristic of heritage speakers. In the U.S. Valdés (2000) includes the notion of dominance shift as applied to Spanish heritage bilinguals. However, other researchers do not assume dominance shift (Nagy, 2015; Kupisch & Rothman, 2018). Finally, dominance shift is associated with a decrease in heritage language proficiency.
3. What is the language proficiency of the speaker?	Language proficiency may be related to language development. For example, for Sevinç and Backus (2017) decreased heritage language use decreases confidence which in turn leads to less use. Moreover, heritage speakers may be perceived as ‘different’ due to disfluencies i.e., low word per minute rate, or high uh-rate (Irizarri & Suchtelen, 2016). This perception is referred to by Nagy (2015) as the “deficiency perspective” which is rejected by scholars such as Flores (2015). Indeed, heritage speakers are described as “unbalanced bilinguals whose heritage (weaker) language is their first language” (Polinsky, 2018: 4).
4. Are there personal ethnic or ancestral ties to the language?	Ethnic and cultural heritage may motivate speakers to learn or re-learn their heritage languages. For example, Carreira (2004) argues that personal ties are central to these special needs speakers. Furthermore, Carreira, along with Polinsky and Kagan (2007) have described these speakers as “heritage learners broad”, meaning that they have limited linguistic knowledge of their heritage language, but strong personal and cultural ties.
5. What was the age of onset of the heritage language exposure & was it acquired naturalistically?	For some approaches, the age of onset of acquisition is critical in determining the overall attainment of heritage language development. The age of onset regarding the critical period and its repercussions was previously covered. Here, suffice is to say that for certain researchers such as for Rothman (2009) critical to heritage languages is the way they are acquired, or “at a young age in a naturalistic setting without being the dominant language of the country.” (Aalberse et al., 2019: 9)
6. Is the heritage language a community language?	Heritage speakers may constitute a community of practice. Language communities may thus provide its members with their own linguistic norms, of utmost importance in sociolinguistic studies. For example, it is advised that “The grammar of each language variety (e.g., heritage vs. homeland, Generation 1 vs. Generation 2) is first examined as a complete variable system that stands on its own. Comparisons between systems (e.g., between generations or between heritage and homeland varieties) are then made using the same methods for each group of speakers.” (Nagy, 2015: 1-2). Finally, tight-knit communities may engender new and complex linguistic varieties. We have already reviewed several examples, but additional complexities include new verbal inflections (Dal Negro, 2004), or finiteness and definiteness marking (Moro, 2016).

We have presented six aspects thought to describe heritage speakers and their languages. Some of these dimensions have already been previously discussed to different extents. For example, the issue of language dominance was considered with reference to balanced-ness on defining the degrees of bilingualism. The rocky issue of language policy in California and its implications for education was also brought to light. Others have already been presented but will be highlighted again since they will be pertinent to the discussion. For example, how

bilinguals are perceived by other bi- and monolingual speakers in and outside of their communities, especially when it comes to language mixing. At the end of the study, we will also see how LIN shows through an ethnographic interview⁴⁷ with me via WhatsApp how she feels about Spanish and English, where she thinks her languages live (through a drawing), and especially her motivations for speaking heritage Spanish.

Nevertheless, the characterizations above are based on six main questions which may be more, or less important to researchers. However, in general terms heritage language speakers are considered native speakers of a minority language that has been learned at home. The term heritage speaker “typically refers to second generation immigrants, the children of the original immigrants, who live in a bilingual/multilingual environment from an early age.” (Benmamoun et al., 2013: 132). For Guadalupe Valdés in an article discussing the bilingualism of American heritage language students, she advances that

American heritage language students include children of native American background, foreign-born immigrants who came to the United States at a young age, the native-born children of foreign-born immigrants, and occasionally the native-born children of native-born individuals of immigrant background. The experiences of these heritage speakers are similar. They speak or hear the heritage language spoken at home and in their immediate communities, but, with few exceptions (e.g., Foreign Language Elementary School programs, Bilingual Education), they receive their formal education in English. They receive no instruction in the heritage language during the elementary or secondary grades and, as a result, become literate only in English. (Valdés, 2005: 413).

Valdés extends, even if cautiously, the definition of heritage speakers to the third-generation. In doing so, LIN a third-generation heritage bilingual thus fits the definition. Furthermore, she captures one lived educational experience of Mexican-American heritage bilinguals. She may thus help us explain this population of heritage bilinguals’ linguistic outcomes, namely their English dominance due to lack of formal education in Spanish. Furthermore, what is striking is that the lack of formal education in Spanish may not be attributed to the public school system alone as Cioè-Peña (2021) found in the New York setting. On the contrary, parents may (un)intentionally play a large part in whether their children become dominant in English, and as a result only develop limited use of heritage Spanish. To highlight this point, I turn your attention to the digital journal entry below. It was recorded on October 22nd, 2018, or after the third day of in-class observations.

⁴⁷ On April 30th, 2021, I had the pleasure of discussing (online) various issues of bilingualism based on my results with Dr. De Houwer. During our conversation Dr. De Houwer suggested that I have a casual phone conversation with LIN to see how she perceived her bilingualism.

I just met BAZ, the Categorical Advisor in charge of student placement at Graham. She bases the student placements on the student enrollment forms completed by parents mentioned above (in my journal). While we'll meet again later for a more formal discussion, she already revealed interesting information. She said that while 255 students qualify for the recently implemented (2018) Dual Language Program based on students' home language, she said that the DLP was shunned by all those parents. The reason: parents told her that they came to the U.S. for their children to learn English, not Spanish. That they (the parents) would teach them Spanish (most likely orally) in the home. BAZ said that Graham was ready to open 3 DLP classes (20 students maximum) in pre-k, but that they only got enough students to barely fill 2 classes. And this, after having invited a Korean woman from the district (who spoke "beautiful Spanish"). As a researcher this really burst my bubble and I realize that if students are not developing their bilingual competence, it is not necessarily a choice they (the children) made, but rather a uniformed choice parents are making for their children that is essentially impacting their bilingual development. (Alvarez, 2018).

After wrapping up my observations for the afternoon in LIN's class, I randomly met with the school's placement advisor coded here as BAZ. Since she learned that I was studying bilingualism in the community, the topic of conversation quickly turned to the recently implemented Dual Language Program and how children could gain enrollment in one of these classes based on the Home Language and Ethnicity Information section of the Los Angeles Unified School District Student Enrollment Form⁴⁸. I learned that most parents disregarded the program. Of slightly under 250⁴⁹ eligible students who spoke Spanish in the home, only two of the three proposed bilingual classes were able to open where each class was limited to 20 students. Low enrollment was because the parents of only 48 students (of 255 according to BAZ) agreed to dual language education. As mentioned previously, the parents' argument was that their mission in coming to the U.S. was for them to learn English. Furthermore, the parents argued that they would teach their children Spanish at home. These enrollment challenges arose, BAZ insisted, even after a Spanish-speaking Korean-American district-level administrator came to encourage the parents to enroll their children in the school's bilingual classes. From my school related observations thus far, I was able to draw two trends. First, as a researcher and community member I realized that parents in this community were in part responsible for hindering heritage Spanish development by blocking their children's access not only to formal Spanish education in the school, but also out of it as we learned in Florence-

⁴⁸ According to BAZ enrollment forms were completed by the parents. Strangely enough however, the form was in English, and I do not remember asking, or being told about a copy translated in Spanish. The information that is referred to above is in section C. It comes after the students' information (section A), and the parent's information (section B). BAZ generously shared this form with me, as well as the documents referred to below. They are all included in the appendices.

⁴⁹ Also included in the appendices are the Elementary EL Profiles based on FOCUS: Reporting & Dashboards, and the Master Plan Roster for LIN's class. The former document supports education through data analytics. It suggests that there were a total of 241 English Learners in K-5, or kindergarten through 5th grade as of November 14th, 2018. Of these, 48 students were enrolled in the Dual Language/Bilingual Education classes. The latter document shows that of the 22 students enrolled in LIN's class, nine of them were L1 Spanish speakers. Finally, it also shows that most of LIN's classmates have Hispanic last names.

Firestone Community Leaders meeting. Second however, that in this community the school played an active role in fostering a bilingual language learning environment contrary to the parents' desires. They did so by promoting a Dual Language Program which implicated important human and financial resources. The school also fostered a bilingual language learning environment by appointing fluent, non-Latino Spanish speakers capable of speaking the community language. They included the interim African-American Vice-Principal, the Korean-American administrator from the District Office, as well as the new school Principal of European descent coded here as TER, who was keenly interested in the plethora of issues related to the teaching and learning of Spanish. My digital field note dated October 5th, 2018, depicts these aspects below.

I met TER the new Principal at Graham (she's been there for 8 days). She said hello to me on the way out. She talked to me about her Spanish background, her interest in Spanish and teaching it, her travels to (the city of) Ensenada and (the state of) Queretaro in Mexico to learn Spanish and that she comes from a school in Hollywood with a large Hispanic population. We really hit it off and talked about issues related to Spanish teaching like who are the teachers, the kind of instruction for these types of language communities, but also challenges related to parental motivation and information, stigma, national-political ideology on language learning and become 'American'. (Alvarez, 2018).

Notwithstanding, in her second official school year LIN was enrolled in the Dual Language Program offered by the school. However, instruction was abruptly interrupted due to the COVID-19 pandemic. Nevertheless, as it pertains to the present discussion on heritage speakers and their languages, the term heritage language essentially identifies languages other than the dominant one that children are susceptible of learning within the family unit. For example, English is the dominant language in the United States. Therefore, most languages other than English may be considered a heritage language. In this sense, for families of Mexican origin living in the U.S., the heritage language, or minority language is likely to be Spanish, or today Spanish with an Amerindian language such as Zapotec due to important recent arrivals from other parts of Mexico.

More specifically, for researchers like Valdés the term heritage speaker, within the context of the United States refers to a bilingual person who is “raised in a home where a non-English language is spoken, who speaks or merely understands the heritage language, and who is to some degree bilingual in English and the heritage language.” (Valdés, 2000: 1). Of course, although this definition is frequently cited in the literature “its usefulness is somewhat limited as it is formulated to apply to Spanish in the United States.” (Aalberse et al., 2019: 4-5). While

this definition will not pose a problem in the present investigation, Benmamoun et al. (2013) have nevertheless proposed a more general version. They suggest that heritage speakers are asymmetrical bilinguals who learned the heritage language (language X) as an L1 in childhood, but who have become dominant in a different language in adulthood. Finally, in defining the term heritage language, Valdés more recently argued that the term “*heritage language* has been used broadly to refer to nonsocietal and nonmajority languages spoken by groups often known as linguistic minorities.” (Valdés, 2005: 411). Furthermore, that members of these linguistic minorities who wish to improve their language skills are referred to as heritage language students, or “members ... who are concerned about the study, maintenance, and revitalization of their minority languages” (Valdés, 2005: 411). We may thus draw a subtle distinction between heritage speakers, and heritage language students. The latter become the former as their inclination to re-learn their heritage language moves them to do so.

In sum, the term heritage speaker may be broadly used to refer to second- and sometimes third-generation individuals that may speak and/or understand a minority language. Usually, heritage bilinguals have also had little educational opportunities for instruction in the heritage language, a challenge which is not always engendered by the school as we saw above. The term heritage language refers to an unofficial language that is often stigmatized and spoken by a portion of people in a given population. In some places like L.A. the fraction of people who speak heritage Spanish may thus be larger than in Salt Lake City for example. Furthermore, as we saw in the introduction, rates may be as high as 90% at the community level, or when we consider linguistic enclaves with high concentrations of recent arrivals, and second- and third-generation speakers. Notwithstanding, two of the central issues that revolve around heritage speakers is that they are not believed to fully acquire their heritage language because of the social and political pressure from the dominant language. This first issue of incomplete acquisition, a concept that is slowly changing as we will see later leads to the second issue of the continuum of proficiency evident in heritage speakers. This notion has already been the object of discussion. Even if heritage speakers may be more competent in their dominant language and thus feel more comfortable using it to communicate, they nevertheless share cultural, or heritage connections to their weaker languages. Within the context of the present research dissertation, based on the overview of heritage languages and heritage speakers, we may claim that LIN is a heritage speaker who is growing up in a dynamic multigenerational household. She is the native-born child (third-generation) of native-born parents (second-generation) of immigrant background. LIN’s grandparents (1.5G) immigrated

to the United States after the age of 10. In what follows, to complete the picture of heritage speakers, we will consider how they have been regarded in terms of social and historical perspectives.

2.1.2 Heritage speakers: A historical and social classification

While heritage speakers may be classified according to their linguistic abilities and in consideration of a bilingual continuum, we may also identify heritage languages with respect to their historical, and social conditions. For example, Valdés argues that

Such minorities include populations who are either indigenous to a particular region of a present-day nation-state (e.g., Aborigines in Australia, speakers of Breton in France, Kurds in Turkey, Iran, and Iraq) or populations that have migrated to areas other than their own regions or nations of origin (e.g., Mexicans in the United States, Turks in Germany, Moroccans in Spain, Pakistanis in England) (Valdés, 2005: 411).

While the examples above are not exhaustive, their classifications are not as clear-cut as they may seem. Historical geo-political conflicts usually with the aim of re-defining national boundaries have served for better or for worse to blur the lines between linguistic and cultural territories. These inhabitants are therefore nestled (or stuck?) in what Bhabha (1994) coined *third spaces*, where he re-thinks the notions of identity, national affiliation, and cultural hybridity as a response to this territorial liminality⁵⁰ in which speakers find themselves. A case in point is the situation of Mexicans in the U.S. Valdés above describes them as people who have gone to regions other than their own nations of origin. However, Mexicans, after their independence from Spain *were* the original inhabitants in many parts of the present-day U.S., and this includes the state of California. Therefore, based on this account alone Mexicans in some states of the U.S. are natives of this territory, and by extension so is the Spanish language. Under these types of accounts, these classifications become tricky. Recently some researchers have found that “early subcategories of HL “types” – for instance, *indigenous*, *colonial*, *immigrant* (Fishman, 2001), and *refugee* (Cummins, 2005) – have been problematized as imprecise or simplistic.” (Ennsner-Kananen & King, 2018: 1). They have nevertheless served as fertile points of departure to research heritage bilingualism. Notwithstanding, below we will briefly present the often-used classification that identifies three distinct types of heritage

⁵⁰ This term is derived from anthropology, and according to Dictionary.com it is defined as “the transitional period or phase of a rite of passage, during which the participant lacks social status or rank, remains anonymous, shows obedience and humility, and follows prescribed forms of conduct, dress, etc.” (accessed, August 24th, 2022: <https://www.dictionary.com/browse/liminality>). Furthermore, it is a notion used in post-colonial studies, and it is linked to post-nationalism and may be resumed as related to the ideas of thought, structure, and control. (C. Ní Ríordáin, personal communication, January 25th, 2016).

languages and heritage speakers in the United States. They are thus based on the perceived historical and social background of minority languages in this specific geographical part of the world. I use the word perceived since as we have seen above across the various definitions and categorizations reviewed, these perceptions are inherently prone to a researcher’s personal, professional, and ideological stances. The table below summarizes the classifications that Fishman put forward.

Table 8: Classifying heritage languages, a summary as put forward by Fishman (2001); & cited by Kelleher (2010: 2)

Heritage language classification	Description
1. Immigrant heritage languages	any of the languages spoken by immigrants arriving in the U.S. after it became an independent country. Immigrant heritage languages may overlap with colonial heritage languages. For example, Spanish was a colonial heritage language, and is now an immigrant language of great importance in the U.S.
2. Indigenous heritage languages	the languages of the people native to the Americas. Many of these languages are now extinct, some are spoken by very few elders and are at risk of being lost. Very few are being maintained within communities of speakers through strong educational efforts.
3. Colonial heritage languages	are the languages of the various European groups that first colonized what is now the U.S. and are still spoken here. These include languages such as Dutch, German, Finnish, French, Spanish, and Swedish.

In his work, Fishman thus classified heritage languages according to whether they were colonial, indigenous, or immigrant languages. Furthermore, he acknowledged that there may be overlaps between these classifications. For example, this might be the case between colonial, and immigrant languages in certain cases. Within the context of this dissertation, since we are considering the socio-historical situation of Mexicans living in the United States, we may claim that Spanish as a heritage language would fall into Fishman’s first, and third category. Spanish in the U.S. was a colonial heritage language (category 3), before Mexico was annexed as part of the U.S. Now however, Spanish is undoubtedly the most important immigrant language (category 1) in the country. Accordingly, over a decade ago the “National Center for Education Statistics (indicated) that in 2009, 8,043,000 5 to 17-year-old students spoke Spanish at home” (McCabe et al., 2013: 3). Thus, even if bilingualism in the U.S. is generally likened to impoverished living conditions (McCabe et al., 2013) it is a well-known, and well documented fact that Spanish is the largest spoken minority language in the country due to its socio-historical roots that span several generations, or 300 plus years (Fishman, 2001). Below we

will thus discuss in more detail the transmission of heritage languages at the intersection of chronological time.

2.1.3 Heritage language transmission: The three-generation rule & the GIDS

As seen throughout the various sections up until now, a breadth of individual, familial, and social factors appear to both help, and hinder heritage bilingual acquisition, or engender the multifaceted outcomes of heritage speakers' proficiency. Moreover, it is well known that in the United States the language with valued cultural capital is English. All the other languages are thought not to have as much cultural (except for maybe Native American languages) or market (except for maybe Spanish) value. As a result, minority, or heritage languages in the U.S. are left to survive on their own at best. At worst, unpardoning language policies are created, and implemented to subjugate, and even eradicate them. This was the case with Spanish at the instructional level throughout the 20th and 21st century as we previously discussed. In both cases however, many studies have argued that it is only a matter of generations, three to be exact, before heritage languages are lost through the multigenerational process of language shift. One reason may be related to issues of attitudes and identity. For example, Bourdieu (1982/1991) advanced that first- and second-generation heritage language speakers, and society in general, valued English over their own languages, as well as over other languages. Concretely, this means that I as a second-generation native Californian would value English, over my heritage Spanish, as well as over Mandarin, or Tagalog, the third and fourth most spoken languages in California (WorldAtlas⁵¹, 2022). While this is clearly not my stance, overall, these rampant negative societal attitudes that place English on a pedestal have and continue to result in intergenerational heritage language loss. We elaborated on this issue in the second section of Chapter 1.

Therefore, to understand the process of language loss across multigenerational groups of speakers, this section will first give an overview of what is known as the three-generation rule. Then, even if “the general consensus among LM researchers working in migrant settings is one that sees LS as the inevitable result of such language contact.” (Pauwels, 2016: 154), we

⁵¹ Cartographer John Moen and his wife Chris Woolwine-Moen launched WorldAtlas in 1994. Today it is considered one of the largest resources to publish on a variety topics including geography, sociology, demography, language etc. (accessed August 24th, 2022: <https://www.worldatlas.com/articles/the-most-spoken-languages-in-california.html>).

will briefly consider the Graded Intergenerational Disruption Scale (GIDS). As far as the three-generation rule is concerned, it is thought to represent

the normal course of language shift and shows how native/heritage languages can fall into disuse and eventually become lost to the community (cf. Wiley 2007: 27f). ... But, it does seem to portray the social changes that succeeding generations encounter as they adapt to new cultural and linguistic surroundings. (Field, 2011: 62).

Field before Pauwels therefore suggested that language shift was a natural response in the life of languages in contact. Language shift also leads to linguistic variation, and variation is inevitable. For example, genetic mutations have not only propelled human evolution, but also given rise to the great diversity in human populations (Heyer, 2022). Furthermore, this inevitable path seemed to be engendered by the unique socio-linguistic bilingual language learning environments i.e., liminal third places, or within this study, a *tercera Hispanidad* (third hispanicity) as coined by Fuentes (1992/2016). Moreover, much like the multiple and complex definitions of bilingualism and the various degrees manifested by bilinguals, it is argued that the three-generation rule “still needs to be viewed as a continuum with blurry boundaries, not necessarily as an inevitable fate in every case.” (Field, 2011: 62). In some communities heritage languages are promptly lost by the second-generation while in others they are maintained beyond the third-generation. McCabe et al. also consider historical time as a critical component to language loss in the U.S. context. This group of researchers sum up the three-generation rule as follows:

Historical time is another temporal consideration in multiple language learning. Heritage language maintenance in the U.S. has sometimes been described as following the “three-generation rule.” The first generation of immigrants maintains the heritage language and may learn little English, their children born in the U.S. become multilingual, and the third generation is typically monolingual in English. (McCabe et al., 2013: 5).

The three-generation rule is tightly related to the issue of language loss over historical time. Much like Tomasello (1999/2022) linguistic and cultural change does not happen all at once. Rather, language loss, but also shift, and even death are the result of smaller modifications in the communicative practices that have been accumulated over time. Thus, through the process of language shift, the native-born grandchildren (third-generation) of immigrant grandparents (first-generation) tend to lose their heritage language. However, as mentioned previously by Croft (2000), languages are not invented all at once, and historical time is also what allows languages to “emerge”, and “evolve” as speakers adapt their languages to different communicative, and often liminal social situations. Thus, while the concept of historical time is portrayed as an important and perhaps even as a positive factor in language development by

Croft, we must not forget that it is also a double-edged sword. According to the three-generation rule, historical time also has the potential to annihilate languages.

Within the context of this study, the three-generation rule will be of particular interest. The family under investigation is multigenerational. It is composed of precisely three-and-a-half generations with one generation (GLO and GUI) between the first and the second. LIN's great-grandparents are first-generation monolingual Spanish speakers. Her grandmother is proficient in both English and Spanish, while her grandfather attained a basic level of English, essentially through his profession. Moreover, as we saw earlier, GUI also communicates in English with LIN. GLO, and GUI are both the 1.5-generation speakers. LIN's second-generation native-born parents are both bilingual. Finally, LIN is a third-generation native child born in L.A. Therefore, according to the three-generation rule, LIN is likely to become a monolingual English speaker, but to what linguistic, or interactional extent in multiparty participation frameworks will she apprehend heritage Spanish? Thus, analyzing when LIN uses Spanish, English, or mixes them both in her day-to-day multimodal social encounters may allow us to get a sense of the process of language shift, as well as to reveal how Spanish is being maintained, or not within the family. In the meantime, we may also get an idea of the vitality of a language at the family, community, and the larger societal levels. As mentioned above the GIDS as proposed by Fishman (1990) was developed as "an aid in diagnosing the state of a language, i.e., in ascertaining the degree of threat ... to a language." (Pauwels, 2016: 154).

Table 9: The Graded Intergenerational Disruption Scale (GIDS) used to diagnose language vitality in bilingual communities; summarized from (Pauwels, 2016: 155-160)

GIDS: from the least to most threatened	Description
Stage 1	The heritage language is the least threatened and used in the highest levels in education, employment, government. It is widely used in the media. A community may receive protection for their language, as well as cultural and/or economic autonomy. However, Fishman cautions that this stage "represents the end of a long and difficult haul, but, most certainly, does not represent the end of RLS problems and concerns. Indeed, the problems at this stage of the GIDS are often particularly aggravated and politicized ones, but there are definite advantageous to being at this stage as well." (Fishman, 1991: 107).
Stage 2	Here the heritage language is just beginning to become available. It is used in mass media, and for specific services i.e., in health, finance, housing etc. This may include the availability of interpreters in courts and hospitals. Nevertheless, these types of services are transitional, or put in place "until the migrant community is able to function in the majority language" (Pauwels, 2016: 159).

Stage 3	The heritage language is increasingly used in shops, and other businesses. This also marks the use of heritage languages with other group members like those of the majority. Critically heritage languages will begin to be used by majority members. However, “there are few if any migrant communities that find themselves at his stage” (Pauwels, 2016: 158) since this is voluntary, or at the discretion of the majority.
Stage 4	The heritage language is finally starting to make its way into the educational domain either through state, or local financing. For example, the state may provide long-term funding for minority language teaching. As we have seen though, language politics and policies have historically been turbulent. This has resulted in inconsistent instruction which is detrimental to heritage language development.
Stage 5	Here the heritage language is used orally across a breadth of community-centered domains. Moreover, many community members show evidence of literacy since the chance to become literate is also present. Typically, this is made possible through community-based instruction, although for García et al. (2013), and Valdés et al. (2006) there is much variation regarding the efforts migrant communities deploy to provide the younger generations with literacy opportunities.
Stage 6	The heritage language is used informally in several community contexts. This includes intergenerational communication. The language used in informal interaction among the three generations. Moreover, this is “an extremely crucial stage ... because the lion’s share of the world’s intergenerationally continuous languages are at this very stage and to continue to survive and, in most cases, without going on to the subsequent (“higher”) stages” (Fishman, 1991: 92). Here, the challenge is to ensure intergenerational transmission beyond the third generation.
Stage 7	Older speakers almost exclusively use the heritage language to talk to each other. There is no intergenerational transmission, especially as parents increasingly use the dominant language in interaction with their children. For Pauwels (2016) an important number of communities may be found at this stage. In second-generation families this is common. That is, heritage language transmission to the third-generation is infrequent due to lack of use even though heritage language use in the family was prominent for the second-generation parents.
Stage 8	Only a few speakers may be left. There is thus little interaction in the language. Here. “the language may be in need of almost full or partial reconstruction, implying that the first task is to document it before it can be acquired again, even by adults.” (Pauwels, 2016: 156). These are now endangered languages and studied by many researchers (Austin & Sallabank, 2011; Flores Farfán & Ramallo, 2010; Nettle & Romaine, 2000; among others).

Fishman’s model above was presented as a systematic approach to understanding and reversing language shift (RLS). Through the application of the GIDS he was thus able to consider some communities as successful, while others in need of additional support. This was the case of Spanish in the U.S. for example. As such, the “GIDS in its role as a (still) powerful tool to assist language communities, activists and possibly policy makers in assessing in which stage of endangerment the language finds itself” (Pauwels, 2016: 155) continues to be used as a model to assess the distinct and ever-shifting gradient contexts in which minority languages are found.

With respect to the present investigation, it is interesting to come back to the GIDS nearly 30 years later to assess the vitality of Spanish in L.A. along two levels. What we find is that many of these stages seem to overlap. For example, stages 1 (the least threatened), 2, and 3 all seem to present the prevalence of the minority language in the media, business, health,

and finance. As of today, Spanish in L.A. is omnipresent across these sectors. Its reach is especially heightened through the abundance of media i.e., radio, and T.V. not only regionally, but (inter)nationally. However, Spanish has started once again to make ground across all levels of education⁵² (stage 4) as we saw in LIN's school and has historically been used in a wide range of community domains (stage 5). For Spanish, stages 1 through 5 are thus applicable at the societal levels. In orienting the GIDS to the family domain, informal multigenerational interaction is crucial according to stage 6. Additionally, globally this seems to be the norm for most languages in contact, a stage which is apparently difficult to surpass. At the family level, LIN's family seems to fit here. However, it also seems to fit in stage 7 since her parents might use more English with her in interaction. Finally, at this stage, our quantitative measures and qualitative analyses may confirm if heritage Spanish is being transmitted to the third generation, even if Spanish use is frequent among the bilingual second-generation speakers.

A review of the GIDS along with the three-generation rule underscores the importance of language transmission, and the challenges that arise at the individual, family, and societal levels at the intersection of chronological time. We also see that while minority languages may be flourishing at the community levels, the opposite may be true at the individual and family levels. Furthermore, this allows us to reconsider Figure 2 further up on how the factors affecting bilingual language development are inherently embedded into one another. While the GIDS has ordered them into distinct stages, we see that in reality they overlap and move according to a diverse range of ever-shifting conditions that are equally in, and out of control. When these conditions are not met at their optimal levels, a heritage speaker is thought to have acquired his or her language incompletely which we will discuss next. However, I too join the diverse group of educational scholars such as Leeman and King (2015), Loza (2017), Valdés (2017), and García and Tupas (2018) among many others to suggest that

research in heritage bilingual development, no matter how focused on just linguistic development and on elucidating the nature of HL mental grammars, must be informed by the sociopolitical realities of systemic marginalization and linguistic insecurity that shape the inequitable multilingual learning experiences of HL speakers and their minoritized communities. (Ortega, 2019: 27).

⁵² The Daily Bruin is UCLA's student newspaper which began publishing in 1919. On October 10th, 2021, in an article entitled *UCLA announces efforts to be designated as a Hispanic-Serving Institution*, a federal designation. As such, UCLA pledged to funnel more resources to Latinx-related research by creating new faculty lines, and fellowships in this area. (accessed August 24th, 2022: <https://dailybruin.com/2021/10/10/ucla-announces-new-efforts-to-be-designated-as-a-hispanic-serving-institution>).

2.1.4 From incomplete acquisition to divergent grammar

Within the U.S. context, languages other than English have been often considered foreign languages. Nevertheless, “many people who live in the United States have cultural connections to and know languages other than English.” (Kelleher, 2010: 1). Therefore, it may be argued that heritage languages are not foreign since they are used in a variety of familiar ways, as well as in specific cultural domains by their speakers either because of language dominance, or due to preference for one language over another (Grosjean, 2008, 2010). In both cases, these speakers who may span multiple generations have historical ties with their minority languages in the U.S. Furthermore, this distribution of use among heritage bilinguals has been used to show that “Some heritage speakers have merely receptive knowledge of the language, while others may have near-native linguistic abilities in listening, speaking, reading and writing.” (Benmamoun et al., 2013: 134). As such, a discussion around the concept of incomplete acquisition, used not only to describe heritage grammars, but also heritage speakers’ language use also entails a discussion of the bilingual continuum. We have already looked at the former in detail in Chapter 1. Therefore, here it will only be mentioned in juxtaposition with incomplete acquisition.

Some heritage speakers may be able to understand, read, speak, and write their heritage language. Others may have more limited competence like only being able to speak it or possess more passive competence. For example, individuals who are only able to understand their heritage language in a limited number of contexts for the first, and those only able to communicate diligually in the second. We will elaborate on diligual conversational styles in Chapter 5 and 6 in discussing heritage language socialization. Nevertheless, the bilingual continuum is inherently tied to the contentious term incomplete acquisition ascribed to heritage speakers. However, it is a current, but changing issue in heritage language studies. In part this may be attributed to a social justice paradigm in psychology which has underscored the need for “a commitment ... to decrease human suffering and to promote human values of equality and justice” (Vasquez, 2012: 227) which are in line with the ethical issues we will discuss in the next chapter. Thus, much like the multiple definitions of bilingualism as well as the bilingual types, we have also seen that there is not one clear-cut definition of heritage speakers and their languages, since “The term “heritage” ... can (also) be used to describe any of these connections between a non-dominant language and a person, a family or a community.” (Kelleher, 2010: 1). This is of particular importance regarding the linguistic abilities of heritage

speakers that can vary greatly from one speaker to the next. Below, Polinsky and Kagan give a thorough description of heritage speakers' linguistic outcomes. I draw your attention to the notion of incompleteness, which is at the center of the variable, but systematic grammatical endpoints, or "version" of the home language acquired at the individual level.

Heritage speakers are people raised in a home where one language is spoken who subsequently switch to another dominant language. The version of the home language that they have not completely acquired-heritage language ... Despite the appearance of a great variation among heritage speakers, they fall along a continuum based on the speaker's distance from the baseline language. (Polinsky & Kagan, 2007: 368).

Heritage speakers often possess varied linguistic abilities based on the quantity and quality of input received during childhood. In other words, "many heritage speakers do not receive sufficient input and use of the language during crucial stages in childhood" (Montrul, 2016: 122), and in particular during the preschool age "when basic vocabulary, inflectional and derivational morphology, and simple and complex syntax are acquired." (Montrul, 2016: 122). In the next part of this section, we will briefly consider some of the varied areas that many scholars (Montrul, 2002, 2008; Silva-Corvalán, 2003; Polinsky, 2006; O'Grady et al., 2011) have analyzed to reinforce the prickly term incomplete acquisition. Furthermore, we see that these researchers hail from each of the theoretical traditions discussed further up. Nevertheless, it should be made clear that from the onset, the term used to characterize the ultimate outcomes of many adult heritage speakers was never "intended as a value judgement, although some may interpret it this way." (Montrul, 2016: 124). Otheguy and Zentella (2011) who researched the Spanish of New York, as well as Pascual y Cabo and Rothman (2012) are among those that have discussed the "(il)logical" issues with the term incomplete acquisition as related to heritage bilingualism.

Thus, heritage speakers' less than ideal language skills, as depicted from researchers' perspectives have also been described as "*reduced, partial, truncated, deficient, halted, and atrophied language acquisition.*" (Montrul, 2016: 124). However, heritage speakers possess different strengths in both of their languages (Valdés, 2005), in the same way that monolingual speakers may demonstrate variable linguistic skills across domains. Here again we should remind ourselves that bilingual competence should not be limited to mere linguistic ability as measured by morphology, syntax, and lexicon etc. in each language, but rather, it should consider those dynamic and multimodal bilingual language practices that are specific to the speech community, even if they are not equally distributed across languages. Inheriting these types of plurisemiotic linguistic resources subsequently enhances a child's ability to deal with

the extended range of multigenerational interlocutors (Chung, 2010) as is the case in the present study. Therefore, even if in a substantial amount of previous work, the term “incomplete acquisition” referred to heritage grammars this notion seems to be questionable on theoretical grounds. For example, researchers have now realized “that referring to a grammar as incomplete can be theoretically problematic if one considers that languages are always changing in some way.” (Montrul, 2016: 125). Moreover, this has been accentuated by the fact that there is great difficulty in determining when an individual grammar is completely acquired. Both Otheguy and Zentella (2012), and Meisel (2013) made this clear in their discussions. For Benmamoun et al. (2013) a crucial component in defining heritage speakers is the identification of a continuum of proficiency previously expressed as incomplete acquisition for those on the lower end of the proficiency scale. However, researchers have now become aware that the term is unintentionally charged with negative connotations that unjustly engender and submit the ethnic minorities who speak these languages to inadvertent human suffering. As such, the term *divergent grammar* has been suggested and it refers to the outcomes of incomplete acquisition. An active awareness of the negative impacts that linguists’ nomenclature are susceptible to produce is not only more ethical, but it may also help bring social justice to heritage speaking communities the world over. It may engender “a philosophy, an approach, and actions that embody treating all people with fairness, respect, dignity, and generosity” (Nieto & Bode, 2012: 12) at least within the socio-politically charged educational realm. This brings us back to Halliday’s (1978) remarks, or that the question of linguistic ‘deficit’ from a linguistic viewpoint is simply *out* of the question. That is

because its functional relevance to the living of life, so almost all language users develop a ‘functional’ knowledge of language as a system, unless there is some radical impairment in the brain ... and this knowledge is always partial for all users. No-one can know a whole language. However, it might be possible that people will typically and habitually select some meanings rather than others across contexts of use over time because some general features of social structure – gender, age and class for example” (Williams, 2008: 64-65).

A functional relevance of language therefore aligns with a more harmonious view of heritage bilingualism. This approach reaches beyond pure linguistic measures (internal), and anchors bilingual language competence according to the specific cultural practices (external) that are inherited from, and thus used within the community through the intricate, and largely implicit process of language socialization. Heritage speakers are thus prone to switching from one language to another or mixing them both depending on the communicative context, among a plethora of other factors that will be discussed later. For Lopez-Burton and Minor (2014) the U.S. is a good point of departure from which to observe heritage bilinguals’ language practices,

and as such to examine how Mexican-Americans' culture is perpetuated across space and time (Telles & Sue, 2019) since cases of heritage bilingualism permeate across the country.

At the time of recording, LIN was almost five years old, or 3;10 to be precise, and thus beyond the one- and two-word stage in her dominant language, English. This is exemplified in Chapter 4 by her MLU measures. Therefore, it may be possible based on these quantifiable, but also qualifiable assessments (Chapter 5 and 6) to make predictions as to whether she will have a divergent grammatical system in heritage Spanish at this point in her life. More generally, the question may be framed by asking how native can heritage speakers be considering the infinite number of hurdles that impact their heritage grammars? We will briefly consider the issue of heritage speaker native-ness in the next, and last section of this chapter. However, for now we may also be able to learn more about the issue of the continuum of proficiency. While proficiency may best be evaluated only after LIN has acquired enough of her heritage Spanish, learning more about when LIN is using Spanish, but also English or mixing languages may reveal in which language she is starting to show more proficiency. This may be done both through TTR measures (also Chapter 4), or through the thick descriptions and explanations where she is engaged in bilingual and multimodal interactions in a wide range of participation frameworks.

2.1.5 So how native are heritage speakers?

To answer the question of heritage speaker native-ness in a nutshell, "Heritage speakers are native speakers, because they start the acquisition of the heritage language early as native speakers but later undergo language shift." (Montrul, 2016: 208). Nevertheless, by now it is well established that heritage bilinguals may manifest linguistic divergences at the so-called endpoints of their language development, but not always. For example, certain aspects of the minority language may show age-appropriate levels of native-like attainment. On the other hand, other linguistic aspects of the heritage language may not be fully acquired in childhood, and this across a breath of grammatical areas. Below we will review some examples of both native-like and non-native like attainment in heritage speakers. But first in the table below we summarize some of the researchers who have studied a wide range of grammatical aspects in heritage bilingual populations across theoretical paradigms.

Table 10: Grammatical aspects studied in heritage bilinguals

Researchers	Grammatical aspects studies in heritage speakers
Polinsky & Kagan (2007)	vocabulary
Polinsky (2008a)	gender classification
Montrul (2002) Lynch (2003) Silva-Corvalán (2006) Polinsky (2008b)	tense, aspect, and modality
Polinsky & Kagan (2007)	case paradigms
Song et al. (1997)	case and word order interaction
O’Grady et al. (2001) Kim (2005)	relative clauses
Bolonyai (2007)	agreement
Song et al. (1997) Kim & Montrul (2004) Kim et al. (2009)	reflexive pronouns
Montrul (2004) Montrul & Bowles (2009)	differential object marking
Montrul (2005)	the semantics of unaccusativity
Montrul (2004)	the contrast between overt and null subjects in ‘pro drop’ languages
Polinsky & Kagan (2007)	quantifier placement
Polinsky & Kagan (2007)	filler-gap dependencies

From the non-exhaustive table above, as well as through the many examples presented throughout this chapter, we have seen that heritage speakers have been studied according to a broad spectrum of grammatical aspects. In so doing, heritage bilinguals who are typically dominant in the majority language range in proficiency. In other words, “the heritage language varies from individual-to-individual ranging from mere receptive to fully productive ability, depending on a variety of life experiences and environmental circumstances.” (Montrul, 2016: 208-209). Heritage bilinguals’ levels of native-ness may be ordered into two main groups, those with native-like ability, and those with non-native-like ability which is generally the case with most heritage speakers. We will start our brief discussion with the high proficiency heritage speakers. Moreover, if we have opted for a succinct presentation, it is essentially because the studies upon which the results are anchored are for the most part experimental in nature with a heavy focus on mental grammars. As a reminder, I must make explicit that this is not our prerogative, and for this reason I will not dwell on those results. On the other hand, the ambition of the present investigation is to advocate for more ecologically oriented studies to assess how plurisemiotic linguistic resources are used in everyday life in multigenerational and multiparty participation frameworks.

2.1.5.1 *High proficiency heritage speakers*

Some advanced heritage speakers do not differ from fully fluent monolingual speakers in their heritage language in some grammatical areas. They may thus be considered *high proficiency heritage speakers*. However, the level of native-ness of heritage speakers is an area that few linguists have aimed at uncovering. Nevertheless, Kupisch et al. (2014) and Kupisch et al. (2013) have attempted to tackle the question within the European context through a battery of experiments. In their bi-national study, the investigation sought to understand whether a language's status (majority or minority) is a contributing factor to the degree of French acquisition in different areas of grammar for participants living in Germany. The linguistic competence of 11 simultaneous French heritage speakers growing up in Germany were compared to 11 age-matched German-French simultaneous bilinguals who mostly grew up in France. The results showed that the French heritage speakers living in Germany did not differ greatly from the German heritage speakers living in France. Moreover, the differences that did emerge according to these researchers were not related to morphological, syntactic, or semantic aspects, but rather to lexical knowledge. Nevertheless, an interesting finding was that most of the French heritage speakers' accents were considered foreign by monolingual French speakers⁵³. In the study above, high proficiency and the frequent use of heritage French likely resulted in the participants native-like abilities. Unlike the North American experience for most heritage speakers, we know that “with consistent input, active use of the language in the society, and instruction at school – heritage speakers can become fully fluent, and in some cases indistinguishable from native speakers in many aspects of their grammar.” (Montrul, 2016: 210).

Native-like ability may also be a question of grammatical areas. Heritage speakers' native-ness may not necessarily occur across all their linguistic domains. Indeed, linguistic knowledge at least in certain areas are rather strong. As such, they are more likely to develop at native levels. On the other hand, the least resilient linguistic areas do not develop to native

⁵³ During my initial one-month long fieldwork in 2018 I attended the Third International Conference on Heritage/Community Languages at UCLA. One take away message of the conference was learning that many researchers highlighted the growing interest in researching heritage accents.

As I child I remember how during trips to Mexico family and friends would remark on the fact that even if I spoke Mexican Spanish, nonetheless there was something in my accent that was slightly different. I suppose that they could have meant intonation as well. These comments were never meant to be hurtful. Perhaps these Spanish monolinguals were just curious. Moreover, I never gave their comments a second thought. In this sense, much like in the study above, monolinguals inadvertently assessed my own heritage accent naturalistically.

levels. One such area that seems to be resilient due to its early acquisition is heritage accents. But, as mentioned above this is an area that needs further research. Nevertheless, input frequency (O'Grady et al., 2011) is an important factor that drives the acquisition of inflectional morphology. This grammatical aspect is not only highly susceptible to being incompletely acquired, but also vulnerable to loss, especially by heritage speakers on the lower end of the proficiency scale. One example is gender agreement in nouns. Even if heritage speakers are not affected to the same degrees, most advanced proficiency heritage Spanish speakers performed like native Spanish speakers in studies conducted by Alarcón (2011), Montrul et al. (2008b), and Montrul et al. (2013, 2014). In two additional, and recent studies revolving around frequent conversational structures in Spanish at the syntax-semantics-discourse interface, Leal Méndez et al. (2014), and Leal Méndez et al. (2015) found high proficiency heritage speakers to perform much like native monolingual Spanish speakers. Through a brief examination of these studies, we may conclude that recent European research points to native-like ability in some heritage speakers, and in certain domains of the heritage language. Nevertheless, it should be underscored that while it would be fruitful to pursue this line of research, the likelihood of native-like ability of heritage speakers for a given population is still unknown. This includes pinpointing the precise circumstances that lead heritage bilinguals to native-like levels of achievement in their minority languages. The focus of this study is not third-generation heritage Spanish gender agreement. However, we may attempt to detect if LIN in spontaneous interaction shows knowledge or difficulty of Spanish gender agreement given that it is highly susceptible and given that she may be considered a lower proficiency heritage speaker. Even if native-like attainment is ideal, most heritage speakers display non-native like ability as we will see next.

2.1.5.2 Low proficiency heritage speakers

When input and active use of the heritage language is not sufficient in the bilingual language learning environment, several aspects of the heritage language are affected. This may lead to either structural changes in the heritage language, or non-native like ability. As a result, these speakers are often considered *low proficiency heritage speakers*. Nevertheless, the linguistic changes that heritage bilinguals present offer rich insight into key theoretical questions, as well as to important practical implications not only regarding the very nature of language, but also as it pertains to language (re)acquisition. Furthermore, low proficiency heritage speakers in many studies (Carreira & Kagan, 2011) have shown that while they have low intermediate

proficiency, they can still communicate at basic levels. This indicates that the factors affecting bilingual language development discussed earlier in Chapter 1 are critical to harmonious bilingual development. Input quality and quantity, as well as language use impact the full linguistic development across many grammatical domains. We have already discussed both what the quality and quantity of input refer to even if quantity, or sufficient input to attain native-like language development is still difficult to determine. That is to say that “The exact quantity that constitutes the “critical mass” for the acquisition of a structure may be debatable, but appears to be linked with the relative transparency/opacity of the structure.” (Mueller-Gathercole & Hoff, 2009: 115). At present we will limit our discussion on insufficient input and language use at the intersection of age that may lead to both incomplete acquisition, attrition, or both in heritage speakers. We will do so by briefly presenting a few studies. Indeed, incomplete acquisition, and attrition are two salient features that are used to characterize low proficiency heritage speakers.

The first study by Flores (2012) is rather unique in that it aimed at documenting the potential attrition of German, the societal language by focusing on object expression, and word order when it became the heritage language. Both age effect and input quantity were investigated in cases of heritage language reversal. That is, Portuguese-German bilinguals of Portuguese origin raised in Germany, and in German-speaking Switzerland who as children returned to Portugal. Even if as children they attended German schools, upon their return to Portugal, their once heritage Portuguese naturally became the majority language whereas German became their new heritage language. Moreover, the age of return was the critical variable controlled in the investigation. The participants, who were divided into child and post puberty returnees had already spent five to 10 years in Portugal at the time of testing. The results of the study confirmed the age effects on heritage German attrition. The two returnee groups produced far more illicit null subjects in German compared to the child and adult control groups who were still in contact with German. Perhaps more strikingly were the findings of the verb placement tasks. Between the returnees who came back in childhood versus those that came back after puberty there was significant difference in the production of illicit word order, or nearly 50% for the child returnees, versus not even 5% for the post puberty participants. The results therefore showed that reduced input in childhood highly affected the German heritage speakers back in Portugal. However, when reduced input occurred after puberty, the effects of attrition seemed to be proportionately smaller. These findings suggest that attrition may

engender ungrammatical constructions in the target language. As we will see next Bylund (2009) also supports age-related explanations for language loss.

In the next study, through several distinct tasks Montrul (2011) investigated the case of a woman of Guatemalan origin in her mid-thirties who was adopted when she was nine, and then brought to rural Illinois in the U.S. where she was raised. Even if she identified as Hispanic, was motivated, and connected with the Spanish speaking community, she reported a complete reduction of Spanish use between the ages of nine and 14. It was only in high school at 15 that she re-engaged with her native Spanish as a heritage language learner. Moreover, her Spanish was deemed non-fluent since she displayed difficulty in retrieving words, as well as in grammatical accuracy. For the latter, according to the study she would mix languages, or borrow words from English as a compensation strategy. Nevertheless, she sounded native. This was attributed to the fact that she lived the first nine years of her life as a monolingual Spanish speaker which greatly contributed to her level of language retention, and acquisition of the Spanish sound system. The results of the first two tasks (proficiency and acceptability judgment) showed that she was below 60%, however native Spanish speakers are typically between 90% and 100%. The Guatemalan woman thus performed well below the range that is expected for native speakers of Spanish. In terms of gender agreement, she showed high attrition with her accuracy being between 60% and 85%. Additional grammatical domains showed poor control (differential object marking), or low verbal accuracy (subjunctive, imperfect below 30%). Only in the preterit did she score 71%. Finally, Montrul (2011) showed that unlike the native speakers, her participant was incapable of distinguishing between the semantic implications in a meaning judgment task (preterit and imperfect forms). In the end, Spanish language attrition engendered by a deprivation of input, and the absence of Spanish use between the ages of nine and 14, followed by unbalanced use and exposure thereafter did not allow for the participant to reach a nine-year-old level in these grammatical areas. The study reinforces the fact that age is a significant variable in assessing language loss, and that attrition is a salient characteristic of non-native ability in heritage speakers.

In the section on modeling bilingual acquisition, we briefly considered Silva-Corvalán's (2014) work that investigated incomplete acquisition through an *almost* ideal method. An ideal method may be described as a longitudinal study that identifies "changes in the same individuals (and follows) heritage speakers from birth into adulthood and in the two languages to trace the acquisition of the two languages and the interaction in response to

changes in input.” (Montrul, 2016: 222). The advantageous of longitudinal studies will be further discussed in the next chapter. Here, Silva-Corvalán followed two children (her grandchildren) from 1;11 until almost six years of age, and to date it is the closest to the optimal research design. The focus was on documenting and accounting for two brothers’ bilingual language development in heritage Spanish and in English. Through audio recordings and journal entries, this included an examination of cross-linguistic influence as related to input quantity, as well as certain grammatical areas in Spanish prone to vulnerability, among others. Moreover, as in the present research dissertation, the two boys received strikingly similar rates of input in both languages as LIN did, or about 70% in English and 30% in Spanish⁵⁴, but for these participants, as in most cases of heritage bilingualism the quantity of Spanish input decreased at the onset of schooling. Nevertheless, when Spanish became the weaker language after the age of three, Silva-Corvalán found that Spanish began to show incomplete development, and structural influence from English for both siblings. This was especially true for the younger brother who used English more frequently, had more reduced Spanish vocabulary, and overall made more errors (grammatical and pragmatic) in Spanish. Furthermore, Silva-Corvalán’s (2014) study focused on the same areas of grammar (the tense-aspect-mood (TAM) verb system) as her 1994 work mentioned further up in the section on sociolinguistic approaches to heritage language development, and its potential simplification across three generations of Mexican-Americans living in L.A. In sum, the two brothers’ verbal systems seemed to be affected the most by input quantity, or lack thereof. Accordingly, the findings showed that less frequent (in the adult input), but more complex verb tenses were either acquired later, or not at all by six years of age. Regarding the present subjunctive, if the younger sibling used it at around 3;6 he stopped using it altogether by six years of age, along with never developing other complex tenses in Spanish. In comparing her 2014 findings (children) with her 1994 study (adults), Silva-Corvalán concluded that the siblings TAM system is like that of other second- and third-generation Spanish-English bilingual adults that do not benefit from formal Spanish instruction. She further argued that interrupted Spanish acquisition, coupled with more intense and formal exposure to English engendered the simplification, and loss identified in the Spanish of the adult bilinguals. In other words, “Tenses that are relatively more complex, and also less frequent in the adult input, are acquired later. This has consequences in the weaker language, Spanish.” (Silva-Corvalán, 2014: 344), a

⁵⁴ In the present study, the input quantities in Spanish are slightly lower longitudinally. This may be in part explained by the fact that we have also accounted for mixed language input.

characteristic frequently attested across the proficiencies of heritage speakers. For Silva-Corvalán incomplete acquisition, and not attrition explain the developmental differences in some grammatical areas that are not as robust, for example the development of copulas. Finally, incomplete acquisition is also a salient feature of non-native ability in most heritage speakers.

With respect to the almost ideal study design of Silva-Corvalán's (2014) book, the present investigation does not focus precisely on the vulnerability of specific grammatical features as related to interrupted Spanish input. However, even if our studies are quite different, in methodological terms we too reach for an almost ideal study design in that we capture the changes of the same child (LIN), as well as the changes of her extended range of multigenerational caregivers longitudinally in English and Spanish to apprehend her use and socialization into Spanish in multiparty participation frameworks. However, due to the time limits in writing a Ph.D., the data collection was significantly shorter, and the data was only transcribed over three data points. It would thus be great to go back into the field to continue to follow LIN's bilingual developmental path into adulthood. This would be especially interesting since there have been rather dramatic socio-affective changes in her bilingual language learning environment that have touched her personally.

2.2 Novel approaches to heritage bilingualism

In sections three and four of the present chapter we covered theories of native language acquisition, followed by the main theoretical approaches to heritage language acquisition respectively. Three key theoretical paradigms were thus presented in section three. They included Universal Grammar (UG), emergentism, and variationist sociolinguistics. Additionally, five key theoretical approaches were discussed in section four, but we focused on the first three since they have produced the most research on heritage speaker populations. These included sociolinguistics, formal linguistics, and emergentism. The last two included Processability and Optimality Theory. Together, the last five frameworks sought to go deeper into issues strictly related to heritage speakers and their linguistic outcomes at the endpoints of their language development. However, how heritage bilingual children go from being novice communicators to experts in their often tension ridden linguistic communities has yet to be fully explored through multimodal, multigenerational, and bilingual approaches grounded in multiparty participation frameworks. The present section therefore starts with a discussion of the social interactionist theory. It will be followed by an overview of the language socialization

paradigm. To contribute to the burgeoning literature in this area, the present study seeks to understand third-generation heritage Spanish use and socialization through the prism of usage- and socialization-based theoretical approaches. Moreover, as we will see later in the section, these frameworks allow to account for not only the multimodal nature of bilingual language use in multigenerational action, but also for how (inter)action is embedded in and affected by the ever-shifting multiparty participation frameworks that form and disperse in the flow of conversation. These too are critical aspects that have explanatory power regarding how heritage bilingual children do, or do not get from here to there in their heritage language.

As studied further up, some approaches have remained largely focused on mental grammars. As Hirsh-Pasek and Golinkoff (1996) put it, they have an inside-to-outside perspective where language originates in the mind (inside) as a tool for thought, before becoming a means of communication (outside). Also, in general, results from these research traditions are largely based on experimental methods. Other paradigms however, even if they also focus on the grammatical aspects of language and seemingly experimental protocols, nonetheless take social-environmental variables into account to explain their findings. One of these approaches stood in opposition to the nativist UG paradigm. The emergentist theory, which is largely a nurture-based paradigm as conceived by cognitive and functional linguists

believe(s) that the intercourse between linguistics and psychology is bidirectional (Lakoff, 1987, 1990; Langacker, 1987a, 1992). In this view, linguists must base their theories on more than formal considerations; they must base them on constructs that are supported by research in the other behavioral and cognitive sciences. Consequently, psychologists and other cognitive scientists may contribute to, as well as benefit from, the construction of linguistic theories. For developmentalists, this means that we must take an active role in helping to theoretically characterize, as well as to empirically investigate, the structure of language as it is experienced by children at different stages of their ontogenies. These new approaches to language thus open up for us, for the first time in recent history, the possibility of investigating in a meaningful way the *psychology* of language and its development. (Tomasello, 1995: 153).

In Tomasello's (1995) response, or rather 20-page poignant review of Pinker's (1994) book mentioned earlier on, the agenda is set for what he suggests linguists must consider other than the formal aspects of language. In investigating how children live language in everyday life across the lifespan, cognitive and functional linguists will not only enhance, but also benefit from the construction of linguistic theories. For Elman et al. (1996), emergentist theories therefore focus on the internal *and* external mechanisms at work in the language learning process, i.e., a child's cognitive abilities *with* the characteristics of the linguistic input afforded in the language learning environment. The role of child agency is non-negligible (but also

bidirectional), if not primordial throughout their language development process. Child agency, or their desire to engage in and subsequently shape interaction will be made explicit through our qualitative analyses. Children are therefore movers and shakers in the bilingual, multimodal, and often multigenerational interactional processes in which they are immersed. They are not just innocent bystanders, or worse yet the black holes⁵⁵ of their linguistic worlds. Children are finely attuned not only to the social interactional frames as they assume varied roles such as ratified participants to overhearers, and anywhere in between (Goffman, 1974, 1981), but they are also attuned to the social-intentional cues. As such, “Usage-based constructivist theories assume that language emerges from the interaction of cognition with experience.” (Silva-Corvalán, 2014: 6) and in doing so this socialization process allows them to (re)shape their *cosmovisión* across ideological, attitudinal, philosophical, religious etc. levels.

Regarding heritage languages and their speakers then, several well-established research paradigms have delved into the grammatical particularities of heritage bilingual speakers’ linguistic outcomes. Furthermore, among the traditional research traditions that try to explain heritage language development, novel, but not new approaches to these unique heritage bilingual populations have emerged. One of these is the theory of language socialization, which came out of linguistic anthropology, and was initially based on the early work of Elinor Ochs (1985) and Bambi Schieffelin (1985). We will take an in-depth look at how these two researchers not only shaped, but also pioneered language socialization studies further below. For now, cultural practices, which encompass language use, interaction, cognition, and socialization, but also customs, social standards, food, beliefs, and pastimes are resumed as a “a form of action that both presupposes and at the same time brings about ways of being in the world.” (Duranti, 1997: 1). All these features are central to the linguistic anthropological perspective. We may therefore place language socialization not only within the broader spectrum of emergentist approaches, but more specifically within social interactionist views of language acquisition⁵⁶. This paradigm highlights the bidirectional, and often asymmetrical (novice-expert) socialization factor in the language development process. Furthermore, it also underscores a distinct methodological program, one in which researchers “attempt to use fine-

⁵⁵ I use this analogy to depict an entity that absorbs energy, or language in this case that is not recast (output) back into the interactional frameworks.

⁵⁶ I consider that Ochs and Schieffelin’s paradigm fits within emergentism because the emergence of language, and the emergence of identity are brought about by the rich social interaction in which speakers, young and old, are immersed.

grained ethnographic and sociolinguistic analyses as an empirical basis for such theoretical aims.” (Heller & Pavlenko, 2010: 79). We will read more on this further below, but it will be detailed in Chapter 3 when our methods and data are discussed. Nevertheless, this methodological approach is in opposition to experiment-based research aims. In the section below we will thus give an account of the linguistic anthropological approach, and the genesis of the language socialization paradigm. Before we do so however, we will start with a discussion of the social interactionist theory of language acquisition, and some of its main concepts.

2.2.1 Social interactionist theory

For many researchers’ multilingual communities have been ground-zero for both anthropologically and sociologically orientated investigations. Garrett (2007) for example claims that these studies have engendered important understandings regarding the various areas related to language socialization, and multilingual children. For Gal (1979) and Kulick (1992/2012) this includes the socio-interactional groundwork for how languages are maintained or how they shift within their communities of practice. Theories of language policy (Ricento, 2006/2009) have also been developed based on these findings, as well as insights into closely related issues. For example, minority language rights as May (2001) has defended, or bilingual education for Baker (2001) in work that considered the foundations for dual language instruction. We have seen throughout our literature review with examples drawn from both research and ethnographic observations that bilingual education has historically been a contentious issue in California. Its roots are grounded not only at the institutional level (public), but also at the familial level (private). Nevertheless, those who bear the brunt of public and/or private family language policy are none other than the heritage bilingual children that these (un)informed policies aim to help. The study of bi- and multilingualism through an anthropological and sociological prism is thus

increasingly concerned with addressing problems of social inequality and understanding both how power is wielded and how it is resisted. They are also concerned with exploring the complexity of the language boundaries that intersect with and form part of social boundaries of all kinds, in order to understand the role language plays in the evolution of social processes and social structures. (Heller & Pavlenko, 2010: 79).

Throughout this research project we have already touched to lesser, or to greater extents on some of the issues mentioned above. For example, a push for social justice among heritage speakers by being conscious of the terminology we, as a scientific community impose on them.

Other issues are yet to be discussed such as the researcher-participant power dynamic, and its influence not only on research findings, but throughout the investigative process. Nevertheless, we may claim that more generally these research prerogatives have been grounded on the social interactionist outside-to-inside perspective to language acquisition. They have been interested in documenting and describing languages' role at the intersection of both social processes, and structures (outside) to arrive at how, or 'how much' language has been learned (inside) by a child.

Regarding the social interactionist theory, according to Beckner et al.'s (2009) position paper, the origins of language are centered around communication, or the dynamic bidirectional process of social exchange. As reviewed earlier, this is also a position shared by Tomasello (1999/2022, 2003). Moreover, this paradigm was originally interested in the early stages of language development, contrary to nativist theories' marginalization of this line of research during this critical period of language development. In large part social interactionists' interest in early language learning emerged thanks to the work of Bates et al. (1975), Bruner (1975), and Ninio and Bruner (1978). These researchers, through observed child-caregiver social-interactional behavior determined that the driving force between children and their caregivers was children's desire, or agency not only to accomplish goals, but moreover to enter interactional frames, and become fully-fledged participants. For this to happen, two environmental, or interactional features were considered critical on behalf of the adults. The first was of course the caregiver's linguistic input, understood in quantitative, qualitative, and attitudinal terms within the framework of this project. The second key aspect was *scaffolding*, a notion that refers to how a child's learning is supported through incremental means (Vygotsky, 1934/1962). In the language socialization paradigm scaffolding

may transpire through explicit practices that express goals and instruct novices, yet vastly more pervasive is socialization through novice's routine participation in semiotically mediated practices, whose temporally unfolding structuring scaffolds and informs their experience, cuing them as to how they should initiate moves and interpret and respond to situational contingencies. (Ochs & Schieffelin, 2011: 12-13).

A section of our qualitative analyses is focused on how the adults in interaction scaffold Spanish input to support LIN's language learning. The adults are found to do so in instances where either single words are challenging to pronounce (word- and sometimes syllable-level scaffolding), as well as with longer more complex utterances in Spanish that are difficult to produce all at once (utterance-level scaffolding). Nevertheless, of particular interest to the researchers mentioned above was what children were interested in, and how adults (re)oriented

the focus of their linguistic input to better help them learn, i.e., through scaffolding. For example, Tomasello and Farrar (1986) by investigating joint attentional frames accounted for how children more easily come to learn new object names when both participants (child and adult) are focused on the object being named. In the present study we will consider how LIN, and her multigenerational interactional partners are sometimes focused, and sometimes not on the objects in question as they navigate through their multiparty participation frameworks. Thus, in moving away from analyses of only child-adult dyads to triads, and beyond the present work makes the leap, and merges the fields of language acquisition, and language socialization through its rich qualitative analyses. We may be able to determine if joint attention, in line with Tomasello and Farrar allows LIN to use and to learn the Spanish terms provided to her through child-directed input since it may be reinforced, in some cases, by the multiplicity of multigenerational adults in the interaction.

According to the social interactionist paradigm, and more specifically to Tomasello's (2003) usage-based approach of language acquisition, joint attentional frames are part of the many general learning mechanisms that promote language learning. In other words, "Learning language does not require a specialized innate ability, such as the Universal Grammar, but instead depends on the ability to understand that others have independent thoughts and motivations" (Poll, 2011: page numbers omitted on online paper). Moreover, as proposed by Bruner (1975), and Tomasello and Kruger (1992) language learning is also dependent on the ability to accurately deduce language related patterns that are anchored in routine social interactions. From a linguistic anthropological perspective, we may thus conceive "language as a social tool and speaking as a cultural practice" (Duranti, 1997: 1). This view also implies that deficits in these socio-cognitive skills, for example in cases of severe autism, may negatively affect language development (Tomasello, 1999/2022). Further up we briefly considered the irreversible, and damaging impact that a deprivation of social interaction, or cultural practice and thus linguistic input had on an American and on a French feral child. While it is unclear if these children were cognitively impaired from the onset, Abbeduto et al. (2006) have found that deficits in these abilities may negatively impact language learning. To underscore the issue of cognitive deficits at the crossroads of language learning I turn your attention to a digital journal entry that I made on August 22nd, 2018. It took place between me

and ALE, LIN's aunt only two days upon arrival in the field and we talked about IGN's⁵⁷ challenges with autism. I write:

That same night we discussed IGN's issues related to autism. IGN's tests show that he is around 1,5 years behind cognitively. This is evident in his general demeanor socially and linguistically. From a cognitive, usage-based linguistic perspective it is interesting to see how (if) delayed/stalled cognitive development in bilingual settings is also detrimental to bilingual language development. In other words, how speech is critically related to cognition and the analytic mechanisms that drive acquisition, understood as the process of linguistic development from babbling to first words, to constructions and on to grammaticalization. A few hours of interaction with him could be interesting from this point of view, but also to see how parents and other caretakers in this extended family adjust linguistically when they interact with him. (Alvarez, 2018).

In the evening we had been discussing GOY's, IGN's older sister (and LIN's older cousin) curious way of using the Spanish term 'agua' (water) to refer to watermelons, but this will not be the object of discussion at present. Our conversation subsequently turned to talking about IGN's diagnosis with autism and how his exam results showed that he presented a cognitive delay that put him 1;5 years behind his chronological age. In my observation I also noted that this was clear from a social and linguistic behavioral point of view (according to my non-expert eyes). Furthermore, in aligning with a usage-based perspective I questioned whether a bilingual language learning environment would further impact this delay. Finally, I commented that it would be interesting to see how the multigenerational speakers in multiparty participation frameworks would adapt to his socio-cognitive abilities. Nevertheless, from the observation above, and in line with Abbeduto et al. (2006) language learning did seem to be impacted by IGN's cognitive deficits. On the other hand, IGN's socio-cognitive situation required that his bilingual and multigenerational family members adapt their interactional practices with him. This includes LIN. Not only is she getting a rich amount of input from this bilingual, multigenerational, and multiparty interactive framework, which is quite special to her hybridized Mexican culture, she is undoubtedly deploying multimodal strategies as she carefully, but dynamically engages in interaction with her younger cousin IGN. A closer look into my data to find these interactional moments will likely yield fruitful results in the future.

Nonetheless, language acquisition theories provide compelling points of departure to study not only native i.e., monolingual acquisition, but also cases of (delayed) heritage bilingual acquisition. Moreover, heritage bilinguals may be readily investigated through the

⁵⁷ IGN was briefly introduced on several occasions. He figured in the family tree in the Introduction. IGN is ALE and RIC's second child (GOY is their first).

social interactionist paradigm since a substantial amount of research has found that these children typically do not meet the early milestones in grammatical domains such as syntax and morphology. Like language impaired children, heritage bilinguals follow the same language development path as their typically developing peers (Dollaghan, 2004; Rescorla & Roberts, 2002), but are thought to be delayed in certain aspects. Thus, we may ask what the social interactional implications are on these linguistic delays considering that the social interactionist school places a prime on environmental influence. A novel approach anchored in this school of thought is the language socialization paradigm. It will be presented next through a historical overview to see how it has been consolidated with the language acquisition paradigm.

2.2.2 Language socialization & Language acquisition: A historical overview

According to Ochs and Schieffelin (2008), the relationship between language socialization and language acquisition has been traditionally split by disciplinary boundaries. However, “one face of language socialization research orients towards language acquisition, the other towards linguistic anthropology.” (Ochs & Schieffelin. 2008: 7). Anthropological and sociological fields of study have focused on the latter, and psychological schools of thought on the former. Furthermore, for Bloom (1970), Brown et al. (1969), and Slobin (1969) developmental psychology has been keenly interested in both the phonological and the grammatical abilities of children. The young child is equipped with the capacity (at neurological and psychological levels) to emerge as a skilled, or competent speaker within their community of practice, and this along the lines of developmental advancement. As we have discussed in detail throughout this chapter, linguistic competence since the late 1960’s has been a contested issue in language acquisition research. For formal linguists (Chomsky, 1965; Pinker, 1994) linguistic competence is innate, whereas for cognitive-functionally orientated linguists such as Snow (1972, 1995) and Tomasello (2003) it is also a question of innate cognitive abilities in social interaction with the input to which a child is exposed. Snow (1972) made this clear from her findings just about 50 years ago in her article. In it she highlighted that the idea that input quantity and quality were independent from language acquisition needed to be revised. Nevertheless, independent, but complementary questions were underscored in socialization research which focused on “the necessity for children to acquire the culturally requisite skills for participating in society, including appropriate ways of acting, feeling, and thinking.” (Ochs & Schieffelin, 2008: 3), and as such,

linguistic anthropologists see the subjects of their study, that is, **speakers**⁵⁸, first and above all as **social actors**, that is, members of particular, interestingly complex, communities, each organized in a variety of social institutions and through a network of intersecting but not necessarily overlapping sets of expectations, beliefs, and moral values about the world. (Duranti, 1997: 3).

However, for Mead (1934), and Parsons (1951), the socialization process was for the most part not concerned with the linguistic resources available to children and adolescents in foundational, cross-cultural anthropological studies. Thus, the socio-cultural core of how children developed their communicative systems essentially remained un- or underexplored, and the disciplines that focused on these paths to knowledge (Ochs & Schieffelin, 2008) remained divided.

It was not until a group of researchers composed of anthropologists, linguists, and psychologists at the University of California, Berkeley that these once isolated disciplines started working together. Their collaboration gave rise to *A Field Manual for Cross-cultural Study of the Acquisition of Communicative Competence*. Slobin's (1967) comparative research program was thus conceived to study language acquisition that was not only influenced, but also enriched by two other well-known scholars. The notion of the *speech community* was therefore framed as a unit of analysis following Gumperz's (1968), and the idea of *communicative competence* following Hymes (1972a) was also entertained. Communicative competence following Duranti (1985), and Hymes (1972a, 2005) is to be understood as

the realm of sociocultural knowledge necessary for members of a speech community to use language in socially appropriate ways. Integral to communicative competence is members' ability to participate in "speech events," that is, socially recognized activities that occur in specified situational settings, involving participants performing one or more socially relevant acts using communicative resources in conventionally expected ways to achieve certain outcomes (Ochs & Schieffelin, 2008: 4).

Our qualitative analyses will also show how LIN, in socially recognized activities uses language mixing to take the floor in multigenerational and multiparty interaction to attain her interactive goals. Language mixing in the family is a conventional communicative mode used by all the bilingual adults in the family. However, it is also used by the monolinguals though to a lesser extent. We thus see how LIN's bilingual communicative competence emerges in socially, and culturally appropriate ways. Furthermore, in linguistic anthropological research, Hymes' (1964) ethnography of communication engendered fieldwork to investigate the interface between "the facets of cultural values and beliefs, social institutions and forms, roles

⁵⁸ Bold font is used in the original work.

and personalities, (and the) history and ecology of a community” (Hymes, 1974: 4), and the communicative forms and functions of a speech community’s linguistic repertoire. As such, “From the late 1960s through the 1970s, the cross-cultural study of children’s developing communicative competence began to take empirical shape.” (Ochs & Schieffelin, 2008: 4). The 1967 field manual therefore guided ethnographies of communication and accounted for the linguistic, social, and cultural communicative development in children and disciplinary divisions were bridged. Moreover, this is how interest in children’s discourse competence as studied by Ervin-Tripp and Mitchell-Kernan (1977), as well as the field of “developmental pragmatics⁵⁹” as studied by Ochs and Schieffelin (1979) took center stage and subsequently paved a path to the research field known today as language socialization.

2.2.3 On the emergence of language socialization

The field referred to as *language socialization* was proposed upon returning from their longitudinal fieldwork where children’s language acquisition was studied among the Kaluli people located in Papua New Guinea for Schieffelin (1985), and among the people of Samoa for Ochs (1985). Language socialization as a paradigm addresses the two main, and interrelated areas of social and cultural development that may be succinctly described as “language learning and culture learning.” (Guardado, 2018: 34). Moreover, both linguistic anthropological and psycholinguistic approaches including their issues related to child language development informed this theoretical approach. Throughout their investigations in the field

each researcher assumed responsibility for (1) systematically collecting and analyzing a corpus of young children’s spontaneous utterances recorded at periodic intervals and (2) documenting the sociocultural ecology of children, including prevailing and historically rooted beliefs, ideologies, bodies of knowledge, sentiments, institutions, conditions of social order, and practices that organize the lifeworlds of growing children within and across social settings. (Ochs & Schieffelin, 2008: 4-5).

For Ochs and Schieffelin then, two critical aspects set language socialization apart as theoretical inquiry. The first is related to “an analytic focus on speech, writing, gestures, images, music, and other signs as primary means and endpoints of the socialization process”, and the second is related to the data collection method. That is, “an ethnographic sensibility that accounts for the socializing forces of these semiotic resources in terms of enduring and

⁵⁹ This area of study “addresses the interactional and discursive context of and precursors to children’s acquisition of syntactic and semantic structures along with the development of children’s discursive and conversational competence.” (Ochs & Schieffelin, 2008: 4).

shifting sociocultural meaningful practices, events, situations ... relationships etc.” (Ochs & Schieffelin, 2011: 10-11). This Ph.D. intentionally aligns with both of these theoretical, and methodological aspects. The fruits of the study come from analyzed mono- and bilingual data containing not only speech, but also gesture, music, household artifacts etc. that were collected ethnographically, and longitudinally in a multigenerational household where multiparty interaction was more the rule than the exception. Acquiring a language, or languages is therefore anchored in and part of being socialized to be a proficient group member in fluid, yet stable contexts that are often ridden with tension, and as we will see next, engender linguistic and cultural transformation. It is argued that

Through language use we also enter an interactional space that has been partly already shaped for us, a world in which some distinctions seem to matter more than others, a world where every choice we make is partly contingent on what happened before and contributes to the definition of what will happen next. (Duranti, 1997: 5).

We too align with this conception of language use in a pre-defined, but always-shifting interactional environment. As such, one of the aims of the present investigation as shown in Chapter 4 through 10 distinct analytical parameters is to account for some of the characteristics of LIN’s bilingual language learning environment as tied to her linguistic input and output. For example, one parameter includes accounting for the language(s) of previous utterance(s). This measure may help shed light on LIN’s communicative choices in heritage Spanish, English, language mixing, or on her emerging, and perhaps fleeting passive Spanish bilingualism as expressed through bilingual conversational practices with both bi- and monolingual Spanish speakers. The process of language acquisition is not only stimulated by neurodevelopmental, or cognitive effects, but it is also motivated, for better or for worse, by the infinite and unique multimodal, and multigenerational socialization practices and ideologies that peoples within their cultures and multiparty participation frameworks readily materialize and (try to) transmit. Said differently, “children learn the language variety and the distinctive ways of speaking of their linguistic community.” (Guardado, 2018: 34). Our quantitative measures supported with their visual illustrations will thus show how or if LIN’s linguistic output resembles that of the adult input in her family. Moreover, through our qualitative analyses we will see how LIN responds, multimodally to the oral, gestural, visual, and other semiotic resources in her bilingual language learning environment. We will see how LIN in the present investigation adapts to or is adapted to the unique bilingual practices in *her* multigenerational community of practice. Indeed, “Language is a great force of socialization, probably the greatest that exists” (Mandelbaum, 1949: 15). This affirmation is attributed to Sapir’s classic 1933 article

Language, that later appeared in the *Selected writings of Edward Sapir in Language, Culture, and Personality*. Nevertheless, it is an affirmation that has stood the test of time. For example, Hymes (1964) also defended it 30 years later, and over 40 years after that, it was also sustained by Duranti (1997, 2003, 2004) in several of his publications. Finally, now nearly 100 years after its initial publication we will see once again how language is indeed probably the greatest force of socialization of all time through a multilingual, multimodal, multigenerational, and multiparty approach to heritage Spanish socialization.

Undoubtedly, the aim of language socialization research is child-centered. That is to say that children's verbal, but more broadly speaking multimodal interactions are analyzed not only for their linguistic regularities, but crucially that they are analyzed as "socially and culturally grounded enactments of preferred and expected sentiments, aesthetics, moralities, ideas, orientations to attend to and engage people and objects, activities, roles, and paths to knowledge and maturity" (Ochs & Schieffelin, 2008: 5). For example, our qualitative analyses will show how LIN is oriented through multigenerational talk in interaction how to behave both in terms of her gender, but also with respect to her age. Moreover, according to Heath (1983), these expectations are largely framed around, and assessed by family, friends, and the extended range of institutional actors at the community level as we have seen further up in examples drawn from research, literature, personal comments, and anecdotes from the participants of the present dissertation. Nevertheless, this too will continue to be highlighted in our qualitative analyses. The expert mono- and bilingual adult speakers in her family through their discursive multiparty practices will attempt to shape LIN's understanding of hierarchy, linguistic knowledge, food, play, and what is considered good, and bad behavior according to their hybridized Mexican culture. In this light, the pre-fabricated, but ever-shifting language learning environments, such as household arrangements, or more broadly speaking the speech communities in which children are immersed both afford and inhibit language socialization practices. As such,

Children's linguistic and social competence has been viewed as a dynamic system of development, but, in light of the social and cultural heterogeneity that prevails across the world's communities, language socialization research holds that (1) languages and communities are themselves undergoing transformation, (2) children's linguistic and cultural production is influenced by this transformation, and (3) children themselves contribute to this transformation. (Ochs & Schieffelin, 2011: 14).

The critical idea here is the notion of transformation regarding social and linguistic competence in a world that is by nature like a richly colored mosaic composed of diverse elements that

nonetheless organically fit together. It is within this ever-shifting, but seamless convergence of sociocultural differences that children’s socio-linguistic lives are planted like seeds, and thus where their communicative abilities sprout. But how may transformation be defined? Transformation may be viewed as “a complete change in the appearance or character of something or someone, especially so that the thing or person is improved” (Cambridge Dictionary Online, accessed July 22, 2022). Moreover, the assessment that socio-cultural heterogeneity is a vector for said transformation, or a change in form, nature, or appearance is made more explicit in zones of linguistic and cultural contact. Improvement in this sense is related to the empowered lives that emanate through the socially and linguistically complex lives of its speakers. It is precisely within these liminal spaces in constant change, referred to here as *third spaces*, or within the framework of this study as a *tercera Hispanidad* that heritage speakers’ languages thrive, survive, or die, but *Si le grain ne meurt*⁶⁰? (If the seed does not die?). Must the seed, in this case a heritage language pay the price of death to live? The answer is perhaps a categoric no. Transformation, whether cultural or linguistic, may be understood as improvement, or it may at least be apprehended in a positive light, *komorebi*, to that which is original. Carlos Fuentes (1958/2000) in *La región más transparente*⁶¹ (The most transparent region) proposes his vision of originality. He advances that

Lo original es lo impuro, lo mixto. Como nosotros, como yo, como México. Es decir: lo original supone una mezcla, una creación, no una puridad anterior a nuestra experiencia. Más que nacer originales, llegamos a ser originales: el origen es una creación⁶² (Fuentes, 1958/2000: 196)⁶³.

Originality for Fuentes is therefore mixture, a blend, or cultural and linguistic hybridity that cross-fertilizes each other and re-creates originality. He further argues that this is not only his case, but the case of Mexico, and by extension the vast number of Mexican-Americans (and

⁶⁰ This is the title of the French Nobel Prize winning writer André Gide’s autobiography published in 1924. The title alludes to the last of four canonical gospels in the New Testament where for him, a seed that does not die is like living life in solitude, whereas a seed that does transcend, bears bountiful fruits.

Si le grain ne meurt was also the object of study for my M.A. dissertation in French language and linguistics over a decade ago where I considered the issue of connotation, or what was inferred “between the lines” through lexical analyses.

⁶¹ This was the first novel that launched Fuentes into the Mexican literary scene, and thus establishing him into the Latin American boom.

⁶² This footnote was in the original publication and stated that “El origen, la originalidad cultural y el sentido de la historia son algunas de las preocupaciones de la “filosofía de lo americano” (México fue el país rector en esta tendencia del pensamiento).” (The origin, cultural originality and the sense of history are some of the preoccupations of the “philosophy of American-ness” (Mexico was the leading country in this line of thought) – My translation.

⁶³ That which is original is impure, mixed. Like us, like you, like Mexico. That is to say: originality implies a mixture, a creation, not a state of purity that precedes our experience. More than being born original, we be-come original: origin is a creation – My translation.

other hyphenated-Americans in my eyes) who live, thrive, and survive in the sometimes not so hospitable contact zones that thus engender original versions of themselves. As a result, this highly fertile process constantly, and endlessly feeds into the feeling that “eu sou um outro” (I am another). For the Portuguese writer, literary critic, and translator Fernando Pessoa⁶⁴ this may suggest that everything that the human being is, and exudes is but a mark in the margin, since in the future (both immediate and long-term), we may no longer be, or do. But what are these zones of contact that we speak of, and that we have incessantly evoked throughout our discussion? For Pratt (1991), *zones of contact* are the prime sites where the linguistic and cultural lives of many (if not most) children and adults’ takes place. Zones of contact are thus defined as

Social and cultural formations (that) enter a long term, often permanent state of crisis that cannot be resolved by either the conqueror or the conquered. Rather the relationships of the conquered/conqueror, invaded/invader, past/present, and before/after become the medium out of which culture, language, society and consciousness get constructed. That construction ... involves continuous negotiation among radically heterogeneous groups whose separate historical trajectories have come to intersect; among radically heterogeneous systems of meaning that have been brought into contact by the encounter; and within the relations of radical inequality enforced by violence. (Pratt: 1996: 6).

In other words, “most communities are characterized by heterogeneity of linguistic and cultural practices” (Ochs & Schieffelin, 2011: 14) that are wedged in an often violent, and frequently permanent state of crisis, or a sort of linguistic and cultural purgatory if you will. It is thus through this socio-cultural, and socio-linguistic friction that identities are negotiated, forged, and emerge. Moreover, social, and linguistic communities in their oscillation between fluidity and stability experience language shift, change, and even more dramatically, language death. Therefore, the experience of heritage bilinguals and their heritage languages may be apprehended through the prism of heritage language socialization as they are earthed, like seeds, in multigenerational, and multimodal multiparty participation frameworks. Heritage speakers are expected “to use the heritage code that displays them as suitable moral persons” (Ochs & Schieffelin, 2011: 16). It is a vision to which heritage bilinguals are subjected (and to which they subject themselves) by a utopian heritage culture. He advances this argument in the first of “10 hypotheses to describe and predict the key variables responsible for HL development” (He, 2011: 595) that she has put forward in her research on heritage Chinese. The assumption states the following:

⁶⁴ Fernando Pessoa is often described as one of the figures in the literary scene of the 20th century with the most significant impact. Pessoa is also often considered as one of the greatest poets in the Lusophone world.

(1) *The rootedness hypothesis*. The degree of success in CHL development correlates positively with the learner's desire to be rooted in his or her heritage culture and to accentuate similarities with members of the CHL community. This explains why CHL students in university CHL classes often claim that they disliked taking Chinese lessons when they were young and did not have the desire to remain connected with their family background whereas, now that they are fully grown and ready to embrace their cultural heritage, they are eager to learn CHL seriously. (He, 2011: 595).

In the next section we thus turn to the emergence of language socialization research that places heritage speakers and their languages at the center of their investigations.

2.2.4 Heritage language socialization

Whether they know it or not, heritage speakers struggle to keep, or to reject the minoritized linguistic and cultural versions of themselves across the lifespan. However, "like many (heritage speakers) caught in zones of contact ... (they) often manage multiple, morally conflicting selves and loyalties." (Ochs & Schieffelin, 2011: 17). To do so heritage speaking children and adults across the multigenerational spectrum rely on at least two means. First, and when they can, they dig into their hybridized linguistic and cultural capital that comes both from the *Mother/land*⁶⁵ and from the host country to construct their original, or hybridized selves at the crossroads of mixed history, ancestry, home, and language of course, as Lima (2021) depicts in her collection of provocative polyvocal⁶⁶ poetry. Second, as many scholars acknowledge, they emerge through the "bi- or multidirectional process in which not only novices but also more experienced community members are being socialized by mutual engagement in language ... practices." (Duff, 2008: xv). Language socialization inquiry though relatively recent in heritage language communities has focused on how languages and cultures in industrialized countries are maintained, or how they shift.

For example, of the many diasporic Spanish speaking communities in the U.S., one that has been investigated includes Zentella's (1997) study of Puerto Rican children growing up

⁶⁵ This collection of experimental poetry merges English and Portuguese. In its questioning of translation and transformation it is thus focused on language, and the intersection of motherhood and immigration, as well as how these aspects impact a speaker's rapport to space, others, and the self, i.e., identity.

Ananda Lima is a linguist turned poet that I met as an undergraduate at UCLA. As a Ph.D. Candidate in linguistics, she was responsible for further teaching syntax to a smaller cohort of the seminar, of which I was a part.

⁶⁶ In ethnographic writing and research question development, polyvocality is defined as the use of many different voices, and as such allowing the reader to be more intimately involved with the text. Polyvocality is also important in anthropology as it encourages these researchers to be more transparent when presenting not only their research methods and data, but also the multiple levels of analyses starting from the literature review, and on to the more quantitative, and qualitative measures.

bilingual in New York. This work is regularly cited in the literature (Guardado, 2018) and it is now not only a modern classic, but it also helped establish heritage language socialization as a line of research. The second study includes Baquedano-López's (2001) work which described the narrative activity in a doctrine class of Mexican children in Los Angeles. The interface of language socialization and linguistic shift has been analyzed in other diasporic groups in the English dominant U.S. context as well. Fader (2001) for example studied a Hasidic Jewish community through the prism of literacy, bilingualism, and gender. He (2001, 2004) on the other hand centered her work on language ambiguity, and identity construction in the Chinese heritage language classroom. The language socialization paradigm has the potential to provide socio-culturally enlightened analyses of the continuity of heritage speakers' languages over developmental space and time (He, 2006). From this approach they are "Analyses illuminating how religious and heritage language institutions, along with familial units, support and amplify sociohistorically rooted language and cultural practices, attempting to draw children into an identification with a community of speakers." (Ochs & Schieffelin, 2008: 11). The acquisition of language repertoires, or linguistic forms including their functions, along with tightly interknitted, complex, and ever-transforming environmental dimensions engendered by the multiplicity of multigenerational speakers is what is involved in heritage language learning. The following section thus continues the discussion around heritage language socialization as an emerging area within language socialization research.

The 1980's and 1990's saw the emergence and development of the language socialization paradigm. But the 2000's was when L2, along with minority, and bilingual language socialization research opened a space within this theoretical approach (Guardado, 2018). Studies in this new line of language socialization inquiry were typically found in edited collections. A few examples include Bayley and Schecter's (2003) *Language Socialization in Bilingual and Multilingual Societies*, Zentella's (2005) *Building on Strength: Language and Literacy in Latino Families and Communities*, and Duff and Hornberger's (2008) *Language Socialization: Encyclopedia of Language and Education Volume 8*. However, Duranti et al.'s (2011) edited volume entitled *The Handbook of Language Socialization* which we have already referred to here is an exhaustive collection of language socialization studies. Moreover, this nearly 700-page volume is organized into five main sections. They include 1) Interactional Foundations, 2) Socialization Strategies, 3) Social Orientations, 4) Aesthetics and Imagination, and 5) Language and Culture Contact, all of which are relevant to the present investigation. However, the fifth section in particular covers significant work that has been vital to the

emergence of heritage language socialization as a research paradigm. The table below briefly summarizes the foundational contributions of part five along with their authors.

Table 11: Part V on Language and Culture Contact in *The Handbook of Language Socialization*

Title of contribution	Author
Language Socialization and Language Ideologies	Kathleen C. Riley
Language Socialization and Language Shift	Paul B Garrett
Language Socialization and Immigration	Patricia Baquedano-López & Arian Mangual-Figueroa
Second Language Socialization	Patricia A. Duff
Heritage Language Socialization	Agnes Weiyun He
Language Socialization and Language Endangerment	Angela M. Nonaka
Language Socialization and Language Revitalization	Debra A. Friedman

Part five is thus composed of seven key articles, and He's in particular is centered around heritage language socialization. Therefore, we may safely advance that heritage language research, across the multiple dimensions noted above has been around for at least a decade, but "it was not until recently that it started to be labeled this way." (Guardado, 2018: 47). Moreover, we may consider that Agnes He led the way in heritage language socialization studies on a couple of grounds. First, He states that "In the past 10 years, my work has centered around delineating the complexity of HL socialization along temporal and spatial dimensions, with a focus on CHL (Chinese heritage language)." (He, 2011: 594). She has devoted her work to "such a fledgling area that there are many more unknowns with respect to HL development." (He, 2011: 587). Second, He has focused on Chinese heritage language research. This is therefore in line with the recommendation that scholars should aim to research languages and cultures with which they are familiar. This is a topic that we touched on previously, but that is further developed next (Chapter 3), and which shows how I too align with the prerequisite to engage in this type of ethnographically orientated research. Nevertheless, according to Guardado (2018), the term "heritage language socialization" was not indexed in any publications in the Google Scholar database. It was only in Duff and Hornberger's (2008) *Language Socialization: Encyclopedia of Language and Education Volume 8* that the term was first employed. Indeed, it was in He's (2008) contribution entitled *Heritage Language Learning and Socialization* where she outlined heritage language socialization as a distinct type of research endeavor. Of course, other early uses of the term may be traced back to Guardado (2009), Delgado (2011), He (2012), Minami (2013), and Tsushima and Guardado (2015) which

together suggest an increasing interest, at least in the North American context, in studying heritage populations from the language socialization perspective.

A different type of socialization research, or inquiry into heritage language socialization opens new avenues to explain how heritage bilinguals get from here to there (that is, at any point along the bilingual continuum). However, unraveling the many unknowns also creates many challenges. The difficulties found in L2 socialization as shown by Morita (2000, 2004) are not necessarily encountered in contexts of L1 socialization. In this light, heritage language socialization heightens these complexities since it brings together features of both L1 and L2 socialization. Heritage language socialization contexts may also bring together multigenerational families where multimodal interaction is anchored in multiparty participation frameworks as is the case in the present investigation. Throughout her substantial amount of work on heritage language acquisition, Montrul (2016) has also underscored the fact that heritage speakers are somewhere between monolingual speakers, and second language learners. Thus,

attempting to develop a single model of HL socialization may not be a sensible objective. Yet, because of the growing recognition of the language socialization paradigm as a powerful and adaptable approach that is compatible with HL research questions, scholars interested in HL issues are increasingly adopting this framework in their work, and in the process, are contributing to the further expansion and conceptualization of language socialization more generally. (Guardado, 2018: 47).

We see then that both from a heritage language acquisition (mentioned earlier on), as well as a heritage language socialization perspective scholars agree that there is no real need to create a model specific to heritage bilinguals. As is, heritage language socialization research is making significant contributions to the theorization of language socialization. Moreover, as the language socialization paradigm is enhanced, it subsequently helps strengthen heritage language socialization inquiry in a sort of symbiotic relationship. This same kind of feedback loop is also attested in heritage acquisition research that informs, and is subsequently informed by theories of native, and bilingual language acquisition. Therefore, a great deal is learned about heritage language socialization through the analyses of naturalistic talk-in-interaction in everyday life. Furthermore, as discussed earlier in the chapter on the three factors that affect bilingual language development, the third point was related to language attitudes, and identity construction. Indeed, “cultural identity plays a key role in the HL socialization, development, and maintenance.” (Guardado, 2018: 48) process. The issue of identity is thus a critical area that supports its development.

The language socialization paradigm (Schieffelin & Ochs, 1986a) has the power to reveal how through the everyday social interactions that children encounter, they construct their social identities. In this sense, as emphasized throughout this chapter, language socialization and language acquisition are interwoven and inseparable processes. That is to say that while language acquisition accounts for the development of communicative skills typically at the grammatical level and in child-mother dyads, it does not account for “the process of identity formation that language learning entails.” (Guardado, 2018: 48), and with the extended range of multigenerational communicative partners. It is in this way that language socialization contributes a missing, but valuable link. This paradigm can show how children as non-experts along with their multiple communicative partners mutually, and multimodally construct each other as fully-fledged members within their unique, but always transforming communities of practice in multiparty participation frameworks. We may therefore claim that 1) heritage language socialization apprehends the intricate processes of how heritage languages are used, maintained, or how they shift, in their ever-shifting multiparty and multigenerational participation frameworks. Furthermore, that 2) through multimodal interaction heritage language socialization at the same time allows for the intense investigation of “the identity development and concomitant interactional complexity and conflict this often entails.” (Guardado, 2018: 48). It thus becomes clear why the founding mothers of the language socialization paradigm concluded that “A twist in the interface of language learning and socialization into identity construction is the phenomena of heritage language socialization” (Ochs & Schieffelin, 2011: 16).

Heritage language socialization research has also shown much like Ochs and Schieffelin (2011) that at the heart of becoming both a communicatively competent, as well as an accepted community member is an extremely sophisticated, but seemingly seamless process. Furthermore, this developmental process for the novice, but also to a certain degree for the expert (since linguistic and cultural influence is bidirectional) depends on adhering to the ideologies that are prized within the often-multigenerational community of practice. This is indeed the case in heritage language socialization contexts, and of course in the innumerable other settings where languages are in troubled, and fuzzy contact zones. Nevertheless, these deeply-rooted beliefs, values, ideologies, sentiments, as well as a language’s worth, and how they are practiced including with whom, in what contexts, when, and how they are used are transmitted implicitly (Ochs & Schieffelin, 2011). Furthermore, a great deal of this implicit transmission takes place within the private family sphere, and in particular during dynamic

family dinners where multigenerational interlocutors (par)take, give, and share in multimodal, and multiparty interaction. Therefore, below we will present how family dinners, or more generally speaking, family mealtimes are a rich site for language socialization studies.

2.2.5 Language socialization & Family dinners

Tomasello's usage-based approach to language acquisition suggests that "It thus takes many years of daily interaction with mature language users for children to attain adult-like skills" (Tomasello, 2003: 2). Moreover, as we have discussed in depth, the language socialization paradigm (Ochs & Schieffelin, 1982) shows how children become competent members within their communities of practice through the language used around them, as well as through the language that they are expected to use themselves. Mealtime is therefore an ideal site to observe these daily interactions in which children are in the process of becoming through, and by language. Mealtime, or the meal environment within the framework of this study "refers to the context within which a meal takes place and the interaction between the different elements of a meal (e.g. portion size, meal organization into courses, eating the same dish, talking about food, etc.)." (Kremer-Sadlik et al., 2015: 85). Our study will also reveal how the multigenerational adult caretakers engage with LIN both in Spanish and in English with the aim of getting her to use Spanish on certain occasions, and on others to simply acquiesce to her requests. In these multimodal moments food is the object of attention. By asking her what certain dishes are, through meal preparation, or even by suggesting that some plates, or drinks are too spicy, or too hot we thus see how heritage Spanish socialization around these elements come together, in dyads, triads, and even multiparty interactional frameworks. Therefore, in considering mealtime practices within the multigenerational family, this study draws upon both constructionist, and social interactionist theories.

This approach is in line with a substantial number of ethnographic studies that have investigated mealtime activities, where interweaved issues related to home, work, and relationships in middle-class American families are brought to light. For example, in their groundbreaking investigation, Ochs and Kremer-Sadlik (2013) are credited with having conducted the biggest ever anthropological study, which stands out in that it is remarkably inquisitive, offering an unprecedented, and unparalleled peek into the lives of modern-day American families. The foundations of this pioneering work were laid by Ochs et al. (1996) nearly two decades prior. Indeed, for many researchers (Ochs & Taylor, 1992; Blum-Kulka,

1997; Sterponi, 2003; Paugh, 2005; and Kremer-Sadlik et al., 2015) mealtime is a rich site where children are socialized into their community's cultural values, norms, and we may add where they are socialized into their heritage languages, and thus emerge as linguistically competent members across cultures, countries, and continents. In Europe for example, Morgenstern et al. (2021) investigated socialization into multiparty interactive practices. In doing so, this group of researchers seeks to understand who talks to whom about what in French family dinners. The present study is in direct line with the ongoing work of my Ph.D. director, Dr. Morgenstern⁶⁷, and her team of linguists.

Moreover, during the first years of language socialization, mature language users, typically the immediate family members are responsible for managing the routine activities that revolve around food. Weisner (2002) has argued that routine activities centered around mealtime are fruitful when it comes to investigating family habits, and by extension children's developmental pathways for three central reasons. First, meals are generally meaningful to all the members of a family from the youngest to the eldest. Second, meals are where values, and objectives are substantiated and as a result shape culture. Third, for the researcher, observing meals is relatively straightforward with the added advantage that the observations may be further discussed in subsequent interviews as needed. Nevertheless, I must mention that observing, or recording mealtime activities may be a relatively easy task. It could simply be a matter of placing a camera in a discrete location and letting it roll. However, as it will be explained in detail in the next chapter, transcribing this type of data, at least in the present multigenerational family where multiparty participation frameworks were the rule, was extremely difficult and time consuming. This was mostly related to the incessant flow of bilingual language practices, as well as to the number of participants in the highly dynamic interactive social encounters.

Nevertheless, many well-known researchers in the field of bilingualism agree that “the family is the primary socializing agent for the development of BFLA.” (De Houwer, 2009: 7), and thus stress as Lanza (1988, 1992) has the importance of the quality and quantity of input

⁶⁷ The focus of my work is also in line with the ANR project Dinlang that Dr. Morgenstern coordinates. ANR stands for Agence Nationale de la Recherche (National Research Agency) which has funded the project between 2021-2025. The Dinlang project through ethnographic methods “aims to capture how semiotic resources (speech/sign, gesture, actions) are coordinated to construct meaning through the language practices transmitted to and used by children during French family dinners.” (Aliyah-Morgenstern.com, accessed August 26th, 2022: <https://aliyah-morgenstern.com/projects/>).

and interaction in bilingual first language acquisition. The influence of the family as the primary source of language socialization has intrigued scholars in fields spanning not only linguistics, but also sociology, psychology, and anthropology. We thus learn that children, for example through the course of food related activities “Along with the language, they learn the cultural practices, attitudes, ways of thinking and feeling and behaving that are embodied in the interactional environment in which they are immersed.” (Brown & Gaskins, 2014: 187). Understanding the influence of social interaction, or the socialization processes into language and culture cannot and should not be ignored when studying language socialization, especially at such critical moments such as mealtime since along with acquiring language, children also learn the many important social skills that are necessary to everyday life. Thus, it is important to understand that language abilities as well as the non-linguistic social skills develop together in an intertwined, interdependent fashion which is not different from a heritage language socialization perspective. In other words,

It becomes more complex when language socialization is expanded to include bilingual and multilingual communities with rapid culture change or recent culture contact. In such cases, socialization through language forms expands to include code-switching, language shift, syncretism, and other phenomena associated with contact between two or more languages and cultures (Kulick, 1992; Schieffelin, 1993; Rymes, 2001; Garrett and Baquedano-López, 2002, Bayley and Schecter, 2003; cited by Brown & Gaskins, 2014: 204).

A multitude of authors therefore suggest that studying language socialization in bilingual contexts, or contact zones as previously mentioned is richer, and perhaps increasingly multidimensional because language and culture is inherently transformational (Tomasello, 1999/2022) in multigenerational settings. Children in going through the process of language socialization must learn not only two (or more) languages as they become bi-lingual and bi-cultural. However, these researchers further suggest that language contact also engenders new, or hybrid linguistic and cultural modes for example code-switching, which we refer to here as language mixing. As a result, this adds yet another dimension to the process of language socialization that takes place in the family during their multiparty mealtimes. Within the context of my dissertation, LIN is being socialized in an English and Spanish speaking multigenerational bilingual family that has lived in the U.S. since the late 70’s. While her primary caregivers are second-generation bilinguals, LIN is also in constant contact with other family members who only speak Spanish. Nevertheless, it will be interesting to see how this relatively recent linguistic and cultural contact has impacted the family’s bilingual and

multimodal language practices at the dinner table⁶⁸, and if LIN, through socialization during these food related activities will acquire other modes of communication for example language mixing. Finally, since mealtimes are very often multimodally intense, three interrelated, and interactionist-based models will help structure our thick qualitative analyses. The first one which we will see below pertains specifically to language, understood here as in oral communication, and the role of the parental discourse strategies in the process of heritage language socialization.

2.2.6 Language socialization, Parental Discourse Strategies, & Language mixing

Input and pragmatic strategies at the family level have been at the center of bilingual language acquisition research for a while now. Moreover, according to a recent conceptual review, “Elizabeth Lanza was the first to present a comprehensive analysis systematically addressing socialization patterns regarding language choice in conversations between a bilingual parent and a bilingually raised young child.” (De Houwer & Nakamura, 2021: 31-32). From this perspective the aim has been to better understand “the effect of these strategies on the successful establishment of productive family bilingualism.” (Juan-Garau & Pérez-Vidal, 2001: 59-60). Results of these studies have often depicted a complex picture. Establishing harmonious bilingualism at the family level is indeed a challenging feat which is amplified for a couple of reasons. First, it is because communities may naturally speak the societal language far more, and across more domains than the parents’ minority language. Second, the immediate caretakers may represent the only sources of input in the minority language. In this sense, both the quantity and quality of heritage language input examined earlier are greatly reduced. Nevertheless, the issue of input and pragmatic strategies at the family level have been the object of study from two distinct, but complementary approaches.

In the first place, input patterns of exposure have been investigated with the finding that simple exposure to more than one language, even if it follows a consistent pattern, does not necessarily appear to guarantee active bilingualism. Consequently, researchers have turned their attention to a second line of research, namely the study of parental discourse strategies, and suggested a number of ways in which the parents’ interactional styles can influence the bilingual acquisition process. (Juan-Garau & Pérez-Vidal, 2001: 60).

In this investigation active bilingualism refers to the development of at least the spoken and the written modalities in the heritage language. Furthermore, the present work aligns with the

⁶⁸ A dinner table here is to be defined as a table where meals are consumed and served, typically in the dining room area of a dwelling. Also, these meals may be served at any time of the day such as for breakfast and lunch.

second perspective, or with the idea that parental discourse strategies are determining factors in both the language acquisition and the language socialization process of both languages. With the permission of Lanza going back to 2015, De Houwer and Nakamura (2021) refer to Lanza's analytical framework as the "bilingual family interaction model", or the BIFIM, but we will refer to it here using Lanza's original denomination, namely: Parental Discourse Strategies. Furthermore, the use of both languages also implies language mixing in multigenerational interaction. Indeed, Ochs and Schieffelin (2006) have argued that mixed language use, and the use of each language separately should be studied not only along with the development of communicative competence, but also through the prism of language socialization.

Lanza (1992) in her study investigating whether Norwegian-English two-year olds were capable of code-switching underscored the need to account for children's linguistic (oral) reactions to their parents' discourse strategies. Indeed, her bilingual family interaction model based on parental discourse strategies "was developed for children who acquire two languages (Language Alpha and Language A) simultaneously in the home from birth (Bilingual First Language Acquisition or BFLA)." (De Houwer & Nakamura, 2021: 32). 30 years after Lanza's work, the present study asks how LIN is using heritage Spanish, and in doing so considers her use of English, language mixing, and passive bilingualism since they too are her additional modes of communication which are difficult to tease apart in interaction. The picture regarding how to establish productive bilingualism is complex. Therefore, accounting for how LIN uses her full range of semiotic resources is essential. Furthermore, LIN's reactions are in large part based on the discursive strategies of her extended range of multigenerational communicative partners. While they naturally include her parents, they also include her aunt, uncle, grandparents, great-grandparents, and even her great-uncle. Moreover, this investigation also accounts for LIN's reactions multimodally, an interactional aspect that remains unaccounted for in the model. In other words, we consider not only what she says, but how what she says is accompanied, and even enriched through her gaze, gesture, stance, as well as her other bodily movements. The issue of multimodality will be developed in the next section. Notwithstanding, Lanza (1992) initially presented "a highly systematic framework for the analysis of parental discourse strategies and their bearing on children's mixing" (Juan-Garau & Pérez-Vidal, 2001: 61) which she subsequently refined (Lanza, 1997). The table below summarizes the five parental discourse strategies in bilingual settings that Lanza advanced that may be placed "on a continuum from 'monolingual' to 'bilingual'." (De Houwer, 2009: 134). Moreover, the

discourse strategies are organized from the most monolingual at the top, to the most bilingual at the bottom of the table.

Table 12: Five parental discourse strategies in bilingual settings adapted from Lanza (1997: 261-269) & from figure 2.1 in De Houwer and Nakamura (2021: 33)

Strategy type	Description
Minimal Grasp Strategy (MGS)	Through the MGS, the parent, or caretaker essentially relies on the child to repeat a repairable utterance, but in the heritage language. This is achieved by asking the child in the heritage language to “Say that again.”, or simply by saying “I don’t understand.”. The goal here is for the child to respond in the heritage language, and thus align to the parental request in the heritage language.
Expressed Guess Strategy (EGS)	Through the EGS, the parent as opposed to the child repairs, or reformulates through translation the utterance in the heritage language. This is achieved by asking the child directly, or indirectly a question in the heritage language, for example “Did you want to say ball?”, or “A ball?”. The parents thus translate what they thought the child intended to say. The goal here is to get the child to respond to the request in the heritage language.
Adult Repetition Strategy (ARS)	Through the ARS, the parent repeats the child’s utterance in the heritage language. However, unlike the EGS above, this is not achieved through a question and therefore does not call for an answer on behalf of the child. Nevertheless, it has been noted that “some children may in turn repeat the parent’s repetition in Language A.” (De Houwer, 2009: 135), or in this case the heritage language.
Move On Strategy (MOS)	Through the MOS, “the parent merely continues the conversation, exhibiting comprehension of the child’s use of the other language.” (Lanza, 1997: 265) although this strategy is difficult to pinpoint. Moreover, here the parent’s bilingual identity is made clear unlike in the strategies above. Finally, within the framework of this investigation this strategy may be at the root of bilingual conversations, that as a result engender and even encourage passive bilingualism. In other words, one is “producing the one language and the other comprehending the other language.” (Lanza, 1997: 266).
Language Switch ⁶⁹ Strategy (LSS)	Through the LSS, when the child mixes languages, or produces an utterance in the dominant language, the parent either mixes languages as well, or switches to the dominant language. In other words, the parent does not continue using the heritage language.

The table above thus nuances the five parental discourse strategies that we may place

on a continuum depending on the degree to which the role of a monolingual or bilingual is highlighted. That is, the parent’s use of one strategy or another can open negotiations for a monolingual context or a bilingual context, or an interaction that is *more monolingual* or *more bilingual* in quality. (Lanza, 1997: 267).

On the one hand, the MGS and EGS may be thought of as encouraging children into monolingual discourse, or to speak the language in which they are addressed by their parents. On the other hand, the ARS is somewhat trickier in that it is not necessarily a bi- or monolingual strategy.

⁶⁹ Following De Houwer (2009) I too rendered the strategy type “Code Switch” to “Language Switch” since depending on the theoretical perspective the term “code switching” may have a vast range of differing meanings.

Indeed, repeating in the heritage language what the child has uttered in the dominant language may have various functions. For example, it

can be taken as (1) a correction of child language choice (a monolingual strategy), (2) a confirmation of the contents of an utterance (neutral as to language choice), or (3) a teaching strategy showing children what their utterance translates as (also neutral). Because of its ambiguity, AR is neither a monolingual nor a bilingual strategy (De Houwer & Nakamura, 2021: 33).

Moreover, with respect to parental discourse strategies in bilingual families “parents develop various specific strategies to respond to their children’s mixed utterances.” (Juan-Garau & Pérez-Vidal, 2001: 61), but not only. For example, bilingual strategies may include the MOS, or the continued use of the dominant language despite the child’s use of the heritage language. The LSS is another bilingual strategy where the parents switch to the other language, or even partake in language mixing. As we will see in the present study, LIN’s parents, and other caretakers may occasionally deploy different discursive strategies to encourage her to speak heritage Spanish as a response to her English use. Furthermore, through these dynamic multiparty encounters we will revisit the notion of the bilingual continuum, and how it re-emerges which is, as we have noted throughout this work omnipresent. Not only has Shuy (1977b) argued that this notion is fundamental in sociolinguistic investigations, but Grosjean (2000) has also presented compelling proof for a circumstantial continuum in bilingual settings. That is, interactional arrangements “in which bilinguals finds themselves in a monolingual or bilingual context, speaking to monolinguals or bilinguals.” (Lanza, 1997: 268). Nevertheless, these strategies guide the course of children’s bilingual language development. For example, Saunders (1988) suggested that his discourse strategies influenced his children to avoid lexical transfers. Moreover, both Saunders (1988) and Taeschner (1983) reported pretending not to understand their children’s use of the dominant language where the aim was for them to repair their utterances in the minority language. We too will see in the qualitative analyses how at times the adults may blatantly pretend not to understand when LIN addresses them in English in an effort to get her to use heritage Spanish.

Within the framework of this Ph.D., we will focus on the role not only of the input, but also of the parental discourse strategies in multigenerational heritage language socialization and acquisition. However, we are fully aware that they form “only part of the totality of discourse strategies parents use in interaction with their children.” (De Houwer & Nakamura, 2021: 33). Concretely, we will analyze the dynamic, bilingual, and multimodal interaction between LIN, her parents, and her extended range of caregivers from a pragmatic, multiparty

perspective. We will account for LIN's reactions to the parental discourse strategies, as well as for the parental reactions to LIN's use of her full range of semiotic resources with a focus on her use of heritage Spanish. In doing so, we will aim to ascertain a link between "parental consistency in language choice when addressing the child and the latter's readiness to abide" (Juan-Garau & Pérez-Vidal, 2001: 62) to these strategies in naturalistic bilingual and multimodal interaction. Thus, in the next section we will review what we mean by multimodality and why accounting for it is critical in language related social-interactional studies.

2.2.7 Language socialization, Bilingualism, & Multimodality

Investigating the use of and socialization into heritage Spanish in longitudinal, naturalistic, and multigenerational data is an exceptional site for a multimodal approach in bilingual language socialization and acquisition. In a case study on the relation of the gesture-speech of a French-Italian bilingual child's language development, researchers found that "the necessity to enter two languages at once might have an influence on the management of the visual-gestural and the auditory modalities." (Benazzo & Morgenstern, 2014: 172). Along their path to becoming competent speakers the study of speech in coordination with gesture, along with other rich semiotic signs allows to outline the developmental trajectory of children's multimodal abilities (Morgenstern & Beaupoil, 2015). Two key reasons lend themselves to investigating the speech-gesture interface. First, we know that a bilingual, and thus bicultural upbringing engenders novel linguistic practices such as language mixing. Therefore, we may assume that "gestures (that are) used by bilingual children are derived from two semiotic systems ... (and) could therefore be more diversified." (Benazzo & Morgenstern, 2014: 172). Second, we know that in most cases growing up bilingual leads to unbalanced bilingualism. The development of a dominant, and a weaker language is the result of uneven exposure. The irregular distribution of languages in the bilingual language learning environment also lends itself to language mixing phenomena. Therefore, aspects such as the number, and type of gestures used in harmony with the verbal modality might be different or hybridized for example when compared to other bi- and monolingual children who are the same age. The present study is not comparative in this regard, so LIN's gesture-speech productions will not be compared to other bi- or monolingual speakers her age. Rather, we will focus on how the coordination of gesture with speech helps support her communicative efforts in bilingual, and often multiparty

interaction. Especially, as she is socialized to use heritage Spanish during the three periods (February 2018, August 2018, and January 2019) of language development under study.

Nevertheless, asymmetries in LIN's bilingual language development might have a distinct impact in her gesture production. Furthermore, there may also be salient quantitative⁷⁰ and qualitative differences in her use of gesture and speech. However, this study through its thick analyses will only consider the qualitative features of LIN's, as well as of her adult family members' gesture-speech synchronization in interaction. We may thus ask what are these socially learned modes of communication? To share meaning across interactional frames, a diverse range of modalities are combined. They include as we know verbal productions, but also "Gestures, ... signs, gaze, facial expressions, postures, (and these) are all part of our socially learned, communicative system." (Benazzo & Morgenstern, 2014: 173), and most of which will be addressed in the qualitative analyses (Chapter 5 and 6). Furthermore, in adult interaction the use of body language, or visible bodily actions as utterances as Kendon (2004) has suggested when synced with speech are firmly bounded in alternating, or interdependent fashion. Therefore, to examine how children come to use language in general and become bilingual in particular "one must examine the broader context in which they experience events and interaction. (Since) Gestures, (and) verbal productions ... are all part of our socially learned, inter-subjective communicative system." (Morgenstern & Beaupoil, 2015: 437). Indeed, if children's bilingual verbal productions are their renditions of adult language, so too are their gestural productions. Thus, analyses of the visual-gestural and the auditory modalities must be anchored in their bilingual, multigenerational, multimodal, and multiparty participation frameworks. This concludes the second interactionist-based model that will help structure our qualitative analyses. The present chapter thus ends with a discussion of participation frameworks, or the third and final integrative model that may help shed light on multigenerational heritage language socialization.

⁷⁰ Due to the complexity of managing the bilingual data in this study, only the child's and adults' oral productions were transcribed, and coded on CLAN. Therefore, it was impossible to quantify her use of gesture with speech. In retrospect, this may be a drawback of the present study. However, the initial aim of the study, despite my research director's insistence to also consider gesture, gaze, etc., was to focus on LIN's oral productions. It was only after selecting the videos and carrying about the first qualifications that it became apparent, thanks again to Aliyah's feedback that the multimodal interactional aspect could not be left out from the analyses.

2.2.8 Language socialization & Participation frameworks

We have previously learned that heritage language socialization is a relatively young field of study. Heritage language acquisition, maintenance, and shift has been around since the 40's thanks to Fishman's work, and language socialization as a paradigm emerged in the mid 80's thanks to Ochs and Schieffelin. However, these two fields only merged in the early 2000's. Since then, the formal and functional aspects of heritage language socialization have been documented through a steadily growing body of empirical studies. This increasingly large body of research has also suggested proposals for future research. For example, He (2000), Byon (2003), and Lo (2004) underscored that accounting for formal settings like schools will help us better understand heritage speakers and their languages. Throughout our literature review we have considered some of the school-related challenges that emerge at the family, and the social-political levels. Moreover, in informal settings, community and language practices at the individual, and family level are also indispensable to our understanding of heritage bilinguals (Bayley & Schechter, 2003; Park, 2008; Xiao, 2008). Along this line, accounting for the extended range of multigenerational family members is a privileged locus of study precisely because it has the potential to yield fruitful results. He for example in her chapter entitled *Heritage Language Socialization* states that

Heritage language socialization research also needs to expand its focus from individual language learners to other co-participants. It will be important to realize that expert guidance in HL socialization may be multiple, conflicting, and contested. The HL learner is engaged in multiple speech events in multiple settings for multiple purposes. The learning of an HL, for example, takes place through the learners' interactions with multiple participants including language instructors, parents, grandparents, siblings, and peers, each of whom positions the learner in unique speech and social roles and each of whose reactions and responses to the HL learner help to shape the path of his language development. (He, 2011: 594).

We see then that future heritage language socialization studies have the potential to underscore the inherently interactive, and co-constructed essence of the activities in which heritage bilinguals are immersed. A shift in focus from the child-mother dyad, traditionally the locus in language acquisition research, to triadic and multiparty interactional social encounters, the site of language socialization studies should produce enlightening results (see Morgenstern et al. (2021) for a discussion). Ochs (1988), Ochs and Schieffelin (1984), and Schieffelin (1990) through their pioneering language socialization studies have underscored the link between children's language learning environments and the intricacy that participation entails. Nevertheless, as previously insisted, it is through these tension ridden, complex, and hybrid

contact zones that experts guide novices, but also where novices influence expert speakers (King & Fogle, 2013). Our qualitative analyses will reveal how multiple participants may come together, dissipate, and come back together again throughout the course of a multigenerational interaction in some cases with the aim of encouraging LIN to speak heritage Spanish. In other cases, we will see how the experts' desire for LIN to use heritage Spanish may be a source of tension, resistance, frustration, and even conflict for all the participants involved. Therefore, to apprehend heritage language socialization in its co-constructed richness as anchored in its multimodal, and multiparty communicative environment this final section will discuss Goffman's (1974, 1981) notion of participation frameworks. This third interactionist-based model may better help us untangle the multimodal nature of heritage language socialization "along dyadic (triadic) or multiparty interactional arrangements ... relevant to early language socialization as well as to children's organization of attention and participation in learning and apprenticeship situations." (De León, 2011: 81).

Our understanding of the underpinnings of social interaction may be enriched by Goffman's idea of participation frameworks. In essence, it makes evident the fact that face-to-face social encounters are not limited to one speaker, and one hearer. The roles and rules for the producers and receivers of visual-gestural and the auditory information is far more complex, and this includes the varying levels of participation. Therefore, to analyze these types of dynamic communicative encounters, especially when there is a multiplicity of speakers, we may turn to the participation framework following De León (2011) as the unit of analysis. This model, as it will be discussed here assumes that different speakers participate in different ways in social gatherings. Moreover, the term participation as it is referred to here includes "actions demonstrating forms of involvement performed by parties within evolving structural talk" (Goodwin & Goodwin, 2004: 222). Furthermore, as it concerns children, previous research has shown that novices may learn language through the various participation roles available to them for example as (uninterested) addressees, or as attentive, (thoughtful) overhearers. De León (1998, 2012), Demuth (1986), and Sidnell (1997) among many others have further shown that children may be prompted and thus embedded as speakers in triadic and multiparty interactions. In our study we will show how LIN takes the floor as an active participant in her multigenerational social encounters, but how she is also attuned to the discourse in her bilingual language learning environment. In both roles, LIN assimilates the language used to and around her to break into interaction. We will also see how through their multimodal discourse

strategies her parents and caretakers prompt her to speak heritage Spanish, and thus embed her in the ever-shifting interactional frames.

In sum, Goffman’s notion of Participation Frameworks

highlights the interactive work in which *both* hearers as well as speakers and other participants engage. Analysis of language socialization and acquisition as processes lodged in participation frameworks reveals:

- 1) The child as an active participant occupying different participatory roles in multiparty interaction.
- 2) The central role of multimodal semiosis (e.g. gaze, gesture, body, and touch) beyond just vocal language in the language acquisition and socialization process.
- 3) The primacy of action and activity as the locus of the socialization process. (De León, 2011: 82).

Moreover, it is important to stress that participation frameworks unfurl across space and time, and that interactional frames, as well as participant roles are also changing across the temporal dimension. Finally, Goffman has deconstructed the participatory encounter along many levels. However, the table below will summarize the key concepts of his participation framework as used in the present investigation.

Table 13: Key concept of Goffman’s Participation Frameworks adapted from Erving Goffman’s Analysis of Participation Frameworks (2020⁷¹)

Type of interaction	Definition
Focused	This is an interaction with one central aim, and where the participants’ roles and rules are strongly defined. Moreover, an activity that derails from the central purpose of the interaction is considered a distraction.
Unfocused	This type of interaction, contrary to the one above does not have a central purpose per se. The notion of distraction is therefore absent since there is no central purpose from which to digress.
Participant Status	Definition
Ratified	The notion of ratification determines whether one was officially included in the interaction. That is, in any social interaction, and primarily in focused ones, some participants are ratified giving them access to the floor and authorizing their right to speak.
Unratified	The unratified participants on the other hand may be observers, or passers by. In this participant status, they technically do not have formal access to the floor, and as such the right to speak.

⁷¹ There are no page numbers on the website (Erving Goffman’s Analysis of Participation Frameworks, accessed on August 26th, 2022: <https://www.howcommunicationworks.com/blog/2020/12/24/erving-goffmans-analysis-of-participation-frameworks>).

Participant Roles	Definitions
Speaker ⁷²	This is the main production role. That is, it is the participant who is mainly doing the talking in the interaction.
Addressee ⁷³	This is the main reception role. The addressee is the participant who is officially addressed in the interaction. That is, the recipient of the message.
Overhearer ⁷⁴	The overhearer falls within the unaddressed role. Simply put, these are individuals who can (over)hear what is being said whether the conversation is private, or not.

A social encounter by definition brings people together and involves them in diverse joint activities. We may thus gather from above that social interactions may be characterized along two dimensions, or those that are focused, from those that are not focused. Before starting each of our qualitative analyses, we will determine whether the ensuing interaction has a central goal, or not. This dimension is important to account for since unfocused interactions have the potential to lend themselves to weaving in and out of different topics, or to switching activities say from preparing a meal to spontaneously repeating or reformulating what a child has just uttered in the heritage language with the new aim of helping them use it. Focused activities may not afford these types of digressions.

The second point related to participation is the notion of interactional ratification. Through this concept, we may more easily draw distinctions between the various people involved in the interaction, and furthermore, their participant role. Also, it must be made clear that an unratified participant status does not mean that one may not participate. It does mean however that their participation is not ratified. In other words, unratified participants typically do not have, or have limited chances to engage in the interaction at hand and this is the most crucial point about the ratification status. Unratified participants who decide to take the floor may be called out by the other ratified speakers, and as such their contribution may be deemed less valid than that of the ratified speakers. At the start of each analysis, we too have pre-defined the ratification status of the participants. Of course, given that interactions unfold

⁷² For Goffman the production role may be further refined beyond the speaker. He suggests three 1) the animator, 2) the author, and 3) the principal. In this study we will refer to the animator role as the speaker. Also, this will be the only production role that we will entertain in our qualitative analyses.

⁷³ Much like in the production roles above, Goffman also describes a couple of reception roles beyond the hearer. He includes 1) the addressee, and 2) the unaddressed. In this study we will limit the reception role to the addressees.

⁷⁴ However, the unaddressed according to Goffman may be further refined to 1) the overhearer, and 2) the eavesdropper. In this study we will limit the unaddressed role to the overhearer.

temporally, these statuses are adjusted on an ongoing basis. Nevertheless, we too will see how LIN ratifies herself into adult conversations. In some cases, she seems to gain ratification status. However, in others she is called out not necessarily because she was an unratified speaker (though she was apparently an overhearer), but because her contribution referred to previous talk that took place in Spanish which teasingly, the ratified bilingual adult suggested that she did not understand. LIN's contribution is thus disqualified due to her presupposed lack of linguistic abilities in Spanish, but perhaps it is a sort of parental discourse strategy to get her to speak Spanish.

Finally, beyond thinking of participation in social encounters in terms of two main roles i.e., speakers and listeners Goffman nuanced several more roles. However, we will limit our discussion to one production, and two reception roles. On the production end we thus have the speaker, or the person who produces the words. Moreover, on the reception end we have the addressee, and the overhearer. The former is officially addressed in a given conversation. Moreover, addressees are typically ratified in an interactional frame though they do not have to be. Those in the latter role are not addressed and not ratified, but they may overhear, and as such they may even be keenly attuned to what is being said around them. This makes the overhearer status particularly interesting. Clark (1996), and Hindmarsh and Pilnick (2002) advanced that the overhearer participant status has not been sufficiently studied. Furthermore, for Lieven (1994) overhearing plays a significant role in children's language learning process, especially in cultures where adults infrequently address them through child-directed speech, or "when communication is not child centered." (De León, 2011: 84). De León summarizes that cross-cultural overhearer participation arrangements demonstrate that

(1) Infants may develop a participatory competence occupying different positions in the participation framework without necessarily being focal addressees.

(2) The participant status of 'overhearer' relativizes the putative centrality of the speaker (primary caregiver) and hearer (infant) dyadic interaction, with child-directed speech as the sole guiding force of language learning.

(3) Overhearing may play a more central role than acquisition theories recognize. It affords children with other learning skills such as observation, attention, inference, and participation long before they learn to speak. (De León, 2011: 84).

Our analyses will also attribute a speaker, an addressee, or an overhearer role to the participants before beginning each of the qualitative analyses. Moreover, by applying the participation framework as a unit of analysis, the present longitudinal investigation of multigenerational third-generation heritage Spanish socialization and acquisition will contribute insight to the

understudied role of the overhearer in multiparty family-centered social encounters. Through the various qualitative analyses, we will see how LIN as an overhearer, and whether she is spatially near or far, is finely attuned to what is being said in her bilingual language learning environment. These peripheral interactional occasions will show that she is attentive to what is being said, and perhaps more strikingly, how she builds on overheard Spanish input to move to the center of interaction (Lave & Wenger, 1991). They will also show how her interactional agency will subsequently influence the adults' language choices as well as the course of the interaction. They may also provide evidence to support the findings that child-directed speech though perhaps more qualitative in nature is not the only guiding force behind her acquisition of heritage Spanish. Finally, our qualitative analyses may show that even if there is not much Spanish output on LIN's behalf in terms of words, the bilingual and bicultural multigenerational, and multiparty participation frameworks are sufficiently rich such that they nevertheless help build LIN's unique linguistic and cultural identity, and this cannot be measured by the amount of heritage Spanish she produces. In other words, beyond gaining grammatical competence LIN is developing communicative competence. Through these examples we will thus see that even though LIN is not always the focal addressee, she is nevertheless developing both participatory, and communicative competence in her pre-fabricated, but always shifting hybrid interactional space, or *tercera Hispanidad*.

CONCLUSION

Chapter 2 was composed of two main sections that centered around heritage languages and heritage speakers, and around interactionist-based theoretical approaches to heritage bilingual populations. The first part began by laying the foundations in the field of heritage linguistics. A review of the literature thus pointed to Joshua Fishman as the founding father (since the 40's). Due to his groundbreaking, but also to his substantial amount of work in language maintenance, shift and loss in marginalized communities, it may be argued that he laid the groundwork in the field nearly 80 years ago. Then, in discussing heritage speakers and heritage languages we found a countless number of definitions for both. However, the specific term 'heritage' originated in Canada, which in part explains why it is most widely used in North America even if it is gaining ground in Europe. Notwithstanding, these denominations were also motivated by researchers' various questions, interests, and even backgrounds. However, our study adopts Valdés' definition of heritage speakers since it best captures the lived experiences of heritage Spanish speakers growing up in an English dominant context in the

U.S. Next, we briefly covered the contentious socio-historical classification of heritage languages. But first, six key questions were thought to help characterize heritage speakers and their languages. Nevertheless, in terms of classification, Spanish in the U.S. may be considered both an immigrant and a colonial language. We then focused on the three-generation rule which proposes that language shift from the minority language is often complete by the third generation of speakers in a given population. Moreover, in this section we also proposed the GIDS, an eight-stage tool to help establish the degree of threat to a language. While this model is helpful, we found that the stages may overlap in certain areas thus making it somewhat challenging to apply, but they are still pertinent to studies like the present one. In the next part we discussed that a shift from the widely used notion of incomplete acquisition to divergent grammar was important for reasons related to social justice, namely as related to the speakers being investigated in this type of research. Given the definitions and characterizations above, the section ended with a discussion related to how native heritage speakers are. We thus presented through a series of studies various characteristics of both high and low proficiency heritage speakers where the latter nevertheless constitute the norm.

The second section of Chapter 2 started by suggesting a move to a novel, but not new interactionist approach to heritage bilingualism. After briefly summarizing the theories of native, and heritage language acquisition previously presented, we advanced that a usage-based framework, coupled with an interactionist-based paradigm grounded in linguistic anthropology may yield fruitful results in researching heritage bilinguals' linguistic development in multigenerational settings. The social interactionist theory is believed to be particularly well adapted for studying bilingual communities. Moreover, we found that the interactionist and emergentist paradigms complement each other which is critical since we draw on both theoretical assumptions, as we advanced in detail, throughout the present investigation. Next, a historical overview showed how language socialization and language acquisition research, traditionally segregated came to fruitfully work together. Furthermore, we highlighted how these two complementary areas may bring much needed insight to investigations of heritage language use and transmission. We then discussed how language socialization as a field of inquiry emerged thanks to the founding mothers Elinor Ochs and Bambi Schieffelin. Their pioneering research in the mid-80's thus allowed for the field of heritage language socialization to come about nearly 20 years after their initial paradigm proposal. Heritage language socialization as a strand of research may therefore be attributed to Agnes He who focused on heritage Chinese. The final four sections allowed us to further delimit our qualitative analyses.

First, we discussed the importance of anchoring our analyses on family dinners. Then, one method and two models that were used to organize our analyses were examined and explained by highlighting pertinent examples. The first model includes the Parental Discourse Strategies which may encourage bilingual children to more monolingual or more bilingual language use. The second model is based on the Participation Frameworks. It allows for a better understanding of the underpinnings of social interaction. Not only does it underscore the fact that social encounters are not limited to one speaker, and one hearer, but it also establishes the roles and rules for the producers and receivers of visual-gestural and auditory information, this also includes the varying levels of participation for each speaker/(over)hearer. Finally, multimodal analyses as a method aims to give a richer picture of how the family members use their plurisemiotic resources in interaction. Analyses that do not consider the multimodal nature of interaction would simply not be complete.

Through the review of the literature spread across seven main discussions in Chapter 1 and 2, one of our goals is to better apprehend LIN's bilingual language learning environment. After presenting the data and methods next in Chapter 3, these socio-linguistic characteristics will be quantified in terms of the input and the output for each of the concerned family members in the case study in Chapter 4. The second goal of the literature review is to apprehend how LIN is socialized to use heritage Spanish with her multigenerational family members and in multiparty participation frameworks. Thus, Chapter 5 and 6 with their thick qualifications will show how LIN uses heritage Spanish across these varied contexts. Furthermore, we will consider her, as well as her family members' language use multimodally, and account for how Spanish is interwoven with the use of English, language mixing, and in dilingual conversations. It is in these dynamic interactional moments that LIN may show her emerging passive bilingualism which depend on her interlocutors' level of bi- or monolingualism, but also on the participation frameworks in which these social encounters are grounded.

3 Data & Research Methods in Bilingual Settings

INTRODUCTION

So much is happening, so much language it's impossible to capture it all. (Alvarez, 2018).

Chapter 3 presents our data and research methods that align both with the sociolinguistic approach to bilingualism, as well as with the language socialization paradigm. To set the tone for what is to come, I begin with the observation above made in my digital journal only 13 days in the field, or on September 8th, 2018. In one short note it shows how only two weeks into the data collection phase of the present investigation it became clear to me that everything that was said in these ever-shifting multigenerational and multiparty social interactions would not be caught. There was just “too much” language going on in the bilingual language learning environment to fathom that recording it all was even possible. This very real, or rather daunting observation aside, the sociolinguistic paradigm (Duranti, 1997) favors quantitative methods in the study of language and society. It also considers social factors as critical aspects of the language development process. Furthermore, for Duranti (1997) language socialization, which stems from linguistic anthropology favors qualitative methods, and therefore allows for these social factors to come together through interactionist-based social analyses. These two areas of study are tightly related, and “Among the disciplines in the social sciences and humanities that study communication, sociolinguistics is the closest to linguistic anthropology ... (and) looking back at the history of the two disciplines, it is sometime difficult to tell them apart.” (Duranti, 1997: 13). This investigation will thus present both quantitative measures as well as thick qualitative analyses in the ensuing chapters. To see how we achieved these results, we will discuss our research methods and data.

Chapter 3 is made up of five main sections. They underscore the research protocol, which is in large part ethnographic, and used to capture, transcribe, code, quantify, and later to qualify aspects of LIN and her family's naturalistic communicative practices longitudinally as they are rooted in her bilingual, multimodal, multigenerational setting in multiparty participation frameworks. Our methods will thus allow us to identify and generate quantitative measures that account for 10 distinct factors thought to influence and to predict harmonious bilingual language development. These 10 points of inquiry will subsequently be presented and analyzed in Chapter 4. They will also be supported with visual illustrations. Moreover, as suggested above, our mixed methods will allow us to pinpoint and subsequently qualify LIN's use of Spanish, English, language mixing, and her passive bilingualism as they were tied to the sociocultural, multimodal, and often multiparty social interactions. We will see how these

dyadic, triadic, and multiparty moments are always in flux at the interactional level, and how they provide her with varied, and dynamic opportunities not only to build her communicative competence, but also to construct her hybrid identity. These analyses will be presented and discussed in depth in Chapter 5 and 6.

The first section of this chapter begins by presenting some of the challenges and approaches to documenting data in bilingual communities. This includes a brief review of the primary tools used to collect the data. The second section shows why longitudinal case studies of multigenerational families are important for the collection of both linguistic and biographical data. One key argument is related to the baseline language issue and how the present data collection method helps circumvent this monolingual bias. Section three then stresses the need for plurilingual corpus creation which are not very common in our linguistic communities. The section goes over how the bilingual data in the present study is managed and prepared for the bilingual transcription phase of the present project. This section also presents the transcription hardware (CLAN) and the coding conventions (CHAT). Section four considers social and linguistic aspects tied to the process of transcribing and coding bilingual data, as well as the use of additional tools (Excel) to quantify and create visuals. The last section on ethical issues underscores some of the relevant challenges regarding the present research project. It also aims to anticipate issues that may emerge when it comes to the dissemination of the results. A short conclusion summarizes the chapter and then briefly introduces Chapter 4, which draws our attention to the quantitative measures of LIN's bilingual language learning environment that the methods in this chapter allow us to produce.

3.1 Documenting bilingual language practices

Conducting fieldwork in bilingual settings to capture multigenerational language use, transmission, and bilingual, or heritage language socialization practices has challenged linguists interested in analyzing naturalistic multimodal interaction. One critical issue is how to document the dynamic language practices at the individual and at the social level when “individual variability is a hallmark of heritage speaker groups” (Montrul, 2016: 165). Of course, more generally speaking variation is the hallmark of the human species (Heyer, 2022). Nevertheless, from a linguistic perspective variation often refers to the rich array of grammatical variation found in adult heritage speakers. Even if language learning is a life-long developmental process whereby young language learners accumulate linguistic modifications

along the way (Tomasello, 1999/2022), traditionally heritage grammars are considered to have reached an “end point” in the acquisition process as we learned in the literature review. Nevertheless, different social and linguistic experiences as tied to the often tension riddled contact zones, for example the lack of formal schooling in Spanish, engenders a wide range of bilingual language practices, and with it, linguistic variation that is often examined through a grammatical perspective. In this study, I extend the notion of individual linguistic variation to three additional, social aspects of language use.

First, I attempt to go beyond the sole study of a heritage language’s internal, or grammatical characteristics as pointed out earlier. As we saw in Chapter 1, this is essentially the affair of formal linguistics who see language as innate, and who place little importance on input and language variation. Instead, we go outwards as emergentists, and interactionists do. We are interested in variation as it is expressed through the complete use of bilingual speakers’ language repertoires. We thus seek to capture the complete set of linguistic practices of LIN and her caretakers in their multigenerational complexity. Their multimodal and bilingual practices include the variable use of heritage Spanish, English, and language mixing, as she interacts with different bi- and monolingual adults in various, often multiparty interactional frameworks. Additionally, we consider passive bilingualism, or the passive use of language. That is, the ability to comprehend, but not to produce language as a means of communication, and an expression of linguistic variability by heritage speakers (Polinsky & Scontras, 2019). In her book, Suzanne Romaine (1989) introduces the field from a sociolinguistic and psycholinguistic perspective. She describes a passive bilingual as a person who “might ... have no productive control over a language but be able to understand utterances in it. In such instances linguists generally speak of ‘passive’ or ‘receptive’ bilingualism.” (Romaine, 1989: 10). For other researchers like Hockett (1958: 16), a passive mode of communication, or interaction may also be described as ‘semibilingualism’. In the present investigation, the term passive bilingualism will be used even though it may be argued that this type of communication is an active⁷⁵ form of linguistic exchange. Second, we attempt to apprehend how bilingual variation is expressed through the multigenerational adults’ language socialization practices regarding LIN’s use of heritage Spanish. One of our goals is thus to assess how the adult, or

⁷⁵ It can be understood as an ‘active form’ at the cognitive level, meaning that activity is nevertheless taking place as the listener is processing the input. For example, through joint attentional frames which according to Tomasello (2003) is an innate cognitive mechanism that plays a key role in the language development process where the child is focused, thus active.

parental discourse strategies discussed in Chapter 2 impact third-generation heritage Spanish use and transmission in dyadic, triadic, and multiparty participation frameworks. Finally, we also consider the role of linguistic variation in the bilingual language learning environment, or the linguistic soundscape (De Houwer, 2009), and how it is subject to longitudinal fluctuations. We may also propose the term multimodalscape, or even multisemioticscape as an alternative that helps explain that the input and output, or the sound that is measured, is the product of the interplay between all the other semiotic means used by the family members (A. Morgenstern, personal communication, August 14th, 2022). Nevertheless, the term linguistic soundscape will be defined and discussed in the next chapter. In this light, we may ask: In the study of multigenerational heritage bilingual socialization and acquisition where a broad range of bilingual practices unfold, how is individual, social, and environmental linguistic variation best captured for qualitative analyses and quantitative measures?

Wurm (1999) advanced that cases of societal multilingualism (or bilingualism), made up of the ensemble of bilingual speakers (who display individual linguistic variation) are the norm. Those cases of individual monolingualism, contrary to popular belief, are the exception. Nevertheless, the belief that there are more monolingual speakers than there are bilingual speakers as discussed in Chapter 1 has impacted more than just how bilingualism is defined. It has had a resounding impact on data collection methods, and as a result, on the corpus creation process for sociolinguists, or linguistic anthropologists seeking to do ethnographic research in urban bilingual settings for the former, and in smaller scale societies for the latter (Duranti, 1997), which are often rural, or even remote. For example, if we consider phenomena related to zones of language contact, a common sociolinguistic situation that engenders language mixing, we learn that this form of talk is frequently regarded as marginal (Nicolai, 2007) at best, and insignificant at worst. For emerging child bilinguals, language mixing is thought to be fleeting, or minor epiphenomenon that eventually disappear as mastery of the languages being acquired increases. However, we may ask how language mixing evolves in cases where only one of the languages, usually the societal, dominant language develops normally? Furthermore, we may ask: In certain communities, are children inadvertently socialized into language mixing through adult discourse strategies, or simply through the mixed language speech they hear in the bilingual language learning environment? And in the case of the frequent use of bilingual language practices by multigenerational speakers, how is heritage Spanish transmitted and subsequently used by the younger generation of speakers? Yet another question is: What role does language mixing play in the spontaneous, and often multiparty

participation frameworks that (dis)appear in the course of the social encounter, and is each language only used with certain interlocutors?

On the other hand, when it comes to mature bilingual speakers, adult language mixing has been typically thought to be due to linguistic incompetence, or to incomplete acquisition as reported by the formal linguists (Montrul, 2016). Moreover, incomplete acquisition has been traditionally considered to be one of the precursors of variation in heritage grammars. Adult language mixing may also be seen as “degenerative” (Mar-Molinero, 2010: 174), and some bilingual speakers even go as far as to attribute their own mixed language practices to “laziness” (Gardner-Chloros, 2009: 14). However, what is astonishing is that we find that fully proficient bilinguals⁷⁶ are not labeled as having incompletely acquired their languages even though they too may mix their languages from very little to excessively both unconsciously, and intentionally in social interaction. In some cases, language mixing for so-called proficient bilinguals may be seen as a deliberate linguistic act, or a display of power, and prowess, and a process of linguistic creation, or performance, literally at the tips of their tongues. The desire to play with languages which sometimes requires conscious effort cannot and should not be explained by laziness alone. Language mixing may be the result of the mostly implicit, but extraordinarily complex language socialization process which allows the speaker to show membership in a social and linguistic community of practice.

Nevertheless, dismissive, and often unfair judgments about the nature of language mixing in heritage bilinguals, children, and adults alike, have often relegated mixed language data to the margins of the documentation and transcription process, and thus their analyses in naturalistic settings of bilingual, multimodal interactions. Given the present issues, to best capture a third-generation child’s variable bilingual language practices in multigenerational interaction, we consider that “Language use that is characterized by extensive CS often reflects just one of the registers in the repertoire of speakers.” (Aalberse et al., 2019: 82). CS, or language mixing as it is used within the framework of this investigation is an expression of individual language variability in social interaction. It is therefore essential to capture and to explain. Furthermore, language mixing should be captured, transcribed, and analyzed along the side of Spanish and English in interaction since these three oral modes are intricately

⁷⁶ Proficient bilinguals are understood as those who can speak and write (active competence), as well as read and comprehend (passive competence) both of their languages.

interwoven into the pre-fabricated, but always re-negotiated communicative setting. We also argue that child language mixing may be the result of the variable and dynamic language socialization practices used within the family as well as stimulated by the linguistic evolution in the bilingual language learning environment. Therefore, this longitudinal case study of heritage bilingualism considers the use and linguistic socialization of a third-generation child into four complementary modes of communication that organically work for the speaker in their social encounters. They include: 1) a robust and thriving variety of Los Angeles Spanish rooted in rural Mexican Spanish⁷⁷ (Parodi, 2003, 2008, 2011), 2) a southern California American English, 3) Spanish-English language mixing, and finally, 4) a passive form of bilingualism. The issue of whether passive bilingualism is a mode of communication is a contentious one. For example, we may ask if it should be placed at the same level as the three other modes that are both receptive and productive. Or, if it is merely a “kind of state or linguistic identity (since) she is a passive bilingual child and thus ... uses the three other modes at different levels.” (A. Morgenstern, personal communication, December 18th, 2021). As argued in the qualitative chapters the stance taken here following De Houwer (2009) and Saviile-Troike (1987) is that passive bilingualism as an interactional mode in social encounters engenders “dilingual conversations”, a mode of communication where meaning is not negotiated through a linguistic code common to two, or more interlocutors in an interactional framework.

Individual linguistic variation, as highlighted by Nagy (2015) reflects the richness and complexity of bilingual development, which is itself a reflection of the bilingual language learning environment. Bilingual speakers’ transition across the bilingual continuum across the lifespan sometimes becoming weaker, and other times becoming stronger in one or the other language. Therefore, a “marginal” mode of communication such as language mixing should not be considered deficient since this type of discourse also allows for dyadic, triadic, and multiparty interactions to flow multimodally in their multigenerational bilingual settings

⁷⁷ The late Claudia Parodi-Lewin, a formal linguist from UCLA influenced and encouraged me in this line of research as an undergraduate student. Parodi-Lewin published an incredible number of articles and chapters on Los Angeles Spanish, also known as Chicano Spanish, or Los Angeles Vernacular Spanish (LAVS) often based on semi-guided interviews. Parodi (2003) suggested that Spanish in L.A. was a koine, or mesh of many Spanish varieties. Furthermore, Parodi (2003) advanced that “el habla de casi todos los inmigrantes hispanos en Estados Unidos es el español rural americano, el cual tiene características generales comunes en toda América Latina. Ello se debe a que conserva rasgos del español antiguo que llevaron los primeros conquistadores y colonizadores del continente americano (the language of almost all the Hispanic immigrants in the U.S. is an American rural Spanish, which has general characteristics across Latin America. It is because it maintains aspects of the old Spanish that the conquistadors and colonizers brought to the American continent) – My translation.

(Chung, 2010). Language mixing may also support the communicative well-being of the family (De, Houwer, 2015). This research project will aim to understand the language socialization process of a third-generation child into these four modes of communication longitudinally. It attributes language mixing to individual variation and not to deficiency, placing it along with the three other linguistic practices mentioned above as a central phenomenon to be studied, like other contact-related phenomena in contact linguistics (Goebel et. al, 1996). Documentation challenges related to how to best capture the variable nature of Spanish use and bilingual language socialization engendered a need to create a plurilingual corpus. Furthermore, an ethnographic approach allowed us to seize the spontaneous linguistic variability and complexity of several bilingual speakers' linguistic repertoires as anchored in their unique bilingual communities of practice. I thus discuss the importance of both collecting naturalistic language data, as well as of the participant observer's role when conducting ethnographic fieldwork.

3.1.1 Collecting language data through participant observation

As we saw in Chapter 1 and 2, each linguistic approach deploys diverse data collection methods. For formal linguists this typically involves controlled environments, and experiments such as language related tasks. On the other hand, for linguistic anthropologists data collection involves recording naturally occurring speech. Nevertheless, the decision to use one data collection method over another is often based on the linguists' specific research question(s). Investigating heritage language use and multigenerational socialization and acquisition is no different. This includes researching related phenomena such as language mixing, or the socialization into a passive mode of bilingualism. To be clear, by passive bilingualism I mean that because LIN has very little productive ability in Spanish, she is a passive bilingual. Notwithstanding, "Three chief traditions inform current practices, namely collecting spontaneous language data, collecting questionnaires, and data elicitation." (Aalberese et al, 2019: 87). Within the framework of this study, we have opted for the collection of bilingual data in the form of naturalistic multigenerational interaction. Naturally then, these types of rich interactions imply ever-shifting dyadic, triadic, and multiparty social encounters. The primary source of data from which we will draw both our quantitative measures and qualitative analyses are video-recorded spontaneous conversations in a private home. They are dynamic, bilingual, and multimodal social encounters between LIN, and various bi- and monolingual adults in various interactional frameworks. Moreover, the first aim of the video-recordings is for them

to be transcribed. Such a data collection method is also “inherited from the study of language contact and minority languages.” (Aalberese et al., 2019: 87). As we saw in the literature review, this is a compatible approach that is also interested in the notions, and the processes of language maintenance, shift, and loss. In part, it also aims to understand the interrelated variable linguistic outcomes at the individual, social, and environmental levels.

The arduous transcription process will be developed in greater detail in subsequent sections. Here we highlight the value of spontaneous language data, whether bi- or monolingual, collected through participant observation. Analyses of naturalistic speech is advantageous in moving the field of heritage linguistics forward (Polinsky & Scontras, 2019). By heritage linguistics we include the field of heritage language acquisition and the field of heritage language socialization. Nevertheless, immersion in the spontaneous language data collection process provides the researcher who is present and (sometimes) participating in the ongoing multiparty interactions with a window through which to peer into how languages are used in, and shape everyday circumstances. Furthermore, it also provides precious insights regarding “various settings or locations rather than having to rely on self-reports.” (Pauwels, 2016: 64) which may be flawed for reasons related to under, or over reporting and other such discrepancies between beliefs and actual language practices (Gharibi & Seals, 2019; Schwartz, 2008). Critically, collecting spontaneous language data through participant observation requires substantial human and material investment. These are methodological aspects that should not be downplayed; therefore, they will be discussed in more detail later. As part of the ethnographic toolkit, participant observation requires “the intensive involvement of the researcher in a given social setting in order to describe and identify, through the use of a variety of complementary research techniques, the cultural patterns and regularities that structure and perpetuate a society” (Poplack, 1980: 60). It serves to mention that even if I strived to be present in all the video-recordings, it was not always possible for reasons related to the very nature of being social. Therefore, at times the camera was intentionally left rolling. However, in most of the qualitative analyses, I was present and participating in the ever-shifting social encounter. When this was not the case it is clearly mentioned at the onset of the analysis. Finally, participation in the ebb and flow of pre-established family life such as routines required harmonious integration into the family’s complex bilingual and sociocultural structure. In the section below, I discuss challenges that emerged as related to building and maintaining healthy relationships through the language documentation process.

3.1.2 Relationships with the participants

One of the central issues regarding the present research project was managing my two-pronged role. That is my position both as a researcher (out group) interested in bilingual language practices, and my role as a community member (in group) who also re-produced bilingual language practices, a position that was almost paradoxical in nature. Linguists such as De Houwer (2009) and Wei (2000) have encouraged researchers to have good knowledge of the languages, and communities under investigation. Indeed, “To know a culture is like knowing a language ... to describe a culture is like describing a language.” (Duranti, 1997: 27). To this end, it would appear as though the best approach for ethnographic inquiry is if the researcher is essentially from the community. Yet, this is where the challenge emerges. On the one hand, there is the need to be from the in group. This is a first step in creating and maintaining healthy relationships with the participants to better apprehend their multifaceted bilingual and bicultural processes. These types of cultural patterns could otherwise be dismissed or even go unnoticed to non-community members. On the other hand, there is also a need to be from the out group. Linguistic and cultural differences may be advantageous when attempting to explain the linguistic phenomena based on objective theoretical grounding for example. In both cases, the question that inevitably arises is “how will you handle the relations of power that necessarily traverse the activity, as well as choosing activities that correspond to the ethical principles to which you adhere.” (Heller et al., 2018: 61). The following example may help elucidate the challenges related to power relations when one is both the researcher and a community member. While onsite during the data collection process, I needed to assess my role as a community member and as a researcher in the face of LIN’s increasing mischievous behavior. To illustrate this point, I turn your attention to the following journal entry. It was made almost one month after arrival to L.A., or on September 18th, 2018, in the digital version of my field journal. I observe that:

In other news, LIN has been through phases of bad behavior. From a researcher’s standpoint, whose well-being should be looked after first. Both. Right? I don’t know, but LIN’s bad behavior is at the limit of harassment when she is spitting or punching. (Alvarez, 2018).

After nearly one month in the field, LIN began to display behavior that was less than correct. Moreover, finding an ideal resolution to this challenge was not easy at first. As a community member and as her great-uncle, I was granted authority, or given the power per se, from her mother ROX to discipline LIN as necessary. However, I felt that in taking this course of action,

or in imposing my authoritative power over her, my data collection efforts would be compromised, and thus my position as a researcher. The fieldwork process thus forced me to question my role as a community member, and researcher as I tried to figure out what to do considering the difficult situation all while maintaining good relations with all the family members, including LIN of course. In terms of ethics, it confronted me with the issue of when to stop filming. The compromise that I found was first to turn the camera when it was in my possession i.e., not on a tripod, and focus on filming LIN's cousins, or younger sibling when she misbehaved. In some cases, I continued filming even without LIN's permission since her parents gave informed consent⁷⁸ for her, a minor, to participate in the investigation. The second compromise was to reward good behavior by taking the polite kids (my great-nephews and nieces) to the local park. LIN did not appreciate when she was not the center of attention whether she was being filmed, or not. Moreover, LIN really enjoyed going to the park, so it was not long before her behavior improved since she really disliked being left out from this fun and friendly excursion. In retrospect, it is possible that my initial intrusion as a researcher, and perhaps instant interest to record her social interactions with her multigenerational family members is what prompted her less than ideal behavior. We may argue that my position as a researcher-community member did have, on occasion, an adverse effect on the target-child LIN. Therefore, I was faced with the challenge of figuring out how to mitigate my role as a researcher and as a community member. The overall goal of establishing healthy relationships and having consent from her parents is what allowed me to meet my data collection objectives in this bilingual, and bicultural family.

3.1.3 Data collection in bilingual communities

I have attempted to explain from the onset of this chapter that conducting fieldwork in bilingual communities inherently raises critical issues. Documenting the dynamic and variable nature of language use and transmission, as well as of the variable bilingual socialization practices is truffled with diverse methodological challenges. The previous section focused on the importance of fostering positive behavioral and emotional relationships with each of the participants. Our focus here is on another difficulty that emerges. That is, the extent of the

⁷⁸ The bilingual "Parent permission for minor to participate in research" forms were approved by the Los Angeles School District (LAUSD) Committee on External Research Review (CERR) after a lengthy review process. They are signed by the participants and included in the appendices. Also included in the appendices are the approved Project Proposal Number 348 that allowed me to gain access to the site (LIN's elementary school), as well as the letter of Approval from the LAUSD.

linguist, ethnographer, or participant-observer's linguistic abilities, and cultural awareness as related to the bilingual community under study. Prominent researchers (De Houwer, 2009; Wei, 2000; Pauwels, 2016) have argued that advanced knowledge of the languages involved under investigation is essential. Their argument may be based on Garner-Chloros (2009) presumption that bilinguals' linguistic behavior may only be adequately apprehended with a certain degree of insider knowledge both of the community where said behaviors are displayed, as well as with an understanding of the circumstances that lead to such behavior. In working within the context of a bilingual community of practice, the researcher who is capable of intimately attuning to both the languages and the cultures may be better equipped to decipher what is sometimes explicitly, and oftentimes what is implicitly said and done by the community of speakers. Within the framework of the present study, I modestly claim to meet the conditions. I outline the reasons below and attempt to illustrate them with an example.

First, I am a second-generation heritage Spanish-English bilingual. I was born and raised in L.A., i.e., the exact location where the present study is based. This bilingual and bicultural position may give me access to privileged insider knowledge as it pertains not only to the languages involved, but also to the multigenerational community, and the context where LIN, a third-generation child attempts to use heritage Spanish, and where she is going through heritage Spanish socialization in multiparty participation frameworks. As a second-generation heritage bilingual, I acquired first the informal and then the formal registers of Spanish and English. I learned standard Spanish in classes designed for heritage language speakers while completing my undergraduate degree in Spanish and Linguistics at UCLA⁷⁹. A heritage language learner according to Leung et al. (1997), and Rampton (1997) may not only display varying levels of language knowledge, but also of language affiliation despite the language they inherited, and this at distinct points in their lives. Furthermore, in our literature review we learned that Valdés (2005) also argues that heritage learners have generally acquired their heritage language both in an informal and naturalistic setting, as well through formal institutional instruction. Thus, even if my language skills have shifted along the bilingual continuum, today I may safely say that I have a certain level of proficiency in both English and Spanish. This includes the ability to use each language independently as needed, but

⁷⁹ I also have vague memories of having learned Spanish in elementary school at Graham, where LIN is currently enrolled. I remember reciting the alphabet in class, counting, and even reciting the Pledge of Allegiance in Spanish. Additional memories of having learned Spanish further in this formal context are absent. This is likely due to the on-off switch of bilingual education programs and their policies in the state of California.

furthermore the ability to mix them naturally, or for performative value. In other words, I have the capacity to resort to language mixing as a third mode of communication depending on the sociolinguistic context. Finally, in reviewing my fieldnotes, it became clear that I too practice the fourth mode of communication with the other multigenerational bilingual speakers. As discussed above, this is a passive form of Spanish bilingualism. Despite being able to respond in Spanish when addressed in Spanish, I responded in English. In our literature review, we also saw how GUI, LIN's grandfather did the same with me. When I addressed him in Spanish, he responded in English, even if Spanish is by far his strongest language. Nevertheless, I argue that LIN, a third-generation child may be socialized into this fourth mode of communication that seemingly and rather seamlessly takes place both between bi- and monolingual adults across the multigenerational spectrum. The qualitative analyses in Chapter 5 and 6 will help determine if indeed parental socialization practices are contributing to LIN's socialization into passive Spanish bilingualism, and as a result, hindering her productive use of heritage Spanish. To illustrate this point, I turn your attention to the entry below. It was made not even one month after arrival to L.A., or on September 4th, 2018, in the digital version of my field journal. I observes the following:

Maybe a passive form of bilingualism is being taught (or modeled). I realized on more than one occasion that when GLO (1.5G) spoke to me (ERI 2G) in Spanish I responded (to her) in English. I should see how ALE (2G) and ROX (2G) are communicating with GLO (1.5G). When I (ERI 2G) speak to LIN (3G) in Spanish she also answers me (ERI 2G) in English just as I do to GLO (1.5G). (Alvarez, 2018).

The fieldnote entry above shows that as a community member, equipped with the requisite language skills, I was able to tune into this passive mode of communication within the family. This finding, first as a participant observer as jotted down into my field journal also helped guide my inspection of the language data in the later description, transcription, and coding stages. Multiple examples are found in the data where LIN shows understanding of adult Spanish input both directed to her, or input that is child-directed, as well as when it is spoken around her, or input that is overheard. These moments of passive Spanish bilingualism will be qualified in the subsequent chapters within the larger bilingual, multimodal, multigenerational, and multiparty interactional frameworks in which they unfold. However, what is important here is that as a researcher and community member, I was able to identify a pattern of passive linguistic social interaction between the adults into which subsequent generations may be socialized. Put differently, passive bilingualism could be a mode of communication that may not be exclusive to third-generation English dominant children going through language shift. Rather, it is a linguistic practice that more-or-less balanced bilinguals in the community deploy

in naturalistic interaction as exemplified in the journal entry above. Nevertheless, passive bilingualism raises a multigenerational transmission issue. For example, “the problem of passive bilingualism is that you need active speakers of the non-dominant language of the child ... generation after generation, that might disappear” (A. Morgenstern, personal communication, July 10th, 2020). If LIN does not acquire productive ability in Spanish, then complete shift to English may likely occur with her children (fourth-generation). In this scenario, passive bilingualism will cease to exist unless for example this fourth mode of communication continues to be modeled by older bilingual speakers within the community.

The previous example thus showed the importance of having thorough insight of the languages and bilingual practices involved. It may be argued that this understanding is in part due to community membership. Furthermore however, beyond the linguistic and cultural advantages, being a member of the community, or family member makes it easier to keep in touch. My deep-rooted ties to L.A. as well as to the family in question pre-established the ability to re-enter the field as needed, or to punctually consult with them certain aspects of my research. Even though I have lived in France for the last 13 years, on average I go back to L.A. at least once a year. Nevertheless, the fact that I am apparently suited to collect data in this bilingual community, my cultural and linguistic attributes did not protect me from other data collection related challenges as discussed below.

3.1.3.1 The Observer’s Paradox

I was not immune for example, to Labov’s (1972) “famous term” (Li, 2008: 81) known as the Observer’s Paradox (OP). This is a recurrent issue within the field of sociolinguistic research (Aalberse et al., 2019). Moreover, it brings to light “serious methodological problems to be dealt with, such as privacy issues, ethical issues, and the asymmetry of the researcher’s perceived power in relation to research participants.” (Li, 2008: 81) that we previously discussed. The OP states that “the aim of linguistic research in the community must be to find out how people talk when they are not being systematically observed; yet we can only do this through systematic observation” (Labov, 1972: 209). It is not because I am member of this L.A.-based multigenerational and bilingual speech community that it can be affirmed that I was able to discretely record the interactions of my participants without influencing their linguistic and cultural behavior. As noted above, my research activities onsite seemed to have influenced LIN’s behavior. Nevertheless, there were moments where I felt that linguistic

choices on behalf of the adult speakers were made precisely because of my presence. Moreover, and perhaps more overtly, there were moments where LIN explicitly asked not to be filmed and refused to engage in interaction with others. There were also other moments where she made it clear that she was aware of the camera. The example below is from the August 2018 data set. It illustrates LIN’s awareness of being filmed i.e., observed and the impact it has on the family members around her. The family is enjoying playtime outside at ALE and RIC’s home. ALE is LIN’s maternal aunt, and they live next door, so LIN visits regularly. All three generations are present and there is a substantial amount of language mixing going on. These types of bilingual language practices are the norm for the family. Since there are many fruit trees in the yard, the interactional moment continues as LIN (1.1) asks her grandmother GLO if the guava fruit she just picked is “bueno”, or “good” to eat. While GLO confirms that it is (1.2), as the interaction proceeds LIN (1.8) affirms to ERI that she sees his camera.

- | | | |
|----|-------|--|
| 1. | *LIN: | [- mix] is this one bueno@s? @GLO
Is this one good? |
| 2. | *GLO: | uhuh. @LIN |
| 3. | *GLO: | you want this one? @LIN |
| 4. | *JUL: | Mama@s:eng&spa. @GLO |
| 5. | *JUL: | mine. @GLO |
| 6. | *GLO: | [- spa] el Gordo se quería (.) ira [: mira] xxx. @ALE
Fatboy wanted to (.) look. |
| 7. | *ALE: | oh, I know it’s from Sally’s. @GLO
... |
| 8. | *LIN: | I saw you camera. @ERI
%exp: a moment of Observer’s Paradox |

Plurilingual Transcript 1: Labov's Observer's Paradox: AUG_26_2018_LIN_GLO_JUL_ALE_GOY_ERI_GUI

The short transcription extract above makes it clear that LIN was aware of being filmed. She does so multimodally, that is both orally and through gesture. She looks directly at the camera as she acknowledges it, and at the same time she points at it with her right hand which is filled with the bright green guava fruit that she was eating. The figure below captures the moment when LIN points at the camera with the juicy guava fruit in her hand.



Figure 12: LIN points at camera to acknowledge its presence.

Her comment reveals that even if temporarily, she is pulled out of the interactional frame to address the camera since her little brother JUL (bottom) was also staring at it. Furthermore, LIN then walks away from the camera's view and completely removes herself from the interaction. Moreover, as can be seen in the video, seconds later her comment also draws the attention of her cousin GOY who then looks at the camera and waves hello, and thus pulling her out of naturalistic interaction as well. The researcher's presence has therefore contributed to a change in the participants' behaviors which subsequently renders the data less spontaneous, and even less natural. It was during the transcription phase that LIN's statement was flagged with a code used for explaining, or %exp: where I annotate that she may have been influenced by the 'observer' even though I am a member of the family. Despite the observer's presence however, some researchers argue that their impact onsite is not a major hurdle in the collection of spontaneous data. For example, we see that

Perhaps surprisingly, the least of these (practical difficulties) has been to obtain natural data. It seems that the ordinary living of life in family contexts soon displaces awareness of recording, so recording interaction between caregivers and children over long, uninterrupted stretches of time does provide authentic data. Children do very occasionally comment on the presence of the recorder but don't sustain attention to it and soon become re-immersed in interaction around shared activities with caregivers. (Williams, 2008: 67).

In line with Williams, as well as with Morgenstern (2009) my observational notes in the field attest that recording not only became more of a standard situation for myself, but also perhaps less of an intrusion for those being recorded. For example, the journal entry below drawn from

my digital field journal only nine days after arrival to L.A. seems to indicate that the collection of spontaneous data became more of a fluid process. It is dated August 29th, 2018, and I note:

With time, filming seems as though it is becoming more normal. I am better able to capture more intimate parent-child interaction with a focus on LIN of course, though I am filming quite a bit on her two-year old brother JUL. (Alvarez, 2018).

Perhaps the fact that this work was longitudinal in nature, the participants eventually assimilated the camera's presence thus rendering the data more natural. Moreover, it helped me collect data of more intimate moments between the multigenerational family members since the recording device seemed to be subsequently dismissed. Nevertheless, for instances such as the one presented above where LIN was fully aware of the camera, and of being filmed, it is only through detailed analyses of the interaction in question that we may reveal the impact of the observer on the observed.

3.1.4 Primary requisites & Tools used for data collection

Despite these inherent challenges, arrangements were made to board with the multigenerational bilingual family. This proximity allowed me to collect nearly 200 hours of naturalistic video-recorded data with the following material: a Canon HD Legria HF G25 camcorder, four SanDisk Ultra 128GB microSDXC-I memory cards, and a Sunpak Ultra 6000PG tripod. The approach to the data collection was ethnographic in nature, therefore aligning with Ochs and Schieffelin's (2011) language socialization paradigm presented in Chapter 2. Moreover, ethnographic research involves bringing together different forms of data collection for in-depth qualitative analysis (Gardner-Chloros, 2009). The primary source of language data in this project includes video-recordings of the family in spontaneous social interaction in multiparty encounters that took place "in the most basic communicative setting in which it (the language[s]) is used: ordinary informal face-to face communication between friends and family." (Aalberese et al., 2019: 92). After the language documentation phase was completed, all the video-recordings of the three selected months were subsequently described on Excel. The logic behind this selection is clarified further down. Nevertheless, this initial process helped me to delimit the set of videos that would later be selected to transcribe on CLAN to create the plurilingual corpus. The transcription process will also be detailed below. As briefly mentioned, but richly demonstrated throughout the present investigation, the data collection process also included observations that were recorded both in a handwritten field journal, i.e., a small Jot Spiral Fat Book and in a digital Word document. Additional data was also collected

through sociolinguistic questionnaires. Both tools (the field journals and the questionnaires) were exploited as secondary sources of information. Finally, the video-recordings were stored and backed up in a WD 4TB My Passport for Mac portable external hard drive. The chart below summarizes the human, and technical materials that were mobilized to document individual, social, and environmental variation in this multigenerational bilingual community.

Table 14: Requisites for conducting fieldwork in bilingual communities

Requisite	Explanation
Knowledge of languages	Researcher is bilingual. He acquired heritage Spanish in the home & learned standard Spanish at the university in L.A.
Knowledge of cultural context	Researcher grew up in the community. He maintains contact through frequent calls & visits on average once a year.
Host Institution on site (mandatory for funding)	NHLRC at UCLA
Funding	Labex EFL (4,000 euros)
Fieldwork mission 1	February 2018 (entire month)
Fieldwork mission 2	August 23, 2018 – January 13, 2019
Camcorder	Canon HD Legria HF G25
Memory Cards	SanDisk Ultra 128GB microSDXC-I (4 cards)
Tripod	Sunpak Ultra 6000PG
External hard drive	WD 4TB My Passport for Mac portable
Field Journal	Jot Spiral Fat Book (180 sheets)

3.2 The need for multigenerational studies

Both the language acquisition and language socialization perspectives place a prime on the input to which children are exposed in their language learning environments. For the former, this usually involves input received from a parent in child-adult dyads. The latter goes beyond the dyad. It strives to capture input that a child hears directly, or indirectly from their extended range of interlocutors not only in dyadic, but also in triadic, and multiparty interactional frameworks (De León, 2011). Moreover, in some cases an increase in the number of family members in a social encounter may also augment the number of generations present. As it pertains to the present study, we have argued that the interactional norm in the family includes a range of multigenerational speakers (which naturally implies a range of bilingual abilities as based on the bilingual continuum) in multiparty participation frameworks. These sociolinguistic characteristics also heighten the number, and the manner of how linguistic resources are deployed in interaction. Therefore, a multigenerational family study also referred to as cross-generational studies in the literature (but we will use the former term), may be fruitful in setting a standard for comparison since the input from multiple speakers, and

multiple generations may be captured and analyzed using this research method. Within the framework of this study for example, the multigenerational “approach helps tease apart the effects of being from a certain generation from those of being from a certain family.” (Aalberese et al., 2019: 116). Moreover, due to an endless number of reasons including economic, social, or political factors, some heritage language groups are prone to form small, and often tight-knit communities of practice that may even be defined and described at the family level as we saw in the state of the art (Chapter 1). The impact of the implicit, but the ever so powerful language socialization practices deployed by the multigenerational family members may also lead to conventionalized language practices such as language mixing, or passive bilingualism, within these highly, but organically integrated (like a mosaic) cohorts of heritage bilingual speakers. To develop this idea, the two studies below found differentiated aspect marking at the family level.

Chen and Shirai (2010), and Chen (2012) found that in Chinese heritage language families, the parental style of aspect marking, or quality of input, could account for the number of aspect markers their children used. Thus, for some researchers if a child’s linguistic practices are influenced both by the familial linguistic patterns of use as well as by speaker generation, “a comparison ... within families can show at what levels speakers from the same generation line up and on what level speakers from the same families do.” (Aalberese et al., 2019: 116). Our approach will therefore enable us to consider how speakers from the same generation compare to each other in terms of their bilingual language use longitudinally by looking at quantitative measures. We will also be able to determine if similarities in language practices may be found multigenerationally. Furthermore, establishing the baseline input language across generations, a notion that we expand on further below, at the family and at the individual level is critical since the speakers’ biographical factors are similar because they hail from the same community of practice. Therefore, to consider the multigenerational bilingual practices in multiparty interaction with other heritage bilinguals and monolingual Spanish speakers, each with their unique linguistic patterns, has the potential to shed light on third-generation heritage Spanish use and transmission. It may also provide us with valuable insight on the changes that result from differentiated generational input (Pires & Rothman, 2009; Domínguez et al., 2019). In sum, as Laleko (2010) argues, heritage speaker parental input is not necessarily comparable to the input to which non-heritage native speakers are exposed.

Despite the abovementioned advantages, one drawback of the multigenerational approach is that of the data collection process. For example, family members may not live in the same country, let alone state, or city. Moreover, with increasing mobility, family members may come and go at any point during the investigation as was the case here. Even so, these parameters are part of the ebb and flow of modern family life, especially for extended families. Therefore, these disadvantageous should be welcomed in our investigations as they too have explanatory power in our analyses. We will see in our quantitative measures how LIN’s great-grandmother GRC, and the fact that she leads a transnational life influences the results of the longitudinal measures. Nevertheless, the present longitudinal study involves one multigenerational family. In terms of speaker participation, this means that most of the family members, with the exception of LIN’s great-grandparents⁸⁰ who live mainly in Mexico but who return regularly to L.A., live together, or in very close proximity. They thus maintain frequent contact and may be considered a tightknit community of practice. The target-child LIN, her younger brother JUL, and her parents ROX and MAR⁸¹ comfortably live with her maternal grandparents GLO and GUI in a large two-story home. LIN’s maternal aunt ALE, her uncle RIC, as well as her cousins GOY and IGN live in a smaller single-family house next door.

3.2.1 The family tree

The color-coded family tree below presents LIN’s close social circle. It illustrates the organization of the family, on the maternal side in terms of kinship, generation, and gender. The three-letter uppercase code in each box identifies the participant. The number to the right of the three-letter code represents each speaker’s generation. The color⁸² scheme represents their biological sex as assigned at birth: pink for the women and blue for the men. At the top, it starts with LIN’s maternal great-grandparents GRC and GRT. Since they arrived in L.A. as adults, they are members of the first-generation (1G). On the second line we see LIN’s grandparents GLO and GUI. They arrived from Mexico to L.A. after the age of 10. Organizing “late” arrivers in terms of generation is a fuzzy, not to say contentious issue. One proposal is to consider these types of speakers to be between the first- and second-generation, or one-and-a-half (1.5G). This is the position assumed here. Along the same line, we see ERI, but since he

⁸⁰ GRT, or the target child’s great-grandfather passed away in May 2019, or about four months after the last recording session was completed.

⁸¹ MAR, LIN’s father tragically died in a motorcycle accident in February 2022.

⁸² The color scheme is conventional, and it was automatically generated by the software used to build the family tree.

was born in L.A., he represents the second-generation (2G). Next, on the third line from the top we have GLO and GUI's offspring in pink. ROX and ALE were also born in L.A., and thus represent the 2G. They are also married so next to them we see their husbands MAR and RIC respectively, who are also 2G heritage Spanish bilinguals. Finally, at the bottom of the family tree we can identify both ROX's children LIN and JUL as well as ALE's children GOY and IGN. ROX and ALE's offspring represent the third-generation (3G). The target-child LIN is identified with the blue circle. In the present investigation, we are interested in how LIN, a 3G child uses heritage Spanish in multigenerational and multiparty participation frameworks. We also aim to understand whether the family's heritage language socialization practices in these varied interactional frameworks support intergenerational transmission of Spanish. To do so, a comprehensive examination of the family in naturalistic interaction is in order. In the next section we thus underscore how case studies may help us achieve this goal.

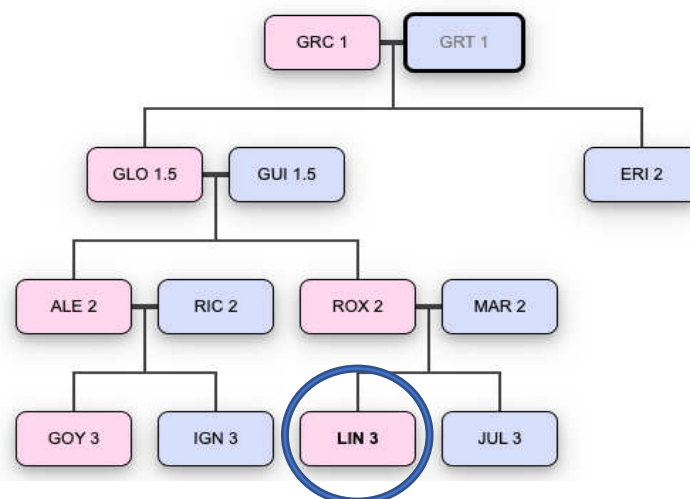

Figure 13: Three-generation family tree

3.2.2 Making a case for case studies

In order to construct a typology of kinds of linguistic environments, we need in-depth case studies of individual families ... in which we can focus on a limited number of variables that have so far been identified as possibly playing a role. (De Houwer, 2009: 327).

The quote above suggests that case studies of individual families help to understand the variable and dynamic bilingual language learning environments in which bilingual children evolve. This alternative research paradigm (De Houwer, 2009) aligns with what Silvina Montrul advanced in her book. She affirms that “methods used by generative, emergentist, and variationist sociolinguistic approaches can be broadly characterized as quantitative because numbers and frequencies are calculated from linguistic behavior, measured quantitatively and

analyzed statistically.” (Montrul, 2016: 167). Findings based on quantitative methods have the advantage of being generalized, or that they can be applied to the speech community from which the speech samples are drawn. However, one pitfall with this argument is the origin of the data itself. The data is generally collected in sterile laboratory-like environments, using a battery of tasks, often on university campuses, and frequently with college level students. Therefore, from this point of view the notion of generalizability can be scrutinized since the results may only speak for a limited part of the bilingual population under study. For example, they may include college aged students with similar educational backgrounds, and who are also motivated to re-learn their heritage language (He, 2011). Furthermore, since the data is generally collected through experimental approaches, how does one validate the authenticity of naturally occurring speech? These drawbacks are not necessarily true for case studies, even if we are aware that they themselves are not bullet-proof, as we will see next.

Duff (2007) insists that case studies do not aim to make far reaching statements about the population at large. Interestingly, she even highlights disadvantages that are associated with case studies. These include issues such as generalizability as evoked by Montrul, but also the lack of objectivity, and of theoretical grounding. Nevertheless, other researchers such as Lambert (2007) argue that as a qualitative approach in applied linguistics, case studies are a commonly used research method. In moving away from a research tradition that tends to be impersonal and based on experimentation, the present project aspires to implement a more social, naturalistic approach. It seeks to study the bilingual socialization of one third-generation heritage Spanish child to determine how she uses Spanish, as well as her additional modes of communication in spontaneous interaction with multiple multigenerational caretakers. This means “engaging in a detailed case study of the child” (Pauwels, 2016: 76) where contrary to statistics, “Completeness, depth of analysis, and readability” (Duff, 2007: 43) are central. Furthermore, the case study method which is both data-driven and inductive is “highly personal and individualist ... furnishing insights into participant’s life experiences, the micro-factors that influence the linguistic process under investigation, (and) the researcher-participant relationship.” (Lambert, 2008: 22.1). The case study may also provide insight into the variable nature across a multitude of levels of LIN’s bilingual language learning environment. Therefore, the data here will attempt to capture the multigenerational family’s linguistic print with the understanding that the findings will not be generalized to the larger speech community in which they are anchored. The term linguistic print is my English translation of the French term “*empreinte linguistique*” within the framework of this project. Like the term fingerprint,

here linguistic print alludes to the unique linguistic patterns that may be attributed to specific people, families, or environments. Finally, it should also be made clear that from the outset of this research project, generalization was not a goal, nor were experimental methods even if “linguistic fieldwork (and) lab-based experimental work ... are less different than they seem” (Polinsky, in press: 1). This is also despite the insistence that case studies while conducive to quantitative analysis “may be seen as problematic for theories of typical behavior. They also present constraints on quantitative analyses and limitations about generalizability because it is not always possible to run inferential statistics.” (Montrul, 2016: 167).

Furthermore, following Muysken (2000) at present the aim of CS, or language mixing research should be not to establish absolute rules, but rather to unearth linguistic tendencies. Case studies have the potential to do just that, or to “generate new hypotheses, models and understandings” (Duff, 2007: 43) about linguistic practices and processes in naturalistic social interaction. These findings in turn “can be seen as a small step toward grand generalisations” (Stake, 2005: 448). Moreover, in considering how language socialization practices in multigenerational settings engender individual linguistic variation, the aim of finding and advancing language use trends will be extended to all the registers, or modes of communication in the target-child’s linguistic repertoire. It is thus reasonable to assume that findings from a case study such as this one may have the potential to reveal the bilingual language use tendencies not only at the individual and the familial level, but also at the environmental level. At the same time, observational notes from the field as we have amply seen throughout the dissertation may also show that languages, as they are used in the bilingual society at large, i.e., the school, may align with the bilingual language practices as they are used in the home. Also, given each family’s unique biographical characteristics, these patterns are bound to be varied, and unique, but also in constant flux for each family. Finally, beyond the depth and breadth of analyses that may be carried out based on this type of primary data, including the detailed background information that may be collected on the speakers, Duff (2007) additionally advances that case studies present the possibility to make in-depth longitudinal observations. Longitudinal studies have the advantage of helping overcome various obstacles. One of these for example is a critical issue in heritage linguistic research, namely that of the baseline input language. These two notions will be discussed below beginning with the baseline language issue.

3.2.3 The baseline input language issue

Many researchers studying heritage language populations are interested in individual linguistic variation resulting from the language acquisition and the language socialization processes. Furthermore, from an acquisition perspective Aalberese et al. (2019) suggest that the following factors influence language variation: linguistic exposure, input, and contact. We will thus define these notions next since they are pertinent to the discussion of the baseline language issue. However, we will be brief since we have already elaborated on the three main factors that affect bilingual language development.

Exposure is related to the age of onset of the languages involved. It is the moment, in chronological terms, when a child begins to hear more than one language whether it is child-directed or overheard. For fledgling bilinguals, exposure to both languages may begin as early as birth, for example in informal familial settings. For others, it may begin in a more structured way, such as at the start of formal education. In both cases, the age of onset of child-directed or overheard input may result in grammatical variation. It may also pave the path to the variable ways bilingual speakers use their linguistic repertoires in both structured and unstructured multigenerational and multiparty settings alike. Next let us define input. Input may be understood in terms of quantity and quality as underscored in Chapter 1, and both elements are crucial to the harmonious linguistic development of a bilingual child. It may be argued that children who are exposed to bilingual input starting from birth hear more of each language than a child who begins bilingual exposure later in life. However, another factor that comes into play is that of the quality of input. Quality itself may be related to a plethora of issues (also examined in Chapter 1) for example individual parenting styles. As discussed by De León (2011) in some cultures, children receive child-directed speech while in others it is mostly overheard until they are considered eligible talking partners at a later developmental stage. Furthermore, quality can also be used to describe the register of a language i.e., a standard monolingual variety versus an emerging vernacular that is learned orally in a bilingual setting such as in L.A. (Parodi, 2003, 2008). Thus, input quality as a factor that influences language variation is not always clear-cut. Finally, contact refers to the competing languages and the impact that this linguistic competition has on the language acquisition and the language socialization processes. Within the framework of this case study, language contact is thought to engender frequent language mixing within the multigenerational family. Additionally, contact brings about the use of monolingual or bilingual discourse strategies on the adults'

behalf when encouraging LIN to speak heritage Spanish in their ever-shifting multiparty participation frameworks. Linguistic attrition later in adulthood even if rare (Schmid, 2011), and language change is also engendered by contact. Aalberese et al. (2019) also advance that variation can be related to language internal, and external factors. For example, language internal factors include input changes across generations, and frequency of use as previously mentioned. Language external factors thought to influence variation may be related to grammatical filtering through the dominant language also discussed at the end of Chapter 1, linguistic convergence, and shifts in the distribution of use. Finding a suitable explanation for linguistic variation is not simple since the elements above are both extremely interrelated, and in a constant state of flux in these tension ridden contact zones. Nevertheless, the issue of the baseline input language is critical in the study of heritage languages. It may help us gain a better understanding of language diversity, how languages develop without institutional support, and how they are lost in transmission. But what is the baseline input language, and (why) do we need it?

The baseline input language is traditionally understood as “the standard for comparison against which we measure their (heritage speakers) linguistic knowledge or development.” (Montrul, 2016: 168). Furthermore, the standard for comparison, especially in experimental studies, has generally been the official language as spoken by monolinguals in their native country. However, based on the discussion above we see why the previous definition is problematic. If this were an experimental project for example, Mexican monolingual Spanish as spoken in Mexico would be the baseline input language. However, at least two challenges emerge regarding the identification of a suitable baseline. First, to who should heritage speakers be compared? According to Ortega (2014, 2019b), who has championed for a social justice perspective in heritage language, and bilingualism studies more generally, the ‘monolingual bias’ is a fundamental problem. Comparing heritage speakers to monolinguals is complicated first “since monolingual processing inherently has different properties from bilingual processing” (Aalberese et al., 2019: 112). Second, each language may be used in different domains. In François Grosjean’s book, he argues that the linguistic diffusion over domains may be thought of as “Le principe de complémentarité” (the principle of complementarity). Grosjean thus suggests that “les bilingues apprennent et utilisent leurs langues dans des situations différentes, avec des personnes variées, pour des objectifs distincts.” (Grosjean, 2015: 41-42) (bilinguals learn to use their languages in different situations, with various people, and for different objectives). Finally, the third difficulty in

comparing monolinguals to heritage bilinguals is related to their grammars. Due to the nature of heritage language acquisition and heritage language socialization, namely differences in input quantity and quality, bilingual grammars are subject to vary (Polinsky, 2018) from one heritage speaker to the next. Determining who heritage speakers should be compared to is not an obvious feat, especially when heritage bilinguals in some communities are rooted in multigenerational households where multiparty social encounters are the norm. However, the second problem in finding a suitable baseline is comparing heritage speakers of the same language pairs. In other words, “comparing different groups of speakers of the HL is a key methodological issue” (Aalberese et al., 2019: 112) since research designs undeniably vary across studies. Thus, in addressing the baseline input language issue, one possible solution to the *who* question is to compare linguistic differences, or similarities of the speakers within a family through studies that are multigenerational and longitudinal. This will be the focus of our discussion next.

3.2.4 Advantages of longitudinal studies

To chart how heritage bilinguals’ languages and language use patterns evolve over time, “the ideal research design ... would be a longitudinal study following the same individuals and documenting changes in their linguistic behavior from time 1 to time 2 or time n.” (Montrul, 2016: 168). Brown and Gaskins (2014), and De Houwer (2009) also argue in favor of longitudinally designed research. Along the same vein, Duff (2007) argues that longitudinal case studies are advantageous. They allow the researcher to verify fluctuations in linguistic use, and development across the lifespan. In both monolingual children like in Brown (1973) and bilingual children like in Silva-Corvalán (2014), and in Anderson (1999) the case study approach is therefore common. On the other hand, longitudinal studies are less frequent given that they require a greater investment in terms of time, and resources. Nevertheless, the following example aims to show how linguistic changes can be traced over time.

In a longitudinal study of heritage Spanish children who came to the U.S., Anderson (1999) considered the gender morphology of two typically developing sisters. Critically, the naturalistic data collection period spanned two years. Overall, the results showed gender agreement decline for both girls. During the first recording session, the eldest girl who was 3;6 at the time had a 0% error rate. However, two years later the results showed that her gender agreement error rate jumped to 5.8%, an above average rate according to Montrul (2016) for a

native speaker. Moreover, her younger sister was 1;6 during the first recording session and she displayed an error rate of 8%. Two years later however, when the data collection ended, her error rate jumped nearly three times to 25%. In sum, Anderson (1999) through a longitudinal study of heritage Spanish in the U.S. was able to demonstrate significant quantitative changes in gender agreement over a two-year period in the linguistic development of two siblings. The crucial idea here is that due to the longitudinal design of the study, each of the child's languages acted as their own baseline. The longitudinal case study in Anderson's investigation was of great value because it was highly informative. Longitudinal case studies may therefore be fittingly extended to research that seeks to understand heritage language acquisition. This is especially the case when investigations are centered around apprehending how heritage bilinguals' languages change over time at the intersection of fluctuating input. Our longitudinal study will thus allow LIN to act as her own baseline. Furthermore, it will also allow us to understand if her language practices may be compared to the adult input that she receives in multigenerational and multiparty interaction.

While Anderson's (1999) study was quantitative, and focused on morphological agreement, the present study is also qualitative in nature. However, LIN's mean length of utterance (MLU), and type-token ratio (TTR) will be measured and integrated into the analyses. A full discussion of the importance of measuring the MLU and TTR in developmental studies will be presented in the next chapter. The aim of these mixed methods is to show through a collection of interactional moments LIN's: 1) linguistic development over time, 2) the dynamic nature of her heritage language socialization in a multigenerational setting, and 3) how she uses her four modes of communication in different, often multiparty interactional frameworks. Thus, the data collection process for the present study was roughly one year long. It began in February 2018, and it ended in January 2019. Moreover, due to the transnational dimension of this project, data was recorded monthly only between August 2018 and January 2019. Therefore, to harmonize the intervals between each of the sampling periods as well as to make the data more manageable within the framework of this Ph.D., we attempted to select the same amounts of hours (roughly eight hours each) for each of the three distinct sampling periods. The table below lists the three months selected for sampling in the first column. Each sampling period is roughly five to six months apart from the next. Next, the approximate number of total hours recorded in each of those months is presented in the second column. The third column represents the approximate number of hours kept after the data description phase. This process will be described at length later. The fourth column shows the approximate number of total

hours that were transcribed. They constitute the plurilingual corpus used for this study. Finally, the last column depicts the approximate number of hours collected longitudinally. How we got to 183 hours will be made explicit further below. The purpose of showing the total amount of hours collected in this project is to give a sense of full set of recorded data. The table below will not show through the first four columns how we arrive at 183 hours. Having highlighted the importance of longitudinal studies in establishing a speaker’s own baseline input language, this section ends by considering additional techniques in the data collection process.

Table 15: Longitudinal design, sampling periods, & number of hours transcribed

Month & Year	Approximate number of hours recorded per month	Approximate number of hours used for sampling	Approximate number of hours of data transcribed on CLAN to create a plurilingual corpus	Approximate number of hours of data collected longitudinally
Feb. 2018 Data	≈ 14h	≈ 8 hours	≈ 24 hours	≈ 183 hours
Aug. 2018 Data	≈ 8h	≈ 8 hours		
Jan. 2019 Data	≈ 11h30	≈ 8 hours		

3.2.4.1 Field notes

For Heller et al. (2018), field notes and video-recordings are the main techniques used to record observational data. Thus, in this section I focus on the use of field notes since they “are a central, yet somewhat invisible, practice of collecting ethnographic data” (Heller et al., 2018: 82). It serves to mention that within the framework of the present study, the annotated observations will be analyzed as secondary sources. They will continue to be integrated into the discussion as necessary for the reasons outlined below.

To record observations, I used two annotation techniques. First, a field journal (handwritten), i.e., a small 180 sheet Jot Spiral Fat Book allowed me to take note of interactional practices in real-time. Second, I also used a running field journal in the form of a Word document (digital). Throughout this investigation I have drawn examples from both. Furthermore, in doing so I have made explicit, as you have read, whether the observation in question came from either the handwritten, or the digital field journal. Regarding their use, I tended to use the digital format when recording thoughts, ideas, and questions in most cases only *after* the observations took place. However, both observational methods were privileged when the camera was not rolling. Moreover, I should insist that field notes whether recorded

digitally or handwritten are highly personal, and thus present their own unique set of challenges.

First, if observations are handwritten, they can be very sloppy, or incomplete making them difficult to read for a variety of reasons. For example, when onsite the researcher who is inundated with rich sociolinguistic information, may strive to record as many observations as quickly as possible, on the spot, and in a limited amount of time, even if we have seen previously, this is simply an impossible feat. Notwithstanding, this sense of urgency can in turn make field notes difficult to interpret when it comes time to reread them at a later stage of the investigation. Another reason could be related to whether a pencil or pen was used to write, as well as how the writing is structured in the document. The two figures below are taken from the handwritten journal. They are dated September 9th, 2018, and September 18th, 2018, respectively. The first entry was written with a pencil and includes specific linguistic interactions between ERI and LIN. They are also written as if they were transcriptions, or one speaker and his/her utterance per line. Additionally, there are some contextual notes sprinkled throughout. It is only one quarter-page long, but it contains observations from two distinct interactional moments, one in a dyadic, and the other most likely in a multiparty participation framework. The second entry was written with a pen and is about four quarter-pages long, which amounts to about one A4 page. The entry here is more of a reflection. It was added after almost one month in the field and has to do with my re-integration into the social structure of the family. In the entry I also observe that there is an overabundance of English spoken in the bilingual language learning environment and this by all the multigenerational family members. Finally, since the clarity of the images is not great, a transcription of the observation is proposed beneath each example.



Figure 14: Example from field journal written in pencil on 09/09/18

Sunday 09/09/18

[door closed Lini knocks]

ERI: ¿Quién es? (Who is it?) [opens door]

LIN: Lini [comes in]

LIN: What are you doing? [sees ERI w/ clothes in hand]

ERI: I'm going to shower because ...

LIN: You smell?

.....

ERI: What Lini? [She's looking @ me.]

LIN: I'm itchy. [scratching herself]

ERI: ¿Tienes comezón? (You're itchy?)

LIN: [knods yes]

We're all sitting in the garage after having had a tasty lunch.

We're going to the beach later. (Alvarez, 2018).

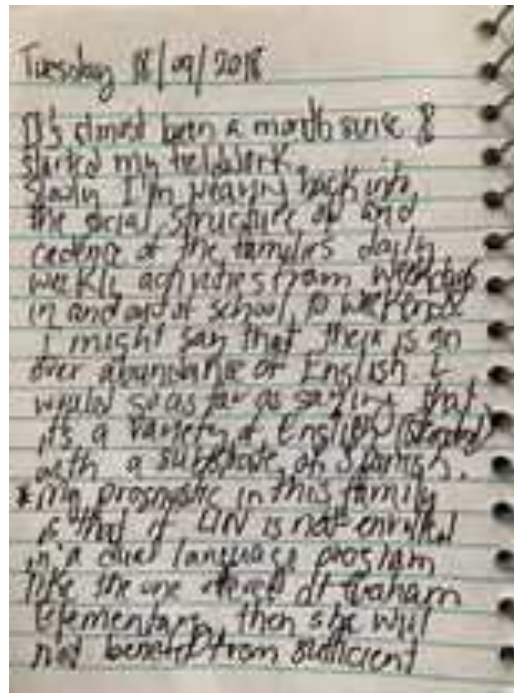

Figure 15: Example from field journal written in pen on 18/09/18

Tuesday 18/09/2018

It's been almost a month since I started my field work. Slowly I'm weaving back into the social structure of and cadence of the family's daily, weekly activities from weekdays in and out of school to weekends. I might say that there is an overabundance of English. I would go as far as saying that it's a variety of English (standard) with a substrate of Spanish. *My prognostic in this family is that if LIN is not enrolled in a dual language program like the one offered at Graham Elementary, then she will not benefit from sufficient

As we can see from the examples above, handwritten field notes are inherently challenging to use as secondary supporting resources. Not only are the entries written in pencil more difficult to read due to the lighter color that tends to fade with time, but they are also more challenging to interpret because the contextual cues may be limited. On the other hand, those that are written in pen are easier to read because of the rich color that holds well on paper over time, but they may progressively get messier. However, they were clear enough to read my early observation in the field as it pertains to the transmission of heritage Spanish. For example, that if a bilingual educational program was not proposed to LIN as it was offered in her school, then not reaping the rewards of enough Spanish input would subsequently impact her heritage Spanish development, at least in a more active (productive) sense. Nevertheless, while messiness may prove to be disadvantageous, one advantage is that a notebook is not only discreet, but also practical to carry, open, and write in as needed.

On the other hand, a digital field journal, i.e., a running Word document has the advantage of legibility and neatness. The figure below is therefore a screenshot from the digital journal that I kept. It is dated August 22nd, 2018, or just two days after my arrival to the field and it is roughly one standard (A4) page long. Much like the previous entry, this one too is a reflection. However, it is perfectly legible since after all, it was written on a Word document. Moreover, another advantage of working on a Word document, as opposed to a handwritten journal is the ability to modify the formatting, and the font, as well as to highlight certain parts. This type of manipulation lends itself to quickly identifying pertinent aspects to accompany later analyses, and in some cases to copy and paste them which in turn saves some time during the writing process. As we may see in the observation below, I considered issues related to identity at the family and social level, language use and dominance among the family members, and language and autism for example, as well as issues related to data collection like pinpointing new moments to record or purchasing essential technical material. I have already presented and discussed pertinent aspects of this entry, so they will no longer be the object of discussion here.

Day 2 – 22/08/2018

ALE described a woman that 'looks' Mexican, but who doesn't speak Spanish as 'Pocha'. Ideologically this may have negative connotations, but it also highlights the idea that passive heritage bilinguals may indeed be described/identified based on their perceived heritage (what they look like) and whether these individuals have productive use of the language they are perceived to speak (in this case Spanish). Is then a 'pocho' not bilingual? But more generally, what is a 'pocho'? According to Urbandictionary, a 'Pocho' is a Mexican that has been Americanized. This means they have lost their cultural heritage. Indeed, it is suggested that one of the key criteria for this label is not having acquired at least in part productive ability in Spanish, only receptive. Moreover, as suggested previously, 'pocho' is considered not only derogatory, but also used to label someone who is trying to "act white". Nevertheless, members of the Chicano community have embraced the term. The term 'pocho' has thus become more empowering and playful, than devastating and hurtful.

Even when CRU a first-generation Spanish speaker is around conversation tends to continue in English with different individuals relaying translations as needed, or when asked.

Also, conversation tends to bifurcate: English with the ALE, ROX etc. and Spanish between ERI, CRU and GLO, lots of code-mixing going on if we're all together

This morning overheard ROX call JUL by saying 'Ven Julian' followed by 'come here' when JUL woke up crying

RIC to IGN 'ahorita te agarro papi, hold on' when IGN complained as we were exiting the car

CRU when together in conversation tells ROX 'habla en español', or to speak in Spanish

The issue of language dominance in the home. Appears as though the number of speakers of any one given language may determine the language spoken. Example, mostly English was being spoken around the dinner table, towards the end of dinner, MAR's Spanish dominant parents (to be confirmed) visited, turning the language of conversation into Spanish, CRU was able to participate and CRU, GLO and visitors sat outside and continued talking in Spanish

ALE on GOY's use of 'orange' and 'watermelon'. ALE told me that GOY will call an orange (fruit) "yellow" even though GOY knows both orange and yellow as colors. Does this mean that GOY sees color differently and that she calls an orange by the color that she perceives it to be and not the object/shape/noun/ that it is? What will GOY do if she's presented with both an orange and a lemon? What will GOY call the lemon? Will she label it by the color, and if so which one, or will GOY label 'lemon' by what it is. Or are all round fruit-like objects called "yellow"?

GOY is also said to call a 'watermelon' an 'agua', or water. After discussion with her parents ALE and RIC, it was thought that it was perhaps because GOY is translating in part the form of the word? In other words, watermelon is a melon made of water and GOY knows that English water is 'agua' in Spanish. Therefore, GOY calls a watermelon an 'agua' (which is not far from the truth), or the closest translation from English to Spanish. Is this evidence that GOY is reasoning/using logic and a reflection of her cognitive capacity? But, as ALE also mentioned, in Spanish the term that is used is 'sandia' and not 'agua'. Thus, GOY is essentially faced with three forms to name an object: watermelon that she calls 'agua', but that is officially called a 'sandia', a word that seemed novel to her when it was offered to her as the conventionalized term for watermelon.

That same night we discussed IGN's issues related to autism. IGN's tests show that he is around 1,5 years behind cognitively. This is evident in his general demeanor socially and linguistically. From a cognitive, usage-based linguistic perspective it is interesting to see how delayed/stalled cognitive development in bilingual settings is also detrimental to bilingual language development. In other words, how speech is critically related to cognition and the analytic mechanisms that drive acquisition, understood as the process of linguistic development from babbling to first words, to constructions and on to grammaticalization. A few hours of interaction with him could be interesting from this point of view, but also to see how parents and other caretakers in this extended family adjust linguistically when they interact with him

Material issue - Bought a new tripod

Figure 16: Example from digital field journal i.e., running Word document

Despite the advantages of using a digital field journal such as a laptop, carrying such a device is not very practical. They may be bulky, their autonomy in terms of battery life may be short-lived, or there may be issues with the cords and plugs. Thus, technically they are not as easy to use, or as discreet as a handwritten field journal since even the typing sounds may distract the participants⁸³, and as such temporarily bring them out of interaction. Lack of discreetness may also heighten the awareness of the observed, which can lead them to adapt their behavior. To further illustrate this point I turn your attention to the entry below. It was taken from the digital

⁸³ After one of LIN's in-class observations, her teacher commented on the fact that she, and some of her students became aware when I arrived and began taking notes on my laptop. Even if she did not ask me to do otherwise, I decided to record my observations using the notebook during the subsequent in-class visits.

field journal discussed above on October 22nd, 2018, during one of my visits to LIN's classroom. In my reflection I write about how it is likely better to use a handwritten field journal in the future. This is because according to COM, laptops may be associated with the formality that school district administrators create in the classroom when they come do their in-class observations. My ethnographic research was in no way intended to evaluate what was happening in class, and less so to impact the participants' behavior. As a result, this was the last time that I took notes digitally when I was in the classroom.

Note to self: When doing in class observations, it's probably best to take notes with paper and pencil and not on a laptop. Laptops make it seem more formal and could stress certain teachers out since according to COM when evaluators who come from the LAUSD (they) often pull out their laptops and 'write' everything that is being said. (Alvarez, 2018).

Nevertheless, another issue that I encountered (after the fact) related to recording field notes is temporal regularity. Since video-recordings were the primary data source in the present study, it was not imperative, or at least I did not think at the time, to jot down impressions with great regularity since they were only intended to complement the multigenerational interactional moments when the camera was off. It serves to mention that for this project the camera was frequently recording. Thus, this can in part explain the random nature of the field notes in both their handwritten and digital formats. However, in the end both the digital and manual methods implemented to record the language data seemed to complement each other.

Finally, ethics is the third issue related to the use of field notes according to Heller et al. (2018), or why field notes are rarely shared with the scientific community. The issue of ethics will be developed at the end of this chapter. What is important to keep in mind is that "making fieldnotes, like any other research practice, is a skill that can be learned." (Heller et al., 2018: 82) with time, and of course with practice. In my case, even if my note taking method and style are a work in progress, a field journal whether it was handwritten or digital turned out to be a useful complementary tool. Field notes, as we have seen thus far have helped me support the various types of bilingual language use patterns unique to the family as they socialize LIN to use Spanish or socialize her out of its use. In other words, we may also ask: Is LIN socialized into language mixing at the expense of third-generation heritage Spanish transmission? In Chapter 5 and 6, detailed analyses of LIN with her caretakers in bilingual, multigenerational, multimodal, and multiparty interactional frameworks may help elucidate these questions. Finally, our field notes have also helped us understand sociolinguistic issues as tied to ideology, culture, politics etc. beyond the family level. They have provided me with

the ability to go back and to apprehend these issues not only in the school, but also in the community at large.

The table below summarizes, side-by-side, the entries recorded in both the handwritten Jot Spiral Fat Book (middle column) and the digital Word document (last column). They are not exactly comparable (and not meant to be) due both to the physical size of each tool, as well as to the size and spacing of a writer’s letters and words on a page. For example, a page in the spiral notebook is a quarter of the size of a standard A4 page. However, we may get an idea of the number of words in each. As seen below, approximately 6 015 words (middle column) were recorded manually. Almost double, or approximately 11 500 words (last column) were entered digitally. To arrive at the number of handwritten words, the number of pages (62) was multiplied by the number of words (97) found in the first reflexive entry (# 24). The number of words in the digital document were generated automatically as is the case in any Word document. Through the various examples that I have presented, a journal entry may include a couple of lines worth of comments, interactions, observations etc., to lengthier reflections ranging from a paragraph to a few pages. They may also vary in their quality, or potential for later interpretation. I give a timeline of the entries below.

Table 16: Handwritten and digital field journal entries

Number of entries overall	Jot Spiral Fat Book (62 handwritten A4-sized pages ≈ 6 015 words)	Word Document (16 digital pages ≈ 11 500 words)
1.		21/08/2018
2.		22/08/2018
3.		23/08/2018
4.		24/08/2018
5.		26/08/2018
6.		27/08/2018
7.		28/08/2018
8.		29/08/2018
9.		30/08/2018
10.		31/08/2018
11.		01/09/2018
12.		02/09/2018
13.		03/04/2018
14.		04/09/2018
15.		05/09/2018
16.		06/09/2018
17.		08/09/2018
18.	09/09/2018	09/09/2018
19.	10/09/2018	10/09/2018
20.		11/09/2018
21.	14/09/2018	14/09/2018
22.	15/09/2018	15/09/2018
23.	17/09/2018	

24.	18/09/2018	18/09/2018
25.		19/09/2018
26.	21/09/2018	21/09/2018
27.	28/09/2018	
28.	10/10/2018	
29.	11/10/2018	11/10/2018
30.	13/10/2018	13/10/2018
31.		14/10/2018
32.	15/10/2018	15/10/2018
33.	16/10/2018	16/10/2018
34.	17/10/2018	17/10/2018
35.	19/10/2018	19/10/2018
36.	22/10/2018	22/10/2018
37.	23/10/2018	
38.	24/10/2018	24/10/2018
39.	04/11/2018	04/11/2018
40.	05/11/2018	05/11/2018
41.	08/11/2018	
42.	09/11/2018	
43.	15/11/2018	
44.	17/11/2018	
45.	19/11/2018	
46.	21/11/2018	
47.	26/11/2018	
48.	17/12/2018	
49.	31/12/2018	
50.	05/01/2019	
Total	30	36

The first column shows a maximum of 50 entries. Each entry corresponds to a different date. This is approximately one entry every day for almost two months. 36 entries were made digitally whereas 30 of them were handwritten. 16 entries overlap, that is they were handwritten and made digitally on the same date. The gradient color scheme distinguishes between the entries from the start of the fieldwork in the second and third column. The first month is in white, and the following five shades of green correspond to the next six months of fieldwork. In total six months are presented: August 21st, 2018, to January 5th, 2019. Furthermore, the table shows an interesting pattern overall. The note-taking process began digitally (last column), then overlapped with entries in both formats, and ended exclusively with manual entries (middle column). Overall, the entry dates highlight the irregularity in the field note taking process. Regardless of the format, field notes were not entered daily. Certain entries were both handwritten and made digitally, and on dates when entries were not made with one tool, they were made on another. In the end however, both tools complemented each other since overall, the method spanned the longevity of the project. Finally, while field notes did not directly involve the participants in the data collection process, questionnaires did. Below I

discuss sociolinguistic questionnaires as another secondary source of information used in this project.

3.2.4.2 *Sociolinguistic questionnaires*

We previously discussed some pros and cons of the field note creation process. In this section I attempt to underscore why questionnaires, as a secondary source of information are helpful in describing and categorizing heritage speakers. According to Aalberese et al. (2019), researchers interested in case studies of minority languages frequently use questionnaires since they are useful in gaging amongst other things, linguistic variation in heritage speakers' multigenerational communities of practice. Moreover, questionnaires like all other research methods differ across research programs. This is largely based on the investigator's goals. They may include a diverse set of questions to assess self-reported proficiency, language use and history, language attitudes, identity, ideology, educational and professional background, socio-economic status (SES) etc. By answering these questions as truthfully⁸⁴ as possible, participants open an additional window into their lives. In turn, this information may be used for a variety of tasks. For example, Polinsky and Kagan (2007) paired and assessed biographical information with the WPM-rate⁸⁵. They suggested that this was an efficient way to streamline the language placement process for students. This shows how using biographical data with other sources of information may help tease apart students' language levels to create more homogeneous cohorts of speakers in the classroom. The type of questionnaire administered to the speakers in this project is the Bilingual Language Profile (BLP). It is open, free, and easily found online. It is also intended to measure the gradient nature of language dominance of the participants (Aalberese et al., 2019). This includes the interrelated factors that influence language dominance. To re-name a few they include: onset of acquisition, years of schooling, linguistic environment, language attitudes etc. that we have previously discussed.

In comparing the results of the Hawai'i Assessment of Language Access⁸⁶ (HALAL) body parts test to those of the BLP, Lindsey (2013) found that when it comes to language dominance, the BLP identified language shift later. In heritage bilingual communities,

⁸⁴ Research suggests that participants tend to over report in self assessments. Thus, it is crucial to keep this issue in mind when analyzing the questionnaires.

⁸⁵ WPM-rate: A measure of words processed in a minute.

⁸⁶ HALAL: Hawai'i Assessment of Language Access: An easy-to-use psycholinguistic measure for assessing language strength suggests that speed of lexical retrieval by bilingual speakers is a good measure of relative language strength.

language dominance is a key trademark, and it is subject to vary across speakers, generations, and the lifespan. Therefore, assessing linguistic dominance is useful. It helps answer questions related to the sociolinguistic profile of heritage bilinguals. An understanding of heritage speakers sociolinguistic background may reveal how they think they are using language, with who, when, and why etc. Furthermore, when coupled with other tools, questionnaires can prove to be quite informative. In another example, Van Osch et al. (2014) matched two groups of speakers in the Netherlands to better understand the age of onset of acquisition as a determining factor in bilingual proficiency. The first group was composed of proficient heritage Spanish speakers. The second group was composed of proficient speakers of Spanish as a second language. Both groups were matched according to similar SES and language history, as well as on linguistic tests. Their findings showed that the closer the speakers from each group were matched, the more their linguistic differences can be attributed to their age of onset of acquisition. In the present study, we are dealing with three generations of speakers each with their own unique language use styles. The BLP was distributed to all the adult speakers⁸⁷ and completed in the presence of the researcher. Due to her young age, a BLP was not completed for LIN. Finally, the sociolinguistic questionnaires as a secondary source of information complemented the video-recordings, or the primary data in this study. Together, the aim is that they help determine the various degrees of language dominance and use both at the individual level, but also at the multigenerational family level, which again is a key feature of heritage speakers within their socially and linguistically multidimensional communities of practice.

3.3 Plurilingual corpus creation

According to Léglise and Alby (2013) the last 15 years have seen an emergence of work on multilingual corpora. However, one issue is that even if these transcripts span a breadth of languages, for the most they have been monolingual in nature. The laborious transcription process has been generally completed in only one language, while leaving the other one out. Furthermore, with these types of corpora, analyses are generally carried out on comparable transcripts where languages have been matched for example, by genre or number. Moreover, language analyses are also carried out on two other similar types of transcripts. The first are parallel transcripts and they are accompanied with their translations. The second are multilingual parallel transcripts, and they go a step further than the first two in that the

⁸⁷ Each of the Bilingual Language Profiles completed by the adult speakers within the framework of this study are included in the appendices.

translation equivalences are both matched and aligned. Despite the various ways to run analyses on multilingual corpora, the fact is that they remain largely monolingual in nature, and of course this can be problematic, especially when working with bilingual communities.

When bilingual speakers deploy different languages for different needs (Grosjean, 2015), as well as when they mix both languages in interaction, how can one run analyses on both languages if only one of them has been transcribed? For example, it would be impossible to measure the MLU, or TTR of a bilingual child based on a multilingual corpus. Therefore, from an acquisition perspective, not only would we run into a dead end in assessing a child's bilingual development longitudinally, but it would also be difficult to measure other bilingual phenomena. Thus, within the scientific community there was a need to create a “corpus plurilingue ... (un) corpus comprenant plusieurs langues au sein de mêmes textes (interactions spontanées plurilingues illustrant des phénomènes de codeswitching ou de mélange entre plusieurs langues)” (Léglise & Alby, 2013: 98) (plurilingual corpus that includes several languages within the same text such as spontaneous plurilingual interactions that highlight phenomena related to code-switching or other types of language mixing). While one of the research questions of this Ph.D. seeks to understand the multigenerational heritage language socialization of a third-generation child, the other research question aims to understand Spanish language use and development in various interactional and multimodal participation frameworks. This includes how LIN uses heritage Spanish, and how the interconnected use of English, language mixing, and the passive use of Spanish as a means of communication help or hinder multigenerational transmission. Thus, to better understand her bilingual language development, LIN's MLU and TTR should be measured and analyzed for both Spanish and English. This aim highlights the importance of transcribing the video-recorded data in both languages and thus rendering bilingual transcription non-negotiable. Finally, language mixing is common within the family under investigation, so a plurilingual corpus may most closely reflect the familial linguistic practices on the ground.

To date, language mixing has been the object of a tremendous amount of research from varied theoretical perspectives and methods. In other words, even if “Substantial chapters or sections have been devoted to CS in the principal volumes on bilingualism and language contact” (Gardner-Chloros, 2009: 13), less is known about this type of language mixing phenomena based on plurilingual corpus studies of spontaneous bilingual interaction, and perhaps even less so in multiparty participation frameworks rooted in multigenerational

settings. According to Alvarez-Cáccamo (1998), the term code-switching may be traced back to Vogt 1954. Code-switching has also been distinguished from the term code-mixing in the literature. For Auer and Eastman (2010), code-mixing refers to switching within a sentence, while code-switching refers to cases where the practice of language alternation takes place within syntactic units that are independent. Within the framework of this Ph.D. the term language mixing will be used to cover both the alternate use of two languages within a sentence, as well as between sentences in the same conversation. Notwithstanding, to answer the research question related to LIN and her family's language mixing practices, as well as to fill a methodological gap in the current state of the art, it was indispensable to build a plurilingual corpus where both Spanish and English were transcribed. Léglise and Alby (2013) insist that contrary to multilingual corpora, plurilingual corpora are still rather scarce, as well as relatively unavailable to the linguistic community interested particularly in bi- and multilingual practices. Indeed, plurilingual corpora are unique, but rare. Therefore, the remainder of the section discusses the human and material resources used to collect the data to create the plurilingual corpus for this project. Perhaps this arduous process may shed insight into why plurilingual corpora are scarce. We thus begin with some pre-departure preparations.

3.3.1 Funding & Networks

Given the transnational and longitudinal nature of this case study, the data collection process included conducting fieldwork in L.A. twice. First, I travelled to L.A. from Paris for the month of February 2018. The trip was made possible for two reasons. On one hand, I was accepted to present a poster outlining the progress of my Ph.D. during the National Heritage Language Resource Center's⁸⁸ (NHLRC) Third International Conference on Heritage/Community Languages. Furthermore, the NHLRC is conveniently based on the campus of the University of California, Los Angeles (UCLA), where the conference was held. This logistical advantage allowed me to both stay with the family under study to collect the required video-recorded data, present my initial results, gain feedback, and continue building networks with scholars interested in heritage linguistics.

⁸⁸ The NHLRC is located at the University of California, Los Angeles. It is one of 15 Language Resource Centers funded by the U.S. Department of Education. Their mission is to develop effective pedagogical approaches to teaching heritage language learners, both by creating a research base and by pursuing curriculum design, materials development, and teacher education.

The second reason the first fieldwork mission was made possible was related to funding. The École Doctorale (ED 625 MAGIIE), or doctoral school to which I am attached at Sorbonne Nouvelle University (SNU) has proved to be financially supportive when it comes to (inter)national research related activities, and other opportunities. Thus, after a standard internal application process I was granted the necessary funds on behalf of SNU to cover the conference fees and a portion of the flight. In parallel to preparing for February 2018's data collection mission and presentation, I had been in touch with Maria Polinsky. Dr. Polinsky, a Professor of Linguistics at the University of Maryland, and leading expert on heritage languages in the U.S. is also a co-director of research at the NHLRC at UCLA. I met her, along with several prominent heritage language researchers in the summer of 2017⁸⁹. My aim in contacting Dr. Polinsky was to see if the NHLRC would invite me at a later date so that I may continue my fieldwork. To apply for additional funding to go back to L.A. a second time, an official invitation from the host institution was necessary as part of the application process. Thanks to Dr. Polinsky's support I secured an invitation⁹⁰ on behalf of the NHLRC. With it, as well as with a lengthy research project proposal⁹¹ that also detailed my motivation, goals, and timeline for the trip, I obtained an external mobility grant for 4,000 euros from Labex EFL⁹². This allowed me to further fund and conduct fieldwork between late August 2018 and mid-January 2019.

In all, the data collection process spanned approximately one year beginning in February 2018 and ending in January 2019. For this reason, the present study of heritage bilingualism and multigenerational transmission and socialization may be considered longitudinal, a research design that De Houwer (2009), among many other linguists interested in bilingualism have encouraged. Finally, it is important to stress that both public and private institutional support as well as networking opportunities made documenting the bilingual linguistic and cultural practices in this multigenerational family possible. The next section will thus give more detail about how the data was managed and described, a crucial phase before the transcription phase.

⁸⁹ It was during a one-week summer school, or École d'été, called LangHerit short for Langues d'héritage : théories, terrains et méthodologies (Heritage languages: theories, terrains and methodologies) that took place at the CNRS in Roscoff, France. The CNRS is the Centre National de la Recherche Scientifique, or the French National Center for Scientific Research. It is among the world's leading research institutions.

⁹⁰ Included in appendices

⁹¹ Labex EFL Mobility Grant Project is included in the appendices.

⁹² Labex EFL: Empirical Foundations of Linguistics: data, methods, models. Promotes innovative and interdisciplinary research within linguistics and its related fields with a special focus on empirical foundations, such as corpus analysis.

3.3.2 Describing & Managing the data

Several measures were taken to manage the rich amount of bilingual data collected for this project. As highlighted above, one of the aims of the present investigation was to create a plurilingual corpus to fill a methodological gap in studies of bilingualism, and more specifically in investigations of heritage language socialization. First all the videos were converted into .mov files in bulk. But prior to this step, I needed to maximize the data storage capacity of my four SanDisk Ultra 128GB microSDXC-I memory cards, an unanticipated issue that needed quick resolution. The digital journal entry below dated August 4th, 2018, underscores how I went about dealing with this challenge in the field.

Material issues – (I) Google searched how to change the type of recording mode in the camcorder to change the amount of data, or the amount of recording time that can be stored in the memory in terms of hours. I went from slightly over 8 hours of recording capacity for a 64gb card to over 19 hours per SD card by changing the mode. Of course, I needed to compromise on the video quality to film for longer recording sessions, so the mode was changed to SP from MXP(*). The figure below shows the recording mode continuum:

Recording mode	MXP(*)	FXP	XP+	SP	LP
	Recording in high image quality ←		→ Recording for long periods		
Bit rate	24Mbps	17Mbps	12Mbps	7Mbps	5Mbps
Size of Video Recordings	1920 × 1080		1440 × 1080		

Indeed, the Canon Legria HF G25 camcorder that I use offers five recording modes and changing the recording modes will cause the recording time available on the memory to increase. While MXP and FXP are used for better movie quality as depicted above, LP is used for longer recording times. I will do a few sessions in SP mode and re-watch to confirm that I can use that level of video quality for my analysis. (Alvarez, 2018).

We may therefore see from the entry above that manipulating the recording modes allowed me to more than double the storage capacity per SD card which was crucial since I was recording for extended periods of time. This was at the expense of visual quality, but in the end, it did not seem as though the quality of the image was adversely impacted. Nevertheless, this issue aside, each bulk of more and less lengthy videos always corresponded to one month of recordings in the conversion phase. This step was crucial since it made the videos compatible with the transcription software CLAN (MacWhinney, 2000). The choice to use CLAN for this project will be discussed in detail further below. Overall, however this seemed like the right choice for a couple of key reasons. First, I was trained to use this language analysis software in both of Dr. Morgenstern’s Master 1 and Master 2 research seminars that revolved around

using CLAN. Second, in continuity with current, and previous Ph.D. studies such as Caët (2013), and Beaupoil (2015) under Dr. Morgenstern’s supervision, it allowed me to show methodological continuity with the projects and protocols of the research lab, especially as a fully financed Ph.D. Candidate.

After the data conversion phase, separate files were created. Each of these files was labeled according to the month and the year the data was collected. All the recordings were then sorted according to the month they were collected, and then they were placed in their corresponding files. There are a total of seven files that together contain almost 200 hours of video-recordings. Six of the files correspond to data collected in 2018. Only one file contains data filmed in 2019. Furthermore, the analyses to be discussed in Chapter 4, 5, and 6 are based on samples taken from the February 2018, August 2018, and January 2019 files. These files are colored in green in the table below in the first column.

Table 17: Data files as archived according to month & year of sampling

Month & Year	Approximate number of films per month	Approximate number of hours recorded per month	Approximate number of hours of data collected longitudinally	Average number of hours recorded per month
February 2018 Data	≈ 79	≈ 14h	≈ 183h	≈ 26h
August 2018 Data	≈ 55	≈ 8h		
September 2018 Data	≈ 128	≈ 41h		
October 2018 Data	≈ 63	≈ 25h		
November 2018 Data	≈ 74	≈ 31h		
December 2018 Data	≈ 101	≈ 45h		
January 2019 Data	≈ 84	≈ 19h		

In the first column, the table also lists the remaining four files (that were intentionally left out in the previous table) not sampled in this study. They correspond to the months of September to December 2018. The second column shows the approximate number of videos per month in each file. The third column presents the approximate number of hours of data contained per month. Overall, the bulk of the hours recorded per month correspond to those months not sampled in the study. The number of hours contained in our samples (February 2018, August 2018, and January 2019) vary between almost 10 to 20 hours, while the number of hours in the months not sampled vary between 25 hours minimum up to 45 hours. Nevertheless, to arrive at these results, the videos give time in hours, minutes, and seconds for example: 00:21:59, or 00:10:22. Seconds were rounded up, or down to the nearest minute. Thus, the former time was rounded up to 22 minutes since it was over 30 seconds while the latter was rounded down to

10 minutes since it was under 30 seconds. The minutes were added, then divided by 60 to obtain the approximate number of total hours. Minutes were also rounded up or down to the nearest hour following the model above. The fourth column shows that approximately 183 hours of data were collected longitudinally for this study of multigenerational heritage bilingualism. Finally, the last column suggests that on average, 26 hours were recorded per month. The files that were not used in this study were stored in my personal external hard drive and will likely be a rich source of data for future research.

The next step in the data management process was to describe the data in each of the three files selected for the study. Combined, this represented approximately 41 hours of dynamic bilingual data to describe. To organize this task, an Excel spreadsheet was created for each file i.e., month, or sampling period. The Excel spreadsheet's title thus included the month, year, type of corpus, and where the recording took place. For example, the February 2018 data is in the Excel file titled: FEB_2018_Bilingual Corpus Description_LA, California. The description process was laborious, even if significantly less so than the transcription phase. It involved completing, as best as possible, seven columns of information per video. The designated Excel sheet was generally opened on the left half of the monitor while the video played on the upper right corner. Whenever an annotation was made, the video was paused. The description process took about two weeks per sampling period. Since there was a total of three sampling periods, the description process took roughly six weeks to complete. In general, the main factors that determined the time and the effort spent describing the data much like when transcribing and coding it, was related to the number of speakers present in the participation framework, and of course the sound quality. The higher the number of multigenerational speakers in the multiparty interactional frames, the more challenging the data was to describe. Difficulty also increased with decreased sound quality. The table below includes the annotation categories on the left column. The right column describes the categories in question. On Excel these categories appear horizontally.

Table 15: FEB_Bilingual Corpus Description_LA, California

Category	Description
Participant(s) + Date	This column was intended to give each video a unique title. Titles were based on the month, day, and year of recording according to the information found in the metadata. On several occasions there were multiple recordings on any given day. So, the title of each video also included the first three letters in CAPS of the participant names in order of verbal appearance. Often, within the first few seconds of the video, we had a good idea of who the main speakers were. Of course, the higher the number of speakers, the more unique the title. This process rendered the titles more unique and thus easier to find.
Transcription	This is where the video's description was annotated. This process turned out to be incredibly time consuming since I ended up essentially transcribing the data. After having finished describing the February 2018 data I turned to my director for workflow advice. Dr. Morgenstern suggested that rather than transcribing, that I consider doing "coarser" description. I applied her advice to the August 2018 data and indeed it saved me several weeks of work. Moreover, for this reason the subsequent two descriptions (August 2018 and January 2019) are shorter than the first.
Salient Features	The idea here was to highlight pertinent linguistic moments. Since this project is centered around the use of heritage Spanish, as well as English, and language mixing by a third-generation child, in this column I added information related to child language mixing, and of course moments when Spanish was uttered. This column also included moments when the target child refused to be filmed, as well as when she showed passive Spanish comprehension, or when she practiced overheard speech.
Transcribe = Y or N	Here, I simply added a "Y" or a "N". The decision to transcribe was based on the preceding column, or whether there were salient features pertinent to the research question. Just as importantly though if not more critical, the decision to transcribe was based on the sensitivity of the information. Indeed, when private issues were discussed throughout the interaction, the video was marked with a "N" and excluded from further analyses. Those that were marked with a "Y" were potential candidates for transcription. This column quickly allowed me to determine the eligible candidates for transcription.
Topic	The topics discussed between the participants were many. They included food, health, money, bilingualism, public services, family, kinship, religion, gender, education, politeness etc. Along with the "Transcription" column, the "Topic" column helped give a general, but quick idea of the content of any given video.
Generation	Next, in keeping with the sociolinguistic aspect of this project, the sixth column was related to the speakers in the interactional frames. This allowed me to indicate the number of generations per video. For example, when speakers from all three generations were present this column was filled with: 1, 2 and 3. If speakers only from the second- and third-generation were present, then this column was tagged as: 2 and 3. This process was helpful in that it allowed to quickly identify videos where all three generations were in interaction. In a multigenerational study such as this one, coding for generation proved to be advantageous.
Time	Finally, the last column included in the description of each video was its duration. The length of any given video ranged from around one minute to almost 40 minutes. This information was helpful. First, it allowed me to get a sense of the amount of data I was dealing with overall as demonstrated above and in each plurilingual corpus. In all, the three files (February 2018, August 2018, and January 2019) amounted to approximately 41 hours of video-recorded data. Moreover, roughly eight hours were selected from each file to transcribe for a total of 24 hours. To have an idea of the length of each video also helped manage workflow. For example, under certain circumstances i.e., time constraints, I could transcribe shorter videos first to not interrupt a transcription session.

Building on the previous table that provides the general description of each category, the table below gives a detailed example of the first video description as it appears in the Excel sheet

labeled: FEB_2018_Bilingual Corpus Description_LA, California. This table corresponds to the first eight hour-long plurilingual corpus that was created and used within the framework of this Ph.D.

Table 18: First two video descriptions in EXCEL labeled: FEB_2018_Bilingual Corpus Description_LA, California

Participants + Date	Description	Salient Features	Transcribe = Y or N	Topic	Generation	Time
FEB_1_2018_ERI_LIN_JUL_ROX	<p>LIN: Mami I want SOPA, you wanna drink xxx xxx TETA</p> <p>GLO: makes POZOLE</p> <p>ROX: don't sound CHIQUIADA</p> <p>ROX: the only thing she says really good is FIDEO</p> <p>JUL: TETA</p> <p>ROX repeats: TETA</p> <p>ROX: AIE TUS IDEAS NINA</p> <p>ROX: just a little bit of honey one CUCCHARADA</p> <p>ROX: it's so heavy because it's like HASTA ARRIBA</p> <p>(LIN and her use of 'last week' to talk about past events)</p>	<p>LIN LMs</p> <p>JUL speaks S</p> <p>ROX LMs & speaks S</p>	Y	Food	2 & 3	00:10:49

Starting with the column on the left, we notice the video's unique title. It includes the month, day, and year followed by the speakers (ERI, LIN, JUL, and ROX) who were present during the recording. Also, the participants' three-letter identification markers are in caps and are separated with underscores. The second column shows the detailed descriptions. They were subsequently shortened or made 'coarser' following my director's advice. The description above shows LIN language mixing coded as LM (third row), as well as ROX, and the use of Spanish by JUL. Key words in Spanish were written in caps to identify them easily visually when quickly scanning the document. The third column highlights the salient features that were described in the previous column for example when LIN mixed languages. They also included the moments when LIN spoke Spanish, or when she demonstrated passive comprehension of Spanish whether the input was child-directed or overheard as uttered by both bi- or monolingual adults. A demonstration of LIN's passive Spanish comprehension was generally marked by her contextually appropriate response, oral or gestural in interaction. The fourth column was simply ticked with a capital Y which stands for yes. In this case the video was eligible to move on to the transcription phase. The decision to tick yes, or no was essentially based on issues related to privacy. Some topics of conversation, while undoubtedly interesting from a linguistic point of view needed to remain protected since they could be quite intense, and thus not disseminated to a larger audience.

I had the opportunity to further discuss how to treat these tense familial moments in my data with a UCLA researcher coded here as TAM. She is a close colleague with whom my research director regularly collaborates, and who I have had the pleasure to meet on several occasions both in France, and in California. In the digital journal entry below dated October 22nd, 2018, I thus recall my conversation with TAM where she suggests that I not only do my best to overlook these family related frictions, but perhaps more importantly that when it comes to the data analysis phase that I simply exclude them. I write:

As far as family tensions, TAM suggested that they be ignored and that when it comes to transcription, or even analysis that I leave them out. (Alvarez, 2018).

Moving forward with the data description protocol, the fifth column attempted to identify the topic of conversation. Again, it was not systematically noted, especially for topics that were considered sensitive as previously discussed. Moreover, on many occasions more than one topic could be attributed to the ongoing interaction. Due to this perhaps normal thematic irregularity, using this column was not as practical to use as I had imagined. In future work I need to iron-out these issues to improve the consistency of this category and thus its use more productively. Next, the sixth column shows the generation of the speakers present in the recorded social encounters. This column was critical in identifying multigenerational interactional frameworks upon which most of our thick qualitative analyses are anchored. These will be presented in Chapter 5 and 6. Finally, the last column shows the duration of the video in terms of hours, minutes, and seconds.

The data management and description phases discussed above were indispensable and most definitely helped with the fluidity of building a plurilingual corpus for this research project. It allowed for the organization of data internally and as a result rendered it quickly, and readily accessible. The use of the descriptive categories also allowed for the rapid identification of the bilingual data. The section below therefore underscore the arduous, but essential transcription phase that was critical in creating the present plurilingual corpus.

3.3.3 Using CLAN: Transcription hardware

to know whether there is any systematicity, then, you need quantitative data that measure the total number of utterances in a corpus and then on the basis of this you can select a subset of relevant sentences. Here we see the methodological need for having transcript-based ... studies. (De Houwer, 2009: 283).

The citation above captures the relevance of transcript-based studies as an important methodological tool for researchers interested in studies of child bilingualism. De Houwer insists that it is highly useful in trying to untangle and then to quantify bilingual language practices, and furthermore whether these language practices are used regularly within the community of practice. This step makes focusing in on and analyzing more specific utterances easier since the data is treated in sets for example by language. Many computerized programs have been developed to store, transcribe, code, and analyze data linked to either video, or audio files. CLAN is one of these programs and it is very well known among the scientific community of researchers interested in language acquisition, and related questions as we will see below. CLAN is an acronym for Computerized Language Analysis. The program was designed by Brian MacWhinney, a Professor of Psychology and Modern Languages at Carnegie Mellon University in the U.S. Moreover, at its core, CLAN is a tool used to analyze talk. In Part 2 of the program manual written by MacWhinney himself, he suggests that:

If you are a researcher studying conversational interaction, language learning, or language disorders, you will want to use CLAN, because it will help you address basic research questions and explore many different language types ... CLAN emphasizes the automatic computation of indices such as MLU ... It also provides powerful methods for speeding transcription, linking transcripts to media ... and automatic computation on a wide range of morphosyntactic features. For all these purposes, CLAN is available free (MacWhinney, 2000: 8).

The presentation above found in the introduction of the CLAN manual describes CLAN as a powerful program capable of performing a variety of linguistic analyses. This is particularly true for the researcher interested in monolingual or bilingual child language development. Furthermore, within the framework of this research project LIN's MLU for Spanish and English will be measured to take a closer look into her heritage bilingual development. Therefore, we may be able to compare how these two languages (Spanish and English) develop over the span of one year. This critical step will also support us in establishing LIN's bilingual linguistic output as her own baseline input language as previously mentioned. Moreover, as needed we may ask CLAN to extract a list of all the different words (types), and the number of times (tokens) known as TTR that she used throughout her interactions. Vocabulary measures are critical in investigations of heritage language acquisition (Montrul, 2016). As such, CLAN's TTR function is therefore helpful in the present study. It will help determine the lexical diversity, or the different kinds of words LIN is using in heritage Spanish, as well as their frequency of use. Depending on LIN's use of Spanish, we may further ask: Can LIN's word types be categorized into specific domains for instance a domain revolving around food as suggested by Grosjean's Principle of Complementarity? Or may we find on the other hand

that there is no real ‘systematicity’ regarding the heritage Spanish LIN is using? The 10th and final analysis in the next chapter may help us elucidate this question. Notwithstanding, CLAN can “count the frequency of occurrence of particular codes in the coding lines or words or word combinations in the speaker lines” (De Houwer, 2009: 68) for example those identified as [-spa] for Spanish, or those words identified with a @s symbol for a language switch, or what we have called language mixing in conversation. Finally, since I seek to better apprehend how LIN uses heritage Spanish as well as the impact of multigenerational transmission on heritage language socialization, CLAN is particularly well suited, especially for those researchers that have attempted to follow the transcription conventions outlined in CHAT as we will see below.

3.3.4 CHAT Transcription Conventions

Over the last 25 years or so, CHAT, the acronym for Codes for Human Analysis of Transcripts has been continually developed globally and in close collaboration with specialists in the field of child language development. Furthermore, De Houwer (2009) advances that when transcribing human speech, CHAT is the international benchmark. Moreover, the fact that there are many linguists and psychologists using this computerized software is advantageous, especially when it comes to troubleshooting. For instance, there are many resources available online. They include blogs and other written guides and videos designated to help us with issues related to running certain analyses or more general technical problems that are bound to occur during the transcription process. Furthermore, when adequate answers cannot be found online, Dr. MacWhinney himself, or one of his team members are readily available to help through email. I am grateful for the prompt solutions and exchanges I had with Dr. MacWhinney and his team when I ran into transcription issues that were due to downloading the latest version of the software⁹³. Nevertheless, the essence of CHAT is the line-by-line transcriptions that stack up vertically one after the other. Each speaker is attributed a different line number that increases every time (s)he speaks. The line number is followed by the speaker code in caps which is followed by their transcribed utterance. The end of each utterance is marked with a timestamp that links the utterance as found on the transcript to the precise moment in the video, or audio file. This is extremely useful for example when the researcher needs to quickly move from the

⁹³ Downloading the latest version of CLAN caused a great deal of stress, and precious time spent trouble shooting rather than transcribing. Since all the functions of the latest version of the software had not been updated before its release, I did not have the same resources, for example the Sonic Mode that I tended to use when transcribing. Old participant roles entered manually were also not carried over to the most recent version, and I was discouraged to re-add my personal participant roles. Looking back, even if Dr. MacWhinney and his team were extremely helpful in trouble shooting, I would not update the software mid-transcription unless it was necessary.

transcript to the video to further qualify a precise, often multimodal interactional moment including language use, context, gesture etc. of the multigenerational participants in the target, often multiparty participation framework as these interrelated communicative multimodalities emerge and unfold.

Moreover, even though CHAT follows a standard format, one advantage is that it nevertheless imposes little constraints when it comes to transcribing utterances (De Houwer, 2009). If one follows the transcription conventions, CLAN can be used to run an array of linguistic analysis as seen above. For example, on a plurilingual corpus such as the one created for this project, CLAN can sort out the linguistic resources coded as belonging to Spanish, or to English. Furthermore, it can sort those linguistic resources coded as mixed, or bivalent. Bivalent words belong to both Spanish and English in this study and we will take a closer look at this subset of words at the end of the next chapter. Also, the coding protocol will be discussed later. However, what is important is that the sorting capability of CLAN further allows the researcher to run analyses on individual sets of languages, individual transcriptions, or on the entire collections of plurilingually transcribed data. To illustrate this discussion, below I present an example of a plurilingual transcript that follows the general conventions provided by CHAT.

- | | | |
|-----|--|---|
| 1. | *ROX: [- spa] ponlo allí arriba de los xxx or@s arriba de los +... | Put it there on top of the xxx or on top of the +... |
| 2. | *JUL: [- spa] Mami. @ROX | Mommy. |
| 3. | *GLO: [- spa] qué Apá [: Papá] ? @JUL | What Dad? |
| 4. | *RIC: and Goya goes back til [: until] Tuesday. @ROX | |
| 5. | *JUL: [- spa] Mamá. @GLO | Mom. |
| 6. | *ROX: [- mix] I think LIN has school Monday el@s Friday no@s:eng&spa. @RIC | I think LIN has school Monday and not on Friday. |
| 7. | *RIC: [- mix] oh I thought you said el@s Monday sale@s a@s las@s four_thirty. @ROX | Oh I thought you said on Monday she comes out at four_thirty. |
| 8. | *ROX: [- mix] no el Monday@s que viene which@s is@s +... @RIC | No this coming Monday which is +... |
| 9. | *JUL: xxx Grandma@s:eng&spa! @GLO | |
| 10. | *GLO: [- spa] Apá [: Papá]. @JUL | Dad. |
| 11. | *ROX: [- mix] except Monday y@s el@s Tuesday a@s las@s one_twenty. @RIC | Except Monday and Tuesday at one_twenty. |

12. *ROX: [- mix] then Wednesday Thursday it's normal and then Friday no@s va@s a@s la@s school. @RIC
Then Wednesday Thursday it's normal and then Friday she doesn't go to school.
13. *ROX: [- mix] so yo@s creo@s que@s Monday sí@s va@s a@s ir@s. @RIC
So I think that Monday she is going.
14. *RIC: Goya's gonna [: going to] be off I think +/. @ROX
15. *GLO: xxx Monday's a holiday. @ROX
16. *ROX: but she doesn't go to school Friday. @GLO
17. *RIC: Goya's not gonna [: going to] go to school Friday til [: until] Tuesday. @ROX
18. *ROX: um on Monday I'll ask the teacher. @GLO
19. *GLO: yeah. @ROX
20. *ROX: because they gave us a paper +... @GLO
21. *ROX: saying the important dates +... @GLO
22. *ROX: [- mix] which is on Monday este@s Monday que@s viene@s. @GLO
Which is on Monday this coming Monday.
23. *ROX: [- spa] va a salir a las doce_y_media. @GLO
She is going to get out at twelve_thirty.
24. *ROX: [- mix] a las Tuesday@s a las una_veinte then@s Wednesday@s Thursday@s normal@s y el Viernes.
@GLO
At Tuesday at one_twenty then Wednesday Thursday normal and Friday.

*Plurilingual Transcript 2: CHAT coding conventions as they appear in the transcriptions:
AUG_26_2018_JUL_GLO_ROX_ROC_ERI_LIN_JUL*

The example above starts with ROX (1.1), the target child's mother. It demonstrates the line-by-line transcriptions attributed to each speaker in this multiparty, and multigenerational interactional framework. ROX's Spanish utterance is followed by LIN's younger brother JUL's bivalent term (1.2). His utterance is followed by his grandmother GLO's Spanish question (1.3). At the end of each transcribed line, the bullet • symbol indicates that the utterance as found on the transcript is linked to the video at that precise moment. Finally, in terms of running linguistic analyses, if we go to the end of the transcript (1.41 not shown here), the following code: [- spa] proceeds ROX's utterance. This allows CLAN to sort and to further analyze it with the rest of her Spanish only utterances. We could learn more about ROX's MLU in terms of her heritage Spanish, even though the MLU is typically used to measure child language development (Brown, 1973; Miller, 1981). The rest of the transcript is truffled with a variety of unique codes. They will be discussed later. For now, the idea is to show why both CLAN and CHAT were used to transcribe and code naturalistic interactional data to create a plurilingual corpora of around 24 hours. The next two sections delve further into some of challenges incurred during the transcription phase, a critical moment of this project since the results obtained could only be as good as the transcriptions themselves. First, I briefly present the transcription hardware and then I discuss the process, or the act of transcribing spontaneous

bilingual speech as it was rooted in its multigenerational, multimodal, and multiparty discursive environment.

3.3.4.1 *A note on transcription hardware*

Having the technical material adapted to one’s comfort level is essential for a harmonious workflow. However, it is easy to forget or ignore since buying new hardware for one’s workstation may be expensive. At Sorbonne Nouvelle University (SNU) most Ph.D. Candidates are not funded, so purchasing extra material may be economically difficult. I obtained a contrat doctoral⁹⁴, or doctoral contract after a rigorous application and selection process, and I am grateful to my research director Dr. Morgenstern for having guided me from the beginning. Obtaining a doctoral contract allowed for more flexibility in terms of adjusting, adapting, and buying hardware as necessary throughout the investigation. Two main tools permitted me to speed up the transcription process that spanned approximately eight months. First, using the correct keyboard when transcribing at home, or abroad. This meant purchasing a wireless keyboard. This was also necessary because it was recommended that I use a 24-inch monitor minimum for the transcription phase. Therefore, my Ph.D. director strongly suggested that I upgrade since it would allow me to move faster because objects and speakers would appear larger on screen and thus become easier to see, identify, and subsequently qualify. A larger monitor continues to be more comfortable as I continue to write. Also, when transcribing, an uninterrupted wireless workflow between these three hardware: keyboard, MacBook and monitor is priceless. To conclude, the table below lists the main tools used throughout the transcription phase, and beyond. The next section will discuss the data transcription process.

Table 16: Transcription hardware

Hardware Description
Apple MacBook Pro 13” 2,3Ghz Intel Core i5
Apple Magic Keyboard
Apple Magic Mouse 2
Bose QuietComfort 35 wireless headphones II
Essentielb Pixel Clear 24VH Ecran PC

⁹⁴ Aspiring students put together a research project in collaboration with his/her future research director. It is then submitted to the doctoral school for review by a selection committee. If the project is validated at this stage, an interview is granted to selected candidates to present their project orally. Doctoral contracts are awarded based on the quality and originality of the research project proposal as well as his/her previous university coursework. The term for a paid contract is three years.

3.4 Transcribing bilingual data

Il est de nos jours absolument nécessaire de transcrire ses enregistrements audio ou vidéo avec des outils informatisés. Ces outils peuvent sembler fastidieux au premier abord, effrayer le novice, mais ils rendent le travail du transcripteur beaucoup plus confortable et rigoureux. Ils permettent d'aller plus vite une fois qu'on les maîtrise, d'utiliser des formats de codage normalisés ... Grâce à ces outils informatisés, on se donne également les moyens d'entrer dans une communauté internationale de chercheurs ... et on apporte sa pierre à la construction des connaissances sur le langage en général et le langage de l'enfant en particulier⁹⁵. (Parisse & Morgenstern, 2010: 3-4).

In the previous section, CLAN and CHAT were presented as the transcription software and the coding conventions respectively that were involved in “turning any form of talk into written form.” (Heller et al., 2018: 182). This section begins with a short citation of Parisse and Morgenstern’s (2010) article that delves into the advantageous and pitfalls encountered when transcribing and analyzing data of spontaneous adult-child interactions. The authors insist that today it is indispensable to use computerized tools to transcribe linguistic data to enrich our understanding of language in general, and child language more specifically. Furthermore, the researchers suggest that using these computerized tools in conjunction with the internet allows linguists to share their data, and thus engage with an international community of scientists interested in corpus-based studies. Finally, and perhaps just as importantly, they make no attempt to minimize the fact that at first transcription is a labor-intensive activity, especially for the beginner. They do say however that it gets easier, and faster with time and practice. The notion of faster transcribing brings forth the time it took to transcribe the approximately 24 hours of bilingual data for this project. The workflow may therefore be divided into three distinct moments. First the data collection phase, then the data description phase, and finally the data transcription phase. Overall, it took nearly a year and a half to create an exploitable plurilingual corpus. The table below illustrates the time it took to build the plurilingual corpus from end to end.

⁹⁵ Today, it is necessary to transcribe video and audio recordings with computerized tools. These tools may seem tedious at first and scare off beginners, but they make the transcriber’s work more comfortable and rigorous. They allow for speedier transcriptions once their use has been mastered, and they also allow for the use of conventionalized coding formats ... Thanks to these computerized tools, we also give ourselves the means to enter an international community of researchers ... and we contribute to knowledge building about language in general and child language in particular. – My translation.

Table 17: Time needed to build plurilingual corpus

Phase	Data collection phase (fieldwork)	Data description phase	Data transcription phase	Total time in months
Time	Around 6 months	Around 2 months	Roughly 8 months	16 months

Roughly 16 months were needed to build a plurilingual corpus for the present investigation of multigenerational heritage bilingualism. Nearly six months (second column) were spent doing fieldwork i.e., collecting data through ethnographic methods. Next, it took about two months to describe the data (third column). Finally, around eight months were dedicated to transcribing the rich bilingual data. Nevertheless, as mentioned by Parisse and Morgenstern (2010), the more rigorous the transcription, the better the results since computerized tools allow for more accurate work. Thus, investing the time needed during the transcription phase was essential since it is a critical aspect, especially when running quantitative analyses to generate the various measures mentioned earlier. Furthermore, it was important to keep in mind when transcribing the data to both capture the family’s unique bilingual language practices all while moving at an appropriate pace. Even so, other challenges subsequently emerged like how to interpret child language in this linguistically dynamic multigenerational bilingual setting where multiparty interactions were the norm.

3.4.1 Challenges in interpreting child language

As stated by Parisse and Morgenstern “L’interprétation des productions enfantines est difficile et souvent subjective en raison de la distance entre les énoncés des enfants et la représentation que nous avons du langage oral” (Parisse & Morgenstern, 2010: 4) (Interpreting child language is difficult and often subjective due to the distance between children’s utterances and the view that we have of oral language). The authors⁹⁶ in line with Elinor Ochs’ (1979) article entitled *Transcription as Theory*, advance that interpreting child language is not only difficult, but it is also subjective. The reason advanced is that it is related to the distance between child utterances and the representation that researchers have of oral language. This interpretation-representation issue is a result of 1) the way we are taught language(s), and 2) the way we write, that is according to the norms imposed by one’s educational upbringing. Within the framework of this

⁹⁶ Linguistics Professor Aliyah Morgenstern is a specialist of multimodality and child language acquisition at Sorbonne Nouvelle University. Christopher Parisse Ph.D. is a specialist of child language developmental disorders and a regular contributor to the development of CLAN. He is a researcher at the University of Paris-West la Défense. Together they bring a wealth of experience to the study of child language acquisition from a corpus-based perspective, and thus understand the many issues related to corpus linguistics as well as to child language analyses.

research project, there were multiple occasions when interpreting LIN's and the other multigenerational adults' oral productions was difficult as it will be attested later in the qualitative analyses. Nevertheless, interpreting oral productions could be related to several reasons. For example, to overlapping speech, to the ever-shifting multiparty participation frameworks, or to loud background noise to name a few. It was also related to the fact that as a busy child, LIN was not always in front of the camera (thereby not being able to consider gesture, gaze, stance etc.), or in proximity to it so her voice was further away sometimes, thus faint to the transcriber. Finally, interpretation was a challenge when she uttered single words. Nevertheless, on certain occasions, interpreting her utterances was made possible based on the additional, multimodal information gathered from the interactional context, or from what the other adult speakers in the social encounter said before, or after to any of the other members in the participation framework.

The following example illustrates a moment where I interpreted LIN's utterances as being composed of at least two words. In each case, I was not able to confidently deduce what she said. The bilingual multigenerational and multiparty interaction takes place as the family is in the process of having dinner. All three generations are present in the participation framework, so some of the adult speakers are weaving in and out of Spanish and English as they go about their activities. ERI, in Spanish asks LIN for a napkin (1.1) to which she simply says no (1.2). Her mother ROX (1.3) in Spanish asks LIN why she does not want to give ERI a napkin. However, LIN's utterance (1.4) is difficult to interpret, and we are left wondering if, or what she responded to ROX. Since it seems like her utterance was composed of at least two words, they were transcribed with two xxx symbols even though according to Ochs (1979) some research suggests that single words may be transcribed phonetically depending on the researcher's goals, as well as that "there are situations in which the speech of older speakers is best represented phonetically." (Ochs, 1979: 175). In this case even though transcribing what the adults said before and after her utterance was for the most part clear, in the end it was not sufficient for me to interpret what LIN said in that precise interactional moment.

1. *ERI: [- spa] LIN (.) me pasas un servilleta por favor ? @LIN
Will you hand me a napkin please?
2. *LIN: nope. @ERI
3. *ROX: [- spa] porqué no? @ LIN
Why not?
4. *LIN: xxx xxx. @ROX
5. *ERI: [- spa] mira una servilleta. @LIN
6. *ALE: excuse me honey. @LIN
7. *GLO: [- spa] ten. @LIN
Here.
8. *LIN: hey this is my spot. @ALE
9. *ROX: xxx xxx.
10. *GLO: [- spa] dale a tu tío. @LIN
Give one to your uncle.
11. *LIN: oh +...
12. *GLO: [- spa] LIN esas servi(lletas) son muchas.
LIN that's a lot of napkins.
13. *RIC: here you go. @ALE
14. *ERI: [- spa] pues gracias LIN.
Well thank you LIN.
15. *ROX: [- spa] gracias. @LIN
Thank you.
16. *LIN: [- spa] no gracias.
No thank you.
17. *RIC: [- spa] pelochas. @JUL
Harry.
18. *JUL: Ricardo (..) Ricardo @GLO
19. *LIN: I'm not saying thank you.
20. *GLO: [- spa] Ricardo dejalo en paz.
Ricardo leave him alone.
21. *LIN: I'm not saying thank you guys.
22. *ROX: LIN (.) wait a minute.

*Plurilingual Transcript 3: Example of difficulty in interpreting child language in interaction:
AUG_30_2018_LIN_ROX_ALE_ERI_GLO_JUL_RIC_MAR.cha*

In a multigenerational and multiparty social encounter like this one, to interpret, or not to interpret is the question. In a case like this, even a timestamped transcription that allows for a deeper second-by-second analysis of the multimodal interactional context may not necessarily yield accurate results. Thus, within the framework of this case study, even after a careful analysis whenever doubt was cast on an utterance that could not be elucidated from contextual

cues, an interpretation was not imposed, and the textual space was filled with an xxx symbol. Furthermore, in Chapter 5 we will return to the present exchange to give a more in-depth qualification since through the rich multimodal exchange, it nonetheless reveals LIN's attitude towards speaking Spanish as well as how the adult discourse strategies shape her language use. Nevertheless, overlapping speech also made discerning one language from another a challenge.

3.4.2 Disentangling overlapping bilingual interactions

Successfully disentangling both the overlapping bilingual speech of multigenerational speakers as they are rooted in their ever-shifting multiparty participation frameworks is intrinsically tied to factors like speaker output, volume, background noise, and the number of speakers in the interaction. These issues will be discussed to further demonstrate why transcription is an “extremely labour intensive” (Heller et al., 2018: 182) task for the researcher. The process of converting fleeting oral data into a fixed and exploitable plurilingual corpus is easier said than done. For example, when one is confronted with a linguistic audio-record from a single person, assuming that the sound is clear, transcription of the data can be done relatively quickly. However, in a study that looks at naturalistic bilingual interaction, a one-person audio-record is not very interesting. Therefore, for researchers interested in bilingual language use and heritage language socialization, an audio-record with at least two speakers is the bare minimum, especially for those interested in dyadic interaction i.e., acquisitionists. However, when we consider the overlapped speech that two speakers are likely to produce in interaction, transcription gets more complicated. From a language contact perspective Heller et al. (2018) estimate that it takes about five hours to transcribe one hour of original recording that involves two people, and up to seven hours per hour depending on the target neatness of the transcript. The issue of neatness reminds us that “a transcript ... should not have too much information. A transcript that is too detailed is difficult to follow and assess.” (Ochs, 1979: 168). Even so, from a language acquisition perspective, in an article that examines coding and interpretation of spontaneous linguistic interactions of children between one and three years of age, it is suggested that “Les processus de collecte et de transcription prennent un temps considérable et exigent un travail fastidieux. Une session d'enregistrement vidéo d'une heure peut demander une cinquantaine d'heures de travail.” (Morgenstern & Paris, 2007: 59) (the process from collection to transcription takes a considerable amount of time and represents fastidious work. A session of one hour of video recording may take up to 50 hours of work). Transcription thus becomes steadily more difficulty both as the number of multigenerational speakers increase,

and moreover when it involves transcribing child language in bilingual settings where language mixing abounds in multiparty participation frameworks. So, a central question in the transcription process is: How can all the voices best be represented in written form while keeping the transcript neat, and how does one identify the speakers?

When transcribing overlapping data, the first aim is to identify the utterances of the individuals whose speech overlaps. The second aim is to establish who the participants are in the overlapping, and always changing interactional frameworks. As a reminder, these may be dyadic, triadic, or multiparty. In our bilingual data, there may be more than two conversations between two or more sets of speakers. Moreover, during interaction interlocutors may shift and temporarily leave a smaller or larger framework for another one before coming back. To put this into perspective, imagine listening to different duos, trios, quadruples etc. at once. Transcribing overlapping utterances is like disentangling multiple songs apart from one another to identify each singer, and to determine to who they are singing, and this accounts for part of its labor intensiveness. Another challenge is speaker output. As in most spontaneous social encounters, utterances are not equally distributed. Interlocutors do not necessarily speak for the same amounts of time in an interaction. Therefore, overlapping speech is not fifty-fifty and one speaker may amount to say 90% of the overlapping speech while the other amounts to 10%. Moreover, if the setting is informal as is the case in the ensemble of the video-recordings used for this project, and the speakers are relaxed and joking “you should count on spending a minimum of nine hours per hour according to audibility conditions” (Heller et al., 2018: 194).

This brings us to the volume issue. Consider for example that one interlocutor is speaking louder than the other one. In such a situation, the louder speaker becomes easier to transcribe whereas the minor speaker’s utterances become more difficult. These issues may be considered entry level data transcription challenges. Now, consider that sometimes overlapping speech includes three, four, or up to 10 people in a participation framework as is the case in the present research project. This begs the question: How can we identify the overlapping utterances of multiple speakers when they are all audible at different volumes as well as taking up different amounts of linguistic space in the bilingual language learning environment? As mentioned above, “transcription gets more difficult the more speakers are present, since in groups people interrupt each other more, talk more often at the same time, and start little side conversations among subsets of the group.” (Aalberse et al., 2019: 94). Data transcription is a dynamic and “selective process reflecting theoretical goals and definitions” (Ochs, 1979: 168),

and its relative difficulty depends on multiple factors such as overlapping utterances, speaker output, volume, and the number of speakers in the participation frameworks. Also, on “how well you master the language(s) used, how good the quality is, and how much detail you need to include.” (Heller et al., 2018: 194). The transcript below aims to illustrate some of these challenges.

1. *ERI: where am I gonna [: going to] put this +...
2. *ERI: what am I gonna [: going to] label it?
3. *ROX: [- spa] quieres onion_rings@s? @GUI?
Do you want onion rings?
4. *GUI: [- spa] no. @ROX
5. *GUI: [- spa] pasame una +... @ROX
Hand me a +...
6. *LIN: I want it Grandma@s:eng&spa.
7. *ROX: [- spa] esto? @GUI?
This?

%exp: slides dressing towards GUI
8. *GLO: wait let me put more. @LIN
9. *ALE: [- mix] here’s more chilito@s. @ERI
Here’s more chili peppers.
10. *ALE: [- mix] you have chilito@s
You have chili peppers.
11. *ERI: I’ve got enough. @ALE
12. *ERI: hashtag this is why.
13. *RIC: why? @ERI
14. *ROX: take a picture. @ERI
15. *ERI: I already did. @ROX
16. *ROX: oh. @ERI
17. *RIC: what does that mean? @ERI
18. *ERI: this is why? @RIC
19. *ROX: he’s fat and gassy. @RIC
20. *ALE: [- spa] estamos gordas.
We’re fat.
21. *GLO: xxx xxx.
22. *ERI: exactly.

%exp: this moment shows overlapping speech of at least 3 speakers in both languages

*Plurilingual Transcript 4: Example of challenges in transcribing overlapping speech from:
AUG_26_2018_GLO_ROX_GUI_ALE_ERI_LIN_RIC.cha*

The speakers are having a family dinner and all three generations are accounted for: GLO and GUI (1.5G); ALE, RIC, ROX, ERI (2G); LIN and GOY (3G). There are a total of eight interlocutors in the multiparty participation framework. Even though the participants seem to speak English overall, Spanish is also spoken, and some language mixing also takes place. The first challenge is pinpointing the addressees for some of the speakers. For example, we do not know who ERI is talking to at the start of the video as he figures out how to accommodate more food on his plate (1.1), or how he will describe his meal on social media (1.2). Later (1.12), we also do not know who ERI addresses when he implicitly explains why he is (we are?) fat. In part this is because we cannot see him, so we do not have the nonverbal cues to aid us. This is not the case for ALE, however. While it is clear that she gives ERI more chili peppers (1.9) as she looks at him, we do not know who she addresses in her following utterance (1.10) since we can only see the back of her head turn to the other family members sitting around the table, but not her gaze. Furthermore, there is also background noise due to the nature of the dynamic dinnertime activities, and some participants are speaking more, are overlapping, and are louder than others. This scenario creates further interpretation challenges. Following ERI's comment, we do not know what GLO says (1.21), nor the language that she uses, or even to who she reacts since her back is also facing the camera and her head is covered by ALE. A strong guess is that she either addresses RIC following his question to ERI (1.17), or that she responds to ERI's statement (1.12). For this reason, we have left the addressee blank at the end of her utterance in the transcript. As it relates to overlapping speech, when ERI confirms to ALE (1.11) that he does have enough chili peppers he follows his utterance with "hashtag this is why" (1.12) without any further explanation. Curious about what ERI meant, RIC inquires (1.13 and 1.17) on two occasions. In a matter of seconds ROX chimes in (1.19) to jokingly comment on ERI's recent weight and stomach issues. At the same time as ROX, ALE (1.20), not aligning to the language of the previous utterance, completes ERI's English statement in Spanish using the feminine plural form to suggest that that is the reason why we are fat. To play with grammatical gender indexation is common in the family by the multigenerational adult speakers. Later in our qualitative analyses we will see how LIN is perhaps already not only aware of the dichotomous Spanish gender system, but more so how she may be beginning to play with the Spanish gender system in her own right. Nevertheless, ROX and ALE's utterances thus eclipse GLO's utterance as mentioned above as they seemingly respond to RIC.

The multigenerational and multiparty interaction further shows how the participation frameworks continually shift throughout the meal. While at first it appears to be multiparty,

ROX and GUI form a dyad (1.3, 1.4, 1.5, and 1.7), while LIN who is sitting on GLO's lap forms another dyad with GLO (1.6 and 1.8). The figure below captures ROX and GUI in brief dyadic interaction as she hands him a bag of onion rings, as well as LIN in dyadic interaction with GLO at the bottom right of the screen while they are all having dinner. Furthermore, while LIN is certainly old enough to sit on her own, as she frequently does during mealtime, the culture in this family shows that it is also quite ok to sit on the laps of her grandmother while they eat. This also shows their fusional relationship. This logistical arrangement may of course be explained by the fact that all the chairs are occupied around the table. However, my experience with the family, as well as through some of the further examples that we will qualify, allows me to confirm that even when there are available chairs, any of the grandchildren may be found sitting on the laps of their older family members.



Figure 17: Two dyads ROX <-> GUI and LIN <-> GLO in multiparty interaction

However, following ERI's comment (1.12), ROX leaves her dyad with GUI to look at ERI, as does RIC who has been mostly overhearing but also tending to his daughter GOY to his right (offscreen). They thus form a temporary triadic participation framework. The figure below captures the interactional shift between ROX and RIC as they engage in triadic interaction with ERI.



Figure 18: The ERI <-> RIC <-> ROX triad is formed in multiparty interaction

The image above shows how both RIC and ROX's gaze is momentarily drawn to ERI, or at least to the tasty food on his plate. Nevertheless, as the multigenerational interaction proceeds, GUI also quickly gazes at ERI. This may show that even if he does not care to comment, as an overhearer he is attuned to what is being said by the other family members. Finally, it is only a couple seconds later when ROX, ALE, and GLO's utterances overlap (1.19-1.21), but only ROX gazes at ERI as she speaks. The triadic interaction expands to a multiparty participation framework where most of the family members, or at least the adults seem to be aware of what is being said around the table, even though we know that children are also highly attuned to overheard speech in interaction.

The present example shows how each of the varied factors may make transcription, especially in multigenerational, and multiparty social encounters difficult. When speakers engage at the same time this often means replaying the same interaction repeatedly to best detangle who said what, to who, and in what language. This is also necessary in the qualitative analysis to include the other multimodal aspects of communication such as gesture, gaze, and stance as mentioned before. Nevertheless, in the example above the transcribed bilingual data showed that the family members understood the implicit meaning of ERI's statement. Through their shifting participation in dyadic, triadic, and multiparty interactional frameworks some of the family members tried to make the meaning explicit by commenting simultaneously in Spanish and English while others just overheard. Finally, while attempting to resolve issues related to untangling bilingual and multimodal interactions as best as possible, we must also remember to code the data at the same time.

3.4.3 Using CHAT format

In the previous discussion we outlined how despite its associated challenges, “Transcription turns our audio-recorded data into a format that is easily recoverable for the user and transferable to others: a written record.” (Heller et al., 2018: 60). In other words, “the transcriptions are the researcher’s data” (Ochs, 1979: 168). However, we should contextualize Ochs’ statement. Unlike today, in the late 70’s software that linked video to transcripts did not exist (Morgenstern, 2009), so multimodal analyses were not practiced, or if they were they were rare since it depended on the researcher’s ethnographic notes (A. Morgenstern, personal communication, December 18th, 2021, and August 14th, 2022). We thus understand why at the time Ochs only considered the transcriptions to be the researcher’s data. In this study, our primary data is composed of both the plurilingual transcripts and the videos that together allow for rich multimodal analyses. This section thus moves us into a parallel step of the analytical process. We discuss how the written record is coded in real-time as the transcription is taking place. Then, we further consider and define the social and linguistic coding categories that were applied to the plurilingual corpus. Transcribing and coding are interrelated processes. However, while the former coding scheme is more unique to the researcher’s goals, the latter is more standardized. Within the framework of this research project, both analytical processes began together on CLAN while using the CHAT coding conventions described above. But while the transcription phase essentially ended when the transcripts were transferred to Excel, the coding continued. Coding is therefore the first analytical stage that renders the code mandatory in corpus-based studies. Before moving forward, we might ask: What is a code and what does it mean to code?

Merriam-Webster’s online dictionary (retrieved July 16, 2020) proposes several nuanced definitions for the noun code. In its nominal form, the term is defined as “a system of symbols (such as letters or numbers) used to represent assigned and often secret meanings”. In its verbal form to code is “to put in or into the form or symbols of a code.”. One of the characteristics that the two definitions have in common is that of a system of symbols used to assign meaning to data. They are thus in-line with what Heller et al. (2018) argue, namely that codes are intended to connect groups of data to different categories of inquiry. Moreover, the notion of a ‘secret’ meaning is also evoked. While at first the idea of secrecy may seem counterintuitive to a researcher’s analytical goals, it nevertheless plays a crucial role, especially when it comes to protecting the speakers’ identities. A sociolinguistic profile with sensitive

information was presented in the background section of the introduction for the multigenerational adult family members. Therefore, codes may help keep identities private. The speakers in the present investigation were introduced using an uppercase three-letter code. The idea is to see the interest of referring to them with a ‘secret’ code. We touch on this issue in the next section when ethics are discussed. For now, let us consider below the main conventionalized codes used for this project as proposed by CHAT.

Table 18: Example of CHAT transcription conventions used

CHAT code	Description
[- eng]	When starting a new transcription on CLAN, mandatory information must be entered beforehand. This includes a code for ‘Languages’ on line 2. As the second line in any new transcript, it identifies the language(s) being transcribed. While one may enter more than one language code as is the case here, the first language code entered for example [- eng] becomes the default language for the remainder of the transcript. Thus, when a speaker begins an utterance in English, the [- eng] code is not mandatory utterance initial.
[- spa]	Multiple language codes may be entered on line 2 of the transcript. Since this research project looks at Spanish-English bilingual practices, the second language code used was [- spa]. This is not the default code so anytime a speaker begins an utterance in Spanish, the [- spa] code is mandatory utterance initial. When running analysis this allows CLAN to sort out the utterances that belong to Spanish from those that belong to English. The [- spa] code along with the default [- eng] are transcript external and are required to start a transcription. The remainder of the codes discussed below are found within the transcription, or transcript internal.
@s	This code acts as a suffix since it is attached to the end of a word. In a study such as this one, this code as well as the one to be described below are primordial since they were used regularly. The @s code indicates that a switch, or what is referred to in this study as a language mix, has occurred. The switch may be a single word embedded within an utterance, or a switch entirely to the other language, until the speaker switches back to the original utterance initial language. This type of switching is prone to repeat itself in interaction.
@s:eng&spa	Like the code above, this one also acts as a suffix and is attached to the end of a word. This code is essential to the study, and it was used frequently. Not only does it indicate a ‘switch’ it further identifies the word as ambiguous. As Woolard (1998) states, this code @s:eng&spa suggests ‘bivalency’, or the idea that the word in question is multilingual and may thus belong to both languages under study.
[:]	The colon [:] code proposes the standard orthography of a speaker’s colloquial terms or expressions. According to Ochs (1979) standard representations of oral speech may shape a linguist’s interpretation of the data. To avoid this bias, transcribed colloquial terms or expressions are followed by their standard versions using the [:] code. A standard version also helps CLAN quantify these terms. A challenge in working with naturalistic data is that speakers tend to reduce/contract words, as well as use colloquial varieties. However, such varieties are invaluable to case studies like this. The [:] code thus contained the researcher’s standard proposal.
xxx	The triple xxx symbol indicates an unintelligible word. More than one xxx symbol attempts to capture the number of words in an unintelligible string. Whether transcribing child or adult output, an utterance may contain the xxx code within it when the context and/or surrounding discourse does not allow the researcher to decipher part or all of what was said. At the one-word stage, Ochs (1979) has suggested a phonemic transcription for child speech. However, LIN was no longer at the one-word stage at the onset of recording, so phonetic transcriptions were not applied.
(...)	The (...) code was used to mark long pauses within a speaker’s utterance. Pauses varied from very short indicated with this (.) version of the code, to a little longer with this code (...).
+...	At the end of an utterance and just before the bullet • symbol used to link the transcript to the video file, the +... code was used to indicate that the speaker’s utterance ran on. In these cases,

	either the information was not clear enough to be transcribed, it was overlapping with other speech, or the utterance was transcribed on a new line.
%exp:	The %exp: code is not transcript internal. This code contains the researcher’s comments or questions about the interactional moment, a specific speaker’s language use, or other interesting patterns that emerged during the transcription process. This code is entered directly under the speaker, or interactional moment in question in an unnumbered line of its own.

The table above is intended to showcase not only how coding is “an analytically driven form of data organization”, but furthermore that this analytical process “amounts to tagging pieces of your data so that you can later select specific subsets to examine them in detail” (Heller et al., 2018: 187), also as argued by De Houwer (2009). Moreover, coding goes together with the selective process of data transcription as Ochs (1979) has advanced since the late 70’s. Thus, in using the series of nine conventionalized codes defined above, we may use CLAN to run analyses on subsets of data. These include the use of heritage Spanish, English, and language mixing by a third-generation child as well as extracting all the different words (types), and the number of times (tokens) along with their frequency of use. From an acquisition perspective, we have learned that Tomasello (2003) considers language use, input, cognition, and frequency as central to the language acquisition process. Thus, this information when quantified for both the adults and the target-child may shed light on the impact, or not, of the adults’ bilingual language practices (input) on the target-child’s bilingual language development (output). We have presented CHAT’s standard coding scheme and how the codes are defined within the framework of this study. Next, we briefly consider how in some cases the standard coding protocols may be adapted.

3.4.4 CHAT (some adaptations)

Some researchers suggest that “you are supposed to be the creator and the master of your own coding set, because codes represent your analytical categories” (Heller et al., 2018: 187). Even though CHAT proposes a wide range of conventions for coding, including how to identify speakers within a transcript, sometimes it is necessary to adapt these standard conventions for the sake of clarity when identifying participants. CHAT proposes for example that the target-child in a transcript be tagged with the code CHI, the mother be assigned the code MOT, and the father be given the code FAT etc. This coding scheme is simple and practical because it anonymizes the speakers and it works in a study involving few participants. It may work just fine in modern European and American middle-class families where there are not only fewer people, but also fewer generations in their social encounters. However, this is not the case in present project. The sociocultural structure is not very middle-class American, which is in part

what renders it unique, and as such, which engendered the need to adapt CHAT. I deviated from this convention for a couple of reasons. First, my plurilingual corpora was rich with child and adult participants including up to 10 speakers on some occasions i.e., highly multigenerational. Therefore, using more personal codes for the speakers as was presented in the introduction allowed me to quickly identify everyone from each other, thus accelerating the analytical process. The second reason was because I felt that using the more general codes as suggested by CHAT was too impersonal of an approach for an ethnographic-based data collection protocol such as this one. The general speaker codes, in my view did not do justice to the wealth of sociolinguistic information that is packed within them. In proposing more unique codes for the speakers I was able to conceive of them as authentic bilingual and bicultural participants while protecting their identities at the same time. This also allowed me to quickly identify them, all while maintaining the three-letter uppercase format proposed by CHAT. When the coding, as well as the transcriptions were completed on CLAN, all the transcribed files were exported to Excel for further coding. We expand on this in the section below.

3.4.5 Using Excel

The previous section delved into the standard coding conventions as proposed by CHAT, before briefly presenting some adaptations used on this study. This part takes a closer look at codes that are unique to the present research project and that were subsequently used on Excel. They are thus personalized to fit the investigator's specific research questions (Heller et al., 2018). Moreover, here too as suggested by Ochs (1979) it is recommended to keep "coding simple, in quantity (try not to exceed a total of 20 basic codes) and in quality (they should be easy to understand)." (Heller et al., 2018: 188). I considered a total of 14 sociolinguistic coding categories to further tag the data in the plurilingual corpus. It is also important to highlight that applying these unique codes was made possible only after successfully exporting the transcripts to Excel. Furthermore, transcription and coding are intimately linked and can be done together depending on the software used and the researcher's goals. However, in this project once the data was moved to Excel and subsequently presented in its new format, the transcription phase was officially over⁹⁷. Coding alone took over and as such was the continuation of the analytical

⁹⁷ Even though the transcription phase on CLAN ended after it was exported to Excel, on occasion qualifying interactions revealed previous unidentified words, words that were misspelled, heard incorrectly, or accidentally omitted. In these cases, the original transcript was amended to reflect the new findings.

process. The table below presents and defines the social and linguistic coding categories that were applied to the plurilingual corpus. Finally, we will also see how Excel, through the series of codes presented below allowed not only for the quantification of the sociolinguistic phenomenon under study, but also allowed for the creation of various visual aids such as graphs and charts (Chapter 4). We thus turn to the main codes that were personalized and used throughout this investigation of third-generation heritage Spanish language acquisition and socialization in bilingual, multigenerational, and multimodal participation frameworks in L.A.

Table 19: Social and linguistic coding categories

Socio-linguistic coding categories	Description	Type of data
Line number	Allows the researcher to identify the precise utterance according to the number as it figures on the CLAN transcript. Each line number is linked to the video with a timestamp. This allows for rapid access to precise moments in the media file under study. It thus saves the researcher a tremendous amount of time.	Metadata: used for quick referencing of video-recordings
Media file	Allows the researcher to find the precise file where the target interaction occurs based on the unique media file name. This code is like the 'line number' code above though more general since it first brings the researcher to the main file while the 'line number' code takes to researcher to the specific line in the media file.	
Language	Allows the researcher to identify the language(s) of the utterances under study namely English (E), and Spanish (S). Moreover, since a mixed language [- mix] code was not used on CLAN when transcribing, mixed language use was subsequently coded on Excel using the code for language mixing (M). The first two codes overlap with the CHAT coding conventions but used in Excel along with the code for mixing adds additional possibilities for quantitative analysis.	Linguistic data: used to analyze linguistic variables
Input type	Allows the researcher to determine if the input to which the target-child LIN reacts is child-directed or overheard. While CLAN allowed to code for input type by using the CHAT code %exp: to insert a comment beneath an interactional sequence, this code on Excel formalizes it, and increases its analytical potential since these instances became quantifiable.	
Passive comprehension	Allows the researcher to tag when LIN seemed to understand child-directed Spanish and thus developing a passive mode of communication. Like above, the CHAT code %exp: allowed the researcher to insert a comment after an interactional sequence, however on Excel it was formalized, thus its analytical potential is increased since these instances became quantifiable.	
Language of previous utterance	Allows the researcher to establish the language of the previous utterance: English (E), Spanish (S), mixed (M) to see if it has an impact on speakers' output, or language choice in interaction as described below.	
Word categories (Nelson, 1973)	Allows the researcher to determine if the target-child LIN's heritage Spanish can be classified in sub-groups i.e., cultural words, food, kinship etc. This code may help us consider Grosjean's (2015) Principle of Complementarity and build a semantic domain analysis.	
Transcription	Allows the researcher to stabilize and analyze the written record of oral data as described in detail above. The transcript includes data in American English, Mexican-based Spanish, and language mixing of both Spanish and English at the discourse level.	
Speaker	Allows the researcher to identify the speaker whose Spanish, English, or mixed utterance was transcribed.	

Generation	Allows the researcher to identify the speakers' generation: first- (1G), first-and-a-half- (1.5G), second- (2G), and third-generation (3G).	used to analyze social variables
Sex	Allows the researcher to identify a speaker's biological aspects as determined by their anatomy as assigned at birth. The participants are thus coded as female (F), or male (M).	
Addressee	Allows the researcher to identify who the speaker was addressing in interaction. This became steadily more difficult as the number of participants in a framework increased. When an utterance was thought to be attributed to more than one addressee, the code was left blank.	
Context	Allows the researcher to determine whether linguistic phenomena occurred in specific locations i.e., in the kitchen, living room, dining room, in the front yard etc., while doing certain activities i.e., eating, playing etc., or while discussing certain topics i.e., family, food, education, money etc.	
Motivation/source	Allows the researcher to interpret what caused the speaker to produce a particular utterance.	

The table above demonstrates not only how coding is an analytically driven form of data organization, but also shows how contrary to the more standard conventions presented earlier in the chapter, codes may vary according to a specific research agenda. The first column shows the socio-linguistic coding categories. The second column describes the codes, and the third column further distinguishes the codes into the types of data discussed below. By using the series of 14 codes, both linguistic and social factors may be addressed in the present project. Finally, in line with Ochs (1979) we were also able to keep the coding simple (under 20 codes), and easy to understand.

A closer look at the table above shows that the codes as applied on Excel break down into three main categories. For example, the third column entitled 'Type of data' includes a subset for the metadata with two codes, one subset for linguistic data with six codes, and finally one subset for social data which also contains six codes. Only after the transcript is fully coded, can Excel be used not only to run analysis on subsets of data, but also to cross-tabulate⁹⁸ data within and across subsets. For example, if we take the linguistic variable 'Language' that identifies the language of the main utterance in interaction as well as the linguistic variable 'Language of previous utterance', it should be "fairly easy to analyze to what extent a particular language is used in response to another language" (De Houwer, 2009: 64) by cross tabulating these two variables. Furthermore, in cross tabulating linguistic and social data like the 'Language' and 'Addressee' for example, we may see "whether there is any pattern in the speaker's language choice when addressing a particular interlocutor." (De Houwer, 2009: 64). Within the framework of the present Ph.D. the use of both linguistic and social criteria may help elucidate LIN and her multigenerational family's bilingual language use and heritage

⁹⁸ Cross tabulation: a method to analyze relationships between variables quantitatively.

language socialization in dynamic and ever-shifting multiparty social encounters. In other words, when LIN speaks heritage Spanish, is she prompted to use Spanish based on the adults' previous language choices? Moreover, when LIN is engaged in language mixing, is this also a result of the previous adult input? Also, can we determine to who these mixed utterances are addressed, and at what rate? Our detailed qualitative analyses in Chapter 5 and 6 may also help us find an answer to these questions.

Thus far, I have attempted to underscore the importance of the code in the present section. Namely, that “Coding involves tagging your data throughout, i.e., creating your own system of marks or labels, your own index, related to the topics or concepts that you want to explore in your data.” (Heller et al., 2018: 60). Utterances, for example unintelligible speech that did not fit into any of the coding categories were filtered out on Excel and were therefore not considered in the results. In all, eight of the 14 coding categories presented above were used for further analyses. There are coding categories in the Excel file that I did not quantify. Indeed, the Excel file is still very rich and this coding along with all its related elements and categories were not all used in this dissertation. However, they will be exploited in the future. Nevertheless, on the linguistic end the codes that we did use included Language, Input type, Language of previous utterance, and of course Transcription. On the social end the codes included Speaker, Generation, Sex, and Addressee. Therefore, using Excel's pivot tables, or cross tabulations quantitative measures were generated. Based on these measures, several visual illustrations were created such as graphs and charts. They will be presented and analyzed in depth in the next chapter. The screenshot below presents, due to spacing limits, 11 of the coding categories described in this section.

Table 20: Example of Excel worksheet with sociolinguistic coding categories

transcript	media file	generated	speaker	sex	language	addressee	input type	pass. conf.	lang. of pl.	word cat.	transcription
11	08_13_2018_ROX 11 JUN_JUL_GMC video										
12			3 *LIN:	Fe	E	ROX					I do eating Mom.
13			2 *ROX:	Fe	S	JUL					-spa] bajate de la mesa.
14			2 *ROX:	Fe	S	JUL					-spa] te vas a caer.
15			2 *ROX:	Fe	E	JUL					here...
16			2 *ROX:	Fe	E	ERI					when you did it it was really spicy no?
17			2 *ROX:	Fe	E	ERI					the eggplant?
18			2 *ROX:	Fe	E	ERI					the last time.
19			2 *ERI:	Ma	E	ROX					yeah because I put like*...
20			2 *ERI:	Ma	E	ROX					more pepper.
21			2 *ERI:	Ma	E	JUL					excuse you.
22			3 *JUL:	Ma	E	JUL					xxx xxx.
23			2 *ERI:	Ma	E	JUL					excuse you.
24			3 *JUL:	Ma	M	ROX					no!
25			2 *ERI:	Ma							hey@hey@!
26			3 *JUL:	Ma	M	ROX					no!
27			3 *JUL:	Ma	M	ROX					no.
28			3 *JUL:	Ma	E	ROX					minel
29			3 *JUL:	Ma	N						no.
30			3 *LIN:	Fe	E	ROX					Mommy.
31			3 *LIN:	Fe	E	ROX					Mommy I want to go to the potty.
32			3 *LIN:	Fe	E	ROX					Mommy I want to go to the potty.
33			2 *ROX:	Fe	E	LIN					ok.
34			3 *LIN:	Fe	E	ROX					I tried getting xxx xxx +...
35			3 *LIN:	Fe	E	ROX					right?
36			2 *ROX:	Fe	E	LIN					yeah.
37			3 *LIN:	Fe	E	ROX					with you.
38			2 *ERI:	Ma	E	JUL					xxx boy.
39			3 *JUL:	Ma	S	ROX					-spa] Amá! : mamá!
40			2 *ROX:	Fe	S	JUL					-spa] bajate de la mesa.
41			2 *ROX:	Fe	S	JUL					-spa] bajate.
42			3 *LIN:	Fe	E	ROX					Mommy I need to go restroom.
43			2 *ROX:	Fe	E	LIN					go go.
44			2 *ROX:	Fe	E	LIN					you know how.
45			3 *LIN:	Fe	E	ROX					Mommy this one?
46			2 *ROX:	Fe	E	LIN					leave my phone here (because you're gonna : going to) drop it in the toilette (!) go to the restroom.
48			3 *LIN:	Fe	E	ROX					no I could put it in the sink.
49			2 *ROX:	Fe	E	LIN					no no go to the restroom.
50			2 *ROX:	Fe	E	LIN					leave it there.
51			3 *LIN:	Fe	E	ROX					I xxx xxx.
52			2 *ROX:	Fe	E	LIN					go.
53			3 *LIN:	Fe	E	ROX					I could put it xxx xxx in the sink.
54			2 *ROX:	Fe	E	LIN					no put it in the restroom.
55			2 *ROX:	Fe	E	LIN					go to the restroom I mean.
56			2 *ERI:	Ma	E	ROX					where did Lin go?

3.5 Ethical & Technical issues

The other issue that I discussed with ALE as well this morning is related to ethics and my stance as a member of the community, but also as a scientist. This is especially flagrant during moments that may be more intimate, or more intense. Do I not say anything and keep the camera rolling? Do I keep the camera rolling, but participate in the conversation for better, or for worse? Do I stop the camera? (Alvarez, 2108).

This reflection on ethics was taken from my digital field journal. It is dated September 14th, 2018, and we may see that various questions related to how to protect the integrity of my participants emerged after about three weeks in the field in a discussion with a family member. These interrogations included my position as a researcher and community member, how to deal with private, and even conflictual moments and whether I should intervene, and whether to keep filming. It is therefore a good point of departure for this section. As I have attempted to highlight throughout this chapter, the methods selected to collect the naturalistic data, as well as to manage, transcribe, code, export, and run analyses on the resulting plurilingual corpora are heavily influenced both by an ethnographic, and sociolinguistic approach. They are also influenced by the fact that I am deeply familiar with the languages involved, the family, and the community. It involved delving into the complex, hybrid, bilingual and bicultural life of the L.A.-based multigenerational family as anchored in their unique, and often conflictual contact zone. Sometimes the data collection process involved participation, and at other times it was better for me to rely on observation alone. This approach allowed me to learn a great deal more about the family's intimate social and linguistic practices in the home. Moreover, it permitted me to gather a substantial amount of highly sensitive information about their lives. In turn, this type of data not only required that it be handled with care, but also that special attention be paid to the ethical implications surrounding the treatment of such information. For example, the issue of ethics and disclosing apparently harmless information was of great concern even when speaking with other members of the community such as LIN's teacher. The reflection below is dated October 17th, 2018, and it is drawn from my digital field journal.

Note to self: ethical questions with regard to what to disclose, or simply talk about with LIN's teacher COM. What can I tell her about LIN's parents, grandparents, their SES etc. (Alvarez, 2018).

From the above field journal extract we may see that I remind myself of what I should, or should not share with COM, LIN's teacher. She and I really hit it off, and we discussed several interesting topics, related to the school, the community, and her students. Since I was there to study LIN, at times the conversations naturally revolved around her, and with it, her home life.

I needed to be careful not to disclose seemingly harmless information (that was harmless in fact) that COM in reality had no need (and perhaps no desire) to know. We may therefore ascertain that “the researcher’s conduct and responsibilities towards the participants, (is) to ensure they suffer no adverse effects from their involvement in the research project.” (Lambert, 2008). This statement also echoes Ortega’s (2019) call for a social justice perspective with the clear aim of avoiding inadvertent human suffering. Therefore, the goal of this last section is to present some of the ethical and technical challenges that revolved around the recording of data, as well as issues that pertained to the researcher-participant relationship and how I best tried to protect the participants’ interests in terms of research dissemination.

3.5.1 On recording

We live in a time where we tend to spontaneously capture any, and for some, almost all aspects of our daily social activities. Connected devices such as smartphones allow us to document these moments either by taking pictures, or by making videos and subsequently rendering them available for a larger audience to see on the varied social networks available today. In these instances, the protagonists are often the ones in control of their data. Also, in some cases if not most this data tends to be carefully curated from end to end before going online to show us under the best light i.e., filter. However, some people for any number of reasons do not like to be captured in pictures or recorded, even by their own family. Therefore, it is primordial to consider the impact of such recording devices on the participants’ behavior. This key methodological issue is not a new one and has been often cited by researchers in the field of sociolinguistics (Erickson, 1982; Milroy, 1987; Clemente, 2008). Earlier in this chapter I tried to make this issue clearer by discussing an extract of one of our plurilingual transcripts. For example, we learned that I was not immune to Labov’s (1972) Observer’s Paradox. Even though I was a member of the bilingual speech community under study, it was not always evident to record the family’s bilingual interactional practices without having an impact on their behavior. Some of these reasons may be related to the fact that personal conversations may have dealt with private matters. Thus, it is perfectly understandable that the speakers would want these types of conversations kept private. Within the framework of this research project, the protocol presented earlier helped deal with this challenge. In describing the data on Excel, recall the annotation category ‘Transcribe’. The decision to transcribe was mainly based on the sensitivity of the information collected. When private issues were discussed, the video was marked with a N for no, and subsequently excluded from further analyses. On the other

hand, those videos marked with a Y for yes became potential candidates for transcription. This column quickly allowed me to determine whether the data would be transcribed and subsequently shared with a larger audience which first included my research director, and of course fellow colleagues in my research unit at SBU.

Moreover, to respect a participant’s desire not to be filmed, on occasion I would either pause, or stop recording altogether even if I had their consent. Interestingly, this was never the case with the adult speakers since they trusted that I would properly handle sensitive information. Trust was based on having built harmonious relationships with the family members. On the other hand, LIN asked not to be recorded on more than one occasion even if what she was saying or doing was not serious, or sensitive by any means since she was just a little girl. The table below represents information taken from the FEB_2018_Bilingual Corpus Description_LA, California file. It depicts a triadic interactional moment when GLO, ERI, and LIN are getting in a car to go run errands. LIN is not in her most cheerful mood, and as the participants move from the house into the car, she explicitly states that she does not want to be recorded.

Table 21: Example from data description file depicting a video that was not transcribed due to ethical reasons

Participant(s) + Date	Transcription	Salient Features	Transcribe = Y or N	Generation	Time
FEB_9_2018_GLO_ROX_LIN_ERI_RIC	In BH in the garage getting ready to go somewhere: GLO Ms, a neighbor asks LIN if she’s upset in S, RIC Ms, LIN’s use of the term “silly girl” to address GLO	Yet another instance of LIN refusing to be filmed	N	1, 2, and 3	04:37

In the third column titled ‘Salient Features’, I annotated “yet another instance of LIN refusing to be filmed”. Thus, in keeping with the protocol, even though LIN was only 3;10 in February 2018 she was already capable of expressing her wishes. Therefore, shortly after getting in the car, I stopped recording even if I had permission from her mother ROX. This also helps to explain the brevity of the interactional moment as can be noted in column six titled ‘Time’. Finally, when it came time to describe the video, in respecting LIN’s wish not to be recorded

in that moment, I added a N in the ‘Transcribe’ category (column four). Thus, this video was not moved on to the transcription phase.

3.5.2 On handling the camera

Recording the family’s spontaneous multigenerational interactions raised unique ethical challenges. It meant juggling between the participants’ desire to be filmed or deciding whether certain conversations were to be kept private for example. However, another issue related to recording that emerged was a technical one. It had to do with how much the participants might not be visually captured by the camera, especially when they were fine with being filmed, or when the topic of the conversation was not a sensitive one. It was a question of how the camera was handled during the data collection process. As mentioned in the first section of the chapter, I used a Canon HD Legria HF G25 camcorder and a Sunpak Ultra 6000PG tripod to record. Given these two tools, the overall aim was naturally to visually capture as many spontaneous bilingual interactions as possible. However, the camera was not always affixed to the tripod which was almost always set and stationed in a corner of the dining room. Part of the reason was because I followed the action where it took place, so sometimes the camera was hand-held and in motion with me. In these cases, it was easier to see and hear most of the participants. Sometimes however, when I followed the action to the dining room and participants were already present, I tried to discretely place the camera on the dining table to not perturb them, or to minimize the camera’s impact on their social and linguistic behavior. In these cases, it was very difficult to see the participants since the camera’s view was often obstructed by diverse objects on the table. When this is the case, it is mentioned at the start of the qualitative analysis. Nevertheless, I could generally rely on the audio recording since what was said was usually clear enough to transcribe and to subsequently analyze. The third scenario was when the camera was affixed to the tripod and set to record before a meal took place. Here, the camera’s presence could be thought of as being the most discreet since only rarely (or so I thought) did the participants acknowledge the recording device. However, here too visually capturing all the bi- and monolingual speakers in their ever-shifting multiparty participation frameworks was a challenge. Given the nature of the family’s mealtime practices, the family members often moved on and off the camera’s field of vision between the kitchen, and sometimes the living room before coming back to the dinner table. The table below presents the three main ways in which the camera was handled to collect the data and why. It shows

whether the participants were visible, or only audible according to how the camera was handled or positioned. Finally, it depicts the level of discretion according to the camera's position.

Table 22: Handling the camera

Camera's position	Reason	Video	Audio	Level of discretion
Camera is hand-held	to follow interactions while both inside and outside the house	Easy to see, images sometimes a little shaky	Easy to hear	Least discreet
Camera on table	placed on dinner table after following interaction from another place in house	Not easy to see	Easy to hear	Not discreet at first, but once placed on table, camera almost blends in with other objects
Camera on tripod	placed and set to record on tripod before a meal took place	Easy to see, except when participants roamed in and out of dining room	Easy to hear, but difficulty increased as participants moved further away from table	Most discreet

Overall, handling the camera brought about its own technical, and analytical challenges. The camera's position not only determined whether the data was available both visually and orally (or just orally), but also the level of discreteness when recording. To maintain a certain level of discretion across the analyses, a few examples, including the first one in the qualitative chapter relied only on oral data. These examples are clearly marked when they are introduced, so they will not come as a surprise. They will show however that even if visibility was difficult at times, audibility was good enough for transcription and further linguistic analysis. Nevertheless, one drawback is that they will not showcase the dynamic multimodal nature of the family's bilingual language practices, therefore the majority of the 21 qualitative analyses relied both on visual and audio data. Finally, another issue that emerged as related to the camera was how to handle recording in public spaces.

3.5.3 Recording in public spheres

Other times, in order not to adversely impact the participants in terms of their larger social circles, especially the target-child LIN, the decision was made not to continue recording during specific moments of the day. For example, let us look at the following entry that took place shortly upon my arrival to L.A. It was annotated on August 24th, 2018, in the digital version of my field journal. I observes the following:

Questions related to filming and ethics – dropping LIN off at school and (the) impact that being filmed can have on her social life in school only two weeks into her first ever and new school year. I need to think about when to stop filming and when to put the camera away when taking her to school as well as the more general issue of filming in public places. (Alvarez, 2018).

From the journal entry above we may gather that as a researcher and community member, it was imperative that I keep in mind ethical questions related to recording as an ethnographic data collection method. More precisely however was the question of “how the project is supposed to, or might, affect the participants, either personally or in terms of the wider social groupings they may belong to.” (Heller et al., 2018: 61). These challenges could be related to the participants’ desire, or not to be filmed as we saw in the first example. On the other hand, the difficulties were related to the researcher’s desire not to negatively impact the participants socially even when they seemed not to mind the camera’s presence. Next, let us take a closer look at the role of participant relationships within the framework of ethics and dissemination.

3.5.4 On dissemination

I cannot insist enough that my position as a trusted community member allowed me to smoothly transition into the field and collect longitudinal data on one multigenerational family living in L.A. Of course, being trustworthy was enough to gain privileged access to the family. However, as a responsible researcher I needed “to make clear at the outset that (I would) not share (my) data with anyone other than the people directly involved” (Heller et al., 2018: 63). In keeping with this promise, on multiple occasions I felt that it was necessary to remind the adult speakers that I, along with my research director, and research team SeSyLIA⁹⁹ would be the only ones to look at the video-recordings at first. Then, just as importantly and when it came time, that the members of the jury would also have access to selected video-recordings. Furthermore, I reassured the family on multiple occasions that only short extracts (free of sensitive information following protocol) from the data would be selected to be considered by other researchers for example in future publications and that they would be consulted beforehand. By sharing data, I tried to make clear to the participants that this meant that aside from myself, data would be shared following the flowchart below.

⁹⁹ SeSyLIA: *Sémantique et syntaxe en linguistique anglaise* (Semantics and Syntax-Language in Action) is one of five research teams belonging to the research unit PRISMES: Langues, Textes, Arts et Cultures du Monde Anglophone-EA 4398 at Sorbonne Nouvelle University.

Table 23: Flowchart for data dissemination

Sharing data	Consult family Yes/No
Research director would be the main linguist to spend the most amount of time with the data to provide detailed feedback on quantitative and qualitative multimodal analysis	No
Members of SeSyLIA would only consider extracts during one-to two-hour long data sessions in a private setting	No
Members of the jury	No
Publishing and communicating the results	Yes - Family to be consulted, and identities protected

In this sense, in terms of dissemination “A fourth common principle is the protection of identity, i.e., that we must disseminate results in ways that our audiences cannot recognize or identify the participants in any way (hence the use of pseudonyms).” (Heller et al., 2018: 62). The ethical issues pertaining to the dissemination of the research results tie back into the section of this chapter that dealt with coding. I intentionally adapted the standard CHAT coding conventions for identifying speakers not only for pragmatic reasons, but also for issues related to privacy in anticipation of disseminating the results. Finally, I am fully aware that these protocols are not bulletproof, but they are my attempt to protect the family that has provided me with such rich ethnographic information as much as possible.

CONCLUSION

This chapter delved into our data and methodology. It introduced key issues and arguments to support the ethnographic methods used. One challenge was documenting linguistic variability in bilingual multigenerational settings. The approach used was data collection through participant observation which meant building positive relationships with the family. Also, while being a member of the speech community is strongly recommended, this does not exempt the researcher from influencing the participants’ behavior. Another key issue was the importance of data collection multigenerationally which necessitate longitudinal case studies to move away from a monolingual bias. The notion of the baseline input language was presented and discussed since it remains a critical methodological issue in heritage bilingual research. The chapter also discussed the process of creating a plurilingual corpus since they are still rare today. Therefore, the procedures applied to describe and manage the data were discussed. We then introduced the computerized transcription hardware CLAN, and the CHAT coding conventions. The fourth section revolved around transcribing bilingual data. It presented some challenges such as interpreting child language or disentangling overlapped bilingual discourse. We then discussed how CHAT was used according to convention, but also

why certain adaptations were necessary. We also examined how Excel was used to further code, and to generate visual illustrations. The chapter ended by touching on interrelated ethical, and technical issues. First, those encountered during the data collection process such as recording in public spheres and secondly, the protocol that will be used to protect the speakers' identities when it comes to dissemination.

Our methodology will thus allow us to generate quantitative measures (Chapter 4) of LIN's bilingual language learning environment which are generally unaccounted for in studies of bilingual language acquisition (De Houwer, 2021). These measures will also allow us to focus on qualitative multigenerational, multimodal analyses (Chapter 5 and 6) of heritage language socialization in diverse, and ever-shifting multiparty participation frameworks. This follows the mixed methods approach (Stivers, 2015) that aims to consider links between interactional practices (individual, familial, and environmental) and sociolinguistic variables. The mixed methods approach is also exemplified in the work of Beaupoil-Hourdel and Morgenstern (2021) in their cross-linguistic developmental case study of French and British children's shrugs. The next chapter thus attempts to quantify a range of language practices in LIN's bilingual language learning environment. After a discussion of bilingual input and output, quantitative analyses of Spanish, English, and language mixing are proposed according to 10-factors. By understanding these environmental aspects, we may learn more about what contributes to (un)successful heritage bilingual development, or communicative well-being (De Houwer, 2015) in linguistically and culturally hybrid spaces that are rooted in multigenerational settings and multiparty social encounters.

4 Characteristics of the Bilingual Language Learning Environment

INTRODUCTION

Chapter 3 described the naturalistic data and methods used to collect it within the framework of this study. It detailed the data collection, transcription, and coding procedures put in place to create a plurilingual corpora. In doing so, it also presented and discussed some of the key issues in the field of heritage bilingualism research. Moreover, it aimed at filling relevant gaps in heritage linguistics specifically and studies in bilingualism in general. First, the data was transcribed bilingually with the aim of building a truly exploitable plurilingual corpus which are still relatively rare. Through our data and methodology, we thus achieved this goal. Secondly, it aimed to characterize LIN's bilingual language learning environment by considering a selected set of the participants' Spanish, English, or mixed utterances. Here too we achieved the goal of bringing to light critical input factors that influence "bilingual outcomes at one or more points of development" (De Houwer, 2021: 59). The third goal that we achieved is to move away from the monolingual bias that seeks to compare bilingual speakers' languages to that of monolinguals. Through our longitudinal and multigenerational case study the participants themselves thus provide the baseline input language as a point of comparison for LIN's output. Moreover, we recognize that this method may not fully help answer "the question of how speakers manage to connect smaller units of language to the larger entities such units participate in." (Duranti, 1997: 280). However, accounting for adult participants' verbal interaction, which is often missing in studies of child bilingualism, is crucial in understanding the impact of adult input on child output longitudinally.

The present chapter is composed of ten sections. After a discussion that highlights key issues related to input and output in bilingual settings, the ten-factor quantitative analyses *per se* are introduced. The first seven sections quantify sets of interrelated linguistic and social variables as discussed in the previous chapter. The next two sections help in assessing LIN's bilingual language development by looking at various measures. The last section focuses on the Spanish that LIN uses. Moreover, each of the sections are illustrated with graphs, tables, or charts. First, we present the results of the linguistic soundscape and the language presentations. Next, we discuss LIN's input versus the adult input, her output in child-adult dyads, her output according to interlocutor generation, and then her output based on the language(s) of previous utterance. Then, the results of LIN's MLUw and TTR are presented. Finally, an analysis of LIN's Spanish in terms of semantic domains along with their English translation equivalents will be considered. The chapter ends with a brief conclusion that reviews some of the main

findings. It also introduces Chapter 5 and 6 which plunge us into 21 thick qualitative analyses that underscore how LIN, through bilingual and multimodal heritage language socialization uses, or refuses to use heritage Spanish in spontaneous interaction.

4.1 Bilingual input & output

A first issue in studying multigenerational bilingual language acquisition in children is that individual adult input, as well as the more global socializing environment, or “linguistic soundscape” (De Houwer, 2009: 97) to which a child is exposed is often not considered. In other words, “Research on bilingual children is generally carried out with little reference to studies of bilingual adults.” (Gardner-Chloros, 2009: 143). Nevertheless, it is through these daily multigenerational, multimodal, and multiparty interactions between adults and children that the family pre-fabricates the rich bilingual language learning environment in which the child is immersed, and from which s/he emerges. Individual adult input that is both overheard, and child-directed may prove to play a crucial role in the bilingual language acquisition and the language socialization processes. This facet of language development through engaged interaction (Tomasello, 1999/2022) was also substantiated in the literature review. Family members are the child’s first socializing unit, and “Language exposure within the family scaffolds the child’s language construction, transmitting style and variation through language choice and usage” (Ghimenton, 2017: 214). Furthermore, the multigenerational caregivers’ verbal interactions with children through their distinct discourse strategies and language choices serve to “socialize (them) into particular language use patterns.” (De Houwer, 2009: 97; De Houwer, 2021: 24). These varied types of linguistic patterns (Müller et al., 2020) influence the interpersonal relationships at the family level as well as help children emerge as competent speakers within their language communities (Ochs, 2002) within the language socialization paradigm.

The second critical issue in studying multigenerational bilingual language acquisition is that research into child bilingualism has typically been conducted by researchers in linguistics within their network and by extension, their social class. However, these types of studies may be thought of as representing the language development of a restricted bilingual population. For example, these children, also known as “elite bilinguals”, as they go through bilingual language acquisition receive input which is typically that of elite bilingual adults. As previously underscored, in typical middle-class European and American households’ language

exposure whether direct or overheard may be limited in terms of the number of speakers in the participation framework and limited in terms of the speakers' generations. This is not the case in the present investigation of heritage Spanish bilingualism in L.A. Subsequently, studies of elite bilinguals alone should not and cannot be representative of the multimodal language practices, or the language development of bilingual speakers of the wider population, which as we have learned constitute the global norm. This is especially true for families that have lived in tightknit, but historically contentious contact zones, or bi- and multilingual settings. In line with what Parodi has shown (2003, 2008) in L.A., "The varieties of language that BFLA children hear in such bilingual communities may be varieties that are influenced by long contact with the other language (or languages ...)" (De Houwer, 2009: 105) where distinct language use patterns simultaneously emerge and evolve at the individual, family, and community level across generations. Many examples of these types of bilingual settings are found in Brehmer and Treffers-Daller's (2020) volume where in my review I state that "the variety of heritage languages (HL) studied is unique as it attempts to describe and understand the variable endpoints of heritage bilingualism (HB), including the factors that motivate variability." (Alvarez, 2022). Finally, with the exception of a few studies such as Zentella's (1997) who investigated bilingual Porto Rican children in New York and Tabouret-Keller's (1969) who worked on child bilingualism in Alsace, France from a sociolinguistic perspective, some researchers have still argued that "We lack studies of ordinary, working class children brought up in native plurilingual environments, who constitute the majority." (Gardner-Chloros, 2009: 143) at the global scale. Thus, the present multigenerational investigation of heritage Spanish use, and transmission in L.A. as rooted in multiparty participation frameworks contributes to the research on heritage language acquisition and on heritage language socialization. First, it considers the child-directed and overheard adult input in Spanish, English and language mixing in LIN's bilingual language learning environment. Second, it considers these dynamic bilingual language practices as they are naturally manifested in the bilingual setting of a not so typical middle-class family (due to the greater number of speakers, as well as to the greater number of generations present) by quantitatively measuring 10 interrelated social and linguistic factors.

4.2 A 10-factor quantitative analysis

The first analysis examines 1) the linguistic soundscape (which we may also refer to as the plurisemioticscape, or the multimodalscape as previously discussed) to which LIN is exposed,

and crucially how this environmental oral input unfolds longitudinally. Critically, as will be discussed further below, the term does not pretend to capture all that can be related to the child's linguistic input such as gesture, stance, and gaze i.e., the multimodal aspects of communication, but it is indeed a result of this plurisemiotic interaction. The next analysis delves into 2) the language presentations, or how each of the multigenerational participants including LIN individually use Spanish, English, and mix languages. This step allows us to go further to see how 3) biological sex as a variable interacts with how languages, or these three modes of communication are presented by LIN's family members. Next, we consider 4) the amount of input that LIN receives in Spanish, English, and mixed language utterances versus the amount of input in these same modes of communication that each of the adults receive from each other. The input presented for the adults also takes into account LIN's output. Moreover, we look at 5) LIN's output in child-adult dyads as is tradition in studies of language acquisition. We first consider LIN and her mother ROX before analyzing other key dyads. In most cases, dyadic interactions are embedded in shifting triadic, and multiparty social encounters as will be detailed further below. This is followed by an account of 6) LIN's output in terms of interlocutor generation, or whether her language choices depend on her interlocutors' birth order according to the proposed family tree. This multigenerational environmental characteristic is a defining feature in LIN's bilingual language learning environment, and a central point of inquiry in our study. The next factor considers 7) the extent to which LIN's language choice is influenced by the language(s) of previous utterance(s). Finally, the last three sections present the results of CLAN-generated computations for the first two. First, we consider 8) LIN's mean length of utterance at the word level (MLUw) to see if English and Spanish are developing according to her age. We also measure 9) LIN's type-token ration (TTR) to understand her lexical diversity in both Spanish and English. The last section is 10) a semantic domain analysis of LIN's Spanish words. It shows whether she has English translation equivalents for her Spanish words. This will be particularly useful when qualifying her use of Spanish, as well as when examining her language mixing in multiparty, and multimodal interaction. When LIN uses Spanish or embeds Spanish words into her otherwise English utterances it may be because she does not possess their English translation equivalents.

The scope of the quantitative measures below is therefore to gain an understanding of the broader language socialization context of LIN's bilingual language learning environment, before moving on to the fine-grained aspects of her input and output with her caretakers in dyadic, triadic, and multiparty participation frameworks. The aim is to consider some of the

specific features of LIN's linguistic exposure over time, and to use them as a backdrop when analyzing the more precise details of her bilingual language development in interaction since "Different language learning environments ... have different effects on bilingual children's language learning trajectories in the first decade of life." (De Houwer, 2021: 5). Within the framework of this Ph.D., we thus seek to understand how LIN is socialized to use Spanish, which is intrinsically tied to the use of English, and language mixing in her diverse and dynamic multigenerational and multiparty social encounters. We do so by providing a rich account of her linguistic environment between 3;10 and 4;9 years of age.

4.3 Linguistic soundscape: The family's Spanish, English, & mixed input

LIN is growing up in what may be described as an (extra)ordinary, middle-class, multigenerational family where bilingual and bicultural semiotic resources are mixed and merged across social encounters. She receives a rich amount of direct and indirect linguistic input by her bi- and monolingual family members who are at varying points of the Spanish-English bilingual continuum. Therefore, by adopting the present multifactor analytical approach, this study attempts to fill a gap in the research within the field of heritage bilingual language acquisition since, "one of the main factors which we need to know about in order to understand the linguistic behaviour of bilingual children is what type of input they receive from their parents or caregivers." (Gardner-Chloros, 2009: 144) in (un)usual settings.

Our analysis therefore begins by investigating the linguistic soundscape to which LIN is potentially exposed. Before going further however, we define the terms potentially, and linguistic landscape. I suggest the term "potentially" because LIN's linguistic exposure includes both child-directed speech as well as overheard speech and previous research has suggested that children are not always attuned to either. For example, "Young children frequently "tune out" the utterances of their partner, because they are otherwise absorbed or because their attention span has been exhausted, or because they are bored, confused, or uncooperative." (Ochs, 1979: 170). Next, the term "linguistic soundscape" encompasses the child-directed and overheard speech to which children are exposed. According to De Houwer (2009), the linguistic soundscape includes all the spoken language in which a child is immersed. This may also include the spoken language encountered through television, on the radio, and on the phone for example when a caller is on speakerphone, as well as the language encountered through a child's extended social network as suggested by Li (1994) in his study

of a three-generation Chinese family in England. Moreover, the notion of linguistic soundscape includes the plethora of overheard speech that is not only dynamic, but also variable both in terms of quantity and quality from people who are both part of, and not part of a child's extended social network.

Nevertheless, it is critical to highlight that the term soundscape in this chapter does not cover the multimodal dimensions of interactional linguistic input. For example, important non-verbal interactional aspects such as gaze, stance, and gesture that are often deployed in tandem with the oral modality are not accounted for in the analyses of the linguistic soundscape to which LIN is exposed. This is largely because I only transcribed the verbal content on CLAN as mentioned in Chapter 3, and not the gestures, actions, gaze, facial expressions etc. I do not have these secondary tiers to measure. However, multimodal interactional aspects such as gesture, gaze, stance etc. as they are tied to the ongoing social encounters across multimodal and multiparty participation frameworks will be included in the thick qualifications in the next two chapters. Notwithstanding, since the data for this study was collected essentially during mealtimes and mainly in one private home, it may be argued that the linguistic soundscape to which LIN is potentially exposed is almost entirely made up of the speakers in her tightknit family network. Finally, as exposed in the data and methods chapter on the challenges of capturing and transcribing *naturalistic* data, the quantifications presented here only reflect speech as it was spoken in natural *interaction*. Audible speech emanating from the radio, television, or the other miscellaneous electronic gadgets such as tablets was not transcribed. Therefore, we start by disentangling the languages that LIN is exposed to regardless of who is talking, and whether it is child-directed or overheard. This will allow us to

focus on the frequency with which children hear each of their languages. That will involve looking both at the absolute frequency, where you count the number of utterances ... in each language, and at relative frequency, where you express those absolute frequencies as a proportion of the total amount of input that children hear. (De Houwer, 2009: 97).

First, while De Houwer (2009) above suggests “input that children hear”, we must bear in mind the difficulty in ascertaining if a child is truly focused, or engaged in the ongoing interactional frameworks s/he is part, or even the center of. At best, the child is potentially focused on the ongoing talk-in-interaction, and the input is child-directed. For example, Veneziano and Parisse (2010) in their study of the acquisition of early verbs in French where child-directed speech was assessed showed “close relationships among patterns of language acquisition,

conversational exchanges and child-directed speech.” (Veneziano and Parisse, 2010: xx¹⁰⁰). Children are thought to benefit or learn more from child-directed speech in dynamic interactional frameworks more so than from overheard speech. Nevertheless, the absolute and relative frequencies of both the child-directed and overheard input that will be presented for the quantitative measures that follow, supported by the longitudinal nature of this case study, will reveal how LIN’s linguistic soundscape, or how the languages as they are spoken in her tension ridden *tercera Hispanidad* fluctuate over the span of nearly one year. This may help elucidate potential shifts in bilingual language use patterns, while considering the impact of sociolinguistic factors. Thus, in assessing the shift in the linguistic soundscape, we attempt to answer the following questions:

1. Can the increase and subsequent decrease of Spanish in this multigenerational family be attributed to the presence or absence of one, or multiple family members?
2. Can the linguistic fluctuations be attributed entirely to sociolinguistic factors, or may other factors be at play such as the data collection methods?

The table below presents the absolute and relative frequencies per utterance and per language for each of the three sampling periods under study. Roughly eight hours of data are accounted for in each month. Moreover, in the bottom row titled “Total” we see that the number of utterances vary significantly from one month to another. For example, August 2018 accounts for the lowest number of transcribed utterances (5 883) and January 2019 for the highest (13 169). Finally, to be precise these analyses are based on a total of 27 518 transcribed Spanish, English, and mixed language utterances across a 24-hour long plurilingual corpus as noted in white at the bottom of the last column.

Table 24: Absolute & relative frequency: Spanish, English & mixed utterances longitudinally

	Language	February 2018		August 2018		January 2019		Total
		Absolute	Relative	Absolute	Relative	Absolute	Relative	
	Spanish	4 266	50%	1 138	19%	2 863	22%	8 267
	English	3 638	43%	4 246	72%	9 067	69%	16 951
	Mixed	563	7%	499	9%	1 238	9%	2 300
Total		8 467		5 883		13 169		27 518

¹⁰⁰ There are no page numbers in the article available online.

LIN participated in *most* of the spontaneous interactional frameworks that were recorded for this project. Furthermore, her presence and active (though perhaps not always focused) participation were the primary criterion used to select the videos to transcribe. However, capturing the linguistic soundscape in which she is immersed was also essential to this study since again, it accounts for her bilingual language learning environment. To exemplify this objective, we turn your attention to the field note below. It was recorded on August 26th, 2018, in digital field journal. I write:

The logistics of who is speaking what language to who and how and when is interesting from a larger extended/intergenerational family picture. Instead of strictly filming LIN, I should film all moments when adults are speaking/interacting with any of the four different bilingual children each one at a different cognitive level: LIN, JUL, GOY, IGN. This is indeed a privileged occasion to participate and observe a family for (five) months with four different children in the household to determine their dynamic language practices. (Alvarez, 2018).

Only after six days in the field, we thus see that the data capturing LIN, while a critical component of the study, would be richer if a maximum number of multigenerational caretakers were also accounted for in multiparty interaction. This of course includes the social encounters between themselves, as well as with LIN's sibling, and cousins who were all at different levels of cognitive development¹⁰¹. Therefore, during the second sampling period (August 2018) for example, there is a slight shift in focus. An attempt is made to zoom in on both the adult input as well as on the global input in the environment as rooted in the various social encounters offered within the family. Thus, an analysis of the linguistic soundscape allows us to further address the following questions regarding this L.A.-based multigenerational family:

3. In terms of relative frequency, to what extent are Spanish, English, and language mixing used longitudinally?
4. How does the linguistic soundscape evolve over time?
5. How can the linguistic soundscape help explain LIN's use of Spanish, English, and language mixing?

In terms of absolute and relative frequencies, the table above captures how LIN's environmental input fluctuates longitudinally. The amount of Spanish abruptly drops from 50% before stabilizing around 19% and 22%. English, on the other hand rises from 43% and

¹⁰¹ Just before beginning my field work, the family's doubt that LIN's little brother JUL might have a speech issue was confirmed. The Therapy Language Center through a *Speech-Language Pathology Evaluation* concluded on July 17th, 2018, that "Currently, JUL has significant delays in the areas of receptive and expressive language and articulation development for his age."

stabilizes around 72% and 69%. Language mixing remains low and stable first at 7% and then rises to 9% during the last two sampling periods. The column graph below better illustrates these fluctuations. However, it considers both the absolute and relative frequencies presented in the table above to show not only how the bilingual language use in the family evolves longitudinally, but also to show how Spanish, English, and language mixing evolve side by side. Lastly, we may also acknowledge that the frequencies closely correspond to LIN's own mastery of English, or her language use as we will see below. The increased and sustained use of English may show how the adults in her environment tend to switch to her dominant language. LIN as a novice language speaker exerts her influence on the more experienced multigenerational bi- and monolingual family members. In the next two chapters, our fine-grained analyses of key interactional moments may allow us to reveal how the increasing use of English in dyadic, triadic, and multiparty participation frameworks unfurl in a bilingual and bicultural context. Moreover, we may consider the adults' discourse strategies that are said to help or hinder bilingual language development in bilingual language socialization research.

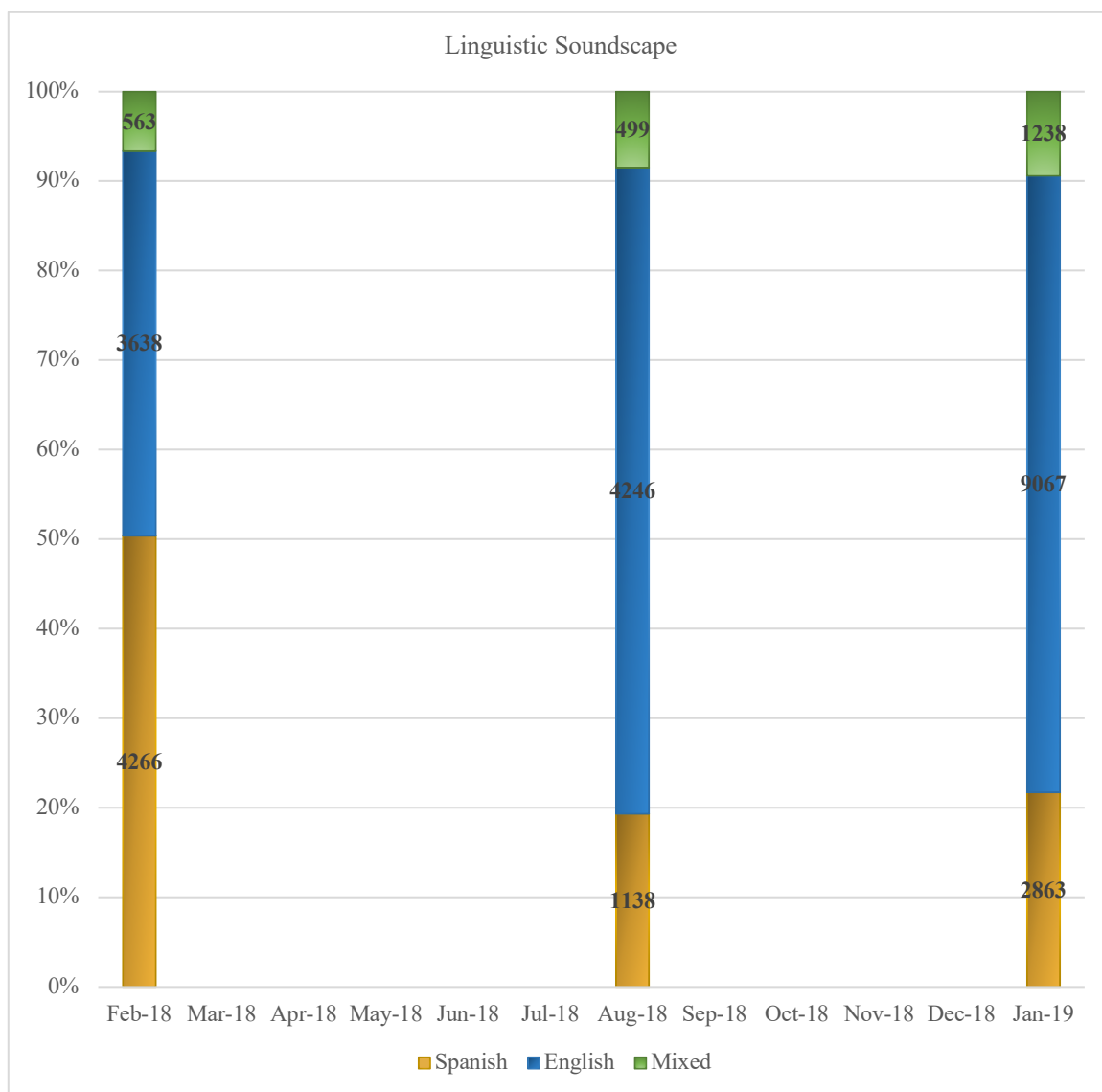

Figure 19: Linguistic Soundscape Evolution: February 2018 to January 2019

The relative frequency of each language is color-coordinated for ease in distinguishing one language, or mode of communication from the other. English is represented with blue. Spanish is represented with yellow, and language mixing is represented with green. Language mixing, or *mixed utterances* may include “words or morphemes from both their languages in one utterance.” (De Houwer, 2009: 41) as we discussed in Chapter 3. Within the framework of this case study, this means that language mixing combines linguistic elements of both Spanish and English. It serves to mention that for the multigenerational bilingual adults in the present study, language mixing may seamlessly, and at times intensely go both ways. The adults may insert Spanish words into English utterances as LIN usually tends to do, or the adults may also embed English words into Spanish utterances, which is so far not reflected in LIN’s language use patterns based on the available data. Finally, the adults may indiscriminately use Spanish and

English words alternately such that it may become difficult to determine what language is embedded into which. Nevertheless, the illustration above highlights the omnipresence of English in the linguistic soundscape (16 951 utterances) longitudinally. It also attests to the fact that it is the most used, or dominant language in the family. Spanish is the second-most spoken language (8 267 utterances). Finally, language mixing never represents more utterances than unilingual English or Spanish utterances. Language mixing (2 300 utterances) thus represents the third most used mode of communication multigenerationally. Below we will take a closer look at these results starting with the first sampling period, or February 2018.

4.3.1 February 2018

In February 2018 the proportion of Spanish amounts to 50% (4 266) making it the month with the most Spanish in the linguistic soundscape. While this is the most prominent language in the bilingual language learning environment, English at 43% (3 638) is not far behind and represents an important proportion of the overall language input. This is expected since English is both the societal language as well as the dominant language for most of the bilingual family members. Furthermore, this is attested in the sociolinguistic questionnaires that were completed for the four second-generation speakers: ROX, MAR, ALE, and RIC. Except for LIN's father MAR, the rest of the speakers are those who spend the most time with LIN. Finally, language mixing accounts for 7% (563) in all.

4.3.2 August 2018

In August 2018 the proportion of Spanish in the environment significantly decreases when compared to February 2018. During the second sampling period Spanish accounts for a mere 19% (1 138) of all utterances while English gains an impressive amount of ground accounting for 72% (4 246). This dramatic shift in language use also accounts for their intersection in the figure above. August 2018 is also the month with the most English in the environment overall. The data shows a not-so-subtle adjustment between the amount of Spanish spoken versus English six months later. Interestingly, the use of language mixing does not seem to be negatively impacted by the readjustment between Spanish and English. On the contrary, language mixing in the bilingual environment slightly increases to 9% (499).

4.3.3 January 2019

Finally, in January 2019 the proportion of Spanish slightly rebounds. Spanish increases to 22% (2 863). Despite this rise however, it is far from the level of Spanish use obtained in February 2018. At the same time, the proportion of English slightly decreases to 69% (9 067). For both English and Spanish, the longitudinal adjustments in the last two sampling periods do not appear to be significant. Moreover, it seems as though English, and Spanish find a point of stable asymmetry regarding their use. In terms of relative frequency, English is proportionally more present than Spanish. Finally, the frequency of language mixing remains constant at 9% (1 238). Much like in August 2018, language mixing is not impacted despite the nuanced shifts between the more present English and Spanish.

Both the table and the line graph above allow us to consider the evolution of the linguistic soundscape longitudinally in terms of their absolute and relative frequencies. Moreover, the pie charts below attempt to give us another perspective across the three sampling periods. They help to further underscore the relative frequencies as a proportion to each language in LIN’s bilingual language learning environment.

Table 25: Relative frequency: Number of utterances longitudinally: Spanish, English, & mixed utterances

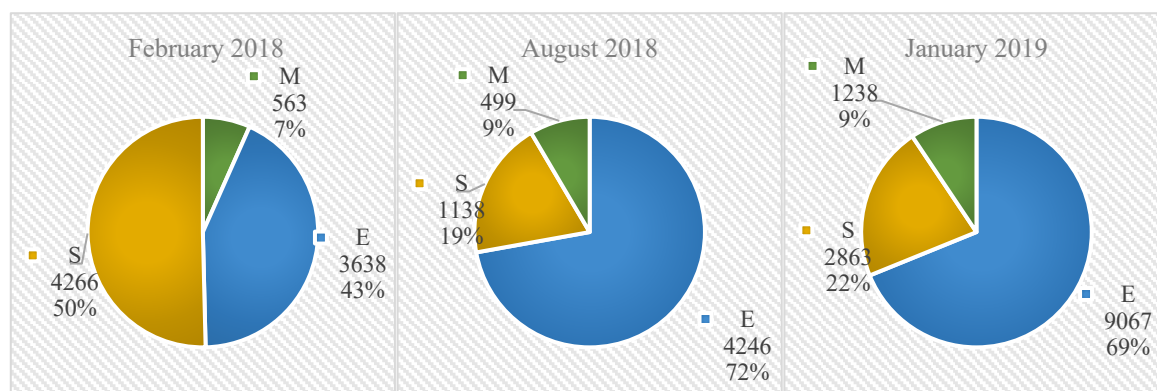

4.4 Language presentations: The maternal line’s Spanish, English, & mixed input

A heritage language socialization environment may be thought of as emerging out of the individual bilingual practices, or language presentations within a multigenerational family. For example, De Houwer describes a bilingual setting for children as one in which, “at least one person must speak another language than other people do”, and furthermore that, “Depending

on the specific family and culture they are born into, babies will have many people to interact with or very few.” (De Houwer, 2009: 99). The cultural organization in LIN’s multigenerational bilingual family is to live together, or in proximity. This means sharing meals, play time, family outings, events, and so forth on a regular basis. This also means that LIN is evolving in a multigenerational family where each member uses their linguistic resources dynamically throughout their social encounters. As a result, LIN is regularly exposed to and interacts with a substantial amount of bi- and monolingual people who are both older (eight adults), or as young (three children) as she is. These interlocutors form her tightknit family, or the bilingual community of practice where the adults engage in the situated child-rearing process (Lave & Wenger, 1991). Furthermore, since LIN’s family members are all at various points of the bilingual continuum, not only do they each present their languages uniquely, but also, their language use patterns are variable and subject to change over time. Before we go any further however, what does “language presentation” mean? De Houwer defines the notion in the following way, “Language presentation refers to who speaks which language(s) to a child and how many: one or two”, and further adds that she, “first looks at the issue of how many languages the important people in a child’s life speak to them.” (De Houwer, 2009: 107). Within the framework of this study, I thus follow De Houwer and use the term language presentation. However, I expand her definition to include not only one, or two languages, but also language mixing since it is also a salient mode of communication in the various social encounters that will be examined later. Furthermore, I too will focus on the language presentations of LIN’s primary caretakers. These individuals happen to be the women on the maternal side. They include her mother ROX, aunt ALE, grandmother GLO, and great-grandmother GRC. Nevertheless, the men in the family share similar language use patterns as we will see below.

4.4.1 Language presentations: Male versus Female Spanish, English, & mixed input

Even though “Evidence from large-scale surveys (e.g., Census surveys) often points towards women’s greater use of the heritage language in migrant settings.” (Pauwels, 2016: 86), according to Goodz (1994) research of parent-child interactions in bilingual families has not confirmed that bilingual children’s languages are accelerated by the mother’s child-directed speech. Furthermore, contrary to the claim that women are more prone to use the heritage language with their children, the pie charts below reveal a different story regarding LIN’s bilingual language learning environment.

Table 26: Relative frequency: Male vs Female Language Presentation of Spanish, English & mixed utterances

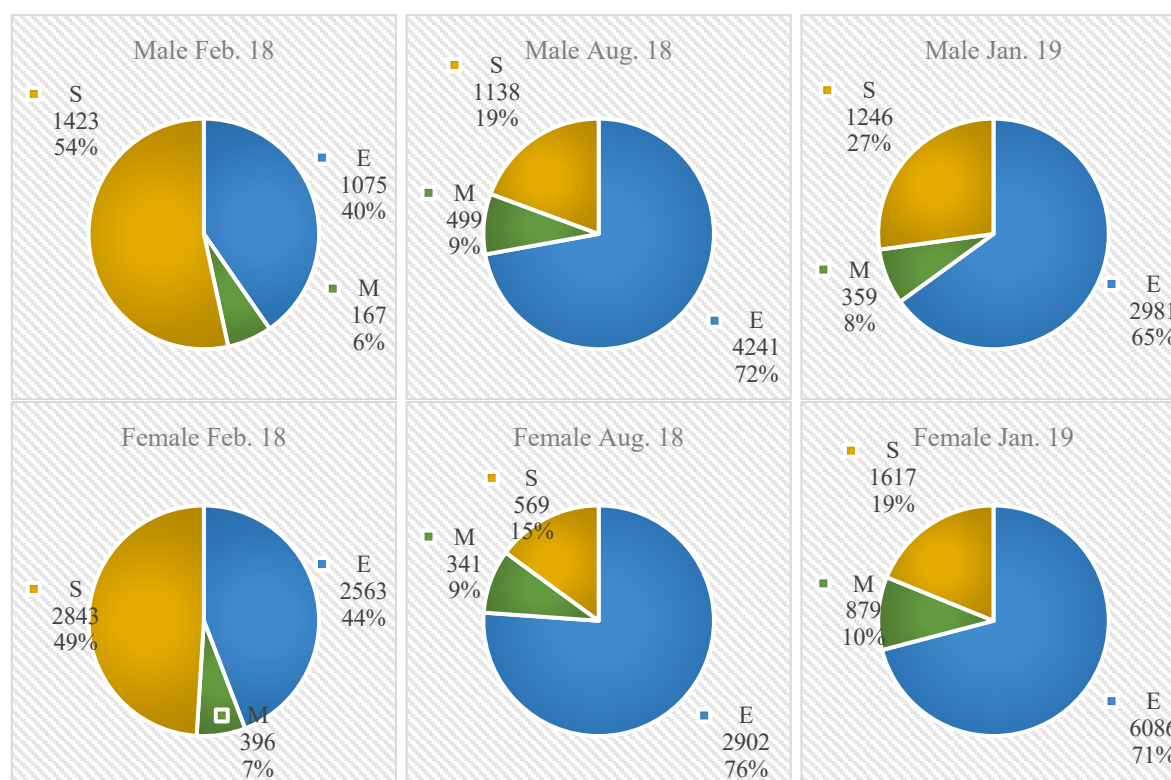

The relative frequencies above show the input coming from both the Male’s (top row) and the Female’s (bottom row) across the three sampling periods. The male speakers include GRT, GUI, ERI, MAR, and RIC. The female speakers include GRC, GLO, ALE, ROX, and LIN. The results show that regardless of gender, their language use profiles are strikingly similar according to how much each language, or mode of communication is used. In general, both the men and women speak English the most, followed by Spanish, and then language mixing. However, a closer look at the heritage language (yellow slice) reveals that the men in LIN’s family consistently use a slightly higher proportion of Spanish (54%, 19%, 27%) than do the women (49%, 15%, 19%). That is, the men use English slightly less (40%, 72%, 65%) than the women (44%, 76%, 71%). Finally, both the men (6%, 9%, 8%) and women (7%, 9%, 10%) mix languages at similar frequencies, although the frequencies are slightly higher for the women. While these measures may not be statistically significant, they nonetheless point to research that has shown that women are often at the forefront of innovative language practices (Eckert, 1989; Labov, 2001, 2006). Nonetheless, as mentioned above we will focus on the women in the present multigenerational study. As LIN’s primary caretakers their presence and thus varied language use patterns are more robust in the data across the three selected sampling periods. The table below presents the absolute and relative frequencies mentioned above according to each of the family member’s biological gender.

Table 27: Relative frequency: Gender & Language Presentation of Spanish, English & mixed utterances

Month	Gender	Absolute (Total)	Spanish		English		Mixed	
			Absolute	Relative	Absolute	Relative	Absolute	Relative
February 2018	Female	5 802	2 843	49%	2 563	44%	396	7%
	Male	2 665	1 423	54%	1 075	40%	167	6%
Total		8 467						
August 2018	Female	3 812	569	15%	2 902	76%	341	9%
	Male	2 066	569	27%	1 339	65%	158	8%
Total		5 879						
January 2019	Female	8 582	1 617	19%	6 086	71%	879	10%
	Male	4 586	1 246	27%	2 981	65%	359	8%
Total		13 168						

The third column from the left titled “Absolute (Total)” in the table above shows that longitudinally the women in LIN’s family speak nearly twice as much as do the men when all the modes of communication are combined. However, when we consider the relative frequencies of Spanish use longitudinally, the men speak more Spanish across the board as mentioned further up. Despite these discrepancies, unlike what Pauwels (2016) states, the relative frequencies above show that the women use less Spanish i.e., less of the heritage language in social encounters than the men do. These results further confirm that the women and the men in this community of practice have unique linguistic prints, or interactional styles like what Lanza (1997) found in her study of English-Norwegian language mixing in a bilingual family in Norway. In other words, as De Houwer states, “Fathers may speak a different language to children than mothers or may speak more of a particular language than mothers.” (De Houwer, 2021: 53). Nevertheless, considering that there is more language to study on the women’s end in both absolute and relative terms, this finding confirms our decision to focus the following analyses on the maternal line.

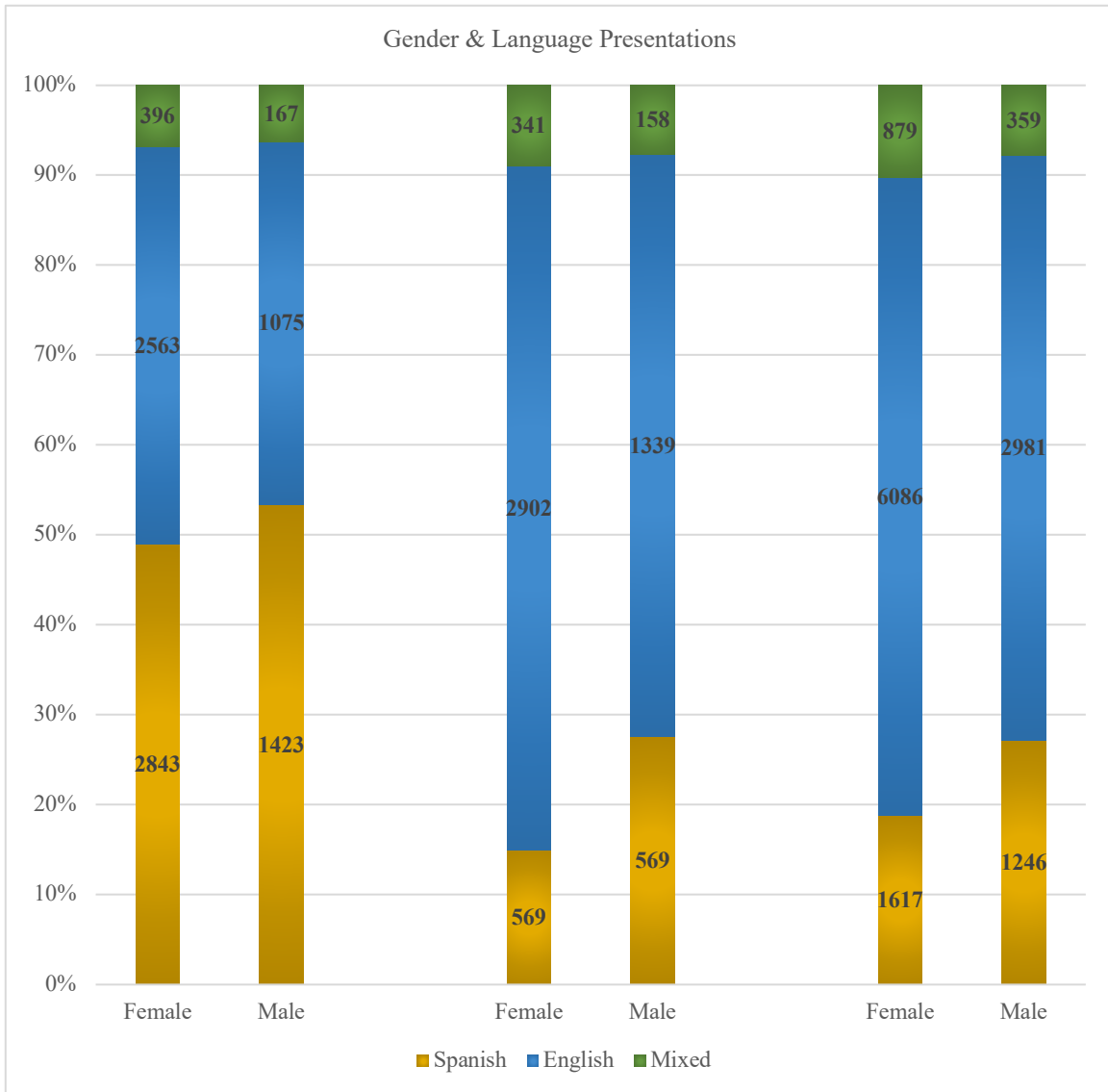

Figure 20: Gender & Language Presentations: Spanish, English & mixed utterances

Thus, much like in the previous section, the longitudinal nature of this multigenerational case study of heritage bilingualism aims to reveal how the women’s language presentations are susceptible to fluctuate over a 12-month period. Furthermore, these analyses may help to explain LIN’s own language presentation, or how she is using Spanish, English, and mixing these two languages in interaction. Therefore, following the first five questions advanced earlier in the chapter, a sixth central question related to the present investigation may be formulated as follows:

6. How does LIN’s language presentation compare to that of her multigenerational primary caretakers?

The table below shows how the ensemble of speakers selected for this study in LIN's close family unit use Spanish, English, and language mixing. For each of the five speakers including LIN, the analyses give the absolute number of utterances as well as their relative frequency. Furthermore, the results below are provided in terms of the three sampling periods starting with February 2018. Each sampling period begins with the target-child LIN. For example, in February 2018, LIN produced a total of 1 273 utterances. Regarding their relative frequency, 3% of her utterances are in Spanish, 91% are in English, and 6% account for language mixing.

Table 28: Relative frequency: Language presentation of Spanish, English & mixed utterances

Month	Speaker	Absolute (Total)	Spanish		English		Mixed	
			Absolute	Relative	Absolute	Relative	Absolute	Relative
February 2018	LIN	1 273	44	3%	1 155	91%	74	6%
	ROX	1 874	733	39%	948	51%	193	10%
	ALE	190	10	5%	163	86%	17	9%
	GLO	644	361	56%	191	30%	92	14%
	GRC	1 714	1 695	99%	3	0%	16	1%
August 2018	LIN	846	39	5%	772	91%	35	4%
	ROX	1 101	87	8%	940	85%	74	7%
	ALE	812	108	13%	613	76%	91	11%
	GLO	786	302	39%	379	48%	105	13%
	GRC	na	na	na	na	na	na	na
January 2019	LIN	1 803	33	2%	1 714	95%	56	3%
	ROX	2 849	340	12%	2 271	80%	238	8%
	ALE	780	63	8%	638	82%	79	10%
	GLO	2 215	571	26%	1 217	55%	427	19%
	GRC	586	559	95%	5	1%	22	4%

The results in the blue column in the table above reveal a strong preference for the use of English for almost all the speakers in the study. Thus, we will consider the relative frequencies of the maternal line's productions starting with English, then Spanish, and finally with language mixing. In each of these language categories, each of the speakers' corresponding modes of communication will be assessed and substantiated with examples drawn from the data.

4.4.2 English

For the women in LIN's family, English utterances almost always account for over 50%, but they never reach the 90% mark with the highest being 86% for ALE in February 2018. LIN however obtains 95% in January 2019. Only twice does LIN's grandmother GLO fall below the 50% mark when using English. The first time is in February 2018, where her English

production accounts for 30% and the second time is in August 2018 at 48%. One exception in terms of English use is LIN's great-grandmother GRC. In February 2018, three of her utterances in English account for less than 1%, whereas five of them account for 1% in January 2019. Below are some examples of GRC's English.

In August 2018 GRC's English includes: "thank you" when ERI turns on the kitchen light, "hello" when she answers the phone, and "cash cash" when discussing a business transaction with ERI. GRC's English utterances are short and simple. They include a couple of common interjections and a noun repeated twice.

Interestingly the examples in January 2019 are repetitions of both adult and child input. For example, when speaking with ROX, GRC repeats, "Chucky_Cheese?", to confirm the name of the pizza restaurant where a family event took place, and "Google stop" to repeat the command one needs to address to a Google Home device for it to stop playing music. When interacting with JUL (LIN's little brother) GRC repeats, "slime?" to confirm the name of the goo he says he is playing with. She also repeats, "unicorn oh ok" to show that she has understood the name of the toy he has in his hand. Even if the nouns and interjections mentioned above are the extent of GRC's English productions, they nevertheless reveal how language influence, as advanced throughout this project, is bidirectional (King & Fogle, 2013). Or, how novice speakers may unwittingly guide the language learning process for experienced monolingual adults in another language. Notwithstanding, in August 2018, GRC is not present so there are no utterances to consider, and they are marked with a (na).

Furthermore, if we focus on LIN's English productions, the results reveal that she holds the highest rates. 91% in February and August 2018, and 95% in January 2019. Interestingly, LIN's rates of English production are like those of her mother ROX and aunt ALE overall. Except for February 2018 where ROX produces only 51% utterances in English, both ROX and ALE's English productions appear to range between 76% and 86% across the three sampling periods. Below are some examples of LIN's English utterances:

In February 2018, she says for example, "I do eating Mom". This affirmative utterance is non-target since she uses the incorrect helping verb "do" as opposed to "be". Nevertheless, her assertion makes it clear that she is involved in the act of consuming the food and nothing else. In another example ROX expresses to ERI that she does not understand LIN since

sometimes, according to LIN, ROX is, “not her mom” (when she is upset), but that sometimes she is, “the best” (when she is not upset) mom. ERI, seizing the opportunity to use the circumstantial evidence replies to ROX and says, “sometimes she (LIN) has toilet paper sticking out of her pants”, to which LIN responds, “stop saying that you little bullshitter”. We thus see developmental variety in her English. Furthermore, for LIN sometimes her short utterances may be not target-like, while at other times her longer utterances are, as demonstrated with the two examples above.

In August 2018, the family is having a meal and ERI in Spanish asks LIN for a napkin, “me pasas una servilleta por favor?” (will you hand me a napkin please?). This example was introduced in the previous chapter along with its plurilingual transcription and video extract. It will be further qualified with its rich multimodal aspects in Chapter 5. Nevertheless, after ERI’s request, LIN promptly says, “nope” and after ERI is handed napkin (no thanks to LIN) ERI sarcastically says, “pues gracias LIN” (well thank you LIN). ROX following ERI also thanks her. LIN seems to think that she is being asked to say thank you which engenders a mixed language utterance on her behalf. LIN replies, “no gracias@s” meaning ‘no I will not say thank you’. Moreover, not knowing if she is clear in her refusal to say thank you in Spanish, or on the contrary if she has accidentally said, “gracias”, her language mixing is quickly followed up with the English only utterance, “I’m not saying thank you guys”, repeated twice, and addressed to all the multigenerational speakers in the multiparty participation framework sitting around the table.

In January 2019, ROX and ERI are jokingly discussing the fact that perhaps he gained some weight during his stay in L.A. and that he may not be recognizable upon his return to France. ROX makes this assertion first in a mixed language utterance with the Spanish insertion, “gorda@s” (fat in the feminine form) followed by its translation in an English only utterance, “fat girl”. Even though ERI disagrees with ROX and says, “no”, LIN chimes in and says, “Eric is a fat girl”. By the last sampling period LIN shows that she can ratify herself into various interactional frameworks through her own commentary. Moreover, through humor she can play with language and gender roles much like the adults do by taking both mixed language and English input to produce English utterances. In the next two chapters we will qualify additional multigenerational and multiparty interactional moments where LIN seems to play with language and gender as she converses with the adults in her participation frameworks. Nevertheless, the examples presented thus far are only a glimpse of the vast array of both target

and non-target English that LIN produces. Utterances like these, within their larger interactional and socialization contexts will be considered in finer detail in Chapter 5 and 6, which are focused on thick qualitative bilingual and multimodal analyses.

4.4.3 Spanish

The results show that LIN rarely produces Spanish utterances. While 3% of her utterances were in Spanish in February 2018, and a mere 2% in January 2019, LIN never surpasses the 5% mark that she obtains in August 2018. Moreover, LIN's mother ROX and aunt ALE despite being proficient Spanish speakers also produce little Spanish. Except in February 2018, when ROX's Spanish utterances account for 39%, both ROX and ALE's Spanish production oscillate between 5% and 13% between February 2018, and January 2019. Spanish utterances are also more prominent for LIN's grandmother though they progressively decline. GLO produces the most Spanish at 56% in February 2018, followed by 39% in August 2018, and finally 26% in January 2019. An exception is LIN's great-grandmother who at 99% in February 2018, and 95% in January 2019, naturally produces the most Spanish of all the speakers in the multigenerational household. This is important to highlight since it essentially places GRC as one of the pillars of LIN's sources of Spanish input. Moreover, what is interesting to note thus far is that much like with the English productions above, LIN's Spanish utterances share similar patterns of production with ROX and ALE. Below we consider some of LIN's Spanish productions.

In February 2018, LIN's Spanish productions may mainly be resumed to one- and two-word utterances that she repeats following child-directed, or overheard speech. For example, to get LIN to name a traditional Mexican stew in Spanish that her grandmother makes ERI and ROX ask, "what kind of food?" it is. After LIN responds in a non-target negative English utterance, "I no know" (I don't know), ROX in Spanish says, "pozole" which LIN repeats. This is another example that we introduced in Chapter 3 with its plurilingual transcription and video extract, and it will be further qualified with its multimodal interactional richness in Chapter 6. In yet another example revolving around food, the family is having pizza. ROX asks LIN to name one of the toppings. LIN correctly says in Spanish, "chile" (chili) to which ROX adds, "jalapeño" to complete the name of the variety of chili. LIN repeats, "jalapeño", but does not actually say the target compound word: "chile jalapeño" (jalapeño pepper), as it is typically referred nor is her pronunciation on-target. This example will also be presented and further

analyzed in Chapter 6. LIN also attempts to produce longer Spanish utterances based on overheard speech. In one example, ERI asks ROX what time LIN's cousin GOY gets out of school. LIN repeats ROX's answer, "doce xxx (y) media." (twelve-thirty). LIN's Spanish utterance is almost target-like. However, she has difficulty segmenting the speech stream and perhaps identifying the Spanish conjunction 'y' (and) so she does not clearly produce it. Speech stream segmentation to help LIN use Spanish is further qualified in Chapter 6 to see how this language learning strategy is integrated in ongoing multigenerational, multimodal, and multiparty social encounters. In another example, ROX is busy changing JUL's diaper and tells him, "no te muevas" (don't move). LIN picks up on the Spanish utterance and insists, "no Ju Ju Ju no (te) muevas". Again, LIN's Spanish utterance is almost target-like. However, she does not produce the Spanish singular reflexive pronoun "te" (yourself) in her utterance. It is not clear if this is the result of the quality of input which causes her not to identify certain words in the speech stream. However, this utterance is unique in that it is one of the rare occasions when LIN uses a Spanish verb. Even though LIN's Spanish utterances are eclipsed by her use of English and to a lesser extent by her language mixing, additional examples of her Spanish use will be examined in more detail in the chapters to come. Finally, the last section of this chapter will pay particular attention to the distribution of LIN's Spanish in terms of semantic domains as they are attested for in the corpus. This analysis will also allow us to identify whether she possesses their English translation equivalents thereby giving us a glimpse into her bilingual repertoire.

4.4.4 Mixed

The relative frequencies of LIN's mixed language utterances show an interesting pattern. Longitudinally, LIN's language mixing rates are like those of her mother ROX and aunt ALE. For example, in February 2018, LIN produces 6% mixed utterances compared to ROX's 10%, and ALE's 9%. In the same month LIN's grandmother GLO is at 14%. In all, LIN, ROX, ALE, and GLO are all around 10% mixed language productions. In August 2018, LIN's mixed language use accounts for 4% while ROX's accounts for 7%. Again, the similarity is nonnegligible. As far as ALE is concerned, she produces 13% while GLO produces 14%. For LIN and ROX mixed language use declines to similar rates below 10%, whereas for ALE and GLO they remain stable between 9% and 14%. Finally, in January 2019, LIN produces 3% mixed language utterances while ROX's language mixing accounts for 8%. The similarity is flagrant between LIN and her mother ROX. Regarding LIN's aunt ALE, her language mixing

is at 10%. ALE's language mixing appears to be stable and seems to vary between 9% and 11%. It is also interesting that GLO's language mixing spikes in January 2019. Thus, at 19% LIN's grandmother GLO presents the highest amount of language mixing not only longitudinally, but also across the five multigenerational speakers. Finally, LIN's great-grandmother GRC mixes languages at the rate of 4% in January 2019, versus 1% in February 2018. Let us look at LIN's language mixing below.

In February 2018 LIN's mixed language productions appear to be as syntactically complex as her English. This is likely because LIN's language mixing is mainly composed of Spanish noun insertions into her typically developing English (as based on her MLUw). Cantone (2007) and Quay (2008) assert that bilingual children tend to borrow nouns (free morphemes) from one language into the other as we see in the following example. The family is in the kitchen making a classic Mexican meal, or "chiles rellenos" (stuffed chili peppers). LIN is participating in the meal preparation activities when she sees her great-grandfather GRT walk by. She takes this opportunity to let him know what she is doing and says, "look what I (am) making Grandpa@s:eng&spa I'm making this because we (are) making chiles@s". As a response to her language mixing ERI asks GRT in Spanish, "¿qué dice LIN?" (what is LIN saying?). GRT does not answer ERI, but LIN understanding his Spanish question does and repeats her mixed language utterance: "I said we (are) making chiles@s". First, this example shows that LIN is attuned to what is said around her. It also attests to her passive comprehension of overheard Spanish. Next, these examples show how LIN is mixing languages in multiparty interaction through the insertion of Spanish nouns into her English. Moreover, even if LIN's English seems to be developing normally, certain aspects are non-target. For example, the use of the irregular verb 'be' as an auxiliary. In constructing the present continuous tense LIN omits the singular and the plural subject verb forms 'am' and 'we' inserted in parentheses above. While this will not be an object of investigation here, a closer examination of the adult speech may reveal if indeed her non-target use is related to her input i.e., if the adult variety of English in the family omits these verb forms. These omissions may also be related to the natural course of English development. That is, because tense-marking morphemes are acquired later in English first language acquisition (Paradis, 2010).

In August 2018 we see a similar example as above. Here, ERI is casually speaking Spanish to LIN and asks her, "¿quién te hizo las trenzas?" (who braided your hair?). LIN's first unintelligible utterance, "xxx" is followed with a single word response, "mamá" (mom). ERI

engages in Spanish again and asks, “¿y dónde están tus zapatos?” (and where are your shoes?). In English LIN says, “take them off”, but ERI in Spanish persists and asks, “¿porqué?” (why?). At this point LIN who is not really engaged in the conversation appears to be annoyed at all these questions. So, in a mixed language utterance she returns the question and asks ERI, “well what happened to your zapatos@s?”. Caught red-handed ERI tells her, “tienes toda la razón” (you are so right). LIN thus displays passive comprehension of multiple child-directed Spanish utterances. On one occasion she also responds in Spanish. However, in the end she produces a mixed language utterance through the insertion of the Spanish noun ‘shoe’ in a successful attempt to end ERI’s interrogation and as such through her agency she has influenced the course of the social encounter in her own right.

In January 2019 LIN evolves from a single Spanish noun insertion to include both an adverb and noun in her mixed language utterances. The family is enjoying a meal. LIN is busy sprinkling salt “sal” on her food when she is told to stop. To regain control of the salt, through language mixing LIN tells her father MAR, “I want more sal@s”. Interestingly, as common as the word salt is, this English translation equivalent is not attested in the data, or her bilingual repertoire which may explain the insertion of the Spanish ‘sal’. She uses this Spanish word throughout the mixed language interaction with her parents. However, as we will see further down in the analysis of her semantic domains in Spanish and whether she has their English translation equivalents, we should keep in mind that absent words may be related to gaps in the data, and not gaps in knowledge. Nevertheless, MAR does not mind her as the interaction proceeds, so LIN tells ROX, “Mom I want more sal@s”. ROX responds by language mixing and says, “no you do not need more sal@s eat your food”. However, LIN demands an explanation and asks ROX, “why I not get no more sal@s?”. LIN is ignored and the meal continues. Later, LIN tells ROX, “I want más@s sal@s Mamá@s”, but ROX’s final answer is “no”. In the end LIN’s father MAR explains to LIN why adding salt is not necessary after every bite. What is striking is that the negotiation takes place through language mixing between LIN and her adult interlocutors in the multiparty participation framework. Moreover, as LIN insists in her failed attempt at getting more salt, her mixed language utterances expand from single-word insertions.

First, she goes from a single Spanish noun insertion “sal” (salt) to inserting an adverb “más” (more) as well as the two nouns “sal” (salt) and “Mamá” (Mom). As a result of growing up bilingual, there may be distinct terms that LIN uses in Spanish, as we will see in the analyses

at the end of this chapter, and those for which she may yet not possess a translation equivalent in English. Finally, a look at her semantic domains in Spanish shows that LIN does use both the terms ‘more’ and ‘Mom’. Therefore, in this case her choice to insert these Spanish terms is not related to a gap in her bilingual repertoire. Three additional points may be highlighted. First, her last mixed language utterance where she uses the Spanish adverb “más” (more) may be an explicit translation of her two initial requests when she declares wanting ‘more’ salt. Second, her failed attempt to win her mother’s favor through the affectionate use of the Spanish noun “Mamá” (Mom) helps expand her mixed language utterance, and through language mixing shows affiliation with the community. Third, LIN’s mixed language production is grammatically correct in that the syntactic structures of both English and Spanish are respected at their point of convergence as Sankoff (1998b), Poplack (1980), and Lipski (1978) have argued regarding code-switching within a sentence, or what we call language mixing in the present study.

Another way to analyze these types of mixed language utterances is as the embedding of one partially schematic construction into another. In a recent paper I focus on a discussion of LIN’s exposure to language mixing, and how these mixed language productions may be conceived as partially schematic constructions. At the time, LIN was almost two years old. I found that the multigenerational adults provide LIN both with a Spanish “más X” and its equivalent English “more X” partially schematic construction (amongst others). Furthermore, I found that “an interesting feature is that contrary to the ‘más X’ constructions that begin in Spanish and end in English, the ‘more X’ construction does the opposite ... the slot is subsequently filled with the Spanish noun” (Alvarez, 2020: 122-123). In the present case LIN is now the speaker and not the adults. She fills the slot (X) of two similar unilingual English partially schematic constructions for example: I want more X and I want X by embedding corresponding Spanish unilingual partially schematic constructions (‘sal’ (salt) in the first, and ‘más sal Mamá’ (more salt Mom) in the second). Grammatically, these partially schematic constructions converge at appropriate points. Moreover, together they result in language mixing where the language choice can be thought to be made at the construction level rather than at the word level. Finally, like with Spanish and English, additional examples of LIN’s mixed utterances will be examined as anchored within their multimodal interactional contexts in the next two chapters.

To conclude this section, the bar graph below illustrates how LIN and her female multigenerational family members present their languages in terms of relative frequencies across the three sampling periods. This allows us to see the change in their language presentations longitudinally. As discussed above LIN and her mother ROX as well as her aunt ALE share similar rates of language use for Spanish, English, and language mixing. Their language presentations are in contrast when compared to LIN’s grandmother GLO, and her great-grandmother GRC.

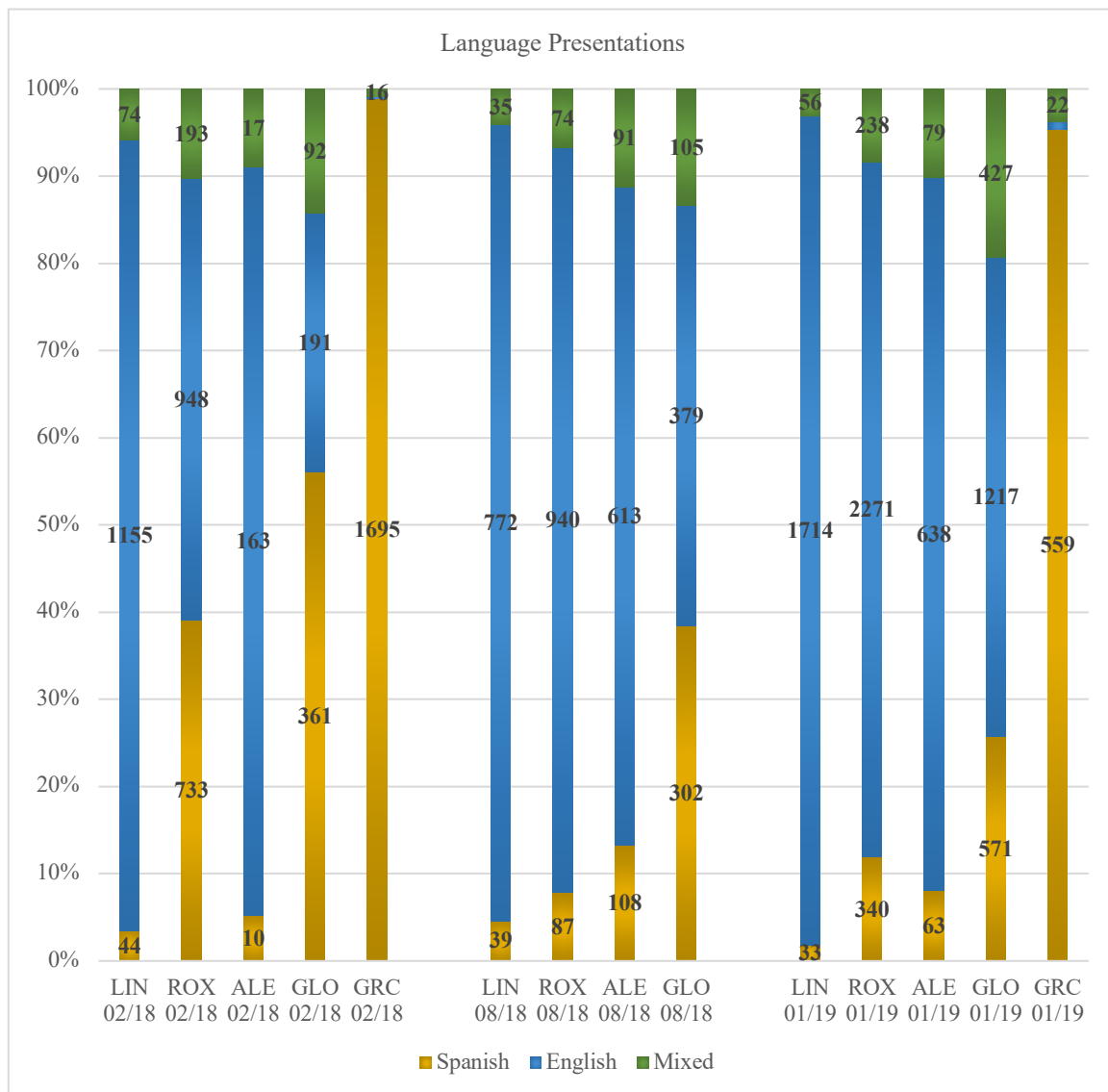

Figure 21: Language Presentations

4.5 LIN's directed input *versus* the adults' directed input: Spanish, English, & mixing

Thus far we have considered aspects of the linguistic soundscape and how Spanish, English, and language mixing are presented by the four principal, and multigenerational women: ROX, ALE, GLO and GRC, in LIN's maternal entourage. The aim of this section is to further analyze all the direct input that LIN and each of the other adult bi- and monolingual speakers receive, generally when in LIN's presence since this was the key criterion in the data selection process. First, we will consider the primary caregivers' language choices when interacting with LIN. Then, we will compare the adults' language choices when interacting amongst themselves. As previously underscored, it is crucial to keep in mind that the language choices presented here, and in the next section on child-adult dyads, are undoubtedly the result of several interrelated sociolinguistic factors (De Houwer, 2009). These factors, according to De Houwer (1990), Genesee et al. (1996), and Lanza (1997) include the interlocutors' language choices and their expectations, but also the topic and the place of interaction. They will thus be considered in deeper detail throughout our qualitative analyses. Another critical variable impacting language choice is the number of participants present. Goffman's (1974, 1981) Participation Framework, as discussed in Chapter 2, allows us to move away from what we think is the typical type of social interaction, namely two people talking to one another. A consideration of the *interaction type*, and *participant roles* extends the analyses to dyadic, triadic, and multiparty social encounters where speaker roles are continuously shifting according to the number of speakers engaged in the framework which is also always in constant movement. In turn, these perpetual adjustments continuously influence language choices. Finally, included in the variables mentioned so far are the (bi)lingual abilities of the speakers present. Within the framework of the current study not only are the interactions often multiparty, but the speakers' linguistic abilities are scattered across the language continuum due in large part to the multigenerational characteristic of the setting. The language abilities may range from Spanish monolingualism with limited knowledge of English (GRC), to more (ROX, ALE, GLO) or less (LIN) balanced Spanish-English bilingualism. Therefore, a consideration of the aforementioned factors will thus allow us to understand: "Who speaks what language to whom and when?" within the family. As highlighted in the literature review, Fishman (1965) through his sociology of language approach determined this question to be "the guiding beacon for the exploration of language-use patterns in multilingual settings" (Pauwels, 2016: 65). Therefore, in addressing this question through quantitative measures, we understand that the figures in the table below are the language choices that result from the dynamic interplay of diverse sociolinguistic

factors. For example, in February 2018 a total of 779 utterances were addressed to LIN by ROX, ALE, GLO, and GRC combined. In terms of relative frequency, the women address 27% Spanish utterances to LIN, and 64% of them are in English. The remaining 9% account for the mixed language utterances addressed to LIN. An analysis of the direct input may allow us to answer the additional three questions below:

7. How do the utterances that the adults address to LIN differ from those utterances that the adults address to each other?
8. Are Spanish utterances more frequently addressed to GRC and GLO, or the first-, and 1.5-generation speakers as could be expected?
9. Is language mixing more frequently addressed to the second-generation speakers ROX and ALE given their bilingual socializing context since birth?

Table 29: Relative frequency: Production of Spanish, English & mixed utterances in adult & child-directed input

Month	Addressee	Absolute (Total)	Spanish		English		Mixed	
			Absolute	Relative	Absolute	Relative	Absolute	Relative
February 2018	LIN	779	209	27%	500	64%	70	9%
	ROX	590	550	93%	26	5%	14	2%
	ALE	30	11	37%	16	53%	3	10%
	GLO	234	146	63%	78	33%	10	4%
	GRC	746	642	86%	20	3%	84	11%
August 2018	LIN	499	68	14%	406	81%	25	5%
	ROX	87	13	15%	66	76%	8	9%
	ALE	105	22	21%	74	70%	9	9%
	GLO	134	15	11%	104	78%	15	11%
January 2019	LIN	792	50	6%	695	88%	47	6%
	ROX	573	252	44%	250	44%	71	12%
	ALE	293	63	22%	180	61%	5	17%
	GLO	468	90	19%	337	72%	41	9%
	GRC	267	218	82%	13	5%	36	13%

The results in the table above present interesting patterns. Overall English is used the most when the adults speak to LIN. The same is true when the women address each other. An exception is ROX, GLO, and GRC. In February 2018 these speakers are addressed mostly in Spanish. In January 2019 GRC is also addressed mostly in Spanish whereas ROX receives equal amounts of Spanish and English input. Next, Spanish utterances come in second when the speakers address one another overall. However, by the third sampling period LIN is addressed the same amount of Spanish and language mixed input. Finally, mixed language

utterances come in third in terms of language choice. Nevertheless, a striking exception emerges with GLO and GRC. GLO in the second sampling period receives equal amounts of Spanish and mixed language input much like LIN in the third sampling period. GRC in February 2018 and January 2019 is addressed more mixed utterances than English. The bar graph below visually represents the language choice patterns made by the adults when addressing LIN versus when they address another adult across the three sampling periods.

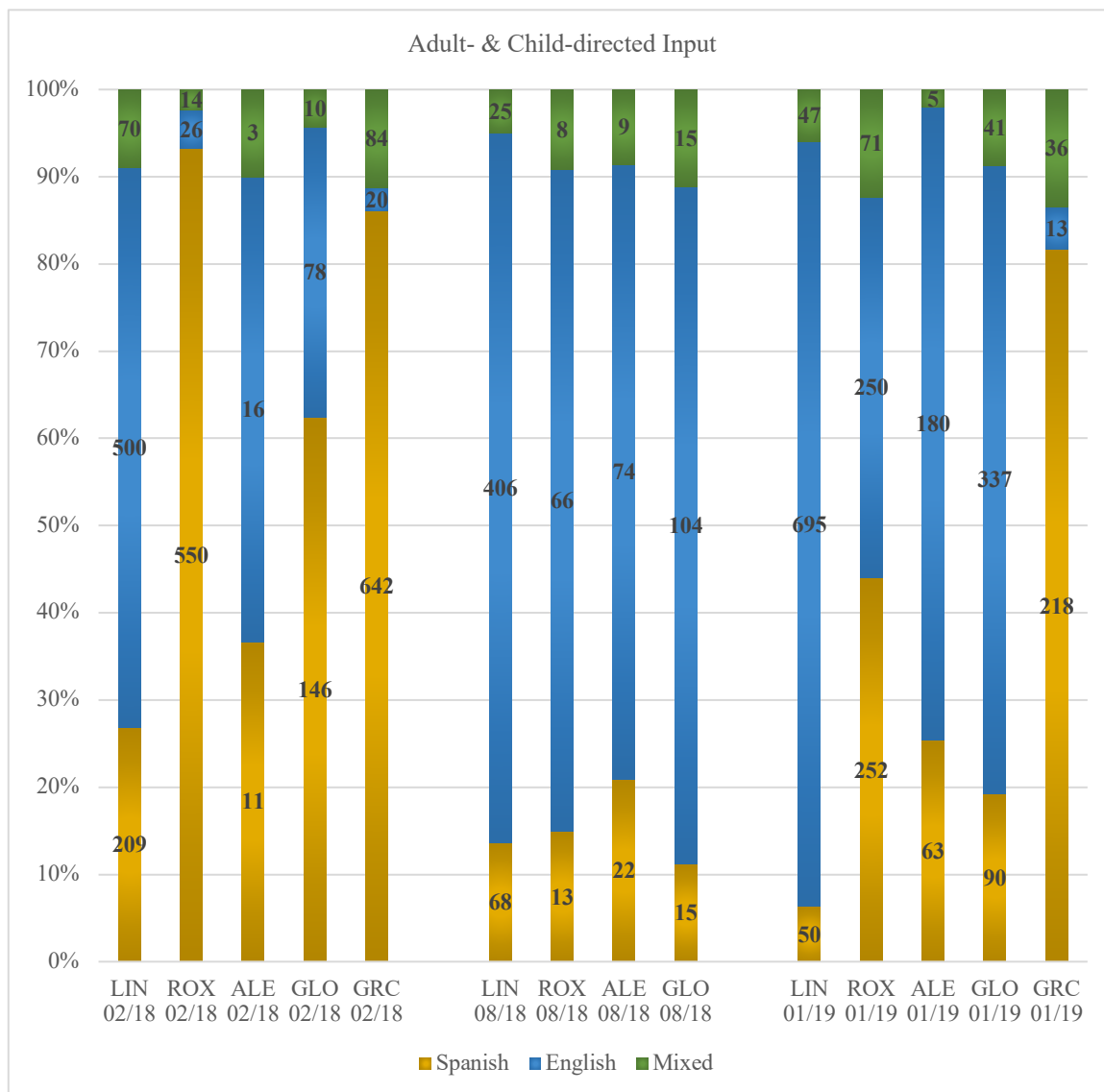

Figure 22: Adult- & Child-directed Input

4.5.1 English first

In terms of relative frequency, the English utterances that the multigenerational adults address to LIN do not differ significantly from those utterances that the adults address to each other longitudinally. However, English input to LIN progressively increases over the course of the

12-month case study. It goes from 64% in February 2018, to 81% in August 2018 and finally to 88% in January 2019, which also accounts for the highest English input of all the family members. Moreover, as for the inter-adult-directed input, the results show that English input falls to 5%, for example ROX in February 2018. But that it reaches 78% in August 2018 for GLO. It is interesting to note that GLO produces the most English input considering that she is a 1.5-generation speaker (born in Mexico). An exception is made for GRC. Since LIN's great-grandmother is not a bilingual speaker, it is understandable that the English input addressed to her is kept to a strict minimum, or 3% in February 2018 and 5% in January 2019.

4.5.2 Spanish second

The results show that much like with the English dynamics described above, Spanish utterances addressed to LIN as well as the inter-adult-directed Spanish do not differ greatly from one another. It is also the second most used language longitudinally. Nevertheless, contrary to the steady and progressive trend we see with LIN regarding her English directed input, the data show the opposite trend for Spanish. While in February 2018 LIN's directed input accounts for 27%, it decreases to 14% percent in August 2018 before falling to 6% in January 2019. Regarding the adults, Spanish is chosen up to 93% as is the case for ROX in February 2018 and never falls under 11%, as noted for GLO in August 2018. Here again it is interesting to note that GLO, given her generation receives the least amount of Spanish input next to LIN. ALE's Spanish input varies from 21% and 37% overall. An exception is made for GRC who understandably attains, for the above-mentioned reasons, 86% Spanish input in February 2018 and 82% in January 2019.

4.5.3 Mixed third

In considering the mixed language utterances the results are like the Spanish and the English speech addressed to LIN as well as to the inter-adult-directed speech in both languages discussed above. Mixed speech is not addressed significantly more, or less to LIN than it is between the adults. Much like with Spanish and English, the results show a substantial degree of inter-interlocutor variation. Furthermore, in terms of adult- and child-directed speech, mixed language input comes in third place. The language mixing directed to LIN fluctuates longitudinally. In February 2018 mixed language child-directed input accounts for 9%. This number drops to 5% in August 2018 and slightly rises to 6% in January 2019. This is an interesting pattern of input, when compared to the steady increase of English and the decrease

of Spanish longitudinally. Moreover, only in January 2019 does LIN receive 6% mixed and Spanish input. In the previous two sampling periods mixed and Spanish language choice rates are not even close. Regarding the inter-adult-directed input, mixed language utterances go as low as 2%, for example ROX in February 2018. Moreover, they never surpass 17%, for example ALE in January 2019. Also, the highest portion of mixed language utterances are addressed to ALE, and to GRC overall. For example, the results show 11% in February 2018, and 13% in January 2019 for GRC. This finding is interesting since ROX and ALE are second-generation speakers and are thus thought to be “more” bilingual than GRC, a first-generation speaker. That is, since “rates of shift are higher in communities in the second generation” (Deumert, 2011: 271) it may be expected that ROX and ALE not only produce more language mixing, but also that they are directed with higher frequencies of language mixed input, but this does not seem to be the case.

The present results, in particular the high number of language mixing addressed to GRC beg the question:

10. Why does GRC, a first-generation speaker receive more mixed language input overall than ROX, ALE, GLO, and LIN?

There is therefore a need for further inspection, and we may be able to find an answer through a multigenerational analysis of the input. However, before we do so, the next section will go a step further and examine the interactional exchanges that directly involve LIN when in pairs with each of the caretakers considered in this investigation. We must keep in mind, as stated above that the language choices expressed through these dyadic exchanges are certainly influenced by the ever-evolving sociolinguistic, and multimodal interactional constellations that were difficult to account for in these measures.

4.6 LIN’s output: Spanish, English, & mixing in child-adult dyads

This case study, as stated from the onset brings together theories, but also methods from the language acquisition as well as the language socialization paradigms. For this reason, the following analysis pays particular attention to the child-adult dyads such as LIN and her mother, and LIN and her additional communicative partners in her bilingual language learning environment. A consideration of the range of child-adult conversational pairs is critical to our

understanding of bilingual language development. Ochs and Schieffelin in their volume state the following:

While language acquisition research privileges mother-child conversations as a site of observation, language socialization research extends the object of inquiry to the range of adult and child communicative partners with whom a child ... routinely engages in some capacity across sociocultural configured settings. (Ochs & Schieffelin, 2011: 1).

Thus, the utterances that LIN addresses to her mother ROX as expressed in terms of their absolute and relative frequency will be examined and vice-versa. The same will be analyzed for each of the other women interlocutors with whom LIN interacts in the home.

Table 30: Relative frequency: Production of Spanish, English & mixed utterances in child-adult dyads

Month	Speaker	Absolute (Total)	Spanish		English		Mixed	
			Absolute	Relative	Absolute	Relative	Absolute	Relative
February 2018	LIN-ROX	619	12	2%	560	90%	47	8%
	ROX-LIN	515	61	12%	409	79%	45	9%
	LIN-ALE	20	0	0%	20	100%	0	0%
	ALE-LIN	30	0	0%	27	90%	3	10%
	LIN-GLO	159	7	4%	146	92%	6	4%
	GLO-LIN	158	73	46%	64	41%	21	13%
	LIN-GRC	25	5	20%	19	76%	1	4%
GRC-LIN	76	75	99%	0	0%	1	1%	
August 2018	LIN-ROX	161	2	1%	157	98%	2	1%
	ROX-LIN	356	28	8%	323	91%	5	1%
	LIN-ALE	53	1	2%	51	96%	1	2%
	ALE-LIN	44	1	2%	40	91%	3	7%
	LIN-GLO	60	0	0%	58	97%	2	3%
	GLO-LIN	99	39	39%	43	44%	17	17%
January 2019	LIN-ROX	537	0	0%	527	98%	10	2%
	ROX-LIN	564	10	2%	535	95%	19	3%
	LIN-ALE	70	3	4%	66	94%	1	2%
	ALE-LIN	64	1	2%	57	89%	6	9%
	LIN-GLO	144	2	1%	129	90%	13	9%
	GLO-LIN	162	37	23%	103	63%	22	14%
	LIN-GRC	1	0	0%	1	100%	0	0%
GRC-LIN	2	2	100%	0	0%	0	0%	

The results in the table above show variation in the child-addressed utterances when compared to the utterances that LIN produces when she addresses another adult. Overall, the relative frequency with which each of the languages is used demonstrates that Spanish is kept to a minimum when LIN addresses her multigenerational interlocutors and vice-versa. Two exceptions are made when GLO and GRC address LIN. Next, language mixing appears to be used more frequently than Spanish when LIN addresses the four family members. Moreover,

in some cases ROX and ALE address LIN with more mixed language speech in return. As far as English is concerned, it is the language that is most widely used within the child-dyad exchanges.

To highlight how the language exchanges between these child-adult dyads evolve longitudinally, we will briefly consider one conversational pair at a time. We will therefore start with the LIN <-> ROX dyad. Finally, the bar graphs below at the start of each analysis illustrate the language choice patterns between each dyad.

Table 31: LIN's output in child-adult dyads

Dyad	Language	Charts & Summaries																																
LIN <-> ROX		<table border="1"> <caption>Data for Table 31 Chart</caption> <thead> <tr> <th>Sampling Period</th> <th>Speaker</th> <th>Spanish</th> <th>English</th> <th>Mixed</th> </tr> </thead> <tbody> <tr> <td rowspan="2">02/18</td> <td>LIN</td> <td>12</td> <td>560</td> <td>47</td> </tr> <tr> <td>ROX</td> <td>61</td> <td>409</td> <td>45</td> </tr> <tr> <td rowspan="2">08/18</td> <td>LIN</td> <td>2</td> <td>157</td> <td>2</td> </tr> <tr> <td>ROX</td> <td>28</td> <td>323</td> <td>5</td> </tr> <tr> <td rowspan="2">01/19</td> <td>LIN</td> <td>0</td> <td>527</td> <td>10</td> </tr> <tr> <td>ROX</td> <td>10</td> <td>535</td> <td>19</td> </tr> </tbody> </table>	Sampling Period	Speaker	Spanish	English	Mixed	02/18	LIN	12	560	47	ROX	61	409	45	08/18	LIN	2	157	2	ROX	28	323	5	01/19	LIN	0	527	10	ROX	10	535	19
	Sampling Period	Speaker	Spanish	English	Mixed																													
	02/18	LIN	12	560	47																													
		ROX	61	409	45																													
08/18	LIN	2	157	2																														
	ROX	28	323	5																														
01/19	LIN	0	527	10																														
	ROX	10	535	19																														
English	When interacting with ROX, the results show divergent frequencies across Spanish, English, and mixed language utterances. LIN increasingly addresses ROX in English from the first sampling period to the last. ROX shows the same pattern of increased English use when addressing LIN. It also appears as though both LIN and ROX's use of English is reciprocal since they both present high and increasing use of English.																																	
Spanish	To address ROX, LIN rarely uses heritage Spanish, and her rates of Spanish use disappear in the last sampling period. This downward spiral is mirrored by a similar decline when ROX addresses LIN. Much like with English, both ROX and LIN's use of heritage Spanish is reciprocal since it is low and decreases longitudinally.																																	
Mixing	Like when LIN uses Spanish to address ROX, LIN's language mixing declines across the three sampling periods. However, unlike with Spanish, LIN's mixed language output towards ROX does not completely disappear. LIN's rate of mixed language utterances towards ROX is always slightly higher than her use of Spanish. ROX addresses LIN with mixed speech at a low and sustained rate. In terms of language mixing for this dyad, their mixed utterances decrease but remain present for LIN, and ROX thus showing reciprocity between these two speakers.																																	

LIN <-> ALE		<table border="1"> <caption>Data from the LIN <-> ALE language use chart</caption> <thead> <tr> <th>Date</th> <th>Speaker</th> <th>Spanish (%)</th> <th>English (%)</th> <th>Mixed (%)</th> </tr> </thead> <tbody> <tr> <td rowspan="2">02/18</td> <td>LIN</td> <td>0</td> <td>20</td> <td>0</td> </tr> <tr> <td>ALE</td> <td>0</td> <td>27</td> <td>3</td> </tr> <tr> <td rowspan="2">08/18</td> <td>LIN</td> <td>1</td> <td>51</td> <td>0</td> </tr> <tr> <td>ALE</td> <td>1</td> <td>40</td> <td>3</td> </tr> <tr> <td rowspan="2">01/19</td> <td>LIN</td> <td>3</td> <td>66</td> <td>1</td> </tr> <tr> <td>ALE</td> <td>1</td> <td>57</td> <td>6</td> </tr> </tbody> </table>	Date	Speaker	Spanish (%)	English (%)	Mixed (%)	02/18	LIN	0	20	0	ALE	0	27	3	08/18	LIN	1	51	0	ALE	1	40	3	01/19	LIN	3	66	1	ALE	1	57	6
Date	Speaker	Spanish (%)	English (%)	Mixed (%)																														
02/18	LIN	0	20	0																														
	ALE	0	27	3																														
08/18	LIN	1	51	0																														
	ALE	1	40	3																														
01/19	LIN	3	66	1																														
	ALE	1	57	6																														
English		<p>When LIN addresses her aunt ALE in English, she does with the same high and sustained frequency as she does with ROX. When it comes to ALE addressing LIN, we also see high and sustained output even if it falls slightly. While we can consider that their English use towards one another is reciprocal in terms of their overall high degree of use, these results should be treated with caution. The frequencies are based on a small number of utterances (between 20 and 70).</p>																																
Spanish		<p>When using Spanish, we witness a similar scenario as the LIN <-> ROX dyad. Overall, the frequency with which LIN uses heritage Spanish to address ALE is low and sustained. However, rather than to decrease it slightly rises. The Spanish that ALE directs to LIN also increases. Their use of Spanish is reciprocal. Furthermore, even though the relative frequency of Spanish is low and sustained, it contrasts with ROX's decreasing directed heritage Spanish to LIN. Finally, much like with English, these rates should be interpreted with caution.</p>																																
Mixing		<p>LIN's mixed language utterances emerge but remain low when she addresses ALE. This trend is opposite to when she addresses ROX. In February 2018 LIN does not address mixed speech to ALE. By August 2018 her mixed language utterances to ALE are 2%. The same frequency is maintained in January 2019. In terms of ALE's mixed language output, as opposed to ROX, ALE addresses more mixed speech to LIN overall. Caution is warranted since the number of utterances from which these results are drawn are small. We may thus say that reciprocity cannot be determined between this dyad.</p>																																

LIN <-> GLO		<table border="1"> <caption>Language Use Data from Chart</caption> <thead> <tr> <th>Time Point</th> <th>Speaker</th> <th>Spanish</th> <th>English</th> <th>Mixed</th> </tr> </thead> <tbody> <tr> <td rowspan="2">02/18</td> <td>LIN</td> <td>7</td> <td>146</td> <td>6</td> </tr> <tr> <td>GLO</td> <td>73</td> <td>64</td> <td>21</td> </tr> <tr> <td rowspan="2">08/18</td> <td>LIN</td> <td>0</td> <td>58</td> <td>2</td> </tr> <tr> <td>GLO</td> <td>39</td> <td>43</td> <td>17</td> </tr> <tr> <td rowspan="2">01/19</td> <td>LIN</td> <td>2</td> <td>129</td> <td>13</td> </tr> <tr> <td>GLO</td> <td>37</td> <td>103</td> <td>22</td> </tr> </tbody> </table>	Time Point	Speaker	Spanish	English	Mixed	02/18	LIN	7	146	6	GLO	73	64	21	08/18	LIN	0	58	2	GLO	39	43	17	01/19	LIN	2	129	13	GLO	37	103	22
Time Point	Speaker	Spanish	English	Mixed																														
02/18	LIN	7	146	6																														
	GLO	73	64	21																														
08/18	LIN	0	58	2																														
	GLO	39	43	17																														
01/19	LIN	2	129	13																														
	GLO	37	103	22																														
English	<p>LIN addresses her grandmother in English with a high and stable relative frequency. These rates are like when LIN addresses ROX and ALE. Regarding GLO addressing LIN, the rates are lower (between 40-60%) but sustained. Thus, as opposed to what the results showed for the LIN <-> ROX and LIN <-> ALE dyad, the English use between LIN and GLO is not reciprocal.</p>																																	
Spanish	<p>Much like with ALE and ROX, LIN uses heritage Spanish to a minimum when addressing GLO. Furthermore, during the second data collection period her Spanish completely disappears. However, GLO represents the highest and most stable form of Spanish input among the other dyads up to this point. Even though GLO's use of Spanish substantially decreases longitudinally, this low, though sustained amount of exposure around and above 25% may prove to be critical for LIN to use and eventually acquire some Spanish. For example, based on parental estimates in a study of English-Spanish input by Pearson et al. (1997), if in a bilingual setting the language input of one of the languages is less than 25%, then chances are that it will not be acquired. Finally, regarding their use of Spanish, there is no reciprocity between GLO and LIN.</p>																																	
Mixing	<p>Overall, when addressing GLO, LIN's language mixing is slightly more frequent than when addressing ROX, or ALE. Initially, these rates were much higher. But closer examination of the data revealed that this was due to LIN often calling her "Grandma". As is noted in the methods section, terms such as "Grandma" and "Grandpa" are tagged with the [:@s:eng&spa] code and appear in the transcript like this: "Grandma@:s:eng&spa". These types of terms suggest 'bivalency', or as Woolard (1999) describes, they are multilingual. Thus, they belong to both languages under study since "Grandma" and "Grandpa" are borrowed from English and commonly used (Moreno-Fenández, 2017) in the Spanish variety of the U.S. Since the coding scheme inflated the proportion of mixed language utterances especially for LIN, they were recoded as [N] to neutralize them and to get more accurate results. There seems to be no reciprocity between LIN and GLO's mixed language utterance use. However, of all three adults, GLO addresses LIN with the most language mixing. Finally, it can be suggested that LIN may get additional exposure to some Spanish not only through GLO's mixed language utterances, but also through the mixed speech of ROX and ALE.</p>																																	

LIN <-> GRC																											
		<table border="1"> <caption>Data for LIN <-> GRC Language Use</caption> <thead> <tr> <th>Period</th> <th>Speaker</th> <th>Spanish (%)</th> <th>English (%)</th> <th>Mixed (%)</th> </tr> </thead> <tbody> <tr> <td>02/18</td> <td>LIN</td> <td>5</td> <td>19</td> <td>1</td> </tr> <tr> <td>02/18</td> <td>GRC</td> <td>75</td> <td>1</td> <td>1</td> </tr> <tr> <td>01/19</td> <td>LIN</td> <td>0</td> <td>0</td> <td>0</td> </tr> <tr> <td>01/19</td> <td>GRC</td> <td>2</td> <td>0</td> <td>0</td> </tr> </tbody> </table>	Period	Speaker	Spanish (%)	English (%)	Mixed (%)	02/18	LIN	5	19	1	02/18	GRC	75	1	1	01/19	LIN	0	0	0	01/19	GRC	2	0	0
Period	Speaker	Spanish (%)	English (%)	Mixed (%)																							
02/18	LIN	5	19	1																							
02/18	GRC	75	1	1																							
01/19	LIN	0	0	0																							
01/19	GRC	2	0	0																							
English		The last dyad considers LIN and her great-grandmother. LIN addresses GRC mainly in English and is not adapting to her interlocutor's monolingualism. This is contrary to what De Houwer (1990), and Genesee et al. (1996) have observed in their studies. For example, Genesee <i>et al.</i> found that four English-French bilingual children around two years of age all made language related accommodations according to the monolingualism of a stranger. Even though LIN knows that GRC only speaks Spanish, she nevertheless addresses her in English. Finally, as a Spanish monolingual speaker, GRC essentially addresses LIN in Spanish.																									
Spanish		Of all the other dyads, LIN interacts with GRC the most in heritage Spanish. Nevertheless, this mainly occurs during the first sampling period. Moreover, GRC almost entirely addresses LIN in Spanish. Even so, caution should be taken when interpreting the results since the relative frequencies are only based on a few interactions. A more detailed qualitative examination of their interactions is in order. It may allow us to see why, and how LIN uses Spanish with GRC. Furthermore, we will be able to consider who are the other members in the participation framework and how they help shape or hinder her Spanish development. There is no reciprocity between this pair's Spanish interactions.																									
Mixing		LIN does not regularly address GRC with mixed language speech and the same is true for GRC when addressing LIN. Since their rates are low it is difficult to determine reciprocity between LIN and GRC in this mode of communication.																									

These results, in particular the increase in LIN's Spanish when interacting with her grandmother GLO and great-grandmother GRC suggest that we analyze her productions while differentiating the female adult speakers by generation. We thus consider the generation factor next.

4.7 LIN's output: Spanish, English, mixing, & interlocutor generation

As we move forward with the data analysis, the next step is to investigate LIN's output when she is interacting with speakers according to their generations. Many individual factors play a role and thus influence whether a child uses and acquires a minority language, or degree of

individual bilingualism (De Houwer, 2021). Some of these factors include “age, gender, educational background, social class, race/ethnicity, religious affiliation or marital status.” (Pauwels, 2016: 83), as well as “socioeconomic and geographic” (Niño-Murcia & Rothman, 2008: 28) background. Moreover, the generation factor may be said to play a crucial role in the understanding of inter-individual language use patterns as they are rooted in their complex, and often tension ridden bilingual settings. At its core a speaker’s generation helps identify those speakers who come from a foreign land (turned motherland) from those speakers who are born and are raised in the new foreign land that eventually, and sometimes seamlessly becomes their own. We have seen that this process of becoming may be manifested through hybridized linguistic and cultural practices. Nonetheless, as Pauwels explicitly states,

The generation a speaker belongs to is one of the most clear-cut factors in the process of LS. This is especially the case for migrant communities where there is almost universal evidence that the second generation maintains the heritage language less than the first generation and that its use in subsequent generations further declines. (Pauwels, 2016: 84-85).

A look at the table below depicts how the linguistic resources (Spanish, English, and language mixing) are used at the intersection of interlocutor generation, as tied to LIN’s bilingual language learning environment.

Table 32: Relative frequency: Generational distribution of LIN’s Spanish, English, & mixed utterances

Month	Generation	Absolute (Total)	Spanish		English		Mixed	
			Absolute	Relative	Absolute	Relative	Absolute	Relative
February 2018	G1	25	5	20%	19	76%	1	4%
August 2018		na	na	na	na	na	na	na
January 2019		1	0	0%	1	100%	0	0%
February 2018	G1.5	159	7	4%	146	92%	6	4%
August 2018		60	0	0%	58	97%	2	3%
January 2019		144	2	1%	129	90%	13	9%
February 2018	G2	639	12	2%	580	91%	47	7%
August 2018		214	3	1%	208	97%	3	2%
January 2019		607	3	0%	593	98%	11	2%
February 2018	G3	80	4	5%	72	90%	4	5%
August 2018		40	1	3%	39	97%	0	0%
January 2019		353	8	2%	327	93%	18	5%

4.7.1 English

The table above aids us in confirming several points. First, we may ascertain the strong presence of English in LIN's productions. Second, that LIN's productions do not appear to be generation-graded. That is, the frequency with which she uses English rises and falls, but it always remains above 70%, multigenerationally.

4.7.2 Spanish

Third, that LIN uses heritage Spanish the least of all three modes of communication. Furthermore, that much like with English, her use of heritage Spanish is not generation-graded even though she uses the most (20%) once with GRC. However, when it comes to Spanish, even if it remains well below 10% across generations, it is interesting to see a slow rise in heritage Spanish use with her generational cohort, or third-generation entourage. These child speakers include her younger brother JUL and her two cousins GOY, and IGN.

4.7.3 Mixed

The fourth point is the presence of language mixing. Like with English and Spanish they also appear not to be generation-graded. Like with Spanish, they remain below 10% but appear to be slightly less static as she gets older. In other words, "The proportion of mixed utterances in individual children can fluctuate with age." (De Houwer, 2009: 268). Furthermore, the frequency with which she resorts to language mixing appears to be intimately intertwined with her use of heritage Spanish. This aspect will be pursued in further detail throughout our qualitative analyses in the next two chapters. Next, two different graphs using the same dates will be presented. The first bar graph below gives a visual illustration of the dynamics of LIN's language use frequencies (absolute and relative) in heritage Spanish, English, and language mixing in relation to the generation of her interlocutors per sampling period as described above.

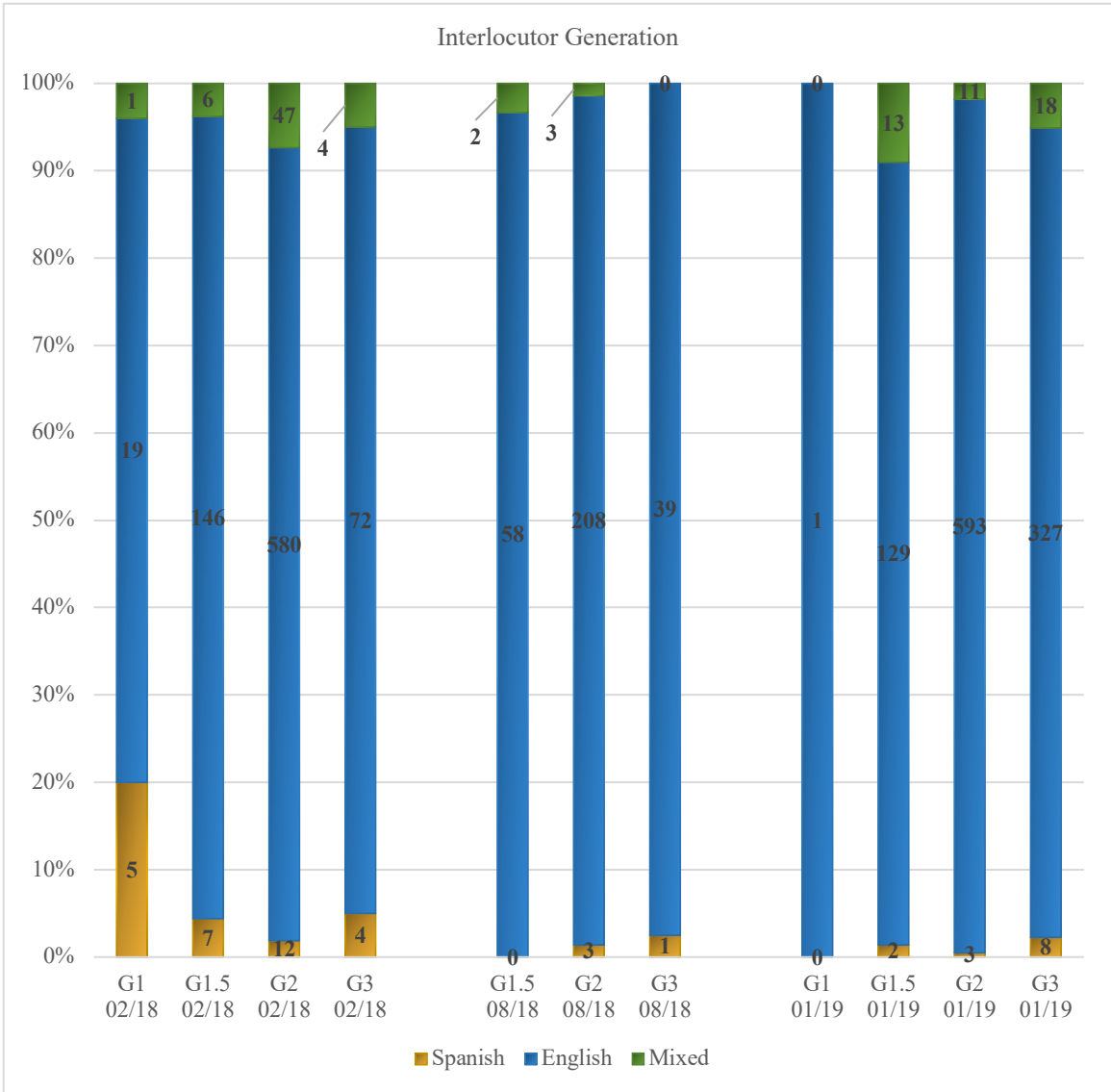

Figure 23: Generational-gradation grouped by sampling period: Spanish, English, & mixed utterances

Based on the same language use frequencies as presented above, the second line graph below gives a visual illustration from a different perspective. Rather than to present LIN’s language use trends from the first- to the third-generation in each of the three months, it groups each speaker by generation. It shows how each bi- and monolingual speaker, starting with the first-generation used Spanish, English, and language mixing longitudinally.

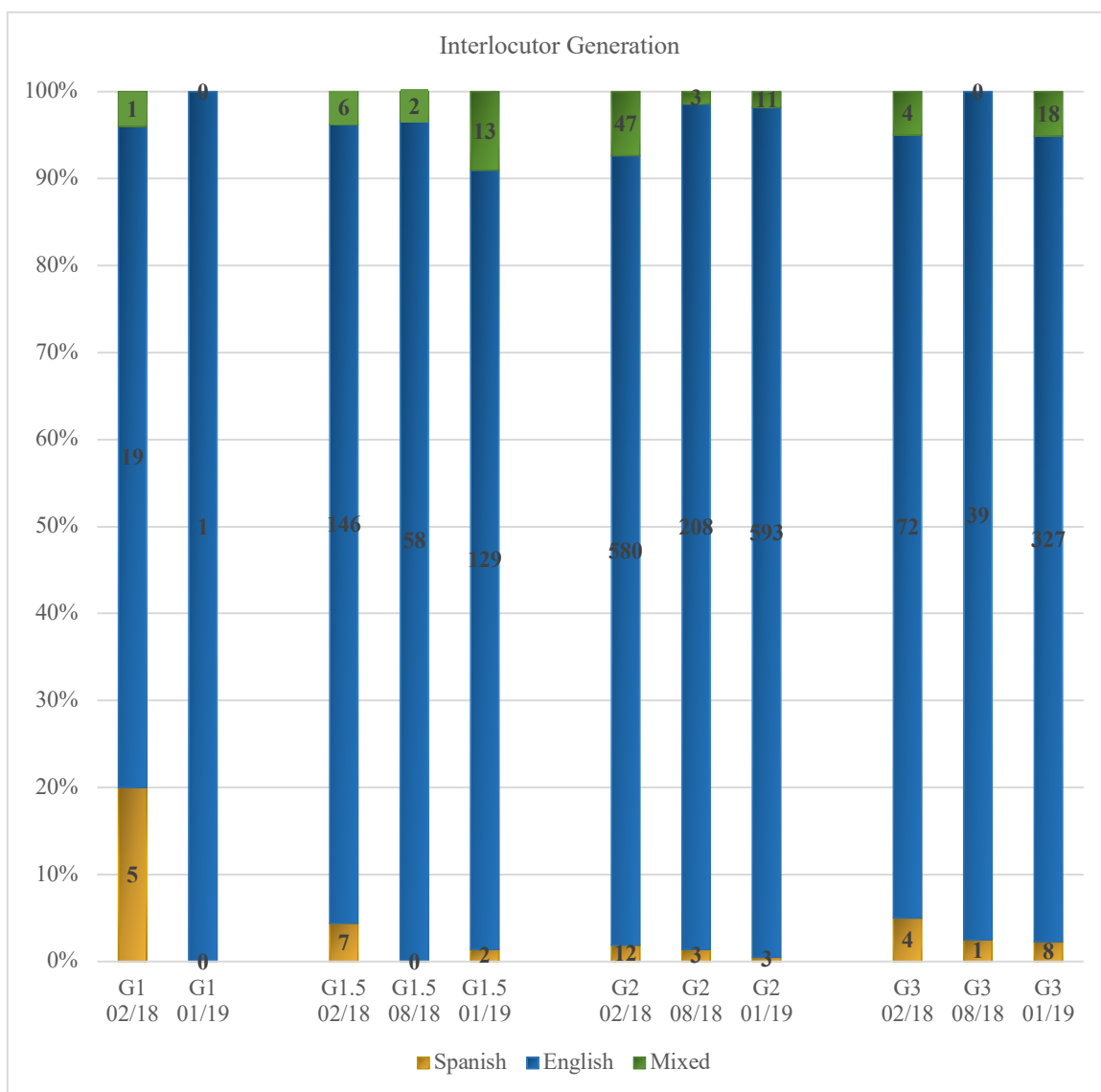

Figure 24: Generational-gradation grouped by generation: Spanish, English, & mixed utterances

These results point to an interesting aspect linked to LIN's use of Spanish and language mixing. Namely, that for the third-generation, heritage Spanish use decreases while language mixing pointed to an increase longitudinally. Moreover, since the central research question is: How does a third-generation child use and is socialized to use heritage Spanish in L.A.? An understanding of how LIN is using heritage Spanish with her great-grandmother GRC as well as with her grandmother GLO may help with its elucidation. Furthermore, as mentioned previously an understanding of how she uses mixed language utterances in interaction with her family in multimodal and multiparty participation frameworks may also show how language mixing supports her use of Spanish. Therefore, a more qualitative approach to the data that is more fine-grained is indispensable. However, before qualifying LIN's rich interactional moments through a bilingual and multimodal participation framework, let us take a brief look

at LIN's output in terms of the previous utterance(s) in her bilingual language learning environment. Following these analyses, we will consider both her MLUw, as well as her TTR. Each of these measures are important in assessing a child's bilingual language development, as well as his or her lexical diversity respectively.

4.8 LIN's output: Spanish, English, mixing, & the language of previous utterance

Having looked at LIN's linguistic production from a multigenerational perspective, in this section we will consider her heritage Spanish, English, and mixed language output as related to the language(s) of previous utterance. To be clear, for LIN to "choose" a language with which to express herself, one of the requisites is for her to be able to speak either of the languages in which she is addressed (De Houwer, 2021). However, "If bilingual children can express themselves only in one language and that language does not overlap with their unfamiliar interlocutor's language, they have the choice between speaking the 'wrong' language or not speaking at all." (De Houwer, 2009: 144). As we have confirmed through the quantitative measures in the previous sections, rather than to stay silent, LIN almost entirely chooses to speak English with her known interlocutors because at this developmental stage she shows little if no productive ability in heritage Spanish. Furthermore, she is likely aware that most of her interlocutors are bilingual, or at least that they understand both languages. So, even if she responds in English when addressed in Spanish, i.e., dilingually, she knows that she will eventually be understood in the social encounter. Finally, when she does speak English to a Spanish monolingual in the presence of other bilinguals, she seems to be aware that they will typically act as language brokers. Bilingual adults thus help in establishing a sense of communicative well-being (De Houwer, 2015) in the family. Therefore, her message will be carried over into English such that the communication channel is not broken, or rather the broken channel is repaired to reach mutual understanding between two (and sometimes more) people as I discuss in an essay on translation as a vector for linguistic mediation¹⁰² (Alvarez, 2023). The family's bicultural framework, and language in this case may be apprehended as a system, or a tool for mediation since "The common use of language takes place at the same level as the common use of all of the objects which surround us in the society in which we were born and in which we live." (Rossi-Landi, 1970: 521). Moreover, the tools that humans

¹⁰² We define mediation here as an interactive process where a third interlocutor (triadic participation framework) aids in the resolution of conflict. In our study, the conflict is related to the use of distinct codes in a social encounter. Furthermore, throughout the process of linguistic mediation, the participants are highly encouraged to proactively participate in the process.

use to regulate their ecosystems are always “entre” by definition, for example between “people and other people (through) (gestures, utterances)” (Duranti, 1997: 39). Notwithstanding, we will also see how translation, at least for pedagogical purposes, is also a source of frustration for LIN. Nevertheless, the ability for any of the bilingual family members to step in and help resolve these types of linguistic puzzles is also one of the strengths tied to LIN’s multigenerational setting. In the qualitative chapters to come we will see several examples of how the bilingual speakers in the family naturally turn to language brokering to maintain the interaction flowing, especially when the social encounter is anchored in triadic, and multiparty interactional frameworks. Nevertheless, we may ask if speaking English is really a choice for her. Beyond the ability for a participant to speak either of the languages in which s/he is addressed, another requisite for language choice is “signaled by the interlocutor’s own language choice” (De Houwer, 2009: 144), or the language(s) in which something is said in the previous utterance. The table below shows that LIN essentially responds in English despite the preceding language(s). For example, in February 2018 only 10% of the previous utterances were Spanish when she spoke Spanish versus 80% in English and 10% in language mixing.

Table 33: Relative frequency: Generational distribution of LIN’s Spanish, English, & mixed utterances

Month	Speaker & Language	Absolute (Total)	Language of Previous Utterance					
			Spanish		English		Mixed	
			Absolute	Relative	Absolute	Relative	Absolute	Relative
February 2018	LIN	1 265						
	Spanish	378	37	10%	304	80%	37	10%
	English	766	7	1%	735	96%	24	3%
	Mixed	121	0	0%	108	89%	13	11%
August 2018	LIN	839						
	Spanish	207	27	13%	165	80%	15	7%
	English	561	10	2%	537	96%	14	2%
	Mixed	71	2	3%	63	89%	6	8%
January 2019	LIN	1 800						
	Spanish	265	19	7%	230	87%	16	6%
	English	1 416	8	0%	1 282	98%	26	2%
	Mixed	119	6	5%	99	83%	14	12%

4.8.1 Spanish

The table above additionally shows that LIN’s heritage Spanish production is preceded by 13% Spanish in August 2018, and 7% in January 2019. Furthermore, English at over 80% is

generally what she hears or is addressed in when she speaks Spanish. It is interesting to note that some language mixing precedes her Spanish. For example, 7% in August 2018 and 6% in January 2019.

4.8.2 English

When LIN speaks English, it is almost exclusively in response to English in her bilingual language learning environment. The frequencies show that previous English utterances correspond to 96% in August 2018, and 98% in January. Also, even if they are low for both languages, when LIN speaks English, language mixing is slightly more frequent as the language of previous utterance as opposed to Spanish. Finally, below we look at the language(s) that precede her language mixing.

4.8.3 Mixed

Regarding mixed language utterances, we see a similar pattern as with Spanish. In this mode of communication, English is typically the language of the previous utterance. Like with heritage Spanish, previous English utterances are present at frequencies in the 80's. For example, 89% in August 2018, and 83% in January 2019. What is also curious is that LIN's mixed language production is never preceded by more than 5% Spanish. This is contrary to her Spanish production where mixed utterances are above 5% and even reach 10%. LIN is mainly responding in English regardless of the previous language choice. The bar graph below illustrates the language(s) of previous utterance when LIN produces heritage Spanish, English, and mixed language utterances.

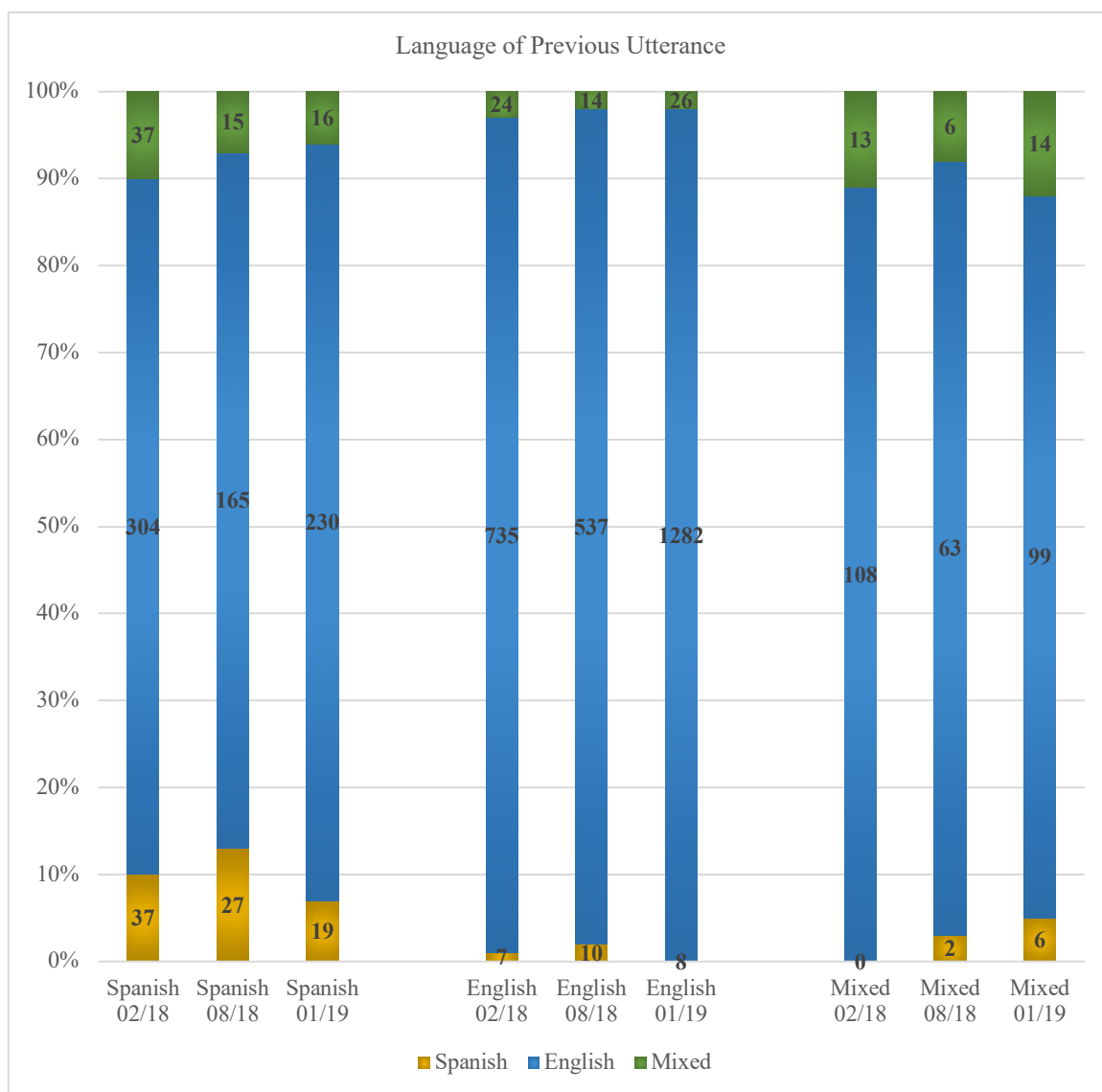

Figure 25: Language of Previous Utterance: Spanish, English, & mixed utterances

4.9 LIN’s Mean Length of Utterance (MLU): Bilingual language development?

Within the framework of this longitudinal case study of heritage language socialization and acquisition, the documentation of spontaneous talk-in-interaction of LIN with her multigenerational caretakers began in February 2018. After the data management process described in Chapter 3 was completed, CLAN was used to transcribe the bilingual data to create a plurilingual corpus since “CLAN emphasizes the automatic computation of indices such as MLU” (MacWhinney, 2000: 8), and furthermore, the “MLU is generally interpreted as a developmental index of language proficiency.” (Silva-Corvalán, 2014: 45). Thus, CLAN’s computerized ability to calculate the MLU would allow us to gain a deeper understanding of LIN’s language development both in heritage Spanish as well as in English. Moreover, it would

allow us to compare the development of these two languages longitudinally. However, as Crystal (1974) has advanced, these computations are not free of problems as we will see below.

Researchers argue that “As a measure of *comparing across languages*, however, MLU is highly problematic. That is because languages differ quite dramatically in their use of bound morphemes.” (De Houwer, 2009: 65). To express the same idea or concept some languages may rely on complex morphological systems, whereas other languages do not. Cruz-Ferreira (2006) in her study of the acquisition of Portuguese in a trilingual setting further discussed the implications of cross-language MLU comparisons. Nevertheless, to resolve this dilemma, De Houwer (2009) states that words as opposed to morphemes have been suggested to count the MLU. Within the framework of the present study De Houwer’s suggestion makes sense. Valian (1991) confirms that like with Italian, the morpheme structure between English and Spanish is not similar. Furthermore, De Houwer cautions however that even if some do consider Spanish and English word structure to be comparable that “there are important differences at the word level, with for instance ‘get up’ in English consisting of two words but its Spanish equivalent ‘levantarse’ consisting of only one” (De Houwer, 2009: 66). We thus get a sense of the morphological richness of Spanish when compared to English to express the same action. Tomasello goes even further and highlights “words composed of multiple morphemes expressing a complex event or situation and its participants ... such as the Spanish *Dámelo!* (Give it to me!)” (Tomasello, 2003: 93). With this example, De Houwer’s words of caution are made even more explicit since at the word level, English consists of four words whereas the Spanish equivalent consists of only one morphologically rich word. Despite the debate between MLUm (m for morphemes) versus MLUw (w for words) calculations to which both De Houwer (2009) and Johnson (2001) have called attention, Silva-Corvalán and Sánchez-Walker (2007) consider that comparing the MLU’s at the word, as opposed to the morpheme level is suitable for English and Spanish even if in some cases it is difficult to determine if the same things are being compared.

Keeping the discussion above in mind, I calculated the MLUw for LIN starting from the first sampling period, or February 2018. Her MLUw was then calculated for the second (August 2018), and then the third sampling period (January 2019). During the initial month of data collection, LIN was thus 46 months old, or 3;10 of age. De Houwer stipulates that “In general, we would expect young children at the end of their third year to be well into the stage where they are producing sentences, which requires an average utterance length of at least 2.5

words.” (De Houwer, 2009: 276). The table below therefore represents LIN’s MLUw for the three sampling periods. On February 1st, 2018, LIN was 3;10 of age, or at the end of her fourth year. Based on 80 utterances (third, blue column) at this age her MLUw is at 2.8 (fourth, blue column). LIN was thus under the expected average MLUw of “at least 2.5 words” even though she was producing sentences in English.

Table 34: MLU Values: English & Spanish

Age	Media file	number of utterances	MLUw English	number of utterances	MLUw Spanish
3;10	FEB_1_2018_ERI_LIN_JUL_ROX.cha	80	2.8	-	-
	FEB_14_2018_ROX_LIN_ERI_RIC.cha	64	4.3	-	-
	FEB_15_2018_GLO_JUL_LIN_ERI.cha	58	3.5	-	-
	FEB_21_2018_GRC_ROX_ERI_LIN.cha	62	3.0	-	-
	FEB_22_2018_ERI_LIN_JUL_GRC.cha	82	3.5	-	-
	FEB_22_2018_LIN_ROX_JUL_RIC_GRC.cha	59	4.0	-	-
	FEB_22_2018_ROX_GRT_GRC_ERI_LIN_ALE.cha	53	3.3	-	-
	FEB_23_2018_ROX_LIN_JUL_GRC.cha	66	3.4	-	-
	FEB_24_2018_LIN_ERI_GLO.cha	91	2.9	-	-
4;4	AUG_26_2018_GLO_ROX_GUI_ALE_ERI_LIN_RIC.cha	70	3.7	-	-
	AUG_26_2018_LIN_GLO_JUL_ALE_GOY_ERI_GUI.cha	57	3.9	-	-
	AUG_28_2018_LIN_JUL_ERI.cha	92	4.1	-	-
	AUG_29_2018_LIN_ERI.cha	56	3.6	-	-
	AUG_30_2018_ERI_LIN_GLO_JUL_ROX_JUL.cha	75	3.8	-	-
	AUG_30_2018_LIN_ROX_ALE_ERI_GLO_JUL_RIC_MAR.cha	63	3.4	-	-
4;9	JAN_01_2019_LIN_ALE_ROX_GLO_GUI_MAR.cha	116	4.0	-	-
	JAN_02_2019_LIN_JUL_ERI_ROX.cha	86	3.6	-	-
	JAN_03_2019_ERI_LIN_GOY_RIC_ALE_ROX.cha	101	3.7	-	-
	JAN_04_2019_JUL_GLO_ERI_LIN_ROX.cha	85	3.5	-	-
	JAN_05_2019_GLO_ROX_JUL_ERI_LIN.cha	90	4.2	-	-
	JAN_06_2019_GLO_ROX_ERI_GUI_LIN_JUL_RIC.cha	62	4.3	-	-
	JAN_06_2019_GUI_ERI_GLO_RIC_JUL_ALE_LIN.cha	83	3.9	-	-
	JAN_09_2019_JUL_ERI_ROX_GLO_LIN_GRC.cha	62	4.2	-	-
	JAN_09_2019_LIN_GLO_ERI_ROX_MAR.cha	102	3.4	-	-
	JAN_11_2019_LIN_ROX_GRC_ERI_JUL.cha	284	4.3	-	-
	JAN_11_2019_ROX_LIN_JUL_GRC_RIC_ERI.cha	221	4.3	-	-
	JAN_12_2019_GLO_ARA_ALE_LIN_JUL_GOY_ROX.cha	76	3.8	-	-

Furthermore, following MacWhinney¹⁰³ (2000) and Silva-Corvalán (2014) the table above presents MLUw calculations that are based on videos with at least 50 utterances longitudinally. Even though all the transcribed video files were subjected to a MLUw calculation, only those transcriptions where LIN spoke at least 50 different times in English or in Spanish were used

¹⁰³ MacWhinney’s study is based on 48 children. However, he explains that during the observation session only 33 children produced more than 50 utterances.

to assess her language development. Next, to my knowledge CLAN is not yet capable of analyzing the MLU for language mixing. For this reason, English-Spanish mixed language utterances are excluded from the table above. Furthermore, since Spanish is morphologically richer than English, word counts are expected to be more reliable reference points for cross-language comparisons. Nevertheless, adding to the complexity of calculating MLUw is the fact that LIN never produced a minimum of 50 Spanish utterances in any of the videos (fifth, yellow column). This is quite telling of her use and acquisition of heritage Spanish, or lack thereof as depicted by the absence of MLUw calculations (last, yellow column). The dashes [-] both in the “number of utterances” and “MLUw Spanish” are therefore used to fill the yellow columns above. Thus, in this study the issue of cross-linguistic developmental comparisons is unfortunately not possible regarding her English and Spanish MLUw.

Counting words is problematic when generating a MLUw for cross-language comparisons. Furthermore, it is compounded by the fact that there was not sufficient words to count in Spanish to generate LIN’s MLUw. Therefore, LIN’s MLUw as an approximate reference point regarding her stages of English development are considered below. The calculations above are intended to be considered as indicators of her developmental tendencies longitudinally. Thus, we should be cautious with their interpretation. Finally, each analysis begins with a line graph to illustrate how her MLUw fluctuates by sampling point, and over the span of the study. The orange dots on each line correspond to the specific date in the month according to the table above. Each date in the line graph is also accompanied by the exact amount of time in minutes and seconds of the recording. For example, the first orange dot below corresponds to February 1st, 2018, and the video is 10 minutes and 49 seconds long, whereas the second one corresponds to February 14th, 2018, where the video is eight minutes and 12 seconds long.

4.9.1 February 2018

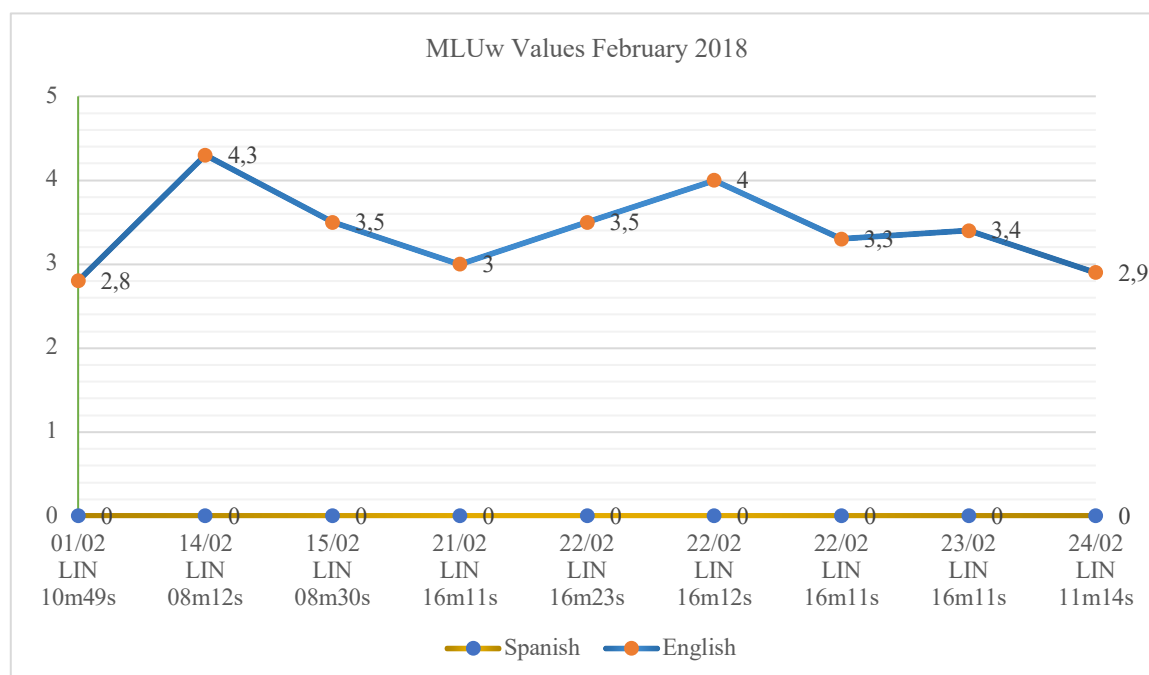

Figure 26: MLUw Values February 2018: English

LIN produced a minimum of 50 utterances or more in a total of nine files. At this point in time, she was 3;10 of age and spoke no less than 53 times, but no more than 91 times. At the end of her fourth year, LIN's MLUw was above and beyond the 2.5-word mark (De Houwer, 2009). Only twice did she obtain a MLUw in the twos: one was calculated at 2.8 while the other was 2.9. Moreover, even though LIN's MLUw was mostly between 3.0 and 3.5 (five occurrences), the value of 4.0 or higher was reached twice, the second one being 4.3. Finally, it is interesting to note that LIN's MLUw cannot be said to have increased steadily as the month progressed, but rather that it fluctuated. Even though LIN reached an MLUw of 4.0, in the last recording session (February 24, 2018) her MLUw was 2.9.

4.9.2 August 2018

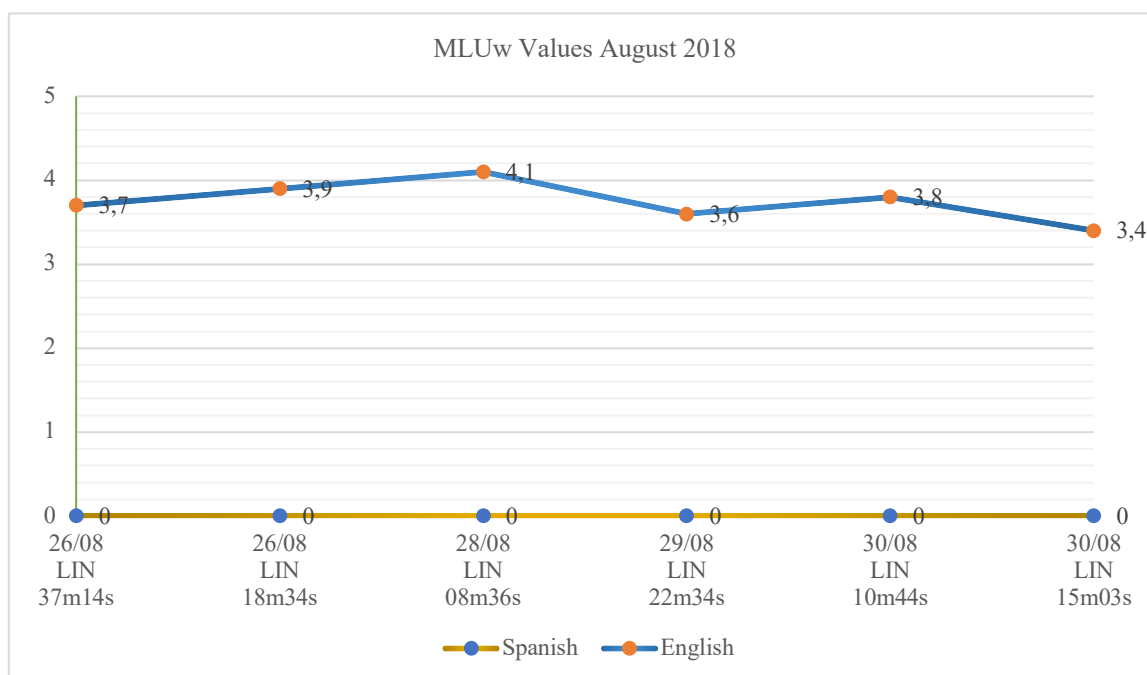

Figure 27: MLUw Values August 2018: English

We were able to exploit a total of six files in August 2018 when LIN was 4;4 years of age. Here she spoke a minimum of 56 times, but no more than 92. Even if the number of files was quantitatively smaller than in February 2018, overall, the number of times LIN spoke per file appeared to remain stable with no major increases or decreases. Also, on the eve of her fifth birthday, LIN was well beyond the two words per utterance suggested as a reference needed to produce sentences. LIN's MLUw was almost entirely in the threes, or 3.4, 3.6, 3.7, 3.8, and 3.9 (five occurrences). The value of 4.1 was reached once. Here again, although globally higher, LIN's MLUw did not increase steadily throughout the month. Instead, much like during the first sampling period, her MLUw varied. For example, in the last recording (August 30, 2018) her MLUw was 3.4.

4.9.3 January 2019

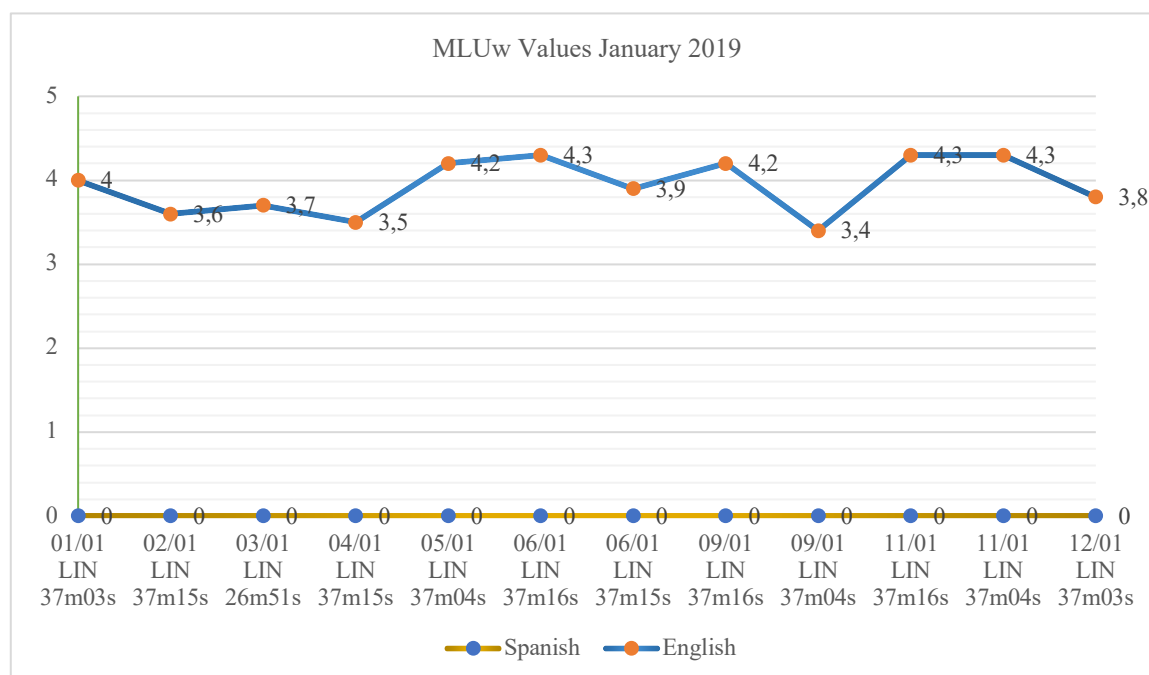

Figure 28: MLUw Values January 2019: English

LIN was 4;9 years of age in the last sampling point. The results showed a total of 12 files that were at or above the 50 utterances minimum. Unlike in February and August 2018, LIN spoke a minimum of 62 times, but also went well beyond 200 utterances on two occasions. Thus, the number of times LIN spoke per file appeared to increase with age. In terms of LIN's MLUw, we noted two things. First, much like in August 2018, half, or six of her values went from 3.4 to 3.9, though not consecutively. Second, the other half of LIN's values were in the fours. The value of 4.0 was reached once, and the value of 4.2 was reached twice. Finally, like in February 2018 the value of 4.3 was reached. However, in January 2019, she reached it a total of three times. By the last sampling period (January 12, 2019) LIN's MLUw was 3.8. Thus, it increased steadily despite the more general fluctuations that characterized her values per sampling period longitudinally. The table below synthesis the average MLUw for each of the three sampling periods. It therefore provides a longitudinal snapshot of LIN's English development.

Table 35: Longitudinal development of English MLUw

Age	Average MLUw in English longitudinally
3;10	3.4
4;4	3.7
4;9	3.9

LIN's MLUw fluctuated from one subset of data to another in each of the three sampling periods. Moreover, the results showed that longitudinally her English while steadily developing, was not do so according to her age. From the second column in the table above we see that in February 2018, her MLUw was 3.4, in August 2018, her MLUw was 3.7, and in January 2019, her MLUw was 3.9. Furthermore, the same sort of progression cannot be attributed to her heritage Spanish. Nevertheless, MLUw measures are certainly not enough to assess bilingual language development (A. Morgenstern, personal communication, April 20th, 2021). Therefore, in the next quantitative section we will analyze the diversity of her vocabulary to gain more insight regarding LIN's bilingual developmental path, even though we may run into the same issue of not having enough Spanish data to run analyses adequately.

4.10 LIN and adult Type/Token Ratio (TTR): Lexical richness?

Previously we considered LIN's MLUw for English. Even if her MLUw shifted across the sampling periods, her English did not seem to develop in line with her age. However, "Not only is it interesting to know the evolution of the MLU but also of the lexicon in each language. It is an important measure in language acquisition" (A. Morgenstern, personal communication, April 20th, 2021). For example, Morgenstern and Parisse (2012) used this measure in the ANR CoLaJe¹⁰⁴ project to compare the language development of the children in their study. Indeed, "Measurements of vocabulary diversity are frequently needed in child language research" (MacWhinney, 2000: 110) and as such have been widely used (Malvern & Richards, 2002). Therefore, in this section, we discuss not only LIN's lexical diversity in heritage Spanish and English, but also that of the four women in the case study.

The first flagrant aspect tied to these analyses is that just as for LIN's MLUw, her TTRs in Spanish were difficult to measure due to the lack of Spanish output in the subset of bilingual data. In this respect, it may certainly be argued that they do not make sense, or that they are not scientifically valid since the ratios are unreliable. As such, only LIN's English TTRs will be examined. However, as it concerns ROX, ALE, GLO, and GRC, we will consider their Spanish and English TTRs given that they are more reliable for this multigenerational group of adult

¹⁰⁴ This project was also funded by the French National Agency (ANR) for research. Its goal was to "piece together the emergence and development of communication and language in young children, using an interdisciplinary and multimodal approach. The simultaneous study of phonology, prosody, gesture, dialogue, allows us to enrich our perspective on the child's linguistic development." (<https://aliyah-morgenstern.com/projects/>, accessed August 31st, 2022).

speakers. This will also provide a cross-linguistic snapshot of the lexical diversity among the family members i.e., the Spanish TTRs are presented in parallel to the English ones which is vital in studies of bilingualism according to many researchers. Accounting for the development of both languages, as we have done throughout the multiple analyses in this chapter is the gold standard when analyzing child, or adult bilinguals' linguistic repertoires. Therefore, since LIN's Spanish TTRs are low, presenting her English ratios along the Spanish and English ratios of her caretakers will nevertheless help paint a more complete picture of the lexical diversity as it is rooted in her bilingual language learning environment. Our discussion will pay special attention to LIN and her mother ROX. Before we get started, below we will briefly discuss how TTRs are calculated.

The abovementioned issue aside, having followed the CHAT transcription conventions, CLAN allowed to perform an analysis of the data as MacWhinney states, "based on the ratio of different words (Types) to the total number of words (Tokens)" (MacWhinney, 2000: 110). In other words, "The type – token ratio is found by calculating the total number of unique words used by a selected speaker (or speakers) and dividing that number by the total number of words used by the same speaker(s)." (MacWhinney, 2000: 72). Furthermore, within the linguistic community, language acquisition researchers frequently refer to the type-token ration as TTR (MacWhinney, 2000). The acronym TTR will thus continue to be used in the remainder of the section. Finally, I follow Templin (1957) who studied 480 children's language development between three and eight years of age. Her TTR compared word types and tokens in data that contained 50 consecutive utterances. Based on her study, Templin established that, "This ratio is approximately one different word for slightly over every two words uttered. The ratio shows little variation over the age range tested among subsamples, sex, and SES groups." (Templin, 1957: 115). Our measures therefore align with Templin's work on the following grounds: 1) LIN falls within the age range established in Templin's study. Moreover, 2) it aligns with the criteria of 50 utterance minimum also used by Silva-Corvalán (2014) and MacWhinney (2000) to run LIN's MLUw. Therefore, LIN's TTRs, as well as those of ROX, ALE, GLO, and GRC presented in the table below correspond to the same media files used in the previous section¹⁰⁵. For example, as a child language variable on February 1, 2018, LIN's

¹⁰⁵ Since these media files correspond precisely to the previous ones discussed, the unique upper case speaker codes following the month, day, and year have been deleted so that the pertinent TTR measures easily fit in their allotted spaces, and thus become easier to read.

TTR in English is 0.449. As an input variable, her mother ROX’s TTR on the same date is 0.382 in English.

Table 36: TTR Values: English for LIN & Spanish & English for the adults

Age	Media file	Speaker									
		LIN		ROX		ALE		GLO		GRC	
		TTR Eng.	TTR Spa.	TTR Eng.	TTR Spa.	TTR Eng.	TTR Spa.	TTR Eng.	TTR Spa.	TTR Eng.	TTR Spa.
3;10	FEB_1_2018	0.449	-	0.382	1.000	-	-	-	-	-	-
	FEB_14_2018	0.331	-	0.448	0.667	-	-	-	-	-	-
	FEB_15_2018	0.371	-	-	-	-	-	0.662	0.636	-	-
	FEB_21_2018	0.351	-	0.383	0.398	-	-	-	-	-	0.515
	FEB_22_2018	0.398	-	0.506	1.000	-	-	-	-	-	0.549
	FEB_22_2018	0.423	-	0.584	0.831	-	-	-	-	-	0.560
	FEB_22_2018	0.447	-	0.505	0.513	0.864	-	-	-	-	0.503
	FEB_23_2018	0.317	-	0.437	0.484	-	-	-	-	-	0.503
	FEB_24_2018	0.388	-	-	-	-	-	0.599	0.586	-	-
4;4	AUG_26_2018	0.402	-	0.372	0.698	0.413	0.838	0.465	0.696	-	-
	AUG_26_2018	0.476	-	-	-	0.356	0.562	0.461	0.587	-	-
	AUG_28_2018	0.318	-	-	-	-	-	-	-	-	-
	AUG_29_2018	0.455	-	-	-	-	-	-	-	-	-
	AUG_30_2018	0.391	-	0.469	0.635	-	-	0.498	0.502	-	-
	AUG_30_2018	0.442	-	0.414	0.794	0.443	0.780	0.602	0.646	-	-
4;9	JAN_01_2019	0.332	-	0.440	0.667	0.433	0.760	0.393	0.513	-	-
	JAN_02_2019	0.344	-	0.199	0.552	-	-	-	-	-	-
	JAN_03_2019	0.315	-	0.386	-	0.644	1.000	-	-	-	-
	JAN_04_2019	0.420	-	0.245	0.878	-	-	0.329	0.484	-	-
	JAN_05_2019	0.300	-	0.285	0.760	-	-	0.298	0.545	-	-
	JAN_06_2019	0.463	-	0.377	0.553	-	-	0.376	0.513	-	-
	JAN_06_2019	0.354	-	0.362	0.688	0.338	0.900	0.333	0.545	-	-
	JAN_09_2019	0.370	-	0.367	0.551	-	-	0.419	0.386		0.294
	JAN_09_2019	0.373	-	0.349	0.584	-	-	0.557	0.714		0.833
	JAN_11_2019	0.205	-	0.321	0.367	-	-	-	-		0.296
	JAN_11_2019	0.220	-	0.302	0.425	-	-	-	-		0.332
	JAN_12_2019	0.389	-	0.308	0.724	0.404	0.700	0.310	0.408	-	-

The table above shows that in English LIN’s TTRs seems to fall around 0.5. However, one issue is the size of speech samples. While TTR “is generally used as a rough measure of lexical diversity ... type – token ratio can only be used to compare samples of equivalent size, because the ratio types to tokens tends to vary with sample size.” (MacWhinney, 2000: 72). In other words, the ratio “falls away rapidly as the number of tokens increases” (Richards, 1987: 205). Due to the ethnographic nature of data collection, within the framework of this case study sample sizes are not always harmonious, especially in February 2018, and August 2018.

Therefore, we must interpret these ratios with caution. We have included in the graphs below the sample size in terms of minutes and seconds for each video recording (subset of data). Nevertheless, another issue to keep in mind is that of the “‘ideal’ TTR: 20/20 = 1’00.” (Richards, 1987: 201). The ideal TTR is obtained using less repetitive vocabulary. For example, a speech sample containing 20 different words all used once results in an ‘ideal’ 1.000 (Richards, 1987) ratio. In the present study LIN never obtains a TTR of 1.000 in English. The next three graphs below illustrate the evolution of LIN’s TTRs in English longitudinally. In the keys we will also find Spanish, but it will not be reflected in the graph. This is to show that Spanish was considered, but that in the end the calculations were unreliable. This also shows that despite this issue Spanish is still present in her bilingual repertoire as it pertains to Spanish types and tokens. Furthermore, due to the unreliable nature of interpreting her TTRs in Spanish, the analyses will be brief. They will be also followed by the absolute numbers of Spanish tokens and types whenever possible according to each age range even if the amount of data is not the same in each subset, since it would be interesting to know if LIN’s use of types increases with age in Spanish or not.

4.10.1 February 2018

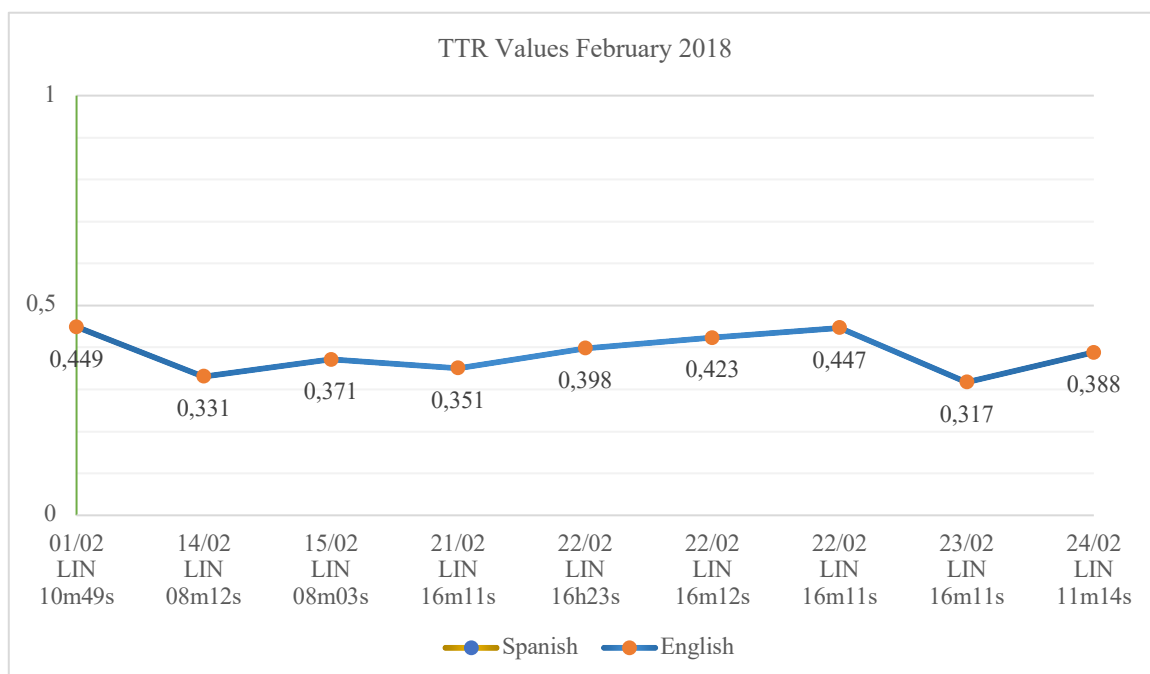

Figure 29: LIN’s TTR Values in February 2018: English

LIN’s TTRs in English remained just below 0.5 in all nine of the samples. Moreover, ROX’s TTRs were not plotted on the graph in Spanish, or in English for clarity in understanding LIN’s

results. However, in the nine recordings, twice she does not speak Spanish, four times they were around 0.5 and the remaining three times her TTRs were above 0.8 including 1.000 twice. ROX’s English however remained around 0.5 much like LIN’s. Finally, most samples sizes were around 16, two were around 10 and two were around 8 minutes in length. The table below shows the number of types and tokens in Spanish that LIN produced in February 2018.

Table 37: Number of Types & Tokens in Spanish for LIN in February 2018 (3;10)

Age	Media file	Spanish Vocabulary	Total number of Types and Tokens used
3;10	FEB_1_2018_ERI_LIN_JUL_ROX.cha	1 pozole	1 Type 1 Token
	FEB_14_2018_ROX_LIN_ERI_RIC.cha	-	-
	FEB_15_2018_GLO_JUL_LIN_ERI.cha	2 mosca	1 Type 2 Tokens
	FEB_21_2018_GRC_ROX_ERI_LIN.cha	1 frutas	1 Type 1 Token
	FEB_22_2018_ERI_LIN_JUL_GRC.cha	2 toronja	1 Type 2 Tokens
	FEB_22_2018_LIN_ROX_JUL_RIC_GRC.cha	1 niño	1 Type 1 Token
	FEB_22_2018_ROX_GRT_GRC_ERI_LIN_ALE.cha	1 chiquita 1 de 1 esta 1 jabón 1 la 1 llemita 1 mire 1 quita	8 Types 8 Tokens
	FEB_23_2018_ROX_LIN_JUL_GRC.cha	-	-
	FEB_24_2018_LIN_ERI_GLO.cha	1 Julián 1 a 1 buenas_noches 1 cámara 2 dos 2 la 1 seis 1 también 1 uno 1 ver 1 y	11 Types 13 Tokens

According to the subset of data, at the age of 3;10 LIN produced 28 words in heritage Spanish. These are figured in the third column of the table above. The fourth column represents this figure in terms of the number of types and tokens per data set. Together they correspond to 24 types, and 28 tokens (0.857 TTR). As we may see, LIN’s use of heritage Spanish is limited. However, the available bilingual data does provide evidence that she is using Spanish in interaction. For example, we will illustrate this with her use of the word fly in Spanish. On February 15th, 2018, LIN overhears GLO name an insect “mosca” (fly) in Spanish while

interacting with JUL in the dining room. On her own in the living room LIN repeats “mosca” (fly). Then she ratifies herself into GLO and JUL’s conversation to encourage JUL to say “mosca” (fly). GLO then expands her utterance and says to JUL “es una mosca.” (It’s a fly.), this time in LIN’s presence. At this point, through language mixing LIN says: “say mosca@s Julian.”, and GLO says “ya se fue.” (It’s gone.) after each of JUL’s two unintelligible “xxx” attempts. GLO’s utterances may be considered repetitions. With this monolingual discourse strategy, the idea was likely to have JUL say “mosca” (fly) and perhaps LIN repeat “es una mosca.” (It’s a fly) and thus limit the interaction to Spanish. But then GLO deploys a bilingual discourse strategy as she ratifies another adult into the interactional framework. In a mixed utterance to ERI she says “anda una mosca pora allí he’s@s all@s amused@s con la mosca you@s see@s it@s?” (there’s a fly around here he’s all amused with the fly you see it?). Since this discourse strategy allows for changes in language, ERI shortly asks “is he?”. This example, along with its plurilingual transcription and video extract will be further qualified in Chapter 6 to consider the multimodal dimension of the interaction. Nevertheless, in this example LIN says the word fly in Spanish twice.

4.10.2 August 2018

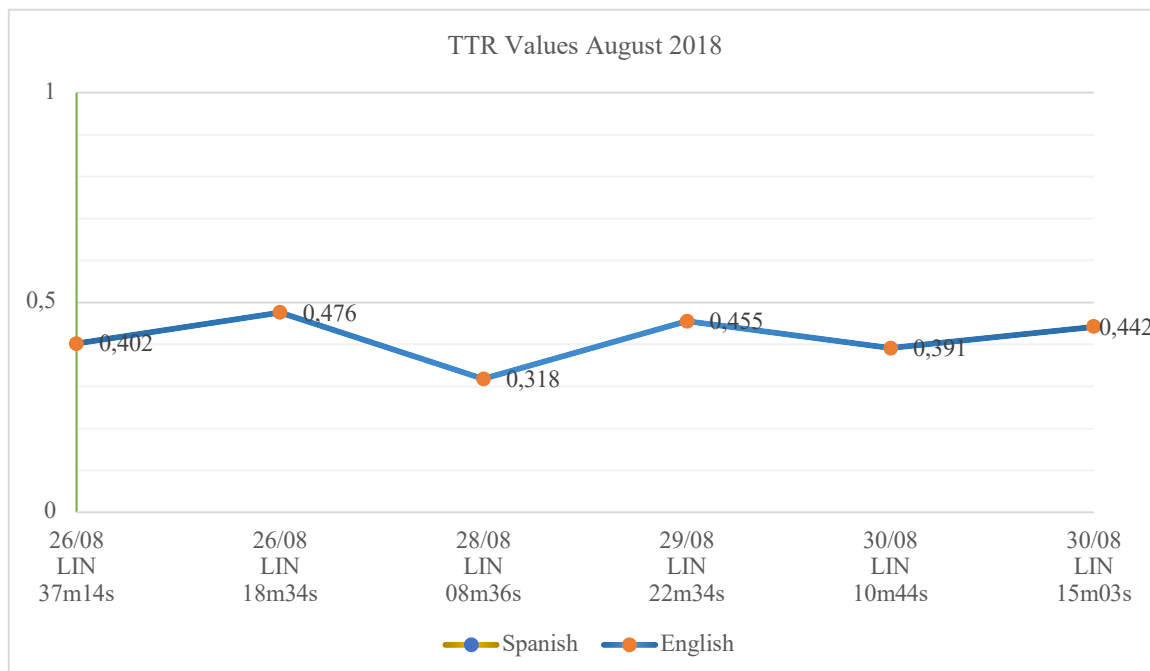

Figure 30: LIN’s TTR Values August 2018: English

LIN’s English TTRs remained around 0.5 in all six speech samples like in the first sampling period. As for ROX, her TTR in Spanish was absent three times just like with English. This is

likely because she was not present in the speech sample. The other two times they were around 0.5 and once it was just below 0.8. Her three English TTRs remained around 0.5. August 2018 is the month when the speech samples are hardly of equivalent size. The table below shows the number of types and tokens in Spanish that LIN produced in August 2018.

Table 38: Number of Types & Tokens in Spanish for LIN in August 2018 (4;4)

Age	Media file	Spanish Vocabulary	Total number of Types and Tokens used
4;4	AUG_26_2018_GLO_ROX_GUI_ALE_ERI_LIN_RIC.cha	1 dormió 2 el 2 en 1 estaba 2 piso 1 se 1 sentanda 2 y	8 Types 12 Tokens
	AUG_26_2018_LIN_GLO_JUL_ALE_GOY_ERI_GUI.cha	8 cosita	1 Type 8 Tokens
	AUG_28_2018_LIN_JUL_ERI.cha	1 Mamá 3 azul 1 rosa	3 Types 5 Tokens
	AUG_29_2018_LIN_ERI.cha	1 chilada (chile) 1 cochinita 1 con 1 cuadro 1 español 2 gatitos 2 globo 1 grandes 1 lista 1 luna 1 ositos 1 oso 2 rojo 1 tacos 1 tres 1 una 1 vaca 2 vaquita	18 Types 22 Tokens
	AUG_30_2018_ERI_LIN_GLO_JUL_ROX_JUL.cha	1 pollo 2 sí	2 Types 3 Tokens
	AUG_30_2018_LIN_ROX_ALE_ERI_GLO_JUL_RIC_MAR.cha	1 estresas 1 me 1 puta 1 sopita 1 tía	5 Types 5 Tokens

According to the data above, at the age of 4;4 LIN produced 55 words in heritage Spanish. These are figured in the third column of the table above. The fourth column represents this

figure in terms of the number of types and tokens per data set. Together they correspond to 37 types, and 55 tokens (0.672 TTR). While LIN's use of heritage Spanish is still limited at this age the number of words used in heritage Spanish has nearly doubled, going from 28 to 55 respectively. In the span of about six months LIN has gone from 24 types to 36 , and from 28 tokens to 55. Furthermore, based on the available bilingual data we may find evidence of how she uses Spanish in interaction. For example, on August 28th, 2018, ERI asks LIN the hair color of her doll in Spanish “¿el pelo de qué color es?”, and LIN responds “pink”. After ERI says “yes”, he continues with a monolingual discourse strategy, or a Repetition and says, “de color de rosa.” (the color pink.) in an attempt to keep the conversation limited to Spanish. LIN then asks, “¿what's that?” followed by a mixed language utterance to confirm her question “what's rosa@s means that means Spanish?” and ERI answers “pink” followed by “uhuh it's in Spanish.”. ERI deploys a bilingual discourse strategy since he aligns to LIN's language mixing, but essentially English utterance leaving the interactional space open to change from one language to the other. This similar type of interactional model also happens for “azul” (blue) right after. Finally, in this example we also see how LIN uses her dominant language English to understand her weaker one Spanish as was discussed in our literature review in the section on compound, coordinate, and subordinate bilinguals.

4.10.3 January 2019

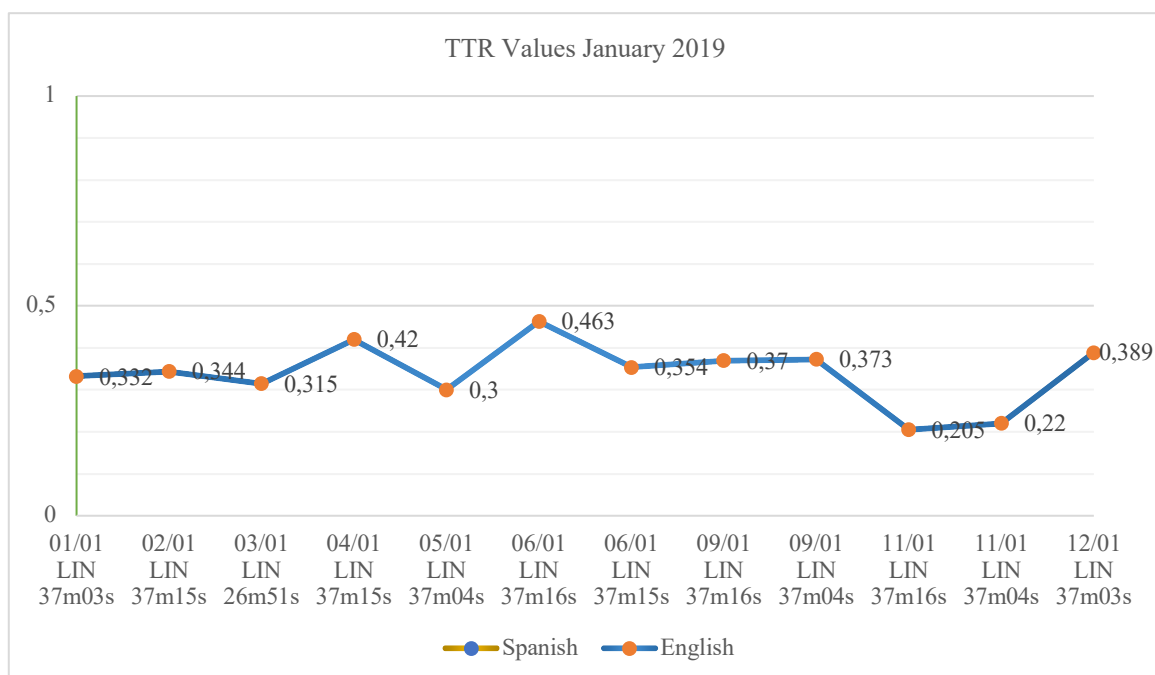

Figure 31: LIN's TTR Values January 2019: English

Like in February 2018, and August 2018, LIN's TTRs were around 0.5 ten times with the remaining two times just above 0.2. For ROX, her Spanish TTR was absent only once, 10 times they fell around 0.5 and it was over 0.8 once. ROX's English was never absent. Her TTRs were globally around 0.5 (nine times). Only three times did ROX's TTRs fall below 0.3. Finally, January 2019 is the month that accounted for the most speech samples. Furthermore, except for the January 3rd, 2019, sample, all the other recordings were of equivalent size at 37 minutes in length. The table below shows the number of types and tokens in Spanish that LIN produced in January 2019.

Table 39: Number of Types & Tokens in Spanish for LIN in January 2019 (4;9)

Age	Media file	Spanish Vocabulary	Total number of Types and Tokens used
4;9	JAN_01_2019_LIN_ALE_ROX_GLO_GUI_MAR.cha	-	-
	JAN_02_2019_LIN_JUL_ERI_ROX.cha	-	-
	JAN_03_2019_ERI_LIN_GOY_RIC_ALE_ROX.cha	-	-
	JAN_04_2019_JUL_GLO_ERI_LIN_ROX.cha	1 chocolate 2 fruta 1 me 1 puta 1 sopita 1 teta	6 Types 7 Tokens
	JAN_05_2019_GLO_ROX_JUL_ERI_LIN.cha	-	-
	JAN_06_2019_GLO_ROX_ERI_GUI_LIN_JUL_RIC.cha	1 chile 1 tío	2 Types 2 Token
	JAN_09_2019_JUL_ERI_ROX_GLO_LIN_GRC.cha	1 agitar 1 mantita 1 sabroso	3 Types 3 Tokens
	JAN_09_2019_LIN_GLO_ERI_ROX_MAR.cha	1 chile 3 ven	2 Types 4 Tokens
	JAN_11_2019_LIN_ROX_GRC_ERI_JUL.cha	2 cinco 2 cuatro 2 dos 1 sí 2 seis 1 tres 2 uno	7 Types 12 Tokens
	JAN_11_2019_ROX_LIN_JUL_GRC_RIC_ERI.cha	1 Julián 1 cinco 1 cuatro 1 dos 1 dulce 1 dulces 2 español 2 hablo 1 no 6 sí 1 seis 1 tres 1 un 2 uno 1 ven	7 Types 23 Tokens

JAN_12_2019_GLO_ARA_ALE_LIN_JUL_GOY_ROX.cha	1 salsa	1 Type 1 Token
---	---------	-------------------

The data above depicts LIN when she was 4;9 years old. In this third and last sample LIN produced 52 words in heritage Spanish. These are figured in the third column of the table above. The fourth column represents this figure in terms of the number of types and tokens per data set. Together they correspond to 28 types (the words in yellow are doubles found in earlier samples and are therefore not counted as new types, but their tokens are taken into account), and 52 tokens (0.538 TTR). LIN’s use of heritage Spanish is still restricted at this age. Moreover, compared to the previous data set the number of words used in heritage Spanish has slightly decreased. This will be presented and discussed below. Finally, the bilingual data provides us with a glimpse of how she is using Spanish in her social encounters, for example, on January 9th, 2019. We focus on this sample because LIN’s Spanish is composed of one noun and one verb which she uses infrequently. She uses the verb “venir” (come) three times. LIN is in the restroom and calls her “Grandma@s:eng@spa” who is upstairs multiple times to come clean her. GLO responds “what?”. LIN then answers with the Spanish verb “ven” (come), but GLO replies in English “come upstairs”. This is a Move On bilingual discourse strategy since GLO does not respond in Spanish thus allowing for the conversation to take place in both languages. The interaction ensues, and later while still in the restroom LIN asks ROX “where’s Grandma@s:eng@spa?”. ROX answers “upstairs”. Frustrated, LIN shouts “Grandma@s:eng@spa!”, and GLO answers again with “what?”. Interestingly, the model where LIN speaks Spanish and is answered in English repeats itself. It is a dilingual conversation where the languages remain the same (Spanish is addressed, but English is received), but what changes are the speakers. Typically, in this mode of communication it is the adult who addresses Spanish to the child (but not only), and the child who responds in English. These types of exchanges may also socialize LIN into this dilingual interactional style. Notwithstanding, LIN again says “ven” (come), but GLO never comes. After shouting “Grandma@s:eng@spa!” nearly a dozen times GLO finally answers in Spanish “¡LIN callate!” (LIN shut up!). GLO’s Spanish language alignment is also a bilingual discourse strategy, or Language Switch. In another example, LIN says “ven” (come) several minutes later, but this time she is upstairs (and out of sight) and seems to be playing with JUL. Her father MAR is having dinner downstairs and ROX is sitting next to him. They are both casually discussing different matters as they language mix. Then, from upstairs LIN tries to get MAR to attend to her brother JUL by calling him in Spanish. The table below synthesis the types and tokens in

Spanish for each of the three sampling periods. Through a rough longitudinal snapshot, it therefore provides LIN’s use of Spanish types and whether they increases with age in Spanish.

Table 40: Longitudinal development of Spanish Types & Tokens

Age	Types in Spanish	Tokens in Spanish	TTR
3;10	24	28	0.857
4;4	37	55	0.672
4;9	28	52	0.538

When we look at LIN’s use of types and tokens overall, we see that her Spanish types have gone from 24 (February 2018), to 37 (August 2018), and then to 28 (January 2019) which does not point to heritage Spanish development. Regarding her tokens, they have gone from 28 (February 2018), to 55 (August 208), and finally to 52 (January 2019). Additionally, for each of these time periods where the subsets of data have been grouped, we have also calculated her TTRs. From this perspective, even if we must interpret these figures with caution, only on February 2018 does LIN come close to the ideal TTR of 1.000 (Richards, 1987), but it appears to decrease over the course of the study. As a reminder, an ideal TTR is obtained using less repetitive vocabulary. Overall, even if the amount of data was not the same in terms of time, it may have made more sense to divide the data with respect to the three sampling periods and to look at the results per period, especially since the number of types and tokens were small. When working with small numbers, it is always worth grouping per period. This is the approach that Beaupoil-Hourdel and Morgenstern (2021) took in their study of shrugs.

Through these last two sections I showed that LIN’s TTRs and MLUw in heritage Spanish could not be used, as generated by CLAN because of the very small amount of data. Moreover, even though the amount of data was not the same, and despite the insufficient amount of Spanish output on LIN’s behalf, grouping the data by period did not allow us to ascertain progression, even if slightly in LIN’s heritage Spanish development. This closes our analyses of LIN’s lexical diversity across the three sampling periods. While these measures give additional insight into LIN’s bilingual developmental path, they do remain somewhat abstract. Also, they do not fully reveal the extent of LIN’s Spanish repertoire as it is anchored in her bilingual language learning environment. Therefore, the final section below presents all the Spanish words that LIN used in the case study, and not just those that she used during the three periods. We will also consider if LIN possesses the English translation equivalents for

the Spanish words in her repertoire, as well as how they are distributed across semantic domains.

4.11 LIN's semantic domains in Spanish, & English translation equivalents

CLAN and Excel allowed us to take various sociolinguistic measures from the plurilingual transcript that was thoroughly presented and described in the previous sections. A longitudinal analysis of LIN's MLUw revealed that in English she is not going through normal language development according to her age. At 3;10 LIN's MLUw was 3.4, at 4;4 it was 3.7, and at 4;9 it was 3.9. However, methodological issues aside such as gender and sociocultural background, these results coincide with Rice et al.'s (2010) study of MLUw in the American English of normally developing children. These researchers found that between the age ranges of 3;6-3;11 the MLUw was 3.71, between 4;0-4;5 it was 4.10, and between 4;6-4;11 it was 4.28. Moreover, LIN's MLUw results also coincide with children going through normal language development in Brazilian Portuguese. Araújo and Befi-Lopes (2004) found an MLUw of 2.83 at 3;0 years of age, and an MLUw of 3.52 at 4;0.

On the other hand, her MLUw for Spanish was null and void across the three sampling periods. However, "It is known that individual children differ considerably, and that age can only serve as a rough indicator of development." (Hellwig et al., 2021: 36). Nevertheless, that we were not able to draw LIN's MLUw measures in Spanish at three distinct ages does suggest that her heritage Spanish is not developing accordingly. Moreover, the same may be said for her lexical diversity, as measured by the TTRs. Her TTRs were age-appropriate in English but absent in heritage Spanish. Given these results, it is imperative to learn as much as we can about the Spanish that LIN *does* use. For example, in further examining the data we may inquire about how her heritage Spanish words are organized according to their semantic domains, as well as whether LIN shows use of the English translation equivalents of said Spanish words. Here again we must keep in mind the discussion further up on mixed language presentations and LIN's insertions of "sal" (salt). Absence of a translation equivalent "does not necessarily mean that they do not know it: It may be a gap in the data. Sample size and sample density crucially influence the likelihood that a form appears in the data" (Hellwig et al., 2021: 31). The data collection method may also play an important part. For example, some forms may not appear in the primary data, but appear in the secondary data such as in field journals. To illustrate this point, I turn your attention to the following two observations that attest to how

video recordings while capable of capturing a wealth of data, nonetheless do not capture everything. The first extract is dated October 14th, 2018, and it was taken from the digital journal. I write:

Some words that LIN says in Spanish:

Pedo = fart

Hormiga = ant

Panza = stomach (Alvarez, 2018).

The second extract was taken from the handwritten version of the field journal and is dated October 15th, 2018. I further note:

LIN: *Cabrón* (noun to refer to a friend (buddy/pal), or an enemy (asshole/dumbass); interjection to express surprise (shit/fuck); adjective to express difficulty (tough/hard, or skill), *Paleta* (popsicle), *Chillona* (cry baby), *Pinche Julián* (bloody/lousy Julian) (Alvarez, 2018).

Other than showing how my field note taking process could vary from one day to the next, these two examples though modest nevertheless show that gaps in the primary data (video-recordings) may lead researchers to believe in an absence of knowledge. Nevertheless, as was underscored at the start of Chapter 3 on Data and Research Methods in Bilingual Settings, one of my first impressions related to capturing language data was that there was so much, that it would be impossible to account for it all. Despite these difficulties, the table below therefore presents LIN’s emergent bilingual repertoire as attested in the longitudinal data. The vocabulary words above will not be accounted for since they fall outside of the three sampling periods. Here they were presented to show how secondary sources may be helpful in filling gaps in the data.

Table 41: LIN's emergent bilingual repertoire as distributed longitudinally

Session/Age	Number	Semantic domains	Spanish terms	English translation equivalents	Mixed utterances
August 2018 Age 3;10	1.	People	niño	boy	
	2.	Food	frutas	fruits	They're not frutas.
	3.	Food	tortilla	(tortilla)	
	4.	Food	no teta	baby bottle/bottle	I'm drinking teta.
	5.	Motion	travesuras	(naughtiness)	
	6.	Spatial relations	ver	see	
	7.	Objects	camara	camera	
	8.	Adverb	también	too	
	9.	Numbers	dos	two	No it's dos
	10.	Numbers	seis	six	Let me say seis.

				I say number seis.
11.	People	Julián	Julian	
12.	Numbers	uno	one	
13.	Expressions	buenas noches	good night	
14.	Sense perception	caliente	hot	
15.	Adverb	sí	yes	
16.	Motion	no muevas	move	
17.	Clothing and grooming	ponme vestido	put	
18.	Expressions	por favor	please	
19.	People	Mamá	Mom	
20.	Clothing and grooming	peiname	brush	
21.	Speech and language	español	Spanish	I don't have to talk español.
22.	Food	chile	(chili)	I don't want chile. We making chiles. Chile and sauce.
23.	Food	jalapeño	(jalapeno pepper)	
24.	Food	pozole	(pozole)	What pozole is it?
25.	People	tío	uncle	You're my tío you're not my uncle
26.	Food	toronja	grapefruit	
27.	Motion	quita jabón	take it off	
28.	Time	doce (y) media	(twelve-thirty)	
29.	Animals	mosca	(fly)	Say mosca Julian.
30.	Food	leche	milk	Mommy he wants leche. I want leche
31.	Emotions and values	puta	(whore)	They called fruits loop puta!
32.	Food	pollo	chicken	Mommy you give him pollo?
33.	People	with Gordo	Fatboy/Fatgirl/Fat ass/Fat	With Gordo
34.	Food	aceite	(oil)	How aceite jumps?
35.	Food	jamón	(jam)	I like jamón.
36.	Sense perception	frio	cold	It's so frio. Mommy I want clothes I so frio.
37.	The body	mocos	(boogers/snot)	Mommy Julian has mocos.
38.	Food	quesadilla	(quesadilla)	I want quesadilla.
39.	Food	sopa	soup	Mommy I want sopa.
40.	Food	agua	water	I like agua.
41.	Food	zapatos	shoes	I don't know where the zapatos Mom.

					Well what happened to your zapatos?
	42.	The body	fuchi	(smelly)	Hi little fuchi.
	43.	Objects	jabón	(soap)	That jabón.
	44.	Food	chiles rellenos	(stuffed chili peppers)	Yeah chiles rellenos.
	45.	Food	huevos/huevito	eggs	Huevito and fries. Julian huevos. Julian where your huevos?
	46.	Food	papitas	fries	Papitas and huevos?
Total/Age			46	31	
August 2018 Age 4;4	1.	Objects	rastrillo	(rake)	
	2.	Motion	cosita	thing	
	3.	Food	mayonesa	(mayonnaise)	
	4.	Colors	azul	blue	Azul is blue.
	5.	Colors	rosa	pink	What's rosa means that means Spanish?
	6.	People	hermanito	brother	
	7.	People	mi Papá	Dad/Daddy	With my Papá.
	8.	Objects	liga	(rubber	
	9.	Food	tacos	(rubber band)	
	10.	The physical world	luna	moon	I think the luna.
	11.	Motion	lista	ready	
	12.	Objects	globo	balloon	
	13.	Colors	rojo	red	
	14.	Objects	cuadro	picture	
	15.	Animals	vaca	(cow)	
	16.	Numbers	una vaquita	one	
	17.	Animals	ositos	(bears)	
	18.	Numbers	tres ositos	three	
	19.	Animals	gatitos	(kittens)	
	20.	Animals	cochinita	(Peppa) Piggy	
	21.	Sense perception	me estresas	(you stress me out)	
	22.	People	tía	(aunt)	
	23.	Objects	vasos	cup	Vasos to dig.
	24.	Sense perception	buena	good	This one buena?
	25.	The body	chichi	(boob/breast)	Look at her chichi.
	26.	Spatial relations	mira	look	And you xxx mira.
	27.	Objects	jaúla	cage	A jaúla but that's the door for our...
	28.	Animals	dinosaurio	dinosaur	How do you know dinosaurio?
	29.	Emotions and values	cucuy	(devil)	You tell me scary cat but the Cucuy... I think aliens not Cucuys.
	30.	Clothing and grooming	pantalones	pants	The only pantalones.

	31.	The physical world	grandes	big	Grandes like this or like this?
	32.	The physical world	tierra	Earth	Our tierra?
Total/Age			32	21	
January 2019 Age 4;9	1.	Expressions	Feliz navidad	(Merry Christmas)	
	2.	Sense perception	sabroso	delicious	
	3.	Motion	ven	come on/out	Julian ven.
	4.	Numbers	cuatro	four	
	5.	Numbers	cinco	five	
	6.	Food	dulce(s)	candy	
	7.	Food	salsa	sauce	
	8.	Food	sal	(salt)	I want more sal. Why I not get no more sal. I want más sal Mamá.
	9.	Quantity	más	more	Mommy I want más.
	10.	Food	paleta	ice-cream	Where's the paleta of Julian?
	11.	People	bebé	baby	No that's my bebé.
	12.	Motion	agitar	shake	Agitar means shake.
	13.	The body	caca	poop	That's caca. Take that you little caca.
	14.	People	muchacha	girl	A muchacha xxx muchacho.
	15.	People	muchacho	boy/boyfriend	
	16.	Numbers	un	(one)	Un Julian
	17.	The house	sala	(living room)	Then we going in the sala.
	18.	The house	baño	bathroom/restroom	In the baño. Julian the baño.
Total/Age			18	14	
Total		19	96	66	51

The table above is intended to give an overall appreciation of LIN's emergent bilingual repertoire. Furthermore, it also allows us to see how her vocabulary is distributed by sampling period, or longitudinally. It gives a snapshot of how it evolves with age and how many of these words are used per period. The table is therefore divided into three main parts as we may see in the first column. The first period corresponds to February 2018, or when LIN was 3;10. At this age LIN used 46 Spanish words (column four) and of these she had 31 English translation equivalents (column five). The second period was in August 2018, and LIN was 4;4 at the time. During the second sampling period LIN used 32 Spanish words and she possessed 21 English translation equivalents. Finally, the last sampling period took place on January 2019, when LIN was 4;9. Here she used 18 Spanish words and of these she showed use of 14 English translation equivalents. The table below synthesis the Spanish vocabulary that LIN used for

each of the three sampling periods along with the English translation equivalents as attested in the data.

Table 42: Longitudinal development of Spanish & English translation equivalents

Session/Age	Spanish terms	English translation equivalents
February 2018 Age 3;10	46	31
August 2018 Age 4;4	32	21
January 2019 Age 4;9	18	14
Total	96	66

The table shows how LIN’s use of heritage Spanish seemed to decrease with age. However, one interesting finding is that she typically had the English translation equivalents for the greater portion of the Spanish terms she did use across the three sampling periods. Next, in Table 38 column two designates the word number, while column three corresponds to their semantic domain. Therefore, in Spanish the data shows that longitudinally LIN used a total of 96 distinct words. Moreover, an analysis of these Spanish words reveals that they may be distributed into roughly 19 semantic domains, or specific areas of cultural significance (Otteneimer, 2005). I identified these areas of cultural emphasis first by filtering LIN’s Spanish output on Excel. Then I proceeded to code the Spanish vocabulary according to the most basic semantic domain that I could think of. This process yielded the 19 semantic domains below. The top five semantic domains for LIN thus include “Food” (24 examples), “People” (11 examples), “Numbers” (8 examples), “Objects” (8 examples), and “Motion” (7 examples). The table below takes the heritage Spanish words in Table 38 above and presents them according to the 19 semantic domains used to organize LIN’s heritage Spanish repertoire.

Table 43: 19 semantic domains of heritage Spanish use

Number of Semantic Categories	Semantic category	Number of examples in data
1.	Food	24
2.	People	11
3.	Numbers	8
4.	Objects	8
5.	Motion	7
6.	Animals	6
7.	Sense perception	5
8.	The body	4
9.	Colors	3
10.	The physical world	3
11.	Clothing and grooming	3
12.	Adverb	2

13.	Expressions	2
14.	Spatial relations	2
15.	Emotions and values	2
16.	The house	1
17.	Time	1
18.	Speech and language	1
19.	Quantity	1

We thus see that about a quarter of the Spanish words that LIN uses are related to the Food category. In Chapter 5 and 6, we will see how LIN's language use and socialization of heritage Spanish is centered around the kitchen and the various multimodal dinnertime activities in her multigenerational bilingual habitat. Therefore, several examples that include both audio, but essentially video files along with their plurilingual corpus where the talk is mainly around food will be thickly qualified as it unfolds in the bilingual language learning environment. Nevertheless, based on the figures above, there is an important decrease from the first semantic category to the second. There are less than half (of 24) that are used for People, and this decreasing trend is similar for Numbers, Objects, and lastly for Motion. However, another way to analyze the distribution of semantic domains is by age. The table below will therefore take the heritage Spanish words and organize them longitudinally according to the 19 semantic domains. The lowercases exes (x) in each of the columns correspond to each Spanish word that LIN uttered.

Table 44: Longitudinal use of Spanish across semantic domains

Number of Semantic categories	February 2018 Age 3;10	August 2018 Age 4;4	January 2019 Age 4;9
1. Food	xxxxxxxxxxxxxxxxxxxx	xx	xxxx
2. People	xxxxx	xxx	xxx
3. Numbers	xxx	xx	xx
4. Objects	xx	xxxxxx	
5. Motion	xxx	xx	xx
6. Animals	x	xxxxx	
7. Sense perception	xx	xx	x
8. The body	xx	x	x
9. Colors		xxx	
10. The physical world		xxx	
11. Clothing and grooming	xx	x	
12. Adverb	x		
13. Expressions	xx		x
14. Spatial relations	x	x	
15. Emotions and values	x	x	
16. The house			xx
17. Time	x		

18.	Speech and language	x		x
19.	Quantity			x
Total		46	32	18

LIN's use of heritage Spanish when organized into semantic domains longitudinally shows that use of these words are spread out over time. LIN seems to use Spanish across the 19 semantic domains from the first sampling period when she was 3;10 (column two) to the last when she was 4;9 (column four). However, given the overall decreasing trend in her Spanish use that we have attested thus far across analyses, there are fewer semantic domains where heritage Spanish is used in the last period. For example, in February 2018, 15 semantic domains were used (46 terms). In August 2018, LIN used 13 semantic domains (32 terms), and finally in January 2019, her Spanish is only spread out across 10 semantic domains (18 terms). This may therefore suggest that overall, her use of Spanish is being reduced with time. Finally, another interesting feature that we may point out is that except for the semantic domain 'Object' in period three, the first to the eighth most used semantic domains are represented in each of the three sampling periods. This is not the case for the remaining semantic domains where approximately half are used in only one period, and the other half are used in two periods. Having considered LIN's longitudinal use of Spanish across semantic categories, next we will focus on her English translation equivalents.

When we go back to Table 38 that presents the list of LIN's Spanish words, the fifth column shows that LIN has English translation equivalents for a total of 66 Spanish terms. Therefore, either the data does not account for 30 English translation equivalents due to gaps, or LIN does not possess them in her bilingual repertoire. However, it is unlikely that this is the case for nearly one-third of her words in Spanish, especially since these words correspond to many common, and frequently used words in English. This idea may be further defended by the fact that she is dominant in English. Nevertheless, in the table above these absent words are depicted by the light red boxes, and the translation equivalents that are unaccounted for in the data are included in parenthesis for our information.

Moreover, of the 30 words in light red, we may find an explanation for the absence of 10 English translation equivalents by the fact that they may either have bivalent coloring to them as discussed in the methods and data chapter, or due to their status as being culturally specific. The bivalently colored terms are therefore the same in both Spanish and English and

they are sometimes adapted at the phonological level where the words may be produced with Spanish, or English phonology. Our qualitative analyses in the next two chapters will show how the family plays with words, but essentially with nouns in that they are pronounced using the sounds of either language. Furthermore, these bivalent words are also often used by the non-Spanish speaking communities at large. Regarding the cultural terms, they are generally used at the community, or family level and typically they are used among Spanish monolinguals or, bilinguals. These words do not benefit from English translation equivalents and furthermore they are not likely to be used by non-native Spanish speakers. However, when monolingual English speakers do use these cultural terms, their production is very often marked by thick English phonology¹⁰⁶. The table below briefly summarizes the small subset of 10 bivalent, and culturally specific words that are accounted for in the data. They are accompanied with their descriptions as discussed above.

Table 45: 10 bivalent and culture specific words

Bivalent words	Definition of bivalent words	Culturally specific words	Definition of culturally specific words
tacos	a popular Mexican meal that consists of a folded tortilla filled with various types of protein	chichi	a term that refers to the body (generally female), and specifically to the breasts
quesadilla	a flour tortilla filled with cheese and heated on a griddle	chiles rellenos	a cheese stuffed chili pepper dipped in an egg batter, fried, and served with sauce
jalapeño	a mild to hot green chili pepper commonly used in Mexican-style cuisine	fuchi	a term that refers to something, or someone that smells bad
chile	a small and hot pod use in Mexican salsas, sauces, or eaten raw	pozole	a hardy and popular stew made of hominy, meat, and assortment of chilis that has its origin in Mexico
tortilla	a thin, flat, and round pancake made from corn flour and cooked on a griddle	cucuy	a term that refers to the devil, or other type of monster used to scare naughty kids

Finally, a look at the sixth column (presented in Table 38) concludes our semantic domain analyses. It provides the entire set of 51 examples of LIN's Spanish lexicon when she language mixes. Of her 96 Spanish words, LIN therefore uses more than half of these to mix languages

¹⁰⁶ Some distinctive features of Spanish words marked with English phonology include aspirated plosives, the inability to produce the Spanish trill, producing the alveolar lateral approximant in English etc.

in dynamic multigenerational, and multiparty participation frameworks. Furthermore, as has been advanced in previous research, we may ascertain that in general LIN also inserts Spanish words into her English utterances. That is, she inserts words from her weaker language into her dominant one in spontaneous interaction. In this study we have also seen some examples of this practice that suggests that she does so to understand heritage Spanish through English. Moreover, one salient feature of her language mixing is that in about one-third of the examples, she will embed a Spanish word into her English utterance even though the data shows that she does possess the English equivalent. Of the 51 Spanish words that she inserts into her English, she has 35 English translation equivalents. For example, based on the table below, she says “vasos” (n.5 in August 2018) instead of cups, “teta” (n.2 in February 2018) instead of bottle, or instead of choosing the word cold in English, she opts to use the word “frio” (n.16 in February 2018) in Spanish. While her choice to use heritage Spanish could be explained by the fact that “the presence of a form does not necessarily mean that the children know it and use it productively: They may have learned it as an unanalyzed form” (Hellwig et al., 2021: 31), it is unlikely that this is the case for LIN since she does seem to know how to use the English translation equivalents productively. On the other hand, language mixing, or the embedding of Spanish into English utterances also occurs for words that are either unaccounted for in the data, that are culturally specific, or that she may not know in English. Some examples include LIN embedding the word “mocos” (snot) (n.17 in February 2018), the word “pozole” (Mexican stew) (n.7 in February 2018), or when she uses the word “sala” (living room) (n.10 in January 2019). Some of these examples will be further qualified in the next two chapters to see how these specific instances of language mixing unfold within the larger multigenerational, multimodal, and multiparty social encounters. The table below presents the subset of mixed utterances that are accounted for in the data according to the session and age when they were produced described above.

Table 46: LIN’s longitudinal use of mixed utterances

Session/Age	Number	Semantic domains	Spanish terms	English translation equivalents	Mixed utterances
February 2018 Age 3;10	1.	Food	frutas	fruits	They’re not frutas.
	2.	Food	no teta	baby bottle/bottle	I’m drinking teta.
	3.	Numbers	dos	two	No it’s dos.
	4.	Numbers	seis	six	Let me say seis. I say number seis.
	5.	Speech and language	español	Spanish	I don’t have to talk español.
	6.	Food	chile	(chili)	I don’t want chile. We making chiles.

					Chile and sauce.
	7.	Food	pozole	(pozole)	What pozole is it?
	8.	People	tío	uncle	You're my tío you're not my uncle.
	9.	Animals	mosca	(fly)	Say mosca Julian.
	10.	Food	leche	milk	Mommy he wants leche. I want leche.
	11.	Emotions and values	puta	(whore)	They called fruits loop puta!
	12.	Food	pollo	chicken	Mommy you give him pollo?
	13.	People	with Gordo	Fatboy/Fatgirl/Fatas s/fat	With Gordo
	14.	Food	aceite	(oil)	How aceite jumps?
	15.	Food	jamón	(jam)	I like jamón.
	16.	Sense perception	frio	cold	It's so frio. Mommy I want clothes I so frio.
	17.	The body	mocos	(boogers/snot)	Mommy Julian has mocos.
	18.	Food	quesadilla	(quesadilla)	I want quesadilla.
	19.	Food	sopa	soup	Mommy I want sopa.
	20.	Food	agua	water	I like agua.
	21.	Food	zapatos	shoes	I don't know where the zapatos Mom. Well what happened to your zapatos?
	22.	The body	fuchi	(smelly)	Hi little fuchi.
	23.	Objects	jabón	(soap)	That jabón.
	24.	Food	chiles rellenos	(stuffed chili peppers)	Yeah chiles rellenos.
	25.	Food	huevos/Huevito	eggs	Huevito and fries. Julian huevos. Julian where your huevos?
	26.	Food	papitas	fries	Papitas and huevos?
Total/Age			26	15	
August 2018 Age 4;4	1.	Colors	azul	blue	Azul is blue.
	2.	Colors	rosa	pink	What's rosa means that means Spanish?
	3.	People	mi Papá	Dad/Daddy	With my Papá.
	4.	The physical world	luna	moon	I think the luna.
	5.	Objects	vasos	cup	Vasos to dig.
	6.	Sense perception	buena	good	This one buena?
	7.	The body	chichi	(boob/breast)	Look at her chichi.
	8.	Spatial relations	mira	look	And you xxx mira.
	9.	Objects	jaúla	cage	A jaúla but that's the door for our...
	10.	Animals	dinosaurio	dinosaur	How do you know dinosaurio?

	11.	Emotions and values	cucuy	(devil)	You tell me scary cat but the Cucuy... I think aliens not Cucuys.
	12.	Clothing and grooming	pantalones	pants	The only pantalones.
	13.	The physical world	grandes	big	Grandes like this or like this?
	14.	The physical world	tierra	Earth	Our tierra?
Total/Age			14	12	
January 2019 Age 4;9	1.	Motion	ven	come on/out	Julian ven.
	2.	Food	sal	(salt)	I want more sal. Why I not get no more sal. I want más sal Mamá.
	3.	Quantity	más	more	Mommy I want más.
	4.	Food	paleta	ice-cream	Where's the paleta of Julian?
	5.	People	bebé	baby	No that's my bebé.
	6.	Motion	agitar	shake	Agitar means shake.
	7.	The body	caca	poop	That's caca. Take that you little caca.
	8.	People	muchacha	girl	A muchacha xxx muchacho.
	9.	Numbers	un	(one)	Un Julian
	10.	The house	sala	(living room)	Then we going in the sala.
	11.	The house	baño	bathroom/restroom	In the baño. Julian the baño.
Total/Age			11	8	
Total			51	35	

Longitudinally we see that LIN's use of heritage Spanish words decreased over time when language mixing. For example, in February 2018 she used 26 Spanish words in her mixed language utterances of which she had English translation equivalents for 15. In August 2018 she used a total of 14 Spanish words in her mixed language productions, but at this age she had English translation equivalents for nearly all of them (12). Finally, in the last sampling period, or when LIN was 4;4 she used Spanish in 11 instances of language mixing, and for eight of these she had their English translation equivalents. These analyses seem to show that LIN is likely to language mix even when she does not have to. As discussed above LIN will insert a Spanish word into her otherwise English utterances even though most of the time, she could opt to use the English forms. Our qualitative analyses in Chapter 5 and 6 may shed more light on her mixed language practices. We may find that her language mixing may be influenced by many interrelated factors. To name a few, language mixing may be engendered by the

language(s) of previous utterance as uttered by any of the speakers in her multigenerational and multiparty interactions. As a reminder, this aspect was difficult to capture in the quantitative analyses further up. Language mixing may also be a way for LIN to draw attention to herself, or a way to enter a multigenerational interactional frame (Chung, 2010). Or perhaps language mixing may be a way to show solidarity, or shared identity with the bi- and monolingual speakers in her ever-shifting L.A.-based *tercera Hispanidad*. The table below organizes LIN’s mixed language utterances into semantic domains over the span of the study.

Table 47: Longitudinal semantic analyses of mixed language utterances

Number of Semantic categories	February 2018 Age 3;10	August 2018 Age 4;4	January 2019 Age 4;9
1. Food	xxxxxxxxxxxxxx		xx
2. People	xx	x	xx
3. The body	xx	x	x
4. Numbers	xx		x
5. Objects	x	xx	
6. The physical world		xxx	
7. Colors		xx	
8. The house			xx
9. Motion			xx
10. Animals	x	x	
11. Sense perception	x	x	
12. Clothing and grooming		x	
13. Spatial relations		x	
14. Emotions and values	x	x	
15. Speech and language	x		
16. Quantity			x
17. Time			
18. Adverb			
19. Expressions			
Total	26	14	11

If we longitudinally consider the use of language mixing and of heritage Spanish according to semantic domains, we find that language mixing is deployed across 16 of the 19 semantic categories identified for her Spanish use above. The top three semantic domains are Food, People, and The Body. Moreover, in February 2018 there were 26 occurrences of language mixing across semantic domains. In August 2018 the number was 14, and by January 2019 there were only 11. Much like with LIN’s heritage Spanish where her use decreased across semantic domains going from 46 in February 2018, to 32 in August 2018, and finally to 18 in

January 2019, her language mixing as a mode of communication seems to be moving towards a reduction in terms of semantic domains.

This concludes Chapter 4 which captured and quantified various socio-linguistic aspects tied to LIN's bilingual language learning environment. I am fully aware that these last three measures and analyses (MLUw, TTR, and semantic domain), along with the previous eight language measures are still not enough to complete the picture of LIN's bilingual language development. Even though the quantitative analyses were fruitful in that they yielded rich linguistic results for LIN (especially in English) and her multigenerational family (in Spanish and English, but mainly in Spanish for GRC) they were also rather frustrating. That is, the quantitative measures seemed to downplay LIN's competence in heritage Spanish. Moreover, these results may paint a somewhat negative picture of heritage bilingualism for LIN, a third-generation speaker since only 96 Spanish words were attested in the entire data compared to the 3 641 English utterances that she used longitudinally. This finding demands that we dig perhaps not deeper, but differently. Or, that we move in another direction and seek explanations through qualitative analyses that might indicate finer, more subtle bilingual skills. For example, the use of passive bilingualism is a mode of communication that the quantitative approach was not apt to underscore here, but that we have seen, and will continue to see glimpses of throughout the present dissertation. From this qualitative prism bilingualism is seen not just as having syntax, morphology, lexicon, but it is also about the conception, not as in an idea, or in a notion, but rather as in the origination of a specific bilingual and bicultural identity, an issue that we discussed in our literature review on transformation and originality. Even if there was very little Spanish words to measure, the richness of bilingual, multigenerational, and multiparty social encounters would not be captured by the amount of Spanish produced.

Thus, in both Chapter 5 and 6, LIN's bilingual language development will be qualitatively assessed through the language socialization paradigm that as we saw in Chapter 2, is well suited to study heritage bilingual populations. Moreover, to help organize the ensuing analyses, first they will be for the most part limited to dinnertime activities. Second, we will consider the number of participants as the participation frameworks shift between dyadic, triadic, and multiparty bilingual interactions. Third, the adult discourse strategies that are thought to help or hinder third-generation heritage language transmission will be accounted for. Finally, the analyses will consider the multimodal nature of talk-in-interaction to show

how gesture, facial expressions, posture, gaze, as well as other non-oral semiotic resources contribute to the meaning making process as interactions unfold.

CONCLUSION

This chapter characterized LIN's bilingual language learning environment by introducing an additional key issue related to bilingual input and output. Namely, that adult input is often missing when assessing child output in bilingualism research. We thus proposed longitudinal quantitative analyses of 10 factors centered around the multigenerational family's language use since

It is only by having a very wide range of information on different aspects of bilingual children's linguistic environments that we will be able to discover what makes the difference between harmonious and unsuccessful bilingual development, and thus, what contributes to bilingual children's well-being. Methodologically, this implies a new focus on the bilingual family as the unit of analysis. (De Houwer, 2009: 326).

We first looked at the linguistic soundscape. Spanish was spoken the most in the first sampling period before being eclipsed by English. This was likely related to her developing English. For example, Van Dijk et al. (2013) showed in a developmental study dynamic adaptation in child-adult interaction. The researchers stated that "When speaking to young children, adults have the tendency to adapt their language to the child's linguistic abilities: They speak in shorter sentences and make syntactic simplifications. The child-directed speech becomes more complex as the child grows into a more competent speaker." (Van Dijk et al., 2013: 243). In LIN's bilingual context the multigenerational adults' adaptation to English is likely because her English is developing. As a result, except for GRC, the other bilingual adults are likely meeting her linguistic needs by using not only more, but also more complex English at the expense of her Spanish. Notwithstanding, regarding the other measures, language mixing remained low and stable longitudinally. In terms of language presentation, LIN's language use resembled ROX and ALE's, especially for language mixing. In considering gender and language use, the women and men presented languages similarly, but the men tended to use Spanish slightly more. Next, LIN's input was examined versus the adults' input. LIN and the other speakers received English input the most, followed by Spanish, and lastly mixed language input. Regarding output however, LIN produced mixed language utterances more than Spanish. Moreover, we characterized LIN's input and output in child-adult dyads. Across dyads, English was the most prominent whereas Spanish was kept to a minimum. Furthermore, LIN used more language mixing to address her family than she did Spanish. This type of linguistic reciprocity

was also confirmed between LIN and ROX, and LIN and ALE. Looking at LIN's output according to generation, we found that her productions were not generation-graded. Next, we considered LIN's language choice according to the language(s) of previous utterance. LIN appeared to adjust, but not in all cases to the language(s) of previous utterances when speaking Spanish and language mixing. Finally, LIN's MLUw, TTRs, and semantic domains were discussed. For the first two measures there was insufficient Spanish to assess, but by counting her types and tokens in Spanish longitudinally we were able to get a sense of its evolution, or that her heritage Spanish was hardly developing. Moreover, regarding English her MLUw showed abnormal developmental progression. Nevertheless, LIN's TTRs in English also depicted normal lexical diversity in English. With regard, to LIN's emergent bilingual repertoire, we learned that she possesses English translation equivalents for well over half of her Spanish words that are spread across 19 semantic domains. Furthermore, she uses well over half of these Spanish words in mixed language utterances even when she knows their English translation equivalents.

Our family-centered quantitative approach was thus based on a broad range of socio-linguistic information. It represented how LIN used Spanish, English, and mixed languages between the age of 3;10 and 4;9 in her bilingual language learning environment. The quantitative measures though frustrating do seem to point to a situation of unsuccessful bilingual language development in heritage Spanish for LIN. The results also point to a certain degree of attrition of active multigenerational bilingualism among the adult bilingual speakers. The quantity, and perhaps even the quality of Spanish in her bilingual input is not enough to harmoniously use and acquire Spanish along the side of English. Nevertheless, the analyses do provide evidence, though small and at times fragmented of LIN using heritage Spanish. These instances may be thought of as moments when the light pierces through the thicket of the forest, or what the Japanese call: *komorebi*, which leave many questions unanswered. To understand how, when, why, and with who she is speaking Spanish, as well as her interlocutors' roles in interaction, a fine-grained multimodal, multigenerational, and multiparty qualitative approach is necessary.

Thus, Chapter 5 and 6 focus on multiple line-by-line analyses of talk between LIN and her bi- and monolingual family members as they use Spanish, English, mixed utterances, and communicate dilingually in spontaneous interaction. Chapter 5 briefly summarizes my

impressions of the field. They are based on my field notes, as well as my role as a community member and they are intended to present the larger cultural framework in which the ensuing microanalyses are grounded. Chapter 5 then continues with a discussion of heritage bilingual socialization. Next, it delves into the first two main analyses centered around LIN's attitudes about speaking Spanish. Recall that in our literature review (Chapter 1) attitudes and identity were critical factors that affected bilingual language development. The first analysis thus considers LIN's attitudes towards Spanish. In the following one, we examine her stance towards Spanish as well, but this time the focus is on her acceptance of the Spanish translation equivalents proposed to her by the bilingual adults in her entourage.

Next, Chapter 6 highlights the bilingual input and output to which LIN is exposed. Through three additional analyses we consider first LIN's use of Spanish when the speech stream is segmented. Finally, the second and third analyses underscore the importance of child-directed, but also of overheard speech when using Spanish. As discussed in our review of the state of the art, the role of the overhearer in interactional frameworks is understudied. To reconstruct her own voice, and thus identity, through the various qualitative analyses we will see how LIN as an overhearer is finely attuned to what is being said, and to what is enacted in her bilingual language learning environment. This context provides a wealth of social and linguistic input at the intersection of cognition and the living, ever-shifting environment as it is rooted in the diverse actions that human beings accomplish in the world (Varela et al., 1993). In other words, "le langage ne reflète pas un monde, mais il crée le monde que nous partageons dans l'action." (Aden & Eschenauer, 2020: 3) (language does not reflect the world, but rather it creates the world that we share in action.)

5 Heritage Language Socialization: Attitudes about speaking Spanish

INTRODUCTION

Chapter 4 examined LIN's input and output by focusing on 10 factors that are intrinsically tied to her bilingual language learning environment. In doing so, we achieved the goal of accounting for a breadth of sociolinguistic information critical to understanding her course of heritage bilingual development. We learned that longitudinally, the family's use of Spanish, English, and language mixing is dynamic, but unbalanced across the 10 points of inquiry. As a result of her relatively small Spanish input, LIN's bilingual language development may be far from harmonious since she rarely uses Spanish. In fact, her Spanish use was so infrequent that it was impossible to generate reliable MLUw and TTR measures developmentally. Nevertheless, one shortcoming of the previous quantitative analyses was that they did not capture how the family's linguistic resources are used in bilingual multiparty participation frameworks. The multigenerational setting under study heavily anchors language use in dyadic, triadic, and multiparty social encounters where participants constantly weave in and out of bilingual interaction. Another shortcoming is that the previous analyses did not account for the situated multimodal nature of these encounters that necessarily combine oral, visual, and gestural means of communication, amongst others which "provide evidence for links between motor and psychological development, cognition, affectivity, and language" (Morgenstern & Goldin-Meadow, 2022: 8), or links at the kinesthetic, cognitive, and emotional levels in plurilingual settings (Aden & Eschenauer, 2020). We thus aim to address these issues through the ensuing qualitative analyses.

The next two chapters present the qualitative analyses of 21 key multigenerational social interactions, and they are divided into five sections. Each of the five sections drew as much as possible on pertinent examples from each of the three time periods in our study to show developmental bilingual language 'progression'. This is the case for example in the first section. Nevertheless, this was not always possible in many of our analyses since robust examples of heritage Spanish use were quite rare (as attested in the previous chapter) in August 2018, and in January 2019, even if to a lesser extent. As a result, as frustrating as it may be, the three sampling points are not represented equally, and therefore are not distributed evenly throughout the next two chapters. Nevertheless, Chapter 5 first specifically analyzes LIN's attitude when she is asked to use Spanish by different multigenerational bi- and monolingual family members. We thus flesh out three extracts that account for her shifting stance regarding her use of heritage Spanish. Then LIN's acceptance regarding translation equivalents by more

experienced bilinguals is considered. Here, we achieve this goal by analyzing in fine-grained detail two more extracts. In this second, and final section of Chapter 5 we will also see how her attitude permeates throughout the interactional moments even when her stance toward Spanish is not the focus of the analysis.

Next, in Chapter 6 we highlight how her use of heritage Spanish is facilitated through speech stream segmentation. Or, how her bi- and monolingual multigenerational family members provide Spanish input at the syllable, word, and utterance level to facilitate her comprehension and subsequent production. The first section in the chapter is thus made up of three analyses. Each one is intended to show how the bi- and monolingual adults scaffold their Spanish so that she is better able not only to understand, but also to use her heritage Spanish in meaningful social interaction since “Acquisition, then, must be a product of both cognitive and social influences.” (Clark, 2001: 379). The next, section centers around her use of Spanish when the input is child-directed and we do so through two additional analyses of spontaneous interaction that revolve around food, her most prominently used semantic domain. The third section of Chapter 6 analyzes LIN’s use of Spanish when the overheard input is provided in her bilingual language learning environment. Overhearing participants have not been widely studied (Clark, 1996; De León, 2011), and present distinct ways to apprehend what it means to listen and to understand (Hindmarsh & Pilnick, 2002) in social interaction. We will thus see how LIN uses overheard Spanish input to break into the various interactional frames afforded by her multifaceted bilingual environment. In short, Chapter 5 introduces both chapters and thickly qualifies LIN’s attitudes about speaking Spanish, while Chapter 6 qualifies LIN’s heritage language socialization in relation to her bilingual input and output, and subsequently concludes both chapters.

Before proceeding to qualify these interactional moments, issues related to the unique cultural framework and to bilingual language socialization are discussed in more detail. Language use, as anchored in its cultural context serves to model and scaffold bilingual language development, and thus explain how LIN uses heritage Spanish, English, and mixed language utterances, as well as how she communicates dilingually in her pre-fabricated cultural community. Therefore, the following interrelated levels of analysis that were extensively discussed in Chapter 2 will be applied to each interactional moment. Goffman’s (1974, 1981) Participation Framework first allows us to apprehend and to follow the complexity of on-going communication when two or more speakers are present. The multiplicity of speakers is a

common social situation specific to this family's culture. It also allows us to understand how interactional participation frameworks are constantly shifting from dyadic, triadic, or multiparty configurations, and furthermore, how these participation frames may be embedded into others, even if momentarily. Fishman's (1965) question: "Who speaks what language to whom and when?" opens a space to focus on the dynamic use of language resources in this bilingual, multigenerational, and hybrid cultural setting. Through this lens, we can determine how the multimodal linguistic resources are used among the mono- and bilingual family members, as well as to give an account of the impact of the previous language(s) choices on the subsequent speaker output. This last framework integrates nicely with the issue of discourse strategies in supporting, or not child bilingualism as it is rooted in its specific cultural constellation. Lanza's (1997) Parental Discourse Strategies is an additional level of analysis that will be applied to the selected moments of talk-in-interaction. It underscores the role of adult discourse in bilingual language socialization. It also provides a framework to better determine both if and how the adults implicitly push for a monolingual, or a bilingual language learning environment in which Spanish and English are readily accepted in conversation. Finally, just as importantly we recall that these dynamic bilingual interactions will be analyzed multimodally to see how oral and gestural modalities mutually support each other in the enacted meaning making interactional processes anchored in the unique dinnertime activities of this multigenerational family.

The two chapters that follow thus focus on 21 qualitative analyses of heritage Spanish productions as they are intimately tied to the use of English, and language mixing. Moreover, it is essential to clarify how the selected three sampling periods are distributed in Chapter 5 and 6. As we learned in Chapter 4, there is no developmental progression (remember: null MLUw and TTRs) in heritage Spanish for LIN. Therefore, I made the decision to organize the analyses into the five key themes presented above. As such, this allowed us to focus on the data where LIN was found to use the most Spanish in spontaneous interaction. This reason was also related to, and a reflection of LIN's socio-linguistic and socio-cultural reality where sometimes there is an abundance of Spanish, and at other times Spanish is simply absent. This reality was also reflected in the analyses that aimed to characterize LIN's bilingual language learning environment in Chapter 4, although the bicultural aspect was difficult to capture in these measures. For these reasons, over half, or 14 of the analyses took place in February 2018, only one took place in August 2018, and four took place in January 2019. In a way, this too resembles the Spanish output that emerged longitudinally. Nevertheless, all these analyses

qualify how the dynamic bi- and monolingual multigenerational adult input assists her in using a variety of Spanish words and short phrases, but also how these moments attest to her passive comprehension of Spanish when in naturalistic interactional frameworks. The ensuing analyses will also point to finer bilingual skills for example the use of passive bilingualism, which was also difficult to capture quantitatively. This practice is none other than a hybrid linguistic manifestation that is inherited from her Mexican and American culture. Furthermore, the analyses also show that LIN's English is not developing accordingly (also confirmed through MLUw and TTR analyses in Chapter 4). Indeed, she demonstrates instability for example, in the non-target use of negation, questions, and tenses. However, LIN's English grammatical development will not be the object of analyses since the present Ph.D.'s focus is on heritage Spanish use, and socialization. Nevertheless, LIN's language mixing will be amply considered. First for example, we will see how LIN may be socialized to language mixing through the family's implicit, but at times explicit discourse strategies. Then, we will also examine how language mixing is inherently tied to the use of heritage Spanish and English in her rich multimodal, multigenerational, and multiparty participation frameworks.

5.1 A note on the cultural framework

My position as a community member provided me with a wealth of data both in terms of breadth and depth as was amply discussed in Chapter 3. Much like LIN is in the process of blossoming in her unique L.A.-based ecosystem, being born to Mexican parents in L.A. myself, I too be-came, or emerged out of the fusion, the push, and the pull, or rather the hybridization of two languages (English and Spanish), and two cultures in a contact zone ridden with tension. One result was that it allowed me to find (sub)conscious ways to marry these ever-shifting bilingual and bicultural characteristics tied to my identity internally (in the mind) and externally (in society). Another fruit of this special positioning is that for my Ph.D. it may also give me a bit more insight to depict, as objectively as possible the cultural underpinnings in which the multigenerational family thrives. Or, where a third-generation seedling is going through the inevitable process of bilingual and bicultural trans-formation. By formation I mean construction, as in the building of her identity. With the prefix trans- I mean across, as in formation through the prism of multiple generations as well as multiple languages. Therefore, to enrich the ensuing microanalyses I will briefly discuss my thoughts about the use of Spanish and English, and the cultural integration of *mexicanidad*, or Mexican-ness in a setting that is English dominant. But what is Mexican-ness? There are many interrelated definitions, however

within the framework of this study “La mexicanidad es esa herencia espiritual y cultural que se ha sido desarrollando en México a lo largo de miles años.” (Instituto de la Mexicanidad, accessed September 8th, 2022, Antonio Velasco Piña) (Mexican-ness is that spiritual and cultural inheritance that has been unfolding in Mexico over thousands of years.). Of course, the notion of culture re-appears. I extend this evolving multidimensional Hispanic heritage to communities outside of Mexico’s national, political boundaries as others have done before me such as Fuentes and Anzaldúa whose work has already been mentioned throughout this dissertation. It may thus be applied to the *tercera Hispanidad* found around the *borderlands* in the U.S. as these authors depicted respectively. These groups of people have inherited precepts but have also imported specific cultural aspects from their country of origin that they have adapted to their new cultural context. As such, the discussion will be based on re-readings of my field notes, the multiple viewings of my primary plurilingual data, and the overall impressions of my life within the family across space and time.

In relation to the use of Spanish and English, I have already shared several reflections, and observations from my field journal throughout this investigation. Not only were both languages omnipresent at the interactional level, but the fact that Spanish and English were highly abundant also made them extremely difficult to capture. Transcribing the video recordings to create a plurilingual corpus was just as difficult. This methodological challenge was already substantiated. Nevertheless, early in the field I felt that English was spoken more than Spanish (confirmed by our results in Chapter 4), that there was an abundance of language mixing, that even if the multigenerational bilingual speakers could interact in a common code, frequently they would converse dilingually in the flow of the social encounter (as we will see below). I even partook, naturally, in this interactional mode of communication having practiced it with GLO for example, but also GUI having practiced it with me, ROX with GLO, and LIN with GLO, GUI, GRT, GRC, ROX, and ERI. These dilingual combinations are infinite and become increasingly complex as the number of participants rises. One of my early observations was also related to LIN’s heritage Spanish development. I proposed that if she did not benefit from formal Spanish instruction, then that she would likely have difficulty maintaining it. Indeed, our quantitative results showed a steady longitudinal decrease in LIN’s use of heritage Spanish. Furthermore, if I ventured to make the initial claim that LIN may not fully acquire Spanish without institutional support, it was due to my decades-long experience with the family. I have watched most of my 15 second-generation nephews and nieces become adults who speak heritage Spanish to variable degrees. Not having benefited from dual language

instruction, and even if most of them had bilingual parents with good command of Spanish, today they each fall on different points of the bilingual continuum. Some of them have stronger productive abilities, whereas others may find it difficult to understand, and thus to speak Spanish. I have witnessed these linguistic challenges in interaction with their grandparents GRC and GRT, but I have also seen it with other monolingual Spanish speaking family members, and friends in a plethora of other social encounters in the U.S., and in Mexico. But if communication was made possible between parties that did not share a common productive code it was in large part due to the frequent multigenerational nature of these interactions. As mentioned further up, there always seemed to be at least one bilingual speaker to mediate between parties, using language as a tool to translate, and thereby facilitate understanding, an issue that I dwell on in Alvarez (2023). The availability of multiple bi- and monolingual speakers was also likely due to the Mexican background intrinsic to this hybrid community of practice.

Finding the time and the space to speak in more intimate arrangements such as in a dyad without interference from other bi- and monolingual family members though possible, was also rather difficult. Perhaps for the family the need for private discussions was also unnatural since they seemed to be open to sharing information about each other. In this sense, the notion of privacy could be an irrelevant social distinction for them. For example,

The fact that some languages do not have a translation for the English word *privacy*, for instance, might indicate that the concept of “privacy” is not present or it is conceptualized in ways that do not allow for a single word to represent it. (Duranti, 1997: 26).

In the present case, the issue is not whether they have a translation equivalent for the notion of privacy in English since they are likely aware of the term and what it means. Rather, it may be a social distinction that is not necessarily present or practiced within their cultural framework. Information sharing was sometimes done with the aim of teasing, or provoking, and at other times it was to blatantly call each other out during their dynamic social encounters. In this sense, there was perhaps no real need for privacy since everyone knew (almost) everything about everyone else. Furthermore, even if information sharing may not be proper to their bicultural framework, to publicly (but within the private family sphere) divulge matters was a way to think through issues together as family, to get feedback, and to offer opinions, or simply put, to problem solve (Duranti, 1997). Undoubtedly this practice also plays a huge role in LIN’s cultural conception, or the way in which she positions herself regarding the on-going discourse

as Forrester (2002) has shown children do. As we will see below, the family was keen on mutual engagement which was fostered by their living arrangement. Nevertheless, my imagined issue of privacy was related to the immediate living arrangement of the family, or their special bicultural framework. That is, an aspect tied to their Mexican culture (but not only) where three families live together or in proximity, play together, and lend each other a hand across the multitude of tasks that emerged on a day-to-day basis. Helping each other out or soliciting the aid of others throughout these daily activities was not necessarily because the individuals needed physical help. These were not tasks that they could not accomplish on their own. Rather, it would seem as though asking others for help was a way to include them in meaningful participation frameworks, or it was maybe even a form of instruction especially for the younger generations. In other words,

It is not by accident that the most common way of transmitting knowledge in the world is apprenticeship. It is a system that limits participation in the task and yet allows a person to feel involved in the whole task. The novice can watch the experts at work and is slowly let into the task. This means that at each stage of learning the learner already has an image of what the next step should be like. (Duranti, 1997: 31-31).

For this family involving adults and children in a diverse range of activities was thus a socio-interactive way not only of showing that they cared, and that their presence was appreciated (even if it was not always said), but also a way to scaffold the cultural, and language learning process. Nevertheless, these types of familial setups necessarily implied multigenerational familial constellations which also seemed to be advantageous to them. The unique cultural setting in which LIN's social, and thus linguistic life is unfolding may provide her with enough Spanish for her to be an effective heritage language learner later in life if she so chooses. Another salient domain in which the family's *mexicanidad* shone revolved around food. Cultural practices including meal preparation and eating together provided a space to talk about the taste, and characteristics of food specific to their Mexican origins such as pozole, chiles rellenos, salsa, and the list goes on. These types of social practices further make the input special, since it may be linked to the Mexican background of the family which is different from monocultural middle-class American families with fewer people and fewer generations.

Mealtime also opened a window where other cultural characteristics proper to their Mexican origin emerged. Some examples include Spanish music playing in the background, or on T.V. (Oswalt, 1986), Mexican cultural artifacts visibly available like embroidered tables

clothes, a molcajete¹⁰⁷, a tortillero¹⁰⁸, a comal¹⁰⁹, and countless other items such as an altar to honor their dearly departed. Beyond this Mexican heritage pulsing through the music and the objects, it also vibrated through their discourse. Mealtime for example, was a privileged site to talk about upcoming trips to Mexico, which were frequent, but also to discuss and participate in bautismos¹¹⁰, quinceañeras¹¹¹, and other religious celebrations related to their Catholic origins that took place at the community level, and where Spanish discourse was omnipresent. In the end, bilingualism is not just an internal grammatical phenomenon. Bilingualism in this family is also an external socio-cultural phenomenon where style and variation are transmitted through bilingual language practices that are culturally specific. For LIN, even if there is very little in terms of her heritage Spanish output, we will see in the next two chapters that the bilingual, multigenerational, multimodal, and often multiparty social encounters increase her social and linguistic competence in dealing with different generations. Finally, it also increases her competence in communicating with the younger family members her age who display divergent cognitive development, which will be the focus of a future investigation.

5.2 Heritage language socialization

Chapter 5 and 6 qualitatively analyze the naturalistic social interactions that unfold between LIN and her mother ROX as well as with several other of her bi- and monolingual adult family members. They include three additional women - GRC, ALE, and GLO - as well as four men - ERI, RIC, LIN's late father MAR, and her late great-grandfather GRT. As such, we strike a balance in terms of biological gender between the eight adult participants. Moreover, the family members span all three generations, and thereby provide a socialization environment which enables dense, and complex interactions multigenerationally. Typically, average middle-class, and often monolingual and monocultural American children do not benefit from these types of social encounters in the home. Therefore, according to their generation and thus degree of bilingualism, together the bi- and monolingual adult speakers provide a snapshot of the dynamic linguistic practices, and thus input that serve to socialize LIN into various unique language use patterns. This includes socialization into the use of heritage Spanish, but also socialization into the emerging use of language mixing, as well as socialization into the use of

¹⁰⁷ A mortar typically made from volcanic rock used to crush spices and chili peppers and used to make a variety of spicy sauces

¹⁰⁸ A round fiber basket used to keep tortillas warm during the meal

¹⁰⁹ A smooth flat griddle used to heat a variety of meal related items like tortillas

¹¹⁰ Baptisms

¹¹¹ Like a Sweet Sixteen celebration, or coming of age for young girls

a passive form of bilingualism that for her, at best allows her to partake in bilingual conversations with her Spanish-only speaking family members. In other words, we are talking about socialization to interactions across generations, including other bilingual and bicultural children her age which “normal” middle-class children generally do not get. Furthermore, along with the quantitative measures presented in Chapter 4 addressing LIN’s developing linguistic structures essentially in English, qualifying the interactions between LIN and her mother ROX, as well as with her extended range of communicative partners is a continued effort at merging as Duff (2008) amongst others have suggested, the two complementary fields of language acquisition, and language socialization. The next two chapters thus address “a question raised by scholars interested in both acquisition and socialization” (Williams, 2008: 58), as it aims “to bridge the gap between linguistic structure and social structure in language acquisition and use” (Kramsch, 2002: 3).

Within the framework of the present investigation centered around heritage bilingual language use and socialization, fusion of the two lines of inquiry is accomplished by examining how “dyadic (triadic) or multiparty interactional arrangements are relevant to early language socialization as well as to children’s organization of attention and participation in learning and apprenticeship situations.” (De León, 2011: 81). Furthermore, in understanding how both parents and children enter what is called parent- and childhood during family dinners, an apprenticeship context discussed in Chapter 2, Duff (2008) as well as Pontecorvo et al. (2001) suggest that the process of language socialization is not a linear one-way process. Within the context of this study the language socialization process is intensified since we are not only dealing with LIN and her parents, or her nuclear family. In interaction we also see LIN’s grandparents, great-grandparents, aunt, uncles, and cousins who are all extended family members. To my knowledge, few studies have investigated heritage language socialization in integrated multiparty, and multigenerational settings multimodally. However, some linguists¹¹² may argue that other researchers have come before me and have indeed studied child heritage language speakers in multigenerational contexts. For example, Smith-Christmas (2014) in her article discusses socialization into language shift and the impact of extended family members on family language policy (FLP) on the Isle of Sky, Scotland. But, upon closer examination of

¹¹² In Annick De Houwer’s 2023 pre-report, a critically constructive review of my dissertation and mandatory element for my defense to proceed, suggested that my dissertation was not unique on the grounds of studying a heritage bilingual in a multigenerational family. To substantiate her claim, she provided the above reference which I of course consulted prior to my defense.

this article we see that the negotiation of Gaelic-centered FLP is centered around the children's mother and paternal grandmother. My work not only includes LIN's grandparents, but it also goes beyond to include her great-grandparents, and great-uncle as well. As such, my work is truly unique in that it digs deeper, going further up, and out in the family tree. Moreover, one debatable issue in Smith-Christmas' (2014) work is whether the children's father, sister, and brother are extended family members as it is claimed. Indeed, in many accounts a child's mother, father, and siblings are considered to be part of the nuclear family, while the extended family goes beyond and includes grandparents, and other relatives such as uncles, cousins, and in some cases in-laws, and even close friends. Therefore, based on the issue above, as well as on the fact that the present investigation goes further in multigenerational terms, this study is truly one of a kind, and Smith-Christmas' (2014) work while rich may not be considered to have come before mine. Notwithstanding, language socialization is indeed more of a complex bidirectional, or even multidirectional *interactional* process that is also very much multimodal. The terms bi- and multidirectional here are to be understood as the flow of language influence in two, or more directions, or from the expert to the novice and vice versa (King & Fogle, 2013). Moreover, the multi- or bidirectionality of an interaction may become even more complex as the number of bi- or monolingual participants expands beyond the dyad. In this family, expanding participation frameworks necessarily implies increased opportunities for multigenerational speakers to engage in interaction. Complexity may also result when multiparty interactions retract. For example, language choices made by participants who (temporarily) leave an interactional framework without a doubt leave a *multimodal trace*. That is, their oral and visual-gestural (re)actions that may continue to resonate in the minds of the speakers as Bakhtin (1981, 1986) suggested in his dialogical approach. These reverberating voices may subsequently influence participants' future language choices. Furthermore, from this perspective "children's entry into language is guided by the language that surrounds them and is also very much triggered by their eagerness to imitate their conversational partners" (Morgenstern, 2020: 65). Therefore, within the ever-expanding and retracting bidirectional, multigenerational, multiparty, and multimodal complexity, it does not make much sense to conceive of children simply as innocent and passive bystanders who only receive language input by adults.

On the contrary, children are active agents and receive, or are attuned to input whether it is child-directed or overheard. Therefore, it is through their engagement in the interactional framework that they may in turn "influence parental language choice patterns" (De Houwer,

2021: 25) in their own right. Researchers such as Schieffelin and Ochs (1986b), Gleason et al. (1984), and Becker (1994) have underscored the fact that while children are often labeled as “novices” in the socialization process, “they are not merely passive receivers but are active participants in constructing metapragmatic knowledge, and have the potential to socialize their caregivers.” (Li, 2008: 73). For example, in a study of the early mixing of a bilingual child, Mishina (1999) found child linguistic influence to be the case when looking at the adults’ discourse strategies. Furthermore, De Houwer and Bornstein (2016b) in their study of bilingual mothers’ child-directed speech also found that caretakers may sometimes align with their child’s previous language choice. A more extreme example is that of Eilers et al. (2006) who researched social factors in childhood bilingualism. They looked at English-Spanish language use in Miami, Florida. Their findings showed that adults may even give up speaking a particular language to infants. Even if the parents in their study were aware of the need to speak Spanish to their children for them to learn it, “one late-talking toddler at 17 months successfully switched her monolingual Spanish-speaking grandmother to speaking English, instead of having the grandmother use Spanish as anticipated.” (Eilers et al., 2006: 74). A similar example directly related to this study occurred in the week of June 6th, 2022, as I was finishing these qualitative analyses. In speaking to GRC via WhatsApp while she was in L.A., she related to me how she managed to understand JUL through multimodal interaction when he asked her for a bowl of cereal one morning. When GRC asked him in Spanish if he wanted a small bowl, or a big one, according to her, he did not seem to understand the question as he looked up towards her with confusion. She therefore enacted his reaction to her question. The figure below shows GRC as she embodies JUL’s apparent confusion when she addressed him in Spanish.



Figure 32: GRC embodies JUL's confusion following her question in Spanish.

Recognizing that JUL did not understand her question in Spanish in their joint attentional frame (Tomasello, 2003), and as she continues to narrate the story, she then tells me that she switched to English, even if within the framework of this study this linguistic transition would have been coded as language mixing. GRC therefore lifts a small bowl in one hand and a larger bowl in the other one while asking “this o@s (or) this?”, after which JUL selects the big bowl. We see then that along with the use of English, her actions are instrumental in working through the meaning making process with a third-generation child. In this encounter, it could also be argued that beyond her use of English, showing the two bowls through her bodily movements were perhaps even more instrumental than a shift to English to negotiate understanding between the two. Nevertheless, the following image depicts GRC once again embodying JUL as he gazes, and then points to the large bowl that GRC was holding in her hand. Moreover, if we examine the screenshot again, it would appear as if GRC simultaneously steps into JUL’s role twice. First, we see GRC incarnate JUL as he looks up and points to the bowl. In taking a closer look however, towards the bottom right edge of the image we also see a trace of her other hand point up towards the bowl. As such, not only does GRC externalize JUL, but she also places him lower in spatial terms which seems to correspond with the difference between their physical height.

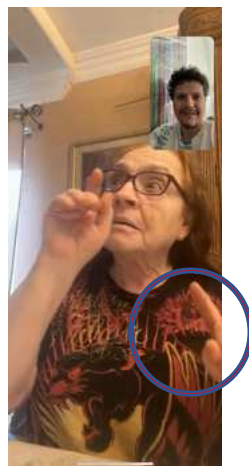

Figure 33: GRC embodies JUL as he points to the large bowl.

Be it as it may, what we have here is yet another situation where a third-generation child who has difficulty understanding heritage Spanish successfully influences a monolingual adult’s linguistic, and multimodal practices. This is also an instance where a first-generation adult (GRC) demonstrates to a second-generation speaker (ERI/me), how she managed to create meaning with her third-generation great-grandchild (JUL) through multimodal means. These types of interactions in turn reinforce the fact that “Children play an important role in changing

the culture that they are learning as they learn.” (Bronson & Watson-Gegeo, 2008: 44). That is, JUL successfully, and even if temporarily changed the linguistic culture from Spanish to English, and multimodal practices. Indeed, the use of the body, as well as of objects is frequently the case in child-directed speech.

These examples thus show how children are not just uninvolved observers and hearers of language in their multifaceted, bilingual, and multimodal interactional settings. On the contrary, it is through the dynamic co-construction of the bilingual, multimodal, and in the present study multigenerational interactional process that both children and adults ‘become’ as they continually (re)negotiate their places and (re)shape their identities as exemplified by Morgenstern (2022) as competent speakers in their unique communities of practice. Children “learn how to use language as a tool to elicit attention, to establish relationships and identities, to perform social actions, and to express certain stances. All this is part of being a speaker of language(s)¹¹³” (Ochs, 1992: 358). Our analyses will touch on each of these aspects. Therefore, grounded on these ever-evolving participation frameworks as Goffman (1974, 1981) argues, or from a usage-based perspective of language acquisition, “periods of joint engagement (that) establish the common ground - (are) what we may call the joint attentional frame*¹¹⁴ - within which adult-child communication may take place.” (Tomasello, 2003: 22). Nevertheless, these dynamic social encounters, or interactional frames are compounded by the linguistic complexity that bilingual socialization entails. We thus consider how child-directed *and* overheard multigenerational input supports the use of heritage Spanish, but also the use of mixed language utterances by a third-generation child in L.A. Certainly, “Children can learn from overheard speech, and children who live in cultures in which children are not talked to may particularly learn to pay attention to speech among others instead.” (Hoff, 2009: 99). While not being talked to is not the case for LIN in the present study, the last three analyses of Chapter 6 show how she is not only attuned to, but also capable of using the overheard speech in her bilingual language learning environment. However, along this vein joint attention is not always critical for children in the early stages of their language learning trajectory (Akhtar, 2005). Therefore, a goal of our approach is to consider in depth the ongoing multimodal and multigenerational interactional moments between LIN and her family members across her four

¹¹³ Ochs uses the words “language” in its singular form. I extend her initial statement to go beyond monolingualism and into the sphere of bilingual language practices.

¹¹⁴ “Other terms that have been used are “joint attentional formats” (Bruner, 1981) and “joint attentional scenes” (Tomasello, 1999)” (Tomasello, 2003: 22).

modes of communication. To better understand LIN's language choices including her mixed language utterances, the approach proposed here aligns with Filipi (2015). In her study, she reported on the recipient design in Australian English-Italian bilingual child-parent interaction and anchored her qualitative analyses on "the sequence structure and to talk as situated social practice" such that "we can arrive at an alternative understanding of the practice of language alternation." (Filipi, 2015: 103), or language mixing. Thus, plurilingual transcripts along with their corresponding videos will be used through the remainder of this, and the next chapter to support each of the ensuing thick qualitative analyses.

The way languages are deployed and layered within the multigenerational L.A.-based family may help to model style and variation. The family's dynamic language use may also serve to scaffold LIN's heritage bilingual language development through dyadic, triadic, and multiparty interactional frameworks. As such, the family's bicultural and bilingual systems of practice are highly complex. Therefore, it would not be prudent to merely focus our inquiry on the isolated moments of LIN's heritage Spanish use and socialization. Following Geertz (1973), our aim is to deploy an analytical approach that underscores the never-ending process of interpretation that is innate to the human experience, which is itself enriched by the infinite bilingual and bicultural practices of those people living at the threshold of languages and cultures. Not only will the use of Spanish, English, and language mixing be integrated and discussed throughout the thick descriptions, but they will also be more succinctly highlighted in each of the 19 syntheses as noted above. Moreover, to focus on a single incident of language use in the following multimodal qualitative analyses would simply be too restrictive, and thus greatly reduce the explanatory power of our ethnographic approach. It will not allow for the broad and interrelated range of language related issues to emerge even in the shortest of interactions that attest to LIN's comprehension and production of Spanish. In other words, "critical readers should ascribe more validity to studies that are longitudinal, genuinely ethnographic, and that are both "thickly" documented and explained – i.e., that include multiple perspective and rich data sets – than to those that focus on a single incident." (Bronson & Watson, 2008: 49). The present investigation is not only longitudinal, and ethnographic, but moreover it aspires to touch on a variety of interrelated issues, or webs of meaning that both help, hinder, and show LIN's use of heritage Spanish through its thickly documented analyses that move beyond a single incident. Through this prism, for Geertz

The concept of culture ... is essentially a semiotic one. Believing, with Max Weber, that man is an animal suspended in webs of significance he himself has spun, I take

culture to be those webs, and the analysis of it to be therefore not an experimental science in search of law but an interpretative one in search of meaning. (Geertz, 1973: 5).

Culture may therefore be likened to “webs” for Geertz, and it is only through the detailed ethnographic inquiry that multiple perspectives of these events may be brought to light. Of course, some readers may argue that they can “see” the videos that are thoughtfully linked to the plurilingual transcripts that they can “read” and that this makes thick documentation unnecessary, or even redundant. However, *thick description* is a key notion in Geertz’s theory of culture where an ethnographer returns to the same data set and subsequently adds “layers” thereby rendering the analysis “thick”. This is what I have aimed to do. I therefore stand by my argument that first, the plurilingual transcripts alone do not do justice to the multilayered, multimodal, and bilingual nature of the multigenerational interactions. Second, the videos alone do not explain the plethora of language related issues that emerge and overlap, at least not in a brief viewing, as they are related to heritage Spanish bilingualism. Furthermore, even if readers play the videos multiple times, only a few are likely to see and to truly feel the Hispanic pulse that underlies these social encounters. Even fewer readers will understand the bilingual and bicultural framework as related to this specific multigenerational family as presented above. As such, my role as an observer and member of the family, along with my field notes will feed the forthcoming multi-layered, and thus thick analyses. This argument is in no way meant to be pretentious. On the contrary, it aligns with what very many bilingualism researchers have defended for decades. I have already cited some of them here. To truly understand the nature of bilingual language practices within their specific communities, it is highly recommended that the researcher has deep knowledge of the languages and cultures under study.

In sum, my thick explanations tie each plurilingual transcript to its corresponding video and to jump directly to the synthesis to read the main points would be like eating a taco without salsa i.e., it would not be as rich and flavorful. The following two chapters may help to explain the way LIN, a novice and an emerging heritage bilingual is socialized to use Spanish, language mixing, and passive bilingualism when interacting with expert bi- and monolingual multigenerational speakers in multiparty participation frameworks. While the central research question is LIN’s heritage Spanish use and socialization, additional questions that emerge include:

1. How does LIN's attitude change about speaking Spanish over the course of the study?
2. How does LIN react when the adults provide Spanish and English translation equivalents?
3. How do LIN's bi- and monolingual family members help her use Spanish in dyadic, triadic, and multiparty interactional frameworks?
4. How does child-directed and overheard multigenerational adult input help LIN use and practice Spanish?
5. How does LIN demonstrate her emerging passive bilingualism, and her ability to communicate with Spanish monolingual speakers?
6. How does the use of English and language mixing support the use of Spanish in interaction?

Chapter 5 and 6 also attempt to show how dyadic, triadic, and multiparty social encounters attest to her comprehension of Spanish, even though she responds entirely in English. De Houwer (2009) following Saviile-Troike (1987) calls these types of adult-child interactions "dilingual conversations". The term *dilingual* according to Saviile-Troike (1987) refers to the negotiation of meaning without the use of a shared code, i.e., the same language. However, we may also conceive of them as a shared code, but along a continuum for each code, where each language is used enough in interaction to reach mutual understanding. We have also already seen several examples drawn from my field journal throughout this work, but we will consider them further here. Furthermore, exchanges such as these, as we will see, may enhance the complex process of bidirectionality described above. Part of the reason may be attributed to the fact that

Language socialization research points out that the coexistence of two or more codes within a particular community, whatever the sociohistorical and political circumstances that have given rise to them or brought them into contact, is rarely neutral in relation to children's developing linguistic and sociocultural competence. (Ochs & Schieffelin, 2008: 10).

One example of this non-neutrality between codes that have so far had an impact on LIN's heritage bilingual development are *dilingual conversations*. These may be typical of speakers who do not, or no longer speak the minority language but can comprehend it. Within the present study a *dilingual conversation* is thus one where LIN possesses little production of Spanish but understands it when she is addressed or when she overhears Spanish spoken to other multigenerational members of her family. Therefore, the interactional model is one in which

she receives information in one code (Spanish) and responds in another code (English). However, we should also make clear that this mode of communication is not only limited to novice bilinguals. De Houwer's chapter on language choice in bilingual interaction suggests that "The force of habitual language choice can conflict with other norms for language choice." (De Houwer, 2019: 336) such as the convergent choice principle (CCP). In essence, the CCP advances that the use of the same code reduces the psychological distance between speakers. However, I argue that non-codical convergence does not necessarily imply psychological distance nor does it designate unaccomplished bilinguals. For example, based on personal experience, the force of habitual language choice has led me and a close French friend to communicate dilingually for about 13 years now. This generally takes place when no other participants are involved in the conversational framework, and whether we are in private or in public settings. She is a fluent English teacher, and I am a fluent French speaker, but we always speak our dominant language to each other. Only once (in public transport) while visiting her in Montréal, Canada did a seemingly perturbed overhearer comment on the fact that I should speak French. Moreover, in Chapter 3 I presented an extract of my field journal where I pondered during my fieldwork about the Spanish-English dilingual conversational style among the multigenerational bilingual adults in the family under study. Notwithstanding, in the present chapter, we will also see how these bilingual adults, on more occasions than one, will partake in dilingual conversations with each other. While it is outside of the scope of the present study, it would be interesting to see if dilingual conversations in the family are only a matter of a few turns, or if on the other hand, they may be like the fully fledged, hours-long conversations that I tend to carry out with my French friend. Nevertheless, moments such as these may implicitly serve to socialize LIN into dilingual language practices even though she is not yet fully bilingual herself (in productive ability) since

Even when the children are prompted, most language socialization of the relation of semiotic forms to context takes place implicitly; children and other novices infer and appropriate indexical meanings through repeated participation in language mediated practices and events that establish routine associations between certain forms and certain settings, relationships, practices emotions, and thought-worlds. (Ochs & Schieffelin, 2008: 9).

In this light, one question related to dilingual conversations that may be asked is the following:

7. How do the bi- and monolingual multigenerational adults respond to LIN's use of English when she is addressed in Spanish?

I will attempt to address each of the questions above in the ensuing qualitative analyses. Moreover, each section is composed of different video, or audio (there are only 5 analyses when the participants are not within the camera's field of vision) extracts selected from the longitudinal data. These are clearly presented at the beginning of each analysis. There may be two (dyads), or more (triads and multiparty) participants in any of the extracts which are also presented before each analysis. Furthermore, for ease of analysis, lengthier extracts may be broken down into shorter more manageable chunks. They are designated with a capital A, B, or C at the end of the title of the plurilingual transcript. Each analysis also begins by briefly presenting the context, the main mode(s) of communication i.e., English, Spanish, or language mixing, the date, the participants, and their respective generations, and whether their gaze, stance, and gestures are considered based on their (in)visibility as mentioned above. Also, to align with Goffman's (1974, 1981) Participation Frameworks, the speakers and overhearers are identified according to their ratification status, and whether the unfolding conversation is focused, or not. Next, the plurilingual transcripts are presented right after each introduction. At the top of each plurilingual transcript will be found a hyperlink to the video or audio file in question. Any numbered utterance that is in Spanish, or in language mixing is translated into English and followed immediately below, but without a line number. A detailed qualitative analysis follows the plurilingual transcript. In the analyses, the language of interaction is only identified when it is heritage Spanish, or language mixing, and rarely in English except when it is pertinent to the discussion. Finally, each thick analysis closes with a synthesis to help untangle the Participant Frameworks to answer who speaks what language to whom (Fishman, 1965; Morgenstern et al., 2021), as well as to assess the impact of the Parental Discourse Strategies deployed by the adults as illustrated by Lanza (1997).

5.3 Attitudes about speaking Spanish: Between no & yes

5.3.1 I don't have to talk español@s

Longitudinally, LIN shows mixed feelings about her use of Spanish. In the first data collection period (February 2018) she asserts knowing how to speak Spanish and affirms that "I know speak Spanish too." when her mother ROX reminds her that her great- "Grandma@s:eng&spa only speaks Spanish." This interaction was briefly examined in Chapter 4, and it was considered as LIN's non-reciprocal, or dilingual interactional pattern which may be seen as an impediment when communicating with GRC. Even if previously, LIN did not address GRC in

Spanish despite her claim that she did know how, later LIN affirms that she does not have to speak Spanish. The triadic interactional exchange below shows how LIN refuses to speak Spanish even though GRC has difficulty understanding her. Moreover, since the camera is sitting on the dining room table, and the participants have moved to the kitchen, sound is good, but visibility of the child or the adults is not. Gaze and gestures are therefore not considered. Also, this interaction is segmented into two parts (A and B). ERI and GRC are in the kitchen. Their Spanish conversation is intense. Spanish is the most used language along with some language mixing. It is about a private family matter regarding a trip to Mexico. It is a focused conversation since the objective is for both ratified speakers ERI and GRC to explain to each other why, or why not other family members need to know about the trip. Therefore, a departure from the main purpose of the conversation may be seen as a distraction. This is when LIN, an unrated overheard who is sitting at the table next to the kitchen breaks into the interaction.

LIN is 3;10

1. *LIN: Grandma@s:eng&spa.
2. *LIN: Grandma@s:eng&spa Grandma@s:eng&spa I xxx cold.
3. *LIN: I not cold. @GRC
4. *GRC: [- spa] habla en español. @LIN
Speak Spanish.
5. *ERI: you're not cold? @LIN
6. *GRC: [- spa] tienes frio? @LIN
Are you cold?
7. *ERI: [- spa] tienes frio o qué? @LIN
Are you cold or what?
8. *LIN: [- mix] I don't have to talk español@s +... @GRC
I don't have to talk Spanish.
9. *LIN: only my tablet has xxx xxx xxx +... @GRC
10. *LIN: [- spa] español. @GRC
Spanish
11. *ERI: [- spa] no te entendemos niña habla en español.
We don't understand you girl speak in Spanish.
12. *GRC: [- spa] a ver qué a ver dile a Eri(c). @LIN
Let's see let's see tell Eric.
13. *LIN: [- mix] my tablet has spañol@s [: español] (.) only in my tablet. @ERI
My tablet has Spanish (.) only in my tablet.
14. *ERI: [- mix] no sé lo que me estás diciendo niña sorry@s no te entiendo.
I don't know what you're telling me girl sorry I don't understand you.
15. *ERI: [- spa] em entonces +/. @GRC
Then +/.
16. *GRC: [- spa] quieres agua?

	Do you want water?
17.	*LIN: I need to go to the bathroom because I not (.) cold. @GRC
18.	*GRC: [- spa] quieres +/. @LIN Do you want +/.
19.	*ERI: [- spa] quieres ir al baño? @LIN Do you want to go to the restroom?
20.	*LIN: Yeah because I'm not cold. @ERI
21.	*ERI: [- spa] que quiere ir al baño porque (.) no tiene frio dice. @GRC That she wants to go to the restroom because (.) she's not cold she says.
22.	*GRC: [- spa] no tienes frio? @LIN You're not cold?
23.	*LIN: no xxx. @GRC
24.	*ERI: anyway.

Plurilingual Transcript 5; ex. 1: FEB_20_2018_GRC_ERI_JUL_LIN_I don't have to talk español_A

In the kitchen and out of the camera's site ERI and GRC discuss their points of view on the topic mentioned above. LIN, an unratified overhearer is standing on a chair in the dining room table. This is the only time she is visible. Her little brother JUL is sitting in a highchair off to the side. He is also unratified and not visible. After finishing her meal, LIN goes to the living room and then to the kitchen with ERI and GRC. LIN breaks herself into their conversation (1.1 and 1.2) to tell GRC that she is not cold. The interactive framework is now triadic. LIN's utterance is difficult to understand at first, but her repetition (1.3) makes it clear. If she is wearing a sweater it is because it tends to be cold in the house. It is also likely that ROX made her wear it since she usually prefers to run around the house in her underwear. Nevertheless, GRC (1.4) tells LIN in Spanish to speak to her in Spanish. At the same time ERI (1.5) asks LIN if she is not cold for clarification. GRC and ERI's two overlapping utterances show the type of bilingual input in which LIN is immersed. They may therefore impact her language choice. One is in English, and the other one is in Spanish, and both streams of input are addressed to her simultaneously. Both the Spanish statement and the English question also require a response on her part. At this point ERI, GRC, and LIN are all ratified speakers, but on a topic different than ERI and GRC's initial one. GRC, following ERI's question asks LIN in Spanish (1.6) if she is cold. Despite that both LIN (1.3) and ERI's (1.5) exchange is in English, and thus momentarily un-ratify GRC, it demonstrates that GRC has some passive understanding of what is said. ERI eager to get back to the focused dyadic conversation insists. ERI (1.7) reformulates his question in Spanish following GRC and asks LIN once again if she is cold. LIN needs to answer for them to get on with their focused conversation. However, rather than to answer ERI or GRC regarding being cold, LIN (1.8) in a mixed language utterance tells GRC, "I don't have

to talk español@s.” since only her tablet speaks (1.9) Spanish (1.10). LIN’s stance towards being told to speak Spanish is not very positive since she transfers the linguistic responsibility of speaking Spanish to an electronic device. Furthermore, her language mixing (1.8) is a response to GRC’s comment (1.4), and not the previous four unilingual Spanish or English utterances (1.4-1.7). LIN also demonstrates her passive bilingualism. Her contextually appropriate mixed language response shows that she understands GRC’s request to speak Spanish. To her negative response, ERI (1.11) tells LIN in Spanish that they do not understand her. Within the monolingual discourse strategies (Lanza, 1997) this can be considered a Minimal Grasp Strategy since the idea is to get LIN to speak Spanish. He uses Spanish to explicitly tell LIN to clarify her needs by pretending not to understand. He thus aligns with GRC again, but this time with her earlier request to speak Spanish (1.4). Then, struggling to understand LIN (1.12), GRC drops the idea of getting her to speak Spanish and asks her in Spanish to tell ERI pronounced as Eri(c) [ɛ.'ri] what she wants. While this is a clear example showing how in the end communication is favored over code (A. Morgenstern, personal communication, August 15th, 2022) facilitated through the multigenerational framework, this may also be seen as a Move On strategy. It relieves LIN from speaking Spanish as ERI is bilingual and can mediate between the two. It also allows for the conversation to flow in both languages to get to the point and move on with the matter at hand. Therefore, LIN (1.13) language mixes a second time to tell ERI that “my tablet has spañol@s [: español] (.) only in my tablet.”. There are clearly some communication issues. First, LIN speaks English to GRC and GRC speaks Spanish to LIN. Second, when GRC asks LIN to tell ERI, LIN assumes that GRC’s request is in reference to LIN’s last utterances (1.9 and 1.10), or that only her tablet speaks Spanish. However, this is not what GRC wants to know. What GRC would like to understand is LIN’s issue regarding her being cold since it is still not clear. LIN’s mixed language response (1.13) does not make sense, so ERI (1.14) tells LIN in a mixed utterance (but almost entirely in Spanish) that he does not understand her. The inserted English adjective “sorry” is also phonologically adapted to Spanish and pronounced ['so.ri] as opposed to ['sari] as it would be in standard English. ERI’s choice to language mix can also be seen as a response to LIN’s previous mixed language utterances since up until now he has only produced Spanish, or English utterances. Thus, this may show how LIN in her own right has actively influenced his language choice (De Houwer, 2021) through her active engagement in the conversation. Moreover, his response can also be seen as a bilingual discourse strategy under Language Switch. Whereas LIN uses English and mixed language utterances in interaction, ERI switches to a mixed mode of communication allowing for the use of a more complete linguistic repertoire. His Spanish utterance (1.15)

attempts once again to refocus the topic with GRC. Nevertheless, GRC not satisfied with her understanding of LIN's needs asks her in Spanish (1.16) if she wants water. But LIN (1.17) responds, "I need to go to the bathroom because I not (.) cold.". Then, GRC (1.18) attempts to ask again in Spanish, but ERI (1.19) cuts her off to confirm with LIN in Spanish if she wants to go to the restroom. This is an Expressed Guess Strategy within the monolingual discourse strategies. ERI uses a Spanish question to translate what LIN has just said. It also functions as a (in)direct request for confirmation where the child is expected to give a yes, or no answer. Although ERI could have confirmed with LIN in English, his bilingual discourse strategy also helps to maintain GRC as a ratified participant in the unfolding interaction. Otherwise, an English response on his behalf would have un-ratified GRC which would not make sense since she is the one who wants to understand LIN's needs. LIN (1.20) confirms that she does want to go to the restroom, but with the conjunction "because" she maintains that she is "not cold.". This may also be considered an instance of passive bilingualism where she answers dilingually since she understands and confirms ERI's reformulated question in Spanish. Moreover, LIN's response seems like an obvious non sequitur at the time. There does not seem to be a relationship between her going to the toilet and her not being cold. For this reason, ERI (1.21) translates to GRC into Spanish what LIN says, another instance of the multigenerational framework in facilitating the meaning making process across generations. Finally, GRC (1.22) understands that LIN is not cold and asks her in Spanish if that is the case. LIN again confirms in her response (1.23), but it is difficult to make out the rest of the utterance since her pitch is too low. ERI (1.24) makes a final attempt to refocus the talk and go back to the topic. His comment regards LIN's intrusions into their conversation as disruptive by marking a rupture between her and them so that they can proceed.

LIN is 3;10

- | | | |
|-----|-------|---|
| 25. | *LIN: | Grandma@s:eng&spa! |
| 26. | *LIN: | [- mix] Grandma@s:eng&spa I go [: I am going] pipi@s.
Grandma@s:eng&spa I am going pee. |
| 27. | *GRC: | [- spa] quieres hacer qué? @LIN
What do you want to do? |
| 28. | *LIN: | [- mix] I go [: I am going] pipi@s. @GRC
I am going pee. |
| 29. | *GRC: | [- spa] hiciste pipi (.) tú te limpeas o te limpeo?
You went pee. (.) will you clean yourself or do I clean you? |
| 30. | *LIN: | You because I don't know how to xxx xxx +... @GRC |
| 31. | *GRC: | [- spa] ya. @LIN |

There.
32. *GRC: [- spa] tu eres muy lista mhija [: mi hija]. @LIN
You're very smart daughter.

Plurilingual Transcript 6; ex. 2: FEB_20_2018_GRC_ERI_JUL_LIN_I don't have to talk spañol_B

Approximately four minutes have gone by since LIN affirmed that she does not have to speak Spanish. In the meantime, LIN goes to the restroom. Thus, she is once again unrattified. This gives ERI and GRC ample time to reengage in the topic at hand. Then, LIN who is sitting in the restroom calls GRC about eight times before shouting to get her attention (1.25). Then LIN tells GRC in a mixed language utterance “Grandma@s:eng&spa I don't have to go pipi” (1.26). Once again LIN interferes and captures GRC's attention, so she asks LIN in Spanish what she wants (1.27). LIN then repeats her mixed utterance to say that she has gone to pee (1.28). This is perhaps intended to mean that she is finished peeing, and as such her way of asking to be cleaned. GRC acknowledges and repeats her mixed utterance in Spanish (1.29). She also asks if she needs help being cleaned. LIN (1.30) tells GRC that she should clean her because she does not know how. GRC (1.31) wipes LIN before telling her (1.32) in Spanish that she is very smart. This last moment is yet another example of LIN's passive bilingualism, or her ability to engage in dilingual conversations. It shows that she may understand that in the Spanish question addressed to her there is a choice between an explicit subject “tu” (you) and an implicit subject “I” morphologically embedded in the verb “limpiar” (clean). GRC gives her the choice of wiping herself “¿tu te limpias?” or doing it for her “¿te limpeo?”. The extract ends when LIN asks GRC to do it since she does not know how to do it correctly yet. For this reason, GRC states that LIN is a very smart girl.

Synthesis

This multigenerational social encounter shows LIN's disengagement towards speaking Spanish when she is asked to do so. However, in her reluctance she produces the word “español” (Spanish) and then the word “pipi” (pee) to ask for help. The participation framework is multigenerational and shifts from a dyad to a triad, and then briefly again to a dyad between ERI and GRC and then between GRC and LIN. It includes GRC who only speaks Spanish and ERI who is bilingual. In their focused conversation the adults only speak Spanish. GRC addresses ERI and LIN in Spanish while ERI addresses GRC in Spanish, and LIN through Spanish, English, and language mixing. When addressing GRC, or ERI, LIN either mixes or resorts to English. Regarding bilingual socialization, several types of parental discourse

strategies seem to be deployed by the adults to encourage LIN to speak Spanish, even if she resists. However, since LIN essentially refuses to speak Spanish, it is by using Spanish, English and mixed language utterances that GRC, ERI and LIN come to understand each other. Partial understanding of LIN’s needs is thus facilitated through a bilingual, triadic, and multigenerational participation framework where all their linguistic resources are deployed. Each family member with their corresponding language abilities brings a unique piece to the linguistic puzzle. It is difficult to interpret child speech (Parisse & Morgenstern, 2010; De Houwer, 2021) in infancy and even later when child speech becomes clearer as is the case here. Even if LIN’s words are mostly intelligible at this stage, their meaning is not since the adults do not understand exactly what she is referring to. Moreover, her speech even seems incoherent at times which may be due to the non-target use of English conjunctions. Perhaps, when LIN says that she is not cold it may be interpreted as her desire to take her sweater off in preparation to go to the restroom. In other words, as Sekali (2012) advances, maybe LIN both wants to say that she needs to pee *and* that she needs to take off her sweater (to do so more comfortably) and thus packages these two ideas into one utterance. Even though a sweater is not the most relevant article of clothes to take off when going to the restroom, perhaps it is simply part of the routine process of undressing to go pee. Nevertheless, this interpretation may also be supported by the fact that she does not like to wear clothes inside the house. Moreover, this interpretative challenge is compounded by the fact that we are not able to analyze the speakers’ gaze or gestures. Finally, despite efforts to encourage LIN to speak Spanish, in the end LIN and GRC continue interacting dilingually, a language practice that is common within the family even among the bilingual adult speakers. As we have seen, LIN refuses to speak Spanish, even though she does use Spanish words on other occasions. However, her attitude to using Spanish changes over time, as we will see in the last analysis (January 2019) of this section. In the analysis that follows that took place on the second sampling period (August 2019) LIN’s attitude about speaking Spanish still seems far from positive. In the meantime, the table below summarizes the main characteristics of the first two analyses.

Table 48: Summary of key analytical features in examples 1 & 2

LIN’s age & example	Multimodal Framework	Multigenerational Framework	Participation Framework	Discourse Strategies	“Who speaks what language to whom?”	Dilingual Conversation or Passive Bilingualism
3;10 ex. 1 & 2	No	LIN (3G) JUL (3G)	From dyad to triad to dyad	ERI-MGS (mono)	LIN E GRC LIN M GRC LIN M ERI	Yes

		ERI (2G) GRC (1G)		ERI-LSS (bi) ERI-EGS (mono)	ERI E LIN ERI S LIN ERI M LIN ERI S GRC GRC S LIN	
--	--	----------------------	--	--------------------------------------	--	--

5.3.2 No gracias

The example below was previously presented to show how LIN's utterances were interpreted as being composed of at least two words, and moreover, that it was not simple to confidently deduce them (1.4). However, this will no longer be the issue of analysis at present. This is an interaction where LIN once again refuses to either speak Spanish, or to say thank you in Spanish. It takes place as the family is having dinner when all three generations are present in the continually shifting interactional frameworks. Some of the adult speakers are weaving in and out of Spanish and English as they are also moving about from the kitchen to the dining room table as they settle to eat. The interactional space is thus in full use through multimodal, and bilingual interaction that includes oral, gestural, and physical meaning-making movements. The following analysis underscores how LIN refuses, and then asserts her refusal to speak Spanish when ERI asks her for a napkin. It takes place on August 2018. ERI is sitting on one end of the table. To his left are ROX, LIN, and JUL who are sitting on their own chairs. GLO is making her way to the table from the kitchen and is about to sit on the other end of the table facing ERI. RIC and ALE remain in the kitchen at first. The camera is sitting on a tripod near a corner of the table. The main participants (ERI, ROX, LIN, and GLO) are visible so their gaze and gestures will be analyzed. Most of the multigenerational participants are beginning to eat so there is not much of a discussion at the time. As such, they may all be unrattified speakers, or overhears and there is no sense of distraction since not much is being said until ERI in Spanish engages in interaction.

LIN is 4;4

1.	*ERI:	[- spa] LIN (.) me pasas un servilleta por favor ? @LIN Will you hand me a napkin please?
2.	*LIN:	nope. @ERI
3.	*ROX:	[- spa] porqué no? @ LIN Why not?
4.	*LIN:	xxx xxx. @ROX
5.	*ERI:	[- spa] mira una servilleta. @LIN

6. *ALE: excuse me honey. @LIN
7. *GLO: [- spa] ten. @LIN
Here.
8. *LIN: hey this is my spot. @ALE
9. *ROX: xxx xxx.
10. *GLO: [- spa] dale a tu tío. @LIN
Give one to your uncle.
11. *LIN: oh +...
12. *GLO: [- spa] LIN esas servi(lletas) son muchas.
LIN that's a lot of napkins.
13. *RIC: here you go. @ALE
14. *ERI: [- spa] pues gracias LIN.
Well thank you LIN.
15. *ROX: [- spa] gracias. @LIN
Thank you.
16. *LIN: [- spa] no gracias.
No thank you.
17. *RIC: [- spa] pelochas. @JUL
Harry.
18. *JUL: Ricardo (..) Ricardo @GLO
19. *LIN: I'm not saying thank you.
20. *GLO: [- spa] Ricardo dejalo en paz.
Ricardo leave him alone.
21. *LIN: I'm not saying thank you guys.
22. *ROX: LIN (..) wait a minute.

Plurilingual Transcript 7; ex. 3: AUG_30_2018_LIN_ROX_ALE_ERI_GLO_JUL_RIC_MAR_No gracias.cha

Before addressing LIN, ERI briefly looks to his left and then proceeds to point with his right finger to the napkins that are sitting across the table. His gesture is also accompanied with his gaze that is looking in the same direction. ERI then calls LIN's attention (1.1) and asks her in Spanish if she will hand in him a napkin. ROX also quickly gazes at the napkins from the corner of her eyes but does not enter the dyadic framework. This signals her status as an overhearer who is indeed following the interaction, but not yet as a ratified speaker. Then, ERI's finger that had slightly fallen, shoots up again and points to the napkins when LIN turns her gaze to him. The figure below shows ERI addressing LIN in Spanish while he points to the napkins. It also captures LIN gazing at ERI following his call for attention.



Figure 34: ERI points at napkins when addressing LIN & LIN looks at him.

When LIN turns to the napkins following ERI's request, she quickly refuses (1.2) and ERI without saying a word lowers his head and shifts his body slightly to the side as he fixes her. His stance may be interpreted as a way to show surprise, or disbelief since LIN disagreed to execute such as small task. Nevertheless, a second later ROX (1.3) ratifies herself as she asks LIN in Spanish, and briefly looking at her, why she does not want to do it. The dyad thus becomes a triad and LIN (1.4) answers ROX while adjusting herself on the chair but looks at ERI and says something that sounds like "because I'm eating". However, her utterance is difficult to determine with certainty. Nevertheless, LIN's response serves to demonstrate her passive bilingualism. Through ROX's question in heritage Spanish she understood that a reason for denying ERI's request was requested on her part, which she gives, but in English. By this time GLO has made it to the other end of the table. Furthermore, it is evident that GLO was following the interaction as an overhearer since soon after setting her plate on the table, she leans over to grab the napkins that ERI asked for and hands them to LIN (who is still looking at ERI) thus ratifying herself in the now multigenerational, and multiparty interactional framework. As GLO does so, ERI lifts his head in the direction of what GLO is doing and then tells LIN in Spanish (1.5) that she is being handed napkins as GLO says here in Spanish (1.7). The figure captures LIN looking at the napkins seconds before taking them from GLO. It also shows ALE coming in from the kitchen as she approaches LIN from behind.



Figure 35: LIN looks at the napkins that GLO hands her.

After LIN takes the napkins from GLO, she is perturbed by her aunt ALE. As ALE approached the table (1.6) she excused herself before slightly moving LIN's chair. And as LIN begins to defend her "spot" on the table (1.8) turning her gaze from GLO to ALE, she takes the handful of napkins and wipes her own face. It seems thus that there is an overload of information in the multimodal bilingual language learning environment. On the one hand ERI addresses her in Spanish to request a napkin, her mother ROX does the same in requesting an answer, while GLO addresses her in Spanish to hand her the napkins. On the other hand, her aunt ALE addresses her in English. We thus have here a bilingual, multimodal, and multigenerational interactional framework that has expanded from the initial dyad to multiparty participation. Nevertheless, after ERI is finished taking a drink from his beverage, with a nod of the head he looks at LIN who is looking at him. Through this gesture, he is thus asking LIN again to give him a napkin, but LIN does not comply. As GLO finally sits on her chair, she commands LIN in Spanish (1.10) to give one to ERI. At this point LIN turns around and says "oh" (1.11), as if she had forgotten to follow through with the original request, and as she looks towards the napkins in the center of the table before realizing that she has a bunch in her hands. Complying with GLO's command also shows the level of respect that LIN has for GLO, her grandmother as opposed to ERI and ROX. Nevertheless, this is another example of LIN's passive bilingualism. In directing LIN in Spanish to give ERI a napkin, GLO uses the Spanish indirect object pronoun (*le*). LIN seems to understand that it refers to the napkins before proceeding to act accordingly as mentioned above. However, LIN does not act quick enough. While she is still looking at GLO, ROX swiftly snatches the napkins from LIN's hands and gives one to ERI and they both proceed (ERI and ROX) to wipe their mouths. Next, both ERI and ROX

(1.14 and 1.15 respectively) look at LIN and then sarcastically thank her in Spanish for the napkins thus shifting the multiparty interaction back to a triad. The image below captures the moment ERI and ROX address LIN to thank her for the napkins in Spanish.



Figure 36: ERI & ROX sarcastically thank LIN for the napkins.

A couple of seconds go by. ERI maintains his gaze on LIN and ROX shifts her gaze from LIN to her drink as she takes a sip. It is not clear whether LIN understood the meaning of ERI and ROX's sarcastic comment since there is absolutely no pragmatic reason to ask her to give thanks. LIN may have interpreted it as a request to either speak Spanish in general, or to say thank you in Spanish in particular, but it was neither of these meanings on behalf of the bilingual adults. The adults have not explicitly, or implicitly deployed any of Lanza's (1997) Parental Discourse Strategies to encourage LIN to speak Spanish since at the moment they seem to be more interested in the meal related activities. Nevertheless, it seems as though LIN inadvertently responds in Spanish (1.16) as she says, "no gracias" (no thank you) while also crossing her arms. LIN's stance here may be interpreted as a firm and multimodal way to show and to support her strong refusal to speak Spanish through her body language. Finally, LIN's reaction may further show that she is recurrently asked both to speak Spanish and to say thank you which perhaps led to her misunderstanding. She misinterprets the frequent directives that she gets in similar situations. The image below captures LIN's negative attitude, and her opposition to saying thank you in Spanish even if this is not what the adults have asked her to say.



Figure 37: Multimodally LIN says no thank you in Spanish as she crosses her arms.

Several more seconds go by, but none of the multigenerational participants, who are still busy eating, react to LIN's previous multimodal refusal in Spanish to say thank you. Therefore, LIN insists as she shifts her head the opposite direction (1.19) that she is not saying thank you and still with her arms crossed. LIN then repeats herself once again (1.21) but this time she relaxes her arms as she reaches for some French fries in the bowl in front of her. What is interesting is that LIN refuses two more times to say thank you even if the others have seemingly moved on, but this time in English while maintaining her arms crossed in the first instance. This is likely because in her first refusal (1.16) she realizes that perhaps she *did* say thank you in Spanish while declining to do so, therefore in her last two refusals (1.19 and 1.21) she does so in English to make it clear that she will not say thank you and moreover, that she will not say it in Spanish. The final screenshot below shows LIN's posture, or the emotional and physical behavior she is enacting towards being asked to speak Spanish.



Figure 38: Multimodally LIN refuses in English to say thank you.

Synthesis

Much like the first analysis in this chapter, the present bilingual, multigenerational, and dynamic multiparty interaction clearly depicts LIN's stance, or attitude towards speaking Spanish. However, this time it occurs when she *thinks* that she *is* asked to do so. As the multifaceted interaction unfolds, she inadvertently says thank you in Spanish, before insisting in English two more times that she will not either say thank you in Spanish specifically, or not speak Spanish in general. On the other hand, it may also be argued that by expressing her refusal to say thank you in Spanish, she intentionally both uses the expression and speaks Spanish. In other words, LIN does say thank you in Spanish, but not in a thanking speech act, but rather in a Spanish speech act intended to refuse. However, of these two interpretations, I privilege the former. Nevertheless, the analysis portrayed the family having dinner in their typical multigenerational framework. Moreover, we witnessed the unfocused participation framework shift from dyadic, to triadic, to multiparty interaction, and then back again to a triad as the adult overhearers ratified themselves into, and out of the interaction. Within this dynamic bilingual language learning environment, ERI and ROX, both second-generation heritage Spanish speakers addressed LIN in Spanish. GLO, a 1.5-generation speaker also addressed LIN in Spanish, while ALE, another second-generation heritage Spanish speaker in her brief dyadic exchange with LIN addressed her in English as she approached the table. In turn, LIN addressed ERI and ROX almost entirely in English except for when she thought that she accidentally spoke to them in Spanish. We may also note that language mixing was not present in the current analysis despite the high number of multigenerational bilingual speakers. Regarding socializing LIN to speak heritage Spanish, the present analysis allows us to confirm that the

adults did not explicitly or implicitly deploy any clear parental discourse strategies to get her to use Spanish. Even if LIN did not seem to capture the meaning of ERI and ROX's sarcastic comments, LIN subsequently emphasized her refusal multimodally in English and by crossing her arms. Moreover, this interactional sequence does open a space for LIN to develop her communicative skills whether she is addressed in Spanish or in English. As advanced by Blum-Kulka (2008),

Dinner time creates occasions not only for learning culturally appropriate levels of (in)directness for directive and expressive speech acting, but also for learning to interpret cues (meta-communicative markers) for subtle shifts in keying redefining the situation. Keying devices—such as sound modification and figurative language—act as local rules of interpretation, suggesting alternative readings of an utterance, as pretend play, humor, sarcasm, and irony. (Blum-Kulka, 2008: 92).

In this way, even if LIN did not quite capture the meaning of the bilingual adults' sarcasm, it became orally and visually clear that she would not cooperate with their requests both imagined (to say thank you) and real (to give ERI napkins). Furthermore, this allows us to briefly touch on the issue of socialization to politeness. This is a theme that will recur throughout the remainder of our analyses. Previous findings (Snow et al., 1990) suggest that even if cultural norms related to (im)politeness are indexed during dinnertime activities,

talk concerned with the business of having dinner does not seem to invite much attention to politeness, close inspection of dinner talk reveals a rich array of overt and covert ways of socializing politeness. Though direct instruction of politeness forms, at least in American families, is quite rare (Blum-Kulka, 2008: 92).

This statement is in line with the present analysis of the bilingual, and bicultural middle-class Mexican-American family in question, as well as with those that will follow. However, we must keep in mind that middle-class families in America are highly heterogeneous. Heterogeneity is further heightened as we move away from monocultural families and into tension ridden bilingual and bicultural communities of practice as is the case in the present study. Notwithstanding, Morgenstern, finds that much like French families, “American middle-class parents seem eager for their children to display what Henri Bergson called *politeness of manner* in ritualized forms that are explicitly taught through coordination of action and talk.” (Morgenstern, 2022: 1). In the present analyses however, we noted that attention to polite behavior is absent since the adults do not urge LIN to be polite, or put differently, to agree to ERI's initial request, especially since he is an older member of the family who has come to visit. In fact, it is only when LIN's grandmother GLO who commands her to do so that she finally initiates the process of handing over the napkins, but in no way was she asked kindly to do it herself. Finally, while efforts were made in the previous analyses to get LIN to use heritage

Spanish, this was not the case at present and the family carries on interacting dilingually. However, as mentioned earlier, LIN’s attitude to using Spanish seems to change over time. In the last analysis (January 2019) of this section LIN’s attitude about speaking heritage Spanish seems to have a more positive outlook. The table below summarizes the key interactional characteristics of the present analysis.

Table 49: Summary of key analytical features in example 3

LIN’s age & example	Multimodal Framework	Multigenerational Framework	Participation Framework	Discourse Strategies	“Who speaks what language to whom?”	Dilingual Conversation or Passive Bilingualism
4;4 ex. 3	Pointing & Gaze Stance Nodding Crossing arms Turning head to the side	LIN (3G) JUL (3G) ROX (2G) ALE (2G) RIC (2G) ERI (2G) GLO (1.5G)	From dyad, to triad, to multiparty, then back to triad Brief dyad between ALE and LIN	No	LIN E ROX LIN S ERI LIN S ROX ROX S LIN ALE E LIN ERI S LIN GLO S LIN	Yes

5.3.3 Sí español

The second multigenerational analysis above provides another glimpse into LIN’s (negative) language attitude regarding being asked to speak heritage Spanish by the adults in the participation framework. However, at the end of the data collection (nearly five months later) LIN’s attitude shifts, appearing to become more positive as she affirms that she does indeed speak Spanish. She even attempts to prove it by saying “español” and “dulces”, as well as by showing ERI that she can count in Spanish. This is also contrary to her first affirmation that she could speak Spanish but simply carried on speaking English. The exchange that ensues starts as two dyadic participation frameworks that then retract to one dyad, into which LIN attempts to ratify herself creating a triad, and where she speaks heritage Spanish. A key difference with respect to the first analysis is that two of the adult speakers are bilingual much like in the second analysis. It takes place in January 2019, and it is segmented in two smaller parts (A and B). ROX, ERI, LIN, and JUL are sitting at the dinner table. LIN and JUL are playing with goo and interacting in English. GRC is in the kitchen washing the dishes. There

are two adult conversations going on in Spanish. One between ERI and GRC related to a UCLA researcher's¹¹⁵ imminent arrival to the home. The other about GRC jokingly asking ROX to exchange her (GRC) old phone for her (ROX) brand new one since the ring tone is louder. The camera is set on a tripod at a corner of the dining room table. Thus, except for GRC, the other participants are visible allowing for gaze and gestures to be analyzed. The interaction is unfocused since there is no central purpose in either discussion. The talk is free flowing, so there is no real sense of distraction. The music playing in the background alternates between English and Spanish which is usual, and therefore colors the bicultural framework in this social encounter. GRC, ROX, and ERI are the ratified speakers. LIN and JUL are exposed to overheard Spanish. They are not addressed and are thus unrated speakers, until GRC absents herself to go to the restroom.

LIN is 4;9

1. *ERI: so, she wants to come up on your phone. @ROX
2. *ROX: she swears. @ERI
3. *ROX: but would she do that? @ERI
4. *ROX: is the question. @ERI
5. *ROX: no. @ERI
6. *LIN: she actually not do that sorry Eric.
7. *ERI: [- spa] LIN tú qué sabes tú no hablas español.
LIN what do you know you don't speak Spanish.
8. *LIN: [- spa] sí. @ERI
Yes.
9. *ERI: [- spa] sí qué? @LIN
Yes what ?
10. *LIN: [- spa] sí xxx [: hablo] español [: español]. @ERI
Yes I speak Spanish.
11. *ROX: like what sense would that make? @ERI
12. *ERI: [- spa] qué? @LIN
What?
13. *LIN: umum. @ERI
14. *ROX: Eric +...
15. *ERI: [- spa] LIN tú no hablas español.
LIN you don't speak Spanish.
16. *ROX: Eric.
17. *LIN: [- spa] sí. @ERI
Yes.

¹¹⁵ Dr. Ji Young Kim is a specialist in heritage language phonology in the Department of Spanish & Portuguese at UCLA. We met when I was a Visiting Graduate Researcher (VGR) there. I joined her L.A. Speaks project that seeks to document linguistic variation and identity in L.A. with the aim of identifying whether there is an L.A. accent in Spanish.

18. *ERI: [- spa] sí qué? @LIN
Yes what ?
19. *JUL: xxx.
20. *LIN: [- spa] sí xxx [: hablo] español [: español]. @ERI
Yes I speak Spanish.
21. *ERI: sí hablas español? @LIN
Yes, you do speak Spanish?
22. *LIN: [- spa] uno dos tres uno +... @ERI
One two three one +...
23. *ROX: [- spa] cuatro cinco seis siete +... @LIN
Four five six seven +...
24. *ERI: [- spa] sabes contar? @LIN
You know how to count?
25. *LIN: [- spa] cuatro cinco seis +... @ERI
Four five six +...
26. *ERI: [- spa] y qué más? @LIN
And what else?
27. *ROX: [- mix] I like it when she says Julian ven@s. @ERI
I like it when she says Julian come here.
28. *ERI: [- spa] y qué más? @LIN
And what else ?
29. *LIN: [- spa] dulce. @ERI
Candy.
30. *LIN: [- spa] dulces.
Candies.
31. *ROX: [- spa] dulces. @LIN
Candies.

Plurilingual Transcript 8; ex. 4: JAN_11_2019_ROX_LIN_JUL_GRC_RIC_ERI_sí español_A

When GRC goes to the restroom, only ROX, ERI, JUL, and LIN are visible and sitting around the table. ERI, an overhearer does not intervene in GRC and ROX's previous phone related dyadic exchange. However, after about 30 seconds go by since GRC is out of sight, ERI comments on their issue thereby forming a dyad with ROX. With his attention focused on his phone ERI (1.1) references GRC wanting ROX's phone. At the end of his utterance, he lifts his gaze and looks at ROX. Following his statement, ROX who has just sat down looks at ERI and answers him with a sort of one-sided conversation. First, ROX's comment (1.2) is a common expression in this community of practice. It is said sarcastically and intended to show disbelief about something outrageous. GRC asks ROX to trade her old iPhone for ROX's brand new one. However, not only did she just buy it, but it was also very expensive. Thus, GRC's proposition does not make sense to ROX. Up to here ROX and ERI are making eye contact, establishing their engagement in the conversation. Next, ROX follows her comment with a

rhetorical question. ERI's gaze goes back to his phone as ROX asks (1.3) if he thinks that GRC would proceed with such a trade. Her intention rather than to get an answer is to make a point. ERI does not comment orally but he does respond with his body. He shakes his head 'no' while remaining focused on his phone. Without losing momentum ROX then adds "is the question." (1.4) that she answers (1.5) with a swift, "no.". ERI does not comment further, and his attention remains on his phone. Then, without looking at ROX or ERI, LIN ratifies herself into the conversation to comment on the situation as she plays with her goo¹¹⁶. At this point the participation framework shifts from a dyad to a triad. LIN (1.6) confirms ROX's affirmation. She says, "she actually not do that sorry Eric". LIN's utterances can thus be taken to be a repetition of ROX's previous utterance. It is also a way to break into the interaction by taking the floor and addressing the current and contentious topic of conversation. As an emerging communicatively competent member of her cultural framework her participation also shows that she shares "certain patterns of thought, ways of understanding the world, making inferences and predictions." (Duranti, 1997: 27). Notwithstanding, up to this point, ROX and ERI entertain this idea in English. However, following LIN's affirmation, ERI (1.7) in Spanish asks LIN how she would know if she does not speak Spanish. As such, this is a way for ERI not to grant LIN authorization to speak. Like when addressing ROX, ERI only looks at LIN at the end of his utterance. ERI's question is also likely in Spanish since ROX and GRC's dyadic exchange was in Spanish. Furthermore, ERI's question turned statement is meant to tease LIN to get her to defend herself by speaking Spanish if she really knows how. This is a way for her to gain the right to participate. Within Lanza's (1997) discourse strategies this may fit under the Expressed Guess Strategy on ERI's behalf. Through his question he switches from addressing ROX in English to addressing LIN in heritage Spanish. His intention is to shift and limit the conversation to Spanish. It is thus a monolingual discourse strategy. After ERI's confrontational statement LIN (1.8) makes eye contact with him and says in Spanish that she does know how. The figure below captures the moment when LIN looks at ERI to affirm that she speaks Spanish.

¹¹⁶ According to Oxford Languages online dictionary the term "goo" is an informal noun and defined as "a sticky or slimy substance ... similar (to) sludge, muck, slush, stickiness gunk" (Accessed August 15th, 2022).

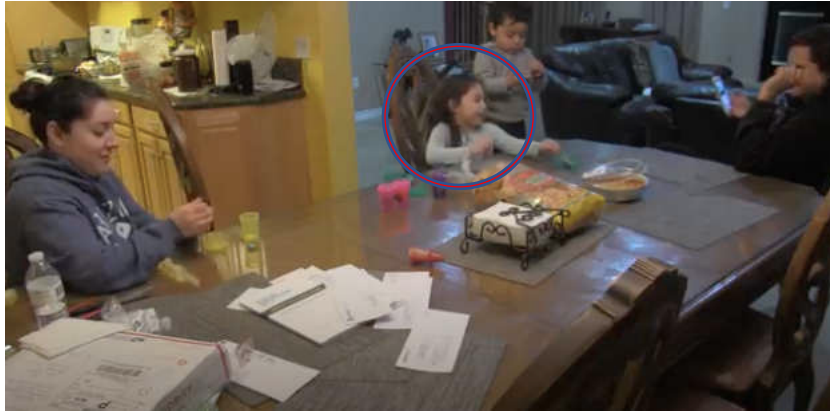

Figure 39: LIN looks at ERI to affirm that she speaks Spanish.

Then she looks at ROX. Perhaps by gazing at ROX, LIN seeks support from her mother, but ROX does not comment, and her gaze does not meet LIN's since ROX is focused on the goo that she is preparing for her. It therefore seems as if LIN is on her own. Nevertheless, LIN's affirmation meets the expectation of the monolingual discourse strategy since 1) she has answered and 2) she has done so in Spanish. Now that they have successfully switched to Spanish ERI pursues (1.9). With his gaze back on his phone he attempts to get LIN to develop by asking her in Spanish "yes what?". LIN answers in Spanish as best as she can to affirm again that she does speak Spanish. However, she does not look at ERI as she says this because at the same time, she bends over to pick up a toy that she drops. ERI's strategy to pursue seems to pay off since LIN does attempt to develop. Moreover, her statement shows that she has difficulty producing the Spanish noun "español". In the meantime, ROX who is a ratified speaker but has not intervened asks ERI (1.11) how GRC's proposal makes sense. ROX only looks at him at the end of her utterance, but ERI does not look at her. Also, in ROX's attempt to take the floor again she speaks English even though both LIN and ERI attempt to communicate in Spanish. In a sense ROX seems to disregard ERI's efforts to create a Spanish speaking language learning environment since she could have addressed him in Spanish. ROX's question does not sidetrack ERI from his objective. He ignores ROX, even though they are still in a triadic framework, and then focuses his gaze on LIN (1.12), after he asks in Spanish, "¿qué?" (what?). The figure below captures the moment when ERI turns his gaze from his phone to LIN to ask her what she has just said.

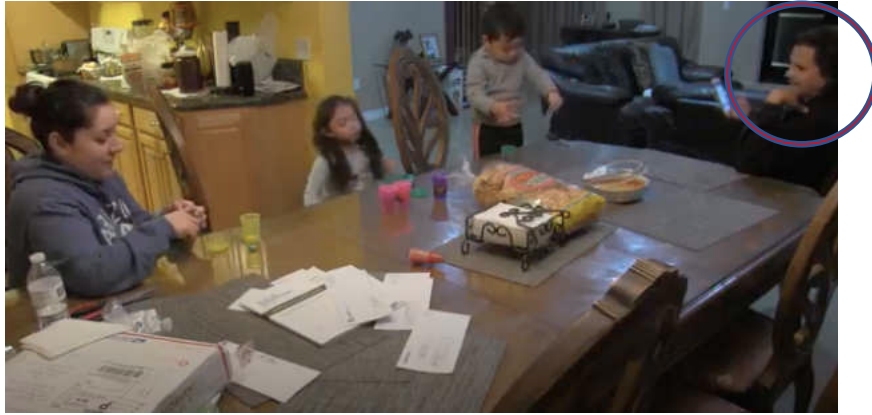

Figure 40: ERI gazes at LIN asking her to repeat herself.

LIN looks at ERI (1.13) as if to disagree with his idea that she cannot speak Spanish. Without looking at him ROX (1.14) unsuccessfully tries to regain ERI's attention by calling him. Next, the following interactional pattern is like what we have previously seen (1.1-1.14). ERI (1.15) teases LIN again. He looks at her and tells her that she does not speak Spanish. ROX (1.16) without looking at ERI calls him again, but she remains ignored. Then, LIN looks at ERI as she says yes again in Spanish (1.17). In Spanish and with his gaze fixed on LIN ERI asks, "yes what?" (1.18) as he insists with a nod of his head. His subtle shake of the head may be understood as a way to nonverbally defy her so as to provoke a response. This time LIN (1.20) holds ERI's gaze and says in Spanish that she does speak Spanish, but as she pronounces the word "español" it seems as if her eyes quickly look away and then back at ERI. While it is difficult to confirm due to the quality of the audio in this segment, it appears as though this time LIN attempts to use the Spanish verb "hablar" (to speak) even though she has difficulty producing it in the first-person present tense. She also runs into the same difficulty producing the noun Spanish the second time around. Following LIN's renewed confirmation and attempt to speak Spanish, ERI (1.21) looking at LIN asks her in Spanish if she does indeed speak Spanish. With a nod of the head LIN says yes as she looks at ERI. To further prove her point and maintaining her gaze (1.22) she begins to count in Spanish. In the figure below LIN while maintaining her gaze on ERI begins to count.

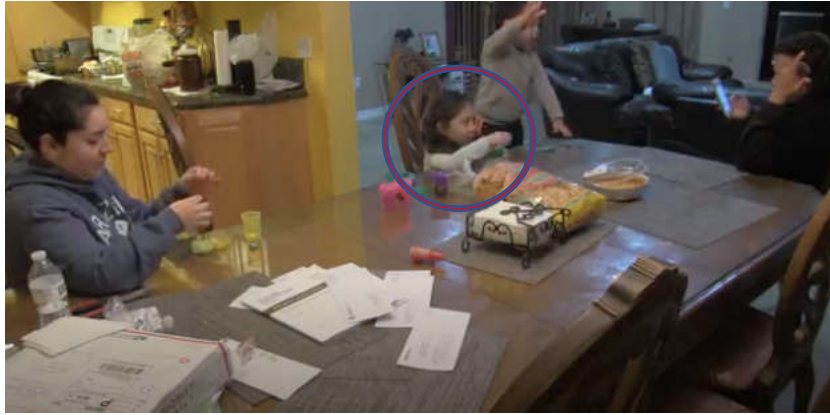

Figure 41: LIN maintains her gaze on ERI & begins to count to prove that she speaks Spanish.

However, after she counts to “three” she hesitates as to what number comes next. Her gaze wonders, likely because she is not sure either what number follows three, or because she does not know how to sound out the number four in Spanish. Therefore, as she starts to say “one” again she begins to duck beneath the table, which could be interpreted as a sign of embarrassment for not getting the numerical sequence right. Perhaps, for LIN, this is a realization that she does not know Spanish that well contrary to what she previously affirmed. The following two figures illustrate the directions of LIN’s gaze. The first one shows LIN looking up into space as she tries to recall what number comes after three. It is followed by the image where she sort of hides when she runs into trouble and as she begins counting starting with number one again in Spanish.

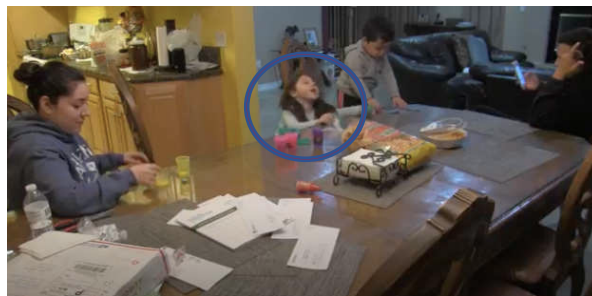

Figure 33: LIN's gaze wonders as she tries to recall the next number in Spanish.



Figure 34: LIN hides behind the table as she starts counting with number one again.

ROX leaving behind the phone issue for a moment and without looking at LIN assists her in Spanish. ROX thus models to LIN in Spanish what comes next (1.23). At this point all three ratified speakers (LIN, ROX, and ERI) are in tune and speaking Spanish. So, ERI (1.24) asks LIN in Spanish if she knows how to count. LIN following ROX's assistance quickly looks at her (1.25) and repeats in Spanish the modeled numbers while looking into space again. When LIN finishes counting ERI (1.26) looks at her to ask what else she can do in Spanish. And even though ROX looks at ERI (1.27) and breaks the Spanish only spell with the language mixed utterance, "I like it when she says Julian ven@s." (come here), this seems not to perturb LIN even though both LIN and ERI's gaze are drawn to ROX. Following ERI's desire to know what else she knows how to say in Spanish LIN with her gaze on ROX says (1.29), "dulce" (candy) and then looks at ERI to say (1.30) "dulces" (candies). Her facial expression at this moment seems to show more confidence in uttering these two Spanish words that she has easily drawn from her bilingual repertoire, and her stance is therefore more optimistic. Two points should be mentioned. First, LIN's contextually appropriate response to the Spanish questions (1.26 and 1.28) shows that she has passive comprehension of the Spanish question, or at least of the word "más" (more). It also shows that she understands that an answer in Spanish is expected which she provides. Second, ROX's statement (1.27) demonstrates that she is aware of the way LIN speaks. Her commentary explicitly displays a positive attitude to the language that she assumes LIN is speaking, namely Spanish. However, this positive feedback may serve to reinforce socialization into a mixed language mode of communication, as opposed to Spanish both through her attitude as well as through her own mixed language production. What ROX likes about LIN's speaking style is none other than the mixed construction, "Julian ven@s." (Julian come here), which is also frequently inversed in spontaneous interaction. To illustrate this mixed language style, I turn your attention to the entry below that is taken from my digital journal. On the second day after arrival in L.A., or on August 22nd, 2018, I made the following observation.

This morning I overheard ROX call JUL by saying 'Ven Julian' followed by 'come here' when JUL woke up crying. (Alvarez, 2018).

Only after two days in the field, I noticed a mixed language style when calling. On this occurrence the utterance began with the Spanish verb come and JUL's name was pronounced with English phonology. This is contrary to ROX's comment above several months later where she inverts the subject and the verb but assigns the same phonological features to both words. Furthermore, ROX's observation shows that LIN contrary to her use of the verb "hablar" (to

speak) correctly uses the verb “venir” (to come) in the third-person present tense. Use of the tense “ven” (come) presented within constructions such as “ven X”, and/or “X ven” as briefly touched on above to call one another within the family is frequent. One might also argue that the proper name “Julian” is neutral. In this case, a construction such as this may be simply coded as Spanish. However, it is typical of this family to implicitly play a sort of ‘Sound Game’ as discussed in the Chapter 4. For certain proper names and common nouns, the family will produce them with English or Spanish phonology. Alternating between sounds is quite relevant since “Ochs demonstrated that very small children are sensitive to and acquire knowledge of socially relevant features of particular phonological, grammatical, and lexical forms that mark salient features of social hierarchy and contextual differentiation.” (Ochs & Shieffelin, 2008: 10). A few salient examples, some in which LIN readily partakes include proper names such as Julian [ˈdʒuːljən] versus Julián [xu.ˈljã̃n] as in the present case, Roxy [ˈraksɪ] versus Roxy [ˈro.si], or Eric [ˈerɪk] versus Eri(c) [ɛ.ˈri]. Even the family dog is included: Coco [ˈkoukou] versus [ˈko.ko] in Spanish where the saliency lies on the aspirated /k/. Thus, this supports the coding of the utterance above as a mixed language utterance since “Julian” is pronounced in English whereas “ven” is produced in Spanish. Finally, I wanted to underscore that the ‘Sound Game’ does not appear to be limited to the family’s language practices, but rather that it extends into the community. The observation below therefore shows that this seems to be a practice that also occurs in the school. It is taken from my in-class observations, and it is dated October 24th, 2018. I observe the following:

ALL: Jesús and Ismael

(interesting that COM, T.A.’s, and classmates pronounce these two names with Spanish phonology [they are religious]) (Alvarez, 2018).

From my brief note above we thus see that LIN’s teacher, the teacher aids, as well as her classmates (who are almost all Latinos) produce the names of two other classmates with Spanish phonology. We may also note that they are religious names and as such we get a sense of the Hispanic pulse at the community level that subsequently influences their linguistic practices. Notwithstanding, the present analysis shows LIN’s commitment to speaking Spanish. Also, at least one type of discourse strategy (Expressed Guess Strategy) is deployed by ERI to encourage LIN to speak heritage Spanish. Teasing as a strategy with persistence also results in LIN using Spanish a little bit more each time she takes the floor. These types of interactions may help her use and thus expand her utterances from one to multiple word productions even if they are not always on target. Furthermore, as LIN engages in Spanish, she

is assisted by the ratified bilingual members of the triadic participation framework ROX and ERI. ROX explicitly assists LIN in modeling her numbers correctly in real time when she gets stuck. ERI through his teasing strategy implicitly models the use of the Spanish words “español” (Spanish), “hablar” (to speak), and “saber” (to know), but also affirmations, negations, and questions multiple times. The interaction also reveals that while she may have difficulty producing Spanish tenses, she shows knowledge of the (not so complex) Spanish singular and plural noun system. Even if it took some effort to switch and maintain the language of conversation from English to Spanish, in the end it seems to pay off. It helps LIN affirm her ability to speak Spanish by using it. At the same time, this bilingual triadic interactional framework also paves the path for the continued use of heritage Spanish. The plurilingual transcript below follows the previous interaction. It further reveals how a seemingly innocent remark about LIN’s language use not only reinforces her use of Spanish, but also how it also engenders the use of language mixing as a mode of communication.

LIN is 4;9

- | | | |
|-----|-------|--|
| 32. | *ERI: | [- spa] Julián ven.
Julian come. |
| 33. | *LIN: | [- spa] Julián ven.
Julian come. |
| 34. | *JUL: | what? @LIN |
| 35. | *JUL: | ok. |
| 36. | *ERI: | [- spa] ten cuidado. @LIN
Be careful. |
| 37. | *ROX: | [- spa] LIN él quién es?
LIN who is he? |
| 38. | *LIN: | [- mix] un Julian@s. @ROX
A Julian. |
| 39. | *ROX: | [- spa] es tu hermano. @LIN
He is your brother. |
| 40. | *LIN: | [- mix] my manona@s [: hermano].@ROX
My brother. |
| 41. | *LIN: | [- mix] I got a manona@s [: hermano].
I got a brother. |
| 42. | *ERI: | [- spa] es tu hermanito LIN.
He is your little brother LIN. |
| 43. | *LIN: | [- spa] sí. @ERI
Yes. |
| 44. | *ROX: | wait let me see. @LIN |
| 45. | *LIN: | what. |
| 46. | *LIN: | xxx xxx. |

- | | |
|-----------|--|
| 47. *ERI: | [- spa] aie no.
Goodness. |
| 48. *LIN: | [- spa] aie no.
Goodness. |
| 49. *ROX: | but like what logic does that have +... @ERI |

Plurilingual Transcript 9; ex. 5: JAN_11_2019_ROX_LIN_JUL_GRC_RIC_ERI_sí español_B

ROX seems to approve of LIN's mixed speech style as discussed above. ERI's gaze remains focused on ROX. Following LIN's last utterance in Spanish (l.30) ROX without looking at LIN repeats it with a rising intonation. In child-adult interaction this may be a way for the adult to confirm a target production. Moreover, LIN's previous utterance in heritage Spanish appears to impact ROX's language choice to use Spanish. However, LIN does not mind ROX, and her gaze remains focused on ERI. Following ROX's statement ERI's gaze turns to JUL who is standing on a chair playing with the goo on the table next to LIN. JUL is the closest to ERI at about arms-length away. In this interaction he has been an unrati ed overhearer. However, ERI (l.32) with a mocking expression on his face says to him in Spanish, "Julián ven" (Julian come here). ERI's intention is not to ratify JUL in addressing him, but rather to see if LIN will repeat after him since she is now ratified in the triadic participation framework. Within Lanza's (1997) proposed discourse strategies his utterance fits under the Repetition Strategy. It is generally a response to a child utterance where the adult repeats what the child says in the other language, or Spanish. In this case however,

Guided repetition is similar to prompting in that more expert members explicitly model linguistic forms for imitation by less expert members. Guided repetition activities, however, are not embedded in ongoing interaction. Rather, they *are* the ongoing interaction, staged for pedagogical purposes (Moore, 2011: 214).

There is no explicit request for the child to respond although s/he may repeat the adult's repetition. Here, the participation framework allows for ERI to expand this strategy in at least three different ways. First, it is a repetition of an adult's utterance which would not be possible in an adult-child dyad only. Second, he recodes a mixed utterance into a Spanish one, as opposed to recoding from one unilingual utterance to another. Third, the target of the utterance is clearly not ROX, but LIN. The intention is to have her speak Spanish based on the previous mixed adult input. Nevertheless, this is a monolingual discourse strategy that pays off. LIN (l.33) repeats in Spanish "Julián ven" (Julian come here) while looking at ERI rather than at JUL. This may show that the pragmatic function of her repetition is not to get JUL to come to her, but rather to use the modeled Spanish. It seems to be a game. As a result, however, this dynamic interplay ratifies JUL into the interaction thus going from a triadic to a multiparty

participation framework. JUL (1.34) asks, “what?” first looking at ERI, then turning his attention to LIN. Then LIN looks back at JUL. The monolingual discourse strategy also seems to reinforce the use of Spanish as opposed to language mixing, even if they both have the same function. Essentially, LIN is confronted with two ways to call JUL. ROX presents a mixed language form that she previously validated. ERI presents a Spanish form that was not explicitly endorsed. In the end, LIN selects the monolingual Spanish utterance, though this is likely because it is the language of the previous utterance. Notwithstanding, her production of “Julián” [xu. 'ljã] in Spanish shows that much like the adults, LIN is socialized into playing the Sound Game. Next, JUL (1.35) says ok to LIN thinking that she has called him showing that he too is developing passive bilingualism in Spanish. LIN tries to lift him off the chair. JUL does not like this and whines. ERI (1.36), hardly taking his eyes off his phone tells LIN in Spanish to be careful. When LIN releases JUL, ROX looks at LIN asking her in Spanish (1.37) who JUL is. In doing so, ROX attempts to keep LIN engaged in Spanish. LIN intermittingly looks at ROX and says in a mixed language utterance, “un Julian@s”. LIN’s answer is not on-target. First, the expected response is to be in Spanish. Second, because the use of “un” (a) is not necessary with proper nouns in Spanish. On the other hand, LIN’s language mixing reveals that she understands the Spanish gender system. Through her use of the indefinite masculine article “un” (a) she shows on-target gender agreement with the male subject (JUL). Moreover, she also demonstrates her ability to say Julian ['dʒu:ljən] with English phonology. Within a matter of seconds she displays her ability to call her brother using the English and Spanish sound systems, thus showing fine attunement to the phonological cues in her bilingual language learning environment. Finally, LIN’s response to ROX attests to her passive comprehension of Spanish as well as when an answer is solicited. Following LIN’s language mixing ROX (1.39) gazes at ERI before turning her attention to LIN to tell her in Spanish that he is her brother. Like above, ROX’s utterance can be considered a monolingual discourse strategy under Repetition. Much like ERI does previously with ROX’s mixed utterance, ROX takes LIN’s mixed language utterance and reformulates it into Spanish substituting JUL for “hermano” (brother). Even if ROX’s intention is not for LIN to repeat, she does so (1.40), but with another mixed utterance. LIN’s mixed production may further reveal that she might have some underlying knowledge of the Spanish second person singular possessive pronoun “tu” (your) that she correctly translates into the English first person possessive pronoun “my” immediately followed by the Spanish, “manona@s [: hermano]”. At the end of her mixed utterance, LIN looks at ROX smiling as she plays with her goo, but ROX does not react, nor does she look at her. LIN seems to be having a good time. However, it is difficult to say if her non-target

pronunciation of brother in heritage Spanish is related to her difficulty in analyzing the speech stream (even though it seems perfectly clear), or if she says it this way for fun. LIN (L41) pursues jokingly and in yet another mixed language utterance she looks at ROX and says, “I got a manona@s [: brother]”, but again ROX does not react or look at her. The fact that LIN repeats her mixed utterance makes re-emerge the gender issue on two fronts. First, grammatically speaking we may ask if she really has acquired the Spanish gender system. Second, socially speaking we may question if she is intentionally and jokingly indexing JUL with a feminine noun. To help untangle these questions we may turn our attention to the observation below. It is based on an ethnographic entry dated September 6th, 2018, in the digital version of my field journal. While having lunch with the family, I jokingly refer to her grandfather (GUI) using a feminine adjective ending in “a¹¹⁷”.

[In the evening with family sitting around the dinner table ERI to GUI]

ERI: Eres una gorda [You’re fat (in the feminine)]

LIN: He’s not a gorda@s because he’s a boy [to ERI]

That may, or may not be beyond them, but I briefly commented on what LIN said and suggested that I was curious as to why/how LIN (knew) that gorda@s is for girls and gordo@s is for boys (Alvarez, 2018).

Following my joke, LIN’s contextually appropriate response reveals that she is bothered by my remark. I cannot refer to her grandfather using a feminine grammatical form since he is not a girl. Furthermore, in Chapter 4 I discuss how LIN teasingly calls ERI a “fat girl” following her mother ROX. It seems thus that LIN may be very aware of the grammatical gender system in Spanish. Moreover, it may be argued that through socialization she too is beginning to play with gender role indexation as the adults do. In other words, “in multilingual communities gender can be indexed by language use, language choice, language maintenance, language shift, and codeswitching.” (Pavlenko, 2001: 128), that is language mixing as is the case with LIN. Through the language learning process LIN may also understand that gender and identity are inextricably linked (Norton, 2000). The extract below drawn from my digital journal further shows that LIN understands the Spanish gender system. The reflection is based on an observation that took place in class on November 5th, 2018. I note:

LIN: Him a boy.

ERI: HE’S a boy, HE’S

¹¹⁷ In the Spanish gender system, generally the “a” marks the feminine while the “o” marks the masculine.

LIN: Niña, boy. See, I know.

[this exchange between researcher and LIN happened as the students were asked to get in line based on 'boy' or 'girl'. When LIN said 'him a boy', I emphasized the correct pronoun twice 'he's' and not 'him' in the structure. However, LIN thought that my recast/correction was based on her accurateness in determining gender. So, LIN replies "niña, boy. See I know." When she utters this, she points first at a niña, or girl and then at a boy next/across from her. (Alvarez, 2018).

Through these examples, one which took place in the home and the other in the school, we see that LIN has functional knowledge of the Spanish gender system. What we do not know however is why ROX does not mind LIN regarding her two (sensitive?) mixed language productions. Perhaps it is because on occasion, curiosity about JUL's emerging sexual orientation has been jokingly raised among the family members¹¹⁸. Despite that, and considering ROX's non responsiveness, ERI while consulting his phone tells LIN that JUL is her little brother. The pattern that we see again is ERI taking a mixed utterance, but this time from LIN and reformulating it in Spanish. ERI's intervention aligns with a monolingual discourse strategy under Repetition. It helps model once again the correct way to reference her brother in Spanish whether she was intentionally playing with gender indexation, or not. Finally, ERI's utterance may implicitly send the message that joking about gender is an adult matter since the line is fine between silly teasing and hurtful bullying. ROX's silence may also index the same idea. To show her cooperation, LIN (1.43) says yes in Spanish, but without looking at ERI since she is engaged with ROX. LIN is clearly enjoying play time (1.44-1.46) but remains attentive to the adult discourse. ERI (1.47), with his attention still on his phone marks the end of the interaction with a Spanish exclamation of fatigue common within the family. Then, LIN (1.48) looks at him, repeats after him and laughs almost as if mocking him while sustaining her gaze. Nevertheless, ERI does not react. Finally, taking advantage of the fact that ERI seems to be done with his impromptu Spanish "lesson" into which she was drawn, ROX (1.49) looks at ERI to reintroduce the phone issue. Her comment thus draws both ERI and LIN's gaze back to her as she continues to seek logic in GRC's proposal. By now however, LIN has defended her ability to speak heritage Spanish. She shows that she can ratify herself as a speaker along with ERI, ROX, and form through her engagement a bilingual multiparty framework with JUL. Moreover, LIN is capable not only of influencing language choice, but also of giving her opinion or defending those of others.

¹¹⁸ Of course, personal experience with the family shows that they are open and welcoming of all people regardless of their sexual orientation.

Synthesis

Contrary to the previous two analyses, the present dynamic interaction shows LIN's commitment to speaking Spanish, especially when she is challenged by an expert adult bilingual speaker. The participants represent only the second- and third-generation, so the interaction flows between Spanish, English, and language mixing. ROX addresses ERI in English and through language mixing, but she does not address him in Spanish. When addressing LIN, ROX does so in English and in Spanish, but does not mix with her. ERI addresses ROX only in English, but he addresses LIN only in Spanish. LIN mixes languages when she answers ROX and uses English and Spanish to address ERI. Moreover, ERI and ROX seem to recode mixed language utterances into unilingual Spanish ones when interacting with LIN. In terms of discourse strategies, the Repetition Strategy seems to be deployed by both adults when engaging LIN and each other in heritage Spanish. This strategy helps maintain, or rather promote monolingual interaction in Spanish even if it is short lived. If LIN attempts to formulate Spanish, it is through the support of child-directed Spanish by the adults. The bilingual triadic participation framework thus facilitates LIN's use of Spanish. ROX and ERI with their corresponding language abilities and discourse strategies help create a bilingual language learning environment that seems to favor the use of heritage Spanish. We may further ask what the role of *play* is in language development. Kibler et al. (2014) discuss second-generation Latino children's influence on the language use of their younger siblings. These researchers find that along with literacy-based activities, play cultivates the use of the dominant language. To contextualize Kibler et al.'s findings, I turn your attention to the following observation. It took place on September 6th, 2018, and it comes from the digital field journal. I write the following:

I overheard LIN teaching JUL to "say: red" and "say: blue" while playing with ERI's colored pill containers. Interesting to hear older sister LIN teach her baby brother JUL. In this sense, input is offered to JUL from a range of speakers each with their level of proficiency ... LIN though on the lower end is teaching (Alvarez, 2018).

The note above thus aligns with what Kibler et al. have found in that it shows how play cultivates the use of the dominant language. LIN is teaching JUL her younger brother how to name different colors in English. In this case however, rather than being second-generation siblings, they represent the third-generation. Nevertheless, within the interactional frames analyzed above, it would appear as though play is also a vector that promotes the learning of the *non-dominant* Spanish. Furthermore, contrary to Kibler et al.'s study, it is not among siblings that language learning takes place, but rather across generations: it is because ERI and

his niece ROX actively promote Spanish as second-generation heritage bilinguals that play fosters a Spanish learning environment. The present investigation may show the added value for heritage language socialization in multigenerational participation frameworks. Play helps foster a laidback, joyful atmosphere where both languages are freely used, manipulated, and mixed. Finally, the present analysis opens a window into our understanding of how LIN may be socialized into certain types of language use. For example, language mixing through ROX’s positive commentary, or playing the ‘Sound Game’ by using the Spanish and English phonological systems for the same proper names. This also includes socialization into playing with gender indexation. It is a language use style that is generally deployed by the adults. However, LIN’s appropriation of this style speaks to her developing linguistic abilities as they are used within her community of practice. This comes from the fact that LIN is confronted to more types of adult input because her life is rooted in bilingual and bicultural multiparty and multigenerational social encounters which she is finely attuned to. It is also the non-child-directed speech that she overhears that socialize her into this competence. In other words,

knowledge of how language relates to gender is not a catalogue of correlations between particular linguistic forms and sex of speakers, referents, addressees and the like. Rather, such knowledge entails tacit understanding of how particular linguistic forms can be used to perform particular linguistic work (such as conveying stance and social action) (Ochs, 1992: 342).

Through these examples we have seen that LIN’s language attitude fluctuates longitudinally when asked to speak heritage Spanish. In the ensuing analyses below, we see how she also resists both English and Spanish translation equivalents in spontaneous interaction. The table below summarizes the key interactional findings in examples four and five above.

Table 50: Summary of key analytical features in example 4 & 5

LIN’s age & example	Multimodal Framework	Multigenerational Framework	Participation Framework	Discourse Strategies	“Who speaks what language to whom?”	Dilingual Conversation or Passive Bilingualism
4;9 ex. 4 & 5	Gaze Head shake for negation Nodding with insistence Wondering gaze	LIN (3G) JUL (3G) ROX (2G) ERI (2G) GRC (1G)	From two dyads to one, then to a triad, then to multiparty	ERI- EGS (mono) ERI-RS (mono) ROX-RS (mono)	LIN E ERI LIN S ERI LIN M ROX ROX E ERI ROX M ERI ROX S LIN ROX E LIN ERI E ROX ERI S LIN	PC

	Hiding					
--	--------	--	--	--	--	--

5.4 Accepting Spanish <-> English translation equivalents, or not

5.4.1 You're my *tío@s*

This multigenerational interaction further considers the interplay between LIN's heritage Spanish use and her mixed language utterances. Here however, she is not specifically asked to speak Spanish. Also, LIN is not taunted about her inability to speak Spanish as we previously noted. The adults in the participation framework represent all three generations, so the interaction is colored through the use of Spanish, English and language mixing. In doing so, LIN is provided with both Spanish and English translation equivalents based on what she says or what she does. The adults do so through language mixing, as well as by using Spanish. Nevertheless, the analysis shows how LIN produces mixed language utterances first by refusing, and then by accepting the translation equivalents. The interaction takes place in February 2018 and it is split into three smaller segments (A, B, and C). Since the camera is sitting on the table, the sound quality is good, but it is difficult to consider gestures and gaze as the speakers are not visible most of the time. The first part begins with RIC and GRC getting home after running errands. They are ratified speakers and converge with ROX, ERI, LIN, and JUL who are around the kitchen and the dinner table. LIN and JUL are playing underneath the table. They are unrati ed overhearers. GRC engages with ROX in Spanish to discuss a babysitting incident that happened the night before while the kids were under her and GRT's watch. It appears as though one of the kids broke the T.V.'s remote control. They are trying to figure out how it happened and who is responsible. Adults and children alike are called into question. Despite that, the interaction in the bilingual multigenerational and multiparty framework is unfocused since the incident is not that serious. The talk is free flowing as they get ready to eat. When GRC asks RIC if he would also like some rice with his meal, he moves around the table and closer to the kitchen. In doing so, he notices that LIN and JUL are under the table.

LIN is 3;10

- | | | |
|----|-------|------------------------------|
| 1. | *RIC: | what's up LIN? |
| 2. | *LIN: | xxx. @RIC |
| 3. | *GRC: | [- spa] porqué? @ROX
Why? |
| 4. | *RIC: | wassup [: what's up] @LIN |

- | | | |
|----|-------|--|
| 5. | *LIN: | you scaring me xxx xxx. @RIC |
| 6. | *RIC: | [- mix] what's up Mamá@s:eng&spa? @LIN
What's up Mom. |
| 7. | *RIC: | what's up muckbutt? @LIN |
| 8. | *LIN: | stop scaring me little shit dock@n. @RIC |
| 9. | *RIC: | xxx Chucky_Cheese. |

Plurilingual Transcript 10; ex. 6: FEB_22_2018_LIN_ROX_JUL_RIC_GRC_you're my tío_A

RIC looks under the table. He greets LIN (1.1) using an informal idiomatic expression. His voice is loud and clear but seems to have caught LIN off guard. Startled, LIN (1.2) emits an unintelligible sound in response. Then RIC looking down towards LIN (who is not within the camera's scope but seems to have crawled out) repeats his greeting in a shorter and more informal form (1.4). As a result, RIC and LIN form an interactional dyad. LIN thus tells RIC (1.5) that he scared her, confirming that she was surprised when he first said hi. RIC however does not react to LIN's comment and proceeds to greet her two more times, once in a seemingly mixed language utterance (1.6), and the other time in English (1.7). Perhaps, RIC's intention is to get LIN to greet him in return following convention, but this seems to fail. Moreover, in both cases, RIC's greetings are ambiguous. First, we do not know if his reference to LIN is in Spanish, English, or in a blend of both (1.6). We do know though that regardless of the 'language category' that they are both employed as terms of endearment. In RIC's second utterance (1.7) things become less clear, even if we know it is only in English. RIC's reference to LIN may either be a term of endearment, or a passive aggressive term of endearment. LIN seems to entertain the latter. LIN (1.8) thus rebounds and says to him, "stop scaring me little shit dock.". Even if the term expressed by RIC apparently refers to people with poor showering habits, given the context, as well as his demeanor and tone, RIC says it in a friendly, playful way. Furthermore, in a video-call with LIN's aunt ALE (RIC's wife), I learned that RIC picked up the expression from the children's movie *Zootopia*¹¹⁹ that the children frequently watched at the time. These elements show that RIC's utterance is not intended to be hurtful. However, in terms of socialization, "in interaction politeness is often subtle and complex, conveyed through verbal and other semiotic channels that vary across situations and communities ... (and) politeness is a central aspect of socialization for many children." (Burdelski, 2011: 275). Therefore, LIN either does understand the subtleness of RIC's greeting, but takes advantage of the situation to use some of the bad words in her repertoire in return. Or, LIN does not grasp this complexity and resorts to foul language to defend herself. From the video we attest that it

¹¹⁹ A fun and entertaining film (comedy-adventure) from Walt Disney Animation Studios released in 2016.

is the former. When LIN responds to RIC, her response is high pitched and playful as she follows him, hopping (bunny-like), into the kitchen and out of sight. Nevertheless, RIC nor the other adults present in the interaction framework reprimand LIN, even if they are overhearers. As a result, for a young language learner, this may lead her to believe that it is ok to use impolite language, at least in familial settings. Even if it is impossible to ascertain, politeness, or the use of nicer words may not play a central role in terms of socialization within this bilingual and bicultural family for the children, or for the adults as we see next.

The following extract is a continuation of the interaction above. Now everyone (GRC, RIC, ROX, ERI, and LIN) is in the kitchen, but they remain out of sight. Moreover, they are still working on serving the meal. GRC, RIC, and ROX are now in a triadic participation framework, and they are still heard discussing the T.V.'s broken remote control in Spanish. In parallel, ROX in English is describing to ERI the variety of chilis that were used to prepare the meal. They are therefore in dyadic interaction where ROX seems to be involved in two on-going interactional frames. The camera is still on the dinner table. Even though there are some yellowish colored square pastry boxes in front of it, audibility remains good enough to clearly hear and identify the participants.

LIN is 3;10

- | | | | |
|-----|--------|---------|---|
| 10. | *GRC : | [- spa] | Teodoro cómo no le quitó el p(aló) (.) con ganas de que +... @RIC |
| | | | Why didn't Teodoro take the stick (.) It would've been good if +... |
| 11. | *GRC: | [- spa] | viera [: hubiera] agarrado el palo y se lo viera [: hubiera] dado en la maceta a ver si +... @RIC |
| | | | He would've taken the stick and would've hit him upside the head to see if +... |
| 12. | *RIC: | [- mix] | why are you hitting your tío@s in the ass? @LIN |
| | | | Why are you hitting your uncle in the ass? |
| 13. | *GRC: | [- spa] | Rosie. |
| | | | Roxy. |
| 14. | *ROX: | | these. @ERI |
| 15. | *GRC : | [- spa] | Rosie. |
| | | | Roxy. |
| 16. | *ROX: | [- spa] | eh? @GRC |
| | | | Huh? |
| 17. | *GRC: | [- spa] | Rosie no agarró el palo y le dio en la cabeza a tu abuelito. |
| | | | Roxy he didn't get the stick and hit your grandpa in the head. |
| 18. | *LIN: | [- mix] | you're my tío@s you're not my uncle him my uncle. @RIC |
| | | | You're my uncle you're not my uncle him my uncle. |
| 19. | *RIC: | | I don't care muckbutt. @LIN |
| 20. | *LIN: | | xxx xxx +... @RIC |

- | |
|---|
| 21. *GRC: [- spa] mhijo [: mi hijo] así como en un xxx +... @ERI
Son like that in a xxx +... |
| 22. *RIC: you heard that I'm not his uncle he's his uncle. |

Plurilingual Transcript 11; ex. 7: FEB_22_2018_LIN_ROX_JUL_RIC_GRC_you're my tío_B

The interaction continues when LIN apparently hits RIC in the behind and subsequently brings him back into their dyad. In response, RIC (1.12) asks LIN in a mixed language utterance why she hit him, her “tío” (uncle) in the “ass”. In addressing LIN two issues emerge. First, RIC provides mixed language input to demand LIN to justify her behavior. RIC’s utterance could have been entirely in English. However, he refers to himself using the Spanish noun uncle thereby producing a mixed utterance. Through this style of address, RIC is also objectified where reference to himself in Spanish and in the third person could potentially cause confusion on LIN’s behalf. However, the confusion lies elsewhere as we will see later since LIN accurately deduces from the context that in using the term “tío” (uncle), RIC refers to himself. Moreover, RIC could have also addressed LIN entirely in Spanish since the transcripts reveal an abundance of Spanish being spoken in the triadic exchange between GRC, ROX, and RIC preceding his turn. His language mixing is perhaps a strategy to draw ROX’s attention to LIN’s behavior who is addressing ERI (1.14). However, ROX does not mind RIC’s comment and LIN’s behavior goes unchecked. At the same time though, RIC ignores GRC who is also trying to regain ROX’s attention in Spanish, calling her twice (1.13 and 1.15). Like all the bilingual speakers in the interaction, ROX is weaving in and out of English and Spanish and mixing them both based on her (potential) interlocutors (GRC, RIC, ERI, and LIN) who are all at different points of the bilingual continuum. ROX like the other speakers is also navigating in and out of overlapping participation frameworks. ROX (1.16) re-establishes dyadic communication with GRC signaling to her to that she is listening and can therefore proceed (1.17). The second issue is that of socialization into politeness that re-emerges. RIC, through his question uses an informal and impolite noun to refer to his buttocks as opposed to a more neutral term such as butt, or behind in addressing LIN. This may lend further evidence that politeness, or the use of less vulgar terms does not necessarily play a key role in the language socialization process. Notwithstanding, LIN manages to weave herself back into the interactional frame with RIC. She remains indifferent to RIC’s question appearing to have her own agenda in mind. Following RIC’s language mixing, LIN (1.18) rather than to answer RIC, in a mixed language utterances confirms that, “you're my tío@s you're not my uncle him my uncle.” As De Houwer (2009) affirms, the family is critical in modeling linguistic behavior for example, “through parental socialization practices.” (De Houwer, 2021: 25). LIN mixes

languages following RIC's mixed language model. She thus aligns to his bilingual discourse where both languages are allowed in conversation. As we have seen, bilingual discourse also seems to favor heritage language development. Notwithstanding, by asserting that RIC is not her uncle, but rather her "tío", LIN inserts the same Spanish noun that he does in her otherwise English only utterance. Furthermore, she thinks that she is correctly establishing the kinship between herself, RIC and ERI. While LIN's language mixing shows that she possesses and that she can use both the Spanish and English terms for uncle, it also shows that for her it is not clear that they are translation equivalents. For LIN these two words do not carry the same meaning, so RIC is her "tío" and ERI is her "uncle". Like for Quay (1995) and Nicoladis (1998) who looked at translation equivalents in an English-Spanish girl and a Portuguese-English boy respectively, they found that translation equivalents may only be established when a word is used interchangeably to mean the same thing. This is not the case for LIN since it appears that this causes her confusion. Perhaps this can be explained by the fact that ERI has only stayed with the family for a couple of weeks. Therefore, LIN has not heard sufficient adult input to understand that ERI can and is also referred to as "tío" (uncle) by her mother ROX, aunt ALE, and on occasion by her father MAR. LIN's reluctance to accept the translation equivalent may also be because the term uncle is more novel since the Spanish translation equivalent has the most currency within the family. Regardless, RIC does not seem to want to further discuss the issue with LIN. He tells her (1.19) that he does not care which signals to LIN that what she thinks is of no importance to him. LIN (1.20) in an indiscernible but playful tone seems to mock him. However, even if RIC makes it appear as though this kinship issue is of little importance, he ignores LIN (1.22) and attempts to ratify either ROX or ERI or both (but not GRC because his utterance is English) into their dyadic interaction to ask if they heard what LIN has just said. However, neither of them react to his call. In the end, we do not know why LIN spansks RIC. It could be as a response to him scaring her, or to him calling her a "muckbutt". It could also be because at the beginning of the interaction GRC (1.10 and 1.11) jokingly suggests to RIC that the child who broke the remote control should have instead hit GRT (their great-grandfather) upside the head. As previously noted, LIN has passive understanding of Spanish, and she was within the limits of the interactional frame as an overhearer. Her behavior could thus have been influenced both by the resonating overheard speech from GRC, as well as by RIC's child-directed input, or a combination of both, but we will never know.

We may thus argue that these overlapping dyadic, and triadic participation frameworks are in bilingual mode, as they are rooted in their casual family environment where the use of

all linguistic resources is accepted in interaction. GRC speaks entirely in Spanish to RIC, ROX, and ERI. ROX speaks Spanish to GRC and English to ERI. RIC speaks English and mixes languages in addressing LIN and vice-versa. Furthermore, LIN is socialized not only into bilingual language practices, but also into the not so polite use of language, and behavior. Therefore, it is not surprising to witness her boldly take a stand verbally and physically. Nevertheless, the third and last extract below as a continuation of the previous two shows how LIN goes from rejecting the translation equivalents through language mixing to finally accepting it, but this time by using unilingual English utterances.

LIN is 3;10

- | | | |
|-----|-------|--|
| 21. | *GRC: | [- spa] y luego el juguito cómo se lo vas a echar? @ROX
And then the sauce how are you going to add it? |
| 22. | *ROX: | [- spa] arriba. @GRC
On top. |
| 23. | *ERI: | [- spa] arriba. @GRC
On top. |
| 24. | *LIN: | [- mix] you're my tío@s. @RIC
You're my uncle. |
| 25. | *RIC: | [- mix] it's the same thing (.) uncle tío@s. @LIN
It's the same thing (.) uncle uncle. |
| 26. | *ROX: | You're gonna [: going to] warm that up separate, no? @ERI |
| 27. | *LIN: | no. @RIC |
| 28. | *RIC: | yes. @LIN |
| 29. | *LIN: | you're not my +... @RIC |
| 30. | *RIC: | you're my muckbutt. @LIN |
| 31. | *LIN: | no. @RIC |
| 32. | *RIC: | yeah! @LIN |
| 33. | *LIN: | you my uncle! @RIC |
| 34. | *RIC: | you're my muckbutt! @LIN |
| 35. | *LIN: | you're my uncle +... |
| 36. | *RIC: | my muckbutt! @LIN |
| 37. | *LIN: | you're my uncle! |
| 38. | *LIN: | you're my uncle. |
| 39. | *LIN: | you're my uncle. |
| 40. | *LIN: | you my uncle. |
| 41. | *ROX: | LIN your xxx your thing's gonna [: going to] break. |
| 42. | *RIC: | Let me see. @LIN |
| 43. | *RIC: | [- mix] put it away Mamá@s cause [: because] it's gonna [: going to] break. @LIN
Put it away Mom because it's going to break. |

Plurilingual Transcript 12; ex. 8: FEB_22_2018_GRC_LIN_RIC_ERI_JUL_GLO_you're my tío_C

As the dynamic interactions proceed, GRC (1.21) asks ROX in Spanish how she will add the tomato sauce to her stuffed chilis. But both ROX and ERI (1.22 and 1.23) answer her in Spanish almost simultaneously forming a brief triad. Also, none of the adults acknowledged RIC's comment regarding LIN's refusal to accept the translation equivalents. LIN who overhears RIC's statement thus takes the opportunity to re-engage in the interaction with a mixed language production. LIN (1.24) insists once again that RIC is her "tío" (uncle). This second repetition allows her to reinforce the modeled mixed speech previously heard in her input. This time however, rather than to say that he does not care, and considering that he does not have the support of the other bi- and monolingual adults, RIC seems to take a different approach. RIC (1.25) through a mixed language utterance simply explains to LIN that both words mean the same thing. In the meantime, ROX addresses ERI (1.26). Following RIC's clarification, LIN does not seem to believe him, as she initially refuses his account (1.27). LIN's, "no" is expressed with an elongated vowel, but RIC insists (1.28) confirming his explanation with a "yes" as he too elongates the vowel. RIC and LIN's conversation is now in English. Their dyadic interaction is nested within the other bilingual dyadic and triadic interactional frames. So, LIN (1.29) attempts to insist one more time that RIC is not her uncle as she slows down her articulation but does not complete her utterance. This may be due to the fact that RIC seems to cut her off before she finishes. LIN's slowed articulation may also be because RIC's explanation starts to make sense. Thus, she may be thinking carefully about what she is about to say. In either case, RIC (1.30) playfully teases LIN again, which she rejects (1.31), but he insists (1.32). After this playful to and fro, LIN (1.33) finally appears to accept RIC as her uncle, and not just ERI. It is in this instance that LIN welcomes RIC's explanation regarding their kinship, or namely that "uncle" and "tío" are translation equivalents. Their dynamic dyadic interactional spar leads LIN to deeper sociolinguistic understanding. Indeed, we see that

Language and culture are inextricably intertwined. The home is where cultural practices are first experienced, and within that context, children born into multilingual families experience this identity through language. Children forge relationships with their families and extended families through language. (Pahl, 2008: 115).

Following LIN's utterance RIC teases LIN again (1.34). He does so as he laughs perhaps because he knows now that LIN has understood the translation equivalents making it difficult to refuse them. As the interaction comes to an end, LIN (1.35 and 1.37-1.40) repeats that RIC is her uncle shifting the interaction to a monolingual English mode. The interaction ends when ROX (1.41) breaks into their conversation to warn LIN that her toy is going to break. RIC (1.42) asks LIN to see her toy. Rebounding off ROX's comment, RIC affirms his authoritative

position as both her uncle and “tío”. RIC (1.43) suggests to LIN that she should put her toy away. However, RIC does so through a mixed language utterance. He inserts the Spanish noun “Mamá” (Mom) which is frequently used as a term of endearment towards children in this community. The way in which he expresses himself also shows that despite his teasing and taunting, it is all in the name of fun, and one of the byproducts of this fun is language learning. Nevertheless, RIC’s utterance also serves to bring forward again, and to perpetuate the family’s typical bilingual and bicultural mode of communication. It is a bilingual language learning environment where the use of all linguistic resources is accepted. Furthermore, it is these types of mixed language utterances that may implicitly model, and thus socialize LIN into language mixing.

Synthesis

The series of three interactional moments above attempted to highlight how LIN goes from refusing to accepting translation equivalents from a more experienced bilingual adult in her family. It also shows her using translation equivalents in mixed language utterance as well as in English ones even if for her they do not mean the same thing. It is not clear however if she can use the Spanish translation equivalent in a Spanish unilingual utterance. Moreover, LIN and RIC’s conversation flows from language mixing to the use of English and back again all while their dyadic interaction is embedded in the other overlapping dyadic and triadic frameworks where Spanish and English are used by the other bi- and monolingual adult speakers. Moreover, unlike in the previous analysis where clear bilingual or monolingual discourse strategies appeared to be deployed by the adults, it does not seem to be the case here. If RIC insists that “tío” is the same as “uncle” perhaps the goal is not to steer the conversation to English, but rather to help LIN ground the same meaning for the two words. It may also be a way to index his status or role at the family level in relation to her. In other words, “adults may involve children in triadic or other multiparty turn-taking directives to socialize them into understandings of complex and diverse social relationships.” (Li, 2008: 74). In the present case, it would be the indexation of his higher social rank in relation to LIN, but equal to ERI in dyadic interaction since he was unable despite his various attempts to involve the other speakers. Nevertheless, this results in an English only production on LIN’s behalf. The issue of language and behavioral socialization can also be entertained. The way LIN speaks, and acts may be a result of both child-directed and overheard input whether it is in English or in Spanish. Her linguistic behavior may be further implicitly approved of especially if the adults do not

call into question what she says or does. It would thus seem as though LIN's language style reflects her input and that she is well on her way to acquiring the adult language practices. Nevertheless, we see that the meaning making process in this case is not facilitated by the multiparty framework as seen previously. Since the bi- and monolingual adults ignored RIC's call for support, the meaning making process relied solely on their dyadic interaction and RIC's ability to convince her. This adult-child frame seems to be enhanced by the environment and namely the role of play. As RIC and LIN interact, they laugh and tease each other, and it is through this glee that LIN finally seems to accept RIC's affirmation. In the end, LIN's appropriation of this translation equivalent, as well as of others is essential in constructing a bilingual and bicultural identity that fits within her family. It thus aligns with "The basic tenet of language socialization theory (or) that children learn language and culture through their active engagement in meaningful social interactions with adults and peers." (Blum-Kulka, 2008: 87). However, as we see next, teaching LIN translation equivalents is not as simple a feat since accepting words from Spanish and English to refer to the same thing appears to be a source of frustration for her. The table below summarizes the main interactional elements of the three interrelated examples considered in the present discussion.

Table 51: Summary of key analytical features in example 6, 7 & 8

LIN's age & example	Multimodal Framework	Multigenerational Framework	Participation Framework	Discourse Strategies	"Who speaks what language to whom?"	Dilingual Conversation or Passive Bilingualism
3;10 ex. 6, 7 & 8	No	LIN (3G) JUL (3G) ROX (2G) RIC (2G) ERI (2G) GRC (1G)	From dyad to triad to dyad Brief dyad between ROX and ERI Brief dyad between ROX and GRC Brief triad between GRC, ROX, and ERI	No	LIN E RIC LIN M RIC ROX S GRC ROX E ERI RIC E LIN RIC M LIN ERI S GRC GRC S RIC GRC S ROX	No

5.4.2 They called fruits loop *puta@s!*

The following interaction highlights how first- and second-generation adults come together throughout the social encounter and use Spanish to encourage LIN to repeat the names of different fruits in Spanish. In doing so, the adults remind LIN that she recently declared wanting to learn Spanish. Nevertheless, even if she is provided several translation equivalents, her use of heritage Spanish results in the production of mixed language utterances. Even so, the analysis shows how LIN learns to take the floor at an appropriate interval in interaction. It further shows how she uses language mixing not only to refuse the Spanish translation equivalents, but also to insult the bilingual adult speakers, perhaps as a way to cope with her frustration. It is interesting to note however that one of her mixed language utterances contains a Spanish expletive, a word that she has apparently been socialized to use more for its function than for its literal meaning. Finally, we see how she is socialized into a particular gender role, or that of a “little girl” which she seems to refuse. The multiparty interaction takes place in February 2018, and it is divided in two parts (A and B). The camera is sitting on the table and the sound quality is good. Gestures and gaze will be considered since most of the speakers (LIN, ROX, GRC, and GRT) are visible. ERI (behind the camera), GRT, and LIN are sitting around the kitchen table. ROX and GRC navigate around the kitchen and the living room as they tidy the space. ERI, GRC, and GRT are ratified speakers, but ERI has been speaking in Spanish for a while about how he enjoyed having lunch, interruption free, with GLO when they went out to lunch. ROX is an overhearer as well as LIN who is in front of the camera opposite of ERI. LIN begins to play with a kitchen towel with embroidered fruits typical in Mexican households. The bilingual interaction is unfocused since participant rules and roles are not rigidly defined. However, when ERI finishes his turn, LIN breaks into the interaction.

LIN is 3;10

- | | | |
|----|-------|--|
| 1. | *ERI: | [- spa] da dolor de cabeza. @GRT
It causes a headache. |
| 2. | *GRT: | [- spa] uhum. @ERI
Yes. |
| 3. | *LIN: | who wants strawberries you? @GRT |
| 4. | *GRT: | xxx. @LIN |
| 5. | *LIN: | ok. @GRT |
| 6. | *ERI: | [- spa] fresas son fresas LIN.
Strawberries they're strawberries LIN. |
| 7. | *LIN: | no strawberries. @ERI |

8. *ERI: strawberries +... @LIN
9. *ERI: [- spa] es una fresa. @LIN
It's a strawberry.
10. *LIN: no. @ERI
11. *ERI: [- spa] sí. @LIN
Yes.
12. *LIN: no! @ERI
13. *ERI: [- spa] sí. @LIN
Yes.
14. *LIN: no. @ERI
15. *ERI: [- spa] esas son uvas. @LIN
Those are grapes.
16. *GRC: [- spa] no grites no grites. @LIN
Don't scream don't scream.
17. *LIN: no it's fruit. @ERI
18. *ERI: [- spa] son frutas. @LIN
They're fruit.
19. *LIN: no it's fruit. @ERI
20. *ERI: [- spa] frutas. @LIN
Fruit.
21. *LIN: fruit.
22. *ERI: [- spa] frutas. @LIN
Fruit.
23. *ROX: I thought you wanted to learn Spanish LIN?
24. *LIN: fruit. @ERI
25. *ERI: [- spa] frutas. @LIN
Fruit.
26. *LIN: well let me do it.
27. *GRC: [- spa] te están enseñando en español di (.) fruta. @LIN
They're teaching you Spanish say (.) fruit.
28. *ERI: [- spa] son uvas +... @LIN
They're grapes.
29. *ERI: grapes.
30. *LIN: [- mix] they called fruits loop puta@s! @ERI
They're called fruit loop whore!
31. *ERI : [- spa] qué? @LIN
What?
32. *ROX: [- spa] qué Má [: Mamá]? @LIN
What Mom?
33. *ROX: [- spa] qué dijiste? @LIN
What did you say?
34. *ERI: [- spa] frutas. @LIN
Fruit.
35. *LIN: [- mix] they're not frutas@s. @ERI

<p style="text-align: center;">They're not fruit.</p> <p>36. *ERI: [- spa] son frutas. @LIN</p> <p style="text-align: center;">They're fruit.</p>

Plurilingual Transcript 13; ex. 9: FEB_21_2018_GRC_ROX_ERI_LIN_they called fruits loop puta!_A

ERI (1.1) finishes his turn in Spanish by saying that it is difficult and unpleasant to have a conversation when there is too much noise and too many interruptions. GRT (1.2) seems to agree with him, even if he appears to maintain his gaze on GRC who is out of site and in the kitchen. At the end of ERI's utterance (1.3), LIN engages in interaction. She looks at her great-grandfather GRT and asks who wants strawberries. GRT turns to LIN as she finishes her utterance, and she points at him asking if he does, and thereby initiates a dyadic exchange with him. With his gaze on LIN (1.4), GRT seems to slightly nod in agreement, but it is not clear if he understands LIN's question. Nevertheless, LIN (1.5) says, "ok" and pretends to pick strawberries from the tablecloth, turning her gaze to ERI and then back down. Then, through a Spanish utterance ERI (1.6) chimes in to give LIN the translation equivalent for strawberries. In doing so he also ratifies himself in their dyad, thus shifting it to a triadic participation framework. ERI's utterance may be considered a Repetition Strategy under Lanza's (1997) monolingual discourse strategies. He tries to bring the conversation to Spanish so that GRT, the original ratified speaker may better understand, and thus more meaningfully interact with her. We have seen before that LIN is asked from time to time to speak Spanish to her great-grandparents since they do not speak English. However, it is not made clear to LIN this time around. Nevertheless, this momentarily draws LIN's gaze back to ERI and then back down to the tablecloth. This also draws GRT's attention to ERI and then back to LIN. The triad thus seems to assess the situation not through oral means, but rather through visual ones. Nevertheless, LIN (1.7) disagrees and refuses the translation equivalent as she looks up at ERI. We may thus ask why LIN refuses the Spanish term, and what it will take for her to accept it. However, influenced by LIN's previous language choice (English), ERI (1.8) begins to respond in English, but he switches back to Spanish (1.9) to insist that "fresas" are strawberries. ERI's choice to keep the conversation in Spanish is also a way to maintain GRT's ratification status in the conversation at least in terms of what he is saying to LIN. Notwithstanding, this is when things get intense. LIN (1.10) places her hands on the table lifting herself up, looks at ERI and disagrees again, but ERI in Spanish says yes (1.11). LIN then shouts, "no" at the top of her lungs (1.12), while ERI (1.13) calmly says yes again in Spanish. LIN then says no again (1.14), this time without shouting as she looks down, pointing at the embroidered fruits. She also smacks the tablecloth with her hand. Since ERI appears to see what LIN hits, he continues to

tell her in Spanish that those are grapes (1.15). At the same time GRC (1.16) from the kitchen tells LIN in Spanish not to shout, momentarily forming a multiparty framework. This draws GRT's gaze from LIN to GRC and then back again to LIN who says (1.17) that it is fruit on the tablecloth, not grapes. Up until now, LIN refuses the Spanish translation equivalents for both strawberries and grapes. But ERI sees this as another opportunity to propose a third translation equivalent, as well as to continue to move the interaction to Spanish. Therefore, ERI (1.18) says to LIN in Spanish that they are "frutas" (fruits), yet LIN (1.19) repeats that they are fruit. ERI (1.20-1.22) and LIN subsequently engage in a bilingual spar as he attempts to impose the translation equivalent on the object going from Spanish (ERI) to English (LIN) to Spanish (ERI). At the same time, ROX who is an overhearer, ratifies herself into the triadic conversation from the living room forming once again a multiparty social encounter. She reminds LIN (1.23) that she wanted to learn Spanish. LIN (1.24) appears to say "fruit" again, but again ERI (1.25) gives her the Spanish translation equivalent. Following ROX's comment, LIN finally seems to say fruit in Spanish under her breath, but her head is lowered so audibility is not clear. It is thus difficult to confirm. However, LIN (1.26) asks to say it on her own, face down, apparently looking at the fruits on the tablecloth. It would appear as though LIN prefers to take what she learns into her own hands. She will say the Spanish word(s) suggested to her, but under her own terms, or only when she is ready and willing to do so. Furthermore, GRC who is not visible, pops back into the camera's view to straighten things out on the table. This allows her to join the family effort to encourage LIN to repeat in Spanish. Along with ERI, and ROX, now GRC (1.27) ratifies herself into the multiparty participation framework almost commanding LIN to say fruit rather than to ask her. Moreover, since she is busy cleaning, GRC does not look at LIN and then pops back out of sight. The multiparty participation framework is multigenerational as the interaction unfolds, but now they are all pressing LIN to say the Spanish translation equivalents both through child-directed English and Spanish input. LIN who is now holding the tablecloth in the air does not mind GRC's comment. However, we can easily see the embroidered grapes and other colored fruit before she sets it back down. This prompts ERI to say grapes first in Spanish (1.28) and then in English (1.29) providing LIN an explicit model of translation equivalents. LIN does not respond. So far in this bilingual multiparty interaction it is not clear whether LIN has uttered any word in heritage Spanish. What is clear is that most of the adult family members (except GRT who seems to remain neutral) have encouraged her to speak Spanish both in English (ROX) and Spanish (ERI and GRC) as the participation framework evolves from a dyadic to a triadic to a multiparty interaction. Nevertheless, LIN holds her ground and refuses to speak Spanish. She even turns

her back on ERI to show her disapproval. Then, LIN (1.30) through a mixed language utterance turns around, looks at ERI and says, “they called fruits loop puta@s” before sitting down on the chair. “Puta” is a Spanish expletive used to designate a whore. Through her mixed language utterance LIN does not produce any of the three Spanish translation equivalents proposed to her. She does however show the ability to correctly produce a different although derogatory Spanish noun. While an expletive of this nature may seem surprising coming from a child, participant-observation allows me to validate that this word is often modelled by the adults, specifically by her father MAR. Also, that the pragmatic strength of the word is context dependent. Seeing as how LIN uses the term to show her frustration, we can argue that the pragmatic strength is elevated, however it is unlikely that she knows the true meaning of the word. LIN’s impolite language choice should not come as a surprise since she is socialized into this type of language use, and as we can see, she has learned how to use “puta” (whore) appropriately. On another note, it is interesting to underscore that LIN selects a word that rhymes with “frutas” (fruit), so there seems to be a sort of play on sounds on her behalf but with the pragmatic effect of expressing aggressivity, or frustration. Nevertheless, as LIN finishes her mixed language epithet, GRT remains indifferent. ERI (1.31) asks her what she has said, but LIN looks over her right shoulder at ROX, perhaps waiting for a response on her part. From the living room ROX looks at ERI following LIN’s comment, then turns to LIN. ROX (1.32) also asks her in Spanish what she said. LIN after bringing her gaze back to the tablecloth in front of her, looks over her shoulder again when ROX (1.33) asks again raising her eyebrows what she just said, but once again LIN, in silence brings her attention back to the tablecloth on the table. Perhaps through her silence LIN signals to ROX and ERI that she has gone too far, but we will never know. To break the awkward silence, ERI (1.34) says that they are fruits in Spanish again. At this moment LIN produces her second mixed language utterance to negate the Spanish translation equivalent (1.35). However, this time around whether she agrees or not, what is certain is that she finally uses the translation equivalent “frutas” (fruits), and ERI insists that they are indeed frutas (1.36).

The following extract follows the one above. LIN has finally said one (fruta/fruit) of the three (fresas/strawberries & uvas/grapes) proposed Spanish translation equivalents. Now however, only LIN and GRT are visible since ROX carries on with her tasks. ERI and LIN remain ratified and locked in interaction. The bilingual multiparty framework seems to slowly retract into a dyad. GRT sits indifferently as he looks at LIN. By indifferent, we mean that GRT does not seem to say much, or to react much throughout the social encounter. He seems

to be calmly content, and perhaps even amused just watching the interaction unfold between his second-generation son ERI, and granddaughter ROX, and of course his third-generation great-granddaughter LIN.

LIN is 3;10

- | |
|---|
| 37. *LIN: no! @ERI |
| 38. *LIN: no! @ERI |
| 39. *ROX: LIN. |
| 40. *ROX: kids don't act like that you're not an animal. @LIN |
| 41. *GRC: [- spa] qué dice?
What's she saying? |
| 42. *ERI: [- spa] no eres animal. @LIN
You're not an animal. |
| 43. *LIN: no! @ERI |
| 44. *GRC: [- spa] qué dice que son?
What does she say they are? |
| 45. *ROX : you're not listening? @LIN |
| 46. *ERI: [- spa] como que quiere decir frutas. @GRC
It seems like she wants to say fruit. |
| 47. *ROX: don't scream. @LIN |
| 48. *ROX: you're not an animal. @LIN |
| 49. *LIN: I do an animal. @ROX |
| 50. *ROX: no you're not stop acting like one. @LIN |
| 51. *LIN: why? @ROX |
| 52. *ERI: [- spa] dice que sí es animal.
She says that she is an animal. |
| 53. *ROX: you wanna [: want to] be an animal +... @LIN |
| 54. *ROX: so I could go send you with the animals. @LIN |
| 55. *LIN: no +... @ROX |
| 56. *ERI: [- spa] con las gallinas.
With the chickens. |
| 57. *ROX: ok then act like a little girl. @LIN |
| 58. *LIN: no! @ROX |

Plurilingual Transcript 14; ex. 10: FEB_21_2018_GRC_ROX_ERI_LIN_they called fruits loop puta!_B

As previously mentioned, in Spanish ERI insists one last time that what LIN sees in the tablecloth are fruits. However, LIN still disagrees. As LIN maintains her eyes on ERI (1.37 and 1.38), she grabs and then pulls the tablecloth under the table and screams, “no!” twice. ROX is an overhearer again but comes back into the interactional frame. ROX (1.39) calls LIN and insists (1.40) that her behavior is not acceptable. As ROX does so, LIN turns her head in the direction of ROX’s voice, who is out of sight. However, before ROX can finish her utterance

LIN turns back around, her gaze quickly looking in ERI's direction before looking at an undetermined object on the table. Then, GRC who is also an overhearer ratifies herself back into the conversation (1.41) to ask what LIN has said, even though all the adults are clear on what she has uttered. Nevertheless, GRC's question briefly draws GRT's attention (who remains silent) to her while in the kitchen, before turning his gaze back to LIN. LIN's shouting catches the attention of both ROX and GRC such that the multiparty framework that seemed to disperse re-emerges and re-engages. GRC's utterance overlaps with ERI's. In a continued effort to provide LIN with translation equivalents, ERI (1.42) repeats ROX's utterance in Spanish, but LIN refuses it (1.43) by shouting, "no" again. Also, since GRC's previous question goes unanswered, she asks again (1.44) in Spanish what LIN says the fruits are. Next, we hear ROX's voice again. ROX asks (1.45) whether LIN is listening. Her question seeks to understand if she will behave. LIN turns in the direction of ROX's voice. At the same time ERI in Spanish answers GRC (1.46). He tells her that it appears as though LIN wants to say "fruit" (fruta), rather than what she really said "puta" (whore) (but we all know what she really said). In any case, there seems to be a connection that LIN is making through sounds. Then ROX reappears ordering LIN not to scream (1.47) and telling her that she is not an animal (1.48) even though according to Geertz (1973) we all are, and due to this condition, we are all caught up in our self-constructed webs of meaning. Nevertheless, LIN looks at ROX until she finishes her utterance. However, when she is done LIN quickly looks at ERI to say that she is an animal with a grin on her face before looking down towards her lap (1.49). ROX (1.50) insists that LIN is not an animal as she approaches the table coming closer to LIN. ROX moves the chair slightly away from the table to lift and set her knee on top taking a more matter of fact stance. As she does so LIN asks why (1.51) looking at ROX through the corner of her eye and her head still maintained low. In the meantime, ERI keeps GRC and GRT abreast of the developing somewhat conflictual situation. So that they remained ratified, he translates LIN's affirmation (1.52) that she is an animal into Spanish. Then ROX (1.53) hovering over LIN and looking down on her as she puts her hair in a bun asks her if she wants to be an animal. The act of tucking her hair is also telling. It typically signifies that the speaker, usually a woman is physically getting ready to take on a difficult task¹²⁰ which is easier to accomplish when her hair is out of her face. It can thus be considered a serious stance on ROX's behalf towards LIN's bilingual and bicultural behavior. In the affirmative ROX says that she will take LIN with the animals

¹²⁰ In Southern California "Chola girls" defined as female Mexican-American gangbangers (which is not ROX's case) who were tough but feminine were often seen or depicted as putting their hair in a bun before getting into a physical altercation.

(1.54). LIN looks at ROX (1.55) and says, “no”. What is not clear about LIN’s negation is if she does not take ROX’s threat seriously. Or, if she does not want to be an animal so as not to end up in the backyard with them. What is clear however, is that much like Pontecorvo et al. (2001) found in Italian families, LIN has been socialized to engage head-on in discussions that may lead into arguments, “whereas in American families children might be socialized into the avoidance of conflict and argumentation.” (Blum-Kulka, 2008: 95). In studies exploring how gender is both constructed and displayed in non-white middle-class American cultural groups, Goodwin (2006) for example has found that the use of strategies to reduce conflict do not hold for working-class Latina girls. Nevertheless, as the interaction continues, ERI stops translating both ROX and LIN’s utterances in their dyadic exchange but keeps speaking in Spanish. Following LIN and ROX’s squabble, ERI reinforces ROX’s threat (1.56) by specifying in Spanish that LIN will be cooped up with the chickens. ERI’s utterance also overlaps with ROX’s statement (1.57) where she tells LIN to, “act like a little girl”. As ROX does so, she turns her gaze from LIN. It is evident from ROX’s facial expression that she is annoyed. GRT finally stops looking at LIN, but still does not say a word as he places his hand over his upper lip. Following ROX’s comment (1.58) on girl-like behavior, the interaction ends. LIN seems to test ROX and mildly shouts, “no” again before ROX takes her by the arm and accompanies her to the restroom where she is placed on timeout. Nevertheless, ROX’s comment may shed light into the role of language socialization and identity construction. One may consider how through language a child may be socialized into specific gender roles, but not only. According to ROX, LIN’s defiant behavior is deemed unsuitable not only for her biological gender, but perhaps also for her age. She is reframed as a child who has misbehaved with adults whom she needs to respect which is part of a healthy adult-child relationship. This may perhaps be a stronger reason for ROX’s intervention. However, it is also through LIN’s language use and choice (Pavlenko, 2001) that LIN takes a stand not only to reject the gender role that is expected of, or imposed on her, but also the Spanish translation equivalents that are provided to her from the more experienced bilingual speakers in her family.

Synthesis

The last two bilingual, multigenerational, multimodal, and ever-shifting participation frameworks are related. They showed how LIN stands her ground and refuses the Spanish translation equivalents proposed to her until the very end despite encouragement from multiple multigenerational family members. The first example also highlights how “Language can be

seen to be part of a wider landscape of communication, including images and gesture, which is multimodal.” (Pahl, 2008: 115) in multilingual urban homes. It is suggested that the relationship between narratives and artifacts (the embroidered Mexican tablecloth) in the home is strong and that these “Key artifacts in homes often ‘held’ a family’s history and identity.” (Pahl, 2008: 121). In our case, the cultural object opened a space for heritage language learning. Moreover, even if LIN does not accept the translation equivalents, she seems to unwittingly produce the translation equivalent “frutas” (fruits) through a mixed language utterance as she negates their sameness. Furthermore, in her frustration, she produces another mixed language utterance containing the Spanish expletive “puta” (whore). However, we argue that she does not know the semantics behind the word, but rather the pragmatic function. We may also suggest that there is a connection that she is making through sounds i.e., fruta/puta. For example, in our data there is a moment when GLO is teaching her the number six, or “seis” and she is heard saying the word “space”. Perhaps rhyming is a way for LIN to make linguistic associations, or sense of her rich bilingual and bicultural input. Nevertheless, this type of reaction on her behalf while unpredictable in interaction aligns with what Goodwin (1990) found in African-American working-class girls, or the observation that they turn to direct commands and even blunt directives in certain circumstances. It shows that LIN has some notions of heritage Spanish in her bilingual repertoire, and that she has insight into how to use the term in a pragmatically correct way. Moreover, the conversation between ERI and LIN is bilingual. He addresses her almost entirely in Spanish and she responds in English and with some language mixing. When GRC and ROX attempt to encourage LIN, GRC does so in Spanish and ROX in English. GRT remains silent from start to finish. His gaze however follows the speakers as they successively come in and out of the participation frames. Regarding the discourse strategies, ERI seems to privilege a monolingual discourse strategy. First, he repeats the nouns that LIN says into Spanish, even if she gets increasingly annoyed. Second, he also repeats ROX and LIN’s discourse into Spanish even as things get heated. ERI’s goal is two-fold 1) to continue to provide LIN with Spanish translation equivalents and thus facilitate her use of Spanish and 2) to maintain both GRC and GRT ratified in the ongoing multimodal, and multigenerational social encounter. The multigenerational, and ever-shifting multiparty participation framework allows for all speakers to weave in and out of the dynamic interaction. Child and adult bilingual speakers through their “natural translations” as Harris (1977) describes and later coined as “language brokering” by Tse (1995) allows them to build linguistic bridges not only in formal institutional spheres, but also in informal family contexts. Regarding language socialization, LIN seems to use the Spanish expletive “puta” (whore)

correctly, or *what to say and when*. Whether it is through child-directed or overheard speech, we may advance that she is thus socialized into (im)politeness which is a central feature of the child socialization process (Burdelski, 2011). The second aspect is socialization into appropriate age, and gender-related roles within this specific community of practice. Included in Bourdieu’s (1977) notion of *habitus*, “which now has been thought of as perhaps too static” (Ochs, 2022) are nevertheless learned temperaments, or particular ways of acting multimodally, that is through both verbal and nonverbal means. Within the framework of this research project, through child-directed input LIN is explicitly asked to conform to a specific gender role, or *how to behave* (“like a little girl”). This highlights the complexity of the language socialization process, especially in bilingual settings. LIN’s linguistic behavior is in large part the result of the language(s) that she is learning at the intersection of the bicultural information embedded in them in this tension ridden contact zone. In other words, “we can identify certain lines of evidence to support the suggestion that in parent-child discourse it is possible to map out an emerging child-self positioning (or self-positionings) embedded in the ongoing talk.” (Forrester, 2001: 198). Finally, the bilingual interactional framework that fluidly moved from dyadic, to triadic to multiparty participation and back was not enough to encourage LIN to accept the translation equivalents, nor is her desire boosted by the bilingual language learning environment and the role of play. As opposed to the previous analysis, this one abruptly ends. LIN’s refusal to use heritage Spanish may therefore threaten the emergence of her bilingual identity. However, even if explicitly teaching LIN translation equivalents may sometimes be a source of frustration, on other occasions she may repeat Spanish on her own initiative as we will see in the next chapter. She will also repeat Spanish when the speech stream is segmented for her even if she continues to mix languages to express her feelings. The main characteristic of examples nine and 10 are presented in the table below.

Table 52: Summary of key analytical features in example 9 & 10

LIN’s age & example	Multimodal Framework	Multigenerational Framework	Participation Framework	Discourse Strategies	“Who speaks what language to whom?”	Dilingual Conversation or Passive Bilingualism
3;10 ex. 9 & 10	Pointing Nodding Gaze Posture	LIN (3G) ROX (2G) ERI (2G) GRC (1G) GRT (1G)	From triad to dyad to triad to multiparty to triad to multiparty to dyad to multiparty to dyad to triad	ERI-RS (mono)	LIN E GRT LIN M ERI ROX E LIN ROX S LIN ERI S LIN ERI E LIN	DL

	Head lowered				GRC S LIN GRC S ERI	
	Using objects					

6 Heritage Language Socialization: Bilingual Input & Output

6.1 Segmenting the speech stream: Spanish one piece at a time

6.1.1 Ponme el vestido por favor

The following three interactions will show how segmenting the speech stream helps LIN repeat multiword Spanish utterances. However, even if she is taught Spanish one word at a time, LIN still seems to have productive difficulty. We will take a closer look at the practice of speech stream segmentation at the end of the analysis. For now, the first sequence shows that she repeats Spanish, even if not on target on her own in various participation frameworks to understand what is said to her. It may also demonstrate how she resorts to language mixing to express her desires in these linguistically complex social encounters. The dyadic, triadic, and multiparty interactions takes place in February 2018. Like in previous analyses, this video recording is broken down into three shorter segments (A, B, and C). The camera is sitting on the table and the sound quality is good. The participant's gestures, stance, and gaze are considered in parallel to the verbal analysis since visibility is mostly clear. The interaction begins with LIN who is standing on a chair, and ERI and GRC who are sitting around the dinner table. All three generations are thus present. ERI and GRC are the ratified speakers in the social encounter. ROX and JUL who are in and around the living room are unrated. LIN is also an unrated overhearer. In Spanish, GRC and ERI are discussing matters related to currency exchanges. They are also trying to determine the best time to run errands. The interaction in the bilingual, multimodal, and multigenerational participation framework is therefore focused since on the one hand ERI is trying to find information online related to their conversation and on the other hand GRC is busy trying to find a business card in her wallet. It is important that GRC and ERI find what they are looking for to proceed with their plans for the day. There is thus a central purpose to their conversation and any activity other than the main one may be seen as a distraction. This is when LIN breaks into their preoccupations.

LIN is 3;10

- | | | |
|----|-------|--|
| 1. | *LIN: | here Grandma@s:eng&spa. |
| 2. | *LIN: | who is this yoghurt Grandma@s:eng&spa? |
| 3. | *GRC: | [- spa] fijate que no la traigo la +... @ERI
Can you imagine that I don't have it. |
| 4. | *ERI: | [- spa] sí me fue muy muy muy pero muy bien. @GRC
Yes it went really really but really well for me. |
| 5. | *GRC: | [- spa] que bueno. @ERI
That's good. |

6. *LIN: Grandma@s:eng&spa who is this yoghurt?
7. *GRC: [- spa] tá [: está] caliente mhija [: mi hija]. @LIN
It's hot daughter.
8. *LIN: [- spa] clayente [: caliente]? @GRC
Hot?
9. *LIN: you could drink it? @GRC
10. *GRC: [- spa] y no lo vayas a tirar. @LIN
And don't go dropping it.
11. *LIN: xxx super big hot.
12. *GRC: [- spa] y no sé si quieres que vayamos ahorita o más tarde (.) como quieras. @ERI
And I don't know if you want to go now or later (.) as you wish.
13. *ERI: [- spa] sí pues si está aquí al lado de todos modos +/. @GRC
Yes, well if it's close by either way +/.
14. *JUL: Má@s:eng&spa [: Mamá, or Mom]. @ROX
15. *GRC: [- spa] tá [: está] cerquitas. @ERI
It's close by.
16. *ERI: [- spa] sí pero creo que preguntar cuánt(o) +... @GRC
Yes, but I think that to ask how much +...
17. *ERI: [- spa] voy a ver a ver en California en internet voy a ver si puedo ver +... @GRC
I'm going to see in California online I'm going to see if I can see +...
18. *ERI: [- spa] algo que me diga cuánto +... @GRC
Something that will tell me how much +...
19. *ERI: [- spa] cómo se llama la la +...@GRC
What's the name of the the +...
20. *LIN: all done.
21. *ERI: [- spa] no es como un Money_Gram? @GRC
It's not like a Money Gram?
22. *ERI: [- spa] cómo se llama la empresa? @GRC
What's the name of the company?
23. *ERI: [- spa] a ver. @GRC
Let's see.
24. *GRC: [- spa] esa no es donde cambiamos. @ERI
That's not where we exchanged.
25. *GRC: [- spa] es otra. @ERI
It's another one.
26. *LIN: Mommy I need clothes Mom.
27. *GRC: [- spa] allí están cerquitas. @ERI
They're close to each other.
28. *GRC: [- spa] allí lo pagan más barato. @ERI
They pay it cheaper there.
29. *LIN: [- mix] Mommy I want clothes I'm so frio@s.
Mommy I want clothes I'm so cold.
30. *ROX: well, I told you upstairs but you didn't listen. @LIN
31. *LIN: [- mix] Mom I'm frio@s.

Mom I'm so cold.

32. *ROX: can you wait til [: until] I'm done with your brother.

33. *LIN: ok. @ROX

34. *ROX: ok. @LIN

35. *LIN: ok. @ROX

36. *LIN: ok little lady. @ROX

37. *ROX: ok little lady. @LIN

38. *GRC: [- spa] Papá porqué andas sin papatos [: zapatos] Papaito [: Papasito]. @JUL

Dad why aren't you wearing shoes Dad.

Plurilingual Transcript 15; ex. 11: FEB_21_2018_LIN_GRC_ERI_ROX_MAR_ponme el vestido por favor_A

LIN's (1.1) participation status shifts from being an overhearer to a speaker who enters GRC and ERI's exchange. She is thus trying to ratify herself as a speaker as she attempts to exchange dyadically with GRC on another topic. She does so first by giving something to GRC on the table. At the moment we cannot see LIN's eyes nor what she gives GRC since the camera's view is blocked by a hat on a tray on the table. We do see however that GRC turns and looks at LIN before going back to searching in her wallet without acknowledging her, so the dyad is not cemented between the two. Then, ERI who is behind the camera moves the hat and tray for better visibility. LIN (1.2) then grabs a drinkable yoghurt that is sitting on the table and asks GRC who it belongs to. Her eyes quickly look at GRC and then at ERI before focusing on the bottle. Perhaps LIN looks at ERI to see if he will react, or maybe ask GRC in Spanish what she has said. Nevertheless, because the dyad between ERI and GRC is focused, LIN's question remains unanswered and GRC (1.3) instead tells ERI in Spanish that she cannot find what she is looking for. ERI (1.4) does not react to GRC's comment. Instead, he initiates a discussion on another topic. The adult speakers therefore do not seem to align, at least momentarily, in terms of the topic of conversation. However, in Spanish GRC (1.5) responds to ERI by saying that that is good news. Then LIN (1.6) asks GRC again who the drinkable yoghurt belongs to as she places it on the table and looks at her, finally establishing a dyadic exchange. GRC (1.7) thus looks at LIN and tells her in Spanish, not who it belongs to, but rather that the drink is warm as she grabs the bottle and gives it a little shake and then looks in direction of the kitchen. That GRC looked towards the kitchen may be interpreted perhaps as a way to remember whether there is a cooler yoghurt in the fridge that she can propose to LIN instead. Nevertheless, as GRC does so, LIN (1.8) repeats the last word in GRC's previous Spanish utterance. LIN produces the non-target Spanish "clayente" [: caliente] (warm) with rising intonation. As LIN repeats the word warm, the expression on her face reveals, along with her intonation that she may not understand either why the drink is warm, or what the word warm means in Spanish.

Our guess is the former however since the Spanish word for warm is commonly used. Then, GRC takes the bottle with a firmer grip and gives it a good shake this time. This likely leads LIN to believe that GRC will drink the yoghurt herself so she looks at GRC (1.9) and asks if she will drink it, but GRC looking back at her does not respond. Instead, GRC (1.10) opens the bottle and hands it to LIN as she tells her in Spanish not to spill it. LIN (1.11) recognizes that the drink is for her, so she stands next to the table and says, “xxx super big hot.” which can be interpreted as a happy dance since in asking who the drink is for, she is implicitly asking if she can have it, and she succeeds in getting it. So far, we may take note of three issues. First, the previous exchanges between GRC and ERI have been in Spanish. However, after multiple attempts LIN has successfully interrupted the adults, and initiated another conversation with GRC. In their dyad she is thus a ratified speaker in the conversation. Also, since she speaks English, she has engendered a bilingual English-Spanish conversation with GRC. Second, LIN in spontaneous interaction utters (at her convenience) the Spanish word for warm. However, LIN’s production seems to go unnoticed and is not turned into a teaching moment. Perhaps this is because the conversation, as mentioned earlier is focused so distractions are to be avoided. Third, LIN appears to be confused when GRC says that the drink is warm. But through her happy dance we infer that her apparent confusion is not due to the term warm in Spanish since she produces its English translation equivalent soon after. Her confusion is likely related to GRC saying that the drink is warm when it is supposed to be cold. Although fleeting, this instance shows LIN’s passive bilingualism. Nevertheless, the interaction continues. GRC (1.12) shifts dyad as she goes back to the business-related topic at hand and asks ERI in Spanish if he prefers to go now or later. At the same time LIN sticks her fingers in the opened bottle and then proceeds to lick them. She does so either to check the temperature, or the flavor before she drinks it. ERI (1.13) agrees to go sooner rather than later. We also hear JUL (1.14) call ROX using a bivalent term as GRC (1.15) confirms with ERI that the place where they will go is local. ERI (1.16-1.18) addresses GRC. With her attention drawn to ERI he suggests that he wants to do a bit of research online related to the matter before going. Then ERI (1.19) asks GRC in Spanish what the name of the company is, but GRC does not answer him. At the same time LIN (1.20) signals that she is finished with the drink. She puts the lid back on the bottle as she glances at GRC, but GRC is still focused on her task and on listening to ERI, so their dyad is not re-established. ERI (1.21) asks GRC in a mixed language utterances if the company that she refers to is like a MoneyGram¹²¹, and then again in Spanish what the company is called

¹²¹ An American money transfer company

(1.22). GRC is still shuffling through her belongings and does not look at ERI, but as a response to his question, she hands him the company's business card which ERI takes (1.23). Since LIN is finished with her drink and is now sitting on the chair, she turns around and addresses ROX (1.26) who is in the living room. LIN tells her that she wants to get dressed, but ROX does not seem to respond to her request. It appears LIN is having a tough time finding an interactional partner. GRC (1.27), still engaged in conversation with ERI tells him in Spanish that the places are not far from each other with a brief up and down movement of her left arm. Moreover, GRC (1.28) states that the place denoted in the card that she just handed him, which she references through her gaze and slight nod of the head, does not have the best exchange rate. At this moment LIN (1.29) produces her first mixed language utterance and says, "Mommy I want clothes I'm so frio@s." (cold). As a response, and without aligning to LIN's previous language mixing ROX (1.30) tells her in English that she should have changed when she was told to do so upstairs, but at least now LIN has successfully initiated a dyad and is a ratified speaker on this new topic. However, LIN (1.31) insists and repeats the second mixed language utterance, "I'm frio@s." (cold). However, ROX (1.32) tells LIN to wait until she is finished tending to her little brother JUL, still not aligning to LIN's language mixing (1.33-1.37) LIN and ROX find middle ground and agree on when LIN will be dressed. Finally, GRC (1.38) while still involved in her task peers over her right shoulder to look at JUL (who is not visible) and asks him in a sort of motherese why he is not wearing shoes, but he does not respond. Up to this point, everyone except for LIN seems to be involved in a focused dyadic interaction.

The main issue here is related to LIN's language mixing. When LIN tells ROX that she is cold we remark that the seven preceding exchanges in the bilingual language learning environment (between ERI and GRC) are almost entirely in Spanish. Only one is in English and it takes place when LIN first tells ROX that she needs clothes. Thus, it may be argued that LIN's mixed language choice does not seem to be influenced by the previous language choices in the bilingual language learning environment. On the other hand, perhaps there is an influence since LIN does resort to language mixing rather than to English alone in a Spanish environment. That is, her mixed language use may be influenced by the adults' Spanish use. We may also ask if LIN's insertion of the Spanish word "frio" (cold) is related to a lexical gap, or that she does not yet have a translation equivalent for this pair. However, a quick search of the LIN's semantic domains analysis which also considered her Spanish and English translation equivalents in Chapter 4 reveals that LIN does have knowledge of the word cold in English. So, her language mixing is not related to a lexical gap. For example, in discussing the weather

LIN asks ROX, “why is so cold today, Mom?”. While this interaction was outside of the three sample periods, LIN uses the word cold in two of our analyses (ex. 1, 1.3; ex. 13, 1.74). LIN’s question therefore shows that she does possess productive use of the *frio*/cold translation equivalent. Perhaps since LIN’s first request for clothes in English went unacknowledged, her mixed language utterance is used pragmatically not only to draw ROX’s attention, but also to persuade ROX to dress her. Holmes (2000) suggests that one of the many reasons for code-switching, or language mixing within the framework of this Ph.D. is related to capturing attention, and persuasion. After LIN language mixes to express her feelings ROX finally responds, and they both subsequently agree on when she will get clothes. Therefore, it may be argued that through her mixed language utterances LIN manages to achieve her communicative goal in this dyadic participation framework. Furthermore, interactions like these may serve to implicitly socialize her into language mixing. If LIN’s English is not enough to flag an interlocutor’s attention when she tries to express her needs, but her language mixing is, then this interactional linguistic dynamic may serve to encourage her to produce and thus develop her mixed mode of communication within the family. The last point is that LIN’s language mixing could be a strategy to ratify GRC into her dyadic encounter with ROX, and thus to recruit her to tend to LIN. Language mixing may thus facilitate both multigenerational communication (Chung, 2010), as well as bilingual language acquisition (Gorter, 2013). However, even if we will never know why LIN language mixes, we do know that within the family’s cultural framework, typically all the family members interchangeably engage in the child rearing activities. For example, when one adult is busy, another one will generally lend a hand to fill a bottle, change a diaper, dress a child etc. We will analyze a specific interaction that shows this shared child-rearing style next. This mutual aid within the family underscores the importance of the multigenerational, multiparty participation frameworks. In other words, this cultural characteristic has a significant impact on LIN’s bilingual and bicultural socialization. However, since GRC is so wrapped up in her activity, LIN’s language mixing is ignored, or is even seen as a distraction in the focused conversation. Nevertheless, LIN’s discourse related to putting clothes on and being cold could have influenced GRC’s following Spanish utterance directed to JUL when she asks him about his shoes. Not only is it cold in the house, but the marble flooring is also cold on bare feet, especially in the winter. GRC is thus worried about JUL being cold or catching a cold and it may also be an indirect way to suggest to ROX that he should wear shoes so that he does not get sick.

The sequence that ensues follows the interaction analyzed above where through language mixing LIN seems to meet her goal of gaining her mother's attention, and thus forming a dyad. Even though ROX does not align with LIN's language mixing, she sits JUL on the table and continues to dress him. By now, GRC has put her belongings away. ERI is still invisible and behind the camera. Since ROX does not act fast enough, LIN takes matters into her own hands and shows GRC her clothes, establishing once again their dyad. This also engenders as mentioned above the second Spanish teaching moment between both LIN and her great-grandmother GRC through child-rearing activities.

LIN is 3;10

- | | | |
|-----|-------|---|
| 39. | *LIN: | Grandma@s:eng&spa. |
| 40. | *GRC: | [- spa] xxx quiéres que te lo ponga? @LIN
Do you want me to put it on you? |
| 41. | *LIN: | yeah yeah yeah. @GRC |
| 42. | *LIN: | yeah yeah. @GRC |
| 43. | *GRC: | [- spa] di mira mhija [: mi hija] di +... @LIN
Say look daughter say +... |
| 44. | *GRC: | [- spa] ponme el vestido +... @LIN
Put the dress on me. |
| 45. | *LIN: | [- spa] ponme el detetido [: vestido]. @ROX
Put the dress on me. |
| 46. | *GRC: | [- spa] el vestido. @LIN
The dress. |
| 47. | *LIN: | [- spa] el vestido. @ROX
The dress. |
| 48. | *GRC: | [- spa] por favor. @LIN
Please. |
| 49. | *LIN: | [- spa] por favor. @ROX
Please |
| 50. | *LIN: | Please. @ROX |
| 51. | *GRC: | [- mix] tu eres bilingue Mamá tu ya sabes spanish@s [: español]. @LIN
You're bilingual Mom you already know Spanish. |

Plurilingual Transcript 16; ex. 12: FEB_21_2018_LIN_GRC_ERI_ROX_MAR_ponme el vestido por favor_B

Since ROX is still busy dressing JUL, LIN gets off her chair and takes a couple steps towards GRC who is sitting next to her. LIN (1.39) calls GRC and raises her hand with an article of clothing. Then, GRC (1.40) turns from her chair to face LIN and asks in Spanish if she wants her (GRC) to dress her (LIN). They are thus in a dyadic participation framework. LIN understands GRC, so as a response to her question LIN (1.41 and 1.42) enthusiastically answers GRC dilingually multiple times. This confirms the observation made in the previous analysis,

or that multigenerational family members other than the primary caretaker (ROX) could be solicited to help at any time either at an adult's, or in this case, a child's initiative. Nevertheless, taking advantage of LIN's spontaneous burst of energy, GRC decides to turn the interaction into a teaching moment to guide it into monolingual Spanish. This also shifts the interaction into a triadic social encounter. In doing so LIN quiets down, almost as if to focus and pay close attention to what GRC will say. Therefore, GRC (1.43 and 1.44) models to LIN in Spanish how to ask her mother to be dressed. We may further argue that GRC's utterance is intended to be instructional since she slows down her articulation and says each of the Spanish words loud and clear. According to Lanza's (1997) discourse strategies this may be assimilated to a Minimal Grasp Strategy with one of the goals being to steer the conversation into only one language. It is thus a response in Spanish to LIN's utterance in English so that she can learn how to express the same needs, but in Spanish. LIN (1.45) says, "ponme el detetido [: vestido]." (put the dress on me.), but her pronunciation of the Spanish noun for dress is non-target and perhaps too flagrant for GRC for it to go uncorrected. So, GRC (1.46) offers an embedded phonological repair by reiterating slowly and clearly how to say dress in Spanish and LIN (1.47) repeats "el vestido" (the dress) with a more target-like production. This sequence is in line with de Pontonx et al.:

As children use many non-conventional forms, in the Western cultures studied in the literature, parents are constantly trying to make sure they understand their children's communicative intentions through reformulations. They thus offer conventional versions of children's productions, which serve as repairs that are either embedded in the flow of conversation or explicitly corrective. This repeated process is key to the development of children's own ability to monitor and repair their own productions. (De Pontonx et al., 2018: 2).

Even if LIN's second attempt at saying dress in heritage Spanish is not perfect, it seems to suffice for GRC since she does not insist any further and moves on with the next bit of Spanish input. Thus, GRC (1.48) in Spanish models how to say please and LIN repeats please in Spanish (1.49) though again with a near-target pronunciation. Since LIN is standing in front of GRC and GRC's back is facing the camera, we cannot see either of their gestures. We can however infer through LIN's voice that she seems to be excited as she repeats the child-directed segmented speech in Spanish. Furthermore, while it is not perfectly clear due to the spatial organization of both LIN and GRC, it does appear as though LIN (1.50) follows her Spanish production of "por favor" with the English translation equivalent, almost as if to show GRC that she knows what the Spanish term means in English. As a result, this provides evidence that LIN has knowledge of another translation equivalent in her repertoire. Here we may also note that contrary to what we have observed in the previous analyses, GRC through her verbal

engagement explicitly socializes LIN to be polite when asking for something. In this sense, socialization into politeness is central to the present triadic interactional framework. Furthermore, socialization into politeness is also straightforward, as opposed to being a more subtle and complex process (Burdelski, 2011). Finally, the sequence comes to an end with an interesting linguistic twist. After LIN's good-natured and cooperative repetitions, GRC (1.51) praises her. While this is an area that is to date understudied in language socialization practices, recent research that explored the praise sequences in parent-child interaction in French family life showed that

Children's self-praise was linked to adult praise and to scaffolding and joyful emotion sharing. Praise was co-constructed and *upgraded* through an array of resources, and the children's actions were sequentially transformed into accomplishments. In this multimodal enactment, praise may change ordinary actions into extraordinary feats, momentarily transforming little children into celebrated heroes of family life. (Aronsson & Morgenstern, 2021: 1).

Notwithstanding, while GRC proudly tells LIN that she is indeed bilingual she does so through language mixing as evidenced by her pronunciation of the noun Spanish with English-like phonology. It should also be highlighted (as demonstrated quantitatively in Chapter 4) that GRC's mixed language productions are almost null longitudinally. Nevertheless, on the one hand, to complement LIN on her emerging bilingualism may undoubtedly serve to encourage her to keep using her heritage Spanish. On the other hand, however, the fact that GRC compliments LIN through language mixing may also serve to implicitly socialize her into language mixing as valid mode of communication in their community of practice. Therefore, the question of why GRC mixes while teaching LIN Spanish is raised. In looking at the language of the 11 previous utterances between her and LIN, we attest that they are all almost entirely in Spanish with only a few of them being in English. Thus, GRC's language mixing does not seem to be influenced by the previously mixed language utterances in the bilingual language learning environment. While it is difficult to provide a conclusive answer, we may engage in some speculation. GRC's mixed language utterance may be interpreted as a way for her to affirm and reassure LIN and her developing bicultural and bilingual identity. By language mixing herself, this could also be a way for GRC to show solidarity, or group membership and shared ethnicity (Holmes, 2000) across generations (Chung, 2010). Finally, GRC's mixed language production could be considered a Language Switch Strategy, or a bilingual discourse strategy (Lanza, 1997). This would allow for the conversation to continue bilingually and perhaps to give LIN, a sort of hybrid heroine, a break after having finished their

Spanish lesson. However, we will see next that GRC's expectation is for LIN to continue to speak Spanish in their triadic participation framework.

For GRC, segmenting the speech stream allows LIN to engage and thus use heritage Spanish more, or less successfully since she is listening to and repeating smaller chunks of Spanish at a time. In the meantime, ROX almost finishes dressing JUL. While they form a dyad, ROX was also very much included in LIN and GRC's triadic exchange since she was the referent in their joint attentional frame. Excited about finally getting her clothes on with the help of GRC, LIN turns to address ROX. This allows GRC to pursue the Spanish lesson, again by segmenting the speech stream. It also gives GRC the opportunity to insist that LIN should continue her conversation in Spanish, or monolingually as opposed to bilingually as was considered above. Therefore, this may show that GRC's previous mixed language production is not necessarily a bilingual discourse strategy.

LIN is 3;10

- | |
|---|
| 52. *LIN: Mom I put my hand +/. |
| 53. *GRC: [- spa] no en español. @LIN
No in Spanish. |
| 54. *GRC: [- spa] Mamá di. @LIN
Say Mom. |
| 55. *LIN: [- spa] Mamá. @ROX
Mom. |
| 56. *GRC: [- spa] quién es? @LIN
Who is it? |
| 57. *GRC: [- spa] xxx xxx. @LIN |
| 58. *LIN: Daddy. |
| 59. *GRC: [- spa] peinmame. @LIN
Brush my hair. |
| 60. *LIN: [- spa] pename [: peiname]. @ROX
Brush my hair. |
| 61. *GRC: [- spa] por favor. @LIN
Please. |
| 62. *LIN: xxx xxx. |
| 63. *GRC: [- spa] por favor. @LIN
Please. |
| 64. *LIN: [- spa] por favor. @ROX |
| 65. *GRC: [- spa] ya ves que habla español mhija [: mi hija]? @ROX
You see that she speaks Spanish daughter? |
| 66. *ROX: [- spa] sí. @GRC
Yes. |

67. *LIN: Yay yay! @GRC
68. *LIN: Mommy I don't need my iPad.
69. *GRC: [- spa] no en español. @LIN
No in Spanish.
70. *GRC: [- spa] dile en español eso. @LIN
Tell her that in Spanish.
71. *ROX: [- spa] qué quieres Linoria? @LIN
What do you want LIN?
72. *GRC: [- spa] quiere qué?
What does she want?
73. *ERI: [- spa] que qué quiere la LIN. @GRC
74. *LIN: It's cold. @GRC.

Plurilingual Transcript 17; ex. 13: FEB_21_2018_LIN_GRC_ERI_ROX_MAR_ponme el vestido por favor_C

The interaction unfolds and LIN (1.52) turns to ROX. LIN wants to let her know how she manipulated her hands to get dressed with GRC's help. However, LIN is stopped in her tracks when GRC (1.53) insists that she should continue to express herself in Spanish when addressing her mother. Since GRC's back is still turned to the camera we cannot see her gaze, or LIN's but we assume that she is looking at LIN who is standing in front of her. This is further supported by the fact that GRC's body is also hunched towards LIN when GRC basically commands her to speak Spanish and uses her left index finger to refer to ROX who is attentive to what GRC is telling LIN, and standing visibly off to the side with JUL. The figure below captures the moment when GRC is focused on LIN but pointing at ROX. It also depicts ROX looking at LIN waiting to hear what she wanted to say.

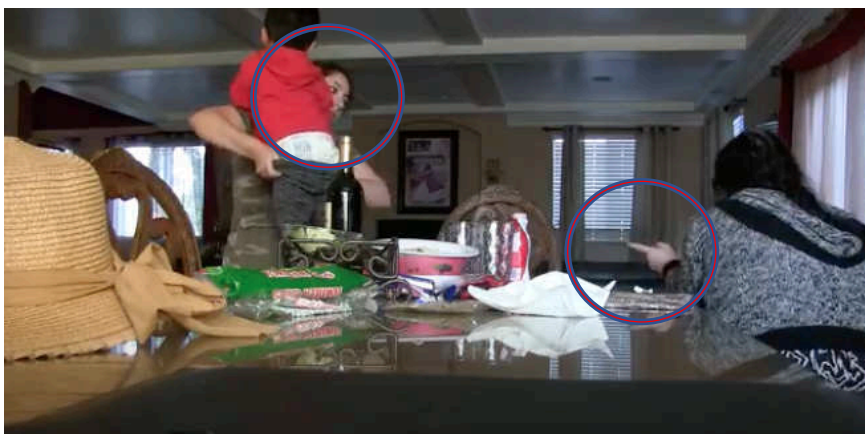

Figure 42: GRC addresses LIN while pointing to ROX to tell her to speak Spanish.

In this short sequence we may ask the following questions: First, what is the meaning, or function of the GRC's non-verbal behavior when addressing her great-grandchild LIN?

Secondly, does GRC gesture as much when speaking to her adult bilingual children? To answer the first question, one lead is that GRC's multimodal strategy is intended to reinforce the meaning of her Spanish utterance. GRC understands that LIN is a novice in Spanish. Her pointing may thus signal to LIN that she is being asked to address her mother in Spanish since at first, it is not explicitly stated in her utterance within their joint attentional frame. Morgenstern et al. (2021), and Kiaer (2023) have also shown that gestures play an important role in the input and output of bilinguals. Similarly, Nicoladis and Smithson (2022) discuss not only the place of gesture in bilingual language acquisition, but they also underscore its impact on both cognition and culture. Notwithstanding, as far as the second question is concerned, closer analyses of the data does not allow to confirm whether GRC gestures as much when addressing other bilingual adults. However, we did see in the previous analysis that GRC did gesture when addressing ERI. We may therefore assume that GRC's Spanish child-directed multimodal discourse serves to stress who the referents are in this triadic participation framework as we see below. Nevertheless, following GRC's directive ROX also looks and nods at LIN as if to encourage her to continue in Spanish. About three seconds of silence go by but LIN does not react. More than likely, this is because LIN does not know how to formulate what she wants to share with ROX in heritage Spanish. Therefore, GRC assists her in using Spanish again by providing a model where the speech stream is segmented, and thus easier to apprehend and subsequently produce as analyzed further up. GRC (1.54) says Mom in Spanish, reinforced again with a quick shake of the same left index finger to point to ROX which she never really released. LIN then repeats Mom in Spanish (1.55) with an on-target production. Also, we do not know if LIN is looking at ROX while she says Mom. However, we can see that ROX maintains her gaze on LIN as she nods her head again to indicate that LIN has her attention. The figure below captures the moment as GRC maintains her pointed finger at ROX, and when ROX nods to LIN letting her know that she has her attention.



Figure 43: GRC segments a Spanish utterance for LIN & ROX nods to let LIN know that she is listening.

After LIN's Spanish production, GRC (1.56) attempts to push the lesson a little further by asking LIN who she (ROX) is. This may be seen as another way for GRC to scaffold and reinforce LIN's use of the word where the expected answer is "Mom" in Spanish, but LIN does not respond. Then while still holding her index finger up towards ROX, GRC (1.57) appears to ask LIN another question, but it is not clear what GRC asks because her voice becomes weak and inaudible. Clearly, LIN is confused as to what to say since it appears as though she says "Daddy" (1.58) but he is not present. However, GRC promptly corrects LIN (1.59) by showing her how to say brush my hair in Spanish, again insisting with her left index finger. LIN (1.60) repeats, but her production is not target-like, and this time GRC does not re-model the term and instead proceeds. GRC (1.62) finishes modelling the Spanish directive with the adverb please turning the utterance into a polite request. Again, as seen above, GRC maintains her effort to socialize LIN into politeness. Nevertheless, LIN's Spanish production (1.62) of the term please is not target enough for GRC. So, GRC (1.63) provides LIN with the correct pronunciation one more time. LIN's second attempt to say please in heritage Spanish (1.64) is more target-like even though it sounds as if she is getting tired or losing interest in the language learning activity, but she quickly gets excited again following GRC's praise. Praise thus seems to be a vector for heritage language learning here since it supports the family's communicative well-being (De Houwer, 2015). GRC (1.65) turns to ROX to confirm to her that LIN does in fact speak Spanish and ROX (1.66) responds yes, in Spanish. In the meantime, LIN appears to be delighted since she is jumping up and down shouting yay (1.67) as she holds GRC's hands. Then while GRC seems to give LIN a kiss on the forehead (1.68), which may also serve to positively reinforce her heritage language learning effort, LIN turns to ROX and in English tells her that she does not need her iPad. What does this mean? Research suggests that

In the contemporary period of globalization, everyday communication and the construction of identity and social relations is increasingly taking place in virtual environments. The worldwide use of computer technology has created a new contact zone in language learning and practice. (Li, 2008: 79).

It would thus appear as though LIN may be in the process of constructing her linguistic identity in relation to her tablet and what she sees and hears (in Spanish) online. In this sense, the abundance of connected gadgets in the home seem to foster a contact zone between English and Spanish. As a result, these virtual environments appear to have a strong influence on her linguistic practices in the home. Namely, her limited use of heritage Spanish, or passive bilingualism that for her, engenders dilingual conversations. Nevertheless, it is critical to mention here how LIN's attitude towards speaking Spanish shifts longitudinally. The first analysis of this chapter began with a discussion of how LIN's attitude goes from not wanting to speak Spanish to claiming that she *can* speak Spanish. We are therefore reminded that through a mixed language utterance LIN sustained her claim that she does not have to speak Spanish stating that, "my tablet has spañol@s [: español] (.) only in my tablet." (ex. 1, 1.13). Here however, this is no longer the case. With some assistance and a positive attitude as Aronsson and Morgenstern (2021) found she too reclaims her ability to speak heritage Spanish thus liberating herself, even if temporarily, from the influence of those electronic devices. These are gadgets to which she had previously ascribed the linguistic burden based on their non-interactive, virtual nature. Nevertheless, LIN's triumph is short-lived because GRC (1.69 and 1.70) directs LIN to repeat what she has just said in Spanish using her left index finger once again to point at ROX. LIN looks at GRC but does not acknowledge her request, then she turns to ROX who lifts JUL from the table and begins to walk towards the living room. As evidenced before, GRC has difficulty understanding LIN in English. It is likely that if GRC knew what LIN said to ROX, GRC would more than likely model to LIN through speech segmentation how to say that she does not need an iPad (1.68) in Spanish. Nevertheless, LIN continues to playfully hop around. GRC recognizes that the Spanish lesson is finished so she turns back around on the chair to face the table. We can also see a grin (of satisfaction?) on GRC's face. Then when ROX asks LIN what she wants in Spanish (1.71) as she is still walking to the living room, GRC's gaze moves back to ROX who is now in the living room. GRC (1.72) asks ROX in Spanish what LIN wants and ERI (1.73) chimes in to inform GRC in Spanish that with her question ROX wants to know what LIN has just said. Through ERI's intervention the interactional frame seems now to be multiparty, and certainly multigenerational. Throughout most of the present bilingual, but overlapping dyadic, and triadic participation frameworks, ROX remains an unratified overhearer until LIN ratifies her into the social encounter.

However, the flexible participation frameworks open a space for ROX to align to GRC's Spanish monolingual discourse strategy since she is aware of her language related goals, even though she is addressed in English by LIN. The multiparty participation framework also allows for ERI to re-engage in the conversation to help untangle any comprehension challenges between the bi- and monolingual, multigenerational participants. The participation framework allows for a sustained and joint effort of heritage Spanish language socialization which would not be as rich in a dyadic child-adult interaction. This is especially true if only one generation is involved since ROX did not seem as interested as GRC to maintain heritage Spanish in the interaction. As such, it may be argued that it is through the multigenerational framework that Spanish may be a sustained mode of communication not only in her input, but also in her output, or at least elicited output which demanded a great deal of effort from GRC. Notwithstanding, GRC is relieved from her role as the Spanish teacher, and the language baton subsequently shifts to another bilingual adult who decides to pursue the Spanish interaction with LIN. The interaction comes to end when LIN (1.74) who is twirling around in front of GRC reaches for the bottle of yoghurt on the table, looks at GRC and tells her in English that it is cold and then goes off to drink some more. In the end, LIN's comment to GRC further goes to demonstrate her passive bilingualism. That is, even though GRC tells her that the drink is warm in Spanish (1.7), after having verified herself, LIN is in the position to tell GRC that it is cold, as opposed to warm. It also shows that despite the effort to get LIN to speak Spanish, her default mode of interaction is bilingual with those who do not speak English like GRC. As such, this may be interpreted as a dual opposition to GRC on LIN's behalf. That is, LIN opposes GRC's evaluation that the drink is hot, as well as her need to speak Spanish.

Synthesis

By providing a line-by-line analysis of the three interactional moments above we underscored how segmenting the speech stream and repairing non-target words helps LIN use heritage Spanish in interaction. In a study that considered the construction of children's productions in situated conversations, we learn that "Adult's repairs are part of the scaffolding process, which enables children to learn the linguistic system in dialogue." (Morgenstern et al., 2013: 3). While LIN can produce single words on her own, her utterances are considerably lengthened and enriched when she is guided, in this case, by an adult monolingual Spanish speaker. Furthermore, the languages of interaction in the diverse participation frameworks are mainly Spanish, with some English, and language mixing to a lesser extent. In determining who speaks

what language to whom, ERI and GRC address each other in Spanish in their focused discussion. However, LIN speaks English to GRC, but GRC speaks Spanish to LIN with one instance of language mixing. GRC and LIN's interactional style may serve to reinforce their bilingual linguistic relationship over time. Even if LIN eventually does become a more proficient heritage Spanish speaker, the force of habitual language choice on LIN's end as De Houwer (2019) states may be so strong that she is not able to bring herself to speak Spanish with GRC. It is difficult to determine what causes GRC to mix languages with LIN. We argue that it is a way for GRC to show solidarity after her efforts to speak Spanish and not so that the interaction proceeds bilingually as Lanza's (1997) Language Switch Strategy warrants. Nevertheless, LIN addresses ROX in English and through language mixing and ROX addresses LIN in English and in Spanish but does not mix languages with her. In considering why LIN language mixes to address ROX, we advance that it has the pragmatic function of capturing attention to persuade (Holmes, 2000). We may also dwell on GRC and LIN's language mixing. Both speakers are not fluent bilinguals. As such, they language mix for seemingly opposite reasons, however, they are in fact similar. Their lack of mastery in one of the languages makes them resort to language mixing in an effort to communicate with the other (Chung, 2010). For GRC language mixing is using English, whereas LIN uses Spanish to mix languages. In this sense, language mixing is a way for each of them to speak their weaker language. Language mixing in this multigenerational framework thus provides a platform for heritage language use as it concerns LIN which is an instrumental interactional aspect that should be linked to this third, often shunned mode of communication. In terms of discourse strategies, GRC does her best to continually steer the conversation into Spanish by deploying the Minimal Grasp Strategy, but not only. As described above, GRC through her constant pointing, resorts to multimodal communication to heighten LIN's awareness of who the referents are in the triadic interactional frame. Indeed, Brunet et al. (2022) demonstrate how gestures are used when the interlocutor does not master the language, or the interlocutor's weaker language. Finally, in terms of language socialization, we have previously noted that there seems to be no explicit directive on behalf of the adults for the children to be polite. This is in line with research findings on American families (Blum-Kulka, 2008). However, GRC by teaching LIN to use Spanish through speech stream segmentation insists that LIN knows how to say thank you to the best of her ability. Socialization into politeness thus seems to play a central role for GRC. A last point to be made relates to language socialization, identity construction, and the influence of electronic devices. The virtual worlds create new contact zones that subsequently impact linguistic practices (Pauwels, 2016). This was the case for LIN even if her attitude to

speaking heritage Spanish shifted longitudinally. Nevertheless, the influence of connected devices needs further investigation. In other words, “A new area to consider is that of diasporas, identities and migration. As global migration is commonplace today, the question should be what are the communicative practices that are emerging from these new cultural spaces?” (Pahl, 2008: 123). Finally, the present interaction is dominated first by GRC and ERI and then by LIN and GRC. Their dyadic interactions overlap within the other bilingual dyadic, and triadic frameworks. They also seem to embed themselves into the social encounter as the participation framework goes multiparty. This allows for the otherwise unrati ed overhearers to take the floor as needed to assist in the bicultural meaning making process which is an essential aspect in their dynamic bilingual language learning environment. We have seen how breaking up the speech stream helps LIN use Spanish. Similarly, in the next example ROX assists LIN to name in Spanish the variety of chili pepper on a slice of pizza. She does so by providing her the second segment of the Spanish compound word “chile jalapeño” (jalapeño pepper) after LIN appears to be linguistically stuck. The table below highlights the central interactional points that emerged throughout the three examples analyzed in the present discussion.

Table 53: Summary of key analytical features in examples 11, 12, & 13

LIN's age & example	Multimodal Framework	Multigenerational Framework	Participation Framework	Discourse Strategies	“Who speaks what language to whom?”	Dilingual Conversation or Passive Bilingualism
3;10 ex. 11, 12 & 13	Gaze Moving arms up and down Nodding Using objects Pointing	LIN (3G) JUL (3G) ROX (2G) ERI (2G) GRC (1G)	From dyad to another dyad to triad to multiparty	GRC-MGS (mono) GRC-LSS (bi)	LIN E GRC LIN S GRC LIN E ROX LIN M ROX LIN S ROX ROX E LIN ROX S GRC ROX S LIN ERI S GRC ERI M GRC GRC S ERI GRC S LIN GRC M LIN	DL & PB

6.1.2 Chile jalapeño

The present interactional analysis further illustrates how providing Spanish words in isolation helps LIN use them meaningfully in the family's frequent multigenerational social encounters. This time however, LIN is assisted by her mother ROX who initiates the Spanish language learning moment. Moreover, as we will also see in the next analysis, the use of Spanish in the family is undeniably linked to the use of both English and language mixing. This interaction took place on February 2018, and it was initially presented in Chapter 4 to quantify LIN's use of Spanish longitudinally, therefore this aspect will no longer be addressed. ERI is holding the camera while he is sitting around the table. The sound quality is therefore good, and we can also clearly see LIN and ROX directly in front of ERI allowing for gesture and gaze to be analyzed. The other participants include LIN's late father MAR who is sitting to LIN's left, and her late great-grandfather GRT who is sitting to her right. ROX is standing next to LIN between her and GRT. Other participants include JUL, ALE, and RIC but they are mostly out of sight. The interaction begins when ROX addresses LIN regarding adding more cheese to her slice of pizza. The participants in their unfocused dinnertime activity are mostly speaking English, with some Spanish, and only one occurrence of language mixing. Dinner proceeds as such until ROX asks LIN what one of the pizza toppings is called.

LIN is 3;10

1. *JUL: Ma Ma Ma Ma @LIN
2. *LIN: I not your mom look +... @JUL
3. *LIN: she you mommy @JUL.
4. *ALE: oh@i damn Ignacious.
5. *LIN: I not you mom @JUL.
6. *ROX: you're not his mom? @LIN
7. *LIN: no. @ROX
8. *ROX: that's my cheese I already put cheese right here look. @LIN
9. *RIC: now it's saying the Internet is not working.
10. *LIN: this tastes like +...
11. *ERI: [- spa] sí le gusto Apá [: Papá]? @GRT
Did you like it Dad?
12. *GRT: [- spa] uhuh. @ERI
Yes
13. *ROX: what is this (.) don't clean yourself on me what is this? @LIN
14. *LIN: a pepperoni. @ROX
15. *ROX: and what else (.) what's this? @LIN
16. *LIN: [- spa] chile. @ROX

Chile	
17.	*ROX: [- spa] jalapeño. @LIN Jalapeno
18.	*LIN: [- spa] jalapeño. @ROX Jalapeno %exp: sounds like she aspirated her 'p'
19.	*ROX: [- spa] jalapeño. @LIN Jalapeno %exp: ROX mocked LIN's pronunciation
20.	*LIN: xxx xxx one more time. @ROX
21.	*MAR: give her one more try.
22.	*LIN: [- mix] this a jalapeño@s. @ROX This a jalapeno.
23.	%exp: LIN seems to have adjusted her pronunciation
24.	*ROX: uhuh. @LIN
25.	*LIN: and this a +... @ROX
26.	*ROX: crust. @LIN
27.	*LIN: crust. @ROX
28.	*ROX: and cheese. @LIN
29.	*LIN: and cheese. @ROX
30.	*LIN: that's it. @ROX

Plurilingual Transcript 18; ex. 14: FEB_13_2018_RIC_ALE_LIN_GLO_ROX_JUL_GRT_chile jalapeño

JUL (1.1) approaches LIN, apparently referring to her as mom, but LIN (1.2) disagrees and then looks up towards ROX (1.3) while also pointing to her to let him know that she (ROX) is his (JUL's) mom. JUL continues and a few seconds later LIN (1.5) insists once again to JUL that she is not his mom. Even if ROX is focused on adding cheese to her slice of pizza, she is overhearing LIN's emerging dyadic interaction with JUL since following her multimodal reaction to his calls but without looking at her, she asks (1.6) LIN if she is not his mom to which she replies no (1.7). JUL therefore fails in establishing a dyad with LIN. Next, as ROX finishes adding the cheese, LIN reaches out to grab some, but ROX (1.8) tells her that she has already added cheese to her slice of pizza. They are once again in a brief, but dyadic interactional framework. After LIN tastes the cheese that she brought to her mouth with pinched fingers (1.10) she attempts to identify the flavor. Up until now, the meal-related interaction has been essentially unfocused, and has taken place in English until ERI (1.11) asks GRT in Spanish if he is enjoying the pizza. At the same time LIN stands on her chair, pinches her pizza and turns to ROX. Consequently, LIN's abrupt movement seems to inspire ROX to ask her to name some of the pizza's toppings forming once again a dyad. ROX thus asks (1.13) LIN to produce the name of one of the ingredients and LIN (1.14) responds pepperoni while they are both looking

at the slice of pizza that ROX is holding in her right hand. It is not clear whether ROX (1.15) validates her answer, but she proceeds to ask LIN to say the name of a different ingredient that she points to with her right index finger. While ROX's request for LIN is in English, the goal seems to be for LIN to say the name in Spanish. Therefore, although the parent (ROX) keeps interacting with the child (LIN) in the same language (English), we can consider that the discourse strategy that she deployed was that of a Language Switch Strategy. This is a bilingual discourse strategy that allows for a conversation to be carried out in two languages, a dynamic discourse style that is typical within the family's bicultural language learning environment. Moreover however, this type of discourse strategy allows for changes from one language to another, or from English to Spanish in this case as we see next. The figure below shows ROX engaged in dyadic interaction with LIN as she points to the other pizza topping with her finger. It also shows that even if MAR is not a ratified participant in their dyadic social encounter, he is still attuned to their dyadic interaction which will become more evident further below.

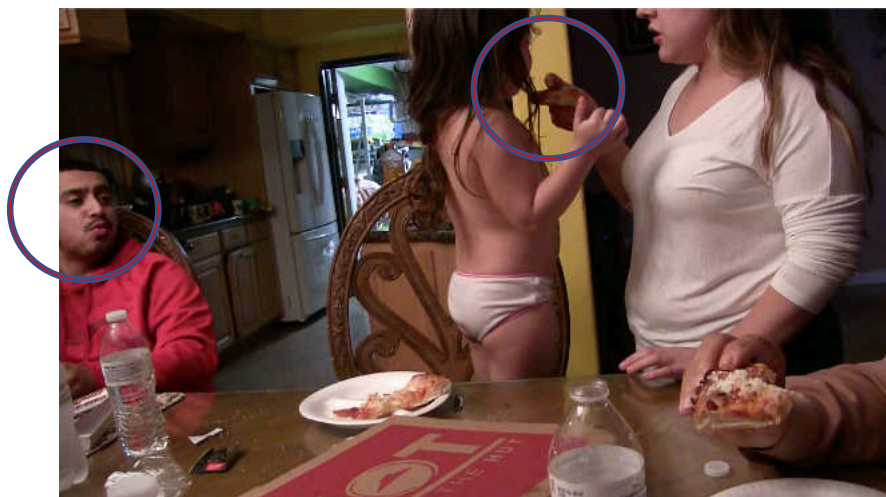

Figure 44: LIN & ROX are engaged in dyadic interaction while ROX points at pizza topping.

LIN's Spanish answer (1.16) "chile" (chili) is almost on target. Furthermore, as she produces the partially correct answer, she looks up at ROX and says it in a tone that may be interpreted as though it was an easy exercise for her. However, within the community these types of chili peppers are typically referred to using their compound name, or "chile jalapeño" (jalapeño pepper). Thus, ROX (1.17) provides LIN with the second segment of the Spanish compound word, namely "jalapeño" which she articulates using Spanish phonology and is clearly marked with an unaspirated /p/. While providing LIN with the second segment of the word helps her repeat it (1.18), we hear that her production is not on-target. Despite the explicit modeling of the word on ROX's behalf, LIN aspirates the /p/ much like an American non-native speaker of

Spanish would pronounce their plosive consonants as discussed previously. Furthermore, what is interesting is that on other occasions LIN has shown accurate production of the unaspirated Spanish /p/ sound, for example with the use of the word “puta” (whore) analyzed in context in the previous section of this chapter (ex. 9, 1.30). Therefore, it is unclear if LIN’s non-target production is due to cross-linguistic phonological transfer, or whether it is intentional on her behalf. Nevertheless, what is clear is that LIN’s production is salient enough to capture ROX’s attention who in turn (l.19) mocks LIN by aspirating the /p/ herself as she repeats the word again. Much like what Kulick (1992/2012) found among Gapun villagers who were keen on their children to learn Taiap, the local vernacular, “Caregivers in Gapun also ignore or criticize their children’s use of the vernacular, unintentionally discouraging its use by children.” (Howard, 2008: 189-190). While ROX’s imitation of LIN’s non-target production may not be interpreted to be hurtful, it may be seen as a sort of implicit criticism of her linguistic abilities in heritage Spanish. Nevertheless, what we also see is that LIN rather than to be discouraged to speak again, asks multimodally to produce the word one more time as she looks at ROX and while pointing her right finger in the air. The image below shows LIN asking ROX to allow her to produce the word again in Spanish.



Figure 45: Multimodally LIN asks ROX to say "jalapeño" one more time.

This motivational aspect is very important since it shows her desire to learn despite her refusal to learn heritage Spanish on other occasions as we have previously discussed. Therefore, LIN through a mixed language utterance attempts to say the word correctly. In doing so, we can see and hear her late father MAR who is an overhearer repeat to another speaker at the table LIN’s request to give her one more try which clearly puts a smile on his face. As mentioned earlier, MAR is not a ratified participant in the framework, but through his comment we understand

that he is indeed attuned to ROX and LIN's ongoing dyadic bilingual language learning interaction. More generally, MAR was also a strong advocate of LIN's education in which he expressed his wish for her to have perfect attendance. He was also found to stimulate LIN's senses through different means. To briefly illustrate this point, I turn your attention to the following digital journal entry. It was taken on August 30th, 2018. I observe the following:

What was striking is that MAR while teaching his kids to be tough and strong and rough and tumble, at the dinner table he also seemed to stimulate LIN intellectually. It seemed as though he took interest in LIN's education by suggesting that she wouldn't go back to school if LIN hadn't learned anything. This comment incited LIN to recite what she had learned and for her to try to express herself with new words that he knew LIN could use. Moreover, during dinner and in a playful manner, MAR challenged LIN to a sensorial experience. With her eyes closed he would put a piece of food in her mouth, and she was to guess at what it could be. On most of the occasions LIN guessed correctly, but this playful interaction between father and daughter seemed to reinforce their bond and for the daughter to benefit from the father's playful, but educational interactional style. (Alvarez, 2018).

MAR certainly played a key role in LIN's physical, and intellectual development, and his teachings will without a doubt resonate throughout LIN's educational journey. Notwithstanding, as it pertains to ROX and LIN's dyadic interaction, LIN thus reproduces the word "jalapeño" (1.22) in a more target-like manner i.e., her initial aspirated /p/ is considerably toned down and ROX nods her head up and down in agreement (1.24) while maintaining her gaze on LIN. This specific instance during dinner may also serve to reveal not only LIN's acute awareness of the Spanish phonological system as contrasted with the English¹²² one, but also her developing meta-communicative skills in interaction (Blum-Kulka, 2008). First, she proves her capacity to interpret ROX's exaggerated repetition of the word "jalapeño" as a cue that implicitly signals her incorrect pronunciation. Second, this interpretation allowed LIN to reposition herself as a ratified speaker to show that she was able to identify the specific 'problem' area, namely the /p/ sound, and thus to try to produce it more accurately in Spanish. The interactional moment ends as LIN names, with ROX's help, two other ingredients in English before LIN (1.30) decides that the exercise is over.

Synthesis

The first example in this section decomposed an interactional moment with LIN's monolingual great-grandmother GRC into three interrelated parts. It showed how segmenting the speech stream into its corresponding words helps LIN use heritage Spanish when starting from

¹²² Additional Spanish-English phonological contrasts were touched upon when the 'Sound Game' was discussed in the first section of this chapter.

'scratch' i.e., when LIN has not used heritage Spanish in her previous utterances. The present example goes a bit further. It demonstrates how LIN can build on her preexisting knowledge of Spanish with the help of her bilingual mother in dyadic interaction. After producing the first word in Spanish ROX provides LIN with the second segment of the Spanish compound word in question. In turn, this helps her come closer to producing the longer word herself even if in the end, she does not. Nevertheless, what is perhaps more remarkable in this exchange is to see how LIN is capable of understanding the subtle interactional cues in her dyadic interaction to deduce that something is not 'right'. It is her developing meta-communicative ability that points her to the pronunciation issue despite the other oral and gestural interferences going on as the family shares a meal. Moreover, it is also noteworthy to highlight that in correcting her articulation of the word "jalapeño" she displays awareness of the Spanish phonological system by identifying and fixing the precise problem area. During the family's dinner, ROX and LIN seemed to be locked, even if momentarily in dyadic, multimodal interaction where gesture and gaze helped heighten their meaning making process as ratified speakers. We must also keep in mind that their bilingual language learning interactional framework was embedded in a larger, and ever-shifting multiparty participation framework which consisted of overhearers such as MAR who seemed to be following their conversation. Thus, the main language of interaction here was English all around with one instance where ERI addresses GRT in Spanish and the others being ROX and LIN's repetitions of the word "jalapeño". Furthermore, ROX seems to deploy the Language Switch Strategy. It is a bilingual discourse strategy that seems to authorize changes from one language to another even if here ROX's use of English was not based on Spanish as the language of the previous utterance, a recurrent Language Switch model (Lanza, 1997). In the end, breaking up the speech stream into more manageable chunks (at the word level) encourages LIN not only to use Spanish a bit more overall, but also to fine-tune her Spanish articulation in the process at the phonological level. In the final analysis of this section, we will thus see how segmenting a word into syllables may also be fruitful in helping LIN apprehend and produce a seemingly difficult word in Spanish. The table below briefly summarizes the key aspects of the present social encounter.

Table 54: Summary of key analytical features in example 14

LIN's age & example	Multimodal Framework	Multigenerational Framework	Participation Framework	Discourse Strategies	"Who speaks what language to whom?"	Dilingual Conversation or Passive Bilingualism
3;10 ex. 14	Pointing Stance Using objects Nodding	LIN (3G) JUL (3G) ROX (2G) MAR (2G) ALE (2G) RIC (2G) ERI (2G) GRT (1G)	Shifting dyads in a larger multiparty frame	ROX-LSS (bi)	LIN E JUL LIN E ROX LIN S ROX ROX E LIN MAR E ??? ERI S GRT	No

6.1.3 Toronja

The following dyadic interaction considers how LIN's ability to use heritage Spanish is also facilitated by her bilingual mother (ROX) rather than by her Spanish monolingual great-grandmother (GRC). Much like GRC, ROX also deploys the same speech segmentation method to make Spanish more manageable in terms of comprehension and as such, LIN's subsequent production. However, since the focus here is only one Spanish word, ROX breaks down the target word "toronja" (grapefruit) into its three corresponding syllables. Furthermore, in the analysis, if ROX decides to help LIN correctly produce the word grapefruit in Spanish, it seems to be due to LIN's multiple unsuccessful attempts to do so on her own. This interaction also helps us understand that learning to use Spanish necessarily involves the use of both English, and mixed language utterances, since language mixing seems to favor bilingualism (Gorter, 2013). In other words, learning to use Spanish cannot be entirely disassociated from using the other linguistic resources at their disposal. The interaction takes place in February 2018. The camera is sitting on the dinner table and the sound quality is good. Nevertheless, we will not consider gestures and gaze since the speakers are in the kitchen and thus not visible. The interaction begins as ROX tells ERI that she is preparing a fruit-infused drink for GLO who will stop by the house to pick it up during her lunch break. ERI comments to ROX that the pastries sitting on the table are tasty. LIN is with ROX in the kitchen getting ready to make the drink. They are all speaking English and they are all ratified speakers at first. Finally, the interaction in the participation framework is focused, but making a drink is not necessarily viewed as a serious matter. Then, ERI leaves the interactional frame leaving ROX and LIN to their task.

1. *LIN: you almost done? @ROX
2. *ROX: xxx check out let's see if I got the cup xxx. @LIN
3. *ROX: let me see you think that's good enough? @LIN
4. *ROX: [- mix] xxx put the pepino@s in? @LIN
xxx put the cucumber in?
5. *LIN: can we shake it now? @ROX
6. *ROX: [- mix] no no no we're gonna [: going to] add toronja@s now. @LIN
No no no we're going to add grapefruit now.
7. *LIN: Mommy I wish I could add +/.
8. *JUL: xxx.
9. *LIN: I could put xxx. @ROX
10. *LIN: [- mix] we could put xxx@s [: toronja]? @ROX
We could put grapefruit?
11. *ROX: [- mix] this is toronja@s. @LIN
This is grapefruit.
12. *LIN: [- mix] we could put xxx@s? @ROX
We could put grapefruit?
13. *ROX: [- spa] to +... @LIN
Grapefruit is segmented into first syllable
14. *LIN: [- spa] to +... @ROX
Repeats first syllable
15. *ROX: [- spa] ron +... @LIN
Grapefruit is segmented into second syllable
16. *LIN: [- spa] lon +... @ROX
Repeats second syllable
17. *ROX: [- spa] ja. @LIN
Grapefruit is segmented into third syllable
18. *LIN: [- spa] ja. @ROX
Repeats third syllable
19. *ROX: [- spa] toronja. @LIN
Grapefruit.
20. *LIN: [- spa] toronja. @ROX
Grapefruit
21. *ROX: uhum. @LIN
22. *LIN: I was still answering xxx I say +... @ROX
23. *ROX: I could do it for you. @LIN
24. *LIN: [- mix] I say a jo@s. @ROX
I say (third syllable)
25. *LIN: [- mix] I was say jo@s and and is xxx@s [: toronja]. @ROX
I was say (third syllable) and and is grapefruit.
26. *LIN: I could shake it. @ROX.
27. *LIN: it doesn't have water? @ROX
28. *ROX: not yet. @LIN

29. *ROX: [- mix] I'ma [: I am going to] put some after we put the toronja@s in there. @LIN
I'm going to put some after we put the grapefruit in there.
30. *LIN: xxx. @ROX
31. *ROX: xxx cut it into pieces first. @LIN
32. *LIN: I can't shake it it's too hard. @ROX

Plurilingual Transcript 19; ex. 15: FEB_22_2018_ERI_LIN_JUL_GRC_toronja

Engaged in dyadic interaction LIN asks ROX (1.1) if she is almost done. ROX (1.2) answers LIN by telling her that she is checking the cup and then ROX (1.3) asks LIN for her opinion regarding the drink that they are preparing for GLO. ROX's question to LIN also shows that they are working together, and that LIN's advice is appreciated which helps create a collaborative, hands-on, and informal participative environment. Furthermore, while the first few exchanges are in English, ROX (1.4) proceeds with a mixed language utterance as she inserts the Spanish masculine noun "pepino" (cucumber) into her question. However, LIN's language choice does not seem to be impacted by ROX's previous language mixing. LIN (1.5) continues in English and asks ROX if it is time to shake the drink. ROX (1.6) answers "no" in another mixed language utterance and instead affirms that now they must add the "toronja" (grapefruit). LIN (1.7) begins to express her desire to add what seems to be the grapefruit. However, LIN's utterance is rendered inaudible since JUL's voice (1.8) overshadows what LIN is about to say as he runs into the kitchen. Nevertheless, LIN (1.9) persists and tells ROX that she could put the grapefruit into the cup, but it is still difficult to determine whether she attempts to say it in Spanish. Even if LIN's articulation is not clear, from the context, as well as from the previous and following utterances it can be inferred that what LIN refers to is indeed the grapefruit, but she is having difficulty producing it in Spanish. Since LIN's previous attempt to say grapefruit in Spanish does not incite a reaction from ROX, LIN (1.10) attempts to produce it again, but differently which results in the mixed language question, "we could put xxx@s [: toronja]?". Indeed, we gather that what LIN tries to say again through her language mixing is the Spanish feminine noun "toronja" (grapefruit) since what is clear from her production is the ending "-a" common to Spanish feminine nouns. This assumption may be further supported by the fact that ROX, in another mixed language affirmation (1.11) tells LIN that what she is referring to is a "toronja" (grapefruit). Thus, LIN makes yet another attempt to repeat the noun grapefruit in heritage Spanish (1.12) but is unsuccessful since it is still far from the target production. On the other hand, even if LIN is not producing the Spanish word on-target, each of these attempts on LIN's behalf serves to reinforce her socialization into language mixing since it is not an impediment to the flow of the conversation, along with the

fact that ROX has seamlessly mixed Spanish nouns into her English utterances from the start of the interaction (1.4). Nevertheless, it appears as though ROX gets frustrated at LIN's inability to say grapefruit in Spanish correctly. As such, LIN through her active engagement influences ROX. That is, ROX is therefore brought to model the word "toronja" (grapefruit) one syllable at a time raising her voice and making it loud and clear. In Spanish, ROX (1.13) thus models the first syllable "to" which LIN repeats (1.14). ROX (1.15) then models the second syllable "ron" (1.16), and LIN also repeats it. Finally, ROX (1.17) models the third syllable "ja" which LIN accurately reproduces (1.18). Before moving further, a few brief remarks on phonetics will be considered. First, an impressionistic observation may be made that LIN produces the voiceless stop consonant /t/ in the first syllable "to" like a native, or a near-native Spanish speaker. It is not aspirated which may be unexpected considering that she is English dominant. This sound along with the other voiceless and voiced stop consonants present distinct differences in English and Spanish (Ronquest & Rao, 2018). Even if LIN has difficulty producing the word grapefruit in Spanish as a whole, the example shows that she can capture and produce at least some Spanish sounds in isolation. Next, when modeling the second syllable "ron" we hear that ROX's production is not target-like. This is likely related to the fact that the word "toronja" has been segmented into its three corresponding syllables. Thus, instead of producing the "r" as a flap /ɾ/ since it is intervocalic, ROX produces it as a trill /r/ due to its word-initial position. In any case, LIN does not manage to produce the proposed pronunciation and instead seems to approximate the sound to an /l/. However, this is not surprising since "it is very difficult for young bilingual speakers of English and Spanish to master the /r/ sound in either language" (González-Bueno, 2005: 1). Moreover, within the framework of her study, the participant, a female English-Spanish bilingual child between 4 and 5 did not show difficulties "in producing the English /r/, but she did when producing the Spanish /r/." (González-Bueno, 2005: 1). Therefore, LIN's inability to produce the Spanish trill /r/ may be explained in part by developmental factors, or the fact that the trilled /r/ in Spanish is acquired at a later stage. The third syllable does not pose a problem for LIN. Following LIN's per-syllable repetitions, ROX (1.19) models the word grapefruit in Spanish in its entirety one more time, almost as if in a formal instructional setting. LIN (1.20) clearly repeats "toronja" (grapefruit) according to the target production, or with an unaspirated /t/ as well as with a flapped /ɾ/. After all this work, ROX (1.21) simply acknowledges her correct production with a subtle interjection. Then, LIN (1.22) reflects on her initial and failed attempts to say grapefruit which shows metalinguistic awareness on her behalf, but ROX (1.23) ignores her comment offering instead to help her with the task at hand. LIN carries on contemplating how she was trying to say grapefruit through a

series of mixed language utterances (1.24 and 1.25). However, even though she can successfully say grapefruit in heritage Spanish when guided, we hear that she reverts to her initial and unintelligible pronunciation when she tries to say it autonomously again. This time though ROX does not attempt to help correct LIN's pronunciation so LIN (1.26 and 1.27) goes back to preparing the drink asking in English if the cup has water so that she could shake it. The dyadic interaction comes to an end when ROX (1.28) says no to LIN and through a mixed language utterance ROX (1.29) re-models the target word grapefruit in Spanish, but with no explicit pedagogical intention. Finally, even if LIN's utterance is unintelligible (1.30), it does not seem as though she tries to repeat the target word again. Indeed, ROX says that she must cut the grapefruit (1.31), so LIN's focus (1.32) turns to shaking the drink.

Synthesis

The previous section on speech stream segmentation showcased how breaking up the flow of language into more manageable chunks helps LIN use heritage Spanish in meaningful social interaction. In this example, we saw that after several unsuccessful attempts to produce the target word grapefruit in Spanish on her own, her mother ROX steps in to help her say it correctly first by breaking it down into syllables. In a sense, this was also an example of how LIN shaped the course of the interaction and elicited Spanish from ROX which she subsequently used to her language learning advantage. Furthermore, LIN and ROX's dyadic interaction reveals that even if she is being taught Spanish, the languages of interaction only include language mixing, and English with no Spanish unilingual utterances on behalf of ROX. The Spanish nouns that ROX uses are fluidly inserted into English which engenders mixed language utterances as has been shown to be the case in previous research in bilingual communities. The present analysis also showed that ROX and LIN, both address each other through English and mixed language utterances in their focused, but not so serious activity. We thus see that in this bilingual setting, learning Spanish may be in part supported by bilingual language practices and not by the mere use of Spanish alone. It is difficult to determine whether a bilingual pedagogical approach will bear its fruits in the long run. Therefore, we may ask if on the contrary, a bilingual approach will only serve to reinforce LIN's mixed language practices. In other words, LIN appears to be socialized into producing Spanish words in isolation, or through language mixing. Moreover, this observation is no way meant to be judgmental. On the contrary, mixed language practices which we view as an innovative mode of communication as stated from the onset of the present study are also viewed as a strong

vector through which LIN is socialized to use heritage Spanish rather than the using only English. In other words, mixed language practices may support bilingual development. Notwithstanding, in considering ROX’s discourse strategies, we did not find that she makes any attempt to encourage LIN to speak only Spanish in this example, but rather to simply utter one Spanish word. On the contrary, she seems to be fine with the Language Switch Strategy that authorizes conversations to emerge through mixed language use. Nevertheless, whether LIN’s more experienced interlocutors are monolingual Spanish speakers, or bilinguals, the previous examples allow us to get a glimpse into how LIN is learning to use heritage Spanish through speech stream segmentation both at the word and at the syllable level. Next, we show that one culturally specific domain of language where LIN uses Spanish is related to food. We thus see how she uses several Spanish nouns when she receives child-directed Spanish, but also when she is exposed to overheard Spanish. The table below captures the main elements of the present dyadic interaction.

Table 55: Summary of key analytical features in example 15

LIN’s age & example	Multimodal Framework	Multigenerational Framework	Participation Framework	Discourse Strategies	“Who speaks what language to whom?”	Dilingual Conversation or Passive Bilingualism
3;10 ex. 15	No	LIN (3G) JUL (3G) ROX (2G)	From one dyad to another	ROX-LSS (bi)	LIN E ROX LIN M ROX ROX E LIN ROX M LIN	No

6.2 Food for thought & child-directed Spanish

6.2.1 Pozole

As we learned in Chapter 4, the semantic category related to “Food” was by far the most robust in LIN’s emerging bilingual repertoire. For this reason, the following five analyses showcase how LIN uses Spanish vocabulary when it involves mainly food related activities. They take place in the presence of both the Spanish monolingual and bilingual multigenerational family members. We will see that sometimes the adults try to elicit Spanish from her through child-directed speech with varying results. On other occasions when LIN repeats the overheard speech in her bilingual language learning environment, this seems to spark the adult speakers’ attention who in turn repeat the target overheard word for LIN. In this way, as noted in the

previous analyses and as argued in the present study, LIN is an agent capable of influencing the adult speakers through her own (un)ratified, but active participation. This is in line with the bidirectional process of language socialization discussed in the introduction of the present chapter. The first interaction below is divided in two segments (A and B) as it has been done with some of the examples presented above. The present extract takes place in February 2018. ROX is in the kitchen rearranging some household items on the counter. LIN is sitting on a stool by the bar looking at ROX. JUL is standing next to them and seems to be upset. ERI is behind them filming, and the overall participation framework is multiparty. Since most of the speakers are visible, gesture and gaze will be taken into consideration as the interaction unfolds. A few minutes before the present analysis begins, ERI walks into the kitchen with the camera as LIN says to ROX in a mixed language utterance “Mommy I want sopa@s” (soup), so she seems to be hungry. The interaction is unfocused, and there seems to be no issues with distractions even if the goal is for the children to eat. Also, the speakers are all ratified in the participation framework, and they are mainly speaking English. However, as LIN begins to eat, ERI sits back and un-ratifies himself from the interactional frame.

LIN is 3;10

1. *ROX: eat baby. @LIN
2. *ROX: you want to eat Julian?
3. *LIN: [- mix] can I drink teta@s teta@s? @ROX
Can I drink from the baby bottle?
4. *ROX: [- mix] you don't need teta@s. @LIN
You don't need the baby bottle.
5. *LIN: ok. @ROX
6. *LIN: Julian.
7. *ROX: here Julian
8. *ROX: [- spa] ven@s. @JUL
Come here
9. *LIN: no Julian no do that.
10. *LIN: I eating. @JUL
11. *LIN: xxx so hot.
12. *LIN: it's good.
13. *ERI: it's good? @LIN
14. *LIN: I put my finger and it's really good.
15. *ERI: what does it taste like? @LIN
16. *LIN: it tastes like +... @ERI
17. *LIN: I don't know. @ERI
18. *ERI: it what's it called? @LIN
19. *LIN: I don't know. @ERI

20. *ERI: the food what is it? @LIN
 21. *LIN: it's the food. @ERI
 22. *ERI: yeah [: yes] but what +/. @LIN
 23. *ROX: what kind of food? @LIN
 24. *ERI: what kind of food? @LIN
 25. *LIN: I no no.
 26. *ROX: grandma@s:eng&spa made it. @LIN
 27. *ROX: what does grandma@s:eng&spa make? @LIN
 28. *LIN: I no no. @ROX
 29. *ROX: [- spa] pozole. @LIN
 Mexican stew
 30. *LIN: [- spa] pozole. @ROX
 Mexican stew
 31. *ERI: [- spa] pozole? @LIN
 Mexican stew
 32. *LIN: yeah [: yes]. @ERI
 33. *ERI: is it delicious? @LIN
 34. *LIN: yup [: yes]. @ERI

Plurilingual Transcript 20; ex. 16: FEB_1_2018_ERI_LIN_JUL_ROX_pozole_A

By this time ROX has served LIN a bowl of “pozole” (Mexican stew) so ROX (1.1) tells LIN to eat, but without really looking at her since she is busy moving a bag of chips off to the side of the counter. Then ROX (1.2) asks JUL if he wants to eat too, but only turns to look down in his direction towards the end of her question. JUL does not answer ROX and instead walks to where LIN is sitting. Next, through a mixed language utterance LIN (1.3) asks ROX if she “can drink teta@s teta@s.” (baby bottle). Also, while requesting to drink from the baby bottle LIN looks and points at it with her right index finger. However, ROX (1.4) is still shuffling objects around from one counter to the other and tells LIN through mixed speech that she cannot without looking at her, or at the bottle that she designated with her finger. Nevertheless, it seems as though in this exchange, one mixed utterance engenders another. LIN’s mixed language choice subsequently influences ROX’s mixed language choice patterns. This sort of linguistic influence is therefore in line with De Houwer’s (2021) research who has found that children through their active participation may shape adult language use. However, after denying LIN’s request, LIN (1.5) does not insist and calmly says ok. The fact that LIN does not push the issue further is striking. Throughout my longitudinal and ethnographic observations with the family (February 2018 through January 2019) the question of whether LIN is allowed to continue drinking from a baby bottle was a contentious issue. Often when she was denied the baby bottle, LIN would throw a temper tantrum and only GLO would cede to her demand.

This is even if ROX disagreed since she considered that LIN was old enough to begin drinking strictly out of cups. Moreover, as we saw previously this is a striking characteristic of the cultural framework. Due to her hierarchy in the family GLO may override ROX's decision, much like when she orders LIN to do something (ex. 3, 1.10) she must do it. Notwithstanding, in this case since GLO is not present, LIN seems to understand that this is a lost cause. Furthermore, since JUL is standing next to LIN, he starts to pivot her chair perhaps to get her attention. But LIN (1.6) looks down at him and calls his name telling him in a serious, almost scolding manner not to move her chair (1.9) because she is eating (1.10), but then LIN turns away from him to face the bowl in front of her. At the same time, ROX (1.7) grabs a spoonful of hot stew from LIN's bowl as she calls JUL. ROX follows her English utterance with the Spanish command (1.8) "ven" (come here). In both of her previous turns ROX does not look at JUL. ROX then blows on the spoon to cool the food down, and only faces JUL when she bends over to feed him. ROX's technique to cool down the stew seems to encourage LIN to blow on her bowl of food as well since she states (1.11) that it is hot. LIN then dips her right finger into her bowl of stew, likely to check the temperature, and then proceeds to lick it. Then, LIN (1.12) turns her head over her right shoulder to look directly at ERI who is filming behind them and mentions to him that her food is good, thus bringing him back into the interaction. By this time, ROX gives JUL one spoonful of stew, but then she goes back into the kitchen briefly leaving the interactional frame, but not necessarily un-ratifying herself from it since she is still responsible for supervising the mealtime activities. However, LIN's comment brings ERI back into the framework, which is now multiparty and ERI (1.13) repeats LIN's statement as a question asking if it is indeed good. LIN answers ERI (1.14) telling him that she tried it by putting her finger in the stew to taste it and she goes through the same motions of putting her finger in the bowl and then in her mouth all over again to show him how she knows that her food is good, and perhaps also that it is the right temperature as mentioned above. ERI (1.15) asks her what it tastes like where for him the expected answer is "pozole", the Spanish name of the Mexican stew since there is not an English equivalent. LIN, with her finger still in her mouth (1.16) appears to think about what it tastes like as she pivots around on her stool to look at ROX who is now in the kitchen. ROX briefly looks at ERI and then at LIN with a grin on her face since she seems to understand what ERI is aiming for as a response but continues to go on about her business without chiming into the conversation. Clearly ROX overhears ERI and LIN. Then, LIN (1.17) says that she does not know what the food is called, as JUL tugs on her stool again bringing her gaze back to ERI. ERI (1.18) insists to know what the name of the food is, but LIN repeats that she does not know (1.19). ERI tries to elicit an answer again (1.20)

only to be met by “the food” as a response (1.21) on LIN’s behalf. ERI (1.22) agrees that it is food, but he is cut off by ROX (1.23) who takes the floor again in the participation framework to ask what kind of food it is. At this point LIN’s gaze turns to ROX who is somewhere in the living room and not within the scope of the camera. ERI (1.24) repeats the same question ROX has asked LIN, but she maintains her gaze on ROX who now comes in from the living room and back into sight. Both ERI and ROX are engaged in eliciting the target response from LIN, but she shakes her head as she says that she does not know (1.25). To help work LIN’s memory, ROX (1.26) first mentions that her grandmother GLO made it as she bends down to get something from the ground next to LIN, and LIN’s gaze follows ROX. This is important because within the family GLO is the only one to prepare this traditional Mexican meal, especially on special occasions, or for other large family gatherings. It is thus part of their cultural framework. Nevertheless, ROX (1.27) who is still bent down turns her statement into a question. But still, LIN (1.28) says that she does not know shaking her head again. Since LIN does not seem to provide the answer, ROX (1.29) says “pozole” (Mexican stew), so LIN lifts her gaze from ROX (1.30) and turns to ERI to repeat the child-directed input in Spanish. Her answer is then repeated by ERI (1.31) in the form of a question to which LIN says yes (1.32). Within this multiparty participation framework, we thus see how the adult bilinguals both seem to collaborate through a statement for one and a question for the other to elicit, and then to reinforce the use of the Spanish target word. Finally, ERI (1.33) asks if it is delicious and of course LIN answers that it is (1.34). While ERI’s question did not seem to have a pedagogical purpose, in the end it may help LIN better cement the tastiness of her meal with its name so that in the future she may be better equipped to recall the term when asked to do so, or simply to talk about it in spontaneous conversation.

The description above shows how LIN uses heritage Spanish when she is guided through child-directed input in Spanish. However, we observe that even if ERI and ROX’s intentions are to get LIN to generate the target answer in Spanish on her own, their strategy does not seem to produce the desired results. The language of interaction between all four of speakers is mainly in English, with some instances of language mixing and only a few moments when they each use the Spanish target term. Nevertheless, as the interrogation starts, the adult bilinguals do not switch to Spanish. Since the hot Mexican stew is a popular meal during the cold winter months, the term “pozole” is widely used, so chances are that LIN does possess this word in her repertoire. Perhaps if ERI and ROX had switched from English to Spanish, LIN would have understood that the desired answer is also in Spanish because she does not

have the English translation equivalent. As such, this may have increased her chances to answer correctly. Nevertheless, when LIN repeats the target answer in Spanish after ROX, ERI in turn remodels and in turn reinforces the child-directed input. In this sense, the adult members of the multiparty participation framework (ROX and ERI) may help LIN use and better anchor the Spanish word in her lexicon.

The plurilingual transcript that follows is the continuation of the previous interaction. After giving LIN the answer, ROX and ERI attempt to dig a little deeper by asking her to describe the food. However, they still do not adapt their language strategy and continue to use English to elicit Spanish. Their strategy is not necessarily incorrect, but what we see next is that rather than to encourage the use of heritage Spanish, instead it seems to engender the use of language mixing amongst all the speakers in the interactional framework. However, language mixing as has been argued throughout the present investigation may also be a form of heritage Spanish, or at least a way in which heritage Spanish is supported in the family. It is part of their bilingual and bicultural heritage.

LIN is 3;10

- | | | |
|-----|-------|---|
| 35. | *ROX: | what color is it? @LIN |
| 36. | *LIN: | it's lellow [: yellow]. @ROX |
| 37. | *ROX: | that's not yellow. @LIN |
| 38. | *LIN: | what's that called? @ROX |
| 39. | *ROX: | what color is it? @LIN |
| 40. | *LIN: | I don't know. @ROX |
| 41. | *ROX: | the juice (.) what's the color of the juice? @LIN |
| 42. | *LIN: | I don't know. @ROX |
| 43. | *ROX: | green. @LIN |
| 44. | *LIN: | green. @ROX |
| 45. | *ROX: | the other one is red remember? @LIN |
| 46. | *LIN: | what red? @ROX |
| 47. | *ROX: | [- mix] the other pozole@s. @LIN
The other Mexican stew |
| 48. | *LIN: | [- mix] what pozole@s is it? @ROX
What Mexican stew is it? |
| 49. | *ROX: | [- mix] that's chicken pozole@s give me the spoon so I can give some to Julian. @LIN
That's chicken Mexican stew give me the spoon so I can give some to Julian. |
| 50. | *LIN: | no. @ROX |
| 51. | *ERI: | [- mix] it's green chicken pozole@s.
It's green chicken Mexican stew |
| 52. | *LIN: | I said green +... @ERI |

53. *ERI: [- mix] green chicken pozole@s. @LIN
Green chicken Mexican stew.
54. *LIN: [- mix] green chicken pozole@s. @ERI
Green chicken Mexican stew.
55. *ERI: uhum. @LIN
56. *ROX: [- mix] don't talk chiquiada@s @LIN
Don't talk in a childish manner.

Plurilingual Transcript 21; ex. 17: FEB_1_2018_ERI_LIN_JUL_ROX_pozole_B

Some seconds have gone by since LIN confirmed to ERI that her stew is tasty, and perhaps even the right temperature to eat. Then, to see if LIN can elaborate now that she has the correct answer of what she is eating in mind, ROX seems to stop what she is doing to look at LIN from the kitchen. She asks LIN (1.35) to tell her what color the broth is. Again, the expected answer would be “verde” (green) since the family tends to make two main variations of this meal: green and red depending on the type of protein that is used (chicken, or pork respectively), and the color is the result of a combination of chilis, or vegetables, and other spices. However, LIN lifts her gaze from her bowl (1.36) and looks at ROX to answer yellow as she puts the handle of the spoon in her mouth almost as if to express doubt. ROX (1.37) disagrees and says that it is not yellow as she looks at LIN and points with her right hand at the bowl before quickly turning her attention to what she was doing on the kitchen counter. Taking the spoon out of her mouth and turning her gaze back to her bowl of stew LIN asks ROX what it is called (1.38), but ROX (1.39) asks again to name the color, however this time she does not look at LIN. LIN looks at ROX (1.40) and says that she does not know with a subtle shrug of her shoulder as she takes a spoonful of stew to her mouth. In the next moment ROX looks at LIN as she walks towards her. As ROX approaches LIN she points with her left index finger to her bowl appearing almost to dip her finger directly into the broth as she asks (1.41) what the color of the broth is. In answering yellow, LIN appears to give the color of the chicken, as opposed to the color of the broth. Despite this, LIN (1.42) looks up at ROX and shakes her head to confirm that she does not know. ROX (1.43) turns her gaze away from LIN as she wipes the counter in front of her and gives her the correct answer: green. LIN thus looks down at her stew (1.44) and repeats the modeled answer. ROX continues to wipe down the counter moving towards the kitchen sink (1.45) and asks LIN, without looking at her whether she remembers that the other stew is red, but LIN does not seem to understand. Thus, LIN looks at ROX (1.46) and asks what it is that she is referring to that is red. This instance subsequently engenders mixed language utterances on behalf of all the speakers until the end of the interaction. ROX (1.47), still without looking at LIN says to her through language mixing that she is referring to the other “pozole”

(Mexican stew). So far LIN has maintained her gaze on ROX, and LIN (1.48) takes ROX's modeled mixed language utterance and reformulates it into a question to ask her "what pozole@s is it?". ROX (1.49) turns around and walks back to where LIN is sitting and tells her through another mixed language utterance that she is eating "chicken pozole@s". ROX also asks for her spoon so that she can feed JUL, but it is difficult to tell whether ROX is looking directly at LIN, or if she is focused on the spoon in her hand that she has just asked for. We see here that there is a misunderstanding between the two. When LIN asks what "pozole" (Mexican stew) ROX is referring to, she likely means the red one that she has just mentioned (made with pork), but ROX, perhaps because she is not entirely engaged in the interaction assumes that LIN's question refers to the stew that she is currently eating. In any case, after ROX asks for LIN's spoon which she is holding between her legs, LIN (1.50) with her gaze maintained on ROX says no while at the same time handing over the spoon. LIN seemed to therefore tease ROX. Then ERI (1.51) ratifies himself back into the participation framework by way of a mixed utterance to confirm to LIN that she is eating "green chicken pozole@s", or "pozole verde" as it is conventionally called in Mexico. ERI's affirmation captures LIN's attention who turns around on her stool to look at him. LIN (1.52) leans her head to one side and still looking at ERI seems to confirm to him that she said "green", but it is not clear. ERI (1.53) then repeats his mixed language utterance, saying it slowly and clearly through speech stream segmentation as ROX and GRC have been observed to do previously in their child-adult interactions. Following, ERI's modeled input, LIN repeats the mixed utterance (1.54) and says, "green chicken pozole@s?" with rising intonation and ERI confirms (1.55). The interaction then comes to an end (1.56). ROX, who is bent over, and busy spoon-feeding JUL tells LIN, again without looking at her, and through language mixing not to speak in a childish manner. What could be interesting to note here is that ROX's comment towards LIN is related to the tone in which she speaks as opposed for example to mixing languages. This is perhaps because even though the aim of the interaction is to get LIN to speak Spanish, we have seen that language mixing is an integral, and accepted mode of communication in this bicultural and bilingual family. Also, as suggested above, in the end language mixing is also a vector for heritage Spanish use. Moreover, since English was the predominant language of interaction, and since the Mexican stew does not have an English translation equivalent it is quite natural for language mixing to emerge. Nevertheless, ROX's mixed language utterances, and other social encounters of the like may serve to socialize LIN into a mixed mode of communication. Through ROX's own language mixing she shows that what is important is not to speak like a spoiled baby, and not necessarily to speak only Spanish. As we have seen previously, ROX expects LIN to "act like

a little girl”, or to show maturity both by not drinking “teta” (baby bottle) and by not talking “chiqueada” (in a childish manner).

Synthesis

The last two multimodal analyses showcased how LIN uses food related Spanish words when she is guided by the bilingual adults through child-directed input. Furthermore, we saw that the conversation between the three participants (since JUL does not say much) is almost entirely in English. The adults’ efforts to get LIN to speak heritage Spanish using English seems to create a bilingual discursive environment. Furthermore, language mixing is also a way to maintain the use of heritage Spanish and may thus be viewed as a strong language socialization motor towards bilingualism despite its place on the continuum. Notwithstanding, the language of interaction transitions from using English to language mixing, but also to using Spanish in single word utterances. Not using more complex monolingual Spanish could also be attributed to the observation that ERI and ROX do not appear to deploy a clear monolingual discourse strategy, or the strict use of Spanish when attempting to elicit Spanish from LIN. De Houwer (2009) advances that discourse strategies are critical in getting a child to speak a target language, otherwise the child may not speak it. This is precisely what we witness in the present analysis. However, in the present case moving from English to language mixing may in fact be a step towards more Spanish knowledge. It is therefore not to be viewed in a negative light, especially since this is part of the multigenerational family’s bilingual and bicultural make up. In determining who speaks what language to whom in the multiparty participation framework, both ERI and ROX address LIN mainly in English in their unfocused discussion. Of course, this is likely related to the fact that ERI is with ROX who tends to speak to LIN in English. Otherwise, in the presence of GRT and GRC, or other Spanish monolinguals, ERI often tries to address LIN in Spanish. In this sense, it may certainly be argued that ERI’s language choices are influenced by the presence of the participants in the interactional framework and their corresponding language abilities. Nevertheless, LIN also mainly speaks English to both adults in return. We also see that the influence of language choice is dynamic and bidirectional. When LIN language mixes to address ROX, her response tends to be mixed as well and vice-versa. The same is true when ERI and LIN address each other in a mixed mode of communication. In terms of socialization, ROX addresses LIN’s verbal and non-verbal behavior through mixed language utterances affirming her place as a ratified speaker. However, ROX’s body language i.e., not looking at LIN when addressing her may give the impression that she is not really

engaged in the interaction. As a result, this may dissuade LIN to participate wholeheartedly in the social encounter since it would appear as though ROX is not fully engaged in the joint attentional frame. Indeed, research shows that

The joint engagement of adults and children in verbal interaction during dinner is a necessary condition for language socialization; children need to be considered ratified participants to have access to the talk, yet their mode of participation may still vary immensely culturally, allowing for different socialization gains. (Blum-Kulka, 2008: 90).

Despite the issue of joint attention above, ROX nevertheless explicitly aims to socialize LIN to certain rules. First, LIN is not allowed to drink “teta” (baby bottle). Second, she is also forbidden to speak “chiqueada”, or in a childish tone. While ROX calls these two issues into question, what is interesting is that LIN’s language mixing is not the object of attention likely because in the end it contains heritage Spanish. Furthermore, this is perhaps due to the fact that LIN’s language choice patterns reflect the bilingual adults’ mixed language practices, a linguistic style that is deemed appropriate in this culturally and linguistically hybrid contact zone. The present analysis showed that language mixing is also supported through the bilingual participation framework which is a critical aspect that marks the family’s bilingual and bicultural identity. While the objective was to accompany LIN to use heritage Spanish through child-directed input, ROX and ERI’s discourse strategies served to reinforce her mixed language use which in the end is a valid mode of communication that promotes the use of heritage Spanish. The next example also shows how the use of Spanish through child-directed speech seems to be inseparable from language mixing when interacting with other bilingual adults. The key findings in examples 16 and 17 are presented in the table that follows.

Table 56: Summary of key analytical features in examples 16 & 17

LIN’s age & example	Multimodal Framework	Multigenerational Framework	Participation Framework	Discourse Strategies	“Who speaks what language to whom?”	Dilingual Conversation or Passive Bilingualism
3;10 ex. 16 & 17	Pointing & Gaze Using objects Head shake for negation Shoulder shrug	LIN (3G) JUL (3G) ROX (2G) ERI (2G)	From multiparty to triad to multiparty	No	LIN M ROX LIN M ROX LIN S ERI LIN M ERI ROX E LIN ROX M LIN ROX E JUL ROX S JUL ROX S LIN ERI S LIN	No

					ERI	M	LIN	
--	--	--	--	--	-----	---	-----	--

6.2.2 Salsa

The short extract below shows LIN repeating child-directed Spanish when the target word is provided by her aunt ALE. Several of LIN's bilingual family members are present in the participation framework as well as her grandmother GLO's longtime friend and neighbor ARE who is also of Mexican origin, bilingual, and an avid language mixer as many of the speakers are in this community of practice. The social encounter is therefore multigenerational, and we may also note that there are several dyadic interactions embedded in a larger multiparty participation framework. The example takes place in January 2019. GLO and ARE have been casually discussing personal matters as well as GLO's upcoming trip to Paris over coffee and pancakes in the dining room as they typically do when ARE comes to visit. ALE is also present and sitting with them, but only GLO and ARE are the ratified speakers. ALE occasionally weaves in and out of their conversation. Moreover, the bilingual adults have been mixing languages overall throughout the interaction. LIN is seen coming back and forth from the living room and then to GLO in the dining room as she plays with her cousin GOY and her brother JUL. The camera is in the corner of the dining room, so the speakers are visible allowing for gestures, and gaze to be analyzed. The interaction is unfocused, and distractions are not an issue since there seems to be no clear goal in mind. After ARE leaves, ROX and GLO walk into the kitchen and out of sight. LIN sits on a chair and asks to eat pancakes, but only ALE is sitting with her. LIN in the meantime looks for something to cut the pancakes so that she can share with GOY and JUL.

LIN is 4;9

1. *LIN: let me cut it Goya (.) thank you.
2. *LIN: thank you. @GOY
3. *ROX: [- mix] I need to get coffee (.) también@s.
I need to get coffee (.) too.
4. *JUL: xxx. @ALE
5. *ALE: you eat it Baby I don't want none. @JUL
6. *GOY: xxx want none ? @ALE
7. *ALE: no. @GOY
8. *LIN: kids eat with their what Goya?
9. *LIN: and what is this? @ALE
10. *LIN: what's this? @ALE

- | | | |
|-----|-------|--|
| 11. | *ALE: | [- mix] that's salsa@s. @LIN
That's hot sauce. |
| 12. | *LIN: | [- spa] salsa. @ALE
Hot sauce. |
| 13. | *ALE: | [- mix] yeah [: yes] it's Mexican-style salsa@s. @LIN
Yes it's Mexican-style hot sauce. |
| 14. | *ROX: | [- mix] a ver Goya move@s I'm@s sitting@s there@s girlfriend@s.
Let's see Goya move I'm sitting there girlfriend. |
| 15. | *ALE: | watch out Baby. @Goya. |

Plurilingual Transcript 22; ex. 18: JAN_12_2019_GLO_ARA_ALE_LIN_JUL_GOY_ROX_salsa

LIN is busy looking at the pancakes that she is holding in her hands. Then, she puts one pancake down on the tray and seems to take a small bite from the one that she is still holding. LIN (1.1) turns to look at GOY, extending her left arm towards her as if to reach for the plastic knife in GOY's possession and asks to let her cut the pancake with it. GOY is not visible since she is standing behind ALE, but LIN (1.2) takes the plastic knife, thanks GOY, and refocuses back on the pancakes on the table in front of her. Next, we hear ROX (1.3) in the kitchen comment through a mixed language utterance that she needs to buy more coffee, but her statement goes ignored since GLO moves from the kitchen to the living room. ALE is busy adding creamer to her cup of coffee. Up to this point everyone seems to be going about their own business. A few seconds go by and JUL (1.4) who is standing next to LIN takes a piece of pancake and holds it up in the air in ALE's direction. It is unclear what JUL says to ALE, but we can deduce, from his gesture that he tries to share a piece with her since ALE (1.5) tells him to eat it himself since she does not want any as she shakes her head in negation. Their dyad therefore ends as quickly as it started. GOY who is still behind ALE seems to repeat ALE's previous utterance addressed to JUL, but in the form of a question (1.6). GOY, who is slightly older than LIN has a speech impediment, therefore it is also difficult to make out what she says. Her spatial orientation regarding the camera also does not help. However, ALE (1.7) without looking at GOY answers no. This leads us to believe that GOY's previous repetition was a question to confirm that ALE does not want to eat. Like with JUL, the dyadic interaction with ALE is brief. In the meantime, LIN is busy with her pancakes and without looking at GOY asks her what kids eat with (1.8). Her question is almost rhetorical in nature in that it does not seem to seek a response. LIN's question may also be interpreted as re-voicing what an adult would say. In the Bakhtinian sense, through imitation she is perhaps taking the role of her past adult conversational partners. Nevertheless, GOY does not seem to respond. Several more seconds go by in silence. LIN is waving her plastic knife in the air like a wand and then taps it against the piece of pancake in

her other hand as she sways her head from side to side. Then LIN reaches for a small package (1.9) that is slightly in front and center from where she is eating. She reaches for it with her right hand and then slides it in her direction while she asks ALE what it is, keeping her right fingers pressed on the package, but without looking at her. LIN (1.10) asks ALE again what it is, however, this time she lifts her gaze and looks at ALE as if to wait for a response. ALE does not seem to look directly at the object that LIN refers to, perhaps because she sees it from the corner of her eye, or because she already knows what it is. In any case, ALE through a mixed language utterance informs LIN that it is “salsa” (hot sauce) (1.11). Following ALE’s answer, LIN (1.12) extracts and repeats the child-directed Spanish word in the mixed language utterance as she looks at ALE. As previously discussed, language mixing seems to provide a steppingstone from which to use Spanish. However, LIN also pushes the package of hot sauce away from her. What LIN was likely looking for was sweet syrup for her pancakes, and not spicy sauce. Nevertheless, ALE who is now adding sugar to her cup of coffee confirms to LIN (1.13) without looking at her that it is Mexican-style hot sauce through another mixed language utterance. Through her statement ALE subtly marks the hybrid cultural framework in which they live, and which most certainly influences the creation of everyday products. That is, the hot sauce that is perhaps produced in the U.S. (and adapted in terms of heat for its consumers) has a Mexican touch to it and as such it is both Mexican and American. Indeed, American culture is going through a sort of Hispanization and there appears to be a “linkage being forged between community identity and marketplace presence as the most significant indicator of Hispanic progress and power in the United States.” (Gil-Gómez, 2002: 537). Notwithstanding, LIN does not ask any further questions. The interaction comes to an end when ROX walks in from the kitchen to the dining room with a cup of coffee in her hands and asks GOY to sit elsewhere through a mixed utterance (1.14). ALE (1.15) also asks GOY to move in English. As mentioned previously, asking a younger child to sit somewhere else also helps to establish hierarchy, and thus social order within the family. However, as the children get older and become communicatively competent members of the community of practice they may push back. We saw LIN do so previously (ex. 3, 1.8) when she told ALE “hey this is my spot” after thinking that she was being asked to surrender her chair.

Synthesis

The brief analysis above showed how LIN uses the Spanish word “salsa” (hot sauce) after ALE tells her explicitly what it was. Moreover, contrary to the previous interactional moment where

ERI and ROX unsuccessfully try to elicit Spanish from her, here LIN’s use of heritage Spanish emerges when unsolicited, in naturalistic interaction. Furthermore, unlike the previous extract, the mode of communication is language mixing where the bilingual adult speakers are heard frequently inserting Spanish into their English utterances or simply mixing between English and Spanish utterances as they go about their daily lives. Thus, in this participation framework, the bilingual adults address each other almost entirely through mixed language utterances. However, when ALE and LIN are sitting at the table in a child-adult dyad, LIN addresses ALE in English and only uses one Spanish word, but ALE answers LIN by language mixing. In this unfocused interaction, embedded in the larger bilingual multigenerational and multiparty participation framework, everyone seems to be doing their own thing. Thus, when LIN questions ALE, ALE’s response does not take the shape of a monolingual discourse strategy that could potentially help guide LIN to use more Spanish utterances. At the same time, ALE like the other bilingual speakers are aware that LIN speaks very little Spanish. As such, it is not surprising that she responds in English, or through language mixing, which we may perceive as a building block not only towards Spanish bilingualism, but also towards the conventionally used mixed language mode of communication deployed by the bilingual adults. Nevertheless, in this example LIN’s use of heritage Spanish is limited to one word from start to finish. However, while LIN does not mix languages here, it is probable that in the future (if she does not do so already) she will insert the Spanish word into her English utterances which is accepted by the family. In a way, this could therefore be understood as a form of socialization into language mixing. As seen above, the bilingual interactions within the family seem to reinforce the use of a mixed mode of communication even if LIN uses child-directed Spanish from time to time. In the last three examples we see how LIN also captures and uses Spanish words that she hears through overheard input and how in some cases, her use of overheard speech triggers the bilingual adults to repeat them for her. A summary of the key features of the present analyses is presented in the table below.

Table 57: Summary of key analytical features in example 18

LIN’s age & example	Multimodal Framework	Multigenerational Framework	Participation Framework	Discourse Strategies	“Who speaks what language to whom?”	Dilingual Conversation or Passive Bilingualism
4;9 ex. 18	Extending arm Using objects	LIN (3G) JUL (3G) GOY (3G) ROX (2G)	From one brief dyad to another	No	LIN E GOY GOY E ALE ROX M GLO	No

		ALE (2G)			ROX M GOY	
		GLO (1.5G)			ALE E JUL	
		ARE (1.5)			ALE M LIN	
					ALE E GOY	

6.3 Food for thought & overheard Spanish

6.3.1 Tortilla

Up until now the examples that we have examined show how LIN uses heritage Spanish in social situations where the child-directed input is provided by different family members (ROX, GRC, RIC, ALE, and ERI) in dynamic and ever-shifting dyadic, triadic, and multiparty participation frameworks. These multigenerational adults have been both monolingual and bilingual speakers and as such they have spanned all three generations in the family. As a result, we observe a broad range of linguistic resources that are deployed in multimodal interaction and that span the bilingual continuum. The next three analyses give an account of how LIN also uses the overheard input in her bilingual language learning environment to use Spanish words. This allows her to both enter the developing interaction, as well as to encourage the other, more novice speakers than herself to do the same. This will be the object of inquiry in the second analysis of this section. For now, in the first exchange below, LIN overhears ROX say to her little brother JUL that he has a “tortilla” in his hand, a round and thin flatbread that is heated and commonly used to accompany most meals in Mexican households¹²³. The interaction takes place in February 2018. GRC, JUL, ROX, GRT, and LIN are sitting around the dinner table. ERI who is not visible is sitting behind the camera which is placed on the table near him. Moreover, we can see the other participants, and partially JUL since even if he is sitting on GRC’s lap, his face is behind a large bottle of honey and another one of olive oil. Therefore, gaze and gestures will be analyzed. Their conversation is almost entirely in Spanish. ERI notices how JUL is using a “tortilla” (flatbread) to eat. He then suggests to the family how using this flat bread as a tool to eat is culturally learned both from watching others do it, and by practicing himself. The discussion is thus unfocused and there is no sense of distraction since there is no objective other than to talk casually and observe JUL eat. Finally, only the adult speakers in the participation framework are ratified. JUL and LIN are unratedified overhearers.

¹²³ This may be likened to the French who often accompany their meals with sliced pieces of baguette on the table.

1. *ERI: [- spa] es cultural aprender +...
It's cultural to learn +...
2. *ERI: [- mix] comer con la tortilla como los Chinos que comen con los chopsticks@s +...
To eat with tortillas like the Chinese who eat with chopsticks +...
3. *ROX: The +... @ERI
4. *GRT: [- spa] uhum. @ERI
Agrees.
5. *ERI: [- spa] con los las los palitos +...
With the little sticks +...
6. *GRC: [- spa] es su cultura. @ERI
It's their culture.
7. *ERI: [- spa] cultura también entonces se me hace simplemente increíble de que pues +...
Also their culture so it seems incredible that +...
8. *ROX: [- spa] es chile Papa [: Papá]. @JUL
It's chili Dad.
9. *JUL: what? @ROX
10. *ROX: [- spa] chile. @JUL
Chili
11. *JUL: xxx. @ROX
12. *GRT: [- spa] pinche mocososo mocososo. @JUL
Little booger boy.
13. *GRC: [- spa] dame un toallita. @ERI
Give me a napkin.
14. *GRT: [- spa] toma toma. @GRC
Take it take it.
15. *JUL: more.
16. *GRT: [- spa] mocososo mocososo! @JUL
Booger boy.
17. *GRT: [- spa] pinche mocososo mocososo. @JUL
Little booger boy.
18. *JUL: xxx.
19. *GRC: [- spa] qué qué pasa? @JUL
What what's happening ?
20. *ROX: [- spa] la cara.
The face.
21. *LIN: I told you he xxx.
22. *ROX: [- spa] que hace nomás por payaso.
That he makes just because he's a silly boy.
23. *ERI: [- spa] sí por eso entonces digo +...
Yes, that's why I say +...
24. *JUL: more.
25. *ROX: [- spa] tortilla. @JUL
Tortilla.

- | | | |
|-----|-------|--------------------------|
| 26. | *ERI: | [- spa] cree que le +... |
| | | Thinks that +... |
| 27. | *LIN: | [- spa] tortilla. |
| | | Tortilla. |
| 28. | *ROX: | [- spa] tortilla. @LIN |
| | | Tortilla. |
| 29. | *LIN: | [- spa] tortilla. @ROX |
| | | Tortilla. |

Plurilingual Transcript 23; ex. 19: FEB_21_2018_ROX_ERI_GRC_GRT_JUL_LIN_tortilla

By this time ERI has drawn the family members attention to JUL who is busy eating with a “tortilla” (flatbread), so they are thus in multiparty interaction. ERI (1.1) shares with them in Spanish that indeed to be able to eat with this type of flatbread is cultural. Then through a mixed language utterance ERI (1.2) suggests that this may be like how Asian children learn to eat with chopsticks, or a culturally unique way of consuming their meals. Ochs et al. (1996) explored the dinnertime activities of 20 middle-class families both in the U.S. and Italy. In their comparison of the socialization of “taste”, they found that a critical site for the socialization of culturally specific eating habits (among others) is around negotiations over food. While food was not the object of negotiation at the moment, JUL demonstrated that he was beginning to imitate the culturally specific way of eating in this household of Mexican origin. Nevertheless, as ERI proceeds, his language mixing is related to the fact that he has difficulty finding the translation equivalent for chopsticks in Spanish. However, ROX (1.3) who is a ratified speaker and looking at JUL looks at ERI and with her right hand pinches her index finger and thumb to symbolize the chopsticks thereby showing that she understands what he means. In this sense, through multimodal interaction, both ERI and ROX deploy verbal and gestural semiotic resources to create meaning. As such, they underscore the notion that “Interaction is not just about language, it is about gesture and the tools we use to make meaning, including signs and symbols.” (Pahl, 2008: 115), although for Morgenstern and Goldin-Meadow (2022) gesture could be said to be very much a part of language which is also the stance taken in the present study. ROX then brings her gaze back to JUL. GRT is also ratified and listening to ERI but looking at JUL with a grin on his face who is sitting across from him. As ERI finishes his mixed language utterance, GRT looks at ERI and agrees (1.4) with a slight nod of the head. ERI then proceeds in Spanish (1.5) hesitating to select the appropriate gender of the definite article to describe the chopsticks, so he calls them, literally, little sticks. Next, GRC who is also a ratified speaker, but focused on eating her own meal, lifts her head and looks at ERI to agree in Spanish that it is indeed cultural (1.6). GRT and GRC’s acceptance of ERI’s proposition is

in tune with what Blum-Kulka (2002) and Keppler and Luckman (1991) have argued, or that family reunions such as the present one around the table may lead to teaching moments where a knowledgeable self-appointed member (ERI) attempts to provide an explanation of either social or natural phenomena. These types of family gatherings are therefore critical sites for the social construction of knowledge (Kiaer, 2023). Nevertheless, GRC's comment draws GRT's gaze towards her and then back down towards JUL. Next, as GRC continues to eat, ERI (1.7) comments in Spanish one last time that he finds this to be fascinating drawing GRT's gaze back to him and as he subtly continues to nod in agreement. In the meantime, LIN who is unrattified is sitting on ROX's lap. Her attention is focused on a black pen that she is manipulating with her hands. At first it is not clear whether she is paying attention to what is being said around her. Then, ROX's eyes quickly turn to ERI (1.8) before looking at what JUL is doing. ROX, likely influenced by the predominant Spanish speaking environment therefore warns JUL in Spanish that what he is getting is chili. JUL (1.9) turns to look at ROX and seems to ask her "what?" in English and ROX looks at him in the eyes (1.10) and reiterates in Spanish that it is chili. JUL (1.11) turns around scanning the table and seems to mouth the Spanish word "chile" (chili), but it is difficult to confirm what he says. Nevertheless, GRT (1.12) who is looking at JUL addresses the fact that he has snot on his face with the use of the Spanish adjective "pinche" which could be literally translated as "damn", but in a context such as this, it is stripped of its vulgar meaning and instead connotes endearment. In parallel to GRT, GRC (1.13) also looks at JUL and realizes that he has snot too, so she asks ERI for a napkin. GRC's voice is extremely faint, but with her gaze and right index finger she points in ERI's direction where the napkin holder is within the camera's scope. Before ERI can react, GRT intercepts GRC's request and tosses her a napkin (1.14) saying take it in Spanish. As GRT tosses the napkin from his side of the table, GRC's gaze turns towards him. However, JUL (1.15) seems to point at the flat breadbasket (meant to keep them warm) as he says more. JUL is distracted when the napkin falls on the table and he looks down at it. GRT (1.16 and 1.17) once again addresses the fact that JUL has snot on his face using the same adjective only that the second time around GRC takes the napkin to his nose to clean him off. After GRC is finished, JUL reacts as if gasping for air (1.18) which GRT mimics from across the table. GRT, ROX and GRC look at JUL and laugh at his apparent silliness. Then GRC asks in Spanish (1.19) first looking at ERI and then quickly turning to ROX to ask what is so funny. While ROX responds in Spanish (1.20) to GRC to say that what was funny is the face that JUL made after getting his nose cleaned, LIN (1.21) looks at JUL suggesting LIN's passive comprehension of Spanish, and that she is attentive to the overheard speech. This may be corroborated by the fact that in

ratifying herself, LIN utters something that begins with “I told you he +...” but the remainder of what she says is indiscernible. It is also not clear who she addresses, but a strong guess is ROX. Perhaps LIN addresses the fact that she had already mentioned that JUL had snot, implicitly suggesting that he should be cleaned, but we will never know. What is certain however, is that even if her attention seems to be focused on the black pen as described earlier on, we now realize that as an overhearer, she is attuned to the overheard Spanish input in her environment and that to an extent she understands what is being said. We therefore get a sense of her passive bilingualism. Nevertheless, LIN’s commentary goes unacknowledged by the adults in the multigenerational, and multiparty participation framework. Since she does not manage to break into the interaction, she goes back to playing with the black pen on the table. ROX (1.22) also follows up her statement to GRC in Spanish to add that JUL is just a silly boy. Then ERI (1.23) begins to speak again in Spanish. GRC and GRT do not look at him, and only ROX quickly glances at him before turning her attention to JUL. JUL (1.24) in English seems to say more as he leans towards ROX. However, it is difficult to see what he has in his hand since the jumbo honey and olive oil jars are in the way. Nevertheless, ROX’s reaction in Spanish (1.25) confirms that JUL has a “tortilla” (flatbread) as she looks at him and seems to take it from his hand. ERI (1.26) tries to continue his thought in Spanish, but he interrupts himself to see if JUL will repeat the Spanish word that ROX has just modeled for him. ROX’s child-directed Spanish input is not repeated by JUL. On the other hand, her input is overheard and captures LIN’s attention who at the same time stops what she is doing with the black pen to look at the piece of flat bread that is passed from JUL to ROX. LIN (1.27) without ratifying herself back into the conversation clearly repeats the overheard Spanish word “tortilla” (flatbread), but with no clear addressee, after which she goes back to her task. Finally, ROX who up to this point is focused on JUL, but also glances at ERI, turns to LIN as she seems to realize a couple of seconds later that she has just repeated the overheard Spanish input. ROX’s glance then goes from LIN to GRT who following LIN’s repetition draws his attention to her. ROX (1.28) therefore intentionally remodels the previously overheard Spanish word for LIN thus perpetuating the bidirectional nature of spontaneous interactions (King & Fogle, 2013). Moreover, LIN (1.29) seems to recognize that ROX’s last Spanish utterance is meant for her. LIN thus briefly turns to look at ROX and then, as she looks back down, she softly repeats one more time “tortilla” (flatbread) with a sort of smile on her face. This is perhaps because she was ‘caught’ practicing heritage Spanish on her own. LIN’s use of overheard Spanish ends there and the bi- and monolingual adults continue with their unfocused conversation in their multigenerational, and multiparty framework.

Synthesis

In the present analysis we showed how LIN is attuned to the input in her bilingual language learning environment. We also demonstrated how she uses overheard Spanish to practice it when she is not asked to do so while in the presence of her multiple bi- and Spanish monolingual family members. We observed that at times LIN tends to use heritage Spanish when she is not pressured to do so, for example when the input is directed at a third party in a joint interactional frame, in this case her little brother JUL. This interactional aspect, or when the input is overheard therefore appears to play a critical role in her learning of Spanish. Of course, overheard talk about the “tortilla” (flatbread), including other cultural objects also supports the construction of her bilingual and bicultural identity in a multilingual context (Blackledge & Pavlenko, 2001). Moreover, since both of her monolingual and maternal great-grandparents are present (GRC and GRT) and engaged in the conversation, the interaction between the adults has been and continues to flow almost entirely in Spanish. Therefore, in this multiparty participation framework, the adult interlocutors speak Spanish to each other with only one occurrence of language mixing which is also supported using gesture to aid in the bilingual meaning making process. Otherwise, it is noteworthy to highlight that the bilingual speakers (ROX and ERI) almost entirely stop language mixing in the presence of GRT and GRC. On the other hand, JUL seems to address ROX only in English. The same can be said for LIN, except for when she briefly repeats and practices Spanish with ROX at the end of the interaction. This is an unfocused bilingual, multigenerational, and multiparty participation framework where JUL seems to be the center of attention. Nevertheless, when ROX overhears LIN repeat the Spanish word directed to JUL, that LIN overheard herself, we see that this is a situation where she speaks “the right language in the right circumstances” (De Houwer, 2009: 133), an inherent facet of bilingual socialization, even if this may not be enough use to “fully” acquire heritage Spanish. Furthermore, this also shows how through LIN’s agency, she can impact the course of an interaction. Namely, inspiring ROX to repeat the overheard target word once again to LIN’s benefit. Nevertheless, ROX and the other adult speakers do not deploy any of the proposed monolingual discourse strategies (Lanza, 1997). Finally, as witnessed before, LIN’s use of heritage Spanish rarely extends beyond the one-word stage, even when the speakers in the bilingual participation framework only use Spanish. The interaction below much like the analysis above shows how LIN uses overheard input to practice Spanish, to engage in interaction, and to encourage others to speak Spanish even as she is busy playing on

her own and further removed from the interactional framework. The table below briefly summarizes the key features of the present analysis.

Table 58: Summary of key analytical features in example 19

LIN's age & example	Multimodal Framework	Multigenerational Framework	Participation Framework	Discourse Strategies	"Who speaks what language to whom?"	Dilingual Conversation or Passive Bilingualism
3;10 ex. 19	Using objects Gestures Nodding Gaze & Pointing Mimicry	LIN (3G) JUL (3G) ROX (2G) ERI (2G) GRC (1G) GRT (1G)	Multiparty	No	LIN E ROX LIN S ??? LIN S ROX JUL E ROX ROX S JUL ROX S GRC ERI S ALL ERI M ALL GRC S ERI GRC S ROX GRT S JUL GRT S GRC	PB

6.3.2 Mosca

In this second example LIN is an unratified speaker and she is playing in the living room. She is thus removed from the multigenerational dyadic participation framework that is taking place in the dining room. Moreover, we remark that despite the spatial distance between the two areas in the house, LIN through her subsequent engagement in the interaction shows that she is attuned to the overheard Spanish in her environment. Like the example above, the Spanish that she overhears is also addressed to her brother JUL in a joint interactional frame. Both adults are bilingual speakers, and they represent the 1.5-generation (GLO) and the second-generation (ERI). In the brief social encounter that ensues, the adults are speaking Spanish and English. Through the following analysis, we therefore underscore how LIN overhears and then uses the Spanish input provided in her bilingual language learning environment. As LIN overhears GLO say the word "mosca" (fly) in Spanish to JUL not only does she repeat it, but she also encourages JUL to do the same. The present interaction was recorded in February 2018. GLO, JUL, and ERI are sitting around the dinner table after the dinner time activities have ended. ERI is behind the camera, which is facing GLO, and JUL. LIN is not visible until

she peers her head from behind the couch in the living room. Since it is after dinner and therefore almost time for bed, the lights are dimmed. However, visibility is good enough to consider gaze and gestures in the analysis. Finally, the slow-paced conversation is unfocused so there is no real sense of distraction. Only LIN is the unratified overhearer until she captures the Spanish word from afar.

LIN is 3;10

- | | | |
|-----|-------|---|
| 1. | *GLO: | [- spa] mosca. @JUL |
| | | Fly |
| 2. | *GLO: | [- spa] mosca. @JUL |
| | | Fly |
| 3. | *JUL: | xxx. @GLO |
| 4. | *LIN: | [- spa] mosca. |
| | | Fly |
| 5. | *ERI: | what are you doing LIN? |
| 6. | *LIN: | Mickey Mouse. @ERI |
| 7. | *LIN: | [- spa] mosca? |
| | | Fly? |
| 8. | *GLO: | [- spa] es una mosca @JUL |
| | | It's a fly. |
| 9. | *LIN: | [- mix] say mosca@s Julian. |
| | | Say fly Julian. |
| 10. | *JUL: | xxx. @GLO |
| 11. | *GLO: | [- spa] ya se fue. @JUL |
| | | It's gone. |
| 12. | *GLO: | [- mix] anda una mosca por allí he's@s all@s amused@s con la mosca you@s see@s it? @ERI |
| | | There's are fly around here he's all amused with the fly you see it? |
| 13. | *ERI: | is he? @GLO |
| 14. | *GLO: | [- spa] aie hijo de tu madre. @JUL |
| | | Son of a buck. |
| 15. | *GLO: | [- spa] pinchi [: pinche] panzón. @JUL |
| | | Damn fatass. |
| 16. | *JUL: | xxx. @GLO |

Plurilingual Transcript 24; ex. 20: FEB_15_GLO_JUL_LIN_ERI_2018_mosca

JUL is sitting on GLO's laps, but he is positioned such that they are face-to-face. He is also captivated by a fly that has been buzzing around. Responding to his curiosity GLO (1.1) looks at him and casually says "mosca" (fly) thereby establishing a dyad. A second goes by and JUL, who was diagnosed with a slight speech delay just before the data collection began, utters unintelligible speech (1.3) while also looking and pointing with his right finger in the direction

of the fly which appears to be in the kitchen. His multimodal production, visual, gestural, and vocal that likely support him in coordinating his social interactions during this developmental phase is executed while GLO (1.4) repeats the word “mosca” (fly). They are therefore in joint attention and focused on a third object. In doing so however, the second time around GLO elongates the vowel as she first looks at JUL and then looks in the direction that he is pointing. That GLO presents the word more slowly the second time around may be a way to make it more accessible to him with the aim perhaps for him to use it, but he does not repeat it. GLO’s production is therefore like the analyses that we presented at the beginning of this chapter on segmenting the speech stream. We noted that these types of techniques may allow novices to better apprehend the sounds of their input language to subsequently facilitate their use. The image¹²⁴ below shows JUL pointing in the direction of the fly. It also shows GLO just after looking at him as she produced the word fly a second time, and as she looks in the direction of JUL’s finger.



Figure 46: JUL's multimodal production to reference a "mosca"

Up until now, ERI has not said much. He seems to be an unrati ed speaker who is observing the dyadic encounter in front of him. However, following GLO and JUL’s brief exchange, he zooms and adjusts the camera as he asks LIN (1.5) from across the dining room table what she is up to. This is perhaps a way to ratify both himself as well as her into GLO and JUL’s conversation. Or maybe it is a way for him to initiate a dyad with her on another topic. Nevertheless, when ERI calls her, LIN repeats the overheard Spanish word “mosca” (fly) as she peers up from behind the couch in the living room where she has been quietly playing on

¹²⁴ The following two images have been formatted to better see JUL, GLO, and LIN in interaction.

her own. The following figure depicts LIN looking up and over the couch towards the dyadic participation framework between GLO and JUL. Moreover, through her Spanish repetition, she officially becomes a ratified member, subsequently reconfiguring the social encounter into a triadic participation framework.



Figure 47: LIN captures and repeats the overheard Spanish word "mosca" as she looks over the couch.

Even if LIN does answer ERI (1.6), it seems as though she is more interested in repeating the word "mosca" (fly) again, which she does only a couple of seconds later but this time with rising intonation (1.7) as if asking a question. While it may be difficult to determine who she is addressing at the moment, a strong guess is that it is a way for her to interrogate GLO regarding the fly since GLO is the one who introduced the word into the interaction with JUL. Furthermore, LIN's question overlaps with GLO's statement (1.8) where she tells JUL in Spanish "es una mosca" (it's a fly) and in doing so, she expands her original utterance from one, to three Spanish words thus allowing for richer, though not overwhelming Spanish input. Moreover, this may be interpreted as a Repetition Strategy on GLO's behalf, or a discourse strategy that does not explicitly require the child to respond, although they may, in the proposed target language. It therefore aligns with a monolingual discourse strategy that aims at keeping the conversation in one language. What happens next is quite extraordinary. Despite GLO's efforts to get JUL to repeat the target word "mosca" (fly), LIN (1.9) through a mixed language utterance encourages him to say it as well. In this sense, even if LIN is not an adult, does not have full productive ability in heritage Spanish, and is not the central language teacher *per se*, her utterance may be likened to Lanza's (1997) Language Switch Strategy. In other words, even if JUL does not seem to produce the target word, LIN language mixes, which is a bilingual discourse strategy that instead opens a space for the interaction to be carried on in Spanish

and/or English. This type of linguistic behavior is typical in bilingual and bicultural households since “The home is a ‘safe space’ for bilingual families.” (Kiaer, 2023: 9) where children can create, and explore through language. Nevertheless, LIN goes back to playing on her own, and the triadic interaction goes back to a dyad as quickly as it began. In parallel, JUL gets off GLO’s lap and goes into the kitchen after the fly as he produces another unintelligible utterance (1.10), but GLO in Spanish (1.11) lets him know that it is gone. Following her Spanish comment to JUL, GLO then turns to ERI and addresses him (1.12) through a complex mixed language utterance letting him know that there is a fly roaming around that seems to amuse JUL, but ERI simply and shortly replies in English (1.13). As such, if GLO tried to establish a dyad with ERI, he did not seem to reciprocate the engagement. Two points may be commented on here. First, we may wonder whether GLO’s mixed language choice addressed to ERI was influenced by LIN’s previous language mixing to JUL. That is, by the fact that she opened a space where both Spanish and English could be used in the bilingual language learning environment. But, when she addresses JUL again (1.14 and 1.15) as the interaction comes to an end, GLO reverts to Spanish. From this perspective, we may also argue that her Spanish utterance was not influenced by ERI’s previous English one addressed to her. The second point to mention is that true to the family’s prevalent bilingual discourse, that ERI responded in English to GLO’s language mixing seems to reinforce a diligual conversational style, but it also confirms that GLO’s previously mixed utterance did not seem to influence his own language choice. That is, both language mixing and diligual conversations are acceptable, and typical forms of interaction among the bilingual, bicultural, and multigenerational family members in this *tercera Hispanidad*, as we have extensively highlighted throughout our thickly documented and explained last two chapters.

Synthesis

With this example we see once again that LIN is attuned to the overheard Spanish in her bilingual language learning environment even when she is spatially removed from the participation framework. Furthermore, the last two examples are of particular interest. The overheard Spanish that LIN seems to pick up and use is addressed to her younger sibling JUL, and it is with reference to a third object. A pattern that we thus see regarding LIN’s heritage Spanish use is that she seems more likely to use it first when she is not explicitly told to do so, and second, when it is addressed to someone else for pedagogical purposes. In this social encounter, all three generations are present although only two (the 1.5-generation GLO and the

third-generation JUL and LIN) are involved in the dyadic and then triadic participation framework respectively. However, only the first two generations (GLO and ERI 2G) have productive ability in Spanish whereas LIN, as we have seen, appears only to comprehend it passively. Nevertheless, the analyses showed that Spanish was the language that was most used with some interesting characteristics. GLO only addressed JUL in Spanish but addressed ERI through language mixing. Moreover, while JUL's utterances remained unintelligible, he deployed other multimodal resources like gesture and gaze to ease the flow of communication as he created meaning in interaction. LIN used heritage Spanish twice (likely to address GLO?), but then mixed languages to encourage JUL to repeat the Spanish word "mosca" (fly). Weaved into this dynamic bilingual complexity, ERI addressed both LIN and GLO in English despite being addressed in Spanish. We may thus ask to what extent the language(s) of previous utterance influence future language choices. We saw that only once GLO's language mixing may have been influenced by LIN's mixed language use when she addressed JUL. Aside from that instance, the interlocutors did not seem to adjust to each other's previous language choices. When considering the parental discourse strategies, we may first note that they are in fact not exclusive to adult, caretaker, or parent interlocutors. On the contrary, while GLO deployed a monolingual discourse strategy through Repetition, LIN through her agency in the triadic participation framework first as an overhearer and then as a ratified participant deployed a bilingual discourse strategy through her Language Switch. In this sense, GLO and LIN's discourse strategies seemed to oppose each other on the surface. However, they both implicitly aimed at getting JUL to use heritage Spanish by attempting to render the language learning environment either monolingual (GLO) or bilingual (LIN). As we argued previously, language mixing is not only a way to support heritage Spanish use, but it also allows for the socialization into culinary aspects of the family's Mexican culture as we have seen throughout the present chapter. Furthermore, a bilingual discourse strategy allows us to consider the issue of bilingual socialization. It would appear as though speaking into being a language environment where more than one language is allowed is not only favorable to the continued use of language mixing, but also to an interactional style that favors bilingual conversations across generations. The following interaction is the final example in this chapter. It shows once again how LIN is attuned to the overheard adult input, but this time when it is addressed to another adult. The table below captures the main elements of the present interaction.

Table 59: Summary of key analytical features in example 20

LIN's age & example	Multimodal Framework	Multigenerational Framework	Participation Framework	Discourse Strategies	"Who speaks what language to whom?"	Dilingual Conversation or Passive Bilingualism
3;10 ex. 20	Using objects Gaze & Pointing	LIN (3G) JUL (3G) ERI (2) GLO (1.5)	From dyad to triad to dyad	GLO-RS (mono) LIN-LSS (bi)	LIN S GLO LIN E ERI LIN M JUL ERI E LIN ERI E GLO GLO S JUL GLO M ERI	DL

6.3.3 Chile

This last analysis below builds on the previous two where we see how LIN attunes to Spanish overheard input to practice and engage in conversation. The participation framework is first dyadic, and then it shifts to a triad before becoming a multiparty social encounter. However, unlike what we observed in the previous examples, even if the adults are all bilingual speakers, they still represent all three generations. This extract is also special because it is one of the rare occasions where her father MAR is a participant in the unfolding social encounter. Moreover, contrary to the first example in this section that is dominated by Spanish discourse, the multiparty interaction here like the previous example is dominated by language mixing on behalf of the adults. Through the following analysis, we highlight how LIN also uses the overheard Spanish input despite the abundance of language mixing to which she is constantly exposed. Below, LIN overhears ROX say the word “chile” (chili). ROX’s comment thus prompts LIN to repeat the overheard word. The interaction takes place in January 2019. Only MAR is sitting at the dinner table at first. ROX is standing near MAR facing him. GLO is standing on the other side of MAR and is partially visible. LIN and JUL are playing in the living room, but they eventually make their way to the dinner table. ERI is sitting in the living room and completely removed from the social encounter. The camera is placed on a tripod near a corner of the table. The main participants (MAR, ROX, LIN, and JUL) are visible so their gaze and gestures will be analyzed. The discussion is unfocused. On the one hand GLO is an unratified overhearer and is shuffling through documents. She addresses ROX from time to time. On the other hand, MAR and ROX are the ratified speakers, and they discuss the ongoing teacher strikes and LIN’s attendance at school. Despite this, there is no sense of distraction

since there is no specific goal to the conversation. Finally, LIN and JUL are unratified overhearers until JUL approaches MAR.

LIN is 4;9

1. *ROX: cause [: because] I don't want her not to have perfect attendance. @MAR
2. *ROX: so +... @MAR
3. *MAR: hey where is Mario and Leida doing it at um Incredibles? @ROX
4. *ROX: at I think it's um +... @MAR
5. *ROX: [- mix] la hijastra de Denis@s. @MAR
Denis' stepdaughter.
6. *JUL: Daddy.
7. *LIN: can I go Incredible? @MAR
8. *JUL: xxx. @MAR
9. *LIN: can I go Incredibles? @MAR
10. *MAR: what's up? @JUL
11. *JUL: that. @MAR
12. *LIN: hey Daddy what you say?
13. *MAR: you want some? @JUL
14. *ROX: on your birthday. @LIN
15. *JUL: yeah. @MAR
16. *ROX: [- mix] no it has chile@s. @MAR
No it has chili.
17. *LIN: [- spa] chile! @JUL
Chili!
18. *ROX: no no.
19. *JUL: [- spa] chi(le) chile. @MAR
Chili chili.
20. *ROX: [- spa] chile. @JUL
Chili.
21. *MAR: [- spa] poquito. @JUL
A little bit.
22. *JUL: no. @MAR
23. *GLO: [- spa] tiraste +... @ROX
Did you throw +...
24. *LIN: [- spa] chile!
Chili!
25. *JUL: LIN help me.
26. *ROX: I didn't throw nothing. @GLO
27. *GLO: [- spa] no encuentro +...
I can't find +...
28. *ROX: LIN move from there you have to shower girl.

Plurilingual Transcript 25; ex. 21: JAN_09_2019_LIN_GLO_ERI_ROX_MAR_chile

As the discussion about the school strikes continues, in their dyad ROX (1.1) comments to MAR that she prefers LIN to have perfect attendance since this is very important to them both. Their preoccupation with education is an aspect that they value and often discuss, and furthermore that they try to instill in LIN. Indeed, it has been argued that “Through participation in everyday routines and social interactions as both active participants and observers, children are socialized into culturally specific orientations toward work, education, time, morality, responsibility, individualism, success, well-being, and what it means to be a family.” (Paugh, 2008: 105). In the interactional frame LIN is an overhearer, however, she may certainly be in close enough proximity to gather through her parents discourse an understanding of what is expected of her not only in terms of education, but also of the other issues that are intimately intertwined. To name a few, these would include being on time, being responsible, and being successful not only for herself, but for the well-being of the family. Therefore, LIN will be sent to school even if the teachers are absent. As ROX does so, she does not look at MAR because she is busy removing clothes from the back of a chair in front of her. Then ROX proceeds (1.2) to further explain, but she is interrupted by MAR’s question. MAR’s left hand is on his head. He also appears to be looking at JUL who is playing nearby, and not at ROX. Moreover, instead of commenting on ROX’s statement, MAR (1.3) removes his hand from his head as he shifts his gaze from JUL up to ROX to ask her where his older brother and his wife are organizing an upcoming birthday party. Now, MAR and ROX are looking at each other and ROX (1.4) begins to answer before pausing. ROX (1.5) answers MAR through a mixed language utterance. Then LIN who is playing with JUL from inside of ROX’s robe, gazes at MAR before making her way to him. JUL (1.6) seems to understand LIN’s intention to go to MAR, so he calls MAR therefore breaking himself into the dyadic interactional frame thereby creating a triad. LIN then joins the social encounter herself as well (1.7), and as such a multiparty participation framework is formed. She does so multimodally first by asking her father if she can go to the party too, then by getting on the chair next to him, looking at him from a very close distance until they are close enough to exchange an affectionate kiss. The figure below seizes the moment when LIN after asking her father for permission to attend the pizza party, moves in for a kiss.



Figure 48: LIN enters interaction multimodally with her late father MAR through speech & affection.

Two points may be highlighted here. First, LIN's reaction to the overheard conversation between her bilingual parents shows that even if she is busy playing with JUL, she is still aware of what is said around her. This may be especially true when what is said is in English since this is by far her dominant language. Second, that at this point the dyadic interaction between MAR and ROX has expanded to a multiparty participation framework of four. This new multimodal, and bilingual frame subsequently engenders the use of Spanish not only by LIN, but by JUL as well. Thus, JUL (1.8) addresses MAR looking up at him and then hugging him. JUL also utters something, but it is unclear what he says. Nevertheless, LIN (1.9) proceeds to ask MAR once again if she can go to the party as she moves slightly away from him to kneel more comfortably on her chair. MAR's gaze is fixed on JUL (1.10). Moreover, he still does not answer LIN's question even though she has now asked him twice. MAR then turns around lifting his left arm up and over JUL and with his right hand he lightly caresses JUL's chin. As he does so, JUL (1.11) looks and points to a soft drink on the table by MAR's bowl of soup and asks for it. In the meantime, after gazing at MAR who is looking at JUL, LIN (1.12) stands on her chair to sit on the table to face him as she asks what he has just said. LIN's shift in position is perhaps to assert herself in the conversation. By sitting on the table, she is also at eye-level with MAR. Indeed, after understanding that JUL has asked for something, MAR asks JUL if he wants some of his soup (1.13). MAR thus shifts his gaze from JUL and looks and points directly into the soup with his right index finger before turning to JUL again who is standing next to him under his left arm. It is difficult to assess if MAR does not truly see what JUL has requested since he pointed straight at it. Also, even if we have a clear view of both MAR and JUL, MAR does not seem to look at the soft drink. Perhaps MAR knows what JUL wants, but instead he proposes something else because he does not want to share, but we will never know.

In any case, ROX who is partially visible and has her back turned to the camera comes back to the interaction, although she was still overhearing as we see next. She stands behind LIN's chair as she gazes at MAR and JUL who are both to her right. Since LIN's questions addressed to MAR remain unanswered, ROX (l.14) tells her that she will go to the pizza place on *her* birthday. However, LIN does not acknowledge ROX's comment since she is busy staring at the bowl of soup that MAR previously identified. Nevertheless, JUL (l.15) seems to agree with MAR's proposition as his gaze goes from the soft drink to the bowl of soup on the table. However, ROX (l.16) through a mixed language utterance suggests that it is not a good idea because it has "chile" (chili). Also, it is not clear whether she addresses MAR, so that he does not feed JUL, or if she addresses JUL so that he does not accept any soup from MAR. A strong guess is that ROX addresses JUL since the adults frequently advise the children when something is spicy, and it is up to them to decide whether they want to try it. Nevertheless, ROX's language mixing is a source of overheard speech for LIN from which she extracts the Spanish word "chile" (chili). LIN who is still sitting on the table facing MAR takes her right hand in the form of a fist, except for her index finger and thumb, and briefly brings it to her mouth. Through her gesture we understand that she knows that chili is spicy and should therefore be consumed with caution. The following figure depicts the moment LIN brings her finger to her mouth after overhearing that the soup is spicy.



Figure 49: LIN takes her fingers to her mouth after overhearing her mother ROX say the word "chile".

Furthermore, LIN's gesture precedes her repetition of the overheard word. LIN's gesture (l.17) is then followed by her enthusiastic Spanish utterance "chile!" (chili) which was perhaps also a warning addressed to JUL following ROX. And, as she does so, LIN leans toward MAR pointing at the center of his chest with her right arm extended, even though she is looking down

at the bowl. The next figure below shows how LIN deploys her linguistic resources multimodally. Not only does she shout the overheard word chili in Spanish, but she also energetically points in her father MAR's direction.



Figure 50: Multimodally LIN repeats the overheard word “chile” & points in MAR's direction.

Moreover, there seems to be a sort of discordance between what LIN is pointing at (MAR) and what she is looking at (the soup). It may be interpreted as a way for her to indicate to her little brother JUL that her father is trying to feed him something spicy. In other words, through her bilingual, and multimodal interaction she is referencing both MAR (by pointing at him) and the soup (by saying chili while she looks at it). Then, ROX who is still looking over all of them says no again twice (1.18) since MAR starts to bring a spoon of soup to JUL's mouth. Furthermore, JUL (1.19) repeats chili in Spanish as he gets ready to take the spoonful of soup. At the same time LIN looks at JUL and then stretches her right arm again to block the spoon with her hand from getting into JUL's mouth. ROX (1.20) insists again while looking at JUL and repeats “chile” (chili), but MAR responds in Spanish by suggesting that he try just a little bit (1.21) with his gaze maintained on JUL. Much like when ROX said “no” further up, here again we do not know whether MAR addresses ROX, or JUL in Spanish. It does appear however, as though the language of previous utterance, or Spanish, may have influenced MAR's language choice. Up until now, MAR has only addressed ROX and JUL in English, but this time he addresses one (or both?) of them in Spanish. Nevertheless, before MAR can get the spoon into JUL's mouth, JUL removes himself from its trajectory by moving to the left of MAR (1.22). Then, GLO begins to ask ROX (1.23) in Spanish if she has thrown a document away that she has been diligently looking for. GLO has been an unratified overhearer in the now multiparty participation framework and her participant role remains the same throughout

except for this brief dyadic exchange with ROX. GLO seems to be looking for it underneath the table, so she does not look at ROX when she addresses her. Nevertheless, GLO's question in Spanish to ROX is not intended to ratify herself into the multiparty interactional frame. Rather GLO and ROX briefly form a bilingual dyadic side conversation within the larger multiparty participation framework. We may ask however, if GLO's Spanish question to ROX is also influenced by the previous language choices made both by ROX and MAR that she has likely overheard. In any case, since JUL refuses to eat the soup, MAR goes back to eating. LIN (1.24) repeats in heritage Spanish one more time "chile" (chili) in a playful tone, this time appearing as though she looks at ROX, but it is difficult to tell since her back is now partially turned to the camera. Then JUL (1.25) looks at LIN as he moves closer to her to ask for help getting on the chair, but LIN does not seem to mind him. After a brief pause between GLO's question in Spanish, ROX (1.26) answers her in English to affirm that she did not throw anything away. ROX's response is also accompanied not only with a gaze that moves away from GLO, but also through her stance, by physically taking a few steps in the opposite direction. In considering ROX and GLO's brief exchange, we also find that ROX engages in a dilingual conversation that Saville-Troike (1987) found in adult-child interactions. The difference here is that not only is ROX an adult, but she is also bilingual so she could have chosen to answer in Spanish. While we do not know why ROX answers GLO in English, these types of dilingual exchanges between multigenerational bilingual adults may serve to socialize LIN to interact with other adults in the same manner. However, LIN is not yet bilingual, so answering in English when she is addressed in Spanish may not favor her use and acquisition of heritage Spanish even if these types of interactional moments do serve to indicate how much she understands as a passive bilingual. The other issue is that some of her adult family members are monolingual Spanish speakers, so they may not necessarily understand her when she speaks to them in English. Nevertheless, as ROX moves away, we hear GLO (1.27) start to say (most likely to ROX) in Spanish what it is that she cannot find. However, by this time ROX is on the other side of LIN and seems to have moved on. ROX (1.28) looks at LIN and tells her first that she needs to get off the table and then that she must shower as she reaches for a napkin on the table. The interaction ends as LIN stands on the chair and turns around to see what ROX is doing.

Synthesis

This final analysis revealed how LIN is attuned to the overheard Spanish input in her bilingual language learning environment, even when it is presented in mixed language utterances. She appears to use heritage Spanish in multimodal interaction first to warn her little brother JUL that the food is spicy, and then to practice after she successfully saves him from eating it. Several bilingual family members are present, namely her father, who in general is absent from the recordings since he was always working. Much like we have seen in previous interactions, LIN seems to use Spanish more freely on her own terms. That is, when Spanish emerges naturally whether she is addressed (child-directed), or when she hears it in her environment (overheard), but not when she is told to speak Spanish explicitly. Furthermore, even if this multiparty participation framework is multigenerational, here all the participants are bilingual, which was not always the case in the varied interactional settings that we studied throughout the last two chapters. Thus, the most frequent mode of communication is English between the adults. However, in answering the question of who speaks what language to whom, MAR addresses ROX and JUL in English. Moreover, MAR speaks Spanish once, and while it is not clear who he addresses, a strong guess is JUL. It is also striking to note that MAR does not address LIN, despite her repeated efforts to interact with him. ROX on the other hand addresses MAR in English and through language mixing and she addresses GLO in English even as GLO addresses ROX in Spanish. This raises the question of socialization into language mixing discussed below. Next, LIN addresses MAR in English and JUL in Spanish after ROX's mixed language utterance. Finally, JUL addresses MAR in English and in Spanish, but LIN in English. One of the difficulties in this multigenerational and multiparty participation framework is that the speakers' gazes do not always seem to point directly to the person they are addressing. It is therefore likely that some utterances are destined to more than one participant in the social encounter. Moreover, towards the end of the interaction it would appear as though ROX's mixed language choice led not to the use of more language mixing, but rather to the use of Spanish first by LIN then by JUL, ROX, MAR, and GLO. Language mixing, as we argued in other analyses appears to open a path towards heritage Spanish bilingualism. In terms of discourse strategies and bilingual socialization, the adults do not seem to attempt to guide LIN, or JUL into further using heritage Spanish in this unfocused participation framework, even as LIN uses Spanish on her own. Finally, we witness ROX engage in a brief bilingual and dyadic side conversation with GLO. Even if we consider that their exchange is not central to the ongoing multiparty interaction, many of our analyses show that LIN is attuned to the overheard

speech, as well as to the bilingual adults' dynamic speech practices. LIN may thus be implicitly socialized to answer in English when she is spoken to in Spanish whether her interlocutor is bilingual, or not. Only further research in more varied interactional contexts, and with other multigenerational speakers may reveal if these types of implicit linguistic practices are hindering her use, and thus acquisition of heritage Spanish as a third-generation child in L.A. As Hoyle and Adger (1998) advance, children, as they go about their lives, are immersed in a broad range of social settings which in turn expand their social networks. This also engenders novel uses of their linguistic repertoires. In other words,

As part of this expanding social life, children's peer, sibling, and play interactions constitute a rich site of language socialization. The language varieties and styles that children use in peer and sibling interactions and the particular ways they deploy their linguistic repertoire, strongly impact and may have profound implications for language change, maintenance, and shift. (Howard, 2008: 193).

Chapter 6 thus closes by highlighting that the language to which children are exposed in their communities of practice scaffold their bilingual, and bicultural construction. This was an argument that was initially advanced in Chapter 4 in our discussion of bilingual input and output. That is, through the adults' language choices and use, children are socialized into particular modes of communication, as well as into distinct language varieties, for example the Los Angeles variety of Spanish in the present case. Of course, LIN is also socialized into the use of English, language mixing, and a passive form of Spanish bilingualism. The last two of which are language styles that nonetheless help maintain the use of heritage Spanish in the multigenerational family. The last table below highlights the main elements underscored in the present analysis.

Table 60: Summary of key analytical features in example 21

LIN's age & example	Multimodal Framework	Multigenerational Framework	Participation Framework	Discourse Strategies	"Who speaks what language to whom?"	Dilingual Conversation or Passive Bilingualism
4;9 ex. 21	Gaze Pointing Stance Gesture Using objects	LIN (3G) JUL (3G) ROX (2G) MAR (2G) GLO (1.5)	From dyad to triad to multiparty	No	LIN E MAR LIN S JUL JUL S MAR ROX E MAR ROX M MAR ROX E LIN ROX M JUL ROX S JUL ROX E GLO MAR E ROX MAR E JUL	DL

					MAR S JUL	
					GLO S ROX	

CONCLUSION

The last two chapters through their rich analyses deepened the characterization of LIN’s bilingual language learning environment by proposing 21 thick qualitative multimodal, and multigenerational analyses based on plurilingual transcripts that were linked to their corresponding videos. First language socialization was defined as a bidirectional interactional process (King & Fogle, 2013) occurring in ever-shifting dyadic, triadic, and multiparty participation frameworks. In other words, “language socialization is inherently bidirectional, despite the obvious asymmetries in power and knowledge, and therein lies the seeds of intergenerational, historical continuity, and change within social groups.” (Ochs & Shieffelin, 2008: 8). LIN is therefore socialized to use heritage Spanish, English, and mixed language utterances when interacting with her mother ROX and with other bi- and monolingual adults in her family. LIN is also socialized to communicate dilingually with other speakers in her community of practice, and for her this means using heritage Spanish passively i.e., she receives input in Spanish, but responds in English.

Moreover, Goffman’s (1974, 1981) Participation Framework, Fishman’s (1965) question of who speaks what language to whom, and Lanza’s (1997) Parental Discourse Strategies guided the organization of our “thickly” documented and explained analyses. They were essentially anchored during the dynamic multimodal, and multigenerational dinnertime activities proper to the cultural framework of this family of Mexican heritage. Thus, the present analyses as Geertz (1973) and Bronson and Watson-Gegeo (2008) recommend, went well beyond those that merely focused on a single interactional moment, and in doing so remained true to the ethnographic approach in language socialization studies. Together, they helped untangle the interactional, and bidirectional complexity as well as to show how the family’s plurisemiotic linguistic resources were deployed to encourage the use of heritage Spanish in five main themes. These included LIN’s attitude to speaking heritage Spanish, her attitude towards accepting translation equivalents, her use of heritage Spanish when guided through speech stream segmentation, and her use of heritage Spanish around mostly food related activities when her input was child-directed, and when it was overheard. Moreover, the 21 socially situated analyses underscored how a child’s language learning trajectory unfolds as an (un)ratiated participant who gravitates to the center of interactional frames in which she is

embedded. Lave and Wenger (1991) have advanced the term *legitimate peripheral participation* and it is defined as “Learning in contexts (where) learners begin at the periphery and gradually move to the center as their skills grow.” (Bronson & Watson-Gegeo, 2008, 47-48). Indeed, on many occasions throughout our analyses we witnessed how LIN moved to the center of the multifaceted bi- and monolingual social encounters whether they were dyadic, triadic, or multiparty. She therefore showed how through her agency, and multimodal engagement she was not only able to enter conversations, but also to shape their paths.

Next, our discussion will bring together both the quantitative measures, and the thick qualitative analyses that were previously treated as individual chapters. That is, the results from Chapter 4, 5, and 6 will be integrated into the proposed answers throughout the ensuing discussion before closing the investigation with a brief conclusion of third-generation heritage Spanish language acquisition and socialization in bilingual, multigenerational, multimodal, and multiparty social encounters in L.A.

Discussion

Restating the research question & aims

The aim of inquiry throughout this dissertation was to better understand how a third-generation child was acquiring and socialized into heritage Spanish in L.A. The Mexican cultural framework is unique to the family in this longitudinal case study when compared to middle-class monocultural, and thus monolingual American families. However, these types of socio-cultural encounters are not the exception, but rather the rule since culturally distinct frameworks involving other languages and cultures abound at the individual, familial, and societal levels, and furthermore they are deeply interwoven into the very fabric of the U.S. (Kiaer, 2023). We have described these areas as linguistically and culturally tension ridden contact zones, or within the context of this study, a *tercera Hispanidad*. Moreover, we argued that points of convergence between languages and cultures may be transformative. They have the potential to yield speakers who are bilingually and biculturally sensitive which cannot, and perhaps should not be measured only by the amount of Spanish one produces. Nevertheless, we argued that heritage Spanish use by the target-child could be the result of several critical factors tied to the bilingual language learning environment. They included the quantity and the quality of input, but just as importantly the child's attitude surrounding the use of heritage Spanish with her multigenerational family members in ever-shifting multiparty participation frameworks. These are interrelated factors that we investigated using a mixed methods approach. We considered quantitative measures in Chapter 4, while in Chapter 5 and 6 we delved into fine-grained qualitative analyses of spontaneous talk-in-interaction. In using mixed methods to arrive at our results, our qualitative research reported on five central themes related to heritage language socialization, whereas our quantitative measures reported on 10 potential relationships between linguistic and social factors. The table below highlights the main research question. It also further unpacks it into 17 sub-questions.

The first 10 questions were related to the characteristics of LIN's bilingual language learning environment which were dealt with quantitatively in Chapter 4. The following seven sub-questions were related to understanding the process of heritage language socialization. These were answered qualitatively, and we did so first by considering LIN's attitudes about speaking heritage Spanish (Chapter 5), and second by accounting for LIN's bilingual input and output (Chapter 6). The table below thus summarizes the main research question, as well as the additional questions posed in Chapter 4, 5, and 6.

Table 61: Central research question & sub-questions

How is a third-generation child acquiring and socialized to use heritage Spanish in Los Angeles, California?	
Chapter	Questions
Chapter 4: Characteristics of the bilingual language learning environment.	1. Can the increase and subsequent decrease of Spanish in this multigenerational family be attributed to the presence or absence of one, or multiple family members?
	2. Can the linguistic fluctuations be attributed entirely to sociolinguistic factors, or may other factors be at play such as the data collection methods?
	3. In terms of relative frequency, to what extent are Spanish, English, and language mixing used longitudinally?
	4. How does the linguistic soundscape evolve over time?
	5. How can the linguistic soundscape help explain LIN's use of Spanish, English, and language mixing?
	6. How does LIN's language presentation compare to that of her primary caretakers?
	7. How do the utterances that the adults address to LIN differ from those utterances that the adults address to each other?
	8. Are Spanish utterances more frequently addressed to GRC and GLO, or the first-, and first-and-a-half-generation speakers as could be expected?
	9. Are mixed language utterances more frequently addressed to the second-generation speakers ROX and ALE given their bilingual socializing context since birth?
	10. Why does GRC, a first-generation speaker receive more mixed language input than ROX, ALE and LIN?
Chapter 5: Heritage language socialization: Attitudes about speaking heritage Spanish	1. How does LIN's attitude change about speaking Spanish over the course of the study?
	2. How does LIN react when the adults provide Spanish and English translation equivalents?
Chapter 6: Heritage language socialization: Bilingual input and output	3. How do LIN's bi- and monolingual family members help her use Spanish in dyadic, triadic, and multiparty interactional frameworks?
	4. How does child-directed and overheard adult input help LIN use and practice Spanish?
	5. How does LIN demonstrate her emerging passive bilingualism, and her ability to communicate with Spanish monolingual speakers?
	6. How does the use of English and language mixing support the use of Spanish in interaction?
	7. How do the bi- and monolingual adults respond to LIN's use of English when she is addressed in Spanish?

The overarching research question of this investigation is at the top of the table. Our discussion will therefore focus on the findings relevant to this main problem. The left column underscores the chapter according to its focus, or theme. The right column presents the sub-questions that emerged. They are arranged according to the chapter in which they are found. In Chapter 4 there are therefore 10 questions while in Chapter 5 and 6 there are a total of seven. Next, we will briefly look at the main results.

Summarizing the key findings in Chapter 4, 5, & 6

In Chapter 4 the data suggests that longitudinally English is spoken to a higher degree than Spanish within the family. LIN therefore uses Spanish in a bilingual language learning

environment where there are less opportunities to hear and as such to speak Spanish. However, these moments are critical since “Learning to understand a language requires that you have had opportunities to hear it. Learning to speak a language implies that you have had opportunities to speak it.” (De Houwer, 2009: 95) which does not seem to be the case according to our results. Moreover, the data shows that language mixing was low, but stable across the three sampling periods, but these quantitative measures do not show how or if it supports the use of heritage Spanish. Regarding the language presentations, the data suggest that LIN’s resembled that of her mother ROX and aunt ALE, especially regarding language mixing. Next, while the men tended to use Spanish slightly more than the women, their language presentations were similar overall. We also considered LIN’s input versus the adult input. The measures suggest that LIN and the bilingual adults received English input the most. The input was followed by Spanish, and lastly by mixed language input. However, regarding output LIN produced mixed language utterances more than Spanish ones. This was also the case when we considered LIN’s input and output in dyads, English was also used the most, and Spanish was kept to a minimum. Regarding LIN’s output according to generation, our measures suggest that her productions were not generation-graded, however they did not depict how mutual understanding was achieved multigenerationally, for example through language mixing. Next, LIN’s language choice according to the language(s) of previous utterance was assessed. LIN appeared to adjust, but not in all cases to the language(s) of previous utterances when speaking Spanish and language mixing. LIN’s MLUw and TTR were inconclusive in Spanish. Moreover, in counting her types and tokens longitudinally, the data suggest that her heritage Spanish is not developing. Also, her English, though showing developmental progression, was not developing according to her age. Finally, regarding LIN’s bilingual repertoire, she has English translation equivalents for over half of her Spanish words spread across 19 semantic domains. Furthermore, she uses well over half of these Spanish words in mixed language utterances even when she knows their English translation equivalents.

These quantitative measures suggest that LIN is unsuccessfully developing heritage Spanish. They also depict a situation where active bilingualism in this multigenerational setting is attriting, which could eventually lead to language death (Harrison, 2007). These measures were frustrating, especially because they seemed to overshadow those moments when LIN did use heritage Spanish, or when her Spanish emerged, even if momentarily like the light that filters through the leaves when walking in the woods. As such, we may suggest that heritage bilingualism is not just about grammar (syntax, morphology, lexicon etc.) as it has traditionally

been conceived (Ochs, 2022). Rather, heritage bilingualism is also about inheriting culturally specific, and dynamic language use conventions that are themselves rooted in tension ridden multigenerational communities of practice. The unique ways in which the linguistic resources were deployed at the individual, and the family level whether measured quantitatively or described qualitatively contribute to the emergence of a bilingual and bicultural identity (Blackledge & Pavlenko, 2001) for LIN that is useful in her multilingual speech community. Furthermore, heritage language acquisition, like the acquisition of any language, is propelled by its increasingly complex use, through scaffolding for example, in daily and meaningful interactions with the various bi- and monolingual speakers in a family unit, or community as Kiaer (2023) recently suggested. The acquisition of a heritage language, we may argue is the result of the bilingual, multigenerational, multimodal, interactional (which implies bidirectional), and mostly implicit process of heritage language socialization as it is rooted in the community of practice. Before summarizing the main findings of Chapter 5 and 6, we will briefly revisit the frameworks that allowed us to organize these qualitative analyses since it will be useful for the ensuing discussion.

In Chapter 5 and 6, I aimed to understand how LIN, a third-generation child growing up in L.A. was using, through the forces of language socialization, heritage Spanish while in contact with English, the socially dominant language. Gaining insight into the process of language socialization is complex. These reasons were outlined both in the review of the literature (Chapter 1 and 2), and in discussing the methods and data (Chapter 3). Therefore, to help organize our thick analyses we were guided by three discourse, or social interactionist-based frameworks that were limited to the multigenerational family's dinnertime activities. Lanza's (1997) Parental Discourse Strategies highlighted the interlocutors' roles in the process of heritage language socialization. The model helped identify how, and if the bi- and monolingual adults through their implicit or explicit discourse encouraged a monolingual, or a bilingual language learning environment. The other model, or rather guiding question was related to Fishman's (1965) inquiry of "Who speaks what language to whom and when?". It allowed to focus our analyses on how, and with who Spanish and English were used multimodally among the mono- and bilingual multigenerational family members in this cultural setting. For example, it permitted us to give a qualitative account of how or if language choices were impacted by the previous language choices in the dynamic bilingual language learning environment. Next, Goffman's (1974, 1981) Participation Frameworks was the third interactionist-based model used to organize our analyses. Since social encounters are not only

limited to two interlocutors, which was certainly the case in the present study due to the family's Mexican heritage, this model allowed us to account for the interactional complexity of on-going communication beyond the dyad. It showed how bilingual, multigenerational, and multimodal participation frameworks are constantly shifting from dyadic, triadic, or multiparty configurations. Moreover, it also showed how these same participation frames may be embedded into other often larger ones, or how they overlap with others where some speakers may be part of two on-going conversations at once, even if momentarily in the social interaction. Finally, a critical aspect of these interrelated, and complementary analyses is that in most cases they were apprehended through both the visual-gestural and the auditory modalities. Only a multimodal analytical approach that considered both gestures and verbal productions was deemed capable of accounting for the rich and ever-shifting modes of communication that were deployed across the dynamic social encounters in this L.A.-based multigenerational bilingual family.

The analyses carried out in Chapter 5 and 6 suggest that monolingual Spanish discourse strategies were deployed throughout the dynamic, bilingual, and multimodal interactions. ROX, GLO, and ERI relied on the Repetition Strategy, whereas GRC, and ERI also deployed the Minimal Grasp Strategy to steer the social encounter to monolingual Spanish. Thus, the multigenerational family members present in the data did seem to create (although not across all the interactions) a bilingual language learning environment where LIN was encouraged to speak only heritage Spanish in meaningful interaction. However, the Language Switch Strategy, which is a bilingual discourse strategy was also used for example by ROX, GRC, and ERI. This strategy was also deployed by LIN which further suggests that she is learning the socially acceptable language practice where both languages are allowed in conversation. Overall, the data suggests that the monolingual discourse strategies may not be consistent enough to promote LIN's heritage Spanish use. There may also not be enough speakers, whether they are bi- or monolingual, explicitly advocating for the use of heritage Spanish for its successful transmission to the third generation. Even if the family agrees that it is important to maintain Spanish, the family does not clearly advocate for the use of Spanish, or for the transmission of heritage bilingualism. These types of discrepancies between declared beliefs and practices were reported by Gharibi and Seals (2019) for Iranian in New Zealand, and by Schwartz (2008) for Russian in Israel. Furthermore, in a study of Polish in Australia, the conclusion suggested that "it is assumed that fostering positive beliefs towards heritage language use will never be sufficient to safeguard heritage language development in children."

(Romanowski, 2021: 1228). Notwithstanding, this sentiment was echoed by GRC in a recent WhatsApp conversation dated September 24th, 2022. She told me that LIN understood Spanish well and then she further mentioned that “si a ellos les pusieran atención, aprenderían español” (if they (the adults) paid attention to them (the children), they would learn Spanish). This insight therefore suggests that for heritage Spanish to be acquired, especially by the third-generation, the adults need to come together and intentionally advocate for its use. Nevertheless, for now this interactional context seems to result in a social situation where LIN produces little Spanish and only seems to interact with GRC, and other Spanish monolinguals through bilingual conversations due to her passive bilingual mode of communication. However, in these instances the data shows that many gestural-visual aspects were used to create or reinforce meaning, or to show a particular stance. Pointing and gazing was rather frequent among the participants to direct attention. For LIN this also included crossing her arms, turning her head, or shrugging her shoulders to show refusal to speak Spanish or to show that she did not understand a term, concept, or question. The use of objects in their joint interactional frames (Tomasello, 2003) was also salient in the meaning making process. Since the referent was visually available this allowed the speakers to draw their attention to it and to cement its meaning which would likely be more difficult with abstract references.

Furthermore, that data shows that LIN’s use of heritage Spanish is intimately tied to the multimodal use of English, and language mixing whether it is the adults who are speaking or LIN. For example, in the same WhatsApp conversation mentioned above, GRC underscored how LIN is curious to learn Spanish words. In one instance LIN asks her in a mixed utterance “Grandma ‘girl’ qué es en español?” (Grandma how do you say girl in Spanish?). Language mixing appears to open a path towards the use of more heritage Spanish, or her developing bilingualism (Gorter, 2013) for LIN, as well as increasing her ability to communicate with different generations (Chung, 2010). In this regard, the question of who spoke what language to whom was an interactional aspect that was difficult to capture through our quantitative measures. Moreover, it was difficult to assess how these dynamic language practices aided LIN in using heritage Spanish. Through bilingual, dyadic, triadic, and multiparty participation frameworks which is in large part due to the unique cultural make up of this family, the multigenerational speakers come to understand each other. This is especially the case when Spanish monolinguals are present in the social encounter. However, language mixing and the use of English may also be seen as impeding heritage Spanish transmission too since for the most part, anyone seems to speak any language at any time regardless of the language(s) of

previous utterance (an exception is of course when monolingual Spanish speakers are present in the social encounter). Notwithstanding, this may not necessarily be the case. In other words, language mixing by the bilingual adults may model a conversational style which is proper to and accepted by this community of practice where some Spanish is used. Additionally, language mixing may be a form of heritage Spanish socialization in that it is a way to maintain heritage Spanish using English. However, we must keep in mind that LIN does not have full productive ability in heritage Spanish. Therefore, familial language mixing may also socialize her into a passive form of bilingualism which eventually results in dilingual conversations. Finally, the data also suggests that ROX seems to be fine with LIN's language mixing and seemed to show more interest in her behavior (as related to her gender and age for example) rather than how, or if she speaks only in Spanish.

The data also shows that the multigenerational family's social interactions were typically embedded in ever-shifting multimodal participation frameworks. This multigenerational and highly multiparty interactional aspect and its effects within LIN's bicultural and bilingual habitus is perhaps what makes the data, and its ensuing results unique since it opens a space for the researcher to witness both how LIN experiences and practices language and culture (Duranti, 1997). In other words,

The theory of practice as practice insists, contrary to positivist materialism, that the objects of knowledge are constructed, not passively recorded, and, contrary to intellectual idealism, that the principle of this construction is the system of structured, structuring dispositions, the *habitus*, which is constituted in practice and is always oriented towards practical functions. (Bourdieu, 1990: 52).

The range of interactional arrangements in which LIN could observe and then perform was endless because they were in constant flux which is also a "recognition of the fluidity of cultures" (Duranti, 1997: 43), or cultural and linguistic systems that are by nature, not stable as Tomasello (1999/2022) as also argued. They moved from dyadic, to triadic interaction and back to a dyad. Or they would change from a triad to a multiparty participation framework and back to a triad. Other times they consisted of brief dyads, or triads embedded in, or in parallel to a larger participation framework. Notwithstanding, the data suggests that it is within these dynamic bilingual and bicultural social encounters that LIN was socialized into politeness, gender roles, age-appropriate behavior, and kinship, or hierarchy to name a few culturally orientated expectations. The analyses further show that using Spanish, English, and language mixing, the family socializes LIN not only into the use of these modes of communication, but also through these language practices into their varied sociocultural beliefs. For example, ROX

tells LIN on several different occasions to act like a little girl, not to speak in a childish manner, and that she can no longer drink from a baby bottle. Her commands thus guide the construction of LIN’s bilingual and bicultural identity and behavior according to both her age and gender. Politeness seems to be important for GRC who in enabling LIN to use Spanish through speech stream segmentation not only enhances her use of heritage Spanish, but also stresses the importance of asking for things in a respectful manner. Moreover, through play RIC socializes LIN into the pre-defined multigenerational family hierarchy where uncles are to be respected, but also assume an important role in the child-rearing activities. Finally, ERI’s presence and participation as a researcher and community member both implicitly and explicitly socialized LIN to the importance of maintaining heritage Spanish for example by addressing her in Spanish or by providing her with translation equivalents. Socialization into language, and through language was thus enriched through the various bilingual, multigenerational, and ever-shifting multimodal and multiparty participation frameworks in which LIN was actively engaged as a ratified speaker and receiver of child-directed input, or as a keenly attuned overhearer that nonetheless showed interactional agency based on the overheard input. The table below summarizes the multimodal discursive elements mentioned above that were individually presented throughout our qualitative analyses.

Table 62: Summary of key multimodal discursive features of the qualitative analyses according to LIN’s age

LIN’s age & example	Multimodal Framework	Multigenerational Framework	Participation Framework	Discourse Strategies	“Who speaks what language to whom?”	Dilingual Conversation or Passive Bilingualism
3;10 ex. 1 & 2	No	LIN (3G) JUL (3G) ERI (2G) GRC (1G)	From dyad to triad to dyad	ERI-MGS (mono) ERI-LSS (bi) ERI-EGS (mono)	LIN E GRC LIN M GRC LIN M ERI ERI E LIN ERI S LIN ERI M LIN ERI S GRC GRC S LIN	Yes
4;4 ex. 3	Pointing & Gaze Stance Nodding Crossing arms	LIN (3G) JUL (3G) ROX (2G) ALE (2G) RIC (2G) ERI (2G) GLO (1.5G)	From dyad, to triad, to multiparty, then back to triad Brief dyad between ALE and LIN	No	LIN E ROX LIN S ERI LIN S ROX ROX S LIN ALE E LIN ERI S LIN GLO S LIN	Yes

	Turning head to the side					
4;9 ex. 4 & 5	Gaze Head shake for negation Nodding with insistence Wondering gaze Hiding	LIN (3G) JUL (3G) ROX (2G) ERI (2G) GRC (1G)	From two dyads to one, then to a triad, then to multiparty	ERI- EGS (mono) ERI-RS (mono) ROX-RS (mono)	LIN E ERI LIN S ERI LIN M ROX ROX E ERI ROX M ERI ROX S LIN ROX E LIN ERI E ROX ERI S LIN	PC
3;10 ex. 6, 7 & 8	No	LIN (3G) JUL (3G) ROX (2G) RIC (2G) ERI (2G) GRC (1G)	From dyad to triad to dyad Brief dyad between ROX and ERI Brief dyad between ROX and GRC Brief triad between GRC, ROX, and ERI	No	LIN E RIC LIN M RIC ROX S GRC ROX E ERI RIC E LIN RIC M LIN ERI S GRC GRC S RIC GRC S ROX	No
3;10 ex. 9 & 10	Pointing Nodding Gaze Posture Head lowered Using objects	LIN (3G) ROX (2G) ERI (2G) GRC (1G) GRT (1G)	From triad to dyad to triad to multiparty to triad to multiparty to dyad to multiparty to dyad to triad	ERI-RS (mono)	LIN E GRT LIN M ERI ROX E LIN ROX S LIN ERI S LIN ERI E LIN GRC S LIN GRC S ERI	DL
3;10 ex. 11, 12 & 13	Gaze Moving arms up and down Nodding Using objects Pointing	LIN (3G) JUL (3G) ROX (2G) ERI (2G) GRC (1G)	From dyad to another dyad to triad to multiparty	GRC-MGS (mono) GRC-LSS (bi)	LIN E GRC LIN S GRC LIN E ROX LIN M ROX LIN S ROX ROX E LIN ROX S GRC ROX S LIN ERI S GRC ERI M GRC GRC S ERI GRC S LIN GRC M LIN	DL & PB

3;10 ex. 14	Pointing Stance Using objects Nodding	LIN (3G) JUL (3G) ROX (2G) MAR (2G) ALE (2G) RIC (2G) ERI (2G) GRT (1G)	Shifting dyads in a larger multiparty frame	ROX-LSS (bi)	LIN E JUL LIN E ROX LIN S ROX ROX E LIN MAR E ??? ERI S GRT	No
3;10 ex. 15	No	LIN (3G) JUL (3G) ROX (2G)	From one dyad to another	ROX-LSS (bi)	LIN E ROX LIN M ROX ROX E LIN ROX M LIN	No
3;10 ex. 16 & 17	Pointing & Gaze Using objects Head shake for negation Shoulder shrug	LIN (3G) JUL (3G) ROX (2G) ERI (2G)	From multiparty to triad to multiparty	No	LIN M ROX LIN M ROX LIN S ERI LIN M ERI ROX E LIN ROX M LIN ROX E JUL ROX S JUL ROX S LIN ERI S LIN ERI M LIN	No
4;9 ex. 18	Extending arm Using objects	LIN (3G) JUL (3G) GOY (3G) ROX (2G) ALE (2G) GLO (1.5G) ARE (1.5)	From one brief dyad to another	No	LIN E GOY GOY E ALE ROX M GLO ROX M GOY ALE E JUL ALE M LIN ALE E GOY	No
3;10 ex. 19	Using objects Gestures Nodding Gaze & Pointing Mimicry	LIN (3G) JUL (3G) ROX (2G) ERI (2G) GRC (1G) GRT (1G)	Multiparty	No	LIN E ROX LIN S ??? LIN S ROX JUL E ROX ROX S JUL ROX S GRC ERI S ALL ERI M ALL GRC S ERI GRC S ROX GRT S JUL GRT S GRC	PB
3;10 ex. 20	Using objects Gaze & Pointing	LIN (3G) JUL (3G) ERI (2)	From dyad to triad to dyad	GLO-RS (mono) LIN-LSS (bi)	LIN S GLO LIN E ERI LIN M JUL ERI E LIN	DL

		GLO (1.5)			ERI E GLO GLO S JUL GLO M ERI	
4;9 ex. 21	Gaze Pointing Stance Gesture Using objets	LIN (3G) JUL (3G) ROX (2G) MAR (2G) GLO (1.5)	From dyad to triad to multiparty	No	LIN E MAR LIN S JUL JUL S MAR ROX E MAR ROX M MAR ROX E LIN ROX M JUL ROX S JUL ROX E GLO MAR E ROX MAR E JUL MAR S JUL GLO S ROX	DL

The summaries of Chapter 4, 5, and 6 above have underscored the central findings as related to our research question, or how LIN a third-generation heritage bilingual is acquiring and socialized to use Spanish in L.A. Moreover, throughout these last three chapters, I have interpreted and explained the meaning of various aspects of the results. In our quantitative measures, as well as in our thick qualitative analyses I not only presented and described the results of this study, but I also discussed how they fit within my research question. In doing so, I attempted to connect the dots between the findings in the present study in relation to the research aims while linking it back to previous studies as well as to the work covered in the literature review. Nevertheless, these discussions were done on a chapter-by-chapter basis. Below I will therefore unpack the key results and attempt to bridge both our quantitative and qualitative findings to each other, to previous research, as well as to the literature covered in the review.

Merging and Interpreting the results

Below I will consider the various syntheses that were proposed throughout the analyses in the last three chapters. This will allow me to better answer the questions posed above through a discussion of the results. Furthermore, since the sub-questions are tightly related as they concern the quantitative measures, they will be merged into two main sections. The first discussion will revolve around the questions related to the linguistic soundscape, and the language presentations, and the second discussion will be centered around LIN's input and output. Finally, the discussion related to LIN's MLUw in English, and her type and token

measures in Spanish will no longer be entertained since for Spanish they were inconclusive, and her use of English, despite its apparent lack of development was not the central problem of the investigation. Indeed, we did see that LIN's English did not develop according to her age. Furthermore, the seven sub-questions related to qualitative results will be answered and integrated into the two sections discussed above. It is important to underscore that the interpretation of our results in our discussion will bring together both the quantitative, and the qualitative results that up until now were treated as separate chapters. They will therefore be integrated into the proposed answers. Creswell and Plano Clark (2018) recommend this type of protocol for interdisciplinary research that is anchored on mixed methods both in terms of the data collection process, and the subsequent analyses of the data as was the case in the present study. The findings will thus be considered in light of those presented and examined both in the review of the state of the art (Chapter 1 and 2), as well those mentioned in the quantitative measures (Chapter 4), and of course those discussed in the qualitative analyses (Chapter 5 and 6). Below we thus start with a discussion of the questions related to the linguistic soundscape and the language presentations.

Questions related to the Linguistic soundscape & Language presentations

Our analyses of third-generation heritage Spanish use in L.A. began by considering the linguistic soundscape in which LIN was immersed. We accounted for the absolute and relative frequencies of Spanish, English, and language mixing as they were captured in LIN's multigenerational bilingual language learning environment both in terms of child-directed and overheard speech. The data suggests that Spanish displayed an inconsistent, or unstable pattern of use longitudinally. While Spanish started out strong (50%), its use significantly dropped in the second month (19%), before slightly rising again in the last sampling period (22%). Moreover, the shifts in Spanish use between August 2018 and January 2019 were not significant. Regarding the use of language mixing, this mode of communication remained stable, but below 10% overall. The use of English in the soundscape on the other hand went from 43%, to 72%, and finally to 69%. These results therefore point towards linguistic fluidity in the use of Spanish, English, and language mixing in LIN's bilingual language learning environment. Furthermore, these longitudinal linguistic soundscape patterns cannot be disassociated from the language presentations. That is, they are a sum of how each multigenerational family member uses Spanish, English, and mixed language utterances throughout their daily social encounters. As such, this demonstrates how "speakers can be

located at various points along the continuum depending on their level of dominance in one or the other of the languages or in both”, and it is this shifting in language use that makes it “in principle possible for an individual to move or be moving towards (hence ‘dynamic’) one or the other end of the continuum at any given stage of his life.” (Silva-Corvalán, 1994: 11). Thus, the perpetual, dynamic, and individual language use shifts along the continuum directly shape what the linguistic soundscape looks like over time.

Furthermore, these dramatic changes in language use may also influence LIN’s attitude about speaking heritage Spanish throughout the course of the study, and in life in general. In terms of heritage language socialization our qualitative analyses revealed that in February 2018 and in August 2018 she was not too enthusiastic about speaking heritage Spanish. Often this was the case when she was explicitly asked to do so, and she affirmed her position through multimodal means as discussed above. Moreover, LIN’s refusal to accept Spanish was underscored through her reaction when the bilingual adults proposed various English and Spanish translation equivalents for example in February 2018. However, by January 2019 her attitude about speaking Spanish seemed to shift. In the last sampling period LIN did indeed declare knowing how to speak Spanish, and therefore displayed a more positive attitude. Nevertheless, it is interesting to highlight that the highest relative frequency of heritage Spanish use (February 2018) in the environment did not correlate with her positive attitude (January 2019) towards speaking heritage Spanish, but rather it was the opposite. We could speculate that prolonged child-directed, or overheard exposure to a minority language would engender at least a neutral attitude towards its use, but this was not the case. Of course, features of the linguistic soundscape alone are certainly not enough to explain her attitude about speaking heritage Spanish. As we saw in the Chapter 1, many factors including the sociopolitical status of the language, individual linguistic practices, and input and use to name a few are not only embedded into one another, but they also play a crucial role in heritage language development. Finally, regarding the linguistic soundscape, these findings raise the following questions: Was Spanish dominance in February 2018 an exception? And: Can the last two, almost identical sampling periods be more representative of the linguistic soundscape in which LIN is immersed on a regular basis?

To explain the shift from Spanish dominance in the linguistic soundscape in the first sampling period to English dominance in the following two sampling periods, sociolinguistic factors may be considered. We could ask if the rise and subsequent fall of Spanish in the

bilingual language learning environment may be attributed to external factors such as the presence of specific bi- or monolingual family members, and their own motivations to transmit Spanish multigenerationally. The short answer may point to ‘yes’ as we will see below. During the first recording session in February 2018, ERI, the author of this study (and great-uncle of the target-child LIN) had just arrived in L.A. to conduct his fieldwork. As described in the methods chapter, he stayed in GLO’s home (LIN’s grandmother). LIN also lives here with her parents. Moreover, ERI’s arrival prompted LIN’s great-grandmother GRC to come to L.A. from Mexico and to stay in her own home in L.A. for the month to spend time with him. GRC’s L.A. home is across the street from LIN’s house so since ERI was in L.A. to “study LIN’s bilingualism” GRC was at LIN’s place with ERI almost daily and interacting with everyone in Spanish. This also included interacting with LIN. As attested in both the absolute and relative frequencies, GRC’s presence appeared to open a considerable space for Spanish to (re)emerge in the linguistic soundscape. GRC implicitly, and at other times explicitly prompted the other multigenerational family members present in the social encounter to interact in more Spanish overall, as she has always done. To briefly illustrate this point, I turn your attention to the short digital journal entry. It was taken on August 22nd, 2018. I observe the following:

GRC when together in conversation tells ROX ‘habla en español’, or to speak in Spanish (Alvarez, 2018).

Thus that GRC influences how much Spanish is used in the family is rather clear especially when we consider the results of when GRC is present in February 2018. During this month ROX and GLO who live under the same roof, spoke the most Spanish longitudinally, or 39% and 56% respectively. In the absence of GRC in August 2018 ROX’s Spanish use dropped to a mere 8% and GLO’s fell to 39%. However, these results should be interpreted with caution since both ROX and GLO’s use of Spanish remained low even when GRC was present again in January 2019. Nevertheless, in line with existing research it is non negligible that “the presence of grandparents or other older relatives in the home or nearby may provide a more constant exposure to the heritage language for both parents and their children.” (Pauwels, 2016: 92). We thus see how GRC may play a critical role not only for the use and transmission of heritage Spanish for LIN, but also for the use and maintenance of Spanish for the second-generation, and 1.5-generation family members who are also susceptible to language shift (Bustamante-López, 2008) in this tension ridden contact zone.

GRC's presence may help us explore how the more experienced family members, in this case a monolingual Spanish speaker helps LIN use heritage Spanish. In terms of heritage language socialization in the ever-shifting participation frameworks our qualitative analyses revealed that in February 2018 GRC through multimodal interaction segmented her child-directed speech stream by presenting it in more manageable chunks. Her efforts to help LIN use heritage Spanish were further sustained by pointing and gazing at the referent (ROX) in their joint attentional frame. Through multimodal Spanish use GRC therefore scaffolded the Spanish utterance that she asked LIN to repeat, which she did quite successfully. However, when LIN's repetitions were not on-target, GRC seemed to propose the Spanish input again before moving on to the next chunk of information. Furthermore, as GRC and LIN's dyadic interaction came to an end we see that the impulse to continue speaking Spanish to LIN was subsequently picked up by her mother ROX. As LIN shifted from dyadic interaction with GRC to ROX, ROX continued to speak to LIN in Spanish, when English is their most common mode of interaction as attested by their dyadic analyses. Therefore, in line with previous research this lends evidence to the argument that grandparents, and other older monolingual speakers are central to the maintenance, and the socialization of heritage languages. This finding is also substantiated by Kiaer (2023) in her study of multimodal communication in young multilingual children. This also highlights the positive role of a multigenerational and multiparty framework, the default cultural setting of this family which is different from monolingual middle-class American families. In other words, heritage Spanish is also supported by speakers who not only span several generations, but also by the multiplicity of interlocutors in the interaction who could, given their level of bilingualism and motivation pursue teaching the heritage language. Nevertheless, one key question remains: Can the measures of the linguistic soundscape and the individual language presentations alone explain how LIN is using, and socialized to use heritage Spanish, but also English, and mixed language utterances? An understanding of these two factors that compose LIN's bilingual language learning environment is critical, but not enough to answer the question adequately. Notwithstanding, we have already considered the former, so in the section that follows we will look at the latter.

The present discussion considers the results of both the absolute and the relative frequency of language mixing, English, and heritage Spanish use for LIN and her extended range of multigenerational caretakers. It gives us a better understanding of LIN's language presentation, and whether they matched the language presentation of one, or more of her primary caretakers. Furthermore, it also provides an account of how the members of her family

deploy their linguistic resources which is in line with research suggesting that “it is evident that Mexican-American bilinguals in Southern California claim ... three fluid linguistic identities: English, Spanish and code switching in English and Spanish.” (Bustamante-López, 2008: 296). Before continuing we are reminded that we opted for the use of the term language mixing as opposed to code switching throughout this investigation. The results thus show that LIN’s language presentation closely resembled that of her mother ROX, as well as that of her aunt ALE. The exceptions were GLO and GRC who generally spoke more Spanish. Stated differently, LIN’s language use patterns, especially in terms of language mixing was 6% for LIN and ROX 10% in February 2018, 4% for LIN and 7% for ROX in August 2018, and 3% for LIN and 8% for ROX in January 2019. Therefore, it may be argued that LIN’s language mixing was consistent with the language use patterns to which she was exposed by her mother. This finding coincides with Huerta-Macías’ (1981) study that looked at the code-switching¹²⁵ behavior of a Latino child going through bilingual language acquisition. Her findings reveal that the child’s language presentation, or language repertoire including code-switching mirrored the utterances that the child was exposed to at home. LIN’s similar linguistic patterns to those of ROX and ALE may further be supported by the fact that her mother ROX and aunt ALE are both stay-at-home moms, and sisters who also grew up together in the same bilingual language learning environment. It is therefore not a surprise that they share similar language use patterns. Moreover, they spend the largest portion of time together when LIN is not in school. Even if LIN has a strong bond with her grandmother GLO who speaks more Spanish than ROX and ALE, their interactions alone may not be sufficient in terms of quantity to support LIN’s use and acquisition of heritage Spanish. Lastly, regarding heritage language socialization the results may be indicative of the bilingual adults’ input, and its impact on LIN’s use of heritage Spanish. The bilingual adults’ language presentations whether they are child-directed or overheard in the largely implicit interactional process of language socialization seem to be reflected in LIN’s linguistic practices. Thus, even if at first the adults’ language presentations do not appear to be conducive to LIN’s use and practice of heritage Spanish, our analyses show that they nevertheless paved a pathway to use, and to maintain Spanish multigenerationally.

¹²⁵ Since Huerta-Macías (1981) used the term code switching, I too have respected the use of the term in the short description of the study.

Notwithstanding, an interesting finding emerged when we zoomed in on the intersection between language presentation and biological gender. The results suggest that both the women and the men in the present study shared similar language use profiles across the board. Furthermore, it was intriguing to find that the men spoke heritage Spanish more than the women. This finding, even if subtle was contrary to Clyne and Kipp's (1997) results from their four large-scale interethnic (Germany, Greece, Italy, Netherlands, and Poland) surveys in Australia (1976, 1986, 1991, and 1996). However, there is one key difference to keep in mind. In the Australian surveys, the patterns corresponded to first-generation men and women. On the other hand, the present results corresponded to second-generation speakers, and as such we know that language shift is consistently impacted by generation (Bustamante-López, 2008; Pauwels, 2016), and especially the second as we reviewed in Chapter 2 on heritage language transmission and the third-generation rule. Geographically closer to the present study, Stevens (1985) looked at mother tongue shift in the U.S. She also found that women shifted less than men, as did De Vries (1994) in the Canadian context. Indeed, that women were found to use heritage languages more so than men did seem to occur regularly in the literature, but it was not the rule. In other words, even if studies "have frequently discovered gender differences in language use and choice ... It is not possible to claim that women maintain the heritage or minority language better or longer than men or vice versa." (Pauwels, 2016: 86). Nevertheless, Pavlenko et al. (2001), Cameron (2003), and Pauwels (1995, 1997, 2011) have argued that our communities are increasingly diverse. As a result, bilingual speakers' language presentations are perpetually carved out of the underlying gender roles which we are assigned. Across our rich qualitative analyses, we witnessed how LIN was socialized into a specific gender role, or that of a little girl (which she seemed to resist for the matter). It is thus likely that being socialized through language to behave in a certain way will have a long-lasting impact both on her social and on her linguistic presentations as she gets older. The multiplicity of bilingual and multigenerational voices that guide her how to speak and that show her how to be will thus resound in her mind and perpetually re-shape the way she speaks and the way she acts in the future which seems to be in tune with previous research. After having covered the results of the linguistic soundscape and the language presentations, in the next section we will discuss four additional aspects that may help characterize her bilingual language learning environment, factors that should be accounted for, but traditionally left out in studies of childhood bilingualism.

Questions related to LIN's bilingual input & output

In the discussion above we considered the individual language presentations, as well as how they interact with gender. We assessed their potential impact on the linguistic soundscape that constituted both the child-directed and the overheard speech in LIN's bilingual language learning environment. We also attempted to understand LIN's use of heritage Spanish based on these first two sociolinguistic elements. Next, we will move beyond the analysis of ambient language per se and discuss four additional environmental factors that may help us better apprehend her heritage Spanish use. These include the language(s) of previous utterance in relation to LIN's language choices, her output according to each generation, LIN's output with respect to child-adult dyads, and finally LIN's input versus the multigenerational adult input. We will thus delve into the more interpersonal linguistic relationships that co-exist and emerge within the family to account for how the varied language socialization patterns unfold.

Our discussion begins by looking at the language(s) of previous utterance. Despite the overall presence of English before Spanish, for both English and language mixing, our data shows that LIN displayed adjustment, but only to a certain degree. For example, when speaking heritage Spanish, the frequency of Spanish was slightly higher than mixed language utterances. The same was true for her language mixing. That is, the frequency of mixed language utterances was greater than Spanish while interacting in this mixed mode of communication. To an extent, these language choice patterns therefore pointed to LIN as aligning to the language she was addressed in and/or the languages that she overheard, in relation to her own language choices. Regarding language mixing for example, this is in line with Comeau et al.'s (2003) experimental study of child mixed language utterances. By studying six English-French bilinguals two years of age, they found adjustment to language mixing. Most of the children in their investigation tended to adjust to the mixed speech addressed to them by the research assistants involved in the data collection. Nevertheless, caution should be taken when interpreting the results of the present study. While whether LIN was addressed, or simply overheard a language does indeed play a significant role in her language choices, this is only part of the story. The other part that helps complete the linguistic puzzle is the interactional and multimodal complexity of human interaction, especially in triadic, and multiparty bilingual social encounters which were frequent in this multigenerational family. The quantitative measures alone made it difficult to capture when both English, Spanish, and mixed language utterances simultaneously (as in overlapping speech) qualified as the languages of previous

utterance(s), and whether LIN's linguistic adjustment, or alignment was a response to one, to the other, or to a combination of two, or all three modes of communication.

To deepen our understanding beyond the limits of the quantitative measures, our qualitative analyses captured LIN's language choices not only in dyadic, but also in dynamic triadic, and multiparty bilingual participation frameworks. What we learned was that throughout several social encounters, LIN received input in both English and in Spanish simultaneously. To add to this complexity these bilingual utterances could take different shapes for example, one could be a statement whereas the other would be a question. Furthermore, in most of these cases LIN only responded in heritage Spanish when she was explicitly assisted, for example, through speech stream segmentation. Otherwise, her default language of choice was English, especially when she was directly asked to speak Spanish. Moreover, when LIN was addressed in Spanish by her bi- and monolingual multigenerational family members, but responded in English, we often found that the bilingual adults responded by either moving on with the conversation, or by using the Language Switch Strategy. As previously discussed, this is a bilingual discourse strategy that does not seem to favor the use of heritage Spanish in engaged, and meaningful social interaction. Additionally, what is also striking is that these types of bilingually oriented adult discourse frameworks seemed to favor socialization into bilingual conversations, or to an emerging passive bilingualism on LIN's end. We must insist though that this situation while seemingly dire, does provide her with a bicultural framework, and perhaps with enough Spanish for later reinforcement, or reactivation, a phenomenon that Silva-Corvalán (1994) calls *cyclic bilingualism*, and which has been attested in the literature (He, 2011).

The other dimension that was essential to account for throughout this study is a (bilingual) child's attention to speech. As Ochs (1979) has suggested some children may tune in and out of both child-directed and overheard discourse in their language learning environment. Viewed from this perspective children's language choices, and adults' too for that matter may not be a 'logical' response to the language(s) of previous utterance i.e., answering in the same language that one is addressed in. This issue is further amplified with mixed language utterances, and even more so with mixed language utterances containing bivalent words, or words that are used cross-culturally across the world's diverse contact zones. Finally, due to the essence of naturalistic talk, as well as to the transcription methods in the present study, it was difficult to determine what exactly constituted a previous utterance.

Excel's powerful cross tabulation function did not exclude utterances that were temporally further away from the target production in question both in terms of seconds, minutes etc. At the same time, how do we know if a child, or even if an adult's response was not triggered by previous discourse resonating in their minds in the Bakhtinian sense i.e., talk that was (over)heard hours, or even days earlier? To this end, the rich qualitative analyses in Chapter 5 and 6 helped us move a step forward in pinpointing the dynamics related to LIN's language choice as a response to the previous utterances in her multigenerational bilingual language learning environment.

LIN's output in relation to speaker generation was also critical to understand the diverse language use patterns across age categories. Generation and age are notions that are interrelated (Pauwels, 2016). The results show that overall LIN's heritage Spanish, English, and mixed language utterances were not generation-graded. On the other hand, the data suggests that the multigenerational framework created an environment where different speakers, each with their own unique linguistic repertoires could help and encourage LIN to use heritage Spanish. Furthermore, our analyses revealed that her languages fluctuate from more to less use regardless of her interlocutor's generation. For example, even though her English utterances were dominant, she used them the least (76%) with GRC in the first sampling period. However, of all the family members, her use of English also happened to be the strongest (100%) with GRC in the last sampling period which is also not surprising since she has little productive ability in Spanish. However, in completing the picture of the family's language use multigenerationally, the data was also measured for her third-generation brother and cousins. The relative frequencies showed that even if small, there was a subtle increase in heritage Spanish use with her cohort of younger third-generation speakers. Although this is an interesting finding, additional longitudinal evidence is needed to establish if indeed LIN will continue to speak more heritage Spanish with the three speakers in her generation in her household. However, my guess is that this will not be the case, even if they do eventually become bilingual. This assumption is based on my experience with my sister GLO and our interactional style. Even if we both speak Spanish, we mainly speak English to each other with bilingual conversations from time to time as presented throughout this study. The exception is of course when there are monolingual Spanish speakers present. Moreover, this English dominant interactional style is also the case with ROX and her sister ALE who are also both bilingual. Therefore, it is likely that these siblings and cousins will speak English to each other even if they know how to speak Spanish.

Finally, even if generation-gradation did not seem to be the case in the present case study, we may ask if the *Principe de complémentarité* (Principle of Complementarity) was at play, which in a sense may be viewed as another type of language use gradation. While uneven language development is the norm (De Houwer, 2009), De Houwer and Bornstein (2016a) claim that bilingual language development is domain specific. Their findings are thus in line with Grosjean in highlighting that a “répartition des langues par domaine et activité est bien connue au niveau sociétal ... à savoir l’utilisation de deux langues ... en distribution complémentaire.” (Grosjean, 2015: 43) (division between languages existing according to domain and activity is well known at the societal level ... including the use of both languages ... in complementary distribution). Our semantic domain analyses allowed us to confirm that a major part of LIN’s heritage Spanish use was related to the cultural domain of food. Notwithstanding, what we may gather from the analyses is that the more Spanish LIN spoke to GRC, the less she spoke English for example, in February 2018. Naturally, this makes sense since it is rather evident, as De Houwer (2021) states that one cannot speak two languages at the same time. The same was true for language mixing. For example, in January 2019 English and language mixing seemed to complement each other. LIN spoke the most English, and the least amount of Spanish with GRC. The opposite distribution was the case when addressing GLO. With her, LIN spoke more Spanish, but less English. This sort of mirror image pattern continued through the second- and on to the third-generation. Finally, in August 2018 when LIN’s English frequency was high but flat, her Spanish and language mixing reflected a similar flat, though low frequency.

Overall, these findings seem to align with research showing that heritage language use, or Spanish in this case, recedes from one generation to the next (Pauwels, 2016). There appears to be a shift from heritage bilingualism towards monolingualism across generations, yet at the same time the potential exists for third-generation bilinguals to maintain heritage Spanish if the older generations continue using the language with the children even if “this case is rare in large urban centres.” (Silva-Corvalán, 1994: 11) such as in L.A. Language maintenance may also be heightened if a more institutional layer is added such as through the school system or through other community-initiated activities i.e., Saturday school, Scout groups etc. Formal instruction in the heritage language not only enriches the home language, but it also helps develop bilingual competence more generally as shown in our literature review. Furthermore, teaching a minority language in the school sends the message that it is a valued linguistic resource. Notwithstanding, according to the National Research Council in 2006 “the loyalty

that many Spanish speakers (especially Mexicans) feel toward their native tongue diminishes across generations especially beyond the second.” (Bustamante-López, 2008: 281). We may therefore ascertain that a speaker’s generation is an unambiguous factor in determining language shift. As a third-generation speaker the results indicate that LIN used Spanish less with the second-generation than she did with the first-generation speakers. Given these results, as suggested above one may expect even more restricted use of heritage Spanish, if it is not obsolete, when LIN interacts with her third-generation brother (JUL) and two cousins (GOY and IGN) who are all growing up together in nearly identical bilingual language learning environments. Moreover, what was also interesting was the instability of mixed language utterances. This was contrary to what may be expected, or that LIN would consistently produce more mixed language utterances when in interaction with the second-generation speakers due to their shared hybrid linguistic and cultural upbringing. However this was not the case. Therefore, with regard to the question: Are mixed language utterances more frequently addressed to the second-generation speakers ROX and ALE? In terms of LIN’s output per generation, the answer is inconclusive. However, a consideration of LIN’s input versus the adult input below may point to a different answer. Before we do so, we will discuss LIN’s output in child-adult dyads to see if their language use patterns are reciprocated between LIN, and any of the more experienced multigenerational bi- and monolingual speakers with whom she is in contact.

We remind ourselves that one of the objectives in analyzing LIN’s output in the child-adult dyads is to bring together the fields of language acquisition and language socialization research in the study of bilingual language development. These two fields of inquiry have traditionally been separated as was shown in our literature review. This task was carried out first by considering LIN’s interactions with her mother ROX, and then by further extending the analysis to LIN and the other important multigenerational communicative partners in her life since, “Communicative interaction is likely necessary for any initial or oral language learning to take place.” (De Houwer, 2021: xx¹²⁶). The second objective is to determine if linguistic reciprocity could be established between any of the five dyads. Active dyadic interaction according to Ortega (2009) is critical in the language learning process. Furthermore, “Children may experience different person-language links, that is, they meet up with diverse patterns of language use across individuals: some people will be bilingual, others

¹²⁶ De Houwer sent me her article before publication, so it had no page number.

monolingual.” (De Houwer, 2009: 111). These are also linguistic constellations that we amply came across throughout our qualitative analyses. Thus, analyzing these dyads could help us to understand if there are unique interactional styles as Lanza (1997) shows to be the case in the language choices made between a mother and a father in a bilingual family in Norway. Furthermore, we may also be able to determine if these language choice patterns influence whether there is language reciprocity between LIN and the women interlocutors in her life.

As may be expected, the results show that English is the main language used for the child-adult dyadic exchanges, Spanish is kept to a minimum both ways, and mixed language utterances seem to be used more than Spanish when LIN addresses her family members. Moreover, two other trends may be suggested according to the data. First, language reciprocity seems to be established between LIN and her mother ROX and aunt ALE, who are both second-generation speakers. Second, language reciprocity between LIN and her grandmother GLO (1.5G) and great-grandmother GRC (1G) are either not established or remain inconclusive due to the limited amount of data. Nevertheless, these initial results seem to align with research suggesting that

When it comes to parent-child interactions in such families, it is best to describe the language-use patterns in terms of a continuum ranging from reciprocal use to nonreciprocal use of the heritage language (i.e., the parent uses the heritage language, but the children do not). (Pauwels, 2016: 91).

Moreover, in considering the LIN <--> ROX and LIN <--> ALE dyads, the results further support previous research on child-adult dyads. Allen et al. (2002) conducted a longitudinal study of spontaneous interactions of five English-Inuktitut families. This language pair is unique because Inuktitut is an indigenous language and “very little is known about the acquisition of rare languages by children.” (B. Hellwig, personal communication, May 4th, 2021). This note aside, these researchers based their analysis on nearly 25,000 transcribed utterances, or roughly 3,000 utterances less than in the present study. Their results show that despite interactional variation between the pairs, each of the five child-adult dyads display similar interactional styles across languages. Their frequency of use in English, Inuktitut and language mixing were strikingly comparable within the pairs. To illustrate how the results of Allen et al.’s study align with those of our investigation, the table below compares the “SR” family’s child-adult productions to the productions of only the LIN <--> ROX dyad.

Table 63: Comparison between “SR” family’s child-adult dyads & LIN<->ROX dyad adapted from Allen et al. ’s Table 1 & 2 (2002: 174)

Family	Date	Relative Inuktitut or Spanish	Relative English	Relative Mixed
SR child	na	11.2%	84.2%	4.6%
SR adult	na	23.6%	72.7%	3.7%
LIN	02/18	2%	90%	8%
ROX	02/18	12%	79%	9%
LIN	08/18	1%	98%	1%
ROX	08/18	8%	91%	1%
LIN	01/19	0%	98%	2%
ROX	01/19	2%	95%	3%

The table above shows that in the SR family pair in the Allen et al. study the adult caregiver produced 72.7% English versus 84.2% for the child. Regarding Inuktitut, the adult produced 23.6% versus 11.2% for the child. Finally, in terms of mixed language utterances 3.7% correspond to the adult versus 4.6% for the child. Of the results provided for the five families, I selected this one since they were suggested to be English dominant much like LIN’s multigenerational family. Therefore, when we compare the English-Inuktitut dyad with the English-Spanish dyad of the present study there seem to be interesting similarities in their linguistic productions. The parent-child interactional patterns appear to be closely reciprocated not only for heritage language production (Spanish), but also for the dominant language (English) as well as for the mixed utterances. Next, as mentioned previously, reciprocity is also the case with the LIN <-> ALE pair which is not surprising considering that the two sisters ROX and ALE spend the most time with LIN. Finally, there is no reciprocity between LIN and the older speakers (GRC and GLO). The bar graph¹²⁷ below illustrates the above-mentioned rates of reciprocity comparing the SR family with LIN and her mother ROX.

¹²⁷ The rates for the SR family were rounded up or down for them to function within the bar graph. For example, the SR child spoke 11.2% Inuktitut, so it was rounded down to 11% and the SR adult spoke 23.6%, so it was rounded up to 24%.

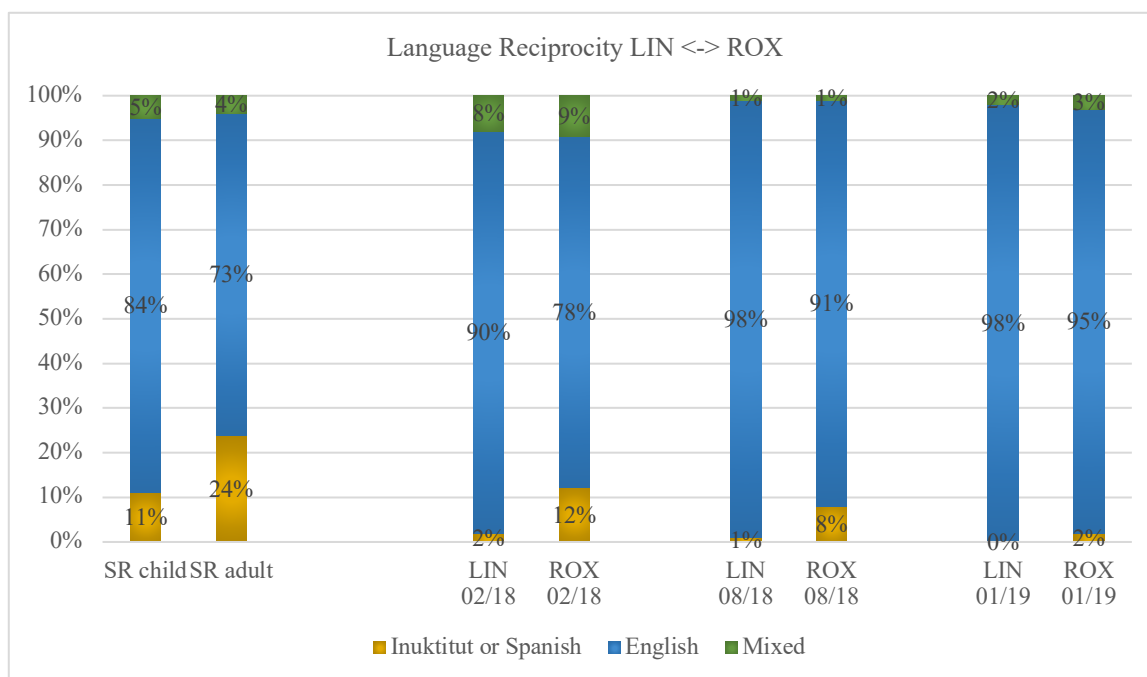

Figure 51: Language Reciprocity LIN <-> ROX: Spanish, English & mixed utterances

While this non-reciprocal interactional pattern is not an impediment for LIN’s bilingual grandmother GLO it does create communicative barriers with her great-grandmother GRC, especially when other bilinguals are not present in the participation framework to carry the messages over from one speaker to the other. This aligns with Skerry who has found that “in the barrios of Los Angeles a persistent complaint is that Mexican grandmothers who speak little English have a hard time communicating with their grandchildren who speak no Spanish.” (Skerry, 1993: 5), even if in the U.S. context Mexican-Americans show durability regarding their ethnicity, and culture (Telles & Sue, 2019) across the generations. In our study there was a moment when GRC in her desire to better understand LIN’s needs asked her to tell another bilingual interlocutor what she wanted so that they may relay the message to her. I too have witnessed this communication difficulty not only in person, but also while on the phone. Recently while on a WhatsApp call with GRC, I overheard JUL who was getting home from school happily tell her in English that he received a star for good work. Not understanding him, she quickly asked me what JUL said and only after I translated his utterance, was she able to joyfully praise him for his academic accomplishment. Communication may thus become difficult between monolingual (great-)grandparents and their grandchildren who show little productive ability in their heritage language. However, we have also shown that a multigenerational framework where at least some speakers are bilingual help render communication possible.

The data suggests that LIN's output may be the result of the language(s) of previous utterances, but this is not always the case. Furthermore, the results show that her output is not necessarily influenced by the generation of her interlocutors. We also learned that in terms of overall language reciprocity, LIN's language use patterns resemble those with whom she spends the most time, namely ROX and ALE, the speakers that are one generation below her own. This discussion brings us to the fourth factor that may help us to understand LIN's use of Spanish by answering the question: How do the utterances that the adults address to LIN differ from those utterances that they address to each other? Given that "Some previous studies have indicated that Mexican-Americans do not maintain Spanish, the language they have inherited" (Skerry, 1993: 5), the question of input may provide an answer to whether Spanish is maintained in this multigenerational family. We thus seek to understand if there is a relationship between the individual adult input and LIN's, and subsequently compare it to her output. The results show that except for GRC, all the speakers including LIN receive English input the most. Spanish input comes in second, and mixed language input is the least prominent for all the speakers. Given the English, Spanish, mixed language input hierarchy from highest to lowest for LIN, one may expect her output to reflect this language use tendency. De Houwer (2009) in a discussion of a one-parent one-language (1P/1L) setting, which concerns most of the comprehensive studies of bilingual language development, suggests that she is not aware of a child who is going through bilingual language acquisition

who produces only or mainly mixed utterances in spite of hearing mainly unilingual utterances in each of the two languages. Instead, all BFLA children that I know or that have been reported in the literature produce unilingual utterances in at least one language ... They may in addition produce mixed utterances but these are normally used with much lower frequency than unilingual ones. (De Houwer, 2009: 109).

LIN is not being raised in a 1P/1L setting, but rather in a one-parent two-language (1P/2L) setting. In a discussion related to the theoretical and analytical implications that case studies engender, Deuchar and Quay (2000) present the case of Manuela. Much like Manuela, LIN is growing up in an English dominant environment in which her parents and other caretakers speak to her in English and in Spanish, though for Manuela it is mostly Spanish in the home, and English in public (Wales). According to De Houwer (2009), this type of 1P/2L setting is thought to be the most successful in promoting bilingual language development. In considering LIN's overall input to her output, we see that the frequency with which she language mixes is by far lower than her English utterances, this finding aligns with what has been reported in the literature as suggested by De Houwer above. However, the same cannot be said for LIN's Spanish utterances. Even if LIN receives more Spanish input, her mixed language output is

nonetheless slightly higher than her Spanish. The pie charts below present the input that LIN receives longitudinally in Spanish, English, and mixed language utterances as well as her corresponding output.

Table 64: Relative frequency: LIN's input vs output of Spanish, English & mixed utterances

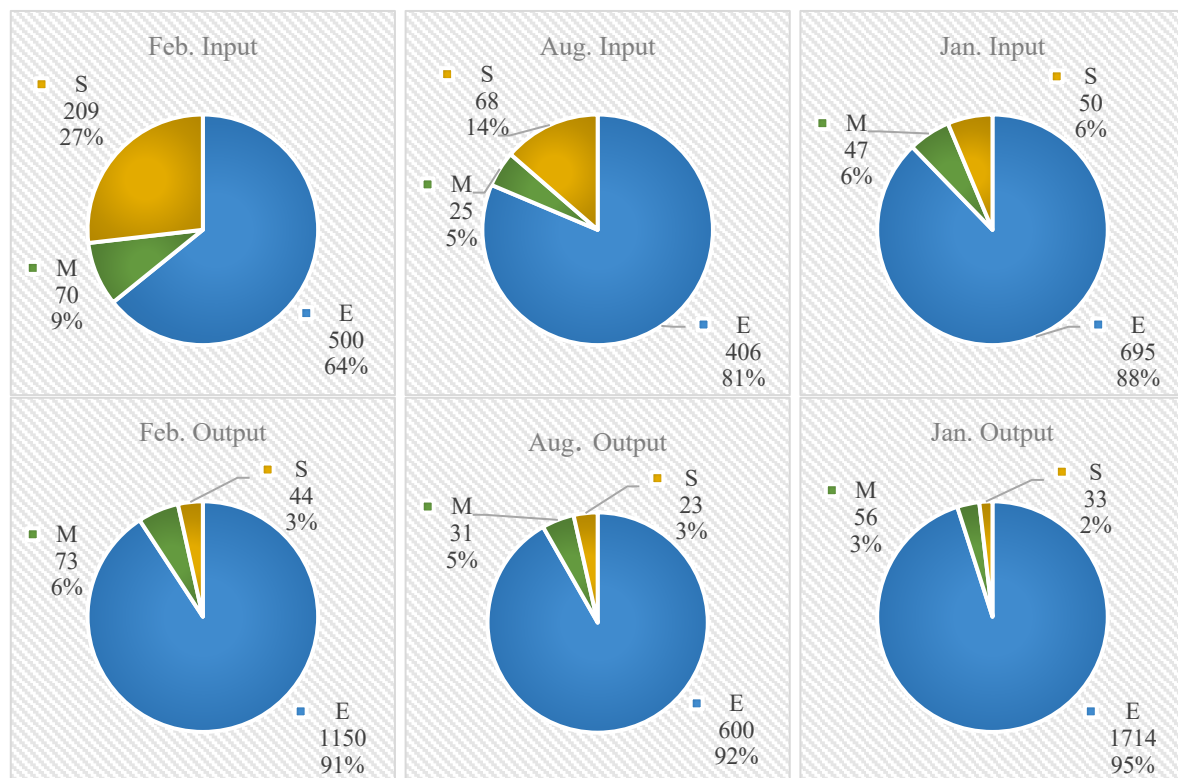

As described above, LIN receives the most English input represented by the blue in the upper three pie charts titled “Input” organized from left to right by the first to the third sampling period. Furthermore, even if she receives the same amount of Spanish input (6%) than she does mixed in January 2019, she receives more Spanish input longitudinally overall. This is represented by the yellow wedge. Finally, the mixed language input addressed to her is in green. The six visual representations help make these proportions clearer. Having established the language *input* trend, now let us turn to LIN’s *output*. The bottom three pie charts titled “Output” show that she produces in blue, English the most across the board. This is not surprising given not only her input, but also her generation. However, what is interesting is that her output following English is seconded by language mixing in green. Despite LIN’s favorable 1P/2L environment for English-Spanish bilingual language development, LIN produces slightly more mixed language utterances (green) than she does Spanish (yellow), but less than English ones (blue). However, reversal between the frequency with which she is addressed with more Spanish but produces more mixed utterances may fall within the norm. To date there

are “no reports of BFLA children producing more mixed utterances than utterances with words and morphemes from just a single language (i.e., unilingual utterances).” (De Houwer, 2009: 267). In other words, given a child’s total language output, mixed utterances always represent a lesser amount than the dominant language, but as is the case here, the same is not always true with the minority language. Within the framework of this case study this would mean that the expectation that LIN reciprocate the English, Spanish, mixed language input hierarchy would hold. Nevertheless, this is not the case. While the findings of the present study did not seem to align with this aspect of De Houwer’s findings, they did align with another of her findings. In terms of mixed language use, “Their proportion typically ranges from 0 to 30%” (De Houwer, 2009: 267). Indeed, the proportion of LIN’s language mixing ranges from 12%, 8% and 7% longitudinally, or well within the 0 to 30% range.

To obtain a more complete picture of LIN’s bilingual language development globally, and her use of heritage Spanish more specifically, we discussed the following seven points in reverse chronological order: 1) LIN’s language choice based on language(s) of previous utterance, 2) LIN’s input versus the adult input, 3) LIN’s output with respect to child-adult dyads, 4) LIN’s output according to generation, 5) the individual language presentations with a focus on 6) gender, and 7) the linguistic soundscape in which LIN is immersed. Moreover, within these discussions we have considered, and answered when pertinent several of the key questions related to heritage language socialization that were posed in the previous two qualitative chapters. Next, I will dwell on the present study’s limitations.

Acknowledging limitations of the study

Despite the attention that was invested in designing the present study, it was difficult to foresee some challenges and limitations while others were clearly assumed from the onset. For example, the main limitation of our investigation is that it is not generalizable to the population at large, or even at the smaller community level. In conducting a case study, we therefore privileged understanding how one third-generation child was using heritage Spanish at a deeper level rather than how multiple heritage bilingual children were using their heritage language at more superficial levels both in terms of their bilingual language learning environment and in terms of their socialization to and by language. Therefore, including more third-generation children from other families in this study would have meant spending more time and resources in the field to record, and in the office to transcribe to create an exploitable plurilingual corpus.

In short, including more participants would have been difficult to do in a Ph.D. project in an adequate amount of time. However, even if conducting a case study was an inherent limitation, on the other hand it allowed me to meet the requisite of having insider knowledge of the unique linguistic and cultural practices of the family under investigation which many seasoned bilingualism researchers have argued in favor for.

Nevertheless, being a community member brought about its own set of challenges that I was not able to anticipate. My choice in this research question stems from my conviction that it is critical to maintain heritage Spanish. My mother GRC socialized me to believe this idea since as far back as I can remember. She inculcated the importance of speaking Spanish, and her voice has forever resonated in my life. The stance that Spanish is important may thus be evident in my research agenda not only as depicted in my writing, but also in the analyses of my actions in the data since I repeatedly tried to get LIN to speak Spanish even as her mother ROX did not always seem to align. While being a community member did bring its advantages, sometimes it was difficult to step out of the role of the great-uncle who believes in bilingual transmission in favor of a more neutral analyst that avoided commentary that could be seen as too evaluative. The researcher-community member status was a challenging position that needed to be continually checked thanks to the thoughtful insight, and firm but fair nudgings of my research director. In sum, one of the limits of the present investigation is that it may be subjective in that my desire to maintain heritage Spanish at times could have had an influence on the way the social encounters unfolded.

Another limit of this work is that it mainly focused on the women in the study, especially in Chapter 4 in characterizing the bilingual language learning environment. Even though researchers suggest that we should consider the most important interlocutors in a child's life which was certainly the case here, it would have been interesting to dig deeper into the men's linguistic practices. This is because overall fathers seem to be lacking in the literature (Romanowski, 2021), and moreover because in this study the men seemed to speak heritage Spanish slightly more than the women. Nevertheless, this was a realization that dawned on me well after I had finished the chapter and had steadily moved on to finish this dissertation on time. On the other hand, one limit of the study even for the women who were present was that in some cases there was not enough data to derive conclusive answers as pointed out. This means that this too would have likely been the case for the men who were often absent, especially MAR and GUI (LIN's father and grandfather respectively). Nevertheless, as

mentioned in our data and methods chapter, I collected nearly 200 hours of naturalistic data. Therefore, I could further this study later by transcribing (parts of) the unexplored 159 hours that I have at my disposal.

Finally, another limit to the present study despite my research director's insistence was related to multimodal analyses. At the onset of my research, I did not understand the importance of the role of the visual-gestural means in communication. As such, since it did not seem relevant to my study at first, I did not transcribe these rich non-oral communicative aspects on CLAN, and as a result I could not measure them in quantitative terms. Even so, CLAN is not the best transcription software to capture dynamic multimodal interaction. However, the critical role of multimodality especially in guiding LIN to use heritage Spanish became clear early in my qualitative analyses. Therefore, while these results were not measured, I sought to compensate per se for this limitation by underscoring their richness through thick descriptions and explanations whenever possible. Despite the non-exhaustive limitations mentioned above, they allowed me to realize, and to accept at the human level the Japanese notion of *wabi-sabi*, or the idea that nothing is ever finished, and that nothing is ever perfect. On the other hand, as it pertains to the present investigation it has allowed me to consider practical applications for the findings and to make suggestions for future research in the field. Some of these ideas will be covered next.

Making recommendations

These limitations could be considered as drawbacks to the study both in terms of their quantitative measures and their qualitative analyses. However, they may also be seen as providing fertile points of departure for future studies in the field, as well for implementing useful applications in the real world. I will discuss the latter idea first.

Some practical applications for the findings is that they may be used to develop awareness of how Spanish may be used in multigenerational familial interactions even when families feel that they speak enough Spanish in the home for children to acquire it. By presenting some of the quantitative measures for example, and even if all families are different, we may show that there may be large gaps between how much one thinks Spanish is spoken in the home, or how important it is to transmit it versus the reality (Schwartz, 2008; Gharibi & Seals, 2019; Romanowski, 2021) and how this subsequently impacts heritage language use.

Moreover, our qualitative analyses may be used to show how the way we speak to our children implicitly and explicitly socializes them into particular language modes. They could thus be used to encourage families to implement discursive strategies that favor the use of the heritage language whenever possible. However, this is not to say that language mixing should be avoided at all costs especially in multigenerational homes. That is, according to each generation and the fluency, or not of their individual bilingualism, some speakers may feel more comfortable with language mixing to transmit heritage Spanish. In the end, this is still better than nothing. Language mixing is a cultural practice that includes Spanish words that refer to Mexican culture and customs, and moreover that facilitates multigenerational communication (Chung, 2010), and fosters bilingualism (Gorter, 2013). Finally, in reaching out by email to a heritage language researcher in California for additional information about her work, I provided a short description of my project based on her request. After doing so she responded “Thanks so much. Please let me know when I can access your dissertation. I(t) will be most valuable to the communities I continue to work with.” (G. Valdés, personal communication, August 15th, 2022). Her enthusiastic response suggests that my work has the potential to be used in the real world, or in the communities who likely need it the most, and in ways that I have yet to consider.

In conducting my research, present in my mind was to capture those seemingly rare moments when LIN used heritage Spanish. But also, it was to understand how she was acquiring and socialized to bilingualism and to biculturalism through the languages used in her bilingual language learning environment. Inherently, this meant that understanding these processes might take several more years, if not decades to reach the ‘final’ goal since language development is a life-long process. This means that the present thesis is only but a small part of the whole story. Nevertheless, our work may suggest future directions for studies in the field of bilingualism from which other scholars may build. First, I would strongly recommend that other researchers underscore the *multi* aspect in their work. In building a plurilingual corpus, they should code language for what it truly is, a multimodal means of communication where visual-gestural productions complement the meaning making process, especially in heritage language settings (Kiaer, 2023). Moreover, I would recommend that the multiple and ever-shifting multiparty participation frameworks are also coded for and quantified to show how much children may learn from their pre-established, but dynamic and interactive social encounters specific to their cultures. In this vein, researchers could also quantify the multigenerational aspect within these participation frameworks to further show how it does

indeed take a village where many generations of speakers each with their own mono- and bilingual abilities come together to facilitate heritage language use, as well as the meaning making process both implicitly and explicitly.

Conclusion

I am a second-generation heritage Spanish speaker. I was born and raised in multi-lingual and cultural L.A. After several years living in France, I designed a Ph.D. investigation that would allow me to go back home as a community member of course, but also as a researcher to understand how a third-generation child was acquiring and socialized to use heritage Spanish in an L.A.-based community of practice like the one I grew up in. Five years later, through this present study I found through quantitative measures that LIN does not use heritage Spanish very much. This finding is in line with a wealth of studies suggesting that the “Data seem to indicate that second and third generation Mexican-Americans will shift completely into English and that Spanish will be lost.” (Bustamante-López, 2008: 289). However, heritage bilingualism is not just about having productive syntax, morphology, or other grammatical features that can be quantified. Heritage bilingualism, even if LIN speaks very little Spanish is also very much about inheriting language practices that are unique to a bilingual and bicultural speech community (Kiaer, 2023). These distinct language practices thus help her not only to build a hybrid cultural identity (Blackledge & Pavlenko, 2001) in her distinct multilingual context, but also to increase her competence in dealing with different generations and this simply cannot be measured by the amount of Spanish that she produces. For example, if language mixing is indeed a form of language (Gee, 2002) that favors bilingualism (Gorter, 2013), this mode of communication is a flexible strategy that is useful in meeting the rich communicative demands not only between, but also within generations in immigrant families (Chung, 2010). By lowering language barriers, language mixing may thus ease communication in the family, and thereby support its well-being (De Houwer, 2015). Nevertheless, our fine-grained qualitative analyses showed that when LIN does use heritage Spanish it is in large part due to the bilingual, multigenerational, multimodal, and ever-shifting multiparty participation frameworks in which she is growing up. Indeed, “heritage language acquisition as well as language maintenance are incumbent primarily on families.” (Romanowski, 2021). Heritage Spanish acquisition and socialization is a dynamic multidirectional, interactional process that gradually molds mostly implicitly, but also explicitly how we come to see our pre-fabricated world and how we come to speak about it, thus changing it in our own right. It is also a process in which the novice child’s agency is just as powerful as the more expert adults’ in shaping not only the course of the social encounter, but also the path of his or her heritage bilingual language development (King & Fogle, 2013).

In this bilingual and bicultural family heritage Spanish acquisition and socialization is therefore intimately rooted in a multigenerational frame, and it is facilitated through the

interwoven use of Spanish, English, and language mixing. Indeed, Kiaer (2023) has described it as the weaving of a linguistic tapestry. These interknitted semiotic systems thus play “a key role in shaping the worldview of individuals and communities.” (Guardado, 2018: 1). However, this ever-evolving state of heritage bilingualism as anchored in a tension ridden contact zone heightens the bidirectional complexity where languages compete against each other and in some cases, lead to a language being lost in transmission despite efforts to maintain them (Hornsby & McLeod, 2022). Nevertheless, we attempted to gain a deeper understanding of LIN’s pre-fabricated, but-ever-shifting bilingual world. That is, how her unique social and linguistic circumstances shaped her use of heritage Spanish, through the use of English, and language mixing, as well as her emerging passive bilingualism across three points in time.

Our literature review discussed the key aspects and issues related to bilingualism. It then focused on theories of native and heritage language acquisition with a concentration on heritage language socialization, their speakers, and their languages. The data and methods chapter discussed the steps we took to collect, manage, and transcribe the naturalistic data in these types of bilingual communities. The goal was to create an exploitable plurilingual corpus in line with our social-interactionist-based theoretical approach. Next, based on our research methods we generated 10 different types of quantitative measures. They allowed us to draw a clearer picture of how LIN and her family members used Spanish, and language mixing, but mainly English longitudinally. This language use pattern was also the case at the individual, and family level. The last two qualitative chapters were organized into five themes, rather than longitudinally since LIN did not seem to present linguistic development in heritage Spanish over the course of the study. However, these analyses opened a window to examine the bilingual and bicultural interactional complexity of LIN’s multigenerational social encounters. We may therefore argue that LIN showed heritage Spanish use in more subtle ways. For example, her attitude towards using Spanish seemed to become more positive over time. Even more than three years after the data collection ended, in an end of study interview I asked LIN if she thought that it was important to learn Spanish. Following De Houwer’s recommendation, the interview took place on May 5th, 2021, when LIN was 7;1 via WhatsApp. In her response, LIN stated

Yes, because I could communicate with GRC and all the other family members who could speak Spanish (such as) GUI’s mom and dad and maybe GRC’s mom (LIN’s maternal great-great-grandmother, and paternal grandparents who all live) in Mexico (where) they all speak Spanish in Mexico (and where she has been) a lot of times. (Alvarez, 2021).

LIN thus recognizes that speaking Spanish will allow her to meaningfully interact with her older monolingual family members who live in Mexico and who only speak Spanish, especially since she goes there frequently. Through her drawing¹²⁸, where LIN placed herself in the middle, she also depicted Spanish as being spoken in Mexico and English in the U.S. when asked where each of these languages were located. She further described the U.S. as an urban environment filled with multiple homes, streets, and cars whereas Mexico, or at least the part of Mexico that she is most familiar with was rural, and next to the ocean and various mountains. LIN also showed a positive attitude when we considered her acceptance of Spanish translation equivalents provided by her caregivers, even if at times she strongly resisted. These findings may suggest that as she gets older, she may become more comfortable using heritage Spanish. LIN also used heritage Spanish when the speech stream was segmented at the syllable, word, or utterance level. We saw that she was also motivated to use Spanish both when she received positive encouragement for example by her great-grandmother GRC, or when she was challenged for example by ERI her great-uncle. It also seemed that she was least likely to use heritage Spanish when she was explicitly told to do so. These examples thus underscored the importance of child-directed input in supporting LIN's use of heritage Spanish. However, overheard speech played a critical role too. Our qualitative analyses revealed how LIN as an overhearer was not only attentive to what was said around her, but how she was able to use overheard speech to prompt more expert users to repeat, and to subsequently help her re-use, and thus reinforce her heritage Spanish. Through these multigenerational language practices where the use of heritage Spanish is also supported by language mixing, and the use of English LIN is therefore inheriting a bicultural *cosmovisión*, or an understanding of how the world works. Furthermore, through her dynamic, yet unique cultural framework she may gather and retain enough Spanish for her to reinforce it later in life if she so decides. We also need to understand that a bilingual language learning environment is always in constant flux, and that sometimes it moves towards further supporting her heritage language development. We may illustrate this point using the same end of study interview mentioned above where I asked LIN if she thought it was a good idea to learn Spanish in school. LIN answered the following:

My Spanish is not that good, but my English is kind of good in reading ... it's because I'm struggling in Spanish because I don't know the words, but sometimes I do because my teacher helps me ("how?"-I ask) She helps me read in Spanish and do math in Spanish. (At home I have books in Spanish (shows me books) ... ("do you like your school's Dual Language program?"-I ask) They're good because they help me learn in both languages. (Alvarez, 2021).

¹²⁸ LIN's visual representation of her languages is included in the appendices.

Right away LIN was up front about not knowing Spanish well because she did not know many words (confirmed through our quantitative measures), but when she did, it was thanks to her teachers' help across different subjects such as in reading. Learning to read and complete homework in Spanish also permeated into the home. This was a video that her mom ROX posted on one of the social network platforms with a positive comment insinuating that LIN was progressing in Spanish. Moreover, LIN suggested that the school's bilingual program was beneficial since it helped her develop both her English and Spanish competence. Indeed, many studies have confirmed the advantages of dual language education for bilingual children. Finally, LIN also showed that she had Spanish books at home. All these pieces of evidence show that in a span of three years, LIN's bilingual language learning environment has shifted at school and in the home, and one result, which is a critical factor in heritage language learning is having a positive attitude about learning and speaking heritage Spanish. LIN is being transmitted language practices that are specific to both of her cultures, and language practices that merge her cultures into one mode of communication. They are thereby increasing her ability to communicate with her multigenerational community of practice. The last two chapters brought a qualitative, multimodal, cognitive-functional, and interactionist-based approach to the study of third-generation heritage Spanish bilingualism as rooted in multigenerational and ever-shifting multiparty social encounters where "Meaning comes about through praxis – in the everyday interactions between the child and significant others " (Budwig, 2003: 108).

Finally, it is crucial to keep in mind that our investigation has at best only scratched the surface of this multigenerational L.A.-based family's plurisemiotic linguistic practices as they were temporarily anchored in their culturally and linguistically hybrid contact zone, or *tercera Hispanidad*. In doing so however, it provided fertile ground in which to plant multiple yet different types of seeds. Some of them have already bloomed and begun their transformational process to various degrees. In this modest light my community has given back in many ways. It allowed me to contribute new insight to heritage bilingualism research beyond the second generation which is still relatively scarce (Pauwels, 2016). Furthermore, it went deeper into the family tree and in doing so we considered the roles of the maternal great-grandparents, and a great-uncle, rendering this investigation truly unique. Our work is also rooted in a heritage language socialization paradigm as He (2011) and Guardado (2018) have encouraged us to do since to date theoretical linguists have produced the largest body of work in this field. A few other contributions include having built a plurilingual corpus which remain rare to this day

(Léglise & Alby, 2013), and that I will render available to our scientific community. As suggested by De Houwer (2009) I have also shifted focus to the bilingual family as the unit of analysis. Richer insight into the underpinnings of a bilingual language learning environment including multiple speakers also helped us further tighten the links between language acquisition and language socialization research, two fields that have been traditionally divided (Ochs & Schieffelin, 2008). Perhaps two other innovative features of this research could be mentioned. The first one is having applied multimodal analyses as Benazzo and Morgenstern (2014), and Kiaer (2023) have done in the study of bilingual children's language development, but at the intersection of multigenerational, and multiparty participation frameworks following De Léon (2011). Indeed, "Language – a social phenomenon – is captured, internalized and reconstructed again and again by each individual child thanks to its transmission by care-givers in their daily interactions with their upspring." (Morgenstern, 2017: 31). The second one is having given a voice, though small for now to the heritage bilingual overhearer, a participant status that according to Clark (1996), and Hindmarsh and Pilnick (2002) has yet to be sufficiently studied. By filling methodological gaps on one hand, and by bringing closer together theoretical, and analytical perspectives on the other, I hope to have showcased how I have not only contributed in an original way, but also how some of these seeds have broken ground and have the potential to blossom, or move forward even if subtly, the field of heritage bilingualism.

Bibliography

- Aalberse, S., Backus, A., & Muysken, P. (2019). *Heritage Languages: A language contact approach*. John Benjamins Publishing Company.
- Abbeduto, L., Keller-Bell, Y., Richmond, E. K., & Murphy, M. M. (2006). Research on Language Development and Mental Retardation: History, Theories, Findings, and Future Directions*. *International Review of Research in Mental Retardation Volume 32*, 32, 1–39. [https://doi.org/10.1016/s0074-7750\(06\)32001-0](https://doi.org/10.1016/s0074-7750(06)32001-0)
- Aden, J., & Eschenauer, S. (2020). Une pédagogie enactive-performative de la translangageance en milieu plurilingue. In *Perspektiven auf Mehrsprachigkeit im Fremdsprachenunterricht – Regards croisés sur le plurilinguisme et l'apprentissage des langues* (pp. 177–199). Springer.
- Akhtar, N. (2005). Is joint attention necessary for early language learning? In B. D. Homer & C. S. Tamis-LeMonda (Eds.), *The development of social cognition and communication* (pp. 165–179). Lawrence Erlbaum Associates Publishers.
- Alarcón, I. (2011). Spanish gender agreement under complete and incomplete acquisition: Early and late bilinguals' linguistic behavior within the noun phrase. *Bilingualism: Language and Cognition*, 14(3), 332–350.
<https://doi.org/doi:10.1017/S1366728910000222>
- Allen, S., Genesee, F., Fish, S., & Crago, M. (2002). Patterns of code mixing in English-Inuktitut bilinguals. In M. Andronis, C. Ball, H. Elston, & S. Neuvel (Eds.), *Proceedings of the 37th Annual Meeting of the Chicago Linguistics Society* (pp. 171–188). Linguistic Society.
https://www.researchgate.net/publication/308621434_Patterns_of_code_mixing_in_English-Inuktitut_bilinguals

- Altarriba, J., & Heredia, R. (Eds.). (2008). *An Introduction to Bilingualism: Principles and Practices*. Lawrence Erlbaum Associates.
- Alvarez, E. (2023). *Translation: A vector for linguistic mediation?* In J. Aden, V. Delorme, L. Nicolas (Eds.), *Médiations dans l'enseignement des langues: perspectives translangagière et transculturelle* (pp. xx-xx). Éditions des Archives contemporaines.
- Alvarez, E. (2020). Partially Schematic Constructions in Multilingual Interaction: A Vector for Intergenerational Transmission? In M. T. Calderón-Quindós, N. Barranco-Izquierdo, & T. Eisenrich (Eds.), *The Manifold Nature of Bilingual Education* (pp. 105–126). Cambridge Scholars Publishing.
- Alvarez, E. (2021). [Review of *(M)othering Labeled Children*, by M. Cioè-Peña]. 127- 134. <https://semas.uaq.mx/index.php/ojs/article/view/113>
- Alvarez, E. (2022). [Review of *Lost in Transmission: The Role of Attrition and Input in Heritage Language Development.*, by B. Brehmer & J. Treffers-Daller]. 203–208. <https://semas.uaq.mx/index.php/ojs/article/view/96>
- Alvarez-Cáccamo, C. (1998). From “Switching Code” to “Code-Switching” Towards a reconceptualisation of communicative codes. In *Code-Switching in Conversation* (pp. 29–48). Routledge.
- Ambridge, B., & Lieven, E. V. M. (2011). *Child Language Acquisition: Contrasting Theoretical Approaches*. Cambridge University Press.
- Anderson, B. (1983). *Imagined Communities: Reflections on the Origin and Spread of Nationalism*. Verso.
- Anderson, R. T. (1999). Loss of Gender Agreement in L1 Attrition: Preliminary Results. *Bilingual Research Journal*, 23(4), 389–408. <https://doi.org/10.1080/15235882.1999.10162742>

- Anderssen, M., & Westergaard, M. (2020). Word order variation in heritage languages: Subject shift and object shift in Norwegian. In B. Brehmer & J. Treffers-Daller (Eds.), *Lost in Transmission: The Role of Attrition and Input in Heritage Language Development* (pp. 99–124). John Benjamins Publishing Company.
- Andreou, M. (2015). *The effects of bilingualism on verbal and non verbal cognition: The micro- and macro-structure of narratives in the weak and the dominant language of the bilingual child* [Ph.D. Dissertation: Unpublished].
- Andreou, M., Tsimpli, I. M., Durrleman, S., & Peristeri, E. (2020). Theory of Mind, Executive Functions, and Syntax in Bilingual Children with Autism Spectrum Disorder. *Languages*, 5(4), 67. <https://doi.org/10.3390/languages5040067>
- Andrews, D. R. (Ed.). (1999). Sociocultural Perspectives on Language Change in Diaspora. *IMPACT: Studies in Language and Society*, 5. <https://doi.org/10.1075/impact.5>
- Anzaldúa, G. (1987). *Borderlands/La frontera: the new mestiza*. Aunt Lute Books.
- Araújo, K., & Befi-Lopes, D. (2004). Extensão média do enunciado de crianças entre 2 e 4 anos de idade: diferenças no uso de palavras e morfemas: *Revista Da Sociedade Brasileira de Fonoaudiologia*, 9, 156–163.
- Aronsson, K., & Morgenstern, A. (2021). “Bravo!”: Co-constructing praise in French family life. *Journal of Pragmatics*, 173, 1–14. <https://doi.org/10.1016/j.pragma.2020.12.002>
- Auer, P., & Eastman, C. M. (2010). Code-switching. *Handbook of Pragmatics*, 14, 1–34. <https://doi.org/10.1075/hop.14.cod1>
- Austin, P., & Sallabank, J. (2011). *The Cambridge Handbook of Endangered Languages*. Cambridge University Press.
- Backus, A., Seza Doğruöz, A., & Heine, B. (2011). Salient stages in contact-induced grammatical change: Evidence from synchronic vs. diachronic contact situations. *Language Sciences*, 33(5), 738–752. <https://doi.org/10.1016/j.langsci.2011.02.004>

- Baetens-Beardsmore, H. (1982). *Bilingualism: Basic Principles*. Multilingual Matters.
- Baetens-Beardsmore, H. (1986). *Bilingualism: Basic Principles* (Second Edition).
Multilingual Matters.
- Baker, C. (2001). *Foundations of Bilingual Education and Bilingualism* (Third Edition).
Multilingual Matters.
- Bakhtin, M. M. (1981). Discourse in the Novel. In M. Holquist (Ed.), & C. Emerson (Trans.),
The Dialogic Imagination: Four Essays by M.M. Bakhtin (pp. 259–422). University
Of Texas Press.
- Bakhtin, M. M. (1986). The Problem of Speech Genres. In M. Holquist (Ed.), & V. W.
McGee (Trans.), *Speech Genres and Other Late Essays* (pp. 60–102). University Of
Texas Press.
- Baquedano-López, P. (1997). Creating Social Identities through Doctrina Narratives. *Issues
in Applied Linguistics*, 8(1). <https://doi.org/10.5070/1481005254>
- Bates, E., Camaioni, L., & Volterra, V. (1975). The acquisition of performatives prior to
speech. *Merrill-Palmer Quarterly of Behavior and Development*, 21(3), 205–226.
- Bates, E., Elman, J., Johnson, M. H., Karmiloff-Smith, A., Domenico Parisi, & Plunkett, K.
(1996). *Rethinking Innateness: A Connectionist Perspective on Development*. MIT
Press.
- Bayley, R., & Schecter, S. (Eds.). (2003). *Language Socialization in Bilingual and
Multilingual Societies*. Multilingual Matters. <https://doi.org/10.21832/9781853596377>
- Bayram, F. (2013). *Acquisition of Turkish by heritage speakers: A processability approach*
[Ph.D. Dissertation]. <http://hdl.handle.net/10443/1905>
- Beupoil, P. (2015). *Approches multimodales de la négation chez l'enfant en anglais et en
français* [Ph.D. Dissertation: Unpublished].

- Beaupoil-Hourdel, P., & Morgenstern, A. (2021). French and British children's shrugs. A cross-linguistic developmental case-study of a recurrent gesture. In S. Harrison, S. H. Ladewig, & J. Bressemer (Eds.), *Gesture* (Vol. 20, Issue 2, pp. 180–218). John Benjamins Publishing Company. <https://doi.org/10.1075/gest.19043.bea>
- Becker, J. A. (1994). Pragmatic socialization: Parental input to preschoolers. *Discourse Processes*, 17(1), 131–148. <https://doi.org/10.1080/01638539409544862>
- Beckner, C., Blythe, R., Bybee, J., Christiansen, M. H., Croft, W., Ellis, N. C., Holland, J., Ke, J., Larsen-Freeman, D., & Schoenemann, T. (2009). Language Is a Complex Adaptive System: Position Paper. *Language Learning*, 59, 1–26. <https://doi.org/10.1111/j.1467-9922.2009.00533.x>
- Benazzo, S., & Morgenstern, A. (2014). A bilingual child's multimodal path into negation. *Gesture*, 14(2), 171–202. <https://doi.org/10.1075/gest.14.2.03ben>
- Benmamoun, E., Montrul, S., & Polinsky, M. (2013a). Defining an “ideal” heritage speaker: Theoretical and methodological challenges Reply to peer commentaries. *Theoretical Linguistics*, 39(3-4). <https://doi.org/10.1515/tl-2013-0018>
- Benmamoun, E., Montrul, S., & Polinsky, M. (2013b). Heritage languages and their speakers: Opportunities and challenges for linguistics. *Theoretical Linguistics*, 39(3-4), 129–181. <https://doi.org/10.1515/tl-2013-0009>
- Bermel, N., & Kagan, O. (2000). The maintenance of written Russian in heritage speakers. In O. Kagan & B. Rifkin (Eds.), *The learning and teaching of Slavic languages and cultures* (pp. 405–436). Slavica.
- Bhabha, H. K. (1994). *The Location of Culture*. W. Ross Macdonald School Resource Services Library.

- Bhabha, H. K. (2006). Cultural Diversity and Cultural Differences. In B. Ashcroft, G. Griffiths, & H. Tiffin (Eds.), *The Post-Colonial Studies Reader* (pp. 155–157). Routledge.
- Bhatt, R. M., & Bolonyai, A. (2011). Code-switching and the optimal grammar of bilingual language use. *Bilingualism: Language and Cognition*, 14(4), 522–546.
- Bilingualism. (2002). In *Le Petit Larousse illustré* (p. 1790). Larousse.
- Blackledge, A., & Pavlenko, A. (2001). Negotiation of identities in multilingual contexts. *International Journal of Bilingualism*, 5(3), 243–257.
<https://doi.org/10.1177/13670069010050030101>
- Bloom, L. (1970). *Language development: Form and Function in Emerging Grammars*. MIT Press. Research Monograph No. 59
- Bloomfield, L. (1933). *Language*. George Alen & Unwin LTD.
- Blum-Kulka, S. (1997). *Dinner Talk*. Routledge.
- Blum-Kulka, S. (2002). “Do you believe that Lot’s wife is blocking the road (to Jeri-cho)?” Co-constructing theories about the world with adults. In S. Blum & C. E. Snow (Eds.), *Talking to Adults* (pp. 85–117). Psychology Press.
- Blum-Kulka, S. (2008). Language Socialization and Family Dinnertime Discourse. In P. A. Duff & N. H. Hornberger (Eds.), *Language Socialization* (pp. 87–99). Springer.
- Bolonyai, A. (2007). (In)vulnerable agreement in incomplete bilingual L1 learners. *International Journal of Bilingualism*, 11(1), 3–23.
<https://doi.org/https://doi.org/10.1177/13670069070110010201>
- Bourdieu, P. (1977). *Outline of a Theory of Practice*. Cambridge University Press.
- Bourdieu, P. (1990). *The Logic of Practice*. Stanford University Press.
- Bourdieu, P. (1991). *Language and Symbolic Power*. Harvard University Press. (Original work published 1982)

- Brehmer, B., & Treffers-Daller, J. (2020). *Lost in Transmission : The Role of Attrition and Input in Heritage Language Development*. John Benjamins Publishing Company.
- Bronson, M. C., & Watson-Gegeo, K. A. (2008). The Critical Moment: Language Socialization and the (Re)visioning of First and Second Language Learning. In P. A. Duff & N. H. Hornberger (Eds.), *Language Socialization* (pp. 43–55). Springer.
https://doi.org/10.1007/978-0-387-30424-3_196
- Brown, P., & Gaskins, S. (2014). Language Acquisition and Language Socialization. In N. J. Enfield, P. Kockelman, & J. Sidnell (Eds.), *Cambridge Handbook of Linguistic Anthropology* (pp. 187–226). Cambridge University Press.
- Brown, R. (1973). *A First Language: The Early Stages*. Harvard University Press.
- Brown, R., Cazden, C., & Bellugi-Klima, U. (1969). The Child's Grammar from I to III. In J. P. Hill (Ed.), *Minnesota Symposia on Child Psychology: Volume 2* (pp. 28–73). University of Minnesota Press.
- Bruner, J. S. (1975). The Ontogenesis of Speech Acts. *Journal of Child Language*, 2(1), 1–19. <https://doi.org/10.1017/s0305000900000866>
- Brunet, A., Akinci, M-A., Atangana, F., Morgenstern, A. (2022). *Conference Presentation: Language Dominance and Gesture in Bilingual Family Dinners*. International Society for Gesture Studies, Chicago.
- Budwig, N. (2003). Context and the dynamic construal of meaning in early childhood. In J. Benson & C. Raeff (Eds.), *Social and Cognitive Development in the Context of Individual, Social, and Cultural Processes* (pp. 103–130). Routledge.
- Burdelski, M. (2009). Language Socialization and Politeness Routines. In A. Duranti, E. Ochs, & B. B. Schieffelin (Eds.), *The Handbook of Language Socialization* (pp. 275–295). Wiley-Blackwell.

- Burgen, S. (2015, June 29). US now has more Spanish speakers than Spain - only Mexico has more. *The Guardian*. <https://www.theguardian.com/us-news/2015/jun/29/us-second-biggest-spanish-speaking-country>
- Bustamante-López, I. (2008). Constructing linguistic identity in Southern California. In M. Niño-Murcia & J. Rothman (Eds.), *Bilingualism and Identity: Spanish at the crossroads with other languages* (pp. 279–299). John Benjamins Publishing Company.
- Bybee, J. (2010). *Language, Usage and Cognition*. Cambridge University Press.
<https://doi.org/10.1017/cbo9780511750526>
- Bylund, E. (2009). Maturation Constraints and First Language Attrition. *Language Learning*, 59(3), 687–715. <https://doi.org/10.1111/j.1467-9922.2009.00521.x>
- Byon, A. S. (2003). Language Socialisation and Korean as a Heritage Language: A Study of Hawaiian Classrooms. *Language, Culture and Curriculum*, 16(3), 269–283.
<https://doi.org/10.1080/07908310308666674>
- Caët, S. (2013). *Des gestes aux mots: du pointage à la verbalisation de la référence à la personne (anglais et français) chez l'enfant tout venant et l'enfant dysphasique* [Ph.D Dissertation: Unpublished].
- Cambridge Dictionary. (2019). *Transformation | meaning in the Cambridge English Dictionary*. Cambridge.org.
<https://dictionary.cambridge.org/dictionary/english/transformation>
- Cambridge Dictionary. (2022, October 19). *Unincorporated*. @CambridgeWords.
<https://dictionary.cambridge.org/dictionary/english/unincorporated>
- Cameron, D. (2003). Gender issues un language change. *Annual Review of Applied Linguistics*, 23, 187–201. <https://doi.org/10.1017/s0267190503000266>
- Cantone, K. F. (2007). *Code-Switching in Bilingual Children*. Springer.

- Carreira, M. (2004). Seeking explanatory adequacy: A dual approach to understanding the term “heritage language learner.” *Heritage Language Journal*, 2(1), 1–25.
- Carreira, M., & Kagan, O. (2007). The Results of the National Heritage Language Survey: Implications for Teaching, Curriculum Design, and Professional Development. *Foreign Language Annals*, 44(1), 40–64.
<https://doi.org/https://doi.org/10.1111/j.1944-9720.2010.01118.x>
- Chen, J. (2012). *Acquisition of Mandarin aspectual marking in child Heritage speakers in the Netherlands* [M.A. Thesis: Unpublished].
- Chen, J., & Shirai, Y. (2009). The development of aspectual marking in child Mandarin Chinese. *Applied Psycholinguistics*, 31(1), 1–28.
<https://doi.org/10.1017/s0142716409990257>
- Chomsky, N. (1965). *Aspects of the theory of syntax*. MIT Press.
- Chung, H.H. (2010). Code switching as a communicative strategy: A case study of Korean-English bilinguals. *Bilingual Research Journal*, 30(2), 293-307.
- Clark, E. V. (2001). Emergent categories in first language acquisition. In M. Bowerman & S. C. Levinson (Eds.), *Language Acquisition and Conceptual Development*. Cambridge University Press.
- Clark, H. H. (1996). *Using Language*. Cambridge University Press.
- Clemente, I. (2008). Recording Audio and Video. In L. Wei & M. Moyer (Eds.), *The Blackwell Guide to Research Methods in Bilingualism* (pp. 177–191). Blackwell.
- Clyne, M., & Kipp, S. (1997). Trends and Changes in Home Language Use and Shift in Australia, 1986-1996. *Journal of Multilingual and Multicultural Development*, 18(6), 451–473. <https://doi.org/10.1080/01434639708666334>

- Comeau, L., Genesee, F., & Lapaquette, L. (2003). The Modeling Hypothesis and child bilingual codemixing. *International Journal of Bilingualism*, 7(2), 113–126.
<https://doi.org/10.1177/13670069030070020101>
- Creese, A., & Blackledge, A. (2015). Translanguaging and Identity in Educational Settings. *Annual Review of Applied Linguistics*, 35, 20–35.
<https://doi.org/10.1017/s0267190514000233>
- Creswell, J. W., & Plano Clark, V. L. (2018). *Designing and Conducting Mixed Methods Research* (3rd ed.). Sage.
- Croft, W. (2000). *Explaining Language Change: An Evolutionary Approach*. Longman.
- Cruz-Ferreira, M. (2006). *Three is a crowd? Acquiring Portuguese in a trilingual environment*. Multilingual Matters.
- Crystal, D. (1974). Review of R. Brown, *A First Language: The Early Stages*. *Journal of Child Language*, 1, 289–307. <https://www.davidcrystal.com/Files/BooksAndArticles/-3891.pdf>
- Cummins, J. (2005). A Proposal for Action: Strategies for Recognizing Heritage Language Competence as a Learning Resource within the Mainstream Classroom. *The Modern Language Journal*, 89(4), 585–592.
- Curtiss, S. R. (1977). *Genie: A Linguistic Study of a Modern Day “Wild” Child*. Academic Press.
- Dabène, L. (1994). *Repères sociolinguistiques pour l’enseignement des langues*. Hachette FLE.
- Daviault, D. (2011). *L’émergence et le développement du langage chez l’enfant*. Chenelière Éducation.
- De Houwer, A. (1990). *The Acquisition of Two Languages from Birth*.
<https://doi.org/10.1017/cbo9780511519789>

- De Houwer, A. (1995). Bilingual Language Acquisition. In P. Fletcher & B. MacWhinney (Eds.), *The Handbook of Child Language* (pp. 219–250). Blackwell.
- De Houwer, A. (2005). *Early Bilingual Acquisition: Focus on Morphosyntax and the Separate Development Hypothesis*. na.
- De Houwer, A. (2009). *Bilingual First Language Acquisition*. Multilingual Matters.
- De Houwer, A. (2015). Harmonious Bilingual Development : Young Families' well-being in Language Contact Situation. *International Journal of Bilingualism*, 19(2), 169-184
- De Houwer, A. (2019). Language choice in bilingual interaction. In L. Ortega & A. De Houwer (Eds.), *The Cambridge handbook of bilingualism* (pp. 324–348). Cambridge University Press.
- De Houwer, A. (2021a). *Bilingual Development in Childhood*. Cambridge University Press.
- De Houwer, A. (2021b). Individual Bilingualism. In Salikoko Mufwene & A.-M. Escobar (Eds.), *The Cambridge Handbook of Language Contact in Population Structure* (pp. 61–89). Cambridge University Press.
- De Houwer, A., & Bornstein, M. H. (2016a). Balance patterns in early bilingual acquisition: A longitudinal study of word comprehension and production. In C. Silva-Corvalán & J. Treffers-Daller (Eds.), *Language Dominance in Bilinguals: Issues of Measurement and Operationalization* (pp. 134–155). Cambridge University Press.
<https://doi.org/10.1017/cbo9781107375345.007>
- De Houwer, A., & Bornstein, M. H. (2016b). Bilingual mothers' language choice in child-directed speech: Continuity and change. *Journal of Multilingual and Multicultural Development*, 37(7), 680–693. <https://doi.org/10.1080/01434632.2015.1127929>
- De Houwer, A., & Nakamura, J. (2021). Developmental Perspectives on Parents' Use of Discourse Strategies with Bilingual Children. In U. Røyneland & R. Blackwood

(Eds.), *Multilingualism across the Lifespan*. Routledge.

<https://doi.org/10.4324/9781003125815>

De León, L. (1998). The Emergent Participant: Interactive Patterns in the Socialization of Tzotzil (Mayan) Infants. *Journal of Linguistic Anthropology*, 8(2), 131–161.

<https://doi.org/10.1525/jlin.1998.8.2.131>

De León, L. (2012). “The j’Ikal is Coming!” Triadic Directives and Emotion in the Socialization of Zinacantec Mayan Children. In P. Nondédéo & A. Breton (Eds.), *Maya Daily Lives. Proceedings of the 13th European Maya Conference* (pp. 185–196). Verlag Anton Saurwein.

De León, L. (2011). Language Socialization and Multiparty Participation Frameworks. In A. Duranti, E. Ochs, & B. B. Schieffelin (Eds.), *The Handbook of Language Socialization* (pp. 81–111). Wiley-Blackwell.

De Pontonx, S., Leroy-Collombel, M., & Morgenstern, A. (2018). How mother and child co-construct non-conventional productions in spontaneous interaction. *First Language*, 39(2), 220–242. <https://doi.org/10.1177/0142723718803155>

De Vries, J. W. (1994). Canada’s official language communities: an overview of the current demolingistic situation. *International Journal of the Sociology of Language*, 37–68.

Definiciones de la mexicanidad – Instituto de la Mexicanidad. (2022). Mexicanidad.org.

<https://mexicanidad.org/definiciones-de-la->

[mexicanidad/#:~:text=La%20mexicanidad%20es%20e1%20modo](https://mexicanidad.org/definiciones-de-la-mexicanidad/#:~:text=La%20mexicanidad%20es%20e1%20modo)

Definition of Bilingualism. (2018). Merriam-Webster.com. <https://www.merriam-webster.com/dictionary/bilingualism>

Definition of Code. (2020). Wwww.merriam-Webster.com. https://www.merriam-webster.com/dictionary/code?utm_campaign=sd&utm_medium=serp&utm_source=js
onld

- Definition of Liminality* | *Dictionary.com*. (2019). www.dictionary.com.
<https://www.dictionary.com/browse/liminality>
- Delgado, M. R. (2011). *Spanish Heritage Language Socialization Practices of a Family of Mexican Origin* [Ph.D. Dissertation].
- Demuth, K. (1986). Prompting routines in the language socialization of Basotho. In B. B. Scheffelin & E. Ochs (Eds.), *Language Socialization Across Cultures* (pp. 51–79). Cambridge University Press.
- Deprez, C. (1994). *Les enfants bilingues: langues et familles*. Didier.
- Deuchar, M., & Quay, S. (2000). *Bilingual Acquisition: Theoretical Implications of a Case Study*. Oxford University Press.
- Deumert, A. (2011). Multilingualism. In R. Mesthrie (Ed.), *The Cambridge Handbook of Sociolinguistics* (pp. 261–282). <https://doi.org/10.1017/cbo9780511997068.021>
- Diebowski, J. (2020). Language contact: Gender agreement in Spanish L2 learners and heritage speakers. In B. Brehmer & J. Treffers-Daller (Eds.), *Lost in Transmission: The Role of Attrition and Input in Heritage Language Development* (pp. 125–150). John Benjamins Publishing Company.
- Doğruöz, A. S., & Backus, A. (2009). Innovative constructions in Dutch Turkish: An assessment of ongoing contact-induced change. *Bilingualism: Language and Cognition*, 12(1), 41–63. <https://doi.org/10.1017/s1366728908003441>
- Dollaghan, C. A. (2004). Taxometric analyses of specific language impairment in 3- and 4-year-old children. *Journal of Speech, Language, and Hearing Research: JSLHR*, 47(2), 464–475. [https://doi.org/https://doi.org/10.1044/1092-4388\(2004/037\)](https://doi.org/https://doi.org/10.1044/1092-4388(2004/037))
- Domínguez, L., Hicks, G., & Slabakova, R. (2019). Terminology choice in generative acquisition research. *Studies in Second Language Acquisition*, 41(2), 241–255. <https://doi.org/10.1017/s0272263119000160>

- Dorian, N. C. (Ed.). (1989). *Investigating obsolescence Studies in language contraction and death*. Cambridge University Press.
- Dornyei, Z., & Csizer, K. (2002). Some Dynamics of Language Attitudes and Motivation: Results of a Longitudinal Nationwide Survey. *Applied Linguistics*, 23(4), 421–462. <https://doi.org/10.1093/applin/23.4.421>
- Dosi, I., Papadopoulou, D., & Tsimpli, I. (2016). *Linguistic and cognitive factors in Elicited Imitation Tasks: A study with mono- and biliterate Greek-Albanian bilingual children. 1.*
- Duff, P. (2007). *Case study research in applied linguistics*. Lawrence Erlbaum.
- Duff, P. A. (2008). Introduction to Volume 8: Language Socialization. In P. A. Duff & N. H. Hornberger (Eds.), *Language Socialization* (pp. xiii–xix). Springer.
- Duranti, A. (1985). Sociocultural Dimensions of Discourse. In T. A. van Dijk (Ed.), *Handbook of Discourse Analysis* (pp. 193–230). Academic Press. <http://www.sscnet.ucla.edu/anthro/faculty/duranti/reprints/socdis.pdf>
- Duranti, A. (1997). *Linguistic Anthropology*. Cambridge University Press. <https://doi.org/10.1017/cbo9780511810190>
- Duranti, A. (2003a). *A Companion to Linguistic Anthropology*. Wiley–Blackwell.
- Duranti, A. (2003b). Language as Culture in U.S. Anthropology. *Current Anthropology*, 44(3), 323–347. <https://doi.org/10.1086/368118>
- Eckert, P. (1989). *Jocks and Burnouts: Social Categories and Identity in the High School*. Teachers College, Columbia University.
- Eilers, R. E., Oller, D. K., & Cobo-Lewis, A. B. (2006). Social factors in bilingual development: The Miami experience. In P. Mccardle & E. Hoff (Eds.), *Childhood bilingualism: Research on infancy through school age* (pp. 68–90). Multilingual Matters.

https://www.researchgate.net/publication/285796015_Social_factors_in_bilingual_development_The_Miami_experience

- Ellis, N. C. (1998). Emergentism, Connectionism and Language Learning. *Language Learning*, 48(4), 631–664. <https://doi.org/10.1111/0023-8333.00063>
- Ellis, N. C. (2002). Frequency Effects in Language Processing. *Studies in Second Language Acquisition*, 24(2), 143–188. <https://doi.org/10.1017/s0272263102002024>
- Elman, J. L., Bates, E. A., & Johnson, M. H. (1996). *Rethinking Innateness: A Connectionist Perspective on Development* (Vol. 10). MIT Press.
- Enns-Kananen, J., & King, K. A. (2018). Heritage Languages and Language Policy. *The Encyclopedia of Applied Linguistics*, 1–6. <https://doi.org/10.1002/9781405198431.wbeal0500.pub2>
- Erickson, F. (1982). Audiovisual Records as a Primary Data Source. *Sociological Methods & Research*, 11(2), 213–232. <https://doi.org/10.1177/0049124182011002008>
- Ervin-Tripp, S. M., Gumperz, J. J., Slobin, D. I., Brukman, J., Kernan, K., Mitchell, C., & Stross, B. (1967). *A Field Manual for Cross-cultural Study of the Acquisition of Communicative Competence* (D. I. Slobin, Ed.; pp. 1–248). Language Behavior Research Laboratory, Berkeley, University of California, Berkeley. https://www.academia.edu/48030012/A_Field_Manual_for_Cross_Cultural_Study_of_the_Acquisition_of_Communicative_Competence_Second_Draft_July_1967
- Ervin-Tripp, S., & Mitchell-Kernan, C. (Eds.). (1977). *Child Discourse*. Academic Press.
- Erving Goffman's Analysis of Participation Frameworks*. (n.d.). How Communication Works. <https://www.howcommunicationworks.com/blog/2020/12/24/erving-goffmans-analysis-of-participation-frameworks>
- Esch-Harding, E., & Riley, P. (2003). *The Bilingual Family: A Handbook for Parents* (Second Edition). Cambridge University Press. (Original work published 1986)

- Fader, A. (2001). Literacy, Bilingualism, and Gender in a Hasidic Community. *Linguistics and Education*, 12(3), 261–283. [https://doi.org/10.1016/s0898-5898\(01\)00056-0](https://doi.org/10.1016/s0898-5898(01)00056-0)
- Fantini, A. E. (1985). *Language acquisition of a bilingual child: a sociolinguistic perspective (to age five)* [Ph.D. Dissertation]. Findings from Fantini's 1974 Ph.D. on his son's language development are integrated into the 1985 publication.
- Fenyvesi, A. (Ed.). (2005). Hungarian Language Contact Outside Hungary. *IMPACT: Studies in Language and Society*, 20. <https://doi.org/10.1075/impact.20>
- Field, F. (2011). *Bilingualism in the USA: The case of the Chicano-Latino community*. John Benjamins Publishing Company.
- Filipi, A. (2015). The Development of Recipient Design in Bilingual Child-Parent Interaction. *Research on Language and Social Interaction*, 48(1), 100–119. <https://doi.org/10.1080/08351813.2015.993858>
- Fishman, J. A. (1964). Language maintenance and language shift as a field of inquiry. A definition of the field and Suggestions for its further development. *Linguistics*, 2(9). <https://doi.org/10.1515/ling.1964.2.9.32>
- Fishman, J. A. (1965). Who Speaks What Language to Whom and When? *La Linguistique*, 1(2), 67–88.
- Fishman, J. A. (1971). *Advances in the Sociology of Language* (Vol. 1). Mouton.
- Fishman, J. A. (1978). *Language loyalty in the United States*. Arno Press. (Original work published 1966)
- Fishman, J. A. (1990). What is reversing language shift (RLS) and how can it succeed? *Journal of Multilingual and Multicultural Development*, 11(1-2), 5–36. <https://doi.org/10.1080/01434632.1990.9994399>
- Fishman, J. A. (1991). *Reversing language shift: Theoretical and empirical foundations of assistance to threatened languages*. Multilingual Matters.

- Fishman, J. A. (Ed.). (2001). *Can Threatened Languages be Saved?* Multilingual Matters.
<https://doi.org/10.21832/9781853597060>
- Fishman, J. A. (2004). Language maintenance, language shift, and reversing language shift.
 In T. K. Bhatia & W. C. Ritchie (Eds.), *The handbook of bilingualism* (pp. 406–436).
 Blackwell.
- Flores Farfán, J. A., & Ramallo, F. F. (Eds.). (2010). *New Perspectives on Endangered Languages: Bridging gaps between sociolinguistics, documentation and language revitalization*. John Benjamins Publishing Company.
- Flores, C. (2012). Differential effects of language attrition in the domains of verb placement and object expression. *Bilingualism: Language and Cognition*, 15(3), 550–567.
<https://doi.org/10.1017/s1366728911000666>
- Flores, C. M. M. (2015). Understanding heritage language acquisition. Some contributions from the research on heritage speakers of European Portuguese. *Lingua*, 164, 251–265. <https://doi.org/10.1016/j.lingua.2014.09.008>
- Flores, N., & Toro, J. (2000). The Persistence of Dialect Features under Conditions of Contact and Leveling. *Southwest Journal of Linguistics*, 19, 31–42.
- Forrester, M. A. (2001). The embedding of the self in early interaction. *Infant and Child Development*, 10(4), 189–202. <https://doi.org/10.1002/icd.278>
- Forrester, M. A. (2002). Appropriating Cultural Conceptions of Childhood: Participation in Conversation. *Childhood*, 9(3), 255–276.
<https://doi.org/10.1177/0907568202009003043>
- Fuentes, C. (2000). *La región más transparente*. Alfaguara. (Original work published 1958)
- Fuentes, C. (2016). *El espejo enterrado*. Delbolsillo. (Original work published 1992)
- Gal, S. (1979). Language shift: Social determinants of linguistic change in bilingual Austria. *Language in Society*, 9(1), 147–152.

- García, O. (2009). *Bilingual Education in the 21st Century : A Global Perspective*. John Wiley And Sons LTD.
- García, O., & Tupas, R. (2018). Doing and Undoing Bilingualism in Education. In A. De Houwer & L. Ortega (Eds.), *The Cambridge Handbook of Bilingualism* (pp. 390–407). Cambridge University Press.
- García, O., & Wei, L. (2014). *Translanguaging: Language, Bilingualism and Education*. Palgrave Macmillan.
- García, O., Zakharia, Z., & Otcu, B. (Eds.). (2013). *Bilingual Community Education and Multilingualism: Beyond Heritage Languages in a Global City*. Multilingual Matters.
- Gardner-Chloros, P. (2009). *Code-Switching*. Cambridge University Press.
<https://doi.org/10.1017/cbo9780511609787>
- Garrett, P. B. (2007). Language Socialization and the (re)Production of Bilingual Subjectivities. In M. Heller (Ed.), *Bilingualism: A Social Approach* (pp. 233–256). Palgrave Macmillan.
- Gee, J.P. (2002). A Sociocultural Perspective on Early Literacy Development. In S.B. Neuman & D.K. Dickinson (Eds.), *Handbook of Early Literacy Research* (pp.30-42). Guilford Press.
- Geertz, C. (1973). *The Interpretation of Cultures*. Basic Books.
- Geisherik, A. (2005). *Aspects of teaching literacy to heritage learners of Russian* (pp. 1–24) [Ph.D. Dissertation]. <https://www.proquest.com/docview/305373822>
- Genesee, F. (1989). Early bilingual development: One language or two? *Journal of Child Language*, 16(1), 161–179. <https://doi.org/10.1017/s0305000900013490>
- Genesee, F. (2000). Introduction. *Bilingualism: Language and Cognition*, 3(3), 167–172.

- Genesee, F. (2016). Shifting perspectives on bilingualism. In E. Nicoladis & S. Montanari (Eds.), *Bilingualism across the lifespan: Factors moderating language proficiency*. (pp. 9–20). De Gruyter Mouton. <https://doi.org/10.1037/14939-002>
- Genesee, F., Boivin, I., & Nicoladis, E. (1996). Talking with strangers: A study of bilingual children's communicative competence. *Applied Psycholinguistics*, 17(04), 427–442. <https://doi.org/10.1017/s0142716400008183>
- Genesee, F., Nicoladis, E., & Paradis, J. (1995). Language differentiation in early bilingual development. *Journal of Child Language*, 22(3), 611–631. <https://doi.org/10.1017/s0305000900009971>
- Gharibi, K., & Seals, C. (2019). Heritage Language Policies of the Iranian diaspora in New Zealand. *International Multilingual Research Journal*, 14(4), 297-303.
- Ghimenton, A. (2017). Socializing language choices: When variation in the language environment supports acquisition. In G. De Vogelaer & M. Katerbow (Eds.) *Acquiring Sociolinguistic Variation*. (pp. 213–233). John Benjamins Publishing Company. <https://doi.org/10.1075/silv.20.08ghi>
- Gide, A. (1949). *Si le grain ne meurt*. Gallimard.
- Gil-Gómez, E. M. (2002). [Review of *Latinos Inc.: The Marketing and Making of a People*, by A. Dávila]. *American Quarterly*, 54(3), 537-542.
- Gleason, J. B., Perlmann, R. Y., & Greif, E. B. (1984). What's the magic word: Learning language through politeness routines. *Discourse Processes*, 7(4), 493–502. <https://doi.org/10.1080/01638538409544603>
- Goebel, H., Nelde, P. H., Stary, Z., & Wölck, W. (Eds.). (1996). *Contact linguistics. An international handbook of contemporary research, vol. I*. De Gruyter.
- Goffman, E. (1974). *Frame Analysis: An Essay on the Organization of Experience*. Northeastern University Press.

- Goffman, E. (1981). *Forms of Talk*. University Of Pennsylvania Press.
- Goldberg, A. E. (1995). *Constructions: A construction grammar approach to argument structure*. University of Chicago Press.
- Goldberg, A. E. (1999). The Emergence of the Semantics of Argument Structure Constructions. In B. MacWhinney (Ed.), *The Emergence of Language*. Psychology Press.
- González-Bueno, M. (2005). Articulatory Difficulties in the Acquisition of Spanish /r/ in a Bilingual Context. In J. Cohen, K. T. McAlister, K. Rolstad, & J. MacSwan (Eds.), *Proceedings of the 4th International Symposium on Bilingualism* (pp. 914–934). Cascadilla Press. <http://www.lingref.com/isb/4/071ISB4.PDF>
- Goodwin, M. H. (1990). *He-said-she-said: Talk as Social Organization among Black Children*. Indiana University Press.
- Goodwin, M. H. (2006). *The Hidden Life of Girls: Games of Stance, Status, and Exclusion*. John Wiley & Sons.
- Goodwin, M. H., & Goodwin, C. (2004). Participation. In A. Duranti (Ed.), *A Companion to Linguistic Anthropology* (pp. 222–244). Blackwell Publishers.
- Goodz, N. (1994). Interactions between parents and children in bilingual families. In F. Genesee (Ed.), *Educating second language children* (pp. 61–81). Cambridge University Press.
- Gordon, R. G. (Ed.). (2005). *Ethnologue: Languages of the World*. Ethnologue. <http://ethnologue.com>
- Gorter, D. (2013). Linguistic Landscapes in a Multilingual World. *Annual Review of Applied Linguistics*, 33, 190–212. <https://doi.org/10.1017/s0267190513000020>
- Grosjean, F. (1982). *Life with two languages: An introduction to bilingualism*. Harvard University Press.

- Grosjean, F. (1989). Neurolinguists, beware! The bilingual is not two monolinguals in one person. *Brain and Language*, 36(1), 3–15. [https://doi.org/10.1016/0093-934x\(89\)90048-5](https://doi.org/10.1016/0093-934x(89)90048-5)
- Grosjean, F. (2000). Processing mixed language: Issues, findings, and models. In L. Wei (Ed.), *The Bilingualism Reader* (pp. 443–469). Routledge.
- Grosjean, F. (2008). *Studying Bilinguals*. Oxford University Press.
- Grosjean, F. (2010). *Bilingual: Life and Reality*. Harvard University Press.
- Grosjean, F. (2012a). Speech perception and comprehension. In F. Grosjean & P. Li (Eds.), *The Psycholinguistics of Bilingualism* (pp. 29–49). Wiley-Blackwell/John Wiley & Sons.
- Grosjean, F. (2012b). Bilingual and Monolingual Language Modes. *The Encyclopedia of Applied Linguistics*, 489–493. <https://doi.org/10.1002/9781405198431.wbeal0090>
- Grosjean, F. (2015). *Parler plusieurs langues: Le monde des bilingues*. Albin Michel.
- Guardado, M. (2006). Engaging language and cultural spaces: Latin American parents' reflections on language loss and maintenance in Vancouver. *Canadian Journal of Applied Linguistics*, 9(1), 51–72.
- Guardado, M. (2009). Speaking Spanish Like a Boy Scout: Language Socialization, Resistance, and Reproduction in a Heritage Language Scout Troop. *Canadian Modern Language Review*, 66(1), 101–129.
- Guardado, M. (2018). *Discourse, ideology and heritage language socialization: Micro and macro perspectives*. De Gruyter Mouton.
- Guardado, M. (2020). “My gain would have been your loss”: Key factors in the heritage language socialization and policies of a middle-class Mexican family in Canada. In P. Romanowski & M. Guardado (Eds.), *The many faces of multilingualism: Language status, learning and use across contexts* (pp. 39–61). De Gruyter Mouton.

- Gumperz, J. (1968). The Speech Community. In P. P. Giglioli (Ed.), *Language and Social Context* (pp. 43–52). Penguin.
- Gumperz, J. J. (1964). Linguistic and Social Interaction in Two Communities¹. *American Anthropologist*, 66(6_PART2), 137–153.
https://anthrosource.onlinelibrary.wiley.com/doi/epdf/10.1525/aa.1964.66.suppl_3.02a00100
- Hagège, C. (2005). *L'enfant aux deux langues*. Odile Jacob.
- Hall, R. A., & Ithaca, Jr. (1952). Bilingualism and Applied Linguistics. *STUF - Language Typology and Universals*, 6(1-2), 13–30.
<https://doi.org/https://doi.org/10.1524/stuf.1952.6.12.13>
- Halliday, M. A. K. (1978). *Language as Social Semiotic: The Social Interpretation of Language and Meaning*. Edward Arnold.
- Hamers, J. F., & Blanc, M. (1983). *Bilinguisme et bilinguisme*. Pierre Mardaga.
- Harris, B. (1977). *The Importance of Natural Translation*. Working Papers on Bilingualism, No. 12.
- Harrison, B. (2000). Passing on the language: Heritage language diversity in Canada. *Canadian Social Trends*, 14–19. <https://www150.statcan.gc.ca/n1/pub/11-008-x/2000002/article/5165-eng.pdf>
- Harrison, K. D. (2007). *When Languages Die: The extinction of the world languages and the erosion of human knowledge*. Oxford University Press.
- He, A. (2011). Heritage Language Socialization. In A. Duranti, E. Ochs, & B. B. Schieffelin (Eds.), *The Handbook of Language Socialization* (pp. 587–609). Wiley-Blackwell.
- He, A. W. (2000). The Grammatical and Interactional Organization of Teacher's Directives: Implications for Socialization of Chinese American Children. *Linguistics and Education*, 11(2), 119–140. [https://doi.org/10.1016/s0898-5898\(00\)00025-5](https://doi.org/10.1016/s0898-5898(00)00025-5)

- He, A. W. (2001). The Language of Ambiguity. *Discourse Studies*, 3(1), 75–96.
<https://doi.org/10.1177/1461445601003001004>
- He, A. W. (2004). Identity construction in Chinese heritage language classes. *Pragmatics. Quarterly Publication of the International Pragmatics Association (IPrA)*, 14(2-3), 199–216. <https://doi.org/10.1075/prag.14.2-3.06he>
- He, A. W. (2006). Toward an identity theory of the development of Chinese as a heritage language. *Heritage Language Journal*, 4(1), 1–28.
- Heath, S. B. (1983). *Ways with words: Language, life, and work in communities and classrooms*. Cambridge University Press.
- Heller, M. (Ed.). (2007). *Bilingualism: A Social Approach*. Palgrave Macmillan.
- Heller, M., & Pavlenko, A. (2010). Bilingualism and Multilingualism. *Society and Language Use*, 7, 71–83. <https://doi.org/10.1075/hoph.7.05hel>
- Heller, M., Pietikäinen S., & Pujolar, J. (2018). *Critical Sociolinguistic Research Methods: Studying Language Issues that Matter*. New York Routledge.
- Hellwig, B., Defina, R., Kidd, E., Allen, S. E. M., Davidson, L., & Kelly, B. F. (2021). Child language documentation: The sketch acquisition project. In G. Haig, S. Schnell, & F. Seifart (Eds.), *Doing corpus-based typology with spoken language data: State of the art* (pp. 29–58). Language Documentation & Conservation Special Publication.
<https://scholarspace.manoa.hawaii.edu/server/api/core/bitstreams/bddf3117-803d-4dfb-b150-c64d8d47e265/content>
- Hélot, C. (2006). De la notion d'écart à la notion de continuum. Comment analyser le caractère inégalitaire du bilinguisme en contexte scolaire? In C. Hélot, E. Hoffmann, M.-L. Scheidhauer, & A. Young (Eds.), *Écarts de langue, écarts de culture. A l'école de l'Autre* (pp. 185–206). Peter Lang.
- Heyer, E. (2022). *La vie secrète des gènes*. Flammarion.

- Hindmarsh, J., & Pilnick, A. (2002). The Tacit Order of Teamwork: Collaboration and Embodied Conduct in Anesthesia. *The Sociological Quarterly*, 43(2), 139–164.
<https://doi.org/10.1111/j.1533-8525.2002.tb00044.x>
- Hirsh-Pasek, K., & Golinkoff, R. M. (1996). *Origins of Grammar: Evidence from Early Language Comprehension*. MIT Press.
- Hockett, C. F. (1958). *A Course in Modern Linguistics*. Macmillan.
- Hoff, E. (2009). *Language Development* (Fourth Edition). Wadsworth Cengage Learning.
<https://www.tadkiroatun.id/wp-content/uploads/2020/09/Wajib-04-Erika-Hoff-Language-Development-2008-Cengage-Learning.pdf>
- Holmes, J. (2000). *An Introduction to Sociolinguistics* (Second Edition). Longman.
- Holt, D. E. (2018). Optimality Theory and Spanish/Hispanic Linguistics. In K. L. Geeslin (Ed.), *The Cambridge Handbook of Spanish Linguistics* (pp. 31–51). Cambridge University Press. <https://doi.org/10.1017/9781316779194.003>
- Hornsby, M., & Mcleod, W. (2022). *Transmitting Minority Languages: Complementary Reversing Language shift Strategies*. Palgrave Macmillan.
- Howard, K. M. (2008). Language Socialization and Language Shift among School-aged Children. In P. A. Duff & N. H. Hornberger (Eds.), *Language Socialization*. Springer.
- Hoyle, S. M., & Adger, C. T. (1998). Introduction. In S. M. Hoyle & C. T. Adger (Eds.), *Kids Talk: Strategic Language Use in Later Childhood*. Oxford University Press.
- Huerta-Macías, A. (1981). Codeswitching: All in the family. In R. P. Durán (Ed.), *Latino Language and Communicative Behavior* (pp. 153–168). Ablex Publishing Corporation.
- Hymes, D. (1974). *Foundations in Sociolinguistics: An Ethnographic Approach*. University of Pennsylvania Press.

- Hymes, D. (2005). Models of the Interaction of Language and Social Life: Toward a Descriptive Theory. In S. F. Kiesling & C. Bratt Paulston (Eds.), *Intercultural Discourse and Communication: The Essential Readings* (pp. 4–16). Blackwell Publishing.
- Hymes, D. H. (1964). *Language in Culture and Society: A Reader in Linguistics and Anthropology*. Harper & Row.
- Hymes, D. H. (1972). On Communicative Competence. In J. B. Pride & J. Holmes (Eds.), *Sociolinguistics. Selected Readings*. (pp. 269–293). Penguin.
- Irizarri van Suchtelen, P. (2016). *Spanish as a heritage language in the Netherlands. A cognitive linguistic exploration* [Ph.D Dissertation].
https://www.lotpublications.nl/Documents/432_fulltext.pdf
- Isaacs, E. (1976). *Greek Children in Sydney*. Australian National University Press.
- Itard, J. (2012). *De l'éducation d'un homme sauvage ou des premiers développements physiques et moraux du jeune sauvage de l'Aveyron*. Tredition Classics. (Original work published 1801)
- Jakobson, M. (2003). *Essais de linguistique générale. I Les fondations du langage* (N. Ruwet, Trans.). Les Éditions De Minuit. (Original work published 1963)
- Jakobson, R., Levi-Strauss, C., Sebeok, T. A., & Voegelin, C. F. (1953). *Results of the Conference of Anthropologists and Linguists: Memoir 8*. Waverly Press.
- Jia, R., & Paradis, J. (2014). The use of referring expressions in narratives by Mandarin heritage language children and the role of language environment factors in predicting individual differences. *Bilingualism: Language and Cognition*, 18(4), 737–752.
<https://doi.org/10.1017/s1366728914000728>
- Johnston, J. R. (2001). An alternate MLU calculation: Magnitude and variability of effects. *Journal of Speech, Language, and Hearing Research : JSLHR*, 44(1), 156–164.

- Juan-Garau, M., & Pérez-Vidal, C. (2001). Mixing and pragmatic parental strategies in early bilingual acquisition. *Journal of Child Language*, 28(1), 59–86.
<https://doi.org/10.1017/s0305000900004591>
- Kagan, O., & Dillon, K. (2001). A New Perspective on Teaching Russian: Focus on the Heritage Learner. *The Slavic and East European Journal*, 45(3), 507–518.
<https://doi.org/10.2307/3086367>
- Kelleher, A. (2010). *What is a heritage language?* (pp. 1–3). Heritage Briefs.
<https://www.cal.org/heritage/pdfs/briefs/What-is-a-Heritage-Language.pdf>
- Kendon, A. (2004). *Gesture: Visible Action as Utterance*. Cambridge University Press.
- Keppler, A. F., & Luckmann, T. (1991). “Teaching”: Conversational transmission of knowledge. In I. Markova & K. Foppa (Eds.), *Asymmetries in Dialogue*. Barnes & Noble Books.
- Kibler, A. K., Palacios, N., & Simpson Baird, A. (2014). The Influence of Older Siblings on Language Use Among Second-Generation Latino Preschoolers. *TESOL Quarterly*, 48(1), 164–175. <https://doi.org/10.1002/tesq.151>
- Kiaer, J. (2023). *Multimodal Communication in Young Multilingual Children*. Channel View Publications.
- Kim, H.-S. H. (2005). *Processing strategies and transfer by heritage and non-heritage learners of Korean* [Ph.D. Dissertation].
- Kim, J.-H., & Montrul, S. (2004). Binding interpretations in Korean heritage speakers. In A. Brugos, L. Micciulla, & C. Smith (Eds.), *Proceedings of 28th Annual Boston University Conference on Language Development* (pp. 307–317). Cascadia Press.
- Kim, J.-H., Montrul, S., & Yoon, J. (2009). Binding Interpretations of Anaphors by Korean Heritage Speakers. *Language Acquisition*, 16(1), 3–35.

- King, K.A., Fogle, L. W. (2013). Family Language Policy and Bilingual Parenting. *Language Teaching*, 46(2), 172-194.
- Komo...what?! | It's Not a Word, It's a Feeling! | KOMOREBI®. (2022). Komorebi.
<https://thekomorebicollecion.com/pages/komo-what>
- Koontz-Garboden, A. (2004). Language contact and Spanish aspectual expression: A formal analysis. *Lingua*, 114(9-10), 1291–1330. <https://doi.org/10.1016/j.lingua.2003.07.008>
- Kramsch, C. J. (2002). Introduction: How can we tell the dancer from the dance. In C. J. Kramsch (Ed.), *Language acquisition and language socialization: Ecological perspectives*. Continuum.
- Kremer-Sadlik, T., Morgenstern, A., Peters, C., Beaupoil, P., Caët, S., Debras, C., & le Mené, M. (2015). Eating fruits and vegetables. An ethnographic study of American and French family dinners. *Appetite*, 89, 84–92.
<https://doi.org/10.1016/j.appet.2015.01.012>
- Kroll, J. F., & De Groot, A. M. B. (Eds.). (2005). *Handbook of Bilingualism: Psycholinguistic Approaches*. Oxford University Press.
- Kulick, D. (2012). *Language Shift and Cultural Reproduction: Socialization, Self, and Syncretism in a Papua New Guinea village*. Cambridge University Press. (Original work published 1992)
- Kupisch, T. (2013). A new term for a better distinction? A view from the higher end of the proficiency scale. *Theoretical Linguistics*, 39(3-4). <https://doi.org/10.1515/tl-2013-0012>
- Kupisch, T., Akpınar, D., & Stöhr, A. (2013). Gender assignment and gender agreement in adult bilinguals and second language learners of French. *Linguistic Approaches to Bilingualism*, 3, 15–179. <https://doi.org/https://dx.doi.org/10.1075/lab.3.2.02kup>

- Kupisch, T., Lein, T., Barton, D., Schröder, D., Stangen, I., & Stoehr, A. (2014). Acquisition outcomes across domains in adult simultaneous bilinguals with French as weaker and stronger language. *Journal of French Language Studies*, 24(3), 347–376.
<https://doi.org/doi:10.1017/S0959269513000197>
- Kupisch, T., & Rothman, J. (2016). Terminology matters! Why difference is not incompleteness and how early child bilinguals are heritage speakers. *International Journal of Bilingualism*, 22(5), 564–582. <https://doi.org/10.1177/1367006916654355>
- LA County Department of Regional Planning. (2019). Florence-Firestone Community Plan. In *LA County Department of Regional Planning*.
https://planning.lacounty.gov/assets/upl/project/ffcp_final_20190903.pdf
- Labov, W. (1972). *Sociolinguistic Patterns*. University Of Pennsylvania.
- Labov, W. (2001). *Principles of Linguistic Change* (Vol. 2). Blackwell.
- Labov, W. (2006). *The Social Stratification of English in New York City*. Cambridge University Press.
- Laleko, O. (2010). *The syntax-pragmatics interface in language loss: Covert restructuring of aspect in heritage Russian* [Ph.D. Dissertation: Unpublished].
- Lambert, B. (2008). *Patricia A. Duff, Case Study Research in Applied Linguistics* [Review of *Patricia A. Duff, Case Study Research in Applied Linguistics*]. 22–24.
<https://www.jbe-platform.com/docserver/fulltext/aral.31.2.09lam.pdf?expires=1665845026&id=id&acname=guest&checksum=7ECC12386788A6B2CB44DBFE1638D123>
- Lambert, W. E. (1984). Culture and Language as Factors in Learning and Education. In J. R. Mallea & J. C. Young (Eds.), *Cultural diversity and Canadian education: Issues and innovations* (pp. 233–264). Carleton University Press.

- Langacker, R. (2008). *Cognitive Grammar: A Basic Introduction*. Oxford University Press.
<https://doi.org/10.1093/acprof:oso/9780195331967.001.0001>
- Langacker, R. W. (1987). *Foundations of Cognitive Grammar* (Vol. 2). Stanford University Press.
- Lanza, E. (1988). Language strategies in the home: Linguistic input and infant bilingualism. In A. Holmen, E. Hansen, J. Gimberl, & J. N. Jørgensen (Eds.), *Bilingualism and the individual* (pp. 69–84). Multilingual Matters.
- Lanza, E. (1992). Can bilingual two-year-olds code-switch? *Journal of Child Language*, 19(3), 633–658. <https://doi.org/10.1017/s0305000900011600>
- Lanza, E. (1997). *Language Mixing in Infant Bilingualism: A Sociolinguistic Perspective*. Clarendon Press.
- Larsson, I., & Johannessen, J. B. (2015). Embedded word order in Heritage Scandinavian. In M. Hilpert, J. Östman, C. Mertzlufft, M. Rießler, & J. Duke (Eds.), *New Trends in Nordic and General Linguistics* (pp. 239–264). De Gruyter.
<https://doi.org/10.1515/9783110346978.239>
- Lave, J., & Wenger, E. (1991). *Situated learning: Legitimate peripheral participation*. Cambridge University Press. <https://doi.org/10.1017/cbo9780511815355>
- Leal Méndez, T., Rothman, J., & Slabakova, R. (2015). Discourse-sensitive clitic-doubled dislocations in heritage Spanish. *Lingua*, 155, 85–97.
<https://doi.org/10.1016/j.lingua.2014.01.002>
- Leal, T., Rothman, J., & Slabakova, R. (2014). A Rare Structure at the Syntax-Discourse Interface: Heritage and Spanish-Dominant Native Speakers Weigh In. *Language Acquisition*, 21(4), 411–429. <https://doi.org/10.1080/10489223.2014.892946>
- Lebrun, Y. (1982). L'aphasie chez les polyglottes. *La Linguistique*, 18(1), 129–144.

- Leeman, J., & King, K. A. (2015). Heritage Language Education Minority Language Speakers, Second Language Instruction, and Monolingual Schooling. In M. Bigelow & J. Enns-Kananen (Eds.), *The Routledge Handbook of Educational Linguistics* (pp. 210–223). Taylor and Francis.
- Léglise, I., & Alby, S. (2013). Les corpus plurilingues, entre linguistique de corpus et linguistique de contact: réflexions et méthodes issues du projet CLAPOTY. *Faits de Langues*, 41(1), 97–124. <https://doi.org/10.1163/19589514-041-01-900000007>
- Les langues d'héritage en France | Structures formelles du langage*. (n.d.). [Www.sfl.cnrs.fr](http://www.sfl.cnrs.fr). Retrieved July 12, 2022, from <https://www.umr7023.cnrs.fr/les-langues-dheritage-en-france>
- Leung, C., Harris, R., & Rampton, B. (1997). The Idealised Native Speaker, Reified Ethnicities, and Classroom Realities. *TESOL Quarterly*, 31(3), 543. <https://doi.org/10.2307/3587837>
- Li, D. (2008). Pragmatic Socialization. In P. A. Duff & N. H. Hornberger (Eds.), *Language Socialization* (pp. 71–83). Springer.
- Li, W. (1994). *Three generations, two languages, one family: Language choice and language shift in a Chinese community in Britain*. Multilingual Matters.
- Lieven, E. V. M. (1994). Crosslinguistic and crosscultural aspects of language addressed to children. In C. Gallaway & B. Richards (Eds.), *Input and Interaction in Language Acquisition* (pp. 56–73). <https://doi.org/10.1017/cbo9780511620690.005>
- Lima, A. (2021). *Mother/land*. Black Lawrence Press.
- Lindsey, K. L. (2013). *How HALA and the BLP can be used for an earlier detection of language attrition in the Chuvash community*. 3rd Annual International Conference of Language Documentation & Conservation, Manoa, Hawaii.

- Lipski, J. M. (1978). On the Use of the Indefinite Article. *Hispania*, 61(1), 105.
<https://doi.org/10.2307/339955>
- Lo, A. (2004). Evidentiality and morality in a Korean heritage language school. *Pragmatics. Quarterly Publication of the International Pragmatics Association (IPrA)*, 14(2-3), 235–256. <https://doi.org/10.1075/prag.14.2-3.08lo>
- López-Burton, N., & Minor, D. E. (2014). *On being a language teacher: A personal and practical guide to success*. Yale University Press.
- Louden, M. L. (2016). *Pennsylvania Dutch: The story of an American language*. Johns Hopkins University Press.
- Loza, S. (2017). Transgressing Standard Language Ideologies in the Spanish Heritage Language (SHL) Classroom. *Chiricú Journal: Latina/O Literatures, Arts, and Cultures*, 1(2), 56–77. <https://doi.org/10.2979/chiricu.1.2.06>
- Lynch, A. (2003). *Toward a Theory of Heritage Language Acquisition: Spanish in the United States*.
- Macias, R. F. (2001). Minority Languages in the United States, with a Focus on Spanish in California. In G. Extra & D. Gorter (Eds.), *The other languages of Europe: Demographic, sociolinguistic, and educational perspectives* (pp. 333–354). Multilingual Matters.
- Macnamara, J. (1967). The Bilingual's Linguistic Performance: A Psychological Overview. *Journal of Social Issues*, 23(2), 58–77. <https://doi.org/10.1111/j.1540-4560.1967.tb00576.x>
- MacWhinney, B. (2000). *The CHILDES Project: Tools for Analyzing Talk. 3rd Edition*. Lawrence Erlbaum Associates.

- Malvern, D., & Richards, B. (2002). Investigating accommodation in language proficiency interviews using a new measure of lexical diversity. *Language Testing*, 19(1), 85–104. <https://doi.org/10.1191/0265532202lt221oa>
- Mandelbaum, D. G. (Ed.). (1949). *Selected writings of Edward Sapir in language, culture, and personality*. University Of California Press.
- Mar-Molinero, C. (2010). The Spread of Global Spanish: From Cervantes to reggaetón. In N. Coupland (Ed.), *The Handbook of Language and Globalization* (pp. 162–181). <https://doi.org/10.1002/9781444324068.ch7>
- María Cioè-Peña. (2021). *(M)othering Labeled Children*. Multilingual Matters.
- May, S. (2001). *Language and minority rights: Ethnicity, nationalism, and the politics of language*. Pearson Education (Longman).
- McCabe, A., Bornstein, M. H., Guerra, A. W., Kuchirko, Y., Páez, M., Tamis-LeMonda, C. S., Cates, C. B., Hirsh-Pasek, K., Melzi, G., Song, L., Golinkoff, R., Hoff, E., & Mendelsohn, A. (2013). Multilingual Children: Beyond Myths and Toward Best Practices and commentaries. *Social Policy Report*, 27(4), 1–37. <https://doi.org/10.1002/j.2379-3988.2013.tb00077.x>
- Mead, G. H. (1934). *Mind, Self, and Society: From the standpoint of a social behaviorist* (C. W. Morris, Ed.). University Of Chicago Press.
- Meisel, J. M. (1989). Early differentiation of languages in bilingual children. In K. Hyldenstam & L. K. Obler (Eds.), *Bilingualism across the Lifespan: Aspects of acquisition, maturity, and loss* (pp. 13–40). Cambridge University Press. <https://doi.org/10.1017/cbo9780511611780.003>
- Meisel, J. M. (1990). Grammatical development in the simultaneous acquisition of two first languages. In J. M. Meisel (Ed.), *Two First Languages: Early Grammatical Development in Bilingual Children* (pp. 5–22). Foris.

<https://doi.org/10.1515/9783110846065.5> Two First

Languages <https://doi.org/10.1515/9783110846065.5>

- Meisel, J. M. (1999). The simultaneous acquisition of two first languages: Early differentiation and subsequent development of grammars. In J. Cenoz & F. Genesee (Eds.), *Trends in bilingual acquisition* (pp. 11–41). John Benjamins Publishing Company.
- Meisel, J. M. (2004). The Bilingual Child. In T. K. Bhatia & W. C. Ritchie (Eds.), *The Handbook of Bilingualism* (pp. 91–113). Blackwell Publishing Ltd.
- Meisel, J. M. (2013). Heritage language learners: Unprecedented opportunities for the study of grammars and their development? *Theoretical Linguistics*, 39(3-4), 225–236.
<https://doi.org/10.1515/tl-2013-0014>
- Miller, J. F. (1981). Eliciting procedures for language. In J. F. Miller (Ed.), *Assessing Language Production in Children: Experimental Procedures*. Edward Arnold.
- Miller, K. (2013). Acquisition of variable rules: /s/-lenition in the speech of Chilean Spanish-speaking children and their caregivers. *Language Variation and Change*, 25(3), 311–340. <https://doi.org/10.1017/s095439451300015x>
- Milroy, L. (1987). *Language and Social Networks*. Blackwell.
- Minami, S. (2013). *Voices within the Canadian mosaic: Japanese women and their children's heritage language socialization* [Master's Thesis].
- Montanari, S. (2010). *Language differentiation in early trilingual development: Evidence from a case study*. Saarbrücken: VDM Verlag.
- Montrul, S. (2002). Incomplete acquisition and attrition of Spanish tense/aspect distinctions in adult bilinguals. *Bilingualism: Language and Cognition*, 5(01), 39–68.
<https://doi.org/10.1017/s1366728902000135>

- Montrul, S. (2004). Subject and object expression in Spanish heritage speakers: A case of morphosyntactic convergence. *Bilingualism: Language and Cognition*, 7(2), 125–142. <https://doi.org/doi:10.1017/S1366728904001464>
- Montrul, S. (2005). Second language acquisition and first language loss in adult early bilinguals: exploring some differences and similarities. *Second Language Research*, 21(3), 199–249. <https://doi.org/10.1191/0267658305sr247oa>
- Montrul, S. (2011). First language retention and attrition in an adult Guatemalan adoptee. *Language, Interaction and Acquisition*, 2(2), 276–311. <https://doi.org/10.1075/lia.2.2.05mon>
- Montrul, S. A. (2016). *The Acquisition of Heritage Languages*. Cambridge University Press.
- Montrul, S., & Bowles, M. (2009). Back to basics: Incomplete knowledge of Differential Object Marking in Spanish heritage speakers. *Bilingualism: Language and Cognition*, 12(3), 363–383. <https://doi.org/doi:10.1017/S1366728909990071>
- Montrul, S., Davidson, J., De la Fuente, I., & Foote, R. (2014). Early language experience facilitates the processing of gender agreement in Spanish heritage speakers. *Bilingualism: Language and Cognition*, 17(1), 118–138. <https://doi.org/doi:10.1017/S1366728913000114>
- Montrul, S., de la Fuente, I., Davidson, J., & Foote, R. (2013). The role of experience in the acquisition and production of diminutives and gender in Spanish: Evidence from L2 learners and heritage speakers. *Second Language Research*, 29(1), 87–118.
- Montrul, S., Foote, R., & Perpiñán, S. (2008). Montrul, S.A., Foote, R., & Perpiñán, S. (2008). Knowledge of Wh-movement in Spanish L2Learners and Heritage Speakers. In J. Bruhn de Garavito & E. Valenzuela (Eds.), *Selected Proceedings of the 10th Hispanic Linguistics Symposium* (pp. 93–106). Cascadia Proceedings Project.

- Moore, L. C. (2011). Language Socialization and Repetition. In A. Duranti, E. Ochs, & B. B. Schieffelin (Eds.), *The Handbook of Language Socialization* (pp. 209–226). Wiley-Blackwell. <https://cpb-us-w2.wpmucdn.com/u.osu.edu/dist/8/3712/files/2009/03/Moore-2011-HLS-proof-rechecked-by-Leslie-April-6-peoxk5.pdf>
- Moreno-Fernández, F. (2017). Lexical Geography of U.S. Spanish. About Anglicism. *Observatorio / Observatorio Reports*. http://cervantesobservatorio.fas.harvard.edu/sites/default/files/informe_anglicismos_en_0.pdf
- Morgenstern, A. (2009). *L'enfant dans la langue*. Presses Sorbonne Nouvelle.
- Morgenstern, A. (2017). Children's Language Blossoms: From Sensations to Words. *Cycnos*, 33(1), 21–38.
- Morgenstern, A. (2020). The Other's Voice in the Co-Construction of Self-Reference in the Dialogic Child. *Bakhtiniana: Revista de Estudos Do Discurso*, 16, 63–87. <https://doi.org/10.1590/2176-457347133>
- Morgenstern, A. (2022). "Politeness has a heart": From Mantras to Stance-Taking in French Children's Socialization to Politeness. In Duranti (Ed.), *Rethinking Politeness with Henri Bergson* (pp. 65–82). Oxford University Press.
- Morgenstern, A., & Beaupoil, P. (2015). Multimodal approaches to language acquisition through the lens of negation. *Vestnik*, 6(717), 435–451.
- Morgenstern, A., Caët, S., Debras, C., Beaupoil-Hourdel, P., & Le Mené, M. (2021). Children's socialization to multi-party interactive practices: Who talks to whom about what in family dinners. In L. Caronia (Ed.), *Language and Social Interaction at Home and School* (pp. 45–86). John Benjamins Publishing Company.

- Morgenstern, A., & Goldin-Meadow, S. (Eds.). (2022). *Gesture in language: Development across the lifespan*. De Gruyter Mouton. <https://doi.org/10.1037/0000269-000>
- Morgenstern, A., Leroy-Collombel, M., & Caët, S. (2013). Self- and other-repairs in child–adult interaction at the intersection of pragmatic abilities and language acquisition. *Journal of Pragmatics*, *56*, 151–167. <https://doi.org/10.1016/j.pragma.2012.06.017>
- Morgenstern, A., & Parrisé, C. (2012). The Paris Corpus. *Journal of French Language Studies*, *22*(1), 7–12. <https://doi.org/10.1017/s095926951100055x>
- Morita, N. (2000). Discourse Socialization through Oral Classroom Activities in a TESL Graduate Program. *TESOL Quarterly*, *34*(2), 279. <https://doi.org/10.2307/3587953>
- Morita, N. (2004). Negotiating Participation and Identity in Second Language Academic Communities. *TESOL Quarterly*, *38*(4), 573. <https://doi.org/10.2307/3588281>
- Moro, F. R. (2016). *Dynamics of Ambon Malay. Comparing Ambon and the Netherlands*. LOT, Netherlands Graduate School.
- Mueller-Gathercole, V. C., & Hoff, E. (2009). Input and the Acquisition of Language: Three Questions. In E. Hoff & M. Shatz (Eds.), *Blackwell Handbook of Language Development* (pp. 107–127). Wiley-Blackwell.
- Müller, L.-M., Howard, K., Wilson, E., Gibson, J., & Katsos, N. (2020). Bilingualism in the family and child well-being: A scoping review. *International Journal of Bilingualism*, *24*(5-6), 10–491070. <https://doi.org/10.1177/1367006920920939>
- Myers-Scotton, C. (2006). *Multiple Voices: An Introduction to Bilingualism*. Blackwell, [I.E.
- Nagy, N. (2015). A sociolinguistic view of null subjects and VOT in Toronto heritage languages. *Lingua*, *164*, 309–327. <https://doi.org/10.1016/j.lingua.2014.04.012>
- Nagy, N., Aghdasi, N., Denis, D., & Motut, A. (2011). Null Subjects in Heritage Languages: Contact Effects in a Cross-linguistic Context. *University of Pennsylvania Working*

Papers in Linguistics, 17(2), 135–144.

<https://repository.upenn.edu/pwpl/vol17/iss2/16>

Nettle, D., & Romaine, S. (2000). *Vanishing Voices: The Extinction of the World's Languages*. Oxford University Press.

Nicoladis, E. (1998). First clues to the existence of two input languages: Pragmatic and lexical differentiation in a bilingual child. *Bilingualism: Language and Cognition*, 1(2), 105–116. <https://doi.org/10.1017/s1366728998000236>

Nicoladis, E., & Smithson, L. (2022). Gesture in bilingual language acquisition. In A. Morgenstern & S. Goldin-Meadow (Eds.), *Gesture in language: Development across the lifespan*. (pp. 297–315). De Gruyter Mouton. <https://doi.org/10.1037/0000269-012>

Nicolăi, R. (2007). *La vision des faits: de l'a posteriori à l'a priori dans la saisie des langues*. L'harmattan.

Nieto, S., & Bode, P. (2012). Understanding the sociopolitical context of schooling. In *Affirming Diversity: The sociopolitical context of multicultural education* (pp. 4–39). Pearson.

Ninio, A., & Bruner, J. (1978). The achievement and antecedents of labelling. *Journal of Child Language*, 5(1), 1–15. <https://doi.org/10.1017/s0305000900001896>

Niño-Murcia, M., & Rothman, J. (2008). Spanish-contact bilingualism and identity. *Studies in Bilingualism*, 9(1), 11–32. <https://doi.org/10.1075/sibil.37.03nin>

Norton, B. (2000). *Identity and language learning: Gender, ethnicity, and educational change*. Longman.
https://www.academia.edu/14417937/Identity_and_language_learning_Gender_ethnicity_and_educational_change

O'Grady, W. (2008). The emergentist program. *Lingua*, 118(4), 447–464.

<https://doi.org/10.1016/j.lingua.2006.12.001>

- O'Grady, W. (2013). The illusion of language acquisition. *Linguistic Approaches to Bilingualism*, 3(3), 253–285. <https://doi.org/10.1075/lab.3.3.01ogr>
- O'Grady, W. D. (2005). *Syntactic carpentry: An emergentist approach to syntax*. Lawrence Erlbaum Associates Publishers.
- O'Grady, W., Kwak, H.-Y., Lee, O.-S., & Lee, M. (2011). An Emergentist Perspective on Heritage Language Acquisition. *Studies in Second Language Acquisition*, 33(2), 223–245.
- O'Grady, W., Lee, M., & Choo, M. (2001). The acquisition of relative clauses by heritage and non-heritage learners of Korean as a second language: A comparative study. *Journal of Korean Language Education*, 12, 283–294.
- O'Grady, W., Lee, O.-S., & Lee, J.-H. (2011). Practical and Theoretical Issues in the Study of Heritage Language Acquisition. *Heritage Language Journal*, 8(3), 315–332. <https://doi.org/10.46538/hlj.8.3.2>
- Ochs, E. (1979). Transcription as Theory. In E. Ochs & B. B. Schieffelin (Eds.), *Developmental Pragmatics* (pp. 43–72). Academic Press. http://www.justinecassell.com/discourse/pdfs/ochs_transcription_as_theory.pdf
- Ochs, E. (1979). What Child Language Can Contribute to Pragmatics. In E. Ochs & B. B. Schieffelin (Eds.), *Developmental Pragmatics* (pp. 1–17). Academic Press. http://www.sscnet.ucla.edu/anthro/faculty/ochs/articles/What_Child_Language_Can_Contribute_to_Pragmatics.pdf
- Ochs, E. (1985). Variation and Error: A Sociolinguistic Approach to Language Acquisition in Samoa. In D. I. Slobin (Ed.), *The crosslinguistic study of language acquisition* (pp. 783–838). Lawrence Erlbaum Associates. http://www.sscnet.ucla.edu/anthro/faculty/ochs/articles/Variation_and_Error.pdf

- Ochs, E. (1988). *Culture and Language Development: Language Acquisition and Language Socialization in a Samoan Village*. Cambridge University Press.
- Ochs, E. (1990). Indexicality and socialization. In J. W. Stigler, R. A. Schweder, & G. Herdt (Eds.), *Cultural Psychology: Essays on Comparative Human Development* (pp. 297–308). Cambridge University Press.
- Ochs, E. (1992a). Acquisition of Competence. In W. Bright (Ed.), *International Encyclopedia of Linguistics* (pp. 358–361). Oxford University Press.
http://www.sscnet.ucla.edu/anthro/faculty/ochs/articles/Ochs_1990_Acquisition_of_Compentence.pdf
- Ochs, E. (1992b). Indexing Gender. In A. Duranti & C. Goodwin (Eds.), *Rethinking Context: Language as an Interactive Phenomenon* (pp. 335–358.). Cambridge University Press.
http://www.sscnet.ucla.edu/anthro/faculty/ochs/articles/Ochs_1993_Indexing_Gender.pdf
- Ochs, E. (2002). Becoming a Speaker of Culture. In C. Kramsch (Ed.), *Language Acquisition and Language Socialization: Ecological Perspectives* (pp. 99–120). Continuum.
http://www.sscnet.ucla.edu/anthro/faculty/ochs/articles/Ochs_2002_Becoming.pdf
- Ochs, E. (forthcoming). *Les enfants jouent-ils? Entretiens avec Elinor Ochs* (A. Morgenstern, Interviewer) [Interview]. In *Cahiers de littérature orale*.
- Ochs, E., & Kremer-Sadlik, T. (2013). *Fast-Forward Family*. University of California Press.
- Ochs, E., Pontecorvo, C., & Fasulo, A. (1996). Socializing Taste. *ETHNOS*, 61(1-2), 7–46.
http://www.sscnet.ucla.edu/anthro/faculty/ochs/articles/Ochs_Pontecorvo_Fasulo_1996_Socializing_Taste.pdf
- Ochs, E., & Schieffelin, B. (2006). The impact of language socialization on grammatical development. In C. Jourdan & K. Tuite (Eds.), *Language, Culture, and Society: Key*

Topics in Linguistic Anthropology (Studies in the Social and Cultural Foundations of Language) (pp. 168–189). Cambridge University Press.

<https://doi.org/10.1017/cbo9780511616792.009>

Ochs, E., & Schieffelin, B. (2008). Language Socialization: An Historical Overview. In P. A. Duff & N. H. Hornberger (Eds.), *Language Socialization* (pp. 3–15). Springer.

Ochs, E., & Schieffelin, B. B. (1982). *Language Acquisition and Socialization: Three Developmental Stories and their Implications*. Southwest Educational Development Laboratory.

http://www.sscnet.ucla.edu/anthro/faculty/ochs/articles/Ochs_Schieffelin_1984_Language_Acquisition_and_Socialization.pdf

Ochs, E., & Schieffelin, B. B. (1984). Language Acquisition and Socialization: Three developmental stories. In R. A. Shweder & R. A. LeVine (Eds.), *Culture Theory: Essays on Mind, Self, and Emotion* (pp. 276–320). Cambridge University Press.

Ochs, E., & Schieffelin, B. B. (2011). The Theory of Language Socialization. In A. Duranti, E. Ochs, & B. B. Schieffelin (Eds.), *The Handbook of Language Socialization* (pp. 1–22). Wiley-Blackwell.

Ochs, E., & Taylor, C. (1992). Family narrative as political activity. *Discourse & Society*, 3(3), 301–340.

https://www.sscnet.ucla.edu/anthro/faculty/ochs/articles/Ochs_Taylor_1992_Family_Narrative.pdf

Oksaar, E. (1989). Psycholinguistic aspects of bilingualism. *Journal of Multilingual and Multicultural Development*, 10(1), 33–46. [https://doi.org/DOI:](https://doi.org/DOI:10.1080/01434632.1989.9994361)

10.1080/01434632.1989.9994361

- Ortega, L. (2014). Ways Forward for a Bi/Multilingual Turn in SLA. In S. May (Ed.), *The Multilingual Turn Implications for SLA, TESOL, and Bilingual Education* (pp. 32–53). Routledge.
- Ortega, L. (2019a). The Study of Heritage Language Development From a Bilingualism and Social Justice Perspective. *Language Learning*, 70, 15–53.
<https://doi.org/https://doi.org/10.1111/lang.12347>
- Ortega, L. (2019b). SLA and the Study of Equitable Multilingualism. *The Modern Language Journal*, 103, 23–38. <https://doi.org/10.1111/modl.12525>
- Ortman, J. M., & Stevens, G. (2008, April 18). *Shift Happens, But When? Inter- and Intra-Generational Language Shift among Hispanic Americans* [Poster Session 6 to Population Association of America].
- Oswalt, W. H. (1986). *Life Cycles and Lifeways: An Introduction to Cultural Anthropology*. Mayfield Publishing Company.
- Otheguy, R., & Zentella, A. C. (2011). *Spanish in New York: Language Contact, Dialectal Leveling, and Structural Continuity*. Oxford University Press.
- Otheguy, R., Zentella, A. C., & Livert, David. (2008). Language and Dialect Contact in Spanish in New York: Toward the Formation of a Speech Community. *Language*, 83(4), 770–802. <https://doi.org/10.1353/lan.2008.0019>
- Ottenheimer, H. (2005). *The Anthropology of Language: An Introduction to Linguistic Anthropology*. Wadsworth.
- Padilla, A. M., & Lindholm, K. J. (1984). Hispanic behavioral science research: Recommendations for future research. *Hispanic Journal of Behavioral Sciences*, 6(1), 13–32. <https://doi.org/https://doi.org/10.1177/07399863840061003>

- Pahl, K. (2008). Language Socialization and Multimodality in Multilingual Urban Homes. In P. A. Duff & N. H. Hornberger (Eds.), *Language Socialization* (pp. 115–126). Springer.
- Paradis, J. (2010). Bilingual Children's Acquisition of English Verb Morphology: Effects of Language Exposure, Structure Complexity, and Task Type. *Language Learning*, 60(3), 651–680. <https://doi.org/10.1111/j.1467-9922.2010.00567.x>
- Paradis, J., & Genesee, F. (1996). Syntactic Acquisition in Bilingual Children. *Studies in Second Language Acquisition*, 18(1), 1–25. <https://doi.org/10.1017/s0272263100014662>
- Parisse, C., & Morgenstern, A. (2010). Transcrire et analyser les corpus d'interactions adulte-enfant. In E. Veneziano, A. Salazar Orvig, & J. Bernicot (Eds.), *Acquisition du langage et interaction* (pp. 201–222). L'Harmattan.
- Park, E. (2008). Intergenerational transmission of cultural values in Korean American families: An analysis of the verb suffix -ta. *Heritage Language Journal*, 6(2), 173–205.
- Parodi, C. (2003). Contacto de dialectos del español en Los Ángeles. In G. Perissinotto (Ed.), *Ensayos de lengua y pedagogía* (pp. 23–38). University of California, Linguistic Minority Research Institute.
- Parodi, C. (2008). Stigmatized Spanish inside the classroom and out: A model of language teaching to heritage speakers. In D. Brinton, O. Kagan, & S. Bauckus (Eds.), *Heritage language education: A new field emerging* (pp. 199–214). Routledge.
- Parodi, C. (2011). El otro México: español chicano, koineización y diglosia en Los Ángeles, California. In R. Barriga Villanueva & P. Martín Butragueño (Eds.), *Realismo en el análisis de corpus orales (Primer coloquio de cambio y variación lingüística)* (pp. 217–243). El Colegio de México.

- Parsons, T. (1951). *The Social System*. Free Press.
- Pascual y Cabo, D. P. Y., & Rothman, J. (2012). The (Il)Logical Problem of Heritage Speaker Bilingualism and Incomplete Acquisition. *Applied Linguistics*, 33(4), 450–455. <https://doi.org/10.1093/applin/ams037>
- Paugh, A. L. (2005). Learning about work at dinnertime: Language socialization in dual-earner American families. *Discourse & Society*, 16(1), 55–78. <https://doi.org/10.1177/0957926505048230>
- Pauwels, A. (1995). Linguistic practices and language maintenance among bilingual women and men in Australia. *Nordlyd*, 21–50.
- Pauwels, A. (1997). The role of gender in immigrant language maintenance in Australia. In W. Wölck & A. De Houwer (Eds.), *Recent studies in contact linguistics* (pp. 276–287). Verlag.
- Pauwels, A. (2011). Risking or boosting masculinity? Men’s language choices in multilingual settings. *Applied Linguistics Review*, 2, 147–168. <https://doi.org/10.1515/9783110239331.147>
- Pauwels, A. (2016). *Language Maintenance and Shift*. Cambridge University Press.
- Pavlenko, A. (2001). Bilingualism, gender, and ideology. *International Journal of Bilingualism*, 5(2), 117–151. <https://doi.org/10.1177/13670069010050020101>
- Pearson, B. Z., Fernandez, S. C., Lewedeg, V., & Oller, D. Kimbrough. (1997). The relation of input factors to lexical learning by bilingual infants. *Applied Psycholinguistics*, 18(1), 41–58. <https://doi.org/10.1017/s0142716400009863>
- Philippe Lejeune. (1975). *Le pacte autobiographique*. Seuil.
- Pienemann, M. (1998). Language Processing and Second Language Development. In *Studies in Bilingualism*. <https://doi.org/10.1075/sibil.15>

- Pienemann, M., & Keßler J.-U. (2011). *Studying Processability Theory: An Introductory Textbook*. John Benjamins Publishing Company.
- Pieter Muysken. (2000). *Bilingual Speech: A Typology of Code-Mixing*. Cambridge University Press.
- Pinker, S. (1994). *The Language Instinct*. William Morrow & Co.
- Pires, A., & Rothman, J. (2009). Disentangling sources of incomplete acquisition: An explanation for competence divergence across heritage grammars. *International Journal of Bilingualism*, 13(2), 211–238. <https://doi.org/10.1177/1367006909339806>
- Polinsky, M. (in press). Experimental Syntax and Linguistic Fieldwork. In *Oxford Handbook of Experimental Syntax*. Oxford University Press.
- Polinsky, M. (2008). Gender under Incomplete Acquisition: Heritage Speakers' Knowledge of Noun Categorization. *Heritage Language Journal*, 6(1), 40–71.
- Polinsky, M. (1995). American Russian: Language Loss Meets Language Acquisition. In *Formal Approaches to Slavic Linguistics. Cornell Meeting* (pp. 370–406). Slavic Publications.
- Polinsky, M. (2000). A composite linguistic profile of a speaker of Russian in the U.S. In O. Kagan & B. Rifkin (Eds.), *The Learning and Teaching of Slavic Languages and Cultures* (pp. 437–465). Slavica.
- Polinsky, M. (2006). Incomplete Acquisition: American Russian. *Journal of Slavic Linguistics*, 14(2), 191–262.
- Polinsky, M. (2008). Without Aspect. In G. Corbett & M. Noonan (Eds.), *Case and Grammatical Relations: Studies in honor of Bernard Comrie* (pp. 263–282). John Benjamins Publishing Company.
- Polinsky, M. (2018). *Heritage Languages and Their Speakers*. Cambridge University Press.

- Polinsky, M., & Kagan, O. (2007). Heritage Languages: In the “Wild” and in the Classroom. *Language and Linguistics Compass*, 1(5), 368–395. <https://doi.org/10.1111/j.1749-818x.2007.00022.x>
- Polinsky, M., & Scontras, G. (2019). Understanding heritage languages. *Bilingualism: Language and Cognition*, 23(1), 1–17. <https://doi.org/10.1017/s1366728919000245>
- Poll, G. H. (2011). Increasing the Odds: Applying Emergentist Theory in Language Intervention. *Language, Speech, and Hearing Services in Schools*, 42(4), 580–591. <https://www.ncbi.nlm.nih.gov/pmc/articles/PMC3164388/#R8>
- Pontecorvo, C., Fasulo, A., & Sterponi, L. (2001). Mutual Apprentices: The Making of Parenthood and Childhood in Family Dinner Conversations. *Human Development*, 44(6), 340–361. <https://www.jstor.org/stable/26763645>
- Poplack, S. (1980). Sometimes I’ll start a sentence in Spanish Y TERMINO EN ESPAÑOL: toward a typology of code-switching¹. *Linguistics*, 18(7-8). <https://doi.org/10.1515/ling.1980.18.7-8.581>
- Pratt, M. L. (1991). Arts of the Contact Zone. *Profession*, 33–40. <https://doi.org/http://www.jstor.org/stable/25595469>
- Pratt, M. L. (1996). Apocalypse in the Andes: Contact Zones and the Struggle for Interpretative Power. In *Encuentros, Vol. 15*. Inter-American Development Bank.
- Prince, A., & Smolensky, P. (Eds.). (2004). *Optimality Theory*. Blackwell Publishing Ltd. <https://doi.org/10.1002/9780470759400> (Original work published 1993)
- Przyblyski, J. M. (2018). *A paseo through time in Florence-Firestone/Un paseo a través del tiempo en Florence-Firestone*. California Institute Of The Arts.
- Quay, S. (1995). The bilingual lexicon: implications for studies of language choice. *Journal of Child Language*, 22(2), 369–387. <https://doi.org/10.1017/s0305000900009831>

- Quay, S. (2008). Dinner conversations with a trilingual two-year-old: Language socialization in a multilingual context. *First Language*, 28(1), 5–33.
<https://doi.org/10.1177/0142723707083557>
- Radford, A. (1996). Towards a Structure-Building Model of Acquisition. *Generative Perspectives on Language Acquisition*, 43. <https://doi.org/10.1075/lald.14.06rad>
- Rampton, B. (1997). Retuning in applied linguistics. *International Journal of Applied Linguistics*, 7(1), 3–25. <https://doi.org/10.1111/j.1473-4192.1997.tb00101.x>
- Redlinger, W. E., & Park, T.-Z. (1980). Language mixing in young bilinguals. *Journal of Child Language*, 7(2), 337–352. <https://doi.org/10.1017/s030500090000266x>
- Rescorla, L., & Roberts, J. (2002). Nominal versus verbal morpheme use in late talkers at ages 3 and 4. *Journal of Speech, Language, and Hearing Research: JSLHR*, 45(6), 1219–1231. [https://doi.org/https://doi.org/10.1044/1092-4388\(2002/098\)](https://doi.org/https://doi.org/10.1044/1092-4388(2002/098))
- Rice, M. L., Smolik, F., Perpich, D., Thompson, T., Rytting, N., & Blossom, M. (2010). Mean Length of Utterance Levels in 6-Month Intervals for Children 3 to 9 Years With and Without Language Impairments. *Journal of Speech, Language, and Hearing Research*, 53(2), 333–349. [https://doi.org/10.1044/1092-4388\(2009/08-0183\)](https://doi.org/10.1044/1092-4388(2009/08-0183))
- Ricento, T. (2009). *An Introduction to Language Policy: Theory and Method*. Wiley-Blackwell. (Original work published 2006)
- Richards, B. (1987). Type/Token Ratios: what do they really tell us? *Journal of Child Language*, 14(2), 201–209.
<https://doi.org/https://hfroehlich.files.wordpress.com/2013/05/s0305000900012885a.pdf>
- Roberts, J. (1997). Acquisition of variable rules: A study of (-t, d) deletion in preschool children. *Journal of Child Language*, 24(2), 351–372.
<https://doi.org/10.1017/s0305000997003073>

- Romaine, S. (1989). *Bilingualism*. Basil Blackwell.
- Romaine, S. (1995). *Bilingualism* (Second Edition). Wiley-Blackwell.
- Romanowski, P. (2021). A Deliberate Language Policy or a Perceived Lack of Agency: Heritage Language Maintenance in the Polish Community in Melbourne. *International Journal of Bilingualism*, 25(5), 1214–1234.
<https://doi.org/10.1177/13670069211000850>
- Romo, R. (1983). *East Los Angeles history of a Barrio*. University of Texas Press.
- Ronquest, R., & Rao, R. (2018). Heritage Spanish Phonetics and Phonology. In K. Potowski (Ed.), *The Routledge Handbook of Spanish as a Heritage Language*. Routledge.
- Rossi-Landi, F. (1970). Linguistic Alienation Problems. In *Linguaggi nella società e nella tecnica* (pp. 513–543). Edizioni di Comunità.
- Rothman, J. (2007). Heritage speaker competence differences, language change, and input type: Inflected infinitives in Heritage Brazilian Portuguese. *International Journal of Bilingualism*, 11(4), 359–389. <https://doi.org/10.1177/13670069070110040201>
- Rothman, J. (2009). Understanding the nature and outcomes of early bilingualism: Romance languages as heritage languages. *International Journal of Bilingualism*, 13(2), 155–163. <https://doi.org/10.1177/1367006909339814>
- Sankoff, D. (1998). The production of code-mixed discourse. *COLING 1998 Volume 1: The 17th International Conference on Computational Linguistics*.
<https://aclanthology.org/C98-1002.pdf>
- Santa Ana, O. (2004). *Tongue-tied: The Lives of Multilingual Children in Public Education*. Rowman & Littlefield Publishers.
- Sapir, E. (1949a). Cultural Anthropology and Psychiatry. In D. G. Mandelbaum (Ed.), *Selected Writings of Edward Sapir in Language, Culture, and Personality*. University of California Press.

- Saunders, G. (1988). *Bilingual Children: From Birth to Teens*. Multilingual Matters.
- Saville-Troike, M. (1987). Dilingual discourse: The negotiation of meaning without a common code. *Linguistics*, 25(1), 81–106. <https://doi.org/10.1515/ling.1987.25.1.81>
- Schieffelin, B. B. (1985). The acquisition of Kaluli. In D. I. Slobin (Ed.), *The crosslinguistic study of language acquisition Vol. 1. The data; Vol. 2. Theoretical issues* (pp. 525–593). Lawrence Erlbaum Associates.
- Schieffelin, B. B., & Ochs, E. (1979). *Developmental Pragmatics*. Academic Press.
- Schieffelin, B. B., & Ochs, E. (Eds.). (1986a). *Language Socialization Across Cultures*. Cambridge University Press.
- Schieffelin, B. B., & Ochs, E. (1986b). Language Socialization. *Annual Review of Anthropology*, 15(1), 163–191. <https://doi.org/10.1146/annurev.an.15.100186.001115>
- Schieffelin, B. B. (1990). *The Give and Take of Everyday Life: Language Socialization of Kaluli children*. Cambridge University Press.
- Schmid, M. S. (2011). *Language and Attrition*. Cambridge University Press.
- Schwartz, M. (2008). Exploring the Relationship between Family Language Policy and Heritage Language Knowledge among Second Generation Russian-Jewish Immigrants in Israel. *Journal of Multilingual and Multicultural Development*, 29(5), 400-418.
- Sekali, M., & Trévisé, A. (2012). Mapping filters and parameters of meaning: issues and tools for interface analyses of meaning construction. In M. Sekali & A. Trévisé (Eds.), *Mapping Parameters of Meaning* (pp. 1–13). Cambridge Scholars Publishing.
- Seliger, H. W., & Vago, R. M. (Eds.). (1991). *First Language Attrition*. Cambridge University Press. <https://doi.org/10.1017/cbo9780511620720>

- Sevinç, Y., & Backus, A. (2017). Anxiety, language use and linguistic competence in an immigrant context: A vicious circle? *International Journal of Bilingual Education and Bilingualism*, 22(6), 706–724. <https://doi.org/10.1080/13670050.2017.1306021>
- Sherkina-Lieber, M., Perez-Leroux, A. T., & Johns, A. (2011). Grammar without speech production: The case of Labrador Inuktitut heritage receptive bilinguals. *Bilingualism: Language and Cognition*, 14(3), 301–317. <https://doi.org/10.1017/s1366728910000210>
- Shuy, R. (1977). Sociolinguistics. In R. Shuy (Ed.), *Linguistic theory: What can it say about reading*. International Reading Association.
- Sidnell, J. (1977). Organizing social and spatial location: Elicitation in Indo-Guyanese village talk. *Journal of Linguistic Anthropology*, 7(2), 143–165.
- Silva-Corvalán, C. (1994). *Language Contact and Change: Spanish in Los Angeles*. Oxford University Press, USA.
- Silva-Corvalán, C. (2003). Linguistic consequences of reduced input in bilingual first language acquisition. In S. Montrul & F. Ordóñez (Eds.), *Linguistic Theory and Language Development in Hispanic Languages* (pp. 375–397). Cascadilla Press.
- Silva-Corvalán, C. (2006). Aspectos del español en Los Ángeles. In A. M. Cestero Mancera, I. Molina Martos, & F. Paredes García (Eds.), *Estudios sociolingüísticos del español de España y América* (pp. 187–194). Arco Libros.
- Silva-Corvalán, C. (2014). The acquisition of Spanish by third generation children. *Informes Del Observatorio / Observatorio Reports*, 1–27. <https://doi.org/10.15427/or005-11/2014en>
- Silva-Corvalán, C., & Sánchez-Walker, N. (2007). Subjects in early dual language development. In K. Potowski & R. Cameron (Eds.), *Spanish in Contact: Policy*,

- Social and Linguistic Inquiries* (Vol. 22, pp. 3–22). John Benjamins Publishing Company. <https://doi.org/10.1075/impact.22.03sil>
- Silva-Corvalán, C. (2014). *Bilingual Language Acquisition: Spanish and English in the First Six Years*. Cambridge University Press.
- Silvia Dal Negro. (2004). *The decay of a language: The case of a German dialect in the Italian Alps*. Peter Lang.
- Silvina Montrul. (2008). *Incomplete Acquisition in Bilingualism: Re-examining the Age Factor*. John Benjamins Publishing Company.
- Skerry, P. (1993). *Mexican Americans: The ambivalent minority*. Maxwell Macmillan.
- Slobin, D. I. (1969). *Universals of Grammatical Development in Children* (pp. 1–18). University of California, Berkeley.
https://www.academia.edu/48029812/Universals_of_Grammatical_Development_in_Children
- Smith-Christmas, C. (2014). Being socialised into language shift: the impact of extended family members on family language policy. *Journal of Multilingual and Multicultural Development*, 35(5), 511–526. <https://doi.org/10.1080/01434632.2014.882930>
- Smith, J., Durham, M., & Fortune, L. (2007). “Mam, my trousers is fa’in doon!”: Community, caregiver, and child in the acquisition of variation in a Scottish dialect. *Language Variation and Change*, 19(01).
<https://doi.org/10.1017/s0954394507070044>
- Snow, C. E. (1972). Mothers’ Speech to Children Learning Language. *Child Development*, 43(2), 549. <https://doi.org/10.2307/1127555>
- Snow, C. E. (1995). Issues in the Study of Input: Finetuning, Universality, Individual and Developmental Differences, and Necessary Causes. In P. Fletcher & B. MacWhinney (Eds.), *The Handbook of Child Language*. Blackwell.

- Snow, C. E., Perlmann, R. Y., Gleason, J. B., & Hooshyar, N. (1990). Developmental perspectives on politeness: Sources of children's knowledge. *Journal of Pragmatics*, 14(2), 289–305. [https://doi.org/10.1016/0378-2166\(90\)90084-q](https://doi.org/10.1016/0378-2166(90)90084-q)
- Søndergaard, B. (1981). Decline and fall of an individual bilingualism. *Journal of Multilingual and Multicultural Development*, 2(4), 297–302. <https://doi.org/10.1080/01434632.1981.9994064>
- Song, M., O'Grady, W., Cho, S., & Lee, M. (1997). The Learning and Teaching of Korean in Community Schools. *The Korean Language in America*, 2, 111–127.
- Sorace, A. (2000). Differential effects of attrition in the L1 syntax of near-native L2 speakers. *Proceedings of the 24th Annual Boston University Conference on Language Development*, 1-2, 719–725.
- Sorace, A. (2004). Native language attrition and developmental instability at the syntax-discourse interface: Data, interpretations, and methods. *Bilingualism: Language and Cognition*, 7(2), 143–145. <https://doi.org/10.1017/s1366728904001543>
- Spolsky, B. (2010). Ferguson and Fishman: Sociolinguistics and the sociology of language. In R. Wodak, B. Johnstone, & P. Kerswill (Eds.), *The SAGE handbook of sociolinguistics* (pp. 11–24). Sage.
- Stake, R. E. (2005). Qualitative Case Studies. In N. K. Denzin & Y. S. Lincoln (Eds.), *The Sage handbook of qualitative research* (pp. 443–466). Sage Publications.
- Sterponi, L. A. (2003). Account episodes in family discourse: the making of morality in everyday interaction. *Discourse Studies*, 5(1), 79–100. <https://doi.org/10.1177/14614456030050010401>
- Stevens, G. (1985). Nativity, Intermarriage, and Mother-Tongue Shift. *American Sociological Review*, 50(1), 74. <https://doi.org/10.2307/2095341>

- Stivers, T. (2015). Coding Social Interaction: A Heretical Approach in Conversation Analysis? *Research on Language and Social Interaction*, 48(1), 1–19.
<https://doi.org/10.1080/08351813.2015.993837>
- Tabouret-Keller, A. (1969). La motivation des emprunts: Un exemple pris sur le vif de l'apparition d'un sabir. *La Linguistique*, 5(1), 25–60.
- Taeschner, T. (1983). *The Sun is Feminine: A study of bilingual acquisition in bilingual children*. Springer.
- Tannenbaum, M., & Berkovich, M. (2005). Family relations and language maintenance: Implications for language educational policies. *Language Policy*, 4(3), 287–309.
<https://doi.org/doi.org/10.1007/s10993-005-7557-7>
- Telles, E., & Sue, C. A. (2019). *Durable Ethnicity: Mexican Americans and the Ethnic Core*. Oxford University Press. <https://doi.org/10.1093/oso/9780190221492.001.0001>
- Templin, M. C. (1957). *Certain Language Skills in Children*. University of Minnesota Press.
- Thordardottir, E. (2013, October). *The effect of amount of input on simultaneous and sequential bilingual acquisition* [Plenary talk]. International Conference of Multilingualism.
- Tomasello, M. (1995a). Joint attention as social cognition. In C. Moore & P. J. Dunham (Eds.), *Joint attention: Its origins and role in development* (pp. 103–130). Lawrence Erlbaum Associates, Inc.
- Tomasello, M. (1995b). Language is Not an Instinct [Review of *The Language Instinct*, by S. Pinker]. *Cognitive Development*, 10, 131–156.
- Tomasello, M. (2022). *Aux origines de la cognition humaine*. La Découverte. (Original work published 1999)
- Tomasello, M. (2003). *Constructing a Language : A Usage-based Theory of Language Acquisition*. Harvard University Press.

- Tomasello, M., & Farrar, M. J. (1986). Joint Attention and Early Language. *Child Development*, 57(6), 1454. <https://doi.org/10.2307/1130423>
- Tomasello, M., & Kruger, A. C. (1992). Joint attention on actions: Acquiring verbs in ostensive and non-ostensive contexts. *Journal of Child Language*, 19(2), 311–333. <https://doi.org/10.1017/s0305000900011430>
- Torres Cacoullos, R., & Travis, C. E. (2018). *Bilingualism in the Community*. Cambridge University Press.
- Tse, L. (1995). Language Brokering among Latino Adolescents: Prevalence, Attitudes, and School Performance. *Hispanic Journal of Behavioral Sciences*, 17(2), 180–193. <https://doi.org/10.1177/07399863950172003>
- Tsimpli, I., Sorace, A., Heycock, C., & Filiaci, F. (2004). First language attrition and syntactic subjects: A study of Greek and Italian near-native speakers of English. *International Journal of Bilingualism*, 8(3), 257–277. <https://doi.org/10.1177/13670069040080030601>
- Tsushima, R., & Guardado, M. (2015). *Japanese mothers in interlingual families: Mobilizing family-generated knowledge through community workshops*. Joint Conference American Association for Applied Linguistics & Canadian Association of Applied Linguistics.
- Tucker, R. (1998). A global perspective on multilingualism and multilingual education. In J. Cenoz & F. Genesee (Eds.), *Beyond bilingualism: multilingualism and multilingual education*. (pp. 3–15). Multilingual Matters.
- UCLA announces new efforts to be designated as a Hispanic-Serving Institution*. (n.d.). Daily Bruin. Retrieved October 13, 2022, from <https://dailybruin.com/2021/10/10/ucla-announces-new-efforts-to-be-designated-as-a-hispanic-serving-institution>

- US Census Bureau. (2016). *American Community Survey (ACS)*. Census.gov.
<https://www.census.gov/programs-surveys/acs>
- Valdés, G. (2000). Introduction. Spanish for native speakers. In *AATSP professional development series. Handbook for teachers K-12*. Harcourt College Publishers.
- Valdés, G. (2005). Bilingualism, Heritage Language Learners, and SLA Research: Opportunities Lost or Seized? *The Modern Language Journal*, 89(3), 410–426.
<https://doi.org/10.1111/j.1540-4781.2005.00314.x>
- Valdés, G. (2006). *Developing Minority Language Resources*. Multilingual Matters.
- Valdés, G. (2017). From language maintenance and intergenerational transmission to language survivance: will “heritage language” education help or hinder? *International Journal of the Sociology of Language*, 2017(243), 67–95. <https://doi.org/10.1515/ijsl-2016-0046>
- Valdés, G., & Figueroa, R. A. (1994). *Bilingualism and Testing: A Special Case of Bias*. Ablex Publishing.
- Valian, V. (1991). Syntactic subjects in the early speech of American and Italian children. *Cognition*, 40(1-2), 21–81. [https://doi.org/10.1016/0010-0277\(91\)90046-7](https://doi.org/10.1016/0010-0277(91)90046-7)
- Van Dijk, M., van Geert, P., Korecky-Kröll, K., Maillochon, I., Laaha, S., Dressler, W. U., & Bassano, D. (2013). Dynamic Adaptation in Child-Adult Language Interaction. *Language Learning*, 63(2), 243–270. <https://doi.org/10.1111/lang.12002>
- Van Osch, B. van, Hulk, A., Sleeman, P., & Irizarri van Suchtelen, P. (2014). Gender agreement in interface contexts in the oral production of heritage speakers of Spanish in the Netherlands. *Linguistics in the Netherlands*, 31, 93–106.
<https://doi.org/10.1075/avt.31.08osc>
- Varela, F. J., Thompson, E., Rosch, E., & Véronique Havelange. (1993). *L'inscription corporelle de l'esprit: sciences cognitives et expérience humaine*. Seuil.

- Vasquez, M. J. T. (2012). Psychology and social justice: Why we do what we do. *American Psychologist*, 67(5), 337–346. <https://doi.org/10.1037/a0029232>
- Veneziano, E., & Parisse, C. (2010). The acquisition of early verbs in French: Assessing the role of conversation and of child-directed speech. *First Language*, 30(3-4), 287–311. <https://doi.org/10.1177/0142723710379785>
- Vogt, H. (1954). Language Contacts. *WORD*, 10(2-3), 365–374. <https://doi.org/10.1080/00437956.1954.11659533>
- Volterra, V., & Taeschner, T. (1978). The acquisition and development of language by bilingual children. *Journal of Child Language*, 5(2), 311–326. <https://doi.org/10.1017/s0305000900007492>
- Vygotsky, L. S. (1962). *Thought and Language*. MIT Press. (Original work published 1934)
- Weedon, C. (1997). *Feminist Practice and Poststructuralist Theory* (Second Edition). Blackwell. (Original work published 1987)
- Wei, L. (2000). *The Bilingualism Reader*. Routledge.
- Wei, L. (2018). Translanguaging as a Practical Theory of Language. *Applied Linguistics*, 39(1), 9–30. <https://doi.org/10.1093/applin/amx039>
- Weinreich, U. (1968). *Languages in Contact: Findings and Problems*. Mouton. (Original work published 1953).
- Weinreich, U., Labov, W., & Herzog, M. I. (1968). *Empirical Foundations for a Theory of Language Change*. University Of Texas Press.
- Weisner, T. S. (2002). Ecocultural Understanding of Children’s Developmental Pathways. *Human Development*, 45(4), 275–281.
- Williams, G. (2008). Language Socialization: A Systemic Functional Perspective. In P. A. Duff & N. H. Hornberger (Eds.), *Language Socialization* (pp. 57–70). Springer. https://doi.org/10.1007/978-3-319-02327-4_4-1

- Woolard, K. A. (1998). Simultaneity and Bivalency as Strategies in Bilingualism. *Journal of Linguistic Anthropology*, 8(1), 3–29.
- WorldAtlas. (2019, March 22). *The Most Spoken Languages in California*. WorldAtlas. <https://www.worldatlas.com/articles/the-most-spoken-languages-in-california.html>
- Wurm, S. A. (1999). Endangered Languages, Multilingualism and Linguistics. *Diogenes*, 47(185), 56–66. <https://doi.org/10.1177/039219219904718507>
- Xiao, Y. (2008). Home literacy environment in CHL development. In A. W. He & Y. Xiao (Eds.), *Chinese as a Heritage Language: Fostering Rotted World Citizenry* (pp. 259–266). University of Hawaii Press.
- Yip, V., & Matthews, S. (2007). *The Bilingual Child: Early Development and Language Contact*. Cambridge University Press.
- Zentella, A. C. (2005). *Building on Strength: Language and Literacy in Latino Families and Communities*. Teachers College Press.

Appendices

Annex 1: Certificate-School Readiness Language Development Program

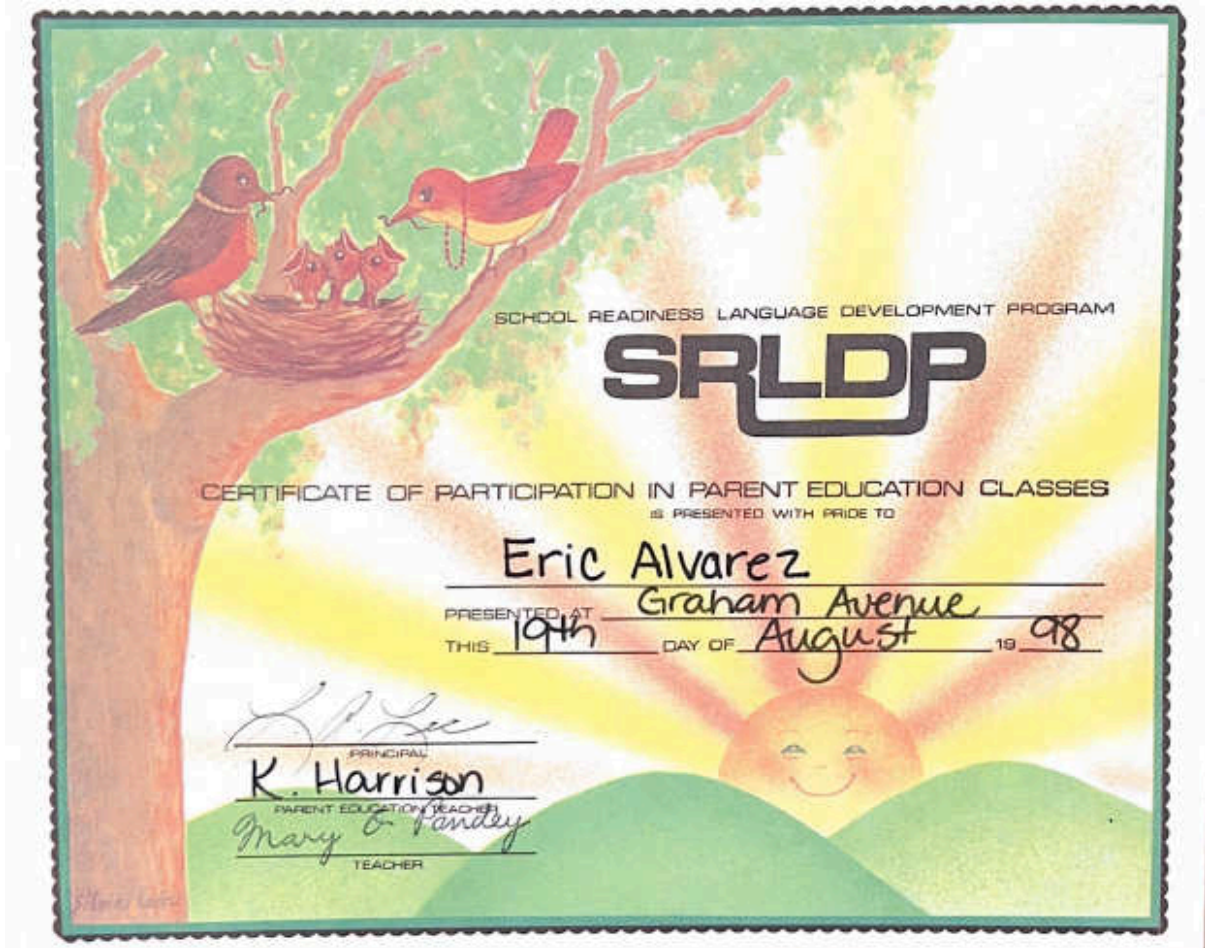





**Florence-Firestone Community Leaders
Meeting Agenda**
LA County Community Services Center
7807 Compton Ave, Los Angeles, CA 90001
February 14, 2018
6:30 – 8:00 p.m.

- I Call to Order**
- a) Attendee Introductions 6:30 PM
- II Guest Speakers**
- a) DWP: Roosevelt Park Stormwater Drain Project 6:40 PM
- b) Regional Planning: Florence-Firestone Community Plan 6:50 PM
- c) Green Zone 7:00 PM
- III Public Service Reports** 7:10 PM
- a) SDC
- b) LA County Sheriff's Dept.
- c) CA Highway Patrol
- d) LA County Library – New Manager at Florence Library
- IV Cabinet Reports** 7:30 PM
- a) Code Enforcement
- b) Public Safety
- c) Economic Development
- d) Treasurer
- e) Way and Means
- V Community Concerns** 7:45 PM
- VI Old Business/New Business** 7:50 PM
- a) Community Clean Up
- b) *A Paseo Through Time: the Florence-Firestone Book*
- c) Recruitment
 - i) Youth
- d) Upcoming events
 - i) Memorial Day Fair
 - ii) National Night Out (August)
- VII Adjournment**

Next Meeting March 14, 2018 at 6:30 PM at the LA County Community Services Center



Florence-Firestone Community Leaders Calendario de reuniones 2018

Únase a nosotros el segundo Miércoles de cada mes a las 6:30 PM para compartir las inquietudes de la comunidad, vengan a conocer a sus vecinos y aprendan sobre los eventos y recursos locales.

Las reuniones se llevan a cabo en el Centro de Servicio Comunitario Florence-Firestone ubicado en:
7807 Compton Avenue Los Angeles, CA 90001
(en la esquina de Compton Ave. y Nadeau St.)

10 de enero del 2018	14 de febrero del 2018
14 de marzo del 2018	11 de abril del 2018
9 de mayo del 2018	13 de junio del 2018
11 de julio del 2018	8 de agosto del 2018
12 de septiembre del 2018	10 de octubre del 2018
14 de noviembre del 2018	12 de diciembre del 2018

Estado de la misión:
El propósito de la organización The Florence Firestone Community Leaders es mejorar el calidad de vida en Florence-Firestone y la entrega de los Servicios del Condado de Los Angeles a sus residentes.



Florence-Firestone Community Leaders 2018 Meeting Schedule

File on book
FFCL

Please join us on the second Wednesday of every month at 6:30 PM to discuss community concerns, learn about local events and resources, and meet your neighbors.

Meetings are held at the Florence-Firestone Community Service Center located at:
7807 Compton Avenue Los Angeles, CA 90001
(on the corner of Compton Ave. and Nadeau St.)

January 10, 2018	February 14, 2018
March 14, 2018	April 11, 2018
May 9, 2018	June 13, 2018
July 11, 2018	August 8, 2018
September 12, 2018	October 10, 2018
November 14, 2018	December 12, 2018

Mission Statement:
The purpose of the organization The Florence Firestone Community Leaders is to improve the quality of life in Florence-Firestone and the delivery of Los Angeles County Services to its residents.

FLORENCE-FIRESTONE COMMUNITY PLAN ZONE CHANGE CSD UPDATE

planning.lacounty.gov/ffcp



Florence Firestone is Located...

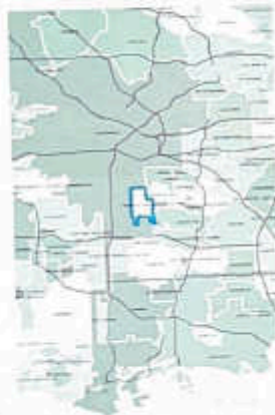

What is a community plan?



- **Guides development**
- **Articulates a vision**

COMMUNITY PLAN

consists of ...

- **Existing conditions**
- **Demographics**
- **Land use and zoning**
- **Goals and policies**
- **Implementation actions**

Florence-Firestone

Community Plan 2017

LA County Department of Regional Planning



COMMUNITY INPUT

The plan was developed with input from the community

- Workshops, meetings and events



Goals and Policies

12 policy categories help realize the vision

- Residential Areas
- Commercial Areas
- Industrial Areas
- Environmental Justice
- Connectivity
- Transit Oriented Development
- Community Identity
- Economic Development
- Parks and Recreation
- Safety and Health
- Public Facilities
- Building Partnerships

Residential Areas

Support a range of housing types



- Mixed income
- Affordable
- Large households
- Senior
- ADU's



Commercial Areas

Support vibrant commercial activity on major corridors



- Florence Ave
- Firestone Blvd
- Central Ave
- Compton Ave



Industrial Areas promote...



- Clean industry
- Reinvestment
- Job growth
- Good neighbor policies



Environmental Justice supports...



- Health
- Safety
- Access
- Well-being



Connectivity

Improve connection between



- Rail

- Bus

- Biking

→ look @ velib in Paris as an example

- Walking

- Internet i.e. wifi @ parks & stations



Transit Oriented Development

Live, work, play near transit stations



Community Identity

People, place, shared history

→ linguistic identity
- electronic has lang; has developed & evolved over time

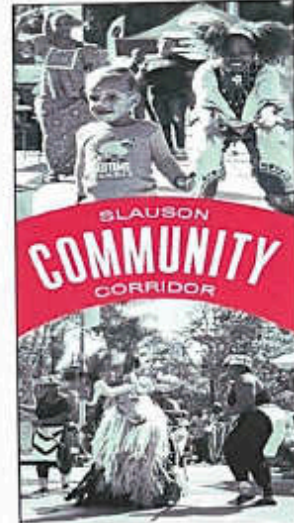
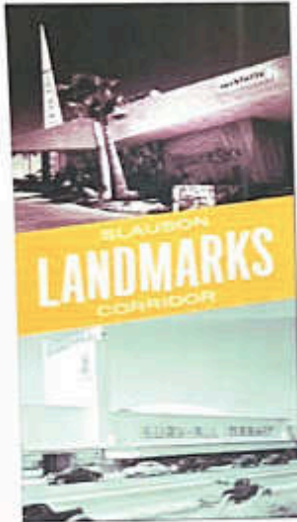

Economic Development



- **Preserve jobs**
- **Expand niche market**
↳ latino purchasing power?
- **Develop labor force**
- **Promote local hiring**



Parks and Recreation

Increase parks and open space throughout the community

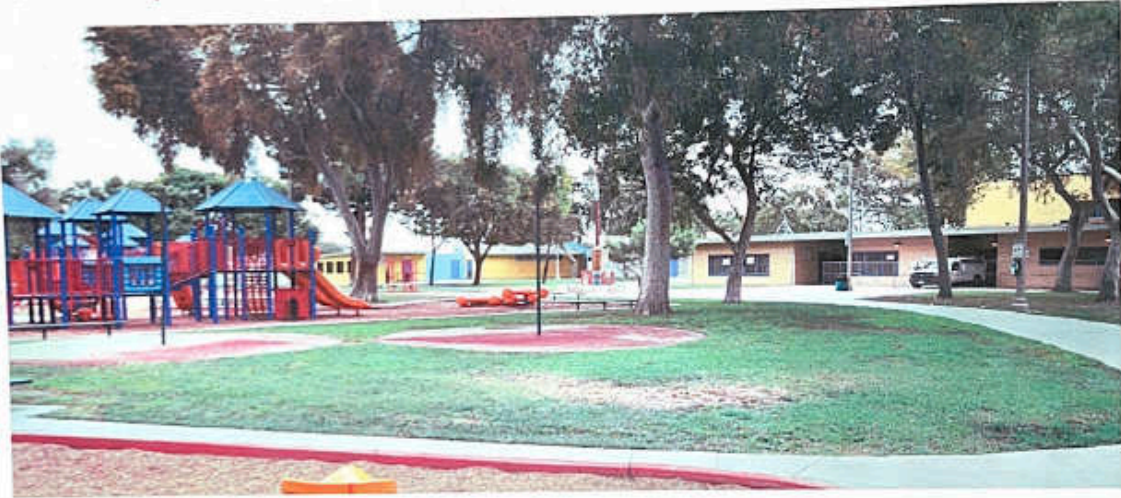

Safety and Health



- Access to healthy food
- Nuisance abatement
- Active and healthy residents
- Public safety



Public Facilities

Provide services and support community involvement



Building Partnerships

Across public, private, and nonprofit sectors



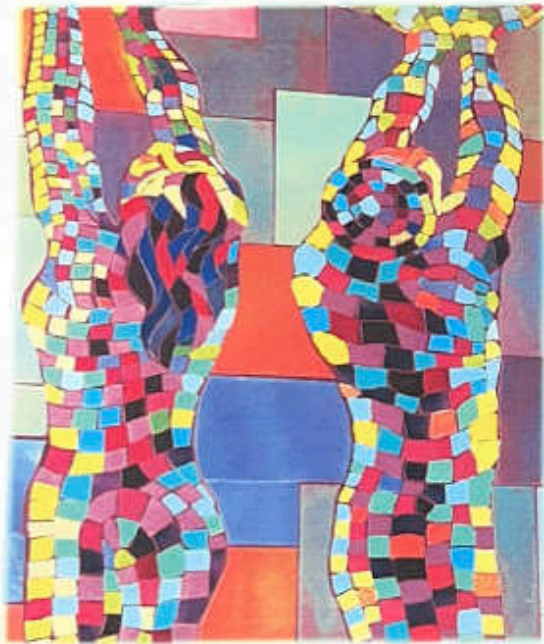

Implementation Strategies

99
 recommended
 actions
 programs
 procedures
 carry out
 goals and policies

ZONE CHANGE On Florence Ave to Mixed Use Zone



CSD UPDATE

To...

- Parking
- Pedestrian orientation
- Security lighting
- Public space



Contact Information

Adrine Arakelian, James Drevno, Mi Kim, Norman Ornelas Jr.

**Los Angeles County Department of Regional Planning
Community Studies East**

commplan@planning.lacounty.gov

(213) 974-6425

LOS ANGELES UNIFIED SCHOOL DISTRICT

PARENT AND COMMUNITY SERVICES

1360 West Temple Street
Los Angeles, California 90026
Toll-Free: (866)669-7272
Tel: (213) 481-3350
Fax: (213) 481-3392



AUSTIN BEUTNER

Superintendent

VIVIAN EKCHIAN

Deputy Superintendent

ROSALINDA LUGO, Ed.D.

Administrator, Parent and Community Services

October 6, 2018

Dear Volunteer **ERIC ALVAREZ**,

Welcome to Los Angeles Unified School District's School Volunteer Program!

Congratulations on completing the volunteer application process. You have decided to become a school volunteer at **GRAHAM EL (1421901)**, sharing your time, skills and talent with the school community. Through your service as a volunteer, you are contributing to the District's goal of 100% Graduation.

Along with this letter you have received your Volunteer Identification Card. Please wear it all times while on your volunteer assignment this year, as it will identify you as an official Los Angeles Unified School District School Volunteer. Please remember to sign in when you enter onto the campus and remember to leave your badge with the volunteer program coordinator before you sign out each day.

If you have any questions or concerns please feel free to call me at (213) 481-3350.

Thank you for all you do to support our students! You are appreciated.

Sincerely,

Heidi Mahmud

Heidi Mahmud, Ed.D., Specialist
Parent and Community Services

Enclosure: Volunteer Identification Card

DISTRITO ESCOLAR UNIFICADO DE LOS ÁNGELES

SERVICIOS PARA LOS PADRES Y LA COMUNIDAD

1360 West Temple Street
Los Angeles, California 90026
Teléfono Gratuito: (866) 669-7272
Tel: (213) 481-3350
Fax: (213) 481-3392



AUSTIN BEUTNER
Superintendente de Escuelas
VIVIAN EKCHIAN
Superintendente Auxiliar
ROSALINDA LUGO, Ed.D.
Administradora, Servicios para los Padres y la
Comunidad

6 de octubre de 2018

Estimado voluntario **ERIC ALVAREZ**,

¡Bienvenido al Programa de voluntariado escolar del Distrito Escolar Unificado de Los Ángeles!

Felicidades en completar el proceso de solicitud de voluntariado. Indicó querer ser un voluntariado escolar en **GRAHAM EL (1421901)**, y querer compartir su tiempo, así como sus destrezas y talentos con la comunidad escolar. Mediante su servicio como voluntario, contribuye a nuestra meta del Distrito que es llegar a 100% de graduación.

Junto con esta carta recibe su tarjeta de identificación como voluntario. Por favor lleve esta identificación a la vista en todo momento mientras esté en su asignación como voluntario este año dado que le identifica como voluntario oficial del Distrito Escolar Unificado de Los Ángeles. Recuerde en firmar al entrar al plantel, así como recordar de dejar su identificación con el coordinador del programa de voluntariado antes de salir todos los días.

Si tiene alguna pregunta o preocupación, no dude en llamarme al (213) 481-3350.

¡Se aprecia y se le agradece por lo que da de sí mismo para apoyar a nuestros estudiantes!

Atentamente,

Heidi Mahmud

Heidi Mahmud, Ed. D., Especialista
Servicios para los Padres y la Comunidad

Adjunto: Tarjeta de identificación como voluntario.

COLOR PRINTING & MAILING (310) 987-1432

Student Name: _____ Date of Birth: ____/____/____

Office Use Only	
1. SCHOOL NAME: _____	6. LAUSD / STATE STUDENT ID NUMBER: _____
2. LOCATION CODE: _____	7. HOUSEHOLD NUMBER: _____
3. TRACK/SLC: _____	8. HOMEROOM: _____
4. ENROLLMENT DATE/CODE: _____	9. TEACHER/COUNSELOR: _____
5. STUDENT ENTRY GRADE LEVEL: _____	10. ENROLLMENT WIZARD USED: <input type="checkbox"/> Yes <input type="checkbox"/> No

LOS ANGELES UNIFIED SCHOOL DISTRICT STUDENT ENROLLMENT FORM

INSTRUCTIONS: Please print using black or blue ink. If you have any questions, please ask for assistance.

A. STUDENT INFORMATION (LAUSD MAX: Family Member Information)

1. Legal Name: Last _____ First _____ Middle _____			2. Alias/Nickname: Last _____ First _____ Middle _____		
3. Home Address: Number _____ Street Apt./Unit _____ City _____		4. Zip Code _____		Home Telephone Number: _____	
5. Sex <input type="checkbox"/> Male <input type="checkbox"/> Female	6. Date of Birth: ____/____/____	7. Place of Birth (City, State/Province, and Country): _____			

B. PARENT/LEGAL GUARDIAN WITH WHOM THE STUDENT LIVES (LAUSD MAX: Caretaker Information)

1. Legal Name: Last _____ First _____ Middle _____			2. Other Names Used _____		
3. Home Telephone Number _____		4. Cell/Pager Number _____		5. Work Telephone Number _____	
				6. E-mail Address _____	
7. Home Correspondence Language (Circle One) Correspondence is provided in the following languages; select preferred language. If Other is indicated, written correspondence will be in English. English Spanish Armenian Chinese Farsi Filipino Korean Russian Vietnamese Other: _____					
8. Highest Level of Education Completed (Circle One) Not a High School Graduate High School Graduate or Equivalent					
Some College (includes AA Degree)		College Graduate		Graduate School/Post Graduate Training	
Decline to State or Unknown					
9. Does the student live with this parent/legal guardian? (Circle one) Yes No					
10. Relationship to Student: _____					

C. HOME LANGUAGE AND ETHNICITY INFORMATION

1. Home Language of the Student	
A. Which language did this student learn when he/she first began to talk? _____	
B. Which language does this student most frequently use at home? _____	
C. Which language do you use most frequently to speak to this student? _____	
D. Which language is most often used by the adults at home? _____	
E. Has this student received any formal English language instruction (listening, speaking, reading, or writing)? (Circle one) Yes No	
2. Is the student's ethnicity Hispanic/Latino? <input type="checkbox"/> Yes <input type="checkbox"/> No	
3. Student's Primary Race (Mark one choice)	
<input type="checkbox"/> African American or Black <input type="checkbox"/> American Indian or Alaska Native <input type="checkbox"/> White <input type="checkbox"/> Asian <input type="checkbox"/> Asian Indian <input type="checkbox"/> Cambodian <input type="checkbox"/> Chinese <input type="checkbox"/> Filipino <input type="checkbox"/> Hmong <input type="checkbox"/> Japanese <input type="checkbox"/> Korean <input type="checkbox"/> Laotian <input type="checkbox"/> Vietnamese <input type="checkbox"/> Other Asian <input type="checkbox"/> Pacific Islander <input type="checkbox"/> Guamanian <input type="checkbox"/> Native Hawaiian <input type="checkbox"/> Samoan <input type="checkbox"/> Tahitian <input type="checkbox"/> Other Pacific Islander	
4. Student's Additional Race (Optional)	
<input type="checkbox"/> African American or Black <input type="checkbox"/> American Indian or Alaska Native <input type="checkbox"/> White <input type="checkbox"/> Asian <input type="checkbox"/> Asian Indian <input type="checkbox"/> Cambodian <input type="checkbox"/> Chinese <input type="checkbox"/> Filipino <input type="checkbox"/> Hmong <input type="checkbox"/> Japanese <input type="checkbox"/> Korean <input type="checkbox"/> Laotian <input type="checkbox"/> Vietnamese <input type="checkbox"/> Other Asian <input type="checkbox"/> Pacific Islander <input type="checkbox"/> Guamanian <input type="checkbox"/> Native Hawaiian <input type="checkbox"/> Samoan <input type="checkbox"/> Tahitian <input type="checkbox"/> Other Pacific Islander	

D. STUDENT EDUCATIONAL INFORMATION

1. Special Services				
If you have any questions regarding this section, please refer to the brochure entitled "Are You Puzzled By Your Child's Special Needs?"				
A. Was this student receiving special education services at his/her previous school? <input type="checkbox"/> Yes <input type="checkbox"/> No				
B. Did this student have a current Individualized Education Program (IEP) at the previous school? <input type="checkbox"/> Yes <input type="checkbox"/> No				
If Yes, do you have a copy of the student's IEP with you? <input type="checkbox"/> Yes <input type="checkbox"/> No				
C. Did this student have a Section 504 Plan at his/her previous school? <input type="checkbox"/> Yes <input type="checkbox"/> No				
If Yes, do you have a copy of the student's Section 504 Plan with you? <input type="checkbox"/> Yes <input type="checkbox"/> No				
D. Does the student have difficulties that interfere with his/her ability to go to school or to learn? <input type="checkbox"/> Yes <input type="checkbox"/> No				
E. Has this student been identified for gifted and talented educational services (GATE)? <input type="checkbox"/> Yes <input type="checkbox"/> No				
2. Previous School Information				
A. Has this student previously attended this school? <input type="checkbox"/> Yes <input type="checkbox"/> No If Yes, when? _____				
B. Has this student previously attended any other school or center in the LAUSD (e.g., early education center, state preschool, SRLDP, Head Start, or other preschool)? <input type="checkbox"/> Yes <input type="checkbox"/> No If Yes, list most recent school/center attended				
Name of School	City/State	Dates Attended	Grade Level(s)	
C. Please list last non-LAUSD school student attended (including early education center, state preschool, SRLDP, Head Start, faith based or other preschool)				
Name of School	City/State	Type of School	Dates Attended	Grade Level(s)

WHITE: STUDENT CUMULATIVE RECORD • YELLOW: ADMINISTRATOR/DESIGNEE • PINK: BILINGUAL COORDINATOR

9861214321 Rev. 06/10

Student Name: _____

Date of Birth: ____/____/____

LOS ANGELES UNIFIED SCHOOL DISTRICT STUDENT ENROLLMENT FORM

D. STUDENT EDUCATIONAL INFORMATION (Continued)

D. Did you attempt to enroll the child in a different school in Los Angeles County for the current or preceding year? Yes No *If No, skip to E.*
1. If Yes, what was the outcome? Accepted Denied Wait Listed Other _____
2. Please provide name of school: _____
E. Is student currently under an expulsion order? Yes No
If Yes, please list the name of the school district _____
F. Date of first U.S. school enrollment excluding preschool (mm/dd/yy) _____
G. Date of first California school enrollment excluding preschool (mm/dd/yy) _____

E. ADDITIONAL HOUSEHOLD INFORMATION

1. Court Orders
A. Are there any court orders you wish to notify the school about regarding legal custody, physical custody or restricted contact with the school or child?
(Circle one) Yes No If Yes, a copy of the court order must be provided to the school.
2. Student Lives with Foster Family Yes No If Yes, Relative Caregiver _____ () _____
If Yes, please provide Notification of Placement Status Form Non-Relative Caregiver Children's Social Worker (CSW) Telephone Number (ext) _____
3. Complete these three rows if student's address is a licensed children's institution/family foster agency/group home/adult residential facility.
A. Facility Name B. Facility Type C. License Number D. Contact Person
E. () F. () G. Facility Telephone Number Alternate Telephone Number Facility Street Address: Number Street Apt./Unit City Zip Code
H. Children's Social Worker (CSW) I. () Telephone Number (ext) _____
4. Does the student have any relatives who are all or part American Indian or Alaska Native? (Circle one) Yes No
5. Has the student's parent or legal guardian worked in one or more of the following industries in the last three years (agriculture, dairy, fishery, food processing/packing, or livestock)? If you respond Yes, you will be contacted at home regarding the Migrant Education Program and whether your child may qualify for its free academic assistance and health benefits. (Circle one) Yes No

F. ADDITIONAL FAMILY INFORMATION

(LAUSD MAX: Caretaker Information)

PARENT/LEGAL GUARDIAN/CAREGIVER:
1. _____ 2. _____
Legal Name: Last First Middle Other Names Used
3. Home Address (if different than student's) Number Street Apt./Unit City Zip Code
4. () 5. () 6. () Day 7. _____
Home Telephone Number Cell/Pager Number Work Telephone Number Evening E-mail Address
8. Preferred Correspondence Language (Circle One) English Spanish Armenian Chinese Farsi Filipino Korean Russian Vietnamese
9. Highest Level of Education Completed (Circle One) Not a High School Graduate High School Graduate or Equivalent
Some College (includes AA Degree) College Graduate Graduate School/Post Graduate Training Decline to State or Unknown
10. Does the student live with this individual? (Circle one) Yes No 11. Relationship to Student: _____

PARENT/LEGAL GUARDIAN/CAREGIVER:
1. _____ 2. _____
Legal Name: Last First Middle Other Names Used
3. Home Address (if different than student's) Number Street Apt./Unit City Zip Code
4. () 5. () 6. () Day 7. _____
Home Telephone Number Cell/Pager Number Work Telephone Number Evening E-mail Address
8. Preferred Correspondence Language (Circle One) English Spanish Armenian Chinese Farsi Filipino Korean Russian Vietnamese
9. Highest Level of Education Completed (Circle One) Not a High School Graduate High School Graduate or Equivalent
Some College (includes AA Degree) College Graduate Graduate School/Post Graduate Training Decline to State or Unknown
10. Does the student live with this individual? (Circle one) Yes No 11. Relationship to Student: _____

9061214321 Rev. 06/10

WHITE: STUDENT CUMULATIVE RECORD • YELLOW: ADMINISTRATOR/DESIGNEE • PINK: BILINGUAL COORDINATOR

Student Name: _____ Date of Birth: ____/____/____

LOS ANGELES UNIFIED SCHOOL DISTRICT STUDENT ENROLLMENT FORM

F. ADDITIONAL FAMILY INFORMATION (Continued)

(LAUSD MAX: Caretaker Information)

PARENT/LEGAL GUARDIAN/CAREGIVER:

1. _____ 2. _____
 Legal Name: Last First Middle Other Names Used

3. _____
 Home Address (if different than student's) Number Street Apt./Unit City Zip Code

4. (____) _____ 5. (____) _____ 6. (____) _____ Day 7. _____
 Home Telephone Number Cell/Pager Number Work Telephone Number Evening E-mail Address

8. Preferred Correspondence Language (Circle One) English Spanish Armenian Chinese Farsi Filipino Korean Russian Vietnamese

9. Highest Level of Education Completed (Circle One) Not a High School Graduate High School Graduate or Equivalent
 Some College (includes AA Degree) College Graduate Graduate School/Post Graduate Training Decline to State or Unknown

10. Does the student live with this individual? (Circle one) Yes No 11. Relationship to Student: _____

ADDITIONAL SCHOOL AGE CHILDREN LIVING IN HOUSEHOLD WITH SAME PARENT(S)/LEGAL GUARDIAN(S) (include brothers, sisters, and cousins)

1.	_____/____/____	Sex: <input type="checkbox"/> Male <input type="checkbox"/> Female	_____
Last Name	First Name	Birth Date	Current School and Track
2.	_____/____/____	Sex: <input type="checkbox"/> Male <input type="checkbox"/> Female	_____
Last Name	First Name	Birth Date	Current School and Track
3.	_____/____/____	Sex: <input type="checkbox"/> Male <input type="checkbox"/> Female	_____
Last Name	First Name	Birth Date	Current School and Track
4.	_____/____/____	Sex: <input type="checkbox"/> Male <input type="checkbox"/> Female	_____
Last Name	First Name	Birth Date	Current School and Track
5.	_____/____/____	Sex: <input type="checkbox"/> Male <input type="checkbox"/> Female	_____
Last Name	First Name	Birth Date	Current School and Track
6.	_____/____/____	Sex: <input type="checkbox"/> Male <input type="checkbox"/> Female	_____
Last Name	First Name	Birth Date	Current School and Track

G. EMERGENCY CONTACT INFORMATION

EMERGENCY CONTACT (other than parent(s)/legal guardian(s) above)

1. _____ 2. (____) _____ 3. (____) _____ 4. (____) _____
 Last Name First Name Home Telephone Number Cell/Pager Number Work Telephone Number

5. _____ 6. _____
 Relationship to student Home Address: Number Street Apartment/Unit City Zip Code

EMERGENCY CONTACT (other than parent(s)/legal guardian(s) above)

1. _____ 2. (____) _____ 3. (____) _____ 4. (____) _____
 Last Name First Name Home Telephone Number Cell/Pager Number Work Telephone Number

5. _____ 6. _____
 Relationship to student Home Address: Number Street Apartment/Unit City Zip Code

THE SCHOOL IS AUTHORIZED TO RELEASE THIS STUDENT TO THE FOLLOWING PERSONS IN NON-EMERGENCY SITUATIONS (after verifying with parent, in addition to the emergency contacts above)

1.	(____)	_____	_____	_____
Last Name	First Name	Home Telephone Number	Relationship to Student	Parent/legal guardian providing authorization
2.	(____)	_____	_____	_____
Last Name	First Name	Home Telephone Number	Relationship to Student	Parent/legal guardian providing authorization

H. SIGNATURE

I verify that the information contained in this document is true and correct to the best of my knowledge.

X _____
 Signature Date: _____

Printed Name: _____

Relationship to Student (Circle one): Parent Legal Guardian Other (Specify) _____

9907/14321 Rev. 06/10

WHITE: STUDENT CUMULATIVE RECORD • YELLOW: ADMINISTRATOR/DESIGNEE • PINK: BILINGUAL COORDINATOR

Annex 8: Elementary EL Profiles based on FOCUS: Reporting & Dashboards

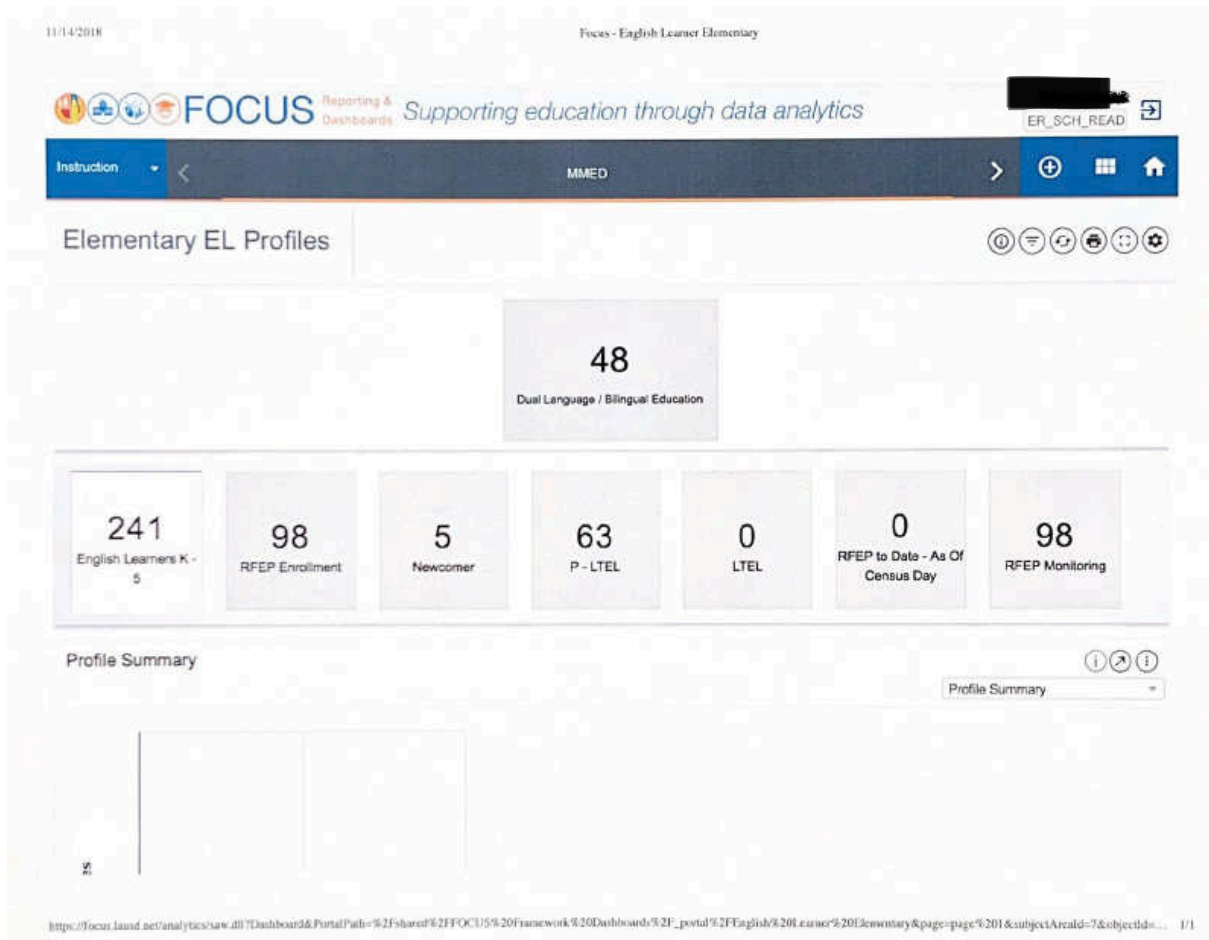

Annex 9: Master Plan Roster of LIN's class

Los Angeles Unified School District

Graham El / Graham [REDACTED] 421901

Master Plan Roster

Master Plan Roster for Room K4 - [REDACTED], Y

Period: 1 Course-Section: 110102-3 Course Name: GRADE EXPAN TK

14 Nov 2018

CLASS	RPEP Date	NAME	GR	L1	MP PROG	ENG PROF	ENG PROF DATE	L1 PROF	L1 PROF DATE	INFORMAL ACCESS	OVERALL PROF LEVEL	CURR START EL DATE
EO	[REDACTED]	[REDACTED]										
EO	[REDACTED]	BAEZ L [REDACTED]	TE									
EO	[REDACTED]	BRYANT-HICKS, [REDACTED] A	TE									
EO	[REDACTED]	[REDACTED] RACHO, [REDACTED] M	TE									
EO	[REDACTED]	CAMBRILLO, [REDACTED] A	TE									
EO	[REDACTED]	GONZALEZ GARCIA, [REDACTED]	TE									
EO	[REDACTED]	MADA [REDACTED]	TE									
EO	[REDACTED]	MAR [REDACTED] D	TE									
EO	[REDACTED]	OS [REDACTED]	TE									
EO	[REDACTED]	PADILLA, A [REDACTED]	TE									
EO	[REDACTED]	REE [REDACTED] T	TE									
EO	[REDACTED]	RUIZ, J [REDACTED]	TE									
EO	[REDACTED]	SMITH HERNANDEZ, [REDACTED]	TE									
EO	[REDACTED]	[REDACTED]	TE									
*** 15												
LEP	[REDACTED]	CANU [REDACTED] ENO,	TE									
LEP	[REDACTED]	DIAZ, [REDACTED]	TE									
LEP	[REDACTED]	[REDACTED]	TE									
LEP	[REDACTED]	GARCIA [REDACTED] N	TE									
LEP	[REDACTED]	HERNANDEZ, [REDACTED] A	TE									
LEP	[REDACTED]	MARTINEZ M [REDACTED] O,	TE									
LEP	[REDACTED]	PINTO, [REDACTED] V	TE									
LEP	[REDACTED]	RAMIREZ NAVARRO,	TE									
LEP	[REDACTED]	RIOS SANTANA, [REDACTED] R	TE									
*** 9												

Total Number of Students for Period: 22

Report ID: RPT_EL3012 Page 1 of 1 Executed on 11/14/2018 1:56:58 PM Executed By LAUSDap_sa_MSISWeb



Intergenerational heritage Spanish use and socialization in L.A.
Uso y socialización intergeneracional del español de herencia en L.A.

Principal Investigator: Eric Alvarez Ph.D. Candidate under the supervision of: Aliyah Morgenstern Ph.D., from Sorbonne Nouvelle University in Paris, France is conducting a research study.

El investigador principal: Eric Alvarez Candidato a doctorado bajo la supervisión de: Aliyah Morgenstern, Ph.D. de la Universidad Sorbonne Nouvelle de Paris, Francia, está llevando a cabo un estudio de investigación.

Your child was selected as a participant in this study because she is of Hispanic/Latin American origin. Your child's participation in this research study is voluntary.

Su hijo/a ha sido seleccionado como participante en este estudio porque ella es de origen hispano latino americano. La participación de su hijo/a es totalmente voluntario.

Why is this study being done?

¿Porqué se está llevando a cabo esta investigación?

This study will look at how the child uses Spanish in an informal family context. It will also attempt to see how different generations of Spanish speakers in Los Angeles socialize the child to use Spanish in spontaneous interaction. Finally, it will try to account for the bilingual language learning environment in which the child is growing up.

Este estudio analizará cómo el/la niño/a usa el español en un contexto familiar e informal. También intentará ver cómo las diferentes generaciones de hispanohablantes en Los Angeles socializan al/la niño/a al uso del español a través de la interacción espontánea. Por último, intentará tomar en cuenta el entorno de aprendizaje bilingüe en el que el/la niño/a está creciendo.

What will happen if my child takes part in this research study?

¿Qué pasará si mi hijo/a participa en este estudio?

If you agree to allow your child to participate in this study, we will ask her to:

Si da permiso para que su hijo/a participe en este estudio, le pediremos a su hijo/a que:

Allow us to film her in an informal family context while interacting with his siblings and parents. The filming sessions will take place throughout the month of February 2018 and between the months of August 2018 and January 2019.

Nos deje grabarlo/a en su contexto informal y familiar mientras que esta conviviendo con sus hermanos/nas y padres. Las sesiones de grabación se llevarían a cabo durante el mes de febrero 2018 y entre los meses de agosto 2018 y enero 2019.

She may be asked to tell us about her summer vacation, her friends, her use of Spanish, or to read short stories in Spanish and English

Es posible que le pidamos a su hijo/a que nos cuente de sus vacaciones, de sus amistades, de su uso del español, o que nos lea cuentos cortos en español e inglés.

Example questions: What have you done this summer? What did you find most exciting? How many friends do you have? What language do you speak together? When do you speak Spanish?

Ejemplos de preguntas: ¿Qué hiciste durante el verano? Entre todo lo que has hecho, ¿qué es lo que más te gustó? ¿Cuántos amigos/as tienes? Cuando andan juntos, ¿cuál idioma hablan? ¿Cuándo hablas español?

Ideally, filming should take place around the dinner table, where no questions will be asked. Filming will also take place anywhere around the house, and it is during these moments that questions may be asked if appropriate. Reading should take place in a quiet room in the house.
Idealmente, nos gustaría grabar cuando la familia está cenando. En esos momentos, no habrá preguntas. Las grabaciones también podrían llevarse a cabo alrededor de la casa, donde podríamos hacerle algunas preguntas si es conveniente. Los ejercicios de lectura de cuentos deberían llevarse a cabo en un lugar tranquilo de la casa.

How long will my child be in the research study?

¿Cuánto tiempo participará mi hijo/a en el estudio?

Participation will take a total of about 12 months.

La participación de se hijo/a durará aproximadamente 12 meses.

Are there any potential risks or discomforts that my child can expect from this study?

¿Habrá riesgos potenciales o incomodidades a los cuales mi hijo/a puede estar expuesta?

Your child may feel shy at first contact, and at the beginning of the filming session. I will see to it that the child is comfortable with my presence before setting up any filming material.

Su hijo/a podrá sentirse un poco avergonzado al principio, y luego al inicio de la sesión de grabación. Me aseguraré de que él/ella esté a gusto con mi presencia antes de instalar mi material de grabación.

Are there any potential benefits to my child if he or she participates?

¿Habrá algunos beneficios de los cuales mi hijo/a gozará si participa en este estudio?

Your child will not directly benefit from her participation in the research.

Su hijo/a no beneficiará directamente al participar en este estudio.

The results of the research may benefit future generations of heritage Spanish speakers, and families in Los Angeles wishing to maintain Spanish alive in the family, and in society.

Los resultados de esta investigación podrán beneficiar a las futuras generaciones de hablantes del español de herencia, y sus familias en Los Angeles que desean mantener el aprendizaje del español vivo en la familia y en la sociedad.

Will information about my child's participation be kept confidential?

¿Será confidencial la información respecto a la participación de mi hijo/a?

Any information that is obtained in connection with this study and that can identify your child will remain confidential. It will be disclosed only with your permission, or as required by law. Confidentiality will be maintained by keeping data in a private external hard drive. The only people who will have access to a selection of videos and questionnaires will be me, my research director, and Ph.D. committee.

La información que obtengamos a lo largo de este estudio, y que pueda divulgar la identidad de su hijo/a será confidencial. Solamente divulgaremos esta información con su permiso, o según los requisitos de la ley. La confidencialidad será asegurada de tal manera: será guardada en un disco duro externo y privado. La única gente que tendrá acceso a una selección de videos y cuestionarios serán yo mismo, mi directora de investigación, y mi comité de doctorado.

What are my and my child's rights if she takes part in this study?

¿Cuáles son mis derechos y los derechos de mi hijo/a si participa en este estudio?

You can choose whether you want your child to be in this study, and you may withdraw your permission and discontinue your child's participation at any time.

Usted puede decidir si quiere o no que su hijo/a participe en el estudio. Además, usted puede anular su permiso y dejar de seguir adelante con la participación de su hijo/a en el estudio en cualquier momento.

Whatever decision you make, there will be no penalty to you or your child, and no loss of benefits to which you or your child were otherwise entitled.

Poco importa la decisión que tome respecto a la participación de su hijo/a, no habrá multa ni para usted ni para su hijo/a. Tampoco habrá pérdida de beneficios a los cuales su hijo/a pueda tener derecho.

Your child may refuse to answer any questions that she does not want to answer and remain in the study.

Su hijo/a tiene el derecho de no responder a cualquier pregunta que no quiera contestar, y seguir con su participación en el estudio.

Who can I contact if I have questions about this study?

¿A quién puedo contactar si tengo preguntas respecto a esta investigación?

The research team:

Al equipo de investigación.

If you have any questions, comments, or concerns about the research, you can talk to one of the researchers. Please contact:

Cualquier pregunta, comentario, o duda puede hablar con uno de los investigadores. Favor de ponerse en contacto con:

Principal Investigator (English and Spanish):

Investigador principal (español e inglés)

Eric Alvarez

[Redacted]
[Redacted]
[Redacted]ance

Research Director (English):

Directora de investigación (inglés)

Dr. Alivah Morgenstern

[Redacted]
[Redacted]
[Redacted]ance

You will be given a copy of this information to keep for your records.

Usted recibirá una copia de este documento para su registro

Intergenerational heritage Spanish use and socialization in L.A.
Uso y socialización intergeneracional del español de herencia en L.A.

Parent permission for minor to participate in research
Permiso de los padres para que el menor participe en la investigación

This form is intended to collect your consent for the collection of data concerning you and your child for the project: Intergenerational heritage Spanish use and socialization in L.A., led by Eric Alvarez, Ph.D. Candidate in linguistics at Sorbonne Nouvelle University, 4 rue des irlandais, 75005 Paris, France, eric.alvarez.perez@gmail.com, laboratory PRISMES

Este formulario está destinado a recopilar su consentimiento para la recopilación de datos que conciernen a usted y a su hijo/a para el proyecto: Uso y socialización intergeneracional del español de herencia en L.A., dirigido por Eric Alvarez, Candidato a doctorado en lingüística en la Universidad Sorbonne Nouvelle, 4 rue des Irlandais, 75005 Paris, Francia, eric.alvarez.perez@gmail.com, laboratorio PRISMES

Participant information
Información del participante

Last name, first name, status (father, mother, legal guardian) of the parents or legal guardians of the child

Apellido, nombre, estado (padre, madre, tutor legal) de los padres o tutores legales del/la niño/a:

Date of birth of the child:

Fecha de nacimiento del/la niño/a:

Contact address:

Dirección de contacto:

E-mail:

Correo electrónico:

Telephone number:

Número de teléfono:

Informed consent

Consentimiento informado

I have read and understood the information provided in the information sheet, I have obtained satisfactory answers to all my questions, and I voluntarily accept that my child (first name, last name

He leído y entendido la información proporcionada en la hoja de información, he obtenido respuestas satisfactorias a todas mis preguntas, y acepto voluntariamente que mi hijo/a (nombre, apellido)

Participate in this research

Participe en esta investigación

Yes/Sí No

I understand that this participation is free and does not entitle me to any compensation.

Entiendo que esta participación es gratuita y no me da derecho a compensación.

Yes/Sí No

I understand that in accordance with the Data Protection Act and the General Data Protection Regulations, I will have the right at any time, without justification, to request deletion of all or part of the data in the project documents and on the platform. When your child reaches the age of 15, s/he will be able to exercise their right of withdrawal themselves.

Entiendo que, de acuerdo con la Ley de Protección de Datos y el Reglamento General de Protección de Datos, tendré derecho en cualquier momento, sin justificación, a solicitar la eliminación total o parcial de los datos en los documentos del proyecto y en la plataforma. Cuando su hijo/a cumpla 15 años, podrá ejercer por sí mismo su derecho de desistimiento.

Yes/Sí No

VIDEOS

VIDEOS

I accept that my image and my words will be filmed and analyzed by Eric, his director, and his Ph.D. committee.

Acepto que mi imagen y mis palabras sean gravadas y analizadas por Eric, su directora, y su comité de doctorado.

Yes/Sí No

I accept that my image and my words be disseminated in the context of scientific conferences, seminars, scientific articles, project website or in any other form of promotion of said project.

Acepto que mi imagen y mis palabras sean difundidas en el contexto de congresos científicos, seminarios, artículos científicos, sitio web del proyecto o en cualquier otra forma de promoción de dicho proyecto.

Yes/Sí No

I agree that the video recordings will be deposited and stored permanently, on an institutional research platform managed in France for data sharing.

Acepto que las grabaciones de video se depositen y se almacenen de forma permanente en una plataforma de investigación institucional administrada en Francia para el intercambio de datos.

Yes/Sí in free access/en acceso libre

Yes/Sí with restricted access to researchers (with university address)/con acceso restringido a investigadores (con domicilio universitario)
No

I accept that the first names produced during the recordings will be kept.
Acepto que se conserven los nombres producidos durante las grabaciones.
 Yes/Sí No

QUESTIONNAIRES CUESTIONARIOS

I accept that my answers to the questions asked will be kept and analyzed by Eric, his director, and his Ph.D. committee.
Acepto que mis respuestas a las preguntas formuladas serán guardadas y analizadas por Eric, su directora, y su comité de doctorado.
 Yes/Sí No

I accept that a pseudonymized version of my answers to the questions asked to be deposited, permanently and with free access, on a university or research platform for data sharing (i.e. CHILDES)
Acepto que una versión seudonimizada de mis respuestas a las preguntas sean depositadas, de forma permanente y con libre acceso, en una universidad o plataforma de investigación para el intercambio de datos.
 Yes/Sí No

REUSE OF DATA REUTILIZACIÓN DE DATOS

I agree that my personal data (marital status, age of child, answers to questionnaires) will be reused in the context of research projects with the same objectives as that of the present project.
Acepto que mis datos personales (estado civil, edad del/ de la niño/a, respuestas a cuestionarios) serán reutilizados en el contexto de proyectos de investigación con los mismos objetivos que el presente proyecto.
 Yes/Sí No

I accept that the videos, transcriptions and codings may be reused in the context of research projects with the same objectives as that of the present project.
Acepto que los videos, transcripciones y codificaciones puedan ser reutilizadas en el contexto de proyectos de investigación con los mismos objetivos que el presente proyecto.
 Yes/Sí No

City/Ciudad: _____ Date/Fecha: _____

Father/Padre, Mother/Madre or legal representatives/Representantes legales _____

Signature/Firma _____

Intergenerational heritage Spanish use and socialization in L.A.
Uso y socialización intergeneracional del español de herencia en L.A.

Parent permission for minor to participate in research
Permiso de los padres para que el menor participe en la investigación

This form is intended to collect your consent for the collection of data concerning you and your child for the project: Intergenerational heritage Spanish use and socialization in L.A., led by Eric Alvarez, Ph.D. Candidate in linguistics at Sorbonne Nouvelle University, 4 rue des irlandais, 75005 Paris, France, eric.alvarez.perez@gmail.com, laboratory PRISMES

Este formulario está destinado a recopilar su consentimiento para la recopilación de datos que conciernen a usted y a su hijo/a para el proyecto: Uso y socialización intergeneracional del español de herencia en L.A., dirigido por Eric Alvarez, Candidato a doctorado en lingüística en la Universidad Sorbonne Nouvelle, 4 rue des Irlandais, 75005 Paris, Francia, eric.alvarez.perez@gmail.com, laboratorio PRISMES

Participant information

Información del participante

Last name, first name, status (father, mother, legal guardian) of the parents or legal guardians of child:

Apellido, nombre, estado (padre, madre, tutor legal) de los padres o tutores legales del/la niño/a:

Last name and first name of the child:

Apellido y nombre del/la niño/a:

Date of birth of the child:

Fecha de nacimiento del/la niño/a:

Contact address:

Dirección de contacto:

E-mail:

Correo electrónico:

Telephone number:

Número de teléfono:

Informed consent

Consentimiento informado

I have read and understood the information provided in the information sheet, I have obtained satisfactory answers to all my questions, and I voluntarily accept that my child (first name, last name

He leído y entendido la información proporcionada en la hoja de información, he obtenido respuestas satisfactorias a todas mis preguntas y acepto voluntariamente que mi hijo/a (nombre, apellido)

Participate in this research

Participe en esta investigación

Yes/Si No

I understand that this participation is free and does not entitle me to any compensation.

Entiendo que esta participación es gratuita y no me da derecho a compensación.

Yes/Si No

I understand that in accordance with the Data Protection Act and the General Data Protection Regulations, I will have the right at any time, without justification, to request deletion of all or part of the data in the project documents and on the platform. When your child reaches the age of 15, s/he will be able to exercise their right of withdrawal themselves.

Entiendo que, de acuerdo con la Ley de Protección de Datos y el Reglamento General de Protección de Datos, tendré derecho en cualquier momento, sin justificación, a solicitar la eliminación total o parcial de los datos en los documentos del proyecto y en la plataforma. Cuando su hijo/a cumpla 15 años, podrá ejercer por sí mismo su derecho de desistimiento.

Yes/Si No

VIDEOS

VIDEOS

I accept that my image and my words will be filmed and analyzed by Eric, his director, and his Ph.D. committee.

Acepto que mi imagen y mis palabras sean gravadas y analizadas por Eric, su directora, y su comité de doctorado.

Yes/Si No

I accept that my image and my words be disseminated in the context of scientific conferences, seminars, scientific articles, project website or in any other form of promotion of said project.

Acepto que mi imagen y mis palabras sean difundidas en el contexto de congresos científicos, seminarios, artículos científicos, sitio web del proyecto o en cualquier otra forma de promoción de dicho proyecto.

Yes/Si No

I agree that the video recordings will be deposited and stored permanently, on an institutional research platform managed in France for data sharing.

Acepto que las grabaciones de video se depositen y se almacenen de forma permanente en una plataforma de investigación institucional administrada en Francia para el intercambio de datos.

Yes/Si in free access/en acceso libre

Yes/Sí with restricted access to researchers (with university address)/con acceso restringido a investigadores (con domicilio universitario)

No

I accept that the first names produced during the recordings will be kept.

Acepto que se conserven los nombres producidos durante las grabaciones.

Yes/Sí No

QUESTIONNAIRES

CUESTIONARIOS

I accept that my answers to the questions asked will be kept and analyzed by Eric, his director, and his Ph.D. committee.

Acepto que mis respuestas a las preguntas formuladas serán guardadas y analizadas por Eric, su directora, y su comité de doctorado.

Yes/Sí No

I accept that a pseudonymized version of my answers to the questions asked to be deposited, permanently and with free access, on a university or research platform for data sharing (i.e. CHILDES)

Acepto que una versión seudonimizada de mis respuestas a las preguntas sean depositadas, de forma permanente y con libre acceso, en una universidad o plataforma de investigación para el intercambio de datos.

Yes/Sí No

REUSE OF DATA

REUTILIZACIÓN DE DATOS

I agree that my personal data (marital status, age of child, answers to questionnaires) will be reused in the context of research projects with the same objectives as that of the present project.

Acepto que mis datos personales (estado civil, edad del/de la niño/a, respuestas a cuestionarios) serán reutilizados en el contexto de proyectos de investigación con los mismos objetivos que el presente proyecto.

Yes/Sí No

I accept that the videos, transcriptions and codings may be reused in the context of research projects with the same objectives as that of the present project.

Acepto que los videos, transcripciones y codificaciones puedan ser reutilizadas en el contexto de proyectos de investigación con los mismos objetivos que el presente proyecto.

Yes/Sí No

City/Ciudad: _____

Date/Fecha: _____

Father/Padre, Mother/Madre, Legal representatives/Representantes legales _____

Signature/Firma _____

Signature/Firma _____

Intergenerational heritage Spanish use and socialization in L.A.
Uso y socialización intergeneracional del español de herencia en L.A.

Parent permission for minor to participate in research
Permiso de los padres para que el menor participe en la investigación

This form is intended to collect your consent for the collection of data concerning you and your child for the project: Intergenerational heritage Spanish use and socialization in L.A., led by Eric Alvarez, Ph.D. Candidate in linguistics at Sorbonne Nouvelle University, 4 rue des Irlandais, 75005 Paris, France, eric.alvarez.perez@gmail.com, laboratory PRISMES

Este formulario está destinado a recopilar su consentimiento para la recopilación de datos que conciernen a usted y a su hijo/a para el proyecto: Uso y socialización intergeneracional del español de herencia en L.A., dirigido por Eric Alvarez, Candidato a doctorado en lingüística en la Universidad Sorbonne Nouvelle, 4 rue des Irlandais, 75005 Paris, Francia, eric.alvarez.perez@gmail.com, laboratorio PRISMES

Participant information
Información del participante

Last name, first name, status (father, mother, legal guardian) of the parents or legal guardians of child:

_____ *padres o tutores legales del/la niño/a:*

Last name and first name of the child:

Date of birth of the child:

Fecha: _____

Contact address:

Dirección de contacto:

E-mail:

Correo electrónico:

Telephone number:

Número de teléfono:

Informed consent

Consentimiento informado

I have read and understood the information provided in the information sheet, I have obtained satisfactory answers to all my questions, and I voluntarily accept that my child (first name, last name

He leído y entendido la información proporcionada en la hoja de información, he obtenido respuestas satisfactorias a todas mis preguntas y acepto voluntariamente que mi hijo/a (nombre, apellido)

Participate in this research

Participe en esta investigación

Yes/Sí No

I understand that this participation is free and does not entitle me to any compensation.

Entiendo que esta participación es gratuita y no me da derecho a compensación.

Yes/Sí No

I understand that in accordance with the Data Protection Act and the General Data Protection Regulations, I will have the right at any time, without justification, to request deletion of all or part of the data in the project documents and on the platform. When your child reaches the age of 15, s/he will be able to exercise their right of withdrawal themselves.

Entiendo que, de acuerdo con la Ley de Protección de Datos y el Reglamento General de Protección de Datos, tendré derecho en cualquier momento, sin justificación, a solicitar la eliminación total o parcial de los datos en los documentos del proyecto y en la plataforma. Cuando su hijo/a cumpla 15 años, podrá ejercer por sí mismo su derecho de desistimiento.

Yes/Sí No

VIDEOS

VIDEOS

I accept that my image and my words will be filmed and analyzed by Eric, his director, and his Ph.D. committee.

Acepto que mi imagen y mis palabras sean grabadas y analizadas por Eric, su directora, y su comité de doctorado

Yes/Sí No

I accept that my image and my words be disseminated in the context of scientific conferences, seminars, scientific articles, project website or in any other form of promotion of said project.

Acepto que mi imagen y mis palabras sean difundidas en el contexto de congresos científicos, seminarios, artículos científicos, sitio web del proyecto o en cualquier otra forma de promoción de dicho proyecto.

Yes/Sí No

I agree that the video recordings will be deposited and stored permanently, on an institutional research platform managed in France for data sharing.

Acepto que las grabaciones de video se depositen y se almacenen de forma permanente en una plataforma de investigación institucional administrada en Francia para el intercambio de datos.

Yes/Sí in free access/en acceso libre

Yes/Si with restricted access to researchers (with university address)/con acceso restringido a investigadores (con domicilio universitario)
No

I accept that the first names produced during the recordings will be kept.
Acepto que se conserven los nombres producidos durante las grabaciones.
 Yes/Si No

QUESTIONNAIRES CUESTIONARIOS

I accept that my answers to the questions asked will be kept and analyzed by Eric, his director, and his Ph.D. committee.
Acepto que mis respuestas a las preguntas formuladas serán guardadas y analizadas por Eric, su directora, y su comité de doctorado.
 Yes/Si No

I accept that a pseudonymized version of my answers to the questions asked to be deposited, permanently and with free access, on a university or research platform for data sharing (i.e. CHILDES)
Acepto que una versión seudonimizada de mis respuestas a las preguntas sean depositadas, de forma permanente y con libre acceso, en una universidad o plataforma de investigación para el intercambio de datos.
 Yes/Si No

REUSE OF DATA REUTILIZACIÓN DE DATOS

I agree that my personal data (marital status, age of child, answers to questionnaires) will be reused in the context of research projects with the same objectives as that of the present project.
Acepto que mis datos personales (estado civil, edad del/de la niño/a, respuestas a cuestionarios) serán reutilizados en el contexto de proyectos de investigación con los mismos objetivos que el presente proyecto.
 Yes/Si No

I accept that the videos, transcriptions and codings may be reused in the context of research projects with the same objectives as that of the present project.
Acepto que los videos, transcripciones y codificaciones puedan ser reutilizadas en el contexto de proyectos de investigación con los mismos objetivos que el presente proyecto.
 Yes/Si No

City/Ciudad: 

Date/fecha: 

Father/Padre, Mother/Madre or/lo Legal representative





Signature/Firma

Signature/Firma

Intergenerational heritage Spanish use and socialization in L.A.
Uso y socialización intergeneracional del español de herencia en L.A.

Parent permission for minor to participate in research
Permiso de los padres para que el menor participe en la investigación

This form is intended to collect your consent for the collection of data concerning you and your child for the project: Intergenerational heritage Spanish use and socialization in L.A., led by Eric Alvarez, Ph.D. Candidate in linguistics at Sorbonne Nouvelle University, 4 rue des irlandais, 75005 Paris, France, eric.alvarez.perez@gmail.com, laboratory PRISMES

Este formulario está destinado a recopilar su consentimiento para la recopilación de datos que conciernen a usted y a su hijo/a para el proyecto: Uso y socialización intergeneracional del español de herencia en L.A., dirigido por Eric Alvarez, Candidato a doctorado en lingüística en la Universidad Sorbonne Nouvelle, 4 rue des Irlandais, 75005 Paris, Francia, eric.alvarez.perez@gmail.com, laboratorio PRISMES

Participant information
Información del participante

Last name, first name, status (father, mother, legal guardian) of the parents or legal guardians

Apellido, nombre, estado (padre, madre, tutor legal) de los padres o tutores legales del/la niño/a:
[Redacted]
[Redacted]

Apellido y nombre del niño/a:
[Redacted]

Date of birth
Fecha de nacimiento del/la niño/a:
[Redacted]

Contact address:
Dirección de contacto:
E-mail:
Correo electrónico:
Telephone number:
Número de teléfono:

Informed consent

Consentimiento informado

I have read and understood the information provided in the information sheet, I have obtained satisfactory answers to all my questions, and I voluntarily accept that my child (first name, last name

He leído y entendido la información proporcionada en la hoja de información, he obtenido respuestas satisfactorias a todas mis preguntas y acepto voluntariamente que mi hijo/a (nombre, apellido)

Participate in this research

Participe en esta investigación

Yes/Si No

I understand that this participation is free and does not entitle me to any compensation.

Entiendo que esta participación es gratuita y no me da derecho a compensación.

Yes/Si No

I understand that in accordance with the Data Protection Act and the General Data Protection Regulations, I will have the right at any time, without justification, to request deletion of all or part of the data in the project documents and on the platform. When your child reaches the age of 15, s/he will be able to exercise their right of withdrawal themselves.

Entiendo que, de acuerdo con la Ley de Protección de Datos y el Reglamento General de Protección de Datos, tendré derecho en cualquier momento, sin justificación, a solicitar la eliminación total o parcial de los datos en los documentos del proyecto y en la plataforma. Cuando su hijo/a cumpla 15 años, podrá ejercer por sí mismo su derecho de desistimiento.

Yes/Si No

VIDEOS

VIDEOS

I accept that my image and my words will be filmed and analyzed by Eric, his director, and his Ph.D. committee.

Acepto que mi imagen y mis palabras sean gravadas y analizadas por Eric, su directora, y su comité de doctorado.

Yes/Si No

I accept that my image and my words be disseminated in the context of scientific conferences, seminars, scientific articles, project website or in any other form of promotion of said project.

Acepto que mi imagen y mis palabras sean difundidas en el contexto de congresos científicos, seminarios, artículos científicos, sitio web del proyecto o en cualquier otra forma de promoción de dicho proyecto.

Yes/Si No

I agree that the video recordings will be deposited and stored permanently, on an institutional research platform managed in France for data sharing.

Acepto que las grabaciones de video se depositen y se almacenen de forma permanente en una plataforma de investigación institucional administrada en Francia para el intercambio de datos.

Yes/Si in free access/en acceso libre

Yes/Si with restricted access to researchers (with university address)/con acceso restringido a investigadores (con domicilio universitario)
No

I accept that the first names produced during the recordings will be kept.
Acepto que se conserven los nombres producidos durante las grabaciones.

Yes/Si No

QUESTIONNAIRES CUESTIONARIOS

I accept that my answers to the questions asked will be kept and analyzed by Eric, his director, and his Ph.D. committee.

Acepto que mis respuestas a las preguntas formuladas serán guardadas y analizadas por Eric, su directora, y su comité de doctorado.

Yes/Si No

I accept that a pseudonymized version of my answers to the questions asked to be deposited, permanently and with free access, on a university or research platform for data sharing (i.e. CHILDES)

Acepto que una versión seudonimizada de mis respuestas a las preguntas sean depositadas, de forma permanente y con libre acceso, en una universidad o plataforma de investigación para el intercambio de datos.

Yes/Si No

REUSE OF DATA

REUTILIZACIÓN DE DATOS

I agree that my personal data (marital status, age of child, answers to questionnaires) will be reused in the context of research projects with the same objectives as that of the present project.

Acepto que mis datos personales (estado civil, edad del/de la niño/a, respuestas a cuestionarios) serán reutilizados en el contexto de proyectos de investigación con los mismos objetivos que el presente proyecto.

Yes/Si No

I accept that the videos, transcriptions and codings may be reused in the context of research projects with the same objectives as that of the present project.

Acepto que los videos, transcripciones y codificaciones puedan ser reutilizadas en el contexto de proyectos de investigación con los mismos objetivos que el presente proyecto.

Yes/Si No

City/Ciudad:

Date/Fecha:

Father/Padre:

Legal representatives/Representante:

Signature:

Background Information

Proposal Number: 348

Proposal Submission Window: November 2016

Researcher First Name: Eric

Researcher Last Name: ALVAREZ

Researcher Title: Doctoral Candidate

Address: [REDACTED], Los Angeles, California [REDACTED]

Phone Number: [REDACTED]

Affiliation: College/University

Name of Institution: Sorbonne Nouvelle University

E-mail Address: [REDACTED]

Is the main contact information the same as Principal Investigator? Yes

LAUSD Employee: No

Will you be conducting research on your own classroom, school, or district office? No

Proposal

Proposal Title: Spanish heritage language acquisition and maintenance in Los Angeles, California

-Type of Research: Ethnographic case study

-Study start date: 02/01/2017

-Study end date: 02/01/2018

Which department will benefit from your work? Multilingual and Multicultural Education Department

Abstract: The present dissertation is rooted in the bicultural and bilingual *Tercera Hispanidad* that English-Spanish contact in Los Angeles has engendered. By analyzing naturalistic and experimental data of second-, third- and fourth-generation Spanish heritage speakers, first, it will aim at understanding how Spanish is used in the home, as well as in school during the after-school programs. Next, the impact that the particular input conditions both from home and school have on heritage Spanish speaker's lexical, morphosyntactic and phonetic features. Finally, if heritage Spanish speakers display specific gestures for each of their languages. This study will focus on interactive and multi-linguistic exchanges and seeks to reveal the contexts in which children use English, Spanish, or mix languages, and is a continuation of previous research on Spanish language use in Los Angeles. By analyzing a child's utterances, data revealed that the child was dominant in English, but that she privileged Spanish, under specific circumstances. Finally, the analysis revealed that code-switching was the second most used form of communication by the adults after English. Thus, this could lead us to believe that through exposure, the child is bound to acquire a hybrid form of communication as her bilingual and bicultural identity emerges in this third space.

Statement of purpose: This research on heritage, or minority language acquisition and maintenance of Spanish in Los Angeles intends to accomplish three main objectives. Through the analysis of naturalistic and experimental data of second-, third- and fourth-generation Spanish heritage speakers, first, it will aim at

understanding how Spanish is used in the home. It seeks to answer the question as posited by Fishman (1971), 'who speaks what language to whom and when'. The second, objective is grammatical, and considers inflectional morphology. While current research has shown that inflectional morphology is affected as language begins to shift Montrul (2016), as well as lexical and phonetic features, most of the research on the topic draws its conclusions from experimental approaches to the study of language acquisition. Using both naturalistic and experimental data, I hope to shed new light on the issues related to lexical, morphosyntactic and phonetic features. Finally, the role of gesture will be examined. Research suggests that much like the sounds of a language are cultural constructs, gestures too are culturally constructed Kendon (1986). Thus, the third line of investigation will seek an answer to the following questions: Do heritage Spanish speakers display specific gestures for each of their languages? In other words, are heritage Spanish speakers in Los Angeles multi-modally bilingual?

Literature review: Tomasello (2013) usage-based theory of language acquisition, suggesting that language structure emerges from language use.

Fishman (1971) sociology of language approach, focusing on the relationship between language and society by seeking to identify 'who speaks what language to whom and when' and also examining the rates of language shift across social groups.

Hymes (1960s) linguistic anthropological approach, emphasizing the need to study everyday encounters, language socialization, language contact, and language shift as participant-observers.

Ervin-Tripp (1976,77,78,79,82) Sociolinguistic approach

Bhabha (1994) Postcolonial and hybridization theory

Allen (2007) functionalist approach, holding "that linguistic structures can only be understood and explained with reference to the semantic and communicative functions of language, whose primary function is to be a vehicle for social interaction among human beings."

My work proposes to look at heritage Spanish bilingual acquisition not as a case of incomplete acquisition as Montrul advances, which is also the omnipresent belief, but rather as an "an instance of native language development." as Moreira Flores (2014) defends, arguing that heritage speakers are highly proficient and have developed "particular linguistic knowledge because they are exposed to particular input conditions."

Research Question(s)/Hypothesis: Through the analysis of naturalistic and experimental data of second-, third- and fourth-generation Spanish heritage speakers, the present research dissertation aims at answering the following questions:

How is Spanish used in the home in Los Angeles, CA.?

What is the impact that the particular input conditions both from home and school have on heritage Spanish speaker's lexical, morphosyntactic and phonetic features?

Do heritage Spanish speakers display specific gestures for each of their languages? In other words, are heritage Spanish speakers in Los Angeles multi-modally bilingual?

Methods Design: If granted approval, I'll approach the principals of the selected schools and ask them if I could visit the study sites to give a brief five-minute presentation during their after-school program. This survey aims at learning more about their language practices, motivations, as well as generational status. Next, this survey will help me identify second-, third- and fourth- generation Spanish heritage speakers in Los Angeles, so that I may get in contact with them if they consent. Next, I will call those families that agree in order to seek permission to film them in their natural family environment, as well as during their after-school programs. I will try to gain permission from at least 10 families and set up appointments with them so that I may film them in the summer 2017 at home and in the fall 2017 during the after-school programs.

Methods Sampling and recruitment: My target population are second-, third-, and fourth-generation Spanish heritage speaking students between 3 and 10 years old who are currently enrolled in a Dual Language Program and a Standard instruction (English only) school within the LAUSD school District, such as Florence Ave. Elementary and Graham Elementary. If granted approval, I'll approach the principals of the selected schools and ask them if I could visit the study sites to give a brief five-minute presentation during their after school program. I'll refer to the study as the 'Spanish project' and explain that I'm looking for children who speak Spanish to do a few simple speaking and reading tasks at school, and then to film them twice at home with their parents. Then, I'll answer student questions and hand out bilingual information packets. Depending on the language preferences of the parents, I'll distribute previously made packets that have the Spanish forms

first and the English second and vice versa. Each packet will consist of a letter to the parents describing the study, a permission form in order to obtain the parent's written consent, and finally a short preliminary questionnaire inquiring about the child's age, place of birth, and first language, including questions regarding each parent's country of origin and level of education. In the event that not many recruitment packets are returned, I'll arrange to speak with the parents in person as they pick up their children in the evening. This could help boost the recruitment numbers and speaking directly to the parents will also eliminate the need for them to complete the preliminary questionnaire. Also, if the parents aren't entirely literate, I can read it to them, as well as answer any questions if they do not understand something. I hope to be able to present the project to the children during the last two months of the school year 2017, and then proceed to contact the selected families, based on the following criteria: generational status (second-, third-, and fourth-generation), age group (3-10 years old), language combination (Spanish-English), and finally number of children in household (at least 2 or more children). Thus, my sampling frame will be between May and June 2017. I will then request an appointment with the selected families in order to film them at two different moments at home, preferably during dinner, for an hour each time, during the summer, preferably during the month of August 2017, and once for one hour during the after-school program in September 2017.

Methods-Measures:

Fishman (1971)

Montrul (2016)

Kendon (1986)

Tomasello (2013)

Hymes (1960s)

Ervin-Tripp (1976,77,78,79,82)

Bhabha (1994)

Allen (2007)

Sociolinguistic survey in English and Spanish

Parent permission form in English and Spanish, for child to be in the study and to be video and audio recorded at home and at school

Assent form in English and Spanish for children seven and older who are old enough to give "assent"

Methods-Data Collection: Once the initial recruitment process has been completed, I'll proceed to collect data through participant-observation, by recording children as they interact with their families in a natural environment at home, as well recording children as they perform speaking and reading tasks during their afternoon program.

Type of data collection: A 2-page paper survey in Spanish and English, interviews, participant observation, and audio and video recording

Methods-Analysis: Ideally, I would strive to analyze both the natural and experimental speech acts of 6-10 children. I will try to have at least 1 participant from each age group per school i.e. 2 three-year olds, 2 four-year olds, and so on. Teachers will not be observed, only children and parents in interaction with their siblings at home, and the children alone at school. The selected student's teachers may be asked to participate in a voluntary interview, so no more than 16 teachers will be interviewed if each student is taught by a different teacher. Each participant will be asked to be recorded twice, for one hour each time during a family dinner, or other interactive family activities during the summer month of August 2017, and once for 40 to 60 minutes during their after-school program in September 2017. Research participants will be compensated in the following way: parents will be offered informal feedback/advice on how to continue enriching the heritage language acquisition of their children, and the participating children will be given a Paris themed pencil, and if possible, a copy of *El principito*, or *The Little Prince* by Saint-Exupéry.

Humans Subjects Protections: The regulations and ethical codes that will govern my research stem from the Federal Policy for the Protection of Human Rights (34 CFR Part 97). My research will adhere to the federal regulations regarding family and pupil rights, privacy, and protection, as well as adhere to the guidelines regarding the protection of human subjects. Furthermore, it should be noted that the subsection: Additional ED Protections for Children Involved as Subjects in Research will be respected due to the nature of the present research dissertation. Finally, I will also abide by the Ethical Principals presented by the LAUSD as adapted from the American Psychological Association (1992).

Burden to the District: I believe that my research will have little to no burden on the District. If granted approval, I'll approach the principals of the selected schools and ask them if I could visit the study sites to give a brief five-minute presentation during their after school program. Or, if granted permission and a few minutes, I can briefly present my research project during the back-to-school parent-teacher assembly/conference in September 2017 and distribute previously made packets that have the Spanish forms first and the English second and vice versa that briefly describes my research project. Finally, the only item that may burden the teachers is eventually a short and voluntary conversation either through Skype, phone, or by email following the data collection and analysis.

Benefit to the District: Benefits that my research is expected to provide to the District in terms of improving educational outcomes across all of the selected heritage language students is that the analysis of how bilingual speakers use Spanish in their natural environment, can inform how Spanish is taught in the Dual Language Programs. It could highlight aspects of language that could be reinforced in school, in order for speakers to improve their communicative and grammatical competence based on how Spanish is used in a natural, social environment. Moreover, studying the lexical, morphosyntactic and phonetic features of second-, third- and fourth- generation Spanish speakers may be able to help improve the design and delivery of Spanish instruction in the classroom on a grammatical level, now that California will bring back bilingual education with the passing of Proposition 58. Indeed, California will now have more power in designing the state's bilingual programs. Finally, this research, by filming child-parent interaction in Spanish, seeks to promote the fact that Spanish language input is necessary for Spanish language acquisition to occur. In this light, on a broad scale, it seeks to improve parent involvement in their children's education, and on a specific level, on their children's linguistic education and acquisition.

Data request: None

Submit IRB Clearance: No

Submit CERR statement of agreement: Yes

Which submission is this? Second

Appendices: Attached

CERR statement of agreement: Attached

I would study the inflectional morphology during the after-school programs of both the Dual Language Program Schools and Standard Schools in order to have a point of comparison.

LINGUISTIC QUESTIONNAIRE, ENGLISH

Questionnaire

1. How many people live in your home? _____
2. Please complete the following table, filling out one column for each person (children as well as adults) who lives in your home, beginning with the child participating in this study. If you need more space, please use the attached half sheet.
 1. Relationship to child (mother, grandmother, aunt, brother, etc.)
 2. Age (in years)
 3. Sex (M = male, F = female)
 4. City and country of birth
 5. Year of arrival in LA (if born in LA, please put "NA")
 6. Highest level of education completed
 7. Native language (first language)
 8. Occupation. If person does not work, please put "NA"
 9. Language(s) that this person speaks with the child
 10. Language(s) that the child speaks with this person

EXAMPLE	A.	B	C
1. IGNACIO = child participating in study	1. Ana = sister	1.	1.
2. 8	2. 23	2.	2.
3. M	3. F	3.	3.
4. LA, USA	4. Los Angeles, USA	4.	4.
5. NA	5. NA	5.	5.
6. 3rd grade	6. College	6.	6.
7. Spanish	7. Spanish	7.	7.
8. NA	8. waitress	8.	8.
9. NA	9. Spanish, English	9.	9.
10. NA	10. English, some Spanish	10.	10.

D	E	F	G
1.	1.	1.	1.
2.	2.	2.	2.
3.	3.	3.	3.
4.	4.	4.	4.

1.	D	1.	E	1.	F	1.	G
5.		5.		5.		5.	
6.		6.		6.		6.	
7.		7.		7.		7.	
8.		8.		8.		8.	
9.		9.		9.		9.	
10.		10.		10.		10.	

Please see other side

3. Please include the information for the child's grandparents below. If they are deceased, please put a "D" next to their age in box # 1. If the child never had contact with the grandparent, please indicate this in boxes # 6 and 7 and put "NA" in each of these.

	grandma (maternal)	grandpa (maternal)	grandma (paternal)	grandpa (paternal)
1. age	1.	1.	1.	1.
2. birthplace (city, country)	2.	2.	2.	2.
3. year arrived in LA	3.	3.	3.	3.
4. highest level of school completed	4.	4.	4.	4.
5. native language(s)	5.	5.	5.	5.
6. language s/he speaks to child	6.	6.	6.	6.
7. language child speaks to him/her	7.	7.	7.	7.

4. Has the child lived somewhere other than Los Angeles?
 Yes. Please write where and for how long: _____
 No.
5. Has the child studied Spanish outside of the home? (For example, in a school, language instituter, cultural institute, community center, etc.)
 Yes. In _____ (name of place) for _____ (# of years)
 No.
6. Has the child always attended a public school here in Los Angeles?
 Yes.
 No. Please explain: _____
7. Does the child visit the country of origin of his close family members (parents, grandparents)?
 Yes. He/she has visited: _____ (cities & countries) _____ times (number)
 No.
8. How often?
 More than 3 times per year
 Between 2 and 3 times per year
 Once every other year
 Once every year
 Once every 3 years
 Once every 4 years
 Other: _____
 Never

Thank you for you participation!

LINGUISTIC QUESTIONNAIRE, SPANISH VERSION

Cuestionario

1. ¿Cuántas personas viven en su casa? _____
2. Por favor complete la siguiente tabla, llenando una columna para cada persona (adultos y niños) que viven en su casa, comenzando con el niño que está participando en esta investigación. Si necesita más espacio, por favor use la hoja adjunta.
 1. Parentesco (madre, abuelo, tía, hermano, etc.)
 2. Edad (en años)
 3. Sexo (M = masculino, F = femenino)
 4. Ciudad y país donde nació
 5. Año en que llegó a este país (si nació aquí, por favor ponga "NA")
 6. Grado de escuela más alto que ha completado. Si nunca asistió a la escuela, por favor ponga "sin estudios"
 7. Lengua materna (primera lengua)
 8. Ocupación. Si no trabaja, por favor ponga "NA"
 9. Lengua(s) que habla con el niño
 10. Lengua(s) en que el niño habla con la persona

EJEMPLO	A.	B	C
1. IGNACIO = niño que participa en esta investigación	1. Teresa = tía	1.	1.
2. 8	2. 32	2.	2.
3. M	3. F	3.	3.
4. Los Angeles, USA	4. Los Angeles, USA	4.	4.
5. NA	5. NA	5.	5.
6. grado 3	6. grado 5	6.	6.
7. español	7. español	7.	7.
8. NA	8. mesera	8.	8.
9. NA	9. español, inglés	9.	9.
10. NA	10. inglés, y un poco de español	10.	10.

1.	D	1.	E	1.	F	1.	C
2.		2.		2.		2.	
3.		3.		3.		3.	
4.		4.		4.		4.	
5.		5.		5.		5.	
6.		6.		6.		6.	
7.		7.		7.		7.	
8.		8.		8.		8.	
9.		9.		9.		9.	
10.		10.		10.		10.	

Por favor vea el otro lado

3. Por favor incluya los datos de los abuelos abajo. Si han fallecido, por favor ponga una "F" junto a la edad, en la casilla # 1. Si el niño nunca tuvo contacto con ellos, por favor indíquelo en las casillas # 6 y 7 y ponga "NA" en cada una.

	abuela materna	abuelo materno	abuela paterna	abuelo paterno
1. edad	1.	1.	1.	1.
2. ciudad y país donde nació	2.	2.	2.	2.
3. año que llegó a LA	3.	3.	3.	3.
4. grado de escuela más alto que completo	4.	4.	4.	4.
5. primera(s) lengua(s)	5.	5.	5.	5.
6. lengua que habla con el niño/a	6.	6.	6.	6.
7. lengua que habla el/la niño/a con él/ella	7.	7.	7.	7.

4. ¿Siempre ha vivido el niño en Los Angeles?
 O Sí.
 O No. Por favor explique dónde y por cuánto tiempo: _____
5. ¿El niño ha estudiado español fuera de casa? (Por ejemplo, en una escuela, un instituto de lenguas, un instituto cultural, un centro comunitario, la iglesia etc.)
 O Sí. En _____ (nombre y lugar) por _____ (# de años)
 O No.
6. ¿El niño siempre ha asistido a una escuela pública aquí en Los Angeles?
 O Sí.
 O No. Por favor explique: _____
7. ¿Visita el niño el país de origen de sus familiares cercanos (padres, abuelos)?
 O Sí. Ha visitado: _____ (ciudad(es) y país(es)) _____ veces (numero)
 O No.

8. ¿Con qué frecuencia visita ese país?

O Más de 3 veces al año

O entre 2 y 3 veces al año

O 1 vez al año

O 1 vez cada 2 años

O 1 vez cada 3 años

O 1 vez cada 4 años o menos

O Sólo fue una vez

O Nunca

¡Gracias por su participación!



Los Angeles Unified School District
Office of Data and Accountability
333 South Beaudry Avenue, 16th Floor, Los Angeles, California 90017
Telephone: (213) 241-2460 Fax: (213) 241-8462

Viriam Ekehian
Interim Superintendent of
Schools

Oscar Lafarga
Executive Director

February 1, 2018

Mr. Eric Alvarez Perez
Doctoral Candidate, Sorbonne Nouvelle University
[REDACTED]
Los Angeles, CA [REDACTED]

Dear Researcher:

The LAUSD Committee for External Research Review has approved your request to initiate the research study entitled "Spanish heritage language acquisition and maintenance in Los Angeles, California." This action by the committee is an approval to conduct research in LAUSD. As you indicated in the Statement of Agreement that you do intend to name the District in your reports and publications, the following policy applies: We require 30 days' review of with an advance copy of any publication to enable us to remove any confidential information. The researcher will delete such LAUSD confidential information at CERR'S request.

This letter does not:

- Create any obligation for district personnel, students, or parents to participate. All participation must be completely voluntary and the confidentiality of all sources must be maintained.
- Permit the principal or staff to engage in research activities (other than observations) that occur during instructional or work time.

The approval is valid for one year from the date of this letter. At the conclusion of your study or one year from today, whichever comes first, please send a practitioner-friendly summary (Power Point presentation, infographic, research brief, etc.) of your findings and copies of any reports to my attention. I wish you the best of luck in your research endeavors.

Sincerely,

A handwritten signature in black ink, appearing to read "Katherine Hayes".

Katherine Hayes, Ph.D.
Coordinator CERR, School Experience Survey
Research and Reporting Branch
Office of Data and Accountability
Los Angeles Unified School District
333 S. Beaudry Ave. 16th Floor

Bilingual Language Profile: English-Spanish

We would like to ask you to help us by answering the following questions concerning your language history, use, attitudes, and proficiency. This survey was created with support from the Center for Open Educational Resources and Language Learning at the University of Texas at Austin to better understand the profiles of bilingual speakers in diverse settings with diverse backgrounds. The survey consists of 19 questions and will take less than 10 minutes to complete. This is not a test, so there are no right or wrong answers. Please answer every question and give your answers sincerely. Thank you very much for your help.

I. Biographical Information

Name	ROX	Today's Date	August / / 2018
Age	24	<input type="checkbox"/> Male / <input checked="" type="checkbox"/> Female	Current place of residence: city/state Los Angeles, CA. country USA
Highest level of formal education:	<input type="checkbox"/> Less than high school	<input type="checkbox"/> High school	<input checked="" type="checkbox"/> Some college
	<input type="checkbox"/> College (B.A., B.S.)	<input type="checkbox"/> Some graduate school	<input type="checkbox"/> Masters
	<input type="checkbox"/> PhD/MD/JD	<input type="checkbox"/> Other: _____	

Please cite as :

Birdsong, D., Gertken, L.M., & Amengual, M. *Bilingual Language Profile: An Easy-to-Use Instrument to Assess Bilingualism*. COERLL, University of Texas at Austin. Web. 20 Jan. 2012. <<https://sites.la.utexas.edu/bilingual/>>.

II. Language history

In this section, we would like you to answer some factual questions about your language history by placing a check in the appropriate box.

1. At what age did you start learning the following languages?

English

Since birth 1 2 3 4 5 6 7 8 9 10 11 12 13 14 15 16 17 18 19 20+

Spanish

Since birth 1 2 3 4 5 6 7 8 9 10 11 12 13 14 15 16 17 18 19 20+

2. At what age did you start to feel comfortable using the following languages?

English

As early as I can remember 1 2 3 4 5 6 7 8 9 10 11 12 13 14 15 16 17 18 19 20+ not yet

Spanish

As early as I can remember 1 2 3 4 5 6 7 8 9 10 11 12 13 14 15 16 17 18 19 20+ not yet

3. How many years of classes (grammar, history, math, etc.) have you had in the following languages (primary school through university)?

English

0 1 2 3 4 5 6 7 8 9 10 11 12 13 14 15 16 17 18 19 20+

Spanish

0 1 2 3 4 5 6 7 8 9 10 11 12 13 14 15 16 17 18 19 20+

4. How many years have you spent in a country/region where the following languages are spoken?

English

0 1 2 3 4 5 6 7 8 9 10 11 12 13 14 15 16 17 18 19 20+

Spanish

0 1 2 3 4 5 6 7 8 9 10 11 12 13 14 15 16 17 18 19 20+

5. How many years have you spent in a family where the following languages are spoken?

English

0 1 2 3 4 5 6 7 8 9 10 11 12 13 14 15 16 17 18 19 20+

Spanish

0 1 2 3 4 5 6 7 8 9 10 11 12 13 14 15 16 17 18 19 20+

6. How many years have you spent in a work environment where the following languages are spoken?

English

0 1 2 3 4 5 6 7 8 9 10 11 12 13 14 15 16 17 18 19 20+

Spanish

0 1 2 3 4 5 6 7 8 9 10 11 12 13 14 15 16 17 18 19 20+

III. Language use

In this section, we would like you to answer some questions about your language use by placing a check in the appropriate box. Total use for all languages in a given question should equal 100%.

7. In an average week, what percentage of the time do you use the following languages **with friends**?

English	<input type="checkbox"/>	<input type="checkbox"/>	<input type="checkbox"/>	<input type="checkbox"/>	<input type="checkbox"/>	<input checked="" type="checkbox"/>	<input type="checkbox"/>	<input type="checkbox"/>	<input type="checkbox"/>	<input type="checkbox"/>	<input type="checkbox"/>
	0%	10%	20%	30%	40%	50%	60%	70%	80%	90%	100%
Spanish	<input type="checkbox"/>	<input type="checkbox"/>	<input type="checkbox"/>	<input type="checkbox"/>	<input type="checkbox"/>	<input checked="" type="checkbox"/>	<input type="checkbox"/>	<input type="checkbox"/>	<input type="checkbox"/>	<input type="checkbox"/>	<input type="checkbox"/>
	0%	10%	20%	30%	40%	50%	60%	70%	80%	90%	100%
Other languages	<input type="checkbox"/>	<input type="checkbox"/>	<input type="checkbox"/>	<input type="checkbox"/>	<input type="checkbox"/>	<input type="checkbox"/>	<input type="checkbox"/>	<input type="checkbox"/>	<input type="checkbox"/>	<input type="checkbox"/>	<input type="checkbox"/>
	0%	10%	20%	30%	40%	50%	60%	70%	80%	90%	100%

8. In an average week, what percentage of the time do you use the following languages **with family**?

English	<input type="checkbox"/>	<input type="checkbox"/>	<input type="checkbox"/>	<input type="checkbox"/>	<input type="checkbox"/>	<input checked="" type="checkbox"/>	<input type="checkbox"/>	<input type="checkbox"/>	<input type="checkbox"/>	<input type="checkbox"/>	<input type="checkbox"/>
	0%	10%	20%	30%	40%	50%	60%	70%	80%	90%	100%
Spanish	<input type="checkbox"/>	<input type="checkbox"/>	<input type="checkbox"/>	<input type="checkbox"/>	<input type="checkbox"/>	<input checked="" type="checkbox"/>	<input type="checkbox"/>	<input type="checkbox"/>	<input type="checkbox"/>	<input type="checkbox"/>	<input type="checkbox"/>
	0%	10%	20%	30%	40%	50%	60%	70%	80%	90%	100%
Other languages	<input type="checkbox"/>	<input type="checkbox"/>	<input type="checkbox"/>	<input type="checkbox"/>	<input type="checkbox"/>	<input type="checkbox"/>	<input type="checkbox"/>	<input type="checkbox"/>	<input type="checkbox"/>	<input type="checkbox"/>	<input type="checkbox"/>
	0%	10%	20%	30%	40%	50%	60%	70%	80%	90%	100%

9. In an average week, what percentage of the time do you use the following languages **at school/work**?

English	<input type="checkbox"/>	<input type="checkbox"/>	<input type="checkbox"/>	<input type="checkbox"/>	<input type="checkbox"/>	<input type="checkbox"/>	<input type="checkbox"/>	<input checked="" type="checkbox"/>	<input type="checkbox"/>	<input type="checkbox"/>	<input type="checkbox"/>
	0%	10%	20%	30%	40%	50%	60%	70%	80%	90%	100%
Spanish	<input type="checkbox"/>	<input type="checkbox"/>	<input type="checkbox"/>	<input checked="" type="checkbox"/>	<input type="checkbox"/>	<input type="checkbox"/>	<input type="checkbox"/>	<input type="checkbox"/>	<input type="checkbox"/>	<input type="checkbox"/>	<input type="checkbox"/>
	0%	10%	20%	30%	40%	50%	60%	70%	80%	90%	100%
Other languages	<input type="checkbox"/>	<input type="checkbox"/>	<input type="checkbox"/>	<input type="checkbox"/>	<input type="checkbox"/>	<input type="checkbox"/>	<input type="checkbox"/>	<input type="checkbox"/>	<input type="checkbox"/>	<input type="checkbox"/>	<input type="checkbox"/>
	0%	10%	20%	30%	40%	50%	60%	70%	80%	90%	100%

10. When you talk to yourself, how often do you **talk to yourself** in the following languages?

English	<input type="checkbox"/>	<input type="checkbox"/>	<input type="checkbox"/>	<input type="checkbox"/>	<input type="checkbox"/>	<input checked="" type="checkbox"/>	<input type="checkbox"/>	<input type="checkbox"/>	<input type="checkbox"/>	<input type="checkbox"/>	<input type="checkbox"/>
	0%	10%	20%	30%	40%	50%	60%	70%	80%	90%	100%
Spanish	<input type="checkbox"/>	<input type="checkbox"/>	<input type="checkbox"/>	<input type="checkbox"/>	<input type="checkbox"/>	<input checked="" type="checkbox"/>	<input type="checkbox"/>	<input type="checkbox"/>	<input type="checkbox"/>	<input type="checkbox"/>	<input type="checkbox"/>
	0%	10%	20%	30%	40%	50%	60%	70%	80%	90%	100%
Other languages	<input type="checkbox"/>	<input type="checkbox"/>	<input type="checkbox"/>	<input type="checkbox"/>	<input type="checkbox"/>	<input type="checkbox"/>	<input type="checkbox"/>	<input type="checkbox"/>	<input type="checkbox"/>	<input type="checkbox"/>	<input type="checkbox"/>
	0%	10%	20%	30%	40%	50%	60%	70%	80%	90%	100%

11. When you count, how often do you **count** in the following languages?

English	<input type="checkbox"/>	<input type="checkbox"/>	<input type="checkbox"/>	<input type="checkbox"/>	<input type="checkbox"/>	<input checked="" type="checkbox"/>	<input type="checkbox"/>	<input type="checkbox"/>	<input type="checkbox"/>	<input type="checkbox"/>	<input type="checkbox"/>
	0%	10%	20%	30%	40%	50%	60%	70%	80%	90%	100%
Spanish	<input type="checkbox"/>	<input type="checkbox"/>	<input type="checkbox"/>	<input type="checkbox"/>	<input type="checkbox"/>	<input checked="" type="checkbox"/>	<input type="checkbox"/>	<input type="checkbox"/>	<input type="checkbox"/>	<input type="checkbox"/>	<input type="checkbox"/>
	0%	10%	20%	30%	40%	50%	60%	70%	80%	90%	100%
Other languages	<input type="checkbox"/>	<input type="checkbox"/>	<input type="checkbox"/>	<input type="checkbox"/>	<input type="checkbox"/>	<input type="checkbox"/>	<input type="checkbox"/>	<input type="checkbox"/>	<input type="checkbox"/>	<input type="checkbox"/>	<input type="checkbox"/>
	0%	10%	20%	30%	40%	50%	60%	70%	80%	90%	100%

IV. Language proficiency

In this section, we would like you to rate your language proficiency by giving marks from 0 to 6.

- 0=not well at all 6=very well
12. a. How well do you speak **English**? 0 1 2 3 4 5 6
- b. How well do you speak **Spanish**? 0 1 2 3 4 5 6
13. a. How well do you understand **English**? 0 1 2 3 4 5 6
- b. How well do you understand **Spanish**? 0 1 2 3 4 5 6
14. a. How well do you read **English**? 0 1 2 3 4 5 6
- b. How well do you read **Spanish**? 0 1 2 3 4 5 6
15. a. How well do you write **English**? 0 1 2 3 4 5 6
- b. How well do you write **Spanish**? 0 1 2 3 4 5 6

V. Language attitudes

In this section, we would like you to respond to statements about language attitudes by giving marks from 0-6.

- | | 0=disagree | | | | | | 6=agree | | | | | | | |
|---|--------------------------|---|--------------------------|---|--------------------------|---|--------------------------|---|-------------------------------------|---|-------------------------------------|---|-------------------------------------|---|
| 16. a. I feel like myself when I speak English . | <input type="checkbox"/> | 0 | <input type="checkbox"/> | 1 | <input type="checkbox"/> | 2 | <input type="checkbox"/> | 3 | <input type="checkbox"/> | 4 | <input type="checkbox"/> | 5 | <input checked="" type="checkbox"/> | 6 |
| b. I feel like myself when I speak Spanish . | <input type="checkbox"/> | 0 | <input type="checkbox"/> | 1 | <input type="checkbox"/> | 2 | <input type="checkbox"/> | 3 | <input type="checkbox"/> | 4 | <input type="checkbox"/> | 5 | <input checked="" type="checkbox"/> | 6 |
| 17. a. I identify with an English-speaking culture. | <input type="checkbox"/> | 0 | <input type="checkbox"/> | 1 | <input type="checkbox"/> | 2 | <input type="checkbox"/> | 3 | <input type="checkbox"/> | 4 | <input type="checkbox"/> | 5 | <input checked="" type="checkbox"/> | 6 |
| b. I identify with a Spanish-speaking culture. | <input type="checkbox"/> | 0 | <input type="checkbox"/> | 1 | <input type="checkbox"/> | 2 | <input type="checkbox"/> | 3 | <input checked="" type="checkbox"/> | 4 | <input type="checkbox"/> | 5 | <input type="checkbox"/> | 6 |
| 18. a. It is important to me to use (or eventually use) English like a native speaker. | <input type="checkbox"/> | 0 | <input type="checkbox"/> | 1 | <input type="checkbox"/> | 2 | <input type="checkbox"/> | 3 | <input type="checkbox"/> | 4 | <input type="checkbox"/> | 5 | <input checked="" type="checkbox"/> | 6 |
| b. It is important to me to use (or eventually use) Spanish like a native speaker. | <input type="checkbox"/> | 0 | <input type="checkbox"/> | 1 | <input type="checkbox"/> | 2 | <input type="checkbox"/> | 3 | <input type="checkbox"/> | 4 | <input checked="" type="checkbox"/> | 5 | <input checked="" type="checkbox"/> | 6 |
| 19. a. I want others to think I am a native speaker of English . | <input type="checkbox"/> | 0 | <input type="checkbox"/> | 1 | <input type="checkbox"/> | 2 | <input type="checkbox"/> | 3 | <input type="checkbox"/> | 4 | <input type="checkbox"/> | 5 | <input checked="" type="checkbox"/> | 6 |
| b. I want others to think I am a native speaker of Spanish . | <input type="checkbox"/> | 0 | <input type="checkbox"/> | 1 | <input type="checkbox"/> | 2 | <input type="checkbox"/> | 3 | <input type="checkbox"/> | 4 | <input type="checkbox"/> | 5 | <input checked="" type="checkbox"/> | 6 |

Bilingual Language Profile: English-Spanish

We would like to ask you to help us by answering the following questions concerning your language history, use, attitudes, and proficiency. This survey was created with support from the Center for Open Educational Resources and Language Learning at the University of Texas at Austin to better understand the profiles of bilingual speakers in diverse settings with diverse backgrounds. The survey consists of 19 questions and will take less than 10 minutes to complete. This is not a test, so there are no right or wrong answers. Please answer every question and give your answers sincerely. Thank you very much for your help.

I. Biographical Information

Name	MAR	Today's Date	August / / 2018
Age	28	<input checked="" type="checkbox"/> Male / <input type="checkbox"/> Female	Current place of residence: city/state Los Angeles, CA. country USA
Highest level of formal education:			
<input checked="" type="checkbox"/> Less than high school	<input type="checkbox"/> High school	<input type="checkbox"/> Some college	
<input type="checkbox"/> College (B.A., B.S.)	<input type="checkbox"/> Some graduate school	<input type="checkbox"/> Masters	
<input type="checkbox"/> PhD/MD/JD	<input checked="" type="checkbox"/> Other: work related certificates		

Please cite as :

Birdsong, D., Gertken, L.M., & Amengual, M. *Bilingual Language Profile: An Easy-to-Use Instrument to Assess Bilingualism*. COERLL, University of Texas at Austin. Web. 20 Jan. 2012. <<https://sites.la.utexas.edu/bilingual/>>.

II. Language history

In this section, we would like you to answer some factual questions about your language history by placing a check in the appropriate box.

1. At what age did you start learning the following languages?

English
 Since birth 1 2 3 4 5 6 7 8 9 10 11 12 13 14 15 16 17 18 19 20+

Spanish
 Since birth 1 2 3 4 5 6 7 8 9 10 11 12 13 14 15 16 17 18 19 20+

2. At what age did you start to feel comfortable using the following languages?

English
 As early as I can remember 1 2 3 4 5 6 7 8 9 10 11 12 13 14 15 16 17 18 19 20+ not yet

Spanish
 As early as I can remember 1 2 3 4 5 6 7 8 9 10 11 12 13 14 15 16 17 18 19 20+ not yet

3. How many years of classes (grammar, history, math, etc.) have you had in the following languages (primary school through university)?

English
 0 1 2 3 4 5 6 7 8 9 10 11 12 13 14 15 16 17 18 19 20+

Spanish
 0 1 2 3 4 5 6 7 8 9 10 11 12 13 14 15 16 17 18 19 20+

4. How many years have you spent in a country/region where the following languages are spoken?

English
 0 1 2 3 4 5 6 7 8 9 10 11 12 13 14 15 16 17 18 19 20+

Spanish
 0 1 2 3 4 5 6 7 8 9 10 11 12 13 14 15 16 17 18 19 20+

5. How many years have you spent in a family where the following languages are spoken?

English
 0 1 2 3 4 5 6 7 8 9 10 11 12 13 14 15 16 17 18 19 20+

Spanish
 0 1 2 3 4 5 6 7 8 9 10 11 12 13 14 15 16 17 18 19 20+

6. How many years have you spent in a work environment where the following languages are spoken?

English
 0 1 2 3 4 5 6 7 8 9 10 11 12 13 14 15 16 17 18 19 20+

Spanish
 0 1 2 3 4 5 6 7 8 9 10 11 12 13 14 15 16 17 18 19 20+

III. Language use

In this section, we would like you to answer some questions about your language use by placing a check in the appropriate box. Total use for all languages in a given question should equal 100%.

7. In an average week, what percentage of the time do you use the following languages **with friends**?

English	<input type="checkbox"/>	<input type="checkbox"/>	<input type="checkbox"/>	<input type="checkbox"/>	<input type="checkbox"/>	<input checked="" type="checkbox"/>	<input type="checkbox"/>	<input type="checkbox"/>	<input type="checkbox"/>	<input type="checkbox"/>	<input type="checkbox"/>
	0%	10%	20%	30%	40%	50%	60%	70%	80%	90%	100%
Spanish	<input type="checkbox"/>	<input type="checkbox"/>	<input type="checkbox"/>	<input type="checkbox"/>	<input type="checkbox"/>	<input checked="" type="checkbox"/>	<input type="checkbox"/>	<input type="checkbox"/>	<input type="checkbox"/>	<input type="checkbox"/>	<input type="checkbox"/>
	0%	10%	20%	30%	40%	50%	60%	70%	80%	90%	100%
Other languages	<input type="checkbox"/>	<input type="checkbox"/>	<input type="checkbox"/>	<input type="checkbox"/>	<input type="checkbox"/>	<input type="checkbox"/>	<input type="checkbox"/>	<input type="checkbox"/>	<input type="checkbox"/>	<input type="checkbox"/>	<input type="checkbox"/>
	0%	10%	20%	30%	40%	50%	60%	70%	80%	90%	100%

8. In an average week, what percentage of the time do you use the following languages **with family**?

English	<input type="checkbox"/>	<input type="checkbox"/>	<input type="checkbox"/>	<input type="checkbox"/>	<input type="checkbox"/>	<input checked="" type="checkbox"/>	<input type="checkbox"/>	<input type="checkbox"/>	<input type="checkbox"/>	<input type="checkbox"/>	<input type="checkbox"/>
	0%	10%	20%	30%	40%	50%	60%	70%	80%	90%	100%
Spanish	<input type="checkbox"/>	<input type="checkbox"/>	<input type="checkbox"/>	<input type="checkbox"/>	<input type="checkbox"/>	<input checked="" type="checkbox"/>	<input type="checkbox"/>	<input type="checkbox"/>	<input type="checkbox"/>	<input type="checkbox"/>	<input type="checkbox"/>
	0%	10%	20%	30%	40%	50%	60%	70%	80%	90%	100%
Other languages	<input type="checkbox"/>	<input type="checkbox"/>	<input type="checkbox"/>	<input type="checkbox"/>	<input type="checkbox"/>	<input type="checkbox"/>	<input type="checkbox"/>	<input type="checkbox"/>	<input type="checkbox"/>	<input type="checkbox"/>	<input type="checkbox"/>
	0%	10%	20%	30%	40%	50%	60%	70%	80%	90%	100%

9. In an average week, what percentage of the time do you use the following languages **at school/work**?

English	<input type="checkbox"/>	<input type="checkbox"/>	<input type="checkbox"/>	<input type="checkbox"/>	<input type="checkbox"/>	<input type="checkbox"/>	<input checked="" type="checkbox"/>	<input type="checkbox"/>	<input type="checkbox"/>	<input type="checkbox"/>	<input type="checkbox"/>
	0%	10%	20%	30%	40%	50%	60%	70%	80%	90%	100%
Spanish	<input type="checkbox"/>	<input type="checkbox"/>	<input type="checkbox"/>	<input type="checkbox"/>	<input checked="" type="checkbox"/>	<input type="checkbox"/>	<input type="checkbox"/>	<input type="checkbox"/>	<input type="checkbox"/>	<input type="checkbox"/>	<input type="checkbox"/>
	0%	10%	20%	30%	40%	50%	60%	70%	80%	90%	100%
Other languages	<input type="checkbox"/>	<input type="checkbox"/>	<input type="checkbox"/>	<input type="checkbox"/>	<input type="checkbox"/>	<input type="checkbox"/>	<input type="checkbox"/>	<input type="checkbox"/>	<input type="checkbox"/>	<input type="checkbox"/>	<input type="checkbox"/>
	0%	10%	20%	30%	40%	50%	60%	70%	80%	90%	100%

10. When you talk to yourself, how often do you **talk to yourself** in the following languages?

English	<input type="checkbox"/>	<input type="checkbox"/>	<input type="checkbox"/>	<input type="checkbox"/>	<input type="checkbox"/>	<input type="checkbox"/>	<input type="checkbox"/>	<input type="checkbox"/>	<input type="checkbox"/>	<input type="checkbox"/>	<input type="checkbox"/>
	0%	10%	20%	30%	40%	50%	60%	70%	80%	90%	100%
Spanish	<input type="checkbox"/>	<input type="checkbox"/>	<input type="checkbox"/>	<input type="checkbox"/>	<input type="checkbox"/>	<input type="checkbox"/>	<input type="checkbox"/>	<input type="checkbox"/>	<input type="checkbox"/>	<input type="checkbox"/>	<input type="checkbox"/>
	0%	10%	20%	30%	40%	50%	60%	70%	80%	90%	100%
Other languages	<input type="checkbox"/>	<input type="checkbox"/>	<input type="checkbox"/>	<input type="checkbox"/>	<input type="checkbox"/>	<input type="checkbox"/>	<input type="checkbox"/>	<input type="checkbox"/>	<input type="checkbox"/>	<input type="checkbox"/>	<input type="checkbox"/>
	0%	10%	20%	30%	40%	50%	60%	70%	80%	90%	100%

11. When you count, how often do you **count** in the following languages?

English	<input type="checkbox"/>	<input type="checkbox"/>	<input type="checkbox"/>	<input type="checkbox"/>	<input type="checkbox"/>	<input type="checkbox"/>	<input type="checkbox"/>	<input type="checkbox"/>	<input type="checkbox"/>	<input type="checkbox"/>	<input type="checkbox"/>
	0%	10%	20%	30%	40%	50%	60%	70%	80%	90%	100%
Spanish	<input type="checkbox"/>	<input type="checkbox"/>	<input type="checkbox"/>	<input type="checkbox"/>	<input type="checkbox"/>	<input type="checkbox"/>	<input type="checkbox"/>	<input type="checkbox"/>	<input type="checkbox"/>	<input type="checkbox"/>	<input type="checkbox"/>
	0%	10%	20%	30%	40%	50%	60%	70%	80%	90%	100%
Other languages	<input type="checkbox"/>	<input type="checkbox"/>	<input type="checkbox"/>	<input type="checkbox"/>	<input type="checkbox"/>	<input type="checkbox"/>	<input type="checkbox"/>	<input type="checkbox"/>	<input type="checkbox"/>	<input type="checkbox"/>	<input type="checkbox"/>
	0%	10%	20%	30%	40%	50%	60%	70%	80%	90%	100%

V. Language attitudes

In this section, we would like you to respond to statements about language attitudes by giving marks from 0-6.

- 0=disagree 6=agree
16. a. I feel like myself when I speak **English**. 0 1 2 3 4 5 6
- b. I feel like myself when I speak **Spanish**. 0 1 2 3 4 5 6
17. a. I identify with an **English-speaking** culture. 0 1 2 3 4 5 6
- b. I identify with a **Spanish-speaking** culture. 0 1 2 3 4 5 6
18. a. It is important to me to use (or eventually use) **English** like a native speaker. 0 1 2 3 4 5 6
- b. It is important to me to use (or eventually use) **Spanish** like a native speaker. 0 1 2 3 4 5 6
19. a. I want others to think I am a native speaker of **English**. 0 1 2 3 4 5 6
- b. I want others to think I am a native speaker of **Spanish**. 0 1 2 3 4 5 6

Bilingual Language Profile: English-Spanish

We would like to ask you to help us by answering the following questions concerning your language history, use, attitudes, and proficiency. This survey was created with support from the Center for Open Educational Resources and Language Learning at the University of Texas at Austin to better understand the profiles of bilingual speakers in diverse settings with diverse backgrounds. The survey consists of 19 questions and will take less than 10 minutes to complete. This is not a test, so there are no right or wrong answers. Please answer every question and give your answers sincerely. Thank you very much for your help.

I. Biographical Information

Name	ALE	Today's Date	August / / 2018
Age	28	<input type="checkbox"/> Male / <input checked="" type="checkbox"/> Female	Current place of residence: city/state Los Angeles, CA. country USA
Highest level of formal education:	<input type="checkbox"/> Less than high school	<input type="checkbox"/> High school	<input checked="" type="checkbox"/> Some college
	<input type="checkbox"/> College (B.A., B.S.)	<input type="checkbox"/> Some graduate school	<input type="checkbox"/> Masters
	<input type="checkbox"/> PhD/MD/JD	<input type="checkbox"/> Other: _____	

Please cite as :

Birdsong, D., Gertken, L.M., & Amengual, M. *Bilingual Language Profile: An Easy-to-Use Instrument to Assess Bilingualism*. COERLL, University of Texas at Austin. Web. 20 Jan. 2012. <<https://sites.la.utexas.edu/bilingual/>>.

II. Language history

In this section, we would like you to answer some factual questions about your language history by placing a check in the appropriate box.

1. At what age did you start learning the following languages?

English
 Since birth 1 2 3 4 5 6 7 8 9 10 11 12 13 14 15 16 17 18 19 20+

Spanish
 Since birth 1 2 3 4 5 6 7 8 9 10 11 12 13 14 15 16 17 18 19 20+

2. At what age did you start to feel comfortable using the following languages?

English
 As early as I can remember 1 2 3 4 5 6 7 8 9 10 11 12 13 14 15 16 17 18 19 20+ not yet

Spanish
 As early as I can remember 1 2 3 4 5 6 7 8 9 10 11 12 13 14 15 16 17 18 19 20+ not yet

3. How many years of classes (grammar, history, math, etc.) have you had in the following languages (primary school through university)?

English
 0 1 2 3 4 5 6 7 8 9 10 11 12 13 14 15 16 17 18 19 20+

Spanish
 0 1 2 3 4 5 6 7 8 9 10 11 12 13 14 15 16 17 18 19 20+

4. How many years have you spent in a country/region where the following languages are spoken?

English
 0 1 2 3 4 5 6 7 8 9 10 11 12 13 14 15 16 17 18 19 20+

Spanish
 0 1 2 3 4 5 6 7 8 9 10 11 12 13 14 15 16 17 18 19 20+

5. How many years have you spent in a family where the following languages are spoken?

English
 0 1 2 3 4 5 6 7 8 9 10 11 12 13 14 15 16 17 18 19 20+

Spanish
 0 1 2 3 4 5 6 7 8 9 10 11 12 13 14 15 16 17 18 19 20+

6. How many years have you spent in a work environment where the following languages are spoken?

English
 0 1 2 3 4 5 6 7 8 9 10 11 12 13 14 15 16 17 18 19 20+

Spanish
 0 1 2 3 4 5 6 7 8 9 10 11 12 13 14 15 16 17 18 19 20+

iii. Language use

In this section, we would like you to answer some questions about your language use by placing a check in the appropriate box. Total use for all languages in a given question should equal 100%.

7. In an average week, what percentage of the time do you use the following languages **with friends**?

English	<input type="checkbox"/>	<input type="checkbox"/>	<input type="checkbox"/>	<input type="checkbox"/>	<input type="checkbox"/>	<input type="checkbox"/>	<input type="checkbox"/>	<input type="checkbox"/>	<input checked="" type="checkbox"/>	<input type="checkbox"/>	<input type="checkbox"/>
	0%	10%	20%	30%	40%	50%	60%	70%	80%	90%	100%
Spanish	<input type="checkbox"/>	<input type="checkbox"/>	<input checked="" type="checkbox"/>	<input type="checkbox"/>	<input type="checkbox"/>	<input type="checkbox"/>	<input type="checkbox"/>	<input type="checkbox"/>	<input type="checkbox"/>	<input type="checkbox"/>	<input type="checkbox"/>
	0%	10%	20%	30%	40%	50%	60%	70%	80%	90%	100%
Other languages	<input type="checkbox"/>	<input type="checkbox"/>	<input type="checkbox"/>	<input type="checkbox"/>	<input type="checkbox"/>	<input type="checkbox"/>	<input type="checkbox"/>	<input type="checkbox"/>	<input type="checkbox"/>	<input type="checkbox"/>	<input type="checkbox"/>
	0%	10%	20%	30%	40%	50%	60%	70%	80%	90%	100%

8. In an average week, what percentage of the time do you use the following languages **with family**?

English	<input type="checkbox"/>	<input type="checkbox"/>	<input type="checkbox"/>	<input type="checkbox"/>	<input type="checkbox"/>	<input type="checkbox"/>	<input type="checkbox"/>	<input checked="" type="checkbox"/>	<input type="checkbox"/>	<input type="checkbox"/>	<input type="checkbox"/>
	0%	10%	20%	30%	40%	50%	60%	70%	80%	90%	100%
Spanish	<input type="checkbox"/>	<input type="checkbox"/>	<input type="checkbox"/>	<input checked="" type="checkbox"/>	<input type="checkbox"/>	<input type="checkbox"/>	<input type="checkbox"/>	<input type="checkbox"/>	<input type="checkbox"/>	<input type="checkbox"/>	<input type="checkbox"/>
	0%	10%	20%	30%	40%	50%	60%	70%	80%	90%	100%
Other languages	<input type="checkbox"/>	<input type="checkbox"/>	<input type="checkbox"/>	<input type="checkbox"/>	<input type="checkbox"/>	<input type="checkbox"/>	<input type="checkbox"/>	<input type="checkbox"/>	<input type="checkbox"/>	<input type="checkbox"/>	<input type="checkbox"/>
	0%	10%	20%	30%	40%	50%	60%	70%	80%	90%	100%

9. In an average week, what percentage of the time do you use the following languages **at school/work**?

English	<input type="checkbox"/>	<input type="checkbox"/>	<input type="checkbox"/>	<input type="checkbox"/>	<input type="checkbox"/>	<input type="checkbox"/>	<input type="checkbox"/>	<input type="checkbox"/>	<input type="checkbox"/>	<input type="checkbox"/>	<input checked="" type="checkbox"/>
	0%	10%	20%	30%	40%	50%	60%	70%	80%	90%	100%
Spanish	<input checked="" type="checkbox"/>	<input type="checkbox"/>	<input type="checkbox"/>	<input type="checkbox"/>	<input type="checkbox"/>	<input type="checkbox"/>	<input type="checkbox"/>	<input type="checkbox"/>	<input type="checkbox"/>	<input type="checkbox"/>	<input type="checkbox"/>
	0%	10%	20%	30%	40%	50%	60%	70%	80%	90%	100%
Other languages	<input type="checkbox"/>	<input type="checkbox"/>	<input type="checkbox"/>	<input type="checkbox"/>	<input type="checkbox"/>	<input type="checkbox"/>	<input type="checkbox"/>	<input type="checkbox"/>	<input type="checkbox"/>	<input type="checkbox"/>	<input type="checkbox"/>
	0%	10%	20%	30%	40%	50%	60%	70%	80%	90%	100%

10. When you talk to yourself, how often do you **talk to yourself** in the following languages?

English	<input type="checkbox"/>	<input type="checkbox"/>	<input type="checkbox"/>	<input type="checkbox"/>	<input type="checkbox"/>	<input type="checkbox"/>	<input type="checkbox"/>	<input type="checkbox"/>	<input type="checkbox"/>	<input type="checkbox"/>	<input checked="" type="checkbox"/>
	0%	10%	20%	30%	40%	50%	60%	70%	80%	90%	100%
Spanish	<input checked="" type="checkbox"/>	<input type="checkbox"/>	<input type="checkbox"/>	<input type="checkbox"/>	<input type="checkbox"/>	<input type="checkbox"/>	<input type="checkbox"/>	<input type="checkbox"/>	<input type="checkbox"/>	<input type="checkbox"/>	<input type="checkbox"/>
	0%	10%	20%	30%	40%	50%	60%	70%	80%	90%	100%
Other languages	<input type="checkbox"/>	<input type="checkbox"/>	<input type="checkbox"/>	<input type="checkbox"/>	<input type="checkbox"/>	<input type="checkbox"/>	<input type="checkbox"/>	<input type="checkbox"/>	<input type="checkbox"/>	<input type="checkbox"/>	<input type="checkbox"/>
	0%	10%	20%	30%	40%	50%	60%	70%	80%	90%	100%

11. When you count, how often do you **count** in the following languages?

English	<input type="checkbox"/>	<input type="checkbox"/>	<input type="checkbox"/>	<input type="checkbox"/>	<input type="checkbox"/>	<input type="checkbox"/>	<input type="checkbox"/>	<input type="checkbox"/>	<input checked="" type="checkbox"/>	<input type="checkbox"/>	<input type="checkbox"/>
	0%	10%	20%	30%	40%	50%	60%	70%	80%	90%	100%
Spanish	<input type="checkbox"/>	<input checked="" type="checkbox"/>	<input type="checkbox"/>	<input type="checkbox"/>	<input type="checkbox"/>	<input type="checkbox"/>	<input type="checkbox"/>	<input type="checkbox"/>	<input type="checkbox"/>	<input type="checkbox"/>	<input type="checkbox"/>
	0%	10%	20%	30%	40%	50%	60%	70%	80%	90%	100%
Other languages	<input type="checkbox"/>	<input type="checkbox"/>	<input type="checkbox"/>	<input type="checkbox"/>	<input type="checkbox"/>	<input type="checkbox"/>	<input type="checkbox"/>	<input type="checkbox"/>	<input type="checkbox"/>	<input type="checkbox"/>	<input type="checkbox"/>
	0%	10%	20%	30%	40%	50%	60%	70%	80%	90%	100%

IV. Language proficiency

In this section, we would like you to rate your language proficiency by giving marks from 0 to 6.

- 0=not well at all 6=very well
12. a. How well do you speak **English**? 0 1 2 3 4 5 6
- b. How well do you speak **Spanish**? 0 1 2 3 4 5 6
13. a. How well do you understand **English**? 0 1 2 3 4 5 6
- b. How well do you understand **Spanish**? 0 1 2 3 4 5 6
14. a. How well do you read **English**? 0 1 2 3 4 5 6
- b. How well do you read **Spanish**? 0 1 2 3 4 5 6
15. a. How well do you write **English**? 0 1 2 3 4 5 6
- b. How well do you write **Spanish**? 0 1 2 3 4 5 6

V. Language attitudes

In this section, we would like you to respond to statements about language attitudes by giving marks from 0-6.

- 0=disagree 6=agree
16. a. I feel like myself when I speak **English**. 0 1 2 3 4 5 6
- b. I feel like myself when I speak **Spanish**. 0 1 2 3 4 5 6
17. a. I identify with an **English-speaking** culture. 0 1 2 3 4 5 6
- b. I identify with a **Spanish-speaking** culture. 0 1 2 3 4 5 6
18. a. It is important to me to use (or eventually use) **English** like a native speaker. 0 1 2 3 4 5 6
- b. It is important to me to use (or eventually use) **Spanish** like a native speaker. 0 1 2 3 4 5 6
19. a. I want others to think I am a native speaker of **English**. 0 1 2 3 4 5 6
- b. I want others to think I am a native speaker of **Spanish**. 0 1 2 3 4 5 6

Bilingual Language Profile: English-Spanish

We would like to ask you to help us by answering the following questions concerning your language history, use, attitudes, and proficiency. This survey was created with support from the Center for Open Educational Resources and Language Learning at the University of Texas at Austin to better understand the profiles of bilingual speakers in diverse settings with diverse backgrounds. The survey consists of 19 questions and will take less than 10 minutes to complete. This is not a test, so there are no right or wrong answers. Please answer every question and give your answers sincerely. Thank you very much for your help.

I. Biographical Information

Name RIC Today's Date August / / 2018

Age 28 Male / Female Current place of residence: city/state Los Angeles, CA. country USA

Highest level of formal education: Less than high school High school Some college
 College (B.A., B.S.) Some graduate school Masters
 PhD/MD/JD Other: _____

Please cite as :

Birdsong, D., Gertken, L.M., & Amengual, M. *Bilingual Language Profile: An Easy-to-Use Instrument to Assess Bilingualism*. COERLL, University of Texas at Austin. Web. 20 Jan. 2012. <<https://sites.la.utexas.edu/bilingual/>>.

II. Language history

In this section, we would like you to answer some factual questions about your language history by placing a check in the appropriate box.

1. At what age did you start learning the following languages?

English
Since birth 1 2 3 4 5 6 7 8 9 10 11 12 13 14 15 16 17 18 19 20+

Spanish
Since birth 1 2 3 4 5 6 7 8 9 10 11 12 13 14 15 16 17 18 19 20+

2. At what age did you start to feel comfortable using the following languages?

English
As early as I can remember 1 2 3 4 5 6 7 8 9 10 11 12 13 14 15 16 17 18 19 20+ not yet

Spanish
As early as I can remember 1 2 3 4 5 6 7 8 9 10 11 12 13 14 15 16 17 18 19 20+ not yet

3. How many years of classes (grammar, history, math, etc.) have you had in the following languages (primary school through university)?

English
0 1 2 3 4 5 6 7 8 9 10 11 12 13 14 15 16 17 18 19 20+

Spanish
0 1 2 3 4 5 6 7 8 9 10 11 12 13 14 15 16 17 18 19 20+

4. How many years have you spent in a country/region where the following languages are spoken?

English
0 1 2 3 4 5 6 7 8 9 10 11 12 13 14 15 16 17 18 19 20+

Spanish
0 1 2 3 4 5 6 7 8 9 10 11 12 13 14 15 16 17 18 19 20+

5. How many years have you spent in a family where the following languages are spoken?

English
0 1 2 3 4 5 6 7 8 9 10 11 12 13 14 15 16 17 18 19 20+

Spanish
0 1 2 3 4 5 6 7 8 9 10 11 12 13 14 15 16 17 18 19 20+

6. How many years have you spent in a work environment where the following languages are spoken?

English
0 1 2 3 4 5 6 7 8 9 10 11 12 13 14 15 16 17 18 19 20+

Spanish
0 1 2 3 4 5 6 7 8 9 10 11 12 13 14 15 16 17 18 19 20+

III. Language use

In this section, we would like you to answer some questions about your language use by placing a check in the appropriate box. Total use for all languages in a given question should equal 100%.

7. In an average week, what percentage of the time do you use the following languages **with friends**?

English	<input type="checkbox"/>	<input type="checkbox"/>	<input type="checkbox"/>	<input type="checkbox"/>	<input type="checkbox"/>	<input type="checkbox"/>	<input type="checkbox"/>	<input type="checkbox"/>	<input checked="" type="checkbox"/>	<input type="checkbox"/>	
	0%	10%	20%	30%	40%	50%	60%	70%	80%	90%	100%
Spanish	<input type="checkbox"/>	<input checked="" type="checkbox"/>	<input type="checkbox"/>	<input type="checkbox"/>	<input type="checkbox"/>	<input type="checkbox"/>	<input type="checkbox"/>	<input type="checkbox"/>	<input type="checkbox"/>	<input type="checkbox"/>	<input type="checkbox"/>
	0%	10%	20%	30%	40%	50%	60%	70%	80%	90%	100%
Other languages	<input type="checkbox"/>	<input type="checkbox"/>	<input type="checkbox"/>	<input type="checkbox"/>	<input type="checkbox"/>	<input type="checkbox"/>	<input type="checkbox"/>	<input type="checkbox"/>	<input type="checkbox"/>	<input type="checkbox"/>	<input type="checkbox"/>
	0%	10%	20%	30%	40%	50%	60%	70%	80%	90%	100%

8. In an average week, what percentage of the time do you use the following languages **with family**?

English	<input type="checkbox"/>	<input type="checkbox"/>	<input type="checkbox"/>	<input type="checkbox"/>	<input type="checkbox"/>	<input type="checkbox"/>	<input checked="" type="checkbox"/>	<input type="checkbox"/>	<input type="checkbox"/>	<input type="checkbox"/>	<input type="checkbox"/>
	0%	10%	20%	30%	40%	50%	60%	70%	80%	90%	100%
Spanish	<input type="checkbox"/>	<input type="checkbox"/>	<input type="checkbox"/>	<input type="checkbox"/>	<input checked="" type="checkbox"/>	<input type="checkbox"/>	<input type="checkbox"/>	<input type="checkbox"/>	<input type="checkbox"/>	<input type="checkbox"/>	<input type="checkbox"/>
	0%	10%	20%	30%	40%	50%	60%	70%	80%	90%	100%
Other languages	<input type="checkbox"/>	<input type="checkbox"/>	<input type="checkbox"/>	<input type="checkbox"/>	<input type="checkbox"/>	<input type="checkbox"/>	<input type="checkbox"/>	<input type="checkbox"/>	<input type="checkbox"/>	<input type="checkbox"/>	<input type="checkbox"/>
	0%	10%	20%	30%	40%	50%	60%	70%	80%	90%	100%

9. In an average week, what percentage of the time do you use the following languages **at school/work**?

English	<input type="checkbox"/>	<input type="checkbox"/>	<input type="checkbox"/>	<input type="checkbox"/>	<input type="checkbox"/>	<input checked="" type="checkbox"/>	<input type="checkbox"/>	<input type="checkbox"/>	<input type="checkbox"/>	<input type="checkbox"/>	<input type="checkbox"/>
	0%	10%	20%	30%	40%	50%	60%	70%	80%	90%	100%
Spanish	<input type="checkbox"/>	<input type="checkbox"/>	<input type="checkbox"/>	<input type="checkbox"/>	<input type="checkbox"/>	<input checked="" type="checkbox"/>	<input type="checkbox"/>	<input type="checkbox"/>	<input type="checkbox"/>	<input type="checkbox"/>	<input type="checkbox"/>
	0%	10%	20%	30%	40%	50%	60%	70%	80%	90%	100%
Other languages	<input type="checkbox"/>	<input type="checkbox"/>	<input type="checkbox"/>	<input type="checkbox"/>	<input type="checkbox"/>	<input type="checkbox"/>	<input type="checkbox"/>	<input type="checkbox"/>	<input type="checkbox"/>	<input type="checkbox"/>	<input type="checkbox"/>
	0%	10%	20%	30%	40%	50%	60%	70%	80%	90%	100%

10. When you talk to yourself, how often do you **talk to yourself** in the following languages?

English	<input type="checkbox"/>	<input type="checkbox"/>	<input type="checkbox"/>	<input type="checkbox"/>	<input type="checkbox"/>	<input type="checkbox"/>	<input type="checkbox"/>	<input type="checkbox"/>	<input type="checkbox"/>	<input type="checkbox"/>	<input checked="" type="checkbox"/>
	0%	10%	20%	30%	40%	50%	60%	70%	80%	90%	100%
Spanish	<input checked="" type="checkbox"/>	<input type="checkbox"/>	<input type="checkbox"/>	<input type="checkbox"/>	<input type="checkbox"/>	<input type="checkbox"/>	<input type="checkbox"/>	<input type="checkbox"/>	<input type="checkbox"/>	<input type="checkbox"/>	<input type="checkbox"/>
	0%	10%	20%	30%	40%	50%	60%	70%	80%	90%	100%
Other languages	<input type="checkbox"/>	<input type="checkbox"/>	<input type="checkbox"/>	<input type="checkbox"/>	<input type="checkbox"/>	<input type="checkbox"/>	<input type="checkbox"/>	<input type="checkbox"/>	<input type="checkbox"/>	<input type="checkbox"/>	<input type="checkbox"/>
	0%	10%	20%	30%	40%	50%	60%	70%	80%	90%	100%

11. When you count, how often do you **count** in the following languages?

English	<input type="checkbox"/>	<input type="checkbox"/>	<input type="checkbox"/>	<input type="checkbox"/>	<input type="checkbox"/>	<input type="checkbox"/>	<input type="checkbox"/>	<input type="checkbox"/>	<input checked="" type="checkbox"/>	<input type="checkbox"/>	<input type="checkbox"/>
	0%	10%	20%	30%	40%	50%	60%	70%	80%	90%	100%
Spanish	<input type="checkbox"/>	<input checked="" type="checkbox"/>	<input type="checkbox"/>	<input type="checkbox"/>	<input type="checkbox"/>	<input type="checkbox"/>	<input type="checkbox"/>	<input type="checkbox"/>	<input type="checkbox"/>	<input type="checkbox"/>	<input type="checkbox"/>
	0%	10%	20%	30%	40%	50%	60%	70%	80%	90%	100%
Other languages	<input type="checkbox"/>	<input type="checkbox"/>	<input type="checkbox"/>	<input type="checkbox"/>	<input type="checkbox"/>	<input type="checkbox"/>	<input type="checkbox"/>	<input type="checkbox"/>	<input type="checkbox"/>	<input type="checkbox"/>	<input type="checkbox"/>
	0%	10%	20%	30%	40%	50%	60%	70%	80%	90%	100%

IV. Language proficiency

In this section, we would like you to rate your language proficiency by giving marks from 0 to 6.

- 0=not well at all 6=very well
12. a. How well do you speak **English**? 0 1 2 3 4 5 6
- b. How well do you speak **Spanish**? 0 1 2 3 4 5 6
13. a. How well do you understand **English**? 0 1 2 3 4 5 6
- b. How well do you understand **Spanish**? 0 1 2 3 4 5 6
14. a. How well do you read **English**? 0 1 2 3 4 5 6
- b. How well do you read **Spanish**? 0 1 2 3 4 5 6
15. a. How well do you write **English**? 0 1 2 3 4 5 6
- b. How well do you write **Spanish**? 0 1 2 3 4 5 6

V. Language attitudes

In this section, we would like you to respond to statements about language attitudes by giving marks from 0-6.

- 0=disagree 6=agree
16. a. I feel like myself when I speak **English**. 0 1 2 3 4 5 6
- b. I feel like myself when I speak **Spanish**. 0 1 2 3 4 5 6
17. a. I identify with an **English-speaking** culture. 0 1 2 3 4 5 6
- b. I identify with a **Spanish-speaking** culture. 0 1 2 3 4 5 6
18. a. It is important to me to use (or eventually use) **English** like a native speaker. 0 1 2 3 4 5 6
- b. It is important to me to use (or eventually use) **Spanish** like a native speaker. 0 1 2 3 4 5 6
19. a. I want others to think I am a native speaker of **English**. 0 1 2 3 4 5 6
- b. I want others to think I am a native speaker of **Spanish**. 0 1 2 3 4 5 6

Bilingual Language Profile: English-Spanish

We would like to ask you to help us by answering the following questions concerning your language history, use, attitudes, and proficiency. This survey was created with support from the Center for Open Educational Resources and Language Learning at the University of Texas at Austin to better understand the profiles of bilingual speakers in diverse settings with diverse backgrounds. The survey consists of 19 questions and will take less than 10 minutes to complete. This is not a test, so there are no right or wrong answers. Please answer every question and give your answers sincerely. Thank you very much for your help.

I. Biographical Information

Name GLO Today's Date August / / 2018

Age 52 Male / Female Current place of residence: city/state Los Angeles, CA. country USA

Highest level of formal education: Less than high school High school Some college
 College (B.A., B.S.) Some graduate school Masters
 PhD/MD/JD Other: _____

Please cite as :

Birdsong, D., Gertken, L.M., & Amengual, M. *Bilingual Language Profile: An Easy-to-Use Instrument to Assess Bilingualism*. COERLL, University of Texas at Austin. Web. 20 Jan. 2012. <<https://sites.la.utexas.edu/bilingual/>>.

II. Language history

In this section, we would like you to answer some factual questions about your language history by placing a check in the appropriate box.

1. At what age did you start learning the following languages?

English
 Since birth 1 2 3 4 5 6 7 8 9 10 11 12 13 14 15 16 17 18 19 20+

Spanish
 Since birth 1 2 3 4 5 6 7 8 9 10 11 12 13 14 15 16 17 18 19 20+

2. At what age did you start to feel comfortable using the following languages?

English
 As early as I can remember 1 2 3 4 5 6 7 8 9 10 11 12 13 14 15 16 17 18 19 20+ not yet

Spanish
 As early as I can remember 1 2 3 4 5 6 7 8 9 10 11 12 13 14 15 16 17 18 19 20+ not yet

3. How many years of classes (grammar, history, math, etc.) have you had in the following languages (primary school through university)?

English
 0 1 2 3 4 5 6 7 8 9 10 11 12 13 14 15 16 17 18 19 20+

Spanish
 0 1 2 3 4 5 6 7 8 9 10 11 12 13 14 15 16 17 18 19 20+

4. How many years have you spent in a country/region where the following languages are spoken?

English
 0 1 2 3 4 5 6 7 8 9 10 11 12 13 14 15 16 17 18 19 20+

Spanish
 0 1 2 3 4 5 6 7 8 9 10 11 12 13 14 15 16 17 18 19 20+

5. How many years have you spent in a family where the following languages are spoken?

English
 0 1 2 3 4 5 6 7 8 9 10 11 12 13 14 15 16 17 18 19 20+

Spanish
 0 1 2 3 4 5 6 7 8 9 10 11 12 13 14 15 16 17 18 19 20+

6. How many years have you spent in a work environment where the following languages are spoken?

English
 0 1 2 3 4 5 6 7 8 9 10 11 12 13 14 15 16 17 18 19 20+

Spanish
 0 1 2 3 4 5 6 7 8 9 10 11 12 13 14 15 16 17 18 19 20+

III. Language use

In this section, we would like you to answer some questions about your language use by placing a check in the appropriate box. Total use for all languages in a given question should equal 100%.

7. In an average week, what percentage of the time do you use the following languages **with friends**?

English	<input type="checkbox"/>	<input type="checkbox"/>	<input type="checkbox"/>	<input type="checkbox"/>	<input type="checkbox"/>	<input checked="" type="checkbox"/>	<input type="checkbox"/>	<input type="checkbox"/>	<input type="checkbox"/>	<input type="checkbox"/>	<input type="checkbox"/>
	0%	10%	20%	30%	40%	50%	60%	70%	80%	90%	100%
Spanish	<input type="checkbox"/>	<input type="checkbox"/>	<input type="checkbox"/>	<input type="checkbox"/>	<input type="checkbox"/>	<input checked="" type="checkbox"/>	<input type="checkbox"/>	<input type="checkbox"/>	<input type="checkbox"/>	<input type="checkbox"/>	<input type="checkbox"/>
	0%	10%	20%	30%	40%	50%	60%	70%	80%	90%	100%
Other languages	<input type="checkbox"/>	<input type="checkbox"/>	<input type="checkbox"/>	<input type="checkbox"/>	<input type="checkbox"/>	<input type="checkbox"/>	<input type="checkbox"/>	<input type="checkbox"/>	<input type="checkbox"/>	<input type="checkbox"/>	<input type="checkbox"/>
	0%	10%	20%	30%	40%	50%	60%	70%	80%	90%	100%

8. In an average week, what percentage of the time do you use the following languages **with family**?

English	<input type="checkbox"/>	<input type="checkbox"/>	<input type="checkbox"/>	<input checked="" type="checkbox"/>	<input type="checkbox"/>	<input type="checkbox"/>	<input type="checkbox"/>	<input type="checkbox"/>	<input type="checkbox"/>	<input type="checkbox"/>	<input type="checkbox"/>
	0%	10%	20%	30%	40%	50%	60%	70%	80%	90%	100%
Spanish	<input type="checkbox"/>	<input type="checkbox"/>	<input type="checkbox"/>	<input type="checkbox"/>	<input type="checkbox"/>	<input type="checkbox"/>	<input type="checkbox"/>	<input checked="" type="checkbox"/>	<input type="checkbox"/>	<input type="checkbox"/>	<input type="checkbox"/>
	0%	10%	20%	30%	40%	50%	60%	70%	80%	90%	100%
Other languages	<input type="checkbox"/>	<input type="checkbox"/>	<input type="checkbox"/>	<input type="checkbox"/>	<input type="checkbox"/>	<input type="checkbox"/>	<input type="checkbox"/>	<input type="checkbox"/>	<input type="checkbox"/>	<input type="checkbox"/>	<input type="checkbox"/>
	0%	10%	20%	30%	40%	50%	60%	70%	80%	90%	100%

9. In an average week, what percentage of the time do you use the following languages **at school/work**?

English	<input type="checkbox"/>	<input type="checkbox"/>	<input type="checkbox"/>	<input type="checkbox"/>	<input type="checkbox"/>	<input checked="" type="checkbox"/>	<input type="checkbox"/>	<input type="checkbox"/>	<input type="checkbox"/>	<input type="checkbox"/>	<input type="checkbox"/>
	0%	10%	20%	30%	40%	50%	60%	70%	80%	90%	100%
Spanish	<input type="checkbox"/>	<input type="checkbox"/>	<input type="checkbox"/>	<input type="checkbox"/>	<input type="checkbox"/>	<input checked="" type="checkbox"/>	<input type="checkbox"/>	<input type="checkbox"/>	<input type="checkbox"/>	<input type="checkbox"/>	<input type="checkbox"/>
	0%	10%	20%	30%	40%	50%	60%	70%	80%	90%	100%
Other languages	<input type="checkbox"/>	<input type="checkbox"/>	<input type="checkbox"/>	<input type="checkbox"/>	<input type="checkbox"/>	<input type="checkbox"/>	<input type="checkbox"/>	<input type="checkbox"/>	<input type="checkbox"/>	<input type="checkbox"/>	<input type="checkbox"/>
	0%	10%	20%	30%	40%	50%	60%	70%	80%	90%	100%

10. When you talk to yourself, how often do you **talk to yourself** in the following languages?

English	<input type="checkbox"/>	<input type="checkbox"/>	<input type="checkbox"/>	<input checked="" type="checkbox"/>	<input type="checkbox"/>	<input type="checkbox"/>	<input type="checkbox"/>	<input type="checkbox"/>	<input type="checkbox"/>	<input type="checkbox"/>	<input type="checkbox"/>
	0%	10%	20%	30%	40%	50%	60%	70%	80%	90%	100%
Spanish	<input type="checkbox"/>	<input type="checkbox"/>	<input type="checkbox"/>	<input type="checkbox"/>	<input type="checkbox"/>	<input type="checkbox"/>	<input type="checkbox"/>	<input checked="" type="checkbox"/>	<input type="checkbox"/>	<input type="checkbox"/>	<input type="checkbox"/>
	0%	10%	20%	30%	40%	50%	60%	70%	80%	90%	100%
Other languages	<input type="checkbox"/>	<input type="checkbox"/>	<input type="checkbox"/>	<input type="checkbox"/>	<input type="checkbox"/>	<input type="checkbox"/>	<input type="checkbox"/>	<input type="checkbox"/>	<input type="checkbox"/>	<input type="checkbox"/>	<input type="checkbox"/>
	0%	10%	20%	30%	40%	50%	60%	70%	80%	90%	100%

11. When you count, how often do you **count** in the following languages?

English	<input type="checkbox"/>	<input type="checkbox"/>	<input type="checkbox"/>	<input checked="" type="checkbox"/>	<input type="checkbox"/>	<input type="checkbox"/>	<input type="checkbox"/>	<input type="checkbox"/>	<input type="checkbox"/>	<input type="checkbox"/>	<input type="checkbox"/>
	0%	10%	20%	30%	40%	50%	60%	70%	80%	90%	100%
Spanish	<input type="checkbox"/>	<input type="checkbox"/>	<input type="checkbox"/>	<input type="checkbox"/>	<input type="checkbox"/>	<input type="checkbox"/>	<input type="checkbox"/>	<input checked="" type="checkbox"/>	<input type="checkbox"/>	<input type="checkbox"/>	<input type="checkbox"/>
	0%	10%	20%	30%	40%	50%	60%	70%	80%	90%	100%
Other languages	<input type="checkbox"/>	<input type="checkbox"/>	<input type="checkbox"/>	<input type="checkbox"/>	<input type="checkbox"/>	<input type="checkbox"/>	<input type="checkbox"/>	<input type="checkbox"/>	<input type="checkbox"/>	<input type="checkbox"/>	<input type="checkbox"/>
	0%	10%	20%	30%	40%	50%	60%	70%	80%	90%	100%

IV. Language proficiency

In this section, we would like you to rate your language proficiency by giving marks from 0 to 6.

- 0=not well at all 6=very well
12. a. How well do you speak **English**? 0 1 2 3 4 5 6
- b. How well do you speak **Spanish**? 0 1 2 3 4 5 6
13. a. How well do you understand **English**? 0 1 2 3 4 5 6
- b. How well do you understand **Spanish**? 0 1 2 3 4 5 6
14. a. How well do you read **English**? 0 1 2 3 4 5 6
- b. How well do you read **Spanish**? 0 1 2 3 4 5 6
15. a. How well do you write **English**? 0 1 2 3 4 5 6
- b. How well do you write **Spanish**? 0 1 2 3 4 5 6

V. Language attitudes

In this section, we would like you to respond to statements about language attitudes by giving marks from 0-6.

- 0=disagree 6=agree
16. a. I feel like myself when I speak **English**. 0 1 2 3 4 5 6
- b. I feel like myself when I speak **Spanish**. 0 1 2 3 4 5 6
17. a. I identify with an **English-speaking** culture. 0 1 2 3 4 5 6
- b. I identify with a **Spanish-speaking** culture. 0 1 2 3 4 5 6
18. a. It is important to me to use (or eventually use) **English** like a native speaker. 0 1 2 3 4 5 6
- b. It is important to me to use (or eventually use) **Spanish** like a native speaker. 0 1 2 3 4 5 6
19. a. I want others to think I am a native speaker of **English**. 0 1 2 3 4 5 6
- b. I want others to think I am a native speaker of **Spanish**. 0 1 2 3 4 5 6

Bilingual Language Profile: English-Spanish

We would like to ask you to help us by answering the following questions concerning your language history, use, attitudes, and proficiency. This survey was created with support from the Center for Open Educational Resources and Language Learning at the University of Texas at Austin to better understand the profiles of bilingual speakers in diverse settings with diverse backgrounds. The survey consists of 19 questions and will take less than 10 minutes to complete. This is not a test, so there are no right or wrong answers. Please answer every question and give your answers sincerely. Thank you very much for your help.

I. Biographical Information

Name GUI	Today's Date August / / 2018		
Age 55	<input checked="" type="checkbox"/> Male / <input type="checkbox"/> Female	Current place of residence: city/state Los Angeles, CA.	country USA
Highest level of formal education:			
<input checked="" type="checkbox"/> Less than high school	<input type="checkbox"/> High school	<input type="checkbox"/> Some college	
<input type="checkbox"/> College (B.A., B.S.)	<input type="checkbox"/> Some graduate school	<input type="checkbox"/> Masters	
<input type="checkbox"/> PhD/MD/JD	<input type="checkbox"/> Other: _____		

Please cite as :

Birdsong, D., Gertken, L.M., & Amengual, M. *Bilingual Language Profile: An Easy-to-Use Instrument to Assess Bilingualism*. COERLL, University of Texas at Austin. Web. 20 Jan. 2012. <<https://sites.la.utexas.edu/bilingual/>>.

II. Language history

In this section, we would like you to answer some factual questions about your language history by placing a check in the appropriate box.

1. At what age did you start learning the following languages?

English
 Since birth 1 2 3 4 5 6 7 8 9 10 11 12 13 14 15 16 17 18 19 20+

Spanish
 Since birth 1 2 3 4 5 6 7 8 9 10 11 12 13 14 15 16 17 18 19 20+

2. At what age did you start to feel comfortable using the following languages?

English
 As early as I can remember 1 2 3 4 5 6 7 8 9 10 11 12 13 14 15 16 17 18 19 20+ not yet

Spanish
 As early as I can remember 1 2 3 4 5 6 7 8 9 10 11 12 13 14 15 16 17 18 19 20+ not yet

3. How many years of classes (grammar, history, math, etc.) have you had in the following languages (primary school through university)?

English
 0 1 2 3 4 5 6 7 8 9 10 11 12 13 14 15 16 17 18 19 20+

Spanish
 0 1 2 3 4 5 6 7 8 9 10 11 12 13 14 15 16 17 18 19 20+

4. How many years have you spent in a country/region where the following languages are spoken?

English
 0 1 2 3 4 5 6 7 8 9 10 11 12 13 14 15 16 17 18 19 20+

Spanish
 0 1 2 3 4 5 6 7 8 9 10 11 12 13 14 15 16 17 18 19 20+

5. How many years have you spent in a family where the following languages are spoken?

English
 0 1 2 3 4 5 6 7 8 9 10 11 12 13 14 15 16 17 18 19 20+

Spanish
 0 1 2 3 4 5 6 7 8 9 10 11 12 13 14 15 16 17 18 19 20+

6. How many years have you spent in a work environment where the following languages are spoken?

English
 0 1 2 3 4 5 6 7 8 9 10 11 12 13 14 15 16 17 18 19 20+

Spanish
 0 1 2 3 4 5 6 7 8 9 10 11 12 13 14 15 16 17 18 19 20+

III. Language use

In this section, we would like you to answer some questions about your language use by placing a check in the appropriate box. Total use for all languages in a given question should equal 100%.

7. In an average week, what percentage of the time do you use the following languages **with friends**?

English	<input type="checkbox"/>	<input type="checkbox"/>	<input checked="" type="checkbox"/>	<input type="checkbox"/>	<input type="checkbox"/>	<input type="checkbox"/>	<input type="checkbox"/>	<input type="checkbox"/>	<input type="checkbox"/>	<input type="checkbox"/>	<input type="checkbox"/>
	0%	10%	20%	30%	40%	50%	60%	70%	80%	90%	100%
Spanish	<input type="checkbox"/>	<input type="checkbox"/>	<input type="checkbox"/>	<input type="checkbox"/>	<input type="checkbox"/>	<input type="checkbox"/>	<input type="checkbox"/>	<input type="checkbox"/>	<input checked="" type="checkbox"/>	<input type="checkbox"/>	<input type="checkbox"/>
	0%	10%	20%	30%	40%	50%	60%	70%	80%	90%	100%
Other languages	<input type="checkbox"/>	<input type="checkbox"/>	<input type="checkbox"/>	<input type="checkbox"/>	<input type="checkbox"/>	<input type="checkbox"/>	<input type="checkbox"/>	<input type="checkbox"/>	<input type="checkbox"/>	<input type="checkbox"/>	<input type="checkbox"/>
	0%	10%	20%	30%	40%	50%	60%	70%	80%	90%	100%

8. In an average week, what percentage of the time do you use the following languages **with family**?

English	<input type="checkbox"/>	<input checked="" type="checkbox"/>	<input type="checkbox"/>	<input type="checkbox"/>	<input type="checkbox"/>	<input type="checkbox"/>	<input type="checkbox"/>	<input type="checkbox"/>	<input type="checkbox"/>	<input type="checkbox"/>	<input type="checkbox"/>
	0%	10%	20%	30%	40%	50%	60%	70%	80%	90%	100%
Spanish	<input type="checkbox"/>	<input type="checkbox"/>	<input type="checkbox"/>	<input type="checkbox"/>	<input type="checkbox"/>	<input type="checkbox"/>	<input type="checkbox"/>	<input type="checkbox"/>	<input checked="" type="checkbox"/>	<input type="checkbox"/>	<input type="checkbox"/>
	0%	10%	20%	30%	40%	50%	60%	70%	80%	90%	100%
Other languages	<input type="checkbox"/>	<input type="checkbox"/>	<input type="checkbox"/>	<input type="checkbox"/>	<input type="checkbox"/>	<input type="checkbox"/>	<input type="checkbox"/>	<input type="checkbox"/>	<input type="checkbox"/>	<input type="checkbox"/>	<input type="checkbox"/>
	0%	10%	20%	30%	40%	50%	60%	70%	80%	90%	100%

9. In an average week, what percentage of the time do you use the following languages **at school/work**?

English	<input type="checkbox"/>	<input type="checkbox"/>	<input type="checkbox"/>	<input type="checkbox"/>	<input type="checkbox"/>	<input checked="" type="checkbox"/>	<input type="checkbox"/>	<input type="checkbox"/>	<input type="checkbox"/>	<input type="checkbox"/>	<input type="checkbox"/>
	0%	10%	20%	30%	40%	50%	60%	70%	80%	90%	100%
Spanish	<input type="checkbox"/>	<input type="checkbox"/>	<input type="checkbox"/>	<input type="checkbox"/>	<input type="checkbox"/>	<input checked="" type="checkbox"/>	<input type="checkbox"/>	<input type="checkbox"/>	<input type="checkbox"/>	<input type="checkbox"/>	<input type="checkbox"/>
	0%	10%	20%	30%	40%	50%	60%	70%	80%	90%	100%
Other languages	<input type="checkbox"/>	<input type="checkbox"/>	<input type="checkbox"/>	<input type="checkbox"/>	<input type="checkbox"/>	<input type="checkbox"/>	<input type="checkbox"/>	<input type="checkbox"/>	<input type="checkbox"/>	<input type="checkbox"/>	<input type="checkbox"/>
	0%	10%	20%	30%	40%	50%	60%	70%	80%	90%	100%

10. When you talk to yourself, how often do you **talk to yourself** in the following languages?

English	<input checked="" type="checkbox"/>	<input type="checkbox"/>	<input type="checkbox"/>	<input type="checkbox"/>	<input type="checkbox"/>	<input type="checkbox"/>	<input type="checkbox"/>	<input type="checkbox"/>	<input type="checkbox"/>	<input type="checkbox"/>	<input type="checkbox"/>
	0%	10%	20%	30%	40%	50%	60%	70%	80%	90%	100%
Spanish	<input type="checkbox"/>	<input type="checkbox"/>	<input type="checkbox"/>	<input type="checkbox"/>	<input type="checkbox"/>	<input type="checkbox"/>	<input type="checkbox"/>	<input type="checkbox"/>	<input type="checkbox"/>	<input type="checkbox"/>	<input checked="" type="checkbox"/>
	0%	10%	20%	30%	40%	50%	60%	70%	80%	90%	100%
Other languages	<input type="checkbox"/>	<input type="checkbox"/>	<input type="checkbox"/>	<input type="checkbox"/>	<input type="checkbox"/>	<input type="checkbox"/>	<input type="checkbox"/>	<input type="checkbox"/>	<input type="checkbox"/>	<input type="checkbox"/>	<input type="checkbox"/>
	0%	10%	20%	30%	40%	50%	60%	70%	80%	90%	100%

11. When you count, how often do you **count** in the following languages?

English	<input checked="" type="checkbox"/>	<input type="checkbox"/>	<input type="checkbox"/>	<input type="checkbox"/>	<input type="checkbox"/>	<input type="checkbox"/>	<input type="checkbox"/>	<input type="checkbox"/>	<input type="checkbox"/>	<input type="checkbox"/>	<input type="checkbox"/>
	0%	10%	20%	30%	40%	50%	60%	70%	80%	90%	100%
Spanish	<input type="checkbox"/>	<input type="checkbox"/>	<input type="checkbox"/>	<input type="checkbox"/>	<input type="checkbox"/>	<input type="checkbox"/>	<input type="checkbox"/>	<input type="checkbox"/>	<input type="checkbox"/>	<input type="checkbox"/>	<input checked="" type="checkbox"/>
	0%	10%	20%	30%	40%	50%	60%	70%	80%	90%	100%
Other languages	<input type="checkbox"/>	<input type="checkbox"/>	<input type="checkbox"/>	<input type="checkbox"/>	<input type="checkbox"/>	<input type="checkbox"/>	<input type="checkbox"/>	<input type="checkbox"/>	<input type="checkbox"/>	<input type="checkbox"/>	<input type="checkbox"/>
	0%	10%	20%	30%	40%	50%	60%	70%	80%	90%	100%

IV. Language proficiency

In this section, we would like you to rate your language proficiency by giving marks from 0 to 6.

- 0=not well at all 6=very well
12. a. How well do you speak **English**? 0 1 2 3 4 5 6
- b. How well do you speak **Spanish**? 0 1 2 3 4 5 6
13. a. How well do you understand **English**? 0 1 2 3 4 5 6
- b. How well do you understand **Spanish**? 0 1 2 3 4 5 6
14. a. How well do you read **English**? 0 1 2 3 4 5 6
- b. How well do you read **Spanish**? 0 1 2 3 4 5 6
15. a. How well do you write **English**? 0 1 2 3 4 5 6
- b. How well do you write **Spanish**? 0 1 2 3 4 5 6

V. Language attitudes

In this section, we would like you to respond to statements about language attitudes by giving marks from 0-6.

- 0=disagree 6=agree
16. a. I feel like myself when I speak **English**. 0 1 2 3 4 5 6
- b. I feel like myself when I speak **Spanish**. 0 1 2 3 4 5 6
17. a. I identify with an **English-speaking** culture. 0 1 2 3 4 5 6
- b. I identify with a **Spanish-speaking** culture. 0 1 2 3 4 5 6
18. a. It is important to me to use (or eventually use) **English** like a native speaker. 0 1 2 3 4 5 6
- b. It is important to me to use (or eventually use) **Spanish** like a native speaker. 0 1 2 3 4 5 6
19. a. I want others to think I am a native speaker of **English**. 0 1 2 3 4 5 6
- b. I want others to think I am a native speaker of **Spanish**. 0 1 2 3 4 5 6

Bilingual Language Profile: English-Spanish

We would like to ask you to help us by answering the following questions concerning your language history, use, attitudes, and proficiency. This survey was created with support from the Center for Open Educational Resources and Language Learning at the University of Texas at Austin to better understand the profiles of bilingual speakers in diverse settings with diverse backgrounds. The survey consists of 19 questions and will take less than 10 minutes to complete. This is not a test, so there are no right or wrong answers. Please answer every question and give your answers sincerely. Thank you very much for your help.

I. Biographical Information

Name	GRC	Today's Date	August / / 2018			
Age	68	<input type="checkbox"/> Male / <input checked="" type="checkbox"/> Female	Current place of residence: city/state	Ensenada, Baja California	country	Mexico
Highest level of formal education:						
<input checked="" type="checkbox"/> Less than high school						
<input type="checkbox"/> High school						
<input type="checkbox"/> Some college						
<input type="checkbox"/> College (B.A., B.S.)						
<input type="checkbox"/> Some graduate school						
<input type="checkbox"/> Masters						
<input type="checkbox"/> PhD/MD/JD						
<input type="checkbox"/> Other: _____						

Please cite as :

Birdsong, D., Gertken, L.M., & Amengual, M. *Bilingual Language Profile: An Easy-to-Use Instrument to Assess Bilingualism*. COERLL, University of Texas at Austin. Web. 20 Jan. 2012. <<https://sites.la.utexas.edu/bilingual/>>.

II. Language history

In this section, we would like you to answer some factual questions about your language history by placing a check in the appropriate box.

1. At what age did you **start learning** the following languages?

English
Since birth 1 2 3 4 5 6 7 8 9 10 11 12 13 14 15 16 17 18 19 20+

Spanish
Since birth 1 2 3 4 5 6 7 8 9 10 11 12 13 14 15 16 17 18 19 20+

2. At what age did you **start to feel comfortable** using the following languages?

English
As early as I can remember 1 2 3 4 5 6 7 8 9 10 11 12 13 14 15 16 17 18 19 20+ not yet

Spanish
As early as I can remember 1 2 3 4 5 6 7 8 9 10 11 12 13 14 15 16 17 18 19 20+ not yet

3. How many years of **classes (grammar, history, math, etc.)** have you had in the following languages (primary school through university)?

English
 0 1 2 3 4 5 6 7 8 9 10 11 12 13 14 15 16 17 18 19 20+

Spanish
 0 1 2 3 4 5 6 7 8 9 10 11 12 13 14 15 16 17 18 19 20+

4. How many years have you spent in a **country/region** where the following languages are spoken?

English
 0 1 2 3 4 5 6 7 8 9 10 11 12 13 14 15 16 17 18 19 20+

Spanish
 0 1 2 3 4 5 6 7 8 9 10 11 12 13 14 15 16 17 18 19 20+

5. How many years have you spent in a **family** where the following languages are spoken?

English
 0 1 2 3 4 5 6 7 8 9 10 11 12 13 14 15 16 17 18 19 20+

Spanish
 0 1 2 3 4 5 6 7 8 9 10 11 12 13 14 15 16 17 18 19 20+

6. How many years have you spent in a **work environment** where the following languages are spoken?

English
 0 1 2 3 4 5 6 7 8 9 10 11 12 13 14 15 16 17 18 19 20+

Spanish
 0 1 2 3 4 5 6 7 8 9 10 11 12 13 14 15 16 17 18 19 20+

III. Language use

In this section, we would like you to answer some questions about your language use by placing a check in the appropriate box. Total use for all languages in a given question should equal 100%.

7. In an average week, what percentage of the time do you use the following languages **with friends**?

English	<input checked="" type="checkbox"/>	<input type="checkbox"/>	<input type="checkbox"/>	<input type="checkbox"/>	<input type="checkbox"/>	<input type="checkbox"/>	<input type="checkbox"/>	<input type="checkbox"/>	<input type="checkbox"/>	<input type="checkbox"/>	<input type="checkbox"/>
	0%	10%	20%	30%	40%	50%	60%	70%	80%	90%	100%
Spanish	<input type="checkbox"/>	<input type="checkbox"/>	<input type="checkbox"/>	<input type="checkbox"/>	<input type="checkbox"/>	<input type="checkbox"/>	<input type="checkbox"/>	<input type="checkbox"/>	<input type="checkbox"/>	<input type="checkbox"/>	<input checked="" type="checkbox"/>
	0%	10%	20%	30%	40%	50%	60%	70%	80%	90%	100%
Other languages	<input type="checkbox"/>	<input type="checkbox"/>	<input type="checkbox"/>	<input type="checkbox"/>	<input type="checkbox"/>	<input type="checkbox"/>	<input type="checkbox"/>	<input type="checkbox"/>	<input type="checkbox"/>	<input type="checkbox"/>	<input type="checkbox"/>
	0%	10%	20%	30%	40%	50%	60%	70%	80%	90%	100%

8. In an average week, what percentage of the time do you use the following languages **with family**?

English	<input checked="" type="checkbox"/>	<input type="checkbox"/>	<input type="checkbox"/>	<input type="checkbox"/>	<input type="checkbox"/>	<input type="checkbox"/>	<input type="checkbox"/>	<input type="checkbox"/>	<input type="checkbox"/>	<input type="checkbox"/>	<input type="checkbox"/>
	0%	10%	20%	30%	40%	50%	60%	70%	80%	90%	100%
Spanish	<input type="checkbox"/>	<input type="checkbox"/>	<input type="checkbox"/>	<input type="checkbox"/>	<input type="checkbox"/>	<input type="checkbox"/>	<input type="checkbox"/>	<input type="checkbox"/>	<input type="checkbox"/>	<input type="checkbox"/>	<input checked="" type="checkbox"/>
	0%	10%	20%	30%	40%	50%	60%	70%	80%	90%	100%
Other languages	<input type="checkbox"/>	<input type="checkbox"/>	<input type="checkbox"/>	<input type="checkbox"/>	<input type="checkbox"/>	<input type="checkbox"/>	<input type="checkbox"/>	<input type="checkbox"/>	<input type="checkbox"/>	<input type="checkbox"/>	<input type="checkbox"/>
	0%	10%	20%	30%	40%	50%	60%	70%	80%	90%	100%

9. In an average week, what percentage of the time do you use the following languages **at school/work**?

English	<input checked="" type="checkbox"/>	<input type="checkbox"/>	<input type="checkbox"/>	<input type="checkbox"/>	<input type="checkbox"/>	<input type="checkbox"/>	<input type="checkbox"/>	<input type="checkbox"/>	<input type="checkbox"/>	<input type="checkbox"/>	<input type="checkbox"/>
	0%	10%	20%	30%	40%	50%	60%	70%	80%	90%	100%
Spanish	<input type="checkbox"/>	<input type="checkbox"/>	<input type="checkbox"/>	<input type="checkbox"/>	<input type="checkbox"/>	<input type="checkbox"/>	<input type="checkbox"/>	<input type="checkbox"/>	<input type="checkbox"/>	<input type="checkbox"/>	<input checked="" type="checkbox"/>
	0%	10%	20%	30%	40%	50%	60%	70%	80%	90%	100%
Other languages	<input type="checkbox"/>	<input type="checkbox"/>	<input type="checkbox"/>	<input type="checkbox"/>	<input type="checkbox"/>	<input type="checkbox"/>	<input type="checkbox"/>	<input type="checkbox"/>	<input type="checkbox"/>	<input type="checkbox"/>	<input type="checkbox"/>
	0%	10%	20%	30%	40%	50%	60%	70%	80%	90%	100%

10. When you talk to yourself, how often do you **talk to yourself** in the following languages?

English	<input checked="" type="checkbox"/>	<input type="checkbox"/>	<input type="checkbox"/>	<input type="checkbox"/>	<input type="checkbox"/>	<input type="checkbox"/>	<input type="checkbox"/>	<input type="checkbox"/>	<input type="checkbox"/>	<input type="checkbox"/>	<input type="checkbox"/>
	0%	10%	20%	30%	40%	50%	60%	70%	80%	90%	100%
Spanish	<input type="checkbox"/>	<input type="checkbox"/>	<input type="checkbox"/>	<input type="checkbox"/>	<input type="checkbox"/>	<input type="checkbox"/>	<input type="checkbox"/>	<input type="checkbox"/>	<input type="checkbox"/>	<input type="checkbox"/>	<input checked="" type="checkbox"/>
	0%	10%	20%	30%	40%	50%	60%	70%	80%	90%	100%
Other languages	<input type="checkbox"/>	<input type="checkbox"/>	<input type="checkbox"/>	<input type="checkbox"/>	<input type="checkbox"/>	<input type="checkbox"/>	<input type="checkbox"/>	<input type="checkbox"/>	<input type="checkbox"/>	<input type="checkbox"/>	<input type="checkbox"/>
	0%	10%	20%	30%	40%	50%	60%	70%	80%	90%	100%

11. When you count, how often do you **count** in the following languages?

English	<input checked="" type="checkbox"/>	<input type="checkbox"/>	<input type="checkbox"/>	<input type="checkbox"/>	<input type="checkbox"/>	<input type="checkbox"/>	<input type="checkbox"/>	<input type="checkbox"/>	<input type="checkbox"/>	<input type="checkbox"/>	<input type="checkbox"/>
	0%	10%	20%	30%	40%	50%	60%	70%	80%	90%	100%
Spanish	<input type="checkbox"/>	<input type="checkbox"/>	<input type="checkbox"/>	<input type="checkbox"/>	<input type="checkbox"/>	<input type="checkbox"/>	<input type="checkbox"/>	<input type="checkbox"/>	<input type="checkbox"/>	<input type="checkbox"/>	<input checked="" type="checkbox"/>
	0%	10%	20%	30%	40%	50%	60%	70%	80%	90%	100%
Other languages	<input type="checkbox"/>	<input type="checkbox"/>	<input type="checkbox"/>	<input type="checkbox"/>	<input type="checkbox"/>	<input type="checkbox"/>	<input type="checkbox"/>	<input type="checkbox"/>	<input type="checkbox"/>	<input type="checkbox"/>	<input type="checkbox"/>
	0%	10%	20%	30%	40%	50%	60%	70%	80%	90%	100%

V. Language attitudes

In this section, we would like you to respond to statements about language attitudes by giving marks from 0-6.

- 0=disagree 6=agree
16. a. I feel like myself when I speak **English**. 0 1 2 3 4 5 6
b. I feel like myself when I speak **Spanish**. 0 1 2 3 4 5 6
17. a. I identify with an **English-speaking** culture. 0 1 2 3 4 5 6
b. I identify with a **Spanish-speaking** culture. 0 1 2 3 4 5 6
18. a. It is important to me to use (or eventually use) **English** like a native speaker. 0 1 2 3 4 5 6
b. It is important to me to use (or eventually use) **Spanish** like a native speaker. 0 1 2 3 4 5 6
19. a. I want others to think I am a native speaker of **English**. 0 1 2 3 4 5 6
b. I want others to think I am a native speaker of **Spanish**. 0 1 2 3 4 5 6

Bilingual Language Profile: English-Spanish

We would like to ask you to help us by answering the following questions concerning your language history, use, attitudes, and proficiency. This survey was created with support from the Center for Open Educational Resources and Language Learning at the University of Texas at Austin to better understand the profiles of bilingual speakers in diverse settings with diverse backgrounds. The survey consists of 19 questions and will take less than 10 minutes to complete. This is not a test, so there are no right or wrong answers. Please answer every question and give your answers sincerely. Thank you very much for your help.

I. Biographical Information

Name GRT Today's Date August / / 2018

Age 70 Male / Female Current place of residence: city/state Ensenada, Baja California country Mexico

Highest level of formal education: Less than high school High school Some college
 College (B.A., B.S.) Some graduate school Masters
 PhD/MD/JD Other: _____

Please cite as :

Birdsong, D., Gertken, L.M., & Amengual, M. *Bilingual Language Profile: An Easy-to-Use Instrument to Assess Bilingualism*. COERLL, University of Texas at Austin. Web. 20 Jan. 2012. <<https://sites.la.utexas.edu/bilingual/>>.

II. Language history

In this section, we would like you to answer some factual questions about your language history by placing a check in the appropriate box.

1. At what age did you **start learning** the following languages?

English
 Since birth 1 2 3 4 5 6 7 8 9 10 11 12 13 14 15 16 17 18 19 20+

Spanish
 Since birth 1 2 3 4 5 6 7 8 9 10 11 12 13 14 15 16 17 18 19 20+

2. At what age did you **start to feel comfortable** using the following languages?

English
 As early as I can remember 1 2 3 4 5 6 7 8 9 10 11 12 13 14 15 16 17 18 19 20+ not yet

Spanish
 As early as I can remember 1 2 3 4 5 6 7 8 9 10 11 12 13 14 15 16 17 18 19 20+ not yet

3. How many years of **classes (grammar, history, math, etc.)** have you had in the following languages (primary school through university)?

English
 0 1 2 3 4 5 6 7 8 9 10 11 12 13 14 15 16 17 18 19 20+

Spanish
 0 1 2 3 4 5 6 7 8 9 10 11 12 13 14 15 16 17 18 19 20+

4. How many years have you spent in a **country/region** where the following languages are spoken?

English
 0 1 2 3 4 5 6 7 8 9 10 11 12 13 14 15 16 17 18 19 20+

Spanish
 0 1 2 3 4 5 6 7 8 9 10 11 12 13 14 15 16 17 18 19 20+

5. How many years have you spent in a **family** where the following languages are spoken?

English
 0 1 2 3 4 5 6 7 8 9 10 11 12 13 14 15 16 17 18 19 20+

Spanish
 0 1 2 3 4 5 6 7 8 9 10 11 12 13 14 15 16 17 18 19 20+

6. How many years have you spent in a **work environment** where the following languages are spoken?

English
 0 1 2 3 4 5 6 7 8 9 10 11 12 13 14 15 16 17 18 19 20+

Spanish
 0 1 2 3 4 5 6 7 8 9 10 11 12 13 14 15 16 17 18 19 20+

III. Language use

In this section, we would like you to answer some questions about your language use by placing a check in the appropriate box. Total use for all languages in a given question should equal 100%.

7. In an average week, what percentage of the time do you use the following languages **with friends**?

English	<input checked="" type="checkbox"/>	<input type="checkbox"/>	<input type="checkbox"/>	<input type="checkbox"/>	<input type="checkbox"/>	<input type="checkbox"/>	<input type="checkbox"/>	<input type="checkbox"/>	<input type="checkbox"/>	<input type="checkbox"/>	<input type="checkbox"/>
	0%	10%	20%	30%	40%	50%	60%	70%	80%	90%	100%
Spanish	<input type="checkbox"/>	<input type="checkbox"/>	<input type="checkbox"/>	<input type="checkbox"/>	<input type="checkbox"/>	<input type="checkbox"/>	<input type="checkbox"/>	<input type="checkbox"/>	<input type="checkbox"/>	<input type="checkbox"/>	<input checked="" type="checkbox"/>
	0%	10%	20%	30%	40%	50%	60%	70%	80%	90%	100%
Other languages	<input type="checkbox"/>	<input type="checkbox"/>	<input type="checkbox"/>	<input type="checkbox"/>	<input type="checkbox"/>	<input type="checkbox"/>	<input type="checkbox"/>	<input type="checkbox"/>	<input type="checkbox"/>	<input type="checkbox"/>	<input type="checkbox"/>
	0%	10%	20%	30%	40%	50%	60%	70%	80%	90%	100%

8. In an average week, what percentage of the time do you use the following languages **with family**?

English	<input checked="" type="checkbox"/>	<input type="checkbox"/>	<input type="checkbox"/>	<input type="checkbox"/>	<input type="checkbox"/>	<input type="checkbox"/>	<input type="checkbox"/>	<input type="checkbox"/>	<input type="checkbox"/>	<input type="checkbox"/>	<input type="checkbox"/>
	0%	10%	20%	30%	40%	50%	60%	70%	80%	90%	100%
Spanish	<input type="checkbox"/>	<input type="checkbox"/>	<input type="checkbox"/>	<input type="checkbox"/>	<input type="checkbox"/>	<input type="checkbox"/>	<input type="checkbox"/>	<input type="checkbox"/>	<input type="checkbox"/>	<input type="checkbox"/>	<input checked="" type="checkbox"/>
	0%	10%	20%	30%	40%	50%	60%	70%	80%	90%	100%
Other languages	<input type="checkbox"/>	<input type="checkbox"/>	<input type="checkbox"/>	<input type="checkbox"/>	<input type="checkbox"/>	<input type="checkbox"/>	<input type="checkbox"/>	<input type="checkbox"/>	<input type="checkbox"/>	<input type="checkbox"/>	<input type="checkbox"/>
	0%	10%	20%	30%	40%	50%	60%	70%	80%	90%	100%

9. In an average week, what percentage of the time do you use the following languages **at school/work**?

English	<input checked="" type="checkbox"/>	<input type="checkbox"/>	<input type="checkbox"/>	<input type="checkbox"/>	<input type="checkbox"/>	<input type="checkbox"/>	<input type="checkbox"/>	<input type="checkbox"/>	<input type="checkbox"/>	<input type="checkbox"/>	<input type="checkbox"/>
	0%	10%	20%	30%	40%	50%	60%	70%	80%	90%	100%
Spanish	<input type="checkbox"/>	<input type="checkbox"/>	<input type="checkbox"/>	<input type="checkbox"/>	<input type="checkbox"/>	<input type="checkbox"/>	<input type="checkbox"/>	<input type="checkbox"/>	<input type="checkbox"/>	<input type="checkbox"/>	<input checked="" type="checkbox"/>
	0%	10%	20%	30%	40%	50%	60%	70%	80%	90%	100%
Other languages	<input type="checkbox"/>	<input type="checkbox"/>	<input type="checkbox"/>	<input type="checkbox"/>	<input type="checkbox"/>	<input type="checkbox"/>	<input type="checkbox"/>	<input type="checkbox"/>	<input type="checkbox"/>	<input type="checkbox"/>	<input type="checkbox"/>
	0%	10%	20%	30%	40%	50%	60%	70%	80%	90%	100%

10. When you talk to yourself, how often do you **talk to yourself** in the following languages?

English	<input checked="" type="checkbox"/>	<input type="checkbox"/>	<input type="checkbox"/>	<input type="checkbox"/>	<input type="checkbox"/>	<input type="checkbox"/>	<input type="checkbox"/>	<input type="checkbox"/>	<input type="checkbox"/>	<input type="checkbox"/>	<input type="checkbox"/>
	0%	10%	20%	30%	40%	50%	60%	70%	80%	90%	100%
Spanish	<input type="checkbox"/>	<input type="checkbox"/>	<input type="checkbox"/>	<input type="checkbox"/>	<input type="checkbox"/>	<input type="checkbox"/>	<input type="checkbox"/>	<input type="checkbox"/>	<input type="checkbox"/>	<input type="checkbox"/>	<input checked="" type="checkbox"/>
	0%	10%	20%	30%	40%	50%	60%	70%	80%	90%	100%
Other languages	<input type="checkbox"/>	<input type="checkbox"/>	<input type="checkbox"/>	<input type="checkbox"/>	<input type="checkbox"/>	<input type="checkbox"/>	<input type="checkbox"/>	<input type="checkbox"/>	<input type="checkbox"/>	<input type="checkbox"/>	<input type="checkbox"/>
	0%	10%	20%	30%	40%	50%	60%	70%	80%	90%	100%

11. When you count, how often do you **count** in the following languages?

English	<input checked="" type="checkbox"/>	<input type="checkbox"/>	<input type="checkbox"/>	<input type="checkbox"/>	<input type="checkbox"/>	<input type="checkbox"/>	<input type="checkbox"/>	<input type="checkbox"/>	<input type="checkbox"/>	<input type="checkbox"/>	<input type="checkbox"/>
	0%	10%	20%	30%	40%	50%	60%	70%	80%	90%	100%
Spanish	<input type="checkbox"/>	<input type="checkbox"/>	<input type="checkbox"/>	<input type="checkbox"/>	<input type="checkbox"/>	<input type="checkbox"/>	<input type="checkbox"/>	<input type="checkbox"/>	<input type="checkbox"/>	<input type="checkbox"/>	<input checked="" type="checkbox"/>
	0%	10%	20%	30%	40%	50%	60%	70%	80%	90%	100%
Other languages	<input type="checkbox"/>	<input type="checkbox"/>	<input type="checkbox"/>	<input type="checkbox"/>	<input type="checkbox"/>	<input type="checkbox"/>	<input type="checkbox"/>	<input type="checkbox"/>	<input type="checkbox"/>	<input type="checkbox"/>	<input type="checkbox"/>
	0%	10%	20%	30%	40%	50%	60%	70%	80%	90%	100%

V. Language attitudes

In this section, we would like you to respond to statements about language attitudes by giving marks from 0-6.

- 0=disagree 6=agree
16. a. I feel like myself when I speak **English**. 0 1 2 3 4 5 6
- b. I feel like myself when I speak **Spanish**. 0 1 2 3 4 5 6
17. a. I identify with an **English-speaking** culture. 0 1 2 3 4 5 6
- b. I identify with a **Spanish-speaking** culture. 0 1 2 3 4 5 6
18. a. It is important to me to use (or eventually use) **English** like a native speaker. 0 1 2 3 4 5 6
- b. It is important to me to use (or eventually use) **Spanish** like a native speaker. 0 1 2 3 4 5 6
19. a. I want others to think I am a native speaker of **English**. 0 1 2 3 4 5 6
- b. I want others to think I am a native speaker of **Spanish**. 0 1 2 3 4 5 6



NATIONAL HERITAGE LANGUAGE RESOURCE CENTER

OLGA KAGAN
Director

133 Hobb Hall
Box 95241
Los Angeles, CA 90095-2411
phone: 310-825-1310
fax: 310-825-1385
www.nhlc.ucla.edu

November 7, 2017

Eric Alvarez
[REDACTED]

Dear Mr. Alvarez:

I am pleased to invite you to spend the period from September 24 through December 14, 2018 as a Visiting Graduate Researcher (VGR) at UCLA. We understand that your stay will be fully self-supported through pending mobility funding through Labex Empirical Foundations of Linguistics, Sorbonne Paris Cité.

During your stay as a Visiting Graduate Researcher, you will have the opportunity to continue your research on bilingualism in Los Angeles. You will be affiliated with the UCLA International Institute's National Heritage Language Resource Center for this appointment. As such, we hope that you will be able to participate in the center's activities while you are on campus. Professor Olga Kagan of the Department of Slavic, East European and Eurasian Languages and Cultures will serve as a faculty sponsor during your work with the center.

VGR status will provide you with access to the UCLA library; you are also welcome to participate in seminars and conferences held on campus. Unfortunately, given space shortages, we are unable to guarantee office space; however, the Center will make every effort to ensure that you will have access to a reasonably private work space.

I am delighted to extend this invitation to you as a Visiting Graduate Researcher at UCLA for the fall quarter, 2018 and we look forward to your arrival in Los Angeles in September.

Sincerely,

Olga Kagan

Professor of Russian

Director, National Heritage Language Resource Center

ALVAREZ, Eric doctorant contractuel Université Sorbonne Nouvelle

Bourse mobilité Labex EFL :

Je suis doctorant en première année à l'École Doctorale 514 sous la direction de Madame Aliyah Morgenstern. Dans le cadre de mes travaux de recherche en sociolinguistique, je souhaite obtenir une Bourse de mobilité Labex EFL afin de me rendre à Los Angeles (L.A.), Californie en septembre 2018. Ainsi, je pourrais à la fois profiter d'un séjour académique à UCLA et faire ma recherche de terrain dans la banlieue sud de L.A. afin de recueillir un corpus qui me permettra de mieux comprendre comment les parents bilingues anglais - espagnol de deuxième génération essaient de transmettre l'espagnol d'héritage à travers le translanguaging, ou l'alternance codique : le langage mixte, et comment leurs enfants acquièrent et utilisent ce mode de communication mixte en interaction dans un contexte naturel.

Accueil et conditions de travail

Je serai accueilli par l'un des 16 "National Heritage Language Resource Centers" (NHLRC) aux États-Unis, des centres de recherche sur les langues d'héritage financés par le "U.S. Department of Education". Le NHLRC a pour mission la recherche et le développement des approches pédagogiques pour l'enseignement des langues d'héritage ainsi que la formation des enseignants. Le NHLRC à Los Angeles est affilié au "International Institute" de l'Université de Californie, Los Angeles (UCLA). Ainsi en tant que "Visiting Graduate Researcher" (VGR) pendant la durée de mon séjour je serai sous la tutelle de la Professeure Olga Kagan, directrice du NHLRC. En tant que VGR, j'aurai un espace de travail dans le centre et je participerai pleinement aux activités scientifiques : ateliers, conférences, semainiers etc., je bénéficierai de la riche bibliothèque inter-universitaire et de la littérature scientifique anglophone sur la question du bilinguisme à L.A. Par ailleurs, en étant VGR j'intégrerai la dimension interdisciplinaire à mes recherches. En effet, je compte me rapprocher du département d'anthropologie afin de suivre des séminaires d'anthropologie linguistique pour mieux me former à l'ethnographie pour ma recherche sur terrain et pour mieux saisir les enjeux quant à la question de l'idéologie et du langage je me mettrai en contact avec le Professeur Paul Kroskrity anthropologue linguiste dans le département. Je compte également rencontrer deux chercheurs avec qui je suis déjà en contact : le Professeur Otto Santa Ana du "Cesar E. Chavez Department of Chicana/o Studies" de UCLA ainsi que la Professeure Émérite Carmen Silva-Corvalán de l'Université du Sud de Californie (USC), tous les deux sociolinguistes travaillant sur la question du contact des langues, de la variation linguistique et du développement de l'espagnol d'héritage chez les enfants et les adultes aux États-Unis.

Recueil de corpus – terrain : Méthode

Après avoir déposé mon projet de recherche, j'ai obtenu les premières autorisations du "External Review Board" du Los Angeles Unified School District (LAUSD). Ainsi, je pourrai pendant le temps extra-scolaire après les cours, rendre visite aux directeurs d'école de Florence Avenue Elementary School et de Graham Elementary School pour présenter mon projet de recherche aux enseignants et aux enfants âgés de quatre et cinq ans. À la fin de la présentation, les enfants partiront chacun avec un dossier bilingue anglais - espagnol. Le dossier sera constitué d'une fiche où je me présenterai aux parents comme résidant membre de la communauté sociolinguistique hispanique ayant grandi et ayant toujours de la famille dans le quartier. J'expliquerai brièvement mon projet de recherche ainsi que les conditions de participation. Le projet sera intitulé : "The Bilingual Project". Le dossier sera également accompagné : d'un court questionnaire sociolinguistique qui cherche à faire ressortir certains critères biographiques essentiels par rapport au protocole de sélection de participants, d'un "Parent Authorisation Form" qui permettra à l'enfant de participer à l'étude et enfin d'un "Minor Consent Form" pour accord de participation des enfants de plus de sept ans vivant dans l'entourage des premiers. L'ensemble des documents ainsi que les deux dernières formes sont conformes à la réglementation de la "Federal Policy for the Protection of Human Rights (34 CFR Part 97) ainsi qu'au code d'éthique établi par le LAUSD et seront distribués à l'ensemble des enfants des deux écoles. Cela permettra de protéger les participants mais aussi permettra que mon projet à volet international respecte et rentre dans le cadre du code de réglementation fédérale des États-Unis.

L'objectif de cette première étape liée à l'accord parental est de bien cadrer le projet au niveau éthique pour pouvoir rentrer dans les écoles publiques du LAUSD et de travailler avec les écoliers pendant leurs temps extra-scolaire. Après les cours donc, je leur soumettrai des tâches de traduction anglais - espagnol qui seront filmées. Cela me permettra de mesurer leurs compétences bilingues dans chaque langue, ces résultats viendront s'ajouter aux analyses globales.

Une fois que j'aurai obtenu l'autorisation écrite, l'objectif de la seconde étape sera de contacter les parents en leur annonçant qu'ils ont été sélectionnés pour participer à la poursuite de l'étude. Je leur proposerai cette fois de filmer l'écolier en milieu naturel, entouré et en interaction avec sa famille, deux fois une heure ou le temps d'un repas. Je ferai connaissance de la famille lors du premier rendez-vous, puis je les aiderai à remplir le deuxième questionnaire sociolinguistique plus approfondi que le premier, avant de commencer l'enregistrement. Je suivrai le même protocole lors de la première et seconde visite chez tous les participants. Ainsi, à travers une approche ethnolinguistique basée sur l'observation participante, des interviews et des questionnaires structurés, j'envisage la création d'une base de données d'au moins 25 heures : 20 heures d'interactions en milieu naturel pour des analyses aussi bien quantitatives que qualitatives et cinq heures d'interactions structurées lors de la tâche de traduction anglais - espagnol pendant le temps extra-scolaire à l'école.

Une fois le corpus collecté, des logiciels spécifiques seront nécessaires pour l'annotation afin de faire ressortir les formes linguistiques recherchées, ou bien l'utilisation du langage mixte anglais - espagnol dans le cadre de mes recherches. Donc, j'utiliserai CLAN pour la transcription et l'analyse des 20 heures de corpus vidéo d'interactions naturelles et des 5 heures d'interactions structurées. CLAN me permettra également d'aligner le texte et la vidéo et enfin de coder toutes les occurrences cibles. Par ailleurs, j'utiliserai EXCEL afin de générer des graphiques ainsi que pour l'élaboration des grilles d'annotation et de codage complémentaires. Enfin, j'envisagerai éventuellement l'utilisation de ELAN pour l'annotation fine des gestes.

Motivations personnelles et bénéfiques pour le Labex EFL

Obtenir une Bourse de mobilité Labex EFL me permettra d'effectuer ma recherche sur terrain dans le sud de L.A. et d'accepter l'invitation du NHLRC en tant que Visiting Graduate Researcher. Par ailleurs, c'est un projet de recherche qui s'inscrit dans les objectifs scientifiques du Labex EFL d'atteindre son but et d'ouvrir de nouvelles perspectives sur la recherche linguistique. Ma recherche ainsi que mes collaborations avec le NHLRC, UCLA, USC et les écoles de la LAUSD offriront une visibilité au Labex EFL sur la côte ouest des États-Unis pendant et après la durée de mes travaux de recherche, à travers notamment des points d'étapes réguliers, la publication de ma thèse, un minimum de trois articles scientifiques ainsi que des présentations à l'occasion des conférences, colloques, journées d'étude etc. Ainsi, je participerai et contribuerai à la dynamique de développement du réseau Labex EFL à l'international.

Par ailleurs, ma recherche s'inscrit particulièrement dans l'axe 3 de recherche et de missions scientifiques : Typologie et dynamique des systèmes linguistiques dirigé par Madame Anaïd Donabédian. L'axe 3 a comme but de décrire et de modéliser la diversité linguistique en tant que systèmes dynamiques. Sur le plan théorique, l'objectif de l'axe 3 est en harmonie avec l'approche sociolinguistique de ma recherche qui considère le langage comme étant composé de systèmes dynamiques, variables et qui se co-construisent, influencés par des facteurs sociaux, politiques, identitaires etc. qui eux influencent le dynamisme linguistique. Dans ce sens, au niveau méthodologique ma recherche rentre dans la mission de l'axe 3 qui cherche un équilibre entre des approches quantitatives et qualitatives et qui intègre aux analyses des critères historiques, régionaux, discursifs etc. Par ailleurs, mon approche basée sur l'usage en acquisition du langage et la dimension bilingue de mon projet me permettront d'être en phase également avec l'axe 4 : Représentation et traitement du langage dans une perspective "lifespan". Aussi, puisque le langage mixte dû au contact de l'anglais et de l'espagnol à L.A. est un phénomène courant et que l'espagnol de L.A. est considéré comme une "variété" de l'espagnol standard, la question de l'émergence des langues (i.e. la pidginisation, la créolisation) pourra mieux être appréhendée en collaborant avec l'axe 4 qui s'intéresse également à la formation du créole. Enfin, partir à L.A. et collaborer au NHLRC me permettra de faire ma recherche sur le terrain et à travers l'approche ethnolinguistique de créer une base de données d'au moins 20 heures d'interaction naturelle et semi-guidé (pour les entretiens) et 5 heures d'interaction basé sur les tâches. L'analyse du corpus nécessitera bien entendu des logiciels spécifiques pour l'annotation afin de faire ressortir l'utilisation du langage mixte anglais - espagnol. Ainsi, une collaboration avec l'axe 6 : Ressources langagières : données, lexiques, corps, outil enrichira ma méthodologie de recherche.

Pour mettre mon projet en place au niveau logistique je propose le calendrier indicatif ainsi que le budget prévisionnel ci-dessous :

ALVAREZ, Eric doctorant contractuel Université Sorbonne Nouvelle

Calendrier indicatif :

Septembre 2018	
Semaine 1	<ul style="list-style-type: none"> - Vol : Paris -> Los Angeles - Installation dans le quartier "Florence District" dans le sud de L.A. - Téléphoner/envoyer email aux directeurs de Florence Ave. (E1) et Graham Elementary School (E2) et confirmer ma venue en semaine 2 établie avant mon arrivée - Contacter : le NHLRC, Paul Kroskrity, Otto Santa Ana, Carmen Silva-Corvalán et prendre RDV - Recherches bibliothécaires à UCLA
Semaine 2	<ul style="list-style-type: none"> - Rendez-vous avec le directeur de E1 - Rendez-vous avec le directeur de E2 - Présentation du "The Bilingual Project" aux enseignants et écoliers de E1 et distribution des dossiers de participation bilingues aux écoliers - Présentation du "The Bilingual Project" aux enseignants et écoliers de E2 et distribution des dossiers de participation bilingues aux écoliers
Semaine 3	<ul style="list-style-type: none"> - Collecte des "Parents Authorization Forms" (PAF) de E1 et E2 - Participation aux activités et observation des écoliers l'après-midi après les cours pour établir une relation de confiance - Contacts avec les parents de E1 et E2 lorsqu'ils viennent chercher leurs enfants afin de collecter et/ou de faire signer davantage de "PAF" - Recherches bibliothécaires à UCLA
Semaine 4	<ul style="list-style-type: none"> - Installation au NHLRC à UCLA et rencontre avec mes collègues - Rendez-vous avec Olga Kagan directrice du centre - Poursuite de la collecte des "PAF" dans les 2 écoles - Participation aux activités et observation des écoliers l'après-midi après les cours afin d'établir une relation de confiance - Première sélection des participants basée sur le premier questionnaire sociolinguistique et choix de 10 écoliers (5 par école) - Diffusion aux 5 écoliers de E1 des taches de traduction anglais - espagnol (2,5 heures d'enregistrement structuré sur 2 jours) - Diffusion aux 5 écoliers de E2 des taches de traduction anglais - espagnol (2,5 heures d'enregistrement structuré sur 2 jours) Total : 5h d'interactions structurées - Contact avec les parents des 10 écoliers sélectionnés pour poursuite de l'étude et pour les filmer chez eux en milieu naturel
Octobre 2018	
Semaine 5	<ul style="list-style-type: none"> - Participation aux activités et observation des écoliers l'après-midi après les cours pour établir la confiance - Rencontre avec les parents sélectionnés de E1 et E2 lorsqu'ils viennent chercher leurs enfants et explication du déroulement des visites chez eux - Diffusion du deuxième questionnaire sociolinguistique à Famille 1 et Famille 2 - Tournage des vidéos chez Famille 1 (sur deux jours) et Famille 2 (sur deux jours) = (2 heures par famille = 4 heures) Total : 4h d'interactions en milieu naturel - Participation aux activités du NHLRC à UCLA
Semaine 6	<ul style="list-style-type: none"> - Rencontre/suivi du séminaire du Professeur et anthropologue linguiste Paul Kroskrity : ethnographie, idéologies des langues - Participation aux activités et observation les écoliers l'après-midi après les cours pour établir la confiance - Rencontre avec les parents sélectionnés de E1 et E2 lorsqu'ils viennent chercher leurs enfants et explication du déroulement des visites chez eux - Diffusion du deuxième questionnaire sociolinguistique à la Famille 3 et la Famille 4 - Tournage des vidéos chez la Famille 3 (sur deux jours) et la Famille 4 (sur deux jours) = (2 heures par famille = 4 heures) 8h d'interactions cumulées en milieu naturel - Participation aux activités du NHLRC à UCLA

ALVAREZ, Eric doctorant contractuel Université Sorbonne Nouvelle

Semaine 7	<ul style="list-style-type: none"> - Participation aux activités et observation des écoliers l'après-midi après les cours pour établir la confiance - Rencontre avec les parents sélectionnés de E1 et E2 lorsqu'ils viennent chercher leurs enfants et explication du déroulement des visites chez eux - Diffusion du deuxième questionnaire sociolinguistique à la Famille 5 et la Famille 6 - Tournage des vidéos chez la Famille 5 (sur deux jours) et la Famille 6 (sur deux jours) = (2 heures par famille = 4 heures) 12h d'interactions cumulées en milieu naturel - Participation aux activités du NHLRC à UCLA
Semaine 8	<ul style="list-style-type: none"> - Rencontre/suivi du séminaire du Professeur et sociolinguiste Otto Santa Ana du "Cesar E. Chavez Department of Chicana/o Studies" de UCLA - Participation aux activités et observation des écoliers l'après-midi après les cours pour établir la confiance - Rencontre avec les parents sélectionnés de E1 et E2 lorsqu'ils viennent chercher leurs enfants et explication du déroulement des visites chez eux - Diffusion du deuxième questionnaire sociolinguistique à la Famille 7 et la Famille 8 - Tournage des vidéos chez la Famille 7 (sur deux jours) et la Famille 8 (sur deux jours) = (2 heures par famille = 4 heures) 16h d'interactions cumulées en milieu naturel - Participation aux activités du NHLRC à UCLA
Semaine 9	<ul style="list-style-type: none"> - Participation aux activités et observation des écoliers l'après-midi après les cours pour établir la confiance - Rencontre avec les parents sélectionnés de E1 et E2 lorsqu'ils viennent chercher leurs enfants et explication du déroulement des visites chez eux - Diffusion du deuxième questionnaire sociolinguistique à la Famille 9 et la Famille 10 - Tournage des vidéos chez la Famille 9 (sur deux jours) et la Famille 10 (sur deux jours) = (2 heures par famille = 4 heures) 20h cumulées d'interactions en milieu naturel - Participation aux activités du NHLRC à UCLA
Novembre 2018	
Semaine 10	<ul style="list-style-type: none"> - Rencontre avec la Professeur et sociolinguiste Carmen Silva-Corvalán de USC - Participation aux activités du NHLRC à UCLA - Participation aux activités et observation des écoliers l'après-midi après les cours pour établir la confiance et, si nécessaire, soumettre une nouvelle fois les tâches de traduction anglais - espagnol - Poursuite éventuelle du tournage des vidéos chez les familles
Semaine 11	<ul style="list-style-type: none"> - Étude et classement des questionnaires sociolinguistiques et, si nécessaire, établissement de la liste des parents à rappeler pour obtention d'informations complémentaires
Décembre 2018	
Semaine 12	<ul style="list-style-type: none"> - Contact avec les parents pour informations complémentaires (si besoin) - Participation aux activités du NHLRC à UCLA - Dernière visite à E1 et E2, remerciements et distribution des petits cadeaux (livres bilingue et crayons) aux participants
Semaine 13	<ul style="list-style-type: none"> - Participation aux activités du NHLRC à UCLA et fin de mission en tant que VGR
Semaine 14	<ul style="list-style-type: none"> - Préparation/organisation/classement avant retour en France
Janvier 2019	
Semaine 15	<ul style="list-style-type: none"> - Vol : Los Angeles -> Paris

ALVAREZ, Eric doctorant contractuel Université Sorbonne Nouvelle

Budget indicatif pour les 15 semaines :

Catégorie	Budget (euros)
A/R Paris <-> L.A.	1000
Frais de scolarité à UCLA	450
Auto : frais de carburants, péages et parkings	800
Hébergement : 400 euros/mois * 4 mois	1600
Nourriture : 15 euros/jour * 100 jours	1500
Articles personnels : frais de reprographies et fournitures divers	400
Divers : les petits cadeaux (stylos, livres bilingues...)	200
Total	5950

Dans l'attente de l'examen de mon dossier, je vous prie d'agréer, Mesdames et Messieurs les membres du comité, mes salutations les plus respectueuses.

Eric ALVAREZ

[REDACTED]

Le 5 janvier 2018

Chers membres du comité mobilité du Labex EFL,

Je soussignée Aliyah Morgenstern, professeure de linguistique, directrice de thèse d'Eric Alvarez souhaite soutenir sa candidature à une bourse mobilité Labex EFL 2018. Je tiens à recommander Eric Alvarez en raison de sa connaissance du sujet sur lequel il a l'intention de travailler, de sa maîtrise de trois langues, l'anglais, l'espagnol et le français, de sa passion pour la transmission langagière et de son enthousiasme communicatif. Il s'agit d'un étudiant très motivé, heureux d'échanger avec les autres et déjà bien formé au monde universitaire, à la fois en matière de recherche et d'enseignement.

Durant son année de Master 2, Eric Alvarez a été un étudiant exemplaire et a suivi un certain nombre de formations en plus des séminaires de recherche obligatoires. Il a en particulier beaucoup aidé notre post-doctorante à évaluer l'impact de la formation sur la recherche et le « story-telling » dans le cadre d'un projet innovant pédagogique financé par la COMUE Sorbonne Paris Cité. Il a par ailleurs été extrêmement assidu dans le cadre des séminaires de notre équipe de recherche en linguistique anglaise et a participé avec enthousiasme à toutes les activités que nous proposons. Il a été membre du comité d'organisation du congrès international sur la gestualité (ISGS7) qui a eu lieu dans notre université en juillet 2016.

Eric Alvarez a réalisé un mémoire de master 2 en anglais de grande qualité avec un corpus difficile à recueillir pour lequel il a obtenu la collaboration fructueuse d'étudiants de UCLA. Il a également rédigé plusieurs essais en anglais et en français avec un bon niveau scientifique.

Malgré son poste de lecteur à plein temps, en 2016-2017, Eric a continué à participer aux séminaires d'équipe et à échanger régulièrement avec nos mastérants et nos doctorants. Il a participé également aux activités scientifiques organisées par notre unité de recherche durant toute l'année universitaire.

Son projet de thèse est en parfaite continuité avec le mémoire de Master 2 qu'il a rédigé sous ma direction et aborde la problématique du bilinguisme particulier des enfants issus de l'immigration à Los Angeles en Californie. Au lieu de considérer l'alternance codique comme une phase de développement à surmonter, sa thèse analysera le fonctionnement de ce que la littérature nomme le « translangaging » et cherchera à en montrer la valeur dans la socialisation langagière de ces enfants à l'identité hybride. Plutôt que de considérer les deux systèmes langagiers comme imperméables, son travail permettra de mettre en valeur l'usage enrichissant d'un système hybride et les capacités cognitives, sociales et linguistique des enfants

capables de manier à la fois l'anglais, l'espagnol et de reconstruire grâce à l'étayage adulte, une forme langagière particulière empreinte de la richesse de leur identité culturelle.

L'approche théorique d'Eric Alvarez est également une forme d'hybridation car il analyse les constructions langagières au sein du corpus avec une démarche basée sur l'usage et en ne cherchant pas à éviter les analyses quantitatives, tout en intégrant l'analyse conversationnelle et une analyse sociolinguistique, voire anthropo-linguistique, du contexte et des pratiques langagières de la communauté linguistique observée. Le recueil de corpus sera associé à des questionnaires et à son propre journal d'observations au quotidien durant son séjour sur son terrain de recherche.

Le corpus sera transcrit avec le logiciel CLAN et codé dans des grilles EXCEL. Le logiciel ELAN pourra être ponctuellement utilisé si la gestualité du corpus est suffisamment riche pour être saisie avec finesse. Le corpus sera en fin de thèse mis en ligne dans des bases de données nationale et internationale (ORTOLANG et CHILDES).

Eric Alvarez, qui a obtenu un contrat doctoral 2017 et qui est donc en thèse depuis fin octobre 2017, a déjà bien avancé dans l'identification du périmètre de son corpus et a obtenu les premières autorisations pour faire les collectes de données. Il a construit son propre réseau au National Heritage Language Resource Center de Los Angeles et sera accueilli par des collègues de renom dans plusieurs universités. Il bénéficiera de mes relations avec le département d'anthropologie de UCLA (plusieurs collègues l'ont déjà rencontré lors de leurs séjours scientifiques à Paris) et de ses propres contacts avec le département de linguistique. Il pourra séjourner sur place au sein de la communauté qu'il étudie et dont il est issu lui-même, ce qui facilitera le recueil d'un corpus aussi authentique que possible.

Cette mission qui allie terrain et intégration scientifique dans le monde académique de UCLA et USC est fondamentale pour la bonne suite de son projet de thèse et lui permettra à la fois de profiter de l'expérience de collègues spécialistes et de recueillir un corpus innovant. Cette mission sera pleinement profitable au labex EFL comme Eric Alvarez le montre dans sa lettre d'intention et elle s'intègre à la fois dans l'axe 3 (diversité linguistique), l'axe 4 (perspective lifespan) et l'axe 6 (corpus).

Je suis à votre disposition pour toute information supplémentaire.



Annex 16: LIN's visual representation of English & Spanish



Title: Third-generation heritage Spanish acquisition and socialization in Los Angeles, California. A cognitive-functional and socio-interactional mixed methods case study of Spanish-English bilingualism.

Abstract

Based on ethnographic data collected in a bilingual setting and subsequently turned into a plurilingual corpus, this dissertation examines some aspects of the acquisition and socialization into the use of heritage Spanish by a third-generation child. LIN's use of heritage Spanish, but also of English, and language mixing is examined between 3;10 and 4;9 as she is engaged in spontaneous interaction with her family. This study is rooted in cognitive-functional, and social-interactionist-based paradigms which argue that language acquisition and socialization are driven by the interaction of cognition, exposure, and use. Each chapter accounts for the impact of the input quantity and quality on LIN's heritage Spanish use, but also of the role that English, and language mixing have on heritage Spanish transmission. Quantitative measures based on 10 linguistic and social factors present LIN's bilingual language learning environment. The results show that overall English is spoken the most in the family, and Spanish is kept to a minimum. Qualitative analyses allow us to untangle the multimodal language production in multigenerational, and multiparty encounters. The results show that heritage bilingualism is not just about acquiring abstract grammatical rules. Rather, heritage bilingualism in LIN's case is also about inheriting bilingual and bicultural practices constructed by, with, and for her community of practice that cannot be measured by the number of Spanish words that she produces. Encouragement, speech stream segmentation, play, child-directed, and overheard speech, but also the presence of Spanish monolingual great-grandparents are also indispensable to her use of heritage Spanish. Finally, linguistic, and cultural practices whether they are hybrid or not are telling about how identities, both hers and her family's, have been constructed through the multiple voices echoed across space and time.

Key-words: heritage acquisition, heritage socialization, heritage Spanish, third-generation bilingualism, multigenerational, multimodality, discourse strategies, participation frameworks

Titre : Acquisition et socialisation à l'espagnol d'héritage de troisième génération à Los Angeles, Californie. Une étude de cas cognitive-fonctionnelle et socio interactionnelle à méthodes mixtes du bilinguisme espagnol-anglais.

Résumé

Basée sur des données ethnographiques, collectées dans un environnement bilingue et transformées par la suite en un corpus plurilingue, cette thèse examine certains aspects de l'acquisition et de la socialisation à l'usage de l'espagnol d'héritage par un enfant de troisième génération. L'usage par LIN de l'espagnol d'héritage, mais aussi de l'anglais, et le mélange des langues sont examinés entre 3:10 et 4:9 alors qu'elle est engagée dans des interactions spontanées avec sa famille. Cette étude est ancrée dans les paradigmes cognitif-fonctionnels et socio-interactionnistes selon lesquelles l'acquisition d'une langue et la socialisation sont déterminées par l'interaction de la cognition, de l'exposition et de l'usage. Chaque chapitre rend compte de l'impact de la quantité et de la qualité de l'input sur l'usage de l'espagnol d'héritage de LIN, mais aussi du rôle que l'anglais et le mélange des langues ont sur la transmission de l'espagnol d'héritage. Des mesures quantitatives basées sur 10 facteurs linguistiques et sociaux présentent l'environnement d'apprentissage bilingue de LIN. Les résultats montrent que, dans l'ensemble, l'anglais est le plus parlé dans la famille, et que l'espagnol est réduit au minimum. Les analyses qualitatives nous permettent de démêler et de décrire finement la production linguistique multimodale dans des rencontres multigénérationnelles et multipartites. Les résultats montrent que le bilinguisme d'héritage ne se limite pas à l'acquisition de règles grammaticales abstraites. Dans le cas de LIN, le bilinguisme d'héritage consiste plutôt à hériter de pratiques bilingues et biculturelles construites par, avec et pour sa communauté de pratique, qui ne peuvent être mesurées par le nombre de mots d'espagnol qu'elle produit. L'encouragement, la segmentation du flux de la parole, le jeu, le discours adressé à l'enfant et le discours entendu par celui-ci, mais aussi la présence d'arrière-grands-parents monolingues en espagnol sont également indispensables à son usage de l'espagnol d'héritage. Enfin, les pratiques linguistiques et culturelles, qu'elles soient hybrides ou non, révèlent la manière dont les identités, la sienne et celle de sa famille, se sont construites à travers les multiples voix qui se font écho dans l'espace et le temps.

Mots-clés : acquisition d'héritage, socialisation d'héritage, espagnol d'héritage, bilinguisme de troisième génération, multigénérationnel, multimodalité, stratégies de discours, cadres participatifs