



HAL
open science

Bio-organoclays for oil-based drilling fluids

Qiang Li

► **To cite this version:**

Qiang Li. Bio-organoclays for oil-based drilling fluids. Chemical Sciences. Sorbonne Université, 2023. English. NNT : 2023SORUS704 . tel-04591445

HAL Id: tel-04591445

<https://theses.hal.science/tel-04591445>

Submitted on 28 May 2024

HAL is a multi-disciplinary open access archive for the deposit and dissemination of scientific research documents, whether they are published or not. The documents may come from teaching and research institutions in France or abroad, or from public or private research centers.

L'archive ouverte pluridisciplinaire **HAL**, est destinée au dépôt et à la diffusion de documents scientifiques de niveau recherche, publiés ou non, émanant des établissements d'enseignement et de recherche français ou étrangers, des laboratoires publics ou privés.

Sorbonne Université

École doctorale 397

Physique et Chimie des Matériaux

Laboratoire : Laboratoire d'Archéologie Moléculaire et Structurale

(LAMS UMR 8220)

Bio-organoclays for oil-based drilling fluids

Par **Qiang Li**

Thèse de doctorat de **Chimie**

Dirigée par Maguy Jaber

Présentée et soutenue publiquement le 24 octobre 2023

Devant un jury composé de :

Jean-François Lambert	Professeur à Sorbonne Université	Examineur
Thomas Georgelin	Directeur général, CMI Roullier	Examineur
Svetlana Mintova	Directrice de recherche, CNRS	Rapporteuse
Nikolay Nesterenko	Directeur chez Sulzer	Rapporteur
Maguy Jaber	Professeure à Sorbonne Université	Directrice de thèse

Acknowledgements

Embarking on a journey of pursuing PhD at the Sorbonne University will undoubtedly leave precious and unforgettable memories in my life. I was fortunate to be surrounded by a very professional academic team and the friendliest colleagues. Engaging with the distinguished professors and scholars here is a pleasant experience, as it involves not only the exploration of academic subjects but also the fascinating intersection of diverse cultural viewpoints. Without the support of these wonderful people, I believe this work could not have been completed on schedule. The following short lines cannot express my gratitude to all of you. I would like to express my heartfelt gratitude, with the sincerest depth of emotion, to all the individuals and institutions that have provided support and guidance in this process.

First of all, I wish to express my sincere gratitude to Prof. Maguy. It is a genuine honor for me to have you as my supervisor, guiding my academic career for three years. I hold deep admiration for your profound passion for research and your unwavering dedication to the pursuit of scientific inquiry. Three years ago, we started to study the challenging topic of organic modification of clays and its applications, and you provided enough support, both in terms of experimental equipment and research methodology, to facilitate the successful completion of this study. Moreover, your proactive encouragement to engage actively in diverse academic conferences not only offered exceptional platforms for the exchange of ideas with scholars from around the globe but also ignited a spark of academic collaboration and innovation. Upon my initial arrival in Paris, my limited proficiency in spoken language and introverted disposition posed certain challenges in our communication. However, your patience, optimism, and unwavering encouragement bolstered my confidence and motivated me to continually strive for improvement. Thanks again to my supervisor. Your hearty laugh is my fondest memory in Paris.

Dear Laurence and Romain, I enjoy discussing academic topics and revising the papers with you. Your perspectives have given me a lot of new inspiration. A multitude of your suggestions have significantly enhanced the paper's quality. We meticulously revise manuscripts and collaborate towards their publication, a truly beautiful process.

Dear Christelle and Lucie, thank you very much for your help in my experimental work. Confronted with unfamiliar experimental equipment and procedures, I frequently found myself uncertain about the appropriate course of action. You consistently and patiently provide guidance on operating the instrument and conducting sample tests. Without your help, I believe the experimental work will be a big challenge for me.

Dear Philippe, thank you for supporting my research work and helping me in my life. I deeply feel the warm and harmonious atmosphere created by LAMS. I am grateful to be a part of this big family.

Guanzheng and Yongjie, I truly appreciate all the help and support you have provided me, both academically and in daily life. Guanzheng is committed to the research of organoclay and provided many professional opinions on my work. Yongjie and I spent 2022 together in the LAMS laboratory. We celebrated the Chinese New Year with the lab colleagues and shared Chinese food, it was a wonderful memory!

Many thanks to all my colleagues in the LAMS lab. I am delighted to have worked and spent three wonderful years with a group of smart and interesting people. Thanks to Emeline, Suzie, Rémi, Alain, Thiéry, Sophie for solving all the troubles I have caused. Thanks to Clarisse, Floriane, Côme, Quentin, Gauthier, Lucile, Linh, Aurore, Caroline. We gathered for activities, enjoyed lunch and the warm sunshine on the lawn and had a great day!

Thanks for the support provided by China Scholarship Council (CSC). Their financial contribution plays a key role in ensuring the successful completion of my PhD, for which I am sincerely grateful.

Last but not least, I am profoundly appreciative of my parents' steadfast support and selfless love. These three years of doctoral pursuit have been a period of personal growth and enlightenment for me. Yet, I am acutely aware that, for my aging parents, this period meant struggling with the challenges of growing older and enduring moments of solitude. Mom and Dad, words fall short in conveying the depth of my love for you. Special thanks to my older sister Tian, who always supported me in every possible way and was always there for my parents!

Abstract

Drilling fluid is commonly regarded as the blood of drilling engineering, and the success of drilling operations largely depends on the performance of drilling fluid. The growing demand for energy has prompted oilfield extraction in harsh geological conditions, where the application of oil-based drilling fluid is prevalent due to their low friction and excellent thermal stability. Organoclays, which are obtained by reacting clay minerals with organic compounds, have long been the subject of research as typical additives that provide rheological properties to oil-based drilling fluids.

In this study, an attempt has been done to investigate the influencing factors and intercalation mechanism of organoclays prepared by modifying bentonite with natural surfactants. The effects of reaction temperature, time, pH, and lecithin concentration on the properties of organoclays were analyzed. The structural properties and intercalation process of organoclays have been examined using XRD, TEM, XRF, FTIR, TG/DTG, and molecular dynamic simulations. The characterization results demonstrate that the intercalation behavior of lecithin can be completed in a short time (0.5 h). Neither reaction time nor temperature displayed a substantial impact on the eventual intercalation properties of the organoclays. The properties of organoclays prepared from lecithin-modified bentonite are pH dependent. The conformation of lecithin molecules in the interlayer space of clays undergoes a transition from a flat-lying layer to a tilted paraffin-type-bilayer with increasing surfactant concentration. This phenomenon occurs under both acidic (pH = 1.0) and alkaline (pH = 9.0) conditions, yet interestingly, follows two distinct mechanisms. When lecithin was introduced at pH = 1.0, almost complete removal of interlayer exchangeable cations in organoclays was observed, indicating that surfactants intercalated within the interlayer space through cation exchange. Conversely, at pH = 9.0, the zwitterionic nature of lecithin facilitated its intercalation through ion-dipole interactions with the cations.

Taking inspiration from ancient paint recipes, Zn^{2+} -montmorillonite was modified by lecithin to synthesize organic montmorillonite (ZnOMt), which was then dispersed in vegetable and mineral oils for the preparation of oil-based drilling fluids. The rheological properties of organoclays in oil-based drilling fluids were also evaluated and linked to organic montmorillonite microstructure information obtained by XRD and TEM. The nature of the oil used and the heating temperature are key parameters influencing the performance of oil-based drilling fluid. The microstructure of ZnOMt in linseed oil undergoes three stages with rising temperature: swelling→exfoliation→high dispersion. The association of exfoliated clay platelets and the intertwining of surfactant molecules adsorbed on the clay surface are the basis for forming a network structure and thixotropy in drilling fluids. In addition, the paraffin oil-based drilling fluids always displayed liquid-like behavior, while linseed oil-based drilling fluids exhibited viscoelastic properties and maximum thixotropy at 120°C. The favorable properties of vegetable oil-based drilling fluids containing organoclays provide great potential for their application in drilling engineering.

Keywords: organic montmorillonite, lecithin, modification, intercalation mechanism, oil-based drilling fluid, rheology

Résumé

Le fluide de forage est communément considéré comme le sang de l'ingénierie de forage, et le succès des opérations de forage dépend en grande partie de la performance du fluide de forage. La demande croissante d'énergie a incité à l'extraction de champs pétrolifères dans des conditions géologiques difficiles, où l'application de fluides de forage à base de pétrole est répandue en raison de leur faible frottement et de leur excellente stabilité thermique. Les argiles organiques, obtenues par réaction de minéraux argileux avec des composés organiques, font depuis longtemps l'objet de recherches en tant qu'additifs typiques conférant des propriétés rhéologiques aux fluides de forage à base de pétrole.

Dans cette étude, une tentative a été faite pour étudier les facteurs d'influence et le mécanisme d'intercalation des argiles organiques préparées en modifiant la bentonite avec des tensioactifs naturels. Les effets de la température, du temps, du pH et de la concentration de lécithine sur les propriétés des argiles organiques ont été analysés. Les propriétés structurales et le processus d'intercalation des argiles organiques ont été examinés à l'aide des techniques d'analyses DRX, TEM, XRF, FTIR, TG/DTG et de simulations de dynamique moléculaire. Les résultats de la caractérisation démontrent que le comportement d'intercalation de la lécithine peut être effectué en peu de temps (0,5 h). Ni le temps de réaction ni la température n'ont eu d'impact substantiel sur les éventuelles propriétés d'intercalation des argiles organiques. Les propriétés des argiles organiques préparées à partir de bentonite modifiée par la lécithine dépendent du pH. La conformation des molécules de lécithine dans l'espace intercalaire des argiles subit une transition d'une couche plane à une bicouche de type paraffine inclinée avec une concentration croissante de tensioactif. Ce phénomène se produit à la fois dans des conditions acides (pH = 1,0) et alcalines (pH = 9,0), mais il est intéressant de noter qu'il suit deux mécanismes distincts. Lorsque la lécithine a été introduite à pH = 1,0, une

élimination presque complète des cations échangeables entre les couches des argiles organiques a été observée, indiquant que les tensioactifs se sont intercalés dans l'espace intercouche par échange de cations. À l'inverse, à pH = 9,0, la nature zwitterionique de la lécithine facilite son intercalation via des interactions ion-dipôle avec les cations.

S'inspirant d'anciennes recettes de peinture, la Zn^{2+} -montmorillonite a été modifiée par de la lécithine pour synthétiser de la montmorillonite organique (ZnOMt), qui a ensuite été dispersée dans des huiles végétales et minérales pour la préparation de fluides de forage à base de pétrole. Les propriétés rhéologiques des argiles organiques dans les fluides de forage à base de pétrole ont également été évaluées et liées aux informations sur la microstructure organique de la montmorillonite obtenues par DRX et TEM. La nature de l'huile utilisée et la température de chauffage sont des paramètres clés influençant les performances du fluide de forage à base de pétrole. La microstructure du ZnOMt dans l'huile de lin subit trois étapes avec l'augmentation de la température : gonflement → exfoliation → forte dispersion. L'association de plaquettes d'argile exfoliées et l'entrelacement de molécules tensioactives adsorbées à la surface de l'argile sont à la base de la formation d'une structure en réseau et de la thixotropie dans les fluides de forage. De plus, les fluides de forage à base d'huile de paraffine présentent toujours un comportement semblable à celui d'un liquide, tandis que les fluides de forage à base d'huile de lin présentent des propriétés viscoélastiques et une thixotropie maximale à 120 °C. Les propriétés favorables des fluides de forage à base d'huile végétale contenant des argiles organiques offrent donc un grand potentiel pour leur application dans l'ingénierie de forage.

Mots clés : montmorillonite organique, lécithine, modification, mécanisme d'intercalation, fluide de forage à base de pétrole, rhéologie

Table of contents

Acknowledgements	I
Abstract	V
Résumé	VII
Chapter 1	1
Introduction	1
1.1 Application of clay mineral in drilling fluid	1
1.2 Consumption of hydrocarbon resources	3
1.3 Problem statement	6
1.4 Project objectives	7
1.5 Methodology	8
1.6 Organization	9
References	11
Chapter 2	14
Literature review	14
2.1 Organic montmorillonite	15
2.1.1 Crystal structure of Mt	15
2.1.2 Organic modification method of Mt	17
2.1.3 Types of OMt	19
2.1.4 Structure of OMt	22
2.1.5 Colloidal chemistry of OMt in oil	25
2.2 Drilling fluid	29
2.2.1 Drilling fluid classification and function	29
2.2.2 Oil-based drilling fluid rheology	31
2.2.3 Influence of temperature on oil-based drilling fluid performance	34
2.2.4 Organoclays as rheological additives in oil-based drilling fluid	36
2.3 Summary	38
References	39
Chapter 3	46
Experimental materials and procedures	46

3.1 Experimental materials	47
3.1.1 Montmorillonite.....	47
3.1.2 Surfactant.....	52
3.1.3 Base oils.....	52
3.2 Preparation of organic montmorillonite	53
3.3 Characterization of organic montmorillonite	54
3.3.1 X-ray diffraction (XRD).....	54
3.3.2 Fourier transform infrared spectroscopy (FTIR).....	55
3.3.3 Thermal analysis.....	56
3.3.4 Transmission electron microscopes (TEM).....	56
3.3.5 X-ray fluorescence (XRF)	56
3.3.6 Energy dispersive X-ray (EDX)	57
3.4 Preparation of oil-based drilling fluid	57
3.5 Performance characterization of oil-based drilling fluid	57
3.5.1 Dispersion.....	57
3.5.2 Rheology.....	58
3.5.3 Viscoelasticity.....	59
References.....	60
Chapter 4	62
Modification of bentonite with lecithin and molecular dynamics simulations	62
4.1 Introduction	63
4.2 Methods	64
4.2.1 Preparation of organic bentonite.....	64
4.2.2 Molecular dynamics simulation setup	65
4.3 Results and discussion	66
4.3.1 Effect of reaction temperature	66
4.3.2 Effect of reaction time	70
4.3.3 Effect of pH	73
4.3.4 Effect of lecithin concentration	76
4.3.5 Molecular dynamics results	82
4.4 Conclusions	85
References.....	86

Chapter 5	90
pH dependence and intercalation mechanism of lecithin-modified bentonite	90
5.1 Introduction	91
5.2 Methods	92
5.3 Results and discussion	93
5.3.1 XRD analysis.....	93
5.3.2 TEM analysis.....	96
5.3.3 Chemical composition analysis	98
5.3.4 FTIR spectra	99
5.3.5 TG analysis.....	104
5.4 Modification mechanism	107
5.5 Conclusions	109
References.....	111
Chapter 6	116
Application performance of organoclay in oil-based drilling fluid	116
6.1 Introduction	117
6.2 Methods	118
6.3 Performance of OBt in oil-based drilling fluids	120
6.3.1 Rheological properties.....	120
6.4 Performance of OMT in linseed oil drilling fluids	123
6.4.1 EDX analysis	124
6.4.2 XRD and TEM analysis.....	126
6.4.3 Rheology and viscoelasticity.....	128
6.5 Performance of ZnOMt in oil-based drilling fluids	131
6.5.1 XRD analysis.....	131
6.5.2 TEM analysis.....	132
6.5.3 Dispersion.....	134
6.5.4 Rheological properties.....	135
6.5.5 Thixotropy	137
6.5.6 Rheological modeling.....	138
6.5.7 Amplitude sweep measurements	143

6.5.8 Frequency sweep measurements	145
6.5.9 Rheological mechanism.....	147
6.6 Conclusions	148
References.....	150
Chapter 7.....	156
Conclusions and perspectives.....	156
7.1 General conclusions.....	157

Chapter 1

Introduction

1.1 Application of clay mineral in drilling fluid

Drilling operation is one of the most critical activities in producing oil and gas from hydrocarbon reservoirs. The drilling process, as the name suggests, is creating a hole in the ground to reach the desired depth which is the formation that has been considered to contain petroleum and natural gas according to the geological and exploration data (Fagan, 1991). During this process, the drill bit breaks the formation rock to produce drilling cuttings, and the drilling fluid remains in circulation and performs specific critical tasks. Hence, the performance of drilling fluid has a considerable impact on both the quality of the wellbore and drilling costs. Drilling fluids are usually complex colloidal systems composed of water or oil, rheology modifiers, filtration control agents, weighting materials and other additives. Whether in water-based or oil-based drilling fluids, clay minerals are the basic constituents of the drilling fluids. They can build up and maintain a suitable viscosity at low solid levels and control the fluid loss throughout the drilling process (Zhang et al., 2020). Due to its cost-effectiveness, environmental friendliness, and its capacity to swell and disperse in aqueous solutions, forming colloidal systems, bentonite has gained popularity as the primary choice for formulating drilling fluids.

Bentonite is a clay mineral mainly composed of montmorillonite. Montmorillonite is a 2:1-type phyllosilicate composed of two tetrahedral sheets filled with silicon sandwiching an octahedral sheet occupied by aluminum partially substituted by magnesium (Guo et al., 2009). Stacking of these layers by van der Waals force or weak dipolar interactions lead to the creation of interlayers space which are occupied by inorganic cations, balancing the charge deficiency caused by isomorphous substitution in the interlayer space (Xie et al., 2001). Natural montmorillonite is hydrophilic due to the existence of hydrated exchangeable cations. It is characterized by fine particle size, high layer charge, and large surface area, which results in a very high viscosity and thixotropy when dispersed in water. Coupled with its substantial swelling capacity, montmorillonite emerges as the pivotal and indispensable component in drilling muds (Elzea and Murray,

1990; Murray, 2000).

The process of clay minerals swelling in water is referred to as hydration. The hydration of montmorillonite in water helps the water-based drilling fluid to transform into a gel, resulting in the solid-like behavior at low shear rates and improving the viscosity (Herzhaft et al., 2006). The process of gelation of bentonite in water-based drilling fluids involves the formation of a three-dimensional network structure from individual platelets or aggregates. This unique property of bentonite makes it a valuable asset to the drilling fluid, as its dispersion and gelation can effectively transfer drilling cuttings from the bottom of the wellbore to the surface. In addition, the process of gelation is responsible for maintaining the suspension of drilling cuttings when drilling fluid is at rest, such as during tripping operations. In the absence of structure-building character in the drilling fluids, the suspended drilling cuttings would begin to settle towards the bottom of the wellbore, reducing hole-cleaning efficiency and potentially leading to cuttings accumulation in narrow well sections, which can increase the risk of drag and stuck pipe (Werner et al., 2017).

The development of clay composites capable of forming gels in oil, similar to those formed by bentonite in water, is a major contribution to the technology of oil-based drilling fluids (Caenn et al., 2011). A family of hydrophobic materials called organoclays, are obtained by an intercalation process between clay minerals and a series of organic compounds. Numerous studies and drilling operations have confirmed that organoclays can produce the appropriate colloidal and rheological properties in oil-based systems, and rapidly form a gel network structure to suspend drilling cuttings when drilling is stopped.

Clay minerals are essential colloidal additives for maintaining the proper viscosity of drilling fluid. The application of clay minerals in drilling fluids has experienced natural clays, organoclays, synthetic clays and nanoclays. Developing high-performance clay minerals products that are cost-effective and environmentally friendly remains a crucial objective in enhancing the efficiency of drilling fluids. The ongoing exploration of the

unique properties of clay minerals to optimize drilling fluid performance will continue to attract significant attention.

1.2 Consumption of hydrocarbon resources

Energy is the foundation and driving force for the progress of human civilization, and the economic growth, social progress and cultural development of human society are heavily reliant on the continuous supply of energy (Cottrell, 2009). In the 18th century, Daimler of Germany created the first gasoline-fueled internal combustion engine. The invention and application of the internal combustion engine marked the dawn of the era of oil and gas as the main energy supply. On the one hand, improvements in drilling and completion technology and the widespread use of hydraulic fracturing are contributing to the growth of oil and gas production. On the other hand, due to the accelerated development of society since the industrial revolution, the demand for energy in modern society has reached unprecedented levels (Zou et al., 2016). Consequently, the share of oil and gas in the primary energy mix grew tremendously to more than 50% in 1965 (Okafor et al., 2021). Oil and natural gas have replaced coal as the world's largest energy source.

Oil and natural gas, the primary fossil fuels, not only provide us with the major energy sources but are also the raw materials for a great variety of manmade products that range from gasoline and diesel oil to varied petrochemical and chemical products (Olah, 2005). Petrochemical products are widely used in transportation, food, clothing, housing, medicine, etc. It can be said that the modern lifestyle is closely related to petrochemical products. Oil and gas remain or even can be thought of, as one of the most treasured, valued and predominant natural resources in present human societies on the planet of Earth (Landa-Marbán et al., 2017; Ali et al., 2020).

Since the 20th century, the foundation of rapid economic development is sufficient energy supply. Fig. 1.1 illustrates the worldwide consumption of fossil fuels from 1980

to 2020. As can be seen, the consumption of coal, oil and natural gas has exhibited a gradual increase, indicating that the current society needs more energy supply. The innovations in horizontal drilling and hydraulic fracturing technologies have boosted the supply and consumption of oil and natural gas, which allows producers to efficiently extract hydrocarbons from low-permeability reservoirs. Furthermore, oil and natural gas have higher energy density and lower negative impact on the environment compared to coal, thereby contributing to their large demand in various industrial fields.

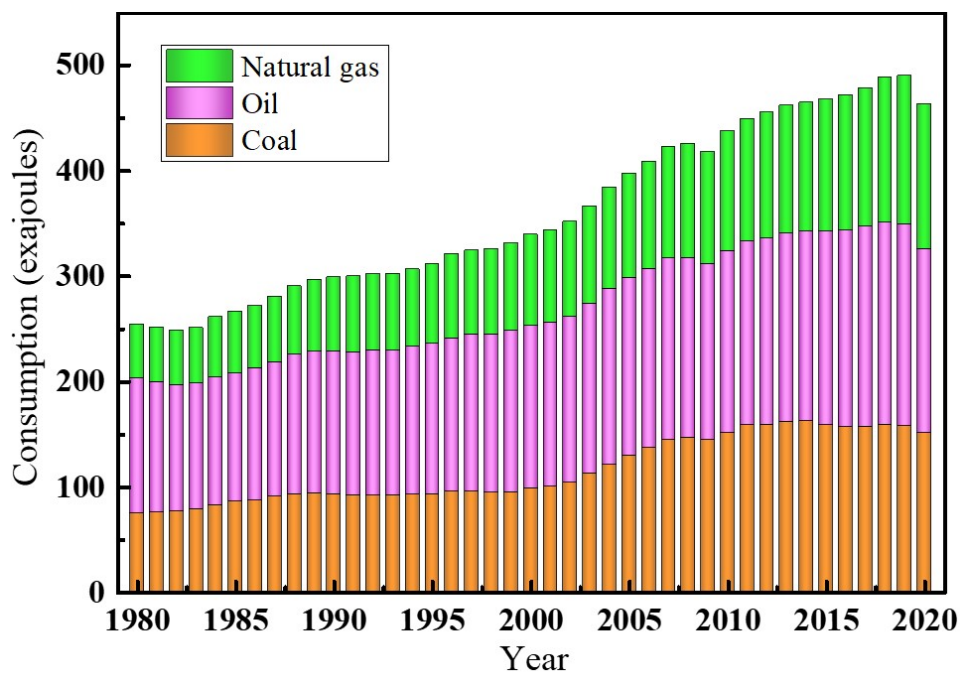

Fig. 1.1 Coal, oil and natural gas consumption from 1980 to 2020

(Data sources: world oil outlook, 2021)

The continuous growth of oil and natural gas consumption seems to be inevitable, and this trend has been confirmed by various forecast models (Ahmad and Zhang, 2020; Geng et al., 2020; Liu et al., 2021). According to the International Energy Agency (IEA, 2021) and British Petroleum (BP, 2021) forecast, global energy demand is likely to increase steadily over the next 25 years, and energy from fossil fuels will continue to dominate energy supply. As shown in Fig. 1.2, due to the need for environmental

protection, the global primary energy mix is expected to witness a decrease in the proportion of coal, while the share of natural gas is projected to rise. The demand for oil and natural gas will grow steadily at an average rate of 0.7% and 1.2% per year, respectively, while the coal consumption will fall by 0.6% per year. It is estimated that by 2045, natural gas will occupy a share of 24.4% in the primary energy mix, reaching a consumption level of 85.9 mboe/d. Although the proportion of oil consumption is expected to drop from 31.1% in 2025 to 28.1% in 2045, the actual consumption is projected to rise from 94.4 mboe/d to 98.9 mboe/d as a result of the overall increase in total energy consumption. Oil and gas resources will continue to account for more than half of the world's energy supply for a long time.

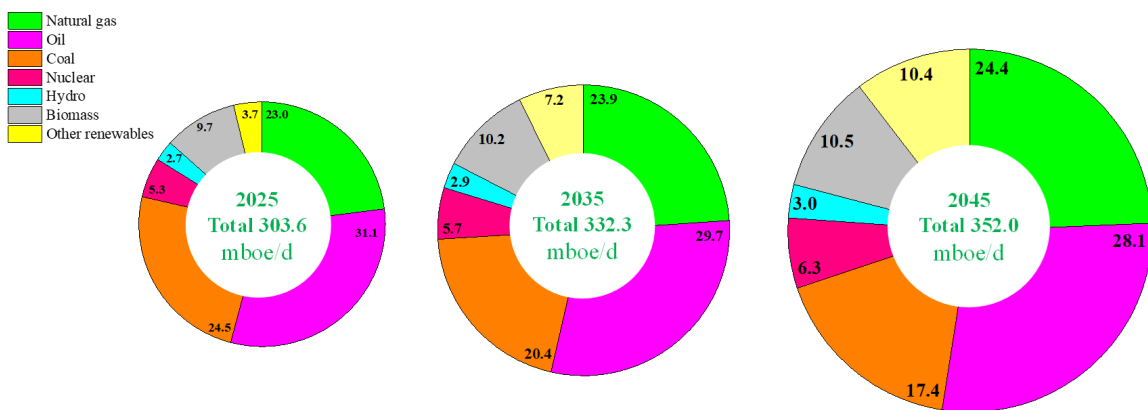

Fig. 1.2 Coal, oil and natural gas demand forecast from 2020 to 2045 (%)

The population growth, advanced technology and expectations for high living standards are driving continued growth in energy demand and consumption. Oil and natural gas have been instrumental in facilitating the economic and cultural prosperity of the previous century and are expected to continue their dominant role in energy supply for the next 30 years (Odell, 2000). Thus, the most cost-effective approach to tackling energy shortages is to intensify oil and gas exploration and extraction efforts, develop innovative techniques for recovering hydrocarbons from challenging geological formations (including offshore oil wells, high-temperature and high-pressure conditions), and explore unconventional energy sources, such as shale oil and gas.

1.3 Problem statement

After decades of exploitation, the shallow inland oil and gas resources have been gradually depleted. The depletion of easily accessible hydrocarbon resources has prompted the petroleum industry to concentrate on developing more complex and challenging reservoirs. The water-based drilling fluids cannot maintain stable performance when dealing with extremely harsh drilling conditions, which limits their application in deep formations. In addition, water-based drilling fluids can induce shale hydration, increasing the risk of wellbore instability when drilling shale formations. Wellbore instability poses a substantial financial challenge for the petroleum industry, with estimated annual losses reaching approximately 1 billion dollars (Zeynali, 2012).

Oil-based drilling fluid exhibits superior performance in drilling harsh and challenging formations as well as shale formations, in comparison to water-based drilling fluid. The oil-based drilling fluids have fascinating features to overcome certain undesirable characteristics of the water-based ones, such as better thermal stability and lubricity, excellent ability to inhibit clay swelling, outstanding corrosion protection, and faster rate of penetration (ROP) (Khodja et al., 2010; Hermoso et al., 2014).

The relationship between rheological behavior and composition is a crucial consideration in formulating oil-based drilling fluids with suitable properties. Organic montmorillonite has been extensively studied for its excellent swelling ability in the oil phase and has been considered as an important component for achieving specific functions in oil-based drilling fluids. The current focus of scientists is to modify clay minerals by utilizing natural surfactants, aiming to improve the biocompatibility of organoclays. Therefore, a comprehensive examination of the impact of reaction conditions on the structure and characteristics of clay minerals modified with natural surfactants, as well as on the intercalation mechanism of surfactants, can broaden the application range of organoclays and provide a valuable perspective on the development of organoclay technology. Additionally, although organic montmorillonite has been

widely used in oil-based drilling fluids, the structural change, viscoelastic properties, and rheological mechanisms of organic montmorillonite in the oil phase remain poorly comprehended. Only by exploring the relationship between the microstructure and macroscopic rheology of organoclay in oil-based drilling fluids can we fundamentally design and select the organoclay suitable for oil-based drilling fluids.

In summary, organic montmorillonite has a great application prospect in oil-based drilling fluid. However, a comprehensive insight into the preparation of bioorganoclays and the intercalation process of biosurfactants in clay minerals is lacking. And the mechanism by which organoclay adjusts the rheology of oil-based drilling fluids also needs to be further explored. Consequently, it is extremely important to thoroughly investigate the intercalation process of organoclays and its mechanisms controlling the rheology of oil-based drilling fluids.

1.4 Project objectives

The overall objectives of this research are to modify bentonite with the natural surfactant lecithin and to reveal the mechanism by which lecithin molecules intercalate into the clay mineral structure. In addition, the synthesized organic clays are used to prepare oil-based drilling fluids at different temperatures to study the structural changes of organic clays in oil as well as the rheological and viscoelastic properties. The specific objectives of this study are as follows:

- (1) To investigate the effect of reaction conditions on the intercalation process of lecithin modified bentonite. The effects of reaction temperature, time, concentration and pH on the properties of organic bentonite will be qualitatively analyzed.
- (2) To reveal the pH dependence of lecithin-intercalated bentonite and discuss its intercalation mechanism.
- (3) To compare the rheology and viscoelasticity of organoclays in vegetable oil-based and mineral oil-based drilling fluids.

(4) To illustrate the temperature dependence of the structure of organic clays in oil-based drilling fluids and the effect of temperature on the rheology and viscoelasticity of oil-based drilling fluids

(5) Modeling the rheological behavior of oil-based drilling fluids at different temperatures.

1.5 Methodology

This thesis presents the theoretical and experimental results related to the modification of organoclay and its application in oil-based drilling fluids. The study analyzes the effects of organoclay as a rheological modifier on viscoelastic properties of oil-based drilling fluids. Furthermore, the thesis reveals the temperature dependence of the organoclay structure in oil-based drilling fluids. The roadmap of the topics addressed in the thesis is shown in Fig. 1.3.

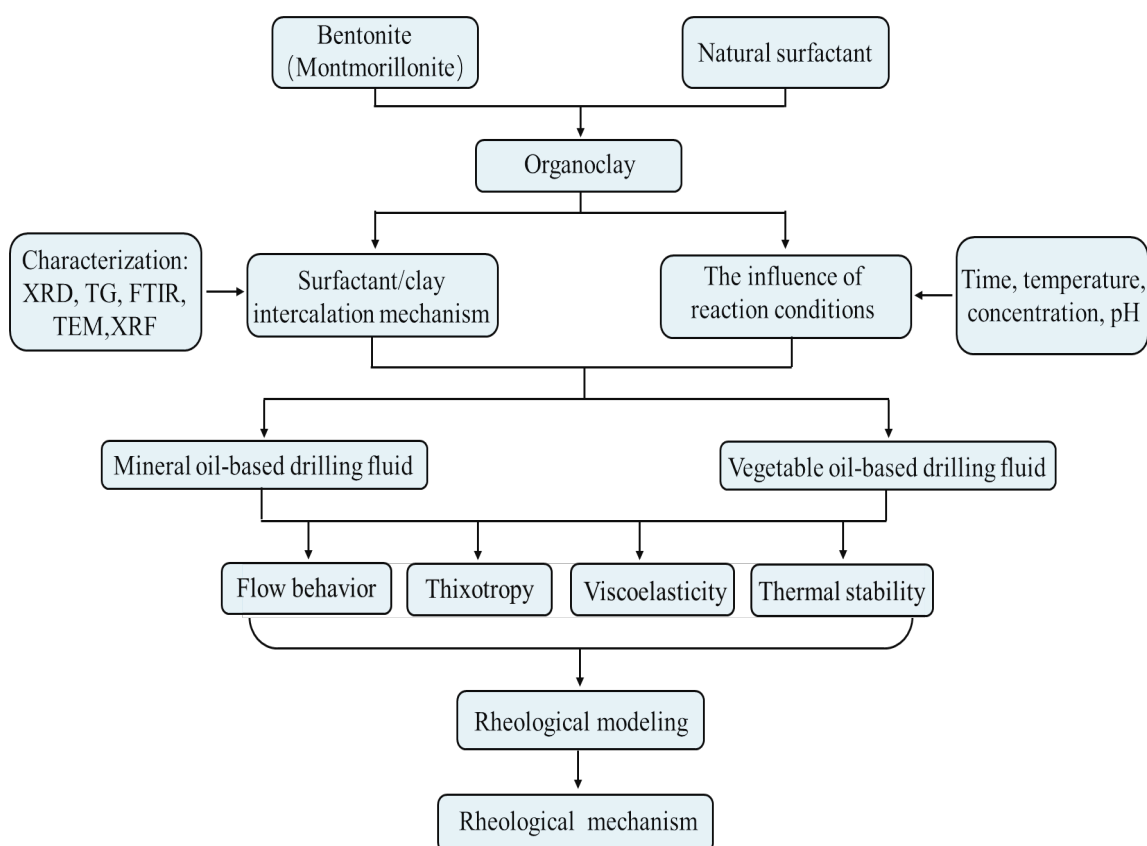

Fig. 1.3 Roadmap of the thesis

1.6 Organization

This thesis is organized into three main parts, each of which is subdivided into several chapters.

Part I is designed to introduce the research background, purpose, and framework of the thesis, while also providing an overview of preliminary concepts and state-of-the-art research advances regarding organic montmorillonite and drilling fluids. This part is structured into two chapters:

- Chapter 1 describes the research background behind the topic considered in this thesis, states the problem to be addressed and the intended methodology. Additionally, a brief overview of the subsequent chapters is provided.
- Chapter 2 presents some fundamental knowledge of the main topics covered in this thesis. That is, the function, rheology and performance of drilling fluid and the physicochemical properties of organoclay. A review of the literature is conducted, aiming at identifying the work relevant to this thesis and the state-of-the-art research in the field.

Part II is the core of this thesis as it contains all the experimental design, results and analysis. These experiments involve the preparation of organoclays and the formulation of oil-based drilling fluids at different temperatures using these organoclays. It is organized in four chapters:

- Chapter 3 introduces the synthesis steps of organoclay and the preparation method of oil-based drilling fluid. The materials, apparatus and characterization techniques involved in the experiment procedure are described in detail.
- Chapter 4 addresses the effect of reaction conditions on lecithin modified bentonite. More specifically, the effects of reaction temperature, time, concentration and pH on the interlayer configuration and thermal stability of the synthesized organoclay are mainly analyzed. In addition, molecular dynamics

simulation techniques were used to study the arrangement of lecithin in the interlayer space of bentonite.

- Chapter 5 proposes the pH dependence of lecithin-modified bentonite based on the experimental results of the previous chapter. In this chapter, the cationic content variation of the organoclay and the fluctuation of the lecithin properties are highlighted, and the distinctions in the intercalation mechanism of lecithin-modified bentonites are demonstrated by a comparative analysis of the physical and chemical properties of organoclays synthesized at varying pH conditions.
- Chapter 6 is concerned with the application of organoclays in oil-based drilling fluids. Oil-based drilling fluids are prepared using linseed oil and paraffin oil mixed with organoclay and aged at different temperatures, respectively. Rheometers are utilized to investigate the rheological behavior and viscoelastic properties of oil-based drilling fluids. The rheological model of oil-based drilling fluids is established and reveals the structure of organoclays in the oil phase as a function of temperature.

Part III consists only of Chapter 7, which draws the conclusion of this thesis by summarizing the main research findings. Furthermore, this thesis suggests several promising directions for future research, which could inspire potential future works in this field.

References

- Ahmad, T., Zhang, D., 2020. A critical review of comparative global historical energy consumption and future demand: The story told so far. *Energy Reports* 6, 1973-1991.
- Ali, J.A., Kalhury, A.M., Sabir, A.N., Ahmed, R.N., Ali, N.H., Abdullah, A.D., 2020. A state-of-the-art review of the application of nanotechnology in the oil and gas industry with a focus on drilling engineering. *Journal of Petroleum Science and Engineering* 191, 107118.
- BP, 2021. BP statistical review of world energy 2021. British Petroleum (2021).
- Caenn, R., Darley, H.C.H., Gray, G.R., 2011. Chapter 4 - Clay Mineralogy and the Colloid Chemistry of Drilling Fluids, in: Caenn, R., Darley, H.C.H., Gray, G.R. (Eds.), *Composition and Properties of Drilling and Completion Fluids (Sixth Edition)*. Gulf Professional Publishing, Boston, pp. 137-177.
- Cottrell, F., 2009. *Energy & society: The relation between energy, social change, and economic development*. AuthorHouse.
- Elzea, J.M., Murray, H.H., 1990. Variation in the mineralogical, chemical and physical properties of the Cretaceous Clay Spur bentonite in Wyoming and Montana (U.S.A.). *Applied Clay Science* 5, 229-248.
- Fagan, A., 1991. An Introduction to the petroleum industry. Terminology 1.
- Geng, Z., Zhang, Y., Li, C., Han, Y., Cui, Y., Yu, B., 2020. Energy optimization and prediction modeling of petrochemical industries: An improved convolutional neural network based on cross-feature. *Energy* 194, 116851.
- Guo, Y.X., Liu, J.H., Gates, W.P., Zhou, C.H.J.C., Minerals, C., 2020. Organo-modification of montmorillonite. 68, 601-622.
- Hermoso, J., Martinez-Boza, F., Gallegos, C., 2014. Influence of viscosity modifier nature and concentration on the viscous flow behaviour of oil-based drilling fluids at high pressure. *Applied Clay Science* 87, 14-21.
- Herzhaft, B., Ragouillaux, A., Coussot, P., 2006. How To Unify Low-Shear-Rate Rheology and Gel Properties of Drilling Muds: A Transient Rheological and Structural Model for Complex Well Applications, IADC/SPE Drilling Conference, pp. SPE-99080-MS.
- IEA, 2021. International Energy Agency World Energy Outlook. Organisation for Economic Co-operation and Development, IEA, Paris and Washington, DC.
- Khodja, M., Canselier, J.P., Bergaya, F., Fourar, K., Khodja, M., Cohaut, N., Benmounah, A., 2010. Shale problems and water-based drilling fluid optimisation in the Hassi Messaoud Algerian oil field. *Applied Clay Science* 49, 383-393.
- Landa-Marbán, D., Radu, F.A., Nordbotten, J.M.J.T.i.P.M., 2017. Modeling and simulation of microbial enhanced oil recovery including interfacial area. 120, 395-413.

Liu, J., Wang, S., Wei, N., Chen, X., Xie, H., Wang, J., 2021. Natural gas consumption forecasting: A discussion on forecasting history and future challenges. *Journal of Natural Gas Science and Engineering* 90, 103930.

Murray, H.H., 2000. Traditional and new applications for kaolin, smectite, and palygorskite: a general overview. *Applied Clay Science* 17, 207-221.

Odell, P.R., 2000. The global energy market in the long term: the continuing dominance of affordable non-renewable resources. *Energy exploration & exploitation* 18, 599-613.

Okafor, C., Madu, C., Ajaero, C., Ibekwe, J., Bebenimibo, H., Nzekwe, C.J.A.E., 2021. Moving beyond fossil fuel in an oil-exporting and emerging economy: Paradigm shift. 9, 379-413.

Olah, G.A., 2005. Beyond Oil and Gas: The Methanol Economy. *Angewandte Chemie International Edition* 44, 2636-2639.

Werner, B., Myrseth, V., Saasen, A., 2017. Viscoelastic properties of drilling fluids and their influence on cuttings transport. *Journal of Petroleum Science and Engineering* 156, 845-851.

Xie, W., Gao, Z., Liu, K., Pan, W.-P., Vaia, R., Hunter, D., Singh, A., 2001. Thermal characterization of organically modified montmorillonite. *Thermochimica Acta* 367, 339-350.

Zeynali, M.E., 2012. Mechanical and physico-chemical aspects of wellbore stability during drilling operations. *Journal of Petroleum Science and Engineering* 82-83, 120-124.

Zhang, J.R., Xu, M.D., Christidis, G.E., Zhou, C.H.J.C.M., 2020. Clay minerals in drilling fluids: functions and challenges. 55, 1-11.

Zou, C., Zhao, Q., Zhang, G., Xiong, B., 2016. Energy revolution: From a fossil energy era to a new energy era. *Natural Gas Industry B* 3, 1-11.

Chapter 2

Literature review

2.1 Organic montmorillonite

Modification of montmorillonite (Mt) by organic molecules is an effective approach to improve its affinity toward non-aqueous media, and has been widely used as a rheology control agent in oil-based drilling fluids (Zhang et al., 2020). The structure of Mt and the colloidal chemistry of organic montmorillonite (OMt) profoundly shape the performance of oil-based drilling fluids in drilling. Therefore, it is essential to have a thorough understanding of the physical and chemical properties of OMt to accurately adjust the rheological properties of oil-based drilling fluids.

2.1.1 Crystal structure of Mt

Clay minerals are a diverse group of hydrous layer aluminosilicates that constitute the greater part of the phyllosilicate family of minerals (Huggett, 2015). Clay minerals, also known as layered silicates, are usually characterized by a layered structure including tetrahedral silicon sheets and octahedral aluminum sheet (Rezaei et al., 2021). According to their layered structure, clay minerals can be divided into three groups: (1) 1:1-type clay minerals consist of one tetrahedral and one octahedral sheet; (2) 2:1-type clay minerals are composed of one octahedral sheet sandwiched between two tetrahedral sheets; (3) 2:1:1 clays are consisted of a succession of the octahedral sheets close to a 2:1 layer (Massaro et al., 2018). The 2:1-type clay minerals include multiple species, such as montmorillonite, bentonite, vermiculite, saponite, and hectorite. The most famous among them are the smectite group.

Montmorillonite (Mt) is a layered material belonging to the phyllosilicate group, and more specifically the smectite group. Mt enjoys a wide range of applications in various industries due to its high cation exchange capacity, swelling ability and high surface area. The ideal formula per half unit cell of Mt is $(Si_4(Al_{2-y}Mg_y)O_{10}(OH)_2, yM^+ \cdot nH_2O)$, where M^+ is the interlayer cation and y is the degree of isomorphic substitution (Bergaya et al., 2011). The thickness of a single layer of Mt is 0.96 nm, but the diameter

varies from nanometers to micrometers. The isomorphous substitution of Al^{3+} by Mg^{2+} in the octahedral sheet results in the negative charge of the Mt layers. Consequently, some exchangeable cations, such as Na^+ and Ca^{2+} exist in the interlayer space to neutralize the negative charges of the clay layers (Pavlidou and Papaspyrides, 2008). The typical morphology of Mt is “sand rose” (Fig. 2.1). The main feature of Mt is the interlayer space which is present between each triple-sheet-layer, and the interlayer space constitutes about the 90% of the total clay surface (Bergaya and Lagaly, 2006).

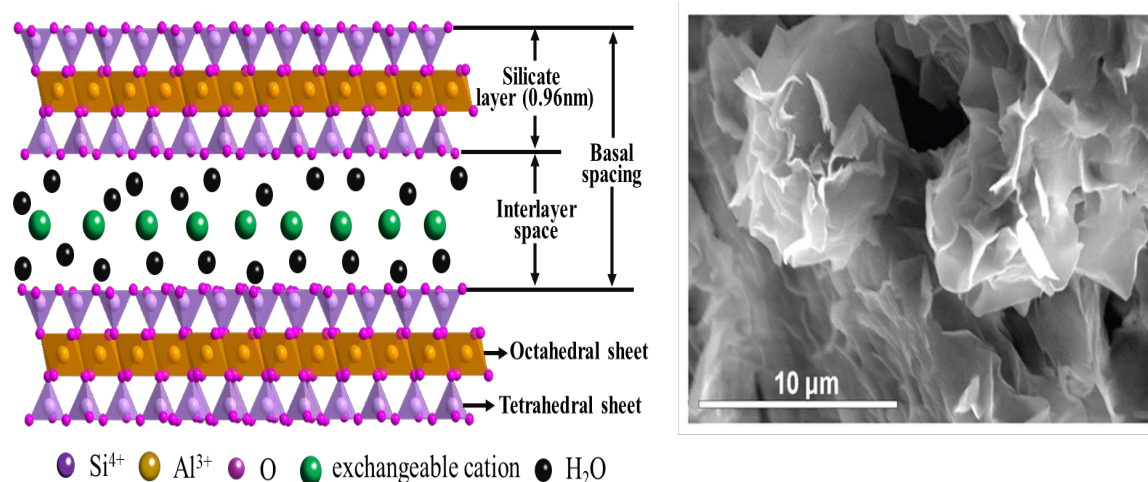

Fig. 2.1 The crystal structure of Mt and corresponding SEM image

Numerous investigations have reported the electrokinetic response and zeta potential of Mt layers (Leroy et al., 2015; Mészáros et al., 2019). In general, the surface charge of Mt can be divided into two categories: layer charge and edge charge. The surface charge of the layers is almost always negative, whereas the edge charge depends on pH (Tsujimoto et al., 2013). The main contribution to the surface charge of the Mt layer is the negative layer charge on the basal planes due to isomorphous substitution, which is also known as permanent negative charge because the layer charge is not affected by chemical conditions (van Olphen, 1964a). The average layer charge of Mt varies between 0.2 and 0.4 eq/formula unit $(\text{Si}, \text{Al})_4\text{O}_{10}$ but most Mt have layer charges around 0.3 eq/formula unit (Lagaly and Ziesmer, 2003). The edges of the Mt layer exhibit aluminol and silanol groups, which can react with hydrogen ions. Therefore, the nature of the edge charge of

Mt is dependent on the pH value of the aqueous dispersion. At low pH, the edges are positively charged, while at higher pH, they become negatively charged (Rand et al., 1980). The surface charge of Mt is the foundation of its various electrochemical properties, which not only impacts the physicochemical performances of Mt, but also governs the flocculation and inter-particle interactions of clays and other treatment agents.

2.1.2 Organic modification method of Mt

Due to the presence of hydrated exchangeable cations, pristine Mt is inherently hydrophilic, which limits its ability to disperse in organic media. Organic modification is regarded as the most effective method for enhancing the affinity of clay minerals towards non-aqueous media, and thus, solving the aforementioned problem. The organic modification of Mt can be achieved by various technical methods. The wet method and dry method have been reported in the literature to prepare organic montmorillonite (OMt). The wet method is the most widespread method adopted for the synthesis of OMt.

2.1.2.1 Wet method

The preparation of OMt, or other organoclay minerals such as organopalygorskite, organosepiolite follows the same synthesis procedure when using the wet method. Firstly, the Mt powder is dispersed in water and stirred under high-speed shearing conditions to make it fully hydrated and swollen. This dispersion is prepared at a low concentration and at a suitable temperature to avoid excessive viscosity during stirring. Then, surfactants or other organic substances are added to the previous Mt dispersion and stirred for a period of time under moderate reaction conditions. During this process, the surfactant in the mixed solution undergoes a cation exchange reaction with the cations present in the Mt, resulting in the aggregation of the Mt particles. Finally, the solid phase particles in the mixed solution are separated by filtration or centrifugation. These samples were dried and ground to obtain OMt powder. In some cases, the solid phase particles were washed several times prior to the drying process in order to remove excess surfactant.

The main process variables for preparing OMt by wet method include the

properties/concentration of surfactant, temperature, time, pH value and washing/purification manner (Merino et al., 2016; Yang et al., 2019). Cationic surfactants are often used to modify Mt because they readily generate cation exchange reactions. Surfactant concentrations used for modification range from 0.2CEC to 5.0CEC, but the most common value is about 1.0CEC of the Mt (Yang et al., 2017). Taking into account the boiling point of water, the reaction temperature for the production of OMt usually varies between room temperature and 80°C. In some examples, reaction time and solution pH can have a profound effect on the performance of OMt (Li et al., 2023). After decades of development and process advancement, the wet method has become the most mature and popular technology for the preparation of OMt.

2.1.2.2 Dry method

Although the preparation of OMt by wet method is simple, a large amount of water is consumed in this process and the generated sewage pollutes the environment. Therefore, researchers have attempted to prepare organoclays through dry reaction. In the dry method, the clay and surfactant solution steps are avoided, which reduces water consumption and wastewater treatment costs. The pristine Mt particles and surfactants are mixed/ground in grinding devices to produce fine particles and to promote contact between the reactants. High shear mixers or planetary ball mills are the main equipment used in the dry process (Zhuang et al., 2015).

The first dry method reactions of clay minerals and ammonium cations were reported by (Ogawa et al., 1990). Numerous dry method reactions rely on ion-dipole interactions. In this interaction, organic molecules containing polar groups attach to the interlayer cations (Beall and Goss, 2004; Yoshimoto et al., 2005; de Paiva et al., 2008). (Zhou et al., 2018) compared the properties of OMt prepared by dry and wet method respectively, and found that the thermal stability, dispersibility and hydrophobicity of OMt obtained by wet method were always better than those prepared by dry method. It is apparent that the approach and methodology employed in the organic modification of Mt significantly impact its overall performance.

2.1.3 Types of OMt

The surface modification of clay minerals has gained significant attention due to its crucial impact on the development of inorganic-organic hybrid materials. Among them, organic surfactant-modified Mt is the preferred way to produce hybrid materials. Based on the ionic nature of the surfactant and the method of utilization, the OMt can be divided into the following types:

2.1.3.1 Cation surfactant-modified Mt

Cation-modified Mt is currently the most extensively researched and widely used type of organoclay. The amount of published studies on cationic surfactant modified Mt is >80% of all the reported ones (Zhang et al., 2010). It can be obtained using organic cations to modify Mt through cation exchange. The surfactants used in cation-modified Mt are mainly quaternary ammonium salts and quaternary phosphonium salts (Xie et al., 2001; Cruz-Guzmán et al., 2006; Vazquez et al., 2008; Liu et al., 2022a). It is notable that quaternary ammonium salts display limited thermal stability, limiting the application of OMt in high temperature environments. The electrostatic interactions between organic cations and the negative charge of Mt surface, hydrophobicity of alkyl chains, and hydrogen bonds are the main driving forces for cationic modification of Mt (Guo et al., 2020).

The interlayer spacing, surface properties and adsorption capacity of OMt prepared with cationic surfactants are closely related to the length and number of alkyl chains, the nature and concentration of polar heads. The interlayer spacing of OMt increases with the length and number of alkyl chains of the surfactant. The interlayer configuration of OMt varies with surfactant concentration. In addition, cationic surfactants occupy the clay interparticle pores resulting in a dramatic decline in pore volume and specific surface area, but the adsorption capacity of organoclays for organic contaminants in solution is greatly increased (He et al., 2006a; He et al., 2014).

2.1.3.2 Anion surfactant-modified Mt

Compared to cationic surfactants, anionic surfactants generally have a higher degradation temperature. Hence, anionic surfactants were employed in an attempt to prepare thermally stable organoclays. Some researchers believed that anions could not effectively modify Mt due to the electrostatic repulsion between the negatively charged clay layer and the negatively charged head of the anionic surfactant (Zheng et al., 2013; Sanqin et al., 2014). However, (Sarier et al., 2010) proposed different viewpoints based on experimental results. Anionic surfactant can intercalate into the Mt interlayer space by ion–dipole attraction to the cations on the surface and by replacing the structural OH groups at the edges and interlayers. (Bayram et al., 2020) reported experiments on the modification of Mt with anionic surfactant sodium dodecyl sulfate (SDS). SDS was successfully intercalated in the interlayer of Mt and expanded the basal spacing from 1.59 to 3.89 nm. Also, the sulfonate groups of SDS formed hydrogen bonds with water molecules in the interlayer space.

2.1.3.3 Nonionic surfactant-modified Mt

Nonionic surfactants are surfactants that have polar head groups that are not electrically charged. They are widely used in industry due to their low cost, non-toxic and biodegradable properties. Because of the absence of ionic and chemical absorption functional groups in nonionic surfactants, hydrogen bonding can be considered as the main driving force for the modification of Mt by nonionic surfactants (Shen, 2001). Organoclays modified with nonionic surfactants can be detected with larger basal spacing, which helps OMt exhibit high swelling index and high degree of exfoliation in organic solvents that improves fluid properties (Silva et al., 2014).

In addition to the role of hydrogen bonding, the mechanism of modification of Mt by nonionic surfactants may be a combination of multiple actions, such as ion-dipole interaction and van der Waals forces. The selection of a suitable nonionic surfactants is critical to the success of clay modification. Not all nonionic modifiers can intercalate the interlayer space of Mt. The basal spacing of OMt, which was modified with OP-10,

increased from 1.45 to 4.26 nm. However, the basal spacings of OMt modified with Span-80 and Span-20 were similar to those of Mt, indicating that these modifiers may not effectively intercalate Mt (Zhuang et al., 2017).

2.1.3.4 Zwitterion surfactant-modified Mt

Zwitterionic surfactants are a class of surfactants composed of both positive and negative charges that typically neutralize each other under normal environmental conditions. Sulfobetaines, as typical zwitterionic surfactants, have similar properties in some respects to both ionic and nonionic surfactants in solution. The preparation and intercalation mechanism of zwitterionic surfactant-modified Mt have been studied (Zhu et al., 2011; Ma et al., 2015; Zhu et al., 2017). Compared with OMt prepared by the traditional cation surfactant, the OMt modified by zwitterionic surfactant can obtain a larger interlayer spacing and higher thermal stability at the same surfactant concentration. (Zhu et al., 2017) demonstrated by elemental analysis method that the intercalation mechanism of zwitterionic surfactant-modified Mt involved an ion-dipole interaction rather than a cation exchange process, and the exchangeable cations were attached to the surfactant molecules and retained in the interlayer space.

2.1.3.5 Joint surfactant-modified Mt

Mt can be co-modified with two or even more surfactants to synthesize OMt, and its performance can be further enhanced by adding joint modification mixtures of various types of surfactants. Such mixtures can exhibit different properties from their corresponding single modifiers, and may benefit from possible synergies between their chemical groups. The types of joint surfactant used for Mt modification are usually combinations of cations and anions (Fu et al., 2016), of cations and non-ionic species (Zhuang et al., 2015), and of anions and non-ions species (Zhang et al., 2012).

The performance of the OMt obtained by the synergistic action of surfactants is indeed better than that of the corresponding single surfactant. The co-modification of Mt by anionic and cationic surfactants promotes the intercalation of anions into Mt, and anion

and cation form ion pairs in the interlayer space, which greatly increases the basal spacing of OMt (Fu et al., 2016). The cationic-nonionic OMt exhibits not only stronger resistance to high temperatures but also excellent dispersibility and swelling ability in oil (Zhuang et al., 2015).

2.1.4 Structure of OMt

The intercalation of organic surfactants changes the physicochemical properties of Mt and improves the basal spacing. The interlayer conformation of surfactants in Mt has long been a central focus of research. With the ongoing advancements in material characterization methods and techniques, various approaches such as X-Ray diffraction (XRD) analysis, Fourier-transform infrared spectroscopy (FTIR), Scanning electron microscopy (SEM), Transmission electron microscopy (TEM) and X-ray fluorescence (XRF) have been extensively utilized to investigate the structure and properties of OMt.

In the early research stage, the XRD technique was first employed to determine the basal spacing of organoclays. Researchers then used this information in combination with the spatial structure and size data of surfactant molecules to elucidate the arrangement of organic molecules within the interlayer space of Mt. The interlayer configuration and orientations of alkylammonium ions in OMt has been reported by (Lagaly, 1969; Lagaly, 1981; Bergaya and Lagaly, 2013). The concentration of alkylammonium ions is the important factor affecting the basal spacing of OMt. The basal spacing of OMt increases with increasing surfactant loading, and the structure of alkylammonium ions within the interlayer space varies with concentration according to the following pattern: monolayer → bilayers → pseudo-trimolecular layers → inclined paraffin-type structure (Fig. 2.2).

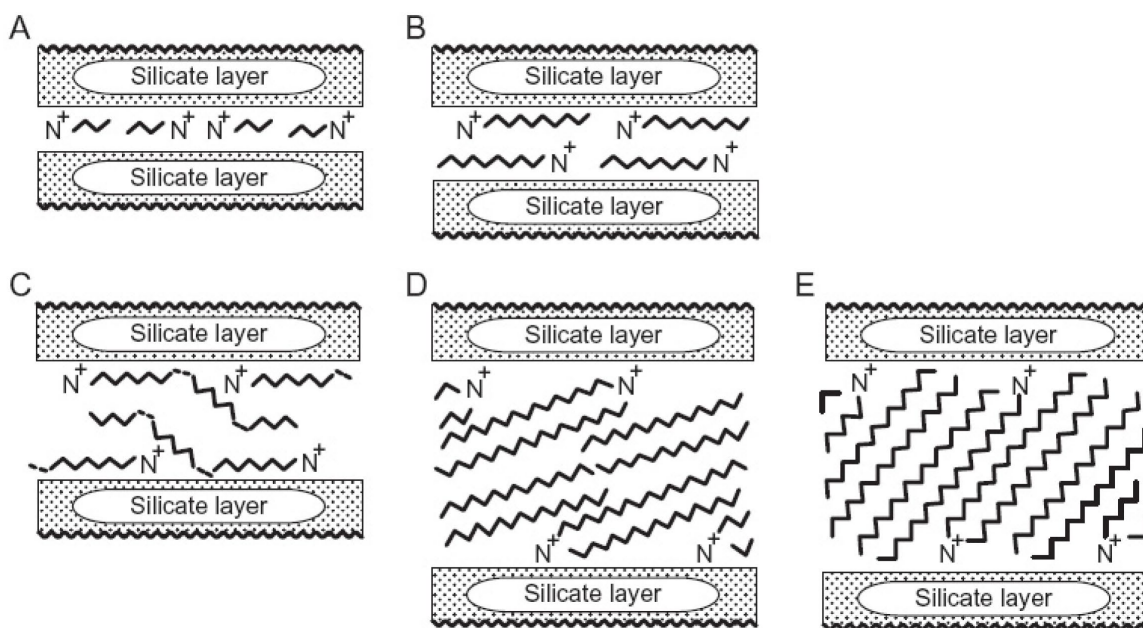

Fig. 2.2 Arrangement of alkylammonium ions in the interlayer space of OMT: (A) monolayers, (B) bilayers, (C) pseudo-trimolecular layers, (D, E) paraffin-type arrangements with different tilting angles of the alkyl chains (Lagaly et al., 2013)

The length of alkyl chain and the charge density of clay layer are responsible for the interlayer configuration of intercalated surfactants in the organoclays. The short-chain alkylammonium ions can only form a monolayer within the interlayer space of Mt. In contrast, organophilic clays intercalated with long-chain surfactant may exhibit bilayers, pseudo-trimolecular layers, or paraffin-type. When highly charged clay minerals intercalate with alkylammonium ions, it promotes the formation of paraffin-type structures. Fig. 2.3 illustrates the correlation between the arrangement of alkylammonium ions in interlayer space with alkyl chain length and layer charge of clay.

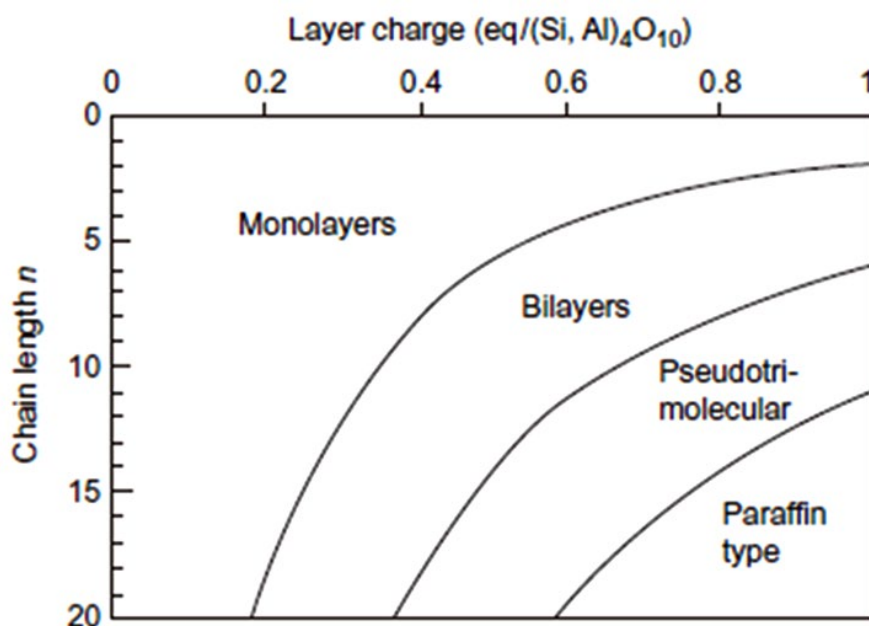

Fig. 2.3 Effect of layer charge and alkyl chain length on the arrangement of alkylammonium ions

n is number of carbon atoms in the n -alkyl chains (Lagaly et al., 2013)

Electron microscopy techniques, such as TEM and SEM, allow researchers to directly observe the macrostructural features of organoclay. The packing density of surfactant within the clay interlayer space can be probed by TEM. SEM has been reported to show the surface morphology of organoclays (Park et al., 2011). OMT with low surfactant packing density are predominantly composed of irregular layer stacking with numerous curved organoclay layers, whereas those with higher surfactant packing density consist mainly of regular layer stacking with fewer curved organoclay layers (Fig. 2.4).

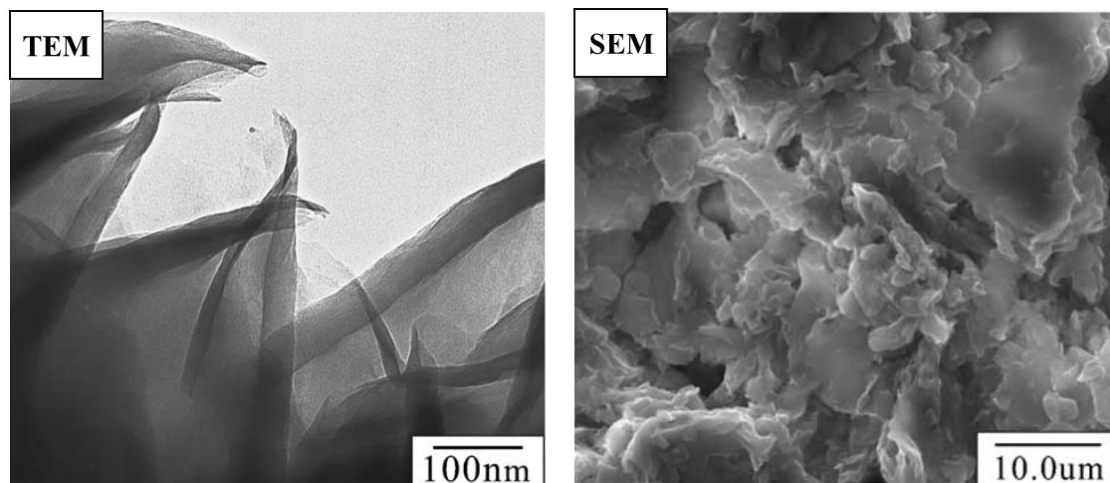

Fig. 2.4 TEM and SEM micrographs of OMt with curved and irregularly intercalated layers (He et al., 2006)

2.1.5 Colloidal chemistry of OMt in oil

The OMt exhibits distinct physicochemical properties compared to the pristine montmorillonite, such as excellent dispersibility and thixotropy in organic media, and better adsorption capacity for organic pollutants and heavy metals. Therefore, OMt is used in a wide range of industrial applications, including adsorbents, polymer hybrid materials, greases, inks, and cosmetics. The best-known application of OMt is in the oil industry to control and adjust the rheological properties of oil-based drilling fluids. Due to the lipophilic nature of OMt, it can disperse, swell, and even exfoliate in the oil phase, which can increase the viscosity of the drilling fluid and exhibit thixotropy.

2.1.5.1 Dispersion and swelling

It is widely recognized that Mt readily adsorbs water molecules on both its external surface and within its interlayer space. The interlayer hydration can result in the swelling of Mt and subsequent exfoliation of its layers, ultimately leading to the formation of a gel system. Similar to the dispersion of Mt in water, OMt also has the ability to disperse and swell in oil. The dispersibility and swelling of OMt in organic solvents depends on multiple parameters. (Jordan, 1949; Jordan et al., 1950) systematically studied the

relationship between the swelling volume of alkylammonium-OMt in organic media and the number of carbon atoms in the aliphatic chain. The results showed that organophilic properties including swelling are negligible when the alkyl chain contains less than 10 carbon atoms, whereas maximum swelling is observed with 12 carbon atoms. For the same alkyl chain length, when the organic chain contains aromatic groups, the swelling ability of OMt is stronger than that containing alkylammonium derivatives (Moraru, 2001). In addition, a few studies have examined the impact of solvent nature on the swelling behavior of OMt. (Ho and Glinka, 2003) proposed that the dispersion force of the solvent is the primary factor determining whether the OMt clay platelets remain suspended, whereas polar forces and H-bonding affect the tactoid formation/structure of the platelets in the dispersion. The addition of polar solvents to OMt suspensions in nonpolar organic solvents proves effective in achieving nanoclay platelet dispersion. The most effective organic solvents are those that combine polarity with a high organophilic character (Burgentzlé et al., 2004). Thus, the binary mixtures of alcohols and organic solvents are commonly employed as swelling media for OMt complexes.

The swelling process of OMt in oil implies the penetration of oil in the interlayer space and the solvation of the OMt. The oil can be adsorbed on the clay sheets and intercalated in the interlayer space, and this process improves the affinity of OMt to organic media, which is beneficial to the solvation process (Hu et al., 2013). The adsorption of polar components from the oil facilitates the separation process of the OMt platelets, as these components improve the micelle's organophilic character and its interaction with the solvent.

2.1.5.2 Exfoliation

The crystal structure of Mt is composed of stacked layers. The neighboring layers of Mt are predominantly bound by van der Waals forces and electrostatic interactions, forming the primary particles of Mt. The organic modification of Mt can increase the basal spacing, but the obtained OMt still maintains a layered structure. The exfoliation of OMt in organic media refers to overcoming the van der Waals and electrostatic forces that

bond the layers together through appropriate physical and chemical techniques. This process leads to the dissociation of OMt aggregates into OMt nanoparticles in the oil phase, which ultimately form individual nanolayers through exfoliation.

The individual nanolayers formed by the exfoliation of organoclays are not randomly distributed in the oil, they associate in a certain pattern and form a continuous gel structure (Bergaya and Lagaly, 2013). The exfoliation state of OMt in oil phase can be investigated by modeling the rheology and gel behavior of organoclay dispersions (Faraz, 2019; Merad et al., 2020). It has been reported in the literature that the gelation of organoclays can be attributed to a 3D network called the "house of cards" formed by clay platelets within the dispersion (Van Olphen, 1964b; Elzea and Murray, 1990). Compared to pure oil phase, the gelation of organoclays in oil may show a considerable increase in viscosity and yield stress of the dispersion and exhibit solid-like behavior in viscoelastic measurements. Dispersions prepared with OMt and organic media typically exhibit non-Newtonian behavior, along with gel strength and thixotropy. From a microscopic perspective, these characteristics are attributed to the interaction among organic clay particles.

The exfoliation degree of OMt in organic media is controlled by a variety of factors. The type of organic surfactants, the extent of organic modification, the polarity and chemical nature of the solvent all impact the exfoliation level of OMt. The chain length and nature of the organic modifiers greatly affect the exfoliation of OMt in oil. Extensive studies have clearly demonstrated that the exfoliation of Mt is facilitated by the presence of organic modifiers with long carbon chains and low Hydrophile-Lipophile Balance (HLB) values, which effectively intercalated into the interlayer space of Mt. In contrast, the short-chain surfactants are not tightly arranged in the interlayer space, and the effect of expanding the interlayer space is poor (Fig. 2.5) (Zhuang et al., 2017b).

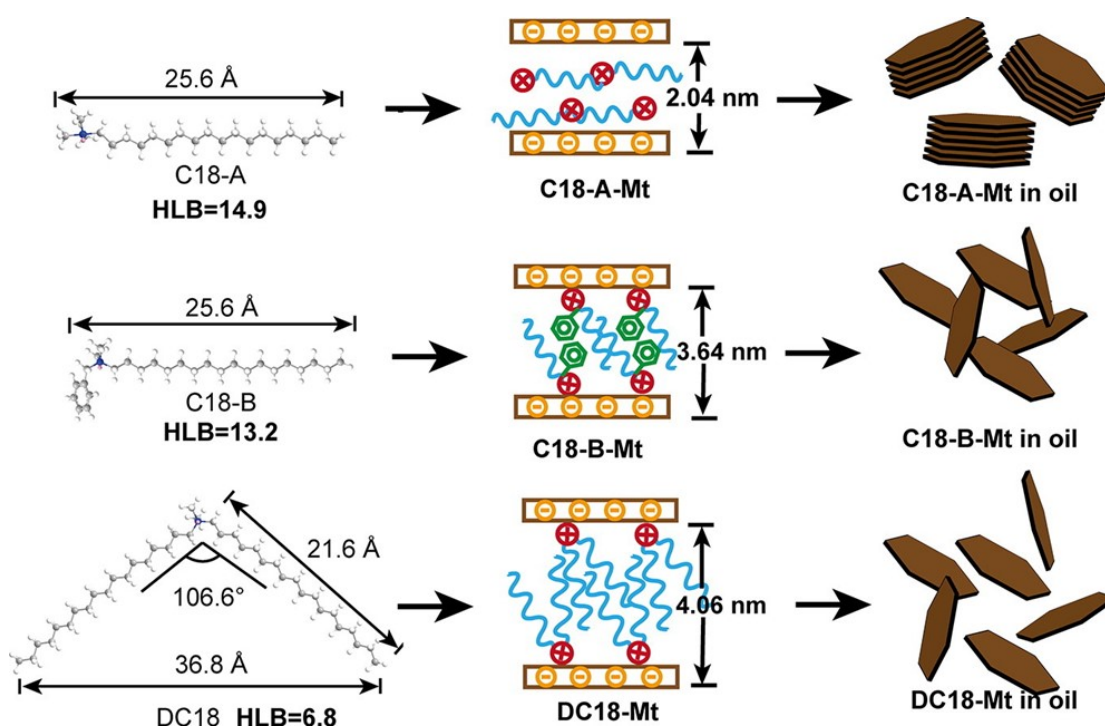

Fig. 2.5 Illustration of the effect of surfactant properties on exfoliation of OMt in oil

In addition to the chain length and properties of surfactants, the exfoliation efficiency is also influenced by the inherent cation exchange capacity (CEC) of Mt (Hojiyev et al., 2017). Mt with a high CEC is favorable for more organic molecules to intercalate into the interlayer space and weaken the electrostatic interaction between clay layers, which results in OMt with higher surface coverage of organic species and high surfactants packing density, promoting compatibility and exfoliation of OMt in organic media (Patro et al., 2009; Zhu et al., 2019).

2.1.5.3 Gelation ability

The primary characteristics of organoclays lie in their organophilicity, as well as their capacity to undergo swelling and form thixotropic gels when dispersed in organic media. Due to these properties, the OMt is widely used in the petroleum industry as a structure-forming and thickening agents in oil-based drilling fluids.

The OMt particles dispersed in the solvent associate with each other to form a 3D

network structures for developing gel behavior. The gel-forming capability of organoclays in oil plays a crucial role in determining the gel strength and rheological properties of oil-based drilling fluids. The gel strength of the drilling fluid indicates its capacity to effectively suspend drill cuttings during circulation. The insufficient gel strength can lead to cuttings settling when fluid circulation ceases, potentially resulting in various complex downhole issues (Agwu et al., 2021).

The gel formation of OMt in organic media is attributed to the anisotropic and interactions between swollen clay particles (Moraru, 2001). The gel structures build up slowly over time as the exfoliated clay particles orient themselves towards positions of minimum free energy under the influence of Brownian motion (Luckham and Rossi, 1999). Some scientists pointed out that the rheological properties and gelation ability of OMt organic dispersions are influenced by key factors, including chemical interactions between organic modifiers and solvents, as well as the role of hydrogen bonds and van der Waals forces (Bhatt et al., 2013). However, most scholars believed that the gelling ability of OMt in oil is achieved through particle association, which can be generalized as face-to-face, face-to-edge, and edge-to-edge, in agreement with the Mt in aqueous (Bergaya et al., 2011; Bergaya and Lagaly, 2013).

2.2 Drilling fluid

Drilling fluids, also known as drilling muds, are as important to petroleum and natural gas extraction as blood is to the human body. It functions as a circulating fluid throughout the entire oil and gas production process and serves the diverse requirements of different stages in drilling engineering. The cost of drilling fluid is on average 10% of the total cost of drilling (Hamida et al., 2009). However, the performance of drilling fluid can impact drilling costs in multiple ways.

2.2.1 Drilling fluid classification and function

Drilling fluids are complex colloidal systems containing multiple components,

which can be divided into three categories according to their continuous phase: water-based drilling fluid, oil-based drilling fluid, and gas-based drilling fluid. Water-based drilling fluid is used to drill approximately 80% of all wells due to its low cost, ease of preparation and low negative impact on the environment (Pereira et al., 2022). Moreover, the addition of special additives to water-based drilling fluid can facilitate specific functions that lead to the development of various types such as dispersed drilling fluid, brine drilling fluid, polymer drilling fluid, and others. Although oil-based drilling fluid may cause environmental pollution issues, they offer several distinct advantages over water-based drilling fluids, including superior high-temperature stability, lubrication, and shale inhibition. The base oils used to prepare oil-based drilling fluids can be diesel oil, kerosene, and mineral oil. In addition, synthetic-based drilling fluids have been developed in an attempt to replace traditional oil-based drilling fluids to reduce environmental pollution, because the non-petroleum organic compounds used as base oils in synthetic-based drilling fluids appear to have a greater potential for biodegradation (Razali et al., 2018). The application of gas-based drilling fluids is limited to depleted zones or areas where the formations are low pressured. Air, nitrogen, and foam are generally utilized as continuous media for gas-based drilling fluids. The types of common drilling fluid systems in the petroleum industry are shown in Fig. 2.6.

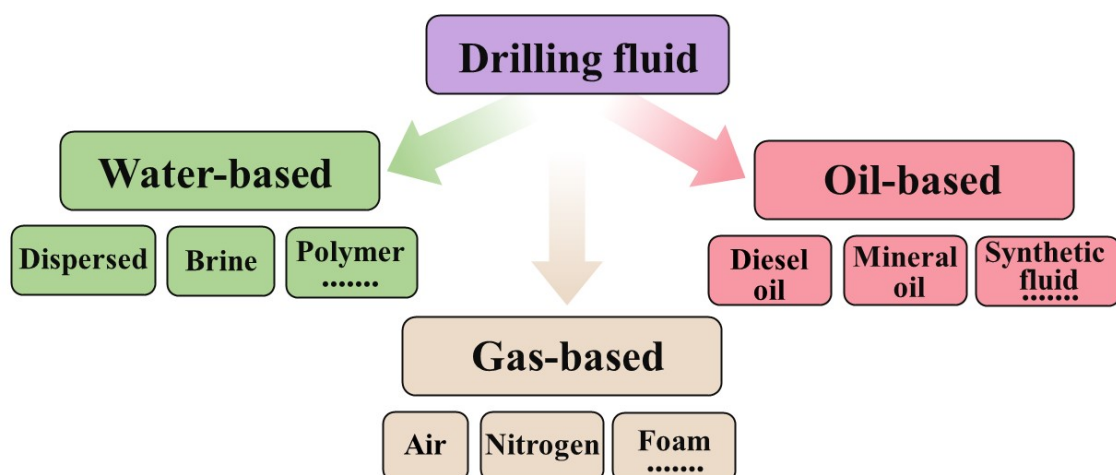

Fig. 2.6 The classification of drilling fluids

After more than a century of exploration, drilling fluid has developed into both a science and an engineering discipline. These fluids are specifically formulated to fulfill a diverse range of functions, with key performance characteristics that include (Caenn and Chillingar, 1996; Apaleke et al., 2012):

- Removing and transporting cuttings from the bottom to the surface — The drilling fluid serves the purpose of removing drilling cuttings from beneath the drill bit, thus preventing repeated breakage of cuttings, and efficiently transporting them from the wellbore bottom to the surface.
- Cooling the drilling bit — As the drilling fluid passes through the operating bit and tool assembly, the heat generated by friction between the bit and the rock is transferred to the drilling fluid, helping to cool the bit.
- Balancing formation pressure — During the drilling process, the hydrostatic pressure exerted by the drilling fluid column is utilized to offset the formation pressure that would otherwise force formation fluids into the borehole, possibly causing well kick or even blowout.
- Transmitting hydraulic horsepower — The drilling fluid is sprayed through nozzles installed on the surface of the drill bit. This hydraulic energy is utilized to power downhole motors and other hardware that steer the bit and acquire drilling or formation data in real-time.
- Forming the filter cake to prevent excessive drilling fluid loss — The solid phase particles in the drilling fluid form a filter cake on the wellbore wall under the action of filtration, which acts as a barrier between the wellbore and the formation. This barrier contributes to reducing reservoir damage and provides wellbore stability.

2.2.2 Oil-based drilling fluid rheology

The rheology of drilling fluids is one of the primary concerns of petroleum engineers, because it has a direct impact on the performance of the mud during drilling operations.

Rheology is a critical indicator that demonstrates the flow and deformation of a drilling fluid under external forces. This property is essential to ensure that drilling fluids suspend and transport cuttings, clean the borehole and promote safe and efficient drilling.

The principal focus of drilling fluid rheology is to investigate the relationship between fluid shear stress and shear rate. This relationship is usually described by rheological models or rheological curves. In general, fluids can be divided into Newtonian fluids and non-Newtonian fluids according to their rheological behavior. The key distinction between non-Newtonian and Newtonian fluids is that the former exhibit a non-linear correlation between shear stress and shear rate, unlike the latter. There are three main types of non-Newtonian fluids: plastic fluids, pseudoplastic fluids, and dilatant fluids. Their rheological curves are presented in Fig. 2.7. Drilling fluid is a typical non-Newtonian fluid, and most drilling fluids widely used at present are plastic and pseudoplastic fluids.

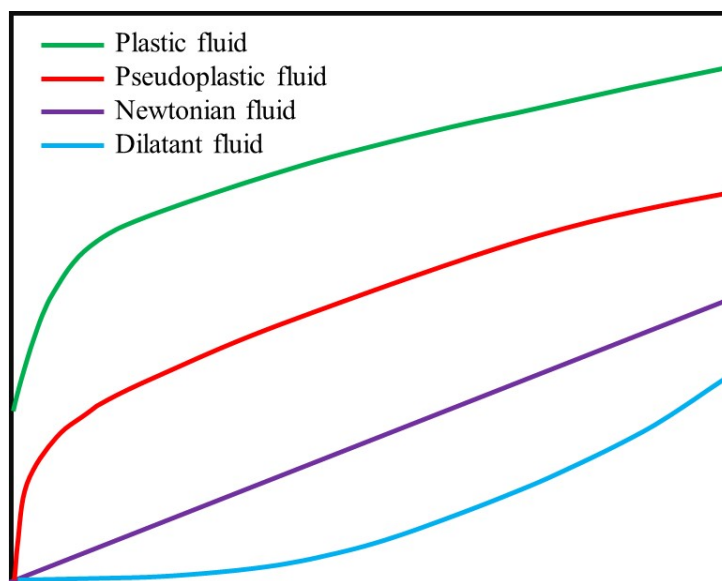

Fig. 2.7 Rheological curves of Newtonian fluid, plastic fluid, pseudoplastic fluid, and dilatant fluid

The circulation of drilling fluid in drilling operations is an extremely complex process (Fig. 2.8). The drilling fluid is pumped through the drill pipe to the drill bit to

perform its functions, then transports the cuttings back to the surface and starts a new cycle. Throughout the circulation cycle of drilling fluid, the mud is subjected to a number of processes that alter its physical parameters. For example, as the well is drilled through deeper formations and encounters gradual increases in temperature and pressure, the viscosity and chemical properties of the drilling fluid can change significantly.

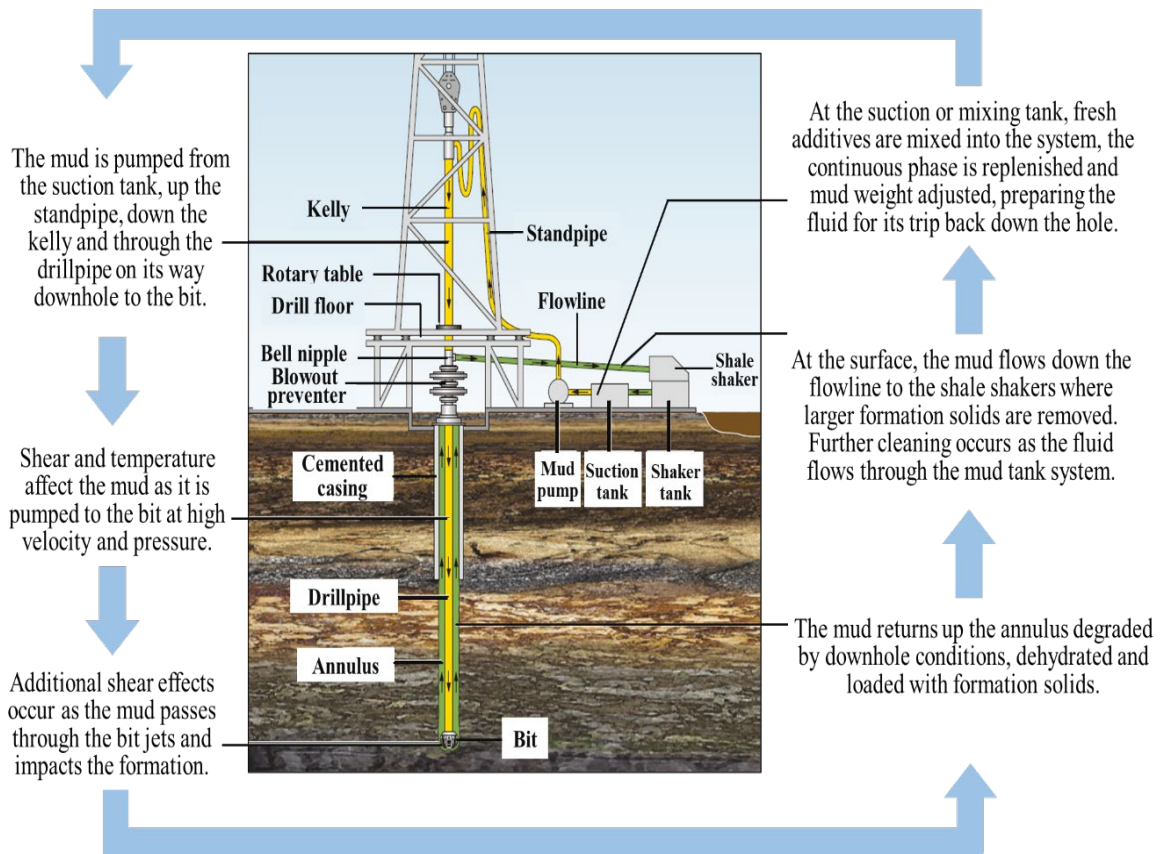

Fig. 2.8 Drilling fluid life cycle (Williamson, 2013)

Shear thinning is a crucial parameter for assessing the oil-based drilling fluid's effectiveness in performing its intended function. Shear thinning involves a decrease in the viscosity of the fluid system as the shear rate increases (Fig. 2.9a). This phenomenon is considered to be beneficial to the drilling fluid. The high viscosity at rest is used to suspend drill cuttings, while the low viscosity at high shear rate is used for rapid pumping into the wellbore (Liu et al., 2022b). Thixotropy is another essential performance of oil-based drilling fluids. Thixotropy, which refers to the reversible destruction of the fluid

microstructure under shear, is a time-dependent response of the fluid microstructure to changes in the applied shear rate (Mewis and Wagner, 2009). The phases of start-up and shutdown of a drilling rig involve a dynamic and complex variation in the shear rate of the drilling fluid, as it transitions from a low-shear state to a high-shear state during drilling operations, and then gradually decreases to a zero-shear state when the drilling process is stopped. This dynamic shear rate variation is a crucial aspect of drilling fluid flow behavior and has a significant impact on drilling performance, wellbore stability, and overall drilling efficiency. The microstructure of drilling fluid is disrupted in the up-sweep, while rebuilt in the down-sweep and hysteresis loop is induced in the flow curves (Fig. 2.9b). In general, the thixotropy of drilling fluids can be described by measuring thixotropic hysteresis loops.

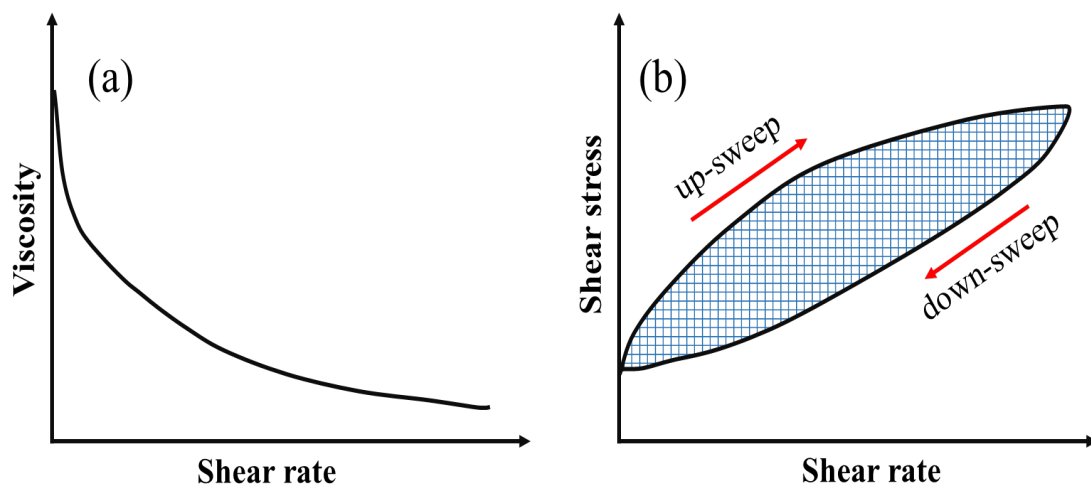

Fig. 2.9 (a) Shear thinning of drilling fluid; (b) formation of drilling fluid thixotropic hysteresis loops

2.2.3 Influence of temperature on oil-based drilling fluid performance

Drilling is a process in which a drill bit continuously penetrates the formation rock until it reaches the oil and gas reservoir. As the drilling depth increases, the drill bit and

drilling fluid encounter a harsh environment of high temperature. The geothermal gradient on Earth is on average approximately $2.55^{\circ}\text{C}/100\text{ m}$ ($1.4^{\circ}\text{ F}/100\text{ ft}$). According to statistics, the occupancy of hydrocarbon dominates in deep ($>4572\text{ m}$) and ultradeep ($>7620\text{ m}$) reservoirs. It is also reported that the worldwide estimated gas resource is approximately 844 trillion cubic feet at a depth higher than 4572 m (Pang et al., 2015; Gautam et al., 2022). Based on the average geothermal gradient, the well depth thresholds of 4572 m and 7620 m would involve borehole temperatures in excess of 140 and 200° C , respectively (Fig. 2.10).

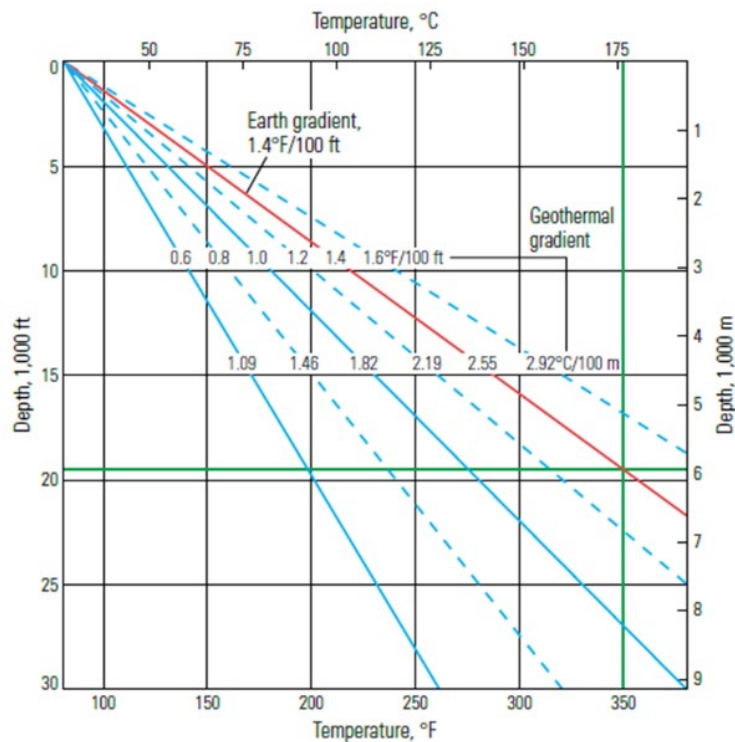

Fig. 2.10 Geothermal gradient of earth (Smithson, 2016)

The extreme heat encountered during drilling operations presents a significant challenge to the proper functioning of drilling fluids. Oil-based drilling fluids are typically selected in deep and ultra-deep wells to address high temperature conditions. The viscosity and density of oil-based drilling fluids at high temperatures are the two most extensively studied rheological properties (Hermoso et al., 2017). (Zamora et al.,

2013) have investigated the combined influence of pressure and temperature on the density of oil-based drilling fluids. As the temperature increases, the densities of both synthetic and mineral oil-based drilling fluids tend to decrease, which may be caused by the volume expansion of drilling fluids at high temperatures. Changes in viscosity and yield stress of oil-based drilling fluids under high temperature conditions have been observed by numerous authors (Demirdal and Cunha, 2009; Baldino et al., 2018). The plastic viscosity and yield point of oil-based drilling fluids are very sensitive to adverse downhole conditions. The influence of temperature on those rheological properties is more significant than the effect of pressure, especially at temperatures lower than 65°C.

High temperatures not only negatively affect the rheology of the oil-based drilling fluid, but may also have an impact on the composition of the drilling fluid. For instance, some fluid-loss-control materials added to control the fluid loss of oil-based drilling fluid will degrade at high temperature, which will alter the composition of the drilling fluid and result in the loss of some its functions. Typical fluid loss control agents such as modified starch and lignite can function at temperature below 150°C but degrade at higher temperatures (Chen et al., 2021). Additionally, organoclays prepared by surfactants are essential additives in oil-based drilling fluids to adjust the rheology of drilling fluids. However, the desorption and degradation of surfactants at high temperatures can modify the properties of organoclay and ultimately affect the overall performance of oil-based drilling fluids (Zhuang et al., 2019).

2.2.4 Organoclays as rheological additives in oil-based drilling fluid

The rheology of oil-based drilling fluid and the relationship between chemical and physical properties, as well as the structure of the components, are critical elements in developing products with suitable performance. In drilling practice, the rheological properties of oil-based drilling fluids are influenced by many factors such as oil-water ratio, temperature, and pressure. However, the impact of organic clay on the rheology of

drilling fluids is dominant. Organic clays are extensively used as rheological additives to drilling fluids because of their excellent gelation ability and economic properties. In particular, organic montmorillonite has been broadly employed in the formulation of oil-based drilling fluids.

The dispersion of organoclays in the oil phase provides drilling fluids with excellent thixotropy and gel strength, which is critical for controlling the rheology of oil-based drilling fluids. Organoclays can offer ideal shear-thinning and viscosity to oil-based drilling fluids even at low concentrations (Minase et al., 2008). The dispersion, swelling and exfoliation properties of organoclay platelets are often used to elaborate their microstructure in oil-based drilling fluids (Zhuang et al., 2016; Zhuang et al., 2017b). The clay particle platelets can form association by aggregation and flocculation. Three main modes of montmorillonite particle association have been proposed (Van Olphen, 1964b): face-to-face (FF), edge-to-face (EF) and edge-to-edge (EE) (Fig. 2.11). FF associations result in the formation of thicker and larger tactoids, which are aggregates of parallel platelets. EF and EE associations lead to the development of three-dimensional structures known as house of cards. Thus, aggregation can be described by FF association, while the continuous gel structure is due to EF and EE association. In addition, the presence of organic clay particles in oil-based drilling fluids can decrease the thickness and permeability of the mud cake and significantly improve the filtration performance of the drilling fluid (Fan et al., 2015).

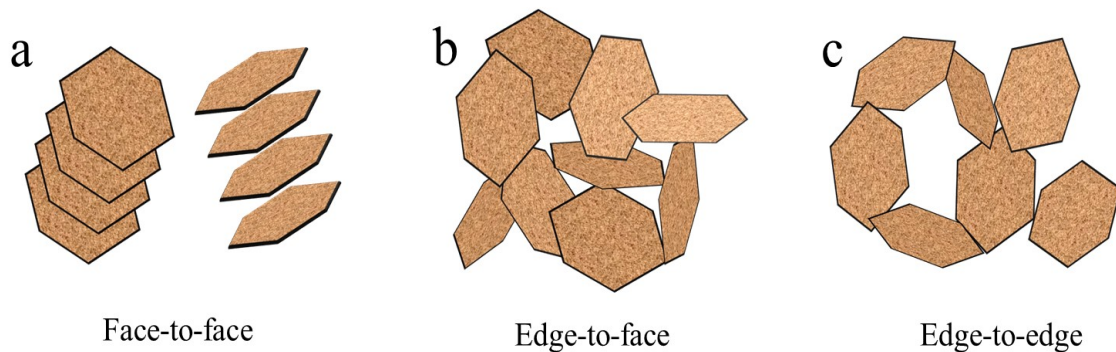

Fig. 2.11 Modes of particle association in clay suspensions

Several works have been done to explain the mechanism by which organic montmorillonite adjusts the rheology of oil-based drilling fluids (Zhuang et al., 2015b; Zhuang et al., 2016). Organic montmorillonite in oil reveals a multi-scale organization involving interlayer space, interparticle space and interaggregate space. Free oil molecules are absorbed and linked in three types of spaces, creating a robust gel-like network structure that increases the viscosity and gel strength of the system. The surfactants in organic montmorillonite may undergo high-temperature degradation and dissolve into the oil-based drilling fluids. Within a certain temperature range, the oil molecules easily penetrated into the organo-montmorillonite interlayer space, resulting in the expansion of interlayers and consequently the exfoliation. The exfoliation of organic montmorillonite can produce more clay platelets and is an effective approach to improve the rheological properties of oil-based drilling fluids.

2.3 Summary

This chapter focuses on the significant application of oil-based drilling fluids in the oil resources exploitation, as well as the role of OMt in regulating the rheology of drilling fluids. The importance of oil-based drilling fluid rheology to drilling operations and the considerable contribution of OMt as a rheological additive to drilling fluid performance were thoroughly analyzed. The preparation, types, structures and colloidal properties of OMt were summarized with the aim of improving the understanding of its crucial role in petroleum production. These investigations and information provide a comprehensive background for the preparation of organo-montmorillonite hybrid materials and their application potential in oil-based drilling fluids.

References

- Agwu, O.E., Akpabio, J.U., Ekpenyong, M.E., Inyang, U.G., Asuquo, D.E., Eyoh, I.J., Adeoye, O.S., 2021. A critical review of drilling mud rheological models. *Journal of Petroleum Science and Engineering* 203, 108659.
- Apaleke, A.S., Al-Majed, A., Hossain, M.E., 2012. State of the Art and Future Trend of Drilling Fluid: An Experimental Study, SPE Latin America and Caribbean Petroleum Engineering Conference, pp. SPE-153676-MS.
- Baldino, S., Osgouei, R.E., Ozbayoglu, E., Miska, S.Z., May, R., 2018. Quemada model approach to oil or synthetic oil-based drilling fluids rheological modelling. *Journal of Petroleum Science and Engineering* 163, 27-36.
- Bayram, T., Bucak, S., Ozturk, D., 2020. BR13 dye removal using sodium dodecyl sulfate modified montmorillonite: Equilibrium, thermodynamic, kinetic and reusability studies. *Chemical Engineering and Processing - Process Intensification* 158, 108186.
- Bergaya, F., Jaber, M., Lambert, J.F., 2011. Clays and clay minerals. *Rubber-Clay Nanocomposites: Science, Technology, Applications*, 1-44.
- Bergaya, F., Lagaly, G., 2006. General introduction: clays, clay minerals, and clay science. *Developments in clay science* 1, 1-18.
- Beall, G.W., Goss, M., 2004. Self-assembly of organic molecules on montmorillonite. *Applied Clay Science* 27, 179-186.
- Bergaya, F., Lagaly, G., 2013. *Handbook of clay science*. Newnes.
- Bhatt, J., Somani, R.S., Mody, H.M., Bajaj, H.C., 2013. Rheological study of organoclays prepared from Indian bentonite: Effect of dispersing methods. *Applied Clay Science* 83-84, 106-114.
- Burgentzlé, D., Duchet, J., Gérard, J.F., Jupin, A., Fillon, B., 2004. Solvent-based nanocomposite coatings: I. Dispersion of organophilic montmorillonite in organic solvents. *Journal of Colloid and Interface Science* 278, 26-39.
- Caenn, R., Chillingar, G.V., 1996. Drilling fluids: State of the art. *Journal of Petroleum Science and Engineering* 14, 221-230.
- Chen, Y., Wu, R., Zhou, J., Chen, H., Tan, Y., 2021. A novel hyper-cross-linked polymer for high-efficient fluid-loss control in oil-based drilling fluids. *Colloids and Surfaces A: Physicochemical and Engineering Aspects* 626, 127004.
- Cruz-Guzmán, M., Celis, R., Hermosín, M.C., Koskinen, W., Nater, E., Cornejo, J., 2006. Heavy metal adsorption by montmorillonites modified with natural organic cations. *Soil Science Society of America Journal* 70, 215-221.
- de Paiva, L.B., Morales, A.R., Valenzuela Díaz, F.R., 2008. Organoclays: Properties, preparation and applications. *Applied Clay Science* 42, 8-24.

Demirdal, B., Cunha, J.C., 2009. Importance of Drilling Fluids' Rheological and Volumetric Characterization to Plan and Optimize Managed Pressure Drilling Operations. *Journal of Canadian Petroleum Technology* 48, 8-14.

Fan, J., Zhu, H., Li, R., Chen, N., 2015. Montmorillonite modified by cationic and nonionic surfactants as high-performance fluid-loss-control additive in oil-based drilling fluids. *Journal of Dispersion Science and Technology* 36, 569-576.

Faraz, M.I., 2019. Rheology of Organoclay Dispersions and Modeling of Gelation Behavior and Finding Overlap Concentration. *Arabian Journal for Science and Engineering* 44, 10117-10126.

Fu, M., Zhang, Z., Wu, L., Zhuang, G., Zhang, S., Yuan, J., Liao, L., 2016. Investigation on the co-modification process of montmorillonite by anionic and cationic surfactants. *Applied Clay Science* 132, 694-701.

Gautam, S., Guria, C., Rajak, V.K., 2022. A state of the art review on the performance of high-pressure and high-temperature drilling fluids: Towards understanding the structure-property relationship of drilling fluid additives. *Journal of Petroleum Science and Engineering* 213, 110318.

Guo, Y.X., Liu, J.H., Gates, W.P., Zhou, C.H., 2020. Organo-modification of montmorillonite. *Clays and Clay Minerals* 68, 601-622.

Hamida, T., Kuru, E., Pickard, M., 2009. Rheological characteristics of aqueous waxy hull-less barley (WHB) solutions. *Journal of Petroleum Science and Engineering* 69, 163-173.

He, H., Frost, R.L., Bostrom, T., Yuan, P., Duong, L., Yang, D., Xi, Y., Kloprogge, J.T., 2006a. Changes in the morphology of organoclays with HDTMA⁺ surfactant loading. *Applied Clay Science* 31, 262-271.

He, H., Ma, L., Zhu, J., Frost, R.L., Theng, B.K.G., Bergaya, F., 2014. Synthesis of organoclays: A critical review and some unresolved issues. *Applied Clay Science* 100, 22-28.

Hermoso, J., Martínez-Boza, F.J., Gallegos, C., 2017. Organoclay influence on high pressure-high temperature volumetric properties of oil-based drilling fluids. *Journal of Petroleum Science and Engineering* 151, 13-23.

Ho, D.L., Glinka, C.J., 2003. Effects of Solvent Solubility Parameters on Organoclay Dispersions. *Chemistry of Materials* 15, 1309-1312.

Hojjiyev, R., Ulcay, Y., Çelik, M.S., Carty, W.M., 2017. Effect of CEC coverage of hexadecyltributylphosphonium modified montmorillonite on polymer compatibility. *Applied Clay Science* 141, 204-211.

Huggett, J.M., 2015. *Clay Minerals, Reference Module in Earth Systems and Environmental Sciences*. Elsevier.

Jordan, J.W., 1949. Organophilic bentonites. I. Swelling in organic liquids. *The Journal*

of Physical Chemistry 53, 294-306.

Jordan, J.W., Hook, B., Finlayson, C., 1950. The Organophilic Bentonites. II. Organic Liquid Gels. The Journal of Physical Chemistry 54, 1196-1208.

Lagaly, G., 1969. Determination of the layer charge in mica-type layer silicates, Proc. Int. Clay Conf. Tokyo, pp. 173-187.

Lagaly, G., 1981. Characterization of clays by organic compounds. Clay minerals 16, 1-21.

Lagaly, G., Ogawa, M., Dékány, I., 2013. Chapter 10.3 - Clay Mineral–Organic Interactions, in: Bergaya, F., Lagaly, G. (Eds.), Developments in Clay Science. Elsevier, pp. 435-505.

Lagaly, G., Ziesmer, S., 2003. Colloid chemistry of clay minerals: the coagulation of montmorillonite dispersions. Advances in Colloid and Interface Science 100-102, 105-128.

Leroy, P., Tournassat, C., Bernard, O., Devau, N., Azaroual, M., 2015. The electrophoretic mobility of montmorillonite. Zeta potential and surface conductivity effects. Journal of Colloid and Interface Science 451, 21-39.

Li, Q., Berraud-Pache, R., Yang, Y., Souprayen, C., Jaber, M., 2023. Biocomposites based on bentonite and lecithin: An experimental approach supported by molecular dynamics. Applied Clay Science 231, 106751.

Liu, H., Guo, C., Cui, Y., Yin, J., Li, S., 2022a. Experimental and modeling investigation of organic modified montmorillonite with octyl quaternary ammonium salt. Scientific Reports 12, 14305.

Liu, K., Du, H., Liu, W., Liu, H., Zhang, M., Xu, T., Si, C., 2022b. Cellulose Nanomaterials for Oil Exploration Applications. Polymer Reviews 62, 585-625.

Luckham, P.F., Rossi, S., 1999. The colloidal and rheological properties of bentonite suspensions. Advances in Colloid and Interface Science 82, 43-92.

Ma, L., Zhu, J., He, H., Xi, Y., Zhu, R., Tao, Q., Liu, D., 2015. Thermal analysis evidence for the location of zwitterionic surfactant on clay minerals. Applied Clay Science 112, 62-67.

Massaro, M., Colletti, C.G., Lazzara, G., Riela, S., 2018. The use of some clay minerals as natural resources for drug carrier applications. Journal of functional biomaterials 9, 58.

Merad, B., Bekkour, K., Gareche, M., 2020. Rheological and structural characterization of organo-hectorite dispersions: Influence of the organoclay loading. Applied Clay Science 184, 105321.

Merino, D., Ollier, R., Lanfranconi, M., Alvarez, V., 2016. Preparation and characterization of soy lecithin-modified bentonites. Applied Clay Science 127-128, 17-22.

- Mészáros, R., Jobbik, A., Varga, G., Bányai, S., 2019. Electrosurface properties of Na-bentonite particles in electrolytes and surfactants solution. *Applied Clay Science* 178, 105127.
- Mewis, J., Wagner, N.J., 2009. Thixotropy. *Advances in Colloid and Interface Science* 147-148, 214-227.
- Minase, M., Kondo, M., Onikata, M., Kawamura, K., 2008. The viscosity of organic liquid suspensions of trimethyldococylammonium-montmorillonite complexes. *Clays and Clay Minerals* 56, 49-65.
- Moraru, V.N., 2001. Structure formation of alkylammonium montmorillonites in organic media. *Applied Clay Science* 19, 11-26.
- Ogawa, M., Handa, T., Kuroda, K., Kato, C., 1990. Formation of organoammonium-montmorillonites by solid-solid reactions. *Chemistry Letters* 19, 71-74.
- Pang, X.-Q., Jia, C.-Z., Wang, W.-Y., 2015. Petroleum geology features and research developments of hydrocarbon accumulation in deep petroliferous basins. *Petroleum Science* 12, 1-53.
- Park, Y., Ayoko, G.A., Frost, R.L., 2011. Application of organoclays for the adsorption of recalcitrant organic molecules from aqueous media. *Journal of Colloid and Interface Science* 354, 292-305.
- Patro, T.U., Khakhar, D.V., Misra, A., 2009. Phosphonium-based layered silicate—Poly (ethylene terephthalate) nanocomposites: Stability, thermal and mechanical properties. *Journal of Applied Polymer Science* 113, 1720-1732.
- Pavlidou, S., Papaspyrides, C.D., 2008. A review on polymer-layered silicate nanocomposites. *Progress in Polymer Science* 33, 1119-1198.
- Pereira, L.B., Sad, C.M.S., Castro, E.V.R., Filgueiras, P.R., Lacerda, V., 2022. Environmental impacts related to drilling fluid waste and treatment methods: A critical review. *Fuel* 310, 122301.
- Rand, B., Pekenć, E., Goodwin, J.W., Smith, R.W., 1980. Investigation into the existence of edge-face coagulated structures in Na-montmorillonite suspensions. *Journal of the Chemical Society, Faraday Transactions 1: Physical Chemistry in Condensed Phases* 76, 225-235.
- Razali, S.Z., Yunus, R., Abdul Rashid, S., Lim, H.N., Mohamed Jan, B., 2018. Review of biodegradable synthetic-based drilling fluid: Progression, performance and future prospect. *Renewable and Sustainable Energy Reviews* 90, 171-186.
- Rezaei, A., Daeihamed, M., Capanoglu, E., Tomas, M., Akbari-Alavijeh, S., Shaddel, R., Khoshnoudi-Nia, S., Boostani, S., Rostamabadi, H., Falsafi, S.R., Jafari, S.M., 2021. Chapter 2 - Possible health risks associated with nanostructures in food, in: Jafari, S.M. (Ed.), *Safety and Regulatory Issues of Nanoencapsulated Food Ingredients*. Academic Press, pp. 31-118.

- Sanqin, W., Zepeng, Z., Yunhua, W., Libing, L., Jiansheng, Z., 2014. Influence of montmorillonites exchange capacity on the basal spacing of cation–anion organo-montmorillonites. *Materials Research Bulletin* 59, 59-64.
- Sarier, N., Onder, E., Ersoy, S., 2010. The modification of Na-montmorillonite by salts of fatty acids: An easy intercalation process. *Colloids and Surfaces A: Physicochemical and Engineering Aspects* 371, 40-49.
- Shen, Y.-H., 2001. Preparations of organobentonite using nonionic surfactants. *Chemosphere* 44, 989-995.
- Silva, I.A., Sousa, F.K.A., Menezes, R.R., Neves, G.A., Santana, L.N.L., Ferreira, H.C., 2014. Modification of bentonites with nonionic surfactants for use in organic-based drilling fluids. *Applied Clay Science* 95, 371-377.
- Smithson, T., 2016. HPHT wells. *Oilfield Review* 1028.
- Tsujimoto, Y., Chassagne, C., Adachi, Y., 2013. Dielectric and electrophoretic response of montmorillonite particles as function of ionic strength. *Journal of Colloid and Interface Science* 404, 72-79.
- Van Olphen, H., 1964a. Internal mutual flocculation in clay suspensions. *Journal of Colloid Science* 19, 313-322.
- van Olphen, H., 1964b. An introduction to clay colloid chemistry. *Soil Science* 97, 290.
- Vazquez, A., López, M., Kortaberria, G., Martín, L., Mondragon, I., 2008. Modification of montmorillonite with cationic surfactants. Thermal and chemical analysis including CEC determination. *Applied Clay Science* 41, 24-36.
- Williamson, D., 2013. Drilling fluid basics. *Oilfield Review* 25.
- Xie, W., Gao, Z., Liu, K., Pan, W.-P., Vaia, R., Hunter, D., Singh, A., 2001. Thermal characterization of organically modified montmorillonite. *Thermochimica Acta* 367, 339-350.
- Yang, J., Yu, K., Liu, C., 2017. Chromium immobilization in soil using quaternary ammonium cations modified montmorillonite: Characterization and mechanism. *Journal of Hazardous Materials* 321, 73-80.
- Yang, Z., Wang, W., Tai, X., Wang, G., 2019. Preparation of modified montmorillonite with different quaternary ammonium salts and application in Pickering emulsion. *New Journal of Chemistry* 43, 11543-11548.
- Yoshimoto, S., Ohashi, F., Kameyama, T.J.S.s.c., 2005. X-ray diffraction studies of intercalation compounds prepared from aniline salts and montmorillonite by a mechanochemical processing. *Solid state communications* 136, 251-256.
- Zamora, M., Roy, S., Slater, K., Troncoso, J., 2013. Study on the Volumetric Behavior of Base Oils, Brines, and Drilling Fluids Under Extreme Temperatures and Pressures. *SPE Drilling & Completion* 28, 278-288.

- Zhang, J.R., Xu, M.D., Christidis, G.E., Zhou, C.H., 2020. Clay minerals in drilling fluids: functions and challenges. *Clay Minerals* 55, 1-11.
- Zhang, Y., Long, Y., Yuancheng, Z., Zhu, Y., Wang, H., Wu, H., Lu, W., 2012. Effect of a mixed anionic-nonionic surfactant adsorption on bentonite structure and on distribution of pentachlorophenol. *Applied clay science* 69, 93-98.
- Zhang, Z., Liao, L., Xia, Z., 2010. Ultrasound-assisted preparation and characterization of anionic surfactant modified montmorillonites. *Applied Clay Science* 50, 576-581.
- Zheng, J., Li, J., Hao, H., Yao, K., 2013. Influence of charge density and chain length on the interaction between organic anion and montmorillonite. *Journal of Wuhan University of Technology-Mater. Sci. Ed.* 28, 6-11.
- Zhou, D., Zhang, Z., Tang, J., Wu, S., Zhao, J., 2018. A comparative study performance of cationic organic montmorillonite prepared by different methods. *Science and Engineering of Composite Materials* 25, 53-58.
- Zhu, J., Zhang, P., Qing, Y., Wen, K., Su, X., Ma, L., Wei, J., Liu, H., He, H., Xi, Y., 2017. Novel intercalation mechanism of zwitterionic surfactant modified montmorillonites. *Applied Clay Science* 141, 265-271.
- Zhu, T.T., Zhou, C.H., Kabwe, F.B., Wu, Q.Q., Li, C.S., Zhang, J.R., 2019. Exfoliation of montmorillonite and related properties of clay/polymer nanocomposites. *Applied Clay Science* 169, 48-66.
- Zhuang, G., Jiang, W., Zhang, Z., 2019. Organic Modifiers of Organo-Montmorillonite in Oil System under High Temperatures: Desorption or Degradation? *Industrial & Engineering Chemistry Research* 58, 2644-2653.
- Zhuang, G., Zhang, Z., Fu, M., Ye, X., Liao, L., 2015. Comparative study on the use of cationic–nonionic-organo-montmorillonite in oil-based drilling fluids. *Applied Clay Science* 116, 257-262.
- Zhuang, G., Zhang, Z., Guo, J., Liao, L., Zhao, J., 2015b. A new ball milling method to produce organo-montmorillonite from anionic and nonionic surfactants. *Applied Clay Science* 104, 18-26.
- Zhuang, G., Zhang, Z., Sun, J., Liao, L., 2016. The structure and rheology of organo-montmorillonite in oil-based system aged under different temperatures. *Applied Clay Science* 124, 21-30.
- Zhuang, G., Zhang, Z., Wu, H., Zhang, H., Zhang, X., Liao, L., 2017b. Influence of the nonionic surfactants' nature on the structures and properties of organo-montmorillonites. *Colloids and Surfaces A: Physicochemical and Engineering Aspects* 518, 116-123.

Chapter 3

Experimental materials and procedures

3.1 Experimental materials

As was mentioned above, this research on the application of organoclays in oil-based drilling fluids involves two parts of experimental work. The experimental materials, apparatus and procedures needed to obtain accurate results are presented in this chapter. The flowchart illustrating the experimental procedures is presented in Fig. 3.1. The experimental study consists of two stages, the first stage is the preparation and characterization of organic clays, and the second stage is the formulation and rheological measurement of oil-based drilling fluids.

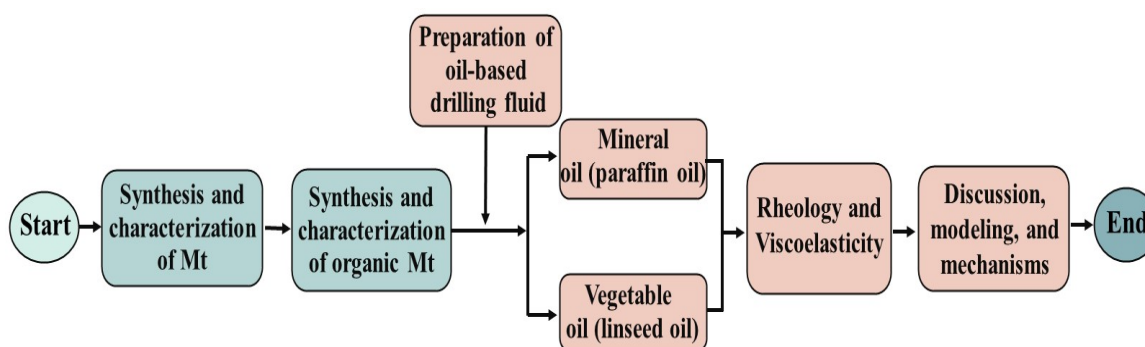

Fig. 3.1 The experimental procedures flowchart of this research

3.1.1 Montmorillonite

In this work, two types of smectites were employed for the synthesis of organoclays. One was a commercial bentonite clay obtained from Sigma-Aldrich, which was used without any additional purification. This bentonite, primarily composed of montmorillonite, is referred to as Bt throughout this study. Its structural formula was determined as $\text{Na}_{0.2}\text{Ca}_{0.08}\text{Si}_4(\text{Al}_{1.64}\text{Mg}_{0.26}\text{Fe}_{0.1})\text{O}_{10}(\text{OH})_2$. The main chemical composition of bentonite includes 65.1% SiO_2 , 22.9% Al_2O_3 , 4.2% Fe_2O_3 , 2.9% MgO , 2.6% Na_2O and 1.2% CaO . The other smectite used was a laboratory-synthesized montmorillonite known as Mt.

The chemicals used for the synthesis of the Mt were hydrofluoric acid (40% w/w;

Fluka), sodium acetate (99%; Sigma-Aldrich), magnesium acetate tetrahydrate (99%, Sigma-Aldrich), aluminium oxide (99%; Sigma-Aldrich) and silica (99.8%; DEGU). Mt was prepared according to a previous methodology (Jaber and Miéhé-Brendlé, 2005; de Oliveira et al., 2021) and had the ideal formula per half unit cell: $\text{Na}_{0.4}[\text{Si}_4\text{Al}_{1.6}\text{Mg}_{0.4}\text{O}_{10}(\text{OH}, \text{F})_2]$. The solution was obtained by adding the reagents in the following order: deionized water (65.61g: 3.65mol), hydrofluoric acid (0.81g: 2.02mmol), sodium acetate (0.32g: 3.90mmol), magnesium acetate tetrahydrate (0.86g: 4.01mmol), aluminium oxide (1.11g: 10.89mmol) and silica (2.42g: 0.04mol). The initial hydrogel was kept under magnetic stirring at 25 °C for 4.0 h and then was transferred to an autoclave and heated at 200 °C for 7 days. The autoclave was cooled to room temperature and the product was thoroughly washed with distilled water and centrifuged. Finally, the synthesized Mt was dried at 60 °C for 48 h. The schematic diagram of the synthesis of Mt was shown in Fig. 3.2.

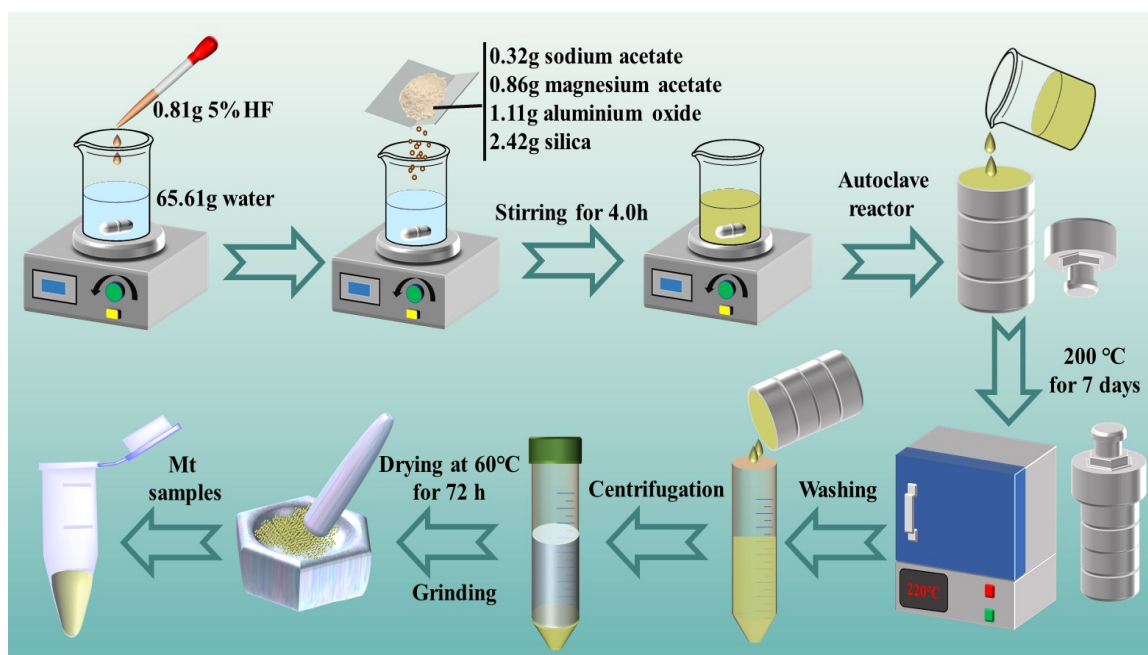

Fig. 3.2 Schematic diagram of the synthesis of Mt

The XRD results of the commercial bentonite (Bt) and synthesized montmorillonite (Mt) samples are shown in Fig. 3.3. The results indicated that Bt primarily consists of

montmorillonite, with a basal spacing of 1.21 nm. The main impurities in Bt include cristobalite, quartz, and ilmenite. The XRD pattern of synthesized Mt matched well with the standard PDF card of Mt and no other reflections are observed, suggesting that Mt has been successfully synthesized and has a high purity. The basal reflection of Mt occurred at $2\theta = 6.04^\circ$, with the basal spacing of 1.47 nm.

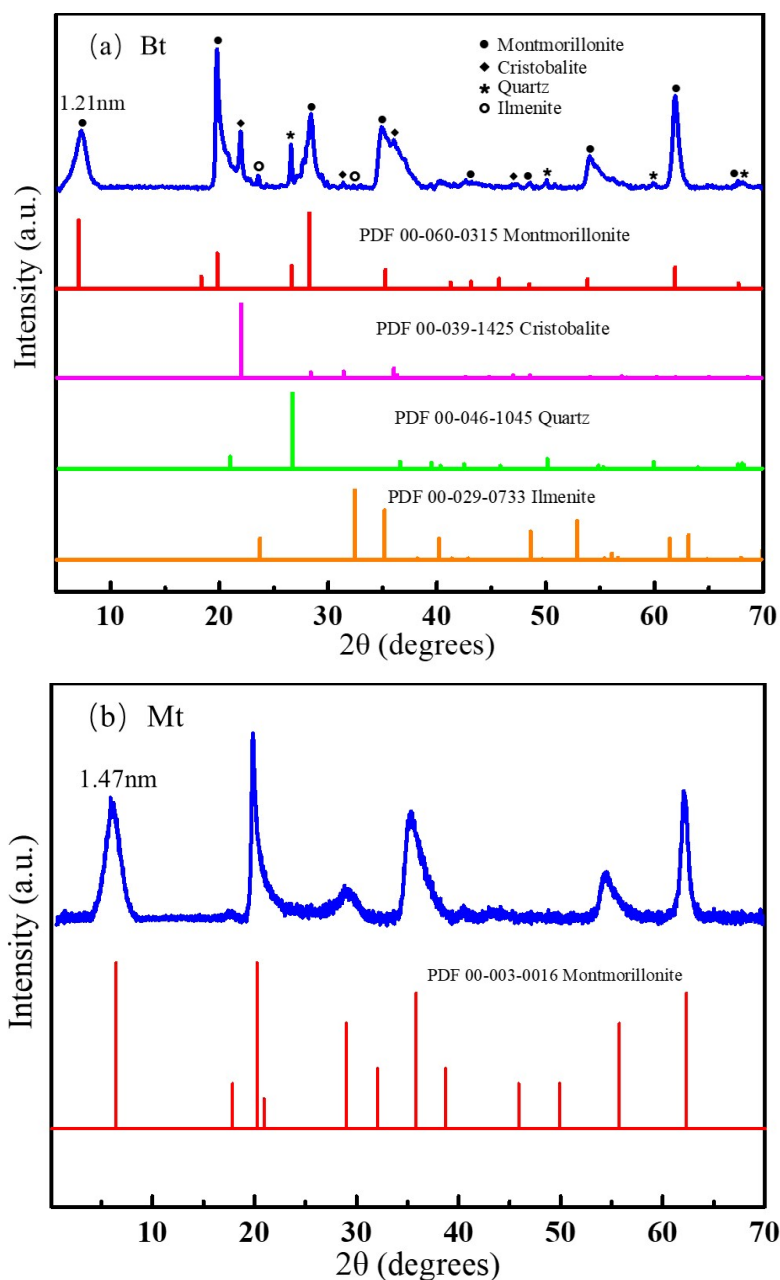

Fig. 3.3 XRD patterns of the commercial Bt and synthesized Mt sample

3.1.1.1 Cation exchange capacity measurement

The cation exchange capacity (CEC) is one of the critical parameters of clay minerals that quantifies the number of negatively charged sites on their surfaces. There are many methods for measuring the cation exchange capacity of clays, such as conductivity measurements at multiple fluid salinities, ammonium acetate wet chemistry technique, membrane potential and methylene blue test methods (Hilche and Mian, 1982; Yukselen and Kaya, 2008). In this study, the methylene blue method was employed to determine the CEC of bentonite due to its rapid and convenient.

Methylene blue is a significant heterocyclic aromatic dye and yields a blue solution when dissolved in water. The molecular formula is $C_{16}H_{18}N_3SCl$ (Fig. 3.4) with a molecular weight of 319.87 g/mol. The methylene blue in aqueous solution is a cationic dye, $C_{16}H_{18}N_3S^+$, which can replace the exchangeable cations of clay minerals. The amount that replacement can be regard as a measure of the clay minerals CEC. The methylene blue test procedure for determining the CEC of bentonite was described as follows (Yukselen and Kaya, 2008; Hayati-Ashtiani et al., 2011):

- (i) methylene blue and bentonite powder were dried in an oven at 105°C for 5h;
- (ii) methylene blue solution was prepared by adding 1.0g dry methylene blue powder into 100ml deionized water;
- (iii) bentonite dispersion was prepared by adding 0.2g dry bentonite powder into 50ml deionized water;
- (iv) titration method was used and methylene blue solution was added into the bentonite dispersion with 0.5ml increments;
- (v) after each addition, the mixed solution was stirred for 1min;
- (vi) a drop of the mixed solution was removed and placed it into the filter paper, the goal is to see a narrow light blue halo around dark blue and this is called the “end point”, it means that methylene blue molecular has replaced cations in the bentonite (Fig. 3.5).

This analysis was repeated three times to ensure the accuracy of experimental results. The CEC value of bentonite was calculated based on the methylene blue amount that required reaching the “end point”. The relationship between CEC and methylene blue used is given:

$$CEC = \frac{W_m}{319.87} \times \frac{1000}{V_s} \times \frac{100 \text{ g}}{W_b} \times V_t$$

Where *CEC* is the cation exchange capacity (meq/100g),

W_m is the weight of dry methylene blue, g,

V_s is the volume of methylene blue solution, ml,

W_b is the weight of dry bentonite, g,

V_t is the volume of methylene blue titrant.

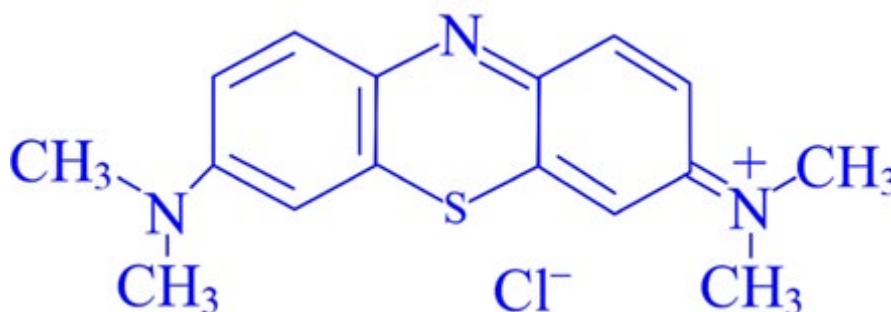

Fig. 3.4 The molecular structure of methylene blue

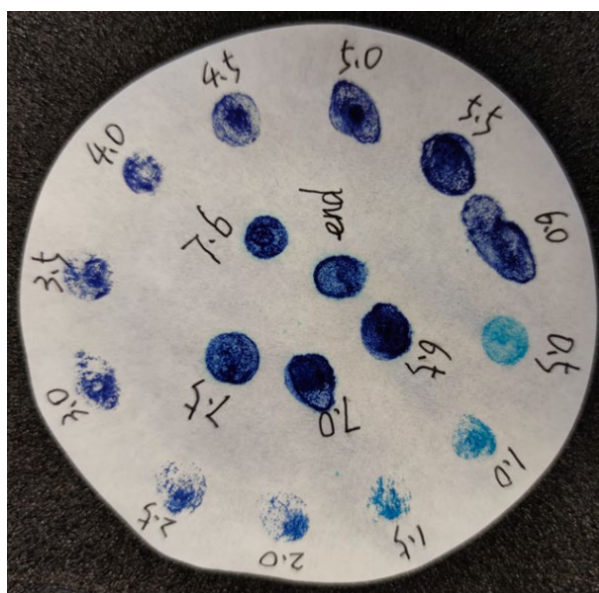

Fig. 3.5 Titration of methylene blue and “end point”

The CEC of Bt determined by the methylene blue method is 120 meq/100g. And the CEC of synthetic Mt is 130 meq/100g.

3.1.2 Surfactant

The natural surfactant lecithin was used in this study to synthesize organoclays. The lecithin, composed of more than 94% phosphatidylcholine (PC) and less than 2% triglycerides, was extracted from soybean. PC comprises a choline component characterized by a negative charge on the phosphate group and a positive charge on the trimethyl-amino group. The lecithin is a pale yellow solid and was purchased from Sigma-Aldrich. The molecular structure and functional groups of PC ($C_{42}H_{80}NO_8P$, molecular weight=758.06g/mol) are described in Fig. 3.6.

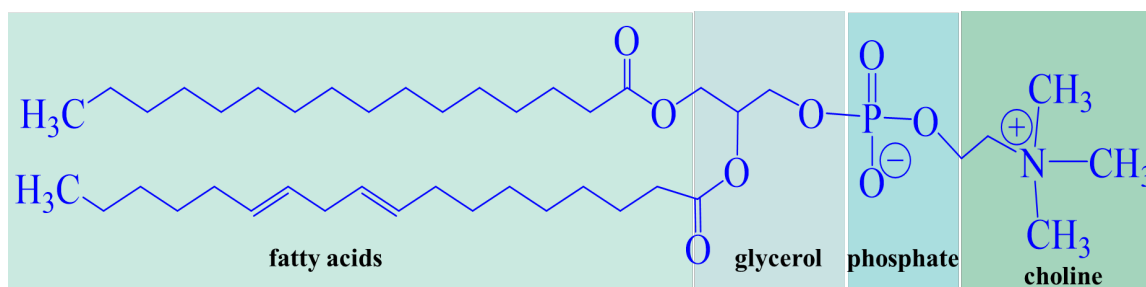

Fig. 3.6 The molecular structure and functional groups of PC

3.1.3 Base oils

The base oils used to formulate oil-based drilling fluids are classified as paraffin oil and linseed oil. The performance of the oil-based drilling fluid is influenced by the nature and composition of the base oil. Paraffin oil, classified as a mineral oil, primarily consists of higher alkanes as its main components. In contrast, linseed oil is a drying vegetable oil whose main component is triglycerides and fatty acids. Both oils were purchased from Sigma-Aldrich and used in their original form without further processing. Their physical and chemical properties are shown in Table 3.1.

Table 3.1 Physical and chemical properties of paraffin oil and linseed oil

Property	Linseed oil	Paraffin oil
freezing point	< -24 °C	< -15 °C
boiling point	>316 °C	260~450 °C
flash point	>113 °C	>215 °C
density	0.93 g/ml at 25 °C	0.83~0.89 g/ml at 20 °C
viscosity (pa·s, 25°C)	0.05	0.13
color	yellow	colorless
main components	triglycerides, fatty acids	higher alkanes

3.2 Preparation of organic montmorillonite

The preparation of organoclays was performed using the following procedure: A quantity of bentonite was dispersed in distilled water, and the mixture was stirred for a duration of 16 h. An amount of lecithin surfactant to yield the desired concentration was dissolved in ethanol and stirred for 2 h. The amount of lecithin added was equivalent to 0.1, 0.2, 0.5, 1.0, 2.0, 3.0, 4.0, and 5.0 times the CEC of bentonite. The weight of lecithin is calculated according to the following formula:

$$W_m = W_b \times CEC \times M \times R / A \times 10^{-3}$$

Where W_m is the weight of lecithin, g,

W_b is the weight of clay minerals, g,

CEC is the cation exchange capacity, meq/g,

M is molar mass of lecithin, g/mol,

R is the ratio of bentonite to lecithin,

A is the purity of lecithin, %.

Next, the lecithin solution was slowly added to the clay dispersion and then HCl was added dropwise to adjust the pH of the mixture solution. The mixture suspension was sonicated for 5 min and stirred continuously at a certain temperature. After this, the mixture was centrifuged and the resulting precipitate washed several times with a 1:1

ethanol-distilled water solution. The resulting precipitate was dried in an oven at 60°C for 48h. Finally, the organic clay sample was finely ground in an agate mortar. The schematic representation of experimental workflow followed for preparing organic clay was provided in Fig. 3.7.

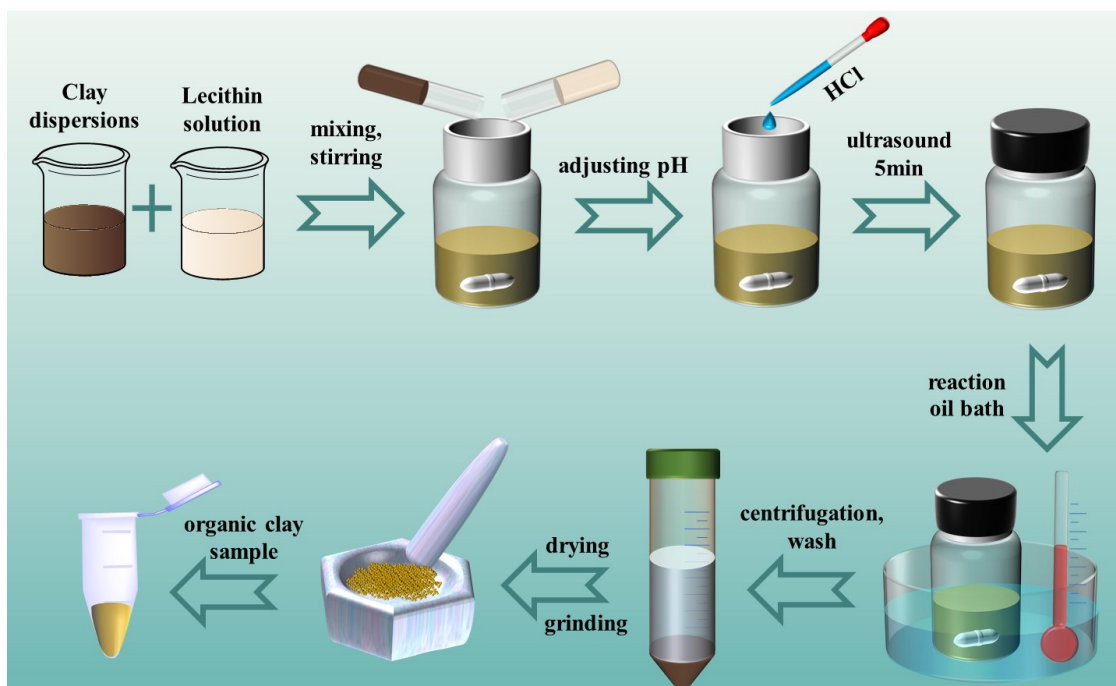

Fig. 3.7 The schematic representation of experimental workflow for preparing organic clay

3.3 Characterization of organic montmorillonite

3.3.1 X-ray diffraction (XRD)

X-ray diffraction was applied to examine the intercalation process of surfactants in organic clays by observing the variation of the basal spacing. XRD patterns of all the samples were measured using Cu-K α radiation ($\lambda=0.15406$ nm) on a Bruker D8 Advance X-ray diffractometer, which was performed at 40 kV and 30 mA. The organic clay powder

was placed into the sample holder, then pressed with a glass slide to ensure that the powder surface leveled with the sample holder's surface. X-ray diffraction patterns were recorded in the 2θ range from 0.8° to 10° with a scanning step of 0.05° .

The XRD characterization method of organic clay in oil was illustrated in Fig. 3.8. Firstly, a high-speed centrifuge was used to remove excess oil from the aged oil-based drilling fluid to obtain organic clay sediment. The obtained organic clay sediment was then uniformly smeared on the glass. Finally, the organic clay sediment can be measured using the X-ray diffractometer similar with powder samples.

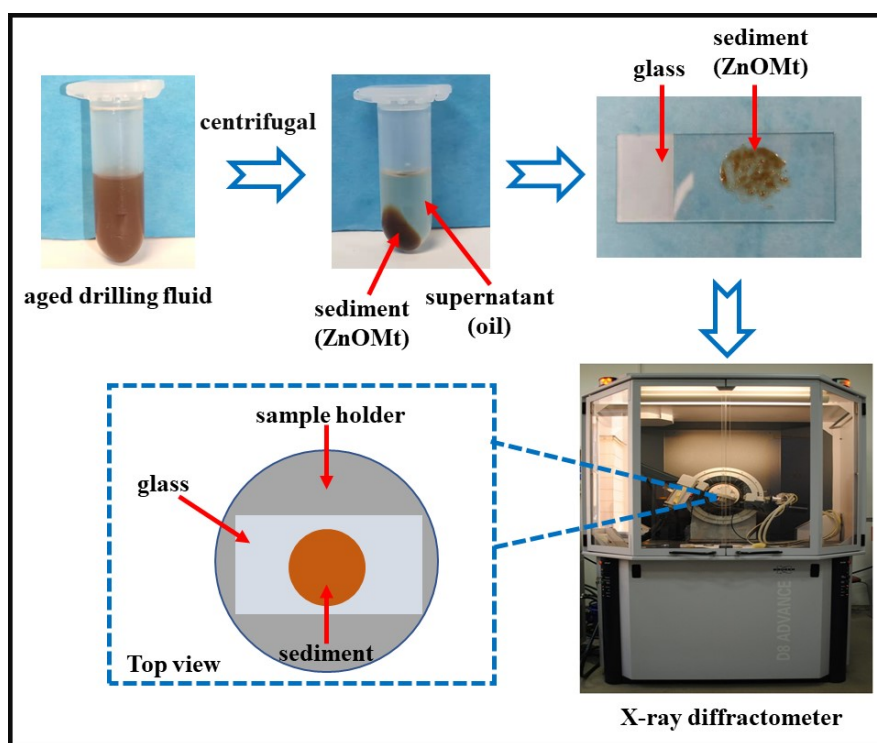

Fig. 3.8 Interpretation diagram of XRD test of organic clay in oil

3.3.2 Fourier transform infrared spectroscopy (FTIR)

FTIR techniques were employed to obtain information regarding the structure, composition, and structural changes upon chemical modification. This analytical

approach serves as a crucial tool for identifying and quantifying functional groups within the material. FTIR spectra were carried out with an Agilent Cary 630 FTIR spectrometer using an Agilent diamond Attenuated Total Reflectance (ATR) technique mode. The wavenumber was measured in absorbance mode ranging from 4000 cm^{-1} to 650 cm^{-1} , with an accumulation of 64 scans at a spectral resolution of 4 cm^{-1} . And the spectra were processed with the Microlab FTIR Software (Agilent Technologies).

3.3.3 Thermal analysis

Thermal analysis techniques, including thermogravimetric analysis (TGA) and derivative thermogravimetry (DTG), were employed to measure thermal effects during temperature programming processes and to evaluate the thermal decomposition reactions and thermal stability of the organoclay samples. TGA and DTG were performed on a TA Instrument SDT Q600 analyzer. The sample was heated from room temperature to $900\text{ }^{\circ}\text{C}$ at $10\text{ }^{\circ}\text{C}/\text{min}$ under an air atmosphere ($75\text{ cm}^3/\text{min}$). Approximately, 8.0~12.0 mg of sample powder was heated in an open alumina pan.

3.3.4 Transmission electron microscopes (TEM)

TEM can provide very detailed information about the structure, texture and morphology of the studied materials. The experiment was carried out with a JEOL 1011 transmission electron microscope, operating at accelerating voltage 100 kV (beam current around $86\text{ }\mu\text{A}$). The samples were imaged in Bright Field (BF) mode and the spot size was of 3. All the samples were examined in high vacuum mode. The samples were prepared by dispersing the powders in ethanol and then deposited on a 400-mesh copper grid covered with an ultrathin carbon membrane of 2–3 nm thickness.

3.3.5 X-ray fluorescence (XRF)

XRF is a commonly used characterization technique for determining the chemical composition and content of materials. The elemental analysis was carried out using the

wavelength-dispersive high-performance X-ray fluorescence (XRF) spectrometer of PANalytical. The sample powder weighing 100 mg was carefully mixed with 100 mg of boric acid. The resulting mixture was then compacted under a pressure of 5 tons for 2 minutes to form pellets with a diameter of 13 mm. Subsequently, the pellets were placed into the sample chamber of the spectrometer, and X-rays were generated by applying a voltage of 30 kV and a current of 1 mA.

3.3.6 Energy dispersive X-ray (EDX)

Energy-dispersive X-ray analysis (EDX) (Quantax-EDX, Bruker, Germany) was performed to determine the elemental composition of the samples. The EDX analysis was made in three different points of the samples and results of these points were later averaged.

3.4 Preparation of oil-based drilling fluid

The organic clay was added to base oils and stirred for 2 h to prepare oil-based drilling fluid with a concentration of 50 kg/m³. The resulting fluid was aged for 16 h in a roller oven at various temperatures (60°C, 120°C, 180°C) to simulate the high temperature conditions during drilling. After aging, the drilling fluid was cooled to room temperature and stirred for one hour prior to testing. All the procedures follow the standards of American Petroleum Institute (API), i.e., API RP 13D-2017 and API RP 13B-2-2018.

3.5 Performance characterization of oil-based drilling fluid

3.5.1 Dispersion

The affinity and dispersibility of organoclays towards oil play a crucial role in the stability and rheology of oil-based drilling fluids. The optical microscopy was carried out by using an Olympus BX51 microscope to obtain the dispersion of organic clays in oil. The specific method involves placing a drop of oil-based drilling fluid onto a clean glass slide and then gently placing a coverslip over the drilling fluid to hold it in place and

protect the microscope lens.

3.5.2 Rheology

Rheology measurements were performed with a Thermo Fisher Scientific HAAKE MARS 40 rheometer, equipped with stainless steel cone plate fixtures (diameter: 35 mm, angle: 2° ; gap: 0.103 mm). The cone plate fixture enables the achievement of uniform shear rates throughout the entire flow field. The geometry and parameters of the cone plate was shown in Fig. 3.9. Each measurement was repeated at least twice to check reproducibility. The viscosity and shear stress were measured as a function of the shear rate and all the measurements were conducted at 25°C . The flow curves were measured in controlled shear rate mode, with the shear rate increasing linearly from 0.1 s^{-1} to 1000 s^{-1} in 180 s. In order to ensure long-lasting measurements, a hermetic cell was positioned around the fixture to minimize contact between the sample and ambient air, thereby preventing drying. The experimental data acquisition and processing were conducted using RheoWin 4.87 software.

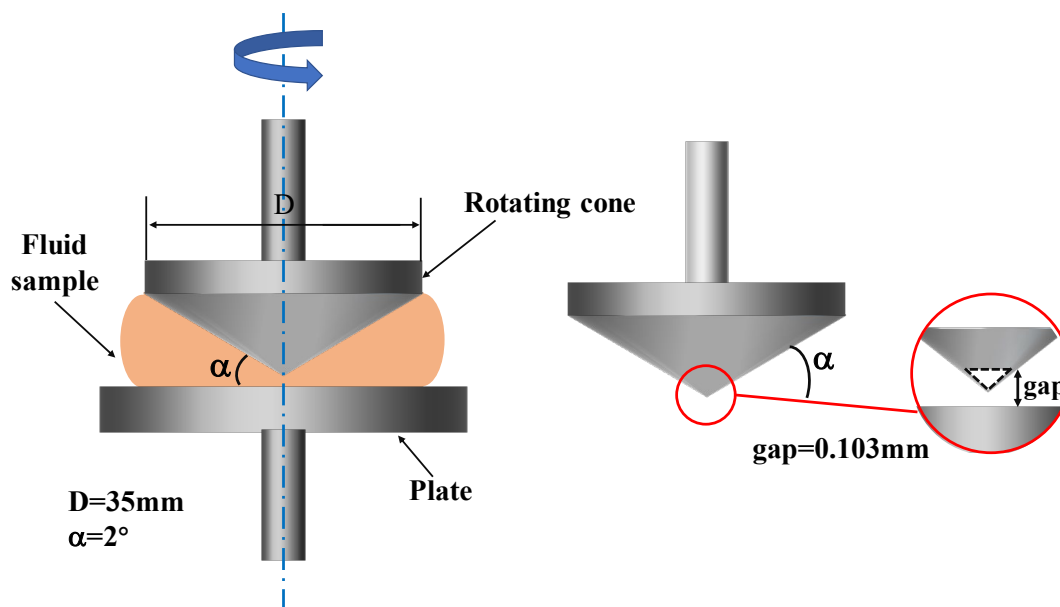

Fig. 3.9 The geometry and parameters of the cone plate fixture

3.5.2.1 Thixotropy

Thixotropy is defined as a reversible, isothermal, time-dependent decrease in the apparent viscosity when a material is subjected to increased shear rate (Mewis, 1979). The hysteresis loop flow curve is usually used to evaluate the thixotropy of oil-based drilling fluid. In this method, shear stress was plotted as a function of shear rate, and the up (loading) and down (unloading) curves were acquired. The drilling fluid samples were sheared with a continuously increasing shear rate and continuously down again to low shear rate. The thixotropy measurement process for oil-based drilling fluid was performed according to the following procedure: the shear rate linearly increased from 0.1 s^{-1} to 1000 s^{-1} in 180 s (up-sweep), and then linearly decreased from 1000 s^{-1} to 0.1 s^{-1} in 180 s (down-sweep).

3.5.3 Viscoelasticity

To determine viscoelasticity of oil-based drilling fluids at various temperatures, oscillatory amplitude and frequency sweep tests were performed. Viscoelasticity testing is a valuable technique that enables the determination of the linear viscoelastic range and assessment of the drilling fluid's response to frequency variations.

3.5.3.1 Oscillatory amplitude sweep

The oscillatory amplitude sweep utilized sinusoidal oscillations at small strain amplitude and constant frequency to assess the linear viscoelastic range (LVER). The tests were performed at $25 \text{ }^{\circ}\text{C}$ with a constant angular frequency of $\omega=6.28 \text{ rad/s}$ and increasing strain amplitude from 0.1 to 100%.

3.5.3.2 Frequency sweep

Frequency sweep was employed to evaluate the viscoelastic behavior of drilling fluid at different frequencies. The oscillatory amplitude sweep, which provided the LVER, served as a further input for the frequency sweep analysis. The frequency sweep test from 100 to 0.1 rad/s at constant strain of 1 % (within LVER) and 25°C was performed.

References

- de Oliveira, L.H., Trigueiro, P., Rigaud, B., da Silva-Filho, E.C., Osajima, J.A., Fonseca, M.G., Lambert, J.-F., Georgelin, T., Jaber, M., 2021. When RNA meets montmorillonite: Influence of the pH and divalent cations. *Applied Clay Science* 214, 106234.
- Hayati-Ashtiani, M., Jazayeri, S.-H., Ghannadi, M., Nozad, A., 2011. Experimental characterizations and swelling studies of natural and activated bentonites with their commercial applications. *Journal of chemical engineering of Japan* 44, 67-77.
- Hilche, D.W., Mian, M.A., 1982. Comparison Of Results From Three Cation Exchange Capacity (cec) Analysis Techniques. *The Log Analyst* 23.
- Jaber, M., Miéché-Brendlé, J., 2005. Influence du milieu de synthèse sur la cristallisation de saponite : proposition de mécanisme réactionnel en milieux acide et basique. *Comptes Rendus Chimie* 8, 229-234.
- Mewis, J., 1979. Thixotropy-a general review. *Journal of Non-Newtonian Fluid Mechanics* 6, 1-20.
- Yukselen, Y., Kaya, A., 2008. Suitability of the methylene blue test for surface area, cation exchange capacity and swell potential determination of clayey soils. *Engineering Geology* 102, 38-45.

Chapter 4

**Modification of bentonite
with lecithin and molecular
dynamics simulations**

4.1 Introduction

In the past two decades, the application of clay minerals in rheological control agents, oil-based drilling fluid, adsorbents of organic pollutants, paints and cosmetics have been widely reported (Park et al., 2013; Trigueiro et al., 2018; Zhuang et al., 2019b; Li et al., 2021). Nowadays, modification of clay minerals has attracted more and more attention (Xavier et al., 2016; Pereira et al., 2017), and the exploration of novel modification methods on clay minerals has never stopped (Zhu et al., 2017). Bentonite, mainly composed of montmorillonite, has gathered considerable research interest due to its availability in mine deposits and soils, nontoxic nature, and high cation exchange capacity (CEC) (Churchman et al., 2006).

In previous studies, quaternary ammonium salts were widely applied in bentonite modification and exhibit superior performances in oil-based drilling fluid, notably a better dispersion (Makhoukhi et al., 2013; Zhuang et al., 2015b; Zhou et al., 2016). Furthermore, the intercalation of oil between the montmorillonite layers induces the layers to swell and exfoliate while the edges and faces of the dispersed layers form a “kind of house-of-cards structure” resulting in a gel system. However, the quaternary ammonium salt and quaternary phosphonium salt surfactants usually induce environmental problems due to their toxicity and poor biocompatibility. This limitation restricts their potential use in some application fields (Liu et al., 2017).

In the last few years, there has been a tremendous amount of interest and various efforts regarding the preparation of bio-organoclays to solve the main problems listed above, especially biocompatibility (Biswas et al., 2019). Phospholipids, particularly lecithin, have emerged as promising candidates for the synthesis of bio-organoclays, as documented in several reports. (Merino et al., 2016) investigated the effect of lecithin concentration and reaction time on modified bentonite and considered that lecithin-bentonites are promising eco-friendly fillers for bio and nanocomposites. (Nagy et al., 2013) studied the adsorption characteristics of nanocomposites containing lecithin and

bentonite composite. In addition, the hybrid materials obtained from lecithin-modified clay minerals have received great attention in the fields of biomedicine and pharmaceuticals (Denning et al., 2017; Ruiz-Hitzky et al., 2019). Lecithin is one of the most common phospholipids and mainly composed of phosphatidylcholine (PC) (Cui and Decker, 2016). It can be extracted from vegetables and animal sources such as soybeans, rice beans, sunflower, marine sources, egg yolk, and milk. Lecithin extracted from soybeans is recognized to be more stable, safer, and affordable from the production point of view (Le et al., 2019). PC contains a choline part, *i.e.* a positively charge trimethyl-amino group, in addition to the negative charge on the phosphate group (Bot et al., 2021). The pKa value of the phosphate group is around 1.5 and it can be protonated at acidic conditions ($\text{pH} < \text{pKa}$), which means that the lecithin can exchange interlayer cations in clay minerals.

This chapter deals with the preparation of new organoclays based on bentonite and soybean lecithin. The effects of reaction temperature, time, pH, and lecithin concentration on the properties of modified bentonite were analyzed by a variety of characterization techniques and molecular dynamics simulations (MD). The interaction between bentonite and lecithin, the intercalation behavior, and the configuration of lecithin in the interlayer space were reported. This study is expected to provide valuable insights into the preparation of bio-organoclays from lecithin. In addition, some conditions can largely impact the physical properties of the organoclay and help design relevant environmentally-friendly materials.

4.2 Methods

4.2.1 Preparation of organic bentonite

The 10 mL of 0.01g/ml bentonite dispersion was added to 10 ml lecithin solution with different concentrations (0.1~3.0 CEC) and stirred continuously. To adjust the pH of the mixture between 1.0 and 9.0, a solution of 6.0 mol/L of HCl was added dropwise. The

mixture solution was then sonicated and heated through an oil bath at different temperatures (room temperature, 40, 60, 80°C). The heating time varies between 0.5 h and 6.0 h. After the reaction is completed, the solution was centrifuged, washed and dried, and finally ground into organic bentonite samples.

4.2.2 Molecular dynamics simulation setup

The montmorillonite structure was modelled using the CLAYFF, a general force field for clay material developed by (Cygan et al., 2004; Cygan et al., 2021). The starting structure was extracted from the publication of (Gournis et al., 2008). Then substitutions were made to reach a cell formula of $\text{Si}_4(\text{Al}_{1.5}\text{Mg}_{0.5})\text{O}_{10}(\text{OH})_2$ with a total charge of -1. The Na^+ was used as cation and water molecules modelled by the SPC model, as described in CLAYFF.

The phosphatidylcholine (PC) parameters were created using the GAFF model from Amber tools 2021 (Wang et al., 2004). The structure of the PC was optimized using ORCA 5.0.3 and B3LYP functional (Becke, 1993; Stephens et al., 1994), D3 correction (Becke and Johnson, 2005) and def2-TZVP basis set with matching auxiliary basis set (Weigend and Ahlrichs, 2005). The RIJCOSX approach applying the resolution of identity (RI) approximation to the Coulomb part and the chain of spheres (COS) seminumerical integration algorithm to the exchange term was also used (Helmich-Paris et al., 2021). After optimization, the harmonic vibrational frequency corrections were computed with the same level of theory to check that the minima had been found. The convergence criteria for both the SCF and geometry optimizations were set to TIGHT and all the other parameters were chosen as default. The Mulliken charges extracted from the optimized structure are used in the parameters file.

The configuration and molecular dynamics simulation were performed using GROMACS 2021.3 (Abraham et al., 2015). The system corresponding to the bentonite at pH=1.0 with PC concentration of CEC=2.0 was chosen to study. For the small systems, a bilayer of $9 \times 9 \times 2$ unit cells were created (162 units cells, 6480 atoms, $5.04 \times 6.76 \times 10.01$

nm). The edge surface of the montmorillonite has not been modeled to simplify the simulations, thus only the interlayer space is available. Then, a certain number of water molecules were added corresponding to the mass loss on the TG results. Here a 2.0% of mass loss corresponds to 642 water molecules. Then, a fixed amount of PC molecules and Na^+ were added to reach a neutral charge. In accordance to the loaded amount of PC measured, 130 PC molecules (80%) and 32 Na^+ (20%) were added resulting in 25728 atoms. In the model, the size of the simulation box was increased by 4 nm in the z direction to limit the interaction between different pbc boxes.

The following workflow was employed for molecular dynamics simulations. After a steep descent minimization, a 50 ps NVT dynamic was performed at $T=333\text{K}$ with the montmorillonite structure restrained. Then a 50 ps NPT dynamic was operated at $T=333\text{K}$ and $P=1\text{ atm}$ with the montmorillonite structure restrained. Then, a productive molecular dynamic simulation of 10 ns was performed at $T = 333\text{ K}$ and $P = 1\text{ atm}$. The time step is 1 fs, the barostat used corresponds to the Parrinello-Rahman (Parrinello and Rahman, 1981) with a coupling constant of 2 ps, and the V-rescale (Bussi et al., 2007) was applied for coupling the simulation box to a thermostat with a coupling constant of 0.1 ps. During the whole process, LINCS algorithm was used to constraint H-bonds (Hess et al., 1997). Finally, we have chosen a Verlet cut-off, while the Coulombing and van der Waals interaction were represented by PME (Fast smooth Particle-mesh Ewald) with a cut-off of 2 nm (Darden et al., 1993). The fourier spacing was increased at 0.24 nm to save computational time.

4.3 Results and discussion

4.3.1 Effect of reaction temperature

The effect of reaction temperature on the interlayer space and thermal stability of modified bentonite was studied by a series of experiments with $\text{pH}=1.0$ and 1.0CEC . The XRD patterns of bentonite and modified bentonite prepared at different temperatures were

shown in Fig. 4.1. The bentonite presented a reflection at $2\theta=7.28^\circ$ with a basal spacing d_{001} of 1.21 nm. This reflection shifted to $2\theta = 6.15^\circ$ in the patterns of modified bentonite (room temperature), and the corresponding basal spacing is $d_{001}=1.44$ nm, indicating that the lecithin molecules were introduced into the bentonite interlayer space (Songurtekin et al., 2013). Since the TOT layer thickness of montmorillonite is 0.96 nm, the lecithin intercalation increased the interlayer space of sample by 0.48 nm. The intercalation behavior is attributed to the monolayer arrangement of lecithin molecules in the interlayer space (Ouellet-Plamondon et al., 2014). In addition, the XRD results of bentonite modified with lecithin at different temperatures showed that temperature do not have an effect on the intercalation behavior of lecithin.

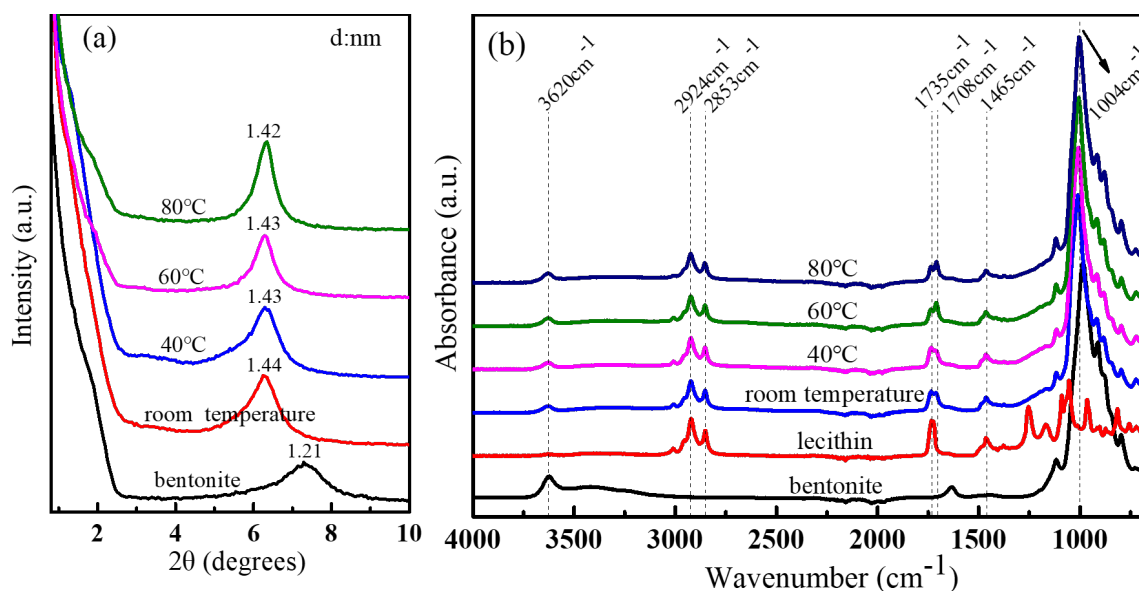

Fig. 4.1 XRD patterns (a) and FTIR spectra (b) of bentonite, lecithin and modified bentonite at different reaction temperatures

FTIR spectroscopy was applied to investigate and compare the functional groups present in raw bentonite, lecithin and modified bentonite. FTIR spectra (Fig. 4.1b) of all modified bentonite samples displayed a band at 3620 cm^{-1} attributed to the -OH stretching vibration of the hydroxyl groups of the bentonite structure. The absorption band centered at around 1004 cm^{-1} is attributed to the Si-O-Si stretching band of bentonite (Xue et al.,

2007). The bands at 2924 cm^{-1} and 2853 cm^{-1} are assigned to the $-\text{CH}_2$ asymmetric and symmetric stretching vibrations of the lecithin, respectively (Li et al., 2008; Zhang et al., 2012b). An intense band attributed to the $\text{C}=\text{O}$ group of lecithin occurred at 1735 cm^{-1} , and another one centered at 1465 cm^{-1} belonged to the deformation vibrations of CH_2/CH_3 (Nagy et al., 2013; Liu et al., 2017). The apparent shift of the $\text{C}=\text{O}$ stretching band at 1735 cm^{-1} in lecithin to 1708 cm^{-1} in modified bentonites indicated possible interactions with the clay layers surface (Merino et al., 2016).

Various reports in the literature indicated that thermogravimetric analysis is often used to research the thermal stability of organoclays (Corcione and Frigione, 2012). The way in which the mass loss steps occur provided information on the structure of the intercalated molecules (Xi et al., 2005). The decomposition of bentonite modified with lecithin often occurs in three steps: dehydration of adsorbed water, lecithin decomposition, and silicate dihydroxylation (Zhu et al., 2011).

The thermal gravimetric (TG) and differential thermogravimetry (DTG) results for bentonite, lecithin and modified bentonite were compared in Fig. 4.2 and the lecithin loading amounts were calculated according to the following formula (Zhu et al., 2017). The mass loss results of the modified bentonite and loading amount of lecithin are summarized in Table 4.1.

$$Q_l = \frac{Q_m}{(1 - Q_m) \times \text{CEC} \times M}$$

where Q_l is the loading amount of lecithin,

Q_m is the mass loss in the temperature range of $150\sim 450^\circ\text{C}$,

M is the molar mass of lecithin.

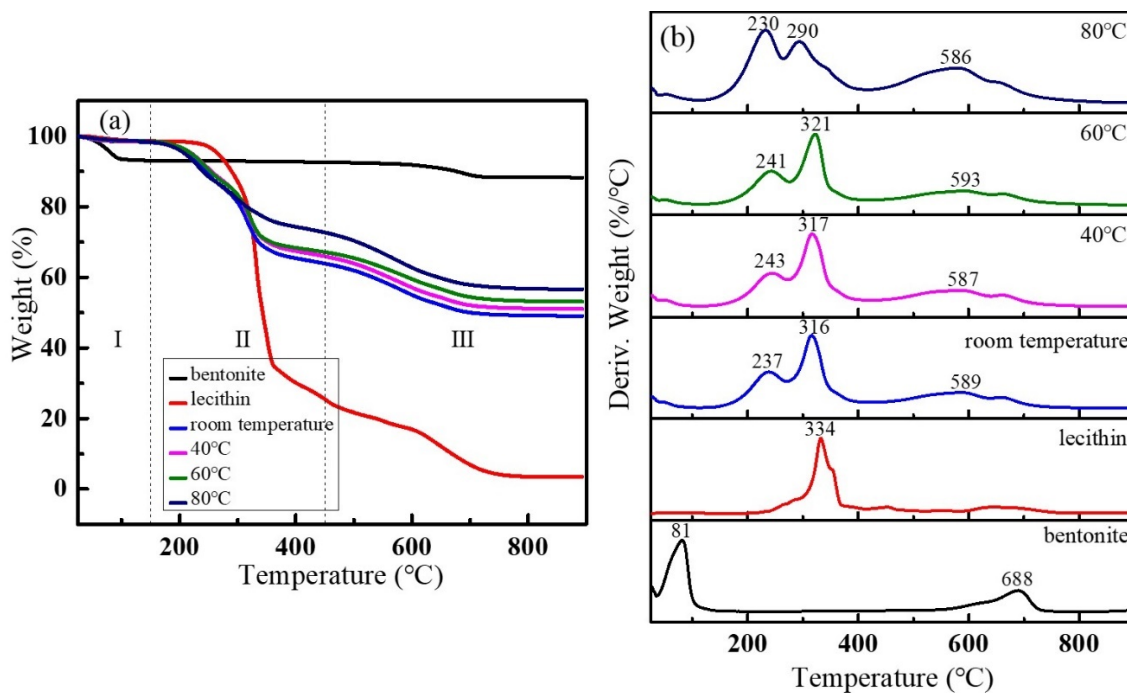

Fig. 4.2 The TG (a) and DTG (b) curves of bentonite, lecithin and modified bentonite at different reaction temperatures

Table 4.1 TG results of bentonite, lecithin and modified bentonite at different reaction temperatures

Reaction temperature /°C	adsorbed water dehydration	lecithin decomposition	silicate dehydroxylation	loading amount of lecithin (CEC)
	mass loss in ambient~150°C (%)	mass loss in 150~450°C (%)	mass loss in 450~900°C (%)	
room temperature	1.8	34.4	14.8	0.58
40	1.6	32.5	14.9	0.53
60	1.5	31.4	14.0	0.50
80	1.7	25.7	16.0	0.38
lecithin	1.4	73.5	-	-
bentonite	6.9	-	4.4	-

In the curve for bentonite (Fig. 4.2b), two major peaks were presented. The first mass loss from the ambient temperature to 150°C and is assigned to dehydration of physisorbed water and represent 6.9%. The other mass loss between 450°C and 900°C is attributed to

the dehydroxylation of the aluminosilicate layer at 688°C (Khalaf et al., 2017). The mass loss of lecithin mainly occurred between 150°C and 450°C with a mass loss of 73.5%. The temperature corresponding to the highest rate of mass loss was at 334°C for lecithin. These results were in accordance with previous literature reports (Wicklein et al., 2010). Three steps of the mass loss were observed for the organoclays: the first mass loss which is attributed to the dehydration of physisorbed water varied between 1.5% and 1.8%. The most remarkable difference between the bentonite and the organic bentonite is in the temperature range 150~450°C. When the reaction was carried out at room temperature, 40°C, 60°C and 80°C, the second mass loss in the temperature of 150~450°C was 34.4%, 32.5%, 31.4% and 25.7%, respectively, which is associated with lecithin decomposition (Ouellet-Plamondon et al., 2014). It is found that there are two peaks in this range, the peaks at 200~260°C, 270~340°C correspond to the decomposition of the adsorbed surfactant and intercalated surfactant lecithin, respectively. The third mass loss step between 450 to 900°C is attributed to the dehydroxylation of the structural OH units of the bentonite. As can be seen from Table 4.1, with the reaction temperature increase, the mass loss of loaded lecithin decreases from 0.58CEC (for room temperature) to 0.38CEC (for 80°C). The reason for this result may be that temperature affects the adsorption capacity of lecithin molecules on the surface of bentonite. As the temperature increased, the adsorption capacity of lecithin on the bentonite surface decreased, which led to the diminution of the lecithin content in the organic bentonite.

4.3.2 Effect of reaction time

The effect of the reaction time on the properties of modified bentonite was also studied. The reaction temperature was set to 60°C. Then, the reaction time was varied from 0.5h to 6.0h.

X-ray diffraction patterns of the modified bentonite at different reaction times were illustrated in Fig. 4.3a. The bentonite showed an interlayer basal spacing of 1.21 nm. After 0.5h of reaction, the X-ray reflection of modified bentonite shifted to a lower angle and

the basal spacing increased from 1.21 to 1.42 nm. This indicated that the intercalation behavior of lecithin molecules was completed at a short time (0.5h). Additionally, the basal spacing d_{001} values (~ 1.42 nm) and reflection intensity did not change for the organo-bentonite samples at different reaction times, which could be attributed to the monolayer arrangement of the lecithin molecules in the interlayer space. This finding indicated that reaction time had no effect on the basal spacing of the modified bentonite. The result has been found to be in good agreement with the literature (Merino et al., 2016).

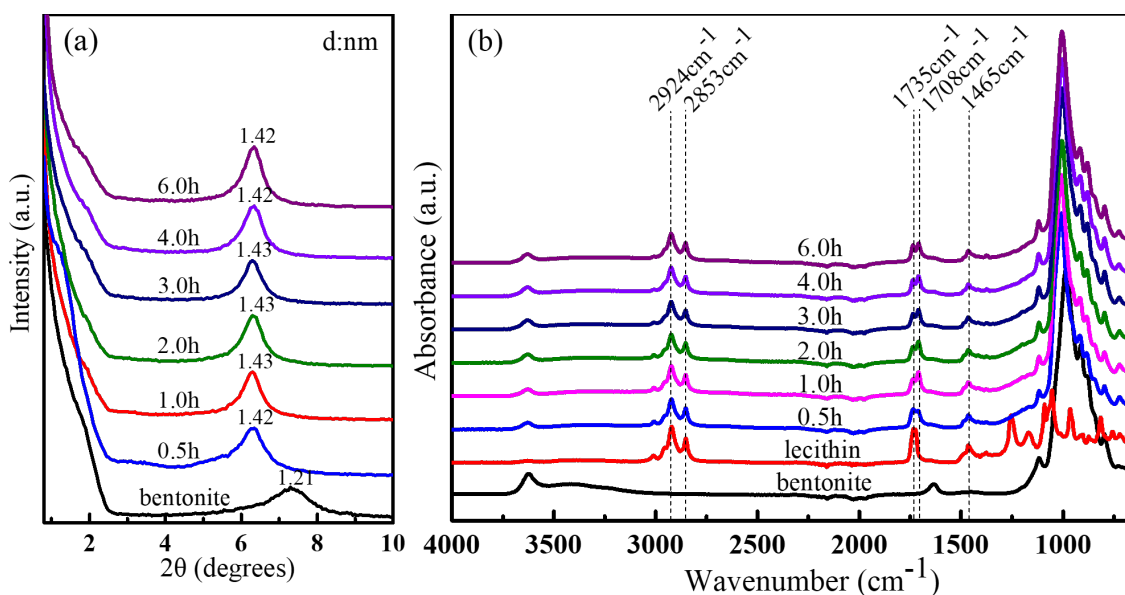

Fig. 4.3 XRD patterns (a) and FTIR spectra (b) of bentonite, lecithin and modified bentonite at different reaction times

The bands in the FTIR spectra were consistent with the ones detailed in the previous section (i.e., the effect of reaction temperature). Upon intercalation with different reaction times, the FTIR experimental results remained consistent. It showed that the reaction time had no influence on the properties of lecithin-modified bentonite, which is agreement with the results of XRD.

The thermal stability of modified bentonite was evaluated by TG analysis and the results of samples were shown in Fig. 4.4. For modified bentonite, between 150 and 450°C, the mass loss is mainly caused by the lecithin decomposition. Table 4.2 listed the

percentages of mass loss of the different stages and loaded amount of lecithin. The maximum mass loss of lecithin, determined from TG curves, was completed at 0.5h (32.6%). When the reaction time increased from 0.5h to 6.0h, the mass loss of lecithin decreased from 32.6% to 27.7%, which demonstrated that the lecithin molecules rearrangement was taken place with the increase of reaction time (Wicklein et al., 2010; Merino et al., 2016). The loaded amount of lecithin molecules slightly decreases with the increases of time. The DTG of the modified bentonites showed two peaks between 150 and 450°C, which are attributed to lecithin decomposition. It can be seen from Fig. 4.4b, the intensity of the first peak increased with reaction time, whereas the second peak intensity decreased. Changes in the endothermic peak intensity suggested different conformation states and environments of lecithin in the modified bentonite (Xie et al., 2001c; Silva et al., 2014). In addition, organo-bentonites began to decompose at slightly higher temperature with the reaction time increased.

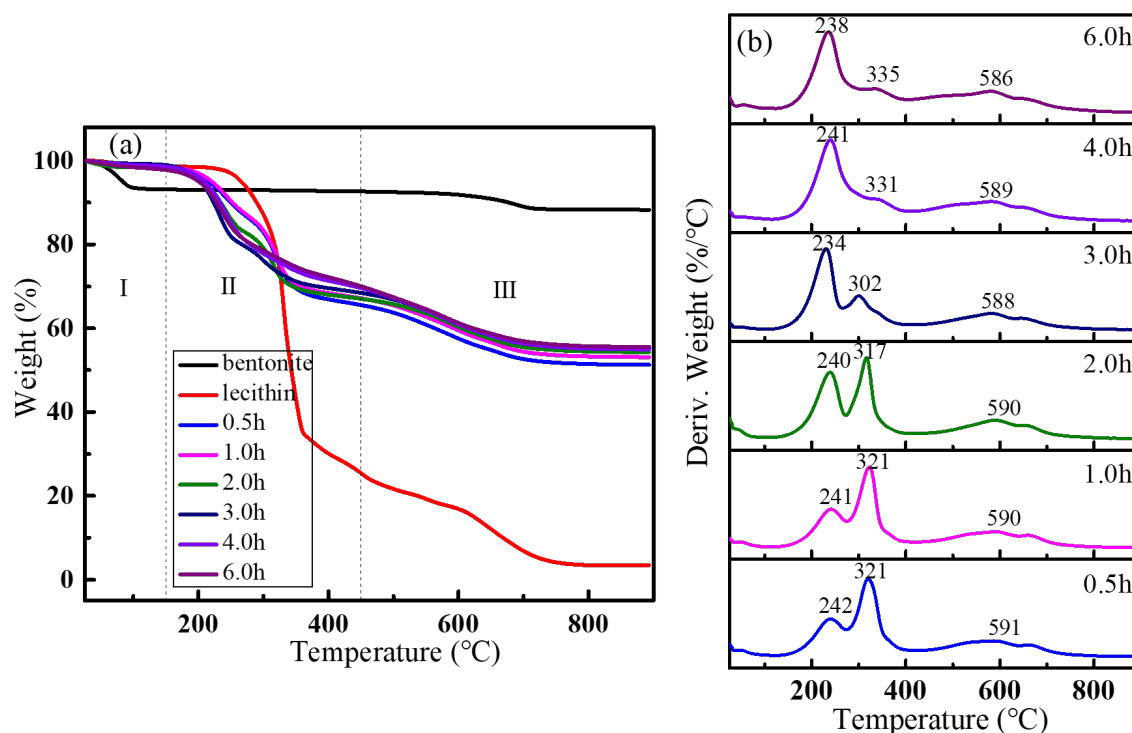

Fig. 4.4 The TG (a) and DTG (b) curves of modified bentonite at different reaction times

Table 4.2 TG results of modified bentonite at different reaction times

Reaction time /h	adsorbed water	lecithin	silicate	loading amount of lecithin (CEC)
	dehydration	decomposition	dehydroxylation	
	mass loss in ambient~150°C (%)	mass loss in 150~450°C (%)	mass loss in 450~900°C (%)	
0.5	1.9	32.6	14.2	0.53
1.0	1.5	31.4	14.0	0.50
2.0	2.0	31.1	12.7	0.50
3.0	1.4	30.2	13.5	0.48
4.0	1.5	29.1	14.5	0.45
6.0	2.3	27.7	14.5	0.42

4.3.3 Effect of pH

The effect of pH on the final performance of modified bentonite was studied. The reaction temperature was set to 60°C and the reaction time was 1.0h. The pH of the mixture solution was varied from pH=1.0 to pH=9.0.

The XRD patterns of modified bentonites at different pH were presented in Fig. 4.5a. The typical XRD reflections of bentonite related to the basal spacing appeared at $2\theta=7.28^\circ$ ($d_{001}=1.21$ nm). This reflection shifted to $2\theta=6.16^\circ$ in the patterns of modified bentonite at pH=1.0, corresponding to a d_{001} -value of 1.43 nm. This result was already discussed in the previous sections. At pH=3.0, the basal spacing of the modified bentonite appeared at $2\theta=1.70^\circ$, corresponding to the d_{001} -value of 5.19 nm. The (001) reflections of samples at pH=5.0, 7.0, 9.0 appeared at $2\theta=1.69^\circ$, 1.71° and 1.72° , corresponding to d_{001} -value of 5.22, 5.16 and 5.13 nm, respectively. In addition, the (002) reflection appears when mixture solution pH exceeds 3.0, indicating that the surfactants were intercalated with a periodic arrangement (Zhu et al., 2011). As expected, pH value of the solution has a great effect on the basal spacing and the intercalation behavior of lecithin.

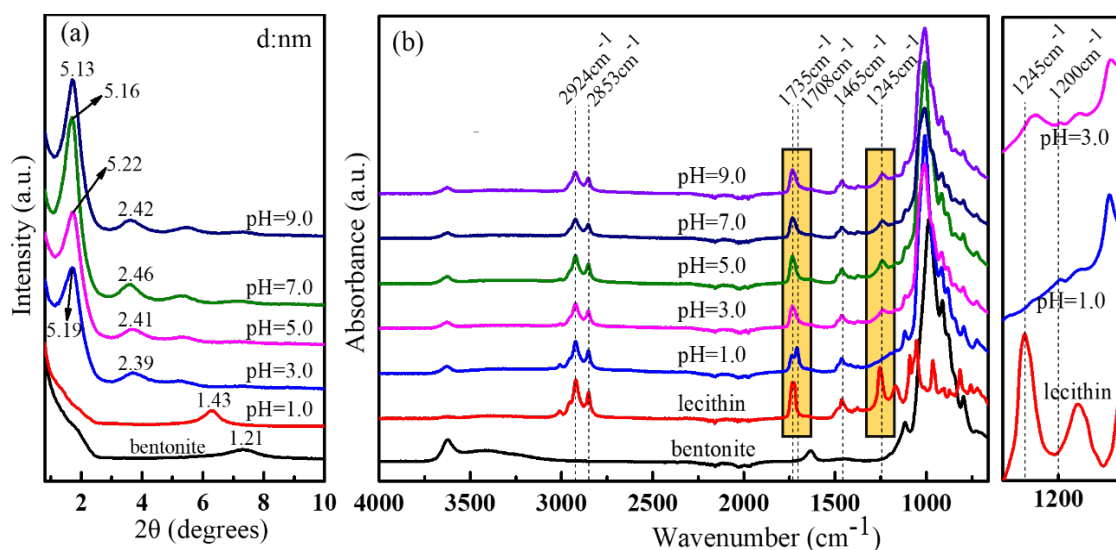

Fig. 4.5 XRD patterns (a) and FTIR spectra (b) of bentonite, lecithin and modified bentonite at different pH

Fig. 4.5b exhibited the FTIR spectra of modified bentonite under different reaction pH. The bands around 1735 cm^{-1} are attributed to the C=O group of lecithin and the bands at 1245 cm^{-1} is assigned to the PO_2 vibration (Nzai and Proctor, 1998). When $\text{pH}=1.0$, the band assigned to C=O stretching shifts from 1735 cm^{-1} to 1708 cm^{-1} , and the PO_2 vibration shifts from 1245 cm^{-1} to 1200 cm^{-1} in modified bentonite. However, when the pH varied from $\text{pH}=3.0$ to $\text{pH}=9.0$, there was no shift of the C=O stretching band and the PO_2 vibration. The protonation of the phosphate group on lecithin is the main reason for this result. The discrepancy reflects the changes of the lecithin properties at different pH conditions. This change is not only directed by the lecithin molecule structure and conformation, but also by interaction with mineral surface.

Phosphatidylcholine (PC), which is the main component of lecithin, contains a choline part that has a negative charge on the phosphate group and a positive charge on the trimethyl-amino group (Bot et al., 2021). The pKa value of the phosphate groups in the PC molecule is around 1.5 (Ogawa et al., 2004). In a strongly acidic medium ($\text{pH} < \text{pKa}$), the phosphate group is protonated, resulting in a positively charged

molecule. This change in properties causes different lecithin molecule arrangement, resulting in obvious increase in the interlayer space.

The TG and DTG results for modified bentonite samples at different pH were shown in Fig. 4.6 and Table 4.3. When the pH of the solution is 1.0, the maximum mass loss is between 150 and 450°C (31.4%). However, it can be found that, when the pH is higher than 1.0, all the TG curves exhibited similar variation tendencies from room temperature to 900°C, and the amount of lecithin decomposition was around 28.0% and the loaded amount of lecithin was around 0.43CEC between 150 and 450°C. The corresponding DTG curves in Fig. 4.6b showed that when $\text{pH} \geq 3.0$, there were two peaks. The center of the peak was 318°C, corresponding to lecithin decomposition and the center of the peak was 615°C, corresponding to the dehydroxylation of the aluminosilicate layer, respectively. However, when $\text{pH}=1.0$, there was three peaks. The centers of the peaks were 241, 321 and 590°C, respectively. Lecithin molecules can exhibit cationic properties due to the protonated choline groups in the highly acid condition ($\text{pH}=1.0$), while display zwitterionic nature when $\text{pH} \geq 3.0$ (Ouellet-Plamondon et al., 2014; Liu et al., 2017). We have also observed that at $\text{pH}=1.0$ there are more lecithin molecules absorbed than at $\text{pH}=3.0$ (Table 4.3) despite having a smaller d_{001} -value, i.e. 1.43 vs 5.19 nm. The main reason for this result is the interaction of protonated lecithin with the negatively charged clay surface at $\text{pH}=1.0$. Some surfactant molecules attach to the bentonite surface increased the amount of lecithin, which can be confirmed by a new peak at 241°C for DTG curves.

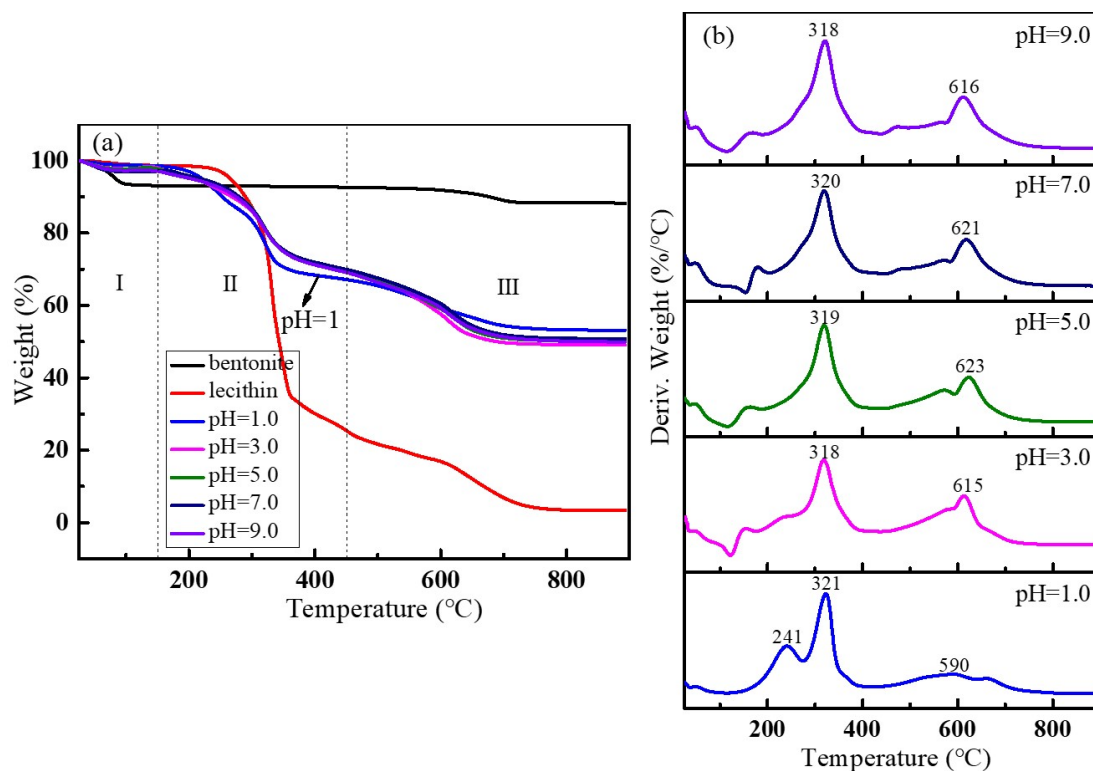

Fig. 4.6 The TG (a) and DTG (b) curves of modified bentonite at different pH

Table 4.3 TG results of modified bentonite at different pH

pH	adsorbed water dehydration	lecithin decomposition	silicate dehydroxylation	loading amount of lecithin (CEC)
	mass loss in ambient~150°C (%)	mass loss in 150~450°C (%)	mass loss in 450~900°C (%)	
pH=1.0	1.5	31.4	14.0	0.50
pH=3.0	2.0	28.6	20.3	0.44
pH=5.0	2.3	28.1	19.5	0.43
pH=7.0	2.9	27.5	19.1	0.42
pH=9.0	2.8	28.0	19.2	0.43

4.3.4 Effect of lecithin concentration

The effect of lecithin concentration on the intercalation process and thermal stability of modified bentonite was studied. The amounts of lecithin selected for the experiment were equivalent to 0.1, 0.5, 1.0, 2.0, and 3.0 times of the bentonite CEC. The pH of the

mixture solution was adjusted to pH=1.0, the temperature was set to 60°C and the reaction time was 1.0h.

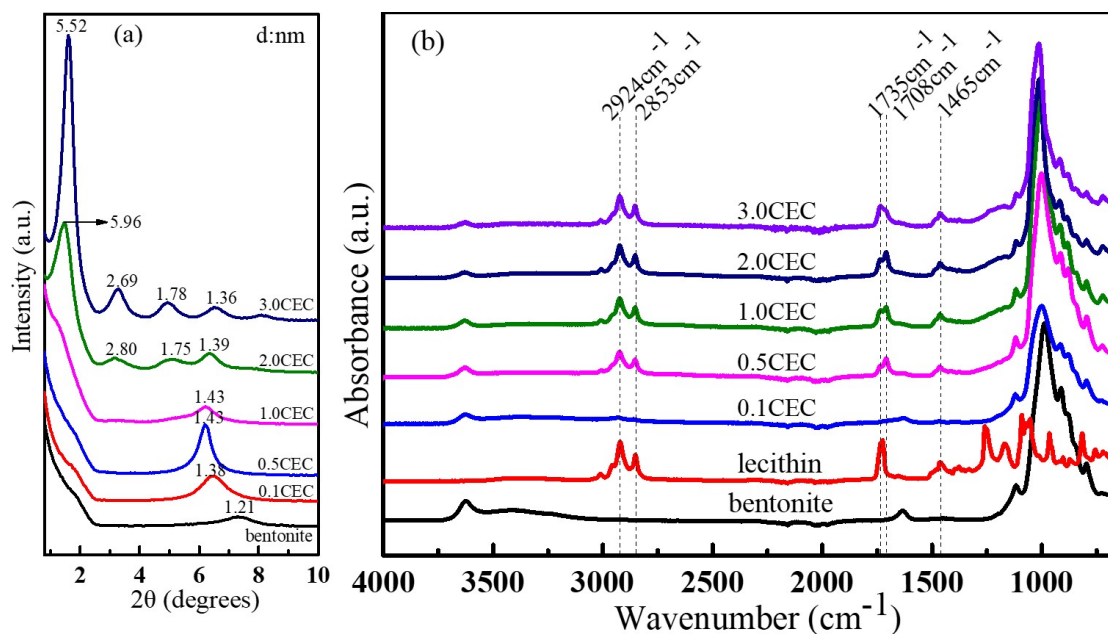

Fig. 4.7 XRD patterns (a) and FTIR spectra (b) of bentonite, lecithin and modified bentonite at different lecithin concentration

XRD patterns of the modified bentonite at different lecithin concentration were illustrated in Fig. 4.7. The basal spacing d_{001} -value of bentonite (1.21nm) shifted to 1.38, 1.43, 1.43, 5.96 and 5.52nm after modification with 0.1, 0.5, 1.0, 2.0 and 3.0CEC, respectively. When the lecithin concentration was between 0.1 and 1.0 CEC, the d_{001} -value increased slightly from 1.38 to 1.43 nm, which is correspond to lateral monolayer arrangement of the lecithin molecule. From 2.0 to 3.0 CEC, lecithin expanded the bentonite basal spacing d_{001} -value up to nearly 5.52 nm, which hold an interlayer space of 4.56 nm (after subtraction of the TOT layer thickness value of 0.96 nm). These results indicated that the lecithin molecule adopt a different conformation in the interlayer space (Fig. 4.8). In regards to the length of one PC molecule (about 3 nm), we can imagine that PC molecules are in an upright position in the interlayer space. In addition, when the lecithin concentration is increased from 2.0 to 3.0 CEC, the 001 reflections turn to be

much sharper and intensity become much higher, which suggested that the lecithin molecules arrangement in the clay layers were more ordered.

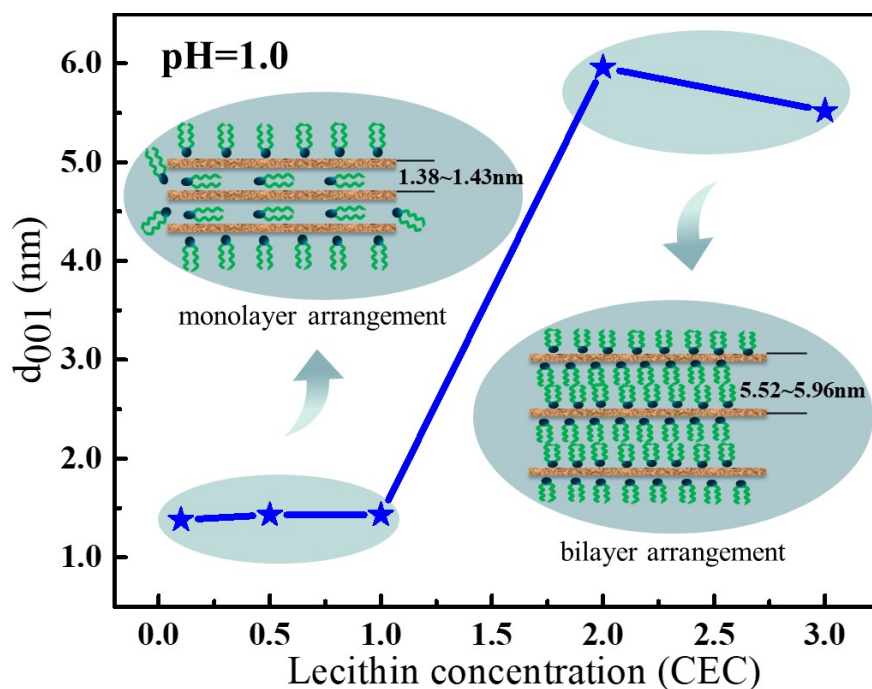

Fig. 4.8 Schematic diagram of the lecithin arrangement in the interlayer space at different concentration

The peaks that appeared in the FTIR spectra (Fig. 4.7b) were consistent with the ones detailed in the previous section (i.e., the effect of reaction temperature). The absorption peak intensity of samples increased as a function of the lecithin concentration, indicating that more lecithin was adsorbed onto the clay surface and intercalated into the interlayer of bentonite.

For organic bentonite modified with 0.5, 1.0, 2.0CEC, the elemental composition of the samples was determined by XRF analysis, obtaining data in Table 4.4. The raw bentonite had alumina and silica as the major species, at 22.9% and 65.1% by weight, respectively. Na^+ and Ca^{2+} are the main exchangeable cation of bentonite. It was found that P_2O_5 were present in organic bentonite at 3.59% (0.5CEC), 6.17% (1.0CEC) and 11.4% (2.0CEC), respectively. This implies that the intercalation of lecithin molecules was

successful. In addition, the experimental results suggest obvious decreases in the cations content of the interlayer (Na^+ , Ca^{2+}), which confirms that cation exchange and replacement are the mechanisms of action in the modification process.

Table 4.4 Chemical composition of raw bentonite and organic bentonite measured by XRF

lecithin concentration /CEC	chemical composition (mass%)								
	Na ₂ O	MgO	CaO	K ₂ O	Al ₂ O ₃	SiO ₂	Fe ₂ O ₃	P ₂ O ₅	other
0 (raw bentonite)	2.56	2.84	1.23	0.32	22.9	65.1	4.22	0.06	0.77
0.5	0.31	2.32	0.42	0.30	23.1	64.9	4.74	3.59	0.24
1.0	0.21	2.51	0.29	0.24	22.7	63.6	4.04	6.17	0.26
2.0	0.15	2.30	0.32	0.24	21.3	60.1	3.97	11.4	0.24

For a better understanding of the morphology of organoclays, TEM micrographs of raw bentonite and the obtained organoclays are presented in Fig. 4.9. The micrograph of raw bentonite suggested that the untreated bentonite is mainly composed of a layered structure with a d_{001} -value measured=1.2 nm, in good agreement with the value obtained by XRD analysis. The second micrograph of organoclay modified with 1.0CEC lecithin clearly displayed an increase in the interlayer spacing compared to raw bentonite. Finally, for organic bentonite modified with 2.0CEC lecithin, basal spacing is observed at 5.8 nm, slightly smaller than the XRD measured d_{001} -value of 5.96 nm. Indeed, XRD results corresponds to an average value while TEM measurements are based on individual layers.

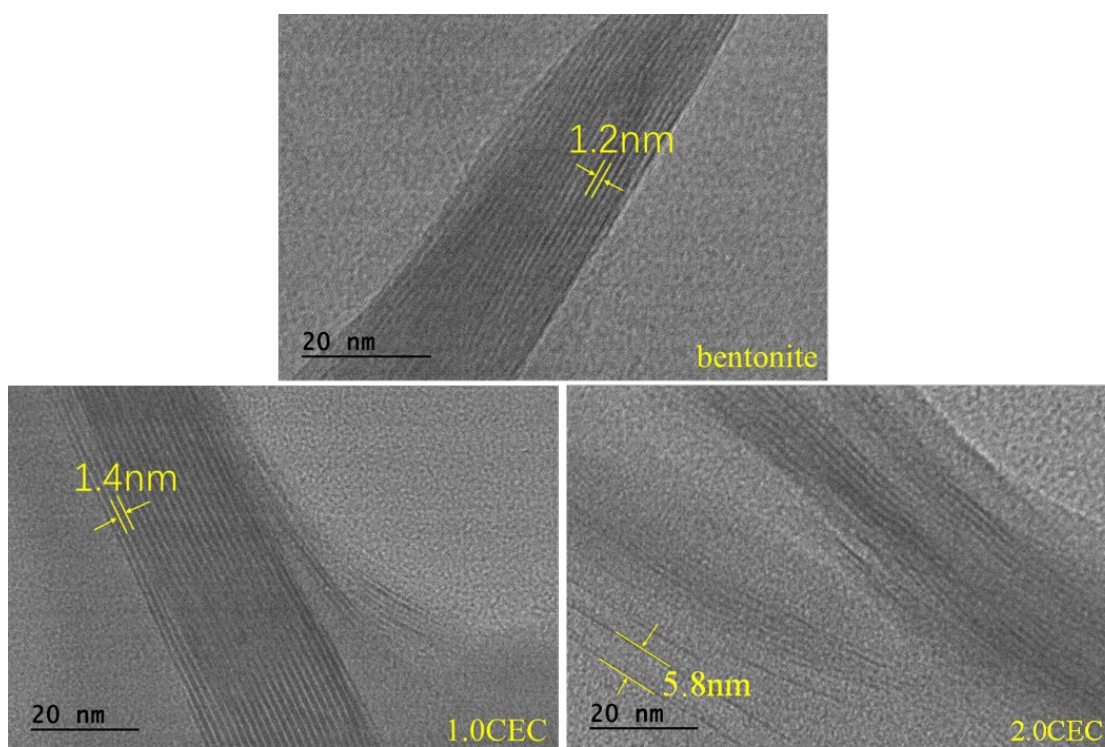

Fig. 4.9 TEM micrographs of raw bentonite and organoclays modified with lecithin at different lecithin concentration

TG and DTG results are presented in Fig. 4.10 and Table 4.5. The mass loss between 150°C and 450°C goes from 4.0% to 43.5% when the lecithin concentration is between 0.1 and 3.0CEC. For bentonite modified with 0.1CEC, the first degradation peak was observed at around 59°C, with a 6.7% mass loss assigned to the evaporation of the adsorbed water. When the temperature was between 150 and 450°C, the sample exhibited only one degradation peaks at 255°C, which can be attributed to the decomposition of intercalated lecithin molecules. The thermal decomposition stages for the 0.5CEC sample are similar to those for the 1.0CEC and 2.0CEC sample with DTG peaks (Fig. 4.10b). But when the temperature varied between 150 and 450°C, the degradation temperature of samples shifted to a higher temperature with the lecithin concentration increased, which displays a further enhancement in the thermal stability. With the increase in surfactant concentration, a new endothermic peak appeared at ~456°C for 3.0CEC. This step could

be ascribed to the presence of triglycerides and other impurity, which is consistent with the already published literature (Ouellet-Plamondon et al., 2014).

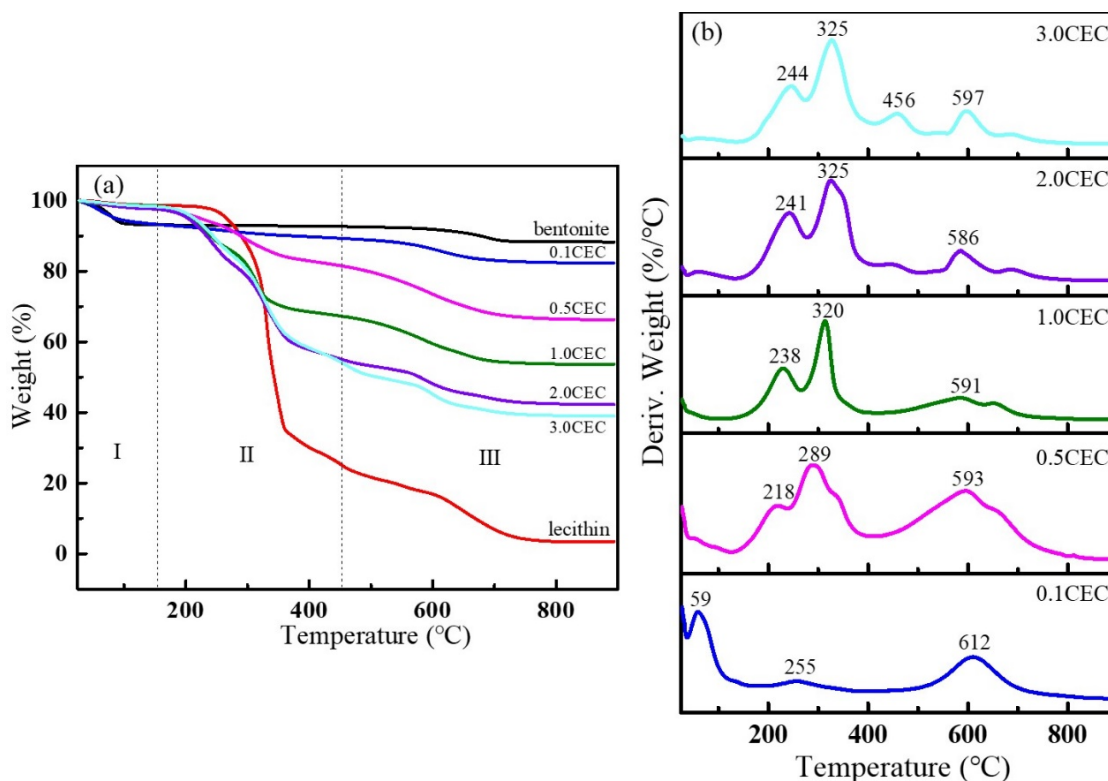

Fig. 4.10 The TG (a) and DTG (b) curves of modified bentonite at different lecithin concentration

Table 4.5 TG results of modified bentonite at different lecithin concentration

lecithin concentration /CEC	adsorbed water dehydration	lecithin decomposition	silicate dehydroxylation	loading amount of lecithin (CEC)
	mass loss in ambient~150°C (%)	mass loss in 150~450°C (%)	mass loss in 450~900°C (%)	
0.1	6.7	4.0	6.9	0.05
0.5	2.2	16.3	15.3	0.22
1.0	1.5	31.4	14.0	0.50
2.0	2.0	41.7	13.9	0.79
3.0	1.7	43.5	14.7	0.85

4.3.5 Molecular dynamics results

In order to have a deeper understanding of the physiochemical processes of organic matter and clay minerals at the microscopic level, classical molecular dynamics (MD) simulations have been proven to be an effective method to obtain structural information among the constituents (Kovář et al., 2010). We have modelled the system at pH=1.0, 60°C and when a PC concentration regarding the 2.0CEC was added.

Five molecular dynamics simulations (MD) of 10 ns were performed on a small slab of montmorillonite, composed of $9 \times 9 \times 2$ (x, y, z) unit cells. At first all PC molecules are added directly inside the interlayer space of the clay randomly, the exact number is related to the experimental loading amount measured.

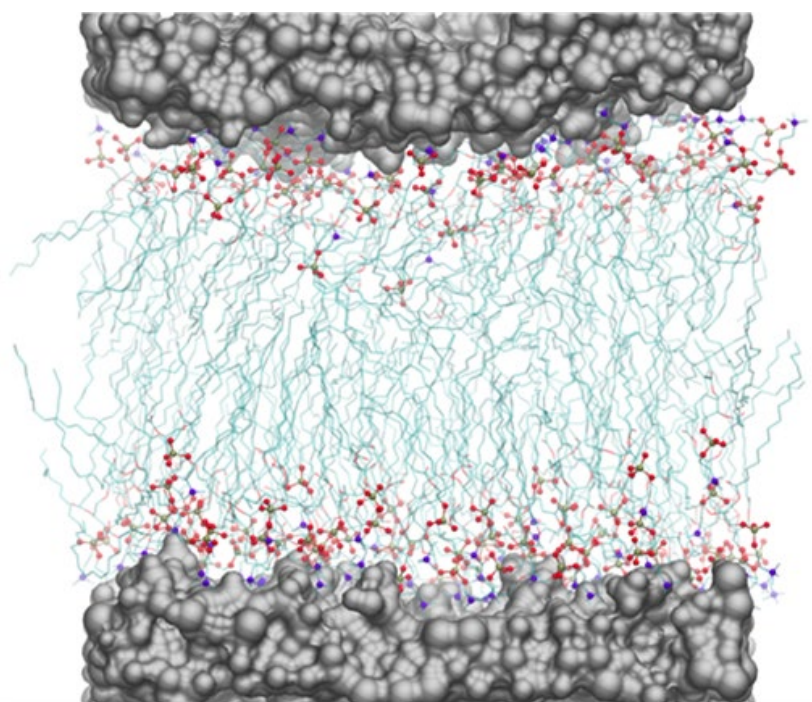

Fig. 4.11 Snapshot of the last step of the MD3. The N and PO4 group of the PC molecules are highlighted using ball representation. The montmorillonite surface is represented by a gray surface with a probe radius of 1 Å.

The color code used is the following: blue N, red O, gold P, and green C

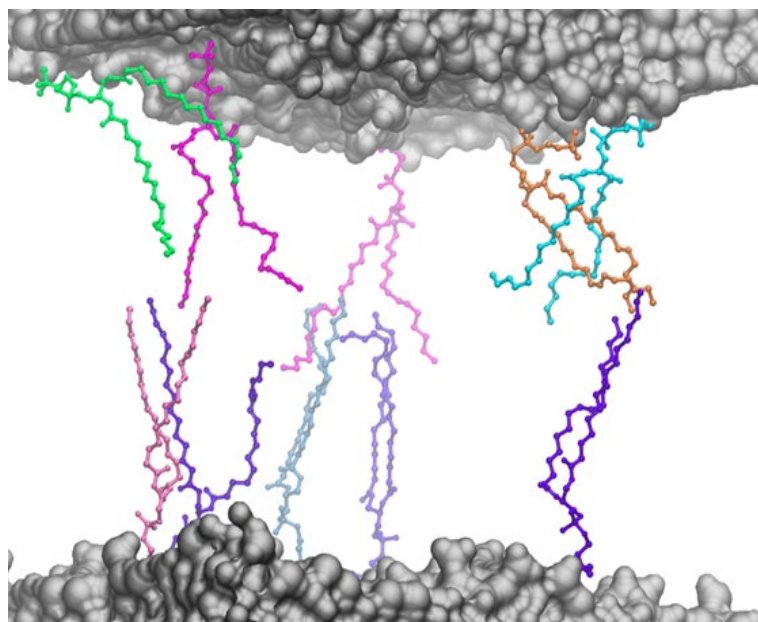

Fig. 4.12 Representative orientation of selected PC in the interlayer space from MD3. The montmorillonite surface is represented by a gray surface with a probe radius of 1 Å. Each PC is represented with a different color

Table 4.6 Computed d_{001} at the last step of the related MD and percentage of N (from amine) or OH (from phosphate) of the PC molecules in interaction with the surface at a distance of 0.68 nm

MD number	1	2	3	4	5
Computed d_{001} (in nm)	6.214	6.14	6.029	6.02	6.33
%N (amine) in interaction with the surface	94%	91%	91%	92%	92%
%OH (phosphate) in interaction with the surface	69%	63%	66%	62%	66%

From these dynamics results, we can draw some conclusions (Fig. 4.11). Firstly, we will discuss about the PC absorption. We have observed that the PC auto-organized themselves quickly, even before the MD production. The amine head points in the direction of the T layer of the montmorillonite. However, it is often not directly in interaction with this one, but in most cases, involved in a hydrogen bond network with a water molecule in between the clay structure and the PC. The second type of interaction

comes from the OH group of the phosphate which is protonated at pH=1.0. It is either directly bonded to the oxygen atom of the T sheet of the montmorillonite or through a water molecule. In Table 4.6, we have printed the percentage of nitrogen (from the amine group) or O (from the OH group of the phosphate) in interaction with the surface i.e. below 0.68 nm. This distance corresponds to the sum of the Van der Waals radius of either the amine group, a water molecule and an oxygen of the silicate or the OH group of the phosphate, a water molecule and an oxygen of the silicate. For all MDs more than 90% of the lecithin molecules are in interaction with the surface. However, some of them do not interact at all and instead in interaction with other PC. Finally, once the PC is in interaction with the montmorillonite, no major displacements are observed during the MD. This tends to validate the experimental observations where the PC is strongly absorbed in the interlayer space at 60°C.

Let's now focus in the orientation of the PC tails in the interlayer space. The PC molecule optimized in vacuo using DFT calculations has a length of 3 nm (from a carbon of the amine group to the last carbon of the tail). In comparison to the maximum interlayer space measured (4.56 nm when removing the TOT distance), 2 PC molecules cannot fit inside the interlayer space without some bending. In the Fig. 4.12, we have represented several possible organizations of the PC molecules. They can adopt a lot of different conformation, some are nearly linear while others are heavily bended. On top of this, several PC (green, orange in Fig. 4.12) interact with the surface with both amine and phosphate groups but also with the oxygen atoms of the linear chains. In the end, the disposition of PC molecules is relatively random, maybe due to the short time of the simulation.

Finally, we also analyzed the distance of the interlayer space during the MD. As written before the PC tends to self-organized very quickly, and after 4 ns the stable regime is observed regarding the total energy of the system. For each MD, the relative distance of the interlayer space is reported in Table 4.2 and taken from the last step of the simulation. It is difficult to give a precise number as the TOT layers of the

montmorillonite are slightly altered by the MD due to not being constrained. In any case, for the 5 MDs the computed d_{001} distance reproduced accurately the measured one with a maximum deviation of 6 %. One of the reasons could be that we have added too many PC molecules in the interlayer space. As written before 5% to 10% of PC molecules are not in interaction with the clay, and instead are freely moving in the interlayer space, disrupting the local order.

4.4 Conclusions

In this study, a series of organo-bentonites were synthesized by using natural soybean lecithin at different experimental conditions. The effects of reaction temperature, time, pH, and lecithin concentration on the properties of modified bentonite were analyzed. The results of FTIR, XRD, TG and molecular dynamic simulations support the intercalation of lecithin in the interlayer space of montmorillonite. The characterization results demonstrate that the intercalation behavior of lecithin can be completed in a short time (0.5h). Lecithin concentration and pH greatly influence the structural characteristic of modified bentonite. In general, the basal spacing of the organo-bentonite has a positive correlation with lecithin concentration and pH. In the case of pH=1.0, the interlayer spacing of modified bentonite increases with the lecithin concentration and the surfactants exhibit different arrangements among the bentonite layers. Lecithin adopts a lateral monolayer arrangement at low concentrations (0.1~1.0CEC) in contrary to a bilayer at high concentrations (2.0~3.0CEC). Regarding the effect of the pH, the samples of organic bentonite samples prepared at $\text{pH} \geq 3.0$ had significantly higher d_{001} -values due to changes in the properties of lecithin. For example, when the pH shifts from 1.0 to 3.0, the interlayer spacing of organoclay was increased from 1.43 to 5.19 nm, which is of great significance for the preparation of low-cost organic bentonite for industrial applications. These results demonstrate that the modified bentonite with lecithin have quite different structural properties, and they may have special applications in the industrial fields.

References

- Abraham, M.J., Murtola, T., Schulz, R., Páll, S., Smith, J.C., Hess, B., Lindahl, E., 2015. GROMACS: High performance molecular simulations through multi-level parallelism from laptops to supercomputers. *SoftwareX* 1, 19-25.
- Becke, A.D., Johnson, E.R., 2005. A density-functional model of the dispersion interaction. *The Journal of Chemical Physics* 123, 154101.
- Beeke, A.D., 1993. Density-functional thermochemistry. III. The role of exact exchange. *J. Chem. Phys* 98, 5648-5646.
- Biswas, B., Warr, L.N., Hilder, E.F., Goswami, N., Rahman, M.M., Churchman, J.G., Vasilev, K., Pan, G., Naidu, R., 2019. Biocompatible functionalisation of nanoclays for improved environmental remediation. *Chemical Society Reviews* 48, 3740-3770.
- Bot, F., Cossuta, D., O'Mahony, J.A., 2021. Inter-relationships between composition, physicochemical properties and functionality of lecithin ingredients. *Trends in Food Science & Technology* 111, 261-270.
- Bussi, G., Donadio, D., Parrinello, M., 2007. Canonical sampling through velocity rescaling. *The Journal of chemical physics* 126, 014101.
- Churchman, G.J., Gates, W.P., Theng, B.K.G., Yuan, G., 2006. Chapter 11.1 Clays and Clay Minerals for Pollution Control, in: Bergaya, F., Theng, B.K.G., Lagaly, G. (Eds.), *Developments in Clay Science*. Elsevier, pp. 625-675.
- Corcione, C.E., Frigione, M., 2012. Characterization of nanocomposites by thermal analysis. *Materials* 5, 2960-2980.
- Cui, L., Decker, E.A., 2016. Phospholipids in foods: prooxidants or antioxidants? *Journal of the Science of Food and Agriculture* 96, 18-31.
- Cygan, R.T., Greathouse, J.A., Kalinichev, A.G., 2021. Advances in Clayff Molecular Simulation of Layered and Nanoporous Materials and Their Aqueous Interfaces. *The Journal of Physical Chemistry C* 125, 17573-17589.
- Cygan, R.T., Liang, J.-J., Kalinichev, A.G., 2004. Molecular Models of Hydroxide, Oxyhydroxide, and Clay Phases and the Development of a General Force Field. *The Journal of Physical Chemistry B* 108, 1255-1266.
- Darden, T., York, D., Pedersen, L., 1993. Particle mesh Ewald: An $N \cdot \log(N)$ method for Ewald sums in large systems. *The Journal of chemical physics* 98, 10089-10092.
- Dening, T.J., Rao, S., Thomas, N., Prestidge, C.A., 2017. Montmorillonite-lipid hybrid carriers for ionizable and neutral poorly water-soluble drugs: Formulation, characterization and in vitro lipolysis studies. *International Journal of Pharmaceutics* 526, 95-105.
- Gournis, D., Lappas, A., Karakassides, M.A., Töbrens, D., Moukarika, A., 2008. A

neutron diffraction study of alkali cation migration in montmorillonites. *Physics and Chemistry of Minerals* 35, 49-58.

Helmich-Paris, B., de Souza, B., Neese, F., Izsák, R., 2021. An improved chain of spheres for exchange algorithm. *The Journal of Chemical Physics* 155, 104109.

Hess, B., Bekker, H., Berendsen, H.J.C., Fraaije, J.G.E.M., 1997. LINCS: A linear constraint solver for molecular simulations. *Journal of computational chemistry* 18, 1463-1472.

Khalaf, A.I., Hegazy, M.A., El-Nashar, D.E., 2017. Synthesis and characterization of cationic gemini surfactant modified Na-bentonite and its applications for rubber nanocomposites. *Polymer composites* 38, 396-403.

Kovář, P., Pospíšil, M., Káfuňková, E., Lang, K., Kovanda, F., 2010. Mg-Al layered double hydroxide intercalated with porphyrin anions: molecular simulations and experiments. *Journal of molecular modeling* 16, 223-233.

Le, N.T., Cao, V.D., Nguyen, T.N., Le, T.T., Tran, T.T., Hoang Thi, T.T., 2019. Soy Lecithin-Derived Liposomal Delivery Systems: Surface Modification and Current Applications, *International Journal of Molecular Sciences*.

Li, S., Mu, B., Wang, X., Wang, A., 2021. Recent researches on natural pigments stabilized by clay minerals: A review. *Dyes and Pigments* 190, 109322.

Li, Z., Jiang, W.-T., Hong, H., 2008. An FTIR investigation of hexadecyltrimethylammonium intercalation into rectorite. *Spectrochimica Acta Part A: Molecular and Biomolecular Spectroscopy* 71, 1525-1534.

Liu, S., Wu, P., Yu, L., Li, L., Gong, B., Zhu, N., Dang, Z., Yang, C., 2017. Preparation and characterization of organo-vermiculite based on phosphatidylcholine and adsorption of two typical antibiotics. *Applied Clay Science* 137, 160-167.

Makhoukhi, B., Villemin, D., Didi, M.A., 2013. Preparation, characterization and thermal stability of bentonite modified with bis-imidazolium salts. *Materials Chemistry and Physics* 138, 199-203.

Merino, D., Ollier, R., Lanfranconi, M., Alvarez, V., 2016. Preparation and characterization of soy lecithin-modified bentonites. *Applied Clay Science* 127-128, 17-22.

Nagy, K., Bíró, G., Berkesi, O., Benczédi, D., Ouali, L., Dékány, I., 2013. Intercalation of lecithins for preparation of layered nanohybrid materials and adsorption of limonene. *Applied clay science* 72, 155-162.

Nzai, J.M., Proctor, A., 1998. Determination of phospholipids in vegetable oil by Fourier transform infrared spectroscopy. *Journal of the American Oil Chemists' Society* 75, 1281-1289.

Ogawa, S., Decker, E.A., McClements, D.J., 2004. Production and characterization of o/w emulsions containing droplets stabilized by lecithin-chitosan-pectin multilayered

- membranes. *Journal of agricultural and food chemistry* 52, 3595-3600.
- Ouellet-Plamondon, C.M., Stasiak, J., Al-Tabbaa, A., 2014. The effect of cationic, non-ionic and amphiphilic surfactants on the intercalation of bentonite. *Colloids and Surfaces A: Physicochemical and Engineering Aspects* 444, 330-337.
- Park, Y., Ayoko, G.A., Horváth, E., Kurdi, R., Kristof, J., Frost, R.L., 2013. Structural characterisation and environmental application of organoclays for the removal of phenolic compounds. *Journal of colloid and interface science* 393, 319-334.
- Parrinello, M., Rahman, A., 1981. Polymorphic transitions in single crystals: A new molecular dynamics method. *Journal of Applied physics* 52, 7182-7190.
- Pereira, F.A., Sousa, K.S., Cavalcanti, G.R., França, D.B., Queiroga, L.N., Santos, I.M., Fonseca, M.G., Jaber, M., 2017. Green biosorbents based on chitosan-montmorillonite beads for anionic dye removal. *Journal of Environmental Chemical Engineering* 5, 3309-3318.
- Ruiz-Hitzky, E., Darder, M., Wicklein, B., Castro-Smirnov, F.A., Aranda, P., 2019. CLAY-BASED BIOHYBRID MATERIALS FOR BIOMEDICAL AND PHARMACEUTICAL APPLICATIONS. *Clays and Clay Minerals* 67, 44-58.
- Silva, I.A., Sousa, F.K.A., Menezes, R.R., Neves, G.A., Santana, L.N.L., Ferreira, H.C., 2014. Modification of bentonites with nonionic surfactants for use in organic-based drilling fluids. *Applied Clay Science* 95, 371-377.
- Songurtekin, D., Yalcinkaya, E.E., Ag, D., Seleci, M., Demirkol, D.O., Timur, S., 2013. Histidine modified montmorillonite: Laccase immobilization and application to flow injection analysis of phenols. *Applied Clay Science* 86, 64-69.
- Stephens, P.J., Devlin, F.J., Chabalowski, C.F., Frisch, M.J., 1994. Ab initio calculation of vibrational absorption and circular dichroism spectra using density functional force fields. *The Journal of physical chemistry* 98, 11623-11627.
- Trigueiro, P., Pedetti, S., Rigaud, B., Balme, S., Janot, J.-M., Dos Santos, I.M., Gougeon, R., Fonseca, M.G., Georgelin, T., Jaber, M., 2018. Going through the wine fining: Intimate dialogue between organics and clays. *Colloids and surfaces B: biointerfaces* 166, 79-88.
- Wang, J., Wolf, R.M., Caldwell, J.W., Kollman, P.A., Case, D.A., 2004. Development and testing of a general amber force field. *Journal of Computational Chemistry* 25, 1157-1174.
- Weigend, F., Ahlrichs, R., 2005. Balanced basis sets of split valence, triple zeta valence and quadruple zeta valence quality for H to Rn: Design and assessment of accuracy. *Physical Chemistry Chemical Physics* 7, 3297-3305.
- Wicklein, B., Darder, M., Aranda, P., Ruiz-Hitzky, E., 2010. Bio-organoclays based on phospholipids as immobilization hosts for biological species. *Langmuir* 26, 5217-5225.
- Xavier, K.C., Santos, M.S., Osajima, J.A., Luz, A.B., Fonseca, M.G., Silva Filho, E.C., 2016. Thermally activated palygorskites as agents to clarify soybean oil. *Applied Clay*

Science 119, 338-347.

Xi, Y., Martens, W., He, H., Frost, R.L., 2005. Thermogravimetric analysis of organoclays intercalated with the surfactant octadecyltrimethylammonium bromide. *Journal of thermal analysis and calorimetry* 81, 91-97.

Xie, W., Gao, Z., Pan, W.-P., Hunter, D., Singh, A., Vaia, R., 2001. Thermal degradation chemistry of alkyl quaternary ammonium montmorillonite. *Chemistry of materials* 13, 2979-2990.

Xue, W., He, H., Zhu, J., Yuan, P., 2007. FTIR investigation of CTAB–Al–montmorillonite complexes. *Spectrochimica Acta Part A: Molecular and Biomolecular Spectroscopy* 67, 1030-1036.

Zhang, Y., Zhao, Y., Zhu, Y., Wu, H., Wang, H., Lu, W., 2012. Adsorption of mixed cationic-nonionic surfactant and its effect on bentonite structure. *Journal of Environmental Sciences* 24, 1525-1532.

Zhou, D., Zhang, Z., Tang, J., Wang, F., Liao, L., 2016. Applied properties of oil-based drilling fluids with montmorillonites modified by cationic and anionic surfactants. *Applied Clay Science* 121-122, 1-8.

Zhu, J., Qing, Y., Wang, T., Zhu, R., Wei, J., Tao, Q., Yuan, P., He, H., 2011. Preparation and characterization of zwitterionic surfactant-modified montmorillonites. *Journal of colloid and interface science* 360, 386-392.

Zhu, J., Zhang, P., Qing, Y., Wen, K., Su, X., Ma, L., Wei, J., Liu, H., He, H., Xi, Y., 2017. Novel intercalation mechanism of zwitterionic surfactant modified montmorillonites. *Applied Clay Science* 141, 265-271.

Zhuang, G., Zhang, Z., Fu, M., Ye, X., Liao, L., 2015. Comparative study on the use of cationic–nonionic-organo-montmorillonite in oil-based drilling fluids. *Applied Clay Science* 116-117, 257-262.

Zhuang, G., Zhang, Z., Jaber, M., 2019. Organoclays used as colloidal and rheological additives in oil-based drilling fluids: An overview. *Applied Clay Science* 177, 63-81.

Chapter 5

**pH dependence and
intercalation mechanism of
lecithin-modified bentonite**

5.1 Introduction

Modification of clay minerals by organic molecules can improve the affinity of natural clay minerals toward non-hydrophilic substances and are of industrial importance in diverse industries including oil-based drilling fluid, paint, grease, ink, cosmetics, environmental clean-up, polymer nanocomposites and pharmaceuticals (Zhuang et al., 2019b; Guo et al., 2020; Al Kausor et al., 2022). Organic modification is typically achieved through cation exchange reactions in a solution, involving the substitution of interlayer cations with positively charged organic molecules. Historically, quaternary ammonium salts in aqueous solutions have been commonly used for this purpose (Shah et al., 2013; Yang et al., 2019).

Since the first introduction of organoclays by (Jordan, 1949), the reaction mechanism of clay minerals with organic compounds has been the subject of many studies. Nowadays cationic, anionic, zwitterionic, nonionic and polymeric surfactants are often selected as candidates to modify clay minerals. Organic modification is generally driven by multiple interactions: van der Waals forces, cation exchange, electrostatic interaction, hydrogen bonds, and ion–dipole interactions (Guo et al., 2020). Inspired by numerous previous research (Vazquez et al., 2008; Zhu et al., 2019), the modification mechanism of cationic surfactants on clay minerals is the cation exchange. Due to the electrostatic repulsion between the negatively charged clay layers and the negatively charged head of anionic surfactants, some researchers believed that anions could not intercalate effectively into the clay interlayer space (Zheng et al., 2013b; Sanqin et al., 2014). However, (Yu et al., 2018) proposed different viewpoints based on experimental results. Anionic surfactant can intercalate into the montmorillonite interlayer space by interacting with hydroxyl groups at the edges of Mt layer. Moreover, considering the general toxicity of organoclays modified by cationic and anionic surfactants, researchers have attempted to enhance biocompatibility with zwitterion-modified clays. Zwitterionic surfactants contain both a cationic hydrophobic group and an anionic hydrophilic group. There are two scientific

views on the reaction mechanism for modifying clays with zwitterionic surfactants. Some suggested that zwitterions can intercalate into interlayer space by cation exchange (Zhu et al., 2011), while others argued that ion–dipole interactions are key (De Oliveira et al., 2018; Meng et al., 2018). As for nonionic surfactants, there are no intercalating force at all between surfactant molecules and clay minerals (Zhu et al., 2017).

As discussed in Chapter 4, a comprehensive investigation was conducted to study the impact of various reaction conditions on the physicochemical properties of lecithin-modified bentonite. These conditions encompassed reaction time, temperature, concentration, with particular emphasis on pH. It is possible to identify significant differences in the properties of lecithin-modified bentonite samples prepared under various pH conditions. However, only limited information is currently available on the interlayer structure and properties of lecithin-modified clays, the interaction mechanism of clay modified with lecithin in acidic and alkaline media is still not understood. The purpose of the present investigation is to study the intercalation mechanism of lecithin into the interlayer space of bentonite and provide a deeper insight into the properties, structures and potential applications. A series of organic bentonites with different lecithin loadings were synthesized at different pH, and the physicochemical properties and element content of lecithin-modified bentonite were analyzed. Accordingly, the possible mechanism of this modification process has been proposed.

5.2 Methods

The preparation of lecithin-modified bentonite at different pH conditions was performed using the following procedure:

2 g of bentonite was dispersed in 100 mL of distilled water and stirred for 16 h. An amount of lecithin surfactant to yield the desired concentration was dissolved in 100 mL ethanol and stirred for 2 h. The amount of lecithin added was equivalent to 0.2, 0.5, 1.0, 2.0, 4.0, and 5.0 times the CEC of bentonite. Next, the lecithin solution was slowly added to the bentonite dispersion and then HCl was added dropwise to confirm that the pH of

the mixture solution was 1.0 and 9.0, respectively. The mixture suspension was sonicated 5 min and stirred 2 h at 60°C, and then the suspension was centrifuged, washed, and the resulting precipitate was dried in an oven at 60°C for 48h. The samples prepared from raw bentonite by adding 1.0 CEC of lecithin surfactant in acidic (pH=1.0) and alkaline (pH=9.0) solution were denoted as Bt-pH1-1.0CEC and Bt-pH9-1.0CEC, respectively. Bt-pH1 referred to all samples prepared at pH=1.0 and Bt-pH9 for the ones prepared at pH=9.0.

5.3 Results and discussion

5.3.1 XRD analysis

The XRD patterns of raw bentonite and organic bentonite prepared with lecithin (0.2 to 5.0 CEC) under pH=1.0 and pH=9.0 are shown in Fig. 5.1. The raw bentonite exhibited a reflection at $2\theta=7.28^\circ$ with a d_{001} -value of 1.21 nm.

The experiments performed in an acidic medium at pH=1.0 are discussed first. At a concentration of 0.2CEC, the d_{001} -value of 1.41 nm for Bt-pH1-0.2CEC was larger than the one recorded for the raw bentonite, indicating that the lecithin molecules were successfully introduced into the interlayer space. The lecithin intercalation increased the interlayer space by 0.2 nm for Bt-pH1-0.2CEC. Notably, a broad shoulder at $2\theta=2^\circ$ was observed in the XRD patterns of Bt-pH1-0.2CEC and Bt-pH1-0.5CEC, which may indicate the formation of partially exfoliated/intercalated structures. When the amount of lecithin was increased to 1.0CEC, the d_{001} -value of organic bentonite did not change. At a dosage of 2.0CEC, the d_{001} -value of 6.30 nm for Bt-pH1-2.0CEC was recorded together with a weak second reflection near 2.81 nm. The d_{001} -values for Bt-pH1-4.0CEC and Bt-pH1-5.0CEC were 5.55 and 6.08 nm, respectively. In summary, for the Bt-pH1, the intercalation of lecithin at 0.2~1.0 CEC did not change the diffraction reflection intensities and the d_{001} -values of organic bentonite, while for lecithin dosages in excess of 2.0CEC, a significant increase in d_{001} -value was observed. This fluctuation in basal

spacing is caused by the different conformations and arrangements adopted by lecithin molecules in the bentonite interlayer.

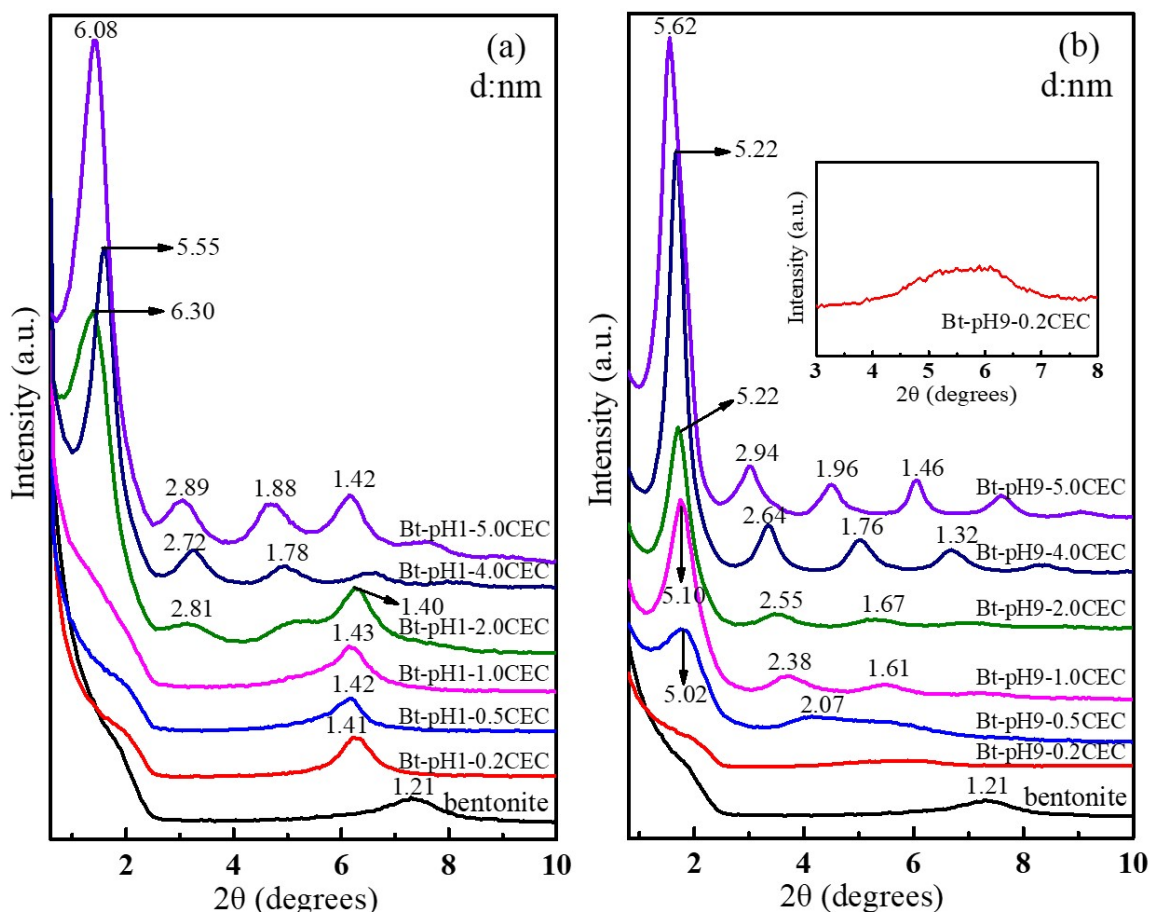

Fig. 5.1 XRD patterns of raw bentonite and prepared organic bentonite with different lecithin concentration at pH=1.0 (a) and pH=9.0 (b)

Secondly, the d_{001} -values of organic bentonite prepared in alkaline (pH=9.0) conditions were investigated. The measured d_{001} -values of Bt-pH9 were clearly different from those of Bt-pH1 samples. In the case of Bt-pH9-0.2CEC, the XRD pattern showed a shoulder within the scope of 4.7–6.8°. The d_{001} -values were about 5.02, and 5.10 nm after intercalation with 0.5 and 1.0 CEC lecithin, respectively. As the concentration of added lecithin molecules increases, the basal spacing of the organic bentonite lightly increases. For lecithin dosages in 2.0, 4.0 and 5.0CEC, the d_{001} -value reached 5.22, 5.22 and 5.62 nm, respectively. (Nagy et al., 2013) found that lecithin molecules have a basal

spacing of 3.2 nm when intercalated into interlayer space with an upright position. Combined with the experimental results of this study, it is suggested that lecithin has the potential to adopt a paraffin-type-bilayer configuration in the interlayer space and exhibits a tilted orientation relative to the layer plane. Furthermore, Bt-pH9 samples clearly presented much sharper reflections with increasing surfactant dosage, which indicated that the arrangement of the lecithin in the bentonite interlayer was more ordered (Zhu et al., 2011).

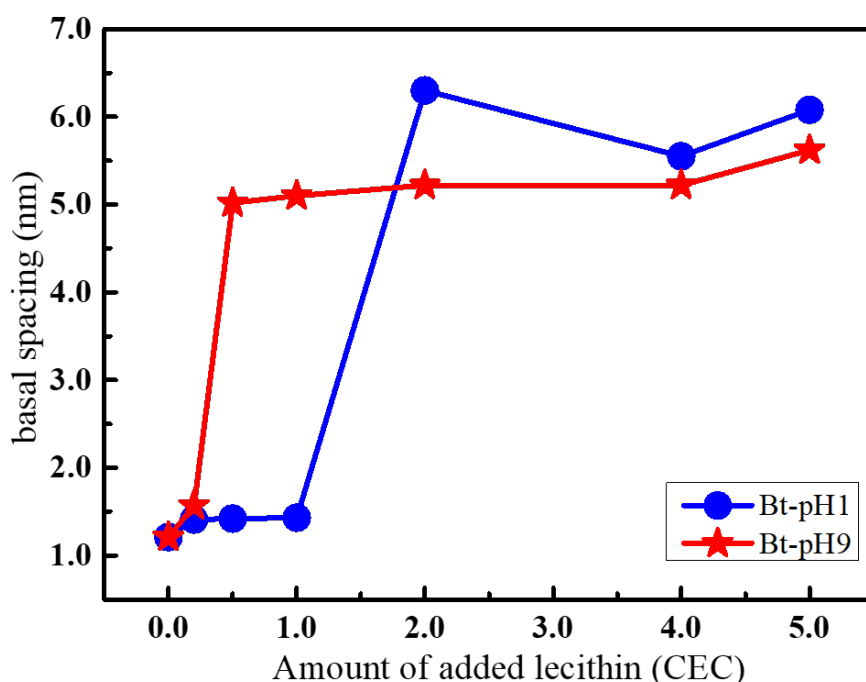

Fig. 5.2 The d_{001} -value of organic bentonite changes with the increase of surfactant loading under different pH conditions

The amount of loaded surfactant as well as the pH value significantly affect the basal spacing of the resulting organic bentonite pattern. Fig. 5.2 showed that the d_{001} -value increased with the increase of the amount of loaded surfactant. However, pH appears to have a more pronounced impact on the basal spacing of organoclays. When the loaded surfactant concentration was low (0.2~1.0 CEC), the basal spacing of Bt-pH1 displayed minimal variation with increasing lecithin concentration, maintaining a value of around

1.42 nm. On the other hand, the basal spacing of Bt-pH9 exhibited a significant increase from 1.21 to 5.1 nm. The Bt-pH9 samples can achieve a large basal spacing at lower concentration (e.g., 0.5CEC), which holds significant importance for producing cost-effective organic clay suitable for various industrial applications. The increase in the d_{001} value of Bt-pH9 became limited when the lecithin concentration exceeded 2.0 CEC, whereas Bt-pH1 experienced a substantial increase from 1.43 to 6.08 nm.

5.3.2 TEM analysis

For a better understanding of the interlayer organization of organoclays, TEM micrographs of raw bentonite and the obtained organoclays are presented in Fig. 5.3. TEM micrographs demonstrated that pH and lecithin concentration have a significant effect on the intercalation process. The raw bentonite image (Fig. 5.3a) suggested that the untreated bentonite is mainly composed of a layered structure with a d_{001} -value of 1.2 nm. The partial intercalation behavior of Bt-pH1-0.2CEC and Bt-pH9-0.2CEC can be clearly seen (Fig. 5.3b, 5.3e), which corresponds to the shoulder of the XRD results. For Bt-pH1-1.0CEC, there was a limited increase in the basal spacing of the organic bentonite (from 1.2 to 1.4 nm), whereas there was a significant increase in the basal spacing for Bt-pH9-1.0CEC (from 1.2 to 5.2 nm). This result reflects the fact that various surfactant arrangements (e.g., monolayer, bilayer, and paraffin bilayer) may be employed at different pH conditions even with constant lecithin concentration. With the increase of surfactant loading, the basal spacing of Bt-pH9-2.0CEC is basically unchanged compared with Bt-pH9-1.0CEC, indicating that lecithin molecules were saturated in the interlayer space and the excess of molecules probably adsorbed on the surface. For Bt-pH1-2.0CEC, both XRD and TEM results showed that the basal spacing expanded from 1.4 to 6.2 nm, suggesting a change in molecular arrangement conformation. The interlayer spacing measured by TEM for samples are in good agreement with the XRD data.

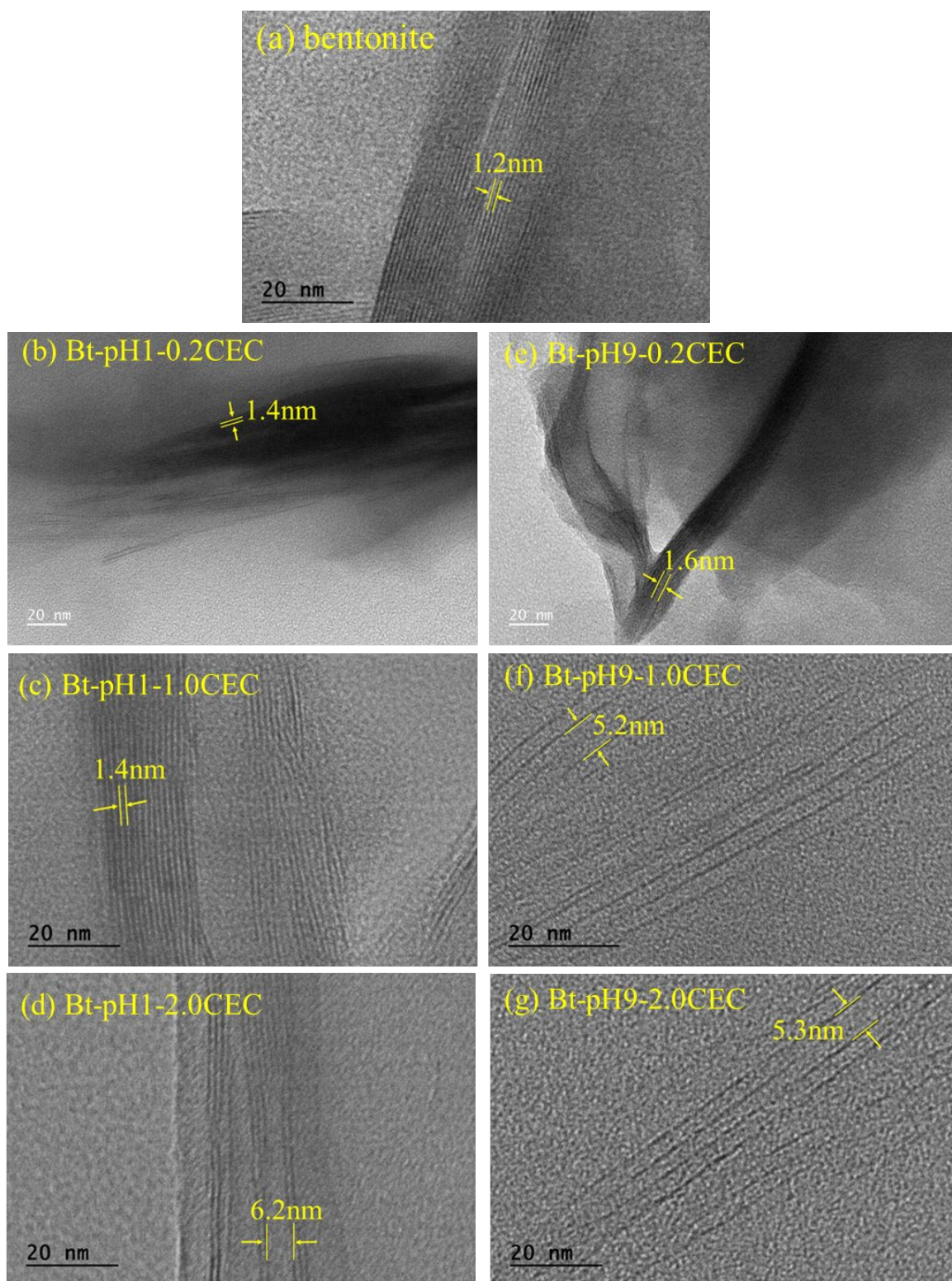

Fig. 5.3 TEM micrographs of raw bentonite (a) and prepared organic bentonite with different lecithin concentration at pH=1.0 (b, c, d) and pH=9.0 (e, f, g)

5.3.3 Chemical composition analysis

The XRF results show that the major components of bentonite are SiO_2 , Al_2O_3 , Na_2O and CaO , Na^+ and Ca^{2+} are the main exchangeable cations in the raw bentonite interlayer. In general, organic substances can replace the cations in order to prepare the organic bentonite. This conclusion has been confirmed by many studies (Morais et al.; Araujo et al., 2011; Tohdee and Kaewsichan, 2018). However, according to XRF results, significant differences in the content of cations in organic bentonite prepared under acidic ($\text{pH}=1.0$) and alkaline ($\text{pH}=9.0$) environments were observed, suggesting that there would be different intercalation mechanisms and behaviors of lecithin (Fig. 5.4). The content of Na^+ and Ca^{2+} were measured and the ratio of interlayer cations to the Al and Si content of bentonite calculated as a criterion to monitor whether Na^+ and Ca^{2+} were replaced or not (Zhu et al., 2017). A significant decrease in cation content can be observed for the organic bentonite at $\text{pH}=1.0$ only. The Na^+ and Ca^{2+} ion contents of the raw bentonite were 2.6% and 1.2%, respectively. After modification under acidic ($\text{pH}=1.0$) conditions, the Na^+ and Ca^{2+} ion contents decreased to 0.2% and 0.3% in Bt-pH1-5.0CEC. This corresponds to a reduction of 92% and 75%, respectively. The dramatic decrease in Na^+ and Ca^{2+} ion content indicates that the interlayer cations are replaced by lecithin molecules. However, at alkaline pH, the number of Na^+ and Ca^{2+} ions released during the preparation of organoclays was limited. Even when the lecithin concentration is 5.0CEC, more than 50% of the Na^+ and Ca^{2+} ions are still present in the interlayer space. In other words, there are no obvious cations exchange reaction occurred between the lecithin molecules and the interlayer cations of bentonite at alkaline conditions.

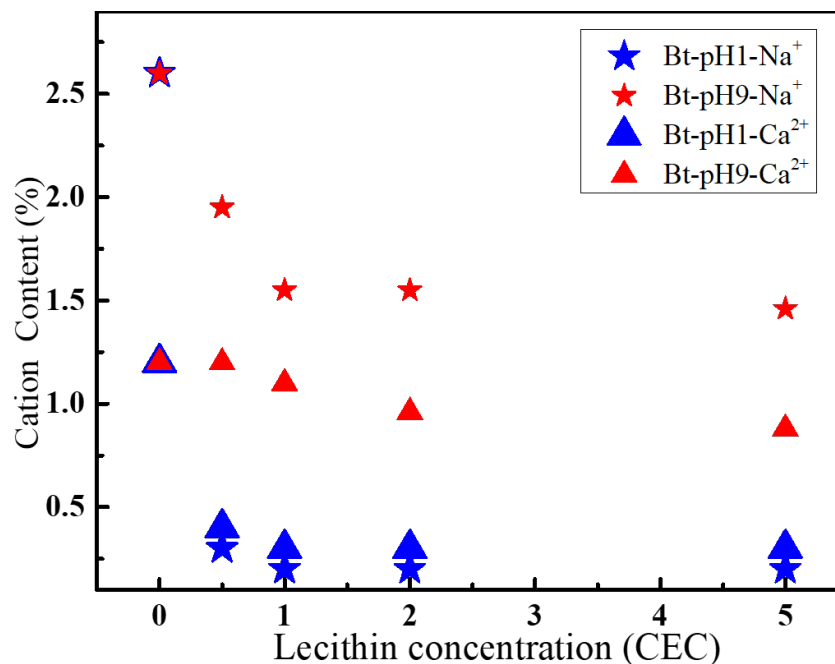

Fig. 5.4 Na⁺ and Ca²⁺ ion contents of raw bentonite and prepared organic bentonite with different lecithin concentration at pH=1.0 and pH=9.0

5.3.4 FTIR spectra

The FTIR spectra of raw bentonite, lecithin, and organic bentonite prepared under acidic (pH=1.0) and alkaline (pH=9.0) conditions are plotted in Fig. 5.5. The FTIR spectrum of bentonite showed the following characteristic bands: the absorption band at 3620 cm^{-1} is attributed to the -OH stretching vibration of hydroxyl groups of the montmorillonite, the bands at 1635 cm^{-1} and 1004 cm^{-1} result from the stretching vibration of the Si-O bond (Zhou et al., 2009; Funes et al., 2020). For hybrid composites, four additional absorption bands are observed at 2924 cm^{-1} , 2853 cm^{-1} , 1735 cm^{-1} and 1465 cm^{-1} . The bands at 2924 cm^{-1} and 2853 cm^{-1} are due to the -CH₂ asymmetric and symmetric stretching vibrations of the lecithin, respectively (Zhang et al., 2012b). An intense band attributed to the C=O group of lecithin occurred at 1735 cm^{-1} , and another one centered at 1465 cm^{-1} belonged to the deformation vibrations of CH₂/CH₃ (Nagy et al., 2013). Compared with the FTIR spectra of Bt-pH1, the absorption bands of the organic bentonite Bt-pH9 exhibited a significant difference at 1735 cm^{-1} and 1245 cm^{-1} . For the Bt-pH9, the absorption band appeared at 1245 cm^{-1} , corresponding to the O-PO₂-

O vibration (Yoon et al., 2000; Krishnamurty et al., 2008), and the peak intensity increased as a function of the lecithin concentration. However, the O-PO₂-O vibration did not appear on Bt-pH1, indicating that the molecular structure and properties of lecithin were changed at different conditions. In addition, the apparent shift of the C=O stretching band at 1735 cm⁻¹ in lecithin to 1708 cm⁻¹ in Bt-pH1 indicated possible interactions with the clay layers surface (Merino et al., 2016).

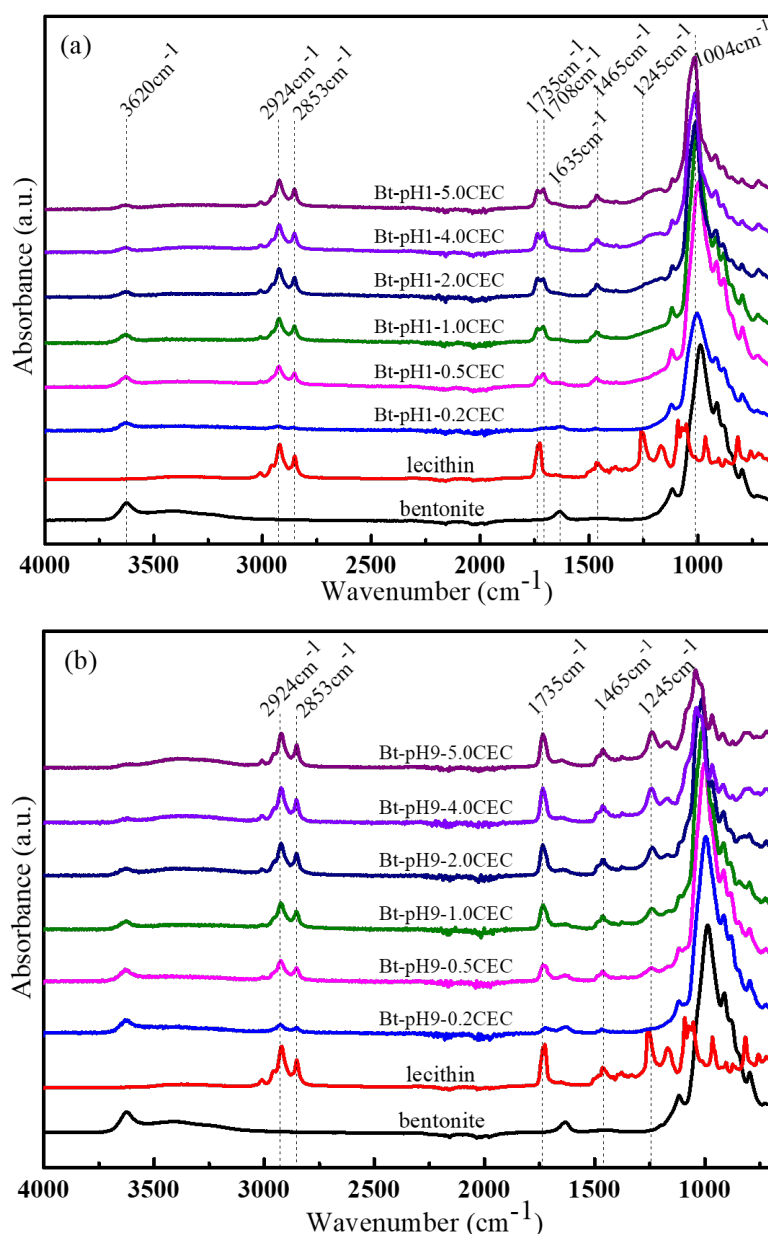

Fig. 5.5 FTIR spectra of raw bentonite, lecithin and modified bentonite with different lecithin concentration at pH=1.0 (a) and pH=9.0 (b)

In order to investigate the impact of chemical environments on the properties of lecithin, a comprehensive study of the functional group variation of lecithin at pH=1.0 and pH=9.0 has been carried out. First, a certain amount of lecithin was completely dissolved in 1:1 ethanol-distilled water solution, and then the solution was adjusted to pH=1.0, pH =9.0 by using hydrochloric acid or sodium hydroxide, respectively. The resulting solution was dried at room temperature and FTIR spectra were used to identify the functional group present in the molecule. The FTIR spectra of the pH1-lecithin and pH9-lecithin are illustrated in Fig. 5.6. The positions and assignments of the observed bands are summarized in Table 5.1.

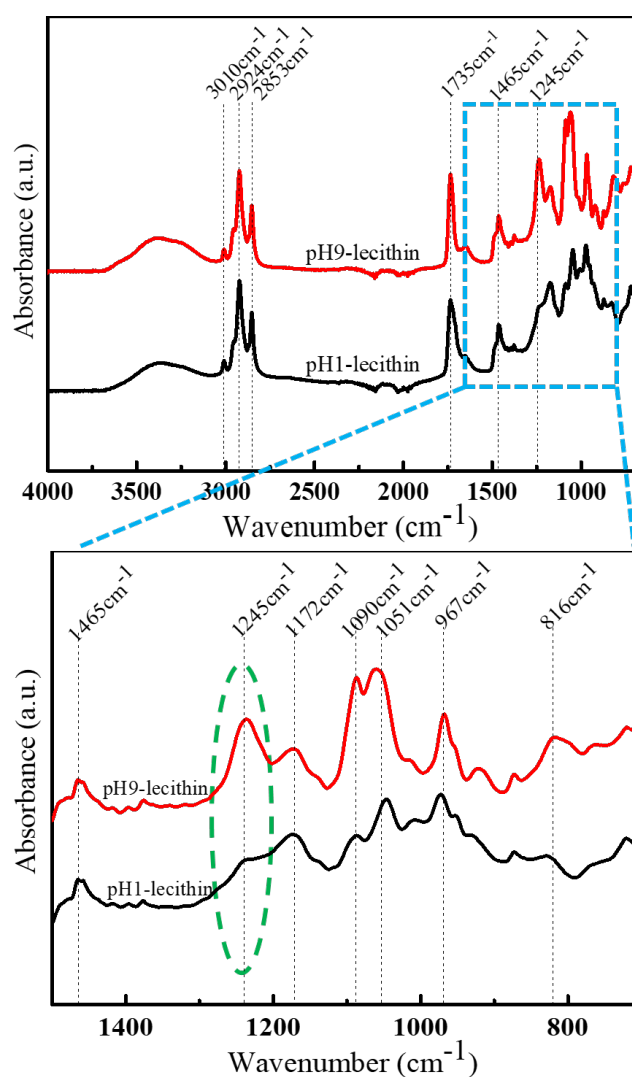

Fig. 5.6 FTIR spectra of lecithin in the range of 4000~650 cm^{-1} at pH=1.0 and pH=9.0

Table 5.1 FTIR vibrational band positions and assignments of lecithin at pH=1.0 and pH=9.0

Absorption band (cm ⁻¹)	Vibration band assignment	Reference
3010	C=C-H	(Yoon et al., 2000; Mohan et al., 2020)
2924	CH ₂	(Yoon et al., 2000; Akkas et al., 2007)
2853	CH ₂	(Akkas et al., 2007; Mohan et al., 2020)
1735	C=O	(Nagy et al., 2013; Liu et al., 2017)
1465	CH ₂ / CH ₃	(Nagy et al., 2013; Merino et al., 2016)
1245	O-PO ₂ -O	(Yoon et al., 2000; Krishnamurty et al., 2008)
1172	O-C in chain (O=C)-O-C	(Yoon et al., 2000; Akkas et al., 2007)
1090	PO ₂ -	(Hübner and Blume, 1998)
1051	P-O-C	(Yoon et al., 2000)
967	C-N in (CH ₃) ₃ N ⁺	(Hübner and Blume, 1998; Akkas et al., 2007)
816	C-N in (CH ₃) ₃ N ⁺	(Krishnamurty et al., 2008)

There was no change in shape, position and intensity of FTIR spectra between pH1-lecithin and pH9-lecithin at larger wavenumber. Therefore, it seems that no functional groups change occurred in the wavenumber range of 4000~1500 cm⁻¹. However, the FTIR spectra displayed notable discrepancy at 1245 cm⁻¹ for the O-PO₂-O vibration. At 1245 cm⁻¹, the absorption band peak of O-PO₂-O is very distinct for pH9-lecithin, but not for pH1-lecithin. Structurally, lecithin molecule consists of a glycerol molecular backbone, two fatty acids and a phosphocholine group. The lecithin molecules are esterified at positions sn-1 and sn-2 of the glycerol backbone with fatty acids, and in position sn-3 with phosphocholine group (Cui and Decker, 2016). The fatty acids assign the lecithin molecule a hydrophobic property, saturated fatty acids tend to be esterified at the sn-1 position, while unsaturated fatty acids are preferentially esterified at the sn-2 position. In position sn-3, a phosphocholine group esterified confers the hydrophilic character to the lecithin molecule (Bot et al., 2021). The lecithin molecule contains a choline moiety that has a positive charge on the nitrogen atom of the trimethyl-amino group and a negative

charge on the phosphate group (Dijkstra, 2017). A.J. De Koning and K.B. McMullan (De Koning and McMullan, 1965), who investigated the acid hydrolysis of phospholipids, have shown that the oxygen atom in the phosphate group was available for protonation. Attributed to the polar phosphatide group and non-polar fatty acids, the lecithin molecule exhibits different physicochemical properties and charges due to dissimilar chemical environments. In a strongly acidic medium (pH=1.0), the phosphate group of lecithin molecule is protonated, causing the molecule to be positively charged. However, the lecithin molecule presents zwitterionic nature and keeps electrically neutral in the pH=3.0~9.0 range (Ishihara et al., 2016). The protonation process of lecithin molecule under acidic conditions is shown in Fig. 5.7. In addition, the previous studies suggested that the lecithin molecule has a large dipole moment in a neutral and alkaline medium (Dijkstra, 2017).

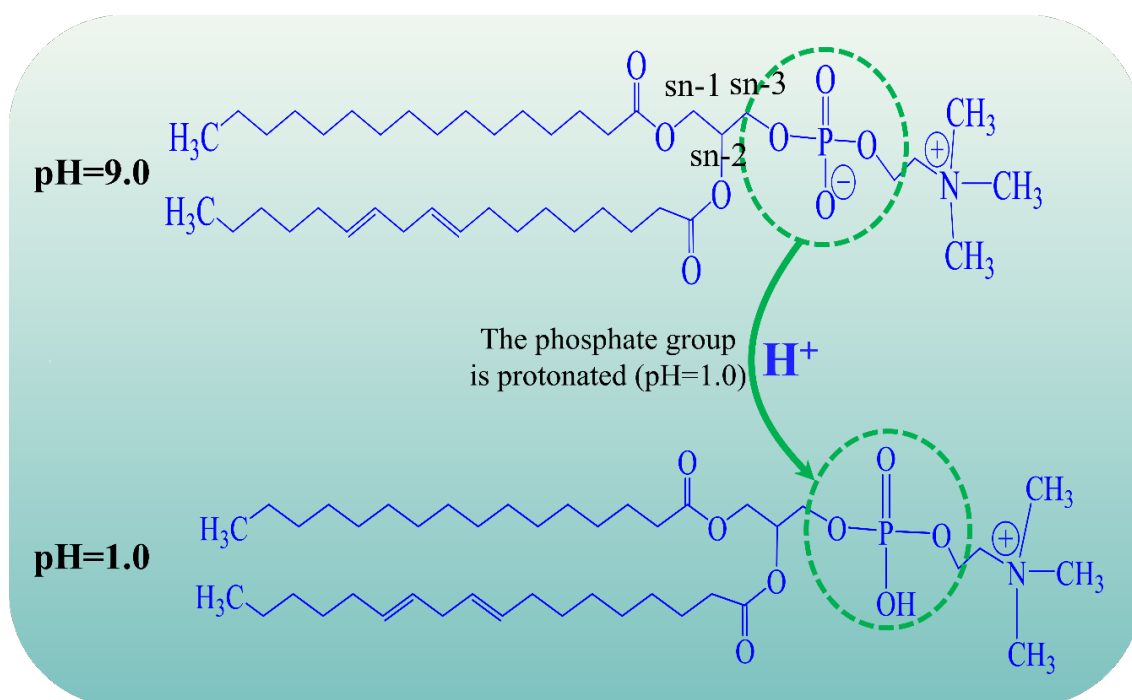

Fig. 5.7 Protonation of phosphate group in lecithin molecule under acidic conditions (pH=1.0)

5.3.5 TG analysis

The derivative thermogravimetry (DTG) curves for the organic bentonite samples are depicted in Fig. 5.8. For organic bentonite prepared at pH=1.0, the first peak of Bt-pH1-0.2CEC and Bt-pH1-0.5CEC in Fig. 5.8a were shown at 54°C, and 56°C, respectively, which attributed to the loss of water molecules. In addition, the decomposition of the intercalated lecithin occurred at around 265°C only. However, when the amount of lecithin added was ≥ 1.0 CEC, the loss peak of water molecules disappeared, which implied that the samples hydrophobicity has increased. A possible explanation is that the presence of lecithin lowers the surface energy of the bentonite, converting the hydrophilic silicate surface to an organophilic one (Marras et al., 2007). Furthermore, Bt-pH1-1.0CEC exhibited two different peaks at 225°C and 306°C for lecithin. The surfactants in the clay minerals are mainly governed by two types of reactions, the cation exchange reaction and the surfactant adsorption (Zhang et al., 1993). When the amount of added lecithin is relatively low (0.2CEC, 0.5CEC), the organic cations exchange with the interlayer metal ions and mainly adhere to surface sites via electrostatic interactions (Xi et al., 2004). With the increase in the concentration of lecithin (1.0CEC, 2.0CEC), some surfactant molecules are adsorbed on the bentonite surface. This results in the appearance of the second peak. For Bt-pH1-4.0CEC and Bt-pH1-5.0CEC, the peaks at 468°C and 465°C in the DTG curve could be attributed to the presence of impurities, which is consistent with the DTG curve of lecithin.

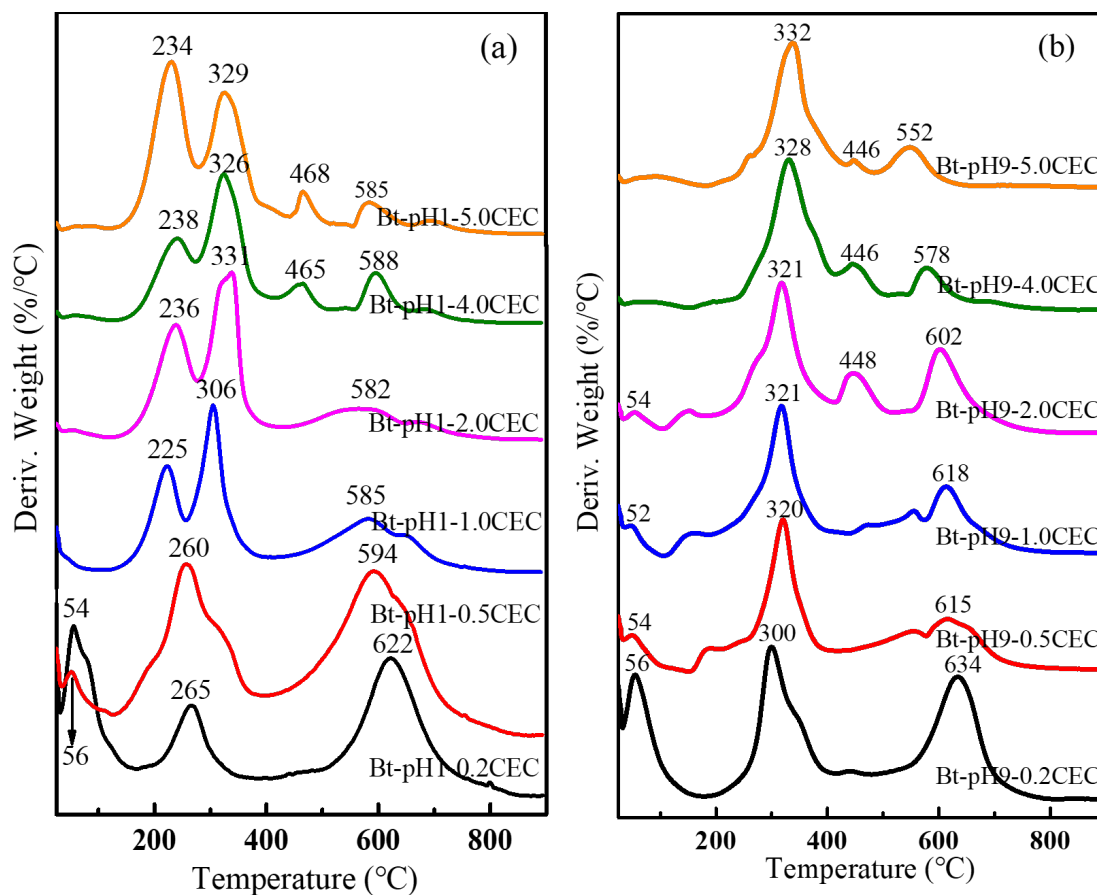

Fig. 5.8 DTG curves of organic bentonite prepared at pH=1.0 (a) and pH=9.0 (b)

The thermal behavior and stability of the organoclay prepared at pH=9.0 showed significant disparity. It can be seen from Table 5.2, Bt-pH9 showed weaker hydrophobicity which is related to the zwitterionic properties exhibited at pH=9.0. During the process of intercalation, the positive charge of lecithin (trimethyl-amino group) interact with the negative clay layer surface, while the negative charge of the phosphate group interact with the interlayer hydrated cations (Zhu et al., 2017). Due to the strong hydration ability of interlayer cations, its presence prevented the transition of the clay mineral from hydrophilic to hydrophobic at lower lecithin concentrations, which was consistent with the XRF results. In the temperature range of 200~400°C, there is one peak at ~320°C, which corresponds to the decomposition of the intercalated surfactant (Fig. 5.8b). This result suggested that lecithin is major intercalated into the interlayer space but not adsorbed on the clay surface. For both Bt-pH1 and Bt-pH9 samples, it is evident that

the mass loss attributed to lecithin degradation at 150~500°C increases with the surfactant concentration. However, a notable observation is that the lecithin mass loss in Bt-pH9 consistently exceeds that of Bt-pH1 at the same surfactant loading, indicating a different lecithin speciation in the bentonite interlayer space under varying pH conditions.

Table 5.2 Mass loss of prepared organic bentonite with different lecithin concentrations at pH=1.0 and pH=9.0

Samples	Mass loss (%)			
	adsorbed water dehydration	lecithin decomposition	silicate dehydroxylation	Total
	<150°C	150-500°C	>500°C	
Bt-pH1-0.2CEC	5.1	5.3	7.5	17.9
Bt-pH1-0.5CEC	2.3	13.2	12.3	27.8
Bt-pH1-1.0CEC	1.5	27.4	12.5	41.4
Bt-pH1-2.0CEC	1.6	41.9	11.3	54.8
Bt-pH1-4.0CEC	1.6	48.0	7.6	57.2
Bt-pH1-5.0CEC	1.5	48.8	11.3	61.6
Bt-pH9-0.2CEC	4.5	9.1	8.2	21.8
Bt-pH9-0.5CEC	3.1	22.0	12.3	37.4
Bt-pH9-1.0CEC	3.2	29.5	15.9	48.6
Bt-pH9-2.0CEC	3.5	58.4	12.0	73.9
Bt-pH9-4.0CEC	2.6	61.3	14.3	78.2
Bt-pH9-5.0CEC	2.9	61.3	14.3	78.5

5.4 Modification mechanism

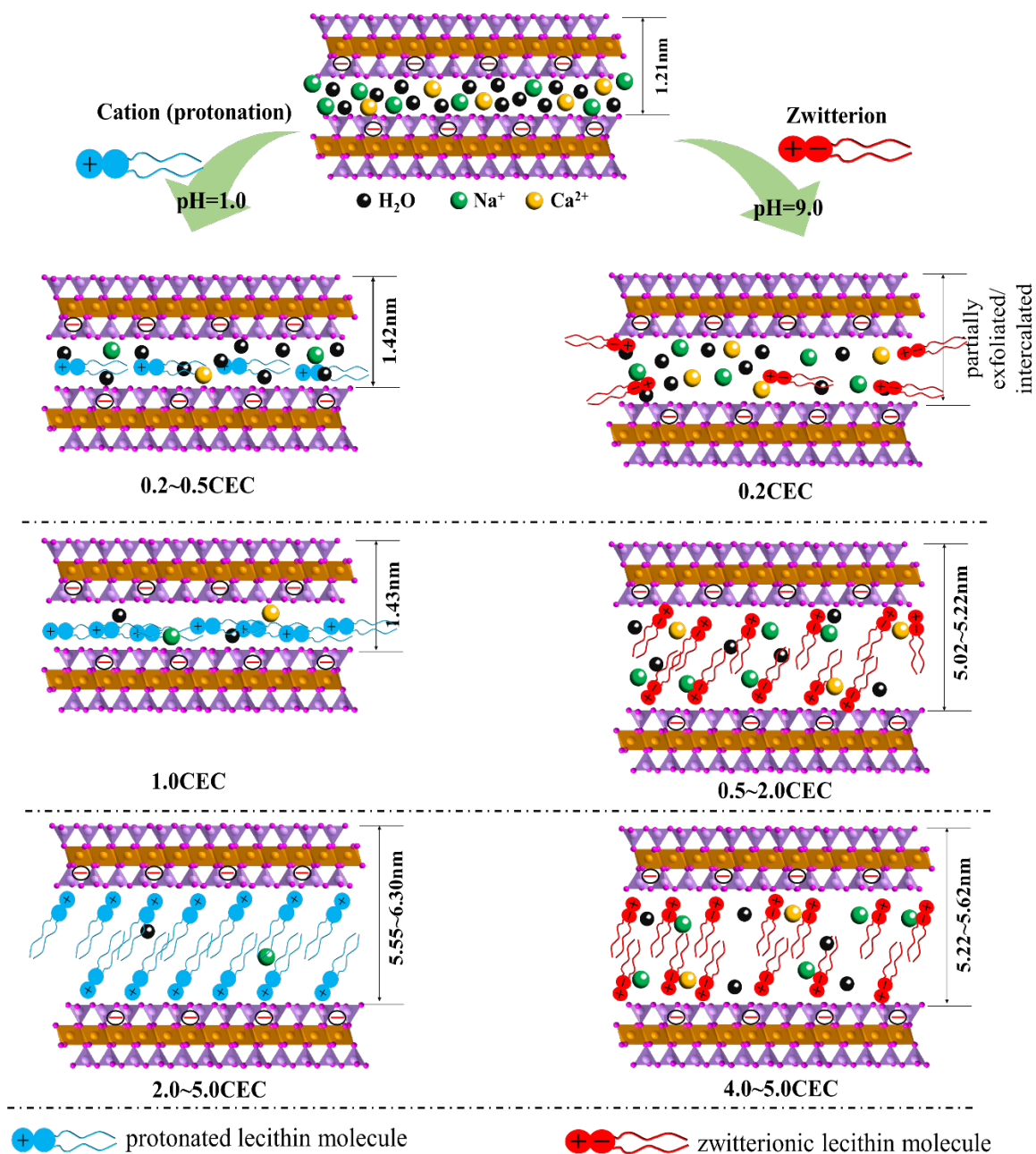

Fig. 5.9 Schematic diagram of the modification processes and mechanism of the lecithin modified bentonite at pH=1.0 and pH=9.0

Bentonite layers have permanent negative charges due to isomorphous substitutions and the imbalance of the negative charges is compensated by exchangeable cations.

Additionally, pH-dependent charges are developed by the surface hydroxyl groups at the montmorillonite's edges (Tombácz et al.). The hydroxyl groups on the edge of montmorillonite have a point of zero charge at pH ~6.5. Positive charges can develop in a protonation reaction of Al–OH sites at edges only at pH below ~6.5, and deprotonation of Si–OH then that of the Al–OH sites takes place with increasing pH of solution resulting in negative charges at edges (Tombacz and Szekeres, 2004).

At pH=1.0, lecithin exhibits cationic properties due to protonation of the phosphate group. The interlayer cations were gradually replaced by lecithin molecules, and the lecithin molecules conformation transitioned from a flat-lying layer to a paraffin-type-bilayer with the increase of lecithin loading (Fig. 5.9). At low dosage (0.2~0.5CEC), the lecithin molecules are not sufficient to replace the interlayer cations, resulting in some residual hydrated cations in the interlayer space. The basal spacing is only up to 1.42 nm, which is attributed to the monolayer arrangement of flat-lying lecithin molecules in the interlayer space (Ouellet-Plamondon et al., 2014). The interlayer cations were almost completely replaced at 1.0CEC lecithin concentration, but the basal spacing did not change, indicating that the lecithin molecules were still arranged in a flat-lying monolayer. Lecithin expanded the bentonite basal spacing up to 5.55~6.30 nm at concentration of 2.0 CEC and higher. According to previous research, a basal spacing of 3.2 nm is measured when the lecithin molecule adopt an upright position in the interlayer space (Nagy et al., 2013). Therefore, lecithin with higher intercalation loading typically tend to arrange into tilted bilayer. As a result, a further increase of the interlayer space at high concentrations can be caused by a paraffin-type-bilayer arrangement of the lecithin.

In alkaline conditions (pH=9.0), lecithin exhibits the properties of a zwitterionic surfactant, characterized by high dipole moments and highly charged groups (Shao and Jiang, 2015). In the intercalation process, the positive head group of zwitterionic surfactant is attached to the negatively charged clay surface, while the negative head group of that is coupled with the interlayer cations. The intercalation is forced by the ion-dipole interaction rather than cation exchange. When the lecithin concentration is 0.2CEC

at pH=9.0 condition, the shoulder reflection is $4.7\sim 6.8^\circ$, which corresponds to a partially intercalated/exfoliated structure according to XRD and XRF results. The amount of lecithin molecules is insufficient to balance the interlayer cations, resulting in some cations still bound to the negatively charged interlayer surface and weak hydrophobicity at low lecithin concentration. When the added amount of lecithin was between 0.5 and 2.0 CEC, the basal spacing was 5.02~5.22 nm, indicating lecithin may adopt a paraffin-type-bilayer configuration. The positive head group is linked to the clay surface and creates an angle between lecithin and clay layer. The monovalent Na^+ are linked by a single negatively charged phosphate group, whereas divalent Ca^{2+} are balanced by two phosphate groups. Furthermore, a potentially interesting result is that the organoclay prepared at pH=9.0 is still weakly hydrophobic compared to the organoclay prepared at pH=1.0, even at a lecithin concentration of 2.0 CEC (Fig. 5.8b). This finding has also been documented by others (Zhu et al., 2011). One possible reason is that the larger hydration energy of Ca^{2+} leads to the coordination of water molecules. The Ca^{2+} is available in the clay interlayer through ion-dipole interaction, implying that adsorption water is also present, which leads to a decrease in hydrophobicity of the organic clay. At the dosage of 4.0~0.5CEC, the interlayer cations are balanced by zwitterionic lecithin molecules, and the arrangement of lecithin molecules becomes more orderly.

5.5 Conclusions

In this work, lecithin was successfully intercalated into the bentonite interlayer at different pH reaction conditions. The structural properties of organo-bentonite have been examined using XRD, TEM, XRF, FTIR and TG/DTG, and the intercalation mechanism and interlayer conformation of surfactants were discussed to understand the lecithin intercalation process. pH affects the physicochemical properties of lecithin, which leads to differences in the intercalation process and organoclay properties. In both cases, the conformation of lecithin molecules in the clay interlayer undergoes a transition from a flat-lying layer to a tilted paraffin-type-bilayer with increasing surfactant concentration.

Due to the protonation of the phosphate groups at pH=1.0, the lecithin molecules can only be intercalated into the interlayer space by cation exchange, resulting in a nearly complete removal of exchangeable cations in organoclay. In contrary, the amount of cations released during the preparation of organo-bentonite at pH=9.0 is very limited. At alkaline pH, the lecithin exhibit zwitterionic properties which lead to a new type of interaction with the bentonite and interlayer cations. Through ion-dipole interaction, the positive head group of the lecithin is attached to the negatively charged clay surface, while its negative head group is coupled with the interlayer cations. The organoclay prepared at pH=9.0 also showed weaker hydrophobicity, further confirming the difference in the intercalation process of lecithin under different pH conditions. The pH dependence exhibited on the intercalation and on the resulting physical and chemical properties of organoclays is crucial for understanding their behavior and broadening application fields.

References

- Akkas, S.B., Severcan, M., Yilmaz, O., Severcan, F., 2007. Effects of lipoic acid supplementation on rat brain tissue: An FTIR spectroscopic and neural network study. *Food Chemistry* 105, 1281-1288.
- Al Kausor, M., Gupta, S.S., Bhattacharyya, K.G., Chakraborty, D., 2022. Montmorillonite and modified montmorillonite as adsorbents for removal of water soluble organic dyes: A review on current status of the art. *Inorganic Chemistry Communications*, 109686.
- Araujo, E.M., Leite, A.M.D., da Paz, R.A., Medeiros, V.d.N., de Melo, T.J.A., Lira, H.d.L., 2011. Polyamide 6 nanocomposites with inorganic particles modified with three quaternary ammonium salts. *Materials* 4, 1956-1966.
- Beall, G.W., Goss, M., 2004. Self-assembly of organic molecules on montmorillonite. *Applied Clay Science* 27, 179-186.
- Bot, F., Cossuta, D., O'Mahony, J.A., 2021. Inter-relationships between composition, physicochemical properties and functionality of lecithin ingredients. *Trends in Food Science & Technology* 111, 261-270.
- Cui, L., Decker, E.A., 2016. Phospholipids in foods: prooxidants or antioxidants? *Journal of the Science of Food and Agriculture* 96, 18-31.
- De Koning, A.J., McMullan, K.B., 1965. Hydrolysis of phospholipids with hydrochloric acid. *Biochimica et Biophysica Acta (BBA)-Lipids and Lipid Metabolism* 106, 519-526.
- De Oliveira, T., Fernandez, E., Fougère, L., Destandau, E., Boussafir, M., Sohmiya, M., Sugahara, Y., Guégan, R., 2018. Competitive association of antibiotics with a clay mineral and organoclay derivatives as a control of their lifetimes in the environment. *ACS omega* 3, 15332-15342.
- Dijkstra, A.J., 2017. About water degumming and the hydration of non-hydratable phosphatides. *European Journal of Lipid Science and Technology* 119, 1600496.
- Funes, I.G.A., Peralta, M.E., Pettinari, G.R., Carlos, L., Parolo, M.E., 2020. Facile modification of montmorillonite by intercalation and grafting: The study of the binding mechanisms of a quaternary alkylammonium surfactant. *Applied Clay Science* 195, 105738.
- Guo, Y.X., Liu, J.H., Gates, W.P., Zhou, C.H., 2020. Organo-modification of montmorillonite. *Clays and Clay Minerals* 68, 601-622.
- Hübner, W., Blume, A., 1998. Interactions at the lipid-water interface. *Chemistry and Physics of Lipids* 96, 99-123.
- Ishihara, K., Liu, Y., Inoue, Y., 2016. Enhancing polyurethane blood compatibility, *Advances in polyurethane biomaterials*. Elsevier, pp. 319-348.

- Jordan, J.W., 1949. Organophilic bentonites. I. Swelling in organic liquids. *The Journal of Physical Chemistry* 53, 294-306.
- Krishnamurty, S., Stefanov, M., Mineva, T., Bégu, S., Devoisselle, J.-M., Goursot, A., Zhu, R., Salahub, D.R., 2008. Density functional theory-based conformational analysis of a phospholipid molecule (dimyristoyl phosphatidylcholine). *The Journal of Physical Chemistry B* 112, 13433-13442.
- Liu, S., Wu, P., Yu, L., Li, L., Gong, B., Zhu, N., Dang, Z., Yang, C., 2017. Preparation and characterization of organo-vermiculite based on phosphatidylcholine and adsorption of two typical antibiotics. *Applied clay science* 137, 160-167.
- Marras, S.I., Tsimpliaraki, A., Zuburtikudis, I., Panayiotou, C., 2007. Thermal and colloidal behavior of amine-treated clays: The role of amphiphilic organic cation concentration. *Journal of Colloid and Interface Science* 315, 520-527.
- Meng, N., Chu, X., Ge, M.Q., Zhang, M., Sun, B., Su, Y.-T., Zhou, N.-L., 2018. Preparation and characterization of Lecithin–heparin intercalated in montmorillonite nanocomposite. *Applied Clay Science* 162, 454-460.
- Merino, D., Ollier, R., Lanfrancioni, M., Alvarez, V., 2016. Preparation and characterization of soy lecithin-modified bentonites. *Applied Clay Science* 127-128, 17-22.
- Mohan, V., Naske, C.D., Britten, C.N., Karimi, L., Walters, K.B., 2020. Hydroxide-catalyzed cleavage of selective ester bonds in phosphatidylcholine: An FTIR study. *Vibrational Spectroscopy* 109, 103055.
- Morais, D.D.S., Barbosa, R., Medeiros, K.M., Araújo, E.M., de Mélo, T.J.A., Modification of Brazilian Bentonite Clay for Use Nano-Biocomposites. *Trans Tech Publ*, pp. 867-872.
- Nagy, K., Bíró, G., Berkesi, O., Benczédi, D., Ouali, L., Dékány, I., 2013. Intercalation of lecithins for preparation of layered nanohybrid materials and adsorption of limonene. *Applied clay science* 72, 155-162.
- Ouellet-Plamondon, C.M., Stasiak, J., Al-Tabbaa, A., 2014. The effect of cationic, non-ionic and amphiphilic surfactants on the intercalation of bentonite. *Colloids and Surfaces A: Physicochemical and Engineering Aspects* 444, 330-337.
- Sanqin, W., Zepeng, Z., Yunhua, W., Libing, L., Jiansheng, Z., 2014. Influence of montmorillonites exchange capacity on the basal spacing of cation–anion organo-montmorillonites. *Materials Research Bulletin* 59, 59-64.
- Shah, K.J., Mishra, M.K., Shukla, A.D., Imae, T., Shah, D.O., 2013. Controlling wettability and hydrophobicity of organoclays modified with quaternary ammonium surfactants. *Journal of colloid and interface science* 407, 493-499.
- Shao, Q., Jiang, S., 2015. Molecular understanding and design of zwitterionic materials. *Advanced Materials* 27, 15-26.

- Tohdee, K., Kaewsichan, L., 2018. Enhancement of adsorption efficiency of heavy metal Cu (II) and Zn (II) onto cationic surfactant modified bentonite. *Journal of Environmental Chemical Engineering* 6, 2821-2828.
- Tombácz, E., Nyilas, T., Libor, Z., Csanaki, C., Surface charge heterogeneity and aggregation of clay lamellae in aqueous suspensions. Springer, pp. 206-215.
- Tombacz, E., Szekeres, M., 2004. Colloidal behavior of aqueous montmorillonite suspensions: the specific role of pH in the presence of indifferent electrolytes. *Applied clay science* 27, 75-94.
- Vazquez, A., López, M., Kortaberria, G., Martín, L., Mondragon, I., 2008. Modification of montmorillonite with cationic surfactants. Thermal and chemical analysis including CEC determination. *Applied Clay Science* 41, 24-36.
- Xi, Y., Ding, Z., He, H., Frost, R.L., 2004. Structure of organoclays—an X-ray diffraction and thermogravimetric analysis study. *Journal of Colloid and Interface Science* 277, 116-120.
- Yang, Z., Wang, W., Tai, X., Wang, G., 2019. Preparation of modified montmorillonite with different quaternary ammonium salts and application in Pickering emulsion. *New Journal of Chemistry* 43, 11543-11548.
- Yoon, S., Kazusaka, A., Fujita, S., 2000. FTIR spectroscopic and HPLC chromatographic studies of carbon tetrachloride induced acute hepatitis in rats: Damage in liver phospholipid membrane. *Biopolymers: Original Research on Biomolecules* 57, 267-271.
- Yu, C., Ke, Y., Deng, Q., Lu, S., Ji, J., Hu, X., Zhao, Y., 2018. Synthesis and Characterization of Polystyrene-Montmorillonite Nanocomposite Particles Using an Anionic-Surfactant-Modified Clay and Their Friction Performance, *Applied Sciences*.
- Zhang, Y., Zhao, Y., Zhu, Y., Wu, H., Wang, H., Lu, W., 2012. Adsorption of mixed cationic-nonionic surfactant and its effect on bentonite structure. *Journal of Environmental Sciences* 24, 1525-1532.
- Zhang, Z.Z., Sparks, D.L., Scrivner, N.C., 1993. Sorption and desorption of quaternary amine cations on clays. *Environmental science & technology* 27, 1625-1631.
- Zheng, J., Li, J., Hao, H., Yao, K., 2013. Influence of charge density and chain length on the interaction between organic anion and montmorillonite. *Journal of Wuhan University of Technology-Mater. Sci. Ed.* 28, 6-11.
- Zhou, L., Chen, H., Jiang, X., Lu, F., Zhou, Y., Yin, W., Ji, X., 2009. Modification of montmorillonite surfaces using a novel class of cationic gemini surfactants. *Journal of colloid and interface science* 332, 16-21.
- Zhu, J., Qing, Y., Wang, T., Zhu, R., Wei, J., Tao, Q., Yuan, P., He, H., 2011. Preparation and characterization of zwitterionic surfactant-modified montmorillonites. *Journal of Colloid and Interface Science* 360, 386-392.
- Zhu, J., Zhang, P., Qing, Y., Wen, K., Su, X., Ma, L., Wei, J., Liu, H., He, H., Xi, Y., 2017.

Novel intercalation mechanism of zwitterionic surfactant modified montmorillonites. *Applied Clay Science* 141, 265-271.

Zhu, T.T., Zhou, C.H., Kabwe, F.B., Wu, Q.Q., Li, C.S., Zhang, J.R., 2019. Exfoliation of montmorillonite and related properties of clay/polymer nanocomposites. *Applied clay science* 169, 48-66.

Zhuang, G., Zhang, Z., Jaber, M., 2019. Organoclays used as colloidal and rheological additives in oil-based drilling fluids: An overview. *Applied Clay Science* 177, 63-81.

Chapter 6

**Application performance
of organoclay in oil-based
drilling fluid**

6.1 Introduction

The dispersion and gelation of Mt in water hold significant value for the drilling fluid, as it facilitates the support and transfer of drilling cuttings. It was reported that the first clay mineral used in drilling fluids was gumbo clay, the main component of which is Mt. Since then, Mt has become an indispensable additive in water-based drilling fluids. Although the water-based drilling fluids have been extensively developed due to their advantages of easy preparation, low cost and good environmental compatibility (Ansari et al., 2021). However, there are some application limitations in complex and shale drilling due to its instability performance. Oil-based drilling fluids have excellent thermal stability and can provide low friction, shale inhibition, and salt resistance. It addresses drawbacks associated with water-based drilling fluids and is recognized as a suitable choice for drilling complex formations.

The ideal oil-based drilling fluid is a non-Newtonian fluid with appropriate rheological and viscoelastic properties. Organoclays are the most important additives used to adjust the colloidal and rheological properties of oil-based drilling fluids. The organoclays is known for its ability to swell and form thixotropic gels in organic media (Moraru, 2001). Most oil-based drilling fluids are formulated with clays modified with quaternary ammonium salts, although these salts are toxic and difficult to degrade. With the deepening concept of environmental protection, biosurfactants and nonionic surfactants have been used to modify clay minerals to prepare environmentally friendly organoclays (Silva et al., 2014; Li et al., 2023).

The rheology of oil-based drilling fluids is not only influenced by the properties and concentration of organoclays, but also affected by the composition and nature of base oil (Hermoso et al., 2014). Diesel and mineral oil are common organic dispersion mediums for preparing oil-based drilling fluids, but these materials will cause serious pollution. The drilling cuttings contaminated with oil-based drilling fluids, drilling fluid wastes and other potential contaminants pose several risks to the terrestrial, aquatic and aerial

environments if not disposed of properly (Pereira et al., 2022). To address this problem, some eco-friendly, cheap and easily available vegetable oil such as palm oil (Sulaimon et al., 2017) and soybean oil (Agwu et al., 2015) have been gradually utilized as dispersion mediums in recent years.

The main components of most vegetable oils are triglycerides and fatty acids. Some vegetable oils, referred to as siccativ oils (such as linseed oil), contain unsaturated fatty esters which can undergo a complex autoxidation mechanism followed by crosslinking, resulting in the formation of a polymer network (Orlova et al., 2021). Additionally, the curing process can be accelerated by heating or adding metallic driers (i.e. Pb^{2+} , Zn^{2+}), which is a common practice in paints (de Viguerie et al., 2016; Artesani, 2020), but which has been rarely reported in the field of oil-based drilling fluids.

It is crucial to understand the interaction between organic clay and oil as it serves as the foundation for controlling the rheological behavior of drilling fluid. In this study, two types of smectites were employed for the synthesis of organoclays. Organic clays are respectively dispersed in mineral oil (paraffin oil) and vegetable oil (linseed oil) to prepare oil-based drilling fluids. In addition, oil-based drilling fluids were aged at different temperatures to simulate the high temperatures of drilling operations. The rheological behavior and viscoelastic properties of oil-based drilling fluids at different temperatures were described by rheometer tests. The microstructure of organic clay in mineral oil and vegetable oil and its effect on the rheological behavior of oil-based drilling fluids were comparatively evaluated. The XRD and TEM techniques were employed to study the microstructure of organic clay suspensions.

6.2 Methods

In this work, bentonite (Bt) and montmorillonite (Mt) were modified by lecithin to prepare organoclay, namely organo-bentonite (OBt) and organo-montmorillonite (OMt). The commercial bentonite obtained from Sigma-Aldrich, which was used without any additional purification. Mt was synthesized in our laboratory by hydrothermal reaction.

The specific synthetic steps of Mt have been provided in detail in Chapter 3.1.

For lecithin modified bentonite, the preparation of OBt was performed using the following procedure: 2 g of bentonite was dispersed in 100 mL of distilled water and stirred for 16 h. 1.0 CEC of lecithin was dissolved in 100 mL ethanol and stirred for 2 h. Next, the lecithin solution was slowly added to the bentonite dispersion and then NaOH was added dropwise to confirm that the pH of the mixture solution was 9.0. The mixture suspension was sonicated 5 min and stirred 2 h at 60 °C, and then the suspension was centrifuged, washed 3 times with 1:1 ethanol-distilled water solution, and the resulting precipitate was dried in an oven at 60 °C for 48 h.

The interlayer cation of the synthesized Mt was sodium ion and the sample was named NaMt. The preparation of NaOMt using NaMt and lecithin followed the synthetic procedure of OBt.

Mt containing zinc ions is obtained through a cation exchange process between zinc acetate and NaMt in an aqueous solution, with the following method: NaMt was suspended in 5.0 CEC of zinc acetate solutions for 12 h under magnetic stirring at 25°C. Then, the obtained mixture solution was centrifuged. The same process was repeated twice. Finally, the sample was dried in an oven at 60°C for 48h. The sample was designated as ZnMt. The procedure for the preparation of ZnOMt using ZnMt and lecithin is the same as for the preparation of OBt. The schematic representation of the experimental workflow used to prepare ZnOMt samples is provided in Fig. 6.1.

The process for preparing and aging oil-based drilling fluid using base oil and organoclay was as described in Chapter 3.4. The oil-based drilling fluids were named following the template of organoclay/oil type-temperature. For example, ZnOMt/paraffin-60 is prepared with ZnOMt and paraffin oil aged at 60 °C.



Fig. 6.1 The schematic representation of experimental workflow for preparing ZnOMt samples

6.3 Performance of OBt in oil-based drilling fluids

As demonstrated by the results of the elemental analysis in Chapter 5, SiO_2 , Al_2O_3 , Na_2O , and CaO are the primary components of commercial bentonite. Na^+ and Ca^{2+} are the main exchangeable cations in the raw bentonite interlayer. At alkaline conditions ($\text{pH}=9.0$), lecithin intercalates into the interlayer space through ion-dipole interactions and balances interlayer cations. Rheological tests were used to preliminarily evaluate the performance of OBt prepared by lecithin and bentonite in oil-based drilling fluids.

6.3.1 Rheological properties

Linseed oil and paraffin oil are used as base oils for the formulation of oil-based drilling fluids, respectively. OBt samples were dispersed in linseed oil and paraffin oil and aged at different temperatures. Viscosity is an important parameter of drilling fluid, which is used to evaluate the ability of drilling fluid to hole cleaning and carry drilling cuttings. The relationship between shear rate and viscosity was adopted to characterize the

rheological behavior of drilling fluids.

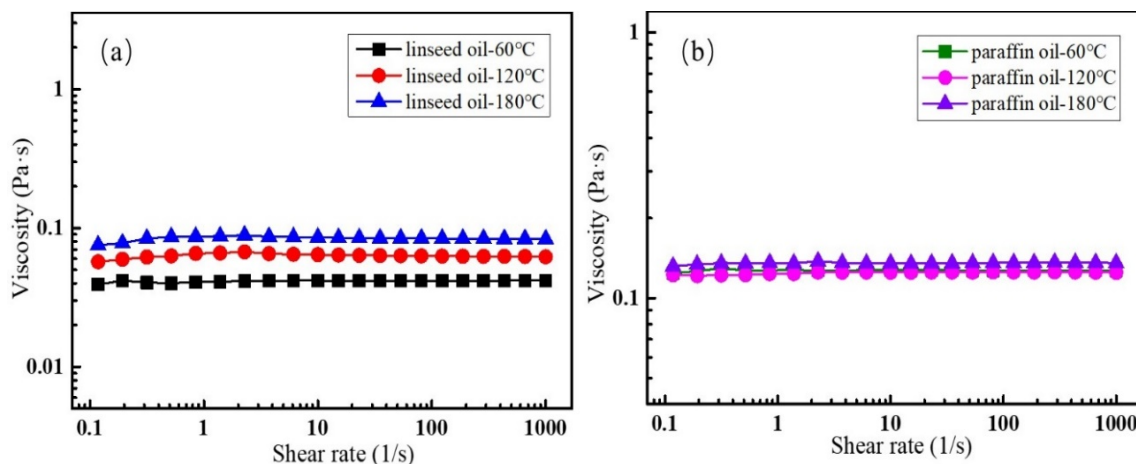

Fig. 6.2 Viscosity as a function of shear rate for pure linseed oil (a) and paraffin oil (b) aged at varying temperatures

As observed in Fig. 6.2, both linseed oil and paraffin oil exhibited Newtonian behavior at any temperature, characterized by a shear rate-independent viscosity. In the case of pure paraffin oil, the influence of temperature on its viscosity is negligible, with the viscosity remaining approximately 0.12 Pa·s. However, with linseed oil, a distinct shift is noticeable. The viscosity of linseed oil displayed a tendency to increase with temperature, although the increase in viscosity is limited. The primary factor accounting for this distinction is the composition of oil. Paraffin oil is classified as a mineral oil primarily composed of alkanes that are stable at high temperatures. Linseed oil is mainly composed of a mixture of triglycerides and contains a large amount of unsaturated fatty acids. The double bonds of the unsaturated fatty acids give the triglyceride molecules a higher chemical reactivity, which allows them to react with oxygen in the air and with one another to form a polymeric network (Lazzari and Chiantore, 1999). Furthermore, the autoxidation process can be accelerated through heating, resulting in a slight increase in the viscosity of linseed oil.

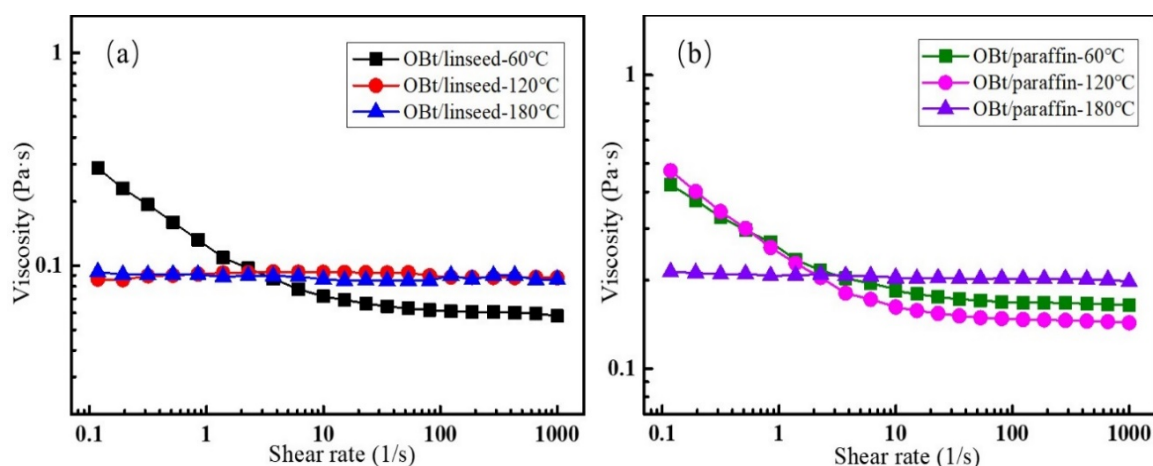

Fig. 6.3 Viscosity as a function of shear rate for OBt/linseed (a) and OBt/paraffin (b) aged at varying temperatures

The rheological behavior of OBt in oil at different temperatures is presented in Fig. 6.3. For linseed oil-based drilling fluids, the rheological behavior changed with the addition of OBt at 60°C. The viscosity varied with the shear rate and showed non-Newtonian fluid properties. The same experimental phenomenon also appeared on the OBt/paraffin-60°C. At low shear rate (0.1 s^{-1}), the viscosity of linseed oil drilling fluid rose from $0.04 \text{ Pa}\cdot\text{s}$ of linseed oil-60°C to $0.3 \text{ Pa}\cdot\text{s}$ of OBt/linseed-60°C, and the viscosity of paraffin oil drilling fluid increased from $0.12 \text{ Pa}\cdot\text{s}$ of paraffin oil-60°C to $0.43 \text{ Pa}\cdot\text{s}$ of OBt/paraffin-60°C. Although the addition of OBt indeed lead to an increase in viscosity, these enhancements remained inadequate for effectively suspending and transporting cuttings during drilling operations. In addition, as the temperature continues to rise, the rheological behavior of the drilling fluid exhibited Newtonian fluid behavior again at $180 \text{ }^\circ\text{C}$, which is unfavorable for drilling operations under high temperature conditions.

The ideal drilling fluid is a non-Newtonian colloidal system that performs multiple functions and has the proper viscosity. The rheological behavior of OBt/linseed and OBt/paraffin oil-based drilling fluids at different temperatures indicate that OBt cannot significantly enhance the viscosity of the base oil and exhibit non-Newtonian fluid properties. The OBt obtained by lecithin-modified bentonite is not suitable for

formulating oil-based drilling fluids. This may be related to the mineralogical, chemical and physical properties of bentonite (Karakaya et al., 2011).

6.4 Performance of OMt in linseed oil drilling fluids

The commercial bentonite purchased directly have not shown satisfactory performance in oil-based drilling fluids. However, organoclays are known for their ability to enhance rheology and increase the viscosity of oil-based drilling fluids. To prepare organoclays that can function in oil-based drilling fluids, we attempted to synthesize sodium montmorillonite (NaMt) in the laboratory. NaMt was then modified with lecithin to prepare organic montmorillonite (NaOMt) for oil-based drilling fluid. In the process of using NaOMt to formulate oil-based drilling fluid, a series of investigations were carried out inspired by paints recipes.

Modifying the oil properties by heating it in presence of inorganic or hybrid materials is a very common practice used in different fields including painting. To improve the drying and rheological properties of oil binders, ancient recipes mention the addition of metal compounds while heating; pigments can then be ground in such treated oils to be used as a paint. Traditional oil paintings were prepared by grinding an appropriate proportion of pigments in a siccativ oil, such as linseed oil. The siccativ oils have the ability to cure and form a solid film by a complex path of autoxidation and polymerization processes. The curing can be accelerated by heating and adding metallic driers (i.e. Pb^{2+} , Zn^{2+}) or directly introducing metal carboxylates (Oyman et al., 2005).

The process of forming a gel system using pigments and oil paint medium has significant similarities to the method of formulating oil-based drilling fluids in the petroleum industry. Drilling fluids are known as the “blood of drilling engineering” and can perform various functions to meet the requirements of drilling operations (Li et al., 2020; Paswan and Mahto, 2020). Drilling fluids are subjected to high-temperature conditions during drilling operations, with some formation temperatures exceeding 200°C. In order to simulate the influence of formation temperatures on the performance of oil-

based drilling fluids, the common practice in the petroleum industry is to fully stir the base oil and additives that perform specific functions, and then place them in a high-temperature furnace for continuous heating to observe the changes. Rheological additives are added to oil-based drilling fluids to form colloidal systems that suspend cuttings and maintain all operations running smoothly (Ibrahim et al., 2022). Rheological additives generally refer to organoclays, which are obtained by modifying montmorillonite with surfactants. Inspired by the zinc cations and siccative oil in oil paints, the biosurfactant lecithin was used to modify Mt containing Zn^{2+} to prepare organoclays, which were then mixed with linseed oil to produce oil-based drilling fluid colloidal systems. Currently oil-based drilling fluids are highly recommended for offshore wells, high-temperature wells, and geothermal wells due to their outstanding properties and versatile characteristics (Ghavami et al., 2018). However, the application of vegetable oil, especially siccative oils, in oil-based drilling fluids has not been the subject of any in-depth investigation.

In this section, the synthesized NaMt was exchanged with Zn^{2+} and then with lecithin to form ZnOMt. After mixing with linseed oil and heating at 120°C, the viscoelastic properties of this materials were compared with the NaOMt/linseed oil samples.

6.4.1 EDX analysis

EDX spectroscopy was employed to determine the elemental components of the NaMt, ZnMt and ZnOMt, and the results are presented in Fig. 6.4. The elements present in the NaMt sample include carbon, oxygen, magnesium, aluminum, silicon, and sodium. These elements originate from chemicals introduced during synthesis, with sodium ions serving as interlayer exchangeable cations.

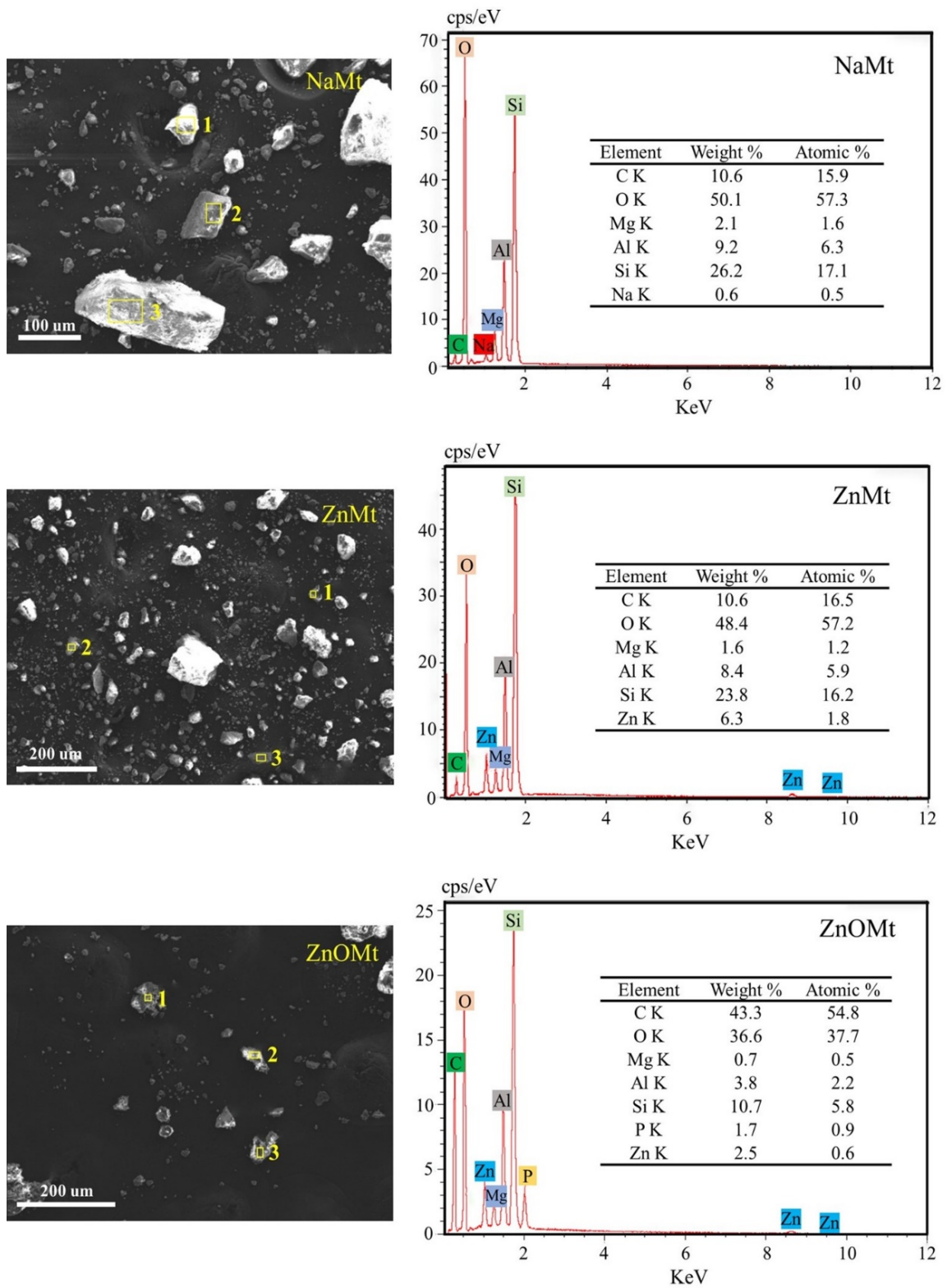
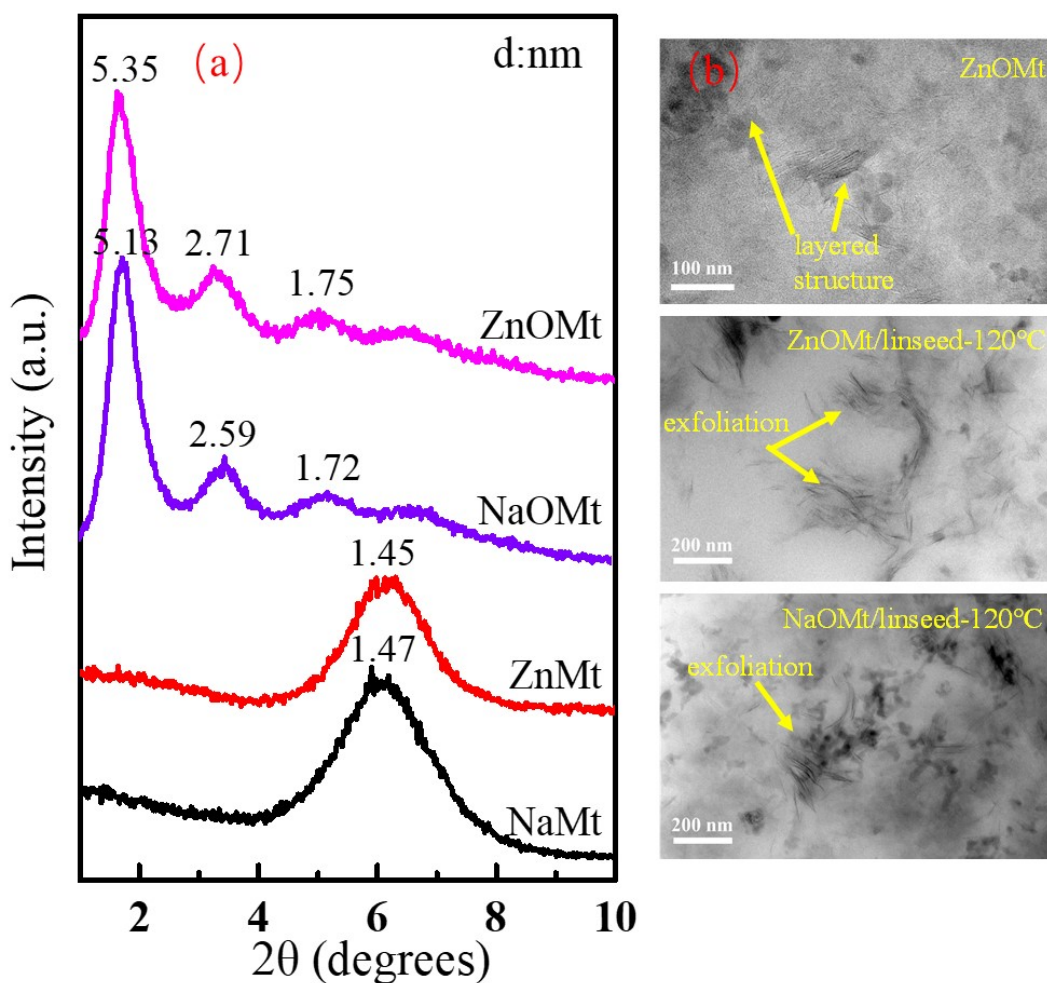

Fig. 6.4 EDX spectra and analysis results of NaMt, ZnMt, and ZnOMt

The ZnMt was prepared by cation exchange of Zn^{2+} with Na^+ from NaMt. The appearance of zinc element in Fig. 6.4 indicated that the ZnMt has been successfully prepared. The disappearance of the Na^+ in the ZnMt means that the Zn^{2+} have completely replaced the Na^+ in the interlayer space. Compared with ZnMt, ZnOMt exhibits noticeable alterations in both the types and contents of elements. Attributed to organic modification, the ZnOMt showed a substantial increase in carbon content. The carbon content increased from 10.6% of ZnMt to 43.3% of ZnOMt. Additionally, the presence of new elements, such as phosphorus, can be attributed to the phosphate groups present in lecithin. The zinc content reached 2.5% in ZnOMt, indicating that lecithin could not fully perform cation exchange with Zn^{2+} . In fact, lecithin molecules balance the interlayer cations through ion-dipole interactions, resulting in the presence of Zn^{2+} within the montmorillonite interlayer. This phenomenon and mechanism have been discussed in detail in Chapter 5.

6.4.2 XRD and TEM analysis

The crystal structure of NaMt after organic modification, and the evolution of the microstructure of NaOMt and ZnOMt in linseed oil were investigated to establish the correlation between the macroscopic properties of drilling fluid system and its microstructure (Fig. 6.5). The synthesized NaMt exhibited a reflection at $2\theta=6.02^\circ$ with a d_{001} -value of 1.47 nm. The interlayer spacing of ZnMt is hardly observed to change after zinc ion exchange. After modification with lecithin, the d_{001} -values of 5.35 nm and 5.13 nm were recorded for ZnOMt and NaOMt, respectively. This result suggested that organic molecules were introduced into the Mt interlayer space. Since Mt is hydrophilic in nature, organic modification aims to change the properties of the clay from hydrophilic to hydrophobic, thereby enhancing the affinity for organic medium (oil).



**Fig. 6.5 XRD patterns of NaMt, ZnMt, NaOMt, ZnOMt powders (a);
TEM image of ZnOMt powder, ZnOMt/linseed-120°C
and NaOMt/linseed-120°C samples (b)**

The microstructure of ZnOMt powder, ZnOMt/linseed-120°C and NaOMt/linseed-120°C were examined by TEM (Fig. 6.5b). The TEM micrograph of ZnOMt powder suggested that the Mt modified with Zn^{2+} and lecithin could still remain layered structure. The image of ZnOMt/linseed-120°C confirmed the exfoliating behavior of organoclay particles in linseed oil. The microstructure is formed by a large number of highly flexible nanosized Mt platelets. The exfoliated nanoclay platelets are not randomly dispersed in the oil but form compact clay tactoids. Finally, the clay platelets formed a huge network

structure in the linseed oil. NaOMt exhibited the same exfoliation behavior in linseed oil as ZnOMt at 120°C. Although organoclays contain different types of cations, this diversity did not affect their exfoliation in linseed oil. Both ZnOMt and NaOMt platelets produced by exfoliation can interconnect and form a network structure, which may be the main reason for the good rheology and viscoelasticity of linseed oil-based drilling fluid.

6.4.3 Rheology and viscoelasticity

The rheological properties of drilling fluid play a key role in the smooth running of the drilling process. The shear-thinning behavior of oil-based drilling fluids is widely recognized as beneficial for drilling operations. It allows the drilling fluid to maintain a high viscosity at rest to effectively suspend cuttings, while exhibiting a low viscosity at high shear rates for rapid pumping into the wellbore. The rheology and viscoelasticity of oil-based drilling fluid system composed of NaOMt and ZnOMt have been monitored (Fig. 6.6). Aged at high temperature, the linseed oil exhibited Newtonian behavior, characterized by a shear rate-independent viscosity. It can be seen that both NaOMt/oil-120°C and ZnOMt/oil-120°C exhibited higher viscosity at low shear rates, which means a greater ability to prevent cuttings deposition in wells when drilling is halted, while at high shear rates, the viscosity of drilling fluids decreased significantly, implying that they can meet the flow requirements during circulation. In addition, the shear-shinning behavior of NaOMt in linseed oil seems to be slightly better than that of ZnOMt, which may be related to the cations contained in organic clay (Yan and Zhang, 2021).

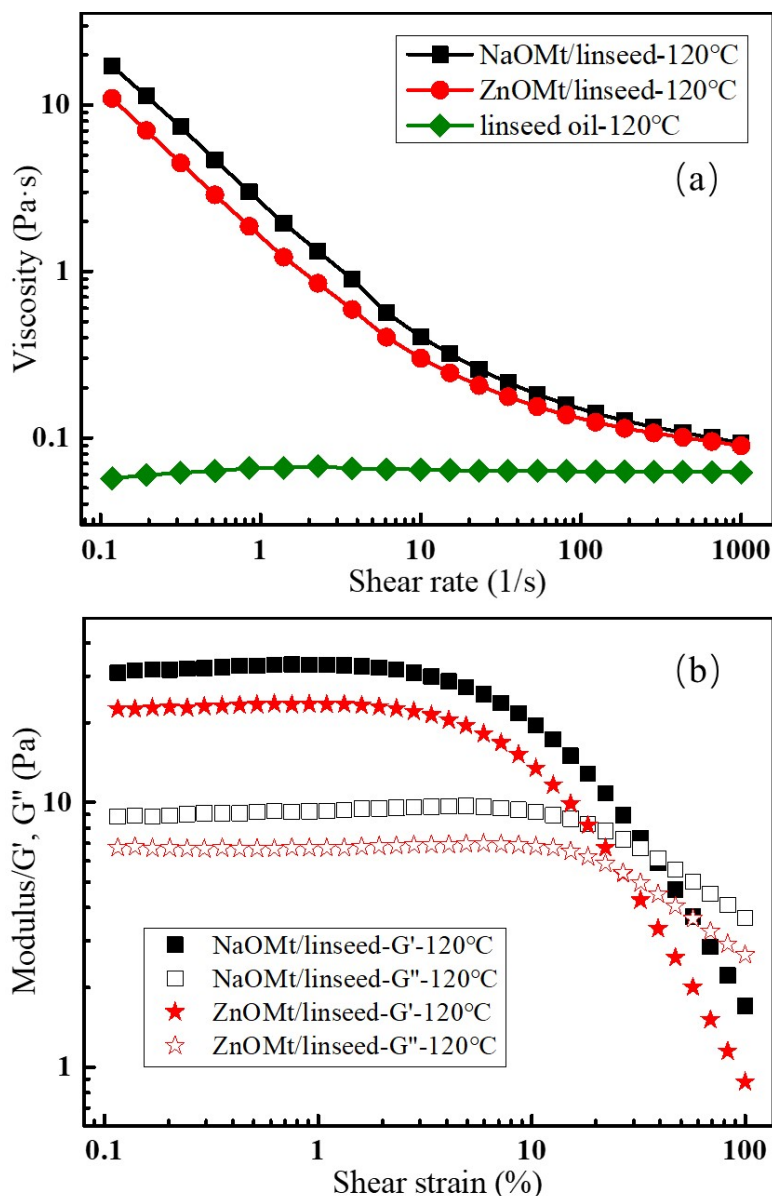

Fig. 6.6 Rheological behavior (a) and amplitude sweep (b) of NaOMt and ZnOMt in linseed oil aged at 120 °C

The dynamic properties of the systems were also investigated by amplitude sweep measurements (Fig. 6.6b). The linear viscoelastic regime (LVER) demonstrates the strain range where storage modulus (G') and loss modulus (G'') curves are constant, until the inner structure of the fluid begins to breakdown. The comparison of G' and G'' at low shear strain is important as it helps to identify the occurrence of dynamic sag at low shear strain (Arain et al., 2022). The LVER of NaOMt/oil drilling fluid corresponds to G' of 32

Pa and G'' of 9 Pa, while ZnOMt/oil drilling fluid showed G' of 23 Pa and G'' of 7 Pa. Within the LVER (low shear strain), the microstructure of the NaOMt/oil and ZnOMt/oil remain intact and has a solid-like structure (G' higher than G''). However, beyond the LVER, with increasing strain, the drilling fluid develops micro-cracks that spread throughout the drilling fluid system, and this phenomenon continues until the flow point is reached (Medhi et al., 2021). The flow point for the NaOMt/oil drilling fluid is at 34% shear strain and 7 Pa of G' . And the flow point for ZnOMt/oil drilling fluid is attained at 27% shear strain and G' of 5 Pa, respectively. The viscoelastic behavior of NaOMt/oil and ZnOMt/oil fluid indicated that the samples are solid-like at low strain while being liquid-like at high strain. The viscoelastic properties of organo-montmorillonite and organo-hectorite in oil-based drilling fluids obtained by modifying clay minerals with quaternary ammonium surfactants have been reported (Geng et al., 2019). Comparing the results to the existing literature, the viscoelasticity of the OMt utilized in this study surpasses that of the organo-hectorite previously reported, demonstrating comparable performance to the organo-montmorillonite documented in the literature.

In summary, the drilling fluid composed of linseed oil and NaOMt or ZnOMt is a viscoelastic material with shear thinning behavior on a macroscopic scale. These properties contribute to drilling fluid flow and suspension of drilling cuttings. TEM and XRD measurements determined the exfoliation of ZnOMt and network formation, confirming the response between microstructure and macroscopic rheological properties of linseed oil drilling fluid. The ancient recipe employed in oil paint mediums have not only yielded aesthetically pleasing visual effects in numerous artworks but have also demonstrated considerable potential in the modern petroleum industry, particularly within the realm of drilling fluids. The combination of siccative oil (linseed oil) and organoclay exhibits satisfactory rheological behavior and viscoelastic properties. The excellent shear thinning ability and elastic modulus meet the requirements of drilling engineering and demonstrate the great prospect of siccative oil as a base oil for oil-based drilling fluids.

6.5 Performance of ZnOMt in oil-based drilling fluids

Based on the preceding discussion, it is now affirmed that the linseed oil-based drilling fluid incorporating ZnOMt demonstrates favorable rheological properties at 120°C. Most of the widely used oil-based drilling fluids are formulated with mineral oil as the base oil. Therefore, ZnOMt was separately dispersed into linseed oil and paraffin oil and aged at different temperatures to compare its properties. In addition, zinc cations and ZnMt were also added into linseed oil and paraffin oil to investigate the effect of cations on drilling fluid properties.

6.5.1 XRD analysis

The XRD pattern of ZnOMt powder has been provided in Fig. 6.5. The basal spacing of ZnOMt increased from 1.45 nm to 5.35 nm, indicating the successful intercalation of lecithin into the interlayer space of ZnMt. XRD technique was used to try to investigate the structural information of organoclays in oil. The specific experimental procedure has been described in detail in Chapter 3.3.1.

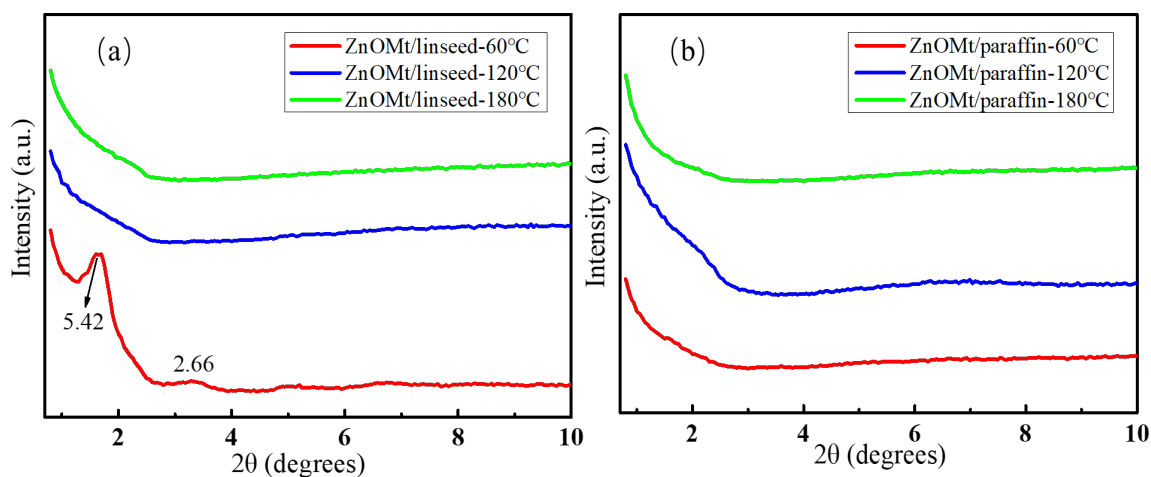

Fig. 6.7 XRD patterns of ZnOMt/linseed (a) and ZnOMt/paraffin(b) aged at different temperatures

The XRD patterns of ZnOMt sediment in linseed and paraffin oil aged at different

temperatures are presented in Fig. 6.7. The base spacing of the synthesized ZnOMt powder was 5.35 nm. However, the XRD results of ZnOMt/linseed and ZnOMt/paraffin showed different trends after aging at various temperatures. The basal spacing of ZnOMt/linseed-60 increased from 5.35 nm to 5.42 nm, suggesting the penetration of oil molecules into the interlayer of ZnOMt and subsequent expansion of the basal spacing. Based on previous research (Zhuang et al., 2017a; Patel et al., 2019), high temperatures can promote the thermal motion of oil molecules, leading to the swelling of ZnOMt in oil. There was no detectable reflection from Mt lattices in the XRD patterns of ZnOMt/linseed aged at 120°C and 180°C. The same results can also be observed in ZnOMt/paraffin systems. Several scholars suggested that the disappearance of the (001) reflection is caused by the exfoliation of organoclays in oil (Luckham and Rossi, 1999; Zhuang et al., 2016a; Zhuang et al., 2017a). As the temperature increased, more oil molecules intercalated into the interlayer space of the ZnOMt, resulting in the exfoliation of clay platelets and reducing the attractive force between Mt sheets. The exfoliated clay platelets form a “house of cards” structure through three different modes of particle association : face-to-face (FF), edge-to-face (EF) and edge-to-edge (EE) (Van Olphen, 1964a). Others believed, however, that the qualitative structural information on d-spacing provided by XRD can not explain the different rheological properties observed in ZnOMt/oil systems, indicating that the basal spacing can not predict the fluid flow behavior (Burgentzlé et al., 2004; Hermoso et al., 2014).

6.5.2 TEM analysis

In order to illustrate the microstructure of ZnOMt in oil-based drilling fluid, taking the ZnOMt/linseed system as an example, the TEM images of drilling fluid at different temperatures are shown in Fig. 6.8. The ZnOMt powder obtained by lecithin modification exhibited a layered structure. When it was dispersed in linseed oil and subjected to aging at 60°C, the layered structure remained unaltered, which is consistent with the XRD results. A large number of aggregated layered ZnOMt particles dispersed in the linseed

oil. As the temperature increased to 120°C, the ZnOMt platelets exfoliated. The exfoliated nanoclay platelets were interconnected to form a network structure. The ZnOMt/linseed-180°C sample was completely exfoliated but presented a different dispersion state from ZnOMt/linseed-120°C. The ZnOMt platelets, of approximately 60 nm, were homogeneously dispersed in the linseed oil, without contact with each other. The network structure formed by the clay platelets was destroyed, because of the degradation of the surfactant in the ZnOMt at high temperature. The effect of temperature on the microstructure of ZnOMt is mainly reflected in the exfoliation and the degradation of surfactants. The relationship between the microstructure and rheological properties of ZnOMt in oil will be explained in detail in the following sections.

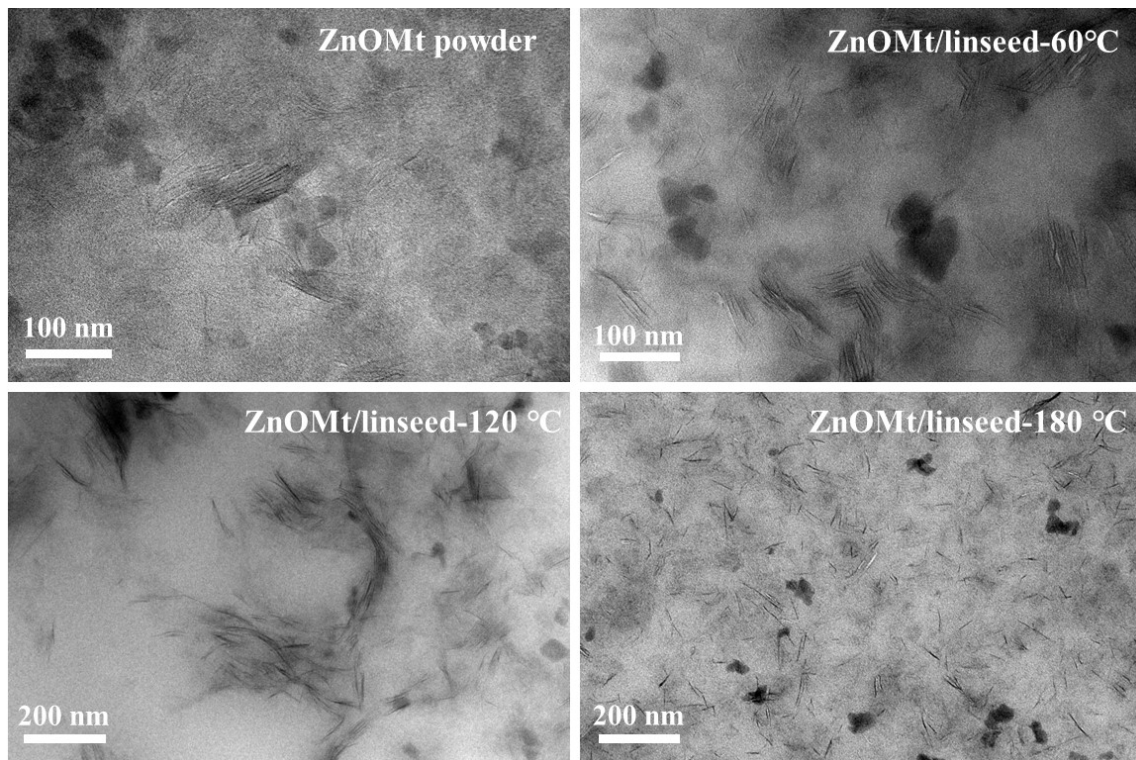

Fig. 6.8 TEM images of ZnOMt powder, and ZnOMt/linseed aged at different temperatures

6.5.3 Dispersion

The dispersion states of ZnOMt and ZnMt powder in paraffin oil and linseed oil at different temperatures were obtained mainly by optical microscopy for observing the overall size distribution of the particles. As shown in Fig. 6.9, the ZnMt samples were not uniformly dispersed throughout the organic medium for either paraffin oil or linseed oil. Due to the strong hydrophilicity of ZnMt, it is difficult for oil molecules to penetrate into the interlayer space to swell the clay particles. However, it is worth noting that the dispersion of ZnMt in paraffin and linseed oil is distinct. The ZnMt samples were randomly dispersed in linseed oil without any contact, whereas in paraffin oil they were interconnected. These particles tend to gather and partially overlap each other and form a net-like structure. The organo-modification of ZnMt with lecithin evidently improved its dispersion in oil. Although the dispersion of ZnOMt in both oils was stable, the dispersion of ZnOMt in linseed oil was more homogeneous and the particle size was smaller. The ZnOMt in paraffin oil presented a large number of aggregated particles. In contrast, the aggregated particles in linseed oil were very limited at any temperature. This is probably due to the fact that linseed oil is polar compared to non-polar paraffin oil, which has a stronger affinity for ZnOMt modified by polar molecules of lecithin (Jones, 1983). In addition, temperature contributes to the dispersion of ZnOMt in oil-based drilling fluids.

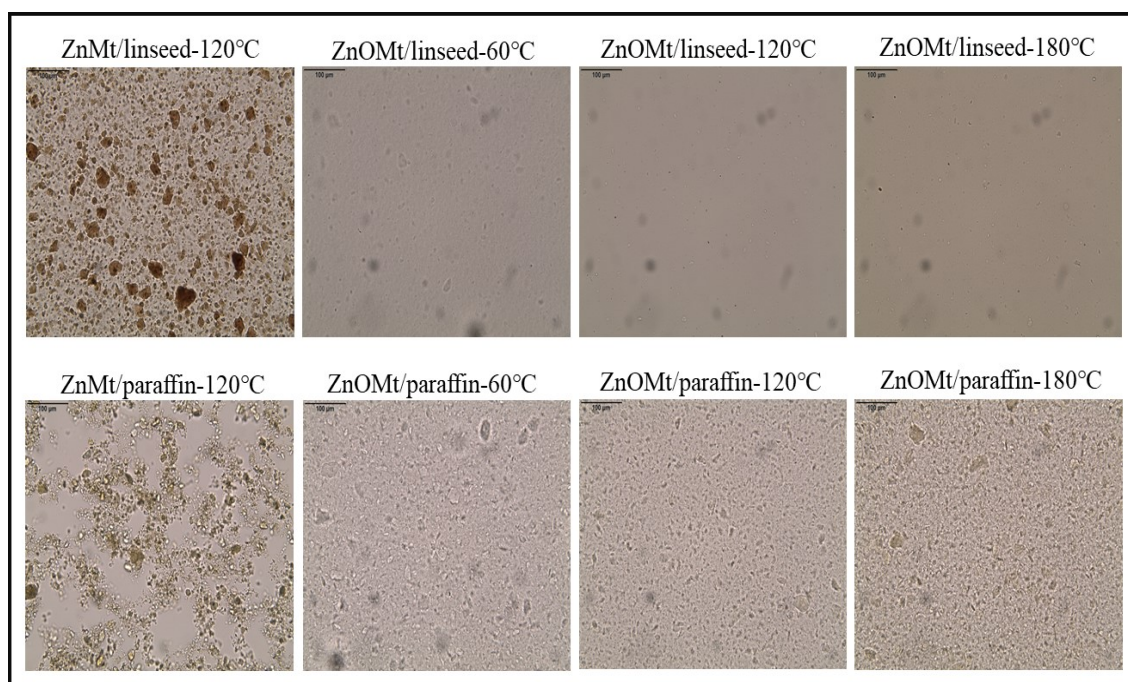

Fig. 6.9 Optical microscope images of ZnMt and ZnOMt in oil-based drilling fluid

6.5.4 Rheological properties

The relationship between shear stress and shear rate is the most accurate description of drilling fluid flow behavior. Fig. 6.10 illustrates the flow behavior of oil-based drilling fluid containing Zn^{2+} , ZnMt, ZnOMt samples as a function of shear rate at 120°C: different rheological behaviors were obtained in oil phases. Pure linseed and paraffin oil are Newtonian fluids, exhibiting a constant viscosity at any shear rate. The addition of Zn^{2+} remarkably increased the viscosity of linseed oil, and the viscosity of the system grew from 0.06 to 0.5 Pa·s, which may be caused by the saponification reaction between the zinc cations and the esters of the siccative oil, as commonly reported in the literature (Osmond, 2019; Artesani, 2020). The addition of ZnMt had no effect on the viscosity of linseed oil, while ZnOMt modified its rheological behavior from Newtonian to shear thinning: the ZnOMt/linseed oil system displayed high viscosity at low shear rates and the viscosity decreased with increasing shear rates, which is highly desirable in drilling operations. For paraffin oil, Zn^{2+} did not affect the flow behavior of paraffin oil, as it is

mainly composed of alkanes that cannot react with Zn^{2+} . Interestingly, paraffin oil containing ZnMt was a non-Newtonian fluid with shear thinning properties, while linseed oil containing ZnMt was a Newtonian fluid. This may be due to the different dispersion states of ZnMt in two oils. The net-like structure (Fig. 6.9) formed by ZnMt in paraffin oil leads to an increase in viscosity. Conversely, the dispersion of ZnOMt in paraffin oil did not yield satisfactory rheological properties. The ZnOMt showed better rheological performance and application potential for drilling fluid in linseed oil compared to paraffin oil.

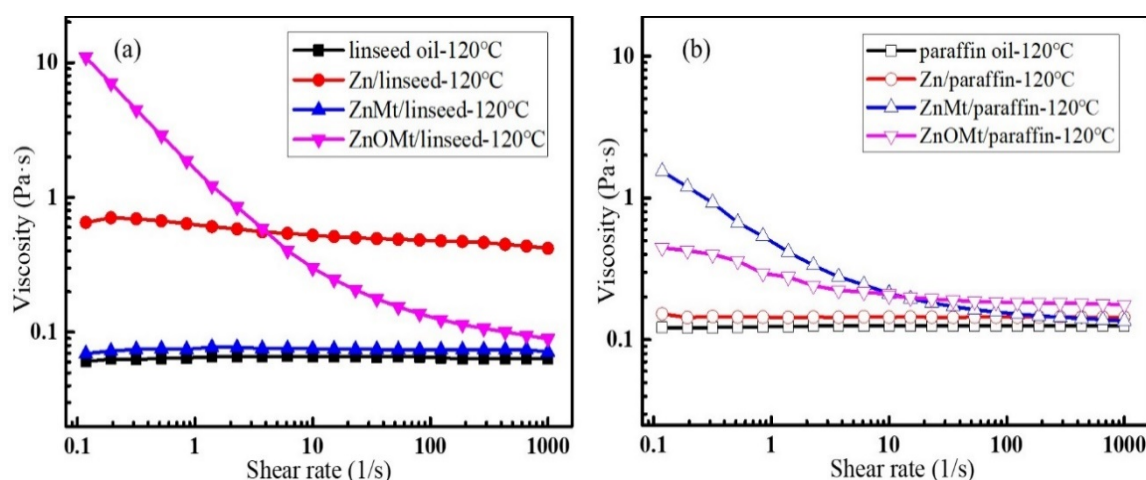

Fig. 6.10 Flow tests of oil-based drilling fluids prepared by Zn^{2+} , ZnMt, ZnOMt at 120°C

The rheological behavior of oil-based drilling fluid is not only affected by the oil nature, but also depends on the temperature. As shown in Fig. 6.11, the rheological properties of oil-based drilling fluids were altered as the temperature increased. At temperatures below 120°C, ZnOMt/linseed fluids exhibited shear thinning behavior at low shear rates. The viscosity measured at zero shear rate can be used to indicate the pumpability of drilling fluids and as a rheological parameter to evaluate barite sag, borehole cleaning, surge, and swab pressures (Maxey et al., 2008). The viscosity of ZnOMt/linseed oil systems at low shear rates decreased gradually with increasing temperature. As the temperature increased to 180°C, the system viscosity decreased to 0.2

Pa·s and became a Newtonian fluid. This reduction may be due to the fact that temperature (180°C) disrupts the structure of clay platelets and reduces the connection and bonding between clay particles. The ZnOMt lost its ability to adjust linseed oil-drilling fluid rheological properties at 180°C, indicating that the electrochemical attraction between clay particles has totally disappeared. The ZnOMt/paraffin oil system exhibited similar rheological behavior to the ZnOMt/linseed oil fluid at 60°C. However, when the temperature rose to 120°C, its viscosity dropped significantly and tended to exhibit the properties of Newtonian fluid. Comparing the rheological properties of ZnOMt in linseed oil and paraffin oil, it can be concluded that the ZnOMt/linseed oil system is more resistant to high temperatures.

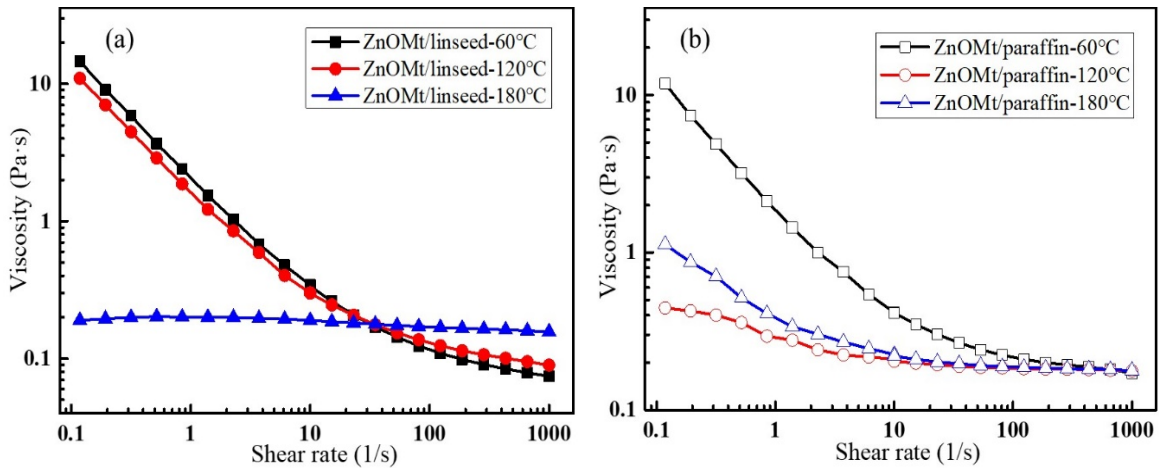

Fig. 6.11 Flow tests of ZnOMt/linseed (a) and ZnOMt/paraffin (b) oil-based drilling fluids at varying temperatures

6.5.5 Thixotropy

The thixotropy of the drilling fluid plays a crucial role in controlling the rate of penetration at low shear rates within the well annulus and ensuring effective suspension of cuttings (Celino et al., 2022). The microstructure of drilling fluid is disrupted in the up-sweep, while rebuilt in the down-sweep and hysteresis is induced in the flow curves. Fig. 6.12 illustrates the thixotropic loop curves of the ZnOMt/oil system at different

temperatures. The loop areas of ZnOMt/linseed-60°C and ZnOMt/linseed-180°C fluids were minimal due to the lack of ZnOMt exfoliation at 60°C and the degradation of surfactant molecules at 180°C, resulting in poor thixotropy. Conversely, the loop area is higher at 120°C indicating greater thixotropy. According to XRD and TEM results, this is due to the exfoliation of ZnOMt and the resulting network structure in linseed oil. Based on the loop area values, the thixotropic loop areas of the ZnOMt/paraffin system were not satisfactory, whatever the temperature.

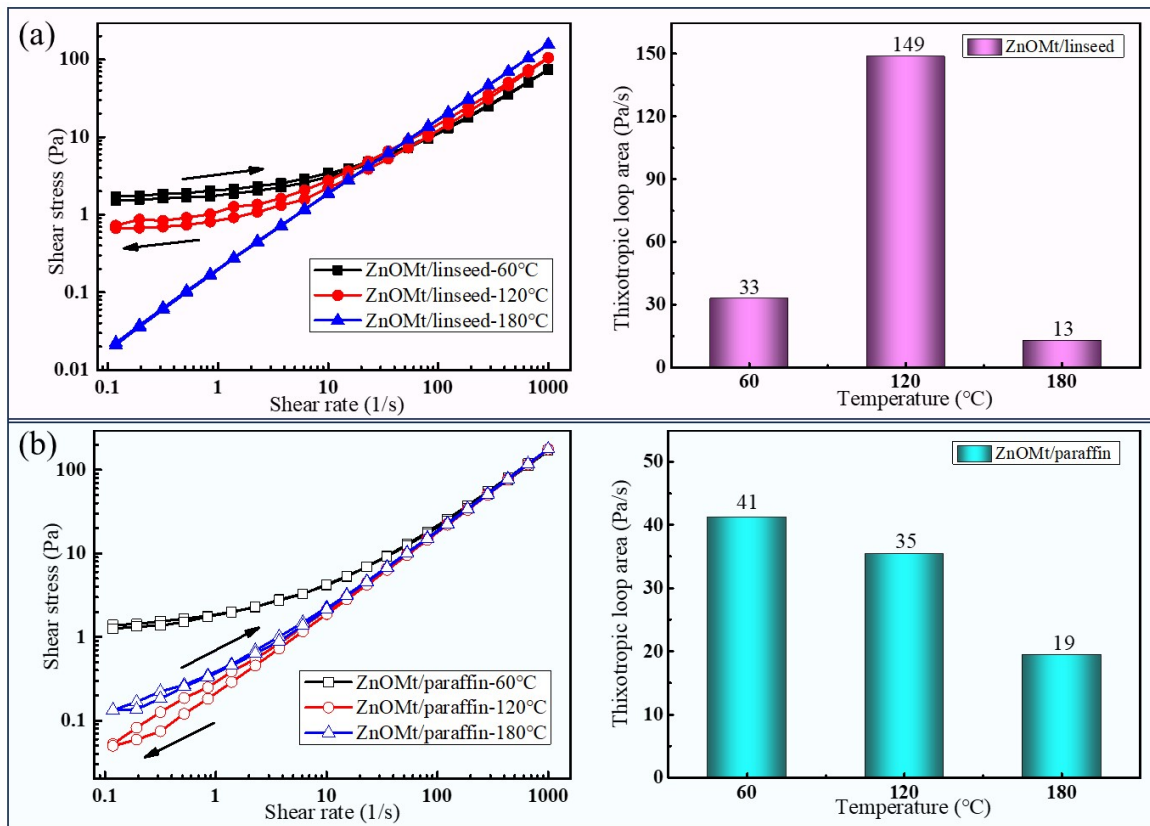

Fig. 6.12 The thixotropic loop curves and areas of the ZnOMt/linseed (a) and ZnOMt/paraffin (b) system at different temperatures

6.5.6 Rheological modeling

Rheological modeling aims to describe the flow behavior of drilling fluids mathematically (Agwu et al., 2021). Rheological models can generally be divided into two groups: (i) the relationship between shear rate and shear stress; (ii) the relationship

between shear rate or shear stress and viscosity. In this study, the rheological data of the drilling fluid at different temperatures were fitted with three rheological model, including two-parameter models (i.e., Bingham-plastic, Casson) and three-parameter models (i.e., Herschel-Bulkey). The Bingham-plastic model is a widely used simple rheological model that describes a linear relationship between shear stress and shear rate. The line intercept is yield stress, and the slope is plastic viscosity. However, this model cannot accurately describe the drilling fluid flow behavior at low shear rates (Adewale et al., 2017). The Bingham-plastic model can be determined from the following equations (Bingham, 1917):

$$\tau = \tau_0 + \mu_p \dot{\gamma}$$

Where τ is the shear stress, τ_0 is the yield stress, μ_p is the plastic viscosity, and $\dot{\gamma}$ is the shear rate.

Another common model used to describe flow behavior of fluid is the Casson model. Casson model is a structure-based model for describing the flow of viscoelastic fluids. This model has a more gradual transition from Newtonian to the yield region (Adewale et al., 2017). Mathematically, it can be expressed as (Casson, 1959):

$$\tau^{0.5} = \tau_0^{0.5} + k \dot{\gamma}^{0.5}$$

where k is the flow consistency coefficient.

One of the most popular and important three-parameter models is the Herschel-Bulkey model. The Herschel-Bulkley model, also known as the modified Power-law model, is a Power-law model with the addition of yield stress to the model. This model is one of the complex models and defines the behavior of drilling fluids better than the other models (Rehm et al., 2012). The model is also recommended by API RP 13D to predict pressure profile in the wellbore due to its accuracy. The Herschel-Bulkley model has the following form (W.H. Herschel, 1926):

$$\tau = \tau_0 + k \dot{\gamma}^n$$

The Herschel-Bulkley model is a general model that can be simplified to the Power-law and Bingham-plastic model. When the τ_0 is 0, the Herschel-Bulkley simplifies to the

Power-law model. And when the n is 1, the Herschel-Bulkley simplifies to the Bingham-plastic model.

The knowledge of the drilling fluid rheological model is crucial, as the accuracy of fitting the model to the actual properties of the drilling fluid will dramatically affect the drilling hydraulics calculations (Wiśniowski et al., 2020). A single rheological model cannot precisely describe the flow behavior of drilling fluids in all shear rate ranges. In this work, the coefficient of determination (R^2), sum of square residuals (SSR), and root-mean-square error (RMSE) are used to determine the performance of the rheological models. These parameters were defined by fitting constants using regression analysis obtained from rheological data. Fig. 6.13 revealed the curve fitting of the oil-based drilling fluid rheology model at different temperatures. The rheological constants and derived statistical parameters obtained from the rheological models are listed in Table 6.1.

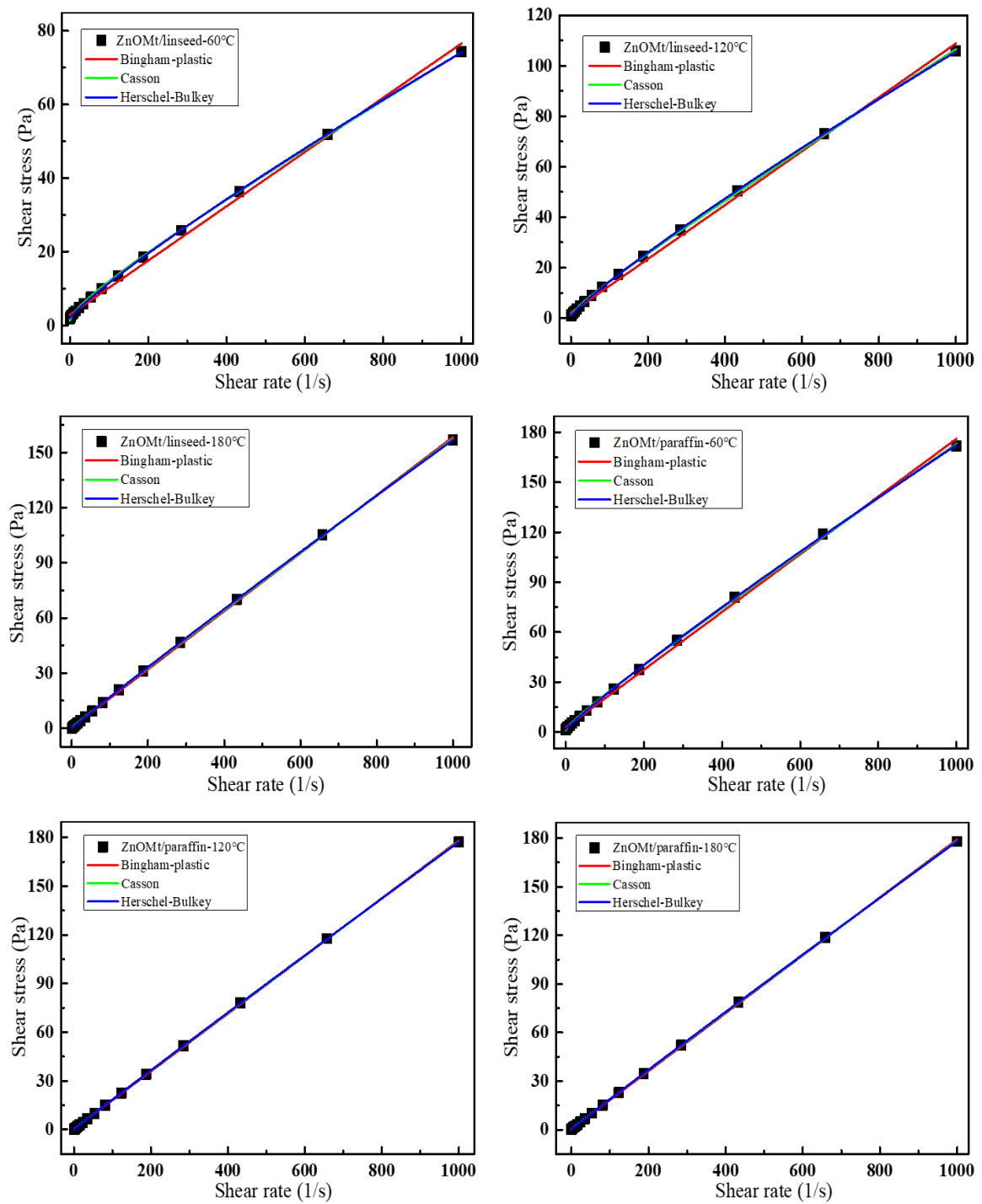

Fig. 6.13 Fitting curves of rheological models for ZnOMt/oil drilling fluids at different temperatures

Table 6.1 The rheological constants and derived statistical parameters of ZnOMt/oil drilling fluids at different temperatures

Models		ZnOMt/linseed			ZnOMt/paraffin		
		60°C	120°C	180°C	60°C	120°C	180°C
Bingham-plastic	τ_0	2.8511	2.0917	0.5049	2.7892	0.3451	0.5083
	μ_p	0.0737	0.1067	0.1578	0.1733	0.1777	0.1786
	R ²	0.9964	0.997	0.9997	0.9985	0.9999	0.9998
	SSR	26.9414	47.0667	9.9898	62.7696	3.2374	4.8909
	RMSE	1.1606	1.5341	0.7068	1.7716	0.4023	0.4945
Casson	τ_0	1.1454	0.6524	0.0566	0.6831	0.0194	0.0348
	K	0.2385	0.3007	0.3892	0.3899	0.4169	0.4165
	R ²	0.9998	0.9998	0.9999	0.9998	0.9999	0.9999
	SSR	1.5284	1.9463	1.9033	8.9719	0.6752	0.9411
	RMSE	0.2764	0.3119	0.3085	0.6698	0.1837	0.2169
Herschel-Bulkey	τ_0	1.9755	0.9416	0.0081	1.5294	0.0726	0.1749
	K	0.167	0.2263	0.2010	0.2941	0.2004	0.2066
	n	0.8785	0.8884	0.9641	0.9214	0.9822	0.9784
	R ²	0.9999	0.9999	0.9999	0.9999	0.9999	0.9999
	SSR	0.5194	0.6038	0.1524	3.0547	0.2016	0.3692
	RMSE	0.1653	0.1783	0.0896	0.4009	0.1031	0.1394

A satisfactory model to characterize the rheological properties of oil-based drilling fluids at different temperatures was determined based on the values of fitted parameters such as R² (greater than 0.99), SSR (less than 5) and RMSE (less than 0.2) (Rafieefar et al., 2021). As expected, the Bingham-plastic model was not suitable for describing the rheological behavior of non-Newtonian drilling fluid because the model expresses a linear relationship. In comparison with the Bingham-plastic model, the Casson model fitted better, revealing the nonlinear relationship between the shear stress and shear rate. The Herschel-Bulkey model represents the most accurate fitting results of drilling fluids at different temperatures. This is why the Herschel-Bulkey model is selected for utilization

in the drilling fluid field.

Rheological parameters such as flow behavior index (n) and consistency coefficient (k) obtained by the Herschel-Bulkley model provide more valuable information. The n value can be used to evaluate the ability of drilling fluids to carry cuttings, and k is the measure of the consistency of the fluid, which is proportional to the effective viscosity (Maiti et al., 2021). The drilling fluid with the lowest n value and the highest k value has a greater ability to suspend and carry drill cuttings. The fitting results obtained from the Herschel-Bulkley model revealed that the ZnOMt/linseed system exhibited an n value of 0.8884 and a k value of 0.2263 at 120°C. These findings indicated that the linseed oil-based drilling fluid demonstrated the most favorable rheological properties at 120°C.

6.5.7 Amplitude sweep measurements

Viscoelastic properties of ZnOMt/oil systems are determined using oscillatory amplitude sweep tests to investigate the structural characteristics of the drilling fluid and understand their short and long-term structural behavior (Bui et al., 2012; Alvi et al., 2020). The amplitude sweep tests aim to characterize the dependence of the storage modulus G' and loss modulus G'' and of the drilling fluid on the amplitude. The storage modulus (G'), also known as elastic modulus, represents the deformation energy which is stored by the sample during shear. Whereas the loss modulus (G'') denotes the deformation energy which is consumed by the sample during shear process (Mezger, 2020; Maiti et al., 2021). The G' signifies the drilling fluid's elastic behavior, while the G'' represents its viscous behavior.

The amplitude sweep tests are presented in Fig. 6.14, indicating the viscoelastic properties (G' and G'') of the ZnOMt/oil system at different temperatures. The linear viscoelastic range (LVER) is defined by the strain range where G' and G'' are approximately constant: the limit of the LVER was 3% for ZnOMt/linseed-60°C and 6% for ZnOMt/linseed-120°C, respectively. The microstructure of the drilling fluid within the LVER remains intact; it is a solid-like structure as the value of G' was higher than that of

G'' . However, the values of G' and G'' begin to fall when the limits of the LVER range are exceeded. The continuous decline in G' and G'' causes a gradual breakdown of the drilling fluid structure and allow it to start flowing. The flow point ($G'=G''$) represents the overlapping point of G' and G'' , implying a transition from solid-like to liquid-like characteristics (Arain et al., 2022). The flow point for ZnOMt/linseed-60°C occurs at a shear strain and G' of 16% and 4.7 Pa, respectively. Similarly, for ZnOMt/linseed-120°C, the flow point is achieved at shear strain and G' of 27% and 5.8 Pa, respectively. Higher flow point normally related to stronger inner structure and suspension capacity. ZnOMt/linseed-60°C and ZnOMt/linseed-120°C mainly demonstrate elastic behavior within the LVER, characterized by a stable inner structure. As the strain increased after the flow point, $G'<G''$ and the drilling fluid behaved more like a liquid-like and viscous structure. At 180°C, $G''>G'$ regardless of the applied strain, indicating liquid-like behavior: the internal structure of the sample was completely disrupted, which is consistent with the TEM results. The ZnOMt/paraffin systems did not exhibit any viscoelasticity with G'' always greater than G' at both high and low temperatures. This result suggested that ZnOMt prepared from lecithin could not form a network structure in paraffin oil. The composition and nature of the base oil is also an important factor in the viscoelasticity of the drilling fluid.

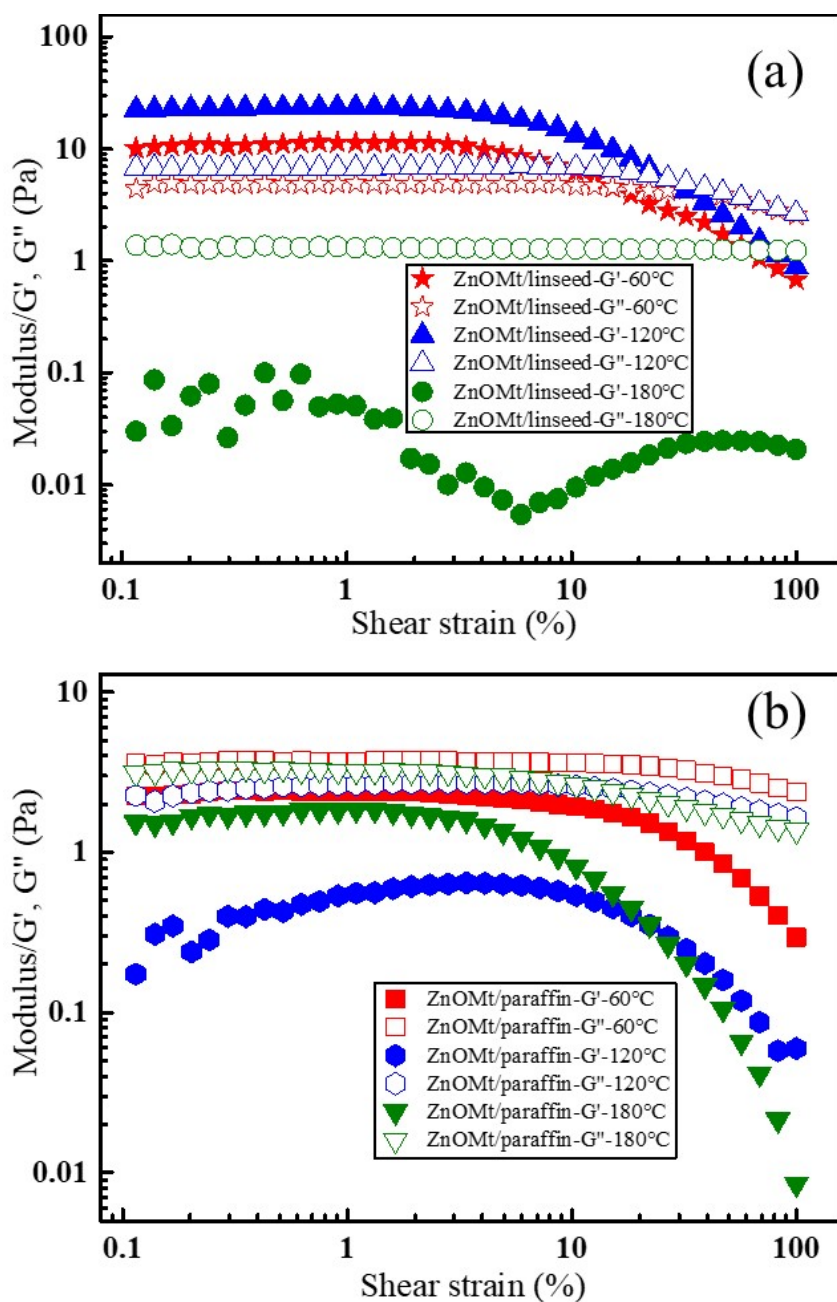

Fig. 6.14 The amplitude sweep tests of the ZnOMt/linseed (a) and ZnOMt/paraffin (b) systems at different temperatures

6.5.8 Frequency sweep measurements

After determining the LVER of the oil-based drilling fluid, the oscillatory frequency sweep tests were conducted within those ranges to understand the influence of frequency

on stability of the systems' viscoelasticity. As shown in Fig. 6.15, frequency exerts distinct effects on the ZnOMt/linseed and ZnOMt/paraffin drilling fluid systems. In the case of ZnOMt/linseed-60°C and ZnOMt/linseed-120°C, both demonstrate a transition from elastic behavior to viscous behavior as the frequency increases. The G'' of these two samples is lower than the G' in low frequency range implying elastic nature of the fluid. However, the G'' is higher than the G' when the frequency exceeds 60 rad/s, indicating that the viscous behavior is dominant. This observation holds significance as it highlights the intrinsic ability of the studied system to flow under high shear rates, while maintaining a stable internal structure during low shear rates (Quainoo et al., 2022). In addition, the G' of ZnOMt/linseed-120°C is significantly larger than that of ZnOMt/linseed-60°C, implying that ZnOMt/linseed-120°C has a stronger network structure and colloidal behavior. In the context of drilling fluids, a stable colloidal structure is critical to keep cuttings in suspension when drilling operations are interrupted. ZnOMt/linseed-180°C displayed G'' dominant behavior throughout the tested frequencies (lower and higher frequencies). This behavior can be attributed to the breakdown of the fluid's internal structure.

The analysis of frequency's influence on the ZnOMt/paraffin oil system reveals a distinct pattern when contrasted with the behavior exhibited by the ZnOMt/linseed oil system. The ZnOMt/paraffin oil fluid, without exception, displayed elastic behavior solely at very low frequencies. However, as the frequency surpassed the threshold of 0.5 rad/s, a clear upward trend in the G'' value was noticed as the frequency increased. ZnOMt/paraffin system demonstrates viscous behavior dominant in almost the entire range of tested frequencies, and the difference is further intensified as G'' values exceed G' . The ZnOMt/paraffin system lacks a stable internal structure required for preserving fluid strength, even when subjected to low frequencies. This viscous behavior hinders the drilling fluid from effectively fulfilling its intended function and has the potential to result in drilling accidents.

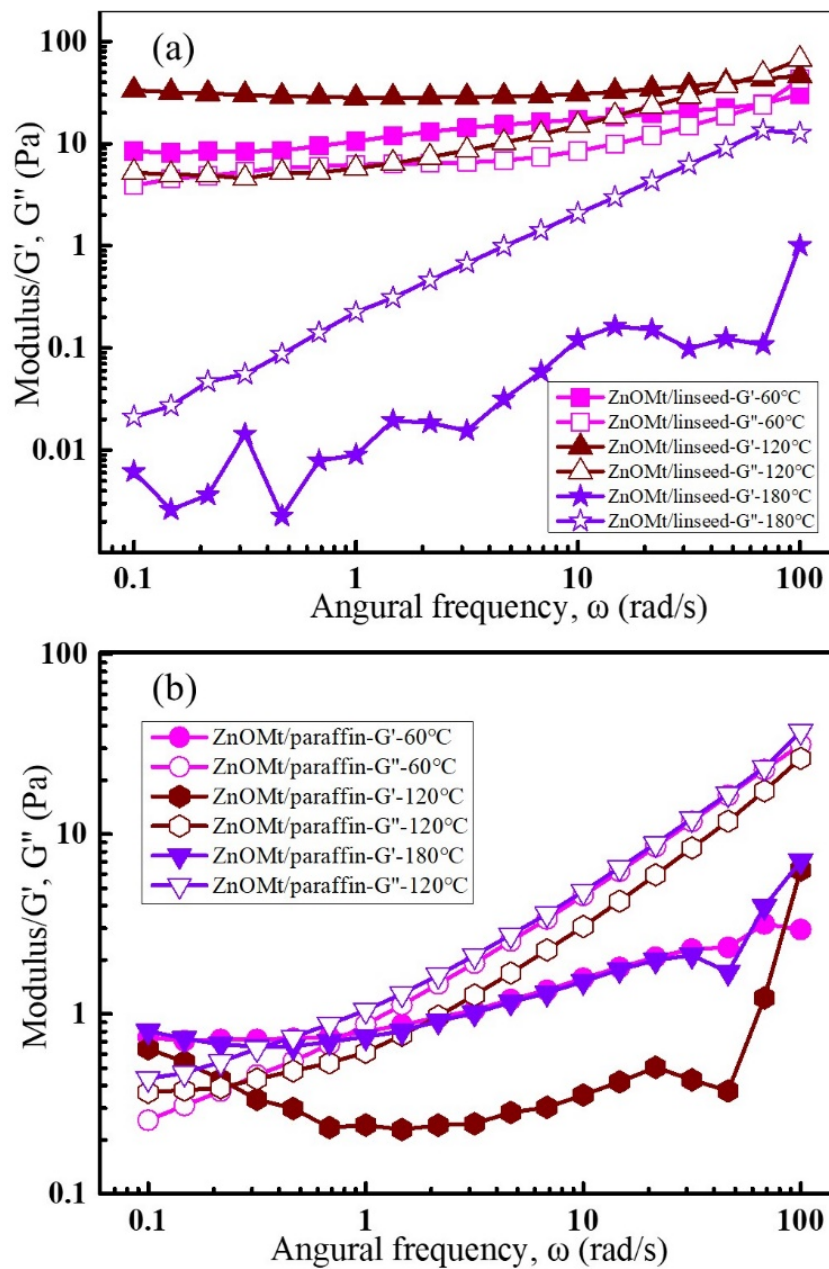

Fig. 6.15 The frequency sweep tests of the ZnOMt/linseed (a) and ZnOMt/paraffin (b) systems at different temperatures

6.5.9 Rheological mechanism

Based on the experimental findings, a comprehensive analysis of the impact of temperature on the rheological properties of linseed oil-based drilling fluid and the microstructure of ZnOMt in linseed oil is thoroughly discussed. A schematic

representation of the microstructure of ZnOMt in linseed oil at different temperatures is proposed in Fig. 6.16. The synthesized ZnOMt maintained the layered structure while exhibiting an increased interlayer spacing, suggesting the intercalation of lecithin. This observation is further supported by the XRD and TEM results. After the dispersion of ZnOMt in linseed oil at 60°C, no exfoliation has been observed. The aggregation of larger clay particles impeded the flow of drilling fluid and resulted in higher viscosity. In addition, the high aspect ratio of the ZnOMt further reinforced this flow resistance (Cruz et al., 2019). When the temperature rose to 120°C, the oil molecules intercalated into the interlayer space and caused exfoliation of the ZnOMt (Van Olphen, 1964a; Luckham and Rossi, 1999). Lecithin molecules adsorbed on the surface of ZnOMt possess long and flexible alkyl chains, which facilitated their entanglement with each other, leading to a physical attraction (Zhuang et al., 2016b). By increasing the temperature up to 180°C, lecithin molecules started to degrade, and the network structure of the drilling fluid was completely destroyed. The exfoliation of ZnOMt resulted in a high aspect ratio leading to homogeneous dispersion in oil as confirmed by observations using optical microscopy and TEM.

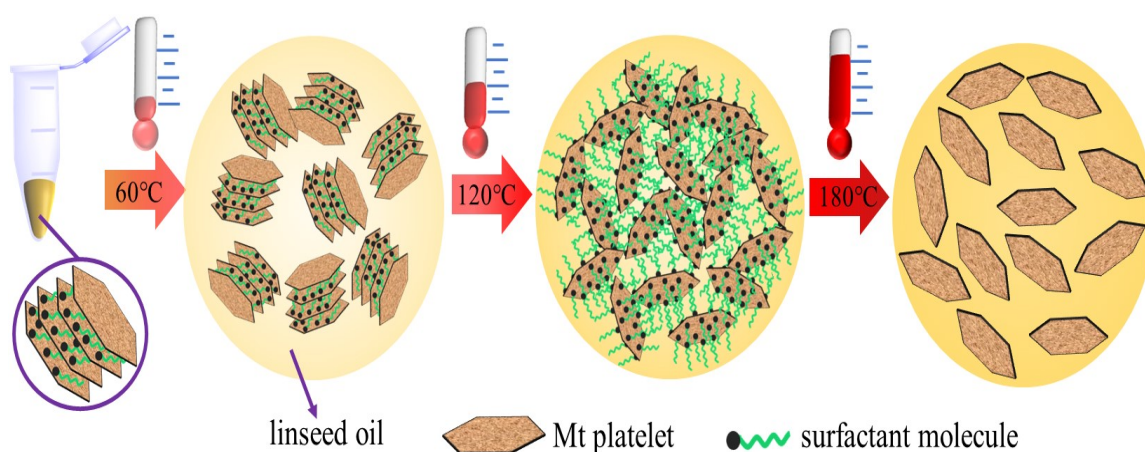

Fig. 6.16 The microstructure of ZnOMt in linseed oil at different temperatures

6.6 Conclusions

Taking inspiration from ancient oil painting recipes, an attempt was undertaken to

formulate oil-based drilling fluids using organoclays containing zinc ions and linseed oil. A systematic and in-depth experimental work was performed to probe the potential of siccative oil (linseed oil) as an alternative to mineral oil-based drilling fluid. The rheology, viscoelasticity, thixotropy and microstructure of ZnOMt in linseed oil and paraffin oil at different temperatures were compared and investigated. In particular, different rheological models were applied to fit the flow behavior to obtain the best compatibility with the actual drilling fluid properties. ZnOMt prepared by zinc ions and lecithin exhibited viscoelastic behavior in linseed oil when the temperature did not reach 120 °C. The microstructure of ZnOMt in linseed oil undergoes three stages with rising temperature: swelling→exfoliation→high dispersion. The association of exfoliated clay platelets and the intertwining of surfactant molecules adsorbed on the clay surface are the basis for forming a network structure and thixotropy in drilling fluids. In addition, the paraffin oil-based drilling fluids always displayed liquid-like behavior, while linseed oil-based drilling fluids exhibited viscoelastic properties and maximum thixotropy at 120°C. The base oil type and temperature are the main factors affecting the rheology and viscoelasticity of drilling fluid. The rheological modeling results indicated that the Herschel–Bulkley model is the most suitable for describing the flow behavior and non-Newtonian shear thinning behavior of drilling fluid. The favorable properties of vegetable oil-based drilling fluids containing organoclays provide great potential for their application in drilling engineering.

References

- Adewale, F.J., Lucky, A.P., Oluwabunmi, A.P., Boluwaji, E.F., 2017. Selecting the most appropriate model for rheological characterization of synthetic based drilling mud. *Int. J. Appl. Eng. Res* 12, 7614-7629.
- Agwu, O.E., Akpabio, J.U., Ekpenyong, M.E., Inyang, U.G., Asuquo, D.E., Eyoh, I.J., Adeoye, O.S., 2021. A critical review of drilling mud rheological models. *Journal of Petroleum Science and Engineering* 203, 108659.
- Agwu, O.E., Okon, A.N., Udoh, F.D., 2015. A comparative study of diesel oil and soybean oil as oil-based drilling mud. *Journal of Petroleum Engineering* 2015, 1-10.
- Alvi, M.A.A., Belayneh, M., Fjelde, K.K., Saasen, A., Bandyopadhyay, S., 2020. Effect of Hydrophobic Iron Oxide Nanoparticles on the Properties of Oil-Based Drilling Fluid. *Journal of Energy Resources Technology* 143.
- Ansari, M., Turney, D.E., Morris, J., Banerjee, S., 2021. Investigations of rheology and a link to microstructure of oil-based drilling fluids. *Journal of Petroleum Science and Engineering* 196, 108031.
- Arain, A.H., Ridha, S., Mohyaldinn, M.E., Suppiah, R.R., 2022. Improving the performance of invert emulsion drilling fluid using boron nitride and graphene nanoplatelets for drilling of unconventional high-temperature shale formations. *Journal of Molecular Liquids* 363, 119806.
- Aramendiz, J., Imqam, A., 2019. Water-based drilling fluid formulation using silica and graphene nanoparticles for unconventional shale applications. *Journal of Petroleum Science and Engineering* 179, 742-749.
- Artesani, A., 2020. Zinc oxide instability in drying oil paint. *Materials Chemistry and Physics* 255.
- Bingham, E.C., 1917. An investigation of the laws of plastic flow.
- Bui, B., Saasen, A., Maxey, J., Ozbayoglu, M.E., Miska, S.Z., Yu, M., Takach, N.E., 2012. Viscoelastic properties of oil-based drilling fluids. *Annu. Trans. Nord. Rheol. Soc* 20, 33-47.
- Burgentzlé, D., Duchet, J., Gérard, J.F., Jupin, A., Fillon, B., 2004. Solvent-based nanocomposite coatings: I. Dispersion of organophilic montmorillonite in organic solvents. *Journal of Colloid and Interface Science* 278, 26-39.
- Casson, N., 1959. Rheology of disperse systems. *Flow Equation for Pigment Oil Suspensions of the Printing Ink Type. Rheology of Disperse Systems*, 84-102.
- Celino, K.N., Fernandes, R.d.S., de Moraes, S.C., de Souza, E.A., Balaban, R.d.C., 2022. Emulsion-based drilling fluids: Rheological properties preservation facing changes on the temperature, pressure and dispersed phase. *Journal of Molecular Liquids* 352, 118753.

- Cruz, N., Forster, J., Bobicki, E.R., 2019. Slurry rheology in mineral processing unit operations: A critical review. *The Canadian Journal of Chemical Engineering* 97, 2102-2120.
- de Viguerie, L., Payard, P.A., Portero, E., Walter, P., Cotte, M., 2016. The drying of linseed oil investigated by Fourier transform infrared spectroscopy: Historical recipes and influence of lead compounds. *Progress in Organic Coatings* 93, 46-60.
- Fenneman, N.M., 1906. Oil fields of the Texas-Louisiana Gulf Coastal Plain, *Bulletin*, -ed.
- Geng, T., Qiu, Z., Zhao, C., Zhang, L., Zhao, X., 2019. Rheological study on the invert emulsion fluids with organoclay at high aged temperatures. *Colloids and Surfaces A: Physicochemical and Engineering Aspects* 573, 211-221.
- Ghavami, M., Hasanzadeh, B., Zhao, Q., Javadi, S., Kebria, D.Y., 2018. Experimental study on microstructure and rheological behavior of organobentonite/oil-based drilling fluid. *Journal of Molecular Liquids* 263, 147-157.
- Govier, G.W.A.K., 1977. *The flow of complex mixtures in pipes*. R.E. Krieger Pub. Co., Huntington, N.Y.
- Hemphill, T., Campos, W., Pilehvari, A., 1993. Yield-power law model more accurately predicts mud rheology. 91, 45-50
- Hermoso, J., Martinez-Boza, F., Gallegos, C., 2014. Influence of viscosity modifier nature and concentration on the viscous flow behaviour of oil-based drilling fluids at high pressure. *Applied Clay Science* 87, 14-21.
- Ibrahim, M.A., Jaafar, M.Z., Yusof, M.A.M., Idris, A.K.J.J.o.P.S., Engineering, 2022. A review on the effect of nanoparticle in drilling fluid on filtration and formation damage. 110922.
- Jones, T.R., 1983. The properties and uses of clays which swell in organic solvents. *Clay Minerals* 18, 399-410.
- Karakaya, M.Ç., Karakaya, N., Bakır, S., 2011. Some properties and potential applications of the Na- and Ca-bentonites of ordu (N.E. Turkey). *Applied Clay Science* 54, 159-165.
- Kelessidis, V.C., 2017. Yield stress of bentonite dispersions. *Rheol: open access* 1.
- Lazzari, M., Chiantore, O., 1999. Drying and oxidative degradation of linseed oil. *Polymer Degradation and Stability* 65, 303-313.
- Li, M.-C., Wu, Q., Han, J., Mei, C., Lei, T., Lee, S.-y., Gwon, J., 2020. Overcoming Salt Contamination of Bentonite Water-Based Drilling Fluids with Blended Dual-Functionalized Cellulose Nanocrystals. *ACS Sustainable Chemistry & Engineering* 8, 11569-11578.
- Li, Q., Berraud-Pache, R., Yang, Y., Souprayan, C., Jaber, M., 2023. Biocomposites based

- on bentonite and lecithin: An experimental approach supported by molecular dynamics. *Applied Clay Science* 231, 106751.
- Liu, K., Du, H., Liu, W., Liu, H., Zhang, M., Xu, T., Si, C., 2022. Cellulose Nanomaterials for Oil Exploration Applications. *Polymer Reviews* 62, 585-625.
- Luckham, P.F., Rossi, S., 1999. The colloidal and rheological properties of bentonite suspensions. *Advances in Colloid and Interface Science* 82, 43-92.
- Maiti, M., Bhaumik, A.K., Mandal, A., 2021. Performance of water-based drilling fluids for deepwater and hydrate reservoirs: Designing and modelling studies. *Petroleum Science* 18, 1709-1728.
- Maxey, J., Ewoldt, R., Winter, P., McKinley, G., 2008. Yield stress: what is the True value, *AADE Fluids Conference and Exhibition*, pp. 1-10.
- Medhi, S., Gupta, D.K., Sangwai, J.S., 2021. Impact of zinc oxide nanoparticles on the rheological and fluid-loss properties, and the hydraulic performance of non-damaging drilling fluid. *Journal of Natural Gas Science and Engineering* 88, 103834.
- Mewis, J., 1979. Thixotropy-a general review. *Journal of Non-Newtonian Fluid Mechanics* 6, 1-20.
- Mezger, T., 2020. *The rheology handbook: for users of rotational and oscillatory rheometers*. European Coatings.
- Mohamed, A., Salehi, S., Ahmed, R., 2021. Significance and complications of drilling fluid rheology in geothermal drilling: A review. *Geothermics* 93, 102066.
- Moraru, V.N., 2001. Structure formation of alkylammonium montmorillonites in organic media. *Applied Clay Science* 19, 11-26.
- Orlova, Y., Harmon, R.E., Broadbelt, L.J., Iedema, P.D., 2021. Review of the kinetics and simulations of linseed oil autoxidation. *Progress in Organic Coatings* 151, 106041.
- Osmond, G., 2019. Zinc soaps: an overview of zinc oxide reactivity and consequences of soap formation in oil-based paintings. *Metal soaps in art: Conservation research*, 25-46.
- Oyman, Z.O., Ming, W., Linde, R.v.d., 2005. Oxidation of drying oils containing non-conjugated and conjugated double bonds catalyzed by a cobalt catalyst. *Progress in Organic Coatings* 54, 198-204.
- Paswan, B.K., Mahto, V., 2020. Development of environment-friendly oil-in-water emulsion based drilling fluid for shale gas formation using sunflower oil. *Journal of Petroleum Science and Engineering* 191, 107129.
- Patel, H.A., Santra, A., Thaemlitz, C.J., 2019. Exceptional flat rheology using a synthetic organic-inorganic hybrid in oil-based muds under high pressure and high temperature, *SPE/IADC International Drilling Conference and Exhibition*. OnePetro.
- Pereira, L.B., Sad, C.M.S., Castro, E.V.R., Filgueiras, P.R., Lacerda, V., 2022. Environmental impacts related to drilling fluid waste and treatment methods: A critical

review. Fuel 310, 122301.

Quainoo, A.K., Bavoh, C.B., Negash, B.M., 2022. Rheological and Viscoelastic Property Characterizations of Amino Acid-Based Hydraulic Fracturing Fluids. Energy & Fuels 36, 3539-3548.

Rafieefar, A., Sharif, F., Hashemi, A., Bazargan, A.M., 2021. Rheological Behavior and Filtration of Water-Based Drilling Fluids Containing Graphene Oxide: Experimental Measurement, Mechanistic Understanding, and Modeling. ACS Omega 6, 29905-29920.

Rehm, B., Haghshenas, A., Paknejad, A., Al-Yami, A., Hughes, J., Schubert, J., 2012. CHAPTER 2 - Flow Drilling: Underbalance Drilling with Liquid Single-Phase Systems, Underbalanced Drilling: Limits and Extremes. Gulf Publishing Company, pp. 39-108.

Silva, I.A., Sousa, F.K.A., Menezes, R.R., Neves, G.A., Santana, L.N.L., Ferreira, H.C., 2014. Modification of bentonites with nonionic surfactants for use in organic-based drilling fluids. Applied Clay Science 95, 371-377.

Sisko, A.W., 1958. The Flow of Lubricating Greases. Industrial & Engineering Chemistry 50, 1789-1792.

Sulaimon, A.A., Adeyemi, B.J., Rahimi, M., 2017. Performance enhancement of selected vegetable oil as base fluid for drilling HPHT formation. Journal of Petroleum Science and Engineering 152, 49-59.

Survey, U.S.G., 2023. Mineral commodity summaries 2023, Mineral Commodity Summaries, Reston, VA, p. 210.

van Olphen, H., 1964. Internal mutual flocculation in clay suspensions. Journal of Colloid Science 19, 313-322.

W.H. Herschel, R.B., 1926. Konsistenzmessungen von Gummi-Benzollösungen 291–300, Kolloid Zeitschrift 21, 291–300.

Wiśniowski, R., Skrzypaszek, K., Małachowski, T., 2020. Selection of a Suitable Rheological Model for Drilling Fluid Using Applied Numerical Methods, Energies.

Yan, H., Zhang, Z., 2021. Effect and mechanism of cation species on the gel properties of montmorillonite. Colloids and Surfaces A: Physicochemical and Engineering Aspects 611, 125824.

Zaman, A., Ali, N., Bég, O.A., 2016. Numerical study of unsteady blood flow through a vessel using Sisko model. Engineering Science and Technology, an International Journal 19, 538-547.

Zhang, L., Zhang, B., Wu, T., Sun, D., Li, Y., 2015. Adsorption behavior and mechanism of chlorophenols onto organoclays in aqueous solution. Colloids and Surfaces A: Physicochemical and Engineering Aspects 484, 118-129.

Zhong, H., Guan, Y., Qiu, Z., Grady, B.P., Su, J., Huang, W., 2023. Application of carbon coated bentonite composite as an ultra-high temperature filtration reducer in water-based

drilling fluid. *Journal of Molecular Liquids* 375, 121360.

Zhou, D., Zhang, Z., Tang, J., Wang, F., Liao, L., 2016. Applied properties of oil-based drilling fluids with montmorillonites modified by cationic and anionic surfactants. *Applied Clay Science* 121-122, 1-8.

Zhuang, G., Zhang, H., Wu, H., Zhang, Z., Liao, L., 2017. Influence of the surfactants' nature on the structure and rheology of organo-montmorillonite in oil-based drilling fluids. *Applied Clay Science* 135, 244-252.

Zhuang, G., Zhang, Z., Jaber, M., 2019. Organoclays used as colloidal and rheological additives in oil-based drilling fluids: An overview. *Applied Clay Science* 177, 63-81.

Zhuang, G., Zhang, Z., Sun, J., Liao, L., 2016a. The structure and rheology of organo-montmorillonite in oil-based system aged under different temperatures. *Applied Clay Science* 124-125, 21-30.

Zhuang, G., Zhang, Z., Sun, J., Liao, L., 2016b. The structure and rheology of organo-montmorillonite in oil-based system aged under different temperatures. *Applied Clay Science* 124, 21-30.

Chapter 7

Conclusions and perspectives

7.1 General conclusions

This thesis manuscript focuses on the modification of bentonite with natural surfactants and the application of organoclays in oil-based drilling fluids. Lecithin was utilized to modify bentonite with the aim of preparing environmentally friendly bio-organic clays. Reaction temperature, time, pH, and surfactant concentration were systematically assessed to examine the influence of reaction conditions on the properties of the organoclay. To gain a deeper understanding of the molecular-level interactions, molecular dynamics simulations were employed. These simulations provided insights into the configuration and arrangement of lecithin molecules within the interlayer spaces of the organic clay structure. The impact of pH on the properties of organoclays was thoroughly investigated, and a comprehensive interpretation was carried out to understand the mechanism of lecithin intercalation into bentonite under varying pH conditions. Additionally, the study drew inspiration from ancient painting recipes, an attempt was made to explore the rheology of organoclay prepared with lecithin modified ZnMt in linseed oil. This investigation extended to a comparative analysis of the rheology, thixotropy and viscoelasticity of ZnOMt in both linseed oil and paraffin oil. Lastly, the microstructure of the ZnOMt within linseed oil was examined using a combination of XRD and TEM to gain a comprehensive understanding of organoclay behavior in oil.

(I) The intercalation behavior of lecithin in the interlayer space of bentonite can be completed in a short time (0.5h). Reaction time and temperature did not have a significant effect on the final properties of the modified bentonite. However, lecithin concentration and pH greatly influence the structural characteristic of modified bentonite. In general, the basal spacing of the organo-bentonite has a positive correlation with lecithin concentration and pH. In the case of pH=1.0, the interlayer spacing of modified bentonite increases with the lecithin concentration and the surfactants exhibit different arrangements among the bentonite layers. Lecithin adopts a lateral monolayer arrangement at low concentrations (0.1~1.0CEC) in contrary to a bilayer at high

concentrations (2.0~3.0CEC), which has been confirmed by experiments and molecular dynamics simulation results. Regarding the effect of the pH, the d_{001} of the organic bentonite was significant higher for the samples prepared at $\text{pH} \geq 3.0$ due to the properties change of lecithin. The shift in pH from 1.0 to 3.0 led to a remarkable increase in the interlayer spacing within the organoclay, a phenomenon that holds significant implications for the cost-effective preparation of organic bentonite tailored for diverse industrial applications.

(II) The impact of pH on the properties of organoclay, derived from lecithin-modified bentonite, primarily manifests through its effect on the properties of lecithin. In both pH is 1.0 and 9.0, the conformation of lecithin molecules in the clay interlayer undergoes a transition from a flat-lying layer to a tilted paraffin-type-bilayer with increasing surfactant concentration. The intercalation behavior of lecithin in bentonite exhibits diverse mechanisms influenced by varying pH conditions: cation exchange serves as the intercalation mechanism at $\text{pH}=1.0$, whereas ion-dipole interactions come into play at $\text{pH}=9.0$. Due to the protonation of the phosphate groups at $\text{pH}=1.0$, the lecithin molecules can only be intercalated into the interlayer space by cation exchange, resulting in a nearly complete removal of exchangeable cations in organoclay. In contrary, the amount of cations released during the preparation of organo-bentonite at $\text{pH}=9.0$ is very limited. In an alkaline environment, the zwitterionic nature of lecithin facilitated its intercalation in the interlayer space via ion-dipole interactions with the cations. The positive head group of the lecithin is attached to the negatively charged clay surface, while its negative head group is coupled with the interlayer cations. The pH-dependent phenomena observed during the intercalation process illustrates the discrepancy in the ultimate physical and chemical characteristics of organoclays. Such pH-driven variations are crucial for revealing the properties of organic clay and expanding their potential applications in various fields.

(III) ZnOMt prepared with zinc ions and lecithin demonstrates superior rheological and viscoelastic properties in linseed oil than in paraffin oil. The base oil type and

temperature are the main factors affecting the rheology and viscoelasticity of oil-based drilling fluid. The microstructure of ZnOMt in linseed oil undergoes a progressive transformation across three stages as temperature increases: swelling, exfoliation, and eventual high dispersion attributed to surfactant degradation. The association of exfoliated clay platelets and the intertwining of surfactant molecules adsorbed onto the clay surface, forming the foundational structure responsible for drilling fluids colloidal system. Furthermore, as the temperature continued to rise, both linseed and paraffin oil-based drilling fluids undergo a transition from non-Newtonian to Newtonian behavior. The XRD and TEM results indicated that the exfoliation of ZnOMt is a pivotal phenomenon explaining the heightened thixotropy and viscoelasticity of vegetable oil-based drilling fluid. However, excessively high temperatures result in the degradation of the organoclay, subsequently leading to a reduction in performance. The paraffin oil fluids consistently exhibited liquid-like behavior, whereas linseed oil fluids displayed distinct viscoelastic properties, reaching peak thixotropy and elastic behavior at 120°C. The outcomes of rheological modeling emphasized the Herschel–Bulkley model's suitability in capturing the drilling fluid's flow behavior and non-Newtonian shear thinning tendencies. The favorable properties of vegetable oil-based drilling fluids containing organoclays provide great potential for their application in drilling engineering.

In conclusion, this doctoral research not only clarified the preparation conditions and intercalation mechanism of lecithin-modified clays, but also investigated the macroscopic rheology and microstructure of organoclays in oil-based drilling fluids. Nonetheless, certain issues concerning the preparation and application of organoclays in oil-based drilling fluids deserve to be further explored.

(I) The thermal stability of organoclays within the oil phase remains a pivotal concern in the drilling fluids and petroleum industries. Although some progress has been made in utilizing the unique properties of organoclays to improve the performance of drilling fluids, there is still an urgent need to further improve their ability to withstand high temperature environments. Organoclays prepared using biosurfactants demonstrate

commendable biocompatibility and environmental friendliness; however, they may undergo structural changes and degradation when exposed to high temperatures. This can lead to a loss of their beneficial properties, such as their ability to control viscosity and fluid loss, ultimately compromising the overall performance of the drilling fluid. Sepiolite and palygorskite are considered promising candidates for improving the thermal stability of drilling fluids due to their inherent high temperature resistant properties. These minerals are known to maintain their structural integrity and functionality at elevated temperatures, making them potentially robust choices for downhole environments with extreme heat. The selection of surfactants for the modification of sepiolite and palygorskite, along with the pursuit of advanced modification techniques to tailor organoclays' properties for drilling fluids, plays a pivotal role in enhancing the thermal stability of organoclays and performing specific functions in drilling fluids. The research in this direction is expected to open up new possibilities and foster innovations in the field of drilling fluids.

(II) The oil-based drilling fluid widely used in the petroleum industry is a complex colloidal system composed of base oil, rheological modifier, filtration control agents, weighing materials, and other additives. This thesis exclusively concentrated on the colloidal chemistry of organoclays in the oil phase. Organoclays are known to have a significant impact on drilling fluid properties, and comprehending their behavior in oil-based drilling fluid systems is critical to optimizing drilling performance and ensuring drilling efficiency. However, as drilling activities gradually transition from shallow to deep formations, the complexity of drilling practices and drilling fluid formulations is steadily increasing. In this context, it is imperative for future research endeavors to transcend the exclusive concentration on organoclays. The compatibility of organoclay with other additives used in oil-based drilling fluids is a key area that needs to be thoroughly investigated. This involves exploring potential synergies, antagonisms, and mechanisms of interaction, all of which can significantly influence drilling fluid performance. Moreover, interdisciplinary collaboration between experts in colloid

chemistry, drilling fluid engineering, and materials science will be essential to advance this research. The ultimate objective is the formulation of drilling fluids that not only ensure harmonious compatibility among all additives but also deliver superior performance, unwavering stability, and environmentally sustainable attributes.

(III) The use of mineral oil as the main ingredient in oil-based drilling fluids has long been the industry standard because of its excellent performance characteristics. However, in the face of growing environmental concerns and the urgent need for environmental protection in various industries, there is a growing realization that alternative solutions are required to align drilling operations with sustainable development. Vegetable oils are emerging as a promising alternative to mineral oil in drilling fluids. Their biodegradability and reduced toxicity make them a greener choice for drilling operations, aligning with the principles of environmental protection and sustainability. Vegetable oil is becoming a promising dispersion medium to replace mineral oil in oil-based drilling fluids. The biodegradability and low toxicity make them a more environmentally friendly choice for drilling operations. Although the environmental benefits of vegetable oils are evident, their application as drilling fluids comes with challenges. The disparity in composition between mineral oils and vegetable oils results in a situation where additives optimized for mineral oils may not perform as effectively in vegetable oils. Historical additives designed for mineral oil-based fluids may not readily integrate with vegetable oil systems. In the process of developing vegetable oil drilling fluids, it is crucial to study additives suitable for vegetable oils and adjust formulation to guarantee the compatibility, stability, and optimal performance of drilling fluids.

(IV) Organoclays serve a dual purpose, functioning not only as rheology modifiers in oil-based drilling fluids, but also as filtration control agents, preventing fluid from leaking into the formation. In the realm of drilling fluid evaluation, rheological properties have long been of interest as a fundamental measure of performance. However, it is becoming increasingly clear that an in-depth examination of filtration performance is equally indispensable. The filtration properties of drilling fluids play a key role in

maintaining wellbore stability and reducing reservoir damage. Currently, the predominant approach for evaluating the filtration performance of drilling fluids primarily involves examining fluid loss following high-temperature aging. While this method provides valuable insights, it often overlooks the significant impact of pressure on fluid loss performance. Given that drilling operations frequently expose drilling fluids to both high temperature and high pressure (HTHP) conditions, simply evaluating filtration at high temperatures may not accurately reflect the performance of drilling fluids under actual conditions where both temperature and pressure are elevated simultaneously. The filtration properties of oil-based drilling fluids containing organoclays under high-temperature and high-pressure conditions needs to be further studied.

Bio-argiles organiques pour fluides de forage à base de pétrole

Résumé :

Les argiles organiques sont connues pour modifier les propriétés rhéologiques des boues de forage dans le domaine pétrolier. Dans le cadre de ce travail, une série d'argiles organiques a été préparée à base de bentonite et de lécithine. Les différents paramètres tels que la température, le temps, le pH et la concentration en lécithine ont été explorés. Le mécanisme d'intercalation de la lécithine dans la bentonite ainsi que la conformation de la matière organique dans l'espace interfoliaire ont été étudiés dans différentes conditions de pH. Enfin, les composites préparés ont été dispersés dans différentes huiles conformément aux normes de l'American Petroleum Institute (API) afin de tester leurs propriétés rhéologiques. Celles-ci ont été corrélées aux informations microstructurales des composites bentonite-lécithine analysés par diffraction de Rayons X et microscopie électronique à transmission. Des résultats prometteurs ont été obtenus montrant le potentiel important de ces matériaux hybrides inorganiques-organiques de l'ingénierie de forage.

Mots clés : montmorillonite organique, lécithine, modification, mécanisme d'intercalation, fluide de forage à base de pétrole, rhéologie

Bio-organoclays for oil-based drilling fluids

Abstract:

Organoclays are typical additives that impart rheological properties to oil-based drilling fluids and have long been the subject of research. This study aims to investigate the preparation of organoclays based on bentonite and lecithin, and explore its potential application in oil-based drilling fluids. Initially, the effects of reaction temperature, time, pH and lecithin concentration on the properties of organoclays were analyzed. Subsequently, the mechanism of lecithin intercalating bentonite and the transition in interlayer conformation were carefully studied under different pH conditions. Finally, the prepared organoclays were used to formulate oil-based drilling fluids according to American Petroleum Institute (API) standards. The rheological properties of these oil-based drilling fluids were evaluated and correlated with the microstructural information of organic clays obtained by XRD and TEM. The promising characteristics of vegetable oil-based drilling fluids incorporating organoclays offer significant potential for their utilization in drilling engineering.

Keywords: organic montmorillonite, lecithin, modification, intercalation mechanism, oil-based drilling fluid, rheology