



HAL
open science

Enhancing adhesion and Water Resistance in Clayey adhesives Mixtures : Strategies for Vertical and Horizontal Applications

Kassem Nejme

► **To cite this version:**

Kassem Nejme. Enhancing adhesion and Water Resistance in Clayey adhesives Mixtures : Strategies for Vertical and Horizontal Applications. Civil Engineering. Université Gustave Eiffel, 2024. English. NNT : 2024UEFL2012 . tel-04608994

HAL Id: tel-04608994

<https://theses.hal.science/tel-04608994v1>

Submitted on 12 Jun 2024

HAL is a multi-disciplinary open access archive for the deposit and dissemination of scientific research documents, whether they are published or not. The documents may come from teaching and research institutions in France or abroad, or from public or private research centers.

L'archive ouverte pluridisciplinaire **HAL**, est destinée au dépôt et à la diffusion de documents scientifiques de niveau recherche, publiés ou non, émanant des établissements d'enseignement et de recherche français ou étrangers, des laboratoires publics ou privés.



UNIVERSITÉ
— PARIS-EST



*Enhancing adhesion and Water Resistance
in Clay Mixtures: Strategies for Vertical
and Horizontal Applications*

A thesis presented by

Kassem NEJMEH

To Université Paris-Est

École Doctorale Sciences, Ingénierie et Environnement

For the Degree of Doctor of Philosophy in Materials Science

Committee members:

M. Arnaud PERROT	Research professor at University of Bretagne-Sud	Reviewer
M. Antonin FABBRI	Research director at ENTPE	Reviewer
Mme. Celine PERLOT-BASCOULES	Research professor at University of Pau and Pays de l'Adour (UPPA)	Examiner
Mme. Ann BOURGES	Research engineer at C2RMF	Co-supervisor
M. Emmanuel KEITA	Researcher at University Gustave Eiffel	Co-supervisor
M. Nicolas ROUSSEL	Director of CPDM lab at University Gustave Eiffel	Supervisor
Mme. Joumana YAMMINE-MALESYS	International R&D manager at Saint-Gobain Weber	Invited

In Champs-sur-Marne, France, on the 19th of January, 2024.

Abstract

Despite their ecological benefits, clay materials are underutilized in the construction industry. Fine clay particles are a critical factor in enhancing the cohesion of these materials, and are particularly interesting candidates for replacing the cement phase and thereby reducing the carbon footprint of construction materials. This thesis is dedicated to exploring clay-based mixtures as viable alternatives to conventional adhesives for ceramic tiling. It aims to develop a material with strong adhesion that maintains its structural integrity even when submerged in water. The inherent porosity of clay mixtures necessitates adherence to specific drying protocols and defined immersion periods.

The initial phase of this research involves a mechanical test to assess the adhesive stress of the clay material before and after immersion, using a standard clay sample as a benchmark. To modulate the mechanical properties, polymers or fibers were added proportionally to the soil mass, intending to improve its cohesion characteristics. These additives were selected strategically to induce significant changes in the material's mechanical properties and its moisture resistance.

The subsequent phase focuses on analyzing the drying process and the kinetics of water uptake following the integration of polymers, establishing that the choice of additive significantly affects the immersion kinetics and the water absorption capacity of the material.

This scientific approach unfolds across three distinct scenarios: enhancing the material's strength by incorporating various polymers and fibers; reducing water uptake by the adhesive; and developing a reversible adhesive that regains its mechanical strength after immersion-induced loss, simply through a drying process. Moreover, strategies tailored to each application method have been devised, addressing both vertical and horizontal applications.

Key words: Clay material, Clay-based mixtures, Tile adhesives, Adhesion strength, Water immersion, Drying, Polymers, Fibers, Imbibition kinetics, Water absorption, Adhesive, Reversible.

Résumé

Le matériau argileux, malgré ses atouts écologiques, est sous-utilisé dans le secteur de la construction. Les particules fines d'argile s'avèrent être un facteur déterminant dans l'amélioration de la cohésion de ces matériaux, et se trouvent être un candidat particulièrement intéressant pour remplacer la phase cimentaire et réduire ainsi l'empreinte carbone de matériaux de construction. Cette thèse se consacre à l'étude de mélanges à base d'argile en tant qu'alternatives viables aux adhésifs conventionnels pour carrelage en céramique. L'objectif de cette thèse est de comprendre les leviers pour formuler un matériau à forte adhérence, préservant son intégrité structurelle en milieu aqueux. La porosité intrinsèque des mélanges argileux impose le respect de protocoles de séchage spécifiques et de périodes d'immersion définies.

L'étape préliminaire de cette recherche implique l'application d'un test mécanique pour évaluer la contrainte adhésive du matériau argileux avant et après immersion, en utilisant un échantillon de référence argileux comme étalon. Afin de moduler les propriétés mécaniques, nous avons introduit proportionnellement à la masse du sol des polymères ou fibres, visant à améliorer ses caractéristiques de cohésion. La sélection de ces additifs est effectuée de manière stratégique pour induire des modifications substantielles dans les propriétés mécaniques et la résistance à l'humidité du matériau.

La seconde phase des travaux de recherche se focalise sur l'analyse du processus de séchage et sur la cinétique d'imbibition consécutive à l'intégration des polymères, établissant que le choix de l'additif influe significativement sur la cinétique d'immersion et la capacité d'absorption d'eau du matériau.

Cette démarche scientifique se déploie selon trois scénarios distincts : l'amélioration de la résistance du matériau par l'incorporation de divers polymères et fibres ; la réduction de l'absorption d'eau par l'adhésif ; et le développement d'un adhésif réversible qui regagne sa résistance mécanique après une perte liée à l'immersion, par un simple processus de dessiccation. En outre, des stratégies adaptées à chaque méthode d'application ont été conçues, couvrant les applications verticales comme horizontales.

Mots-clés: Matériau argileux, Mélanges à base d'argile, Adhésifs pour carreaux, Résistance à l'adhérence, Immersion dans l'eau, séchage, Polymères, Fibres, Cinétique d'imbibition, Absorption d'eau, Adhésif, Réversible.

Acknowledgements

As I conclude my three-year journey towards this doctoral thesis, I am overwhelmed with gratitude for the invaluable contributions and unwavering support from the remarkable individuals and institutions who have made this accomplishment possible.

I extend my heartfelt appreciation to the NAVIER laboratory at University Gustave Eiffel, whose generous resources and nurturing environment have been the bedrock of my research endeavors.

I am especially grateful to my thesis director, Nicolas Roussel, whose mentorship, wisdom, and unwavering support have been the cornerstone of my academic journey. Nicolas, your guidance has been instrumental in shaping this thesis, and your belief in my potential has been a constant source of motivation. I am fortunate to have you as a mentor.

I extend my heartfelt appreciation to Emmanuel Keita, my University supervisor, for his valuable insights, guidance, and scholarly contributions that have enriched this research. Emmanuel, your dedication to my academic growth and your willingness to provide constructive feedback have been instrumental in shaping the direction of this thesis. Your mentorship has not only enhanced the quality of my work but also broadened my intellectual horizons.

Collaborations with exceptional institutions and individuals have significantly enriched this journey. Ann Bourges from C2RMF, your guidance, collaboration, and unyielding support have been instrumental in navigating the complexities of our research domain. Aline Magnien, representing LRMH, has provided invaluable insights.

I extend my heartfelt appreciation to Saint-Gobain and its dedicated team, led by Joumana Yammine-Malesys, Nelly Brielles, Yannick Sallier, Domitille Benoit, and Lionel Bertrand. Your collaboration has been a cornerstone of this research endeavor, and your industry expertise has added immense value to my work.

The support, guidance, and resources provided by Saint-Gobain have allowed me to delve deeper into my research, explore innovative solutions, and bridge the gap between academia and industry. Your consistent commitment to the success of this project have been integral to its achievements. I am deeply thankful to the dedicated technicians and researchers at NAVIER laboratory—Patrick Berlin, Benjamin Maillet, Rahima Sidi Boulénouar, and Cédric Mézière—for their persistent assistance.

To my cherished colleagues and friends, your camaraderie and encouragement have been a constant source of motivation.

I would like to extend my heartfelt gratitude to Houda, whose unwavering support and encouragement have been pivotal throughout my academic journey. Her ability to create a warm and nurturing environment has been a source of immense comfort and inspiration, especially during times of challenge and uncertainty. Her kindness, patience, and understanding have not only enriched my personal life but have also contributed significantly to my academic success. I am deeply thankful for her companionship and for all the ways in which she has contributed to making this journey memorable and fulfilling.

Lastly, but most importantly, I owe an immeasurable debt of gratitude to my family. Their unconditional love and support have been the bedrock of my journey, not just during this thesis but from the very first day of my schooling. They have been with me through every step of my academic path, offering encouragement and understanding day by day. Seeing the pride in their eyes has been my greatest source of motivation and strength. Their unwavering belief in me has fueled my aspirations and achievements, turning each milestone into a shared family triumph. This thesis, therefore, is not just my accomplishment but a testament to their enduring support and the sacrifices they've made to see me succeed. I am forever indebted and grateful for their love, which has been my anchor and guiding light throughout my life.

This thesis is a collective effort, a testament to the collaborative spirit of all mentioned. I am profoundly thankful for this opportunity and eager to carry the knowledge and experiences gained here into the next phase of my academic and professional journey.

Table of Content

ABSTRACT	I
RESUME	II
ACKNOWLEDGEMENTS	III
TABLE OF CONTENT	V
CHAPTER I. INDUSTRIAL QUESTION AND BACKGROUND	1
I.1. EARTH BASED TILE ADHESIVES	1
I.2. MORTAR AND TILE ADHESIVE	3
I.3. WATER CLAY MIXTURES	5
I.3.1. <i>Water adsorption and surface charges</i>	8
I.3.2. <i>Ion Exchange</i>	9
I.3.3. <i>Hydration or swelling</i>	10
I.3.4. <i>Surface Tension and Wettability</i>	12
I.3.5. <i>Menisci and capillary forces</i>	14
I.3.6. <i>Saturated clay and colloidal forces</i>	15
I.4. REQUIREMENTS ON TILE ADHESIVES	16
I.4.1. <i>Classification of Adhesives in European standards</i>	16
I.4.2. <i>Strength Requirements</i>	18
I.4.3. <i>Water resistance requirements</i>	21
I.5. PULL-OFF TEST FOR CEMENTITIOUS ADHESIVE (C) STRENGTH IN EUROPEAN STANDARDS	22
I.6. SHEAR TEST FOR DISPERSION (D) AND REACTION RESIN (R) ADHESIVES STRENGTH IN EUROPEAN STANDARDS	25
I.7. STRATEGIES TO RESOLVE THE PROBLEM	27
I.8. CONCLUSION	28
CHAPTER II. DEVELOPING NEW TESTS AND THEIR VALIDATION	29
II.1. ADHESIVE	29
II.1.1. <i>Definition of adhesive</i>	29
II.1.2. <i>Mechanisms of Adhesion</i>	31
II.1.3. <i>Testing and Standards Methods of Evaluating Adhesion Quality</i>	32
II.2. MATERIALS	33
II.2.1. <i>Clays</i>	35
II.2.1.1 Clay Minerals	36
II.2.1.2 Kaolinite	40
II.2.1.3 Illite	43
II.2.1.4 Montmorillonite	45
II.2.2. <i>Sand</i>	48
II.2.3. <i>Limestone Filler</i>	49
II.2.4. <i>Workability Additives : Cellulose Ether and Lime</i>	51
II.2.4.1 Cellulose Ether (HEMC 0.3% by weight)	51
II.2.4.2 Lime (1% by weight)	51
II.2.5. <i>Studied service properties enhancing additives</i>	52
II.2.5.1 RDP (Redispersible Powder- copolymer of Ethylene Vinyl Acetate (EVA))	52
II.2.5.2 Floset (Polycarboxylate Polymer)	54
II.2.5.3 Starch (Amylopectin)	54
II.2.5.4 Tannin	54
II.2.5.5 Iron Chloride and Iron Oxide	55
II.2.5.1 Nanoparticles LUDOX (Colloidal Silica)	55

II.2.5.2	Hydrophobic agent (HYDROWAX (HWX))	55
II.2.5.3	TEOS (Tetraethyl Orthosilicate)	56
II.2.5.4	Cellulose Fiber (long)	56
II.2.6.	<i>Tiles</i>	57
II.3.	DEVELOPED SIMPLE SHEAR TEST SUITABLE FOR CLAYEY ADHESIVES	59
II.3.1.	<i>Introduction</i>	59
II.3.2.	<i>Purpose of the Shear Test</i>	59
II.3.3.	<i>Test Procedure</i>	59
II.3.4.	<i>Key Considerations and Interpretation</i>	60
II.3.4.1	Correlation between Developed shear test and tensile pull-off test by standards	61
II.3.5.	<i>Acceptance Criteria</i>	63
II.3.6.	<i>Conclusion</i>	63
II.4.	TOAST BUTTER TEST FOR EVALUATING ADDITIVE EFFICIENCY IN CLAYEY ADHESIVES	64
II.4.1.	<i>Introduction</i>	64
II.4.2.	<i>Concept and Purpose of the Toast Butter Test</i>	64
II.4.3.	<i>Test Procedure</i>	65
II.4.4.	<i>Key Considerations and Interpretation</i>	65
II.4.4.1	Correlation between Toast Butter and developed shear test	65
II.4.4.2	Acceptance Criteria	69
II.4.5.	<i>Conclusion</i>	70
II.5.	CONCLUSION OF THE CHAPTER	70
CHAPTER III.	REINFORCEMENT BY ADDITIVES, STRATEGY NUMBER ONE	72
III.1.	REFERENCE FORMULA	72
III.2.	FORMULATIONS	75
III.2.1.	<i>Measured properties</i>	76
III.2.1.1	Enhanced Workability	76
III.2.1.2	Effect on Strength	79
III.2.1.3	Effect of dosage	80
III.2.1.4	Pore size distribution	84
III.2.2.	<i>Conclusion</i>	85
III.3.	CONCLUSION OF THE CHAPTER	86
CHAPTER IV.	PREVENTING WATER FROM ENTERING, STRATEGY NUMBER TWO	87
IV.1.	INTRODUCTION	87
IV.2.	WATER PENETRATION MECHANISMS	88
IV.2.1.	<i>Capillary Action</i>	88
IV.2.2.	<i>Permeability</i>	90
IV.3.	EXPERIMENTAL APPROACH	92
IV.3.1.	<i>Additives Used</i>	93
IV.3.2.	<i>Sample Preparation</i>	94
IV.3.3.	<i>Test Methods</i>	95
IV.4.	RESULTS AND DISCUSSION	97
IV.4.1.	<i>Experimental results from menisci method</i>	99
IV.5.	CONCLUSION	101
CHAPTER V.	REVERSIBLE MATERIALS, STRATEGY NUMBER THREE	102
V.1.	INTRODUCTION TO REVERSIBLE MATERIALS	102
V.2.	EXPERIMENTAL APPROACH FOR REVERSIBLE ADHESIVE	103
V.2.1.	<i>Selection of Additives</i>	103
V.2.2.	<i>Sample Preparation</i>	103
V.2.3.	<i>Testing Conditions for Shear Tests</i>	104
V.3.	RESULTS AND DISCUSSION	105
V.3.1.	<i>Loss of Mechanical Strength upon Immersion</i>	105

V.3.2.	<i>Regaining Strength upon Re-drying</i>	108
V.3.3.	<i>Comparison with Traditional Materials</i>	109
V.4.	IMPLICATIONS AND FUTURE APPLICATIONS	109
V.5.	CONCLUSION	110
CHAPTER VI.	CONCLUSION AND PERSPECTIVES	112
VI.1.	SUMMARY OF KEY FINDINGS	112
VI.1.1.	<i>Development of Clayey Adhesive assessment tools</i>	112
VI.1.2.	<i>Reinforcement of clayey adhesive by additives</i>	113
VI.1.3.	<i>Challenges in Water Resistance</i>	113
VI.1.4.	<i>Discovery of Reversible Material</i>	114
VI.2.	CONTRIBUTIONS TO THE FIELD	115
VI.3.	RECOMMENDATIONS FOR FUTURE WORK	115
VI.4.	FINAL REMARKS	116
REFERENCES		117

Chapter I. Industrial question and background

I.1. Earth based tile adhesives

Given the inherent carbon dioxide emission equivalent to the mass of cement produced [1]–[4], it is both scientifically sensible and environmentally beneficial to replace cement in mortar with earth-based materials, according to studies [5], [6]. It is estimated that for every ton of cement produced, approximately between 600 kg and one ton of CO₂ is released into the atmosphere[7]. In response to this environmental exigency (Figure I.1), the corporation Saint Gobain Weber is spearheading an initiative to replace traditional adhesive substances or cement mortars, currently employed for adhering ceramic tiles to a concrete substrate, with an innovative clay-derived alternative.

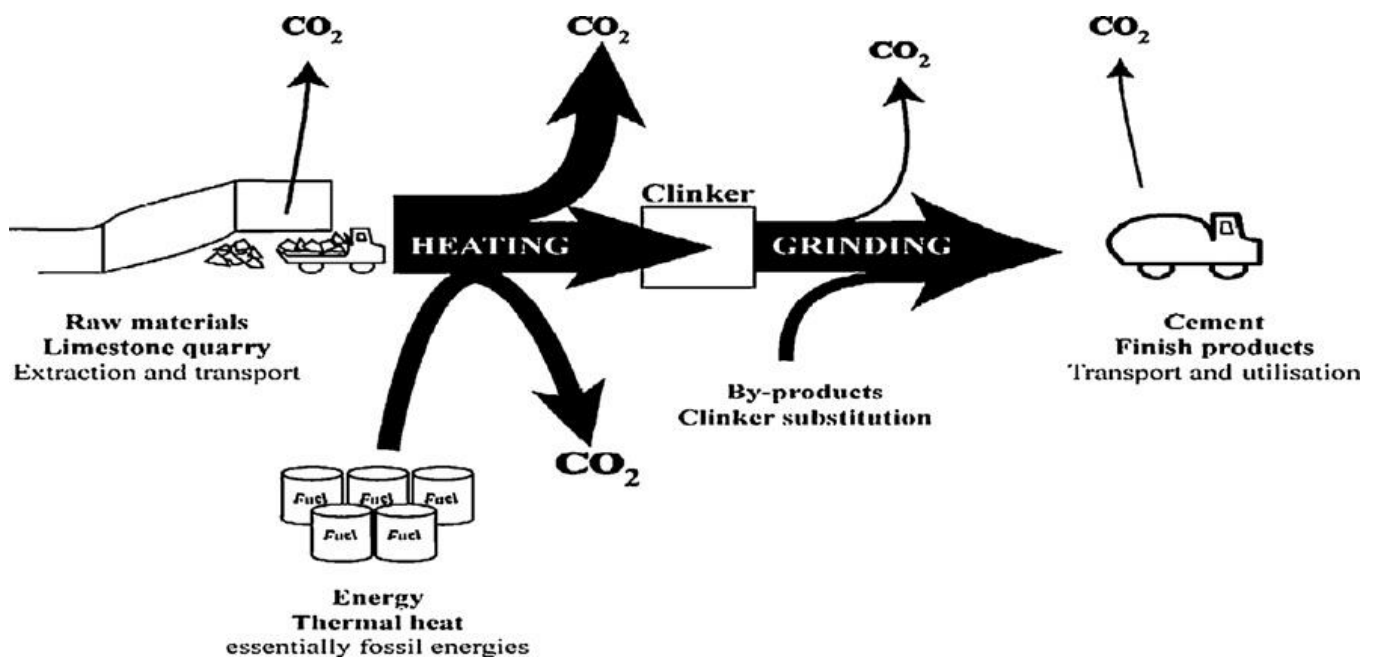

Figure I.1: Simplified cement fabrication process, with a specific interest in the CO₂ emissions [8]

The European standards delineating the prerequisites for adhesive used with tiles circumscribe the methodology for mixture preparation, the procedural strategy for application, the dimensions of ceramic tiles and concrete slabs, the duration of the adhesion test as well as its pre and post immersion iterations [9] (Section I.5, Table I.4). Saint Gobain Weber not only adhered to these stringent standards but also conducted rigorous shear test on soil-based mixtures applied to ceramic tiles with an area of 50x50 mm², following a week-long drying period and a subsequent seven-day immersion phase. The concrete slab, in this experimental setup, is a substitute for an absorbent tile, behaving akin to a porous medium.

The endeavor at hand is to design a novel experimental protocol that can determine the adhesive stress of the clay-based material in a more simplified, yet equally robust, manner while also reducing the time consumption.

Furthermore, our methodology for the preparation, fabrication, and evaluation of the samples diverges significantly from the protocol delineated in the established standards[9]. This indicates the necessity for further scientific investigation and regulatory review to ensure the environmental efficacy and practical viability of the clay-based adhesion solution.

The objective of Saint Gobain Weber is to develop a clayey adhesive that complies with European standards. Specifically, the goal is to create a tile adhesive based on clay that exhibits excellent water resistance, meeting the European standards[9]. In this chapter, a distinction will be made between two cases: horizontal and vertical applications for the tile adhesives[10]. Tile adhesive is commonly used in both bathroom (walls and floors) and other rooms on the floor. Tiles, in general, have two main uses: exterior applications exposed to water and temperature changes and interior applications subjected to dry conditions[11], [12].

Tile adhesive usage varies depending on the orientation of the application, primarily differentiating between horizontal and vertical applications (Figure I.2)[10], [13]. The type of tile adhesive and its properties need to be selected based on these applications to ensure optimal adhesion, durability, and performance.

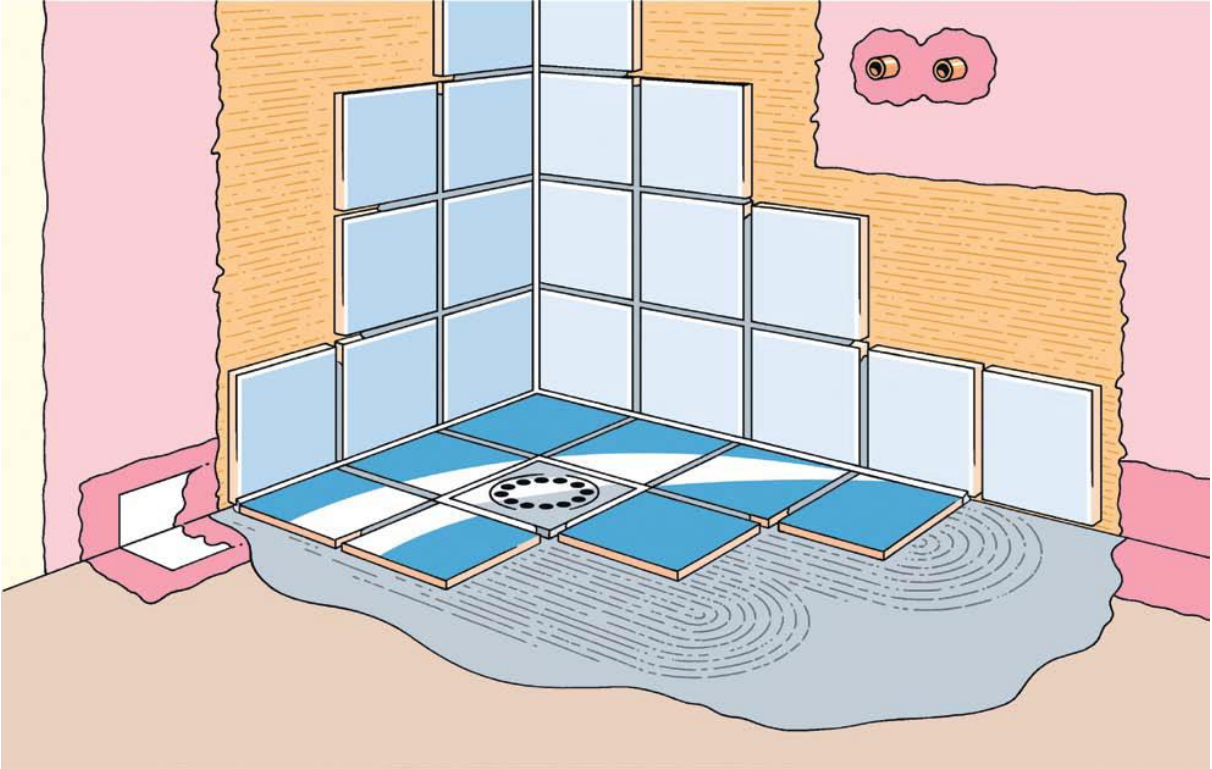

Figure I.2: Horizontal and vertical application for tile adhesive and grout system for wet areas [13]

In horizontal applications, such as roofing tiles, toilet floor tiles, and outdoor patio tiles, the primary forces acting on the adhesive are compressive in nature due to the weight of the tiles and any additional load placed on them. Here, the adhesive should possess high compressive strength to resist deformation under load. Additionally, horizontal applications, particularly

outdoor ones, are often exposed to various environmental factors like temperature changes, moisture, and wear, which demand the adhesive to have good resistance to thermal expansion, water resistance, and abrasion resistance.

On the other hand, vertical applications, such as wall tiles, primarily experience shear forces due to gravity pulling the tiles downward. Consequently, the adhesive used in these cases needs high shear strength to prevent the tiles from sliding or falling off. Non-slip or thickening properties are also essential in vertical applications to hold the tiles in place during installation, before the adhesive sets[10]. Furthermore, these adhesives need to exhibit good flexibility to tolerate any movement or vibration within the wall structure.

In summary, tile adhesive selection should be based on the forces acting on the tile and the environmental conditions the tile will be exposed to. Horizontal applications require adhesives with high compressive strength and environmental resistance, while vertical applications necessitate adhesives with high shear strength and non-slip properties.

I.2. Mortar and tile adhesive

In the context of civil engineering, mortar is a workable paste used to bind construction blocks together and fill the gaps between them. The blocks may be stone, brick, cinder blocks, tiles, etc. Mortar gains strength when it sets, resulting in a rigid, strong, and durable structure[14].

The typical composition of mortar includes a binder (cement or lime), an aggregate (usually sand), and water[15]. The mixture ratios depend on the specific use and properties required[16]. The strength, workability, and durability of the mortar can be adjusted by using different proportions of these ingredients[17]–[19].

There are different types of mortars used in civil engineering and construction:

1. **Cement Mortar:** The most common type of mortar made of cement, sand, and water. It provides high strength and durability[20].
2. **Lime Mortar:** Made with lime, sand, and water. It is less strong than cement mortar but provides better flexibility. A traditional building material predominantly used in the restoration and repair of old buildings, is typically formulated with a mix ratio of approximately 1:3 (lime to sand), and undergoes the process of carbonation to set and harden[21].
3. **Gypsum Mortar:** a prevalent building material particularly used for wall plastering and for indoor applications, has notable limitations in building and statue construction due to its low compressive strength, high water absorption, and short setting time[22].
4. **Polymer Mortar (adhesive):** A more recent type of mortar. It uses polymers as a binder and is characterized by high strength, chemical resistance, and excellent adhesive

properties. Polymer added into mortar is called “polymer modified mortar” or “adhesive” and in the case of natural polymer the mortar is called “natural polymer modified mortar”[23].

5. Cement-lime mortar: A mix of both lime and cement as the binder, providing a balance of mechanical strength (cement provide better strength than lime) and flexibility (Lime-rich mortars are able to deform more before breakage)[24].

The selection of mortar type depends on the nature of the construction project, the types of materials being joined, and the specific performance characteristics required.

"Mortar" and "adhesive" are terms with distinct applications and characteristics within the construction industry[25]. While mortar, composed of a mixture of cement, sand, water, and possibly lime, is employed to bond larger structural elements like bricks and stones, the term "adhesive" or specifically "tile adhesive" refers to specialized binding materials[26]. These are often polymer-modified and designed to adhere tiles to surfaces such as walls or floors. Although adhesives might incorporate mortar ingredients like cement, they are further formulated with additional polymers and substances to improve flexibility, water resistance, and bonding strength[27]. Unlike the robust and rigid connection provided by mortar in constructing walls and large structures, adhesives are reserved for tasks necessitating strong but more refined connections, including tile installation[28].

I.3. Water clay mixtures

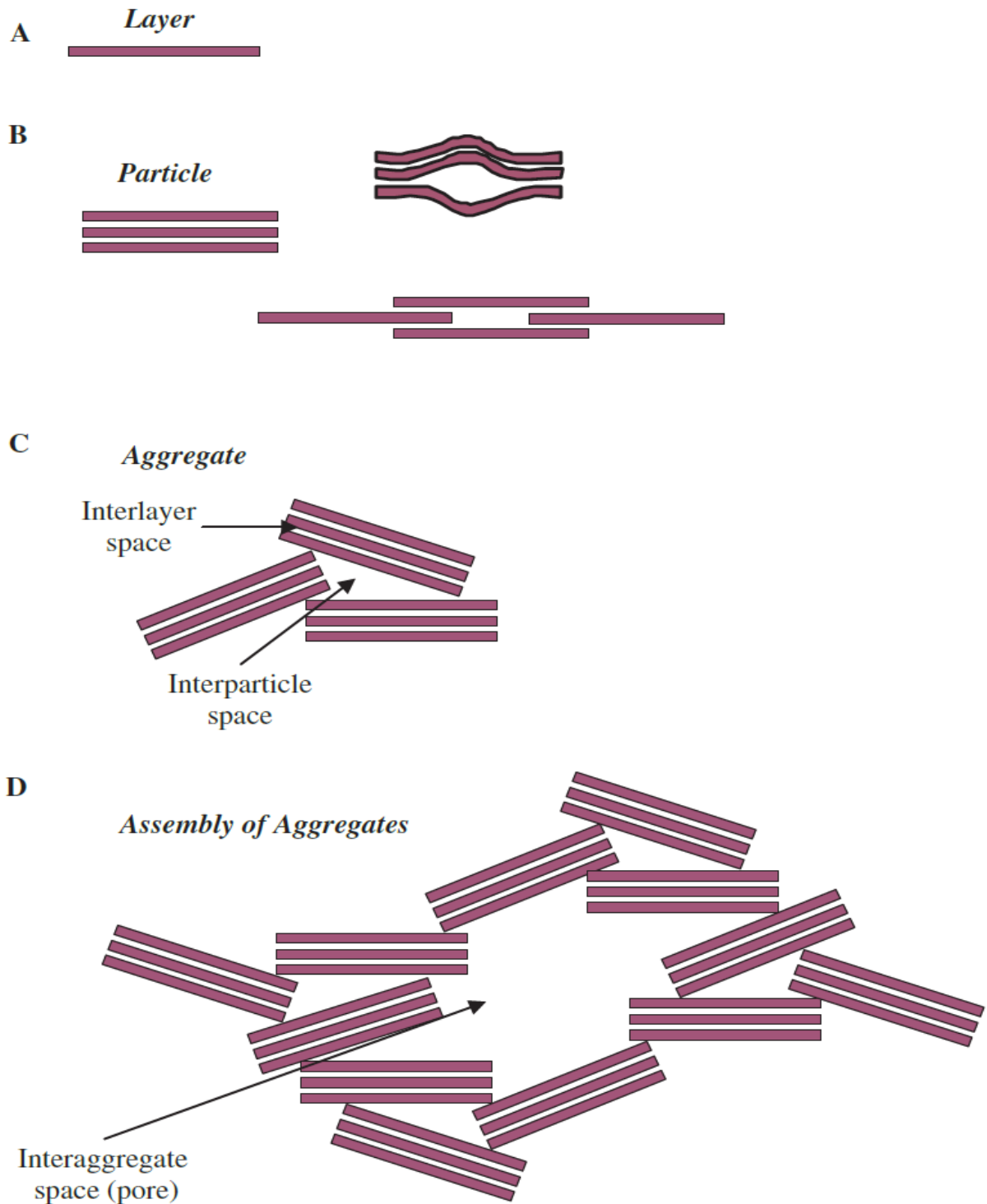
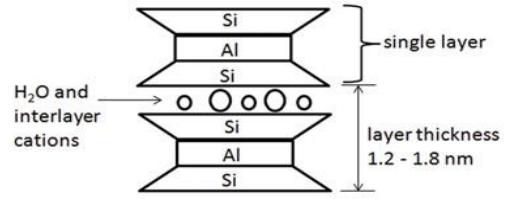
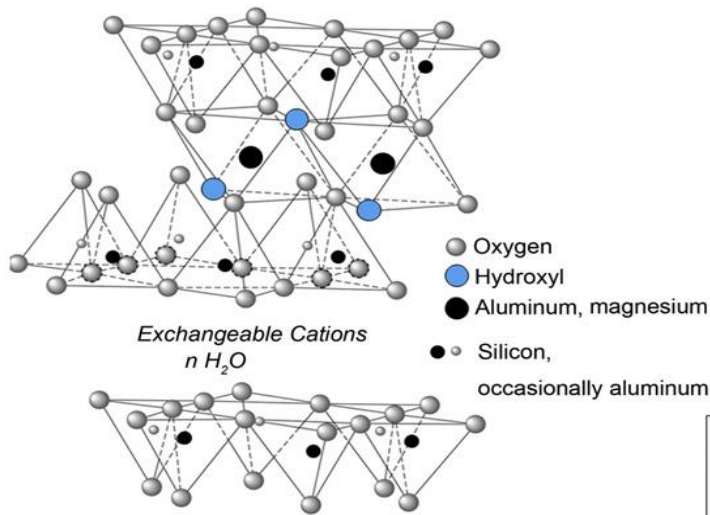

Figure I.3: Diagram showing (A) a clay mineral layer; (B) a particle, made up of stacked layers; layer translation and deformation can give rise to a lenticular pore; (C) an aggregate, showing an interlayer space and an interparticle space; and (D) an assembly of aggregates, enclosing an interaggregate space (pore) [29]

Clays are fine-grained, naturally occurring earth materials composed of one or more minerals [30]–[32]. They exhibit plasticity when mixed with water but become hard, brittle, and non-plastic upon drying or firing [33]. Clays typically originate from the chemical weathering and gradual decomposition of rocks, with primary types including kaolinite, illite, and montmorillonite [34], [35]. Each type possesses different properties, like varying degrees of plasticity and permeability, making them suitable for different uses[36]. Clay gains its strength from the electrostatic and van der Waals forces among its particles, which interlock when water is added, forming a 'house of cards' structure (Figure I.3) [37]–[40]. As the clay dries or is fired, the water between the layers evaporates, allowing the particles to bond more tightly together, enhancing the material's strength [41]. Electrostatic and van der Waals forces promote the adhesion of water molecules to the clay particles, enabling the clay to exhibit plasticity when wet [42]. When clay is immersed in water, it can expand (or swell), particularly in the case of smectite clays like montmorillonite [43]–[46]. This swelling occurs because water molecules infiltrate the spaces between the clay layers, driven by the negative charge on the clay particles. Clay particles have a negative charge due to isomorphous substitution, where lower-charge ions replace higher-charge ions in the clay's crystalline structure, and from broken bonds at the edges of the particles, which leave oxygen atoms with an excess negative charge. Then the clay becomes more plastic or malleable [45], [47]–[49]. Figure I.4 shows the structure of three different types of clays.

While the electrostatic and van der Waals forces inherent in clays like kaolinite, illite, and montmorillonite contribute to the material's water retention and plasticity, the inclusion of additives such as Cellulose ether and lime, as well as specialized chemical additives, significantly modifies these interactions. For instance, lime's alkaline nature can neutralize the negatively charged clay particles by cation exchange phenomena caused by the adsorption of Ca^{2+} [50], potentially reducing swelling but increasing structural stability. Cellulose ether, on the other hand, can enhance the water retention properties of clays, making the adhesive formulation more workable[51]. Furthermore, chemical additives aimed at improving mechanical properties interact differently with the various types of clay, given their unique particle sizes and surface chemistries. This interaction is pivotal for fine-tuning the adhesive's attributes such as tensile strength, flexibility, and water resistance. Thus, the granular size and specific type of clay used become critical variables in the context of the overall adhesive formulation, warranting a deeper investigation into their synergistic behaviors.



montmorillonite (2:1)

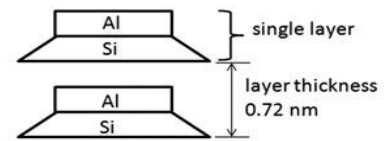
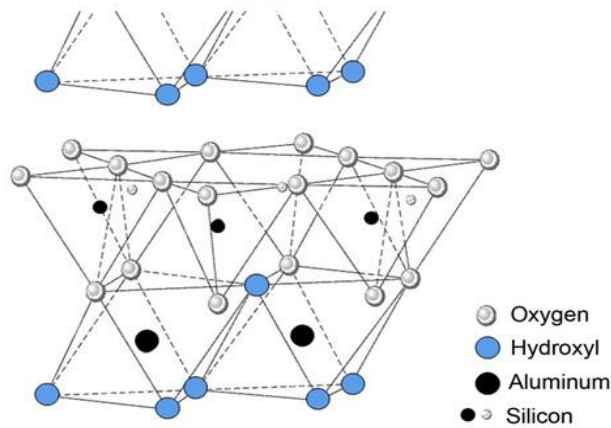
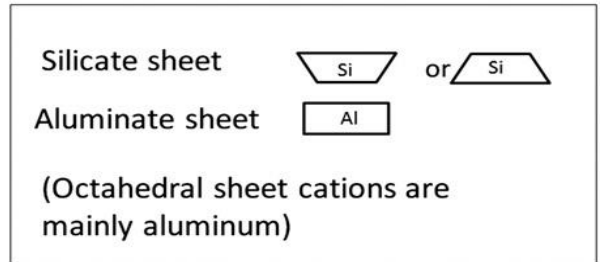

kaolinite (1:1)

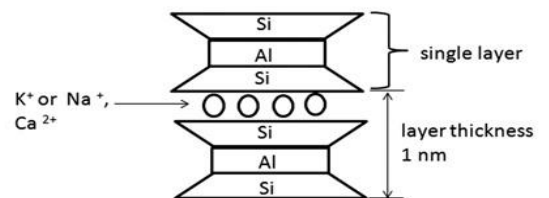
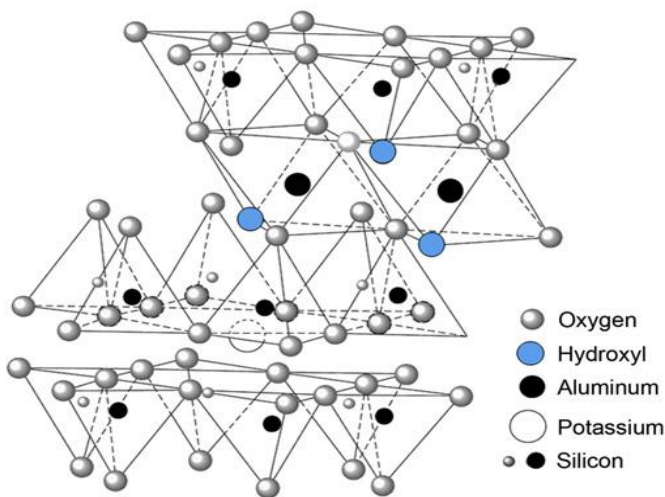

muscovite (2:1)

Figure I.4: Principle structure of the major clay minerals [52]

1.3.1. Water adsorption and surface charges

The interactions between water and clays are essential to understand the behavior of clay-water systems in various scientific and practical applications. The unique properties of clay minerals and the characteristics of water give rise to a range of possible interactions between these two ingredients. In this discussion, we will explore some of the key possibilities in the interactions between water and clays, including adsorption, ion exchange, hydration, surface tension and wettability, capillary action, and case of saturation and colloidal effects.

One significant mode of interaction between water and clays is through adsorption[53]. Clay minerals possess charged surfaces that attract water molecules through electrostatic forces. Water molecules are adsorbed onto the clay surfaces, forming a monolayer or multilayer depending on the surface properties[54]. The adsorbed water provides a thin film on the clay particles, influencing their physical and chemical properties[55].

Adsorption of water by clays is a complex phenomenon that occurs due to the interplay of various factors, including the mineral composition of clays and the characteristics of water[56]. Understanding the scientific basis of water adsorption on clays involves considering the parameters that control this interaction.

Clay minerals possess unique surface properties, primarily derived from their crystal structure and the presence of charged sites. The surfaces of clay particles are typically negatively or positively charged, resulting from the substitution of ions within the crystal lattice or the presence of broken bonds on the surface[55]. These charged sites attract water molecules due to electrostatic interactions.

Electrostatic forces play a crucial role in the adsorption of water by clays. Water is a polar molecule, consisting of positively charged hydrogen atoms and negatively charged oxygen atoms. The negatively charged surfaces of clays attract the positively charged hydrogen atoms of water molecules, while the oxygen atoms are attracted to the positively charged surfaces of clays. This electrostatic attraction facilitates the adsorption of water onto clay surfaces.

In addition to electrostatic forces, van der Waals forces also contribute to water adsorption by clays[57]. Van der Waals forces arise from the temporary fluctuations in electron density within molecules[58]. These forces act over short distances and are responsible for the attractive interactions between water molecules and clay surfaces. Van der Waals forces further enhance the adsorption of water onto clay particles.

The specific surface area of clays, which refers to the total surface area per unit mass of clay material, significantly influences water adsorption[59], [60]. Clays with larger specific surface areas provide more surface sites for water adsorption[61]. This is particularly relevant for clays with a higher proportion of smaller-sized particles, as they typically possess larger specific surface areas[62].

The pH and ionic strength of the aqueous solution also affect the adsorption of water by clays. The pH influences the surface charge of the clay particles, which, in turn, affects the adsorption behavior. In general, clays with a higher pH tend to have a more negative surface charge, leading to increased water adsorption[63]. Similarly, the ionic strength of the solution affects the screening of electrostatic forces, influencing the extent of water adsorption[64].

Temperature plays a role in water adsorption as it affects the kinetics and energetics of the process. Higher temperatures generally promote desorption, reducing the amount of water adsorbed onto clay surfaces[65]. However, temperature can also influence the hydration of clay minerals, leading to swelling and increased water content within the interlayer spaces[66].

The adsorption of water by clays is a complex phenomenon influenced by various parameters. The surface properties of clays, including their charged sites and specific surface area, along with electrostatic and van der Waals forces, govern the adsorption process. Additionally, factors such as pH, ionic strength, and temperature further modulate the extent of water adsorption. Understanding these parameters is essential for comprehending the behavior of clay-water systems and optimizing the performance of clays.

1.3.2. Ion Exchange

Clay minerals exhibit the ability to undergo ion exchange with water. The exchangeable cations present in the clay lattice can be replaced by cations present in the water. This ion exchange process leads to a modification of the clay's chemical composition and properties. The exchange of ions between water and clay plays a crucial role in the transport of nutrients, pollutants, and other dissolved species in natural environments[67]–[71].

Ion exchange is an important phenomenon that occurs when water interacts with clay minerals, leading to the exchange of cations on the clay surfaces with other cations present in the surrounding water. This process is scientifically governed by several mechanisms and influenced by various parameters[67], [68].

Ion exchange in clay minerals occurs due to the presence of negatively or positively charged sites on their surfaces. These charged sites arise from the substitution of ions within the crystal lattice structure of the clay or from broken bonds on the surface. The presence of these charged sites allows for the exchange of ions between the clay surfaces and the surrounding water[67]–[71].

The ion exchange process is driven by electrostatic forces. Water molecules contain dissolved cations that can interact with the charged sites on the clay surfaces. The charged sites attract and hold cations from the water phase, leading to their replacement of the exchangeable cations initially present on the clay surfaces. The exchangeable cations in clay minerals commonly include sodium (Na^+), calcium (Ca^{2+}), potassium (K^+), and magnesium (Mg^{2+})[72]–[74].

The parameters that control ion exchange in water-clay systems include the concentration and type of cations present in the water, as well as the characteristics of the clay mineral itself. The concentration of dissolved cations in the water phase affects the availability and likelihood of ion exchange. Higher concentrations of specific cations can lead to increased ion exchange on the clay surfaces[75], [76].

The selectivity of ion exchange is influenced by the specific clay mineral composition. Different clay minerals exhibit varying affinities for certain cations, depending on their crystal structure and surface charge characteristics. For example, certain clay minerals, such as montmorillonite, have a high affinity for exchanging sodium ions (Na^+) with other cations in the water, while others may prefer calcium ions (Ca^{2+}) or other specific cations[71], [72], [77].

pH and ionic strength also play a role in ion exchange. pH affects the surface charge of clay minerals and consequently influences their affinity for specific cations. The ionic strength of the water, which is a measure of the concentration of all ions present, can impact the competition between cations for binding sites on the clay surfaces. Higher ionic strength can reduce the affinity for ion exchange by increasing the screening effect of the surrounding ions[77].

Temperature can influence the rate and extent of ion exchange. Higher temperatures generally enhance ion exchange reactions by increasing the kinetic energy of the system, facilitating the movement of ions between the water and clay surfaces[78].

Ion exchange in water-clay systems occurs due to the interaction between charged sites on clay surfaces and cations present in the surrounding water. The concentration and type of cations, clay mineral composition, pH, ionic strength, and temperature are important parameters that control ion exchange. These mechanisms influence the behavior of clay-water systems and their interactions with other dissolved species.

1.3.3. Hydration or swelling

Clay minerals have the ability to undergo hydration, wherein water molecules are incorporated into their crystal lattice structure, resulting in the expansion and swelling of the clay[79], [80]. The extent of hydration is influenced by factors such as the mineral composition, interlayer spacing, and water availability[81], [82].

Hydration occurs when water molecules penetrate the interlayer spaces or interstitial sites within the layered structure of clay minerals. This penetration disrupts the weak interlayer forces, causing the layers to separate and leading to an increase in interlayer spacing[83]. The interlayer spacing plays a crucial role in hydration, as it determines the capacity of water molecules to enter and interact with the clay mineral structure[84].

The cation exchange capacity (CEC) of clay minerals also affects their hydration behavior. CEC refers to the ability of clay minerals to exchange cations on their surfaces with other cations in the surrounding environment[85]–[87]. Clay minerals with higher CEC have a larger SSA

(Figure I.5) and hence greater capacity for water molecules to enter the interlayer spaces, replacing the exchangeable cations and enhancing hydration[88].

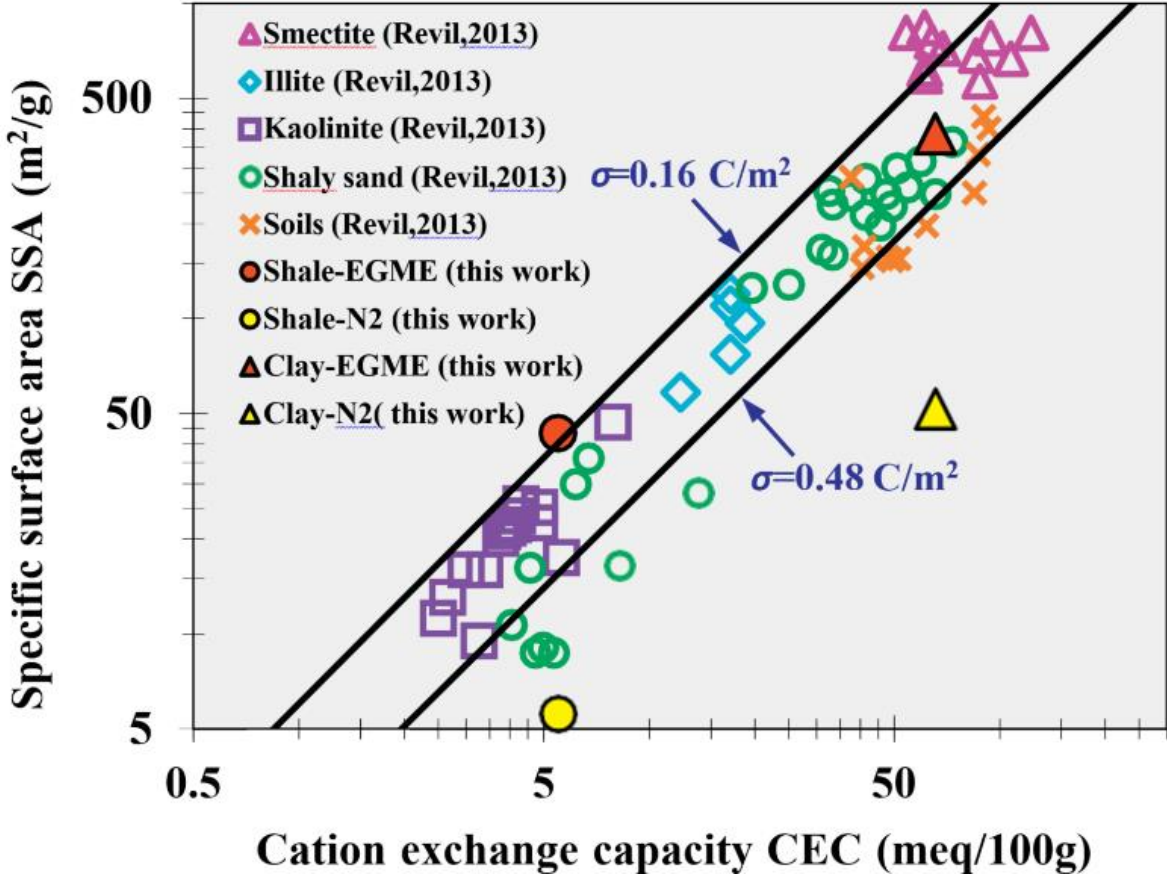

Figure I.5: Relationship between specific surface area (SSA) and cation exchange capacity (CEC) [87]

The specific surface area of clay minerals, which represents the total surface area per unit mass of clay material, plays a significant role in hydration. Clay minerals with larger specific surface areas provide more sites for water adsorption and hydration[68]. Finely divided clays, such as montmorillonite, exhibit higher specific surface areas and consequently show greater swelling capacities upon hydration. Kaolinite, on the other hand, has a lower specific surface area (10 to 30 m²/g) compared to montmorillonite (50 to 800 m²/g)[89], [90]. Its hydration capacity is generally less pronounced due to its limited interlayer spacing and lower water absorption capabilities. However, kaolinite's layered structure still allows for some water absorption between its layers, contributing to the overall hydration process, although to a lesser extent compared to montmorillonite.

Water availability is another important factor in clay hydration. If water is readily accessible, clay minerals can readily absorb and incorporate water molecules into their structures. However, limited water availability can impede or slow down the hydration process.

Temperature and pressure conditions also impact clay hydration. Higher temperatures generally promote hydration and swelling as they provide the necessary energy for water molecules to overcome interlayer forces and penetrate the interlayer spaces. Pressure can also influence hydration, particularly in confined clay environments where external pressures can affect interlayer spacing and water absorption.

Different clay minerals exhibit varying hydration behaviors. For instance, smectite clay minerals, including montmorillonite, possess high hydration capacities due to their expandable interlayer structures. In contrast, clay minerals like kaolinite have limited hydration capabilities due to their relatively fixed interlayer spacing and reduced propensity for swelling.

Understanding the interplay between interlayer spacing, cation exchange capacity, specific surface area, water availability, temperature, pressure, and clay mineral composition is crucial in comprehending the hydration phenomenon of water by clays.

I.3.4. Surface Tension and Wettability

The surface tension of water and clay particles influences its interaction with clay surfaces. The contact angle (CA) between water droplets and the clay surface determines the wettability of the clay (Figure I.6) [91]. A smaller contact angle indicates better wetting, where water spreads readily over the clay surface, indicating stronger interactions between water and clay. In contrast, a larger contact angle suggests reduced affinity between water and clay, resulting in poorer wetting[92], [93].

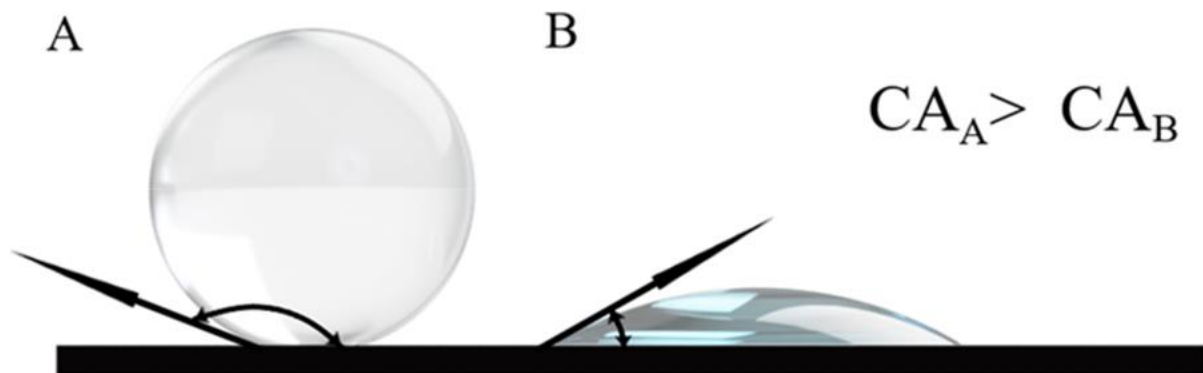

Figure I.6: State of two different liquids on a surface: A has high CA and low wettability whereas B has low CA and high wettability [94]

Surface tension, between water and clay particles, and wettability are important phenomena that influence the interaction between water and clay surfaces. These phenomena are governed by several mechanisms and influenced by various parameters.

Surface tension refers to the cohesive forces between water molecules at the liquid-air interface[95]. Water molecules are attracted to each other, resulting in a net inward force that

causes the surface to behave like a stretched elastic film. In the context of water-clay systems, surface tension plays a significant role in wetting and spreading over clay surfaces.

Wettability, on the other hand, refers to how easily water spreads and adheres to a solid surface. The wettability of clay surfaces depends on their mineralogy, surface charge, and surface roughness[96], [97]. The wetting behavior determines the contact angle between water droplets and the clay surface[63]. A smaller contact angle indicates stronger wetting, where water spreads readily over the clay surface, while a larger contact angle suggests reduced affinity and poorer wetting.

The wetting behavior of water on clay surfaces is influenced by several parameters. One crucial parameter is the surface charge of clay minerals. Clay minerals possess charged surfaces, and the charge characteristics vary depending on the mineralogy. The surface charge affects the interaction between water molecules and clay surfaces, influencing the wetting behavior. For instance, clay minerals with a negative surface charge (montmorillonite, illite) tend to exhibit better wetting, while those with a positive surface charge (kaolinite, vermiculite) show reduced wetting[63], [98].

Another parameter that affects wetting behavior is the roughness or surface topography of clay particles. Surface roughness provides additional sites for water molecules to adhere and spread, enhancing wetting. Smoother surfaces may exhibit reduced wetting due to a lower number of available sites for water adsorption[99].

pH also plays a role in wetting behavior as it influences the surface charge of clay minerals[75]. Changes in pH can alter the charge characteristics, thereby affecting the wetting behavior. Additionally, ionic strength, which is a measure of the concentration of ions in the water, can influence wetting. Higher ionic strength can alter the surface charge and hydration properties of clay surfaces, affecting the wetting behavior[100].

Surface tension and wettability can be modified by the presence of dissolved substances in the water. For example, the addition of surfactants can reduce surface tension, leading to enhanced wetting and lower contact angles. The presence of dissolved salts or other substances can also affect the wetting behavior by altering the surface charge and properties of both water and clay surfaces[101].

Surface tension and wettability are important phenomena that influence the interaction between water and clay surfaces. The wetting behavior of clay surfaces depends on surface charge, surface roughness, pH, and ionic strength.

1.3.5. Menisci and capillary forces

The menisci mentioned here are the curved surfaces that water forms when it comes into contact with the solid particles in these small pore spaces[102]. The shape of the meniscus, whether it's concave or convex, depends on the interaction between adhesive forces (between the water and the solid particles) and cohesive forces (among water molecules themselves)[103], [104].

In the case of clay, the fine particles and resulting small pore spaces lead to the formation of concave menisci when water is present. This is because the adhesive forces between water and clay particles are stronger than the cohesive forces among the water molecules, causing the water to climb up the pore spaces in a process known as capillary rise[105].

The capillary forces are due to the surface tension of the water forming these menisci in the small clay pore spaces. Surface tension is a property of liquids arising from the tendency of its molecules to stick together [106]. The force responsible for molding the menisci and facilitating capillary action, which is the capacity of a liquid to flow in narrow spaces independently and against external forces such as gravity, is the driving factor [107].

When the water molecules form a meniscus within these pore spaces, they create a tension force that can cause the water to resist external forces, such as gravity. This phenomenon is what allows water to stay within the pore spaces of the clay even when subjected to other forces, thus giving rise to the capillary forces within the clay material[108], [109].

Capillary forces play a significant role in the behavior of water in clay systems[102]. The small pore spaces and interconnected voids in clay materials allow for capillary rise, where water is drawn upwards against gravity[110]. Capillary action is driven by the menisci formed at the solid-liquid interfaces, resulting in the movement and retention of water within the clay matrix[111]. This phenomenon is crucial in understanding water movement and moisture retention in clay-rich soils.

Capillary action is a significant phenomenon that occurs when water is drawn into the small pore spaces and interconnected voids of clay minerals[112]. This process is driven by several scientific mechanisms and is influenced by various parameters.

Capillary action arises from the presence of menisci, which are concave liquid surfaces formed at the interface between water and solid surfaces[113]. In the case of clay minerals, these menisci form at the contact points between the clay particles and the surrounding water. The curvature of the menisci is a result of the cohesive forces within the water molecules and the adhesive forces between the water and the clay surfaces[111].

The key parameter controlling capillary action in water-clay systems is the size and geometry of the pore spaces[114]. Clay minerals possess small-sized pores and interconnected voids, creating a capillary network. The size and distribution of these pores influence the rate and extent of capillary rise. Smaller pores provide a greater capillary rise due to the higher capillary forces generated[115].

Surface tension, which is a measure of the cohesive forces between water molecules, also plays a crucial role in capillary action. Water has a relatively high surface tension, allowing it to form menisci within the clay pores. Surface tension is influenced by factors such as temperature and the presence of dissolved substances, which can affect the capillary rise in clay-water systems.

The wetting properties of clay surfaces also impact capillary action. Wetting refers to how easily water spreads and adheres to a solid surface. Clay minerals possess different wetting behaviors, depending on their mineralogy, surface charge, and surface roughness. The wetting behavior determines the contact angle between water and clay, with a smaller contact angle indicating stronger wetting and greater capillary rise[116]–[118].

Additionally, the viscosity of water affects the capillary action in clay systems. Higher viscosity tends to reduce the rate of capillary rise, as it creates greater resistance to the movement of water within the clay pores[119], [120].

Other parameters that can influence capillary action include the presence of dissolved salts or other substances in the water, as they can alter the surface tension and wetting properties. The pH and ionic strength of the water can also affect the capillary rise, as they can modify the surface charge and hydration characteristics of the clay particles[121]–[123].

Capillary action in water-clay systems occurs due to the presence of menisci at the interface between clay particles and water. The size and geometry of the clay pores, surface tension, wetting properties, viscosity, and the presence of dissolved substances are key parameters that control the capillary rise in clay materials.

I.3.6. Saturated clay and colloidal forces

Upon complete immersion of clay in water, the phenomenon of the vanishing capillary forces can be explained through the disruption of menisci and changes in interfacial properties at the solid-liquid interface. Initially, capillary forces arise from the curvature of menisci formed at the points of contact between clay particles and the surrounding water[111], [124]. These menisci originate due to the interfacial tension at the solid-liquid interface, resulting in attractive forces between the two phases. Importantly, the immersion displaces residual air or gas in the interparticle voids, which is crucial for the initial formation of menisci, with the continuous water phase. This displacement establishes direct liquid-solid interactions, thereby disrupting the menisci and diminishing the capillary forces. The phenomenon of meniscus disruption can be explained by the concept of wetting behavior, which is governed by the contact angle between the water and clay surfaces[111], [113]. A smaller contact angle indicates stronger wetting and a reduced resistance to liquid penetration[102]. As clay becomes fully immersed, the contact angle decreases, signifying enhanced wetting and a subsequent reduction in capillary forces. Consequently, the absence of menisci and the altered wetting characteristics collectively contribute to the gradual attenuation and ultimate cessation of capillary forces in immersed clay systems.

I.4. Requirements on tile adhesives

This part provides a comprehensive and detailed explanation of the European standard EN 12004-1:2 2017, which pertains to adhesives for tiles and related materials. The standard plays a crucial role in ensuring the quality, performance, and safety of adhesives used in tiling applications. This section will discuss the scope, purpose, and key provisions of the standard, followed by an in-depth exploration of its technical aspects and requirements.

EN 12004-1:2 2017 is a harmonized European standard that specifies the requirements and test methods for adhesives used in the fixing of ceramic tiles, natural stone tiles, and other similar materials. The standard is designed to ensure the compatibility, durability, and performance of adhesives, and to provide guidance to manufacturers, suppliers, and users of these products. By adhering to this standard, users can confidently select and utilize adhesives that meet stringent quality and safety criteria.

I.4.1. Classification of Adhesives in European standards

In accordance with the EN 12004-1:2 2017 standard, adhesives are systematically categorized based on their compositional elements. The standard delineates for ceramic tiles, three principal adhesive types: cementitious, dispersion, and reaction resin adhesives.

Type	Description
C	Cementitious adhesive
D	Dispersion adhesive
R	Reaction resin adhesive

Table I.1: Types of adhesives for ceramic tiles [125]

Cementitious Adhesive: This is a concoction comprising hydraulic binding agents, aggregates, and specific organic additives. For utilization, it necessitates the addition of water or a specialized liquid admixture immediately prior to application.

Dispersion Adhesive: This adhesive formulation is a pre-prepared blend, comprising organic binding agents presented as an aqueous polymer dispersion, supplemented with organic additives and mineral fillers.

Reaction Resin Adhesive: This category encompasses mixtures that may involve multiple ingredients, such as synthetic resins, mineral fillers, and distinct organic additives. The solidification process of this adhesive type transpires due to a chemical reaction.

Furthermore, the standard provides sub-classifications for adhesives based on performance attributes. Recognized classes within this subdivision include: C1, C1T, C2, C2T, C2TE,

C2TES1, C2TES2, C2TE-S1, C2TE-S2, C2F, and C2FT. Such a detailed classification scheme accounts for adhesive traits like flexibility, water resistance, and deformability, thus offering a comprehensive guide for users to determine the optimal adhesive for specific tiling needs. For each of the three types it is possible to have different classes. These classes are designated with the following abbreviations:

Abbreviation	Description
1	Normal adhesive
2	Improved adhesive (meet the requirements for all the additional characteristics)
F	Fast setting adhesive
T	Adhesive with reduced slip
E	Adhesive with extended open time
S1	Deformable adhesive
S2	Highly deformable adhesive

Table I.2: Abbreviations for different characteristics classified [125]

Class C1 adhesives come with restrictions on their applicability; they are not suitable for fully vitrified tiles or areas prone to elevated thermal stress, such as balconies, rooftops, or terraces. In contrast, Class C2 adhesives offer versatility, as they are compatible with a broad range of tiles and underlying surfaces. The key distinction between the two adhesive classes lies in the amount of redispersible polymer powder incorporated into the mixture. The provided formulation (Table I.3) serves as a general reference for manufacturers and can differ based on the specific ingredients chosen for the adhesive[11], [126].

Ingredient name	Example	Dosage (%)	
		C1 class	C2 class
Binder	Portland cement	30-50	30-40
Aggregates	Silica sand	45-70	45-60
Co-filler	Calcium Carbonate	5-10	5-10
Redispersible polymer powder	SBR, EVA, VA/VeoVa, SAE, PAE	0-3	3-6
Water Retention Agents	HEMC	0.2-0.5	0.2-0.5
Accelerator	Calcium formate	<1	<1

Table I.3: typical formulation of a cement tile adhesives [126]

This systematic categorization ensures that professionals can make informed decisions when choosing adhesives for varied applications.

The standard defines the composition requirements for adhesives, encompassing aspects such as water content, adhesion strength, open time, and slip resistance. Adhesives complying with EN 12004-1:2 2017 are expected to exhibit optimal bond strength, chemical stability, and resistance to environmental factors such as moisture and temperature variations.

EN 12004-1:2 2017 includes a range of test methods to evaluate the performance and properties of adhesives. These methods cover various aspects, including adhesive strength, deformability, water resistance, and slip resistance. The standard provides detailed guidelines on specimen preparation, testing conditions, and measurement techniques to ensure consistency and accuracy across different laboratories.

The standard emphasizes the importance of quality control measures throughout the production and distribution of adhesives. Manufacturers are expected to implement robust quality management systems to ensure the consistent performance and compliance of their products. Additionally, certification bodies play a vital role in verifying that adhesives meet the requirements of EN 12004-1:2 2017. Certifications, such as the CE marking, provide a visible indicator of compliance and assist users in identifying adhesives that conform to the standard.

EN 12004-1:2 2017 offers several significant implications and benefits for stakeholders involved in the selection and use of adhesives for tiling applications. Firstly, the standard enhances consumer confidence by providing clear guidelines and performance requirements, enabling users to make informed decisions regarding adhesive selection. Secondly, it promotes fair competition among manufacturers by establishing a level playing field based on quality and performance criteria. Lastly, EN 12004-1:2 2017 contributes to the overall safety and longevity of tiled installations, reducing the risks associated with adhesive failure and enhancing the durability of tiled surfaces.

This part provided a detailed explanation of the European standard EN 12004-1:2 2017, which serves as a critical reference for adhesives used in tiling applications. By adhering to this standard, users can ensure the compatibility, durability, and performance of adhesives while minimizing the risks associated with adhesive failure. The comprehensive technical aspects and requirements outlined in EN 12004-1:2 2017 provide a solid foundation for the development, production, and use of high-quality adhesives, ultimately contributing to the advancement of the tiling industry.

I.4.2. Strength Requirements

Within the context of the European standards, the parameters delineating the adhesive strength acceptance criteria are carefully specified, considering both the intended application and the materials to be bonded. These criteria establish the minimum adhesive strength necessary to ensure optimal performance and longevity. Adhesives that achieve or surpass these stipulated criteria are deemed appropriate for their intended application. Pertaining to cementitious (C) adhesives utilized for ceramic tiles, the strength requirements, as ascertained through the tensile test, are detailed in Table I.4. Correspondingly, for dispersion adhesives, the strength requisites, determined via the shear test, are elucidated in Table I.5. Lastly, the specifications for reaction resin adhesives, also gauged by the shear test, are comprehensively presented in Table I.6.

Fundamental Characteristics		
Characteristics	Requirement	Test Method
<i>Normal setting adhesives (C1)</i>		
Initial tensile adhesion strength	$\geq 0,5\text{N/mm}^2$	
Tensile adhesion strength after water immersion	$\geq 0,5\text{N/mm}^2$	
Tensile adhesion strength after heat ageing	$\geq 0,5\text{N/mm}^2$	8.3 of EN 12004-2:2017
Tensile adhesion strength after freeze-thaw cycles	$\geq 0,5\text{N/mm}^2$	
Open time: tensile adhesion strength	$\geq 0,5\text{N/mm}^2$	8.1 of EN 12004-2:2017
<i>Fast setting adhesives (CIF)</i>		
Early tensile adhesion strength	$\geq 0,5\text{N/mm}^2$	8.3 of EN 12004-2:2017
Open time: tensile adhesion strength	$\geq 0,5\text{N/mm}^2$	8.1 of EN 12004-2:2017
All other requirements as for normal setting adhesives (C1)		8.3 of EN 12004-2:2017
Optional characteristics		
Characteristics	Requirement	Test Method
<i>Special characteristics</i>		
Slip (T)	$\leq 0,5 \text{ mm}$	8.2 of EN 12004-2:2017
Extended open time (E): tensile adhesion strength	$\geq 0,5 \text{ N/mm}^2$	8.1 of EN 12004-2:2017
Deformable adhesive (S1): transverse deformation	$\geq 2,5 \text{ mm and } < 5 \text{ mm}$	8.6 of EN 12004-2:2017
Highly deformable adhesive (S2): transverse deformation	$\geq 5 \text{ mm}$	
<i>Additional characteristics (C2)</i>		
High initial tensile adhesion strength	$\geq 1 \text{ N/mm}^2$	
High initial adhesion strength after water immersion	$\geq 1 \text{ N/mm}^2$	8.3 of EN 12004-2:2017
High tensile adhesion strength after heat ageing	$\geq 1 \text{ N/mm}^2$	
High tensile adhesion strength after freeze-thaw cycles	$\geq 1 \text{ N/mm}^2$	

Table I.4: Requirements for cementitious (C) adhesives for ceramic tiles (CTA) according to EN 12004:2017+A1:2012 [127]

Fundamental Characteristics		
Characteristics	Requirement	Test Method
<i>Normal setting adhesives (D1)</i>		
Initial shear adhesion strength	$\geq 1 \text{ N/mm}^2$	8.4 of EN 12004-2:2017
Shear adhesion strength after heating ageing	$\geq 1 \text{ N/mm}^2$	
Open time: tensile adhesion strength	$\geq 0,5 \text{ N/mm}^2$	8.1 of EN 12004-2:2017
Optional characteristics		
Characteristics	Requirement	Test Method
<i>Special characteristics</i>		
Slip (T)	$\leq 0,5 \text{ mm}$	8.2 of EN 12004-2:2017
Extended open time (E): tensile adhesion strength	$\geq 0,5 \text{ N/mm}^2$	8.1 of EN 12004-2:2017
<i>Additional characteristics (D2)</i>		
Shear adhesion strength after water immersion	$\geq 0,5 \text{ N/mm}^2$	8.4 of EN 12004-2:2017
Shear adhesion strength at elevated temperature	$\geq 1 \text{ N/mm}^2$	

Table I.5: Requirements for dispersion (D) adhesives for ceramic tiles (CTA) according to EN 12004:2017+A1:2012 [127]

Fundamental Characteristics		
Characteristics	Requirement	Test Method
<i>Normal setting adhesives (R1)</i>		
Initial shear adhesion strength	$\geq 2 \text{ N/mm}^2$	8.5 of EN 12004-2:2017
Shear adhesion strength after heating ageing	$\geq 2 \text{ N/mm}^2$	
Open time: tensile adhesion strength	$\geq 0,5 \text{ N/mm}^2$	8.1 of EN 12004-2:2017
Optional characteristics		
Characteristics	Requirement	Test Method
<i>Special characteristics</i>		
Slip (T)	$\leq 0,5 \text{ mm}$	8.2 of EN 12004-2:2017
<i>Additional characteristics (R2)</i>		
Shear adhesion strength at elevated temperature	$\geq 1 \text{ N/mm}^2$	8.5 of EN 12004-2:2017

Table I.6: Requirements for reaction resin (R) adhesives for ceramic tiles (CTA) according to EN 12004:2017+A1:2012 [127]

I.4.3. Water resistance requirements

In the evaluation of cementitious adhesives' (C) water resistance, the European standards stipulate the necessity of a tensile mechanical assay post water submersion. This testing regimen mandates disparate preparatory and procedural methodologies contingent upon ambient versus water immersion states. Initially, samples are conditioned for a period of 28 days under a controlled environment—specifically, 25°C and 1 atmosphere. Subsequent to this conditioning phase, a tensile load is applied uniformly at a rate of 250 N/s, with an allowable deviation of ± 50 N/s. Conversely, for the assessment under conditions of moisture, samples are first subjected to a standard environmental regimen for a duration of 7 days, followed by an immersion interval of 21 days at a normative temperature of 23°C, with an acceptable variance of ± 2 °C. Thereafter, the tensile evaluation is conducted identically to the dry state, adhering to the specified rate of force application.

Regarding the assessment of dispersion adhesives (D), the European standards necessitate a shear mechanical test subsequent to the water immersion of specimens to ascertain the adhesives' resistance to moisture ingress. The preparation and procedural facets differ significantly between dry and wet conditions. In the absence of moisture, samples are stored under standardized conditions for 14 days. The shear mechanical test is then executed by situating the specimen within the testing apparatus and applying a lateral force until the point of failure, with the crosshead advancing at a calibrated velocity of 5 mm/min, subject to a tolerance of ± 0.5 mm/min. In wet scenarios, the samples undergo a 7-day period of desiccated standard condition storage, succeeded by a 7-day submersion in water maintained at the standardized temperature of 23°C, plus or minus 2°C. The shear test is then performed in congruence with the procedures delineated for the initial dry state.

For reaction resin adhesives (R), the European standards similarly prescribe a shear mechanical assay following the aquatic submersion of specimens to evaluate moisture resistance. The test preparations and executions bifurcate depending on whether the conditions are dry or wet. Under dry conditions, the protocol involves a 7-day period of standard-condition storage followed by the placement of the specimen in the shear test fixture. A shear force is then applied, progressing the crosshead at a rate of 5 mm/min, within a tolerance of ± 0.5 mm/min, until failure is observed. For wet conditions, after a similar 7-day period of storage under standard dry conditions, the samples are immersed in water at the standard temperature of 23°C (with a 2°C permissible deviation) for a 21-day period. The shear test is subsequently conducted as per the protocol established for dry conditions.

Type of the adhesive classified by European standards	Adhesive	Evaluation test method	Requirement	
			Dry conditions	After water immersion
C1	Normal cementitious	Tensile adhesion strength	$\geq 0,5 \text{ N/mm}^2$	$\geq 0,5 \text{ N/mm}^2$
D1	Normal dispersion	Shear adhesion strength	$\geq 1 \text{ N/mm}^2$	$\geq 0,5 \text{ N/mm}^2$
R1	Normal reaction resin	Shear adhesion strength	$\geq 2 \text{ N/mm}^2$	$\geq 2 \text{ N/mm}^2$

Table I.7: Requirements according to European standards for dry and wet conditions for normal cementitious (C), dispersion (D) and reaction resin (R) adhesives [125]

I.5. Pull-off Test for Cementitious Adhesive (C) Strength in European Standards

This section provides a detailed explanation of the pull-off test method used to determine the adhesive strength of bonded materials according to European standards. The pull-off test is widely employed to assess the bond strength and performance of adhesives used in various applications. This section will discuss the purpose, procedure, and key considerations of the pull-off test as outlined in the European standards.

The pull-off test is designed to evaluate the adhesive strength between a substrate and an adhesive material. It measures the maximum tensile force required to detach a defined test specimen from the substrate, providing a quantitative measure of the adhesive bond strength. The results of the pull-off test help assess the quality and durability of adhesive bonds and ensure compliance with European standards, which set specific requirements for different applications.

To perform the pull-off test, specific sample preparations are required. The substrate should be prepared according to the relevant European standard, ensuring it is clean, dry, and free from any contaminants that may affect the adhesive bond. The adhesive material is then applied to the substrate in accordance with the manufacturer's instructions, following the recommended thickness and coverage.



Figure I.7: Samples prepared for the pull-off test [128]

The pull-off test requires a specialized test apparatus, such as a hydraulic or mechanical testing machine (Figure I.8), equipped with a pulling device. The pulling device is typically a circular or square disc, which is bonded to the adhesive material and acts as the interface for applying the tensile force. The test equipment should be capable of applying a uniform and controlled force to ensure accurate and repeatable results.

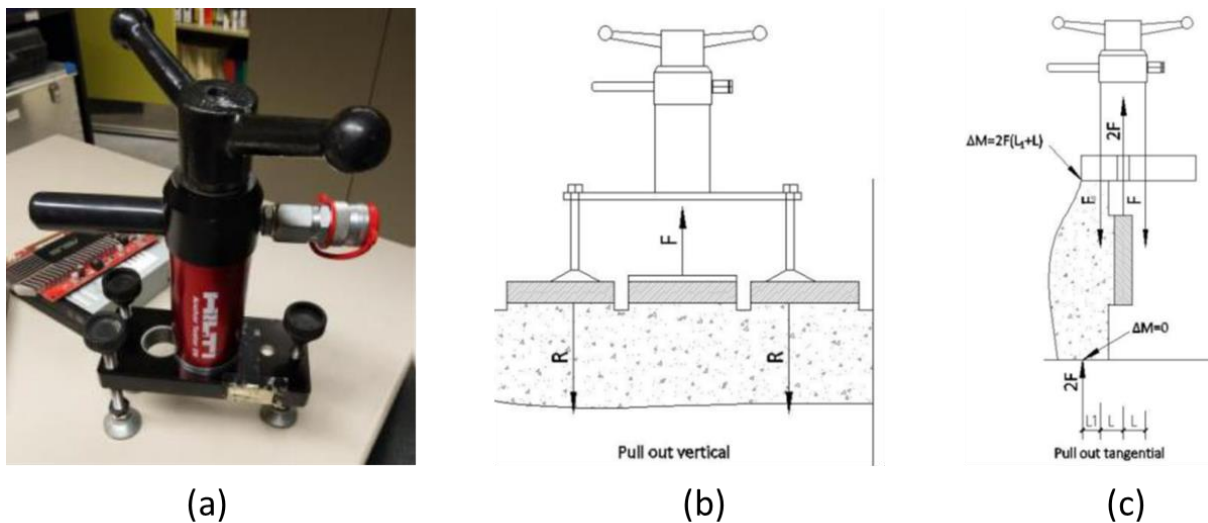

Figure I.8: Pull-off test on each masonry piece. (a) Manuel jack, (b) tensile and (c) direct shear types [129]

Once the adhesive has cured for the specified period (depends on the test; if dry differs from wet conditions), the pull-off test can be conducted. The pulling device is attached to the adhesive surface, ensuring proper alignment and contact. The testing machine then applies a steadily increasing tensile force to the pulling device until the adhesive bond fails. The force required to cause detachment is recorded as the peak load or maximum tensile force.

The adhesive strength is calculated by dividing the peak load (maximum tensile force) by the bonded area of the pulling device (in our case is 40x40 mm²). This results in a value expressed in units of force per unit area (e.g., N/mm² or MPa), representing the adhesive strength of the bond. It is essential to note that the calculation considers the actual bonded area rather than the nominal area of the pulling device.

European standards prescribe specific test parameters, including temperature, humidity, and curing time, to ensure standardized testing conditions. Adhering to these parameters allows for reliable and comparable results across different laboratories and adhesive products.

During the pull-off test, various failure modes may occur (Figure I.9), providing valuable insights into the bond strength and adhesive performance. The common failure modes include cohesive failure within the adhesive itself, adhesive failure at the substrate interface, or a combination of both. The location and extent of the failure can indicate the weakest link in the adhesive system and guide improvements in adhesive formulation or substrate preparation.

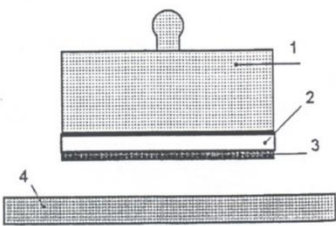

Adhesive failure between adhesive and substrate

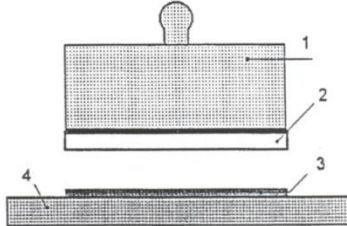

Adhesive failure between tile and adhesive

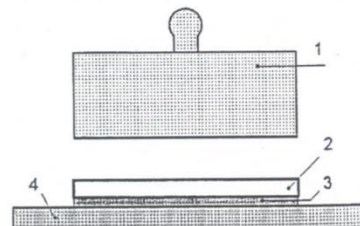

Adhesive failure between tile & pull head plate

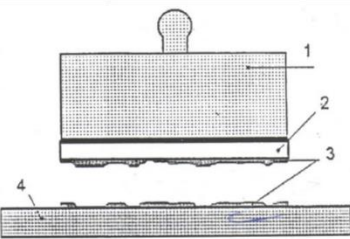

Cohesive failure within the adhesive

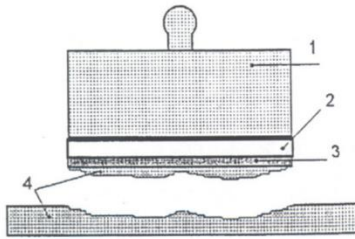

Cohesive failure within the substrate

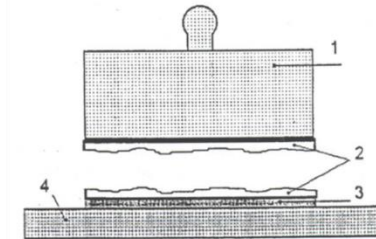

Cohesive failure within the tile

Key

- 1 Pull head plate
- 2 Tile
- 3 Adhesive
- 4 Substrate (Concrete slab)

Figure I.9: Failure patterns according to EN 12004:2007+A1:2012

The pull-off test (tensile) is a fundamental method for assessing adhesive strength and bond performance according to European standards. By following the prescribed test procedure, utilizing appropriate test equipment, and considering key factors such as test parameters and failure modes, reliable and comparable results can be obtained. The adhesive strength determined through this test aids in evaluating the quality and durability of adhesive bonds, ensuring compliance with European standards and facilitating informed decision-making in various industries and applications.

I.6. Shear Test for Dispersion (D) and Reaction Resin (R) Adhesives Strength in European Standards

This section provides a detailed explanation of the shear test method used to assess the adhesive strength of bonded materials according to European standards. The shear test is a widely recognized technique for evaluating the cohesive strength and performance of adhesives in various applications. This section will discuss the purpose, procedure, and key considerations of the shear test as outlined in the European standards.

The shear test is designed to measure the adhesive strength between two adherends bonded with an adhesive material. It evaluates the ability of the adhesive to withstand shear forces applied parallel to the bond interface. The results of the shear test provide quantitative data on the strength and integrity of the adhesive bond, allowing for the assessment of its performance and compliance with European standards.

To perform the shear test, specific sample preparations are required. Two adherends are chosen based on the intended application and material characteristics. The adherends should be prepared according to the relevant European standard, ensuring they are clean, dry, and free from any contaminants that may affect the adhesive bond. The adhesive material is applied between the adherends following the manufacturer's instructions, considering the recommended thickness and coverage.

The shear test is typically conducted using a testing machine equipped with appropriate grips or fixtures to hold the bonded specimens. The adherends are securely clamped in the grips or fixtures, aligning the bond interface perpendicular to the applied shear force (Figure I.10). The test configuration ensures uniform stress distribution along the bond line during the test.



Figure I.10: Tensile test used to measure the adhesive shear bond strength of rigid-to-rigid assemblies [130]

Once the adhesive has cured for the specified period, the shear test can be performed. The testing machine applies a steady and controlled shear force to the bonded specimens until the adhesive bond fails. The force required to cause bond failure is recorded as the peak load or maximum shear force.

The adhesive strength is calculated by dividing the peak load (maximum shear force) by the bonded area of the adherends. This results in a value expressed in units of force per unit area (e.g., N/mm² or MPa), representing the adhesive strength of the bond. The calculation considers the actual bonded area rather than the nominal area of the adherends.

European standards specify certain test parameters, including temperature, humidity, and curing time, to ensure standardized testing conditions. Adhering to these parameters allows for reliable and comparable results across different laboratories and adhesive products.

During the shear test, various failure modes may occur, indicating different aspects of the adhesive bond strength and performance. Common failure modes include cohesive failure within the adhesive itself, adhesive failure at the bond interface, or a combination of both (Figure I.11). The type and location of the failure can provide valuable insights into the adhesive's performance characteristics and guide improvements in adhesive formulation or adherend surface preparation.



Adhesive failure

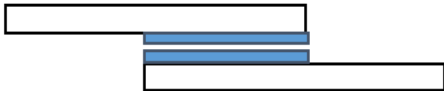

Cohesive failure



Adhesion/cohesion failure

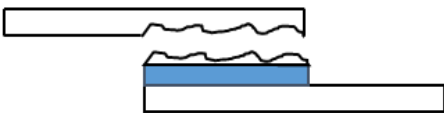

Substrate failure

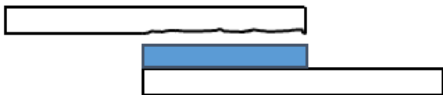

Light-Substrate failure



Stock-break failure

Figure I.11: Representation of failure modes characteristic of adhesive [131], [132]

European standards provide acceptance criteria for adhesive strength based on the specific application and materials being bonded. These criteria define the minimum required adhesive strength to ensure satisfactory performance and durability. Adhesive bonds that meet or exceed the specified acceptance criteria are considered suitable for the intended application.

The shear test is a fundamental method for evaluating the adhesive strength and bond performance of adhesives according to European standards. By following the prescribed test procedure, utilizing appropriate test equipment, and considering key factors such as test parameters and failure modes, reliable and comparable results can be obtained. The adhesive strength determined through this test aids in assessing the quality and integrity of adhesive bonds, ensuring compliance with European standards and facilitating informed decision-making in various industries and applications.

I.7. Strategies to resolve the problem

According to the European standards the tile adhesive must be tested in both dry and wet conditions (NF EN 12004-1: 2017-04 Part 1, Part 2)[127]. Hence, adhesives have to obey the requirements of the standards in the dry conditions, they must have a strength (depending on the application). Similarly under water where they must have certain strength after immersion.

In accordance with the stringent guidelines outlined by the European standards (NF EN 12004-1: 2017-04 Part 1, Part 2)[133], tile adhesive is mandated to undergo thorough testing under both dry and wet conditions. This mandate ensures the quality, reliability, and durability of the adhesive across a broad range of environmental circumstances. Under dry conditions, the adhesive is expected to meet or surpass specific strength criteria, which are contingent upon its intended application. Equally critical is the adhesive's performance under water, where it must maintain a predetermined level of strength following immersion. These provisions, diligently observed, guarantee the adhesive's ability to withstand diverse operational challenges and meet the demanding standards of quality and resilience set forth in the European standards.

Consequently, it is necessary to address three scenarios:

Scenario #1: Reinforcing the adhesive using additives

Scenario #2: Preventing water ingress

Scenario #3: Exploring reversible materials

Given that any product in the European market must adhere to European standards, it is crucial to ensure compliance with these standards. However, many of these standards are material and time-consuming. Therefore, new techniques and tests need to be developed that accurately reflect the relevant physical aspects and conform to the application's conditions and boundaries.

I.8. Conclusion

Saint Gobain Weber's primary objective is to pioneer the development of a clay-based adhesive, an endeavor central to accelerating the decarbonization trajectory within the industrial sector. The development of this innovative adhesive mandates compliance with a series of requirements stipulated by the European standards.

The interactions between water and clays encompass a range of mechanisms, including adsorption, hydration, capillary action, ion exchange, and surface tension effects. These interactions significantly influence the behavior of clay-water systems in various scientific and practical contexts, such as geotechnical engineering, environmental sciences, and materials science. Understanding these interactions is crucial for optimizing the performance of clay materials in different applications.

In this thesis, we first embark on a comprehensive exploration of the tests and mixing protocols enshrined in the standards in the inaugural chapter. This examination will elucidate the merits and drawbacks of the prevailing procedures, subsequently leading us to conceptualize more efficient, less time-intensive testing alternatives. The validation of these novel methods will be achieved through a comparative analysis against the benchmarks set by the standard tests.

The second chapter will delve into our inaugural strategy, which hinges on fortifying the adhesive with polymers or fibrous materials. This will involve rigorous testing of the reinforcement mechanism and its subsequent impact on the mechanical properties of the adhesive.

In the third chapter, we outline our secondary strategy. This pertains to the prevention of water ingress into the adhesive, a critical factor in preserving its structural integrity. A series of empirical tests and theoretical considerations will be employed to validate this water-resistant approach.

Our fourth chapter explores our tertiary strategy revolving around the deployment of reversible materials. These materials possess the remarkable capability to recover their mechanical strength post immersion, achieved simply by allowing the adhesive to dry. This 'reversible' property could be instrumental in enhancing the durability and longevity of adhesive.

Concluding the thesis, the fifth chapter will encapsulate the core findings and discuss the future directions of the project. This will include potential areas for further research, possible improvements in the developed strategies, and a reflection on the project's contribution to the broader goal of industrial decarbonization.

Chapter II. Developing new tests and their validation

II.1. Adhesive

II.1.1. Definition of adhesive

Adhesive is the term used to describe the material that bonds two or more substances, called adherends, through either a physical or chemical process. When physical, the adhesive forms an inner bond through solvent evaporation or cooling; when chemical, it may harden through cold or heat reactions. Essentially, adhesive bonding is the joining of parts by solidifying a non-metallic material between the connecting surfaces[134].

Adhesion can be described as the ability of the adhesive bond to transfer a force from one adherend to another (Figure II.1). The strength of the adhesive bond is directly proportional to the amount of mechanical energy that it is able to absorb, leading to an increase in adhesion or adhesive strength[135]. The understanding of adhesion is critical in the development of adhesives and adhesive systems for a wide range of applications.

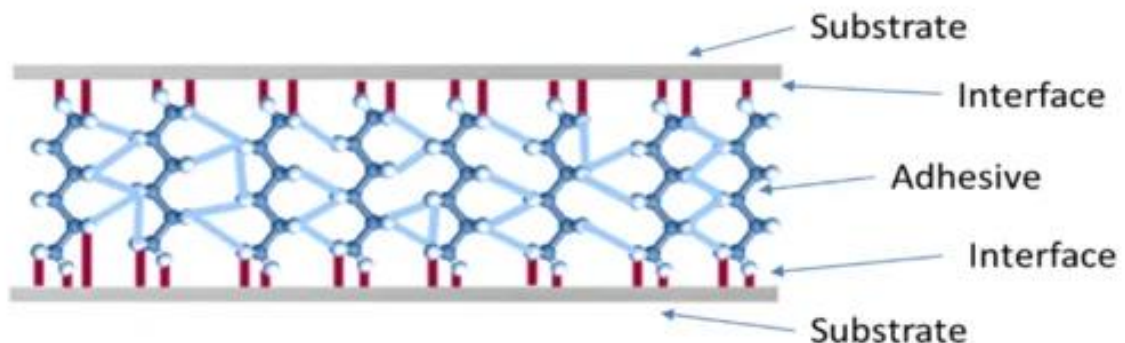

Figure II.1: Adhesive between two substrates, interface between adhesive and substrate [136].

In order to quantify adhesive strength, it is necessary to determine the force that can be applied to the adhesive bond before adhesion begins to diminish. This can be achieved through the use of mechanical force, which is typically measured using either of two standardized methods[127]: shear adhesion strength pull-off adhesion strength.

- Shear adhesion strength: measured by the application of a force parallel to the plane of the adhesive bond
- Pull-off adhesion strength: measured by the application of a force perpendicular to the plane of the adhesive bond (Tension force).

Adhesion quality is determined by a complex interplay of multiple factors. Key among them is the condition of the surfaces involved: cleanliness, roughness, and surface energy all play pivotal roles[137]. Higher energy surfaces generally fostering better friction and adhesion through improved wetting[138]. The adhesive's intrinsic properties—such as type, viscosity, flexibility, and curing[139], [140]—are equally significant, requiring a careful balance and compatibility with the materials involved[141].

The fundamental principles behind adhesion are rooted in the physical and chemical interactions that occur between the adhesive material and the surfaces (or adherends) being bonded together[142]. These principles can be broadly classified into the following categories:

Mechanical Adhesion: This occurs when the adhesive flows into the microscopic irregularities present on the surface of the adherends. It fills the voids and forms mechanical locks as it solidifies, creating a bond. The micro-pores increase the total surface area and enhance the mechanical interlocking between the adhesive and the adherends[143].

Chemical Adhesion: Chemical forces at the molecular level create bonds between the adhesive and the adherend. These forces include covalent bonds, hydrogen bonds, van der Waals forces, and electrostatic forces. The specific nature of the chemical bond depends on the adhesive and the surface materials[144].

Diffusive Adhesion: In some cases, if both the adhesive and the adherend are made of similar materials, molecules from each may intermingle and entangle at the bonding interface, creating a bond through diffusion

Adhesion is a specific type of bonding that involves the attachment of two different materials through interfacial forces. It is distinct from other types of bonding:

Adhesion vs. Cohesion: While adhesion refers to the bonding between two dissimilar materials, cohesion refers to the bonding forces within a single material. Cohesion is the attraction between like molecules, whereas adhesion is the attraction between unlike molecules[145].

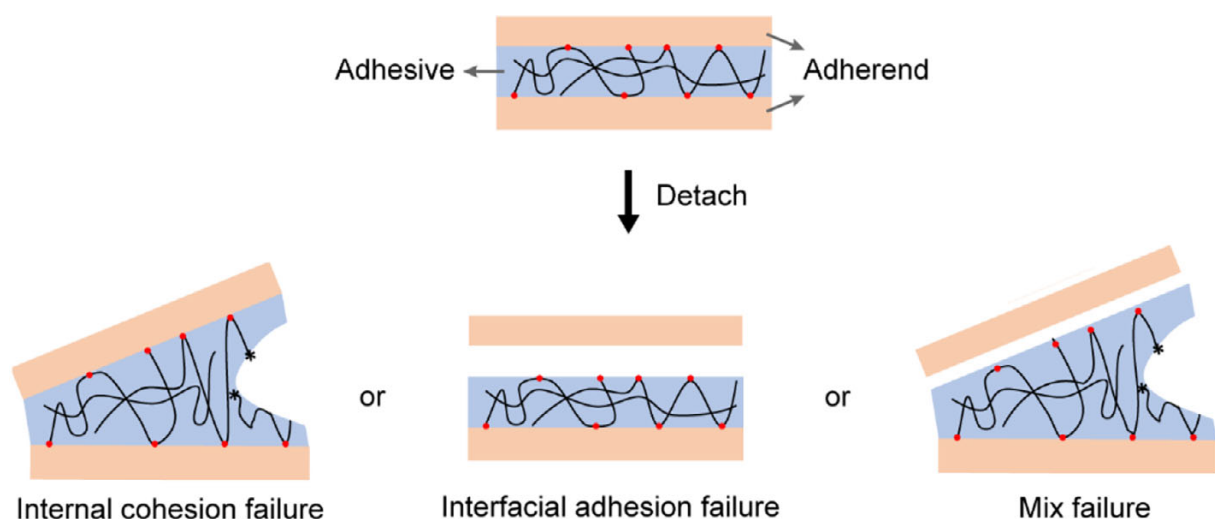

Figure II.2: Adhesion and cohesion of adhesive [146].

In summary, adhesion stands out as a unique mechanism that relies on interfacial forces to unite two dissimilar materials. Contrasting with cohesion, which describes the forces binding like molecules within a singular material, adhesion pertains to the attraction between diverse molecules. Unlike methods such as mechanical fastening, fusion bonding, and soldering, which physically join materials through hardware, melting, or filler metals, adhesion leverages a bonding agent, ensuring a more even distribution of stress. Moreover, adhesion operates predominantly at lower temperatures and doesn't demand alterations to the materials being bonded. Importantly, while chemical bonding is an atomic or molecular event within a single material, adhesion is a macroscopic event that involves the bulk properties of materials. In the context of tile adhesives, both these cohesive and adhesive forces play a pivotal role, determining the bond strength between tiles and the adhesive substance.

II.1.2. Mechanisms of Adhesion

In the realm of materials science, the bonding of materials can be achieved through either chemical or physical adhesion, each governed by its distinct forces and interactions. Chemical adhesion manifests through the establishment of actual chemical bonds, typically offering a stronger and more enduring union, in contrast to physical adhesion, which depends on transient intermolecular forces, thus rendering it more ephemeral and susceptible to environmental influences. The determination to employ chemical or physical adhesion is contingent upon the application's unique demands, such as the requisite strength, longevity, reversibility, or the compatibility with specific materials.

A multitude of key mechanisms are instrumental in the bonding process provided by adhesives, each mechanism's efficacy being contingent upon various factors including the nature of the adhesive, the characteristics of the materials in question, the preparatory treatment of the surface, and prevailing environmental conditions. For instance, mechanical interlocking occurs when an adhesive permeates the surface irregularities and, upon curing, forms a mechanical lock within these anomalies, securing itself robustly to the surface [144], [147], [148]. This mechanism is significantly influenced by the surface roughness and the viscosity of the adhesive.

Conversely, chemical bonding is characterized by the formation of chemical linkages between the adhesive and the substrate, which may encompass covalent bonds or hydrogen bonds, facilitating specific interactions at the molecular level between the adhesive and the surface [149]–[151]. The success of this bonding is predicated upon the adhesive's compatibility with the substrate and the presence of functional groups capable of forming bonds.

Additionally, van der Waals forces contribute to physical adhesion through weak intermolecular forces between the adhesive and the surface molecules. Despite their individual weakness, collectively these forces can substantially fortify adhesion, encompassing interactions such as dispersion forces and dipole-dipole interactions [152]–[154]. This mechanism is largely influenced by the surface energy and the adhesive's formulation.

Diffusion bonding is another vital mechanism, particularly prevalent in polymer-to-polymer bonding scenarios, where the adhesive and substrate molecules intermingle at the interface, effectively welding the two surfaces together through an interlacing zone [155]. This process hinges on the compatibility of the polymers and is influenced by temperature and duration of bonding.

Furthermore, electrostatic adhesion derives from the attraction between charged entities within the adhesive and the surface, contributing an additional facet to the adhesion process [156]. This aspect is modulated by the electrical properties of the adhesive and the substrate, as well as ambient humidity levels.

Adsorption as a mechanism entails the adhesive molecules adhering to the surface via physical or chemical forces without delving into the surface structure [157], with surface energy and the molecular structure of the adhesive being the critical factors.

Lastly, moisture-induced adhesion is observed where water or other solvents facilitate the bonding of the adhesive with the substrate, a phenomenon particularly relevant to water-based adhesives [158], with humidity and adhesive formulation playing pivotal roles.

In practical applications, it is often a confluence of these mechanisms that conspires to create a robust adhesive bond. An informed understanding of these mechanisms is indispensable for the selection or development of adhesives tailored to specific uses. Moreover, enhancing these mechanisms through meticulous surface preparation, such as thorough cleaning and strategic roughening, can significantly bolster the resultant bond's strength and durability.

II.1.3. Testing and Standards Methods of Evaluating Adhesion Quality

In Europe, adhesion quality is tested and evaluated following various standards and regulations. These standards are often developed and maintained by organizations like CEN (European Committee for Standardization) and ISO (International Organization for Standardization).

Peel Tests, based on the EN 28510-1 and EN 28510-2 standards, are essential for assessing how well an adhesive can maintain a bond when subjected to peeling forces. These tests are crucial in scenarios where the bond will face peeling stress, such as labels or tapes, and involve measuring the force required to peel a flexible bonded material from a rigid substrate at a consistent angle and speed [159].

Shear Tests, following the EN 1465 standard, are designed to quantify the shear strength of an adhesive bond by applying a force along the plane of the bond until failure occurs. This test is critical for applications where the adhesive will experience loads parallel to the bond line, such as in bonded metal joints, and helps in predicting the load-bearing capacity of the adhesive under shear stress [160].

Tensile Tests, as described in EN 24624, provide a method to determine the tensile strength of an adhesive bond. This involves pulling the bonded materials apart from each other in opposite directions. The test evaluates the maximum tensile stress the adhesive can withstand before the bond breaks, which is paramount for applications where the adhesive is expected to hold materials under tension [161].

Non-Destructive Testing (NDT), including standards like EN ISO 17640, involve techniques that inspect and evaluate the properties of a material or assembly without causing damage. Ultrasonic testing, for example, can detect flaws or discontinuities within the adhesive bond, enabling quality control and longevity assessments without compromising the material's integrity [162].

Construction-Specific Standards, particularly EN 12004 and EN 1348, set forth criteria for adhesives used in tiling. These standards ensure that tile adhesives possess the necessary attributes for secure installation, such as sufficient bond strength, resistance to moisture, and longevity under the specific stresses encountered in building environments [163].

In summary, adhesion quality testing and evaluation in Europe is governed by a comprehensive set of standards and regulations that cover various aspects of adhesives, including their mechanical properties, environmental performance, safety, and application in specific industries. Adhering to these standards ensures that the adhesives meet the required quality and performance criteria for their intended use.

II.2. Materials

Understanding the granular size distribution in adhesive formulations is critical for optimizing mechanical properties, especially in complex systems involving various clays, fillers, and both traditional and advanced additives [164]. Uniformity in particle sizes ensures a homogeneous adhesive composition, crucial for applications requiring consistent bonding strength [157]. Particle size significantly influences surface-to-volume ratios, affecting the overall surface energy of the particles [165]. For instance, smaller particles like clay possess higher surface energies that enhance adhesive and cohesive forces, while larger particles like sand contribute structural integrity at the cost of lower cohesive strength [166].

Balanced granular distribution is vital for optimizing these forces and also plays a role in porosity and water resistance [167]. Smaller particles can fill gaps left by larger particles, reducing porosity and enhancing the adhesive's water resistance. The distribution of particle sizes impacts not only the adhesive's mechanical strength but also its elasticity [168]. Additives like RDP ethylene vinyl acetate and TEOS, which are nano-to-micro-sized, further fine-tune these mechanical properties [11], [169]. Advanced additives such as RDP vinyl acetate, HYDROWAX (HWX), TEOS, and LUDOX interact at a microscopic level with adhesive ingredients, their particle sizes being pivotal for optimizing these interactions and thus directly impacting mechanical properties. For example, nano-sized RDP particles can penetrate smaller gaps, providing additional bonding sites and enhancing mechanical strength [170]–[172].

In the quest to elevate the performance of clay-based adhesives, particularly in terms of adhesion and water resistance, the granular size distribution of the composite materials is of paramount importance. This chapter section is dedicated to a comparative analysis of the granular sizes among the key constituents involved in these adhesives, including various types of clays, fillers, and additives. By examining these size-related properties, the analysis will elucidate not only the nuanced interactions at the particle level but also their collective impact on broader performance metrics such as adhesive strength, setting time, heat and strength resistance [173], and hydrophobicity. The section will illustrate the reported correlation between granular size distribution and these vital performance attributes. This enables the formulation of optimized clay adhesive composites that exhibit enhanced adhesive properties and water resistance, without compromising other essential characteristics like mechanical strength and durability. The role that granularity plays in the development of high-performance clay adhesives suitable for both vertical and horizontal applications will be emphasized.

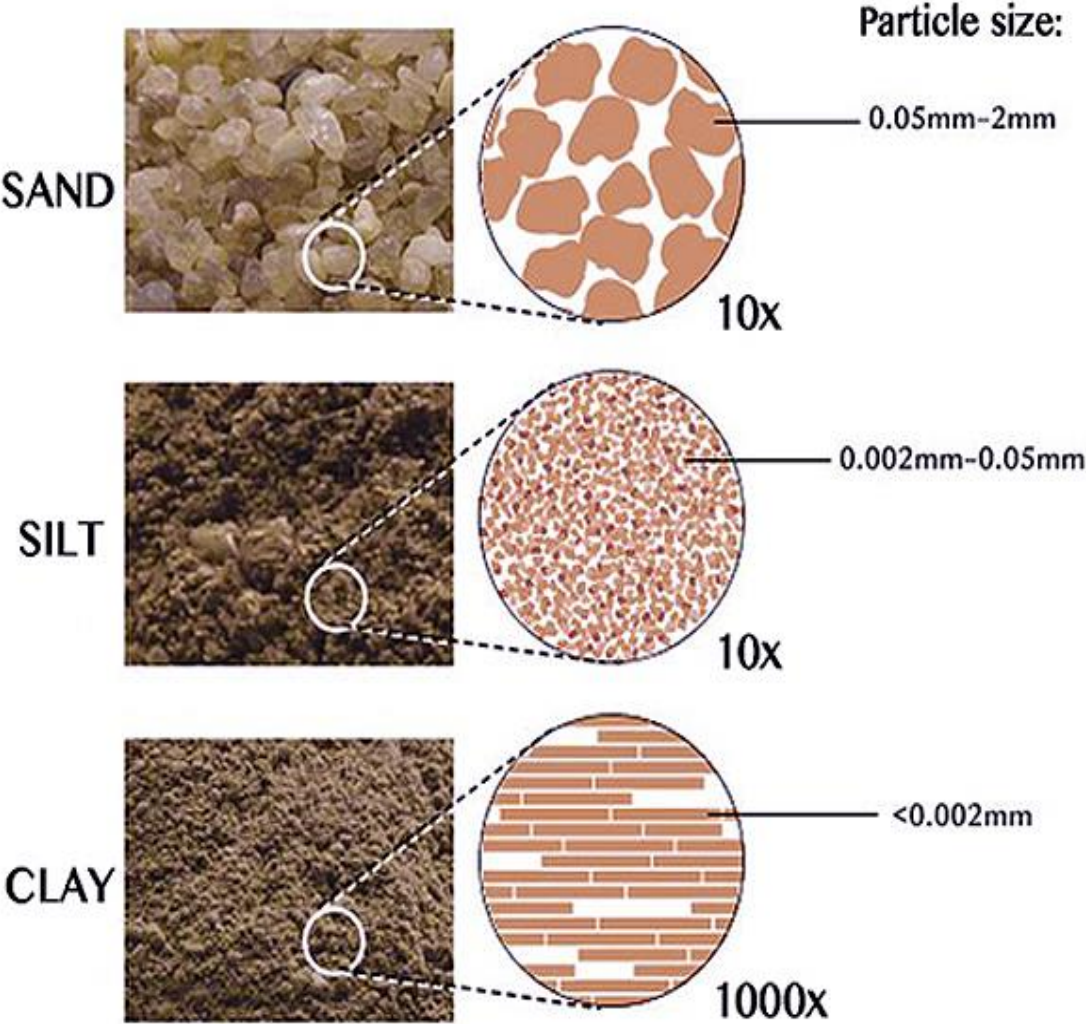

Figure II.3: Particle size different soil types [174].

II.2.1. Clays

To be classified as clay, a material must meet several specific criteria as outlined by [175]. Firstly, the material must be naturally occurring, thus excluding synthetic substances like fly ash and laponite, which, despite their granular characteristics and potential for plasticity, do not qualify as clay. Particle size is another factor, clay being one of the smallest soil type with particles generally less than 0.002 mm in diameter (Figure II.4) [176] .

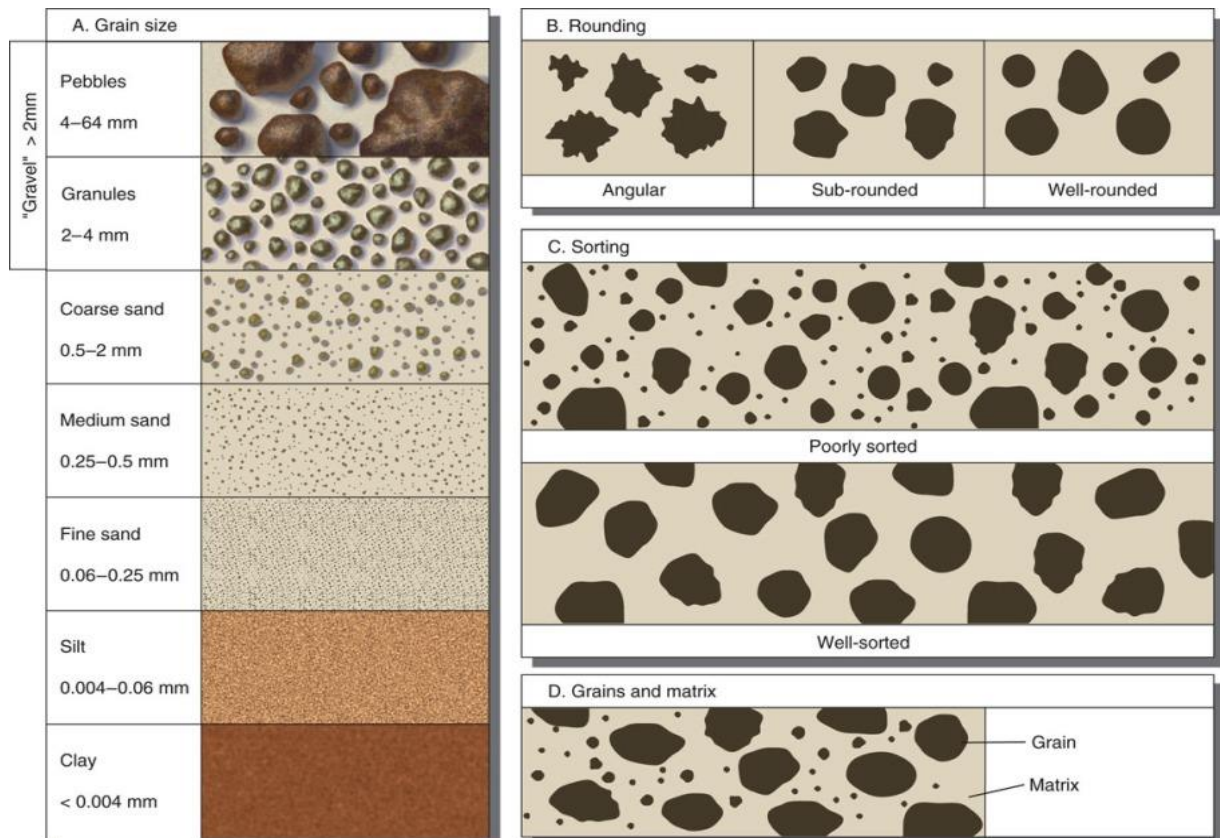

Figure II.4: Soil Classification Chart [177].

Nonetheless, the material should predominantly consist of inorganic minerals, disqualifying substances like peat or muck, which contain significant quantities of organic matter. Further, clay should exhibit plasticity when exposed to the appropriate water content, forming a malleable, sticky mass. Some materials such as flint clay and Fuller's earth lack this plastic characteristic but are often nonetheless considered clays due to their similar origin and range of applications. Finally, clays must have the ability to harden upon either drying or firing; they become brittle when air-dried and form a rigid, irreversibly solidified mass when fired

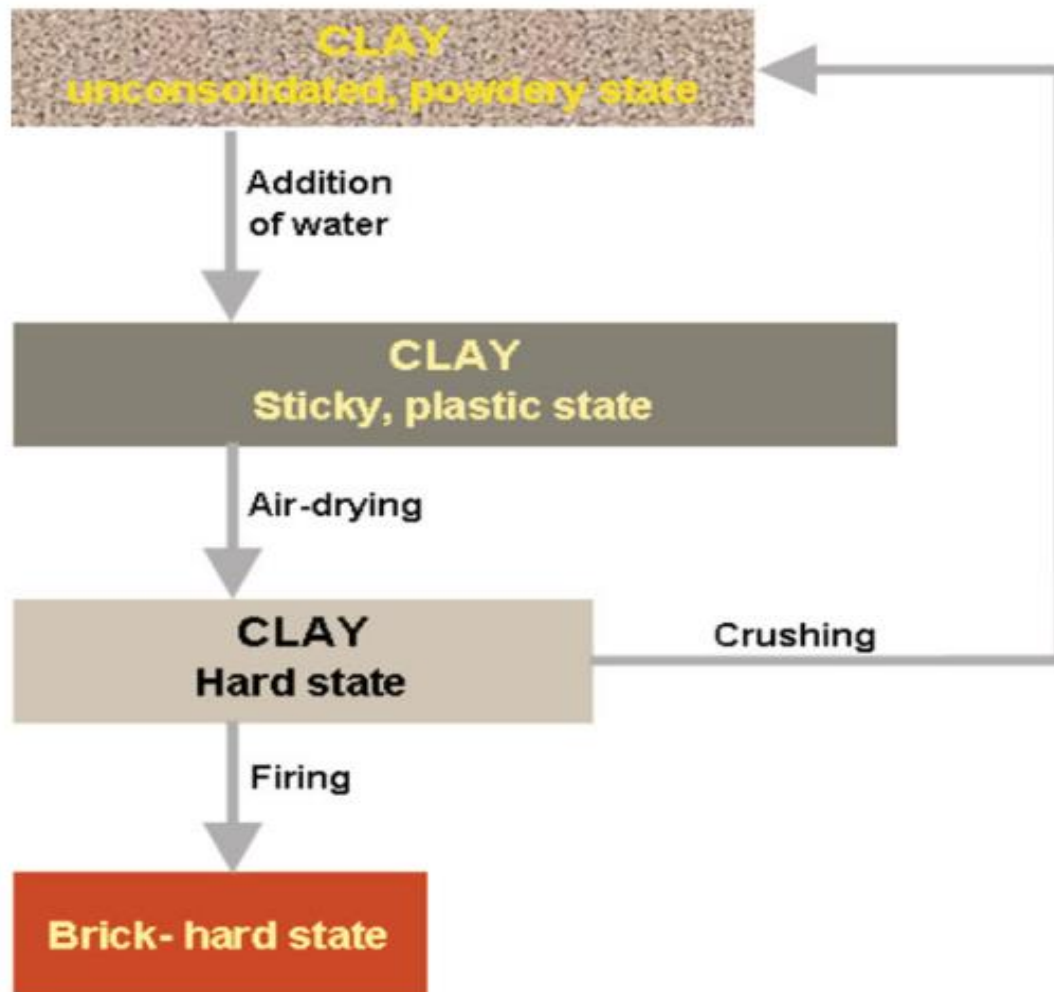

Figure II.5: Change of the physical states of clays [175].

Scientific nomenclature around clay and its mineral constituents often varies by disciplinary context. Generally speaking, "clay" is a term reserved for fine-grained geological materials with specific particle size limits. "Clay minerals," on the other hand, are identified by their compositional and functional features, falling under a broad classification of phyllosilicate minerals—such as kaolins, smectites, chlorites, micas, and serpentines—that contribute diverse properties like plasticity and hardening to clay-based products.

II.2.1.1 Clay Minerals

Clay minerals, a specific class of crystalline substances, come into existence through distinct geological processes [178]. Among these, aluminosilicates, comprising elemental ingredients such as aluminum, silicon, and oxygen, are notably prevalent. The conditions under which these clay minerals are formed have a substantial impact on their ensuing structural and functional attributes. Typically originating in high-temperature and high-pressure environments, these minerals are commonly derived from either igneous or metamorphic source rocks [179].

However, it is important to note that clay minerals can contain various associated minerals and impurities such as quartz, cristobalite, and alunite. These diverse structures result in clay

minerals having a range of physical and chemical properties. Particularly, the variations affect the distribution of charges on their surfaces and the types of bonds between atoms and molecules. These attributes in turn influence their utility in diverse applications including their use as feed additives.

The basic structural unit of these minerals comprises silica tetrahedral and aluminum octahedral sheets, linked by oxygen and hydroxyl groups [179]. These primary materials can further transform into secondary, more stable structures known as phyllosilicates. These phyllosilicates can be categorized based on their layering into 1:1 or 2:1 types (Figure II.6). The 1:1 type consists of one tetrahedral sheet of SiO₄ linked to one octahedral sheet of Al- or Mg- atoms. In contrast, the 2:1 type is characterized by one octahedral sheet sandwiched between two tetrahedral sheets [179], [180].

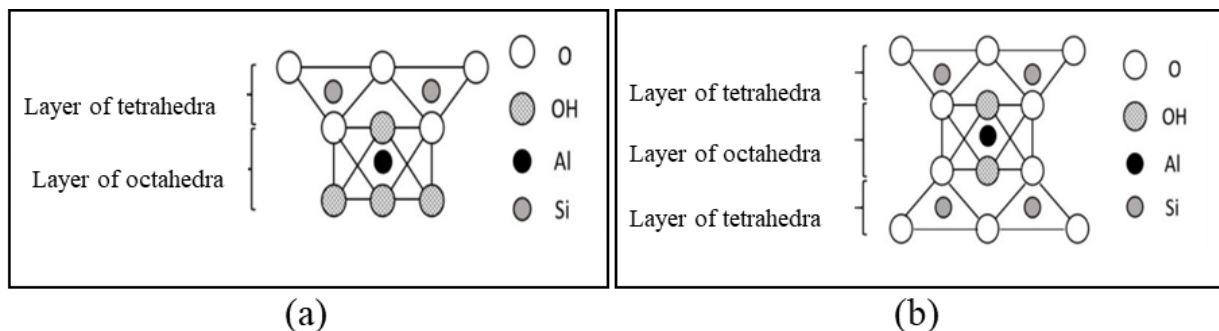

Figure II.6: (a) The 1:1 layer phyllosilicate structure. (b) The 2:1 layer phyllosilicate structure [179].

In the development of clay adhesives, the microstructural architecture of clay minerals is crucial, influencing both mechanical and chemical performance. Clay minerals are broadly categorized into 1:1 and 2:1 layer structures. The kaolinite group, which is a primary representative of the 1:1 layer minerals, plays a unique role in the realm of clay minerals. It is not only abundant but has also been extensively studied for its structure, properties, and various industrial applications. Kaolinite is characterized structurally by its 1:1 layer architecture, as depicted in Figure II.10, Figure II.7a [181]. This structure consists of a single tetrahedral sheet of silica tightly bound to an octahedral sheet of aluminum, detailed in Figure II.7-a. In this composition, aluminum ions predominantly occupy two-thirds of the octahedral sites, leading to its idealized chemical formula $Al_2Si_2O_5(OH)_4$.

On the other hand, the 2:1 layer minerals are more intricate, subdivided into three primary subgroups: mica (illite) (Figure II.7b), smectite (montmorillonite) (Figure II.7c), and talc. These minerals feature a central octahedral sheet that is enveloped by two tetrahedral sheets. Particularly noteworthy within the context of clay adhesives is the smectite group, owing to their unique interlayer spaces where exchangeable cations are positioned between water molecules. This configuration endows smectites with specific properties such as high cation exchange capacities, swelling, and reactivity, which are critically relevant for adhesive formulations.

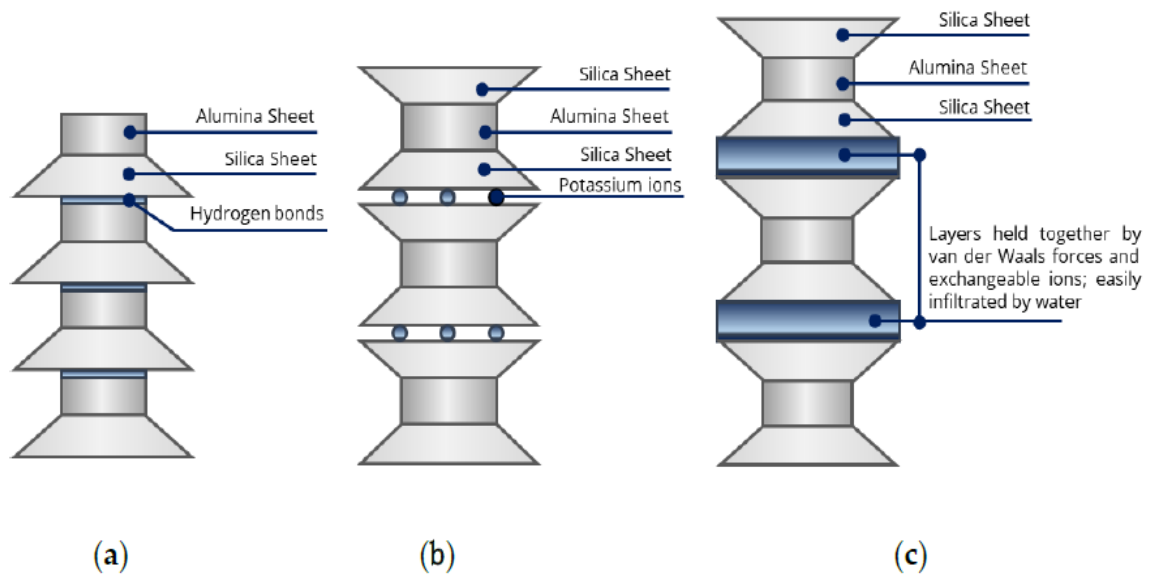

Figure II.7: Main groups of clay minerals. (a) Kaolinite (1:1 non-expanding); (b) illite (2:1 nonexpanding) (c) montmorillonite (2:1 expanding) [182].

The unique properties of various clay minerals—specifically kaolinite, illite, and montmorillonite—significantly impact the quality of adhesive, affecting its ability to adhere, its resistance to water, and its overall longevity. For example, smectites, a category that includes montmorillonite, have special chemical traits that can be used to enhance the adhesive capabilities of adhesive. Understanding these nuanced characteristics is not just a matter of scientific curiosity; it has practical implications for developing more effective and durable adhesive used in a wide range of industrial applications. Moreover, these particular clay minerals are abundant in soils worldwide, making their optimized use a topic of global importance (Figure II.8). A deeper understanding of the key features of these clays can contribute greatly to their effective utilization in industrial formulations, thereby enhancing adhesive performance across different settings (Table II.1).

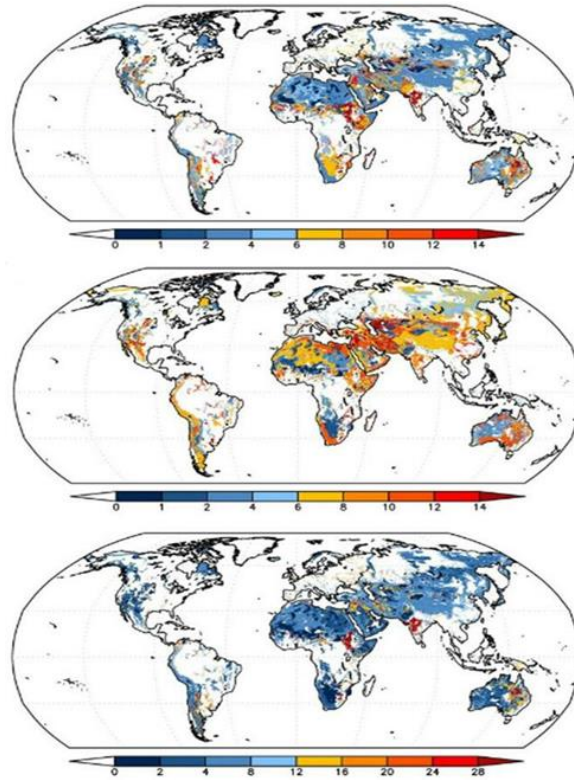

Figure II.8: Global distribution of kaolinite (top), Illite (middle) and smectite (bottom) in soils

Clay Mineral	Chemical Formula & Layer Structure	Specific Characteristics in Adhesive	Optimal Applications in Adhesive	General Use in Industry
Kaolinite	$\text{Al}_2\text{Si}_2\text{O}_5(\text{OH})_4$ (1:1 Layer)	High resistance to moisture, stable structure	Water-resistant coatings, external facades	Cosmetics, Paper Industry
Illite	$\text{KAl}_4(\text{Si}_4\text{O}_{10})(\text{OH})_2$ (2:1 Layer)	Moderate ion-exchange capacity, good compressive strength	Interior walls, non-load-bearing structures	Pharmaceuticals, Paints
Montmorillonite	$(\text{Al}_2\text{O}_3)_4(\text{SiO}_2)\text{H}_2\text{O}$ (2:1 Layer)	High swelling capability, less stable when wet	Foundation sealing, expansive grouts	Drilling fluids, cat litter
Halloysite	$\text{Al}_2\text{Si}_2\text{O}_5(\text{OH})_4 \cdot 2\text{H}_2\text{O}$ (1:1 Layer)	High surface area, tube-like structure	Water retention, controlled-release applications	Pharmaceuticals, Ceramics
Chlorite	$(\text{Mg,Fe})_3(\text{Si,Al})_4\text{O}_{10}(\text{OH})_2 \cdot (\text{Mg,Fe})_3(\text{OH})_6$ (2:1:1 Layer)	Resistance to chemical breakdown	Chemically harsh environments	Geotechnical applications, catalysis

Table II.1: Clay minerals commonly utilized in adhesive mixtures, delineating their chemical structure, specific attributes, optimal applications, and general industry uses

II.2.1.2 Kaolinite

Kaolinite is a common clay mineral belonging to the kaolin group. Its chemical formula is $Al_2Si_2O_5(OH)_4$, indicating the presence of aluminum, silicon, oxygen, and hydroxyl groups. Kaolinite forms through the weathering of aluminum-rich rocks such as feldspar. It is known for its white color, fine particle size, and platy structure.

The term "kaolinite" owes its etymology to the Chinese word "Gaoling," denoting a quarry in Jiangxi Province, China, where porcelain, one of the earliest applications of kaolinite, was invented. This culturally rich beginning has paved the way for kaolinite to evolve into an indispensable material in a plethora of industrial applications. Kaolinite is generally characterized by its white to off-white color (Figure II.9), although it may exhibit tints of yellow, brown, or even red due to impurities such as iron oxides. The mineral has a characteristic earthy texture and is soft to the touch, often leaving a white streak upon friction. The mineral is most notably found in large deposits in regions such as the United States (Georgia), the United Kingdom (Cornwall), and Brazil. In Europe, significant reserves are found in the Czech Republic, particularly in the western Bohemia region. These mines contribute substantially to the European kaolin market and are known for producing kaolinite of high quality.



Figure II.9: White mass of Kaolinite with many shrinkage cracks. Several faces are covered with dendritic patterns of manganese oxide. Ex. A. Lincoln Sherk II, MD. (1896-1970) [183]

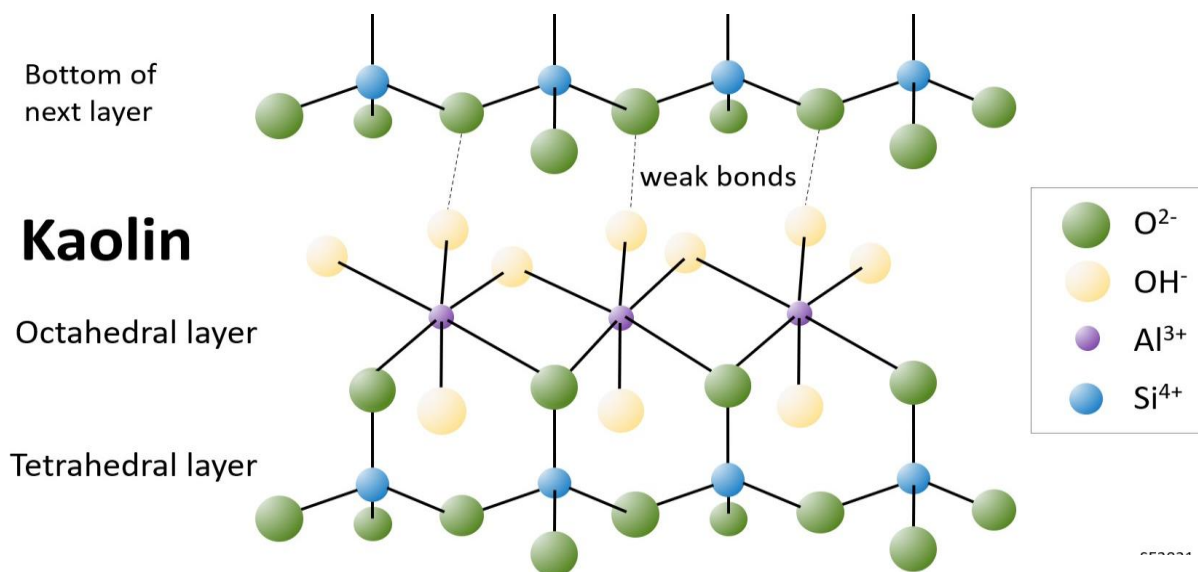

Figure II.10: A representation of Kaolin's 1:1 Tetrahedral-Octahedral Layer Configuration, Stabilized by Weak van der Waals Interactions [184]



Figure II.11: Difference in Water Swelling Between Kaolinite (Right) and Smectite-Type Swelling Clay (Left) [185].

Among the kaolin group of minerals—which also consists of nacrite, dickite, and halloysite—kaolinite is distinct for its specific layer stacking and by extension restricts the ability of the interlayer spaces to admit water or other polar molecules and so the property of limited swelling (Figure II.11). It displays a broad range of naturally occurring properties like particle sizes, crystallinity, elemental compositions, and chemical reactivity. These attributes accord it a specific surface area around $5\text{m}^2/\text{g}$ and a cation exchange capacity less than $10\text{meq}/100\text{g}$ [178]. Such characteristics make kaolinite a preferred choice in paper coatings, pottery, and sanitary ware.

Although kaolinite is widely utilized, it has certain limitations. Its specific surface area and cation exchange capacities, which are vital for functions such as catalysts, metal scavengers, and absorbents, are somewhat restricted [186]. Improving these characteristics could significantly expand the range of kaolinite's industrial applications.

Kaolinite exhibits low plasticity and high heat resistance, making it suitable for various industrial applications [187]. It is extensively used in the production of ceramics, paper, paints, rubber, and cosmetics. Due to its low reactivity and relatively inert nature, kaolinite has minimal impact on the environment compared to other clay minerals [188], [189].

Kaolinite particles typically fall within the micron range, often between 0.1 and 2 microns. Their platy morphology contributes to the overall adhesiveness and water resistance of the adhesive.

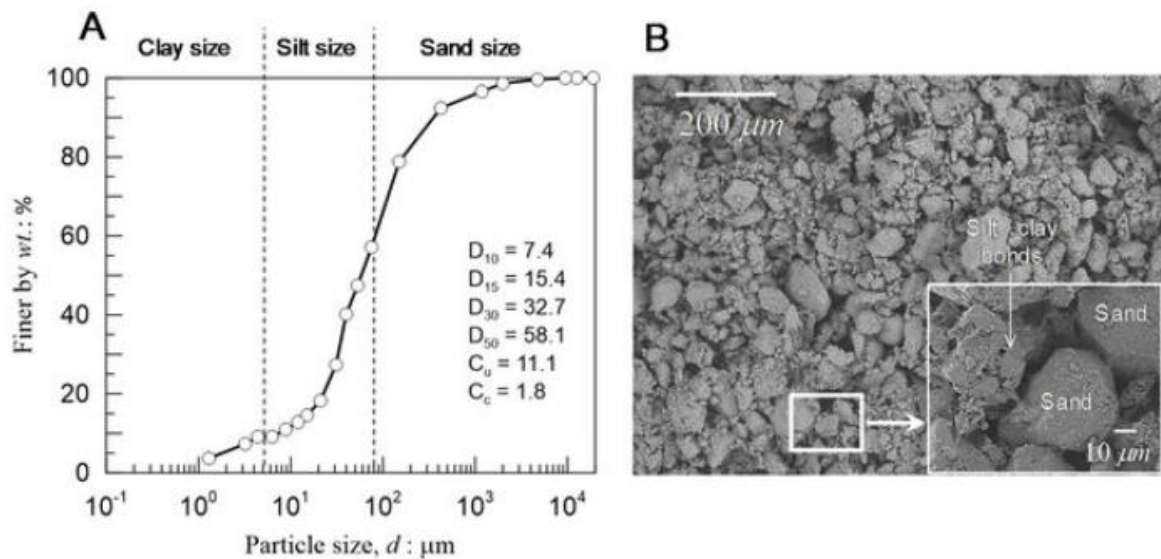

Figure II.12: Particle size distribution and pore structure of the studied loess deposit: (A) Apparent particle size distribution obtained using dry sieving and hydrometry. (B) SEM photomicrograph showing the particle arrangement [190].

Clays serve as the foundational material in adhesive mixtures [191], As a naturally occurring material, clays can be sourced in abundant quantities at a relatively low expense, there by contributing to its extensive array of applications [192]. Their granular characteristics, that vary from clay mineral type to another (Figure II.12), are pivotal in determining the overall performance of the adhesive, enhancing different types of properties such as mechanical properties [193] and thermal stability [194]. The need for adhesive substances is closely tied to the clay's surface dimensions and demands meticulous regulation, as it also influences visual attributes such as hue, luminosity, clarity, and texture. The following subsections delve into the granular dimensions of commonly employed clays in adhesive applications.

Kaolinite particles predominantly exist within the micron range, specifically between 0.1 and 2 microns. Kaolin is integrated into specific formulations to enhance adhesive properties, expedite the drying process, and elevate viscosity levels [195]. When kaolin undergoes calcination, the surface hydroxyl groups are removed, resulting in reduced moisture absorption. This characteristic makes calcined kaolin particularly effective in applications involving sealants sensitive to moisture. Additionally, the plate-like morphology and white hue of kaolin are considered advantageous attributes in certain adhesives and sealants. The platy morphology of kaolinite particles contributes synergistically to the adhesive properties and water resistance of the adhesive. The larger surface area per unit mass enhances the mechanical interlocking and hydrogen bonding, thereby improving adhesion and reducing water permeability. In the context of adhesives, film strength is a critical attribute, particularly for coatings formulated with kaolinite [196]. The film's resilience is influenced by the precise infiltration of adhesive ingredients into the underlying material and the strategic orientation of kaolinite particles. Optimal film durability is achieved when the coating incorporates kaolinite particles that are not only finely dispersed but also small in size and exhibit minimal sedimentation volume.

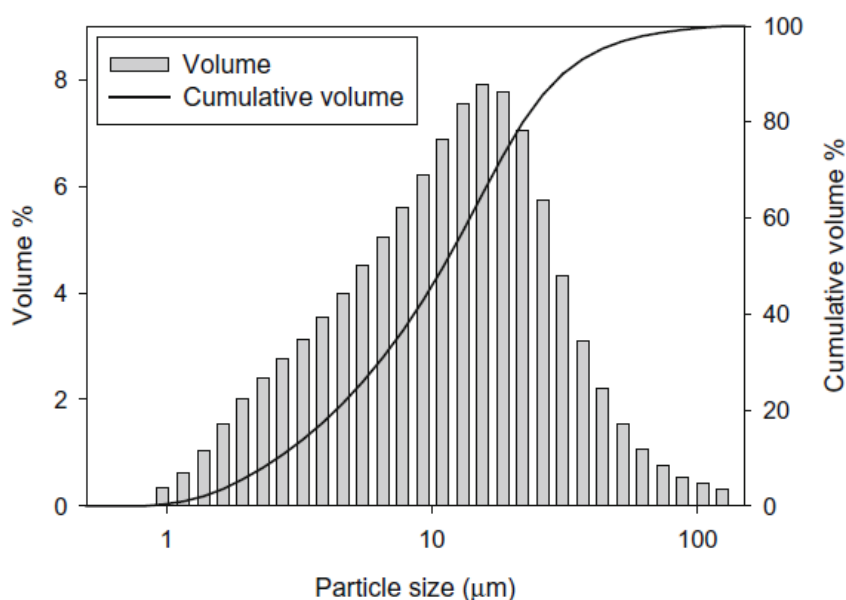

Figure II.13: Kaolinite Particle Size Distribution [197].

II.2.1.3 Illite

Illite is a clay mineral belonging to the mica group. It is a non-expanding, layered silicate mineral with a complex composition. The chemical formula of illite is approximately $(K, H_3O)(Al, Mg, Fe)_2(Si, Al)_4O_{10}[(OH)_2, (H_2O)]$, indicating the presence of potassium, aluminum, magnesium, iron, silicon, and hydroxyl or water molecules.

Illite, a cornerstone in the realm of clay minerals, holds considerable industrial and agricultural importance. Uniquely characterized by its 2:1 layer lattice structure (Figure II.15), illite is synthesized predominantly through the weathering of parent rocks rich in potassium and aluminum. This particular lattice configuration not only sets illite apart from its clay mineral counterparts but also plays a pivotal role in its intercalative behavior. Specifically, the concept

of "modification" in illite refers to intercalation—the insertion of ions, atoms, complex ions, or molecules into the interlayer spaces between the mineral's structural layers [198] . These intercalative processes aim to alter the interactions between individual layers, optimize the compatibility between the clay and polymeric matrices, increase interlayer spacing, and strategically modify the mineral's overall physical and chemical properties. Outcrop of the Decorah Formation Featuring Illite-Dominant Green Shale Layers and Fossil- Rich Limey Coquinas: A Road Cut Near Clay Corners, 8 Miles East of River Falls, Pierce County, Wisconsin



Figure II.14: Outcrop of the Decorah Formation Featuring Illite-Dominant Green Shale Layers and Fossil-Rich Limey Coquinas: A Road Cut Near Clay Corners, 8 Miles East of River Falls, Pierce County, Wisconsin[199].

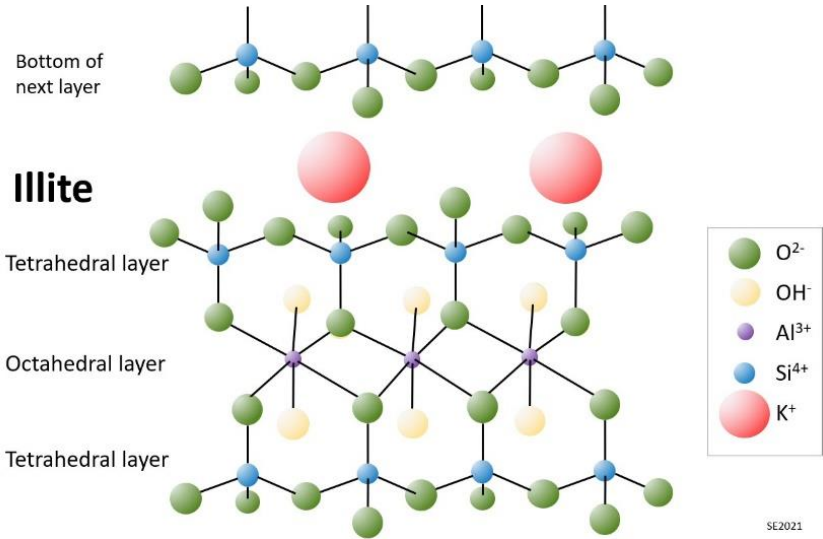

Figure II.15: A representation of Illite's 2:1 Tetrahedral-Octahedral-Tetrahedral Layered Configuration[184].

Emerging predominantly from the alkaline weathering of such parent materials, illite distinguishes itself through its specialized properties. Illite originates from the decomposition of biotite, in which the space between layers is completely filled with potassium ions [200]. The mineral is non-expansive due to the presence of weakly hydrated cations, such as

potassium, calcium, or magnesium, filling the interstitial spaces between its crystalline structures. These cations act as a barrier, preventing water molecules from penetrating the clay structure. Boasting a cation exchange capacity that varies between 20 and 40 meq per 100 grams [201], which enhances the excellent property of adsorption of illite [202]. This latter exhibits a color spectrum that ranges from grey-white and silvery-white to a greenish-grey hue. Thanks to its high potassium content, illite finds utility not just in the structural clay industry but also serves as an essential agro-mineral [203].

In summary, illite's unique structural attributes and non-swelling properties render it a material of considerable industrial and agricultural importance. Its high cation exchange capacity and color variations further add to its versatile utility across various sectors.

Illite is characterized by its distinct micaceous or flaky structure and is often found in association with other clay minerals, quartz, and feldspars. It exhibits good plasticity, high cation exchange capacity, and adsorptive properties [204], [205]. Illite has applications in the ceramics industry, geotechnical engineering, and as a drilling mud additive in the oil and gas industry [198], [201].

II.2.1.4 Montmorillonite

Montmorillonite is a swelling clay mineral belonging to the smectite group. Its chemical formula is approximately $(Na, Ca)_{0.33}(Al, Mg)_2(Si_4O_{10})(OH)_2 \cdot nH_2O$, indicating the presence of sodium, calcium, aluminum, magnesium, silicon, hydroxyl groups, and variable amounts of water molecules. Montmorillonite forms from the alteration of volcanic ash or other weathering processes.



Figure II.16: Montmorillonite Specimen from the Sanders-Defiance Plateau Region, Apache County, Arizona, USA [206].

Montmorillonite, from the group of smecties, is characterized by a distinct dioctahedral phyllosilicate architecture. The unit structure consists of a central sheet of aluminum-oxygen octahedra, flanked by two silicon-oxygen tetrahedral layers (Figure II.17) [207]. The molecular configuration can be generalized as

$(Na, Ca)_{0.33}(Al, Mg)_2Si_4O_{10} \cdot nH_2O$ [208]. Within its nanoscale structural framework, each layer measures roughly 1 nm in thickness [209] and is comprised of the said tetrahedral and octahedral sheets. These neighboring layers are interconnected through van der Waals and

electrostatic forces, giving rise to primary particles. Subsequently, these particles form aggregates whose size varies from 0.1 to 10 μm [210].

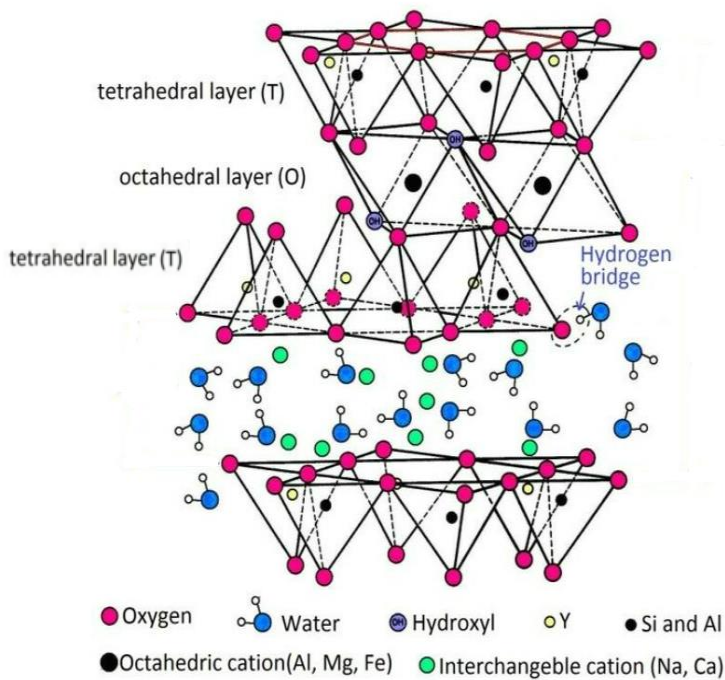

Figure II.17: A representation of Montmorillonite's 2:1 Tetrahedral-Octahedral-Tetrahedral Layered Configuration [211].

Montmorillonite is particularly noted for its unique combination of properties which extend well beyond the more commonly known traits of swelling, dispersibility, adsorption, and adhesion. The electrostatic charges on its layers permit the intercalation of hydrated cations, thereby influencing its cation exchange capacity, which is of paramount importance in environmental remediation applications. Montmorillonites serve as versatile agents in multiple industrial sectors due to their distinct physicochemical characteristics, including expansive surface areas, robust adsorptive capacities, structural porosity, elevated cation exchange capabilities, as well as exceptional hydration and swelling attributes [212]. These features make them ideal for roles in adsorption, rheological regulation, and ion exchange processes. Furthermore, its low hydraulic conductivity makes it a favorable choice in barrier systems for waste containment. Its high surface area enhances its role in catalysis, and its reactivity with organic molecules enables the development of polymer-clay nanocomposites.

Montmorillonite stands out with its ultra-thin unit cell thickness of approximately 1 nm (Figure II.18-C), emphasizing its nanoscale granularity. Illite falls in the intermediary category between the three clay minerals cited above, featuring platelet thicknesses generally ranging from 8 to 20 nm (Figure II.18-B). In stark contrast, kaolinite exhibits a significantly more robust structure, with thicknesses ranging from 40 to 70 nm (Figure II.18-A) and aspect ratios varying from 2 to 10. These variations in structural dimensions serve as crucial markers for the differing mechanical and functional properties inherent to each of these clay minerals.

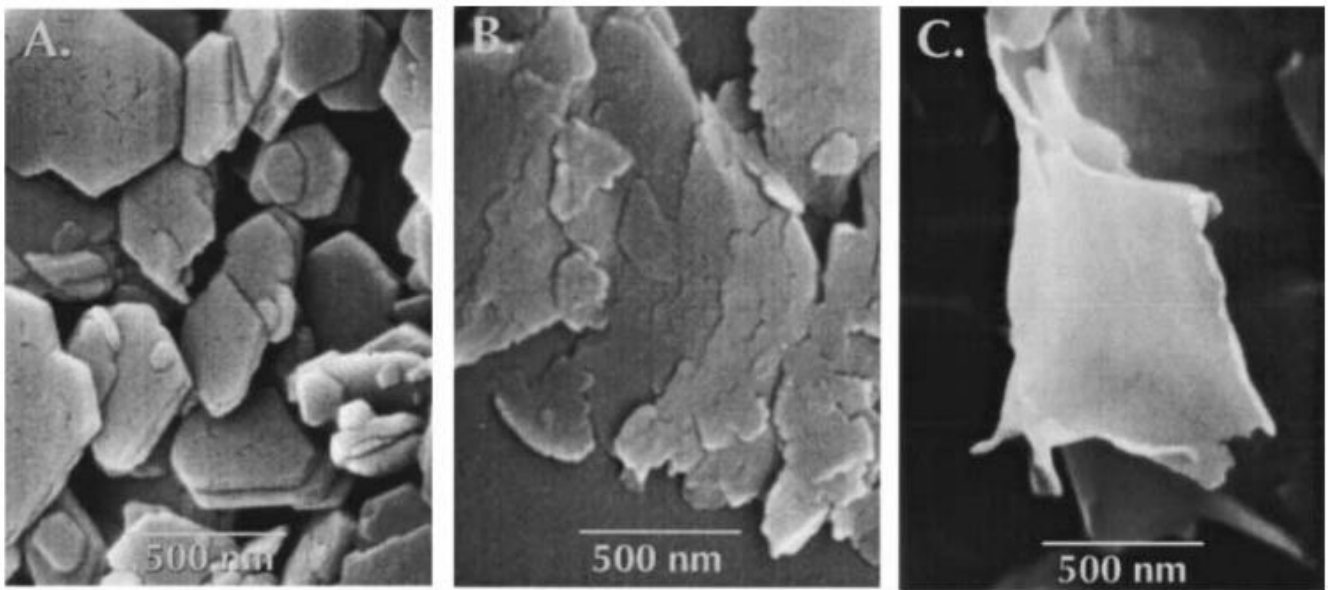

Figure II.18: *Scanning electron micrographs of clays, (A) kaolinite, (B) illite, and (C) Na-montmorillonite*

Montmorillonite has a unique 2:1 layer structure with a high cation exchange capacity, allowing it to adsorb and exchange various ions. It exhibits significant swelling properties when hydrated, leading to changes in volume. These characteristics make montmorillonite useful in applications such as drilling fluids, catalysts, absorbents, and as a soil amendment for its ability to retain water and nutrients [213], [214].

Clay minerals, including kaolinite, illite, and montmorillonite, have several environmental implications [215, p. 1]. They contribute to soil formation, affecting soil properties such as texture, fertility, and water-holding capacity. Clay minerals also influence the transport and fate of contaminants in soils, acting as sorbents for pollutants and aiding in their immobilization [216], [217].

Furthermore, clays play a crucial role in geotechnical engineering, as their properties influence the stability and behavior of slopes, embankments, and foundation materials [218], [219]. The presence of expansive clays, such as montmorillonite, can lead to significant challenges in construction due to their high swelling potential and shrinkage characteristics [220].

In aquatic environments, clay minerals can affect water quality and sediment transport. Fine clay particles can suspend in water, causing turbidity and impacting light penetration. Additionally, clays can act as carriers for nutrients, organic matter, and contaminants, influencing the fate and transport of these substances in aquatic ecosystems [221].

Kaolinite, illite, and montmorillonite are three important clay minerals with distinct properties and applications. They have significant implications in various fields, including industry, geotechnical engineering, and environmental science. Understanding their characteristics and behavior is crucial for harnessing their potential benefits and mitigating any potential adverse effects on the environment. Further research and monitoring efforts are necessary to comprehensively assess and manage the environmental impact of these clays in different contexts.

II.2.2. Sand

In contrast to clay particles, sand grains are much larger, often ranging from 0.0625 mm to 2 mm. The coarser nature of sand plays a vital role in imparting stiffness to the adhesive.

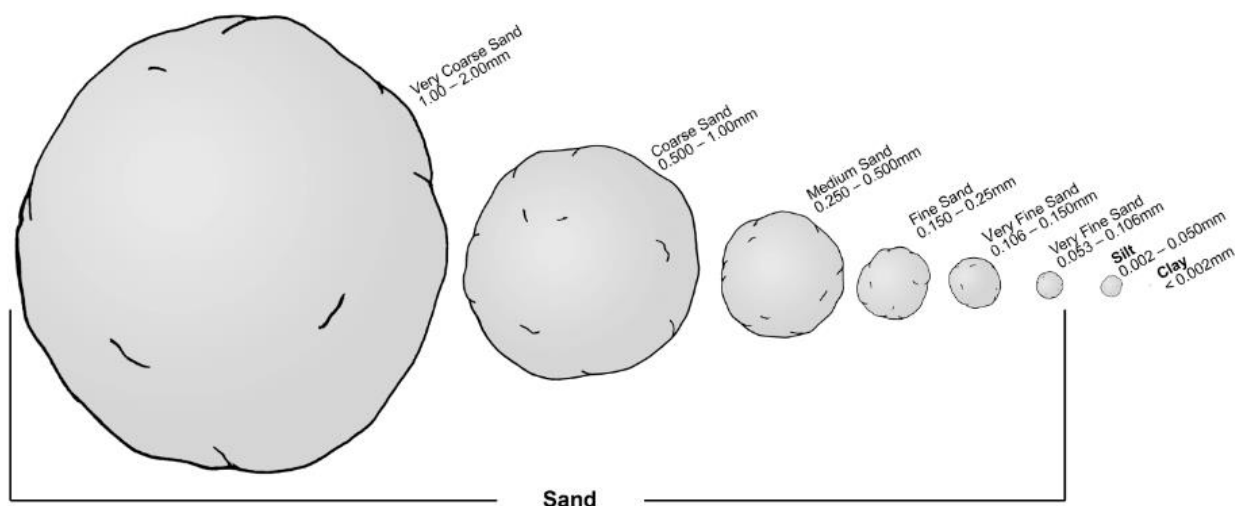

Figure II.19: Particle size distribution for sand [222].

The incorporation of sand into adhesive mixtures has a nuanced impact on the system's rheological properties, largely mediated by the morphological attributes of the sand particles. Specifically, the shape of these particles plays a pivotal role in altering the thickness of the interstitial paste film within the adhesive [223]. This morphological influence extends to affect the packing fraction, thereby modulating the overall rheological behavior of the sand-infused adhesive. It is crucial to recognize that sand exhibits a broad particle size distribution [224], adding an additional layer of complexity to the system. As such, sand particles of varying dimensions contribute differentially to the rheological characteristics of the adhesive [225], each bringing its own set of geometric features into play.

Fillers play a crucial role in adhesives by enhancing their properties and performance. Two commonly used fillers in adhesive compositions are sands and limestone. This section provides a detailed explanation of the role and characteristics of these fillers, their composition, formation, and their interaction with clays[226]–[228].

Sands are an essential filler ingredient in adhesives. They contribute to the bulk of the adhesive matrix, providing structural support and dimensional stability. Sands help improve workability, reduce shrinkage, and enhance the overall strength and durability of the adhesive [229]. They also act as a cost-effective filler option, widely available in various particle sizes and types [230].

Sands used as fillers in adhesives consist of fine to coarse particles of predominantly silica (SiO₂). The particle sizes can vary, typically ranging from 0.06 mm to 2 mm. The composition of sands can vary depending on their source and geographical location, but silica is the primary mineral ingredient [231].

Square mesh size (mm)	2	1.6	1	0.5	0.16	0.08
Cumulative sieve residue (%)	0	7 ± 5	33 ± 5	67 ± 5	87 ± 5	99 ± 1

Table II.2: Particle size distribution of the CEN European Committee for Standardization

Reference sand [232]

Sands are formed through the weathering and erosion of rocks containing high amounts of quartz, such as granite, gneiss, or sandstone. Over time, these rocks undergo physical and chemical processes that break them down into smaller particles, resulting in the formation of sand deposits. Sands are commonly found in riverbeds, coastal areas, and desert regions [233], [234].

In adhesive compositions, the presence of sands influences the overall particle packing and rheological behavior of the mixture. Sands provide a coarser texture and help fill voids between larger aggregate particles, contributing to the adhesive's overall strength and stability. When combined with clay minerals, sands can modify the workability and plasticity of the adhesive, affecting its setting time and adhesive properties [235]–[237].

II.2.3. Limestone Filler

Limestone is another commonly used filler in adhesives. It serves several important functions, including enhancing workability, controlling shrinkage, and improving the mechanical properties of the adhesive [238], [239]. Limestone fillers can also contribute to the adhesive's aesthetic appeal, providing a desired color and texture. In addition, CaCO₃ can be used to prevent the cake formation of the polymer powder [11].

Limestone is a sedimentary rock primarily composed of calcium carbonate (CaCO₃). It can occur in various forms, such as chalk, limestone, or marble. Limestone fillers used in adhesives typically consist of finely ground particles with sizes ranging from a few micrometers to a few millimeters [240], [241].

Limestone forms through the accumulation of calcium carbonate-rich marine organisms, such as corals and shells, over millions of years. These deposits undergo compaction and lithification, resulting in the formation of limestone rock. Limestone is abundant in many regions worldwide and often serves as a valuable natural resource for construction materials [242], [243].

Limestone fillers can interact with clays in adhesives through physical and chemical processes. The calcium carbonate in limestone can react with clay minerals in the presence of water, contributing to the formation of secondary minerals and cementitious compounds. This interaction can enhance the strength and durability of the adhesive, particularly in terms of its long-term performance and resistance to environmental factors [244]–[246].

Sands and limestone are widely used fillers in adhesives, offering distinct benefits and contributions to the overall performance of the mixture. Sands provide structural support, workability, and dimensional stability, while limestone enhances workability, mechanical properties, and can contribute to cementitious reactions. Understanding the characteristics, composition, formation, and interaction of these fillers with clays is crucial for designing adhesives with optimal properties and ensuring their long-term durability. Further research and experimentation are necessary to explore the potential of different filler combinations and optimize their effects on adhesive performance.

Limestone particles commonly range from 2 to 50 microns. Due to their calcitic nature, they can also contribute to the pH stabilization of the adhesive mix.

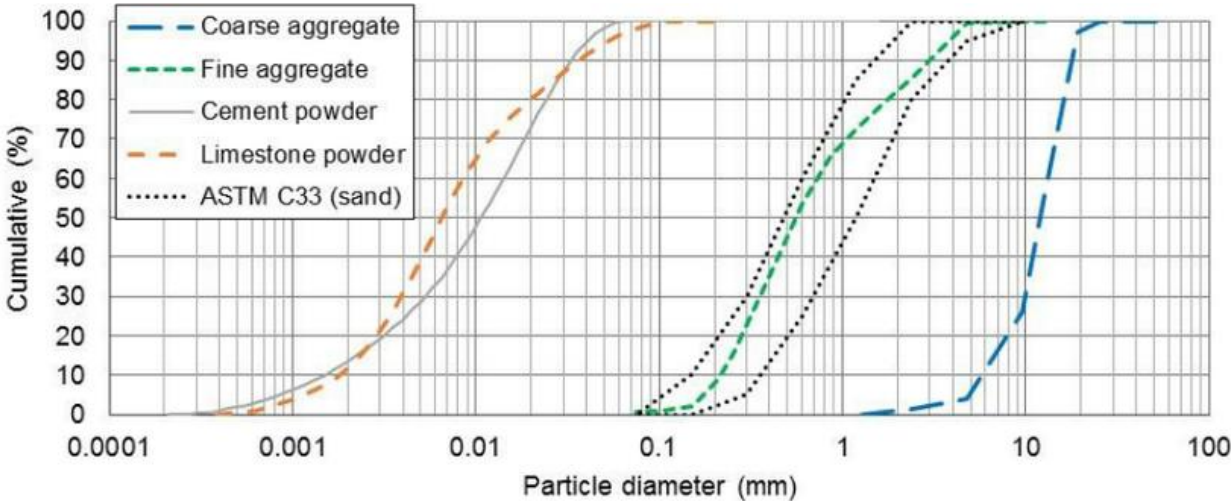

Figure II.20: Cumulative particle size distributions for limestone powder, cement, sand, and coarse aggregate used in the three concrete mixtures [247].

In summary, the granular size distribution of the various ingredients in the adhesive is a critical parameter that impacts its mechanical properties, including its strength, flexibility, and water

resistance. A carefully selected and well-balanced granular distribution can synergistically enhance these properties, making it possible to fine-tune the adhesive for specialized applications.

This understanding forms a cornerstone for the experimental approach outlined in subsequent chapters, informing the selection and proportioning of clays, fillers, and additives.

Understanding the granular sizes of the different constituents of the adhesive is pivotal for predicting and controlling its mechanical and water-resistant properties. Each constituent contributes uniquely to the adhesive and cohesive forces, workability, and water resistance of the adhesive. Therefore, a balanced mixture of these various granular materials is crucial for achieving the desired application-specific properties, be it for vertical or horizontal surfaces.

II.2.4. Workability Additives : Cellulose Ether and Lime

These additives are usually incorporated in small percentages. Cellulose ether (hydroxyethyl methyl cellulose (HEMC)) particles range between 20 and 200 microns, whereas lime particles are typically smaller than 50 microns.

Organic polymers are macromolecules composed of repeating subunits, which offer an array of functionalities when added to clay-based systems. They can enhance mechanical properties, improve workability, and contribute to overall stability.

Plasticizers and superplasticizers are additives that improve the workability of clayey adhesive by reducing its viscosity and increasing flowability without compromising strength. These additives disperse the clay particles and provide better lubrication, allowing for easier mixing, molding, and shaping.

II.2.4.1 Cellulose Ether (HEMC 0.3% by weight)

Cellulose ether (hydroxyethyl methyl cellulose (HEMC 16000)) polymers are plasticizers known for their water retention capabilities, which help in avoiding premature drying and thus improve the workability of clay-based adhesives. Their unique molecular structure imparts thixotropic attributes to the material, optimizing its rheological properties (viscosity 16000 Pa.s) through shear-thinning behavior. Owing to these multifaceted benefits, cellulose ether is incorporated as a key additive in the reference formula and is consistently present in all other formulations at a concentration of 0.3% by weight.

II.2.4.2 Lime (1% by weight)

Lime acts as an alkaline catalyst, playing a crucial role in facilitating the hydration reactions integral to the curing process of clay-based adhesives. By modulating the pH levels, it optimizes the reactivity of other additives, particularly pozzolanic materials, thereby enhancing the overall performance of the adhesive matrix. In this study, Lime is an essential ingredient of the reference formula and is uniformly incorporated into all the experimental formulations at a concentration of 1% by weight to provide a consistent source of calcium cations.

II.2.5. Studied service properties enhancing additives

These additives vary in size, but are generally nano-to-micro-sized. RDP Vinyl Acetate particles range from 10 to 100 microns. TEOS (Tetraethyl orthosilicate) and LUDOX particles are generally nanoscale, often less than 100 nm, which facilitates the alteration of surface chemistry and enhances mechanical properties.

Clayey adhesives are widely utilized in construction and various industries due to their abundance, low cost, and specific properties [248]. However, clayey adhesives can present challenges such as shrinkage, cracking, poor workability, and limited durability. To overcome these limitations and enhance the performance of clayey adhesives, additives are commonly employed. Additives are substances that are incorporated into clayey adhesive formulations in small quantities to improve specific properties and address various concerns. This general introduction explores the importance and use of additives in clayey adhesive, highlighting their benefits and applications [249], [250].

Organic Polymers	Inorganic Compounds	Nanoparticles	Waxes and Hydrophobing Agents	Natural Fibers
Cellulose (hydroxyethyl cellulose (HEMC))	Ether methyl Lime	LUDOX (Colloidal Silica)	HYDROWAX (HWX)	Cellulose Fiber (long)
RDP Powder (Redispersible Powder Ethylene Vinyl Acetate EVA)	Iron Chloride		TEOS (Tetraethyl Orthosilicate)	
Floset (Polycarboxylate Polymer)	Iron Oxide			
Starch (Amylopectin)				
Tannin				

Table II.3: Classification of All Additives Utilized in the Current Study

II.2.5.1 RDP (Redispersible Powder- copolymer of Ethylene Vinyl Acetate (EVA))

Redispersible powders, copolymer consisting of vinyl acetate and ethylene polymers, are converted into a dry, powder form that can be reactivated upon exposure to water. These polymers offer remarkable tensile strength and superior adhesion capabilities, even when

applied to substrates with high moisture content. Additionally, they enhance the thermal stability and UV resistance of the adhesive.

The chemical formula for vinyl acetate is $C_4H_6O_2$, and for ethylene, it is C_2H_4 .

In a vinyl acetate-ethylene copolymer, these two units are polymerized together. However, the specific chemical formula for the copolymer would depend on the ratio of vinyl acetate to ethylene in the polymer chain, as well as the degree of polymerization.

The repeat unit in the copolymer would be something along the lines of:

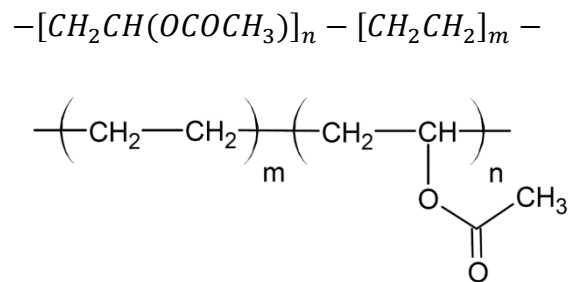

Figure II.21: Structure of the Ethylene Vinyl acetate (EVA) copolymer [251].

Here, $-\text{CH}_2\text{CH}(\text{OCOCH}_3)-$ is the vinyl acetate unit and $-\text{CH}_2\text{CH}_2-$ is the ethylene unit. Note that this is a simplified representation and the actual structure would depend on the polymerization conditions and the ratio of the two monomers. This representation indicates that there are n repeat units of the vinyl acetate monomer and m repeat units of the ethylene monomer in the copolymer chain[251].

Particle sizes: $<0.1\mu\text{m} - 10\mu\text{m}$ [252]

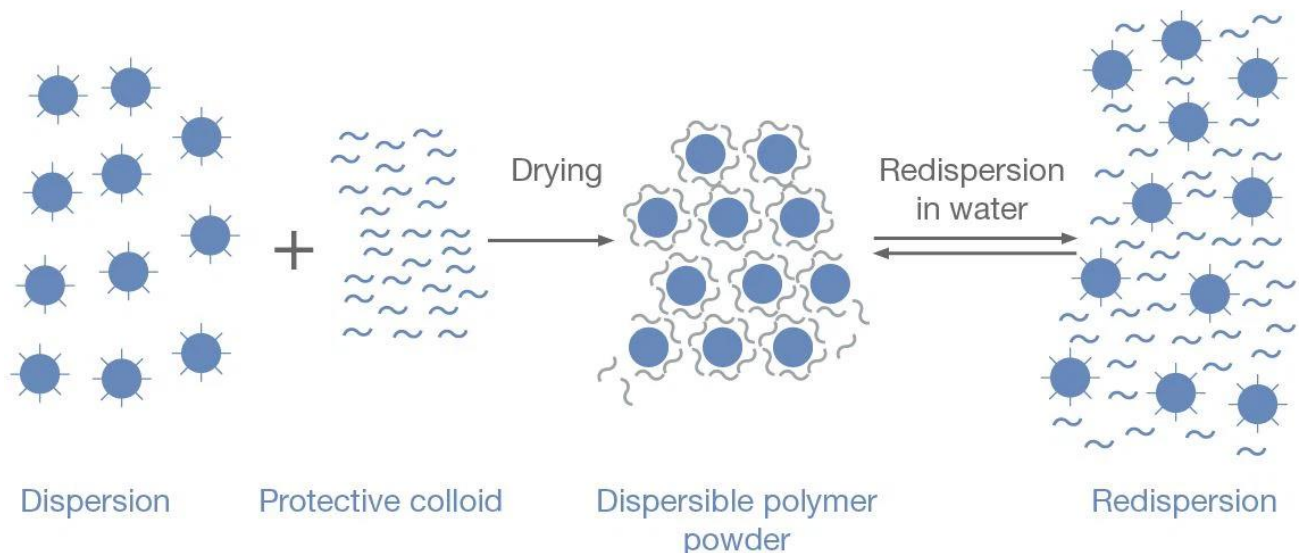

Figure II.22: Dispersion-Redispersion in water process [253].

II.2.5.2 Floset (Polycarboxylate Polymer)

Polycarboxylate polymers are high-performance superplasticizers dispersants that improve the rheology of clay-based systems. They help in reducing the water-to-cement ratio without affecting workability, which consequently leads to higher compressive strengths and better durability.

II.2.5.3 Starch (Amylopectin)

Starch is a polysaccharide, primarily found in cereals and tubers, composed of glucose units connected by α (1 4) bonds and characterized by its constituent polysaccharides, amylose, and amylopectin [254]. The gelification of these starch granules at high temperatures plays a critical role in modifying the mechanical properties of clay. This process, particularly the release of amylopectin, fosters the creation of a dense 3D network within the building material, which not only enhances its compressive strength but also evenly distributes stress during compression [255].

The inclusion of wheat starch notably increases the compressive strength of construction earth to 4.5 MPa, a marked improvement compared to the standard 3.5 MPa [256]. This enhancement is attributed to starch's ability to establish hydrogen bonds with clay surfaces, thereby reinforcing the material both physically and physicochemically [256] [254]. Rice starch, in particular, strengthens kaolinite through molecular interactions, further corroborated by FTIR spectroscopy data shows the adsorption of starch on kaolinite surfaces [255].

Additionally, the incorporation of starch into clayey mortars results in improved surface properties, such as a reduced sensitivity to abrasion, indicating an enhancement in durability [255]. The thermophysical properties of starch-enhanced materials, including changes in thermal conductivity and specific heat capacity, also reflect alterations in the material's hygrothermal behavior. Collectively, these findings from multiple studies underscore the potential of starch as an effective and environmentally friendly additive, capable of significantly improving various properties of clayey mortars, thus positioning it as a vital component in the development of advanced, sustainable construction technologies. [255]

II.2.5.4 Tannin

Tannin, a natural polyphenolic compound widely found in various parts of plants, has been traditionally used in vernacular construction techniques and is now recognized as a valuable additive in modern sustainable construction for enhancing clayey mortars [257]. Its application significantly alters the clay's rheological properties, as demonstrated when oak tannin at 2% concentration transforms clay from a flocculated to a highly dispersed state, thus increasing its workability and reducing its elastic modulus [258]. The subsequent addition of iron chloride counteracts this effect, causing the re-flocculation of clay particles, a process attributed to the complexation reaction between tannin and iron [258]. This interplay of deflocculation and coagulation, driven by tannin's acidic and positively charged nature, illustrates the nuanced control it offers over clay properties [257]. Moreover, the tannin and iron chloride combination enhances the compressive strength and water resistance of clay mortars, highlighting its

effectiveness in improving mechanical and durability aspects of the material [258]. The study's focus on oak tannin combined with iron chloride underscores tannin's potential as an innovative and environmentally friendly additive, offering new avenues for the development of advanced, more sustainable clayey adhesives [259].

Tannin acts as a complexing agent, especially effective when used with metal ions like those from Iron Chloride or Iron Oxide. Its polyphenolic structure allows for the formation of stable chelates, which can impart improved mechanical properties like tensile strength and compressive strength to the clayey adhesive.

Inorganic compounds often serve as fillers, stabilizers, and catalysts in the curing process of clay-based adhesives. They enhance the overall performance by modifying the chemical and mechanical properties of the material. Air entrainers introduce tiny air bubbles into the adhesive, improving its freeze-thaw resistance and reducing the risk of cracking due to thermal stress [260]. These additives enhance the adhesive's ability to accommodate volume changes caused by temperature variations, thereby improving its durability in harsh climates [261], [262].

II.2.5.5 Iron Chloride and Iron Oxide

When used with Tannin, Iron Chloride can act as a cross-linking agent that accelerates the curing process. On the other hand, Iron Oxide not only enhances mechanical properties but also provides UV stability and pigmentation.

II.2.5.1 Nanoparticles LUDOX (Colloidal Silica)

Nanoparticles, due to their high surface-to-volume ratio, can provide unique mechanical and thermal properties to clay-based adhesives.

Colloidal silica nanoparticles contribute to the mechanical strength of clay-based adhesives through improved particle-particle interactions. Their small size allows them to fit into micro-spaces between clay particles, thus enhancing density and reducing porosity.

II.2.5.2 Hydrophobic agent (HYDROWAX (HWX))

These are primarily used to make the adhesive water-resistant, improving its longevity and durability. Water repellents and waterproofing agents are additives that modify the surface properties of clayey adhesive, making it more resistant to water penetration [263], [264]. These additives form a protective barrier, reducing moisture absorption, and preventing damage caused by water, such as efflorescence, staining, or deterioration [265], [266].

HYDROWAX (HWX) is a commercial product, serves as a hydrophobic additive specifically formulated to enhance the water resistance of adhesive and similar adhesive materials. When incorporated into the adhesive, this wax emulsion creates a hydrophobic barrier on the surface, significantly reducing water absorption and thereby extending the material's durability and lifespan. Intended for hydrophobization, HYDROWAX (HWX) effectively mitigates water penetration into the adhesive matrix. The emulsion comprises two distinct particle types: the first consists of larger liquid hydrophobing wax particles, approximately 100 microns in size; the second is a conventional wax dispersion with smaller particle sizes ranging between 1 to 5 microns. The product has a water content of 40%.

II.2.5.3 TEOS (Tetraethyl Orthosilicate)

Tetraethyl orthosilicate (TEOS), chemically known as the ethyl ester of orthosilicic acid with the formula $\text{Si}(\text{OC}_2\text{H}_5)_4$, plays a pivotal role in enhancing the properties of clay-based adhesives through a hydrolysis and polymerization process. When TEOS interacts with water, it undergoes a transformative hydrolysis reaction, converting to silicon dioxide SiO_2 and ethanol $\text{C}_2\text{H}_5\text{OH}$ as shown in the chemical equation [267]:

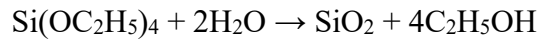

This reaction is not only a simple hydrolysis but progresses further through a series of condensation reactions.

During these condensation reactions, the TEOS molecules gradually polymerize to form a network of Si-O-Si linkages, which is reminiscent of the structure found in mineral-like solids. This formation of a silica network is integral to the performance of the adhesive, as it imparts hydrophobic (water-repelling) characteristics to the clay-based adhesive. The hydrophobic nature of the resulting silica network can significantly improve the moisture resistance of the adhesive, making it more suitable for applications where exposure to moisture is a concern.

The transformation of TEOS into a silica network within the adhesive matrix not only enhances its hydrophobicity but also contributes to the overall mechanical strength and durability of the adhesive. The Si-O-Si linkages formed are known for their robustness, providing a stable and durable bond within the adhesive compound. This characteristic is particularly valuable in extending the lifespan and effectiveness of clay-based adhesives in various environmental conditions.

TEOS is a crucial additive in clay-based adhesives, where its ability to undergo hydrolysis and subsequent polymerization results in the formation of a durable, hydrophobic silica network. This network not only improves the moisture resistance of the adhesive but also enhances its overall mechanical strength and stability.

II.2.5.4 Cellulose Fiber (long)

Natural fibers like cellulose offer a sustainable and biodegradable option for reinforcing clay-based adhesives.

Fiber reinforcements, such as polypropylene or glass fibers, are additives that enhance the tensile strength and crack resistance of clayey adhesive [268], [269]. These fibers provide structural reinforcement, improving the adhesive's ability to withstand external forces and reducing the risk of cracking or failure [270].

These fibers, when incorporated into the adhesive, improve its tensile and flexural strengths. They act as a reinforcing agent, forming a fiber matrix that enhances the material's resistance to cracking and deformation.

II.2.6. Tiles

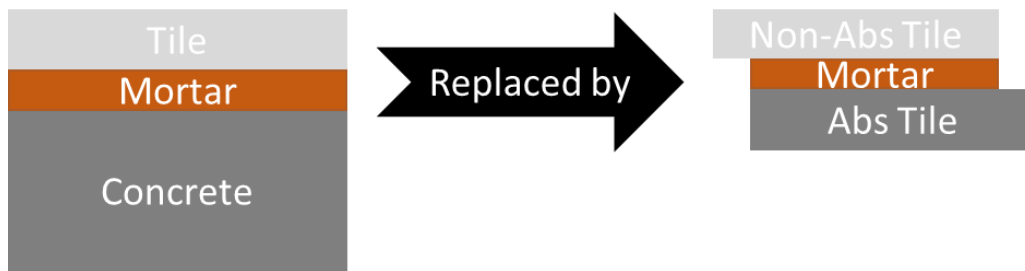

Figure II.23: Schematic illustration of real-life tiles installation and the replacement with Non-absorbent and absorbent tiles

In this study, two distinct types of tiles were utilized to represent different material characteristics. The first type is a non-absorbent tile, specifically a BI Winckelmans tile, which has an absorption capacity of less than 0.1%. This tile is akin to porcelain tiles commonly used in real-life applications due to their porcelain-like qualities. Porcelain tiles, a specific category of ceramic tiles, are crafted from more refined clay and subjected to higher firing temperatures. This process yields a tile that is denser, less porous, and significantly more durable than its non-porcelain counterparts. The low water absorption rate of the BI Winckelmans tile, below 0.1%, makes it an ideal choice for environments exposed to high moisture levels, offering enhanced frost resistance and durability.

On the other hand, the study also employed a BIII tile, characterized by a higher water absorption rate, typically reaching up to 18%. This type of tile was chosen to simulate the properties of a concrete slab, which often has a high absorption capacity. The BIII category of tiles, falling into the broader porcelain tile classification, is less suitable for damp environments due to its greater porosity. While BI tiles like Winckelmans are renowned for their low water absorption and high durability, making them suitable for both residential and commercial settings, the BIII tiles are more appropriate for interior use where moisture is not a significant concern. Non-porcelain ceramic tiles, generally, are more amenable to cutting and are frequently used in interior spaces, often featuring a glazed finish to enhance their visual appeal and provide a waterproof surface. The selection of these two tile types in the study enables a comprehensive examination of materials that mimic real-world conditions, ranging from highly durable and moisture-resistant surfaces to more porous substrates similar to concrete.

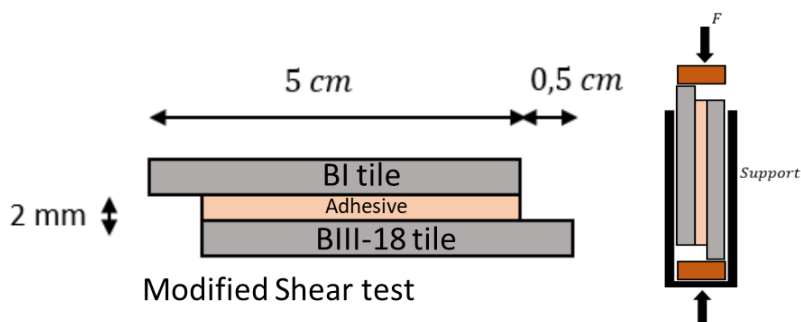

Figure II.24: Schematic illustration of the dimensions for the tiles and their spacing



Figure II.25: The two types of tiles used in this study

	BI Winckelmans	BIII-18
Absorption capacity (%)	0.08	18.57
Absorption capacity (g)	0.02	4.98

Table II.4: Absorption capacities in % and in grams, for BI Winckelmans and BIII-18 tiles

II.3. Developed Simple Shear Test Suitable for Clayey Adhesives

II.3.1. Introduction

Traditional methods of gauging the adhesive strength of clayey adhesive, such as the tensile (pull-off) test, often require complex procedures and extended periods. The need for an efficient and accurate method to assess the adhesive strength of clayey adhesive has led to the development of this new simple shear test. This test, tailored specifically for clayey adhesives, integrates the ease of the shear test with a setup that better mirrors real-world application scenarios.

The utilization of tensile adhesion strength and open time (the maximum duration post-CTA “Cementitious Tile Adhesive” application in which ceramic tiles can be incorporated into the adhesive layer to achieve a tensile adhesion strength of either 0.5 N/mm^2 for C1 or 1 N/mm^2 for C2 Table I.4) as key attributes of CTAs has been questioned. It has been observed that evaluating shear forces within the substrate-CTA-ceramic tile assembly, specifically parallel shear forces, could offer a more accurate representation of the system compared to measurements relying on vertically-directed forces in tensile adhesion strength tests[271]. Nonetheless, the challenges associated with gauging shear strength are substantially greater than those encountered in tensile adhesion strength tests (European standard protocol), which is why shear strength assessments are typically not conducted for cementitious tile adhesives.

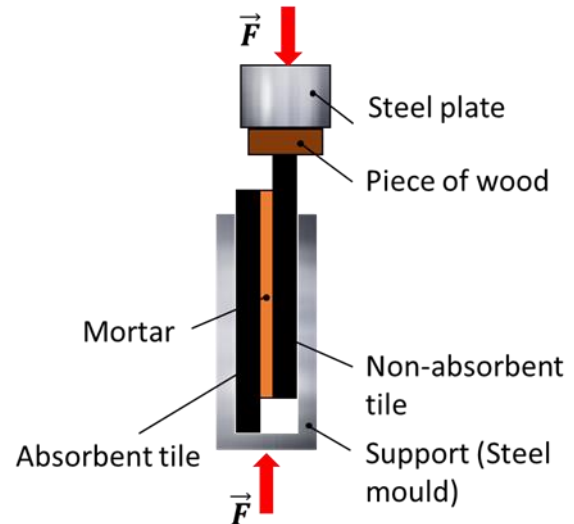

Table II.5: Schematic illustration of the developed shear test.

II.3.2. Purpose of the Shear Test

The primary purpose of this developed shear test is to measure the adhesive strength of clayey adhesive, simulating real-life scenarios through the use of absorbent and non-absorbent tiles. It aims to provide accurate and reliable data on how clayey adhesives perform in actual applications.

II.3.3. Test Procedure

The sample preparation process comprises two distinct steps. The first step involves adhesive mixing using a planetary mixer. This process starts with incorporating dry powder ingredients, followed by the introduction of distilled water and liquid additives. The mixture is then mixed until a consistent blend is achieved, with manual refinement of the mixture as necessary. The

second step is tile coating. For this, a uniform layer of the adhesive mix is spread on the non-absorbent tile. On the absorbent tile, a pyramid-shaped layer is applied through a buttering technique, ensuring appropriate coverage and thickness for optimal adhesive performance.

The test configuration and execution involve a series of meticulous steps to ensure precise results. In the test configuration phase, the first step is spacer integration. A T-shaped spacer, 2 mm thick, is positioned between both tiles. Additionally, a 5mm spacer is placed at the third edge for the offset. The second step is the tile assembly, where the non-absorbent tile is manually pressed into the adhesive layer to ensure seamless adherence. It's crucial to make sure that the T-shaped spacers are correctly positioned on both edges of the tile system for uniformity.

Moving to the test execution phase, the first step is the setting. The assembly is allowed to set or dry for a specific period, typically based on recommended or observed drying times for the adhesive. Usually, a drying period of 7 days is used. The second step involves stress application. A shear force is applied using a compression machine “Shimadzu Trapezium X” with 300kN sensor at constant displacement velocity 0.2mm/minute on the offset edge, during which tile movement and adhesive behavior are closely monitored until the point of failure. This step is critical for assessing the adhesive's strength and durability under stress conditions.

The shear stress is computed by dividing the maximum shear force (N) before over the surface area of the adhesive between the two tiles (40x40 mm²).

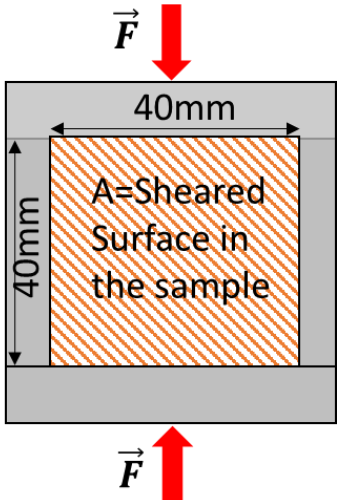

Figure II.26: Illustration of the sheared surface area between the two tiles

II.3.4. Key Considerations and Interpretation

In the testing process, particular attention to test parameters and failure modes is essential. Consistency in adhesive composition is critical. The types of tiles used must be carefully selected, with one side being an absorbent tile and the other a non-absorbent tile. Additionally, the force application during the test needs to be consistent, with the tiles maintained perpendicular to the steel mold to uphold the test's validity.

Observations of failure modes are essential. These may indicate different types of failures, such as adhesive failure, characterized by the separation of the adhesive from either tile surface. Cohesive failure, where a fracture occurs within the adhesive layer itself, is another possibility.

Lastly, mixed failure, which is a combination of both adhesive and cohesive failures, can also be observed. Understanding these failure modes is crucial for a comprehensive analysis and interpretation of the test results.

II.3.4.1 Correlation between Developed shear test and tensile pull-off test by standards

The introduction of a novel testing method inevitably raises questions concerning its validity and correlation with existing standardized tests. To address these concerns, a series of meticulously controlled experiments was conducted, wherein both the developed shear test and the standard tensile pull-off test were applied to a diverse array of adhesive formulations.

For the purpose of this study, nine distinct formulations were prepared, leveraging a combination of two types of clays—montmorillonite and kaolinite—as well as two traditional additives, namely cellulose ether (hydroxyethyl methyl cellulose (HEMC)) and lime. Additionally, three advanced additives were incorporated: RDP (Redispersible Polymer Powder, chiefly comprised of Ethylene Vinyl Acetate), HWX (Hydrowax, a hydrophobic wax), and Floset (a Polycarboxylate Polymer). The specific combinations of these components are detailed in Table II.6.

The developed shear test yielded shear stress values ranging from 200 kPa to 2000 kPa. This range corresponded well with the tensile stresses observed in the standardized pull-off test, which varied between 50 kPa and 1250 kPa. Importantly, this span encapsulates a broad spectrum of stresses, thereby ensuring that the tests are comprehensive in their coverage.

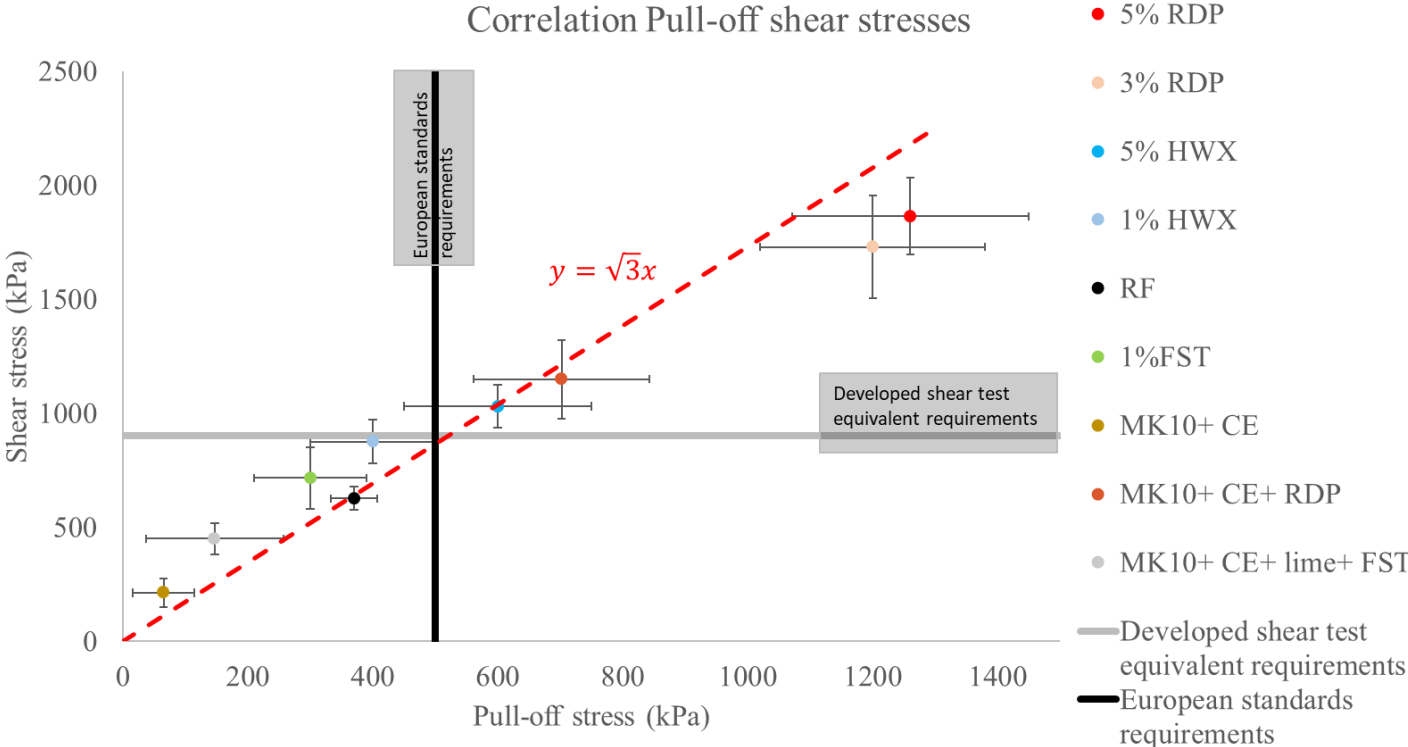

Figure II.27: Correlation between developed shear stress and pull-off stress recommended by the European standards

Upon juxtaposing the shear stresses obtained from the developed test with the tensile stresses from the standard pull-off test, a discernible correlation emerged (Figure II.27). This relationship is quantitatively expressed in Equation **Developed Shear stress** (τ) = **Pull – off tensile stress** ($\sigma_{tensile\ pull-off}$) $\times \sqrt{3}$ II-1, which serves as a mathematical manifestation of the observed correlation:

$$\text{Developed Shear stress } (\tau) = \text{Pull – off tensile stress } (\sigma_{tensile\ pull-off}) \times \sqrt{3} \quad \text{II-1}$$

By establishing this correlation, the developed shear test gains empirical validation, enhancing its credibility and potential applicability in both academic research and industrial settings. Moreover, this establishes a foundational framework for the developed shear test to be considered as a reliable alternative or supplementary method to the standard tensile pull-off test, particularly in contexts where the latter may be less feasible or informative.

Thus, the successful correlation between the developed shear test and the standard tensile pull-off test not only validates the former but also expands the toolkit available for the rigorous evaluation of adhesive formulations in line with European standards.

Formula	Kaolinite	Montmorillonite	Additive % by weight	Lime
5%RDP	<input checked="" type="checkbox"/>	<input type="checkbox"/>	5% of RDP	<input checked="" type="checkbox"/>
1%RDP	<input checked="" type="checkbox"/>	<input type="checkbox"/>	1% of RDP	<input checked="" type="checkbox"/>
5% HWX	<input checked="" type="checkbox"/>	<input type="checkbox"/>	5% of HWX	<input checked="" type="checkbox"/>
1% HWX	<input checked="" type="checkbox"/>	<input type="checkbox"/>	1% of HWX	<input checked="" type="checkbox"/>
RF	<input checked="" type="checkbox"/>	<input type="checkbox"/>	<input type="checkbox"/>	<input checked="" type="checkbox"/>
1%FST	<input checked="" type="checkbox"/>	<input type="checkbox"/>	1% Floset	<input checked="" type="checkbox"/>
MK10+CE	<input type="checkbox"/>	<input checked="" type="checkbox"/>	<input type="checkbox"/>	<input type="checkbox"/>
MK10+CE+RDP	<input type="checkbox"/>	<input checked="" type="checkbox"/>	5% RDP	<input type="checkbox"/>
MK10+CE+lime+FST	<input type="checkbox"/>	<input checked="" type="checkbox"/>	5% Floset	<input checked="" type="checkbox"/>

Table II.6: Ingredients for different formulas used under both developed shear and pull-off tests. Note that all formulations contain sand, limestone as fillers and cellulose ether at 0.3% by weight.

II.3.5. Acceptance Criteria

The determination of satisfactory adhesion strength is contingent upon a predefined threshold, established through a correlative analysis between the simple shear test and the standard pull-off test. This correlation serves as the basis for defining acceptable levels of adhesion strength specific to the shear test under investigation.

Utilizing

Developed Shear stress (τ) = Pull – off tensile stress ($\sigma_{tensile\ pull-off}$) $\times \sqrt{3}$ II-1, which delineates the relationship between shear stress and tensile pull-off stress, we can extrapolate the requisite standards for adhesive classification. For an adhesive to be designated as 'C1' according to the pull-off stress standards, it must demonstrate a tensile pull-off stress of 500 kPa in dry conditions (after 28 days of drying). Additionally, it must maintain this level of performance after 21 days of water immersion, which follows an initial 7-day drying period post-fabrication.

Translating these requirements to the context of the developed shear test, an equivalent performance criterion would be to achieve a shear stress of approximately 900 kPa under dry conditions. This is measured after a 7-day drying period specific to this test. Furthermore, the adhesive must also meet or exceed this 900 kPa threshold after a single day of water immersion, subsequent to the initial 7-day drying period post-fabrication.

Thus, through this correlation, we establish a comprehensive framework that allows for the evaluation of adhesive performance across different test modalities, ensuring that the adhesive formulations meet both the shear stress and tensile pull-off stress requirements as specified by industry standards.

II.3.6. Conclusion

The shear test developed specifically for evaluating clayey adhesives stands as a robust, precise instrument for gauging the material's adhesive strength. Designed to emulate real-world conditions by concentrating on shear stresses, this innovative method represents not merely an alternative but a significant advancement over traditional testing paradigms. By establishing a strong empirical correlation with the well-regarded standard tensile pull-off test, the developed shear test gains both credibility and utility. Consequently, it offers an enhanced methodological framework that could be pivotal for both academic research and industrial applications, particularly in the context of meeting or exceeding European standards.

II.4. Toast Butter Test for Evaluating Additive Efficiency in Clayey Adhesives

II.4.1. Introduction

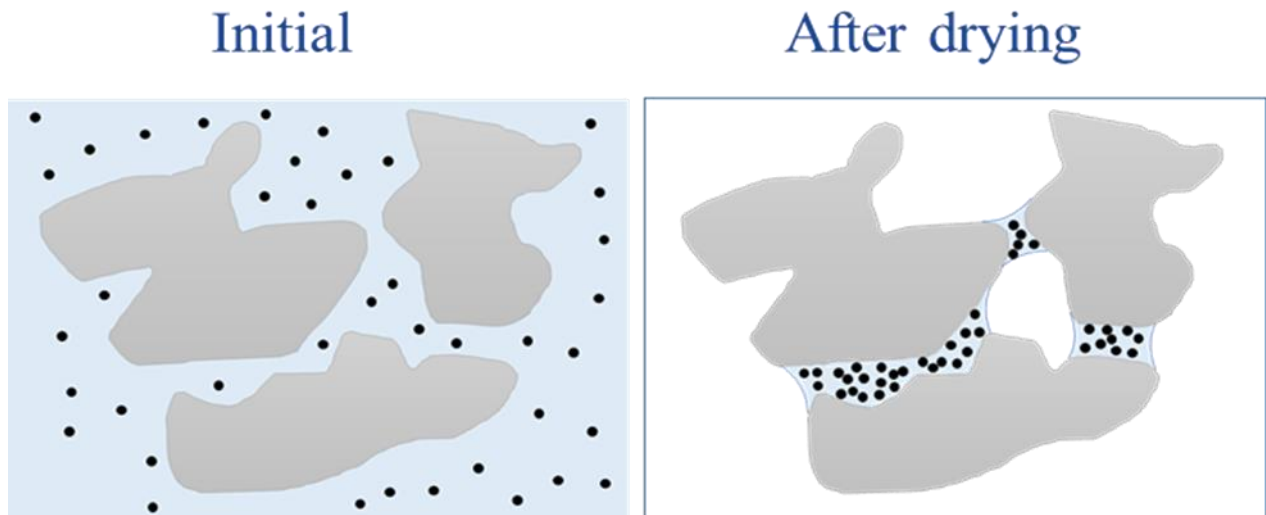

Figure II.28: Schematic illustration of using drying to over-concentrate reactive additives into interparticle solid bridges.

The cohesive forces within the lamellar structure of clay are predominantly influenced by capillary interactions. Upon immersion in a liquid medium, these forces are diminished, thereby elevating the significance of additives in maintaining structural integrity. To elucidate these binding dynamics more comprehensively, the "Toast Butter Test" has been conceptualized. This innovative experimental framework is tailored to mimic the bonding phenomena in clay at an exaggerated scale, providing a deeper understanding of the adhesive properties imparted by various additives.

The Toast Butter Test is methodically structured to investigate the adhesive enhancements imparted by additives in clay matrices. It simulates the formation of additive-mediated bridges between particulate components in a dried state. This methodology enables the quantification and assessment of an additive's capacity to augment the adhesive strength within clay-based composites. By closely analyzing these interactions, the test offers valuable insights into the potential of specific additives to enhance the cohesiveness and mechanical stability of clay-based materials under varying environmental conditions.

II.4.2. Concept and Purpose of the Toast Butter Test

When immersed in a water, the capillary forces within clay sheets diminish. As a result, the adhesive role is relegated solely to the additives. The Toast Butter Test utilizes two large plates

to simulate these additive "bridges" on a macro scale, replacing the granular clay system. By evaluating the shear force that this simulated system can endure, a correlation with the actual granular-clay system's strength can be established. This allows for an assessment of an additive's efficacy in enhancing the adhesion strength of a clayey adhesive using the Toast Butter Test.

II.4.3. Test Procedure

The test procedure involves a comprehensive approach for assessing the adhesive properties of a specific mixture. Initially, in the sample preparation stage, the process starts with the creation of a mixture, where an additive is thoroughly mixed with lime and cellulose ether, specifically hydroxyethyl methyl cellulose (HEMC). This mixture is then uniformly applied between non-absorbent tiles to ensure consistency. To keep an even spacing, 1mm spacers are inserted between the tiles. The next stage is the test configuration, which begins with a drying process, allowing the mixture to solidify and bond the tiles together. Once the setup has dried, the spacers are removed. The final step involves positioning the bonded tiles within a steel mold and attaching a wooden piece to the upper edge of the tile, readying it for further testing and evaluation. The assembly is then subjected to a shear force using a press machine, with careful observation made to note the point at which the bond fails.

II.4.4. Key Considerations and Interpretation

Understanding the test involves a careful examination of several critical aspects. Uniformity is paramount in this process. It is essential to ensure consistent mixing of ingredients and to maintain a precise gap between the tiles to guarantee the reliability of the test results. In terms of failure modes, observation is crucial. The test should account for different types of failures, including adhesive failure, which is a breakage between the paste and tile; cohesive failure, occurring within the paste itself; and combined failure modes, which encompass both adhesive and cohesive failures. Understanding these failure modes is vital for accurately interpreting the test outcomes.

II.4.4.1 Correlation between Toast Butter and developed shear test

The underlying principle of the Toast Butter test is to evaluate the strength of inter-particle bridges created by a minuscule amount of additive. By examining these bridges on a macroscopic scale, this novel test aims to provide quick yet insightful assessments of additive performance. To establish the validity of this newly developed test, it was essential to correlate it with an existing, validated test.

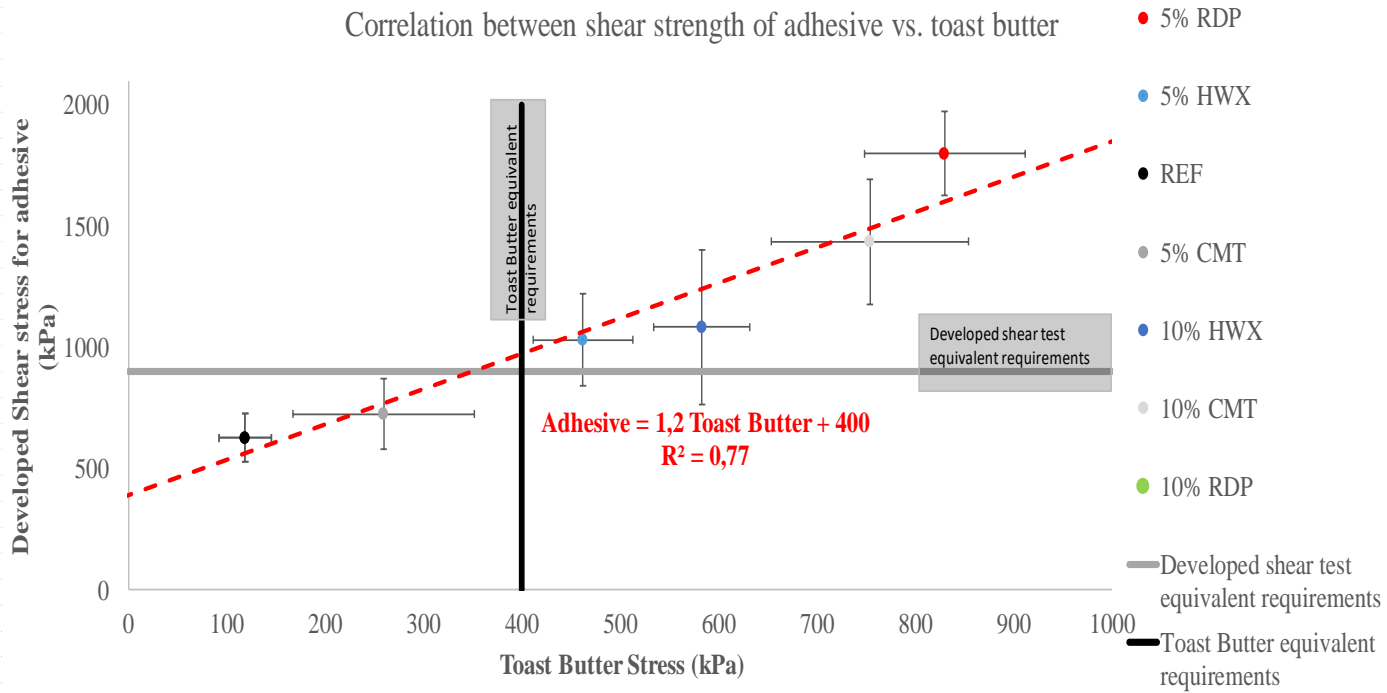

Figure II.29: Correlation between Toast Butter and Developed shear tests

The newly developed shear test was selected for this purpose for several reasons. Firstly, it offers a methodological advantage over the traditional pull-off test, which is considerably more time-consuming and resource-intensive. Secondly, validating the Toast Butter test using the developed shear test serves as an initial application of the latter, thereby enhancing its utility and relevance in the field.

For the purpose of validation, a selection of materials including Redispersible Polymer Powder (RDP), cement, Hydrowax, and a reference formula were tested. The additives were incorporated at varying concentrations, either 5% or 10% by weight, to generate a wide spectrum of strengths that would contribute to a robust validation.

Upon comparing the results from the developed shear test with those of the Toast Butter test, a strong correlation emerged between the two. This relationship can be mathematically represented by the following empirical equations:

$$\text{Developed shear stress (kPa)} = 1.2 \times \text{Toast Butter shear (kPa)} + 400 \quad \text{II-2}$$

Alternatively, when reformulated in terms of the Toast Butter shear stress, the equation becomes:

$$\text{Toast Butter shear stress (kPa)} = 0.83 \text{ developed shear stress (kPa)} - 333 \quad \text{II-3}$$

These equations not only validate the Toast Butter test but also further substantiate the developed shear test, demonstrating their complementary roles in assessing adhesive strengths.

	European standards Pull-off test Tensile stress (kPa)	Developed shear test Shear stress (kPa)	Toast Butter test Shear stress (kPa)
Dry condition	500	900	400
After immersion	500	900	400

Table II.7: Requirements according to European standards for dry and wet conditions for normal cementitious (C) adhesive and their equivalents with developed shear test and the Toast Butter test

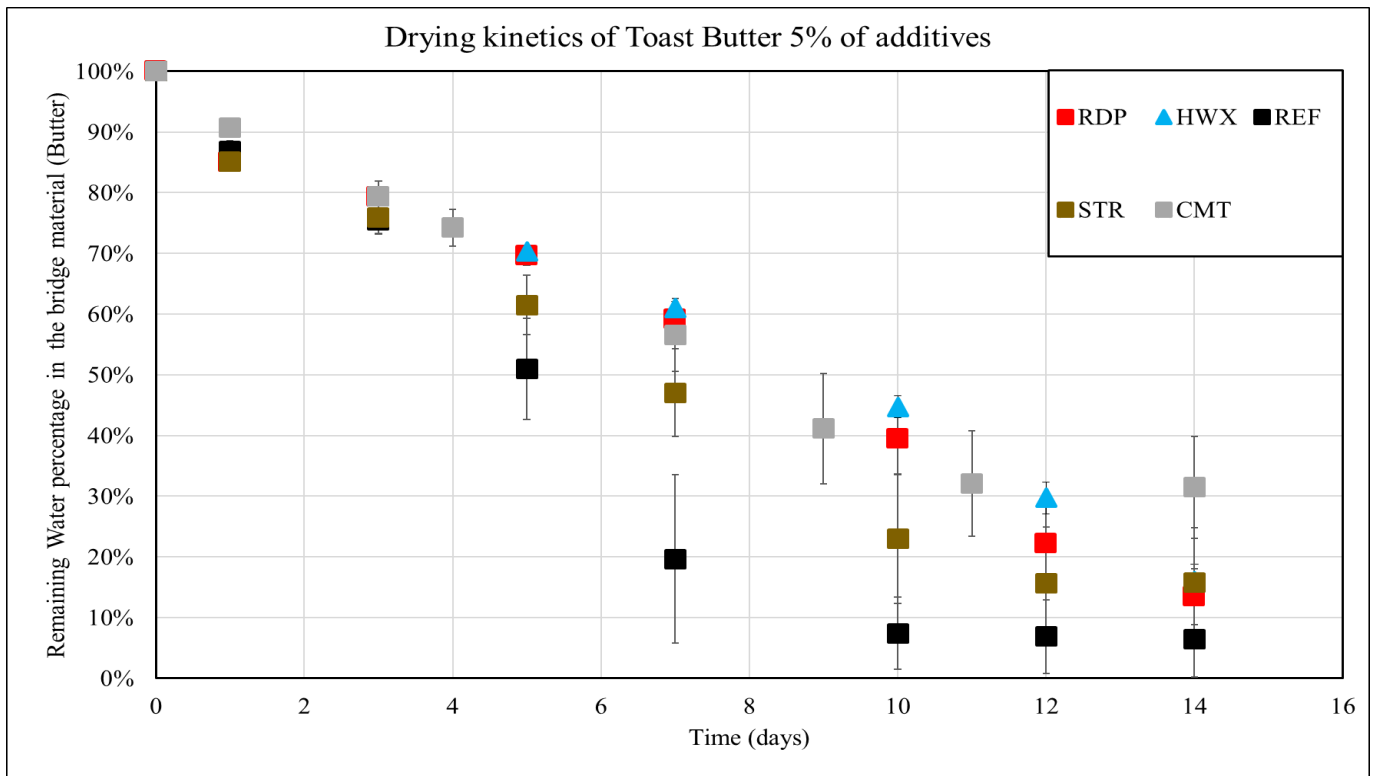

Figure II.30: Drying kinetic of different Bridge material (Butter) with 5% by weight additive.

Drying kinetics serve as a pivotal factor in assessing mechanical strength, particularly in tests like the Toast Butter and the developed shear test. The presence of residual water within the system has multi-faceted implications. It could indicate that certain particles have not been fully activated, or that inter-particle bridges, which are essential for mechanical strength, have not yet formed. These bridges (Figure II.28) are generated through various mechanisms—be it precipitation for soluble species, flocculation for colloidal particles, or entanglement for polymers—depending on the nature of the additive used.

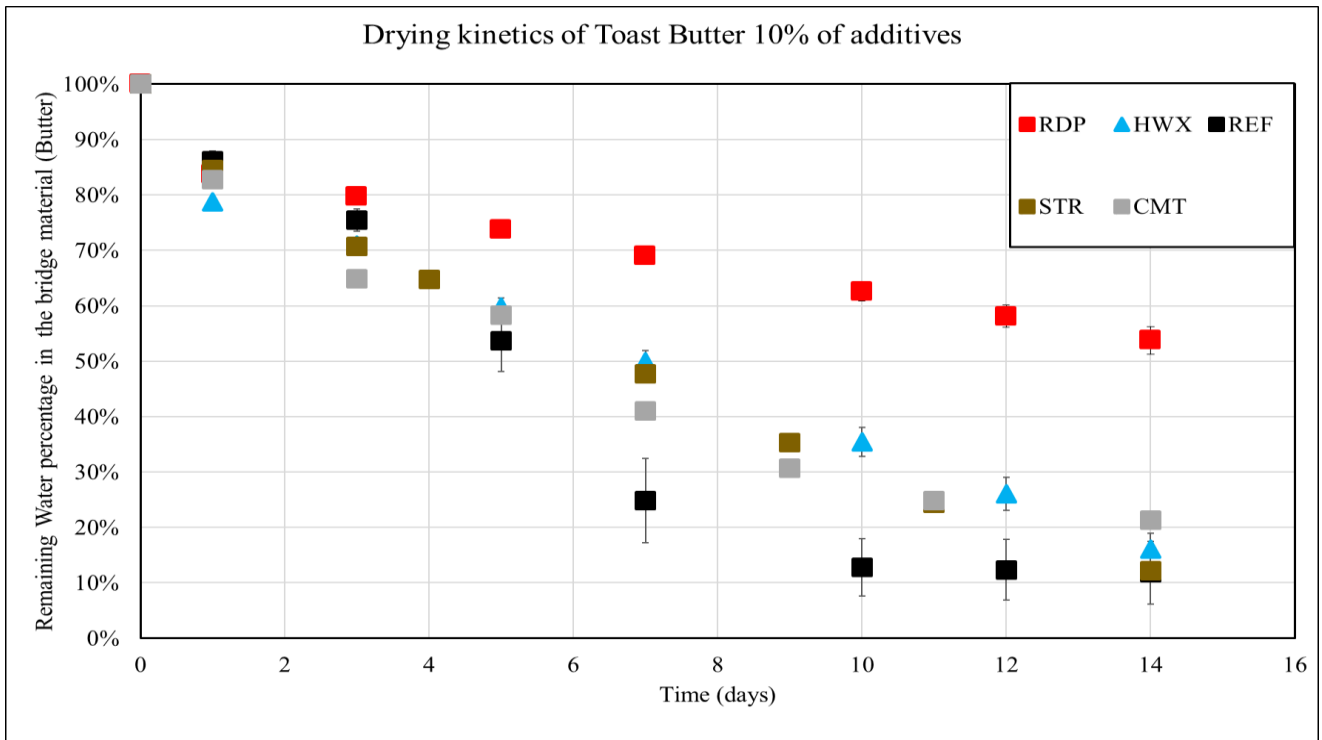

Figure II.31: Drying kinetic of different Bridge material (Butter) with 10% by weight additive.

In essence, if a Toast Butter sample has not sufficiently dried, or contains a significant amount of residual water, the formation of these crucial inter-particle bridges may be compromised. This, in turn, adversely affects the macro-mechanical strength of the sample. A case in point is the formulation containing 10% Redispersible Polymer Powder (RDP), as depicted in Figure II.32. This formulation recorded a developed shear stress of approximately 3500 kPa. However, based on the correlation established in Equation **$Toast\ Butter\ shear\ stress\ (kPa) = 0.83\ developed\ shear\ stress\ (kPa) - 333$** II-3, the expected Toast Butter shear stress should be around 2500 kPa. The actual recorded value was a mere 350 kPa, which is an astounding 86% lower than the anticipated value.

This discrepancy prompts the question: what accounts for this significant variation in strength? The answer becomes evident when examining the drying kinetics of the 10% RDP formulation, as illustrated in Figure II.31. After 14 days of drying, the sample had achieved less than 50% of its drying potential. This suggests that the microscale bridges, crucial for mechanical strength, were not adequately formed. In contrast, most other formulations attained a drying ratio exceeding 80% (with the exception of cement, where other reactions are in play).

Therefore, it can be concluded that the drying state of the sample is a critical limitation for the Toast Butter test. A sample must be adequately dried prior to conducting the test; otherwise, the results obtained may lack accuracy and reliability.

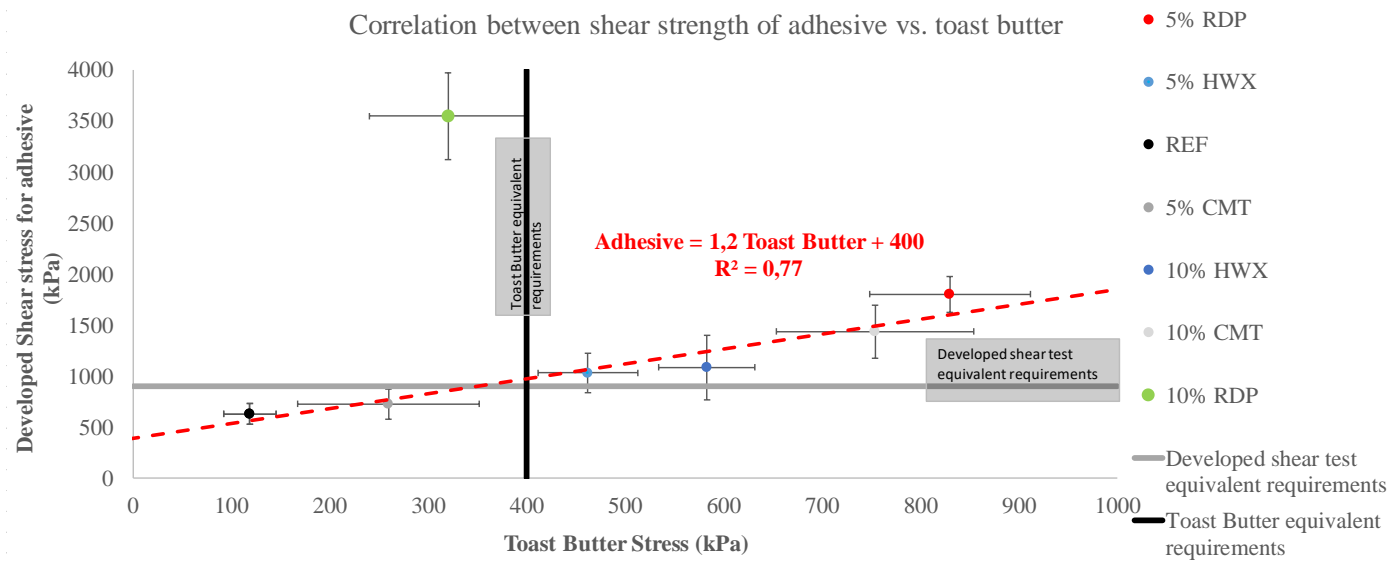

Figure II.32: Correlation between Toast Butter and developed shear tests, with a point not dry

II.4.4.2 Acceptance Criteria

The European standards delineate specific acceptance criteria for tensile pull-off tests on adhesive classification C1. Specifically, the adhesive is required to withstand a tensile pull-off stress of 500 kPa, both under dry conditions (after 28 days of drying) and post-immersion conditions (following 21 days of immersion and an additional 7 days of drying). These standards serve as a benchmark for adhesive performance.

In this research, we have successfully established correlations that link tensile pull-off stress with developed shear stress, and subsequently, developed shear stress with Toast Butter shear stress, under the condition that the samples are fully dried. Mathematically, this relationship can be expressed through the following equation, derived by substituting Equation

$$\text{Developed Shear stress } (\tau) = \text{Pull-off tensile stress } (\sigma_{\text{tensile pull-off}}) \times \sqrt{3} \quad \text{II-1}$$

into Equation

$$\text{Toast Butter shear stress (kPa)} = 0.83 \text{ developed shear stress (kPa)} - 333 \quad \text{II-3}$$

$$\text{Shear for Toast Butter (kPa)} = 1.44 \text{ Tensile Pull-off (kPa)} - 333 \quad \text{II-4}$$

This equation enables us to define new acceptance criteria for adhesives based solely on the Toast Butter shear stress of the additives used. According to Equation II-4, a tensile pull-off stress of 500 kPa corresponds to a Toast Butter shear stress of approximately 400 kPa. Therefore, **any adhesive formulation with additive that achieves a Toast Butter shear stress of 400 kPa under dry conditions can be expected to also meet the 500 kPa requirement for tensile pull-off stress, as stipulated by European standards.**

By utilizing this equation, we can more efficiently screen potential adhesive formulations using the Toast Butter test, thereby offering a streamlined, resource-efficient approach to evaluating adhesive performance against established industry standards.

II.4.5. Conclusion

The Toast Butter Test stands as a seminal advancement in the laboratory assessment of adhesives, particularly those involving granular-clay materials. Conceived to emulate the behavior of a material system represented by two infinite planes, this innovative test provides a macroscopic lens through which the efficacy of additive-induced bridges can be scrutinized.

This methodological innovation serves multiple functions. Firstly, it allows for an empirical evaluation of the additive's capability to enhance the mechanical properties, specifically the adhesion strength, of clay-based adhesives. Secondly, by reducing the volume of additive material required for testing, it offers an efficient and resource-conserving alternative to traditional test methods. This efficiency is especially crucial when assessing high-cost or limited-availability additives, streamlining the process of material screening and thereby accelerating the pace of research and development.

Moreover, the test provides quantifiable data that can be correlated with other established testing methodologies, such as the newly developed shear test. This correlation further validates the Toast Butter Test as a reliable assessment tool and extends its applicability as a supplemental or even alternative testing procedure.

Ultimately, the Toast Butter Test has the potential to significantly influence both the theoretical understanding and practical application of adhesive materials in the construction industry. It paves the way for more targeted, effective, and sustainable material design, thereby contributing a substantial methodological and conceptual advance to the field.

II.5. Conclusion of the Chapter

In this chapter, we have systematically examined the rigorous criteria set forth by European standards as a benchmark for material innovation, particularly in the realm of adhesive technologies. The focus has been on unpacking the complexities of adhesive mechanics—both at the macro and micro scales—to deepen our collective understanding of how these adhesives interact with different substrates and environmental conditions.

We have expounded upon European standards, specifically addressing the pull-off and shear tests, to provide a comprehensive overview of their respective advantages and limitations. While these tests hold a pivotal role in the validation and standardization of new materials, it

was recognized that they come with their own set of constraints, most notably the considerable time and resource commitments they entail.

In an endeavor to ameliorate these limitations, this study introduced alternative testing mechanisms, namely the newly developed shear test and the innovative Toast Butter test. These tests are not only more resource-efficient but also offer the advantage of quick turnaround times without compromising the reliability or accuracy of the results. Moreover, they serve as potent tools for exploring the utility of various additives in enhancing the adhesive characteristics of clay-based materials.

The chapter also shed light on the feasibility of correlating the results from these alternative tests with established tests like the pull-off test, thereby augmenting their credibility and potential for broader adoption. These newly introduced tests, particularly when utilized in tandem, could potentially revolutionize the methodology of adhesive testing, making it more streamlined, efficient, and adaptable to the needs of the rapidly evolving construction industry.

Chapter III. Reinforcement by additives,

strategy number one

III.1. Reference formula

The development of a sustainable and efficient tile adhesive reference formula is a challenging task that requires a blend of scientific innovation and practical expertise. This endeavor was significantly advanced through the collaboration between Ranal Gharib and Saint-Gobain Weber during her internship at the NAVIER laboratory. This partnership led to the creation of a reference formula that embodies both the theoretical insights gained from academic research and the practical considerations of industrial application.

Tile adhesive is typically composed of a blend of cement (Portland cement), sand, and a water-retaining agent [272]. The water-retaining agent may be either an organic compound or a synthetic polymer, and it helps to keep the mixture moist and workable while it is being applied to the substrate [273].

In addition to these basic ingredients, various additives may be included in the adhesive mix to improve its performance. For example, some formulations may include latex [274] or other bonding agents to enhance the adhesive properties of the adhesive [275]. Others may contain chemical additives to improve the flexibility, strength, or water resistance of the cured adhesive [232].

Sand is commonly used in adhesive and other building materials as a main ingredient due to its desirable physical properties [232]. According to the European standards, the role of sand in tile adhesive is to provide bulk and improve the mechanical properties of the mixture [125]. The sand particles act as a filler, occupying space in the mixture and reducing shrinkage as the adhesive dries. This can help to reduce the likelihood of cracking or other forms of damage. In addition, the use of sand can improve the workability and consistency of the adhesive, making it easier to apply and ensuring that it adheres properly to the substrate [125].

The European Standard EN 12004-1:2017 "Adhesives for tiles - Part 1: Requirements, evaluation of conformity, classification and designation" provides guidelines for the minimum and maximum proportions of sand and limestone in tile adhesive. The standard states that the proportion of sand should be at least 50% of the total dry weight of the mixture, and the proportion of limestone (or other fine filler) should be no more than 50% of the total dry weight of the mixture.

Limestone is commonly used in adhesive and other building materials due to its high calcium carbonate content and desirable physical properties. Limestone particles are typically fine and uniform in size, which allows them to mix well with other materials and contribute to the strength and durability of the final product [276]. The calcium carbonate in limestone can also react with other ingredients in the mixture, to improve the setting and hardening of the material.

The proportion of sand and limestone in tile adhesive can vary depending on the specific product and application, as well as regional or national standards. However, the general guideline is to use a higher proportion of sand than limestone, as the sand provides bulk and improves the workability of the mixture, while the limestone contributes to the strength and durability of the final product.

The role of kaolinite is to increase the plasticity, workability, and durability of the mixture. The recommended percentage of kaolinite in clayey adhesive is usually between 5% and 15%. Cellulose ether (hydroxyethyl methyl cellulose (HEMC 16000)), on the other hand, is added to improve the water retention and workability of the adhesive, and to reduce cracking and shrinkage during the curing process. The recommended percentage of cellulose ether in the adhesive is usually between 0.1% and 0.5%.

Lime is commonly used in adhesive as a binding agent, which can help to increase the strength, durability, and resistance to weathering. The amount of lime required in the adhesive will be a 1% to enrich the system with calcium.

In the course of Ranal Gharib's study at the NAVIER laboratory in collaboration with Saint-Gobain Weber, it's important to note that all formulations she examined incorporated sand and limestone as filler materials. The primary objective of the study was to establish a foundational formula to guide further experiments. She focused on the clays kaolinite and montmorillonite, assessing them in various compositions as laid out in Table 1. Results concerning deformation in relation to shear stress indicated that montmorillonite samples demonstrated considerable variation in the data. When comparing the formulations F1, F2, F5, and F6 (which were all formulated without any additives), F6 stood out for its consistent shear strength and minimal data dispersion, as confirmed by its low standard deviation. Composed of kaolinite, sand, limestone, and cellulose ether (hydroxyethyl methyl cellulose (HEMC)), F6 was identified as the most promising candidate to serve as the reference formula for this thesis. To further optimize the formulation, a 1% addition of lime will be introduced to enrich the system with calcium ions. Lime not only acts as an alkaline catalyst but is also critical for the hydration reactions that are essential for the curing of clay-based adhesives. By moderating the pH, lime enhances the reactivity of other additives, particularly pozzolanic materials, thus improving the overall performance of the adhesive.

The comparison of these formulations underscores the significant role that cellulose ether plays in augmenting adhesive strength. For instance, when F1 is compared to F2, the shear strength of F2 is noticeably higher, attributed to the presence of cellulose ether. A similar trend is observed between F5 and F6; F6, which includes cellulose ether, is substantially stronger than F5, which lacks this ingredient.

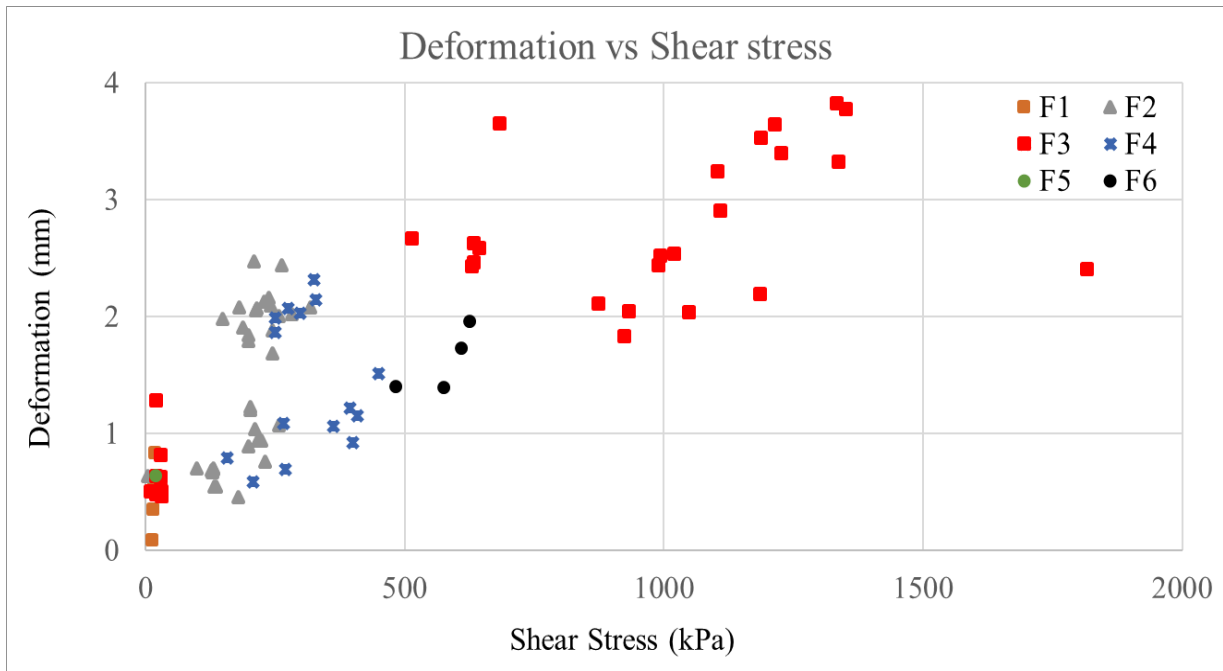

Figure III.1: Comparative Analysis of Shear Stress (kPa) and Deformation (mm) Across Various Formulations for the Purpose of Selecting a Reference Formula: Based on Experimental Data from Ranal GHARIB

		Cellulose Ether (HEMC)	Additive	$\frac{m_{water}}{m_{soil}}$
F1	Montmorillonite MK10	<input type="checkbox"/>	<input type="checkbox"/>	24%
F2	Montmorillonite MK10	<input checked="" type="checkbox"/>	<input type="checkbox"/>	24%
F3	Montmorillonite MK10	<input checked="" type="checkbox"/>	Redispersible Powder Ethylene Vinyl acetate	24%
F4	Montmorillonite MK10	<input checked="" type="checkbox"/>	FLOSET	20%
F5	Kaolinite MOTA E	<input type="checkbox"/>	<input type="checkbox"/>	24%
F6	Kaolinite MOTA E	<input checked="" type="checkbox"/>	<input type="checkbox"/>	24%

Table III.1: Ingredients in Formulations F1 to F6: Excluding Common Constituents of Sand and Limestone.

The reference formula consists of a combination of constituents by weight, including 71.68% sand, 21.78% limestone CaCO_3 , 5.25% kaolinite, 0.3% cellulose ether (hydroxyethyl methyl cellulose (HEMC)), and 0.99% lime Ca(OH)_2 . Furthermore, the water to solid ratio is 18.81%, which signifies the proportion of water relative to the total solids present in the system. These numerical values denote the chemical composition and water content of the reference formula and are integral ingredients to understanding its physical properties and potential applications.

Material	% by Mass
Kaolinite	5.25
Sand	21.78
Limestone CaCO₃	71.68
Cellulose Ether (hydroxyethyl methyl cellulose (HEMC))	0.3
Lime Ca(OH)₂	0.99
Water/Total solid ratio	18.81

Table III.2: Ingredients Constituting the Reference Formula: Serving as the Control Formulation for Subsequent Investigations

III.2. Formulations

We are set to develop variations of this reference formula, maintaining a constant total solid volume. This volume encompasses components such as sand, limestone, kaolinite, cellulose ether, and lime. Throughout this process, we will adhere to a consistent water to solid ratio of 18.81% for all formulations.

Ingredients	% of Additives			
	RF=0%	1%	3%	5%
Kaolinite	5,25	5,20	5,09	4,99
Limestone CaCO₃	21,78	21,56	21,13	20,69
Sand	71,68	70,97	69,53	68,10
Cellulose Ether (hydroxyethyl methyl cellulose (HEMC))	0,30	0,29	0,29	0,28
Lime Ca(OH)₂	0,99	0,98	0,96	0,94
Solid particles in HYDROWAX (HWX)	0,00	1,00	3,00	5,00
Water in HYDROWAX (HWX)	0,00	1,37	4,12	6,87
Total HYDROWAX (HWX)	0,00	2,37	7,12	11,87

Total solids Without Additives	100,00	99,00	97,00	95,00
Total solids	100,00	100,00	100,00	100,00
Distilled water	18,81	17,44	14,69	11,94
Total Water	18,81	18,81	18,81	18,81
w/s ratio	0,1881	0,1881	0,1881	0,1881

Table III.3: Ingredients of different % by weight for formulations with HYDROWAX (HWX) as additive.

Ingredients	% of Additives			
	RF=0%	1%	3%	5%
Kaolinite	5,25	5,20	5,09	4,99
Limestone CaCO₃	21,78	21,56	21,13	20,69
Sand	71,68	70,97	69,53	68,10
Cellulose Ether (hydroxyethyl methyl cellulose (HEMC))	0,30	0,29	0,29	0,28
Lime Ca(OH)₂	0,99	0,98	0,96	0,94
Additive weight (powder)	0,00	1,00	3,00	5,00
Distilled Water	18,81	18,81	18,81	18,81
w/s ratio	0,1881	0,1881	0,1881	0,1881

Table III.4: Ingredients of different percentage by weight for formulations with powder additive (RDP, FLOSET)

III.2.1. Measured properties

III.2.1.1 Enhanced Workability

Clayey adhesives often exhibit poor workability, making it difficult to handle, shape, and apply. Additives can significantly enhance the workability of clayey adhesive by reducing water demand, improving flow, and increasing cohesiveness [277]. This allows for easier mixing, spreading, and application of the adhesive, resulting in improved productivity and efficiency in construction projects [166], [278].

All experimental results were obtained under controlled conditions—namely at a temperature of 25°C, pressure of 1 atm, and consistent humidity and drying conditions. Each data point in Figure III.3, and throughout this thesis, represents the mean value calculated from multiple samples. The statistical indicators employed in this analysis include the sample mean (**Average**(\bar{x}) = $\frac{\sum_{i=1}^n x_i}{n}$ III-1, Table III.5), standard deviation (**Standard Deviation**(σ) = $\sqrt{\frac{\sum_{i=1}^n (x_i - \bar{x})^2}{n-1}}$ III-2), standard error (**Standard Error** (**SE**) = $\frac{\sigma}{\sqrt{n}}$ III-3), and the Margin of Error (MOE) (**MOE** = $t \times \left(\frac{\sigma}{\sqrt{n}}\right)$ = $t \times SE$ III-4). All statistical calculations are carried out with a 95% confidence level.

Sample mean (\bar{x}): calculated as the sum of all data points ($\sum_{i=1}^n x_i$) divided by the total number of samples (n)

$$\text{Average}(\bar{x}) = \frac{\sum_{i=1}^n x_i}{n} \quad \text{III-1}$$

Sample Standard Deviation (σ): Calculated using the formula:

$$\text{Standard Deviation}(\sigma) = \sqrt{\frac{\sum_{i=1}^n (x_i - \bar{x})^2}{n-1}} \quad \text{III-2}$$

Where x_i represents each individual data point, and \bar{x} is the sample mean.

Standard Error (SE): Obtained by dividing the sample standard deviation (σ) by the square root of the sample size (n).

$$\text{Standard Error (SE)} = \frac{\sigma}{\sqrt{n}} \quad \text{III-3}$$

Where σ is the sample standard deviation and n is the number of samples.

Margin of Error (MOE): Calculated as follows:

$$\text{MOE} = t \times \left(\frac{\sigma}{\sqrt{n}}\right) = t \times SE \quad \text{III-4}$$

Where t is the t-score, which depends on the confidence level (95% in this case) and the degrees of freedom ($df = n - 1$).

Formulation	Number of samples (n)	Margin of Error MOE (kPa)	Formulation	Number of samples (n)	Margin of Error MOE (kPa)
RF	57	40	10% TEOS	10	100
1% RDP	18	75	15% TEOS	10	100

3% RDP	18	75	1% FST	18	75
5% RDP	52	40	3% FST	18	75
10% RDP	6	130	5% FST	25	65
1% HYDROWAX (HWX)	18	75	5% TIO	9	105
3% HYDROWAX (HWX)	8	110	3% TIC	5	140
5% HYDROWAX (HWX)	30	60	5% TIC	5	140
10% HYDROWAX (HWX)	16	80	5% CF	10	100
0,01% TEOS	10	100	5% STR	16	80
0,1% TEOS	10	100	10% STR	6	130
1% TEOS	18	75	5% CMT	6	130
3% TEOS	8	110	10% CMT	6	130
5% TEOS	24	65			

Table III.5: Sample Size (n) and Associated Margin of Error MOE (kPa) for Each Fabricated Formulation.

To determine the appropriate sample size n for our experiments, we used preliminary data to estimate the standard deviation σ and then employed the sample size formula. Specifically, for an initial experiment where the standard deviation was estimated to be 160 kPa, and with a target margin of error (MOE) of 100 kPa, a 95% confidence level was used. According to the sample size formula:

$$n = \left(\frac{Z \times \sigma}{MOE} \right)^2 \quad \text{III-5}$$

Where $Z = 1.96$ corresponds to the Z-value for a 95% confidence level, we calculated a minimum sample size of 10.

For experiments that required more precision, particularly those involving the reference formula and RDP with 5%, a lower margin of error of 45 kPa was targeted. In this case, the required sample size was increased to 50, as calculated using the same formula.

On the other hand, in experiments where only a broad estimation of strength was needed, and high precision was not a requirement, we opted for a higher MOE, specifically between 130-140 kPa. Accordingly, the formula indicated a minimum required sample size of 5-6, utilizing the same Equation.

The variation in the number of samples across different formulations arises from the specific MOE goals set for each. Certain formulations were of primary interest, necessitating a lower MOE and, consequently, a larger sample size. For others, a higher MOE was deemed acceptable, allowing for a smaller sample size.

III.2.1.2 Effect on Strength

The shear strength, measured in kilopascals (kPa), was evaluated following a 7-day drying period post-fabrication. These results are illustrated in Figure III.2. In an evaluation of the effects of various additives on the shear stress of an adhesive formula, a bar chart provides a clear comparison against the reference formula (RF) and European standards requirements. The adhesive modified with RDP additive demonstrates a substantial enhancement in mechanical strength, with a shear stress value towering over both the RF and the benchmark set by European standards. This indicates that RDP is highly effective in reinforcing the adhesive's performance.

Following RDP, the HWX additive also shows an improvement in shear stress, albeit to a lesser extent. However, its performance still exceeds that of the RF and meets European standards, suggesting that HWX is a suitable choice for boosting the mechanical strength of the adhesive.

The reference formula itself, without any additives, does not meet the European standards for shear stress, indicating its baseline performance is inadequate. Additives like FST, while marginally improving upon the RF, fail to reach the compliance threshold set by European standards. This outcome suggests that FST does not significantly enhance the adhesive's strength.

Conversely, additives such as TEOS and STR result in lower shear stresses compared to the RF, with TEOS showing a particularly notable decrease. Their inclusion not only fails to meet European standards but also appears to diminish the mechanical strength compared to the RF. TIC exhibits the most pronounced reduction in shear stress, significantly undermining the mechanical strength of the adhesive and falling short of both the RF's performance and the European requirements.

CMT offers a slight improvement over TIC but still does not achieve the level of performance needed to meet European standards, nor does it surpass the RF. This suggests that while CMT may have some beneficial effects, it is not effective enough to enhance the adhesive's mechanical strength to a desirable level.

In conclusion, among all the additives tested, RDP stands out as the most effective in enhancing shear stress, followed by HWX, with both surpassing the European standard requirements. The other additives, particularly TEOS, STR, and TIC, were less effective, with some even reducing the adhesive's mechanical strength below that of the unmodified reference formula.

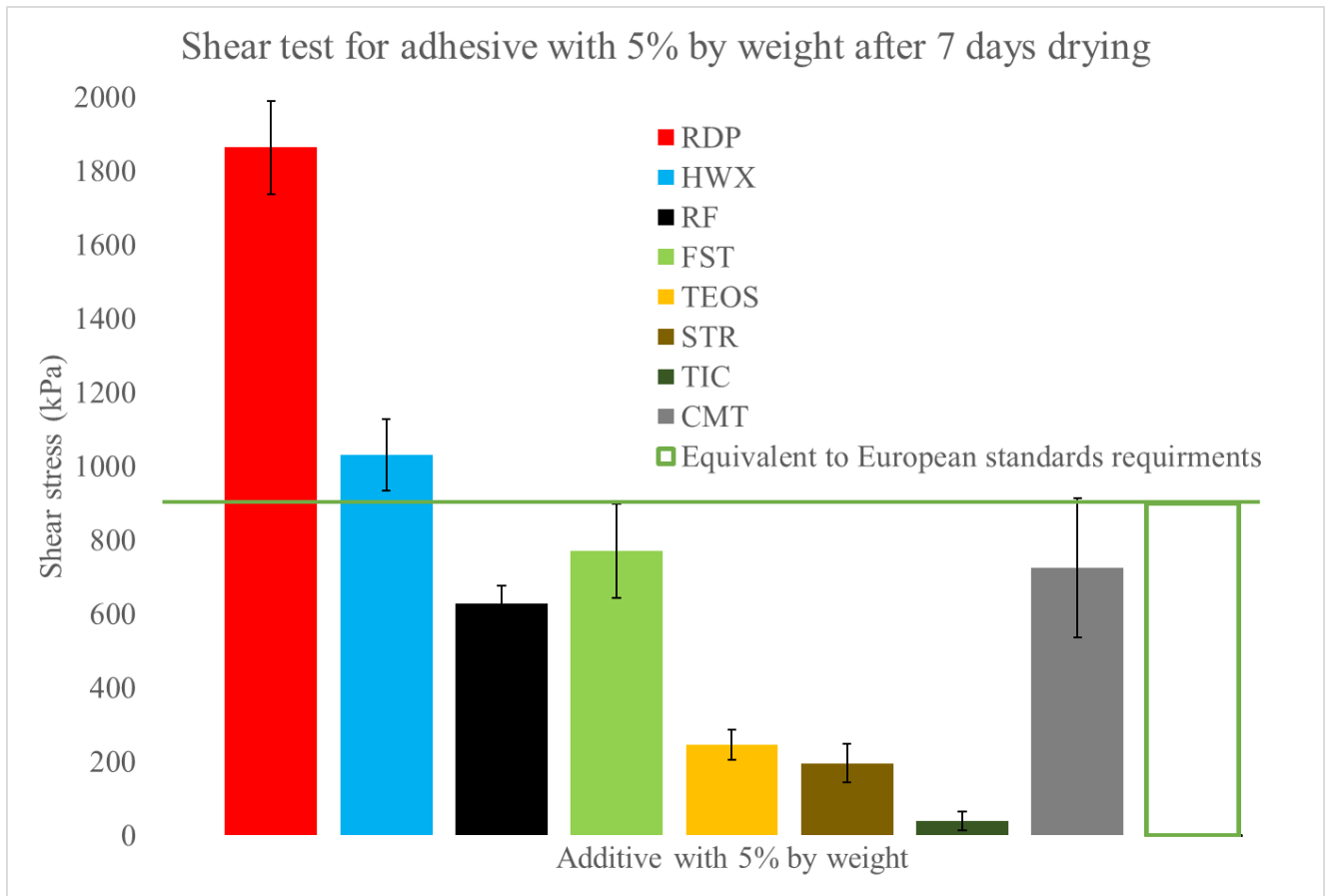

Figure III.2: Shear Strength (kPa) Following 7-Day Drying Period Post-Fabrication.

III.2.1.3 Effect of dosage

In the experimental investigation of the mechanical properties of clayey adhesive formulations, various additives were incorporated at a concentration of 5% by weight, as depicted in Figure III.2. The shear strength of these modified samples was evaluated seven days post-fabrication under desiccated conditions.

Significant enhancements in shear strength were observed for formulations with specific additives: Redispersible Polymer Powder (RDP) yielded a shear strength of 1850 ± 125 kPa, Hydrophobic agent (HYDROWAX (HWX)) at 1030 ± 100 kPa, FLOSET at 770 ± 130 kPa, and a formulation with 5% cement at 725 ± 190 kPa. These values were notably superior to the shear strength of the control formula, which was measured at 630 ± 50 kPa.

Conversely, certain additives exhibited a deleterious impact on the mechanical integrity of the adhesive. Specifically, Tetraethyl Orthosilicate (TEOS) resulted in a reduced shear strength of 250 ± 40 kPa, starch yielded 200 ± 50 kPa, and a combination of tannin with iron chloride produced a markedly low shear strength of 40 ± 25 kPa.

Upon analysis, it can be ascertained that RDP is the most efficacious additive for augmenting the adhesive shear strength of the clayey adhesive under dry conditions, followed by HYDROWAX (HWX). As evidenced in Figure III.3, a linear relationship is observed between the additive concentration and the resultant shear strength for most additives. Notably, RDP continues to amplify shear strength in a positive linear fashion, reaching an apex at 3550 ± 550 kPa when the concentration is increased to 10%. Similarly, HYDROWAX (HWX) at a 10% concentration yielded a shear strength of 1100 ± 150 kPa.

Interestingly, FLOSET exhibited a plateau effect, demonstrating neither a significant increase nor decrease in shear strength upon increasing its concentration. The addition of small quantities of TEOS, ranging from 0.01% to 0.1%, resulted in an enhancement of the mechanical strength by approximately 30% to 40%. However, incorporating more than 1% of TEOS led to a reduction in shear strength. Further increases in TEOS concentration significantly weakened the mechanical properties of the clayey adhesive, as illustrated in Figure III.4. Therefore, TEOS should be used sparingly and well-dispersed within the adhesive to mitigate its adverse effects on mechanical strength. However, these minimal amounts are not practical for industrial applications, particularly because TEOS is a liquid that needs to be added just before use. Such conditions are not favorable for on-site practicality.

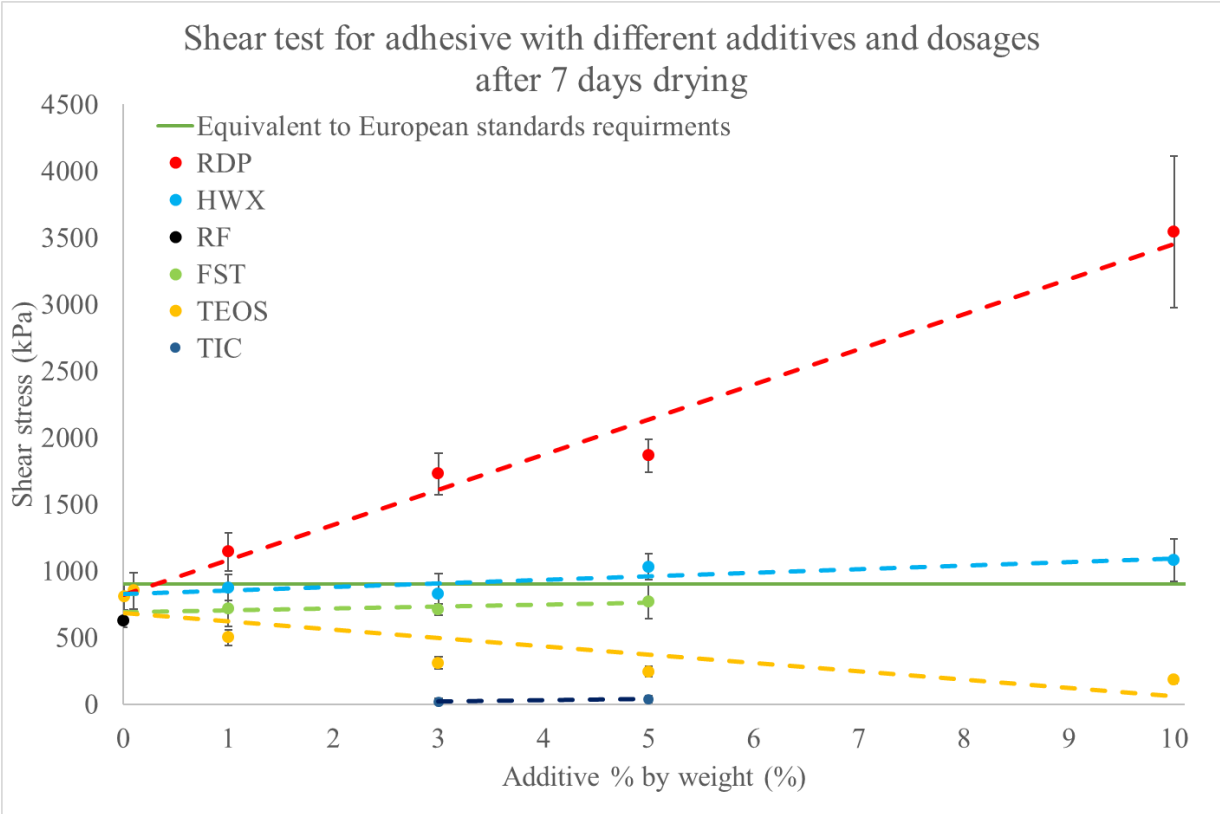

Figure III.3: Shear Strength (kPa) of the Reference Formula with Varying Additive Concentrations (1%, 3%, 5%, 10%) Measured at Dry Condition Following a 7-Day Drying Period Post-Fabrication.

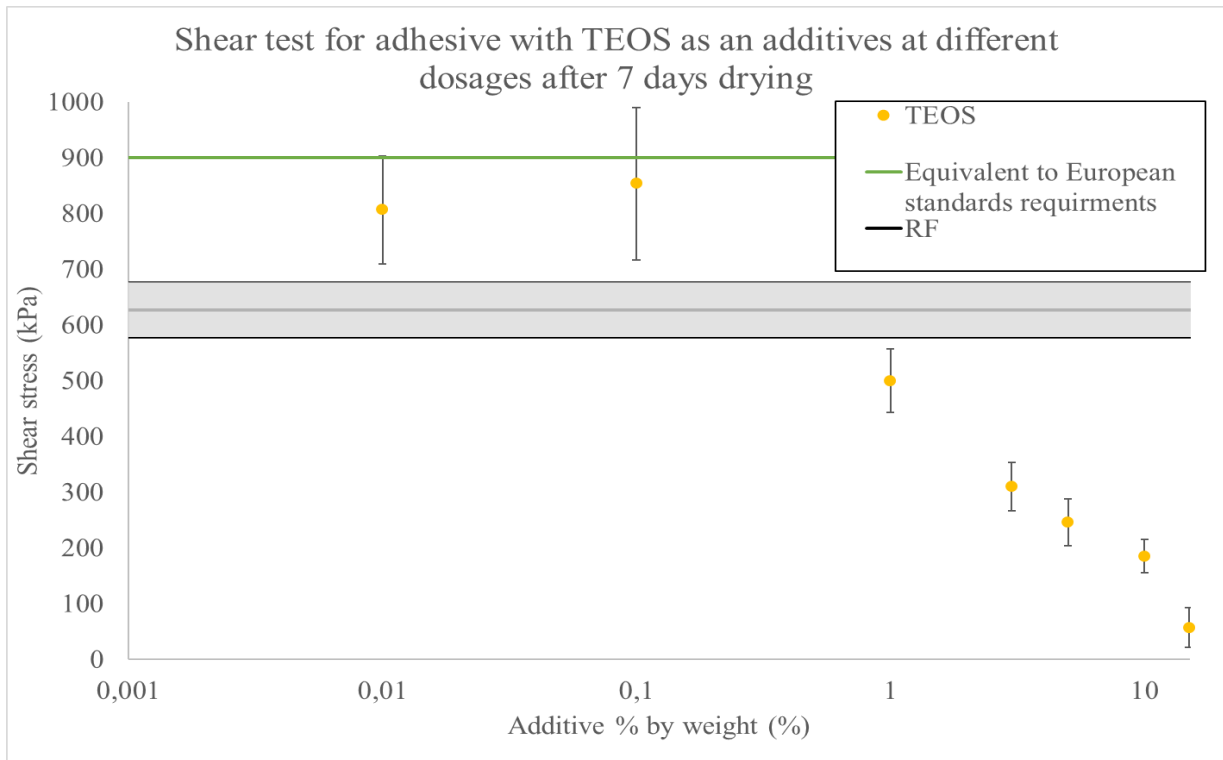

Figure III.4: Shear Stress (kPa) in the Reference Formula with Varying Concentrations of TEOS Additive (0.01%, 0.1%, 1%, 3%, 5%, 10%, and 15% by Weight) Measured at Dry Condition Following a 7-Day Drying Period Post-Fabrication.

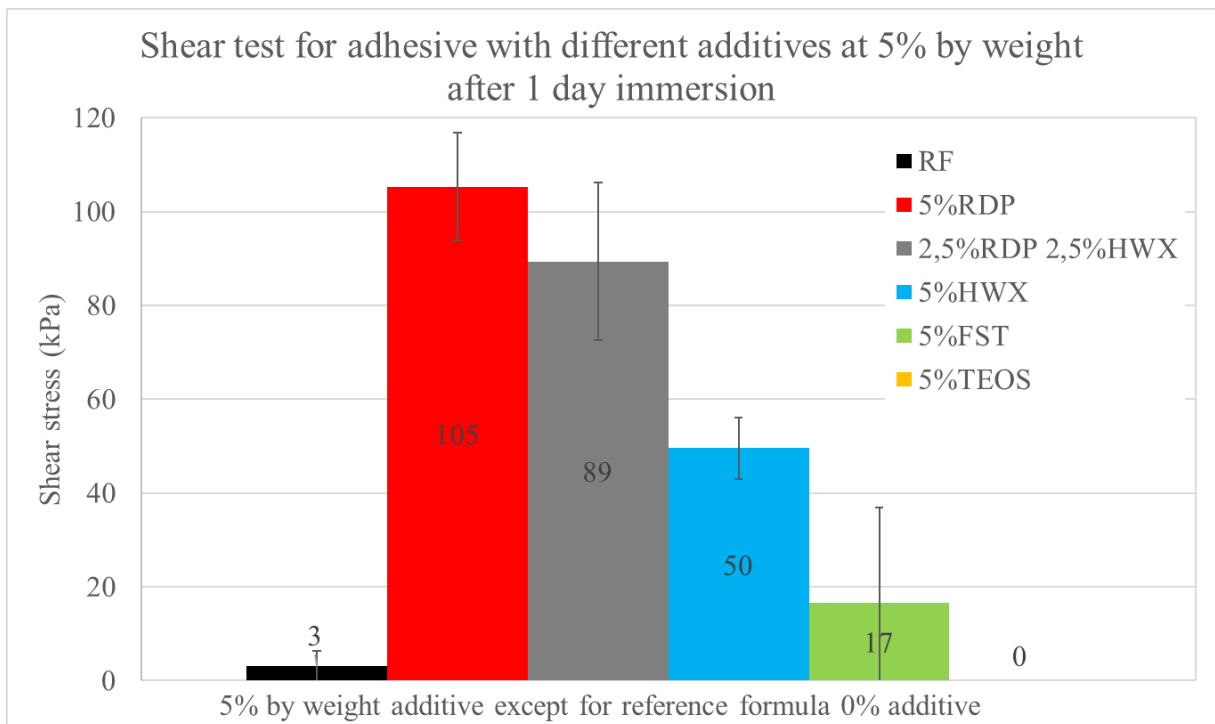

Figure III.5: Shear Strength (kPa) Following a 1-Day Immersion in Water, Subsequent to a 7-Day Drying Period Post-Fabrication

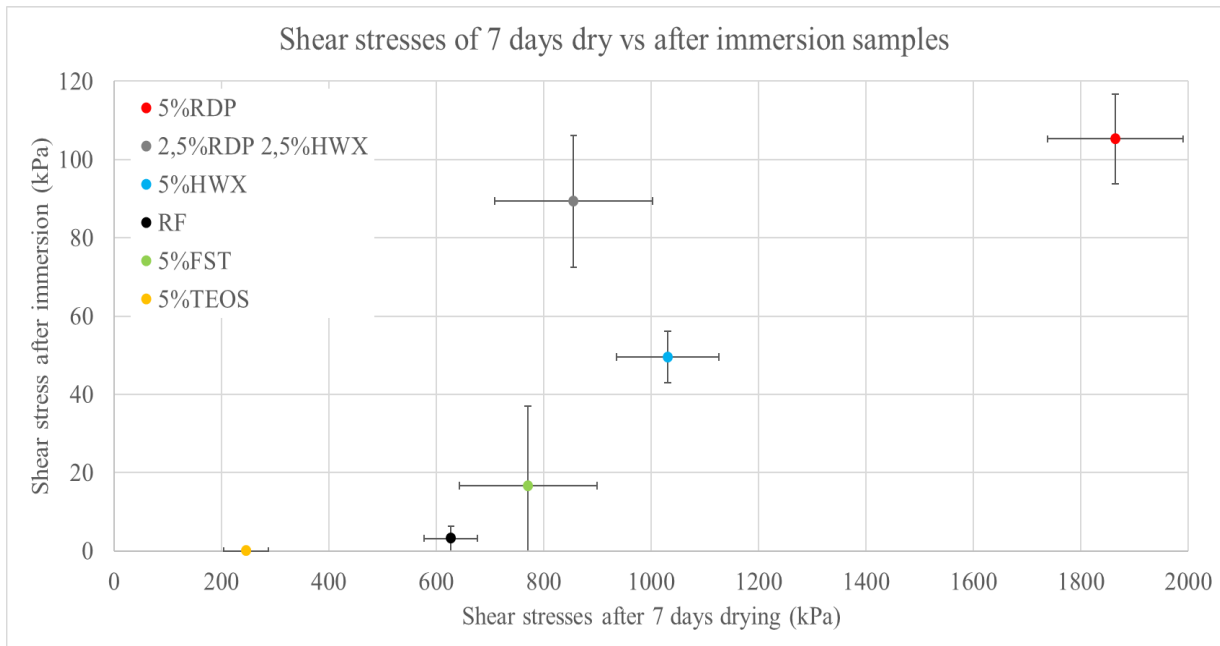

Figure III.6: Comparative Analysis of Shear Stress (kPa) for Various Formulations: Post 7-Day Drying Period vs. One-Day Immersion Following a Seven-Day Drying Period

In alignment with the compliance criteria stipulated by European standards, as outlined in Chapter II, the adhesive formulations under investigation were subjected to a wet-condition imbibition test. This involved the immersion of both the reference and modified adhesive samples, each formulated with specific additives at a concentration of 5% by weight. In the case of a binary additive system comprising Redispersible Polymer Powder (RDP) and HYDROWAX (HWX), each ingredient was incorporated at a 2.5% concentration, thereby cumulatively forming a 5% additive concentration.

Notably, the formulation containing Ludox exhibited immediate detachment upon water exposure, rendering it impossible to measure its shear strength. Therefore, it can be definitively stated that Ludox-infused adhesive had a post-immersion shear strength of 0 kPa.

As illustrated in Figure III.5, the mechanical properties of the remaining adhesives exhibited distinct responses to water exposure. The reference formulation registered a shear strength of 3 ± 3 kPa, effectively losing almost its entire adhesive capability upon immersion. Formulations with RDP and a mixture of RDP and HYDROWAX (HWX) demonstrated superior shear strengths of 105 ± 10 kPa and 90 ± 17 kPa, respectively. HYDROWAX (HWX) alone yielded 50 ± 6 kPa, while FLOSET resulted in 17 ± 20 kPa. Remarkably, the adhesive formulation with Tetraethyl Orthosilicate (TEOS) failed catastrophically, disintegrating to the point where it could not sustain any measurable force.

Upon quantitative analysis, it becomes evident that even the most promising additives—namely RDP and HYDROWAX (HWX)—suffered a dramatic reduction in adhesive shear strength post-immersion, exceeding a 95% loss as illustrated in Figure III.6. Consequently, none of the modified formulations satisfied the requisite mechanical performance (900 kPa) criteria set forth by the relevant European standards for post-immersion conditions. Thus, the findings underscore the critical challenge of enhancing both dry and wet-condition performance in clayey adhesives, a subject warranting further in-depth scientific investigation.

III.2.1.4 Pore size distribution

In this section, we examine whether additives alter the pore size distribution in the dried materials. We report the total porosity and throat diameter in Table III.6. Additionally, the distribution of pore sizes is depicted in Figure III.7.

Additive	Porosity (%)	Throat diameter (mm)
No Additive (RF)	37	0.75
RDP	40	2
Floset	33	5
TEOS	40	0.3
HYDROWAX (HWX)	28	0.2
Ludox	34	0.2

Table III.6: Porosity (%) and Throat Diameter (mm) Measured via Mercury Porosimetry Across Various Formulations: Reference Formula and Select Additives at 5% by Weight (RDP, FLOSET, TEOS, HYDROWAX (HWX), and LUDOX).

The mercury porosimetry results (Figure III.7, Table III.6) elucidate critical morphological attributes of the adhesive formulations with distinct additives. In the reference formula, a porosity of 37% and throat diameter of 0.75 mm are observed, setting a baseline for comparative analysis. When RDP is added, the porosity increases to 40% and the throat diameter enlarges to 2 mm, suggesting the formation of larger, interconnected voids. This alteration could be linked to the increased mechanical strength, as a porous structure can distribute applied stresses more effectively. For Floset, a reduction in porosity to 33% and a substantial increase in throat diameter to 5 mm are noted. The enlarged pore throats might facilitate quicker water infiltration but seem to compromise mechanical adhesion. TEOS shows similar porosity to RDP but significantly reduces the throat diameter to 0.3 mm, correlating with its compromised adhesive strength and fast water ingress. HYDROWAX (HWX) leads to the lowest porosity (28%) and smallest throat diameter (0.2 mm), likely accounting for its superior mechanical and water-resistant properties. Finally, LUDOX, with a porosity of 34% and throat diameter of 0.2 mm, fails to enhance mechanical strength, raising questions about the interplay between these morphological parameters and adhesive properties. The correlations between pore structure and functional properties underscore the need for a targeted approach to pore architecture optimization for achieving desired adhesive characteristics.

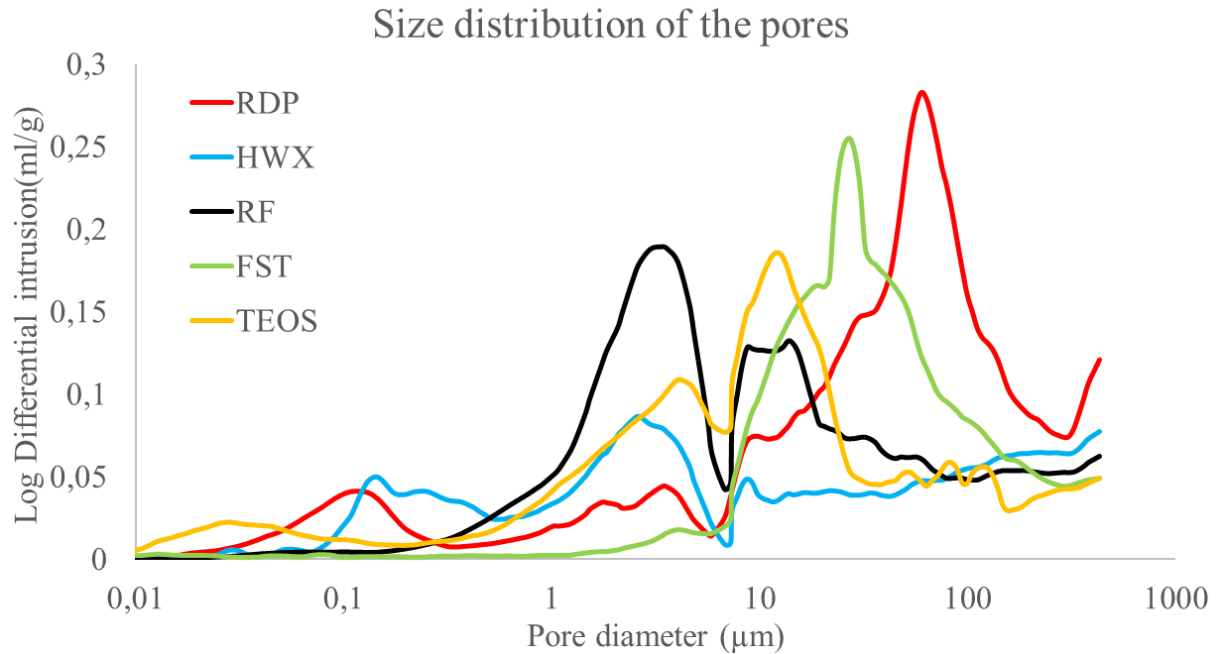

Figure III.7: Log Differential Intrusion (ml/g) vs. Pore Diameter (μm): Pore Size Distribution as Determined by Mercury Porosimetry

III.2.2. Conclusion

Additives play a crucial role in improving the performance, workability, and durability of clayey adhesives. By incorporating specific additives, the limitations associated with clayey adhesives can be overcome, resulting in enhanced workability, increased strength, improved adhesion, and controlled shrinkage. Understanding the benefits and applications of different additives allows for the formulation of tailored clayey adhesives to meet specific project requirements, ensuring high-quality and long-lasting constructions. Ongoing research and development efforts continue to expand the range of additives available for clayey adhesives, enabling further advancements in their properties and performance.

This study systematically investigated the impact of various additives on the mechanical properties of clayey adhesives, both in dry and wet conditions. While additives like Redispersible Polymer Powder (RDP) significantly enhanced shear strength in dry conditions, all formulations fell short of meeting European standards for wet-condition performance. Notably, certain additives like Ludox exhibited complete failure upon water exposure. The study underscores the complexity of developing an adhesive with robust mechanical properties that are maintained across varying environmental conditions, thereby highlighting the need for further in-depth research to address this critical gap.

III.3. Conclusion of the chapter

In summary, this chapter has provided an exhaustive exploration of various facets critical to the development of high-performance clayey adhesives. The granular size distribution emerged as a pivotal parameter influencing not only mechanical properties but also water resistance. The analysis underpins the importance of judicious selection of clays, fillers, and additives for specialized applications. The unique characteristics of clay minerals like kaolinite, illite, and montmorillonite, as well as fillers like sands and limestone, further underscore their role in the composite behavior of the adhesive. While additives like RDP and HYDROWAX (HWX) have shown promise in enhancing dry-condition performance, they notably fell short in wet-condition tests, losing over 95% of their adhesive strength upon water exposure.

This disparity of performance between dry and wet conditions indicates a significant gap in our current understanding and formulation strategies. The observed performance degradation under wet conditions highlights the urgency for further research aimed at uncovering new strategies to improve the water resistance of clayey adhesives. This sets the stage for the subsequent chapters, which will focus on novel approaches to prevent water ingress, thereby aiming to develop a more robust and versatile adhesive formulation.

Chapter IV. Preventing water from entering, strategy number two

IV.1. Introduction

In Chapter 3 of this dissertation, the initial strategy of enhancing clayey adhesives through the incorporation of additives was comprehensively explored. A multitude of additives, such as Ethylene Vinyl Acetate Redispersible Polymer Powder (RDP) and Hydrophobic agent (HYDROWAX (HWX)), were investigated for their potential to improve the shear strength of the adhesive in dry conditions. This exploration yielded promising results, with certain additives demonstrating substantial improvements in dry shear strength. However, these gains were almost entirely negated when the adhesive samples were subjected to water immersion tests. This outcome not only emphasized the limitations of the additive-based approach but also accentuated the need for alternative strategies focused explicitly on water resistance.

Building on research that elucidates the adverse effects of humidity on the shear strength of clays, the inability of additives to sustain mechanical robustness under wet conditions reveals a noteworthy research gap that merits further exploration [279]. Specifically, it indicates that while additives may contribute to mechanical robustness in a dry state, they do not necessarily confer water-resistant properties to the adhesive. Therefore, a new line of investigation is required, one that pivots from merely reinforcing the adhesive to actively preventing water infiltration. This leads us to the main objective of Chapter 4: to explore strategies for inhibiting water penetration into clayey adhesives, thereby enhancing their water resistance.

To achieve this objective, Chapter 4 will delve into the fundamental mechanisms that govern water penetration in clayey matrices, namely capillary action and permeability. Understanding these mechanisms is critical for devising effective strategies to mitigate water ingress. To this end, this chapter will provide a detailed experimental approach, including the choice of additives specifically designed to inhibit water penetration, sample preparation protocols, and a suite of test methods. These methods will assess the effectiveness of the additives in delaying water penetration and will also offer insights into the failure mechanisms when water does infiltrate the adhesive.

The importance of this chapter lies in its alignment with the broader research aims of this thesis, which seeks to develop a clayey adhesive that meets the stringent performance criteria set by European standards. This involves engineering an adhesive with robust mechanical properties

that are retained even when the material is subjected to water, making it suitable for both vertical and horizontal applications.

The chapter will be structured as follows: Section I.2 will discuss the mechanisms of water penetration, including capillary action and permeability. Section I.3 will detail the experimental approach, encompassing the choice of additives, sample preparation, and test methods. Section I.4 will present the results and discussion, focusing on the delay in water penetration and the analysis of failure mechanisms. Finally, Section I.5 will provide a conclusion that synthesizes the key findings and outlines future research directions.

IV.2. Water Penetration Mechanisms

The ingress of water into porous substrates like clayey adhesives is principally governed by two key mechanisms: capillary action, often studied through capillary absorption tests [280], and permeability, which together determine the rate at which water infiltrates the material's interior. Each of these mechanisms operates under different conditions and is influenced by various factors, including the material's porosity, pore size distribution [281], and surface chemistry. This section aims to elaborate on these mechanisms and provide the theoretical underpinnings essential for their understanding.

IV.2.1. Capillary Action

Definition and Basic Principles

Capillary action, also known as capillarity, is the ability of a liquid to flow against gravity through a porous material due to adhesive and cohesive forces. It governs the anti-gravitational movement of wetting fluids in porous media due to capillary pressure gradients [282]. This phenomenon is ubiquitous across various disciplines, affecting systems ranging from groundwater ascension in soils to oil displacement in petroleum reservoirs. Importantly, in clayey materials, capillary action is a critical factor influencing mechanical properties and water resistance. The underlying mechanisms have been studied extensively in fields such as hydrogeology, petroleum engineering, and construction material science. In the context of clayey adhesives, this is particularly relevant because the porous nature of these materials makes them susceptible to water ingress via capillary action.

Governing Equations

The height (h) to which water will rise or fall in a capillary tube is given by Jurin's Law, which is expressed as:

$$h = \frac{2\gamma \cos \theta}{\rho g r} \quad IV-1$$

Where:

γ is the liquid-air surface tension

θ is the contact angle between the liquid and the surface

ρ is the liquid density

g is the acceleration due to gravity

r is the radius of the capillary

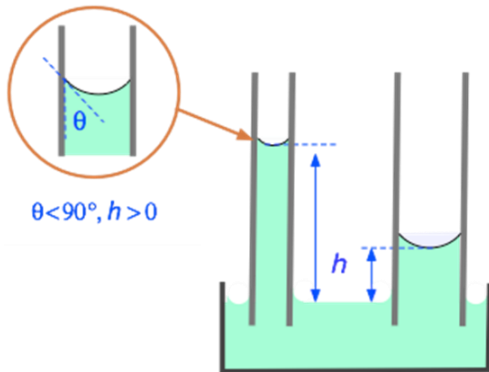

Figure IV.1: Diagram showing the liquid-meniscus interaction in a capillary tube [277]

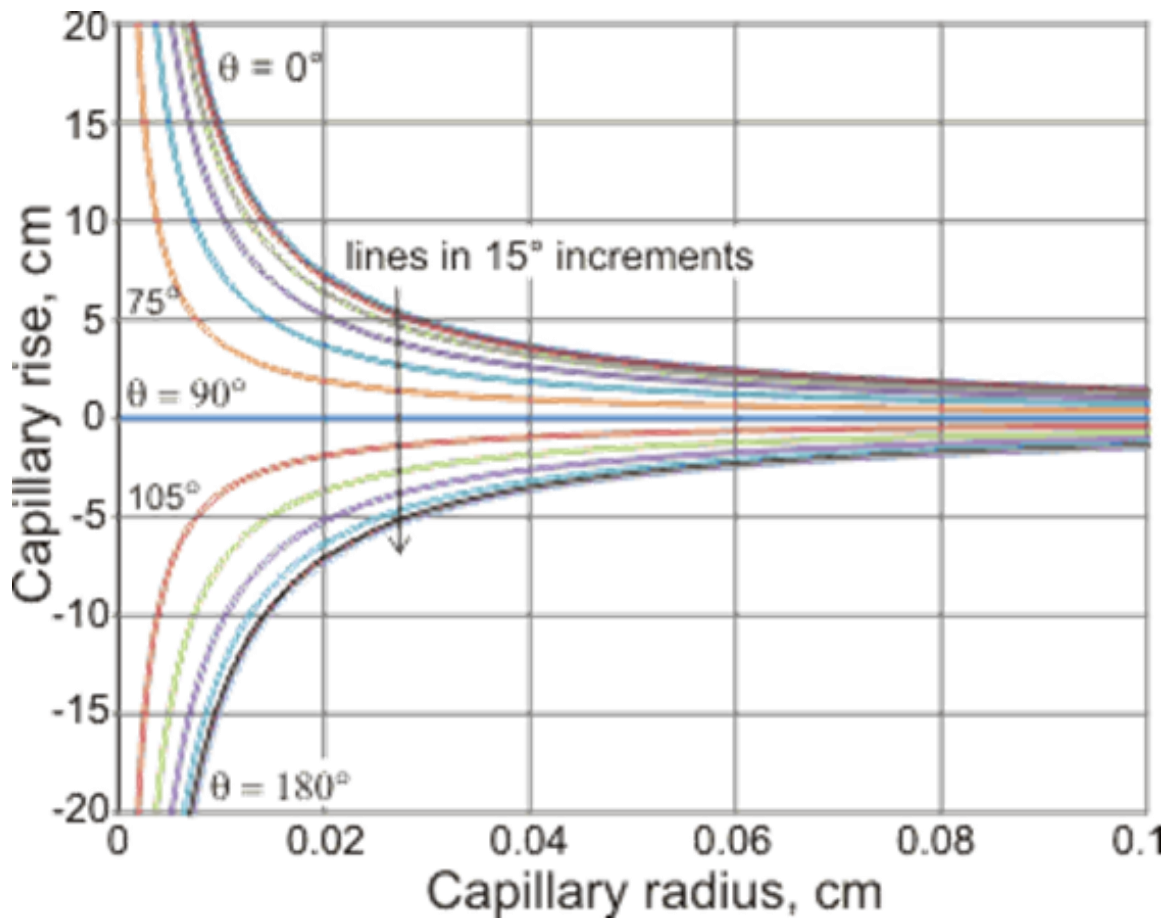

Figure IV.2: Capillary rise with capillary radius and contact angle (θ) [283].

Factors Affecting Capillary Action

Several factors influence capillary action in clayey adhesives:

1. Pore Size: Smaller pores result in greater capillary action (Figure IV.1 [284]).
2. Surface Chemistry: Hydrophilic surfaces enhance capillary action.
3. Liquid Properties: Surface tension and viscosity also play roles.

IV.2.2. Permeability

Definition and Basic Principles

Permeability refers to the material's ability to transmit fluids through its porous structure under the influence of a pressure gradient [285]. It is a property intrinsic to the material and is crucial for understanding how water moves through clayey adhesives.

Governing Equations

Darcy's Law governs the flow of water through a porous medium and can be expressed as:

$$Q = -kA \frac{\Delta h}{L} \quad IV-2$$

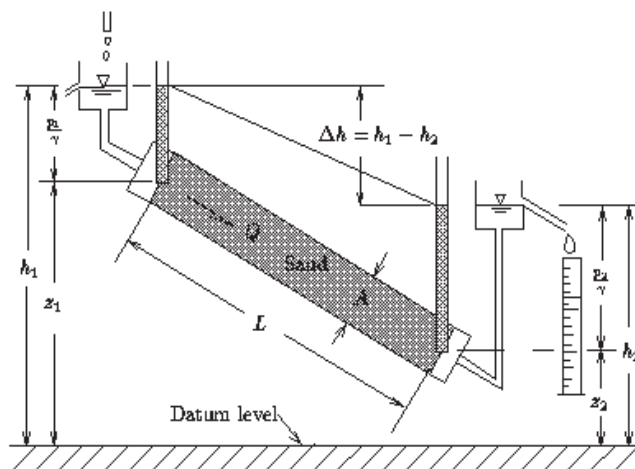

Where

Q is the volumetric flow rate (m^3/s)

k is the permeability of the material (m/s)

A is the cross-sectional area (m^2)

Δh is the height difference (m)

L is the length over which the pressure difference is applied (m)

Figure IV.3: Schema of Darcy's experiment [286].

The permeability k is closely related to the porosity ϕ of the material and the effective pore diameter d , often approximated by the Kozeny–Carman Equation [287]:

$$k = \frac{d^2 \cdot \phi^3}{C(1-\phi)^2} \quad IV-3$$

Where k is intrinsic permeability (m^2), d is the grain diameter (m), ϕ is the porosity, and C is the Kozeny constant.

To derive a form of the Kozeny–Carman equation that gives permeability (k) in units of meters per second (m/s), we need to consider that the Kozeny-Carman equation is typically used to estimate the intrinsic permeability of a porous medium, which is a measure of the medium's ability to transmit fluids. This intrinsic permeability is typically given in units of area (e.g., m²).

However, we can convert intrinsic permeability into hydraulic conductivity, which is given in units of velocity (m/s), by incorporating the fluid's dynamic viscosity. The hydraulic conductivity (K) is related to intrinsic permeability (k) and fluid viscosity (μ) as follows:

$$K = \frac{k\rho g}{\mu} \quad IV-4$$

K is hydraulic conductivity (m/s), k is intrinsic permeability (m²), ρ is the density of the fluid (kg/m³), g is the acceleration due to gravity (m/s²), μ is the dynamic viscosity of the fluid (Pa·s or kg/(m·s)).

Analysis in Clayey Context:

In a clayey adhesive system (kaolinite, sand, and limestone), the permeability will be dependent on the detailed microstructure, specifically the porosity φ, and the effective pore diameter d. The particle size distribution in sandstones plays a key role in shaping the correlation between permeability and porosity [288]. These parameters are influenced by the initial composition of the adhesive and the processes (e.g., drying) it undergoes.

Factors Affecting Permeability

1. Pore Connectivity: Greater connectivity leads to higher permeability.
2. Pore Size Distribution: A broader distribution can lead to complex flow paths.
3. Material Composition: The presence of additives can alter permeability.

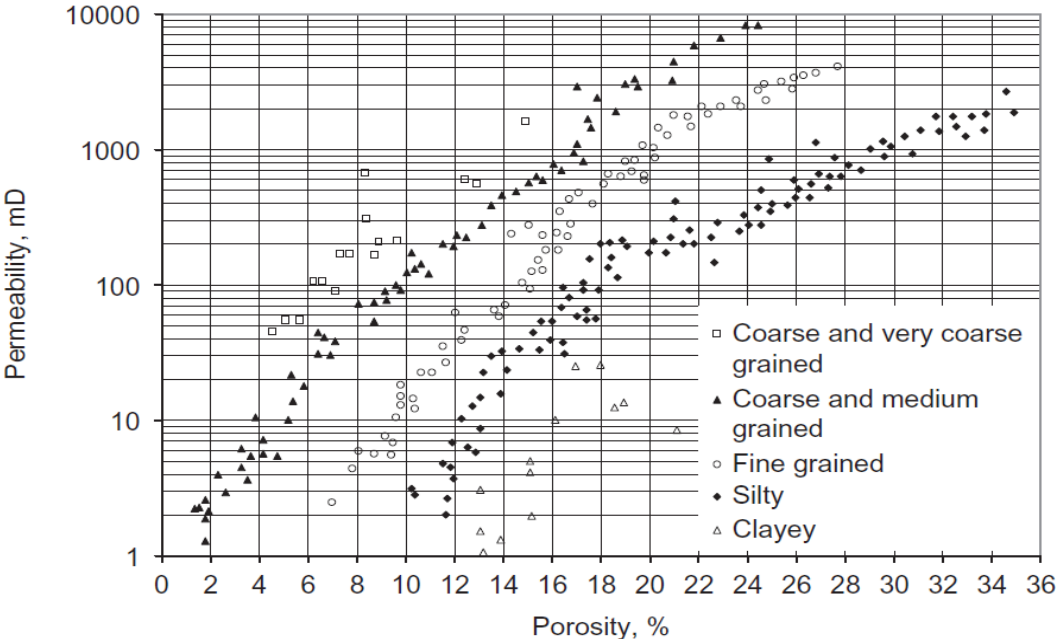

Figure IV.4: Influence of grain size on the relationship between permeability and porosity [19]

Porosity serves as an indicator of the volume fraction of void spaces within a material, while permeability quantifies the material's capability to transmit fluids. These two attributes are intrinsically related and depend on factors such as the size, number, and connectivity of the voids or pores within the material.

Understanding the mechanisms of capillary action and permeability is fundamental to the study of water penetration in clayey adhesives. These mechanisms are governed by specific equations and influenced by various material and fluid properties, offering potential avenues for engineering water-resistant clayey adhesives.

This section aims to provide a scientific foundation for understanding how water penetrates clayey adhesives, thereby setting the stage for the experimental investigations that follow. Given the complexity and interdependence of these mechanisms, a multi-pronged approach that combines theoretical understanding with empirical evaluation is essential for developing clayey adhesives with enhanced water resistance.

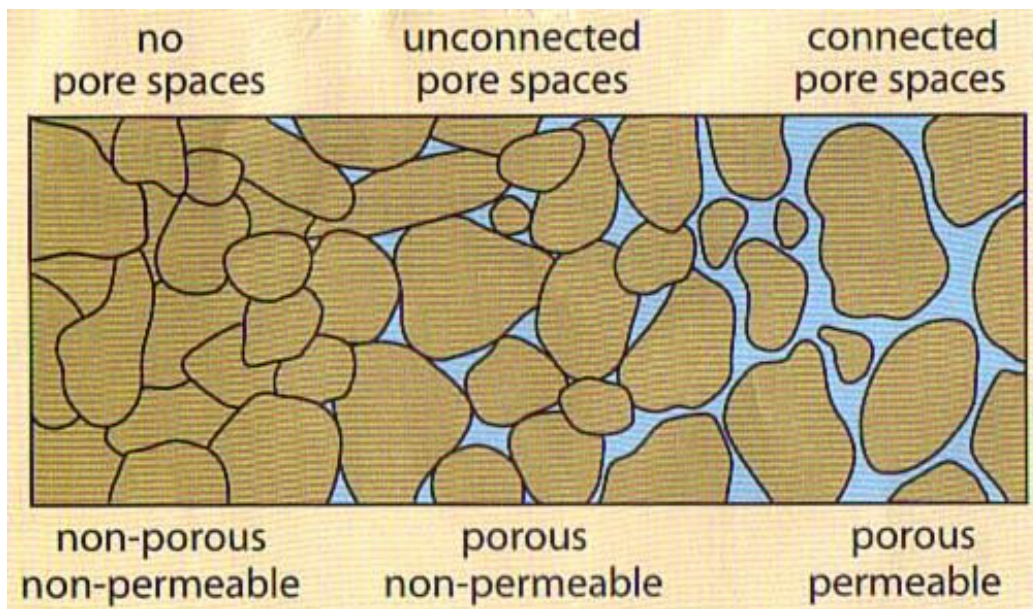

Figure IV.5: Differences between permeability and porosity [289].

IV.3. Experimental Approach

Objective and Rationale

The primary objective of this experimental segment is to examine closely the kinetics of water imbibition in the adhesive system, both in the reference formula and in formulations augmented with various additives. The ultimate aim is to elucidate whether these additives can effectively inhibit water ingress, thereby preventing the loss of mechanical strength upon wetting (Figure III.5).

IV.3.1. Additives Used

Organic Polymers	Inorganic Compounds	Nanoparticles	Waxes and Hydrophobing Agents
Cellulose Ether (hydroxyethyl methyl cellulose (HEMC))	Lime	LUDOX (Colloidal Silica)	HYDROWAX (HWX)
RDP (Redispersible Powder Polymer Ethylene Vinyl Acetate EVA)			TEOS (Tetraethyl Orthosilicate)
Floset (Polycarboxylate Polymer)			

Table IV.1: Categories of additives used in this experiment.

The additives selected for this experimental phase are broadly categorized into two distinct groups. The first group comprises additives that are consistently present in the reference formula as well as in all other formulations; specifically, these are cellulose ether (HEMC) and lime. The second group of additives is employed in a more targeted manner, with each mixture containing the reference formula enhanced by an additional 5% (by weight) of a specific additive.

The dual categorization of additives aims to facilitate a comparative analysis of their respective impacts on the adhesive properties. The core focus of this experimentation is to ascertain the efficacy of these additives in mitigating water ingress into the adhesive system.

It is noteworthy that the compositions and percentages of these formulations have been maintained consistently with those used in previous shear strength experiments (refer to Table III.3 and Table III.4 for formulation details). This ensures that the data generated can be directly related to the earlier phases of research, thereby enhancing the comprehensiveness and integrity of the overall study.

IV.3.2. Sample Preparation

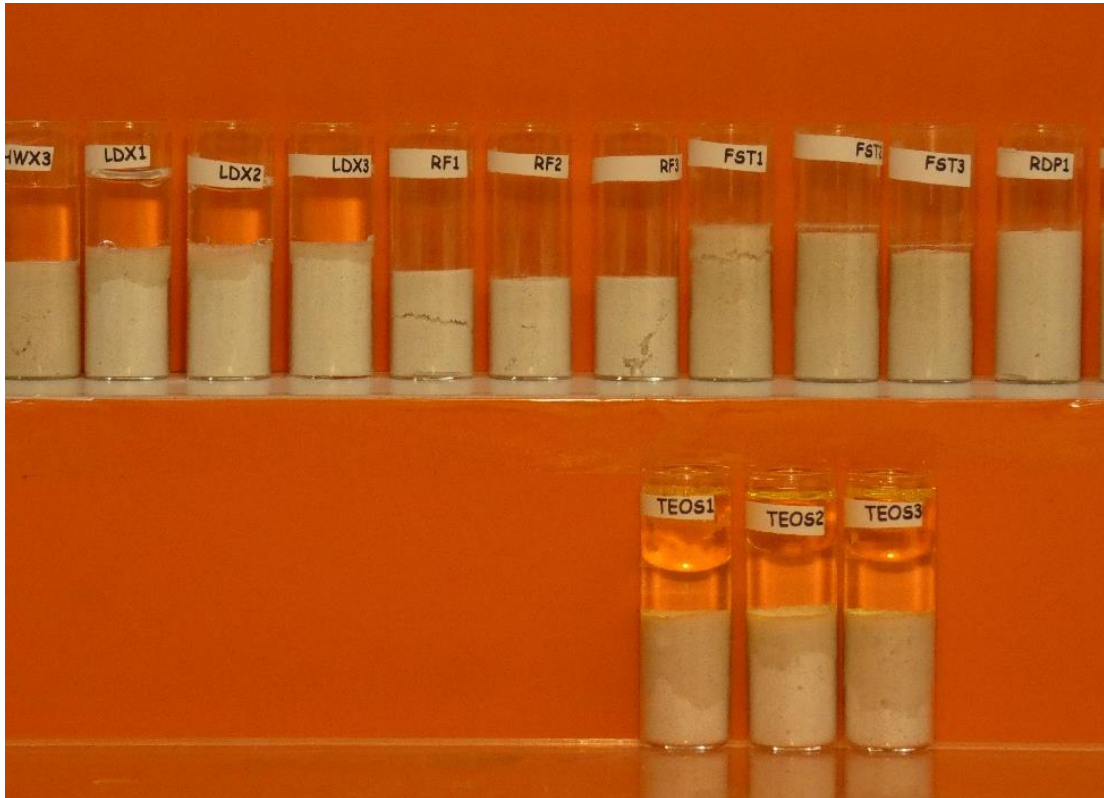

Figure IV.6: Imbibition set-up.

The process of adhesive formulation using a planetary mixer involves several steps. Initially, dry constituents such as various proportions of clay, sand, and other solid additives are incorporated into the mixer's bowl. This is followed by the addition of liquid components, including distilled water and any liquid additives, with careful attention to precise volumetric or gravimetric measurements. The planetary mixer is then activated to blend the mixture until it achieves a homogeneous consistency. During this blending process, periodic pauses are made to manually refine the mixture, ensuring even distribution of ingredients.

In the tube filling stage using a spatula, the adhesive mixture is carefully filled into transparent glass tubes, approximately 3 cm deep. Care is taken to avoid the formation of voids or air pockets, which is critical for the accuracy of subsequent water imbibition tests. After filling, it is important to meticulously clean the inner walls of the tube above the adhesive layer, maintaining visual clarity for image capture and analysis in later stages.

IV.3.3. Test Methods

We resort to a simplified, one-dimensional experimental setup designed to offer a clear visualization of water penetration over time. In this configuration, adhesive samples—prepared identically to those used in the shear strength tests—are allowed to dry thoroughly for a period of 14 days to achieve a fully desiccated state (Figure IV.10).

After the drying period, these samples are then placed vertically in transparent glass tubes and subsequently submerged in water. This setup is carefully designed to facilitate real-time monitoring of water imbibition.

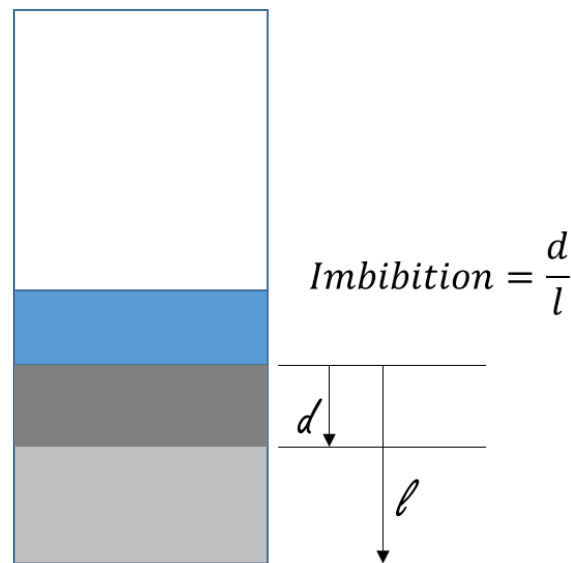

Figure IV.7: Schematic illustration of the imbibition of water in adhesive

A high-resolution camera is employed to capture time-lapse images of the water-front progression within the adhesive. Utilizing a specialized image analysis software, ImageJ, we quantify the water imbibition depth based on contrast variations in the captured images.

This data allows for the precise determination of imbibition kinetics, providing valuable insights into the efficiency of different additives in retarding water ingress into the adhesive system.

This methodological approach aims to provide a rigorous, quantitative assessment of the kinetics of water imbibition in clayey adhesives. The findings from these tests will serve as a critical evaluation metric for the efficacy of additives in preventing water penetration, thereby addressing one of the core challenges in enhancing the mechanical resilience and environmental stability of clayey adhesives.

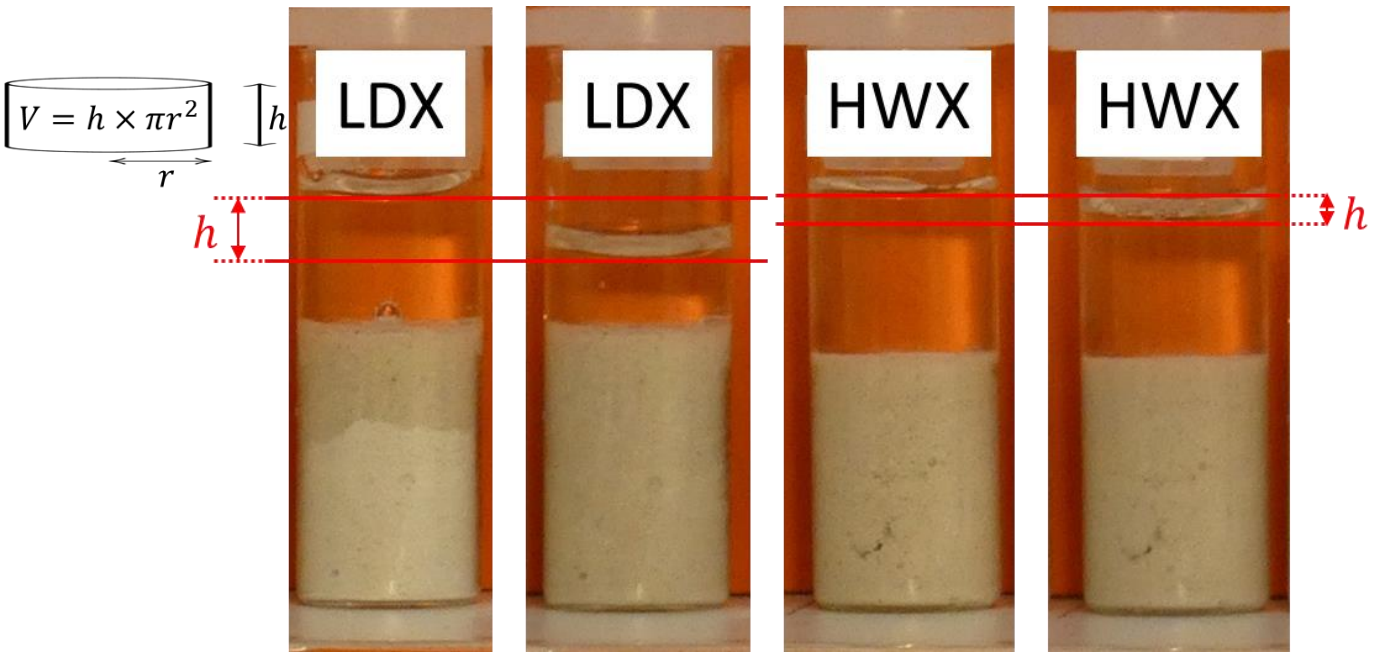

Figure IV.8: Imbibition computed from the level of the menisci at the top of the adhesive.

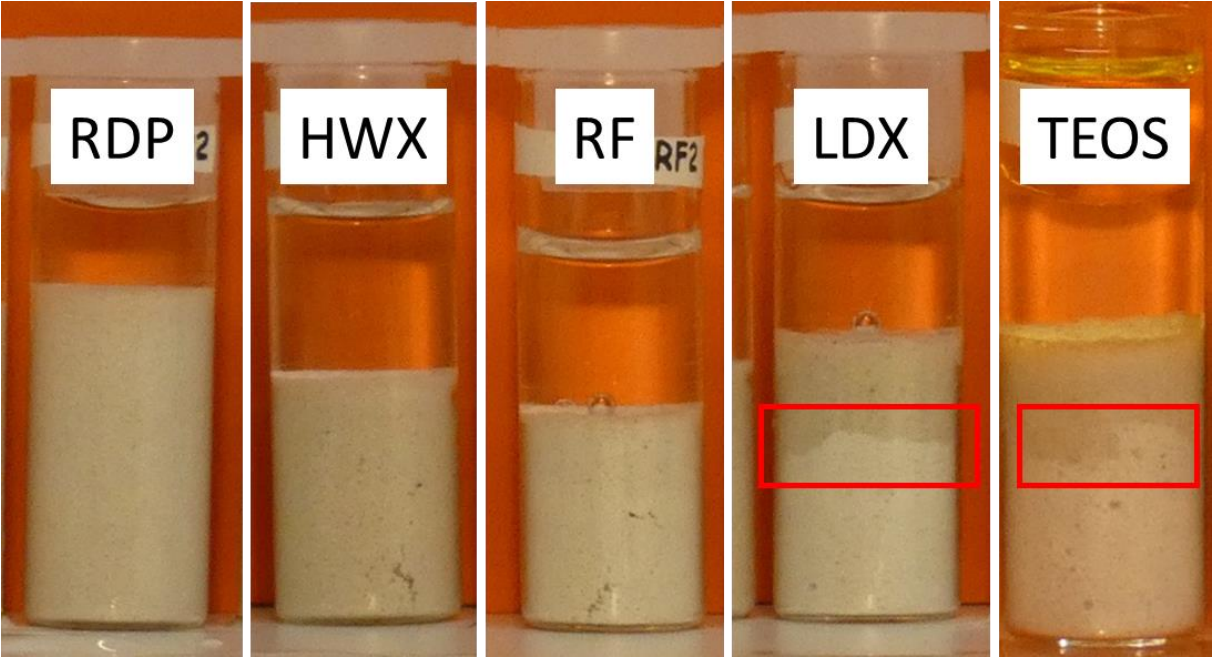

Figure IV.9: Different visual visibility of the boundary limit between wet and dry areas. Samples are from the left to the right: RDP Ethylene Vinyl Acetate, HYDROWAX (HWX), Reference formula, Ludox nanoparticles and TEOS Tetraethyl orthosilicate.

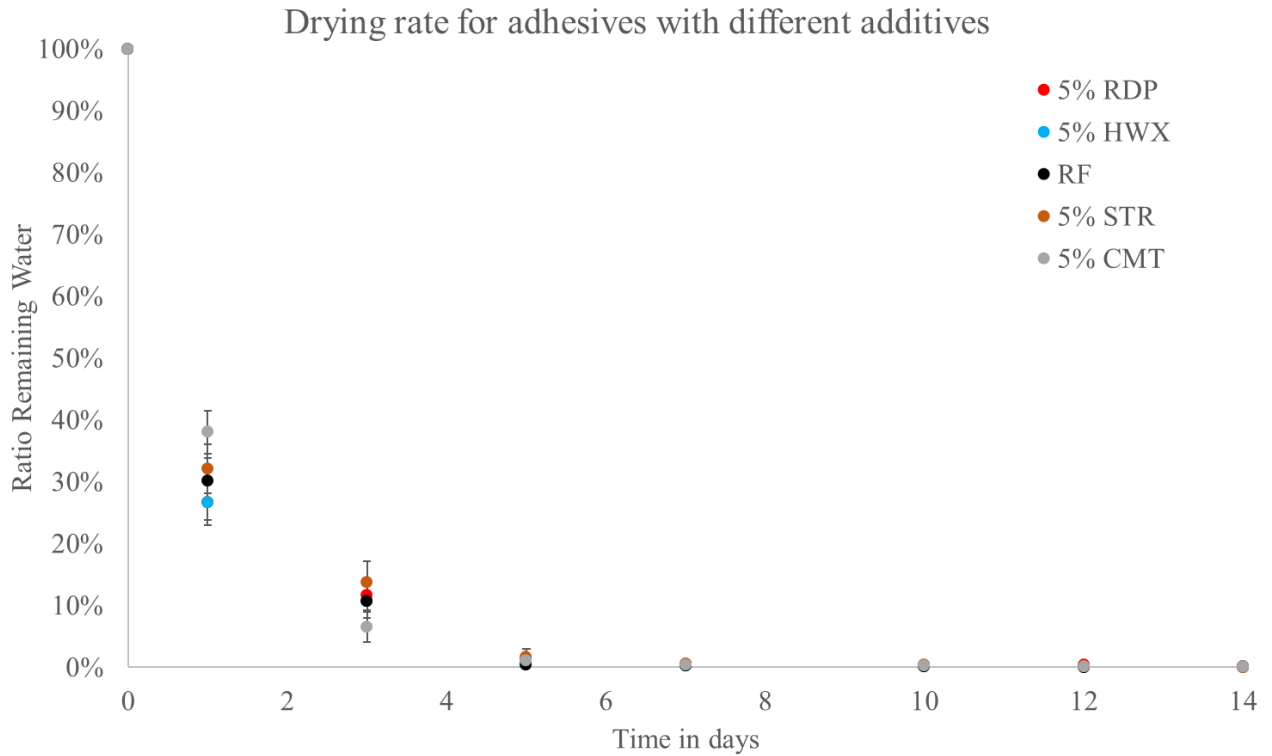

Figure IV.10: Drying kinetics for different adhesive formulations at 25°C and 1 atm.

IV.4. Results and Discussion

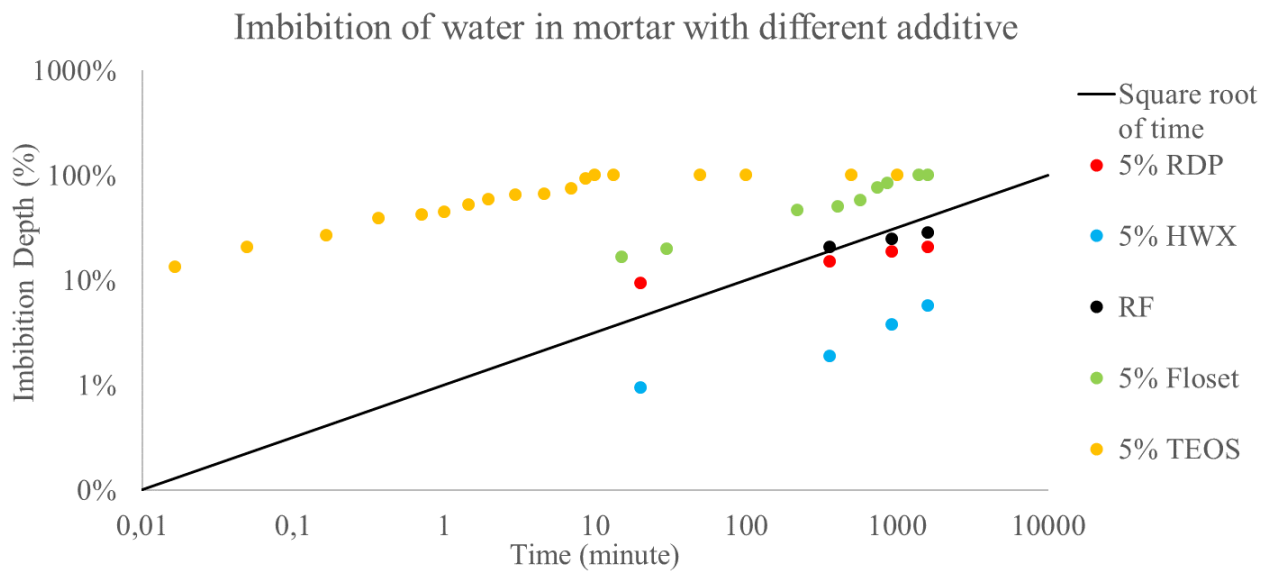

Figure IV.11: Imbibition of water calculated by different contrast in adhesive zone

Utilizing the computational capabilities of ImageJ software, we analyzed the extent of water imbibition within various adhesive formulations, as visually depicted in Figure IV.9. Initial observations indicate that the reference formula experiences a significant imbibition level, ranging from 30% to 40%, within the first 24 hours of water exposure. In stark contrast, adhesives enhanced with TEOS and Ludox display accelerated imbibition kinetics relative to

the reference formula. Conversely, RDP demonstrated a more favorable performance in water retardation, but the most impressive outcome was noted for the formulation incorporating the hydrophobic agent HYDROWAX (HWX), which restricted imbibition to approximately 8% after one day of immersion.

These results suggest varying degrees of internal connectivity within the adhesive formulations. TEOS and Ludox appear to facilitate greater connectivity, allowing for more rapid water ingress. On the other hand, RDP seems to reduce internal connectivity, with HYDROWAX (HWX) exhibiting the least connected porous network among all formulations.

Mercury intrusion porosimetry further substantiates these observations. The porosity percentages and average throat diameters for the different formulations are as follows:

	Porosity (%)	Throat diameter (mm)
RDP	40	2
TEOS	40	0.3
Reference Formula	37	0.75
LUDOX	34	0.2
HXW (Hydrowax)	28	2

Table IV.2: Porosity (%) and throat diameter (mm) according to mercury porosimetry results for different additives with the reference formula

HYDROWAX (HWX)'s lower porosity and throat diameter make it least conducive to internal fluid flow, while TEOS and Ludox exhibit high porosity but low throat diameter, suggesting high connectivity despite smaller pore sizes. RDP presents an intriguing case of high porosity coupled with larger throat diameters but reduced connectivity.

While these findings offer valuable insights for formulations like RDP and HYDROWAX (HWX) in terms of delaying water ingress, it's important to acknowledge the limitations of the current methodology. The approach relies on visual contrast differences between wet and dry zones within the adhesive, which may not be universally applicable or quantitatively reliable across different formulations. To address this, the subsequent section will introduce a refined methodology that measures imbibition based on the levels of the menisci above the adhesive. This alternative approach aims to eliminate the variability introduced by contrast differences and offers a more accurate, quantitative measure of water penetration.

IV.4.1. Experimental results from menisci method

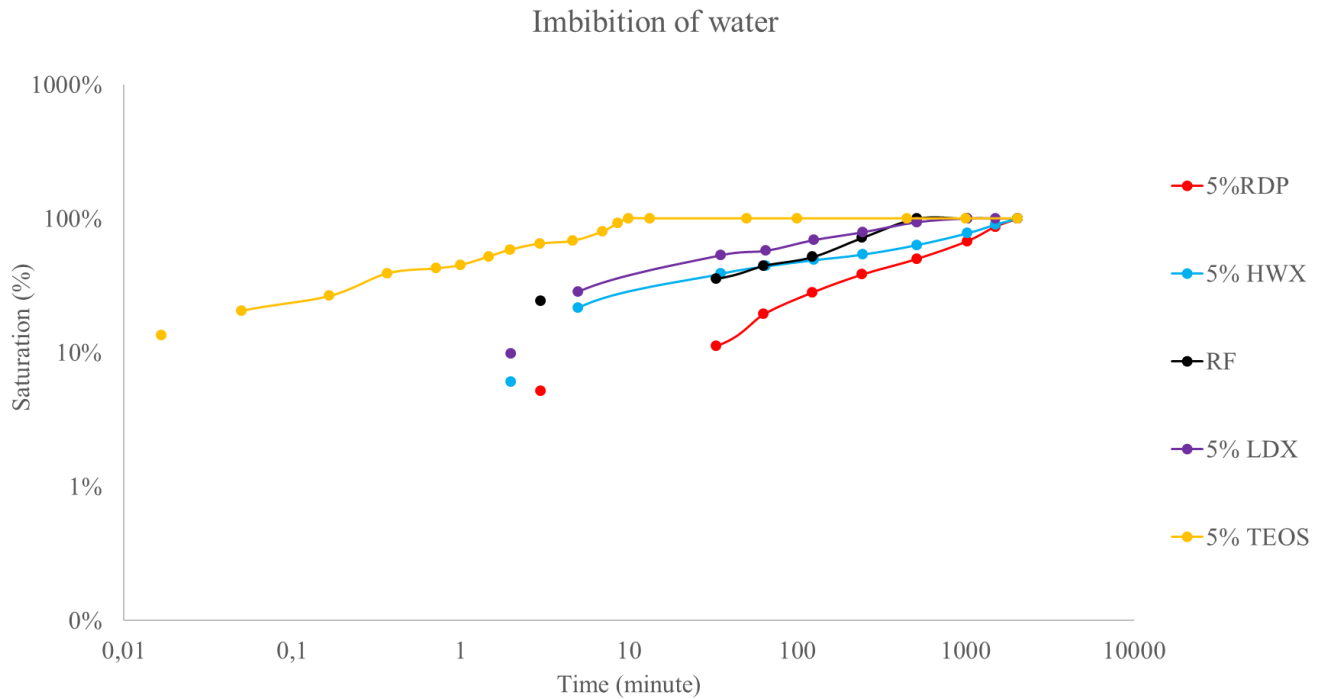

Figure IV.12: Imbibition of water in adhesive calculated by the level of menisci above the adhesive

The water imbibition patterns observed in all adhesive samples align well with the Washburn equation. This equation describes capillary flow in porous materials and has been extensively used to model the dynamics of liquid penetration into porous structures. The congruence between the Washburn equation and our empirical data lends theoretical robustness to our observations and suggests that capillarity is a dominant mechanism in the water ingress process for these adhesives.

$$t = \frac{r^2 \eta}{2\gamma \cos \theta} \quad IV-5$$

t is the time required for the liquid to rise to a certain height in the capillary.

r is the radius of the capillary.

η is the viscosity of the liquid.

γ is the surface tension of the liquid.

θ is the contact angle between the liquid and the solid surface.

In the context of porous materials, the equation is often reformulated to:

$$L = \sqrt{\frac{2\gamma \cos \theta \cdot t}{\eta \cdot r}} \quad IV-6$$

Where L is the distance the liquid has penetrated into the porous medium.

While the previous analysis utilized ImageJ to gauge water imbibition through visual contrast differences, the current methodology employs a more robust approach. By measuring the height difference of the menisci above the adhesive, we can calculate the volume of water entering the adhesive system. This offers a more precise quantitative measure of water ingress, especially in cases where visual contrast is not sufficiently reliable, as observed in HYDROWAX (HWX) samples (Figure IV.8).

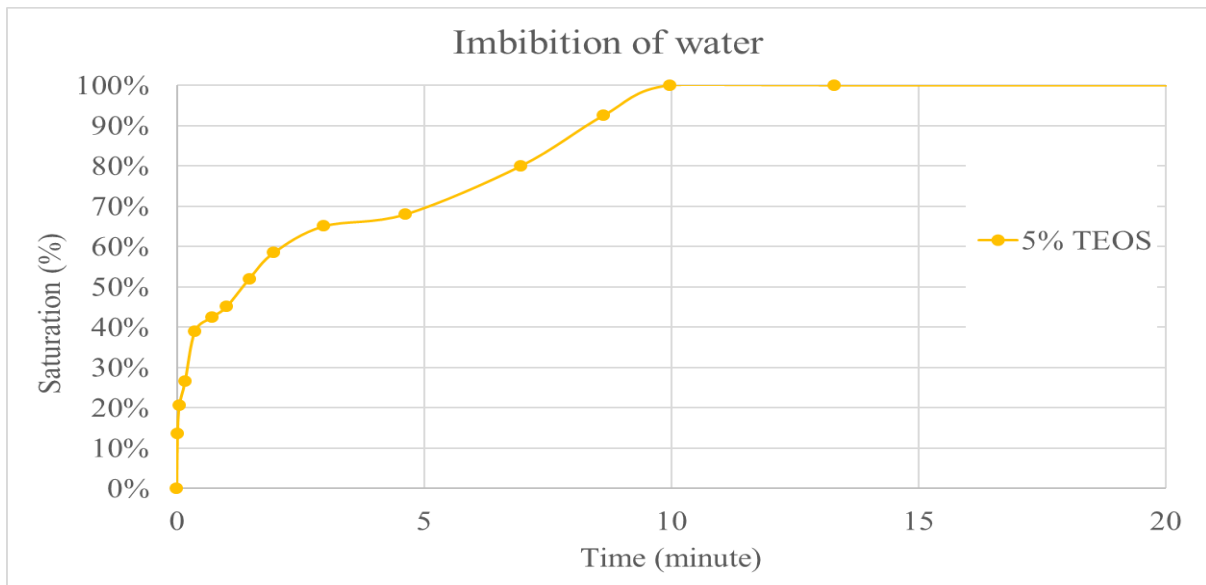

Figure IV.13: Imbibition of water in adhesive with TEOS. Calculated by the level of menisci above the adhesive.

Utilizing this advanced method, we computed the saturation levels for each adhesive formulation with 5% additive (RDP, HYDROWAX (HWX), Ludox, and TEOS) in comparison to the reference formula (Figure IV.12). Remarkably, TEOS exhibited the fastest water ingress, taking less than 10 minutes for total imbibition. In contrast, Ludox took approximately 15 hours for full saturation. Most notably, formulations with RDP and HYDROWAX (HWX) took about 35 hours for complete imbibition. However, it is essential to note that both RDP and HYDROWAX (HWX) exhibited over 50% saturation of their porous volume within the initial 8 hours of water exposure.

Despite the extended hours needed for complete saturation in RDP and HYDROWAX (HWX), these results fall short of meeting the stringent requirements of European standards for wet condition tests, which mandate a 21-day immersion period. Consequently, none of the additives tested in this experiment were successful in preventing water ingress over the period stipulated by the standards.

The data indicates that time to complete saturation is not the only metric of concern. The rate at which porous volumes become saturated also provides crucial insights into the effectiveness of the additives in delaying water ingress. For instance, more than half of the connected void volume in RDP and HYDROWAX (HWX) samples was filled within the first 8 hours, suggesting that mere delay in water ingress is insufficient for long-term performance.

IV.5. Conclusion

The adoption of menisci-level analysis has offered a more accurate and reliable assessment of water ingress in adhesive formulations, validating the limitations inherent in the preceding visual contrast-based methods. This advanced analytical approach not only quantified the rate of water imbibition but also did so in a manner independent of the visual characteristics of the materials, thereby eliminating potential sources of error and subjectivity.

Interestingly, the observed patterns of water imbibition were found to align closely with the theoretical framework provided by the Washburn equation. This congruence between empirical data and established scientific theory lends additional credibility to the research findings, confirming that capillary forces are a dominant factor in water ingress. Such theoretical validation further reinforces the necessity of developing innovative strategies that can effectively counter these natural phenomena.

Despite the more nuanced insights provided by the menisci-level analysis, the overarching conclusion remains unaltered: none of the additives tested—RDP, HYDROWAX (HWX), Ludox, TEOS, or the reference formula—were effective in preventing water ingress over periods that would be relevant in practical or industrial applications. While some additives did show a capability to delay water penetration, this delay was insufficient in the face of stringent European standards that require a 21-day immersion test.

Given these findings, it is clear that the current approaches for enhancing water resistance in adhesive formulations are inadequate. This realization, though disconcerting, also presents an opportunity. It unequivocally sets the stage for subsequent phases of research that will explore alternative strategies to improve the water-resistant properties of these adhesive formulations. Whether it's the investigation of new additive combinations, alterations in material composition, or the application of novel engineering solutions, the quest for truly water-resistant adhesives remains an open and compelling challenge.

Chapter V. Reversible Materials, strategy number three

V.1. Introduction to Reversible Materials

The engineering of clayey adhesives with enhanced adhesion and water resistance has proven to be a formidable challenge. Previous strategies, including additive reinforcement and inhibition of water penetration, have yielded limited success. While additives like Redispersible Polymer Powder (RDP) and Hydrophobic agent (HYDROWAX (HWX)) exhibited promising results in increasing dry shear strength, their effectiveness diminished dramatically upon water immersion. This recurring issue underscores the necessity for an alternative strategy, one that addresses the reversible loss and regain of mechanical strength in clayey adhesives.

The overarching objective of this chapter is to explore the potential for reversibility in the mechanical strength of clayey adhesives. Specifically, this involves investigating whether materials that have shown high adhesive strength in dry conditions can regain this strength upon re-drying after wetting. Such a capability would signify a groundbreaking advancement in the field, yielding a class of materials that can cyclically lose and recover their mechanical strength, thereby earning them the designation of "reversible materials."

To achieve this, the chapter will employ a structured experimental approach. An initial selection of additives, guided by the findings from Chapter 3, will be incorporated into clayey adhesive formulations. Subsequently, these samples will undergo a series of immersion tests to evaluate the loss of mechanical strength upon wetting. The core of this investigation will focus on the ability of these materials to recover their initial mechanical strength upon re-drying, thereby assessing their reversibility.

This focus on reversible materials is aligned with the broader research objectives of this thesis, which aims to engineer clayey adhesives that not only adhere effectively but also exhibit resilience against environmental conditions, specifically water exposure. Understanding the mechanisms underpinning reversibility could pave the way for new application avenues and extend the utility of clayey adhesives beyond their current limitations.

The chapter will progress through the following sections:

- Outlines the experimental approach, detailing additive selection, sample preparation, and test procedures.
- Presents the results and discussion, focusing on the loss and recovery of mechanical strength, and draws comparisons with traditional materials.
- Discusses the implications of these findings for future applications.
- Concludes the chapter, summarizing key takeaways and suggesting directions for future research.

V.2. Experimental Approach for Reversible Adhesive

V.2.1. Selection of Additives

The choice of additives for inclusion in this chapter's experimental section is highly informed by the set of data gathered in prior phases of this research, specifically from the mechanical shear tests conducted in Chapter III (see Figures III-25, III-27, and III-28). The overarching objective is to enhance the mechanical strength of the adhesive mortar formulations, particularly their ability to recover strength after water immersion.

It's essential to emphasize that not all additives are suitable for this stage of research. Certain additives, such as TEOS, Tannin with iron chloride, and Floset, exhibited a significant loss of mechanical strength in both dry and wet conditions. These additives were therefore deemed unsuitable for further exploration in the context of developing reversible adhesive formulations that can recover their mechanical strength post-immersion.

Conversely, additives like RDP (Redispersible Polymer Powder, primarily composed of Ethylene Vinyl Acetate) and Hydrowax (a hydrophobic wax), showed promising potential for enhancing mechanical strength in both dry and wet states. These additives not only maintained but, in some instances, increased the shear strength of the adhesive formulations. This makes them prime candidates for investigating the reversible mechanical properties of the adhesive mortars.

For the sake of experimental consistency and to facilitate meaningful comparisons with prior work, the selected additives—RDP and Hydrowax—will be incorporated at a concentration of 5% by weight into the reference formula. This standardized approach allows for a more robust analysis of their effectiveness in contributing to the reversibility of mechanical strength in adhesive mortars.

This selection strategy aligns with the broader research objectives and sets the stage for rigorous evaluations aimed at fulfilling the real-world, industry-specific requirements for tile adhesives in both vertical and horizontal applications.

V.2.2. Sample Preparation

Adhesive Formulation:

The process begins with the preparation of the adhesive formulation. A planetary mixer is employed for the mixing process to ensure thorough integration of all components. The procedure starts with the addition of all dry ingredients into the mixer. Following this, distilled

water and any liquid additives are sequentially introduced. The mixing operation is continued until a uniform mixture is achieved. It might be necessary to undertake additional manual refinement to ensure that the mixture attains the same consistency as the reference formula.

Application on Tiles:

The method of application varies depending on the tile type. For non-absorbent tiles, a uniform layer of the prepared adhesive mix is distributed across the surface. In contrast, for absorbent tiles, a buttering technique is employed to apply a pyramid-shaped layer of adhesive. This differentiation in application technique is critical for optimal adherence.

Curing Period:

After the application of the adhesive, the tile-adhesive assembly is set aside for a designated drying duration. The recommended drying time is 7 days, as discussed and justified in further detail in the relevant section of the study.

Shear Stress Testing:

The testing of the adhesive's strength is conducted as described in Chapter III. This involves subjecting the tile-adhesive assembly to shear stress testing to evaluate its adhesive properties.

Shear Stress Calculation:

To quantify the shear stress, the maximum shear force exerted on the assembly is measured in Newtons. This force is then divided by the adhesive's interfacial surface area between the two tiles, which is measured as 40x40 mm². This calculation provides a precise measure of the adhesive's strength under stress.

V.2.3. Testing Conditions for Shear Tests

Dry Conditions:

Shear tests under dry conditions were conducted following a 7-day drying period at ambient conditions (25°C and 1 atm pressure). It's worth noting that in this chapter, we also investigated the influence of varying drying durations (3, 7, 14, 28, and 56 days) on shear strength. In each instance, shear tests were executed after the specified number of drying days.

Immersion Conditions:

Samples were fully submerged for 24 hours underwater subsequent to the above 7-days drying period post-fabrication. Shear test was conducted immediately after removal from the immersion conditions.

Re-drying Conditions:

After subjecting some other samples to a 24 hours immersion period, these were re-dried for an additional 7 days. The shear test in this scenario was executed after this 7-days re-drying period, which therefore followed the initial 7-days drying period post-fabrication.

V.3. Results and Discussion

V.3.1. Loss of Mechanical Strength upon Immersion

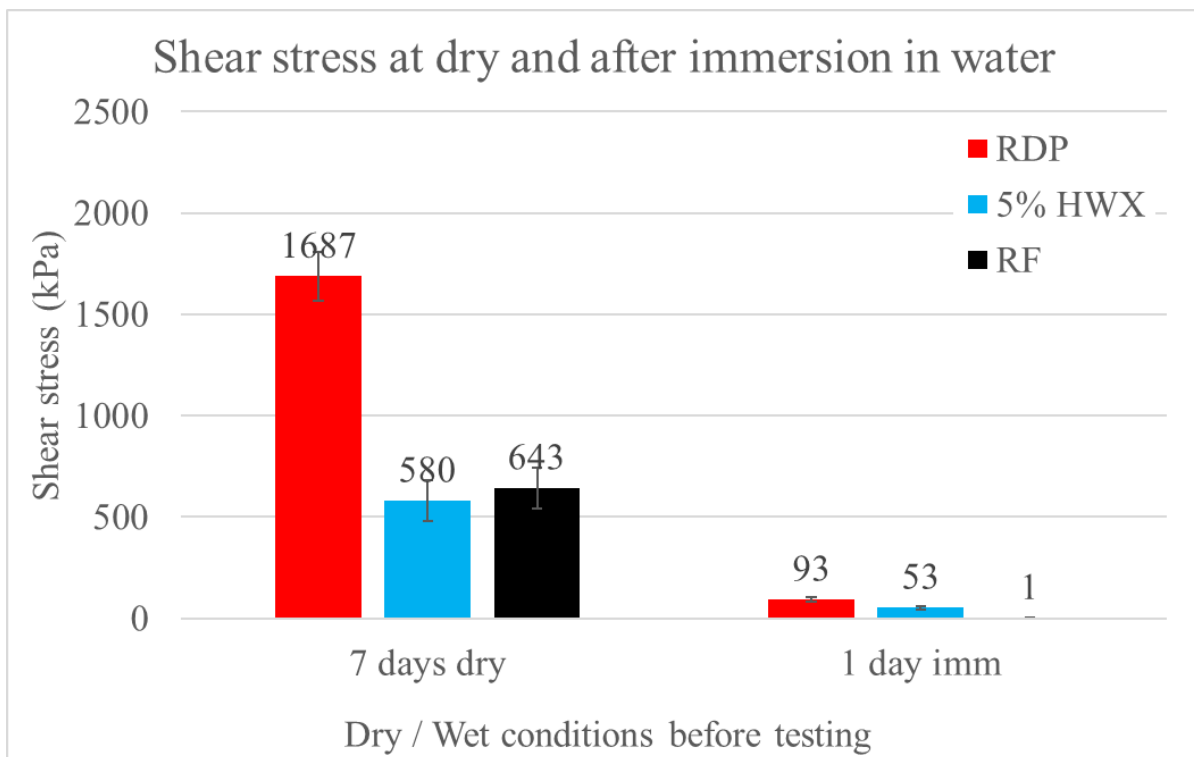

Figure V.1: Shear stress (kPa) for RDP, HYDROWAX (HWX) and reference formula at both dry (7 days drying) and wet (after immersion) conditions.

As depicted in Figure V.1, the shear stress values for adhesives with different additives exhibit notable differences. For the dry condition (measured after 7 days post-fabrication drying), an adhesive with 5% by weight of RDP (Ethylene Vinyl Acetate) registered an average shear stress of approximately 1687 kPa. Conversely, an adhesive containing 5% by weight of HYDROWAX (HWX) recorded a substantially lower average of 580 kPa, while the reference formula had an average shear stress of 643 kPa.

Upon examining the right segment of the histogram, which represents the adhesives after 24 hours of water immersion (post 7-day drying), we observe further disparities. The adhesive with 5% by weight of RDP displayed a markedly reduced average shear stress of 95 kPa. Similarly,

the adhesive with 5% by weight of HYDROWAX (HWX) dropped to an average of 55 kPa. Intriguingly, the reference formula exhibited a complete loss of its shear strength. This data implies that both adhesives with RDP and HYDROWAX (HWX) lost approximately 90% to 95% of their initial shear strength after just one day of water immersion. Notably, the reference formula outperformed the HYDROWAX (HWX) adhesive under dry conditions but failed entirely upon water immersion, whereas the HYDROWAX (HWX)-containing adhesive retained around 10% of its original strength.

In light of these findings and considering the results from the shear tests after immersion in Chapter III, it becomes evident that water immersion has a profoundly detrimental impact on adhesive shear strength. These results also underscore the challenge of meeting standard requirements (500 kPa in Pull-off, estimated to be 867 kPa in the developed shear test according to estimation done in chapter II by the relation given by the Equation **Shear stress** (τ) = **Pull – off tensile stress**($\sigma_{tensile\ pull-off}$) $\times \sqrt{3}$ V-1) under dry conditions, only to subsequently fail the tests due to a dramatic loss of strength upon water immersion.

$$\text{Shear stress } (\tau) = \text{Pull – off tensile stress}(\sigma_{tensile\ pull-off}) \times \sqrt{3} \quad V-1$$

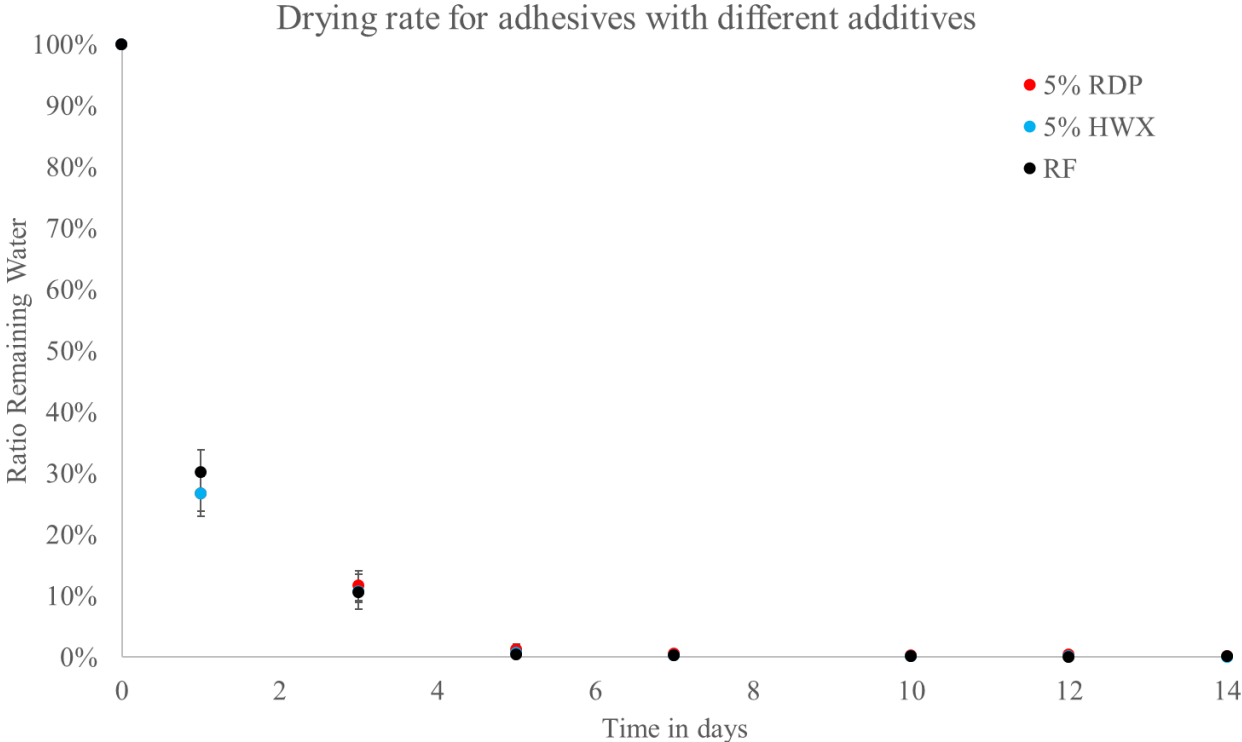

Figure V.2: Drying kinetics for samples of adhesives with RDP, HYDROWAX (HWX) and the reference formula. (Drying over 14 days).

In Figure V.2, we observe that after a drying period of three days, adhesives formulated with the reference formula, RDP, and HYDROWAX (HWX) retain between 10% to 15% of their initial water content. After five days, approximately 98% of the residual water has evaporated, and all adhesive formulations enter a plateau phase where the water content remains constant.

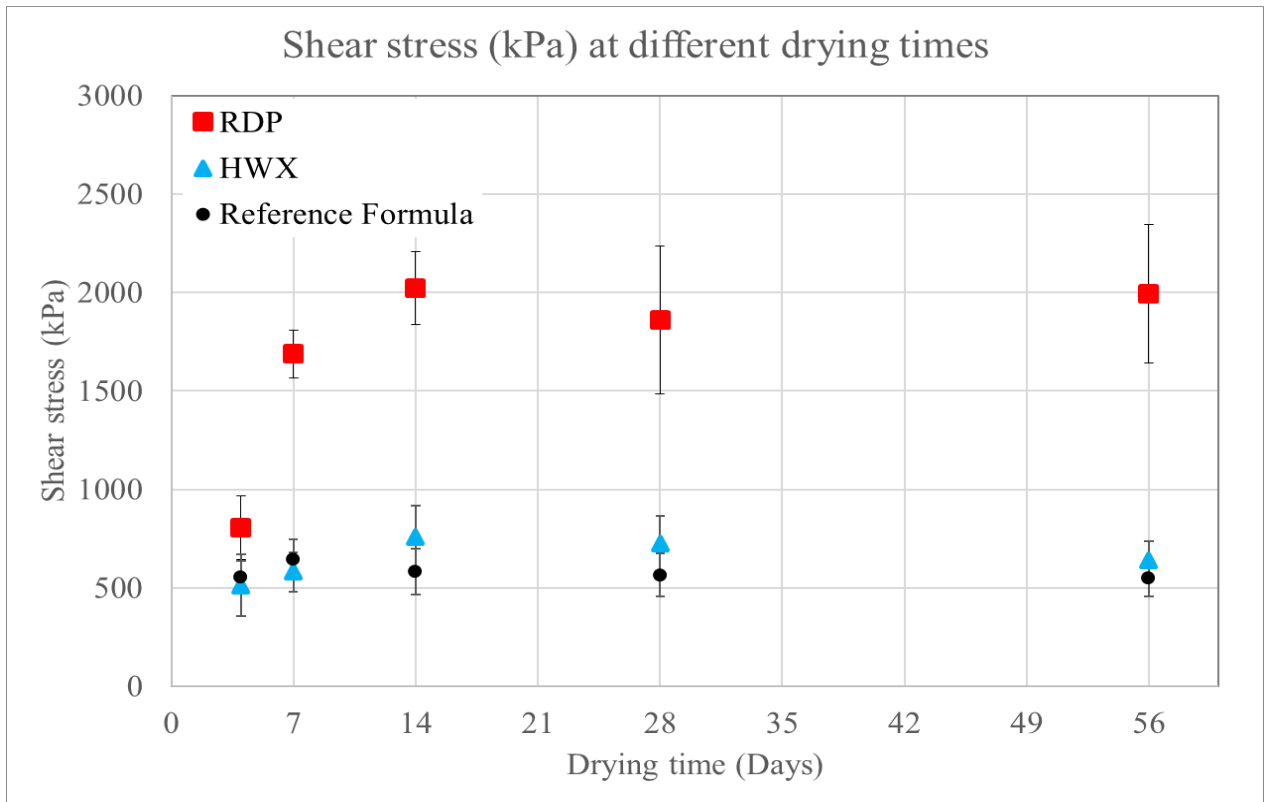

Figure V.3: Shear stress (kPa) for RDP, HYDROWAX (HWX) and reference formula at different drying times (dry conditions).

Figure V.3 reveals differential behavior in shear strength among the adhesives over varying drying periods at 25°C and 1 atm. Specifically, adhesives formulated with 5% by weight of HYDROWAX (HWX) and the reference formula exhibit comparable shear strengths across all measured drying times (3, 7, 14, 28, and 56 days). Conversely, the adhesive containing 5% by weight of RDP exhibits a distinct drying-time dependency. After three days of drying, the shear strength is recorded at approximately 800 kPa. This value significantly increases to a range of 1700 to 2000 kPa after seven days of drying and maintains this level through days 28 and 56.

These findings suggest that adhesives formulated with the reference formula and HYDROWAX (HWX) achieve their full shear strength within just three days, despite retaining approximately 10% of their initial water content. In contrast, adhesives containing 5% by weight of RDP exhibit a pronounced dependency on drying time for achieving their full shear strength, doubling their shear strength once fully dried. For all samples the final strength is reached after 7 days of drying.

V.3.2. Regaining Strength upon Re-drying

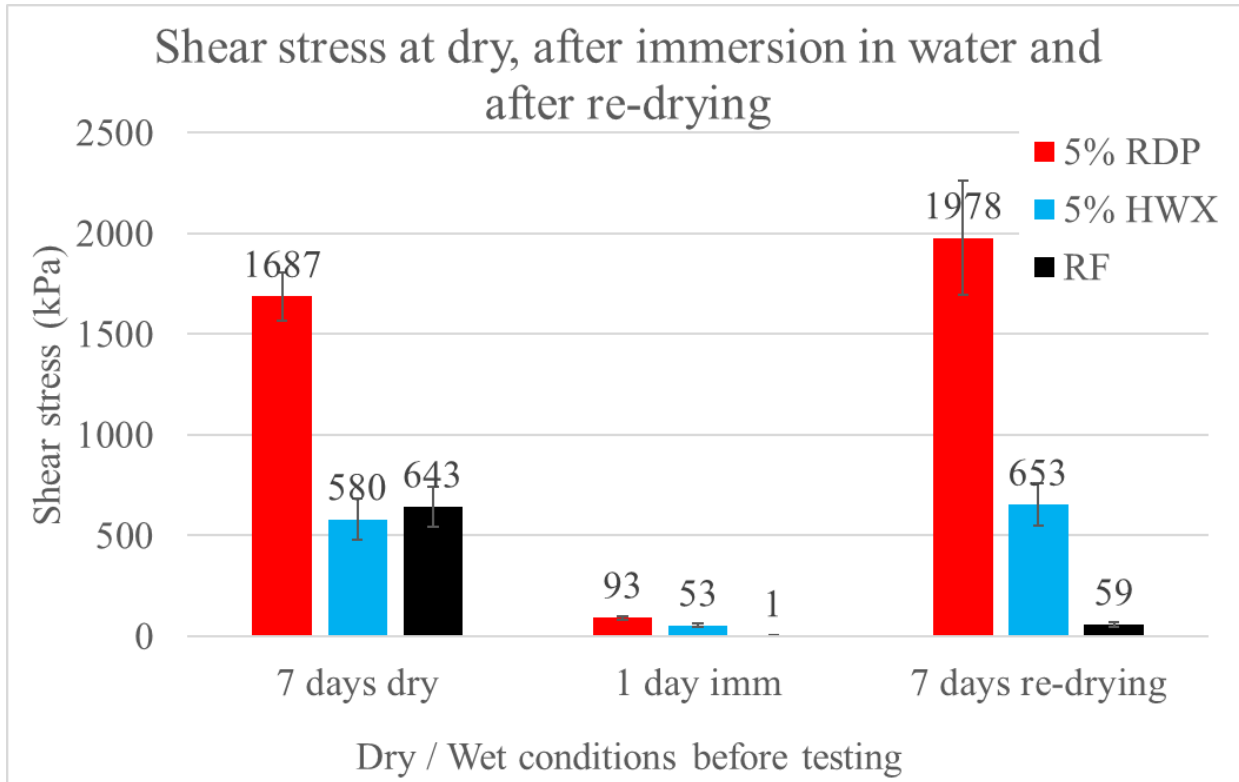

Figure V.4: Shear stress (kPa) for RDP, HYDROWAX (HWX) and reference formula adhesives. After 7 days drying, 1 day immersion after 7 days drying and after 7 days re-drying after immersion.

In Figure V.4, a comprehensive trend of strength loss and subsequent regain is illustrated for both RDP (Ethylene Vinyl Acetate) and HYDROWAX (HWX) additives in the adhesive formulations. Interestingly, the reference formula serves as a stark contrast, revealing its inadequacies in moisture resilience.

Starting with the adhesive containing 5% RDP, the initial shear stress in dry conditions was approximately 1700 kPa. Upon submerging the sample in water, this value plummeted to a meager 95 kPa, signifying a substantial loss of nearly 90-95% in shear strength. However, the adhesive remarkably rebounded upon re-drying, regaining its full initial strength of about 2000 kPa.

The scenario was somewhat similar for the adhesive formulation containing 5% Hydrowax. Initially, in dry conditions, the shear stress was measured at around 580 kPa. This dropped precipitously to around 50 kPa after the immersion cycle, corresponding to a nearly 90% loss in shear strength. Nevertheless, just like its RDP counterpart, the Hydrowax-infused adhesive recovered impressively after the re-drying phase, achieving an average shear stress of 650 kPa.

In stark contrast, the reference formula displayed a completely different behavior. Initially, it had a comparable shear stress of about 650 kPa in dry conditions. However, it suffered a total annihilation of its shear strength upon water immersion. More disheartening was its inability to recover post re-drying; it managed to muster a shear stress of only around 60 kPa, which is less than 10% of its initial dry strength.

This set of results underscores the remarkable resilience of RDP and Hydrowax additives in the face of moisture-induced challenges, contrasting sharply with the vulnerability exhibited by the reference formula. It also opens up further avenues for understanding the mechanisms behind such recoveries in adhesive strengths.

V.3.3. Comparison with Traditional Materials

Upon examination of the preceding data, the transformative role of additives in bestowing reversible properties to the adhesive material becomes unequivocally clear. The reference formula, composed of an amalgamation of kaolinite, sand, limestone, cellulose ether (CE), and lime, starkly fails the test of resilience. After a complete submersion, it suffers a catastrophic loss of mechanical strength and, more critically, shows no ability to recover upon re-drying.

In stark contrast, the formulations enriched with 5% by weight of either RDP or Hydrowax weather the storm of immersion. Such resilience implicitly highlights the pivotal role these additives play in imparting a unique 'reversibility' to the material's mechanical properties.

Therefore, this study unequivocally demonstrates that the introduction of these specific additives transcends mere improvement; it revolutionizes the adhesive's fundamental behavior, turning what was once a one-way street of degradation into a cycle of loss and rejuvenation. This not only amplifies the material's utility but also marks a significant stride toward sustainable and resilient building materials.

V.4. Implications and Future Applications

We can broadly categorize tiling applications into two principal domains: horizontal (such as flooring) and vertical (or inclined, as in the case of ramps). These distinct applications are subject to different force regimes, contingent upon their orientation and function. Specifically, vertical tiling is typically subject to a persistent downward shear stress, engendered by its own dead load as well as any ancillary loads that may be applied, which may cause detachment of the tile if the adhesive loses its adhesion strength. Conversely, horizontal applications like flooring primarily experience compressive forces directed downward, owing to both their dead load and any live load in the favor of the direction of attaching the tile to the substrate.

Given these contrasting mechanical environments, the reversible adhesive materials developed in this study find their most practical application in horizontal indoor flooring. These

formulations are capable in dry conditions of withstanding forces and stresses that surpass European standard benchmarks, including a tensile pull-off stress of 500 kPa and an estimated shear stress of 870 kPa based on developed correlations. Notably, even when subjected to wet conditions, these adhesives retain approximately 10% of their original strength, thereby maintaining their adherence to the substrate during moisture exposure cycles. Furthermore, the intrinsic reversibility of these materials provides an opportunity to rejuvenate their adhesive strength upon re-drying, adding a layer of resilience and adaptability to their performance profile.

V.5. Conclusion

The investigation into the reversible mechanical properties of clayey adhesives has yielded results of significant academic and practical import. This chapter set out to explore whether adhesives that demonstrate robust shear strength in dry conditions could recover that strength after a cycle of wetting and re-drying. Not only was this objective met, but the data also revealed nuances that hold substantial implications for the broader field of adhesive technology.

Initial tests confirmed the limitations of traditional clay-based adhesives, represented by the reference formula. In stark contrast to this, the formulations containing 5% by weight of either Redispersible Polymer Powder (RDP) or Hydrophobic agent (Hydrowax) showcased remarkable resilience to wetting cycles. These additives not only helped the adhesives retain a portion of their mechanical strength during water immersion but also facilitated a complete—and in some instances, enhanced—recovery of strength upon re-drying. This behavior effectively elevates these formulations to the status of "reversible materials," capable of cyclically losing and regaining their mechanical properties.

The potential applications of these reversible adhesives are notably wide-ranging but find immediate utility in horizontal tiling situations. Given that these adhesives can meet and even exceed European standards for mechanical strength in dry conditions, their use could revolutionize indoor flooring applications. The ability to withstand and recover from moisture exposure cycles offers an additional layer of resilience, which is particularly beneficial in environments prone to fluctuating moisture levels.

Moreover, the findings of this chapter align closely with the overarching aim of this thesis—to develop clayey adhesives that are not just effective in adhesion but also resilient to environmental conditions. The reversible mechanical properties of these new formulations could very well serve as a stepping stone for future research, potentially opening new avenues for the application of clayey adhesives, extending their utility, and addressing some of the longstanding challenges in the field.

In conclusion, this chapter has not only fulfilled its specified objectives but has also made a seminal contribution to the field of adhesive technology. It has demonstrated that the incorporation of specific additives can imbue clay-based adhesives with reversible mechanical properties, effectively transforming a heretofore static material into one capable of dynamic response to environmental conditions. This paves the way for further research, aiming to refine these findings and explore their broader applications, thereby making strides towards more sustainable and resilient building materials.

Chapter VI. Conclusion and Perspectives

VI.1. Summary of Key Findings

VI.1.1. Development of Clayey Adhesive assessment tools

The inception of this research was marked by an urgent need to develop a robust set of evaluative tools specifically designed for the complexities inherent in clayey adhesives. The initial challenge lay in the translation of industrial challenges into a coherent framework of scientific questions, thereby setting the stage for a methodical investigation. This translation was vital as it bridged the gap between industrial needs and scientific research, ensuring that the outcomes of the study would be both academically rigorous and practically applicable.

A cornerstone of this methodological development was the creation of a novel shear test, meticulously tailored to assess the adhesive qualities of clayey materials. This innovation arose from the limitations observed in traditional pull-off tests, which often failed to capture the nuanced behaviors of clayey adhesives under various conditions. The newly-developed shear test not only addressed these limitations but also offered a more accurate and reliable measurement of adhesive strength. In doing so, it stands as a seminal contribution to the field, offering a new paradigm for the evaluation of adhesive materials.

In addition to the shear test, another groundbreaking development was the introduction of the Toast Butter test. This test, although seemingly simple, has profound implications. It presents an efficient way to assess the efficacy of additives in adhesive formulations, requiring significantly fewer materials than standard tests. This economy of scale is particularly advantageous when dealing with high-cost polymers or other expensive materials that are often used in small quantities in research and development stages. The Toast Butter test serves as an effective screening tool, enabling a quick yet insightful evaluation of how various additives impact the adhesive system. Unlike conventional methods, this test allows for the assessment of an additive's effectiveness in isolation, using just the additive and matrix, without requiring the full formulation. This innovative approach provides an unprecedented level of granularity in understanding the role of each component in the adhesive system.

By revolutionizing the assessment methodologies, both through the shear test and the Toast Butter test, this research has substantially advanced the toolset available for the study and development of clayey adhesives. These methodological contributions serve as a robust platform for future studies, potentially transforming the way researchers and industry professionals approach adhesive evaluation and formulation.

VI.1.2. Reinforcement of clayey adhesive by additives

In the quest to augment the mechanical strength of clayey adhesives, a multi-faceted approach was adopted, exploring the potentials of various additives. A noteworthy example was the use of Redispersible Polymer Powder (RDP), which is primarily composed of Ethylene Vinyl Acetate. Another significant additive was Hydrophobic Wax (HYDROWAX (HWX)), designed to impart water-resistant properties to the adhesive formulation. Initial results in a dry state were promising for both of these additives, registering a noticeable enhancement in the adhesive's shear strength.

However, this optimism was short-lived when these modified adhesives were subjected to water immersion tests. Despite their initial promise in bolstering mechanical strength under dry conditions, both RDP and HYDROWAX (HWX) exhibited significant vulnerabilities when exposed to moisture. The shear strength, which had shown encouraging signs of improvement in a dry environment, dramatically plummeted upon water immersion. This susceptibility to water indicated a critical shortcoming in these otherwise promising additives, rendering our first strategy ineffective for achieving the desired water-resistant properties.

In addition to RDP and HYDROWAX (HWX), a range of other additives were also scrutinized for their potential efficacy. These included Floset (a Polycarboxylate Polymer), Ludos (comprising nanoparticles), Tannin (combined with either iron chloride or iron oxide), Tetraethyl Orthosilicate (TEOS), Starch (specifically, Amplopectin), and cellulose fibers. Contrary to expectations, these additives not only failed to enhance the mechanical properties of the adhesive but, in some cases, were counterproductive. They led to a decline in shear strength, further compounding the challenges in achieving the desired mechanical performance.

In summary, the first strategy, which was anchored on the introduction of various additives to improve the mechanical strength of clayey adhesives, did not yield the anticipated results. While certain additives showed potential in dry conditions, their effectiveness was severely compromised in the presence of water. Other additives proved detrimental across the board, irrespective of the environmental conditions.

VI.1.3. Challenges in Water Resistance

The journey towards crafting a clayey adhesive that embodies both robust mechanical strength and resilience against water exposure has proven to be a formidable endeavor. Initial optimism was fueled by the exploration of two primary strategies: the first being the reinforcement of the adhesive matrix through the incorporation of various additives, and the second focusing on the prevention of water ingress into the adhesive material. Despite the theoretical promise of these approaches, neither proved capable of mitigating the deleterious effects of water on the adhesive's mechanical properties, necessitating a recalibration of the research trajectory.

Recognizing the limitations of the initial strategies, the research pivoted towards a more nuanced approach. A novel protocol was developed and evaluated through two distinct methods aimed at assessing the adhesive's interaction with water. The first of these methods relied on visual observation, focusing on the delineation between dry and wet zones within the adhesive matrix. However, this approach encountered limitations, particularly when the boundary between the dry and wet regions was not distinctly discernible, leading to potential inaccuracies in assessment.

The second method took a more quantitative approach, relying on the computation of the level of menisci within the adhesive matrix. This method presented a more robust and reliable assessment technique, circumventing the subjectivity associated with visual observations. It offered a standardized measure that was less reliant on visual cues, thereby making it more universally applicable.

Yet, even with these advanced assessment techniques, the secondary strategy also encountered setbacks. Both Redispersible Polymer Powder (RDP) and Hydrophobic Wax (HYDROWAX (HWX)), which initially showed promise in delaying water ingress, ultimately proved insufficient for this task. While they did slow down the penetration of water into the adhesive matrix, the delay was not extensive enough to avert the subsequent weakening of the adhesive's mechanical properties. Thus, despite the incremental advancements, the second strategy also succumbed to the challenge posed by water, underscoring the complexity of achieving a water-resistant, mechanically robust clayey adhesive.

VI.1.4. Discovery of Reversible Material

Certainly, the pivotal moment in this research journey manifested in the conceptualization, development, and empirical validation of reversible materials—adhesive formulations capable of regaining their mechanical integrity upon undergoing a re-drying process following water immersion. This discovery was no mere incremental advance; it constituted a paradigm shift in the way we understand and deploy adhesive technologies.

Incorporating additives such as Redispersible Polymer Powder (RDP) and Hydrophobic Wax (HYDROWAX (HWX)) into these reversible materials demonstrated a heretofore unattained level of resilience. Not only did these materials recover their original mechanical strength post-immersion, but they also occasionally surpassed their initial strength levels, illustrating a rare and valuable property of mechanical 'rejuvenation.' This intriguing phenomenon was meticulously evidenced through a series of shear tests, under both dry and post-immersion conditions, as delineated in Chapter 5.

Such a breakthrough has profound implications, particularly in the construction sector, where the demands for durable, resilient, and yet flexible materials are ever-increasing. The reversibility of these adhesive formulations effectively broadens the scope of their applicability, making them well-suited for environments that undergo cyclical changes in moisture levels.

Moreover, the ability to regain mechanical strength introduces a new layer of sustainability, as it potentially extends the material's lifecycle, thereby contributing to resource conservation.

In summary, the discovery of these reversible materials not only addresses a long-standing gap in the field but also opens up new vistas for research and practical applications, fundamentally redefining what adhesive technologies can achieve.

VI.2. Contributions to the Field

This research contributes to the field of construction materials and, more specifically, to the science of adhesives, in several substantial ways:

1. **Methodological Advancements:** One of the standout contributions is the innovative shear test developed specifically for clayey adhesives. This test represents a methodological leap, offering an alternative that is not only more precise but also more reflective of real-world applications compared to traditional pull-off tests. Additionally, the introduction of the Toast Butter test offers another layer of methodological richness. This test, requiring significantly smaller amounts of material, serves as a revolutionary tool for rapid screening of expensive or rare additives, thereby accelerating the iterative process of material optimization.
2. **Material Innovation:** The seminal discovery of reversible materials fundamentally alters the landscape of adhesive technologies. These materials, enhanced with specific additives, have the unprecedented ability to recover—and in some cases, exceed—their original mechanical strength upon re-drying after a water immersion cycle. This opens up new frontiers in the development of both resilient and sustainable construction materials, answering a longstanding challenge in the field.
3. **Insight into Additive Efficacy:** The research also serves as a comprehensive repository of empirical data on the performance of various additives, both traditional and advanced. This detailed evaluation not only assesses the mechanical strength under dry and wet conditions but also explores the additives' impact on water resistance and reversibility. The findings offer invaluable insights that could serve as a cornerstone for future research and industrial applications.

VI.3. Recommendations for Future Work

1. **Further Validation of Shear Test Methodology:** Given the promising initial results, there is a compelling need for extensive validation of the newly developed shear test. Future work should aim to apply this test method across a more comprehensive array of adhesive formulations and under varying environmental conditions to establish its generalizability.
2. **Integrative Testing with Toast Butter Method:** Given the reduced material requirements of the Toast Butter test, it would be beneficial to employ this test in long-term studies, potentially using it as a rapid screening tool for new additives or formulations.

3. **Material Optimization for Reversibility:** While the discovery of reversible materials constitutes a significant breakthrough, there remains an expansive scope for optimization. Future research could involve fine-tuning the current formulations and exploring the integration of novel additives to enhance both mechanical strength and reversibility. This could also include revisiting additives that were previously deemed ineffective to examine if they might play a role in optimized, multi-component systems.
4. **Scale-up Feasibility Studies:** The successful transition of these reversible materials from laboratory conditions to industrial applications is a critical next step. Future studies should address the challenges and considerations involved in scaling up the production of these materials, including cost-effectiveness, manufacturability, and compliance with industry standards.
5. **Longitudinal Performance Analysis:** Although the initial tests have been promising, the long-term performance of these reversible materials remains largely unexplored. Future investigations should focus on assessing the durability, reliability, and potential degradation mechanisms of these reversible adhesives under prolonged real-world conditions.

VI.4. Final Remarks

This research journey, undertaken in collaboration with Saint-Gobain Weber, has been both challenging and enlightening, yielding valuable insights and significant discoveries that have the potential to shape the future of construction materials. While not all strategies met with universal success, the key objectives—most notably the development of stronger, more resilient adhesives—were largely fulfilled. The groundbreaking discovery of reversible materials serves as a pinnacle achievement in this research, illustrating the transformative power of innovative scientific inquiry.

Saint-Gobain Weber's involvement not only underscores the industrial relevance of this work but also highlights its potential applicability in real-world scenarios. Given their prominence in the construction materials sector, the partnership serves as a validation of the research's significance and its prospective impact on the market.

Yet, as is the case with any scientific endeavor, this research opens the door to numerous questions, offering multiple pathways for future inquiry. Whether it's refining the newly developed shear test or optimizing the formulations of reversible materials, there is much to explore. It is the aspiration that this work, enriched by the collaborative efforts with Saint-Gobain Weber, will serve as a foundational pillar for future research aimed at realizing more robust, durable, and sustainable construction materials.

References

- [1] Z. Liu and W. Meng, “Fundamental understanding of carbonation curing and durability of carbonation-cured cement-based composites: A review,” *Journal of CO2 Utilization*, vol. 44, p. 101428, Feb. 2021, doi: 10.1016/j.jcou.2020.101428.
- [2] E. Benhelal, E. Shamsaei, and M. I. Rashid, “Challenges against CO2 abatement strategies in cement industry: A review,” *Journal of Environmental Sciences*, vol. 104, pp. 84–101, Jun. 2021, doi: 10.1016/j.jes.2020.11.020.
- [3] C.-Y. Zhang, R. Han, B. Yu, and Y.-M. Wei, “Accounting process-related CO2 emissions from global cement production under Shared Socioeconomic Pathways,” *Journal of Cleaner Production*, vol. 184, pp. 451–465, May 2018, doi: 10.1016/j.jclepro.2018.02.284.
- [4] S. Nie *et al.*, “Analysis of theoretical carbon dioxide emissions from cement production: Methodology and application,” *Journal of Cleaner Production*, vol. 334, p. 130270, Feb. 2022, doi: 10.1016/j.jclepro.2021.130270.
- [5] A. Ventura *et al.*, “Environmental Potential of Earth-Based Building Materials: Key Facts and Issues from a Life Cycle Assessment Perspective,” in *Testing and Characterisation of Earth-based Building Materials and Elements: State-of-the-Art Report of the RILEM TC 274-TCE*, A. Fabbri, J.-C. Morel, J.-E. Aubert, Q.-B. Bui, D. Gallipoli, and B. V. V. Reddy, Eds., in RILEM State-of-the-Art Reports. , Cham: Springer International Publishing, 2022, pp. 261–296. doi: 10.1007/978-3-030-83297-1_8.
- [6] G. Minke, Ed., “Introduction,” in *Building with Earth: Design and Technology of a Sustainable Architecture*, Basel: Birkhäuser, 2006, pp. 11–18. doi: 10.1007/3-7643-7873-5_1.
- [7] M. B. Ali, R. Saidur, and M. S. Hossain, “A review on emission analysis in cement industries,” *Renewable and Sustainable Energy Reviews*, vol. 15, no. 5, pp. 2252–2261, Jun. 2011, doi: 10.1016/j.rser.2011.02.014.
- [8] G. Habert, C. Billard, P. Rossi, C. Chen, and N. Roussel, “Cement production technology improvement compared to factor 4 objectives,” *Cement and Concrete Research*, vol. 40, no. 5, pp. 820–826, May 2010, doi: 10.1016/j.cemconres.2009.09.031.
- [9] “Ceramic Tile—Grouts and adhesive—Part 1: Terms, Definitions and Specifications for Adhesive.” Geneva, Switzerland, 2014. [Online]. Available: <https://www.iso.org/standard/60880.html>
- [10] V. A. Voitovich, “Cement-polymer adhesive materials,” *Polym. Sci. Ser. D*, vol. 2, no. 3, Art. no. 3, Jul. 2009, doi: 10.1134/S1995421209030137.
- [11] M. Bin Mobarak, Md. S. Hossain, M. Mahmud, and S. Ahmed, “Redispersible polymer powder modified cementitious tile adhesive as an alternative to ordinary cement-sand grout,” *Heliyon*, vol. 7, no. 11, Art. no. 11, Nov. 2021, doi: 10.1016/j.heliyon.2021.e08411.
- [12] N. Khan, N. Abas, M. S. Tahir, and G. Abbas, “Thermal Performance Study of White Cement Tiles,” 2016.
- [13] “Eurocol.” Accessed: Aug. 03, 2023. [Online]. Available: <https://www.forbo.com/eurocol/en/downloads/p54icw>
- [14] P. L. B. Chuan, “EFFECT OF SAW-DUST - SEA SHELL POWDER MIXTURE ON COMPRESSIVE STRENGTH OF CEMENT MORTAR”.

- [15] M. Stefanidou and I. Papayianni, "The role of aggregates on the structure and properties of lime mortars," *Cement and Concrete Composites*, vol. 27, no. 9–10, pp. 914–919, Oct. 2005, doi: 10.1016/j.cemconcomp.2005.05.001.
- [16] P. F. G. Banfill, "Rheological methods for assessing the flow properties of mortar and related materials," *Construction and Building Materials*, vol. 8, no. 1, pp. 43–50, Jan. 1994, doi: 10.1016/0950-0618(94)90007-8.
- [17] A. Abbas, G. Fathifazl, O. B. Isgor, A. G. Razaqpur, B. Fournier, and S. Foo, "Durability of recycled aggregate concrete designed with equivalent mortar volume method," *Cement and Concrete Composites*, vol. 31, no. 8, pp. 555–563, Sep. 2009, doi: 10.1016/j.cemconcomp.2009.02.012.
- [18] M. Tate, "THE MOST IMPORTANT PROPERTY OF CEMENT-LIME MORTAR IN MASONRY CONSTRUCTION IS".
- [19] H. Zhao, Q. Xiao, D. Huang, and S. Zhang, "Influence of Pore Structure on Compressive Strength of Cement Mortar," *The Scientific World Journal*, vol. 2014, pp. 1–12, 2014, doi: 10.1155/2014/247058.
- [20] M. S. M. Al-kahtani, H. Zhu, Y. E. Ibrahim, and S. I. Haruna, "Experimental study on the strength and durability-related properties of ordinary Portland and rapid hardening Portland cement mortar containing polyurethane binder," *Case Studies in Construction Materials*, vol. 17, p. e01530, Dec. 2022, doi: 10.1016/j.cscm.2022.e01530.
- [21] "Chapter 28 - Mortars and grouts".
- [22] "Essential Improvements in Gypsum Mortar Characteristics," *IJE*, vol. 34, no. 2, Feb. 2021, doi: 10.5829/ije.2021.34.02b.03.
- [23] Rr. M. I. R. Susilorini *et al.*, "The Advantage of Natural Polymer Modified Mortar with Seaweed: Green Construction Material Innovation for Sustainable Concrete," *Procedia Engineering*, vol. 95, pp. 419–425, 2014, doi: 10.1016/j.proeng.2014.12.201.
- [24] M. Arandigoyen and J. I. Alvarez, "Pore structure and mechanical properties of cement–lime mortars," *Cement and Concrete Research*, vol. 37, no. 5, pp. 767–775, May 2007, doi: 10.1016/j.cemconres.2007.02.023.
- [25] "Tiles wale: What is tile adhesive." Accessed: Aug. 03, 2023. [Online]. Available: <https://tileswale.com/blog-detail/tile-adhesive-an-ultimate-guide>
- [26] "My klatcrete: What is the tile adhesive."
- [27] Y.-K. Jo, "Adhesion in tension of polymer cement mortar by curing conditions using polymer dispersions as cement modifier," *Construction and Building Materials*, vol. 242, p. 118134, May 2020, doi: 10.1016/j.conbuildmat.2020.118134.
- [28] "Derek Song. Tile Adhesive Vs Mortar - Can I Use Tile Adhesive Instead Of Mortar To Lay Tiles. June 7, 2021."
- [29] F. Bergaya, Ed., *Handbook of clay science*, 1. ed., Reprint. in *Developments in clay science*, no. 1. Amsterdam Heidelberg: Elsevier, 2008.
- [30] I. C. Bourg and J. B. Ajo-Franklin, "Clay, Water, and Salt: Controls on the Permeability of Fine-Grained Sedimentary Rocks," *Acc. Chem. Res.*, vol. 50, no. 9, Art. no. 9, Sep. 2017, doi: 10.1021/acs.accounts.7b00261.
- [31] B. Velde, "Composition and Mineralogy of Clay Minerals," in *Origin and Mineralogy of Clays*, B. Velde, Ed., Berlin, Heidelberg: Springer Berlin Heidelberg, 1995, pp. 8–42. doi: 10.1007/978-3-662-12648-6_2.
- [32] N. Kumari and C. Mohan, "Basics of Clay Minerals and Their Characteristic Properties," in *Clay and Clay Minerals*, G. Morari Do Nascimento, Ed., IntechOpen, 2021. doi: 10.5772/intechopen.97672.
- [33] F. A. Andrade, H. A. Al-Qureshi, and D. Hotza, "Measuring the plasticity of clays: A review," *Applied Clay Science*, vol. 51, no. 1–2, Art. no. 1–2, Jan. 2011, doi: 10.1016/j.clay.2010.10.028.

- [34] C. F. Chiu and C. W. W. Ng, "Relationships between chemical weathering indices and physical and mechanical properties of decomposed granite," *Engineering Geology*, vol. 179, pp. 76–89, Sep. 2014, doi: 10.1016/j.enggeo.2014.06.021.
- [35] H. H. Murray, "Chapter 2 Structure and Composition of the Clay Minerals and their Physical and Chemical Properties," in *Developments in Clay Science*, vol. 2, Elsevier, 2006, pp. 7–31. doi: 10.1016/S1572-4352(06)02002-2.
- [36] M. J. Dumbleton and G. West, "Some factors affecting the relation between the clay minerals in soils and their plasticity," *Clay miner.*, vol. 6, no. 3, Art. no. 3, Jul. 1966, doi: 10.1180/claymin.1966.006.3.05.
- [37] X.-Y. Shang, K. Zhao, W.-X. Qian, Q.-Y. Zhu, and G.-Q. Zhou, "On the Calculation of Van der Waals Force between Clay Particles," *Minerals*, vol. 10, no. 11, Art. no. 11, Nov. 2020, doi: 10.3390/min10110993.
- [38] A. Anandarajah and J. Chen, "Van Der Waals Attractive Force Between Clay Particles in Water and Contaminants," *Soils and Foundations*, vol. 37, no. 2, Art. no. 2, Jun. 1997, doi: 10.3208/sandf.37.2_27.
- [39] M. Dijkstra, J. P. Hansen, and P. A. Madden, "Gelation of a Clay Colloid Suspension," *Phys. Rev. Lett.*, vol. 75, no. 11, Art. no. 11, Sep. 1995, doi: 10.1103/PhysRevLett.75.2236.
- [40] J. D. Mangadlao, K. J. Lim, C. Danda, M. L. Dalida, and R. C. Advincula, "House of Cards Nanostructuring of Graphene Oxide and Montmorillonite Clay for Oil-Water Separation," *Macromol. Mater. Eng.*, vol. 303, no. 1, Art. no. 1, Jan. 2018, doi: 10.1002/mame.201700314.
- [41] "Clays and Glazes.pdf."
- [42] F. Min, C. Peng, and S. Song, "Hydration Layers on Clay Mineral Surfaces in Aqueous Solutions: a Review/Warstwy Uwodnione Na Powierzchni Mineralów Ilastycznych W Roztworach Wodnych: Przegląd," *Archives of Mining Sciences*, vol. 59, no. 2, Art. no. 2, Jun. 2014, doi: 10.2478/amsc-2014-0035.
- [43] E. J. M. Hensen and B. Smit, "Why Clays Swell," *J. Phys. Chem. B*, vol. 106, no. 49, Art. no. 49, Dec. 2002, doi: 10.1021/jp0264883.
- [44] R. L. Anderson, I. Ratcliffe, H. C. Greenwell, P. A. Williams, S. Cliffe, and P. V. Coveney, "Clay swelling — A challenge in the oilfield," *Earth-Science Reviews*, vol. 98, no. 3–4, Art. no. 3–4, Feb. 2010, doi: 10.1016/j.earscirev.2009.11.003.
- [45] G. E. Christidis, A. E. Blum, and D. D. Eberl, "Influence of layer charge and charge distribution of smectites on the flow behaviour and swelling of bentonites," *Applied Clay Science*, vol. 34, no. 1–4, Art. no. 1–4, Oct. 2006, doi: 10.1016/j.clay.2006.05.008.
- [46] K. Norrish, "The swelling of montmorillonite," *Discuss. Faraday Soc.*, vol. 18, p. 120, 1954, doi: 10.1039/df9541800120.
- [47] D. A. Laird, "Influence of layer charge on swelling of smectites," *Applied Clay Science*, vol. 34, no. 1–4, Art. no. 1–4, Oct. 2006, doi: 10.1016/j.clay.2006.01.009.
- [48] M. Makaremi, K. D. Jordan, G. D. Guthrie, and E. M. Myshakin, "Multiphase Monte Carlo and Molecular Dynamics Simulations of Water and CO₂ Intercalation in Montmorillonite and Beidellite," *J. Phys. Chem. C*, vol. 119, no. 27, Art. no. 27, Jul. 2015, doi: 10.1021/acs.jpcc.5b01754.
- [49] S. J. Abbey, E. U. Eyo, and S. Ng'ambi, "Swell and microstructural characteristics of high-plasticity clay blended with cement," *Bull Eng Geol Environ*, vol. 79, no. 4, Art. no. 4, May 2020, doi: 10.1007/s10064-019-01621-z.
- [50] C. Cherian and D. N. Arnepalli, "A Critical Appraisal of the Role of Clay Mineralogy in Lime Stabilization," *Int. J. of Geosynth. and Ground Eng.*, vol. 1, no. 1, p. 8, Mar. 2015, doi: 10.1007/s40891-015-0009-3.

- [51] H.-Y. Hwang, Y.-H. Kwon, S.-G. Hong, and S.-H. Kang, “Comparative study of effects of natural organic additives and cellulose ether on properties of lime-clay mortars,” *Journal of Building Engineering*, vol. 48, p. 103972, May 2022, doi: 10.1016/j.jobe.2021.103972.
- [52] L. Lei and J. Plank, “A study on the impact of different clay minerals on the dispersing force of conventional and modified vinyl ether based polycarboxylate superplasticizers,” *Cement and Concrete Research*, vol. 60, pp. 1–10, Jun. 2014, doi: 10.1016/j.cemconres.2014.02.009.
- [53] K. G. Bhattacharyya and S. Sen Gupta, “Adsorption of Chromium(VI) from Water by Clays,” *Ind. Eng. Chem. Res.*, vol. 45, no. 21, Art. no. 21, Oct. 2006, doi: 10.1021/ie060586j.
- [54] C. Peng, F. Min, L. Liu, and J. Chen, “A periodic DFT study of adsorption of water on sodium-montmorillonite (001) basal and (010) edge surface,” *Applied Surface Science*, vol. 387, pp. 308–316, Nov. 2016, doi: 10.1016/j.apsusc.2016.06.079.
- [55] C. Tournassat, I. C. Bourg, C. I. Steefel, and F. Bergaya, “Surface Properties of Clay Minerals,” in *Developments in Clay Science*, vol. 6, Elsevier, 2015, pp. 5–31. doi: 10.1016/B978-0-08-100027-4.00001-2.
- [56] K. M. Dontsova, L. D. Norton, C. T. Johnston, and J. M. Bigham, “Influence of Exchangeable Cations on Water Adsorption by Soil Clays,” *Soil Sci. Soc. Am. j.*, vol. 68, no. 4, Art. no. 4, Jul. 2004, doi: 10.2136/sssaj2004.1218.
- [57] M. Tuller and D. Or, “Water films and scaling of soil characteristic curves at low water contents: SCALING OF CHARACTERISTIC CURVES,” *Water Resour. Res.*, vol. 41, no. 9, Art. no. 9, Sep. 2005, doi: 10.1029/2005WR004142.
- [58] S. Kawai *et al.*, “Van der Waals interactions and the limits of isolated atom models at interfaces,” *Nat Commun*, vol. 7, no. 1, Art. no. 1, May 2016, doi: 10.1038/ncomms11559.
- [59] F. Salles *et al.*, “Hydration sequence of swelling clays: Evolutions of specific surface area and hydration energy,” *Journal of Colloid and Interface Science*, vol. 333, no. 2, Art. no. 2, May 2009, doi: 10.1016/j.jcis.2009.02.018.
- [60] M. Maček, A. Mauko, A. Mladenovič, B. Majes, and A. Petkovšek, “A comparison of methods used to characterize the soil specific surface area of clays,” *Applied Clay Science*, vol. 83–84, pp. 144–152, Oct. 2013, doi: 10.1016/j.clay.2013.08.026.
- [61] Y. Yukselen-Aksoy and A. Kaya, “Method dependency of relationships between specific surface area and soil physicochemical properties,” *Applied Clay Science*, vol. 50, no. 2, Art. no. 2, Oct. 2010, doi: 10.1016/j.clay.2010.07.020.
- [62] U. Kuila and M. Prasad, “Specific surface area and pore-size distribution in clays and shales: *Specific surface area and pore-size distribution in clays and shales*,” *Geophysical Prospecting*, vol. 61, no. 2, Art. no. 2, Mar. 2013, doi: 10.1111/1365-2478.12028.
- [63] I. Mohammed, D. Al Shehri, M. Mahmoud, M. S. Kamal, and O. S. Alade, “A Surface Charge Approach to Investigating the Influence of Oil Contacting Clay Minerals on Wettability Alteration,” *ACS Omega*, vol. 6, no. 19, pp. 12841–12852, May 2021, doi: 10.1021/acsomega.1c01221.
- [64] H. Li, B. J. Teppen, D. A. Laird, C. T. Johnston, and S. A. Boyd, “Effects of Increasing Potassium Chloride and Calcium Chloride Ionic Strength on Pesticide Sorption by Potassium- and Calcium-Smectite,” *Soil Sci. Soc. Am. J.*, vol. 70, no. 6, Art. no. 6, Nov. 2006, doi: 10.2136/sssaj2005.0392.
- [65] A. A. Adeyemo, I. O. Adeoye, and O. S. Bello, “Adsorption of dyes using different types of clay: a review,” *Appl Water Sci*, vol. 7, no. 2, Art. no. 2, May 2017, doi: 10.1007/s13201-015-0322-y.

- [66] B. Akinwunmi, L. Sun, J. T. Hirvi, S. Kasa, and T. A. Pakkanen, "Influence of temperature on the swelling pressure of bentonite clay," *Chemical Physics*, vol. 516, pp. 177–181, Jan. 2019, doi: 10.1016/j.chemphys.2018.09.009.
- [67] D. Ewis, M. M. Ba-Abbad, A. Benamor, and M. H. El-Naas, "Adsorption of organic water pollutants by clays and clay minerals composites: A comprehensive review," *Applied Clay Science*, vol. 229, p. 106686, Nov. 2022, doi: 10.1016/j.clay.2022.106686.
- [68] G. G. Haciosmanoğlu, C. Mejías, J. Martín, J. L. Santos, I. Aparicio, and E. Alonso, "Antibiotic adsorption by natural and modified clay minerals as designer adsorbents for wastewater treatment: A comprehensive review," *Journal of Environmental Management*, vol. 317, p. 115397, Sep. 2022, doi: 10.1016/j.jenvman.2022.115397.
- [69] P. O. Oladoye, "Natural, low-cost adsorbents for toxic Pb(II) ion sequestration from (waste)water: A state-of-the-art review," *Chemosphere*, vol. 287, p. 132130, Jan. 2022, doi: 10.1016/j.chemosphere.2021.132130.
- [70] D. B. França *et al.*, "The versatility of montmorillonite in water remediation using adsorption: Current studies and challenges in drug removal," *Journal of Environmental Chemical Engineering*, vol. 10, no. 2, p. 107341, Apr. 2022, doi: 10.1016/j.jece.2022.107341.
- [71] N. Subramanian and L. Nielsen Lammers, "Thermodynamics of ion exchange coupled with swelling reactions in hydrated clay minerals," *Journal of Colloid and Interface Science*, vol. 608, pp. 692–701, Feb. 2022, doi: 10.1016/j.jcis.2021.09.106.
- [72] Ö. Tekinalp, P. Zimmermann, S. Holdcroft, O. S. Burheim, and L. Deng, "Cation Exchange Membranes and Process Optimizations in Electrodialysis for Selective Metal Separation: A Review," *Membranes*, vol. 13, no. 6, p. 566, May 2023, doi: 10.3390/membranes13060566.
- [73] T. M. Khoi *et al.*, "Selective and continuous ion recovery using flow electrode capacitive deionization with polymer multilayers functionalized ion exchange membrane," *Desalination*, vol. 558, p. 116626, Jul. 2023, doi: 10.1016/j.desal.2023.116626.
- [74] H. Song and I. Choi, "Unveiling the adsorption mechanism of organic foulants on anion exchange membrane in reverse electrodialysis using electrochemical methods," *J Appl Electrochem*, vol. 53, no. 5, pp. 1043–1056, May 2023, doi: 10.1007/s10800-022-01816-5.
- [75] T. Puntervold *et al.*, "Role of Kaolinite Clay Minerals in Enhanced Oil Recovery by Low Salinity Water Injection," *Energy Fuels*, vol. 32, no. 7, pp. 7374–7382, Jul. 2018, doi: 10.1021/acs.energyfuels.8b00790.
- [76] "Characterization and applications of ion-exchange membranes.pdf."
- [77] H. Wan *et al.*, "anion-exchange brushes and role of water chemistry".
- [78] T. A. Pham and M. Sutman, "A Simplified Method for Bearing-Capacity Analysis of Energy Piles Integrating Temperature-Dependent Model of Soil–Water Characteristic Curve," *J. Geotech. Geoenviron. Eng.*, vol. 149, no. 9, p. 04023080, Sep. 2023, doi: 10.1061/JGGEFK.GTENG-11095.
- [79] J. Jia, D. Wu, J. Lin, and X. Jiang, "Molecular dynamics simulation of illite: From particle associations to hydration properties," *Applied Clay Science*, vol. 234, p. 106850, Mar. 2023, doi: 10.1016/j.clay.2023.106850.
- [80] W. L. Chen, R. C. Grabowski, and S. Goel, "Clay Swelling: Role of Cations in Stabilizing/Destabilizing Mechanisms," *ACS Omega*, vol. 7, no. 4, Art. no. 4, Feb. 2022, doi: 10.1021/acsomega.1c04384.
- [81] N. B. Singh, "Clays and Clay Minerals in the Construction Industry," *Minerals*, vol. 12, no. 3, Art. no. 3, Feb. 2022, doi: 10.3390/min12030301.

- [82] J. Ren, X. Liu, M. Niu, and Z. Yin, "Effect of sodium montmorillonite clay on the kinetics of CH₄ hydrate - implication for energy recovery," *Chemical Engineering Journal*, vol. 437, p. 135368, Jun. 2022, doi: 10.1016/j.cej.2022.135368.
- [83] Y. Wang *et al.*, "Nanoscale chemomechanical variations of montmorillonite induced by the specificity of counterions—An in situ XRD and AFM study," *Applied Clay Science*, vol. 232, p. 106760, Feb. 2023, doi: 10.1016/j.clay.2022.106760.
- [84] P. A. Benavides, J. Kowalik, S. Guggenheim, and A. F. Koster Van Groos, "Effect of CO₂ pressure, temperature, and brine composition on the interlayer spacing of Na-rich and K-exchanged montmorillonite," *Applied Clay Science*, vol. 198, p. 105819, Nov. 2020, doi: 10.1016/j.clay.2020.105819.
- [85] H. G. Şahin, Ö. Biricik, and A. Mardani-Aghabaglou, "Polycarboxylate-based water reducing admixture – clay compatibility; literature review," *J Polym Res*, vol. 29, no. 1, Art. no. 1, Jan. 2022, doi: 10.1007/s10965-021-02884-5.
- [86] S. Barakan and V. Aghazadeh, "The advantages of clay mineral modification methods for enhancing adsorption efficiency in wastewater treatment: a review," *Environ Sci Pollut Res*, vol. 28, no. 3, Art. no. 3, Jan. 2021, doi: 10.1007/s11356-020-10985-9.
- [87] J. Li, X. Li, K. Wu, D. Feng, T. Zhang, and Y. Zhang, "Thickness and stability of water film confined inside nanoslits and nanocapillaries of shale and clay," *International Journal of Coal Geology*, vol. 179, pp. 253–268, Jun. 2017, doi: 10.1016/j.coal.2017.06.008.
- [88] Y. Ma *et al.*, "Research progress on polycarboxylate based superplasticizers with tolerance to clays - A review," *Construction and Building Materials*, vol. 255, p. 119386, Sep. 2020, doi: 10.1016/j.conbuildmat.2020.119386.
- [89] K. Klumpp, C. Marcolli, A. Alonso-Hellweg, C. H. Dreimol, and T. Peter, "Comparing the ice nucleation properties of the kaolin minerals kaolinite and halloysite," *Atmos. Chem. Phys.*, vol. 23, no. 2, Art. no. 2, Jan. 2023, doi: 10.5194/acp-23-1579-2023.
- [90] M. Kostić *et al.*, "Effect of montmorillonite activation method on formaldehyde content in urea-formaldehyde composites," *International Journal of Adhesion and Adhesives*, vol. 124, p. 103390, May 2023, doi: 10.1016/j.ijadhadh.2023.103390.
- [91] A. Khaldoun *et al.*, "Influence of heavy metals adsorption on the surface-energy properties of fluorinated montmorillonite clays 'Rassoul,'" *Colloids and Surfaces A: Physicochemical and Engineering Aspects*, vol. 290, no. 1–3, pp. 1–6, Nov. 2006, doi: 10.1016/j.colsurfa.2006.04.033.
- [92] C. M. Tenney and R. T. Cygan, "Molecular Simulation of Carbon Dioxide, Brine, and Clay Mineral Interactions and Determination of Contact Angles," *Environ. Sci. Technol.*, vol. 48, no. 3, pp. 2035–2042, Feb. 2014, doi: 10.1021/es404075k.
- [93] B. Pan, C. Gong, X. Wang, Y. Li, and S. Iglauer, "The interfacial properties of clay-coated quartz at reservoir conditions," *Fuel*, vol. 262, p. 116461, Feb. 2020, doi: 10.1016/j.fuel.2019.116461.
- [94] A. Goswami, S. C. Pillai, and G. McGranaghan, "Surface modifications to enhance dropwise condensation," *Surfaces and Interfaces*, vol. 25, p. 101143, Aug. 2021, doi: 10.1016/j.surfin.2021.101143.
- [95] S. Ebnesajjad, "Surface Tension and Its Measurement," in *Handbook of Adhesives and Surface Preparation*, Elsevier, 2011, pp. 21–30. doi: 10.1016/B978-1-4377-4461-3.10003-3.
- [96] M. E. Schrader, "Wettability of Clay Minerals," *Journal of Colloid and Interface Science*, vol. 136, no. 1, 1990.
- [97] G. Garfi, C. M. John, Q. Lin, S. Berg, and S. Krevor, "Fluid Surface Coverage Showing the Controls of Rock Mineralogy on the Wetting State," *Geophys. Res. Lett.*, vol. 47, no. 8, Apr. 2020, doi: 10.1029/2019GL086380.

- [98] A. Borysenko *et al.*, “Experimental investigations of the wettability of clays and shales,” *J. Geophys. Res.*, vol. 114, no. B7, p. B07202, Jul. 2009, doi: 10.1029/2008JB005928.
- [99] Y. Rudich, I. Benjamin, R. Naaman, E. Thomas, S. Trakhtenberg, and R. Ussyshkin, “Wetting of Hydrophobic Organic Surfaces and Its Implications to Organic Aerosols in the Atmosphere,” *J. Phys. Chem. A*, vol. 104, no. 22, pp. 5238–5245, Jun. 2000, doi: 10.1021/jp994203p.
- [100] J.-W. Jung and J. Wan, “Supercritical CO₂ and Ionic Strength Effects on Wettability of Silica Surfaces: Equilibrium Contact Angle Measurements,” *Energy Fuels*, vol. 26, no. 9, pp. 6053–6059, Sep. 2012, doi: 10.1021/ef300913t.
- [101] E. V. Lebedeva and A. Fogden, “Wettability alteration of kaolinite exposed to crude oil in salt solutions,” *Colloids and Surfaces A: Physicochemical and Engineering Aspects*, vol. 377, no. 1–3, pp. 115–122, Mar. 2011, doi: 10.1016/j.colsurfa.2010.12.051.
- [102] P. M. Amarasinghe and A. Anandarajah, “Influence of fabric variables on clay–water–air capillary meniscus,” *Can. Geotech. J.*, vol. 48, no. 7, Art. no. 7, Jul. 2011, doi: 10.1139/t11-018.
- [103] S. D. N. LOURENÇO, D. Gallipoli, C. E. Augarde, D. G. Toll, P. C. Fisher, and A. Congreve, “Formation and evolution of water menisci in unsaturated granular media,” *Géotechnique*, vol. 62, no. 3, Art. no. 3, Mar. 2012, doi: 10.1680/geot.11.P.034.
- [104] E. Santiso, C. Herdes, and E. Müller, “On the Calculation of Solid-Fluid Contact Angles from Molecular Dynamics,” *Entropy*, vol. 15, no. 12, Art. no. 12, Sep. 2013, doi: 10.3390/e15093734.
- [105] X. Song and Z. Zhang, “Determination of clay-water contact angle via molecular dynamics and deep-learning enhanced methods,” *Acta Geotech.*, vol. 17, no. 2, Art. no. 2, Feb. 2022, doi: 10.1007/s11440-021-01238-1.
- [106] C. J. Van Oss, “The Hydrophilicity and Hydrophobicity of Clay Minerals,” *Clays and Clay Minerals*, vol. 43, no. 4, Art. no. 4, 1995, doi: 10.1346/CCMN.1995.0430411.
- [107] B. Athukorallage and R. Iyer, “Investigation of energy dissipation due to contact angle hysteresis in capillary effect,” *J. Phys.: Conf. Ser.*, vol. 727, p. 012003, Jun. 2016, doi: 10.1088/1742-6596/727/1/012003.
- [108] X. Song and M. Wang, “Molecular dynamics modeling of a partially saturated clay-water system at finite temperature,” *Int J Numer Anal Methods Geomech*, vol. 43, no. 13, Art. no. 13, Sep. 2019, doi: 10.1002/nag.2944.
- [109] P. M. Amarasinghe, A. Anandarajah, and P. Ghosh, “Molecular dynamic study of capillary forces on clay particles,” *Applied Clay Science*, vol. 88–89, pp. 170–177, Feb. 2014, doi: 10.1016/j.clay.2013.12.022.
- [110] J. R. Maranha, C. Pereira, and R. Cardoso, “Effective stress in unsaturated soils: Lessons from capillarity in regular sphere arrangements,” *Geomechanics for Energy and the Environment*, vol. 32, p. 100341, Dec. 2022, doi: 10.1016/j.gete.2022.100341.
- [111] T. A. Pham, M. Sutman, and G. M. Medero, “Validation, Reliability, and Performance of Shear Strength Models for Unsaturated Soils,” *Geotech Geol Eng*, Jul. 2023, doi: 10.1007/s10706-023-02520-7.
- [112] N. Lu and W. J. Likos, “Suction Stress Characteristic Curve for Unsaturated Soil,” *J. Geotech. Geoenviron. Eng.*, vol. 132, no. 2, pp. 131–142, Feb. 2006, doi: 10.1061/(ASCE)1090-0241(2006)132:2(131).
- [113] S. Luo, N. Lu, C. Zhang, and W. Likos, “Soil water potential: A historical perspective and recent breakthroughs,” *Vadose Zone Journal*, vol. 21, no. 4, Jul. 2022, doi: 10.1002/vzj2.20203.

- [114] K. Bencheikh and S. Messast, “The Influence of Particle Separation Distance on the Behavior of Unsaturated Soils,” *Geotech Geol Eng*, vol. 41, no. 2, pp. 1353–1370, Mar. 2023, doi: 10.1007/s10706-022-02340-1.
- [115] S. Gruener, H. E. Hermes, B. Schillinger, S. U. Egelhaaf, and P. Huber, “Capillary rise dynamics of liquid hydrocarbons in mesoporous silica as explored by gravimetry, optical and neutron imaging: Nano-rheology and determination of pore size distributions from the shape of imbibition fronts,” *Colloids and Surfaces A: Physicochemical and Engineering Aspects*, vol. 496, pp. 13–27, May 2016, doi: 10.1016/j.colsurfa.2015.09.055.
- [116] F. A. L. Dullien, M. S. El-Sayed, and V. K. Batra, “Rate of capillary rise in porous media with nonuniform pores,” *Journal of Colloid and Interface Science*, vol. 60, no. 3, pp. 497–506, Jul. 1977, doi: 10.1016/0021-9797(77)90314-9.
- [117] T. Dang-Vu and J. Hupka, “CHARACTERIZATION OF POROUS MATERIALS BY CAPILLARY RISE METHOD”.
- [118] A. Cramer, P. Benard, M. Zarebanadkouki, A. Kaestner, and A. Carminati, “Microplastic induces soil water repellency and limits capillary flow,” *Vadose Zone Journal*, vol. 22, no. 1, Jan. 2023, doi: 10.1002/vzj2.20215.
- [119] S. Wen, W.-C. Cheng, D. Li, and W. Hu, “Evaluating gas breakthrough pressure and gas permeability in a landfill cover layer for mitigation of hazardous gas emissions,” *Journal of Environmental Management*, vol. 336, p. 117617, Jun. 2023, doi: 10.1016/j.jenvman.2023.117617.
- [120] A. R. Erdogan *et al.*, “Swelling of compacted bentonite in organic solvents: Correlation of rate and extent of swelling with solvent properties,” *Applied Clay Science*, vol. 241, p. 107000, Sep. 2023, doi: 10.1016/j.clay.2023.107000.
- [121] X. Li, H. Feng, Y. Xing, Q. Chang, and J. Zhang, “Capillary suction under unsaturated condition drives strong specific affinity of ions at the surface of clay mineral,” *Journal of Colloid and Interface Science*, vol. 644, pp. 73–80, Aug. 2023, doi: 10.1016/j.jcis.2023.04.065.
- [122] J. Ren, S. Zeng, D. Chen, M. Yang, P. Linga, and Z. Yin, “Roles of montmorillonite clay on the kinetics and morphology of CO₂ hydrate in hydrate-based CO₂ sequestration,” *Applied Energy*, vol. 340, p. 120997, Jun. 2023, doi: 10.1016/j.apenergy.2023.120997.
- [123] A. Cramer *et al.*, “Ferrihydrite coating reduces microplastic induced soil water repellency,” *Environ. Sci.: Processes Impacts*, vol. 25, no. 6, pp. 1094–1101, 2023, doi: 10.1039/D3EM00077J.
- [124] K. Huang *et al.*, “Relationship between capillary water absorption mechanism and pore structure and microfracture of red-layer mudstone in central Sichuan,” *Bull Eng Geol Environ*, vol. 82, no. 4, p. 100, Apr. 2023, doi: 10.1007/s10064-023-03115-5.
- [125] “EN 12004-1:2017 - Adhesives for ceramic tiles - Part 1: Requirements, assessment and verification of constancy of performance, classification and marking,” iTeh Standards. Accessed: Sep. 28, 2023. [Online]. Available: <https://standards.iteh.ai/catalog/standards/cen/48998e72-43b4-4ab9-9385-a9399c2c4689/en-12004-1-2017>
- [126] J. K. Felixberger, “Polymer-modified Thin-Bed Tile Adhesive, Inst. Promocio Ceram,” *Castell o Spain*, 2008.
- [127] “Adhesives for Ceramic Tiles—Part 1: Requirements, Assessment, and Verification of Constancy of Performance; Classification, and Marking.” Brussels, Belgium, 2017. [Online]. Available: <https://standards.iteh.ai/catalog/standards/cen/48998e72-43b4-4ab9-9385-a9399c2c4689/en-12004-1-2017>

- [128] R. Zurauskiene and L. Navickiene, “Foam Glass Granule Usage in Tile Glue Mixtures That Use a Reduced Portland Cement Amount,” *Materials*, vol. 16, no. 3, p. 1269, Feb. 2023, doi: 10.3390/ma16031269.
- [129] D. Huang, O. Pons, and A. Albareda, “Bond Strength Tests under Pure Shear and Tension between Masonry and Sprayed Mortar,” *Materials*, vol. 13, no. 9, p. 2183, May 2020, doi: 10.3390/ma13092183.
- [130] “EN 1465 Adhesives Lap Shear Bond Strength of Rigid-to-Rigid Assemblies.” Accessed: Sep. 27, 2023. [Online]. Available: <https://www.instron.com/fr-fr/testing-solutions/other-standards/en-1465>
- [131] R. Alexander, “Adhesive Failures Types - Lawrence Pennsylvania | Tom Brown Inc,” Tom Brown Inc. Accessed: Sep. 27, 2023. [Online]. Available: <https://tombrowninc.com/blog/understanding-adhesive-failures/>
- [132] J. G. Quini and G. Marinucci, “Polyurethane structural adhesives applied in automotive composite joints,” *Mat. Res.*, vol. 15, no. 3, pp. 434–439, May 2012, doi: 10.1590/S1516-14392012005000042.
- [133] “EN 12004-2:2017 Adhesives for ceramic tiles - Part 2: Test methods.” Brussels, Belgium, 2017. [Online]. Available: <https://standards.iteh.ai/catalog/standards/cen/0199171f-0443-4924-aa63-fe644acf79fe/en-12004-2-2017>
- [134] S. Lathabai, “Joining of aluminium and its alloys,” in *Fundamentals of Aluminium Metallurgy*, Elsevier, 2011, pp. 607–654. doi: 10.1533/9780857090256.3.607.
- [135] “What is adhesion.” [Online]. Available: <https://www.brighton-science.com/what-is-adhesion>
- [136] “The Benefits of Benchmarking Surface Quality in Manufacturing.” Accessed: Sep. 01, 2023. [Online]. Available: <https://www.brighton-science.com/blog/the-benefits-of-benchmarking-surface-quality-in-manufacturing>
- [137] J. KIM, G. ZHANG, M. SHI, and Z. SUO, “Fracture, fatigue, and friction of polymers in which entanglements greatly outnumber cross-links,” *Science*, pp. 212–216, Oct. 07, 2021.
- [138] G. T. Dee and B. B. Sauer, “The surface tension of polymer liquids,” *Advances in Physics*, vol. 47, no. 2, pp. 161–205, Mar. 1998, doi: 10.1080/000187398243546.
- [139] C. Wang, Z. Fan, C. Li, H. Zhang, and X. Xiao, “Preparation and engineering properties of low-viscosity epoxy grouting materials modified with silicone for microcrack repair,” *Construction and Building Materials*, vol. 290, p. 123270, Jul. 2021, doi: 10.1016/j.conbuildmat.2021.123270.
- [140] S. Oprea, S. Vlad, A. Stanciu, and M. Macoveanu, “Epoxy urethane acrylate,” *European Polymer Journal*, vol. 36, no. 2, pp. 373–378, Feb. 2000, doi: 10.1016/S0014-3057(99)00077-4.
- [141] Q. Yuan, Z. Wang, H. Yao, J. Huang, S. Zuo, and H. Huang, “Comparative study of reactive diluents with different molecular structures on the curing properties of epoxy adhesives and the interface bonding properties with mortar,” *International Journal of Adhesion and Adhesives*, vol. 126, p. 103473, Aug. 2023, doi: 10.1016/j.ijadhadh.2023.103473.
- [142] L. Bacakova, E. Filova, M. Parizek, T. Ruml, and V. Svorcik, “Modulation of cell adhesion, proliferation and differentiation on materials designed for body implants,” *Biotechnology Advances*, vol. 29, no. 6, pp. 739–767, Nov. 2011, doi: 10.1016/j.biotechadv.2011.06.004.
- [143] R. Tao, L. Fatta, R. Melentiev, A. K. Tevtia, and G. Lubineau, “Contributions of chemical interactions and mechanical interlocking for the adhesion of electroplated

- copper to ABS in the Cr(VI) etching process,” *International Journal of Adhesion and Adhesives*, vol. 126, p. 103450, Aug. 2023, doi: 10.1016/j.ijadhadh.2023.103450.
- [144] S. Ahmadi and M. Eisaei, “Composition Properties and Standards for Cementitious Ceramic Tile Adhesive: A Review,” *ACERP*, vol. 9, no. 1, Art. no. 1, Mar. 2023, doi: 10.30501/acp.2023.375810.1113.
- [145] J. A. Von Fraunhofer, “Adhesion and Cohesion,” *International Journal of Dentistry*, vol. 2012, pp. 1–8, 2012, doi: 10.1155/2012/951324.
- [146] Y. Wan, W. Qiu, H. Zhu, Q. Zhang, and S. Zhu, “Engineering cohesion and adhesion through dynamic bonds for advanced adhesive materials,” *Can J Chem Eng*, vol. 101, no. 9, pp. 4941–4954, Sep. 2023, doi: 10.1002/cjce.24849.
- [147] J. Y. Boey, C. K. Lee, and G. S. Tay, “Factors Affecting Mechanical Properties of Reinforced Bioplastics: A Review,” *Polymers*, vol. 14, no. 18, Art. no. 18, Sep. 2022, doi: 10.3390/polym14183737.
- [148] M. Nasir, R. Hashim, O. Sulaiman, N. A. Nordin, J. Lamaming, and M. Asim, “Laccase, an Emerging Tool to Fabricate Green Composites: A Review,” *BioResources*, vol. 10, no. 3, Art. no. 3, Jul. 2015, doi: 10.15376/biores.10.3.Nasir.
- [149] F. Cavezza, M. Boehm, H. Terryn, and T. Hauffman, “A Review on Adhesively Bonded Aluminium Joints in the Automotive Industry,” *Metals*, vol. 10, no. 6, Art. no. 6, Jun. 2020, doi: 10.3390/met10060730.
- [150] Q. Tian, S. Wang, Y. Sui, and Z. Lv, “Alkali-activated materials as coatings deposited on various substrates: A review,” *International Journal of Adhesion and Adhesives*, vol. 110, p. 102934, Oct. 2021, doi: 10.1016/j.ijadhadh.2021.102934.
- [151] A. Marques *et al.*, “Review on Adhesives and Surface Treatments for Structural Applications: Recent Developments on Sustainability and Implementation for Metal and Composite Substrates,” *Materials*, vol. 13, no. 24, Art. no. 24, Dec. 2020, doi: 10.3390/ma13245590.
- [152] C. Cai, Z. Chen, Y. Chen, H. Li, Z. Yang, and H. Liu, “Mechanisms and applications of bioinspired underwater/wet adhesives,” *Journal of Polymer Science*, vol. 59, no. 23, Art. no. 23, Dec. 2021, doi: 10.1002/pol.20210521.
- [153] A. Bal-Ozturk *et al.*, “Tissue adhesives: From research to clinical translation,” *Nano Today*, vol. 36, p. 101049, Feb. 2021, doi: 10.1016/j.nantod.2020.101049.
- [154] U. Bobe, J. Hofmann, K. Sommer, U. Beck, and G. Reiners, “Adhesion – where cleaning starts,” *Trends in Food Science & Technology*, vol. 18, pp. S36–S39, Jan. 2007, doi: 10.1016/j.tifs.2006.10.019.
- [155] L. Chai and S. A. Tassou, “A review of printed circuit heat exchangers for helium and supercritical CO₂ Brayton cycles,” *Thermal Science and Engineering Progress*, vol. 18, p. 100543, Aug. 2020, doi: 10.1016/j.tsep.2020.100543.
- [156] S. Sikdar, M. H. Rahman, A. Siddaiah, and P. L. Menezes, “Gecko-Inspired Adhesive Mechanisms and Adhesives for Robots—A Review,” *Robotics*, vol. 11, no. 6, Art. no. 6, Dec. 2022, doi: 10.3390/robotics11060143.
- [157] J. Salustio *et al.*, “Mortar Bond Strength: A Brief Literature Review, Tests for Analysis, New Research Needs and Initial Experiments,” *Materials*, vol. 15, no. 6, Art. no. 6, Mar. 2022, doi: 10.3390/ma15062332.
- [158] Y. Chen, Z. Zhu, M. Steinhart, and S. N. Gorb, “Bio-inspired adhesion control with liquids,” *iScience*, vol. 25, no. 3, Art. no. 3, Mar. 2022, doi: 10.1016/j.isci.2022.103864.
- [159] “EN 28510-2:1993 - Adhesives - Peel test for a flexible-bonded-to-rigid test specimen assembly - Part 2: 180° peel.” England, 1993. [Online]. Available: https://global.ihs.com/doc_detail.cfm?document_name=BS%20EN%2028510%2D2&item_s_key=00213410

- [160] “EN 1465:2009 Adhesives Lap Shear Bond Strength of Rigid-to-Rigid Assemblies.” Slovakia, 2009.
- [161] “EN ISO 4624:2016 Paints and varnishes— Pull-off test for adhesion.” 2016. [Online]. Available: <https://www.boutique.afnor.org/fr-fr/norme/nf-en-iso-4624/peintures-et-verniss-essai-de-traction/fa179377/57387>
- [162] “ISO 17640:2018 Non-destructive testing of welds — Ultrasonic testing — Techniques, testing levels, and assessment.” France, 2018. [Online]. Available: <https://www.iso.org/standard/75737.html>
- [163] “EN 1348:2007 Adhesives for tiles - Determination of tensile adhesion strength for cementitious adhesives.” 2007. [Online]. Available: <https://standards.iteh.ai/catalog/standards/cen/48bc66c7-1d1d-4476-852f-d64437b1c164/en-1348-2007>
- [164] M. Bouasker, P. Mounanga, P. Turcry, A. Loukili, and A. Khelidj, “Chemical shrinkage of cement pastes and mortars at very early age: Effect of limestone filler and granular inclusions,” *Cement and Concrete Composites*, vol. 30, no. 1, pp. 13–22, Jan. 2008, doi: 10.1016/j.cemconcomp.2007.06.004.
- [165] R. Cepuritis, B. J. Wigum, E. J. Garboczi, E. Mørtzell, and S. Jacobsen, “Filler from crushed aggregate for concrete: Pore structure, specific surface, particle shape and size distribution,” *Cement and Concrete Composites*, vol. 54, pp. 2–16, Nov. 2014, doi: 10.1016/j.cemconcomp.2014.03.010.
- [166] Y. C. Chemedá, D. Deneele, G. E. Christidis, and G. Ouvrard, “Influence of hydrated lime on the surface properties and interaction of kaolinite particles,” *Applied Clay Science*, vol. 107, pp. 1–13, Apr. 2015, doi: 10.1016/j.clay.2015.01.019.
- [167] D. Hatungimana, C. Taşköprü, M. İçhedef, M. M. Saç, and Ş. Yazıcı, “Compressive strength, water absorption, water sorptivity and surface radon exhalation rate of silica fume and fly ash based mortar,” *Journal of Building Engineering*, vol. 23, pp. 369–376, May 2019, doi: 10.1016/j.job.2019.01.011.
- [168] S. Ishihara, G. Franks, and J. Kano, “Effect of particle packing structure on the elastic modulus of wet powder compacts analyzed by persistent homology,” *Advanced Powder Technology*, vol. 34, no. 1, p. 103874, Jan. 2023, doi: 10.1016/j.ap.2022.103874.
- [169] M. Ramli and A. A. Tabassi, “Mechanical behaviour of polymer-modified ferrocement under different exposure conditions: An experimental study,” *Composites Part B: Engineering*, vol. 43, no. 2, pp. 447–456, Mar. 2012, doi: 10.1016/j.compositesb.2011.11.058.
- [170] J.-Y. Petit, B. Comelli, R. Perrin, and E. Wirquin, “Effect of formulation parameters on adhesive properties of ANSI 118-15 and 118-11 compliant tile adhesive mortars,” *International Journal of Adhesion and Adhesives*, vol. 66, pp. 73–80, Apr. 2016, doi: 10.1016/j.ijadhadh.2015.12.011.
- [171] X. Yang, J. Liu, H. Li, and Q. Ren, “Performance and ITZ of pervious concrete modified by vinyl acetate and ethylene copolymer dispersible powder,” *Construction and Building Materials*, vol. 235, p. 117532, Feb. 2020, doi: 10.1016/j.conbuildmat.2019.117532.
- [172] A. M. Betioli, P. J. P. Gleize, V. M. John, and R. G. Pileggi, “Effect of EVA on the fresh properties of cement paste,” *Cement and Concrete Composites*, vol. 34, no. 2, pp. 255–260, Feb. 2012, doi: 10.1016/j.cemconcomp.2011.10.004.
- [173] E. P. Giannelis, “Polymer-layered silicate nanocomposites: Synthesis, properties and applications,” *Appl. Organometal. Chem.*, vol. 12, no. 10–11, pp. 675–680, Oct. 1998, doi: 10.1002/(SICI)1099-0739(199810/11)12:10/11<675::AID-AOC779>3.0.CO;2-V.
- [174] J. Ridnour, “What is Soil?,” TurfMasterSod-Master. Accessed: Oct. 02, 2023. [Online]. Available: <https://www.turfmastersod.com/single-post/2019/04/02/what-is-soil>

- [175] S. Mukherjee and B. Ghosh, *The science of clays: applications in industry, engineering and environment*. Dordrecht: Springer, 2013.
- [176] A. Meunier, “Why are clay minerals small?,” *Clay Miner.*, vol. 41, no. 2, pp. 551–566, Jun. 2006, doi: 10.1180/0009855064120205.
- [177] T Al Ani and O Sarapää, “Clay and clay mineralogy,” 2008. [Online]. Available: https://www.researchgate.net/publication/292706105_Clay_and_clay_mineralogy
- [178] “Clay and Clay Mineralogy.pdf.”
- [179] Nadziakiewicz, Kehoe, and Micek, “Physico-Chemical Properties of Clay Minerals and Their Use as a Health Promoting Feed Additive,” *Animals*, vol. 9, no. 10, p. 714, Sep. 2019, doi: 10.3390/ani9100714.
- [180] J. Madejová, “FTIR techniques in clay mineral studies,” *Vibrational Spectroscopy*, vol. 31, no. 1, pp. 1–10, Jan. 2003, doi: 10.1016/S0924-2031(02)00065-6.
- [181] M. F. Brigatti, E. Galán, and B. K. G. Theng, “Structure and Mineralogy of Clay Minerals,” in *Developments in Clay Science*, vol. 5, Elsevier, 2013, pp. 21–81. doi: 10.1016/B978-0-08-098258-8.00002-X.
- [182] Chen, F.H., *Foundations on Expansive Soils*, vol. 463. Amsterdam, The Netherlands: Elsevier Science Publishers, 1988.
- [183] “Kaolinite: The clay mineral kaolinite information and pictures.” Accessed: Oct. 01, 2023. [Online]. Available: <https://www.minerals.net/mineral/kaolinite.aspx>
- [184] S. Earle, “10.5 Clay Minerals”, Accessed: Oct. 01, 2023. [Online]. Available: <https://environmental-geol.pressbooks.tru.ca/chapter/clay-minerals/>
- [185] R. Anger, “Approche granulaire et colloïdale du matériau terre pour la construction”.
- [186] M. I. Carretero and M. Pozo, “Clay and non-clay minerals in the pharmaceutical industry,” *Applied Clay Science*, vol. 46, no. 1, pp. 73–80, Sep. 2009, doi: 10.1016/j.clay.2009.07.017.
- [187] Z. Cao, Q. Wang, and H. Cheng, “Recent advances in kaolinite-based material for photocatalysts,” *Chinese Chemical Letters*, vol. 32, no. 9, Art. no. 9, Sep. 2021, doi: 10.1016/j.ccllet.2021.01.009.
- [188] “KAOLIN APPLICATIONS.pdf.”
- [189] E. Gianni, K. Avgoustakis, and D. Papoulis, “Kaolinite group minerals: Applications in cancer diagnosis and treatment,” *European Journal of Pharmaceutics and Biopharmaceutics*, vol. 154, pp. 359–376, Sep. 2020, doi: 10.1016/j.ejpb.2020.07.030.
- [190] A. Seiphoori and M. Zamanian, “Improving mechanical behaviour of collapsible soils by grouting active clay nanoparticles,” *Engineering*, preprint, Oct. 2020. doi: 10.31223/X5588R.
- [191] J. Kajtna and U. Šebenik, “Microsphere pressure sensitive adhesives—acrylic polymer/montmorillonite clay nanocomposite materials,” *International Journal of Adhesion and Adhesives*, vol. 29, no. 5, pp. 543–550, Jul. 2009, doi: 10.1016/j.ijadhadh.2009.01.001.
- [192] M. R. Ayatollahi, M. M. Shokrieh, S. Shadlou, A. R. Kefayati, and M. Chitsazzadeh, “MECHANICAL AND ELECTRICAL PROPERTIES OF EPOXY/ MULTI-WALLED CARBON NANOTUBE/NANOCLAY NANOCOMPOSITES”.
- [193] M. Barmar, M. Barikani, and M. Fereidounnia, “Study of Polyurethane/Clay Nanocomposites Produced via Melt Intercalation Method”.
- [194] M. S. Lakshmi, B. Narmadha, and B. S. R. Reddy, “Enhanced thermal stability and structural characteristics of different MMT-Clay/epoxy-nanocomposite materials,” *Polymer Degradation and Stability*, vol. 93, no. 1, pp. 201–213, Jan. 2008, doi: 10.1016/j.polymdegradstab.2007.10.005.

- [195] Haydn H. Murray, "Chapter 5 Kaolin Applications," in *Developments in Clay Science: Applied Clay Mineralogy - Occurrences, Processing and Application of Kaolins, Bentonites, Palygorskite-Sepiolite, and Common Clays Volume 2*, 2006, pp. 85–109.
- [196] M. S. Prasad, K. J. Reid, and H. H. Murray, "Kaolin: processing, properties and applications," *Applied Clay Science*, vol. 6, no. 2, pp. 87–119, Sep. 1991, doi: 10.1016/0169-1317(91)90001-P.
- [197] R. I. Jeldres, E. C. Picerros, L. Wong, W. H. Leiva, N. Herrera, and P. G. Toledo, "Dynamic moduli of flocculated kaolinite sediments: effect of salinity, flocculant dose, and settling time," *Colloid Polym Sci*, vol. 296, no. 12, pp. 1935–1943, Dec. 2018, doi: 10.1007/s00396-018-4420-x.
- [198] M. Pajtašová *et al.*, "The use of illite in function of filler applied in rubber blend," *IOP Conf. Ser.: Mater. Sci. Eng.*, vol. 1199, no. 1, p. 012035, Nov. 2021, doi: 10.1088/1757-899X/1199/1/012035.
- [199] "Illite," WGNHS. Accessed: Oct. 01, 2023. [Online]. Available: <https://home.wgnhs.wisc.edu/minerals/illite/>
- [200] M. L. Jackson, "Interlayering of Expansible Layer Silicates in Soils by Chemical Weathering," *Clays and Clay Minerals*, vol. 11, no. 1, pp. 29–46, 1962, doi: 10.1346/CCMN.1962.0110104.
- [201] O. Ochieng, "Characterization and classification of clay minerals for potential applications in Rugi Ward, Kenya," *Afr. J. Environ. Sci. Technol.*, vol. 10, no. 11, pp. 415–431, Nov. 2016, doi: 10.5897/AJEST2016.2184.
- [202] J. Lee, S.-M. Park, E.-K. Jeon, and K. Baek, "Selective and irreversible adsorption mechanism of cesium on illite," *Applied Geochemistry*, vol. 85, pp. 188–193, Oct. 2017, doi: 10.1016/j.apgeochem.2017.05.019.
- [203] E. N. Njoka, O. Ombaka, J. M. Gichumbi, D. I. Kibaara, and O. M. Nderi, "Characterization of clays from Tharaka-Nithi County in Kenya for industrial and agricultural applications," *Afr. J. Environ. Sci. Technol.*, vol. 9, no. 3, pp. 228–243, Mar. 2015, doi: 10.5897/AJEST2014.1816.
- [204] V. Montoya *et al.*, "Sorptions of Sr, Co and Zn on illite: Batch experiments and modelling including Co in-diffusion measurements on compacted samples," *Geochimica et Cosmochimica Acta*, vol. 223, pp. 1–20, Feb. 2018, doi: 10.1016/j.gca.2017.11.027.
- [205] J. Yin, C. Deng, Z. Yu, X. Wang, and G. Xu, "Effective Removal of Lead Ions from Aqueous Solution Using Nano Illite/Smectite Clay: Isotherm, Kinetic, and Thermodynamic Modeling of Adsorption," *Water*, vol. 10, no. 2, p. 210, Feb. 2018, doi: 10.3390/w10020210.
- [206] "Montmorillonite," mindat.org. Accessed: Oct. 01, 2023. [Online]. Available: <https://www.mindat.org/photo-1187265.html>
- [207] M. I. Magzoub *et al.*, "Effects of sodium carbonate addition, heat and agitation on swelling and rheological behavior of Ca-bentonite colloidal dispersions," *Applied Clay Science*, vol. 147, pp. 176–183, Oct. 2017, doi: 10.1016/j.clay.2017.07.032.
- [208] J. Cui, Z. Zhang, and F. Han, "Effects of pH on the gel properties of montmorillonite, palygorskite and montmorillonite-palygorskite composite clay," *Applied Clay Science*, vol. 190, p. 105543, Jun. 2020, doi: 10.1016/j.clay.2020.105543.
- [209] T. T. Zhu, C. H. Zhou, F. B. Kabwe, Q. Q. Wu, C. S. Li, and J. R. Zhang, "Exfoliation of montmorillonite and related properties of clay/polymer nanocomposites," *Applied Clay Science*, vol. 169, pp. 48–66, Mar. 2019, doi: 10.1016/j.clay.2018.12.006.
- [210] I. Díazñez, I. Martínez, and P. Partal, "Synergistic effect of combined nanoparticles to elaborate exfoliated egg-white protein-based nanobiocomposites," *Composites Part B: Engineering*, vol. 88, pp. 36–43, Mar. 2016, doi: 10.1016/j.compositesb.2015.10.034.

- [211] G. G. Gutiérrez, “Oxydation of Clay Nanoreinforced Polyolefins”.
- [212] B. Caglar *et al.*, “Structural, thermal, morphological and surface charge properties of dodecyltrimethylammonium-smectite composites,” *Journal of Molecular Structure*, vol. 1105, pp. 70–79, Feb. 2016, doi: 10.1016/j.molstruc.2015.10.017.
- [213] Z. Gong, L. Liao, G. Lv, and X. Wang, “A simple method for physical purification of bentonite,” *Applied Clay Science*, vol. 119, pp. 294–300, Jan. 2016, doi: 10.1016/j.clay.2015.10.031.
- [214] F. Boylu, “Optimization of foundry sand characteristics of soda-activated calcium bentonite,” *Applied Clay Science*, vol. 52, no. 1–2, pp. 104–108, Apr. 2011, doi: 10.1016/j.clay.2011.02.005.
- [215] F. Bergaya and G. Lagaly, “Chapter 1 General Introduction: Clays, Clay Minerals, and Clay Science,” in *Developments in Clay Science*, vol. 1, Elsevier, 2006, pp. 1–18. doi: 10.1016/S1572-4352(05)01001-9.
- [216] G. K. Kome, R. K. Enang, F. O. Tabi, and B. P. K. Yerima, “Influence of Clay Minerals on Some Soil Fertility Attributes: A Review,” *OJSS*, vol. 09, no. 09, pp. 155–188, 2019, doi: 10.4236/ojss.2019.99010.
- [217] T. W. Lewis, P. Pivonka, and D. W. Smith, “Theoretical investigation of the effects of consolidation on contaminant transport through clay barriers,” *Int. J. Numer. Anal. Meth. Geomech.*, vol. 33, no. 1, pp. 95–116, Jan. 2009, doi: 10.1002/nag.708.
- [218] N. Ural, “The Importance of Clay in Geotechnical Engineering,” in *Current Topics in the Utilization of Clay in Industrial and Medical Applications*, M. Zoveidavianpoor, Ed., InTech, 2018. doi: 10.5772/intechopen.75817.
- [219] M. A. Mohammed Al-Bared and A. Marto, “A review on the geotechnical and engineering characteristics of marine clay and the modern methods of improvements,” *Mal. J. Fund. Appl. Sci.*, vol. 13, no. 4, pp. 825–831, Dec. 2017, doi: 10.11113/mjfas.v13n4.921.
- [220] K. Katti and D. Katti, “Effect Of Clay-Water Interactions On Swelling In Montmorillonite Clay”.
- [221] H. Chamley, “Clay Mineral Sedimentation in the Ocean,” in *Soils and Sediments*, Berlin, Heidelberg: Springer Berlin Heidelberg, 1997, pp. 269–302. doi: 10.1007/978-3-642-60525-3_13.
- [222] A. E. Smith, “Particle Size Distribution,” DCS on Turf. Accessed: Oct. 02, 2023. [Online]. Available: <https://dcsturf.wordpress.com/2019/08/22/particle-size-distribution/>
- [223] Y. Chen, J. Wei, F. Li, J. Hu, and Q. Yu, “Effect of the paste coating layer and mortar coating layer on the properties of fresh self-compacting concrete,” *Journal of Sustainable Cement-Based Materials*, vol. 4, no. 3–4, pp. 194–204, Oct. 2015, doi: 10.1080/21650373.2015.1018984.
- [224] J. P. Gonçalves, L. M. Tavares, R. D. Toledo Filho, E. M. R. Fairbairn, and E. R. Cunha, “Comparison of natural and manufactured fine aggregates in cement mortars,” *Cement and Concrete Research*, vol. 37, no. 6, pp. 924–932, Jun. 2007, doi: 10.1016/j.cemconres.2007.03.009.
- [225] Q. Ren, Y. Tao, D. Jiao, Z. Jiang, G. Ye, and G. De Schutter, “Plastic viscosity of cement mortar with manufactured sand as influenced by geometric features and particle size,” *Cement and Concrete Composites*, vol. 122, p. 104163, Sep. 2021, doi: 10.1016/j.cemconcomp.2021.104163.
- [226] L. M. Silva, R. A. Ribeiro, J. A. Labrincha, and V. M. Ferreira, “Role of lightweight fillers on the properties of a mixed-binder mortar,” *Cement and Concrete Composites*, vol. 32, no. 1, pp. 19–24, Jan. 2010, doi: 10.1016/j.cemconcomp.2009.07.003.

- [227] A. Fragata and R. Veiga, “Air Lime Mortars: The Influence of Calcareous Aggregate and Filler Addition,” *MSF*, vol. 636–637, pp. 1280–1285, Jan. 2010, doi: 10.4028/www.scientific.net/MSF.636-637.1280.
- [228] B. Benabed, E.-H. Kadri, L. Azzouz, and S. Kenai, “Properties of self-compacting mortar made with various types of sand,” *Cement and Concrete Composites*, vol. 34, no. 10, pp. 1167–1173, Nov. 2012, doi: 10.1016/j.cemconcomp.2012.07.007.
- [229] L. Berredjem, N. Arabi, and L. Molez, “Influence of recycled sand containing fillers on the rheological and mechanical properties of masonry mortars,” 2018.
- [230] K. Ramamurthy and N. Narayanan, “Influence of composition and curing on drying shrinkage of aerated concrete,” *Mat. Struct.*, vol. 33, no. 4, pp. 243–250, May 2000, doi: 10.1007/BF02479334.
- [231] F. Farshidfar and M. Ghassemi Kakroudi, “Effect of Chromite-Silica Sands Characteristics on Performance of Ladle Filler Sands for Continuous Casting,” *J. Iron Steel Res. Int.*, vol. 19, no. 3, pp. 11–13, Mar. 2012, doi: 10.1016/S1006-706X(12)60066-1.
- [232] “EN 196-1:2016 - Methods of testing cement - Part 1: Determination of strength,” iTeh Standards. Accessed: Sep. 28, 2023. [Online]. Available: <https://standards.itih.ai/catalog/standards/cen/37b8816e-4085-4dcc-a642-a383d9bddd6c/en-196-1-2016>
- [233] E. Peretomode, G. Oluyemi, and N. H. Faisal, “Sand production due to chemical-rock interaction. A review,” *Engineering Failure Analysis*, vol. 142, p. 106745, Dec. 2022, doi: 10.1016/j.engfailanal.2022.106745.
- [234] E. O. Wuyep, G. F. Oluyemi, K. Yates, and A. R. Akisanya, “Evaluation of Interactions Between Oilfield Chemicals and Reservoir Rocks,” *Nat Resour Res*, vol. 29, no. 2, pp. 1239–1258, Apr. 2020, doi: 10.1007/s11053-019-09523-3.
- [235] J. Bu, Z. Tian, S. Zheng, and Z. Tang, “Effect of sand content on strength and pore structure of cement mortar,” *J. Wuhan Univ. Technol.-Mat. Sci. Edit.*, vol. 32, no. 2, pp. 382–390, Apr. 2017, doi: 10.1007/s11595-017-1607-9.
- [236] A. Srivastava and S. K. Singh, “Utilization of alternative sand for preparation of sustainable mortar: A review,” *Journal of Cleaner Production*, vol. 253, p. 119706, Apr. 2020, doi: 10.1016/j.jclepro.2019.119706.
- [237] “Effects of Sand Content, Superplasticizer Dosage, and Mixing Time on Compressive Strength of Mortar,” *MJ*, vol. 110, no. 1, 2013, doi: 10.14359/51684363.
- [238] C. Aquino, M. Inoue, H. Miura, M. Mizuta, and T. Okamoto, “The effects of limestone aggregate on concrete properties,” *Construction and Building Materials*, vol. 24, no. 12, pp. 2363–2368, Dec. 2010, doi: 10.1016/j.conbuildmat.2010.05.008.
- [239] A. T. Souza, T. F. Barbosa, L. A. Riccio, and W. J. D. Santos, “Effect of limestone powder substitution on mechanical properties and durability of slender precast components of structural mortar,” *Journal of Materials Research and Technology*, vol. 9, no. 1, pp. 847–856, Jan. 2020, doi: 10.1016/j.jmrt.2019.11.024.
- [240] P. Šiler, I. Kolářová, J. Bednárek, M. Janča, P. Musil, and T. Opravil, “The possibilities of analysis of limestone chemical composition,” *IOP Conf. Ser.: Mater. Sci. Eng.*, vol. 379, p. 012033, Jun. 2018, doi: 10.1088/1757-899X/379/1/012033.
- [241] N. R. Rakhimova, R. Z. Rakhimov, N. I. Naumkina, A. F. Khuzin, and Y. N. Osin, “Influence of limestone content, fineness, and composition on the properties and microstructure of alkali-activated slag cement,” *Cement and Concrete Composites*, vol. 72, pp. 268–274, Sep. 2016, doi: 10.1016/j.cemconcomp.2016.06.015.
- [242] E. A. Shinn and D. M. Robbin, “Mechanical and Chemical Compaction in Fine-Grained Shallow-Water Limestones”.

- [243] J. D. Hudson, “Stable isotopes and limestone lithification,” *JGS*, vol. 133, no. 6, pp. 637–660, Aug. 1977, doi: 10.1144/gsjgs.133.6.0637.
- [244] J. Ston and K. Scrivener, “Basic creep of limestone–calcined clay cements: An experimental and numerical approach,” *Theoretical and Applied Fracture Mechanics*, vol. 103, p. 102270, Oct. 2019, doi: 10.1016/j.tafmec.2019.102270.
- [245] Z. Shi *et al.*, “Sulfate resistance of calcined clay – Limestone – Portland cements,” *Cement and Concrete Research*, vol. 116, pp. 238–251, Feb. 2019, doi: 10.1016/j.cemconres.2018.11.003.
- [246] E. Ermilova, Z. Kamalova, and R. Ravil, “Influence of clay mineral composition on properties of blended portland cement with complex additives of clays and carbonates,” *IOP Conf. Ser.: Mater. Sci. Eng.*, vol. 890, p. 012087, Aug. 2020, doi: 10.1088/1757-899X/890/1/012087.
- [247] D. P. Bentz, S. Z. Jones, and D. Lootens, “Minimizing Paste Content in Concrete Using Limestone Powders - Demonstration Mixtures,” National Institute of Standards and Technology, NIST TN 1906, Jan. 2016. doi: 10.6028/NIST.TN.1906.
- [248] A. Acharya, “Role of Additives in Mortars: Historic Precedents,” *IJERA*, vol. 7, no. 2, pp. 07–12, Mar. 2017, doi: 10.9790/9622-0702050712.
- [249] S. Wang, W. Yao, Z. Lu, S. Wang, B. Li, and B. Liu, “Characterization and durability assessment of fibre-reinforced tung oil lime putties for restoration,” *Journal of Building Engineering*, vol. 38, p. 102241, Jun. 2021, doi: 10.1016/j.jobe.2021.102241.
- [250] I. Centauro, E. Cantisani, C. Grandin, A. Salvini, and S. Vettori, “The Influence of Natural Organic Materials on the Properties of Traditional Lime-Based Mortars,” *International Journal of Architectural Heritage*, pp. 1–15, Feb. 2017, doi: 10.1080/15583058.2017.1287978.
- [251] P. Vera, E. Canellas, C. Nerín, N. Dreolin, and J. Goshawk, “The migration of NIAS from ethylene-vinyl acetate corks and their identification using gas chromatography mass spectrometry and liquid chromatography ion mobility quadrupole time-of-flight mass spectrometry,” *Food Chemistry*, vol. 366, p. 130592, Jan. 2022, doi: 10.1016/j.foodchem.2021.130592.
- [252] A. D. Orfila, “1.4. Numéro d’appel d’urgence”.
- [253] “China Dispersible Polymer Powder CAS NO. 24937-78-8 Suppliers, Manufacturers - Factory Direct Price - BOTAI.” Accessed: Sep. 30, 2023. [Online]. Available: <https://www.hnbotai.com/redispersible-polymer-powder/dispersible-polymer-powder-cas-no-24937-78-8.html>
- [254] J. Tourtelot, I. Ghattassi, R. Le Roy, A. Bourgès, and E. Keita, “Yield stress measurement for earth-based building materials: the weighted plunger test,” *Mater Struct*, vol. 54, no. 1, p. 6, Feb. 2021, doi: 10.1617/s11527-020-01588-4.
- [255] T. Joffroy *et al.*, “Renforcement des matériaux argileux par des biopolymères pour la construction en terre crue”.
- [256] Navier Lab, University Gustave Eiffel, ENPC, CNRS, Champs-sur-Marne, France *et al.*, “Influence of Biopolymers on the Mechanical Behavior of Earth-Based Building Materials,” *RPM*, vol. 03, no. 03, pp. 1–1, Mar. 2021, doi: 10.21926/rpm.2103031.
- [257] “Effect of oak tannin and iron chloride on the rheological properties of clay pastes.pdf.”
- [258] Y. Du, G. Habert, and C. Brumaud, “Influence of tannin and iron ions on the water resistance of clay materials,” *Construction and Building Materials*, vol. 323, p. 126571, Mar. 2022, doi: 10.1016/j.conbuildmat.2022.126571.
- [259] Y. Du, G. Habert, and C. Brumaud, “Design of Tannin-Based Poured Earth Material via Deflocculation–Coagulation Control: Additive Selection and Tannin Variation,” *ACS Sustainable Chem. Eng.*, vol. 10, no. 44, pp. 14495–14502, Nov. 2022, doi: 10.1021/acssuschemeng.2c04078.

- [260] Y. Qian, D. Zhang, and T. Ueda, “Interfacial Tensile Bond between Substrate Concrete and Repairing Mortar under Freeze-Thaw Cycles,” *ACT*, vol. 14, no. 8, Art. no. 8, Aug. 2016, doi: 10.3151/jact.14.421.
- [261] G. G. Litvan, “Air entrainment in the presence of superplasticizers”.
- [262] S. Chatterji, “Freezing of air-entrained cement-based materials and specific actions of air-entraining agents,” *Cement and Concrete Composites*, vol. 25, no. 7, pp. 759–765, Oct. 2003, doi: 10.1016/S0958-9465(02)00099-9.
- [263] L. Falchi, U. Müller, P. Fontana, F. C. Izzo, and E. Zendri, “Influence and effectiveness of water-repellent admixtures on pozzolana–lime mortars for restoration application,” *Construction and Building Materials*, vol. 49, pp. 272–280, Dec. 2013, doi: 10.1016/j.conbuildmat.2013.08.030.
- [264] A. E. Charola, “Water-Repellent Treatments for Building Stones: A Practical Overview,” *APT Bulletin*, vol. 26, no. 2/3, Art. no. 2/3, 1995, doi: 10.2307/1504480.
- [265] B. Lubelli, “Evaluation of the Effect of Nano-Coatings with Water Repellent Properties on the Absorption and Drying Behaviour of Brick”.
- [266] J. Carmeliet, G. Houvenaghel, J. V. Schijndel, and S. Roels, “Moisture phenomena in hydrophobic porous building material Part 1: Measurements and physical interpretations”.
- [267] D. J. Boday, J. T. Wertz, and J. P. Kuczynski, “Functionalization of Silica Nanoparticles for Corrosion Prevention of Underlying Metal,” in *Nanomaterials, Polymers, and Devices*, John Wiley & Sons, Ltd, 2015, pp. 121–140. doi: 10.1002/9781118867204.ch5.
- [268] F. F. Khorasani and M. Z. Kabir, “Experimental study on the effectiveness of short fiber reinforced clay mortars and plasters on the mechanical behavior of adobe masonry walls,” *Case Studies in Construction Materials*, vol. 16, p. e00918, Jun. 2022, doi: 10.1016/j.cscm.2022.e00918.
- [269] F. Kesikidou and M. Stefanidou, “Natural fiber-reinforced mortars,” *Journal of Building Engineering*, vol. 25, p. 100786, Sep. 2019, doi: 10.1016/j.job.2019.100786.
- [270] R. Hooton, A. Khaloo, and N. Kim, “Mechanical Properties of Normal to High-Strength Steel Fiber-Reinforced Concrete,” *Cement, Concrete, Aggr.*, vol. 18, no. 2, p. 92, 1996, doi: 10.1520/CCA10156J.
- [271] M. Łukasik, B. Michałowski, and J. Michalak, “Assessment of the Constancy of Performance of Cementitious Adhesives for Ceramic Tiles: Analysis of the Test Results Commissioned by Polish Market Surveillance Authorities,” *Applied Sciences*, vol. 10, no. 18, p. 6561, Sep. 2020, doi: 10.3390/app10186561.
- [272] “The Differences Between Cement, Concrete, and Mortar,” The Spruce. Accessed: Sep. 28, 2023. [Online]. Available: <https://www.thespruce.com/difference-between-cement-concrete-and-mortar-2130884>
- [273] N. Chen, P. Wang, L. Zhao, and G. Zhang, “Water Retention Mechanism of HPMC in Cement Mortar,” *Materials*, vol. 13, no. 13, p. 2918, Jun. 2020, doi: 10.3390/ma13132918.
- [274] D. C. Blackley, *Polymer Latices*. Dordrecht: Springer Netherlands, 1997. doi: 10.1007/978-94-011-5848-0.
- [275] S. Zhong and Z. Chen, “Properties of latex blends and its modified cement mortars,” *Cement and Concrete Research*, vol. 32, no. 10, pp. 1515–1524, Oct. 2002, doi: 10.1016/S0008-8846(02)00813-X.
- [276] Y. Dhandapani, M. Santhanam, G. Kaladharan, and S. Ramanathan, “Towards ternary binders involving limestone additions — A review,” *Cement and Concrete Research*, vol. 143, p. 106396, May 2021, doi: 10.1016/j.cemconres.2021.106396.

- [277] G. Habert, N. Choupay, G. Escadeillas, D. Guillaume, and J. M. Montel, “Clay content of argillites: Influence on cement based mortars,” *Applied Clay Science*, vol. 43, no. 3–4, pp. 322–330, Mar. 2009, doi: 10.1016/j.clay.2008.09.009.
- [278] F. Winnefeld and K. G. Böttger, “How clayey fines in aggregates influence the properties of lime mortars,” *Mater Struct*, vol. 39, no. 4, pp. 433–443, Aug. 2007, doi: 10.1617/s11527-005-9023-6.
- [279] F. L. Pellet, M. Keshavarz, and M. Boulon, “Influence of humidity conditions on shear strength of clay rock discontinuities,” *Engineering Geology*, vol. 157, pp. 33–38, May 2013, doi: 10.1016/j.enggeo.2013.02.002.
- [280] Y. Wang, L. Li, M. An, Y. Sun, Z. Yu, and H. Huang, “Factors Influencing the Capillary Water Absorption Characteristics of Concrete and Their Relationship to Pore Structure,” *Applied Sciences*, vol. 12, no. 4, p. 2211, Feb. 2022, doi: 10.3390/app12042211.
- [281] D. R. Ceratti *et al.*, “Critical effect of pore characteristics on capillary infiltration in mesoporous films,” *Nanoscale*, vol. 7, no. 12, pp. 5371–5382, 2015, doi: 10.1039/C4NR03021D.
- [282] J. Cai, T. Jin, J. Kou, S. Zou, J. Xiao, and Q. Meng, “Lucas–Washburn Equation-Based Modeling of Capillary-Driven Flow in Porous Systems,” *Langmuir*, vol. 37, no. 5, pp. 1623–1636, Feb. 2021, doi: 10.1021/acs.langmuir.0c03134.
- [283] “Capillaries.” Accessed: Oct. 02, 2023. [Online]. Available: <https://water.lsbu.ac.uk/water/capillaries.html>
- [284] “The surface tension of benzene at 20°C is 28.85 dyne/cm. In a capillary apparatus the liquid rose to a height of 1.832 cm. The density of benzene is 0.8765 g/mL. How would you calculate the diameter of the capillary tube in mm? | Socratic,” Socratic.org. Accessed: Oct. 02, 2023. [Online]. Available: <https://socratic.org/questions/the-surface-tension-of-benzene-at-20-c-is-28-85-dyne-cm-in-a-capillary-apparatus>
- [285] K. Kostur, “Modeling of flowing underground waters and leakage of syngas from Underground Coal Gasification,” in *2016 17th International Carpathian Control Conference (ICCC)*, High Tatras, Slovakia: IEEE, May 2016, pp. 352–357. doi: 10.1109/CarpathianCC.2016.7501122.
- [286] “Modeling of flowing underground waters and leakage of syngas from Underground Coal Gasification 2016.pdf.”
- [287] E. Steiakakis, C. Gamvroudis, and G. Alevizos, “Kozeny-Carman Equation and Hydraulic Conductivity of Compacted Clayey Soils,” *GM*, vol. 02, no. 02, pp. 37–41, 2012, doi: 10.4236/gm.2012.22006.
- [288] D. Tiab and E. C. Donaldson, “Porosity and Permeability,” in *Petrophysics*, Elsevier, 2012, pp. 85–219. doi: 10.1016/B978-0-12-383848-3.00003-7.
- [289] R. Joseferd and S. M. Mahmood, “CERTIFICATION OF APPROVAL IMPORTANCE OF POROSITY – PERMEABILITY RELATIONSHIP IN SANDSTONE : PETROPHYSICAL PROPERTIES,” 2015. Accessed: Oct. 02, 2023. [Online]. Available: <https://www.semanticscholar.org/paper/CERTIFICATION-OF-APPROVAL-IMPORTANCE-OF-POROSITY-%E2%80%93-Joseferd-Mahmood/821317ad2821a881dfbed24b35e7d0b70212d10d>