



**HAL**  
open science

# Exploring the potential of emerging technologies in the transformation chain of insects : case of *Tenebrio molitor* larvae

Rachelle El Hajj

## ► To cite this version:

Rachelle El Hajj. Exploring the potential of emerging technologies in the transformation chain of insects : case of *Tenebrio molitor* larvae. Chemical and Process Engineering. Université de Technologie de Compiègne, 2023. English. NNT : 2023COMP2748 . tel-04617890

**HAL Id: tel-04617890**

**<https://theses.hal.science/tel-04617890v1>**

Submitted on 19 Jun 2024

**HAL** is a multi-disciplinary open access archive for the deposit and dissemination of scientific research documents, whether they are published or not. The documents may come from teaching and research institutions in France or abroad, or from public or private research centers.

L'archive ouverte pluridisciplinaire **HAL**, est destinée au dépôt et à la diffusion de documents scientifiques de niveau recherche, publiés ou non, émanant des établissements d'enseignement et de recherche français ou étrangers, des laboratoires publics ou privés.

Par **Rachelle EL HAJJ**

*Exploring the potential of emerging technologies  
in the transformation chain of insects :  
case of *Tenebrio molitor* larvae*

Thèse présentée  
pour l'obtention du grade  
de Docteur de l'UTC

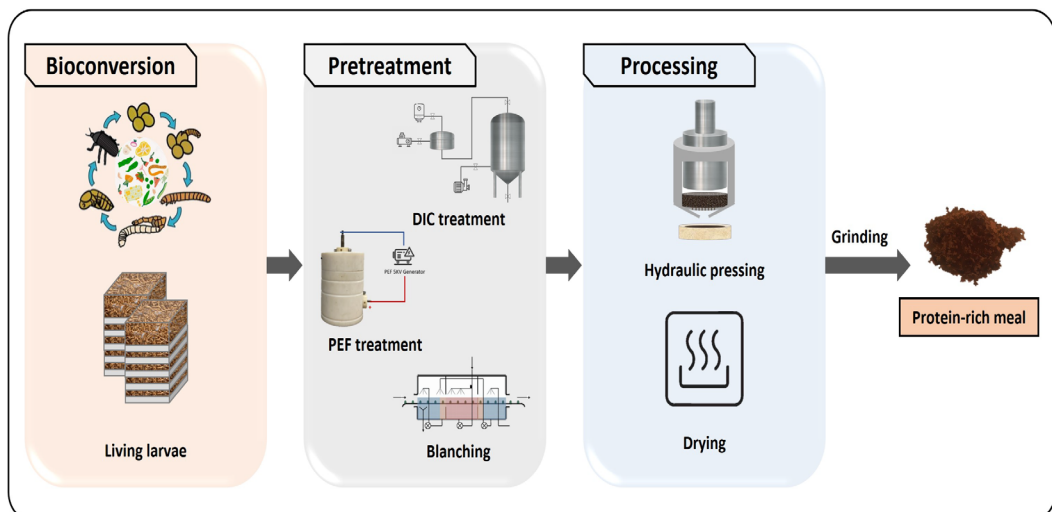

Soutenu le 11 mai 2023

**Spécialité :** Génie des Procédés Industriels : Transformations  
intégrées de la matière renouvelable (EA-4297)

D2748

# Thèse présentée pour l'obtention du grade de Docteur de l'UTC

Spécialité : Génie des Procédés Industriels

Par **Rachelle EL HAJJ**

*Exploring the potential of emerging technologies in the transformation chain of insects : case of Tenebrio molitor larvae*

Soutenue le 11 mai 2023

Devant le jury composé de :

<b>M. Krasimir DIMITROV</b>	:	Professeur des Universités Polytech - Lille - France	Rapporteur
<b>M<sup>me</sup> Francine FAYOLLE</b>	:	Professeur des Universités Oniris - Nantes- France	Rapporteur
<b>M. Romdhane KAROUI</b>	:	Professeur des Universités Université d'Artois - Arras - France	Examineur
<b>M. Samir MEZDOUR</b>	:	Enseignant Chercheur AgroParis Tech - Palaiseau - France	Examineur
<b>M<sup>me</sup> Nadia BOUSETTA</b>	:	Maître de conférences UTC – Compiègne - France	Examineur
<b>M. Victor LEFRANCOIS</b>	:	Industriel ABCAR DIC - Compiègne - France	Membre invité
<b>M. Houcine MHEMDI</b>	:	Enseignant-Chercheur ESCOM - Compiègne - France	Directeur de thèse
<b>M. Karim ALLAF</b>	:	Professeur des Universités Université de la Rochelle - France	Directeur de thèse
<b>M. Eugène VOROBIEV</b>	:	Professeur des Universités UTC – Compiègne - France	Co-directeur de thèse

## Acknowledgments

After three years of hard work and dedication at the University of Technology of Compiègne, I am delighted to present my thesis manuscript. I am truly grateful to everyone who has supported me along the journey and contributed to the success of this project.

I would like to express my sincere gratitude to my supervisor, M. **Houcine Mhemdi**, for his invaluable contributions to this journey. His expertise and insightful suggestions have helped to shape the direction and outcome of my work. His belief in me has been an inspiration, motivating me to give my best to this thesis and strive for perfection. I am grateful for his dedication to my development as a researcher, and I will always remember the influence he has had on my academic and personal growth.

I would like to extend my heartfelt gratitude to my supervisor, M. **Karim Allaf**. He has always believed in me and has been an inspiration and source of encouragement for me. His guidance has been essential in helping overcome the difficulties of this academic journey. I appreciate his efforts and the fact that he is a mentor who truly cares about his students.

I am truly grateful to my co-supervisor, M. **Eugène Vorobiev**, for his contributions to my project. During the process, his feedback and helpful recommendations were crucial in guiding me to success. His trust in me has given me a feeling of pride and determination that has carried me through the course of this thesis. I am extremely delighted to have worked with a person who is both competent and supportive.

I would like to extend my appreciation to M. **Antoine Fayeulle**. His provision of necessary equipment and laboratory space, as well as his insightful advice, were essential to the achievement of an important part of my research. I am also grateful for his kind and selfless nature, which made the experience of working with him a pleasure.

I acknowledge the Hauts-de-France region for their financial support to this project. And I would also like to thank M. **Victor Lefrancois** and ABCAR DIC process company for their support during my experimentation process. I am thankful for their provision of DIC treatments and access to necessary instruments, which were critical to the successful completion of my work.

I would like to express my gratitude to M. **Krasimir Dimitrov**, M<sup>me</sup> **Francine Fayolle**, M. **Romdhane Karoui**, M. **Samir Mezdour**, and M<sup>me</sup> **Nadia Boussetta**, who have generously dedicated their time and expertise to evaluating my work. I am honored by their willingness to be a part of this process and to offer their guidance.

I would also like to thank all my colleagues and friends at UTC. It was a pleasure to work with each and every one of you, and I am thankful for the friendship, knowledge, and laughter that we

shared. Your insights and perspectives have been incredibly valuable, and I have learned so much from all of you.

I would like to thank my interns, **Axel Marbeuf**, **Lucie Corjon** and **Fouad Chalhoub**, for their assistance in conducting experiments, analyzing data, and providing insightful feedback, which surely contributed to the accomplishment of this thesis. I thank them for their hard work and talent, and I look forward to witnessing the great things they will achieve in their future careers.

I would like to express my deepest gratitude to my life partner, for his support, encouragement, and understanding throughout the completion of this thesis. His patience, presence and love have been a constant source of motivation and inspiration. His faith in me even during the most challenging times, helped me to stay focused and dedicated to my work. I am grateful for the many ways in which he has supported me, making it possible for me to achieve this goal. I am incredibly blessed to have such a wonderful partner in my life.

To my beloved mother and sister, I am eternally grateful for your endless love, support, and encouragement, which sustained me through the highs and lows of this journey. I appreciate the many ways in which you have helped me to balance the demands of academic life and personal responsibilities.

I dedicate this thesis to the memory of my beloved father that is a source of inspiration to me. His love for knowledge and his dedication to hard work continue to guide me in my pursuit of academic and personal success. I hope that this work honors his memory and serves as a tribute to his enduring impact on my life.

Thank you all for your support and presence.

Sincerely,

*Rachelle El Hajj*

## Abstract

This thesis aims to explore the use of two emerging technologies, the Instant Controlled Pressure Drop (DIC) and the Pulsed Electric Fields (PEF), as pretreatments for yellow mealworms transformation in a biorefinery concept. The impacts of these technologies on larval microbial decontamination, mortality (killing), enzymatic browning, mechanical pressing for defatting and dewatering, and drying processes were investigated. Conventional blanching in hot water was used as a control for comparison.

Results showed that DIC and PEF were both efficient killing methods. The application of DIC treatment at 0.3 MPa resulted in the reduction of the total viable count (TVC) and yeasts and molds counts (YMC) to levels below the established European standards with decimal reduction times of 3.8 s and 3 s for TVC and YMC, respectively. Conventional blanching at 90°C for 360 s also reduced the counts, but with slower decimal reduction times of 67.8 s and 57 s, respectively. However, PEF treatment was not successful in reducing the initial microbial load of the larvae. Moreover, the DIC treatment resulted in a marked improvement in the brightness of the larval juice color which may be attributed to the inactivation of oxidative enzymes, whereas the juice color of blanched, PEF-treated, and untreated larvae was much darker. Blanching followed by hydraulic pressing resulted in a 68% pressing yield, a 48% recovery of the initial protein content, and a press cake with 14.7% lipids/db and 45% dry matter. DIC and PEF both seem to improve this outcome, but each in a different way. Increasing DIC treatment pressure from 0.15 to 0.45 MPa reduced the pressing yield from 68 to 55%, which is believed to be caused by protein aggregation and denaturation, confirmed by fluorescence spectroscopy analysis. As a result of the reduced pressing yield, more proteins were retained in the press cake, resulting in a high protein recovery of 78% and a press cake with 55% dry matter and 12% lipids/db. On the other hand, PEF treatment increased the pressing yield of larvae up to 78% resulting in a higher protein loss in the pressing juice, with a protein recovery of 43%. The press cake generated had 54% dry matter and with 14% lipids/db.

PEF was found to be the best method that preserves protein quality, followed by blanching then DIC. Moreover, compared to blanched larvae, DIC treatment reduced drying shrinkage and improved water diffusivity. Additionally, the treatment increased the specific surface area of the dried meal by up to 125% and resulted in a more uniform particle size distribution, both of which improve the end product's quality. PEF treatment also accelerated drying compared to blanching but still lags behind DIC in terms of drying kinetics and water diffusivity. PEF was found to be the most energy-efficient treatment (21.7 kWh/t), followed by blanching (61.7 kWh/t) and DIC (111 kWh/t).

**Keywords:** *Tenebrio molitor*; larvae; blanching; DIC; PEF; decontamination; pressing; drying.

## Résumé

Cette thèse vise à explorer l'utilisation de deux technologies émergentes, la Détente Instantanée Contrôlée (DIC) et les Champs Electriques Pulsés (CEP), comme prétraitements pour la transformation des vers de farine dans un concept de bioraffinerie. Les impacts de ces technologies sur la décontamination microbienne des larves, la mortalité (mise à mort), le brunissement enzymatique, le pressage mécanique pour la délipidation et la déshydratation, et le séchage des larves ont été étudiés. Le procédé conventionnel de blanchiment à l'eau chaude a été utilisé comme référence pour la comparaison.

Les résultats ont montré que la DIC et les CEP sont deux techniques efficaces pour la mise à mort des larves. L'application de la DIC à 0,3 MPa a entraîné une réduction de la flore aérobie totale et du nombre des levures et moisissures en dessous des seuils fixés par les directives Européennes avec des temps de réduction décimale de 3,8 s et 3 s, respectivement. Le blanchiment conventionnel à 90°C pendant 360 s a également réduit efficacement le nombre de contaminants, mais avec des temps de réduction décimale plus lents de 67,8 s et 57 s, respectivement. En revanche, CEP n'a pas permis de réduire la charge microbienne initiale des larves. Par ailleurs, la DIC a entraîné une amélioration de la clarté du jus de larves, tandis que la couleur du jus des larves blanchies, traitées par CEP et non traitées était beaucoup plus foncée. Ce résultat pourrait être attribué à l'inactivation des enzymes oxydatives par DIC. Le blanchiment suivi d'un pressage a permis d'obtenir un rendement en jus de 68%, une récupération de 48% des protéines et un tourteau contenant 14,7% de lipides/MS et 45% de matière sèche. La DIC et les CEP semblent toutes les deux améliorer ce résultat, mais d'une manière différente. Pour la DIC, l'augmentation de la pression appliquée de 0,15 à 0,45 MPa a réduit le rendement de pressage de 68 à 55 %. Cette baisse de rendement pourrait être attribuée à l'agrégation et la dénaturation des protéines comme il a été montré par spectroscopie de fluorescence. En conséquence, il en résulte une meilleure rétention des protéines dans le gâteau (78% des protéines) et l'obtention d'un gâteau avec 55% de MS dont 12% de lipides/MS. En revanche, le traitement par les CEP a augmenté le rendement de pressage des larves jusqu'à 78 %, entraînant une perte de protéines plus élevée dans le jus (une récupération de 43 % des protéines), et génère un gâteau avec 54% de MS dont 14% de lipides/MS.

Les analyses ont montré que le CEP est le traitement qui préserve le mieux la qualité des protéines, suivi du blanchiment puis de la DIC. En outre, la DIC a amélioré la diffusivité de l'eau et a limité le rétrécissement de la taille des larves durant le séchage. De plus, elle a entraîné une augmentation de 125% de la surface spécifique de la farine d'insectes obtenue avec une distribution de taille de particules plus uniforme, ce qui améliore la qualité du produit final. Le traitement par CEP a aussi amélioré le séchage par rapport au blanchiment, mais reste moins efficace que la DIC. Enfin, le traitement par CEP est le moins énergivore (21.7 kWh/t), suivi par le blanchiment (61.7 kWh/t) et la DIC (111 kWh/t).

**Mots-clés :** *Tenebrio molitor* ; larves ; blanchiment ; DIC ; CEP ; décontamination ; pressage ; séchage.

# Table of Contents

Acknowledgments.....	1
Abstract.....	3
Résumé.....	4
<b>General Introduction.....</b>	<b>7</b>
<b>Chapter I - Literature Review.....</b>	<b>10</b>
I.1. Edible insects.....	10
I.1.1. Insects' generalities.....	10
I.1.2. Global Food security and the need for alternative sources of protein.....	11
I.1.3. Edible insects farming.....	12
I.1.4. Environmental sustainability and economic benefits.....	12
I.1.5. Food safety implications.....	14
I.1.6. Nutritional Composition.....	16
I.2. Edible insects processing.....	20
I.2.1. The necessity of insect processing.....	20
I.2.2. Article 1: Edible insects' transformation for feed and food uses: an overview of current insights and future developments in the field.....	21
I.2.3. Implementation of novel/emerging technologies for insect processing.....	47
I.3. Conclusion and research objectives.....	55
<b>Chapter II - Impacts of Instant controlled pressure-drop (DIC) pretreatment on yellow mealworms transformation chain.....</b>	<b>58</b>
II.1. Introduction.....	58
II.2. Article 2: Use of Instant Controlled Pressure Drop technology for the preservation of edible insects' (yellow mealworm) quality: Assessment of microbial inactivation.....	59
II.3. Article 3: Instant controlled pressure-drop assisted pressing for defatting and dewatering of yellow mealworm larvae: process study and optimization.....	80
II.4. Article 4: Impact of instant controlled pressure-drop (DIC) texturing on the drying of yellow mealworms.....	112
II.5. Conclusions.....	146
<b>Chapter III - Pulsed electric field (PEF) pretreatment effect on yellow mealworms.....</b>	<b>147</b>
III.1. Introduction.....	147



III.2.	Article 5: Application of pulsed electric fields assisted mechanical pressing to produce a protein-rich insect's meal from <i>Tenebrio molitor</i> larvae .....	148
III.3.	Article 6: Impact of pulsed electric field treatment on the viability of <i>Tenebrio molitor</i> insect biomass, and on the following pressing and drying processes .....	169
III.4.	Conclusions .....	191
	<b>Chapter IV - Comparative Study between PEF and DIC technologies for insect processing: technical, energetic, and quality aspects</b> .....	192
IV.1.	Introduction .....	192
IV.2.	Comparison of different pretreatment methods based on their energy and economic costs	192
IV.3.	Comparison of pretreatments effects on key aspects of larvae .....	196
IV.3.1.	Larval mortality .....	196
IV.3.2.	Microbial inactivation .....	196
IV.3.3.	Defatting and dewatering by mechanical expression .....	197
IV.3.4.	Color .....	197
IV.3.5.	Drying .....	197
IV.3.6.	Protein Quality .....	197
IV.4.	Conclusion .....	199
	<b>General Conclusion and Prospects</b> .....	200
	<b>References</b> .....	203

## General Introduction

The combination of population growth and climate change is exacerbating concerns about food security worldwide, particularly regarding conventional protein sources. The increasing demand for protein, in addition to the harmful environmental effects of animal agriculture such as deforestation, land use alteration, and water and air pollution, are making conventional protein sources less viable. Therefore, it is essential to find new sources of sustainable protein that can meet the growing population's nutritional needs without exhausting the Earth's resources (Lange and Nakamura, 2021; van Huis, 2013). Some potential alternatives include plant-based protein sources, single-cell proteins such as mycoprotein, yeasts, fungi, bacteria, photosynthetic microalgae, and cyanobacteria, macroalgae, cell-based meat, and edible insects. These alternatives have the potential to provide the necessary nutrients while minimizing the environmental impact of protein production (Green *et al.*, 2022; Lähteenmäki-Uutela *et al.*, 2021).

Insects are a highly sustainable source of protein, as they can be farmed using the "circular economy" concept, which involves converting agricultural by-products into protein and fat. Insect farming not only reduces waste but also requires minimal resources such as land and water, and generates less greenhouse gas emissions compared to traditional livestock production making it a more sustainable option (Gasco *et al.*, 2020). Additionally, insects are a highly nutritious source of food, rich in protein, essential amino acids (EAA), fat, and fiber (chitin). They are also rich in vitamins and essential nutrients such as zinc, iron, and calcium (Rumpold and Schlüter, 2013).

However, in Western cultures, insects are not a traditional food source, hence, processing them in a manner that is easy to consume and familiar to consumers may help increase their acceptance as a food source. This can be done by incorporating them into familiar products such as burgers, pasta, bread, protein bars etc. This will not only help increase acceptance but also generate a safe product, and often make the nutrients more accessible (Żuk-Gołaszewska *et al.*, 2022).

Insect processing includes traditional methods such as grinding, baking, roasting, pressing, and oven-drying. However, recently some emerging technologies are being applied to different biomass matrices (fruits, vegetables, algae, sea products, etc..) transformation chains including high-pressure processing (HPP), cold atmospheric pressure plasma (CAPP), ultrasound (US), instant controlled pressure drop (DIC), pulsed electric field (PEF), supercritical CO<sub>2</sub> extraction, and extrusion. These technologies are still being developed and tested, but they have demonstrated encouraging results in enhancing the transformation process, including intensifying transfer phenomena (pressing, diffusion, drying), as well as improving the characteristics of the final product, such as texture, taste, and safety while preserving the nutritional value of products. Additionally, these technologies can be used to extend the shelf-life of the transformed products, which can facilitate their commercialization and distribution (Ojha *et al.*, 2021; Parniakov *et al.*, 2022). There has been limited exploration into the potential use of emerging technologies for processing insects, making it necessary to conduct further investigation on this matter.

In such context, this thesis aims to explore the application of two emerging technologies: Pulsed Electric Field (PEF) and Instant Controlled Pressure Drop (DIC), to the insect processing chain to improve the quality of the final products while reducing costs. Pulsed Electric Field (PEF) technology is a non-thermal treatment that uses short-duration electric pulses to create membrane electropermeabilization, a process where the electric field causes damage to the cell membrane, which enhances different transfer phenomena while preserving the quality and nutritional value of the food (Vorobiev and Lebovka, 2020). Instant Controlled Pressure Drop (DIC), on the other hand, is a high-temperature/short-time treatment that involves applying high pressure for a short time and instantly reducing the pressure to below the atmospheric pressure resulting in immediate auto-vaporization of water and some volatile molecules, instant cooling of the sample, and often expansion and texturing of the product, all of which improves unit operations and final product quality (Allaf and Allaf, 2014).

The goal of this study is to identify cost-effective solutions that can improve the yield and quality of the final products, while also enhancing the overall efficiency of the processing chain. The research also includes an analysis of the economic and energetic impacts of implementing these technologies in the insect industry. Ultimately, the findings of this thesis will provide valuable insights and recommendations for the insect industry to improve its production process and increase its competitiveness in the market.

The thesis is divided into four chapters that include six articles that have been either published or submitted for publication in academic journals. Each chapter focuses on a specific aspect of the research. These chapters are designed to provide a logical and coherent structure to the thesis, and they help to guide the reader through the various arguments and findings.

**Chapter I** of the thesis provides a comprehensive overview of the general characteristics of insects and their importance as a food source, with a focus on the potential of edible insects to contribute to global food security and environmental sustainability. The second part of this chapter delves deeper into the topic of insect processing with [Article 1](#), a review article that discusses the transformation steps and technologies used to transform insects into edible products, the advantages and limitations of each method, and the challenges and opportunities of the sector. This chapter also includes a presentation of the DIC and PEF technologies.

**Chapter II** consists of three articles aimed at exploring the use of Instant Controlled Pressure Drop (DIC) technology for enhancing the transformation of yellow mealworms. [Article 2](#) focuses on the examination of microbial inactivation through DIC technology, [Article 3](#) investigates the effects of DIC on larval properties and hydraulic pressing for effective lipid extraction and water removal, and finally, [Article 4](#) explores the impact of DIC texturing on the drying process of larvae.

**Chapter III** focuses on the use of Pulsed Electric Field (PEF) technology to enhance the processing of yellow mealworms and its impact on the final product's quality and efficiency. The

chapter includes two articles, with Article 5 centered on optimizing PEF conditions, and Article 6 examining the effects of PEF treatment on the false mortality of *Tenebrio molitor* larvae, as well as the hydraulic pressing and air-drying processes.

**Chapter IV** compares the energy consumption and effects on various aspects of larvae of the emerging technologies, DIC and PEF, as well as the conventional method, blanching, which were explored in chapters II and III. The goal is to provide a clear understanding of the overall benefits and drawbacks of each treatment method.

And ultimately, a comprehensive general conclusion is provided that summarizes key findings, draws implications, and identifies potential areas for further investigation.

## Chapter I - Literature Review

### I.1. Edible insects

#### I.1.1. Insects' generalities

Insects are invertebrates with six legs, three body sections (a head, a thorax and an abdomen), antennae and a cuticle, the exoskeleton. They have muscular, digestive, circulatory, respiratory, nervous, glandular, and reproductive systems and are the most diverse group of animals on the planet, with the largest number of species (Gullan and Cranston, 2010).

They are categorized as a class (Insecta) and divided into 29 orders. Based on their development pattern, these orders may be divided into three groups: holometabolous, with complete metamorphosis (i.e., larva, pupa, adult), hemimetabolous, with incomplete metamorphosis (i.e., nymphs with wing buds that appear as adults and have no pupal stage), and ametabolous, wingless insects (i.e., no distinction between larvae and adults, no nymphs, with secondary wingless insects not ametabolous).

The largest orders are the Lepidoptera (butterflies and moths), Coleoptera (beetles), Hymenoptera (bees, ants, and wasps), and Diptera (true flies), which are all holometabolous. They are very large groups, each one thought to have more than a million species (Figure I.1). Coleoptera belongs to the largest group of arthropods, which are the largest group of animals, and the animals have the most species of any kingdom in the world's biota (Eggleton, 2020). Many anatomical features of the body parts, particularly the mouthparts, legs, wings, and abdominal apex, are critical to identifying higher groups within the hexapods, such as insect orders, families, and genera (Gullan and Cranston, 2010).

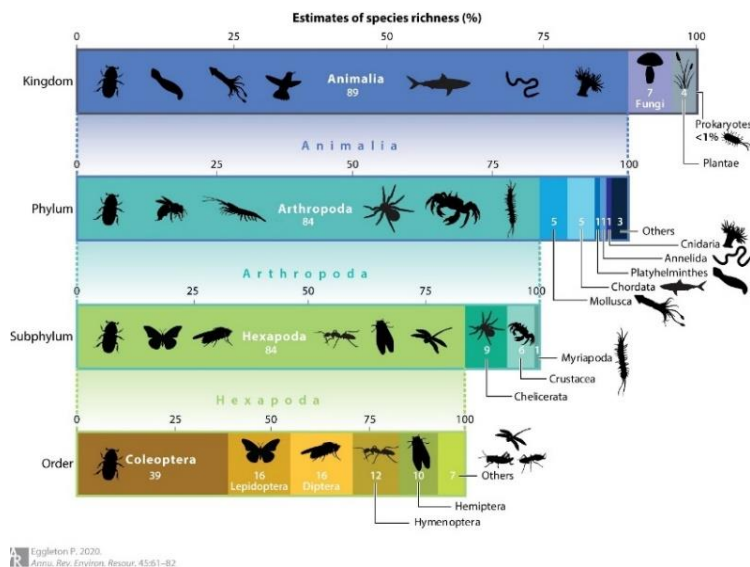

**Figure I.1** An estimation of global biotic species richness for groups, expressed as a percentage of higher taxonomic groups, at kingdom, phylum, subphylum, and order level, based on 2019 species estimates data (Eggleton, 2020)

### I.1.2. Global Food security and the need for alternative sources of protein

The Food and Agriculture Organization (FAO) of the United Nations forecasts that the world's population will exceed 9 billion by 2050, requiring a huge increase in food production (United Nations, 2015). While human population growth drives food demand, there is a parallel decrease in available land resources required to generate this food, which also is likely to be aggravated by global warming. Climate change will reduce the extent of land available for agriculture, thereby exacerbating food insecurity, with low-income countries bearing the brunt of the impacts, including an increase in poverty and malnutrition which will widen the food security gap between high- and low - income countries (Lange and Nakamura, 2021).

The proportion of undernourishment, as a stand-alone indicator, fails to capture the complexity and multidimensionality of food security. As per the FAO's Declaration of the World Summit on Food Security: "Food security exists when all people, at all times, have physical, social and economic access to sufficient, safe and nutritious food to meet their dietary needs and food preferences for an active and healthy life. The four pillars of food security are availability, access, utilization and stability" (FAO, 2009). In other words, food security exists when food is available, affordable, evenly distributed, and safe to consume (Lange and Nakamura, 2021). And food availability comprises the availability of an average dietary energy supply, an average value of food production, a share of dietary energy supply derived from grains, roots, and tubers, an average protein supply and an average protein supply from animal sources (FAO *et al.*, 2013). Since the population is predicted to continue to grow rapidly, establishing food security, and especially a sufficient protein supply, is a crucial worldwide priority (Lange and Nakamura, 2021).

Intensive agricultural practices, genetic selection, and, more recently, the development of genetically modified organisms (GMOs) have all contributed to improvements in food production systems. However, increasing yields through agricultural intensification often has a negative impact on environmental sustainability and animal welfare. Besides that, little attention has been given to expanding plant and animal food sources, which is particularly true for animal-derived foods because the Western diet only incorporates a few animal species (Belluco *et al.*, 2013). From a "Western culture" perspective, the animal kingdom is unscientifically classified into a few categories, including animals that can be eaten, pests (insects, rats, and so on), pets, and others (Harris, 1998). On the other hand, as numerous publications reporting on eating habits in various nations have extensively reported, people worldwide consume thousands of insect species as food (Belluco *et al.*, 2013).

Entomophagy (i.e. insect consumption) may be a potential solution to the problem of global food insecurity in terms of both the amount of food required to fulfill metabolic needs and the quality and nutritional value of foods required to maintain health since they are a good source of protein, vitamins and minerals needed for human health and wellbeing (Lange and Nakamura, 2021). Aside from entomophagy, with global animal feed prices rising as availability declines, insects are seen

as an intriguing alternative protein source that may be utilized as animal feed, replacing fish meal, fish oil, and soybeans in aquaculture and animal diets (van Huis, 2013).

### I.1.3. Edible insects farming

Insect species selected for large-scale production should have rapid growth, a high survival rate, a high reproduction rate, a short development cycle, the capacity to live in high densities, and a low vulnerability to pathogens (Gałęcki *et al.*, 2021). They should also be easy to breed, able to be fed on a wide range of resources including waste from crop production and the agri-food industry as well as have great nutritional properties for food and feed uses (Żuk-Gołaszewska *et al.*, 2022).

Edible insects have the potential to play a significant part in the bioconversion of agri-food wastes, the worldwide output of which is estimated to be 1.3 billion tons per year. They can readily convert different sources of waste biomass and agri-food waste into nourishing products, which could close nutrient cycles, reduce food production's environmental impact, and lower production costs. The selection of insect feed is heavily influenced by economic and logistical considerations (Żuk-Gołaszewska *et al.*, 2022). Several regulations have been implemented in the EU to ensure the safety of animal feeds (Commission Regulation (EC) No.1069/2009, 2009; Commission Regulation (EU) No 142/2011, 2011; Commission Regulation (EU) No 1137/2014, 2014; Regulation (EC) No 767/2009, 2009; Regulation (EC) No 999/2001, 2001). These regulations establish feed safety requirements for the production of edible insects for human (EU, 2021) and animal (EU, 2017) use. However, the implemented regulations severely limit the use of many common foodstuffs as insect feed (Żuk-Gołaszewska *et al.*, 2022).

### I.1.4. Environmental sustainability and economic benefits

To feed the world's rising population, food production will need to increase significantly. Intensive protein production in current livestock farming and crop production will place huge pressure on limited natural resources such as energy, water, land, and oceans, and will lead to deforestation, environmental degradation, and increased greenhouse gas emissions. Livestock production, in particular, will contribute to these environmental concerns, since it accounts for around 70% of global agricultural land usage. Edible insect farming is emerging as a cost-effective and environmentally friendly alternative to conventional farming. Since insect farming includes effective bioconversion of byproducts, as well as low feed conversion ratios, greenhouse gas emissions, and land and water use (Figure I.2) (Lange and Nakamura, 2021; van Huis, 2013; Yi *et al.*, 2013).

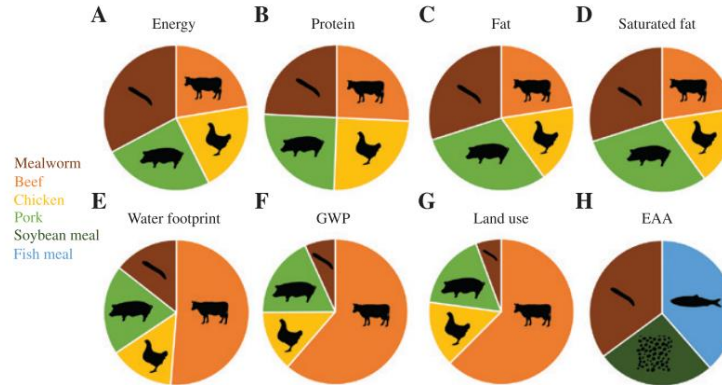

**Figure I.2** Nutritional values and sustainability of mealworms and conventional food/feed. (A–D) The nutritional value of a 100-g edible portion of mealworms compared with various livestock meats. (E–G) The comparative effect of mealworms and livestock on the environment presented as water footprint per edible ton, global warming potential (GWP) for each 1 kg edible portion, and land use for each 1 kg edible portion. (H) Essential amino acid (EAA) comparison of mealworms and classic feeds such as soybean and fish meal (Grau *et al.*, 2017)

#### I.1.4.1. Feed Conversion Ratio

Feed conversion ratio (FCR= mass of feed/ mass of weight gain) is extremely important since the increased demand for meat results in a greater-than-proportional need for grain and high-protein foods. FCRs differ considerably based on the type of animal and the techniques used to produce the meat (van Huis, 2013). Crickets require less than 2 kg of feed for every 1 kg of body weight gain, whereas chicken, pig, and beef require 2.5, 5, and 10 kg, respectively. Moreover, it is estimated that up to 80% of a cricket may be consumed and digested, compared to 55% for hens and pigs and 40% for cattle. This results in feed-to-meat conversion rates (mass of feed/mass of edible meat) of 2.1, 4.5, 9.1, and 25 kg/kg edible weight for crickets, chickens, pigs, and cattle respectively (Collavo *et al.*, 2005; Nakagaki and Defoliart, 1991; Smil, 2002; van Huis, 2013). Insects are most likely more efficient at converting feed to body mass than conventional livestock because they are poikilothermic (cold-blooded) and thus do not invest metabolic energy in maintaining a constant body temperature (Oonincx *et al.*, 2010)

#### I.1.4.2. Greenhouse Gas and Ammonia Emissions

Published data estimated that livestock production accounts for 18% of greenhouse gas emissions (van Huis, 2013). Methane and nitrous oxide generated by livestock husbandry, via enteric fermentation and manure, are the leading causes of surface water eutrophication and soil acidification. When measured in CO<sub>2</sub> equivalents, beef has the biggest environmental effect (14.8 kg CO<sub>2</sub> eq/kg of mass gain), followed by pigs (3.8 kg CO<sub>2</sub> eq/kg), and chickens (1.1 kg CO<sub>2</sub> eq/kg) (van Huis, 2013). The greenhouse gas emissions associated with the farming of edible insects, such as crickets, locusts and mealworm larvae, have been reported to be lower than pigs and cattle (Oonincx *et al.*, 2010).



#### I.1.4.3. Land and water use

The world's growing population will require feeding on the same area of land that is currently available. In this context, mealworms were found to use only 43% of the land needed to produce one kg of edible animal protein as milk, and 10% of the land needed to produce beef meat (Oonincx and de Boer, 2012).

It is anticipated that by 2025, about 1.8 billion individuals would be living in water-stressed areas. Water scarcity will endanger biodiversity, agricultural productivity, and food production worldwide. Agriculture consumes more than 70% of freshwater worldwide, and meat production, in particular, requires large quantities of water (Lange and Nakamura, 2021). The volume of water required to produce 1 kg of meat is estimated to be 15 415 L for beef, 5 988 L for pigs, 4 325 L for chickens, and 4 341 L for mealworms. In terms of water usage per gram of protein, the estimates are 112 L for beef, 57 L for pigs, 34 L for chickens and 23 L for mealworms (Miglietta *et al.*, 2015). The lower water consumption for insects can be attributed to their drought-resistant nature, ability to feed on organic byproducts, and efficient FCRs, especially for species like the yellow mealworm (*Tenebrio molitor*) and lesser mealworm (*Alphitobius diaperinus*) (van Huis, 2013).

#### I.1.5. Food safety implications

Potential consumer and animal health safety hazards should be addressed and controlled when producing food/feed from edible insects and insect-based ingredients (van Huis, 2013). The lack of food safety knowledge regarding the use of insects in food production is estimated to be a barrier to the introduction and promotion of the use of insects in human diets in Western nations. Edible insects, like other foodstuffs, may be associated with a variety of health risks, including allergens as well as toxicological and biological hazards. Contaminant incidence and concentration in edible insects are affected by insect species, harvest stage, feed substrate utilized, and production processes.

##### I.1.5.1. Allergens

The risk for allergic reactions should be addressed for each novel food for human consumption, including insects or insect-derived products. Food allergies are commonly (glyco)proteins. It is reasonable to assume that products derived from insects will always contain proteins, as the insects will act as novel protein sources, and some proteins found in edible insects, such as arginine kinase,  $\alpha$ -amylase, and tropomyosin, are considered to be allergens. Therefore, food derived from insects may induce allergic reactions through de novo sensitization or cross-reaction, and the production process may magnify allergenic activity by revealing hidden allergens or concentrating allergens that are already present (EFSA, 2015). Furthermore, the presence of arthropod allergens such as arachnids, crustaceans (lobster, shrimp, crab), myriapods, and insects may increase the likelihood of insect allergies. Similarly, the allergens of mollusks and helminths are frequently extremely similar to those of insects, which might lead to cross-allergies (Belluco *et al.*, 2013; EFSA, 2015).

More study on the risk of insect-based food triggering allergic responses in humans is needed to protect consumer health.

#### I.1.5.2. Microbiological Hazards

Edible insects can carry pathogenic microorganisms, representing a health concern to consumers. The magnitude to which edible insects are infected depends on insect species, collection techniques, hygiene measures, feed substrates, and handling and processing methods adopted in insect preparation (Lange and Nakamura, 2021). Studies on fresh *Zophobas morio*, *Tenebrio molitor*, *Galleria mellonella*, and *Acheta domesticus* revealed a high microbial charge ( $10^5$  to  $10^6$  cfu/g) on samples derived from closed-cycle farms. The microbial charge was mainly composed of Gram-positive bacteria as fecal and total coliforms (e.g., *Micrococcus* spp., *Lactobacillus* spp., and *Staphylococcus* spp.). *Salmonella* spp. and *Listeria monocytogenes* were never detected in the tested samples (Belluco *et al.*, 2013).

The microbiological profile of fresh, processed (boiled or roasted), and stored (cold or ambient temperature) mealworms and crickets were studied. Fresh insects were found to carry Enterobacteriaceae and spore-forming bacteria that did not belong to pathogenic species. Boiling for 5 min was sufficient to eliminate Enterobacteriaceae but not spore-forming bacteria, whereas roasting is found to be insufficient for decontamination, it is proposed to be coupled with boiling. Moreover, lactic acid fermentation was also found to inactivate Enterobacteriaceae and maintain spore-forming bacteria stable at acceptable values. It is recommended that processed insects be stored at 5 to 7 °C to inhibit spore development and product spoilage (Klunder *et al.*, 2012). These findings demonstrate that insect hygienic handling, processing and storage should be prioritized in order to minimize potential risks of infection following their intake (Belluco *et al.*, 2013).

Insects being taxonomically farther distant from humans than livestock, the chance of zoonotic diseases being transmitted to humans and livestock is lower for insects than for birds and mammals (van Huis, 2013).

#### I.1.5.3. Antinutritional compounds

Antinutritional compounds are naturally occurring compounds in foods that might limit macronutrient and micronutrient intake, digestion, absorption, and utilization, thereby causing detrimental health effects in consumers. Antinutrients such as alkaloids, saponins, tannins, oxalate, phytate, and hydrocyanide have been found in certain edible insect species (Lange and Nakamura, 2021). However, boiling and drying were shown to lower the concentration of three anti-nutritive components (oxalates, tannins, and alkaloids) in the stinkbug *Encosternum delegorguei*, often consumed in Zimbabwe. The EFSA panel, on the other hand, determined that house cricket (*Acheta domesticus*) powder contained anti-nutritive factors (e.g., tannins, oxalic acid, phytic acid, hydrogen cyanide, and trypsin inhibitors) comparable to those found in other common foods, and thus concluded that consumption of this insect-based powder was not nutritionally detrimental (Aguilar-Toalá *et al.*, 2022). A greater understanding of the types of antinutritional compounds

found in various insect species, as well as ways for eliminating them is essential (Lange and Nakamura, 2021).

#### I.1.5.4. Heavy metals

Low levels of heavy metals exposure, such as lead, cadmium, mercury, and arsenic, are known to have toxic and detrimental health consequences in both humans and animals. Heavy metal transmission from substrates (e.g., organic matter, plants) appears to be the most important route of contamination for insects. Their occurrence and accumulation in insects are influenced by the elements' properties and concentrations in the substrates, the insect species, and their growth phase. Although data on the transfer of contaminants from diverse substrates to insects are scarce, we do know that insects may accumulate heavy metals, particularly cadmium, from their substrates; nevertheless, there is insufficient evidence on the food safety of insects in this regard. Bioaccumulation of heavy metals is found to be less likely in insects with a short life cycle (with limited repeated feeding on a contaminated substrate) than in insects reared over a longer period (EFSA, 2015; Lange and Nakamura, 2021).

#### I.1.6. Nutritional Composition

Insects are a highly nutritious source of food, with high content of protein, fat, vitamins, minerals, and fibers. The nutritional profile of the 1,900 edible insects so far recorded is highly variable depending on the species, diet, metamorphic stage, habitat, and environmental circumstances (Lange and Nakamura, 2021; van Huis, 2013).

Mealworms, for example, have a high protein level (13.68-22.32 g/100 g edible part wb) and fat content (8.90-19.94 g/100 g edible part wb), as well as significant quantities of polyunsaturated fatty acids. They are also a good source of zinc and magnesium, and can also be considered a source of niacin, pyridoxine, riboflavin, folate, and vitamin B12 (Grau *et al.*, 2017). Table 1 presents the average composition of five insect species in terms of moisture, fat, and protein based on live weight (Yi *et al.*, 2013).

**Table I.1** Proximate composition of five insect species on a live weight basis (mean  $\pm$  S.D., n = 2) (Yi *et al.*, 2013).

Insects	Moisture (%)	Fat (%)	Crude protein (%) (including chitin nitrogen)	Other components (%) (e.g., carbs, minerals, and vitamins)
<i>Tenebrio molitor</i>	63.5 $\pm$ 1.8	9.9 $\pm$ 1.0	19.1 $\pm$ 1.3	7.5 $\pm$ 2.2
<i>Alphitobius diaperinus</i>	64.5 $\pm$ 1.0	8.5 $\pm$ 0.2	20.6 $\pm$ 0.1	6.4 $\pm$ 1.0
<i>Zophobas morio</i>	59.9 $\pm$ 5.4	16.0 $\pm$ 0.7	20.7 $\pm$ 0.3	3.4 $\pm$ 5.5
<i>Acheta domesticus</i>	70.8 $\pm$ 2.0	3.6 $\pm$ 0.4	21.5 $\pm$ 0.5	4.1 $\pm$ 2.1
<i>Blaptica dubia</i>	67.4 $\pm$ 2.1	7.7 $\pm$ 0.1	19.3 $\pm$ 0.9	5.6 $\pm$ 2.3

### I.1.6.1. Amino acids profile and digestibility

The quality of insect protein with respect to human requirements is determined by amino acid profiles and digestibility (van Huis, 2013). The larvae of *A. diaperinus*, *T. molitor*, and *Z. morio* were found to have all of the essential amino acids in sufficient quantities for humans (FAO/WHO/UNU, 1985; Yi *et al.*, 2013).

Table I.2 presents the amino acid composition and essential amino acid index of five insect species, casein, and soybean protein, and the recommendation for EAA intake. Interestingly, the total essential amino acid (EAA) content of *A. diaperinus*, *T. molitor*, and *Z. morio* was similar to that of soybean protein but significantly lower than that of casein. Furthermore, the total of EAA for *A. domesticus* and *B. dubia* was lower than for casein and soybean protein, nonetheless they were present in sufficient quantities for human consumption (277 mg/g crude protein). The essential amino acid index (EAAI) of *A. diaperinus*, *T. molitor*, and *Z. morio* were somewhat greater than that of soybean but lower than that of casein, indicating that the quality of the insect protein for these three insect species was equivalent to conventional food protein sources (Yi *et al.*, 2013). Additionally, mealworms' nutritional profile has been compared to livestock proteins, indicating that mealworms have a much higher nutritional value than beef and chicken while being no less nutritionally balanced (Grau *et al.*, 2017)

**Table I.2** Amino acid composition of five insect species, casein, and soybean protein, the recommendation for adults and the calculated essential amino acid index (Yi *et al.*, 2013).

Unit (mg/g crude protein)	<i>A. diaperinus</i>	<i>T. molitor</i>	<i>Z. morio</i>	<i>A. domesticus</i>	<i>B. dubia</i>	Casein	Soybean	1985 FAO/WHO /UNU
Essential amino acid (EAA)								
Histidine	34	29	31	21	23	32	25	15
Isoleucine	43	43	46	36	31	54	47	30
Leucine	66	73	71	66	56	95	85	59
Lysine	61	54	54	53	43	85	63	45
Methionine + Cysteine	26	26	24	25	23	35	24	22
Phenylalanine + tyrosine	120	100	111	92	93	111	97	38
Threonine	39	39	40	35	32	42	38	23
Tryptophan	12	12	14	9	8	14	11	6
Valine	58	61	63	55	52	63	49	39
Sum of EAA	459	437	454	392	361	531	439	277
Non-essential amino acid								
Alanine	66	70	68	81	71			
Arginine	54	54	54	65	46			
Aspartic acid	83	80	82	73	67			

Glutamic acid	123	109	127	110	96		
Glycine	46	50	48	51	53		
Proline	56	66	56	54	48		
Serine	40	44	42	38	34		
Sum of total AA	927	910	931	864	776		
EAAI	1.65	1.6	1.66	1.39	1.28	1.93	1.56

Yi *et al.*, (2016) identified the proteins present in water-soluble (supernatant) and water-insoluble (pellet) fractions of *T. molitor* insect. The most abundant proteins found in the supernatant fraction were hemolymph proteins, the potential allergen alpha-amylase, two putative proteinases, and stress-related proteins, as for the proteins found in the pellet fraction, they were mainly muscle proteins including actin, tropomyosin, and troponin T.

Insect protein digestibility is believed to be high, with most species ranging between 80% and 90%. According to a comparative study of 17 insect species with fishmeal and soybean meal, *Z. morio*, *T. molitor*, *M. domestica*, *B. mori* (pupae), and even the cockroach *P. americana* showed a similar digestibility to fish meal (84.9 - 85.7%) and a little lower digestion than soybean meal (95%).

The processing step can affect the quantity and quality of bioavailable protein by modifying the nutritional profile of insects and the digestibility of their proteins. Pretreatment is defined as any procedure performed on insects, from slaughter to their use as a substrate for in vitro hydrolysis (Rodríguez-Rodríguez *et al.*, 2022).

Leni *et al.*, (2019) studied the impact of the slaughter method on the digestibility of *H. illucens*. They have found that blanching improved the enzymatic digestibility of larvae, which they linked to the inhibition of the enzymatic browning process that reduces amino acid loss, in addition to that, it enhances enzymatic digestion because it probably denatures proteins, allowing digestive enzymes to act on the unfolded polypeptide chain.

A comparison of protein digestibility of defatted meals and protein isolate from the same insects revealed that protein digestibility was much greater in the protein isolate, which has been attributed to the absence of chitin in this fraction, as chitin lowers digestibility (Séré *et al.*, 2021). Different heat processing techniques were applied to *T. molitor* larvae (vacuum-cooked, fried, boiled, and baked for 15-30 min in an oven at 70 °C). When compared to control (uncooked) larvae, all treatments (except frying) were found to significantly enhance protein digestibility (Caparros Megido *et al.*, 2018). Opstvedt *et al.*, 2003 stated that excessively high temperatures can impair protein digestibility by triggering amino acid reactions that interfere with enzymatic digestion.

Extrusion is a common feed processing method in animal nutrition that increases the nutritional content of feed by destroying antinutritional factors and unwanted enzymes, enhancing feed digestibility and increasing the solubility of dietary fibers. Extrusion's effect on insects is found to be complex, it depends on species, degree of inclusion, pressure, temperature, humidity, and even numerous interactions between these parameters (Rodríguez-Rodríguez *et al.*, 2022).

### I.1.6.2. Chitin

Insect exoskeletons are made up of chitin, which consists almost entirely of fiber. Chitin is a polysaccharide composed of glucosamine and N-acetylglucosamine which is embedded in a scleroprotein matrix. It is neither digested nor absorbed in the small intestine and may have "anti-nutritional" properties due to its possible negative impacts on protein digestibility (Lange and Nakamura, 2021; Rodríguez-Rodríguez *et al.*, 2022).

Chitin represents around 10% of an insect's dry weight and varies according to insect species and developmental stage. Purified chitin contains approximately 90% dietary fiber that is digestible by humans. Chitin removal enhanced protein digestibility, amino acid content, protein efficiency ratio, and net protein utilization, according to Ozimek *et al.*, 1985. However, while chitin can be considered indigestible, its digestibility is dependent on the enzyme package of the consuming species, such as the presence of chitinolytic enzymes from bacteria located in the gastrointestinal tract. Another noteworthy feature of exoskeleton chitin is that it can provide health advantages by boosting the immune system, improving cardiovascular and intestinal health, lowering cholesterol, and having wound-healing properties (Rodríguez-Rodríguez *et al.*, 2022).

### I.1.6.3. Fatty acid profile

The lipid content and fatty acid composition of insects are affected by species, feed substrate and developmental stage. The fatty acid composition of edible insects appears to be comparable to that of animal fats and vegetable oils. Table 3 represents the fatty acid profile of *A. domesticus* and *T. molitor*, two edible insects. They have up to 77% unsaturated fatty acids (UFA): palmitoleic (C16:1), margaroleic (C17:1), oleic (C18:1), linoleic (C18:2) and gadoleic (C20:1) acids, and 30% saturated fatty acids (SFA): lauric (C12:0), myristic (C14:0), pentadecanoic (C15:0), palmitic (C16:0), heptadecanoic (C17:0), stearic (C18:0), arachidic (C20:0) and behenic (C22:0) acids. Linoleic acid, followed by oleic and palmitic acids, is the most abundant fatty acid in both insects. *T. molitor* has a relatively higher total UFA content than *A. domesticus* (77.2% and 70.7%, respectively) (Table I.3).

The omega-3 polyunsaturated and other fatty acid composition of mealworms is found to be equivalent to that of fish and greater than that of pigs and cattle, as for the omega-6/omega-3 fatty acid ratio, it is influenced by insect diet (Otero *et al.*, 2020).

**Table I.3** Fatty acid profile (g/100g FAMES) of *A. domesticus* and *T. molitor* insects (mean  $\pm$  S.D., n = 3) (Otero *et al.*, 2020).

FAME	<i>A. domesticus</i>	<i>T. molitor</i>
12:0	0.07 $\pm$ 0.00	0.19 $\pm$ 0.03
14:0	1.28 $\pm$ 0.03	4.05 $\pm$ 0.04
15:0	0.17 $\pm$ 0.02	0.12 $\pm$ 0.04
16:0	22.84 $\pm$ 0.27	16.66 $\pm$ 0.09
16:1	1.69 $\pm$ 0.07	3.01 $\pm$ 0.11
17:0	0.13 $\pm$ 0.02	0.11 $\pm$ 0.06

17:1	0.05 ± 0.02	0.17 ± 0.01
18:0	4.65 ± 0.12	1.57 ± 0.04
18:1	20.91 ± 0.24	34.26 ± 1.26
18:2	48.00 ± 0.39	39.85 ± 1.23
20:0	0.15 ± 0.02	0.05 ± 0.01
20:1	0.04 ± 0.01	0.04 ± 0.01
22:0	0.03 ± 0.00	0.01 ± 0.00
ΣSFA	29.33 ± 0.22	22.75 ± 0.10
ΣMUFA	22.68 ± 0.18	37.39 ± 1.27
ΣPUFA	48.00 ± 0.39	39.85 ± 1.23

#### I.1.6.4. Vitamins and minerals

There are significant differences in mineral content across edible insect species. They were identified to have relatively high quantities of B complex vitamins (riboflavin, pantothenic acid, and biotin), but low levels of vitamin C, calcium, sodium, and potassium. Vitamin B levels in grasshoppers have been found to stay consistent throughout development, but vitamin A, C, D, and E levels increase throughout life phases. Cricket powder has been shown to be high in magnesium, zinc, and copper, whereas grasshoppers and mealworms were found to have copper, magnesium, manganese, and zinc levels that are higher than those found in beef. This is highly important since iron and zinc deficits are common in underdeveloped nations, particularly among children and women of reproductive age, where around 2 billion individuals are zinc deficient, and 1 billion suffer from anemia. However, additional research is needed to assess the bioavailability of iron and zinc from insects (Lange and Nakamura, 2021; van Huis, 2013).

### I.2. Edible insects processing

#### I.2.1. The necessity of insect processing

The processing and incorporation of edible insects' fractions into common consumer products appear to promote entomophagy while also improving the nutritional composition of the insects. Consequently, appropriate processing methods must be explored in order to enhance the marketing of insect products.

In Western countries, consumer acceptance is found to be linked to extracting and purifying proteins, and incorporating them into common food products such as bread, pasta chips protein bars etc. Furthermore, nutrient extraction is an important step since it has been proven to increase protein digestibility, and also high chitin concentrations may have an adverse effect on the digestibility of insect-based products (van Huis, 2013; Żuk-Gołaszewska *et al.*, 2022).

In recent years, the transformation of edible insects for food and feed purposes has gained significant attention. The upcoming '**Article 1: Edible insects' transformation for feed and food uses: an overview of current insights and future developments in the field**' is a review article that was published in the Journal 'Processes' (<https://doi.org/10.3390/pr10050970>) and provides a

comprehensive overview of various research and studies focused on extracting lipids, proteins, and chitin from various insect species. It highlights the latest developments and research findings in the field of edible insects.

I.2.2. Article 1: Edible insects' transformation for feed and food uses: an overview of current insights and future developments in the field

(The article is presented in the following pages)



# Edible Insects' Transformation for Feed and Food Uses: An Overview of Current Insights and Future Developments in the Field

Rachelle El Hajj <sup>1</sup>, Houcine Mhemdi <sup>1,\*</sup>, Colette Besombes <sup>2</sup>, Karim Allaf <sup>2</sup>, Victor Lefrançois<sup>3</sup> and Eugène Vorobiev <sup>1</sup>

<sup>1</sup> Université de Technologie de Compiègne, ESCOM, TIMR (Integrated Transformations of Renewable Matter), Centre de Recherche Royallieu—CS 60 319—60203 Compiègne, France;

<sup>2</sup> University of La Rochelle, Laboratory of Engineering Science for Environment LaSIE-UMR-CNRS 7356, 17042 La Rochelle, France;

<sup>3</sup> ABCAR DIC Process, 11 Rue du Four Saint-Jacques, 60200 Compiègne, France;

\*Correspondence: h.mhemdi@escom.fr or h.mhemdi@live.fr; Tel.: +33-3-44-23-88-20

## Transformation of Edible insects for Food and Feed

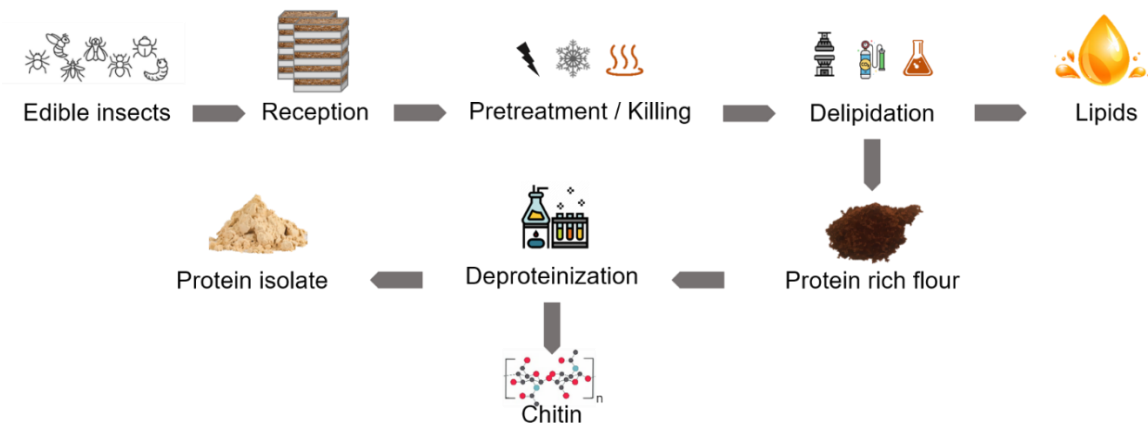

Published: May 2022

Processes Journal

<https://doi.org/10.3390/pr10050970>

## **Abstract**

The integration of insect-derived extracts in feed and food products has become a field of growing interest in recent years. In this review, we collect different studies carried out on edible insects' transformation processes and focus on the various treatment operations, extraction technologies, and solvents used in different processing steps. We include an overview of current insights into the different steps of the transformation process: insect reception, killing methods, pretreatments, storage, delipidation, protein extraction, as well as chitin and chitosan extraction. Finally, we reflect on the most important future challenges of this sector.

**Keywords:** edible insects; lipids; chitin; chitosan; proteins; extraction; biomolecules

## 1. Introduction

Nowadays, generating sufficient food for the world's population, which is expected to reach 9 billion by 2050, is one of the greatest challenges facing the food industry [1]. To meet this need, new sustainable agricultural techniques for food production [2] as well as alternative sustainable protein sources for the food and feed industries must be investigated [3]. In other words, there is a massive need to change traditional farming practices and to find new protein sources that have lower environmental impacts (e.g., water consumption, greenhouse gas emissions, etc.) [4] than conventional sources (e.g., cattle, sheep, pig, and poultry livestock). In this regard, plant-based meat alternatives, single-cell proteins (i.e., mycoprotein, yeasts, fungi, bacteria, photosynthetic microalgae, and cyanobacteria), macroalgae (i.e., red seaweed), insects, and cultured meat are all being explored as alternative proteins and future foods [5,6,7]. Among these alternative protein sources, cultured meat has the highest environmental impact and cost due to high-energy requirements for the medium and meat-growing processes, followed by mycoprotein-based food, which has high-energy needs and agricultural feed-growing activities. Insect-based and soy meal-based alternatives have the lowest impact, because of the use of efficient processing and growing methods, as well as the usage of by-products and side streams [8].

The number of edible insect species consumed worldwide in 2017, at their different life stages, is estimated to be around 2000, spread across Asia, Australia, Central, and South America, and narrowly across Europe and North America [9]. However, insects are currently gaining attention in Europe as a promising alternative protein source that can answer the growing demand for animal protein products while being low cost, nutritious, safe, and environmentally friendly [10,11].

The most consumed insect species in the world, in decreasing order, are beetles (*Coleoptera*, 31%); caterpillars (*Lepidoptera*, 17%); ants, bees, and wasps (*Hymenoptera*, 15%); grasshoppers and locusts (*Orthoptera*, 13%); true bugs (*Hemiptera*, 11%); dragonflies (*Odonata*, 3%); termites (*Isoptera*, 3%); flies (*Diptera*, 2%); cockroaches (*Blattodea*, 2%); others 3% [9]. *Coleoptera*, *Lepidoptera*, and *Diptera* are mainly consumed in the larval stage, while *Orthoptera*, *Blattodea*, *Hymenoptera*, *Hemiptera*, and *Isoptera* are consumed in the adult stage [2].

Entomophagy, i.e., the consumption of insects is frowned upon in most Western countries. It is worthy to mention that most people are averse to the idea of eating insects and they link the practice with primitive behavior. In addition to basic human perceptions, the origins of disgust may be traced back to culture (i.e., “taste is culture”), which has a significant impact on eating habits. The laws that define what is edible are impacted by culture, which is influenced by the environment, history, community organization, human endeavor, mobility, and economical status [12]. On the one hand, low levels of readiness and intention to try insects have been linked to the fear of trying new foodstuffs (food neophobia) [13]. Curiosity, on the other hand, appears to be one of the most powerful motivators for individuals to try insects, according to a recent study [14]. Hence, despite being very nourishing, as well as rich in proteins, minerals, lipids, and vitamins, insects have been found to be disliked, and commonly, not accepted as a human food source in most developed

countries [15]; this psychological barrier to entomophagy acceptance is highly influenced by metamorphological life-stage, type of gastronomic preparation, and level of insect visibility [16].

Therefore, to increase consumer acceptance, insect proteins can be extracted in the form of protein flour, and “hidden” in familiar processed foods (such as bread, meat, pasta, and pizza) [17] or used as a feed source for animals such as poultry, fish, and pigs (indirect entomophagy) [15].

Insect usage as an alternative food source is not only nutritious but also has a positive impact on the environment and the economy [2]. Insect larvae can be raised by consuming agricultural bio-waste and food waste, and converting them into protein and fat; this is the “circular economy” concept [18]. The circular economy has become one of the most central concerns in the last decade, emphasizing the development of sustainable and resource-efficient policies for long-term socioeconomic and environmental advantages. The circular economy approach seeks to break the linear pattern of production and consumption in industrial production systems by implementing circular or “closing the loop” processes [19]. Thus, due to their ability to transform organic matter into protein, insects can help to solve the problem of food waste [20]. Commercial insect rearing is a viable method for reintroducing nutrients into the food chain in the form of protein-rich animal feed, human food, and fertilizer [19]. However, insects can only be fed with substrates that are eligible as feed materials for farmed animals, according to the animal by-products EU regulation (1069/2009) [21].

Insect farming presents many other advantages over conventional livestock farming including better feed-conversion efficiency, lower water pollution, higher reproduction rates, lower greenhouse gas emissions, and minimal land area use. To produce the same protein quantity obtained from 1 ha of mealworm, it requires 2 to 3.5 ha for chickens or pigs and 10 ha for cattle [2].

Insects contain around 35–61% (DM) of protein and 15–40% of fats. They also contain fiber, non-protein nitrogen, and ash, in no specific order, depending on the insect species (Figure 1) and developmental stages [22]. Insect composition may vary within the same species, and these variations can originate from many factors such as origin, processing treatments, measuring methods, as well as some extrinsic factors such as feeding and rearing conditions [22,23].

The literature analysis shows a lack of reviews dealing with the transformation processes of edible insects. In the current context marked by the growth of the insect transformation field, there is a need for a review that brings together all of the published works. Moreover, it is essential to provide to readers a document that covers all aspects of these works, as well as a critical analysis, to open the door to future developmental opportunities based on the field’s challenges and areas that require improvement. This review sheds light on the use of innovative and emerging technologies in receiving, killing, pretreating, and processing edible insects to obtain extracts that can be used in feed and food. Particularly, it focuses on comparing lipid, protein, and chitin extraction, as well as transformation process methods from insects using different conventional and emerging technologies.

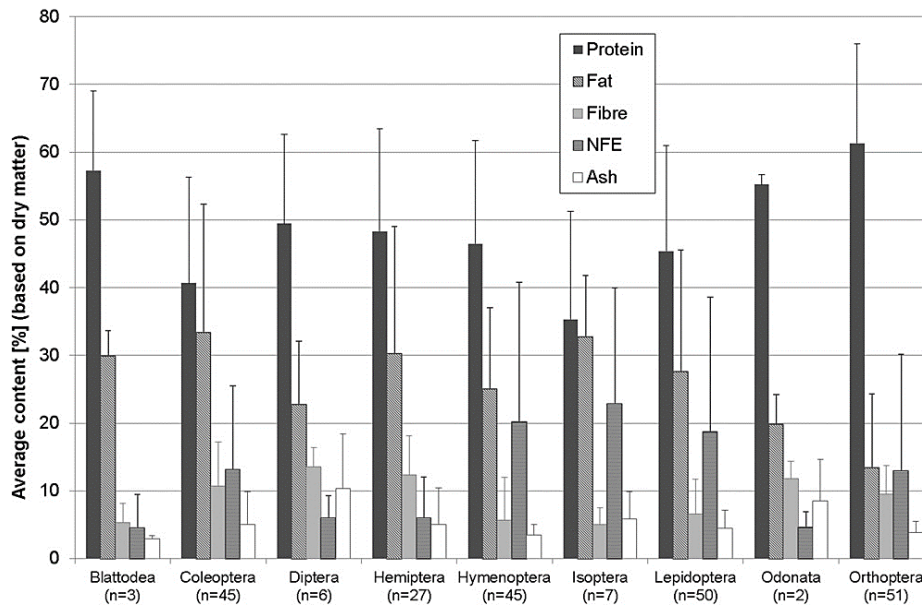

**Figure 1.** Average nutrient contents (%) (based on the dry matter) of edible insects belonging to the same order. n, number of insect samples obtained from literature; NFE, nitrogen-free extract [22].

## 2. Transformation Processes for Edible Insects

### 1.1. Raw Materials and Sample Preparation

The most commonly used edible insect species in protein extraction processes are presented in Table 1.

**Table 1.** The most commonly used edible insect species in protein extraction processes.

Order	Family	Genus	Species	Common name	Stage	References
Coleoptera	Tenebrionidae	<i>Tenebrio</i>	<i>molitor</i>	Yellow mealworm	Larvae	[1,10,24–27]
	Tenebrionidae	<i>Alphitobius</i>	<i>diaperinus</i>	Lesser mealworm	Larvae	[15,25,28]
	Tenebrionidae	<i>Zophobas</i>	<i>morio</i>	Superworm	Larvae	[28]
Orthoptera	Gryllidae	<i>Grylloides</i>	<i>sigillatus</i>	Tropical house cricket	Adult	[26,27]
	Acrididae	<i>Schistocerca</i>	<i>gregaria</i>	Desert locust	Adult	[27,29]
	Gryllidae	<i>Acheta</i>	<i>domesticus</i>	House cricket	Adult	[15,26,28]
Blattodea	Gryllidae	<i>Gryllus</i>	<i>bimaculatus</i>	Two-spotted cricket	Adult	[24]
	Blaberidae	<i>Blaptica</i>	<i>dubia</i>	Dubia cockroach	Adult	[15,28]
Lepidoptera	Sphingidae	<i>Clanis</i>	<i>bilineata</i>	Two-lined Velvet hawkmoth	Larvae	[30]
	Bombycidae	<i>Bombyx</i>	<i>mori</i>	Silkworm moth	Pupae	[24]
Diptera	Stratiomyidae	<i>Hermetia</i>	<i>illucens</i>	Black soldier fly	Larvae and prepupae	[3,10,25]
Hymenoptera	Apidae	<i>Apis</i>	<i>melifera</i>	Honey bee	Larvae and pupae	[29]

Insects can be either collected in the wild, cultivated indoors, or issued as by-products from other productions (e.g., *Bombyx mori* from silk production) [23]. In general, farmed insects are reared in specific conditions, mainly by following a specific diet, aiming at achieving the highest feed conversion ratio, reducing mortality, accelerating their development, and improving their nutritional composition. They can be fed on plant resources (e.g., wheat, wheat bran, cereal, oats, soy, rye, corn, chicken mash, and organic young wheat plants), fruits and vegetables (e.g., carrots), microbial resources (e.g., beer yeast), premix, and NaCl [1,15,27,28,29]. By-products and organic wastes can also be used in the diet as complements [31].

Upon collection, to clear their digestive tracts, insects should be fasted between 24 and 48 h, and then sieved to separate them from frass before processing [10,15,27,28,29,32], yet this step is not mandatory [33]. Afterward, many different ways of reception, storage, and pretreatments can be applied to the insects before their transformation. Generally, insects are received from the supplier alive, frozen, or dried (lyophilized, microwave dried, etc.), and then they are stored and pretreated accordingly (Figure 2).

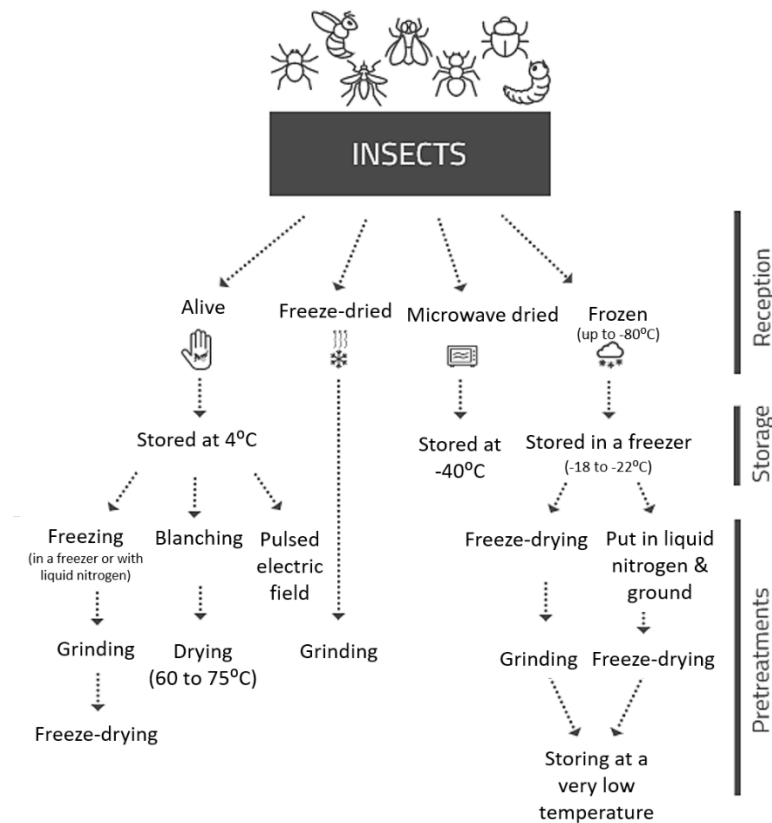

**Figure 2.** Different methods of reception, storage, and pretreatments of edible insects.

If they are received alive, they should be stored at 4 °C until further processing (with or without fasting). Fresh insects can be killed in various methods, including freezing with liquid nitrogen or freezing at -20 °C and then grinding and freeze-drying, blanching in boiling water [3,28,30,34],

or by applying pulsed electric fields (PEF) as both a killing method and a pretreatment at once [35]. Alles *et al.* (2020) [32] studied the effect of PEF on insect larvae (*Hermetia illucens*) as a killing method and a pretreatment to enhance drying rate and oil extraction. This study proved that applying PEF as a pretreatment at high levels ( $\geq 3$  kV/cm, 5 kJ/kg) induced insects' mortality and increased oil yield slightly, and that levels of 2 to 3 kV/cm and 20 kJ/kg reduced drying time by 30%. Another study by Psarianos *et al.* (2022) [34] found that at 4.90 kJ/kg, PEF treatment improved the functional properties of house cricket flour as well as the separation of interesting molecules. The flour's oil binding capacity, emulsifying capacity, and antioxidant activity were increased by 19.53, 22.06, and 45.79%, respectively, while the extraction yields of protein and fat were increased by 18 and 40%, respectively.

If insects are received in a lyophilized form, they should first be ground, and then transformed [26]. If they are received after microwave drying, they should be stored at  $-40$  °C until processing [24]. When they are received frozen, either with liquid nitrogen or in a freezer, they should be stored between  $-18$  and  $-22$  °C, and then pretreated. The pretreatment can be freeze-drying followed by grinding or liquid nitrogen followed by grinding and freeze-drying. In all cases, the samples should be stored at a very low temperature until use [1,10,15,24,25,27,29].

Leni *et al.* (2019) [3] studied the effect of two killing methods on the browning and the quality of protein fraction of black soldier fly (BSF, *H. Illucens*) prepupae. By comparing the color of *H. Illucens* killed by blanching and freezing, it was confirmed, visually and with absorbance measurements, that the insects killed by freezing have a darker appearance than the blanched insects. This is explained by the fact that steam-blanching inactivates the enzymes responsible for color changing, thus, controlling the enzymatic browning. In addition, a comparison of the intensity of some metabolites of *H. Illucens* prepupae killed by freezing and blanching was done. This comparison showed that the samples killed by freezing exhibited numerous energy metabolisms, including glucose hydrolysis, lactic acid synthesis, citric acid consumption, and lipolysis. These transformations were not visible in samples killed by steam blanching because, unlike freezing, blanching is a rapid killing method that results in the thermal inactivation of enzymes involved in metabolic activities. Moreover, concerning the total amino acid profile, Leni *et al.* (2019) [3] proved that killing by freezing induced partial degradation of Cys and Lys, which was not seen in steam-blanched insects. Cys and Lys are essential amino acids that are associated with the insect melanization process as well as protein aggregations. Thus, proteins from blanched BSFs require less intense conditions for extraction and present a better nutritional profile than frozen BSFs. Hence, blanching is found to be a better killing method than freezing since it results in the inactivation of energy metabolisms and avoids browning.

Moreover, these facts reveal the importance of insect-killing methods in further processing steps such as lipid and protein extractions and their incorporation in food and feed products as well as the final product's nutritional profile.

In light of that, when implementing new pretreatment/killing techniques, their effect on the larval enzymatic activities and energy metabolisms must be considered.

## **1.2. Extraction Processes**

### **1.2.1. Insect Delipidation**

Before proceeding to protein extraction, fat removal is recommended for insects, as they generally have a high lipid content. They can be primarily pressed either in a continuous screw press or in a hydraulic discontinuous press, which removes part of their water and fat content [1,35], and then they are dried and ground for further fat removal steps [1].

Defatting may be done in many ways; the most widespread methods are solvent extraction, accelerated solvent extraction (ASE), Soxhlet extraction, Folch extraction, supercritical CO<sub>2</sub> extraction, and aqueous extraction.

Solvents used for lipid solvent extraction are mainly hexane (100%), ethanol (99.5%), or a mixture of hexane and isopropanol (ratio 3/2) [1,10,24,29,33,36]. This method (Figure 3) consists of dissolving insect powder in the solvent 1:5 (w/v), and then stirring on a magnetic stirrer for 1 h. After sedimentation, the solvent-fat mixture is decanted, and the whole process is repeated until clarity of the solvent. Afterward, residual solvent is removed by evaporation overnight [10,29]. Alternatively, after dissolving insect powder in solvent, the mixture can be vortexed/shaken for 15 min, then centrifuged, and finally, solvent removal is done using a rotary evaporator, and the remaining insoluble product is dried to a powder form by passing it through nitrogen gas. An additional step of fine grinding of the defatted insect powder can produce defatted insect flour that should then be stored at -20 °C until usage [36]. High hydrostatic pressure (HHP)-assisted fat extraction was studied by Bolat *et al.* (2021) [37] on mealworm and cricket powders, to improve the defatting process. The HHP study was carried out at a pressure of 500 MPa for 15 min at two different temperatures, i.e., 30 °C and 40 °C, using the original powder/solvent ratio. According to the findings, HHP and temperature seemed to have no influence on fat extraction; however, the functional properties and antioxidant activities of the studied insects were significantly affected by both parameters.

Amarender *et al.* (2020) [36] carried out a comparison study between defatting insects by solvent extraction using hexane and ethanol. The results confirmed that ethanol, as compared with hexane, resulted in a higher lipid extraction rate. Therefore, it is a good alternative, and it is also preferred in the food industry over hexane since it is a green solvent. Alternatively, the influence of several defatting solvents (aqueous, methanol, ethanol, and n-hexane) on the characteristics and functional properties of isolated proteins from *Protaetia brevitarsis* larvae was studied by Kim *et al.* (2021) [38]. In terms of protein functional qualities such as foam and emulsion characteristics, as well as essential amino acid index, the findings suggested that hexane extract was the best solvent for protein processing. Whilst ethanol extract had lower protein content, quality, and stability than



hexane extract, foam and emulsion capacity were comparable to hexane extract after defatting with ethanol.

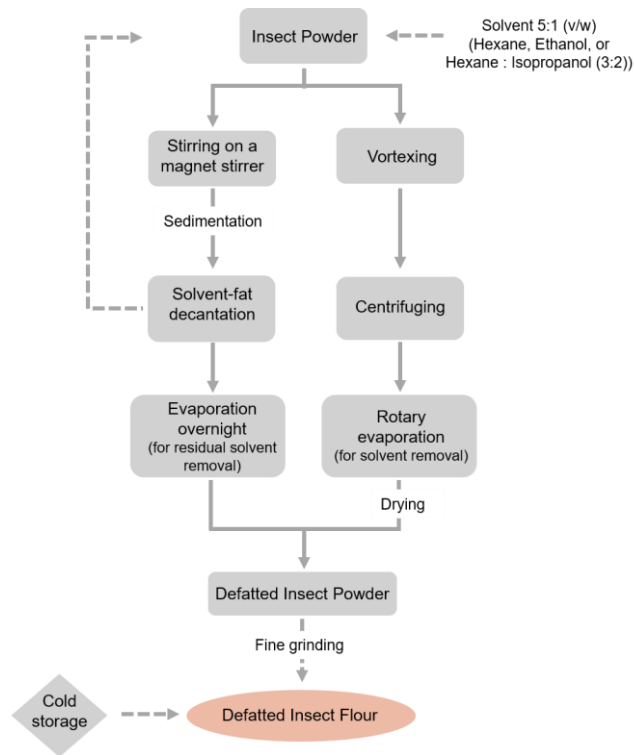

**Figure 3.** Flow diagram for fat solvent extraction.

An alternative intensified method of solvent extraction is accelerated solvent extraction (ASE) [1], so-called pressurized solvent extraction (Figure 4). This process uses the same solvents previously cited and it is performed under high pressure (up to 140 bars.) and at an elevated temperature (up to 200 °C). The extractor is developed in a manner that it is capable of withstanding high pressures, which allows an increase in temperature above the boiling point of the used solvent and maintains the solvent in a liquid form at a high temperature. This method has several advantages such as improved solvent diffusivity, less solvent consumption, accelerated operation time, as well as higher extraction yield and rate [39].

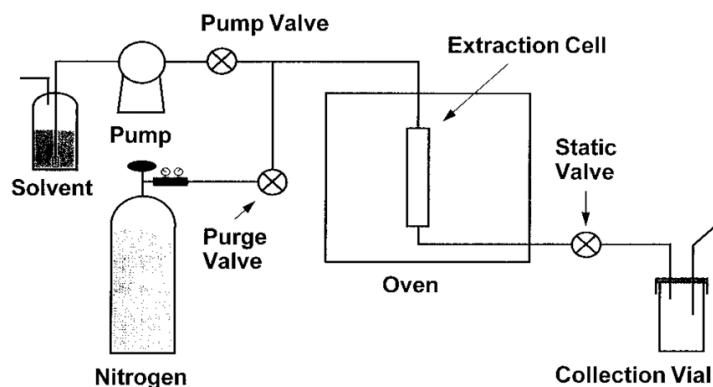

**Figure 4.** Schematic diagram of an accelerated solvent extraction (ASE) system [40].

Soxhlet extraction is one of the most often used methods for lipid extraction. It employs organic solvents such as hexane, diethyl ether, petroleum ether, acetone, and ethanol. This is a specific solvent extraction method usually performed in a Soxhlet apparatus for 6 h (Figure 5).

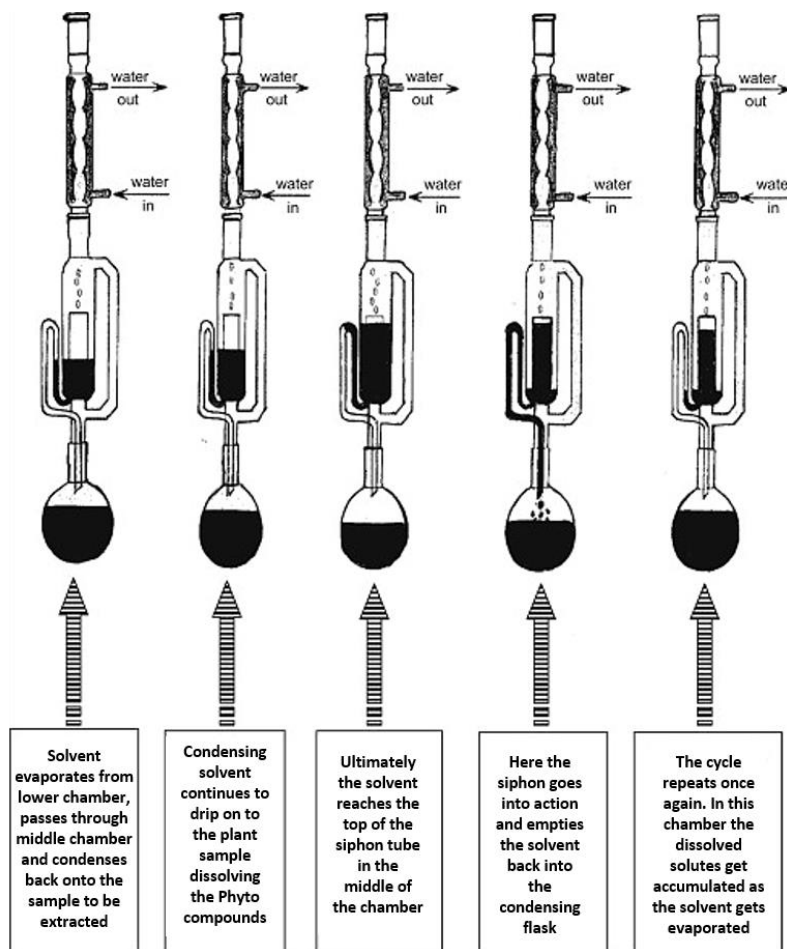

**Figure 5.** Schematic diagram showing the Soxhlet extraction technique [39].

Afterward, the residual solvent is evaporated either under a nitrogen N<sub>2</sub> stream at a temperature between 45 and 60 °C for 1.5 to 3 h (depending on the solvent) or using a rotary evaporator [3,15,25–28].

A comparison study for the five organic solvents on ground cricket samples was carried out by Ribeiro *et al.* (2019) [26] to determine the specific best conditions of Soxhlet fat extraction. The quantity of extracted fat was determined gravimetrically. The results are reported in Table 2 and indicated that: ethanol had the highest crickets' fat extraction followed by acetone, with no detected differences between diethyl ether, ether petroleum, and hexane. Mainly, crickets defatted using ethanol had between 61.3% (*G. sigillatus*) and 70.1% (*A. domesticus*) less lipids than when defatted using the other solvents. These results were comparable to a study conducted by Laroche *et al.* (2019) [41], who concluded that the highest fat extraction rate (22.7% w/w) of *A. domesticus* and *T. molitor* was produced by ethanol and that hexane was the least efficient solvent. However, they also concluded that ethanol was less effective at extracting nonpolar fatty acids, according to fatty acid profiles obtained by gas chromatography. Therefore, the defatting method should be chosen based on the fat composition profile of the edible insects.

**Table 2.** Ether extract content (g/100 g DM  $\pm$  s.d.) of whole and defatted *Acheta domesticus* and *Grylloides sigillatus* determined with different solvents. <sup>a,b,c</sup>—Represents in each column homogeneous groups in accordance with the Turkey's test, within each cricket species ( $p < 0.050$ ). Results are means of three (defatted) and four (whole) replications [26].

Solvent	<i>A. domesticus</i>		<i>G. sigillatus</i>	
	Whole	Defatted	Whole	Defatted
Acetone	24.6 $\pm$ 1.02 <sup>b</sup>	4.7 $\pm$ 1.99 <sup>ab</sup>	23.5 $\pm$ 0.27 <sup>b</sup>	5.8 $\pm$ 1.93 <sup>ab</sup>
Diethyl ether	20.8 $\pm$ 1.17 <sup>c</sup>	4.4 $\pm$ 0.55 <sup>ab</sup>	20.8 $\pm$ 0.96 <sup>c</sup>	6.5 $\pm$ 2.28 <sup>b</sup>
Ethanol	28.2 $\pm$ 1.63 <sup>a</sup>	1.4 $\pm$ 0.74 <sup>a</sup>	28.4 $\pm$ 1.10 <sup>a</sup>	2.3 $\pm$ 0.65 <sup>a</sup>
Ether petroleum	21.3 $\pm$ 0.31 <sup>c</sup>	4.1 $\pm$ 0.66 <sup>ab</sup>	20.2 $\pm$ 0.36 <sup>c</sup>	6.9 $\pm$ 0.50 <sup>b</sup>
Hexane	18.9 $\pm$ 1.65 <sup>c</sup>	5.5 $\pm$ 2.47 <sup>b</sup>	20.8 $\pm$ 0.97 <sup>c</sup>	4.6 $\pm$ 1.02 <sup>ab</sup>

Regarding the Folch extraction, it consists of diluting the insects with dichloromethane/methanol (1:1, v/v), and then shaking the mixture for 20 s. After that, it is sonicated for 10 min before being shaken on a rotary shaker for 2 h. Next, a specific quantity of demineralized water is added to induce phase separation, and the mixture is centrifuged for 20 min. At this point, an upper phase with non-lipid compounds and a lower phase containing lipids with the organic solvents are obtained (Figure 6). The upper phase is removed using a glass pipette and the lower one is filtered using a paper filter. Later, the organic solvents are evaporated in a rotary evaporator [15].

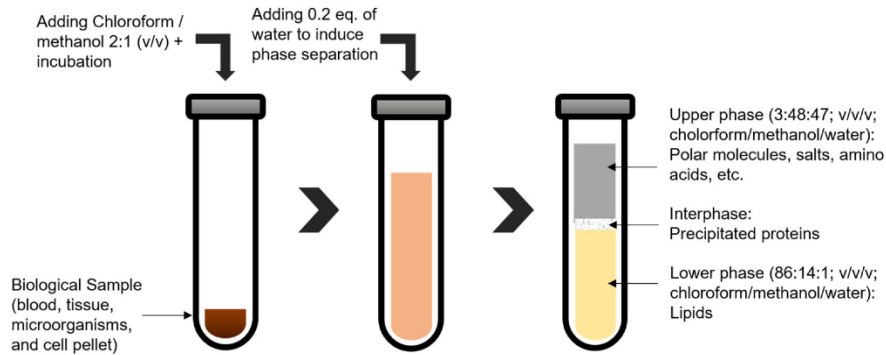

**Figure 6.** Workflow according to the Folch's extraction method [42].

Moreover, supercritical CO<sub>2</sub> (SC-CO<sub>2</sub>) fat extraction (Figure 7) is considered to be a promising eco-friendly alternative to the conventional solvent extraction methods. This operation presents several advantages such as safety because of the use of nonorganic solvents, high product quality due to the moderated operating temperature (lower than 60 °C), an extract free of residues, and selective extraction [43]. Wu (2012) studied the optimum conditions for supercritical CO<sub>2</sub> fat extraction from *Clanis bilineata*. He concluded that the highest extraction yield (97%) for 20 g of dried CB meat was achieved at a temperature and pressure of 35 °C and 25 MPa, respectively, with a supercritical CO<sub>2</sub> flow rate of 20 L/min and in an extraction time of 60 min [44]. However, Laroche *et al.* (2019) [41] proved that the SC-CO<sub>2</sub> extraction method, despite being sustainable, was less efficient than Soxhlet extraction, and therefore, proposed its optimization using co-solvents.

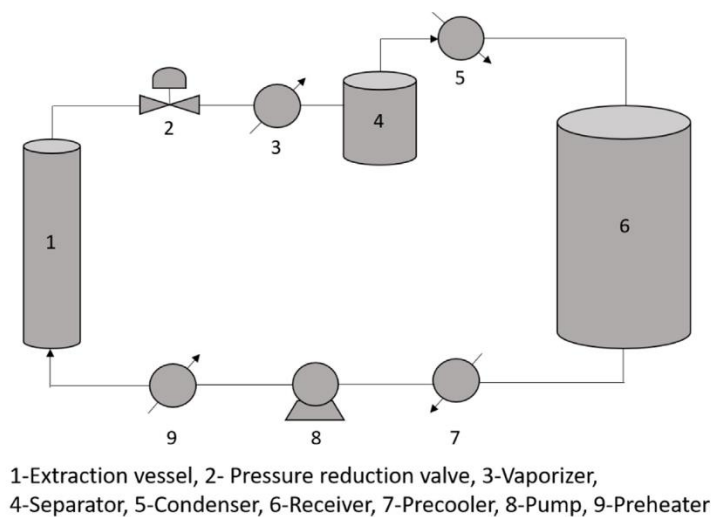

**Figure 7.** General flow diagram of a supercritical fluid extraction process from solid material [39].

Finally, for the aqueous extraction, 200 g of frozen insects are dissolved in 600 mL of demineralized water and mixed for 1 min. Afterward, the mixture is sonicated for 15 min, then sieved through a 350 µm stainless steel filter sieve, and centrifuged for 30 min at 4 °C. By this stage, the mixture is divided into three phases: an upper lipid phase, the supernatant in the middle

phase, and the pellet in the lower phase. The lipid phase undergoes a second centrifugation at 40 °C which results in another three phases: a transparent anhydrous lipid extract at the top, a thin cream layer in the middle, and finally water and water-soluble compounds in the lowest phase [15].

Tzompa-Sosa *et al.* (2014) [15] conducted a comparison study among Soxhlet lipid extraction (SLE), Folch lipid extraction (FLE), and aqueous lipid extraction (ALE), on four insect species. They calculated the extracted lipid content (g/100 g of fresh insects) for each method and compared the yields (%) of aqueous and Soxhlet lipid extraction relative to Folch lipid extraction using the following formulas: ALE/FLE and SLE/FLE (Table 3).

**Table 3.** Total lipid quantity extracted from four insect species after aqueous, Soxhlet, and Folch extraction expressed on the basis of live weight. Extraction yields of aqueous and Soxhlet extraction relative to Folch extraction (mean  $\pm$  S.D., N = 3) [15].

Insect Species	Extracted Lipid (g/100 g Fresh Insects)			Yield (%) (ALE/FLE)	Yield (%) (SLE/FLE)
	Aqueous	Soxhlet	Folch		
<i>T. molitor</i>	7.8 $\pm$ 0.4 <sup>A</sup>	12.7 $\pm$ 2.4 <sup>B</sup>	12.9 $\pm$ 0.2 <sup>B</sup>	60.3 $\pm$ 0.4	98.4 $\pm$ 2.4
<i>A. diaperinus</i>	5.5 $\pm$ 1.0 <sup>A</sup>	10.7 $\pm$ 0.5 <sup>B</sup>	9.4 $\pm$ 1.0 <sup>B</sup>	58.3 $\pm$ 1.4	113.5 $\pm$ 1.1
<i>A. domesticus</i>	1.6 $\pm$ 0.1 <sup>A</sup>	6.0 $\pm$ 0.3 <sup>B</sup>	8.0 $\pm$ 1.1 <sup>C</sup>	19.2 $\pm$ 1.1	74.8 $\pm$ 1.1
<i>B. dubia</i>	3.1 $\pm$ 0.3 <sup>A</sup>	7.6 $\pm$ 0.2 <sup>B</sup>	7.5 $\pm$ 0.3 <sup>B</sup>	40.9 $\pm$ 0.4	100.5 $\pm$ 0.4

Their results show that lipid extraction (g/100 g in fresh insects) of all species ranged between 1.6 and 7.8% for the ALE, between 6 and 12.7% for SLE, and between 7.5 and 12.9% for FLE. Concerning the comparison to the Folch extraction method: SLE/FLE reached almost 100% for *T. molitor*, *A. diaperinus*, and *B. dubia*, and 74.8% for *A. domesticus*; regarding ALE/FLE, the values were much lower (between 19 and 60.3%). These findings indicate that Soxhlet and Folch extraction methods provide nearly the same lipid extraction efficiencies, with the highest quantities extracted, which is not the case for the aqueous extraction [15].

In short, after insect pressing, which extracts a high amount of lipids and water in a low-energy manner, solvent extraction is needed. Although ethanol has been found to be the most efficient solvent for extracting lipids from insects, it is the least effective at extracting nonpolar fatty acids. Therefore, combining a nonpolar and a polar solvent, such as hexane/ethanol and hexane/propan-2-ol, might be a solution to improve the lipid extraction yield. When it comes to the SC-CO<sub>2</sub>, coupling it with a co-solvent such as ethanol might be a solution to improve its efficiency in an environmentally friendly way.

### 1.2.2. Insect Protein Extraction

Insect proteins are extracted by diffusion in water either in an alkaline or an acidic environment, possibly assisted by the sonication technique.

Alkaline aqueous extraction of the soluble proteins (Figure 8) consists of adding distilled water to defatted insects and adjusting the pH of the solution to 10 using sodium hydroxide (0.1 or 1 N

NaOH) with constant stirring (magnetic stirrer) and at a constant temperature (between 45 and 90 °C), from 30 min to 1 h, maintaining the pH at 10. Next, the solution is centrifuged, the supernatant is collected [1] and undergoes isoelectric protein precipitation at pH 4.5 to 5, by adding 0.1 M of hydrochloric acid (HCl) [27,29,33,45]. Re-extraction at either pH 2 [10] or pH 10 [33] of the pellet followed by isoelectric precipitation might be conducted at this stage. Precipitated proteins from both extractions are collected and go through another centrifugation, to be washed with distilled water. The obtained proteins are frozen, freeze-dried, and then ground and preserved at low temperature [1,10,27,33,45]. Sonication can be applied instead of the magnetic stirrer for a sonication-assistant extraction [29].

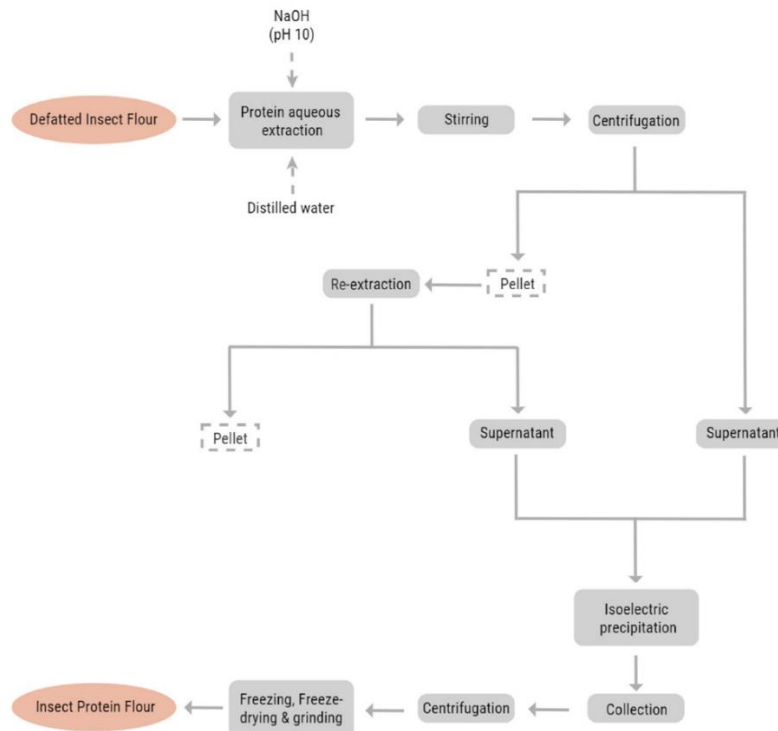

**Figure 8.** Schematic representation of insect protein extraction from defatted insect flour.

On the one hand, Zhao *et al.* (2016) [33] worked on finding the most optimal alkaline extraction conditions for yellow mealworms. After a study based on the fractional factorial experimental design, they found the following optimal conditions: 0.25 M NaOH solution as extraction solvent, liquid/solid ratio of 15 mL/g,  $T = 40\text{ }^{\circ}\text{C}$ , and  $t = 1\text{ h}$ .

On the other hand, an acidic aqueous extraction was performed as an alternative method of aqueous extraction. It consisted of adding ascorbic acid to the solution instead of NaOH followed by vortexing and finally centrifuging. The supernatant and gel layer were collected, and a second extraction was conducted on the pellet, followed by vortexing and centrifuging, to obtain a protein extract, which was frozen and freeze-dried [36].

Otherwise, proteins are extracted by sonication using an ultrasonic generator set to 20 kHz for 15 to 20 min, with 75% AMPL (amplitude), and pulsed every 3 s with equal resting intervals. Then, samples are filtered using a stainless-steel filter of 1 mm, and filtrates are collected, freeze-dried, and stored at cold for further usage [24,46]. The effect of the ultrasound-assisted process (UAP) on the yield, functional, antioxidant, and molecular properties of protein isolated from Bombay locusts (*Patanga succinta* L.) was studied by Kingwascharapong *et al.* (2021) [47]. They stated that to avoid undesirable effects on the protein's molecular structure, the right UAP condition should be assessed. For Bombay locust, UAP at 60% amplitude for 20 min was identified as being a good condition for protein extraction with minimal side effects.

Laroche *et al.* (2019) [41] conducted a study on the influence of the defatting methods on proteins purity. This study proved that the lipid extraction method affected protein extraction and ethanol-Soxhlet defatting produced a higher protein purity in *A. domesticus* as compared with other solvents such as petroleum ether, ethyl acetate, hexane, and even as compared with supercritical CO<sub>2</sub> extraction.

Bußler *et al.* (2016) [10] indicated that during the protein extraction process, protein solubility was extremely dependent on the pH. Usually, protein solubility of defatted insect flour is higher in pH 2 and 11, and it decreases as it approaches the isoelectric point (pI) around pH 4 (Figure 9) [27,33]. On this line, Amarender *et al.* (2020) [36] conducted a comparative analysis of the extraction of defatted cricket proteins in an alkaline (NaOH) and an acidic solution (Ascorbic acid). The results (Table 4) led to the following conclusion: extraction in an acidic medium (pH from 2 to 3) gave an extract with higher protein content (69.69%) than the one issued from the extraction in an alkaline medium of pH 13 (61.75%). This can be explained by the high solubility of cricket proteins in an acidic solution rather than an alkaline solution. A study done by Brogan *et al.* (2021) [48] determined that proteins can be successfully separated from insects through pH solubility precipitation and that this method results in isolates with good nutritional and functional qualities.

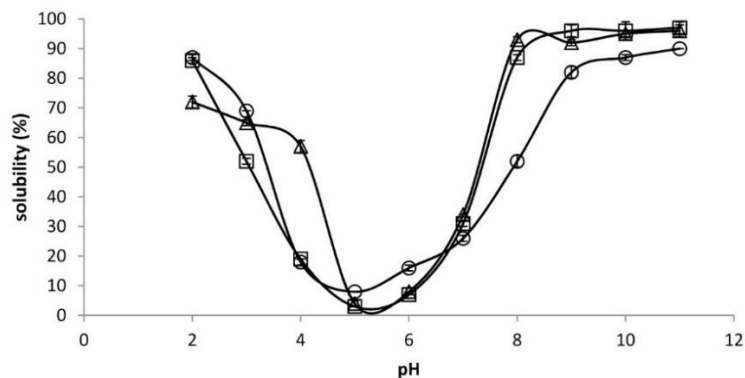

**Figure 9.** Protein solubility (%) with changes at pH 2–11. *Tenebrio molitor* (square), *Gryllodes sigillatus* (triangle), and *Schistocerca gregoria* (circle) [27].

**Table 4.** Extraction yield, true protein content, and extraction rate of protein from ethanol defatted cricket powder [36].

Sample	Extraction Yield (%) of Defatted Cricket Powder	True Protein (%)	Extraction Rate of Protein (%)
Defatted protein extract (ascorbic acid)	87.75 ± 1.53 <sup>a</sup>	69.69	82.95
Defatted protein extract (NaOH)	80.78 ± 0.17 <sup>b</sup>	61.75	67.66

The protein content of insects is generally determined using the Kjeldahl method. This method gives the total nitrogen content, and then a protein-to-nitrogen conversion factor (Kp) of 6.25 is used to calculate the protein content [1] (equivalent to 0.16 g nitrogen per gram of protein). However, scientists have assumed that using the Kp factor of 6.25 has led to a large overestimation of protein content and this is due to the presence of non-protein nitrogen (NPN) mainly as chitin-bound nitrogen in the exoskeleton, nucleic acid, and inorganic nitrogen.

To avoid this overestimation, Janssen *et al.* (2017) [25] conducted a study on three insect species, to calculate the Kp factors to be used for whole insect and protein extracts derived from insects. First, they determined the exact protein content, by calculating the amino acid composition of insects and concluding from it the total amino acid content, which is equivalent to the total true protein content. Then, they calculated the adjusted Kp factors that should be used for insects to be able to determine the true protein contents based on the nitrogen content using the Kjeldahl method. They proposed to use an insect-specific Kp factor of 4.76 for protein content in the whole larvae (Figure 10) and 5.60 for soluble proteins extracted from insects. The last one is significantly higher than the Kp of the whole larvae and this is due to the elimination of NPN during the extraction steps. In addition, the right estimation of protein content in the whole insect will lead to an increase in protein extraction yield (%) due to the removal of initial protein overestimation.

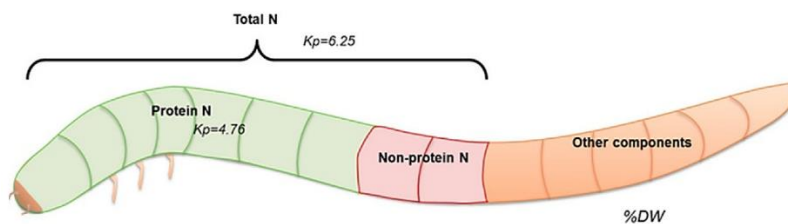
**Figure 10.** Insect larvae nitrogen-to-protein conversion factors [25].

Kim *et al.* (2020) [49] studied the effect of protein extraction steps, i.e., grinding, defatting, and extraction, on the essential amino acid composition and changes in protein qualities and functionalities. They determined that the essential amino acid index (EAAI) increased during extraction, and that protein functionalities such as foam capacity and stability increased as well, which might be due to the removal of chitin and hydrophobic amino acids. They also indicated a slight increase in the emulsion capacity and a decrease in emulsion stability with the extraction steps for the most studied insect species. Moreover, Zielińska *et al.* (2018) [27] studied the water



holding capacity (WHC g/g) and the oil holding capacity (OHC g/g). They noticed a higher WHC as well as OHC in protein extracts than in whole insects. These results prove that protein extraction is beneficial in improving protein qualities and functionalities of edible insects, and, these properties, in addition to insects' solubility in a wide pH range (Figure 9), are very important for the use of protein extracts in food and feed applications.

This being said, protein extraction is often carried out in an extremely alkaline or acidic environment, using HCl, NaOH, and ascorbic acid, and could be enhanced by sonication. However, natural alternatives to currently used chemicals, such as the use of ionic liquids (ILs), notably natural deep eutectic solvents (NADES), should be considered.

### 1.2.3. Chitin and Chitosan Extraction

Chitin is a biopolymer found in the exoskeleton of arthropods (i.e., insects, arachnids, and crustaceans). It is chemically a linear polymer of N-acetylglucosamine units, a cellulose derivative, and classified into three types:  $\alpha$ ,  $\beta$ , and  $\gamma$  [50,51]. Since it is insoluble in most solvents due to its compact structure, chemical treatments are needed to obtain a more soluble substance called chitosan [51].

Currently, chitin and chitosan are gaining high interest in various industrial fields such as the chemical, pharmaceutical, and food industries. This attention is due to their antimicrobial, emulsifying, thickening, and stabilizing properties, in addition to being biodegradable, non-toxic, wound healing promoters, hemostatic, hypolipidemic, enhancers for the immune system, and most importantly, very abundant in the environment [50,51].

A study carried out by Kaya *et al.* (2016) [50], revealed that insects' chitin content increased progressively with their developmental stages. Chitin contents of *Vespa crabro* (wasp) larvae, pupa, and adult were found to be respectively 2.2, 6.2, and 10.3% (dry basis), which indicated that an intense production in chitin takes place between the larvae and pupa stage.

Chitin is found in the exoskeleton in form of chitin nanofibrils wrapped with proteins, and the chitin-protein fibers are incorporated in a protein-mineral matrix [52]. Thus, to obtain pure chitin, an extraction process is required. Chitin is commonly isolated from entire insects or by-products issued from the insect protein extraction process. [53].

Chemical chitin extraction consists of two essential steps: demineralization and deproteinization. For demineralization, samples are treated with HCl at a high temperature, to remove minerals, then, they are filtered/centrifuged and rinsed with distilled water several times. Sediments collected from the previous step undergo the deproteinization step: they are heated in NaOH to remove proteins, and the extract is filtered and washed with distilled water until the pH becomes neutral, and then dried. The extract obtained is designated as the isolated chitin in the form of light brown powder that requires decolorization to remove pigments and impurities. This step is done by passing the sample through a mixture of chloroform, methanol, and distilled water in the ratio

of 1/2/4 at ambient temperature and stirring, then rinsing in distilled water, and finally drying [50,53,54,55].

Alternatively, to overcome chemical extraction problems such as the deterioration of the quality and the physicochemical properties of chitin by concentrated acids and bases, and high temperatures, a biological extraction of chitin is possible. This method uses enzymes (proteases, e.g., alcalase) from proteolytic bacteria for deproteinization and acid from acid-producing bacteria (like lactobacillus) for demineralization, which produces a chitin extract of high quality (Figure 11). However, this method as compared with the chemical method is less efficient in demineralization and deproteinization, therefore, it is still limited to a laboratory scale [56].

At this point, extracted chitin has to be deacetylated to obtain chitosan, which, unlike chitin, is soluble in acidic solutions. This is done by treating chitin with NaOH at 100 °C for 3 h, washing with water until achieving a neutral pH, and then drying in an oven for 24 h [53,57].

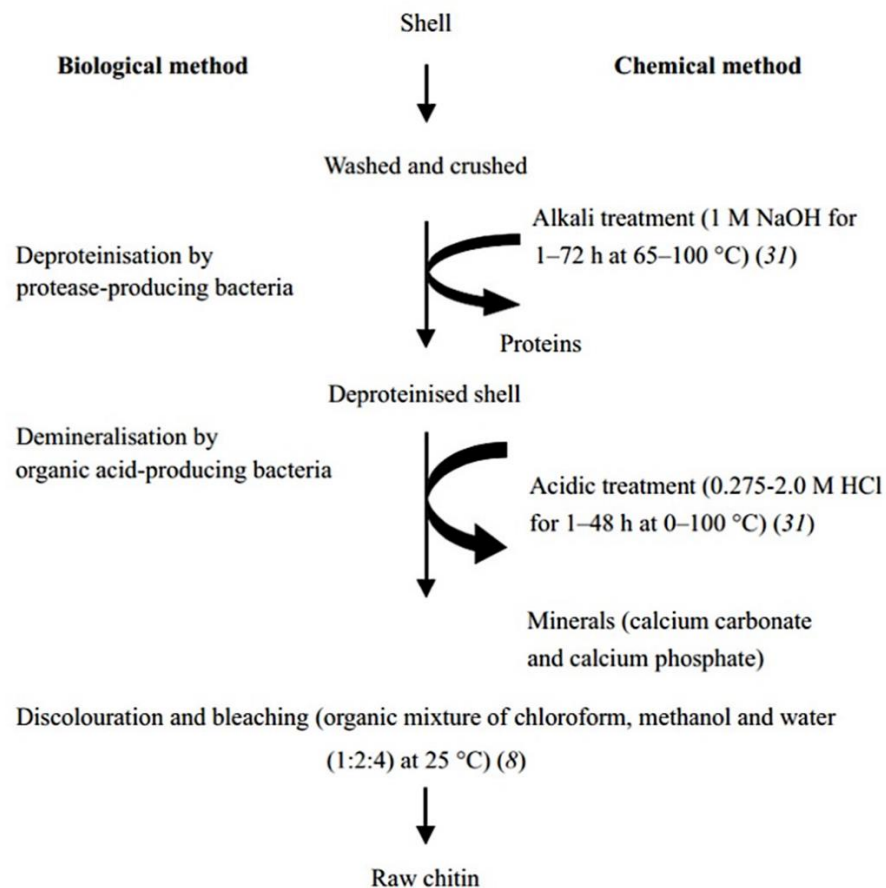

**Figure 11.** Chitin recovery by chemical and biological methods [56].

### 3. Future Challenges for the Sector

To achieve an eco-efficient production system, as well as development and transformation of insect larvae, several key points must be addressed by further research. The major relevant key points are the following:

- Study the integration of the insect rearing step in an ecological and economic space and the valorization of various agricultural wastes and by-products from the agri-food industry (peels, grape pomace, downgraded fruits and vegetables, etc.) by using them as potentially effective raw materials for bioconversion by insects [19];
- Establishing environmental assessments of the two main phases of the insect sector, i.e., the production of insect larvae [58] and the industrial transformation of the larvae into lipid, flour, and protein isolates, by comparing several scenarios of feeding and transformation of insects;
- Water and energy are the main resources used in the transformation of insects. Therefore, a Pinch analysis must be done along with a technical-economic study to reduce the use of these resources through energy integration by using new ways and techniques of extraction. In this context, substantial interest should be paid to the use of emerging technologies to: intensify transfer phenomena, obtain purified extracts, preserve product quality, avoid its oxidation, increase production yield, and reduce both energy and chemical consumption. To do this, low-energy pretreatments such as pulsed electric fields (PEFs) can be applied to insects to permeabilize their cells and facilitate the extraction steps and fractionation downstream. This pretreatment can be used as a killing method at once [35]. Another innovative technology that might be used in this context is the instant controlled pressure drop DIC. It can be used as a pretreatment to intensify the extraction steps, such as DIC-assisted solvent or press extraction of lipids, which have been studied in various cases of pulses and oleaginous grains and seeds [59,60], or to intensify the drying process and preserve the quality of products [61]. DIC-autovaporisation can also be studied as a highly effective desolventation way;
- Innovative and less energy-consuming dehydration techniques should be adopted, such as concentration by the superheated steam while preserving the quality of proteins [62];
- Improving the efficiency of the SC-CO<sub>2</sub> extraction process, especially with the use of co-solvents [41].

### 4. Conclusions

With the rapid growth in world population, farming and processing of edible insects are considered to be, nowadays, one of the promising solutions to answer the mounting demand for food and feed supply as a new sustainable alternative for protein sources. Recently, many studies have focused on the importance of insect consumption, but the insect processing sector is still in its initial stages.

In this review, we have focused on the current insect processing methods from reception to final products: lipids, proteins, and chitin/chitosan. The collective results implicate that blanching is an effective killing method that preserves larval quality and appearance. Lipid extraction is usually done in two steps: pressing and solvent extraction. The optimal solvent has been shown to be ethanol, which is noteworthy since it is a green solvent; nevertheless, to extract both polar and nonpolar fatty acids, an improvement might be considered. As for the extraction of proteins, isoelectric precipitation is the most widely used and successful method; however, natural alternatives might be explored to reduce the need for chemicals in the process. Finally, using emerging technologies to intensify the processing steps might be an efficient way to improve the whole process while staying environmentally friendly, cost-effective, and producing high-quality final products.

Bottom line, more studies on industrial-scale farming and processing cost, as well as on processing steps optimization and the use of novel processing technologies, are required to formulate functional and accepted insect-based ingredients that can promote global entomophagy the right way.

## 5. Statements & Declarations

**Author Contributions:** Writing, R.E.H.; review and editing, all the authors; project administration and funding acquisition, H.M. All authors have read and agreed to the published version of the manuscript.

**Funding:** This work is a part of the project RAFINSECT (2022-2025) funded by the region Hauts de France.

**Institutional Review Board Statement:** Not applicable.

**Informed Consent Statement:** Not applicable.

**Data Availability Statement:** Not applicable.

**Acknowledgments:** The authors would like to thank the region Hauts de France for the financial support.

**Conflicts of Interest:** The authors declare no conflict of interest.

## 6. References

1. Azagoh, C.; Ducept, F.; Garcia, R.; Rakotozafy, L.; Cuvelier, M.E.; Keller, S.; Lewandowski, R.; Mezdoor, S. Extraction and Physicochemical Characterization of *Tenebrio Molitor* Proteins. *Food Res. Int.* **2016**, *88*, 24–31. <https://doi.org/10.1016/J.FOODRES.2016.06.010>.
2. Sun-Waterhouse, D.; Waterhouse, G.I.N.; You, L.; Zhang, J.; Liu, Y.; Ma, L.; Gao, J.; Dong, Y. Transforming Insect Biomass into Consumer Wellness Foods: A Review. *Food Res. Int.* **2016**, *89*, 129–151. <https://doi.org/10.1016/J.FOODRES.2016.10.001>.

3. Leni, G.; Caligiani, A.; Sforza, S. Killing Method Affects the Browning and the Quality of the Protein Fraction of Black Soldier Fly (*Hermetia Illucens*) Prepupae: A Metabolomics and Proteomic Insight. *Food Res. Int.* **2019**, *115*, 116–125. <https://doi.org/10.1016/J.FOODRES.2018.08.021>.
4. Hilborn, R.; Banobi, J.; Hall, S.J.; Pucylowski, T.; Walsworth, T.E. The Environmental Cost of Animal Source Foods. *Front. Ecol. Environ.* **2018**, *16*, 329–335. <https://doi.org/10.1002/FEE.1822>.
5. Green, A.; Blatmann, C.; Chen, C.; Mathys, A. The Role of Alternative Proteins and Future Foods in Sustainable and Contextually-Adapted Flexitarian Diets. *Trends Food Sci. Technol.* **2022**, *124*, 250–258. <https://doi.org/10.1016/J.TIFS.2022.03.026>.
6. Rawiwan, P.; Peng, Y.; Paramayuda, I.G.P.B.; Quek, S.Y. Red Seaweed: A Promising Alternative Protein Source for Global Food Sustainability. *Trends Food Sci. Technol.* **2022**, *123*, 37–56. <https://doi.org/10.1016/J.TIFS.2022.03.003>.
7. Lähteenmäki-Uutela, A.; Rahikainen, M.; Lonkila, A.; Yang, B. Alternative Proteins and EU Food Law. *Food Control* **2021**, *130*, 108336. <https://doi.org/10.1016/J.FOODCONT.2021.108336>.
8. Smetana, S.; Mathys, A.; Knoch, A.; Heinz, V. Meat Alternatives: Life Cycle Assessment of Most Known Meat Substitutes. *Int. J. Life Cycle Assess.* **2015**, *20*, 1254–1267. <https://doi.org/10.1007/S11367-015-0931-6/TABLES/2>.
9. Jongema, Y. List of Edible Insects of the World (1 April 2017)—WUR. Available online: <https://www.wur.nl/en/Research-Results/Chair-groups/Plant-Sciences/Laboratory-of-Entomology/Edible-insects/Worldwide-species-list.htm> (accessed on 9 February 2022).
10. Bußler, S.; Rumpold, B.A.; Jander, E.; Rawel, H.M.; Schlüter, O.K. Recovery and Techno-Functionality of Flours and Proteins from Two Edible Insect Species: Meal Worm (*Tenebrio Molitor*) and Black Soldier Fly (*Hermetia Illucens*) Larvae. *Heliyon* **2016**, *2*, e00218. <https://doi.org/10.1016/J.HELIYON.2016.E00218>.
11. Otero, P.; Gutierrez-Docio, A.; Navarro del Hierro, J.; Reglero, G.; Martin, D. Extracts from the Edible Insects *Acheta Domesticus* and *Tenebrio Molitor* with Improved Fatty Acid Profile Due to Ultrasound Assisted or Pressurized Liquid Extraction. *Food Chem.* **2020**, *314*, 126200. <https://doi.org/10.1016/j.foodchem.2020.126200>.
12. van Huis, A.; Van Itterbeeck, J.; Klunder, H.; Food and Agriculture Organization of the United Nations. Edible Insects. In *Future Prospects for Food and Feed Security*; FAO: Rome, Italy, 2013; Volume 171. ISBN 9789251075951.
13. Dagevos, H. A Literature Review of Consumer Research on Edible Insects: Recent Evidence and New Vistas from 2019 Studies. *J. Insects Food Feed.* **2021**, *7*, 249–259. <https://doi.org/10.3920/JIFF2020.0052>.
14. Bisconsin-Júnior, A.; Rodrigues, H.; Behrens, J.H.; da Silva, M.A.A.P.; Mariutti, L.R.B. “Food Made with Edible Insects”: Exploring the Social Representation of Entomophagy Where It Is Unfamiliar. *Appetite* **2022**, *173*, 106001. <https://doi.org/10.1016/J.APPET.2022.106001>.
15. Tzompa-Sosa, D.A.; Yi, L.; van Valenberg, H.J.F.; van Boekel, M.A.J.S.; Lakemond, C.M.M. Insect Lipid Profile: Aqueous versus Organic Solvent-Based Extraction Methods. *Food Res. Int.* **2014**, *62*, 1087–1094. <https://doi.org/10.1016/J.FOODRES.2014.05.052>.

16. Tuccillo, F.; Marino, M.G.; Torri, L. Italian Consumers' Attitudes towards Entomophagy: Influence of Human Factors and Properties of Insects and Insect-Based Food. *Food Res. Int.* **2020**, *137*, 109619. <https://doi.org/10.1016/J.FOODRES.2020.109619>.
17. Mancini, S.; Sogari, G.; Diaz, S.E.; Menozzi, D.; Paci, G.; Moruzzo, R. Exploring the Future of Edible Insects in Europe. *Foods* **2022**, *11*, 455. <https://doi.org/10.3390/FOODS11030455>.
18. Gasco, L.; Biancarosa, I.; Liland, N.S. From Waste to Feed: A Review of Recent Knowledge on Insects as Producers of Protein and Fat for Animal Feeds. *Curr. Opin. Green Sustain. Chem.* **2020**, *23*, 67–79. <https://doi.org/10.1016/J.COGSC.2020.03.003>.
19. Ojha, S.; Bußler, S.; Schlüter, O.K. Food Waste Valorisation and Circular Economy Concepts in Insect Production and Processing. *Waste Manag.* **2020**, *118*, 600–609. <https://doi.org/10.1016/J.WASMAN.2020.09.010>.
20. Moruzzo, R.; Riccioli, F.; Espinosa Diaz, S.; Secci, C.; Poli, G.; Mancini, S. Mealworm (*Tenebrio Molitor*): Potential and Challenges to Promote Circular Economy. *Animals* **2021**, *11*, 2568. <https://doi.org/10.3390/ANI11092568>.
21. Regulation (EC) No 1069/2009 of the European Parliament and of the Council. *Off. J. Eur. Union* **2009**, L300 PP 1-33.
22. Rumpold, B.A.; Schlüter, O.K. Nutritional Composition and Safety Aspects of Edible Insects. *Mol. Nutr. Food Res.* **2013**, *57*, 802–823. <https://doi.org/10.1002/MNFR.201200735>.
23. Nongonierma, A.B.; FitzGerald, R.J. Unlocking the Biological Potential of Proteins from Edible Insects through Enzymatic Hydrolysis: A Review. *Innov. Food Sci. Emerg. Technol.* **2017**, *43*, 239–252. <https://doi.org/10.1016/J.IFSET.2017.08.014>.
24. Choi, B.D.; Wong, N.A.K.; Auh, J.H. Defatting and Sonication Enhances Protein Extraction from Edible Insects. *Korean J. Food Sci. Anim. Resour.* **2017**, *37*, 955–961. <https://doi.org/10.5851/KOSFA.2017.37.6.955>.
25. Janssen, R.H.; Vincken, J.-P.; van den Broek, L.A.M.; Fogliano, V.; Lakemond, C.M.M. Nitrogen-to-Protein Conversion Factors for Three Edible Insects: *Tenebrio Molitor*, *Alphitobius Diaperinus*, and *Hermetia Illucens*. *J. Agric. Food Chem.* **2017**, *65*, 2275–2278. <https://doi.org/10.1021/acs.jafc.7b00471>.
26. Ribeiro, J.C.; Lima, R.C.; Maia, M.R.G.; Almeida, A.A.; Fonseca, A.J.M.; Cabrita, A.R.J.; Cunha, L.M. Impact of Defatting Freeze-Dried Edible Crickets (*Acheta Domesticus* and *Gryllobates Domestica*) on the Nutritive Value, Overall Liking and Sensory Profile of Cereal Bars. *LWT—Food Sci. Technol.* **2019**, *113*, 108335. <https://doi.org/10.1016/J.LWT.2019.108335>.
27. Zielińska, E.; Karaś, M.; Baraniak, B. Comparison of Functional Properties of Edible Insects and Protein Preparations Thereof. *LWT—Food Sci. Technol.* **2018**, *91*, 168–174. <https://doi.org/10.1016/J.LWT.2018.01.058>.
28. Yi, L.; Lakemond, C.M.M.; Sagis, L.M.C.; Eisner-Schadler, V.; van Huis, A.; Boekel, M.A.J.S.V. Extraction and Characterisation of Protein Fractions from Five Insect Species. *Food Chem.* **2013**, *141*, 3341–3348. <https://doi.org/10.1016/J.FOODCHEM.2013.05.115>.

29. Mishyna, M.; Martinez, J.J.I.; Chen, J.; Benjamin, O. Extraction, Characterization and Functional Properties of Soluble Proteins from Edible Grasshopper (*Schistocerca Gregaria*) and Honey Bee (*Apis Mellifera*). *Food Res. Int.* **2019**, *116*, 697–706. <https://doi.org/10.1016/J.FOODRES.2018.08.098>.
30. Xia, Z.; Wu, S.; Pan, S.; Kim, J.M. Nutritional Evaluation of Protein from *Clanis Bilineata* (Lepidoptera), an Edible Insect. *J. Sci. Food Agric.* **2012**, *92*, 1479–1482. <https://doi.org/10.1002/jsfa.4730>.
31. Melgar-Lalanne, G.; Hernández-Álvarez, A.J.; Salinas-Castro, A. Edible Insects Processing: Traditional and Innovative Technologies. *Compr. Rev. Food Sci. Food Saf.* **2019**, *18*, 1166–1191. <https://doi.org/10.1111/1541-4337.12463>.
32. Alles, M.C.; Smetana, S.; Parniakov, O.; Shorstkii, I.; Toepfl, S.; Aganovic, K.; Heinz, V. Bio-Refinery of Insects with Pulsed Electric Field Pre-Treatment. *Innov. Food Sci. Emerg. Technol.* **2020**, *64*, 102403. <https://doi.org/10.1016/J.IFSET.2020.102403>.
33. Zhao, X.; Vázquez-Gutiérrez, J.L.; Johansson, D.P.; Landberg, R.; Langton, M. Yellow Mealworm Protein for Food Purposes—Extraction and Functional Properties. *PLoS ONE* **2016**, *11*, e0147791. <https://doi.org/10.1371/JOURNAL.PONE.0147791>.
34. Psarianos, M.; Dimopoulos, G.; Ojha, S.; Cavini, A.C.M.; Bußler, S.; Taoukis, P.; Schlüter, O.K. Effect of Pulsed Electric Fields on Cricket (*Acheta Domesticus*) Flour: Extraction Yield (Protein, Fat and Chitin) and Techno-Functional Properties. *Innov. Food Sci. Emerg. Technol.* **2022**, *76*, 102908. <https://doi.org/10.1016/j.ifset.2021.102908>.
35. Smetana, S.; Mhemdi, H.; Mezdour, S.; Heinz, V. Chapter 11—PEF Treated Insects and Algae as Future Food Ingredients. In *Pulsed Electric Fields to Obtain Healthier and Sustainable Food for Tomorrow*; Elsevier Science: Amsterdam, The Netherlands, 2020.
36. Amarender, R.V.; Bhargava, K.; Dossey, A.T.; Gamagedara, S. Lipid and Protein Extraction from Edible Insects—Crickets (*Gryllidae*). *LWT—Food Sci. Technol.* **2020**, *125*, 109222. <https://doi.org/10.1016/J.LWT.2020.109222>.
37. Bolat, B.; Ugur, A.E.; Oztop, M.H.; Alpas, H. Effects of High Hydrostatic Pressure Assisted Degreasing on the Technological Properties of Insect Powders Obtained from *Acheta Domesticus* & *Tenebrio Molitor*. *J. Food Eng.* **2021**, *292*, 110359. <https://doi.org/10.1016/J.JFOODENG.2020.110359>.
38. Kim, T.-K.; Yong, H.I.; Kim, Y.-B.; Jung, S.; Kim, H.-W.; Choi, Y.-S. Effects of Organic Solvent on Functional Properties of Defatted Proteins Extracted from *Protaetia Brevitarsis* Larvae. *Food Chem.* **2021**, *336*, 127679. <https://doi.org/10.1016/j.foodchem.2020.127679>.
39. Mandal, S.C.; Mandal, V.; Das, A.K. Classification of Extraction Methods. In *Essentials of Botanical Extraction*; Elsevier: Amsterdam, The Netherlands, 2015; pp. 83–136. <https://doi.org/10.1016/B978-0-12-802325-9.00006-9>.
40. Richter, B.E.; Jones, B.A.; Ezzell, J.L.; Porter, N.L.; Avdalovic, N.; Pohl, C. Accelerated Solvent Extraction: A Technique for Sample Preparation. *Anal. Chem.* **1996**, *68*, 1033–1039. <https://doi.org/10.1021/AC9508199>.

41. Laroche, M.; Perreault, V.; Marciniak, A.; Gravel, A.; Chamberland, J.; Doyen, A. Comparison of Conventional and Sustainable Lipid Extraction Methods for the Production of Oil and Protein Isolate from Edible Insect Meal. *Foods* **2019**, *8*, 572. <https://doi.org/10.3390/FOODS8110572>.
42. Eggers, L.F.; Schwudke, D. Liquid Extraction: Folch. In *Encyclopedia of Lipidomics*; Wenk, M.R., Ed.; Springer: Berlin/Heidelberg, Germany, 2016; pp. 1–6.
43. Sahena, F.; Zaidul, I.S.M.; Jinap, S.; Karim, A.A.; Abbas, K.A.; Norulaini, N.A.N.; Omar, A.K.M. Application of Supercritical CO<sub>2</sub> in Lipid Extraction—A Review. *J. Food Eng.* **2009**, *95*, 240–253. <https://doi.org/10.1016/J.JFOODENG.2009.06.026>.
44. Wu, S. Supercritical Carbon Dioxide Extraction of Oil from *Clanis Bilineata* (Lepidoptera), an Edible Insect. *Afr. J. Biotechnol.* **2012**, *11*, 4607–4610. <https://doi.org/10.5897/AJB11.4102>.
45. Baigts-Allende, D.; Doost, A.S.; Ramírez-Rodrigues, M.; Dewettinck, K.; van der Meeren, P.; de Meulenaer, B.; Tzompa-Sosa, D. Insect Protein Concentrates from Mexican Edible Insects: Structural and Functional Characterization. *LWT—Food Sci. Technol.* **2021**, *152*, 112267. <https://doi.org/10.1016/J.LWT.2021.112267>.
46. Yoon, S.; Wong, N.A.K.; Chae, M.; Auh, J.H. Comparative Characterization of Protein Hydrolysates from Three Edible Insects: Mealworm Larvae, Adult Crickets, and Silkworm Pupae. *Foods* **2019**, *8*, 563. <https://doi.org/10.3390/FOODS8110563>.
47. Kingwascharapong, P.; Chaijan, M.; Karnjanapratum, S. Ultrasound-Assisted Extraction of Protein from Bombay Locusts and Its Impact on Functional and Antioxidative Properties. *Sci. Rep.* **2021**, *11*, 1–14. <https://doi.org/10.1038/s41598-021-96694-w>.
48. Brogan, E.N.; Park, Y.-L.; Matak, K.E.; Jaczynski, J. Characterization of Protein in Cricket (*Acheta Domesticus*), Locust (*Locusta Migratoria*), and Silk Worm Pupae (*Bombyx Mori*) Insect Powders. *LWT—Food Sci. Technol.* **2021**, *152*, 112314. <https://doi.org/10.1016/j.lwt.2021.112314>.
49. Kim, T.K.; Yong, H.I.; Chun, H.H.; Lee, M.A.; Kim, Y.B.; Choi, Y.S. Changes of Amino Acid Composition and Protein Technical Functionality of Edible Insects by Extracting Steps. *J. Asia-Pac. Entomol.* **2020**, *23*, 298–305. <https://doi.org/10.1016/J.ASPEN.2019.12.017>.
50. Kaya, M.; Sofi, K.; Sargin, I.; Mujtaba, M. Changes in Physicochemical Properties of Chitin at Developmental Stages (Larvae, Pupa and Adult) of *Vespa Crabro* (Wasp). *Carbohydr. Polym.* **2016**, *145*, 64–70. <https://doi.org/10.1016/J.CARBPOL.2016.03.010>.
51. Liu, S.; Sun, J.; Yu, L.; Zhang, C.; Bi, J.; Zhu, F.; Qu, M.; Jiang, C.; Yang, Q. Extraction and Characterization of Chitin from the Beetle *Holotrichia Parallela* Motschulsky. *Molecules* **2012**, *17*, 4604–4611. <https://doi.org/10.3390/MOLECULES17044604>.
52. Ding, F.; Deng, H.; Du, Y.; Shi, X.; Wang, Q. Emerging Chitin and Chitosan Nanofibrous Materials for Biomedical Applications. *Nanoscale* **2014**, *6*, 9477–9493. <https://doi.org/10.1039/C4NR02814G>.
53. Song, Y.S.; Kim, M.W.; Moon, C.; Seo, D.J.; Han, Y.S.; Jo, Y.H.; Noh, M.Y.; Park, Y.K.; Kim, S.A.; Kim, Y.W.; *et al.* Extraction of Chitin and Chitosan from Larval Exuvium and Whole Body of Edible Mealworm, *Tenebrio Molitor*. *Entomol. Res.* **2018**, *48*, 227–233. <https://doi.org/10.1111/1748-5967.12304>.



54. González, C.M.; Garzón, R.; Rosell, C.M. Insects as Ingredients for Bakery Goods. A Comparison Study of *H. Illucens*, *A. Domestica* and *T. Molitor* Flours. *Innov. Food Sci. Emerg. Technol.* **2019**, *51*, 205–210. <https://doi.org/10.1016/j.ifset.2018.03.021>.
55. Kaya, M.; Erdogan, S.; Mol, A.; Baran, T. Comparison of Chitin Structures Isolated from Seven Orthoptera Species. *Int. J. Biol. Macromol.* **2015**, *72*, 797–805. <https://doi.org/10.1016/J.IJBIOMAC.2014.09.034>.
56. Arbia, W.; Arbia, L.; Adour, L.; Amrane, A. Chitin Extraction from Crustacean Shells Using Biological Methods—A Review. *Food Technol. Biotechnol.* **2012**, *51*, 12–25.
57. Kaya, M.; Baran, T.; Erdoğan, S.; Menteş, A.; Aşan Özüsağlam, M.; Çakmak, Y.S. Physicochemical Comparison of Chitin and Chitosan Obtained from Larvae and Adult Colorado Potato Beetle (*Leptinotarsa Decemlineata*). *Mater. Sci. Eng. C Mater. Biol. Appl.* **2014**, *45*, 72–81. <https://doi.org/10.1016/J.MSEC.2014.09.004>.
58. Baiano, A. Edible Insects: An Overview on Nutritional Characteristics, Safety, Farming, Production Technologies, Regulatory Framework, and Socio-Economic and Ethical Implications. *Trends Food Sci. Technol.* **2020**, *100*, 35–50. <https://doi.org/10.1016/J.TIFS.2020.03.040>.
59. Bamerni, F. Plant-Based (*Camelina Sativa*) Biodiesel Manufacturing Using the Technology of Instant Controlled Pressure Drop (DIC): Process Performance and Biofuel Quality, Chemical and Process Engineering. Ph.D. Thesis. Université de La Rochelle, La Rochelle, France, 2018.
60. Mkaouar, S.; Bahloul, N.; Gelicus, A.; Allaf, K.; Kechaou, N. Instant Controlled Pressure Drop Texturing for Intensifying Ethanol Solvent Extraction of Olive (*Olea Europaea*) Leaf Polyphenols. *Sep. Purif. Technol.* **2015**, *145*, 139–146. <https://doi.org/10.1016/J.SEPPUR.2015.03.014>.
61. Mounir, S.; Allaf, T.; Mujumdar, A.S.; Allaf, K. Swell Drying: Coupling Instant Controlled Pressure Drop DIC to Standard Convection Drying Processes to Intensify Transfer Phenomena and Improve Quality-An Overview. *Dry. Technol.* **2012**, *30*, 1508–1531. <https://doi.org/10.1080/07373937.2012.693145>.
62. Sehrawat, R.; Nema, P.K.; Kaur, B.P. Effect of Superheated Steam Drying on Properties of Foodstuffs and Kinetic Modeling. *Innov. Food Sci. Emerg. Technol.* **2016**, *34*, 285–301. <https://doi.org/10.1016/J.IFSET.2016.02.003>.

### I.2.3. Implementation of novel/emerging technologies for insect processing

Novel technologies are innovative and emerging techniques, tools or methods that are developed to address new challenges or improve the efficiency of existing processes. These technologies are often characterized by their safety, minimal processing, and reduction of energy and water consumption, which reduce a process's carbon and water footprint (Khouryieh, 2021). Although novel technologies have demonstrated their potential in several processes in the food sector, their use in edible insect processing is currently limited. Due to the significant diversity of insect-products and the complexity of process optimization, traditional processes that are well understood and easy to use are still preferred.

However, as previously outlined in the review, the application of novel technologies can lead to enhanced extraction, fractionation, energy efficiency, and production yield, as well as improved quality and safety of insect-based products, and ensuring increased customer acceptability. Some of the explored insect processing technologies and the main findings are summarized in Table I.4 (Ojha *et al.*, 2021).

**Table I.4.** Innovative technology in insect processing (Ojha *et al.*, 2021).

Process goal	Technology and processing condition	Insect species and form	Main findings	Reference
Microbial decontamination	HHP treatment (35 L vessel, at room temperature) at 400 MPa and 600 MPa; 1.5 min and 10 min.	<i>Hermetia illucens</i> larvae	HHP resulted in a lower inactivation for TVC and 600 MPa was needed to achieve similar reductions against Enterobacteria, LAB, and YM.	(Campbell <i>et al.</i> , 2020)
	HHP treatment (250 to 400 MPa, for 1.5 to 15 min).	<i>H. illucens</i> larvae	HHP was effective against natural contaminating YM, resulting in more than 5 log cycle reductions at 400 MPa for all treatments; however, a low reduction of the total microbial load was achieved.	(Kashiri <i>et al.</i> , 2018)
	CAPP generated at sinusoidal voltage of 8.8 kV <sub>PP</sub> at a frequency of 3.0 kHz using air as working gas; treatments up to 15 min.	<i>Tenebrio molitor</i> flour	Total microbial load reduced from 7.72 to 4.73 log <sub>10</sub> cfu/g in 15 min CAPP treatment.	(Bußler <i>et al.</i> , 2016)
	HHP treatment (400, 500, and 600 MPa; up to 15 min).	<i>T. molitor</i> larvae	A HHP treatment at 600 MPa for 10 min resulted in an inactivation of 3 log cycles.	(Rumpold <i>et al.</i> , 2014)
	Indirect plasma treatment at a frequency of 2.45 GHz and power consumption in the range of 1.2 kW.	<i>T. molitor</i> larvae	Plasma treatment (10 min) resulted in up to 7 log cycles reduction.	(Rumpold <i>et al.</i> , 2014)

Drying	PEF at 2 and 3 kV/cm; 5, 10 and 20 kJ/kg wet basis.	Live <i>H. illucens</i> larvae	PEF pre-treatment can significantly reduce (up to 30%) drying time of insect biomass.	(Alles <i>et al.</i> , 2020)
Enzymatic hydrolysis	HHP treatment at 380 MPa for 1 min applied before or during the enzymatic hydrolysis by pepsin or Alcalase®.	<i>T. molitor</i> larvae powder	<ul style="list-style-type: none"> <li>- HHP applied before the enzymatic hydrolysis improved the enzymatic hydrolysis by Alcalase® (but not by pepsin) at the very beginning of the process.</li> <li>- Partial reduction of allergenic properties was observed.</li> <li>- No alterations on the protein profile were observed.</li> </ul>	(Boukil <i>et al.</i> , 2020)
	Ultrasound pretreatment at 600 W and 40±2 kHz for 30 min. Pulse interval of 15 s on and 5 s off. Temperature of 50 °C.	Defatted <i>H. illucens</i> meal	US pretreatment enhances the enzymolysis reaction, by altering the molecular structure and arrangement and improving the enzyme-substrate interactions	(Mintah <i>et al.</i> , 2019a)
	Ultrasound pretreatment at 600 W and 40±2 kHz for 10-20-30 min. Pulse interval of 15 s on and 5 s off.	Dried defatted <i>H. illucens</i> meal	US-assisted hydrolysis leads to hydrolysates with higher antioxidant activity.	(Mintah <i>et al.</i> , 2019b)
	Ultrasound pretreatment at 600 W and 40±2 kHz with a pulse interval of 15 s on and 5 s off.	Dried defatted <i>H. illucens</i> larvae	<ul style="list-style-type: none"> <li>- Ultrasound pretreatment increases the sample lightness by reducing the protein hydrolysate molecular weight.</li> <li>- Sonic treatments alter the secondary protein structure, reducing the hydrolysate turbidity and increasing the protein dispersibility.</li> </ul>	(Mintah <i>et al.</i> , 2020)
Enzyme inactivation	HHP treatment (4 l vessel) at 250, 300, 400 and 500 MPa for 3 min	<i>T. molitor</i> larvae	A pressure of 400 MPa prevented the enzymatic browning.	(Tonnejck-Srpová <i>et al.</i> , 2019)
Extraction	Ultrasound-assisted extraction by direct sonication at 20 kHz, amplitude of 89.9 µm in continuous pulse; 15 min.	Lyophilised and grounded <i>Acheta domesticus</i> and <i>T. molitor</i>	The extraction yield was dependent on the nature insect species and the solvent of extraction. Ultrasound can be used to obtain insect extracts with an improved fatty acid profile.	(Otero <i>et al.</i> , 2020)
	Ultrasonic-assisted aqueous extraction by sonication at 20 kHz (several parameters combinations tested).	Lyophilised and grounded <i>Clanis bilineata</i> larvae	<ul style="list-style-type: none"> <li>- Ultrasound treatment allowed for increasing oil extraction yield and oil quality.</li> <li>- The higher yield was reached with an ultrasound treatment of 50 min at 40 °C and 400 W, with a pulsation interval of 2 s.</li> <li>- Ultrasound treatment can increase the thermo- stability and antioxidant activity of the oil.</li> </ul>	(Sun <i>et al.</i> , 2018)

Ultrasound-assisted extraction by sonication at 20 kHz, 75% of amplitude, 3 seconds of pulsation interval; 1, 15 and 20 min.	Lyophilised and grounded <i>Bombyx mori</i> Microwave dried and grounded <i>T. molitor</i> and <i>Gryllus bimaculatus</i>	<ul style="list-style-type: none"> <li>- Ultrasound sonication significantly affects the protein extraction yield without changing the amino acid profile.</li> <li>- Sonication time had a different impact on protein extraction yield among several insect species (maximum yield reaches after 15 min for <i>T. molitor</i> and <i>G. bimaculatus</i> and 5 min for <i>B. mori</i>).</li> <li>- The protein extraction yield was dependent on the insect species and their life stage.</li> </ul>	(Choi <i>et al.</i> , 2017)
Ultrasound-assisted protein extraction by sonication with amplitude 70% for 6 min. pulsation interval of 30 s.	Defatted powder of <i>Apis mellifera</i> larvae and pupae Defatted powder of <i>Schistocerca gregaria</i> adults	<ul style="list-style-type: none"> <li>- Ultrasound sonication improve the protein extraction yield</li> <li>- Method used for protein extraction alter the molecular characteristics of protein, determining a changing on its hydrophobicity. But a specie- specific effect has to be addressed.</li> </ul>	(Mishyna <i>et al.</i> , 2019)
PEF at 2 and 3 kV/cm; 5, 10 and 20 kJ/kg wet basis	Live <i>H. illucens</i> larvae	<ul style="list-style-type: none"> <li>- Oil extraction yield was not affected significantly by PEF treatment.</li> <li>- Higher amount of amino acids was recovered in oil after PEF treatment</li> </ul>	(Alles <i>et al.</i> , 2020)

CAPP = cold atmospheric pressure plasma; HHP = high hydrostatic pressure; LAB = lactic acid bacteria; PEF = pulsed electric field; TVC = total viable count; US = ultrasound; YM = yeasts and moulds

Based on the existing studies, we have decided to focus our research on the two following emerging technologies:

- Instant controlled pressure drop (DIC): this emerging technology is known to enhance various food processes, but no research on insects was previously reported.
- Pulsed electric fields (PEFs): research on the influence of this technology on insect processing is limited, but available studies indicate a good prospect for this innovative method to enhance the insect processing chain.

#### I.2.3.1. Instant controlled pressure drop (DIC)

The Instant Controlled Pressure-drop (Figure I.3), abbreviated DIC (Détente Instantanée Contrôlée), is an emerging thermo-mechanical process based on the principle of instantaneous thermodynamics that uses high-temperature/high-pressure treatments for a short time (HTST). Thus, the DIC process involves subjecting biological food matrices to a saturated steam pressure of up to 700 kPa and 160 °C for a few seconds, followed by an abrupt and controlled pressure drop (of more than 500 kPa/s) to a final vacuum of absolute pressure of 10 to 5 kPa, significantly lower

than the atmospheric pressure (101.325 kPa). The DIC leads to an instantaneous auto-vaporization of water, an expulsion of some molecules to the vacuum tank, along with rapid cooling and an expansion of treated products (Pech-Almeida *et al.*, 2021).

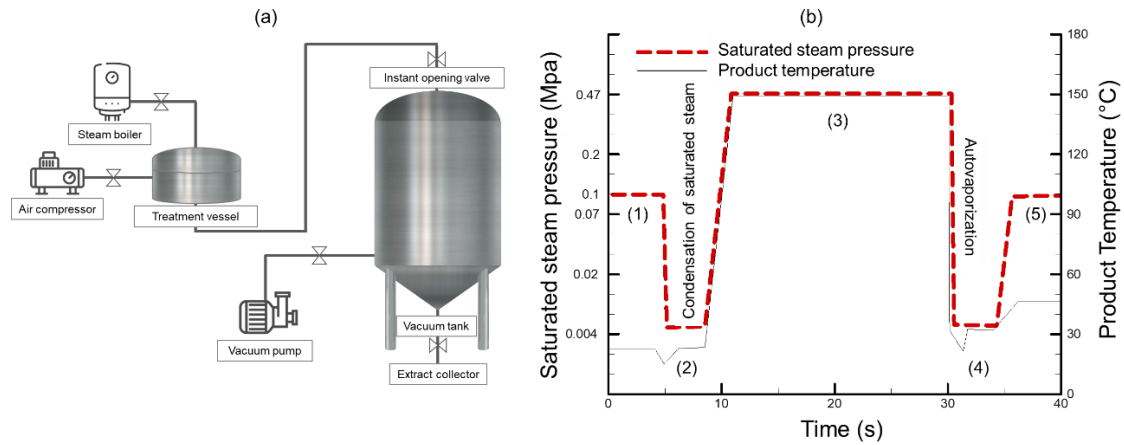

**Figure I.3.** Schematic representation of Instant controlled pressure drop (DIC) (a) apparatus and (b) the temperature and pressure correlations during a treatment cycle

In drying operations, DIC was found to improve drying kinetics, thus reducing energy consumption and improving the overall quality of dried products (Haddad *et al.*, 2008; Louka and Allaf, 2002).

Haddad *et al.* (2008) have studied the drying kinetics of untreated, DIC treated and DIC treated and microwave-assisted by ambient temperature air drying of apple strips and sweet potato slices. The results presented in Figure I.4 show that DIC treatment is an effective method that enhances the drying kinetics (final moisture content of 4.9% db instead on 11.4% db for untreated larvae), and that using microwave-assisted by ambient temperature air drying of sample expanded by DIC led to a moisture content of 5% db with a very high final product quality within less than 5 min of drying.

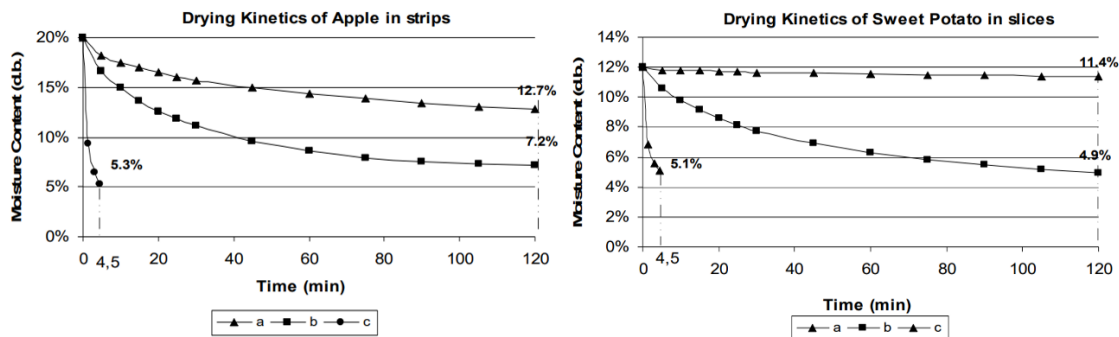

**Figure I.4.** Kinetics of the second stage of drying of pre-dried green apple strips and sweet potato slices, a) raw material dried by hot air at 45 °C, b) sample treated by DIC and then dried by hot air at 45°C (simple intensification), c) sample treated by DIC and then dried by microwave-assisted by ambient temperature air (double intensification) (Haddad *et al.*, 2008).

Additionally, DIC improves pressing yield (Bamerni, 2018) and solvent extraction kinetics, by providing better solvent infiltration (Allaf *et al.*, 2014; Jablaoui *et al.*, 2020).

Jablaoui *et al.* (2020) compared the effects of an expander and DIC method as pretreatments for soybeans in terms of oil extraction enhancement. Figure I.5 shows that DIC treatment resulted in the extraction of 247 mg oil/g db, compared to 224 mg oil/g db for expanded soybeans and 207 mg oil/g db for both cracked and flaked samples. To achieve the same yields obtained in 160 min of extraction for both cracked and flaked soybean, the expander and DIC treatments took 120 min and 35 min respectively. On the other hand, they stated that DIC led to the best preservation of soybean oil quality, with fatty acid levels nearly comparable to those of untreated seeds, attributed to the rapid heat treatment and the instant product cooling.

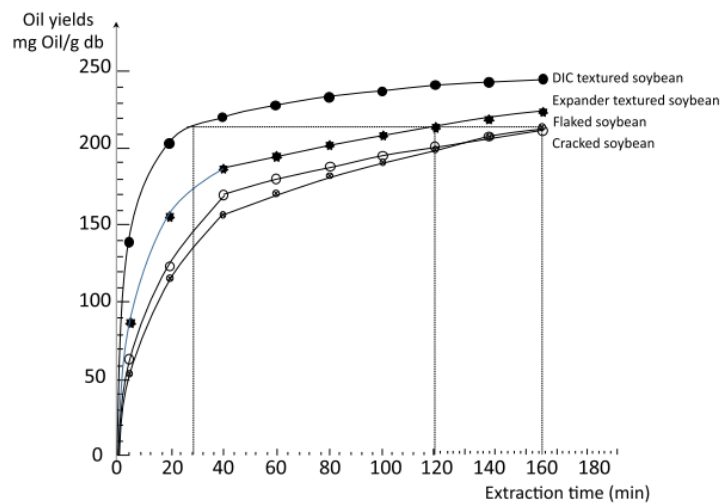

**Figure I.5.** Impact of Instant Controlled Pressure-Drop DIC texturing on oil extraction kinetics of different pretreated soybeans (Jablaoui *et al.*, 2020).

Moreover, thanks to the thermo-mechanical effect, DIC was found to be an effective microbial decontamination method (Allaf *et al.*, 2011). It can be also used as an extraction technique for volatile molecules (e.g. essential oils) through the auto-vaporization phenomenon (Berka-Zougali *et al.*, 2010; Besombes *et al.*, 2010).

Given the reported advantages of DIC treatment on various processing operations, researching its impact on different larval processing operations was an intriguing topic, especially as no previous studies on the impact of DIC treatment on insect larvae had been conducted.

### I.2.3.2. Pulsed electric fields (PEFs)

Pulsed electric field (PEF) treatment is an innovative and promising approach for non-thermal food processing. It is a moderately invasive cell disruption that prevents undesired alterations in a biological product and accelerates its extraction by electrically breaking down cellular membranes which result in the loss of their barrier functions (Lebovka *et al.*, 2016; Vorobiev and Lebovka, 2020). The cell membrane is a layer that surrounds the cell and regulates the exchange of

intracellular and extracellular fluids. When cells are subjected to an electric field, their membranes might be damaged, causing pores to form. Pore creation can be temporary (reversible pore opening and sealing) or permanent (irreversible pore formation) (Zhu, 2014).

If the field strength exceeds the reversible threshold and the exposure is of sufficient duration, reversible electroporation occurs; the membrane is permeabilized and remains in a state of higher permeability for a while but is eventually able to spontaneously return to its original state through membrane resealing, a process in which the pores close and the cell restores its normal transmembrane potential. By contrast, if the field strength and quantity of delivered energy are too high, reversible damage becomes irreversible, resulting in mechanical destruction of the cell and the development of many pores in proportion to the membrane surface. This phenomenon of cell damage causes permeabilization of cell membranes and is called “electroporation” or “electropermeabilization” (Figure I.6) (Zhang, 2020; Zhu, 2014).

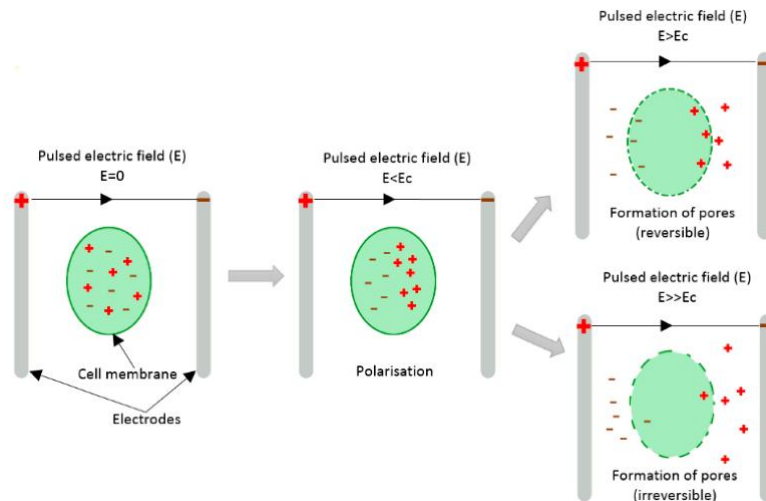

**Figure I.6.** A biological cell exposed to an external electric field (polarization) (Szwarc and Głowacka, 2021).

Several theories, based on the increase in transmembrane potential, electromechanical compression of the cell membrane, and conformational changes in lipids or protein molecules, have been suggested to explain this phenomenon (Vorobiev and Lebovka, 2020). Zimmermann (1986) proposed an explanation, arguing that the membrane might be seen as a capacitor filled with dielectrics. The electric field charges the capacitor by creating transmembrane potential  $u_m$ , and the cell is compressed due to the attraction of opposing charges that accumulate on the membrane. As a result of the increased transmembrane potential, the membrane thickness decreases, and membrane disruption is expected when  $u_m$  reaches a crucial value. This "dielectric breakdown theory" is one of the most widely adopted theories.

PEF treatment is often used in food and biomaterials for microbial inactivation, extraction improvement, drying, pressing, osmotic dehydration, freezing, freeze-drying, and wastewater treatment (Vorobiev and Lebovka, 2020).

Recently, the effects of PEF treatment on the reproduction of insects, extraction yields, and drying kinetics were studied.

The experiments of PEF treatment (at electric field strength  $E=1-4$  kV/cm) of *Drosophila melanogaste* insect revealed that the application of the electric field increased insect reproduction by up to 30%, and induced a mild stress factor that has led to a slight induction of DNA fragmentation (Panagopoulos, 2016). The effects of PEF on mosquito larvae (*Culex pipiens*) at low electric field intensities ( $E=66.66-116.66$  V/cm) have been studied (Mohamad *et al.*, 2022). PEF treatment has been shown to produce genotoxicity in mosquito larvae, alterations in the insect's body proteins, and to trigger oxidative stress in insect cells.

PEF treatment impact on the extraction yields (protein, fat and chitin) and functional properties of house crickets (*Acheta domesticus*) flour have been evaluated (Psarianos *et al.*, 2022). Insects were washed, ground fresh then treated. PEF treatment was done at electric field strength  $E= 1.5$  kV/cm and different specific energy inputs  $W= 4.9- 49.1$  kJ/kg. Results showed that PEF treatment significantly increased the extraction yields of protein, and fat by over 18% and 40% (Figure I.7), and increased the oil binding capacity, emulsifying capacity, and antioxidant activity of the cricket flour (Figure I.8).

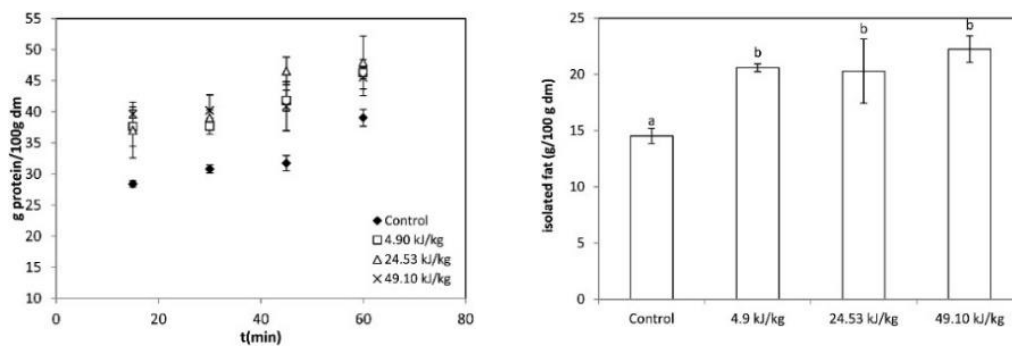

**Figure I.7.** Effect of PEF pretreatment on the protein and fat extraction yields (g /100 g dm). The error bars indicate the standard errors of measurements. Superscript letters (a,b,c...) indicate the significant differences ( $p < 0.05$ ) between the means of the functional properties of PEF-treated samples and the untreated sample (control) (Psarianos *et al.*, 2022) .



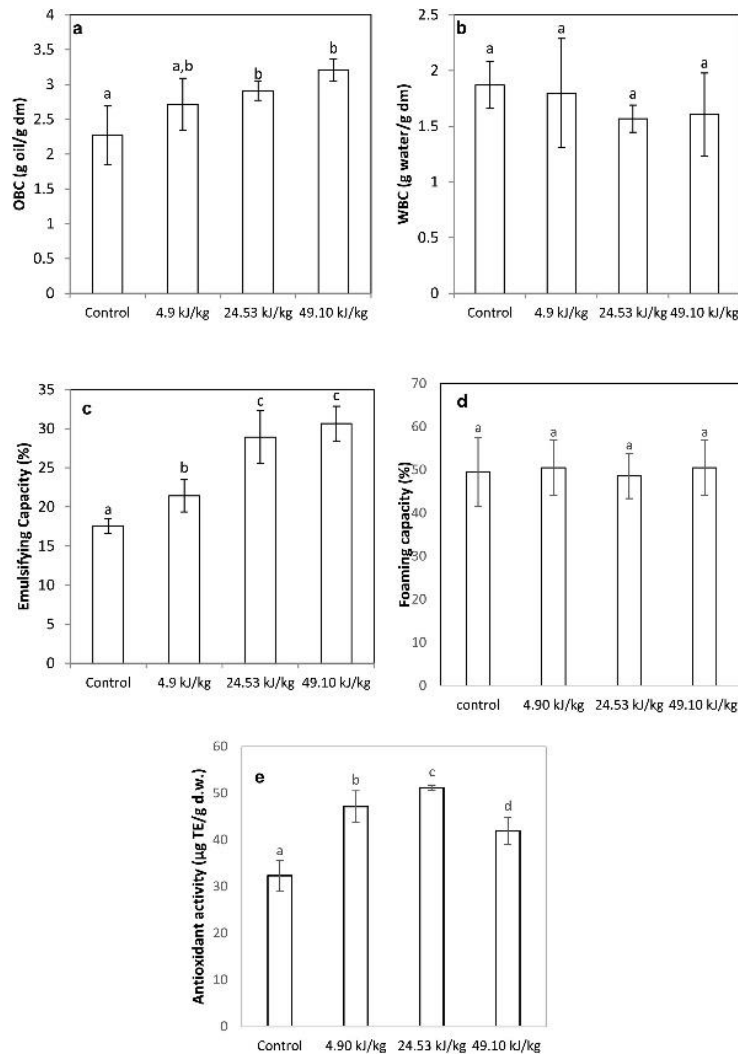

**Figure I.8.** Effect of PEF pretreatment on the functional properties of the cricket flour: (a) oil binding capacity (g oil/g d.m.), (b) water binding capacity (g water/g d.m.), (c) emulsifying capacity (%), (d) foaming capacity (%), (e) antioxidant activity ( $\mu\text{g TE/g d.w.}$ ). The error bars indicate the standard errors of measurements. Superscript letters (a,b,c...) indicate the significant differences ( $p < 0.05$ ) between the means of the functional properties of PEF-treated samples and the untreated sample (control) (Psarianos *et al.*, 2022).

Additionally, the effects of PEF treatment on the drying of *H. illucens* and *T. molitor* larvae have been studied (Alles *et al.*, 2020; Bogusz *et al.*, 2022; Shorstkii *et al.*, 2022). The impact of PEF pre-treatment of *H. illucens* on hot air drying at different temperatures  $T_d=50-90\text{ }^\circ\text{C}$  (at  $E=2\text{ kV/cm}$  and specific energy inputs  $W=10-20\text{ kJ/kg}$ ) was investigated. The processing parameters  $W=11.2-13.1\text{ kJ/kg}$  and  $T_d=81-84\text{ }^\circ\text{C}$  were shown to be optimal for larvae drying (Shorstkii *et al.*, 2022). PEF treatment was also found to reduce the infrared drying time of *T. molitor* and *H. illucens* larvae by up to 10% (Figure I.9) and may reduce the microbial load of fresh larvae by 0.5–1.0 log cycle (Bogusz *et al.*, 2022).

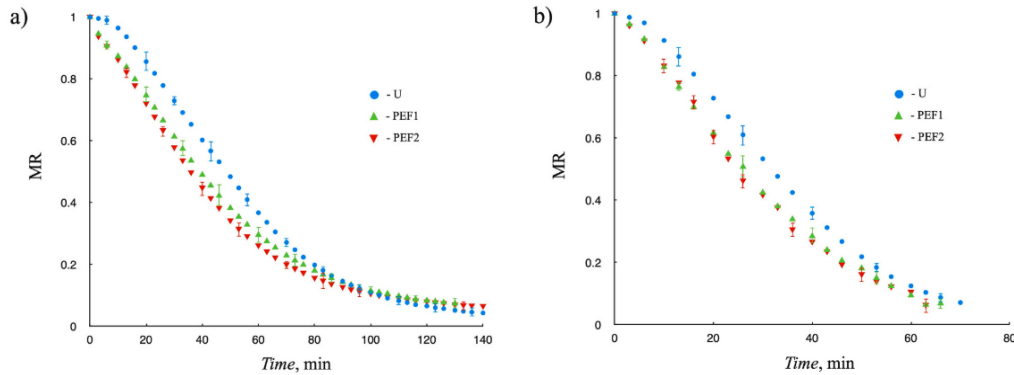

**Figure I.9.** Infrared drying kinetics of *H. illucens* (a) and *T. molitor* (b) larvae without pre-treatment (U) and with pulsed electric field treatment (PEF1 and PEF2 – input energy 5 and 20 kJ/kg, respectively) (Bogusz *et al.*, 2022).

The presented studies emphasize the need for ongoing exploration of the use of PEF technology in the insect sector. Additionally, it highlights the importance to study the potential impact of DIC technology on the sector as well. These emerging technologies hold great promise for the development of sustainable and nutritious insect-based food products, and their continued exploration and application in the insect industry can significantly contribute to advancing this field.

### I.3. Conclusion and research objectives

With the world's population expanding, entomophagy is being regarded as a possible solution to global food insecurity since insects are high in protein, vitamins, and minerals and may therefore meet the growing need for novel food sources.

In addition to being highly nutritious, edible insects are a cost-effective and environmentally friendly alternative to conventional farming, since they are fed on byproducts, they have low feed conversion ratios, greenhouse gas emissions, and land and water use.

However, to be accepted as a food source, mainly in Western countries, edible insects must be processed and transformed into undistinguishable forms and incorporated into common food products.

Recently, the European Commission has authorized 4 insect species to be placed on the market as novel food products: yellow mealworm (*Tenebrio molitor*) (Turck *et al.*, 2021a), migratory locust (*Locusta migratoria*) (Turck *et al.*, 2021b), house cricket (*Acheta domesticus*) (Turck *et al.*, 2022a), and lesser mealworm (*Alphitobius diaperinus*) (Turck *et al.*, 2022b).

Among those interesting species, we chose yellow mealworms (*Tenebrio molitor* Larvae) as the raw material in our study. Yellow mealworms are insects of the Tenebrionidae family and are native to Europe but are now found worldwide. *T. molitor* is a pest of grain, flour, and food stores, however, it is not a major concern because of its small population. Mealworms are easy to breed and feed, and they have a high protein profile, therefore they are produced industrially as feed for

animals such as birds, reptiles, small mammals, amphibians, and fish. They are usually fed alive, although they can also be found canned, dried, or in powder form (Makkar *et al.*, 2014).

*T. molitor*'s life cycle is presented in Figure I.10. Larvae hatch after 10-12 days (at 18-20°C) and mature after 8 to 20 stages, usually after 3-4 months (at ambient temperature), however, the larva stage can persist up to 18 months. The adult larva is 20-32 mm long, weighs 130-160 mg, and has a light yellow-brown color. The pupal stage lasts 7-9 days at 25 °C and up to 20 days at lower temperatures and the adult lives for 2 to 3 months (Finke, 2002).

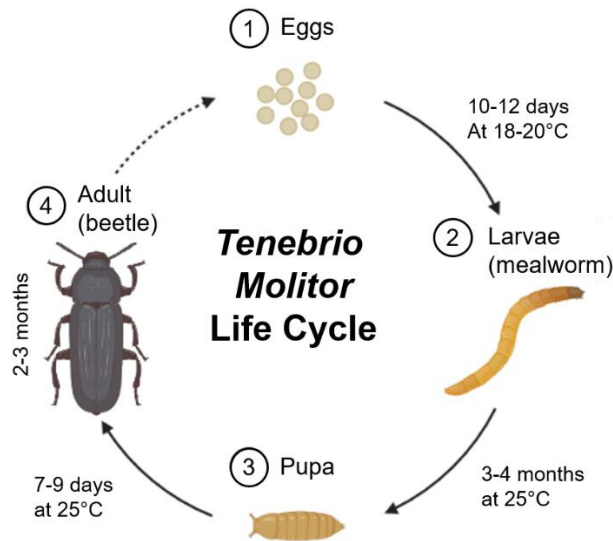

**Figure I.10.** *Tenebrio molitor* life cycle. Created with BioRender.com

Mealworms are omnivorous, eating a variety of plant materials as well as animal products and low-quality waste. They are usually fed cereal bran or flour (wheat, oats, maize) with added protein sources such as soybean flour, skimmed milk powder, or yeast. Fresh fruits and vegetables (carrots, potatoes, lettuce) are also mentioned as water sources. Although they can survive on small quantities of water present in dry feeds, this reduces their productivity from 6 to 1 generation per year and can promote cannibalism (Makkar *et al.*, 2014).

The selected species is one of the most popular and widely consumed edible insects in the world as it holds significant relevance and suitability for the concept of biorefinery. Mealworms offer high nutritional value as they are a rich source of protein, vitamins, and minerals, making them an excellent food source. They are accessible and cost-effective to farm and cultivate compared to other edible insects, and they can be raised in various environments, providing a sustainable protein source. Furthermore, their mild nutty flavor makes them easier to include into a variety of meals, thereby increasing their acceptability by customers who may be hesitant to try insect-based food products.

The present thesis aims to develop techniques for fractionating larvae that are both environmentally friendly and cost-effective. To achieve this goal, the study will explore the impact

of two pretreatment technologies, Instant controlled pressure drop (DIC) and Pulsed electric fields (PEFs), on the following factors:

- Kinetics of larval mortality and total mortality thresholds
- Physical, quantitative, and qualitative characteristics of larvae
- Microbial decontamination and the ability to reduce microbial load below the European Commission's acceptable levels
- Hydraulic pressing yield and press cake's water content
- Effective separation of proteins from other molecules with hydraulic pressing
- Larval enzymatic browning
- Drying kinetics, dried powder characteristics, sorption isotherms and model fitting

Along with an evaluation of the energetic consumption and processing costs of the explored emerging methods and a general comparison with blanching, the conventionally used method.

## **Chapter II - Impacts of Instant controlled pressure-drop (DIC) pretreatment on yellow mealworms transformation chain**

### II.1. Introduction

The Instant Controlled Pressure-drop (DIC) is a thermo-mechanical process that uses high-temperature/high-pressure treatments for a short time, followed by an abrupt and controlled pressure drop to a final vacuum. This process is known to improve drying kinetics, pressing yield, solvent extraction kinetics, and microbial decontamination. It can also be used for the extraction of volatile molecules. Given its advantages, we were interested in researching its impact on different larval processing operations, as no previous studies on insect larvae have been conducted so far.

This chapter aims to investigate the potential of Instant Controlled Pressure Drop (DIC) technology for improving the transformation chain of edible insects, specifically yellow mealworms. The chapter includes three parts: (1) an assessment of microbial inactivation using DIC technology, (2) a process study and optimization of DIC-assisted pressing for defatting and dewatering of yellow mealworm larvae, and (3) an examination of the impact of DIC texturing on the drying process of yellow mealworms. The goal of this study is to determine the effectiveness of DIC technology in improving the safety and quality of edible insects as a food source and provide guidelines for the optimization of DIC processes to produce safe and high-quality insect-based food products.

In the first part ‘**Article 2: Use of Instant Controlled Pressure Drop technology for the preservation of edible insects’ (yellow mealworm) quality: Assessment of microbial inactivation**’ is presented. This article has been published in the journal of Environmental Sciences and Pollution Research (<https://doi.org/10.1007/s11356-023-26030-4>). It investigates and compares the effectiveness of DIC and blanching treatments in reducing the initial load of microorganisms in yellow mealworms to meet the acceptable values set by the European Commission for the commercial sale of insects as a food source. The insects were subjected to different parameters of each method, such as pressure and temperature for DIC and time for blanching at 90°C, to identify the optimal decontamination conditions. The study also evaluates the impact of the applied treatments on the color changes of the larvae, to assess the overall effectiveness of each method in preserving the microbial and phenotypic quality of the insects.

The second part of this chapter is devoted to ‘**Article 3: Instant controlled pressure-drop assisted pressing for defatting and dewatering of yellow mealworm larvae: process study and optimization.**’ This paper was published in the Journal of Insects as Food and Feed (JIFF) (<https://doi.org/10.3920/JIFF2022.0062>). It investigates the use of DIC technology as a pretreatment for living mealworms. The effects of DIC on the physical and chemical characteristics were first investigated. Larvae were then defatted and dewatered by using mechanical pressing. A preliminary study was carried out to identify the optimal conditions for

hydraulic pressing of *Tenebrio molitor* larvae. The killing threshold with DIC technology was identified and an experimental design with DIC operative parameters was established to conduct the study.

In the final part of this chapter is presented ‘**Article 4: Impact of instant controlled pressure-drop (DIC) texturing on the drying of yellow mealworms.**’ This article has been accepted in the Journal of Insects as Food and Feed (JIFF). It focuses on understanding the effects of DIC pretreatment on the shrinkage and overall quality of dried yellow mealworms. It investigates the impact of DIC on the drying process, including its effect on water diffusivity, drying kinetics, final moisture content, and sorption isotherms. Additionally, the study includes the modeling of sorption isotherms to fit the experimental data.

II.2. Article 2: Use of Instant Controlled Pressure Drop technology for the preservation of edible insects’ (yellow mealworm) quality: Assessment of microbial inactivation.

(The article is presented on the following pages)

# **Use of Instant Controlled Pressure Drop technology for the preservation of edible insects' (yellow mealworm) quality: Assessment of microbial inactivation**

**Rachelle El Hajj<sup>\*1</sup>, Houcine Mhemdi<sup>1</sup>, Antoine Fayeulle<sup>1</sup>, Lucie Corjon<sup>1</sup>, Victor Lefrancois<sup>2</sup>, Karim Allaf<sup>3</sup>,**

**Eugène Vorobiev<sup>1</sup>**

<sup>1</sup> Université de Technologie de Compiègne, ESCOM, TIMR (Integrated Transformations of Renewable Matter), Centre de recherche Royallieu - CS 60 319 - 60 203 Compiègne Cedex, France ;

<sup>2</sup> ABCAR DIC Process Company, 11 Rue du Four Saint-Jacques, 60200 Compiègne, France ;

<sup>3</sup> University of La Rochelle, Laboratory of Engineering Science for Environment LaSIE -UMR-CNRS 7356, 17042 La Rochelle, France;

\* Corresponding author: rachele.el-hajj@utc.fr; hajjrachelle@hotmail.com;

Published: February 2023

Journal of Environmental Science and Pollution Research

Special issue: Microbes, Bioconversion Technologies and Sustainable Environment: Targeting for Food Processing Waste Utilization

<https://doi.org/10.1007/s11356-023-26030-4>

## Abstract

The world population is expanding, and with it, so is the need for proteins for the food and feed sectors. Conventional livestock production is correlated with negative environmental repercussions such as global warming, land degradation, and biodiversity loss. The nutritional content of edible insects is comparable to that of conventional meat, and insect farming offers various environmental advantages over livestock production, making it a favorable sustainable protein resource. However, to be placed on the market, insects should be processed, and their microbial load should be within the accepted range of the European Commission regulation (EU) 2021/882. The purpose of this research is to investigate the use of instant controlled pressure drop (DIC) technology for the microbial inactivation of yellow mealworm larvae. This innovative decontamination treatment was compared to blanching in hot water, the conventional processing method. We also investigated the impacts on enzymatic browning. Results showed that the application of rapid (20 s) DIC treatment at 0.3 MPa allowed reducing the total aerobic count and the total yeasts and molds count of larvae below the thresholds authorized by the commission regulation. Pressure, temperature and number of cycles factors were found to have significant effects on the decontamination, while the treatment time had no effect for most treatments. In regards to blanching, we were able to get the authorized load at 90°C for 360 s. Decimal reduction times for DIC and blanching treatments were found to be 3.8 s and 67.8 s for total aerobic count, and 3 s and 57 s for total yeasts and molds count, respectively. Furthermore, DIC-treated larvae showed a significant increase in juice color brightness, which could be traced back to the oxidative enzymatic inactivation of larvae, whereas there was a slight difference between blanched and untreated larvae juice colors.

**Keywords:** *Tenebrio molitor*; Larvae; Decontamination; Instant controlled pressure drop DIC; Emerging technologies; Blanching; Pretreatment.

## Abbreviations

DIC	Instant controlled pressure-drop
CFU	Colony-forming unit
TVC	Total viable aerobic count
YMC	Total Yeasts and molds count
TSA	Tryptone Soya Agar
PDA	Potato Dextrose Agar
MSA	Mannitol Salt Agar



## 1. Introduction

An ever-increasing world population, along with constantly rising economic growth and urbanization, lead to an increase in demand for high-value protein, exerting further strain on the world's livestock production industry. This growth would most likely have a detrimental impact on the environment, taking into account carbon emissions, land and water use, public health hazards etc. (Steinfeld *et al.* 2006; Klunder *et al.* 2012). In this regard, edible insects provide a potentially sustainable alternative to meet the increasing need for nutritional foods and proteins (van Huis *et al.* 2013). In Asia, Africa, and America, edible insects are a widely known meal. Nearly 2111 insect species are estimated to be consumed by humans worldwide (Jongema 2017).

Insects are comparable to conventional livestock meat in terms of nutritional content. Nevertheless, they use less water, land, and feed to generate the same quantity of nutritious molecules. As poikilotherms or cold-blooded animals, insects can convert almost all the feed they consume into body mass, lowering the feed conversion ratio. Moreover, they may be reared on various substrates, such as byproducts of the agri-food sectors that have no other usage, allowing them to fit into the circular economy approach. Numerous international agencies and organizations have acknowledged insects as potential actors in the commercial food chain, and active players in decreasing environmental impacts while expanding animal production (Mancini *et al.* 2022; Cacchiarelli *et al.* 2022).

Multiple international organizations, such as IPIFF (International Platform of Insects as Food and Feed, Brussels, Belgium), AFFIA (Asian Food and Feed Insect Association, Bangkok, Thailand), NACIA (North America Coalition for Insect Agriculture, Chicago, IL, USA), and IPAA (Insect Protein Association of Australia, Canberra, ACT) are supporting the insect sector worldwide. In many countries around the world, edible insects are becoming part of the human diet, whether directly or indirectly (Mancini *et al.* 2022).

*Tenebrio molitor* (Coleoptera: Tenebrionidae), often known as yellow mealworm, is one of the most used/investigated insects for food (EU 2021) and feed (EU 2017) applications due to its balanced composition, ease of rearing, high production output, and minimal environmental impact (van Huis *et al.* 2013; Mancini *et al.* 2019). This species is high in proteins and lipids and is a good source of essential amino acids, vitamins, and minerals; it can have up to 50% and 34% of proteins and lipids, respectively, in its dry mass (Cacchiarelli *et al.* 2022). According to the EU regulation 2021/882, *T. molitor* larvae for human consumption, currently, must be blanched and oven-dried (EU 2021).

However, various barriers limit the use of insects as food, especially in nations where entomophagy is not widespread. For example, European consumers are found to be not very enthusiastic and receptive towards the idea of eating insects, instead expressing revulsion (Dagevos 2021). In fact, the style of culinary preparation and degree of insect visibility greatly influence this psychological barrier to entomophagy acceptance. Therefore, insect proteins can be

isolated as protein flour and "hidden" in familiar processed products to enhance consumer acceptability (such as bread, meat, pasta, and pizza) (El Hajj *et al.* 2022).

Another important factor influencing consumer willingness to eat insects is safety concerns due to the fear of allergic, parasitic, chemical, and microbiological risks. However, proper rearing, handling, and processing methods can reduce the microbial load, and low-temperature storage ensures that the microbial load remains low while prolonging the product's shelf-life. Additionally, color is an important trait influencing any product acceptance, and browning is usually a major issue in processing many edible insect species, and it is usually linked to other reactions that reduce protein digestibility, deteriorate flavor, and change the product's techno-functional properties (Mancini *et al.* 2019).

Emerging technologies applied as a pretreatment to raw materials, such as pulsed electric fields (PEFs), ultrasound (US), instant controlled pressure-drop (DIC), and high hydrostatic pressure (HHP), have recently prompted a rush of interest in the food and feed processing sectors for presenting several advantages over conventional procedures, such as reduced energy and water consumption, cost-effectiveness, sustainability, eco-friendly operations, and enhanced product quality (Knorr *et al.* 2011; Smetana *et al.* 2020). Plasma and hydrostatic pressure treatments efficiently decrease microbial load for *T. molitor* processing. Among the studied treatments, the combination of high hydrostatic pressure (600 MPa) and high temperature (90 °C) was the most successful (Rumpold *et al.* 2014; EFSA 2015).

The Instant Controlled Pressure-drop, called DIC (French acronym: Détente Instantanée Contrôlée), is a new method based on hydro-thermo-mechanical phenomena, typically applied as a pretreatment for raw materials. It is an HTST (High-Temperature/Short-Time) method that alters the structure of the treated materials by expansion (El Zahar *et al.* 2015). This novel process has been studied, developed, optimized, and applied at the industrial scale for many applications such as solid/liquid extraction, mechanical expression (Bamerni, 2018; Jablaoui *et al.*, 2020), drying (Louka and Allaf 2002; Haddad *et al.* 2008), decontamination (Allaf *et al.* 2011), pretreatment for extraction of non-volatile molecules, and direct extraction of volatile compounds (Berka-Zougali *et al.* 2010; Besombes *et al.* 2010). The DIC is a low-energy batch process, requiring 0.80 kWh/kg of DM in swell drying (Mounir *et al.* 2012) and 0.11 kWh/kg per cycle of lavender essential oil extraction (Besombes *et al.* 2010) on an industrial scale. Previous studies revealed that DIC treatment is an effective decontamination method, it kills microorganisms by heat treatment as well as mechanical stress induced by the quick pressure drop that induces their explosion. Fresh cassava roots' bacterial load was reduced by 85.7% after DIC treatment (Puguh Setyoprato *et al.* 2009), whereas Albitar *et al.* 2011 reported that swell-drying significantly decontaminates onions (from 875,000 germs/g up to 100 germs/g). Yet, no studies on the effect of DIC technology on edible insect larval decontamination have been conducted so far.

This research aims to study the impact of Instant Controlled Pressure Drop (DIC) technology on microbiological decontamination and color changes in *T. molitor* larvae and compare it to blanching, the conventional method that is generally used as an insect pretreatment.

## **2. Materials and methods**

### **2.1. Yellow mealworm samples**

Yellow mealworms (*T. molitor* larvae) between the 13<sup>th</sup> and 16<sup>th</sup> instar were purchased from the France insects farm (Crevecœur-le-grand, France), where they were reared on miller's bran. The larvae were fasted for at least 24 h at 4°C and then sieved by shaking their perforated plastic bags to separate the frass.

### **2.2. Blanching parameters**

Blanching is a conventional pretreatment step used to kill larvae, reduce microbial load, and inactivate the degradative enzymes that cause spoiling before further processing (Vandeweyer *et al.* 2017b; Saucier *et al.* 2021; Cacchiarelli *et al.* 2022). Blanching was done in a 90°C water bath. Sterile falcon tubes were preheated empty, and then 10 g of live larvae were introduced. The closed tubes are placed in the water bath for various treatment times: 120, 240, 360, and 480 s. Following that, all treated samples were frozen for 90 min at -20 °C to deactivate any larvae that were still alive without affecting their microbiological profile. It is important to note that the 90 min freeze did not result in the death of the larvae, and if allowed to thaw, they will regain activity.

### **2.3. Instant controlled pressure drop DIC-pretreatment**

Instant controlled pressure drop lab-scale equipment was from ABCAR-DIC Process (Compiègne, France). Figure 1 (a) illustrates a laboratory DIC unit design. It is a batch treatment unit made up of a treatment vessel connected to a saturated steam generator, a vacuum tank, and the atmosphere. The system is capable of sensing, regulating, and recording pressure changes. The DIC treatment cycle is a five-step thermo-mechanical process (Fig. 1(b)); (1) The first step consists of placing the material to be treated into the DIC treatment chamber, (2) applying a vacuum in the treatment chamber (absolute pressure of 10 to 5 kPa) to promote optimal performance of the subsequent step, (3) injecting a dry saturated steam into the DIC treatment vessel (hydrothermal processing step) until reaching a set target pressure (up to 700 kPa) for a short treatment time (<60 s), (4) applying a pressure-drop towards a vacuum (between 10 to 5 kPa) (abrupt pressure-drop step), and (5) re-establishing the atmospheric pressure inside the treatment chamber (atmospheric releasing step). When applying more than one cycle, steps from 2 to 4 are repeated until reaching the desired number of cycles (Allaf *et al.* 2013a, b; Allaf and Allaf 2014; Pech-Almeida *et al.* 2021).

To assess the impact of each parameter on bacterial decontamination, we perform a three-factor, five-level central composite experimental design presented in Table 1. The variable factors are the treatment time, the saturated steam pressure/temperature, and the number of cycles. The total treatment time is the time of a cycle multiplied by the number of cycles. Moreover, for the decontamination kinetics study, 4 levels of pressure/temperature were set, the treatment time was varied between 5 and 25 s, and the number of cycles was set to 1. The quantity of treated larvae was fixed at 230 g per batch.

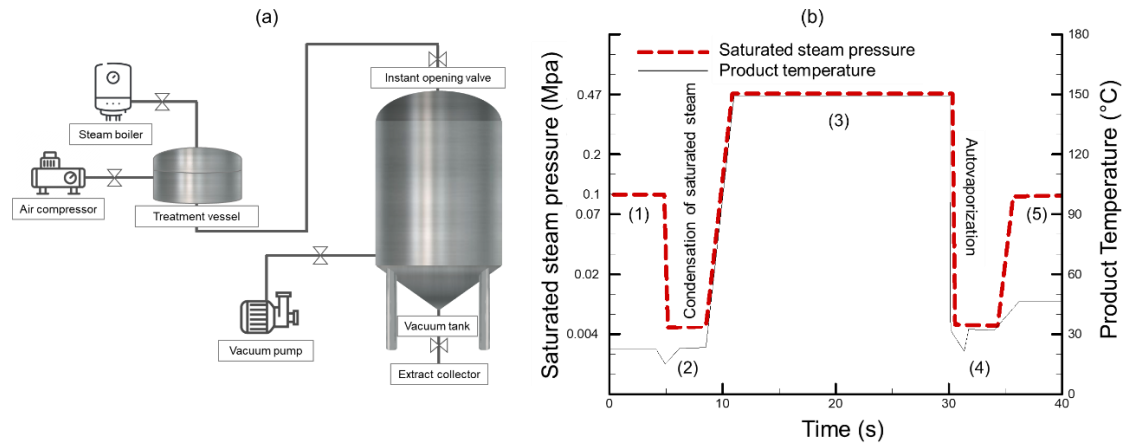

**Fig. 1** Schematic representation of Instant controlled pressure drop (DIC) (a) apparatus and (b) the temperature and pressure correlations during a treatment cycle

**Table. 1** DIC-pretreatment 3-factor 5-level central composite design parameters

Factor	Point min (- $\alpha$ )	Point (-1)	Central point	Point (+1)	Point max (+ $\alpha$ )
Total treatment time (s)	5	9	15	21	25
Pressure (kPa)/	100 kPa/	150 kPa/	225 kPa/	300 kPa/	350 kPa/
Temperature (°C)	100 °C	112 °C	124 °C	134 °C	139 °C
No. of cycles	1	2	3	4	5

#### 2.4. Microbiological study

Figure 2 illustrates the experimental steps that preceded the microbiological analysis. Pretreated larvae were directly collected in sterile containers. They were subjected to a freezing step at  $-20^{\circ}\text{C}$  for 90 min to deactivate any larvae that were still alive without affecting their microbiological profile. Except for the treatment application, the control samples (living) followed the same procedure. Following that, 10 g of larvae were inserted in sterile filter bags (BagFilter P, Interscience, France), and sterile saline water of 0.9% NaCl was added to the bag at a ratio of 1:90 (w:v) (Macias *et al.* 2008; Mancini *et al.* 2019). For high treatment conditions, the ratio was adjusted to 1:1 (w:v) to minimize the detection threshold to 1 log cfu/g. At this point, larvae were crushed through the closed bags using a pestle to release the microbiota from the insects' intestines before being placed in an orbital shaker (Infors AG Aerotron, Switzerland) for 10 min to

homogenize the solution. The filtrate was pipetted and subjected to different dilution factors (1, 103, and 106) before being plated on the culture medium under sterile conditions. Plating was done using an automatic spiral plater (easySpiral, Interscience, France).

Since many previous research studies reported the absence of *Escherichia coli* (Enterobacterales: Enterobacteriaceae), *Bacillus cereus* (Bacillales: Bacillaceae), *Listeria monocytogenes* (Bacillales: Listeriaceae), and *Salmonella spp.* (Enterobacterales: Enterobacteriaceae) bacteria in edible insects reared for human consumption (Vandeweyer *et al.* 2017a; Osimani *et al.* 2017; Mancini *et al.* 2019), we were only interested in the total viable aerobic count (TVC), total yeasts and molds count (YMC), and staphylococci bacteria in the present study. We used Tryptone Soya Agar (TSA) as a growing medium for the TVC, Potato Dextrose Agar (PDA) for the YMC detection, and Mannitol Salt Agar (MSA) for staphylococci detection. The incubation was done at 30°C in the dark for 24h for bacteria and at 22°C under a 12h/12h photoperiod for 48h for yeasts and molds, and microbial counts were expressed in log colony-forming unit (cfu)/g.

The decontamination was calculated as follows:

$$\text{Log } N/N_0 \quad (1)$$

where N is the number of enumerated colonies, and N<sub>0</sub> is the initial colony count of untreated larvae (cfu/g), respectively.

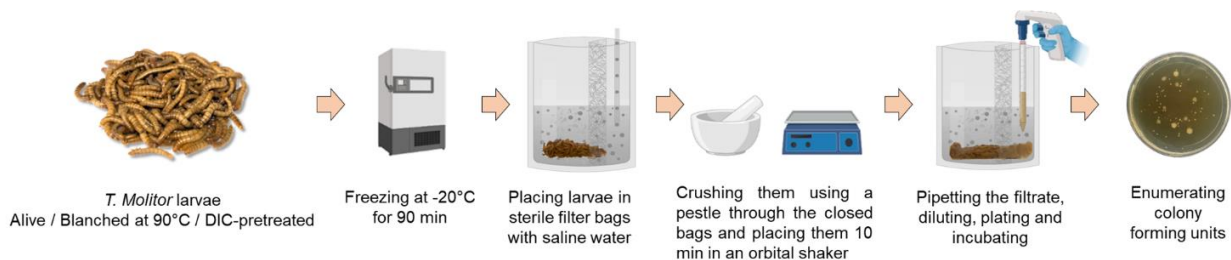

**Fig. 2** Microbiological study protocol

### 2.5. Image processing

Image color analysis was done using ImageJ 1.53t software (National institute of health, USA) on the same filtrate obtained for the decontamination study (Fig. 2) with a dilution ratio of (1:1) (w:v) in 0.9% NaCl. It is a Java-based image-processing program for multidimensional scientific images. The comparison was given in grayscale units, with the lowermost value being 0 for black color and the highest being 255 for white color.

### 2.6. Experimental design and statistical analysis

The DIC pretreatment was carried out using a three-factor (pressure, time and number of cycles), five-level central composite design with eight central points. Since our experimental data meet the criteria for parametric analysis, a statistical analysis was conducted using ANOVA to gain a comprehensive understanding of the relationship between the independent variables and the dependent variable. The results were evaluated using Pareto charts (with a significance level of  $p < 0.05$ ), main effects plots, and estimated response surfaces (Statgraphics, centurion XVI, StatPoint Technologies). A T-test was also used to determine the significance of the difference between the means of two groups with, at least, three measurements performed on each sample.

### 3. Results and discussions

#### 3.1. Decontamination kinetics

For the study of decontamination kinetics with DIC, we set the treatment temperature/pressure to 100°C/0.1MPa, 112°C/0.15MPa, 134°C/0.3MPa, and 139°C/0.35MPa, and set the treatment cycles to 1, and varied the treatment duration between 5 and 25 s (intervals of 5 s), whereas, for blanching, we set the temperature to 90°C and varied the treatment time between 120 and 480 s (intervals of 120 s) (Table 2).

Under our rearing, feeding, and handling conditions, the initial microbial load of our larvae was 10.1 log cfu/g for TVC, and 7.4-9.4 log cfu/g for YMC, which is higher than the initial load mentioned by Nyangena *et al.*, 2020, Stoops *et al.*, 2017, Wynants *et al.*, 2017 but closer to that obtained by Larouche *et al.*, 2019. Microbial counts of different treatments are presented in Table 2.

**Table. 2** Microbial counts (log cfu/g) of untreated, DIC-treated, and blanched *T. molitor* larvae

Treatment	Treatment time (s)	Total aerobic count (log cfu/g)	Total yeasts and molds count (log cfu/g)
DIC-treated at 0.1 MPa (100°C)	0	10.1±0.1	9.4±0.2
	5	9.8±0.1	9.4±0.1
	10	9.2±0.2	8.5±0.1
	15	9±0.1	8.8±0.1
	20	9.5±0.2	8.9±0.1
	25	9.1±0.1	8.4±0.1
DIC-treated at 0.15 MPa (112°C)	0	10.1±0.1	9.4±0.2
	5	7.4±0.1	6.4±0.2
	10	8±0.2	6.8±0.1
	15	7.1±0.1	6.4±0.2
	20	7.6±0.3	7.6±0.3
	25	6.8±0.1	6.0±0.1
DIC-treated at 0.3 MPa (134°C)	0	10.1±0.1	9.4±0.2
	5	7.8±0.2	6.2±0.2

	10	6.3±0.2	6.2±0.1
	15	6.1±0.3	4.0±0.2
	20	5.1±0.3	2.0±0.1
	25	3.7±0.1	2.1±0.2
	0	10.1±0.1	9.4±0.2
	5	1.7±0.5	<1
DIC-treated at 0.35 MPa (139°C)	10	2.0±0.1	<1
	15	1.9±0.2	1.0±0.3
	20	2.0±0.1	<1
	25	<1	<1
	0	10.1±0.1	7.4±0.1
	120	9.1±0.1	4.5±0.2
Blanched at 90°C	240	7.1±0.2	1.8±0.2
	360	3.3±0.1	<1
	480	3.2±0.1	<1

The decontamination kinetics of DIC treatment are presented in Fig 3. As can be observed, the effect of DIC on the TVC decontamination profile is remarkably similar to that on YMC. We notice that treatment duration variation between 5 and 25 s has a very slight influence on decontamination, with increasing treatment time causing a maximum decontamination increase of 0.7 and 1 log in TVC and YMC, respectively. Therefore, we can state that at the studied parameters, the decontamination is solely impacted by the temperature/pressure combination, except for the treatment at 134°C, when we can see the effect of time. It might be explained by the fact that the treatment at 134°C is an intermediate treatment, whereas the other treatments are either too mild to notice a significant influence of time or too intense, where the bacterial load instantly reaches a very low value. Allaf *et al.*, 2011 reported that both treatment time and saturated steam pressure had an influence on reducing the microbial load of seaweeds and skimmed milk powders, but this might be because they applied a wide range of time (between 20 and 60 s) in their study, which is not the case in ours.

On the other hand, the decontamination kinetics of blanched larvae (Fig 4) show comparable curves in both TVC and YMC. However, the decontamination level is more pronounced in YMC than in TVC, which could be attributed to the fact that yeasts and molds are heat-sensitive and easily destroyed at high temperatures (Garnier *et al.* 2017). Furthermore, TVC and YMC decontaminations versus treatment time presented nearly linear curves which is not in line with the findings of Cacchiarelli *et al.*, 2022, who stated that blanching the larvae at 90°C for 1 min resulted in a complete decrease of the TVC to a value below the detection limit of the method, but still, the detection limit value in their method was not mentioned.

Additionally, blanching at 90°C for 360 and 480 s (Table 2) led to approximately the same bacterial load, 3.3 and 3.2 log cfu/g, respectively, which is comparable to the findings of (Klunder *et al.*

2012), who reported that extending the boiling duration from 5 to 10 min resulted in TVC of 2.5 and 2.8 log cfu/g, respectively.

The European Commission regulation requires a TVC of  $\leq 5$  log cfu/g and YMC counts of  $\leq 2$  log cfu/g for dried *T. molitor* larvae to be placed on the market as a novel food (EU 2021). These required values for both counts were achieved in DIC-treated larvae at 134°C (0.3MPa) for  $\geq 20$ s, and at 139°C (0.35MPa) for  $\geq 5$ s (Fig 3), and in the blanched larvae at 90°C for  $\geq 360$  s (Fig 4). However, if the initial microbial loads were lower, which is affected by proper sample handling and separation from the frass, possibly with the use of a plastic web under their bags (Mancini *et al.* 2019), these values would have been reached at milder treatment conditions.

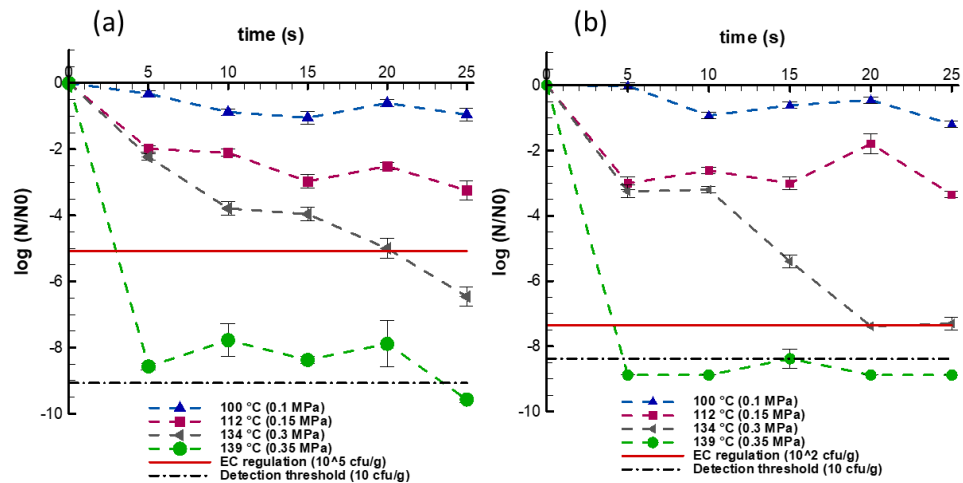

Fig. 3 Decontamination kinetics after different DIC-pretreatment conditions of (a) TVC and (b) YMC

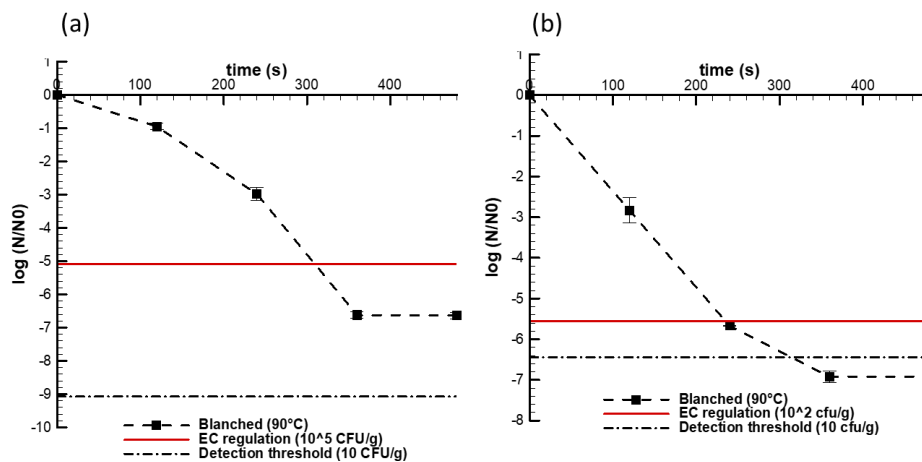
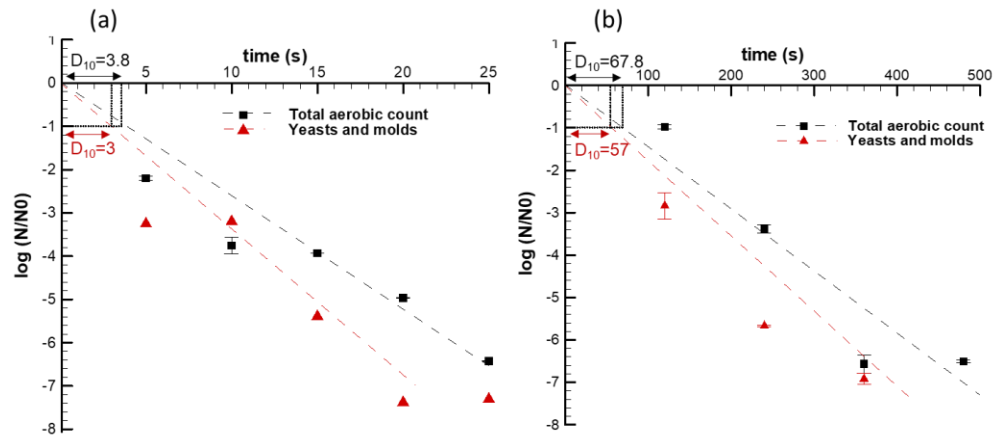

Fig. 4 Decontamination kinetics of blanching at 90°C of (a) TVC and (b) YMC

The decimal reduction time (D-value), or the time required at a given condition to achieve one log reduction, that is, to kill 90% of relevant microorganisms, was calculated for blanched larvae at



90°C and DIC-treated larvae at 134°C, where the decontamination kinetics profiles could be regarded as linear. As shown in Fig. 5, decimal reduction times for DIC-treated larvae at 134°C and blanched larvae at 90°C were found to be 3.8 s and 67.8 s for TVC and 3 s and 57 s for YMC, respectively. These findings reveal that DIC treatment takes up to 19 times less time than blanching to achieve a given decontamination value.



**Fig. 5** Linear fit and decimal reduction times of TVC and YMC for (a) DIC-treated larvae at 134°C and (b) blanched larvae at 90 °C

Figure 6 represents the decontamination kinetics of staphylococci bacteria. The identified strain is *Staphylococcus aureus* (Bacillales: Staphylococcaceae), a Gram-positive spherically shaped bacterium, one of the most important bacteria that cause illness in humans. *Staphylococcus aureus* is recognized by the formation of gold colonies and the production of yellow zones on MSA (Fig. 6) (Bano *et al.* 2020). The initial load of our larvae was 7.3-7.6 log cfu/g, which is similar to the initial load reported by Nyangena *et al.*, 2020. To be placed on the market, the European Commission regulation requires the Coagulase-positive staphylococci load of edible insects to be  $\leq 100$  cfu/g (EU 2021).

Treatment time influences *S. aureus* bacterial load in both DIC (0.3 MPa) and blanching (90°C). DIC treatment at 0.3MPa was insufficient to decrease the *S. aureus* load to below the EC regulatory threshold, whereas blanching surpassed the threshold within 240 s, and then at  $t > 240$  s the *S. aureus* load remained nearly unchanged. Similarly, Montanari *et al.*, 2015 have found that a heat treatment at 80°C of isolated *S. aureus* strains shows a first decline (up to 3.39 min and 2.08 min for *S. aureus* DSM 20231T and *S. aureus* SS3, respectively) during which the initial population was reduced of about 6 log units. Then the number of survivors did not change with the increase of treatment time up to 20 min. DIC treatment at 0.35 MPa for  $\geq 5$  s, on the other hand, resulted in a TVC load of  $\leq 2$  log cfu/g (table 2), ensuring that the *S. aureus* load is  $\leq 2$  log cfu/g, which is the EC regulation requirement. Our results are comparable to Nyangena *et al.*, 2020, who stated that boiling and toasting reduced *S. aureus* load by 4.8–6.4 logs.

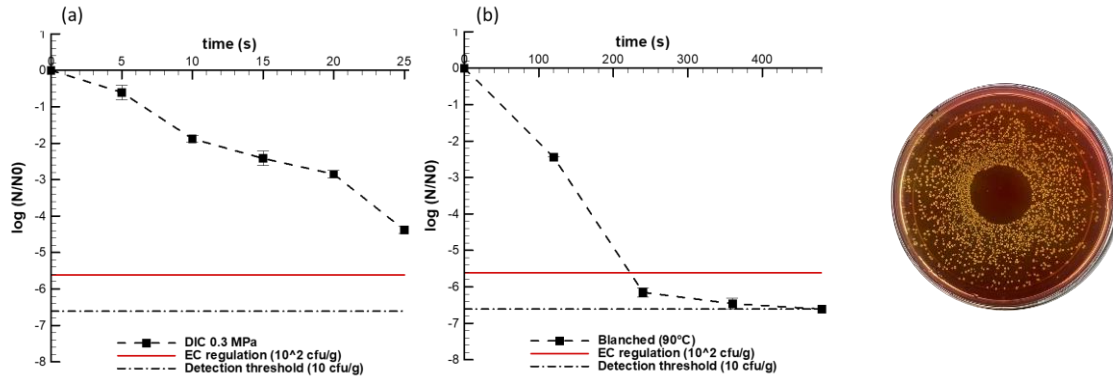
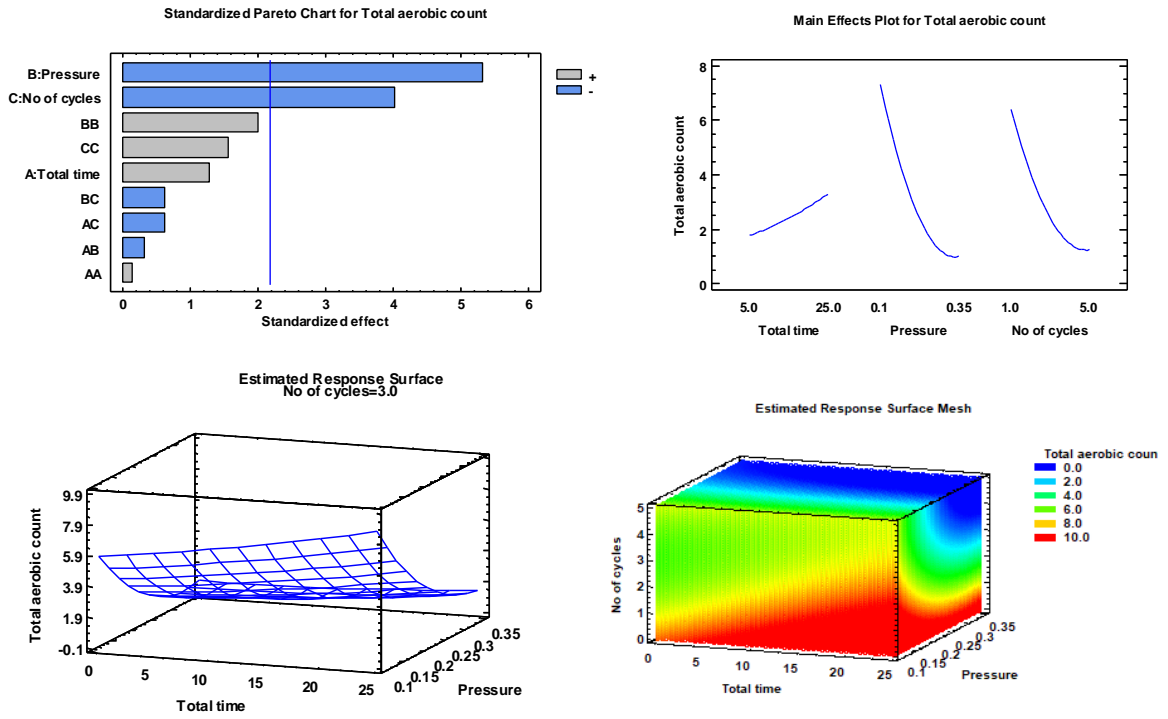

**Fig. 6** Decontamination kinetics of *S. aureus* with (a) DIC treatment at 0.3 MPa and (b) blanching at 90°C; and a petri dish showing the formation of gold colonies and the outset of the emergence of yellow zones on MSA medium

### 3.2. Effect of DIC parameters on the decontamination

DIC treatment eliminates microorganisms by two main mechanisms: highly controlled heat treatment and mechanical stress on the microorganisms induced by the quick pressure drop that provokes their explosion (Allaf *et al.* 2011). To study the impact of these mechanisms on the decontamination of yellow mealworms, we performed a 3-factor design of experiments (Table 1). Figure 7 shows the effect of each DIC factor (Saturated steam pressure, time, and number of cycles) on *T. molitor* larvae decontamination, represented by Pareto charts, main effects plot, estimated response surface (at a no. of cycles = 3), and estimated response surface mesh. Pressure and number of cycles were negatively correlated with the microbial load, whereas treatment duration had no significant effect. To address the influence of the number of cycles, we held constant all variables while the number of cycles varied from 2 to 4 cycles. Figure 8 shows that by increasing the number of cycles while keeping the temperature/pressure and total treatment time constants, we were able to increase the decontamination level of TVC from -2.4 log to -4.6 log and from -6.5 log to -10 log for DIC-treatment at 112°C/20s and 134°C/20s, respectively. The same effect was observed by Allaf *et al.*, 2011, who reported that the increase in the treatment temperature increased the influence of the number of cycles on the decontamination level.

(a)



(b)

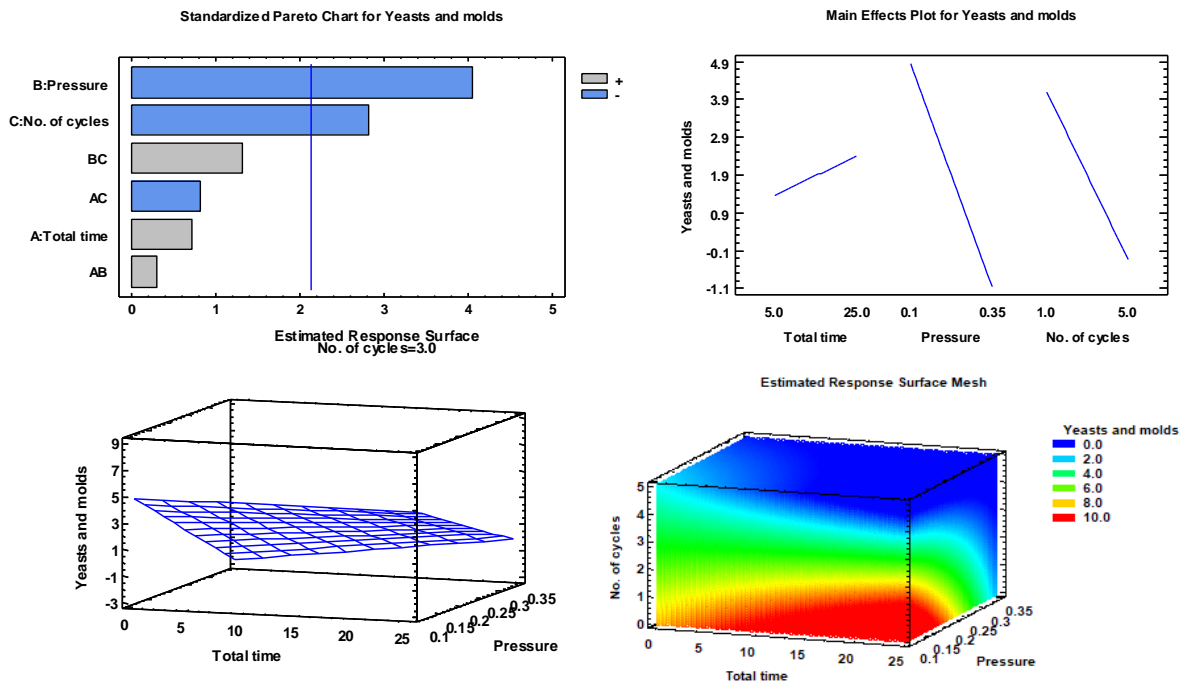
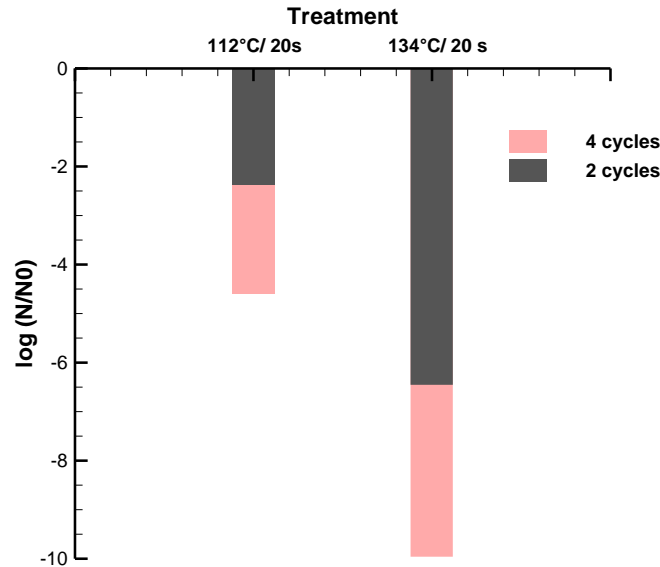

Fig. 7 Statistical analysis showing the effect of DIC factors on (a) TVC and (b) YMC









**Fig. 8** Effect of DIC number of cycles on TVC decontamination

### 3.3. Color analysis

To investigate the impact of DIC and blanching on the enzymes responsible for browning, we extracted the intracellular juice and analyzed its color. Table 3 presents image color analysis of extracted liquids from untreated, blanched, and DIC-treated larvae in the grayscale unit. There are no considerable changes in color intensity between untreated and blanched larvae at 90°C for 360 s, which is around 47, although we observe an increase to 62 at 480 s. Contrarily, (Mancini *et al.* 2019) observed that blanching larvae at 60°C for 5 min was sufficient to block the browning process in yellow mealworms. On the other hand, the color of DIC-treated larvae at 0.3 MPa gradually increases from 47 to 99 as treatment duration increases from 0 to 25 s, respectively, indicating a brighter color. The inactivation of oxidative enzymes in larvae which is usually associated with the DIC treatment led to an increased color brightness of DIC-treated samples (Setyoprato *et al.* 2012). Indeed, color is one of the most critical factors influencing consumer perception and readiness to buy and consume a product. It is especially critical when addressing a new product. Furthermore, browning relates to other reactions that impair protein digestibility, degrade flavor, and change the product's techno-functional aspects (Friedman 1997; Kroll *et al.* 2003; Rohn *et al.* 2006).

**Table. 3** Juice color and grayscale units of *T. molitor* after different treatment conditions

Treatment	Color	Grayscale unit 0 (black) → 255 (white)
Untreated		47.8±2.3
Blanched 90°C/ 360s		47.0±5.5
Blanched 90°C /480s		62.0±9.8
DIC 0.3 MPa /5s		57.1±5.4
DIC 0.3 MPa /10s		65.1±1.5
DIC 0.3 MPa/15s		93.3±2.4
DIC 0.3 MPa /25s		99.5±2.6

#### 4. Conclusion

Insects, like other animal-derived foodstuffs, are high in moisture and their gut microbiota provides a rich environment for the growth of undesirable microorganisms. Therefore, edible insects must be processed and handled with care. In this study, the Instant Controlled Pressure Drop (DIC) technology presents an effective decontamination method for *T. molitor* larvae and an interesting alternative to blanching. DIC reduced the TVC and YMC loads under the EC regulation requirements. These required values for both counts were achieved in DIC-treated larvae at 134°C (0.3 MPa) for  $\geq 20$ s, and at 139°C (0.35 MPa) for  $\geq 5$ s, as for the blanched at 90°C it required  $\geq 360$  s (for TVC) and  $\geq 240$  s (for YMC). The *Staphylococcus aureus* load reached the EC requirements with DIC treatment at 0.35 MPa  $\geq 5$ s and blanching treatment at 90°C for 240 s.

The DIC treatment pressure/temperature and number of cycles significantly impacted the decontamination. However, the effect of treatment time only occurred in the intermediate intense treatment at 0.3 MPa (134°C). Decimal reduction times for DIC (at 0.3 MPa) and blanching (at 90°C) treatments were 3.8 s and 67.8 s for TVC and 3 s and 57 s for YMC, respectively. Additionally, the larval juice color had a brighter color with DIC treatment, and with the increase of treatment time, as for the blanching at 90°C for 480 s, the juice showed a slightly brighter color than the untreated larvae. However, implementing a DIC unit on an industrial level entails a higher cost compared to a blanching unit. Therefore, to make an informed decision, it is important to conduct a full assessment of its implementation cost, energy consumption, and the additional value it provides. Even though the studied processes were able to ensure microbial safe products, proper storage techniques, as well as careful handling during the next processing steps, must be employed, to avoid re-contamination of the product. Additionally, even though *S. aureus* is thermosensitive,

staphylococcal enterotoxins, which are a byproduct of the development of some strains of *S. aureus*, are very stable, heat resistant, and resistant to extreme environmental conditions. They can also induce staphylococcal foodborne disease outbreaks. Therefore, further studies on the effects of pretreatments on potentially thermoresistant toxins produced by *S. aureus* could be of interest.

## 5. Statements & Declarations

**Funding:** This work is a part of the project RAFINSECT funded by the region Hauts-de-France of France.

**Competing interest:** The authors have no competing interests to declare that are relevant to the content of this article.

**Consent to Participate:** Not applicable

**Consent to Publish:** Not applicable

**Authors Contributions:** R. El Hajj: experimental work, data interpretation, manuscript writing, submitting and editing; H. Mhemdi: funding acquisition, manuscript review and supervision; A. Fayeulle: conceptualization, manuscript review and supervision; L. Corjon: experimental work; V. Lefrancois: DIC treatment; K. Allaf: conceptualization and manuscript review; E. Vorobiev: conceptualization and manuscript review. All authors read and approved the final manuscript.

**Availability of data and materials:** The datasets used during this study are available from the corresponding author on reasonable request.

**Ethical Approval:** The welfare of insects was maximized in our work by following the foundation for ethical consideration of individuals, the '3Rs' of animal exploitation in research: Replace, Reduce, and Refine, and there are no legal concerns with the adopted killing methods.

## 6. References

- Albitar N, Mounir S, Besombes C, Allaf K (2011) Improving the drying of onion using the instant controlled pressure drop technology. *Drying Technology* 29:993-1001. <https://doi.org/10.1080/07373937.2010.507912>
- Allaf T, Allaf K (2014) Instant Controlled Pressure Drop (D.I.C.) in Food Processing: from fundamental to industrial applications. Food engineering series. Springer New York, NY, pp 1-183
- Allaf T, Besombes C, Mih I, *et al* (2011) Decontamination of solid and powder foodstuffs using DIC technology. In: Schmidt, M (ed.) *Advances in Computer Science and Engineering*. InTech, Rijeka, Croatia, pp 261-282. <https://doi.org/10.5772/16025>

- Allaf T, Tomao V, Besombes C, Chemat F (2013a) Thermal and mechanical intensification of essential oil extraction from orange peel via instant autovaporization. *Chemical Engineering and Processing: Process Intensification* 72:24-30. <https://doi.org/10.1016/J.CEP.2013.06.005>
- Allaf T, Tomao V, Ruiz K, Chemat F (2013b) Instant controlled pressure drop technology and ultrasound assisted extraction for sequential extraction of essential oil and antioxidants. *Ultrasonics Sonochemistry* 20:239-246. <https://doi.org/10.1016/j.ultsonch.2012.05.013>
- Bamerni F (2018) Plant-based (*Camelina sativa*) biodiesel manufacturing using the technology of Instant Controlled pressure Drop (DIC): process performance and biofuel quality. Thesis dissertation, Université de La Rochelle.
- Bano SA, Hayat M, Samreen T, *et al* (2020) Detection of Pathogenic Bacteria *Staphylococcus aureus* and *Salmonella* sp. from Raw Milk Samples of Different Cities of Pakistan. *Natural Science* 12:295-306. <https://doi.org/10.4236/NS.2020.125026>
- Berka-Zougali B, Hassani A, Besombes C, Allaf K (2010) Extraction of essential oils from Algerian myrtle leaves using instant controlled pressure drop technology. *Journal of Chromatography A* 1217:6134-6142. <https://doi.org/10.1016/J.CHROMA.2010.07.080>
- Besombes C, Berka-Zougali B, Allaf K (2010) Instant controlled pressure drop extraction of lavandin essential oils: Fundamentals and experimental studies. *Journal of Chromatography A* 1217:6807-6815. <https://doi.org/10.1016/j.chroma.2010.08.050>
- Cacchiarelli C, Fratini F, Puccini M, *et al* (2022) Effects of different blanching treatments on colour and microbiological profile of *Tenebrio molitor* and *Zophobas morio* larvae. *LWT - Food Science and Technology* 157:113112. <https://doi.org/10.1016/J.LWT.2022.113112>
- Dagevos H (2021) A Literature Review of Consumer Research on Edible Insects: Recent Evidence and New Vistas from 2019 Studies. *Journal of Insects as Food and Feed* 7:249-259. <https://doi.org/10.3920/JIFF2020.0052>
- EFSA (2015) Risk profile related to production and consumption of insects as food and feed. *European Food Safety Authority Journal* 13:4257. <https://doi.org/10.2903/j.efsa.2015.4257>
- El Hajj R, Mhemdi H, Besombes C, *et al* (2022) Edible insects' transformation for feed and food uses: an overview of current insights and future developments in the field. *Processes* 10:970. <https://doi.org/10.3390/PR10050970>
- El Zahar K, Mounir S, Allaf T, Allaf K (2015) Fundamental modeling, functional attributes, porosity, cohesivity index (Hausner ratio) and compressibility of expanded-granule powder of Egyptian Ras pure cheese. *LWT* 64:297-307. <https://doi.org/10.1016/j.lwt.2015.05.032>
- EU (2021) Commission implementing regulation (EU) 2021/882 authorising the placing on the market of dried *Tenebrio molitor* larva as a novel food under Regulation (EU) 2015/2283 of

- the European Parliament and of the Council, and amending Commission Implementing Regulation. Official Journal of the European Union 10
- EU (2017) Commission regulation (EU) 2017/893 of 24 May 2017 amending Annexes I and IV to Regulation (EC) No 999/2001 of the European Parliament and of the Council and Annexes X, XIV and XV to Commission Regulation (EU) No 142/2011 as regards the provisions on proc. Official Journal of the European Union
- Friedman M (1997) Chemistry, Biochemistry, and Dietary Role of Potato Polyphenols. A Review. *Journal of Agricultural and Food Chemistry* 45:1523-1540. <https://doi.org/10.1021/JF960900S>
- Garnier L, Valence F, Mounier J (2017) Diversity and Control of Spoilage Fungi in Dairy Products: An Update. *Microorganisms* 5:42. <https://doi.org/10.3390/MICROORGANISMS5030042>
- Haddad M Al, Mounir S, Sobolik V, Allaf K (2008) Fruits & Vegetables Drying Combining Hot Air, DIC Technology and Microwaves. *International Journal of Food Engineering* 4:6. <https://doi.org/10.2202/1556-3758.1491>
- Jablaoui C, Besombes C, Jamoussi B, *et al* (2020) Comparison of expander and Instant Controlled Pressure-Drop DIC technologies as thermomechanical pretreatments in enhancing solvent extraction of vegetal soybean oil. *Arabian Journal of Chemistry* 13:7235-7246. <https://doi.org/10.1016/J.ARABJC.2020.08.005>
- Jongema Y (2017) List of edible insects of the world (April 1, 2017) - WUR. <https://www.wur.nl/en/Research-Results/Chair-groups/Plant-Sciences/Laboratory-of-Entomology/Edible-insects/Worldwide-species-list.htm>. Accessed 9 Feb 2022
- Klunder HC, Wolkers-Rooijackers J, Korpela JM, Nout MJR (2012) Microbiological aspects of processing and storage of edible insects. *Food Control* 26:628-631. <https://doi.org/10.1016/J.FOODCONT.2012.02.013>
- Knorr D, Froehling A, Jaeger H, *et al* (2011) Emerging technologies in food processing. *Annual review of food science and technology* 2:203-235
- Kroll J, Rawel HM, Rohn S (2003) Reactions of Plant Phenolics with Food Proteins and Enzymes under Special Consideration of Covalent Bonds. *Food Science and Technology Research* 9:205-218. <https://doi.org/10.3136/FSTR.9.205>
- Larouche J, Deschamps MH, Saucier L, *et al* (2019) Effects of killing methods on lipid oxidation, colour and microbial load of black soldier fly (*Hermetia illucens*) larvae. *Animals* 9:4. <https://doi.org/10.3390/ANI9040182>
- Louka N, Allaf K (2002) New process for texturizing partially dehydrated biological products using controlled sudden decompression to the vacuum: Application on potatoes. *Journal of Food Science* 67:3033-3038. <https://doi.org/10.1111/J.1365-2621.2002.TB08855.X>



- Macias AE, de Leon SP, Huertas M, *et al* (2008) Endemic infusate contamination and related bacteremia. *American Journal of Infection Control* 36:48-53. <https://doi.org/10.1016/j.ajic.2007.02.003>
- Mancini S, Fratini F, Tuccinardi T, *et al* (2019) Effects of different blanching treatments on microbiological profile and quality of the mealworm (*Tenebrio molitor*). *Journal of Insects as Food and Feed* 5:225-234. <https://doi.org/10.3920/JIFF2018.0034>
- Mancini S, Sogari G, Diaz SE, *et al* (2022) Exploring the Future of Edible Insects in Europe. *Foods* 2022, 11:455. <https://doi.org/10.3390/FOODS11030455>
- Mkaouar S, Bahloul N, Gelicus A, *et al* (2015) Instant controlled pressure drop texturing for intensifying ethanol solvent extraction of olive (*Olea europaea*) leaf polyphenols. *Separation and Purification Technology* 145:139-146. <https://doi.org/10.1016/J.SEPPUR.2015.03.014>
- Montanari C, Serrazanetti DI, Felis G, *et al* (2015) New insights in thermal resistance of staphylococcal strains belonging to the species *Staphylococcus epidermidis*, *Staphylococcus lugdunensis* and *Staphylococcus aureus*. *Food Control* 50:605-612. <https://doi.org/10.1016/j.foodcont.2014.09.039>
- Mounir S, Allaf T, Mujumdar AS, Allaf K (2012) Swell drying: coupling instant controlled pressure drop DIC to standard convection drying processes to intensify transfer phenomena and improve quality—an overview. *Drying Technology* 30:1508-1531. <https://doi.org/10.1080/07373937.2012.693145>
- Nyangena DN, Mutungi C, Imathiu S, *et al* (2020) Effects of Traditional Processing Techniques on the Nutritional and Microbiological Quality of Four Edible Insect Species Used for Food and Feed in East Africa. *Foods* 9:574. <https://doi.org/10.3390/FOODS9050574>
- Osimani A, Garofalo C, Milanović V, *et al* (2017) Insight into the proximate composition and microbial diversity of edible insects marketed in the European Union. *European Food Research and Technology* 243:1157-1171. <https://doi.org/10.1007/S00217-016-2828-4>
- Pech-Almeida JL, Téllez-Pérez C, Alonzo-Macías M, *et al* (2021) An overview on food applications of the instant controlled pressure-drop technology, an innovative high pressure-short time process. *Molecules* 26:21. <https://doi.org/10.3390/MOLECULES26216519>
- Rohn S, Petzke KJ, Rawel HM, Kroll J (2006) Reactions of chlorogenic acid and quercetin with a soy protein isolate - Influence on the in vivo food protein quality in rats. *Molecular Nutrition & Food Research* 50:696-704. <https://doi.org/10.1002/MNFR.200600043>
- Rumpold BA, Fröhling A, Reineke K, *et al* (2014) Comparison of volumetric and surface decontamination techniques for innovative processing of mealworm larvae (*Tenebrio molitor*). *Innovative Food Science and Emerging Technologies* 26:232-241. <https://doi.org/10.1016/J.IFSET.2014.09.002>

- Saucier L, M'ballou C, Ratti C, *et al* (2021) Comparison of black soldier fly larvae pre-treatments and drying techniques on the microbial load and physico-chemical characteristics. 8:45-64. <https://doi.org/10.3920/JIFF2021.0002>
- Setyoprato P, Fatmawati A, Allaf K (2009) Texturing by Instant Controlled Pressure Drop DIC in the Production of Cassava Flour: Impact on Dehydration Kinetics, Product Physical Properties and Microbial Decontamination. In: World Congress on Engineering and Computer Science. San Francisco, USA
- Setyoprato P, Fatmawati A, Sutrisna PD, *et al* (2012) The dehydration kinetics, physical properties and nutritional content of banana textured by instantaneous controlled pressure drop. *Asia-Pacific Journal of Chemical Engineering* 7:726-732. <https://doi.org/10.1002/APJ.624>
- Smetana S, Mhemdi H, Mezdour S, Heinz V (2020) Chapter 11—PEF treated insects and algae as future food ingredients. In: Pulsed Electric Fields to Obtain Healthier and Sustainable Food for Tomorrow. Academic Press, London, United Kingdom, pp 247-266
- Steinfeld H, Gerber P, Wassenaar T, *et al* (2006) Livestock's long shadow: environmental issues and options. *FAO* 322-342. <https://doi.org/10.3/JQUERY-UIJS>
- Stoops J, Vandeweyer D, Crauwels S, *et al* (2017) Minced meat-like products from mealworm larvae (*Tenebrio molitor* and *Alphitobius diaperinus*): microbial dynamics during production and storage. *Innovative Food Science & Emerging Technologies* 41:1-9. <https://doi.org/10.1016/J.IFSET.2017.02.001>
- van Huis A, Itterbeek J Van, Klunder H, *et al* (2013) Edible insects. Future prospects for food and feed security. *FAO*, Rome, 171:1-201
- Vandeweyer D, Crauwels S, Lievens B, Van Campenhout L (2017a) Microbial counts of mealworm larvae (*Tenebrio molitor*) and crickets (*Acheta domesticus* and *Gryllobates sigillatus*) from different rearing companies and different production batches. *International Journal of Food Microbiology* 242:13-18. <https://doi.org/10.1016/J.IJFOODMICRO.2016.11.007>
- Vandeweyer D, Lenaerts S, Callens A, Van Campenhout L (2017b) Effect of blanching followed by refrigerated storage or industrial microwave drying on the microbial load of yellow mealworm larvae (*Tenebrio molitor*). *Food Control* 71:311-314. <https://doi.org/10.1016/j.foodcont.2016.07.011>
- Wynants E, Crauwels S, Lievens B, *et al* (2017) Effect of post-harvest starvation and rinsing on the microbial numbers and the bacterial community composition of mealworm larvae (*Tenebrio molitor*). *Innovative Food Science & Emerging Technologies* 42:8-15. <https://doi.org/10.1016/j.ifset.2017.06.004>

II.3. Article 3: Instant controlled pressure-drop assisted pressing for defatting and dewatering of yellow mealworm larvae: process study and optimization.

(The article is presented on the following pages)

# **Instant controlled pressure-drop assisted pressing for defatting and dewatering of yellow mealworm larvae: process study and optimization**

**Rachelle El Hajj<sup>\*1</sup>, Houcine Mhemdi<sup>1</sup>, Colette Besombes<sup>2</sup>, Victor Lefrancois<sup>3</sup>, Karim Allaf<sup>2</sup>, Eugène Vorobiev<sup>1</sup>**

<sup>1</sup> Université de Technologie de Compiègne, ESCOM, TIMR (Integrated Transformations of Renewable Matter), Centre de recherche Royallieu - CS 60 319 - 60 203 Compiègne Cedex, France ;

<sup>2</sup> University of La Rochelle, Laboratory of Engineering Science for Environment LaSIE -UMR-CNRS 7356, 17042 La Rochelle, France;

<sup>3</sup> ABCAR DIC Process Company, 11 Rue du Four Saint-Jacques, 60200 Compiègne, France ;

\* Corresponding author: rachele.el-hajj@utc.fr;

Published: January 2023

Journal of insects as food and feed

<https://doi.org/10.3920/JIFF2022.0062>

## **Abstract**

Insects are gaining interest as a sustainable and highly nutritious source of proteins and lipids for food and feed production sectors. Insect bio-refinery includes lipid extraction by pressing, dewatering, microbiological decontamination, and protein fractionation. The present study is experimenting the use of instant controlled pressure-drop (DIC), an emerging technology, for treating yellow mealworms and evaluating its combined effects on insect bio-refinery steps. A preliminary study allowed identifying the optimal hydraulic pressing conditions for *Tenebrio molitor* larvae. Then, establishing an experimental design with DIC operative parameters of the saturated dry steam absolute pressure and treatment time ranging between (0.15 and 0.45 MPa) and (15 and 35 s), respectively, allowed identifying the DIC impact as a pretreatment on different larvae properties. It was possible to identify the optimal pressing parameters at 6 MPa, 60 °C, 2 cm of thickness, and 0.15 mm/s as initial piston speed. Moreover, DIC performed at 0.15 MPa for 25 seconds stood as an efficient killing method. Thanks to the changes in the membrane's structure it provokes, DIC treatment modified larvae properties, ensured a partial expulsion of the matter (up to 0.47 g/g dry basis (db)), and resulted in larval expansion (up to 67%) which resulted in a decrease in the apparent density. As for the chemical properties, the larvae and larvae juice colours were found to become lighter as we increased the treatment conditions, which might be caused by the inactivation of oxidative enzymes. Moreover, severe DIC operative parameters decreased the pressing yields from 68 to 55%, possibly caused by protein aggregation and denaturation phenomena that prevent molecules from coming out by pressing. However, the water activity and moisture, lipid, and protein contents remained unaffected.

**Keywords:** edible insects, *Tenebrio molitor*, pretreatment, protein, lipid

## 1. Introduction

The world's population would reach 9 billion by 2050. Consequently, it is essential to find new sustainable agricultural practices and protein sources for food and feed production, with minimal environmental impacts (Hilborn *et al.*, 2018; Leni *et al.*, 2019; Sun-Waterhouse *et al.*, 2016).

Edible insects have recently received attention in Europe as a protein-rich food source (Otero *et al.*, 2020) by presenting numerous advantages over conventional livestock, such as using fewer resources (land, water, and energy), having a lower environmental impact (less greenhouse gas and ammonia emissions), and holding a low feed conversion ratio (FCR = feed consumed/animal weight gain) (Hilborn *et al.*, 2018). In fact, to produce 1 kg of live weight, beef cattle, pigs, chicken, and insects need 10, 5, 2.5, and 1.7 kg of feed, respectively (Gahukar, 2016), and to produce 1 kg of edible protein, beef emits (75-170 kg of GHGs in CO<sub>2</sub> equivalent), pigs (21-53 kg CO<sub>2</sub>-e), chicken (18-36 kg CO<sub>2</sub>-e) and insect mealworms 2.7 kg CO<sub>2</sub>-e (De Vries and De Boer, 2010; Oonincx and de Boer, 2012).

In January 2021, following a request from the European Commission, EFSA (European Food Safety Authority) gave a favourable stance regarding the consumption of yellow mealworm (*Tenebrio molitor* larva) as whole dried insects or as a powder. Studies have shown that the consumption of *T. molitor* does imply no safety problem. It would only induce an allergic reaction in subjects that are allergic to crustaceans and dust mites (Turck *et al.*, 2021). In June 2021, selling *T. molitor* larva products as a novel food in the marketplaces of Europe was authorized as of the regulation (EU) 2021/882 (Commission Implementing Regulation (EU) 2021/882 of 1 June, 2021).

Yellow mealworm insects are a highly nutritious food source, as they are rich in high-quality proteins (40% db), fat (30% db), fiber (chitin), minerals, and vitamins (Barker *et al.*, 1998; Yi *et al.*, 2013). However, to increase consumer acceptance, different insect fractions can be extracted and integrated into food products (Tzompa-Sosa *et al.*, 2014). On this subject, many research works were conducted on the larvae, studying the effect of different killing methods on the quality of proteins and lipid oxidation (Leni *et al.*, 2019), comparing the lipid and protein extraction techniques (Azagoh *et al.*, 2016; Bußler *et al.*, 2016; El Hajj *et al.*, 2022; Mishyna *et al.*, 2019; Zhao *et al.*, 2016), and studying the protein qualities and functionalities (Kim *et al.*, 2020; Zielińska *et al.*, 2018), etc.

Recently, emerging technologies such as Pulsed electric fields (PEFs), Ultrasound (US), Instant controlled pressure-drop (DIC), and High hydrostatic pressure (HHP)) used as a pretreatment to raw materials sparked a surge of interest in manifold food and feed processing industries. They mainly presented many advantages over conventional processes in terms of lower energy and water consumption, cost-effectiveness, sustainability, environmentally friendly operations, and higher product quality (healthier, safer, and minimally processed products) (Knorr *et al.*, 2011; Smetana *et al.*, 2020).

The Instant Controlled Pressure-drop, known by its French acronym DIC (*Détente Instantanée Contrôlée*) is an emerging technology based on hydro-thermo-mechanical effects used mainly as a pretreatment to raw materials. It is an HTST (High-Temperature/ Short-Time) batch process that modifies the structure of the treated materials by expansion and low tortuosity (El Zahar *et al.*, 2015). DIC pretreatment improves the drying kinetics while preserving the quality of the products (Haddad *et al.*, 2008; Louka and Allaf, 2002), enhances solvent extraction, and increases the pressing yield (e.g. in pulses, oleaginous grains, seeds, vegetables, and fruits) (Bamerni, 2018; Jablaoui *et al.*, 2020). Mkaouar *et al.*, 2015 have found that DIC texturing on the solvent extraction of polyphenols from olive leaves boosts extraction yield by 312% and allows for the generation of extract richer in bioactive components. Moreover, DIC is a powerfully effective bacterial decontamination method (Allaf *et al.*, 2011). It also stands as an extraction technique for volatile molecules (e.g. essential oils) through the autovaporization phenomenon (Berka-Zougali *et al.*, 2010; Besombes *et al.*, 2010). On an industrial scale, the DIC is a low-energy batch process, requiring 0.8 kWh/kg of dry material in swell drying (Mounir *et al.*, 2012) and 0.110 kWh/kg per cycle of lavandin essential oil extraction (Besombes *et al.*, 2010). However, there are not yet studies on the effect of DIC technology on insect larvae structure and extraction properties.

This paper studies the effect of instant controlled pressure-drop (DIC) pretreatment on larval characteristics and compound extraction by pressing as a low-energy consuming dewatering and defatting technique. It also seeks to establish the DIC effect on the pressing yield and product quality as a part of a bio-refinery concept. The foremost goal is to produce high-quality insect products as direct food and feed sources or transform them into ingredients that can be formulated into food and feed products.

## **2. Materials and methods**

### **2.1. Raw Material**

Yellow mealworm (*Tenebrio molitor*) larvae were purchased from 'France insects' (Crevecoeur-le-grand, France). They were received alive and stored at 4°C. Before processing, larvae were fasted for at least 24 h and then sieved to separate frass. Their phenotypic properties and composition are displayed in Table 1. The larvae devoted to optimizing micro-press operating parameters initially underwent "freezing/thawing" process to acquire an outspread cell wall: freezing was done at -18°C for more than 24 h, and the thawing was done at room temperature. Larvae used as control samples for all the steps were either pressed alive or underwent blanching at 90 °C for 4 min in closed tubes to avoid direct contact with water, and larvae treated in DIC were alive.

In our study we have maximized the welfare of insects by applying the foundation for the ethical consideration of individuals, the '3Rs' of animal use in research: Replace, Reduce and Refine. However, unlike vertebrates, most invertebrate species are exempted from animal research restrictions due to the lack of evidence and knowledge regarding their ability to experience pain,

discomfort, or stress (Freelance, 2019), therefore, there is no legal concern with the applied killing methods (pressed alive, blanched and DIC). Additionally, in the council regulation (EC) 1099/2009 (EU, 2009b) on the protection of animals at the time of killing, no prescriptions are laid down for insects (Belluco *et al.*, 2017). Furthermore, no specific killing method was mentioned in the official bulletin of the French Ministry of Agriculture and Food (DGAL/SDSPA/2017-860) (Direction générale de l'alimentation, 2017). However, pressed alive insects without heat treatment are used as a control raw sample and are not to be used as feed and food, since the raw insect materials are required to undergo a heat treatment process as outlined in animal-by-products legislation (Regulation (EC) 1069/2009) (EU, 2009a; Turck *et al.*, 2021)

**Table 1.** Yellow mealworm larvae's phenotypic properties and composition

Phenotypic properties				Composition		
Avg. weight	Avg. thickness	Avg. length	Avg. density	Water content	Dry basis	
					Protein content	Lipid content
66.1 ±5.2 mg	2.06 ±0.15 mm	26.4 ±6.8 mm	714.3 ±5.5 kg/m <sup>3</sup>	65.0 ±0.8 %	40.6 ±1.5 %	27.8 ±0.7%

## 2.2. Experimental Protocol

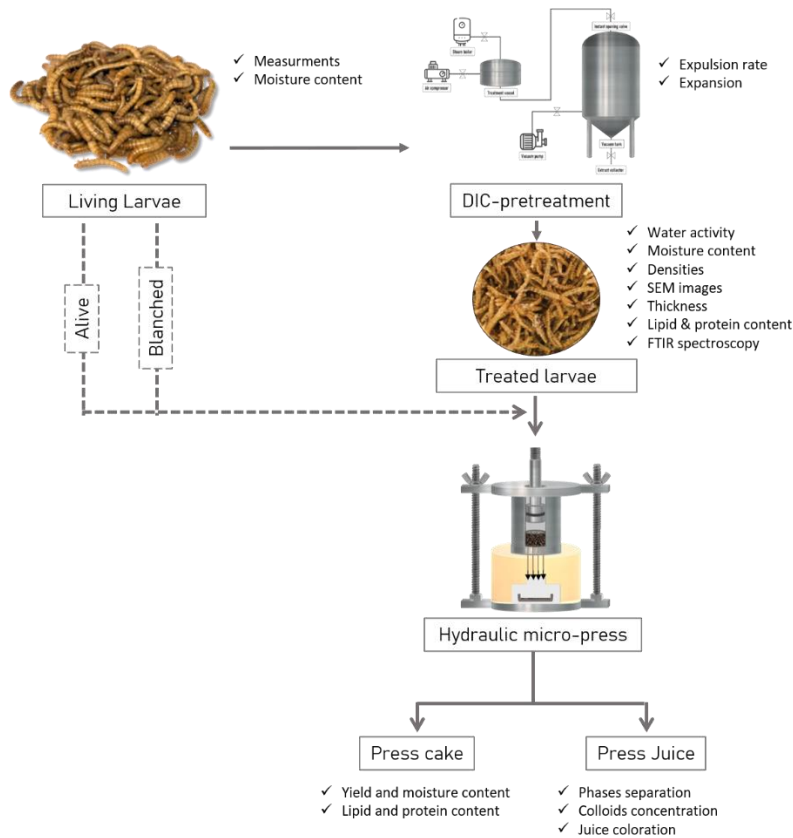

**Figure 1.** Experimental protocol



Figure 1 shows the whole experimental setup of processing and assessing operations. Initially, larvae to be treated were characterized. Then DIC treatment of yellow mealworms was followed by a study of its effect on several processes and phenomena such as killing, texturing, autovaporization and expulsion. This was done by identifying the mortality threshold, calculating the expulsion ratio and volumetric relative expansion, and comparing larval characteristics (water activity, moisture content, densities, thickness, and lipid and protein contents).

Under optimal conditions defined in the hydraulic micro-press, pressing permits separating the liquid fraction from the cake. The final assessment stage entails measuring the yield, moisture, protein, and lipid contents of the press cake as well as separating the main phases of the press juice and identifying their colloid concentration and colour.

### 2.3. Hydraulic micro-press

Besides the characteristics of the raw materials to press (species, composition, state (untreated or pretreated larvae), etc.), five independent operating parameters influence the pressing operation: the piston hydraulic pressure ( $P$ ), initial drop or compression speed ( $V_P$ ), pressing time ( $t_P$ ), cake temperature ( $T_P$ ) and the sample initial thickness ( $h$ ) (Lanoisellé, 1995).

Thus, we devoted the first step of this work to optimize the operating parameters in the micro-scale hydraulic press in the case of *Tenebrio molitor* larvae. The goal was to combine parameters that lead to the best process performance regarding the highest expression yield and the best quality product to constitute an essential basis for the transition to the pilot scale.

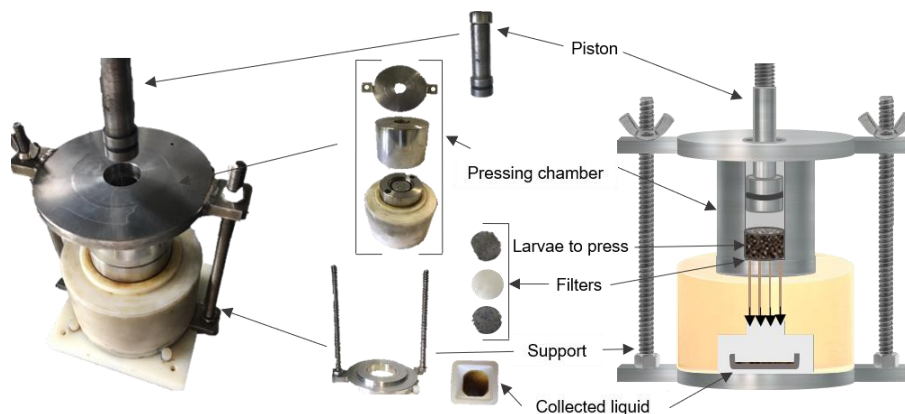

**Figure 2.** Hydraulic micro-press apparatus

Micro-press apparatus is presented in Figure 2. A stainless-steel piston connects the microcell with the texturometer. The pressing chamber assembles two stainless steel pieces, with a maximum volume capacity of  $30.4 \text{ cm}^3$ , and a lower support to the cylinder perforated to provide drainage of the filtrate towards the collection crucible located in the lower center of the pressing chamber. A filtration system made from two independent metal filters and one filter paper ensures the liquid's drainage. The metal filters are made of woven stainless steel and have an opening of  $0.165 \text{ mm}$ , they provide liquid drainage and are placed on either side of the sample to be treated. Filter paper

(5-13  $\mu\text{m}$ ; VWR international, Rosny-sous-Bois, France) permits holding the solid fraction. The cell control system includes a heating collar positioned around the vertical cylinder to heat up to 80 °C. The temperature of the cylinder is monitored using a thermometer (SDL200, 4-channel datalogging thermometer; Extech, Nashua, NH, USA) with a thermocouple type K.

The TA-HDi texturometer system (stable microsystems, Surrey, UK) allows applying the setpoint force and keeping this force constant for a definite time. A measurement system throughout the whole experiment equipped with a 500 kg load cell offers a maximum force capacity and pressure of 4905 N and 10 MPa, respectively. The descent speed ranges between 0.01 mm/s and 10 mm/s. The 'Texture Expert Exceed' software system (Stable Microsystems) assures to set the processing parameters of each experiment (The setpoint force, the initial descent speed of the piston, and the pressing time at a constant force) and register the data collected from the texturometer (the applied force and the distance of movement per second) (Savoire, 2008).

Once assembling the system, we weighed the whole frozen/thawed *Tenebrio molitor* larvae on a precision scale, introduced it to the pressing chamber covered by the metal filter and filter paper, and added the second metal filter in the cylinder, on top of the sample. For the experiments that require heating, the system is preheated using the heating collar for about an hour and monitored with the thermocouple. The sample follows the monitoring temperature when the system reaches the set temperature. At this point, the piston manually moves down until it touches the upper filter to allow tackling the experiment.

Identifying the optimal pressing parameters corresponds to the successive variation of one parameter after another and measuring the yield of the liquid extracted to the initial quantity of pressed larvae and the cake's dry matter content. The operating parameters used were the following: applied pressure (P) between 2000 and 10 MPa, cake's temperature ( $T_P$ ) between 10 and 80°C, the pressed cake's thickness (h) between 1 and 3 cm, and initial piston's drop speed ( $V_P$ ) between 0.05 and 0.2 mm/s, all pressed at constant pressure for 900 s ( $t_P$ ). The pressing yield (Y) is calculated as:

$$Y(\%) = (m_i - m_f) / m_i \quad (1)$$

With  $m_i$  and  $m_f$  being the weight of larvae before and after pressing.

#### **2.4. Instant controlled pressure-drop DIC: Equipment and treatment**

ABCAR-DIC Process Company (Compiègne, France) provided the DIC lab-scale equipment consisting of three main components (Figure 3): A treatment vessel, a vacuum system, and an instantaneous opening pneumatic valve.

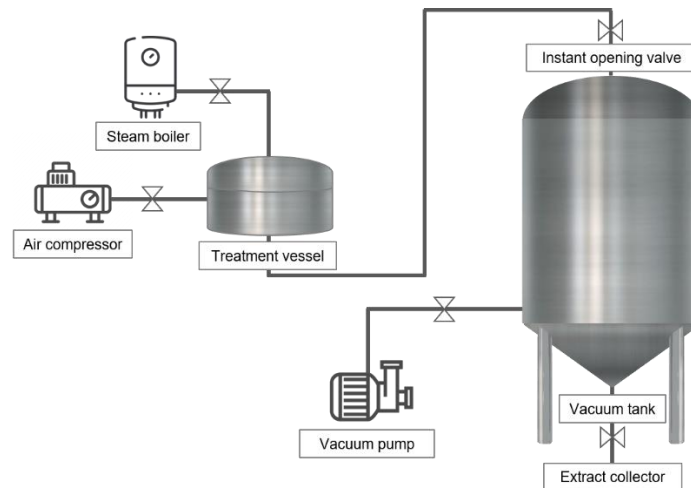

**Figure 3.** Schematic representation of Instant controlled pressure-drop (DIC) apparatus

The DIC process is an HTST (High-Temperature/ Short-Time) treatment that consists of a heating step at a high saturated steam absolute pressure (up to 0.7 MPa and 160 °C), done by injecting and keeping constant saturated steam for a short time (< 60 sec): this step increases the pressure as well as the temperature in the treatment chamber. Afterwards, an abrupt pressure-drop occurs, inducing a partial autovaporization of water and conceivably other volatile molecules, an instant cooling, and a possible expansion of the treated product (Allaf *et al.*, 2013; Bouallegue *et al.*, 2016; Mounir *et al.*, 2012). Figure 4 presents the temperature and pressure correlations during a DIC cycle.

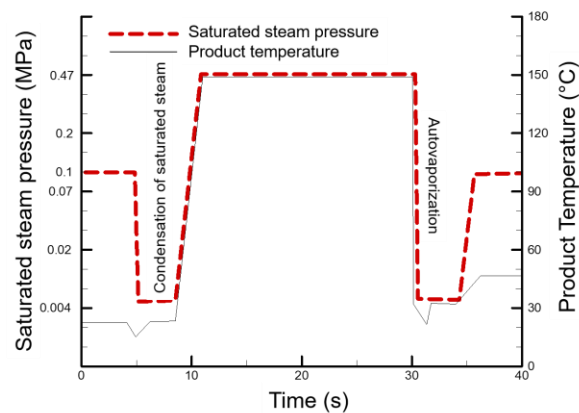

**Figure 4.** Instant controlled pressure-drop (DIC) processing cycle

Different experiments allowed identifying the larval mortality threshold in DIC treatment at 0.15 MPa for 25 seconds to serve as a basis for defining a functional design of experiments (DoE) containing 13 trials with the treatment pressure ranging between 0.15 and 0.45 MPa (along with a temperature ranging between 111 °C and 147.9 °C) and treatment time between 15 and 35 s (Table 2). Larvae were treated in batches of 230g with three repetitions for each point. They were weighed

pre and post-DIC treatment (respectively  $m_i$  and  $m_f$ ), and the mass difference indicated that an expulsion phenomenon of the visceral content had occurred during the auto vaporization step. Earlier it was also reported (Nguyen Van, 2010) a similar mechanical expulsion of non-volatile rapeseed oil. Equation (2) gives the expulsion ratio:

$$\text{Expulsion ratio (\%)} = (m_i - m_f) / m_i \quad (2)$$

**Table 2.** DIC-pretreatment experimental points

Factor	Point min (- $\alpha$ )	Point (-1)	Central point	Point (+1)	Point max (+ $\alpha$ )
Time (s)	15	18	25	32	35
Pressure (MPa)	0.15	0.194	0.3	0.4	0.45

Then the mixture of the expelled material and the condensed steam was collected from the vacuum tank (through the extract collector) and was centrifuged at 14500 rpm for 10 min to identify its different phases.

### 2.5. Solid-phase analyses

Moisture content was determined by drying the samples in an oven at 105°C for 24 h or in an infrared moisture analyzer at 105°C. The water activity was measured using the aw-meter AquaLab (series 3, METER Group, Inc., Pullman, WA, USA). Measuring the true (or intrinsic) density requires establishing the sample's mass and the volume of the solid (excluding the pore volume). It was measured using a helium pycnometer. As for the apparent density it is determined based on the sample's mass and its apparent volume (including the pore volume) (Basu, 2013). To determine the apparent volume of the larvae, we weighed a sample, placed it in a cylinder, and applied many external tapping to reduce the air volume until it became steady, and assumed this value as the apparent sample volume. Larval thickness was measured using a calliper. At least 20 larvae were measured to obtain an average thickness value. Equation 3 gives the volumetric relative expansion ratio that DIC-pretreatment would cause:

$$\text{Volumetric relative expansion (\%)} = (V_f - V_i) / V_i \quad (3)$$

Where  $V_i$  and  $V_f$  are the volumes before and after DIC pretreatment, respectively. The volumes were calculated by dividing the average weight of a larva over its apparent density.

For protein content determination, the Dumas method was used according to AOAC method 993.13 (AOAC, 1962). A known mass of dried and ground samples (<1g) is heated in a high-temperature furnace at 1000°C in the presence of oxygen where a gas mixture of H<sub>2</sub>O, CO<sub>2</sub> and nitrogen oxides is produced. This gas mixture passes then to a reduction chamber at 650°C with the presence of copper, where nitrogen oxides are converted into nitrogen gas (N<sub>2</sub>), then the residual H<sub>2</sub>O, CO<sub>2</sub>, and O<sub>2</sub> are removed by different traps and the total nitrogen content is measured by a thermal conductivity detector (Jung *et al.*, 2003) In insects, the presence of non-protein nitrogen (NPN) mostly as chitin-bound nitrogen, inorganic nitrogen, and nucleic acid leads to an

overestimation in the protein content if the nitrogen-to-protein conversion factor ( $K_p$ ) of 6.25 is used. To avoid this overestimation, Janssen *et al.*, 2017 calculated a specific  $K_p$  factor of 4.76 for insects, which we will be using in this paper to calculate the protein content.

Lipid content was determined by the Soxhlet extraction technique. Soxhlet apparatus consists of an extraction thimble with a siphon, condenser, and distillation flask. Before extraction, the preparatory stages were drying at 105 °C for 24 h, and finely grinding each sample. The extraction process consists of weighing and placing the sample (>5g) in a filter paper in the thimble before adding the extraction solvent (n-Heptane) to the distillation flask and heating the system within a sand bath. The solvent recirculation was left for 4 h, or until complete extraction is achieved (clear solvent in the extraction chamber) (Zygler *et al.*, 2012). Afterwards, the solvent is separated from lipids using a rotary evaporator, and the lipid content is calculated.

Surface structural images for whole larvae were obtained using the SEM imaging technique for a better understanding of the effect of DIC pretreatment on the outer membrane and its permeability.

ATR-FTIR analysis was used to determine the presence of functional groups as a function of wavelength (wavenumbers in the range of 500 to 4000  $\text{cm}^{-1}$ ). Larvae samples were dried and ground to undergo the analysis. The peaks are observed as absorbance.

To determine the impact of DIC treatment on protein denaturation in larvae, we used fluorescence spectroscopy as indicated in the work of Saulnier *et al.*, 1991, using two fluorophores: ANS and Tryptophan. ANS (1-anilino-8-naphthalene sulfonate) is a fluorescent "hydrophobic probe" widely used to examine the hydrophobicity of proteins (extrinsic probe) as for the Tryptophan (Trp), it is an aromatic amino acid which is a natural fluorophore (intrinsic probe), and it is a marker that is used to track conformational changes in proteins. A 5% protein solution was prepared for each sample to successively add ANS concentrations ranging from 0 to 150  $\mu\text{M}$ . This analysis was done on blanched larvae at 90°C for 4 min (control) and on DIC-treated larvae at 0.3 MPa (133.5°C) for 25 s, which is a central experimental point, for comparison. Fluorescence spectra were recorded using a Fluoromax-4 spectrofluorometer (Jobin Yvon, Horiba Scientific, Piscataway, NJ, USA). The emission spectra of tryptophan residues (305-450 nm) and ANS (350 nm) were recorded with the excitation wavelengths set at 290 and 400-650 nm, respectively. For each sample, 3 spectra were recorded.

## 2.6. *Liquid-phase analyses*

After centrifuging the liquid obtained from larvae, at 14500 rpm for 10 min, the aqueous phase was retained to determine the total colloid concentration using Cherniavskaia's ethanol precipitation method (Cherniavskaia *et al.*, 1995). It consists of adding 1 mL of the sample liquid to 10 mL of 96% ethanol in a boiling flask and heating the mixture in a reflux system for 15 min. After that, left to cool down at room temperature, the mixture underwent filtration using a filter paper and washing with 20 mL of 90% ethanol and left overnight at room temperature to dry. The concentration of colloids was calculated using Equation (4):

$$C_{co} = (m_f - m_0)/0.001 \quad (4)$$

With  $C_{co}$  being the concentration of colloids (g/L),  $m_0$  the initial mass of the filter paper (g), and  $m_f$  the mass of the filter paper with the precipitate after drying (g).

To characterize the juice colour, the juice was diluted 15 times and then filtered through a 0.45  $\mu\text{m}$  syringe and its absorbance was measured at 420 nm.

Bradford's method allowed determining the protein concentration in the juice. Briefly, we mixed 1000  $\mu\text{l}$  of Bradford reagent with 100  $\mu\text{l}$  of the solution to be analyzed using a vortex and left it in the dark for 10 min. After that, the absorbance at 595 nm allowed calculating the concentration through a standard curve issued from known protein concentrations (BSA) (Bradford, 1976).

### 2.7. *Statistical Analysis*

DIC treatment followed a two-factor 5-level central composite experimental design. A preliminary study identified a suitable range of DIC operating parameters. Statistical analysis (ANOVA and Pareto charts ( $p < 0.05$ )) of the experimental data reflects the significance of the variation of the independent DIC variables on different responses (dependent variables). It aims to understand and optimize the effect of DIC treatment. All experiments were done at least in triplicate for each sample. Statistical treatments of the data were performed using Statgraphics (centurion XVI, StatPoint Technologies, Warrenton, VA, USA).

## 3. Results and discussions

### 3.1. *Hydraulic micro-press optimization*

Figure 5 shows the effect of each studied parameter on the pressing yield and the dry matter content of the obtained press cake. It can be shown that the extraction yield increases with the rise of the applied pressure, but past 6 MPa the increase is not noteworthy: a 5% higher yield correlated with pressure increasing from 6 to 10 MPa. Thus, a pressure of 6 MPa was considered the optimal applied pressure. As for the temperature, below 60°C there is no significant difference between the reached yields, at 60°C we can clearly see an important increase, and then past this temperature, there is a remarkable yield drop. This phenomenon is possibly related to larvae protein denaturation and the formation of aggregates at high temperatures (>60°C): (Lee *et al.*, 2019) stated that heating *T. molitor* leads to the formation of protein aggregation and protein surface changes such as protein-protein and protein-lipid interactions. Moreover, it is worth noticing that the piston's initial speed of descent also influences the yield: when it is below or equal to 0.15 mm/s, we obtain the best pressing yield. A higher piston's speed probably leads to a sudden rise of the press-cake hydraulic resistance, which hindrance the internal liquid flowing and decreases the juice yield. Besides, we identified the sample initial thickness as a contributing factor: a thickness between 1.5 and 2 cm can correlate to the best yield. The cake's dry matter content was proportional to the yields in all the experimental points.

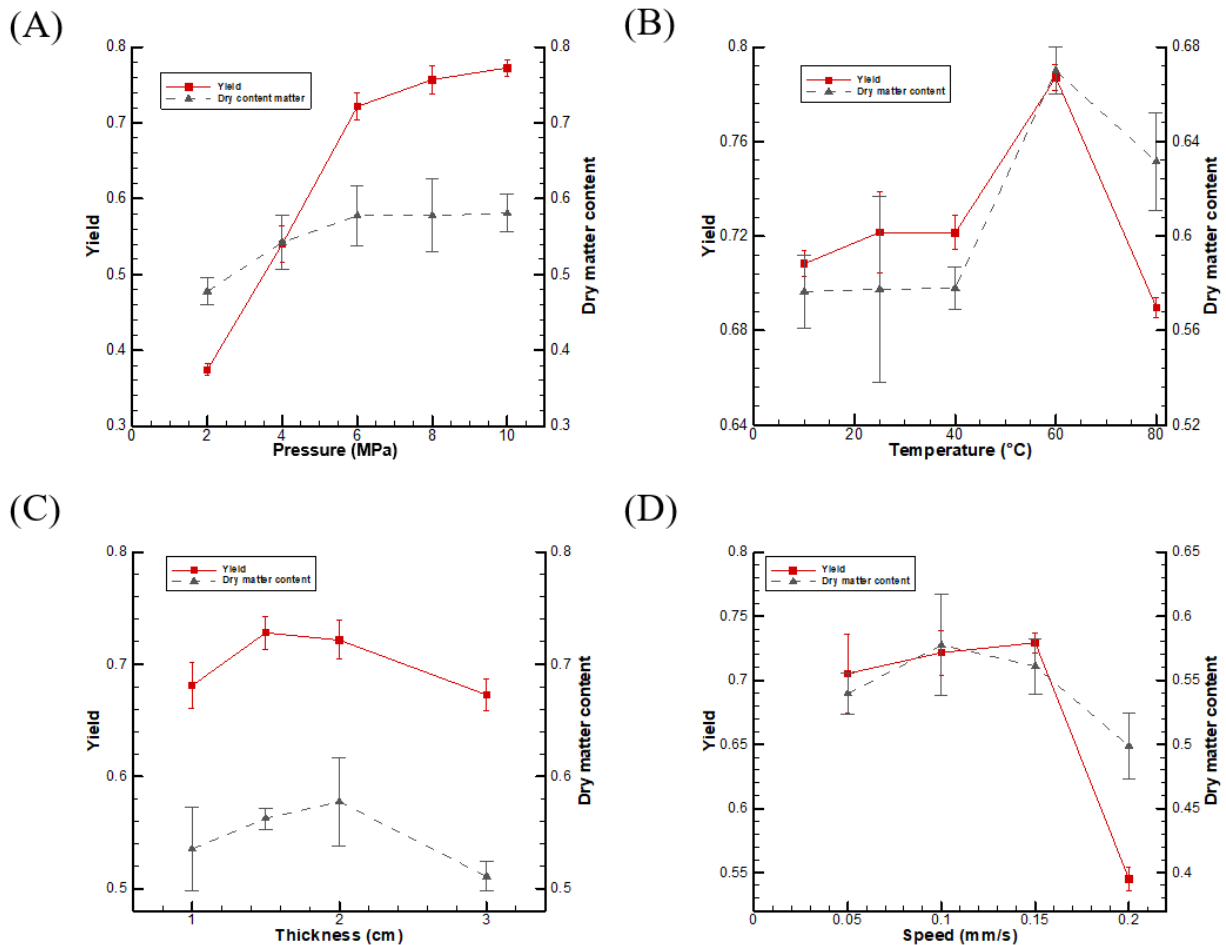

**Figure 5.** Impact of (A) pressure, (B) cake's temperature, (C) sample initial thickness, and (D) piston's initial speed of descent on the pressing yield and the dry matter content of *T. molitor* larvae. (A) varying P between 2 and 10 MPa with T=25°C, h=2 cm and  $V_P=0.1$  mm/s, (B) varying TP between 10 and 80°C with P=6 MPa, h=2 cm and  $V_P=0.1$  mm/s, (C) varying h between 1 and 3 cm with P=6 MPa, TP=60°C and  $V_P=0.1$  mm/s, (D) varying the  $V_P$  between 0.05 and 0.2mm/s with P=6 MPa, TP =60°C and h=2

Hence, after having optimized the pressing parameters individually, a press with the optimal conditions was done (6 MPa, 60°C, 0.15mm/s, and 2 cm) on frozen/thawed samples of yellow mealworms, and it has led to an extraction yield of 76%.

### 3.2. Instant controlled pressure-drop DIC pretreatment

A quick comparison of visual observation between DIC-treated and conventionally dried larvae (Supplementary Figure S1) revealed that the more severe the treatment conditions, the lighter the larval colour. These observations let us suppose that DIC pretreatment has an impact on the enzymatic activity of the larvae, which led us towards carrying out additional studies.

### 3.3. *Expulsion phenomenon*

DIC pretreatment results in a partial expulsion of non-volatile compounds whose ratio depends on the experimental conditions. As shown in Table 3, the expulsion ratio varies from 0% to 16.4%, ranging from the lowest to the highest treatment conditions (0.15 MPa; 25 s) to (0.45 MPa; 25 s), respectively. In other words, the expulsion ratio varies from zero to 0.47 g expelled/g db (dry basis). Figure S2 visualizes the effect of the DIC treatment pressure and time on the expulsion phenomenon. Both pressure and time are positively correlated with the expulsion ratio. Thus, the higher the saturated steam pressure, the more important the expulsion ratio is for the same treatment time. While, for the same pressure, the variation of time induces a minimal effect. Therefore, the pressure would be the main factor affecting the expulsion ratio.

**Table 3.** DIC-pretreatment experimental conditions and expulsion ratio

<b>Run no.<sup>1</sup></b>	<b>P (MPa)</b>	<b>t (s)</b>	<b>T (°C)</b>	<b>Expulsion ratio (%)</b>	<b>g expelled/g db</b>
Central points (1,4,7,10,13) <sup>2</sup>	0.3	25	133.5	5.8 ±0.9	0.21
2	0.3	35	133.5	8.6	0.25
3	0.45	25	147.9	16.4	0.47
5	0.4	32	144.2	15.4	0.44
6	0.194	32	119.2	1.1	0.03
8	0.194	18	119.2	0.0	0
9	0.4	18	144.2	12.9	0.37
11	0.3	15	133.5	3.8	0.11
12	0.15	25	111.3	0.0	0

<sup>1</sup> Run no. are numbers given to each experimental point in the experimental plan

<sup>2</sup> Central points are repetitive runs at the center of the experimental plan that provide an estimate of experimental error

In fact, at high treatment pressures, larvae are almost emptied from their visceral content by the expulsion phenomenon. It is either expelled to the vacuum tank or stuck on the exoskeleton (Supplementary Figure S3).

The vacuum tank extract was collected and centrifuged. Two phases were detected in different treatment conditions: an aqueous upper phase and a pellet lower phase (Figure 6). At DIC conditions of (0.15 MPa/25 sec), (0.3 MPa/25 sec), and (0.45 MPa/25 sec), the protein concentration of the aqueous phase submitted to Bradford method gave values of 0.3, 0.59, and 0.73 mg/ml, respectively.



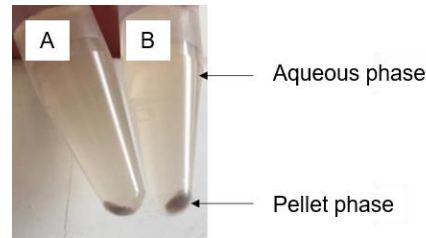

**Figure 6.** The vacuum tank extract: (A) 0.15 MPa/25 sec and (B) 0.45 MPa/25 sec, centrifuged, showing both an aqueous and a pellet phase

### 3.4. SEM images

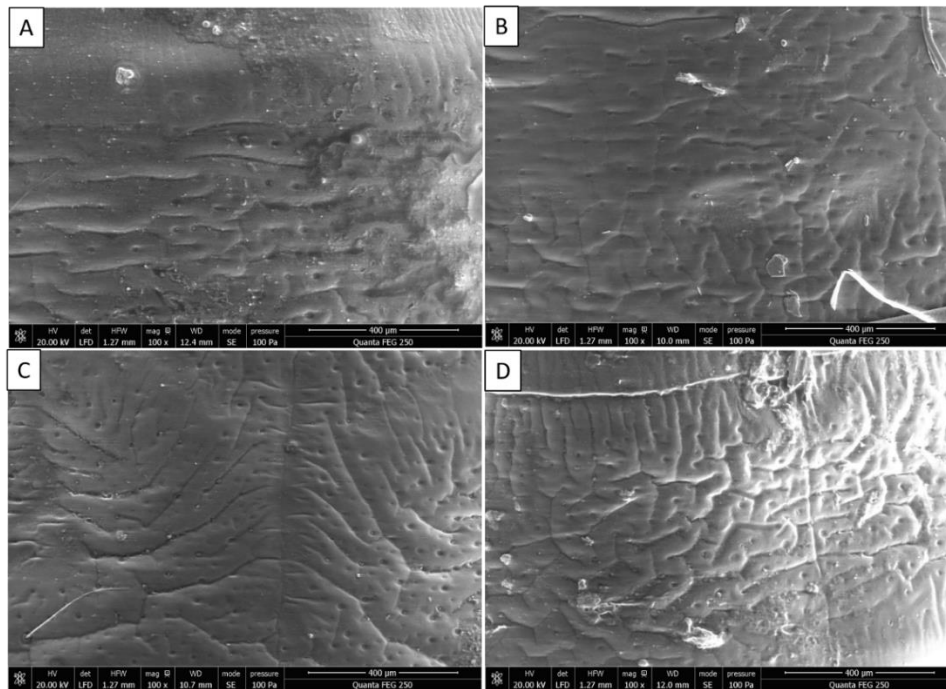

**Figure 7.** SEM images at 400µm for *T. molitor* larva (A) Without treatment, (B) Treated at 0.15 MPa/15 sec, (C) Treated at 0.3 MPa/25 sec, and (D) Treated at 0.4 MPa/18 sec

The SEM images in Figure 7 show that DIC-treated larvae present changes in their membrane structure, and the higher the treatment pressure, the more visible the damage. In dried strawberries (Alonzo-Macías *et al.*, 2013) and orange by-products (Louati *et al.*, 2019), structural variations between raw material and DIC treated samples were also reported. Before DIC treatment, raw material had a compact and well-organized cell structure; after DIC treatment, the cell structure became more porous. These changes are found to be highly dependent on the operating parameters. This phenomenon might be attributed to the mechanical effect generated by dropping the pressure towards a vacuum. Such structural changes from the interstitial zone to damaged cell walls can have a significant impact on mass transfer phenomena such as improving diffusivity and permeability within the matrix (Allaf *et al.*, 2012).

### 3.5. Qualitative analysis of ATR-FTIR spectra

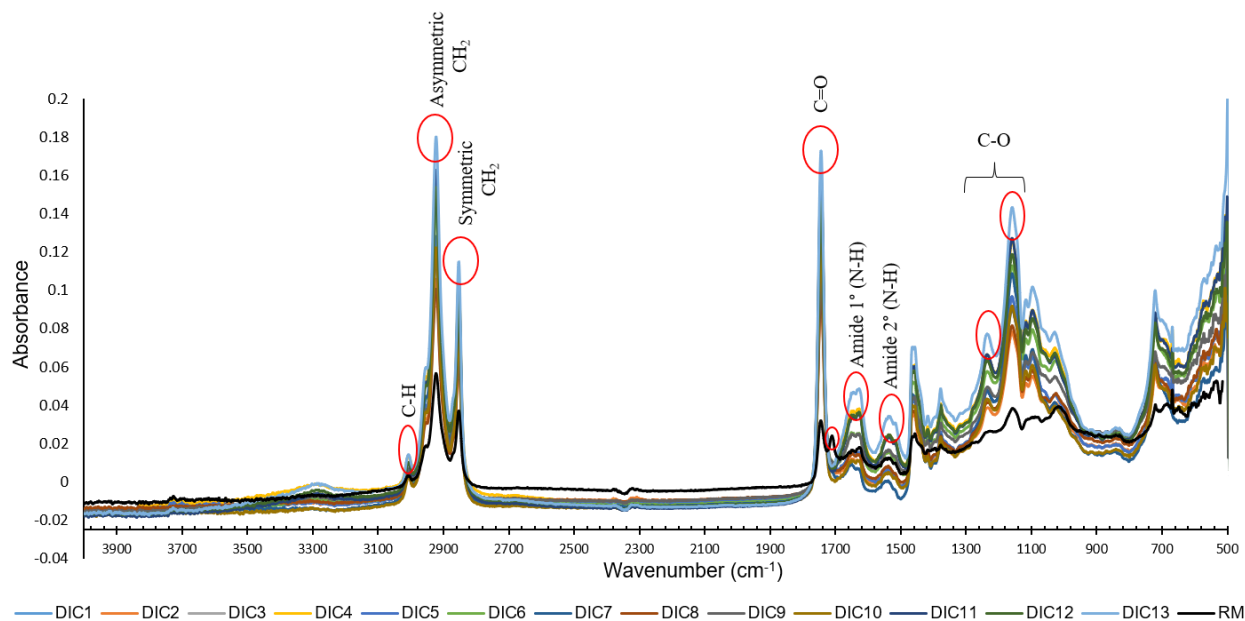

**Figure 8.** ATR-FTIR spectra for various samples of yellow mealworm larvae

ATR-FT-IR analysis was done on the raw material (RM) and DIC-treated samples. Even though the larva is a complex matrix, Figure 8 allows discerning peaks corresponding to the main functional groups. The peak at  $3009\text{ cm}^{-1}$  indicates the C-H stretching vibration of the polyunsaturated fatty acids' cis-double bond ( $=\text{CH}$ ) groups. The  $2923$  and  $2853\text{ cm}^{-1}$  peaks would reveal the asymmetric and symmetric stretching vibrations of  $\text{CH}_2$  groups, respectively, which are associated with the hydrocarbon chains of the lipids. The spectral band observed at  $1740\text{ cm}^{-1}$ , and the small band at  $1710\text{ cm}^{-1}$  characterize the function  $\text{C}=\text{O}$  of the ester groups, and it is related to the presence of amino acids and fatty acids in the sample. In the regions  $1650\text{--}1590\text{ cm}^{-1}$  and  $1570\text{--}1510\text{ cm}^{-1}$ , we notice overlapping bands that characterize the primary and secondary amide groups (N-H) respectively. These overlapping bands are composed of multiple peaks that correspond mainly to the secondary structures of proteins ( $\alpha$  helix,  $\beta$  sheet, 3-turn helix, and random coil). Between  $1300$  and  $1000\text{ cm}^{-1}$ , we perceive two stretching bands (at  $1235$  and  $1160\text{ cm}^{-1}$ ) that correspond to the C-O bonds of the ester group. The section between  $1500$  and  $600\text{ cm}^{-1}$  is complex and covers many peaks caused by several vibrations. It offers information about organic composites like alcohols, sugars, and organic acids. However, it is not easy to analyze because of its complexity.

By comparing the spectra of all the samples, we can perceive no difference in the molecular composition of the DIC-treated larvae and the non-treated ones, as they present almost the same peak bands confirming that DIC treatment is not destructive.

### 3.6. Characteristics of the untreated and DIC treated larvae

**Table 4.** Moisture content, aw, thickness, and densities for *T. molitor* larvae

Run no. <sup>1</sup>	P (MPa)	t (s)	T (°C)	Moisture content (% wb)	aw	Thick ness (mm)	$\rho$ true (kg/m <sup>3</sup> )	$\rho$ apparent (kg/m <sup>3</sup> )	Volume (mm <sup>3</sup> )	Relative expansion (%)
Living larvae	/	/	/	65.00 ±0.8						
Blanched	/	/	/	59.07 ±0.9	0.954 ±0.001	2.06	1073.0	714.3	92	0.0
Central points (1,4,7,10,13) <sup>2</sup>	0.3	25	133.5	65.55 ±1.0	0.983 ±0.002	2.20 ±0.05	1091.1± 7.8	507.8 ±45	123 ±11	33.5 ±11.5
2	0.3	35	133.5	64.99 ±0.6	0.975 ±0.001	2.16	1109.0	392.8	154	66.2
3	0.45	25	147.9	63.74 ±0.4	0.988 ±0.001	2.44	1089.3	357.1	155	67.2
5	0.4	32	144.2	67.83 ±0.9	0.994 ±0.002	2.42	1097.0	333.9	167	81.0
6	0.194	32	119.2	64.09 ±1.3	0.983 ±0.008	2.08	1094.7	607.1	108	16.4
8	0.194	18	119.2	67.39 ±1.8	0.980 ±0.006	2.09	1093.4	692.8	95	3.1
9	0.4	18	144.2	63.30 ±1.8	0.982 ±0.005	2.42	1084.4	375.0	153	65.9
11	0.3	15	133.5	66.67 ±0.9	0.984 ±0.003	2.16	1094.3	596.4	106	15.2
12	0.15	25	111.3	67.29 ±0.2	0.968 ±0.002	2.06	1090.0	714.3	92	0.0
DIC average <sup>3</sup>				65.62 ±1.5	0.982 ±0.006		1092.9 ±7.3			

<sup>1</sup> Run no. are numbers given to each experimental point in the experimental plan

<sup>2</sup> Central points are repetitive runs at the center of the experimental plan that provide an estimate of experimental error

<sup>3</sup> DIC = instant controlled pressure drop

Table 4 sums up the different characteristics of untreated and DIC-treated larvae. The larvae's moisture content shows no significant difference before and after different DIC treatment conditions: its average value is 65% with a standard deviation of 1.5%, which is not different from that of the living larvae. Therefore, DIC ensures water and dry matter are expelled in proportion, resulting in the same content as untreated larvae. The same goes for water activity (aw), with an average value of 0.982. However, the blanched larvae's moisture content and water activity are slightly lower than the living ones due to water evaporation during the blanching process. In terms of larvae's thickness, a positive correlation with the pressure of treatment is noticed, with no significant effect on the treatment time (Supplementary Figure S4) due to the expansion phenomenon caused by DIC treatment.

As for the densities: there is no significant difference between the larvae's intrinsic density values; however, the apparent densities decrease with the increase of the DIC pressure and time (Supplementary Figure S4). This observation can be explained by the loss of matter during expulsion (a decrease in larval weight) and larval expansion (an increase in larval volume). Accordingly, the calculated larval volumetric relative expansion increases from 0 to 67% from the lowest to the highest treatment conditions. Similarly, Mounir *et al.*, 2011 reported that the DIC parameters had no effect on the intrinsic (true) density of treated cheese and that the specific density decreased when the DIC parameters were increased. They also stated that DIC treatment at 0.5 MPa/22s increased the expansion ratio by up to 35 times. Likewise, Namir *et al.*, 2017, found a relative expansion ratio of up to 21x in cactus pear following DIC treatment (0.6 MPa/15s) when compared to the raw material.

In terms of protein and lipid contents, Table 5 shows no differences between the pressed alive larvae and DIC-treated larvae. Knowing that water and dry matter are expelled proportionally, these findings show that the expulsion of the dry matter occurs proportionally between its protein, lipid, and moisture content, resulting in the same proportions as the initial one. As a result, we may assume that the proteins, lipids and humidity are all expelled in a non-selective manner, leaving their contents unaltered.

**Table 5.** Yellow mealworm protein and lipid content

Run no. <sup>1</sup>	P (MPa)	t (s)	T (°C)	N (%)	Protein content (% in db)	Protein mass (g/100 g larvae)	Lipid content (% in db)	Mass of lipids (g/100 g larvae)
Pressed alive	/	/	/	8.64	41.15	14.4	27.94	9.8
Central points (1,4,7,10,13) <sup>2</sup>	0.3	25	0.3	7.958 ± 0.3	37.88	13.2	28.4	9.8
2	0.3	35	0.3	8.665	41.24	14.4	28.01	9.8
3	0.45	25	0.45	8.86	42.17	15.3	27.47	10.0
5	0.4	32	0.4	8.522	40.56	13.0	27.41	8.8
6	0.194	32	0.194	8.667	41.25	14.8	27.73	10.0
8	0.194	18	0.194	8.548	40.69	13.3	27.9	9.1
9	0.4	18	0.4	8.495	40.43	14.8	27.29	10.0
11	0.3	15	0.3	8.429	40.12	13.4	26.98	9.0
12	0.15	25	0.15	8.725	41.53	13.6	27.12	8.9
DIC Average <sup>3</sup>				8.361 ± 0.4	40.65 ± 1.1	13.9 ± 0.8	27.59 ± 0.43	9.5 ± 0.5

<sup>1</sup> Run no. are numbers given to each experimental point in the experimental plan  
<sup>2</sup> Central points are repetitive runs at the center of the experimental plan that provide an estimate of experimental error  
<sup>3</sup> DIC = instant controlled pressure drop

**Table 6.** Pressing yield and dry matter content for DIC-pretreated larvae

Run no. <sup>1</sup>	P (MPa)	t (s)	T (°C)	Yield (%)	Cake's dry matter content (%)
Pressed alive	/	/	/	65.60	41.80
Blanched	/	/	/	68.04	46.18
Central points (1,4,7,10,13) <sup>2</sup>	0.3	25	133.5	59.56 ± 2.8	55.39 ± 2.7
2	0.3	35	133.5	57.50	52.57
3	0.45	25	147.9	55.67	54.45
5	0.4	32	144.2	56.27	57.74
6	0.194	32	119.2	66.66	56.5
8	0.194	18	119.2	66.67	54.55
9	0.4	18	144.2	57.59	54.06
11	0.3	15	133.5	62.47	55.28
12	0.15	25	111.3	67.58	55.82

<sup>1</sup> Run no. are numbers given to each experimental point in the experimental plan  
<sup>2</sup> Central points are repetitive runs at the center of the experimental plan that provide an estimate of experimental error

Both untreated blanched samples and DIC-treated larvae underwent pressing in a hydraulic micro-press at the optimal pressing conditions: 6 MPa, 60°C, 2 cm, and 0.1 mm/s for 900 s. Table 6 presents the pressing yield and cake's dry matter content after each pressing.

The statistical analysis of pressing yield after DIC pretreatment presented in Supplementary Figure S5 shows that the yield decreases significantly by increasing the treatment pressure. It decreases from 67% to 55% respectively from the lowest to the highest treatment pressure (Table 6), with little influence of treatment time. The cake's dry matter content remains almost the same with 55.2 %  $\pm$  2 for all treatment conditions, except for the pressed alive and blanched larvae, where it was 42% and 46%, respectively. Larval structural modifications, protein aggregation, and denaturation phenomenon increase with DIC pressure and temperature. These phenomena can explain the decrease in yield. Mahler *et al.*, 2009 stated that thermal and mechanical stress can cause protein aggregates to form. High temperatures can affect the conformation of polypeptide chains and their structures, leading to temperature-induced unfolding. Although the pressure-drop in DIC induces instant cooling of the treated materials, the treatment temperature is relatively high, varying from 111 °C to 147 °C, depending on the treatment pressures, during 25 s of treatment. Protein aggregation and denaturation might result from the previously mentioned factor and from the mechanical stress caused by the applied pressure, leading to the retention of a larger quantity of matter in the cake, consequently decreasing the pressing yield. Additionally, expansion of larvae structure caused by DIC treatment leads to higher air content in larvae tissue, which may also hinder the pressing yield.

According to Lee *et al.*, 2019, heating (at 55, 75, and 95 °C) affects the functional properties of *T. molitor* proteins, and the effect increases with the heating duration (20, 40, and 60 min). Thus, the higher the applied temperature and time, the higher the water holding capacity WHC, the foam stability, and the gel stability, the lower the oil holding capacity OHC, the foam capacity, and the emulsion activity and stability.

Figure 9 brings together the total extract from DIC treated larvae adding up the pressing yield and the expelled matter rate. The total extracted matted varies between 60 and 68%.

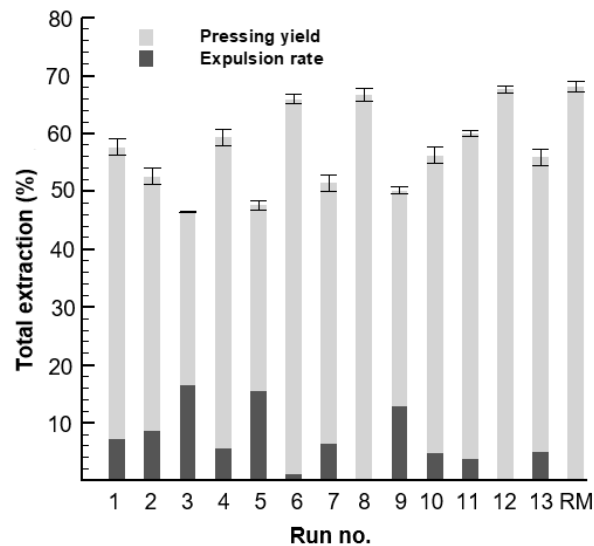

**Figure 9.** Total extracted matter from larvae

### 3.7. Impact of DIC on the quality and the composition of larvae press-cake and juice

Table 7 shows that mechanical pressing of the raw material allowed removing 78% of the larvae's initial lipid content. Indeed, the lipid mass decreased from 9.8 g/100 g of larvae (Table 5) to 2.1g/100g of pressed larvae. As for the other treatment conditions, we extracted  $73 \pm 2.5\%$  of the initial lipid content, with no significant difference.

**Table 7.** The fraction of total lipids present in the pressing juice of yellow mealworms

Run no. <sup>1</sup>	P (MPa)	t (s)	T (°C)	Cake's lipid content (% in db)	Mass (g) of lipids in 100 g of press cake	Lipids in the liquid phase (% w/w of total lipids)
Pressed alive	/	/	/	$14.71 \pm 0.26$	2.1	$78.4 \pm 0.5$
Central points (1,4,7,10,13) <sup>2</sup>	0.3	25	133.5	$11.96 \pm 0.35$	2.7	$72.6 \pm 2.2$
2	0.3	35	133.5	11.89	2.7	72.9
3	0.45	25	147.9	11.15	2.7	73.0
5	0.4	32	144.2	10.68	2.7	69.4
6	0.194	32	119.2	12.91	2.4	75.6
8	0.194	18	119.2	11.20	2.0	77.6
9	0.4	18	144.2	11.00	2.5	74.8
11	0.3	15	133.5	11.35	2.3	73.8
12	0.15	25	111.3	14.88	2.7	69.6

<sup>1</sup> Run no. are numbers given to each experimental point in the experimental plan

<sup>2</sup> Central points are repetitive runs at the center of the experimental plan that provide an estimate of experimental error

Table 8 shows that increasing DIC pressure decreases the fraction of proteins that pass in the liquid phase. It drops from 49.2% for the RM to 17.7% for DIC-treated larvae at 0.45 MPa. These findings confirm the previously stated hypothesis of proteins' thermal and mechanical aggregation causing their retention in the press cake and thus justify the pressing yield drop. This result may be very useful in retaining the proteins in a meal that is very suitable for feed applications.

**Table 8.** The fraction of total proteins present in the pressing juice (aqueous phase) of yellow mealworms

Run no.	P (MPa)	t (s)	T (°C)	Cake's protein content (g/100 g db)	Mass of proteins (g/100 g pressed larvae cake)	Proteins in the liquid's aqueous phase (% w/w of total proteins)
Pressed alive	/	/	/	51.0	7.3	49.2
12	0.15	25	111.3	46.0	8.4	38.4
13	0.3	25	133.5	52.6	11.1	18.8
3	0.45	25	147.9	52.2	12.6	17.7

Table 9 shows no significant differences in the colloid concentration in the extracted liquid between different DIC conditions, with 52.95 g/L, against 75.45 g/L for the pressed alive raw material. These results correlate with the previously stated phenomenon of protein aggregation in the pressing cake.

As for the juice colouration, absorbance decreases from 1.267 to 0.372, from the raw material to the most severe DIC treatment conditions, with a pH of  $4.65 \pm 0.35$  for all juices (blanched and DIC treated). Moreover, the statistical responses in Supplementary Figure S6 confirm these findings: the colour of the larvae juice becomes lighter by increasing the DIC treatment pressure, while the treatment time has little or no influence. In addition, the visual observation of larvae colours after different treatment conditions (Supplementary Figure S1) reveals that DIC pretreatment might gradually inhibit the enzymatic activities of *T. molitor* larvae with the threshold being at 0.3 MPa/15 s. A similar effect of the DIC on the enzymatic activity of bananas was stated by Setyoprato *et al.*, 2012, who reported that DIC texturing of bananas prevented the conversion of the starch to reducing sugar, which was attributed to enzymatic deactivation during the DIC treatment process. Besides, blanching the larvae at 90°C for 4 min does not seem to surpass the inhibition threshold of the enzymatic activities (Supplementary Figure S1, left), which is not in line with the findings of Cacchiarelli *et al.*, 2022, who stated that blanching mealworms at 90 °C for 1 min was sufficient to block the enzymatic browning of their juice. On this subject, Mancini *et al.*, 2019 have found that the enzymatic activity was partially inactivated in mealworms blanched at 90 °C for 2.5 min and totally inactivated in the ones blanched at 90 °C for 5 min.

**Table 9.** The aqueous phase colloids concentration and colouration of yellow mealworm pressing juice

Run no.	P (MPa)	t (s)	T (°C)	Colloids (g/L)	Juice absorbance (at 420 nm)
Pressed alive <sup>1</sup>	/	/	/	75.45	1.267
Central points (1,4,7,10,13) <sup>2</sup>	0.3	25	133.5	51.28 ± 1.3	0.602 ± 0.115
2	0.3	35	133.5	54.10	0.410
3	0.45	25	147.9	50.95	0.372
5	0.4	32	144.2	55.75	0.365
6	0.194	32	119.2	56.05	1.229
8	0.194	18	119.2	52.30	1.256
9	0.4	18	144.2	54.45	0.344
11	0.3	15	133.5	51.20	0.895
12	0.15	25	111.3	57.10	1.224
DIC average <sup>3</sup>				53.68	

<sup>1</sup> Run no. are numbers given to each experimental point in the experimental plan

<sup>2</sup> Central points are repetitive runs at the center of the experimental plan that provide an estimate of experimental error

<sup>3</sup> DIC = instant controlled pressure drop

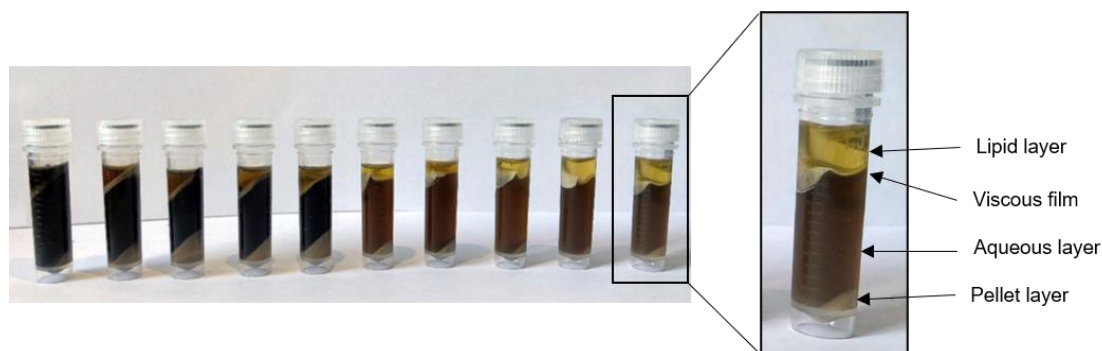

**Figure 10.** Centrifuged pressing larvae juice in ascending order from blanched to the highest DIC pressure treatment conditions, from left to right

Centrifugation of the expressed juice permits identifying three distinct layers: lipid, aqueous, and pellet (Figure 10). Thus, between a lipid upper layer and an aqueous phase, a viscous dark film occurs. It is worth noticing that the more severe the DIC treatment conditions, the more distinctive the lipid layer, going from 3% to 17% (from the RM to the highest treatment conditions) (Figure 10), even though the same lipid content is present (Table 7). These results prove that more severe DIC conditions result in less emulsion stability of pressing juice, possibly because of the heat denaturation and lipid droplet flocculation/coalescence (Lee *et al.*, 2019).

### 3.8. Impact of DIC treatment on the qualitative aspect of larval proteins

In Figure 11 we can see the spectra obtained for (A) blanched (90°C; 4 min) and (B) DIC-treated larvae (0.3 MPa; 25 s) at different concentrations of ANS and (C) the spectra of the Tryptophan method, of unhydrated (powder) and hydrated (solution) (5% protein) samples of both blanched



and DIC treated larvae. The variations of the maximum fluorescence intensity ( $F_{\max}$ ) indicate the degree of protein denaturation. According to Saulnier *et al.*, 1991 when the heat treatment is more severe, it results in the unfolding of the proteins, the hydrophobic sites became more accessible and the fluorescence increases. In both methods, the DIC-treated larvae seem to have a greater  $F_{\max}$  than the blanched ones, implying that it has the most hydrophobic sites on the surface of the proteins, and consequently a more pronounced protein denaturation.

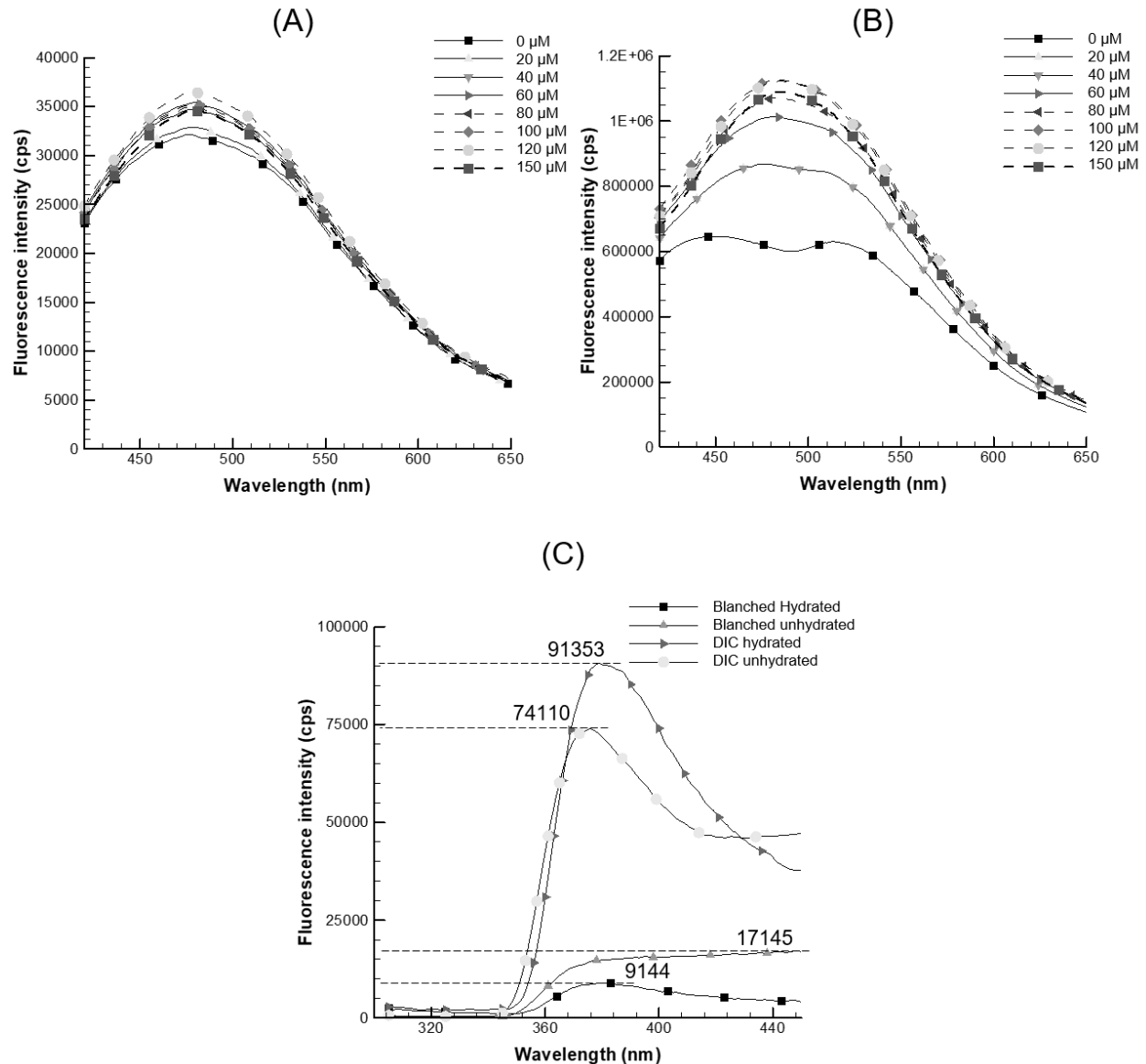

**Figure 11.** ANS spectra obtained for (A) blanched larvae and (B) DIC-treated larvae at different concentrations of ANS (0 to 150  $\mu\text{M}$ ) successively added to a 5% protein solution, and (C) tryptophan spectra for unhydrated (powder) and hydrated samples (solutions) (5% protein).

## 4. Conclusion

This study determined the optimal hydraulic pressing conditions to extract the maximum juice yield from *T. molitor* larvae. The best pressing results were obtained at a temperature of 60 °C, a pressure of 6 MPa, a sample initial thickness of 2 cm, and an initial piston speed of 0.15 mm/s, giving a yield of 76% in frozen/thawed larvae and 68% for blanched larvae.

Moreover, instant controlled pressure-drop (DIC) treatment could kill the *T. molitor* larvae at relatively mild conditions (0.15 MPa for 25 s) with no other significant consequences. The high DIC treatment conditions resulted in changes in membrane structure, a decrease in the apparent density, an expansion, and a matter expulsion to the vacuum tank, all commensurate with the treatment harshness, with no changes in their protein, lipid, and moisture contents. Larvae and larvae juice colours became lighter with more severe treatment conditions, possibly because of oxidative enzyme deactivation. As for the pressing, the increased DIC conditions result in lower yield caused by possible protein denaturation and changes in molecule interactions that bring higher aggregation and protein content in the press cake. DIC treatment slightly decreases the lipid extraction yield from  $78.4 \pm 0.5\%$  to  $73 \pm 2.5\%$  with no significant difference between different treatment conditions. Furthermore, the treatment affects lipid emulsion, decreasing its stability and facilitating other separation processes. DIC treatment time is perceived to have little or no effect on the integrity of these phenomena. Fluorescence spectroscopy showed that DIC treatment at 0.3 MPa for 25 s causes protein denaturation in comparison with blanching at 90 °C for 4 min, which confirms our hypothesis of protein denaturation causing protein aggregation and decreased lipid emulsion stability. However, it is important to note that protein denaturation makes them easier to digest, has no effect on a sample's nutritional properties, and increased surface hydrophobicity may be beneficial for certain applications.

These findings allow understanding of the impacts of instant controlled pressure-drop technology on different physical and chemical properties of yellow mealworms, thus it could be used as a pretreatment step prior to the mechanical pressing to improve protein separation from lipids: generating a protein-rich press cake and a liquid with a readily separable lipid phase through simple centrifugation. The corollary of this is to construct foundational material to expand in further studies.

## 5. Statements & Declarations

**Acknowledgements:** A special thanks for Romdhane Karoui and Gaoussou Karamoko from Artois University, for performing the qualitative protein analysis.

**Funding:** This work is a part of the project RAFINSECT funded by the region Hauts de France.

**Conflict of interest:** The authors declare no conflict of interest.

## 6. References

- Al Haddad, M., Mounir, S., Sobolik, V. and Allaf, K., 2008. Fruits & vegetables drying combining hot air, DIC technology and microwaves. *International Journal of Food Engineering* 4. <https://doi.org/10.2202/1556-3758.1491>
- Allaf, T., Besombes, C., Mih, I., Lefevre, L. and Allaf, K., 2011. Decontamination of solid and powder foodstuffs using DIC technology. In: Schmidt, M. (ed) *Advances in computer science and engineering*. InTech Open, London, UK, pp. 261-282. <https://doi.org/10.5772/16025>
- Allaf, T., Mounir, S., Tomao, V. and Chemat, F., 2012. Instant controlled pressure drop combined to ultrasounds as innovative extraction process combination: fundamental aspects. *Procedia Engineering* 42: 1061-1078.
- Allaf, T., Tomao, V., Ruiz, K. and Chemat, F., 2013. Instant controlled pressure drop technology and ultrasound assisted extraction for sequential extraction of essential oil and antioxidants. *Ultrasonics Sonochemistry* 20: 239-246.
- Alonzo-Macías, M., Cardador-Martínez, A., Mounir, S., MontejanoGaitán, G. and Allaf, K., 2013. Comparative study of the effects of drying methods on antioxidant activity of dried strawberry (*Fragaria* Var. Camarosa). *Journal of Food Research Canadian Center of Science and Education* 2: 92.
- AOAC International, 1996. Official methods of analysis of AOAC International. 993.13 nitrogen (total) in fertilizers. Combustion method. AOAC International, Rockville, MD, USA, pp. 1-2.
- Azagoh, C., Ducept, F., Garcia, R., Rakotozafy, L., Cuvelier, M.E., Keller, S., Lewandowski, R. and Mezdour, S., 2016. Extraction and physicochemical characterization of *Tenebrio molitor* proteins. *Food Research International* 88: 24-31.
- Bamerni, F., 2018. Plant-based (*Camelina sativa*) biodiesel manufacturing using the technology of instant controlled pressure drop (DIC) : process performance and biofuel quality. Université de La Rochelle, La Rochelle, France.
- Barker, D., Fitzpatrick, M.P. and Dierenfeld, E.S., 1998. Nutrient composition of selected whole invertebrates. *Zoo Biology* 17: 123-134.
- Basu, P., 2013. Biomass characteristics. Chapter 3. In: *Biomass gasification, pyrolysis and torrefaction*. Academic Press, Cambridge, MA, USA, pp. 47-86.
- Belluco, S., Halloran, A. and Ricci, A., 2017. New protein sources and food legislation: the case of edible insects and EU law. *Food Security* 9: 803-814.
- Berka-Zougali, B., Hassani, A., Besombes, C. and Allaf, K., 2010. Extraction of essential oils from Algerian myrtle leaves using instant controlled pressure drop technology. *Journal of Chromatography A* 1217: 6134-6142.
- Besombes, C., Berka-Zougali, B. and Allaf, K., 2010. Instant controlled pressure drop extraction of lavandin essential oils: fundamentals and experimental studies. *Journal of Chromatography A* 1217: 6807-6815.

- Bouallegue, K., Allaf, T., Ben Younes, R. and Allaf, K., 2016. Texturing and instant cooling of rapeseed as pretreatment prior to pressing and solvent extraction of oil. *Food and Bioprocess Technology* 9: 1521-1534.
- Bradford, M., 1976. A rapid and sensitive method for the quantitation of microgram quantities of protein utilizing the principle of proteindye binding. *Analytical Biochemistry* 72: 248-254.
- Bußler, S., Rumpold, B.A., Jander, E., Rawel, H.M. and Schlüter, O.K., 2016. Recovery and techno-functionality of flours and proteins from two edible insect species: Meal worm (*Tenebrio molitor*) and black soldier fly (*Hermetia illucens*) larvae. *Heliyon* 2: e00218. <https://doi.org/10.1016/J.HELIYON.2016.E00218>
- Cacchiarelli, C., Fratini, F., Puccini, M., Vitolo, S., Paci, G. and Mancini, S., 2022. Effects of different blanching treatments on colour and microbiological profile of *Tenebrio molitor* and *Zophobas morio* larvae. *LWT – Food Science and Technology* 157: 113112.
- Cherniavskaia, L., Pustohod, A. and Ivolga, N., 1995. Technochemical control of granulated sugar and refined sugar. Kolos, Moscow, Russia.
- De Vries, M. and De Boer, I.J.M., 2010. Comparing environmental impacts for livestock products: a review of life cycle assessments. *Livestock Science* 128: 1-11.
- Direction générale de l'alimentation, 2017. Utilisation des protéines et autres produits dérivés d'insectes dans l'alimentation humaine, animale et pour des usages techniques. Ministère de l'agriculture et de la souveraineté alimentaire. Available at: <https://info.agriculture.gouv.fr/gedei/site/bo-agri/instruction-2017-860>.
- El Hajj, R., Mhemdi, H., Besombes, C., Allaf, K., Lefrançois, V. and Vorobiev, E., 2022. Edible insects' transformation for feed and food uses: an overview of current insights and future developments in the field. *Processes* 10: 970.
- El Zahar, K., Mounir, S., Allaf, T. and Allaf, K., 2015. Fundamental modeling, functional attributes, porosity, cohesivity index (Hausner ratio) and compressibility of expanded-granule powder of Egyptian Ras pure cheese. *LWT – Food Science and Technology* 64: 297-307.
- European Union (EU), 2009a. Regulation (EC) No 1069/2009 of 21 October 2009 laying down health rules as regards animal byproducts and derived products not intended for human consumption and repealing Regulation (EC) No 1774/2002 (animal by-products Regulation). *Official Journal of the European Union* L 300: 1-33. Available at: <http://data.europa.eu/eli/reg/2009/1069/oj>.
- European Union (EU), 2009b. Council Regulation (EC) No 1099/2009 of 24 September 2009 on the protection of animals at the time of killing. *Official Journal of the European Union* L 303: 1-30. Available at: <http://data.europa.eu/eli/reg/2009/1099/oj>.
- European Union (EU), 2021. Commission Implementing Regulation (EU) 2021/882 of 1 June 2021 authorising the placing on the market of dried *Tenebrio molitor* larva as a novel food under Regulation (EU) 2015/2283 of the European Parliament and of the Council, and amending Commission Implementing Regulation (EU) 2017/2470. *Official Journal of the European Union* L 194: 16-20. [http://data.europa.eu/eli/reg\\_impl/2021/882/oj](http://data.europa.eu/eli/reg_impl/2021/882/oj).

- Freelance, C.B., 2019. To regulate or not to regulate? The future of animal ethics in experimental research with insects. *Science and Engineering Ethics* 25: 1339-1355.
- Gahukar, R.T., 2016. Edible insects farming: efficiency and impact on family livelihood, food security, and environment compared with livestock and crops. In: Dossey, A.T., Morales-Ramos, J.A. and Guadalupe Rojas, M. (eds) *Insects as sustainable food ingredients*. Academic Press, Cambridge, MA, USA, pp. 85-111.
- Hilborn, R., Banobi, J., Hall, S.J., Pucylowski, T. and Walsworth, T.E., 2018. The environmental cost of animal source foods. *Frontiers in Ecology and the Environment* 16: 329-335.
- Jablaoui, C., Besombes, C., Jamoussi, B., Rhazi, L. and Allaf, K., 2020. Comparison of expander and instant controlled pressure-drop DIC technologies as thermomechanical pretreatments in enhancing solvent extraction of vegetal soybean oil. *Arabian Journal of Chemistry* 13: 7235-7246.
- Janssen, R.H., Vincken, J.-P., Van den Broek, L.A.M., Fogliano, V. and Lakemond, C.M.M., 2017. Nitrogen-to-protein conversion factors for three edible insects: *Tenebrio molitor*, *Alphitobius diaperinus*, and *Hermetia illucens*. *Journal of Agricultural and Food Chemistry* 65: 2275-2278.
- Jung, S., Rickert, D.A., Deak, N.A., Aldin, E.D., Recknor, J., Johnson, L.A. and Murphy, P.A., 2003. Comparison of Kjeldahl and Dumas methods for determining protein contents of soybean products. *Journal of the American Oil Chemists' Society* 80: 1169-1173.
- Kim, T.K., Yong, H.I., Chun, H.H., Lee, M.A., Kim, Y.B. and Choi, Y.S., 2020. Changes of amino acid composition and protein technical functionality of edible insects by extracting steps. *Journal of AsiaPacific Entomology* 23: 298-305.
- Knorr, D., Froehling, A., Jaeger, H., Reineke, K., Schlueter, O. and Schoessler, K., 2011. Emerging technologies in food processing. *Annual Review of Food Science and Technology* 3: 203-235.
- Lanoisellé, J.-L., 1995. Contribution à l'étude du pressage hydraulique des graines oléoprotéagineuses : mécanisme de pressage et modélisation. Paris, France. Available at: <http://www.theses.fr/1995PA120006>.
- Lee, H.J., Kim, J.H., Ji, D.S. and Lee, C.H., 2019. Effects of heating time and temperature on functional properties of proteins of yellow mealworm larvae (*Tenebrio molitor* L.). *Food Science of Animal Resources* 39: 296-308.
- Leni, G., Caligiani, A. and Sforza, S., 2019. Killing method affects the browning and the quality of the protein fraction of black soldier fly (*Hermetia illucens*) prepupae: a metabolomics and proteomic insight. *Food Research International* 115: 116-125.
- Louati, I., Bahloul, N., Besombes, C., Allaf, K. and Kechaou, N., 2019. Instant controlled pressure-drop as texturing pretreatment for intensifying both final drying stage and extraction of phenolic compounds to valorize orange industry by-products (*Citrus sinensis* L.). *Food and Bioprocess Technology* 114: 85-94.

- Louka, N. and Allaf, K., 2002. New process for texturizing partially dehydrated biological products using controlled sudden decompression to the vacuum: application on potatoes. *Journal of Food Science* 67: 3033-3038.
- Mahler, H.C., Friess, W., Grauschopf, U. and Kiese, S., 2009. Protein aggregation: pathways, induction factors and analysis. *Journal of Pharmaceutical Sciences* 98: 2909-2934. <https://doi.org/10.1002/jps.21566>
- Mancini, S., Fratini, F., Tuccinardi, T., Turchi, B., Nuvoloni, R. and Paci, G., 2019. Effects of different blanching treatments on microbiological profile and quality of the mealworm (*Tenebrio molitor*). *Journal of Insects as Food and Feed* 5: 225-234.
- Mishyna, M., Martinez, J.-J.I., Chen, J. and Benjamin, O., 2019. Extraction, characterization and functional properties of soluble proteins from edible grasshopper (*Schistocerca gregaria*) and honey bee (*Apis mellifera*). *Food Research International* 116: 697-706.
- Mkaouar, S., Bahloul, N., Gelicus, A., Allaf, K. and Kechaou, N., 2015. Instant controlled pressure drop texturing for intensifying ethanol solvent extraction of olive (*Olea europaea*) leaf polyphenols. *Separation and Purification Technology* 145: 139-146.
- Mounir, S., Allaf, T., Mujumdar, A.S. and Allaf, K., 2012. Swell drying: coupling instant controlled pressure drop DIC to standard convection drying processes to intensify transfer phenomena and improve quality – an overview. *Drying Technology* 30: 1508-1531.
- Mounir, S., Halle, D. and Allaf, K., 2011. Characterization of pure cheese snacks and expanded granule powders textured by the instant controlled pressure drop (DIC) process. *Dairy Science and Technology* 91: 441-455.
- Namir, M., Elzahar, K., Ramadan, M.F. and Allaf, K., 2017. Cactus pear peel snacks prepared by instant pressure drop texturing: effect of process variables on bioactive compounds and functional properties. *Journal of Food Measurement and Characterization* 11: 388-400.
- Nguyen Van, C., 2010. Maîtrise de l'aptitude technologique des oléagineux par modification structurelle ; applications aux opérations d' extraction et de transestérification *in-situ*. These. La Rochelle, France. Available at: <http://www.theses.fr/2010LAROS308>.
- Ooninx, D.G.A.B. and De Boer, I.J.M., 2012. Environmental impact of the production of mealworms as a protein source for humans – a life cycle assessment. *PLoS ONE* 7: 0051145. <https://doi.org/10.1371/journal.pone.0051145>
- Otero, P., Gutierrez-Docio, A., Navarro del Hierro, J., Reglero, G. and Martin, D., 2020. Extracts from the edible insects *Acheta domesticus* and *Tenebrio molitor* with improved fatty acid profile due to ultrasound assisted or pressurized liquid extraction. *Food Chemistry* 314: 126200 <https://doi.org/10.1016/j.foodchem.2020.126200>
- Saulnier, F., Ferrera, F., Choukri, A., Girardet, J.-M. and Linden, G., 1991. Estimation of protein denaturation by spectrofluorimetry: application to industrial wheys. *Lait* 71: 511-518. <https://doi.org/10.1051/lait:1991439>
- Savoire, R., 2008. Etude multi-échelles de la séparation solide-liquide dans la trituration du lin oléagineux. Compiègne, France.

- Setyoprato, P., Fatmawati, A., Sutrisna, P.D., Savitri, E. and Allaf, K., 2012. The dehydration kinetics, physical properties and nutritional content of banana textured by instantaneous controlled pressure drop. *Asia-Pacific Journal of Chemical Engineering* 7: 726-732.
- Smetana, S., Mhemdi, H., Mezdour, S. and Heinz, V., 2020. PEF treated insects and algae as future food ingredients. Chapter 11. In: Barba,
- F., Parniakov, O. and Wiktor, A. (eds) *Pulsed electric fields to obtain healthier and sustainable food for tomorrow*. Academic Press, Cambridge, MA, USA, pp. 247-266.
- Sun-Waterhouse, D., Waterhouse, G.I.N., You, L., Zhang, J., Liu, Y., Ma, L., Gao, J. and Dong, Y., 2016. Transforming insect biomass into consumer wellness foods: a review. *Food Research International* 89: 129-151.
- Turck, D., Castenmiller, J., De Henauw, S., Hirsch-Ernst, K.I., Kearney, J., Maciuk, A., Mangelsdorf, I., McArdle, H.J., Naska, A., Pelaez, C., Pentieva, K., Siani, A., Thies, F., Tsabouri, S., Vinceti, M., Cubadda, F., Frenzel, T., Heinonen, M., Marchelli, R., Neuhäuser-Berthold, M., Poulsen, M., Prieto Maradona, M., Schlatter, J.R., Van Loveren, H., Ververis, E. and Knutsen, H.K., 2021. Safety of dried yellow mealworm (*Tenebrio molitor* larva) as a novel food pursuant to Regulation (EU) 2015/2283. *EFSA Journal* 19(1): e06343. <https://doi.org/10.2903/J.EFSA.2021.6343>
- Tzompa-Sosa, D.A., Yi, L., Van Valenberg, H.J.F., Van Boekel, M.A.J.S. and Lakemond, C.M.M., 2014. Insect lipid profile: aqueous versus organic solvent-based extraction methods. *Food Research International* 62: 1087-1094.
- Yi, L., Lakemond, C.M.M., Sagis, L.M.C., Eisner-Schadler, V., Van Huis, A. and Van Boekel, M.A.J.S., 2013. Extraction and characterization of protein fractions from five insect species. *Food Chemistry* 141: 3341-3348.
- Zhao, X., Vázquez-Gutiérrez, J.L., Johansson, D.P., Landberg, R. and Langton, M., 2016. Yellow mealworm protein for food purposes – extraction and functional properties. *PLoS ONE* 11: e0147791.
- Zielińska, E., Karaś, M. and Baraniak, B., 2018. Comparison of functional properties of edible insects and protein preparations thereof. *LWT* 91: 168-174.
- Zygler, A., Słomińska, M. and Namieśnik, J., 2012. Soxhlet extraction and new developments such as soxtec. *Comprehensive Sampling and Sample Preparation* 2: 65-82.

## 7. Supplementary material



**Figure S1.** Larvae in ascending order from blanched raw material to the highest instant controlled pressure-drop treatment conditions.

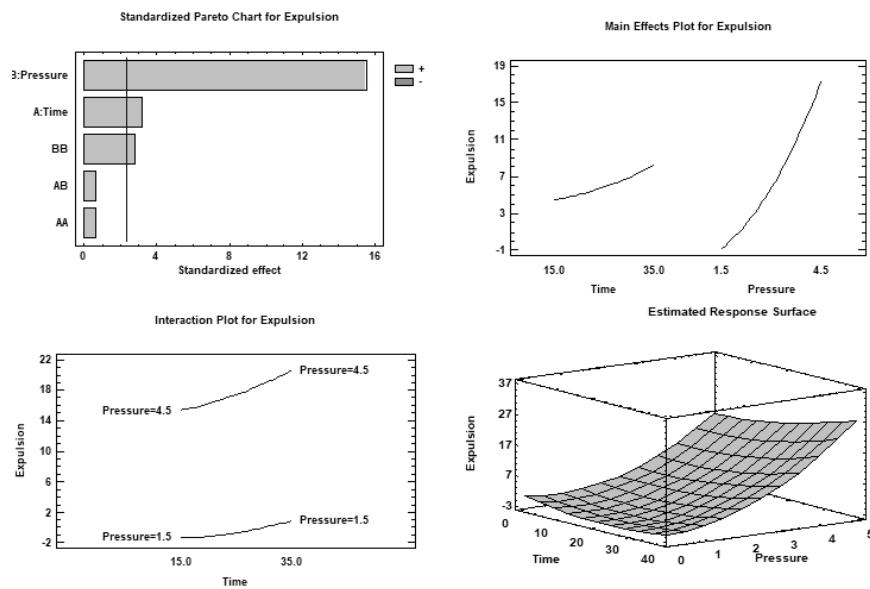

**Figure S2.** Effect of DIC-pretreatment parameters (pressure and time) on the expulsion rate.



**Figure S3.** Dried larvae after instant controlled pressuredrop treatment at 0.45 MPa for 25 sec showing semitransparent colour with their visceral content expelled (A) or expelled and stuck on the exoskeleton (B).



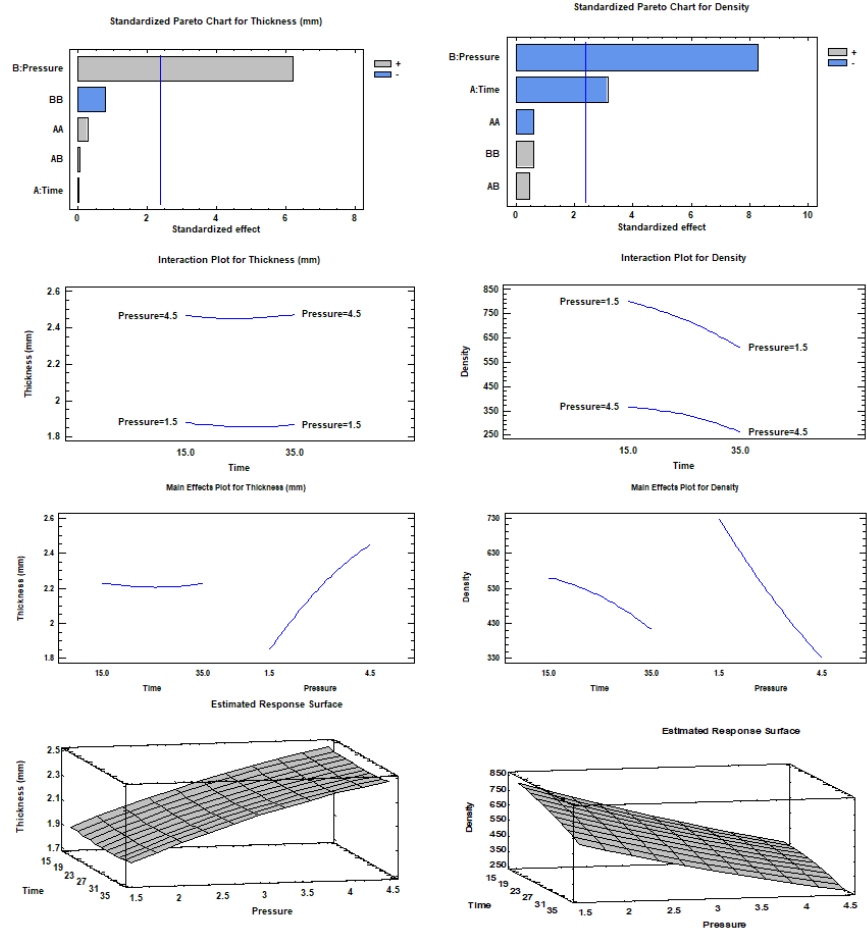

Figure S4. Effect of DIC-pretreatment parameters (pressure and time) on the apparent density and thickness of larvae.

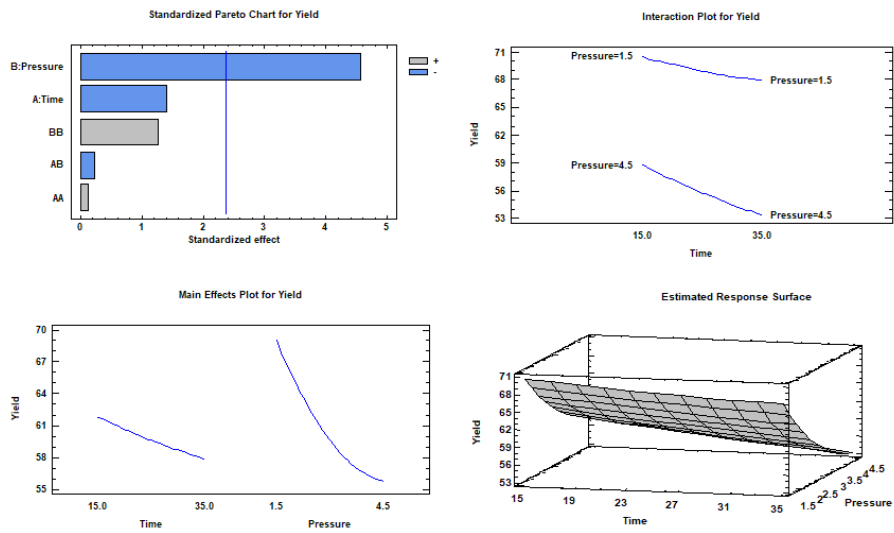
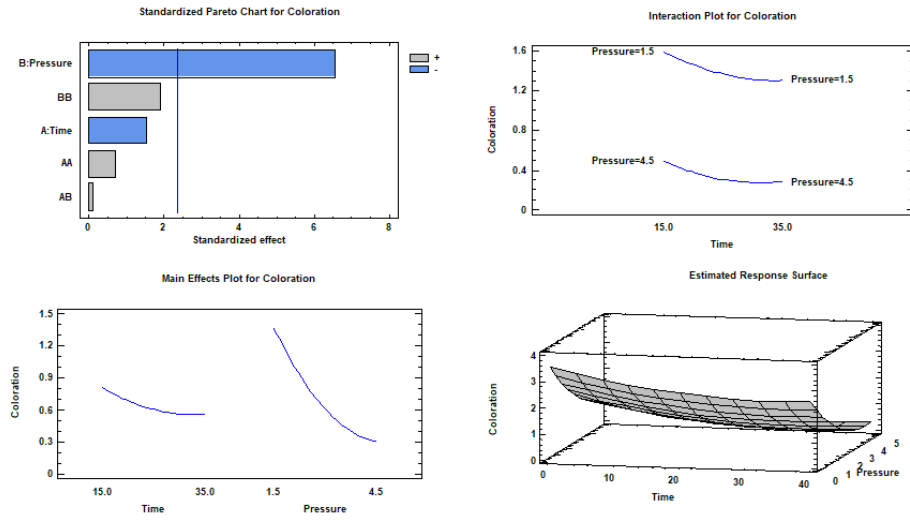

Figure S5. Effect of DIC-pretreatment parameters (pressure and time) on the pressing yield of larvae.



**Figure S6.** Effect of DIC-pretreatment parameters (pressure and time) on the pressing juice colouration of yellow mealworm larvae.

II.4. Article 4: Impact of instant controlled pressure-drop (DIC) texturing on the drying of yellow mealworms

(The article is presented on the following pages)

## **Impact of instant controlled pressure-drop (DIC) texturing on the drying of yellow mealworms**

**Rachelle El Hajj<sup>1\*</sup>, Houcine Mhemdi<sup>1</sup>, Saleh Khashayar<sup>1</sup>, Victor Lefrançois<sup>2</sup>, Karim Allaf<sup>3</sup>, Eugène Vorobiev<sup>1</sup>**

<sup>1</sup> Université de Technologie de Compiègne, ESCOM, TIMR (Integrated Transformations of Renewable Matter), Centre de recherche Royallieu - CS 60 319 - 60 203 Compiègne Cedex, France;

<sup>2</sup> ABCAR DIC Process Company, 11 Rue du Four Saint-Jacques, 60200 Compiègne, France ;

<sup>3</sup> University of La Rochelle, Laboratory of Engineering Science for Environment lasie -UMR-CNRS 7356, 17042 La Rochelle, France;

\* Corresponding author: [rachele.el-hajj@utc.fr](mailto:rachele.el-hajj@utc.fr); [hajjrachelle@hotmail.com](mailto:hajjrachelle@hotmail.com)

Accepted: April 2023

Journal of insects as food and feed

## Abstract

Insects are increasingly being evaluated as promising protein sources for the food and feed sectors. However, to be accepted as a viable food source, insects must undergo proper processing. Drying is a crucial step in insect processing, as it inhibits the growth of harmful microorganisms, improves their stability and extends their shelf life. After drying, insects can be further processed into various forms, to make them more socially acceptable as food and feed. During drying, biological materials are prone to shrinking, which usually affects their quality. Shrinkage of dried biological material results in a compact structure and causes a significant reduction in water diffusivity. It is typically escorted with unsatisfactory organoleptic quality and problems with grinding. Therefore, including retexturing and structure-expanding techniques in regular drying procedures is becoming essential. The instant controlled pressure-drop (DIC) technique was suggested as a texturing technique for yellow mealworms. DIC treatment successfully overcame shrinkage at treatment conditions of 0.194 MPa/32 s and above, resulting in enhanced water diffusivity of 1833 % and 682 % for DIC-treated larvae at 0.45 MPa/25 s, dried at 50 and 60°C, respectively, as compared to blanched larvae. Furthermore, DIC caused a 125% increase in the specific surface area of the dried meal, and a more uniform particle size distribution, both of which reflect the influence of this pretreatment on grinding and, consequently, the end product's quality. Finally, experimental data of sorption isotherms at 20, 30, and 40°C were fitted with Brunauer-Emmett-Teller (BET), Guggenheim-Anderson-de Boer (GAB), and Oswin models to represent the sorption behaviour.

**Keywords:** water diffusivity; shrinkage; edible insects; fitting; sorption isotherms.

## Nomenclature

A	Area of a water molecule ( $1.06 \times 10^{-19} \text{ m}^2$ )
$a_w$	water activity
C, K and N	Constants related to the sorption isotherm
$D_{\text{eff}}$	Effective diffusivity ( $\text{m}^2/\text{s}$ )
db	Dry basis
$d_p$	The equivalent radius of the material (m)
EMC or $M_\infty$	Equilibrium moisture content (g / g db)
$m_d$	Dry matter mass
$m_f$	mass (g) after DIC treatment
$m_i$	mass (g) before DIC treatment
$m_t$	mass (g) at time t
M	Moisture content (g / g db)
$M_i$	Initial moisture content (g/g db)
$M_t$	moisture content during drying at time t (g / g db)
$M_0$	Monolayer moisture content (g /100g dry db)
$M_{\text{H}_2\text{O}}$	Molecular weight of water (18g/mol)
MR	Moisture ratio (dimensionless)
n	Number of terms in the series
$N_{\text{Avogadro}}$	Avogadro's number ( $6 \times 10^{23} \text{ mol}^{-1}$ )
$T_g$	Temperature of glass transition

$V_f$	Volume of larvae after DIC treatment ( $\text{mm}^3$ )
$V_i$	Volume of larvae before DIC treatment ( $\text{mm}^3$ )
<b>Greek letters</b>	
$\emptyset$	thickness (mm)
$\rho$	density ( $\text{kg}/\text{m}^3$ )
$\sigma$	solid surface area ( $\text{m}^2/\text{g}$ )

## 1. Introduction

The exponential rise of the world's population and the scarcity of our resources necessitate a reassessment of our eating habits, particularly those related to protein intake. Insects present promising biomass for food and feed applications since they are rich in protein and fat, have a low feed conversion ratio (FCR), and involve minimal greenhouse gas emissions (van Huis, 2013). For instance, the yellow mealworm (*Tenebrio molitor*), one of the most known edible insect species, is composed of nearly 50% of protein, and 30% of fat, in addition to containing chitin, vitamins, and minerals (Jones *et al.*, 1972). However, entomophagy (human consumption of insects) is uncommon or even socially unacceptable in Western civilization. Thus, it has rarely been addressed as part of international organizations' sustainability and food security programs (van Huis, 2013).

There are three ways to distribute insects for human or animal consumption: whole insects, insects processed into a powder (meal), and purified extracts such as protein isolate, lipid, or chitin (EFSA, 2015). Since insects (cooked or raw) have low acceptance, they may have a better perception as food for human consumption when processed into high-protein food products or as protein extracts (Zhao *et al.*, 2016). Various processes can be applied to insects such as pretreatments (freezing, blanching, ultrasound, Pulsed Electric Field), drying (traditional sun-drying, smoke drying, roasting, microwave drying, freeze-drying, and oven-drying), and extraction (pressing, delipidation, ultrasound-assisted extraction, supercritical CO<sub>2</sub> extraction, alkaline aqueous protein extraction, and enzymatic hydrolysis for protein and chitin extraction) (El Hajj *et al.*, 2022; Ojha *et al.*, 2021; Parniakov *et al.*, 2022).

On an industrial level, oven drying is the most commonly used technology for drying insects due to its scalability, despite potential negative impacts on the sample such as denatured proteins, enzymatic oxidation, colour changes, hard texture, and loss of potential health benefits. In order to maintain the nutrient and sensory quality of insects and their products, alternative drying methods, such as traditional sun drying, freeze drying, and microwave-assisted drying, have been explored, and pretreatments like blanching have also been used to reduce microbiological load, prevent enzymatic oxidation, and improve some sensory properties (Hernández-Álvarez *et al.*, 2021; Kröncke *et al.*, 2019). Yet, balancing drying energy cost with the quality of the dried larvae is very important (Kröncke *et al.*, 2019).

Since drying time and temperature are found to be the main factors affecting the expenses and the overall quality (biochemical, functional, and organoleptic characteristics) of any dried foodstuff, scientists and industrials of different sectors have been adopting novel drying techniques or assisting conventional drying with emerging technologies to enhance different drying processes (Mounir *et al.*, 2012). Hence, in the insect processing chain, industrials are facing a challenge in finding suitable drying technologies that can preserve insects for prolonged storage periods without compromising their nutrient and sensory quality (Kröncke *et al.*, 2019), therefore it is essential to focus on developing novel and environmentally-friendly drying techniques that are specific to each insect species, while considering the technological and bio-functional quality of the final product. This includes addressing concerns related to shelf life, safety, and sensory quality, as well as evaluating the impact of the drying process on the potential health benefits of the bioactive compounds present in the insects (Hernández-Álvarez *et al.*, 2021).

Drying mealworms using fluidized bed proved to be challenging due to the lightweight nature of the larvae, requiring constant regulation of air supply to prevent material from being blown out. Microwave and freeze drying were found to be dependent on the thickness of the larval bed to be dried, with higher loading rates resulting in higher moisture content and water activity. While conventional hot-air and freeze-drying techniques are highly effective, they are associated with lengthy processing times. Freezing larvae prior to drying is effective in decelerating microbial growth, but it has some drawbacks such as the degradation of the cell membrane which results in the loss of flavor and taste (Kröncke *et al.*, 2018).

In general, heat pretreatment is required to kill vegetative bacteria and limit the presence of aerobic spores. Blanching is currently the most often used pre-treatment step for insect drying to avoid browning, preserve colour and nutritional value, and inactivate enzymes and microorganisms that cause spoiling during storage. It is found to improve the drying process and the final quality and safety of insect products, but the particular parameters vary based on the insect and desired product properties (Hernández-Álvarez *et al.*, 2021). Also, the application of pulsed electric field (PEF) as a pre-treatment for *H. illucens* larvae before drying showed promise. Electric field strengths of 2 kV/cm and 3 kV/cm with specific energies ranging from 5 kJ/kg to 20 kJ/kg resulted in improved insect biomass and up to 30% reduction in drying time (Alles *et al.*, 2020).

Instant Controlled Pressure-drop (French acronym DIC) is a novel technology used mainly as a pretreatment for raw materials. This High-Temperature/Short-Time (HTST) hydro-thermo-mechanical treatment alters the structure of the treated materials through expansion. DIC pretreatment is known to improve solvent extraction (Jablaoui *et al.*, 2020; Mkaouar *et al.*, 2015), increase pressing yield (Pérez *et al.*, 2014), as well as being an extremely efficient microbial decontamination method (Allaf *et al.*, 2011). DIC can also be used as an extraction technique for both volatile molecules (such as essential oils) (Allaf *et al.*, 2013; Berka-Zougali *et al.*, 2010; Besombes *et al.*, 2010) and non-volatile compounds. DIC treatment typically improves drying kinetics while preserving product quality (Mounir *et al.*, 2012). With the DIC-induced texture expansion, conventional hot air drying can be significantly improved by avoiding the phenomenon

of shrinkage, reducing drying time, and increasing effective diffusivity and starting accessibility, thus reducing energy consumption and improving the quality of dried products (El Zahar *et al.*, 2015; Mounir *et al.*, 2011, 2018; Pech-Almeida *et al.*, 2021).

In two recent studies (El Hajj *et al.* “in press”, 2023) we investigated the impact of DIC pretreatment on yellow mealworms larval properties and compound extraction by pressing as a low-energy consuming dewatering and defatting approach, as well as its effect on pressing yield, product quality and microbial inactivation. The current work extends these previous studies by exploring for the first time the impact of DIC pretreatment on the drying process of insect larvae, analyzing its effects on drying kinetics, end-product quality, and sorption isotherm behaviour modelling.

## **2. Materials and methods**

### **2.1. Raw material**

Living *T. molitor* larvae were supplied by France insects farm (Crevecoeur-le-grand, France). Before processing, they were fasted for at least 24 h at 4°C and then sieved. On average, a larva weighs  $95 \pm 15$  mg, has a thickness of  $2 \pm 0.15$  mm, and has an average length of  $20 \pm 5$  mm. Larvae treated with DIC were initially alive, with an initial moisture content of 65%. The ones used as control samples were blanched at 90 °C for 4 min in preheated closed tubes, with no direct contact with water.

The welfare of insects was maximized in our work by following the foundation for ethical consideration of individuals, the '3Rs' of animal exploitation in research: Replace, Reduce, and Refine, and there are no legal concerns with the adopted killing methods.

### **2.2. Experimental protocol**

Instant Controlled Pressure Drop (DIC) was applied to living mealworms as a killing method and a pretreatment at once before drying them in a ventilated oven at 2 m/s at two different temperatures (50 and 60 °C). The control samples were blanched at 90 °C for 4 min and dried under the same drying conditions (Figure 1).



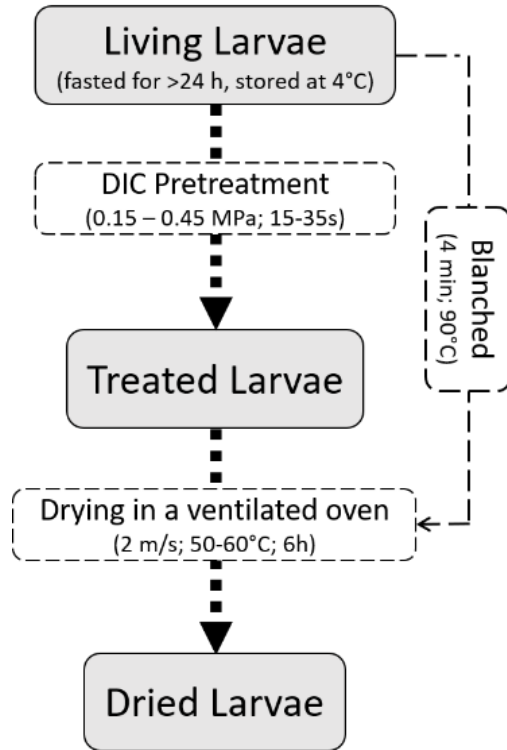
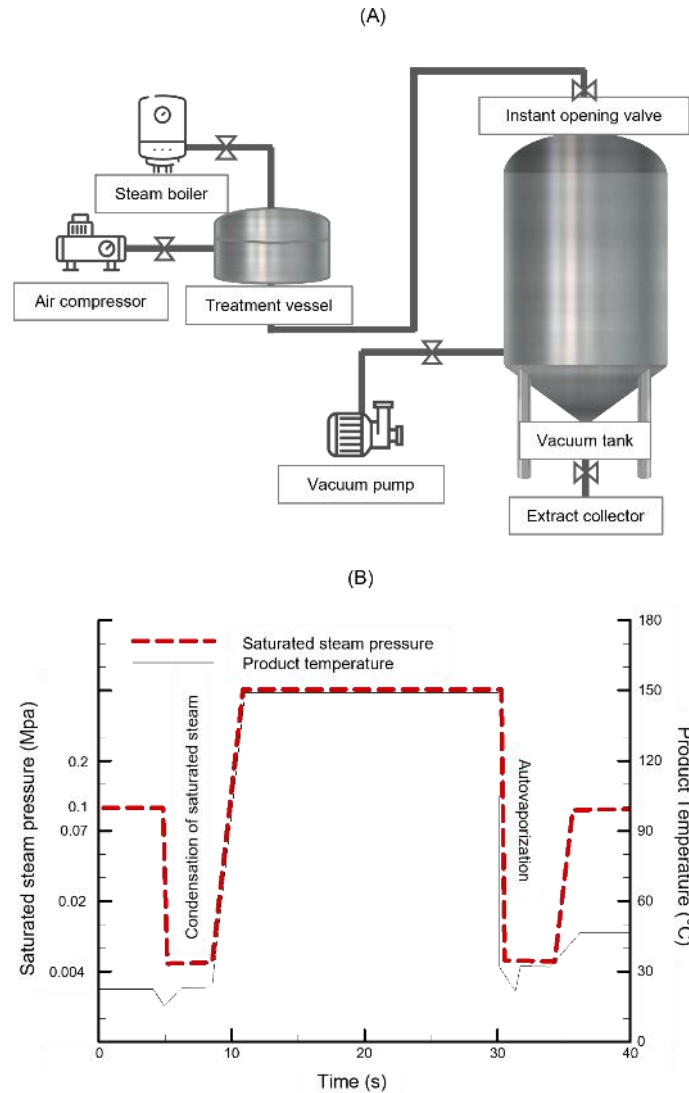

Figure 1. Experimental protocol

### 2.3. *Instant controlled pressure-drop DIC*

Larvae were treated with the DIC unit provided by ABCAR-DIC Process company (Compiègne, France). The DIC apparatus (Figure 2 (A)) includes a treatment chamber and a vacuum system connected by an instant opening valve.



**Figure 2.** Schematic representation of (A) Instant controlled pressure drop (DIC) apparatus and (B) the temperature and pressure correlations during a treatment cycle

The DIC treatment cycle presented in Figure 2 (B) consists of two steps: 1) a quick heating step that can induce an absolute pressure of up to 0.7 MPa and a temperature of 160 °C, and it is done by injecting saturated steam into the treatment chamber for less than 60 sec; 2) a prompt pressure drop that induces immediate auto-vaporization of water and some volatile molecules, an instant cooling of the sample, and often an expansion and texturing of the product (Allaf *et al.*, 2013; Bouallegue *et al.*, 2016; Mounir *et al.*, 2012). Going from a high-temperature-high-moisture state to a low-temperature/low-moisture state may lead the product to cross the glass transition ( $T_g$ ) zone from the rubbery (viscoelastic) to the glassy state allowing drying to occur without shrinking and the expanded structure to be kept (Mounir *et al.*, 2011).

Larvae treatment with DIC was carried out using a two-factor 5-level central composite experimental design with 230 g larvae treated per batch and at least two repetitions for each point.

The two independent variable factors were the pressure and the treatment time and were varied between 0.15-0.45 MPa and 15-35 s, respectively (Table 1).

**Table 1.** DIC-pretreatment experimental points

Factor	Point min (- $\alpha$ )	Point (-1)	Central point	Point (+1)	Point max (+ $\alpha$ )
Time (s)	15	18	25	32	35
Pressure (MPa)	0.150	0.194	0.300	0.400	0.450

Preliminary tests showed that the lowermost combination of 0.15 MPa/25 s was the larval mortality threshold. During the pressure drop step, the high rate of autovaporized water expels some of the visceral content into the vacuum tank while assuring an expansion of the larvae.

Equation (1) expresses the expulsion rate:

$$\text{Expulsion rate (\%)} = \frac{m_i - m_f}{m_i} \quad (1)$$

with  $m_i$  and  $m_f$  representing the mass of the larvae before and after DIC treatment, respectively, and the relative volumetric expansion was calculated based on the sample's volume variation as follows, Equation (2):

$$\text{Relative volumetric expansion (\%)} = \frac{V_f - V_i}{V_i} \quad (2)$$

with  $V_i$  and  $V_f$  representing a larva's average initial and final volumes obtained by dividing its average weight by its apparent density.

#### 2.4. Qualitative and quantitative analyses

The moisture content of the samples was assessed by drying them in an oven at 105°C for 24 h. A calliper was used to measure the thickness of the larvae, with at least 15 repetitions to determine the average thickness.

A gravimetric dynamic sorption analyzer (SPS23, ProUmid GmbH & Co, Germany) was used to determine the sorption isotherms and kinetics of dried yellow mealworm meal. This equipment can simultaneously measure the water vapour sorption isotherms on up to 23 samples. It records the value of every sample's water intake every 10 min using a high-accuracy microbalance ( $\pm 10 \mu\text{g}$ ). Samples were first dried in an oven at 105 °C for 24 h and then ground with a coffee grinder. They were then kept at 0% RH at the specified temperature for at least 48 h to ensure that they were totally dry. Following that, they were subjected to a series of relative humidity (RH) jumps at constant temperatures (20, 30 and 40°C) until reaching equilibrium. Once the humidification step was complete, the desorption cycle was carried out by gradually decreasing the RH to zero (Afrassiabian and Saleh, 2020).

A laser diffraction testing instrument (*Mastersizer 2000*, Malvern Panalytical, UK) was used to evaluate particle size distribution (PSD). The measurements were done on dried (at 105°C/24 h) and ground samples. Then the Sauter mean diameter (SMD or  $D_{32}$ ), which is the diameter of a sphere with the same volume-to-surface-area ratio as the particle of interest, was used to compute the specific surface area (Scala, 2013).

### 2.5. Drying kinetics

The drying was done in a ventilated oven (UN750, Memmert, Germany) at two different drying temperatures: 50 and 60 °C, with an airflow rate of 2 m/s measured using a digital anemometer (Shenzhen Tomtop Technology Co., Ltd., China). Samples of 50 g DIC-treated whole larvae were put in well-perforated stainless-steel baskets (65x70mm) and were weighed for 6 h at intervals of 30 min, then they were left at the same drying temperature overnight. After a total drying time of 20 h, samples were weighed, their moisture content was determined, and then they were left at the same drying temperature for 7 more days to determine the dry matter's content at the equilibrium level. The drying kinetics study was done in duplicate.

Moisture content on a dry basis is calculated using Equation (3) (Benseddik *et al.*, 2020):

$$M_t = \frac{m_t - m_d}{m_d} \quad (3)$$

where  $M_t$  is the sample's moisture content based on its dry weight at time  $t$  (g H<sub>2</sub>O/g db),  $m_t$  is the mass measured at time  $t$  (g), and  $m_d$  is the dry matter mass (g).

### 2.6. Modelling of drying kinetics

For the modelling of drying kinetics, larvae were considered as infinite slabs (Alles *et al.*, 2020; Da Silva *et al.*, 2019). Fick's second law of diffusion mathematically describes the kinetics of moisture transfer throughout the drying process (supposing  $D_{eff}$  is constant) (Benseddik *et al.*, 2019):

$$\frac{\partial M}{\partial t} = D_{eff} \nabla^2 M \quad (4)$$

where  $M$  is the moisture content,  $D_{eff}$  is the effective diffusivity (m<sup>2</sup>/s), and  $t$  is the time.

Assuming that the airflow velocity is greater than the Critical Airflow Velocity, we considered that the drying process is controlled by internal water diffusion. Furthermore, assuming that the airflow temperature and internal effective water diffusivity are constant and that there is no shrinkage, we may use Crank's analytical solution of Equation (4), which gives the total diffusing material that enters or leaves an infinite slab (Crank, 1979), Equation (5):

$$MR = \frac{M_t - M_\infty}{M_i - M_\infty} = \frac{8}{\pi^2} \sum_{n=0}^{\infty} \frac{1}{(2n+1)^2} \exp^{-\frac{(2n+1)^2 \pi^2 D_{eff} t}{dp^2}} \quad (5)$$

where MR is the moisture ratio,  $M_t$ ,  $M_i$ , and  $M_\infty$  are the moisture contents (g/g db), at time  $t$ ,  $t = 0$ , and  $t = \infty$ , respectively, and  $dp$  is the equivalent radius of the material (m).

Over a sufficiently long drying time, the second and all higher terms in Equation (5) are negligible when compared to the first term ( $n=1$ ) (Benseddik *et al.*, 2020; Chinenye *et al.*, 2010; Doymaz, 2007). As a result, Equation (5) can become the following:

$$MR = \frac{8}{\pi^2} \exp^{-\frac{\pi^2 D_{eff} t}{4dp^2}} \quad (6)$$

By rearranging Equation (6), we obtain:

$$\ln(MR) = \ln\left(\frac{8}{\pi^2}\right) - \frac{\pi^2 D_{eff} t}{4dp^2} \quad (7)$$

For the drying time  $t$  higher than the starting accessibility,  $\ln(MR)$  of the drying experimental data can be plotted versus drying time  $t$ , and the effective diffusivity  $D_{eff}$  can be calculated using the obtained slope  $k$  (Benseddik *et al.*, 2019; Chinenye *et al.*, 2010; Doymaz, 2007) as follows:

$$\text{Slope } k = -\frac{\pi^2 D_{eff}}{4dp^2} \quad (8)$$

## 2.7. Sorption isotherms modelling

In this study, we have applied Brunauer-Emmett-Teller (BET), Guggenheim-Anderson-de Boer (GAB), and Oswin models to fit our experimental sorption isotherms data. BET is the most frequent and commonly used two-parameter model. It gives good data fitting for a wide variety of foods throughout the range  $0.05 < a_w < 0.45$  (Brunauer *et al.*, 1938). On the other hand, the three-parameter GAB equation is the most accurate with the best-fitting model for a wide variety of foodstuffs throughout an extensive water activity range (up to 0.9). Both BET and GAB models indicate the quantity of water tightly bound to primary adsorption sites (monolayer value) (Marcos *et al.*, 1997). The BET and GAB models are mathematically expressed by their respective equations as follows:

$$\text{BET (Brunauer } et al., 1938) \quad M = \frac{M_0 C a_w}{(1 - a_w)(1 - a_w + C a_w)} \quad (9)$$

$$\text{GAB (Maroulis } et al., 1988) \quad EMC = \frac{M_0 C K a_w}{(1 - K a_w)(1 - K a_w + C K a_w)} \quad (10)$$

Where EMC and  $M_0$  are the equilibrium moisture content and the monolayer moisture content (g H<sub>2</sub>O/100g dry matter), respectively and C and K are the constants related to the sorption isotherm.

The conversion of BET and GAB models to linear and second-order polynomial equations, respectively, allows computing the values of the constants through the regression coefficients (Marcos *et al.*, 1997).

The purely empirical Oswin model Equation 11, which is based on mathematical series expansion for sigmoid-shaped curves (Chirife and Iglesias, 1978), has long been recognized as a good model for a wide range of isotherm types and materials with up to 0.5 water activity. The Oswin equation is the following:

$$\text{Oswin (Chia-Chung Chen, 1990)} \quad M = K \left( \frac{a_w}{1 - a_w} \right)^N \quad (11)$$

The linearization of equation (11) gives the sorption isotherm constants K and N (Télliez-Pérez *et al.*, 2015):

$$\ln M = N \ln \left( \frac{a_w}{1 - a_w} \right) + \ln K \quad (12)$$

The mean relative percentage deviation modulus (E) and the root mean square (RMS) allow evaluation of the model goodness-of-fit and pertinence (Iguedjtal *et al.*, 2008):

$$E(\%) = \frac{1}{N} \sum_{i=1}^N \frac{|M_{exp} - M_{th}|}{M_{exp}} \quad (13)$$

$$\text{RMS}(\%) = \sqrt{\frac{1}{N} \sum_{i=1}^N \left( \frac{M_{exp} - M_{th}}{M_{exp}} \right)^2} \quad (14)$$

Where  $M_{exp}$  is the experimental moisture content,  $M_{th}$  is the theoretical moisture content, and N is the number of experimental points.

Additionally, the solid surface area,  $\sigma$  (m<sup>2</sup>/g), was determined from the monolayer moisture content using Equation (15) (Iguedjtal *et al.*, 2008; Mazza and LeMaguer, 1978):

$$\sigma = \frac{A_{H2O} N_{Avogadro} M_0}{M_{H2O}} = 3530 M_0 \quad (15)$$

Where  $\sigma$  is the solid surface area (m<sup>2</sup>/g), A is the area of a water molecule (1.06x10<sup>-19</sup> m<sup>2</sup>),  $N_{Avogadro}$  is Avogadro's number (6x10<sup>23</sup> mol<sup>-1</sup>),  $M_0$  is the monolayer moisture content (g/g db),  $M_{H2O}$  is the molecular weight of water (18 g/mol).

## **2.8. *Experimental design and statistical analysis***

A two-factor central composite experimental design was used to treat larvae with different DIC conditions. The significance of variable variation was determined by analyzing the data obtained from the experimental study using ANOVA and Pareto charts (with a significance level of  $p < 0.05$ ) in Statgraphics (centurion XVI, StatPoint Technologies, Virginia, US).

As for all other experiments, a t-test (Microsoft excel) was used to determine the significance of the difference between the means of two groups with at least two measurements performed on each sample.

## **3. Results and discussions**

### **3.1. *Larval characteristics before and after the DIC treatment***

In our previous paper, different larval characteristics were measured before and after DIC treatment and the main findings are presented in Table 2 as they are relevant to the current study (El Hajj *et al.*, “in press”). The larvae’s moisture content and water activity ( $a_w$ ) show no significant difference, with an average value of  $65\% \pm 1.5$  and  $0.982 \pm 0.006$ , respectively. However, the blanched larvae's moisture content and water activity decreased slightly due to some water evaporation during the blanching process. The expulsion of the larval content to the vacuum tank ranges from 0% (0.15 MPa/25s) to 16.4% (0.45 MPa/25 s).

As a result of the DIC expansion, the larvae's thickness increases with the treatment intensity from 2.06 to 2.44 mm. There was no significant difference found between the larvae’s true (intrinsic) densities ( $1091 \pm 8.7$ ), however, the apparent density was found to decrease with increasing the treatment intensity, which is due to substance loss during expulsion as well as the increase in larvae’s thickness. Moreover, the calculated relative volumetric expansion ranges from 0 to 67.2% proportionally with the treatment intensity.

**Table 2.** Larval characteristics before and after the DIC treatment (El Hajj *et al.*, “in press”)

Run no. <sup>1</sup>	P (MPa)	t (s)	T (°C)	M (% wet basis)	a <sub>w</sub>	Ø (mm)	Expulsion (%)	ρ <sub>apparent</sub> (kg/m <sup>3</sup> )	V (mm <sup>3</sup> )	Relative expansion (%)
Living	/	/	/	65.0	/	2.06	/	/	/	/
Blanched	/	/	/	59.0	0.954	2.06	/	714.3	92	0.0
Central points <sup>2</sup> (1,4,7,10,13)	0.300	25	133.5	65.5	0.982	2.20	5.8	507.8	123	33.5
2	0.300	35	133.5	65.0	0.975	2.16	8.6	392.8	154	66.2
3	0.450	25	147.9	63.7	0.988	2.44	16.4	357.1	155	67.2
5	0.400	32	144.2	67.8	0.994	2.42	15.4	333.9	167	81.0
6	0.194	32	119.2	64.1	0.983	2.08	1.1	607.1	108	16.4
8	0.194	18	119.2	67.4	0.980	2.09	0.0	692.8	95	3.1
9	0.400	18	144.2	63.3	0.982	2.42	12.9	375.0	153	65.9
11	0.300	15	133.5	66.7	0.984	2.16	3.8	596.4	106	15.2
12	0.150	25	111.3	67.3	0.968	2.06	0.0	714.3	92	0.0
DIC average <sup>3</sup>				65.6 ±1.5	0.982 ±0.006					

<sup>1</sup> Run no. are numbers given to each experimental point in the experimental plan.

<sup>2</sup> Central points are repetitive runs at the centre of the experimental plan that provide an estimate of experimental error.

<sup>3</sup> DIC = instant controlled pressure-drop

### 3.2. Drying kinetics

Based on the drying experimental data, a linear correlation was found between  $\ln(MR)$  and time for all samples, with an average coefficient of determination ( $R^2$ ) of 0.99 at both drying temperatures (50 and 60 °C) and the effective moisture diffusivity ( $D_{\text{eff}}$ ) of each sample was calculated from the correlation's slope and is presented in Table 3. As can be observed, the DIC-treated larvae had effective water diffusivities ranging up to  $5.50 \cdot 10^{-11}$  and  $6.34 \cdot 10^{-11} \text{ m}^2/\text{s}$ , which are significantly higher than  $0.30 \cdot 10^{-11}$  and  $0.93 \cdot 10^{-11} \text{ m}^2/\text{s}$  for blanched samples, during drying at 50 and 60 °C, respectively. DIC pretreatment significantly improved diffusivity, increasing it up to 1833% and 682% for drying at 50 and 60 °C, respectively. The t-test revealed a significant difference in water diffusivity at 50°C between blanched larvae ( $0.3 \cdot 10^{-11}$ ) and DIC-treated 0.15 MPa/25s ( $0.6 \cdot 10^{-11}$ ) with  $t(2) = 5.08$ ,  $p = 0.0183$ . At 60°C, a similar trend was observed in diffusivity between blanched larvae ( $0.93 \cdot 10^{-11}$ ) and DIC-treated 0.15 MPa/25s ( $1.14 \cdot 10^{-11}$ ) with  $t(2) = 4.32$ ,  $p = 0.0247$ . Also, this significant difference in diffusivity was consistently observed between blanched and all higher DIC treatments. Moreover, the statistical analysis presented in Supplementary Table S1, Table S2 and Figure S1 allows a better understanding of the influence of DIC factors on effective moisture diffusivity. According to the Pareto charts and the estimated response surfaces, the water diffusivity within the material is positively correlated with the saturated steam pressure, which is the only factor affecting this response. Similarly, Albitar *et al.*, (2011) reported a 223% improvement in diffusivity for onion samples treated with DIC at 0.46 MPa for 14 s and dried at 40°C. On this subject, Alles *et al.*, (2020) observed an increase in



diffusion coefficient value of up to 170% for PEF-treated *H. illucens* larvae of at  $E = 2$  kV/cm and 20 kJ/kg when compared to untreated samples.

Azzollini *et al.*, (2016) reported that the  $D_{eff}$  values for yellow mealworm larvae showed a gradual increase as the temperature increased from 50 °C to 60 °C. At 60 °C, the values were 3.3 times higher than at 50 °C. In this study, we observed a similar pattern for blanched larvae, with values at 60 °C being three times higher than those at 50 °C. However, when the larvae were treated with DIC, this difference was reduced and continued to decrease as the treatment intensity increased. Eventually, for DIC-treated larvae at 0.45 MPa/25 s, the values at 60 °C were only 1.15 times higher than those at 50 °C.

**Table 3.** Effective moisture diffusivity of larvae dried at 50 and 60 °C after different treatments

Run no. <sup>1</sup>	Drying at 50 °C		Drying at 60 °C	
	$D_{eff}$ (x 10 <sup>-11</sup> m <sup>2</sup> /s)	Improvement of Diffusivity $\left(\frac{D_{eff}}{D_{eff_{Blanched}}}\right)$ (%)	$D_{eff}$ (x 10 <sup>-11</sup> m <sup>2</sup> /s)	Improvement of Diffusivity $\left(\frac{D_{eff}}{D_{eff_{Blanched}}}\right)$ (%)
Blanched	0.30	100	0.93	100
0.150 MPa/25 s	0.60	200	1.14	123
0.194 MPa/18 s	1.21	403	2.04	219
0.194 MPa/32 s	1.40	467	2.32	249
0.300 MPa/15 s	3.07	1023	4.16	447
0.300 MPa/25 s	2.97	992	4.46	479
0.300 MPa/35 s	4.02	1340	5.52	594
0.400 MPa/18 s	4.72	1573	5.06	544
0.400 MPa/32 s	5.16	1720	6.97	749
0.450 MPa/25 s	5.50	1833	6.34	682

<sup>1</sup> Run no. are numbers given to each experimental point in the experimental plan.

Conventionally, the shrinkage phenomenon, strictly associated with the hot air-drying process, enhances heat conductivity while decreasing water and vapour diffusivity inside the matter. As a result, the mass transfer becomes the limiting factor, significantly decreasing the drying kinetics (Louka *et al.*, 2004). The obtained hard dried particles are difficult to grind, leading to thick and large particle dimensions, which results in a low specific surface area powder and undesirable functional, sanitary, nutritional, and sensory properties (Mounir *et al.*, 2011).

However, in the present study, DIC treatment overcame the shrinking concerns of the drying process (Figure 3). Larval thickness measurement pre- and post-drying (at 50 and 60°C) for samples that underwent different treatment conditions (Table 4), shows that for the blanched larvae and the ones treated with DIC at 0.150 MPa for 25 s and at 0.194 MPa for 18 s, the thickness has shrunk from 2 to 1.5 mm after the drying step at both drying temperatures. When treated at 0.194 MPa for 32 s and above, larval thickness remains constant after drying, which could be explained

by crossing the previously mentioned glass transition state ( $T_g$ ), increasing diffusivity and improving drying kinetics significantly.

The paired t-test was used to statistically analyze the variability in larvae thickness before and after drying at 50 and 60°C for blanched and DIC-treated samples. The results indicated that the thickness significantly changed after drying at both temperatures for the blanched and DIC-treated larvae at 0.15 MPa/25s and 0.194 MPa/18s, with  $t(2) = 36.93$ ;  $p = 0.0003$  at 50 °C and  $t(2) = 25.46$ ;  $p = 0.0007$  at 60°C. As for the remaining DIC-treated larvae, the paired t-test results showed that there was no significant change in the thickness before and after drying at both temperatures, with  $t(6) = -0.22$ ;  $p = 0.415$  at 50 °C and  $t(6) = 1.03$ ;  $p = 0.171$  at 60 °C.

Purschke *et al.*, (2018) evaluated the morphology of yellow mealworms following conventional hot air drying, freeze-drying, and fluidized bed drying. They stated that freeze-drying preserves the original structure of larvae by preventing undesirable shrinkage and producing dried larvae that have high porosity. However, due to tissue collapse and loss of porosity, oven and fluidized bed drying generated shrivelled larvae with decreased length and diameter and a much higher density than freeze-dried larvae.

Furthermore, as can be seen in Figure 3, the colour of the dried larvae appeared lighter when the DIC treatment intensity was increased. This colour change is most likely caused by the inhibition of the enzymes that induce oxidation, which is an effect previously observed in bananas treated by the DIC (Setyoprato *et al.*, 2012). According to Purschke *et al.*, (2018), untreated air-dried *Tenebrio molitor* larvae at 80 °C displayed a low colour lightness due to a combination of enzymatic and non-enzymatic browning, resulting in the formation of brown pigments. Blanching followed by oven drying or fluidized bed drying caused less browning due to the inactivation of some browning enzymes. Blanching followed by freeze-drying was found to be the method that best preserved the colour. However, Azzollini *et al.*, (2016) have stated that fresh freeze-dried *T. molitor* larvae had a higher luminosity compared to blanched freeze-dried, unblanched air-dried at 70 °C, and blanched air-dried at 50 °C, 60 °C, and 70 °C. They suggested that blanching treatments and extended drying at high temperatures, necessary to achieve dehydration equilibrium, likely facilitated non-enzymatic browning reactions which are well-known to cause a reduction in lightness values.

**Table 4.** Larvae thickness before and after drying kinetics at 50 °C and 60 °C

Treatment conditions	Ø Before drying (mm)	Ø (mm) after drying at 50 °C	Ø (mm) after drying at 60 °C
Blanched	2.06 ± 0.05	1.50 ±0.02	1.50 ±0.02
0.150 MPa/25 s	2.06 ± 0.2	1.55 ±0.15	1.57 ±0.33
0.194 MPa/18 s	2.09 ± 0.23	1.55 ±0.17	1.55 ±0.17
0.194 MPa/32 s	2.08 ± 0.24	2.17 ±0.19	2.18 ±0.19
0.300 MPa/15 s	2.16 ± 0.15	2.15 ±0.37	2.15 ±0.37

0.300 MPa/25 s	2.20 ± 0.26	2.19 ±0.23	2.15 ±0.19
0.300 MPa/35 s	2.16 ± 0.21	2.22 ±0.21	2.1 ±0.11
0.400 MPa/18 s	2.42 ± 0.42	2.39 ±0.42	2.39 ±0.42
0.400 MPa/32 s	2.42 ± 0.5	2.37 ±0.36	2.40 ±0.4
0.450 MPa/25 s	2.44 ± 0.31	2.42 ±0.3	2.34 ±0.32



**Figure 3.** Photos of larvae in ascending order from blanched to the highest DIC-treatment intensity

After 6 h of drying (Table 5), the blanched larvae had a final dry matter content of 35% and 44% (1.88 and 1.29 g H<sub>2</sub>O/g db), for drying at 50 and 60 °C, respectively. As for the DIC-treated larvae, the final dry matter content increased with increasing the treatment intensity until reaching a maximum value of 77% and 85% (0.3 and 0.18 g H<sub>2</sub>O/g db) for drying at 50 and 60°C respectively, for DIC treatment at 0.450 MPa/25 s. Albitar *et al.* (2011), observed a similar improvement where the moisture content of DIC-treated onion decreased from 4.15 to 0.05 g/g db in 700 min compared to 3200 min for the untreated onion.

**Table 5.** Dry matter content (wet basis) and moisture content (dry basis) after the hot air-drying process

Treatment conditions	Drying at 50 °C				Drying at 60 °C			
	After drying kinetics (6h)		At equilibrium level (7 days at 50°C)		After drying kinetics (6h)		At equilibrium level (7 days at 60°C)	
	% DM	g H <sub>2</sub> O /g db	% DM	g H <sub>2</sub> O /g db	% DM	g H <sub>2</sub> O /g db	% DM	g H <sub>2</sub> O /g db
Blanched	35 ±1.6	1.88	97.0	0.03	44 ±0.0	1.29	96.8	0.03
0.15 MPa/25s	41 ±1.9	1.44	97.6	0.02	50 ±0.4	1.02	98.0	0.02
0.19 MPa/18s	46 ±3.4	1.19	97.9	0.02	53 ±4.0	0.88	98.2	0.02
0.19 MPa/32s	47 ±1.6	1.14	98.2	0.02	59 ±4.1	0.71	98.2	0.02
0.30 MPa/15s	64 ±0.2	0.57	98.6	0.01	75 ±1.8	0.33	98.6	0.01
0.30 MPa/25s	65 ±4.6	0.54	98.9	0.01	76 ±6.3	0.33	98.8	0.01

0.30 MPa/35s	75 ±0.4	0.34	98.9	0.01	85 ±0.1	0.18	98.7	0.01
0.40 MPa/18s	76 ±1.9	0.32	98.9	0.01	75 ±0.6	0.33	98.9	0.01
0.40 MPa/32s	77 ±3.2	0.30	98.7	0.01	85 ±1.7	0.18	98.8	0.01
0.45 MPa/25s	76 ±8.2	0.33	99.0	0.01	82 ±5.4	0.23	98.9	0.01

Figure 4 shows that larvae treated with DIC at 0.15, 0.3 and 0.45 MPa for 25 s required respectively 135, 60, and 41 min of drying at 50 °C to obtain the moisture content of 1.88 g/g db. The same moisture content was reached after 360 min of drying for the blanched larvae, which reflects a decrease of 88% in drying time. Additionally, at 60°C, the same samples took 270, 120, and 90 min, respectively to reach a moisture content of 1.29 g/g db, against 360 min of drying for the blanched larvae (75% decrease in drying time). On this subject, Alles *et al.*, (2020) found that the application of Pulsed electric fields ( $E = 2$  kV/cm and  $W = 20$  kJ/kg) on *H. illucens* larvae as a pre-treatment before drying decreased the drying time by around 30%.

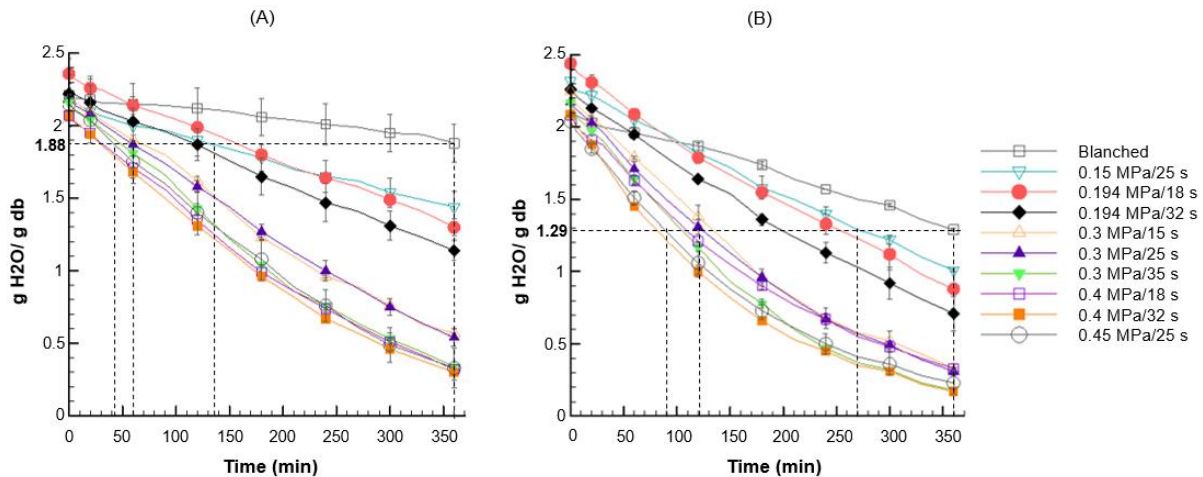

**Figure 4.** Moisture content (M, g H<sub>2</sub>O/g db) kinetics during drying at (A) 50 °C, and (B) 60 °C for 6 h after different treatment conditions

### 3.3. Particle size distribution and specific surface area

Figure 5 shows that the ground larval meals of blanched and DIC-treated larvae do not have a noticeable difference in particle volume (%). However, DIC-treated meal has a more homogenous distribution of particle size number (%), implying a more uniform and easier grinding, with no effect of treatment intensity. Likewise, Purschke *et al.*, (2018) noted that the low-density, porous structure of freeze-dried *T. molitor* larvae resulted in a significantly lower compression force required for deformation as compared to the shrunk, compacted structure of thermally dried samples.

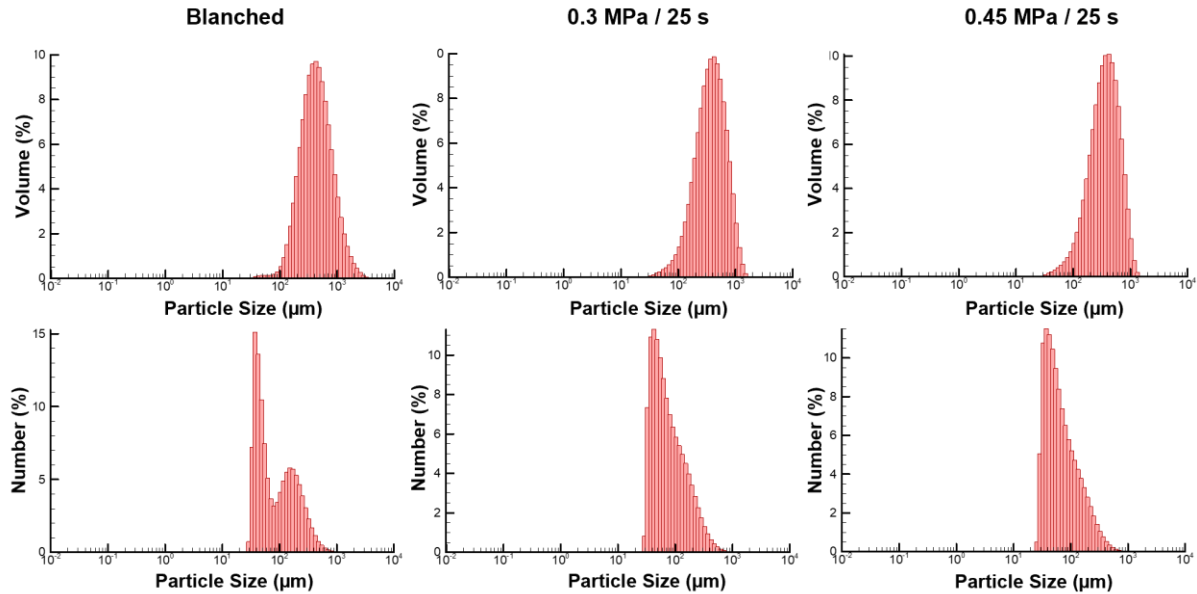

**Figure 5.** Particle size distribution in volume (%) and number (%) for the untreated and DIC-treated larvae at 0.3 MPa/25s and 0.45 MPa/25s

According to Table 6, blanched and DIC-treated larvae at 0.3 MPa/25 s and 0.45 MPa/25 s have a specific surface area of 15.87, 18.75, and 19.93 m<sup>2</sup>/kg, respectively. These findings indicate an increase in specific surface area of 118% and 125% for DIC-treated larvae at 0.3 MPa/25s and 0.45 MPa/25 s, respectively, as compared to blanched larvae. Thus, the higher the saturated steam pressure, the greater the specific surface area, which is linked to the expanded structure of DIC-textured larvae (Mounir and Allaf, 2008). A similar effect was observed with swell-dried apple powder, where a 200 % increase was observed at 0.3 MPa/18 s (Mounir *et al.*, 2011). In this regard, Mounir *et al.* (2018) stated that expanded granule structures often allow for an increase in specific surface area. This finding is particularly interesting given that manufacturers strive for extremely fine powder to increase specific surface area, expedite drying kinetics, and improve functional qualities.

**Table 6.** Specific surface area (m<sup>2</sup>/kg) of dried larvae meal

Treatment	Specific surface area (m <sup>2</sup> /kg)
Blanched	15.87 ± 0.586
DIC-treated 0.3 MPa/25 s	18.75 ± 0.566
DIC-treated 0.45 MPa/25 s	19.93 ± 0.8303

### 3.4. Isotherms of sorption

Figure 6 shows sigmoid-shaped sorption isotherms that correspond to type II of Brunauer's classification (Brunauer *et al.*, 1940). This isotherm is seen in many hygroscopic products and is caused by the monolayer-multilayer sorption process (Al-Muhtaseb *et al.*, 2002). Type II has been previously reported for *T. molitor* (Azzollini *et al.*, 2016), *A. domesticus* and *H. illucens* larvae (Kamau *et al.*, 2018).

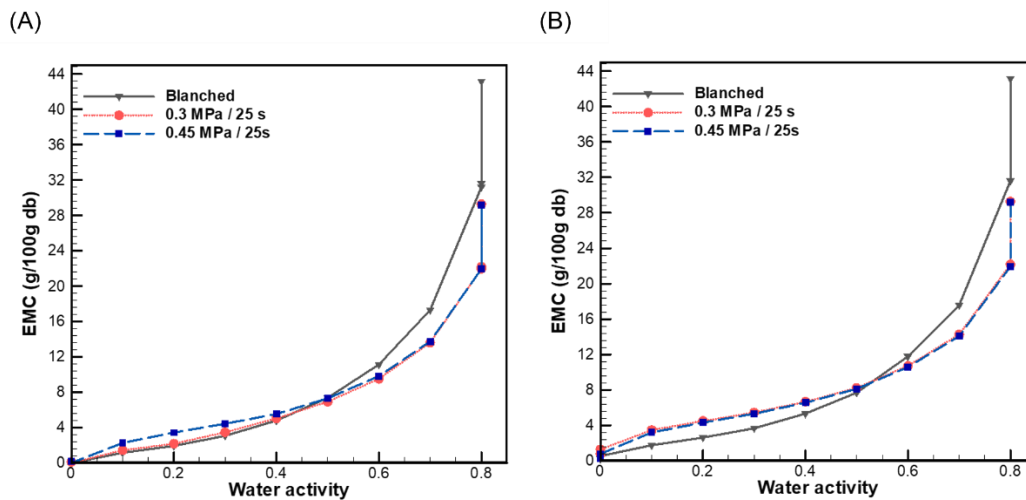

**Figure 6.** (A) adsorption and (B) desorption isotherms at 20 °C of blanched and DIC-treated larvae at 0.3 MPa/25 s and 0.45 MPa/25 s

It is worth stating the presence of a hysteresis phenomenon between adsorption and desorption curves. Figure 7 shows that during the desorption phase, for a given equilibrium relative humidity, more moisture is retained, leading to the detection of higher moisture content (Caballero-Cerón *et al.*, 2015).

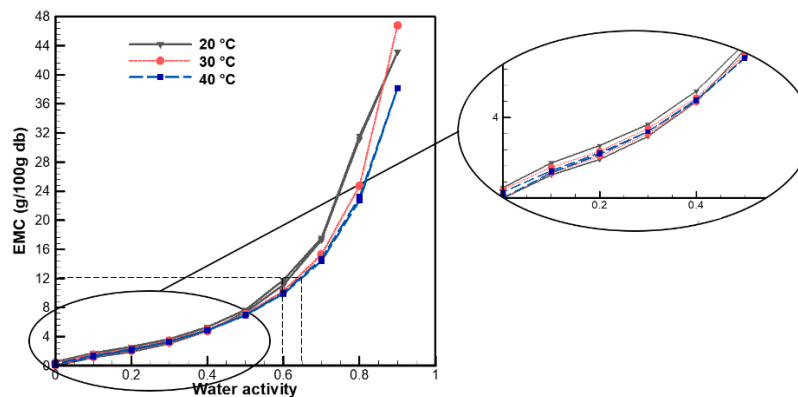
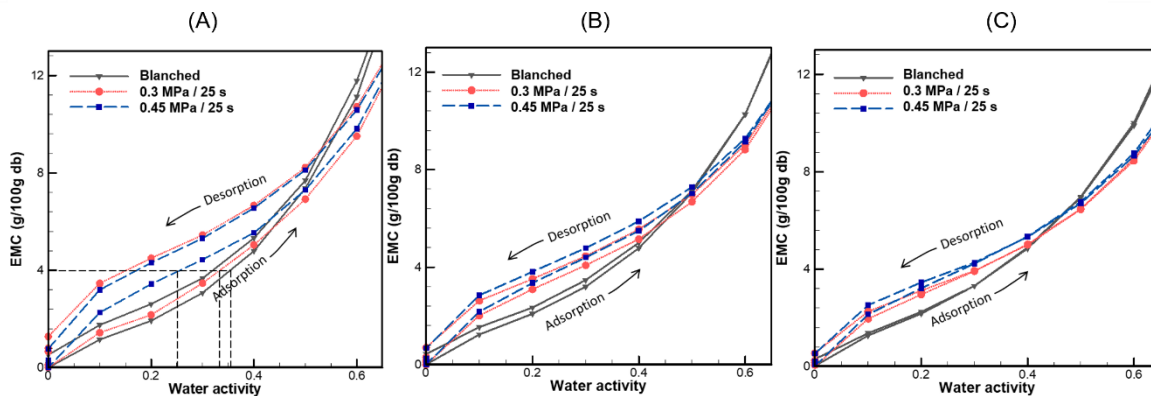

**Figure 7.** Sorption isotherms of blanched larvae at 20, 30 and 40 °C

In food products, water mobility and the dynamic exchange between vapour and absorbed phases are affected by temperature. When temperature rises, the binding energy between molecules decreases, resulting in a drop in water molecule adsorption capacity (reduced product hygroscopy), leading to changes in the sorption isotherm. As illustrated in Figure 7, increasing the temperature (from 20 to 40 °C) leads to an increase of  $a_w$  (from 0.6 to 0.65) at the same equilibrium moisture content (12 g H<sub>2</sub>O/100 g db), denoting a reduction in the total number of active sites for water adsorption due to physical or chemical changes caused by higher temperatures (Abdulla *et al.*, 2009; Caballero-Cerón *et al.*, 2015; Iguedjtal *et al.*, 2007).

At  $a_w < 0.5$ , for a given equilibrium moisture content (EMC), DIC-treated samples have lower water activity than raw material. It is worth noting that the higher the saturated steam pressure, the lower the water activity (Figure 8). For example, for an EMC of 4 g H<sub>2</sub>O/100 g db,  $a_w$  is equal to 0.35, 0.33, and 0.25 for the blanched, and DIC-treated larvae at 0.3 MPa/25 s and 0.45 MPa/25 s, respectively.

The greater expansion and porosity of DIC-treated products can explain this behaviour. Indeed, an increase in the available surface for the hydrophilic water-binding (polar sites) decreases the amount of free water. Therefore, DIC-treated products are likely to be more stable at the same moisture content than non-treated ones (Iguedjtal *et al.*, 2008; Téllez-Pérez *et al.*, 2015).



**Figure 8.** Sorption isotherms ( $0 < a_w < 0.65$ ) for DIC-treated and non-treated larvae at (A) 20°C, (B) 30 °C and (C) 40 °C

### 3.5. Modelling

The isotherm models (BET, GAB, and Oswin) were applied to fit the experimental data for dried larvae (Supplementary Figures S2, S3, S4, and S5). Tables 7, 8, 9 and 10 displays the estimated parameters values from the models, the mean relative deviation (E), and the root mean square (RMS). Lower E and RMS values indicate a better fitting of the model.

The results show that the models do not provide a good fit for the sorption data of blanched larvae ( $5 \% < E < 10 \%$  and  $5 \% < RMS < 14 \%$ ) (Table 7). Conversely, the DIC-treated larvae at 0.194 MPa/32 s (Table 8) presented improved values of E and RMS but were still in the high ranges.

However, the models fit very well for DIC-treated larvae at 0.3 MPa/25 s and 0.45 MPa/25 s (Tables 9 and 10) with a deviation modulus E and RMS of less than 4%. Hence, BET, GAB, and Oswin equations are suitable for modelling the isothermal water sorption in the case of DIC-treated dried larvae. Our results are not in line with those of Azzollini *et al.*, (2016), who reported that the GAB model was suitable for interpolating isotherms of blanched air-dried *T. molitor* larvae.

The monolayer moisture content ( $M_0$ ) is the optimal moisture content to maximize the shelf life of dry products and enhance their stability and powdering operations, it typically falls between  $a_w$  values of 0.2 to 0.4. When moisture content exceeds the monolayer level, chemical reactions that require water can occur, while both above and below this value the lipid oxidation rate increases (Azzollini *et al.*, 2016). The data presented in Tables 9 and 10 of larvae treated at 0.3 and 0.45 MPa/25 s (E and RMS < 4%), show that the monolayer moisture content, estimated through the use of BET and GAB models, is around 3.7 g H<sub>2</sub>O/100 g dry matter.

The solid surface area calculated from the monolayer moisture content is shown to increase with increasing the DIC treatment intensity (Tables 9 and 10). Regardless of the temperature, for the adsorption and desorption data, the average surface area in both BET and GAB models increases from 127 to 137.7 m<sup>2</sup>/g for DIC-treated larvae at 0.3 and 0.45 MPa for 25s, respectively. Here too, the increase of DIC-induced expansion coupled with the formation of a microporous structure and a greater surface of adsorption may explain this phenomenon. Iguedjal *et al.* (2007, 2008) observed a similar effect with granny smith apples and potatoes.

**Table 7.** Sorption model constants for Blanched larvae

		Blanched					
		ADSORPTION			DESORPTION		
		20°C	30°C	40°C	20°C	30°C	40°C
<b>BET</b>	$M_0$ (g/100g db)	5.272	4.731	4.651	4.563	4.363	4.401
	$\sigma$ (m <sup>2</sup> /g)	186.112	166.987	164.186	161.081	154.014	155.373
	C	1.877	2.395	2.599	3.796	3.454	3.023
	<b>E (%)</b>	<b>7.8%</b>	<b>6.1%</b>	<b>4.8%</b>	<b>7.7%</b>	<b>6.9%</b>	<b>5.7%</b>
	<b>RMS (%)</b>	<b>8.7%</b>	<b>6.7%</b>	<b>5.4%</b>	<b>8.6%</b>	<b>7.8%</b>	<b>6.4%</b>
<b>GAB</b>	$M_0$ (g/100g db)	4.597	4.534	4.462	4.112	4.214	4.201
	$\sigma$ (m <sup>2</sup> /g)	162.269	160.033	157.498	145.146	148.764	148.306
	C	2.106	2.477	2.705	4.193	3.509	3.149
	K	1.068	1.032	1.027	1.075	1.038	1.033
	<b>E (%)</b>	<b>10.6%</b>	<b>9.0%</b>	<b>5.8%</b>	<b>10.4%</b>	<b>9.8%</b>	<b>6.3%</b>
	<b>RMS (%)</b>	<b>14.6%</b>	<b>12.2%</b>	<b>7.3%</b>	<b>14.4%</b>	<b>13.3%</b>	<b>7.7%</b>
<b>Oswin</b>	A	6.798	6.686	6.686	7.076	6.680	5.895
	B	0.844	0.777	0.777	0.672	0.702	0.480
	<b>E (%)</b>	<b>6.7%</b>	<b>3.7%</b>	<b>3.7%</b>	<b>6.5%</b>	<b>5.6%</b>	<b>3.4%</b>
	<b>RMS (%)</b>	<b>7.5%</b>	<b>4.0%</b>	<b>4.0%</b>	<b>7.1%</b>	<b>6.2%</b>	<b>3.7%</b>



**Table 8.** Sorption model constants for DIC-treated larvae at 0.194 MPa/18 s

DIC-treated 0.194 MPa/18 s							
		ADSORPTION			DESORPTION		
		20°C	30°C	40°C	20°C	30°C	40°C
<b>BET</b>	M <sub>0</sub> (g/100g db)	4.666	3.540	3.493	4.021	3.516	3.387
	σ (m <sup>2</sup> /g)	164.708	124.954	123.301	141.928	124.126	119.551
	C	1.741	5.971	6.006	14.288	7.990	6.405
	E (%)	<b>9.9%</b>	<b>3.4%</b>	<b>3.3%</b>	<b>3.4%</b>	<b>4.4%</b>	<b>4.8%</b>
	RMS (%)	<b>11.4%</b>	<b>3.7%</b>	<b>3.7%</b>	<b>4.1%</b>	<b>5.1%</b>	<b>5.5%</b>
<b>GAB</b>	M <sub>0</sub> (g/100g db)	4.080	3.564	3.483	3.905	3.522	3.320
	σ (m <sup>2</sup> /g)	144.012	125.798	122.936	137.847	124.322	117.195
	C	2.023	5.790	6.012	15.451	7.870	6.652
	K	1.043	1.014	1.011	1.030	1.013	1.017
	E (%)	<b>10.3%</b>	<b>5.6%</b>	<b>4.0%</b>	<b>3.2%</b>	<b>6.0%</b>	<b>5.0%</b>
<b>Oswin</b>	RMS (%)	<b>11.5%</b>	<b>7.2%</b>	<b>4.7%</b>	<b>4.0%</b>	<b>7.5%</b>	<b>5.8%</b>
	A	5.820	5.974	5.899	7.230	6.065	5.708
	B	0.852	0.590	0.589	0.428	0.521	0.564
	E (%)	<b>9.5%</b>	<b>2.9%</b>	<b>2.7%</b>	<b>4.4%</b>	<b>4.2%</b>	<b>4.3%</b>
	RMS (%)	<b>10.4%</b>	<b>3.1%</b>	<b>2.9%</b>	<b>4.7%</b>	<b>4.5%</b>	<b>4.6%</b>

**Table 9.** Sorption model constants for DIC-treated larvae at 0.3 MPa/25 s

DIC-treated 0.3 MPa/25 s							
		ADSORPTION			DESORPTION		
		20°C	30°C	40°C	20°C	30°C	40°C
<b>BET</b>	M <sub>0</sub> (g/100g db)	3.665	3.600	3.489	3.911	3.579	3.333
	σ (m <sup>2</sup> /g)	129.387	127.082	123.145	138.058	126.356	117.651
	C	7.813	7.951	7.996	14.960	12.763	10.459
	E (%)	<b>3.1%</b>	<b>1.6%</b>	<b>1.7%</b>	<b>1.8%</b>	<b>2.2%</b>	<b>3.1%</b>
	RMS (%)	<b>3.5%</b>	<b>1.7%</b>	<b>2.0%</b>	<b>2.2%</b>	<b>2.7%</b>	<b>3.6%</b>
<b>GAB</b>	M <sub>0</sub> (g/100g db)	3.596	3.715	3.486	3.880	3.652	3.273
	σ (m <sup>2</sup> /g)	126.944	131.135	123.058	136.972	128.914	115.531
	C	7.802	7.441	8.032	15.360	12.183	11.100
	K	1.034	0.991	1.002	1.009	0.991	1.011
	E (%)	<b>4.4%</b>	<b>3.2%</b>	<b>1.9%</b>	<b>1.8%</b>	<b>3.2%</b>	<b>2.7%</b>
<b>Oswin</b>	RMS (%)	<b>5.5%</b>	<b>4.0%</b>	<b>2.1%</b>	<b>2.1%</b>	<b>3.9%</b>	<b>3.0%</b>
	A	6.383	6.306	6.107	7.113	6.426	5.895
	B	0.538	0.543	0.541	0.434	0.452	0.480
	E (%)	<b>2.9%</b>	<b>1.6%</b>	<b>1.7%</b>	<b>2.9%</b>	<b>3.0%</b>	<b>3.4%</b>
	RMS (%)	<b>3.1%</b>	<b>1.8%</b>	<b>1.8%</b>	<b>3.1%</b>	<b>3.2%</b>	<b>3.7%</b>

**Table 10.** Sorption model constants for DIC-treated larvae at 0.45 MPa/25 s

DIC-treated 0.45 MPa/25 s							
		ADSORPTION			DESORPTION		
		20°C	30°C	40°C	20°C	30°C	40°C
<b>BET</b>	M <sub>0</sub> (g/100g db)	3.969	3.892	3.748	4.277	3.863	3.558
	σ (m <sup>2</sup> /g)	140.101	137.385	132.315	150.992	136.368	125.599
	C	8.910	9.000	9.188	17.114	16.265	14.300
	E (%)	<b>1.8%</b>	<b>0.5%</b>	<b>0.8%</b>	<b>1.0%</b>	<b>1.1%</b>	<b>1.5%</b>

	<b>RMS (%)</b>	<b>2.0%</b>	<b>0.6%</b>	<b>1.0%</b>	<b>1.3%</b>	<b>1.4%</b>	<b>1.9%</b>
<b>GAB</b>	$M_0$ (g/100g db)	3.813	4.075	3.869	4.142	3.993	3.627
	$\sigma$ (m <sup>2</sup> /g)	134.607	143.841	136.581	146.210	140.946	128.046
	C	9.402	8.187	8.682	19.477	14.962	13.794
	K	1.038	0.972	0.975	1.019	0.974	0.984
	<b>E (%)</b>	<b>2.2%</b>	<b>1.9%</b>	<b>1.4%</b>	<b>1.5%</b>	<b>1.9%</b>	<b>1.8%</b>
	<b>RMS (%)</b>	<b>2.7%</b>	<b>2.4%</b>	<b>1.5%</b>	<b>2.2%</b>	<b>2.2%</b>	<b>2.0%</b>
<b>Oswin</b>	A	7.037	6.920	6.656	7.847	7.050	6.446
	B	0.522	0.528	0.521	0.421	0.427	0.441
	<b>E (%)</b>	<b>2.0%</b>	<b>1.0%</b>	<b>1.1%</b>	<b>2.0%</b>	<b>2.4%</b>	<b>2.6%</b>
	<b>RMS (%)</b>	<b>2.3%</b>	<b>1%</b>	<b>1.1%</b>	<b>3.0%</b>	<b>2.6%</b>	<b>2.9%</b>

#### 4. Conclusion

DIC treatment induces larval expansion and eradicates product shrinkage, which is one of the critical challenges of drying, and consequently, it has highly improved water diffusivity. This has resulted in easier and finer grinding and an increase in the meal's specific surface area as well as a more homogeneous particle size distribution, leading to high-end product quality.

Furthermore, the sorption isotherm models: BET, GAB, and Oswin, were found to fit well the experimental data of DIC-treated dried yellow mealworms at 0.3 MPa/25 s and 0.45 MPa/25 s. Moreover, DIC-treated samples had lower water activity at the same equilibrium moisture content than non-treated larvae. This phenomenon is attributed to the product's expansion and the microporous structure induced by DIC, leading to an increase in the available surface for the polar sites, and thus a decrease in the amount of free water. As a result, at the same moisture content, DIC-treated products are considered to be more stable than non-treated ones. The findings in this study represent a step forward in the optimization of insect larvae drying processes; however, further research is needed.

#### 5. Statements & Declarations

**Conflict of interest:** The authors declare no conflict of interest.

**Funding:** This work is a part of the project RAFINSECT funded by the Hauts-de-France region.

#### 6. References

- Abdulla, G., Belghit, A. and Allaf, K., 2009. Impact of instant controlled pressure drop treatment on moisture adsorption isotherm of cork granules. *Drying Technology* 27: 237-247. <https://doi.org/10.1080/07373930802605990>
- Afrassiabian, Z. and Saleh, K., 2020. Caking of anhydrous lactose powder owing to phase transition and solid-state hydration under humid conditions: from microscopic to bulk behavior. *Powder Technology*, 363: 488-499. <https://doi.org/10.1016/J.POWTEC.2020.01.033>

- Al-Muhtaseb, A.H., McMinn, W.A.M. and Magee, T.R.A., 2002. Moisture sorption isotherm characteristics of food products: a review. *Food and Bioproducts Processing*, 80: 118-128. <https://doi.org/10.1205/09603080252938753>
- Albitar, N., Mounir, S., Besombes, C. and Allaf, K., 2011. Improving the drying of onion using the instant controlled pressure drop technology. *Drying Technology* 29: 993-1001. <https://doi.org/10.1080/07373937.2010.507912>
- Allaf, T., Besombes, C., Mih, I., Lefevre, L. and Allaf, K., 2011. Decontamination of solid and powder foodstuffs using DIC technology. In: Schmidt, M. (ed.) *Advances in Computer Science and Engineering*. <https://doi.org/10.5772/16025>
- Allaf, T., Tomao, V., Ruiz, K. and Chemat, F., 2013. Instant controlled pressure drop technology and ultrasound assisted extraction for sequential extraction of essential oil and antioxidants. *Ultrasonics Sonochemistry* 20: 239-246. <https://doi.org/10.1016/j.ultsonch.2012.05.013>
- Alles, M.C., Smetana, S., Parniakov, O., Shorstkii, I., Toepfl, S., Aganovic, K. and Heinz, V., 2020. Bio-refinery of insects with pulsed electric field pre-treatment. *Innovative Food Science & Emerging Technologies*, 64: 102403. <https://doi.org/10.1016/J.IFSET.2020.102403>
- Azzollini, D., Derossi, A. and Severini, C., 2016. Understanding the drying kinetic and hygroscopic behaviour of larvae of yellow mealworm (*Tenebrio molitor*) and the effects on their quality. *Journal of Insects as Food and Feed*, 2: 233-243. <https://doi.org/10.3920/JIFF2016.0001>
- Benseddik, A., Azzi, A., Lalmi, D., Bensaha, H., Zidoune, M.N. and Allaf, K., 2020. Empirical mathematical model to evaluate the effective diffusivity of pumpkin slice during forced air convection dryer. In: Belasri, A., Beldjilali, S. (eds) *ICREEC 2019*. Springer Proceedings in Energy. Springer, Singapore, pp. 45-52. [https://doi.org/10.1007/978-981-15-5444-5\\_6](https://doi.org/10.1007/978-981-15-5444-5_6)
- Benseddik, A., Azzi, A., Zidoune, M.N., Khanniche, R. and Besombes, C., 2019. Empirical and diffusion models of rehydration process of differently dried pumpkin slices. *Journal of the Saudi Society of Agricultural Sciences King Saud University*, 18: 401-410. <https://doi.org/10.1016/j.jssas.2018.01.003>
- Berka-Zougali, B., Hassani, A., Besombes, C. and Allaf, K., 2010. Extraction of essential oils from algerian myrtle leaves using instant controlled pressure drop technology. *Journal of Chromatography A* 1217: 6134-6142. <https://doi.org/10.1016/j.chroma.2010.07.080>
- Besombes, C., Berka-Zougali, B. and Allaf, K., 2010. Instant controlled pressure drop extraction of lavandin essential oils: fundamentals and experimental studies. *Journal of Chromatography A* 1217: 6807-6815. <https://doi.org/10.1016/j.chroma.2010.08.050>
- Bouallegue, K., Allaf, T., Ben Younes, R. and Allaf, K., 2016. Texturing and instant cooling of rapeseed as pretreatment prior to pressing and solvent extraction of oil. *Food and Bioprocess Technology* 9: 1521-1534. <https://doi.org/10.1007/S11947-016-1734-X>
- Brunauer, S., Deming, L.S., Deming, W.E. and Teller, E., 1940. On a theory of the Van der Waals adsorption of gases. *Journal of the American Chemical Society* 62: 1723-1732. <https://doi.org/10.1021/JA01864A025>

- Brunauer, S., Emmett, P.H. and Teller, E., 1938. Adsorption of gases in multimolecular layers. *Journal of the American Chemical Society* 60: 309-319. <https://doi.org/10.1021/ja01269a023>
- Caballero-Cerón, C., Guerrero-Beltrán, J.A., Mújica-Paz, H., Torres, J.A. and Welti-Chanes, J., 2015. Moisture sorption isotherms of foods: experimental methodology, mathematical analysis, and practical applications. In: Gutiérrez-López, G., Alamilla-Beltrán, L., del Pilar Buera, M., Welti-Chanes, J., Parada-Arias, E., Barbosa-Cánovas, G. (eds) *Water Stress in Biological, Chemical, Pharmaceutical and Food Systems*. Food Engineering Series. Springer, New York, NY. [https://doi.org/10.1007/978-1-4939-2578-0\\_15](https://doi.org/10.1007/978-1-4939-2578-0_15)
- Chia-Chung Chen, 1990. Modification of Oswin EMC/ERH equation. *Journal of Agricultural Research* 39: 367-376. <https://doi.org/10.29951/JARC.199012.0011>.
- Chinenye, N.M.M., Ogunlowo, A.S. and Olukunle, O.J., 2010. Cocoa bean (*Theobroma cacao* L.) drying kinetics. *Chilean Journal of Agricultural Research* 70: 633-639. <https://doi.org/10.4067/S0718-58392010000400014>
- Chirife, J. and Iglesias, H.A., 1978. Equations for fitting water sorption isotherms of foods: part 1 - a review. *International Journal of Food Science & Technology* 13: 159-174. <https://doi.org/10.1111/j.1365-2621.1978.tb00792.x>
- Crank, J., 1979. *The mathematics of diffusion*. Oxford University Press. 414 pp.
- Da Silva, P., Ribeiro, N., Coelho Pinheiro, M.N. and Costa, R., 2019. Modelling drying kinetics of black soldier fly (*Hermetia illucens*, L.) larvae. In: *E3S Web of Conferences* 128: 1-6, November 2019. EDP Sciences. <https://doi.org/10.1051/e3sconf/201912809011>.
- Doymaz, I., 2007. Air-drying characteristics of tomatoes. *Journal of Food Engineering* 78: 1291-1297. <https://doi.org/10.1016/j.jfoodeng.2005.12.047>
- EFSA, 2015. Risk profile related to production and consumption of insects as food and feed. *European Food Safety Authority Journal* 13: 4257. <https://doi.org/10.2903/j.efsa.2015.4257>
- El Hajj, R., Mhemdi, H., Besombes, C., Allaf, K., Lefrançois, V. and Vorobiev, E., 2022. Edible insects' transformation for feed and food uses: an overview of current insights and future developments in the field. *Processes* 10: 970. <https://doi.org/10.3390/PR10050970>
- El Hajj, R., Mhemdi, H., Besombes, C., Lefrançois, V., Allaf, K. and Vorobiev, E., "in press". Instant controlled pressure-drop assisted pressing for defatting and dewatering of yellow mealworm larvae: process study and optimisation. *Journal of Insects as Food and Feed* pp. 1-20 <https://doi.org/10.3920/JIFF2022.0062>
- El Hajj, R., Mhemdi, H., Fayeulle, A., Corjon, L., Lefrançois, V., Allaf, K. and Vorobiev, E., 2023. Use of instant controlled pressure drop technology for the preservation of edible insects' (yellow mealworm) quality: assessment of microbial inactivation. *Environmental Science and Pollution Research*. <https://doi.org/10.1007/S11356-023-26030-4>
- El Zahar, K., Mounir, S., Allaf, T. and Allaf, K., 2015. Fundamental modeling, functional attributes, porosity, cohesivity index (hausner ratio) and compressibility of expanded-granule powder of egyptian ras pure cheese. *Lebensmittel-Wissenschaft & Technologie* 64: 297-307. <https://doi.org/10.1016/j.lwt.2015.05.032>

- Hernández-Álvarez, A.-J., Mondor, M., Piña-Domínguez, I.-A., Sánchez-Velázquez, O.-A. and Melgar Lalanne, G., 2021. Drying technologies for edible insects and their derived ingredients. *Drying Technology*, 39: 13 1991-2009. <https://doi.org/10.1080/07373937.2021.1915796>
- Iguedjtal, T., Louka, N. and Allaf, K., 2007. Sorption isotherms of granny smith apples hot-air dried and texturized by “controlled sudden decompression to the vacuum.” *International Journal of Food Engineering* 3 <https://doi.org/10.2202/1556-3758.1151>.
- Iguedjtal, T., Louka, N. and Allaf, K., 2008. Sorption isotherms of potato slices dried and texturized by controlled sudden decompression. *Journal of Food Engineering* 85: 180-190. <https://doi.org/10.1016/J.JFOODENG.2007.06.028>
- Jablaoui, C., Besombes, C., Jamoussi, B., Rhazi, L. and Allaf, K., 2020. Comparison of expander and instant controlled pressure-drop DIC technologies as thermomechanical pretreatments in enhancing solvent extraction of vegetal soybean oil. *Arabian Journal of Chemistry Elsevier* 13: 7235-7246. <https://doi.org/10.1016/J.ARABJC.2020.08.005>
- Jones, L.D., Cooper, R.W. and Harding, R.S., 1972. Composition of mealworm *Tenebrio molitor* larvae. *The Journal of Zoo Animal Medicine* 3: 34. <https://doi.org/10.2307/20094161>
- Kamau, E., Mutungi, C., Kinyuru, J., Imathiu, S., Tanga, C., Affognon, H., Ekesi, S., Nakimbugwe, D. and Fiaboe, K.K.M., 2018. Moisture adsorption properties and shelf-life estimation of dried and pulverised edible house cricket *Acheta domesticus* (L.) and black soldier fly larvae *Hermetia illucens* (L.). *Food Research International*, 106: 420-427. <https://doi.org/10.1016/j.foodres.2018.01.012>
- Kröncke, N., Bösch, V., Woyzichovski, J., Demtröder, S. and Benning, R., 2018. Comparison of suitable drying processes for mealworms (*Tenebrio molitor*). *Innovative Food Science & Emerging Technologies*, 50: 20-25. <https://doi.org/10.1016/J.IFSET.2018.10.009>
- Kröncke, N., Grebenteuch, S., Keil, C., Demtröder, S., Kroh, L., Thünemann, A.F., Benning, R. and Haase, H., 2019. Effect of different drying methods on nutrient quality of the yellow mealworm (*Tenebrio molitor* L.). *Insects*, 10. <https://doi.org/10.3390/INSECTS10040084>.
- Louka, N., Juhel, F. and Allaf, K., 2004. Quality studies on various types of partially dried vegetables texturized by controlled sudden decompression. *Journal of Food Engineering* 65: 245-253. <https://doi.org/10.1016/j.jfoodeng.2004.01.021>
- Marcos, B., Esteban, M., López, P., Alcalá, M., Gómez, R., Espejo, J. and Marcos, A., 1997. Monolayer values at 30°C of various spices as computed by the BET and GAB models. *Z Lebensm Unters Forsch* 204: 109-112. <https://doi.org/10.1007/s002170050046>
- Maroulis, Z.B., Tsarni, E., Marinou-Kouris, D. and Saravacos, G.D., 1988. Application of the GAB model to the moisture sorption isotherms for dried fruits. *Journal of Food Engineering* 7: 63-78. [https://doi.org/10.1016/0260-8774\(88\)90069-6](https://doi.org/10.1016/0260-8774(88)90069-6)
- Mazza, G. and LeMaguer, M., 1978. Water sorption properties of yellow globe onion (*Allium cepa* L.). *Canadian Institute of Food Science and Technology Journal* 11: 189-193. [https://doi.org/10.1016/S0315-5463\(78\)73269-4](https://doi.org/10.1016/S0315-5463(78)73269-4)
- Mkaouar, S., Bahloul, N., Gelicus, A., Allaf, K. and Kechaou, N., 2015. Instant controlled pressure drop texturing for intensifying ethanol solvent extraction of olive (*Olea europaea*) leaf

- polyphenols. *Separation and Purification Technology* 145: 139-146. <https://doi.org/10.1016/J.SEPPUR.2015.03.014>
- Mounir, S. and Allaf, K., 2008. Three-stage spray drying: new process involving instant controlled pressure drop. *Drying Technology* 26: 452-463. <https://doi.org/10.1080/07373930801929334>
- Mounir, S., Allaf, T. and Allaf, K., 2018. Swell drying SD. In: Nema, P.K., Kaur B.P., and Mujumdar A.S. (eds) *Drying Technologies For Foods: Fundamentals And Applications: Part III*. New India Publishing Agency, New Delhi, India, pp. 63-91.
- Mounir, S., Allaf, T., Mujumdar, A.S. and Allaf, K., 2012. Swell drying: coupling instant controlled pressure drop DIC to standard convection drying processes to intensify transfer phenomena and improve quality—an overview. *Drying Technology* 30: 1508-1531. <https://doi.org/10.1080/07373937.2012.693145>
- Mounir, S., Besombes, C., Al-Bitar, N. and Allaf, K., 2011. Study of instant controlled pressure drop dic treatment in manufacturing snack and expanded granule powder of apple and onion. *Drying Technology* 29: 331-341. <https://doi.org/10.1080/07373937.2010.491585>
- Ojha, S., Bußler, S., Psarianos, M., Rossi, G. and Schlüter, O.K., 2021. Edible insect processing pathways and implementation of emerging technologies. *Journal of Insects as Food and Feed* 7: 877-900. <https://doi.org/10.3920/JIFF2020.0121>
- Parniakov, O., Mikhrovska, M., Wiktor, A., Alles, M., Ristic, D., Bogusz, R., Nowacka, M., Devahastin, S., Mujumdar, A. and Heinz, V., 2022. Insect processing for food and feed: a review of drying methods. *Drying Technology* 40: 1500-1513. <https://doi.org/10.1080/07373937.2021.1962905>
- Pech-Almeida, J.L., Téllez-Pérez, C., Alonzo-Macías, M., Teresa-Martínez, G.D., Allaf, K., Allaf, T. and Cardador-Martínez, A., 2021. An overview on food applications of the instant controlled pressure-drop technology, an innovative high pressure-short time process. *Molecules* 26 <https://doi.org/10.3390/MOLECULES26216519>.
- Pérez, I., Bald, C., de Marañón, Í.M., Allaf, K., 2014. DIC intensification of the mechanical extraction of lipids by pressing. In: Allaf, T., Allaf, K. (eds) *Instant controlled pressure drop (D.I.C.) in food processing*. Food Engineering Series. Springer, New York, NY. [https://doi.org/10.1007/978-1-4614-8669-5\\_9](https://doi.org/10.1007/978-1-4614-8669-5_9)
- Purschke, B., Brüggem, H., Scheibelberger, R. and Jäger, H., 2018. Effect of pre-treatment and drying method on physico-chemical properties and dry fractionation behaviour of mealworm larvae (*Tenebrio molitor* L.). *European Food Research and Technology*, 244: 269-280. <https://doi.org/10.1007/s00217-017-2953-8>
- Scala, F., 2013. Fluidized bed technologies for near-zero emission combustion and gasification, In *Woodhead Publishing Series in Energy*. Woodhead Publishing, 1058 pp. <https://doi.org/10.1533/9780857098801>
- Setyoprato, P., Fatmawati, A., Sutrisna, P.D., Savitri, E. and Allaf, K., 2012. The dehydration kinetics, physical properties and nutritional content of banana textured by instantaneous controlled pressure drop. *Asia-Pacific Journal of Chemical Engineering* 7: 726-732. <https://doi.org/10.1002/APJ.624>

- Télez-Pérez, C., Sobolik, V., Montejano-Gaitán, J.G., Abdulla, G. and Allaf, K., 2015. Impact of swell-drying process on water activity and drying kinetics of moroccan pepper (*Capsicum annum*). *Drying Technology* 33: 131-142. <https://doi.org/10.1080/07373937.2014.936556>
- van Huis, A., 2013. Potential of insects as food and feed in assuring food security. *Annual Review of Entomology* 58: 563-583. <https://doi.org/10.1146/annurev-ento-120811-153704>
- Zhao, X., Vázquez-Gutiérrez, J.L., Johansson, D.P., Landberg, R. and Langton, M., 2016. Yellow mealworm protein for food purposes - extraction and functional properties. *Public Library of Science One* 11: e0147791. <https://doi.org/10.1371/journal.pone.0147791>

## 7. Supplementary material

**Table S1.** Two-Way ANOVA Analysis of DIC factors on water diffusivity at 50°C (R2=97.6%)

Source	Sum of Squares	df	Mean Square	F-Ratio	P-Value
A: Time	0.00515012	1	0.00515012	5.67	0.0487
B: Pressure	0.25008	1	0.25008	275.56	0.0000
AA	0.00508658	1	0.00508658	5.60	0.0498
AB	0.000423701	1	0.000423701	0.47	0.5164
BB	0.000631203	1	0.000631203	0.70	0.4318
Total error	0.00635281	7	0.000907545		
Total (corr.)	0.266292	12			

**Table S2.** Two-Way ANOVA Analysis of DIC factors on water diffusivity at 60°C (R2=88%)

Source	Sum of Squares	df	Mean Square	F-Ratio	P-Value
A: Time	0.0229064	1	0.0229064	3.28	0.1131
B: Pressure	0.31848	1	0.31848	45.59	0.0003
AA	0.00292869	1	0.00292869	0.42	0.5380
AB	0.00632921	1	0.00632921	0.91	0.3729
BB	0.00660639	1	0.00660639	0.95	0.3632
Total error	0.0488974	7	0.00698534		
Total (corr.)	0.410492	12			

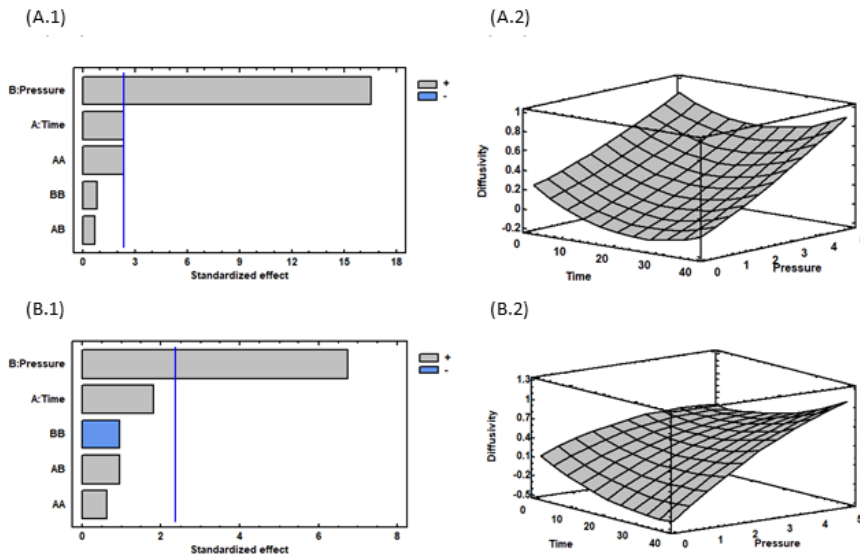

**Figure S1.** Pareto charts and estimated response surfaces showing the effect of DIC treatment parameters on the effective diffusivity during larvae drying at 50 °C (A.1-2) and 60°C (B.1-2)



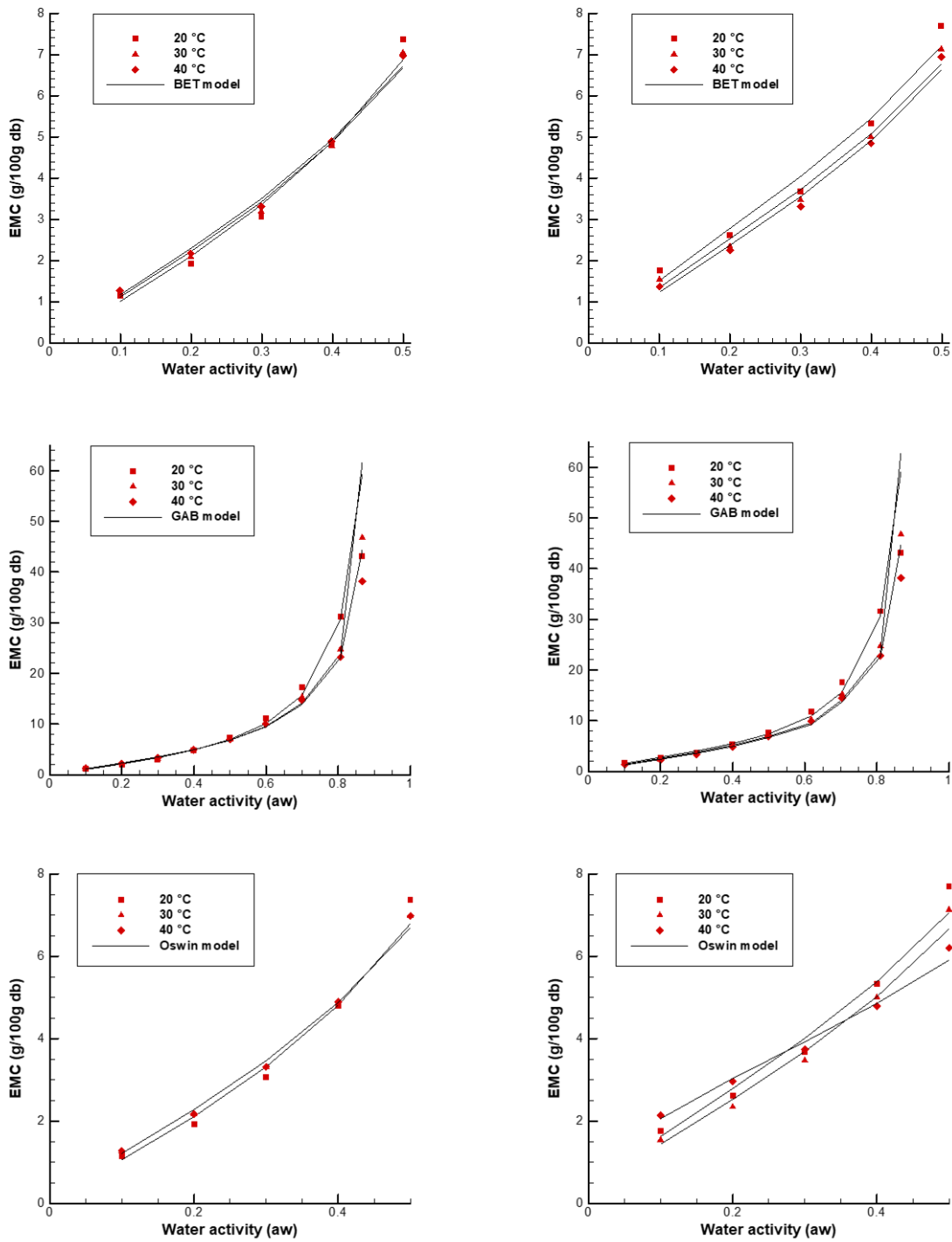

Figure S2. Models fitting for blached larvae

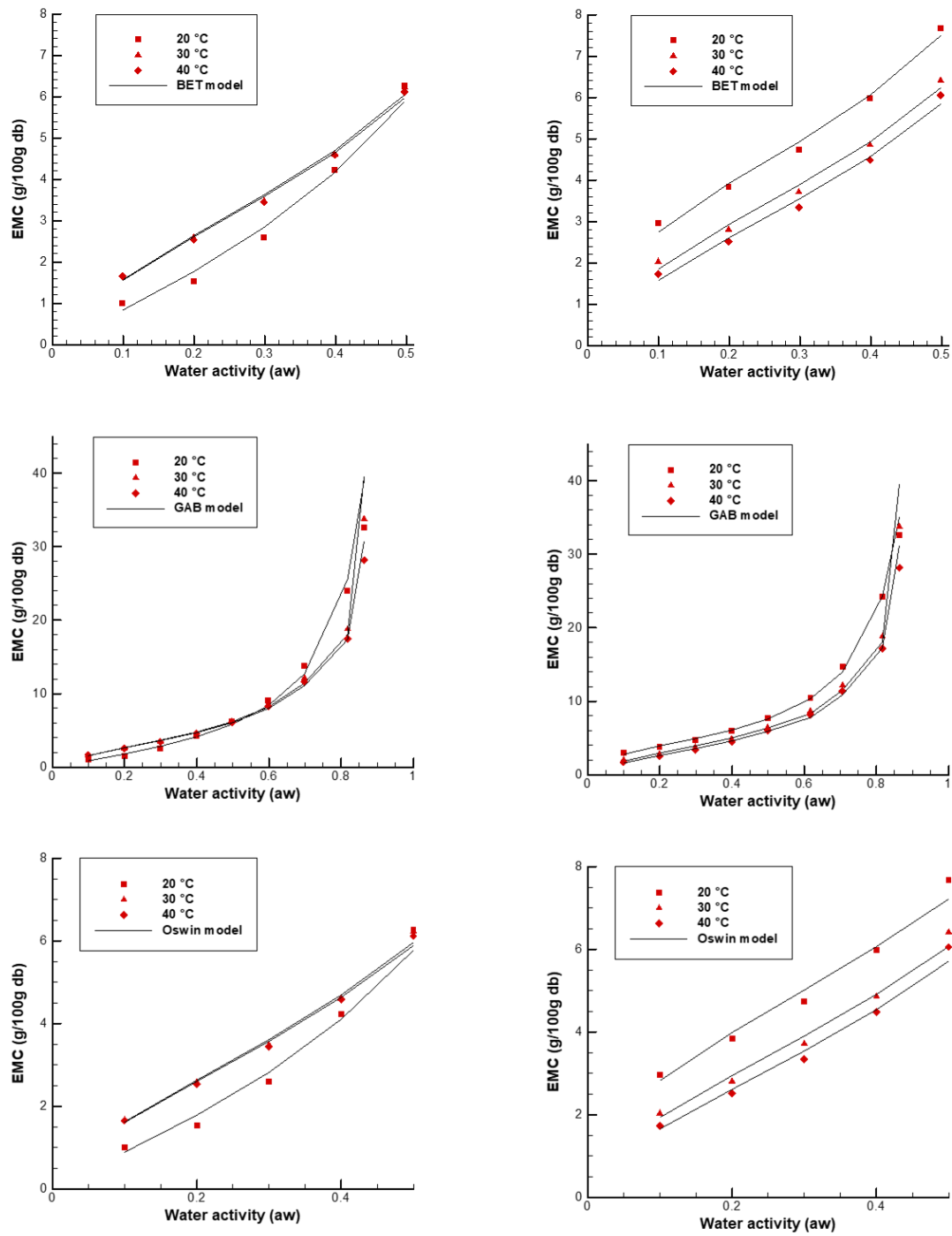

Figure S3. Models fitting for DIC-treated larvae at 0.194 MPa for 18s

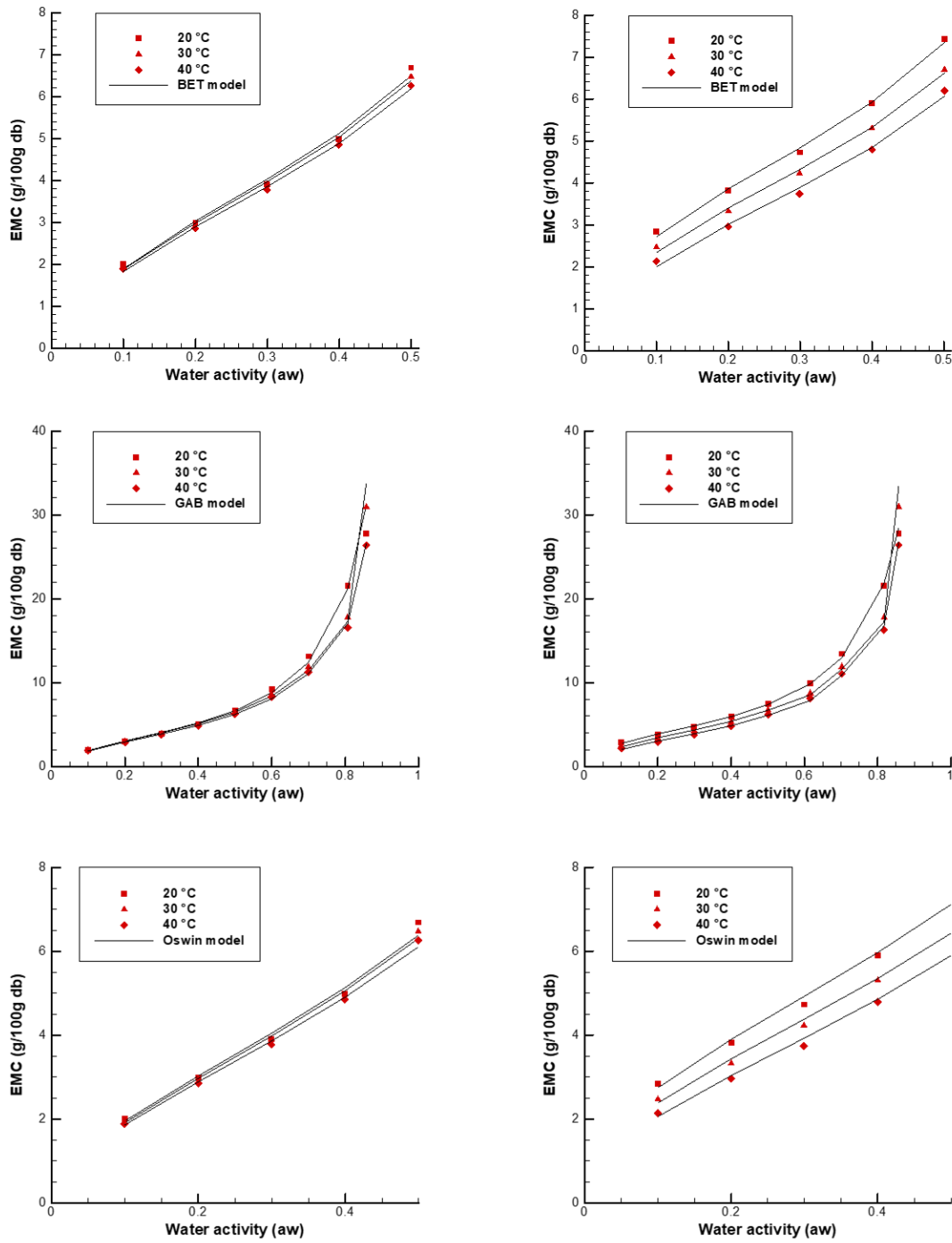

Figure S4. Models fitting for DIC-treated larvae at 0.3 MPa for 25s

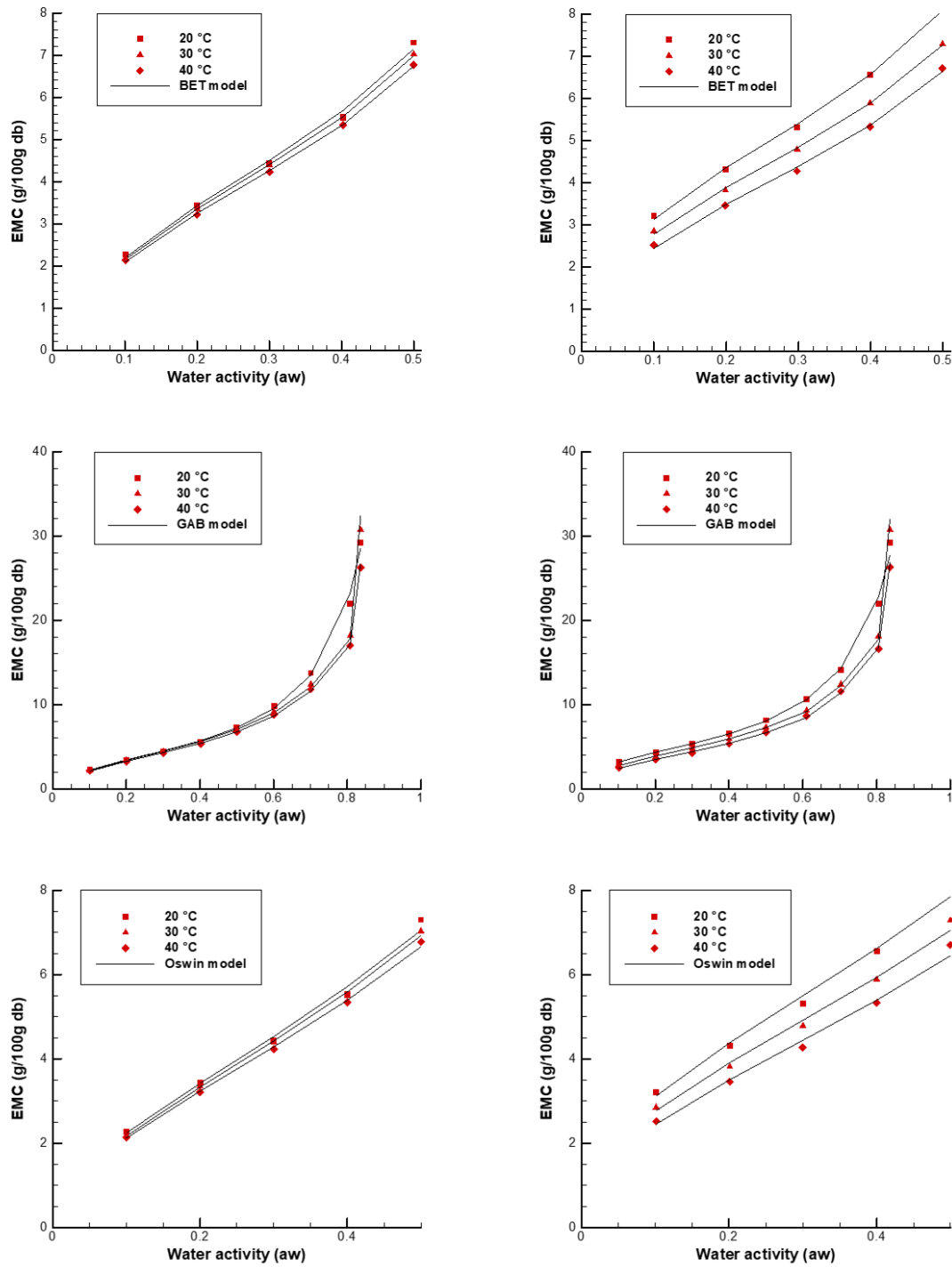

Figure S5. Models fitting for DIC-treated larvae at 0.45 MPa for 25s

## II.5. Conclusions

The findings presented in this chapter demonstrate that DIC technology is an effective decontamination method for *T. molitor* larvae. It was able to reduce the microbial loads (TVC and YMC) to meet the EC regulation requirements. Specifically, larvae treated with DIC at 134°C (0.3 MPa) for  $\geq 20$ s, or at 139°C (0.35 MPa) for  $\geq 5$ s, achieved the required values for both counts, while blanching at 90°C required  $\geq 360$  s for TVC and  $\geq 240$  s for YMC. In terms of *Staphylococcus aureus* load, both DIC treatment at 0.35 MPa  $\geq 5$ s and blanching at 90°C for 240 s met the EC requirements.

DIC treatment has also resulted in changes in membrane structure, a decrease in apparent density, expansion, matter expulsion, and prevented enzymatic browning of larvae and larval juice. Additionally, it has led to a decrease in pressing yield from 68 to 59% due to the denaturation of proteins and alterations in molecular interactions, which made it an effective pretreatment step for larvae to improve protein separation from lipids and obtaining a protein-rich press cake and a liquid with a readily separable lipid phase through simple centrifugation. However, it's worth noting that the protein denaturation caused by DIC treatment could limit its use in the food sector.

Moreover, DIC treatment has been found to increase the quality of dried yellow mealworms by reducing drying time by up to 88%, avoiding shrinkage, and increasing specific surface area by up to 125%, resulting in easier and finer grinding and a more homogenous particle size distribution. By causing product's expansion and microporous structure, it results in a decreased water activity and greater stability at a given moisture content.

Overall, the results of this chapter reveal that DIC technology is a promising technology for improving the quality and safety of *T. molitor* larvae, as well as increasing the efficiency of the drying and pressing processes. While further research is needed to fully optimize the use of DIC technology in the insect industry, the findings of this study suggest that it has the potential to be a valuable tool in intensifying the processing of this alternative protein source.

## Chapter III - Pulsed electric field (PEF) pretreatment effect on yellow mealworms

### III.1. Introduction

Pulsed Electric Field (PEF) treatment is a non-thermal food processing method that involves the application of high-voltage electrical pulses to food products. These pulses create an electric field within the product's cells, which can result in temporary or permanent modifications to the cell membrane structure, allowing for the release of important intracellular components. PEF treatment offers various benefits over traditional food processing methods such as improving the quality of the final product, increasing the extraction yield, shortening the processing time, and improving food safety.

This chapter thoroughly investigates the application of Pulsed electric field (PEF) technology to improve the processing of yellow mealworms and its effect on the end product's quality and efficiency. The study is divided into two parts, with the first part focused on optimizing PEF operation conditions and the second part exploring the effects of pulsed electric field treatment on the mortality of *Tenebrio molitor* larvae, as well as the pressing and drying processes that follow. The goal of this chapter is to assess the potential of PEF technology in enhancing the overall transformation process of yellow mealworms and to determine its impact on the quality and efficiency of the end-product.

The first part of the chapter showcases '**Article 5: Application of pulsed electric fields assisted mechanical pressing to produce a protein-rich insect's meal from *Tenebrio molitor* larvae**'. This article has been submitted to the journal 'Processes'. In this study, the operating conditions of PEFs, including the sample's apparent density, electric field strength, and duration of treatment, were optimized through the evaluation of the disintegration cell index and microscopic analysis. Additionally, the impact of PEF-assisted pressing on the release of intracellular compounds was explored to further understand its potential benefits. The results of this research offer valuable insights into the optimization and application of PEFs in the production of insect-based meals, laying the foundation for further studies in the field. The next article builds upon these findings and expands the scope of this research to provide a more comprehensive understanding of the use of PEFs in this industry.

The second part of this chapter is dedicated to '**Article 6: Impact of pulsed electric field treatment on the viability of *Tenebrio molitor* insect biomass, and on the following pressing and drying processes.**' This paper was published in the Journal of Innovative Food Science and Emerging Technologies (IFSET) (<https://doi.org/10.1016/j.ifset.2023.103462>). It investigates the effects of PEF on the false mortality of yellow mealworms and the hydraulic pressing process. It also focuses on the kinetics, modeling, and activation energy of the air-drying process. The effects of PEF are compared with those of blanching and freezing/thawing. The outcomes of this research

will deepen the understanding of the impact of PEF on the transformation chain of yellow mealworms and its influence on the process efficiency and the quality of the final product.

### III.2. Article 5: Application of pulsed electric fields assisted mechanical pressing to produce a protein-rich insect's meal from *Tenebrio molitor* larvae

(The article is presented on the following pages)

# **Application of pulsed electric fields assisted mechanical pressing to produce a protein-rich insect's meal from *Tenebrio molitor* larvae**

**Rachelle El Hajj<sup>1</sup>, Samir Mezdour<sup>2</sup>, Chaima Dridi<sup>1,2</sup>, Houcine Mhemdi<sup>\*1</sup>, Karim Allaf<sup>3</sup>, and Eugène Vorobiev<sup>1</sup>**

<sup>1</sup> Université de Technologie de Compiègne, ESCOM, TIMR (Integrated Transformations of Renewable Matter), Centre de recherche Royallieu - CS 60 319 - 60 203 Compiègne Cedex, France;

<sup>2</sup> AgroParisTech, URM GENIAL, 1 Rue des Olympiades, 91300 Massy, France;

<sup>3</sup> University of La Rochelle, Laboratory of Engineering Science for Environment LaSIE -UMR-CNRS 7356, 17042 La Rochelle, France ;

\*Correspondence: h.mhemdi@escom.fr;

Submitted: March 2023

Processes journal



## Abstract

Yellow mealworms (*T. molitor*) are considered to be a good protein source for animal and human consumption. This study aimed to produce a protein-rich insect's meal from *Tenebrio molitor* larvae by combining mechanical pressing with pulsed electric fields (PEFs). First, PEFs operating conditions (sample's apparent density  $d$ , electric field strength  $E$ , and duration  $t_{PEF}$ ) were optimized by measuring the disintegration cell index  $Z$  and by comparing images taken by scanning electronic microscopy (SEM). The application of a short PEF pre-treatment ( $E = 800$  V/cm,  $t_{PEF} = 200$  ms) on a bed of larvae with a density of  $d = 0.8$  resulted in total permeabilization ( $Z \approx 0.95$ ) of the tissue with low energy consumption. SEM images showed clearly the damage that PEFs induced to cell membranes in these conditions. Tests of PEF-assisted pressing were then carried out on a pilot scale (200 g). The results confirmed the interest in using PEF to improve juice and lipid yields during cold pressing at 60 bars and a short time (15 min). Similarly, microscopic observations and Fourier transform infrared spectroscopy (FTIR) analysis of cakes indicated that PEF treatment is less damaging to the molecules of interest and preserves proteins better than standard treatments such as crushing. Therefore, PEF-assisted cold pressing represents an efficient method for larvae dewatering and defatting to obtain a meal rich in proteins and suitable for food and feed uses.

**Keywords:** *Tenebrio molitor*; insect; PEF; pressing; proteins; dewatering; fats; meal

## 1. Introduction

The current global context is marked by environmental degradation, an increase in population density along with a scarcity of land dedicated to agricultural production and natural resources. According to FAO (FAO, 2011) global consumption of livestock and dairy products would increase by 173 % and 158 %, respectively, by 2050 in comparison to 2010. And since the livestock industry requires a lot of natural resources and has a highly negative environmental impact involving high energy, land, and water consumption, as well as considerable ammonia and greenhouse gas production, alternative sustainable proteins are now being considered (Kröncke *et al.*, 2019; Lähteenmäki-Uutela *et al.*, 2021; Oonincx and de Boer, 2012). Amongst those being explored, insects represent more than a million arthropod species and offer an inexhaustible source of compounds that could be exploited in sectors such as the agri-food industry, i.e. proteins for human foods and animal feeds, lipids, chitin, and minerals, or energy in the form of fatty acids for the production of biofuels (Manzano-Agugliaro *et al.*, 2012). Moreover, it can provide a source of chitin which is of great interest and high economic value due to its numerous applications in food, cosmetics, pharmaceuticals, and the textile industries (Caligiani *et al.*, 2018).

The candidates with the most potential for large-scale production, due to their yield and ease of rearing, are mainly the larvae of the black soldier fly (*Hermetia illucens*), the common house fly (*Musca domestica*) and yellow mealworm (*Tenebrio molitor*) (van Huis *et al.*, 2013).

Yellow mealworms, which belong to the family of Tenebrionidae, are considered a potential animal feed and human food due to their high content of crude protein (42-63 % DM), well-balanced amino acid profile, and high protein digestibility (Makkar *et al.*, 2014). Their nutritional profile has been compared to that of traditional meats, and it has been determined that mealworms have a considerably higher nutritional value than beef and chicken while being no less nutritionally balanced and having all essential amino acids (Grau *et al.*, 2017). This insect species is commonly reared on wheat bran, although it could be raised on organic byproducts and grains (Azagoh *et al.*, 2016; Broekhoven, 2015; Ramos-Elorduy *et al.*, 2002).

Despite widespread interest in insects, various scientific and technological barriers need to be overcome to produce innovative insect-based products and ingredients on a large scale (pilot and industrial) by establishing cost-effective, competitive and sustainable transformation processes. Among these barriers is the cost, both environmental and energy-wise, of extraction processes that mainly rely on the use of solvents (El Hajj *et al.*, 2022).

Insects must undergo a series of treatments to make them fit for industrial use. Of utmost importance is the need to master not only the quality and supply of insects used as raw material (selection, development stage, insect diet) but also the operating conditions required to obtain end-products showing the desired properties. Insects could potentially either be processed as whole insects (dried or freeze-dried) or fractionated into various components such as protein (protein-rich flour or protein iso-lates), lipid or chitin (Azagoh *et al.*, 2016; Melgar-Lalanne *et al.*, 2019;

Song *et al.*, 2018; Yi *et al.*, 2013). The preparation of protein concentrates or isolates often involves the extraction of the lipid fraction from the raw material as a first step (defatting) (Choi *et al.*, 2017).

Typically, there are four possible ways for transforming larvae into various insect-based products: mechanical, i.e., pressing, as a low-energy dewatering and defatting process (Azagoh *et al.*, 2016), thermal, i.e., drying, heating or blanching blanching (Larouche *et al.*, 2019; Sun *et al.*, 2021; Tobolková *et al.*, 2021), biological, i.e., enzymatic extraction (Caligiani *et al.*, 2018), and chemical, i.e., using solvents (Kumar Yadav *et al.*, 2019; Mishyna *et al.*, 2019).

However, these conventional processes can be expensive, denature insect proteins, and may not always be compatible with nutritional requirements and economic and environmental concerns.

In this context, pulsed electric field technology (PEF) has emerged as a novel approach that has the potential to be effective in the establishment of an economically viable biorefinery. Several studies have shown that PEFs can be used to improve the extraction of intracellular compounds, such as pigments, flavors, proteins and other compounds from different products (Chemat *et al.*, 2017).

Pulsed electric field treatment involves applying a non-continuous electric field to biological cells or tissues to modify the properties of their membrane (Carullo *et al.*, 2018; García-Sánchez *et al.*, 2018). Other advantages of PEF treatment are its low energy consumption (10-15 kJ/kg) and the possibility of its implementation at the industrial scale.

Previous studies have reported on PEF pretreatment of insect larvae and its effect on the quality aspects of infrared-dried black soldier fly and yellow mealworm larvae (Bogusz *et al.*, 2022), on drying and oil extraction enhancement in black soldier fly larvae (Alles *et al.*, 2020), on the extraction of protein, fat, and chitin from house crickets and the material's functional properties (Psarianos *et al.*, 2022), and on the extraction of proteins from yellow mealworm larvae in the production of insect milk (Tello *et al.*, 2021).

This study aims to produce a dewatered and defatted meal from *Tenebrio molitor* larvae by using mechanical pressing processing intensified by pulsed electric field treatment. The optimum condition of PEF treatment, its effect on cell disintegration and its energy consumption were first studied. Additionally, the biomolecular ex-tractability and selectivity (proteins and lipids) using mechanical pressing assisted by PEF were determined by comparing them with a control sample and a reference treatment like crushing.

## **2. Materials and methods**

### **2.1. Raw material**

Larvae of *Tenebrio molitor* were used within the framework of this study. Living larvae, 11 weeks old, were supplied by France Insectes (Crèvecœur-le-Grand, France). These larvae were fed with

a diet consisting generally of wheat bran. Some of the larvae were dried in an oven at 105°C for 24 h and then ground, with a coffee grinder (SEB, France), to obtain fine powders which were used for the physical-chemical characterization. The others were treated with PEF and then underwent mechanical pressing (hydraulic press), for dewatering and defatting, to obtain a protein-rich meal.

## 2.2. Pulsed Electric Field treatment

The effect of PEF operating conditions on cell permeabilization was studied using a laboratory generator (1500V-20A) linked to a treatment cell (Choquenot, France) (Figure 1). The compression chamber (treatment cell) consisted of a support, a piston and a cylindrical cavity compartment. Larvae were placed in the treatment chamber between two electrodes (stainless steel spherical electrodes 16 mm in diameter). The larvae packing bed can be conceived of as a porous substance. The initial thickness of the loose packing bed of larvae was  $h_0 \approx 10$  mm (Figure 1). It corresponds to the initial apparent density of uncompressed larvae  $d_0 \approx 0.4$  g/cm<sup>3</sup>. The larvae were compacted by moving down the piston and the mobile electrode. The decrease of the distance between electrodes,  $h$ , increased the apparent density of the compacted slices,  $d$ , to 1 g/cm<sup>3</sup>.

The PEF generator provides monopolar pulses of near-rectangular shape.  $N$  number of trains (series) were used for the PEF treatment. An individual train consists of  $n = 20$  pulses with a pulse duration of  $t_i = 100$   $\mu$ s, a resting time between pulses of  $\Delta t = 10$  ms and a resting time between the trains of  $\Delta t_T = 10$  s. The effective PEF treatment time is calculated as  $t_{PEF} = nNt_i$  and the total time of PEF processing,  $t_T$ , is  $\approx N\Delta t_T$ . The electric field strength  $E$  was varied between 200 and 1000 V/cm and the number of trains  $N$  was varied between 1 and 100 trains. Experiments were carried out at ambient temperature. The temperature was measured before and after electrical treatment using a thermocouple Thermocoax type 2-AB 25 NN (Thermocoax, Suresnes, France); due to the relatively long inter-series pause  $\Delta t_T$ , the temperature elevation,  $\Delta T$ , during each PEF series application was  $< 2$  °C for all the experiments. The electrodes are connected to the PEF generator and the electrical conductivity of the sample is measured at 0.5 kHz during the inter-series period. This frequency was chosen to minimize the polarizing effects on the electrodes and tissue samples (Lebovka *et al.*, 2013). All the output data (current, voltage, electrical conductivity, and temperature) were collected using a data logger and special software, developed by the electronic service of the UTC, Compiègne, France.

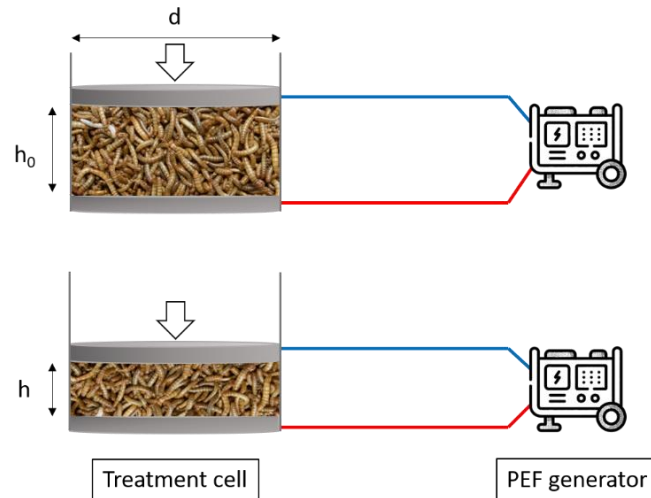

**Figure 1.** Illustration of PEF treatment

The degree of tissue damage was estimated from the electrical conductivity disintegration index,  $Z$  (Lebovka *et al.*, 2002) using Equation 1:

$$Z = \frac{\sigma - \sigma_0}{\sigma_d - \sigma_0} \quad (1)$$

$\sigma$  (S/m) is the measured electrical conductivity value during PEF treatment,  $\sigma_0$  is the initial conductivity of the untreated (intact) tissue and  $\sigma_d$  is the conductivity of the completely damaged tissue. The value of  $\sigma_d$  was estimated from a tissue damaged by long PEF treatment ( $> 1$  s) at  $E = 1000$  V/cm, and it could be used to determine the electrical conductivity of completely damaged tissue.  $Z=0$  for intact larvae cells and  $Z=1$  for completely distorted cells (Vorobiev and Lebovka, 2010).

The energy consumption of PEF treatment ( $W$ , kJ / kg) was calculated using Equation 2:

$$W = \frac{U \cdot I \cdot t_{PEF}}{m_{larvae}} \quad (2)$$

$U$  is the applied tension (V),  $I$  is the measured current strength (A) and  $m$  is the mass of treated larvae (kg).

### 2.3. Juice extraction

#### 2.3.1. PEF-assisted mechanical expression

The pressing of untreated and PEF pre-treated larvae (200 g) was carried out using a laboratory hydraulic press (Creusot-Loire, France). The pressing was carried under constant pressure (60 bars) for 15 min. The extracted juice is collected and weighed continuously by an electronic balance. The juice yield was calculated using Equation 3 :

$$Y(\%) = \frac{m_{\text{juice}}}{m_{\text{larvae}}} \quad (3)$$

with Y is the juice yield,  $m_{\text{juice}}$  is the mass of juice obtained by pressing in g, and  $m_{\text{larvae}}$  is the mass of the sample before pressing in g.

### 2.3.2. *Crushing*

Crushing was applied as a reference treatment. It was realized using a mixer (Ultra-Turrax T50). It consists in fragmenting the material into fine particles and altering the tissues and cell walls to release the intracellular juice. This process allows a complete fragmentation of the material to obtain the highest juice yield by centrifugation. The mixing was performed for 10 min and the centrifugation was achieved at 5000 rpm for 30 min to separate the juice and the residual solid.

## 2.4. *Analysis*

### 2.4.1. *Dry matter content determination*

The dry matter content (DM) of the larvae before and after pressing or crushing was measured by drying 5 g of the product at 105°C to a constant weight using a moisture analyzer MA160 (Sartorius, Göttingen, Germany).

### 2.4.2. *Lipid content*

The lipid content of larvae and the press cake was determined by hexane extraction according to international standard ISO 659:2009.

### 2.4.3. *Protein content*

The protein content in the juice (mg/L) was determined using the Bradford method (Bradford, 1976). A volume of 500  $\mu\text{L}$  of raw juice and 500  $\mu\text{L}$  of Bradford Reagent were mixed. The resulting samples were kept for 10 min in the dark at room temperature before analysis. The absorbance was then measured at wavelength  $\lambda = 595 \text{ nm}$  by the UV/Vis UV-6300 PC spectrophotometer (VWR, Strasbourg France). The standard calibration curve was constructed using aqueous bovine serum albumin solution (BSA) at different concentrations from 0 to 10 mg/L. Protein content in solid samples (larvae) was determined using the Kjeldahl method (ISO 5983-2:2009).

### 2.4.4. *Infrared characterization (FTIR)*

Untreated and PEF-treated larvae were analyzed before and after juice extraction (pressed or crushed), by Fourier transform infrared spectroscopy from press discs using a Nicolet iS5 ID1 Transmission FTIR Spectrometer (Thermo Scientific) and FTIR spectra were recorded in the range of 4000-400  $\text{cm}^{-1}$ , averaging the data of 16 successive scan. Briefly, press discs were prepared from a mixture of larvae and KBr pellets as powder.

### 2.4.5. Scanning electron microscopy (SEM) analysis

The morphological features of untreated or pre-treated larvae cells were visualized using a Scanning Electron Microscopy SEM instrument Quanta FEG 250 (FEI, Hollande) applied in an accelerating voltage of 20 kV, at the physical-chemical platform of the University of Technology of Compiègne (France).

### 2.5. Statistical analysis

All treatments and analyses were performed in triplicate and the results were reported as mean values, the statistical analysis was realized by SPSS software 17 and the significant differences ( $p \leq 0.05$ ) between the means were evaluated using one-way analysis of variance (ANOVA).

## 3. Results and discussion

### 3.1. Impact of PEF on cell permeabilization

Figure 2 shows the evolution of the electric conductivity of the porous bed of intact larvae versus the apparent density. The data shows that the conductivity ( $\sigma$ ) is minimal for uncompact larvae ( $d=0.4 \text{ g/cm}^3$ ) and it increased with the increase of the apparent density ( $d$ ). Indeed, when the layer of particles formed by insect larvae is compacted, the air between the particles is expelled, leading to an increase in conductivity. A linear correlation is observed up to a density of  $1 \text{ g/cm}^3$  ( $\sigma = 2 \cdot 10^{-5} \text{ s/m}$ ). As stated by (Mhemdi *et al.*, 2013) the power equation may be used to fit the curve  $\sigma$  vs.  $d$ .

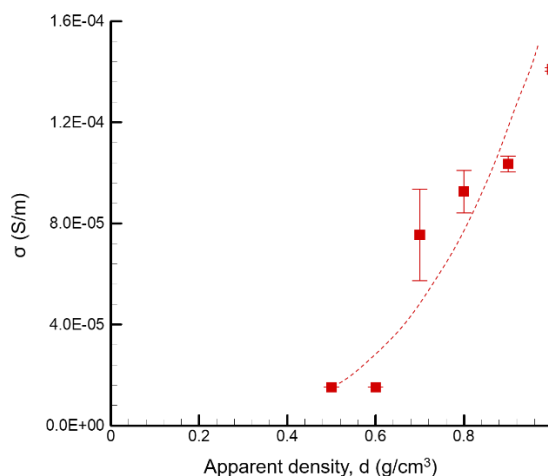

**Figure 2.** Electrical conductivity  $\sigma$  versus the apparent density  $d$  of the porous untreated larvae particles bed

To characterize the degree of tissue damage, the electrical conductivity was measured and recorded during the treatment and the permeabilization index  $Z$  was calculated according to Eq. 1. Figure 3

displays the cell permeabilization kinetics vs time of PEF treatment. Index  $Z$  increases during the electrical treatment, showing the PEF's influence on cell permeabilization regardless of particle density. Furthermore, the results are consistent with the conductivity trend seen in Figure 2. The apparent density of the layer of larval particles significantly affects the degree of tissue damage (Mhemdi *et al.*, 2013). For example, for the same electric field  $E=800\text{V/cm}$ , the electrical disintegration index  $Z$  reaches its maximum and almost complete value  $Z=0.94$  at the apparent density of  $\geq 0.8$ . High conductivity implies better current flow to the sample, which leads to improved treatment efficiency and permeabilization. Thus, the optimal apparent density of the layer of larvae particles is set to  $0.8\text{ g/cm}^3$  for the subsequent studies.

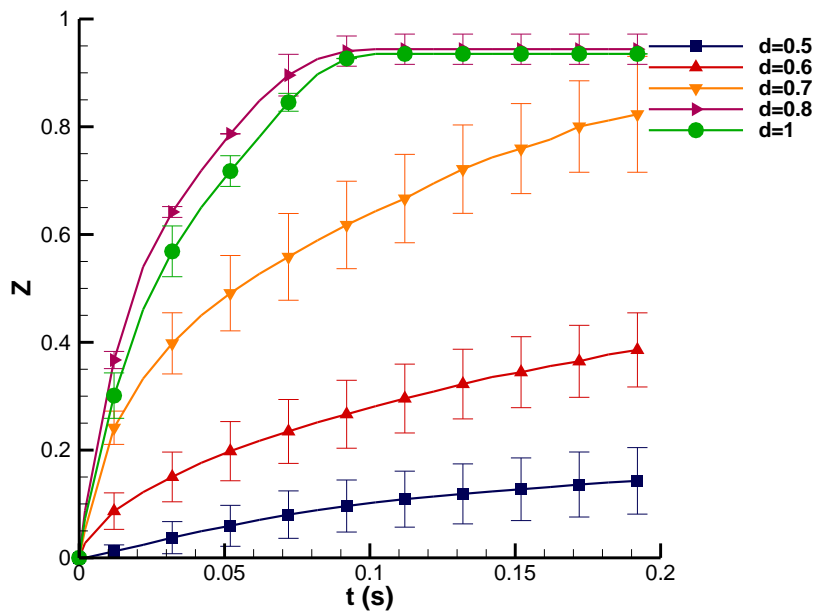

**Figure 3.** Permeabilization index  $Z$  versus time  $t$  for larvae tissue at different apparent densities  $d$ ; with:  $E=800\text{V/cm}$ ,  $N=100$  trains,  $n=20$  pulses,  $t_i=100\mu\text{s}$ .

The effectiveness of a pulsed electric field treatment depends on the intensity of the applied electric field and the effective treatment time. Figure 4 shows the effect of PEF treatment intensity (varied from  $200$  to  $1000\text{V/cm}$ ) at a fixed density of  $0.8$ , on the kinetics of cellular damage. This graphic shows that increasing the intensity of electric fields allows for greater tissue permeabilization. Indeed, the maximum permeabilization index obtained at the end of the treatment ( $Z_{\text{max}}$ ) is  $0.3$  for  $E = 200\text{V/cm}$  and  $0.94$  for  $E = 800\text{V/cm}$ . Similarly, (Ben Ammar *et al.*, 2011; Lebovka *et al.*, 2014; Zhu *et al.*, 2015) indicated that an increasingly intense PEF treatment leads to increased permeabilization of cells. In addition, low intensities ( $200\text{V/cm}$ ,  $400\text{V/cm}$  and  $600\text{V/cm}$ ) lead to partial damage to the larvae. Furthermore, the results demonstrated that duration of  $100\text{ms}$  at  $800\text{V/cm}$  is sufficient to induce maximal cell damage.



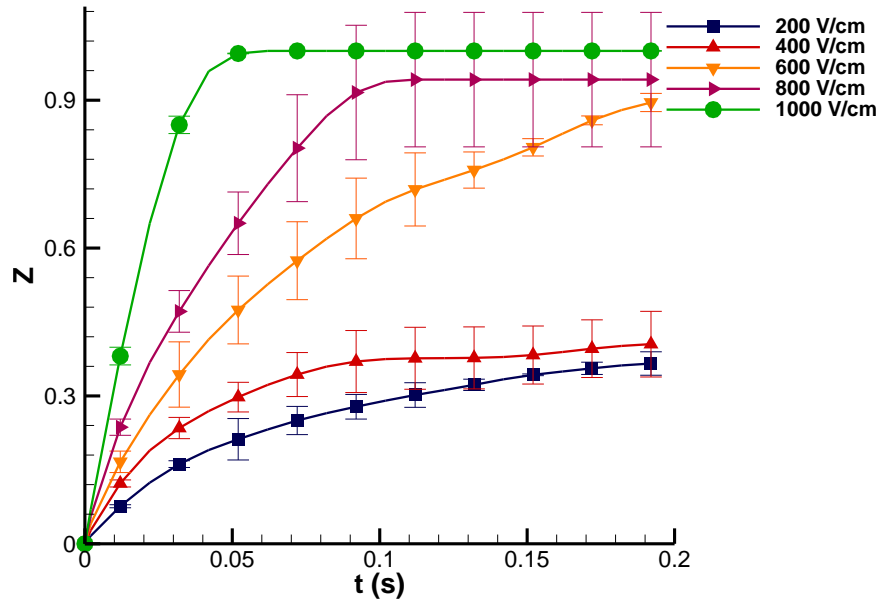

**Figure 4.** Permeabilization index  $Z$  versus time  $t$  for larvae tissue at different electric field intensities; with  $N=100$  trains,  $n=20$  pulses,  $t_i=100\mu\text{s}$ .

Figure 5 presents maximal tissue permeabilization  $Z_{\text{max}}$ , characteristic treatment time  $t_{Z=0.5}$  and specific energy input  $Q_{Z=0.5}$  required to achieve a 50% larvae cell damage at different PEF intensities. Specific energy was calculated using Equation 3. For instance, to damage 50% of the cells, a treatment time of 152 ms is required at  $E=400\text{V/cm}$ , whereas 22 ms are sufficient at  $E=800\text{V/cm}$  and  $E=1000\text{V/cm}$ . This treatment time is substantially longer compared to other plant tissues such as beetroots, which on the other side need 10 ms at  $800\text{V/cm}$  (Mhemdi *et al.*, 2014). This discrepancy may be explained by the presence of chitin, which covers the cell membrane. Chitin provides some rigidity to the membrane and may induce some resistance to the pulsed electric field. Additionally, Figure 5 shows that higher PEF intensities require less energy to semi-permeabilize larval tissue ( $Q_{Z=0.5}=28\text{kJ/kg}$  at  $E=600\text{V/cm}$  and  $Q_{Z=0.5}=15\text{kJ/kg}$  at  $E=1000\text{V/cm}$ ). In contrast, an earlier study by (Mhemdi *et al.*, 2014) showed that for sugar beet, the optimal treatment conditions that ensure total cell damage were  $E = 600\text{V/cm}$ ,  $t_{\text{PEF}} = 10\text{ms}$  and  $Q = 10\text{kJ/kg}$ . This difference is probably due to the rigidity of the exoskeleton of larvae as stated earlier.

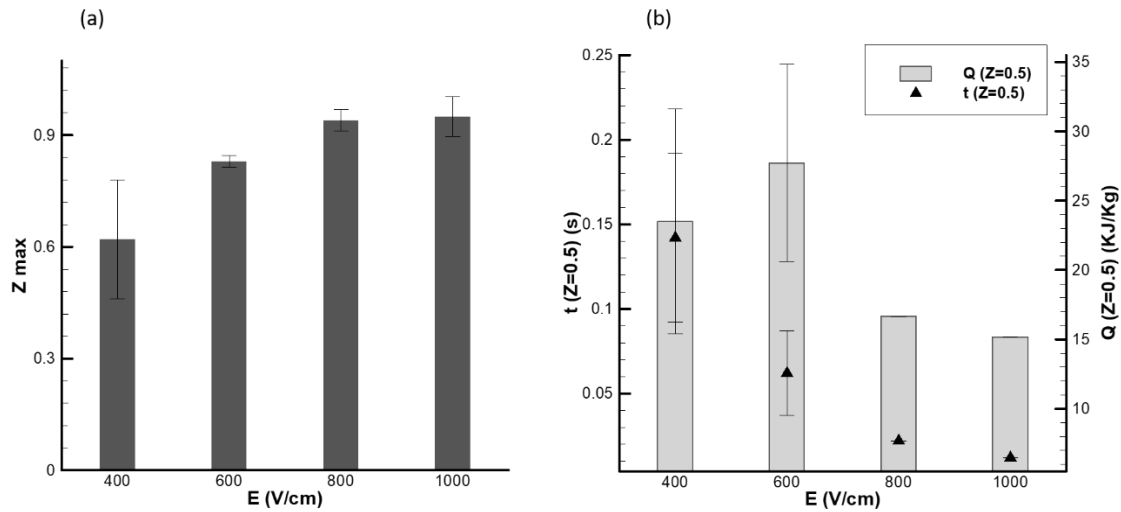

**Figure 5.** (a) Maximal tissue permeabilization  $Z_{max}$ , and (b) Characteristic treatment time and specific energy needed to attain a semi-permeabilization of larvae tissue at different PEF electric field strengths.

### 3.2. Impact of PEF on the cell structure

Figure 6 shows SEM images of larval cells derived from untreated and PEF-treated samples at various electric field strengths (400V/cm, 800V/cm, and 1000V/cm). The findings clearly show the impact of PEF on the cell structure of larvae. An intact cell bounded by cell membranes is observed on the untreated sample (control). At 400V/cm the presence of some intact cells can also be detected. However, at a high electric field strength ( $E \geq 800$ V/cm) the intact cells are not present anymore and the tissues form a homogeneous continuous medium which shows the fragility of the cell walls. All of this confirms the effect of PEF treatment, which degrades cell membranes and induces nearly total permeabilization at 800V/cm.

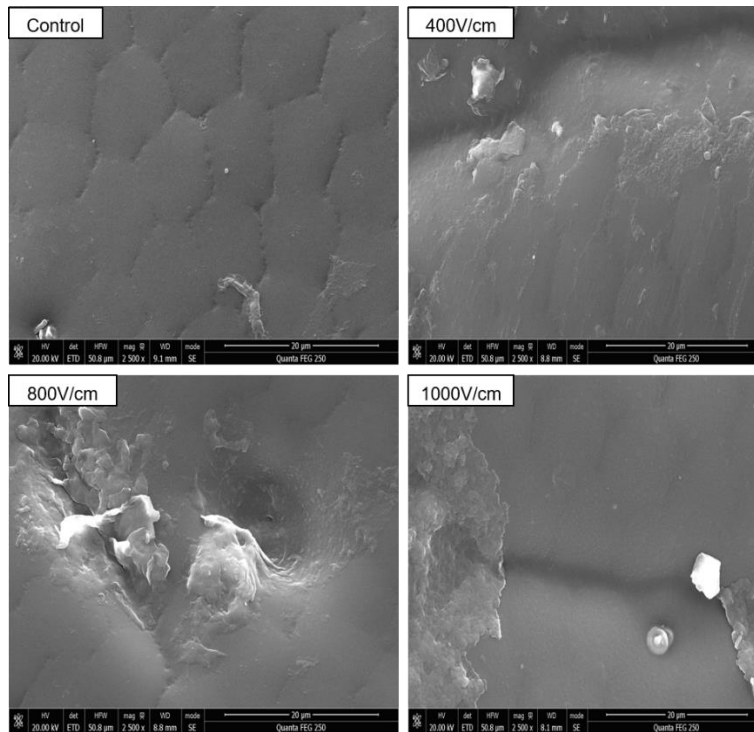
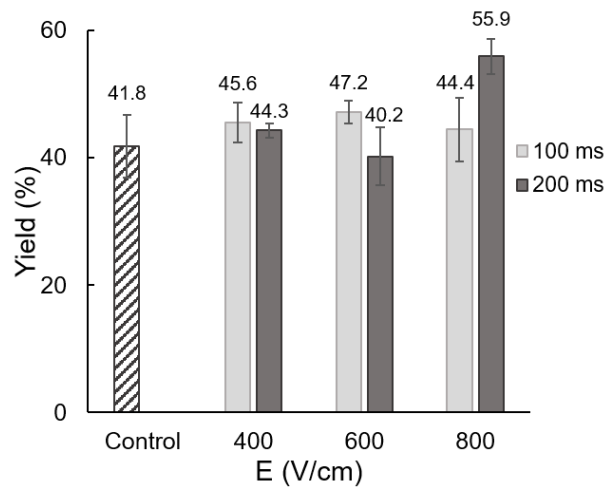

**Figure 6.** Scanning electron microscope (SEM) of *T. molitor* cells before (control) and after PEF treatment at different electric field strengths (400V/cm, 800V/cm and 1000V/cm)

### 3.3. Influence of PEF and mechanical pressing on the release of intracellular compounds

The effect of PEF pretreatment on intracellular compounds extractability during mechanical pressing was determined by measuring the dry matter content of the press cake, as well as protein and lipid extraction yields. Crushing was used as a reference treatment to evaluate the efficiency and the selectivity of the PEF treatment.

Figure 7 presents the press juice extraction yields of untreated larvae (control) and PEF-treated larvae for 100 ms and 200 ms. The results show that the application of the PEF increases the extraction yield progressively as the electric field intensity increases. The yield was increased from 41% for the control sample to 56% for the PEF-treated sample at  $E = 800\text{V/cm}$  and  $t_{\text{PEF}} = 200\text{ms}$ . Thus stronger cell disintegration leads to more efficient extraction of intracellular compounds. Moreover, the duration of PEF treatment doesn't seem to have an influence on the degree of cell permeabilization and consequently on the amount of extracted juice except at high electric field strength ( $E=800\text{V/cm}$ ). Similarly, the effect of the electric field strength was observed by other authors with apple juice extraction (Grimi *et al.*, 2011), highlighting the important effect of PEF on the intensification of juice and intracellular compounds extraction yield.



**Figure 7.** Juice extraction yield from untreated (control) and PEF-treated larvae at different electric field strengths (varying from 400V/cm to 800V/cm).

The quantity of released intracellular compounds was determined by measuring the dry matter content of the press cake of untreated larvae (control), crushed larvae and PEF-treated larvae. Figure 8 (a) shows the press cake's dry matter content for different treatment conditions. The maximum value of dry matter content (39.3%) was detected in the sample treated by PEF at  $E=800\text{V/cm}$  for 200ms compared to untreated and crushed samples, with a dry matter content of 34.9 and 17.4 % respectively. This result is in line with the extraction yields given in Figure 7 and indicates that a maximal evacuation of intracellular water was enhanced with the application of PEF, which was the goal of the study.

Figure 8 (b) and (c), indicate that pressing with PEF treatment extracts 49.7% of total lipid content which is quite close to the control sample (46.8%) and that the reference treatment (crushing) leads to the extraction of 74.7% of total lipid content. As for the protein content of the press juice, there is no significant difference for different treatment conditions, they vary between 1.4 and 1.8 g/L. Thus, from these results, it can be concluded that applying an electric field strength of 800 V/cm at 200 ms could be an efficient dewatering method.

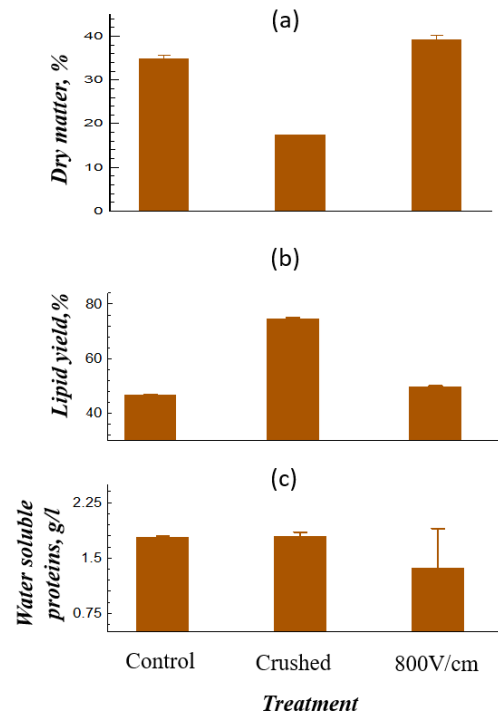

**Figure 8.** (a) Press cake's dry matter content, (b) Lipid extraction yield, and (c) concentration of proteins in the press juice of untreated (control), crushed and PEF-treated larvae.

To observe the effect of different treatments on the tissue structure of the powder obtained, microscopic observations were made. SEM images (Figure 9) show the presence of residual fat in all the samples. Interestingly, the results show clearly the appearance of granules in the samples that have been crushed. For samples pretreated with PEF, the cell network remains homogeneous with the presence of some granular bodies similar to those mentioned above. According to similar previous studies (Koubaa *et al.*, 2015), these granules could correspond to polysaccharides (starch, cellulose, lignin). As a result, crushing causes total fragmentation of the material, which may result in the release of these molecules, as opposed to PEF treatment, which is less destructive and can keep the integration of the cellular structure.

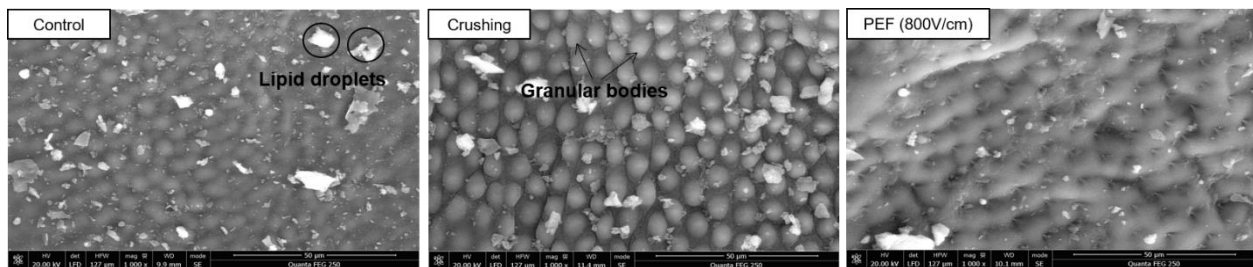

**Figure 9.** Microscopic observations of larvae powder morphology.

### 3.4. Solid characterization-FTIR spectroscopy

Figure 10 presents the infrared spectra of larvae meal (raw sample), untreated pressed sample, PEF treated and pressed sample ( $E=800\text{V}/\text{cm}$  at 200ms) and the sample obtained after crushing.

**Table 1.** Interpretation of the distribution of functional groups bands determined by FTIR

Wavenumber ( $\text{cm}^{-1}$ )	Functional group	Compound class
3700	O-H	Alcohol and Phenol
3500	N-H	Primary amine
3290	N-H	Secondary amine
2930	C-H ( $\text{CH}_2$ )	Asymmetric stretching in fatty acids
2850	C-H ( $\text{CH}_2$ )	Symmetric stretching in fatty acids
1620	C=O	Amide
1467	C-H ( $\text{CH}_2$ )	Alkane
1164	C-O	Tertiary alcohol
<900	C=C and C-H	Aromatic

The FTIR molecular profile analysis shows similar profiles with the same absorption bands. However, the comparison of the spectra of the samples before and after pressing reveals a decrease in the intensity of some peaks which became more accentuated with the crushed samples. This decrease is explained by the extraction of molecules during pressing. The main identified peaks are presented in Table 1. The presence of functional groups such as amine, amide, and aromatic compounds reveals the richness of the protein samples even after treatment and pressing. For instance, the band at  $3290\text{ cm}^{-1}$  represents the stretching vibration of bonded NH groups which was totally disappeared after crushing while pretreated samples by PEF had the same peak as untreated samples. Therefore, exposing larvae to the PEF treatment seemed to not affect the meal composition.

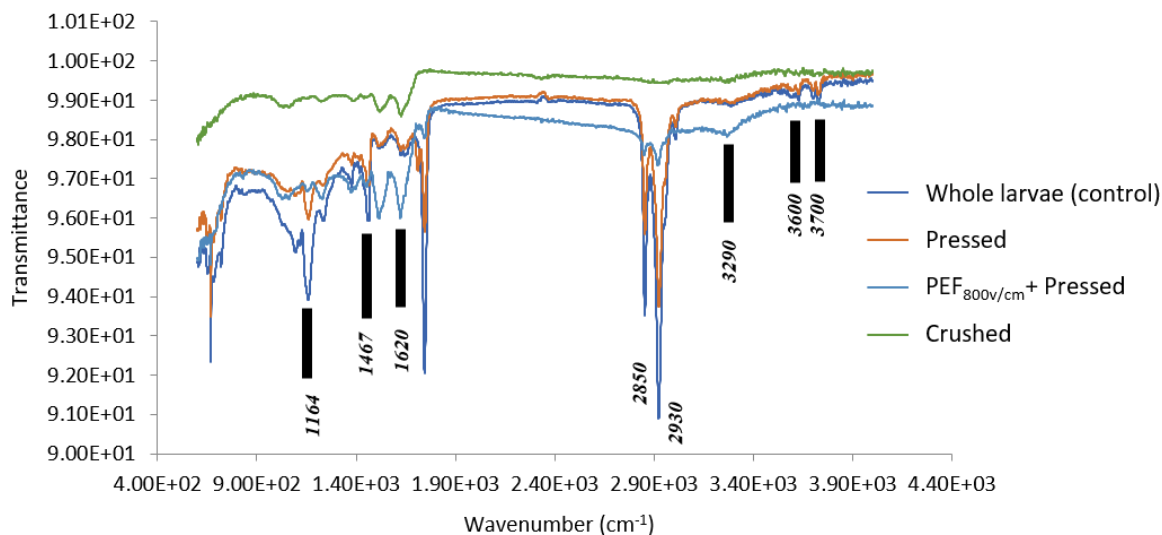

**Figure 10.** FTIR spectra of mealworm larvae before treatment (Control), after extraction (pressed and PEF + Pressed) and crushed sample

## 4. Conclusion

This study demonstrated the effect of electric field strength on cell disintegration and larvae dewatering. The optimum parameters (apparent density of 0.8,  $E= 800\text{V/cm}$  and  $t_{\text{PEF}}=200\text{ms}$ ) allow for a maximum permeabilization ( $Z=0.95$ ).

Results from this work showed, that PEF could be used as a pre-treatment before pressing insect mass to improve pressing yield (10% gain in yields) and water extraction at relatively low pressure (60 bars) and short time (15 min).

In addition, analyses by FTIR spectroscopy and SEM performed on the press cakes show that the treatment with PEF is less destructive for the tissue structure and more selective compared to other treatments (crushing). As a result, it is reasonable to believe that mechanical pressing assisted by PEF treatment would be extremely promising to improve extraction and obtain a protein-rich dry meal.

Further studies are needed for the identification of insect proteins, their isolation and determination of their technological suitability as ingredients.

This will allow for a better understanding of the relationship between their functional properties and the development of extraction and production processes to make them more suitable for usage in the feed and food industries.

## 5. Statements & Declarations

**Conflicts of Interest:** The authors declare no conflict of interest.

**Funding:** This work is a part of the project RAFINSECT funded by the Hauts-de-France region

## 6. References

- Alles, M.C., Smetana, S., Parniakov, O., Shorstkii, I., Toepfl, S., Aganovic, K. and Heinz, V., 2020. Bio-refinery of insects with pulsed electric field pre-treatment. *Innovative Food Science and Emerging Technologies* 64 <https://doi.org/10.1016/J.IFSET.2020.102403>.
- Azagoh, C., Ducept, F., Garcia, R., Rakotozafy, L., Cuvelier, M.E., Keller, S., Lewandowski, R. and Mezdour, S., 2016. Extraction and physicochemical characterization of *Tenebrio molitor* proteins. *Food Research International* 88: 24–31.
- Ben Ammar, J., Lanoisellé, J.-L., Lebovka, N.I., Van Hecke, E. and Vorobiev, E., 2011. Impact of a pulsed electric field on damage of plant tissues: effects of cell size and tissue electrical conductivity. *Journal of Food Science* 76: E90–E97.

- Bogusz, R., Smetana, S., Wiktor, A., Parniakov, O., Pobiega, K., Rybak, K. and Nowacka, M., 2022. The selected quality aspects of infrared-dried black soldier fly (*Hermetia illucens*) and yellow mealworm (*Tenebrio molitor*) larvae pre-treated by pulsed electric field. *Innovative Food Science & Emerging Technologies* 80: 103085.
- Bradford, M., 1976. A rapid and sensitive method for the quantitation of microgram quantities of protein utilizing the principle of protein-dye binding. *Analytical Biochemistry* 72: 248–254.
- Broekhoven, S. van, 2015. Quality and safety aspects of mealworms as human food. *Quality and safety aspects of mealworms as human food*. 178 pp.
- Caligiani, A., Marseglia, A., Leni, G., Baldassarre, S., Maistrello, L., Dossena, A. and Sforza, S., 2018. Composition of black soldier fly prepupae and systematic approaches for extraction and fractionation of proteins, lipids and chitin. *Food Research International* 105: 812–820.
- Carullo, D., Abera, B.D., Casazza, A.A., Donsì, F., Perego, P., Ferrari, G. and Pataro, G., 2018. Effect of pulsed electric fields and high pressure homogenization on the aqueous extraction of intracellular compounds from the microalgae *Chlorella vulgaris*. *Algal Research* 31: 60–69.
- Chemat, F., Rombaut, N., Meullemiestre, A., Turk, M., Périno, S., Fabiano-Tixier, A.-S. and Abert-Vian, M., 2017. Review of green food processing techniques. preservation, transformation, and extraction. *Innovative food science and emerging technologies* 41: 357–377.
- Choi, B.D., Wong, N.A.K. and Auh, J.H., 2017. Defatting and sonication enhances protein extraction from edible insects. *Korean journal for food science of animal resources* 37: 955–961.
- El Hajj, R., Mhemdi, H., Besombes, C., Allaf, K., Lefrançois, V. and Vorobiev, E., 2022. Edible insects' transformation for feed and food uses: an overview of current insights and future developments in the field. *Processes* 10: 970.
- FAO, 2011. World livestock 2011 - livestock in food security. FAO. 130 pp Available at: <http://www.fao.org/3/i2373e/i2373e.pdf>. Accessed May 12, 2022.
- García-Sánchez, T., Merla, C., Fontaine, J., Muscat, A. and Mir, L.M., 2018. Sine wave electropermeabilization reveals the frequency-dependent response of the biological membranes. *Biochimica et Biophysica Acta (BBA) - Biomembranes* 1860: 1022–1034.
- Grau, T., Vilcinskas, A. and Joop, G., 2017. Sustainable farming of the mealworm *Tenebrio molitor* for the production of food and feed. *Zeitschrift für Naturforschung - Section C Journal of Biosciences* 72: 337–349.



- Grimi, N., Mamouni, F., Lebovka, N., Vorobiev, E. and Vaxelaire, J., 2011. Impact of apple processing modes on extracted juice quality: pressing assisted by pulsed electric fields. *Journal of Food Engineering* 103: 52–61.
- Koubaa, M., Barba, F.J., Mhemdi, H., Grimi, N., Koubaa, W. and Vorobiev, E., 2015. Gas assisted mechanical expression (game) as a promising technology for oil and phenolic compound recovery from tiger nuts. *Innovative Food Science & Emerging Technologies* 32: 172–180.
- Kröncke, N., Grebenteuch, S., Keil, C., Demtröder, S., Kroh, L., Thünemann, A.F., Benning, R. and Haase, H., 2019. Effect of different drying methods on nutrient quality of the yellow mealworm (*Tenebrio molitor* L.). *Insects* 10 <https://doi.org/10.3390/INSECTS10040084>.
- Kumar Yadav, B., Rawson, A. and Binod Kumar Yadav, C., 2019. Optimization of protein extraction from yellow mealworm larvae. *International Journal of Chemical Studies* 7: 4577–4582.
- Lähtenmäki-Uutela, A., Rahikainen, M., Lonkila, A. and Yang, B., 2021. Alternative proteins and EU food law. *Food Control* 130: 108336.
- Larouche, J., Deschamps, M.H., Saucier, L., Lebeuf, Y., Doyen, A. and Vandenberg, G.W., 2019. Effects of killing methods on lipid oxidation, colour and microbial load of black soldier fly (*Hermetia illucens*) larvae. *Animals* 9 <https://doi.org/10.3390/ANI9040182>.
- Lebovka, N., Bazhal, M. and Vorobiev, E., 2002. Estimation of characteristic damage time of food materials in pulsed-electric fields. *Journal of Food Engineering* 54: 337–346.
- Lebovka, N., Melnyk, V., Mamunya, Y., Klishevich, G., Goncharuk, A. and Pivovarova, N., 2013. Low-temperature phase transformations in 4-cyano-4'-pentyl-biphenyl (5cb) filled by multiwalled carbon nanotubes. *Physica E: Low-Dimensional Systems and Nanostructures* 52: 65–69.
- Lebovka, N.I., Mhemdi, H., Grimi, N., Bals, O. and Vorobiev, E., 2014. Treatment of potato tissue by pulsed electric fields with time-variable strength: theoretical and experimental analysis. *Journal of Food Engineering* 137: 23–31.
- Makkar, H.P.S., Tran, G., Heuzé, V. and Ankers, P., 2014. State-of-the-art on use of insects as animal feed. *Animal Feed Science and Technology* 197: 1–33.
- Manzano-Agugliaro, F., Sanchez-Muros, M.J., Barroso, F.G., Martínez-Sánchez, A., Rojo, S. and Pérez-Bañón, C., 2012. Insects for biodiesel production. *Renewable and Sustainable Energy Reviews*, 3744–3753.
- Melgar-Lalanne, G., Hernández-Álvarez, A.J. and Salinas-Castro, A., 2019. Edible insects processing: traditional and innovative technologies. *Comprehensive Reviews in Food Science and Food Safety* 18: 1166–1191.

- Mhemdi, H., Bals, O., Grimi, N. and Vorobiev, E., 2014. Alternative pressing/ultrafiltration process for sugar beet valorization: impact of pulsed electric field and cossettes preheating on the qualitative characteristics of juices. *Food and Bioprocess Technology* 7: 795–805.
- Mhemdi, H., Grimi, N., Bals, O., Lebovka, N.I. and Vorobiev, E., 2013. Effect of apparent density of sliced food particles on the efficiency of pulsed electric field treatment. *Innovative Food Science & Emerging Technologies* 18: 115–119.
- Mishyna, M., Martinez, J.-J.I., Chen, J. and Benjamin, O., 2019. Extraction, characterization and functional properties of soluble proteins from edible grasshopper (*Schistocerca gregaria*) and honey bee (*Apis mellifera*). *Food Research International* 116: 697–706.
- Oonincx, D.G.A.B. and de Boer, I.J.M., 2012. Environmental impact of the production of mealworms as a protein source for humans - a life cycle assessment. *PLoS ONE* 7 <https://doi.org/10.1371/journal.pone.0051145>.
- Psarianos, M., Dimopoulos, G., Ojha, S., Cavini, A.C.M., Bußler, S., Taoukis, P. and Schlüter, O.K., 2022. Effect of pulsed electric fields on cricket (*Acheta domesticus*) flour: extraction yield (protein, fat and chitin) and techno-functional properties. *Innovative Food Science & Emerging Technologies* 76: 102908.
- Ramos-Elorduy, J., González, E.A., Hernández, A.R. and Pino, J.M., 2002. Use of *Tenebrio molitor* (coleoptera: tenebrionidae) to recycle organic wastes and as feed for broiler chickens. *Journal of economic entomology* 95: 214–220.
- Song, Y.-S., Kim, M.-W., Moon, C., Seo, D.-J., Han, Y.S., Jo, Y.H., Noh, M.Y., Park, Y.-K., Kim, S.-A., Kim, Y.W. and Jung, W.-J., 2018. Extraction of chitin and chitosan from larval exuvium and whole body of edible mealworm, *Tenebrio molitor*. *Entomological Research* 48: 227–233.
- Sun, H., Necochea Velazco, O., Lakemond, C., Dekker, M., Cadesky, L. and Mishyna, M., 2021. Differences in moisture sorption characteristics and browning of lesser mealworm (*Alphitobius diaperinus*) ingredients. *Lebensmittel-Wissenschaft & Technologie* 142: 110989.
- Tello, A., Aganovic, K., Parniakov, O., Carter, A., Heinz, V. and Smetana, S., 2021. Product development and environmental impact of an insect-based milk alternative. *Future Foods* 4: 100080.
- Tobolková, B., Takáč, P., Mangová, B. and Kozánek, M., 2021. A comparative study of colour characteristics of thermally/non-thermally treated mealworm larvae (*Tenebrio molitor*) by means of UV/Vis spectroscopy and multivariate analysis. *Journal of Food Measurement and Characterization* 15: 3791–3799.
- van Huis, A., Itterbeeck, J. Van, Klunder, H., Mertens, E., Halloran, A., Muir, G. and Vantomme, P., 2013. Edible insects. future prospects for food and feed security. Food and Agriculture Organization of the United Nations. 1–201 pp.

- Vorobiev, E. and Lebovka, N., 2010. Enhanced extraction from solid foods and biosuspensions by pulsed electrical energy. *Food Engineering Reviews* 2: 95–108.
- Yi, L., Lakemond, C.M.M., Sagis, L.M.C., Eisner-Schadler, V., van Huis, A. and van Boekel, M.A.J.S., 2013. Extraction and characterisation of protein fractions from five insect species. *Food Chemistry* 141: 3341–3348.
- Zhu, Z., Mhemdi, H., Ding, L., Bals, O., Jaffrin, M.Y., Grimi, N. and Vorobiev, E., 2015. Dead-end dynamic ultrafiltration of juice expressed from electroporated sugar beets. *Food and Bioprocess Technology* 8: 615–622.

III.3. Article 6: Impact of pulsed electric field treatment on the viability of *Tenebrio molitor* insect biomass, and on the following pressing and drying processes

(The article is presented on the following pages)

# **Impact of pulsed electric field treatment on the viability of *Tenebrio molitor* insect biomass, and on the following pressing and drying processes**

**Rachelle El Hajj<sup>1\*</sup>, Houcine Mhemdi<sup>1</sup>, Gaoussou Karamoko<sup>2</sup>, Romdhane Karoui<sup>2</sup>, Karim Allaf<sup>3</sup>, Nikolai Lebovka<sup>1,4</sup>, Eugène Vorobiev<sup>1</sup>**

<sup>1</sup> Université de Technologie de Compiègne, ESCOM, TIMR (Integrated Transformations of Renewable Matter), Centre de recherche Royallieu - CS 60 319 - 60 203 Compiègne Cedex

<sup>2</sup> Univ. Artois, Univ. Lille, Univ. Littoral Côte d'Opale, Univ. Picardie Jules Verne, Univ. de Liège, INRAE, Junia, UMR-T 1158, BioEcoAgro, F-62300 Lens, France

<sup>3</sup> University of La Rochelle, Laboratory of Engineering Science for Environment lasie -UMR-CNRS 7356, 17042 La Rochelle, France

<sup>4</sup> Institute of Biocolloidal Chemistry named after F. D. Ovcharenko, NAS of Ukraine, 42, blvr. Vernadskogo, Kyiv 03142, Ukraine

\*Corresponding Author: rachele.el-hajj@utc.fr; hajjrachelle@hotmail.com;

Published: October 2023

Journal of innovative food science and emerging technologies

<https://doi.org/10.1016/j.ifset.2023.103462>

## Abstract

This work explores the impact of pulsed electrical fields (PEF) on false mortality or latent vitality of yellow mealworms (*Tenebrio molitor* larvae) and following processes of hydraulic pressing (at pressure  $P=6$  MPa and temperature  $T_p=60$  °C) and air drying in a ventilated oven ( $T_d=50-70$  °C). The observed PEF effects were compared with data for blanched and frozen-thawed samples. Rinsing the larvae before the treatment significantly increased larval mortality. Analysis of SEM images revealed the presence of large-scale damages such as necrotic spots, after applying severe PEF treatment conditions to achieve complete mortality. In the pressing experiments, remarkable improvements were observed, with pressing yield increasing from 65% in untreated larvae up to 80% in PEF-treated larvae. Simultaneously, the water content of the resulting press cake decreased from 58% to 46%, with all studied samples displaying an inverse linear correlation between the press cake's water content and the pressing yield. Regarding the drying process, it was observed that blanched samples exhibited the slowest drying rate, whereas PEF-treated samples displayed a first-order kinetic process with a noteworthy acceleration in drying. These findings indicate that PEF treatment improves and boosts the overall drying process. Furthermore, PEF treatment resulted in a notable decrease in the activation energy of larvae, dropping from 80 kJ/mol for blanched and frozen-thawed samples to a range of 40-50 kJ/mol for PEF-treated larvae. This reduction in activation energy highlights the potential of PEF treatment in optimizing the overall efficiency of larval drying.

Industrial relevance: *T. molitor* larvae were approved by the European Food Safety Authority as a novel food. It is also a promising candidate for industrial-scale production, with relatively low contamination levels and high nutrient values as food sources for humans and domestic animals (such as birds, fish, and pets). It was demonstrated that PEF treatments significantly affect larval viability and can significantly improve the pressing and drying processes of *T. molitor* insect biomass. Obtained data may be useful for the industrial optimization of these processes.

**Keywords:** Insect biomass; *Tenebrio molitor*, Pulsed electric fields, Mortality, Pressing, Drying

## 1. Introduction

In recent years edible insect biomasses have attracted increasing interest as feed and food products (Aguilera *et al.*, 2021). Typically they have high nutritional values with high content of proteins, fatty acids, chitin, and micronutrients similar to conventional meat sources (do Carmo *et al.*, 2021; Laroche *et al.*, 2019; Mishyna *et al.*, 2021). Large-scale production of feed and food products from edible insects has recently begun in France, China, the United States, and Spain (Hong *et al.*, 2020). It was demonstrated that the production of insect-based feed and food products is more environmentally beneficial than that of traditional products (Smetana *et al.*, 2016, 2019).

*Tenebrio molitor* (*T. molitor*) larva, known as "yellow mealworm," is an extensively studied insect and approved as a novel food source in Europe (Errico *et al.*, 2022; Turck *et al.*, 2021). It offers high nutritional value, including high protein (41-66% w/w on a dry basis) and lipid (15-50% w/w on a dry basis) content, high protein digestibility, along with fiber (1.97-18.84% w/w) and essential vitamins and minerals (Gkinali *et al.*, 2022). Comprehensive data on the nutritional value of *T. molitor* larvae were recently collected (Errico *et al.*, 2022; Hong *et al.*, 2020).

Fresh larvae have a considerable water content, up to 68%. To preserve their nutritional and sensory quality during storage, a range of processing methods are necessary (Kröncke *et al.*, 2019). These methods include pretreatments, delipidation, protein, chitin, and chitosan extraction techniques, along with different killing methods (El Hajj *et al.*, 2022). The initial processing involves inactivation (blanching, freezing, grinding, and asphyxiation), followed by post-inactivation processes such as drying and grinding (Hong *et al.*, 2020). Additionally, mechanical pressing is often applied as a low-energy consuming process to remove water and fat from the larvae before further processes such as drying, grinding and extraction (El Hajj *et al.*, 2023; Smetana *et al.*, 2020). Drying methods include oven drying, vacuum drying, freeze-drying, and microwave drying. After drying, the larvae can be used as they are or undergo additional processes, such as grinding and lipid extraction (Melgar-Lalanne *et al.*, 2019). Preliminary processing methods can significantly affect the nutritional composition of the larvae (Baek *et al.*, 2019; Errico *et al.*, 2022; Laroche *et al.*, 2019). For example, traditional thermal treatments like boiling and blanching, which are used for microbial reduction, may impact the nutritional properties and sensory characteristics of the final products (Yan *et al.*, 2022).

The potential of novel insect processing techniques including high hydrostatic pressure (HHP), pulsed electric fields (PEF), ultrasound (US), microwaves, and cold atmospheric pressure plasma (CAAP) have been discussed (Hernández-Álvarez *et al.*, 2021; Huang *et al.*, 2023; Ojha *et al.*, 2021).

Recently, the effects of PEF treatment on the reproduction of insects, extraction yields, and drying kinetics were intensively studied. Experiments with PEF treatment ( $E=1-4$  kV/cm) of *Drosophila melanogaster* insect revealed the presence of a mild stress factor, DNA fragmentation and cell death (Panagopoulos, 2016). Another study showed that PEF treatment increased the extraction of

protein and fat from house crickets (*Acheta domesticus*) flour, as well as improved oil binding, emulsifying capacity, and antioxidant activity of cricket flour (Psarianos *et al.*, 2022). Additionally, studies on mosquito larvae (*Culex pipiens*) indicated genotoxic effects, changes in body proteins, and oxidative stress under PEF treatment at low electric field strengths ( $E=66.66\text{--}116.66\text{ V/cm}$ ) (Mohamad *et al.*, 2022).

Several studies have investigated the effects of PEF treatment on insect drying (Alles *et al.*, 2020; Bogusz *et al.*, 2022; Shorstkii *et al.*, 2022). PEF pretreatment (at  $E=2$  and  $3\text{ kV/cm}$ ) of *Hermetia illucens* resulted in a significant reduction (up to 30%) in drying time during hot air drying at  $90^\circ\text{C}$ , with no noticeable effects on fatty indices and amino acids profile (Alles *et al.*, 2020). Another study investigated the impact of PEF pretreatment on *H. illucens* hot air drying at different temperatures ( $T_d=50\text{--}90^\circ\text{C}$ ), revealing optimal processing parameters at  $W=11.2\text{--}13.1\text{ kJ/kg}$  and  $T_d=81\text{--}84^\circ\text{C}$  (Shorstkii *et al.*, 2022). The impact of PEF treatment (at  $E\approx 1\text{ kV/cm}$ ) on infrared-assisted air drying kinetics of *T. molitor* and *H. illucens* larvae has been evaluated (Bogusz *et al.*, 2022). It was demonstrated that PEF treatment reduces the infrared drying time by up to 10% and may reduce the microbial load of fresh larvae by  $0.5\text{--}1.0$  log cycle. A general review on insect drying with different methods including PEF-enhanced lyophilization was recently presented (Parniakov *et al.*, 2022).

A study by (Smetana *et al.*, 2020) investigated the impact of PEF ( $E=200$  to  $1000\text{ V/cm}$ ) on cell permeabilization in *T. molitor* larvae. They found that at higher values of electric field strength and larval density, significant permeabilization ( $Z\approx 0.8\text{--}1$ ) occurred due to the compacted tissue's high conductivity, resulting from air expulsion. Additionally, PEF treatment under optimal conditions ( $E = 800\text{ V/cm}$ ,  $t_{\text{PEF}} = 200\text{ ms}$ ,  $\rho_l = 0.8\text{ g/cm}^3$ ) was found to increase the juice yield of the mechanical pressing process.

The current study builds upon previous research conducted by Smetana *et al.* (2020), which explored the effects of PEF on *T. molitor* larvae. The PEF-induced stress and larvae mortality were studied in dependence on PEF protocol and the presence or absence of preliminary aqueous rinsing of larvae. After the PEF treatment, the larvae were subjected to two different processes. Some larvae underwent a low-energy pressing method to decrease their water and lipid content, while others were dried as whole larvae in a ventilated oven at temperatures ranging from  $50$  to  $70^\circ\text{C}$ . The study involved comparing untreated, blanched, frozen-thawed, and PEF-treated samples to assess and compare the impact of each treatment on the larvae.

## 2. Materials and methods

### 2.1. Insect samples

Yellow mealworms (*T. molitor* larvae) were supplied by France insects farm (Crevecoeur-le-grand, France). They were fed with wheat bran and delivered in sealed boxes before being held at  $4^\circ\text{C}$  and starved for more than 24h before processing then sieved to separate the frass. Handling



was done within 10 days of reception. On average, a larva weighs  $66.1 \pm 5.2$  mg, has an average thickness of  $2.06 \pm 0.15$  mm, and an average length of  $26.4 \pm 6.8$  mm. Larvae were treated alive and had an initial moisture content of 65 % (65g/100g wb). The protein content of insects calculated from total nitrogen using the nitrogen-to-protein conversion factor ( $K_p$ ) of 4.76 (Janssen *et al.*, 2017) was  $\approx 40\%$  db and lipid content was  $\approx 28\%$  db.

In this research, we maximized the welfare of insects by following the '3Rs' of animal usage in research: Replace, Reduce, and Refine. Furthermore, the used killing methods raise no legal concerns as there are no guidelines for insect killing methods in Council Regulation (EC) 1099/2009 on animal protection at the time of killing (Belluco *et al.*, 2017) or in the official bulletin of the French Ministry of Agriculture and Food (DGAL/SDSPA/2017-860) (DGAL, 2017).

## 2.2. Pretreatment methods

Figure 1 presents the scheme of the applied experimental methods. The pretreatments included PEF treatment, blanching and freezing/thawing. Simultaneously, the pretreatments served the dual purpose of inactivation and processing treatment.

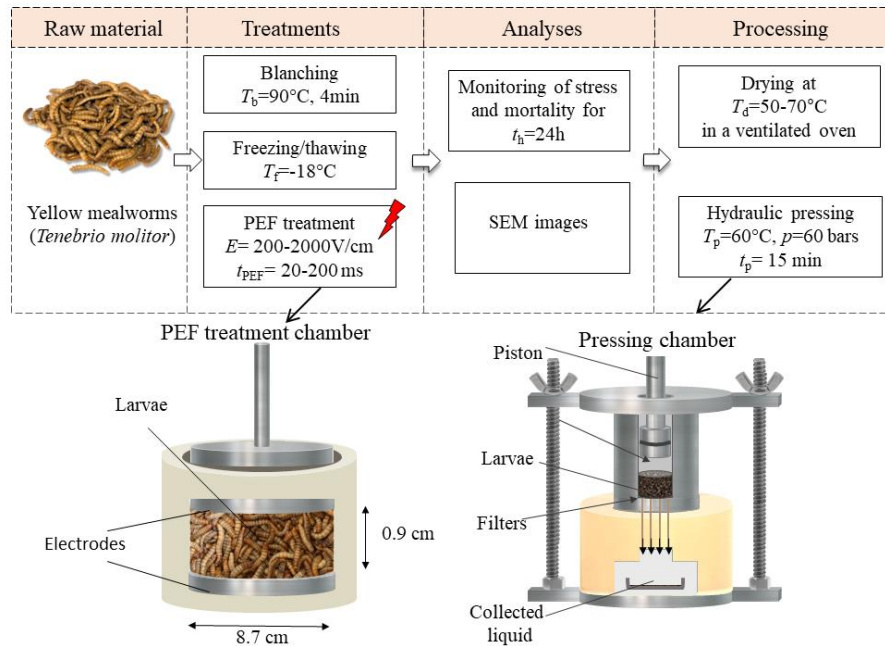

**Figure 1.** Description of the applied experimental methods

### 2.2.1. Pulsed electric field (PEF)

The PEF pre-treatment was applied on rinsed (R) and non-rinsed (NR) samples. Larvae to be rinsed were placed in a strainer and exposed to tap water. 50 g of larvae to be treated were placed in a cylindrical treatment chamber between two parallel disk electrodes of 8.7 cm in diameter. The

larvae were compacted to a density of  $\rho_1 = 0.9 \text{ g/cm}^3$  by reducing the distance between the electrodes to 0.9 cm, resulting in greater conductivity within the samples.

The PEF generator (5 kV, 1 kA) (Hazemeyer, France) was used in this study. It provided monopolar pulses of a near-rectangular shape. The treatment data (number of trains, current, and voltage) were recorded using the Agilent VEE-PRO version 8.5 software. An electric field strength of  $E = 200\text{-}2000 \text{ V/cm}$  was applied. PEF protocol consisted of  $N$  applied trains ( $N=5\text{-}20$ ) with a relatively long pause between them  $\Delta t_i=10\text{-}30 \text{ s}$ . In order to avoid overheating the samples were periodically cooled during the inter-train periods and the elevation of the temperature never exceeded  $40^\circ\text{C}$ .

One train consisted of  $n$  pulses ( $n = 20\text{-}100$ ), with the pulse duration of  $t_i = 100 \text{ }\mu\text{s}$ , and distance between pulses  $\Delta t = 100 \text{ ms}$ . The total time of PEF treatment  $t_{\text{PEF}} = t_i n N$  was  $t_{\text{PEF}} = 10\text{-}1000 \text{ ms}$ . At such treatment conditions the PEF-induced disintegration can be rather high (Smetana *et al.*, 2020).

The electrical conductivity disintegration index, was defined as (Vorobiev & Lebovka, 2020):

$$Z = (\sigma - \sigma_i) / (\sigma_\infty - \sigma_i), \quad (1)$$

Here  $\sigma$  is the electrical conductivity of the sample, and the subscripts  $i$  and  $\infty$  refer to intact and completely damaged samples for rinsed (R) and non-rinsed (NR) samples, respectively. The value of  $\sigma_\infty$  has been estimated when the PEF treatment reached its saturation point after an extended treatment time  $\sigma \rightarrow \sigma_\infty$ .

Therefore, the selected protocols of PEF treatments allow for obtaining different impacts on survival mortality levels of larvae samples.

### 2.2.2. *Blanching*

Blanching is a conventional pretreatment step used to kill the larvae, minimize the microbial load and inactivate the degradative enzymes responsible for spoilage, before further processing. It could be done at different temperature/time combinations (Mancini *et al.*, 2019; Vandeweyer *et al.*, 2017). Closed sample bottles of 60 ml were preheated in a water bath at  $90^\circ\text{C}$  before being loaded with 20 g of living larvae. The blanching time required at  $90^\circ\text{C}$  to induce 100% larval mortality was identified to be 4 min.

### 2.2.3. *Freezing/thawing*

The freezing/thawing was used as a reference treatment since it is known to produce cell damage through the formation of ice crystals, which improves subsequent processing steps (Vorobiev & Lebovka, 2020). Freezing was done at  $T_f = -18^\circ\text{C}$  for 48 h in freezer TCH501E (Thomson, China) and followed by thawing at room temperature, taking approximately 1 h to reach the ambient temperature.

### 2.3. *Sample analysis*

Sample analysis included the evaluation of the mortality level and scanning electron microscopy (SEM) images (Figure.1).

#### 2.3.1. *Monitoring of PEF-induced stress and mortality of larvae*

After the PEF treatment, larvae were homogenized and two representative sample groups of 50 larvae were formed, and their PEF-induced stress and mortality were monitored for up to 24 h (holding time  $t_h$ ). The level of larval mortality  $L_m$  (%) was determined by counting the larvae with no vital signs (complete lack of movement).

#### 2.3.2. *SEM analysis*

Scanning electron microscopy (SEM) images of whole larvae were taken at 250 folds magnification at 20 kV accelerating voltage and low pressure, using an environmental Scanning Electron Microscope QUANTA 250 FEG (Thermo Fisher Scientific, USA). The Quanta equipment permits observation of life-sciences samples in environmental conditions.

### 2.4. *Processing methods*

After different pretreatments, *T. molitor* larvae were subjected to hydraulic pressing and air drying in a ventilated oven (Figure 1).

#### 2.4.1. *Hydraulic pressing*

The hydraulic pressing experiments employed the TA-HDi texturometer system (Stable Microsystems, Surrey, UK) as a micro-press apparatus. Serving as the strength source, this texturometer was equipped with a force capacity sensor of 4903 N (equivalent to 100 bar) with a precision of 10 N that ensures accurate force measurements throughout the entire pressing process.

The apparatus is essentially made of a stainless-steel piston, a pressing chamber (with a maximum volume capacity of 30.4 cm<sup>3</sup>), and a filtration system (Figure. 1). The latter is made of metal filters (with 0.165 mm pores) set on each side of the material to be pressed and a filter paper (5-13µm) placed beneath the sample to retain the solid fraction. A heating collar is positioned around the vertical cylinder, and the temperature of the cylinder is monitored using a thermometer and a thermocouple type K (Extech, SDL200, 4-Channel Datalogging Thermometer, USA).

In a preliminary study, the different pressing parameters were optimized to obtain the highest extraction yield. Identifying the optimal pressing parameters was done by comparing the yield of the liquid extracted. The selected optimal pressed cake thickness  $h=2$  cm and piston speed  $V_p=0.15$  mm/s allowed an optimal performance of the filtration process. The optimum pressure was selected to be  $P=6$  MPa because the increase in liquid yield above this pressure was insignificant.

The pressing temperature was relatively moderate,  $T_p = 60^\circ\text{C}$ , in order to avoid protein denaturation and aggregation.

The samples were weighed on a precision scale (Mettler Toledo ME54, USA) before and after pressing. The total time of pressing was selected to be 15 min. This time was large enough to obtain the saturation levels for pressing yield  $Y_p$  and press cake's water content  $W_c$ .

The value of  $Y_p$  (%) was calculated as  $Y_p = 100(m_i - m_f)/m_i$  where  $m_i$  and  $m_f$  are the initial (before pressing) and final (after pressing) masses, respectively. After the pressing, the press cake's water content  $W_c$  (% , wb) was determined using an infrared moisture analyzer at  $105^\circ\text{C}$  MA160 (Sartorius, Germany).

#### 2.4.2. *Oven-drying*

In this study, the drying kinetics was carried out in a ventilated oven (Memmert UN750, Germany), at three different drying temperatures  $T_d = 50, 60, \text{ and } 70^\circ\text{C}$ . The airflow velocity was fixed at 2 m/s and measured using a digital anemometer (Shenzhen Tomtop Technology Co., Ltd., China). In the drying procedure, 30 g of pretreated samples were placed in well-perforated stainless-steel baskets (65x70mm) and then they were placed in the oven. Samples were periodically weighed, and the total drying time was 20 h. Moisture content on a dry basis  $M$  was calculated as

$$M(t) = (m(t) - m_d) / m_d \quad (2)$$

where  $m(t)$  is the mass measured at time  $t$ , and  $m_d$  is the dry matter mass that was determined after drying in an oven at  $105^\circ\text{C}$  for 24 h.

#### 2.5. *Drying modeling*

The analysis and modeling of the drying data were conducted using Table Curve 2D software (Version 5.0, Systat Software Inc, San Jose, California, US). This software tool was employed to analyze and fit the drying data with the objective of identifying the most suitable mathematical models that accurately represent the drying behavior of the samples.

#### 2.6. *Statistical analysis*

Every experiment was carried out at least three times. All data are given as means, and the standard deviations are presented as error bars. The significance of differences between mean values was determined using the least significant difference test at a level of  $p < 0.05$  (using Microsoft Excel 2019).

### 3. Results and discussion

Figure 2 compares the  $Z(t_{PEF})$  behavior for rinsed (R) and non-rinsed (NR) PEF-treated samples at  $E = 800 \text{ V/cm}$  and  $\rho_1 = 0.9 \text{ g/cm}^3$  for PEF treatment time in the interval  $t_{PEF} = 0\text{-}1000 \text{ ms}$ . For the

compacted NR samples the higher level of  $Z$  was only observed at a relatively long time of PEF treatment,  $t_{PEF} \approx 1000$  ms. However, for the compacted R samples the PEF-induced disintegration was observed at a significantly shorter time,  $t_{PEF} \approx 100$  ms.

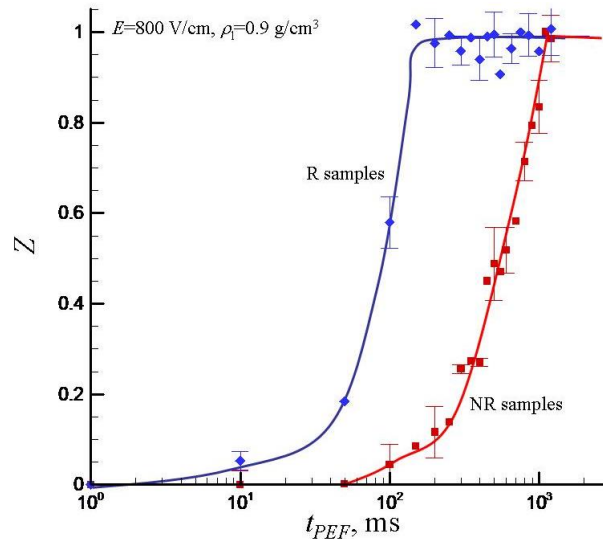

**Figure 2.** Disintegration index  $Z$  versus PEF treatment time  $t_{PEF}$  at electric field strength  $E=800$  V/cm and compacted larvae with density of  $\rho_l=0.9$  g/cm<sup>3</sup> for rinsed (R) and non-rinsed (NR) samples. The curves are drawn only for visual guidance.

Such differences in PEF-induced disintegration behavior can be explained by the presence of a very rigid and resistant exoskeleton of the larvae, whose role is to protect the insect from the environment (Caveney, 1970; Roberts & Willis, 1980). The exoskeleton has a rather complex structure, and it is composed of two layers represented by a thin outer protein layer, the epicuticle that contains waxes (thickness of 1  $\mu\text{m}$ ) and a thick inner chitin-protein layer, the procuticle. The procuticle consists of an outer layer, exocuticle (thickness of 20-30  $\mu\text{m}$ ) and an inner layer, endocuticle (thickness of  $\approx 15$   $\mu\text{m}$ ). In the absence of any preliminary rinsing step, the NR sample represents the packing of larvae with relatively small conductivity and large air gaps between them. The increase of  $Z$  during the PEF treatment can be explained by the improvement of electrical contact between individual larvae. For the preliminary rinsed R samples, the contact between individual larvae is improved and it results in an improvement in PEF treatment efficiency.

Figure 3 shows the mortality level of *T. molitor* larvae PEF-treated without (a, NR samples) and with (b, R samples) rinsing at different electric field strengths ( $E=200$ - $2000$  V/cm) and treatment times ( $t_{PEF}=50$ - $200$  ms). The data are presented at different holding times  $t_h=0, 2$  and  $24$  h after the PEF treatment. Immediately after the PEF treatment at  $t_h=0$  h, many larvae remained motionless and can be assumed to be dead. However, some of them were under a shock (mild stress) resulting from the application of PEF treatment and after some time ( $t_h=2$  h), survivors started to move. Therefore, at relatively moderate PEF treatment, the effect of false mortality or latent vitality was observed. This behavior was rather similar to that observed after the PEF treatment of Mexican fruit fly, *Anastrepha ludens* (Loew) insects (Hallman & Zhang, 1997; Pinpathomrat *et al.*, 2011).

The PEF-treated insects displayed a variety of pathological symptoms (sluggishness, partial pupariation, and development of necrotic spots throughout the body). It has been shown that PEF treatment can also influence the development characteristics of the larvae and restrain larvae from becoming mature. The potential biological consequences produced by the mild stress placed on the organism by pulsed electric fields were addressed in precise detail in (Panagopoulos, 2016).

In our experiments at a long holding time after the PEF treatment ( $t_h=24$  h) a part of the surviving larvae died and the mortality level increased. Additionally, the rinsing step had a significant impact on the increase in mortality. For example, for the PEF treatment with  $E=1500\text{V/cm}$  and  $t_{PEF}=50$  ms for  $t_h=24$  h, the mortality levels were  $\approx 50\%$  (Figure. 3a) for NR samples and  $\approx 100\%$  (Figure. 3b) for R samples. This effect can be explained by the increased electrical conductivity with the rinsing step as mentioned previously.

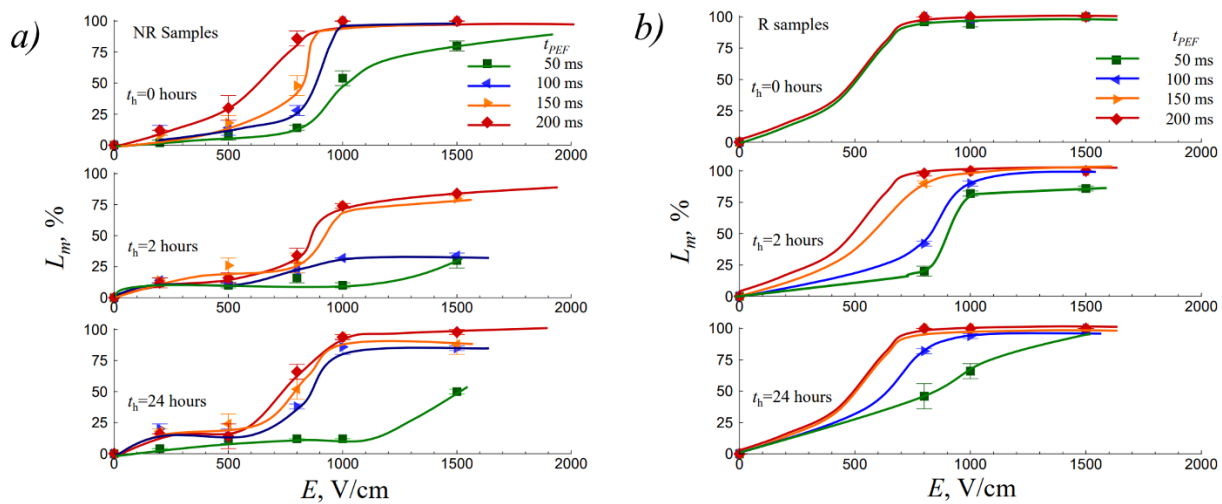

**Figure 3.** Mortality level  $L_m(\%)$  of *T. molitor* larvae versus electric field strength  $E$  at different PEF treatment times  $t_{PEF}$  for samples without (a, NR samples) and with (b, R samples) preliminary rinsing. The data are presented for compacted larvae with density of  $\rho_l=0.9 \text{ g/cm}^3$  at different holding times  $t_h=0, 2$  and  $24$  h after the PEF treatment. The curves are drawn only for visual guidance.

Figure 4 illustrates the dependencies of the mortality level  $L_m$  versus the holding time after the PEF treatment and holding time  $t_h$ . The data are presented for the samples without (NR samples, dashed curves) and with (R samples, solid curves) preliminary rinsing PEF treated at electric field strength  $E=800\text{V/cm}$  and treatment time  $t_{PEF}=50$  and  $200$  ms.

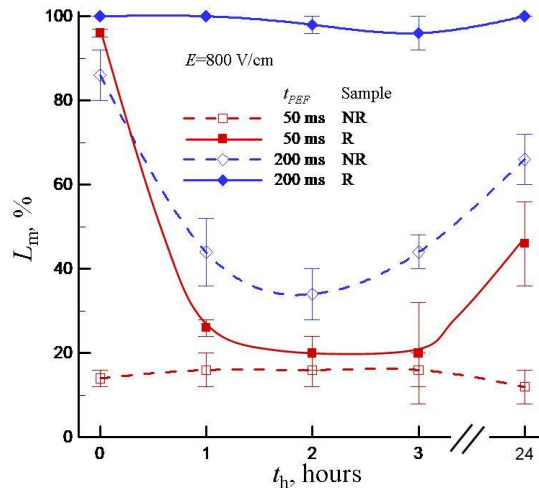

**Figure 4.** Mortality level  $L_m$  (%) of *T. molitor* larvae versus the holding time  $t_h$  for samples without (NR samples) and with (R samples) preliminary rinsing. The data are presented for compacted larvae with a density of  $\rho = 0.9$  g/cm<sup>3</sup> PEF treated at  $E = 800$  V/cm,  $t_{PEF} = 50$  and 200 ms. The curves are drawn only for visual guidance.

At shorter  $t_{PEF}$  ( $=50$  ms), the values of  $L_m$  were insignificant ( $\approx 10$ -17 %) for NR samples during all the holding time of  $t_h = 0$ -24 h. However, the situation changed drastically for R samples. Here, the mortality was near complete at  $t_h = 0$  h, it dropped significantly during the initial period of  $t_h = 1$ -3 h, and then increased up to  $\approx 40$  % at  $t_h = 24$  h.

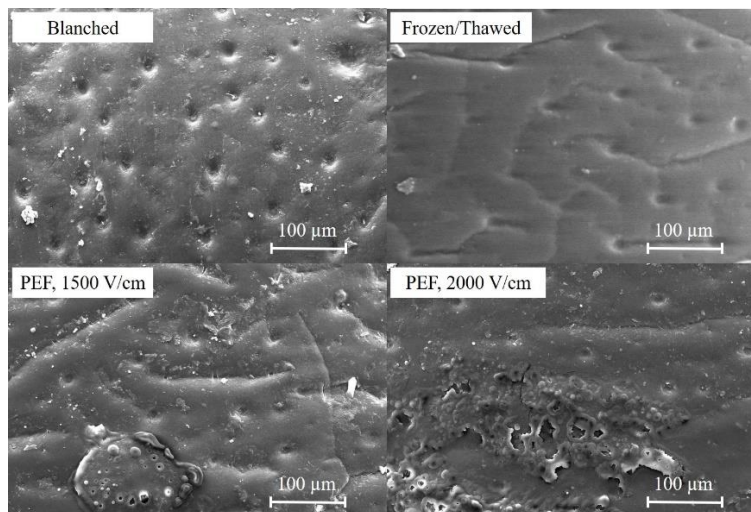

**Figure 5.** SEM images of *T. molitor* larvae: blanched, frozen/thawed, and PEF-treated (R samples with preliminary rinsing,  $E = 1500$  V/cm and 2000 V/cm).

At a longer time of PEF treatment ( $t_{PEF} = 200$  ms), a similar behavior was observed for NR samples, i.e., the mortality level dropped significantly during the initial period  $t_h = 1$ -3 h, but for R samples the mortality level was close to 100 % during all the holding time. The parabolic-like behavior of mortality level with partial survival of larvae over the holding time  $t_h$  was only observed at rather high PEF-induced changes for both NR and R samples. Finally, the irreversible killing of insects was observed only for intensive PEF treatment of R samples.

SEM images of larvae that underwent different pretreatments are presented in Figure. 5. The observed pores in all images are canal pores that are present in the yellow mealworm exoskeleton. The structure of pore canals in *T. molitor* insects was discussed in (Caveney, 1970). The larvae pores on their exoskeleton extend from the epidermis to the procuticle and are used to carry waxes, cement, and occasionally other materials to the insect's surface (epicuticle) (Nation, 2008; Wigglesworth, 1948). These pore canals were clearly observed for blanched and frozen/thawed samples (Figure 5).

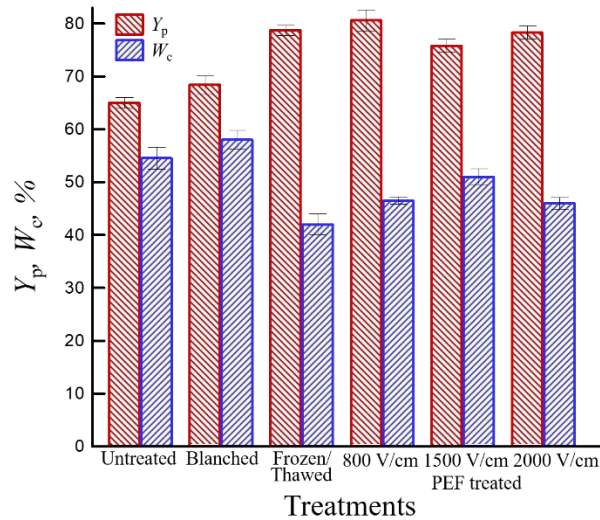

**Figure 6.** Pressing yield  $Y_p$  and press cake's water content  $W_c$  at different treatment conditions.

However, some changes have been observed for PEF-treated larvae at strong treatment conditions to obtain complete mortality (e.g. at  $E=1500\text{V/cm}$ ,  $t_{\text{PEF}}=50\text{ ms}$  and  $E=2000\text{V/cm}$ ,  $t_{\text{PEF}}=20\text{ ms}$ ). In these cases, PEF treatment significantly affected the structure of the exoskeleton and large-scale damages (100-500  $\mu\text{m}$ ), and necrotic spots on the surface of larvae were visually observed (Figure 5).

Larvae pressing is a commonly applied process to separate water and lipids from proteins and chitins. The main objective is to retain most proteins in the press cake, resulting in a protein-rich meal, while water and lipids are partially extracted into the pressing liquid. The compounds obtained in the liquid, including lipids and proteins, are also to be extracted and valued. Figure 6 shows results for the pressing yield  $Y_p$  and press cake's water content  $W_c$  at different treatment conditions. The PEF treatments were applied on R samples at intense treatment conditions to obtain total mortality (e.g., at  $E=800\text{V/cm}$ ,  $t_{\text{PEF}}=200\text{ ms}$ ,  $E=1500\text{V/cm}$ ,  $t_{\text{PEF}}=50\text{ ms}$  and  $E=2000\text{V/cm}$ ,  $t_{\text{PEF}}=20\text{ ms}$ ).

Significant increases in pressing yield ( $Y_p$ ) were observed in frozen-thawed and PEF-treated larvae samples compared to untreated larvae. The pressing yield values were as follows: 78.7% for frozen-thawed, 80.6% for PEF-treated at 800 V/cm for 200 ms, 75.8% for PEF-treated at 1500



V/cm for 50 ms, 78.3% for PEF-treated at 2000 V/cm for 20 ms, and 65% for untreated larvae. However, it is essential to highlight that blanching treatment did not lead to a significant increase in yield (68.4%) when compared to untreated larvae. Regarding the press cake's water content, it was found to be 42% for frozen-thawed larvae, 46.5% for PEF-treated at 800 V/cm for 200 ms, 51% for PEF-treated at 1500 V/cm for 50 ms, 46% for PEF-treated at 2000 V/cm for 20 ms, and 58% for untreated larvae.

An inverse linear correlation between values of  $W_c$  and  $Y_p$  was observed (Figure 7):

$$W_c = a - bY_p \quad (3)$$

where  $a = 114 \pm 14$ ,  $b = -0.87 \pm 0.18$  with correlation coefficient of  $R^2 = 0.847$ .

These findings support the existence of a strong relationship between the press cake's water content and the pressing yield. The results also indicate that PEF-treated larvae exhibited an increase in pressing yield and a decrease in the water content of the press cake when compared to untreated and blanched larvae. This outcome leads to a more dewatered protein-rich press cake, which is highly advantageous in reducing the remaining water that needs to be evaporated in subsequent processes.

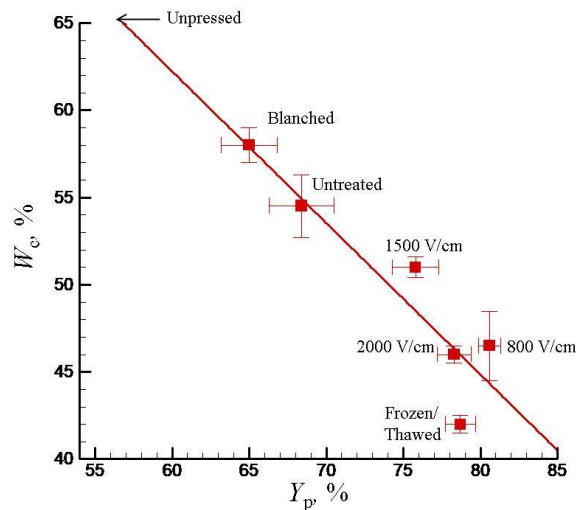

**Figure 7.** Press cake's water content  $W_c$  (%) versus the pressing yield  $Y_p$  (%) correlation curve at different treatment conditions. The symbols correspond to experimental data and curves were obtained from fitting using the extended exponential function (Eq. (3)).

Different treatment conditions had a significant impact on the oven-drying process as well. It is well known that the energy costs for oven drying of *T. molitor* are much lower than that for freeze drying and vacuum oven drying (Kröncke *et al.*, 2019). In our work, relatively low temperatures of drying  $T_d = 50-70$  °C were selected in order to avoid protein denaturation as well as the pronounced color darkening with the progress of the Maillard reaction. However, at low drying temperatures, long process times should be avoided, and PEF treatment can be useful for the acceleration of drying.

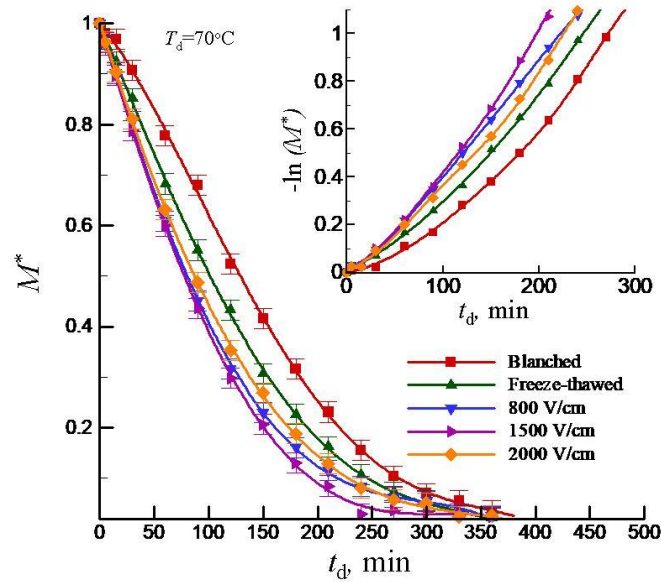

**Figure 8.** Relative water content  $M^*=M(t)/M(0)$  versus the drying time  $t_d$  at temperature  $T_d=70^\circ\text{C}$  for blanched, frozen/thawed, and PEF-treated R samples with preliminary rinsing (at  $E=800\text{V/cm}$ ,  $t_{\text{PEF}}=200$  ms,  $E=1500\text{V/cm}$ ,  $t_{\text{PEF}}=50$  ms and  $E=2000\text{V/cm}$ ,  $t_{\text{PEF}}=20$  ms). Inset shows the same dependencies in logarithmic  $-\ln(M^*)$  versus  $t_d$  coordinates. The symbols correspond to experimental data and curves were obtained from fitting using extended exponential function (Eq. (4)).

Figure 8 shows examples of the variations of the sample's relative moisture content  $M^*=M(t)/M(0)$  versus the drying time  $t_d$  for the blanched, frozen/thawed, and PEF-treated samples. All these data are presented for R samples at drying temperature  $T_d=70^\circ\text{C}$  and the chosen PEF treatments were high treatment conditions with complete mortality (e.g., at  $E=800\text{V/cm}$ ,  $t_{\text{PEF}}=200$  ms,  $E=1500\text{V/cm}$ ,  $t_{\text{PEF}}=50$  ms and  $E=2000\text{V/cm}$ ,  $t_{\text{PEF}}=20$  ms). Similar dependencies were obtained at  $T_d=50^\circ\text{C}$  and  $60^\circ\text{C}$ . The findings show that blanched samples had the slowest drying kinetics, frozen/thawed samples had relatively faster drying kinetics, and PEF-treated samples had the fastest drying kinetics. Notably, among the PEF-treated samples, the treatment at  $2000\text{V/cm}$  for 20 ms resulted in slightly slower drying kinetics in comparison to the treatments at  $800\text{V/cm}$  for 200 ms and  $1500\text{V/cm}$  for 50 ms. This observation highlights the potential influence of treatment duration on the effectiveness of the PEF treatment. Note that the impact of freezing on the drying processes of edible yellow mealworms was previously reported (Melis *et al.*, 2018).

Analysis of the drying data has shown that all the curves can be well-fitted with extended exponential functions of type (Vorobiev & Lebovka, 2020):

$$M^*(t)=\exp(-(t_d/\tau_d)^\beta), \quad (4)$$

where  $\tau_d$  is a characteristic drying time and  $\tau > 1$  is an exponent. In the literature on drying the extended exponential model is also called a Page model (Page, 1949).

The presentation of the data in logarithmic  $-\ln(M^*)$  versus  $t_d$  coordinates (see inset to Figure 8) reveals that  $\beta > 1$ . Particularly at  $T_d=70$  °C, the data fittings give  $\beta=1.50\pm 0.03$  for blanched samples,  $\beta=1.26\pm 0.03$  for freeze-thawed samples, and  $\beta=1.17\pm 0.05$  for PEF-treated samples. Note that formally the first-order kinetic model ( $\beta = 1$ ) corresponds to the process with a single characteristic time,  $\tau_d$ , whereas the extended exponential model accounts for the presence of a distribution of the characteristic times.

The process with  $\beta > 1$  is called the process with a compressed distribution function and the value  $\beta=2$  corresponds to the Gaussian distribution. It shows that blanching or freeze-thawing can cause the strong isolation of internal water inside larvae and the appearance of a barrier against drying. However, PEF treatment results in the formation of many paths for the evaporation of internal water and the PEF-assisted drying is close to the first-order kinetic process with a single characteristic time.

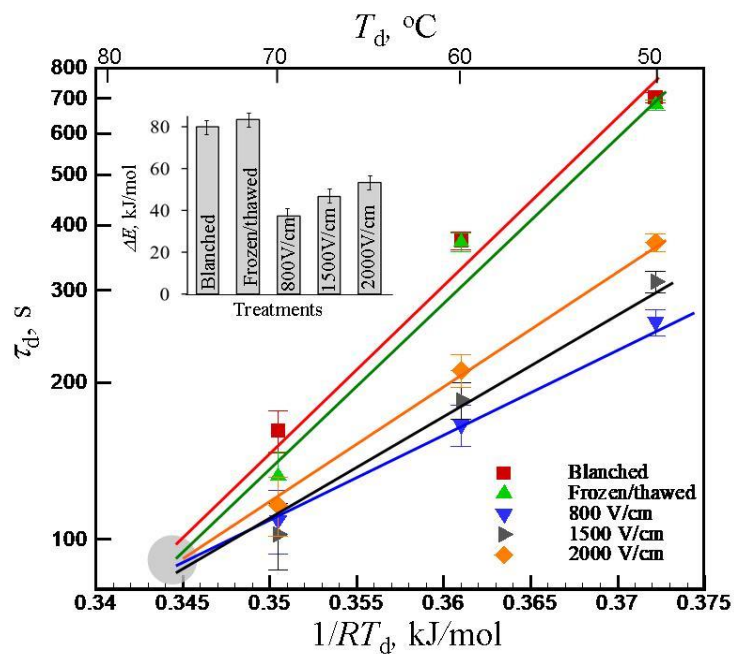

**Figure 9.** Arrhenius plots of the characteristic drying time  $\tau_d$  versus the inverse thermal energy  $1/(RT_d)$  for the blanched, frozen/thawed, and PEF-treated R samples with preliminary rinsing (at  $E=800\text{V/cm}$ ,  $t_{\text{PEF}}=200$  ms,  $E=1500\text{V/cm}$ ,  $t_{\text{PEF}}=50$  ms and  $E=2000\text{V/cm}$ ,  $t_{\text{PEF}}=20$  ms). Inset shows the activation energies  $\Delta E$  for different treatments. The symbols correspond to experimental data and curves were obtained from exponential fittings.

Figure 9 presents the characteristic drying time  $\tau_d$  versus the inverse thermal energy  $1/(RT_d)$ , where  $R$  is the universal gas constant. The values  $\tau_d$  decreased with increasing temperature and all dependencies were near-Arrhenius,  $\tau_d = \tau_d \exp(-\Delta E/RT_d)$ , with  $\Delta E$  drying activation energies. The highest drying activation energies  $\Delta E \approx 80$  kJ/mol were observed for the blanched and frozen/thawed samples. However, for the PEF-treated samples, the activation energies were significantly lower,  $\Delta E \approx 40\text{-}50$  kJ/mol.

These data also revealed the presence of a barrier against the evaporation of water during the drying of the blanched and frozen/thawed samples. It is interesting that at some critical temperature of the order of 75-80 °C all the Arrhenius plots converge to an area with approximately the same value  $\tau_d \approx 90$  min. This behaviour can reflect the destruction of the barrier against evaporation for the blanched and frozen/thawed samples at sufficiently high temperatures.

#### 4. Conclusion

Application of PEF with an electric field strength of  $E = 200-2000$  V/cm and treatment duration of  $t_{PEF} = 10-200$  ms allowed effective electroporation of larvae with a high level of mortality. At relatively moderate PEF treatment the effect of false mortality or latent vitality of larvae was observed. Immediately after PEF treatment, many larvae looked dead, but after some time, some of them survived and started to move. Additionally, the rinsing step significantly affected the increase in mortality. Particularly at  $E \geq 800$  V/cm, the parabolic-like behavior of mortality level with partial survival of larvae over the holding time  $t_h$  was observed for both NR and R samples. Analysis of SEM images revealed significant changes in the structure of the exoskeleton and visible large-scale damages (100-500  $\mu$ m) after the PEF treatment at strong treatment conditions (to obtain the complete mortality). A development of necrotic spots on the surface of the larvae took place. PEF treatment increased pressing yield  $Y_p$  and an inverse linear correlation between values of press cake's water content  $W_c$  and pressing yield  $Y_p$  was observed for all samples (blanched, frozen-thawed, and PEF treated), making the PEF treatment an interesting dewatering method. The different treatment conditions also significantly influenced the oven-drying processes at drying temperatures  $T_d = 50-70$  °C. The slowest drying processes were observed for the blanched samples. Analysis of drying data using the Page model revealed the presence of strong isolation of water inside larvae for blanching or freezing-thawing treatment. However, PEF treatment results in the formation of many paths for the evaporation of internal water and the PEF-assisted drying is close to the first-order kinetic process with a single characteristic time. The impact of further combined mechanical and ultrasonic stresses coupled with preliminary PEF treatments will be a focus of our future studies.

#### 5. Statements & Declarations

**Conflicts of Interest:** The authors declare no conflict of interest.

**Acknowledgments:** This work is part of the RAFINSECT project, which is funded by the Hauts de France region.

#### 6. References

Aguilera, Y., Pastrana, I., Rebollo-Hernanz, M., Benitez, V., Álvarez-Rivera, G., Viejo, J. L., & Martín-Cabrejas, M. A. (2021). Investigating edible insects as a sustainable food source:

- nutritional value and techno-functional and physiological properties. *Food & Function*, 12(14), 6309–6322. <https://doi.org/10.1039/D0FO03291C>
- Alles, M. C., Smetana, S., Parniakov, O., Shorstkii, I., Toepfl, S., Aganovic, K., & Heinz, V. (2020). Bio-refinery of insects with Pulsed electric field pre-treatment. *Innovative Food Science & Emerging Technologies*, 64, 102403. <https://doi.org/10.1016/J.IFSET.2020.102403>
- Baek, M., Kim, M.-A., Kwon, Y.-S., Hwang, J.-S., Goo, T.-W., Jun, M., & Yun, E.-Y. (2019). Effects of processing methods on nutritional composition and antioxidant activity of mealworm (*Tenebrio molitor*) larvae. *Entomological Research*, 49(6), 284–293. <https://doi.org/10.1111/1748-5967.12363>
- Belluco, S., Halloran, A., & Ricci, A. (2017). New protein sources and food legislation: the case of edible insects and EU law. *Food Security*, 9(4), 803–814. <https://doi.org/10.1007/s12571-017-0704-0>
- Bogusz, R., Smetana, S., Wiktor, A., Parniakov, O., Pobiega, K., Rybak, K., & Nowacka, M. (2022). The selected quality aspects of infrared-dried black soldier fly (*Hermetia illucens*) and yellow mealworm (*Tenebrio molitor*) larvae pre-treated by pulsed electric field. *Innovative Food Science & Emerging Technologies*, 80, 103085. <https://doi.org/10.1016/J.IFSET.2022.103085>
- Cappelli, A., Cini, E., Lorini, C., Oliva, N., & Bonaccorsi, G. (2020). Insects as food: A review on risks assessments of Tenebrionidae and Gryllidae in relation to a first machines and plants development. *Food Control*, 108, 106877. <https://doi.org/10.1016/j.foodcont.2019.106877>
- Caveney, S. (1970). Juvenile hormone and wound modelling of *Tenebrio* cuticle architecture. *Journal of Insect Physiology*, 16(6). [https://doi.org/10.1016/0022-1910\(70\)90200-3](https://doi.org/10.1016/0022-1910(70)90200-3)
- Costa, S., Pedro, S., Lourenço, H., Batista, I., Teixeira, B., Bandarra, N. M., Murta, D., Nunes, R., & Pires, C. (2020). Evaluation of *Tenebrio molitor* larvae as an alternative food source. *NFS (Nutrition and Food Science) Journal*, 21, 57–64. <https://doi.org/10.1016/j.nfs.2020.10.001>
- DGAL. (2017). Utilisation des protéines et autres produits dérivés d’insectes dans l’alimentation humaine, animale et pour des usages techniques. In Ministère de l’agriculture et de la souveraineté alimentaire (DGAL/SDSPA/2017-860). <https://info.agriculture.gouv.fr/gedei/site/bo-agri/instruction-2017-860>
- do Carmo, C. S., Costa, L., Serra, A. T., Knutsen, S. H., Sahlstrøm, S., & Bronze, M. R. (2021). Alternative protein sources. In *Food Technology Disruptions* (pp. 131–174). Elsevier.
- El Hajj, R., Mhemdi, H., Besombes, C., Allaf, K., Lefrançois, V., & Vorobiev, E. (2022). Edible insects’ transformation for feed and food uses: an overview of current insights and future developments in the field. *Processes*, 10(5), 970. <https://doi.org/10.3390/PR10050970>
- Errico, S., Spagnoletta, A., Verardi, A., Moliterni, S., Dimatteo, S., & Sangiorgio, P. (2022). *Tenebrio molitor* as a source of interesting natural compounds, their recovery processes, biological effects, and safety aspects. *Comprehensive Reviews in Food Science and Food Safety*, 21(1), 148–197. <https://doi.org/10.1111/1541-4337.12863>
- Finke, M. D., Rojo, S., Roos, N., van Huis, A., & Yen, A. L. (2015). The European Food Safety Authority scientific opinion on a risk profile related to production and consumption of insects as food and feed. *Journal of Insects as Food and Feed*. <https://doi.org/10.3920/JIFF2015.x006>

- Frings, H. (1952). Factors determining the effects of radio-frequency electromagnetic fields on insects and materials they infest. *Journal of Economic Entomology*, 45(3), 396–408. <https://doi.org/10.1093/jee/45.3.396>
- Gkinali, A.-A., Matsakidou, A., Vasileiou, E., & Paraskevopoulou, A. (2022). Potentiality of *Tenebrio molitor* larva-based ingredients for the food industry: A review. *Trends in Food Science & Technology*, 119, 495–507. <https://doi.org/10.1016/j.tifs.2021.11.024>
- Hallman, G. J., & Zhang, Q. H. (1997). Inhibition of fruit fly (Diptera: Tephritidae) development by pulsed electric field. *Florida Entomologist*, 239–248. <https://doi.org/10.2307/3495556>
- Hernández-Álvarez, A.-J., Mondor, M., Piña-Domínguez, I.-A., Sánchez-Velázquez, O.-A., & Melgar Lalanne, G. (2021). Drying technologies for edible insects and their derived ingredients. *Drying Technology*, 39(13), 1991–2009. <https://doi.org/10.1080/07373937.2021.1915796>
- Hong, J., Han, T., & Kim, Y. Y. (2020). Mealworm (*Tenebrio molitor* Larvae) as an alternative protein source for monogastric animal: A review. *Animals*, 10(11), 2068. <https://doi.org/10.3390/ani10112068>
- Huang, D., Li, W., Li, G., Zhang, W., Chen, H., Jiang, Y., & Li, D. (2023). Effect of high-intensity ultrasound on the physicochemical properties of *Tenebrio Molitor* Protein. *Food Hydrocolloids*, 134, 108056. <https://doi.org/10.1016/j.foodhyd.2022.108056>
- Janssen, R. H., Vincken, J.-P., van den Broek, L. A. M., Fogliano, V., & Lakemond, C. M. M. (2017). Nitrogen-to-protein conversion factors for three edible insects: *Tenebrio molitor*, *Alphitobius diaperinus*, and *Hermetia illucens*. *Journal of Agricultural and Food Chemistry*, 65(11), 2275–2278. <https://doi.org/10.1021/acs.jafc.7b00471>
- Kadoum, A. M. (1969). Effect of radiofrequency electric field treatment on protein metabolism in yellow mealworm larvae. *Journal of Economic Entomology*, 62(1), 220–223. <https://doi.org/10.1093/jee/62.1.220>
- Kadoum, A. M., Ball, H. J., & Nelson, S. O. (1967). Morphological abnormalities resulting from radiofrequency treatment of larvae of *Tenebrio molitor*. *Annals of the Entomological Society of America*, 60(5), 889–903. <https://doi.org/10.1093/aesa/60.5.889>
- Kadoum, A. M., Ball, H. J., & Stetson, L. V. E. (1967). Metabolism in the yellow mealworm, *Tenebrio molitor* (Coleoptera: Tenebrionidae), following exposure to radiofrequency electric fields. *Annals of the Entomological Society of America*, 60(6), 1195–1199. <https://doi.org/10.1093/aesa/60.6.1195>
- Kröncke, N., Grebenteuch, S., Keil, C., Demtröder, S., Kroh, L., Thünemann, A. F., Benning, R., & Haase, H. (2019). Effect of Different Drying Methods on Nutrient Quality of the Yellow Mealworm (*Tenebrio molitor* L.). *Insects*, 10(4). <https://doi.org/10.3390/INSECTS10040084>
- Kumar, M., Vivekanand, V., & Pareek, N. (2020). Insect chitin and chitosan: structure, properties, production, and implementation prospective. In *Natural Materials and Products from Insects: Chemistry and Applications* (pp. 51–66). Springer. [https://doi.org/10.1007/978-3-030-36610-0\\_4](https://doi.org/10.1007/978-3-030-36610-0_4)
- Laroche, M., Perreault, V., Marciniak, A., Gravel, A., Chamberland, J., & Doyen, A. (2019). Comparison of Conventional and Sustainable Lipid Extraction Methods for the Production of

- Oil and Protein Isolate from Edible Insect Meal. *Foods*, 8(11).  
<https://doi.org/10.3390/FOODS8110572>
- Mancini, S., Fratini, F., Tuccinardi, T., Turchi, B., Nuvoloni, R., & Paci, G. (2019). Effects of different blanching treatments on microbiological profile and quality of the mealworm (*Tenebrio molitor*). *Journal of Insects as Food and Feed*, 5(3), 225–234.  
<https://doi.org/10.3920/JIFF2018.0034>
- Melgar-Lalanne, G., Hernández-Álvarez, A. J., & Salinas-Castro, A. (2019). Edible Insects Processing: Traditional and Innovative Technologies. *Comprehensive Reviews in Food Science and Food Safety*, 18(4), 1166–1191. <https://doi.org/10.1111/1541-4337.12463>
- Melis, R., Braca, A., Mulas, G., Sanna, R., Spada, S., Serra, G., Fadda, M. L., Roggio, T., Uzzau, S., & Anedda, R. (2018). Effect of freezing and drying processes on the molecular traits of edible yellow mealworm. *Innovative Food Science & Emerging Technologies*, 48, 138–149.  
<https://doi.org/10.1016/J.IFSET.2018.06.003>
- Mishyna, M., Keppler, J. K., & Chen, J. (2021). Techno-functional properties of edible insect proteins and effects of processing. *Current Opinion in Colloid & Interface Science*, 56, 101508.  
<https://doi.org/10.1016/J.COCIS.2021.101508>
- Mohamad, E. A., Elfky, A. A., El-Gebaly, R. H., & Afify, A. (2022). Study the change in the mosquito larvae (*Culex pipiens*) in water treated with short pulses electric filed. *Electromagnetic Biology and Medicine*, 41(1), 80–92.  
<https://doi.org/10.1080/15368378.2021.2012787>
- Nation, J. L. (2008). *Encyclopedia of Entomology* (J. L. Capinera (ed.); Second, Vol. 4, pp. 2015–2019). Springer Science+Business Media B.V.
- Nelson, S. O., Stetson, L. E., & Rhine, J. J. (1966). Factors influencing effectiveness of radio-frequency electric fields for stored-grain insect control. *Transactions of the ASAE*, 9(6), 809–815. <https://doi.org/10.13031/2013.40103>
- Ojha, S., Bußler, S., Psarianos, M., Rossi, G., & Schlüter, O. K. (2021). Edible insect processing pathways and implementation of emerging technologies. *Journal of Insects as Food and Feed*, 7(5), 877–900. <https://doi.org/10.3920/JIFF2020.0121>
- Page, G. E. (1949). Factors influencing the maximum rates of air drying shelled corn in thin layers. Master of Science thesis, Purdue University, West Lafayette.
- Panagopoulos, D. J. (2016). Pulsed electric field increases reproduction. *International Journal of Radiation Biology*, 92(2), 94–106.
- Parniakov, O., Mikhrovska, M., Wiktor, A., Alles, M., Ristic, D., Bogusz, R., Nowacka, M., Devahastin, S., Mujumdar, A., & Heinz, V. (2022). Insect processing for food and feed: A review of drying methods. *Drying Technology*, 40(8), 1500–1513.  
<https://doi.org/10.1080/07373937.2021.1962905>
- Pinpathomrat, N., Kaweferngfu, T., Laphodom, A., Islam, N. E., & Kirawanich, P. (2011). Inhibition of *Culex quinquefasciatus* (Diptera: Culicidae) viability by nanosecond pulsed electric field radiation. *Journal of Electrostatics*, 69(4), 339–344.

- Ponomaryova, I. A., Rivera Oyarzabal, L. N. de, & Ruíz Sánchez, E. (2008). Interaction of radio-frequency, high-strength electric fields with harmful insects. *Journal of Microwave Power and Electromagnetic Energy*, 43(4), 17–27. <https://doi.org/10.1080/08327823.2008.11688621>
- Psarianos, M., Dimopoulos, G., Ojha, S., Cavini, A. C. M., Bußler, S., Taoukis, P., & Schlüter, O. K. (2022). Effect of pulsed electric fields on cricket (*Acheta domesticus*) flour: Extraction yield (protein, fat and chitin) and techno-functional properties. *Innovative Food Science & Emerging Technologies*, 76, 102908. <https://doi.org/10.1016/J.IFSET.2021.102908>
- Ravzanaadii, N., Kim, S.-H., Choi, W.-H., Hong, S.-J., & Kim, N.-J. (2012). Nutritional value of mealworm, *Tenebrio molitor* as food source. *International Journal of Industrial Entomology*, 25(1), 93–98. <https://doi.org/10.7852/ijie.2012.25.1.093>
- Roberts, P. E., & Willis, J. H. (1980). The cuticular proteins of *Tenebrio molitor*. I. Electrophoretic banding patterns during postembryonic development. *Developmental Biology*, 75(1), 59–69. [https://doi.org/10.1016/0012-1606\(80\)90143-8](https://doi.org/10.1016/0012-1606(80)90143-8)
- Shorstkii, I., Comiotto Alles, M., Parniakov, O., Smetana, S., Aganovic, K., Sosnin, M., Toepfl, S., & Heinz, V. (2022). Optimization of pulsed electric field assisted drying process of black soldier fly (*Hermetia illucens*) larvae. *Drying Technology*, 40(3), 595–603. <https://doi.org/10.1080/07373937.2020.1819825>
- Siemianowska, E., Kosewska, A., Aljewicz, M., Skibniewska, K. A., Polak-Juszczak, L., Jarocki, A., & Jedras, M. (2013). Larvae of mealworm (*Tenebrio molitor* L.) as European novel food. *Agricultural Sciences*, 4, 287–291. <https://doi.org/10.4236/as.2013.46041>
- Smetana, S., Mhemdi, H., Mezdoor, S., & Heinz, V. (2020). Pulsed electric field--treated insects and algae as future food ingredients. In *Pulsed Electric Fields to Obtain Healthier and Sustainable Food for Tomorrow* (pp. 247–266). Elsevier.
- Smetana, S., Palanisamy, M., Mathys, A., & Heinz, V. (2016). Sustainability of insect use for feed and food: Life cycle assessment perspective. *Journal of Cleaner Production*, 137, 741–751. <https://doi.org/10.1016/j.jclepro.2016.07.148>
- Smetana, S., Schmitt, E., & Mathys, A. (2019). Sustainable use of *Hermetia illucens* insect biomass for feed and food: Attributional and consequential life cycle assessment. *Resources, Conservation and Recycling*, 144, 285–296. <https://doi.org/10.1016/j.resconrec.2019.01.042>
- Turck, D., Bohn, T., Castenmiller, J., De Henauw, S., Ildico Hirsch-Ernst, K., Maciuk, A., Mangelsdorf, I., McArdle, H. J., Naska, A., Pelaez, C., Pentieva, K., Siani, A., Thies, F., Tsabouri, S., Vinceti, M., Cubadda, F., Frenzel, T., Heinonen, M., Marchelli, R., ... Katrine Knutsen, H. (2021). Safety of frozen and dried formulations from whole yellow mealworm (*Tenebrio molitor* larva) as a novel food pursuant to Regulation (EU) 2015/2283 EFSA Panel on Nutrition, Novel Foods and Food Allergens (NDA), Panel members. *Journal*, 19(7), 6778. <https://doi.org/10.2903/j.efsa.2021.6778>
- Vandeweyer, D., Lenaerts, S., Callens, A., & Van Campenhout, L. (2017). Effect of blanching followed by refrigerated storage or industrial microwave drying on the microbial load of yellow mealworm larvae (*Tenebrio molitor*). *Food Control*, 71, 311–314. <https://doi.org/10.1016/j.foodcont.2016.07.011>



- Vorobiev, E., & Lebovka, N. (2020). Processing of foods and biomass feedstocks by pulsed electric energy. *Processing of Foods and Biomass Feedstocks by Pulsed Electric Energy*, 1–399. <https://doi.org/10.1007/978-3-030-40917-3/COVER>
- Wigglesworth, V. B. (1948). The structure and deposition of the cuticle in the adult mealworm, *Tenebrio molitor* L. (Coleoptera). *Journal of Cell Science*, 3(6), 197–216.
- Yan, X., Laurent, S., Federighi, M., Boué, G., & Jury, V. (2022). Processing edible insects into powders: a review of available processes and potential microbial inactivation methods. *Journal of Insects as Food and Feed*, In Press, 1–14. <https://doi.org/10.3920/JIFF2021.0203>

### III.4. Conclusions

This chapter provides valuable insights into the effects of Pulsed Electric Field (PEF) treatment on the transformation chain of yellow mealworms. The findings reveal that PEF treatment before pressing larvae can significantly improve the pressing yield by up to 10%, as compared to blanched larvae. Additionally, PEF treatment improves water extraction, reducing the press cake's water content from 58% in blanched larvae to 46%, although with high protein loss. The study also indicates that PEF treatment is less destructive to the tissue structure and more selective compared to other treatments such as crushing.

Furthermore, PEF treatment was found to cause both false and real mortality in larvae, and adding a washing step before the treatment can significantly increase effective electroporation and mortality. Analysis of SEM images also shows that intense PEF treatment causes significant changes in the structure of the exoskeleton and visible large-scale damages.

Moreover, the findings suggest that applying PEF treatment prior to drying can be an effective method for releasing internal water in larvae, thereby making the drying process more efficient and closer to a first-order kinetic process. PEF creates multiple pathways for water evaporation, resulting in a faster drying process with a single characteristic time. In contrast, other treatments like blanching or freezing-thawing showed slower drying and stronger isolation of water inside the larvae. PEF-treated larvae showed drying activation energies of 40-50 kJ/mol, which is much lower than the 80 kJ/mol seen for blanched larvae.

In conclusion, this study highlights the potential of PEF as a pre-treatment method for enhancing the production of protein-rich meals made from *Tenebrio molitor* larvae through assisted mechanical pressing and drying processes. PEF treatment can significantly improve pressing yield, water extraction, and drying kinetics while also being less destructive to the tissue structure compared to other treatments. The findings of this study could have implications for the development of more efficient and sustainable methods for producing insect-based protein products.

## **Chapter IV - Comparative Study between PEF and DIC technologies for insect processing: technical, energetic, and quality aspects**

### **IV.1. Introduction**

Insect processing is critical for providing safe and high-quality raw materials, components, and products for large-scale food and feed applications. The processing routes vary depending on the nature of the raw material and the intended end-products and may include many unit operations that are already in use in food and feed processing. Harvesting, pre-processing, decontamination, additional processing, packing, and storage are all common steps in the insect processing chain. The selection of the most suitable transformation route is a key point to maximize yield, minimize inputs (use of chemicals reagents, solvents, energy consumption, etc..) and continually enhance product quality. In this line, the use of innovative technologies can improve the quality and safety of insect-based products as well as extraction, fractionation, energy efficiency, and production yield (Ojha *et al.*, 2021).

In this work, DIC and PEF technologies were selected and their application for insect processing was investigated. The aim of this chapter is to compare the energy consumption and effects on many larval aspects of these innovative pretreatments (DIC and PEF), along with the conventional treatment, blanching, that were all explored in **Chapters II and III**.

The first section of this chapter compares the energy consumption of different pretreatment pathways for treating fresh mealworms, and the second section summarizes the key findings of pretreatments' impacts on larval aspects throughout this entire research and compares the overall outcome of the pretreatment on a given aspect. As a result, by the end of this chapter, we should have a clear understanding of the overall benefits and drawbacks of each pretreatment.

### **IV.2. Comparison of different pretreatment methods based on their energy and economic costs**

The energy consumption of different pretreatment pathways for the treatment of 1 ton of fresh yellow mealworms is presented in Figure IV.1. The optimal conditions determined in the previous chapters were used for comparison.

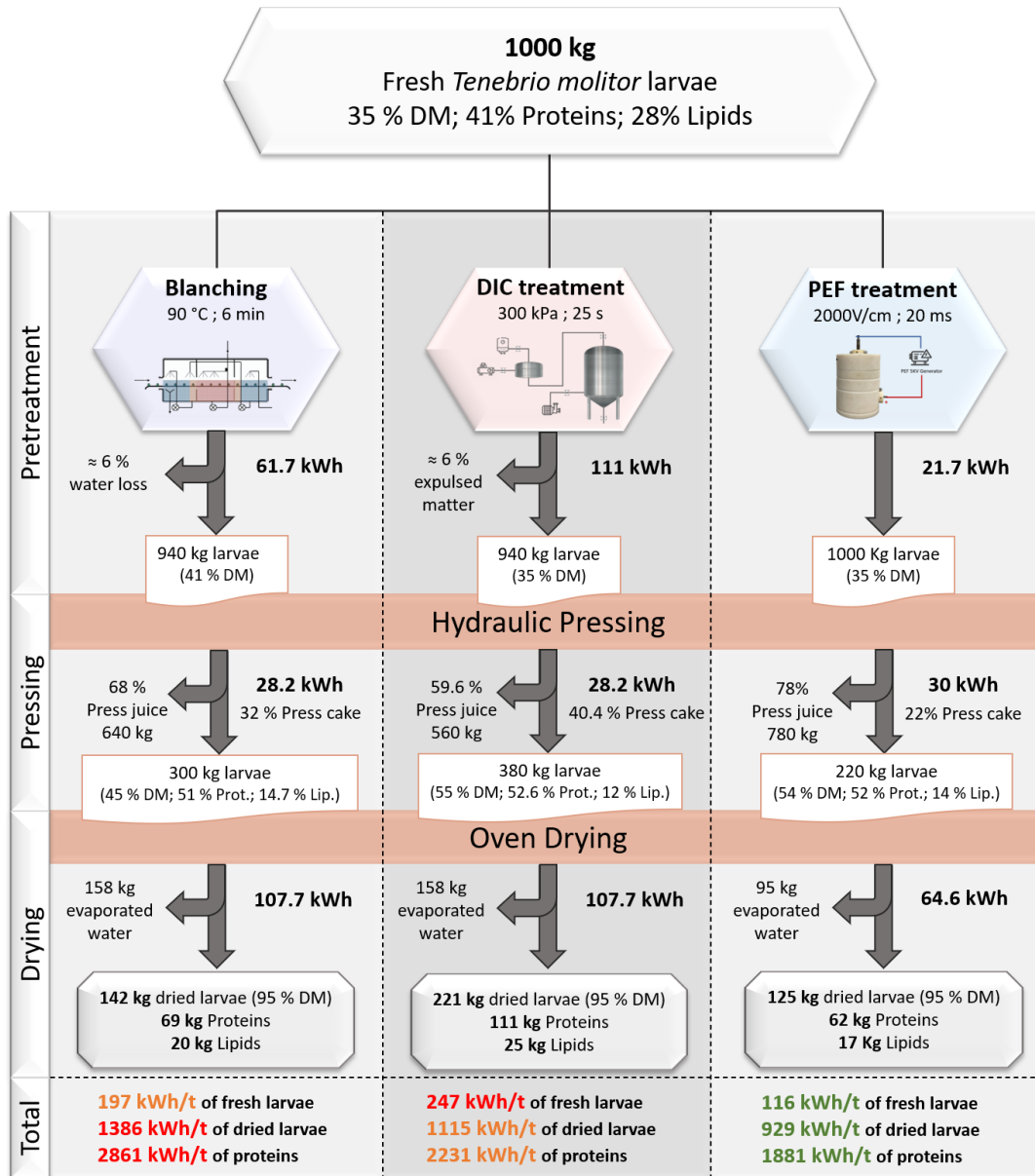
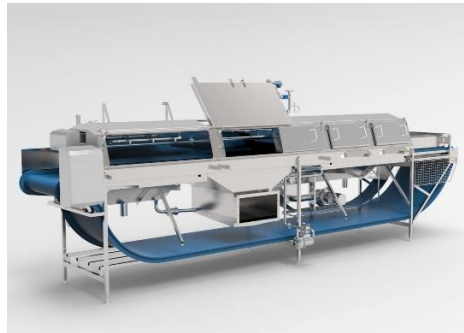

**Figure IV.1.** Energy consumption of different processing pathways for the production of protein-rich cake

The pretreatments adopted for comparison are:

- Blanching:** Treatment at 90°C for 6 min was taken for comparison. The pretreatment is done in an isolated tank, thus the energy required to heat water is considered negligible as the same hot water is used for many consecutive treatments. Therefore, this method is estimated to consume about 61.7 kWh/ton of treated larvae at 90°C. Blanching is a common processing technique for food and vegetables. Industrial continuous blanchers can handle capacities from 1 to 30 tons per hour using water, steam, water and steam, or forced steam. In the case of larvae treatment, a hot water blancher is a suitable option. The BC BACW blancher (figure IV.2) is designed for small capacities of products, from 2 to 9 t/h, and is

compact in size. The blancher has four sections: an infeed section, a blanching section where the product is heated with re-circulated water, an air-cooling section, and a re-circulated chilled water cooling section. The BAC blancher uses a combination of air and re-circulated chilled water to cool the product, minimizing the amount of cooling water needed. The temperature of the product can be reduced from 90°C to approximately 20°C, depending on the cooling air's relative humidity. The cost of the BAC 2 blancher, which can treat 2 t /h, is around 112,000 €.



**Figure IV.2.** BAC blancher cooler

- **DIC pretreatment:** For this method, the treatment parameters of 300 kPa / 25 s were taken for comparison since they were proved to be relatively gentle on larvae while being effective in different ways. The total energy consumed by this technique is calculated to be around 111 kWh/ton of treated larvae, including the costs of generating the saturated steam and increasing the pressure in the treatment chamber. ABCAR DIC process is the founder and developer of the DIC technology. DIC is a batch-based process carried out on an industrial scale for the processing of different foodstuffs such as fruits, vegetables, coffee, cocoa, and pulses, and for the extraction of essential oils. The DIC treatment unit (Figure IV.3) has a capacity of 15 liters per batch and can process between 100 and 400 kg/h. The total cost of installing a DIC unit, including a vacuum tank, boiler, compressor, and treatment vessel, is approximately 400,000€.



**Figure IV.3.** DIC industrial scale unit

- PEF pretreatment:** Treatment of pre-rinsed and compacted larvae at 2000V/cm for 20 ms was taken for comparison. The energy consumed using this method is around 21.7 kWh/ton of treated larvae. PEF technology is applied on an industrial scale for the treatment of fruits and vegetables. Elea is a leading manufacturer of PEF treatment lines worldwide. The PEF belt system developed by Elea is suitable for the large-scale processing of roots, tubers, and fruits, and can also be used for insect treatment. The Elea PEF Advantage Belt system is an energy-efficient and low-temperature process that eliminates the need for blanching insects before processing. This system reduces energy and water consumption by up to 90%, and offers uniform treatment of fresh produce, thanks to its volumetric treatment process. The pilot model B10-320 has a capacity of up to 12 tons per hour. The cost of installing a PEF unit is around 450,000 €.



**Figure IV.3.** PEF Advantage Belt system B10-320

After different pretreatments, larvae should be subjected to hydraulic pressing, which is found to be an effective low-energy dewatering method with around 30 kWh/t of pressed matter and then dried in an oven to remove residual water and obtain a protein-rich cake dried to 95% of dry matter content. The energy cost of drying is known to be about 680 kWh/t of evaporated water.

Even though the same processing steps were followed after different pretreatments, the energy consumption of each step was different depending on the following: the remaining quantity to be pressed, the pressing yield, the press cake's dry matter content, and the remaining water to be evaporated to reach 95% of final dry matter content. Thus, the energy required by blanching, DIC and PEF **to process a ton of fresh larvae** is found to be 197 kWh, 247 kWh, and 116 kWh, respectively. However, blanching, DIC, and PEF require respectively 1386 kWh, 1115 kWh, and 929 kWh **to produce a ton of dried larvae** (protein-rich cake), and 2861 kWh, 2231 kWh, and 1881 kWh, **to produce a ton of proteins**.

As a result, the PEF treatment is found to be the most energy-effective treatment among the three energy comparison criteria. As for the DIC, it is shown to be more energy intensive than blanching for processing a ton of fresh larvae but better for producing a ton of dried larvae and a ton of proteins.

Table IV.1 presents a summary of the energy and economic costs of the pretreatments that were studied.

**Table IV.1.** A comparison of energy consumption, production yield, and installation cost.

	Blanching	DIC	PEF
Process type	Continuous	Batch	Batch
Energy consumption	197 kWh/t of fresh larvae	247 kWh/t of fresh larvae	116 kWh/t of fresh larvae
	1386 kWh/t of dried larvae	1115 kWh/t of dried larvae	929 kWh/t of dried larvae
	2861 kWh/t of proteins	2231 kWh/t of proteins	1881 kWh/t of proteins
Quantity of generated proteins per ton of treated larvae	69 kg	111 kg	62 kg
Yield of protein recovery of total protein quantity (143 kg/t)	48 %	78 %	43 %
Unit installation cost	112,000 €	400,000 €	450,000 €

### IV.3. Comparison of pretreatments effects on key aspects of larvae

The effects of each pretreatment method on different characteristics of *Tenebrio molitor* larvae were evaluated as part of our current research comprising effective killing and mortality threshold, microbial decontamination, hydraulic pressing, product color, air-drying, and protein denaturation.

#### IV.3.1. Larval mortality

All three studied technologies were proven effective as a killing method for larvae. Blanching at 90 °C induced total mortality at  $t \geq 4$  min. In DIC, the lowest combination of factors causing total mortality is found to be 1 cycle of DIC at 150 kPa for 25 s. As for the PEF, the lowest combinations of factors causing total mortality for pre-rinsed and compacted larvae are 800V/cm for 200 ms, 1000V/cm for 150 ms, 1500V/cm for 50 ms, and 2000V/cm for 20 ms. Consequently, all the treatment conditions employed for comparison in the study resulted in total larval mortality.

#### IV.3.2. Microbial inactivation

In terms of microbial decontamination, blanching was effective in lowering the microbial count to meet the EU regulations for mealworms to be approved for sale as a novel food (EU, 2021). DIC under the optimal conditions used in this study achieved the desired values for total viable count and yeast and mold count, but the *S. aureus* content slightly exceeded the regulations (by 1 log cfu/g). However, the implementation of proper sample rearing and handling techniques, such as separating the larvae from their frass using a plastic web, could decrease the initial microbial load, resulting in milder treatment conditions needed to bring the microbial content into compliance with regulations. Regarding PEF, it was ineffective in achieving the decontamination of larvae. And even with a treatment at an electrical field strength of up to 40,000V/cm and a duration of 4.5

ms, the initial microbial load remained unchanged. Although PEF treatment at high electrical field strengths is a well-known effective decontamination method, it is typically applied to liquids or semi-liquids (Amiali and Ngadi, 2012; Delso *et al.*, 2022; Puligundla *et al.*, 2018).

#### IV.3.3. Defatting and dewatering by mechanical expression

Blanching followed by hydraulic pressing gives a pressing yield of 68%, a recovery of around 48% of the initial protein content, and a press cake with 14.7% lipids/db and high water content (158 kg of water to evaporate to reach 95% of dry matter). DIC and PEF both seem to improve this outcome, but each in a different way. DIC has decreased the pressing yield (59.6%), increased protein recovery (78%), and generated a press cake with 12% lipids/db but with a high water content (158 kg of water to evaporate). PEF has increased the pressing yield by up to 78%, resulting in a higher protein loss in the pressing juice (protein recovery of 43%) and a press cake with 14% lipids/db but with a lower quantity of water that needs to be evaporated (95 kg).

#### IV.3.4. Color

The color of dead larvae tends to become dark due to enzymatic browning. Measuring the juice color using ImageJ software revealed that blanched larvae and PEF-treated larvae have dark colors of  $46 \pm 5.5$  and  $48 \pm 2.3$  grayscale, respectively, comparable to untreated larvae ( $47.8 \pm 2.3$ ). DIC treatment, on the other hand, resulted in a highly clear juice color of  $99.5 \pm 2.6$  grayscale, indicating that the oxidative enzymes responsible for browning were inactivated.

#### IV.3.5. Drying

Drying whole larvae in a ventilated oven was found to be the slowest with blanched larvae, followed by PEF treated and finally the fastest are the DIC treated. In addition to drying speed, the final water contents after 6 h of drying following blanching, PEF, and DIC treatments are 65%, 48%, and 35% at 50 °C, and 56%, 26%, and 24% at 60 °C, respectively. However, after 24 h of drying, they all have a final water content of 5%.

#### IV.3.6. Protein Quality

Protein quality after different pretreatments was reflected by the quantity of unfolded /denatured proteins determined by the maximum fluorescence intensity  $F_{\max}$  using fluorescence spectroscopy with two fluorophores: ANS and tryptophane. According to Saulnier *et al.* (1991), when the heat treatment is more intense, the proteins unfold, leaving the hydrophobic sites more accessible and the fluorescence increases.  $F_{\max}$  values of ANS fluorophore method for blanched, DIC-treated and PEF-treated larvae are 50 000, 500 000 and 1111 cps, respectively.  $F_{\max}$  values for the tryptophane fluorophore method are 19 095, 76 073 and 18 373 cps for unhydrated samples and 8 832, 90 434 and 6 369 cps for hydrated samples of blanched, DIC-treated and PEF-treated larvae respectively.

These results indicate that DIC treatment induces the most protein denaturation, with very high  $F_{\max}$  values, followed by blanching and finally PEF treatment, with minimal difference between the blanching and PEF values.



A summary of the main effects of pretreatments on different larval aspects is presented in Table IV.2. The method's overall effect on a particular aspect is depicted through the use of three distinct colors: green indicates a favorable effect, orange indicates a moderate effect, and red represents a negative effect.

**Table IV.2.** A comparison of main larval aspects after different pretreatment.

	<b>Blanching (90 °C; 6 min)</b>	<b>DIC (300 kPa; 25 s)</b>	<b>PEF (2000 V/cm; 20 ms)</b>
Killing	100% mortality	100 % mortality	100 % mortality
Decontamination	Treating at 90°C for 6 min was effective to reach the EC regulation thresholds for total viable counts, yeasts and molds counts and <i>staphylococcus aureus</i> count.	Treating at 350 kPa for $\geq 5$ s was effective to reach the EC regulation thresholds for total viable counts, yeasts and molds counts and <i>staphylococcus aureus</i> count.	Treating at 40 000V/cm for up to 4.5 ms was not effective to reduce the initial microbial load.
Hydraulic pressing	Pressing yield 68%. High protein loss in press juice (49%), and a press cake with 14.7% lipids/ DM and a high quantity of remaining water to evaporate (158 kg).	Pressing yield 59.6%. Very low protein loss in press juice (17%), a press cake with 12% lipids/DM, and a high quantity of remaining water to evaporate as well (158 kg).	Pressing yield 78%. High protein loss in press juice (57%), a press cake with 14% lipids/DM and a low remaining water to be evaporated (95 kg).
Color	Dark color of $46 \pm 5.5$ in grayscale unit, reflecting high enzymatic browning.	Very light color of $99.5 \pm 2.6$ grayscale unit.	Dark color of $48 \pm 2.3$ grayscale unit, reflecting high enzymatic browning.
Drying	Slowest drying kinetics with high water content after 6 h (65% at 50°C and 56% at 60°C).	Fastest drying kinetics with relatively low water content after 6 h (35% at 50°C and 24% at 60°C), and water diffusivity improved up to 17 times than blanching.	Drying kinetics faster than blanching with lower final water content after 6 h (48% at 50°C and 26% at 60°C), however still higher than DIC.
Protein quality	$F_{max}$ much lower than the DIC treatment but higher than PEF treatment, reflecting intermediate quantity of unfolded proteins.	Very high $F_{max}$ values reflecting a high quantity of unfolded/denatured proteins.	Lowest $F_{max}$ values, reflecting the lowest protein denaturation.

	Good
	Moderate
	Bad

#### IV.4. Conclusion

This chapter is dedicated to comparing conventional (blanching) and emerging technologies (PEF and DIC) pretreatment pathways of yellow mealworms: energy consumption and main impacts on larval characteristics that were identified throughout our research.

Blanching, the control treatment, is found to be a good killing and decontamination method with moderate protein denaturation; however, it has a negative effect on hydraulic pressing yield and press cake's characteristics, the drying kinetics is found to be very slow with high final moisture content, and it does not prevent the enzymatic browning of larvae. This method requires the least implementation cost but has the highest energy consumption to produce a dry meal rich in proteins.

DIC, on the other hand, is an effective killing and decontamination treatment, improves the separation of interesting compounds during pressing, has the fastest drying kinetics with very low final moisture content, and inhibits enzymatic browning of larvae, resulting in a brighter-colored product. This method, however, considerably denatures the proteins, affecting their functional properties, and thus limiting its application to when the functional properties are not critical, such as when producing dried larvae or formulating the proteins in animal feed, although more research should be done to ensure that the nutritional profile and digestibility of proteins are not negatively affected by the treatment. The DIC has high unit implementation cost but consumes less energy per ton of dried larvae and per ton of proteins than blanching.

PEF has been proven to be an efficient killing method, improving pressing yield but with considerable protein loss, moderately improving drying kinetics and final moisture content, and preserving protein quality, but it fails to decontaminate larvae and prevent their enzymatic browning. This approach has the most expensive implementation cost but uses the lowest amount of energy per ton of treated larvae, dried larvae, and generated proteins.

Overall, the study findings indicate that novel pretreatments outperform blanching, but each method has its benefits and drawbacks, and choosing one over another will be a matter of compromising on the needed features depending on the final application of the generated product (i.e., human food, animal feed, chitosan production etc..).

## General Conclusion and Prospects

This thesis has explored the potential of two novel technologies, Instant controlled pressure drop (DIC) and Pulsed electric fields (PEFs), as pre-treatments for yellow mealworms (*Tenebrio molitor* larvae) as an alternative protein source that addresses global food insecurity.

The main thesis findings can be summarized as follows:

1. DIC technology has been proven effective in reducing microbial loads to meet regulatory requirements, while also preventing enzymatic browning of larvae and larval juice. Although it reduces the pressing yield (from 68 to 59%), it is found to improve the pressing process by retaining the proteins in the press cake and generating an easily separable lipid phase. In fact, the protein recovery yield from DIC technology is 78%, significantly higher than the 48% yield obtained through blanching.
2. The application of DIC treatment resulted in a significant decrease in the drying time of larvae. Larvae treated with DIC at 0.45 MPa achieved a moisture content of 1.88 g/g db and 1.29 g/g db after only 41 min of drying at 50°C and 90 min of drying at 60°C, respectively. In contrast, achieving the same moisture content for blanched larvae required 360 min of drying, indicating a reduction in drying time of 88% and 75% at 50°C and 60°C, respectively.
3. The application of DIC treatment effectively addressed shrinkage issues and improved water diffusivity by up to 1833% and 682% for larvae dried at 50°C and 60°C, respectively, compared to blanched larvae. Additionally, DIC treatment resulted in an increase in specific surface area up to 125% and a more uniform particle size distribution, indicating an improvement in the quality of the end-product.
4. DIC treatment causes protein denaturation, which could limit its application mainly in the food sector.
5. PEF technology leads to a noteworthy enhancement in pressing yield, up to 78%, and the expulsion of internal water from larvae, resulting in a low-moisture meal that requires minimal drying. However, 57% of protein passed in the liquid fraction (juice) and only 43% of proteins are recovered in the solid fraction (press cake).
6. PEF treatment induces notable modifications in the exoskeleton structure and enhances the kinetics of drying, while leaving protein functionalities unaffected. The drying activation energies for PEF-treated larvae were approximately 40-50 kJ/mol, which is significantly lower than the 80 kJ/mol observed for blanched larvae. Following 6 h of drying, the moisture content of PEF-treated larvae reached 48% at 50°C and 26% at 60°C, compared to 65% at 50°C and 56% at 60°C for blanched larvae.

7. PEF treatment is found to be the most energy-effective method among the three treatments (blanching, DIC, and PEF) that were compared. On the other hand, the DIC treatment was found to be more energy-intensive than blanching when processing a ton of fresh larvae, but it was more favorable for producing a ton of dried larvae and a ton of proteins.

The study results suggest that novel pretreatments, DIC and PEF, are more effective than traditional methods like blanching and have the potential to be valuable tools in the processing of insect-based products. However, each method has its strengths and weaknesses, and the choice of treatment will depend on the desired features and final application of the processed insect-based product. Therefore, the decision to choose one method over another will require careful consideration of trade-offs and a careful balance between the desired features and the potential drawbacks of each method.

Based on the findings of this thesis, there are several prospects for further research in the area of insect processing and the use of novel technologies. Some of the areas that could benefit from additional investigations include:

1. Protein Digestibility: Examining the effect of the applied treatments (DIC, PEF and blanching) on the digestibility of processed larvae for their application in the food and feed sectors.
2. Protein and chitin isolation: Investigating the impact of pretreatment methods on the efficiency of protein and chitin isolation and evaluating their effects on the quality and yield of the isolation and purification processes.
3. Formulating insect proteins in food products: studying the formulation of insect proteins in food products to assess their functional, textural, and sensory characteristics, and determining the most efficient method to produce a palatable and nutritionally adequate product, such as baked goods, meat analogues, and protein bars, etc...
4. Conducting a life cycle assessment (LCA) of the processing pathways: evaluating their environmental impact, including resource utilization, energy consumption, greenhouse gas emissions, carbon footprint, and waste generation, with the purpose of determining the most sustainable option. Moreover, comparing the results of the LCA with other protein production methods to determine the sustainability of larvae-based protein production and provide a comprehensive picture of its impact on the environment.
5. Scale-up: investigation of the potential for scaling up the most promising pretreatment methods for commercial production and application in various industries, such as animal feed and human food.

6. Studying other edible insect species: the results of this thesis were based on studies of yellow mealworms (*T. molitor*). Further research is needed to determine whether these treatments are effective for other insect species and to determine the optimal conditions for processing different insects.

In conclusion, this thesis lays the groundwork for future research on the utilization of innovative technologies to enhance the production of insect-based food products. The results of this thesis indicate a vast potential to be harnessed by conducting more in-depth evaluations of the advantages and limitations of these technologies, to determine the most optimal methods of incorporating them into the processing pipeline.

## References

- Abdulla, G., Belghit, A. and Allaf, K., 2009. Impact of instant controlled pressure drop treatment on moisture adsorption isotherm of cork granules. *Drying Technology* 27: 237–247.
- Afrassiabian, Z. and Saleh, K., 2020. Caking of anhydrous lactose powder owing to phase transition and solid-state hydration under humid conditions: from microscopic to bulk behavior. *Powder Technology* 363: 488–499.
- Aguilar-Toalá, J.E., Cruz-Monterrosa, R.G. and Liceaga, A.M., 2022. Beyond human nutrition of edible insects: health benefits and safety aspects. *Insects* 2022, Vol. 13, Page 1007 13: 1007.
- Aguilera, Y., Pastrana, I., Rebollo-Hernanz, M., Benitez, V., Álvarez-Rivera, G., Viejo, J.L. and Martín-Cabrejas, M.A., 2021. Investigating edible insects as a sustainable food source: nutritional value and techno-functional and physiological properties. *Food & Function* 12: 6309–6322.
- Al-Muhtaseb, A.H., McMinn, W.A.M. and Magee, T.R.A., 2002. Moisture sorption isotherm characteristics of food products: a review. *Food and Bioproducts Processing* 80: 118–128.
- Albitar, N., Mounir, S., Besombes, C. and Allaf, K., 2011. Improving the drying of onion using the instant controlled pressure drop technology. *Drying Technology* 29: 993–1001.
- Allaf, T. and Allaf, K., 2014. Instant controlled pressure drop (D.I.C.) in food processing : from fundamental to industrial applications. <https://doi.org/10.1007/978-1-4614-8669-5>.
- Allaf, T., Besombes, C., Mih, I., Lefevre, L. and Allaf, K., 2011. Decontamination of solid and powder foodstuffs using DIC technology. *Advances in Computer Science and Engineering*. <https://doi.org/10.5772/16025>.
- Allaf, T., Fine, F., Tomao, V., Nguyen, C., Ginies, C. and Chemat, F., 2014. Impact of instant controlled pressure drop pre-treatment on solvent extraction of edible oil from rapeseed seeds. *OCL - Oilseeds and fats* 21: A301.
- Allaf, T., Mounir, S., Tomao, V. and Chemat, F., 2012. Instant controlled pressure drop combined to ultrasounds as innovative extraction process combination: fundamental aspects. *Procedia Engineering* 42: 1061–1078.
- Allaf, T., Tomao, V., Besombes, C. and Chemat, F., 2013a. Thermal and mechanical intensification of essential oil extraction from orange peel via instant autovaporization. *Chemical Engineering and Processing: Process Intensification* 72: 24–30.
- Allaf, T., Tomao, V., Ruiz, K. and Chemat, F., 2013b. Instant controlled pressure drop technology and ultrasound assisted extraction for sequential extraction of essential oil and antioxidants. *Ultrasonics Sonochemistry* 20: 239–246.
- Alles, M.C., Smetana, S., Parniakov, O., Shorstkii, I., Toepfl, S., Aganovic, K. and Heinz, V., 2020. Bio-refinery of insects with pulsed electric field pre-treatment. *Innovative Food Science and Emerging Technologies* 64 <https://doi.org/10.1016/J.IFSET.2020.102403>.

- Alonzo-Macías, M., Cardador-Martínez, A., Mounir, S., Montejano-Gaitán, G. and Allaf, K., 2013. Comparative study of the effects of drying methods on antioxidant activity of dried strawberry (*Fragaria var. camarosa*). *Journal of Food Research* 2: p92.
- Amarender, R.V., Bhargava, K., Dossey, A.T. and Gamagedara, S., 2020. Lipid and protein extraction from edible insects – crickets (gryllidae). *LWT - Food Science and Technology* 125: 109222.
- Amiali, M. and Ngadi, M.O., 2012. Microbial decontamination of food by pulsed electric fields (PEFS). *Microbial Decontamination in the Food Industry: Novel Methods and Applications* 407–449.
- AOAC official method, 1996. AOAC 993.13 nitrogen (total) in fertilizers. combustion method. AOAC International 1–2.
- Arbia, W., Arbia, L., Adour, L. and Amrane, A., 2012. Chitin extraction from crustacean shells using biological methods - a review. *Food Technology and Biotechnology* 51: 12–25.
- Azagoh, C., Ducept, F., Garcia, R., Rakotozafy, L., Cuvelier, M.E., Keller, S., Lewandowski, R. and Mezdour, S., 2016. Extraction and physicochemical characterization of *Tenebrio molitor* proteins. *Food Research International* 88: 24–31.
- Azzollini, D., Derossi, A. and Severini, C., 2016. Understanding the drying kinetic and hygroscopic behaviour of larvae of yellow mealworm (*Tenebrio molitor*) and the effects on their quality. *Journal of Insects as Food and Feed* 2: 233–243.
- Baek, M., Kim, M.-A., Kwon, Y.-S., Hwang, J.-S., Goo, T.-W., Jun, M. and Yun, E.-Y., 2019. Effects of processing methods on nutritional composition and antioxidant activity of mealworm (*Tenebrio molitor*) larvae. *Entomological Research* 49: 284–293.
- Baiano, A., 2020. Edible insects: an overview on nutritional characteristics, safety, farming, production technologies, regulatory framework, and socio-economic and ethical implications. *Trends in Food Science & Technology* 100: 35–50.
- Baigts-Allende, D., Doost, A.S., Ramírez-Rodrigues, M., Dewettinck, K., Van der Meeren, P., de Meulenaer, B. and Tzompa-Sosa, D., 2021. Insect protein concentrates from mexican edible insects: structural and functional characterization. *LWT - Food Science and Technology* 152: 112267.
- Bamerni, F., 2018. Plant-based (camelina sativa) biodiesel manufacturing using the technology of instant controlled pressure drop (DIC) : process performance and biofuel quality. Université de La Rochelle Available at: <https://tel.archives-ouvertes.fr/tel-02009827>. Accessed February 9, 2022.
- Bano, S.A., Hayat, M., Samreen, T., Asif, M., Habiba, U. and Uzair, B., 2020. Detection of pathogenic bacteria staphylococcus aureus and salmonella sp. from raw milk samples of different cities of pakistan. *Natural Science* 12: 295–306.
- Barker, D., Fitzpatrick, M.P. and Dierenfeld, E.S., 1998. Nutrient composition of selected whole invertebrates. *Zoo Biology* 17: 123–134.

- Basu, P., 2013. Biomass characteristics. *Biomass Gasification, Pyrolysis and Torrefaction*. pp. 47–86.
- Belluco, S., Halloran, A. and Ricci, A., 2017. New protein sources and food legislation: the case of edible insects and eu law. *Food Security* 9: 803–814.
- Belluco, S., Losasso, C., Maggioletti, M., Alonzi, C.C., Paoletti, M.G. and Ricci, A., 2013. Edible insects in a food safety and nutritional perspective: a critical review. *Comprehensive Reviews in Food Science and Food Safety* 12: 296–313.
- Ben Ammar, J., Lanoisellé, J.-L., Lebovka, N.I., Van Hecke, E. and Vorobiev, E., 2011. Impact of a pulsed electric field on damage of plant tissues: effects of cell size and tissue electrical conductivity. *Journal of Food Science* 76: E90–E97.
- Benseddik, A., Azzi, A., Lalmi, D., Bensaha, H., Zidoune, M.N. and Allaf, K., 2020. Empirical mathematical model to evaluate the effective diffusivity of pumpkin slice during forced air convection dryer. In: Belasri, A. and Beldjilali, S. (eds.) *In: ICREEC 2019*. Springer Proceedings in Energy. pp. 45–52.
- Benseddik, A., Azzi, A., Zidoune, M.N., Khanniche, R. and Besombes, C., 2019. Empirical and diffusion models of rehydration process of differently dried pumpkin slices. *Journal of the Saudi Society of Agricultural Sciences* 18: 401–410.
- Berka-Zougali, B., Hassani, A., Besombes, C. and Allaf, K., 2010. Extraction of essential oils from algerian myrtle leaves using instant controlled pressure drop technology. *Journal of Chromatography A* 1217: 6134–6142.
- Besombes, C., Berka-Zougali, B. and Allaf, K., 2010. Instant controlled pressure drop extraction of lavandin essential oils: fundamentals and experimental studies. *Journal of Chromatography A* 1217: 6807–6815.
- Biconsin-Júnior, A., Rodrigues, H., Behrens, J.H., da Silva, M.A.A.P. and Mariutti, L.R.B., 2022. “Food made with edible insects”: exploring the social representation of entomophagy where it is unfamiliar. *Appetite* 173: 106001.
- Bogusz, R., Smetana, S., Wiktor, A., Parniakov, O., Pobiega, K., Rybak, K. and Nowacka, M., 2022. The selected quality aspects of infrared-dried black soldier fly (*Hermetia illucens*) and yellow mealworm (*Tenebrio molitor*) larvae pre-treated by pulsed electric field. *Innovative Food Science & Emerging Technologies* 80: 103085.
- Bolat, B., Ugur, A.E., Oztop, M.H. and Alpas, H., 2021. Effects of high hydrostatic pressure assisted degreasing on the technological properties of insect powders obtained from *Acheta domesticus* & *Tenebrio molitor*. *Journal of Food Engineering* 292: 110359.
- Bouallegue, K., Allaf, T., Ben Younes, R. and Allaf, K., 2016. Texturing and instant cooling of rapeseed as pretreatment prior to pressing and solvent extraction of oil. *Food and Bioprocess Technology* 9: 1521–1534.
- Boukil, A., Perreault, V., Chamberland, J., Mezdour, S., Pouliot, Y. and Doyen, A., 2020. High hydrostatic pressure-assisted enzymatic hydrolysis affect mealworm allergenic proteins. *Molecules* 25 <https://doi.org/10.3390/MOLECULES25112685>.



- Bradford, M., 1976. A rapid and sensitive method for the quantitation of microgram quantities of protein utilizing the principle of protein-dye binding. *Analytical Biochemistry* 72: 248–254.
- Broekhoven, S. van, 2015. Quality and safety aspects of mealworms as human food. Quality and safety aspects of mealworms as human food. 178 pp.
- Brogan, E.N., Park, Y.-L., Matak, K.E. and Jaczynski, J., 2021. Characterization of protein in cricket (*Acheta domesticus*), locust (*Locusta migratoria*), and silk worm pupae (*Bombyx mori*) insect powders. *LWT - Food Science and Technology* 152: 112314.
- Brunauer, S., Deming, L.S., Deming, W.E. and Teller, E., 1940. On a theory of the van der waals adsorption of gases. *Journal of the American Chemical Society* 62: 1723–1732.
- Brunauer, S., Emmett, P.H. and Teller, E., 1938. Adsorption of gases in multimolecular layers. *Journal of the American Chemical Society* 60: 309–319.
- Bußler, S., Rumpold, B.A., Fröhling, A., Jander, E., Rawel, H.M. and Schlüter, O.K., 2016a. Cold atmospheric pressure plasma processing of insect flour from tenebrio molitor: impact on microbial load and quality attributes in comparison to dry heat treatment. *Innovative Food Science and Emerging Technologies* 36: 277–286.
- Bußler, S., Rumpold, B.A., Jander, E., Rawel, H.M. and Schlüter, O.K., 2016b. Recovery and techno-functionality of flours and proteins from two edible insect species: meal worm (*Tenebrio molitor*) and black soldier fly (*Hermetia illucens*) larvae. *Heliyon* 2 <https://doi.org/10.1016/j.heliyon.2016.e00218>.
- Caballero-Cerón, C., Guerrero-Beltrán, J.A., Mújica-Paz, H., Torres, J.A. and Welti-Chanes, J., 2015. Moisture sorption isotherms of foods: experimental methodology, mathematical analysis, and practical applications. In: Gutiérrez-López, G., Alamilla-Beltrán, L., del Pilar Buera, M., Welti-Chanes, J., Parada-Arias, E. and Barbosa-Cánovas, G. (eds.) *Water Stress in Biological, Chemical, Pharmaceutical and Food Systems*. Food Engineering Series. pp. 187–214.
- Cacchiarelli, C., Fratini, F., Puccini, M., Vitolo, S., Paci, G. and Mancini, S., 2022. Effects of different blanching treatments on colour and microbiological profile of *Tenebrio molitor* and *Zophobas morio* larvae. *LWT - Food Science and Technology* 157: 113112.
- Caligiani, A., Marseglia, A., Leni, G., Baldassarre, S., Maistrello, L., Dossena, A. and Sforza, S., 2018. Composition of black soldier fly prepupae and systematic approaches for extraction and fractionation of proteins, lipids and chitin. *Food Research International* 105: 812–820.
- Campbell, M., Ortuño, J., Ch Stratakos, A., Linton, M., Corcionivoschi, N., Elliott, T., Koidis, A. and Theodoridou, K., 2020. Impact of thermal and high-pressure treatments on the microbiological quality and in vitro digestibility of black soldier fly (*Hermetia illucens*) larvae. 10: 682.
- Caparros Megido, R., Poelaert, C., Ernens, M., Liotta, M., Blecker, C., Danthine, S., Tyteca, E., Haubruge, É., Alabi, T., Bindelle, J. and Francis, F., 2018. Effect of household cooking techniques on the microbiological load and the nutritional quality of mealworms (*Tenebrio molitor* l. 1758). *Food Research International* 106: 503–508.

- Cappelli, A., Cini, E., Lorini, C., Oliva, N. and Bonaccorsi, G., 2020. Insects as food: a review on risks assessments of tenebrionidae and gryllidae in relation to a first machines and plants development. *Food Control* 108: 106877.
- Carullo, D., Abera, B.D., Casazza, A.A., Donsì, F., Perego, P., Ferrari, G. and Pataro, G., 2018. Effect of pulsed electric fields and high pressure homogenization on the aqueous extraction of intracellular compounds from the microalgae *chlorella vulgaris*. *Algal Research* 31: 60–69.
- Caveney, S., 1970. Juvenile hormone and wound modelling of tenebrio cuticle architecture. *Journal of Insect Physiology* 16 [https://doi.org/10.1016/0022-1910\(70\)90200-3](https://doi.org/10.1016/0022-1910(70)90200-3).
- Chemat, F., Rombaut, N., Meullemiestre, A., Turk, M., Périno, S., Fabiano-Tixier, A.-S. and Abert-Vian, M., 2017. Review of green food processing techniques. preservation, transformation, and extraction. *innovative food science and emerging technologies*. Comment citer ce document 41: 357–377.
- Cherniavskaia, L., Pustohod, A. and Ivolga, N., 1995. Technochemical control of granulated sugar and refined sugar. Moscow: Kolos.
- Chia-Chung Chen, 1990. Modification of oswin EMC/ERH equation. *Journal of Agricultural Research* 39: 367–376.
- Chinenye, N.M.M., Ogunlowo, A.S. and Olukunle, O.J., 2010. Cocoa bean (*Theobroma cacao* l.) drying kinetics. *Chilean Journal of Agricultural Research* 70: 633–639.
- Chirife, J. and Iglesias, H.A., 1978. Equations for fitting water sorption isotherms of foods: part 1 - a review. *International Journal of Food Science & Technology* 13: 159–174.
- Choi, B.D., Wong, N.A.K. and Auh, J.H., 2017. Defatting and sonication enhances protein extraction from edible insects. *Korean journal for food science of animal resources* 37: 955–961.
- Collavo, A., Glew, R., Huang, Y.-S., Chuang, L., Bosse, R. and Paoletti, M., 2005. House cricket small-scale farming. *Ecological Implications of Minilivestock*. pp. 533–558.
- Commission Regulation (EC) No.1069/2009, 2009. Regulation (EC) no 1069/2009 of 21 october 2009 laying down health rules as regards animal by-products and derived products not intended for human consumption and repealing regulation (EC) no 1774/2002 (animal by-p. Official Journal of the European Union L 300. , 1–33.
- Commission Regulation (EU) No 142/2011, 2011. Commission regulation (EU) no 142/2011 of 25 february 2011 implementing regulation (EC) no 1069/2009 of the european parliament and of the council laying down health rules as regards animal by-products and derived products not intended for human consumption and implementing council directive 97/78/EC as regards certain samples and items exempt from veterinary checks at the border under that directive. Official Journal of the European Union. Available at: <https://eur-lex.europa.eu/legal-content/EN/TXT/?uri=CELEX:32011R0142>. Accessed November 30, 2022.
- Commission Regulation (EU) No 1137/2014, 2014. Commission regulation (EU) no 1137/2014 of 27 october 2014 amending annex iii of regulation (EC) no 853/2004 of the european parliament and of the council as regards the handling of certain offal from animals intended for human consumption. Official Journal of the European Union.

- Costa, S., Pedro, S., Lourenço, H., Batista, I., Teixeira, B., Bandarra, N.M., Murta, D., Nunes, R. and Pires, C., 2020. Evaluation of *tenebrio molitor* larvae as an alternative food source. *NFS (Nutrition and Food Science) Journal* 21: 57–64.
- Council of the European Union, 2009. Council regulation (EC) no 1099/2009 of 24 september 2009 on the protection of animals at the time of killing. *Official Journal of the European Union* L 303. , 1–30.
- Crank, J., 1979. *The mathematics of diffusion*. Oxford University Press. 414 pp.
- Da Silva, P., Ribeiro, N., Coelho Pinheiro, M.N. and Costa, R., 2019. Modelling drying kinetics of black soldier fly (*Hermetia illucens*, L.) larvae. In: *E3S Web of Conferences*. <https://doi.org/10.1051/e3sconf/201912809011>.
- Dagevos, H., 2021. A literature review of consumer research on edible insects: recent evidence and new vistas from 2019 studies. *Journal of Insects as Food and Feed* 7: 249–259.
- De Vries, M. and De Boer, I.J.M., 2010. Comparing environmental impacts for livestock products: a review of life cycle assessments. *Livestock Science* 128: 1–11.
- Delso, C., Berzosa, A., Sanz, J., Álvarez, I. and Raso, J., 2022. Microbial decontamination by pulsed electric fields (PEF) in winemaking. *Grapes and Wine* <https://doi.org/10.5772/INTECHOPEN.101112>.
- DGAL, 2017. Utilisation des protéines et autres produits dérivés d’insectes dans l’alimentation humaine, animale et pour des usages techniques. Ministère de l’agriculture et de la souveraineté alimentaire. 1–11 pp Available at: <https://info.agriculture.gouv.fr/gedei/site/bo-agri/instruction-2017-860>. Accessed September 18, 2022.
- Ding, F., Deng, H., Du, Y., Shi, X. and Wang, Q., 2014. Emerging chitin and chitosan nanofibrous materials for biomedical applications. *Nanoscale* 6: 9477–9493.
- do Carmo, C.S., Costa, L., Serra, A.T., Knutsen, S.H., Sahlstrøm, S. and Bronze, M.R., 2021. Alternative protein sources. *Food Technology Disruptions*. pp. 131–174.
- Doymaz, I., 2007. Air-drying characteristics of tomatoes. *Journal of Food Engineering* 78: 1291–1297.
- EFSA, 2015. Risk profile related to production and consumption of insects as food and feed. *European Food Safety Authority Journal* 13: 4257.
- Eggers, L. F., & Schwudke, D., 2016. Liquid extraction : folch. in m. r. wenk (éd.). *Encyclopedia of Lipidomics*. , 1–6.
- Eggleton, P., 2020. Annual review of environment and resources the state of the world’s insects. <https://doi.org/10.1146/annurev-environ-012420>.
- El Hajj, R., Mhemdi, H., Besombes, C., Allaf, K., Lefrançois, V. and Vorobiev, E., 2022. Edible insects’ transformation for feed and food uses: an overview of current insights and future developments in the field. *Processes* 10: 970.

- El Hajj, R., Mhemdi, H., Besombes, C., Lefrancois, V., Allaf, K. and Vorobiev, E., 2023a. Instant controlled pressure-drop assisted pressing for defatting and dewatering of yellow mealworm larvae: process study and optimisation. *Journal of Insects as Food and Feed* 9: 761–779.
- El Hajj, R., Mhemdi, H., Fayeulle, A., Corjon, L., Lefrancois, V., Allaf, K. and Vorobiev, E., 2023b. Use of instant controlled pressure drop technology for the preservation of edible insects' (yellow mealworm) quality: assessment of microbial inactivation. *Environmental Science and Pollution Research* <https://doi.org/10.1007/s11356-023-26030-4>.
- El Zahar, K., Mounir, S., Allaf, T. and Allaf, K., 2015. Fundamental modeling, functional attributes, porosity, cohesivity index (hausner ratio) and compressibility of expanded-granule powder of egyptian ras pure cheese. *Lebensmittel-Wissenschaft & Technologie* 64: 297–307.
- Errico, S., Spagnoletta, A., Verardi, A., Moliterni, S., Dimatteo, S. and Sangiorgio, P., 2022. *Tenebrio molitor* as a source of interesting natural compounds, their recovery processes, biological effects, and safety aspects. *Comprehensive Reviews in Food Science and Food Safety* 21: 148–197.
- EU, 2017. Commission regulation (EU) 2017/893 of 24 may 2017 amending annexes i and iv to regulation (EC) no 999/2001 of the european parliament and of the council and annexes x, xiv and xv to commission regulation (EU) no 142/2011 as regards the provisions on proc. L 138/92, 92–116.
- EU, 2021. Commission implementing regulation (EU) 2021/882 authorising the placing on the market of dried *tenebrio molitor* larva as a novel food under regulation (EU) 2015/2283 of the european parliament and of the council, and amending commission implementing regu. *Official Journal of the European Union* 10.
- FAO/WHO/UNU, 1985. Expert consultation on energy and protein requirements. 206 pp Available at: <https://apps.who.int/iris/handle/10665/39527>. Accessed December 4, 2022.
- FAO, 2009. Declaration of the world summit on food security. 1–7 pp.
- FAO, 2011. World livestock 2011 - livestock in food security. FAO. 130 pp Available at: <http://www.fao.org/3/i2373e/i2373e.pdf>. Accessed May 12, 2022.
- FAO, IFAD and WFP, 2013. The state of food insecurity in the world 2013. The multiple dimensions of food security.
- Finke, M.D., 2002. Complete nutrient composition of commercially raised invertebrates used as food for insectivores. *Zoo Biology* 21: 269–285.
- Finke, M.D., Rojo, S., Roos, N., van Huis, A. and Yen, A.L., 2015. The european food safety authority scientific opinion on a risk profile related to production and consumption of insects as food and feed. *Journal of Insects as Food and Feed* <https://doi.org/10.3920/JIFF2015.x006>.
- Freelance, C.B., 2019. To regulate or not to regulate? the future of animal ethics in experimental research with insects. *Science and Engineering Ethics* 25: 1339–1355.
- Friedman, M., 1997. Chemistry, biochemistry, and dietary role of potato polyphenols. a review. *Journal of Agricultural and Food Chemistry* 45: 1523–1540.

- Frings, H., 1952. Factors determining the effects of radio-frequency electromagnetic fields on insects and materials they infest. *Journal of economic entomology* 45: 396–408.
- Gahukar, R.T., 2016. Edible insects farming: efficiency and impact on family livelihood, food security, and environment compared with livestock and crops. *Insects as Sustainable Food Ingredients* 85–111.
- Gałęcki, R., Zielonka, Ł., Zasepa, M., Gołębiowska, J. and Bakula, T., 2021. Potential utilization of edible insects as an alternative source of protein in animal diets in Poland. *Frontiers in Sustainable Food Systems* 5 <https://doi.org/10.3389/FSUFS.2021.675796/FULL>.
- García-Sánchez, T., Merla, C., Fontaine, J., Muscat, A. and Mir, L.M., 2018. Sine wave electroporation reveals the frequency-dependent response of the biological membranes. *Biochimica et Biophysica Acta (BBA) - Biomembranes* 1860: 1022–1034.
- Garnier, L., Valence, F. and Mounier, J., 2017. Diversity and control of spoilage fungi in dairy products: an update. *Microorganisms* 2017, Vol. 5, Page 42 5: 42.
- Gasco, L., Biancarosa, I. and Liland, N.S., 2020. From waste to feed: a review of recent knowledge on insects as producers of protein and fat for animal feeds. *Current Opinion in Green and Sustainable Chemistry* 23: 67–79.
- Gkinali, A.-A., Matsakidou, A., Vasileiou, E. and Paraskevopoulou, A., 2022. Potentiality of *Tenebrio molitor* larva-based ingredients for the food industry: a review. *Trends in Food Science & Technology* 119: 495–507.
- González, C.M., Garzón, R. and Rosell, C.M., 2019. Insects as ingredients for bakery goods. a comparison study of *H. illucens*, *a. domestica* and *t. molitor* flours. *Innovative Food Science and Emerging Technologies* 51: 205–210.
- Grau, T., Vilcinskis, A. and Joop, G., 2017. Sustainable farming of the mealworm *tenebrio molitor* for the production of food and feed. *Zeitschrift für Naturforschung - Section C Journal of Biosciences* 72: 337–349.
- Green, A., Blatmann, C., Chen, C. and Mathys, A., 2022. The role of alternative proteins and future foods in sustainable and contextually-adapted flexitarian diets. *Trends in Food Science & Technology* <https://doi.org/10.1016/J.TIFS.2022.03.026>.
- Grimi, N., Mamouni, F., Lebovka, N., Vorobiev, E. and Vaxelaire, J., 2011. Impact of apple processing modes on extracted juice quality: pressing assisted by pulsed electric fields. *Journal of Food Engineering* 103: 52–61.
- Gullan, P.J. and Cranston, P.S., 2001. The insects: an outline of entomology. *African Journal of Ecology* 39: 231–232.
- Haddad, M. Al, Mounir, S., Sobolik, V. and Allaf, K., 2008. Fruits & vegetables drying combining hot air, DIC technology and microwaves. *International Journal of Food Engineering* 4 <https://doi.org/10.2202/1556-3758.1491>.
- Hallman, G.J. and Zhang, Q.H., 1997. Inhibition of fruit fly (diptera: tephritidae) development by pulsed electric field. *Florida Entomologist* 239–248.

- Harris, M., 1998. Good to eat: riddles of food and culture. 187 pp.
- Hernández-Álvarez, A.-J., Mondor, M., Piña-Domínguez, I.-A., Sánchez-Velázquez, O.-A. and Melgar Lalanne, G., 2021. Drying technologies for edible insects and their derived ingredients. *Drying Technology* 39: 1991–2009.
- Hilborn, R., Banobi, J., Hall, S.J., Pucylowski, T. and Walsworth, T.E., 2018. The environmental cost of animal source foods. *Frontiers in Ecology and the Environment* 16: 329–335.
- Hong, J., Han, T. and Kim, Y.Y., 2020. Mealworm (*Tenebrio molitor* larvae) as an alternative protein source for monogastric animal: a review. *Animals* 10: 2068.
- Huang, D., Li, W., Li, G., Zhang, W., Chen, H., Jiang, Y. and Li, D., 2023. Effect of high-intensity ultrasound on the physicochemical properties of tenebrio molitor protein. *Food Hydrocolloids* 134: 108056.
- Iguedjtal, T., Louka, N. and Allaf, K., 2007. Sorption isotherms of granny smith apples hot-air dried and texturized by “controlled sudden decompression to the vacuum.” *International Journal of Food Engineering* 3 <https://doi.org/10.2202/1556-3758.1151>.
- Iguedjtal, T., Louka, N. and Allaf, K., 2008. Sorption isotherms of potato slices dried and texturized by controlled sudden decompression. *Journal of Food Engineering* 85: 180–190.
- Jablaoui, C., Besombes, C., Jamoussi, B., Rhazi, L. and Allaf, K., 2020. Comparison of expander and instant controlled pressure-drop technologies as thermomechanical pretreatments in enhancing solvent extraction of vegetal soybean oil. *Arabian Journal of Chemistry* 13: 7235–7246.
- Janssen, R.H., Vincken, J.-P., van den Broek, L.A.M., Fogliano, V. and Lakemond, C.M.M., 2017. Nitrogen-to-protein conversion factors for three edible insects: tenebrio molitor, alphetobius diaperinus, and hermetia illucens. *Journal of Agricultural and Food Chemistry* 65: 2275–2278.
- Jones, L.D., Cooper, R.W. and Harding, R.S., 1972. Composition of mealworm tenebrio molitor larvae. *The Journal of Zoo Animal Medicine* 3: 34.
- Jongema, Y., 2017. List of edible insects of the world (april 1, 2017) - wur. Available at: <https://www.wur.nl/en/Research-Results/Chair-groups/Plant-Sciences/Laboratory-of-Entomology/Edible-insects/Worldwide-species-list.htm>. Accessed February 9, 2022.
- Jung, S., Rickert, D.A., Deak, N.A., Aldin, E.D., Recknor, J., Johnson, L.A. and Murphy, P.A., 2003. Comparison of kjeldahl and dumas methods for determining protein contents of soybean products. *Journal of the American Oil Chemists’ Society* 80: 1169–1173.
- Kadoum, A.M., 1969. Effect of radiofrequency electric field treatment on protein metabolism in yellow meal worm larvae. *Journal of Economic Entomology* 62: 220–223.
- Kadoum, A.M., Ball, H.J. and Nelson, S.O., 1967a. Morphological abnormalities resulting from radiofrequency treatment of larvae of *Tenebrio molitor*. *Annals of the Entomological Society of America* 60: 889–903.

- Kadoum, A.M., Ball, H.J. and Stetson, L.V.E., 1967b. Metabolism in the yellow mealworm, *Tenebrio molitor* (coleoptera: tenebrionidae), following exposure to radiofrequency electric fields. *Annals of the Entomological Society of America* 60: 1195–1199.
- Kamau, E., Mutungi, C., Kinyuru, J., Imathiu, S., Tanga, C., Affognon, H., Ekesi, S., Nakimbugwe, D. and Fiaboe, K.K.M., 2018. Moisture adsorption properties and shelf-life estimation of dried and pulverised edible house cricket *Acheta domesticus* (L.) and black soldier fly larvae *Hermetia illucens* (L.). *Food Research International* 106: 420–427.
- Kashiri, M., Marin, C., Garzón, R., Rosell, C.M., Rodrigo, D. and Martínez, A., 2018. Use of high hydrostatic pressure to inactivate natural contaminating microorganisms and inoculated e. coli o157:h7 on *Hermetia illucens* larvae. *PLOS ONE* 13: e0194477.
- Kaya, M., Baran, T., Erdoğan, S., Menteş, A., Aşan Özüsallam, M. and Çakmak, Y.S., 2014. Physicochemical comparison of chitin and chitosan obtained from larvae and adult colorado potato beetle (*leptinotarsa decemlineata*). *Materials science & engineering. C, Materials for biological applications* 45: 72–81.
- Kaya, M., Erdogan, S., Mol, A. and Baran, T., 2015. Comparison of chitin structures isolated from seven orthoptera species. *International Journal of Biological Macromolecules* 72: 797–805.
- Kaya, M., Sofi, K., Sargin, I. and Mujtaba, M., 2016. Changes in physicochemical properties of chitin at developmental stages (larvae, pupa and adult) of vespa crabro (wasp). *Carbohydrate polymers* 145: 64–70.
- Khouryieh, H.A., 2021. Novel and emerging technologies used by the U.S. food processing industry. *Innovative Food Science & Emerging Technologies* 67: 102559.
- Kim, T.-K., Yong, H.I., Kim, Y.-B., Jung, S., Kim, H.-W. and Choi, Y.-S., 2021. Effects of organic solvent on functional properties of defatted proteins extracted from protaetia brevitarsis larvae. *Food Chemistry* 336: 127679.
- Kim, T.K., Yong, H.I., Chun, H.H., Lee, M.A., Kim, Y.B. and Choi, Y.S., 2020. Changes of amino acid composition and protein technical functionality of edible insects by extracting steps. *Journal of Asia-Pacific Entomology* 23: 298–305.
- Kingwascharapong, P., Chaijan, M. and Karnjanapratum, S., 2021. Ultrasound-assisted extraction of protein from *Bombay locusts* and its impact on functional and antioxidative properties. *Scientific Reports* 2021 11:1 11: 1–14.
- Klunder, H.C., Wolkers-Rooijackers, J., Korpela, J.M. and Nout, M.J.R., 2012. Microbiological aspects of processing and storage of edible insects. *Food Control* 26: 628–631.
- Knorr, D., Froehling, A., Jaeger, H., Reineke, K., Schlueter, O. and Schoessler, K., 2011. Emerging technologies in food processing. *Annual review of food science and technology.* , 203–235.
- Koubaa, M., Barba, F.J., Mhemdi, H., Grimi, N., Koubaa, W. and Vorobiev, E., 2015. Gas assisted mechanical expression (game) as a promising technology for oil and phenolic compound recovery from tiger nuts. *Innovative Food Science & Emerging Technologies* 32: 172–180.

- Kroll, J., Rawel, H.M. and Rohn, S., 2003. Reactions of plant phenolics with food proteins and enzymes under special consideration of covalent bonds. *Food Science and Technology Research* 9: 205–218.
- Kröncke, N., Bösch, V., Woyzichovski, J., Demtröder, S. and Benning, R., 2018. Comparison of suitable drying processes for mealworms (*Tenebrio molitor*). *Innovative Food Science & Emerging Technologies* 50: 20–25.
- Kröncke, N., Grebenteuch, S., Keil, C., Demtröder, S., Kroh, L., Thünemann, A.F., Benning, R. and Haase, H., 2019. Effect of different drying methods on nutrient quality of the yellow mealworm (*Tenebrio molitor* L.). *Insects* 10 <https://doi.org/10.3390/INSECTS10040084>.
- Kumar, M., Vivekanand, V. and Pareek, N., 2020. Insect chitin and chitosan: structure, properties, production, and implementation prospective. *Natural Materials and Products from Insects: Chemistry and Applications*. pp. 51–66.
- Kumar Yadav, B., Rawson, A. and Binod Kumar Yadav, C., 2019. Optimization of protein extraction from yellow mealworm larvae. ~ 4577 ~ *International Journal of Chemical Studies* 7: 4577–4582.
- Lähteenmäki-Uutela, A., Rahikainen, M., Lonkila, A. and Yang, B., 2021. Alternative proteins and eu food law. *Food Control* 130: 108336.
- Lange, K.W. and Nakamura, Y., 2021. Edible insects as future food: chances and challenges. *Journal of Future Foods* 1: 38–46.
- Lanoisellé, J.-L., 1995. Contribution à l'étude du pressage hydraulique des graines oléoprotéagineuses : mécanisme de pressage et modélisation. <http://www.theses.fr> Available at: <http://www.theses.fr/1995PA120006>. Accessed September 6, 2021.
- Laroche, M., Perreault, V., Marciniak, A., Gravel, A., Chamberland, J. and Doyen, A., 2019. Comparison of conventional and sustainable lipid extraction methods for the production of oil and protein isolate from edible insect meal. *Foods* 8 <https://doi.org/10.3390/FOODS8110572>.
- Larouche, J., Deschamps, M.H., Saucier, L., Lebeuf, Y., Doyen, A. and Vandenberg, G.W., 2019. Effects of killing methods on lipid oxidation, colour and microbial load of black soldier fly (*Hermetia illucens*) larvae. *Animals* 9 <https://doi.org/10.3390/ANI9040182>.
- Lebovka, N., Bazhal, M. and Vorobiev, E., 2002. Estimation of characteristic damage time of food materials in pulsed-electric fields. *Journal of Food Engineering* 54: 337–346.
- Lebovka, N., Melnyk, V., Mamunya, Y., Klishevich, G., Goncharuk, A. and Pivovarova, N., 2013. Low-temperature phase transformations in 4-cyano-4'-pentyl-biphenyl (5cb) filled by multiwalled carbon nanotubes. *Physica E: Low-Dimensional Systems and Nanostructures* 52: 65–69.
- Lebovka, N., Vorobiev, E. and Chemat, F., 2016. Enhancing extraction processes in the food industry. *Enhancing Extraction Processes in the Food Industry* <https://doi.org/10.1201/B11241>.
- Lebovka, N.I., Mhemdi, H., Grimi, N., Bals, O. and Vorobiev, E., 2014. Treatment of potato tissue by pulsed electric fields with time-variable strength: theoretical and experimental analysis. *Journal of Food Engineering* 137: 23–31.



- Lee, H.J., Kim, J.H., Ji, D.S. and Lee, C.H., 2019. Effects of heating time and temperature on functional properties of proteins of yellow mealworm larvae (*Tenebrio molitor* L.). *Food Science of Animal Resources* 39: 296–308.
- Leni, G., Caligiani, A. and Sforza, S., 2019. Killing method affects the browning and the quality of the protein fraction of black soldier fly (*Hermetia illucens*) prepupae: a metabolomics and proteomic insight. *Food Research International* 115: 116–125.
- Liu, S., Sun, J., Yu, L., Zhang, C., Bi, J., Zhu, F., Qu, M., Jiang, C. and Yang, Q., 2012. Extraction and characterization of chitin from the beetle holotrichia parallela motschulsky. *Molecules (Basel, Switzerland)* 17: 4604–4611.
- Louati, I., Bahloul, N., Besombes, C., Allaf, K. and Kechaou, N., 2019. Instant controlled pressure-drop as texturing pretreatment for intensifying both final drying stage and extraction of phenolic compounds to valorize orange industry by-products (citrus sinensis L.). *Food and Bioprocess Technology* 114: 85–94.
- Louka, N. and Allaf, K., 2002. New process for texturizing partially dehydrated biological products using controlled sudden decompression to the vacuum: application on potatoes. *Journal of Food Science* 67: 3033–3038.
- Louka, N., Juhel, F. and Allaf, K., 2004. Quality studies on various types of partially dried vegetables texturized by controlled sudden decompression. *Journal of Food Engineering* 65: 245–253.
- Macias, A.E., de Leon, S.P., Huertas, M., Maravilla, E., Romero, C., Montoya, T.G., Muñoz, J.M. and Lopez-Vidal, Y., 2008. Endemic infusate contamination and related bacteremia. *American Journal of Infection Control* 36: 48–53.
- Mahler, H.C., Friess, W., Grauschopf, U. and Kiese, S., 2009. Protein aggregation: pathways, induction factors and analysis. *Journal of Pharmaceutical Sciences* , 2909–2934.
- Makkar, H.P.S., Tran, G., Heuzé, V. and Ankers, P., 2014. State-of-the-art on use of insects as animal feed. *Animal Feed Science and Technology* 197: 1–33.
- Mancini, S., Fratini, F., Tuccinardi, T., Turchi, B., Nuvoloni, R. and Paci, G., 2019. Effects of different blanching treatments on microbiological profile and quality of the mealworm (*Tenebrio molitor*). *Journal of Insects as Food and Feed* 5: 225–234.
- Mancini, S., Sogari, G., Diaz, S.E., Menozzi, D., Paci, G. and Moruzzo, R., 2022. Exploring the future of edible insects in Europe. *Foods* 2022, Vol. 11, Page 455 11: 455.
- Mandal, S.C., Mandal, V. and Das, A.K., 2015. Classification of extraction methods. *Essentials of Botanical Extraction* 83–136.
- Manzano-Agugliaro, F., Sanchez-Muros, M.J., Barroso, F.G., Martínez-Sánchez, A., Rojo, S. and Pérez-Bañón, C., 2012. Insects for biodiesel production. *Renewable and Sustainable Energy Reviews* , 3744–3753.
- Marcos, B., Esteban, M., López, P., Alcalá, M., Gómez, R., Espejo, J. and Marcos, A., 1997. Monolayer values at 30°C of various spices as computed by the BET and GAB models. *Z Lebensm Unters Forsch* 204: 109–112.

- Maroulis, Z.B., Tsarni, E., Marinos-Kouris, D. and Saravacos, G.D., 1988. Application of the GAB model to the moisture sorption isotherms for dried fruits. *Journal of Food Engineering* 7: 63–78.
- Mazza, G. and LeMaguer, M., 1978. Water sorption properties of yellow globe onion (*Allium cepa* L.). *Canadian Institute of Food Science and Technology Journal* 11: 189–193.
- Melgar-Lalanne, G., Hernández-Álvarez, A.J. and Salinas-Castro, A., 2019. Edible insects processing: traditional and innovative technologies. *Comprehensive Reviews in Food Science and Food Safety* 18: 1166–1191.
- Melis, R., Braca, A., Mulas, G., Sanna, R., Spada, S., Serra, G., Fadda, M.L., Roggio, T., Uzzau, S. and Anedda, R., 2018. Effect of freezing and drying processes on the molecular traits of edible yellow mealworm. *Innovative Food Science & Emerging Technologies* 48: 138–149.
- Mhemdi, H., Bals, O., Grimi, N. and Vorobiev, E., 2014. Alternative pressing/ultrafiltration process for sugar beet valorization: impact of pulsed electric field and cossettes preheating on the qualitative characteristics of juices. *Food and Bioprocess Technology* 7: 795–805.
- Mhemdi, H., Grimi, N., Bals, O., Lebovka, N.I. and Vorobiev, E., 2013. Effect of apparent density of sliced food particles on the efficiency of pulsed electric field treatment. *Innovative Food Science & Emerging Technologies* 18: 115–119.
- Miglietta, P., De Leo, F., Ruberti, M. and Massari, S., 2015. Mealworms for food: a water footprint perspective. *Water* 7: 6190–6203.
- Mintah, B.K., He, R., Dabbour, M., Agyekum, A.A., Xing, Z., Golly, M.K. and Ma, H., 2019a. Sonochemical action and reaction of edible insect protein: influence on enzymolysis reaction-kinetics, free-gibbs, structure, and antioxidant capacity. *Journal of food biochemistry* 43 <https://doi.org/10.1111/JFBC.12982>.
- Mintah, B.K., He, R., Dabbour, M., Golly, M.K., Agyekum, A.A. and Ma, H., 2019b. Effect of sonication pretreatment parameters and their optimization on the antioxidant activity of *Hermitia illucens* larvae meal protein hydrolysates. *Journal of Food Processing and Preservation* 43: e14093.
- Mintah, B.K., He, R., Dabbour, M., Xiang, J., Jiang, H., Agyekum, A.A. and Ma, H., 2020. Characterization of edible soldier fly protein and hydrolysate altered by multiple-frequency ultrasound: structural, physical, and functional attributes. *Process Biochemistry* 95: 157–165.
- Mishyna, M., Keppler, J.K. and Chen, J., 2021. Techno-functional properties of edible insect proteins and effects of processing. *Current Opinion in Colloid & Interface Science* 56: 101508.
- Mishyna, M., Martinez, J.-J.I., Chen, J. and Benjamin, O., 2019. Extraction, characterization and functional properties of soluble proteins from edible grasshopper (*Schistocerca gregaria*) and honey bee (*Apis mellifera*). *Food Research International* 116: 697–706.
- Mkaouar, S., Bahloul, N., Gelicus, A., Allaf, K. and Kechaou, N., 2015. Instant controlled pressure drop texturing for intensifying ethanol solvent extraction of olive (*Olea europaea*) leaf polyphenols. *Separation and Purification Technology* 145: 139–146.

- Mohamad, E.A., Elfky, A.A., El-Gebaly, R.H. and Afify, A., 2022. Study the change in the mosquito larvae (*Culex pipiens*) in water treated with short pulses electric filed. *Electromagnetic Biology and Medicine* 41: 80–92.
- Montanari, C., Serrazanetti, D.I., Felis, G., Torriani, S., Tabanelli, G., Lanciotti, R. and Gardini, F., 2015. New insights in thermal resistance of staphylococcal strains belonging to the species staphylococcus epidermidis, staphylococcus lugdunensis and staphylococcus aureus. *Food Control* 50: 605–612.
- Moruzzo, R., Riccioli, F., Espinosa Diaz, S., Secci, C., Poli, G. and Mancini, S., 2021. Mealworm (*Tenebrio molitor*): potential and challenges to promote circular economy. *Animals* 2021, Vol. 11, Page 2568 11: 2568.
- Mounir, S. and Allaf, K., 2008. Three-stage spray drying: new process involving instant controlled pressure drop. *Drying Technology* 26: 452–463.
- Mounir, S., Allaf, T. and Allaf, K., 2018. Swell drying sd. In: Nema, P.K., Kaur, B.P. and Mujumdar, A.S. (eds.) In: *Drying Technologies For Foods: Fundamentals And Applications: Part III*. pp. 63–91.
- Mounir, S., Allaf, T., Mujumdar, A.S. and Allaf, K., 2012. Swell drying: coupling instant controlled pressure drop dic to standard convection drying processes to intensify transfer phenomena and improve quality—an overview. *Drying Technology* 30: 1508–1531.
- Mounir, S., Besombes, C., Al-Bitar, N. and Allaf, K., 2011a. Study of instant controlled pressure drop DIC treatment in manufacturing snack and expanded granule powder of apple and onion. *Drying Technology* 29: 331–341.
- Mounir, S., Halle, D. and Allaf, K., 2011b. Characterization of pure cheese snacks and expanded granule powders textured by the instant controlled pressure drop (DIC) process. *Dairy Science and Technology* 91: 441–455.
- Nakagaki, B.J. and Defoliart, G.R., 1991. Comparison of diets for mass-rearing *Acheta domesticus* (orthoptera: gryllidae) as a novelty food, and comparison of food conversion efficiency with values reported for livestock. *Journal of Economic Entomology* 84: 891–896.
- Namir, M., Elzahar, K., Ramadan, M.F. and Allaf, K., 2017. Cactus pear peel snacks prepared by instant pressure drop texturing: effect of process variables on bioactive compounds and functional properties. *Journal of Food Measurement and Characterization* 11: 388–400.
- Nation, J.L., 2008. Encyclopedia of entomology. In: Capinera, J.L. (ed.) pp. 2015–2019.
- Nelson, S.O., Stetson, L.E. and Rhine, J.J., 1966. Factors influencing effectiveness of radio-frequency electric fields for stored-grain insect control. *Transactions of the ASAE* 9: 809–815.
- Nguyen Van, C., 2010. Maîtrise de l’aptitude technologique des oléagineux par modification structurelle ; applications aux opérations d ’ extraction et de transestérification in-situ. These. La Rochelle Available at: <http://www.theses.fr/2010LAROS308>. Accessed September 6, 2021.
- Nongonierma, A.B. and FitzGerald, R.J., 2017. Unlocking the biological potential of proteins from edible insects through enzymatic hydrolysis: a review. *Innovative Food Science & Emerging Technologies* 43: 239–252.

- Nyangena, D.N., Mutungi, C., Imathiu, S., Kinyuru, J., Affognon, H., Ekesi, S., Nakimbugwe, D. and Fiaboe, K.K.M., 2020. Effects of traditional processing techniques on the nutritional and microbiological quality of four edible insect species used for food and feed in east africa. *Foods* 2020, Vol. 9, Page 574 9: 574.
- Ojha, S., Bußler, S., Psarianos, M., Rossi, G. and Schlüter, O.K., 2021. Edible insect processing pathways and implementation of emerging technologies. *Journal of Insects as Food and Feed* 7: 877–900.
- Ojha, S., Bußler, S. and Schlüter, O.K., 2020. Food waste valorisation and circular economy concepts in insect production and processing. *Waste Management* 118: 600–609.
- Oonincx, D.G.A.B. and de Boer, I.J.M., 2012. Environmental impact of the production of mealworms as a protein source for humans - a life cycle assessment. *PLoS ONE* 7 <https://doi.org/10.1371/journal.pone.0051145>.
- Oonincx, D.G.A.B., van Itterbeeck, J., Heetkamp, M.J.W., van den Brand, H., van Loon, J.J.A. and van Huis, A., 2010. An exploration on greenhouse gas and ammonia production by insect species suitable for animal or human consumption. *PLOS ONE* 5: e14445.
- Opstvedt, J., Nygård, E., Samuelsen, T.A., Venturini, G., Luzzana, U. and Mundheim, H., 2003. Effect on protein digestibility of different processing conditions in the production of fish meal and fish feed. *Journal of the Science of Food and Agriculture* 83: 775–782.
- Osimani, A., Garofalo, C., Milanović, V., Taccari, M., Cardinali, F., Aquilanti, L., Pasquini, M., Mozzon, M., Raffaelli, N., Ruschioni, S., Riolo, P., Isidoro, N. and Clementi, F., 2017. Insight into the proximate composition and microbial diversity of edible insects marketed in the european union. *European Food Research and Technology* 243: 1157–1171.
- Otero, P., Gutierrez-Docio, A., Navarro del Hierro, J., Reglero, G. and Martin, D., 2020. Extracts from the edible insects *Acheta domesticus* and *Tenebrio molitor* with improved fatty acid profile due to ultrasound assisted or pressurized liquid extraction. *Food Chemistry* 314 <https://doi.org/10.1016/j.foodchem.2020.126200>.
- Ozimek, L., Sauer, W.C., Kozikowzki, V., Ryan, J.K., Jørgensen, H. and Jelen, P., 1985. Nutritive value of protein extracted from honey bees. *Journal of Food Science* 50: 1327–1329.
- Page, G.E., 1949. Factors influencing the maximum rates of air drying shelled corn in thin layers. Master of Science thesis, Purdue University, West Lafayette.
- Panagopoulos, D.J., 2016. Pulsed electric field increases reproduction. *International Journal of Radiation Biology* 92: 94–106.
- Parniakov, O., Mikhrovska, M., Wiktor, A., Alles, M., Ristic, D., Bogusz, R., Nowacka, M., Devahastin, S., Mujumdar, A. and Heinz, V., 2022. Insect processing for food and feed: a review of drying methods. *Drying Technology* 40: 1500–1513.
- Pech-Almeida, J.L., Téllez-Pérez, C., Alonzo-Macías, M., Teresa-Martínez, G.D., Allaf, K., Allaf, T. and Cardador-Martínez, A., 2021. An overview on food applications of the instant controlled pressure-drop technology, an innovative high pressure-short time process. *Molecules* 26 <https://doi.org/10.3390/MOLECULES26216519>.

- Pérez, I., Bald, C., de Marañón, Í.M. and Allaf, K., 2014. DIC intensification of the mechanical extraction of lipids by pressing. In: Allaf, T. A.K. (ed.) Instant Controlled Pressure Drop (D.I.C.) in Food Processing. Food Engineering Series. pp. 163–176.
- Pinpathomrat, N., Kaweeferngfu, T., Laphodom, A., Islam, N.E. and Kirawanich, P., 2011. Inhibition of *Culex quinquefasciatus* (diptera: culicidae) viability by nanosecond pulsed electric field radiation. *Journal of Electrostatics* 69: 339–344.
- Ponomaryova, I.A., Rivera Oyarzabal, L.N. de and Ruíz Sánchez, E., 2008. Interaction of radio-frequency, high-strength electric fields with harmful insects. *Journal of Microwave Power and Electromagnetic Energy* 43: 17–27.
- Psarianos, M., Dimopoulos, G., Ojha, S., Cavini, A.C.M., Bußler, S., Taoukis, P. and Schlüter, O.K., 2022. Effect of pulsed electric fields on cricket (*Acheta domesticus*) flour: extraction yield (protein, fat and chitin) and techno-functional properties. *Innovative Food Science & Emerging Technologies* 76: 102908.
- Puguh Setyoprato, Akbarningrum Fatmawati and Karim Allaf, 2009. Texturing by instant controlled pressure drop in the production of cassava flour: impact on dehydration kinetics, product physical properties and microbial decontamination. *World Congress on Engineering and Computer Science*.
- Puligundla, P., Pyun, Y.R. and Mok, C., 2018. Pulsed electric field (PEF) technology for microbial inactivation in low-alcohol red wine. *Food Science and Biotechnology* 27: 1691.
- Purschke, B., Brüggem, H., Scheibelberger, R. and Jäger, H., 2018. Effect of pre-treatment and drying method on physico-chemical properties and dry fractionation behaviour of mealworm larvae (*Tenebrio molitor* L.). *European Food Research and Technology* 244: 269–280.
- Ramos-Elorduy, J., González, E.A., Hernández, A.R. and Pino, J.M., 2002. Use of *Tenebrio molitor* (coleoptera: tenebrionidae) to recycle organic wastes and as feed for broiler chickens. *Journal of economic entomology* 95: 214–220.
- Ravzanaadii, N., Kim, S.-H., Choi, W.-H., Hong, S.-J. and Kim, N.-J., 2012. Nutritional value of mealworm, *Tenebrio molitor* as food source. *International Journal of Industrial Entomology* 25: 93–98.
- Rawiwan, P., Peng, Y., Paramayuda, I.G.P.B. and Quek, S.Y., 2022. Red seaweed: a promising alternative protein source for global food sustainability. *Trends in Food Science & Technology* 123: 37–56.
- Regulation (EC) No 767/2009, 2009. Regulation (EC) no 767/2009 of the European Parliament and of the Council of 13 July 2009 on the placing on the market and use of feed, amending European Parliament and Council Regulation (EC) no 1831/2003 and repealing Council Directive 79/373/EEC, Comm. Official Journal of the European Union. Available at: <https://eur-lex.europa.eu/legal-content/EN/TXT/?uri=CELEX%3A32009R0767>. Accessed November 30, 2022.
- Regulation (EC) No 999/2001, 2001. Regulation (EC) no 999/2001 of the European Parliament and of the Council of 22 May 2001 laying down rules for the prevention, control and eradication of certain transmissible spongiform encephalopathies. Available at: <https://eur-lex.europa.eu/legal-content/EN/TXT/?uri=CELEX%3A32001R0999>.

- lex.europa.eu/legal-content/EN/ALL/?uri=CELEX%3A32001R0999. Accessed November 30, 2022.
- Ribeiro, J.C., Lima, R.C., Maia, M.R.G., Almeida, A.A., Fonseca, A.J.M., Cabrita, A.R.J. and Cunha, L.M., 2019. Impact of defatting freeze-dried edible crickets (*Acheta domesticus* and *Grylloides sigillatus*) on the nutritive value, overall liking and sensory profile of cereal bars. *LWT - Food Science and Technology* 113 <https://doi.org/10.1016/J.LWT.2019.108335>.
- Richter, B.E., Jones, B.A., Ezzell, J.L., Porter, N.L., Avdalovic, N. and Pohl, C., 1996. Accelerated solvent extraction: a technique for sample preparation. *Analytical Chemistry* 68: 1033–1039.
- Roberts, P.E. and Willis, J.H., 1980. The cuticular proteins of *tenebrio molitor*. i. electrophoretic banding patterns during postembryonic development. *Developmental Biology* 75: 59–69.
- Rodríguez-Rodríguez, M., Barroso, F.G., Fabrikov, D. and Sánchez-Muros, M.J., 2022. In vitro crude protein digestibility of insects: a review. *Insects* 2022, Vol. 13, Page 682 13: 682.
- Rumpold, B.A., Fröhling, A., Reineke, K., Knorr, D., Boguslawski, S., Ehlbeck, J. and Schlüter, O., 2014. Comparison of volumetric and surface decontamination techniques for innovative processing of mealworm larvae (*Tenebrio molitor*). *Innovative Food Science and Emerging Technologies* 26: 232–241.
- Rumpold, B.A. and Schlüter, O.K., 2013. Nutritional composition and safety aspects of edible insects. *Molecular nutrition & food research* 57: 802–823.
- Sahena, F., Zaidul, I.S.M., Jinap, S., Karim, A.A., Abbas, K.A., Norulaini, N.A.N. and Omar, A.K.M., 2009. Application of supercritical CO<sub>2</sub> in lipid extraction – a review. *Journal of Food Engineering* 95: 240–253.
- Saucier, L., M'ballou, C., Ratti, C., Deschamps, M.H., Lebeuf, Y. and Vandenberg, G.W., 2021. Comparison of black soldier fly larvae pre-treatments and drying techniques on the microbial load and physico-chemical characteristics. <https://doi.org/10.3920/JIFF2021.0002> 8: 45–64.
- Saulnier, F., Ferrera, F., Choukri, A., Girardet, J.-M. and Linden, G., 1991. Estimation of protein denaturation by spectrofluorimetry: application to industrial wheys. <http://dx.doi.org/10.1051/lait:1991439> 71: 511–518.
- Savoire, R., 2008. Etude multi-échelles de la séparation solide-liquide dans la trituration du lin oléagineux. <http://www.theses.fr> Available at: <http://www.theses.fr/2008COMP1760>. Accessed September 6, 2021.
- Scala, F., 2013. Fluidized bed technologies for near-zero emission combustion and gasification. Woodhead Publishing series in energy. 1058 pp <https://doi.org/10.1533/9780857098801>.
- Sehrawat, R., Nema, P.K. and Kaur, B.P., 2016. Effect of superheated steam drying on properties of foodstuffs and kinetic modeling. *Innovative Food Science & Emerging Technologies* 34: 285–301.
- Séré, A., Bougma, A., Bazié, B.S.R., Traoré, E., Parkouda, C., Gnankiné, O. and Bassolé, I.H.N., 2021. Chemical composition, energy and nutritional values, digestibility and functional properties of defatted flour, protein concentrates and isolates from *Carbula marginella*

- (hemiptera: pentatomidae) and *Cirina butyrospermi* (lepidoptera: saturniidae). BMC Chemistry 15: 1–11.
- Setyoprato, P., Fatmawati, A., Sutrisna, P.D., Savitri, E. and Allaf, K., 2012. The dehydration kinetics, physical properties and nutritional content of banana textured by instantaneous controlled pressure drop. Asia-Pacific Journal of Chemical Engineering 7: 726–732.
- Shorstkii, I., Comiotto Alles, M., Parniakov, O., Smetana, S., Aganovic, K., Sosnin, M., Toepfl, S. and Heinz, V., 2022. Optimization of pulsed electric field assisted drying process of black soldier fly (*Hermetia illucens*) larvae. Drying Technology 40: 595–603.
- Siemianowska, E., Kosewska, A., Aljewicz, M., Skibniewska, K.A., Polak-Juszczak, L., Jarocki, A. and Jedras, M., 2013. Larvae of mealworm (*Tenebrio molitor* L.) as european novel food. Agricultural Sciences 4: 287–291.
- Smetana, S., Mathys, A., Knoch, A. and Heinz, V., 2015. Meat alternatives: life cycle assessment of most known meat substitutes. International Journal of Life Cycle Assessment 20: 1254–1267.
- Smetana, S., Mhemdi, H., Mezdour, S. and Heinz, V., 2020. Pulsed electric field–treated insects and algae as future food ingredients. Pulsed Electric Fields to Obtain Healthier and Sustainable Food for Tomorrow 247–266.
- Smetana, S., Palanisamy, M., Mathys, A. and Heinz, V., 2016. Sustainability of insect use for feed and food: life cycle assessment perspective. Journal of Cleaner Production 137: 741–751.
- Smetana, S., Schmitt, E. and Mathys, A., 2019. Sustainable use of hermetia illucens insect biomass for feed and food: attributional and consequential life cycle assessment. Resources, Conservation and Recycling 144: 285–296.
- Smil, V., 2002. Worldwide transformation of diets, burdens of meat production and opportunities for novel food proteins. Enzyme and Microbial Technology 30: 305–311.
- Song, Y.-S., Kim, M.-W., Moon, C., Seo, D.-J., Han, Y.S., Jo, Y.H., Noh, M.Y., Park, Y.-K., Kim, S.-A., Kim, Y.W. and Jung, W.-J., 2018. Extraction of chitin and chitosan from larval exuvium and whole body of edible mealworm, *Tenebrio molitor*. Entomological Research 48: 227–233.
- Steinfeld, H., Gerber, P., Wassenaar, T., Castel, V., Rosales, M. and de Haan, C., 2006. Livestock’s long shadow: environmental issues and options. FAO 322–342.
- Stoops, J., Vandeweyer, D., Crauwels, S., Verreth, C., Boeckx, H., Van Der Borght, M., Claes, J., Lievens, B. and Van Campenhout, L., 2017. Minced meat-like products from mealworm larvae (*Tenebrio molitor* and *Alphitobius diaperinus*): microbial dynamics during production and storage. Innovative Food Science & Emerging Technologies 41: 1–9.
- Sun-Waterhouse, D., Waterhouse, G.I.N., You, L., Zhang, J., Liu, Y., Ma, L., Gao, J. and Dong, Y., 2016. Transforming insect biomass into consumer wellness foods: a review. Food Research International 89: 129–151.
- Sun, H., Necochea Velazco, O., Lakemond, C., Dekker, M., Cadesky, L. and Mishyna, M., 2021. Differences in moisture sorption characteristics and browning of lesser mealworm (*Alphitobius diaperinus*) ingredients. Lebensmittel-Wissenschaft & Technologie 142: 110989.

- Sun, M., Xu, X., Zhang, Q., Rui, X., Wu, J. and Dong, M., 2018. Ultrasonic-assisted aqueous extraction and physicochemical characterization of oil from *clanis bilineata*. *Journal of oleo science* 67: 151–165.
- Szwarc, D. and Głowacka, K., 2021. Increasing the biogas potential of rapeseed straw using pulsed electric field pre-treatment. *Energies* 2021, Vol. 14, Page 8307 14: 8307.
- Téllez-Pérez, C., Sobolik, V., Montejano-Gaitán, J.G., Abdulla, G. and Allaf, K., 2015. Impact of swell-drying process on water activity and drying kinetics of moroccan pepper (*Capsicum annum*). *Drying Technology* 33: 131–142.
- Tello, A., Aganovic, K., Parniakov, O., Carter, A., Heinz, V. and Smetana, S., 2021. Product development and environmental impact of an insect-based milk alternative. *Future Foods* 4: 100080.
- Tobolková, B., Takáč, P., Mangová, B. and Kozánek, M., 2021. A comparative study of colour characteristics of thermally/non-thermally treated mealworm larvae (*Tenebrio molitor*) by means of uv/vis spectroscopy and multivariate analysis. *Journal of Food Measurement and Characterization* 15: 3791–3799.
- Tonneijck-Srpová, L., Venturini, E., Humblet-Hua, K.N.P. and Bruins, M.E., 2019. Impact of processing on enzymatic browning and texturization of yellow mealworms. <https://doi.org/10.3920/JIFF2018.0025> 5: 267–277.
- Tuccillo, F., Marino, M.G. and Torri, L., 2020. Italian consumers' attitudes towards entomophagy: influence of human factors and properties of insects and insect-based food. *Food Research International* 137: 109619.
- Turck, D., Bohn, T., Castenmiller, J., De Henauw, S., Hirsch-Ernst, K.I., Maciuk, A., Mangelsdorf, I., McArdle, H.J., Naska, A., Pelaez, C., Pentieva, K., Siani, A., Thies, F., Tsabouri, S., Vinceti, M., Cubadda, F., Frenzel, T., Heinonen, M., Marchelli, R., Neuhäuser-Berthold, M., Poulsen, M., Maradona, M.P., Schlatter, J.R., van Loveren, H., Azzollini, D. and Knutsen, H.K., 2022a. Safety of partially defatted house cricket (*Acheta domestica*) powder as a novel food pursuant to regulation (EU) 2015/2283. *EFSA Journal* 20 <https://doi.org/10.2903/J.EFSA.2022.7258>.
- Turck, D., Bohn, T., Castenmiller, J., De Henauw, S., Hirsch-Ernst, K.I., Maciuk, A., Mangelsdorf, I., McArdle, H.J., Naska, A., Pelaez, C., Pentieva, K., Siani, A., Thies, F., Tsabouri, S., Vinceti, M., Cubadda, F., Frenzel, T., Heinonen, M., Marchelli, R., Neuhäuser-Berthold, M., Poulsen, M., Prieto Maradona, M., Schlatter, J.R., van Loveren, H., Ververis, E. and Knutsen, H.K., 2022b. Safety of frozen and freeze-dried formulations of the lesser mealworm (*alphitobius diaperinus* larva) as a novel food pursuant to regulation (EU) 2015/2283. *EFSA Journal* 20 <https://doi.org/10.2903/J.EFSA.2022.7325>.
- Turck, D., Bohn, T., Castenmiller, J., De Henauw, S., Ildico Hirsch-Ernst, K., Maciuk, A., Mangelsdorf, I., McArdle, H.J., Naska, A., Pelaez, C., Pentieva, K., Siani, A., Thies, F., Tsabouri, S., Vinceti, M., Cubadda, F., Frenzel, T., Heinonen, M., Marchelli, R., Neuh, M., Poulsen, M., Prieto Maradona, M., Rudolf Schlatter, J., van Loveren, H., Ververis, E. and Katrine Knutsen, H., 2021a. Safety of frozen and dried formulations from whole yellow mealworm (*Tenebrio molitor* larva) as a novel food pursuant to regulation (EU) 2015/2283 efsa panel on nutrition, novel foods and food allergens (nda), panel members. *Journal* 19: 6778.



- Turck, D., Castenmiller, J., De Henauw, S., Hirsch-Ernst, K.I., Kearney, J., Maciuk, A., Mangelsdorf, I., McArdle, H.J., Naska, A., Pelaez, C., Pentieva, K., Siani, A., Thies, F., Tsabouri, S., Vinceti, M., Cubadda, F., Frenzel, T., Heinonen, M., Marchelli, R., Neuhäuser-Berthold, M., Poulsen, M., Maradona, M.P., Schlatter, J.R., van Loveren, H., Azzollini, D. and Knutsen, H.K., 2021b. Safety of frozen and dried formulations from migratory locust (*Locusta migratoria*) as a novel food pursuant to regulation (EU) 2015/2283. *EFSA Journal* 19 <https://doi.org/10.2903/J.EFSA.2021.6667>.
- Turck, D., Castenmiller, J., De Henauw, S., Hirsch-Ernst, K.I., Kearney, J., Maciuk, A., Mangelsdorf, I., McArdle, H.J., Naska, A., Pelaez, C., Pentieva, K., Siani, A., Thies, F., Tsabouri, S., Vinceti, M., Cubadda, F., Frenzel, T., Heinonen, M., Marchelli, R., Neuhäuser-Berthold, M., Poulsen, M., Prieto Maradona, M., Schlatter, J.R., van Loveren, H., Verwer, E. and Knutsen, H.K., 2021c. Safety of dried yellow mealworm (*Tenebrio molitor* larva) as a novel food pursuant to regulation (EU) 2015/2283. *EFSA Journal* 19 <https://doi.org/10.2903/J.EFSA.2021.6343>.
- Tzompa-Sosa, D.A., Yi, L., van Valenberg, H.J.F., van Boekel, M.A.J.S. and Lakemond, C.M.M., 2014. Insect lipid profile: aqueous versus organic solvent-based extraction methods. *Food Research International* 62: 1087–1094.
- United Nations, 2014. World population prospects: 2015 revision, key findings and advance tables. 7250-7 pp.
- van Huis, A., 2013. Potential of insects as food and feed in assuring food security. *Annual Review of Entomology* 58: 563–583.
- van Huis, A., Itterbeeck, J. Van, Klunder, H., Mertens, E., Halloran, A., Muir, G. and Vantomme, P., 2013. Edible insects. future prospects for food and feed security. Food and Agriculture Organization of the United Nations. 1–201 pp.
- Vandeweyer, D., Crauwels, S., Lievens, B. and Van Campenhout, L., 2017a. Microbial counts of mealworm larvae (*Tenebrio molitor*) and crickets (*Acheta domesticus* and *Gryllodes sigillatus*) from different rearing companies and different production batches. *International Journal of Food Microbiology* 242: 13–18.
- Vandeweyer, D., Lenaerts, S., Callens, A. and Van Campenhout, L., 2017b. Effect of blanching followed by refrigerated storage or industrial microwave drying on the microbial load of yellow mealworm larvae (*Tenebrio molitor*). *Food Control* 71: 311–314.
- Vorobiev, E. and Lebovka, N., 2010. Enhanced extraction from solid foods and biosuspensions by pulsed electrical energy. *Food Engineering Reviews* 2: 95–108.
- Vorobiev, E. and Lebovka, N., 2020. Processing of foods and biomass feedstocks by pulsed electric energy. *Processing of Foods and Biomass Feedstocks by Pulsed Electric Energy* 1–399.
- Wigglesworth, V.B., 1948. The structure and deposition of the cuticle in the adult mealworm, *Tenebrio molitor* L. (coleoptera). *Journal of Cell Science* 3: 197–216.
- Wu, S., 2012. Supercritical carbon dioxide extraction of oil from *Clanis bilineata* (lepidoptera), an edible insect. *African Journal of Biotechnology* 11: 4607–4610.

- Wynants, E., Crauwels, S., Lievens, B., Luca, S., Claes, J., Borremans, A., Bruyninckx, L. and Van Campenhout, L., 2017. Effect of post-harvest starvation and rinsing on the microbial numbers and the bacterial community composition of mealworm larvae ( *Tenebrio molitor* ). *Innovative Food Science & Emerging Technologies* 42: 8–15.
- Xia, Z., Wu, S., Pan, S. and Kim, J.M., 2012. Nutritional evaluation of protein from *Clanis bilineata* (lepidoptera), an edible insect. *Journal of the Science of Food and Agriculture* 92: 1479–1482.
- Yan, X., Laurent, S., Federighi, M., Boué, G. and Jury, V., 2022. Processing edible insects into powders: a review of available processes and potential microbial inactivation methods. *Journal of Insects as Food and Feed In Press*: 1–14.
- Yi, L., Lakemond, C.M.M., Sagis, L.M.C., Eisner-Schadler, V., van Huis, A. and van Boekel, M.A.J.S., 2013. Extraction and characterisation of protein fractions from five insect species. *Food Chemistry* 141: 3341–3348.
- Yi, L., Martinus, ·, Van Boekel, A.J.S., Sjef Boeren, · and Lakemond, C.M.M., 2016. Protein identification and in vitro digestion of fractions from tenebrio molitor. *European Food Research and Technology* 242: 1285–1297.
- Yoon, S., Wong, N.A.K., Chae, M. and Auh, J.H., 2019. Comparative characterization of protein hydrolysates from three edible insects: mealworm larvae, adult crickets, and silkworm pupae. *Foods* 2019, Vol. 8, Page 563 8: 563.
- Zhang, R., 2020. Impact of emerging technologies on the cell disruption and fractionation of microalgal biomass. Université de Technologie de Compiègne Available at: <https://theses.hal.science/tel-02947021>. Accessed December 12, 2022.
- Zhao, X., Vázquez-Gutiérrez, J.L., Johansson, D.P., Landberg, R. and Langton, M., 2016. Yellow mealworm protein for food purposes - extraction and functional properties. *Public Library of Science One* 11: e0147791.
- Zhu, Z., 2014. Study of pulsed electric fields (pef) assisted inulin extraction from chicory root and chicory juice purification. Université de Technologie de Compiègne Available at: <https://scanr.enseignementsup-recherche.gouv.fr/publication/these2014COMP2135>. Accessed December 12, 2022.
- Zhu, Z., Mhemdi, H., Ding, L., Bals, O., Jaffrin, M.Y., Grimi, N. and Vorobiev, E., 2015. Dead-end dynamic ultrafiltration of juice expressed from electroporated sugar beets. *Food and Bioprocess Technology* 8: 615–622.
- Zielińska, E., Karaś, M. and Baraniak, B., 2018. Comparison of functional properties of edible insects and protein preparations thereof. *LWT* 91: 168–174.
- Zimmermann, U., 1986. Electrical breakdown, electropermeabilization and electrofusion. *Reviews of physiology, biochemistry and pharmacology* 105: 176–256.
- Żuk-Gołaszewska, K., Gałęcki, R., Obremski, K., Smetana, S., Figiel, S. and Gołaszewski, J., 2022. Edible insect farming in the context of the eu regulations and marketing - an overview. *Insects* 2022, Vol. 13, Page 446 13: 446.

Zygler, A., Słomińska, M. and Namieśnik, J., 2012. Soxhlet extraction and new developments such as soxtec. *Comprehensive Sampling and Sample Preparation 2*: 65–82.