



HAL
open science

Evaluation des compétences sphinctériennes du système gastro-intestinal par système EndoFLIP

Charlotte Desprez

► **To cite this version:**

Charlotte Desprez. Evaluation des compétences sphinctériennes du système gastro-intestinal par système EndoFLIP. Médecine humaine et pathologie. Normandie Université, 2022. Français. NNT : 2022NORMR097 . tel-04621988

HAL Id: tel-04621988

<https://theses.hal.science/tel-04621988>

Submitted on 24 Jun 2024

HAL is a multi-disciplinary open access archive for the deposit and dissemination of scientific research documents, whether they are published or not. The documents may come from teaching and research institutions in France or abroad, or from public or private research centers.

L'archive ouverte pluridisciplinaire **HAL**, est destinée au dépôt et à la diffusion de documents scientifiques de niveau recherche, publiés ou non, émanant des établissements d'enseignement et de recherche français ou étrangers, des laboratoires publics ou privés.



Normandie Université

THÈSE

Pour obtenir le diplôme de doctorat

Spécialité SCIENCES DE LA VIE ET DE LA SANTE

Préparée au sein de l'Université de Rouen Normandie

Evaluation des compétences sphinctériennes du système gastro-intestinal par système EndoFLIP

Présentée et soutenue par
CHARLOTTE DESPREZ

Thèse soutenue le 23/11/2022
devant le jury composé de

| | | |
|------------------------|---|-----------------------|
| M. BENOIT COFFIN | PROFESSEUR DES UNIV - PRATICIEN HOSP., UNIVERSITE PARIS 7 PARIS DIDEROT | Rapporteur du jury |
| MME MURIEL MATHONNET | PROFESSEUR DES UNIV - PRATICIEN HOSP., UNIVERSITE LIMOGES | Rapporteur du jury |
| M. FRANK ZERBIB | PROFESSEUR DES UNIV - PRATICIEN HOSP., UNIVERSITE DE BORDEAUX | Membre du jury |
| MME VALERIE BRIDOUX | PROFESSEUR DES UNIV - PRATICIEN HOSP., Université de Rouen Normandie | Président du jury |
| MME ANNE-MARIE LEROI | PROFESSEUR DES UNIV - PRATICIEN HOSP., Université de Rouen Normandie | Directeur de thèse |
| M. GUILLAUME GOURCEROL | PROFESSEUR DES UNIV - PRATICIEN HOSP., Université de Rouen Normandie | Co-directeur de thèse |

Thèse dirigée par ANNE-MARIE LEROI (NUTRITION, INFLAMMATION ET AXE MICROBIOTE INTESTIN-CERVEAU) et GUILLAUME GOURCEROL (NUTRITION, INFLAMMATION ET AXE MICROBIOTE INTESTIN-CERVEAU)

Table des matières

| | |
|--|------------|
| REMERCIEMENTS | 3 |
| LISTE DES PUBLICATIONS ISSUES DE LA THESE | 4 |
| LISTE DES FIGURES | 5 |
| LISTE DES ABREVIATIONS | 6 |
| INTRODUCTION | 7 |
| PREMIERE PARTIE : TECHNIQUE D'ENDOFLIP® | 10 |
| 1. PRINCIPES DE LA TECHNIQUE D'ENDOFLIP® | 10 |
| 2. PARAMETRES MESURES AVEC LE SYSTEME ENDOFLIP® ET LEURS VALEURS NORMALES | 12 |
| DEUXIEME PARTIE : PRINCIPALES INDICATIONS DE LA TECHNIQUE D'ENDOFLIP® | 21 |
| 1. ACHALASIE..... | 21 |
| 2. AUTRES TROUBLES MOTEURS CESOPHAGIENS | 32 |
| TROISIEME PARTIE : ENDOFLIP® ET PYLORE | 37 |
| 1. RAPPELS ANATOMO-PHYSIOLOGIQUES DU PYLORE | 37 |
| 2. ROLE DU PYLORE DANS LA GASTROPARESIE | 39 |
| 3. EXPLORATIONS PYLORIQUES | 40 |
| 4. TRAITEMENTS ENDOSCOPIQUES CIBLANT LE PYLORE..... | 42 |
| QUATRIEME PARTIE : ENDOFLIP® ET SPHINCTER ANAL | 46 |
| 1. RAPPELS ANATOMO-PHYSIOLOGIQUES DU SPHINCTER ANAL | 46 |
| 2. ROLE DU SPHINCTER ANAL DANS L'INCONTINENCE FECALE..... | 48 |
| 3. EXPLORATIONS DU SPHINCTER ANAL..... | 49 |
| 4. TRAITEMENTS..... | 51 |
| CINQUIEME PARTIE : PRESENTATION DU TRAVAIL DE THESE | 53 |
| OBJECTIFS DE LA THESE | 53 |
| 1 ^{ER} AXE : INTERET MECANISTIQUE DE L'ENDOFLIP® AU NIVEAU DU PYLORE ET DU SPHINCTER ANAL..... | 55 |
| 1. <i>Évaluation de la distensibilité et de la pression pylorique chez les patients atteints de gastroparésie diabétique</i> | 55 |
| 2. <i>La mesure de la distensibilité pylorique après chirurgie oeso-gastrique : quelles chirurgies sont associées à un pylorospasme ?</i> | 65 |
| 3. <i>La relation entre les résultats de l'EndoFLIP® anal et la présentation clinique de l'incontinence fécale</i> 73 | |
| 2 ^{EME} AXE : INTERET THERAPEUTIQUE DE L'ENDOFLIP® AU NIVEAU DU PYLORE | 86 |
| <i>La mesure de la distensibilité pylorique permet de prédire la réponse symptomatique aux injections intra-pyloriques de toxine botulique.</i> | 86 |
| 3 ^{EME} AXE : AMELIORATION DE LA METHODOLOGIE DE LA TECHNIQUE | 96 |
| <i>Impact de l'anesthésie générale sur les caractéristiques pyloriques mesurées par le système EndoFLIP® chez les patients atteints de gastroparésie</i> | 96 |
| SIXIEME PARTIE : DISCUSSION GENERALE ET CONCLUSIONS | 123 |
| CONCLUSIONS & PERSPECTIVES | 136 |
| BIBLIOGRAPHIE | 138 |
| ANNEXE | 163 |
| RESUME | 182 |

Remerciements

A Monsieur le Professeur Benoit Coffin, Gastroentérologue, Professeur à l'Université de Paris, qui me fait l'honneur d'évaluer et de juger ce travail en qualité de rapporteur. Veuillez trouver ici l'expression de mon profond respect et de mes sincères remerciements pour votre regard critique sur ce travail.

A Madame le Professeur Muriel Mathonnet, Chirurgien viscéral, Professeur à l'Université de Limoges, qui me fait l'honneur d'évaluer et de juger ce travail en qualité de rapporteur. Veuillez trouver ici l'expression de mon profond respect et je vous remercie d'avoir accepté d'évaluer mon travail.

A Madame le Professeur Valérie Bridoux, Chirurgien viscéral, Professeur à l'Université de Rouen, qui me fait l'honneur de juger ce travail. Je te remercie d'avoir accepté de faire partie de mon jury, mais également pour tes conseils et ta confiance pour ces dernières années mais également celles à venir.

A Monsieur le Professeur Frank Zerbib, Gastroentérologue, Professeur à l'Université de Bordeaux, qui me fait l'honneur de juger ce travail. Veuillez trouver ici l'expression de mes sincères remerciements pour votre évaluation de mon travail et de mon profond respect.

A Madame le Professeur Anne-Marie Leroi, Neurologue, Professeur à l'Université de Rouen. Merci pour votre soutien indéfectible tout au long de ce travail de thèse, mais également pour votre accueil, votre disponibilité et vos précieux conseils depuis ces dernières années. Trouvez ici l'expression de ma profonde admiration et de mon attachement.

A Monsieur le Professeur Guillaume Gourcerol, Gastroentérologue, Professeur à l'Université de Rouen. Merci pour ton soutien sans faille depuis ces dernières années, ton écoute et ta disponibilité. Trouve ici l'expression de ma profonde admiration et de mon attachement.

A l'ensemble de l'équipe de l'unité INSERM 1073 et particulièrement au Professeur Pierre Déchelotte et au Professeur Moïse Coeffier, un grand merci pour vos encouragements et vos conseils tout au long de ces années.

Liste des publications issues de la thèse

Articles originaux publiés

- **Desprez C**, Chambaz M, Melchior C, et al. Assessment of pyloric sphincter distensibility and pressure in patients with diabetic gastroparesis. *Neurogastroenterol Motil.* 2021. Aug;33(8):e14064.
- **Desprez C**, Melchior C, Wuestenberghs F, et al. Pyloric distensibility measurement after gastric surgery: Which surgeries are associated with pylorospasm? *Neurogastroenterol Motil.* 2020 May;32(5):e13790.
- **Desprez C**, Gourcerol G, Savoye-Collet C, et al. Relationship between anal functional lumen imaging probe (EndoFLIP®) results and the clinical presentation of faecal incontinence. *Colorectal Dis.* 2022 Jun; Online ahead of print.
- **Desprez C**, Melchior C, Wuestenberghs F, et al. Pyloric distensibility measurement predicts symptomatic response to intrapyloric botulinum toxin injection. *Gastrointest Endosc.* 2019 Nov;90:754-760.

Revue de la littérature publiée : Article donné en Annexe

- **Desprez C**, Roman S, Leroi AM, et al. The use of impedance planimetry (Endoscopic Functional Lumen Imaging Probe, EndoFLIP®) in the gastrointestinal tract: A systematic review. *Neurogastroenterol Motil.* 2020 Sep;32(9):e13980.

Articles originaux en cours de préparation

- **Desprez C**, Jacques, J, Clavier T, et al. Impact of anesthetics on pyloric characteristics measured using the EndoFLIP® system in patients with gastroparesis. Soumission prévue dans *Neurogastroenterol Motil.*

Liste des figures

Figure 1 : Schématisation du système EndoFLIP®.

Figure 2. Représentation schématique de la loi d'Ohm.

Figure 3 : (A) : représentation traditionnelle de l'EndoFLIP® au niveau de la jonction oeso-gastrique. (B) : photographie du cathéter d'EndoFLIP® (EF325-N).

Figure 4 : exemple de FLIP panométrie chez un sujet volontaire sain.

Figure 5 : Exemples de sous-types d'achalasia prédits par la FLIP panométrie.

Figure 6 : Tracé de manométrie antro-pyloro-duodénale perfusée.

Liste des abréviations

CSA : cross-sectionnal area, surface de section transversale

DES : spasme distal de l'œsophage

DI : index de distensibilité

DP : plateau de distension

EGJOO : obstruction fonctionnelle de la jonction oeso-gastrique

EndoFLIP® : Endoscopic Functional Lumen Imaging Probe

G-POEM : myotomie per orale par voie endoscopique gastrique

HM : myotomie de Heller

JOG : jonction oeso-gastrique

MOHR : manométrie œsophagienne haute-résolution

ND : non détaillé

PD : dilatation pneumatique

POEM : myotomie per orale par voie endoscopique

PRI : pression de relaxation intégrée

RACs : contraction antérogrades répétitives

RRCs : contractions rétrogrades répétitives

SIO : sphincter inférieur de l'œsophage

TOGD : transit oeso-gastro-duodéal

VS : volontaires sains

INTRODUCTION

D'une manière historique, les sphincters du système gastro-intestinal ont pu être étudiés via l'utilisation de techniques de manométrie perfusée placée à travers le site d'intérêt et, plus récemment, avec les sondes de manométrie haute-résolution(1)(2). Cependant, si la manométrie permet l'étude de la pression au repos, mais également lors de la contraction et de la relaxation sphinctérienne, il a été démontré qu'il existait une faible corrélation entre ces paramètres et la compétence sphinctérienne(3). Ainsi, Harris et al. ont pu mettre en évidence qu'un sphincter n'a pas nécessairement besoin de réaliser une contraction de grande amplitude pour être compétent et que la résistance du sphincter à la distension pourrait être le déterminant principal de la compétence sphinctérienne(4). Le système EndoFLIP® (Endoscopic Functional Lumen Imaging Probe) a donc été développé secondairement afin de pouvoir étudier la résistance à la distension des sphincters du système gastro-intestinal et ceci grâce à l'utilisation d'un ballonnet positionné au niveau du site d'intérêt.

A notre connaissance, la première étude pilote rapportant l'utilisation du système EndoFLIP® a été réalisée en 2005 et s'est intéressée à l'évaluation de la jonction oeso-gastrique (JOG)(5). Jusqu'à ce jour, la majorité des travaux de publications et les principales applications du système l'EndoFLIP® concernent l'évaluation de la résistance à la distension du sphincter inférieur de l'œsophage (SIO) et du corps œsophagien, dans le cadre du diagnostic des troubles moteurs primaires de l'œsophage. Néanmoins, l'EndoFLIP® a également été utilisé dans d'autres régions sphinctériennes et non-sphinctériennes du système gastro-intestinal. Quelques études, peu nombreuses, se sont intéressées à ses applications potentielles au niveau du sphincter pylorique et du canal anal. Il a pourtant été mis en évidence que le spasme du pylore ou pylorospasme, pouvait jouer un rôle important dans le ralentissement de la vidange gastrique

et donc dans la physiopathologie de la gastroparésie (6). La mise en évidence de ce mécanisme nécessite la réalisation d'une technique de manométrie spécifique au niveau du sphincter pylorique, ce qui en a limité la diffusion au sein des centres spécialisés. Depuis, quelques études ont pu montrer la faisabilité de la réalisation de l'EndoFLIP® au niveau pylorique chez des sujets volontaires sains ou chez des patients atteints de gastroparésie(7),(8),(9). Cependant, il existe un manque d'homogénéité dans les modalités de réalisation de l'EndoFLIP® en fonction des études. En particulier, les procédures d'anesthésie, avant réalisation de l'EndoFLIP®, diffèrent d'une étude à l'autre.

En ce qui concerne le canal anal, la fonction sphinctérienne anale est classiquement étudiée en mesurant la pression de repos et la pression lors de la contraction volontaire via la manométrie ano-rectale perfusée ou haute-résolution(10). Mais, si ces techniques manométriques permettent la mesure directe des forces de clôture du canal anal, elles ne permettent pas de quantifier la dimension d'ouverture, qui est une variable importante dans la détermination du flux trans-sphinctérien(11). Cependant, là encore, très peu d'études ont été effectuées concernant l'utilisation de l'EndoFLIP® dans l'évaluation de la compétence sphinctérienne anale(12):(13).

Mon travail de Thèse s'est donc intéressé à l'évaluation de la technique d'EndoFLIP® au niveau de ces deux sphincters peu explorés jusqu'ici, à savoir le sphincter pylorique et le sphincter anal.

Le plan de ce mémoire est le suivant :

- La **première partie** est consacrée à la technique d'EndoFLIP® avec des rappels concernant le matériel utilisé, la technique de mesure et les résultats que l'on peut en obtenir ;

- La **seconde partie** est une synthèse bibliographique des principales applications actuelles de la technique d'EndoFLIP® dans le cadre du diagnostic des troubles moteurs primitifs œsophagiens ;
- La **troisième partie** porte sur l'utilisation de la technique d'EndoFLIP® au niveau du pylore précédé de rappels anatomo-physiologiques sur ce sphincter ;
- La **quatrième partie** porte sur l'utilisation de la technique d'EndoFLIP® au niveau du sphincter anal précédé de rappels anatomo-physiologiques sur ce sphincter ;
- La **cinquième partie** expose les objectifs et les résultats des différents travaux qui font l'objet de ma thèse ;
- La **sixième partie** comprend la discussion des résultats, ainsi que les conclusions et perspectives de mon travail de thèse.

Première partie : Technique d'EndoFLIP®

1. Principes de la technique d'EndoFLIP®

Le principe de la technique d'EndoFLIP® repose sur l'utilisation de la planimétrie d'impédance. Le système EndoFLIP® est composé d'une sonde de 5 mm de diamètre qui comprend 16 paires d'électrodes de mesure d'impédance, sur laquelle est montée un ballon non-compliant constitué de polyuréthane. Ce ballon va pouvoir être distendu de manière croissante (Figure 1) par l'instillation d'une solution conductrice saline au sein de laquelle un courant continu est conduit. Deux types de sondes sont actuellement disponibles sur le marché, la sonde EF325-N et la sonde EF322-N. Les différences entre ces deux sondes reposent principalement sur l'espacement entre les paires d'électrodes et la taille du ballonnet : tous les 5 mm avec un ballonnet de 8 cm (sonde EF325-N) ou tous les 1 cm avec un ballonnet de 16 cm (sonde EF322-N). Le panel des volumes de distension possibles est également différent selon les sondes, pouvant aller entre 0 et 50 mL pour la sonde EF325-N et entre 0 et 70 mL pour la sonde EF322-N.

La technique d'EndoFLIP® permet de mesurer au niveau de chaque paire d'électrodes la surface de section transversale (« cross sectionnal area » en anglais, CSA) à partir de l'impédance de la solution saline dans le ballon. Ainsi, lorsqu'un courant d'intensité I (*ampère*) est induit au sein de la solution saline conductrice par les deux électrodes d'excitation, la différence de potentiel V (*volt*) entre les électrodes de détection est définie comme $V = I.Z$ (loi d'Ohm). Z (*ohm*) est l'impédance électrique du fluide et est exprimée comme $\frac{d.p}{CSA}$ où d est la distance entre les électrodes de détection et p est la conductivité du fluide (Figure 2). En conséquence, le voltage est inversement proportionnel au CSA(14).

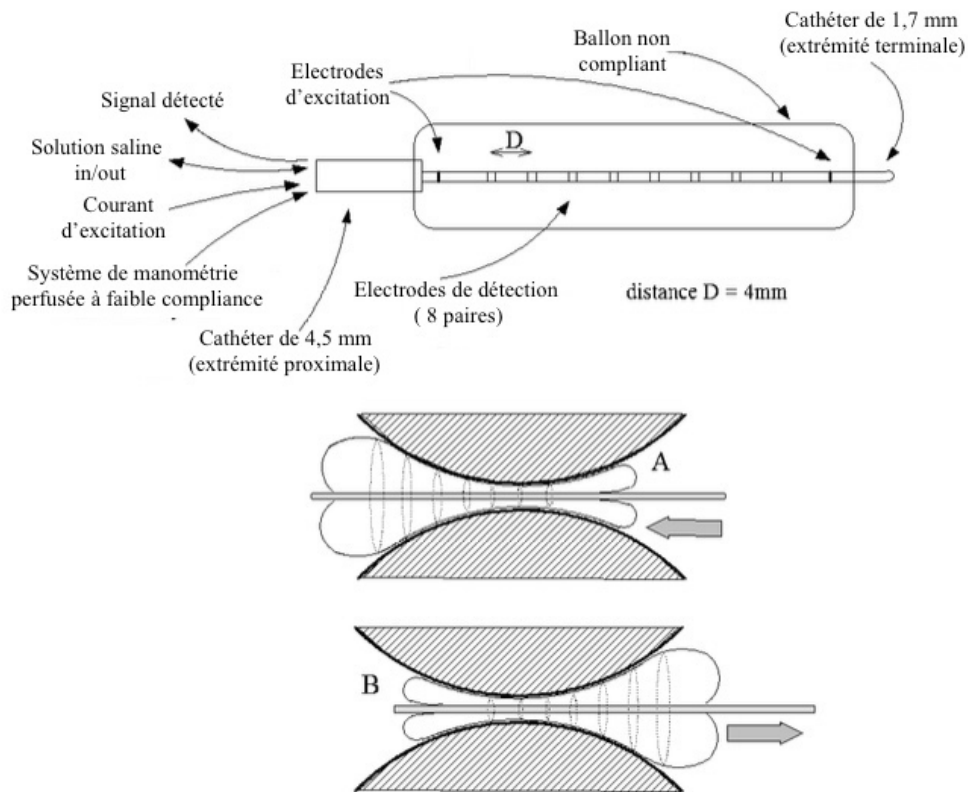

Figure 1. Schématisation du système EndoFLIP®. Les chaînes de signal, de remplissage et de perfusion sont montrées au niveau de l'extrémité proximale. Le ballon peut être mobilisé vers la gauche (A) ou vers la droite (B) sans dislocation de celui-ci. D'après McMahon et al.(5)

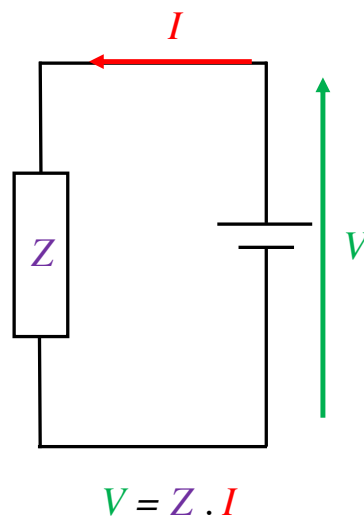

Figure 2. Représentation schématique de la loi d'Ohm avec V la différence de potentiel en volt, Z l'impédance en ohm et I l'intensité du courant en ampère.

Étant donné que 16 paires d'électrodes de détection sont situées le long de la sonde, le système EndoFLIP® est ainsi capable de mesurer une série totale de 16 CSAs de manière

longitudinale au sein du ballonnet. L'acquisition d'une manière simultanée de ces CSAs le long du sphincter et leur analyse permet de simuler la région sphinctérienne d'intérêt comme un profil en 3 dimensions (Figure 3). Un capteur de pression est également situé à l'extrémité distale de la sonde dans le ballonnet et permet une mesure globale de la pression intra-ballonnet. Un résultat important donné par le système EndoFLIP® est la possibilité d'évaluer la distensibilité sphinctérienne, qui est définie comme la division du CSA minimum, correspondant à la partie où le sphincter est le plus étroit, par la pression intra-ballonnet au même moment.

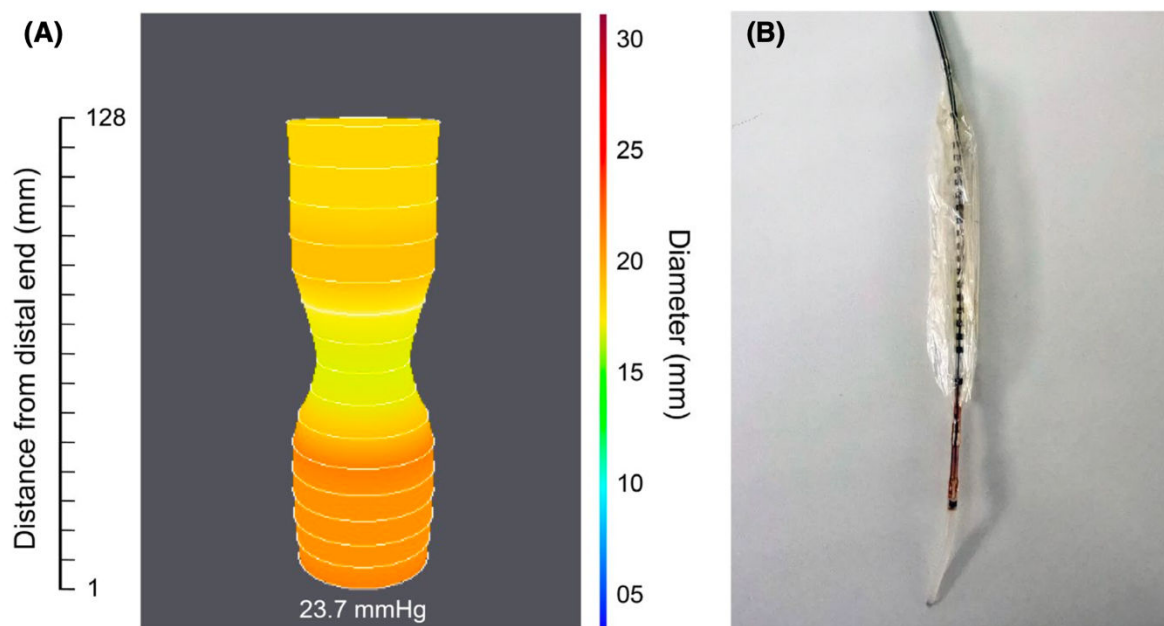

Figure 3 : (A) : représentation traditionnelle de l'EndoFLIP® au niveau de la jonction oeso-gastrique avec une simulation de la région sphinctérienne comme un profil en 3-dimensions indiquée par des changements de couleur du bleu (diamètre le plus petit) au rouge (diamètre le plus élevé). La direction orale est vers le haut. La pression intra-ballon est indiquée. (B) : photographie du cathéter d'EndoFLIP® (EF325-N), montrant le ballon de 8 cm avec ses 16 paires d'électrodes positionnées tous les 5 mm le long de la sonde.

2. Paramètres mesurés avec le système EndoFLIP® et leurs valeurs normales

Les paramètres mesurés classiquement au niveau d'un sphincter grâce à la technique d'EndoFLIP® sont les suivants :

- Surface de section transversale (« Cross sectional area », CSA, mm²) : les électrodes d'excitation positionnées à chaque extrémité du ballon émettent un faible courant continu. La tension (V) est mesurée entre les électrodes d'impédance planimétrie appariées en s'appuyant sur la loi d'Ohm, afin de fournir une mesure du CSA à des intervalles basés sur l'espacement entre les électrodes d'impédance ;
- Diamètre (mm) : les données de diamètre au niveau de chaque paire d'électrodes d'impédance planimétrie varient entre 5 et 30 mm et sont colorées sur la base d'une échelle de couleur (petits diamètres en rouge, larges diamètres en bleu) ;
- Index de distensibilité (DI, mm²/mmHg) : il s'agit de la mesure de la distensibilité sphinctérienne qui peut être calculée en divisant le plus petit CSA médian (au sein de la région anatomique d'intérêt) par la pression médiane intra-ballon à un temps donné. Il s'agit du paramètre le plus utilisé dans la littérature ;
- Pression intra-ballon (mmHg) : un capteur de pression est situé à la partie distale du ballon, et permet la mesure globale de la pression intra-ballon.

La validation de la faisabilité de ces mesures a été réalisée initialement au niveau de la JOG. A ce jour, vingt études se sont intéressées à la physiologie de la JOG grâce aux mesures données par le système EndoFLIP® chez des sujets volontaires sains (Table 1). Les résultats en termes de pression intra-ballon, plus petit CSA et index de distensibilité à différents volumes de distension sont donnés dans la Table 2. En utilisant le 10^{ème} percentile chez les volontaires sains, deux études de Rohof et al. en 2012(15) et Smeets et al. en 2015(16) ont défini un cut-off pour la normalité de l'index de distensibilité de respectivement 2,9 mm²/mmHg et de 2,1 mm²/mmHg à 50 mL de distension. Ces deux études ont été réalisées chez 15 sujets volontaires sains sans anesthésie générale.

Table 1 : caractéristiques des études réalisées chez des sujets volontaires sains*VS : volontaires sains ; JOG : jonction oeso-gastrique ; ND : non détaillé*

| Publication | Method | | Niveau de preuve / Grade de recommandation | Sonde | Mesures EndoFLIP® : temps (s) et volumes de distension (mL) | Pression de calibration | Caractéristiques de la procedure | Site de distension |
|---|------------------|----------------------------------|--|----------|---|-------------------------|--|--------------------|
| | Nombre de VS (n) | Design de l'étude | | | | | | |
| Carlson et al, 2019 (=Carlson et al, 2020)(17) | 20 | Prospective, série de cas | 3/C | EF322 -N | 30s, 20-25-30-35-40-45-50-55-60-65-70 mL | Atmosphérique | Voie orale, sédation consciente (midazolam, fentanyl), sans contrôle endoscopique | JOG & Corps |
| Mikami et al, 2018(18) | 8 | Prospective, étude cas-contrôles | 3/C | EF325 -N | 30s, 20-30-40 mL | Intra-gastrique | Transnasale, anesthésie locale, sans contrôle endoscopique | JOG |
| Liao et al, 2018(19) | 6 | Prospective, série de cas | 3/C | EF325 -N | 20-30-40 mL | ND | Voie orale, sans sédation, sans contrôle endoscopique | JOG |
| Carlson et al, 2016 (= Lin Z 2013 & Carlson 2015)(20) | 10 | Prospective, étude cas-contrôles | 3/C | EF322 -N | 20-30s, 5 to 60 mL (par palier de 5-mL) | Atmosphérique | Voie orale, sédation consciente (midazolam, fentanyl), sans contrôle endoscopique | JOG & Corps |
| Mikami et al, 2016(21) | 8 | Prospective, série de cas | 3/C | EF325 -N | 30s, 20-30-40 mL | Intra-gastrique | Transnasale, anesthésie locale, sans contrôle endoscopique | JOG |
| Fynne et al, 2016(22) | 11 | Prospective, étude cas-contrôles | 3/C | EF325 -N | 30s, 20-30-40-50mL | ND | Voie orale, sédation consciente midazolam ou sans sédation, sans contrôle endoscopique | JOG |
| Smeets et al, 2015(16) | 15 | Prospective, étude cas-contrôles | 3/C | EF325 -N | 30s, 30-40-50 mL | Atmosphérique | Voie orale, sans sédation, sans contrôle endoscopique | JOG |
| Lottrup et al, 2015(23) | 14 | Prospective, étude cas-contrôles | 3/C | EF325 -N | 30s, 20-30-40-50mL | Atmosphérique | Voie orale, sédation consciente (midazolam), sans contrôle endoscopique | JOG |
| Fukazawa et al, 2013(24) | 9 | Prospective, série de cas | 3/C | EF325 -N | 30s, 20-40-50 mL | Atmosphérique | Transnasale, anesthésie locale, sans contrôle endoscopique | JOG |
| Tucker et al, 2013(25) | 21 | Prospective, étude cas-contrôles | 3/C | EF325 -N | 30s, 20-30 mL | ND | Voie orale, anesthésie générale (midazolam, pethidine), sous contrôle endoscopique | JOG |

| Publication | Nombre de VS (n) | Design de l'étude | Niveau de preuve / Grade de recommandation | Sonde | Mesures EndoFLIP® : temps (s) et volume de distension (ml) | Pression de calibration | Caractéristiques de la procédure | Site de distension |
|-------------------------------------|------------------|----------------------------------|--|----------|--|-------------------------|---|--------------------|
| Lin Z et al, 2013(26) | 2 | Prospective, étude cas-contrôles | 3/C | EF325 -N | 5-20s, 5 to 40 mL (par palier de 2-mL) | Atmosphérique | Voie orale, sans sédation, sous contrôle endoscopique | JOG & Corps |
| Rieder et al, 2012(27) | 4 | Prospective, série de cas | 4/C | EF325 -N | 30s; 30-40 mL | Atmosphérique | Voie orale, anesthésie générale, sous contrôle endoscopique | JOG |
| Rohof et al, 2012 (=Ponds 2016)(15) | 15 | Prospective, étude cas-contrôles | 3/C | EF325 -N | 30s, 20-30-40-50mL | Atmosphérique | Transnasale, anesthésie locale, sans contrôle endoscopique | JOG |
| Kwiatek et al, 2012(28) | 15 | Prospective, étude cas-contrôles | 3/C | EF325 -N | 30s; 20-30 mL (JOG); 2-40mL; par palier de 2-mL (corps) | Atmosphérique | Voie orale, sédation consciente (midazolam, fentanyl), sans contrôle endoscopique | JOG & Corps |
| Kwiatek et al, 2011(11) | 20 | Prospective, étude cas-contrôles | 3/C | EF325 -N | 30s, 10-20-30-40 mL | Intragastrique | Voie orale, sédation consciente (midazolam, fentanyl), sous contrôle endoscopique | JOG |
| Nathanson et al, 2011(29) | 50 | Prospective, série de cas | 3/C | EF325 -N | 30s; 30-40 mL | Atmosphérique | Voie orale, anesthésie générale, sans contrôle endoscopique | JOG |
| Kwiatek et al, 2010(30) | 10 | Prospective, étude cas-contrôles | 3/C | ND | 30s, 30-40-50 mL | Atmosphérique | Transnasale, anesthésie locale, sans contrôle endoscopique | JOG |
| Beaumont et al, 2009(31) | 8 | Prospective, étude cas-contrôles | 3/C | ND | ND; par palier de 10-mL | Atmosphérique | Voie orale, anesthésie locale, sans contrôle endoscopique | Corps |
| McMahon et al, 2007(32) | 8 | Prospective, série de cas | 3/C | ND | ND; 20-30-40-50-60 mL | Atmosphérique | Voie orale, anesthésie locale, sans contrôle endoscopique | JOG |
| McMahon et al, 2005(3) | 3 | Prospective, série de cas | 4/C | ND | ND; 0-40 mL | Atmosphérique | Voie orale, anesthésie locale, sans contrôle endoscopique | JOG |

Table 2 : Évaluation de la jonction oeso-gastrique (CSA, DI, Pression intra-ballon) par le système EndoFLIP® à différents volumes de distension chez les volontaires sains.

CSA : Surface de section transversale ; DI : index de distensibilité.

| Publication | CSA (mm ²) | | | DI (mm ² /mmHg) | | | Pression intra-ballon (mmHg) | | |
|--|------------------------|--------------------|---------------------|----------------------------|----------------|---------------|------------------------------|------------------|------------------|
| | 30 ml | 40ml | 50 ml | 30 ml | 40 ml | 50 ml | 30 mL | 40 mL | 50 mL |
| Carlson et al, 2016 (= Lin Z 2013 & Carlson 2015) (20) | | | | 3,2 (1,0–11,6) | 5,7 (1,4–15,8) | 5,9 (1,6–9,3) | | | |
| Mikami et al, 2018(18) | 89,4 +/- 10,4 | 150,3 +/- 12,2 | | 3,4 +/- 0,5 | 3,5 +/- 0,4 | | 23,4 ± 2,1 | 40,8 ± 2,0 | |
| Liao et al, 2018(19) | | | | | | | 27,4 ± 1,2 | 40,2 ± 1,5 | |
| Mikami et al, 2016(21) | 84,5 ± 33,2 | 152,4 ± 34,2 | | 3,5 ± 0,6 | 4,5 ± 0,5 | | 22,0 ± 6,0 | 31,2 ± 6,8 | |
| Smets et al, 2015(16) | 50,4 (41,7–69,1) | 99,5 (79,5–138,0) | 169,4 (131,7–187,9) | 2,0 (1,6–3,0) | 3,0 (2,2–4,2) | 3,4 (2,7–4,2) | 25,9 (21,4–30,0) | 34,5 (29,0–40,2) | 45,8 (41,9–53,4) |
| Fukazawa et al, 2013(24) | | 163,0 ± 5,9 | 259,6 ± 12,0 | | 7,1 ± 0,9 | 8,2 ± 0,8 | | 25,9 ± 3,2 | 33,1 ± 2,3 |
| Rohof et al, 2012 (=Ponds 2016) (15) | | | | | | 6,3 ± 0,7 | | | |
| Kwiatek et al, 2012(28) | | | | 0,8 (0,4 – 2,8) | | | | | |
| Rieder et al, 2012(27) | | 122,3 (72,9–170,9) | | | 2,7 (2,4–8,3) | | | 36,8 (20,7–45,8) | |
| Kwiatek et al, 2011(11) | 94,0 (27,0–225,0) | 264,0 (99,0–496,0) | | 4,0 [1,0–14,0] | | | 25,0 (6,0–47,0) | 39,0 (17,0–60,0) | |
| Kwiatek et al, 2010(30) | 50,0 (50,0–68,0) | 50,0 (50,0–50,0) | 50,0 (50,0–52,0) | | | | 16,0 (13,0–19,0) | 17,0 (11,0–21,0) | |

En plus de ces mesures classiques au niveau d'un sphincter, certains auteurs ont cherché d'autres moyens d'évaluation de la compétence sphinctérienne grâce à la technique EndoFLIP®, Ces mesures possibles sont détaillées ci-dessous :

- Le module élastique pression-déformation (Ep ; kPa), calculé comme le changement de diamètre au point le plus étroit divisé par le changement de pression intra-ballon en relation avec un diamètre de référence(22) aussi appelé rigidité au niveau du canal anal

(33)(34)(35). Il est calculé comme $\frac{\Delta p}{\Delta d} \cdot D$ avec Δp le changement de pression, Δd le changement de diamètre et D le diamètre de référence ;

- La résistance au flux du canal anal (mm^3), définie à partir de la longueur du canal anal, du diamètre au niveau du milieu du canal anal et de la viscosité du ballon distendu(36) ;
- Le travail mécanique (mJ) du muscle sphinctérien anal, défini comme le produit de la force musculaire et le changement de rayon, formule complexe utilisée uniquement dans une étude(37) ;
- La tension pariétale (mmHg.mm), calculée comme le produit de la pression intra-ballon et du rayon(38) ;
- La compliance anale (mm/mmHg) calculée comme la division du diamètre par la pression intra-ballon(37) ;
- La pression limite d'élasticité (mmHg) lorsque la partie la plus résistante du sphincter anal commence à se distendre(33)(34)(35).

Par ailleurs, à côté de cette utilisation classique de la technique d'EndoFLIP[®] évaluant la résistance à la distension au niveau d'un sphincter, certaines équipes se sont intéressées à l'emploi de l'EndoFLIP[®] directement dans la lumière du tube digestif, plus particulièrement au niveau du corps œsophagien, initialement avec la sonde classique EN325-N et plus récemment avec la sonde EF322-N. Ce type d'approche est qualifié de FLIP panométrie (panometry en anglais) dans la littérature. Ces publications ont ainsi introduit le concept de plateau de distension, qui est défini comme le reflet du diamètre luminal fixé, c'est-à-dire qui ne parvient plus à être augmenté malgré une pression intra-ballon croissante(20)(17). De plus, la réponse contractile de l'œsophage à la distension, définie comme le péristaltisme secondaire, a pu être mise en évidence dans ces études, avec l'introduction de nouveaux profils de contraction(20)(17)(39)(40) :

- Les contractions du corps de l'œsophage, correspondant à une diminution transitoire de ≥ 5 mm du diamètre luminal dans ≥ 3 paires d'électrodes d'impédance planimétrie adjacentes ;
- Les contractions antérogrades répétitives, répondant à la définition de contractions du corps de l'œsophage, avec ≥ 6 contractions antérogrades consécutives et sur plus de 6 cm de grand axe le long de la sonde d'EndoFLIP® ;
- Les contractions répétitives rétrogrades, répondant à la définition de contractions du corps de l'œsophage, avec ≥ 3 contractions rétrogrades consécutives ;
- L'absence de contraction ;
- Les contractions spastiques occlusives (diamètre luminal < 6 mm) ou non occlusives.

Ces différents profils de contractions ne peuvent pas être mis en évidence lors de la manométrie œsophagienne classique, qui est le reflet du péristaltisme primaire induit lors de la déglutition de liquide(41). Le motif de contractions antérogrades répétitives (Figure 4) qui se produit toutes les 6 à 10 secondes, a pu être mis en évidence comme la réponse contractile normale à une distension chez 95% des volontaires sains, principalement à 40 et 50 mL de distension et est assimilé au péristaltisme secondaire (Table 3)(39)-(40). Une étude récente, reprenant les tracés de FLIP panométrie de 35 volontaires sains et de 706 patients atteints de troubles moteurs primaires de l'œsophage avec une MOHR disponible, a récemment publié une classification de ces troubles du péristaltisme secondaire, en différenciant ceux-ci en réponse contractile normale, borderline, anormale, absente ou spastique(41).

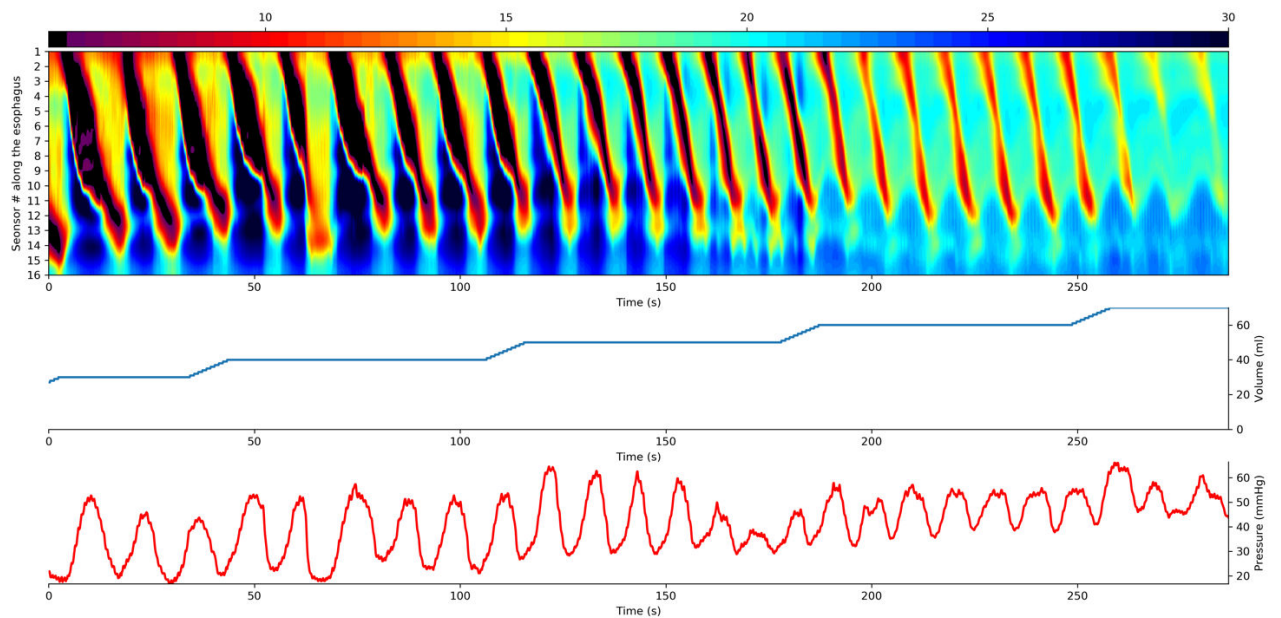

Figure 4 : exemple de FLIP panométrie chez un sujet volontaire sain. La sonde EF322-N a été utilisée chez ce patient, avec 16 paires d'électrodes positionnées tous les 1 cm le long de la sonde (axe vertical). La représentation topographique des changements de diamètre interpolaire en fonction du temps utilise une échelle de couleur (bleu : diamètre le plus large, rouge : diamètre le plus étroit) de 5 à 30 mm. La courbe bleue illustre les différents volumes de distension utilisés en fonction du temps : de 40 à 70 ml par seuils de 5 ml. La courbe rouge illustre les variations de pression globale intra-ballon (mmHg) en fonction du temps. La figure montre un motif de contractions antérogrades répétitives chez un sujet volontaire sain, avec des contractions répétitives antérogrades qui surviennent toutes les 6 à 10 secondes. Tracé fourni avec la courtoisie du Esophageal Center of Northwestern University, Chicago, IL, USA(42).

Table 3 : Évaluation du corps de l'œsophage (DP, motifs RACs et RRCs) via l'utilisation du système EndoFLIP® à différents volumes de distension chez les volontaires sains.

VS : volontaires sains ; DP : plateau de distension ; RACs : contractions répétitives antérogrades ; RRCs : contractions répétitives rétrogrades ; ND : non détaillé.

| Référence | Nombre de patients inclus (n) | Mesures par EndoFLIP® : durée (s) et volumes de distension (mL) | Caractéristiques de la procédure | DP (mm or mm ²) | Présence du motif RAC (%) | Volume médian d'apparition du motif RACs (mL) | Pression médiane d'apparition du motif RACs (mmHg) | Diamètre maximal d'apparition du motif RACs (mm) | Amplitude de contraction (mmHg) | Motif RRCs |
|--|-------------------------------|---|--|---|---------------------------|---|--|--|---------------------------------|------------|
| Carlson et al, 2021(41) | 35 VS 706 tracés | 30s, 20-70 mL (paliers de 10 mL) | Voie orale, sédation consciente (midazolam, fentanyl) | ND | 89% | ND | ND | ND | ND | ND |
| Carlson et al, 2020(43) | 8 VS | 30s, 20-70 mL (paliers de 10 mL) | Voie orale, sédation consciente (midazolam, fentanyl) | ND | 88% | ND | ND | ND | ND | ND |
| Carlson et al, 2019 (=Carlson et al, 2020) (17),(44) | 20 VS | 30s, 20-25-30-35-40-45-50-55-60-65-70 mL | Voie orale, sédation consciente (midazolam, fentanyl) | Œsophage proximal : 21.2 (19.8 – 24.9) mm; oesophage distal : 20.2 (19.4 – 20.4) mm | 95% | 40(30-44) | 22(16-27) | ND | 21,2 (13-33) | Absent |
| Carlson et al, 2016 (= Lin Z 2013 & Carlson 2015) (20) | 10 VS | 20-30s, 5 to 60 mL (paliers de 5-mL) | Voie orale, sédation consciente (midazolam, fentanyl) | ND | 80% | 29(25-35,8) | 10,7(8,5-15,9) | 18,5(17,5-19,6) | 20,8(7,9-22,7) | Absent |
| Lin Z et al, 2013(45) | 2 VS | 5-20s, 5 to 40 mL (paliers de 2-mL) | Voie orale, pas de sédation | ND | ND | ND | ND | ND | ND | ND |
| Kwiattek et al, 2012(28) | 15 VS | 30s; 20-30 mL (JOG); 2-40mL paliers de 2-mL (corps) | Voie orale, sédation consciente (midazolam, fentanyl) +/- sous contrôle endoscopique | 438(227-491) mm ² | ND | ND | ND | ND | ND | ND |
| Beaumont et al, 2009(31) | 8 VS | ND ; paliers de 10-mL | Voie orale, anesthésie locale | ND | ND | ND | ND | ND | ND | ND |

Deuxième partie : principales indications de la technique d'EndoFLIP®

Dans cette seconde partie, nous avons choisi de nous intéresser aux indications actuelles de la technique d'EndoFLIP® au niveau de l'œsophage, pour le diagnostic des troubles moteurs primaires de l'œsophage, afin d'exposer les apports de cette technique en comparaison aux techniques plus classiques que représentent la manométrie œsophagienne ou le transit baryté oeso-gastro-duodéal. Nous avons donc pris le parti de présenter les données de la littérature actuelle sur cette thématique, sans rappeler la physiologie du SIO et du corps œsophagien qui ne correspondent pas aux objectifs principaux de mon travail de Thèse.

Le protocole de mesure des caractéristiques œsophagiennes avec l'outil EndoFLIP® ne fait actuellement l'objet d'aucun consensus, ce qui représente une première limite dans l'interprétation des résultats. La sonde EF325-N a été utilisée pour étudier la jonction oeso-gastrique, tandis que la sonde EF322-N a été majoritairement utilisée pour le corps de l'œsophage.

1. Achalasie

Intérêt diagnostique de l'EndoFLIP® dans l'achalasie

L'achalasie du sphincter inférieur de l'œsophage (SIO) est un trouble moteur primaire de l'œsophage dont le diagnostic est classiquement posé à l'aide d'une MOHR(46). D'après la classification de Chicago v4.0, qui permet la classification des troubles moteurs primaires de l'œsophage, le diagnostic d'achalasie est classiquement posé en présence d'une pression de relaxation intégrée élevée du SIO, en association à un péristaltisme œsophagien primaire anormal, ce qui en définira le sous-type (I : acontractile, II : contractions pan-oesophagiennes, III : contractions spastiques) (47). Trente-sept études au total ont actuellement publié les résultats de la technique d'EndoFLIP® réalisée chez des patients atteints d'achalasie (Table 4).

Toutes ces études ont utilisé la classification de Chicago afin de déterminer le type d'achalasia en se basant sur les résultats de la manométrie œsophagienne haute-résolution(46). En comparaison avec des volontaires sains, les patients avec une achalasia du SIO et naïfs de traitement avaient une distensibilité de la JOG plus faible à différents volumes de distension(15)(16)(48)(49). Il a ainsi été démontré que 91 à 96% des patients avec une achalasia du SIO présentaient une distensibilité de la JOG en dessous de la valeur seuil précédemment décrite chez les sujets volontaires sains(16),(50). De plus, il existait chez ces patients une corrélation inverse entre cet index de distensibilité et l'intensité des symptômes définie à l'aide du score d'Eckardt. Ce score est validé dans le cadre de l'évaluation des symptômes chez les patients atteints d'achalasia, et comprend quatre items (régurgitations, dysphagie, douleur rétro-sternale et perte de poids) gradés chacun entre 0 (symptôme absent) et 3 (survenant à chaque repas ou perte de poids >10 kg) avec une échelle de Lickert(15). Cependant, il existe un manque d'homogénéité parmi ces études en ce qui concerne à la fois les protocoles de distension, la méthode de placement de la sonde d'EndoFLIP® et le type d'anesthésie (Table 5). Ainsi, une étude prospective récente réalisée chez des patients avec une achalasia du SIO a retrouvé des valeurs plus faibles de distensibilité et de CSA de la JOG lorsque la mesure était réalisée sous contrôle endoscopique en comparaison à ces mêmes mesures réalisées après retrait de l'endoscope(51).

Table 4 : Caractéristiques des études réalisées chez les patients avec achalasie.

VS : volontaires sains ; EGJOO : obstruction fonctionnelle de la jonction oeso-gastrique ; POEM : myotomie per orale par voie endoscopique ; DES : spasme distal de l'œsophage ; PD : dilatation pneumatique ; ND : non détaillé ; JOG : jonction oeso-gastrique ; HM : myotomie de Heller.

| Publication | Méthode | | Niveau de preuve / Grade de recommandation | EndoFLIP®: durée (s) et volumes de distension (mL) | Caractéristiques de la procédure | Site de distension |
|--------------------------|-------------------------------|-----------------------------|--|--|---|--------------------|
| | Nombre de patients inclus (n) | Design de l'étude | | | | |
| Carlson et al, 2022(52) | 687 MOHR, 35 VS | Prospective, série de cas | 3/C | 30s ; 20-70 mL paliers | Voie orale, sédation consciente (midazolam, fentanyl), sous contrôle endoscopique | Corps + JOG |
| Attaar et al, 2022(53) | 28 Achalasie (POEM) | Rétrospective, série de cas | 4/C | ND ; 30 mL | Voie orale, anesthésie générale, sous contrôle endoscopique | JOG |
| Amundson et al, 2022(54) | 35 Achalasie (POEM) | Rétrospective, série de cas | 4/C | 30s ; 30-40 mL | Voie orale, anesthésie générale, +/- sous contrôle endoscopique | JOG |
| Hsing et al, 2022(55) | 68 Achalasie (POEM) | Rétrospective, série de cas | 4/C | 30s ; 30-70 mL (paliers de 10 mL) | Voie orale, anesthésie générale, sous contrôle endoscopique | Corps |
| Acharya et al, 2021(56) | 45 Achalasie, 14 VS | Rétrospective, série de cas | 4/C | 30s ; 20-70 mL paliers | Voie orale, sédation consciente (midazolam, fentanyl), sans contrôle endoscopique | JOG |
| Carlson et al, 2021(57) | 180 Achalasie | Rétrospective, série de cas | 4/C | 30s ; 20-70 mL paliers | Voie orale, sédation consciente (midazolam, fentanyl), sans contrôle endoscopique | Corps |
| Rooney et al, 2021(50) | 240 Achalasie | Rétrospective, série de cas | 4/C | 30s ; 20-70 mL paliers | Voie orale, anesthésie générale, sous contrôle endoscopique | JOG |
| Acharya et al, 2020(44) | 45 Achalasie, 14 VS | Rétrospective, série de cas | 4/C | 30s ; 20-70 mL paliers | Voie orale, sédation consciente (midazolam, fentanyl), sans contrôle endoscopique | Corps |
| Attaar et al, 2020(58) | 43 Achalasie (POEM) | Prospective, série de cas | 3/C | 30s ; 30-40 mL | Voie orale, anesthésie générale, sous contrôle endoscopique | JOG |

| Publication | Nombre de patients inclus (n) | Design de l'étude | Niveau de preuve / Grade de recommandation | EndoFLIP® : durée (s) et volumes de distension (mL) | Caractéristiques de la procédure | Site de distension |
|--------------------------|--|-----------------------------|--|---|--|--------------------|
| Sloan et al, 2020(59) | 37 Achalasie, 14 EGJOO | Rétrospective, série de cas | 4/C | ND; 30 mL | Voie orale, anesthésie générale, sous contrôle endoscopique | JOG |
| Schnurre et al, 2020(60) | 28 Achalasie | Rétrospective, série de cas | 4/C | 30s, 30-40 mL | Voie orale, anesthésie générale, sous contrôle endoscopique | JOG |
| Kim et al, 2020(61) | 89 Achalasie | Rétrospective, série de cas | 4/C | 30s; ND | ND | JOG |
| Su et al, 2020(62) | 94 POEM | Prospective, série de cas | 3/C | 30s; 30-40 mL | Voie orale, anesthésie générale, +/- sous contrôle endoscopique | JOG |
| Su et al, 2020(63) | 77 Achalasie (71 POEM & 6 HM) | Prospective, série de cas | 3/C | 30s, 30 mL | Voie orale, anesthésie générale, sous contrôle endoscopique | JOG |
| Bianca et al, 2020(51) | 18 Achalasie, 43 EGJOO | Prospective, série de cas | 3/C | 30s; 30-40-50 mL | Voie orale, anesthésie générale, +/- sous contrôle endoscopique | JOG |
| Carlson et al, 2020(39) | 20 VS, 140 Achalasie | Prospective, série de cas | 3/C | 30s, 20-25-30-35-40-45-50-55-60-65-70 mL | Voie orale, sédation consciente (midazolam, fentanyl), sans contrôle endoscopique | Corps |
| Law et al, 2020(64) | 36 Achalasie | Rétrospective, série de cas | 4/C | 30s ; 20-30 mL | Voie orale, anesthésie générale, sans contrôle endoscopique | JOG |
| Campagna et al, 2019(65) | 27 Achalasie, 7 EGJOO | Prospective, série de cas | 3/C | 30-60s ; 30-40-50-60-70 mL | Pré-opératoire: Voie orale, sédation consciente (midazolam, fentanyl), sous contrôle endoscopique / péri-opératoire: Voie orale, anesthésie générale, sous contrôle endoscopique | JOG & Corps |
| Jain et al, 2019(66) | 79 Achalasie (non naïfs de traitement) | Prospective, série de cas | 3/C | 10-30s, 20-25-30-35-40-45-50-55-60-65-70 mL | Voie orale, anesthésie générale, +/- sous contrôle endoscopique | JOG & Corps |

| Publication | Nombre de patients inclus (n) | Design de l'étude | Niveau de preuve / Grade de recommandation | EndoFLIP®: durée (s) et volumes de distension (mL) | Caractéristiques de la procédure | Site de distension |
|--------------------------------|--|-------------------------------|--|--|--|--------------------|
| Yoo et al, 2019(67) | 52 Achalasie (POEM) | Rétrospective, série de cas | 4/C | ND; 30-40 mL | Voie orale, anesthésie générale, +/- sous contrôle endoscopique | JOG |
| Carlson et al, 2019(68) | 9 Achalasie, 10 EGJOO, 1 DES, 2 œsophage marteau-piqueur | Prospective, série de cas | 3/C | 30-60s; 20-25-30-35-40-45-50-55-60-65-70 mL | Voie orale, sédation consciente (midazolam, fentanyl) +/- propofol, sans contrôle endoscopique | JOG & Corps |
| Wu et al, 2017(69) | 54 PD, 15 VS | Prospective, étude cas-témoin | 3/C | 30s, 10-20-30-40 mL | Voie orale, anesthésie générale, sous contrôle endoscopique | JOG |
| Carlson et al, 2017(20) | 32 Fundoplicature, 25 Achalasie | Prospective, série de cas | 3/C | 30s, 20-30-40-50-60-70 mL | Voie orale, sédation consciente (midazolam, fentanyl), sans contrôle endoscopique | JOG |
| Ahuja et al, 2017(70) | 24 Achalasie | Rétrospective, série de cas | 4/C | 30s, 20-30-40-50mL | Voie orale, anesthésie générale, sous contrôle endoscopique | JOG & Corps |
| Ponds et al, 2016(71) | 13 Achalasie | Prospective, étude cas-témoin | 3/C | 30s, 20-30-40-50mL | Transnasal, anesthésie locale, sans contrôle endoscopique | JOG |
| Carlson et al, 2016(49) | 70 Achalasie, 38 EGJOO, 3 œsophage marteau-piqueur | Prospective, série de cas | 3/C | 10-30s, 20-25-30-35-40-45-50-55-60-65-70 mL | Voie orale, sédation consciente (midazolam, fentanyl) ou anesthésie générale, sans contrôle endoscopique | Corps |
| Dehaan et al, 2016(72) | 14 Achalasie (HM) | Rétrospective, série de cas | 4/C | ND; 30-40 mL | Voie orale, anesthésie générale, sous contrôle endoscopique | JOG |
| Teitelbaum et al, 2016(73) | 16 Achalasie (POEM) | Prospective, série de cas | 3/C | ND; 40 mL | Voie orale, anesthésie générale, sous contrôle endoscopique | JOG |
| Ngamruengphong et al, 2015(74) | 63 Achalasie (POEM) | Rétrospective, série de cas | 4/C | 30s; 30-40 mL | Voie orale, anesthésie générale, sous contrôle endoscopique | JOG |

| Publication | Nombre de patients inclus (n) | Design de l'étude | Niveau de preuve / Grade de recommandation | EndoFLIP® : durée (s) et volumes de distension (mL) | Caractéristiques de la procédure | Site de distension |
|----------------------------|-------------------------------------|---|--|---|--|--------------------|
| Carlson et al, 2015(40) | 51 Achalasie, 10 VS | Prospective, étude cas-témoin | 3/C | 5-20s; 20-25-30-35-40-45-50-55-60-65-70 mL | Voie orale, sédation consciente (midazolam, fentanyl) ou anesthésie générale, sans contrôle endoscopique | Corps |
| Smeets et al, 2015(16) | 26 Achalasie, 15 VS | Prospective, étude cas-témoin | 3/C | 30s; 30-40-50 mL | Voie orale, sédation consciente (midazolam, fentanyl), sans contrôle endoscopique | JOG |
| Ilcyszyn et al, 2015(75) | 38 Achalasie (HM) | Rétrospective (8 patients) et prospective (30 patients), étude cas-témoin | 4/C | 30s; 30-40 mL | Voie orale, anesthésie générale, sans contrôle endoscopique | JOG |
| Teitelbaum et al, 2015(76) | 58 Achalasie (20 HM, 38 POEM) | Prospective, série de cas | 3/C | ND; 40 mL | Voie orale, anesthésie générale, sous contrôle endoscopique | JOG |
| Kappelle et al, 2015(77) | 10 Achalasie (PD) | Prospective, série de cas | 3/C | ND; 30 mL | Voie orale, anesthésie générale, sous contrôle endoscopique | JOG |
| Familiari et al, 2014(78) | 21 Achalasie (POEM) | Prospective, série de cas | 3/C | ND; 30 mL | Voie orale, anesthésie générale, sous contrôle endoscopique | JOG |
| Teitelbaum et al, 2014(79) | 31 Achalasie (12 HM, 19 POEM) | Prospective, série de cas | 3/C | ND; 30-40 mL | Voie orale, anesthésie générale, sous contrôle endoscopique | JOG |
| Teitelbaum et al, 2013(80) | 25 Achalasie (11 HM, 14 POEM) | Prospective, série de cas | 3/C | ND; 30-40-50 mL | Voie orale, anesthésie générale, sous contrôle endoscopique | JOG |
| Pandolfino et al, 2013(48) | 54 Achalasie (17 PD, 10 HM, 4 POEM) | Prospective, étude cas-témoin | 3/C | 30s; 40 mL | Voie orale, sédation consciente (midazolam, fentanyl) +/- sous contrôle endoscopique | JOG |
| Verlaan et al, 2013(81) | 10 Achalasie (POEM) | Prospective, série de cas | 3/C | 30s; 20-30-40-50s | Voie orale, sans sédation, sans contrôle endoscopique | JOG |

| Publication | Nombre de patients inclus (n) | Design de l'étude | Niveau de preuve / Grade de recommandation | EndoFLIP®: durée (s) et volumes de distension (mL) | Caractéristiques de la procédure | Site de distension |
|-------------------------|-------------------------------|-------------------------------|--|--|---|--------------------|
| Rieder et al, 2012(27) | 4 Achalasie (POEM), 4 VS | Prospective, série de cas | 4/C | 30s; 30-40 mL | Voie orale, anesthésie générale, sous contrôle endoscopique | JOG |
| Rohof et al, 2012(15) | 15 VS, 30 Achalasie | Prospective, étude cas-témoin | 3/C | 30s, 20-30-40-50mL | Transnasal, anesthésie locale, sans contrôle endoscopique | JOG |
| McMahon et al, 2007(32) | 8 VS, 2 Achalasie | Prospective, étude cas-témoin | 3/C | ND; 20-30-40-50-60 mL | Voie orale, anesthésie locale, sans contrôle endoscopique | JOG |

Intérêt pronostique de l'EndoFLIP® dans l'achalasie

Plusieurs études ont démontré que les résultats de l'EndoFLIP® variaient après traitement chez des patients atteints d'achalasie du SIO. Ainsi, une augmentation significative de la distensibilité de la JOG a été retrouvée après myotomie de Heller(15),(48),(62),(63),(64),(72),(75),(79),(80), et dilatation pneumatique(15),(16),(48),(69),(77). Des résultats similaires ont été montrés après myotomie œsophagienne par voie orale (POEM), avec une augmentation significative de la distensibilité de la JOG dans la plupart des études immédiatement après POEM(27),(53),(54),(58),(62),(63),(67),(73),(74),(76),(79),(80) ou à 3 mois(81). L'évaluation per-opératoire de la JOG pendant la réalisation du POEM a pu mettre en évidence que la création du tunnel sous-muqueux et la myotomie (6 cm en amont de la JOG et 2-3 cm en distalité) permettaient une élévation de la distensibilité de la JOG(73),(79),(80). Ni l'addition d'une extension proximale à la myotomie(79), ni son extension gastrique(73) ne semblaient changer la distensibilité de la JOG. Par ailleurs, cette variation de la distensibilité de la JOG semblerait évoluer à distance du POEM(53), suggérant de possibles phénomènes de remodelages.

Certaines études ont suggéré que la distensibilité de la JOG mesurée avec le système EndoFLIP®, était prédictive des résultats post-opératoires. De fait, il a été mis en évidence que

les patients présentant une achalasie avec une réponse incomplète après traitement (Score d'Eckardt >3), avaient une distensibilité de la JOG, après intervention, plus basse que celles des patients qui étaient traités avec succès(15)(48)(76)(62)(69). Ainsi, Pandolfino et al. 2013(48) ont pu montrer d'une manière prospective (n=54 patients) qu'une distensibilité de la JOG après traitement supérieure à 2,8 mm²/mmHg à 40 mL de distension était prédictive de succès. Une autre étude prospective de Teitelbaum et al, 2015 a montré qu'une distensibilité de la JOG après traitement entre 4,5-8,5 mm²/mmHg permettait de prédire l'efficacité clinique à 6 mois d'un POEM (Score d'Eckardt <1) avec une sensibilité de 68% et une spécificité de 80%(76). L'évaluation directe de la JOG pendant la réalisation du POEM permettrait ainsi d'aider à prédire une réponse incomplète au POEM avec différentes valeurs seuils retrouvées selon les études(48)(76)(74)(67).

Étant donné que le traitement de l'achalasie peut entraîner l'apparition d'un reflux gastro-œsophagien chez 30 à 40% des patients(76), quelques études se sont intéressées à la corrélation entre les résultats de l'EndoFLIP[®] et le risque de reflux gastro-œsophagien après traitement. Une première série(62) a mis en évidence que les patients avec un score de symptômes de reflux gastro-œsophagien élevé (Reflux Symptom Index score > 13) à 2 ans d'un POEM ou d'une myotomie de Heller avaient un CSA > 96,0 mm², mais sur une faible cohorte de patients (n=4). Une autre étude de Teitelbaum et al.(76) sur un plus grand effectif de patients a pu montrer qu'une valeur de la distensibilité de la JOG inférieure 8,5 mm²/mmHg après POEM ou myotomie de Heller permettait un résultat fonctionnel optimal avec à la fois une efficacité clinique définie par un score d'Eckardt <3 et un score symptomatique de reflux gastro-œsophagien négatif (GERD score <1). D'autres séries du même centre sur de faibles effectifs de patients ont pu montrer que le changement de distensibilité de la JOG n'était pas

corrélé à la survenue d'une œsophagite ou d'une exposition acide pathologique en pH-métrie œsophagienne(53),(58).

Comparaison de l'intérêt de la MOHR et de l'EndoFLIP® dans la prise en charge de l'achalasia

Par ailleurs, d'autres essais ont pu identifier un sous-groupe de patients avec des symptômes typiques d'achalasia, des signes radiologiques en faveur d'une achalasia sur le transit baryté oeso-gastro-duodéal et une relaxation normale du SIO en MOHR (soit une pression de relaxation intégrée > 15 mmHg), mais qui présentaient cependant une distensibilité de la JOG inférieure à la valeur seuil de 2,9 mm²/mmHg définie chez les volontaires sains(71). Ce sous-groupe représentait 5,2% des patients atteints d'une achalasia dans cette série de cas prospective et souligne une limite de la MOHR dans l'exploration de l'achalasia du SIO(71). Kim et al, 2020(61) ont pu démontrer que la réponse clinique au traitement par POEM, mesurée par le score d'Eckardt, n'était pas différente dans cette sous-population en comparaison aux patients atteints d'achalasia avec une pression de relaxation intégrée anormale en MOHR. Compte-tenu de ces résultats, l'EndoFLIP® de la JOG a été intégré aux recommandations de la Classification de Chicago v4.0, en cas d'absence de diagnostic formel d'achalasia sur la MOHR, afin d'étayer celui-ci(47). En parallèle à ces résultats, il a également pu être mis en évidence une supériorité de la distensibilité de la JOG par rapport à la pression de relaxation intégrée, pour identifier les patients en échec de traitement. Une étude a montré que, parmi les patients en échec de traitement à 6 mois de l'intervention initiale, 92% avaient une distensibilité altérée, alors que seulement 42% avaient une pression de relaxation intégrée anormale en MOHR ($p < 0,01$)(15). Ces résultats ont été confirmés par une seconde étude, qui a démontré une valeur prédictive de l'échec thérapeutique plus élevée de la distensibilité de la JOG en association à un transit oeso-gastro-duodéal pathologique (0,90) que de la pression de relaxation intégrée (0,64) et cela à 3 mois du traitement(66).

Le système de FLIP panométrie a été utilisé pour évaluer les contractions du corps de l'œsophage chez des patients avec achalasia dans 10 études (Table 4). Si le profil de contractions antérogrades répétitives (Figure 4) a pu être mis en évidence en réponse à une distension chez 95% (19/20) des volontaires sains comme précédemment détaillé, il est retrouvé chez moins d'1% (1/140) des patients atteints d'achalasia dans une large cohorte de patients(39). De plus, s'il a pu être démontré que les patients atteints d'achalasia de type I ou II ne présentaient pas de contraction ou de profil de contractions antérogrades répétitives, les patients atteints d'achalasia de type III peuvent également présenter un profil de contractions répétitives cette fois-ci rétrogrades ou des contractions occlusives (diamètre luminal < 6mm), ce qui n'a jamais été observé chez les volontaires sains(20)(40)(82). Ainsi, Il a été proposé un arbre de classification, utilisant le système de FLIP panométrie, afin de différencier les patients avec achalasia de type I ou II de ceux avec une achalasia de type III avec une exactitude de 90% (Figure 5)(57). Par ailleurs, une modification de ces anomalies de péristaltisme secondaire a été démontrée après myotomie du SIO(65). Ainsi, la présence d'un motif de type contractions répétitives antérogrades après POEM semble prédictive de la contractilité du corps œsophagien en MOHR après intervention(55).

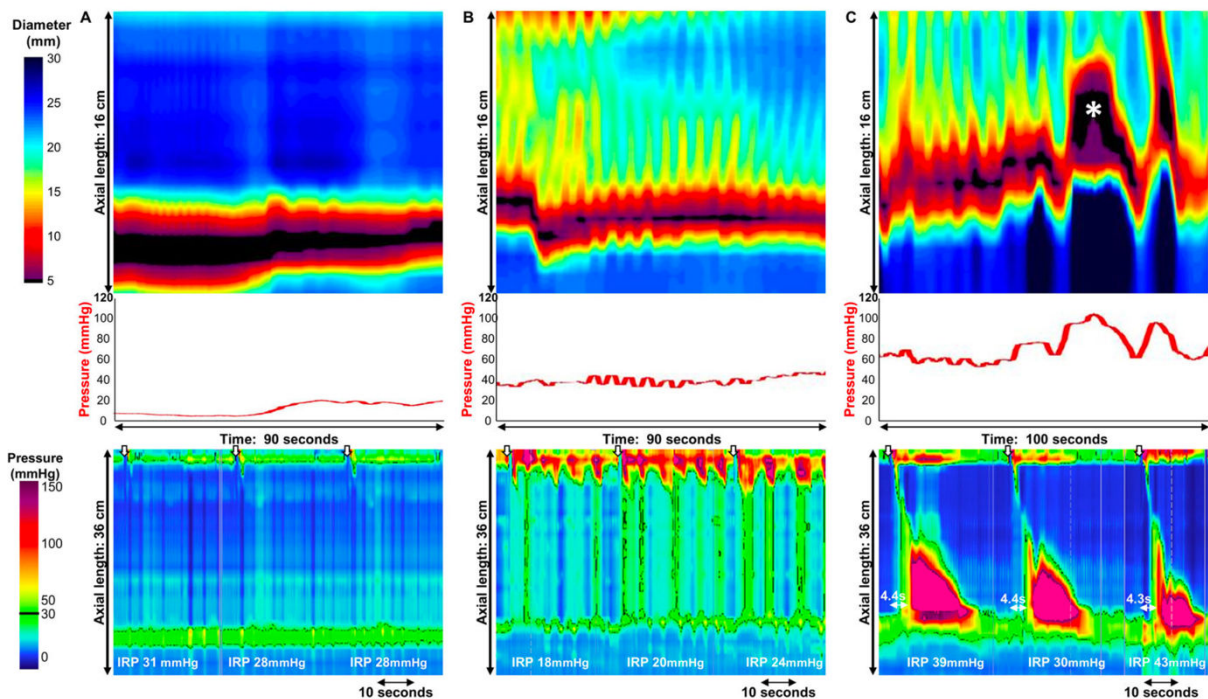

Figure 5 : Exemples de sous-types d'achalasia prédits par la FLIP panométrie. *FLIP panométrie (en haut) et MOHR (en bas) ; déglutitions liquides en MOHR indiquées par des flèches blanches. A) FLIP panométrie montrant une pression intra-ballon < 34 mmHg et une absence de contractilité, prédictif du type I visualisé en MOHR. B) FLIP panométrie montrant une pression intra-ballon > 34 mmHg et des contractions à la fois antérogrades et rétrogrades, cependant sans motif RACs ou RRCs ou contractions occlusives, prédictif du type II visualisé en MOHR. C) Motricité de type RRCs avec une contraction occlusive et une pression intra-ballon > 48 mmHg, prédictif d'un type III visualisé en MOHR. D'après Carlson et al, 2021(57).*

La discordance entre la MOHR et l'EndoFLIP® pour le diagnostic d'achalasia a également été suggérée en utilisant à la fois la distensibilité de la JOG et le profil de contractions du corps de l'œsophage(20). Dans cette étude, si tous les patients atteints d'achalasia sur la MOHR (106/106) présentaient un résultat anormal sur l'EndoFLIP® (distensibilité de la JOG anormale, contractions répétitives rétrogrades, absence de péristaltisme secondaire), jusqu'à 50% (17/34) des patients atteints de dysphagie sans diagnostic de trouble majeur de la motricité œsophagienne en MOHR présentaient un résultat anormal sur l'évaluation par EndoFLIP®(20).

En résumé, le système EndoFLIP® a pu montrer son intérêt dans le diagnostic des formes atypiques d'achalasia, mais également pour la prédiction du résultat fonctionnel après traitement. L'évaluation du SIO par le système EndoFLIP® fait maintenant partie intégrante de la classification de Chicago v4.0 pour le diagnostic d'achalasia, en cas de résultat de MOHR non concluant. Cependant, la valeur seuil de distensibilité associée au succès ou à un échec du traitement reste encore à déterminer, ainsi que la place en pratique courante de la FLIP panométrie.

2. Autres troubles moteurs œsophagiens

Dix études (Table 5) ont inclus des patients avec un trouble majeur de la motricité œsophagienne autre que l'achalasia, principalement le syndrome d'obstruction fonctionnelle de la jonction oeso-gastrique (« esophagogastric junction outflow obstruction » en anglais) (20),(51),(59),(65),(68),(83),(84). Ce diagnostic est porté en cas de pression de relaxation intégrée élevée (>15 mmHg), avec dans $\geq 20\%$ des déglutitions une pressurisation intra-bolus et la présence d'un péristaltisme, en association avec des symptômes (dysphagie, douleur rétro-sternale) d'après la classification de Chicago v4.0(47). La problématique actuelle de ce diagnostic est qu'environ 30% des patients, avec ce type d'anomalies manométriques, n'auraient pas de symptôme clinique et pourraient donc faire l'objet de traitements inappropriés. Pour éviter cela, la présence de symptômes au cours de la manométrie est nécessaire pour la certitude diagnostique dans la dernière version de la classification de Chicago(47). Une étude a mis en évidence que les patients avec diagnostic de syndrome d'obstruction fonctionnelle de la jonction oeso-gastrique sur la MOHR et un transit oeso-gastro-duodéal pathologique avaient une distensibilité de la JOG plus basse que les patients avec syndrome d'obstruction fonctionnelle de la jonction oeso-gastrique sur la MOHR sans transit oeso-gastro-duodéal anormal ($p=0,03$)(84). Dans une autre étude reprenant les données de 687

MOHR, 128 patients (19%) présentaient un diagnostic d'obstruction fonctionnelle de la JOG non conclusif d'après la Classification de Chicago 4.0 (absence de symptôme pendant l'enregistrement, pression de relaxation intégrée anormale isolée)(47). Ces patients présentaient une distensibilité de la JOG et un diamètre maximal de la JOG plus bas que les patients sans trouble de la motricité en MOHR(52). Par ailleurs, un essai prospectif (N=15 patients) a évalué l'efficacité du POEM chez des patients atteints de syndrome d'obstruction fonctionnelle de la jonction oeso-gastrique sur la MOHR avec confirmation du diagnostic par un abaissement de la distensibilité de la JOG au cours de l'EndoFLIP®(85). Il a pu être mis en évidence une amélioration significative de cette distensibilité après myotomie, avec un succès clinique (score Eckardt \leq 3) chez 87% des patients à un an de suivi. Les recommandations de Chicago 4.0(47) incluent actuellement la réalisation de l'EndoFLIP® ou d'un transit oeso-gastro-duodéal complémentaire en cas de diagnostic manométrique de syndrome d'obstruction fonctionnelle de la jonction oeso-gastrique afin de confirmer l'obstruction de la JOG et la pertinence clinique du diagnostic.

Table 5 : Caractéristiques des études réalisées chez les patients avec achalasia ou autres troubles moteurs œsophagiens.

VS : volontaires sains ; EGJOO : obstruction fonctionnelle de la jonction oeso-gastrique ; POEM : myotomie per orale par voie endoscopique ; DES : spasme distal de l'œsophage ; PD : dilatation pneumatique ; ND : non détaillé ; JOG : jonction oeso-gastrique ; HM : myotomie de Heller.

| Publication | Nombre de patients inclus (n) | Design de l'étude | Niveau de preuve / Grade de recommandation | EndoFLIP®: durée (s) et volumes de distension (mL) | Caractéristiques de la procédure | Site de distension |
|----------------------------|-------------------------------|-----------------------------|--|--|---|--------------------|
| Carlson et al, 2021(86) | 164 MOHR normale | Prospective, série de cas | 3/C | 30s ; 20-70 mL paliers | Voie orale, sédation consciente (midazolam, fentanyl), sous contrôle endoscopique | Corps + JOG |
| Nguyen et al, 2021(87) | 10 IEM ou MOHR normale | Rétrospective, série de cas | 4/C | 30s ; 20-70 mL paliers | Voie orale, sédation consciente (midazolam, fentanyl), sous contrôle endoscopique | Corps |
| Ichkhanian et al, 2020(85) | 15 EGJOO (POEM) | Prospective, série de cas | 3/C | 30s ; 20-30-40 mL | Voie orale, anesthésie générale, sous contrôle endoscopique | JOG |
| Reddy et al, 2020(88) | 44 EGJOO | Rétrospective, série de cas | 4/C | 30s ; 20-30-40 mL | Voie orale, sédation consciente (midazolam, fentanyl), sans contrôle endoscopique | JOG |
| Sloan et al, 2020(59) | 37 Achalasia, 14 EGJOO | Rétrospective, série de cas | 4/C | ND; 30 mL | Voie orale, anesthésie générale, sous contrôle endoscopique | JOG |
| Baumann et al, 2020(83) | 10 IEM, 20 EGJOO | Rétrospective, série de cas | 4/C | 30-60s; 20-25-30-35-40-45-50-55-60-65-70 mL | Voie orale, sédation consciente (midazolam, fentanyl), sans contrôle endoscopique | Corps |
| Bianca et al, 2020(51) | 18 Achalasia, 43 EGJOO | Prospective, série de cas | 3/C | 30s; 30-40-50 mL | Voie orale, anesthésie générale, avec ou sans contrôle endoscopique | JOG |
| Triggs et al, 2019(84) | 34 EGJOO | Rétrospective, série de cas | 3/C | 30-60s; 20-25-30-35-40-45-50-55-60-65-70 mL | Voie orale, sédation consciente (midazolam, fentanyl), sous contrôle endoscopique | JOG & Corps |

| Publication | Nombre de patients inclus (n) | Design de l'étude | Niveau de preuve / Grade de recommandation | EndoFLIP® : durée (s) et volumes de distension (mL) | Caractéristiques de la procédure | Site de distension |
|--------------------------|--|---------------------------|--|---|--|--------------------|
| Carlson et al, 2019(68) | 9 Achalasie, 10 EGJOO, 1 DES, 2 œsophage marteau-piqueur | Prospective, série de cas | 3/C | 30-60s; 20-25-30-35-40-45-50-55-60-65-70 mL | Voie orale, sédation consciente (midazolam, fentanyl) +/- propofol, sans contrôle endoscopique | JOG & Corps |
| Campagna et al, 2019(65) | 27 Achalasie, 7 EGJOO | Prospective, série de cas | 3/C | 30-60s; 30-40-50-60-70 mL | Pré-opératoire: Voie orale, sédation consciente (midazolam, fentanyl), sous contrôle endoscopique / péri-opératoire: voie orale, anesthésie générale, sous contrôle endoscopique | JOG & Corps |
| Carlson et al, 2016(49) | 70 Achalasie, 38 EGJOO, 3 œsophage marteau-piqueur | Prospective, série de cas | 3/C | 10-30s, 20-25-30-35-40-45-50-55-60-65-70 mL | Voie orale, sédation consciente (midazolam, fentanyl) ou anesthésie générale, sans contrôle endoscopique | Corps |

Les études s'étant intéressées à l'évaluation de la réponse contractile du corps œsophagien en FLIP panométrie dans le cas d'autres troubles moteurs œsophagiens sont résumées dans la Table 5. Quatre-vingt-sept pour cent des patients avec un diagnostic formel de syndrome d'obstruction fonctionnelle de la JOG en MOHR présentaient un résultat anormal en FLIP panométrie (distensibilité de la JOG altérée, contractions répétitives rétrogrades ou absence de réponse contractile) dans une première étude (20). Les 5 autres patients de cette étude sans anomalie en FLIP panométrie présentaient un transit oeso-gastro-duodéal normal et furent donc traités de manière conservatrice au cours du suivi(20). Une seconde étude s'est intéressée aux patients avec FLIP panométrie normale malgré un syndrome d'obstruction fonctionnelle de la JOG en MOHR(83). Étant donné que 17/20 (85%) de ces patients présentaient des déglutitions normales en position semi-assise et 10/20 avaient un transit oeso-

gastro-duodéal normal, un traitement conservateur fut également proposé chez l'ensemble de ces patients. Par ailleurs, Carlson et al(86) ont pu montrer, dans une cohorte prospective de 164 patients symptomatiques avec MOHR normale, que la distensibilité de la JOG était plus élevée chez les patients présentant le profil normal de contractions répétitives antérogrades après distension, que chez les patients qui présentaient une réponse contractile anormale en FLIP panométrie, suggérant également une supériorité de l'évaluation par FLIP panométrie en comparaison à la MOHR classique.

L'ensemble de ces résultats est donc en faveur de l'utilisation de l'EndoFLIP® afin de sélectionner les patients avec un diagnostic manométrique de syndrome d'obstruction fonctionnelle de la JOG, qui pourraient bénéficier d'une prise en charge thérapeutique similaire aux patients atteints d'achalasia par POEM notamment. Ainsi, l'EndoFLIP® a été intégré à la classification de Chicago v4.0 dans ce but. Cependant, sa supériorité face au transit oeso-gastro-duodéal reste encore à démontrer, et d'autres études seront également nécessaires pour confirmer l'application de la FLIP panométrie dans ce contexte.

Troisième partie : EndoFLIP® et pylore

1. Rappels anatomo-physiologiques du pylore

Le pylore joue un rôle majeur dans la régulation de la vidange gastrique, même si les différents mécanismes responsables de son contrôle ne sont pas encore totalement compris(89). Il semblerait qu'en période post-prandiale, tandis que les contractions péristaltiques progressent depuis le corps gastrique jusqu'au pylore, il y ait une brève période de vidange gastrique des liquides et particules fines(89). Mais dès que les contractions péristaltiques atteignent la partie terminale de l'antrum, il apparaît alors une phase de contraction pylorique permettant un broyage des aliments en particules fines (2-4 mm) au niveau antral(89). La relaxation pylorique en coordination avec l'activité motrice antro-pyloro-duodénale permet ensuite la vidange gastrique des aliments de manière progressive(90).

Les études du muscle pylorique in vitro suggèrent qu'il existe au moins 2 aires fonctionnelles indépendantes au niveau du muscle pylorique(91). La première couche musculaire circulaire est proche du plexus myentérique, dont les contractions sont liées à la propagation des ondes lentes gastriques, résultant en une contraction sphinctérienne à la fin de chaque événement gastrique péristaltique(92). Une deuxième couche musculaire circulaire est également présente, plus profonde et épaisse, qui bénéficie d'un contrôle neurologique indépendant des ondes lentes gastriques, qui ne sont pas propagées au sein de cette seconde couche musculaire(91). Même s'il existe des connexions anatomiques claires au niveau de la jonction gastro-duodénale, les fonctions électriques et mécaniques sont bien séparées entre l'estomac et le duodénum(93). Ceci pourrait être expliqué par une diminution de la densité des cellules interstitielles de Cajal au sein du muscle pylorique(94), entraînant l'arrêt de la propagation des ondes lentes gastriques et facilitant cette indépendance entre les deux organes(94).

La régulation des contractions et relaxations pylorique est sous la dépendance à la fois du système nerveux intrinsèque et extrinsèque(95). L'innervation intrinsèque est réalisée grâce au plexus myentérique, via la libération de neurotransmetteurs par les motoneurones entériques vers les cellules musculaires lisses. Cependant, il existe des arguments en faveur d'une communication médiée en partie par les cellules interstitielles de Cajal. Ainsi, les cellules interstitielles de Cajal, exprimant des récepteurs aux neurotransmetteurs des motoneurones entériques, peuvent transduire ces signaux neurotransmetteurs et les faire converger vers les cellules musculaires lisses via des gap junctions(91). La réponse inhibitrice est médiée par l'oxyde nitrique et les purines(91) tandis que la réponse excitatrice est plutôt médiée par la substance P et les enképhalines(96).

L'innervation extrinsèque est constituée principalement par les branches du nerf vague qui transportent en grande majorité des signaux afférents vers le noyau du tractus solitaire. Il existe une forte densité de récepteurs à l'étirement au niveau du pylore, avec des seuils d'activation bas en comparaison à d'autres localisations comme l'antre(96). Les fibres motrices du nerf vague exercent à la fois un effet excitateur sur le pylore via une interaction avec le système nerveux entérique par le relargage d'enképhalines et d'acétylcholine, et un effet inhibiteur médié à l'aide du vasoactive intestinal peptide et de l'oxyde nitrique(96). Il existe également des fibres sympathiques au niveau du pylore, mais elles ne semblent pas jouer de rôle majeur(97). La stimulation du nerf vague entraîne de manière reproductible une diminution de la résistance pylorique, en faveur d'un effet inhibiteur prédominant du nerf vague(98). Enfin, l'élévation de l'acidité dans le duodénum entraîne une activité contractile du pylore via le réflexe vago-vagal entérogastrique(91).

2. Rôle du pylore dans la gastroparésie

La gastroparésie est définie comme un ralentissement de la vidange gastrique en l'absence d'obstacle organique et en présence de symptômes suggestifs(91). A notre connaissance, le pylorospasme ou spasme du pylore a été décrit pour la première fois chez des patients atteints de gastroparésie en 1986 dans l'étude menée par Mearin et al.(6). Le pylorospasme a pu directement être mis en évidence via une étude manométrique antro-pyloro-duodénale chez 24 patients diabétiques présentant des symptômes de gastroparésie. Le pylorospasme était défini par une contraction pylorique de durée supérieure à 3 minutes et d'amplitude supérieure à 10 mmHg (Figure 6). La fréquence et la durée des épisodes de pylorospasme étaient augmentées chez les patients gastroparétiques diabétiques en comparaison avec les sujets contrôles(6).

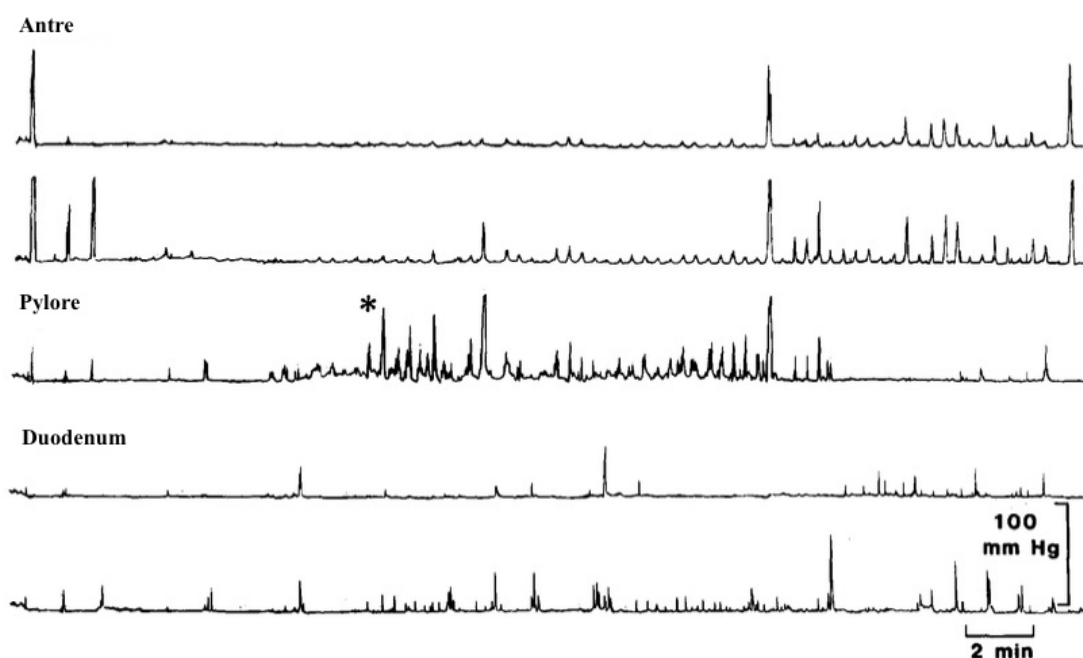

Figure 6. Tracé de manométrie antro-pyloro-duodénale perfusée. Présence d'un épisode de pylorospasme (*) sur l'enregistrement manométrique réalisé au niveau du pylore. D'après Mearin et al.(6)

La présence d'un pylorospasme, d'une hypomotricité antrale et de signes de dysautonomie extra-intestinale chez 13 des 24 patients suggèrent que le pylorospasme serait dû à une neuropathie diabétique impliquant le nerf vague(6). La dysfonction pylorique influencerait directement la vidange gastrique en augmentant la résistance au flux de particules solides à travers la jonction antro-duodénale et indirectement en affectant la motilité antrale et duodénale. Les études sur des modèles animaux ont suggéré que le pylorospasme pourrait être secondaire à une atteinte des voies inhibitrices, représentées principalement par la voie nitrergique(99). Des lésions de cette voie pourraient être secondaires à une perte de la synthèse d'oxyde nitrique, une perte des neurones possédant cette enzyme, ou encore une perte des cellules de Cajal, qui régulent la réponse nitrergique(100). Une altération de cette voie pourrait entraîner un défaut de relaxation du pylore. Chez l'Homme, une perte des cellules interstitielles de Cajal a ainsi été rapportée au sein de biopsies gastriques et pyloriques chez des patients atteints de gastroparésie diabétique²⁹. Enfin, il a pu être mis en évidence, chez le chien, qu'une vagotomie tronculaire ou proximale gastrique pouvait entraîner une perte de la relaxation pylorique, entraînant une diminution du flux transpylorique(101).

3. Explorations pyloriques

Comme nous l'avons précédemment détaillé, il a été démontré que le pylorospasme pouvait jouer un rôle dans le ralentissement de la vidange gastrique et dans l'apparition des symptômes de gastroparésie. Pour identifier ce pylorospasme, Mearin et al. (6) ont utilisé la technique de manométrie antro-pyloro-duodénale perfusée. Cependant, les difficultés pour la mise en place correcte de la sonde et la tolérance de l'examen par les patients en ont limité la diffusion au sein des centres spécialisés. Pour cette raison, ces résultats n'ont pas été confirmés par d'autres études.

Plus récemment, la mesure de la distensibilité pylorique avec le système EndoFLIP® dans le cadre de la gastroparésie a été validée comme mesure complémentaire à la pression sphinctérienne. Cette mesure de distensibilité pylorique peut être effectuée facilement en plaçant la sonde sous contrôle radioscopique(102) ou avec l'aide d'un endoscope(103):(104). Une première étude, réalisée chez 21 sujets volontaires sains sans sédation, a rapporté une distensibilité pylorique moyenne de 25,2 mm²/mmHg pour un volume de distension de 40 mL, avec un seuil de normalité établi à 10 mm²/mmHg en utilisant le 90^{ème} percentile(102). Deux autres études plus récentes(8),(9) réalisées respectivement chez 24 et 20 sujets volontaires sains ont retrouvé des index de distensibilité moins élevés, évoquant la nécessité d'une standardisation du protocole de mesure comprenant, par exemple, la méthode de calibrage de la sonde et/ou la réalisation avec ou sans anesthésie de l'examen.

Des études réalisées chez 27(102), 20(103) et 54(104) patients atteints de gastroparésie ont pu mettre en évidence une distensibilité pylorique moyenne de 16,9 mm²/mmHg, 12,4 mm²/mmHg et 10,7 mm²/mmHg respectivement. En utilisant le seuil de 10 mm²/mmHg, environ un tiers des patients atteints de gastroparésie diabétique ou idiopathique présentaient une distensibilité pylorique altérée(102):(104). Une autre étude, réalisée chez des patients avec nausée et/ou vomissements, quel que soit le résultat de la vidange gastrique, retrouvait une distensibilité pylorique plus basse chez les patients avec vidange gastrique ralentie (moyenne de 8,0 mm²/mmHg) en comparaison avec ceux présentant une vidange gastrique normale (moyenne de 12,4 mm²/mmHg)(105). A noter que, dans ces études, la pression pylorique n'était pas différente entre les patients avec ou sans ralentissement de la vidange gastrique, que celle-ci soit mesurée par la sonde d'EndoFLIP® ou par manométrie(102):(105). Dans toutes les études, la distensibilité pylorique était inversement corrélée avec la vidange gastrique(102):(104):(105). Par ailleurs, la distensibilité pylorique était aussi inversement corrélée avec les symptômes de gastroparésie, incluant la nausée(102):(105), la sensation de

plénitude gastrique(102)(104), la satiété précoce(102)(104) et la qualité de vie(102)(104). Ceci contraste avec la mesure de vidange gastrique qui est, quant à elle, faiblement corrélée avec les symptômes ou la qualité de vie (106)(107)(108). Toutes ces données suggèrent donc que la distensibilité pylorique pourrait être une mesure cliniquement intéressante dans une population de patients atteints de gastroparésie afin de mieux identifier les mécanismes impliqués dans le ralentissement de la vidange gastrique(63)(109).

4. Traitements endoscopiques ciblant le pylore

Compte-tenu du rôle du pylorospasme dans le ralentissement de la vidange gastrique et dans l'apparition des symptômes de gastroparésie, mais également de la possibilité de faire le diagnostic de pylorospasme à l'aide de l'EndoFLIP[®], nous nous sommes intéressés aux différents traitements possibles du pylorospasme et à l'apport de l'EndoFLIP[®] dans l'indication de ces traitements.

A. Dilatation hydraulique du pylore

La première technique endoscopique ciblant le pylore était la dilatation pylorique par ballonnet, rapportée initialement chez l'enfant (110). Depuis, quelques séries rétrospectives ont été publiées chez l'adulte(111,112). En ce qui concerne les patients atteints de gastroparésie réfractaire, une efficacité clinique d'environ 50% était rapportée lors de l'évaluation à 2 mois, avec un maintien de celle-ci chez seulement un tiers des patients à 2 ans(111,112). Aucune complication n'a été rapportée dans ces études avec une dilatation hydraulique allant jusqu'à 20 mm. Concernant l'utilisation de l'EndoFLIP[®] avant dilatation, une seule étude a démontré qu'une distensibilité pylorique inférieure à 10 mm²/mmHg pouvait prédire une efficacité clinique après dilatation pylorique(102).

B. Injections intra-pyloriques de toxine botulique

La toxine botulique est une protéine produite de manière native par la bactérie *Clostridium difficile*, qui bloque la conduction neuromusculaire entraînant une paralysie du muscle concerné. Il a donc été émis l'hypothèse que les injections de toxine intra-pyloriques pourraient lever le spasme pylorique et faciliter la vidange gastrique. Le premier cas d'injections intra-pyloriques de toxine botulique chez un patient atteint de gastroparésie réfractaire, a été décrit en 1998(113). Par la suite, les effets positifs des injections de toxine intra-pyloriques dans la gastroparésie réfractaire ont été rapportés dans deux séries prospectives non contrôlées(114),(115) et par une étude rétrospective datant de 2005(116). Cependant ces résultats n'ont pas été confirmés dans deux essais contrôlés randomisés(117)-(118). La première de ces deux études a été réalisée chez 23 patients atteints de gastroparésie, avec une administration intra-pylorique de 100 unités de botox ou de placebo par patient. Il existait une amélioration du score symptomatique de gastroparésie GCSI (Gastroparesis Cardinal Symptom Index) et du temps de vidange gastrique à la fois dans le groupe interventionnel et le groupe placebo, et cela sans différence significative entre les deux(117). Le second essai clinique a été mené chez 32 patients atteints de gastroparésie, avec administration de 200 unités de Botox® ou de placebo. A 4 semaines, aucune différence significative n'était rapportée entre les deux groupes(118). La négativité de ces études contrôlées randomisées pourrait être expliquée par l'absence de sélection des patients candidats à la toxine botulique. En effet, une étude rétrospective incluant 179 patients atteints de gastroparésie réfractaire, a pu identifier l'existence de facteurs prédictifs d'efficacité des injections intra-pyloriques de toxine botulique à savoir : 1/ une dose de 200 unités de Botox® ; 2/ le sexe féminin ; 3/ un âge inférieur à 50 ans ; 4/ une gastroparésie idiopathique(119). La Table 6 résume les différentes études évaluant l'efficacité des injections de toxine botulique intra-pyloriques chez les patients

gastroparétiques. Cependant, aucune de ces études n'a utilisé l'EndoFLIP® pour sélectionner les meilleurs candidats à ce traitement.

Table 6 : Principales études réalisées dans le cadre de l'évaluation de l'efficacité des injections intra-pyloriques de toxine botulique pour gastroparésie réfractaire.

| Étude | Nombre de patients | Design de l'étude | Etiologies de gastroparésie | Dose de TB (UI) | Évaluation de la fonction pylorique ? | Critère d'évaluation subjectif | Critère d'évaluation objectif |
|------------------------------|--------------------|--|---|-----------------|---------------------------------------|--|--|
| Ezzedine et al, 2002(114) | 6 | Prospectif, ouvert | Diabétique | 100 | Non | Amélioration des symptômes à 6 semaines | Amélioration de la vidange gastrique à 6 semaines |
| Miller et al, 2002(115) | 10 | Prospectif, ouvert | Idiopathique | 80-100 | Non | 90% d'amélioration des symptômes à 4 semaines | 70% d'amélioration de la vidange gastrique des solides à 4 semaines, pas pour les liquides |
| Bromer et al, 2005(116) | 63 | Rétrospectif, ouvert | Idiopathique (35), diabète (26), post-opératoire (2) | 100 ou 200 | Non | 43% d'amélioration des symptômes d'une durée de 5 mois environ | Non évalué |
| Arts et al, 2007(118) | 23 | Randomisé contrôlé, double aveugle, cross-over | Idiopathique (19), diabétique (2), post-opératoire (2) | 100 | Non | Pas de différence | Pas de différence |
| Friedenberg et al, 2008(117) | 32 | Randomisé contrôlé, double aveugle | Diabétique (18), idiopathique (13), post-opératoire (1) | 200 | Non | Pas de différence | Amélioration de la vidange gastrique à 4 semaines |
| Coleski et al, 2009(119) | 179 | Rétrospectif, ouvert | Diabétique (81), idiopathique (79) | 100, 150 ou 200 | Non | 51% d'amélioration à 1-4 semaines | Non évalué |
| Hoofst et al, 2014(120) | 13 | Rétrospectif, ouvert | Post-opératoire | 100 | Non | Non évalué | 76% d'amélioration de la vidange gastrique à 4 semaines |

C. Pyloromyotomie endoscopique (G-POEM)

La première procédure de myotomie endoscopique par voie orale fut réalisée au niveau du SIO dans le cadre du traitement de l'achalasia du SIO(121). Cette technique a ensuite été

transposée au niveau du sphincter pylorique dans le cadre de la gastroparésie réfractaire. Au cours d'une endoscopie sous anesthésie générale, une incision muqueuse longitudinale ou transverse de 1,5 à 2 cm de long est réalisée entre 3 et 5 cm en amont du pylore. L'endoscope est ensuite introduit dans l'aire sous-muqueuse et un tunnel sous-muqueux est ensuite réalisé, jusqu'à la visualisation de l'anneau blanc du muscle pylorique. La myotomie est ensuite réalisée sur environ 2 à 3 cm, puis l'endoscope est progressivement retiré et le tunnel fermé à l'aide de clips(122). Aucune standardisation concernant le mode opératoire et le choix du matériel n'est disponible actuellement.

Plusieurs études sont actuellement disponibles concernant l'efficacité du G-POEM dans le cadre de la gastroparésie réfractaire(123–129). Une méta-analyse récente regroupant les données de 482 patients inclus dans 10 études a permis d'établir un taux de succès de 61% à un an(130). Les données sur le long-terme varient quant à elles entre 33% et 74% d'efficacité clinique à 2 ans(131). Enfin, deux études contrôlées, randomisées sont disponibles à ce jour. La première étude (n=41 patients) a rapporté une efficacité clinique (amélioration de 50% du score symptomatique de gastroparésie Gastroparesis Cardinal Symptom Index) à 6 mois chez 71% des patients du groupe G-POEM versus 22% des patients du groupe placebo (p=0,005)(132). La seconde étude contrôlée et randomisée (n=40 patients) est quant à elle négative(133).

Quatrième partie : EndoFLIP® et sphincter anal

1. Rappels anatomo-physiologiques du sphincter anal

Le canal anal est entouré par un double manchon de fibres circulaires qui forment l'appareil sphinctérien. Le sphincter anal interne (SAI) correspond à un épaissement de la couche circulaire des fibres lisses de la musculature rectale. Le sphincter anal externe (SAE) est composé de trois faisceaux de fibres musculaires striées : sous-cutané, superficiel et profond, lui-même en continuité avec le muscle releveur de l'anus (faisceau pubo-rectal).

La zone de haute pression du canal anal est due à l'activité électrique spontanée du SAI qui est constituée par une succession de dépolarisations lentes dont le rythme varie entre 9 à 30 par minute(134)(135). Celle-ci est quasi permanente et empêche le passage de matières fécales ou de gaz. En effet, le SAI est responsable de 70 à 85% de la pression dans le canal anal et est donc un acteur essentiel du maintien de la continence. Son tonus est indépendant des structures nerveuses supra-spinales(136). L'innervation du SAI est dépendante à la fois du système nerveux intrinsèque et extrinsèque. Ainsi, l'innervation intrinsèque de l'appareil recto-sphinctérien est constituée d'une part des plexus situés dans la sous-muqueuse, le plexus de Meissner, et d'autre part de plexus situés entre les deux couches de la musculature, le plexus d'Auerbach. Les faisceaux nerveux qui connectent les différents ganglions de ces plexus entre eux contiennent également des fibres nerveuses d'origine extrinsèque. L'innervation parasympathique du SAI provient de la moelle épinière sacrée, de S2 à S4, via les nerfs pelviens. L'innervation sympathique du SAI provient de la moelle épinière lombaires, entre L1 et L2, via les nerfs hypogastriques.

Les muscles striés de la région ano-rectale présentent quant à eux un tonus quasi permanent, ce qui les différencie des autres muscles à commande volontaire. Cependant, la contribution du SAE à la zone de haute pression du canal anal serait minime. En effet, le SAE interviendrait essentiellement lors de

l'arrivée de matières dans le rectum, afin de permettre au rectum de s'adapter à son contenu et lors des augmentations de pression abdominale (effort de toux, port de charge etc..). Par ailleurs, le faisceau pubo-rectal semble jouer un rôle important afin de préserver la continence, notamment en cas d'élévation de la pression intra-abdominale, grâce à l'angulation anorectale qu'il maintient par son tonus. Enfin, les faisceaux pubo-coccygien et ilio-coccygien du muscle releveur de l'anus sont également impliqués dans la fermeture du canal anal lors de l'augmentation de la pression intra-abdominale. Les corps cellulaires des motoneurones qui innervent le SAE, sont situés au niveau du noyau d'Onuf, dans la corne ventrale de la moelle épinière sacrée. Les axones de ces motoneurones cheminent jusqu'au SAE, via les nerfs pudendaux. L'activité tonique du SAE est secondaire à un réflexe spinal sacré impliquant les afférences et les efférences cheminant dans le nerf pudendal. Néanmoins, le tonus du SAE est modulé en permanence par les structures supra-spinales(137)(138).

La continence fécale est due au système capacitif représenté par le rectum et au système résistif représenté par les sphincters de l'anus et le muscle releveur, qui permettent d'assurer une barrière de pression et d'oblitérer la lumière du canal anal. Elle repose également sur une sensibilité fine, permettant à la fois d'analyser la distension rectale comme un besoin exonérateur, mais également d'analyser le contenu fécal. Ainsi, l'arrivée de matières fécales dans l'ampoule rectale va entraîner une distension de la paroi rectale et donc l'activation des mécanorécepteurs à l'origine du déclenchement du réflexe d'échantillonnage ou réflexe recto-anal inhibiteur. La contraction du rectum (réflexe recto-rectal) et le relâchement du SAI (réflexe recto-anal inhibiteur) permettent aux matières fécales d'atteindre la partie haute du canal anal, tandis que la contraction réflexe du SAE (réflexe recto-anal excitateur) et du muscle puborectal assurent le maintien de la continence. La partie haute du canal anal sera le lieu d'une analyse fine du contenu fécal grâce à son innervation sensitive riche. En fonction des résultats de cette analyse et des conditions environnementales, l'évacuation des matières fécales peut être déclenchée ou différée. Lorsque l'évacuation est différée, il se produit une contraction

volontaire du sphincter anal externe qui permettra au rectum, grâce à ses propriétés viscoélastiques, d'adapter son volume à son contenu. Dès lors, la stimulation des mécanorécepteurs cesse, l'envie de défécation disparaît et la zone de haute pression du canal anal est rétablie, à la fin du réflexe recto-anal inhibiteur, avec la contraction du sphincter anal interne.

2. Rôle du sphincter anal dans l'incontinence fécale

L'incontinence fécale (IF) est définie comme la présence d'au moins deux épisodes de perte involontaire de selles (liquides ou solides) par mois depuis au moins 6 mois par les critères de Rome IV(139). Différents types d'IF sont décrits dans la littérature : 1/ active avec perte involontaire de selles à la suite d'un besoin exonérateur impérieux ; 2/ passive avec perte involontaire de selles sans perception préalable d'un besoin exonérateur impérieux ; 3/ mixte définie comme une combinaison des deux autres sous-types(140). L'incontinence fécale peut être secondaire à une atteinte du système résistif sphinctérien et/ou du système capacitif rectal et est le plus souvent multifactorielle(141). Ainsi, une diminution de la capacité et/ou de la compliance rectale peuvent entraîner une altération du système capacitif dans de nombreux cas, comme dans les maladies inflammatoires chroniques intestinales (maladie de Crohn, rectocolite hémorragique), ou encore après chirurgie rectale ou irradiation pelvienne. L'atteinte du système résistif sphinctérien peut être due à une atteinte du SAI et/ou du SAE. La cause la plus fréquente de lésion anatomique sphinctérienne est représentée par les traumatismes obstétricaux chez la femme, qui peuvent concerner le SAE et/ou le SAI(142). D'autres causes de lésion sphinctérienne sont également observées, comme les antécédents de chirurgie anale pour pathologie hémorroïdaire, fissure ou fistule anale et les traumatismes du périnée. Par ailleurs, les atteintes nerveuses peuvent également entraîner une IF suite à une atteinte du système nerveux central ou périphérique du nerf pudendal par exemple en cas d'étirement du nerf

pudendal suite à un accouchement dystocique(141). Enfin, en cas de constipation chronique, les efforts de poussée abdominale répétés peuvent entraîner une dénervation progressive du plancher pelvien via une neuropathie pudendale d'étirement.

3. Explorations du sphincter anal

Différentes méthodes peuvent être utilisées afin d'étudier le sphincter anal. L'imagerie par résonance magnétique ou l'échographie endo-anale sont communément utilisées afin de déterminer la morphologie des sphincters anaux, tandis que les tests électrophysiologiques du périnée permettent d'évaluer l'innervation du sphincter anal externe(143). Le plus souvent, la fonction sphinctérienne anale est étudiée en mesurant la pression de repos et la pression lors de la contraction volontaire via la manométrie ano-rectale(10). Tandis que les techniques manométriques, incluant la manométrie haute-résolution avec reconstructions en 3-dimensions, permettent la mesure directe des forces de clôture du canal anal via une sonde de diamètre fixe et non rétractable, elles ne permettent pas de quantifier la dimension d'ouverture, qui est une variable importante dans la détermination du flux trans-sphinctérien(11). En effet, il a été suggéré que la capacité des muscles sphinctériens à résister à la distension était plus importante pour la continence que leur capacité à se contracter(144).

Plusieurs études ont donc évalué la résistance du canal anal à la distension grâce au système EndoFLIP® chez des sujets volontaires sains et chez des patients atteints d'IF (12)(13). Bien que la méthodologie employée ait été similaire entre ces études, il n'y a à ce jour aucun consensus disponible concernant les meilleurs paramètres à enregistrer avec la technologie EndoFLIP®. En effet, différents paramètres ont été suggérés, allant du plus complexe (comme la *rigidité* du canal anal(33)(34)(35), la *résistance au flux* du canal anal(36) ou le *travail mécanique* du muscle sphinctérien anal(37)) au plus simple, comme la *tension pariétale*(38),

l'index de distensibilité du canal anal(12),(13), la *compliance* anale(37), et enfin la *pression limite d'élasticité*(33),(34),(35). Ces différents paramètres sont définis dans la Partie 1 du manuscrit. Plus récemment, Zifan et al. ont décrit l'analyse d'aires de pression et de boucles d'aire de tension des sphincters anaux et du muscle pubo-rectal chez des sujets normaux et chez des patients atteints d'IF, permettant d'évaluer la relation entre les variations de longueur de muscle (secondaires à la distension anale) et la capacité musculaire(145),(146). Il a été également démontré que la géométrie de la lumière du canal anal et les propriétés biomécaniques du canal anal ne sont pas uniformes durant la distension(38). Luft et al.(38) attribue la partie la moins compliant à la partie moyenne du canal anal, région où il existe un chevauchement entre les sphincters anaux interne et externe. Au total, même si une dizaine d'études ont rapporté des mesures d'EndoFLIP® au niveau du canal anal chez des sujets volontaires sains(12),(33),(35),(37),(38),(145),(147),(148),(149), aucune valeur normale validée n'est actuellement disponible devant l'absence de protocole standardisé comprenant à la fois la mesure et l'analyse des paramètres mesurés avec l'EndoFLIP®.

Quel que soit le critère de jugement utilisé, une distensibilité anale significativement plus élevée a été retrouvée chez les patients atteints d'IF en comparaison aux sujets volontaires sains dans toutes les études cliniques(12),(33),(36),(146),(148). Ceci a pu également être montré chez les patients atteints de sclérodémie systémique avec dysfonction du sphincter interne(148), chez les patients traités par radiothérapie avec épargne sphinctérienne ou par chimiothérapie pour cancer anal(36),(150) et enfin quelle que soit la cause de l'IF (12),(13). Il a également été suggéré que l'évaluation par l'EndoFLIP® pourrait permettre de mieux discriminer les patients avec IF, des sujets volontaires sains(12). Cependant, ces résultats n'ont pas été confirmés par une autre étude(151). Etant donné qu'il existe une forte corrélation entre les résultats de l'EndoFLIP® et de la manométrie haute-résolution pour le diagnostic de

faiblesse du sphincter anal(12)(13)(151), l'utilité et la place de l'EndoFLIP® dans le diagnostic et la prise en charge des patients incontinents fécaux reste encore à définir. Certains ont suggéré que la résistance du canal anal à la distension évaluée grâce à l'EndoFLIP®, pourrait être un meilleur critère que la pression anale pour déterminer l'efficacité d'un traitement(34)(146), mais cela reste à confirmer.

4. Traitements

Le traitement conservateur représente la 1^{ère} étape dans la prise en charge des patients avec IF, avec pour but d'optimiser le transit et la consistance des selles(139). Le régime alimentaire et les traitements médicamenteux peuvent être utiles pour ralentir le transit et/ou améliorer la consistance des selles (loperamide, cholestyramine)(152),(153). En cas de constipation associée à l'IF, les mesures visant à améliorer la vidange rectale comme les suppositoires, les lavements, la supplémentation en fibres, les traitements laxatifs en complément de mesures comportementales, sont actuellement recommandées(139). Le traitement conservateur ne doit pas être négligé car il permet une amélioration des symptômes d'IF chez plus de la moitié des patients(154). La rééducation périnéale avec biofeedback permet, via une amélioration de la coordination et un renforcement musculaire du plancher pelvien, d'améliorer jusqu'à 70% des patients(155). Enfin, les irrigations coliques par voie trans-anale sont recommandées chez les patients en échec de traitement conservateur, en particulier en cas d'atteinte neurologique associée(156).

La correction d'anomalies anatomiques (prolapsus rectal, fistule péri-rectale ou recto-vaginale) doit toujours être recherchée et traitée d'une manière chirurgicale si possible. En cas d'absence de ces anomalies, la neuromodulation des racines sacrées est actuellement recommandée en 1^{ère} intention en cas d'échec du traitement conservateur par l'International

Continence Society(157). Ce traitement présente une efficacité clinique à court et moyen termes oscillant entre 81 et 86%(158), cependant peu de données sont actuellement disponibles concernant son efficacité sur le long terme. Une étude récente de notre groupe avait pu montrer une efficacité chez environ 50% des patients à plus de 10 ans de l'implantation du dispositif(159), ce qui reste raisonnable dans le cadre d'une pathologie chronique qui peut s'aggraver dans le temps. La réparation sphinctérienne anale (sphinctéroplastie) peut être proposée en cas de défaut du SAE, mais avec des résultats décevants sur le long-terme. En effet, moins de 50% des patients présentent toujours une efficacité de ce traitement après 40-60 mois de suivi, avec une nouvelle détérioration de cette efficacité ultérieurement(160). C'est pour cette raison que la réparation sphinctérienne anale est actuellement réservée aux patientes avec lésion sphinctérienne en post-partum immédiat. D'autres alternatives comme le sphincter anal artificiel et la graciloplastie ont été abandonnées en raison de taux élevée d'infection et d'érosion, de même que le sphincter magnétique anal qui n'est actuellement plus disponible(161). Les injections d'agents comblant sont également décevantes et ne font pas partie des algorithmes de prise en charge de l'IF actuellement(139). Enfin, en cas d'échec de tout traitement et selon le retentissement de l'IF, une colostomie de dérivation peut être proposée aux patients demandeurs.

Cinquième partie : Présentation du travail de Thèse

Objectifs de la Thèse

Le premier axe de mon travail de Thèse était centré sur l'intérêt mécanistique de l'EndoFLIP® dans l'exploration de deux sphincters encore peu étudiés jusqu'ici, qui sont le pylore et le sphincter anal. L'objectif général était de savoir si l'EndoFLIP® était un outil permettant d'orienter vers le mécanisme physiopathologique et donc la cause à l'origine du trouble fonctionnel digestif (gastroparésie ou incontinence fécale). Les objectifs spécifiques de ces travaux étaient :

- De déterminer si la pression et la distensibilité pyloriques, évaluées par l'EndoFLIP®, chez des sujets atteints de gastroparésie diabétique étaient différentes de celles mesurées chez les patients avec une gastroparésie idiopathique et chez un groupe de sujets volontaires sains puis d'évaluer l'impact des caractéristiques du diabète sur la distensibilité pylorique ;
- D'évaluer la pression et la distensibilité pyloriques chez des patients ayant subi une chirurgie oeso-gastrique avec suspicion de vagotomie (fundoplicature de Nissen, oesophagectomie et sleeve-gastrectomie) en comparaison avec une population de volontaires sains ;
- D'évaluer la relation entre la distensibilité anale mesurée par l'EndoFLIP® et le sous-type d'incontinence fécale (active, passive ou mixte) et cela afin de préciser les mécanismes physiopathologiques responsables des différents sous-types d'IF.

Le second axe de ce travail était centré sur l'intérêt thérapeutique de l'EndoFLIP®.

L'objectif général était de savoir si l'EndoFLIP® était un outil permettant de prédire l'efficacité d'un traitement. L'objectif spécifique était :

- D'évaluer si la mesure de la distensibilité pylorique pouvait être prédictive de la réponse symptomatique aux injections intra-pyloriques de toxine botulique chez des patients avec gastroparésie.

Le troisième axe de mon travail était centré sur l'amélioration de la méthodologie de la technique EndoFLIP®. Nous avons précédemment vu que la méthodologie de l'EndoFLIP® était très différente d'une étude à une autre, ce qui rendait les comparaisons entre les études difficiles. L'objectif général était d'évaluer si des méthodologies différentes de réalisation de l'EndoFLIP® pylorique pouvaient influencer les mesures effectuées. L'objectif spécifique était :

- D'évaluer l'impact potentiel de l'anesthésie générale sur les résultats de l'EndoFLIP® du pylore chez des patients atteints de gastroparésie.

1^{er} axe : Intérêt mécanistique de l'EndoFLIP[®] au niveau du pylore et du sphincter anal

1. Évaluation de la distensibilité et de la pression pylorique chez les patients atteints de gastroparésie diabétique

Il a été démontré précédemment que la distensibilité pylorique pouvait être altérée chez 30 à 50% des patients atteints de gastroparésie(102). Cependant, peu d'études se sont intéressées à la population particulière des patients atteints de gastroparésie diabétique et les caractéristiques du diabète n'étaient pas analysées dans ces études(102),(104),(162). Or la gastroparésie diabétique peut être expliquée par différents mécanismes. Il a été démontré que le diabète pouvait provoquer des anomalies de la motricité gastrique secondaires à une altération du pace maker gastrique responsable de gastroparésie(163). L'hyperglycémie peut également provoquer des dysfonctionnements de la motricité gastrique(164). En conséquence, les objectifs de notre étude étaient d'évaluer la distensibilité et la pression pylorique mesurées par EndoFLIP[®] chez des patients atteints de gastroparésie diabétique, et de comparer ces données avec celles retrouvées chez une population de patients atteints de gastroparésie idiopathique et chez des volontaires sains. Le second objectif était d'évaluer les caractéristiques du diabète et leur corrélation aux mesures de distensibilité du sphincter pylorique.



Pour cela, nous avons étudié la distensibilité et la pression du pylore dans ces trois groupes de populations. L'altération de la distensibilité pylorique était définie comme une mesure inférieure à 10 mm²/mmHg à 40 mL de distension comme précédemment démontré(102). Par ailleurs, différentes caractéristiques du diabète étaient recueillies chez les patients, comme la glycémie à jeun, l'hémoglobine glyquée, la durée d'évolution du diabète, les complications et les traitements.

Nos résultats ont pu montrer que la distensibilité pylorique moyenne à 40 mL de distension était plus faible chez les patients atteints de gastroparésie diabétique et idiopathique

que chez les volontaires sains, sans différence entre les deux types de gastroparésie ($p < 0,005$). Environ 50% des patients gastroparétiques présentaient une altération de la distensibilité pylorique, contre 10% des volontaires sains. Aucune corrélation n'a été retrouvée entre les paramètres pylorique et les caractéristiques du diabète, incluant la glycémie à jeun, l'hémoglobine glyquée, la durée d'évolution, les complications et les traitements.

Ce travail confirme donc que la dysfonction pylorique est fréquemment observée chez les patients avec gastroparésie diabétique, comme chez les patients ayant une gastroparésie idiopathique, et cela quelque soient les index de contrôle glycémique. La dysfonction pylorique fait donc partie des mécanismes identifiés pouvant expliquer une gastroparésie chez des patients diabétiques et pourrait être une cible thérapeutique potentielle dans la gastroparésie diabétique.

Assessment of pyloric sphincter distensibility and pressure in patients with diabetic gastroparesis

Charlotte Desprez^{1,2}  | Marion Chambaz³ | Chloé Melchior^{2,4} | Paul Basile⁴ | Gaetan Prevost⁵ | Jérémie Jacques⁶ | Anne-Marie Leroi^{1,2,7}  | Guillaume Gourcerol^{1,2,7} 

¹Digestive Physiology Department, Rouen University Hospital, Rouen, France

²Nutrition, Brain and Gut Laboratory UMR 1073, Rouen University, Rouen, France

³Gastroenterology Department, Rennes University Hospital, Rennes, France

⁴Gastroenterology Department, Rouen University Hospital, Rouen, France

⁵Endocrinology Department, Rouen University Hospital, Rouen, France

⁶Gastroenterology Department, Limoges University Hospital, Limoges, France

⁷INSERM CIC-CRB 1404, Rouen University Hospital, Rouen, France

Correspondence

Charlotte Desprez, Digestive physiology Unit, Rouen University Hospital – 1 rue de Germont, 76031 Rouen, cedex, France.
Email: charlotte-desprez@orange.fr

Abstract

Background: Recent studies have shown that pyloric distensibility is altered in 30–50% of gastroparetic patients but the number of diabetic patients included in prior reports has been small. The aim of the present study was to assess pyloric sphincter measurements in diabetic patients with gastroparesis and to determine whether diabetes characteristics were correlated to pyloric disfunction.

Methods: Pyloric distensibility and pressure were measured using EndoFLIP[®] system in 46 patients with diabetic gastroparesis (DGP) and compared with 21 healthy volunteers (HV), and 33 patients with idiopathic gastroparesis (IGP). Altered pyloric distensibility was defined as the measurement below 10 mm²/mmHg at 40 ml of inflation. In diabetic patients, blood glucose, glycated hemoglobin, duration, complications, and treatments were collected.

Key Results: Mean pyloric distensibility at 40 ml of inflation was lower in DGP and IGP groups with, respectively, 10.8 ± 0.9 mm²/mmHg and 14.8 ± 2.2 mm²/mmHg in comparison with the HV group (25.2 ± 2.3 mm²/mmHg; *p* < 0.005). 56.5% of patients had a decreased pyloric distensibility in the DGP group, 51.5% of patients in the IGP group, and 10% of patients in the HV group. No correlation was found between pyloric sphincter measurements and diabetes characteristics, including blood glucose, glycated hemoglobin, diabetes mellitus type, neuropathy, or GLP1 agonists intake.

Conclusion and Interferences: Pyloric sphincter distensibility and pressure were altered both in diabetic and idiopathic gastroparesis. Pyloric sphincter distensibility was not correlated to diabetes parameters.

KEYWORDS

diabetes mellitus, distensibility, EndoFLIP, gastroparesis, pyloric sphincter

1 | INTRODUCTION

Gastroparesis is a chronic disorder defined as an objectively delayed gastric emptying in the absence of mechanical obstruction. The most common symptoms of gastroparesis are early satiety, upper abdominal

pain, nausea, vomiting, and postprandial fullness. Gastroparesis^{1,2} is in many cases idiopathic (30%), but most often etiologies remain diabetes (35%, mostly type 1 of diabetes mellitus), and surgery (20%).³ Incidence rate of diabetic gastroparesis tends to increase with the worldwide increasing diabetic population.⁴ Symptoms reported in

Charlotte Desprez and Marion Chambaz contributed equally to this work

Guarantor of the article: Professor Guillaume Gourcerol.

[Corrections added on February 2, 2021, after first online publication: Forenames and surnames are corrected for all the authors in the byline.]

diabetic gastroparesis are comparable to other causes of gastroparesis, although some diabetic patients may also develop asymptomatic gastroparesis that may impair the control of blood glucose.²⁻⁵

Several mechanisms are involved in the pathophysiology of diabetic gastroparesis. In fact, gastric motility depends mainly on both fundic and antral contractions and pyloric relaxation,¹ which are controlled by the electrical slow wave activity generated by the interstitial cells of Cajal. Abnormal interstitial cells of Cajal and myenteric neuropathy (enteric neuropathy and autonomic neuropathy) found in diabetic gastroparesis are mainly responsible for the loss of gastric pacemaker activity.⁶ In addition, hyperglycemia is also known to directly cause alteration of antral and fundic contractions.^{6,7} Likewise, hyperglycemia seems to be responsible for pyloric spasm and delayed gastric emptying.^{8,9} Nevertheless, poor correlation was found in previous studies between gastric emptying and hyperglycemia in patients with diabetes.⁵⁻¹⁰

Pyloric sphincter assessment using Endoscopic Functional Luminal Imaging Probe (EndoFLIP® system, Crospon Inc, Galway, Ireland) measures pyloric sphincter pressure, diameter, and distensibility. It has been shown that pyloric distensibility was altered in 30–50% of patients with gastroparesis.^{11,12} Moreover, pyloric sphincter distensibility has been shown to be inversely correlated with gastric emptying.^{11,12} Nevertheless, only a few studies evaluated pyloric distensibility in the particular population of patients with diabetic gastroparesis. Malik et al. and Snape et al. evaluated, respectively, 15 and 47 patients with diabetic gastroparesis.¹¹⁻¹³ The EndoFLIP® parameters were not different between patients with idiopathic GP and patients with diabetic GP. However, in these two former studies, diabetic parameters were neither monitored nor analyzed. We hypothesized that pyloric sphincter dysfunction could be correlated with diabetes characteristics.

The aims of this study were to evaluate both pyloric sphincter distensibility and pyloric sphincter pressure using EndoFLIP® system in patients with diabetic gastroparesis and to compare these parameters with the results found in a population of patients with idiopathic gastroparesis and healthy volunteers. Then, we evaluated diabetic patient's characteristics and their correlation with pyloric sphincter measurements.

2 | PATIENTS AND METHODS

2.1 | Approval

Approval was obtained from the Ethics Committee of Upper Normandy (CPP2011-012) and CERNI (Comité d'Ethique de la Recherche Non-Interventionnelle, No 2018/457/OB). The study was registered with clinicaltrials.gov (number NCT01519180). A written informed consent was obtained from all subjects.

2.2 | Patients

Seventy-nine patients were retrospectively included from January 2012 to June 2019 at Rouen University Hospital and at Limoges

Key Message

- The aim of the present study was to assess pyloric sphincter measurements in diabetic patients with gastroparesis.
- Pyloric distensibility and pressure were measured using EndoFLIP® system in 46 patients with diabetic gastroparesis (DGP) and compared with 21 healthy volunteers (HV), and 33 patients with idiopathic gastroparesis (IGP).
- Altered pyloric distensibility was defined as the measurement below 10 mm²/mmHg at 40 ml of inflation.
- Pyloric sphincter distensibility and pressure were altered both in diabetic and idiopathic gastroparesis. Pyloric sphincter distensibility was not correlated with diabetes parameters.

University Hospital. Written informed consent was obtained from all patients. Thirty-three patients with idiopathic GP (IGP) and 46 patients with diabetic GP (DGP) were consecutively investigated. All patients had a normal previous upper endoscopy without mechanical obstruction. Data of DGP and IGP groups were compared with data obtained from 21 healthy volunteers (HV). Information and measurements from healthy subject were obtained from a previous study performed at Rouen University Hospital and already published elsewhere, as well as the data from the 20 first patients with IGP.¹²

2.3 | Clinical evaluation and patients characteristics

Clinical investigation was performed using specific symptomatic scores for vomiting, bloating, gastric fullness, early satiety, regurgitation, and nausea. Patients rated each symptom from 0 (absence of symptom) to 4 (extremely severe symptom) using a five-point Likert scale. Gastrointestinal Quality of Life Index (GIQLI) evaluated overall dyspeptic symptoms and quality of life.¹⁴ GIQLI score ranged from 0 (worst quality of life) to 144 (best quality of life). For each DGP patient, type of diabetes mellitus (type 1 or type 2), duration of diabetes, and treatments were evaluated. Presence of macro-angiopathy and micro-angiopathy was also registered. Micro-angiopathy was defined as nephropathy, retinopathy, or peripheral neuropathy associated with diabetes. Neuropathy was defined as a chronic symmetrical length-dependant sensorimotor polyneuropathy. Arteriopathy, myocardial ischemia, and ischemic stroke were classified as macro-angiopathy. Fasting blood glucose concentration was performed at time of EndoFLIP® measurement. Glycated hemoglobin in the 3 months before EndoFLIP® measurement was also collected (HbA1c level).

2.4 | Pyloric evaluation

Pyloric sphincter distensibility and pressure were recorded using the EndoFLIP® system in all HV, IGP, and DGP subjects after 12 h of fasting. The EndoFLIP® catheter (EF-325 N; Crospon Ltd., Galway, Ireland) uses 16 serial impedance sensors placed 5 mm apart, enclosed in 8-cm-long cylindrical compliant bag. The balloon is connected to a pump and allows from 0 to 60 ml of saline solution. Real-time evaluation of intra bag pressure was measured. It allowed assessment of the cross-sectional areas (CSA) and the distensibility of the pyloric sphincter. The catheter was either inserted trans-nasally, and correct positioning was under the control of videofluoroscopy. Either it was passed through a single channel large diameter endoscope when endoscopy was performed in the same time. Correct positioning was also confirmed with the distinctive shape of the pylorus visible as a narrow segment with decreased CSA. After positioning, the balloon was filled at 10, 20, 30, 40, and 50 ml of inflation, and for each volume, at least three recordings were performed. The mean value of these three measures of the smallest CSA and the corresponding pressure were taken for distensibility analysis. Measurements were recorded when pyloric pressure and CSA were stable for at least 5 s in order to avoid variations in pylorus volume and/or pressure during peristaltic contractions. Distensibility was calculated using minimum CSA divided by the pressure at each balloon fill volume. A cutoff of 10 mm²/mmHg at 40 ml of inflation for normality of distensibility was determined in a previous study¹² in healthy subjects. Using this threshold value of 10 mm²/mmHg, pyloric distensibility was classified as normal (>10 mm²/mmHg) or decreased (<10 mm²/mmHg) among subjects.

2.5 | Measurement of gastric emptying

Gastric emptying measurement was performed using ¹³C-octanoic acid breath test, in DGP and IGP patients after 12 h of fasting.^{15,16} Patients ingested a 250-kcal test meal between 8:00 AM and 9:00 AM including butter (17 g), bread (50 g), and an egg with 91 mg of ¹³C-octanoic acid (Euriso -Top, St Aubin, France), (43% carbohydrate, 38% fat, and 1% protein). Expired breath was analyzed before meal and every 15 min after for 8 h. Presence of ¹³CO₂ was detected by isotope selective non-dispersive infrared spectrometry (IRIS; Wagner/Analysen Technik, Bremen, Germany). The solid half time rate (T_{1/2}) for gastric emptying was determined by linear regression analysis using IRIS Software GE2. DEM according to Ghooos et al.¹⁶ T_{1/2} was available in 45 of 46 DGP patients and in 31 of 33 IGP patients. Indeed, three subjects vomited the meal. Delayed gastric emptying was defined with T_{1/2} higher than 166 min.¹⁵

2.6 | Statistics

Mann-Whitney's test was used to compare two groups and ANOVA one-way test for more than 2 groups. Correlation studies used

the Spearman test. Statistical significance was defined as *p*-value <0.05. Continuous variables were expressed as mean ± S.E.M. Data were analyzed using GraphPad Prism version 5.03 for Windows (GraphPad Software Inc, San Diego, California, USA, www.graphpad.com).

3 | RESULTS

3.1 | Patients

One hundred subjects were analyzed. Patients characteristics are summarized in Table 1. The GIQLI score was 135.0 ± 1.0 in the HV group. The GIQLI score decreased in both IGP and DGP groups in comparison with the HV group (*p* < 0.05), with no difference found in score between DGP and IGP groups (respectively, 66.0 ± 2.9 and 71.0 ± 3.4; *p* = 0.14). T_{1/2} was higher in the DGP group (299.3 ± 25.0 min) in comparison with the IGP group (224.3 ± 8.5 min, *p* = 0.04). Regarding medication in the DGP group, 16 patients were treated with oral antidiabetic agents, 6 patients were treated with GLP-1 agonists, 15 with metformin, and 7 with sulfonamides treatment. Mean HbA1c was 8.1 ± 0.3%, and mean duration of diabetes mellitus was 16.8 ± 1.2 years. Sixty-one percent of the DGP patients had type 1 diabetes and 39.0% of the DGP patients had type 2 diabetes. The complications of diabetes and characteristics of the diabetic patients are given in Table 2.

TABLE 1 Patients characteristics among the three different groups

| | Healthy volunteers | Diabetic GP | Idiopathic GP |
|--------------------------|--------------------|-------------------------|-------------------------|
| N | 21 | 46 | 33 |
| Age | 46.1 ± 3.3 | 49.9 ± 1.9 | 48.5 ± 2.6 |
| Men/women | 5/16 | 18/28 | 13/20 |
| BMI (kg/m ²) | 24.2 ± 0.7 | 27.3 ± 0.9 | 23.6 ± 0.9 |
| GIQLI score | 135 ± 1 | 66.0 ± 2.9* | 71.0 ± 3.4* |
| T _{1/2} (min) | | 299.3 ± 25.0 | 224.3 ± 8.5 |
| Abdominal pain | 0.5 ± 0.2 | 2.2 ± 0.3* | 2.4 ± 0.2* |
| Fullness | 0.4 ± 0.1 | 2.3 ± 0.3* [#] | 3.0 ± 0.1* ^μ |
| Bloating | 1.0 ± 0.2 | 2.2 ± 0.2* | 2.5 ± 0.2* |
| Early satiety | 0.4 ± 0.2 | 2.0 ± 0.2* | 2.0 ± 0.2* |
| Nausea | 0.1 ± 0.1 | 1.1 ± 0.7 | 1.9 ± 0.2 |
| Vomiting | 0.0 ± 0.0 | 1.7 ± 0.2* | 1.6 ± 0.3* |

Note: Results are expressed as mean ± SEM.

Abbreviations: BMI, body mass index; GIQLI, gastrointestinal quality of life index.

**p* < 0.05 in comparison with HV.

[#]*p* < 0.05 compared to idiopathic GP.

^μ*p* < 0.05 compared to diabetic GP.

TABLE 2 Patients characteristics in DGP group

| | Diabetic GP |
|---|-------------|
| N = | 46 |
| HbA1c (%) | 8.1 ± 0.3 |
| Fasting blood glucose concentration (g/L) | 1.8 ± 0.1 |
| Duration | 16.8 ± 1.2 |
| Type 1 | 28 (61%) |
| Type 2 | 18 (39%) |
| Retinopathy | 16 (35%) |
| Nephropathy | 11 (24%) |
| Neuropathy | 16 (35%) |
| Micro-angiopathy | 22 (48%) |
| Macro-angiopathy | 11 (24%) |

Note: Results are expressed as mean ± SEM.

3.2 | Pyloric sphincter measurements

Figure 1 shows an EndoFLIP® measurement from a patient with DGP and decreased pyloric distensibility. Table 3 shows pyloric sphincter measurements with EndoFLIP® bag inflated at 30, 40, and 50 ml. A decrease in pyloric sphincter distensibility at 30 ml of inflation was observed in both the DGP and IGP groups with, respectively, $8.9 \pm 1.2 \text{ mm}^2/\text{mmHg}$ and $18.0 \pm 4.9 \text{ mm}^2/\text{mmHg}$ in comparison with the HV group ($30.4 \pm 3.6 \text{ mm}^2/\text{mmHg}$; $p < 0.005$; Figure 2). Pyloric distensibility at 40 ml of inflation was decreased in the DGP and IGP groups with, respectively, $10.8 \pm 0.9 \text{ mm}^2/\text{mmHg}$ and $14.8 \pm 2.2 \text{ mm}^2/\text{mmHg}$ in comparison with the HV group ($25.2 \pm 2.3 \text{ mm}^2/\text{mmHg}$; $p < 0.005$). No difference in pyloric distensibility was observed between the DGP and IGP groups at 30 and 40 ml of inflation. Pyloric sphincter pressure at 30 ml of inflation was increased in both the DGP and IGP groups with, respectively, $15.3 \pm 1.1 \text{ mmHg}$ and $11.3 \pm 1.3 \text{ mmHg}$ in comparison with the HV group ($6.7 \pm 0.5 \text{ mmHg}$; $p < 0.005$) and in the DGP group in comparison with the IGP group ($p < 0.005$). Pyloric sphincter pressure at 40 ml of inflation was increased in both the DGP and IGP groups with, respectively, $19.5 \pm 1.5 \text{ mmHg}$ and $16.9 \pm 2.6 \text{ mmHg}$ in comparison with the HV group (9.7 ± 1.0 ; $p < 0.005$; Figure 2). Using the threshold of $10 \text{ mm}^2/\text{mmHg}$ to determine altered pyloric distensibility, 26/46 patients (56.5%) had a decreased pyloric distensibility among the DGP group and 17/33 patients (51.5%) had altered pyloric distensibility among the IGP group, in contrary to the HV group (10.0%).

3.3 | Correlation between diabetes characteristics of patients and pyloric sphincter measurements using EndoFLIP® at 40 ml of inflation, T(½), and GIQLI

No correlation was found between pyloric sphincter measurements at 40 ml of inflation and diabetes characteristics as shown in Table 4. Moreover, no correlation was described between T(½) and GIQLI

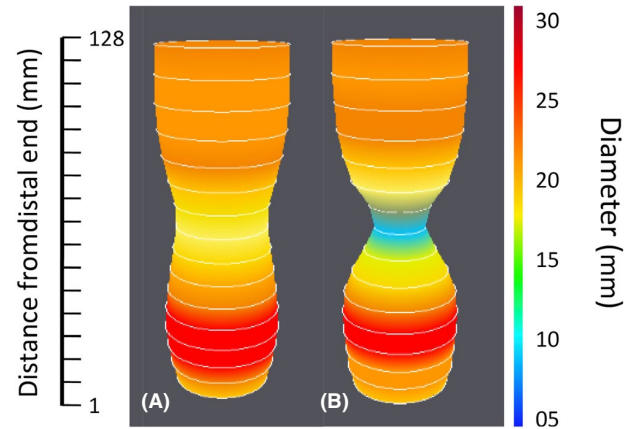

FIGURE 1 Representative EndoFLIP® measurement at 40 ml of inflation from a healthy volunteer subject (A) and from a patient with DGP and altered pyloric sphincter distensibility of $4 \text{ mm}^2/\text{mmHg}$ (B)

and diabetes characteristics (Table 4). Results were similar with balloon inflation of 50 ml.

No difference was found in pyloric sphincter measurements at 40 ml of inflation, T(½), and GIQLI in DGP group on the basis of diabetes complication, chronic intake of insulin or GLP-1 therapy (Table 5). Results were similar with balloon inflation of 50 ml.

4 | DISCUSSION

In the present study, we confirmed that pyloric sphincter distensibility was decreased in patients with diabetic and idiopathic gastroparesis, in comparison with healthy volunteers. It was also found that pyloric sphincter pressure was increased in patients with diabetic and idiopathic gastroparesis, in comparison with healthy volunteers. However, there was no difference in pyloric sphincter measurements between patients with diabetic or idiopathic gastroparesis. Moreover, no correlation was found between characteristics of diabetic patients and both pyloric sphincter and gastric emptying measurements. To our knowledge, the present study is the first to have assessed characteristics of diabetic patients at the time of EndoFLIP measurements of pyloric sphincter characteristics in a large cohort of patients with diabetic and idiopathic gastroparesis.

No correlation was found between characteristics of diabetic patients and pyloric sphincter or gastric emptying measurements. This might be explained by the complex pathogenesis of gastroparesis in diabetic patients. Histological data from patients with diabetic gastroparesis found loss of cells of Cajal, progressive neuronal loss and reduce stem cell factor links smooth myopathy.^{17,18} These histological lesions are responsible for antral dysmotility and/or pylorospasm. Presence of peripheral neuropathy was possibly mentioned as a gastroparesis risk factor.¹⁰ However, the present study found no significant difference in pyloric sphincter measurements in the diabetic gastroparesis group on basis of the presence or absence of

TABLE 3 Comparison of pyloric sphincter distensibility, pressure, and diameter at 30, 40, and 50 ml of inflation between patients from DGP, IGP, and HV groups.

| | HV (n = 21) | Diabetic GP (n = 46) | Idiopathic GP (n = 33) |
|--|-------------|---------------------------|---------------------------|
| 30 ml of inflation | | | |
| Diameter (mm) | 14.2 ± 0.6 | 10.6 ± 0.5 [†] | 12.4 ± 1.1 |
| Pressure (mmHg) | 6.7 ± 0.5 | 15.3 ± 1.1 ^{#,*} | 11.3 ± 1.3 ^{#,†} |
| Distensibility (mm ² /mmHg) | 30.4 ± 3.6 | 8.9 ± 1.2 [†] | 18.0 ± 4.9 [†] |
| 40 ml of inflation | | | |
| Diameter (mm) | 16.0 ± 0.5 | 14.1 ± 0.4 | 14.9 ± 0.9 |
| Pressure (mmHg) | 9.7 ± 1.0 | 19.5 ± 1.4 [†] | 16.9 ± 2.6 [†] |
| Distensibility (mm ² /mmHg) | 25.2 ± 2.3 | 10.8 ± 0.9 [†] | 14.8 ± 2.2 [†] |
| 50 ml of inflation | | | |
| Diameter (mm) | NA | 17.5 ± 0.6 | 16.3 ± 2.6 |
| Pressure (mmHg) | NA | 35.9 ± 2.3 | 39.6 ± 6.1 |
| Distensibility (mm ² /mmHg) | NA | 8.9 ± 1.2 | 7.2 ± 3.6 |

Note: Results are expressed as mean ± SEM.

Abbreviation: NA, not applicable.

[#]p < 0.05 compared to idiopathic GP.

[†]p < 0.05 compared to diabetic GP.

^{*}p < 0.05 compared to healthy volunteers HV.

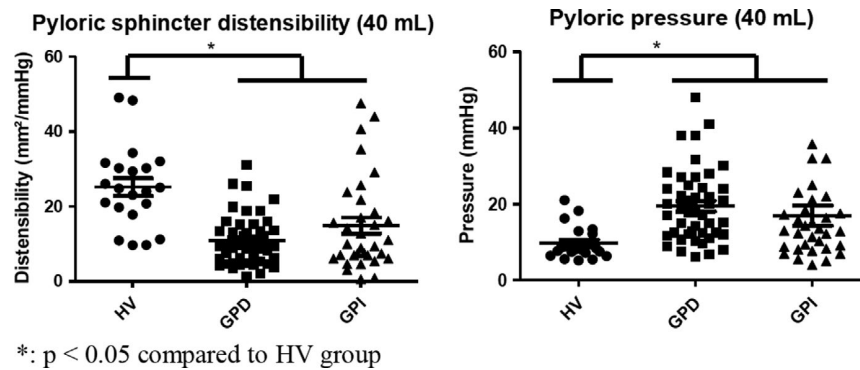

FIGURE 2 Comparison of pyloric sphincter distensibility and pressure at 40 ml of inflation between patients from DGP, IGP, and HV groups. ^{*}p < 0.05 compared to HV group

TABLE 4 Correlation between diabetic patients' characteristics and pyloric sphincter distensibility and pressure at 40 ml of inflation, T(½), and GIQLI

| | Distensibility at 40 ml | Pressure at 40 ml | T(½) | GIQLI |
|-------------------------------------|-------------------------|--------------------|--------------------|--------------------|
| HbA1c | 0.18 [-0.13;0.47] | -0.14 [-0.44;0.18] | -0.11 [-0.41;0.21] | -0.14 [-0.44;0.18] |
| Diabetes duration | 0.02 [-0.27;0.32] | 0.02 [-0.28;0.31] | -0.08 [-0.37;0.22] | 0.14 [-0.16;0.43] |
| Fasting blood glucose concentration | 0.06 [-0.24;0.36] | -0.14 [-0.43;0.16] | -0.13 [-0.41;0.18] | 0.07 [-0.25;0.37] |

Note: Results are expressed coefficients correlation and 95% confidence interval using Spearman test.

neuropathy. On one hand, this may be explained by the small number of patients with neuropathy included, with probably a lack of power. On the other hand, pyloric distensibility may rely more on pyloric structural changes (myopathy, local NO release within the enteric nervous system) rather than on extrinsic innervation. Further work, with either clinical studies in DG patients with peripheral neuropathy

or basic studies in preclinical models of DG are warranted to precise this discrepancy.

Moreover, it is now recognized that hyperglycemia slows gastric emptying,¹⁹ in particular in patients with diabetes.¹⁰ Increased blood glucose concentration is associated with suppression of antral contraction, reduced fundal tone, and gastric electrical dysarrhythmia.²⁰

| | Distensibility at 40 ml | Pressure at 40 ml | T(%) | GIQLI |
|----------------------------------|-------------------------|-------------------|---------------|-------------|
| Neuropathy (n = 16) | 10.6 ± 1.4 | 19.2 ± 2.4 | 313.0 ± 51.7 | 60.4 ± 2.9 |
| No neuropathy (n = 30) | 10.9 ± 1.4 | 19.6 ± 1.8 | 290.1 ± 24.4 | 69.5 ± 4.2 |
| <i>p</i> | 0.82 | 0.89 | 0.57 | 0.24 |
| Retinopathy (n = 16) | 9.5 ± 1.3 | 21.0 ± 2.9 | 342.4 ± 57.1 | 64.3 ± 5.4 |
| No retinopathy (n = 30) | 11.5 ± 1.3 | 18.6 ± 1.5 | 248.9 ± 13.1 | 66.9 ± 3.4 |
| <i>p</i> | 0.66 | 0.65 | 0.30 | 0.40 |
| Nephropathy (n = 11) | 9.5 ± 1.6 | 20.9 ± 3.1 | 258.8 ± 37.9 | 69.3 ± 5.0 |
| No nephropathy (n = 35) | 13.6 ± 1.5 | 19.1 ± 1.6 | 291.7 ± 28.0 | 64.8 ± 3.5 |
| <i>p</i> | 0.06 | 0.63 | 0.32 | 0.50 |
| Insulin (n = 30) | 11.3 ± 1.2 | 18.9 ± 1.8 | 298.3 ± 28.8 | 65.5 ± 3.4 |
| Oral antidiabetic agent (n = 16) | 9.5 ± 1.7 | 21.1 ± 2.2 | 232.8 ± 18.2 | 67.3 ± 5.7 |
| <i>p</i> | 0.39 | 0.31 | 0.23 | 0.74 |
| GLP1 agonist (n = 6) | 9.3 ± 8.4 | 25.6 ± 8.9 | 286.2 ± 60.1 | 52.2 ± 11.0 |
| Other therapy (n = 40) | 10.9 ± 6.5 | 19.0 ± 9.2 | 287.0 ± 155.3 | 65.5 ± 22.3 |
| <i>p</i> | 0.28 | 0.11 | 0.46 | 0.15 |

Note: Results are expressed as mean ± SEM.

Abbreviation: GIQLI, gastrointestinal quality of life index.

In the present study, we did not find any correlation between gastric emptying and fasting blood glucose concentration, but the latter was measured immediately before upper gastroscopy and not before gastric emptying measurement. Literature remains scarce regarding relationships between hyperglycemia and pylorospasm. Pylorospasm was firstly described²¹ in 14/24 diabetic patients with recurrence of nausea and vomiting, but there was no monitoring of blood glucose concentration during antro-pyloro-duodenal manometric measurements. Another study in HV showed an increase of localized pyloric contractions induced by hyperglycemia induced by intravenous dextrose (blood glucose concentration 12–16 mmol/L) in comparison with euglycemia (3–5 mmol/L)²² and a suppressive effect on antral activity. As suggested by animal models, hyperglycemia can suppress efferent vagal activity and results in an increased pyloric activity.²³ Nevertheless, no correlation was found between pyloric pressure and fasting blood glucose concentration in the present study. It could be explained by the fact that the mean range of fasting blood glucose concentration was 1.8 ± 0.1 g/L (10.0 ± 1.0 mmol/L) in the present study and consequently lower than the ranges used to determine hyperglycemia in previous studies assessing pyloric sphincter.²² Lastly, measurement of HbA1c level in the 3 months before the EndoFLIP could be a limitation to the present study due to its possible change in the 3 months.

The results of the present study regarding pyloric sphincter measurements were similar to those found in other previous studies

TABLE 5 Comparison of pyloric sphincter distensibility and pressure at 40 ml of inflation, T(%), and GIQLI in the presence or absence of diabetic patients characteristics including neuropathy, retinopathy, nephropathy, and on basis of type of treatment

on diabetic patients with gastroparesis. Malik et al.¹¹ (n = 15) found similar results on pyloric sphincter pressure and distensibility with EndoFLIP[®] balloon inflated at 40 ml (with 17.7 ± 2.28 mm²/mmHg and 10.7 ± 2.57 mmHg, respectively). Snape and al.¹³ evaluated 27 diabetic patients with nausea and vomiting. They also had similar results on pyloric sphincter pressure and distensibility were noted (with 17.4 ± 1.3 mm²/mmHg and 8.5 ± 1.1 mmHg, respectively). Lastly, a prior study using Dent sleeve catheter showed elevated pyloric pressure in diabetic patients with gastroparesis in comparison with healthy volunteers.²¹

We observed a wide range of pyloric sphincter distensibility and pressure in diabetic patients with gastroparesis. It could suggest that some patients with diabetic gastroparesis have more severe pyloric dysfunction. Previous studies of our Department used a cutoff of 10 mm²/mmHg to define altered pyloric sphincter distensibility^{12–24} with 30–50% of gastroparetic patients with altered pyloric sphincter distensibility. However, the number of patients with diabetic gastroparesis was low in these reports. In the present study, 26/46 patients (56.5%) had a decreased pyloric distensibility in patients with diabetic gastroparesis and 17/33 patients (51.5%) in patients with idiopathic gastroparesis. Using pyloric distensibility measurement, these patients could be selected to receive targeted pyloric sphincter therapies to increase pyloric distensibility. A previous study found an increase in pyloric sphincter distensibility after hydraulic dilatation in 10 patients

with gastroparesis (10-day evaluation; $p = 0.04$).¹² Moreover, several studies evaluated botulinum toxin injection as a treatment of gastroparesis but there was no assessment of pyloric sphincter distensibility.²⁵⁻²⁷ A prospective cohort²⁴ found significant improvement of symptoms, GIQLI, and gastric emptying at 3 months after intra-pyloric botulinum toxin injection in gastroparetic patients with altered pyloric sphincter distensibility but not in patients with normal pyloric sphincter distensibility. Lastly, another prospective study showed a threshold of 9.2 mm²/mmHg associated with 3-month clinical efficacy of G-POEM (sensitivity 72.2%, specificity 100%).²⁸ However, the proportion of patients with diabetic gastroparesis was low in these reports and further studies are necessary to confirm these findings in the particular population of patients with diabetic gastroparesis.

5 | CONCLUSION

In this study, we have shown that pyloric sphincter distensibility was decreased and pyloric pressure was increased in patients with diabetic and idiopathic gastroparesis, in comparison with healthy volunteers. Pyloric sphincter distensibility was not correlated with any of the diabetes parameters. Thus, treatment targeting pyloric dysfunction may be beneficial in patients with diabetic gastroparesis but remains to be evaluated in further studies.

CONFLICT OF INTEREST

The authors have no conflict of interest to declare.

AUTHOR CONTRIBUTIONS

DC, CM, GG, and PG performed the research, DC, CM, and GG collected and analyzed the data, DC, CM, and GG designed the research study and wrote the paper, and DC, CM, MC, PG, BP, JJ, AML, and GG contributed to editing the manuscript.

AUTHORSHIP STATEMENT

All authors approved the final version of the article, including the authorship list.

ORCID

Desprez Charlotte  <https://orcid.org/0000-0002-1280-7675>

Leroi Anne-Marie  <https://orcid.org/0000-0002-6266-4203>

Gourcerol Guillaume  <https://orcid.org/0000-0001-8220-9155>

REFERENCES

- Pasricha PJ, Parkman HP. Gastroparesis: definitions and diagnosis. *Gastroenterol Clin North Am*. 2015;44:1-7.
- Camilleri M, Parkman HP, Shafi MA, Abell TL, Gerson L. Clinical guideline: management of gastroparesis. *Am J Gastroenterol*. 2013;108(1):18-37;quiz 38.
- Hasler WL. Gastroparesis: pathogenesis, diagnosis and management. *Nat Rev Gastroenterol Hepatol*. 2011;8:438-453.
- Bharucha AE. Epidemiology and natural history of gastroparesis. *Gastroenterol Clin North Am*. 2015;44:9-19.
- Choung RS, Locke GR, Schleck CD, Zinsmeister AR, Melton JL, Talley NJ. Risk of gastroparesis in subjects with type 1 and 2 diabetes in the general population. *Am J Gastroenterol*. 2012;107:82-88.
- Chang J, Rayner CK, Jones KL, Horowitz M. Diabetic gastroparesis and its impact on glycemia. *Endocrinol Metab Clin North Am*. 2010;39:745-762.
- Barnett JL, Owyang C. Serum glucose concentration as a modulator of interdigestive gastric motility. *Gastroenterology*. 1988;94:739-744.
- Schvarcz E, Palmér M, Aman J, Horowitz M, Stridsberg M, Berne C. Physiological hyperglycemia slows gastric emptying in normal subjects and patients with insulin-dependent diabetes mellitus. *Gastroenterology*. 1997;113:60-66.
- Fraser RJ, Horowitz M, Maddox AF, Harding PE, Chatterton BE, Dent J. Hyperglycaemia slows gastric emptying in type 1 (insulin-dependent) diabetes mellitus. *Diabetologia*. 1990;33:675-680.
- Jones KL, Russo A, Stevens JE, Wishart JM, Berry MK, Horowitz M. Predictors of delayed gastric emptying in diabetes. *Diabetes Care*. 2001;24:1264-1269.
- Malik Z, Sankineni A, Parkman HP. Assessing pyloric sphincter pathophysiology using EndoFLIP in patients with gastroparesis. *Neurogastroenterol Motil Off J Eur Gastrointest Motil Soc*. 2015;27:524-531.
- Gourcerol G, Tissier F, Melchior C, et al. Impaired fasting pyloric compliance in gastroparesis and the therapeutic response to pyloric dilatation. *Aliment Pharmacol Ther*. 2015;41:360-367.
- Snape WJ, Lin MS, Agarwal N, Shaw RE. Evaluation of the pylorus with concurrent intraluminal pressure and EndoFLIP in patients with nausea and vomiting. *Neurogastroenterol Motil Off J Eur Gastrointest Motil Soc*. 2016;28:758-764.
- Eypasch E, Williams JI, Wood-Dauphinee S, et al. Gastrointestinal Quality of Life Index: development, validation and application of a new instrument. *Br J Surg*. 1995;82:216-222.
- Marie I, Gourcerol G, Leroi A-M, Ménard JF, Levesque H, Ducrotté P. Delayed gastric emptying determined using the 13C-octanoic acid breath test in patients with systemic sclerosis. *Arthritis Rheum*. 2012;64:2346-2355.
- Ghoos YF, Maes BD, Geypens BJ, et al. Measurement of gastric emptying rate of solids by means of a carbon-labeled octanoic acid breath test. *Gastroenterology*. 1993;104:1640-1647.
- Watkins CC, Sawa A, Jaffrey S, et al. Insulin restores neuronal nitric oxide synthase expression and function that is lost in diabetic gastropathy. *J Clin Invest*. 2000;106:373-384.
- Horváth VJ, Vittal H, Lörincz A, et al. Reduced stem cell factor links smooth myopathy and loss of interstitial cells of cajal in murine diabetic gastroparesis. *Gastroenterology*. 2006;130:759-770.
- Jebbink RJA, Samsom M, Bruijs PPM, et al. Hyperglycemia induces abnormalities of gastric myoelectrical activity in patients with type I diabetes mellitus. *Gastroenterology*. 1994;107:1390-1397.
- Rayner CK, Samsom M, Jones KL, Horowitz M. Relationships of upper gastrointestinal motor and sensory function with glycemic control. *Diabetes Care*. 2001;24:371-381.
- Mearin F, Camilleri M, Malagelada JR. Pyloric dysfunction in diabetics with recurrent nausea and vomiting. *Gastroenterology*. 1986;90:1919-1925.
- Fraser R, Horowitz M, Dent J. Hyperglycaemia stimulates pyloric motility in normal subjects. *Gut*. 1991;32:475-478.
- Allescher HD, Daniel EE, Dent J, Fox JE, Kostolanska F. Extrinsic and intrinsic neural control of pyloric sphincter pressure in the dog. *J Physiol*. 1988;401:17-38.
- Desprez C, Melchior C, Wuestenberghs F, et al. Pyloric distensibility measurement predicts symptomatic response to intrapyloric botulinum toxin injection. *Gastrointest Endosc*. 2019;90(5):754.e1-760.e1.
- Pasricha TS, Pasricha PJ. Botulinum toxin injection for treatment of gastroparesis. *Gastrointest Endosc Clin N Am*. 2019;29:97-106.

26. Arts J, Holvoet L, Caenepeel P, et al. Clinical trial: a randomized-controlled crossover study of intrapyloric injection of botulinum toxin in gastroparesis. *Aliment Pharmacol Ther.* 2007;26:1251-1258.
27. Friedenberg FK, Palit A, Parkman HP, Hanlon A, Nelson DB. Botulinum toxin A for the treatment of delayed gastric emptying. *Am J Gastroenterol.* 2008;103:416-423.
28. Jacques J, Pagnon L, Hure F, et al. Peroral endoscopic pyloromyotomy is efficacious and safe for refractory gastroparesis: prospective trial with assessment of pyloric function. *Endoscopy.* 2018;51(1):40-49.

How to cite this article: Desprez C, Chambaz M, Melchior C, et al. Assessment of pyloric sphincter distensibility and pressure in patients with diabetic gastroparesis. *Neurogastroenterology & Motility.* 2021;33:e14064.

<https://doi.org/10.1111/nmo.14064>

2. La mesure de la distensibilité pylorique après chirurgie oeso-gastrique : quelles chirurgies sont associées à un pylorospasme ?







Un antécédent de chirurgie oeso-gastrique est retrouvé chez 10% des patients atteints de gastroparésie. Une lésion du nerf vague est alors souvent suspectée mais difficile à diagnostiquer(91). Bien qu'une lésion vagale soit susceptible de provoquer un pylorospasme, aucune étude ne s'est intéressée jusqu'ici à l'impact des différentes chirurgies oeso-gastriques sur la distensibilité pylorique. L'objectif de notre étude était donc d'évaluer la distensibilité pylorique chez des patients ayant subi une chirurgie oeso-gastrique avec suspicion de vagotomie (fundoplicature de Nissen, oesophagectomie et sleeve-gastrectomie) en comparaison avec une population de volontaires sains.

La mesure des paramètres du pylore était effectuée avec l'outil EndoFLIP® chez des patients avec symptômes dyspeptiques après fundoplicature de Nissen, oesophagectomie et sleeve-gastrectomie. L'altération de la distensibilité pylorique était définie comme une mesure inférieure à 10 mm²/mmHg à 40 mL de distension comme précédemment démontré(102).

Nos résultats ont montré que la distensibilité pylorique était altérée chez 61,1% des patients ayant subi une fundoplicature de Nissen et 75,0% des patients ayant subi une oesophagectomie. En revanche, la distensibilité ainsi que la pression pylorique étaient comparables chez les volontaires sains et les patients ayant eu une sleeve-gastrectomie (p=0.42). L'altération de la distensibilité pylorique était présente chez 18,7% des patients ayant eu une sleeve-gastrectomie ce qui témoigne du faible taux de lésion vagale de cette chirurgie.

Ainsi, l'EndoFLIP® réalisé chez des patients souffrant de symptômes dyspeptiques post-opératoires, donnerait des arguments en faveur d'une lésion vagale responsable d'un pylorospasme et orienterait vers un traitement ayant pour cible le pylore.

Pyloric distensibility measurement after gastric surgery: Which surgeries are associated with pylorospasm?

Charlotte Desprez^{1,2}  | Chloé Melchior^{2,3}  | Fabien Wuestenberghs^{1,2}  |
Emmanuel Huet^{2,4} | Alberto Zalar³ | Jérémie Jacques⁵  | Anne-Marie Lerol^{1,2,6}  |
Guillaume Gourcerol^{1,2,6} 

¹Physiology Department, Rouen University Hospital, Rouen, France

²Nutrition, Brain and Gut Laboratory, INSERM Unit 1073, Rouen University Hospital, Rouen, France

³Hepatogastroenterology Department, Rouen University Hospital, Rouen, France

⁴Digestive Surgery Department, Rouen University Hospital, Rouen, France

⁵Hepatogastroenterology Department, Limoges University Hospital, Limoges, France

⁶Clinical Investigation Center, INSERM 0204, Rouen University Hospital, Rouen, France

Correspondence

Charlotte Desprez, Digestive Physiology Unit, Rouen University Hospital - 1 rue de Germont, 76031, Rouen, Cedex, France.
Email: charlotte-desprez@orange.fr

Abstract

Background and study aims: History of gastric surgery is found in 10% of patients with gastroparesis, and vagal lesion is often suspected to be the cause of pylorospasm. Recently, pyloric distensibility measurement using the EndoFLIP[®] system showed that pylorospasm was present in 30%-50% of gastroparetic patients. Our objective was to assess whether pylorospasm, diagnosed using EndoFLIP[®] system was observed in three different types of gastric surgeries: antireflux surgery, sleeve gastrectomy, and esophagectomy.

Patients and Methods: Pyloric distensibility and pressure were measured using the EndoFLIP[®] system in 43 patients from two centers (18 antireflux surgery, 16 sleeve gastrectomy, and nine esophagectomy) with dyspeptic symptoms after gastric surgery, and in 21 healthy volunteers. Altered pyloric distensibility was defined as distensibility below 10 mm²/mm Hg as previously reported.

Results: Compared to healthy volunteers (distensibility: 25.2 ± 2.4 mm²/mm Hg; pressure: 9.7 ± 4.4 mm Hg), pyloric distensibility was decreased in 61.1% of patients in the antireflux surgery group (14.5 ± 3.4 mm²/mm Hg; *P* < .01) and 75.0% of patients in the esophagectomy group (10.8 ± 2.1 mm²/mm Hg; *P* < .05), while pyloric pressure was only increased in the antireflux surgery group (18.9 ± 2.2 mm Hg; *P* < .01). Pyloric distensibility and pressure were similar in healthy volunteers and in sleeve gastrectomy (distensibility: 20.3 ± 3.8 mm²/mm Hg; pressure: 15.8 ± 1.6 mm Hg) groups, with decreased pyloric distensibility affecting 18.7% of sleeve gastrectomy patients.

Conclusion: Antireflux surgery and esophagectomy were associated with pylorospasm although pylorospasm was not found in all patients. Sleeve gastrectomy was not associated with altered pyloric distensibility nor altered pyloric pressure.

KEYWORDS

antireflux surgery, distensibility, gastroparesis, pylorus, sleeve gastrectomy, sphincter

1 | INTRODUCTION

Gastroparesis is defined as delayed gastric emptying and is often accompanied with dyspeptic symptoms, including gastric fullness, nausea, and vomiting. Postsurgical gastroparesis accounts for 7.2%¹ to 13%² of gastroparetic patients among studies, but the exact prevalence is difficult to assess in the absence of studies describing preoperative and postoperative gastric emptying measurements in large cohorts of patients. Lesion of the vagus nerves is suspected to be the main mechanism, although up to now there is no routine diagnostic tool to assess vagal lesion. Nevertheless, vagotomy is known to induce spasm of the pylorus,³ and therefore, is associated with delayed gastric emptying.

Different types of esogastric surgery have been suspected to delay gastric emptying. Historically, postsurgical gastroparesis was frequently diagnosed among patients undergoing vagotomy in the case of peptic ulcer disease,⁴ which has become exceptional over time by the use of proton pump inhibitors. Antireflux surgery, mostly Nissen fundoplication, was suspected to delay gastric emptying in 3.8% of operated patients in a large retrospective cohort of 3512 patients,⁵ leading to reoperation in 2% of patients. Moreover, delayed gastric emptying has also been suspected to explain dyspeptic symptoms after bariatric surgery, including sleeve gastrectomy.^{2,6} Last, we previously showed that laparoscopic esophagectomy, which involves the removal of the vagus nerves, is associated with pyloric dysfunction in the absence of pyloroplasty in patients reporting dyspeptic symptoms.⁷ Of note, although gastric emptying is suspected to be delayed in the two latter situations with partial gastrectomy, gastric emptying tests are meaningless in the absence of normal values performed in asymptomatic patients.

Recently, sphincter distensibility measurements were enabled using EndoFLIP® technology (Endoluminal Functional Imaging Probe). Previous works performed in healthy volunteers and gastroparetic patients identified decreased pyloric distensibility in approximately one-third of gastroparetic patients.⁷ Pyloric dysfunction was associated with symptom severity, quality of life, and gastric emptying.

Therefore, we took the opportunity to explore pyloric distensibility, as a surrogate of vagal lesion, in patients undergoing these three types of surgery, and compared them with previously reported normal values.

2 | PATIENTS AND METHODS

2.1 | Approval

Approval was obtained from the Ethics Committee of Upper Normandy (CPP2011-012) and CERNI (Comité d'Ethique de la Recherche Non-Interventionnelle, no E2019-07). The study was registered with clinicaltrials.gov (number NCT01519180). Written informed consent was obtained from all subjects.

Key Points

- Patients with dyspeptic symptoms after gastric surgery and healthy volunteers underwent a pyloric distensibility measurement using the EndoFLIP system. Altered pyloric distensibility was defined as distensibility below 10 mm²/mm Hg as previously reported.
- Antireflux surgery and esophagectomy were associated with pylorospasm although pylorospasm was not found in all patients.
- Sleeve gastrectomy was not associated with altered pyloric distensibility nor altered pyloric pressure.

2.2 | Patients

Eighteen patients with a history of laparoscopic Nissen fundoplication were investigated. All patients reported dyspeptic symptoms starting after surgery associated with delayed gastric emptying using the octanoic breath test as described below. Sixteen patients reporting dyspeptic symptoms after laparoscopic sleeve gastrectomy for morbid obesity were also investigated. Nine patients who had undergone esophagectomy without pyloroplasty served as positive controls. All patients had an upper gastrointestinal endoscopy prior to investigations, and the presence of an organic disease was ruled out by multiple biopsies and anatomopathological examination in patients with significant lesion at inspection (eg, hiatal hernia <3 cm, mild gastritis, grade I esophagitis, etc.). *Helicobacter pylori* infection was ruled out either by serology or anatomopathologic examination. Moreover, no narrowing of the esophageal segment operated on was notified during the endoscopic evaluation, and patients were investigated off-prokinetic agents. Dyspeptic symptoms including vomiting, nausea, epigastric pain, bloating, fullness, and satiety were investigated. An assessment of each item was realized using a 5-point Likert scale which varies from 0 (absent) to 4 (most severe symptoms). Total symptomatic score (TSS) was defined as the aggregation of individual symptom scores.^{8,9} A minimal TSS of eight for each patient was necessary for inclusion in the present study.

Twenty-one healthy volunteers (eight males), median age 40 ± 3.2 years (range 29-58), were recruited by local advertising. None of these subjects had any evidence of organic or functional gastrointestinal disorders, and none were on any medication known to affect gastrointestinal function. Data related to healthy volunteers have already been published in a previous report.⁷

2.3 | Quality of life

Quality of life and overall dyspeptic symptoms were evaluated using Gastrointestinal Quality of Life Index (GIQLI)¹⁰ which was previously

validated in French.¹¹ The GIQLI score is specific for digestive diseases and varies from 0 (worst quality of life possible) to 144 (best quality of life).

2.4 | Pyloric distensibility

EndoFLIP[®] probe (Crospon Inc) was used to assess pyloric sphincter characteristics in all subjects after 12-hour fasting as previously reported.⁷ After trans-nasal insertion of the catheter, correct positioning in the pylorus was controlled using either videofluoroscopy or endoscopy. Previous studies showed that both positioning techniques achieved similar values in patients.^{12,13} The EndoFLIP[®] probe allowed real-time measurement of the cross-sectional areas (CSA) and the pressure of the pyloric sphincter using a bag inflated within the sphincter. Correct positioning was also ascertained continuously with the distinctive shape of the pylorus represented as a narrow segment with decreased CSA. After correct positioning, the bag was filled at set volumes of 10, 20, 30, 40, and 50 mL. For each set volume, pyloric pressure and pyloric distensibility were measured as previously described.⁷ A cut-off of 10 mm²/mm Hg at 40 mL of inflation for normality of distensibility was determined in a previous study^{7,14} in healthy volunteers. Using this threshold value of 10 mm²/mm Hg, pyloric distensibility was classified as normal (>10 mm²/mm Hg) or decreased (<10 mm²/mm Hg).

2.5 | ¹³C-octanoic acid breath test

To ascertain the presence of gastroparesis, gastric emptying measurement was performed after 12-hour fasting as previously reported¹⁵ in patients with history of laparoscopic antireflux surgery. Gastric emptying was not investigated in patients with sleeve gastrectomy or esophagectomy, as there are no normal values established in asymptomatic subjects with similar surgical modification of the gastric architecture.

2.6 | Statistics

Group analyses were carried out using Kruskal-Wallis test followed by Dunn's post-test for multiple comparisons. Correlation studies used the Spearman test. Intraindividual analysis was performed using Wilcoxon test or one-way ANOVA for repeated measures when two or more groups were compared, respectively. A $P < 0.05$ was considered as significant. Results are expressed as the median [25th-75th percentile].

3 | RESULTS

3.1 | Patients

Patients' characteristics were similar between the four groups, except for age that was higher in the esophagectomy group [63 years;

60-73] in comparison with the healthy volunteer group [40 years; 29-58; $P = .01$]. In addition, a lower BMI was observed in the antireflux surgery group [20.9 kg/m²; 19.1-23.9] versus the sleeve gastrectomy group [29.1 kg/m²; 26.2-36.5; $P = .01$]. The delay between surgery and pyloric studies was significantly increased in patients with fundoplication in comparison to patients with sleeve gastrectomy ($P < .05$; Table 1). Characteristics of patients are summarized in Table 1.

Data on GIQLI score were available for all healthy volunteers, but only for 10 patients with fundoplication, eight patients with sleeve gastrectomy, and five patients with esophagectomy. As expected, GIQLI score was lower in all surgical groups in comparison with healthy volunteers ($P < .0001$). However, no difference was observed between the esophagectomy, postfundoplication, and sleeve gastrectomy groups (Table 1).

3.2 | Fasting pyloric distensibility and pressure at 40 mL of inflation

In comparison to the healthy volunteer group [24.8 mm²/mm Hg; 18.7-30.9], fasting pyloric distensibility at 40 mL of inflation was decreased in the antireflux surgery group [7.5 mm²/mm Hg; 4.5-18.3; $P < .01$] and in the esophagectomy group [9.5 mm²/mm Hg; 6.0-15.8; $P < .05$], while it remained unchanged in the sleeve gastrectomy group [18.3 mm²/mm Hg; 13.3-21.4; $P = .42$]. Fasting pyloric pressure at 40 mL of inflation was only increased in the antireflux surgery group [20.5 mm²/mm Hg; 12.0-23.1; $P < .01$] versus the healthy volunteer group [7.9 mm²/mm Hg; 6.8-12.5], while it remained unchanged in both sleeve gastrectomy and esophagectomy groups (Figures 1 and 2).

3.3 | Pyloric dysfunction after surgery at 40 mL inflation

Using the threshold of 10 mm²/mm Hg (ie, the 90% percentile of healthy subjects as previously reported⁷) to determine the normality of fasting pyloric distensibility among groups, 11/18 patients (61.1%) in the antireflux surgery group, 6/9 patients (75%) in the esophagectomy group, and 3/16 patients (18.7%) in the sleeve gastrectomy group ($P < .001$) had decreased pyloric distensibility (Figure 3).

3.4 | Fasting pyloric distensibility and pressure at 10, 20, and 30 mL of inflation (Supporting information)

At 10 mL of inflation, fasting pyloric distensibility was only decreased in the antireflux surgery group [3.8; 1.9-9.1; $P = .035$; Table S1] versus the healthy volunteer group [12.0; 9.2-17.0], while there was no difference in either sleeve gastrectomy or esophagectomy groups ($P > .05$). Fasting pyloric pressure remained unchanged between the

TABLE 1 Patients' characteristics

| | Healthy volunteers | Antireflux surgery | Sleeve gastrectomy | Esophagectomy |
|---|----------------------------|-------------------------------|--------------------|------------------|
| Number | 21 | 18 | 16 | 9 |
| Age (y) | 40 [29-58] | 51 [43-66] | 53 [40-61] | 63 [60-73]* |
| Men/Women | 8/13 | 8/11 | 4/12 | 7/2 |
| Body mass index (kg/m ²) | 23.5 [21.9-26.0] | 20.9 [19.1-23.9] [#] | 29.1 [26.2-36.5] | 22.9 [20.1-24.6] |
| GIQLI score | 137 [131-140] [§] | 61 [54-89] | 77 [70-93] | 77 [70-91] |
| Delay between surgery and pyloric studies (y) | | 4.5 [1.9-12.3] [#] | 1.5 [1.0-2.2] | 1.5 [0.5-4.0] |

Note: Results are expressed either as number or as median [25th-75th percentile].

Abbreviation: GIQLI, Gastrointestinal Quality of Life Index.

**P* < .05 vs healthy volunteers.

[#]*P* < .05 vs sleeve gastrectomy.

[§]*P* < .05 vs all other groups.

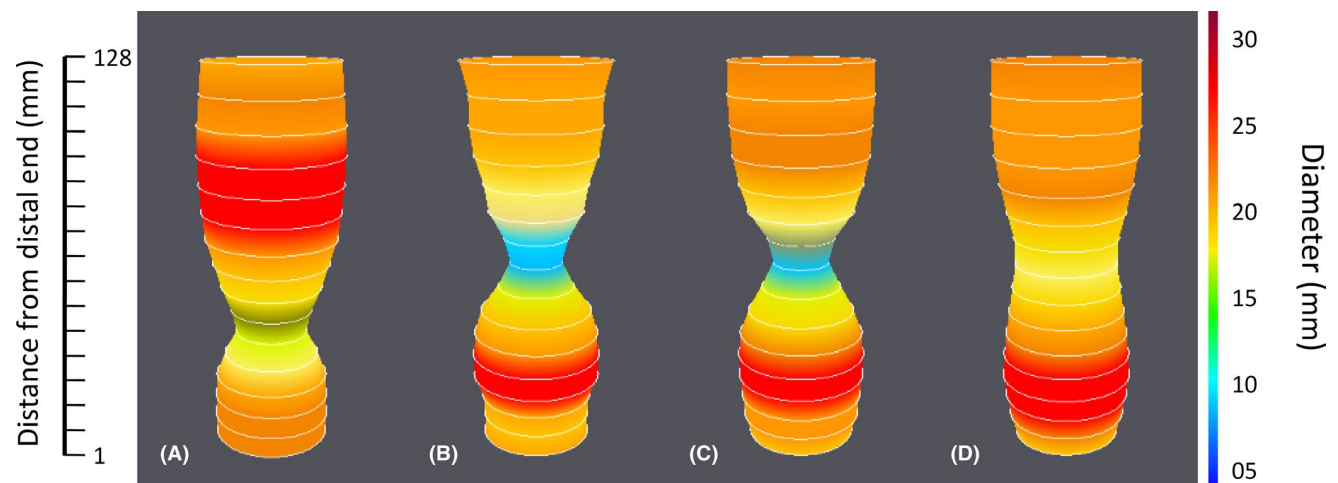

FIGURE 1 Representative recordings of fasting pyloric distensibility in a patient from the Nissen fundoplication (A), sleeve gastrectomy (B), and esophagectomy (C) group with an altered pyloric distensibility of respectively 8.9, 4.1, and 5.8 mm²/mm Hg and in a healthy volunteer with a normal pyloric distensibility of 32.5 mm²/mm Hg (D)

four groups at 10 mL of inflation. Increased fasting pyloric pressure [10.0; 6.6-14.5; *P* = .04] and decreased fasting pyloric distensibility [5.0; 3.1-13.5; *P* < .01] at 20 mL and 30 mL [with respectively 11.9; 8.9-12.8; *P* = .03 and 7.0; 3.7-19.9; *P* < .01] of inflation were only described in the antireflux surgery group vs healthy volunteers, while it remained unchanged in the other groups.

4 | DISCUSSION

To our knowledge, this study is the first to have assessed pyloric sphincter characteristics using EndoFLIP[®] after gastric surgery. Decreased fasting pyloric distensibility at 40 mL of inflation was found in our study in the antireflux surgery and esophagectomy groups, but not in the sleeve gastrectomy group. Increased fasting pyloric pressure at 40 mL of inflation was only found in the antireflux surgery group. Using the threshold of 10 mm²/mm Hg of distensibility at 40 mL of inflation, altered fasting pyloric distensibility was found in 61.1% of

patients in the antireflux surgery group, 75.0% in the esophagectomy group, and 18.7% in the sleeve gastrectomy group in patients with dyspeptic symptoms. Even if these results need further confirmatory studies, this is the first evaluation of the percentage of pylorospasm diagnosed using EndoFLIP[®] system among patients with dyspeptic symptoms following upper gastrointestinal surgery. We recently reported that pyloric distensibility may be of use to better select patients undergoing intrapyloric botox.¹⁴ Likewise, a previous report suggested that pyloric distensibility could also predict patient outcome after Gastric Per-Oral Endoscopic Pyloromyotomy (G-POEM).¹⁶ Given the fact that the presence of altered pyloric distensibility was not observed in all patients, whatever the surgery type, this assessment may help in the future to better select patients who could benefit from pyloric intervention.

Esophagectomy surgery was mostly associated with altered pyloric distensibility in the present study, impacting 75% of patients with dyspeptic symptoms. In fact, thoracoabdominal esophagectomy is constantly associated with truncal vagotomy during the

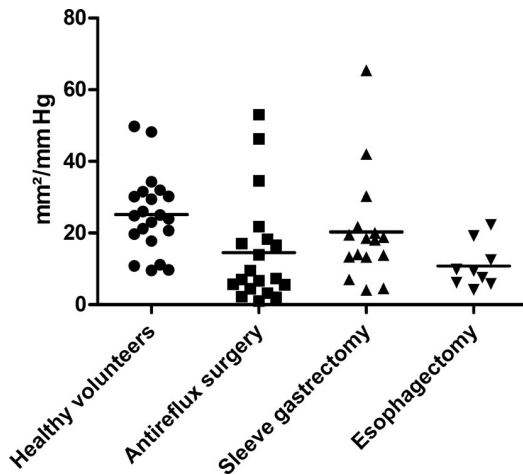

FIGURE 2 Pyloric distensibility at 40 mL (A) was decreased in the antireflux surgery group [7.5 mm²/mm Hg; 4.5-18.3; $P < .01$] and in the esophagectomy group [9.5 mm²/mm Hg; 6.0-15.8; $P < .05$] in comparison to healthy volunteers. Pyloric pressure (B) was only increased in the antireflux surgery group [20.5 mm²/mm Hg; 12.0-23.1; $P < .01$] in comparison to healthy volunteers

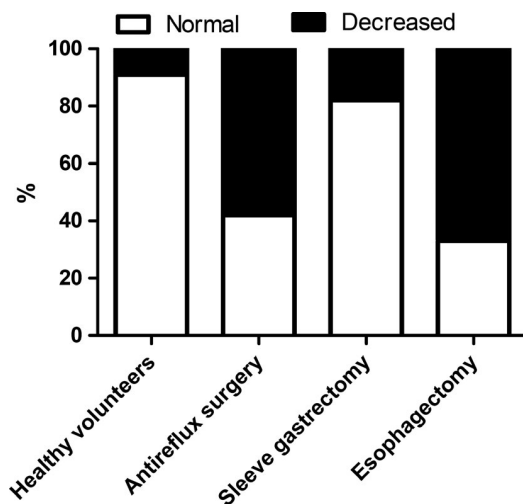

FIGURE 3 Percentage of patients with normal and decreased pyloric distensibility at 40 mL in the four groups of patients

procedure.¹⁷ However, the pathophysiology of delayed gastric emptying following esophagectomy remains controversial. On the one hand, vagal damage following gastric tubulization is thought to affect gastric motility and to lead to pyloric denervation.¹⁸ On the other hand, there is some evidence that motor activity of the gastric tube,¹⁹ especially pyloric and antral motility, can recover at distance from surgery without reaching normality and this even after pyloroplasty.²⁰ Consequently, symptoms of delayed gastric emptying are frequent after esophagectomy, affecting 10%-50% of patients²¹ among studies and are associated with worsened outcomes, poor quality of life, and higher rate of reoperation.²² However, definitive diagnosis of gastroparesis following esophagectomy is difficult to assess because there is no normal value of gastric emptying measurement in asymptomatic patients with esophagectomy in the

literature. This explains why diagnosis of gastroparesis is, in most reports, only based on clinical evaluation.²³ In the present study, the rate of pylorospasm was particularly high in these patients, but all included patients reported symptoms of delayed gastric emptying. Recent meta-analyses^{23,24} have attempted to evaluate the influence of systematic pyloric intervention during esophageal reconstruction on outcomes of esophagectomy. Their results showed that systematic pyloric intervention (including pyloromyotomy, pyloroplasty, digital fracture, and botox injection) did not influence the incidence of symptoms of delayed gastric emptying after esophagectomy. Moreover, systematic pyloric intervention can lead to complications like dumping syndrome or biliary reflux, not compensating unproven benefits. Therefore, there are arguments in order to better select candidates for pyloric drainage as not all patients presented pylorospasm in the present study, even if all patients were symptomatic.

Nissen fundoplication was also mainly associated (61.1% of patients) with decreased fasting pyloric distensibility in the present study. Even if diagnosis of gastroparesis can be done in case of delayed gastric emptying symptoms following surgery, the incidence of gastroparesis after Nissen fundoplication remains debated. A recent retrospective cohort which collected data from 3152 patients who underwent Nissen fundoplication found 3.8% of gastroparesis diagnosed following surgery, but the diagnostic of gastroparesis was in most cases based on the necessity of secondary pyloric intervention.⁵ The incidence of patients with pylorospasm following Nissen fundoplication in our study was particularly high but all patients included had proven gastroparesis before investigation. It has been reported that pylorospasm can occur in 30%-50% of patients with gastroparesis in a study including three patients with postfundoplication gastroparesis⁷ among 27 gastroparetic patients, using the same threshold of 10 mm²/mm Hg to assess pyloric dysfunction. Our results confirm these previous data and the higher number of patients with decreased pyloric distensibility could be explained by the fact that all our patients were symptomatic contrary to those in this study. Moreover, another study²⁵ showed that pyloroplasty can offer relief from postfundoplication gastroparesis symptoms in patients whose symptoms were improved after botulinum toxin injection. This study therefore suggests a better selection of patients undergoing targeted pyloric therapies in this subgroup of patients. Two previous studies investigated the potential predictive effect of pyloric distensibility on symptomatic response to pyloric therapies. The first one showed, in a prospective cohort of 35 gastroparetic patients, including six cases of postfundoplication gastroparesis, that decreased pyloric distensibility was associated with a better symptomatic response to intrapyloric botulinum toxin injections.¹⁴ The second one investigated the efficacy of G-POEM in gastroparetic patients, showing in a small number of patients that decreased pyloric distensibility <9.2 mm²/mm Hg was associated with 3-month clinical efficacy.¹⁶ These interesting results cannot yet be extrapolated to postfundoplication gastroparesis, but this will be the object of further studies. Lastly, pyloric dysfunction is not the only mechanism that could explain dyspeptic symptoms following Nissen fundoplication, indeed almost 38.1% of patients had normal pyloric

distensibility. Impaired gastric accommodation was found increased in post-Nissen dyspepsia patients.²⁶

Among the three types of surgery in our study, sleeve gastrectomy had the lowest rate of decreased fasting pyloric distensibility with only 18.7% of patients. As sleeve gastrectomy is a frequent surgery due to a worldwide increase in bariatric surgery,²⁷ it is important to understand its influence on pyloric sphincter characteristics. In fact, the impact of sleeve gastrectomy on gastric emptying remains controversial in the literature. On the one hand, several studies have reported accelerated gastric emptying following sleeve gastrectomy.^{6,28} This may result from the reduction in volume of the gastric reservoir which is specific to the proximal stomach which may lead to increased intragastric pressure after meals, resulting in accelerated passage of nutrients to the small bowel.^{29,30} On the other hand, the resection of the gastric pacemaker zone during sleeve gastrectomy can result in aberrant distal ectopic pacemaking or bioelectrical quiescence according to results from a recent study.³¹ However, the clinical relevance of this postoperative gastric dysrhythmia requires further investigations. Conversely, the literature regarding vagal nerve lesions and associated gastroparesis following sleeve gastrectomy remains scant. As for esogastrectomy, there is no normal value to assess gastric emptying in patients with sleeve gastrectomy. The low incidence of pylorospasm following sleeve gastrectomy in the present study suggests that vagal injury after sleeve gastrectomy remains exceptional, but mechanisms of residual pylorospasm (18.7% of patients) are still unclear in this subgroup of symptomatic patients.

EndoFLIP[®] system could be used in patients with dyspeptic symptoms following esogastric surgery. As it reflects vagotomy or gastroparesis, it could be complementary to gastric emptying. Moreover, it might help to better select patients undergoing treatments targeting pyloric therapies in case of pylorospasm, like botulinum toxin injections or G-POEM for example.^{14,16} In a previous study including a small number of patients with postfundoplication gastroparesis, it was shown that an altered pyloric distensibility was associated with the symptomatic response to intrapyloric botulinum toxin injections but not a normal pyloric distensibility.¹⁴ Moreover, our results suggest that vagal nerve injury was not present in all patients in the esophagectomy group, which is in contradiction with the performance of systematic vagotomy during laparotomy. This point will need further investigations to determine whether vagal nerve injury can affect other mechanisms than pylorospasm, like accommodation dysfunction.

A limitation of our study could be the small number of patients included which however is not different from that of a cohort found in the literature in evaluation of EndoFLIP[®] system.^{7,12} This may also be related to the low incidence of delayed gastric emptying following esogastric surgery. A second limitation is that gastric emptying was not measured in patients with esophagectomy or sleeve gastrectomy. As previously outlined, normal values are lacking for this particular subgroup of patients. In addition, we did not perform correlation studies between pyloric studies and validated questionnaires like GCSI (Gastroparesis Cardinal Symptom Index) in the present study. Last, we have not reported in the present study patients'

follow-up after pyloric intervention. In fact, we only identified 20 patients with decreased pyloric distensibility which is too small a number to assess prospectively the predictive value of EndoFLIP[®] on symptoms.

5 | CONCLUSION

Decreased pyloric distensibility was found in the majority of patients with dyspeptic symptoms after antireflux surgery and esophagectomy, but not in all patients. In contrast, a minority of patients displayed altered pyloric distensibility after sleeve gastrectomy. This suggests that pylorospasm is not a frequent consequence of sleeve gastrectomy, and that this surgery is barely associated with vagal lesion. However, these first results warrant further confirmatory studies.

ACKNOWLEDGMENTS

We are grateful to Nikki Sabourin-Gibbs, Rouen University Hospital, for her help in editing the manuscript.

CONFLICT OF INTEREST

Guillaume Gourcerol has received consulting fees from Allergan. The other authors have no conflict of interest to declare.

AUTHOR CONTRIBUTIONS

GG is the guarantor of article. GG conceptualised and designed the study; GG, CM, EH, and JJ performed patient recruitment and selection; GG and JJ involved in data acquisition: Endoflip measures; GG, AML, and CD performed gastric emptying; GG and CD analyzed data; GG, AML, and CD performed interpretation of data; GG and CD wrote the manuscript. All authors have approved the final version of the article, including the authorship list.

ORCID

Charlotte Desprez  <https://orcid.org/0000-0002-1280-7675>

Chloé Melchior  <https://orcid.org/0000-0002-8146-1540>

Fabien Wuestenberghs  <https://orcid.org/0000-0001-6100-6017>

Jérémie Jacques  <https://orcid.org/0000-0003-4105-6804>

Anne-Marie Leroi  <https://orcid.org/0000-0002-6266-4203>

Guillaume Gourcerol  <https://orcid.org/0000-0001-8220-9155>

REFERENCES

1. Jung H, Choung RS, Locke GR, et al. The incidence, prevalence, and outcomes of patients with gastroparesis in Olmsted County, Minnesota, from 1996 to 2006. *Gastroenterology*. 2009;136:1225-1233.
2. Soykan I, Sivri B, Sarosiek I, et al. Demography, clinical characteristics, psychological and abuse profiles, treatment, and long-term follow-up of patients with gastroparesis. *Dig Dis Sci*. 1998;43:2398-2404.
3. Maier WP, Masloff ML, Rosemond GP. Changes in the pylorus following vagotomy in dogs. *Arch Surg*. 1968;97:108-110.
4. Eagon JC, Miedema BW, Kelly KA. Postgastrectomy syndromes. *Surg Clin North Am*. 1992;72:445-465.
5. Lu D, Altieri MS, Yang J, et al. Investigating rates of reoperation or postsurgical gastroparesis following fundoplication or

- paraesophageal hernia repair in New York State. *Surg Endosc*. 2018;33(9):2886-2894.
6. Ardila-Hani A, Soffer EE. Review article: the impact of bariatric surgery on gastrointestinal motility. *Aliment Pharmacol Ther*. 2011;34:825-831.
 7. Gourcerol G, Tissier F, Melchior C, et al. Impaired fasting pyloric compliance in gastroparesis and the therapeutic response to pyloric dilatation. *Aliment Pharmacol Ther*. 2015;41:360-367.
 8. Davis BR, Sarosiek I, Bashashati M, Alvarado B, McCallum RW. The long-term efficacy and safety of pyloroplasty combined with gastric electrical stimulation therapy in gastroparesis. *J Gastrointest Surg*. 2017;21:222-227.
 9. Grover I, Kim R, Spree DC, et al. Gastric electrical stimulation is an option for patients with refractory cyclic vomiting syndrome. *J Neurogastroenterol Motil*. 2016;22:643-649.
 10. Eypasch E, Williams JI, Wood-Dauphinee S, et al. Gastrointestinal Quality of Life Index: development, validation and application of a new instrument. *Br J Surg*. 1995;82:216-222.
 11. Slim K, Bousquet J, Kwiatkowski F, et al. First validation of the French version of the Gastrointestinal Quality of Life Index (GIQLI). *Gastroenterol Clin Biol*. 1999;23:25-31.
 12. Malik Z, Sankineni A, Parkman HP. Assessing pyloric sphincter pathophysiology using EndoFLIP in patients with gastroparesis. *Neurogastroenterol Motil*. 2015;27:524-531.
 13. Snape WJ, Lin MS, Agarwal N, Shaw RE. Evaluation of the pylorus with concurrent intraluminal pressure and EndoFLIP in patients with nausea and vomiting. *Neurogastroenterol Motil*. 2016;28:758-764.
 14. Desprez C, Melchior C, Wuestenberghs F, et al. Pyloric distensibility measurement predicts symptomatic response to intrapyloric botulinum toxin injection. *Gastrointest Endosc*. 2019;90(5):754-760.e1. <https://doi.org/10.1016/j.gie.2019.04.228>.
 15. Ghooos YF, Maes BD, Geypens BJ, et al. Measurement of gastric emptying rate of solids by means of a carbon-labeled octanoic acid breath test. *Gastroenterology*. 1993;104:1640-1647.
 16. Jacques J, Pagnon L, Hure F, et al. Peroral endoscopic pyloromyotomy is efficacious and safe for refractory gastroparesis: prospective trial with assessment of pyloric function. *Endoscopy*. 2018;51(01), 40-49.
 17. Müller JM, Erasmí H, Stelzner M, Zieren U, Pichlmaier H. Surgical therapy of oesophageal carcinoma. *Br J Surg*. 1990;77:845-857.
 18. Gupta S, Chattopadhyay TK, Gopinath PG, et al. Emptying of the intrathoracic stomach with and without pyloroplasty. *Am J Gastroenterol*. 1989;84:921-923.
 19. Collard JM, Romagnoli R, Otte JB, et al. The denervated stomach as an esophageal substitute is a contractile organ. *Ann Surg*. 1998;227:33-39.
 20. Nakabayashi T, Mochiki E, Garcia M, et al. Gastropyloric motor activity and the effects of erythromycin given orally after esophagectomy. *Am J Surg*. 2002;183:317-323.
 21. Poghosyan T, Gaujoux S, Chirica M, Munoz-Bongrand N, Sarfati E, Cattán P. Functional disorders and quality of life after esophagectomy and gastric tube reconstruction for cancer. *J Visc Surg*. 2011;148:e327-e335.
 22. Benedix F, Willems T, Kropf S, Schubert D, Stübs P, Wolff S. Risk factors for delayed gastric emptying after esophagectomy. *Langenbecks Arch Surg*. 2017;402:547-554.
 23. Akkerman RDL, Haverkamp L, van Hillegersberg R, Ruurda JP. Surgical techniques to prevent delayed gastric emptying after esophagectomy with gastric interposition: a systematic review. *Ann Thorac Surg*. 2014;98:1512-1519.
 24. Arya S, Markar SR, Karthikesalingam A, Hanna GB. The impact of pyloric drainage on clinical outcome following esophagectomy: a systematic review. *Dis Esophagus*. 2015;28:326-335.
 25. Gilsdorf D, Volckmann E, Brickley A, Taylor LJ, Glasgow RE, Fang J. Pyloroplasty offers relief of postfundoplication gastroparesis in patients who improved after botulinum toxin injection. *J Laparoendosc Adv Surg Tech A*. 2017;27:1180-1184.
 26. Pauwels A, Boecxstaens V, Broers C, Tack JF. Severely impaired gastric accommodation is a hallmark of post-Nissen functional dyspepsia symptoms. *Neurogastroenterol Motil*. 2017;29.
 27. Benaiges D, Más-Lorenzo A, Goday A, et al. Laparoscopic sleeve gastrectomy: more than a restrictive bariatric surgery procedure? *World J Gastroenterol*. 2015;21:11804-11814.
 28. Camilleri M, Chedid V, Ford AC, et al. Gastroparesis. *Nat Rev Dis Primers*. 2018;4:41.
 29. Mans E, Serra-Prat M, Palomera E, Suñol X, Clavé P. Sleeve gastrectomy effects on hunger, satiation, and gastrointestinal hormone and motility responses after a liquid meal test. *Am J Clin Nutr*. 2015;102:540-547.
 30. Sista F, Abruzzese V, Clementi M, Carandina S, Cecilia M, Amicucci G. The effect of sleeve gastrectomy on GLP-1 secretion and gastric emptying: a prospective study. *Surg Obes Relat Dis*. 2017;13:7-14.
 31. Berry R, Cheng LK, Du P, et al. Patterns of abnormal gastric pacing after sleeve gastrectomy defined by laparoscopic high-resolution electrical mapping. *Obes Surg*. 2017;27:1929-1937.

SUPPORTING INFORMATION

Additional supporting information may be found online in the Supporting Information section.

How to cite this article: Desprez C, Melchior C, Wuestenberghs F, et al. Pyloric distensibility measurement after gastric surgery: Which surgeries are associated with pylorospasm?. *Neurogastroenterol Motil*. 2020;00:e13790. <https://doi.org/10.1111/nmo.13790>

3. La relation entre les résultats de l'EndoFLIP® anal et la présentation clinique de l'incontinence fécale

Il a été mis en évidence que la distensibilité du canal anal était plus élevée chez les patients avec incontinence fécale (IF) en comparaison aux volontaires sains(165). Par ailleurs, l'index de distensibilité anale serait un paramètre permettant une meilleure discrimination entre les sujets continents et incontinents que la pression anale manométrique(13). Actuellement, 3 sous-types d'IF sont décrits et utilisés au cours du bilan clinique des patients : active (IF précédée d'un besoin exonérateur impérieux), passive (IF sans besoin exonérateur préalable), ou mixte. La détermination du sous-type d'IF est importante car elle oriente vers un des mécanismes physiopathologiques de l'IF qui conditionne le traitement médical de 1^{ère} ligne. Ainsi, une IF active serait en faveur d'une incompétence du sphincter anal externe, alors que l'IF passive serait associée à une incompétence du sphincter anal interne(140). La manométrie anorectale n'a pas permis de confirmer l'association entre sous-type d'IF et incompétence sphinctérienne(140). L'objectif de notre étude était donc d'évaluer la relation entre le sous-type d'IF et la distensibilité du canal anal via l'utilisation de la technologie EndoFLIP®.

Pour cela, nous avons étudié la corrélation entre le sous-type d'IF, évalué cliniquement, et les résultats des différents examens réalisés chez des patients avec IF, dans notre centre (manométrie ano-rectale, anoscopie, rectoscopie, tests électrophysiologiques du périnée, échographie endo-anale) et les résultats de l'EndoFLIP® anal. Les paramètres de l'EndoFLIP® étudiés étaient la distensibilité anale au repos et lors de la contraction volontaire.

Nos résultats ont pu montrer que, parmi 133 patients inclus, 41% présentaient une IF active, 30% passive et 29% mixte. L'index de distensibilité anale au repos à 50 mL de distension était plus faible chez les patients avec IF active que chez les patients avec IF passive ($p=0,04$). Au repos, à 50 mL de distension, une distensibilité anale $\geq 7,3 \text{ mm}^2/\text{mmHg}$ et une distensibilité anale $< 1,3 \text{ mm}^2/\text{mmHg}$ étaient associées respectivement avec les sous-types d'IF passive et

active, avec un faible pouvoir discriminant (exactitude de 0,49). Aucune différence n'a été mise en évidence pour les résultats des autres explorations parmi les différents sous-types d'IF. Ce faible pouvoir discriminant de l'EndoFLIP® pour la détermination du sous-type d'IF était probablement lié à la fréquence des mécanismes multifactoriels responsables de l'IF. Ainsi, l'IF active était significativement plus fréquente chez des patients présentant à la fois une incompétence du sphincter anal externe, un miro-rectum et une diarrhée chronique.

Ce travail a démontré une faible valeur de la distensibilité anale au repos et lors de la contraction volontaire pour prédire le sous-type d'IF.



ORIGINAL ARTICLE

Relationship between anal functional lumen imaging probe (EndoFLIP®) results and the clinical presentation of faecal incontinence

Charlotte Desprez¹ | Guillaume Gourcerol² | Céline Savoye-Collet³ | Valérie Bridoux⁴ | Thomas Dufлот⁵  | Anne-Marie Leroi²

¹Department of Digestive Physiology, Rouen University Hospital, Rouen, France

²Department of Digestive Physiology, CIC-CRB 1404, Inserm U1073, CHU Rouen, Normandie Université, UNIROUEN, Rouen, France

³Department of Radiology, Normandie Université, UNIROUEN, CHU Rouen, Rouen, France

⁴Department of Digestive Surgery, Inserm U1073, Normandie Université, UNIROUEN, CHU Rouen, Rouen, France

⁵Department of Pharmacology, Normandie Université, UNIROUEN, Inserm U1096, CHU Rouen, Rouen, France

Correspondence

Charlotte Desprez, Digestive Physiology Unit, Rouen University Hospital, 1 Rue de Germont, 76031 Rouen, Cedex, France.
Email: charlotte.desprez@chu-rouen.fr

Funding information

None. This research did not receive any funding from the public, commercial or not-for-profit sectors.

Abstract

Aim: Faecal incontinence (FI) subtypes (urge, passive, mixed) are linked to the pathophysiological mechanism of FI. Previous studies have failed to demonstrate a consistent relationship between FI subtype and anal sphincter dysfunction. Our aim was to evaluate the relationship between anal sphincter function, assessed using the new EndoFLIP® technology, and FI subtype.

Method: Patients referred for FI were prospectively enrolled between October 2015 and May 2021 in a registry, and data were retrospectively examined. Each patient underwent a clinical assessment as well as three-dimensional high-resolution or water-perfused anorectal manometry, anal EndoFLIP®, and anorectal electrophysiological and endoanal ultrasound tests. The results of the investigations were compared across FI subtypes.

Results: The cohort included 133 patients, 54 (41%) of whom met the criteria for urge FI, 40 (30%) for passive FI and 39 (29%) for mixed FI. The resting anal distensibility index (DI) at 50 ml of distension was significantly lower in patients with urge FI than in patients with passive FI ($p = 0.04$). At rest, a DI at 50 ml of distension $\geq 7.3 \text{ mm}^2 \text{ mmHg}^{-1}$ and a DI at 40 ml of distension $< 1.3 \text{ mm}^2 \text{ mmHg}^{-1}$ were associated with the passive and urge FI subtypes, respectively, with poor discriminatory power (an accuracy of 0.49 compared with 0.33 for random assignment). There were no differences in anorectal manometry, endoanal ultrasound or electrophysiological test results among the urge, passive and mixed FI subgroups (all $p > 0.05$).

Conclusion: The anal sphincter DI using the EndoFLIP® system displayed poor predictive performance in distinguishing among FI subtypes.

What does this paper add to the literature?

The relationship between faecal incontinence (FI) subtype and anal sphincter dysfunction has not been clearly elucidated using

standard tests. The new EndoFLIP® system for measuring anal distensibility can distinguish between FI subtypes in some extreme cases but is not powerful enough to be used alone to diagnose a given FI subtype.

This is an open access article under the terms of the [Creative Commons Attribution](https://creativecommons.org/licenses/by/4.0/) License, which permits use, distribution and reproduction in any medium, provided the original work is properly cited.

© 2022 The Authors. *Colorectal Disease* published by John Wiley & Sons Ltd on behalf of Association of Coloproctology of Great Britain and Ireland.

INTRODUCTION

Faecal incontinence (FI) is defined by the Rome IV criteria as the involuntary loss of faeces at least twice a month over a 6 month period [1]. This condition is classified by the International Continence Society (ICS) into two subtypes: urge incontinence, defined as the unwanted loss of stool despite active attempts to inhibit defaecation, and passive incontinence, defined as unwanted loss of stool without patient awareness [2]. However, a third subtype, mixed FI, is also described in many studies and is defined as a combination of urge and passive FI [3]. This subtype may be related to the underlying pathophysiological mechanisms responsible for FI and may serve as a guide for first-line therapeutics [4]. In clinical practice, dysfunction of the external anal sphincter leading to decreased squeeze pressures is associated with urge FI [5–7] while impairment of the internal anal sphincter has been linked to passive incontinence [5, 8]. Previous studies have not demonstrated a clear association between FI subtype and anal sphincter dysfunction [3]. This could be due to a lack of sensitivity of current anorectal investigations (i.e. manometry) for properly assessing anal sphincter function [9].

The EndoFLIP® system was developed to study a new parameter of anal sphincter competence, i.e. sphincter resistance to transsphincteric flow or the distensibility index (DI) [10]. The DI is abnormally high in patients with FI [11–14] and better discriminates healthy subjects from patients with FI than manometric anal pressures [13]. The anal DI could thus be a prime determinant of sphincteric strength [15].

The aim of the present study was to evaluate the relationship between FI subtype and the anal DI evaluated using EndoFLIP® technology.

METHOD

Patients

Patients with FI who were referred to the Physiology Unit of Rouen University Hospital (France) between October 2015 and May 2021 for physiological investigations of anorectal function were prospectively enrolled in a registry, and their data were retrospectively examined. Age (below 18 years) and isolated gas incontinence were the only exclusion criteria. As our objective was to assess the relationship between FI subtypes and their mechanisms using EndoFLIP® technology, we wanted to explore a large population of FI patients with no criteria of selection for age or sex to avoid selection bias with respect to the aetiology of the sphincter deficiency (e.g. obstetric trauma could be more frequently observed in younger women) and to evaluate EndoFLIP® in the routine practice of a tertiary care centre.

Some of the patients had been included in a previous study [14]. Ethical approval for data collection from patients with FI was obtained in accordance with data protection and civil liberties legislation (CNIL, E2022-07).

Clinical assessment of FI patients

During the screening visit, the clinical characteristics of the patients were recorded. Additional information, including duration of FI, details of stool consistency using the Bristol stool form scale [16] and the presence of transit disorders [17] (Rome IV criteria) was collected. FI severity was assessed using the Cleveland Clinic Incontinence Score (CCIS) [18] and the Vaizey score [19]. The Vaizey score considers the same items as the CCIS in addition to items concerning the use of constipating medication and the lack of ability to defer defaecation for 15 min [19]. Quality of life (QOL) was assessed using the French version of the American Society of Colon and Rectal Surgeons QOL auto-questionnaire for FI (FIQL) [20]. One of the items of the embarrassment domain of the FIQL questionnaire is related to passive FI ('I leak stool without even knowing it.') [20].

To classify patients according to FI subtype, definitions validated by the ICS were used in the present study [2]. Urge incontinence was defined as the unwanted loss of stool despite active attempts to inhibit defaecation. Passive incontinence was defined as the unwanted loss of stool without the person being aware. This information was collected during structured interviews that were not standardized and/or validated conducted in our routine practice by three trained physicians from our department (AML, VB, GG). Patients who said they were almost exclusively incontinent because they had 'great urgency and could not reach the toilet on time' were considered to have urge incontinence whereas patients who said they were almost exclusively 'unaware when the leakage was actually happening' were considered to have passive incontinence. Lastly, patients who reported both FI subtypes were considered to have mixed incontinence. Three subgroups of patients were created based on FI subtype (urge, passive, mixed).

Anorectal functional tests

Each FI patient underwent a clinical examination and a battery of pelvic floor examinations, including three-dimensional high-resolution anorectal manometry (3D-HRAM) or water-perfused anorectal manometry (depending on the time period), as well as electrophysiological and endoanal ultrasound tests. An anoscopy-rectoscopy was performed to assess anorectal intussusception and prolapse. Water-perfused anorectal manometry and 3D-HRAM, endoanal ultrasounds, electrophysiological tests and anoscopy-rectoscopy were performed as previously described [14, 21, 22].

Regardless of the type of manometry used (3D-HR or water-perfused), manoeuvres were performed with a standard sequence that included a 30 s recovery period between each manoeuvre: rest—anorectal pressures were measured with the subject relaxed after a 15 min rest period; squeeze—the subject was instructed to squeeze the anal canal as strongly and for as long as possible (two attempts). The best performance of the two trials was selected and used for the analysis. The rectal sensory test involved inflating a

rectal balloon with air in 10 ml increments using a hand-held syringe and recording the threshold volumes and pressures for minimal sensation and maximum tolerated volume [14].

The likely underlying mechanisms of FI were determined based on clinical assessment, anorectal manometry, EndoFLIP® and anoscopy-rectoscopy results. Nine possible isolated or associated underlying mechanisms for FI were identified for each patient: anal hypocontractility (abnormal maximal voluntary squeeze pressure and/or duration), anal hypotonia (abnormal anal resting pressure), rectal hypersensitivity (reduced rectal capacity with or without low compliance), rectal hyposensitivity (elevated rectal capacity with or without high compliance), constipation, diarrhoea, proci-dencia/prolapse, low anterior resection syndrome (LARS) and id-iopathic. As the subtype of FI is supposed to direct us toward an anorectal dysfunction without prejudging its aetiology, we only listed the different types of anorectal dysfunctions but not the potential causes of these dysfunctions (i.e. anal sphincter defect, pudendal neuropathy).

EndoFLIP® assessments

The DI of the anal sphincter was measured using the EndoFLIP® system (Crospon Ltd) as previously described [13]. The device (catheter EF-325 N) consists of a two-lumen polyethylene tube with an outer diameter of 3 mm. Seventeen ring electrodes placed at 4 mm intervals measured electrical impedance to estimate the cross-sectional area (CSA) at 16 points, 5 mm apart. The CSA measurements were performed over an 8 cm long zone. A 12 cm long bag was mounted on the probe and was filled with saline solution to a maximum diameter of 25 mm. The intra-bag pressure was calculated using a solid-state pressure transducer placed inside the bag at the distal end. During the procedure, the EndoFLIP® probe was inserted and two detection electrodes remained visible outside the anal verge. The probe was held in place manually. The bag was filled with 0–50 ml of conductive saline solution in 10 ml increments at a rate of 40 ml/min. The resting measurements were recorded after 30 s, following which the subjects were asked to squeeze for each inflation level.

Statistical analyses

The concurrent validity, including sensitivity, specificity and positive and negative predictive values of the two items related to faecal urgency in the Vaizey score [19] and to passive FI in the FIQL questionnaire [20] were analysed and were compared with the medical interview as a reference standard.

The EndoFLIP® and 3D-HRAM data were analysed as described elsewhere [13]. Sixteen CSAs and intra-bag pressures were assessed with 40 ml and 50 ml of saline solution at rest and during voluntary contractions. The DI ($\text{mm}^2 \text{mmHg}^{-1}$) was defined as the CSA at the narrowest point divided by the corresponding intra-bag pressure at

rest and during peak voluntary contraction. As we have previously shown that the 40 ml and 50 ml DI at rest and during squeeze are the most relevant parameters for exploring patients with FI [13], we only used these indices in the present study. For anorectal manometry, the following parameters were analysed: length of the high-pressure zone (for 3D-HRAM), resting pressure (eSleeve resting pressure for 3D-HRAM), incremental maximal and mean squeeze pressures (maximal/mean squeeze pressure minus resting pressure), duration of the sustained anal contraction, rectal sensation, volumes and compliance [14].

Given the different manometric systems (high-resolution and water-perfused) with specific normal values, the manometry and EndoFLIP® measurements were also expressed as normal or abnormal sphincter/rectal function. The cut-off values for the DIs, pressures and volumes used to divide the patients into normal and abnormal groups were obtained from a study of a normal healthy population of women for the 3D-HRM and EndoFLIP® [13] measurements (10th–90th percentiles) and from our unpublished data for water-perfused anorectal manometry (Table 1).

The FI subtypes were compared between patients with a majority of FI mechanisms known to provoke urge incontinence (anal

TABLE 1 Cut-off values for the pressures, volumes, compliance and DIs used to divide patients into two groups (normal and abnormal) obtained from a study on a normal healthy population of women for 3D-HRAM and EndoFLIP® (Gourcerol, 2016; 10th–90th percentiles) and from our unpublished data for water-perfused anorectal manometry

| Parameters | Normal values |
|--|---------------|
| Water-perfused anorectal manometry | |
| Anal resting tone (cmH_2O) | ≥ 60 |
| Maximum squeeze pressure (cmH_2O) | ≥ 60 |
| Threshold volume (ml) | ≤ 20 |
| Maximal tolerated volume (ml) | 100–400 |
| Rectal compliance ($\text{ml cmH}_2\text{O}^{-1}$) | 2–10 |
| 3D-HRAM | |
| Anal resting tone (mmHg) | > 58 |
| Maximum squeeze pressure (mmHg) | > 54 |
| Mean squeeze pressure (mmHg) | > 6 |
| Squeeze pressure duration (s) | > 15 |
| Threshold volume (ml) | > 30 |
| Maximal tolerated volume (ml) | 150–340 |
| Rectal compliance (ml mmHg^{-1}) | 5–12 |
| Anal EndoFLIP® | |
| 40 ml DI at rest ($\text{mm}^2 \text{mmHg}^{-1}$) | < 1 |
| 40 ml DI during squeeze ($\text{mm}^2 \text{mmHg}^{-1}$) | < 0.6 |
| 50 ml DI at rest ($\text{mm}^2 \text{mmHg}^{-1}$) | < 2.9 |
| 50 ml DI during squeeze ($\text{mm}^2 \text{mmHg}^{-1}$) | < 1.5 |

Abbreviations: 3D-HRAM, three-dimensional high-resolution anal manometry; DI, distensibility index.

TABLE 2 Clinical characteristics of the 133 patients with FI according to subtype

| Parameter | All (N = 133) | Urge FI (N = 54) | Passive FI (N = 40) | Mixed FI (N = 39) | p-value |
|---------------------------------------|------------------|------------------|---------------------|-------------------|---------|
| Age (years) | 64 [55-73] | 64.5 [55.5-71.5] | 70 [59-76]* | 63 [50-69]* | 0.014 |
| Sex (male/female) | 14/119 | 5/49 | 6/34 | 3/36 | 0.593 |
| BMI (kg m ⁻²) | 26.3 [23.1-29.3] | 27.0 [22.7-29.7] | 24.8 [22.1-27.4] | 26.6 [24.1-29.6] | 0.143 |
| Parity | 2.2 [1.8-3] | 2.0 [2.0-3.0] | 2 [2.0-3.0] | 2 [1.0-2.5] | 0.127 |
| Medical comorbidities, n (%) | | | | | |
| Neurological disease | 17 (12.8) | 4 (7.4) | 6 (15) | 7 (17.9) | 0.285 |
| Psychiatric disease | 18 (13.3) | 5 (9.3) | 6 (15.0) | 7 (17.9) | 0.457 |
| Anorectal surgery | 39 (29.3) | 12 (22.2)** | 8 (20.0)* | 19 (48.7)*** | 0.006 |
| Diabetes | 12 (9.0) | 8 (14.8) | 3 (7.5) | 1 (2.6) | 0.115 |
| Colorectal cancer | 4 (3.0) | 1 (1.9) | 0 (0.0) | 3 (7.7) | 0.139 |
| Irritable bowel syndrome | 37 (28.7) | 9 (17.3) | 14 (35.9) | 14 (36.8) | 0.063 |
| Menopause | 89 (73.6) | 36 (73.5) | 30 (85.7) | 23 (62.2) | 0.077 |
| Traumatic delivery | 72 (59.5) | 32 (65.3) | 16 (45.7) | 24 (64.9) | 0.143 |
| Associated urinary incontinence | 40 (30.1) | 14 (25.9) | 15 (37.5) | 11 (28.2) | 0.665 |
| Transit disorders, n (%) | | | | | |
| Diarrhoea | 30 (22.5) | 15 (27.8) | 5 (12.5) | 10 (25.6) | 0.185 |
| Constipation | 21 (15.8) | 2 (3.7)*** | 17 (42.5)**** | 2 (5.1)* | 0.0001 |
| Duration, n (%) | N = 130 | N = 52 | N = 39 | N = 39 | |
| <1 year | 18 (13.8) | 6 (11.5) | 6 (15.4) | 6 (15.4) | |
| 1-5 years | 57 (43.8) | 21 (40.4) | 21 (53.8) | 15 (38.5) | |
| 5-10 years | 29 (22.3) | 13 (25.0) | 7 (17.9) | 9 (23.1) | |
| >10 years | 26 (22.0) | 12 (23.1) | 5 (12.8) | 9 (23.1) | |
| CCIS | 11 [8-14] | 11 [8-14] | 11 [8-14] | 12 [10-15] | 0.073 |
| Vaizey score | 14 [11-17] | 14 [12-16] | 12 [10-16]* | 15 [13-18]* | 0.009 |
| FIQL | | | | | |
| Lifestyle | 2.6 [1.8-3.1] | 2.7 [1.7-3.1] | 2.7 [2.3-3.3]* | 2.3 [1.5-3.0]* | 0.048 |
| Coping and behaviour | 1.7 [1.3-2.3] | 1.7 [1.2-2.1]*** | 1.9 [1.4-2.8]**** | 1.4 [1.2-2.2]* | 0.007 |
| Depression and self-perception | 2.6 [1.9-3.3] | 2.7 [2.0-3.2] | 2.7 [2.1-3.4] | 2.1 [1.8-3.3] | 0.348 |
| Embarrassment | 2.0 [1.3-2.7] | 2.0 [1.7-2.7]** | 2.0 [1.3-2.7] | 1.7 [1.2-2.0]** | 0.020 |
| Bristol stool form scale ^a | N = 129 | N = 52 | N = 39 | N = 38 | - |
| Type I-II | 32 (24.8%) | 14 (26.9%) | 12 (30.8%) | 6 (15.8%) | 0.283 |
| Type III-IV-V | 65 (50.4%) | 21 (40.4%) | 20 (51.3%) | 24 (63.2%) | 0.102 |
| Type VI-VII | 50 (38.8%) | 24 (46.2%) | 13 (33.3%) | 13 (34.2%) | 0.366 |
| Wearing a protective pad | N = 130 | N = 52 | N = 39 | N = 39 | |
| Never | 28 (21.5%) | 15 (28.8%) | 8 (20.5%) | 5 (12.8%) | 0.299 |
| <1 per week | 14 (10.8%) | 7 (13.5%) | 2 (5.1%) | 5 (12.8%) | |
| >1 per week | 15 (11.5%) | 4 (7.7%) | 7 (17.9%) | 4 (10.3%) | |
| Every day | 73 (56.2%) | 26 (50.0%) | 22 (56.4%) | 25 (64.1%) | |
| Endoanal ultrasonography | N = 114 | N = 47 | N = 32 | N = 35 | |
| External anal sphincter defect | 31 (27.2%) | 15 (31.9%) | 5 (15.6%) | 11 (31.4%) | 0.198 |
| Internal anal sphincter defect | 33 (28.9%) | 14 (29.8%) | 6 (18.8%) | 13 (37.1%) | 0.240 |
| Anorectal electrophysiological tests | N = 99 | N = 45 | N = 25 | N = 29 | |
| Abnormal tests | 59 (59.6%) | 25 (55.6%) | 18 (72%) | 16 (55.2%) | 0.331 |

Note: Data are expressed as medians [IQR], n (%), or n/N (%), where N is the total number of patients with available data. p-values were computed using the chi-square test or Fisher's exact test for nominal data and analysis of variance for continuous data. Post hoc pairwise comparison tests were performed when the Fisher's exact test values were significant. Tukey's honestly significant difference method was used for nominal and continuous values.

Abbreviations: BMI, body mass index; CCIS, Cleveland Clinic Incontinence Score; FI, faecal incontinence; FIQL, Faecal Incontinence Quality of Life.

*p < 0.05 passive FI vs. mixed FI.

**p < 0.05 urge FI vs. mixed FI.

***p < 0.05 urge FI vs. passive FI.

^aSome patients may belong to several groups.

hypocontractility, hypersensitive rectum, diarrhoea) [7, 23] and those with a majority of mechanisms known to provoke passive FI (anal hypotonia, hyposensitive rectum, proclivencia, constipation) [24–26].

Continuous and count data were expressed as medians [interquartile range, IQR] and n (%), or n/N (%), respectively, where N is

the total number of patients with available data. The p -values were computed using the chi-square test or Fisher's exact test for nominal data and analysis of variance (ANOVA) for continuous data. A post hoc pairwise comparison test was performed when the values of Fisher's exact test were significant, with corrections for multiple testing (false discovery rate, Benjamini–Hochberg). Tukey's

TABLE 3 Sensitivity, specificity, positive and negative predictive values and Youden's index of each item related to urge FI of the Vaizey score and passive FI of the FIQL score compared to the medical interview, which was the reference standard, to classify patients into the urge or passive FI subgroup

| | Sensitivity (%) | Specificity (%) | Youden's index (%) | PPV (%) | NPV (%) |
|------------------------------|-----------------|-----------------|--------------------|---------|---------|
| Item urgency (Vaizey score) | 92 | 23 | 15 | 61.5 | 69 |
| Item passive FI (FIQL score) | 87 | 23 | 9 | 46 | 70.6 |

Abbreviations: FI, faecal incontinence; FIQL, Faecal Incontinence Quality of Life; NPV, negative predictive value; PPV, positive predictive value.

TABLE 4 Results of perfused anorectal manometry and high-resolution anorectal manometry and the proportion of abnormal findings using both methods according to FI subtype

| Parameters | Urge FI | Passive FI | Mixed FI | p -value |
|--|------------------|-------------------|------------------|------------|
| Water-perfused anorectal manometry | $N = 22$ | $N = 15$ | $N = 17$ | |
| Maximal resting anal pressure (cmH ₂ O) | 56.0 [34.8–70.8] | 35.0 [23.5–77.5] | 45.0 [37.0–60.0] | 0.776 |
| Maximal VC amplitude (cmH ₂ O) | 29.0 [19.3–46.0] | 46.0 [10.0–97.5] | 23.0 [15.0–80.0] | 0.708 |
| Mean VC amplitude (cmH ₂ O) | 17.0 [11.0–24.0] | 10.0 [0.0–26] | 15.0 [10.0–27.0] | 0.998 |
| Duration of VC (s) | 18.5 [5.3–40.8] | 10.0 [1.5–42.5] | 15.0 [6.0–47.0] | 0.829 |
| First sensation volume (ml) | 10 [10–10] | 10 [10–10] | 10.0 [10.0–10.0] | 0.893 |
| Constant sensation volume (ml) | 100 [81–119] | 88 [50–138] | 75 [44–125] | 0.452 |
| Maximum tolerated volume (ml) | 150 [125–175] | 125 [100–188] | 150 [75–200] | 0.813 |
| Compliance (ml cmH ₂ O ⁻¹) | 3.4 [2.4–4.4] | 3.2 [1.7–4.8] | 3.1 [2.1–4.0] | 0.284 |
| High-resolution anorectal manometry | $N = 32$ | $N = 25$ | $N = 22$ | |
| Maximal resting anal pressure (cmH ₂ O) | 52.6 [34.3–64.8] | 38.0 [29.0–49.0] | 38.0 [28.0–53.8] | 0.117 |
| Maximal VC amplitude (cmH ₂ O) | 49.5 [26.8–68.3] | 62.0 [40.0–110.0] | 42.5 [26.3–75.5] | 0.479 |
| Mean VC amplitude (cmH ₂ O) | 10.0 [5.0–18.0] | 13.0 [9.5–19.0] | 12.0 [5.0–26.0] | 0.992 |
| Duration of VC (s) | 19.0 [5.0–44.3] | 15.0 [6.0–44.0] | 40.0 [12.0–44.0] | 0.543 |
| First sensation volume (ml) | 15 [10–30] | 20 [10–30] | 10 [10–20] | 0.181 |
| Constant sensation volume (ml) | 100 [75–125] | 100 [75–138] | 125 [75–150] | 0.353 |
| Maximum tolerated volume (ml) | 150 [125–200] | 150 [125–225] | 175 [150–206] | 0.383 |
| Compliance (ml cmH ₂ O ⁻¹) | 4.7 [3.8–6.1] | 6.5 [5.0–8.4] | 6.8 [4.9–9.6] | 0.463 |
| Overall | $N = 54$ | $N = 40$ | $N = 39$ | |
| Abnormal resting anal pressure | 32 (59.2%) | 31 (77.5%) | 30 (76.9%) | 0.087 |
| Abnormal maximal VC amplitude | 37 (68.5%) | 18 (45.0%) | 25 (64.1%) | 0.059 |
| Abnormal VC duration | 25 (46.3%) | 23 (57.5%) | 15 (38.5%) | 0.560 |
| | $N = 47$ | $N = 32$ | $N = 36$ | |
| Rectal hypersensitivity | 18 (33.3%) | 15 (46.9%) | 12 (33.3%) | 0.512 |
| Rectal hyposensitivity | 2 (4.2%) | 2 (6.2%) | 2 (5.5%) | 0.921 |

Note: Data are expressed as median [IQR], n (%) or n/N (%), where N is the total number of patients with available data.

p -values were computed using the chi-square test or Fisher's exact test for nominal data and analysis of variance for continuous data. Post hoc pairwise comparison tests were performed when the Fisher's exact test values were significant. Tukey's honestly significant difference method was used for nominal and continuous values.

Abbreviations: FI, faecal incontinence; VC, voluntary contraction.

honestly significant difference method was used for nominal and continuous data. The FI subtype classification tree was built based on the EndoFLIP® results using the recursive partitioning method. Hyperparameters were optimized by machine learning.

Data analyses, statistical analyses and graph plotting were performed using R v.4.1.0 [27], *rstatix* [28], *caret* [29], *ggplot2* [30], *ggsci* [31], *ggpubr* [32], *rpart* [33], *rpart.plo* [34], and *mlr* [35]. Raw data as well as the R code are available as Supplementary Material S1

TABLE 5 Results of EndoFLIP® measurements according to FI subtype in a cohort of 133 patients

| Parameters | Urge FI (N = 54) | Passive FI (N = 40) | Mixed FI (N = 39) | p-value |
|--|-------------------|---------------------|-------------------|---------|
| DI at rest, 40 ml of distension ($\text{mm}^2 \text{mmHg}^{-1}$) | 1.92 [0.70–2.53] | 1.85 [0.68–3.09] | 1.50 [1.15–2.55] | 0.121 |
| Abnormal, n (%) | 35 (64.8) | 27 (67.5) | 31 (79.5) | 0.274 |
| DI during VC, 40 ml of distension ($\text{mm}^2 \text{mmHg}^{-1}$) | 0.95 [0.50–1.48] | 0.75 [0.40–1.75] | 1.10 [0.40–1.30] | 0.937 |
| Abnormal, n (%) | 38 (70.4) | 25 (62.5) | 28 (71.8) | 0.626 |
| DI at rest, 50 ml of distension ($\text{mm}^2 \text{mmHg}^{-1}$) | 2.25 [1.40–4.83]* | 3.45 [1.83–6.78]* | 3.20 [1.95–4.80] | 0.046 |
| Abnormal, n (%) | 19 (35.2) | 22 (55) | 22 (56.4) | 0.064 |
| DI during VC, 50 ml of distension ($\text{mm}^2 \text{mmHg}^{-1}$) | 1.70 [1.10–2.83] | 2.19 [1.00–2.60] | 2.08 [0.95–2.80] | 0.924 |
| Abnormal, n (%) | 28 (51.9) | 23 (57.5) | 24 (61.5) | 0.844 |

Note: Data are expressed as medians [IQR], n (%) or n/N (%), where N is the total number of patients with available data.

p-values were computed using the chi-square test or Fisher's exact test for nominal data and analysis of variance for continuous data. Post hoc pairwise comparison tests were performed when the Fisher's exact test values were significant. Tukey's honestly significant difference method was used for nominal and continuous values.

Abbreviations: DI, Distensibility Index; FI, faecal incontinence; VC, voluntary contraction.

* $p < 0.05$ urge FI vs. passive FI.

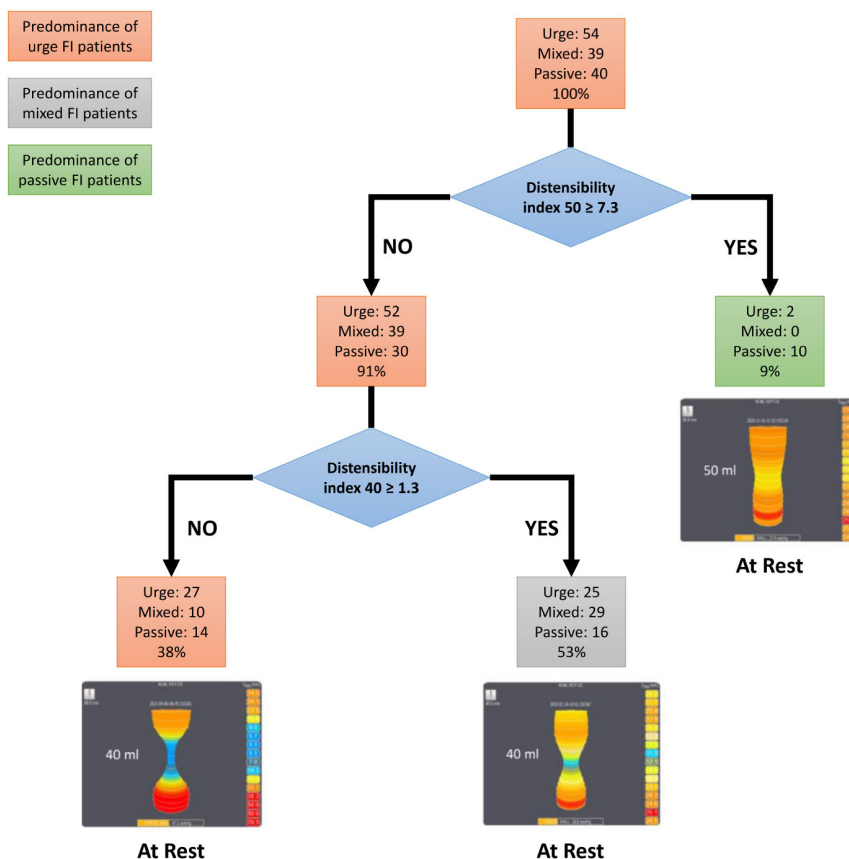

FIGURE 1 Classification tree of faecal incontinence (FI) subtypes based on EndoFLIP® measurements at rest. Values inside nodes correspond to the number of patients with urge, mixed or passive FI, and the corresponding percentage of total patients (lower value). The predominant type of FI is given for each box using colours (orange for urge FI, grey for mixed FI and green for passive FI). For each distensibility index, an example of an EndoFLIP® measurement is given. FI, faecal incontinence

and S2, respectively. Our study meets the criteria of the Strobe List (Appendix S1)

RESULTS

Clinical characteristics of patients

One hundred thirty-three patients were consecutively included in the present study (median age 64 [55–73] years; M:F ratio 14:119). Patient characteristics are summarized in Table 2. After an interview, 54 (41%) patients were assigned to the urge FI subgroup, 40 (30%) to the passive FI subgroup and 39 (29%) to the mixed FI subgroup. The items of the scores concerning the presence of urge FI (faecal urgency with the Vaizey score) and passive FI (stool leakage without awareness with the FIQL score) showed fairly good sensitivity but poor specificity for discriminating the FI subtype compared with the medical interview, which was the reference standard (Table 3).

TABLE 6 Performance parameters of the classification tree given in Figure 1 for detecting FI subtypes using distensibility index (DI) thresholds at 40 and 50 ml of distension

| | Urge FI | Mixed FI | Passive FI |
|---------------------------|---------|----------|------------|
| Sensitivity | 0.53 | 0.41 | 0.83 |
| Specificity | 0.67 | 0.84 | 0.75 |
| Positive predictive value | 0.50 | 0.74 | 0.25 |
| Negative predictive value | 0.70 | 0.56 | 0.98 |

Note: At rest, a DI at 50 ml of distension $\geq 7.3 \text{ mm}^2 \text{ mmHg}^{-1}$ identified patients with passive FI and a DI at 40 ml of distension $< 1.3 \text{ mm}^2 \text{ mmHg}^{-1}$ distinguished urge FI from mixed FI. Abbreviation: FI, faecal incontinence.

A comparison of patient characteristics in the different subgroups is shown in Table 2. Patients with passive FI were older than patients with mixed FI ($p = 0.01$; Table 2). More patients with mixed FI underwent anorectal surgery (rectopexy, proctectomy, haemorrhoid surgery, fissurectomy, treatment of anal fistula) than patients with urge or passive FI ($p < 0.001$; Table 2). Constipation occurred more frequently in patients with passive FI than in the two other subgroups ($p < 0.001$; Table 2).

The FIQL lifestyle and coping scores were lower in patients with mixed FI than in patients with passive FI ($p = 0.048$ and $p = 0.007$, respectively; Table 2). The FIQL coping score was lower in patients with urge FI than in patients with passive FI ($p = 0.007$; Table 2). The FIQL embarrassment score was lower in patients with mixed FI than in those with urge FI ($p = 0.020$; Table 2). The Vaizey score was higher in patients with mixed FI than in patients with passive FI ($p = 0.009$; Table 2).

Anorectal functional tests

Anorectal manometry

There was no difference between FI subtypes with respect to the parameters measured with either HRAM or water-perfused anorectal manometry, even after pooling the patients based on normal/abnormal results (Table 4).

EndoFLIP®

There was no difference between FI subtypes for the DI at 40 ml of distension at rest and during voluntary contraction (Table 5). The DI at rest at 50 ml of distension was lower in patients with urge FI

FIGURE 2 Pelvic floor disorders (recto-anal intussusception, muco-haemorrhoidal prolapse, rectocele, enterocele) found on anoscopy-rectoscopy in 97 patients based on faecal incontinence (FI) subtype. Some patients could have more than one disorder. * $p < 0.05$

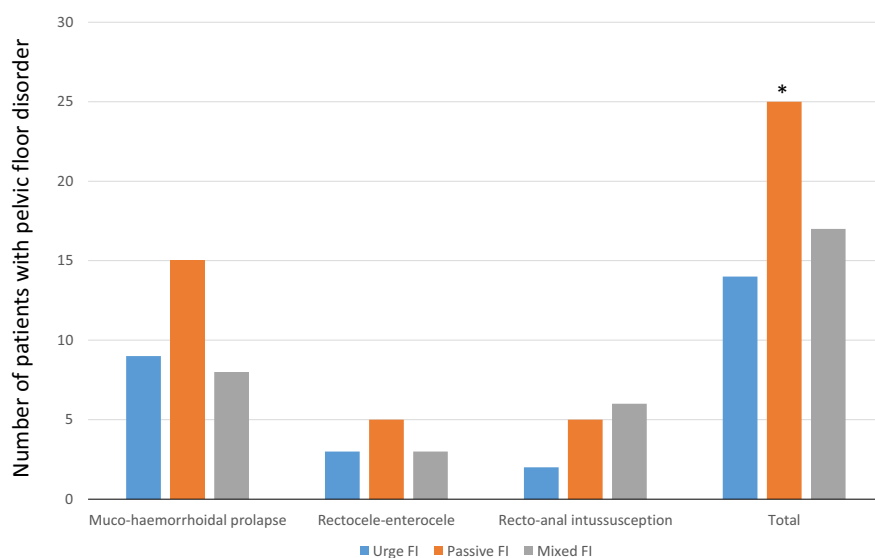

N = 97 patients

TABLE 7 Underlying mechanisms of FI in a cohort of 133 patients complaining of FI

| Identified FI mechanisms | No. of patients (N = 133) |
|---|---------------------------|
| Isolated mechanisms | |
| Anal hypocontractility | 10 |
| Anal hypotonia | 9 |
| Rectal hyposensitivity | 1 |
| Constipation | 3 |
| Idiopathic | 3 |
| Associated mechanisms | |
| Anal hypocontractility + anal hypotonia | |
| Isolated | 23 |
| With transit disorders | 14 |
| With transit disorders and procidencia | 1 |
| With procidencia | 1 |
| Anal hypocontractility + anal hypotonia + rectal hypersensitivity | |
| Isolated | 15 |
| With transit disorders | 10 |
| With procidencia | 1 |
| Anal hypocontractility + anal hypotonia + rectal hyposensitivity | |
| Isolated | 1 |
| With transit disorders | 2 |
| Anal hypocontractility + rectal hypersensitivity | |
| Isolated | 5 |
| With transit disorders | 1 |
| With procidencia | 1 |
| With transit disorders and procidencia | 1 |
| Anal hypocontractility + rectal hyposensitivity | |
| Isolated | 2 |
| With transit disorders | 1 |
| Anal hypocontractility + transit disorders | |
| Isolated | 4 |
| With transit disorders | 3 |
| Anal hypotonia + rectal hyposensitivity | |
| Isolated | 1 |
| Anal hypotonia + rectal hypersensitivity | |
| Isolated | 4 |
| With transit disorders | 3 |
| Anal hypotonia + rectal hyposensitivity | |
| Isolated | 1 |
| Anal hypotonia + transit disorders | |
| Isolated | 5 |
| Anal hypotonia + procidencia | |
| Isolated | 1 |
| Rectal hypersensitivity + transit disorders | |
| Isolated | 1 |
| Rectal hyposensitivity + transit disorders | |
| Isolated | 1 |
| LARS | 5 |

Abbreviations: FI, faecal incontinence; LARS, low anterior resection syndrome.

than in patients with passive FI ($p = 0.046$; [Table 5](#)), but not during voluntary contraction ([Table 5](#)).

A classification tree was built to determine whether DI thresholds at 40 or 50 ml of distension could predict FI subtype ([Figure 1](#)). At rest, a DI at 50 ml of distension $\geq 7.3 \text{ mm}^2 \text{ mmHg}^{-1}$ identified patients with passive FI and a DI at 40 ml of distension $< 1.3 \text{ mm}^2 \text{ mmHg}^{-1}$

distinguished urge FI from mixed FI. The accuracy of the classification tree was 0.49 (95% CI 0.41–0.58). The sensitivity, specificity and positive and negative predictive values of the classification tree to detect FI subtypes are given in [Table 6](#).

Other tests

One hundred fourteen patients underwent endoanal ultrasonography (86%). There was no difference between the different FI subtypes with respect to the presence of anal sphincter lesions for both internal and external anal sphincters ([Table 2](#)). Anorectal electrophysiological tests were performed in 99 patients (74%). There was no association between the anorectal electrophysiological test results (normal/abnormal) and the FI subtype ([Table 2](#)). Pelvic floor disorders on anoscopy-rectoscopy were found more frequently in patients with passive or mixed FI than in patients with urge FI ($p = 0.005$; [Figure 2](#)).

Mechanisms of FI

One hundred and seven patients (80%) had several associated identified mechanisms that could explain their incontinence ([Table 7](#)). Patients with a predominance of identified mechanisms known to induce urge incontinence were significantly more represented in the urge FI subgroup ($p = 0.0004$; [Figure 3](#)). Similarly, patients with a predominance of identified mechanisms known to induce passive incontinence were significantly more represented in the passive FI subgroup ($p = 0.0004$; [Figure 3](#)).

DISCUSSION

We studied the relationship between anal DI and FI subtype using the EndoFLIP® system. A weak relationship was detected between the anal DI at rest at 50 ml of distension and passive FI. A dysfunction of the internal anal sphincter may lead to poor sealing of the anal canal under rest, which may cause passive FI. A dysfunction of the external anal sphincter may lead to insufficient closure of the anal canal when stool arrives in the rectum, which may cause urge incontinence [1]. Given these two mechanisms, we expected to correlate urge FI with external anal sphincter dysfunction and passive FI with internal anal sphincter dysfunction. However, as previously reported, we did not find any significant difference in the distribution of anal hypocontractility and anal hypotonia recorded by anal manometry between the three FI subtypes [6, 36–38]. The frequency of anatomical and/or neuropathic sphincter lesions was not related to a particular FI subtype, as expected, as this represented more the potential cause of the dysfunction than the dysfunction itself. Given the superiority of the EndoFLIP® system in quantifying resistance to anal distension, an important variable for anal continence [10, 12, 39], it should be more accurate in detecting sphincter dysfunctions. In the present study, the resting anal DI at 50 ml of distension

FIGURE 3 Relationship between the identified mechanisms of faecal incontinence (FI) in a cohort of 133 patients and FI subtype. * $p < 0.05$

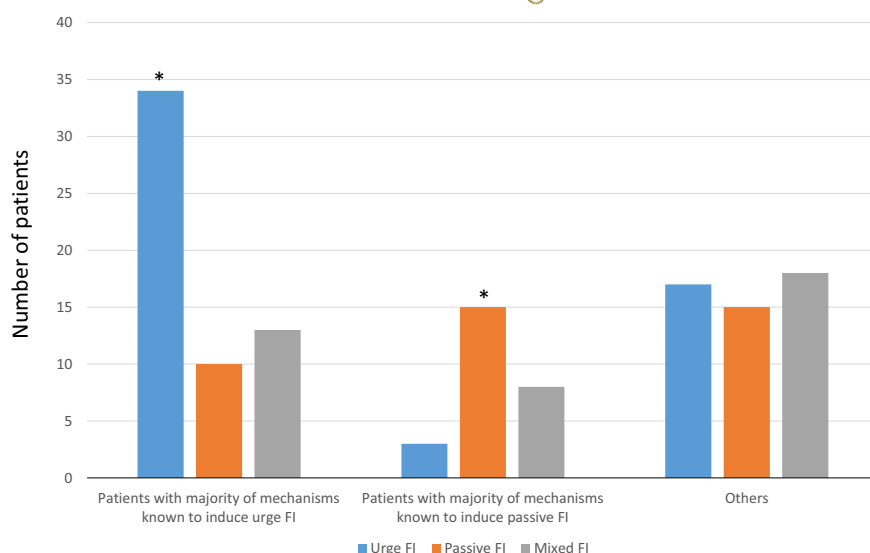

N= 133 patients

differed significantly, with the passive subtype having the highest values and the urge subtype the lowest. However, anal DI during voluntary contraction was not significantly different between the FI subtypes. The DI at squeeze may more reflect the isolated action of the external anal sphincter while the DI at rest may more reflect the isolated action of the internal anal sphincter [13]. We identified the values of the DIs that allowed us to discriminate patients according to their FI subtype in a descriptive manner. We used a classification tree to show that patients with a resting DI at 50 ml of distension $\geq 7.3 \text{ mm}^2 \text{ mmHg}^{-1}$ and that resting DIs at 40 ml of distension $< 1.3 \text{ mm}^2 \text{ mmHg}^{-1}$ were related to the passive and urge FI subtypes, respectively. However, the discriminatory power of the classification tree was low (an accuracy of 0.49 compared with 0.33 for random assignment). Although EndoFLIP® can distinguish between different FI subtypes, this is true only for extreme DI values.

The main premise for explaining discrepancies between anal sphincter function and FI subtype could be the lack of consensus in categorizing patients into the different subgroups. Other studies have used medical interviews, validated FI scores or rating scales [3]. The present study showed that these choices are very important given the poor agreement between the FI score results and the interviews conducted by a trained physician to classify patients according to FI subtype. In addition, we categorized patients based on the exclusivity of one type of FI compared with others. This made it possible to have more homogeneous groups of patients but had the disadvantage of creating smaller groups.

Lastly, our findings suggested that the most likely premise for explaining why FI subtype is moderately helpful in identifying the mechanism of incontinence is the multiple pathophysiological abnormalities identified in 80% of our patients. Sphincter problems are not the only reason for FI. Transit, pelvic floor disorders and rectal dysfunction may also be involved [7, 23–26]. Although our results confirmed the association between the presence of passive FI, constipation and/or pelvic floor disorders, there were no statistically significant differences

in the frequency of diarrhoea, abnormal rectal sensory volumes or compliance between the three subgroups of incontinent patients. The differences observed from other studies could be related to a declarative definition of diarrhoea or the non-use of a barostat, a reference technique for assessing rectal capacity, sensitivity and compliance. However, when we identified the different FI mechanisms in each patient and distinguished patients in whom the mechanisms known to cause urge or passive FI were predominant, a significant relationship between FI subtype and the mechanisms was observed.

Although FI subtype appears insufficient to identify the exact mechanisms of FI, it remains useful for the evaluation and therapeutic management of incontinent patients. Like others [37], we observed that patients with urge or mixed FI have worse QOL scores than patients with passive FI. Patients with urge or mixed FI may thus benefit from rapid additional counselling on coping mechanisms for dealing with their symptoms.

The present study had some limitations. Although the data were prospectively collected, the analysis was retrospective. As explorations have changed with the arrival of HRAM, two types of anorectal manometries (water-perfused and high-resolution) were used, resulting in a loss of statistical power. Even dichotomizing patients on the basis of normal/abnormal features did not allow us to precisely compare the performances of the manometry and EndoFLIP® techniques to predict FI subtype. Lastly, our definition of normal values for the DI, pressures and volumes was based on a preliminary study conducted only with women [13], unlike the present study that included a minority of men. However, the population of women studied was comparable in terms of parity with that of healthy subjects [13].

CONCLUSION

In conclusion, the present study showed that the anal sphincter DI at rest can distinguish between FI subtypes, but with poor

performance. The determination of the FI subtype appears inadequate for identifying the pathophysiological mechanisms of FI because of its frequent multiplicity. Although the determination of the FI subtype is interesting for evaluating patients, explorations that help identify the physiopathological mechanisms responsible for the FI and orientate the treatment are still required.

AUTHOR CONTRIBUTIONS

All authors made substantial contributions to the conception and design of the study. CD and AML designed the research study and wrote the paper. CD, AML, GG and VB contributed to the inclusion of patients, CD and TD analysed the data, and CD, AML, TD, GG and VB contributed to the editing of the manuscript. All authors participated in drafting the manuscript or revising it critically for important intellectual content. They all gave final approval of the version to be submitted and of any revised versions.

ACKNOWLEDGEMENTS

The authors would like to thank Gene Bourgeau for editing the manuscript.

CONFLICT OF INTEREST

CD, VB and TD declare no conflicts of interest. AML provides expertise for Medtronic and gives oral presentations for Coloplast. GG gives oral presentations for Coloplast.

ETHICAL STATEMENT

Ethical approval for data collection from patients was obtained in accordance with data protection and civil liberties legislation (CNIL, E2022-07).

DATA AVAILABILITY STATEMENT

Research data are not shared.

ORCID

Thomas Dufrot  <https://orcid.org/0000-0002-8730-284X>

REFERENCES

- Rao SS, Bharucha AE, Chiarioni G, Felt-Bersma R, Knowles C, Malcolm A, et al. Functional anorectal disorders. *Gastroenterology*. 2016;150:1430–42. e4. <https://doi.org/10.1053/j.gastro.2016.02.009>
- Abrams P, Andersson KE, Birdir L, Brubaker L, Cardozo L, Chapple C, et al. Fourth international consultation on incontinence recommendations of the international scientific committee: evaluation and treatment of urinary incontinence, pelvic organ prolapse, and fecal incontinence. *Neurourol Urodyn*. 2010;29:213–40. <https://doi.org/10.1002/nau.20870>
- Desprez C, Turmel N, Chesnel C, Mistry P, Tamiatto M, Haddad R, et al. Comparison of clinical and paraclinical characteristics of patients with urge, mixed, and passive fecal incontinence: a systematic literature review. *Int J Colorectal Dis*. 2021;36:633–44. <https://doi.org/10.1007/s00384-020-03803-8>
- Knol ME, Snijders HS, van der Heyden JT, Baeten CI. Fecal incontinence: the importance of a structured pathophysiological model. *J Anus Rectum Colon*. 2022;6:58–66. <https://doi.org/10.23922/jarc.2021-04>
- Engel AF, Kamm MA, Bartram CI, Nicholls RJ. Relationship of symptoms in faecal incontinence to specific sphincter abnormalities. *Int J Colorectal Dis*. 1995;10:152–5. <https://doi.org/10.1007/BF00298538>
- Gee AS, Durdey P. Urge incontinence of feces is a marker of severe external anal-sphincter dysfunction. *Br J Surg*. 1995;82:1179–82. <https://doi.org/10.1002/bjs.1800820910>
- Chan CLH, Lunniss PJ, Wang D, Williams NS, Scott SM. Rectal sensorimotor dysfunction in patients with urge faecal incontinence: evidence from prolonged manometric studies. *Gut*. 2005;54(9):1263–72. <https://doi.org/10.1136/gut.2005.071613>
- Vaizey CJ, Kamm MA, Bartram CI. Primary degeneration of the internal anal sphincter as a cause of passive faecal incontinence. *Lancet*. 1997;349:612–5. [https://doi.org/10.1016/S0140-6736\(96\)09188-X](https://doi.org/10.1016/S0140-6736(96)09188-X)
- Coss-Adame E, Rao SSC, Valestin J, Ali-Azamar A, Remes-Troche JM. Accuracy and reproducibility of high-definition anorectal manometry and pressure topography analyses in healthy subjects. *Clin Gastroenterol Hepatol*. 2015;13:1143–50. <https://doi.org/10.1016/j.cgh.2014.12.034>
- Kwiatek MA, Pandolfino JE, Hirano L, Kahrilas PJ. Esophagogastric junction distensibility assessed with an endoscopic functional lumenal imaging probe (EndoFLIP). *Gastrointest Endosc*. 2010;72:272–8. <https://doi.org/10.1016/j.gie.2010.01.069>
- Fynne L, Luft F, Gregersen H, Buntzen S, Lundby L, Lundager F, et al. Distensibility of the anal canal in patients with systemic sclerosis: a study with the functional lumen imaging probe. *Colorectal Dis*. 2012;15:e40–7. <https://doi.org/10.1111/codi.12063>
- Sorensen G, Liao D, Lundby L, Fynne L, Buntzen S, Gregersen H, et al. Distensibility of the anal canal in patients with idiopathic fecal incontinence: a study with the functional lumen imaging probe. *Neurogastroenterol Motil*. 2014;26:255–63. <https://doi.org/10.1111/nmo.12258>
- Gourcerol G, Granier S, Bridoux V, Menard JF, Ducrotte P, Leroi AM. Do endoflip assessments of anal sphincter distensibility provide more information on patients with fecal incontinence than high-resolution anal manometry? *Neurogastroenterol Motil*. 2016;28:399–409. <https://doi.org/10.1111/nmo.12740>
- Leroi AM, Melchior C, Charpentier C, Bridoux V, Savoye-Collet C, Houivet E, et al. The diagnostic value of the functional lumen imaging probe versus high-resolution anorectal manometry in patients with fecal incontinence. *Neurogastroenterol Motil*. 2018;30:e13291. <https://doi.org/10.1111/nmo.13291>
- Ata-Lawenko RM, Lee YY. Emerging roles of the Endoluminal functional lumen imaging probe in gastrointestinal motility disorders. *J Neurogastroenterol Motil*. 2017;23:164–70. <https://doi.org/10.5056/jnm16171>
- Lewis SJ, Heaton KW. Stool form scale as a useful guide to intestinal transit time. *Scand J Gastroenterol*. 1997;32:920–4. <https://doi.org/10.3109/00365529709011203>
- Mearin F, Lacy BE, Chang L, Chey WD, Lembo AJ, Simren M, et al. Bowel disorders. *Gastroenterology*. 2016;150:1393–407. <https://doi.org/10.1053/j.gastro.2016.02.031>
- Jorge JM, Wexner SD. Etiology and management of fecal incontinence. *Dis Colon Rectum*. 1993;36:77–97. <https://doi.org/10.1007/BF02050307>
- Vaizey CJ, Carapeti E, Cahill JA, Kamm MA. Prospective comparison of faecal incontinence grading systems. *Gut*. 1999;44:77–80. [https://doi.org/10.1016/S0140-6736\(96\)09188-X](https://doi.org/10.1016/S0140-6736(96)09188-X)
- Rullier E, Zerbib F, Marrel A, Amouretti M, Lehur PA. Validation of the French version of the Fecal Incontinence Quality-of-Life (FIQL) scale. *Gastroenterol Clin Biol*. 2004;28:562–8. [https://doi.org/10.1016/s0399-8320\(04\)95012-9](https://doi.org/10.1016/s0399-8320(04)95012-9)

21. Savoye-Collet C, Savoye G, Koning E, Sassi A, Leroi AM, Dacher JN. Endosonography in the evaluation of anal function after primary repair of a third-degree obstetric tear. *Scand J Gastroenterol.* 2003;38:1149–53. <https://doi.org/10.1080/00365520310005631>
22. Gourcerol G, Gallas S, Michot F, Denis P, Leroi AM. Sacral nerve stimulation in fecal incontinence: are there factors associated with success? *Dis Colon Rectum.* 2007;50:3–12. <https://doi.org/10.1007/s10350-006-0746-4>
23. Chan CL, Scott SM, Williams NS, Lunniss PJ. Rectal hypersensitivity worsens stool frequency, urgency, and lifestyle in patients with urge fecal incontinence. *Dis Colon Rectum.* 2005;48:134–40. <https://doi.org/10.1007/s10350-004-0774-x>
24. Bharucha AE, Fletcher JG, Harper CM, Hough D, Daube JR, Stevens C, et al. Relationship between symptoms and disordered continence mechanisms in women with idiopathic faecal incontinence. *Gut.* 2005;54:546–55. <https://doi.org/10.1136/gut.2004.047696>
25. Deutekom M, Dobben AC, Terra MP, Engel AF, Stoker J, Bossuyt PMM, et al. Clinical presentation of fecal incontinence and anorectal function: what is the relationship? *Am J Gastroenterol.* 2007;102:351–61. <https://doi.org/10.1111/j.1572-0241.2006.00927.x>
26. Consten EC, van Iersel JJ, Verheijen PM, Broeders IA, Wolthuis AM, D'Hoore A. Long-term outcome after laparoscopic ventral mesh rectopexy: an observational study of 919 consecutive patients. *Ann Surg.* 2015;262:742–8. <https://doi.org/10.1097/SLA.0000000000001401>
27. R Core Team. R: a language and environment for statistical computing. Vienna: R Foundation for Statistical Computing; 2021 [cited 2021 Nov 1]. Available from: <https://www.R-project.org/>
28. Alboukadel K. Rstatix: pipe-friendly framework for basic statistical tests. R package version 0.7.0; 2021 [cited 2021 Feb 13]. Available from: <https://CRAN.R-project.org/package=rstatix>.
29. Kuhn M. caret: classification and regression training. R package version 6.0-88; 2021 [cited 2021 Apr 4]. Available from: <https://CRAN.R-project.org/package=caret>
30. Wickham H (2016). *ggplot2: Elegant graphics for data analysis.* New-York, NY: Springer-Verlag.
31. Xiao N. Ggsci: scientific journal and sci-fi themed color palettes for “ggplot2”. R package version 2.9, Org/package=rpart; 2018 [cited 2018 Jan 19]. Available from: <https://CRAN.R-project>
32. Alboukadel K. Ggpubr: “ggplot2” based publication ready plots. R package version 0.4.0; 2020 [cited 2020 Jan 8]. Available from: <https://CRAN.R-project.org/package=ggpubr>
33. Therneau T, Atkinson B. Rpart: recursive partitioning and regression trees. R package version 4; 2020. 1-15 [cited 2019 Apr 12]. Available from: <https://CRAN.R-project.org/package=rpart>
34. Milborrow S. Rpart.Plot: plot “rpart” models: an enhanced version of “plot.Rpart”. R package version 3.1.0; 2021 [cited 2021 Oct 4]. Available from: <https://CRAN.R-project.org/package=rpart.plot>
35. Bischl B, Lang M, Kotthoff L, Schiffner J, Richter J, Studerus E, et al. Mlr: machine learning in R. *J Mach Learn Res.* 2016;17(170):1–5.
36. Hornung BR, Mitchell PJ, Carlson GL, Klarskov N, Lose G, Kiff ES. Comparative study of anal acoustic reflectometry and anal manometry in the assessment of faecal incontinence. *Br J Surg.* 2012;99:1718–24. <https://doi.org/10.1002/bjs.8943>
37. Pahwa AK, Khanijow KD, Harvie HS, Arya LA, Andy UU. Comparison of patient impact and clinical characteristics between urgency and passive fecal incontinence phenotypes. *Female Pelvic Med Reconstr Surg.* 2020;6:570–4. <https://doi.org/10.1097/SPV.0000000000000603>
38. Mimura T, Kaminishi M, Kamm MA. Diagnostic evaluation of patients with faecal incontinence at a specialist institution. *Dig Surg.* 2004;21:235–41. <https://doi.org/10.1159/000079493>
39. Harris LD, Winans CS, Pope CE 2nd. Determination of yield pressures: a method for measuring anal sphincter competence. *Gastroenterology.* 1966;50:754–60.

SUPPORTING INFORMATION

Additional supporting information can be found online in the Supporting Information section at the end of this article.

How to cite this article: Desprez C, Gourcerol G, Savoye-Collet C, Bridoux V, Duflot T, Leroi A-M. Relationship between anal functional lumen imaging probe (EndoFLIP®) results and the clinical presentation of faecal incontinence. *Colorectal Dis.* 2022;00:1–11. <https://doi.org/10.1111/codi.16225>

2^{ème} axe : Intérêt thérapeutique de l'EndoFLIP[®] au niveau du pylore

La mesure de la distensibilité pylorique permet de prédire la réponse symptomatique aux injections intra-pyloriques de toxine botulique.

Il a été démontré que la distensibilité pylorique était altérée chez 30-50% des patients atteints de gastroparésie quelle qu'en soit l'origine(102). Différentes thérapies ciblant le pylore sont actuellement disponibles, comme les injections intra-pyloriques de toxine botulique qui permettent de relaxer le pylore et de faciliter la vidange gastrique(113). Cependant, les résultats positifs des études de cohortes(114) n'ont pas été confirmés par les 2 études contrôlées, randomisées contre placebo(117)-(118). Par ailleurs, aucune étude préalable de la fonction pylorique n'avait été réalisée dans toutes ces essais. L'objectif de notre étude était donc d'évaluer si la mesure de la distensibilité pylorique pouvait prédire la réponse symptomatique aux injections intra-pyloriques de toxine botulique chez des patients avec gastroparésie réfractaire.

Pour cela, une mesure de la distensibilité pylorique était réalisée juste avant l'injection de toxine. La distensibilité était définie comme anormale si elle était inférieure à $10\text{mm}^2/\text{mmHg}$ (102). Une évaluation symptomatique (total symptomatique score, Gastrointestinal Quality of Life Index) et une mesure de la vidange gastrique étaient réalisées avant puis à 3 mois des injections de toxine botulique.

Nos résultats ont pu montrer que 19 des 35 patients (54%) atteints de gastroparésie présentaient une distensibilité pylorique altérée. Le score symptomatique total ainsi que le score de qualité de vie GIQLI étaient significativement améliorés 3 mois après les injections chez les patients avec distensibilité pylorique altérée, tandis qu'ils restaient inchangés chez les patients avec distensibilité pylorique normale. Le temps de demi-vidange gastrique était accéléré après

injection chez les patients avec distensibilité pylorique altérée, tandis qu'il demeurerait inchangé chez les patients avec distensibilité pylorique normale.

L'EndoFLIP® pourrait permettre de prédire l'efficacité des injections de toxine botulique intra-pylorique en cas de gastroparésie et permettrait donc une meilleure sélection des patients candidats à ces injections.

Pyloric distensibility measurement predicts symptomatic response to intrapyloric botulinum toxin injection

Charlotte Desprez, MD,^{1,2} Chloé Melchior, MD, PhD,^{2,3} Fabien Wuestenberghs, MD,^{1,2} Alberto Zalar, MD,³ Jérémie Jacques, MD, PhD,⁴ Anne-Marie Leroi, MD, PhD,^{1,5} Guillaume Gourcerol, MD, PhD^{1,3,5}

Rouen, Limoges, France

GRAPHICAL ABSTRACT

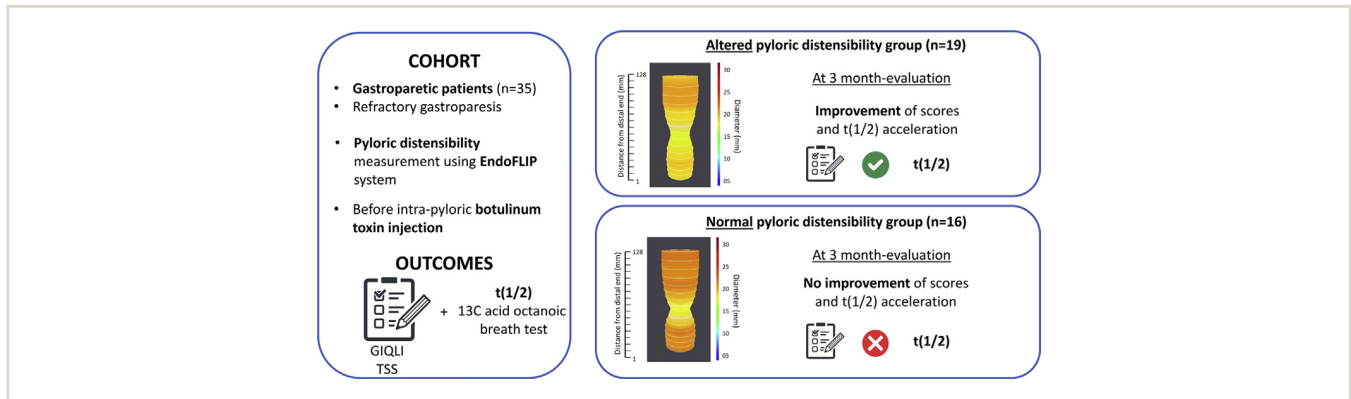

Background and Aims: Recent studies have reported that pyloric distensibility was altered in 30% to 50% of patients with gastroparesis, and this was correlated with gastric emptying and symptom severity. The aim of this study was to assess whether pyloric distensibility measurement was predictive of symptomatic response after intrapyloric botulinum toxin (BT) injection.

Methods: Pyloric distensibility was measured using the EndoFLIP system (Crospon, Galway, Ireland) before intrapyloric BT injection. Altered pyloric distensibility was defined as distensibility below 10 mm²/mm Hg. Total symptomatic score (TSS), dyspeptic symptoms, Gastrointestinal Quality of Life Index (GIQLI), and gastric emptying were investigated prospectively before and 3 months after BT injection.

Results: Nineteen of 35 patients had altered pyloric distensibility. In those patients, TSS decreased at 3 months from 13.5 to 10.5 ($P < .01$), whereas it remained unchanged in patients with normal pyloric distensibility ($P = .7$). Gastric fullness (from 3.5 to 2.5; $P = .03$) and bloating (from 3.0 to 2.0; $P = .01$) were the only symptoms that improved in patients with altered pyloric distensibility, whereas none of them was improved in patients with normal pyloric distensibility. GIQLI score increased from 59.5 to 76.5 in patients with altered pyloric distensibility ($P = .02$), whereas there was no statistical difference ($P = .43$) in patients with normal pyloric distensibility. In patients with altered pyloric distensibility, gastric emptying half time was 223 minutes before and 190 minutes 3 months after injection ($P = .02$), whereas it remained unchanged in patients with normal pyloric distensibility ($P = .6$).

Conclusions: Pyloric distensibility measurement before intrapyloric BT injection predicted symptomatic and quality of life response 3 months after injection in patients with gastroparesis. (Gastrointest Endosc 2019; ■:1-7.)

(footnotes appear on last page of article)

Gastroparesis is defined as objectively delayed gastric emptying in the absence of mechanical obstruction, leading to dyspeptic symptoms.¹ Its prevalence in the U.S. general population was estimated at 24.2 per

100,000 persons in 2007,² revealing medical issues in long-term care with an increase in morbidity and mortality in those patients. In the most-severe cases, gastroparesis can alter quality of life and nutritional

status, with an increasing number of hospitalizations.³ In addition to idiopathic gastroparesis, which is the most-frequent form, the main causes of gastroparesis are diabetes and surgery.⁴

The pathophysiology of gastroparesis is complex, with possible contributions of several mechanisms⁵⁻⁷ leading to gastroduodenal motor abnormalities,⁸ including pylorospasm.⁹ To the best of our knowledge, Mearin et al⁹ was the first to assess the implication of impaired pyloric contraction in gastroparesis patients and found that the occurrence and duration of pylorospasm were increased in patients with diabetic gastroparesis compared with healthy control subjects. A previous prospective study using the EndoFLIP system (Crospon, Galway, Ireland) to assess pyloric characteristics showed that fasting pyloric distensibility could be altered in a subgroup of 10 of 26 patients with gastroparesis.¹⁰ Moreover, there was an association in this study between altered pyloric distensibility and delayed gastric emptying. Altered pyloric distensibility was also correlated with more severe dyspeptic symptoms and altered quality of life. In contrast, there was no association with pyloric pressure. These results were confirmed in other populations of patients with gastroparesis or dyspepsia.^{11,12}

Botulinum toxin (BT) is a protein natively produced by the bacterium *Clostridium botulinum*, which blocks neuromuscular conduction. The first case of intrapyloric injection of BT was reported in 1998.¹³ The positive findings of open-label case series¹⁴ and a retrospective review¹⁵ were not confirmed in 2 randomized placebo-controlled trials.^{16,17} A retrospective analysis identified the existence of a potentially definable subgroup of patients for whom intrapyloric BT injection might be beneficial.¹⁸ However, there is a lack of direct measurement of pyloric motility to identify the best candidates for such treatment in randomized controlled-placebo studies. Therefore, we hypothesized that altered fasting pyloric compliance could predict positive response to intrapyloric BT injection among patients with gastroparesis. The objective of this study was to assess whether pyloric distensibility measurement was predictive of symptomatic response after intrapyloric BT injection.

METHODS

Approval

The study received the agreement of the local ethical review board (Comité d'Ethique de la Recherche Non-Interventionnelle no. E2018-68). All patients had given written informed consent before the investigation.

Patients

Patients with a diagnosis of gastroparesis refractory to medical therapy (involving resistance to all prokinetics at maximal posology available in France such as oral metoclo-

pramide 40 mg/day, oral domperidone 40 mg/day, and oral erythromycin 750 mg/day¹) were consecutively included in the study. Organic GI obstruction was ruled out using routine biologic blood tests and upper GI endoscopy with biopsy sampling. Patients who had previous endoscopic treatment for gastroparesis were excluded from the study. Improvement at 3 months on symptom scores, quality of life, and gastric emptying were used as evaluation of treatment.

Clinical evaluation

Dyspeptic symptoms (vomiting, nausea, epigastric pain, bloating, fullness, and satiety) were recorded before and at 3 months after intrapyloric BT injection using specific symptomatic scales. Each item was graded using a 5-point Likert scale from 0 (absent) to 4 (most-severe symptoms). Total symptomatic score (TSS) was defined as the aggregation of individual symptom scores. Quality of life was measured using the Gastrointestinal Quality of Life Index (GIQLI) score ranging from 0 (worst quality of life) to 144 (best quality of life).¹⁹ The GIQLI score is specific for digestive disease and has also been validated in French.²⁰ All questionnaires were answered prospectively by patients during their hospitalization before intrapyloric BT injection and at a 3-month evaluation.

¹³C-Octanoic acid breath test

All patients had gastric emptying measurement before and 3 months after intrapyloric BT injection and were off prokinetics for at least 1 week. After 12 hours of fasting, a ¹³C-octanoic breath acid breath test was performed according to a previously published method.^{21,22} The breath test started between 8:00 AM and 9:00 AM with ingestion of a 250-kcal test meal (19% protein, 43% carbohydrate, 38% fat) consisting of white bread (50 g), butter (17 g), and an egg dosed with 91 mg of ¹³C-octanoic acid (Euriso-Top, Saint Aubin, France). Breath samples were collected immediately before meal ingestion and every 15 minutes after the meal for up to 8 hours. Breath samples were investigated for the presence of ¹³CO₂ by isotope-selective nondispersive infrared spectrometry (Wagner/Analysen Technik, Bremen, Germany). The solid half-time rate for gastric emptying was calculated by linear regression analysis using the infrared spectrometry software GE2.DEM (Wagner/Analysen Technik, Bremen, Germany).

Pyloric distensibility

No chronic intake of medication known to affect GI function was noted, and patients were investigated off prokinetic agents. Pyloric distensibility was investigated after 12-hour fasting using an EndoFLIP probe (Crospon) before intrapyloric BT injection. The pyloric measurements were performed with the patient under general anesthesia (propofol). An EndoFLIP catheter (EF-325N; Crospon) was inserted through the single channel of the endoscope. Visual control of the EndoFLIP catheter through the

pylorus and the distinctive shape of the pylorus represented as a narrow segment with decreased cross-sectional area were necessary to validate correct positioning. The 8-cm balloon was filled with different volumes (10, 20, 30, 40, and 50 mL), and for each set volume at least 3 recordings were made. Retained values needed stable pyloric pressure and cross-sectional area for at least 5 seconds to avoid variations in pylorus volume and/or pressure during peristaltic contractions. Moreover, measurement of antral pressure was realized with the deflated bag before and after intrapyloric probe positioning. In our study, pyloric pressure was expressed relative to antral pressure as previously described.¹⁰ The mean value of 3 measures of the smallest cross-sectional area and the corresponding pressure were taken for compliance analysis for each subject. Distensibility was computed using minimum cross-sectional area divided by the pressure at each balloon fill volume. A cut-off of 10 mm²/mm Hg at 40 mL of inflation for normality of distensibility was determined in a previous study¹⁰ in healthy subjects. We used this threshold value of 10 mm²/mm Hg to classify patients into 2 groups on the basis of normal (>10 mm²/mm Hg) or decreased (<10 mm²/mm Hg) pyloric distensibility.

Intrapyloric BT injection

Immediately after investigation of pyloric distensibility by the EndoFLIP system, intrapyloric BT injection was performed during upper GI endoscopy with the patient under general anesthesia. A .5-mm sclerotherapy needle was introduced through the biopsy channel of the endoscope. Two hundred units of BT (Dysport; Ipsen/Biotech, Paris, France) were diluted into 4 mL of saline solution and then injected per 1-mL dose in each quadrant of the pylorus.

Data analysis

Intraindividual analysis used Wilcoxon signed ranked test for continuous variables (2-tailed). A $P < .05$ was considered as statistically significant. Correlation studies used the Spearman test. Results were expressed as the median and the 25th and 75th percentile. Data were analyzed using GraphPad Prism version 5.03 for Windows (GraphPad Software Inc, San Diego, Calif).

RESULTS

Patients

Thirty-five patients with gastroparesis (12 men), median age 55.1 years (range, 25-80), were included between January 2016 and June 2018. The main etiologies of gastroparesis among patients were diabetes (11/35, 31.4%) and surgery (6/35, 17.1%) with 6 Nissen funduplications. Eighteen of 35 patients (51%) had idiopathic gastroparesis. Using the threshold of 10 mm²/mm Hg at 40 mL of inflation, we found that 19 of 35 patients (54.2%) had altered pyloric distensibility, whereas 16 of 35 patients had normal pyloric distensibility (Fig. 1).

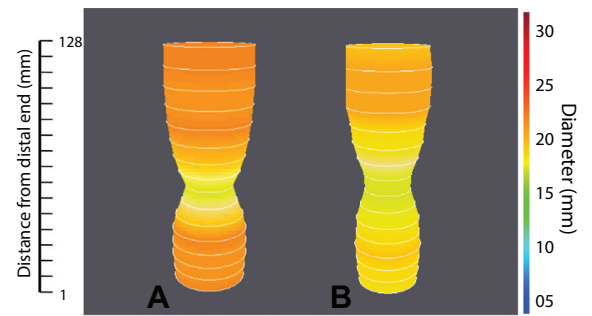

Figure 1. Representative recording of fasting pyloric distensibility in 1 patient with altered pyloric distensibility of 6.3 mm²/mm Hg (A) and in another patient with altered pyloric distensibility of 13.4 mm²/mm Hg (B). Measurements were made at 40 mL of inflation.

TABLE 1. Patient characteristics before intrapyloric botulinum toxin injection

| | Altered pyloric distensibility (n = 19) | Normal pyloric distensibility (n = 16) | P value |
|---------------------------|---|--|---------|
| Sex | | | |
| Men | 7 | 6 | |
| Women | 12 | 10 | |
| Etiology of gastroparesis | | | |
| Diabetic | 7 | 4 | |
| Postfundoplication | 2 | 4 | |
| Idiopathic | 10 | 8 | |
| BMI, kg/m ² | 22.9 | 23.1 | .72 |
| Age, yr | 56 | 55 | .66 |
| Solid half-time rate, min | 223 (157-282) | 214 (193-240) | .15 |
| TSS | 13.5 (11.0-16.0) | 12.0 (9.0-14.5) | .29 |
| GIQLI | 59.5 (38.0-82.0) | 75.5 (52.0-87.0) | .21 |
| Dyspeptic symptoms | | | |
| Epigastric pain | 3.0 (2.0-3.0) | 2.0 (1.0-3.0) | .22 |
| Gastric fullness | 3.5 (2.3-4.0) | 3.0 (2.0-4.0) | .22 |
| Bloating | 3.0 (2.0-3.8) | 2.0 (.8-4.0) | .42 |
| Early satiety | 2.5 (2.0-3.0) | 1.5 (1.0-3.3) | .18 |
| Nausea | 2.0 (.0-3.0) | 2.0 (.8-3.0) | .99 |
| Vomiting | .0 (.0-3.0) | .0 (.0-2.0) | .72 |

BMI, Body mass index; TSS, total symptomatic score; GIQLI, Gastrointestinal Quality of Life Index.

Characteristics of patients are summarized in Table 1, and no difference was found between the 2 groups.

Impact of pyloric distensibility on TSS and dyspeptic symptoms at 3-month evaluation

Twenty-eight of 35 patients answered questionnaires and were included in statistical analyses (reasons for missing data are summarized in Supplementary Fig. 1, available online at www.giejournal.org). In patients with

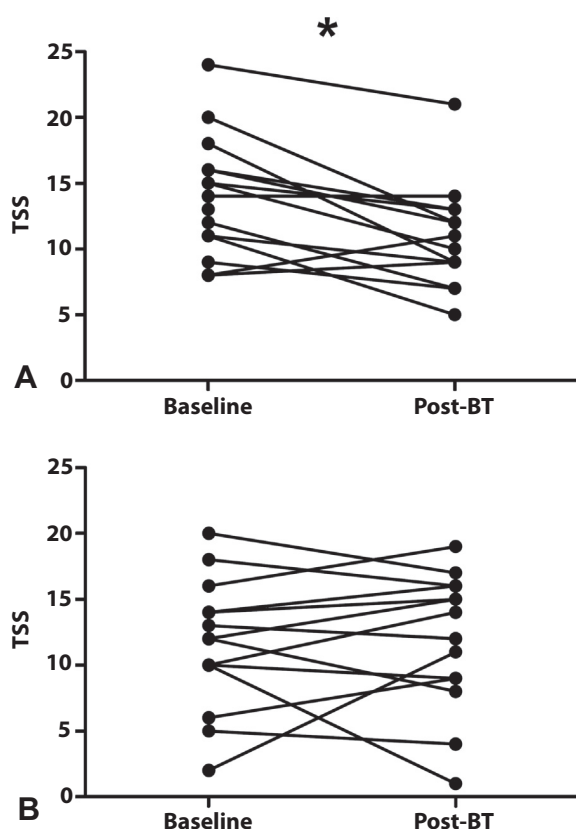

Figure 2. Evolution of the total symptomatic score (TSS) at 3 months after intrapyloric botulinum toxin injection in patients with altered pyloric distensibility (A) and in patients with normal pyloric distensibility (B). TSS decreased at 3 months after injection in patients with altered pyloric distensibility ($P < .01$), whereas no difference was noticed at 3 months in patients with normal pyloric distensibility. BT, Botulinum toxin.

altered pyloric distensibility, TSS decreased at 3 months from 13.5 (range, 11.0-16.0) to 10.5 (range, 8.5-13.0; $P < .01$), whereas it remained relatively unchanged in patients with normal pyloric distensibility from 12.0 (range, 9.0-14.5) to 13.0 (range, 8.8-16.0; $P = .7$; Fig. 2). Regarding dyspeptic symptoms, gastric fullness and bloating were improved in patients with altered pyloric distensibility, with a decrease in scores, respectively, from 3.5 (range, 2.3-4.0) to 2.5 (range, 1.8-3.0; $P = .03$) and from 3.0 (range, 2.0-3.8) to 2.0 (range, 1.8-3.0; $P = .01$). None of the dyspeptic symptoms was improved in patients with normal pyloric distensibility. Results of dyspeptic symptoms are more detailed in Table 2. Moreover, similar results were found when the threshold for pyloric distensibility was set at 8 and 9 mm²/mm Hg (data not shown).

Impact of pyloric distensibility on quality of life at 3-month evaluation

Among patients with altered pyloric distensibility, quality of life was improved, with an increase in GIQLI score from 59.5 (range, 38.0-82.0) to 76.5 (range, 66.5-91.0; $P = .03$), whereas it remained relatively unchanged in patients with

TABLE 2. Evolution of dyspeptic symptoms at 3 months after intrapyloric botulinum toxin injection in patients with altered pyloric distensibility and in patients with normal pyloric distensibility

| | Normal pyloric distensibility | Altered pyloric distensibility |
|-------------------------|-------------------------------|--------------------------------|
| Vomiting | | |
| Preinjection | .0 (.0-2.0) | .0 (.0-3.0) |
| Postinjection | .0 (.0-1.3) | .0 (.0-0) |
| <i>P</i> value | .63 | .055 |
| Nausea | | |
| Preinjection | 2.0 (.8-3.0) | 2.0 (.0-3.0) |
| Postinjection | 2.0 (1.0-3.0) | 1.0 (.8-2.0) |
| <i>P</i> value | .32 | .08 |
| Epigastric pain | | |
| Preinjection | 2.0 (1.0-3.0) | 3.0 (2.0-3.0) |
| Postinjection | 2.0 (.8-3.3) | 2.0 (2.0-3.0) |
| <i>P</i> value | .90 | .24 |
| Bloating | | |
| Preinjection | 2.0 (.8-4.0) | 3.0 (2.0-3.8) |
| Postinjection | 2.0 (1.0-3.3) | 2.0 (1.8-3.0) |
| <i>P</i> value | .62 | .01* |
| Gastric fullness | | |
| Preinjection | 3.0 (2.0-4.0) | 3.5 (2.3-4.0) |
| Postinjection | 3.0 (1.0-3.3) | 2.5 (1.8-3.0) |
| <i>P</i> value | .60 | .03* |
| Satiety | | |
| Preinjection | 1.5 (1.0-3.3) | 2.5 (2.0-3.0) |
| Postinjection | 2.0 (1.8-3.0) | 2.5 (1.0-3.0) |
| <i>P</i> value | .66 | .37 |

* $P < .05$

normal pyloric distensibility (from 75.5 [range, 52.0-87.0] to 67.0 [range, 48.0-89.5]; $P = .43$; Fig. 3). Similar results were found when the threshold for pyloric distensibility was set at 8 and 9 mm²/mm Hg (data not shown).

Gastric emptying half-time

Twenty-eight of 35 patients had a ¹³C-octanoic acid breath test and were included in the statistical analysis (reasons for missing data are summarized in Supplementary Fig. 1). Gastric emptying half-time was decreased from 223 minutes (range, 157-282) to 190 minutes (range, 151-242) at 3 months after intrapyloric BT injection ($P = .02$) in patients with altered pyloric distensibility. In contrast, in patients with normal pyloric distensibility, gastric emptying half-time remained relatively unchanged from 214 minutes (range, 193-240) to 210 minutes (range, 149-243) at 3 months after injection ($P = .6$; Fig. 4). Last, similar results were found when the threshold for pyloric distensibility was set at 8 and 9 mm²/mm Hg (data not shown).

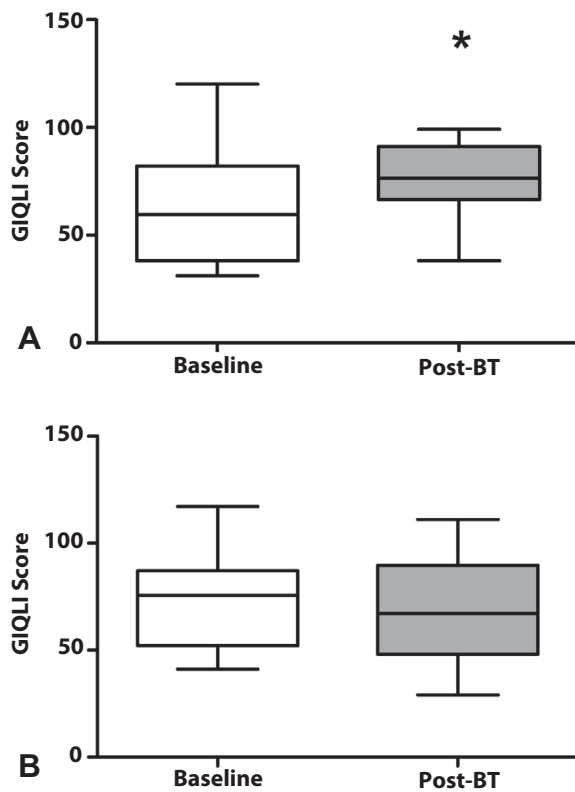

Figure 3. Evolution of the Gastrointestinal Quality of Life Index (GIQLI) at 3 months after intrapyloric botulinum toxin injection in patients with altered pyloric distensibility (**A**) and in patients with normal pyloric distensibility (**B**). Results are expressed using boxplot (median represented as a line in the interior of the box, 25th and 75th percentiles represented as the lower and upper endpoints of the box). GIQLI score was improved at 3 months in patients with altered pyloric distensibility ($P = .02$), whereas it remained unchanged in patients with normal pyloric distensibility. *BT*, Botulinum toxin.

DISCUSSION

To our knowledge, the present study is the first to have assessed the efficacy of intrapyloric BT injection in patients with gastroparesis, based on the alteration of fasting pyloric distensibility. In our study, altered fasting pyloric compliance was associated with improvement in symptom scores (TSS, gastric fullness, and bloating) and quality of life, in contrast to gastroparesis associated with normal fasting pyloric compliance. Moreover, only decreased fasting pyloric compliance was associated with a decrease in gastric emptying. This is a first signal based on the pathophysiology of gastroparesis to better select patients for pyloric targeting therapeutics. Further confirmatory studies are needed to verify whether this marker is relevant to predict the outcome of gastroparesis treatment.

We chose fasting pyloric distensibility to assess the efficacy of BT injection in the present study. It has been shown that pyloric distensibility, but not pyloric pressure, was different between healthy volunteers and gastroparetic patients.^{10,11} Moreover, altered pyloric distensibility was

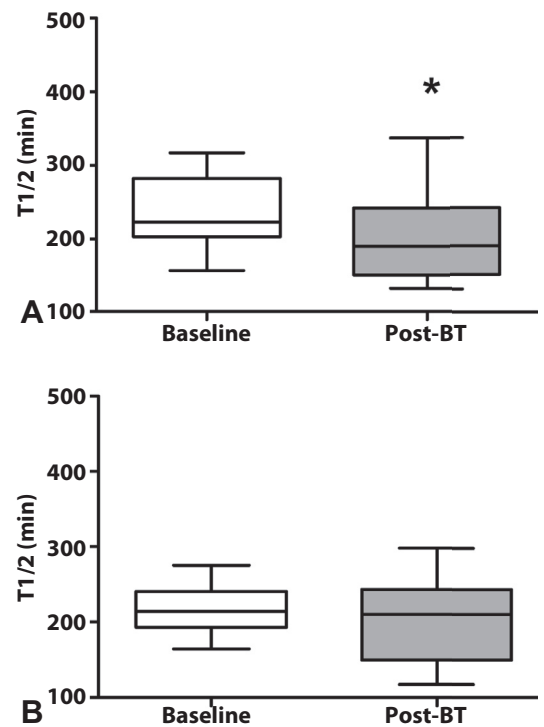

Figure 4. Evolution of solid half-time rate ($T_{1/2}$) for gastric emptying at 3 months after intrapyloric botulinum toxin injection in patients with altered pyloric distensibility (**A**) and in patients with normal pyloric distensibility (**B**). Results are expressed using boxplot (median represented as a line in the interior of the box, 25th and 75th percentiles represented as the lower and upper endpoints of the box). $T_{1/2}$ was decreased in patients with altered pyloric distensibility at 3 months ($P = .02$), whereas no difference was noticed in patients with normal pyloric distensibility. *BT*, Botulinum toxin.

also predictive of delayed gastric emptying, worse symptoms, and quality of life,^{10,11} confirming our findings. In addition, even if a second pyloric distensibility measurement after BT injection was not reported in the present study, we found in a previous report that pyloric dilatation in 10 patients with gastroparesis and altered pyloric compliance increased pyloric compliance from 7.4 to 20.1 mm²/mm Hg.¹⁰

Regarding intrapyloric BT injection, the efficacy of this treatment remains controversial based on the analysis of the 2 randomized controlled-placebo trials available in the literature. Arts et al¹⁷ did not find a difference in symptom improvement after saline solution or BT injection, suggesting an important placebo effect by endoscopic therapy. However, in their study the population was heterogeneous with mostly idiopathic gastroparesis and the number of subjects limited to 23 with insufficient statistical power reported by the authors. Similarly, Friedenberget al¹⁶ did not find an improvement in symptom scores and quality of life. These similar findings could be partially explained by the overestimated effect of BT on the basis of open reports but also by the absence of data on pyloric distensibility.

It could be interesting to perform further randomized placebo-controlled studies using the EndoFLIP system to assess pyloric distensibility and consequently confirm the association between altered pyloric distensibility and response to BT injection. One limit of BT injection is the necessity of repeating injections every 6 to 9 months according to their efficacy among patients. Therefore, other therapeutic interventions specific to the pylorus have been proposed in recent years, with early promising results for many of them.²³ On the basis of our results, it would be interesting to reproduce pyloric measurements to assess the efficiency of these different interventions and if possible at a longer time than 3 months. A French prospective study²⁴ evaluated the efficacy of gastric peroral endoscopic myotomy with assessment of pylorus characteristics using EndoFLIP. They found a distensibility threshold $<9.2 \text{ mm}^2/\text{mm Hg}$ before the gastric peroral endoscopic myotomy to discriminate responders and nonresponders; however, all patients were responders at 3 months in this study.

The convenience and reproducibility of EndoFLIP to assess pyloric dysfunction have also been demonstrated using either the single-channel therapeutic endoscope, with the catheter easily inserted into the pylorus and adjusted under endoscopic and fluoroscopic control,¹¹ or transnasal insertion under local anesthesia.¹⁰ We found a mean fasting pyloric distensibility of 10.04 ± 1.67 at 40 mL in our cohort of patients with gastroparesis, with similar findings as previous studies,^{10,11} which were performed with the patients under local or general anesthesia. Only fasting pyloric compliance can be measured because of technical feasibility and the possibility of adverse events. This fasting measure is the only pyloric compliance measurement available in the literature to our knowledge. Nineteen of 35 patients had decreased fasting pyloric distensibility in our study, using the cut-off of $10 \text{ mm}^2/\text{mm Hg}$ as previously demonstrated.¹⁰ This cut-off was fixed on the basis of a fasting pyloric distensibility measure in healthy volunteers in this study, using the 90th percentile of results on fasting pyloric distensibility at 40 mL of inflation. Our results on symptom scores, quality of life, and gastric emptying were similar when the threshold was set at 8 and $9 \text{ mm}^2/\text{mm Hg}$ at 40 mL inflation (data not shown). Moreover, we found a correlation between the results of pyloric distensibility with bag volume set at 40 mL and 50 mL (95% confidence interval, .7407-.9340; $P < .0001$).

A limitation of our study is the number of missing data (Supplementary Fig. 1), with a high number of patients who declined to fill questionnaires (7/35) or who did not have the ¹³C-octanoic acid breath test (7/35). It has to be underlined that intrapyloric BT injections for refractory gastroparesis are not yet reimbursed and that our hospital accepted financial support in exceptional cases. However, even if a small number of patients were included, a significant difference was shown on both symptomatic

response and gastric emptying, revealing efficient statistical power. In addition, in previous randomized controlled placebo studies, the number of patients included was similar.^{16,17} The BT injection has local neurolytic effects, and its duration of response is probably limited by axonal regeneration of cholinergic neurons. Even if a 3-month evaluation can be considered premature, there is often a decreased effect of BT after this time. Moreover, in the same randomized controlled trials, the evaluation was performed earlier after only 1 month of follow-up.

We did not use the Gastroparesis Cardinal Score Index²⁵ in our study because to our knowledge this score has not yet been validated in French at the time we started the study. In addition, the TSS^{10,26,27} is based on the same items as the Gastroparesis Cardinal Score Index, and only the Likert scale and the nausea/vomiting subscale, which is composed of nausea, retching, and vomiting, differs from the TSS. In fact, the literal translation of retching in French is similar to that of nausea. We also did not use the Patient Assessment of Upper Gastrointestinal Disorders-Quality of Life questionnaire.²⁸ This questionnaire was developed to assess quality of life in upper GI disorders, but the number of patients with gastroparesis was low (only 28), with no French patients in this subgroup. Each item in the Patient Assessment of Upper Gastrointestinal Disorders-Quality of Life questionnaire is graduated in a 6-point scale, with difficulty of translation in French between them. On the contrary, the GIQLI score has been validated in French²⁰ and uses a 5-point scale for each item, even if less specified for upper GI disorders. Finally, all questionnaires were answered prospectively by all patients at the time of evaluation.

In conclusion, in the present study we have shown that pyloric distensibility measurements before intrapyloric BT injection predicted symptomatic and quality of life response 3 months after intrapyloric BT injection in patients with gastroparesis. Further confirmatory studies are needed to verify whether this marker is relevant to predict outcome of gastroparesis treatment and better select patients for pyloric targeting therapeutics.

ACKNOWLEDGMENT

The authors are grateful to Nikki Sabourin-Gibbs, Rouen University Hospital, for editing the manuscript.

REFERENCES

1. Camilleri M, Parkman HP, Shafi MA, et al. Clinical guideline: management of gastroparesis. *Am J Gastroenterol* 2013;108:18-38.
2. Jung H-K, Choung RS, Locke GR, et al. The incidence, prevalence, and outcomes of patients with gastroparesis in Olmsted County, Minnesota, from 1996 to 2006. *Gastroenterology* 2009;136:1225-33.
3. Bharucha AE. Epidemiology and natural history of gastroparesis. *Gastroenterol Clin North Am* 2015;44:9-19.

4. Soykan I, Sivri B, Sarosiek I, et al. Demography, clinical characteristics, psychological and abuse profiles, treatment, and long-term follow-up of patients with gastroparesis. *Dig Dis Sci* 1998;43:2398-404.
5. Buyschaert M, Donckier J, Dive A, et al. Gastric acid and pancreatic polypeptide responses to sham feeding are impaired in diabetic subjects with autonomic neuropathy. *Diabetes* 1985;34:1181-5.
6. Grover M, Farrugia G, Lurken MS, et al. Cellular changes in diabetic and idiopathic gastroparesis. *Gastroenterology* 2011;140:1575-85.
7. Choi KM, Gibbons SJ, Nguyen TV, et al. Heme oxygenase-1 protects interstitial cells of Cajal from oxidative stress and reverses diabetic gastroparesis. *Gastroenterology* 2008;135:2055-64.
8. Camilleri M, Brown ML, Malagelada JR. Relationship between impaired gastric emptying and abnormal gastrointestinal motility. *Gastroenterology* 1986;91:94-9.
9. Mearin F, Camilleri M, Malagelada JR. Pyloric dysfunction in diabetics with recurrent nausea and vomiting. *Gastroenterology* 1986;90:1919-25.
10. Gourcerol G, Tissier F, Melchior C, et al. Impaired fasting pyloric compliance in gastroparesis and the therapeutic response to pyloric dilatation. *Aliment Pharmacol Ther* 2015;41:360-7.
11. Malik Z, Sankineni A, Parkman HP. Assessing pyloric sphincter pathophysiology using EndoFLIP in patients with gastroparesis. *Neurogastroenterol Motil* 2015;27:524-31.
12. Snape WJ, Lin MS, Agarwal N, et al. Evaluation of the pylorus with concurrent intraluminal pressure and EndoFLIP in patients with nausea and vomiting. *Neurogastroenterol Motil* 2016;28:758-64.
13. Sharma VK, Glassman SB, Howden CW, et al. Pyloric intrasphincteric botulinum toxin (Botox) improved symptoms and gastric emptying in a patient with diabetic gastroparesis [abstract]. *Am J Gastroenterol* 1998;93:456.
14. Ezzeddine D, Jit R, Katz N, et al. Pyloric injection of botulinum toxin for treatment of diabetic gastroparesis. *Gastrointest Endosc* 2002;55:920-3.
15. Bromer MQ, Friedenberg F, Miller LS, et al. Endoscopic pyloric injection of botulinum toxin A for the treatment of refractory gastroparesis. *Gastrointest Endosc* 2005;61:833-9.
16. Friedenberg FK, Palit A, Parkman HP, et al. Botulinum toxin A for the treatment of delayed gastric emptying. *Am J Gastroenterol* 2008;103:416-23.
17. Arts J, Holvoet L, Caenepeel P, et al. Clinical trial: a randomized-controlled crossover study of intrapyloric injection of botulinum toxin in gastroparesis. *Aliment Pharmacol Ther* 2007;26:1251-8.
18. Coleski R, Anderson MA, Hasler WL. Factors associated with symptom response to pyloric injection of botulinum toxin in a large series of gastroparesis patients. *Dig Dis Sci* 2009;54:2634-42.
19. Eypasch E, Williams JI, Wood-Dauphinee S, et al. Gastrointestinal Quality of Life Index: development, validation and application of a new instrument. *Br J Surg* 1995;82:216-22.
20. Slim K, Bousquet J, Kwiatkowski F, et al. First validation of the French version of the Gastrointestinal Quality of Life Index (GIQLI) [in French with English abstract]. *Gastroenterol Clin Biol* 1999;23:25-31.
21. Ghoo YF, Maes BD, Geypens BJ, et al. Measurement of gastric emptying rate of solids by means of a carbon-labeled octanoic acid breath test. *Gastroenterology* 1993;104:1640-7.
22. Gourcerol G, Benanni Y, Boueyre E, et al. Influence of gastric emptying on gastro-esophageal reflux: a combined pH-impedance study. *Neurogastroenterol Motil* 2013;25:800-e634.
23. Ahuja NK, Clarke JO. Pyloric therapies for gastroparesis. *Curr Treat Options Gastroenterol* 2017;15:230-40.
24. Jacques J, Pagnon L, Hure F, et al. Peroral endoscopic pyloromyotomy is efficacious and safe for refractory gastroparesis: prospective trial with assessment of pyloric function. *Endoscopy* 2018;51:40-9.
25. Revicki DA, Rentz AM, Dubois D, et al. Gastroparesis Cardinal Symptom Index (GCSI): development and validation of a patient reported assessment of severity of gastroparesis symptoms. *Qual Life Res* 2004;13:833-44.
26. Davis BR, Sarosiek I, Bashashati M, et al. The long-term efficacy and safety of pyloroplasty combined with gastric electrical stimulation therapy in gastroparesis. *J Gastrointest Surg* 2017;21:222-7.
27. Grover I, Kim R, Spree DC, et al. Gastric electrical stimulation is an option for patients with refractory cyclic vomiting syndrome. *J Neurogastroenterol Motil* 2016;22:643-9.
28. Loge C de la, Trudeau E, Marquis P, et al. Cross-cultural development and validation of a patient self-administered questionnaire to assess quality of life in upper gastrointestinal disorders: the PAGI-QOL. *Qual Life Res* 2004;13:1751-62.

Abbreviations: BT, botulinum toxin; GIQLI, Gastrointestinal Quality of Life Index; TSS, total symptomatic score.

DISCLOSURE: The following authors disclosed financial relationships relevant to this publication: G. Gourcerol: Consultant for Allergan. All other authors disclosed no financial relationships relevant to this publication.

Copyright © 2019 by the American Society for Gastrointestinal Endoscopy 0016-5107/\$36.00
<https://doi.org/10.1016/j.gie.2019.04.228>

Received December 14, 2018. Accepted April 16, 2019.

Current affiliations: Digestive Physiology Unit (1), Gastroenterology Department (3), INSERM CIC 1404 (5), Rouen University Hospital, Rouen, France; Nutrition, Brain and Gut Laboratory UMR 1073, Rouen University, Rouen, France (2), Gastroenterology Department, Limoges University Hospital, Limoges, France (4).

Reprint requests: Charlotte Desprez, MD, Digestive Physiology Unit, Rouen University Hospital, 1 rue de Germont, 76031 Rouen, Cedex, France.

If you would like to chat with an author of this article, you may contact Dr Desprez at charlotte-desprez@orange.fr.

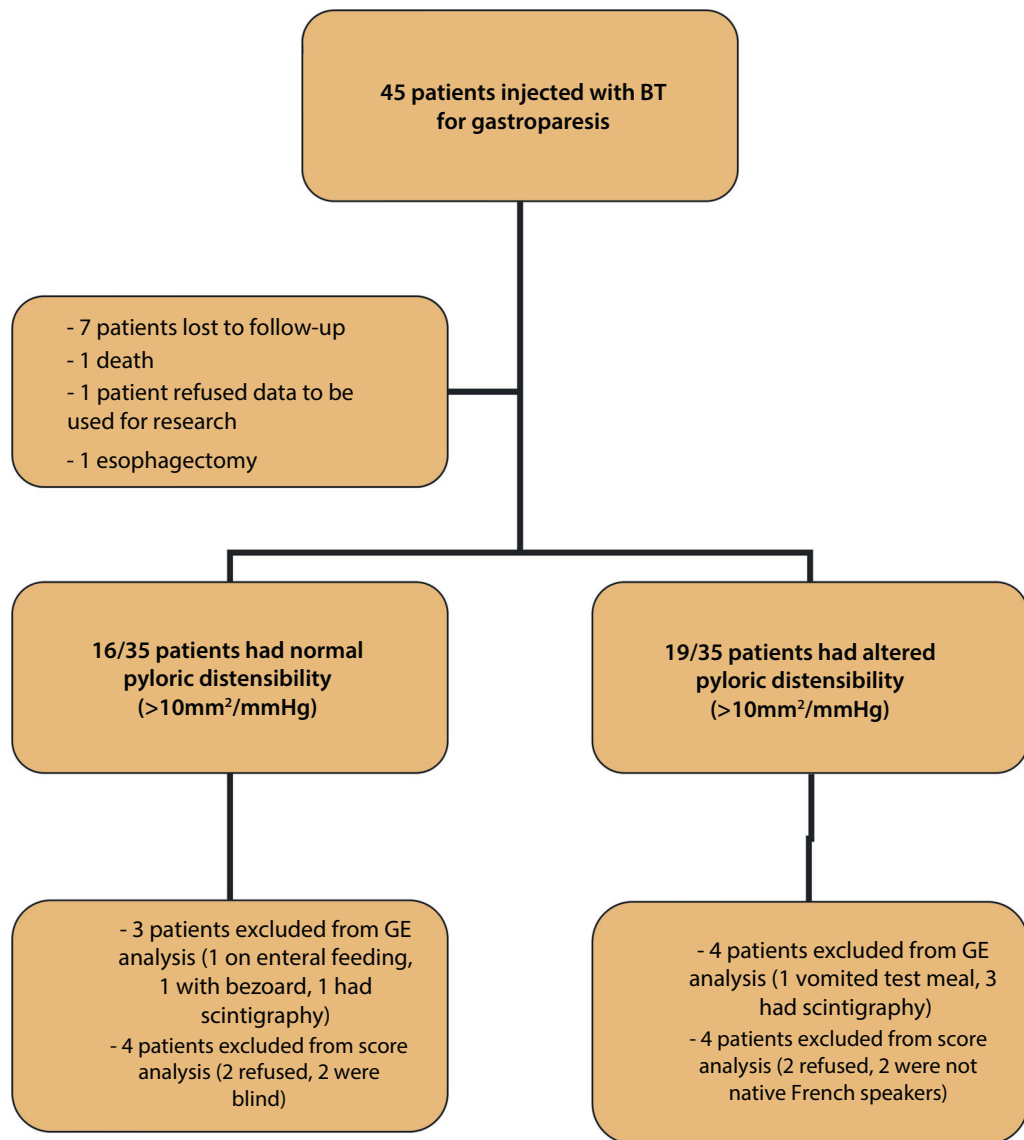

Supplementary Figure 1. Flowchart of patients who had intrapyloric botulinum toxin injection. *BT*, Botulinum toxin; *GE*, gastric emptying.

3^{ème} axe : Amélioration de la méthodologie de la technique

Impact de l'anesthésie générale sur les caractéristiques pyloriques mesurées par le système EndoFLIP[®] chez les patients atteints de gastroparésie

Le troisième axe de ce travail de thèse était centré sur l'amélioration de la méthodologie de la technique d'EndoFLIP[®]. Nous avons pu voir précédemment que la méthodologie de l'EndoFLIP[®] était très différente d'une étude à une autre, ce qui rendait les comparaisons entre les études difficiles(42). Nous nous sommes donc intéressés à l'impact des différents types d'anesthésie sur les mesures de distensibilité pylorique dans 3 centres différents. En effet, les protocoles d'anesthésie diffèrent selon les centres et il n'existe pas, jusqu'à présent, de consensus quant à la réalisation de ces mesures avec le système d'EndoFLIP[®]. L'objectif de ce travail était donc d'évaluer l'impact des produits d'anesthésie sur les mesures obtenues par EndoFLIP[®] du pylore.

Pour ce travail, nous avons analysé rétrospectivement les données issues de patients gastroparétiques provenant de 3 centres (Rouen, Rennes et Limoges). Les patients avec un antécédent d'intervention ciblant le pylore étaient exclus de l'analyse. Les dossiers médicaux ont été étudiés afin de lister les produits d'anesthésie potentiellement utilisés pendant les mesures par EndoFLIP[®].

Cent vingt-cinq patients ont été inclus dans notre travail (âge médian : 55,0 (43,0-66,0)). Trente-quatre patients (27,2%) avaient eu un EndoFLIP[®] pylorique sans anesthésie générale et 91 patients (72,8%) sous anesthésie générale. La pression pylorique à 40 ml de distension était plus élevée chez les patients du groupe anesthésie générale que ceux du groupe sans anesthésie [18,7 (13,0-25,6) mmHg versus 15,4 (11,9-20,7) mmHg ; p=0,044]. Enfin, dans l'analyse multivariée, l'administration de suxamethonium était associée avec une distensibilité pylorique diminuée (OR : 3,9 ; IC95% : 1,3-11,4 ; p=0,013) mais pas l'éphédrine (OR : 0,3; IC95% : 0,1-0,9 ; p=0,036).

Notre étude est la première à avoir évalué l'impact de l'anesthésie générale et des différents agents pharmacologiques utilisés pendant l'anesthésie, sur les mesures de l'EndoFLIP® du pylore. Étant donné que cet outil peut être utilisé afin de prédire la performance de certaines thérapies comme le G-POEM(103) et, comme nous l'avons montré précédemment, la toxine botulique, il est important de confirmer nos résultats de manière prospective afin de savoir si le protocole de sédation pourrait influencer les mesures par EndoFLIP® et également d'homogénéiser les pratiques entre les centres, afin d'éviter de potentiels facteurs confondants, comme les produits d'anesthésie.

Le manuscrit de cette dernière étude (english editing en cours) sera soumis prochainement à la revue *Neurogastroenterology & Motility*.

Journal cible : Neurogastroenterology & Motility

Word count: 3037 words

Title: Impact of anesthetics on pyloric characteristics measured using the EndoFLIP® system in patients with gastroparesis.

Short running title: Impact of general anesthesia on pyloric characteristics in patients with gastroparesis

Authorship:

Charlotte DESPREZ (1, 2), Jérémie JACQUES (3), Thomas CLAVIER (4), Timothée WALLENHORST (5), Anne Marie LEROI (1, 2, 6), Guillaume GOURCEROL (1, 2, 6)

1: Physiology Department, Rouen University Hospital, Rouen, France

2: Nutrition, Brain and Gut Laboratory, INSERM unit 1073, Rouen University Hospital, Rouen, France

3: Hepatogastroenterology Department, Limoges University Hospital, Limoges, France.

4: Department of Anesthesiology, Critical Care and Perioperative Medicine, Rouen University Hospital, Rouen, France

5: Hepatogastroenterology Department, Rennes University Hospital, Rennes, France.

6: Clinical Investigation Center, INSERM 0204, Rouen University Hospital, Rouen, France

Authorship statement:

All authors have approved the final version of the article, including the authorship list.

Guarantor of article: Guillaume Gourcerol

Corresponding author:

Charlotte Desprez

Digestive Physiology Unit

Rouen University Hospital – 1 rue de Germont, 76031 Rouen, cedex, France

Phone: + (33) 232 888 096

Fax: + (33) 235 151 623

Email address: charlotte-desprez@orange.fr

Specific author contributions:

Study conception and design: GG, CD

Patient recruitment and selection: CD, JJ, AZ, TW, AML, GG

Acquisition of data: CD, JJ, AZ, TW, AML, GG

Analysis of data: GG, CD

Interpretation of data: GG, CD

Paper writing: GG, CD

Conflict of interest:

Guillaume Gourcerol has received consulting fees from Allergan, Takeda, Naturex and kvowa Kirin; GG served as conference speaker for Medtronic. The other authors have no conflict of interest to declare.

ABSTRACT (222 words)

Background: Pyloric distensibility has been reported as a predictive measure in gastroparesis. Measures can be obtained either during endoscopy under anesthesia or in unsedated patients. However, the impact of anesthetic drugs on the results of pyloric characteristics remains unknown. The objective of the present study was to determine the impact anesthetics on pyloric measures in gastroparesis.

Methods: Consecutive gastroparetic patients with gastroparesis from 3 French tertiary centers were retrospectively analysed. Patients with previous history of prior pyloric intervention were not considered for analysis. Medical records were reviewed to list the potential use of anaesthetic drugs during the EndoFLIP® measurement.

Key results: One hundred twenty-five patients were included in the present study [median age: 55.0 (43.0-66.0)]. Thirty-four patients (27.2%) underwent pyloric assessment without general anesthesia and 91 patients (72.8%) under general anesthesia. Pyloric pressure at 40 ml of distension was higher in patients with general anaesthesia in comparison to patients without sedation [18.7 (13.0-25.6) mmHg versus 15.4 (11.9-20.7) mmHg; $p=0.044$]. In multivariate analysis, suxamethonium chloride administration was associated with decreased pyloric distensibility (OR:3.9; IC95%: 1.3-11.4; $p=0.013$) while ephedrine administration was not (OR:0.3; IC95%: 0.1-0.9; $p=0.036$).

Conclusion: This study is the first to have found an impact of general anaesthesia on pyloric measurement using the EndoFLIP®. There is consequently a need of further studies to confirm these findings, if possible, in a prospective way.

Key words: EndoFLIP®, pylorus, general anaesthesia, gastroparesis

INTRODUCTION

Gastroparesis is defined as an objectively delayed gastric emptying without mechanical obstruction. Clinical diagnosis of gastroparesis can be challenging since the pattern or the severity of dyspeptic symptoms are poorly correlated with gastric emptying(1)(2)(3). Recently, the endoscopic functional luminal imaging probe (EndoFLIP® system, Medtronic, Minneapolis, Minn, USA) technology was developed to assess sphincter elastic characteristics of the gastro-intestinal tract. To date, several studies in patients with gastroparesis investigated the usefulness of pyloric assessment using the EndoFLIP® device, including pyloric pressure and cross-sectional area (CSA) as a surrogate of pyloric diameter and pyloric distensibility. Altered pyloric distensibility was found in approximately 30 to 50% of patients with gastroparesis(4), and in up to 70-80% of patients with suspected or confirmed vagotomy(5). Moreover, pyloric distensibility and/or CSA were recently suggested as a predictive measure to therapeutic success of pyloric interventions, including intra-pyloric botulinum toxin injections or per oral pyloromyotomy(6),(7),(8).

However, there is a lack of data regarding the impact of anaesthetic drugs on the results of pyloric characteristics measured using the EndoFLIP®. This is of importance as pyloric measurements are often performed during pyloric interventions under general anesthesia, although such measures can also be performed in unsedated patients. The objective of the present study was therefore to determine in gastroparesis whether pyloric characteristics (including diameter, pressure and distensibility index) could differ among patients with or without general anesthesia.

METHODS

Patients:

Consecutive patients aged over 18 years with a diagnosis of gastroparesis and who underwent pyloric assessment using the EndoFLIP® system in three French tertiary referral centers (Rouen, Limoges, and Rennes) were eligible to the present study. Clinical and physiological data were prospectively collected from medical records from January 2013 until June 2022 and were then retrospectively reviewed. All patients had upper endoscopy excluding mechanical obstruction and delayed gastric emptying diagnosed either on scintigraphy (retention >10% at 4 hours)(9) or on C13 acid octanoic breath test(10),(11). Patients with normal gastric emptying and/or prior pyloric intervention (including endoscopic and/or surgical treatments, i.e., gastric peroral endoscopic myotomy, pyloroplasty, pyloric dilation and botulinum toxin injections) were not considered for analysis. The study was conducted in accordance with the ethical guidelines of the Declaration of Helsinki (6th revision, 2008) and was approved by a local human research committee (E2019-26) as required by national legislation.

Clinical evaluation:

The following data were recorded for each patient: demographic characteristics (age, gender, body mass index), medical history (including diabetes, esogastric surgery), aetiology of gastroparesis (diabetic, post-surgery, idiopathic or any other aetiology), and medical therapy. In patients who underwent general anaesthesia, medical records were reviewed to list the potential use of drugs during the endoscopy. The use of opioid analgesia (i.e., fentanyl citrate, morphine chloride), sedative agent (i.e., propofol, ketamine, sevoflurane), neuromuscular-blocking agent (i.e., suxamethonium chloride, atracurium besilate), and sympathomimetic agent (ephedrine) were noted. Clinical evaluation also included specific symptomatic scores for vomiting, nausea, gastric fullness, early satiety, and bloating. Each symptom was rated by patients from 0 (absence of symptom) to 4 (extremely severe symptom) using a 5-point Likert scale. Gastrointestinal Quality of Life Index (GIQLI)(12) was also performed to evaluate

overall dyspeptic symptoms and quality of life. This latter score ranges from 0 (worst quality of life) to 144 (best quality of life).

Pylopic EndoFLIP® measurement:

Pylopic sphincter characteristics including diameter and pressure were measured using the EndoFLIP® system as previously described(4). Briefly, the EndoFLIP® catheter (EF-325N; Crospon Ltd., Galway, Ireland) uses 16 serial impedance sensors placed 5 mm apart, enclosed in an 8-cm-long cylindrical compliant bag. The balloon is connected to a pump and can be inflated from 0 to 60 mL with saline solution. Real time evaluation of intra bag pressure and diameter was measured. For patients who underwent general anaesthesia, the catheter was passed through the single channel large diameter endoscope. Correct positioning was confirmed with the distinctive shape of the pylorus visible as a narrow segment with decreased diameter. For patients who did not undergo general anaesthesia, the catheter could be inserted during endoscopy or trans-nasally. In the latter situation, correct positioning was controlled during videofluoroscopy. After positioning, the balloon was filled at 10, 20, 30, 40 and 50 mL of inflation and for each volume, at least three recordings were performed. Measurements were recorded when pyloric pressure and diameter were stable for at least 5 seconds to avoid variations in pylorus volume and/or pressure during peristaltic contractions. The mean value of these 3 measurements was taken for both smallest diameter and pressure. Distensibility was calculated using minimum CSA ($=\pi*R^2$, where R=radius) divided by the pressure at each balloon fill volume. A cut-off of less than 9.2mm²/mmHg at 40 mL of inflation before G-POEM was found as predictive of clinical success of G-POEM with 72% of sensitivity and 100% of specificity in a previous study(6). Using this threshold value of 9.2mm²/mmHg, pyloric distensibility was classified as normal (>9.2mm²/mmHg) or altered (<9.2mm²/mmHg) among subjects.

Data analysis:

Continuous variables were expressed as median (25th-75th percentiles). Continuous variables were studied using Mann Whitney's test to compare two groups and ANOVA one-way test for more than 2 groups. Categorical variables were studied using Fischer's exact test. Statistical significance was defined as p-value < 0.05. Logistic regression was used to determine if general anaesthesia might alter results of EndoFLIP[®] assessment. For each pyloric sphincter parameter measured with the EndoFLIP[®] system (diameter, pressure, distensibility index), an individual regression model was made to determine the predictors of decreased diameter and pyloric distensibility or increased pyloric pressure. Demographic characteristics as well as clinical scores and gastric emptying were studied in this analysis to avoid potential confounding variables. All variables with a p-value < 0.2 in the univariate analysis were included in the logistic regression model. Results from the logistic regression model were presented as Odds Ratio (OR) [95% Confidence Interval]. Data were analysed using GraphPad Prism version 5.03 for Windows (GraphPad Software Inc, San Diego, California, USA, www.graphpad.com) and Statview software (Version 7.2, Microsoft Windows 10, Wake County, NC, USA).

RESULTS

Patients

A total of 125 patients were included in the present study [median age: 55.0 (43.0-66.0); female sex n=79 (63.2%)] after the exclusion of patients with prior pyloric therapy and normal gastric emptying (Figure 1). Among these patients, 34 patients (27.2%) underwent pyloric assessment without general anesthesia and 91 patients (72.8%) under general anesthesia. Patients' characteristics are summarized in Table 1. No difference was seen between groups in terms of age, gender ratio, body mass index, chronic intake of opioids drugs, GIQLI score and gastric emptying half-time ($T_{1/2}$). Post-surgical gastroparesis was more frequent in the group of

patients without general anesthesia while “fulness” and “bloating” scores were higher in the group of patients with general anesthesia (Table 1). Lastly, in the group of patients with general anesthesia, propofol, fentanyl and sevoflurane were the most frequently used with a frequency of 97.6% (n=83), 97.6% (n=83), and 91.8% (n=78) respectively. By contrast, suxamethonium chloride and ephedrine were used in only 57 (67.1%) and 25 (29.4%) patients, respectively.

Impact of general anaesthesia on pyloric pressure, diameter and distensibility

Pyloric pressure at 30 ml, 40 ml, and 50 ml of inflation was higher in patients with general anaesthesia in comparison with patients without sedation (Table 2). No difference was seen for pyloric diameter at 30 ml, 40 ml, and 50 ml of distension between patients with and without general anaesthesia. Lastly, no difference was seen for pyloric distensibility at 30 ml, 40 ml, and 50 ml of distension between patients with and without general anaesthesia, however, the proportion of patients with altered pyloric distensibility at 40 ml of distension was higher in patients with sedation [(58/91 (63.7%) versus 14/34 (41.2%); p=0.027; Table 2].

Impact of drug administration and timing on pyloric pressure, diameter and distensibility

Patients’ characteristics and the EndoFLIP® results were compared according to anaesthetics use and anaesthetics administration timing. The use of fentanyl, sevoflurane and propofol was not analysed as these 3 drugs were used in more than 90% of patients, ending with groups of less than 5 patients for each drug analysis. In patients with suxamethonium chloride use, a higher pyloric pressure and a lower pyloric distensibility were observed at both 40 and 50 mL of inflation, in comparison to patients without suxamethonium chloride use (Table 3). No difference was noticed for pyloric diameter in these groups. By contrast, patients with ephedrine administration exhibited a lower pyloric pressure in comparison to patients without ephedrine

use, at both 40 and 50 mL of inflation (Table 3). No difference was seen between these groups for both pyloric diameter and distensibility.

Moreover, we analysed two main sedation protocols during the reviewing of medical charts: remifentanyl was administered either shortly at the very beginning of the induction protocol (less than 2 minutes after the induction; Protocol A) or at the very end of the procedure (at least 3 minutes after EndoFLIP[®] measurement) to avoid post-intervention pain (Protocol B). In the group with early administration of remifentanyl, a higher pyloric pressure was noticed with a subsequent lower pyloric distensibility at 40 mL of inflation in comparison to the late administration group (Table 4). However, a higher number of patients with co-administration of ephedrine administration was noticed in the late administration group (Table 4).

Multivariate analysis

A first logistic regression model was built to determine the predictors of decreased pyloric distensibility (Table 5A). Among the different variables that were associated with an altered pyloric distensibility in the univariate analysis (body mass index, general anaesthesia, use of sevoflurane, propofol, suxamethonium chloride and fentanyl), suxamethonium chloride use was a factor of decreased pyloric distensibility (OR:3.9; IC95%: 1.3-11.4; p=0.013) while ephedrine displayed the opposite effect (OR:0.3; IC95%: 0.1-0.9; p=0.036). No predictor of decreased pyloric diameter was found (Table 5B). Lastly, suxamethonium chloride administration was a factor of increased pyloric pressure (OR:2.9; IC95%: 1.0-8.7; p=0.046) while ephedrine was associated with a decrease in pyloric pressure (OR:0.1; IC95%: 0.0-0.4; p<0.001; Table 5C).

DISCUSSION

In the present study, we found that pyloric pressure at 30 ml, 40 ml, and 50 ml of distension was higher in patients with general anaesthesia in comparison with patients without sedation.

No difference was seen for pyloric diameter, and the proportion of patients with altered pyloric distensibility was higher in patients with general anaesthesia. Moreover, suxamethonium chloride administration was found to be predictive of increased pyloric pressure and decreased pyloric distensibility in multivariate analysis, while ephedrine had the opposite actions.

Due to the retrospective design of the present study, the impact of each sedative agent could not be studied separately, with consequently some limitations regarding the interpretation of our results. However, suxamethonium chloride administration was found to be predictive of increased pyloric pressure and decreased distensibility in multivariate analysis. Suxamethonium chloride is a short-term neuromuscular-blocking agent and is known to depolarize skeletal muscle from their normal resting membrane potential to a more positive potential, leading to neuromuscular blockade(13). As it is made of two molecules of acetylcholine linked together, suxamethonium chloride might reproduce effects of acetylcholine on both nicotinic and muscarinic receptors(14). In the present study, the EndoFLIP[®] measurements were performed at distance from suxamethonium administration, with confirmation of complete neuromuscular blockade using train-of-four stimulation. To our knowledge, there is no available report which directly assessed the impact of curare administration on pyloric function. In literature, reports suggest that an increase of both intragastric pressure and lower oesophagus tone can be observed directly after the administration of suxamethonium during anaesthesia induction(15),(16),(17). The underlying mechanisms are unclear, as the transient fasciculations of the abdominal muscles following the administration of suxamethonium (onset of “phase I” block) are too incoordinate to raise the intragastric pressure markedly(15). However, this phenomenon cannot explain the higher pyloric pressure observed in patients with general anaesthesia as EndoFLIP[®] measurements were performed after complete neuromuscular blockade.

Ephedrine is known as a sympathomimetic amine and was administered in 25 patients (29.4%) in our report. To our knowledge, no study investigated the pyloric function during ephedrine administration in vivo in Human. A prior report assessed human pyloric strips in vitro and found that α -adrenoreceptors agonists induced inhibition of the strip's contraction in main cases(18). Another report in sedated fasting cats showed that α -adrenergic stimulation by phenylephrine could inhibit pyloric contractions induced by histamine administration, which was reversed by α -adrenergic antagonist phentolamine(19). It was also demonstrated in dogs that α -adrenergic agonists do not affect basal pyloric motor activity but can inhibit pyloric activity after stimulation by duodenal field stimulation or by intraduodenal acid infusion(20). The same findings were obtained with β -adrenoreceptors agonists(18),(21). In our study, ephedrine use was associated with increased pyloric distensibility and decreased pyloric pressure in the multivariate analysis. In the univariate analysis, this drug was more administered in patients with delayed administration of remifentanyl (protocol B), who exhibited both higher pyloric distensibility and lower pyloric pressure values than patients from the early administration group. Prior reports seem consequently to be in line with our results and it can be hypothesized that a reduced pyloric pressure could be due to reduced pyloric contractions induced by ephedrine administration.

The impact of the opioids on the gastrointestinal system is well known, but surprisingly no effect of remifentanyl on pyloric function was found in our multivariate analysis. Remifentanyl is a specific μ -receptor agonist and is rapidly metabolized to an inactive form. This drug was administered in most patients studied (97.6%), but its impact on pyloric function cannot be clearly drawn from our results, as it was administered either at the very beginning of the induction protocol, or after the EndoFLIP[®] measurement among centers. In addition,

remifentanyl has a very short half-life time during intravenous administration. However, exogenous opioid intake is known to affect gastric function. Opioid users are frequently found in patients with gastroparesis and known to exhibit higher levels of gastric retention, worse quality of life and symptoms in comparison to nonusers(22),(23). Moreover, intravenous administration of μ -receptors agonists increases pyloric phasic pressure and tonic activity and inhibits antral phasic contractility in a dose-dependent fashion, resulting in delayed gastric emptying(24),(25). On the contrary, naloxone administration inhibits the effect of beta-endorphins on the pylorus(25). It is hypothesized by authors that exogenous opioids can suppress inhibitory neural responses (mainly nitrgergic inhibition) in pyloric muscles(24). Lastly, a loss of pyloric nitrgergic neurons and interstitial cells of Cajal can be observed in patients with gastroparesis(26),(27),(28), with consequently a hypothetical lesser effect of exogenous opioids administration. As the time of administration of remifentanyl differed between centers but a difference was found regarding pyloric distensibility in the univariate analysis among sedation protocol, a potential impact of remifentanyl on pyloric distensibility cannot be excluded from the interpretation of our results.

Lastly, several reports on the effect of propofol administration on gastrointestinal motility are available in literature. Intravenous propofol sedation does not seem to influence gastric emptying in healthy volunteers at sub hypnotic and hypnotic doses in comparison to enflurane(29) or isoflurane(30) anaesthesia. However, it is unclear if propofol delays gastric emptying, as the range of gastric emptying varied widely among the subjects included in these studies. Another report found a delayed gastric emptying in mice sedated with propofol, with a dose-effect relationship(31). In an in vitro study(32), the use of propofol on human gastric smooth muscle stripes revealed that propofol might impair gastric contractile activity at sedative dose. Moreover, propofol sedation might increase lower oesophageal sphincter

pressure at sedative dose and not at low dose of propofol(33). As no study investigated pyloric sphincter properties during propofol sedation, no conclusion can be drawn from our results. Lastly, only a few studies investigated the potential impact of volatile agents on gastrointestinal motility. Volatile anaesthetics might have inhibitory effects on gastric motility, but this effect seems to stop quickly after termination of the agents(34),(35). However, sevoflurane was only used during the induction of the sedation protocol in our study, with unclear effects on pyloric characteristics. Lastly, no effect of ketamine on gastrointestinal motility is described in literature to our knowledge, but as this drug was administered in only 2 patients, we could not study its effect on pyloric function(16).

The present study does have some limitations. Firstly, due to its retrospective design, the impact of each sedative agent could not be studied separately, with consequently some limitations regarding the interpretation of our results. However, our two groups (sedated versus non-sedated patients) were comparable as no difference was seen between groups regarding demographic characteristics, symptoms and quality of life severity, and gastric emptying. The only difference was the proportion of esogastric surgery, mainly Nissen fundoplication, which was higher in the non-sedated group. But the etiology of gastroparesis was not found as a predictor of altered pyloric distensibility in our multivariate analysis. Moreover, as propofol, sevoflurane and remifentanyl were used in most patients, the individual action of these drugs could not be studied. This study is the first one to have assessed the impact of the general anaesthesia on pyloric function and our findings suggest that it can have an impact on the EndoFLIP® measurements. There is consequently a need of further studies to confirm these findings, if possible, in a prospective way. As the EndoFLIP® results can predict the performance of pyloric interventions like botulinum toxin(36) or G-POEM(6), it is necessary to confirm if the sedation protocol can alter these pyloric measurements, and therefore lead to

unnecessary treatment in patients with gastroparesis. Moreover, several studies reported intraoperative evaluation of the pylorus using the EndoFLIP[®], with predictors of success like distensibility(6),(8) or diameter(7). According to our results, these findings should be carefully extrapolated to other centers as the sedation protocol could differ among centers and patients. Therefore, there is probably also a need to develop a protocol for EndoFLIP[®] measurements and homogenise its performance, to avoid potential confounding factors that could impact its results like anaesthetic drugs.

CONCLUSION

In conclusion, we found that pyloric pressure at 30 ml, 40 ml, and 50 ml of distension was higher in patients with general anaesthesia in comparison to patients without sedation. Both general anaesthesia, suxamethonium chloride and ephedrine administration seem to have an impact on the pyloric metrics measured using EndoFLIP[®]. The sedation protocol should therefore be taken carefully into account during EndoFLIP[®] measurements. There is consequently a need of further studies to confirm these findings, if possible, in a prospective way.

REFERENCES

1. Talley NJ, Locke GR, Lahr BD, Zinsmeister AR, Tougas G, Ligozio G, et al. Functional dyspepsia, delayed gastric emptying, and impaired quality of life. *Gut*. juill 2006;55(7):933-9.
2. Parkman HP, Yates K, Hasler WL, Nguyen L, Pasricha PJ, Snape WJ, et al. Clinical features of idiopathic gastroparesis vary with sex, body mass, symptom onset, delay in gastric emptying, and gastroparesis severity. *Gastroenterology*. janv 2011;140(1):101-15.
3. Wuestenberghs F, Juge M, Melchior C, Desprez C, Leroi AM, Gourcerol G. Association Between Symptoms, Quality of Life, and Gastric Emptying in Dyspeptic Patients. *J Neurogastroenterol Motil*. 30 oct 2019;25(4):534-43.
4. Gourcerol G, Tissier F, Melchior C, Touchais JY, Huet E, Prevost G, et al. Impaired fasting pyloric compliance in gastroparesis and the therapeutic response to pyloric dilatation. *Aliment Pharmacol Ther*. févr 2015;41(4):360-7.
5. Desprez C, Melchior C, Wuestenberghs F, Huet E, Zalar A, Jacques J, et al. Pyloric distensibility measurement after gastric surgery: Which surgeries are associated with pylorospasm? *Neurogastroenterol Motil*. 8 janv 2020;e13790.
6. Jacques J, Pagnon L, Hure F, Legros R, Crepin S, Fauchais AL, et al. Peroral endoscopic pyloromyotomy is efficacious and safe for refractory gastroparesis: prospective trial with assessment of pyloric function. *Endoscopy*. 12 juin 2018;
7. Watts LS, Baker JR, Lee AA, Harer K, Bowers N, Law R, et al. Impact of gastric peroral endoscopic myotomy on static and dynamic pyloric function in gastroparesis patients. *Neurogastroenterol Motil*. 15 juin 2020;e13892.
8. Hedberg HM, Carbray J, Ujiki MB. Initial Experience with Endoscopic Pyloromyotomy, with Description and Video of Technique. *J Gastrointest Surg*. 2019;23(8):1706-10.
9. Camilleri M, Chedid V, Ford AC, Haruma K, Horowitz M, Jones KL, et al.

Gastroparesis. *Nature Reviews Disease Primers*. 1 nov 2018;4(1):41.

10. Ghos YF, Maes BD, Geypens BJ, Mys G, Hiele MI, Rutgeerts PJ, et al. Measurement of gastric emptying rate of solids by means of a carbon-labeled octanoic acid breath test. *Gastroenterology*. juin 1993;104(6):1640-7.
11. Marie I, Gourcerol G, Leroi AM, Ménard JF, Levesque H, Ducrotté P. Delayed gastric emptying determined using the ¹³C-octanoic acid breath test in patients with systemic sclerosis. *Arthritis Rheum*. juill 2012;64(7):2346-55.
12. Eypasch E, Williams JJ, Wood-Dauphinee S, Ure BM, Schmülling C, Neugebauer E, et al. Gastrointestinal Quality of Life Index: development, validation and application of a new instrument. *Br J Surg*. févr 1995;82(2):216-22.
13. Durant NN, Katz RL. Suxamethonium. *Br J Anaesth*. févr 1982;54(2):195-208.
14. Berthoud MC, Reilly CS. Adverse effects of general anaesthetics. *Drug Saf*. déc 1992;7(6):434-59.
15. Roe RB. The effect of suxamethonium on intragastric pressure. *Anaesthesia*. avr 1962;17:179-81.
16. Chassard D, Lansiaux S, Duflo F, Mion F, Bleyzac N, Debon R, et al. Effects of subhypnotic doses of propofol on gastric emptying in volunteers. *Anesthesiology*. juill 2002;97(1):96-101.
17. La Cour D. Rise in intragastric pressure caused by suxamethonium fasciculations. *Acta Anaesthesiol Scand*. 1969;13(4):255-61.
18. Haffner JF, Liavåg I, Setekleiv J. Excitatory adrenergic receptors in the human stomach and pylorus. *Scand J Gastroenterol*. 1969;4(2):145-50.
19. Biancani P, CiCalzi LK, McCallum RW. Mechanism of histamine-induced excitation of the cat pylorus. *J Clin Invest*. sept 1981;68(3):582-8.
20. Allescher HD, Ahmad S, Kostolanska F, Kwan CY, Daniel EE. Modulation of pyloric

motor activity via adrenergic receptors. *J Pharmacol Exp Ther.* mai 1989;249(2):652-9.

21. Gáti T, Gelencsér F, Hideg J. The role of adrenergic receptors in the regulation of gastric motility in the rat. *Z Exp Chir.* 1975;8(3):179-84.

22. Hasler WL, Wilson LA, Nguyen LA, Snape WJ, Abell TL, Koch KL, et al. Opioid Use and Potency Are Associated With Clinical Features, Quality of Life, and Use of Resources in Patients With Gastroparesis. *Clin Gastroenterol Hepatol.* juin 2019;17(7):1285-1294.e1.

23. Jehangir A, Parkman HP. Chronic opioids in gastroparesis: Relationship with gastrointestinal symptoms, healthcare utilization and employment. *World J Gastroenterol.* 28 oct 2017;23(40):7310-20.

24. Camilleri M, Sanders KM. Opiates, the Pylorus, and Gastroparesis. *Gastroenterology.* août 2020;159(2):414-21.

25. Camilleri M, Malagelada JR, Stanghellini V, Zinsmeister AR, Kao PC, Li CH. Dose-related effects of synthetic human beta-endorphin and naloxone on fed gastrointestinal motility. *Am J Physiol.* juill 1986;251(1 Pt 1):G147-154.

26. Grover M, Farrugia G, Lurken MS, Bernard CE, Faussone-Pellegrini MS, Smyrk TC, et al. Cellular changes in diabetic and idiopathic gastroparesis. *Gastroenterology.* mai 2011;140(5):1575-1585.e8.

27. Faussone-Pellegrini MS, Grover M, Pasricha PJ, Bernard CE, Lurken MS, Smyrk TC, et al. Ultrastructural differences between diabetic and idiopathic gastroparesis. *J Cell Mol Med.* juill 2012;16(7):1573-81.

28. Bashashati M, Moraveji S, Torabi A, Sarosiek I, Davis BR, Diaz J, et al. Pathological Findings of the Antral and Pyloric Smooth Muscle in Patients with Gastroparesis-Like Syndrome Compared to Gastroparesis: Similarities and Differences. *Dig Dis Sci.* oct 2017;62(10):2828-33.

29. Bennett MW, Bembridge JL, Shah MV. A comparison of the effect on gastric emptying

of either enflurane or propofol given during maintenance of anaesthesia for minor surgery. *Anaesthesia*. août 1994;49(8):675-7.

30. Freye E, Sundermann S, Wilder-Smith OH. No inhibition of gastro-intestinal propulsion after propofol- or propofol/ketamine-N₂O/O₂ anaesthesia. A comparison of gastro-caecal transit after isoflurane anaesthesia. *Acta Anaesthesiol Scand*. juill 1998;42(6):664-9.

31. Inada T, Asai T, Yamada M, Shingu K. Propofol and midazolam inhibit gastric emptying and gastrointestinal transit in mice. *Anesth Analg*. oct 2004;99(4):1102-6.

32. Lee TL, Ang SB, Dambisya YM, Adaikan GP, Lau LC. The effect of propofol on human gastric and colonic muscle contractions. *Anesth Analg*. nov 1999;89(5):1246-9.

33. de Leon A, Ahlstrand R, Thörn SE, Wattwil M. Effects of propofol on oesophageal sphincters: a study on young and elderly volunteers using high-resolution solid-state manometry. *Eur J Anaesthesiol*. avr 2011;28(4):273-8.

34. Marshall FN, Pittinger CB, Long JP. Effects of halothane on gastrointestinal motility. *Anesthesiology*. juin 1961;22:363-6.

35. Walldén J, Thörn SE, Löqvist A, Wattwil L, Wattwil M. The effect of anesthetic technique on early postoperative gastric emptying: comparison of propofol-remifentanyl and opioid-free sevoflurane anesthesia. *J Anesth*. 2006;20(4):261-7.

36. Desprez C, Melchior C, Wuestenberghs F, Zalar A, Jacques J, Leroi AM, et al. Pyloric distensibility measurement predicts symptomatic response to intrapyloric botulinum toxin injection. *Gastrointest Endosc*. 2019;90(5):754-760.e1.

FIGURES

FIGURE 1: Flow chart of the study.

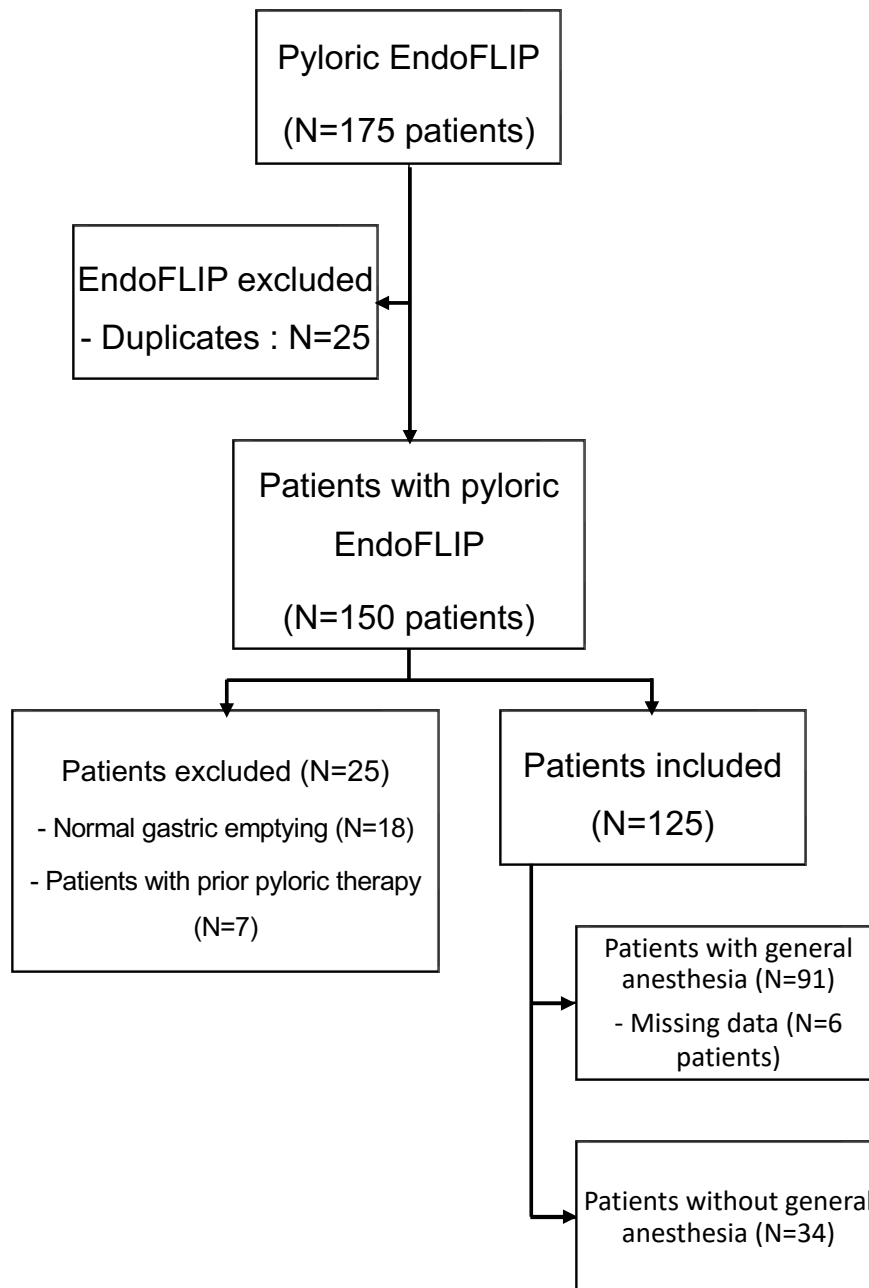

TABLES

Table 1: characteristics of the patients

| | All (N=125) | Without general anesthesia (N=34) | With general anesthesia (N=91) | P |
|--|---------------------|-----------------------------------|--------------------------------|---------------|
| Age (years) | 55.0 (43.0-66.0) | 56.5 (44.3-65.8) | 56.0 (43.0-66.0) | 0.46 |
| Sex (male/female) | 46/79 | 13/21 | 33/58 | 0.83 |
| Body mass index (kg/m ²) | 24.3 (20.6-28.0) | 24.2 (20.6-27.1) | 24.6 (20.6-28.4) | 0.438 |
| Etiology of gastroparesis | | | | |
| Mellitus diabetes | 50 (40.0%) | 14 (41.2%) | 36 (39.6%) | 0.99 |
| Esogastric surgery | 25 (20.0%) | 11 (32.4%) | 14 (15.4%) | 0.045* |
| Idiopathic | 43 (34.4%) | 8 (23.5%) | 35 (38.5%) | 0.14 |
| Other | 7 (5.6%) | 1 (2.9%) | 6 (6.6%) | 0.99 |
| Chronic intake of opioid drugs | 11 (8.8%) | 4 (11.8%) | 7 (7.6%) | 0.99 |
| Use of the following during general anesthesia | N=119 | N=34 | N=85 | |
| Sevoflurane | 78 (65.5%) | 0 (0.0%) | 78 (91.8%) | |
| Propofol | 83 (69.7%) | 0 (0.0%) | 83 (97.6%) | |
| Suxamethonium chloride | 57 (47.8%) | 0 (0.0%) | 57 (67.1%) | |
| Ketamine | 2 (1.7%) | 0 (0.0%) | 2 (2.4%) | |
| Fentanyl | 83 (69.7%) | 0 (0.0%) | 83 (97.6%) | |
| Ephedrine | 25 (21.0%) | 0 (0.0%) | 25 (29.4%) | |
| GIQLI score | N=111 | N=32 | N=79 | |
| | 66.0 (55.0-82.0) | 66.0 (33.0-83.0) | 66.0 (55.0-82.0) | 0.703 |
| Nausea | 2.0 (1.0-4.0) | 2.0 (1.0-3.0) | 2.0 (1.0-4.0) | 0.247 |
| Vomiting | 2.0 (1.0-4.0) | 2.0 (1.0-4.0) | 2.0 (1.0-4.0) | 0.238 |
| Stomach fullness | 2.0 (1.0-3.0) | 1.0 (1.0-2.0) | 2.0 (1.0-4.0) | 0.017* |
| Feeling excessively full after a meal | 1.0 (1.0-3.0) | 1.0 (1.0-2.0) | 1.0 (0.0-3.8) | 0.284 |
| Bloating | 1.0 (1.0-3.0) | 1.0 (0.0-2.0) | 2.0 (1.0-4.0) | 0.007* |
| T(1/2) (min) | N = 116 | N= 32 | N= 84 | |
| | 220.5 (196.6-301.0) | 218.0 (196.1-310.3) | 221.5 (197.3-301.0) | 0.877 |

GIQLI: Gastrointestinal Quality of Life Index; T(1/2): gastric emptying half-time

*: p<0.05. Results are presented as median (25th-75th percentiles)

Table 2: Comparison of pyloric characteristics measured in patients with and without general anaesthesia using the EndoFLIP® system

| | Without general anesthesia (N=34) | With general anesthesia (N=91) | p |
|--|-----------------------------------|--------------------------------|---------------|
| 40 mL of inflation | | | |
| Diameter (mm) | 12.7 (10.5-15.8) | 14.4 (12.9-15.8) | 0.069 |
| Pressure (mmHg) | 15.4 (11.9-20.7) | 18.7 (13.0-25.6) | 0.044* |
| Distensibility index (mm ² /mmHg) | 11.6 (5.68-18.8) | 8.7 (6.3-12.5) | 0.156 |
| Altered distensibility index, n (%) | 14/34 (41.2%) | 58/91 (63.7%) | 0.027* |
| 50 mL of inflation | | | |
| Diameter (mm) | 17.4 (15.6-19.4) | 16.7 (15.0-19.0) | 0.522 |
| Pressure (mmHg) | 30.2 (24.6-35.8) | 36.0 (28.7-43.8) | 0.028* |
| Distensibility index (mm ² /mmHg) | 8.1 (5.9-10.3) | 6.5 (4.7-8.8) | 0.138 |

*: p<0.05. Results are presented as median (25th-75th percentiles)

Table 3: Comparison of pyloric characteristics measured in patients with and without suxamethonium chloride (A) or ephedrine (B) using the EndoFLIP® system

| | With suxamethonium chloride (N=57) | Without suxamethonium chloride (N=28) | p |
|--|------------------------------------|---------------------------------------|-------------------|
| 40 mL of inflation | | | |
| Diameter (mm) | 14.6 (12.7-15.7) | 14.3 (12.9-17.2) | 0.124 |
| Pressure (mmHg) | 22.1 (14.6-28.2) | 15.5 (9.9-20.7) | <0.001* |
| Distensibility index (mm ² /mmHg) | 8.0 (5.1-9.9) | 11.3 (8.7-16.5) | <0.001* |
| 50 mL of inflation | | | |
| Diameter (mm) | 16.6 (15.1-18.5) | 17.0 (15.0-19.8) | 0.42 |
| Pressure (mmHg) | 38.8 (29.8-46.5) | 30.2 (22.5-41.9) | 0.002* |
| Distensibility index (mm ² /mmHg) | 5.9 (4.3-7.9) | 7.8 (5.9-11.1) | 0.008* |

*:p<0.05

| | With ephedrine (N=25) | Without ephedrine (N=60) | p |
|--|-------------------------|--------------------------|---------------|
| 40 mL of inflation | | | |
| Diameter (mm) | 14.7 (12.7-15.7) | 14.3 (12.8-16.0) | 0.187 |
| Pressure (mmHg) | 14.2 (11.1-20.6) | 21.4 (15.2-27.8) | 0.003* |
| Distensibility index (mm ² /mmHg) | 9.9 (7.9-15.4) | 8.6 (6.1-10.6) | 0.071 |
| 50 mL of inflation | | | |
| Diameter (mm) | 16.7 (15.0-18.6) | 16.7 (15.0-19.2) | 0.739 |
| Pressure (mmHg) | 29.5 (24.9-39.3) | 38.9 (30.0-46.8) | 0.003* |
| Distensibility index (mm ² /mmHg) | 7.6 (5.0-9.2) | 6.1 (4.7-8.6) | 0.108 |

*:p<0.05

Table 4: comparison of pyloric characteristics at 40 mL of distension among the two sedation protocols in patients with general anesthesia.

| | Sedation protocol A (N=68) | Sedation protocol B (N=23) | p |
|---|-------------------------------|-------------------------------|--------------------|
| Age (years) | 56.5 (22.0-66.5) | 56.0 (43.0-67.0) | 0.887 |
| Sex (male/female) | 26 (38.2%) | 7 (30.4%) | 0.619 |
| Body mass index (kg/m ²) | 24.6 (20.7-28.4) | 24.3 (19.1-28.6) | 0.712 |
| Etiology of gastroparesis | | | |
| Mellitus diabetes | 26 (38.2%) | 10 (43.5%) | 0.806 |
| Esogastric surgery | 13 (19.1%) | 1 (4.3%) | 0.107 |
| Idiopathic | 28 (41.2%) | 7 (30.4%) | 0.459 |
| Chronic intake of opioid drugs | 7 (10.3%) | 0 (0.0%) | 0.185 |
| Use of the following during general anesthesia | N=62 | N=23 | |
| Sevoflurane | 59 (95.2%) | 19 (82.6%) | 0.38 |
| Propofol | 61 (98.4%) | 22 (95.7%) | 0.47 |
| Suxamethonium chloride | 44 (70.9%) | 13 (56.5%) | 0.298 |
| Ketamine | 2 (3.2%) | 0 (0.0%) | 0.999 |
| Fentanyl | 60 (96.8%) | 23 (100.0%) | 0.999 |
| Ephedrine | 13 (20.9%) | 12 (52.2%) | 0.008* |
| GIQLI score | 70.0 (58.5-82.5) | 62.0 (52.8-70.0) | 0.113 |
| T(1/2) (min) | 223.0 (202.0-282.0) | 217.0 (129.0-360.0) | 0.718 |
| 40 mL of inflation | | | |
| Diameter (mm) | 15.0 (13.0-16.0) | 13.7 (12.3-15.0) | 0.075 |
| Pressure (mmHg) | 21.4 (15.9-27.8) | 12.4 (11.0-17.3) | <0.0001* |
| Distensibility index (mm ² /mmHg) | 7.9 (6.1-11.3) | 10.5 (8.2-16.0) | 0.007* |

GIQLI: Gastrointestinal Quality of Life Index; OR: Odds ratio, IC95%: 95% confidence interval; T(1/2): gastric emptying half-time

*: p<0.05. Results are presented as median (25th-75th percentiles)

Table 5: Predictors of (A) altered pyloric distensibility, (B) altered pyloric diameter and (C) altered pyloric pressure at 40 mL of inflation

A

| | Altered pyloric distensibility (N=72) | Normal pyloric distensibility (N=53) | p | Logistic regression | | |
|--|---------------------------------------|--------------------------------------|----------------|---------------------|---------------------|--------------|
| | | | | OR | IC95% | P |
| Age (years) | 58.0 (47.0-67.8) | 51.0 (38.5-64.0) | 0.125 | 1.028 | 0.998-1.059 | 0.064 |
| Sex (male/female) | 28/44 | 18/35 | 0.707 | 1.294 | 0.538-2.110 | 0.546 |
| Body mass index (kg/m ²) | 24.7 (21.8-28.4) | 23.5 (19.5-26.9) | 0.031* | 1.016 | 0.935-1.105 | 0.702 |
| Etiology of gastroparesis | | | | | | |
| Mellitus diabetes | 29 (40.3%) | 21 (39.6%) | 0.99 | | | |
| Esogastric surgery | 17 (23.6%) | 8 (15.1%) | 0.365 | | | |
| Idiopathic | 22 (30.6%) | 21 (39.6%) | 0.343 | | | |
| Other | 4 (5.5%) | 3 (5.7%) | 0.99 | | | |
| Chronic intake of opioid drugs | 4 | 7 | 0.201 | | | |
| Number of patients undergoing general anesthesia | 58 | 33 | 0.027* | 14.877 | 0.000-3829.082 | 0.997 |
| GIQLI score | 69.0 (57.3-78.5) | 65.0 (53.5-84.0) | 0.588 | | | |
| Use of the following during general anesthesia | N=69 | N=51 | | | | |
| Sevoflurane | 52 (76,5%) | 26 (50,9%) | 0,007* | 2.930 | 0.562-15.284 | 0.202 |
| Propofol | 54 (78,3%) | 29 (56,9%) | 0,016* | 0.725 | 0.025-21.212 | 0.851 |
| Suxamethonium chloride | 42 (60,9%) | 15 (29,4%) | 0,0008* | 3.897 | 1.327-11.449 | 0.013 |
| Ketamine | 2 (2,8%) | 0 (0,0%) | 0,99 | | | |
| Fentanyl | 53 (73,6%) | 30 (58,8%) | 0,046* | 2.1 ^{E-7} | 0.000-3829.082 | 0.997 |
| Ephedrine | 12 (16,7%) | 13 (25,5%) | 0,363 | 0.0317 | 0.108-0.929 | 0.036 |
| T(1/2) (min) | 220.0 (196.6-301.8) | 222.5 (194.8-297.0) | 0.67 | | | |

GIQLI: Gastrointestinal Quality of Life Index; OR: Odds ratio, IC95%: 95% confidence interval; T(1/2): gastric emptying half-time

*: p<0.05. Results are presented as median (25th-75th percentiles)

B

| | | | | Logistic regression | | |
|--|---------------------------------|--------------------------------|-------|---------------------|-------|---|
| | Altered pyloric diameter (N=60) | Normal pyloric diameter (N=58) | p | OR | IC95% | P |
| Age (years) | 55.5 (42.3-64.0) | 53.5 (41.8-70.0) | 0.467 | | | |
| Sex (male/female) | 23/37 | 21/37 | 0.851 | | | |
| Body mass index (kg/m ²) | 24.5 (20.9-27.8) | 23.9 (20.2-28.2) | 0.669 | | | |
| Etiology of gastroparesis | | | | | | |
| Mellitus diabetes | 23 (38.3%) | 25 (43.1%) | 0.708 | | | |
| Esogastric surgery | 16 (26.6%) | 8 (13.7%) | 0.110 | | | |
| Idiopathic | 17 (28.3%) | 23 (39.7%) | 0.244 | | | |
| Other | 4 (6.7%) | 3 (5.2%) | 0.990 | | | |
| Chronic intake of opioid drugs | 5 (8.3%) | 6 (10.3%) | 0.947 | | | |
| Number of patients undergoing general anesthesia | 43 (71.7%) | 47 (81.0%) | 0.282 | | | |
| Use of the following during general anesthesia | N=57 | N=55 | | | | |
| Sevoflurane | 37 (64,9%) | 40 (72,7%) | 0,444 | | | |
| Propofol | 38 (66,7%) | 44 (80,0%) | 0,164 | | | |
| Suxamethonium chloride | 27 (47,4%) | 29 (52,7%) | 0,713 | | | |
| Ketamine | 1 (1,7%) | 1 (1,8%) | 0,990 | | | |
| Fentanyl | 39 (68,4%) | 43 (78,2%) | 0,321 | | | |
| Ephedrine | 12 (21,1%) | 13 (23,6%) | 0,824 | | | |
| GIQLI score | 69.0 (54.0-79.0) | 65.0 (55.5-85.5) | 0,974 | | | |
| T(1/2) (min) | 225.0 (196.6-296.8) | 215.0 (194.0-302.0) | 0.507 | | | |

GIQLI: Gastrointestinal Quality of Life Index; OR: Odds ratio, IC95%: 95% confidence interval; T(1/2): gastric emptying half-time

*: p<0.05. Results are presented as median (25th-75th percentiles)

C

| | Altered pyloric pressure (N=61) | Normal pyloric pressure (N=59) | p | Logistic regression | | |
|--|---------------------------------|--------------------------------|---------------|---------------------|--------------------|-------------------|
| | | | | OR | IC95% | P |
| Age (years) | 59.0 (47.3-68.5) | 51.0 (40.0-64.0) | 0.147 | 1.037 | 1.006-1.070 | 0.019* |
| Sex (male/female) | 21/39 | 24/35 | 0.574 | 0.642 | 0.260-1.581 | 0.334 |
| Body mass index (kg/m ²) | 24.7 (20.9-28.4) | 24.2 (20.2-26.9) | 0.209 | 0.959 | 0.877-1.049 | 0.359 |
| Etiology of gastroparesis | | | | | | |
| Mellitus diabetes | 26 (42.6%) | 22 (37.3%) | 0.581 | | | |
| Esogastric surgery | 14 (22.9%) | 10 (16.9%) | 0.496 | | | |
| Idiopathic | 17 (27.9%) | 23 (38.9%) | 0.246 | | | |
| Other | 3 (4.9%) | 4 (6.8%) | 0.990 | | | |
| Chronic intake of opioid drugs | 4 (6.6%) | 7 (11.8%) | 0.385 | | | |
| Number of patients undergoing general anesthesia | 50 (81.9%) | 41 (69.5%) | 0.137 | 0.281 | 0.001-54.918 | 0.359 |
| Use of the following during general anesthesia | N=57 | N=56 | | | | |
| Sevoflurane | 45 (78,9%) | 33 (58,9%) | 0,026* | 4.594 | 0.690-30.581 | 0.114 |
| Propofol | 46 (80,7%) | 37 (66,1%) | 0,091 | 0.299 | 0.008-10.647 | 0.5076 |
| Suxamethonium chloride | 35 (61,4%) | 22 (39,3%) | 0,024* | 2.978 | 1.020-8.695 | 0.046* |
| Ketamine | 2 (3,5%) | 0 (0,0%) | 0,990 | | | |
| Fentanyl | 46 (80,7%) | 37 (62,7%) | 0,091 | 8.534 | 0.333-218.905 | 0.195 |
| Ephedrine | 7 (12,3%) | 18 (32,1%) | 0,013* | 0.121 | 0.038-0.388 | <0.001* |
| GIQLI score | 69.5 (55.8-85.3) | 66.0 (53.0-79.8) | 0.523 | | | |
| T(1/2) (min) | 221.5 (196.9-299.3) | 217.0 (195.0-292.0) | 0.419 | | | |

*: p<0.05. Results are presented as median (25th-75th percentiles)

GIQLI: Gastrointestinal Quality of Life Index; OR: Odds ratio, IC95%: 95% confidence interval

Sixième partie : discussion générale et conclusions

Le premier axe de ce travail était d'évaluer les qualités diagnostiques de l'EndoFLIP® et, en particulier, de déterminer si l'EndoFLIP® permettait d'identifier les mécanismes physiopathologiques responsables d'un trouble fonctionnel digestif tel que la gastroparésie ou l'incontinence fécale.

Concernant l'EndoFLIP® pylorique, un des objectifs était d'évaluer la valeur mécanistique de l'EndoFLIP® chez les patients souffrant de gastroparésie diabétique et post-chirurgicale. Le diabète est une cause connue de gastroparésie(91) qui, en dehors des symptômes digestifs invalidants (nausée, vomissements, douleur/pesanteur épigastrique, satiété précoce), peut être source de déséquilibre dans le contrôle glycémique des patients(91). Plusieurs mécanismes ont été évoqués pour expliquer la gastroparésie diabétique : dont un dysfonctionnement de la motricité gastrique mais également pylorique secondaires au diabète et/ou à l'hyperglycémie(6),(164),(166)(167).

Peu d'études se sont intéressées à la fonction pylorique des patients diabétiques probablement en raison des difficultés d'exploration du pylore. Mearin et al.(6) avaient mis en évidence un pylorospasme en manométrie antro-pyloro-duodénale chez des patients diabétiques présentant des symptômes de gastroparésie, avec une pression pylorique plus élevée chez ces patients en comparaison aux volontaires sains. Plus récemment, la technique d'EndoFLIP® a rendu l'exploration du pylore plus facile. Ainsi, Malik et al.(104) (n=15) et Snape et al.(162) (n=27) ont décrit respectivement une augmentation de la pression pylorique évaluée à $17,7 \pm 2,3$ mmHg et à $17,4 \pm 1,3$ mmHg et une diminution de la distensibilité pylorique à $10,7 \pm 2,6$ mmHg et de $8,5 \pm 1,1$ mmHg chez des patients avec gastroparésie diabétique. Les résultats de notre étude ont confirmé l'implication du dysfonctionnement pylorique dans la physiopathologie de la gastroparésie diabétique dans une large cohorte de

patients. Ainsi, en utilisant l'index de distensibilité de 10 mm²/mmHg déjà publié par notre centre afin de définir le seuil de distensibilité pylorique altérée(102)(169), 26/46 patients (56,5%) des patients atteints de gastroparésie diabétique présentaient une distensibilité pylorique altérée, avec un taux similaire retrouvé chez les patients atteints de gastroparésie idiopathique (17/33 patient, 51,5%). Par ailleurs, nous avons observé une dispersion des valeurs de distensibilité pylorique chez les patients atteints de gastroparésie diabétique. Ceci pourrait refléter le caractère multifactoriel de la gastroparésie diabétique, certains patients présentant une dysfonction pylorique sévère et d'autre une atteinte plus ciblée sur la motricité antrale et/ou fundique gastrique.

Contrairement à ce que nous attendions, nous n'avons retrouvé aucune corrélation entre les caractéristiques du diabète des patients étudiés et les mesures de distensibilité pylorique ou la mesure de vidange gastrique. Bien que la neuropathie autonome extrinsèque fasse partie des causes possibles de gastroparésie(101) et que la présence d'une neuropathie périphérique ait été mentionnée comme un potentiel facteur de risque de gastroparésie(170), nous n'avons pas retrouvé de différence significative en ce qui concerne les mesures de la fonction pylorique, chez les patients diabétiques sur la base de la présence ou non d'une neuropathie périphérique. Ceci pourrait être expliqué d'une part, par le faible nombre de patients qui présentaient une neuropathie périphérique dans notre étude, et d'autre part, parce que l'altération de la distensibilité pylorique pourrait être davantage en lien avec des changements de structure au niveau pylorique (myopathie, relargage local de NO en lien avec le système nerveux entérique) qu'en lien avec l'innervation extrinsèque. Il est connu que l'hyperglycémie peut ralentir la vidange gastrique(164), en particulier chez les patients diabétiques(170). L'élévation sanguine de la concentration en glucose est associée à une suppression des contractions antrales, à un tonus fundique plus bas et à une dysrythmie gastrique(171). Pourtant, nous n'avons pas mis en évidence de corrélation entre le temps de vidange gastrique et la glycémie à jeun. Cela pourrait

être lié à la réalisation de la mesure glycémique directement avant la réalisation de l'EndoFLIP® et non avant la mesure de la vidange gastrique. Par ailleurs, la littérature reste pauvre concernant les relations potentielles entre l'hyperglycémie et le pylorospasme. Le pylorospasme a été décrit pour la 1^{ère} fois(6) chez des patients diabétiques présentant des nausées et vomissements récurrents, mais il n'y avait aucune surveillance de la glycémie pendant les mesures manométriques de la motricité antro-pyloro-duodénale. Une autre étude chez les volontaires sains a montré une élévation localisée des contractions pyloriques induites par l'hyperglycémie (glycémie entre 12-16 mmol/l) en comparaison avec l'euglycémie (3-5 mmol/l)(172) et un effet supprimeur sur l'activité antrale. Comme suggéré par les modèles animaux, l'hyperglycémie pourrait supprimer l'activité vagale efférente, ce qui entraînerait une élévation de l'activité pylorique(173). Néanmoins, aucune corrélation n'a été retrouvée entre la pression pylorique et la glycémie à jeun dans notre étude. Ceci pourrait s'expliquer par un taux de glycémie observé plus faible dans notre étude (10.0 ± 1.0 mmol/l) que dans les études précédemment décrites (172).

Notre étude a donc permis de mettre en évidence que plus de la moitié des patients diabétiques avec gastroparésie présentaient un dysfonctionnement pylorique, qui pourrait être une cible thérapeutique avec pour objectif de lever le spasme pylorique par dilatation, par injection de toxine botulique ou par G-POEM. Cependant, comme le pylorospasme n'est pas systématiquement retrouvé chez les patients avec gastroparésie diabétique et que nous n'avons retrouvé aucun facteur prédictif de la fonction pylorique, l'EndoFLIP® serait alors un outil diagnostique indispensable pour permettre la détection des patients avec dysfonction pylorique, susceptibles d'être de bons candidats pour ces thérapies. D'autres études seront nécessaires pour confirmer nos données et évaluer l'efficacité des thérapies permettant de lever le pylorospasme chez ces patients.

Après avoir mis en évidence une altération de la distensibilité pylorique chez les patients avec gastroparésie diabétique, nous nous sommes intéressés aux résultats de l'EndoFLIP® chez les patients présentant des symptômes dyspeptiques après chirurgie oeso-gastrique.

En fonction des études, la gastroparésie post-chirurgicale concernerait entre 7,2% et 13% des patients souffrant de gastroparésie(174). Les chirurgies les plus exposées seraient la cure de reflux gastro-œsophagien selon Nissen, la sleeve-gastrectomie et l'oesophagectomie. La lésion vagale est connue chez l'animal pour induire un spasme du pylore susceptible de provoquer une gastroparésie(101). Il s'agit donc d'un des principaux mécanismes de gastroparésie post-chirurgicale suspectés et cela bien qu'il n'existât pas, jusqu'alors, d'outil spécifique permettant d'en faire le diagnostic. L'EndoFLIP® pylorique nous permet d'évaluer l'existence d'un pylorospasme en faveur d'une lésion vagale post-chirurgicale. Nous avons donc étudié, pour la première fois, la fonction pylorique des patients souffrant de gastroparésie post-chirurgicale. Nous avons démontré que la distensibilité pylorique était altérée chez 61,1% des patients du groupe chirurgie anti-reflux, 75,0% du groupe oesophagectomie sans pyloroplastie et 18,7% du groupe sleeve-gastrectomie.

L'oesophagectomie sans pyloroplastie était donc la chirurgie la plus fréquemment associée à une altération de la distensibilité pylorique dans notre étude, reflétant le fait qu'une vagotomie tronculaire est réalisée de manière constante dans ce type de procédure(175). Cependant la physiopathologie du ralentissement de la vidange gastrique après oesophagectomie reste controversée. Certes, les dommages du nerf vague lors de la tubulisation gastrique sont sensés affecter la motilité gastrique et mener à une dénervation du sphincter pylorique(176). A l'inverse, il existe des preuves en faveur d'une récupération partielle de l'activité motrice du tube gastrique à distance de la chirurgie(177), en particulier antrale et pylorique, y compris après pyloroplastie(178). Par ailleurs, le diagnostic définitif de gastroparésie est difficile à réaliser chez ces patients, car il n'y a à ce jour aucune donnée

concernant les valeurs normales de mesures de vidange gastrique chez des patients asymptomatique avec antécédent d'oesophagectomie, avec par conséquent un diagnostic basé principalement sur l'évaluation clinique(179). Enfin, des méta-analyses récentes(179)-(180) ont montré qu'une intervention pylorique systématique pendant la réalisation de l'oesophagectomie (pyloromyotomie, pyloroplastie, injections de toxine botulique) n'influençait pas l'incidence des symptômes de gastroparésie après oesophagectomie. De plus, ces interventions systématiques peuvent entraîner des complications comme le reflux biliaire ou le dumping syndrome. Comme la gastroparésie post-oesophagectomie ne semble pas avoir un mécanisme univoque, l'utilisation de l'EndoFLIP® pour déterminer l'existence d'un spasme pylorique permettrait de sélectionner les patients chez lesquels une intervention pylorique paraît nécessaire.

Parmi les patients étudiés présentant une gastroparésie après fundoplicature de Nissen, la majorité (61,1%) présentaient une distensibilité pylorique altérée. Même si le diagnostic de gastroparésie après chirurgie anti-reflux peut être posé sur une mesure de la vidange gastrique, l'incidence de la gastroparésie après cette chirurgie reste encore débattue. Une étude rétrospective récente a collecté les données issues de 3152 patients et a pu mettre en évidence une incidence de gastroparésie de 3,8% après fundoplicature de Nissen, mais le diagnostic de gastroparésie était basé sur la nécessité de réaliser secondairement une intervention sur le pylore pour améliorer la symptomatologie post-opératoire des patients (181). Une autre étude a également pu montrer une amélioration des symptômes après injection de toxine botulique intra-pylorique(182). Cependant, la dysfonction pylorique ne semble pas être le seul mécanisme pouvant expliquer le développement de symptômes dyspeptiques après fundoplicature de Nissen, puisqu'environ 38% des patients de notre étude avaient une distensibilité pylorique normale. Une altération de l'accommodation gastrique a ainsi pu être mise en évidence chez des patients dyspeptiques après fundoplicature de Nissen(183). L'utilisation de l'EndoFLIP®

devrait permettre de mieux comprendre les mécanismes responsables de la gastroparésie post-Nissen et d'orienter vers un geste thérapeutique sur le pylore si nécessaire.

Enfin, parmi les 3 types de chirurgie que nous avons étudiés, la sleeve-gastrectomie était celle qui présentait le taux le plus faible d'altération de la distensibilité pylorique (seulement 18,7% des patients). Étant donné que le recours à la chirurgie bariatrique est de plus en plus important en raison de l'élévation de la fréquence de l'obésité dans les pays industrialisés (184), il est important de comprendre l'influence de cette chirurgie sur la physiologie du sphincter pylorique, qui reste encore controversée dans la littérature. D'une part, plusieurs études ont retrouvé une accélération de la vidange gastrique après sleeve-gastrectomie(185)-(186), probablement en lien avec une réduction du volume du réservoir gastrique spécifique à la partie proximale de l'estomac. Ceci pourrait résulter en une élévation de la pression gastrique en post-prandial, pouvant entraîner une accélération du passage des nutriments dans le duodénum(187)-(188). D'autre part, la résection de la zone du pacemaker gastrique durant la sleeve-gastrectomie peut résulter en un foyer pacemaker ectopique distal aberrant ou en une quiescence bioélectrique selon les résultats d'une étude récente(189), mais l'impact clinique de ces anomalies reste encore à démontrer. Par ailleurs, très peu de données sont disponibles quant à une association possible entre de potentielles lésions vagues et une gastroparésie secondaire. Comme pour l'oesophagectomie, il n'y a pas de valeur normale de mesure de vidange gastrique après sleeve-gastrectomie. L'incidence faible du pylorospasme dans notre étude semble indiquer que les lésions vagues lors de la réalisation de la sleeve-gastrectomie sont exceptionnelles, mais les mécanismes de ce pylorospasme restent à déterminer dans ce sous-groupe de patients.

Après avoir étudié le caractère diagnostique de l'EndoFLIP® au niveau pylorique, nous nous sommes intéressés à son intérêt diagnostique dans l'évaluation du sphincter anal.

Dans la littérature, il est admis qu'une dysfonction du sphincter anal interne peut provoquer une pression de clôture insuffisante du canal anal, et donc aboutir à une IF passive (sans perception de besoin exonérateur préalable), tandis que la dysfonction du sphincter anal externe peut entraîner une fermeture insuffisante du canal anal lors de l'arrivée de selles dans le rectum, entraînant une IF active (avec perception du besoin exonérateur préalable)(190). Cette classification est importante car elle permettrait d'orienter vers une cause de l'IF et donc vers un choix thérapeutique au moins en première ligne. Cependant, l'hypotonie anale (qui reflète l'activité du sphincter anal interne) et l'hypocontractilité anale (qui reflète l'activité du sphincter anal externe), enregistrées manométriquement, ne semblent pas être associées significativement à un des sous-types d'IF(140). De même, la fréquence de la présence d'anomalie anatomique et/ou de lésion neurologique sphinctérienne n'était pas associée à un sous-type d'IF(140). Étant donné la supériorité du système EndoFLIP® pour l'évaluation de la résistance à la distension anale, une variable importante pour la continence (191), nous avons émis l'hypothèse que cet outil pourrait être plus performant dans la détection d'une dysfonction sphinctérienne et donc dans la prédiction du sous-type d'IF.

Dans notre travail, la distensibilité au repos du canal anal à 50 mL de distension était différente selon les sous-types d'IF, avec des valeurs plus élevées dans le groupe IF passive, et plus faibles dans le groupe IF active. Cela paraissait logique compte-tenu du rôle prédominant du sphincter anal interne dans la clôture du canal anal au repos. Cependant, aucune différence n'était notée entre les sous-types d'IF lors de l'évaluation de la distensibilité du canal anal pendant la contraction volontaire. Nous avons pu montrer, via l'utilisation d'un arbre de classification, qu'une distensibilité au repos à 50 mL de distension de plus de 7,3 mm²/mmHg et de moins de 1,3 mm²/mmHg à 40 mL de distension étaient associées respectivement aux sous-types passif et actif d'IF. Cependant, la puissance discriminative de cette classification

était faible. Ainsi, même si l'EndoFLIP® peut prédire le type d'IF, ceci n'est vrai que pour les valeurs extrêmes de distensibilité.

Une explication potentielle aux difficultés pour trouver une relation entre la fonction sphinctérienne anale explorée en manométrie ou avec l'EndoFLIP® et le sous-type d'IF, pourrait être le manque de consensus à propos de la classification des patients parmi les différents sous-types d'IF(140). Notre travail a montré que le choix de l'outil pour classer les patients est primordial, étant donné que nous avons mis en évidence un faible agrément entre d'une part, les réponses aux scores d'IF et d'autre part, les entretiens conduits par des médecins expérimentés dans la classification des patients parmi les différents sous-groupes. De plus, nous avons classé les patients sur l'exclusivité d'un seul type d'IF, ce qui a permis l'obtention de groupes homogènes de patients, mais avec le désavantage d'effectifs plus petits parmi les différents sous-types.

Par ailleurs, nos résultats suggèrent que les mécanismes physiopathologiques très souvent multifactoriels de l'IF pourraient induire un biais. En effet, les anomalies sphinctériennes ne sont pas les seules causes de l'IF, car les troubles du transit, de la statique pelvienne et la dysfonction rectale peuvent aussi être impliqués dans la genèse des troubles(192),(193)(194). Dans notre travail, nous avons identifié pour chaque patients les mécanismes potentiels responsables de l'IF et pour chacun de ces mécanismes, nous avons distingué ceux qui étaient connus pour causer une IF active ou passive. Lorsque nous avons comparé les patients avec une majorité de causes connues pour donner une IF active ou passive, une association significative était alors notée entre les sous-types d'IF et les mécanismes prédominant observés. Ainsi, nous avons démontré que l'EndoFLIP® anal ne permettait pas d'orienter vers un sous-type d'IF principalement parce que le mécanisme de l'IF est très souvent multifactoriel. Bien que le type d'IF soit intéressant dans l'évaluation des patients, cette

classification ne dispense pas de réaliser les explorations nécessaires afin de déterminer le mécanisme précis de l'IF pour orienter au mieux le traitement.

Le second axe de ce travail était centré sur l'intérêt de l'EndoFLIP® pour prédire l'efficacité d'un traitement.

Après avoir démontré que l'altération de la distensibilité pylorique était présente chez seulement un sous-groupe de patients atteints de gastroparésie, nous avons émis l'hypothèse que la mesure de la distensibilité pylorique pouvait prédire l'efficacité des injections de toxine botulique intra-pyloriques. Notre travail a ainsi pu mettre en évidence que les scores symptomatiques et de qualité de vie étaient significativement améliorés chez les patients avec distensibilité pylorique altérée, à 3 mois des injections, tandis qu'il restait inchangé chez les patients avec distensibilité pylorique normale. Le temps de demi-vidange gastrique était également accéléré après injection chez les patients avec distensibilité pylorique altérée, tandis qu'il demeurait inchangé chez les patients avec distensibilité pylorique normale. Nous avons ainsi confirmé le rôle prédictif de la distensibilité pylorique, mesurée en pré-opératoire, sur les résultats des injections intra-pyloriques de toxine botulique. Nos résultats peuvent en partie expliquer l'efficacité controversée des injections de toxine botulique dans la littérature (118)(117). En effet, aucune donnée concernant la distensibilité pylorique n'était disponible dans ces études.

Par ailleurs, étant donné qu'une des limites des injections de toxine botulique est son effet transitoire, avec une nécessité de répéter celles-ci tous les 6 à 9 mois, d'autres thérapies ciblant le pylore ont été développées récemment, avec des résultats encourageants(195). A la suite de notre travail, d'autres études ont été publiées sur le rôle prédictif de la mesure de la distensibilité pylorique sur l'efficacité du G-POEM. Une première étude de cohorte prospective

portant sur 34 patients a pu montrer que les patients répondeurs présentaient une distensibilité plus basse avant G-POEM que ceux qui étaient en échec de ce traitement(196). Jacques et al. ont également montré, dans une étude prospective sur 20 patients, qu'une distensibilité pylorique inférieure à 9,2 mm²/mmHg à 50 mL de distension était prédictive du succès clinique du G-POEM avec une spécificité de 100% et une sensibilité de 72,2%(103). En revanche, aucun facteur prédictif de succès clinique parmi les différentes mesures réalisées par l'EndoFLIP[®] n'a été mis en évidence dans 2 autres études mais de qualité méthodologique inférieure(197),(198). Enfin, Vosoughi et al.(199) ont pu montrer qu'un CSA post-procédure pouvait être le meilleur facteur prédictif de succès symptomatique et d'accélération de la vidange gastrique. Un seuil de CSA > 154 mm² à 40 ml de distension serait prédictif de succès à 1 an, avec une sensibilité de 71% et une spécificité de 91% (199). Une autre étude a pu montrer qu'une amélioration d'au moins 20% de l'index de distensibilité par rapport à celui avant intervention était corrélée à un succès clinique(200). Ces résultats suggèrent que l'utilisation de l'EndoFLIP[®] avant et/ou après procédure pourrait prédire l'efficacité de la pyloromyotomie et devenir un outil pour guider l'intervention en per-opératoire, comme cela a pu être suggéré pour le SIO dans l'achalasie. Il existe donc très probablement une place pour la réalisation de l'EndoFLIP[®] afin d'orienter le choix thérapeutique des patients atteints de gastroparésie.

Le troisième axe de ce travail était centré sur l'amélioration de la méthodologie de la technique d'EndoFLIP[®].

Nous avons précédemment vu que la méthodologie de l'EndoFLIP[®] était très différente d'une étude à une autre, ce qui rendait les comparaisons entre les études difficiles(42). Nous nous sommes donc intéressés à l'impact des différents types d'anesthésie sur les mesures de distensibilité pylorique dans 3 centres différents. En effet, les protocoles d'anesthésie diffèrent

selon les centres et il n'existe pas, jusqu'à présent, de consensus quant à la réalisation de ces mesures avec le système d'EndoFLIP®. Notre travail a démontré que la pression pylorique était significativement plus élevée ($p=0,044$) chez les patients dont les mesures étaient effectuées sous anesthésie générale, en comparaison avec les patients dont les mesures ont été effectuées sans anesthésie. Par ailleurs, l'administration de suxamethonium (célocurine) était prédictive d'une pression pylorique élevée et d'une distensibilité pylorique basse en analyse multivariée, à l'inverse de l'administration d'éphédrine.

En raison du design rétrospectif de cette étude, l'impact isolé de chaque produit d'anesthésie n'a pas pu être étudié, limitant quelque peu l'interprétation de nos résultats. Cependant, l'administration de suxamethonium lors de l'induction anesthésique était prédictive d'une pression pylorique élevée et d'une distensibilité pylorique basse en analyse multivariée. Le suxamethonium est un agent bloquant neuromusculaire de la famille des curares qui possède une action à court-terme et permet la dépolarisation des cellules musculaires squelettiques, entraînant un blocage neuromusculaire(201). Cet anesthésiant est composée de 2 molécules d'acétylcholine liées entre elles et pourrait donc reproduire certains de ses effets sur ses récepteurs nicotiniques et muscariniques(202). A notre connaissance, aucune mesure directe des caractéristiques du pylore n'a été réalisée après administration de suxamethonium et ses seuls effets connus sur l'estomac sont une élévation de la pression intragastrique et une diminution du tonus du SIO lors de l'induction de l'anesthésie générale(203),(204),(205). Ceci serait potentiellement expliqué par la fasciculation transitoire des muscles de la paroi abdominale (« Phase I »), mais ces contractions sont trop incoordonnées pour élever la pression intragastrique de manière marquée(203). Cependant, les mesures par EndoFLIP® réalisées dans notre travail étaient faites à distance de l'administration de suxamethonium, avec confirmation du blocage neuromusculaire complet par stimulation TOF (train-of-four). Ce phénomène

n'expliquerait donc pas à lui seul la pression pylorique plus élevée retrouvée chez les patients avec anesthésie générale dans notre travail.

L'éphédrine est une amine sympathomimétique et fut administrée chez 25 patients dans notre étude (29,4%). A notre connaissance, aucune étude ne s'est intéressée à la fonction pylorique pendant l'administration d'éphédrine in vivo chez l'Homme. Une 1^{ère} étude in vitro sur des bandes prélevées au niveau pylorique a pu montrer que la stimulation par phényléphrine (un agent alpha-adrénergique) pouvait inhiber les contractions pyloriques induites par l'administration d'histamine et que cet effet était réversible par administration d'un antagoniste α -adrénergique (phentolamine)(206). Il a également été montré chez le chien que les agonistes α -adrénergiques n'affectent pas l'activité motrice basale du pylore mais peuvent inhiber son activité après stimulation par acidification intra-duodénale(207). Ces données semblent en accord avec nos résultats, car nous avons pu montrer que l'éphédrine était associée avec une distensibilité pylorique élevée et une pression pylorique diminuée dans notre analyse multivariée. Il existe donc potentiellement un impact de l'administration d'éphédrine lors de l'anesthésie générale chez les patients étudiés.

L'administration d'opioïdes exogènes comme le remifentanyl, un agoniste spécifique des récepteurs μ , est connue pour affecter le fonctionnement gastrique(89),(208). Ainsi, les consommateurs d'opioïdes sont fréquemment retrouvés parmi les patients gastroparétiques, avec une altération plus importante de la vidange gastrique, de la qualité de vie et des symptômes majorés en comparaison aux patients qui n'en consomment pas(209),(210). De plus, il a été montré que l'administration intraveineuse d'agonistes des récepteurs μ augmente la pression phasique ainsi que l'activité tonique du pylore en plus d'une inhibition de l'activité contractile antrale, d'une manière dose-dépendante, ce qui résulte en un allongement de la vidange gastrique(89),(208). Au contraire, l'administration de Naloxone permet d'inhiber les effets des beta-endorphines sur le pylore(208). Certains auteurs pensent que les opioïdes

exogènes suppriment l'activité neurale inhibitrice (principalement régulée par la voie nitrergique) du muscle pylorique(89). Cependant, aucun effet de l'administration de remifentanil sur la fonction pylorique n'a été retrouvé dans notre travail. Le remifentanil a été administré chez la plupart des patients (97,6%) avec un temps d'administration différent, soit lors de l'induction de l'anesthésie générale, soit après les mesures par EndoFLIP®. Ce médicament est connu pour sa demi-vie très courte, rendant difficile l'interprétation de son impact dans notre étude. Étant donné qu'une différence de distensibilité pylorique a été retrouvée entre les deux protocoles d'administration du remifentanil dans l'analyse multivariée, un impact potentiel de cet agent pharmacologique sur la distensibilité pylorique ne peut être exclue, même si cette différence pourrait être expliquée par le fait qu'un nombre de patients plus élevé a reçu de l'éphédrine dans un de ces groupes.

Même si notre étude était rétrospective, les deux groupes de patients avec ou sans anesthésie générale étaient comparables. La seule différence notable était un taux plus élevé de patients ayant bénéficié d'une chirurgie oeso-gastrique dans le groupe sans anesthésie générale, mais ce facteur ne ressortait pas lors de l'analyse multivariée. Par ailleurs, étant donné que le remifentanil, le propofol et le sevoflurane étaient administrés chez la quasi-totalité des patients, leur action individuelle n'a pas pu être étudiée précisément.

Cependant, notre étude est la première à avoir évalué l'impact de l'anesthésie générale et des différents agents pharmacologiques utilisés, sur les mesures de l'EndoFLIP® du pylore. Étant donné que cet outil peut être utilisé afin de prédire la performance de certaines thérapies comme le G-POEM et les injections de toxine botulique, il est important de confirmer nos résultats de manière prospective, afin de savoir si le protocole de sédation pourrait influencer les mesures par l'EndoFLIP®. Par ailleurs, nos résultats semblent confirmer que l'exploitation des résultats de l'EndoFLIP® pylorique entre différents centres semble délicate tant que les pratiques inter-centres ne sont pas similaires. Il semble donc nécessaire d'homogénéiser les

pratiques entre les centres afin d'éviter de potentiels facteurs confondants, comme les produits d'anesthésie utilisés.

CONCLUSIONS & PERSPECTIVES

L'ensemble de mon travail de thèse a démontré l'intérêt des mesures de pression et de distensibilité pyloriques chez les patients souffrant de gastroparésie. Une augmentation de pression et une diminution de la distensibilité pylorique mises en évidence grâce au système EndoFLIP[®], ont été identifiées comme est un des mécanismes possibles expliquant la gastroparésie, que celle-ci soit diabétique, idiopathique ou post-chirurgicale. En cas de dysfonctionnement pylorique, un geste thérapeutique ciblé sur le pylore serait indiqué comme semblent le démontrer les résultats concernant le traitement par toxine botulique. Cependant, de futures études devront confirmer cette hypothèse.

En revanche, nous n'avons pas réussi à démontrer l'intérêt de la mesure de la distensibilité anale dans l'exploration des mécanismes responsables d'une incontinence fécale active, passive ou mixte, et cela compte-tenu du caractère plurifactoriel de l'incontinence. Étant donné l'importante corrélation entre les résultats de l'EndoFLIP[®] anal et de la manométrie anorectale, de l'absence de supériorité clairement démontrée de l'EndoFLIP[®] par comparaison à la manométrie, d'autres études seront nécessaires pour évaluer l'utilité de ce nouvel outil dans l'exploration de la compétence sphinctérienne anale. En particulier, j'étudie actuellement la valeur diagnostique de l'EndoFLIP[®] dans le diagnostic de dyssynergie recto-sphinctérienne.

Les études ultérieures devront également confirmer l'intérêt de l'EndoFLIP[®] pylorique pour l'orientation thérapeutique et devront déterminer s'il existe une place pour l'EndoFLIP[®] anal dans l'algorithme de prise en charge des patients souffrant d'IF. Enfin, notre dernière étude concernant l'impact du protocole d'anesthésie sur les résultats des mesures pyloriques par le

système EndoFLIP[®], a souligné l'importance d'un consensus quant aux modalités de réalisation de cet examen. Cela est un élément déterminant pour comparer les résultats de l'EndoFLIP[®] d'un centre à un autre et pouvoir réaliser des études multicentriques.

BIBLIOGRAPHIE

1. Dent J. A new technique for continuous sphincter pressure measurement. *Gastroenterology*. août 1976;71(2):263-7.
2. Nicodème F, Lin Z, Pandolfino JE, Kahrilas PJ. Esophagogastric Junction pressure morphology: comparison between a station pull-through and real-time 3D-HRM representation. *Neurogastroenterol Motil*. sept 2013;25(9):e591-598.
3. McMahon BP, Drewes AM, Gregersen H. Functional oesophago-gastric junction imaging. *World J Gastroenterol*. 14 mai 2006;12(18):2818-24.
4. Harris LD, Pope CE. "Squeeze" vs. Resistance: An Evaluation of the Mechanism of Sphincter Competence*. *J Clin Invest*. déc 1964;43(12):2272-8.
5. McMahon BP, Frøkjær JB, Liao D, Kunwald P, Drewes AM, Gregersen H. A new technique for evaluating sphincter function in visceral organs: application of the functional lumen imaging probe (FLIP) for the evaluation of the oesophago-gastric junction. *Physiol Meas*. oct 2005;26(5):823-36.
6. Mearin F, Camilleri M, Malagelada JR. Pyloric dysfunction in diabetics with recurrent nausea and vomiting. *Gastroenterology*. juin 1986;90(6):1919-25.
7. Gourcerol G, Tissier F, Melchior C, Touchais JY, Huet E, Prevost G, et al. Impaired fasting pyloric compliance in gastroparesis and the therapeutic response to pyloric dilatation. *Aliment Pharmacol Ther*. févr 2015;41(4):360-7.
8. Zheng T, Vosoughi K, Busciglio I, Tebay L, Burton D, Camilleri M. Fasting pyloric diameter and distensibility by functional endoluminal imaging probe in unsedated healthy volunteers. *Neurogastroenterol Motil*. 25 avr 2022;e14386.
9. Jagtap N, Kalapala R, Reddy DN. Assessment of Pyloric Sphincter Physiology Using Functional Luminal Imaging Probe in Healthy Volunteers. *J Neurogastroenterol Motil*. 30 juill 2020;26(3):391-6.

10. Azpiroz F, Enck P, Whitehead WE. Anorectal functional testing: review of collective experience. *Am J Gastroenterol.* févr 2002;97(2):232-40.
11. Kwiatek MA, Pandolfino JE, Hirano I, Kahrilas PJ. Esophagogastric junction distensibility assessed with an endoscopic functional luminal imaging probe (EndoFLIP). *Gastrointest Endosc.* août 2010;72(2):272-8.
12. Gourcerol G, Granier S, Bridoux V, Menard JF, Ducrotté P, Leroi AM. Do endoflip assessments of anal sphincter distensibility provide more information on patients with fecal incontinence than high-resolution anal manometry? *Neurogastroenterol Motil.* mars 2016;28(3):399-409.
13. Leroi AM, Melchior C, Charpentier C, Bridoux V, Savoye-Collet C, Houivet E, et al. The diagnostic value of the functional lumen imaging probe versus high-resolution anorectal manometry in patients with fecal incontinence. *Neurogastroenterol Motil.* 2018;30(6):e13291.
14. Assentoft JE, Gregersen H, O'Brien WD. Determination of biomechanical properties in guinea pig esophagus by means of high frequency ultrasound and impedance planimetry. *Dig Dis Sci.* juill 2000;45(7):1260-6.
15. Rohof WO, Hirsch DP, Kessing BF, Boeckxstaens GE. Efficacy of treatment for patients with achalasia depends on the distensibility of the esophagogastric junction. *Gastroenterology.* août 2012;143(2):328-35.
16. Smeets FGM, Masclee A a. M, Keszthelyi D, Tjwa ETTL, Conchillo JM. Esophagogastric junction distensibility in the management of achalasia patients: relation to treatment outcome. *Neurogastroenterol Motil.* oct 2015;27(10):1495-503.
17. Carlson DA, Kou W, Lin Z, Hinchcliff M, Thakrar A, Falmagne S, et al. Normal Values of Esophageal Distensibility and Distension-Induced Contractility Measured by Functional Luminal Imaging Probe Panometry. *Clin Gastroenterol Hepatol.* 2019;17(4):674-681.e1.
18. Mikami H, Ishimura N, Fukazawa K, Okada M, Izumi D, Shimura S, et al. Effects of

Metoclopramide on Esophageal Motor Activity and Esophagogastric Junction Compliance in Healthy Volunteers. *J Neurogastroenterol Motil.* janv 2016;22(1):112-7.

19. Liao D, Lottrup C, Fynne L, McMahon BP, Krogh K, Drewes AM, et al. Axial Movements and Length Changes of the Human Lower Esophageal Sphincter During Respiration and Distension-induced Secondary Peristalsis Using Functional Luminal Imaging Probe. *J Neurogastroenterol Motil.* avr 2018;24(2):255-67.

20. Carlson DA, Kahrilas PJ, Lin Z, Hirano I, Gonsalves N, Listernick Z, et al. Evaluation of Esophageal Motility Utilizing the Functional Lumen Imaging Probe. *Am J Gastroenterol.* 2016;111(12):1726-35.

21. Mikami H, Ishimura N, Okada M, Izumi D, Okimoto E, Ishihara S, et al. Acotiamide Has No Effects on Esophageal Motor Activity or Esophagogastric Junction Compliance. *J Neurogastroenterol Motil.* 30 avr 2018;24(2):241-7.

22. Fynne L, Liao D, Aksglaede K, Lottrup C, Gregersen H, Bjerregaard NC, et al. Esophagogastric junction in systemic sclerosis: A study with the functional lumen imaging probe. *Neurogastroenterol Motil.* août 2017;29(8).

23. Lottrup C, McMahon BP, Ejstrup P, Ostapiuk MA, Funch-Jensen P, Drewes AM. Esophagogastric junction distensibility in hiatus hernia. *Dis Esophagus.* juill 2016;29(5):463-71.

24. Fukazawa K, Furuta K, Adachi K, Moritou Y, Saito T, Kusunoki R, et al. Effects of mosapride on esophageal motor activity and esophagogastric junction compliance in healthy volunteers. *J Gastroenterol.* sept 2014;49(9):1307-13.

25. Tucker E, Sweis R, Anggiansah A, Wong T, Telakis E, Knowles K, et al. Measurement of esophago-gastric junction cross-sectional area and distensibility by an endoluminal functional lumen imaging probe for the diagnosis of gastro-esophageal reflux disease. *Neurogastroenterol Motil.* nov 2013;25(11):904-10.

26. Lin Z, Nicodème F, Boris L, Lin CY, Kahrilas PJ, Pandolfino JE. Regional variation in distal esophagus distensibility assessed using the functional luminal imaging probe (FLIP). *Neurogastroenterol Motil.* nov 2013;25(11):e765-771.
27. Rieder E, Swanström LL, Perretta S, Lenglinger J, Riegler M, Dunst CM. Intraoperative assessment of esophagogastric junction distensibility during per oral endoscopic myotomy (POEM) for esophageal motility disorders. *Surg Endosc.* févr 2013;27(2):400-5.
28. Kwiatek MA, Hirano I, Kahrilas PJ, Rothe J, Luger D, Pandolfino JE. Mechanical properties of the esophagus in eosinophilic esophagitis. *Gastroenterology.* janv 2011;140(1):82-90.
29. Nathanson LK, Brunott N, Cavallucci D. Adult esophagogastric junction distensibility during general anesthesia assessed with an endoscopic functional luminal imaging probe (EndoFLIP®). *Surg Endosc.* avr 2012;26(4):1051-5.
30. Kwiatek MA, Kahrilas K, Soper NJ, Bulsiewicz WJ, McMahon BP, Gregersen H, et al. Esophagogastric junction distensibility after fundoplication assessed with a novel functional luminal imaging probe. *J Gastrointest Surg.* févr 2010;14(2):268-76.
31. Beaumont H, Gondrie JJ, McMahon BP, Pouw RE, Gregersen H, Bergman JJ, et al. Stepwise radiofrequency ablation of Barrett's esophagus preserves esophageal inner diameter, compliance, and motility. *Endoscopy.* janv 2009;41(1):2-8.
32. McMahon BP, Frøkjaer JB, Kunwald P, Liao D, Funch-Jensen P, Drewes AM, et al. The functional lumen imaging probe (FLIP) for evaluation of the esophagogastric junction. *Am J Physiol Gastrointest Liver Physiol.* janv 2007;292(1):G377-384.
33. Sørensen G, Liao D, Lundby L, Fynne L, Buntzen S, Gregersen H, et al. Distensibility of the anal canal in patients with idiopathic fecal incontinence: a study with the Functional Lumen Imaging Probe. *Neurogastroenterol Motil.* févr 2014;26(2):255-63.
34. Haas S, Liao D, Gregersen H, Lundby L, Laurberg S, Krogh K. Increased yield pressure

in the anal canal during sacral nerve stimulation: a pilot study with the functional lumen imaging probe. *Neurogastroenterol Motil.* févr 2017;29(2).

35. Grønlund D, Poulsen JL, Krogh K, Brock C, Liao D, Gregersen H, et al. The impact of naloxegol on anal sphincter function - Using a human experimental model of opioid-induced bowel dysfunction. *Eur J Pharm Sci.* 30 mai 2018;117:187-92.

36. Haas S, Faaborg P, Liao D, Laurberg S, Gregersen H, Lundby L, et al. Anal sphincter dysfunction in patients treated with primary radiotherapy for anal cancer: a study with the functional lumen imaging probe. *Acta Oncol.* avr 2018;57(4):465-72.

37. Brusa T, Abler D, Tutuian R, Gingert C, Heverhagen JT, Adamina M, et al. Anatomy and mechanical properties of the anal sphincter muscles in healthy senior volunteers. *Neurogastroenterol Motil.* 15 mars 2018;

38. Luft F, Fynne L, Gregersen H, Lundager F, Buntzen S, Lundby L, et al. Functional luminal imaging probe: a new technique for dynamic evaluation of mechanical properties of the anal canal. *Tech Coloproctol.* déc 2012;16(6):451-7.

39. Carlson DA, Kou W, Pandolfino JE. The rhythm and rate of distension-induced esophageal contractility: A physiologic marker of esophageal function. *Neurogastroenterol Motil.* mai 2020;32(5):e13794.

40. Carlson DA, Lin Z, Rogers MC, Lin CY, Kahrilas PJ, Pandolfino JE. Utilizing functional lumen imaging probe topography to evaluate esophageal contractility during volumetric distention: a pilot study. *Neurogastroenterol Motil.* juill 2015;27(7):981-9.

41. Carlson DA, Baumann AJ, Prescott JE, Donnan EN, Yadlapati R, Khan A, et al. Validation of secondary peristalsis classification using FLIP panometry in 741 subjects undergoing manometry. *Neurogastroenterol Motil.* janv 2022;34(1):e14192.

42. Desprez C, Roman S, Leroi AM, Gourcerol G. The use of impedance planimetry (Endoscopic Functional Lumen Imaging Probe, EndoFLIP®) in the gastrointestinal tract: A

systematic review. *Neurogastroenterol Motil.* 2020;32(9):e13980.

43. Carlson DA, Kou W, Masihi M, Acharya S, Baumann AJ, Donnan EN, et al. Repetitive Antegrade Contractions: A novel response to sustained esophageal distension is modulated by cholinergic influence. *Am J Physiol Gastrointest Liver Physiol.* 7 oct 2020;
44. Acharya S, Halder S, Carlson DA, Kou W, Kahrilas PJ, Pandolfino JE, et al. Assessment of esophageal body peristaltic work using functional lumen imaging probe panometry. *Am J Physiol Gastrointest Liver Physiol.* 1 févr 2021;320(2):G217-26.
45. Lin Z, Kahrilas PJ, Xiao Y, Nicodème F, Gonsalves N, Hirano I, et al. Functional luminal imaging probe topography: an improved method for characterizing esophageal distensibility in eosinophilic esophagitis. *Therap Adv Gastroenterol.* mars 2013;6(2):97-107.
46. Kahrilas PJ, Bredenoord AJ, Fox M, Gyawali CP, Roman S, Smout AJPM, et al. The Chicago Classification of esophageal motility disorders, v3.0. *Neurogastroenterol Motil.* févr 2015;27(2):160-74.
47. Yadlapati R, Kahrilas PJ, Fox MR, Bredenoord AJ, Prakash Gyawali C, Roman S, et al. Esophageal motility disorders on high-resolution manometry: Chicago classification version 4.0©. *Neurogastroenterol Motil.* janv 2021;33(1):e14058.
48. Pandolfino JE, de Ruigh A, Nicodème F, Xiao Y, Boris L, Kahrilas PJ. Distensibility of the esophagogastric junction assessed with the functional lumen imaging probe (FLIP™) in achalasia patients. *Neurogastroenterol Motil.* juin 2013;25(6):496-501.
49. Carlson DA, Lin Z, Kahrilas PJ, Sternbach J, Donnan EN, Friesen L, et al. The Functional Lumen Imaging Probe Detects Esophageal Contractility Not Observed With Manometry in Patients With Achalasia. *Gastroenterology.* déc 2015;149(7):1742-51.
50. Rooney KP, Baumann AJ, Donnan E, Kou W, Triggs JR, Prescott J, et al. Esophagogastric Junction Opening Parameters Are Consistently Abnormal in Untreated Achalasia. *Clin Gastroenterol Hepatol.* mai 2021;19(5):1058-1060.e1.

51. Bianca A, Schindler V, Schnurre L, Murray F, Runggaldier D, Gyawali CP, et al. Endoscope presence during endoluminal functional lumen imaging probe (FLIP) influences FLIP metrics in the evaluation of esophageal dysmotility. *Neurogastroenterol Motil.* juin 2020;32(6):e13823.
52. Carlson DA, Prescott JE, Baumann AJ, Schauer JM, Krause A, Donnan EN, et al. Validation of Clinically Relevant Thresholds of Esophagogastric Junction Obstruction Using FLIP Panometry. *Clin Gastroenterol Hepatol.* juin 2022;20(6):e1250-62.
53. Attaar M, Wong HJ, Wu H, Campbell M, Kuchta K, Denham W, et al. Changes in impedance planimetry (EndoFLIP) measurements at follow-up after peroral endoscopic myotomy (POEM). *Surg Endosc.* 3 mai 2022;
54. Amundson JR, Wu H, VanDruff V, Campbell M, Kuchta K, Hedberg HM, et al. Esophagogastric junction compliance on impedance planimetry (EndoFLIP™) following peroral endoscopic myotomy (POEM) predicts improvement in postoperative Eckardt score. *Surg Endosc.* 15 juill 2022;
55. Hsing LC, Choi K, Jung KW, Joo S, Kim N, Kim GH, et al. The Predictive Value of Intraoperative Esophageal Functional Luminal Imaging Probe Panometry in Patients With Achalasia Undergoing Peroral Endoscopic Myotomy: A Single-center Experience. *J Neurogastroenterol Motil.* 30 juill 2022;28(3):474-82.
56. Acharya S, Halder S, Carlson DA, Kou W, Kahrilas PJ, Pandolfino JE, et al. Estimation of mechanical work done to open the esophagogastric junction using functional lumen imaging probe panometry. *Am J Physiol Gastrointest Liver Physiol.* 1 mai 2021;320(5):G780-90.
57. Carlson DA, Kou W, Rooney KP, Baumann AJ, Donnan E, Triggs JR, et al. Achalasia subtypes can be identified with functional luminal imaging probe (FLIP) panometry using a supervised machine learning process. *Neurogastroenterol Motil.* mars 2021;33(3):e13932.
58. Attaar M, Su B, Wong HJ, Kuchta K, Denham W, Haggerty SP, et al. Intraoperative

impedance planimetry (EndoFLIP™) results and development of esophagitis in patients undergoing peroral endoscopic myotomy (POEM). *Surg Endosc.* août 2021;35(8):4555-62.

59. Sloan JA, Triggs JR, Pandolfino JE, Dbouk M, Brewer Gutierrez OI, El Zein M, et al. Treatment experience with a novel 30-mm hydrostatic balloon in esophageal dysmotility: a multicenter retrospective analysis. *Gastrointest Endosc.* 14 mai 2020;

60. Schnurre L, Murray FR, Schindler V, Runggaldier D, Fischbach L, Bordier V, et al. Short-term outcome after singular hydraulic EsoFLIP dilation in patients with achalasia: A feasibility study. *Neurogastroenterol Motil.* 11 mai 2020;e13864.

61. Kim E, Yoo IK, Yon DK, Cho JY, Hong SP. Characteristics of a Subset of Achalasia With Normal Integrated Relaxation Pressure. *J Neurogastroenterol Motil.* 30 avr 2020;26(2):274-80.

62. Su B, Callahan ZM, Novak S, Kuchta K, Ujiki MB. Using Impedance Planimetry (EndoFLIP) to Evaluate Myotomy and Predict Outcomes After Surgery for Achalasia. *J Gastrointest Surg.* avr 2020;24(4):964-71.

63. Su B, Callahan ZM, Kuchta K, Linn JG, Haggerty SP, Denham W, et al. Use of Impedance Planimetry (Endoflip) in Foregut Surgery Practice: Experience of More than 400 Cases. *J Am Coll Surg.* 17 févr 2020;

64. Law YY, Nguyen DT, Meisenbach LM, Chihara RK, Chan EY, Graviss EA, et al. Intraoperative diagnosis and treatment of Achalasia using EndoFLIP during Heller Myotomy and Dor fundoplication. *Surg Endosc.* avr 2022;36(4):2365-72.

65. Campagna RAJ, Carlson DA, Hungness ES, Holmstrom AL, Pandolfino JE, Soper NJ, et al. Intraoperative assessment of esophageal motility using FLIP during myotomy for achalasia. *Surg Endosc.* juin 2020;34(6):2593-600.

66. Jain AS, Carlson DA, Triggs J, Tye M, Kou W, Campagna R, et al. Esophagogastric Junction Distensibility on Functional Lumen Imaging Probe Topography Predicts Treatment

Response in Achalasia-Anatomy Matters! *Am J Gastroenterol.* 2019;114(9):1455-63.

67. Yoo IK, Choi SA, Kim WH, Hong SP, Cakir OO, Cho JY. Assessment of Clinical Outcomes after Peroral Endoscopic Myotomy via Esophageal Distensibility Measurements with the Endoluminal Functional Lumen Imaging Probe. *Gut Liver.* 15 2019;13(1):32-9.

68. Carlson DA, Gyawali CP, Kahrilas PJ, Triggs JR, Falmagne S, Prescott J, et al. Esophageal motility classification can be established at the time of endoscopy: a study evaluating real-time functional luminal imaging probe panometry. *Gastrointest Endosc.* 2019;90(6):915-923.e1.

69. Wu PI, Szczesniak MM, Craig PI, Choo L, Engelman J, Terkasher B, et al. Novel Intra-Procedural Distensibility Measurement Accurately Predicts Immediate Outcome of Pneumatic Dilatation for Idiopathic Achalasia. *Am J Gastroenterol.* 2018;113(2):205-12.

70. Ahuja NK, Agnihotri A, Lynch KL, Hoo-Fatt D, Onyimba F, McKnight M, et al. Esophageal distensibility measurement: impact on clinical management and procedure length. *Dis Esophagus.* 1 août 2017;30(8):1-8.

71. Ponds FA, Bredenoord AJ, Kessing BF, Smout AJPM. Esophagogastric junction distensibility identifies achalasia subgroup with manometrically normal esophagogastric junction relaxation. *Neurogastroenterol Motil.* janv 2017;29(1).

72. DeHaan RK, Frelich MJ, Gould JC. Intraoperative Assessment of Esophagogastric Junction Distensibility During Laparoscopic Heller Myotomy. *Surg Laparosc Endosc Percutan Tech.* avr 2016;26(2):137-40.

73. Teitelbaum EN, Sternbach JM, El Khoury R, Soper NJ, Pandolfino JE, Kahrilas PJ, et al. The effect of incremental distal gastric myotomy lengths on EGJ distensibility during POEM for achalasia. *Surg Endosc.* févr 2016;30(2):745-50.

74. Ngamruengphong S, von Rahden BHA, Filser J, Tyberg A, Desai A, Sharaiha RZ, et al. Intraoperative measurement of esophagogastric junction cross-sectional area by impedance

planimetry correlates with clinical outcomes of peroral endoscopic myotomy for achalasia: a multicenter study. *Surg Endosc.* 2016;30(7):2886-94.

75. Ilcyszyn A, Hamaoui K, Cartwright J, Botha A. Intraoperative distensibility measurement during laparoscopic Heller's myotomy for achalasia may reduce the myotomy length without compromising patient outcome. *Dis Esophagus.* juill 2016;29(5):455-62.

76. Teitelbaum EN, Soper NJ, Pandolfino JE, Kahrilas PJ, Hirano I, Boris L, et al. Esophagogastric junction distensibility measurements during Heller myotomy and POEM for achalasia predict postoperative symptomatic outcomes. *Surg Endosc.* mars 2015;29(3):522-8.

77. Kappelle WFW, Bogte A, Siersema PD. Hydraulic dilation with a shape-measuring balloon in idiopathic achalasia: a feasibility study. *Endoscopy.* nov 2015;47(11):1028-34.

78. Familiari P, Gigante G, Marchese M, Boskoski I, Bove V, Tringali A, et al. EndoFLIP system for the intraoperative evaluation of peroral endoscopic myotomy. *United European Gastroenterol J.* avr 2014;2(2):77-83.

79. Teitelbaum EN, Soper NJ, Pandolfino JE, Kahrilas PJ, Boris L, Nicodème F, et al. An extended proximal esophageal myotomy is necessary to normalize EGJ distensibility during Heller myotomy for achalasia, but not POEM. *Surg Endosc.* oct 2014;28(10):2840-7.

80. Teitelbaum EN, Boris L, Arafat FO, Nicodème F, Lin Z, Kahrilas PJ, et al. Comparison of esophagogastric junction distensibility changes during POEM and Heller myotomy using intraoperative FLIP. *Surg Endosc.* déc 2013;27(12):4547-55.

81. Verlaan T, Rohof WO, Bredenoord AJ, Eberl S, Rösch T, Fockens P. Effect of peroral endoscopic myotomy on esophagogastric junction physiology in patients with achalasia. *Gastrointest Endosc.* juill 2013;78(1):39-44.

82. Carlson DA, Kahrilas PJ, Ritter K, Lin Z, Pandolfino JE. Mechanisms of repetitive retrograde contractions in response to sustained esophageal distension: a study evaluating patients with postfundoplication dysphagia. *Am J Physiol Gastrointest Liver Physiol.* 01

2018;314(3):G334-40.

83. Baumann AJ, Donnan EN, Triggs JR, Kou W, Prescott J, Decorrevont A, et al. Normal Functional Luminal Imaging Probe Panometry Findings Associate With Lack of Major Esophageal Motility Disorder on High-Resolution Manometry. *Clin Gastroenterol Hepatol*. 20 mars 2020;

84. Triggs JR, Carlson DA, Beveridge C, Kou W, Kahrilas PJ, Pandolfino JE. Functional Luminal Imaging Probe Panometry Identifies Achalasia-Type Esophagogastric Junction Outflow Obstruction. *Clin Gastroenterol Hepatol*. 25 nov 2019;

85. Ichkhanian Y, Sanaei O, Canakis A, Vosoughi K, Almazan E, Ghandour B, et al. Esophageal peroral endoscopic myotomy (POEM) for treatment of esophagogastric junction outflow obstruction: results from the first prospective trial. *Endosc Int Open*. sept 2020;8(9):E1137-43.

86. Carlson DA, Baumann AJ, Donnan EN, Krause A, Kou W, Pandolfino JE. Evaluating esophageal motility beyond primary peristalsis: Assessing esophagogastric junction opening mechanics and secondary peristalsis in patients with normal manometry. *Neurogastroenterol Motil*. oct 2021;33(10):e14116.

87. Nguyen AD, Ellison A, Reddy CA, Mendoza R, Podgaetz E, Ward MA, et al. Spastic secondary contractile patterns identified by FLIP panometry in symptomatic patients with unremarkable high-resolution manometry. *Neurogastroenterol Motil*. juill 2022;34(7):e14321.

88. Reddy AT, Shimpi RA, Parish A, Niedzwiecki D, Leiman DA. Predictors of Abnormal Functional Luminal Impedance Planimetry Findings in Non-mechanical Esophagogastric Junction Outflow Obstruction. *Dig Dis Sci*. nov 2021;66(11):3968-75.

89. Camilleri M, Sanders KM. Opiates, the Pylorus, and Gastroparesis. *Gastroenterology*. août 2020;159(2):414-21.

90. Hinder RA. Individual and combined roles of the pylorus and the antrum in the canine

- gastric emptying of a liquid and a digestible solid. *Gastroenterology*. févr 1983;84(2):281-6.
91. Camilleri M, Sanders KM. Gastroparesis. *Gastroenterology*. janv 2022;162(1):68-87.e1.
92. Camilleri M, Sanders KM. Gastroparesis. *Gastroenterology*. janv 2022;162(1):68-87.e1.
93. Ward SM, Morris G, Reese L, Wang XY, Sanders KM. Interstitial cells of Cajal mediate enteric inhibitory neurotransmission in the lower esophageal and pyloric sphincters. *Gastroenterology*. août 1998;115(2):314-29.
94. Wang XY, Lammers WJEP, Bercik P, Huizinga JD. Lack of pyloric interstitial cells of Cajal explains distinct peristaltic motor patterns in stomach and small intestine. *American Journal of Physiology-Gastrointestinal and Liver Physiology*. 1 sept 2005;289(3):G539-49.
95. Allescher HD, Daniel EE, Dent J, Fox JE, Kostolanska F. Extrinsic and intrinsic neural control of pyloric sphincter pressure in the dog. *J Physiol*. juill 1988;401:17-38.
96. Ramkumar D, Schulze KS. The pylorus. *Neurogastroenterol Motil*. juin 2005;17 Suppl 1:22-30.
97. Goyal RK, Guo Y, Mashimo H. Advances in the physiology of gastric emptying. *Neurogastroenterol Motil*. avr 2019;31(4):e13546.
98. Malbert CH, Mathis C, Laplace JP. Vagal control of pyloric resistance. *Am J Physiol*. oct 1995;269(4 Pt 1):G558-569.
99. Ward SM, Xue C, Sanders KM. Localization of nitric oxide synthase in canine ileocolonic and pyloric sphincters. *Cell Tissue Res*. mars 1994;275(3):513-27.
100. Sivarao DV, Mashimo H, Goyal RK. Pyloric Sphincter Dysfunction in nNOS^{-/-} and W/W^v Mutant Mice: Animal Models of Gastroparesis and Duodenogastric Reflux. *Gastroenterology*. 1 oct 2008;135(4):1258-66.
101. Wilbur BG, Kelly KA. Effect of proximal gastric, complete gastric, and truncal

vagotomy on canine gastric electric activity, motility, and emptying. *Ann Surg.* sept 1973;178(3):295-303.

102. Gourcerol G, Tissier F, Melchior C, Touchais JY, Huet E, Prevost G, et al. Impaired fasting pyloric compliance in gastroparesis and the therapeutic response to pyloric dilatation. *Aliment Pharmacol Ther.* févr 2015;41(4):360-7.

103. Jacques J, Pagnon L, Hure F, Legros R, Crepin S, Fauchais AL, et al. Peroral endoscopic pyloromyotomy is efficacious and safe for refractory gastroparesis: prospective trial with assessment of pyloric function. *Endoscopy.* 12 juin 2018;

104. Malik Z, Sankineni A, Parkman HP. Assessing pyloric sphincter pathophysiology using EndoFLIP in patients with gastroparesis. *Neurogastroenterol Motil.* avr 2015;27(4):524-31.

105. Snape WJ, Lin MS, Agarwal N, Shaw RE. Evaluation of the pylorus with concurrent intraluminal pressure and EndoFLIP in patients with nausea and vomiting. *Neurogastroenterol Motil.* 2016;28(5):758-64.

106. Talley NJ, Locke GR, Lahr BD, Zinsmeister AR, Tougas G, Ligozio G, et al. Functional dyspepsia, delayed gastric emptying, and impaired quality of life. *Gut.* juill 2006;55(7):933-9.

107. Parkman HP, Yates K, Hasler WL, Nguyen L, Pasricha PJ, Snape WJ, et al. Clinical features of idiopathic gastroparesis vary with sex, body mass, symptom onset, delay in gastric emptying, and gastroparesis severity. *Gastroenterology.* janv 2011;140(1):101-15.

108. Wuestenberghs F, Juge M, Melchior C, Desprez C, Leroi AM, Gourcerol G. Association Between Symptoms, Quality of Life, and Gastric Emptying in Dyspeptic Patients. *J Neurogastroenterol Motil.* 30 oct 2019;25(4):534-43.

109. Jacques J, Legros R, Monteil J, Sautereau D, Gourcerol G. Outcomes and Future Directions of Per-Oral Endoscopic Pyloromyotomy: A View from France. *Gastrointest Endosc Clin N Am.* janv 2019;29(1):139-49.

110. Israel DM, Mahdi G, Hassall E. Pyloric balloon dilation for delayed gastric emptying in

children. *Can J Gastroenterol.* nov 2001;15(11):723-7.

111. Jehangir A, Malik Z, Petrov RV, Parkman HP. EndoFLIP and Pyloric Dilation for Gastroparesis Symptoms Refractory to Pyloromyotomy/Pyloroplasty. *Dig Dis Sci* [Internet]. 4 août 2020 [cité 4 mars 2021]; Disponible sur: <https://doi.org/10.1007/s10620-020-06510-0>

112. Soliman H, Oiknine E, Cohen-Sors B, Moszkowicz D, Gorbachev C, Dior M, et al. Efficacy and safety of endoscopic pyloric balloon dilation in patients with refractory gastroparesis. *Surg Endosc.* 18 avr 2022;

113. Sharma VK, Glassman SB, Howden CW, et al. Pyloric intrasphincteric botulinum toxin (Botox) improved symptoms and gastric emptying in a patient with diabetic gastroparesis (abstr) *Am J Gastroenterol.* 1998;93:456.

114. Ezzeddine D, Jit R, Katz N, Gopalswamy N, Bhutani MS. Pyloric injection of botulinum toxin for treatment of diabetic gastroparesis. *Gastrointest Endosc.* juin 2002;55(7):920-3.

115. Miller LS, Szych GA, Kantor SB, Bromer MQ, Knight LC, Maurer AH, et al. Treatment of idiopathic gastroparesis with injection of botulinum toxin into the pyloric sphincter muscle. *Am J Gastroenterol.* juill 2002;97(7):1653-60.

116. Bromer MQ, Friedenberg F, Miller LS, Fisher RS, Swartz K, Parkman HP. Endoscopic pyloric injection of botulinum toxin A for the treatment of refractory gastroparesis. *Gastrointest Endosc.* juin 2005;61(7):833-9.

117. Friedenberg FK, Palit A, Parkman HP, Hanlon A, Nelson DB. Botulinum toxin A for the treatment of delayed gastric emptying. *Am J Gastroenterol.* févr 2008;103(2):416-23.

118. Arts J, Holvoet L, Caenepeel P, Bisschops R, Sifrim D, Verbeke K, et al. Clinical trial: a randomized-controlled crossover study of intrapyloric injection of botulinum toxin in gastroparesis. *Aliment Pharmacol Ther.* 1 nov 2007;26(9):1251-8.

119. Coleski R, Anderson MA, Hasler WL. Factors associated with symptom response to pyloric injection of botulinum toxin in a large series of gastroparesis patients. *Dig Dis Sci.* déc

2009;54(12):2634-42.

120. Hooft N, Smith M, Huang J, Bremner R, Walia R. Gastroparesis is common after lung transplantation and may be ameliorated by botulinum toxin-A injection of the pylorus. *The Journal of Heart and Lung Transplantation*. 1 déc 2014;33(12):1314-6.

121. Inoue H, Minami H, Kobayashi Y, Sato Y, Kaga M, Suzuki M, et al. Peroral endoscopic myotomy (POEM) for esophageal achalasia. *Endoscopy*. avr 2010;42(4):265-71.

122. Weusten BLAM, Barret M, Bredenoord AJ, Familiari P, Gonzalez JM, van Hooft JE, et al. Endoscopic management of gastrointestinal motility disorders - part 1: European Society of Gastrointestinal Endoscopy (ESGE) Guideline. *Endoscopy*. juin 2020;52(6):498-515.

123. Gonzalez JM, Benezech A, Vitton V, Barthet M. G-POEM with antro-pyloromyotomy for the treatment of refractory gastroparesis: mid-term follow-up and factors predicting outcome. *Aliment Pharmacol Ther*. août 2017;46(3):364-70.

124. Khashab MA, Ngamruengphong S, Carr-Locke D, Bapaye A, Benias PC, Serouya S, et al. Gastric per-oral endoscopic myotomy for refractory gastroparesis: results from the first multicenter study on endoscopic pyloromyotomy (with video). *Gastrointest Endosc*. janv 2017;85(1):123-8.

125. Malik Z, Kataria R, Modayil R, Ehrlich AC, Schey R, Parkman HP, et al. Gastric Per Oral Endoscopic Myotomy (G-POEM) for the Treatment of Refractory Gastroparesis: Early Experience. *Dig Dis Sci*. sept 2018;63(9):2405-12.

126. Dacha S, Mekaroonkamol P, Li L, Shahnava N, Sakaria S, Keilin S, et al. Outcomes and quality-of-life assessment after gastric per-oral endoscopic pyloromyotomy (with video). *Gastrointest Endosc*. août 2017;86(2):282-9.

127. Rodriguez J, Strong AT, Haskins IN, Landreneau JP, Allemang MT, El-Hayek K, et al. Per-oral Pyloromyotomy (POP) for Medically Refractory Gastroparesis: Short Term Results From the First 100 Patients at a High Volume Center. *Ann Surg*. sept 2018;268(3):421-30.

128. Kahaleh M, Gonzalez JM, Xu MM, Andalib I, Gaidhane M, Tyberg A, et al. Gastric peroral endoscopic myotomy for the treatment of refractory gastroparesis: a multicenter international experience. *Endoscopy*. nov 2018;50(11):1053-8.
129. Mekaroonkamol P, Dacha S, Wang L, Li X, Jiang Y, Li L, et al. Gastric Peroral Endoscopic Pyloromyotomy Reduces Symptoms, Increases Quality of Life, and Reduces Health Care Use For Patients With Gastroparesis. *Clin Gastroenterol Hepatol*. janv 2019;17(1):82-9.
130. Kamal F, Khan MA, Lee-Smith W, Sharma S, Acharya A, Jowhar D, et al. Systematic review with meta-analysis: one-year outcomes of gastric peroral endoscopic myotomy for refractory gastroparesis. *Aliment Pharmacol Ther*. janv 2022;55(2):168-77.
131. Ragi O, Jacques J, Branche J, Leblanc S, Vanbiervliet G, Legros R, et al. One-year results of gastric peroral endoscopic myotomy for refractory gastroparesis: a French multicenter study. *Endoscopy*. 23 juin 2020;
132. Martinek J, Hustak R, Mares J, Vackova Z, Spicak J, Kieslichova E, et al. Endoscopic pyloromyotomy for the treatment of severe and refractory gastroparesis: a pilot, randomised, sham-controlled trial. *Gut* [Internet]. 24 avr 2022 [cité 28 avr 2022]; Disponible sur: <https://gut.bmj.com/content/early/2022/04/24/gutjnl-2022-326904>
133. Gonzalez JM, Pioche M, Garbay V, Mion F, Roman S, Barthet M, et al. Etude randomisée en double aveugle évaluant l'efficacité de la pylorotomie endoscopique (G-POEM) en comparaison avec la toxine botulinique, dans la gastroparésie réfractaire [Internet]. [cité 11 avr 2022]. Disponible sur: <https://www.snfge.org/content/etude-randomisee-en-double-aveugle-evaluant>
134. Monges H, Salducci J., Naudy B., Ranieri F., Gonella J., Bouvier M. The electrical activity of the internal anal sphincter: a comparative study in man and cats In: Christensen J. *Gastroenterology motility* 1980;New York:Raven Press; 495–501.

135. Bouvier M, Gonella J. Electrical activity from smooth muscle of the anal sphincteric area of the cat. *J Physiol.* janv 1981;310:445-56.
136. Frenckner B. Function of the anal sphincters in spinal man. *Gut.* août 1975;16(8):638-44.
137. Abysique A, Orsoni P, Bouvier M. Evidence for supraspinal nervous control of external anal sphincter motility in the cat. *Brain Res.* 8 juin 1998;795(1-2):147-56.
138. Vitton V, Grimaud JC, Bouvier M, Abysique A. Supraspinal control of external anal sphincter motility: effects of vesical distension in humans and cats. *Neurogastroenterol Motil.* nov 2006;18(11):1031-40.
139. Rao SSC, Bharucha AE, Chiarioni G, Felt-Bersma R, Knowles C, Malcolm A, et al. Anorectal Disorders. *Gastroenterology.* 1 mai 2016;150(6):1430-1442.e4.
140. Desprez C, Turmel N, Chesnel C, Mistry P, Tamiatto M, Haddad R, et al. Comparison of clinical and paraclinical characteristics of patients with urge, mixed, and passive fecal incontinence: a systematic literature review. *Int J Colorectal Dis.* 18 nov 2020;
141. Rao SSC. Pathophysiology of adult fecal incontinence. *Gastroenterology.* janv 2004;126(1 Suppl 1):S14-22.
142. Sultan AH, Kamm MA, Hudson CN, Thomas JM, Bartram CI. Anal-sphincter disruption during vaginal delivery. *N Engl J Med.* 23 déc 1993;329(26):1905-11.
143. Wald A, Bharucha AE, Cosman BC, Whitehead WE. ACG clinical guideline: management of benign anorectal disorders. *Am J Gastroenterol.* août 2014;109(8):1141-57; (Quiz) 1058.
144. Harris LD, Pope CE. « SQUEEZE » VS. RESISTANCE: AN EVALUATION OF THE MECHANISM OF SPHINCTER COMPETENCE. *J Clin Invest.* déc 1964;43:2272-8.
145. Tuttle LJ, Zifan A, Sun C, Swartz J, Roalkvam S, Mittal RK. Measuring length-tension function of the anal sphincters and puborectalis muscle using the functional luminal imaging

probe. *Am J Physiol Gastrointest Liver Physiol.* 01 2018;315(5):G781-7.

146. Zifan A, Mittal RK, Kunkel DC, Swartz J, Barr G, Tuttle LJ. Loop analysis of the anal sphincter complex in fecal incontinent patients using functional luminal imaging probe. *Am J Physiol Gastrointest Liver Physiol.* 01 2020;318(1):G66-76.

147. Alqudah MM, Gregersen H, Drewes AM, McMahon BP. Evaluation of anal sphincter resistance and distensibility in healthy controls using EndoFLIP ©. *Neurogastroenterol Motil.* déc 2012;24(12):e591-599.

148. Fynne L, Luft F, Gregersen H, Buntzen S, Lundby L, Lundager F, et al. Distensibility of the anal canal in patients with systemic sclerosis: a study with the functional lumen imaging probe. *Colorectal Dis.* janv 2013;15(1):e40-47.

149. Brusa T, Abler D, Tutuian R, Studer P, Fattorini E, Gingert C, et al. MR-FLIP: a new method that combines a functional lumen imaging probe with anatomical information for spatial compliance assessment of the anal sphincter muscles. *Colorectal Dis.* août 2017;19(8):764-71.

150. Faaborg PM, Haas S, Liao D, Ploen J, Jakobsen A, Rahr HB, et al. Long-term anorectal function in rectal cancer patients treated with chemoradiotherapy and endorectal brachytherapy. *Colorectal Disease.* 2021;23(9):2311-9.

151. Zifan A, Sun C, Gourcerol G, Leroi AM, Mittal RK. Endoflip vs high-definition manometry in the assessment of fecal incontinence: A data-driven unsupervised comparison. *Neurogastroenterol Motil.* 2018;30(12):e13462.

152. Bliss DZ, Savik K, Jung HJG, Whitebird R, Lowry A, Sheng X. Dietary fiber supplementation for fecal incontinence: a randomized clinical trial. *Res Nurs Health.* oct 2014;37(5):367-78.

153. Read M, Read NW, Barber DC, Duthie HL. Effects of loperamide on anal sphincter function in patients complaining of chronic diarrhea with fecal incontinence and urgency. *Dig*

Dis Sci. sept 1982;27(9):807-14.

154. Demirci S, Gallas S, Bertot-Sassigneux P, Michot F, Denis P, Leroi AM. Anal incontinence: the role of medical management. *Gastroenterol Clin Biol.* sept 2006;30(8-9):954-60.

155. Heymen S, Scarlett Y, Jones K, Ringel Y, Drossman D, Whitehead WE. Randomized controlled trial shows biofeedback to be superior to pelvic floor exercises for fecal incontinence. *Dis Colon Rectum.* oct 2009;52(10):1730-7.

156. Christensen P, Krogh K, Buntzen S, Payandeh F, Laurberg S. Long-term outcome and safety of transanal irrigation for constipation and fecal incontinence. *Dis Colon Rectum.* févr 2009;52(2):286-92.

157. Goldman HB, Lloyd JC, Noblett KL, Carey MP, Castaño Botero JC, Gajewski JB, et al. International Continence Society best practice statement for use of sacral neuromodulation. *Neurourol Urodyn.* 2018;37(5):1823-48.

158. Goldman HB, Lloyd JC, Noblett KL, Carey MP, Castaño Botero JC, Gajewski JB, et al. International Continence Society best practice statement for use of sacral neuromodulation. *Neurourol Urodyn.* 2018;37(5):1823-48.

159. Desprez C, Damon H, Meurette G, Mege D, Faucheron JL, Brochard C, et al. Ten-year Evaluation of a Large Retrospective Cohort Treated by Sacral Nerve Modulation for Fecal Incontinence: Results of a French Multicenter Study. *Ann Surg.* 24 juill 2020;

160. Halverson AL, Hull TL. Long-term outcome of overlapping anal sphincter repair. *Dis Colon Rectum.* mars 2002;45(3):345-8.

161. Bortolotti M. The disappointing performance of the new « Magnetic Sphincters »: a wrong idea or a wrong realization? *J Gastrointestin Liver Dis.* juin 2015;24(2):149-50.

162. Snape WJ, Lin MS, Agarwal N, Shaw RE. Evaluation of the pylorus with concurrent intraluminal pressure and EndoFLIP in patients with nausea and vomiting. *Neurogastroenterol*

Motil. 2016;28(5):758-64.

163. Chang J, Rayner CK, Jones KL, Horowitz M. Diabetic gastroparesis and its impact on glycemia. *Endocrinol Metab Clin North Am.* déc 2010;39(4):745-62.

164. Jebbink RJA, Samsom M, Bruijs PPM, Bravenboer B, Akkermans LMA, Vanberge-Henegouwen GP, et al. Hyperglycemia induces abnormalities of gastric myoelectrical activity in patients with type I diabetes mellitus. *Gastroenterology.* 1 nov 1994;107(5):1390-7.

165. Gourcerol G, Granier S, Bridoux V, Menard JF, Ducrotté P, Leroi AM. Do endoflip assessments of anal sphincter distensibility provide more information on patients with fecal incontinence than high-resolution anal manometry? *Neurogastroenterol Motil.* mars 2016;28(3):399-409.

166. Watkins CC, Sawa A, Jaffrey S, Blackshaw S, Barrow RK, Snyder SH, et al. Insulin restores neuronal nitric oxide synthase expression and function that is lost in diabetic gastropathy. *J Clin Invest.* août 2000;106(3):373-84.

167. Horváth VJ, Vittal H, Lörincz A, Chen H, Almeida-Porada G, Redelman D, et al. Reduced stem cell factor links smooth myopathy and loss of interstitial cells of cajal in murine diabetic gastroparesis. *Gastroenterology.* mars 2006;130(3):759-70.

168. Gourcerol G, Tissier F, Melchior C, Touchais JY, Huet E, Prevost G, et al. Impaired fasting pyloric compliance in gastroparesis and the therapeutic response to pyloric dilatation. *Aliment Pharmacol Ther.* févr 2015;41(4):360-7.

169. Desprez C, Melchior C, Wuestenberghs F, Zalar A, Jacques J, Leroi AM, et al. Pyloric distensibility measurement predicts symptomatic response to intrapyloric botulinum toxin injection. *Gastrointest Endosc.* 24 avr 2019;

170. Jones KL, Russo A, Stevens JE, Wishart JM, Berry MK, Horowitz M. Predictors of delayed gastric emptying in diabetes. *Diabetes Care.* juill 2001;24(7):1264-9.

171. Rayner CK, Samsom M, Jones KL, Horowitz M. Relationships of upper gastrointestinal

motor and sensory function with glycemic control. *Diabetes Care*. févr 2001;24(2):371-81.

172. Fraser R, Horowitz M, Dent J. Hyperglycaemia stimulates pyloric motility in normal subjects. *Gut*. mai 1991;32(5):475-8.

173. Allescher HD, Daniel EE, Dent J, Fox JE, Kostolanska F. Extrinsic and intrinsic neural control of pyloric sphincter pressure in the dog. *J Physiol (Lond)*. juill 1988;401:17-38.

174. Soykan I, Sivri B, Sarosiek I, Kiernan B, McCallum RW. Demography, clinical characteristics, psychological and abuse profiles, treatment, and long-term follow-up of patients with gastroparesis. *Dig Dis Sci*. nov 1998;43(11):2398-404.

175. Müller JM, Erasmi H, Stelzner M, Zieren U, Pichlmaier H. Surgical therapy of oesophageal carcinoma. *Br J Surg*. août 1990;77(8):845-57.

176. Gupta S, Chattopadhyay TK, Gopinath PG, Kapoor VK, Sharma LK. Emptying of the intrathoracic stomach with and without pyloroplasty. *Am J Gastroenterol*. août 1989;84(8):921-3.

177. Collard JM, Romagnoli R, Otte JB, Kestens PJ. The denervated stomach as an esophageal substitute is a contractile organ. *Ann Surg*. janv 1998;227(1):33-9.

178. Nakabayashi T, Mochiki E, Garcia M, Haga N, Kato H, Suzuki T, et al. Gastropyloric motor activity and the effects of erythromycin given orally after esophagectomy. *Am J Surg*. mars 2002;183(3):317-23.

179. Akkerman RDL, Haverkamp L, van Hillegersberg R, Ruurda JP. Surgical techniques to prevent delayed gastric emptying after esophagectomy with gastric interposition: a systematic review. *Ann Thorac Surg*. oct 2014;98(4):1512-9.

180. Arya S, Markar SR, Karthikesalingam A, Hanna GB. The impact of pyloric drainage on clinical outcome following esophagectomy: a systematic review. *Dis Esophagus*. juin 2015;28(4):326-35.

181. Lu D, Altieri MS, Yang J, Yin D, Obeid N, Spaniolas K, et al. Investigating rates of

reoperation or postsurgical gastroparesis following fundoplication or paraesophageal hernia repair in New York State. *Surg Endosc.* 26 nov 2018;

182. Gilsdorf D, Volckmann E, Brickley A, Taylor LJ, Glasgow RE, Fang J. Pyloroplasty Offers Relief of Postfundoplication Gastroparesis in Patients Who Improved After Botulinum Toxin Injection. *J Laparoendosc Adv Surg Tech A.* nov 2017;27(11):1180-4.

183. Pauwels A, Boecxstaens V, Broers C, Tack JF. Severely impaired gastric accommodation is a hallmark of post-Nissen functional dyspepsia symptoms. *Neurogastroenterol Motil.* août 2017;29(8).

184. Benaiges D, Más-Lorenzo A, Goday A, Ramon JM, Chillarón JJ, Pedro-Botet J, et al. Laparoscopic sleeve gastrectomy: More than a restrictive bariatric surgery procedure? *World J Gastroenterol.* 7 nov 2015;21(41):11804-14.

185. Ardila-Hani A, Soffer EE. Review article: the impact of bariatric surgery on gastrointestinal motility. *Alimentary Pharmacology & Therapeutics.* 2011;34(8):825-31.

186. Camilleri M, Chedid V, Ford AC, Haruma K, Horowitz M, Jones KL, et al. Gastroparesis. *Nat Rev Dis Primers.* 1 nov 2018;4(1):41.

187. Mans E, Serra-Prat M, Palomera E, Suñol X, Clavé P. Sleeve gastrectomy effects on hunger, satiation, and gastrointestinal hormone and motility responses after a liquid meal test. *Am J Clin Nutr.* sept 2015;102(3):540-7.

188. Sista F, Abruzzese V, Clementi M, Carandina S, Cecilia M, Amicucci G. The effect of sleeve gastrectomy on GLP-1 secretion and gastric emptying: a prospective study. *Surg Obes Relat Dis.* janv 2017;13(1):7-14.

189. Berry R, Cheng LK, Du P, Paskaranandavadivel N, Angeli TR, Mayne T, et al. Patterns of Abnormal Gastric Pacemaking After Sleeve Gastrectomy Defined by Laparoscopic High-Resolution Electrical Mapping. *Obes Surg.* 2017;27(8):1929-37.

190. Rao SSC, Bharucha AE, Chiarioni G, Felt-Bersma R, Knowles C, Malcolm A, et al.

Anorectal Disorders. *Gastroenterology*. 1 mai 2016;150(6):1430-1442.e4.

191. Kwiatek MA, Pandolfino JE, Hirano I, Kahrilas PJ. Esophagogastric junction distensibility assessed with an endoscopic functional luminal imaging probe (EndoFLIP). *Gastrointest Endosc*. août 2010;72(2):272-8.

192. Chan CLH, Scott SM, Williams NS, Lunniss PJ. Rectal hypersensitivity worsens stool frequency, urgency, and lifestyle in patients with urge fecal incontinence. *Dis Colon Rectum*. janv 2005;48(1):134-40.

193. Deutekom M, Dobben AC, Terra MP, Engel AF, Stoker J, Bossuyt PMM, et al. Clinical presentation of fecal incontinence and anorectal function: what is the relationship? *Am J Gastroenterol*. févr 2007;102(2):351-61.

194. Bharucha AE, Fletcher JG, Harper CM, Hough D, Daube JR, Stevens C, et al. Relationship between symptoms and disordered continence mechanisms in women with idiopathic faecal incontinence. *Gut*. avr 2005;54(4):546-55.

195. Ahuja NK, Clarke JO. Pyloric Therapies for Gastroparesis. *Curr Treat Options Gastroenterol*. mars 2017;15(1):230-40.

196. Attaar M, Su B, Wong HJ, Kuchta K, Denham W, Haggerty S, et al. Significant changes in impedance planimetry (EndoFLIP™) measurements after peroral pyloromyotomy for delayed gastric emptying. *Surg Endosc*. févr 2022;36(2):1536-43.

197. Gregor L, Wo J, DeWitt J, Yim B, Siwec R, Nowak T, et al. Gastric peroral endoscopic myotomy for the treatment of refractory gastroparesis: a prospective single-center experience with mid-term follow-up (with video). *Gastrointest Endosc*. juill 2021;94(1):35-44.

198. Conchillo JM, Straathof JWA, Mujagic Z, Brouns JH, Bouvy ND, Keszthelyi D, et al. Gastric peroral endoscopic pyloromyotomy for decompensated gastroparesis: comprehensive motility analysis in relation to treatment outcomes. *Endosc Int Open*. févr 2021;9(2):E137-44.

199. Vosoughi K, Ichkhanian Y, Jacques J, Aadam AA, Benias PC, Law R, et al. Role of

endoscopic functional luminal imaging probe in predicting the outcome of gastric peroral endoscopic pyloromyotomy (with video). *Gastrointest Endosc.* juin 2020;91(6):1289-99.

200. Conchillo JM, Straathof JWA, Mujagic Z, Brouns JH, Bouvy ND, Keszthelyi D, et al. Gastric peroral endoscopic pyloromyotomy for decompensated gastroparesis: comprehensive motility analysis in relation to treatment outcomes. *Endosc Int Open.* févr 2021;9(2):E137-44.

201. Durant NN, Katz RL. Suxamethonium. *Br J Anaesth.* févr 1982;54(2):195-208.

202. Berthoud MC, Reilly CS. Adverse effects of general anaesthetics. *Drug Saf.* déc 1992;7(6):434-59.

203. Roe RB. The effect of suxamethonium on intragastric pressure. *Anaesthesia.* avr 1962;17:179-81.

204. Chassard D, Lansiaux S, Duflo F, Mion F, Bleyzac N, Debon R, et al. Effects of subhypnotic doses of propofol on gastric emptying in volunteers. *Anesthesiology.* juill 2002;97(1):96-101.

205. La Cour D. Rise in intragastric pressure caused by suxamethonium fasciculations. *Acta Anaesthesiol Scand.* 1969;13(4):255-61.

206. Biancani P, CiCalzi LK, McCallum RW. Mechanism of histamine-induced excitation of the cat pylorus. *J Clin Invest.* sept 1981;68(3):582-8.

207. Allescher HD, Ahmad S, Kostolanska F, Kwan CY, Daniel EE. Modulation of pyloric motor activity via adrenergic receptors. *J Pharmacol Exp Ther.* mai 1989;249(2):652-9.

208. Camilleri M, Malagelada JR, Stanghellini V, Zinsmeister AR, Kao PC, Li CH. Dose-related effects of synthetic human beta-endorphin and naloxone on fed gastrointestinal motility. *Am J Physiol.* juill 1986;251(1 Pt 1):G147-154.

209. Hasler WL, Wilson LA, Nguyen LA, Snape WJ, Abell TL, Koch KL, et al. Opioid Use and Potency Are Associated With Clinical Features, Quality of Life, and Use of Resources in Patients With Gastroparesis. *Clin Gastroenterol Hepatol.* juin 2019;17(7):1285-1294.e1.

210. Jehangir A, Parkman HP. Chronic opioids in gastroparesis: Relationship with gastrointestinal symptoms, healthcare utilization and employment. *World J Gastroenterol.* 28 oct 2017;23(40):7310-20.

The use of impedance planimetry (Endoscopic Functional Lumen Imaging Probe, EndoFLIP[®]) in the gastrointestinal tract: A systematic review

Charlotte Desprez^{1,2}  | Sabine Roman³  | Anne Marie Leroi^{1,2,4}  |
Guillaume Gourcerol^{1,2,4} 

¹Digestive Physiology Department, Rouen University Hospital, Rouen, France

²Nutrition, Brain and Gut Laboratory, INSERM unit 1073, Rouen University Hospital, Rouen, France

³Digestive Physiology Department, Hospices Civils de Lyon, Hopital H Herriot, Lyon, France

⁴Clinical Investigation Center, CIC-CRB 1404, Rouen University Hospital, Rouen, France

Correspondence

Charlotte Desprez, Digestive Physiology Unit, Rouen University Hospital - 1 rue de Germont, 76031 Rouen, Cedex, France.
Email: charlotte-desprez@orange.fr

Abstract

Background and purpose: The EndoFLIP[®] system is a method of delineating impedance and was first designed to investigate the characteristics of the esophago-gastric junction. In the last decade, its use was widened to investigate other sphincteric and non-sphincteric systems of the gastrointestinal tract. The objective of the present systematic review was to summarize the available data in literature on the use of the EndoFLIP[®] system in the gastrointestinal tract, including sphincteric and non-sphincteric regions. We performed a systematic review in accordance with recommendations for systematic review using PRISMA guidelines without date restriction, until June 2020, using MEDLINE-PubMed, Cochrane Library, and Google Scholar databases. Only articles written in English were included in the present review. Five hundred and six unique citations were identified from all database combined. Of those, 95 met the inclusion criteria. There was a lack of standardization among studies in terms of anesthetic drugs use, probe placement, and inflation protocol. In most cases, only small cohorts of patients were included. Most studies investigated the EGJ, with a potential use of the EndoFLIP[®] to identify a subgroup of patients with achalasia and for intraoperative assessment of treatment efficacy in achalasia. However, the use of EndoFLIP[®] in the esophageal body (esophageal panometry), other esophageal diseases (gastro-esophageal reflux disease, eosinophilic esophagitis), and other sphincter regions (anal canal, pylorus) will need further confirmatory studies. The EndoFLIP[®] system provides detailed geometric data of the gastrointestinal lumen but further works are needed to determine its use in clinical practice.

KEYWORDS

anal canal, EndoFLIP[®] system, esophagus, gastrointestinal tract, pylorus, sphincter

1 | INTRODUCTION

Historically, gastrointestinal (GI) sphincters were investigated using pull-through and stationary manometry techniques, or with the more

recent high-resolution manometry.^{1,2} However, if manometry and Dent sleeve brought important physiological data such as the study of resting pressure and relaxation of the lower esophageal sphincter (LES) during and after swallowing, a poor correlation was found with the strength or sphincter competence.³ The Endoscopic Functional Lumen Imaging Probe (EndoFLIP[®] system) was first developed to

Guarantor of article: Anne-Marie Leroi

test the competence of GI sphincters using bag distension in the site of interest. The underlying principle for the EndoFLIP[®] is the use of “impedance planimetry” with the measurement of cross-sectional area (CSA) inside a distension bag obtained from electrical impedance measurements and from intrabag pressure. As several electrodes are positioned along the probe, the EndoFLIP[®] system is able to measure a longitudinal series of equally spaced 16 CSAs inside the bag, every 5 mm (EF325-N probe) or every 1 cm (EF322-N probe). Sphincter length CSA pooled acquisition and analysis allow the simulation of the sphincteric region as a three-dimensional profile of estimated diameters (Figure 1). One important result given by the EndoFLIP[®] is the possibility to investigate the distensibility of the sphincter, which is defined as the relationship between the minimum CSA in the narrow region and the bag pressure at the same point⁴ (Table 1). Even if the EndoFLIP[®] was originally developed to investigate the esophago-gastric junction (EGJ), it is also used in other sphincteric and non-sphincteric regions of the GI tract.

The objectives of the present systematic review were to summarize the available data in literature on the use of the EndoFLIP[®] system in the GI tract, including sphincteric and non-sphincteric regions, and to determine the clinical utility of EndoFlip in the GI tract.

2 | METHODS

This systematic literature review was performed in accordance with recommendations for systematic review and meta-analysis using PRISMA guidelines.⁵ The present review was not registered at PROSPERO. This systematic review was performed without temporal limitation using MEDLINE-PubMed, Cochrane Library, and Google Scholar databases. We completed our research by searching pertinent references from bibliography in all selected articles. The key words used were “endoflip,” “flip,” “functional lumen imaging probe,” “impedance planimetry,” and “functional luminal imaging probe.”

All articles published until June 2020 were screened by identification of key words. Only articles written in English were included in the present review. The exclusion criteria were non-human

Key Points

- The objective of the present systematic review was to summarize the available data in literature on the use of the EndoFLIP system in the gastrointestinal tract, including sphincteric and non-sphincteric regions.
- The EndoFLIP system provides detailed geometric data of the gastrointestinal lumen but further works are needed to determine its use in clinical practice.

studies, pediatric studies, case reports, animal studies, and impedance planimetry using other system than the EndoFLIP[®]. Two investigators (CD and AML) reviewed independently titles, abstract, and articles. All results were analyzed for MEDLINE-PubMed and Cochrane Library. Articles whose title did not refer to the subject were excluded from the present review. All the abstracts of the remaining articles were entirely read, and if potentially eligible, articles underwent full-text screening. Reasons for article exclusion are presented in Figure 2. Differences in screening decision were reviewed by a third investigator (GG). A level of evidence (LE) was set for each selected article.⁶

3 | RESULTS

Five hundred and six unique citations were identified, of which 95 studies met the inclusion criteria and were included in the present review (Figure 2).

3.1 | Part 1. Esophagus

3.1.1 | Methodology

There is currently no standardization of the EndoFLIP[®] protocol in the esophagus, representing a first limitation in the interpretation

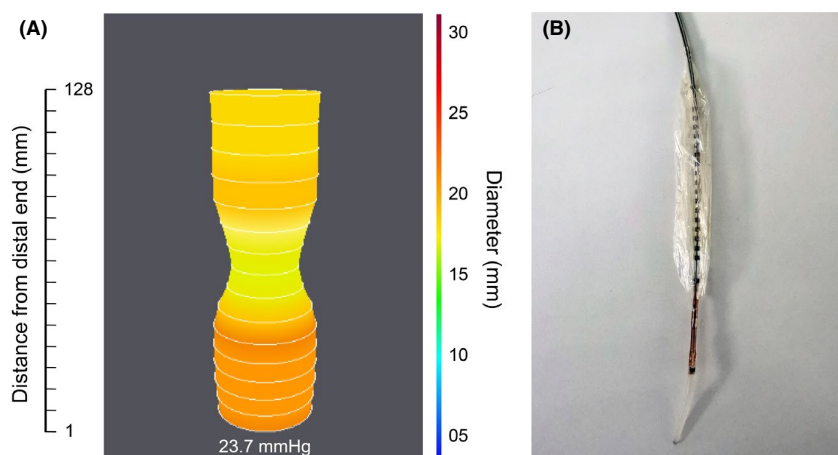

FIGURE 1 A, Traditional representation of the EndoFLIP of the EGJ with simulation of the sphincteric region as a three-dimensional profile of estimated diameters indicated by changes in color from blue (smaller diameter) to red (larger diameter). Oral direction is upward. Intrabag pressure (mm Hg) is indicated. B, Picture of the EndoFLIP catheter itself, showing the 8-cm balloon with 16 electrodes positioned each 5 mm along the probe

of data. The EF325-N probe was used in the EGJ and the EF322-N probe was used to assess the body of the esophagus. As the mode of anesthesia and the distension protocol differed among studies, these data are detailed below.

3.1.2 | Esophago-gastric junction

Healthy volunteers

Twenty studies investigated esophageal physiologic properties using the EndoFLIP[®] system in healthy volunteers (HV; Table 2). Results regarding intrabag pressure, narrowest CSA, and distensibility index (DI) (ie, narrowest CSA divided by intrabag pressure) at different volumes of inflation are given in Table 3 (LE 3). Using the 10th percentile in HV, two studies from Rohof et al, 2012⁷ and Smeets et al, 2015⁸ found a cutoff for the normality of the DI of, respectively, 2.9 mm²/mm Hg and of 2.1 mm²/mm Hg at 50 mL of inflation (LE 3). Both studies were prospectively performed in 15 HV without general anesthesia.

Three publications investigated the effect of different drugs on the esophagus using the EndoFLIP[®] system.⁹⁻¹¹ No difference was found in regard to CSA and DI of the LES values before and after administration of oral acotiamide (peripheral inhibitor of acetylcholinesterase; LE 3) and intravenous metoclopramide (central dopamine D2 receptor agonist; LE 3). However, these studies were performed in a small number of HV and without placebo control. In contrast, EGJ DI at 40 and 50 mL of inflation was lower during the administration of mosapride (serotonin 5-HT₄ agonist) in one study, but also without placebo control (LE 3).

Achalasia

Achalasia is a primary esophageal motor disorder classically diagnosed with esophageal manometry.¹² Thirty-two studies reported results regarding patients with achalasia in the literature (Table 4). All studies used the Chicago Classification¹² to determine achalasia

TABLE 1 Metrics that the EndoFLIP system can measure and what they mean

Cross-sectional area (CSA, mm²): excitation electrodes positioned at either end of the balloon emit a continuous low electric current and the voltage is measured across the paired impedance planimetry electrodes by leveraging Ohm's law to provide a measurement of CSA and volume at intervals based on excitation electrode spacing.

Diameter (mm): diameter data from each impedance planimetry channel are scaled from 5 to 30 mm and are interpolated and color-coded on a hot/cold scale (small diameters are red/large diameters are blue).

Distensibility index (DI, mm²/mm Hg): is the measure of sphincter distensibility and is calculated by dividing the median narrowest CSA (within the anatomical zone of interest) by the median intrabag pressure over a set timeframe (or distension volume).

Intrabag pressure (mm Hg): a solid-state pressure transducer is located at the distal end of the bag and allows the measure of the intrabag pressure.

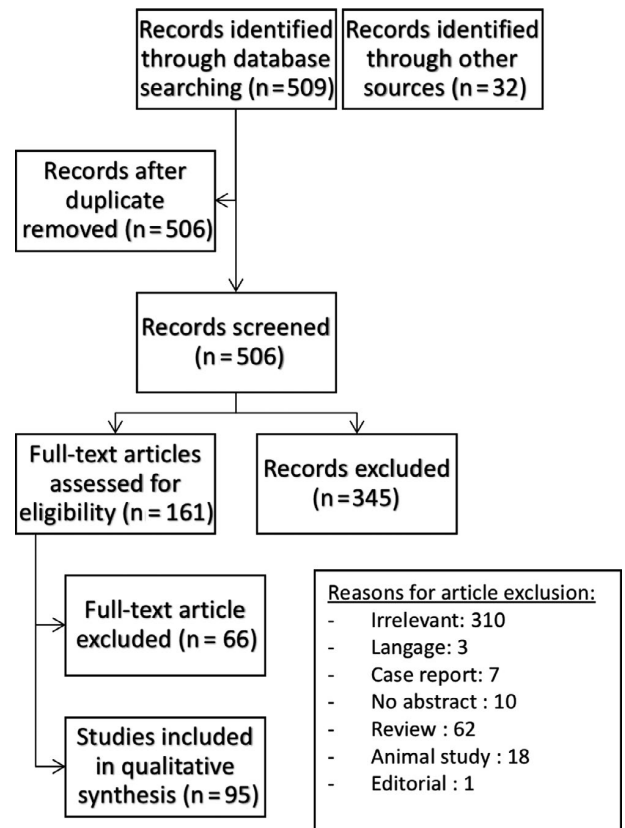

FIGURE 2 Flowchart of the study with reasons of exclusion

subtypes among patients. However, there was also a lack of homogeneity in these studies regarding both distension protocols, probe placement methods, and the mode of anesthesia (Table 4). A recent prospective study performed in patients with achalasia¹³ found lower values for both EGJ DI and CSA under endoscopic control of the EndoFLIP[®] in comparison with values after the withdrawal of the endoscope. Compared to HV, patients with untreated achalasia had lower EGJ DI at different distension volumes^{7,8,14,15} (LE 3) and it correlated with the severity of symptoms assessed by Eckardt score (ES)¹⁶ (LE 3). It was also found that 96% of patients with achalasia had an EGJ DI below the cutoff value set for HV⁸ (LE 3).

Several studies used the EndoFLIP[®] to assess the response of treatment in achalasia. A significant decrease of the EGJ DI was found for Heller myotomy^{7,14,17-22} and pneumatic dilation^{7,8,14,23,24} (LE 3). Similar results were found regarding POEM (Per Oral Esophageal Myotomy), with a significant increase of the EGJ DI found in most studies immediately after POEM^{16-20,25-28} or at 3 months²⁹ (LE 3). Intraoperative evaluation of EGJ during POEM showed that both submucosal tunnel creation and myotomy (6 cm proximal to the EGJ to 2-3 cm distal) caused an increase in EGJ DI^{19,20,26} (LE 3). However, neither the addition of a proximal extension²⁰ nor final gastric extension²⁶ to the EGJ myotomy seemed to change EGJ DI (LE 3). Lastly, two studies^{30,31} used a new EndoFLIP[®] device, the EsoFLIP 330, to perform dilation of the EGJ in patients with achalasia. Success defined by ES < 3 was obtained in, respectively, 63.8% (23/36) and

TABLE 2 Characteristics of studies performed in healthy volunteers

| Reference | Method | | Level of evidence/ Grade of recommendation | Probe | EndoFLIP measurement: time (s) and volumes of distension (mL) |
|---|---------------------|---------------------------------|--|---------|---|
| | Number of HV (n) | Design of the study | | | |
| <i>Healthy volunteers</i> | | | | | |
| Carlson et al, 2019 (=Carlson et al, 2020) ⁵⁷ | 20 | Prospective, case series study | 3/C | EF322-N | 30 s, 20-25-30-35-40-45- 50-55-60-65-70 mL |
| Mikami et al, 2018 ⁹ | 8 | Prospective, case-control study | 3/C | EF325-N | 30 s, 20-30-40 mL |
| Liao et al, 2018 ¹⁰⁷ | 6 | Prospective, case series study | 3/C | EF325-N | 20-30-40 mL |
| Carlson et al, 2016 (=Lin Z 2013 & Carlson 2015) ³⁸ | 10 | Prospective, case-control study | 3/C | EF322-N | 20-30 s, 5-60 mL (by 5-mL step) |
| Mikami et al, 2016 ¹⁰ | 8 | Prospective, case series study | 3/C | EF325-N | 30 s, 20-30-40 mL |
| Fynne et al, 2016 ⁵¹ | 11 | Prospective, case-control study | 3/C | EF325-N | 30 s, 20-30-40-50 mL |
| Smeets et al, 2015 ⁸ | 15 | Prospective, case-control study | 3/C | EF325-N | 30 s, 30-40-50 mL |
| Lottrup et al, 2015 ⁴⁹ | 14 | Prospective, case-control study | 3/C | EF325-N | 30 s, 20-30-40-50 mL |
| Fukazawa et al, 2013 ¹¹ | 9 | Prospective, case series study | 3/C | EF325-N | 30 s, 20-40-50 mL |
| Tucker et al, 2013 ⁴¹ | 21 | Prospective, case-control study | 3/C | EF325-N | 30 s, 20-30 mL |
| Lin Z et al, 2013 ⁵⁶ | 2 | Prospective, case-control study | 3/C | EF325-N | 5-20 s, 5-40 mL (by 2-mL step) |
| Rieder et al, 2012 ²⁵ | 4 | Prospective, case series study | 4/C | EF325-N | 30 s; 30-40 mL |
| Rohof et al, 2012 (=Ponds 2016) ⁷ | 15 | Prospective, case-control study | 3/C | EF325-N | 30 s, 20-30-40-50 mL |
| Kwiatek et al, 2012 ⁵⁵ | 15 | Prospective, case-control study | 3/C | EF325-N | 30 s; 20-30 mL (EGJ); 2-40 mL by 2-mL step (body) |
| Kwiatek et al, 2011 ⁹¹ | 20 | Prospective, case-control study | 3/C | EF325-N | 30 s, 10-20-30-40 mL |
| Nathanson et al, 2011 ¹⁰⁸ | 50 | Prospective, case series study | 3/C | EF325-N | 30 s; 30-40 mL |
| Kwiatek et al, 2010 ⁴⁰ | 10 | Prospective, case-control study | 3/C | ND | 30 s, 30-40-50 mL |
| Beaumont et al, 2009 ⁵⁴ | 8 | Prospective, case-control study | 3/C | ND | ND; by 10-mL step |
| McMahon et al, 2007 ⁴ | 8 | Prospective, case series study | 3/C | ND | ND; 20-30-40-50-60 mL |
| McMahon et al, 2005 ³ | 3 | Prospective, case series study | 4/C | ND | ND; 0-40 mL |

Abbreviations: EGJ, esophago-gastric junction; HV, healthy volunteers; ND, not detailed.

85% (23/27) of patients at 6 months of dilatation without major adverse effect.

In addition, several studies found that patients with incomplete response (ie, ES > 3) had a lower EGJ DI than patients with success of treatment^{7,14,16,18,23} (LE 3). Indeed, Pandolfino et al, 2013¹⁴ showed prospectively (n = 54) that an EGJ DI of 2.8 mm²/mmHg at 40 mL of inflation was predictive of early success with an AUC of 0.864 (LE 3). A prospective study (n = 58) from Teitelbaum et al (2015)¹⁶ found an EGJ DI of 4.5-8.5 mm²/mm Hg to predict 6-month efficacy of POEM (Eckardt score (ES) < 1 and gastro-esophageal reflux disease (GERD) score < 7) with a sensitivity of 68% and a specificity of 80% (LE 3). The assessment of EGJ during POEM could also help to predict incomplete response to POEM with different cutoff values found among studies.^{14,16,27,28}

Moreover, previous reports identified a subgroup of patients with typical symptoms, radiological findings of achalasia using timed barium esophagogram (TBE), and normal relaxation of the LES with an integrated relaxation pressure (IRP) <15 mm Hg, but with a DI below the cutoff value of 2.9 mm²/mm Hg set for HV³²

(LE 3). This subgroup represented 5.2% of patients with achalasia in this prospective case series and underlined a limitation of high-resolution manometry in the exploration of achalasia. Kim et al, 2020³³ showed that therapeutic outcomes measured with ES were not different between this subgroup of patients and patients with achalasia and abnormal IRP at distance from POEM. In parallel to these results, there was also a superiority of the DI of LES on IRP to identify patients with failure of treatment. One report⁷ found that in patients with failure at 6 months of treatment (ie, ES ≥ 3), 92% had impaired EGJ DI whereas 42% had elevated LES (>15 mm Hg) pressure using high-resolution manometry (HRM) (P < .01; LE 3). These results were confirmed by a more recent study³⁴ (LE 3) with a higher AUC for EGJ metrics in association with pathological TBE for EGJ DI (0.90) than IRP at 3 months after treatment (0.64).

Two studies^{16,18} investigated the postoperative risk of GERD. Su et al, 2020¹⁸ found that patients with Reflux Symptom Index score of >13 at 2 years had a CSA > 96.0 mm² but the number of patients with GERD was small (n = 4). Teitelbaum et al, 2015¹⁶ showed that

| Calibration pressure | Procedure characteristics | Site of balloon inflation |
|----------------------|--|---------------------------|
| Atmospheric | Transoral, conscious sedation (midazolam, fentanyl), without endoscopic control | EGJ & body |
| Intragastric | Transnasal, local anesthesia, without endoscopic control | EGJ |
| ND | Transoral, no sedation, without endoscopic control | EGJ |
| Atmospheric | Transoral, conscious sedation (midazolam, fentanyl), without endoscopic control | EGJ & body |
| Intragastric | Transnasal, local anesthesia, without endoscopic control | EGJ |
| ND | Transoral, midazolam or no sedation, without endoscopic control | EGJ |
| Atmospheric | Transorally, no sedation, without endoscopic control | EGJ |
| Atmospheric | Transoral, conscious sedation (midazolam), without endoscopic control | EGJ |
| Atmospheric | Transnasal, local anesthesia, without endoscopic control | EGJ |
| ND | Transoral, general anesthesia (midazolam, pethidine), under gastroscopic control | EGJ |
| Atmospheric | Transorally, no sedation, under endoscopic control | EGJ & body |
| Atmospheric | Transoral, general anesthesia, under endoscopic control | EGJ |
| Atmospheric | Transnasal, local anesthesia, without endoscopic control | EGJ |
| Atmospheric | Transoral, conscious sedation (midazolam, fentanyl), without endoscopic control | EGJ & body |
| Intragastric | Transoral, conscious sedation (midazolam, fentanyl), under endoscopic control | EGJ |
| Atmospheric | Transoral, general anesthesia, without endoscopic control | EGJ |
| Atmospheric | Transnasal, local anesthesia, without endoscopic control | EGJ |
| Atmospheric | Transoral, local anesthesia, without endoscopic control | Body |
| Atmospheric | Transoral, local anesthesia, without endoscopic control | EGJ |
| Atmospheric | Transoral, local anesthesia, without endoscopic control | EGJ |

patients with GERD had a higher EGJ DI with a maximal range value of 8.5 mm²/mm Hg to predict optimal symptomatic results (GERD score < 1).

In summary, the EndoFLIP system demonstrated its relevance in the diagnosis of atypical achalasia, but also in the prediction of the treatment outcome in achalasia. However, the precise EGJ DI threshold associated with success and prolonged response remains to be determined in further studies.

Other esophageal dysmotility disorders

Seven studies (Table 4) included patients with other major motility disorders than achalasia (ie, esophago-gastric junction outflow obstruction: EGJOO).^{13,30,35-39} One study³⁶ showed that patients with EGJOO on HRM and pathological TBE had a lower EGJ DI ($P = .03$) than patients with EGJOO on HRM and normal TBE (LE 3) with a cut-off value of 2.0 mm²/mm Hg (NPV: 100% and PPV: 75%). These results suggest that EGJ DI could help to identify patients with EGJOO that could undergo achalasia-like therapy, but there is a need for confirmatory studies.

Gastro-esophageal reflux disease

Thirteen studies investigated EGJ in GERD patients using the EndoFLIP[®] system (Table 5). In all of these reports, patients were assessed with upper GI endoscopy and reflux monitoring (esophageal pH monitoring) in addition to symptomatic evaluation. Kwiatek et al, 2011⁴⁰ found that EGJ DI was about twofold higher at both 30 and 40 mL distension volumes in GERD patients ($n = 20$) in comparison with HV ($n = 20$; $P = .04$; LE 3), with a high variability of DI values in GERD patients. However, these findings were not confirmed in a more recent publication but with several limitations like the absence of matching between HV and GERD patients on demographic factors⁴¹ (LE 3). No correlation was found between EGJ DI and reflux parameters including acid exposure time (AET), number of reflux episodes, and longest reflux episodes in one study.⁴²

The EGJ changes following fundoplication (FP) were also evaluated in nine studies, but EndoFLIP[®] protocol varied among studies (Table 5), in particular regarding the timing of EGJ evaluation during FP: before, after pneumoperitoneum or after completion of the FP. Most studies showed a significant decrease of EGJ DI immediately

TABLE 3 Assessment of the esophago-gastric junction (CSA, DI, intrabag pressure) using the EndoFLIP® system at different volumes of inflation in healthy volunteers

| Reference | Number of patients included (n) | Procedure characteristics | CSA 20 mL (mm ²) | CSA 30 mL (mm ²) | CSA 40 mL (mm ²) | CSA 50 mL (mm ²) |
|---|---------------------------------|---|------------------------------|------------------------------|------------------------------|------------------------------|
| <i>Healthy volunteers</i> | | | | | | |
| Carlson et al, 2016 (= Lin Z 2013 & Carlson 2015) ³⁸ | 10 HV | Transoral, conscious sedation (midazolam, fentanyl), without endoscopic control | | | | |
| Mikami et al, 2018 ⁹ | 8 HV | Transnasal, local anesthesia, without endoscopic control | 40.4 ± 9.0 | 89.4 ± 10.4 | 150.3 ± 12.2 | |
| Liao et al, 2018 ¹⁰⁷ | 6 HV | Transoral, no sedation, without endoscopic control | | | | |
| Mikami et al, 2016 ¹⁰ | 8 HV | Transnasal, local anesthesia, without endoscopic control | 32.9 ± 10.0 | 84.5 ± 33.2 | 152.4 ± 34.2 | |
| Smeets et al, 2015 ⁸ | 15 HV | Transorally, no sedation, without endoscopic control | | 50.4 (41.7-69.1) | 99.5 (79.5-138.0) | 169.4 (131.7-187.9) |
| Fukazawa et al, 2013 ¹¹ | 9 HV | Transnasal, local anesthesia, without endoscopic control | 25.2 ± 2.5 | | 163.0 ± 5.9 | 259.6 ± 12.0 |
| Rohof et al, 2012 (=Ponds 2016) ⁷ | 15 HV | Transnasal, local anesthesia, without endoscopic control | | | | |
| Kwiatek et al, 2012 ⁵⁵ | 15 HV | Transoral, conscious sedation (midazolam, fentanyl), without endoscopic control | | | | |
| Rieder et al, 2012 ²⁵ | 4 HV | Transoral, general anesthesia, under endoscopic control | | | 122.3 (72.9-170.9) | |
| Kwiatek et al, 2011 ⁹¹ | 20 HV | Transoral, conscious sedation (midazolam, fentanyl), under endoscopic control | 38 (13-94) | 94 (27-225) | 264 (99-496) | |
| Kwiatek et al, 2010 ⁴⁰ | 10 HV | Transnasal, local anesthesia, without endoscopic control | | 50 (50-68) | 50 (50-50) | 50 (50-52) |

Note: Results are given as median (25th-75th percentile) or as mean ± SD

Abbreviations: CSA, cross-sectional area; DI, distensibility index; EGJ, esophago-gastric junction; HV, healthy volunteers.

after completion of FP^{17,40,43-45} (LE 3) and this despite the type of FP (ie, Nissen or Toupet FP) in one study⁴³ (LE 3) but not in another study⁴⁴ (LE 4). Moreover, the importance of the timing of EGJ evaluation during FP was also demonstrated. In fact, it was shown that EGJ DI was decreased after pneumoperitoneum in comparison with initial measurements after induction of anesthesia^{44,45} (LE 3 & 4). Nevertheless, the clinical implication of post-FP EndoFLIP® findings remains controversial. Turner et al⁴⁶ found that EGJ pressure and DI variations following FP did not correlate with symptomatic outcomes at 6 months contrary to CSA and Dmin variations (LE 3). However, only 7 patients had a failure of FP in this cohort. Another recent study⁴³ showed that there was no correlation between post-FP EGJ DI and both dysphagia score and GERD-HRQL score at 1 year from FP (LE 3). In addition, transoral incisionless FP using the EsophyX-2 device was evaluated in two reports (n = 15 and n = 42)^{47,48} (LE 3) using EndoFLIP®. A lower EGJ DI and CSA were found after FP in both studies and patients with lower AET at 6 months had a lower preoperative EGJ DI.⁴⁷ No association was found between postoperative EGJ DI and AET.

In summary, patients with GERD seem to have a higher EGJ DI than HV among studies, but the relevance of the EndoFLIP system in the prediction of the efficacy of fundoplication remains undemonstrated.

Hiatal hernia

Two studies^{49,50} specifically assessed patients with hiatal hernia (HH) using the EndoFLIP® system. In a prospective controlled study⁴⁹ (sliding HH n = 30; HV n = 14; LE 3), a specific profile was visible with EndoFLIP® a double-diameter zone (LES and crural diaphragm components) permitting the diagnosis of HH with a sensitivity of 100% and a specificity of 77.8% using endoscopic findings as gold standard. Patients with sliding HH had a lower LES pressure ($P < .001$) and a higher LES DI ($P < .001$) compared to HV. The crural diaphragm (CD) component had a lower pressure and a higher DI than the LES ($P < .001$). Interestingly, higher symptom scores were associated with lowest LES pressure and highest LES DI ($P < .01$), but not with pressure or DI of the CD. However, there is to date no confirmatory study available.

| DI 20 mL (mm ² / mm Hg) | DI 30 mL (mm ² /mm Hg) | DI 40 mL (mm ² /mm Hg) | DI 50 mL (mm ² / mm Hg) | Intrabag pressure 20 mL (mm Hg) | Intrabag pressure 30 mL (mm Hg) | Intrabag pressure 40 mL (mm Hg) | Intrabag pressure 50 mL (mm Hg) |
|--|--------------------------------------|--------------------------------------|--|--|------------------------------------|------------------------------------|---------------------------------------|
| | 3.2 (1.0-11.6) | 5.7 (1.4-15.8) | 5.9 (1.6-9.3) | | | | |
| 2.2 ± 0.5 | 3.4 ± 0.5 | 3.5 ± 0.4 | | 14.7 ± 0.8 | 23.4 ± 2.1 | 40.8 ± 2.0 | |
| | | | | 16.3 ± 0.5 | 27.4 ± 1.2 | 40.2 ± 1.5 | |
| 1.8 ± 0.2 | 3.5 ± 0.6 | 4.5 ± 0.5 | | 15.5 ± 5.1 | 22.0 ± 6.0 | 31.2 ± 6.8 | |
| | 2.0 (1.6-3.0) | 3.0 (2.2-4.2) | 3.4 (2.7-4.2) | | 25.9 (21.4-30.0) | 34.5 (29.0-40.2) | 45.8 (41.9-53.4) |
| 2.9 ± 0.6 | | 7.1 ± 0.9 | 8.2 ± 0.8 | 10.3 ± 1.4 | | 25.9 ± 3.2 | 33.1 ± 2.3 |
| | | | 6.3 ± 0.7 | | | | |
| 0.9 (0.3 - 1.4) | 0.8 (0.4 - 2.8) | | | | | | |
| | | 2.7 (2.4-8.3) | | | | 36.8 (20.7-45.8) | |
| 2 [1-9] | 4 [1-14] | | | 9 (2-20) | 25 (6-47) | 39 (17-60) | |
| | | | | | 16 (13-19) | 17 (11-21) | |

Another retrospective report (n = 40; LE 4)⁵⁰ used the EndoFLIP[®] device to determine how tight to create the fundoplication with an arbitrary set final EGJ DI near 1 mm²/mm Hg at 30 mL of inflation. If the use of EndoFLIP[®] eliminated the need for a bougie in this study without dysphagia or GERD symptoms at 1 month, there is a need to confirm these findings in further large prospective studies with a longer time of follow-up. Lastly, some studies on fundoplication in GERD patients included a low number of patients with HH, but without particular analysis of this subgroup of patients.^{17,42,45,47,48}

Systemic sclerosis

Only one prospective report (LE 3)⁵¹ investigated EGJ parameters in patients with diffuse systemic scleroderma (SSc, n = 11) in comparison with HV (n = 10). All patients had mild-to-moderate digestive symptoms with hypomotility on HRM in 7/11 patients. The authors did not use the DI in this study but the pressure strain elastic modulus (defined as the change in the diameter at the narrowest point of the EGJ divided by change in the bag pressure

relative to a reference diameter), which was lower in patients with SSc, indicating reduced resistance to distension. However, due to the small and heterogenic cohort of patients, these results need confirmatory studies.

Sleeve gastrectomy

One prospective study⁵² (n = 15; LE 3) showed an increase in EGJ DI during per operatory evaluation but no correlation was found between EGJ DI and GERD-HRQL score at 3 and 6 months of follow-up. However, the number of patients who developed postoperative GERD was small in this cohort (n = 4), with a need for other confirmatory studies.

Esophageal stenosis

One retrospective study⁵³ (n = 56; LE 4) compared videofluoroscopy including a tablet test (placebo sugar tablets of spherical shape, 14 mm diameter) to EndoFLIP[®] for the evaluation of esophageal stenosis in patients with dysphagia. A significant correlation was found between tablet impaction with a delay of more

TABLE 4 Characteristics of studies performed in patients with achalasia or other esophageal dysmotility disorders

| Reference | Method | | Level of evidence/ Grade of recommendation | EndoFLIP measurement: time (s) and volumes of distension (mL) | Procedure characteristics | Site of balloon inflation |
|------------------------------------|--|----------------------------------|---|---|---|---------------------------|
| | Number of patients included (n) | Design of the study | | | | |
| Achalasia | | | | | | |
| Sloan et al, 2020 ³⁰ | 37 Achalasia, 14 EGJOO | Retrospective, case series study | 4/C | ND; 30 mL | Transoral, general anesthesia, under endoscopic control | EGJ |
| Schnurre et al, 2020 ³¹ | 28 Achalasia | Retrospective, case series study | 4/C | 30 s, 30-40 mL | Transoral, general anesthesia, under endoscopic control | EGJ |
| Kim et al, 2020 ³³ | 89 Achalasia | Retrospective, case series study | 4/C | 30 s; ND | ND | EGJ |
| Su et al, 2020 ¹⁸ | 94 POEM | Prospective, case series study | 3/C | 30 s; 30-40 mL | Transoral, general anesthesia, ±under endoscopic control | EGJ |
| Su et al, 2020 ¹⁷ | 77 Achalasia (71 POEM & 6 HM) | Prospective, case series study | 3/C | 30 s, 30 mL | Transoral, general anesthesia, under endoscopic control | EGJ |
| Bianca et al, 2020 ¹³ | 18 Achalasia, 43 EGJOO | Prospective, case series study | 3/C | 30 s; 30-40-50 mL | Transoral, general anesthesia, ±under endoscopic control | EGJ |
| Carlson et al, 2020 ⁵⁸ | 20 HV, 140 Achalasia | Prospective, case series study | 3/C | 30 s, 20-25-30-35-40-45-50-55-60-65-70 mL | Transoral, conscious sedation (midazolam, fentanyl), without endoscopic control | Body |
| Campagna et al, 2019 ³⁷ | 27 Achalasia, 7 EGJOO | Prospective, case series study | 3/C | 30-60 s; 30-40-50-60-70 mL | Preoperative: Transoral, conscious sedation (midazolam, fentanyl), under endoscopic control/Intraoperative: transoral, general anesthesia, under endoscopic control | EGJ & Body |
| Jain et al, 2019 ³⁴ | 79 Achalasia (not naive of treatment) | Prospective, case series study | 3/C | 10-30 s, 20-25-30-35-40-45-50-55-60-65-70 mL | Transoral, general anesthesia, ±under endoscopic control | EGJ & Body |
| Yoo et al, 2019 ²⁸ | 52 Achalasia (POEM) | Retrospective, case series study | 4/C | ND; 30-40 mL | Transoral, general anesthesia, ± under endoscopic control | EGJ |
| Carlson et al, 2019 ³⁹ | 9 Achalasia, 10 EGJOO, 1 DES, 2 Jackhammer esophagus | Prospective, case series study | 3/C | 30-60 s; 20-25-30-35-40-45-50-55-60-65-70 mL | Transoral, conscious sedation (midazolam, fentanyl)±propofol, without endoscopic control | EGJ & body |
| Wu et al, 2017 ²³ | 54 PD, 15 HV | Prospective, case-control study | 3/C | 30 s, 10-20-30-40 mL | Transoral, general anesthesia, under endoscopic control | EGJ |
| Carlson et al, 2017 ³⁸ | 32 Fundoplication, 25 Achalasia | Prospective, case series study | 3/C | 30 s, 20-30-40-50-60-70 mL | Transoral, conscious sedation (midazolam, fentanyl), without endoscopic control | EGJ & body |
| Ahuja et al, 2017 ¹⁰⁹ | 24 Achalasia | Retrospective, case series study | 4/C | 30 s, 20-30-40-50 mL | Transoral, general anesthesia, under endoscopic control | EGJ & body |

(Continues)

TABLE 4 (Continued)

| Reference | Method | | Level of evidence/ Grade of recommendation | EndoFLIP measurement: time (s) and volumes of distension (mL) | Procedure characteristics | Site of balloon inflation |
|--|--------------------------------------|--|---|---|---|---------------------------|
| | Number of patients included (n) | Design of the study | | | | |
| Ponds et al, 2016 ³² | 13 Achalasia | Prospective, case-control study | 3/C | 30 s; 20-30-40-50 mL | Transnasal, local anesthesia, without endoscopic control | EGJ |
| Carlson et al, 2016 ¹⁵ | 70 Achalasia, 38 EGJOO, 3 Jackhammer | Prospective, case series study | 3/C | 10-30 s; 20-25-30-35-40-45-50-55-60-65-70 mL | Transoral, conscious sedation (midazolam, fentanyl) or general anesthesia, without endoscopic control | Body |
| Dehaan et al, 2016 ²² | 14 Achalasia (HM) | Retrospective, case series study | 4/C | ND; 30-40 mL | Transoral, general anesthesia, under endoscopic control | EGJ |
| Teitelbaum et al, 2016 ²⁶ | 16 Achalasia (POEM) | Prospective, case series study | 3/C | ND; 40 mL | Transoral, general anesthesia, under endoscopic control | EGJ |
| Ngamruengphong et al, 2015 ²⁷ | 63 Achalasia (POEM) | Retrospective, case series study | 4/C | 30 s; 30-40 mL | Transoral, general anesthesia, under endoscopic control | EGJ |
| Carlson et al, 2015 ⁵⁹ | 51 Achalasia, 10 HV | Prospective, case-control study | 3/C | 5-20 s; 20-25-30-35-40-45-50-55-60-65-70 mL | Transoral, conscious sedation (midazolam, fentanyl) or general anesthesia, without endoscopic control | Body |
| Smeets et al, 2015 ⁸ | 26 Achalasia, 15 HV | Prospective, case-control study | 3/C | 30 s; 30-40-50 mL | Transoral, conscious sedation (midazolam, fentanyl), without endoscopic control | EGJ |
| Ilczyszyn et al, 2015 ²¹ | 38 Achalasia (HM) | Retrospective (8 patients) and prospective (30 patients), case-control study | 4/C | 30 s; 30-40 mL | Transoral, general anesthesia, without endoscopic control | EGJ |
| Teitelbaum et al, 2015 ¹⁶ | 58 Achalasia (20 LHM, 38 POEM) | Prospective, case series study | 3/C | ND; 40 mL | Transoral, general anesthesia, under endoscopic control | EGJ |
| Kappelle et al, 2015 ²⁴ | 10 Achalasia (PD) | Prospective, case series study | 3/C | ND; 30 mL | Transoral, general anesthesia, under endoscopic control | EGJ |
| Familiari et al, 2014 ¹¹⁰ | 21 Achalasia (POEM) | Prospective, case series study | 3/C | ND; 30 mL | Transoral, general anesthesia, under endoscopic control | EGJ |
| Teitelbaum et al, 2014 ²⁰ | 31 Achalasia (12 HM, 19 POEM) | Prospective, case series study | 3/C | ND; 30-40 mL | Transoral, general anesthesia, under endoscopic control | EGJ |
| Teitelbaum et al, 2013 ¹⁹ | 25 Achalasia (11 HM, 14 POEM) | Prospective, case series study | 3/C | ND; 30-40-50 mL | Transoral, general anesthesia, under endoscopic control | EGJ |

(Continues)

TABLE 4 (Continued)

| Reference | Method | | Level of evidence/ Grade of recommendation | EndoFLIP measurement: time (s) and volumes of distension (mL) | Procedure characteristics | Site of balloon inflation |
|--------------------------------------|--|----------------------------------|--|--|---|------------------------------|
| | Number of patients included (n) | Design of the study | | | | |
| Pandolfino et al, 2013 ¹⁴ | 54 Achalasia (17 PD, 10 HM, 4 POEM) | Prospective, case-control study | 3/C | 30 s; 40 mL | Transoral, conscious sedation (midazolam, fentanyl)±under endoscopic control | EGJ |
| Verlaan et al, 2013 ²⁹ | 10 Achalasia (POEM) | Prospective, case series study | 3/C | 30 s; 20-30-40-50 s | Transorally, no sedation, without endoscopic control | EGJ |
| Rieder et al, 2012 ²⁵ | 4 Achalasia (POEM), 4 HV | Prospective, case series study | 4/C | 30 s; 30-40 mL | Transoral, general anesthesia, under endoscopic control | EGJ |
| Rohof et al, 2012 ⁷ | 15 HV, 30 Achalasia | Prospective, case-control study | 3/C | 30 s, 20-30-40-50 mL | Transnasal, local anesthesia, without endoscopic control | EGJ |
| McMahon et al, 2007 ⁴ | 8 HV, 2 Achalasia | Prospective, case-control study | 3/C | ND; 20-30-40-50-60 mL | Transoral, local anesthesia, without endoscopic control | EGJ |
| <i>Other dysmotility disorders</i> | | | | | | |
| Sloan et al, 2020 ³⁰ | 37 Achalasia, 14 EGJOO | Retrospective, case series study | 4/C | ND; 30 mL | Transoral, general anesthesia, under endoscopic control | EGJ |
| Baumann et al, 2020 ³⁵ | 10 IEM, 20 EGJOO | Retrospective, case series study | 4/C | 30-60 s; 20-25-30-35-40-45-50-55-60-65-70 mL | Transoral, conscious sedation (midazolam, fentanyl), without endoscopic control | Body |
| Bianca et al, 2020 ¹³ | 18 Achalasia, 43 EGJOO | Prospective, case series study | 3/C | 30 s; 30-40-50 mL | Transoral, general anesthesia, with and without endoscopic control | EGJ |
| Triggs et al, 2019 ³⁶ | 34 EGJOO | Retrospective, case series study | 3/C | 30-60 s; 20-25-30-35-40-45-50-55-60-65-70 mL | Transoral, conscious sedation (midazolam, fentanyl), under endoscopic control | EGJ & body |
| Carlson et al, 2019 ³⁹ | 9 Achalasia, 10 EGJOO, 1 DES, 2 Jackhammer esophagus | Prospective, case series study | 3/C | 30-60 s; 20-25-30-35-40-45-50-55-60-65-70 mL | Transoral, conscious sedation (midazolam, fentanyl)±propofol, without endoscopic control | EGJ & body |
| Campagna et al, 2019 ³⁷ | 27 Achalasia, 7 EGJOO | Prospective, case series study | 3/C | 30-60 s; 30-40-50-60-70 mL | Preoperative: Transoral, conscious sedation (midazolam, fentanyl), under endoscopic control/Intraoperative: transoral, general anesthesia, under endoscopic control | EGJ & Body |
| Carlson et al, 2016 ¹⁵ | 70 Achalasia, 38 EGJOO, 3 Jackhammer | Prospective, case series study | 3/C | 10-30 s, 20-25-30-35-40-45-50-55-60-65-70 mL | Transoral, conscious sedation (midazolam, fentanyl) or general anesthesia, without endoscopic control | Body |

Note: Abbreviations: DES, distal esophageal spasm; EGJ, esogastric junction; EGJOO, esophago-gastric junction outflow obstruction; HM, Heller myotomy; HV, healthy volunteers; ND, not detailed; PD, pneumatic dilation; POEM, per oral endoscopic myotomy.

than 15 seconds and an EndoFLIP® esophageal diameter of less than 15.1 mm ($P = .035$). However, the etiologies of esophageal stenosis were heterogeneous in this population and some patients had an impaction of videofluoroscopy proximally to EndoFLIP® placement.

3.1.3 | Body of the esophagus

Healthy volunteers

The body of the esophagus was studied in 6 reports in healthy volunteers ($n = 2-20$) using⁵⁴⁻⁵⁶ the classical 8 cm probe or a more recent 16-cm probe (EF322-N).^{38,57,58} These publications introduced the concept of *distension plateau (DP)*, which was defined as the reflection of the fixed luminal diameter that would fail to expand despite increasing intraballloon pressures.^{38,57} Moreover, the contractility response of the esophagus to distension (ie, secondary peristalsis) could be identified in these studies, with the introduction of new parameters: 1/esophageal body contractions (transient decrease of ≥ 5 mm in the luminal diameter in ≥ 3 adjacent impedance planimetry channels); 2/repetitive anterograde contractions (RACs; ≥ 3 anterograde contractions consecutively); and 3/repetitive retrograde contractions (RRCs; ≥ 3 retrograde contractions consecutively).^{38,57-59} The RAC pattern, occurring every 6-10 seconds, was found to be the normal contractile response to sustained volume distension in 95% of HV (LE 3)^{58,59} mostly at 40 and 50 mL fill volume and was assimilated to secondary peristalsis (Figure 3). Table S1 (Supplemental material) summarizes results regarding esophageal body studies in HV.

Eosinophilic esophagitis

Six reports assessed esophageal properties in eosinophilic esophagitis (EoE) using the EndoFLIP® system (Table 4). The DI of the distal esophageal body was significantly reduced in patients with EoE ($n = 33$) in comparison with HV ($n = 15$) in a prospective report (LE 3),⁵⁵ with a DP of the distal esophageal body of <300 m² in 73% of EoE patients whereas it was >400 m² in 67% of HV. These findings were confirmed by another group (LE 3).⁶⁰ The EGJ DI was also lower at different inflation volumes in patients with EoE than in HV ($P = .01$). No correlation was found between the DP and mucosal eosinophilic count from proximal or distal biopsies, age, gender, and proton pump inhibitors use.⁵⁵ However, the symptomatic relevance or association with endoscopic patterns of EoE was not assessed in this study. Another prospective study⁶¹ ($n = 70$, LE 3) showed that the association between the DP and the follow-up symptom score at 12 months was stronger than the association between the follow-up symptom score and eosinophilic density. In addition, patients with a history of food impaction had a significantly lower DP, but there was no difference in eosinophilic density, compared to those without food impaction in the same study. The association between endoscopic severity of EoE (rings, strictures, exudates) using the EoE Endoscopic Reference Score and esophageal distensibility was assessed in a

retrospective study ($n = 72$; LE 4).⁶² The main findings were that higher ring scores were associated with lower DP ($P < .001$) but not with mucosal eosinophilic density. On the contrary, the severity of exudates and furrows were not associated with distensibility parameters, in contrary to mucosal eosinophilic density ($P < .001$). Lastly, an analysis of a small retrospective cohort of patients with EoE ($n = 18$; LE 4) suggested that the median esophageal DP was higher more than 3 months after initiation of therapy (including PPI, topical steroids, or elimination diet) in comparison with baseline. Moreover, the improvement in DP was associated to an improvement in ring scores and not mucosal eosinophilic density or inflammatory endoscopic changes.

All these results suggest that there is a disconnect between the degree of tissue remodeling and inflammation. Thus, the fibrostenotic changes could be independent of the inflammatory influence of activated eosinophils. In fact, previous reports showed a disconnection between symptomatic outcome and eosinophilic density,⁶³ with a relevant place for an endoscopic evaluation in patients with EoE. However, the place of EndoFLIP® in the evaluation of patients with EoE will need further evaluation studies, as its superiority to esophageal biopsies evaluation and its use to guide treatment remains still unclear.

Achalasia

The body of the esophagus was also investigated in patients with achalasia in six reports (ie, panometry).^{37-39,58,59,64} Contrary to 95% (19/20) of HV, less than 1% (1/140) of patients with achalasia exhibited the RAC pattern as response to distension in a large cohort of patients⁵⁸ (LE 3). Moreover, type I and type II achalasia patients demonstrated absent contractility or non-RAC contractility pattern, whereas patients with type III achalasia showed RRC pattern, which was not observed in HV^{38,59,64} (LE 3). Discrepancy between HRM and EndoFLIP® was also demonstrated in one study³⁸ (LE 3). All (106/106) patients with achalasia on HRM had abnormal FLIP topography (ie, abnormal EGJ DI, RRCs, absent contractility) but 50% (17/34) of patients with dysphagia and without major motility disorder on HRM had abnormal FLIP topography. One report showed that there was a modification of these abnormal contractility patterns following myotomy of the LES³⁷ (LE 3). Lastly, one recent report showed an excellent agreement ($\kappa = 0.939$; $P < .01$) between new real-time panometry (FLIP 2.0) interpretation and classical post hoc panometry interpretation (MATLAB) for detecting major contractility disorders of the esophagus.³⁹

Other motility disorders than achalasia

Abnormal FLIP topography (ie, abnormal EGJ DI, RRCs, absent contractility) was found in 33/38 (87%) patients with EGJOO on HRM (defined by LES IRP > 15 mm Hg) in one study³⁸ and the remaining five patients had normal TBE in majority and were managed without invasive therapy (LE 3). However, the time of follow-up after FLIP assessments was short in this cohort. Another report³⁵ investigated patients with normal FLIP panometry and EGJOO diagnosed on HRM. 17/20 (85%) of these patients had normal bolus transit on

TABLE 5 Characteristics of studies performed in patients with gastro-esophageal reflux disease or hiatal hernia or eosinophilic esophagitis

| Reference | Method | | Design of the study | Level of evidence/ Grade of recommendation | EndoFLIP measurement: time (s) and volumes of distension (mL) | Procedure characteristics | Site of balloon inflation |
|-------------------------------------|---------------------------------|------------------------------|----------------------------------|---|---|---|---------------------------|
| | Number of patients included (n) | | | | | | |
| GERD | | | | | | | |
| Su et al, 2020 ¹⁷ | 226 | Fundoplication | Prospective, case series study | 3/C | 30 s, 30-40 mL | Transoral, general anesthesia, ±under endoscopic control | EGJ |
| Turner et al, 2019 ⁴⁶ | 43 | Fundoplication | Retrospective, case series study | 4/C | 20 s, 30 mL | Transoral, general anesthesia, without endoscopic control | EGJ |
| Su et al, 2019 ⁴³ | 175 | Fundoplication | Prospective, case series study | 3/C | 30 s, 20-30-40 mL | Transoral, general anesthesia, without endoscopic control | EGJ |
| Mikami et al, 2018 ⁹ | 8 HV, 3 GERD | | Prospective, case-control study | 3/C | 30 s, 20-30-40 mL | Transnasal, local anesthesia, without endoscopic control | EGJ |
| Carlson et al, 2018 ⁴² | 25 | GERD | Prospective, case series study | 3/C | 30 s, 20-30-40-50-60-70 mL | Transoral, conscious sedation (midazolam, fentanyl), without endoscopic control | EGJ & Body |
| Carlson et al, 2017 ⁴⁴ | 32 | Fundoplication, 25 Achalasia | Prospective, case series study | 3/C | 30 s, 20-30-40-50-60-70 mL | Transoral, conscious sedation (midazolam, fentanyl), without endoscopic control | EGJ & Body |
| Dehaan et al, 2016 ⁴⁴ | 75 | Fundoplication | Retrospective, case series study | 4/C | 20 s, 30-40 mL | Transoral, conscious sedation (midazolam, fentanyl), under endoscopic control | EGJ |
| Smeets et al, 2015 ⁴⁷ | 42 | Fundoplication | Prospective, case series study | 3/C | 30 s, 20-30 mL | Transoral, general anesthesia, without endoscopic control | EGJ |
| Tucker et al, 2013 ⁴¹ | 21 HV, 18 GERD | | Prospective, case-control study | 3/C | 30 s, 20 and 30 mL | Transoral, general anesthesia (midazolam, pethidine), under endoscopic control | EGJ |
| Rinsma et al, 2013 ⁴⁸ | 15 | Fundoplication | Prospective, case series study | 3/C | 30 s, 30 mL | Transoral, general anesthesia, without endoscopic control | EGJ |
| Ilczyszyn et al, 2013 ⁴⁵ | 17 | Fundoplication | Prospective, case series study | 3/C | 30 s, 30-40 mL | Transoral, general anesthesia, without endoscopic control | EGJ |
| Kwiatk et al, 2011 ⁴⁰ | 20 HV, 20 GERD | | Prospective, case-control study | 3/C | 30 s, 10-20-30-40 mL | Transoral, conscious sedation (midazolam, fentanyl), under endoscopic control | EGJ |
| Kwiatk et al, 2010 ⁹¹ | 8 HV, 7 post-FP | | Prospective, case-control study | 3/C | 30 s, 30-40-50 mL | Transnasal, local anesthesia, without endoscopic control | EGJ |
| Hiatal hernia | | | | | | | |
| Kim et al, 2018 ⁵⁰ | 40 | Fundoplication | Retrospective, case series study | 4/C | 30 s, 30 mL | Transoral, general anesthesia, without endoscopic control | EGJ |

(Continues)

TABLE 5 (Continued)

| Reference | Method | | Level of evidence/ Grade of recommendation | EndoFLIP measurement: time (s) and volumes of distension (mL) | Procedure characteristics | Site of balloon inflation |
|---------------------------------------|------------------------------------|-------------------------------------|--|--|---|---------------------------------|
| | Number of patients included (n) | Design of the study | | | | |
| Lottrup et al, 2015 ⁴⁹ | 30 HH, 14 HV | Prospective, case- control study | 3/C | 30 s, 20-30-40-50 mL | Transoral, conscious sedation (midazolam), without endoscopic control | EGJ |
| <i>Eosinophilic esophagitis</i> | | | | | | |
| Carlson et al, 2017 ¹¹¹ | 18 EoE | Retrospective, case series study | 4/C | 20-30 s, 5-60 mL (by 5-mL step) | Transoral, conscious sedation (midazolam, fentanyl), without endoscopic control | EGJ & Body |
| Chen et al, 2016 ⁶² | 72 EoE | Retrospective, case series study | 4/C | 5-20 s, 2-40 mL (by 2-mL step) | Transoral, conscious sedation (midazolam, fentanyl), without endoscopic control | Body |
| Carlson et al, 2016 ⁶⁰ | 9 HV, 20 EoE | Prospective, case- control study | 3/C | 20-30 s, 5-60 mL (by 5-mL step) | Transoral, conscious sedation (midazolam, fentanyl), without endoscopic control | EGJ & body |
| Lin Z et al, 2013 ¹¹² | 2 HV, 6 EoE | Prospective, case- control study | 3/C | 5-20 s, 5-40 mL (by 2-mL step) | Transorally, no sedation, under endoscopic control | EGJ & body |
| Nicodème et al, 2013 ⁶¹ | 10 HV, 70 EoE | Prospective, case- control study | 3/C | 5-20 s, 2-40 mL (by 2-mL step) | Transoral, conscious sedation (midazolam, fentanyl), without endoscopic control | Body |
| Kwiatk et al, 2012 ⁵⁵ | 15 HV, 33 EoE | Prospective, case- control study | 3/C | 30 s; 20-30 mL (EGJ); 2-40 mL by 2-mL step (body) | Transoral, conscious sedation (midazolam, fentanyl), without endoscopic control | EGJ & Body |

Abbreviations: EGJ, esogastric junction; EoE, eosinophilic esophagitis; FP, fundoplication; GERD, gastro-esophageal reflux disease; HH, hiatal hernia; HV, healthy volunteers; ND, not detailed.

supine swallows and 10/20 (50%) had normal TBE, with therefore conservative therapy in all patients (LE 4).

Gastro-esophageal reflux disease

The body of the esophagus was investigated in 2 studies using panometry. Carlson et al, 2018⁴² found that total esophageal acid exposure time was lower in GERD patients exhibiting RAC pattern (6.1%) than in those that did not generate RACs (14.9%; $P = .009$; LE 3), but this cohort included patients with typical and atypical GERD symptoms. In patients with dysphagia post-Nissen FP, it was found that RRC pattern could occur in these patients, but in a lesser degree than in patients with type III achalasia ($P < .001$), and these abnormalities were in mainly cases associated with HRM findings of neural imbalance favoring excitation⁶⁴ (LE 3).

3.1.4 | Pharyngoesophageal junction

Pharyngoesophageal junction motility during swallowing is traditionally difficult to explore, even using the most recent technology, including videofluoroscopy and HRM coupled with intraluminal impedance recording manometry. This relies on the lack of reliable objective measures and/or limited interrater reliability to assess upper esophageal sphincter resting pressure and opening.^{65,66} The recent development of FLIP measurement provided a new tool to assess dynamic change of pharyngoesophageal junction geometry and distensibility, especially during swallowing. Two studies from the same group in 11 and 14 HV demonstrated the feasibility of this investigation with the balloon inflated up to 20 mL.^{67,68} CSA increased during swallowing compared to the resting period, while intraball pressure dropped. A third study showed similar data in seven patients with total laryngectomy.⁶⁹ Unfortunately, no comparison with values obtained from HV was carried out. A last report investigated 60 patients with head and neck cancer treated either with chemotherapy or laryngectomy + radiotherapy.⁷⁰ Pharyngoesophageal junction distensibility was found to be decreased in patients with strictures compared to patients free of strictures with a diagnostic performance of 100%. Additionally, endoscopic dilation of pharyngoesophageal junction strictures resulted in an increase in pharyngoesophageal junction distensibility. Altogether, these data suggest that the measurement of the pharyngoesophageal junction distensibility provides additional information on swallowing dynamics and may be of use in the future in patients with dysphagia, especially after head-neck cancer.

3.2 | Part 2. Pyloric distensibility measurement in gastroparesis

Clinical diagnosis of gastroparesis may be challenging as symptoms patterns and severity are poorly correlated with gastric emptying.⁷¹⁻⁷³ Historically, the role of pylorus in gastric emptying delay and symptom generation has been highlighted. In fact, a first report published in 1986

by Mearin et al⁷⁴ identified pyloric dysfunction as unusually prolonged and named intermittent pyloric contractions “pylorospasms.” However, this study required a specific manometric assembly which limited its spread among specialized centers. More recently, pyloric distensibility measurement using EndoFLIP[®] technology has been validated as a complementary measurement to sphincter pressure in gastroparesis. Pyloric distensibility measurement can be easily achieved using probe placement either by radiofluoroscopy guidance⁷⁵ or through the endoscope.^{76,77} Whether anesthetics impact or not pyloric distensibility measurement has however not yet been investigated.

An initial study (LE 3) in HV ($n = 21$) reported mean pyloric distensibility at 25.2 mm²/mm Hg using a 40-mL inflated bag while the normal lower range was set at 10 mm²/mm Hg.⁷⁵ Subsequent studies performed in 27,⁷⁵ 20,⁷⁶ and 54⁷⁷ gastroparetic patients reported mean pyloric distensibility at 16.9, 12.4, and 10.7 mm²/mm Hg, respectively (LE 3). Using the threshold of 10 mm²/mm Hg, nearly one third of patients with idiopathic or diabetic gastroparesis had decreased pyloric distensibility^{75,77} (LE 3). Altered pyloric distensibility is even more likely to be found in patients with suspected or confirmed vagotomy, namely postfundoplication gastroparesis and esophagectomy, with decreased pyloric distensibility found in 61% and 75%, respectively⁷⁸ (LE 4). Another study performed in patients with nausea and/or vomiting, either associated with delayed or normal gastric emptying, found decreased pyloric distensibility (mean = 8.0 mm²/mm Hg) in patients with gastric retention compared with patients with normal gastric emptying (mean = 12.4 mm²/mm Hg)⁷⁹ (LE 3). Interestingly, in these studies, pyloric pressure measured either using EndoFLIP[®] system or manometry was not different between subjects with or without delayed gastric emptying.^{75,79} In all studies, pyloric distensibility was inversely correlated with gastric emptying^{75,77,79} (LE 3). In addition, pyloric distensibility correlated negatively with gastroparesis symptoms, including nausea,^{75,79} gastric fullness,^{75,77} early satiety,^{75,77} and quality of life.^{75,77} This contrasts with gastric emptying measurement which is poorly correlated with symptoms or quality of life⁷¹⁻⁷³ (LE 3). This suggests therefore that pyloric distensibility may be a clinically relevant tool in a subset of gastroparetic patients to better identify precisely one of the underlying mechanisms involved in gastric retention.^{17,80}

Based on these results, subsequent studies investigated whether pyloric distensibility measurement could predict clinical outcome of pyloric targeted therapies, including pyloric dilation, intrapyloric botulinum toxin injection, or gastric POEM (G-POEM).⁸⁰ Proof-of-concept studies identified that prokinetics,⁸¹ pyloric dilation,⁷⁵ and G-POEM^{76,82,83} increased pyloric distensibility, but not pyloric pressure (LE 3). Likewise, patients with decreased pyloric distensibility at baseline were more likely to normalize gastric emptying rate after botulinum toxin compared with patients with normal pyloric distensibility⁸⁴ (LE 4). Cohort studies showed that pyloric distensibility lower than 8-10 mm²/mm Hg could predict favorable outcome after pyloric dilation,⁷⁵ intrapyloric botulinum toxin injection,^{84,85} and G-POEM^{76,86} (LE 3). This remains, however, to be further confirmed by randomized controlled trials.

3.3 | Part 3. SPHINCTER OF ODDI

Manometry of the sphincter of Oddi is currently the gold standard for assessment of SO physiology. This technique is used to diagnose sphincter of Oddi dysfunction characterized by elevated basal SO pressure that may lead to sphincterotomy operations.⁸⁷ A pilot study evaluated the feasibility of an alternative technique based on sphincter distensibility measurement⁸⁸ (LE 4). This was achieved using a custom-made miniaturized probe inserted into the SO during an endoscopic retrograde cholangiopancreatography in four subjects. However, such a probe has since never been marketed and is therefore not currently available for clinical use.

3.4 | Part 4. Anal sphincter evaluation

Several methods can be used to investigate the anal sphincter. Magnetic resonance imaging or transanal ultrasound is commonly used to determine the morphology of the anal sphincters while electrophysiological tests are used to assess the innervation of the external anal sphincter.⁸⁹ Most often, anal sphincter function is assessed by measuring anal resting and voluntary contraction pressures by manometry.⁹⁰ While manometric techniques, including 3D-HRM, provide direct measurements of closure forces of the anal canal using a fixed diameter, non-collapsible probe, they cannot be used to quantify the opening dimension, which is a major variable for determining trans sphincteric flow.⁹¹ Indeed, it has been suggested

that the ability of sphincter muscles to withstand distension is more important for continence than their contraction capabilities.⁹²

Several studies have evaluated anal canal resistance to distension with the FLIP technique in HV and patients with fecal incontinence. While the methodology used was quite similar among all studies, there is until now, no consensus about the best parameters to record with FLIP technology. Several parameters have been suggested from the most complexes (anal canal stiffness defined on the basis of the pressure and diameter changes when the volume increased from 1 to 50 mL,⁹³⁻⁹⁵ flow resistance of the anal canal defined from the anal canal length, the middle part diameter of the anal canal and the dynamic viscosity of the inflated bag⁹⁶ or mechanical work of the anal sphincter muscle,⁹⁷ to the most simple (wall tension ($T = P \cdot r$),⁹⁸ anal DI (CSA/P),^{99,100} anal compliance (D/P),⁹⁷ yield pressure when the most resistant (middle) part of the sphincter begins to distend.⁹³⁻⁹⁵ More recently, Zifan et al described the use of area-pressure and area-tension-loop analysis of the anal sphincters and puborectalis muscles in normal subjects and fecal incontinent patients, assessing the relationship between changes in muscle length (secondary to anal distension) and muscle function.^{101,102} Thus, although 10 studies have reported results of FLIP measurements in the anal canal in HV,^{93,95,97-99,101,103-105} no reliable normal values are yet available because of the absence of standardized protocols for assessing and analyzing FLIP measurements. However, some of these studies have demonstrated that the geometry of the lumen and the biomechanical properties of the anal canal are not uniform during distension. Luft et al⁹⁸ attribute the least compliant position to the mid-anal

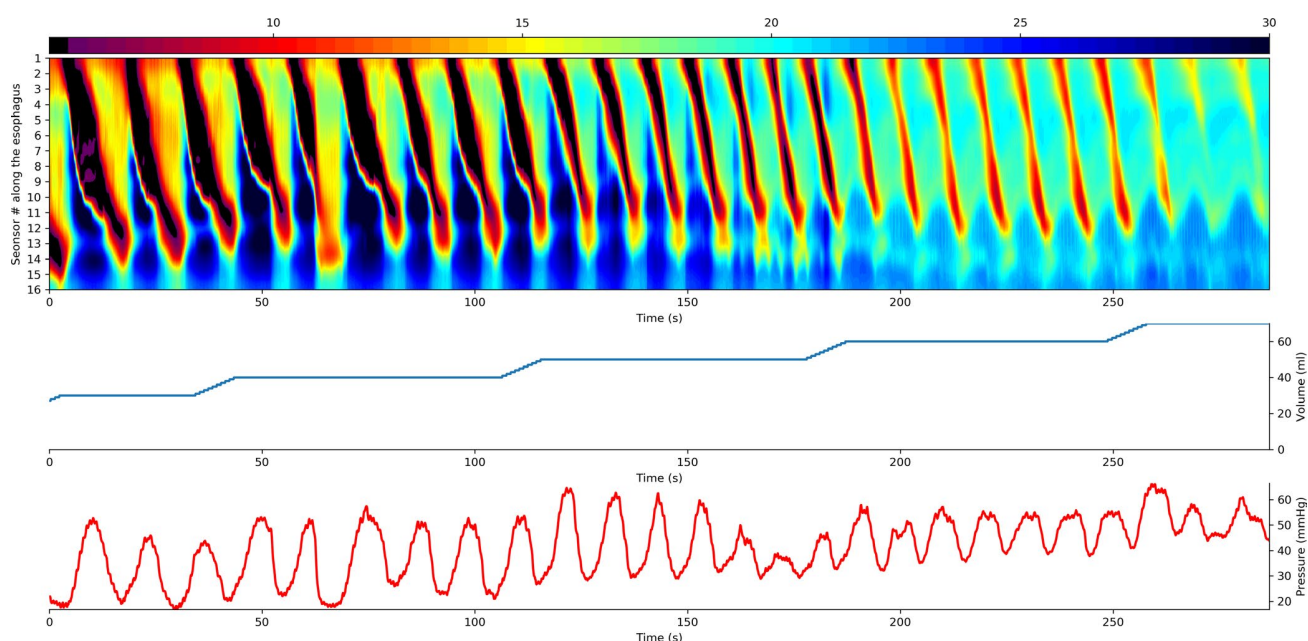

FIGURE 3 Example of FLIP topography in a HV. The EF322-N probe was used in this patient, with 16 electrodes positioned every 1 cm along the probe (vertical axis). Topographic representation of interpolated diameter changes over time using a color scale (blue: largest diameter; red narrowest diameter) from 5 to 30 mm. The blue curve illustrates the different inflation volumes used in the study over time: from 40 to 70 mL by 5 mL levels. The red curve illustrates the variation of intrabag pressure (mm Hg) over time. The figure shows the RAC pattern in a HV subject, with repetitive anterograde contractions occurring every 6-10 s. Courtesy of the Esophageal Center of Northwestern University, Chicago, IL, USA

canal, where the extern anal sphincter (EAS) and intern anal sphincter (IAS) overlap.

Regardless of the endpoints used, significantly higher anal distensibility was found in patients with fecal incontinence than in HV in all clinical studies.^{93,96,99,102,104} This has been demonstrated in patients with poor internal anal sphincter function resulting from systemic sclerosis,¹⁰⁴ in patients treated with sphincter-sparing radiotherapy or chemoradiation for anal cancer⁹⁶ and whatever the cause of fecal incontinence.^{99,100} It has been suggested that FLIP assessment would be a more selective tool to discriminate between patients with fecal incontinence and HV⁹⁹ but not confirmed by others.¹⁰⁶ However, because there is substantial diagnostic agreement about the anal sphincter weakness between high-resolution anorectal manometry and FLIP in patients with fecal incontinence,^{99,100,106} the usefulness and the place of FLIP in diagnosing and managing fecal incontinence need to be identified. Some suggest that the resistance of the anal canal to distension evaluated with FLIP would be a better criterion than anal pressure to assess treatment effectiveness^{94,102} but other larger studies may shed light on this issue.

4 | CONCLUSION

Most studies investigated the esophago-gastric junction, with a promising role of the EndoFLIP[®] in the diagnosis of atypical achalasia or EGJOO and in the prediction of treatment outcome in achalasia using EGJ DI threshold. However, the application of the use of EndoFLIP[®] in the body of the esophagus (esophageal panometry), other esophageal diseases (GERD, eosinophilic esophagitis), and other sphincter regions (anal canal, pylorus) will need further confirmatory studies. Moreover, the cost and the availability of the EndoFLIP system could be an important limitation to the application of this interesting tool in daily practice. In conclusion, the EndoFLIP[®] system provides detailed geometric data of the gastrointestinal lumen and further works are needed to determine its use in clinical practice.

ACKNOWLEDGMENTS

We are grateful to Nikki Sabourin-Gibbs, Rouen University Hospital, for her help in editing the manuscript. The authors are grateful to the Esophageal Center of Northwestern University, Chicago, IL, USA.

CONFLICT OF INTEREST

Guillaume Gourcerol has received consulting fees from Allergan. Sabine Roman served as consultant for Medtronic and received research grants from Medtronic and Diversatek Healthcare. Anne-Marie Leroi is a member of scientific board for the Medtronic Company. The other authors have no conflict of interest to declare.

AUTHOR CONTRIBUTIONS

All authors have approved the final version of the article, including the authorship list. CD conceived and designed the study; and GG, CD, AML, and SR wrote the article and edited the manuscript.

ORCID

Charlotte Desprez  <https://orcid.org/0000-0002-1280-7675>

Sabine Roman  <https://orcid.org/0000-0002-7798-7638>

Anne Marie Leroi  <https://orcid.org/0000-0002-6266-4203>

Guillaume Gourcerol  <https://orcid.org/0000-0001-8220-9155>

REFERENCES

- Dent J. A new technique for continuous sphincter pressure measurement. *Gastroenterology*. 1976;71:263-267.
- Nicodème F, Lin Z, Pandolfino JE, Kahrilas PJ. Esophagogastric Junction pressure morphology: comparison between a station pull-through and real-time 3D-HRM representation. *Neurogastroenterol Motil*. 2013;25:e591-e598.
- McMahon BP, Drewes AM, Gregersen H. Functional oesophago-gastric junction imaging. *World J Gastroenterol*. 2006;12:2818-2824.
- McMahon BP, Frøkjær JB, Kunwald P, et al. The functional lumen imaging probe (FLIP) for evaluation of the esophagogastric junction. *Am J Physiol Gastrointest Liver Physiol*. 2007;292:G377-384.
- Moher D, Liberati A, Tetzlaff J, Altman DG. Preferred reporting items for systematic reviews and meta-analyses: the PRISMA statement. *J Clin Epidemiol*. 2009;62:1006-1012.
- Burns PB, Rohrich RJ, Chung KC. The Levels of Evidence and their role in Evidence-Based Medicine. *Plast Reconstr Surg*. 2011;128:305-310.
- Rohof WO, Hirsch DP, Kessing BF, Boeckxstaens GE. Efficacy of treatment for patients with achalasia depends on the distensibility of the esophagogastric junction. *Gastroenterology*. 2012;143:328-335.
- Smeets FGM, Masclee AAM, Keszhelyi D, Tjwa ETTL, Conchillo JM. relation to treatment outcome. Esophagogastric junction distensibility in the management of achalasia patients: relation to treatment outcome. *Neurogastroenterol Motil*. 2015;27:1495-1503.
- Mikami H, Ishimura N, Fukazawa K, et al. Effects of metoclopramide on esophageal motor activity and esophagogastric junction compliance in healthy volunteers. *J Neurogastroenterol Motil*. 2016;22:112-117.
- Mikami H, Ishimura N, Okada M, et al. Acotiamide has no effects on esophageal motor activity or esophagogastric junction compliance. *J Neurogastroenterol Motil*. 2018;24:241-247.
- Fukazawa K, Furuta K, Adachi K, et al. Effects of mosapride on esophageal motor activity and esophagogastric junction compliance in healthy volunteers. *J Gastroenterol*. 2014;49:1307-1313.
- Kahrilas PJ, Bredenoord AJ, Fox M, et al. The Chicago Classification of esophageal motility disorders, v3.0. *Neurogastroenterol Motil*. 2015;27:160-174.
- Bianca A, Schindler V, Schnurre L, et al. Endoscope presence during endoluminal functional lumen imaging probe (FLIP) influences FLIP metrics in the evaluation of esophageal dysmotility. *Neurogastroenterol Motil*. 2020;32:e13823.
- Pandolfino JE, de Ruigh A, Nicodème F, et al. Distensibility of the esophagogastric junction assessed with the functional lumen imaging probe (FLIPTM) in achalasia patients. *Neurogastroenterol Motil*. 2013;25:496-501.
- Carlson DA, Lin Z, Kahrilas PJ, et al. The functional lumen imaging probe detects esophageal contractility not observed with manometry in patients with achalasia. *Gastroenterology*. 2015;149:1742-1751.
- Teitelbaum EN, Soper NJ, Pandolfino JE, et al. Esophagogastric junction distensibility measurements during Heller myotomy and POEM for achalasia predict postoperative symptomatic outcomes. *Surg Endosc*. 2015;29:522-528.

17. Su B, Callahan ZM, Kuchta K, et al. Use of impedance planimetry (Endoflip) in foregut surgery practice: experience of more than 400 cases. *J Am Coll Surg*. 2020;231:160-171.
18. Su B, Callahan ZM, Novak S, Kuchta K, Ujiki MB. Using impedance planimetry (EndoFLIP) to evaluate myotomy and predict outcomes after surgery for achalasia. *J Gastrointest Surg*. 2020;24:964-971.
19. Teitelbaum EN, Boris L, Arafat FO, et al. Comparison of esophago-gastric junction distensibility changes during POEM and Heller myotomy using intraoperative FLIP. *Surg Endosc*. 2013;27:4547-4555.
20. Teitelbaum EN, Soper NJ, Pandolfino JE, et al. An extended proximal esophageal myotomy is necessary to normalize EGJ distensibility during Heller myotomy for achalasia, but not POEM. *Surg Endosc*. 2014;28:2840-2847.
21. Ilcyszyn A, Hamaoui K, Cartwright J, Botha A. Intraoperative distensibility measurement during laparoscopic Heller's myotomy for achalasia may reduce the myotomy length without compromising patient outcome. *Dis Esophagus*. 2016;29:455-462.
22. DeHaan RK, Frelich MJ, Gould JC. Intraoperative assessment of esophago-gastric junction distensibility during laparoscopic Heller myotomy. *Surg Laparosc Endosc Percutan Tech*. 2016;26:137-140.
23. Wu PI, Szczesniak MM, Craig PI, et al. Novel intra-procedural distensibility measurement accurately predicts immediate outcome of pneumatic dilatation for idiopathic achalasia. *Am J Gastroenterol*. 2018;113:205-212.
24. Kappelle WFW, Bogte A, Siersema PD. Hydraulic dilation with a shape-measuring balloon in idiopathic achalasia: a feasibility study. *Endoscopy*. 2015;47:1028-1034.
25. Rieder E, Swanström LL, Perretta S, Lenglinger J, Riegler M, Dunst CM. Intraoperative assessment of esophago-gastric junction distensibility during per oral endoscopic myotomy (POEM) for esophageal motility disorders. *Surg Endosc*. 2013;27:400-405.
26. Teitelbaum EN, Sternbach JM, El Khoury R, et al. The effect of incremental distal gastric myotomy lengths on EGJ distensibility during POEM for achalasia. *Surg Endosc*. 2016;30:745-750.
27. Ngamruengphong S, von Rahden BHA, Filser J, et al. Intraoperative measurement of esophago-gastric junction cross-sectional area by impedance planimetry correlates with clinical outcomes of peroral endoscopic myotomy for achalasia: a multicenter study. *Surg Endosc*. 2016;30:2886-2894.
28. Yoo IK, Choi SA, Kim WH, Hong SP, Cakir OO, Cho JY. Assessment of clinical outcomes after peroral endoscopic myotomy via esophageal distensibility measurements with the endoluminal functional lumen imaging probe. *Gut Liv*. 2019;13:32-39.
29. Verlaan T, Rohof WO, Bredenoord AJ, Eberl S, Rösch T, Fockens P. Effect of peroral endoscopic myotomy on esophago-gastric junction physiology in patients with achalasia. *Gastrointest Endosc*. 2013;78:39-44.
30. Sloan JA, Triggs JR, Pandolfino JE, et al. Treatment experience with a novel 30-mm hydrostatic balloon in esophageal dysmotility: a multicenter retrospective analysis. *Gastrointest Endosc*. 2020. <https://doi.org/10.1016/j.gie.2020.04.076>.
31. Schnurre L, Murray FR, Schindler V, et al. Short-term outcome after singular hydraulic EsoFLIP dilation in patients with achalasia: a feasibility study. *Neurogastroenterol Motil*. 2020:e13864.
32. Ponds FA, Bredenoord AJ, Kessing BF, Smout AJPM. Esophago-gastric junction distensibility identifies achalasia subgroup with manometrically normal esophago-gastric junction relaxation. *Neurogastroenterol Motil*. 2017;29:e12908.
33. Kim E, Yoo IK, Yon DK, Cho JY, Hong SP. Characteristics of a subset of achalasia with normal integrated relaxation pressure. *J Neurogastroenterol Motil*. 2020;26:274-280.
34. Jain AS, Carlson DA, Triggs J, et al. Esophago-gastric junction distensibility on functional lumen imaging probe topography predicts treatment response in achalasia-anatomy matters!. *Am J Gastroenterol*. 2019;114:1455-1463.
35. Baumann AJ, Donnan EN, Triggs JR, et al. Normal functional luminal imaging probe panometry findings associate with lack of major esophageal motility disorder on high-resolution manometry. *Clin Gastroenterol Hepatol*. 2020. <https://doi.org/10.1016/j.cgh.2020.03.040>
36. Triggs JR, Carlson DA, Beveridge C, et al. Functional luminal imaging probe panometry identifies achalasia-type esophago-gastric junction outflow obstruction. *Clin Gastroenterol Hepatol*. 2019. <https://doi.org/10.1016/j.cgh.2019.11.037>
37. Campagna RAJ, Carlson DA, Hungness ES, et al. Intraoperative assessment of esophageal motility using FLIP during myotomy for achalasia. *Surg Endosc*. 2020;34:2593-2600.
38. Carlson DA, Kahrilas PJ, Lin Z, et al. Evaluation of esophageal motility utilizing the functional lumen imaging probe. *Am J Gastroenterol*. 2016;111:1726-1735.
39. Carlson DA, Gyawali CP, Kahrilas PJ, et al. Esophageal motility classification can be established at the time of endoscopy: a study evaluating real-time functional luminal imaging probe panometry. *Gastrointest Endosc*. 2019;90:915-923.e1.
40. Kwiatek MA, Kahrilas PJ, Soper NJ, et al. Esophago-gastric junction distensibility after fundoplication assessed with a novel functional luminal imaging probe. *J Gastrointest Surg*. 2010;14:268-276.
41. Tucker E, Sweis R, Anggiansah A, et al. Measurement of esophago-gastric junction cross-sectional area and distensibility by an endoluminal functional lumen imaging probe for the diagnosis of gastro-esophageal reflux disease. *Neurogastroenterol Motil*. 2013;25:904-910.
42. Carlson DA, Kathpalia P, Craft J, et al. The relationship between esophageal acid exposure and the esophageal response to volumetric distention. *Neurogastroenterol Motil*. 2018;30:e13240.
43. Su B, Novak S, Callahan ZM, Kuchta K, Carbray J, Ujiki MB. Using impedance planimetry (EndoFLIP™) in the operating room to assess gastroesophageal junction distensibility and predict patient outcomes following fundoplication. *Surg Endosc*. 2020;34:1761-1768.
44. DeHaan RK, Davila D, Frelich MJ, Gould JC. Esophago-gastric junction distensibility is greater following Toupet compared to Nissen fundoplication. *Surg Endosc*. 2017;31:193-198.
45. Ilcyszyn A, Botha AJ. Feasibility of esophago-gastric junction distensibility measurement during Nissen fundoplication. *Dis Esophagus*. 2014;27:637-644.
46. Turner B, Helm M, Hetzel E, Gould JC. Is that 'floppy' fundoplication tight enough? *Surg Endosc*. 2020;34:1823-1828.
47. Smeets FGM, Keszthelyi D, Bouvy ND, Masclee AAM, Conchillo JM. Does measurement of esophago-gastric junction distensibility by EndoFLIP predict therapy- responsiveness to endoluminal fundoplication in patients with gastroesophageal reflux disease? *J Neurogastroenterol Motil*. 2015;21:255-264.
48. Rinsma NF, Smeets FG, Bruls DW, et al. Effect of transoral incisionless fundoplication on reflux mechanisms. *Surg Endosc*. 2014;28:941-949.
49. Lottrup C, McMahon BP, Ejstrup P, et al. Esophago-gastric junction distensibility in hiatus hernia. *Dis Esophagus*. 2016;29:463-471.
50. Kim MP, Meisenbach LM, Chan EY. Tailored fundoplication with endoluminal functional lumen imaging probe allows for successful minimally invasive hiatal hernia repair. *Surg Laparosc Endosc Percutan Tech*. 2018;28:178-182.
51. Fynne L, Liao D, Aksglaede K, et al. Esophago-gastric junction in systemic sclerosis: a study with the functional lumen imaging probe. *Neurogastroenterol Motil*. 2017;29.
52. Reynolds JL, Zehetner J, Shiraga S, Lipham JC, Katkhouda N. Intraoperative assessment of the effects of laparoscopic sleeve gastrectomy on the distensibility of the lower esophageal sphincter using impedance planimetry. *Surg Endosc*. 2016;30:4904-4909.
53. Scharitzer M, Lenglinger J, Schima W, et al. Comparison of videofluoroscopy and impedance planimetry for the

- evaluation of oesophageal stenosis: a retrospective study. *Eur Radiol.* 2017;27:1760-1767.
54. Beaumont H, Gondrie J, McMahon B, et al. Stepwise radiofrequency ablation of Barrett's esophagus preserves esophageal inner diameter, compliance, and motility. *Endoscopy.* 2009;41:2-8.
 55. Kwiatek MA, Hirano I, Kahrilas PJ, et al. Mechanical properties of the esophagus in eosinophilic esophagitis. *Gastroenterology.* 2011;140:82-90.
 56. Lin Z, Nicodème F, Boris L, Lin CY, Kahrilas PJ, Pandolfino JE. Regional variation in distal esophagus distensibility assessed using the functional luminal imaging probe (FLIP). *Neurogastroenterol Motil.* 2013;25:e765-e771.
 57. Carlson DA, Kou W, Lin Z, et al. Normal values of esophageal distensibility and distension-induced contractility measured by functional luminal imaging probe panometry. *Clin Gastroenterol Hepatol.* 2019;17:674-681.e1.
 58. Carlson DA, Kou W, Pandolfino JE. The rhythm and rate of distension-induced esophageal contractility: a physiologic marker of esophageal function. *Neurogastroenterol Motil.* 2020;32:e13794.
 59. Carlson DA, Lin Z, Rogers MC, Lin CY, Kahrilas PJ, Pandolfino JE. Utilizing functional lumen imaging probe topography to evaluate esophageal contractility during volumetric distention: a pilot study. *Neurogastroenterol Motil.* 2015;27:981-989.
 60. Carlson DA, Lin Z, Hirano I, Gonsalves N, Zaleski A, Pandolfino JE. Evaluation of esophageal distensibility in eosinophilic esophagitis: an update and comparison of functional lumen imaging probe analytic methods. *Neurogastroenterol Motil.* 2016;28:1844-1853.
 61. Nicodème F, Hirano I, Chen J, et al. Esophageal distensibility as a measure of disease severity in patients with eosinophilic esophagitis. *Clin Gastroenterol Hepatol.* 2013;11:1101-1107.e1.
 62. Chen J, Pandolfino J, Lin Z, et al. Severity of endoscopically identified esophageal rings correlates with reduced esophageal distensibility in eosinophilic esophagitis. *Endoscopy.* 2016;48:794-801.
 63. Hirano I. Therapeutic end points in eosinophilic esophagitis: is elimination of esophageal eosinophils enough? *Clin Gastroenterol Hepatol.* 2012;10:750-752.
 64. Carlson DA, Kahrilas PJ, Ritter K, Lin Z, Pandolfino JE. Mechanisms of repetitive retrograde contractions in response to sustained esophageal distension: a study evaluating patients with post-fundoplication dysphagia. *Am J Physiol Gastrointest Liver Physiol.* 2018;314:G334-G340.
 65. Omari TI, Ciucci M, Gozdziowska K, et al. High-resolution pharyngeal manometry and impedance: protocols and metrics recommendations of a high-resolution pharyngeal manometry international working group. *Dysphagia.* 2020;35:281-295.
 66. Omari TI, Dejaeger E, Van Beckevoort D, et al. A novel method for the nonradiological assessment of ineffective swallowing. *Am J Gastroenterol.* 2011;106:1796-1802.
 67. Regan J, Walshe M, Rommel N, Tack J, McMahon BP. New measures of upper esophageal sphincter distensibility and opening patterns during swallowing in healthy subjects using EndoFLIP®. *Neurogastroenterol Motil.* 2013;25:e25-e34.
 68. Regan J, Walshe M, Rommel N, McMahon BP. A new evaluation of the upper esophageal sphincter using the functional lumen imaging probe: a preliminary report. *Dis Esophagus.* 2013;26:117-123.
 69. Regan J, Walshe M, Timon C, McMahon BP. Endoflip® evaluation of pharyngo-oesophageal segment tone and swallowing in a clinical population: a total laryngectomy case series. *Clin Otolaryngol.* 2015;40:121-129.
 70. Wu P, Szczesniak M, Maclean J, et al. Clinical utility of a functional lumen imaging probe in management of dysphagia following head and neck cancer therapies. *Endoscopy.* 2017;49:848-854.
 71. Talley NJ, Locke GR, Lahr BD, et al. Functional dyspepsia, delayed gastric emptying, and impaired quality of life. *Gut.* 2006;55:933-939.
 72. Parkman HP, Yates K, Hasler WL, et al. Clinical features of idiopathic gastroparesis vary with sex, body mass, symptom onset, delay in gastric emptying, and gastroparesis severity. *Gastroenterology.* 2011;140:101-115.
 73. Wuestenberghs F, Juge M, Melchior C, et al. Association between symptoms, quality of life, and gastric emptying in dyspeptic patients. *J Neurogastroenterol Motil.* 2019;25:534-543.
 74. Mearin F, Camilleri M, Malagelada JR. Pyloric dysfunction in diabetics with recurrent nausea and vomiting. *Gastroenterology.* 1986;90:1919-1925.
 75. Gourcerol G, Tissier F, Melchior C, et al. Impaired fasting pyloric compliance in gastroparesis and the therapeutic response to pyloric dilatation. *Aliment Pharmacol Ther.* 2015;41:360-367.
 76. Jacques J, Pagnon L, Hure F, et al. Peroral endoscopic pyloromyotomy is efficacious and safe for refractory gastroparesis: prospective trial with assessment of pyloric function. *Endoscopy.* 2019;51:40-49.
 77. Malik Z, Sankineni A, Parkman HP. Assessing pyloric sphincter pathophysiology using EndoFLIP in patients with gastroparesis. *Neurogastroenterol Motil.* 2015;27:524-531.
 78. Desprez C, Melchior C, Wuestenberghs F, et al. Pyloric distensibility measurement after gastric surgery: Which surgeries are associated with pylorospasm? *Neurogastroenterol Motil.* 2020;32:e13790.
 79. Snape WJ, Lin MS, Agarwal N, Shaw RE. Evaluation of the pylorus with concurrent intraluminal pressure and EndoFLIP in patients with nausea and vomiting. *Neurogastroenterol Motil.* 2016;28:758-764.
 80. Jacques J, Legros R, Monteil J, Sautereau D, Gourcerol G. Outcomes and future directions of per-oral endoscopic pyloromyotomy: a view from France. *Gastrointest Endosc Clin N Am.* 2019;29:139-149.
 81. Arroyo Vázquez JA, Bergström M, Bligh S, McMahon BP, Park P-O. Exploring pyloric dynamics in stenting using a distensibility technique. *Neurogastroenterol Motil.* 2018;30:e13445.
 82. Watts LS, Baker JR, Lee AA, et al. Impact of gastric per-oral endoscopic myotomy on static and dynamic pyloric function in gastroparesis patients. *Neurogastroenterol Motil.* 2020.e13892.
 83. Hedberg HM, Carbray J, Ujiki MB. Initial experience with endoscopic pyloromyotomy, with description and video of technique. *J Gastrointest Surg.* 2019;23:1706-1710.
 84. Desprez C, Melchior C, Wuestenberghs F, et al. Pyloric distensibility measurement predicts symptomatic response to intrapyloric botulinum toxin injection. *Gastrointest Endosc.* 2019;90:754-760.e1.
 85. Saadi M, Yu D, Malik Z, Parkman HP, Schey R. Pyloric sphincter characteristics using EndoFLIP® in gastroparesis. *Rev Gastroenterol Mex.* 2018;83:375-384.
 86. Vosoughi K, Ichkhanian Y, Jacques J, et al. Role of endoscopic functional luminal imaging probe in predicting the outcome of gastric peroral endoscopic pyloromyotomy (with video). *Gastrointest Endosc.* 2020;91:1289-1299.
 87. Craig AG, Toouli J. Sphincterotomy for biliary sphincter of Oddi dysfunction. *Cochrane Database Syst Rev.* 2001;3:CD001509. <https://doi.org/10.1002/14651858>
 88. Kunwald P, Drewes AM, Kjaer D, et al. A new distensibility technique to measure sphincter of Oddi function. *Neurogastroenterol Motil.* 2010;22:978-983, e253.
 89. Wald A, Bharucha AE, Cosman BC, Whitehead WE. ACG clinical guideline: management of benign anorectal disorders. *Am J Gastroenterol.* 2014;109(8):1141-1157 (Quiz) 1058 (2014).
 90. Azpiroz F, Enck P, Whitehead WE. Anorectal functional testing: review of collective experience. *Am J Gastroenterol.* 2002;97:232-240.
 91. Kwiatek MA, Pandolfino JE, Hirano I, Kahrilas PJ. Esophagogastric junction distensibility assessed with an endoscopic functional luminal imaging probe (EndoFLIP). *Gastrointest Endosc.* 2010;72:272-278.

92. Harris LD, Pope CE. 'squeeze' vs. resistance: an evaluation of the mechanism of sphincter competence. *J Clin Invest*. 1964;43:2272-2278.
93. Sørensen G, Liao D, Lundby L, et al. Distensibility of the anal canal in patients with idiopathic fecal incontinence: a study with the Functional Lumen Imaging Probe. *Neurogastroenterol Motil*. 2014;26:255-263.
94. Haas S, Liao D, Gregersen H, Lundby L, Laurberg S, Krogh K. Increased yield pressure in the anal canal during sacral nerve stimulation: a pilot study with the functional lumen imaging probe. *Neurogastroenterol Motil*. 2017;29:e12929.
95. Grønlund D, Poulsen JL, Krogh K, et al. The impact of naloxegol on anal sphincter function - Using a human experimental model of opioid-induced bowel dysfunction. *Eur J Pharm Sci*. 2018;117:187-192.
96. Haas S, Faaborg P, Liao D, et al. Anal sphincter dysfunction in patients treated with primary radiotherapy for anal cancer: a study with the functional lumen imaging probe. *Acta Oncol*. 2018;57:465-472.
97. Brusa T, Abler D, Tutuian R, et al. Anatomy and mechanical properties of the anal sphincter muscles in healthy senior volunteers. *Neurogastroenterology Motility*. 2018;30:e13335.
98. Luft F, Fynne L, Gregersen H, et al. Functional luminal imaging probe: a new technique for dynamic evaluation of mechanical properties of the anal canal. *Tech Coloproctol*. 2012;16:451-457.
99. Gourcerol G, Granier S, Bridoux V, Menard JF, Ducrotté P, Leroi AM. Do endoflip assessments of anal sphincter distensibility provide more information on patients with fecal incontinence than high-resolution anal manometry? *Neurogastroenterol Motil*. 2016;28:399-409.
100. Leroi AM, Melchior C, Charpentier C, et al. The diagnostic value of the functional lumen imaging probe versus high-resolution anorectal manometry in patients with fecal incontinence. *Neurogastroenterol Motil*. 2018;30:e13291.
101. Tuttle LJ, Zifan A, Sun C, et al. Measuring length-tension function of the anal sphincters and puborectalis muscle using the functional luminal imaging probe. *Am J Physiol Gastrointest Liver Physiol*. 2018;315:G781-G787.
102. Zifan A, Mittal RK, Kunkel DC, et al. Loop analysis of the anal sphincter complex in fecal incontinent patients using functional luminal imaging probe. *Am J Physiol Gastrointest Liver Physiol*. 2020;318:G66-G76.
103. Alqudah MM, Gregersen H, Drewes AM, McMahon BP. Evaluation of anal sphincter resistance and distensibility in healthy controls using EndoFLIP ©. *Neurogastroenterol Motil*. 2012;24:e591-e599.
104. Fynne L, Luft F, Gregersen H, et al. Distensibility of the anal canal in patients with systemic sclerosis: a study with the functional lumen imaging probe. *Colorectal Dis*. 2013;15:e40-e47.
105. Brusa T, Abler D, Tutuian R, et al. MR-FLIP: a new method that combines a functional lumen imaging probe with anatomical information for spatial compliance assessment of the anal sphincter muscles. *Colorectal Dis*. 2017;19:764-771.
106. Zifan A, Sun C, Gourcerol G, Leroi AM, Mittal RK. Endoflip vs high-definition manometry in the assessment of fecal incontinence: a data-driven unsupervised comparison. *Neurogastroenterol Motil*. 2018;30:e13462.
107. Liao D, Lottrup C, Fynne L, et al. Axial movements and length changes of the human lower esophageal sphincter during respiration and distension-induced secondary peristalsis using functional luminal imaging probe. *J Neurogastroenterol Motil*. 2018;24:255-267.
108. Nathanson LK, Brunott N, Cavallucci D. Adult esophagogastric junction distensibility during general anesthesia assessed with an endoscopic functional luminal imaging probe (EndoFLIP®). *Surg Endosc*. 2012;26:1051-1055.
109. Ahuja NK, Agnihotri A, Lynch KL, et al. Esophageal distensibility measurement: impact on clinical management and procedure length. *Dis Esophagus*. 2017;30:1-8.
110. Familiari P, Gigante G, Marchese M, et al. EndoFLIP system for the intraoperative evaluation of peroral endoscopic myotomy. *United European Gastroenterol J*. 2014;2:77-83.
111. Carlson DA, Hirano I, Zalewski A, et al. Improvement in esophageal distensibility in response to medical and diet therapy in eosinophilic esophagitis. *Clin Transl Gastroenterol*. 2017;8:e119.
112. Lin Z, Kahrilas PJ, Xiao Y, et al. Functional luminal imaging probe topography: an improved method for characterizing esophageal distensibility in eosinophilic esophagitis. *Therap Adv Gastroenterol*. 2013;6:97-107.

SUPPORTING INFORMATION

Additional supporting information may be found online in the Supporting Information section.

How to cite this article: Desprez C, Roman S, Leroi AM, Gourcerol G. The use of impedance planimetry (Endoscopic Functional Lumen Imaging Probe, EndoFLIP®) in the gastrointestinal tract: A systematic review. *Neurogastroenterol Motil*. 2020;32:e13980. <https://doi.org/10.1111/nmo.13980>

Résumé

Titre : Évaluation des compétences sphinctériennes du système gastro-intestinal par le système EndoFLIP®.

Le système EndoFLIP® permet l'obtention de données géométriques à différents niveaux du système digestif, notamment les sphincters. La plupart des études ont évalué son utilité au niveau de l'œsophage, mais peu d'études se sont intéressées à son intérêt au niveau du sphincter pylorique et du canal anal. Le premier axe de ce travail avait pour but d'évaluer l'intérêt mécanistique de l'EndoFLIP® du pylore et du canal anal. Nous avons pu montrer que 56,5% des patients atteints de gastroparésie diabétique présentaient une distensibilité pylorique altérée, avec un taux similaire retrouvé chez les patients atteints de gastroparésie idiopathique (51,5%). En revanche, il n'existait pas de corrélation entre les caractéristiques du diabète et les différents paramètres du pylore chez les patients atteints de gastroparésie diabétique. Chez les patients avec symptômes dyspeptiques apparus après chirurgie oeso-gastrique, la distensibilité pylorique était altérée chez 61,1% des patients du groupe chirurgie anti-reflux, 75,0% du groupe oesophagectomie et 18,7% du groupe sleeve-gastrectomie. Nous avons pu montrer qu'il existait une faible relation entre le type d'incontinence fécale et la distensibilité du canal anal. Le 2^{ème} axe de notre travail portait sur l'intérêt de l'EndoFLIP® pour évaluer l'efficacité d'un traitement. La mesure de la distensibilité pylorique était ainsi prédictive de la réponse symptomatique aux injections intra-pyloriques de toxine botulique chez les patients atteints de gastroparésie réfractaire. Le 3^{ème} axe de notre travail portait sur l'amélioration de la technique d'EndoFLIP®. Nous avons pu mettre en évidence qu'il existait un impact de l'anesthésie générale et des anesthésiants sur les résultats de l'EndoFLIP® du pylore.

Mots clés : EndoFLIP®, système digestif, pylore, gastroparésie, anesthésie générale, canal anal, incontinence fécale.

Title: Evaluation of the sphincter functions of the gastro-intestinal system by the EndoFLIP® system.

The EndoFLIP® system allows the obtention of geometrical data at different levels in the digestive system, in particular in sphincters. Most studies assessed its relevance in the esophageal area, but only a few studies evaluated its interest regarding both pyloric and canal anal evaluation. The first step of this work was to assess the mechanistic interest of the pyloric and anal EndoFLIP®. We found that 56.5% of patients with diabetic gastroparesis exhibited altered pyloric distensibility, in a similar range as the one found in idiopathic gastroparesis (51.5%). However, we did not find any correlation between diabetes characteristics and pyloric parameters in patients with diabetic gastroparesis. In patients with dyspeptic symptoms developed after oeso-gastric surgery, we found an altered pyloric distensibility in 61.1% of patients with prior anti reflux surgery, 75.0% of patients with prior esophagectomy and 18.7% of patients with sleeve-gastrectomy. Lastly, we found a weak correlation between fecal incontinence subtypes and anal sphincter distensibility. The 2nd step of this work was to assess the interest of the EndoFLIP® used to evaluate treatment efficacy. We found that pyloric distensibility was predictive of the efficacy of intrapyloric botulinum toxin injections in patients with refractory gastroparesis. The 3rd step of this work was to improve the method of the EndoFLIP®. We found that there was an impact of general anesthesia and anesthetics on the pyloric EndoFLIP® measurements.

Key words: EndoFLIP®, digestive system, pylorus, gastroparesis, general anesthesia, anal canal, fecal incontinence.